

MELSOFT

SCREEN DESIGN SOFTWARE  
**GT Designer3**  
Version1

Screen Design Manual **Fundamentals 1/2** Fundamentals 2/2

(For GOT1000 Series)

A grayscale collage background featuring a computer keyboard, a hand holding a mouse, and a detailed view of a Mitsubishi GOT1000 Series operation panel. The operation panel displays a screen with four motor status indicators (Motor A, B, C, D) and various control buttons.

# GT Designer3



# ● SAFETY PRECAUTIONS ●

(Be sure to read these instructions before using the product)

Before using this product, read this manual and the relevant manuals introduced in this manual carefully and handle the product correctly with full attention to safety.

Note that these precautions apply only to this product.

In this manual, the safety instructions are ranked as "WARNING" and "CAUTION".



Indicates that incorrect handling may cause hazardous conditions, resulting in death or severe injury.



CAUTION Indicates that incorrect handling may cause hazardous conditions, resulting in minor or moderate injury or property damage.

Note that failure to observe the  CAUTION level instructions may also lead to serious results depending on the circumstances.

Be sure to observe the instructions of both levels to ensure personal safety.

Please keep this manual in accessible place and be sure to forward it to the end user.

[Test operation precautions]

## WARNING

- Before testing the operation of a user-created screen (such as turning on or off a bit device, changing the current value of a word device, changing the set value or current value of a timer or counter, and changing the current value of a buffer memory), thoroughly read the manual to fully understand the operating procedure.  
When testing, never change the data of the devices that control the operation essential for the system.  
Faulty output and malfunction may result in an accident.

[Precautions for Remote Control]

## WARNING

- Remote control is available through a network by using GOT functions, including the SoftGOT-GOT link function, the remote personal computer operation function, and the VNC server function.  
If these functions are used to perform remote control of control equipment, the field operator may not notice the remote control, possibly leading to an accident.  
In addition, a communication delay or interruption may occur depending on the network environment, and remote control of control equipment cannot be performed normally in some cases.  
Before using the above functions to perform remote control, fully grasp the circumstances of the field site and ensure safety.

[Design Precautions]

## WARNING

- To maintain the security (confidentiality, integrity, and availability) of the GOT and the system against unauthorized access, DoS<sup>\*1</sup> attacks, computer viruses, and other cyberattacks from unreliable networks and devices via network, take appropriate measures such as firewalls, virtual private networks (VPNs), and antivirus solutions.  
Mitsubishi Electric shall have no responsibility or liability for any problems involving GOT trouble and system trouble by unauthorized access, DoS attacks, computer viruses, and other cyberattacks.  
<sup>\*1</sup> DoS: A denial-of-service (DoS) attack disrupts services by overloading systems or exploiting vulnerabilities, resulting in a denial-of-service (DoS) state.

## CAUTIONS FOR USING THIS SOFTWARE

### (1) Required memory of a personal computer and the free capacity of the hard disk

For required memory and the free capacity of the hard disk, refer to the following.

☞ 2.1 Operating Environment

### (2) Error messages displayed while starting and editing

"Operation will be terminated because of insufficient memory. Would you like to stop?"

If the above message appears, close other running application software or reboot Windows® in order to secure at least 50M bytes of free hard disk space.

### (3) GT Designer3 and the GOT display

(a) Precautions for displaying straight line other than full line (dotted line and others) in bold  
When straight line other than full line is drawn in bold, the line may not be displayed with its actual line width on a personal computer.

However, it will be displayed correctly on GOT. This phenomenon does not mean data problem.

(b) Display of end points of straight line/line freeform/polygon

As shown below, the end points of straight line, line freeform, or polygon is displayed differently between GT Designer3 and the GOT.

GT Designer3



On GOT



(c) Start position for filling patterns

Some filling patterns may be differently displayed. For example, the start position may be different between GT Designer3 and the GOT.

(d) Drawing of different type lines

The length of the dots varies in different dotted lines (for example: the chain lines).

(e) Display of object

- The display position of the scale value displayed in the graph is different between GT Designer3 and the GOT.
- Even if the display-start-line of a comment is set, the comment is displayed from the first line on GT Designer3.

(f) Display magnification

When display magnification is changed, the connected lines or figures may be separated or the filled-paint may be out of outline of the figure. However, if they are displayed correctly on the preview screen (Display magnification: 100%), they will appear correctly on the GOT as well.

Example: When filled-paint is out of the outline.

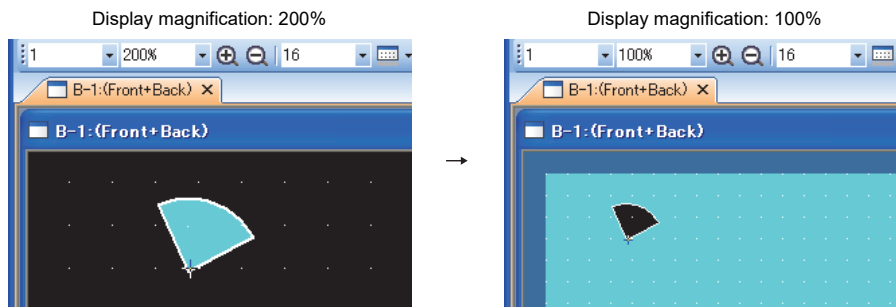



**(4) Restrictions when the color setting is changed to the setting of less colors in the system environment (256 colors → 2 colors)**

- The color palette for setting color will be changed according to the new settings.
- The color on the drawing screen will be kept the same as prior to the change.

If the color setting for a red rectangle-figure is changed to [2(mono)], the red color remains.

- The colors of the image data (BMP file or JPEG file) will be reduced when the project is stored, the screen is closed and that image data is double-clicked.

**(5) When device type is changed**

Confirm the device type when the set bit device is changed from bit device into word device. The device flag may be represented as "??", depending on the settings.

Example: D0.b0 → D0D0.b5 → ??

**(6) OS setting**

Set the font size to [Normal] when setting OS (Windows®) screens.

If the font size is set to other than [Normal], the GT Designer3 dialog box and others cannot be displayed correctly.

# INTRODUCTION

---

Thank you for choosing Mitsubishi Electric Graphic Operation Terminal (Mitsubishi Electric GOT).  
Read this manual and make sure you understand the functions and performance of the GOT thoroughly in advance to ensure correct use.

# CONTENTS

---

## **GT Designer3 Version1 Screen Design Manual (Fundamentals) 1/2**

SAFETY PRECAUTIONS .....	A - 1
CAUTIONS FOR USING THIS SOFTWARE .....	A - 2
INTRODUCTION .....	A - 4
CONTENTS .....	A - 4
MANUALS.....	A - 12
QUICK REFERENCE .....	A - 14
ABBREVIATIONS AND GENERIC TERMS .....	A - 16
HOW TO USE THIS MANUAL.....	A - 21

## **REGARDING GT Designer3**

---

### **1. OVERVIEW**

---

#### **GT Designer3 SPECIFICATIONS**

---

### **2. GT Designer3 SPECIFICATIONS**

---

2.1	Operating Environment.....	2 - 1
2.2	Project Format Handled with GT Designer3 .....	2 - 3
2.3	Types and Number of Creatable Screens .....	2 - 5
2.3.1	Screen specifications for each GOT type .....	2 - 6
2.3.2	Relations of base screen and window screen .....	2 - 11
2.3.3	Layer.....	2 - 13
2.4	Figures and Data Capacity .....	2 - 14
2.5	Specifications of Applicable Characters .....	2 - 17
2.5.1	Fonts.....	2 - 18
2.5.2	KANJI regions.....	2 - 29
2.5.3	Application example.....	2 - 31
2.5.4	Font selection .....	2 - 33
2.5.5	Precautions.....	2 - 34
2.6	Specifications of Available Functions Set with GT Designer3 .....	2 - 35
2.6.1	Specifications.....	2 - 35
2.7	Clock Function Specifications .....	2 - 40
2.8	Supported Devices .....	2 - 41
2.9	Available Numeric Data .....	2 - 43

## GT Designer3 OPERATION

---

### 3. GT Designer3 OPERATION

---

3.1	Starting GT Designer3 .....	3 - 1
3.2	Screen Configuration of GT Designer3.....	3 - 3
3.2.1	Operating editor tab.....	3 - 4
3.2.2	Operating work tree .....	3 - 5
3.2.3	Operation of screen image list.....	3 - 8
3.3	Menu Configuration .....	3 - 9
3.4	Type of Tool Bars and Short Cut Keys .....	3 - 10
3.5	Customizing Screen Configuration and Toolbars .....	3 - 18
3.5.1	Customizing screen configuration .....	3 - 18
3.5.2	Customizing the toolbars .....	3 - 22
3.5.3	Customizing actions and default value of GT Designer3.....	3 - 25
3.6	Creating/Editing Project.....	3 - 32
3.6.1	Creating a new project.....	3 - 32
3.6.2	Opening/closing a project.....	3 - 40
3.6.3	Setting the project title .....	3 - 44
3.7	Creating/Opening/Closing Screen .....	3 - 46
3.7.1	Creating a new screen.....	3 - 46
3.7.2	Opening/closing a screen .....	3 - 49
3.8	Basic Operation of Drawing Screen.....	3 - 53
3.8.1	Relation of the screen editor and the screen displayed on the GOT .....	3 - 53
3.8.2	Layer display switching operation.....	3 - 56
3.8.3	Redisplaying the screen editor .....	3 - 56
3.8.4	Selecting the screen editor to be edited .....	3 - 57
3.8.5	Displaying opened screen editors overlapped/aligned .....	3 - 58
3.9	Changing Screen Property .....	3 - 59
3.10	Displaying Frame on Screen Editor .....	3 - 60
3.11	Viewing Created Screen Image.....	3 - 61
3.11.1	Displaying a preview.....	3 - 61
3.11.2	Displaying the window screen preview in the screen editor of the base screen.....	3 - 65
3.12	Copying/Deleting Screen .....	3 - 67
3.12.1	Copying a screen.....	3 - 67
3.12.2	Deleting a screen.....	3 - 69
3.13	Data Check.....	3 - 70
3.14	Securing Project .....	3 - 72
3.14.1	Procedures for setting project security .....	3 - 73
3.14.2	Settings.....	3 - 74
3.14.3	Logging into project .....	3 - 80
3.14.4	Operations after the project security is set .....	3 - 80
3.14.5	Precautions.....	3 - 83
3.15	Printing Project/File Output.....	3 - 84
3.15.1	Print setting.....	3 - 85
3.15.2	Previewing print image .....	3 - 92
3.15.3	Outputting examples.....	3 - 93
3.16	Saving Project.....	3 - 100

3.16.1	Overwriting projects .....	3 - 100
3.16.2	Saving as a new file .....	3 - 101
3.17	Deleting Project .....	3 - 104
3.18	Ending GT Designer3 .....	3 - 104
3.19	How to Use Help .....	3 - 105
3.19.1	Displaying the GT Designer3 Help .....	3 - 105
3.19.2	Displaying PDF manuals .....	3 - 105
3.19.3	Connecting to MITSUBISHI ELECTRIC FA Global Website .....	3 - 107
3.19.4	Confirming GT Designer3 version .....	3 - 107

## COMMON SETTING

---

### 4. COMMON SETTING

---

4.1	GOT Type Setting .....	4 - 3
4.1.1	Settings .....	4 - 3
4.1.2	Precautions .....	4 - 8
4.2	Screen Switching Device Setting .....	4 - 10
4.2.1	Display position of window screen .....	4 - 13
4.2.2	Settings .....	4 - 15
4.2.3	Precautions .....	4 - 19
4.3	Language Switching Device Setting .....	4 - 20
4.3.1	Settings .....	4 - 21
4.3.2	Precautions .....	4 - 23
4.4	Setting Message to be Displayed on GOT .....	4 - 25
4.4.1	Creating a dialog window .....	4 - 26
4.4.2	Settings .....	4 - 28
4.4.3	Precautions .....	4 - 31
4.5	Key Window Setting .....	4 - 34
4.5.1	Key window type .....	4 - 34
4.5.2	Buttons on standard key window and display items .....	4 - 36
4.5.3	How to operate key window .....	4 - 40
4.5.4	How to create user-created key window .....	4 - 42
4.5.5	Settings .....	4 - 49
4.5.6	Relevant settings .....	4 - 60
4.5.7	Precautions .....	4 - 61
4.6	System Information Setting .....	4 - 63
4.6.1	Settings .....	4 - 64
4.6.2	Details of system information .....	4 - 66
4.6.3	Application example .....	4 - 77
4.6.4	Precautions .....	4 - 83
4.7	Security Setting .....	4 - 84
4.7.1	Settings .....	4 - 88
4.7.2	Relevant settings .....	4 - 95
4.7.3	Authentication methods and setting procedures .....	4 - 95
4.7.4	GOT operator management information conversion tool .....	4 - 100
4.7.5	Precautions .....	4 - 108
4.8	GOT Startup Logo Setting .....	4 - 112
4.8.1	Settings .....	4 - 112
4.8.2	Setting/deleting procedure .....	4 - 113

4.8.3	Precautions.....	4 - 114
4.9	GOT Display and Operation Setting .....	4 - 115
4.9.1	Settings.....	4 - 115
4.9.2	How to match clock data between the GOT and controllers .....	4 - 125
4.9.3	Precautions.....	4 - 129
4.10	Station No. Switching Device Setting .....	4 - 132
4.10.1	Settings.....	4 - 134
4.10.2	Relevant settings .....	4 - 135
4.10.3	Precautions.....	4 - 136
4.11	Buffer Memory Unit No. Switching Device Setting (Controller Setting) .....	4 - 137
4.11.1	Settings.....	4 - 138
4.11.2	Relevant settings .....	4 - 139
4.11.3	Precautions.....	4 - 140
4.12	Comment Setting .....	4 - 141
4.12.1	Displaying the [Comment List] dialog box .....	4 - 143
4.12.2	Basic operations for comment registration .....	4 - 146
4.12.3	Comment registration .....	4 - 157
4.12.4	Registering comment group columns .....	4 - 160
4.12.5	Copying or cutting a comment.....	4 - 161
4.12.6	Deleting a comment or clearing a text.....	4 - 164
4.12.7	Deleting columns in comment group .....	4 - 166
4.12.8	Changing comment settings .....	4 - 167
4.12.9	Saving/Reading comments as file .....	4 - 168
4.12.10	Editing comment saved as Text/CSV file .....	4 - 171
4.12.11	Precautions.....	4 - 176
4.13	Registering Parts .....	4 - 177
4.13.1	Basic operation for registering parts.....	4 - 178
4.13.2	Registering parts .....	4 - 181
4.13.3	Copying parts .....	4 - 185
4.13.4	Deleting parts .....	4 - 187
4.13.5	Editing parts.....	4 - 188
4.13.6	Changing part numbers and names .....	4 - 189
4.13.7	Precautions.....	4 - 190
4.14	Registering BMP/JPEG Files for Parts in Memory Card.....	4 - 192
4.14.1	Specifications for BMP/JPEG files that can be stored in a memory card and displayed as parts.....	4 - 192
4.14.2	Storing BMP/JPEG file parts in a memory card.....	4 - 195
4.14.3	Precautions.....	4 - 197

## **EDITING AND SETTING FIGURES AND OBJECTS**

---

### **5. EDITING AND SETTING FIGURES AND OBJECTS**

---

5.1	Arranging Figures and Objects.....	5 - 1
5.2	Editing Figure and Object .....	5 - 5
5.2.1	Selecting figure and object .....	5 - 5
5.2.2	Editing figure and object.....	5 - 8
5.2.3	Grouping multiple figures and objects .....	5 - 9
5.2.4	Undo, redo .....	5 - 9
5.2.5	Aligning figures and objects.....	5 - 10
5.2.6	Changing attributes of figures and objects .....	5 - 14

5.2.7	Changing size of figures/objects .....	5 - 16
5.2.8	Copying figures and objects .....	5 - 22
5.2.9	Copying figures and objects consecutively .....	5 - 23
5.3	Common Settings of Objects .....	5 - 25
5.3.1	Device setting .....	5 - 25
5.3.2	Label setting .....	5 - 28
5.3.3	Shape setting .....	5 - 39
5.3.4	State setting .....	5 - 41
5.3.5	Security setting .....	5 - 47
5.3.6	Offset setting .....	5 - 59
5.3.7	Superimposition setting .....	5 - 62
5.3.8	Trigger setting .....	5 - 75
5.3.9	Data operation setting .....	5 - 87

## USING LIBRARY

---

### 6. LIBRARY

---

6.1	Operation of Library List .....	6 - 4
6.2	Pasting Figures, Objects and Templates by Library .....	6 - 10
6.3	Editing User-Created Library .....	6 - 11
6.3.1	Registering library data .....	6 - 11
6.3.2	Registering shapes for objects in library .....	6 - 13
6.3.3	Copying library .....	6 - 15
6.3.4	Deleting library .....	6 - 17
6.3.5	Editing library data .....	6 - 19
6.3.6	Changing library attribute .....	6 - 21
6.3.7	Saving library .....	6 - 22
6.3.8	Opening library .....	6 - 24
6.3.9	Importing library .....	6 - 26
6.3.10	Exporting library .....	6 - 30

## USING TEMPLATE

---

### 7. TEMPLATE

---

7.1	Specifications .....	7 - 2
7.1.1	Template specifications .....	7 - 2
7.1.2	Templates in the system library .....	7 - 3
7.2	Creating a Screen by Using a Template .....	7 - 37
7.2.1	Using a template in the library .....	7 - 37
7.2.2	Checking the settings in a template .....	7 - 39
7.2.3	Changing the setting value in the attribute of a figure or object .....	7 - 41
7.3	Creating or Editing a Template .....	7 - 45
7.3.1	Registering a figure or object to a template .....	7 - 45
7.3.2	Deleting a figure or object from a template .....	7 - 45
7.3.3	Editing a template attribute .....	7 - 46
7.3.4	Registering a template in the library .....	7 - 53
7.4	Deleting a Template .....	7 - 53
7.5	Precautions .....	7 - 54

## COMMUNICATION WITH GOT

---

### 8. COMMUNICATION WITH GOT

---

8.1	Transferring Data between GOT and Personal Computer .....	8 - 1
8.1.1	Connecting personal computer and GOT with cable .....	8 - 8
8.1.2	Interface setting of the GOT .....	8 - 13
8.1.3	Setting communication .....	8 - 22
8.1.4	Writing and installing on GOT .....	8 - 26
8.1.5	Reading from GOT .....	8 - 43
8.1.6	Verifying with GOT .....	8 - 49
8.2	Transferring Data to Memory Card or USB Memory .....	8 - 51
8.2.1	Transferring project data, OS, and special data to memory card or USB memory.....	8 - 53
8.2.2	Transferring Boot OS to memory card or USB memory .....	8 - 61
8.2.3	Transferring CoreOS to memory card .....	8 - 66
8.3	Transferring Data Using GT10-LDR .....	8 - 69
8.3.1	Preparation for data transfer.....	8 - 69
8.3.2	Connecting cable.....	8 - 74
8.3.3	Setting communication .....	8 - 80
8.3.4	Installing GT10-LDR OS.....	8 - 82
8.3.5	Writing project data and installing OS .....	8 - 84
8.3.6	Obtaining memory information .....	8 - 85
8.3.7	Reading project data .....	8 - 86
8.3.8	Reading resource data .....	8 - 87
8.4	Transferring Data Using GT01-RS4-M .....	8 - 88
8.4.1	Preparation for data transfer.....	8 - 88
8.4.2	Connecting the PC and GT01-RS4-M via USB cable .....	8 - 89
8.4.3	Setting communication .....	8 - 90
8.4.4	Installing OS to GT01-RS4-M.....	8 - 91
8.4.5	Writing communication parameter to GT01-RS4-M .....	8 - 92
8.4.6	Reading communication parameter from GT01-RS4-M .....	8 - 94
8.5	Data Types and Sizes Transferred to the GOT .....	8 - 95
8.5.1	Data types and storage destinations .....	8 - 95
8.5.2	Drive capacity required for data transfer .....	8 - 123
8.6	Error Messages Displayed at Data Transfer.....	8 - 142

## USEFUL FUNCTIONS

---

### 9. USEFUL FUNCTIONS FOR DRAWING

---

9.1	Utilizing Other Project Data .....	9 - 1
9.2	Referring to Device Comment (Importing GX Developer Device Comment) .....	9 - 9
9.3	Importing Tags Created by Third Party Programming Software.....	9 - 14
9.4	Displaying in List and Editing Screen/Figure/Object Settings (Property sheet).....	9 - 20
9.5	Displaying in List and Batch Editing Settings.....	9 - 25
9.5.1	Batch setting and managing figures/objects for each purpose (Category list) .....	9 - 25
9.5.2	Editing attributes of figures/objects and devices in a batch (Batch edit) .....	9 - 29

9.5.3	Selecting overlapped figure (Data view).....	9 - 33
9.5.4	Checking devices in use (Device list).....	9 - 34
9.5.5	Checking text in use (Text list).....	9 - 36
9.5.6	Searching for and editing figures, objects, and others in a project data (Data browser)....	9 - 38
9.6	Entering Multiple Languages (Multi-Language Input Function).....	9 - 44
9.7	Checking Project Data for Errors.....	9 - 46
9.8	Confirming Created Data Size.....	9 - 47
9.9	Verifying Project Data Opened by GT Designer3 with Saved Project Data.....	9 - 48
9.10	Starting Up Simulator (GT Simulator3).....	9 - 50

## 10. USEFUL FUNCTIONS FOR USING GOT

---

10.1	Displaying Documents such as Word and Excel (Document Display).....	10 - 1
10.1.1	Before using the document display function.....	10 - 1
10.1.2	Relevant settings.....	10 - 3
10.1.3	Document conversion using Document Converter.....	10 - 3
10.1.4	Placement and settings.....	10 - 11
10.1.5	Setting items.....	10 - 12
10.1.6	Description on touch switches for document display.....	10 - 15
10.1.7	Precautions.....	10 - 17
10.2	Changing Screen According to Situation (Set Overlay Screen).....	10 - 19
10.3	Switching ON/OFF Device (Test Function).....	10 - 26
10.4	Starting GOT with Memory Card.....	10 - 28
10.5	Operating GOT with USB Mouse/Keyboard (USB Mouse/Keyboard Function).....	10 - 29
10.5.1	Settings.....	10 - 30
10.5.2	Relevant settings.....	10 - 30
10.5.3	Actions.....	10 - 31
10.5.4	Precautions.....	10 - 34
10.6	Synchronizing GT SoftGOT1000 data with GOT data (SoftGOT-GOT Link Function).....	10 - 35

## APPENDICES

---

Appendix1	DATA CAPACITY LIST.....	App - 1
Appendix.1.1	Data Capacity List.....	App - 1
Appendix.1.2	Capacity of Data Stored in a Memory Card.....	App - 10
Appendix.1.3	Capacity of data to be saved in the SRAM user area.....	App - 13
Appendix2	GOT Internal Devices.....	App - 14
Appendix.2.1	GOT bit register (GB).....	App - 14
Appendix.2.2	GOT data register (GD).....	App - 15
Appendix.2.3	GOT special register (GS).....	App - 17
Appendix3	Device of Controllers.....	App - 58
Appendix4	Setting device of each controller.....	App - 192
Appendix5	Key Code List.....	App - 239
Appendix6	Synthesized Colors Available for XOR.....	App - 244
Appendix7	ASCII Code List.....	App - 245
Appendix8	Relevant Settings.....	App - 247
Appendix9	Precautions for Using Unicode Text File.....	App - 284



**INDEX**

---

**REVISIONS**

---

**WARRANTY**

---

**Intellectual Property Rights**

---

## MANUALS

The following table lists the manual relevant to this product.  
Refer to each manual for any purpose.

### ■ Screen creation software manuals

Manual Name	Delivery method	Manual Number
GT Works3 Installation Instructions	Enclosed in product	-
GT Designer3 Version1 Screen Design Manual (Fundamentals) 1/2, 2/2	*1	SH-080866ENG
GT Designer3 Version1 Screen Design Manual (Functions) 1/2, 2/2	*1	SH-080867ENG
GT Simulator3 Version1 Operating Manual for GT Works3	*1	SH-080861ENG
GT Converter2 Version3 Operating Manual for GT Works3	*1	SH-080862ENG

\*1 Contact your local distributor.

### ■ Connection manuals

Manual Name	Delivery method	Manual Number
GOT1000 Series Connection Manual (Mitsubishi Electric Products) for GT Works3	*1	SH-080868ENG
GOT1000 Series Connection Manual (Non-Mitsubishi Electric Products 1) for GT Works3	*1	SH-080869ENG
GOT1000 Series Connection Manual (Non-Mitsubishi Electric Products 2) for GT Works3	*1	SH-080870ENG
GOT1000 Series Connection Manual (Microcomputer, MODBUS Products, Peripherals) for GT Works3	*1	SH-080871ENG
GOT1000 Series Connection Manual ( $\alpha$ 2 Connection) for GT Works3	*1	JY997D39201

\*1 Contact your local distributor.

### ■ Extended and option function manuals

Manual Name	Delivery method	Manual Number
GOT1000 Series Gateway Functions Manual for GT Works3	*1	SH-080858ENG
GOT1000 Series MES Interface Function Manual for GT Works3	*1	SH-080859ENG
GOT1000 Series User's Manual (Extended Functions, Option Functions) for GT Works3	*1	SH-080863ENG

\*1 Contact your local distributor.

### ■ GT SoftGOT1000 manuals

Manual Name	Delivery method	Manual Number
GT SoftGOT1000 Version3 Operating Manual for GT Works3	*1	SH-080860ENG

\*1 Contact your local distributor.

## ■ GT16 manuals

Manual Name	Delivery method	Manual Number
GT16 User's Manual (Hardware)	*1	SH-080928ENG
GT16 User's Manual (Basic Utility)	*1	SH-080929ENG
GT16 Handy GOT User's Manual	*1	JY997D41201 JY997D41202

\*1 Contact your local distributor.

## ■ GT15 manuals

Manual Name	Delivery method	Manual Number
GT15 User's Manual	*1	SH-080528ENG

\*1 Contact your local distributor.

## ■ GT14 manuals

Manual Name	Delivery method	Manual Number
GT14 User's Manual	*1	JY997D44801

\*1 Contact your local distributor.

## ■ GT12 manuals

Manual Name	Delivery method	Manual Number
GT12 User's Manual	*1	SH-080977ENG

\*1 Contact your local distributor.

## ■ GT11 manuals

Manual Name	Delivery method	Manual Number
GT11 User's Manual	*1	JY997D17501
GT11 Handy GOT User's Manual	*1	JY997D20101 JY997D20102

\*1 Contact your local distributor.

## ■ GT10 manuals

Manual Name	Delivery method	Manual Number
GT10 User's Manual	*1	JY997D24701

\*1 Contact your local distributor.

## **QUICK REFERENCE**

### **■ Creating a project**

Obtaining the specifications and operation methods of GT Designer3	GT Designer3 Version1 Screen Design Manual (Fundamentals) 1/2, 2/2
Setting available functions on GT Designer3	
Creating a screen displayed on the GOT	
Obtaining useful functions to increase efficiency of drawing	
Setting details for figures and objects	GT Designer3 Version1 Screen Design Manual (Functions) 1/2, 2/2
Setting functions for the data collection or trigger action	
Setting functions to use peripheral devices	
Simulating a created project on a personal computer	GT Simulator3 Version1 Operating Manual for GT Works3

### **■ Connecting a controller to the GOT**

Obtaining information of Mitsubishi Electric products applicable to the GOT	GOT1000 Series Connection Manual (Mitsubishi Electric Products) for GT Works3
Connecting Mitsubishi Electric products to the GOT	
Connecting multiple controllers to one GOT (Multi-channel function)	
Establishing communication between a personal computer and a controller via the GOT (FA transparent function)	
Obtaining information of Non-Mitsubishi Electric products applicable to the GOT	• GOT1000 Series Connection Manual (Non-Mitsubishi Electric Products 1) for GT Works3 • GOT1000 Series Connection Manual (Non-Mitsubishi Electric Products 2) for GT Works3
Connecting Non-Mitsubishi Electric products to the GOT	
Obtaining information of peripheral devices applicable to the GOT	GOT1000 Series Connection Manual (Microcomputer, MODBUS Products, Peripherals) for GT Works3
Connecting peripheral devices including a barcode reader to the GOT	
Connecting α2 with GOT	GOT1000 Series Connection Manual (α2 Connection) for GT Works3

### **■ Transferring data to the GOT**

Writing data to the GOT	GT Designer3 Version1 Screen Design Manual (Fundamentals) 1/2, 2/2
Reading data from the GOT	
Verifying an editing project to a GOT project	

## ■ Others

Obtaining specifications (including part names, external dimensions, and options) of each GOT	<ul style="list-style-type: none"><li>• GT16 User's Manual (Hardware)</li><li>• GT16 Handy GOT User's Manual</li><li>• GT15 User's Manual</li><li>• GT14 User's Manual</li><li>• GT12 User's Manual</li><li>• GT11 User's Manual</li><li>• GT11 Handy GOT User's Manual</li><li>• GT10 User's Manual</li></ul>
Installing the GOT	
Operating the utility	<ul style="list-style-type: none"><li>• GT16 User's Manual (Basic Utility)</li><li>• GT16 Handy GOT User's Manual</li><li>• GT15 User's Manual</li><li>• GT14 User's Manual</li><li>• GT12 User's Manual</li><li>• GT11 User's Manual</li><li>• GT11 Handy GOT User's Manual</li><li>• GT10 User's Manual</li></ul>
Configuring the gateway function	GOT1000 Series Gateway Functions Manual for GT Works3
Configuring the MES interface function	GOT1000 Series MES Interface Function Manual for GT Works3
Configuring the extended function and option function	GOT1000 Series User's Manual (Extended Functions, Option Functions) for GT Works3
Using a personal computer as the GOT	GT SoftGOT1000 Version3 Operating Manual for GT Works3

## ABBREVIATIONS AND GENERIC TERMS

### ■ GOT

Abbreviations and generic terms		Description
GT1695	GT1695M-X	Abbreviation of GT1695M-XTBA, GT1695M-XTBD
GT1685	GT1685M-S	Abbreviation of GT1685M-STBA, GT1685M-STBD
GT1675	GT1675M-S	Abbreviation of GT1675M-STBA, GT1675M-STBD
	GT1675M-V	Abbreviation of GT1675M-VTBA, GT1675M-VTBD
	GT1675-VN	Abbreviation of GT1675-VNBA, GT1675-VNBD
GT1672	GT1672-VN	Abbreviation of GT1672-VNBA, GT1672-VNBD
GT1665	GT1665M-S	Abbreviation of GT1665M-STBA, GT1665M-STBD
	GT1665M-V	Abbreviation of GT1665M-VTBA, GT1665M-VTBD
GT1662	GT1662-VN	Abbreviation of GT1662-VNBA, GT1662-VNBD
GT1655	GT1655-V	Abbreviation of GT1655-VTBD
GT16		Abbreviation of GT1695, GT1685, GT1675, GT1672, GT1665, GT1662, GT1655, GT16 Handy GOT
GT1595	GT1595-X	Abbreviation of GT1595-XTBA, GT1595-XTBD
GT1585	GT1585V-S	Abbreviation of GT1585V-STBA, GT1585V-STBD
	GT1585-S	Abbreviation of GT1585-STBA, GT1585-STBD
GT157□	GT1575V-S	Abbreviation of GT1575V-STBA, GT1575V-STBD
	GT1575-S	Abbreviation of GT1575-STBA, GT1575-STBD
	GT1575-V	Abbreviation of GT1575-VTBA, GT1575-VTBD
	GT1575-VN	Abbreviation of GT1575-VNBA, GT1575-VNBD
	GT1572-VN	Abbreviation of GT1572-VNBA, GT1572-VNBD
GT156□	GT1565-V	Abbreviation of GT1565-VTBA, GT1565-VTBD
	GT1562-VN	Abbreviation of GT1562-VNBA, GT1562-VNBD
GT155□	GT1555-V	Abbreviation of GT1555-VTBD
	GT1555-Q	Abbreviation of GT1555-QTBD, GT1555-QSBD
	GT1550-Q	Abbreviation of GT1550-QLBD
GT15		Abbreviation of GT1595, GT1585, GT157□, GT156□, GT155□
GT145□	GT1455-Q	Abbreviation of GT1455-QTBD, GT1455-QTBD
	GT1450-Q	Abbreviation of GT1450-QMBDE, GT1450-QMBD, GT1450-QLBDE, GT1450-QLBD
GT14		Abbreviation of GT1455-Q, GT1450-Q
GT1275	GT1275-V	Abbreviation of GT1275-VNBA, GT1275-VNBD
GT1265	GT1265-V	Abbreviation of GT1265-VNBA, GT1265-VNBD
GT12		Abbreviation of GT1275, GT1265
GT115□	GT1155-Q	Abbreviation of GT1155-QTBDQ, GT1155-QSBDQ, GT1155-QTBDA, GT1155-QSBDA, GT1155-QTBD, GT1155-QSBD
	GT1150-Q	Abbreviation of GT1150-QLBDQ, GT1150-QLBDA, GT1150-QLBD
GT11		Abbreviation of GT115□, GT11 Handy GOT,
GT105□	GT1055-Q	Abbreviation of GT1055-QSBD
	GT1050-Q	Abbreviation of GT1050-QBBD
GT104□	GT1045-Q	Abbreviation of GT1045-QSBD
	GT1040-Q	Abbreviation of GT1040-QBBD
GT1030		Abbreviation of GT1030-LBD, GT1030-LBD2, GT1030-LBL, GT1030-LBDW, GT1030-LBDW2, GT1030-LBLW, GT1030-LWD, GT1030-LWD2, GT1030-LWL, GT1030-LWDW, GT1030-LWDW2, GT1030-LWLW, GT1030-HBD, GT1030-HBD2, GT1030-HBL, GT1030-HBDW, GT1030-HBDW2, GT1030-HBLW, GT1030-HWD, GT1030-HWD2, GT1030-HWL, GT1030-HWDW, GT1030-HWDW2, GT1030-HWLW
GT1020		Abbreviation of GT1020-LBD, GT1020-LBD2, GT1020-LBL, GT1020-LBDW, GT1020-LBDW2, GT1020-LBLW, GT1020-LWD, GT1020LWD2, GT1020-LWL, GT1020-LWDW, GT1020-LWDW2, GT1020-LWLW
GT10		Abbreviation of GT105□, GT104□, GT1030, GT1020

Abbreviations and generic terms			Description	
GOT1000 Series	Handy GOT	GT16 Handy GOT	GT1665HS-V	Abbreviation of GT1665HS-VTBD
		GT11 Handy GOT	GT1155HS-Q	Abbreviation of GT1155HS-QSBD
			GT1150HS-Q	Abbreviation of GT1150HS-QLBD
	GT SoftGOT1000		Abbreviation of GT SoftGOT1000	
GOT900 Series			Abbreviation of GOT-A900 series, GOT-F900 series	
GOT800 Series			Abbreviation of GOT-800 series	

## ■ Communication unit

Abbreviations and generic terms	Description
Bus connection unit	GT15-QBUS, GT15-QBUS2, GT15-ABUS, GT15-ABUS2, GT15-75QBUSL, GT15-75QBUS2L, GT15-75ABUSL, GT15-75ABUS2L
Serial communication unit	GT15-RS2-9P, GT15-RS4-9S, GT15-RS4-TE
RS-422 conversion unit	GT15-RS2T4-9P, GT15-RS2T4-25P
Ethernet communication unit	GT15-J71E71-100
MELSECNET/H communication unit	GT15-J71LP23-25, GT15-J71BR13
MELSECNET/10 communication unit	GT15-75J71LP23-Z <sup>*1</sup> , GT15-75J71BR13-Z <sup>*2</sup>
CC-Link IE Controller Network communication unit	GT15-J71GP23-SX
CC-Link IE Field Network communication unit	GT15-J71GF13-T2
CC-Link communication unit	GT15-J61BT13, GT15-75J61BT13-Z <sup>*3</sup>
Interface converter unit	GT15-75IF900
Serial multi-drop connection unit	GT01-RS4-M
Connection Conversion Adapter	GT10-9PT5S
RS-232/485 signal conversion adapter	GT14-RS2T4-9P

\*1 A9GT-QJ71LP23 + GT15-75IF900 set

\*2 A9GT-QJ71BR13 + GT15-75IF900 set

\*3 A8GT-J61BT13 + GT15-75IF900 set

## ■ Option unit

Abbreviations and generic terms	Description	
Printer unit	GT15-PRN	
Video/RGB unit	Video input unit	GT16M-V4, GT15V-75V4
	RGB input unit	GT16M-R2, GT15V-75R1
	Video/RGB input unit	GT16M-V4R1, GT15V-75V4R1
	RGB output unit	GT16M-ROUT, GT15V-75ROUT
Multimedia unit	GT16M-MMR	
CF card unit	GT15-CFCD	
CF card extension unit <sup>*1</sup>	GT15-CFEX-C08SET	
External I/O unit	GT15-DIO, GT15-DIOR	
Sound output unit	GT15-SOUT	

\*1 GT15-CFEX + GT15-CFEXIF + GT15-C08CF set.

## ■ Option

Abbreviations and generic terms		Description
Memory card	CF card	GT05-MEM-16MC, GT05-MEM-32MC, GT05-MEM-64MC, GT05-MEM-128MC, GT05-MEM-256MC, GT05-MEM-512MC, GT05-MEM-1GC, GT05-MEM-2GC, GT05-MEM-4GC, GT05-MEM-8GC, GT05-MEM-16GC
	SD card	NZ1MEM-2GBSD, NZ1MEM-4GBSD, NZ1MEM-8GBSD, NZ1MEM-16GBSD, L1MEM-2GBSD, L1MEM-4GBSD
Memory card adaptor		GT05-MEM-ADPC
Option function board		GT16-MESB, GT15-FNB, GT15-QFNB, GT15-QFNB16M, GT15-QFNB32M, GT15-QFNB48M, GT11-50FNB, GT15-MESB48M
Battery		GT15-BAT, GT11-50BAT
Protective Sheet	For GT16	GT16-90PSCB, GT16-90PSGB, GT16-90PSCW, GT16-90PSGW, GT16-80PSCB, GT16-80PSGB, GT16-80PSCW, GT16-80PSGW, GT16-70PSCB, GT16-70PSGB, GT16-70PSCW, GT16-70PSGW, GT16-60PSCB, GT16-60PSGB, GT16-60PSCW, GT16-60PSGW, GT16-50PSCB, GT16-50PSGB, GT16-50PSCW, GT16-50PSGW, GT16-90PSCB-012, GT16-80PSCB-012, GT16-70PSCB-012, GT16-60PSCB-012, GT16-50PSCB-012, GT16H-60PSC
	For GT15	GT15-90PSCB, GT15-90PSGB, GT15-90PSCW, GT15-90PSGW, GT15-80PSCB, GT15-80PSGB, GT15-80PSCW, GT15-80PSGW, GT15-70PSCB, GT15-70PSGB, GT15-70PSCW, GT15-70PSGW, GT15-60PSCB, GT15-60PSGB, GT15-60PSCW, GT15-60PSGW, GT15-50PSCB, GT15-50PSGB, GT15-50PSCW, GT15-50PSGW
	For GT14	GT14-50PSCB, GT14-50PSGB, GT14-50PSCW, GT14-50PSGW
	For GT12	GT11-70PSCB, GT11-65PSCB
	For GT11	GT11-50PSCB, GT11-50PSGB, GT11-50PSCW, GT11-50PSGW, GT11H-50PSC
	For GT10	GT10-50PSCB, GT10-50PSGB, GT10-50PSCW, GT10-50PSGW, GT10-40PSCB, GT10-40PSGB, GT10-40PSCW, GT10-40PSGW, GT10-30PSCB, GT10-30PSGB, GT10-30PSCW, GT10-30PSGW, GT10-20PSCB, GT10-20PSGB, GT10-20PSCW, GT10-20PSGW
Protective cover for oil		GT05-90PCO, GT05-80PCO, GT05-70PCO, GT05-60PCO, GT05-50PCO, GT16-50PCO, GT10-40PCO, GT10-30PCO, GT10-20PCO
USB environmental protection cover		GT16-UCOV, GT16-50UCOV, GT15-UCOV, GT14-50UCOV, GT11-50UCOV
Stand		GT15-90STAND, GT15-80STAND, GT15-70STAND, A9GT-50STAND, GT05-50STAND
Attachment		GT15-70ATT-98, GT15-70ATT-87, GT15-60ATT-97, GT15-60ATT-96, GT15-60ATT-87, GT15-60ATT-77, GT15-50ATT-95W, GT15-50ATT-85
Backlight		GT16-90XLTT, GT16-80SLTT, GT16-70SLTT, GT16-70VLTT, GT16-70VLTTA, GT16-70VLTN, GT16-60SLTT, GT16-60VLTT, GT16-60VLTN, GT15-90XLTT, GT15-80SLTT, GT15-70SLTT, GT15-70VLTT, GT15-70VLTN, GT15-60VLTT, GT15-60VLTN
Multi-color display board		GT15-XHNB, GT15-VHNB
Connector conversion box		GT11H-CNB-37S, GT16H-CNB-42S
Emergency stop sw guard cover		GT11H-50ESCOV, GT16H-60ESCOV
Wall-hanging fitting		GT14H-50ATT
Memory loader		GT10-LDR
Memory board		GT10-50FMB
Panel-mounted USB port extension		GT14-C10EXUSB-4S, GT10-C10EXUSB-5S



## ■ Software

Abbreviations and generic terms		Description
GT Works3		Abbreviation of the SW□DND-GTWK3-E and SW□DND-GTWK3-EA
GT Designer3		Abbreviation of screen drawing software GT Designer3 for GOT1000 series
GT Simulator3		Abbreviation of screen simulator GT Simulator3 for GOT1000/GOT900 series
GT SoftGOT1000		Abbreviation of monitoring software GT SoftGOT1000
GT Converter2		Abbreviation of data conversion software GT Converter2 for GOT1000/GOT900 series
GT Designer2 Classic		Abbreviation of screen drawing software GT Designer2 Classic for GOT900 series
GT Designer2		Abbreviation of screen drawing software GT Designer2 for GOT1000/GOT900 series
iQ Works		Abbreviation of iQ Platform compatible engineering environment MELSOFT iQ Works
MELSOFT Navigator		Generic term for integrated development environment software included in the SW□DNC-IQWK (iQ Platform compatible engineering environment MELSOFT iQ Works)
MELSOFT iQ AppPortal		SW□DND-IQAPL-M type integrated application management software
GX Works3		Abbreviation of SW□DND-GXW3-E and SW□DND-GXW3-EA type programmable controller engineering software
GX Works2		Abbreviation of SW□DNC-GXW2-E and SW□DNC-GXW2-EA type programmable controller engineering software
Controller simulator	GX Simulator3	Abbreviation of GX Works3 with the simulation function
	GX Simulator2	Abbreviation of GX Works2 with the simulation function
	GX Simulator	Abbreviation of SW□D5C-LLT-E(-EV) type ladder logic test tool function software packages (SW5D5C-LLT (-EV) or later versions)
GX Developer		Abbreviation of SW□D5C-GPPW-E(-EV)/SW D5F-GPPW-E type software package
GX LogViewer		Abbreviation of SW□DNN-VIEWER-E type software package
PX Developer		Abbreviation of SW□D5C-FBDQ-E type FBD software package for process control
MT Works2		Abbreviation of motion controller engineering environment MELSOFT MT Works2(SW□DND-MTW2-E)
MT Developer		Abbreviation of SW□RNC-GSV type integrated start-up support software for motion controller Q series
MR Configurator2		Abbreviation of SW□DNC-MRC2-E type Servo Configuration Software
MR Configurator		Abbreviation of MRZJW□-SETUP□E type Servo Configuration Software
FR Configurator		Abbreviation of Inverter Setup Software (FR-SW□-SETUP-WE)
NC Configurator		Abbreviation of CNC parameter setting support tool NC Configurator
FX Configurator-FP		Abbreviation of parameter setting, monitoring, and testing software packages for FX3U-20SSC-H (SW□D5C-FXSSC-E)
FX3U-ENET-L Configuration tool		Abbreviation of FX3U-ENET-L type Ethernet module setting software (SW1D5-FXENETL-E)
FX Configurator-EN		Abbreviation of FX3U-ENET type Ethernet module setting software (SW1D5C-FXENET-E)
RT ToolBox2		Abbreviation of robot program creation software (3D-11C-WINE)
MX Component		Abbreviation of MX Component Version□ (SW□D5C-ACT-E, SW□D5C-ACT-EA)
MX Sheet		Abbreviation of MX Sheet Version□ (SW□D5C-SHEET-E, SW□D5C-SHEET-EA)
CPU Module Logging Configuration Tool		Abbreviation of CPU Module Logging Configuration Tool (SW1DNN-LLUTL-E)

## ■ License key (for GT SoftGOT1000)

Abbreviations and generic terms	Description
License	GT15-SGTKEY-U, GT15-SGTKEY-P

## ■ Others

Abbreviations and generic terms	Description
IAI	Abbreviation of IAI Corporation
AZBIL	Abbreviation of Azbil Corporation (former Yamatake Corporation)
OMRON	Abbreviation of OMRON Corporation
KEYENCE	Abbreviation of KEYENCE CORPORATION
JTEKT ELECTRONICS	Abbreviation of JTEKT ELECTRONICS CORPORATION (formerly KOYO ELECTRONICS INDUSTRIES CO., LTD.)
SHARP	Abbreviation of Sharp Corporation
JTEKT	Abbreviation of JTEKT Corporation
SHINKO	Abbreviation of Shinko Technos Co., Ltd.
CHINO	Abbreviation of CHINO CORPORATION
TOSHIBA	Abbreviation of TOSHIBA CORPORATION
TOSHIBA MACHINE	Abbreviation of TOSHIBA MACHINE CO., LTD.
HITACHI IES	Abbreviation of Hitachi Industrial Equipment Systems Co., Ltd.
HITACHI	Abbreviation of Hitachi, Ltd.
FUJI	Abbreviation of FUJI ELECTRIC CO., LTD.
PANASONIC	Abbreviation of Panasonic Corporation
PANASONIC INDUSTRIAL DEVICES SUNX	Abbreviation of Panasonic Industrial Devices SUNX Co., Ltd.
YASKAWA	Abbreviation of YASKAWA Electric Corporation
YOKOGAWA	Abbreviation of Yokogawa Electric Corporation
ALLEN-BRADLEY	Abbreviation of Allen-Bradley products manufactured by Rockwell Automation, Inc.
GE	Abbreviation of GE Intelligent Platforms
LS ELECTRIC	Abbreviation of LS ELECTRIC Co., Ltd (formerly LS Industrial Systems Co., Ltd.)
MITSUBISHI INDIA	Mitsubishi Electric India Pvt. Ltd.
SCHNEIDER	Abbreviation of Schneider Electric SA
SICK	Abbreviation of SICK AG
SIEMENS	Abbreviation of Siemens AG
RKC	Abbreviation of RKC INSTRUMENT INC.
HIRATA	Abbreviation of Hirata Corporation
MURATEC	Abbreviation of Muratec products manufactured by Muratec Automation Co., Ltd.
PLC	Abbreviation of programmable controller
Temperature controller	Generic term for temperature controller manufactured by each corporation
Indicating controller	Generic term for indicating controller manufactured by each corporation
Control equipment	Generic term for control equipment manufactured by each corporation
CHINO controller	Abbreviation of indicating controller manufactured by CHINO CORPORATION
PC CPU module	Abbreviation of PC CPU Unit manufactured by CONTEC CO., LTD
GOT (server)	Abbreviation of GOTs that use the server function
GOT (client)	Abbreviation of GOTs that use the client function
Windows® font	Abbreviation of TrueType font and OpenType font available for Windows® (Differs from the True Type fonts settable with GT Designer3)
Intelligent function module	Indicates the modules other than the PLC CPU, power supply module and I/O module that are mounted to the base unit
MODBUS® /RTU	Generic term for the protocol designed to use MODBUS® protocol messages on a serial communication
MODBUS® /TCP	Generic term for the protocol designed to use MODBUS® protocol messages on a TCP/IP network

# HOW TO USE THIS MANUAL

The following symbols are used in this manual.

### 4.1 GOT Type Setting

#### 4.1.1 Settings

Select [Common] → [GOT Type Setting] from the menu to display the [GOT Type Setting] dialog box.

**HINT**

**Settings relevant to functions**  
For the common settings in a project data, some settings are relevant to multiple GOT functions.  
For each setting relevant to the GOT functions, refer to the following.

Appendix8 Relevant Settings

Shows whether the GT16, GT15, GT14, GT12, GT11, GT10, and GT SoftGOT1000 are applicable.

- : Applicable
- × : Not applicable

[ ] : Shows the setting item displayed on the software screen or the GOT screen.

**POINT** : Refers to information required for operation.

**HINT** : Refers to information useful for operation.

Shows a chapter, section, relevant manual, or others of relevant information.

- (Fundamentals): GT Designer3 Version1 Screen Design Manual (Fundamentals)
- (Functions): GT Designer3 Version1 Screen Design Manual (Functions)

Shows the operation steps.  
Operate the steps from the step 1.

**Setting for each screen**

- Select a screen editor to set a key window, and select [Screen] → [Screen Property] from the menu to display the [Screen Property] dialog box.
- Select the [Key Window Basic Setting] tab or the [Key Window Advanced Setting] tab, and set the required items.

**HINT**

**Settings relevant to functions**  
For the key window settings, some settings are relevant to multiple GOT functions.  
For each setting relevant to the GOT functions, refer to the following.

Appendix8 Relevant Settings

(1) Key Window Basic Setting tab

Item	Description	Model
Prioritize screen setting over project setting	Select this item to give the setting for each screen priority over the setting for each project.	gt16, gt15, gt14, gt12, gt11, gt10, gtsoft1000
Key Window	This item is available when [Prioritize screen setting over project setting] is selected for [Key Window Setting]. (Standard Key Window/User-created Key Window)	gt16, gt15, gt14, gt12, gt11, gt10, gtsoft1000
Display standard key window for ASCII	Select this item to display the standard key window at ASCII input.	gt16, gt15, gt14, gt12, gt11, gt10, gtsoft1000
Key Window Setting	This item is available when [User-created Key Window] is	

Shows whether the GT16, GT15, GT14, GT12, GT11, GT10, and GT SoftGOT1000 are applicable.

- Black: Applicable
- Gray: Not applicable

The above is different from the actual page, as it is provided for explanation only.



# REGARDING GT Designer3

---



# 1. OVERVIEW

GT Designer3 is software to create a project for the GOT1000 series.

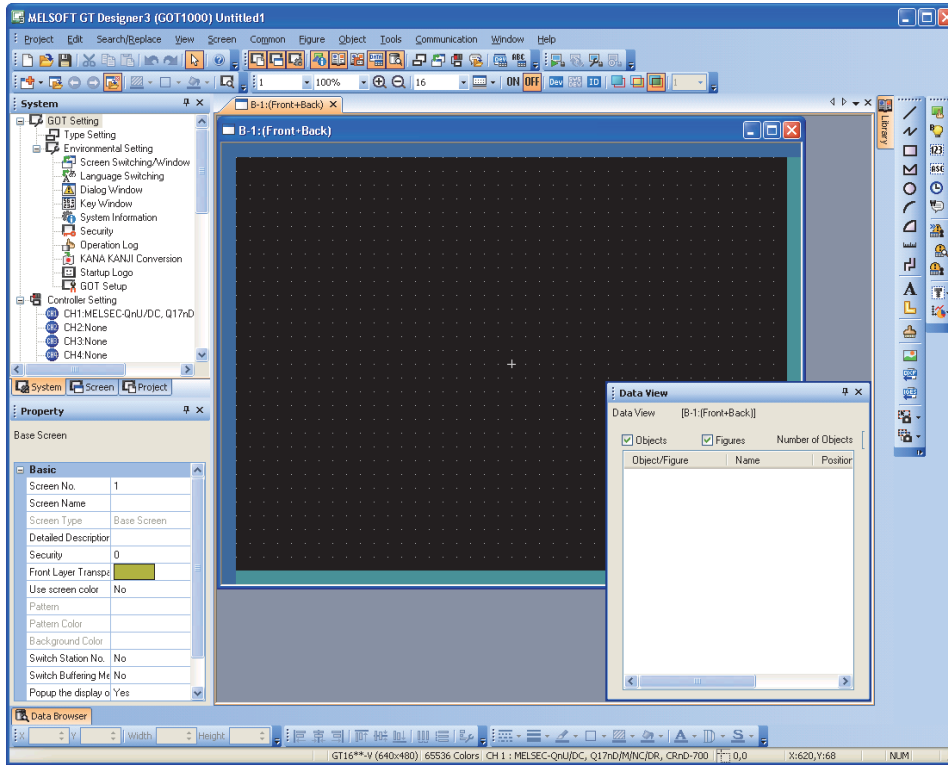

The created project can be displayed by being written to the GOT or opened with GT SoftGOT1000.

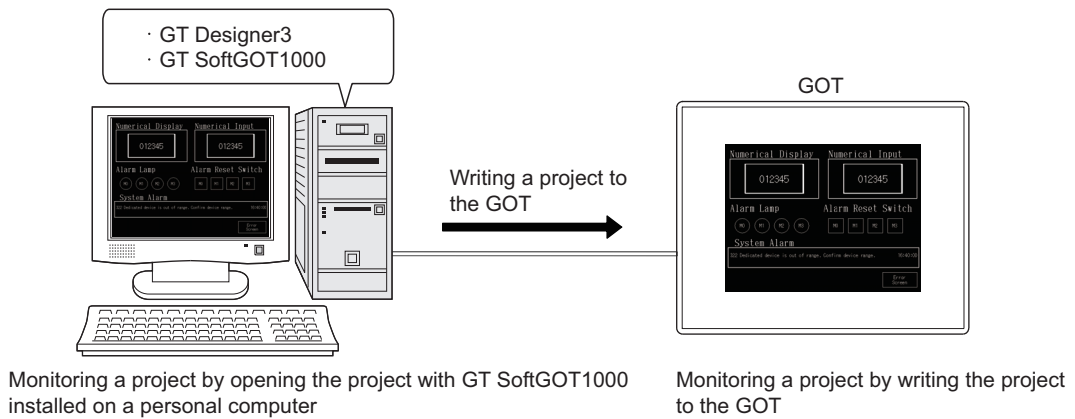

## Project creation/edit for GOT900

When creating or editing the project for GOT900, use GT Designer2 Classic.  
Contact your local distributor.





# **GT Designer3 SPECIFICATIONS**

---



# 2. GT Designer3 SPECIFICATIONS

## 2.1 Operating Environment

Item	Description
Personal computer	PC/AT compatible personal computer that the following OSs run on.
OS (English version) <sup>*1</sup> *2*5*8	<ul style="list-style-type: none"> <li>Microsoft® Windows® 11 Education (64 bit)<sup>*6*9*10*12</sup></li> <li>Microsoft® Windows® 11 Enterprise (64 bit)<sup>*6*9*10*12</sup></li> <li>Microsoft® Windows® 11 Pro (64 bit)<sup>*6*9*10*12</sup></li> <li>Microsoft® Windows® 11 Home (64 bit)<sup>*6*9*10*12</sup></li> <li>Microsoft® Windows® 10 Enterprise (64 bit, 32 bit)<sup>*6*7</sup></li> <li>Microsoft® Windows® 10 Pro (64 bit, 32 bit)<sup>*6*7</sup></li> <li>Microsoft® Windows® 10 Home (64 bit, 32 bit)<sup>*6*7</sup></li> </ul>
CPU	<ul style="list-style-type: none"> <li>• Windows 11: 64 bit-compatible processor with dual-core or more or System on a Chip (SoC)<sup>*11</sup></li> <li>• Other than Windows 11: Intel Core 2 Duo Processor 2.0 GHz or more recommended<sup>*11</sup></li> </ul>
Memory	<ul style="list-style-type: none"> <li>• For Windows 11: 4 GB or more recommended</li> <li>• For 64-bit OS other than Windows 11: 2 GB or more recommended</li> <li>• For 32-bit OS other than Windows 11: 1 GB or more recommended</li> </ul>
Display	Resolution XGA (1024×768 dots) or more
Hard disk space	<ul style="list-style-type: none"> <li>• For installation: 5GB or more recommended</li> <li>• For execution: 512MB or more recommended</li> </ul>
Display color	High Color(16 bits) or more
Software	<p>When using the simulation function and simulating with one personal computer, either of the following software is required.</p> <ul style="list-style-type: none"> <li>• GX Simulator2 (included in GX Works2 Version1.12N or later)<sup>*4</sup></li> <li>• GX Simulator Version5.00A or later<sup>*4</sup></li> </ul>
Others	Mouse, key board, printer, DVD drive, sound function (sound card) <sup>*3</sup> , speaker <sup>*3</sup>

- \*1 For installation, administrator privileges are required.  
 For use, the standard user or administrator account is required.  
 To interact GT Designer3 with other MELSOFT applications, use GT Designer3 under the administrator authority when the other MELSOFT applications are used under the administrator authority.  
 When simulating the GOT-A900, the administrator authority is required.
- \*2 The following functions are not supported.
- Activating the application with Windows® compatibility mode
  - Fast user switching
  - Change your desktop themes (fonts)
  - Remote desktop
  - Setting the size of text and illustrations on the screen to any size other than [Small-100%]
- \*3 Only when the simulation function is used.
- \*4 Applicable software version of GX Works2 and GX Simulator varies according to the PLC CPU that is simulated. For the applicable software version of GX Works2 and GX Simulator for each PLC CPU, refer to the following.
-  GT Simulator3 Version1 Operating Manual for GT Works3
- \*5 Operation is not supported in an environment with the text cursor indicator turned on.
- \*6 The touch feature is not supported.
- \*7 Modern UI style is not supported.

- \*8 Operation in a virtual environment such as Hyper-V is not supported.
- \*9 Tablet mode is not supported.
- \*10 Unified Write Filter is not supported.
- \*11 ARM64 and ARM32 are not supported.
- \*12 Communication with GT1020 or GT1030 is not supported.

## POINT

---

### **Operating environment on iQ Works**

When starting GT Designer3 from MELSOFT Navigator, the operating environment of GT Designer3 is same as that of MELSOFT Navigator.

For the operating environment of MELSOFT Navigator, refer to the following.

 [iQ Works Installation Instructions](#)

---

## 2.2 Project Format Handled with GT Designer3

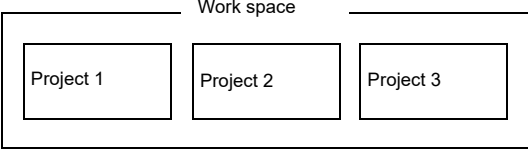
Project format	Description	Available operation on GT Designer3		
		Open	Reading other project	Save
GT Designer3 project	Format of the project registered in the work space. More than one project can be registered for the work space. 	○	○	○
A single file format project (GTW format)(* .GTW)	Compressed format of GT Designer3 project.	○	○	○
G1 format (*.G1) (Created by GT Designer3)	Format of the project written to the GOT, the memory card, or the USB memory.	○	×	×
G1 format (*.G1) (Created by GT Designer2)		○	×	×
GTE format (*.GTE)	Format of the project created by GT Designer2.	○	○	×
GTD format (*.GTD) <sup>*1</sup>		○	×	×

\*1 Change the GOT type for the project to the GOT1000 series in GT Designer2 before opening in GT designer3.  
The projects created with FX-PCS-DU/WIN and resaved by GT Designer2 cannot be opened.

### POINT

#### Backward compatibility of project data created with GT Designer3

Project data created with GT Designer3 cannot be used with GT Designer2.

#### ■ Configuration of GT Designer3 project file

A GT Designer3 project is saved in the following file composition.

To copy or move the GT Designer3 project, keep the following file composition.

Do not rename or delete a workspace folder and a project folder.

If the folders are renamed or deleted, the GT Designer3 project cannot be opened in MELSOFT Navigator.

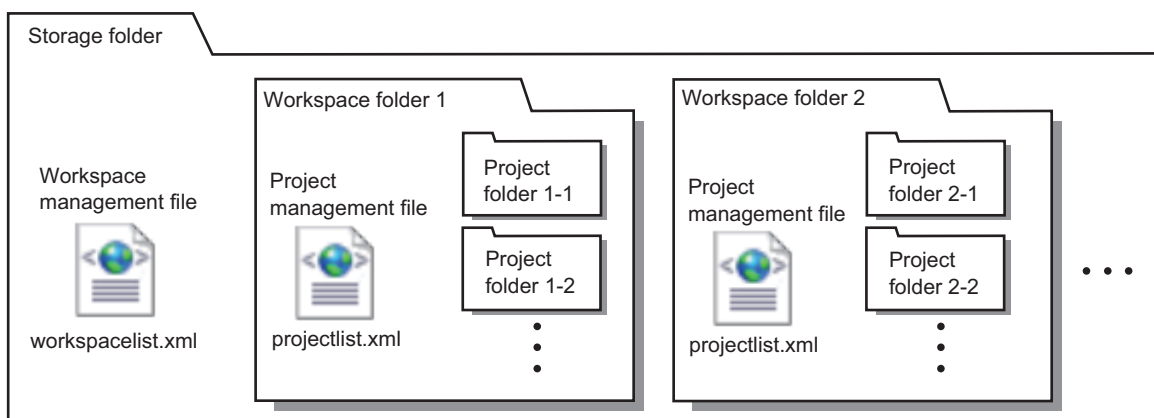

#### (1) Workspace management file and project management file

A workspace management file (workspacelist.xml) manages a workspace in a storage folder where the workspaces and GT Designer3 projects are saved.

A project management file (projectlist.xml) manages a GT Designer3 project in the workspace.

Do not delete the workspace management file (workspacelist.xml) and the project management file (projectlist.xml).

If the files are deleted, the workspace or the GT Designer3 project cannot be opened in MELSOFT Navigator.

**(2) Files in a project folder**

Files in the project folder are the data of a GT Designer3 project.

Do not rename or delete the files.

If the files are renamed or deleted, the GT Designer3 project cannot be opened in GT Designer3.

**POINT**

**(1) Folder or file operation for GT Designer3 projects**

Use MELSOFT Navigator or GT Designer3 for the folder or file operations, including moving, renaming, copying, and deleting a GT Designer3 project.

If the folder or file is operated other than GT Designer3 such as Explorer, data may have some problems.

For the file and folder operation in GT Designer3, refer to the following.

☞ 3.16 Saving Project

3.17 Deleting Project

**(2) Workspace or project registration to a workspace management file or project management file**

With Explorer or others, even if a workspace or project is moved to an existing storage folder where the workspaces and projects are saved, the workspace or project is not registered in the workspace management file or project management file.

Open the workspace or project, and save the workspace or project again.

The moved workspace and project are registered in the workspace management file or project management file.

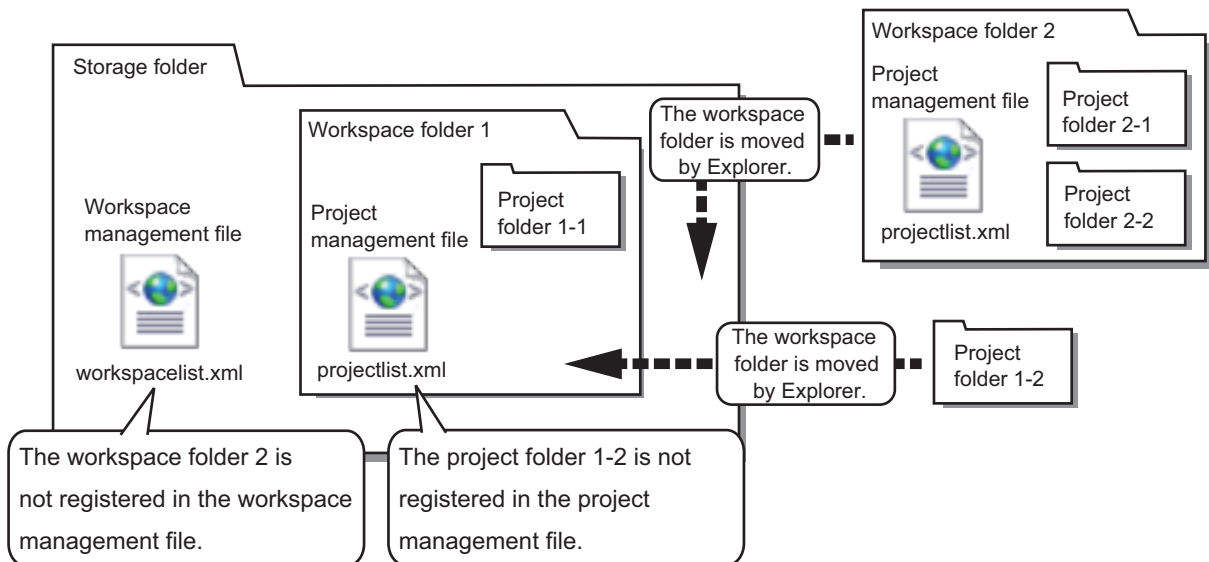

**■ Configuration of a single file format project file (\*.GTW)**

A single file format project (\*.GTW) is a single file.

The compressed file can be opened in GT Designer3 even after moving or renaming the file.

It is useful when copying and duplicating the project file or others.

**■ Project format that can be handled with iQ Works**

For iQ Works, the following project format is available.

- GT Designer3 project

☞ 3.6.2 Opening/closing a project

## 2.3 Types and Number of Creatable Screens

The following shows screens that can be created by GT Designer3.

The screen type and number of screens that can be created differ according to the GOT to use.

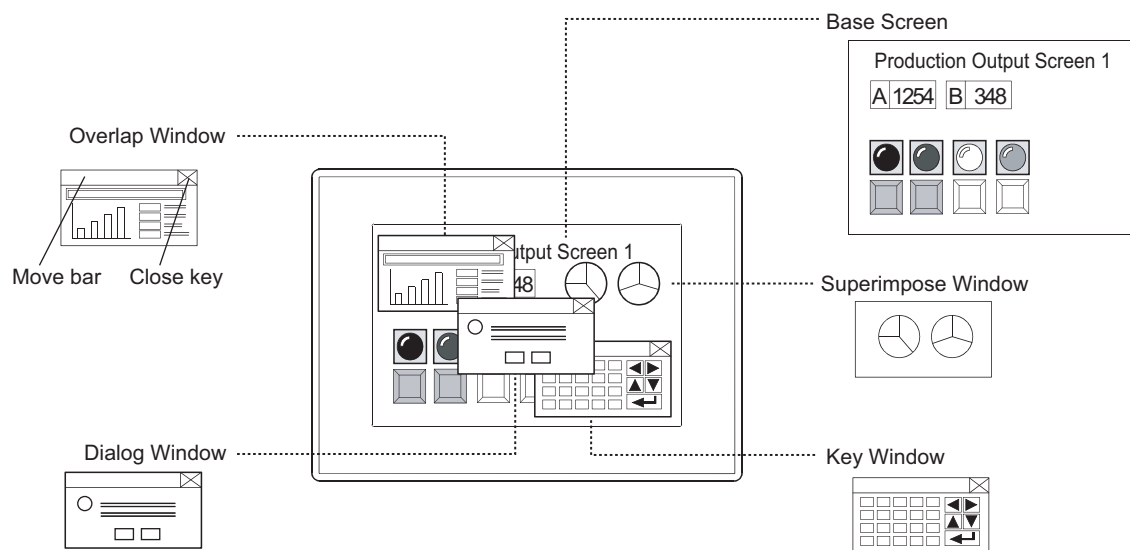

Screen	Description	Model	
Base Screen	A base screen of the GOT screen display.		
Window Screen	A screen overlaid on the base screen. The created window screen can be displayed on the GOT as the overlap window, superimpose window, key window, or dialog window.		
	Overlap Window	A pop-up window that appears over the base screen. With the close key displayed, the window can be moved or closed manually. For displaying the overlap window, refer to the following. 4.2 Screen Switching Device Setting	
	Superimpose Window	A composite window placed on the base Screen. If super impose window is switched, the corresponding parts of the base screen will be changed. Figures and objects for the superimpose window are arranged in the free area of the base screen. For displaying the superimpose window, refer to the following. 4.2 Screen Switching Device Setting	
	Key Window	A pop-up window for inputting numerical values and others to be displayed on the base screen. There are two types of the key window: standard key window and user-created key window. For displaying the key window, refer to the following. 4.5 Key Window Setting	
	Dialog Window	A window that displays errors and warnings as a system. The dialog window can be displayed instead of the system message displayed by the GOT. For displaying the dialog window, refer to the following. 4.4 Setting Message to be Displayed on GOT	
Report Screen	A screen for creating the format output by the report function.		

## 2.3.1 Screen specifications for each GOT type

### ■ Base screen specifications

GOT	Screen size (width×height, dots)	Max. number of registered screens	Applicable screen No. range
GT16**-X(1024×768)	1024×768	4096 (screens)	1 - 32767
GT16**-S(800×600)	800×600		
GT16**-V(640×480)	640×480		
GT165*-V(640×480)			
GT15**-X(1024×768)	1024×768	4096 (screens)	1 - 32767
GT15**-S(800×600)	800×600		
GT15**-V(640×480)	640×480		
GT155*-V(640×480)			
GT15**-Q(320×240)			
GT14**-Q(320×240)	Horizontal display: 320×240 Vertical display: 240×320	4096 (screens)	1 - 32767
GT12**-V(640×480)	640×480	4096 (screens)	1 - 32767
GT11**-Q(320×240)	Horizontal display: 320×240 Vertical display: 240×320	4096 (screens)	1 - 32767
GT11**-Q*BDA(Built-in A Bus) (320×240)			
GT11**-Q*BDQ(Built-in Q Bus) (320×240)			
GT10**-Q(320×240)	Horizontal display: 320×240 Vertical display: 240×320	1024 (screens)	1 - 32767
GT1030(288×96)	Horizontal display: 288×96 Vertical display: 96×288		
GT1020(160×64)	Horizontal display: 160×64 Vertical display: 64×160		
GT SoftGOT1000	640×480 - 1920×1200	4096 (screens)	1 - 32767



## Window screen specifications

GOT	Screen size (width×height, dots) <sup>*1</sup>		Max. number of registered screens	Applicable screen No. range
	Close key displayed	Close key hidden		
GT16**-X(1024×768)	16×2 - 1022×751	16×2 - 1024×768	1024 (screens)	1 - 32767
GT16**-S(800×600)	16×2 - 798×583	16×2 - 800×600		
GT16**-V(640×480)	16×2 - 638×463	16×2 - 640×480		
GT165*-V(640×480)				
GT15**-X(1024×768)	16×2 - 1022×751	16×2 - 1024×768	1024 (screens)	1 - 32767
GT15**-S(800×600)	16×2 - 798×583	16×2 - 800×600		
GT15**-V(640×480)	16×2 - 638×463	16×2 - 640×480		
GT155*-V(640×480)				
GT15**-Q(320×240)	16×2 - 318×223	16×2 - 320×240	1024 (screens)	1 - 32767
GT14**-Q(320×240)	Horizontal display: 16×2 - 318×223 Vertical display: 16×2 - 238×303	Horizontal display: 16×2 - 320×240 Vertical display: 16×2 - 240×320		
GT12**-V(640×480)	16×2 - 638×463	16×2 - 640×480		
GT11**-Q(320×240)	Horizontal display: 16×2 - 318×223 Vertical display: 16×2 - 238×303	Horizontal display: 16×2 - 320×240 Vertical display: 16×2 - 240×320		
GT11**-Q*BDA(Built-in A Bus) (320×240)				
GT11**-Q*BDQ(Built-in Q Bus) (320×240)				
GT10**-Q(320×240)	Horizontal display: 16×16 - 320×224 Vertical display: 16×16 - 240×304	Horizontal display: 16×16 - 320×240 Vertical display: 16×16 - 240×320	512 (screens)	1 - 32767
GT1030(288×96)	Horizontal display: 16×16 - 288×80 Vertical display: 16×16 - 94×271	Horizontal display: 16×16 - 288×96 Vertical display: 16×16 - 96×288		
GT1020(160×64)	Horizontal display: 16×16 - 160×48 Vertical display: 16×16 - 62×143	Horizontal display: 16×16 - 160×64 Vertical display: 16×16 - 64×160		
GT SoftGOT1000	16×2 - 1918×1193	16×2 - 1920×1200	1024 (screens)	1 - 32767

\*1 The following shows the screen size (width × height) with the close key displayed or hidden.

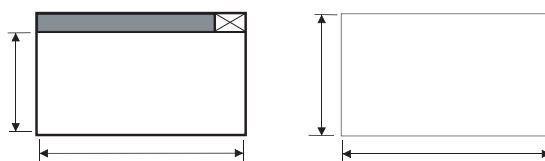

Displaying the close key

Hiding the close key

For setting of the close key display, refer to the following.

4.2 Screen Switching Device Setting

## (1) Overlap window specifications

GOT	Screen size (width×height dots) <sup>*1</sup>		Number of screens displayed in one base screen
	Close key displayed <sup>*2</sup>	Close key hidden	
GT16**-X(1024×768)	16×2 - 1022×751	16×2 - 1024×768	5 (screens)
GT16**-S(800×600)	16×2 - 798×583	16×2 - 800×600	
GT16**-V(640×480)	16×2 - 638×463	16×2 - 640×480	
GT165*-V(640×480)			
GT15**-X(1024×768)	16×2 - 1022×751	16×2 - 1024×768	2 (screens)
GT15**-S(800×600)	16×2 - 798×583	16×2 - 800×600	
GT15**-V(640×480)	16×2 - 638×463	16×2 - 640×480	
GT155*-V(640×480)			
GT15**-Q(320×240)	16×2 - 318×223	16×2 - 320×240	2 (screens)
GT14**-Q(320×240)	Horizontal display: 16×2 - 318×223 Vertical display: 16×2 - 238×303	Horizontal display: 16×2 - 320×240 Vertical display: 16×2 - 240×320	
GT12**-V(640×480)	16×2 - 638×463	16×2 - 640×480	2 (screens)
GT11**-Q(320×240)	Horizontal display: 16×2 - 318×223 Vertical display: 16×2 - 238×303	Horizontal display: 16×2 - 320×240 Vertical display: 16×2 - 240×320	2 (screens)
GT11**-Q*BDA(Built-in A Bus) (320×240)			
GT11**-Q*BDQ(Built-in Q Bus) (320×240)			
GT10**-Q(320×240)	Horizontal display: 16×16 - 320×224 Vertical display: 16×16 - 240×304	Horizontal display: 16×16 - 320×240 Vertical display: 16×16 - 240×320	2 (screens)
GT1030(288×96)	Horizontal display: 16×16 - 288×78 Vertical display: 16×16 - 94×271	Horizontal display: 16×16 - 288×96 Vertical display: 16×16 - 96×288	
GT1020(160×64)	Horizontal display: 16×16 - 158×47 Vertical display: 16×16 - 62×143	Horizontal display: 16×16 - 160×64 Vertical display: 16×16 - 64×160	
GT SoftGOT1000	16×2 - 1918×1193	16×2 - 1920×1200	

\*1 The following shows the screen size (width×height) with the close key displayed or hidden.

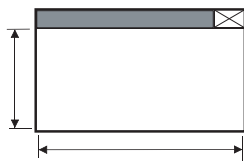

The close key is displayed.

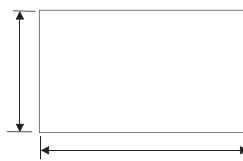

The close key is hidden.

For setting of the close key display, refer to the following.

☞ 4.2 Screen Switching Device Setting

\*2 To display the close key, set the width of the overlap window at 24 dots or more.

The close key is not available if the width of the overlap window is set at 23 dots or less.

For setting of the window display size, refer to the following.

☞ 3.7.1 Creating a new screen

## (2) Superimpose window specifications

GOT	Screen size (width×height dots)	Number of screens displayed in one base screen
GT16**-X(1024×768)	16×2 - 1024×768	2 (screens)
GT16**-S(800×600)	16×2 - 800×600	
GT16**-V(640×480)	16×2 - 640×480	
GT165*-V(640×480)		
GT15**-X(1024×768)	16×2 - 1024×768	2 (screens)
GT15**-S(800×600)	16×2 - 800×600	
GT15**-V(640×480)	16×2 - 640×480	
GT155*-V(640×480)		
GT15**-Q(320×240)	16×2 - 320×240	2 (screens)
GT14**-Q(320×240)	Horizontal display: 16×2 - 320×240 Vertical display: 16×2 - 240×320	
GT12**-V(640×480)	16×2 - 640×480	
GT11**-Q(320×240)	Horizontal display: 16×2 - 320×240 Vertical display: 16×2 - 240×320	
GT11**-Q*BDA(Built-in A Bus) (320×240)		
GT11**-Q*BDQ(Built-in Q Bus) (320×240)		
GT10**-Q(320×240)	Horizontal display: 16×16 - 320×240 Vertical display: 16×16 - 240×320	2 (screens)
GT1030(288×96)	Horizontal display: 16×16 - 288×96 Vertical display: 16×16 - 96×288	
GT1020(160×64)	Horizontal display: 16×16 - 160×64 Vertical display: 16×16 - 64×160	
GT SoftGOT1000	16×2 - 1920×1200	

## (3) Key window specifications

GOT	Screen size (width×height dots)		
	Standard key window		User-created key window*1
	Value currently inputting/value before inputting/hiding input range	Value currently inputting/value before inputting/displaying input range	
GT16**-X(1024×768)	318×159	318×207	16×2 - 1022×751
GT16**-S(800×600)	318×159	318×207	16×2 - 798×583
GT16**-V(640×480)	318×159	318×207	16×2 - 638×463
GT165*-V(640×480)	318×335	318×383	
GT15**-X(1024×768)	318×159	318×207	16×2 - 1022×751
GT15**-S(800×600)	318×159	318×207	16×2 - 798×583
GT15**-V(640×480)	318×159	318×207	16×2 - 638×463
GT155*-V(640×480)	318×335	318×383	
GT15**-Q(320×240)	318×159	318×207	16×2 - 318×223
GT14**-Q(320×240)	Horizontal display: 318×159 Vertical display: 190×127(For decimal input) 222×127(For hexadecimal input)	Horizontal display: 318×207 Vertical display: 190×159(For decimal input) 222×159(For hexadecimal input)	Horizontal display: 16×2 - 318×223 Vertical display: 16×2 - 238×303
GT12**-V(640×480)	318×159	318×207	16×2 - 638×463

(Continued to next page)

GOT	Screen size (width×height dots)		
	Standard key window		User-created key window <sup>*1</sup>
	Value currently inputting/value before inputting/hiding input range	Value currently inputting/value before inputting/displaying input range	
GT11**-Q(320×240)	Horizontal display: 318×159 Vertical display: 190×127(For decimal input) 222×127(For hexadecimal input)	Horizontal display: 318×207 Vertical display: 190×159(For decimal input) 222×159(For hexadecimal input)	Horizontal display: 16×2 - 318×223 Vertical display: 16×2 - 238×303
GT11**-Q*BDA(Built-in A Bus) (320×240)			
GT11**-Q*BDQ(Built-in Q Bus) (320×240)			
GT10**-Q(320×240)	128×160(For decimal input) 160×160(For hexadecimal input)		Horizontal display: 16×16 - 320×224 Vertical display: 16×16 - 240×304
GT1030(288×96)	288×96		16×16 - 288×96
GT1020(160×64)	160×64		16×16 - 160×64
GT SoftGOT1000	318×159	318×207	16×2 - 1918×1183

\*1 Set the width of the user-created key window at 24 dots or more.  
The close key is not available if the width of the overlap window is set at 23 dots or less.  
For setting of the window display size, refer to the following.

 3.7.1 Creating a new screen

#### (4) Dialog window specifications

GOT	Screen size (width×height dots)
GT16**-X(1024×768)	16×2 - 320×240
GT16**-S(800×600)	
GT16**-V(640×480)	
GT165*-V(640×480)	
GT15**-X(1024×768)	16×2 - 320×240
GT15**-S(800×600)	
GT15**-V(640×480)	
GT155*-V(640×480)	
GT15**-Q(320×240)	
GT14**-Q(320×240)	Horizontal display: 16×2 - 320×240 Vertical display: 16×2 - 240×320
GT12**-V(640×480)	16×2 - 320×240
GT11**-Q(320×240)	Horizontal display: 16×2 - 320×240 Vertical display: 16×2 - 240×320
GT11**-Q*BDA(Built-in A Bus) (320×240)	
GT11**-Q*BDQ(Built-in Q Bus) (320×240)	
GT SoftGOT1000	16×2 - 320×240

#### Report screen specifications

The report screen is a screen for creating the format output by the report function.  
For the report screen specifications, refer to the following.

 (Functions) 39. REPORT FUNCTION

## 2.3.2 Relations of base screen and window screen

### ■ Screen laying

The screens are layered by type and displayed as shown below.

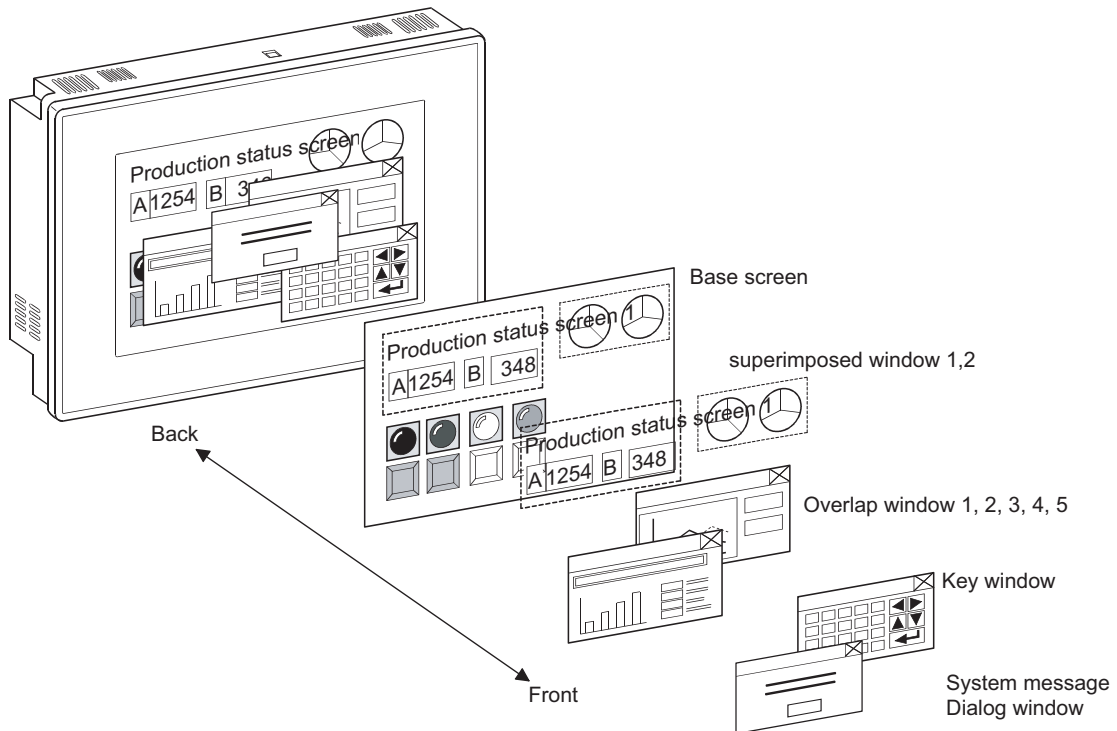

Type of screen	Screen laying
Base screen	Located at the back.
Superimposed window	Superimposed window overlaid in front of the base screen is displayed as a base screen. When two superimpose windows are displayed, the later appeared window is brought to the front.
Overlap window	Located in front of the superimpose window. The objects of the base screen arranged in the rear of the overlap window are not displayed. To confirm or operate the rear objects, close or move the overlap window. When multiple overlap windows are displayed, the later appeared or operated window is displayed in the front. (When switching the rear overlap window by the screen switching device, the window is not brought to the front.)
Key window	Located in the front of an overlap window.
Dialog window	Located in the top front of displayed windows.

### ■ Overlap-display of figures and objects

Overlapping figures and objects are displayed according to the order of layer.

On the base screen and superimposed window, the object being changed is brought to the front.

### ■ Input object (touch switches, numerical input, ASCII input) operation

#### (1) Overlap-display of base screen and superimpose window

The input objects in the base screen located behind the superimpose window can be operated.

If the touch switches on the superimposed window and base window overlap, both touch switches are available by touching.

(If the touch time is not long enough, only the touch switches on the superimposed window may operate.)

**(2) Overlap-display of base screen and overlap window**

The input objects in the base screen on which an overlap window is overlaid can not be operated.

The area around the overlap window is invalid even when touching the input objects, depending on the overlap window size.

To eliminate the invalid area, it is recommended to use the overlap window that is multiples of 16 dots in size and does not display the close key.

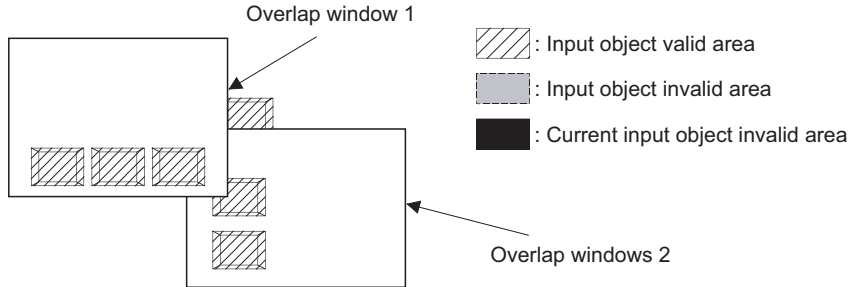

If an overlap window other than recommended above is displayed, the part of input object inside 16-dot area around the overlap window is invalid and do not operate.

**(a) When close key and movement bar are displayed**

The invalid area refers to 16-dot areas including areas where the window part in the 16-dot area is smaller than 16-dot area, and the surrounding 16-dot areas.

Example) When 10 dots are insufficient

The range of 10 dots + 16 dots is the invalid area.

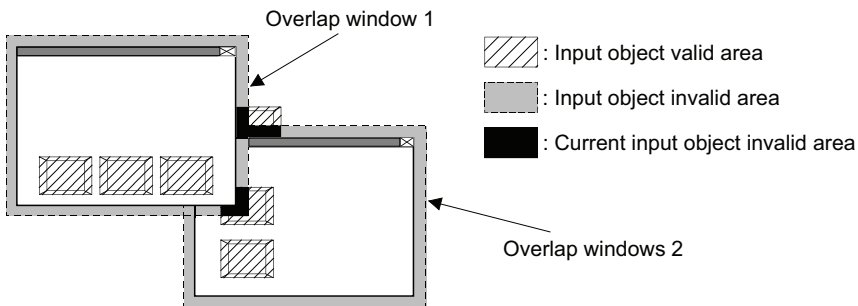

**(b) When neither close key nor movement bar is displayed**

The invalid area refers to 16-dot areas including areas where the window part in the 16-dot area is smaller than 16-dot area.

Example) When 10 dots are insufficient

The range of 10 dots is the invalid area.

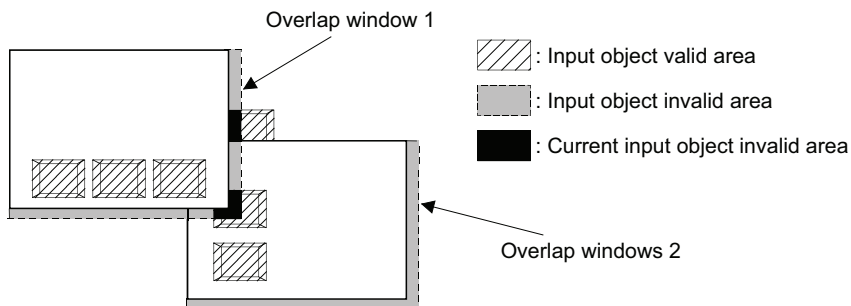

**Overlapping the quota objects**

Make sure not to set more than two System Alarm Display in one screen using the overlap window or superimpose window.

## 2.3.3 Layer

GT 16 GT 15 GT 14 GT 12 GT 11 GT 10 Soft SOT 1000

The base screen and window screen consist of two layers (the front layer and back layer). Set the objects on either of the two layers (front layer or back layer). Then, overlay the two layers to superimpose the set objects.

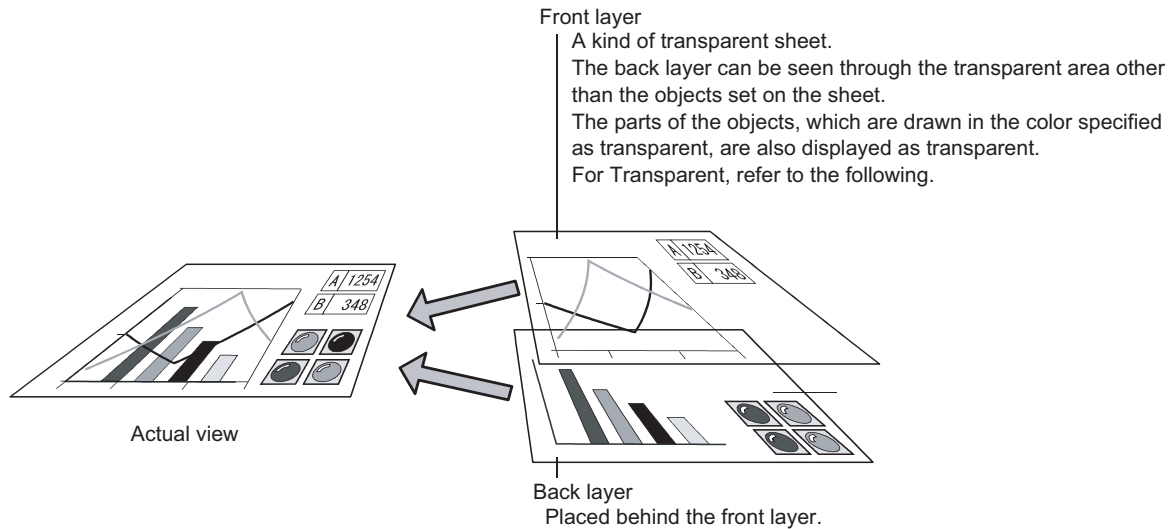

The layers of the window screen can be disabled according to the window screen.

Window screen	Layer setting
Overlap window	The layers are disabled. The figures and the objects on both the layers are processed so that they are on one layer.
Superimpose window	The layers are enabled.
Key window	The layers are disabled. The figures and the objects on both the layers are processed so that they are on one layer.
Dialog window	The layers are disabled. Only the figures and the objects on the back layer are displayed.

The following shows the figures and objects that can be arranged in each layer.



Layer	Figure and object that can be arranged
Front layer	Figures (only the piping figures with the lamp attribute used) and object
Back layer	Figures and objects

For layered figures and superimposed objects, refer to the following.

 5.3.7 Superimposition setting

## 2.4 Figures and Data Capacity

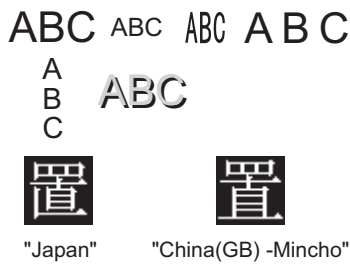
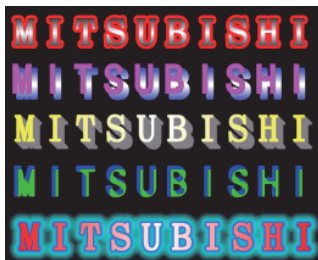
### ■ Figure specifications

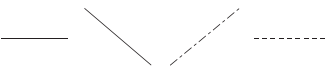
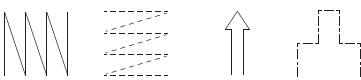
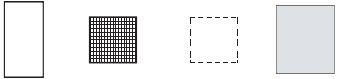
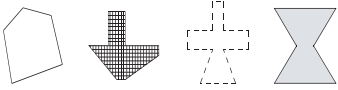
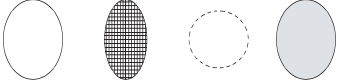
Figure	Drawing examples	Data capacity (byte) <sup>*1</sup>	Model
Text <sup>*2</sup>	 <p>"Japan" "China(GB) -Mincho"</p>	<p>The data capacity differs according to the font set.</p> <ul style="list-style-type: none"> <li>• Standard font <math>28+NR \times 8+NT \times 2</math></li> <li>• HQ font <math>Y+128 \times NT</math></li> <li>• TrueType font <math>Y+24+(8 \times NR)+(NT \times NS \times K)</math></li> <li>• Windows<sup>®</sup> font Varies according to the font or font size used<sup>*3</sup></li> <li>• Stroke font <math>Y+12</math></li> </ul> <p>NR: Number of lines NT: Number of characters NS: Character size K: Single byte character : 2, Double byte character : 4 Y: Capacity of standard font</p>	
Logo Text		<p><math>96+\text{character information}+\text{effect}+(\text{character width} \times \text{character height})</math></p> <p>Character information: <math>[2+(2 \times N)]+24+W</math></p> <p>Effect:</p> <ul style="list-style-type: none"> <li>Outline: 16</li> <li>Solid: 20</li> <li>3D: 16</li> <li>Stamp: 16</li> <li>Neon: 32</li> </ul> <p>N: Number of characters One line feed is counted as two characters. When the number of characters is an even, the number of characters is rounded up to an odd.</p> <p>W: Windows<sup>®</sup> font information size TrueType font is 0. For Windows<sup>®</sup>, the data capacity varies according to the font or font size used.<sup>*3</sup></p>	
Line <sup>*2</sup>		24	
Line Freeform		$20 + 4 \times \text{number of vertexes}$	
Rectangle		<p>The data capacity differs according to the figure type set.</p> <ul style="list-style-type: none"> <li>• Rectangle, Rectangle (Rounded): 28</li> <li>• Rectangle (Octagonal): 56</li> </ul>	
Polygon		<p><math>20 + 4 \times (\text{number of vertexes} + 1)</math></p> <p>Start point and end point counted as one vertex</p>	
Circle		28	

(Continued to next page)



Figure	Drawing examples	Data capacity (byte) <sup>*1</sup>	Model
Arc		36	
Sector		40	
Scale		28	
Piping		32+4(the number of vertices×3+1) Start point and end point counted as one vertex (Data capacity when all the corners are right angles.)	
Paint		20	
Import Image Data (BMP format)		28+data capacity of imported bit map file	
Import Image Data (JPEG format)		32+data capacity of imported JPEG file	
Import DXF Data		Varies according to the contents of an image.	
Import IGES Data			

\*1 When the lamp attribute is set, the size of the data increases as below.

Data size of one figure + 156

\*2 When setting for the report screen, the data size of figures is included in the report setting capacity. For the report setting capacity, refer to the following.

2.6 Specifications of Available Functions Set with GT Designer3

\*3 Confirm the data capacity before writing the project to the GOT.

For drawing and setting of figures, refer to the following.

(Functions) 1. FIGURES, 4. GRAPHIC CHARACTERS



### GOT-compatible text

Texts that are displayed in the screen editor of GT Designer3 can be displayed on the GOT. The following texts are not displayed on the GOT.

- The texts that are not displayed in the screen editor after being input and defined
- The texts that are covered with specified color after being input and defined
- The texts of which text sizes are changed after being input and defined

## ■ BMP/JPEG/DXF/IGES file specifications handled with GT Designer3

### POINT

#### (1) How to use BMP/JPEG/DXF/IGES files

For how to read BMP/JPEG/DXF/IGES files to GT Designer3 and precautions for use, refer to the following.

 GT Designer3 Version1 Screen Design Manual (Functions)

#### (2) The image quality when using JPEG files

The image quality of JPEG files may be deteriorated than that of BMP files.

To avoid the image quality deterioration, use BMP files.

#### (3) Difference between data available for BMP/JPEG file parts and registered parts

The BMP/JPEG file (BMP/JPEG file part) specifications that can be stored in a memory card differ from the BMP/JPEG file that can be used in GT Designer3 (registered part).

The data used as a registered part in GT Designer3 may not be used as a BMP/JPEG file part.

For the BMP/JPEG file that can be used as BMP/JPEG file parts, refer to the following.

 4.14.1 Specifications for BMP/JPEG files that can be stored in a memory card and displayed as parts

#### (1) BMP file

The number of displayed colors is reduced to the colors supported by the used GOT.

Item	Description
BMP data	65536 colors *1, 256 colors, 16 colors or monochrome
Resolution *2	2000×1600 or more: Display the BMP data reduced to a resolution of 2000×1600 or less on GT Designer3. When the data is reduced, the resolution for vertical and horizontal is the same ratio. 2000×1600 or less: Display without changing the resolution.

\*1 For GOTs that have 65536-color display capacity, refer to the following.

 User's Manual for the GOT used

\*2 Errors may occur when a personal computer has insufficient memory for reading the BMP data. When errors occur, the BMP data is not displayed on a screen for GT Designer3.

#### (2) JPEG file

The number of displayed colors is reduced to the colors supported by the used GOT.

Not supported by the GT11 and GT10.

Item	Description
File format	JFIF, EXIF
Data format	Base line, progressive
Number of colors	Full-color, gray-scale
Resolution *1	2000×1600 or more: Display the BMP data reduced to a resolution of 2000×1600 or less on GT Designer3. When the data is reduced, the resolution for vertical and horizontal is the same ratio. 2000×1600 or less: Display without changing the resolution.

\*1 Errors may occur when a personal computer has insufficient memory for reading the JPEG files. When errors occur, the JPEG files are not displayed on a screen for GT Designer3.

#### (3) DXF file

Item	Description
DXF data	Release 12, Release 13, Release 14
Resolution	2048×1536 or less

#### (4) IGES file

Not supported by the GT10.

Item	Description
File format	IGS, IGE, and IGES data (wire frame format) created with Autodesk's Autodesk Inventor

## 2.5 Specifications of Applicable Characters

### ■ Font



























Some fonts cannot be used depending on the figure or object.  
Confirm the usable fonts by referring to each figure or object setting.

 GT Designer3 Version1 Screen Design Manual (Functions)

The text code to be used can be set for the ASCII display and the ASCII input.

When the Shift JIS code is used as the text code, only the JIS level-1 and level-2 characters can be displayed on the GOT.

The following shows the available fonts in GT Designer3.

Font specifications		Font image	Model
Classification	Type		
Standard font	6×8 dot(Gothic)		   
	12dot Standard(Gothic)*1		
	16dot Standar(Mincho)*2		
	16dot Standar(Gothic)*2		
HQ font	12dot HQ Mincho		
	12dot HQ Gothic		
	16dot HQ Mincho6		
	16dot HQ Gothic		
TrueType font	TrueType Mincho		
	TrueType Gothic		
	TrueType Numerical(Gothic)*3		
	TrueType Numerical(7-Segment)*3		
Stroke font	Stroke		   
Windows® font	TrueType font and OpenType font displayable on the personal computer (other than vertical font)		   

\*1 Not supported by the GT1020

\*2 Set the font type for 16 dot Standard (Mincho/Gothic) in project units.

 4.1 GOT Type Setting

\*3 Set the font type for TrueType Numerical (Gothic/7-Segment) in project units.

 4.1 GOT Type Setting

## ■ KANJI region

Some Chinese characters look different depending on the region where Chinese characters are used, for example, Japan, China (GB) or China (Big5).

The GOT displays the Chinese characters according to the selected region.

Selectable KANJI regions are shown below.

KANJI region	Font image	Model
Japan		
China (GB)		gr16 gr15 gr14 gr12 gr11 gr10 SoriGOT1000
China (Big5)		

## 2.5.1 Fonts

This section describes the specifications of fonts applicable to GOT and how to display them.

### ■ Font specifications

The specifications of fonts applicable to the GOT are provided below.

○ : Available - : Not available

Font type	Character size			Character pitch	Character color	Text style	Effects	Storage area <sup>*3</sup>	
	HS	FS	DS						
6×8 dot	○	-	-	Fixed	○	○	-	System area/ User area <sup>*3</sup>	
12dot Standard(Gothic)	○	○	○			○	-		
16dot Standar(Mincho/Gothic)	○	○	○			○	-		
12dot HQ Mincho	○	○	○			○	-	User area	
12dot HQ Gothic						○	-		
16dot HQ Mincho						○	-		
16dot HQ Gothic						○	-		
TrueType Mincho <sup>*1</sup>	○	○	○			Proportiona <sup>*2</sup>	○		-
TrueType Gothic <sup>*1</sup>							○		-
TrueType Numerical <sup>*1</sup>							-		-
Stroke <sup>*1</sup>	○	○	○	Fixed	○		-	User area	
Windows <sup>â</sup> font <sup>*1</sup>	○	○	○	Depend on the Windows <sup>â</sup> fonts selected	○	○			

\*1 Horizontal writing only.

\*2 Different depending on characters.

The number of the characters in a line varies according the arranged characters.

\*3 Standard fonts (Standard) are stored in the system area while standard fonts (Option) are stored in the user area.

(1) Standard font



### Font Selection

For font selection, refer to the following.

2.5.4 Font selection

## (1) Standard font

The standard font includes the following types.

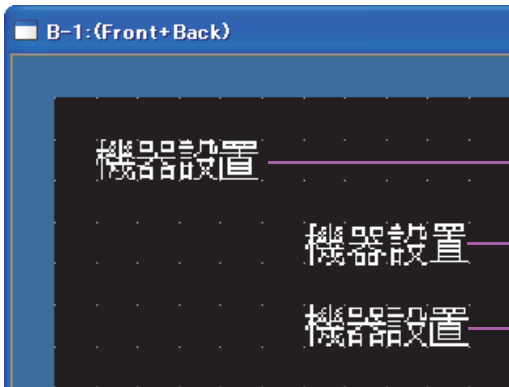

### Standard font (Standard)

The standard font (Standard) is the basic font for the entire project. When fonts can be set for objects and figures, the standard font (Standard) is displayed with specifying the standard font or HQ font.

- Required OS: Standard monitor OS (Standard font)
- Setting item: Standard font in the [GOT Type Setting] dialog box

### Standard font (Option)

Set the standard font (Option) for displaying Chinese characters other than the Chinese character specified for the standard font (Standard). With setting [Kanji Region] for objects and figures, Chinese characters other than the Chinese character set as the standard font (Standard) can be displayed.

- Required OS: Option OS (Standard font)
- Setting item: [Kanji Region]

The following describes details of the standard font.

### (a) Standard font (Standard)

Standard font (Standard) includes the following fonts.

Item	Description	Font image	Model
Japanese	Fonts of Unicode 2.1 European characters (Latin-1 Supplement, Latin Extended-A, Basic Greek and Cyrillic) <sup>*1</sup> are displayed in 2-byte characters. Japanese Kanji characters are displayed.		
Japanese (supporting Europe)	Fonts of Unicode 2.1 European characters (Latin-1 Supplement, Latin Extended-A, Basic Greek and Cyrillic) <sup>*1</sup> are displayed in 1-byte characters. Japanese Kanji characters are displayed.		
Chinese (Simplified)	Fonts of Unicode 2.1 European characters (Latin-1 Supplement, Latin Extended-A, Basic Greek and Cyrillic) <sup>*1</sup> are displayed in 2-byte characters. Simplified Chinese characters are displayed.		
Chinese (Simplified) (supporting Europe) <sup>*2</sup>	Fonts of Unicode 2.1 European characters (Latin-1 Supplement, Latin Extended-A, Basic Greek and Cyrillic) <sup>*1</sup> are displayed in 1-byte characters. Simplified Chinese characters are displayed.		
Chinese(Traditional) (supporting Europe)	Fonts of Unicode 2.1 European characters (Latin-1 Supplement, Latin Extended-A, Basic Greek and Cyrillic) <sup>*1</sup> are displayed in 1-byte characters. Traditional Chinese characters are displayed.		

\*1 In this manual, Latin-1 Supplement, Latin Extended-A, Basic Greek and Cyrillic are collectively expressed as European characters.

\*2 European characters are not included in the Chinese government approved fonts. To use the Chinese government approved fonts including European characters, use Chinese (Simplified).

- (b) Standard font (Option)  
Standard font (option) includes the following fonts.

Item*1	Description	Font image	Model
Chinese (Simplified)	Displays Chinese characters of Chinese (Simplified) region.		
Chinese (Traditional)	Displays Chinese characters of Chinese (Traditional) region.		gr16 gr15 gr14 gr12 gr11 gr10 SoftGoT1000
Japanese	Displays Chinese characters of Japanese region.		

\*1 Specification of multiple kinds is possible.



**(1) Usage of standard fonts**

For details, refer to the following.

■ Installing font data

**(2) Example of standard font display**

For details on how to display fonts, refer to the following.

2.5.4 Font selection

**(2) HQ font**

The HQ font is a standard font (12 dots or 16dots) with a HQ character (Mincho or Gothic).

Note that setting of HQ font is not allowed depending on objects.

For the fonts that can be set for the individual objects, check the setting item of each object.

The settings for displaying European characters and the kanji region are the same as those for the standard font.

**(3) TrueType font**

TrueType fonts can be set for the individual objects.

Note that setting of TrueType font is not allowed depending on objects.

For the fonts that can be set for the individual objects, check the setting item of each object.

#### (4) Stroke font

The stroke font includes the following types.

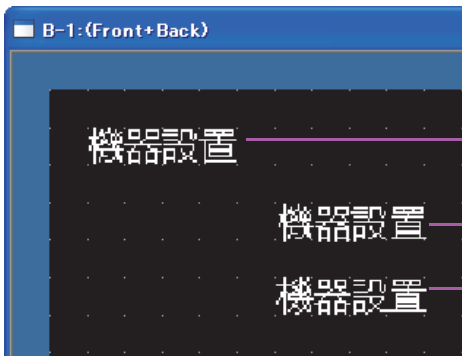

##### Stroke standard font (Extended)

The font can be set for each object.

- Required OS: Extended function OS (Stroke standard font)
- Setting item: [Font Setting](select [Stroke])

##### Stroke font (Option)

Set the stroke font (Option) for displaying Chinese characters other than the Chinese character specified for the stroke standard font (Extended). With setting [Kanji Region] for objects and figures, Chinese characters other than the Chinese character set as the stroke standard font (Extended) can be displayed.

- Required OS: Option OS (Stroke font)
- Setting item: [Font Setting] (select [Stroke]), [Kanji Region]

The following describes details of the stroke font.

##### (a) Stroke standard font (Extended)

Depending on the object to be used, the stroke font cannot be selected.

For the stroke font applicable to each object, refer to the setting items for each object.

The stroke standard font (Extended) includes the following types.

Item <sup>*1</sup>	Description	Model
Stroke Font Support Data	When the stroke standard font is installed, the item is installed with the font.	
Stroke Standard Font(JPN)	Unicode 2.1 font Only the following fonts can be used on the GOT. • Basic Latin • Latin-1 Supplement • Thai <sup>*1</sup> • Basic Greek • Hiragana <sup>*2</sup> • Katakana <sup>*2</sup> • Unified CJK Ideographs Hangul characters cannot be displayed. Japanese Kanji characters are displayed.	
Stroke Standard Font(JPN)(supporting Hangul)	Unicode 2.1 font Only the following fonts can be used on the GOT. • Basic Latin • Latin-1 Supplement • Thai <sup>*1</sup> • Basic Greek • Hiragana <sup>*2</sup> • Katakana <sup>*2</sup> • Unified CJK Ideographs Hangul characters cannot be displayed. Japanese Kanji characters are displayed.	GT16 GT15 GT14 GT12 GT11 GT10 SoftGOT1000
Stroke Standard Font(China GB)	Unicode 2.1 font Only the following fonts can be used on the GOT. • Basic Latin • Latin-1 Supplement • Thai <sup>*1</sup> • Basic Greek • Hiragana <sup>*2</sup> • Katakana <sup>*2</sup> • Unified CJK Ideographs Hangul characters cannot be displayed. Simplified Chinese characters are displayed.	
Stroke Standard Font(China GB)(supporting Hangul)	Unicode 2.1 font Only the following fonts can be used on the GOT. • Basic Latin • Latin-1 Supplement • Thai <sup>*1</sup> • Basic Greek • Hiragana <sup>*2</sup> • Katakana <sup>*2</sup> • Unified CJK Ideographs Hangul characters are displayed. Simplified Chinese characters are displayed.	

\*1 Thai characters are complicated. If the character size is small, the characters can be hard to read.

For Thai, it is recommended that the character size is set to 20 dots or more.



\*2 Some characters of hiragana and katakana cannot be used.

Confirm the applicable characters in GT Designer3.

(Characters correctly displayed in GT Designer3 are also displayed on the GOT.)

(b) Stroke font (Option)

The stroke font (Option) includes the following types.

Item <sup>*1</sup>	Description	Font image	Model
Chinese (Simplified)	Displays Chinese characters of Chinese (Simplified) region.		
Chinese (Traditional)	Displays Chinese characters of Chinese (Traditional) region.		gr16 gr15 gr14 gr12 gr11 gr10 SoftGoT1000
Japanese	Displays Chinese characters of Japanese region.		

\*1 Multiple items can be specified.

(5) Windows<sup>®</sup> font

For Windows<sup>®</sup> fonts, TrueType font or OpenType fonts installed on the personal computer is displayed (other than vertical fonts).

Note that setting of Windows<sup>®</sup> font is not allowed depending on objects.

For the fonts that can be set for the individual objects, check the setting item of each object.

**POINT**

(1) When opening a project which uses Windows<sup>®</sup> fonts on other personal computer

The Windows<sup>®</sup> fonts used in the project have to be installed in the personal computer.

If operations other than character shifting and character color change are performed when Windows<sup>®</sup> fonts are not installed, fonts will be changed to the ones installed in the personal computer.

(2) When Windows<sup>®</sup> fonts were installed during GT Designer3 activation

Restart GT Designer3 to use Windows<sup>®</sup> fonts installed during GT Designer3 activation.



## ■ Relationship between the message displaying language selectable by the utility and the standard font

The language to be selected by the utility, used for displaying a message, varies depending on the standard font installed to the GOT.

Message displaying language selectable by utility	Required standard font		
	GT16, GT15, GT14	GT12, GT11	GT10
Japanese	Install one of the following fonts. Standard font (Standard): Japanese font, Japanese (supporting Europe) font Standard font (Option): Japanese font	Install one of the following fonts. Standard font (Standard): Japanese font, Japanese (supporting Europe) font	Install one of the following fonts. Standard font (Standard) Japanese font, Japanese (supporting Europe) font
English	Selectable independently of the installed standard font.		
Chinese (Simplified)	Install one of the following fonts. Standard font (Standard) Chinese (Simplified) font, Chinese (Simplified) (supporting Europe) font Standard font (Option) Chinese (Simplified) font	Install one of the following fonts. Standard font (Standard) Chinese (Simplified) font, Chinese (Simplified) (supporting Europe) font	Install one of the following fonts. Standard font (Standard) Chinese (Simplified) font, Chinese (Simplified) (supporting Europe) font
Chinese (Traditional)	Install one of the following fonts. Standard font (Standard) Chinese (Simplified) font, Chinese (Simplified) (supporting Europe) font Standard font (Option) Chinese (Simplified) font	Install the following font. Standard font (Standard) Chinese (Simplified) (supporting Europe) font	Not selectable
Korean	Selectable independently of the installed standard font.	Selectable independently of the installed standard font.	Not selectable
German	Install one of the following fonts. Standard font (Standard) Japanese (supporting Europe) font Chinese (Simplified) font Chinese (Simplified) (supporting Europe) font		Not selectable

## ■ Font magnification and character size

The applicable magnification varies depending on the fonts used.

The following table shows font magnification and size.

### (1) Standard font, HQ font

Set character sizes by setting the ratio of horizontal size and vertical size.

Font	Character size magnification	
	Width magnification (times) <sup>*1</sup>	Height magnification (times) <sup>*1</sup>
6×8 dot	1	0.5
12dot Standard(Gothic)	1 to 8	1 to 8
16dot Standar(Mincho/Gothic)	0.5, 1 to 8	0.5, 1 to 8
12dot HQ Mincho	2, 4, 6, 8	2, 4, 6, 8
12dot HQ Gothic		
16dot HQ Mincho		
16dot HQ Gothic		

\*1 Horizontal size and vertical size can be set by selecting [Other] for size.

**(2) TrueType font, Stroke font, Windows® font**  
Set character sizes by setting font sizes (dot).

Font	Size (dot)
TrueType Mincho* <sup>1</sup>	8 to 128, in 1-dots unit.
TrueType Gothic* <sup>1</sup>	
TrueType Numerical* <sup>1</sup>	16 to 128, in 4-dots unit.
Stroke* <sup>1</sup>	8 to 128, in 1-dots unit.
Windows® font* <sup>1</sup>	

Example) Displaying five double-size characters in the 16-dot Standard (Gothic) font.

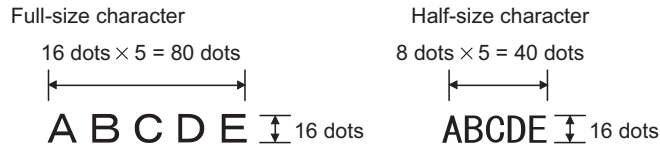

**When fonts were changed**

When the set fonts are changed, the display size of characters may be changed.

**Text color**

Only one can be specified from maximum of 256 colors. (The GOT will select the nearest color match when an incompatible color is specified.)

**Text style**

The following text styles are available.

Regular	Bold	Solid	Raised	Rotate	Raised/Rotate
A	A	A	A	A	A

**Effects**

The following character effects can be set.

Regular	Italic	Underline	Both
A	A	A	A

## ■ To display the font on GOT

The following explain how to use each font.

For how to communicate with the GOT, refer to the following.

 8. COMMUNICATION WITH GOT



### Font data size

Font data are stored in the system area or user area within the built-in memory.(Data size varies depending on the font.)

It is recommended to confirm the capacity (data size) required for installation by referring to the [Communicate with GOT] dialog box in advance.

For how to display the [Communicate with GOT] dialog box, refer to the following.

 8. COMMUNICATION WITH GOT

## (1) Standard font

### (a) Standard font (Standard)

1. Select the used standard font in [Standard Font] of the [GOT Type Setting] dialog box.

 4.1 GOT Type Setting

2. Install the same font data as the set standard font to the GOT using the [Communicate with GOT] dialog box.

 8. COMMUNICATION WITH GOT

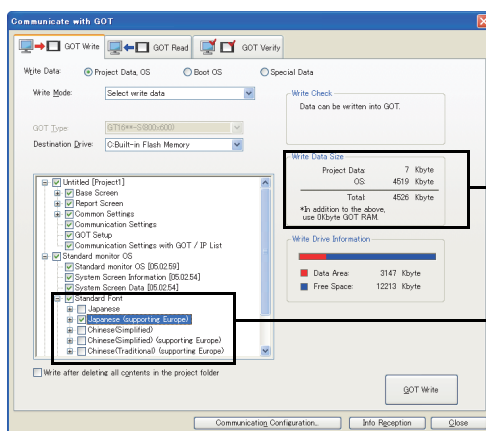

Confirm [Write Data Size].

Select [Standard monitor OS], and then select one standard font. When using the 16dot standard font and selecting [Japanese] or [Japanese(Supporting Europe)], select the same font as set for [12dot Standard] in the [GOT Type Setting] dialog box.

(b) Standard font (Option)

Install the font data to the GOT using the [Communicate with GOT] dialog box.

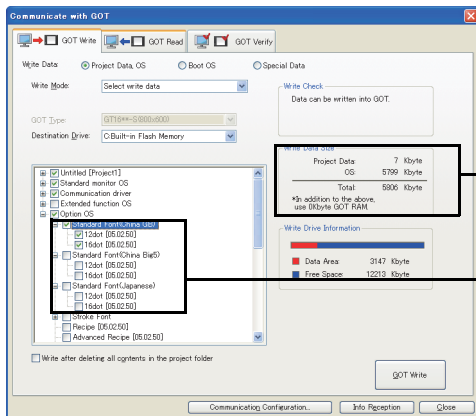

Confirm [Write Data Size].

Select [Option OS], and then select the standard font. Multiple fonts can be selected.

(2) HQ font

Install the font data to the GOT using the [Communicate with GOT] dialog box.

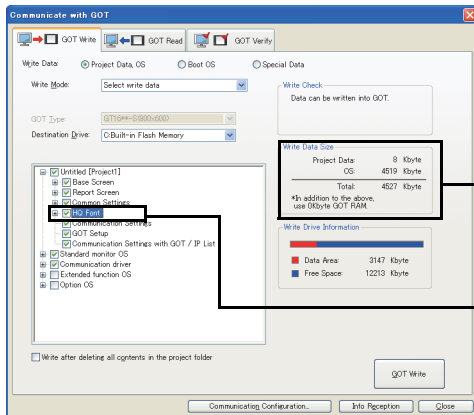

Confirm [Write Data Size].

Select [HQ Font].  
(Checking one will automatically select all the fonts. These fonts are displayed only when the project data includes them.)

(3) TrueType font

(a) TrueType Mincho, TrueType Gothic

Install the font data to the GOT using the [Communicate with GOT] dialog box.  
(The font data are included in the screen data.)

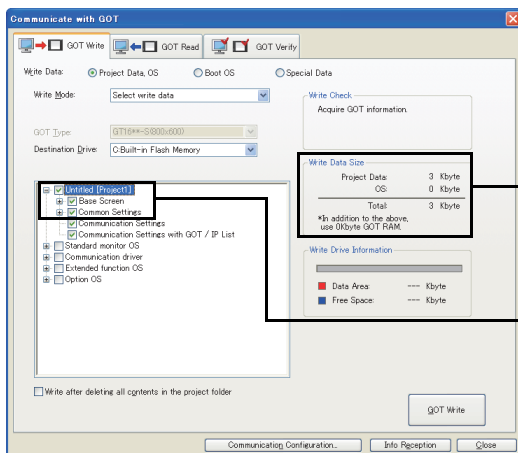

Confirm [Write Data Size].

Select the screen to be written to the GOT.

(b) TrueType Numerical

1. Select the used TrueType numerical font in [TrueType Numerical Font] of the [GOT Type Setting] dialog box.  
☞ 4.1 GOT Type Setting
2. Install the same font data as the set TrueType numerical font to the GOT using the [Communicate with GOT] dialog box.

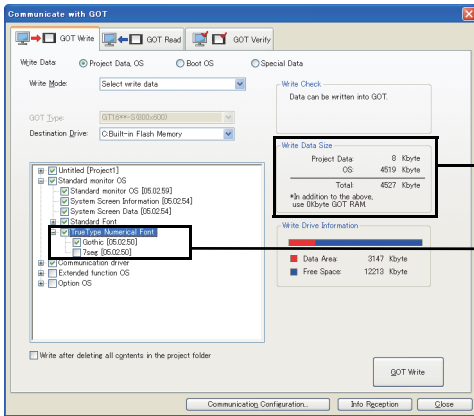

Confirm [Write Data Size].

Select [Standard monitor OS], and then select one TrueType numerical font.  
Select the same font as set for [TrueType Numerical Font] in the [GOT Type Setting] dialog box.

(4) Windows® font

Install the font data to the GOT using the [Communicate with GOT] dialog box.  
(The font data are included in the screen data.)

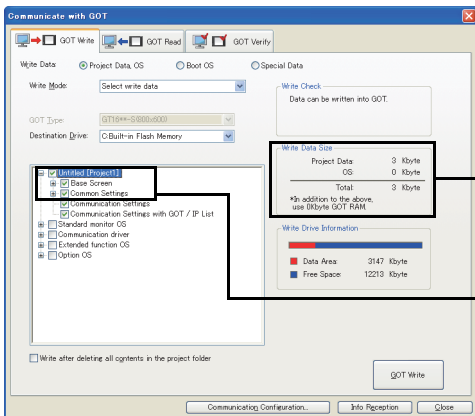

Confirm [Write Data Size].

Select the screen to be written to the GOT.

**(5) Stroke font**

**(a) Stroke standard font (Extended)**

Install the extended function OS (Stroke Standard Font) to the GOT using the [Communicate with GOT] dialog box.

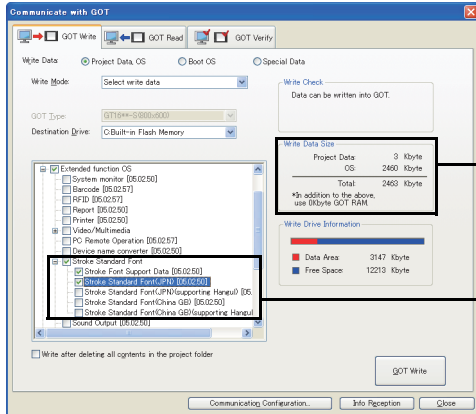

Confirm [Write Data Size].

Select [Extended function OS], and then select [Stroke Standard Font].

[Stroke Font Support Data] is automatically selected.

**(b) Stroke font(Optional)**

Install the option function OS (Stroke Font) to the GOT using the [Communicate with GOT] dialog box.

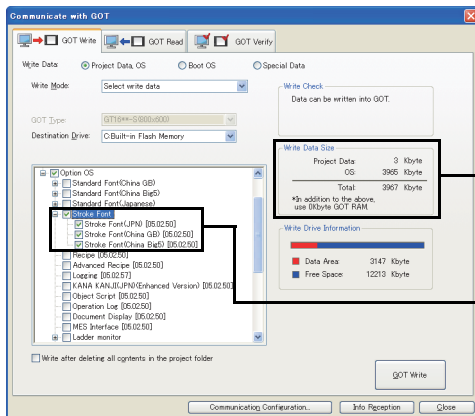

Confirm [Write Data Size].

Select [Option OS], select [Stroke Font].  
Multiple fonts can be selected.

## 2.5.2 KANJI regions

Set the kanji region for displaying the Chinese characters other than the Chinese characters set for the standard font (Standard) and the stroke standard font (Extended).



### Displaying Kanji in Windows® fonts

On the object which Windows® fonts can be specified, characters in the region corresponds to the selected Windows® fonts can be displayed.

2.5.1 ■Font specifications

### ■ Installing font data

For using the Chinese character specified for [Kanji Region], install the standard font data (Option) and the stroke font data (Option) to the GOT when the OS is installed.

### ■ Character strings that can be displayed

#### (1) Japanese characters

Chinese characters of the Shift JIS coding system are displayed.

Those other than the Shift JIS coding system are displayed in the manner shown below.

Item	Description
Kanji characters mapped in Unicode2.1	Kanji characters mapped in Unicode 2.1 are displayed. (For Kanji characters for which the same codes are used by Japanese Kanji characters, Japanese Kanji characters are displayed.)
Kanji characters not mapped in Unicode 2.1	Not displayed.

#### (2) China (GB) characters

Chinese characters of GB2312 code are displayed.

Kanji characters, other than GB2312 code, are displayed as shown below.

Item	Description
Kanji characters mapped in Unicode2.1	Kanji characters mapped in Unicode 2.1 are displayed. (For Kanji characters for which the same codes are used by Japanese Kanji characters, Japanese Kanji characters are displayed.)
Kanji characters not mapped in Unicode 2.1	Not displayed.

Characters shown below, which are not mapped in Unicode 2.1, are not displayed.

	0	1	2	3	4	5	6	7	8	9	10	11	12	13	14	15	16	17	18	19
082								α	μ	ν	ξ	η	ζ							
100		!	"	#	¥	%	&	'	(	)	*	+	,	-	.	/	0	1	2	3
102	4	5	6	7	8	9	:	;	<	=	>	?	@	A	B	C	D	E	F	G
104	H	I	J	K	L	M	N	O	P	Q	R	S	T	U	V	W	X	Y	Z	[
106	\	]	^	_	`	a	b	c	d	e	f	g	h	i	j	k	l	m	n	o
108	p	q	r	s	t	u	v	w	x	y	z	{		}						
110		ā	á	ă	à	ē	é	ě	è	ī	í	ĭ	ì	ō	ó	ö	ò	ū	ú	ŭ
112	ù	ū	ú	ŭ	ù	ü	ê	α	μ	ν	ξ	η	ζ	█	█	█	█	█	█	█

The fonts of various countries are mixed depending on the character string.

As the font of China(GB) is Mincho, characters are displayed in Mincho even if Gothic has been selected for the font.

**(3) China (Big5) characters**

Chinese characters of Big5 code are displayed.

Kanji characters other than Big5 code, are displayed as shown below.

Item	Description
Kanji characters mapped in Unicode2.1	Kanji characters mapped in Unicode 2.1 are displayed. (For Kanji characters for which the same codes are used by Japanese Kanji characters, Japanese Kanji characters are displayed.)
Kanji characters not mapped in Unicode 2.1	Not displayed.

Characters shown below, which are not mapped in Unicode 2.1, are not displayed.

	+0	+1	+2	+3	+4	+5	+6	+7	+8	+9	+A	+B	+C	+D	+E	+F
A150											—					
A1C0				-		—										
A1F0																
A240	\															
A2C0													十		卅	
F9D0							碁	鏽	裏	墻	恒	粧	嫻	𠄎	𠄏	𠄐
F9E0	𠄑	𠄒	𠄓	𠄔	𠄕	𠄖	𠄗	𠄘	𠄙	𠄚	𠄛	𠄜	𠄝	𠄞	𠄟	𠄠
F9F0	𠄡	𠄢	𠄣	𠄤	𠄥	𠄦	𠄧	𠄨	𠄩	𠄪	𠄫	𠄬	𠄭	𠄮	■	

The fonts of various countries may be mixed depending on character string.

As the font of China (Big5) is Gothic, characters are displayed in Gothic even if Mincho has been selected for the font.

■ **TrueType font**

The kanji region settings are inapplicable.

To specify a kanji region item, use a font other than TrueType.

■ **Stroke fonts**

The kanji region can be set.

For specifying the kanji region, install the option OS (Stroke font).

■ **Windows® fonts**

The kanji region settings are inapplicable. (setting is not necessary)

When specifying Windows® fonts item, characters in the region corresponding to the selected fonts can be displayed.



## 2.5.3 Application example

### ■ To display Japanese (supporting Europe) in the entire project while displaying Chinese (Simplified) characters for specific objects

1. Select [Japanese (supporting Europe)] for [Font] in the [GOT Type Setting] dialog box.  
 ➔ 4.1 GOT Type Setting

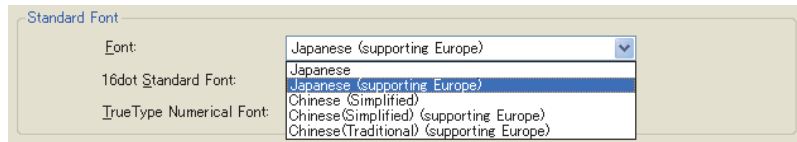

2. Create a screen.  
 For objects on which Chinese(Simplified) is displayed, set [Chinese(Simplified)] for [Kanji Region].  
 Setting of [Kanji Region] is required for each object.

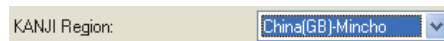

3. Install the font data to the GOT.  
 ➔ 2.5.1 ■To display the font on GOT  
 For Standard Font(Standard), select [Japanese (supporting Europe)].  
 For Standard Font(Optional), select [China GB].

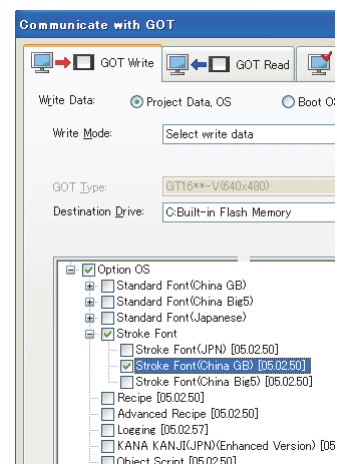
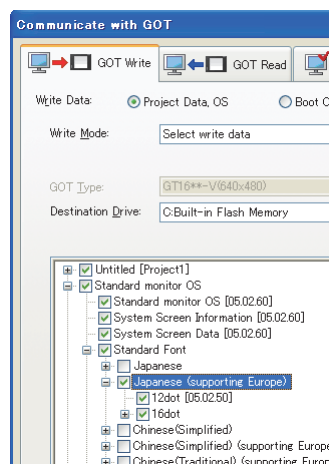

## ■ To display HQ fonts (1-byte European characters)

1. Select either of the following for [Font] in the [GOT Type Setting] dialog box.
  - [Japanese(supporting Europe)]
  - [Chinese(Simplified)(supporting Europe)]
  - [Chinese(Traditional)(supporting Europe)]

☞ 4.1 GOT Type Setting

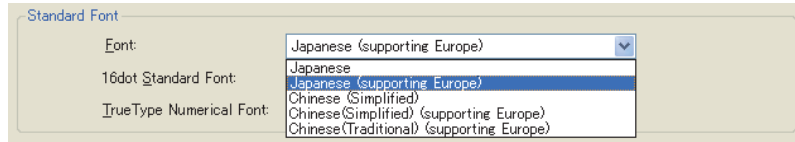

2. Create a screen data.  
For objects on which HQ font should be displayed, select the HQ font for [Font].



3. Install the font data to the GOT.

☞ 2.5.1 ■To display the font on GOT

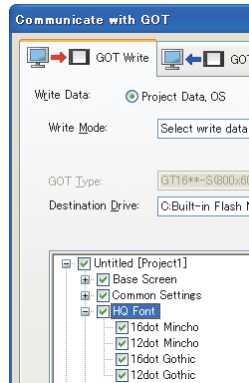

### Displaying HQ font European characters in 2-byte characters

To display European characters in 2-byte characters, select [Japanese] or [Chinese(Simplified)] for [Font] in the [GOT Type Setting] dialog box.

☞ 4.1 GOT Type Setting

## 2.5.4 Font selection

Fonts applicable to the GOT varies depending on purposes.  
 Select the suitable font corresponding to the change method for font type.  
 The font selection guide is shown below.

Application	Font	
	Changing text size by 1-dot units	Changing text size by integral multiple rate
Non-switching the displayed text Example) Display texts with graphic characters	<ul style="list-style-type: none"> <li>• TrueType Mincho</li> <li>• TrueType Gothic</li> <li>• Stroke</li> <li>• Windows<sup>®</sup> font</li> </ul>	<ul style="list-style-type: none"> <li>• 6×8 dot</li> <li>• 12dot Standard(Gothic)</li> <li>• 16dot Standard(Mincho/Gothic)</li> <li>• 12dot HQ Mincho</li> <li>• 12dot HQ Gothic</li> <li>• 16dot HQ Mincho</li> <li>• 16dot HQ Gothic</li> </ul>
Switching and displaying the text with comments Example) Display comments that is switched by the comment display	<ul style="list-style-type: none"> <li>• Stroke</li> </ul>	<ul style="list-style-type: none"> <li>• 12dot Standard(Gothic)</li> <li>• 16dot Standard(Mincho/Gothic)</li> <li>• 12 dot HQ Mincho</li> <li>• 12 dot HQ Gothic</li> <li>• 16 dot HQ Mincho</li> <li>• 16 dot HQ Gothic</li> </ul>
Display the text with the numeric display, numeric input, date display, or time display.	<ul style="list-style-type: none"> <li>• TrueType Gothic</li> <li>• TrueType Numerical(Gothic/7-Segment)</li> <li>• Stroke</li> </ul>	<ul style="list-style-type: none"> <li>• 6×8 dot</li> <li>• 12dot Standard(Gothic)</li> <li>• 16dot Standard(Mincho/Gothic)</li> <li>• 12dot HQ Mincho</li> <li>• 12dot HQ Gothic</li> <li>• 16dot HQ Mincho</li> <li>• 16dot HQ Gothic</li> </ul>
Display the text with the ASCII display or ASCII input.	<ul style="list-style-type: none"> <li>• Stroke</li> </ul>	<ul style="list-style-type: none"> <li>• 6×8 dot</li> <li>• 12dot Standard(Gothic)</li> <li>• 16dot Standard(Mincho/Gothic)</li> </ul>

### POINT

#### Precautions for using stroke font

Compared with other fonts, the stroke font requires extra time to display on the screen.

Note that switching the display with frequency or displaying many texts may cause the delay of screen-displayed.

## 2.5.5 Precautions

### ■ Precautions on drawing

**(1) When the setting for the [GOT Type Setting] dialog box and the installed font data to the GOT are different**

Characters are displayed in Standard Font (Standard) installed to the GOT.

**(2) When using Chinese (Simplified) (supporting Europe) for the standard font (Standard)**

European characters are not included in the Chinese government approved fonts.

To use the Chinese government approved fonts including European characters, select Chinese (Simplified) for the standard font (Standard).

**(3) When using Japanese or Chinese (Simplified) for the standard font (Standard)**

It is not possible to select German for the system language that displays the utility.

To select German, set any of the following for the standard font (Standard).

- Japanese (supporting Europe)
- Chinese (Simplified) (supporting Europe)
- Chinese (Traditional) (supporting Europe)

**(4) Displaying objects on which KANJI region is set without installing option function board (GT15 only)**

The Chinese characters selected for the standard font (Standard) are displayed.

**(5) When both of 2-byte and 1-byte characters exist in European characters of standard font and HQ font**

Install Standard Font (Standard), which has been set in the [GOT Type Setting] dialog box of GT Designer3, to the GOT.

If the Standard Font (Standard) installed to the GOT and the Standard Font (Standard) set in the [GOT Type Setting] dialog box of GT Designer3 are different, 2-byte and 1-byte characters may exist in the European characters of standard font and HQ font.

**(6) Displaying symbols**

Symbols are included in the standard font (Standard).

The standard font (Option) includes only Chinese characters.

To display region dependent symbols correctly, select the font of the corresponding regions in the standard font (Standard).

**(7) Character form difference when using Chinese (Simplified or Traditional)**

Some character forms may differ whether the stroke font is used or the other font is used.



**(8) When using TrueType Numerical (Gothic or 7-Segment)**

When a 16-dot or 20-dot TrueType numerical font is set, the forms of displayed characters differ between GT Designer3 and the GOT.

When the TrueType numerical font is used, check the displayed characters.

### ■ Precautions on hardware

To use the KANJI region with the GT15, mount an option function board to the GOT.

No option function board is required for the GT16 and the GT14.

For GOTs with built-in option function boards, refer to the following.

 Appendix10 Precautions for Option Function Board

### ■ Precautions for use

When a text code used for the ASCII display or ASCII input is changed by the text code format control (GS456), the KANJI region setting of displayed Chinese characters is changed.

For details of the text code format control (GS456), refer to the following.

 Appendix.2.3 GOT special register (GS)

## 2.6 Specifications of Available Functions Set with GT Designer3

### 2.6.1 Specifications

#### POINT

**(1) Difference of specifications depending on GOT type**

The specifications and precautions for each function may differ depending on the used GOT type.

**(2) Maximum number of objects that can be set**

Up to 1024 objects can be set on a base screen, and up to 512 objects can be set on a window screen. The objects outside the range are invalid. (The objects are not displayed.)  
Though a base screen displays up to 1024 input objects, the 1001st and subsequent objects cannot be touched.

To set many objects on one screen, note the maximum number of objects as shown above.

**(3) Maximum number of objects in which trigger has been set to sampling**

Up to 100 objects can be set in one screen.  
101st object or later is invalid. (The object will not operate.)

#### HINT



**Data capacity for each function**

For the data capacity when setting each function on GT Designer3, refer to the following.

 Appendix1 DATA CAPACITY LIST

#### Touch Switches

 (Functions) 2. TOUCH SWITCH

Function	Max. No. of setting objects in one screen	Model
Switch	<ul style="list-style-type: none"> <li>• GT16, GT15, GT14, GT12, GT11, GT SoftGOT1000</li> <li>Base screen: 1000 objects</li> <li>Window screen: 512 objects</li> <li>• GT10: 50 objects</li> <li>(For objects in which maximum number of actions has been set: up to 10, for objects in which on delay and off delay has been set: up to 100)</li> </ul>	
Switch(Bit Switch)		
Switch(Word Switch)		
Switch(Go To Screen Switch)		
Switch(Change Station No. Switch)		
Switch(Special Function Switch)		
Switch(Key Window Display Switch)		
Switch(Key Code Switch)		

#### Lamps

 (Functions) 3. LAMP

Function	Max. No. of setting objects in one screen	Model
Lamp(Bit Lamp)	<ul style="list-style-type: none"> <li>• Base screen: 1000 objects</li> <li>• Window screen: 512 objects</li> </ul>	
Lamp(Word Lamp)		
Lamp(Lamp Area)		

## ■ Numeric value, character

☞ (Functions) 5. to 10.

Function	Max. No. of setting objects in one screen	Model
Numerical Display	<ul style="list-style-type: none"> <li>• Base screen: 1000 objects</li> <li>• Window screen: 512 objects</li> </ul>	
Numerical Input	<ul style="list-style-type: none"> <li>• GT16, GT15, GT14, GT12, GT11, GT SoftGOT1000</li> <li>Base screen: 1000 objects</li> <li>Window screen: 512 objects</li> <li>• GT10 :50 objects (Total number of the numerical inputs and ASCII inputs)</li> </ul>	gr16 gr15 gr14 gr12 gr11 gr10 SoftGOT1000
ASCII Display	<ul style="list-style-type: none"> <li>• Base screen: 1000 objects</li> <li>• Window screen: 512 objects</li> </ul>	
ASCII Input	<ul style="list-style-type: none"> <li>• GT16, GT15, GT14, GT12, GT11, GT SoftGOT1000</li> <li>Base screen: 1000 objects</li> <li>Window screen: 512 objects</li> <li>• GT10 :50 objects (Total number of the numerical inputs and ASCII inputs)</li> </ul>	
Data List Display	1 object	gr16 gr15 gr14 gr12 gr11 gr10 SoftGOT1000
Historical Data List Display	GT16, GT15, GT14, GT SoftGOT1000: 8 objects GT12: 1 object	gr16 gr15 gr14 gr12 gr11 gr10 SoftGOT1000
Data Display	2 objects	
Time Display	2 objects	
Comment Display(Bit Comment)	<ul style="list-style-type: none"> <li>• Base screen: 1000 objects</li> <li>• Window screen: 512 objects</li> </ul>	
Comment Display(Word Comment)	<ul style="list-style-type: none"> <li>• Base screen: 1000 objects</li> <li>• Window screen: 512 objects</li> </ul>	gr16 gr15 gr14 gr12 gr11 gr10 SoftGOT1000
Comment Display(Simple Comment)	<ul style="list-style-type: none"> <li>• Base screen: 1000 objects</li> <li>• Window screen: 512 objects</li> </ul>	
Basic comment	32767 comments (for each project)	
Comment group	32767 comments (for each comment group)	



## ■ Alarms

☞ (Functions) 11. ALARM

Function	Max. No. of setting objects in one screen	Model
Advanced User Alarm Display	8 objects	gr16 gr15 gr14 gr12 gr11 gr10 SoftGOT1000
Advanced System Alarm Display	8 objects	
Alarm History Display	1 object	
User Alarm Display	<ul style="list-style-type: none"> <li>• GT16, GT15, GT14, GT12, GT11, GT SoftGOT1000: 24 objects (For objects with the memory storage setting: Up to 16 objects for each project)</li> <li>• GT10: 1 object (For an object with the memory storage setting: 1 object for each project (For the GT1020, only the user alarm with 64 or less alarms can be set.))</li> </ul>	gr16 gr15 gr14 gr12 gr11 gr10 SoftGOT1000
System Alarm Display	1 object	gr16 gr15 gr14 gr12 gr11 gr10 SoftGOT1000
Advanced Alarm Popup Display	1 setting (For each project)	gr16 gr15 gr14 gr12 gr11 gr10 SoftGOT1000
Alarm Flow	1 setting (For each project)	gr16 gr15 gr14 gr12 gr11 gr10 SoftGOT1000



## ■ Graphs, meters

 (Functions) 12. to 20.

Function	Max. No. of setting objects in one screen	Model
Level	<ul style="list-style-type: none"> <li>• Base screen: 1000 objects</li> <li>• Window screen: 512 objects</li> </ul>	
Panelmeter	<ul style="list-style-type: none"> <li>• Base screen: 1000 objects</li> <li>• Window screen: 512 objects</li> </ul>	
Line Graph	<ul style="list-style-type: none"> <li>• GT16, GT15, GT14, GT12, GT11, GT SoftGOT1000: 32 (For objects with the locus mode settings: 1 for each project.)</li> <li>• GT10: 1 object</li> </ul>	
Trend Graph	<ul style="list-style-type: none"> <li>• GT16, GT15, GT14, GT12, GT11, GT SoftGOT1000: 24 objects (For objects with the memory storage setting: Up to 16 objects for each project)</li> <li>• GT10: 1 object (For an object with the memory storage setting: 1 object for each project)</li> </ul>	
Bar Graph	<ul style="list-style-type: none"> <li>• Base screen: 1000 objects</li> <li>• Window screen: 512 objects</li> </ul>	
Statistics Bar Graph	32 objects	
Statistics Pie Graph	32 objects	
Scatter Graph	24 objects (For objects with the memory storage setting: up to 16)	
Historical Trend Graph	GT16, GT15, GT14, GT SoftGOT1000: 8 objects GT12: 1 object	



## ■ Parts

 (Functions) 21. to 22.

Function	Max. No. of setting objects in one screen	Model
Parts Display(Bit Parts)	<ul style="list-style-type: none"> <li>• Base screen: 1000 objects</li> <li>• Window screen: 512 objects</li> </ul>	
Parts Display(Word Parts)	<ul style="list-style-type: none"> <li>• Base screen: 1000 objects</li> <li>• Window screen: 512 objects</li> </ul>	
Parts Display(Fixed Parts)	<ul style="list-style-type: none"> <li>• Base screen: 1000 objects</li> <li>• Window screen: 512 objects</li> </ul>	
Parts Movement(Bit Parts)	<ul style="list-style-type: none"> <li>• Base screen: 1000 objects</li> <li>• Window screen: 512 objects</li> </ul>	
Parts Movement(Word Parts)	<ul style="list-style-type: none"> <li>• Base screen: 1000 objects</li> <li>• Window screen: 512 objects</li> </ul>	
Parts Movement(Fixed Parts)	<ul style="list-style-type: none"> <li>• Base screen: 1000 objects</li> <li>• Window screen: 512 objects</li> </ul>	

## ■ Data collection

 (Functions) 23. to 24.

Function	Max. No. of setting objects in one screen	Model
Operaton Log	1 setting (For each project)	
Logging	GT16, GT15, GT SoftGOT1000: 32 settings (For each project) GT14: 8 settings (For each project) GT12: 4 settings (For each project)	

## Recipe

 (Functions) 25. RECIPE

Function	Max. No. of setting objects in one screen	Model
Recipe	256 settings (For each project)	Gr16 Gr15 Gr14 Gr12 Gr11 Gr10 SoftGot1000
Advanced Recipe	2048 settings (For each project)	Gr16 Gr15 Gr14 Gr12 Gr11 Gr10 SoftGot1000

## Trigger actions

 (Functions) 26. to 29.

Function	Max. No. of setting objects in one screen	Model
Device Data Transfer	255 settings (For each project)	Gr16 Gr15 Gr14 Gr12 Gr11 Gr10 SoftGot1000
Status Observation	512 settings (For each project)	
Trigger Action	50 settings (For each project)	Gr16 Gr15 Gr14 Gr12 Gr11 Gr10 SoftGot1000
Time Action	32 settings (For each project)	SoftGot1000

## Scripts

 (Functions) 30. SCRIPT FUNCTION

Function	Max. No. of setting objects in one screen	Model
Script	256 settings (For each project)	Gr16 Gr15 Gr14 Gr12 Gr11 Gr10 SoftGot1000
Object Script Symbol		
Object script function	-	Gr16 Gr15 Gr14 Gr12 Gr11 Gr10 SoftGot1000

## Peripherals

 (Functions) 31. to 40.

Function	Max. No. of setting objects in one screen	Model
Bar Code	1 setting (For each project)	Gr16 Gr15 Gr14 Gr12 Gr11 Gr10 SoftGot1000
RFID	1 setting (For each project)	Gr16 Gr15 Gr14 Gr12 Gr11 Gr10 SoftGot1000
Remote personal computer operation (Serial)	1 setting (For each project)	Gr16 Gr15 Gr14 Gr12 Gr11 Gr10 SoftGot1000
Remote personal computer operation (Ethernet)	1 setting (For each project)	Gr16 Gr15 Gr14 Gr12 Gr11 Gr10 SoftGot1000
VNC® server function	1 setting (For each project)	
Video/RGB Input	1 setting (For each project)	Gr16 Gr15 Gr14 Gr12 Gr11 Gr10 SoftGot1000

(Continued to next page)



Function	Max. No. of setting objects in one screen	Model
Multimedia	1 setting (For each project)	GT16 GT15 GT14 GT12 GT11 GT10 SoftGOT1000
Operation Panel/External I/O	1 setting (For each project)	GT16 GT15 GT14 GT12 GT11 GT10 SoftGOT1000
RGB output	1 setting (For each project)	GT16 GT15 GT14 GT12 GT11 GT10 SoftGOT1000
Report	8 screens (For each project)	GT16 GT15 GT14 GT12 GT11 GT10 SoftGOT1000
Hard Copy	1 setting (For each project)	GT16 GT15 GT14 GT12 GT11 GT10 SoftGOT1000
Sound Output	100 settings (For each project)	GT16 GT15 GT14 GT12 GT11 GT10 SoftGOT1000

## Useful functions

### 10. USEFUL FUNCTIONS FOR USING GOT

Function	Max. No. of setting objects in one screen	Model
Document Display	1 object	GT16 GT15 GT14 GT12 GT11 GT10 SoftGOT1000
Set overlay screen	GT16, GT15, GT14, GT12, GT11, GT SoftGOT1000: 2047 objects GT10: 5 objects	GT16 GT15 GT14 GT12 GT11 GT10 SoftGOT1000

## Other functions

- GOT1000 Series Gateway Functions Manual for GT Works3
- GOT1000 Series MES Interface Function Manual for GT Works3

Function	Max. No. of setting objects in one screen	Model
Gateway	Server, client function: 1 setting (For each project)	GT16 GT15 GT14 GT12 GT11 GT10 SoftGOT1000
	Mail send function: 1 setting (For each project)	GT16 GT15 GT14 GT12 GT11 GT10 SoftGOT1000
	FTP server function: 1 setting (For each project)	GT16 GT15 GT14 GT12 GT11 GT10 SoftGOT1000
	File transfer function (FTP client): 1 setting (For each project)	GT16 GT15 GT14 GT12 GT11 GT10 SoftGOT1000
MES Interface	1 setting (For each project)	GT16 GT15 GT14 GT12 GT11 GT10 SoftGOT1000

## 2.7 Clock Function Specifications

---

GOT	Description
GT16, GT15, GT14, GT12, GT11, GT105□, GT104□, GT1030	The clock data of the GOT or controller is used.
GT1020	The clock data of the controller is used.
GT SoftGOT1000	The clock data of the personal computer is used.

For setting the clock data control of the GOT, refer to the following.

 4.9 GOT Display and Operation Setting

### POINT

#### Clock function

##### (1) When controller has a clock

When the controller has a clock, match the GOT clock and controller clock.

For how to match the GOT clock and controller clock, refer to the following.

 4.9 GOT Display and Operation Setting

##### (2) When controller has no clock



For the GT16, GT15, GT14, GT12, GT11, GT105□, GT104□, and GT1030, use the GOT clock when the controller has no clock.

In this case, set the clock of the GOT with the utility.

For operating the utility, refer to the following.

 User's Manual for the GOT used

## 2.8 Supported Devices

Device type	Description
GOT internal device	Devices located inside the GOT. They can be used regardless of a connection type of the GOT. (However, they cannot be controlled in sequence programs of the controller.) The GOT internal device includes the GOT bit register, GOT data register, and GOT special register.
	GOT bit register (GB)   Bit register located inside the GOT and used as bit devices.
	GOT data register (GD)   Data register located inside the GOT and used as word devices.
	GOT special register (GS)   Special register located inside the GOT, which stores internal information, communication statuses, error information, and others. By monitoring GS with the object function, various information of the GOT can be checked.
Controller device	Device located in a controller. The controller device can be monitored with the GOT. For details of controller devices that can be set with GT Designer3, refer to the following.  Appendix3 Device of Controllers
System label	Label used commonly to each project in the workspace for iQ Works. Assign a controller device to a system label before using the system label. For setting the system label, refer to the following.  5.3.2 Label setting

### ■ Setting range of GOT internal device

Device name	Setting range	Notation for device number
Bit device GOT bit register (GB)	<ul style="list-style-type: none"> <li>GT16, GT15, GT14, GT12, GT11, GT SoftGOT1000 GB0 to GB65535</li> <li>GT105□, GT104□, GT1030 GB0 to GB1023</li> <li>GT1020*1 GB0 to GB255</li> </ul>	Decimal
Word device	<ul style="list-style-type: none"> <li>GT16, GT15, GT14, GT12, GT11, GT SoftGOT1000 GD0 to GD65535</li> <li>GT105□, GT104□, GT1030 GD0 to GD1023</li> <li>GT1020*1 GD0 to GD255</li> </ul>	Decimal
	GOT special register (GS)	

\*1 Even though a device outside the setting range is set, the device does not operate.

For details of the GOT internal device that can be set with GT Designer3, refer to the following.

 Appendix2 GOT Internal Devices

### POINT

#### (1) Unusable GOT internal devices

When using GB and GS, do not set the reserved GOT internal devices.  
For the reserved GOT internal devices, refer to the following.

 Appendix2 GOT Internal Devices

#### (2) Value in GOT internal device when the GOT is turned off or reset

When the GOT is turned off or reset, "0" is stored in the internal GOT.  
When writing the project data to the GOT, the value is held.  
When writing the controller setting to the GOT, "0" is stored.



---

#### **Application of GB and GD**

GB and GD are useful for processing in the areas where the devices do not have to be used in the controller.

- Device for screen switching
  - Work area for the script function
  - Storage area for bar code read values etc
-

## 2.9 Available Numeric Data

The following shows the numeric data type and data range that can be handled with GT Designer3.

Data type	Description	Data length	Data range
Signed BIN16	Binary value including a sign	16 bits	-32768 to 32767
Signed BIN32		32 bits	-2147483648 to 2147483647
Unsigned BIN16	Binary value including no sign	16 bits	0 to 65535
Unsigned BIN32		32 bits	0 to 4294967295
BCD16	Binary Coded Decimal	16 bits	0 to 9999
BCD32		32 bits	0 to 99999999
Real	Floating point type real	32 bits	Signed 13-digit notation (floating point format only)*1

- \*1 The real number precision is given up to the sixth decimal place.  
 The accuracy of the 7th and later decimal places cannot be guaranteed.  
 If a number having 7th and later digits is displayed on GOT, there are cases the displayed value differs from the value displayed on programming software of controller.  
 Example: When the value of a real number (floating point data) of the controller is 4.123
- Display on programming software of controller : 4.123000
  - Display on GOT (display of up to 6th digit) : 4.123000
  - Display on GOT (display of up to 13th digit) : 4.1230001449585
- For details of real number (floating point data), refer to the following.
-  QCPU User's Manual (Function Explanation, Program Fundamentals)



# **GT Designer3 OPERATION**

---







# 3. GT Designer3 OPERATION

## 3.1 Starting GT Designer3

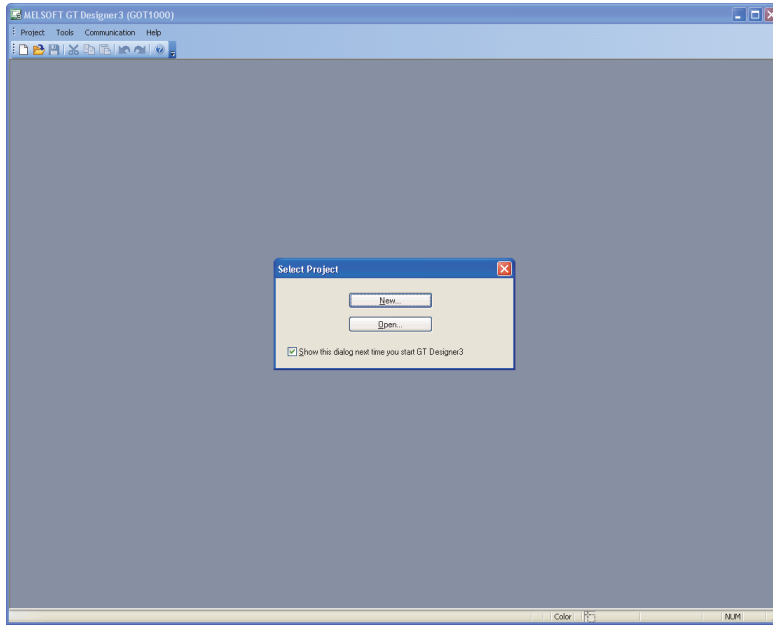
1. From the Windows® start menu\*1, select [MELSOFT]\*2 → [GT Works3] → [GT Designer3] to start GT Designer3.
  - \*1 Select [All Programs] on the [Start] screen, or select [Start] → [All Programs].
  - \*2 [MELSOFT Application] appears for a version of GT Works3 earlier than 1.136S.
2. In the [Select Project] dialog box, create a project, or open an existing project.

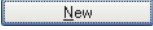

Item	Description
	Click this button to create a new project. For subsequent procedures, refer to the following. ☞ 3.6.1 Creating a new project
	Click ct this button to open the existing project. For subsequent procedures, refer to the following. ☞ 3.6.2 Opening/closing a project
Show this dialog next time you start GT Designer3	Clear this item not to display the [Select Project] dialog box next time GT Designer3 is started.

## POINT

---

### Starting GT Designer3 on iQ Works

For iQ Works, start GT Designer3 from MELSOFT Navigator.

When GT Designer3 is not started from MELSOFT Navigator, some functions of iQ Works are disabled.

For starting GT Designer3 from MELSOFT Navigator, refer to the following.

 Help for MELSOFT Navigator

---

## HINT

### Setting of displaying Select Project dialog box

Whether to display the [Select Project] dialog box or not when starting GT Designer3 can be set by selecting the following item in the [Options] dialog box.

- [Display the project selection dialog at the time of startup] in the [Operation] tab

For the [Options] dialog box, refer to the following.

 3.5.3 Customizing actions and default value of GT Designer3

---

## 3.2 Screen Configuration of GT Designer3

The following shows the screens, toolbars, and screen configurations for windows of GT Designer3.

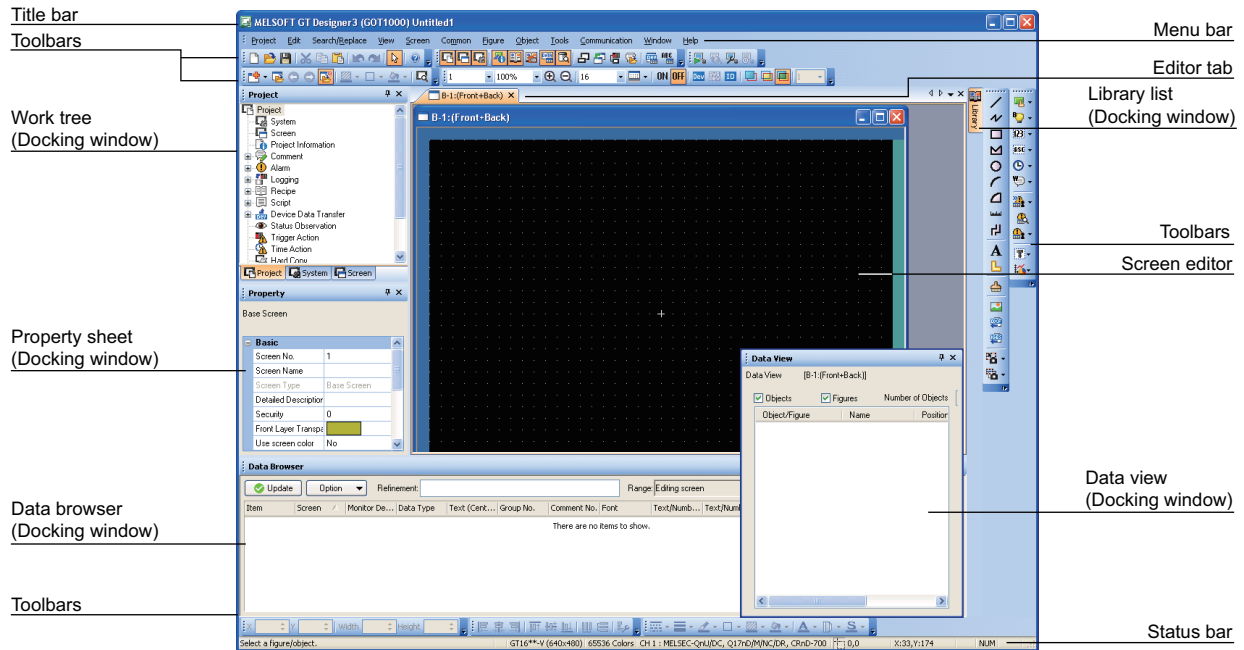

Item	Description	Reference	
Title bar	Names of software, project, or project file is displayed.	-	
Menu bar	GT Designer3 can be operated from the drop down menu.	3.3	
Toolbar	GT Designer3 can be operated by selecting icons.	3.4	
Editor tab	Tabs of opened screen editor, the [Controller Setting] dialog box, or the [Environmental Setting] dialog box are displayed.	3.2.1	
Screen editor	Screens displayed on the GOT can be created. Arrange figures and objects in the screen editor.	3.7	
Docking window	The docking window includes the following types.	-	
	Work tree	The work tree includes the project tree, screen tree, and system tree. The work tree is combined by default.	3.2.2
	Property sheet	The screen, figure, or object settings can be displayed and edited as a list. The property sheet is combined by default. ☞ 3.5.1 Customizing screen configuration	9.4
	Library list	Figures and objects registered in the library can be displayed as a list. The library list is combined by default. ☞ 3.5.1 Customizing screen configuration	6.1
	Controller type list	The controller settings can be displayed as a list.	-
	Data view	Figures and objects arranged in the screen can be displayed as a list.	3.5.3
	Screen image list	The thumbnail display, screen creation, or screen edit of base screen/window screen is available.	3.7.2
	Category list	Figures and objects can be displayed for each category.	9.5.1
	Parts image list	Figures registered as a part can be displayed as a list. Also registering and editing parts is available.	4.13
Data browser	Figures and objects used for a project can be displayed as a list. The figures and objects in the list can be searched or edited.	9.5.6	
Status bar	The explanation of the menu or icon on which a cursor is placed, and the GT Designer3 status are displayed.	-	

## 3.2.1 Operating editor tab

The editor tab displays tabs of the currently displayed screen editor, the [Environmental Setting] dialog box, the [Controller Setting] dialog box, or others.

The screen to be edited can be brought to the top front by selecting the tab.

The screen can be closed by closing the tab.

### Basic operation of editor tab

#### (1) Editor tab

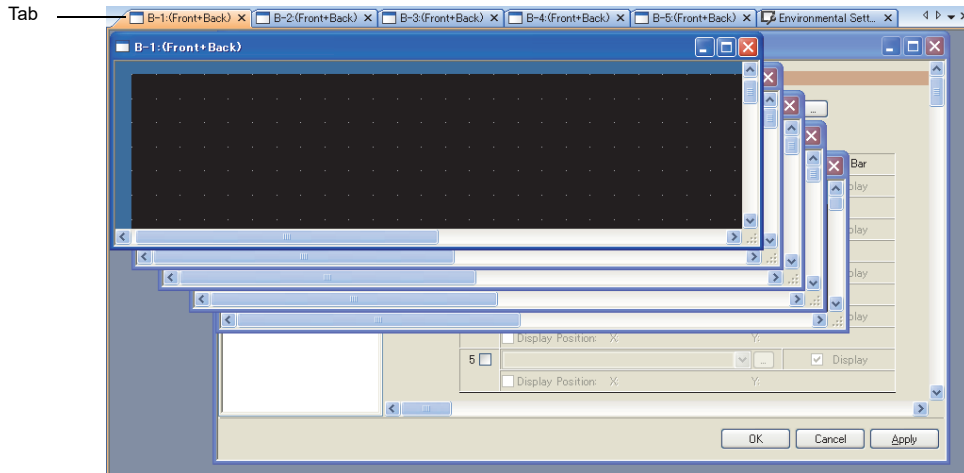

Item	Description
Tab	Displays tabs of currently opened screen editor or others. The display order of tabs can be switched by dragging the tab.
	Click this button to scroll the tabs to the left or right. This item is enabled when the tabs are full in the editor tab.
	Click this button to display the currently opened screen editor or others in the drop down menu. To bring the screen to the top front, select the screen in the drop down menu.
	Click this button to close the selected tab.

#### (2) Menu displayed by right-clicking on the tab

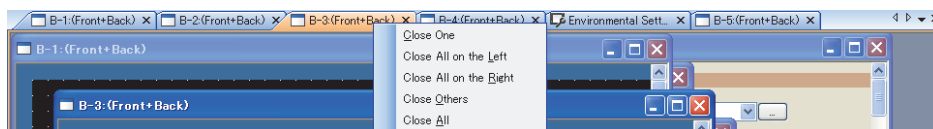

Item	Description
Close One	Closes the right-clicked tab.
Close All on the Left	Closes all the tabs displayed to the left of the right-clicked tab.
Close All on the Right	Closes all the tabs displayed to the right of the right-clicked tab.
Close Others	Closes all the tabs other than the right-clicked tab.
Close All	Closes all tabs.



#### Editor tab display (displayed or hidden)

The editor tab can be displayed or hidden with [Editor Tab] displayed by selecting [View] from the menu.

3.5.1 Customizing screen configuration

## 3.2.2 Operating work tree

The work tree displays the common settings for a project or created screens for each data type in the tree structure. The data of the overall project can be managed or edited easily. The work tree includes the following.

Type	Description
Project Tree	The overall project settings are displayed in the tree structure.
Screen Tree	Screens existing in the currently-creating project are displayed respectively for the base screen, window screen, and report screen in the tree structure.
System Tree	The settings for the GOT, peripherals, or controllers are displayed in the tree structure.



Customizing the docking window

For customizing the docking window, refer to the following.

 3.5.1 Customizing screen configuration

### Basic operation of work tree

#### (1) Project Tree

The common settings for project are displayed in the tree structure.

The creation and edit of settings, or switching of the work trees are available by double-clicking or with the menu displayed by right-clicking.

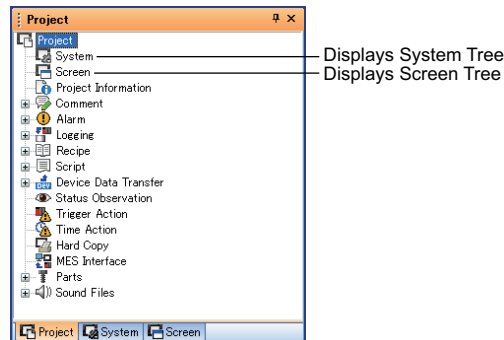

**(2) Screen Tree**

Screens existing in the currently-creating project are displayed respectively for the base screen, window screen, and report screen in the tree structure.

The creation and copy of screens is available by double-clicking or with the menu displayed by right-clicking.

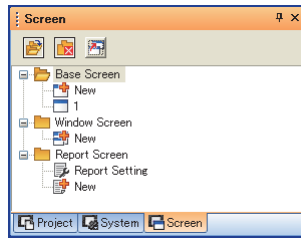

Item	Description
	Click this button to display all screens existing in a project respectively for the base screen, window screen, and report screen.
	Click this button to hide all screens existing in a project respectively for the base screen, window screen, and report screen.
	Click this button to display or hide the name of the called screen. 10.2 Changing Screen According to Situation (Set Overlay Screen)



**Icon of a screen (Display or edit disabled)**

When the project security disables displaying or editing a screen, any of the following icons appears.

- Display disabled:

- Edit disabled:

For the project security, refer to the following.

3.14 Securing Project

### (3) System Tree

GOT Type Setting, Environmental Setting, Controller Setting, and Peripheral Unit Setting are displayed in the tree structure.



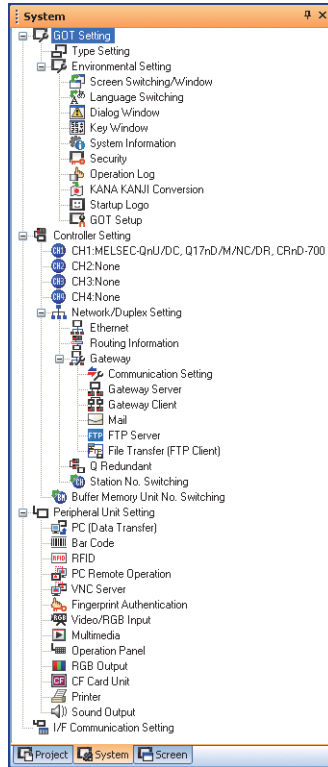





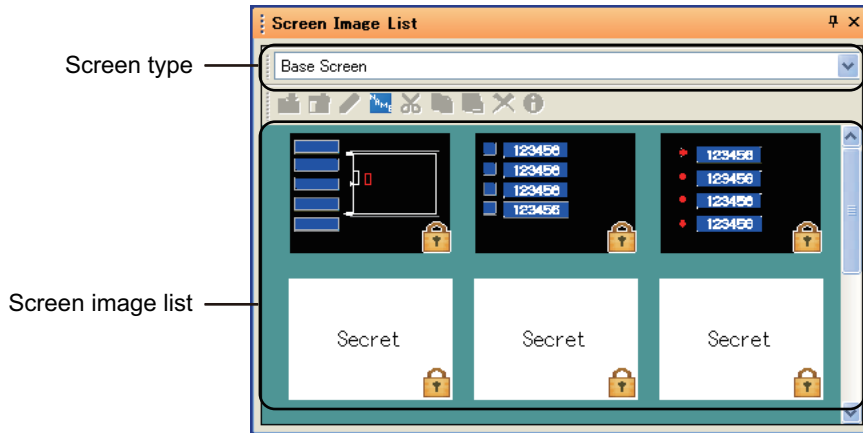

Each setting dialog box is displayed by double-clicking.



### 3.2.3 Operation of screen image list

Select [View] → [Docking Window] → [Screen Image List] from the menu to display the [Screen Image List] window.



Item	Description
Screen type	Select the screen type to be displayed as thumbnails in the screen image list.
	Creates a new screen, and arranges the selected figure and object on the new screen. ☞ 3.7.1 Creating a new screen
	Creates a new screen of the same screen type selected for the screen type. ☞ 3.7.1 Creating a new screen
	Displays the selected screen on the screen editor.
	Switches the display type of screen number or title for each screen in the screen image list (display or non-display).
	Cuts the selected screen.
	Copies the selected screen.
	Pastes the copied or cut screen.
	Deletes the selected screen.
	Displays the [Screen Property] dialog box for the selected screen. ☞ 3.9 Changing Screen Property
Screen image list	Displays screen images of the same screen type selected for the screen type. When the project security disables displaying or editing a screen,  appears on a thumbnail.



## 3.3 Menu Configuration

Project Edit Search/Replace View Screen Common Figure Object Tools Communication Window Help

Item	Description
Project	Contains the following functions and others: Creating/saving/opening projects, setting project information, reading data of GX Developer device comments and others, setting the security, or printing.
Edit	Contains the following functions and others: Copying/pasting/deleting arranged figures and objects, or redoing edit operation.
Search/Replace	Contains the following functions and others: List display/searching/batch editing of devices and texts set in a project.
View	Contains the following functions and others: Displaying previews, or selecting whether to display or hide the toolbar/docking window/editor tab/status bar.
Screen	Contains the following functions and others: Utilizing/creating screens, opening/closing screens, or editing screens.
Common	Contains the following functions and others: Setting for overall project including type setting of the used GOT, controller setting, or comment.
Figure	Contains the following functions and others: Drawing figures, painting figures, or installing image data.
Object	Contains the following functions and others: Setting for objects arranged in the screen including touch switches and lamps.
Tools	Contains the following functions and others: Data error check, system label update/check, data size display, starting GT Simulator3, CSV/Unicode text file conversion of operation log data or advanced recipe data, importing/exporting of the default setting, or customizing the drawing environment.
Communication	Contains the following functions and others: Writing data to the GOT, reading data from the GOT, or project verification between the GOT and a personal computer.
Window	Contains the following function and others : Aligning the screen editors.
Help	Contains the following functions and others: Displaying the GT Designer3 Help and the PDF manuals relevant to GT Designer3, or checking the software version.

The menu configuration varies according to the selected GOT type.

## 3.4 Type of Tool Bars and Short Cut Keys

The following types of toolbars are available.

Whether to display or hide the tool bars can be set with the [View] from the menu. (For the displayed tool bar,  is displayed to the left.)

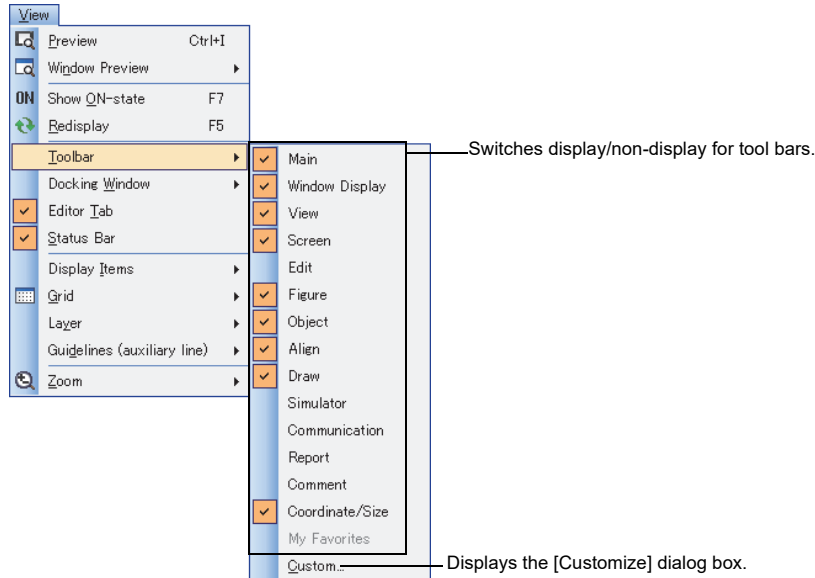

### ■ Main



Icon	Description	Shortcut key
	Creates a new project. 3.6.1 Creating a new project	Ctrl+N
	Opens an existing project. 3.6.2 Opening/closing a project	Ctrl+O
	Overwrites the project currently being edited. 3.16.1 Overwriting projects	Ctrl+S
	Cuts the selected figures, objects, and others.	Ctrl+X
	Copies the selected figures, objects, and others.	Ctrl+C
	Pastes the selected figures, objects, and others.	Ctrl+V
	Cancel the last operation to recover the status before change.	Ctrl+Z
	Redoes the canceled operation.	Ctrl+Y
	Selects figures and objects.	-
	Displays the GT Designer3 Help.	F1

## ■ Window Display



Icon	Description	Shortcut key
	Switches the display type of the project tree (display or non-display). 3.2.2 Operating work tree	Alt+0
	Switches the display type of the screen tree (display or non-display). 3.2.2 Operating work tree	-
	Switches the display type of the system tree (display or non-display). 3.2.2 Operating work tree	-
	Switches the display type of the property sheet (display or non-display). 9.4 Displaying in List and Editing Screen/Figure/Object Settings (Property sheet)	Alt+1
	Switches the display type of the library list window (display or non-display). 6. LIBRARY	F9
	Displays the library list window with the template folder in the system library opened. 7. TEMPLATE	Alt+F9
	Switches the display type of the data view window (display or non-display). 9.5.3 Selecting overlapped figure (Data view)	-
	Switches the display type of the data browser (display or non-display). 9.5.6 Searching for and editing figures, objects, and others in a project data (Data browser)	Ctrl+E
	Displays the [GOT Type Setting] dialog box. 4.1 GOT Type Setting	-
	Displays the [Environmental Setting] dialog box (Screen Switching/Window). 4.2 Screen Switching Device Setting	-
	Displays the [Controller Setting] dialog box. GOT1000 Series Connection Manual for GT Works3 and a controller used	-
	Displays the [Open Comment Group] dialog box. 4.12 Comment Setting	-
	Displays the [Device List] dialog box. 9.5.4 Checking devices in use (Device list)	-
	Displays the [Text List] dialog box. 9.5.5 Checking text in use (Text list)	-

1

OVERVIEW

2

GT Designer3  
SPECIFICATIONS

3

GT Designer3  
OPERATION

4

COMMON SETTING

5

EDITING AND  
SETTING FIGURES  
AND OBJECTS

6

LIBRARY

7

TEMPLATE

## View



Icon	Description	Shortcut key
	Snap movement of the cursor is set.	-
	Screen display magnification of the screen editor is set (50% to 400%).	-
	Screen display magnification of the screen editor can be zoomed in by 10% increments.	Ctrl+Num+
	Screen display magnification of the screen editor can be zoomed out by 10% increments.	Ctrl+Num-
	Grid spacing of the screen editor is set.	-
	Grid color of the screen editor is set.	-
	Switches screen images of the screen editor when a device is turned on or turned off.	F7/F8
	Switches the display type of devices (display or non-display).	-
	Switches the display type of a device assigned to a system label (display or non-display).	-
	Switches the display type of object IDs (display or non-display).	-
	Displays the front layer. ☞ 3.8.2 Layer display switching operation	-
	Displays the back layer. ☞ 3.8.2 Layer display switching operation	-
	Displays with the front layer and back layer overlaid. ☞ 3.8.2 Layer display switching operation	-
	The preview column No.of the language switching is set. ☞ 4.3 Language Switching Device Setting	-

## Screen



Icon	Description	Shortcut key
	Creates a new screen. ☞ 3.7.1 Creating a new screen	-
	Opens closed screens. ☞ 3.7.2 Opening/closing a screen	-
	Opens a screen of which screen No. is smaller by one than that of the screen currently being edited.	Ctrl+Alt+P
	Opens a screen of which screen No. is larger by one than that of the screen currently being edited.	Ctrl+Alt+N
	When opening screens with  or  button, switches the display type of the closed screens (opening or closing the closed screens). ☞ 3.7.2 Opening/closing a screen	-
	Sets the color of screen back ground pattern of screen.	-
	Sets the back ground pattern of screen.	-
	Sets the back ground color of screen.	-
	Displays a preview window of screen. ☞ 3.11 Viewing Created Screen Image	Ctrl+I

## ■ Edit



















### ☞ 5.2 Editing Figure and Object

Icon	Description	Shortcut key
	Places the selected figures and objects in the front.	-
	Places the selected figures and objects in the back.	-
	Groups the selected figures and objects.	Ctrl+G
	Cancels grouping of the selected figures and objects.	Ctrl+U
	Registers the selected figures and objects to the template.	-
	Deletes the selected figures and objects from the template.	-
	Edits the template attribute of the selected template information.	-
	Flips the selected figures horizontally.	Ctrl+H
	Flips the selected figures vertically.	Ctrl+J
	Rotates the selected figures 90 degrees to the left.	Ctrl+L
	Rotates the selected figures 90 degrees to the right.	Ctrl+R
	Changes the length of freeform lines or polygon lines.	-
	Aligns the selected figures and objects.	-
	Selects only figures.	-
	Selects only objects.	-
	Selects both figures and objects.	-
	Selects whether the overlay screen is selected or not.	-
	Selects whether [Adjust Direct Text Size] is valid or invalid.	-

■ **Figure**



☞ GT Designer3 Version1 Screen Design Manual (Functions)

Icon	Description	Shortcut key
	Draws a line.	-
	Draws a continuous line.	-
	Draws a rectangle.	-
	Draws a polygon.	-
	Draws a circle.	-
	Draws an arc.	-
	Draws a sector.	-
	Draws a scale.	-
	Draws a piping figure.	-
	Sets a text.	-
	Sets a logo text.	-
	Paints with a selected color and pattern.	-
	Imports and pastes BMP or JPEG file on the screen editor.	-
	Imports and pastes DXF file on the screen editor.	-
	Imports and pastes IGES file on the screen editor.	-
	Captures the specified rectangular range area in BMP/JPEG format, and pastes it on the screen editor.	-
	Captures the specified window in BMP/JPEG format, and pastes it on the screen editor.	-

## Object



☞ GT Designer3 Version1 Screen Design Manual (Functions)

Icon	Description	Shortcut key
	Sets a touch switch. ☞ (Functions) 2. TOUCH SWITCH	-
	Sets a lamp.	-
	Sets the numerical display or numerical input.	-
	Sets the ASCII display or ASCII input.	-
	Sets the date display or time display.	-
	Sets the comment display.	-
	Sets the advanced alarm display.	-
	Sets the alarm history.	-
	Sets the alarm display.	-
	Sets the parts display.	-
	Sets a graph.	-

## Align











☞ 5.2 Editing Figure and Object

Icon	Description	Shortcut key
	Aligns selected figures and objects with the leftmost figure or object.	-
	Aligns selected figures and objects at the center horizontally.	-
	Aligns selected figures and objects with the rightmost figure or object.	-
	Aligns selected figures and objects with the uppermost figure or object.	-
	Aligns selected figures and objects at the center vertically.	-
	Aligns selected figures and objects with the lowermost figure or object.	-
	Aligns selected figures and objects evenly in the horizontal direction.	-
	Aligns selected figures and objects evenly in the vertical direction.	-
	Displays the [Align] dialog box.	-

## ■ Draw







☞ GT Designer3 Version1 Screen Design Manual (Functions)

Icon	Description	Shortcut key
	Sets the line style of figures.	-
	Sets the line width of figures.	-
	Sets the line color of figures.	-
	Sets the pattern of figures.	-
	Sets the color of figure patterns.	-
	Sets the background color of figures.	-
	Sets the text color of figures.	-
	Sets the text style of figures.	-
	Sets the text solid color of figures.	-

## ■ Simulator







☞ 9.10 Starting Up Simulator (GT Simulator3)

Icon	Description	Shortcut key
	Starts GT Simulator3.	Ctrl+F10
	Updates the project being simulated with GT Simulator3 by the project being edited with GT Designer3.	Alt+F10
	Changes the GT Simulator3 setting and others.	-
	Ends GT Simulator3.	-

## ■ Communication



☞ 8. COMMUNICATION WITH GOT

Icon	Description	Shortcut key
	Writes data to the GOT.	Shift+F11
	Reads out data from the GOT.	-
	Verifies projects between the GOT and a personal computer.	-
	Configure the communication setting.	-



## Report



☞ (Functions) 39. REPORT FUNCTION

Icon	Description	Shortcut key
	Draws a line (rectangle).	-
	Sets a text.	-
	Sets the numerical value for printing.	-
	Sets the comment (Bit) for printing.	-
	Sets the comment (Word) for printing.	-
	Sets the header row.	-
	Sets the repeat row.	-
	Selects only the report rows.	-

## Comment

For the comment toolbar, refer to the following.

☞ 4.12.2 Basic operations for comment registration

## Coordinate/Size



☞ 5.2 Editing Figure and Object

Icon	Description	Shortcut key
	The X coordinate that is on the top-left of selected figure or object is set.	-
	The Y coordinate that is on the top-left of selected figure or object is set.	-
	The width of selected figure or object is set.	-
	The height of selected figure or object is set.	-

## My favorites

My favorites can be displayed by registering data of my favorites in the library.

The registered figures, objects, and templates in my favorites can be displayed as my favorites toolbar.

# 3.5 Customizing Screen Configuration and Toolbars

Screen configuration and toolbars can be customized on the GT Designer3 to facilitate operation by users.

Creating a toolbar of frequently used icons.

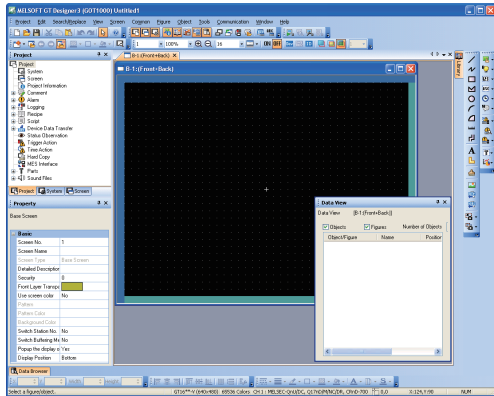

Before customizing

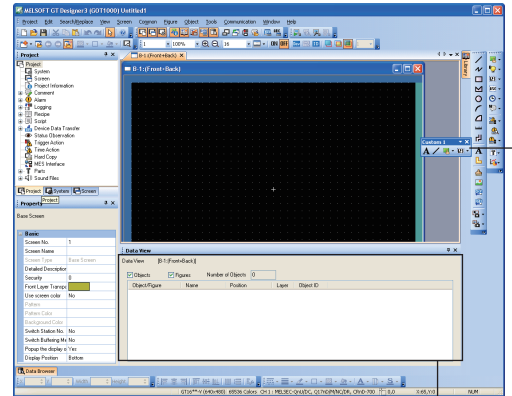

Combining the docking window with the main window

After customizing

## POINT

### Customized screen on GT Designer3

**(1) At the next start-up**

GT Designer3 memorizes the customized settings of the screen configuration. At the next start-up, the previously customized status screen is displayed.

**(2) When setting the security for project**

When registering a user for a project, GT Designer3 memorizes the customized settings for each user. The customized settings for grids can be memorized in project units.

☞ 3.5.3 Customizing actions and default value of GT Designer3

## 3.5.1 Customizing screen configuration

### ■ Switching of display/non-display

The [View] menu allows you to switch toolbars and docking windows between displayed and hidden.

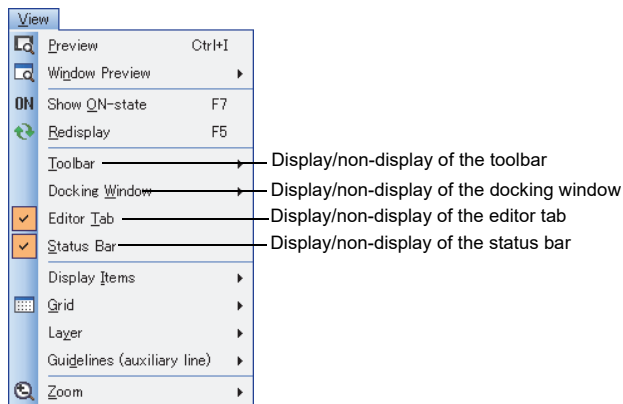

## ■ Combining a docking window

A docking window can be combined with the main screen or the other docking windows on GT Designer3. The combined docking window can be displayed or hidden as required.

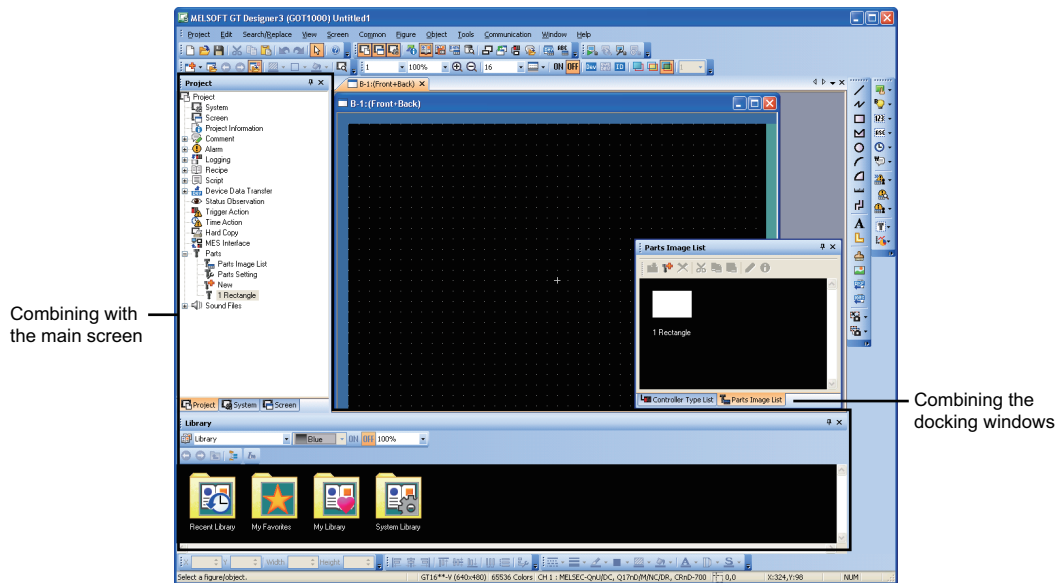





For the types of the docking window, refer to the following.

### ☞ 3.2 Screen Configuration of GT Designer3

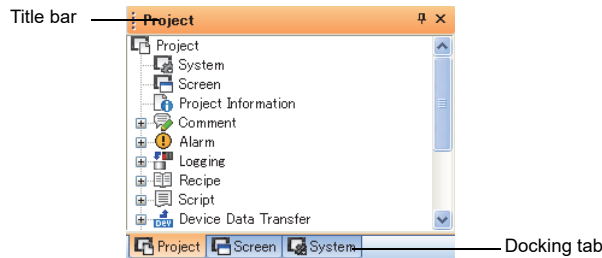
#### (1) Basic operation of docking window

The following shows the basic operation of the docking window using the work tree as an example.



Item	Description
Title bar	Drag the title bar to move the docking window. A guide line for combining (docking guide) is displayed when dragging.
 (Pushpin icon)	Switches the autohide of the docking window between enabled and disabled. <ul style="list-style-type: none"> <li> : Autohide disabled</li> <li> : Autohide enabled</li> </ul>
	Hides the docking window. To redisplay the docking window, use the [View] menu.
Docking tab	Click the docking tab to switch the docking windows. The docking tab appears when the docking windows are combined. Drag the docking tab to separate the combined docking window.

**(2) Operation for combining**

1. Drag the title bar of the docking window to be combined to display the docking guide. The docking guide includes the inner guide, tab guide, and outer guide.

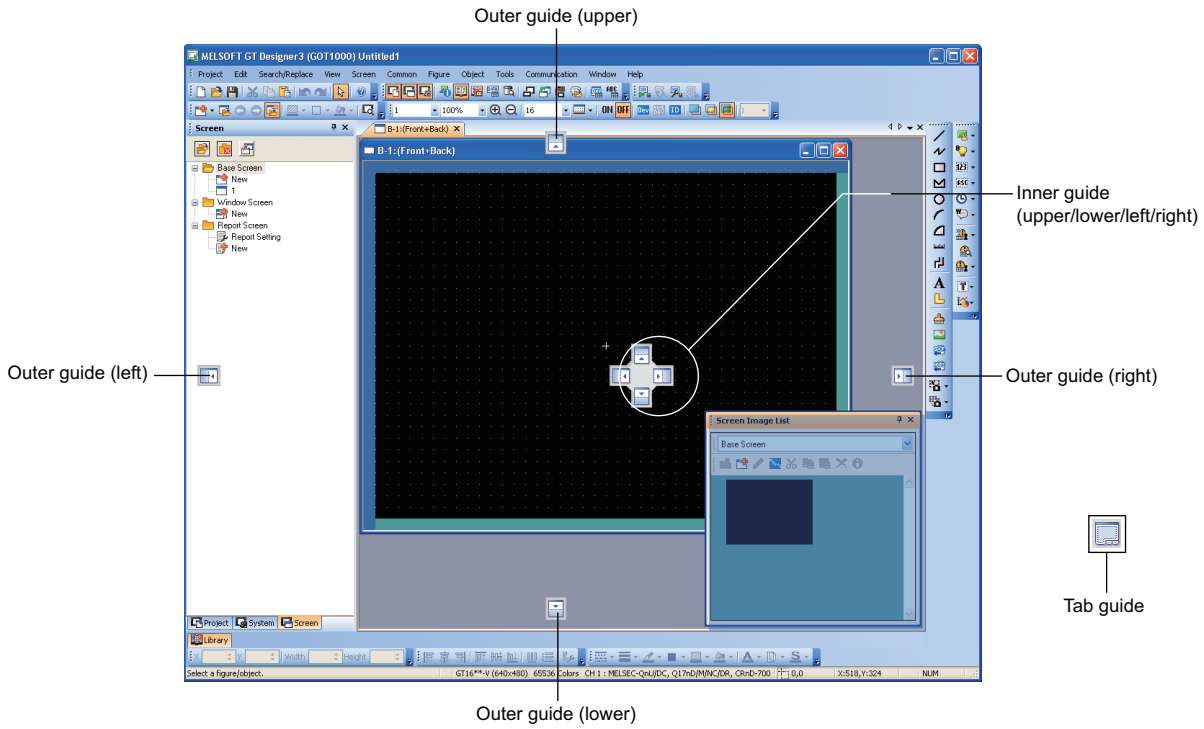

Item	Description
Inner guide (upper/lower/left/right)	Combines a docking window at the inner side than at the combined docking window.
Tab guide	The tab guide appears in the center of the inner guide while a docking window is dragged to the other docking windows. Combines docking windows.
Outer guide (upper/lower/left/right)	Combines a docking window at the outer side than at the combined docking window.

2. Place the mouse pointer over the docking guide while dragging the docking window to display the arranged position of the docking window when it is combined.

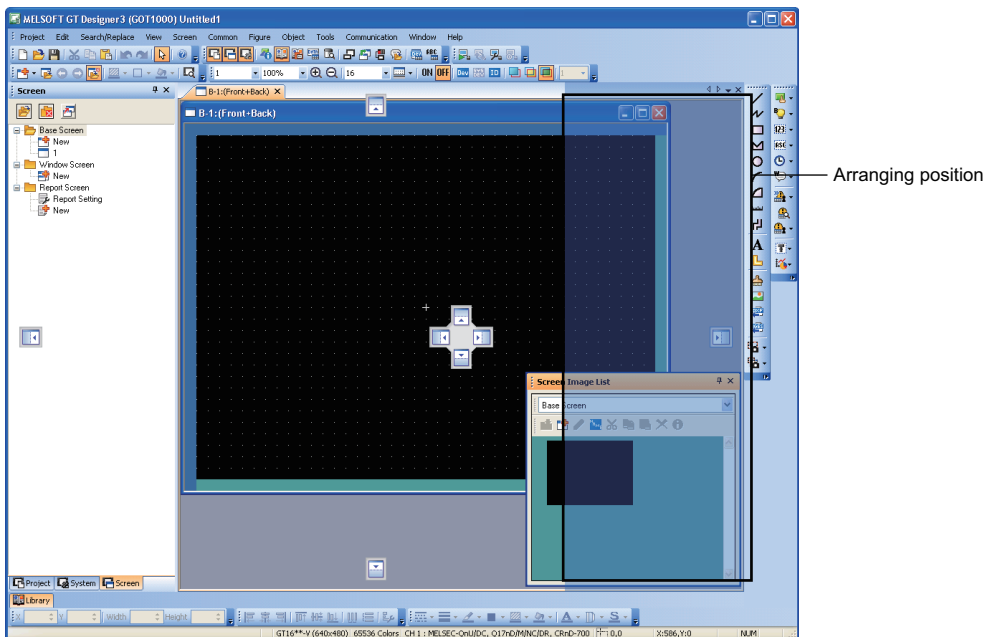

- Drop the docking window on the docking guide to combine the docking window in the position where the arranged position is displayed.

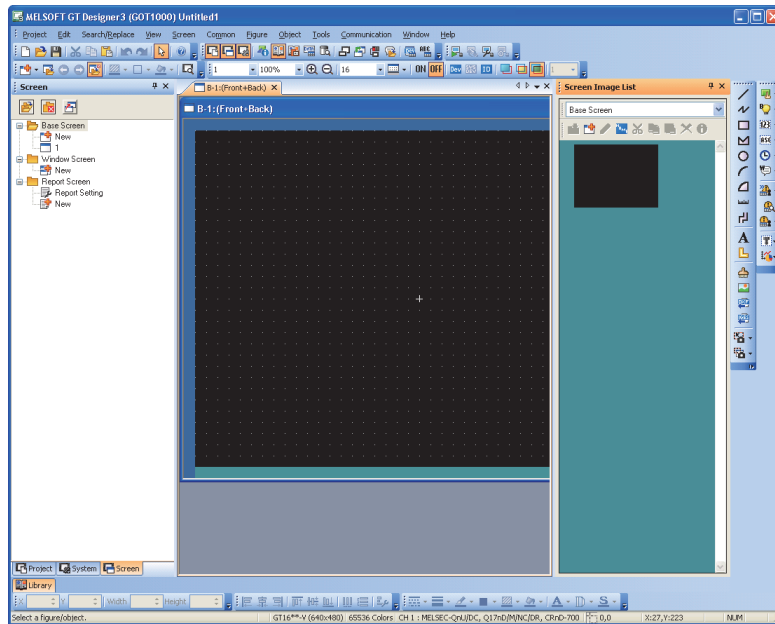

- When the autohide is enabled by the pushpin icon (📌), only the tab is displayed. Place the mouse pointer over the tab to display the combined docking window.

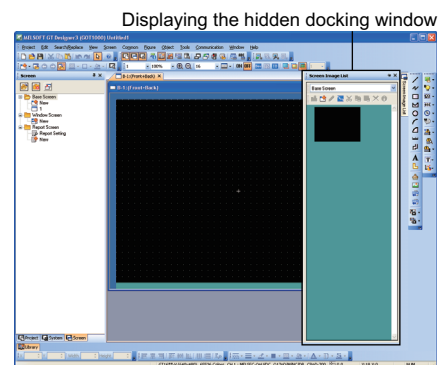
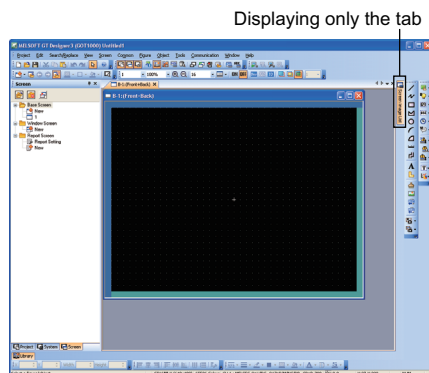

### (3) Operation for separating the combined docking window

Disable the autohide (📌) of the combined docking window.

To separate the combined docking window, drag the title bar of the window.

(Double-clicking the title bar also separates the combined docking window.)

To separate the window where docking windows are combined, drag the docking tab.

(Double-clicking the docking tab also separates the combined docking window.)

### ■ Changing the docking window size

To change the docking window size, place the mouse pointer over the docking window frame and drag the pointer.

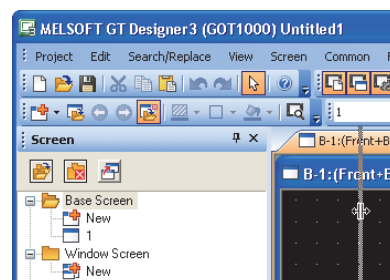

## 3.5.2 Customizing the toolbars

Switching of display/non-display for toolbars, addition/deletion of icons, and others are available.

### ■ Setting

Select [Tools] → [Customize] from the menu to display the [Customize] dialog box.

#### POINT

##### Timing when setting of the Customize dialog box is reflected



The contents set with the [Customize] dialog box are reflected immediately after the operation.

This operation cannot be cancelled.

#### (1) Toolbar tab

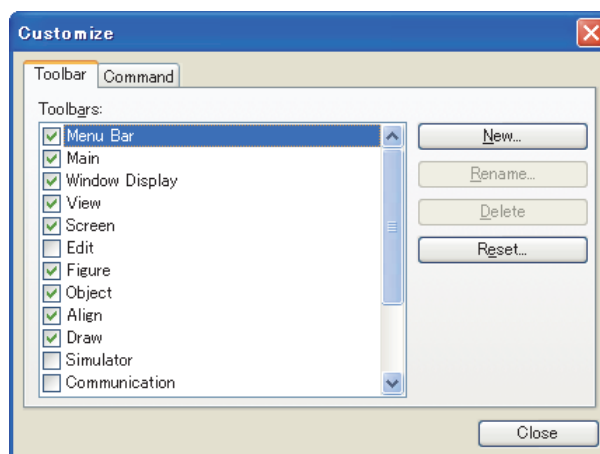
Toolbars can be created or edited.

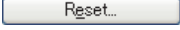

Item	Description	Model
Toolbars	Toolbars are displayed as a list. Select the toolbars to be displayed on GT Designer3.	
	Click this button to display the [New Toolbar] dialog box. To create a toolbar, enter [Toolbar name] and then click the [OK] button.	
	Clicking this button displays the [Rename Toolbar] dialog box and enables to change the name of toolbar. This button is available only for user-created toolbars. To change the name of toolbar, enter [Toolbar name] and then click the [OK] button.	gr16 gr15 gr14 gr12 gr11 gr10 SoftGoT1000
	Click this button to delete toolbars. This button is available only for user-created toolbars.	
	Click this button to reset the selected toolbar to default status. This button is available only for toolbars setting on GT Designer3 by default.	

**(2) Command tab**

Icons of toolbars are added or deleted.

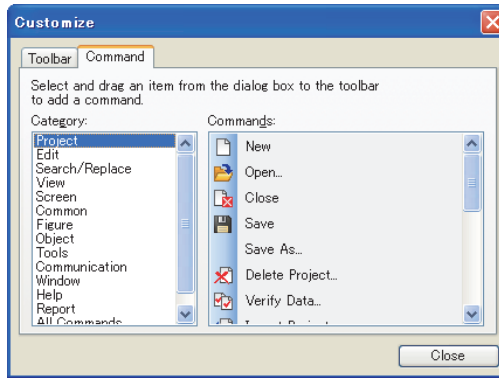

Item	Description	Model
Category	Displays a category of icons.	GT16 GT15 GT14 GT12 GT11 GT10 SoftGOT1000
Commands	Displays icons according to the selected item in [Category].	

**■ Operation of editing icons**

Editing icons is available only when the [Customize] dialog box is displayed. Close the [Customize] dialog box after editing icons.

**(1) Adding icons**

Drag the icon to be added to the toolbar.

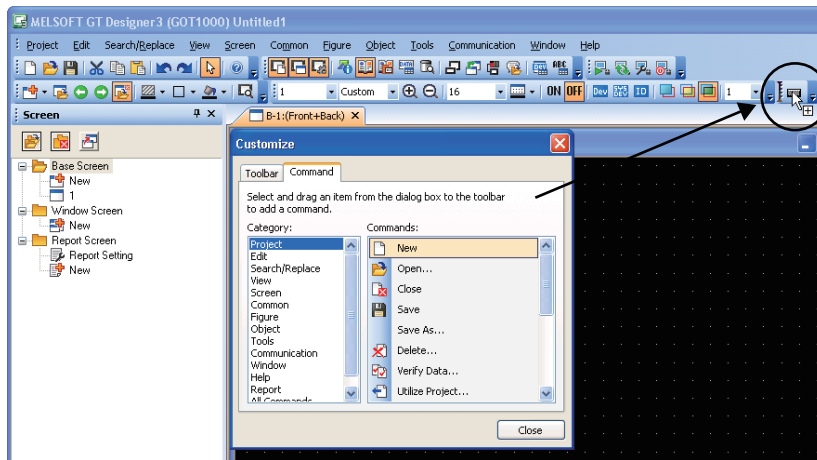

**(2) Deleting icons**

Drag the icon to be deleted out of the toolbar.

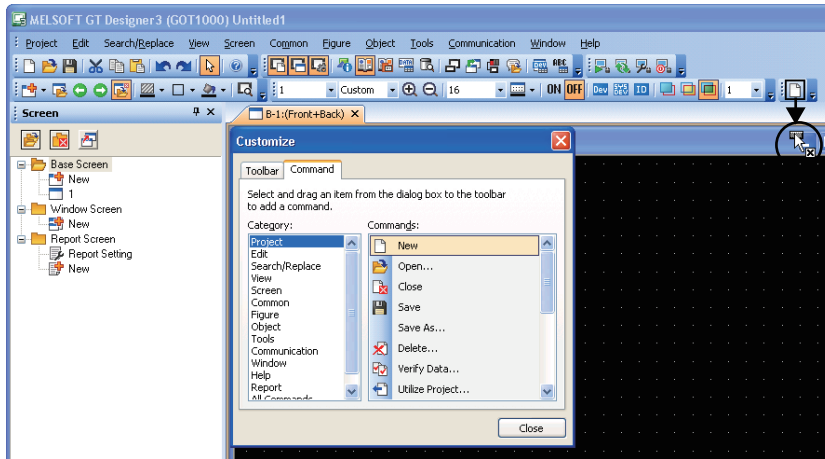

**(3) Moving icons**

Drag the icon to the toolbar where the icon is placed.

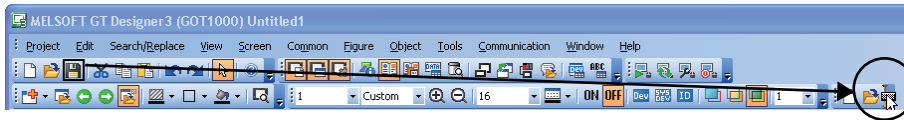



### 3.5.3 Customizing actions and default value of GT Designer3

Displayed information, actions, and others when drawing can be customized.

#### ■ Setting

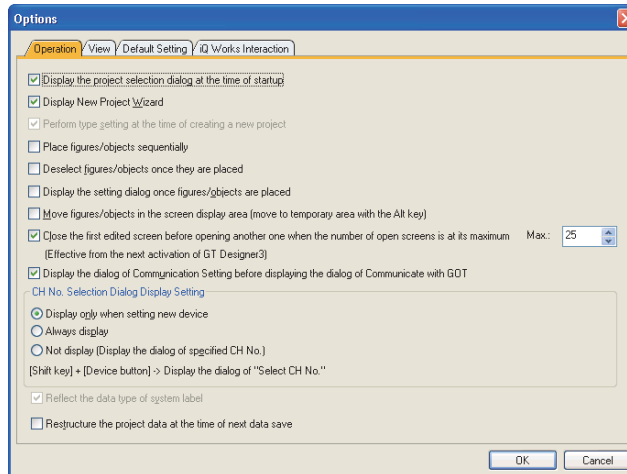

Select [Tools] → [Option] from the menu to display the [Options] dialog box.

##### (1) Operation tab



Item	Description	Model	
Display the project selection dialog at the time of startup	Select this item to display [Select Project] dialog box (creating a new project or opening an existing project can be selected) when starting GT Designer3.		
Display New Project Wizard	Select this item to display [New Project Wizard] when creating a new project.		
Perform type setting at the time of creating a new project	Select this item to display the [GOT Type Setting] dialog box when creating a new project.		
Place figures/objects sequentially	Select this item to place figures or objects sequentially. (To stop this operation, right-click or press the [ESC] key.)		
Deselect figures/objects once they are placed	Select this item to deselect figures or objects after placing the figures or objects.	GT16 GT15 GT14 GT12 GT11 GT10 SoftGOT1000	
Display the setting dialog figures/objects are placed	Select this item to display the setting dialog box automatically after placing figures or objects.		
Move figures/objects in the screen display area (move to temporary area with the Alt key)	Select this item to place figures or objects only in the screen display area of the screen editor. Figures or objects can be placed in the temporary area with the figures or objects moved pressing the [ALT] key.		
Close the first edited screen before opening another one when the number of open screens is at its maximum (Effective from the next activation of GT Designer3)	Select this item to close the first-opened screen when the maximum screen number set for the screen editors of the base screen, window screen, and report screen is opened. After the selection, set [Max]. (1 to 25) The setting is enabled at the next start-up.		
Display the dialog of Communication Setting before displaying the dialog of Communicate with GOT	Select this item to display the [Communication Configuration] dialog box before the [Communicate with GOT] dialog box.	GT16 GT15 GT14 GT12 GT11 GT10 SoftGOT1000	
CH No. Selection Dialog Display Setting	Select whether to display or hide the [Select CH No.] dialog box when setting a device. The [Select CH No.] dialog box is displayed when two channels or more are set with the [Controller Setting] dialog box.  5.3.1 Device setting	GT16 GT15 GT14 GT12 GT11 GT10 SoftGOT1000	
	Display only when setting new device	Select this item to display the [Select CH No.] dialog box only when a new device is set.	
	Always display	Select this item to constantly display the [Select CH No.] dialog box when setting a device.	

(Continued to next page)

Item	Description		Model
CH No. Selection Dialog Display Setting	Not display (Display the dialog of specified CH No.)	Select this item to hide the [Select CH No.] dialog box when setting a device. After the selection, set a channel number or label in [Label/CH No.]. When a channel number is selected, the [Device] dialog box of the set channel number appears. When a label is selected, the [Import System Labels to Project] dialog box appears.	
Reflect the data type of system label	Select this item to reflect the data type of system label to the data type of GT Designer3 when setting a system label for a device setting.*1		
Restructure the project data at the time of next data save	Select this item to delete unnecessary data to reduce the project data size. After the project data is saved, this item is cleared. This setting is not held even if the project data is saved. For restructuring the project data, note the following. <ul style="list-style-type: none"> <li>• When the Windows font used for the project is not installed to the personal computer, where the project data is saved and restructured, the Windows font is changed to the one in the default setting.</li> <li>• The verification result after the restructuring may differ from the result before the restructuring.</li> <li>• When the restructured project data is written to the GOT, all the screen data is written.</li> </ul>		

**\*1 The data type of device that corresponds to the data type of system label**

The data type of system label is reflected to the data type of device as follows.

Data type of system label	Data type of device	Notation of system label
Bit	Bit	System label name
Word[Signed]	Signed BIN16	
Word[Unsigned]/Bit[16bit]	Unsigned BIN16	
Double Word[Signed]	Signed BIN32	
Double Word[Unsigned]/Bit[32Bit]	Unsigned BIN32	
Timer	Signed BIN16	System label name
	Bit	System label name/T
		System label name/C
Counter	Signed BIN16	System label name
	Bit	System label name/T
		System label name/C
Retentive Timer	Signed BIN16	System label name
	Bit	System label name/T
		System label name/C
FLOAT[Single Precision]	Real	System label name
FLOAT[Double Precision]	Not reflected	Not reflected
String		
Pointer		
Time		

**POINT**

**System label with data type of [Timer], [Counter], and [Retentive Timer]**

For a system label with the data type of [Timer], [Counter], and [Retentive Timer], MELSOFT Navigator processes the data as one system label. However, GT Designer3 processes the data as three label data (current value (system label name), contact (system label name/T), and coil (system label name/C)).

(2) View tab

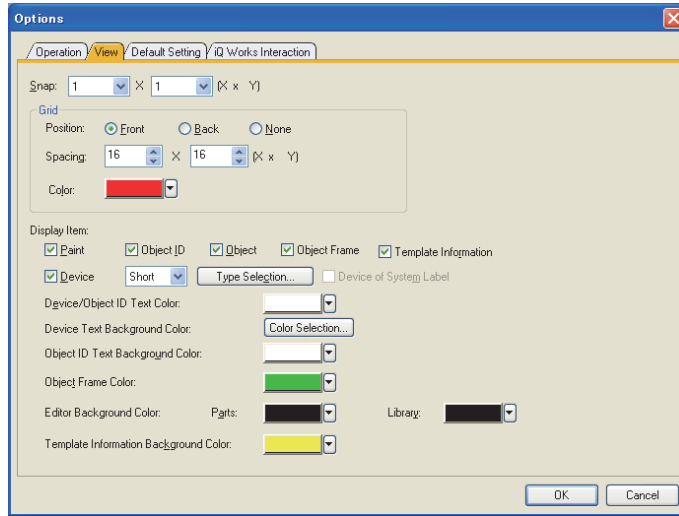

Item	Description	Model
Snap	Select the interval between figures or objects (X and Y) when they are arranged or moved in the screen editor. (1,2,4,8,16 (dots))	
Grid	Position	Select the display position of grid.(Front,Back, or None) When selecting [Front] or [Back], [Spacing] and [Color] can be selected.
	Spacing	Set the grid spacing (X and Y). (2 to 64)
	Color	Select the display color of grid.
Display Item	The information to be displayed on the screen editor of GT Designer3 can be set.	
	Paint	Select this item to display the filled status of the painted area.
	Object ID	Select this item to display the object ID on the object.
	Object	Select this item to display the object on the screen editor.
	Object Frame	Select this item to display the object frame on the screen editor.
	Template Information	Select this item to display the template information boxes on the screen editor.
	Device	Select this item to display the set device on the object. After the selection, the display type of the device can be selected. • Short: Displaying only the device. • Full: Displaying the CH No., NW No., PC station number, and device.
		Displays the [Type Selection] dialog box. (a) Type Selection dialog box
	Device of System Label	Select this item to display the device name, which is assigned to a system label, on the object.
	Device/Object ID Text Color	Select the text color of device or object ID displayed on the object. This selection is available when [Device] or [Object ID] is selected.
Device Text Background Color	Select the text background color of the device displayed on the object. Click the [Color Selection] button to display the [Type Selection] dialog box. Then, set the text background color. (a) Type Selection dialog box	
Object ID Text Background Color	Select the text background color of the object ID displayed on the object.	

(Continued to next page)

Item	Description		Model
Display Item	Object Frame Color	Select the display color of [Object Frame].	gr16 gr15 gr14 gr12 gr11 gr10 softgr1000
	Editor Background Color	Displays the back ground color of the parts editor and library editor. Parts: Set the back ground color of the parts editor. Library: Set the back ground color of the library editor.	
	Template Information Background Color	Set the background color of the template information boxes on the screen editor.	

## POINT

### (1) Customizing the grid

The grid can be set for GT Designer3, not for each project.

The customized grid is enabled regardless of the project to be opened.

### (2) Device displayed on an object

(a) When multiple objects overlap

The devices are displayed on the objects in the stacking order set for the objects.

Therefore, the device on the object that is placed under another object is not displayed.

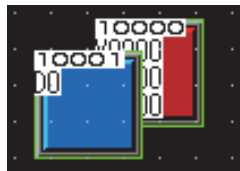

(b) When [Device of System Label] is selected

The device and the system label are displayed.



## HINT

### Changing from menu bar or toolbar

Items set in the [View] tab can be changed from the menu bars or toolbars.

#### (1) Changing from menu bar

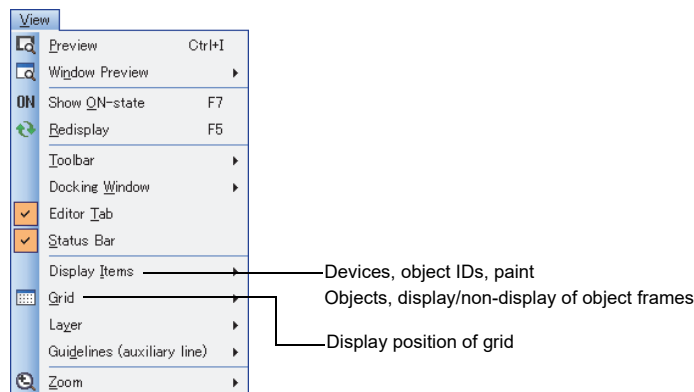

#### (2) Changing from toolbar

For the changing method from toolbars, refer to the following.

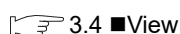

3.4 View

- (a) Type Selection dialog box  
Set the type of devices displayed on objects.

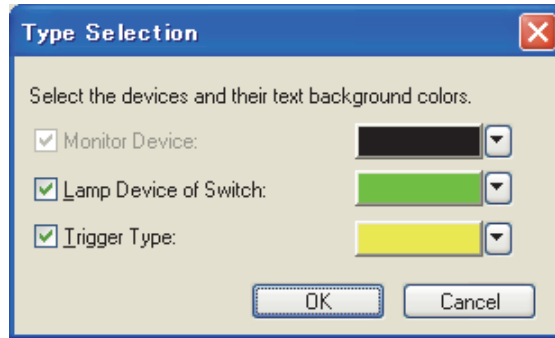

Item	Description	Model
Monitor Device	The monitor device is displayed on the object. (This item cannot be cleared.) Select the text background color of the device.	
Lamp Device of Switch	Select this item to display the device set for the lamp function of a touch switch. Select the text background color of the device.	GT16 GT15 GT14 GT12 GT11 GT10 SMTGT1000
Trigger Type	Select this item to display the device set for the trigger setting. Select the text background color of the device.	

### (3) Default Setting tab

The default value can be set when figures or objects are newly set.

The set default value is reflected after the subsequent GT Designer3 start-up.

## POINT





### Setting of default value

The default value is a setting when figures or objects are arranged (initial status).

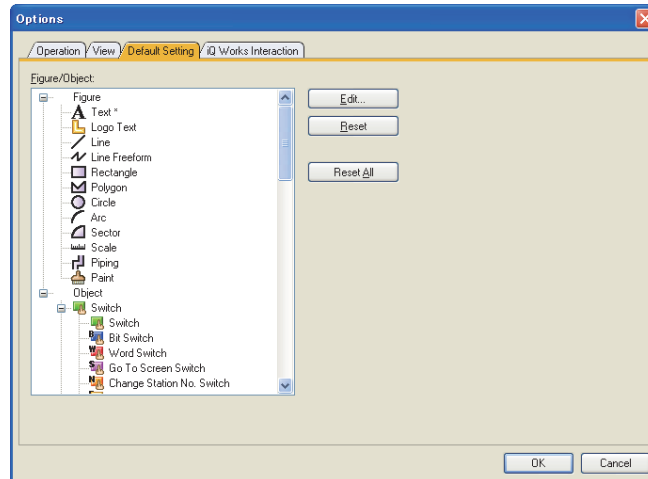
The initial setting of devices, figures, fonts, text colors, or others can be customized by changing the default value. Save time and steps of changing the setting for arranged figures or objects by setting the often-used setting as the default value beforehand.

However, the default value cannot be set for some items (including [Lamp] for figures) depending on the figure or object.



Item	Description	Model
Figure/Object	Figures and objects are displayed in a tree structure. * is displayed to the right of item name, for the item which the default value is changed. Double-clicking the item also displays the setting dialog box.	
	Click this button to display the setting dialog box of figures or objects selected in [Figure/Object]. Click the [OK] button to change the default value. For each setting dialog box, refer to the following.  GT Designer3 Version1 Screen Design Manual(Functions)	gr16 gr15 gr14 gr12 gr11 gr10 SoftGOT1000
	Click this button to reset the default value of figures or objects selected by [Figure/Object] to the initial value.	
	Click this button to display the confirmation dialog box. To reset default values of all figures or objects to initial values, click the [Yes] button. To retain default values of figures or objects, click the [No] button.	



### (1) Exporting or importing the setting of default values

The setting of default values can be exported or imported as follows.

#### (a) Export

1. Select [Tools] → [Default Setting] → [Export] from the menu.
2. The [Save As] dialog box appears.  
Set the save location and name of the file in which the default value setting is written.
3. Click the [Save] button.

#### (b) Import

1. Select [Tools] → [Default Setting] → [Import] from the menu.
2. The [Open Default Setting File] dialog box appears.  
Set the save location and name of the file in which the default value setting is written.
3. Click the [Open] button.

### (2) Setting the default value with using figures or objects

Setting the default value is also available by selecting [Set to Default] from the menu displayed by rightclicking the figures or objects on the screen editor.

**(4) iQ Works interaction tab**

The setting regarding GT Designer3 operation when interacting with MELSOFT Navigator can be changed.

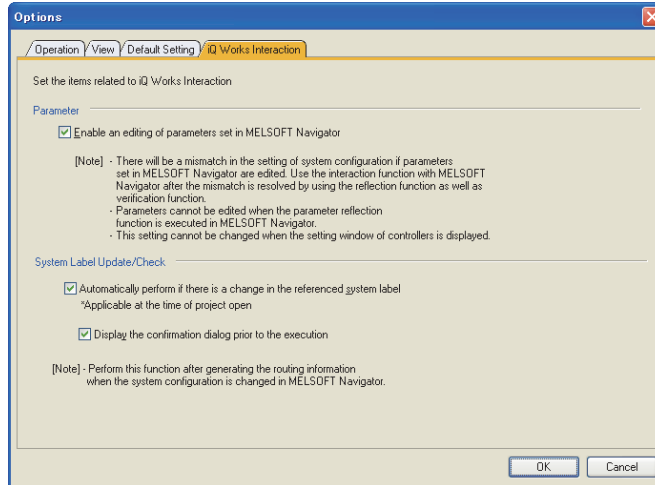

Item	Description		Model
Parameter	Enable an editing of parameters set in MELSOFT Navigator	Select this item to edit parameters reflected from MELSOFT Navigator with GT Designer3.	
System Label Update/Check	Set the items to automatically execute the system label update/check. For details of the system label update/check, refer to the following. 5.3.2 Label setting		
	Automatically perform if there is a change in the referenced system label	Select this item to automatically execute the system label update/check when opening a project. If the system label is not changed, the system label update/check is not executed.	
	Display the confirmation dialog prior to the execution	Select this item to display the confirmation dialog box before the system label update/check is automatically executed.	

**POINT**

**(1) Editing the reflected parameters**

When editing parameters reflected from MELSOFT Navigator, change the setting contents for MELSOFT Navigator likewise.

If the setting contents between MELSOFT Navigator and GT Designer3 differ, communication between the GOT and controllers may not be executed after sending a project data to the GOT.

Match the setting contents between MELSOFT Navigator and GT Designer3 using [Parameter Reflection] and [Verification of System Configuration Information and Parameters] of MELSOFT Navigator.

For how to use MELSOFT Navigator, refer to the following.

Help for MELSOFT Navigator

**(2) System label update/check for project created by old version of GT Designer3**

When a GT Designer3 project created by GT Designer3 with the version 1.17 or earlier is opened for the first time only, the system label update/check is executed regardless of the setting of the [iQ Works Interaction] tab.

When a GT Designer3 project created by GT Designer3 with the version 1.18U or later is opened, the system label update/check is executed according to the setting of the [iQ Works Interaction] tab.

## 3.6 Creating/Editing Project

### 3.6.1 Creating a new project

When creating a project, the following settings are required. (The setting can be changed after creating the project.)

- Setting of GOT type to be used
- Communication setting
- Screen switching device setting of the base screen

The required setting for creating the new project can be configured accordingly with [New Project Wizard]. Also, a project can be created without using [New Project Wizard].

#### POINT

##### Operating on iQ Works

A new project cannot be created with GT Designer3 when GT Designer3 is started from MELSOFT Navigator.

Create a new project with MELSOFT Navigator.

For MELSOFT Navigator operation, refer to the following.

 [Help for MELSOFT Navigator](#)

#### ■ With [New Project Wizard]

When using [New Project Wizard], select [Display New Project Wizard] in the [Operation] tab of the [Options] dialog box.

(Selected by initial status.)

 [3.5.3 Customizing actions and default value of GT Designer3](#)

1. To display [New Project Wizard], perform either of the following operations.
  - Click the [New] button of the [Project Select] dialog box.
  - Select [Project] → [New] from the menu.



To hide the wizard for the next time a new project is created, clear [Display New Project Wizard].

Click the [Next] button.



2. Select the GOT type to be used and color setting. Click the [Next] button.

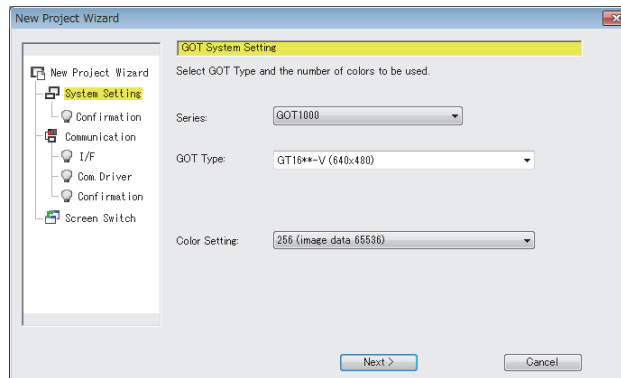

Item	Description	Model
Series	Select the GOT series to be used.	GT16 GT15 GT14 GT12 GT11 GT10 SoftGOT1000
GOT Type	Select the appropriate GOT type to be used.	GT16 GT15 GT14 GT12 GT11 GT10 SoftGOT1000
Setup Direction	Select the setup direction of the GOT. (Horizontal or Vertical)	GT16 GT15 GT14 GT12 GT11 GT10 SoftGOT1000
Resolution	Select the resolution according to GT SoftGOT1000 to be used. (X and Y)	GT16 GT15 GT14 GT12 GT11 GT10 SoftGOT1000
Color Setting	Select the number of colors displayed on the GOT according to the GOT to be used. The number of colors available on GT Designer3 is set to the selected number of colors.	GT16 GT15 GT14 GT12 GT11 GT10 SoftGOT1000

3. Confirm the setting contents selected in the step 2. Click the [Next] button.

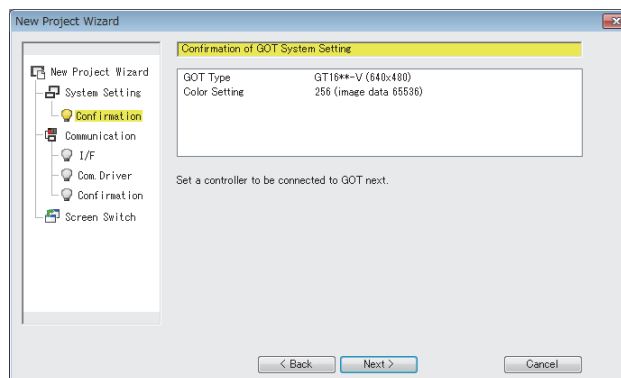



### Changing the GOT type setting

The GOT type setting can be changed with the [GOT Type Setting] dialog box.

☞ 4.1 GOT Type Setting

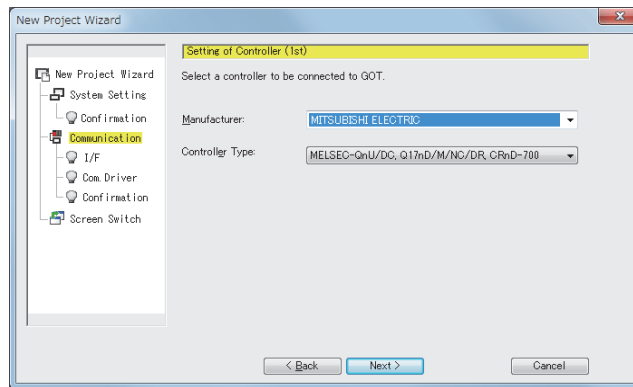
4. Select the controller to be connected to the GOT. Click the [Next] button.



Item	Description	Model
Manufacturer	Select the manufacturer of the controller connected to the GOT.	gr16 gr15 gr14 gr12
Controller Type	Select the controller type connected to the GOT.  GOT1000 Series Connection Manual for GT Works3 and a controller used	gr11 gr10 SoftGOT1000

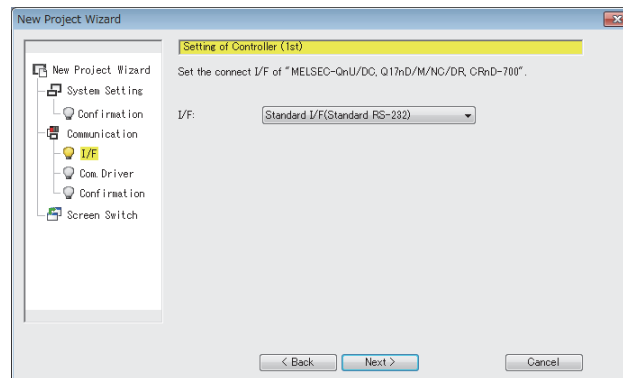

5. Select the interface to connect the controller. Click the [Next] button.

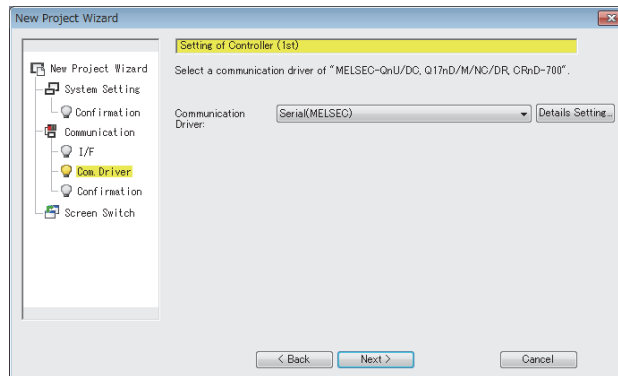

Item	Description	Model
I/F	Select the interface to connect the controller.  GOT1000 Series Connection Manual for GT Works3 and a controller used	gr16 gr15 gr14 gr12 gr11 gr10 SoftGOT1000

6. Select the communication driver to be used. Click the [Next] button.

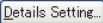
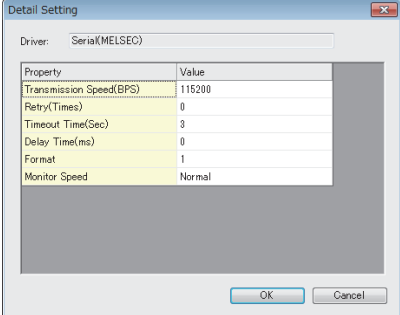

Item	Description	Model
Communication Driver	Select the communication driver to be installed on the GOT.  GOT1000 Series Connection Manual for GT Works3 and a controller used	
	Click this button to display the [Detail Setting] dialog box. The setting items differ depending on the selected communication driver. Example) When selecting [Serial(MELSEC)] for [Communication Driver]. 	

7. For the GT16, GT15, GT14, GT12, the second and later controllers can be set using the multi-channel function. When connecting to more than one controller, click the [Add] button. Click the [Next] button on completion of controller setting.

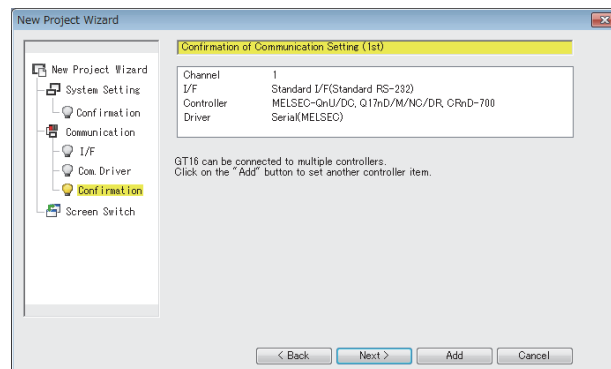

## POINT

### Multi-channel function

The multi-channel function enables one GOT to monitor multiple controllers (multiple channels) by installing multiple drivers on the GOT.

The number of available channels differs according to the GOT.

☞ GOT1000 Series Connection Manual(Mitsubishi Electric Products) for GT Works3

## HINT

### Changing the communication setting

The communication setting can be changed in the [Controller Setting] dialog box.

☞ GOT1000 Series Connection Manual for GT Works3 and a controller used

8. Set screen switching devices for the base screen and required screens. Click the [Next] button. For the screen switching device, refer to the following.

 4.2 Screen Switching Device Setting

For the device setting, refer to the following.

 5.3.1 Device setting

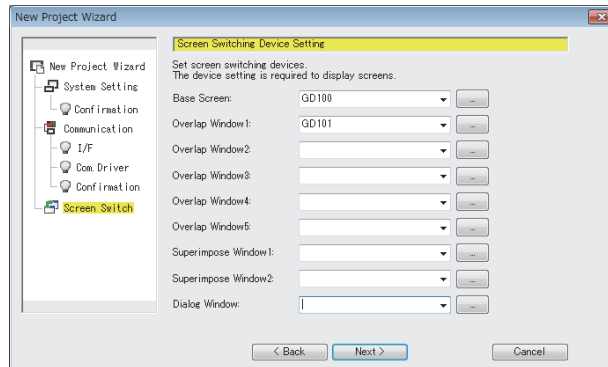

Item	Description	Model
Base Screen	Set the screen switching device for the base screen.	GT16 GT15 GT14 GT12 GT11 GT10 SoftGOT1000
Overlap Window1	Set the screen switching device for the overlap window 1.	
Overlap Window2	Set the screen switching device for the overlap window 2.	
Overlap Window3	Set the screen switching device for the overlap window 3.	
Overlap Window4	Set the screen switching device for the overlap window 4.	GT16 GT15 GT14 GT12 GT11 GT10 SoftGOT1000
Overlap Window5	Set the screen switching device for the overlap window 5.	
Superimpose Window1	Set the screen switching device for the superimpose window 1.	GT16 GT15 GT14 GT12 GT11 GT10 SoftGOT1000
Superimpose Window2	Set the screen switching device for the superimpose window 2.	
Dialog Window	Set the screen switching device for the dialog window.	GT16 GT15 GT14 GT12 GT11 GT10 SoftGOT1000



### Changing the screen switching device

The screen switching device can be changed in the [Environmental Window] dialog box (Screen Switching/Window).

 4.2 Screen Switching Device Setting

- Confirm the contents set with [New Project Wizard]. Click the [Finish] button to complete the setting.

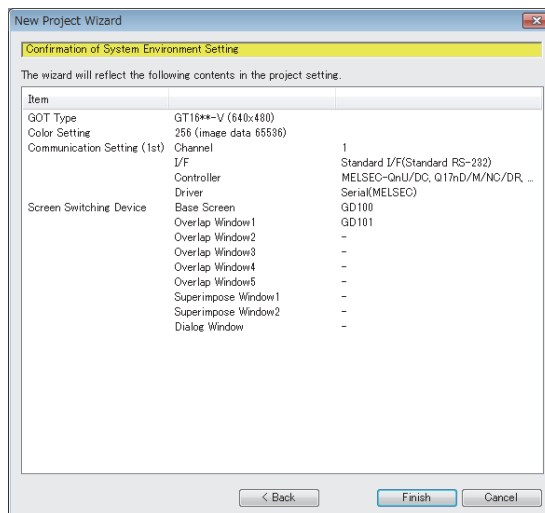

## Without [New Project Wizard]

When creating a project without [New Project Wizard], clear [Display New Project Wizard] in the [Operation] tab of the [Options] dialog box.

☞ 3.5.3 Customizing actions and default value of GT Designer3

To display the [GOT Type Setting] dialog box and [Controller Setting] dialog box in the step 1 and 2, select [Perform type setting at the time of creating a new project] in the [Operation] tab of the [Options] dialog box. (Selected by initial status.)

When [Perform type setting at the time of creating a new project] is cleared, the project is created with the setting of previously created project.

- To display the [GOT Type Setting] dialog box, perform either of the following operations.

- Click the [New] button in the [Select Project] dialog box.
- Select [Project] → [New] from the menu.

For the [GOT Type Setting] dialog box, refer to the following.

☞ 4.1 GOT Type Setting

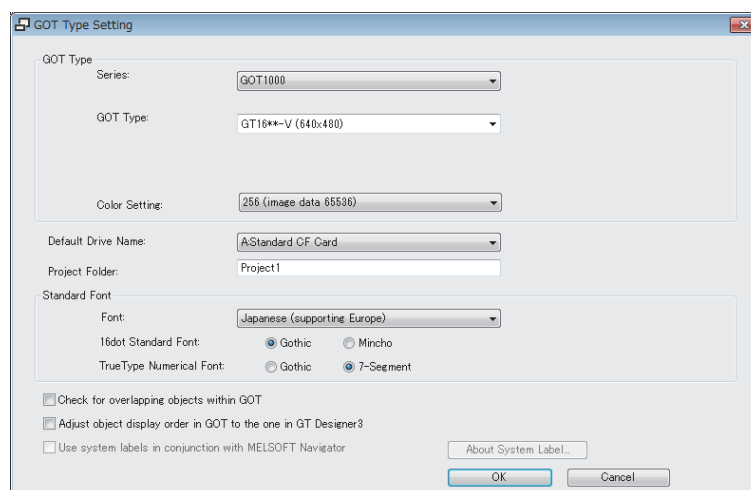

Set the required items, and then click the [OK] button.

2. A project is created and the [Controller Setting] dialog box appears. Select the manufacturer, type, GOT interface, and communication driver for the controller to be connected. For the [Controller Setting] dialog box, refer to the following.

 GOT1000 Series Connection Manual for GT Works3 and a controller used

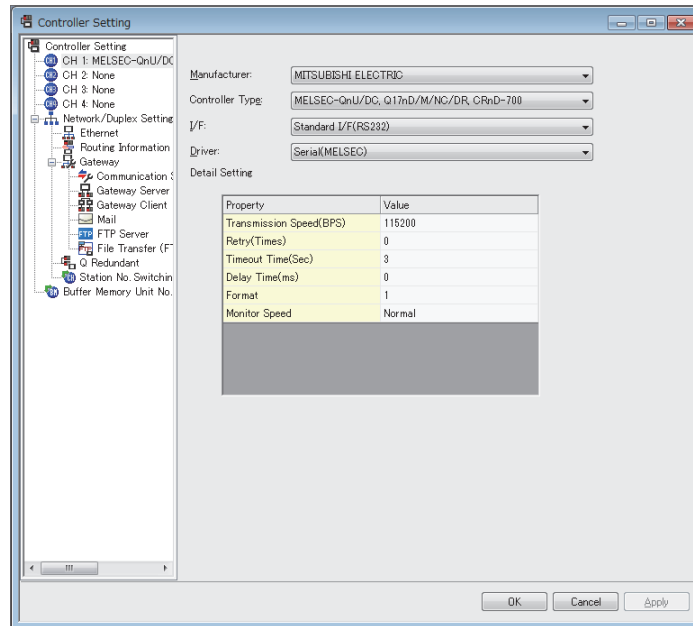

Set the required items, and then click the [OK] button.

3. Select [Common] → [GOT Environmental Setting] → [Screen Switching/Windows] from the menu. The [Environmental Window] dialog box (Screen Switching/Window) appears. For the [Environmental Window] dialog box (Screen Switching/Window), refer to the following.

 4.2 Screen Switching Device Setting

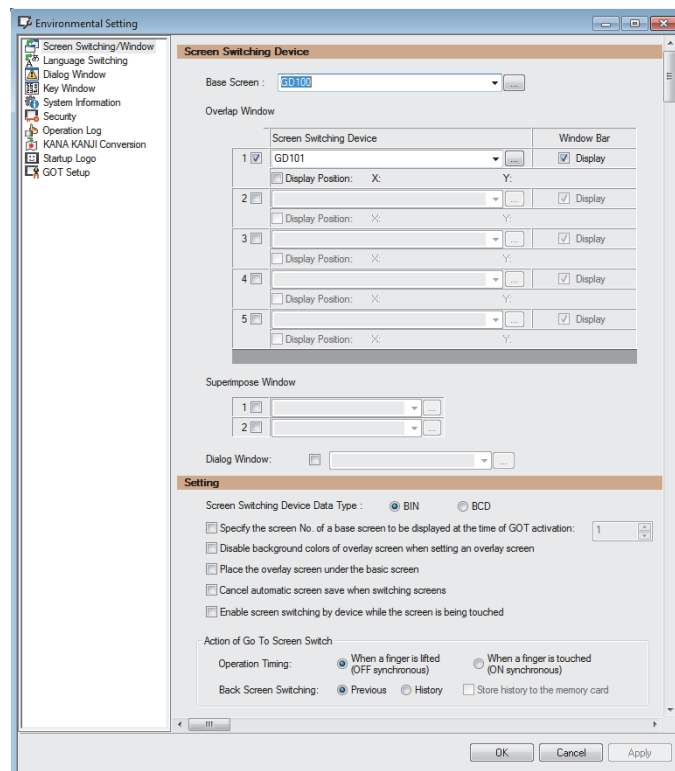

Set screen switching devices for the base screen and required screens. Click the [OK] button.

## 3.6.2 Opening/closing a project

Opening method of project differs depending on the project format.  
For the project format handled with GT Designer3, refer to the following.

### 2.2 Project Format Handled with GT Designer3

Operation	Project format	Reference
Opening a project	GT Designer3 project	■Opening GT Designer3 project
	GTW format (*.GTW), GTE format (*.GTE), GTD format (*.GTD)*1, G1 format (*.G1)	■Opening a single file format project
Closing a project	-	■Closing project

\*1 Change the GOT type for the project to the GOT1000 series in GT Designer2 before opening in GT Designer3.  
The projects created with FX-PCS-DU/WIN and resaved by GT Designer2 cannot be opened.

### POINT

#### (1) When a project is secured

When the project security is set for a project, the user authentication is required.  
For the project security, refer to the following.

#### 3.14 Securing Project

#### (2) Entering the password when opening a G1 format project

To open a G1 format project that satisfies all of the following conditions, enter the data transfer/utility password.

- When the data transfer/utility password is set in the project data
- Before the project data is written in the GOT, the project security has been set for the project data by using GT Designer3 Version 1.43V or later.

For the data transfer/utility password, refer to the following.

#### 4.7 Security Setting

#### (3) Operating on iQ Works

##### (a) Opening a project

A project cannot be opened with GT Designer3 when GT Designer3 is started from MELSOFT Navigator.  
Open a project with MELSOFT Navigator.  
For MELSOFT Navigator operation, refer to the following.

#### Help for MELSOFT Navigator

##### (b) Project format

When GT Designer3 is started from MELSOFT Navigator, the project format that can be handled with GT Designer3 is GT Designer3 project only.  
Other project format data become available by saving it as a GT Designer3 project in the workspace created in MELSOFT Navigator as follows.

1. Open a project with GT Designer3 (not from MELSOFT Navigator).
2. Select [Project] → [Save As] from the menu to save the project in the workspace created in MELSOFT Navigator.



## ■ Opening GT Designer3 project

1. Select [Project] → [Open] from the menu to display the [Open Project] dialog box.
2. Open the project by referring to the following.

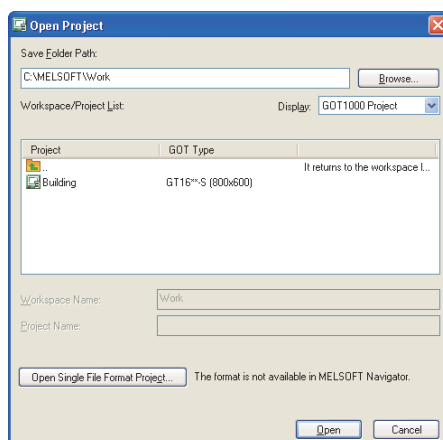

Item	Description
Save Folder Path	Enter the path of the location where the workspace is stored. The save destination path can be set by the [Browse] button also. Up to 200 characters can be entered.
Workspace/Project List	Displays the workspace or project existing in the same path entered for [Folder path to save]. Double-click the workspace to be opened to display projects stored in the workspace.*1 Select the project to be opened.
Display	All Folders Displays all the files and folders in a folder. Select this item when a workspace or GT Designer3 project to be opened is not displayed in the workspace or project list because a workspace management file or project management file is deleted.
	GOT2000 Project Displays the files and folders of the GOT2000 series. Select this item when opening a project file of the GOT2000 series.
	GOT1000 Project Displays the files and folders of the GOT1000 series. Select this item when opening a project file of the GOT1000 series.
Workspace Name	Displays the workspace name where the project selected in [Workspace/Project List] is stored.
Project Name	Displays the project name selected in [Workspace/Project List].
Open a Single File Format Project...	Click this button to open a GTW format (*.GTW), GTE format (*.GTE), GTD format (*.GTD), or G1 format (*.G1) project. After clicking this button, the [Open Project] (single file format) dialog box appears. Open the project by referring to the following. ■ Opening a single file format project

\*1 The following workspace or project is not displayed in the workspace or project list.

- Workspace or GT Designer3 project that does not include the workspace management file or project management file
  - Workspace or GT Designer3 project that is not registered in the workspace management file or project management file
- For the file composition of GT Designer3, refer to the following.

2. ■ Configuration of GT Designer3 project file

3. Click the [Open] button to open the selected GT Designer3 project.

## POINT

**(1) Maximum number of text for [Save Folder Path], [Workspace Name], and [Project Name]**

Set the total number of text for [Folder path to save], [Workspace Name], and [Project Name] at 200 characters or less. ("\" placed at the end of the project name is not included.)

**(2) Reading G1 format project data for which a system label is set**

A system label cannot be used if the data of workspace where a G1 format project is created does not exist. When using a system label, resave the project in the workspace as follows.

1. Read G1 format project data for which a system label is set, and then the following dialog box appears. Click the [Yes] button.

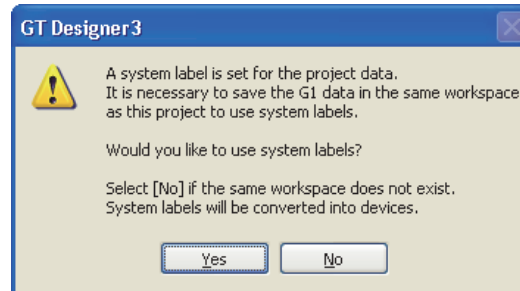



2. Select [Project] → [Save As] from the menu to save the project in the workspace where the G1 format project is created. The system label can be used properly again.

## ■ Opening a single file format project

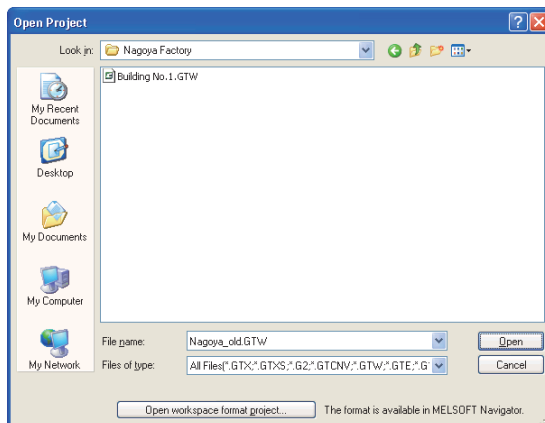
1. Select [Project] → [Open] from the menu to display the [Open Project] dialog box.
2. Click the [Open a Single File Format Project] button.  
The following dialog box appears.

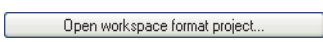

Item	Description
Look in	Enter the path of the location to store a single file format project (*.GTW).
File name	Enter the name of a single file format project (*.GTW).
Files of type	The file format is displayed.(A single file format project)
	Click this button to open a GT Designer3 project. After clicking this button, the [Open Project] dialog box appears.  ■ Opening GT Designer3 project

3. Select a project to be opened. Click the [Open] button to open the selected project.

## ■ Closing project

Select [Project] → [Close] from the menu to close a project.



When GT Designer3 is started from MELSOFT Navigator, [Close] cannot be selected from the menu.  
Click the [×] button to close the window.

### 3.6.3 Setting the project title

The title, ID, and others can be set for a project.

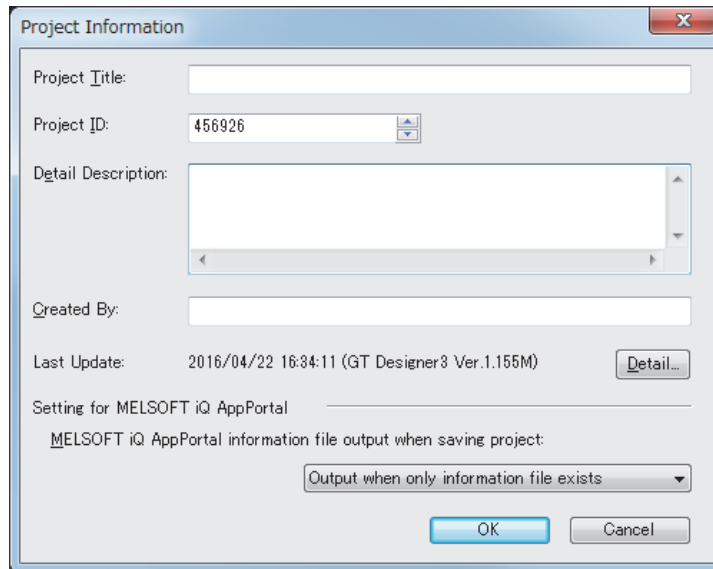
1. Select [Project] → [Project Information] from the menu to display the [Project Information] dialog box.
2. Set the required items and click the [OK] button. The set contents are reflected in the project.

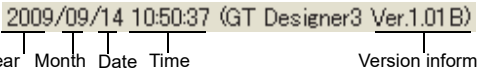

Item	Description
Project Title	Set the project title as necessary. Up to 32 characters can be entered.
Project ID <sup>*1</sup>	The project ID is automatically set when creating the project. The project ID can be changed within the range from 1 to 4294967295.
Detail Description	Enter the explanation for the screen as necessary. Up to 512 characters can be entered. (A line feed is counted as two characters.)
Created By	Set the author name as necessary. Up to 8 characters can be entered.
Last Update	Displays the latest date and time of the project saved and the software version.  Click the [Detail] button to display the [Edit Version History] dialog box.  3.6.3 (1) Edit Version History dialog box
MELSOFT iQ AppPortal information file output when saving project	Select the setting to output a MELSOFT iQ AppPortal information file when the project is saved. The following shows the items to be selected. <ul style="list-style-type: none"> <li>• [Always output] Outputs a MELSOFT iQ AppPortal information file each time the project is saved.</li> <li>• [Output when only information file exists] Overwrites an existing MELSOFT iQ AppPortal information file when the project is saved.</li> <li>• [Not to output (delete information file)] Does not output a MELSOFT iQ AppPortal information file when the project is saved. Deletes an existing MELSOFT iQ AppPortal information file.</li> </ul> For the details of MELSOFT iQ AppPortal, refer to the following.  iQ AppPortal Operating Manual

\*1 When a part of the screen in the project is written to the GOT, the Project ID is verified with the one registered in the GOT. If it results in the ID mismatch, a message appears to urge the user to take caution. (The project data can be written.) It is recommended to register different project IDs for each machine, as this allows the caution message to appear when a part of the project data with an incorrect ID is written by mistake.

#### (1) Edit Version History dialog box

The edit history of project is displayed.

To delete the edit history, click the [Delete Edit History] button.

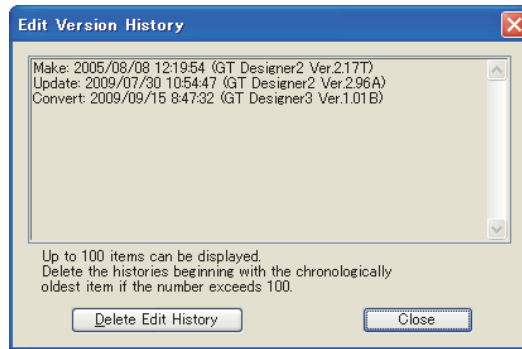

# 3.7 Creating/Opening/Closing Screen

## 3.7.1 Creating a new screen

Creating method differs depending on a screen.

### ■ Creating the base window and window screen

1. Select [Screen] → [New] → [Base Screen] or [Window Screen] from the menu to display the [Screen Property] dialog box.



#### (1) Operating by the screen tree

The [Screen Property] dialog box appears also by double-clicking [New] of [Base Screen] or [Window Screen] in the screen tree.

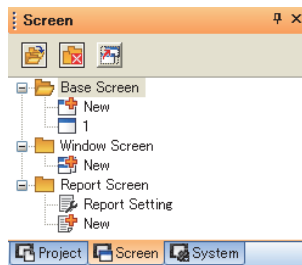

#### (2) Access authority of a project when the project security is set

When the project security for a project disables editing the project, a new screen cannot be created.

3.14 Securing Project





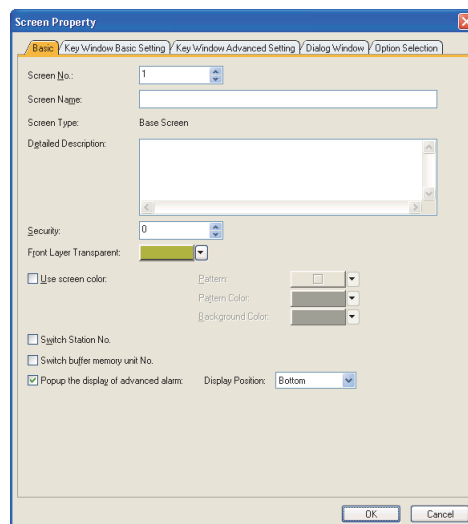





2. Set the required items. Click the [OK] button to create a new screen.

#### (1) Basic tab





Item	Description	Model
Screen No.	Set the screen number.	
Screen Name	Set the screen title. Up to 32 characters can be entered.	gr16 gr15 gr14 gr12 gr11 gr10 softcor1000
Screen Type	Displays the screen type to be created.	

(Continued to next page)

Item	Description	Model	
Detail Description	Enter the explanation for the screen as necessary. Up to 512 characters can be entered. (A line feed is counted as two characters.)		
Security	Set the security level of the screen. (0 to 15) When the security function is not used, set to "0". For details of the security function, refer to the following.  4.7 Security Setting	GT16 GT15 GT14 GT12 GT11 GT10 SoftGOT1000	
Front Layer Transparent	The front layer transparent can be set only for the base screen. Select the color to be transparent among all colors assigned to the objects placed on the front layer. The back layer can be seen through the parts specified as transparent. For the transparent color, refer to the following.  5.3.7 Superimposition setting	GT16 GT15 GT14 GT12 GT11 GT10 SoftGOT1000	
Use screen color	Select this item to enable the setting for [Pattern], [Pattern Color], and [Background Color].	GT16 GT15 GT14 GT12 GT11 GT10 SoftGOT1000	
	Pattern		Select the pattern, pattern color, and background color for the screen. The pattern is displayed over the background.
	Background Color		(Example) Background color:  Pattern + pattern color  →  Pattern  Pattern color  Background color 
Switch Station No.	Select this item to switch station numbers by each screen.	GT16 GT15 GT14 GT12 GT11 GT10 SoftGOT1000	
Switch buffer memory unit No.	Select this item to switch buffer memory unit numbers by each screen.	GT16 GT15 GT14 GT12 GT11 GT10 SoftGOT1000	
Specify the touch area	Select this item to set the touch area and a figure separately. Not supported by GT1020.	GT16 GT15 GT14 GT12 GT11 GT10 SoftGOT1000	
Popup the display of advanced alarm	Set this item on the base screen only. Select this item to enable the advanced alarm popup display.	GT16 GT15 GT14 GT12 GT11 GT10 SoftGOT1000	
	Display Position		Select the position to display the advanced alarm popup display on the screen.(Top/Center/Bottom)
Display key window objects when using this screen as an overlap window	Set this item on the window screen only. Select this item to display the key window object on the overlap window.  4.5 ■Display of the input value area, the input range area, and the previous value area on the screens other than the key window	GT16 GT15 GT14 GT12 GT11 GT10 SoftGOT1000	
Display alarm flow	Select this item to enable the alarm flow.	GT16 GT15 GT14 GT12 GT11 GT10 SoftGOT1000	
	Display Position		Select the position to display the alarm flow on the screen.(Top/Center/Bottom)
Backlight	Select the backlight color.	GT16 GT15 GT14 GT12 GT11 GT10 SoftGOT1000	
Blink Backlight	Select whether to blink the backlight or not.	GT16 GT15 GT14 GT12 GT11 GT10 SoftGOT1000	
	Set this item on the window screen only. Click this button to display the [Change window Screen Size] dialog box.  (a) Change Window Screen Size dialog box	GT16 GT15 GT14 GT12 GT11 GT10 SoftGOT1000	

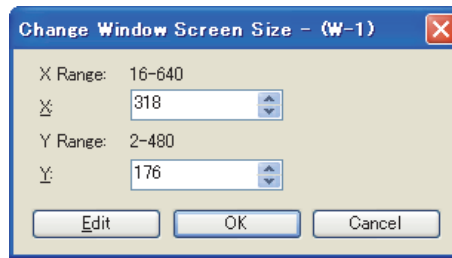
(a) Change Window Screen Size dialog box



Item	Description	Model
X	Horizontal window screen size is set.	
Y	Vertical window screen size is set.	
	<p>This button is displayed only when editing the window screen that has been already created.                      (Not displayed when creating a new window screen.)                      Click this button to display the handle on the screen editor.                      Drag the handle to change the window screen size.                      When the screen becomes appropriate size, move the cursor off the handle and click to determine the window screen size.</p>	

**(2) Key Window Basic Setting tab**

For the [Key Window Basic Setting] tab, refer to the following.

 4.5 Key Window Setting

**(3) Key Window Advanced Setting tab**

For the [Key Window Advanced Setting] tab, refer to the following.

 4.5 Key Window Setting

**(4) Dialog Window tab**

For the [Dialog Window] tab, refer to the following.

 4.4 Setting Message to be Displayed on GOT

**(5) Option Selection tab**

For the [Option Selection] tab, refer to the following.

 (Functions) 6. ASCII DISPLAY/ASCII INPUT

**■ Creating the window screen (Dialog Window)**

For creating the window screen (dialog window), refer to the following.

 4.4 Setting Message to be Displayed on GOT

**■ Creating the report screen**

For creating the report screen, refer to the following.

 (Functions) 39. REPORT FUNCTION



## 3.7.2 Opening/closing a screen

### ■ Opening a screen

#### POINT

##### Maximum number of screens that can be opened

Up to 25 screen editors can be opened.

The maximum number can be changed in the [Operation] tab of the [Options] dialog box.

 3.5.3 Customizing actions and default value of GT Designer3

#### (1) Opening by the screen tree

1. Double-click the screen to be opened in the screen tree.

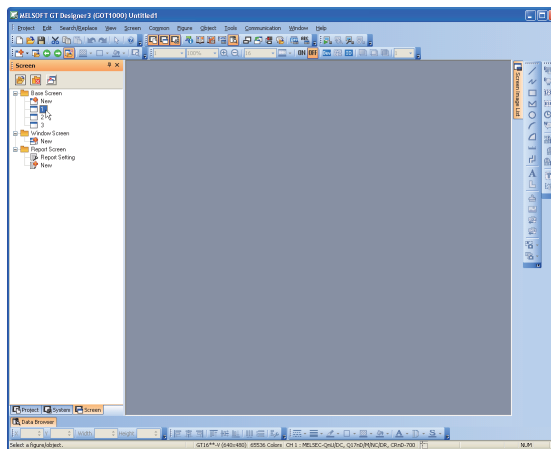

2. The double-clicked screen is opened.

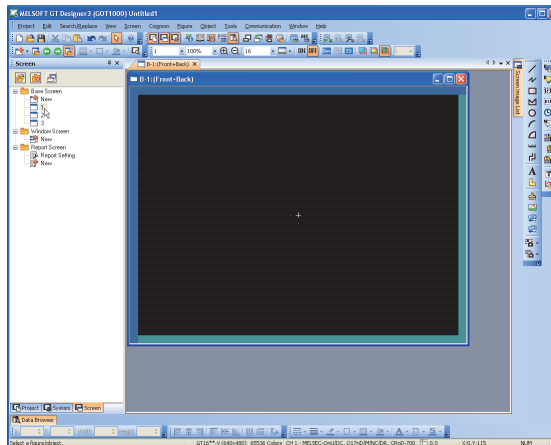

## HINT

### (1) Opening multiple screens at a time

Select multiple screens to be opened by either of the following method. Select [Open] from the menu displayed by right-click, and then the selected screens are opened.

- Select screens with holding down the [Shift] key.
- Select screens with holding down the [Ctrl] key.

### (2) Access authority of a project when the project security is set

When the project security for each screen is set, displaying or editing the screen is disabled according to the access authority set for each screen.

 3.14 Securing Project

## (2) Opening from the menu

1. Select [Screen] → [Open] from the menu to display the [Open Screen] dialog box.  
(Double-clicking the screen to be opened in the [Open Screen] dialog box also opens a screen.)

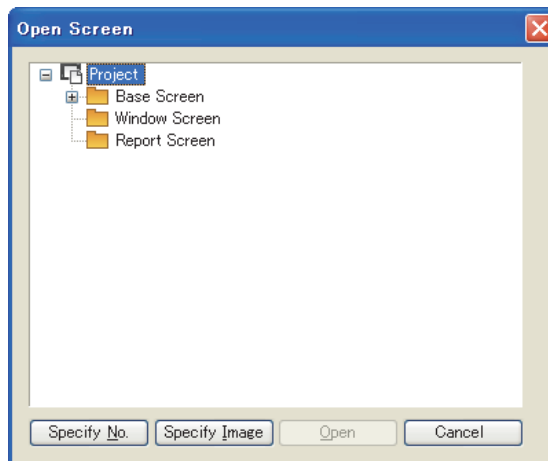

2. Perform either of the following operations.
  - Click the [Specify] button.  
The [Specify] dialog box appears.  
Set [Screen Type] and [Screen No.]. Click the [Open] button to open the set screen.

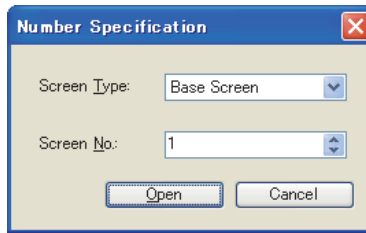

- Click the [Specify Image] button.  
The [Screen Image List] dialog box appears.  
Select [Screen Type] and the screen image to be opened. Click the [OK] button to open the selected screen.

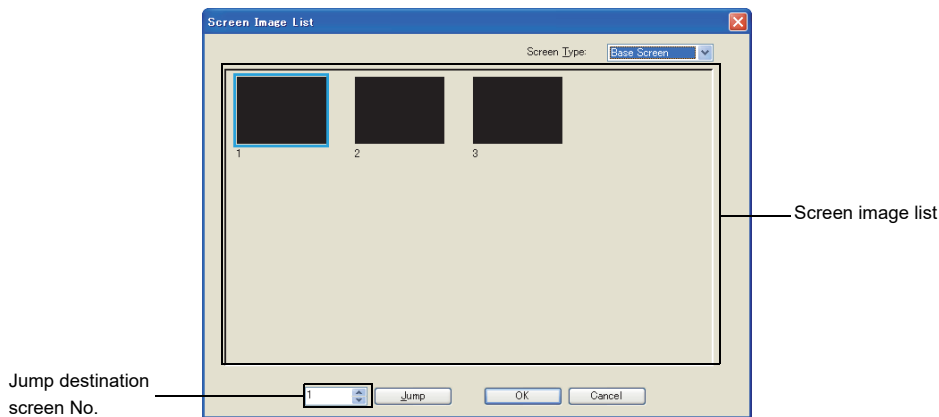



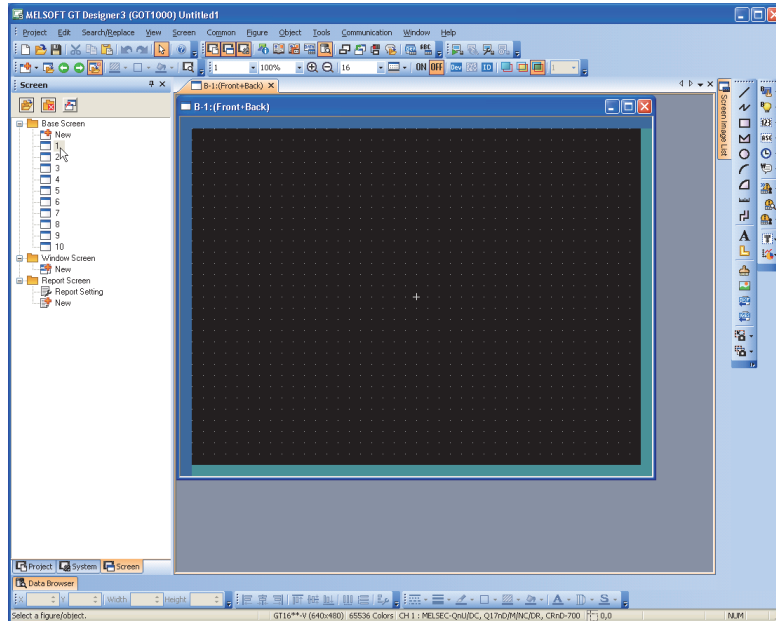

Item	Description	Model
Screen Type	Select the screen type to be displayed in the screen image list.	
Screen image list	Screen images of the screen type selected for [Screen Type] are displayed. (Double-clicking the screen image also opens a screen.)	
Jump destination screen No.	Set a screen No. where the screen jumps to. Click the [Jump] button, and then the screen set for the jump destination screen No. is selected.	

### (3) Opening same type of screen (base screen/window screen) consecutively

1. Open a screen to be opened continuously.



2. Enable  in the screen toolbar (.

3. Click  /  in the screen toolbar to open the previous or next screen of opened screen one by one.

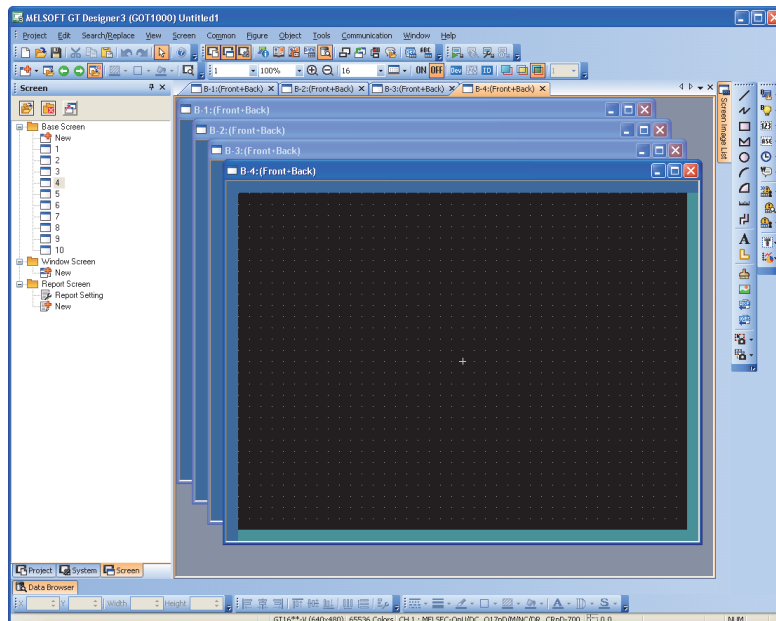

### ■ Closing a screen

#### (1) Closing a screen

Perform either of the following operations to close a screen being edited.

- Select [Screen] → [Close] from the menu.
- Click  in the title bar of each screen.

#### (2) Closing all screens

Select [Screen] → [Close All] from the menu to close all screens.

## 3.8 Basic Operation of Drawing Screen

### 3.8.1 Relation of the screen editor and the screen displayed on the GOT

The screen editor of base screen and window screen includes the following areas.

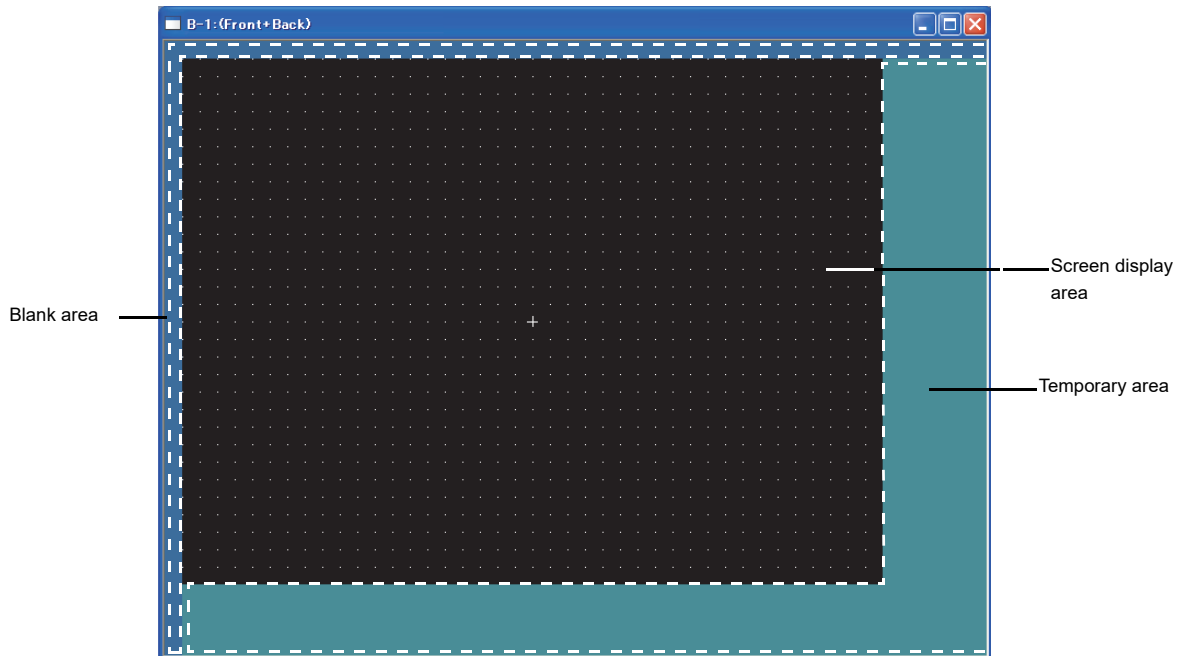

Area	Description
Screen display area	Area displayed on the GOT. Figures and objects to be displayed on the GOT can be arranged.
Blank area	Area not displayed on the GOT. Figures and objects cannot be arranged.
Temporary area	Area not displayed on the GOT. Figures and objects can be arranged temporarily. Figures and objects arranged in the temporary area are included in the data size of the base screen. Before writing the project data to the GOT, delete the figures and objects arranged in the temporary area.

For arranging and setting figures and objects, refer to the following.

 5. EDITING AND SETTING FIGURES AND OBJECTS



#### Access authority of a project when the project security is set

When the project security for each screen is set, displaying or editing the screen is disabled according to the access authority set for each screen.

 3.14 Securing Project

## ■ Figures or objects placed on the area boundary

When placed on a boundary between the screen display area and temporary area, figures and objects are displayed as described below.

### (1) Displaying figures

Only figures and a part of figures arranged in the screen display area can be displayed.

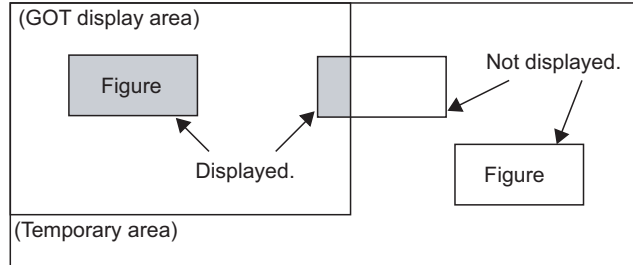

### (2) Displaying paints

When paint marks (" x " shown below) are placed in the screen display area, the marked figures are painted.

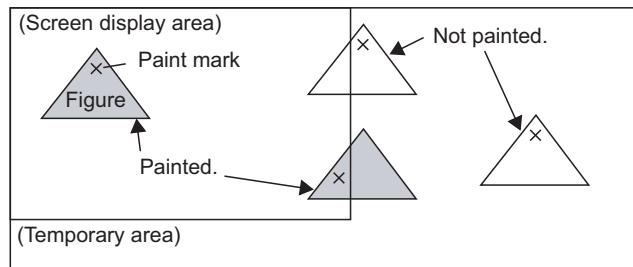

### (3) Displaying objects

The object is displayed on the GOT if its entire object frame is inside the screen display area (1), 2)).

The object is not displayed on the GOT if any part of its object frame is outside the screen display area (3), 4), 5), 6)).

The conditions for displaying historical trend graphs are different from those for displaying other graphs.

If the scale of historical trend graphs is out of the screen display area, the entire graph cannot be displayed on the GOT.

(Other graphs can be displayed because the scale of other graphs is not included in the object frame.)

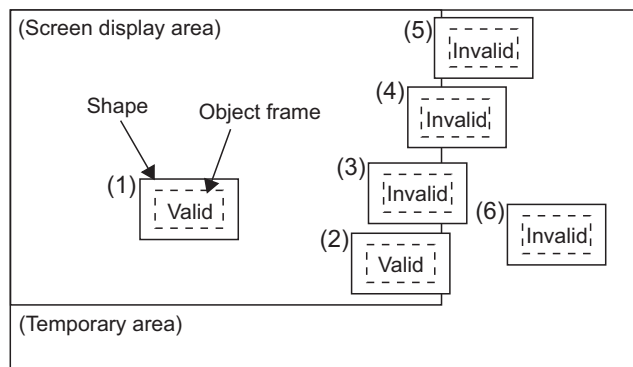

**(4) Using the superimpose window**

If a character (nameplate) or shape arranged in the window screen protrudes to the temporary area, the protruding part is left on the base screen after the superimpose window is displayed then hidden. (Switching the base screen erases the remaining character (nameplate) or shape.)

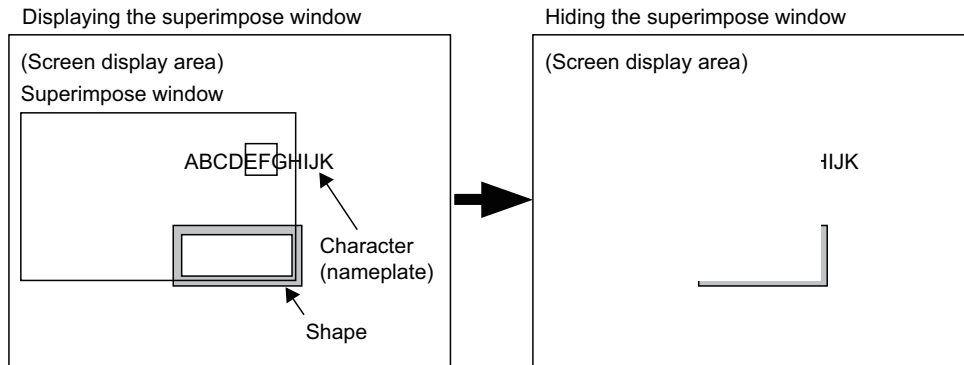

When arranging the object, display the object and shape with GT Designer 3 to check for protrusion in the temporary area.

Use the data check function of GT Designer 3 to check.

When performing the above check, select the longest comment among those, which are displayed as a character string (nameplate), in the preview number.

### 3.8.2 Layer display switching operation

This section explains how to switch the layer of the drawing screen. Normally select [Front + Back] for drawing. For overlapping figures and objects using the layer, refer to the following.

 5.3.7 Superimposition setting

1. Select the screen editor of which the layer display is switched.
2. Select [View] → [Layer] → [All Screens], [Front], [Back], or [Front + Back] from the menu to switch the displayed layers.

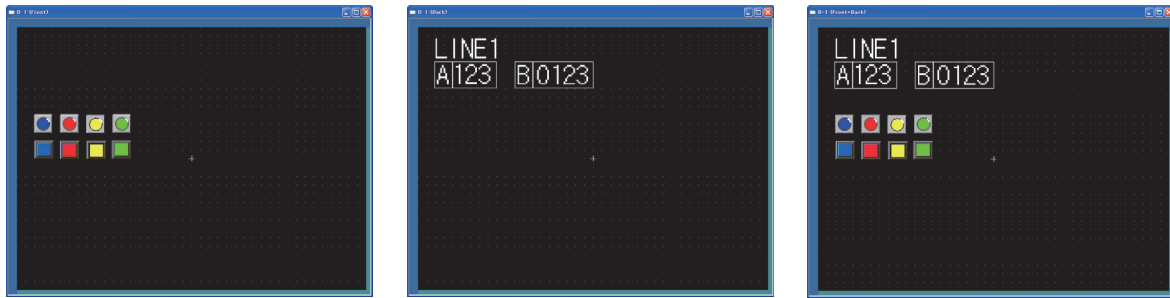

Front

Back

Front + Back

Item	Description
All Screens	Select whether to set the layer setting for each screen or common to all screens. Select this item to reflect the layer setting on all screens.
Front	Displays the front layer.
Back	Displays the back layer.
Front + Back	Displays the front layer and back layer overlapped.

### 3.8.3 Redisplaying the screen editor

In some cases, use of Paint may cause some area to remain unpainted. The screen can be displayed correctly by redisplaying the screen editor.

1. Select the screen editor to be redisplayed.
2. Select [View] → [Redisplay] from the menu to redisplay the contents of the selected screen editor.

Example) When the object placed on the figure marked with Paint is moved

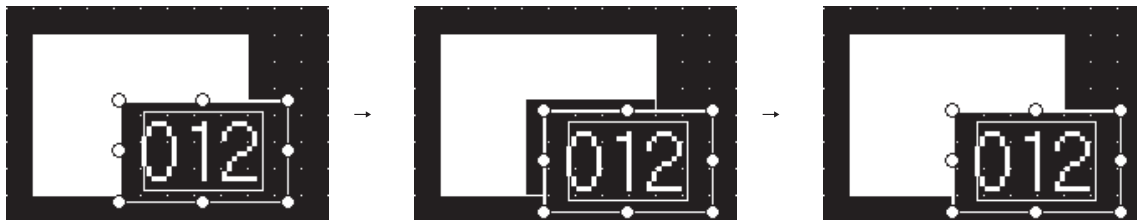

The object Placed on the figure marked with Paint is moved.

Some area remains unpainted in the figure.

Select [View] → [Redisplay] from the menu to redisplay.



### 3.8.4 Selecting the screen editor to be edited

Selecting the screen editor to be edited is available by clicking any part of the screen editor. The selected screen editor is brought to the top front. When multiple screens are opened, the following method is useful.

#### ■ Selecting with the editor tab

1. Perform either of the following operations.
  - In the editor tab, select the tab of the screen editor to be edited.
  - Click ▾ of the screen editor, and then select the screen editor to be edited from the dropdown menu.
2. The selected screen editor is brought to the top front.

#### ■ Selecting with the Window Selection dialog box

1. Select [Window] → [Select Windows] from the menu to display the [Window Selection] dialog box.

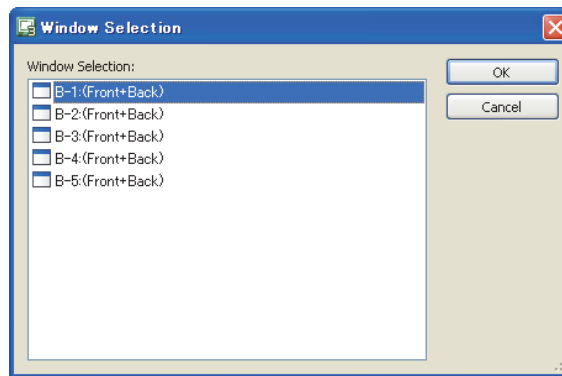

2. Select the screen editor to be edited. Click the [OK] button to display the screen editor in top front.



#### Record of the screen editor

Up to nine screen editors currently opened are displayed in the dropdown menu by selecting [Window] from the menu.

Also, the screen editor can be selected in the dropdown menu by selecting [Window] from the menu.

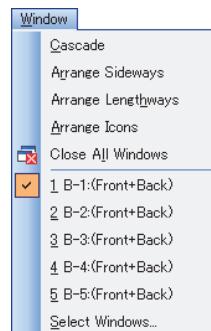

### 3.8.5 Displaying opened screen editors overlapped/aligned

---

The following shows how to align the screen editors when multiple screen editors are opened.

1. Select [Window] → [Cascade], [Arrange Sideways], or [Arrange Lengthways] from the menu.
2. The opened screen editors are aligned.

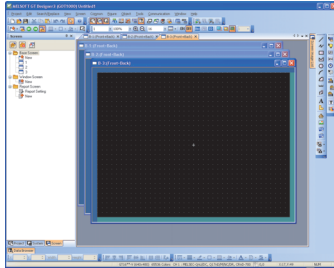

Cascade

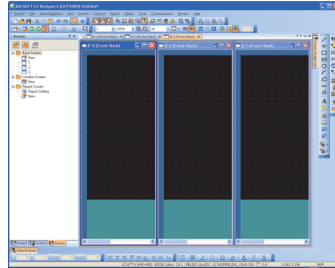

Arrange Sideways

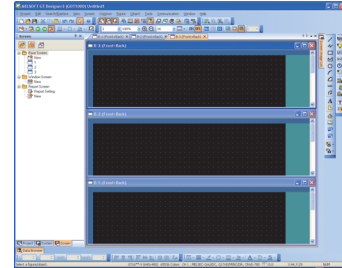

Arrange Lengthways

## 3.9 Changing Screen Property

The screen number, screen title, and others can be changed.

Select the screen editor to change its setting. Select the [Screen] → [Screen Property] from the menu to display the [Screen Property] dialog box.

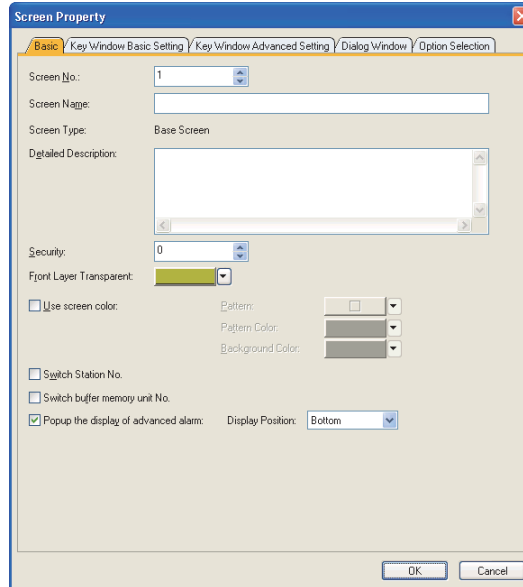

### (1) Basic tab

For the [Basic] tab, refer to the following.

 3.7.1 Creating a new screen

### (2) Key Window Basic Setting tab

For the [Key Window Basic Setting] tab, refer to the following.

 4.5 Key Window Setting

### (3) Key Window Advanced Setting tab

For the [Key Window Advanced Setting] tab, refer to the following.

 4.5 Key Window Setting

### (4) Dialog Window tab

For the [Dialog Window] tab, refer to the following.

 4.4 Setting Message to be Displayed on GOT

### (5) Option Selection tab

For the [Option Selection] tab, refer to the following.

 GT Designer3 Version1 Screen Design Manual(Functions)



### (1) Screen property changing of the report screen

For screen property changing of the report screen, refer to the following.

 GT Designer3 Version1 Screen Design Manual(Functions)

### (2) Access authority of a project when the project security is set

When the project security for each screen is set, displaying or editing the screen is disabled according to the access authority set for each screen.

 3.14 Securing Project

## 3.10 Displaying Frame on Screen Editor

This function displays an outer frame, which looks like the GOT frame, on the screen editor of the base screen. With this function, a screen can be created as if it is displayed on the GOT.

Select [View] → [Display Items] → [Frame] from the menu to display the frame.

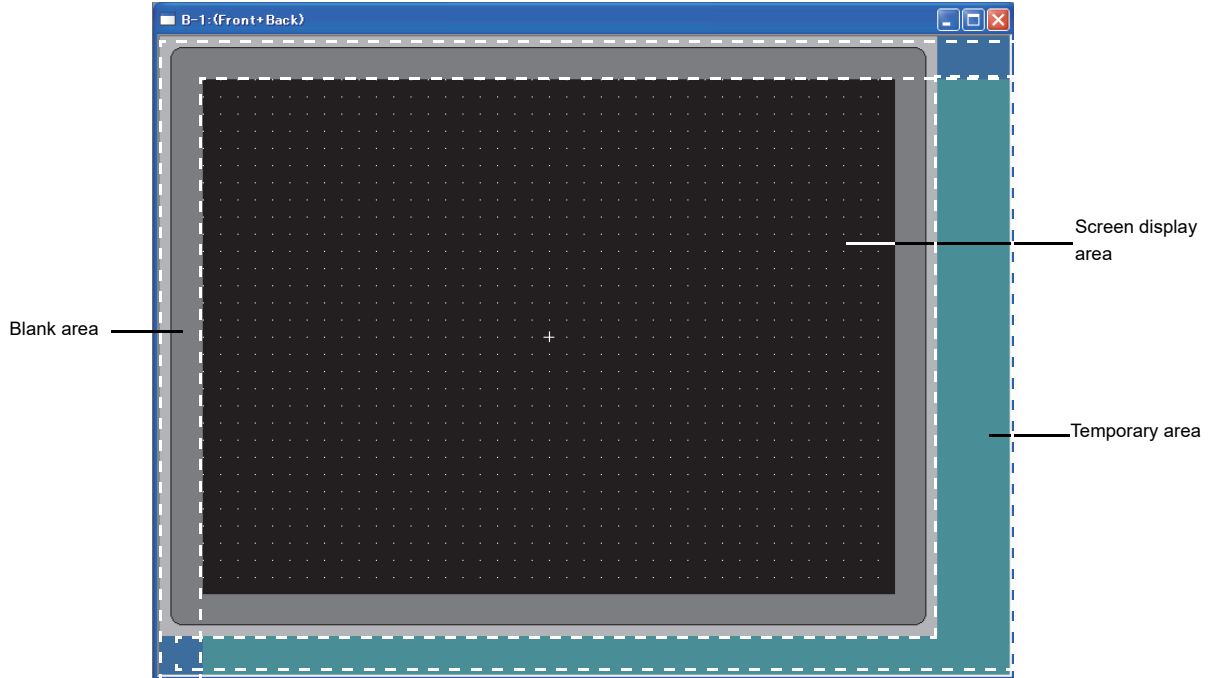

Area	Description
Screen display area	Area displayed on the GOT. Figures and objects to be displayed on the GOT can be arranged.
Blank area	Area not displayed on the GOT. Figures and objects cannot be arranged.
Temporary area	Area not displayed on the GOT. Figures and objects can be arranged temporarily. Figures and objects arranged in the temporary area are included in the data size of the base screen. Before writing the project data to the GOT, delete the figures and objects arranged in the temporary area.

# 3.11 Viewing Created Screen Image

Created screen image displayed on the GOT can be checked.

## 3.11.1 Displaying a preview

Check the operations of figures, objects, window screens, and others in the preview window. For how to operate figures, objects, and window screens in the preview window, refer to the description bar. The operations relevant to device values cannot be checked.

### ■ Displaying the preview window

Select [View] → [Preview] from the menu to display the preview window.

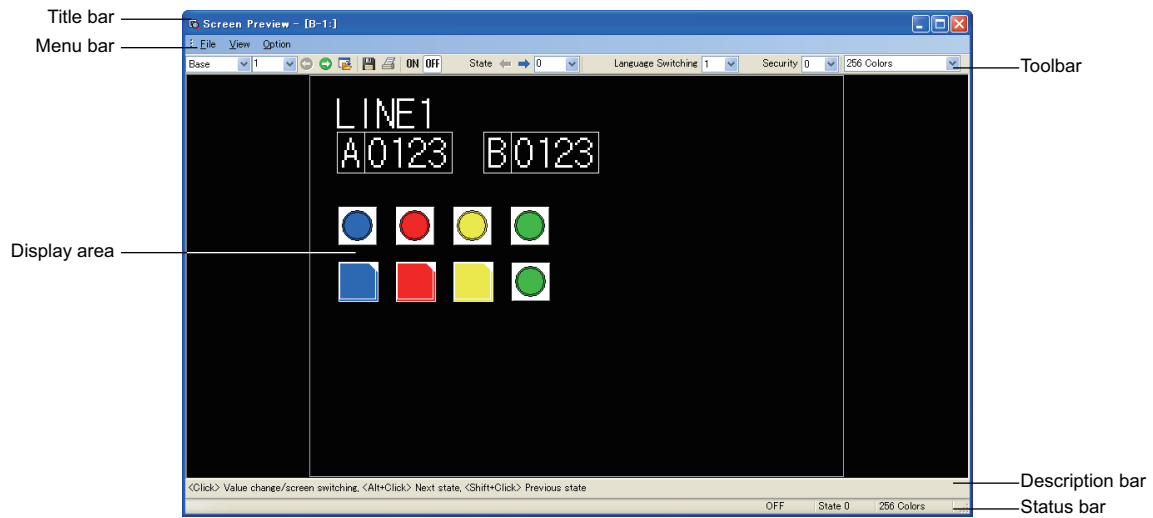

### POINT

- (1) Changing the preview values of the numerical display, numerical input, ASCII display, and ASCII input**  
Change the preview values of the placed numerical display, numerical input, ASCII display and ASCII input in the preview window.  
To change the preview values, refer to the following procedure.
  1. Click the numerical display, numerical input, ASCII display, or ASCII input.
  2. The [Preview Value] dialog box appears, and then change the value of [Preview Value].

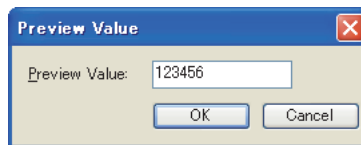

When the preview value is changed, the display changes according to the conditions set with the numerical display, numerical input, ASCII display, or ASCII input. The new preview values in the preview window are not reflected in the screen editor.

**(2) Screen number specification for screen switching**

When [Back (Previous/History)] or [Device] is selected for [Next Screen] of a go to screen switch, specifying the screen displayed after screen switching is available in the preview window.

To specify the screen, refer to the following procedure.

1. Click the go to screen switch.
2. The screen number specification dialog box appears, and then specify the screen number with [Screen No.].

Example) When clicking the go to screen switch placed on the base screen

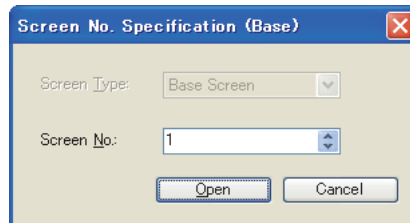

**(3) Selecting figures and objects in the background**

Click the part where figures or objects are overlapped while pressing the [Ctrl] key.

As with the screen editor, the selected figure shifts by each click.

 5.2.1 Selecting figure and object

**(4) Operation with the right-click**

Right-clicking a figure or an object in the preview window displays the menu. With the menu, the display of the figure or the object and the preview value of the object can be changed.

---

## ■ Operating method of the preview window

### (1) Menu bar

#### (a) File

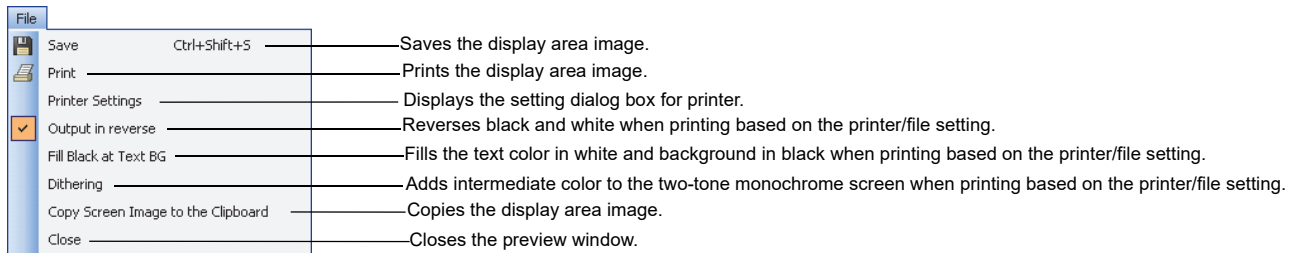

#### (b) View

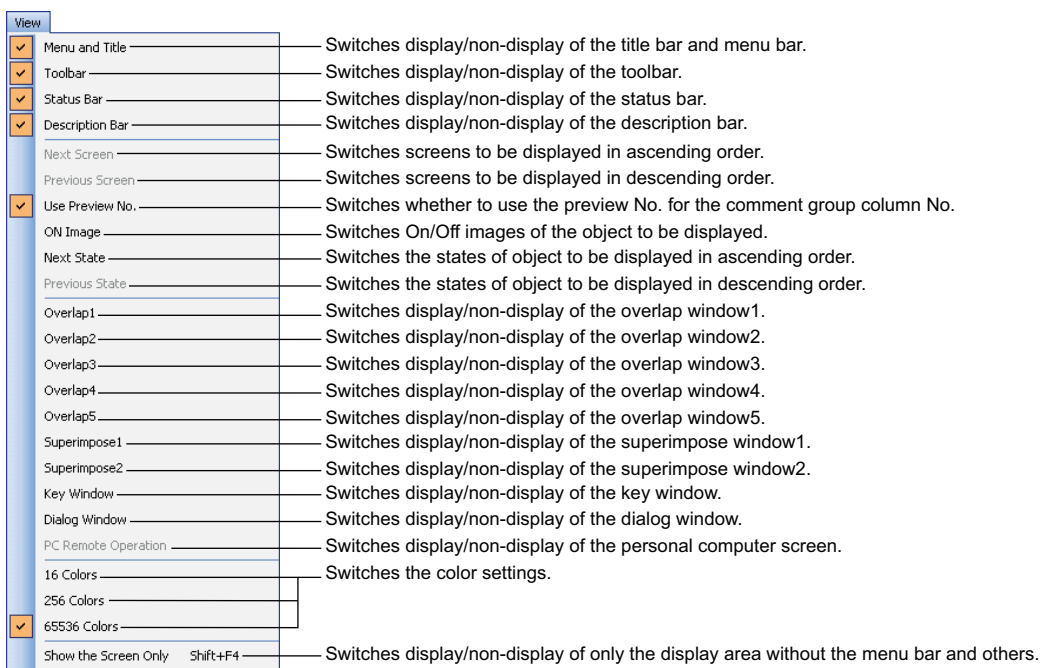

#### (c) Option

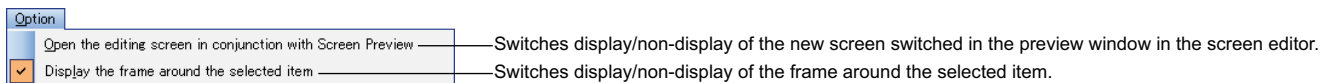

## (2) Toolbar



Icon	Description
	Select the screen type and screen No. to be displayed.
	Switches the screens to be displayed.
	Displays the new screen switched in the preview window in the screen editor.
	Saves the screen displayed in the display area as BMP file. Click this item to display the [Save As] dialog box.
	Prints the screen displayed in the display area. Click this item to display the [Print] dialog box.
	Switches between on and off image of objects or figures to be displayed in the display area.
	Switches or select the states of objects or figures to be displayed in the display area.
	Select the column No. of the comment group to be displayed in the display area.
	Select the security level of objects to be displayed in the display area.
	Select the color setting to be displayed in the display area.

### ■ Precautions for preview

#### (1) Objects not displayed on the preview window

The preview window does not display the parts display if the parts type is set to the base screen or window screen.

The GOT displays the set base screen or window screen.

The preview window does not display the lamp area and the parts movement regardless of the setting.

#### (2) Objects displayed only on the preview window

The items displayed on the preview window (including display/non-display of object, object ID, or device) can be changed in the [View] tab of the [Options] dialog box.

The object ID and device displayed on the preview window are not displayed on the GOT.





### 3.11.2 Displaying the window screen preview in the screen editor of the base screen

When the window position is placed in the screen editor of the base screen, the window screen preview can be displayed.

The position of the window screen can be adjusted easily.

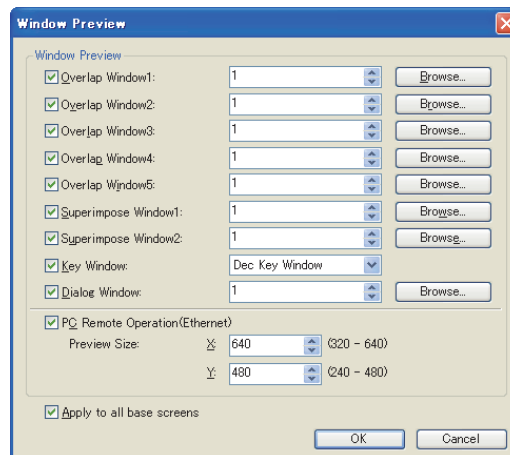
1. Select [View] → [Window Preview] → [Custome] from the menu to display the [Window Preview] dialog box.
2. Set the window screens to be displayed, and then click the [OK] button.



Item	Description	
Window Preview	Set the window screen to be displayed on the screen editor of the base screen. Select the windows to display the preview. Set the screen No. of window screen for previewing as each window. Setting with the [Screen Image List] dialog box by clicking the [Browse] button is also available.	
	Overlap Window1	After selecting, set the screen No. of the window screen to display the preview as overlap window1.
	Overlap Window2	After selecting, set the screen No. of the window screen to display the preview as overlap window2.
	Overlap Window3	After selecting, set the screen No. of the window screen to display the preview as overlap window3.
	Overlap Window4	After selecting, set the screen No. of the window screen to display the preview as overlap window4.
	Overlap Window5	After selecting, set the screen No. of the window screen to display the preview as overlap window5.
	Superimpose Window1	After selecting, set the screen No. of the window screen to display the preview as superimpose window1.
	Superimpose Window2	After selecting, set the screen No. of the window screen to display the preview as superimpose window2.
	Key Window	After selecting, select the standard key window to display the preview.
	Dialog Window	After selecting, set the screen No. of the window screen to display the preview as dialog window.
PC Remote Operation(Ethernet)	Set the preview display size of a personal computer screen on the GOT operated by the remote personal computer operation function. For details of the remote personal computer operation (Ethernet), refer to the following.  (Functions) 33.2 Remote Personal Computer Operation (Ethernet)	
	Preview Size	Set the horizontal and vertical size of the preview display for a personal computer screen on the GOT.
Apply to all base screens	Select this item to apply the setting of [Window Preview] to all base screens.	

3. The window screen preview is displayed in the position where the window position is placed in the screen editor.

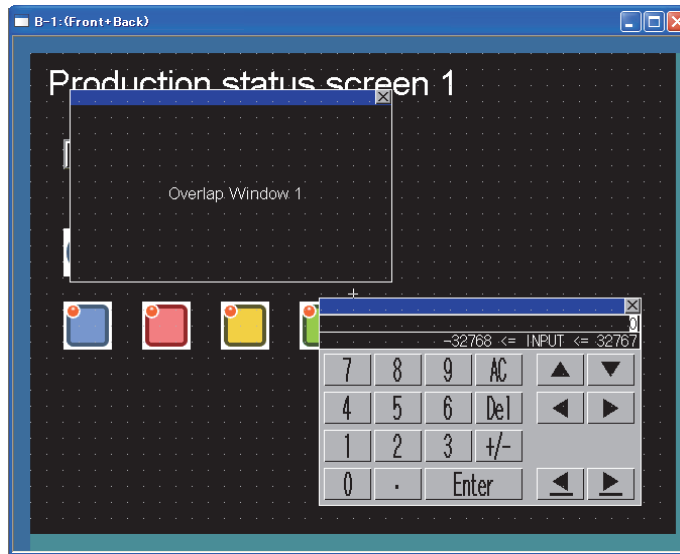

## 3.12 Copying/Deleting Screen

### 3.12.1 Copying a screen

1. Right-click the screen to be copied in the screen tree. Select [Copy] from the menu.



Copying multiple screens at a time

Multiple screens can be selected by either of the following methods.

- Select screens with holding down the [Shift] key.
- Select screens with holding down the [Ctrl] key.

2. Right-click [Base Screen] in the screen tree, and then select [Paste] from the menu.
3. The [Screen Property] dialog box appears.

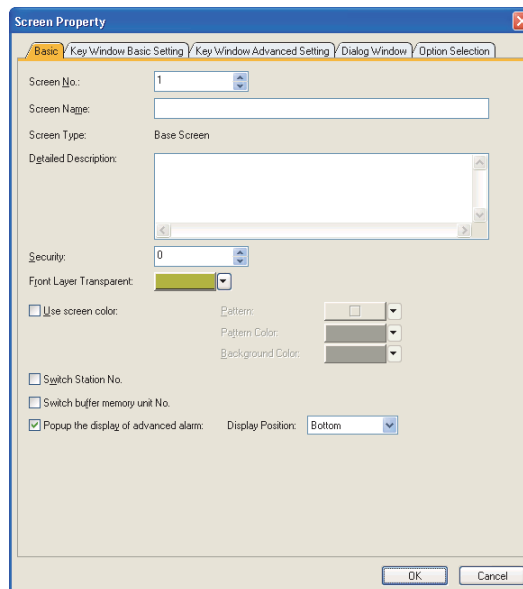

For the [Screen Property] dialog box, refer to the following.

 3.7.1 Creating a new screen

4. Set the required items. Click the [OK] button to copy the screen.  
(The [Screen Property] dialog box is displayed as many as the copied screens.)

**HINT**

**(1) Copying screens continuously**

One screen can be copied to multiple screens by either of the following method.

1. Select [Screen] → [Utilize] from the menu to display the [Utilize] dialog box.

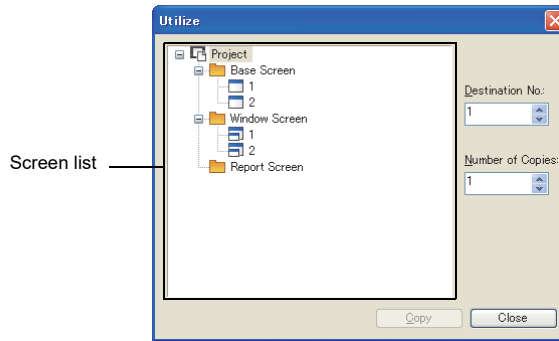

Item	Description
Screen list	Select the screen to be copied. Up to 25 screens can be selected at a time.
Destination No.	Set the screen No. of the screen created by copying (1 to 32767).
Number of Copies	Set the number of copies (1 to 100).

2. Select the screen to be copied. Set [Destination No.] and [Number of Copies], and then click the [Copy] button.

The selected screen is copied.

Example: When setting the screen to be copied to "base screen 1", [Destination No.] to "3", and [Number of Copies] to "2"

The base screen 1 is copied, and the base screen 3 and 4 are created.

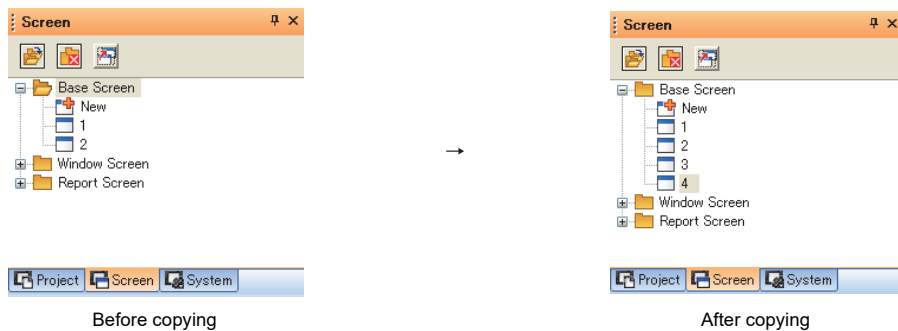

**(2) Access authority of a project when the project security is set**

When the project security for each screen disables displaying the screen, the screen cannot be copied.

☞ 3.14 Securing Project

## 3.12.2 Deleting a screen

1. Select the screen to be deleted in the screen tree.
2. Right-click the screen to be deleted, and then select [Delete] from the menu.

### HINT

Deleting multiple screens at a time

Multiple screens to be deleted can be selected by either of the following methods.

- Select screens with holding down the [Shift] key.
- Select screens with holding down the [Ctrl] key.

3. The confirm dialog box for deletion appears. Click the [Yes] or [Delete All] button.
  - [Yes] button: Deletes the selected screen one by one.
  - [Delete All] button: Deleted all the selected screens.

### HINT

#### (1) Deleting with the Delete Screen dialog box

Screens can be deleted with the [Delete Screen] dialog box also.

1. Select [Screen] → [Delete] from the menu to display the [Delete Screen] dialog box.

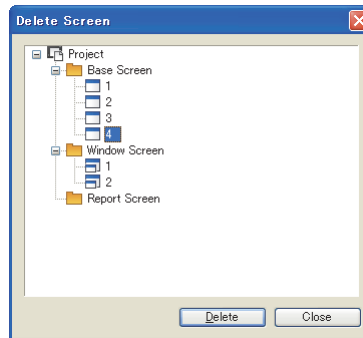

2. Select the screen to be deleted. Click the [Delete] button to delete the selected screen.

#### (2) Access authority of a project when the project security is set

When the project security for each screen disables editing the screen, the screen cannot be deleted.

 3.14 Securing Project

## 3.13 Data Check

Whether the created project data has an error or not can be checked.

1. Select [Tools] → [Data Check] from the menu to display the [Data Check] dialog box.
2. Select the items and screens to be checked, and then click the [Check] button.

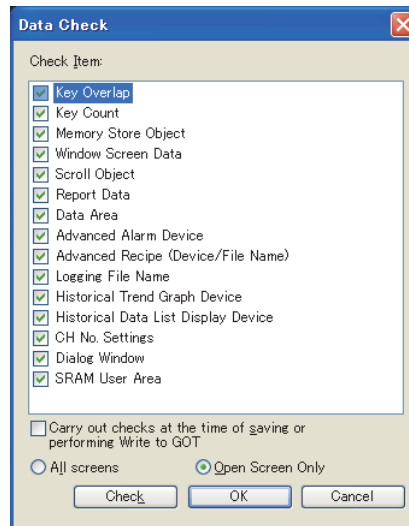

Item	Description	Model								
	Select the items to enable the data check.									
Touch Area	Checks the following. <ul style="list-style-type: none"> <li>The touch switches are overlapped each other.</li> <li>Numerical input or ASCII input is overlapped with the touch switches.</li> </ul>	<table border="1"> <tr><td>gr16</td><td>gr15</td></tr> <tr><td>gr14</td><td>gr12</td></tr> <tr><td>gr11</td><td>gr10</td></tr> <tr><td colspan="2">SoftGOT1000</td></tr> </table>	gr16	gr15	gr14	gr12	gr11	gr10	SoftGOT1000	
gr16	gr15									
gr14	gr12									
gr11	gr10									
SoftGOT1000										
Key Count	Checks whether more than 1000 touch switches are placed in the screen display area for each screen (front layer and back layer).									
Memory Store Object	Checks whether the number of the following objects, which the memory storage or locus is set, exceeds maximum number. <ul style="list-style-type: none"> <li>User alarm display (memory storage): up to 16 per project</li> <li>Line graph (locus): up to 1 per project</li> <li>Trend graph (memory storage): up to 16 per project</li> <li>Scatter graph (memory storage): up to 16 per project</li> </ul>	<table border="1"> <tr><td>gr16</td><td>gr15</td></tr> <tr><td>gr14</td><td>gr12</td></tr> <tr><td>gr11</td><td>gr10</td></tr> <tr><td colspan="2">SoftGOT1000</td></tr> </table>	gr16	gr15	gr14	gr12	gr11	gr10	SoftGOT1000	
gr16	gr15									
gr14	gr12									
gr11	gr10									
SoftGOT1000										
Window Screen Data	Checks whether the data list display and alarm history display are arranged on the window screen. (The data list display and alarm history display are inapplicable to the window screen.)									
Scroll Object	Checks whether multiple objects that need to be scrolled are set on a single screen. <ul style="list-style-type: none"> <li>Data List Display</li> <li>Alarm History Display</li> <li>User Alarm Display</li> </ul>	<table border="1"> <tr><td>gr16</td><td>gr15</td></tr> <tr><td>gr14</td><td>gr12</td></tr> <tr><td>gr11</td><td>gr10</td></tr> <tr><td colspan="2">SoftGOT1000</td></tr> </table>	gr16	gr15	gr14	gr12	gr11	gr10	SoftGOT1000	
gr16	gr15									
gr14	gr12									
gr11	gr10									
SoftGOT1000										
Report Data	Checks the following. <ul style="list-style-type: none"> <li>The setting of the [Printing] tab and [Data Collection] tab in the [Screen Property] dialog box.</li> <li>The setting of the [Header/Repeat] dialog box.</li> </ul>	<table border="1"> <tr><td>gr16</td><td>gr15</td></tr> <tr><td>gr14</td><td>gr12</td></tr> <tr><td>gr11</td><td>gr10</td></tr> <tr><td colspan="2">SoftGOT1000</td></tr> </table>	gr16	gr15	gr14	gr12	gr11	gr10	SoftGOT1000	
gr16	gr15									
gr14	gr12									
gr11	gr10									
SoftGOT1000										
Data Area	Checks whether any of the objects is arranged outside the screen range.	<table border="1"> <tr><td>gr16</td><td>gr15</td></tr> <tr><td>gr14</td><td>gr12</td></tr> <tr><td>gr11</td><td>gr10</td></tr> <tr><td colspan="2">SoftGOT1000</td></tr> </table>	gr16	gr15	gr14	gr12	gr11	gr10	SoftGOT1000	
gr16	gr15									
gr14	gr12									
gr11	gr10									
SoftGOT1000										
Advanced Alarm Device	Checks for incorrect alarm device and alarm range settings.	<table border="1"> <tr><td>gr16</td><td>gr15</td></tr> <tr><td>gr14</td><td>gr12</td></tr> <tr><td>gr11</td><td>gr10</td></tr> <tr><td colspan="2">SoftGOT1000</td></tr> </table>	gr16	gr15	gr14	gr12	gr11	gr10	SoftGOT1000	
gr16	gr15									
gr14	gr12									
gr11	gr10									
SoftGOT1000										

(Continued to next page)

Item	Description	Model	
Check Item	Advanced Recipe (Device and File Name)	<ul style="list-style-type: none"> <li>Checks the following. <ul style="list-style-type: none"> <li>Consistency of the external control device and external notification device common for the advanced recipe with the screen switching device, station No. switching device and device specified in the system data</li> <li>Duplication of the advanced recipe file name of each piece of advanced recipe data</li> </ul> </li> </ul>	GT16 GT15 GT14 GT12 GT11 GT10 SoftGOT1000
	Logging File Name	Checks that the set logging file name does not already exist.	
	Historical Trend Graph Device	Checks if the logging settings match the historical trend graph device settings.	GT16 GT15 GT14 GT12 GT11 GT10 SoftGOT1000
	Historical Data List Display Device	<ul style="list-style-type: none"> <li>Checks the following. <ul style="list-style-type: none"> <li>The logging settings match the historical data list device settings.</li> <li>In the historical data list display, the device type matches the display format.</li> </ul> </li> </ul>	
	CH No. Setting	<ul style="list-style-type: none"> <li>Checks that the channel No. set to [None] in the [Controller Setting] dialog box is not set for the following items. <ul style="list-style-type: none"> <li>[Adjust CH No.] or [Broadcast CH No.] in the [Clock Setting] tab of the [Environmental Setting] dialog box (GOT Setup)</li> <li>[Controller CH No.] in the [Transparent] tab of the [Environmental Setting] dialog box (GOT Setup)</li> <li>[CH No. for Station No.] of the [Controller Setting] dialog box (Station No. Switching)</li> </ul> </li> </ul>	GT16 GT15 GT14 GT12 GT11 GT10 SoftGOT1000
		Checks that there are no settings invalid in the CH No.Settings.	GT16 GT15 GT14 GT12 GT11 GT10 SoftGOT1000
	Dialog Window	<ul style="list-style-type: none"> <li>Checks the following. <ul style="list-style-type: none"> <li>Dialog window</li> <li>Whether the set window screen size (width × height) exceeds the maximum size (320 × 240). (GT15, GT16, GT14, GT SoftGOT1000 only)</li> </ul> </li> </ul>	GT16 GT15 GT14 GT12 GT11 GT10 SoftGOT1000
SRAM User Area	<ul style="list-style-type: none"> <li>Checks the following. <ul style="list-style-type: none"> <li>The number of settings for retaining data under power failure in the SRAM user area is less than or equal to 10 each for the advanced alarm and logging function.</li> <li>The total capacity of the SRAM user area used for retaining data under power failure is 500KB or less.</li> </ul> </li> </ul>	GT16 GT15 GT14 GT12 GT11 GT10 SoftGOT1000	
Carry out checks at the time of saving or performing Write to GOT	Select this item to automatically execute the data check when saving the project or communicating with the GOT.		
All Screens	Select this item to enable the data check on all screens.		
Open Screen Only	Select this item to enable the data check on open screen.		
<input type="button" value="Check"/>	Click this button to execute the data check.	GT16 GT15 GT14 GT12 GT11 GT10 SoftGOT1000	
<input type="button" value="OK"/>	Click this button to determine the setting and close the [Data Check] dialog box.		
<input type="button" value="Cancel"/>	Click this button to cancel the setting and close the [Data Check] dialog box.		

3. If an error is detected, the following dialog box appears.  
Example: When touch switches are overlapped

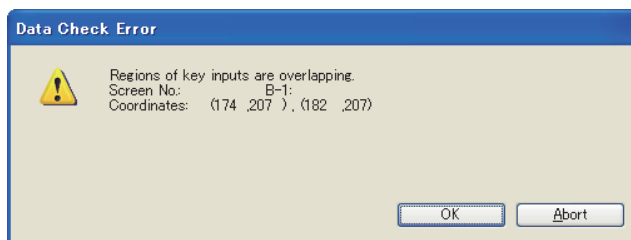

Click the [OK] button to continue the data check for any other error.  
Click the [Cancel] button to cancel the data check.

# 3.14 Securing Project

The project security protects a project from being displayed or edited by unauthorized personnel. The access authority setting restricts displaying and editing the project according to the user.

## Security for a project and each screen

The project security restricts displaying and editing a project. The security for the project protects the common settings, including the comment, logging, and alarm.

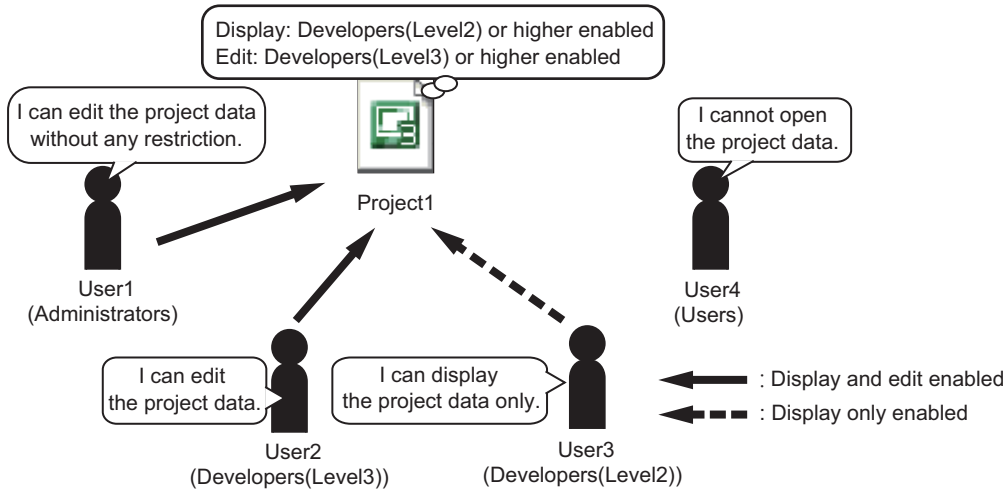

In addition, the access authority setting can be set in each screen as required. The access authority setting restricts displaying and editing the specific screen according to the user.

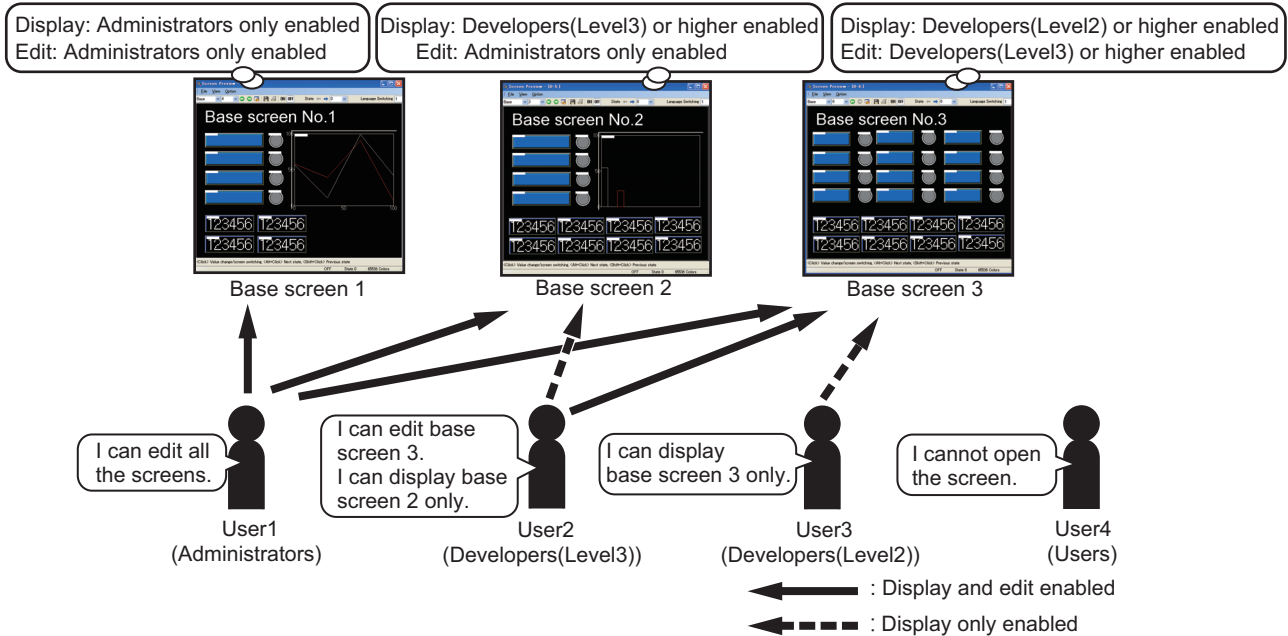

## Registering users for project

The project security can be set by registering users for a project. When registering users for the project, set the access level for each user. For the first time security is set, user registration with the administrators access level is necessary.

👉 3.14.2 ■When setting security for the first time



## ■ Setting the access authority for each access level

The user access level determines the access authority (availability of displaying and editing a project) of the user. Configure the settings (availability of displaying and editing a project) for each access level. The following access levels are provided for the project security.

Access level	
Administrators	High ↑ ↓ Low
Developers (Level3)	
Developers (Level2)	
Developers (Level1)	
Users	

For Administrators, displaying and editing a project are always enabled.

For Developers (Level 3), Developers (Level 2), and Developers (Level 1), displaying and editing a project are enabled or disabled.

For Users, displaying a project is enabled or disabled, however, editing the project is always disabled.

The access authority setting can be set for a project and each screen.

 3.14.2 ■ Access control setting

## ■ Managing users

Adding users, deleting users, registering user information, changing password, and others are available.

 3.14.2 ■ User management

## ■ Logging into project

When opening the project for which the user is registered, the user authentication is required for login.

 3.14.3 Logging into project

### 3.14.1 Procedures for setting project security

#### ■ Security setting procedures for project

The following shows the setting security procedures for a project.

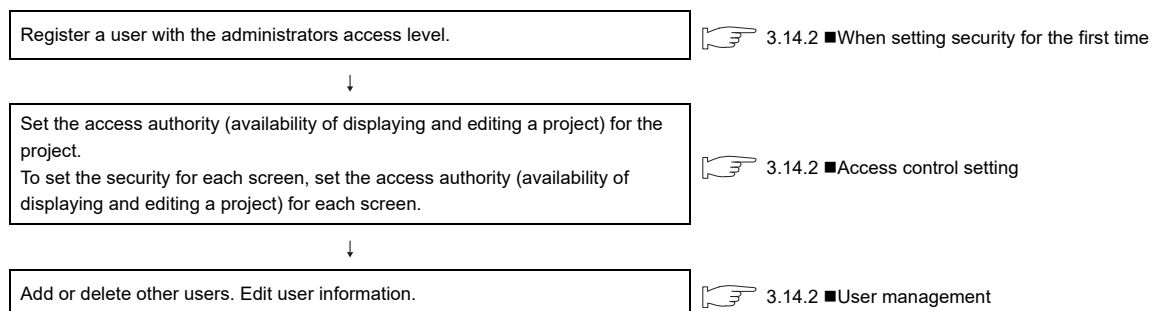

#### ■ Login procedures for project

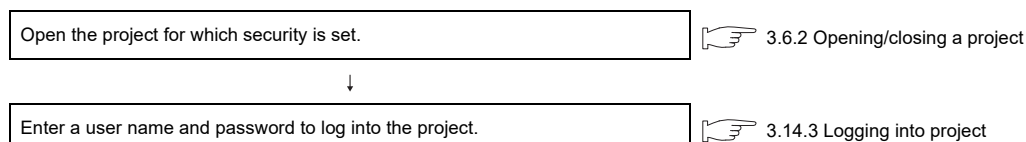



### 3.14.2 Settings

#### ■ When setting security for the first time

When setting security for a project, user registration with the administrator access level is required beforehand. Up to 128 users can be registered.

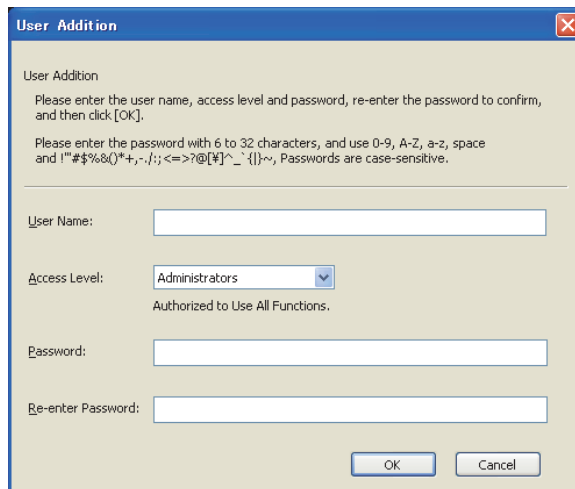
1. For the project for which a user is not registered, select [Project] → [Security] → [User Management] from the menu to display the [User Addition] dialog box.  
(When security is already set, click the [Add] button of the [User Management] dialog box to display the [User Addition] dialog box.)
2. Set [User Name], [Access Level] (fixed to [Administrators]), [Password], and [Re-enter Password]. Click the [OK] button to register a user.  
(When security is already set, [Access Level] can be set.)



Item	Description	Model
User Name	<p>Set a user name to be registered for the project.</p> <p>The user name must include 1 to 20 one-byte characters. (No two-byte or one-byte space can be input at the end of the user name.)</p> <p>The following shows characters applicable to the user name. (Uppercase and lowercase characters are recognized, respectively.) (space)!\"#\$%&amp;()*+,-./:;&lt;=&gt;@[\\]^_`{ }~0123456789 AaBbCcDdEeFfGgHhIiJjKkLlMmNnOoPpQqRrSsTtUuVvWwXxYyZz</p>	
Access Level	<p>Set the access level of the user registered for the project.</p> <p>For the project for which a user is not registered, only [Administrators] can be selected.</p> <ul style="list-style-type: none"> <li>• Administrators: All the functions are available.</li> <li>• Developers(Level3): Restricts the security settings, data access, and certain operations.</li> <li>• Developers(Level2): Restricts the security settings, data access, and certain operations.</li> <li>• Developers(Level1): Restricts the security settings, data access, and certain operations.</li> <li>• Users: Only browsing data is available.</li> </ul> <p>Developers(Level1), Developers(Level2), Developers(Level3) have the same default setting. Changing the access authority is available in the [Setup Access Authority] dialog box.</p> <p> ■ Access control setting</p>	<div style="display: flex; flex-direction: column; align-items: center;"> <div style="display: flex; gap: 5px;"> <div style="border: 1px solid black; padding: 2px;">gr16</div> <div style="border: 1px solid black; padding: 2px;">gr15</div> </div> <div style="display: flex; gap: 5px;"> <div style="border: 1px solid black; padding: 2px;">gr14</div> <div style="border: 1px solid black; padding: 2px;">gr12</div> </div> <div style="display: flex; gap: 5px;"> <div style="border: 1px solid black; padding: 2px;">gr11</div> <div style="border: 1px solid black; padding: 2px;">gr10</div> </div> <div style="border: 1px solid black; padding: 2px;">SoftGoT1000</div> </div>
Password	<p>Set the password used for user authentication when opening the project. (The password is displayed as *.)</p> <p>The password must include 6 to 32 one-byte characters.</p> <p>The following shows characters applicable to the password. (Uppercase and lowercase characters are recognized, respectively.) (space)!\"#\$%&amp;()*+,-./:;&lt;=&gt;@[\\]^_`{ }~0123456789 AaBbCcDdEeFfGgHhIiJjKkLlMmNnOoPpQqRrSsTtUuVvWwXxYyZz</p>	
Re-enter Password	<p>Re-enter the password set for [Password]. (The password is displayed as *.)</p> <p>Check consistency between [Password] and [Re-enter Password].</p>	

## Access control setting

Set the access authority for a project or each screen.

Select [Project] → [Security] → [Data Security Setting] from the menu to display the [Setup Access Authority] dialog box.

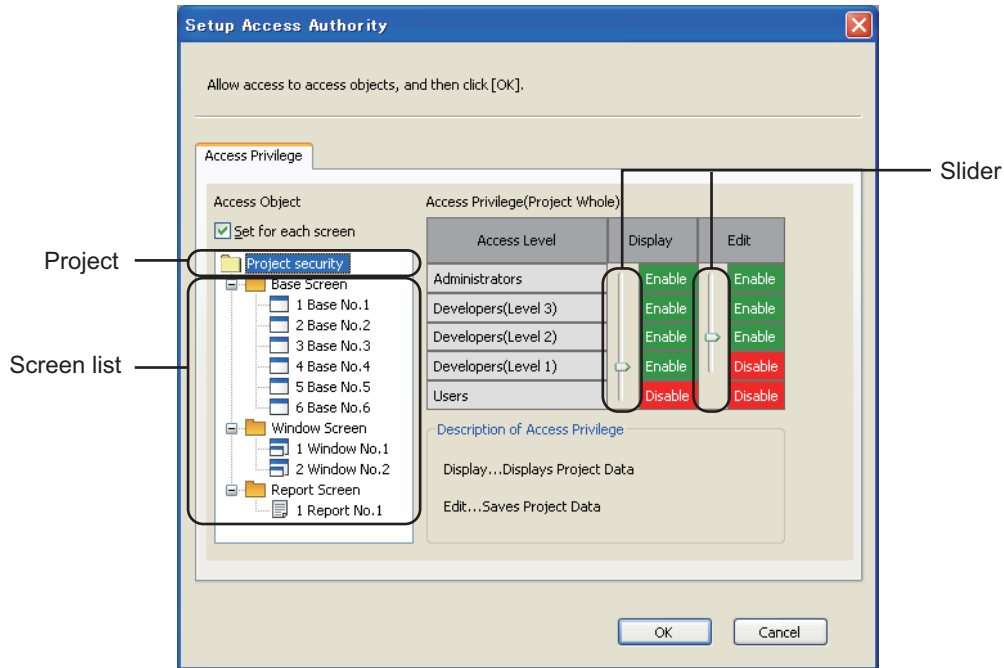

Item	Description	Model
Access Object	Displays the target project for the access control and the screen list. Select the project and the screen with the access authority to be changed. Then, set the access authority.	
Set for each screen	Select this item to set the project security for each screen. The security for each screen can be set in the base screen, the window screen, and the report screen. Select the screen from the tree to set the project security, and then set the access authority. To remove the security for each screen, clear this item.	<div style="display: flex; flex-direction: column; align-items: center;"> <div style="display: flex; gap: 5px;"> <span style="border: 1px solid black; padding: 2px;">GT16</span> <span style="border: 1px solid black; padding: 2px;">GT15</span> </div> <div style="display: flex; gap: 5px;"> <span style="border: 1px solid black; padding: 2px;">GT14</span> <span style="border: 1px solid black; padding: 2px;">GT12</span> </div> <div style="display: flex; gap: 5px;"> <span style="border: 1px solid black; padding: 2px;">GT11</span> <span style="border: 1px solid black; padding: 2px;">GT10</span> </div> </div>
Access Privilege *1	For each access level, set the access authority (enabled or disabled) of [Display] and [Edit]. Moving the slider up and down changes the access authority. <ul style="list-style-type: none"> <li>Display: Restricts displaying the project or the screen.</li> <li>Edit: Restricts editing the project or the screen.</li> </ul> For setting the access levels, refer to the following. ■ User management	

For \*1, refer to the following.

### \*1 Access Authority

The access authority setting has restrictions according to the access level of the login user.

The following shows settable access levels and access authority.

○ : Settable    × : Not settable

Access level (Login user)		Access authority setting (enable/disable)					Remark
		Administrators	Developers (Level3)	Developers (Level2)	Developers (Level1)	Users	
High ↑ ↓ Low	Administrators	×	○	○	○	○	[Display] and [Edit] are fixed to [Enable].
	Developers(Level3)	×	×	○	○	○	-
	Developers(Level2)	×	×	×	○	○	-
	Developers(Level1)	×	×	×	×	○	-
	Users	×	×	×	×	×	[Edit] is fixed to [Disable].

## POINT

---

### **Restrictions on settable access authority**

The user can set the access authority of users with the access levels below the login user level in the project.

Only display-enabled user (edit-disabled user) cannot execute the following operations.

- Changing the user's password
  - Editing the security of the screen of other users with the lower access level than the user's access level
  - Editing the access authority of other users with the lower access level than the user's access level
-

## ■ User management

Adding or deleting users and changing user information or password are available.

### (1) When no users are registered





Select [Project] → [Security] → [User Management] from the menu to display the [User Addition] dialog box.

 ■ When setting security for the first time

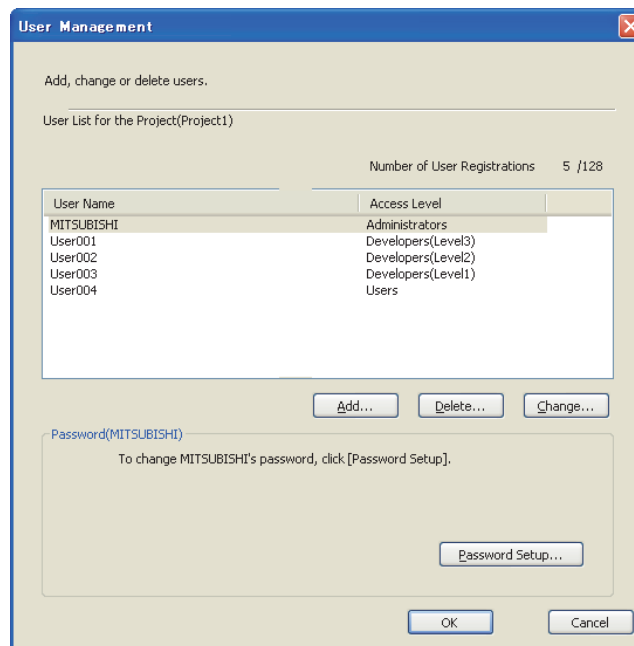

### (2) When users are already registered

1. Select [Project] → [Security] → [User Management] from the menu to display the [User Management] dialog box.
2. Click each button to register, delete, or edit the user.
3. After registering, deleting, or editing the user, click the [OK] button. The changed contents are determined, and the [User Management] dialog box is closed.



Item	Description	Model
User List for the Project	Displays the target project name for the user management.	
Number of User Registrations	Displays the numbers of registered users and registerable users. Up to 128 users can be registered.	
User Name	Displays the user names registered for the project.	
Access Level	Displays the access levels set for the users.	
 *1	Click the [Add] button. The [User Addition] dialog box appears, and add a user.  ■ When setting security for the first time	gr16 gr15 gr14 gr12 gr11 gr10 SRSRGT1000
 *1	Delete a registered user. Select a user to be deleted, and then click the [Delete] button to delete the user. Deleting all registered users clears the security setting.	
 *1	Change the user information. Select a user with the user information to be changed, and then click the [Change] button. The [Change User Data] dialog box appears, and change the user information.  (a) Change User Data dialog box	

(Continued to next page)

Item	Description	Model
 *1	Change the password for a user. Select a user with the password to be changed, and click the [Change Password] button. The [Change Password] dialog box appears, and change the password.  (b) Change Password dialog box	

For details of \*1, refer to the following.



### \*1 Restrictions

The user management setting has restrictions according to the access level of the login user.  
 The following shows the settable user management setting according to each access level.

Access level (Login user)	User management setting				
	Administrators	Developers(Level3)	Developers(Level2)	Developers(Level1)	Users
Administrators	<input type="radio"/>	<input type="radio"/>	<input type="radio"/>	<input type="radio"/>	<input type="radio"/>
Developers(Level3)	Not settable	Not settable	<input type="radio"/>	<input type="radio"/>	<input type="radio"/>
Developers(Level2)	Not settable	Not settable	Not settable	<input type="radio"/>	<input type="radio"/>
Developers(Level1)	Not settable	Not settable	Not settable	Not settable	<input type="radio"/>
Users	Not settable	Not settable	Not settable	Not settable	Not settable

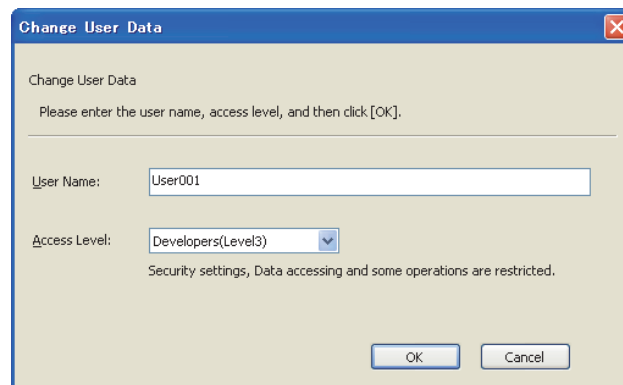
### (a) Change User Data dialog box



Item	Description	Model
User Name	Set the name of a user to be added to the GT Designer3 project. The following shows characters applicable to the user name.  ■When setting security for the first time	
Access Level	Set the access level for the user added to the GT Designer2 project. Changing the access authority is available in the access control setting. For the access control setting, refer to the following.  ■When setting security for the first time	

- (b) Change Password dialog box  
 Change the password of a user selected in [User List for the Project] of the [User Management] dialog box.  
 For changing the password of the login user, refer to the following.

☞ ■ Changing password of login user

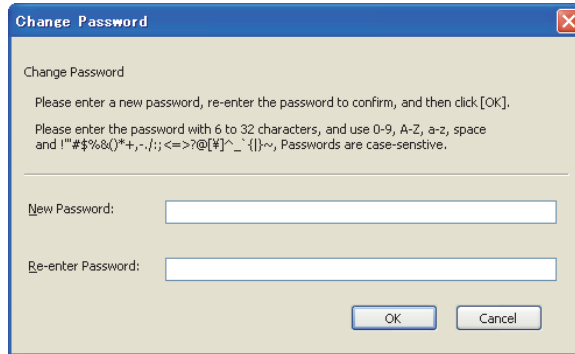

Item	Description	Model
New Password	Set a new password. (The password is displayed as *.) For details of characters applicable to the password, refer to the following. ☞ ■ When setting security for the first time	GT16 GT15 GT14 GT12 GT11 GT10 SoftGT1000
Re-enter Password	Re-enter the password set for [New Password]. (The password is displayed as *.) Check consistency between [New Password] and [Re-enter Password].	

■ Changing password of login user

Change the password of the login user.

Select [Project] → [Security] → [Change Password] from the menu to display the [Change Password] dialog box.

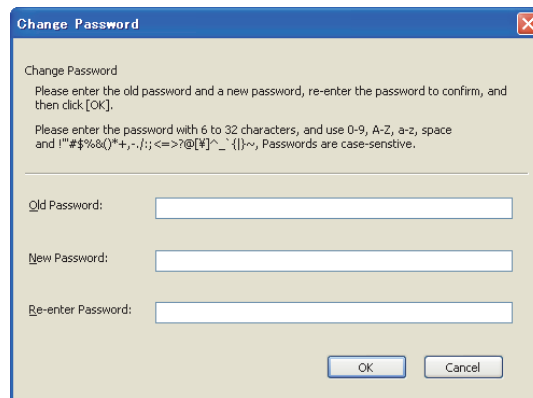

Item	Description	Model
Old Password	Set the old password. (The password is displayed as *.)	
New Password	Set a new password. (The password is displayed as *.) For details of characters applicable to the password, refer to the following. ☞ ■ When setting security for the first time	GT16 GT15 GT14 GT12 GT11 GT10 SoftGT1000
Re-enter Password	Check consistency between [New Password] and [Re-enter Password]. (The password is displayed as *.)	

### 3.14.3 Logging into project

1. Open a project with security, and the [User Authentication] dialog box appears.  
 3.6.2 Opening/closing a project
2. Enter [User Name] and [Password] of a registered user. Click the [OK] button to log into the project.

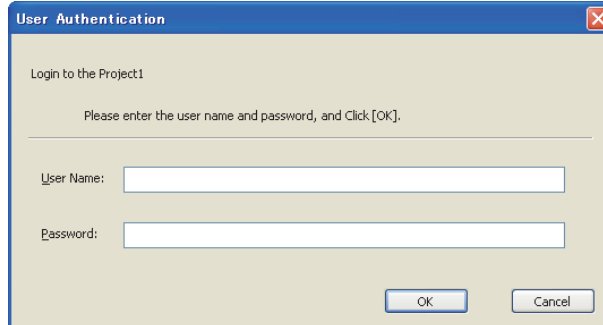

Item	Description	Model
User Name	Set the user name for login.	gr16 gr15 gr14 gr12
Password	Set the user password for login. (The password is displayed as *.)	gr11 gr10 SoftGor1000

### 3.14.4 Operations after the project security is set

The security for a project has a higher priority than the security for each screen. Therefore, the disabled operations cannot be executed even if the operations are enabled by the security for each screen.

#### ■ Security for a project

When the project security is set, according to the access authority of the user, the operations of GT Designer3 are restricted as shown below.

##### (1) Display-enabled and edit-enabled user (Edit-enabled user)

When the access authority enables the user to edit the project, the user can open and display the project data. In addition, the user can edit the project data, change the settings, save the project data, and others. However, some operations may be restricted.

Item	Description	Condition
GOT type setting	The GOT type cannot be changed.	The project has a screen with the security for each screen that disables displaying or editing the project.
Controller setting	The settings of the manufacturer and the model cannot be changed.	
Writing data in the GOT or the GT10-LDR	The project data cannot be written in the GOT or the GT10-LDR.	When all of the following conditions are satisfied <ul style="list-style-type: none"> <li>• The access level of the user is other than the administrator.</li> <li>• The data transfer/utility password is not set in the project data.</li> </ul>  4.7.1 ■System Security tab
Writing data in a memory card or a USB memory	The project data cannot be written in the memory card or the USB memory.	



**(2) Only display-enabled user (Edit-disabled user)**

When the access authority enables the user to display a project data and disables the user to edit the project data, the user can only display the project data.

The user cannot edit the project data, change the settings, and save the project data.

The following operations are enabled.

- Deleting project data
- Writing project data in the GOT
- Verifying project data
- Setting the project security
- Printing project data

The communication with the GOT is restricted as shown below.

Item	Description	Condition
Writing data in the GOT or the GT10-LDR	The project data cannot be written in the GOT or the GT10-LDR.	The data transfer/utility password is not set in the project data.  4.7.1 ■ System Security tab
Writing data in a memory card or a USB memory	The project data cannot be written in the memory card or the USB memory.	

**(3) Display-disabled user**

When the access authority disables the user to display and edit project data, the user cannot open the project data. (The user cannot log into the project data.)

**■ Security for each screen**

When the security is set for each screen, according to the access authority of the user, the operations for screens are restricted as shown below.

**(1) Display-enabled and edit-enabled user (Edit-enabled user)**

The user can edit a screen with the security, change the settings, and save the screen.

However, some operations may be restricted.

Item	Description	Condition
Project security setting (Access authority change)	The access authority cannot be changed.	The access level of a login user is equivalent to or lower than the level of a user whose access authority is to be changed.
Preview	A dummy screen is displayed instead of the called screen.	Screens (display disabled) are specified in the settings for a called screen, an overlap window, and others.
Calling a screen, window position (Object)	A dummy screen is displayed on the screen editor.	The screen (display disabled) is arranged.

**(2) Only display-enabled user (Edit-disabled user)**

A screen with the security can be displayed.

The setting dialog box can be opened and the user can check the settings.

However, the user cannot edit the screen with the security, change the settings, and delete the screen.

The data browser and others can display figures/objects on the screen (edit disabled) and set devices. However, the operations, including editing or deleting the figures/objects on the screen (edit disabled), set devices, and others, are disabled.

With exception, the following operations are enabled.

Item	Description	Condition
Project security setting (Access authority change)	The access authority can be changed.	The access level of a login user is changed to the level lower than the login user level.
Editing the screen script	The screen script can be edited.	Editing the screen script is enabled by the security for a project and the screen script is edited in the script list.

### (3) Display-disabled user

A screen with the security cannot be displayed.

The data browser and others cannot display figures/objects on the screen (display disabled) and set devices.

With exception, the following operations are enabled.

Item	Description	Condition
Displaying and editing the screen script	The screen script can be edited.	Editing the screen script is enabled by the security for a project and the screen script is edited in the script list.



#### Display in the screen image list and the screen tree

The screen image list and the screen tree display the screens (display and edit disabled) as shown below.

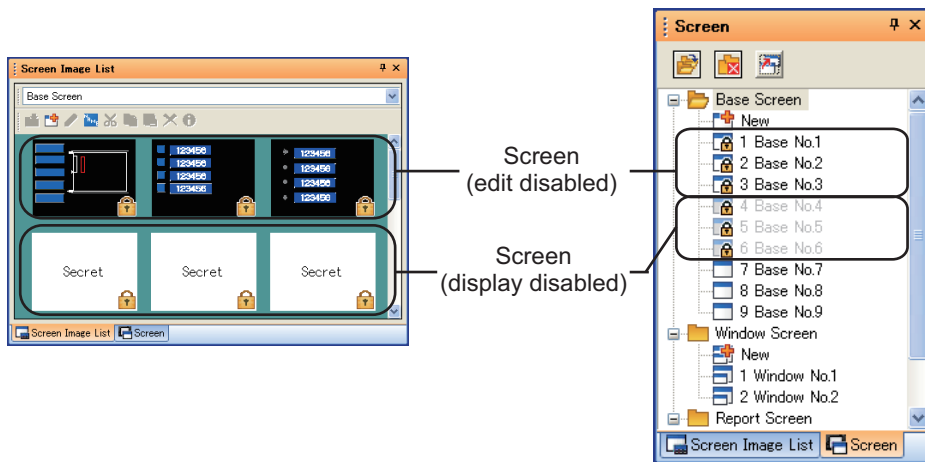

## 3.14.5 Precautions

### ■ Precautions for writing a project in the GOT

#### (1) Writing a project in the GOT

When the data transfer/utility password is not set in the project data, the user with the access level other than the administrator cannot write the project data in the GOT.

For the details of the data transfer/utility password, refer to the following.

 4.7.1 ■ System Security tab

#### (2) Transferring a project in a memory card

When the data transfer/utility password is not set in the project data, the user with the access level other than the administrator cannot write the project data in a memory card and a USB memory.

#### (3) Project security after a project is written in the GOT

The project security setting cannot be written in the GOT.

Therefore, the GOT displays the screen (display disabled).

For the project data read from the GOT, the project security setting is removed.

After reading the project data from the GOT and editing the project data, set the project security again.

#### (4) Writing a project in the GOT by using Data Transfer Tool

To write a project data created by using GT Designer3 Version 1.43V or later in the GOT, use Data Transfer Tool Version 2.15R or later.

When the version of Data Transfer Tool is earlier than Version 2.15R, the project data cannot be written in the GOT.

### ■ Precautions for drawing

#### (1) Prohibition of use of the project data created with GT Designer3 Version 1.43V or later on older version of GT Designer3

When the project security is set for the project data by using GT Designer3 Version 1.43V or later, the project data is not compatible with an older version of GT Designer3. Depending on the conditions, the project data can be opened on GT Designer3, however, the data becomes invalid and does not work correctly.

In the above case, use the latest version of GT Designer3.

#### (2) Using the project security and the data transfer/utility password together

To use the project security, set the data transfer/utility password.

The project security setting cannot be written in the GOT. To protect the project written in the GOT, set the data transfer/utility password.

#### (3) Library data change

When the access authority disable the user to edit a project, the user can change library data in the library list, including registering, editing, and deleting the library data.

#### (4) Project data with no project management file

When the project management file does not exist, the user management setting is not available in the project data.

Save the project data as a GT Designer3 project and configure the setting again.

### ■ Precautions for simulation

GT Simulator3 does not support the project security.

Therefore, GT Simulator3 displays the screen (display disabled).

### ■ When user forgets user name and password

When the user forgets the user name and password, the user cannot open the corresponding project with the security.

Delete the project, and then create a new project.

## 3.15 Printing Project/File Output

---

Settings or screen image of created project can be output to a file or printer.  
The data output to a file can be used for various documents after editing with a commercially available word processor software.

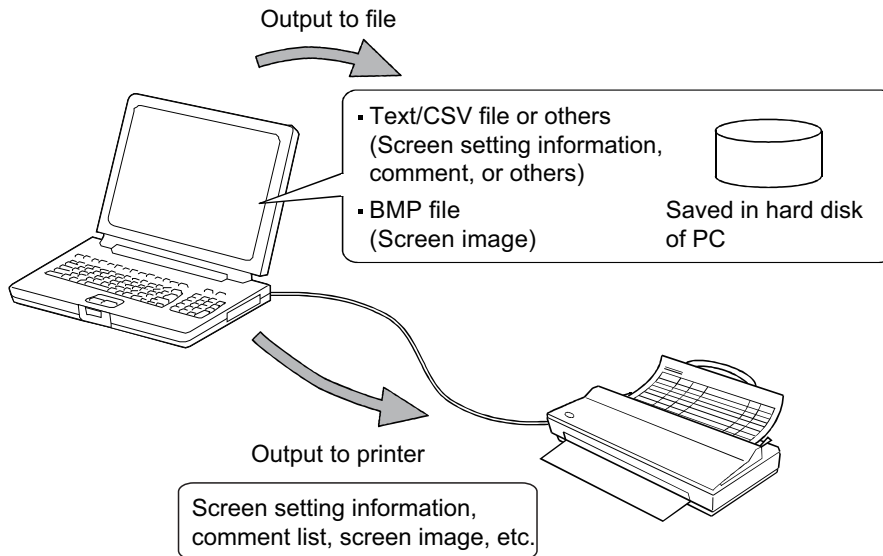

### POINT

#### Print setting

- (1) Papers are printed in the portrait mode.
- (2) Font and font size for printing cannot be changed.
- (3) The header information (date, file name) are automatically printed when output to a printer.

### HINT

#### Access authority of a project when the project security is set

When the project security for each screen disables displaying or editing a screen, the screen cannot be printed.

☞ 3.14 Securing Project

### 3.15.1 Print setting

The setting dialog box differs depending on the set contents as follows.

Setting contents	Setting dialog box
Setting for output target	[Print] dialog box
Setting for layout/color tone of screen image when outputting	[Page Setup] dialog box

#### Print dialog box

Select [Project] → [Print] from the menu to display the [Print] dialog box.

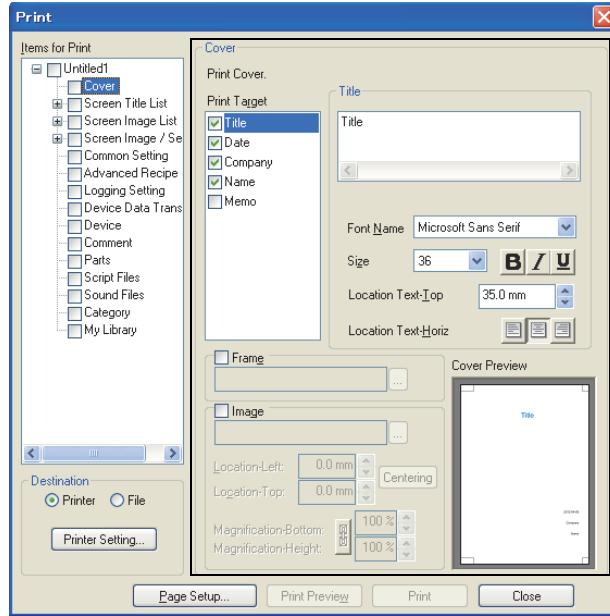







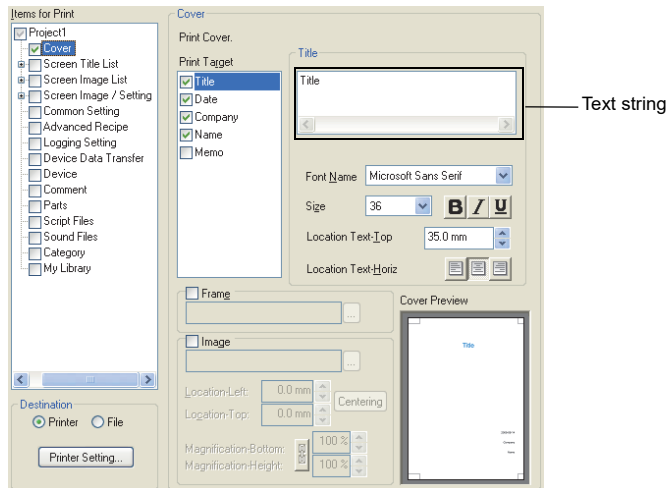

Setting for print item

Item	Description	Model
Items for Print	Select items to enable the output. For output images and files for each item, refer to the following. ☞ 3.15.3 Outputting examples	
Destination	Select the output destination. <ul style="list-style-type: none"> <li>• Printer: Set the output destination to [Printer]. Click the [Printer Setting] button for the printer setting. The printer setting differs depending on the printer driver for used OS.</li> <li>• File : Set the output destination to [File]. Set [File Format] (CSV/TXT) and [Image Format] (BMP/JPEG).</li> </ul>	
Setting for print item	When selecting either of the following items in [Items for Print], relevant setting items are displayed. <ul style="list-style-type: none"> <li>• Cover ☞ (1) Cover</li> <li>• Screen Image List-Base Screen/Window Screen ☞ (2) Screen Image List (Base Screen/Window Screen)</li> <li>• Screen Image/Setting-Base Screen/Window Screen/Report Screen ☞ (3) Screen Image/Setting (Base Screen/Window Screen/Report Screen)</li> <li>• Advanced Recipe/Logging Setting/Device Data Transfer/Comment/Category ☞ (4) Advanced Recipe/Logging Setting/Device Data Transfer/Comment/Category</li> <li>• Device ☞ (5) Device</li> </ul>	<div style="display: flex; flex-direction: column; gap: 2px;"> <div style="display: flex; gap: 5px;"> <span style="border: 1px solid black; padding: 1px;">GT16</span> <span style="border: 1px solid black; padding: 1px;">GT15</span> </div> <div style="display: flex; gap: 5px;"> <span style="border: 1px solid black; padding: 1px;">GT14</span> <span style="border: 1px solid black; padding: 1px;">GT12</span> </div> <div style="display: flex; gap: 5px;"> <span style="border: 1px solid black; padding: 1px;">GT11</span> <span style="border: 1px solid black; padding: 1px;">GT10</span> </div> <div style="border: 1px solid black; padding: 1px;">SoftGOT1000</div> </div>
	Click this button to display the [Page Setup] dialog box. ☞ ■Page Setup dialog box	
	Click this button to display the print preview window. ☞ 3.15.2 Previewing print image	
	Click this button to output the items set in [Items for Print] to a printer or a file.	
	Click this button to close the [Print] dialog box.	

**(1) Cover**



Item	Description	Model
Items for Print	Select items to enable the output.	
Title/ate/Company/ Name/Memo	The display changes according to the set items in [Print Target].	
	Text string	Set the text to be displayed.
		Enters today's date in the text.
	Font Name	Select the font.
	Size	Select the text size.
		Set the text style to bold.
		Set the text style to italic face.
		Apply an underscore to the font.
Location Text-Top	Set the vertical display position of the text based on the top of the print area. (0.0mm to 999.9mm)	
Location Text Horiz	Set the horizontal display position of the text. (Left Align/Center Align/Right Align)	
Frame	Select this item to display a page frame on the cover. Click the [...] button, and select the frame in the [Frame List] dialog box.  (a) Frame List dialog box	gr16 gr15 gr14 gr12 gr11 gr10 SoftGoT1000
Image	Select this item to display the image file on the cover. Click the [...] button. The [Select Image] dialog box appears, and set the image file.	
	Loc-Left	Set the horizontal display position of the image based on the left of the header or footer area. (-999.9mm to 999.9mm)
	Loc-Top	Set the vertical display position of the image based on the top of the header or footer area. (-999.9mm to 999.9mm)
	Loc-Width	Set the display magnification for the width of the image. (0% to 100%)
	Loc-Height	Set the display magnification for the height of the image. (0% to 100%)
		Select whether the [Mag-Width] and [Mag-Height] setting to be linked (  ) or not to be linked (  )
	Click this button to set the image display position to the center of the header or footer.	
Cover	Displays the preview of the setting contents.	

(a) Frame List dialog box

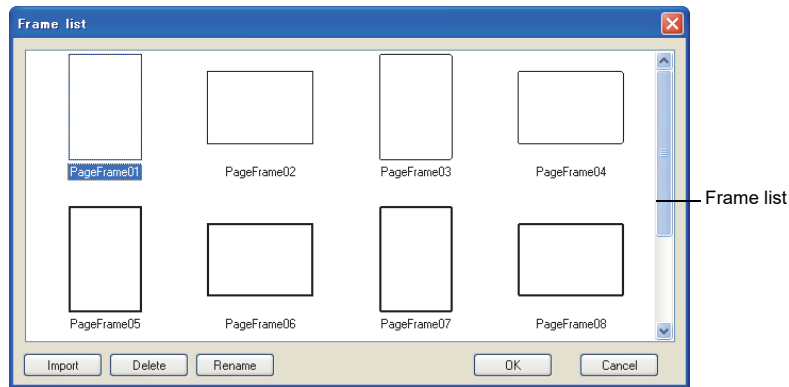

Item	Description	Model
Frame list	Frame images are displayed.	
	Click this button to display the [Import frame image] dialog box. The image file (WMF format or EMF format) used as frame image can be imported. The imported image is displayed in the frame list.	GT16 GT15 GT14 GT12 GT11 GT10 SoftGOT1000
	Click this button to delete the frame image selected in the frame list.	
	Click this button to change the file name of the frame image selected in the frame list.	
	Click this button to set the frame image selected in the frame list as a cover page frame.	
	Click this button to close the [Frame List] dialog box.	

(2) Screen Image List (Base Screen/Window Screen)

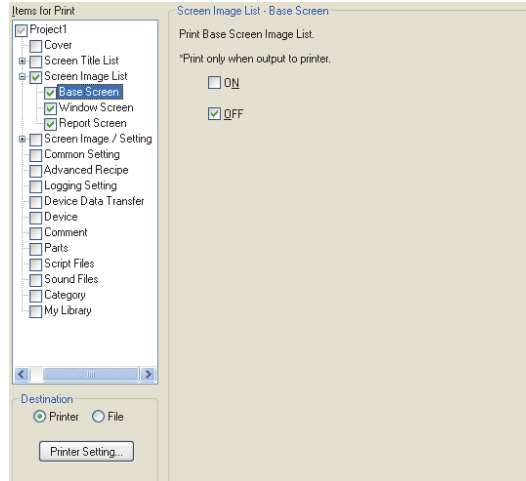

Item	Description	Model
ON	Select this item to output the image when the device is turned on. Applicable only when setting to [Printer] in the [Destination].	GT16 GT15 GT14 GT12 GT11 GT10 SoftGOT1000
OFF	Select this item to output the image when the device is turned off. Applicable only when setting to [Printer] in the [Destination].	

**(3) Screen Image/Setting (Base Screen/Window Screen/Report Screen)**

The report screen is applicable for the GT16, GT15, and GTSoftGOT1000 only.

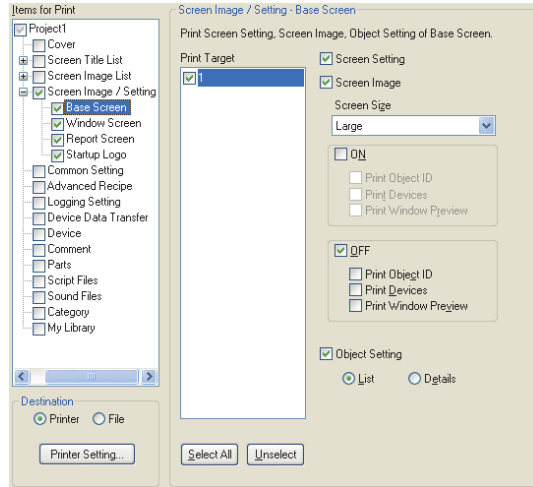

Item	Description	Model
Items for Print	Select items to enable the output.	
	Click this button to select all items in [Print Target].	
	Click this button to clear all items in [Print Target].	
Screen Setting	Select this item to enable the output of the screen setting.	
Screen Image	Select this item to enable the output of the screen image.	
	Screen Size	Select the screen image size. (Large/Medium/Small)
	ON/OFF	Select this item to enable the output of the setting when the device is turned on or off. Displaying [OFF] is applicable only when [Base Screen] or [Window Screen] of [Screen Image/Setting] in [Items for Print] is selected.
	Print Object ID	Applicable only when [ON] or [OFF] is selected. Select this item to display object IDs on the screen image when the device is turned on or off.
	Print Devices	Applicable only when [ON] or [OFF] is selected. Select this item to display the device on the screen image when the device is turned on or off.
Screen Image	Print Window Preview	Applicable only when [ON] or [OFF] is selected. Select this item to display the window screen preview on the screen image when the device is turned on or off. Applicable only when [Base Screen] of [Screen Image/Setting] in [Items for Print] is selected.
	Object Setting	Select this item to enable the output of the object setting. After selecting, select the contents to be output. (List/Details)

GT16 GT15  
GT14 GT12  
GT11 GT10  
SoftGOT1000



**(4) Advanced Recipe/Logging Setting/Device Data Transfer/Comment/Category**

The advanced recipe and the device data transfer are applicable for the GT16, GT15, GT14, and GT SoftGOT1000 only.

The logging setting is applicable for the GT16, GT15, GT14, GT12, and GT SoftGOT1000 only.

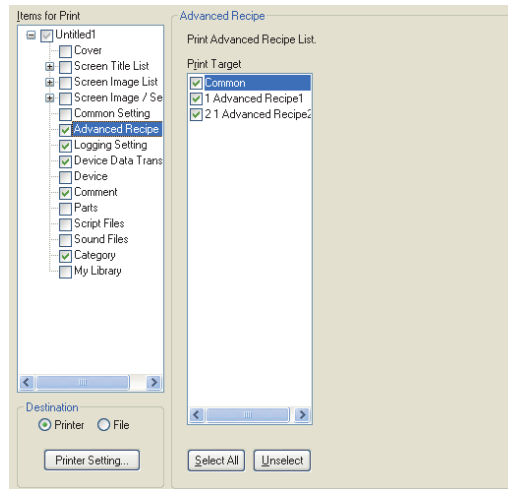

Item	Description	Model
Items for Print	Select items to enable the output.	
<input type="button" value="Select All"/>	Click this button to select all items in [Print Target].	GT16 GT15 GT14 GT12 GT11 GT10 SoftGOT1000
<input type="button" value="Unselect"/>	Click this button to clear all items in [Print Target].	

**(5) Device**

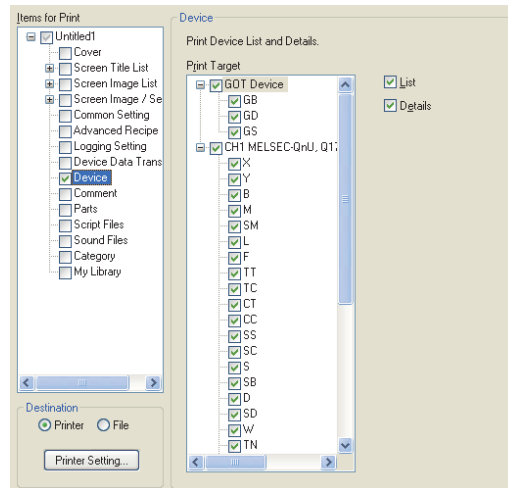

Item	Description	Model
Print Target	Select items to enable the output.	
List	Select this item to enable the output of the list of devices.	GT16 GT15 GT14 GT12 GT11 GT10 SoftGOT1000
Detail	Select this item to enable the output of the details for devices.	





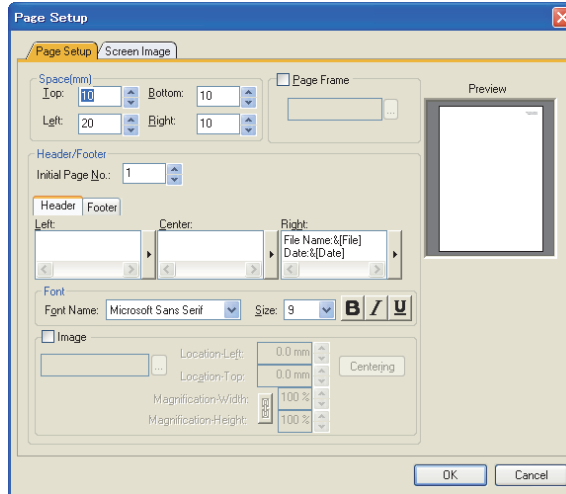

## ■ Page Setup dialog box

Select [Project] → [Page Setup] from the menu to display the [Page Setup] dialog box.

### (1) Page Setup tab

The layout setting when outputting is available.



Item	Description	Model
Space(mm)	Set the margin for top, bottom, left, and right of the page. (0mm to 100mm)	
Page Frame	Select this item to display a page frame on the cover. Click the [...] button. The [Frame List] dialog box appears, and set the page frame.  ■Print dialog box (1) (a) Frame List dialog box	
Header/Footer	Initial Page No.	Set the initial page number. (1 to 9999)
	Header/Footer	Switches the item to be set (header/footer) by the tab.
	Left/Center/Right	Set the text displayed in [Left], [Center], or [Right] of the header or footer. Click the  button. The auto-text list appears, and select the auto-text.
	Font	Set the font name, text size, or text style of the header or footer. The font setting is common to [Left], [Center], or [Right]. <ul style="list-style-type: none"> <li>Font name: Select the font.</li> <li>Size: Select the text size.</li> <li><b>B</b> : Set the text style to bold.</li> <li><i>I</i> : Set the text style to italic face.</li> <li><u>U</u> : Apply an underscore to the font.</li> </ul>
Image	Select this item to display the image file in the header or footer. The image is displayed behind the text set in [Left], [Center], or [Right]. Click the [...] button. The [Select Image] dialog box appears, and set the image file. <ul style="list-style-type: none"> <li>Location-Left: Set the horizontal display position of the image based on the left of the header or footer area. (-999.9mm to 999.9mm)</li> <li>Location-Top: Set the vertical display position of the image based on the top of the header or footer area. (-999.9mm to 999.9mm)</li> <li>Magnification-Width: Set the display magnification for the width of the image. (0% to 100%)</li> <li>Magnification-Height: Set the display magnification for the height of the image. (0% to 100%)</li> <li> : Select whether the [Magnification-Width] and [Magnification-Height] setting to be linked () or not to be linked ()</li> <li><b>Centering</b>: Click this button to set the image display position to the center of the header or footer.</li> </ul>	er16 er15 er14 er12 er11 er10 SoftGo1000
Preview	Displays the preview of the set contents.	

**(2) Screen Image tab**

The color tone setting of screen image when outputting is available.

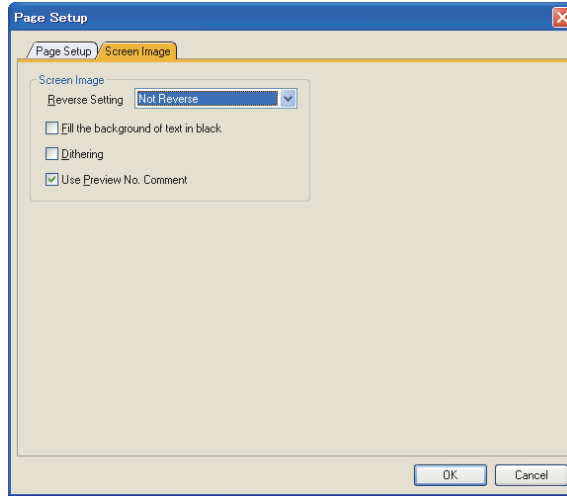

Item	Description		Model
Screen Image	Reverse Setting	Select the inverting process for the color tone of the screen image. Not Reverse : No inverting is processed. Reverse Black & White : Outputs with black and white inverted. Reverse Negative & Positive: Outputs with all color tone inverted.	
	Fill the background of text in black	Select this item to output with the text color filled in white and background filled in black.	GT16 GT15 GT14 GT12 GT11 GT10 SerGOT1000
	Dithering	Select this item to output with the intermediate color added to the two-tone monochrome screen.	
	Use Preview No. Comment	Select this item to output with the comment of the comment column No. set for the preview No. displayed.	

### 3.15.2 Previewing print image

Select [Project] → [Print Preview] from the menu to display the print preview window.

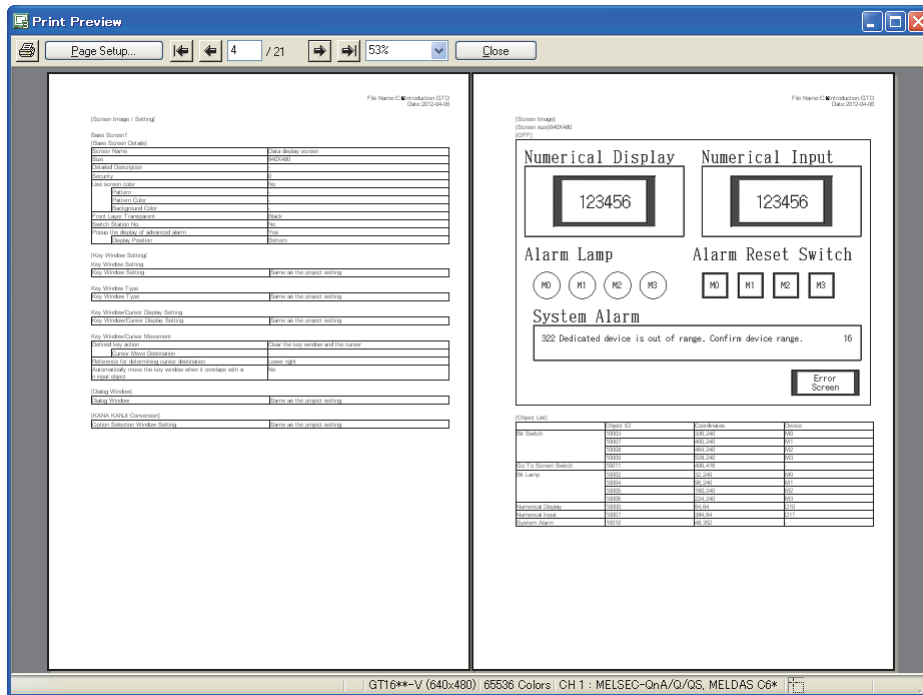

Item	Description	Model
	Click this button to display the [Print] dialog box.	<b>gr16</b> <b>gr15</b> <b>gr14</b> <b>gr12</b> <b>gr11</b> <b>gr10</b> <b>SoftGoT1000</b>
	Click this button to display the [Page Setup] dialog box.	
	Click this button to display the first or last page.	
	Click this button to display the previous or next page.	
<input type="text" value="2"/>	Displays the page No. of the image currently displayed. Set the page No., and press the [Enter] key. The image of the set page No. is displayed.	
	Zooms in or out of the displayed image.	
	Click this button to close the [Print Preview] window.	

#### POINT

##### When no print item is set

The [Print] dialog box appears.  
Set [Items for Print], and use the print preview.

■ Print dialog box

### 3.15.3 Outputting examples

#### ■ Printer output

Cover

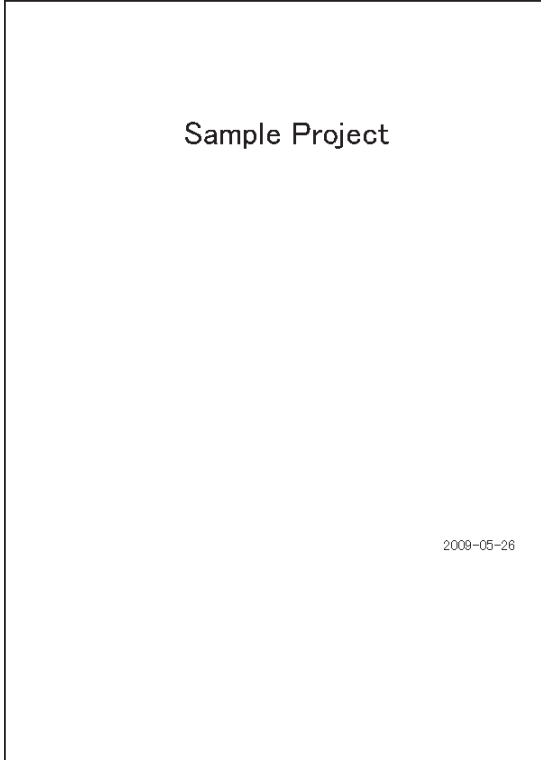

Screen Title List

File: C:\Project\Wahutsunokure\GTF (Project1)  
Date: 2010-11-26

[Base Screen Title List]	
1	[Base_Screen1]
2	[Base_Screen2]
3	[Base_Screen3]

[Window Screen Title List]	
1	[Window_Screen1]
2	[Window_Screen2]
3	[Window_Screen3]

Screen Image List

File: C:\Project\Wahutsunokure\GTF (Project1)  
Date: 2010-11-26

[Base Screen Image List]			
1: Base_Screen1(OFF)	2: Base_Screen2(OFF)	3: Base_Screen3(OFF)	
Base screen1	Base screen2	Base screen3	

Screen Image/Setting

File: C:\Project\Wahutsunokure\GTF (Project1)  
Date: 2010-11-26

[Screen Image / Setting]	
Base_Screen1	
[Base_Screen_Details]	
Screen Name	Base_Screen1
Size	840x600
Detailed Description	
Security	No
Use screen color	No
Pattern	
Pattern Color	
Background Color	
Front Layer Transparent	Dark Yellow
Switch Station No.	No
Prevent the display of advanced alarm	Yes
Display Position	Bottom
[Key Window Setting]	
Key Window Setting	
Key Window Setting	Same as the project setting
[Key Window Type]	
Key Window/Cursor Display Setting	Same as the project setting
[Key Window/Cursor Display Setting]	
Key Window/Cursor Display Setting	Same as the project setting
[Key Window/Cursor Movement]	
Key Window/Cursor Movement	Same as the project setting
[Dialog Window]	
Dialog Window	Same as the project setting
[KANJI Conversion]	
Option Selection Window Setting	Same as the project setting

### Common Setting

File: C:\Kajicis\Wahubayukurei\DTW (Project11)  
Date: 2010-11-26

[Common Setting]

**Project information**  
 [Project Title]  
 Sample

[Project ID]  
 Z175542

[Detail Description]  
 -

[Created By]  
 -

**GOT Setting**  
 GOT Type Setting  
 (GOT Type)  
 GT16\*\*~V (640x480)

[Color Setting]  
 256 Image data (5536)

[Default Drive Name]  
 A: Standard CF Card

[Project Folder]  
 Project1

[Font]  
 - Japanese (supporting Europe)

[16dot Standard Font]  
 Gothic

[True Type Numerical Font]  
 Gothic

[Check for overlapping objects within GOT]  
 No

[Adjust object display order in GOT to the one in GT Designer?]  
 No

[Use system labels in conjunction with MELSOFT Navigator]  
 No

**Environmental Setting**  
 [Screen Switching/Window]

Screen Switching Device	X Display Position	Y Display Position	Window Bar
Base Screen	GD100	-	-
Overlap Window1	D101	-	Yes
Overlap Window2	D102	-	Yes
Overlap Window3	D103	-	Yes
Overlap Window4	D104	-	Yes
Overlap Window5	D105	-	Yes
Superimpose Window1	D111	-	-
Superimpose Window2	D112	-	-
Dialog Window	-	-	-

Setting  
 [Screen Switching Device Data Type] BIN  
 [Enable background colors of overlay screen when setting a k.uovstlav-screen] No

### Advanced Recipe

File: C:\Kajicis\Wahubayukurei\DTW (Project11)  
Date: 2010-11-26

[Advanced Recipe Common]

External Control Device D500  
 File Conversion External Control No  
 External Notification Device No

[Advanced Recipe]  
 No. 1

Recipe Name	Advanced Recipe1
Recipe File	Use
Drive Name	A: Standard CF Card
Folder Name	Project1
File Name	AR P00001.G1P
Include device comments in conversion target	No
Maximum number of characters	-
Write Tipper Device1	No
Write Tipper Device2	-
Read Tipper Device1	No
Read Tipper Device2	-
Record No. Device	-
Convert Format	-
Destination	-
Drive Name	-
Folder Name	-
File Name	-
Device Number	1
Block Number	1
Record Number	1

### Logging Setting

File: C:\Kajicis\Wahubayukurei\DTW (Project11)  
Date: 2010-11-26

[Logging]

Logging ID : 1

Logging Name Logging1

Logging Mode File Save

Number of Files 1

Number of Log a File 1

File Terminal Trigger No

File Terminal Notification Device -

Logging Trigger Type Sampling

Sampling 1

Logging Notification Device No

Logging Count Device No

Retain data in the embedded memory in GOT even when the power goes off. (The battery will be required.) No

Log Storage Number 1 (Number of Items)  
 => 1 Kbyte of the memory to be used

Block Number 1

File Output Attribute Yes

Drive Name A: Standard CF Card

Folder Name Project1\LOG00001

File Name LOG00001

Add date information to file name No

Save Tipper Type None

Additional File Type None

Destination -

Drive Name -

Folder Name -

File Name -

Specify File Output Time Information Format No

Date/Time Format -

Writing Notification Device No

Writing Error Notification Device No

### Device Data Transfer

File: C:\Kajicis\Wahubayukurei\DTW (Project11)  
Date: 2010-11-26

[Device Data Transfer]

Device Data Transfer ID : 1

Device Data Transfer Name Device Data Transfer1

Transfer Type Sampling

Sampling (00ms) 100

External Control Device D500

Transfer Device -

Transfer Inverting Flag Device D600 b1

External Notification Device No

Device Data Transfer Notification Signal -

Device Data Transfer Error Notification Signal -

Device Number 1

Block Number 1

Device (List)

File: G:\Project\Wahutaurohurei.GTW (Project1)  
Date: 2010-11-25

[Device List]

[GOT Device]  
[Word Device]  
[GD List]

Device
0-FF GD100 GD101

[CHI-MELSEC-QnA/Q/S, MELDAS C5\*]  
[Bit Device]  
[X List]

Device
0-FF X0001

[Word Device]  
[D List]

Device
0-FF D102 D103 D104 D105 D111 D112 D200 D300 D350 D400 D500 D550 D600 D610 D620

Device (Details)

File: G:\Project\Wahutaurohurei.GTW (Project1)  
Date: 2010-11-25

[Device Details]  
[GOT Device]  
[Word Device]  
[GD Details]

Device	Points	Screen Number	Object	Coordinates	Object ID
0-FF GD100		Common Setting	Screen Switching	-	-
		Common Setting	Script-No.1	-	-
GD101		Common Setting	Screen Switching	-	-

[CHI-MELSEC-QnA/Q/S, MELDAS C5\*]  
[Bit Device]  
[X Details]

Device	Points	Screen Number	Object	Coordinates	Object ID
0-FF X0001		Common Setting	Device Tripper	-	-

[Word Device]  
[D Details]

Device	Points	Screen Number	Object	Coordinates	Object ID
0-FF D102		Common Setting	Screen Switching	-	-
D103		Common Setting	Screen Switching	-	-
D104		Common Setting	Screen Switching	-	-
D105		Common Setting	Screen Switching	-	-
D111		Common Setting	Screen Switching	-	-
D112		Common Setting	Screen Switching	-	-
D200		Common Setting	Language Switching	-	-
D300	3	Common Setting	System Information	-	-
D350	17	Common Setting	System Information	-	-
D400	1	Common Setting	Language Setting	-	-
D500	3	Common Setting	Advanced Recipe Common Setting	-	-
D550	1	Common Setting	Advanced Recipe Setting	-	-
D600		Common Setting	Device Data Transfer	-	-
D610	1	Common Setting	Device Data Transfer	-	-
D620	1	Common Setting	Device Data Transfer	-	-

Comment

File: G:\Project\Wahutaurohurei.GTW (Project1)  
Date: 2010-11-25

[Comment List]

Basic Comment

Id	Basic Comment1
0	Basic Comment1
1	Basic Comment2

Basic Comment Attribute

Id	Text Color/Reverse/No/Blnk/None/HD/Font/No/Style/Regular
0	Text Color/White/Reverse/No/Blnk/None/HD/Font/No/Style/Regular
1	Text Color/White/Reverse/No/Blnk/None/HD/Font/No/Style/Regular



Parts

File: G:\Project\Wahutaurohurei.GTW (Project1)  
Date: 2010-11-25

[Parts Setting]

Setting	Yes	No
Show overlapped areas of shapes in XOR when Display Mode of Parts Display is XOR		Yes
Show image files in the memory card at the time of specifying Parts No. S001-S999		No

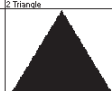
[Parts]

Circle	Triangle	Rectangle
		

### Script Files

File: C:\Kproject\Wshutsubayokurei.DTW (Project 1)  
Date: 2010-11-28

[Script]

[Script File]			
No.	Comment	Modified	Script Name
1		2009/05/26 16:16:00	Script1

[Script Options]	
Data Storage Destination	Project Data
Script	Display the script data update confirmation message when processing write to GOT
Script Editor Type	Script Editor
Editor Path	-
Option	-
File Handling Function Storage Order	Low → High
Cancel Internal device (GD/QB) assignment delay	Yes

### Sound Files

File: C:\Kproject\Wshutsubayokurei.DTW (Project 1)  
Date: 2010-11-28

[Sound File Setting]

Use a sound file for touch line tone	No
Give top priority to sound output of a switch	-

[Sound File]

No.	File Name
1	h01.wav

### Category

File: C:\Kproject\Wshutsubayokurei.DTW (Project 1)  
Date: 2010-11-28

[Category]



[Switch]		
	Screen	Coordinates
Special Function Switch	B-1	448, 388
Go To Screen Switch	B-1	80, 388
Go To Screen Switch	B-1	264, 388
Special Function Switch	B-2	448, 388
Go To Screen Switch	B-2	80, 388
Go To Screen Switch	B-2	264, 388
Special Function Switch	B-3	448, 388
Go To Screen Switch	B-3	80, 388
Go To Screen Switch	B-3	264, 388

[Other]		
	Screen	Coordinates
Test	B-1	176, 65
Test	B-2	176, 64
Test	B-3	176, 63
Test	W-1	40, 32
Test	W-2	40, 32
Test	W-3	40, 32

### My Library

File: C:\Kproject\Wshutsubayokurei.DTW (Project 1)  
Date: 2010-11-28

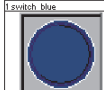
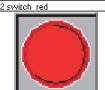
[My Library]

1.my library Folder			
1.switch blue	2.switch red	3.switch yellow	4.switch green
			



## ■ File output

### (1) Files to be output

In file output, the following files are output to the specified folder.

#### (a) Text file

The file format (CSV/TXT) can be selected in the [Print] dialog box.

 3.15.1 ■Print dialog box

Item	File	Remark
Cover	• Cover.CSV/TXT	-
Screen Title List	• Screen Title List.CSV/TXT	-
Screen Image / Setting	• Screen Image Setting.CSV/TXT	-
Common Setting	• Common Setting.CSV/TXT	-
Advanced Recipe	• Advanced Recipe Common.CSV/TXT	-
	• Advanced Recipe Setting-****.CSV/TXT	Substitute "*****" with a recipe number.
Logging Setting	• Logging Settings-****.CSV/TXT	Substitute "*****" with a logging ID.
Device Data Transfer	• Device Data Transfer-****.CSV/TXT	Substitute "*****" with a device data transfer ID.
Device	• Device List-CH*.CSV/TXT	Substitute "*" with a channel number.
	• Device List-GOT.CSV/TXT	
	• Device Details-CH*.CSV/TXT	Substitute "*" with a channel number.
	• Device Details-GOT.CSV/TXT	
Comment	• Comment List.CSV/TXT	-
	• Comment List-***.CSV/TXT	Substitute "*****" with a comment group number.
Parts	• Parts.CSV/TXT	-
Script Files	• Script.CSV/TXT	-
Sound Files	• Sound Files.CSV/TXT	-
Category	• Category.CSV/TXT	-
My Library	• My Library.CSV/TXT	-

#### (b) Image file

The file format (BMP/JPEG) can be selected in the [Print] dialog box.

 3.15.1 ■Print dialog box

Item	File	Remark
Screen Image/Setting (Base Screen)	<ul style="list-style-type: none"> <li>• BaseON-****.BMP/JPG</li> <li>• BaseOFF-****.BMP/JPG</li> <li>• BaseONObjectID-****.BMP/JPG</li> <li>• BaseOFFObjectID-****.BMP/JPG</li> <li>• BaseONDevice-****.BMP/JPG</li> <li>• BaseOFFDevice-****.BMP/JPG</li> </ul>	Substitute "*****" with a screen number.
Screen Image/Setting (Window Screen)	<ul style="list-style-type: none"> <li>• WindowON-****.BMP/JPG</li> <li>• WindowOFF-****.BMP/JPG</li> <li>• WindowONObjectID-****.BMP/JPG</li> <li>• WindowOFFObjectID-****.BMP/JPG</li> <li>• WindowONDevice-****.BMP/JPG</li> <li>• WindowOFFObjectID-****.BMP/JPG</li> </ul>	Substitute "*****" with a screen number.
Parts	• Parts-****.BMP/JPG	Substitute "*****" with a part number.
My Library	• My Library-***-***.BMP/JPG	Substitute "***-***" with "a library folder number-library data number".

**(2) Output image (When set to CSV file)**

Cover.CSV

	A	B	C	D	E	F	G	H	I
1	[Cover]								
2									
3		Title	Sample Project						
4		Date	2009/5/26						
5									
6									
7									
8									
9									
10									
11									
12									
13									
14									
15									
16									
17									

Screen Title List.CSV

	A	B	C	D	E	F	G	H	I
1	[Screen Title List]								
2									
3	[Base Screen Title List]								
4		1	Base Screen1						
5		2	Base Screen2						
6		3	Base Screen3						
7									
8	[Window Screen Title List]								
9		1	Window Screen1						
10		2	Window Screen2						
11		3	Window Screen3						
12									
13									
14									
15									
16									
17									

Screen Image Setting.CSV

	A	B	C	D	E	F	G	H	I
1	[Screen Image / Setting]								
2									
3	Base Screen1								
4	[Base Screen Details]								
5		Screen Na	Base Screen1						
6		Size	640X480						
7		Detailed De-							
8		Security	0						
9		Use screen No							
10		Pattern	-						
11		Pattern Co-							
12		Background-							
13		Front Layer	Dark Yellow						
14		Switch Sta	No						
15		Popup the	Yes						
16		Display Pos	Bottom						
17									

Common Setting.CSV

	A	B	C	D	E	F	G	H	I
1	[Common Setting]								
2									
3	Project information								
4	[Project Title]								
5		Sample							
6									
7	[Project ID]								
8		2175542							
9									
10	[Detail Description]								
11									
12									
13	[Created By]								
14									
15									
16	GOT Setting								
17	GOT Type Setting								

Advanced Recipe Setting-\*\*\*\*.CSV

	A	B	C	D	E	F	G	H	I
1	[Advanced Recipe]								
2	No. 1								
3		Recipe Nar	Advanced Recipe1						
4		Recipe File Use							
5		Drive Name	A:Standard CF Card						
6		Folder Nar	Project1						
7		File Name	ARP00001.G1P						
8		Write Trigg-							
9		Write Trigg-							
10		Read Trigg-							
11		Read Trigg-							
12		Record No-							
13		Convert Fc-							
14		Destination-							
15		Drive Name-							
16		Folder Nar-							
17		File Name -							

Logging Settings-\*\*\*\*.CSV

	A	B	C	D	E	F	G	H	I
1	[Logging]								
2									
3	Logging ID : 1								
4		Logging Na	Logging1						
5		Logging Mc	File Save						
6		Number of	1						
7		Number of	1						
8		File Termin-							
9		File Termin-							
10		Logging Tr	Sampling/1						
11		Logging No-							
12		Logging Co-							
13		Log Stora	1(number of items) --> 1 Kbyte of the memory to be used						
14		Block Num	1						
15		File Output	Yes						
16		Drive Name	A:Standard CF Card						
17		Folder Nar	Project1 \LOG00001						

Device Data Transfer-\*\*\*\*.CSV

	A	B	C	D	E	F	G	H	I
1	[Device Data Transfer]								
2									
3	Device Data Transfer ID : 1								
4		Device Dat	Device Data Transfer1						
5		Trigger Ty	Sampling 100(x1.00ms)						
6		External Ct	D600						
7		Trigger De	D600.b0						
8		Transfer Ir	D600.bt						
9		External Nc-							
10		Device Dat-							
11		Device Dat-							
12		Device Num	1						
13		Block Num	1						
14									
15		No.	Device Ty	Points	Source De	Destinatio	Comment	Offset	
16		1	Signed BIN	1	D610	D620	-	None	
17									

Device List-CH\*.CSV

	A	B	C	D	E	F	G	H	I
1	[Device List]								
2									
3	[CH1:MELESEC-QnA/Q/GS, MELDAS C6*]								
4	[Bit Device]								
5	[X List]								
6			Device						
7		0-FF	X0001						
8									
9	[Word Device]								
10	[D List]								
11			Device						
12		0-FF	D103	D104	D105	D111	D112	D200	D300
13			D350	D400	D500	D5			
14									
15									
16									
17									

Device Details-CH\*.CSV

	A	B	C	D	E	F	G	H	I
1	[Device Data Transfer]								
2									
3	Device Data Transfer ID : 1								
4		Device Dat	Device Data Transfer						
5		Trigger Ty	(Sampling 100x100ms)						
6		External C	D600						
7		Trigger De	D600.b0						
8		Transfer Ir	D600.b1						
9		External N	-						
10		Device Dat	-						
11		Device Dat	-						
12		Device Nui	1						
13		Block Num	1						
14									
15		No.	Device Ty	Points	Source De	Destinator	Comment	Offset	
16		1	Signed BIN	1	D610	D620	-	None	
17									

Comment List.CSV

	A	B	C	D	E	F	G	H	I
1	[Comment List]								
2									
3	Basic Comment								
4			1	Basic Comment1					
5			2	Basic Comment2					
6			3	Basic Comment3					
7									
8	Basic Comment								
9			1	Text Color:White/Reverse.No/Blink:None/HQ Font.No/Style Regular					
10			2	Text Color:White/Reverse.No/Blink:None/HQ Font.No/Style Regular					
11			3	Text Color:White/Reverse.No/Blink:None/HQ Font.No/Style Regular					
12									
13									
14									
15									
16									
17									

Parts.CSV

	A	B	C	D	E	F	G	H	I
1	[Parts Setting]								
2									
3		Show over	Yes						
4		Show imag	No						
5									
6	[Parts]								
7		1	Circle						
8		2	Triangle						
9		3	Rectangle						
10									
11									
12									
13									
14									
15									
16									
17									

Script.CSV

	A	B	C	D	E	F	G	H	I
1	[Script]								
2									
3	[Script File]								
4		No.	Comment	Modified	Script Name				
5		1	-	2009/5/26 16:16	Script1				
6									
7	[Script Options]								
8		Script Date	Project Data						
9		Display the	-						
10		Script Edit	Script Editor						
11		Editor Path	-						
12		Option	-						
13		File Handlr	Low --> High						
14		Cancel Int	Yes						
15									
16									
17									

Sound Files.CSV

	A	B	C	D	E	F	G	H	I
1	[Sound Files Setting]								
2									
3		The Sound	No						
4		Prioritize	tl-						
5									
6	[Sound Files]								
7		No.	File Name						
8		1	a01.wav						
9									
10									
11									
12									
13									
14									
15									
16									
17									

Category.CSV

	A	B	C	D	E	F	G	H	I
1	[Category]								
2									
3	[Switch]								
4			Screen	Coordinates					
5		Special Fur	B-1	448,368					
6		Go To Scr	B-1	80,368					
7		Go To Scr	B-1	264,368					
8		Special Fur	B-2	448,368					
9		Go To Scr	B-2	80,368					
10		Go To Scr	B-2	264,368					
11		Special Fur	B-3	448,368					
12		Go To Scr	B-3	80,368					
13		Go To Scr	B-3	264,368					
14									
15	[Other]								
16			Screen	Coordinates					
17		Text	B-1	176,65					

My Library.CSV

	A	B	C	D	E	F	G	H	I
1	[My Library]								
2									
3	1	my library Folder							
4		1	New Library data						
5		2	New Library data						
6		3	New Library data						
7		4	New Library data						
8									
9									
10									
11									
12									
13									
14									
15									
16									
17									

## 3.16 Saving Project

---

GT Designer3 saves projects as the following formats.

- GT Designer3 project
- A single file format project (\*.GTW)

For the project format, refer to the following.

 2.2 Project Format Handled with GT Designer3

### 3.16.1 Overwriting projects

---

Select [Project] → [Save] from the menu to overwrite a project.

When an editing project is never saved, the [Save As Project] dialog box appears.

For the [Save As Project] dialog box, refer to the following.

 3.16.2 Saving as a new file

#### **POINT**

##### **Data processed as GT Designer3 projects that are never saved before**

The following projects are processed as GT Designer3 projects that are never saved before.

Name and save the following projects as a GT Designer3 project or a single file format project (\*.GTW).



- GTE format (\*.GTE), GTD format (\*.GTD), G1 format (\*.G1) projects
  - GT Designer3 project that does not include a project management file
-

### 3.16.2 Saving as a new file

#### ■ Saving a GT Designer3 project.

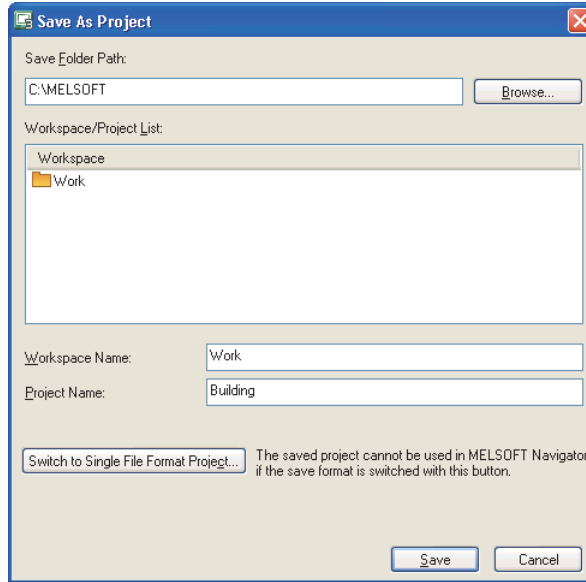
1. Select [Project] → [Save As] from the menu to display the [Save As Project] dialog box (single file format).
2. Click the [Switch to workspace format project] button.  
The following dialog box appears.



Item	Description
Save Folder Path	Set the path for the workspace where the project is saved. Also, the save destination path can be set in the [Browse For Folder] dialog box displayed by clicking the [Browse] button. Do not save the project in the following path. <ul style="list-style-type: none"> <li>• &lt;Installation path&gt;\GTD3_2000\App</li> <li>• &lt;Installation path&gt;\GTD3</li> </ul>
Workspace/Project List	The workspace or project is displayed existing in the path set for [Folder path to save].
Workspace Name	Set the workspace name where the project is saved. If the set workspace does not exist in the [Workspace/Project List], the workspace is created when saving.
Project Name	Set the project name of a project to be saved.
	Click this button to save the project as a single file format project (*.GTW). After clicking this button, the [Save As Project] dialog box (single file format) appears. Save as a single file format project by referring to the following. <ul style="list-style-type: none"> <li> ■ Opening a single file format project</li> </ul>

3. Set [Save Folder Path], [Workspace Name], and [Project Name]. Click the [Save] button to save the project in the workspace.



## POINT

- (1) **Maximum number of text for [Save Folder Path], [Workspace Name], and [Project Name]**  
Set the total number of text for [Save Folder Path], [Workspace Name], and [Project Name] at 200 characters or less. ("\" placed at the end of the project name is not included.)
- (2) **When a project already exists**  
When saving a project as a new file, the same name for other project already existing cannot be used. Save under other name, or delete the project that has the same name.  
 3.17 Deleting Project
- (3) **Operating on iQ Works**  
Save a project with a different name, a project cannot be saved with a different name. Only overwriting is available.  
To save a project with a different name, save the project with the workspace from MELSOFT Navigator.

### ■ Saving as a single file format project(\*.GTW)

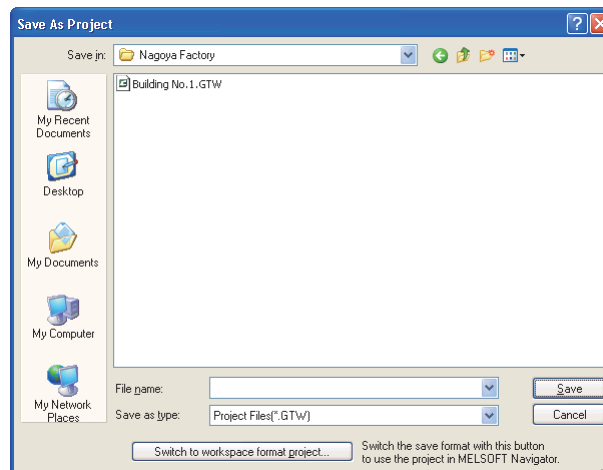
1. Select [Project] → [Save As] from the menu to display the [Save As Project] dialog box.
2. Click the [Switch to Single File Format Project] button.  
The following dialog box appears.



Item	Description
Save in	Select a location where a project is saved. Do not save the project in the following path. <ul style="list-style-type: none"> <li>• &lt;Installation path&gt;\GTD3_2000\App</li> <li>• &lt;Installation path&gt;\GTD3</li> </ul>
File name	Set a file name of the project.
Save as type	The saving format of the file is displayed.
	Click this button to save the project as a GT Designer3 project. After clicking this button, the [Save As Project] dialog box appears. Save a GT Designer3 project by referring to the following.  ■ Saving a GT Designer3 project.

3. Select a project and click the [Save] button to save the selected project.

## HINT

### Handling a folder or file of GT Designer3 project

Use GT Designer3 for the folder or file operations, including moving, renaming, copying, and deleting a GT Designer3 project.

If the folder or file is operated other than GT Designer3 such as Explorer, data may have some problems.

#### (1) Move

1. Open a GT Designer3 project to be moved.
2. Select [Project] → [Save As] from the menu. Change [Folder path to save] to a path where a file or folder is saved, and save the project.
3. Delete the project saved in the previous folder.  
 3.17 Deleting Project

#### (2) Rename

1. Open a GT Designer3 project to be renamed.
2. Select [Project] → [Save As] from the menu. Change the name, and save the project.
3. Delete the project saved in the previous folder.  
 3.17 Deleting Project

#### (3) Copy

1. Open a GT Designer3 project to be copied.
2. Select [Project] → [Save As] from the menu. Change the name, and save the project.

#### (4) Delete

For deleting a GT Designer3 project, refer to the following.

 3.17 Deleting Project

## 3.17 Deleting Project

This section explains how to delete a GT Designer3 project registered in the workspace.

1. Select [Project] → [Delete] from the menu to display the [Delete Project] dialog box.
2. Select the project to be deleted in [Workspace/Project List]. Click the [Delete] button to delete the selected project.

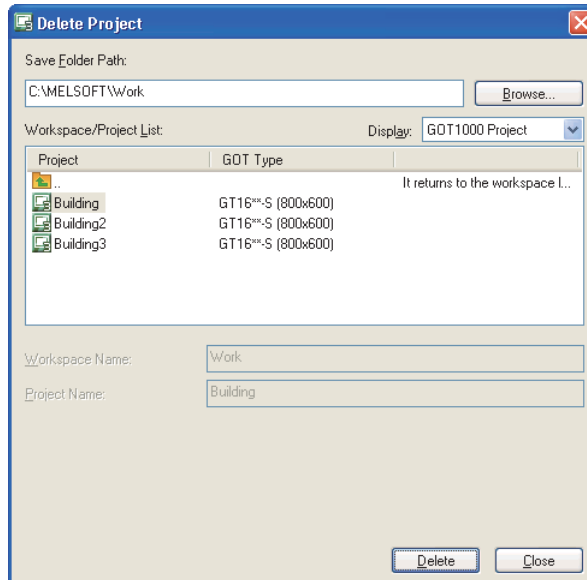

Item		Description
Folder path to save		Set a path for the workspace where a project is stored. Also, the save destination path can be set in the [Browse For Folder] dialog box displayed by clicking the [Browse] button.
Workspace/Project List		The workspace or project existing in the path set for [Folder path to save] is displayed. Select a project to be deleted.
Display	GOT2000 Project	The project files of the GOT2000 series existing in the path set for [Save Folder Path] are displayed. Select this item when deleting project files of the GOT2000 series.
	GOT1000 Project	The project files of the GOT1000 series existing in the path set for [Save Folder Path] are displayed. Select this item when deleting project files of the GOT1000 series.
Workspace Name		Displays the workspace name where the project selected in [Workspace/Project List] is stored.
Project Name		Displays the project name selected in [Workspace/Project List].

## 3.18 Ending GT Designer3

To end GT Designer3, perform either of the following operations.

- Select [Project] → [Exit] from the menu.
- Click  in the title bar.



# 3.19 How to Use Help

This section explains how to display the GT Designer3 Help and the PDF manuals relevant to GT Designer3, and confirm the version of GT Designer3.

## 3.19.1 Displaying the GT Designer3 Help

### ■ Operating environment

A personal computer with Internet Explorer 7 or later is recommended.

### ■ How to display the GT Designer3 Help

The simple operation method of GT Designer3 can be confirmed with the GT Designer3 Help.

The following shows how to display the GT Designer3 Help.

- Select [Help] → [GT Designer3 Help] from the menu.
- Press the [F1] key.

Displaying the GT Designer3 Help by pressing the [F1] key shows the contents that correspond to the status of GT Designer3.

Example) When the setting dialog box of the bit switch ([Device] tab) is displayed

Pressing the [F1] key displays the GT Designer3 Help with the page of the bit switch setting dialog box ([Device] tab).

Depending on the status of GT Designer3, the GT Designer3 Help may not display the corresponding contents.

## 3.19.2 Displaying PDF manuals

### POINT

#### Before displaying the PDF manuals

To display the PDF manuals, install GT Manual3 and Adobe® Reader® on the personal computer.

### ■ Displaying the PDF manuals by selecting [Help] from the menu

To display a PDF manual, select [Help] → [Manual] from the menu and select the PDF manual.

Item	Description
Screen Design Manual (Fundamentals)	The GT Designer3 Version1 Screen Design Manual (Fundamentals) is displayed.
Screen Design Manual (Functions)	The GT Designer3 Version1 Screen Design Manual (Functions) is displayed.
Index	The INDEX MENU is displayed. Displaying the manuals relevant to GT Designer3 is available from the INDEX MENU.

**(1) Selecting Screen Design Manual (Fundamentals)/Screen Design Manual (Functions)**

For operating Adobe® Reader®, refer to the [help] for Adobe® Reader®.  
Click the INEDX MENU to display a list of manuals.

☞ (2) Selecting Index

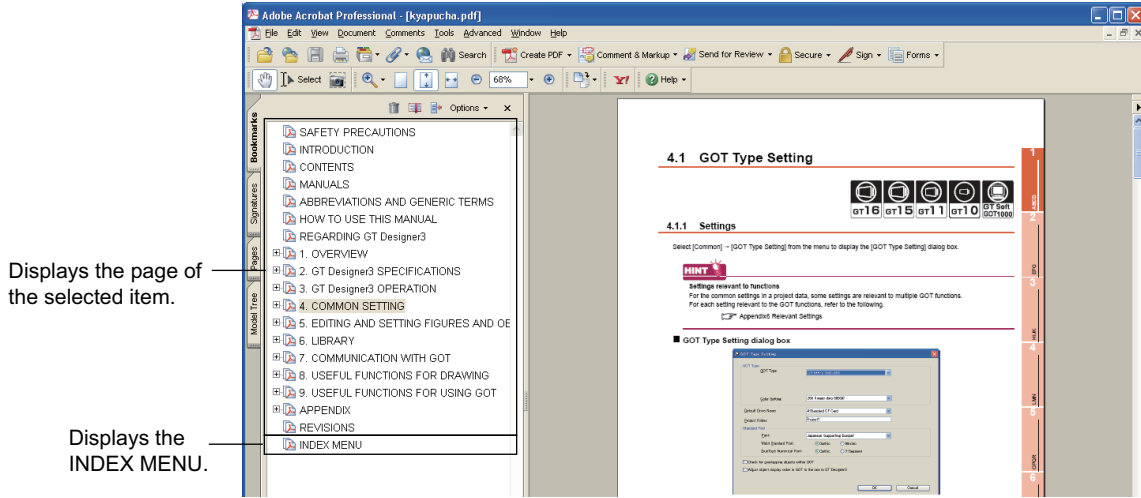

**(2) Selecting Index**

1. Click the manual to be viewed in the INDEX MENU.

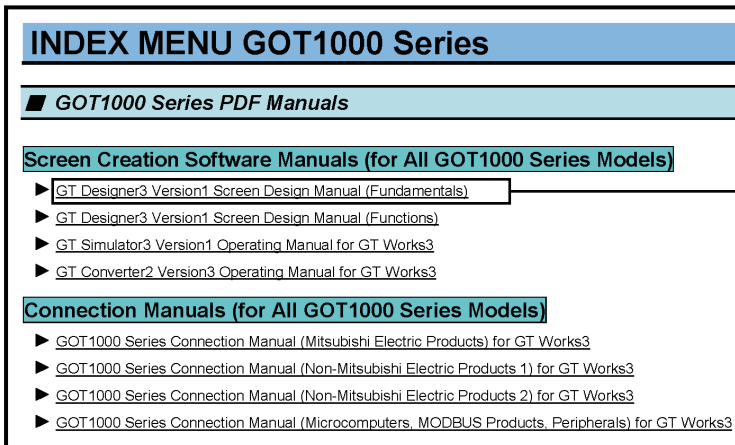

2. The clicked manual is displayed.

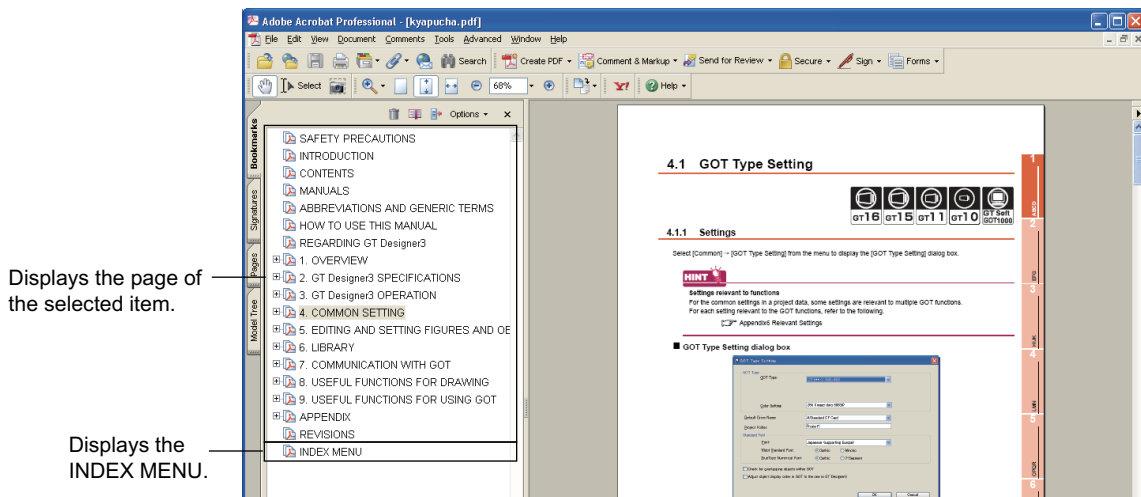

### 3.19.3 Connecting to MITSUBISHI ELECTRIC FA Global Website

Select [Help] → [MITSUBISHI ELECTRIC FA Global Website] from the menu to launch the web browser. The MITSUBISHI ELECTRIC FA Global Website is displayed.

### 3.19.4 Confirming GT Designer3 version

Select [Help] → [About GTD3] from the menu to display the [About GT Designer3] dialog box.

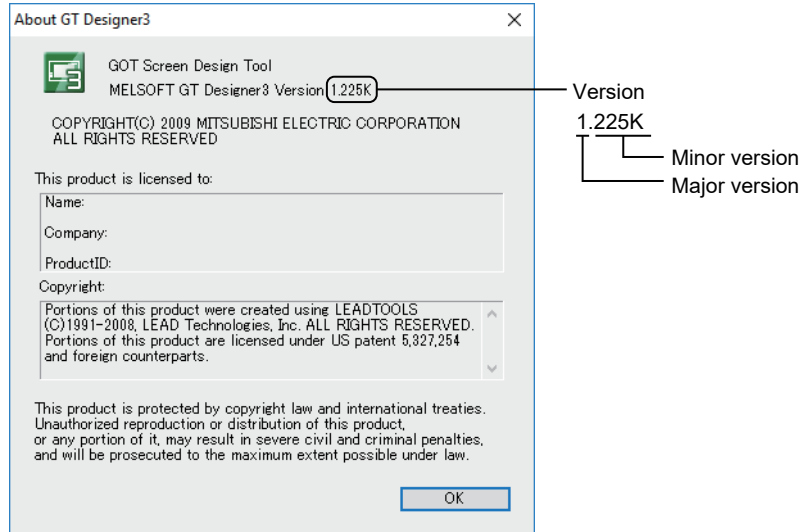



# COMMON SETTING

---



# 4. COMMON SETTING

Item	Model	Reference
GOT Type Setting	Gr16 Gr15 Gr14 Gr12 Gr11 Gr10 SoftGOT1000	4.1
GOT Environmental Setting	Screen Switching/Window	4.2
	Language Switching	4.3
	Dialog Window	4.4
	Key Window	4.5
	System Information	4.6
	Security	4.7
	Operation Log	(Functions) 23. OPERATION LOG FUNCTION
	KANA KANJI Conversion	(Functions) 6. ASCII DISPLAY/ASCII INPUT
	Startup Logo	4.8
GOT Setup	4.9	
Controller Setting	CH*	GOT1000 Series Connection Manual for GT Works3 and a controller used
	Ethernet	GOT1000 Series Connection Manual for GT Works3 and a controller used
	Routing Information	GOT1000 Series Connection Manual for GT Works3 and a controller used
	Gateway	GOT1000 Series Gateway Functions Manual for GT Works3
	Q Redundant	GOT1000 Series Connection Manual for GT Works3
	Station No. Switching	4.10
	Buffer memory unit No. switching	4.11
Peripheral Setting	PC (Data Transfer)	8.1
	Bar Code	(Functions) 31. BARCODE FUNCTION
	RFID	(Functions) 32. RFID FUNCTION
	PC Remote Operation	(Functions) 33. REMOTE PERSONAL COMPUTER OPERATION FUNCTION
	VNC Server	(Functions) 34. VNC(R) SERVER FUNCTION
	Fingerprint Authentication	GOT1000 Series Connection Manual (Microcomputer, MODBUS Products, Peripherals) for GT Works3
	Video/RGB Input	(Functions) 35. VIDEO DISPLAY FUNCTION

(Continued to next page)

Item	Model	Reference
Peripheral Setting	Multimedia 	(Functions) 36. MULTIMEDIA FUNCTION
	Operation Panel 	(Functions) 37. OPERATION PANEL FUNCTION/EXTERNAL I/O FUNCTION
	RGB Output 	(Functions) 38. RGB DISPLAY FUNCTION
	CF Card Unit 	GT Designer3 Version1 Screen Design Manual (Functions)
	Printer 	GOT1000 Series Connection Manual (Microcomputer, MODBUS Products, Peripherals) for GT Works3
	Sound Output 	GOT1000 Series Connection Manual (Microcomputer, MODBUS Products, Peripherals) for GT Works3
	GOT(Extended Computer) 	GOT1000 Series Connection Manual (Microcomputer, MODBUS Products, Peripherals) for GT Works3
I/F Communication Setting 	GOT1000 Series Connection Manual for GT Works3 and a controller used	
Comment		4.13
Alarm		(Functions) 11. ALARM
Logging		(Functions) 24. LOGGING FUNCTION
Recipe		(Functions) 25. RECIPE
Script		(Functions) 30. SCRIPT FUNCTION
Device Data Transfer		(Functions) 26. DEVICE DATA TRANSFER FUNCTION
Status Observation		(Functions) 27. STATUS OBSERVATION FUNCTION
Trigger Action		(Functions) 28. TRIGGER ACTION FUNCTION
Time Action		(Functions) 29. TIME ACTION FUNCTION
Hard Copy		(Functions) 40. HARD COPY FUNCTION
MES Interface		GOT1000 Series MES Interface Function Manual for GT Works3
Parts		4.14
Sound		(Functions) 41. SOUND OUTPUT FUNCTION



# 4.1 GOT Type Setting



## 4.1.1 Settings

Select [Common] → [GOT Type Setting] from the menu to display the [GOT Type Setting] dialog box.











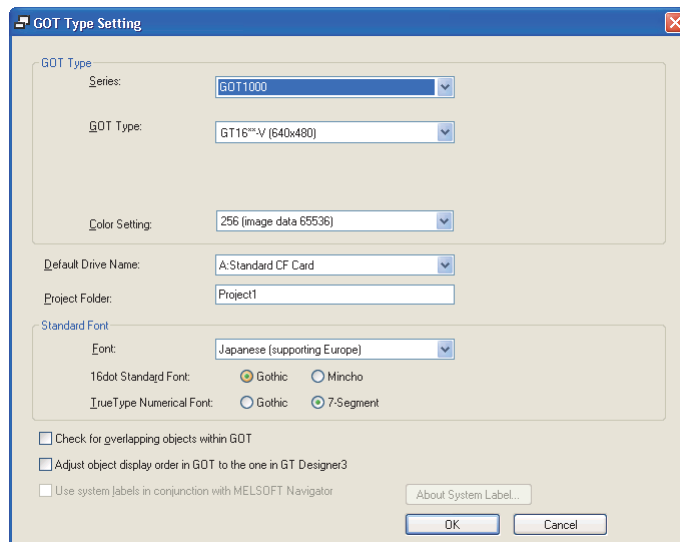











































### Settings relevant to functions

For the common settings in a project data, some settings are relevant to multiple GOT functions. For each setting relevant to the GOT functions, refer to the following.





Appendix8 Relevant Settings

### ■ GOT Type Setting dialog box

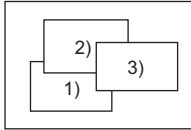
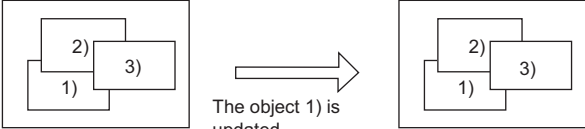
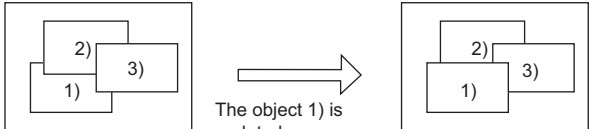

Item	Description		Model
GOT Type	Series	Select the GOT series to be used. The series can be changed after creating a project.	
	GOT Type	Select the type of the GOT used. The type can be changed after creating a project. When the GOT type that screen size differs from the old screen size is changed, and the [OK] button is clicked, a conversion setting dialog box appears.  (1) Conversion setting dialog box	      
	Setup Direction	Select the direction to install the GOT. (Horizontal/Vertical)	      
	Resolution	Select the resolution (horizontal or vertical) according to GT SoftGOT1000 to be used.	      
	Color Setting* <sup>5</sup>	Select the number of colors displayed on the GOT in accordance with the GOT display color. The selected number of colors is set as the number of colors applicable to GT Designer3.	      
Default Drive Name	Select a default drive for functions that use a memory card. The selected drive is set for the default setting of each function available for the drive setting.	      	
Project Folder <sup>*1*2</sup>	<p>This is indispensable for creating a project. Specify it without fail. Set a folder name of a folder created in the GOT, a memory card, or a USB memory when one of the following is performed.</p> <ul style="list-style-type: none"> <li>• Writing a project from GT Designer3 to the GOT, a memory card, or a USB memory</li> <li>• Reading a project from the GOT to a memory card or a USB memory</li> </ul> <p>ASCII characters can be entered from 1 to 32 characters.</p>		      
Standard Font	Font	Select the font to be used in all projects.  2.5.1 Fonts	      
	16dot Standard Font	Select the font type of the 16-dot standard font. (Gothic/Mincho)	
	TrueType Numerical Font	Select a font type of the TrueType numerical font. (Gothic/7-Segment)	

(Continued to next page)

Item	Description	Model
Check for overlapping objects within GOT	<p>Select this item to display the message on the GOT if the objects are overlapping each other. This item is not available when [Adjust object display order in GOT to the one in GT Designer3] is selected.</p>	
Adjust object display order in GOT to the one in GT Designer3 <sup>*3*4</sup>	<p>Select this item to adjust the order of displaying objects on the GOT to the order of the overlapped objects on GT Designer3. This setting applies to base screens, overlap windows, and superimpose windows. For the overlapping of the figures and objects, refer to the following.</p> <p> 5.3.7 Superimposition setting</p> <p>This item is not available when [Check for overlapping objects within GOT] is selected.</p> <p>Example) When objects that are overlapped on one layer with GT Designer3 are displayed on the GOT</p>  <p>3)...Third placed object (Top) 2)...Second placed object (Middle) 1)...First placed object (Bottom)</p> <ul style="list-style-type: none"> <li>When the order of displaying objects on the GOT is adjusted to that of the overlapped objects on GT Designer3</li> </ul>  <p>The object 1) is updated.</p> <p>All the objects are redrawn, and the order of displaying objects on the GOT is adjusted to that of the overlapped objects on GT Designer3.</p> <ul style="list-style-type: none"> <li>When the order of displaying objects on the GOT is not adjusted to that of the overlapped objects on GT Designer3</li> </ul>  <p>The object 1) is updated.</p> <p>Only the object 1) is redrawn, and the object is displayed at the top on the GOT. (The order of displaying objects on the GOT differs from that of the overlapped objects on GT Designer3.)</p>	
Use system labels in conjunction with MELSOFT Navigator	<p>Select this item to use a system label for GT Designer3 device setting. For the system label setting, refer to the following.</p> <p> 5.3.2 Label setting</p> <p>Clear this item when a system label is not used. When this item is cleared, the system label update/check is executed. When no error occurs, a system label is converted to a device name to which the system label is assigned. When any error occurs, a system label is not converted to a device name to which the system label is assigned. Therefore, this item is not cleared. Check or modify the system label setting, and clear this item again.</p>	
	Click this button to display an explanation for a system label.	

1	OVERVIEW
2	GT Designer3 SPECIFICATIONS
3	GT Designer3 OPERATION
4	COMMON SETTING
5	EDITING AND SETTING FIGURES AND OBJECTS
6	LIBRARY
7	TEMPLATE

- \*1 The following shows the available ASCII characters.

ASCII characters available for project folder name
#, \$, %, &, ', (, ), +, -, ., 0 to 9, =, @, A to Z, [, ], ^, _, a to z, {, }, *, space. (The character ", is not applicable.)

The following character strings are not available for the project folder name.

Character strings not available for project folder name
COM1 to COM9, com1 to com9, LPT1 to LPT9, lpt1 to lpt9, AUX, aux, CON, con, NUL, nul, PRN, prn, CLOCK\$, clock\$, name starting with "G1" , "g1" or "." (period), name ending with "." (period), name consisting of "." (one period) or ".." (two periods)

- \*2 Do not change the directory path of the folder for [Project Folder] created in a memory card or a USB memory on the personal computer.  
Example) Changing the directory path of the A drive
- Before change: A/Project1
  - After change: A:/abc/XYZ/Project1
- When the directory path is changed as shown above and the project is downloaded to the C drive on the GOT, the abc/XYZ folder is not deleted from the GOT, even if the project folder is deleted from the GOT utility.  
To delete the above folder, the BootOS must be installed on the GOT again.  
For the details of \*3, refer to the following.

 4.1.2 ■Restrictions when [Adjust object display order in GOT to the one in GT Designer3] check box is selected

- \*4 The layers are disabled in an overlap window.  
When [Adjust object display order in GOT to the one in GT Designer3] is selected, regardless of the layers, the order of the displayed objects on the GOT is the order of the placed objects on GT Designer3.  
To adjust the order of the displayed objects on the GOT to the order of the overlapped objects on GT Designer3 in the overlap window, place the objects on the back layer only.
- \*5 For the following GOT types, even when [256 (image data 65536)] is selected for [Color Setting], the number of colors for image data on the GOT screen is reduced to 4096.  
(On the screen editor of GT Designer3, the image data is displayed as the same number of colors set for [Color Setting]).
- GT1675-VN
  - GT1555-QSBD

## POINT

### Color setting and number of colors available on the GOT

For [Color Setting], set the number of colors available for the GOT used.

When more than the number of colors available for the GOT is set, the number of colors on the GOT screen is reduced.

**(1) Conversion setting dialog box**

Select whether to automatically adjust the positions or sizes of the figures and objects arranged on the screen editor.

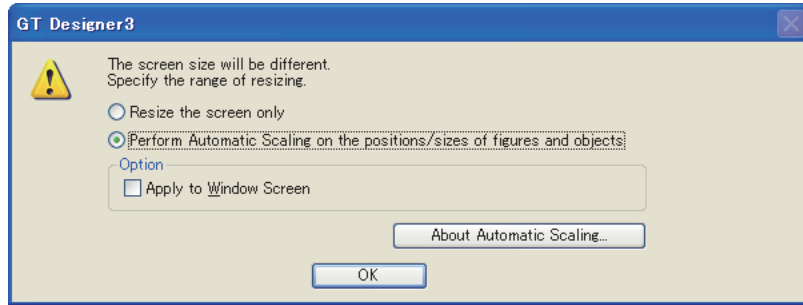

Item	Description	Model
Resize the screen only	Select this item to change the screen size only. After changing, the positions and sizes of the figures and objects on the screen are not changed.	
Perform Automatic Scaling on the positions/sizes of figures and objects	Select this item to automatically change the positions and sizes of the figures and objects to adjust those of the changed GOT type.	GT16 GT15 GT14 GT12 GT11 GT10 SoftGOT1000
Apply to Window Screen	This item is available when [Perform Automatic Scaling on the positions/sizes of figures and objects] is selected. Select this item to automatically adjust the positions and sizes of figures and objects on the screen editor for the window screen.	
About Automatic Scaling...	Select this item to display the explanation for the automatic scaling.	

**POINT**

**(1) Specifications of the scaling for each screen**

Screen	Specification
Base screen	Figures and objects are zoomed in or zoomed out automatically corresponding to the GOT screen size.
Window screen	When the used GOT type is changed to a smaller type, the window screen is zoomed out automatically. (The window screen is not zoomed in.) The figures and objects are zoomed out automatically corresponding to the maximum size of the window screen.

**(2) Objects restricted on the scaling**

The following shows the objects restricted on the scaling.

Object	Restriction
Numerical Display/Input, Ascii Display/Input, Date/Time Display	<ul style="list-style-type: none"> <li>The numerical size is zoomed in or zoomed out within the available display range set for GT Designer3.</li> <li>When [6 × 8dot] is set for the fonts, the object area is not zoomed in or zoomed out.</li> <li>When the frame format is set, figures set for objects are zoomed in or zoomed out and the object area is not zoomed in or zoomed out.</li> </ul>
Data List, Advanced User Alarm Display, Advanced System Alarm Display, Alarm History Display	The object area is not zoomed in or zoomed out. When the frame format is set, only figures are zoomed in or zoomed out.
Parts Movement	The objects are zoomed in or zoomed out only when [Line] is set for the movement method.
Parts Display, Set Overlay Screen, Window Position	For the parts display and the set overlay screen, objects and the screen size are not zoomed in or zoomed out. For the window position, the position set on the base or window screen is not changed.

## 4.1.2 Precautions

---

### ■ Precautions for changing the GOT type

If GOT type is changed, this may change or delete the some function settings or affect the figure/frame settings. Therefore, change GOT type while paying full attention to followings.  
(Also, make sure to check other settings.)

#### POINT

##### Before changing the GOT type

Before changing the GOT type, copying the project data is recommended not to delete the settings by mistake.

---

#### (1) History of [Undo] and [Redo]

The settings of [Undo] and [Redo] are reset when the GOT type is changed.

#### (2) Figures and objects not supported by the changed GOT type

After GOT type is changed, some settings, figures and objects may be deleted, if they are not supported by the GOT currently set.

Even if the [GOT Type] setting is changed to the previous one, the deleted settings are not restored.

#### (3) Device range not applicable to the changed GOT type

For the device range that is not applicable to the changed GOT type, GT Designer3 displays the devices out of the range as [?]. Configure the device settings again.

Some device types (BCD, real number) of the devices may be deleted, as the devices are not supported by the changed GOT type.

#### (4) Some setting items must be set after GOT type change is completed, as they are not included in the previous GOT type. Note that default values are set for these setting items.

#### (5) Shape set for the object

When the same shape is not included in the shapes for the changed GOT type, the shape is changed to a shape set at the top of the [Shape] combo box.

#### (6) Figures and objects set out of the display range for the screen editor

Figures and objects set out of the display range are not automatically zoomed in or zoomed out.

Relayout figures and objects into the display range when figures and objects are out of the display range.

#### (7) User defined libraries will not be changed.

The data within user defined libraries are usable even after GOT type is changed. However, if they include figures or objects that are not supported by the GOT, the libraries cannot be used.

#### (8) Setting the logo image

When [GOT Type] is changed to the GOT type of which screen size is different, the size of the logo image may be changed.

(When [GOT Type] is changed from the GOTGT1030 and GT1020 to other than the GOTGT1030 and GT1020, the start-up logo setting is deleted.)

When the size of the logo image is changed, set the logo image again.

#### (9) Changing GOT types from GT11 or GT10 to GT16, GT15, GT14, GT12, or GT SoftGOT1000

The settings in the [Alarm Flow] dialog box correspond to the changed GOT type settings of the advanced user alarm observation and the advanced alarm popup display, respectively.

#### (10) Setting a system label

The system label setting is retained if the GOT type is changed.

However, if changed to the GOT type for which a system label cannot be used, the check box of [Use system labels in conjunction with MELSOFT Navigator] in the [GOT Type Setting] dialog box is cleared.

The system label update/check is executed at this time.

When no error occurs, a system label is converted to a device name to which the system label is assigned, and the GOT type is changed.

When any error occurs, a system label is not converted to a device name to which the system label is assigned. Therefore, the GOT type cannot be changed.

### (11) Protection by the project security

When the project security is set, and if the user is under the following conditions, the user cannot change the GOT type.

- The project security for a project disables the user to edit the project.
- The project security for each screen disables the user to display or edit any of screens.

For the details of the project security, refer to the following.

 3.14 Securing Project

### (12) Setting a channel No. of a special function switch

When the GOT type is changed, if no channel No. set in the special function switch exists, the setting of the channel No. is automatically changed.

Check the setting of the channel No. of the special function switch when the following functions are set in the special function switch.

- Ladder monitor
- Ladder editor
- CNC monitor
- CNC data I/O
- CNC machining program edit
- SFC monitor

## ■ Restrictions when [Adjust object display order in GOT to the one in GT Designer3] check box is selected

The following restrictions apply to the setting of this function. When designing a screen, make sure to check the type and the attribute of an object used.

### (1) When any of the following objects overlap the other objects, the display order may differ between GT Designer3 and the GOT.

- Object with the [Blink] setting
- Numerical input or an ASCII input with the cursor
- Historical trend graph
- Advanced user alarm display or advanced system alarm display with [Flow] set for [Display Type]
- Line graph with the [Locus] setting

### (2) Even when the locus is set for the following objects, the locus setting is disabled.

- Scatter graph with [Sample] set for [Graph Type], or [Batch] set for [Graph Type] and [Locus] set for [Display Mode]
- Parts display with [Overwrite] set for [Display Mode]
- Parts movement with [Locus] set for [Display Mode]

### (3) The object script is disabled.

### (4) For an object with the [Blink] setting, the object may blink irregularly.

### (5) The VNC<sup>®</sup> server function is disabled.

## 4.2 Screen Switching Device Setting



The GOT switches base screens or displays window screens by using the screen switching device. The screen switching device can be set for the following screens.

Screen
Base screen, Overlap window 1 to 5, Superimpose window 1 to 2, Dialog window

### Switching base screens

The GOT displays a base screen with the screen number that is stored in the screen switching device for the base screen.

By setting a value for the screen switching device for the base screen, the GOT switches the displayed base screens. There are the following two methods for specifying the base screen No. At using these methods, the screen No. is stored into the switching screen device.

- (1) Storing the screen number in the screen switching device for the base screen
- (2) Switching screens by a touch switch (go to screen switch).

Example) Setting the screen switching device for the base screen to D100

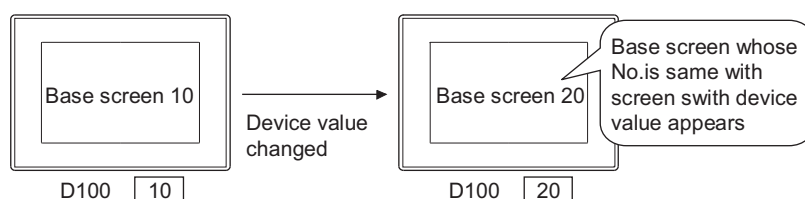

### Storing the screen number that is not written to the GOT in the screen switching device for the base screen

When 0 is stored to the screen switching device, the GOT displays the base screen with the smallest number in the GOT. (In this case, system alarms are not displayed.)

When a screen number that is not in the GOT is stored to the screen switch device, the base screens are not switched. (In this case, system alarms are displayed.)

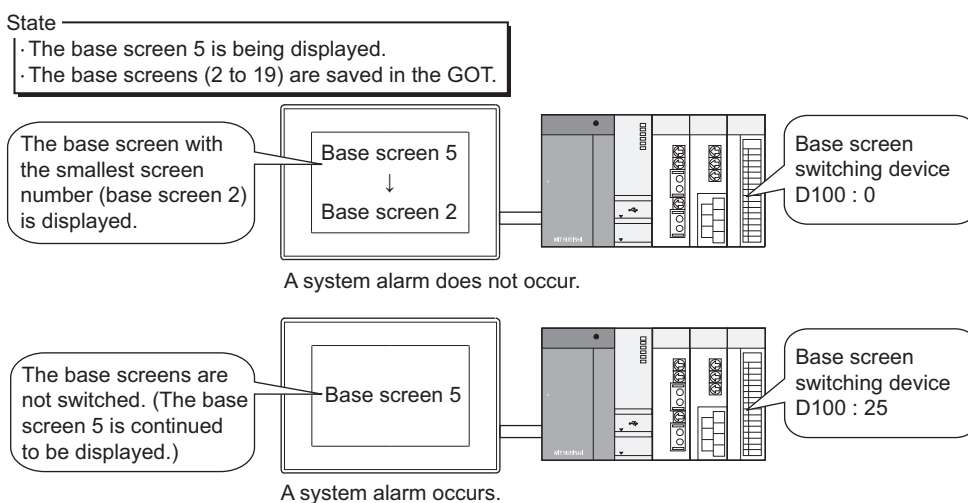



## ■ Displaying, closing, or moving window screen

### (1) Overlap window, superimpose window

The GOT displays the window screen with a screen number that is stored in the screen switching device for the window screen.

When "0" is stored in the screen switching device, the window screen is closed.

There are the following two methods for specifying the window screen No. At using these methods, the screen No. is stored into the switching screen device.

- Storing a screen number in the screen switching device for the window screen
- The screen is switched by the touch switch (go to screen switch).

Example: Relation between created window screen and device for switching window screen.

Screen switching device	Settings
Screen switching device for overlap window 1	D100
Screen switching device for superimposed window	D200

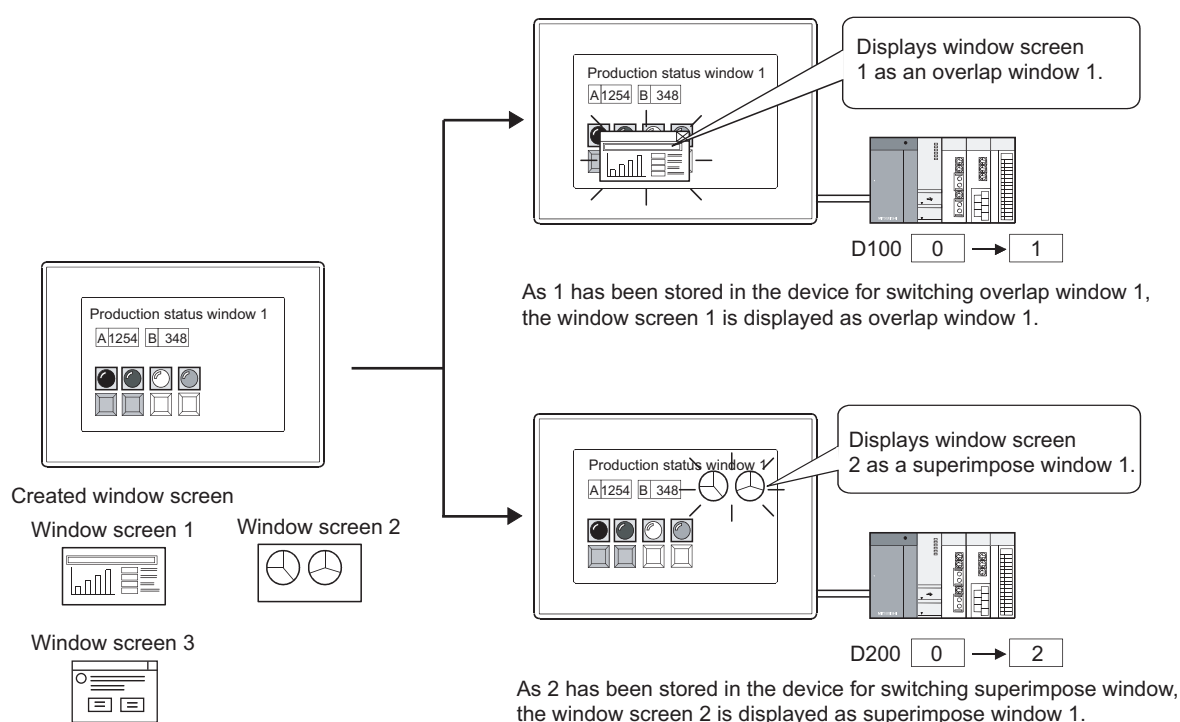

When the close key is displayed on an overlap window, touching the close key closes the overlap window. ("0" is stored in the screen switching device for the closed overlap window.)

☞ 4.2.2 Settings

## (2) Dialog window

The following two types show how to display a created dialog window.

### (a) Displaying a created dialog window instead of a GOT system message

For how to display a created dialog window instead of a GOT system message, refer to the following.

#### ☞ 4.4 Setting Message to be Displayed on GOT

When a created dialog window is displayed, the displayed dialog window screen number is stored in the screen switching device (Dialog Window).

When a GOT system message is displayed

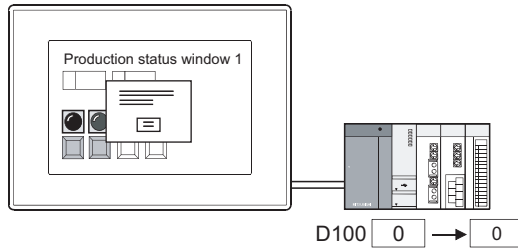

When a dialog window is displayed instead of a system message

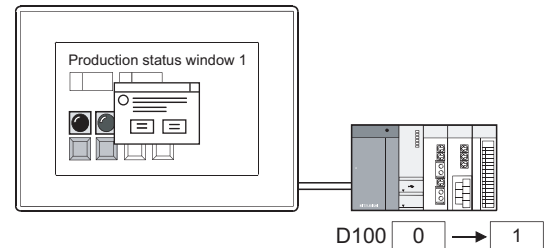

### (b) Displaying a created dialog window as a new message

The created dialog window is displayed when the dialog window screen number is stored in the screen switching device for the window screen (Dialog Window).

## HINT

### (1) Setting for a display position of a window screen

Set a display position of a window screen by GT Designer3.

(A display position of a dialog window cannot be set because the display position is fixed.)

- Overlap window, superimpose window

#### ☞ 4.2.1 Display position of window screen

- Key window

#### ☞ 4.5.3 How to operate key window

### (2) Switching screen device setting

Switching screen device is set as the following.

#### (a) GOT internal device

It is recommended to use this device only for switching the screen by the touch switch (go to screen switch).

Screen switching cannot be controlled by the controller.

However, screen switching of only base screens can be controlled by the controller with the script function.

(Example)[w:GD10]=[w:D10]; //D10 value is stored into GD10.

#### (b) Controller device

It is recommended to use this device to control screen switching from the controller.

The GOT can switch the screens by the go to screen switch.

## 4.2.1 Display position of window screen

### ■ Setting for a display position of a window screen

You can specify the display position of an overlap window or a superimpose window by setting [Window Position] on a base screen.

However, when you switch a base screen on which a window screen is being displayed, note the following:

Even if you configure different [Window Position] settings on the destination base screen, the window screen remains in the same position after the base screen switching.

On the base screen having no [Window Position] setting, the display position of a window screen is as follows.

- A window screen initially appears in the center of the GOT screen.
- When a window screen has been displayed before, the window screen appears at the previously displayed position.

A display position of the window can be set by the following procedure.

1. Select [Object] → [Window Position] → [Overlap1]/[Overlap2]/[Overlap3]/[Overlap4]/[Overlap5]/[Superimpose1]/[Superimpose2] from the menu.
2. Click the mouse on the display position to display an overlap window or a superimpose window.  
When using other than the GT16, GT1595-X, GT14, GT12, GT1020, and GT SoftGOT1000, set multiples of 16 for X and Y coordinates for an overlap window.  
When setting a value other than multiples of 16, a remainder of 7 or less is rounded down, and a remainder of 8 or more is rounded up.

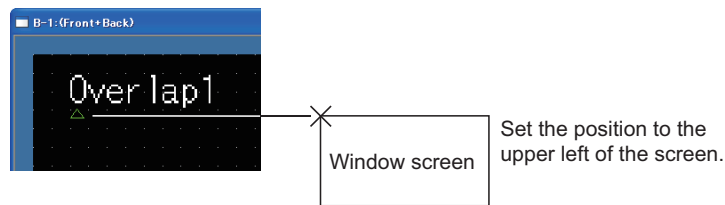

### POINT

#### (1) Disabling a display position of a window screen

The setting for a display position of a window screen is enabled only for the base screen.

When the screen where the display position has been set is called and displayed by the set overlay screen function, the display position setting is ineffective.

👉 10.2 Changing Screen According to Situation (Set Overlay Screen)

#### (2) Setting a display position of a window screen out of a base screen

The window screen size will not be checked when setting its display position.

Make sure to set the display position of a window screen while considering its screen size.

- Overlap window

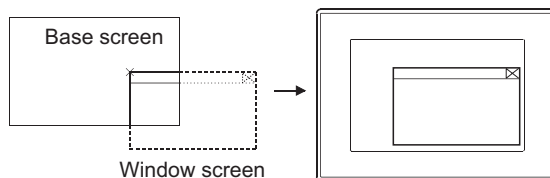

When the window screen is out of the base screen, GOT will automatically move the window screen to inside of the base screen.

- Superimpose window

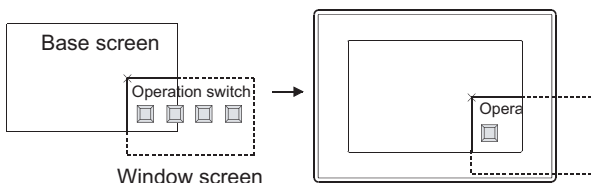

The part outside the base screen will not be displayed.  
The object will not be displayed.

## HINT

### Controlling a display position of an overlap window with a device value

The display position of an overlap window can be controlled with a device value.

 4.2.2 Settings

## ■ Methods of moving window screen

A display position of an overlap window displayed on the GOT can be moved.  
(A superimpose window cannot be moved.)

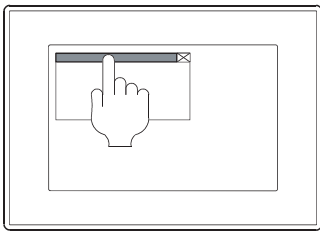

1. Touch the position at top of the window to highlight the movement key.  
While the movement key is highlighted, the GOT is the window move mode with beeping the buzzer.

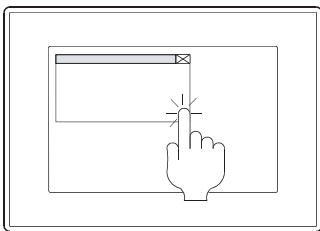

2. Touch the position where the window is moved within three seconds.  
When the object is touched within less than three seconds, the object does not act.  
With three seconds or more, the movement mode of the key window is canceled.

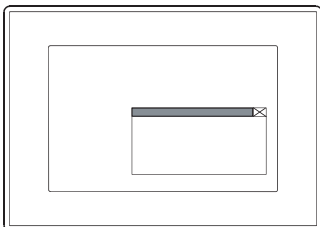

3. The window is moved to the touched position.

## HINT

### (1) Buzzer volume settings

To set whether the buzzer beeps, configure the setting in GT Designer3 or the GOT utility.  
For the settings in GT Designer3, refer to the following.

 4.9 GOT Display and Operation Setting

For the setting in the GOT utility, refer to the following.

 User's Manual for the GOT used

### (2) Display position when the moved and closed overlap window is displayed again

The overlap window appears at the last closed position.

## 4.2.2 Settings

Select [Common] → [GOT Environmental Setting] → [Screen Switching/Window] from the menu to display the [Environmental Setting] dialog box.



### Settings relevant to functions

For the common settings in a project data, some settings are relevant to multiple GOT functions. For each setting relevant to the GOT functions, refer to the following.





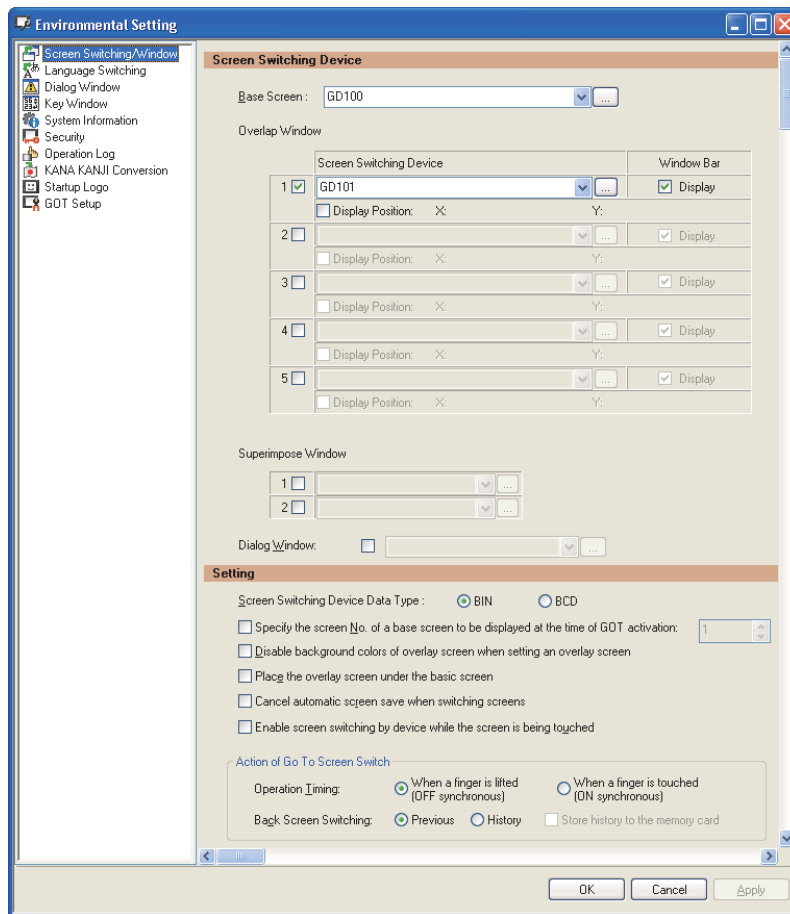

Appendix8 Relevant Settings

### Screen Switching/Window

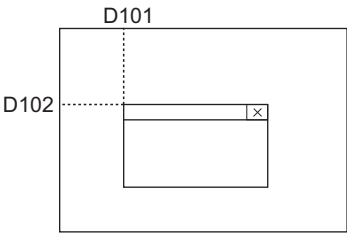
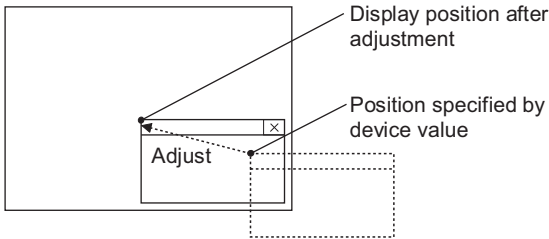

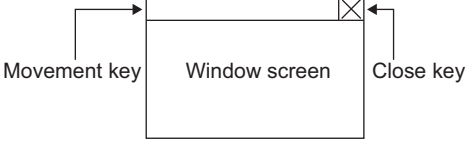
Item	Description		Model
Base Screen	Set the screen switching device for base screen. 5.3.1 Device setting		
Overlap Window	1 to 5	Select this item to set a screen switching device to display each overlap window. The available overlap window differs according to the GOT used. • GT16, GT SoftGOT1000: Overlap window 1 to 5 • GT15, GT14, GT12, GT11, GT10: Overlap window 1 to 2	GT16 GT15 GT14 GT12 GT11 GT10 SoftGOT1000
	Screen Switching Device	Set the screen switching device for the overlap window. 5.3.1 Device setting	

(Continued to next page)

Item		Description	Model
Overlap Window	Display Position	<p>Select this item to be set the device with specifying the display position (horizontal and vertical) of the overlap window.</p> <p>For the display position specification device, selecting this item sets the subsequent devices with starting from the device set in the screen switching device.</p> <p>When using other than the GT16, GT1595-X, GT14, GT12, GT1020, or GT SoftGOT1000, set multiples of 16 for the display position of the overlap window.</p> <p>When specifying a value that cannot be divided by 16, a remainder of 7 or less is rounded down, and a remainder of 8 or more is rounded up. If the result of rounding is the same coordinate as the original one, re-drawing is not made.</p> <p>Example: In the case that switching screen device is set to D100.            Display position (horizontal): D101,            Display position (vertical): D102</p> <p>The display position of the window screen is specified as shown below.</p>  <p>If the device value exceeding the range for display in GOT is stored as the device value that stores display position, the GOT will automatically adjust the display position and then display the window screen. The device value will not be updated with the above adjustment.</p> 	
	Window Bar*1	<p>Select this item to display the close key and movement key on the overlap window.</p> <p>The overlap window with displaying the close key and movement key can be moved or closed by manual.</p>  <p>To move or close the overlap window without displaying the close key and movement key, use the display position specification device or screen switching device.</p>	
Superimpose Window	1 to 2	<p>Select this item to set a screen switching device to display each superimpose window.</p> <p> 5.3.1 Device setting</p>	
Dialog Window		<p>Select this item to set a screen switching device to display the dialog window.</p> <p> 5.3.1 Device setting</p>	
Screen Switching Device Data Type		<p>Select the data type of the screen switching device.</p> <ul style="list-style-type: none"> <li>• BIN: Processes the screen switching device value as binary value.            The screen switching device can store the values (screen numbers) from 1 to 32767.</li> <li>• BCD: Processes the screen switching device value as a binary-coded decimal number.            The screen switching device can store the values (screen numbers) from 1 to 9999.</li> </ul>	

(Continued to next page)

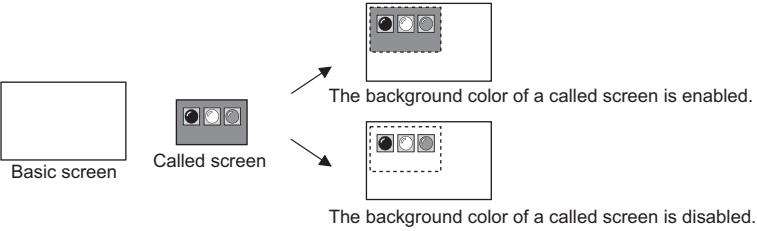
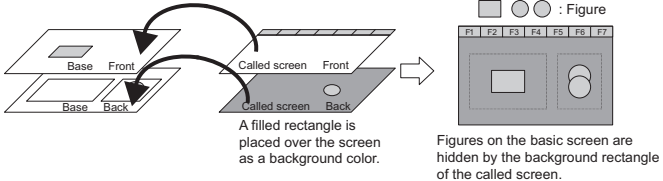
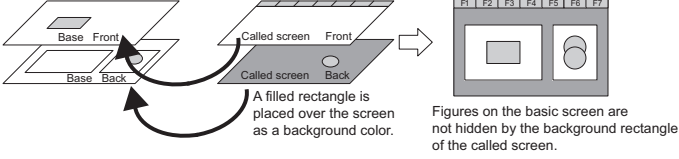
Item	Description	Model
Specify the screen No. of a base screen to be displayed at the time of GOT activation	Select this item to specify the base screen displayed at the GOT startup. Set the screen number of the base screen displayed at the GOT startup.	
Disable background colors of overlay screen when setting an overlay screen	<p>Select this item to disable the background colors of a called screen.</p> 	
Place the overlay screen under the basic screen	<p>Select this item to place the screen called by the set overlay screen under the basic screen.</p> <ul style="list-style-type: none"> <li>• Not selected (Placing the called screen on the basic screen) The called screen front layer is placed over the basic screen front layer. The called screen back layer is placed over the basic screen back layer.</li> </ul>  <ul style="list-style-type: none"> <li>• Selected (Placing the called screen under the basic screen) The called screen front layer is placed under the basic screen front layer. The called screen back layer is placed under the basic screen back layer.</li> </ul> 	<div style="border: 1px solid black; padding: 2px;">       Gt16 Gt15        Gt14 Gt12        Gt11 Gt10        SerGOT1000     </div>
Cancel automatic screen save when switching screens	Select this item to cancel the screen saver when screens are switched.	
Display the screen of value stored in screen switching device +1	<p>Select this item to display the screen with the screen number (screen switching device value) incremented by one.</p> <p>Select this item to use the GOT with the sequence program that specifies screen number 0 as the start number.</p>	<div style="border: 1px solid black; padding: 2px;">       Gt16 Gt15        Gt14 Gt12        Gt11 Gt10        SerGOT1000     </div>

(Continued to next page)

Item	Description		Model
Enable screen switching by device while the screen is being touched	Select this item to enable screen switching by device while the screen is being touched.		
Action of Go To Screen Switch	Operation Timing	Select timing when the touch switch (Go To Screen Switch) is operated. <ul style="list-style-type: none"> <li>When a finger is lifted (OFF synchronous): Switches screens when the finger is released from the switch.</li> <li>When a finger is touched (ON synchronous): Switches when the finger is touched on the switch.</li> </ul>	GT16 GT15 GT14 GT12 GT11 GT10 SoftGOT1000
	Back Screen Switching	Select operation of the touch switch (Go To Screen Switch) that is selected for [Back (Previous/History)] in [Next Screen]. <ul style="list-style-type: none"> <li>Previous: Operates by the previous mode.</li> <li>History: Operates by the history mode.</li> </ul>	
	Store history to the memory card	Set this item when [History] is selected for [Back Screen Switching]. Select this item to store the history of the screen switching in a memory card.	

\*1 The window pane is displayed on an overlap window that displays the close key and the movement key.  
For the GT10, the window pane is not displayed.

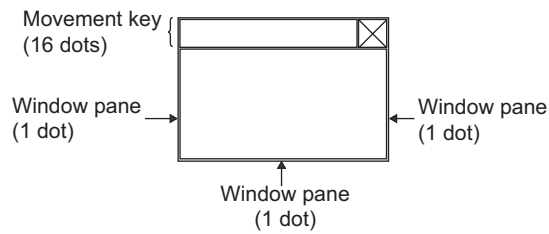

GT16, GT15, GT14, GT12, GT11, GT SoftGOT1000

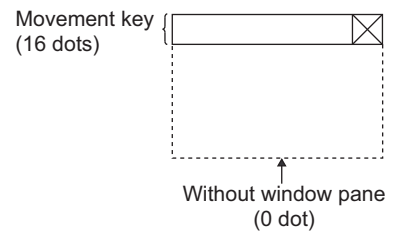

GT10



## 4.2.3 Precautions

This section explains the precautions for the screen switching device.

### ■ Precautions for drawing

**(1) Device set for the screen switching device**

Use a device set for the screen switching device only when switching the GOT screens.

**(2) Default setting of the screen switching device for the base screen**

The default value of the screen switching device for the base screen is set to GD100.

Change the setting of the switching screen device for the base screen when GD100 is used in another object or others.

**(3) Window display restrictions when a line graph is arranged**

When a line graph with [Locus] is arranged on the base screen, some windows cannot be displayed.

The following shows the windows that cannot be displayed on each GOT.

GOT	Windows that cannot be displayed
GT16, GT SoftGOT1000	Overlap window 5
GT15, GT14, GT12, GT11, GT10	Overlap window 2

**(4) Access authority of a project when the project security is set**

When the project security for each screen disables displaying a screen, the screen cannot be displayed on GT Designer3.

For the details of the project security, refer to the following.

 3.14 Securing Project

### ■ Precautions for use

If the screen No. that is not written to the GOT is stored as the value of the screen switching device, the GOT continues to display the current screen. (A system alarm occurs.)

This action is common in the base screen, overlap window, and superimpose window.

Example: In case of base screen

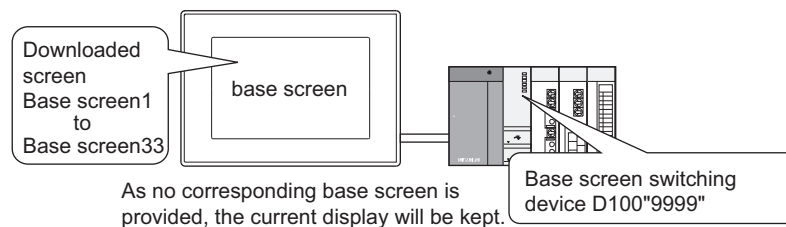

## 4.3 Language Switching Device Setting



The GOT switches comments displayed on the object according to a value (column number of comment group) in the language switching device.

If registering messages of Japanese, English, Chinese and other language in each column of comment group, the language of the comment displayed can be switched.

The system language switching device enables switching system languages.

The value stored in the system language switching device determines the system language set after system language switching from among Japanese, English, Chinese, and others.

For the comment registration, refer to the following.

4.12 Comment Setting

Example: When switching language by Comment display (Word):

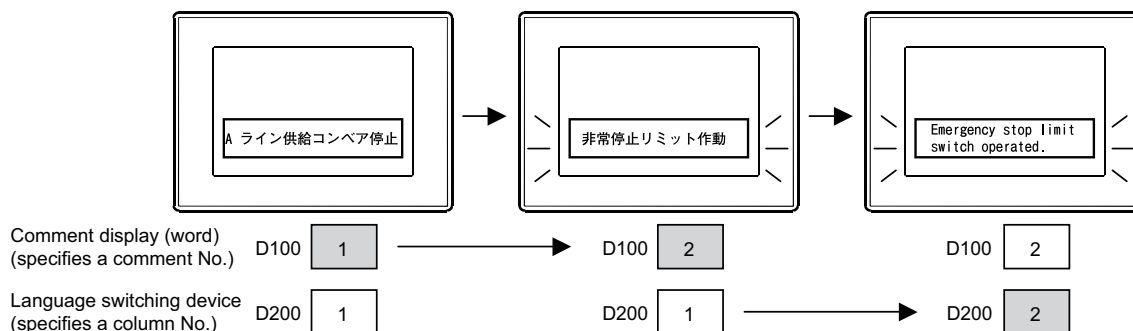

No. 1 Comment Group 1 Comment List			
Column No.			
Comment No.	1	2	3
	1 Aライン供給コンベア停止。	A-line supply conveyer stopped.	A生产线的补给输送带停止
	2 非常停止リミット作動。	Emergency stop limit switch operated.	紧急停止装置启动
	3 加工品リミット油圧低下	Product limit switch does not operate.	加工启动装置不工作
	4 加工機-1の油圧低下。	Hydraulic pressure of finishing machine 1 is low.	加工机-1的油压下降

### POINT

#### Application usage of switching languages

The language switching function other than switching languages is available.

For example, when outlines (English) are registered in the column No.1 and details (English) are registered in the column No.2, the appropriate comments can be displayed according to the usage of the user.

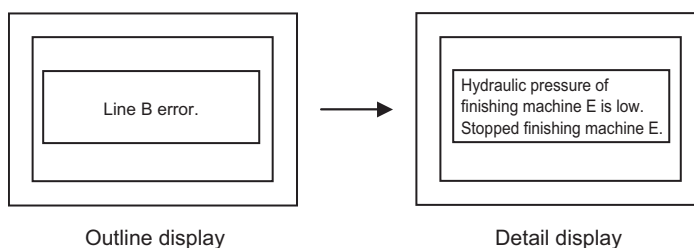

## 4.3.1 Settings

Select [Common] → [GOT Environmental Setting] → [Language Switching] from the menu to display the [Environmental Setting] dialog box.

### ■ Language Switching

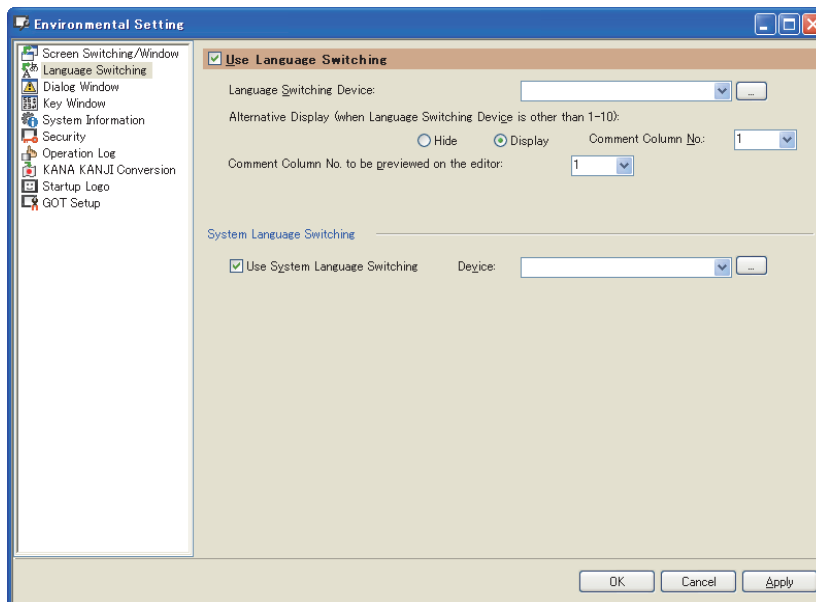

Item	Description	Model
Use Language Switching	Select this item to set the language switching device.	
Language Switching Device	Set the language switching device. ☞ 5.3.1 Device setting	
Alternative Display (when Language Switching Device is other than 1-10)	Set this item to select whether to display the comments when the language switching device value is set to other than 1 to 10. When [Display] is selected, the column number of the comment set for [Comment Column No.] is displayed.*1 When [Hide] is selected, the comment is hidden.	GT16 GT15 GT14 GT12 GT11 GT10 SoftGOT1000
Comment Column No. to be previewed on the editor	Set the column No. of the comments to be previewed in the screen editor on GT Designer3.	
Use System Language Switching*2	Select this item to set the system language switching device. When the set device stores a value, the system language is switched.	

\*1 At GOT startup, the comment of the comment column specified for [Comment Column No.] is displayed until the communication is established.  
If the communication is interrupted while the GOT is in operation, the comment of the comment column displayed until then is displayed.  
For details of \*2, refer to the following.

**\*2 System language switching device**

Storing a value in the device as shown below switches system languages.



b2 to b0: Specify the system language set after system language switching.

Storage value			System language	
b2	b1	b0	GT16, GT15, GT14, GT12, GT11, GT SoftGOT1000	GT10
0	0	0	System language set in the utility	System language set in the utility
0	0	1	Japanese	Japanese
0	1	0	English	English
0	1	1	Chinese (Simplified)	Chinese (Simplified)
1	0	0	Chinese (Traditional)	System language set in the utility
1	0	1	Korean	
1	1	0	German	
1	1	1	System language set in the utility	

b15 to b3: Use prohibited



**Device value of the language switching device**

The comment column number registerable for a comment group is 1 to 10.

Set the value specified for the comment column No. for the language switching device.

## 4.3.2 Precautions

### ■ Precautions for drawing

**(1) Language switching device setting**

The language switching device can be set for each project.  
It cannot be set up for each screen.

**(2) Comment group registration without setting the language switching device**

In this case, register comments in the column No.1 of comment group.  
Even if comments are registered in the column No.2-10 of comment group, they cannot be displayed.

**(3) When switching to Chinese characters of standard font (Option) (GT16, GT15, and GT14 only)**

Mounting an option function board or installing the corresponding font data is required according to the GOT.  
When the option function board is not mounted or the font data is not installed on the GOT, Chinese characters of the standard font (Standard) are displayed.

The following shows which GOT requires an option function board or option function OS.

GOT	Option function board	Option function OS
GT16, GT14	Not required	Required
GT15	Required (No option function board is required for GOTs with built-in option function boards.) For GOTs with built-in option function boards, refer to the following.  Appendix10 Precautions for Option Function Board	Required

For the standard font (Standard), refer to the following.

 2.5.1 Fonts

For the installation method of the option function board, refer to the manual below.

 User's Manual for the GOT used

**(4) Objects available for the language switching function**

The language switching function is available only for objects that are supported by comment group.  
For the objects supported by comment group, refer to the following.

 4.12 Comment Setting

**(5) Switching to the language that the GOT has no applicable font**

If the GOT has no font applicable to the language specified for the system language switching, the GOT uses the system language set in the utility.

On the GT16, GT15, GT14, GT12, GT11, and GT SoftGOT1000, a system alarm occurs.

### ■ Precautions for use

**(1) Operation when a column number of an unregistered comment group No. is stored in the language switching device**

If a column number of an unregistered comment group is stored in the language switching device, the comment is not displayed correctly at each object.

When "0" is stored, display varies depending on the specification of the object to be used.

For details of display at each object, refer to the following.

 GT Designer3 Version1 Screen Design Manual(Functions)

**(2) Effect of language switching or system language switching on objects**

Switching languages or system languages while the GOT monitors data makes the GOT display the currently displayed screen again. This can affect the display of objects and others.

If the screen being monitored displays the following objects, make sure to check the display of the objects at language switching or system language switching.

Object	Description
Trend Graph	If store memory is not set, the historical information is erased.
Scatter Graph	
User Alarm Display	If store memory is not set, the occurrence time of alarm is changed to the time of language switching. If display is being scrolled, data are displayed from the top.
Data List Display	If display is being scrolled, data are displayed from the top.
Advanced User Alarm Display, Advanced System Alarm Display	
Alarm History Display	
Parts Movement	If the display mode is set to Locus, the locus is erased.

**(3) Timing of reflecting the new system language after system language switching**

The new system language after system language switching is reflected only when the GOT displays a user-created screen.

Therefore, when the GOT displays the utility or other screens, even though the value in the system language switching device is changed, the system language is not switched.

The system language is switched when the GOT displays the user-created screen.

**(4) Effect of system language switching on the option functions**

After the SFC monitor, the ladder editor, or the motion SFC monitor is ended, if the function is started again with a different system language compared to when the function is previously started, the GOT does not obtain the program displayed when the function is previously started.

Set the same system language as the one when the function is previously started, and start the function.

**(5) System language of the restarted GOT**

After system language switching by the system language switching device, if the GOT restarts, the GOT uses the system language set in the utility until the device stores a value.

**(6) Operation with the utility when the system language is switched with the system language switching device**

When the system language is switched with the system language switching device, the system language switching with the utility is unavailable.

Even though the system language is switched with the device, the utility still displays the old system language set before the system language switching.

To switch the system language with the utility, store 0 or 7 in the device in advance.

**(7) Functions that do not support the system language switching with the system language switching device**

When a file is converted with the advanced system alarm observation or the operation log function, according to the setting, the file is converted into a file in the system language set with the utility but not specified with the system language switching device.

For the details, refer to the following.

 GT Designer3 Version1 Screen Design Manual(Functions)

**(8) System language switching with the MES interface function**

The MES interface function does not support the system language switching.

With the MES interface function, the comments and others for the advanced system alarm uses the system language set with the utility.

## 4.4 Setting Message to be Displayed on GOT



By using a user-created dialog window, a system message displayed on the GOT can be replaced by the window, or a new system message can be created.

### ■ Replacing a system message displayed on the GOT with a user-created dialog window

A system message displayed on the GOT can be replaced with a created dialog window. The GOT can display more specific and system-matched message.

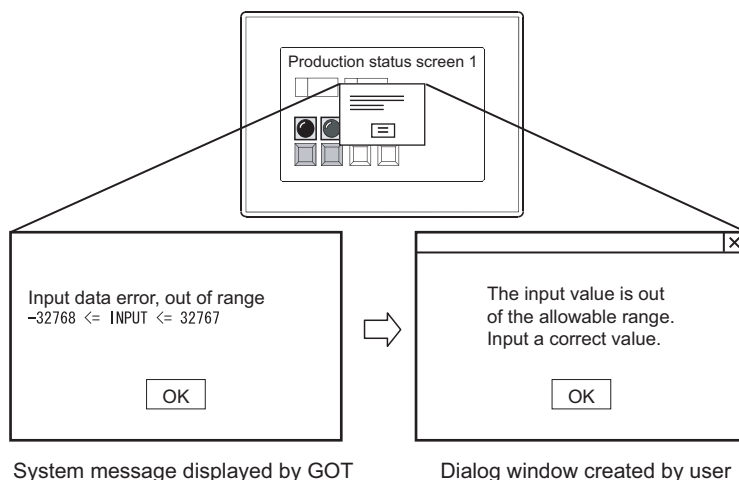

### ■ Displaying a user-created dialog window as a new system message

By creating a dialog window for an error or warning as a system, the GOT can display the dialog window as a system message.

Creating the dialog window enables the GOT to display the window that does not allow displaying of the next screen unless a response to the displayed message is input, and to display the window that requires the operator to confirm the information, and others.

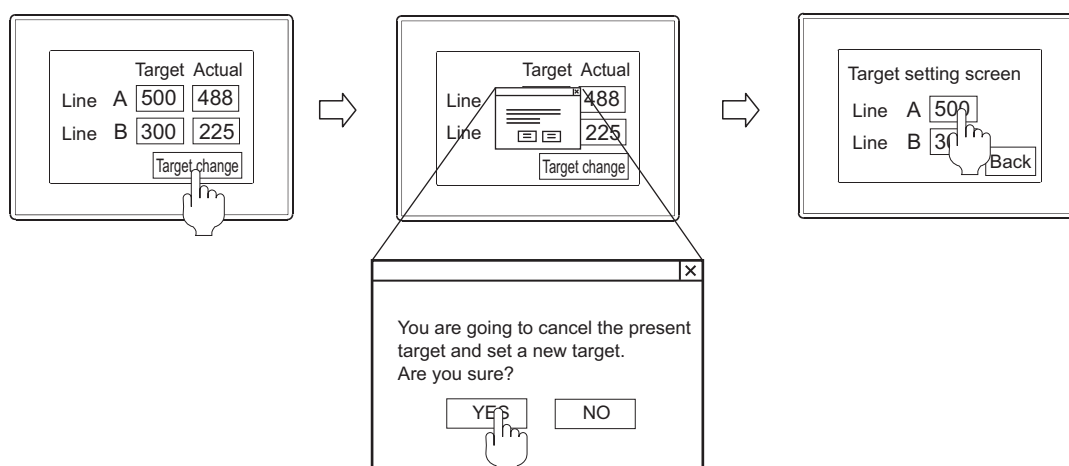

A dialog window such as guiding an operator to confirm the operation can be displayed.

## 4.4.1 Creating a dialog window

1. Select [Screen] → [New] → [Dialog Window Wizard] from the menu.
2. In the dialog window wizard, set the required items and click the [OK] button.

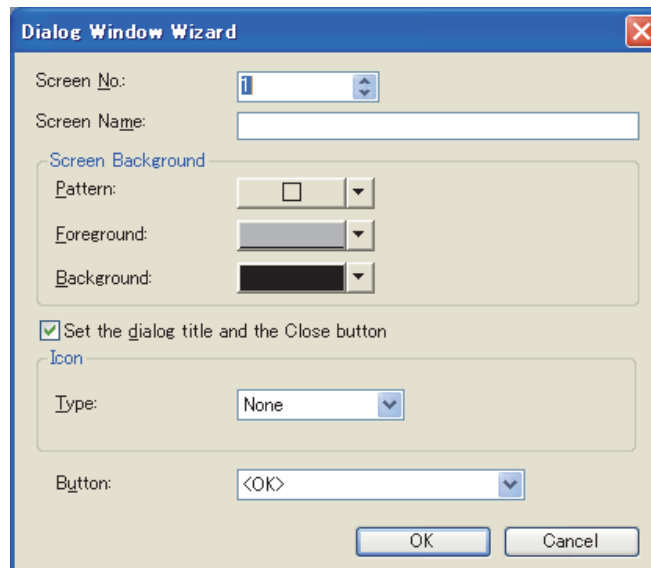

Item	Description	Model	
Screen No.	Set a screen number.		
Screen Name	Set a screen title. Up to 32 characters can be input (either in 2-byte characters or in 1-byte characters).		
Screen Background	Pattern		Select the pattern, pattern color and background color of the screen The pattern is displayed over the background. Example) Background color :   Pattern + Pattern color Pattern :    → Pattern color :  Background color
	Foreground		
	Background		
Set the dialog title and the Close button	Select this item to display the title bar, and close button on the dialog window.		
Icon	Type		Select the type of icon to be displayed on the dialog window.
Button	Select the type of button to be displayed on the dialog window.		



3. The dialog window is created and the screen editor appears.  
Set a title, message, object, and others.



## HINT



**(1) Screens displayed as dialog windows**

Not only dialog windows, window screens can be also used as dialog windows.

**(2) Changing the dialog window setting**

The dialog window setting can be changed for the [Screen Property] dialog box.

For the [Screen Property] dialog box, refer to the following.

 3.7.1 Creating a new screen

**(3) Changing a title bar, icon, and button**

To change a title bar, icon, and button, use the data in the library.

For the library, refer to the following.

 6. LIBRARY

## 4.4.2 Settings



### ■ Replacing GOT system messages with created window screens

The setting to replace a system message with a created window screen can be configured for each project or screen.

#### (1) Setting for each project

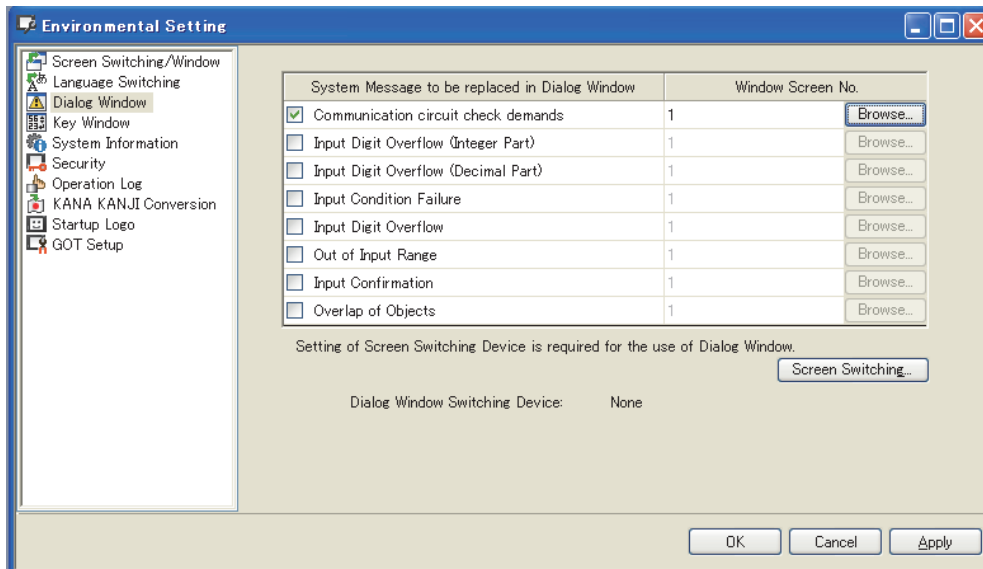
Select [Common] → [GOT Environmental Setting] → [Dialog Window] from the menu to display the [Environmental Setting] dialog box.



Item	Description	Model
System Message to be replaced in Dialog Window	Select this item to configure the setting for replacing each GOT system message with a created window screen. After selecting this item, set [Window Screen No.].	
Window Screen No.	Set a screen number of a window screen to be replaced with a system message. Click the [Browse] button to display the [Screen Image List] dialog box.  4.4.2 ■ Replacing GOT system messages with created window screens (1) (a) Screen Image List dialog box	gr16 gr15 gr14 gr12 gr11 gr10 SoftGOT1000
	Displays [Screen Switching] for the [Environmental Setting] dialog box.  4.2 Screen Switching Device Setting	
Dialog Window Switching Device	Displays the screen switching device for the dialog window.	

(a) Screen Image List dialog box

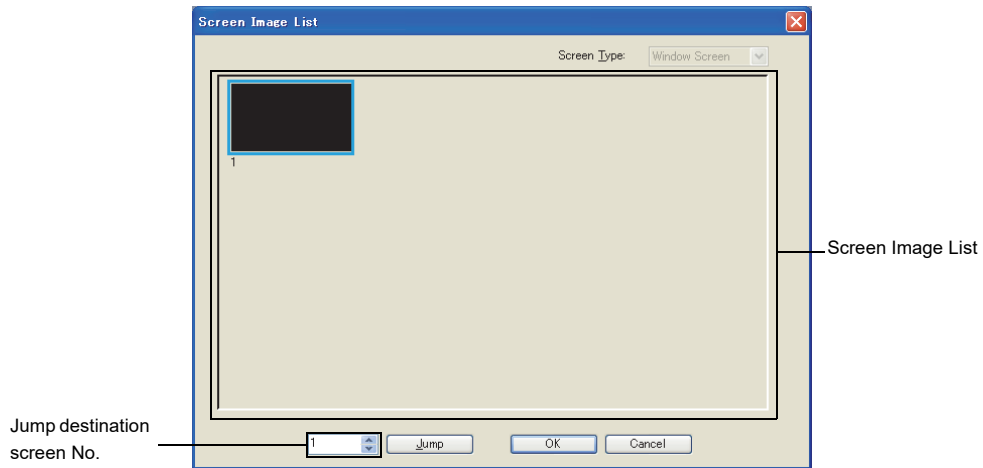

Item	Description	Model
Screen Image List	Displays the screen image of the screen type selected for [Screen Type]. Select the screen image and click the [OK] button to set the selected screen number for [Window Screen No.]. (The setting is available by double-clicking the screen image.)	GT16 GT15 GT14 GT12 GT11 GT10 SoftGOT1000
Jump destination screen No.	Set a screen number of a screen to jump to the set screen number. By clicking the [Jump] button, the screen set for the screen number to jump to the screen is the selected status.	

**(2) Setting for each screen**

1. Select the screen editor to be set, and then select [Screen] → [Screen Property] from the menu to display the [Screen Property] dialog box.
2. Select the [Dialog Window] tab and set the required items.

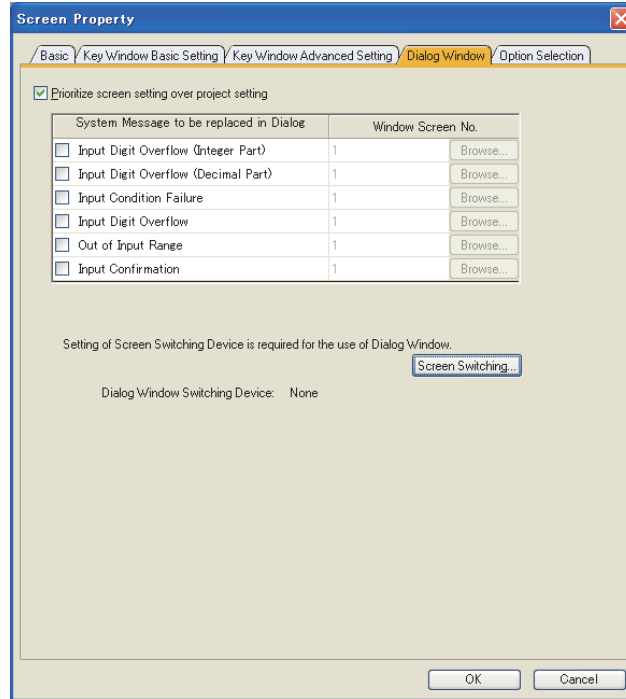

Item	Description	Model
Prioritize screen setting over project setting	Select this item to give the setting for each screen priority over the setting for each project.	
Select the System Message that replace in dialog	Select this item to configure the setting for replacing each GOT system message with a created window screen. After selecting this item, set [Window Screen No.].	
Window Screen No.	Set a screen number of a window screen to be replaced with a system message. Click the [Browse] button to display the [Screen Image List] dialog box. 4.4.2 ■Replacing GOT system messages with created window screens (1) (a) Screen Image List dialog box	gr16 gr15 gr14 gr12 gr11 gr10 SoftGOT1000
	Click this button to close the [Screen Property] dialog box and display [Screen Switching] of the [Environmental Setting] dialog box. 4.2 Screen Switching Device Setting	
Dialog Window Switching Device	Displays the screen switching device for the dialog window.	

**■ Displaying a user-created dialog window as a new system message**

The GOT can display a dialog window by storing the screen number of the window screen in the screen switching device of the dialog window.

To set the screen switching device, refer to the following.

4.2 Screen Switching Device Setting

## 4.4.3 Precautions

### ■ Precautions for drawing

#### (1) Before using a dialog window

To use a dialog window, set a screen switching device for the dialog window.  
To set the screen switching device, refer to the following.

 4.2 Screen Switching Device Setting

#### (2) Maximum number of objects that can be arranged on one screen

Up to 32 objects can be arranged on one screen.

If 33 or more objects are arranged, the objects are not displayed on the GOT.

Objects for the key window ([Input Value Area Setting], [Input Range Area Setting], [Input Maximum Value Area Setting], [Input Minimum Value Area Setting]) are excluded.

#### (3) Figures and objects that can be arranged on the dialog window

The following shows figures and objects that can be arranged on the dialog window.

Figure, Object	Description
Figures	All figures
Objects	Touch switch, Numerical Display, Comment Display, Key Window Object (Input Value Area Setting, Input Range Area Setting, Input Maximum Value Area Setting, Input Minimum Value Area Setting)

#### (4) Restrictions relevant to the object setting

##### (a) Conditions for displaying the objects in a key window

The GOT displays the following objects: the input value area setting, the input maximum value area setting, and the input minimum value area setting when the following system messages are replaced with dialog windows only.

- [Input digits over (Integer part)]      • [Input digits over (Decimal part)]      • [Input digits over]
- [Input out of range]                      • [Input confirmation]

For the object functions and the precautions for the objects, refer to the following.

 4.5 Key Window Setting

##### (b) Restrictions relevant to the touch switch, numerical display, and comment display arranged on the dialog window

For the setting dialog box of the touch switch, numerical display, and comment display, only the following tabs are available.

Some of the functions in the tabs cannot be used.

Object	Settable tab	Precautions	
Switch	Action	Extended Action cannot be set. Key codes other than 000DH (execute) and 001BH (cancel) cannot be used. Lamp function cannot be used.	
	Style	-	
	Text	-	
	Extended	Only the category is available.	
Touch switch	Bit Switch	Device	Lamp function cannot be used.
		Style	-
		Text	-
		Extended	Only the category is available.
Word Switch	Word Switch	Device	Lamp function cannot be used.
		Style	-
		Text	-
		Extended	Only the category is available.

(Continued to next page)

Object		Settable tab	Precautions
Touch switch	Go To Screen Switch	Next Screen	Lamp function cannot be used.
		Style	-
		Text	-
		Extended	Only the category is available.
	Change Station No. Switch	Next Station	Lamp function cannot be used.
		Style	-
		Text	-
		Extended	Only the category is available.
	Key Code Switch	Key Code	Key codes other than 000DH (execute) and 001BH (cancel) cannot be used.
		Style	-
		Text	-
		Extended	Only the category is available.
Numerical Display		Device/Style	Blink cannot be used.
		Extended	Only the category is available.
		Operation/Script	The script function is not available.
Comment Display	Bit Comment, Word Comment	Device/Style	-
		Comment	Blink cannot be used.
		Extended	Only the category is available.

- (c) System dialog replacement settings on base screens and window screens  
When displaying a window screen as a superimpose window or called screen (set overlay screen function), the replacement settings for each screen set in the window screens are invalid.
- When displaying system dialog as a superimpose window  
The system dialog replacement settings of the base screen on which the superimpose window is displayed is valid.
  - When displaying system dialog as a called screen (Set Overlay Screen)  
The system dialog replacement settings of the basic screen is valid.
- (d) Other precautions
- Overlaying of objects is not allowed.
  - The settings relevant to the dialog window are enabled only when the settings are configured in [Dialog Window] for the [Environmental Setting] dialog box or in the [Dialog Window] tab for the [Screen Property] dialog box.
  - When setting a key code (000DH (execute) or 001BH (cancel)) in a touch switch, configure the setting so that 0 is stored to a screen switching device for the dialog window.
  - The function for the screen script is not available.

#### (5) Displaying of a dialog window

- (a) Objects on a dialog window  
The device status of an object is the same as when the dialog window has been displayed.  
Even if a device value is changed while the object is displayed on the dialog window, the display of the object on the dialog window is not changed.
- (b) Displaying system message and dialog window  
System message and dialog window cannot be displayed simultaneously.  
When an attempt is made to display them simultaneously, a system message is displayed.
- (c) Base/window screen switching and dialog window display  
Do not switch the screen display between base screen and window screen at the same time a dialog window is displayed.  
Switching of base/window screen display may be delayed.  
(Base/window screen switching takes place after the dialog window is closed.)

**(6) Applicable range for changing the dialog window size**

Change the dialog window screen size (horizontal × vertical) in the range of 16 × 2 dots to 320 × 240 dots. When the range of the dialog window screen size is changed to other than the above, the GOT does not display the dialog window correctly.

For the dialog window specifications, refer to the following.

 2.3 Types and Number of Creatable Screens

**(7) Setting for closing a dialog window**

Configure a setting to close a dialog window (including the setting of a touch switch to close the window and a program to write "0" to the screen switching device for the dialog window).

Operation of a monitor screen or the utility is disabled on the GOT unless the dialog window is closed.

**■ Precautions for use**

**(1) Display priority between a currently displayed dialog window and a newly occurred system message**

(a) When a newly occurred system message is created by the user

The currently displayed dialog window remains displayed.

The occurred system message is not displayed.

(b) When the occurred system message is a system message that is set for GOT

The currently displayed dialog window closes and "0" is stored in the screen switching device for the dialog window.

After that a new system message is displayed.

If a button is arranged on the currently displayed dialog window, the following processing is executed before the dialog window closes.

- For the dialog window where only the [OK] button is arranged, the same processing as the one for touching the [OK] button is executed.
- For the dialog window where the [Cancel] button exists, the same processing as the one for touching the [Cancel] button is executed.

**(2) Communications between the GOT and GT Designer3**

While a dialog window is displayed, the GOT may not communicate with GT Designer3.

For the above case, close the dialog window.

## 4.5 Key Window Setting



This section explains how to operate a key window for the numerical input or ASCII input, and how to create a user-created key window.

### 4.5.1 Key window type

Key window can be classified into two types: GOT original key window (standard key window) and key window created by user (user-created key window).

#### ■ Standard key window

A standard key window is automatically displayed according to the data type of an input area (hexadecimal, decimal, octal, binary, or ASCII).

##### (1) Key window for numeric values

When the data type of an input area is in hexadecimal, octal, or binary format, a key window for hexadecimal numbers is displayed.

When the data type of an input area is in decimal format, a key window for decimal numbers is displayed.



Example) Key window for decimal



Example) Key window for hexadecimal

##### (2) Key window for ASCII characters

When the data type of an input area is in ASCII format, a key window for ASCII characters is displayed.

Character types of the key window can be switched by either the keys to switch character types sequentially or keys to switch character types directly.

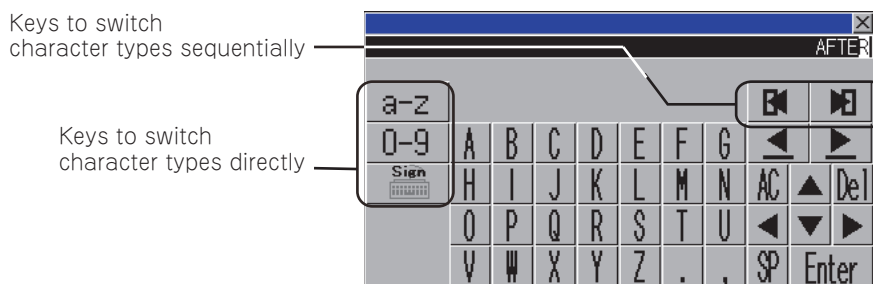

Example) key window for ASCII characters (uppercase alphabetic characters)



## ■ User-created key window

User's original key window can be created by registering a user-created window as key window. To use ASCII input function, create a key window with a user-created key window.

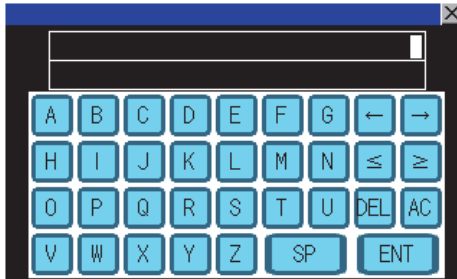

Example) User-created key window(Created for ASCII input)

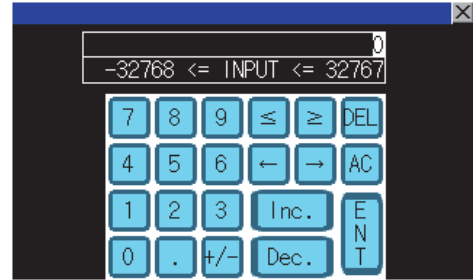

Example) User-created key window(Created for numeric input (decimal))

### HINT

#### (1) Key window to be displayed

A key window to be displayed can be set in project unit or screen unit.

A suitable key window for each screen can be displayed from multiple key windows created beforehand. For the setting of the key window to be displayed, refer to the following.

☞ 4.5.5 Settings

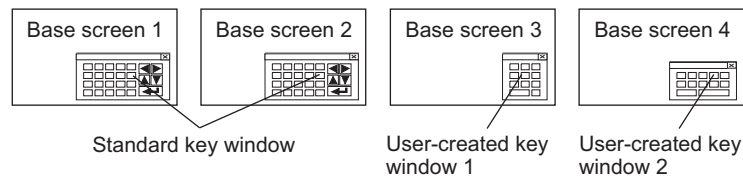

#### (2) Switching key windows for ASCII characters

By setting multiple key windows for ASCII characters, the user can use an appropriate key window according to the character type to be input.

To switch the key windows, use the key code switch assigned with the key code for switching key windows. For the setting of the key window to be displayed, refer to the following.

☞ 4.5.5 Settings

For the setting method of a key code switch, refer to the following.

☞ (Functions) 2.8 Setting Key Code Switch

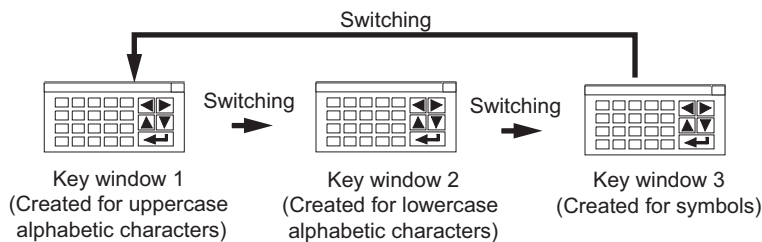

## 4.5.2 Buttons on standard key window and display items



### Option of the key window for numeric values

For the GT14, GT11, GT105□, and GT104□, the size of the key window for numeric values is selectable. For the setting, refer to the following.

☞ 4.5.5 Settings

## ■ Standard key window for the GT16, GT15, GT14, GT12, GT11, and GT SoftGOT1000

### (1) Key window for numeric values







Example) Key window for decimal



Example) Key window for hexadecimal

Item	Description
	Displays the input value.
	Displays the current value.
	<p>Displays the input range.</p> <p>INPUT : Indicates the input value.</p> <p>&lt;: The left side of the inequality is less than the right side.</p> <p>&lt;=: The left side of the inequality is less than or equal to the right side.</p> <p>==: The left side of the inequality is equal to the right side.</p> <p>!=: The left side of the inequality differs from the right side.</p> <p>The number of digits set for the target numerical input object determines the displayed input range. (In the numerical input setting, specifying [Format String] disables [Digits], and the number of # (number signs) is that of the displayed digits.)</p> <p>Example) Numerical input ([Data Type]: [Signed BIN16], [Digits]: 4)</p> <p>Range when [Data Type] is set to [Signed BIN16]</p> <p></p> <p>Range when [Digits] is set to 4</p> <p> ← Displayed as the input range.</p> <p>When conditions are set in the [Numerical Input] dialog box ([Input Case] tab), the condition with the smallest number applies to the displayed input range.</p> <p>For the precautions for the input range, refer to the following.</p> <p>☞ 4.5.7 Precautions</p>
	Inputs numeric values and decimal points.
	Changes the sign (+ or -) of the input value.
	Moves the input cursor.
	<p>Moves the cursor in the object being input.</p> <p>If move the cursor while range check is performed during a numeric value input, the range check is performed not during inputting but after determining the input value.</p> <p>To perform a range check while inputting a value, hide the cursor (cancel inputting of the numeric value) and reinput the numeric value.</p>

(Continued to next page)

Item	Description
	The key to delete the least significant digit of the numeric value being input and shift the whole numeric value to right by one digit.
	Clears all input numeric values.
	Writes the input numeric value to a device. (Enter key)
	Closes the key window.







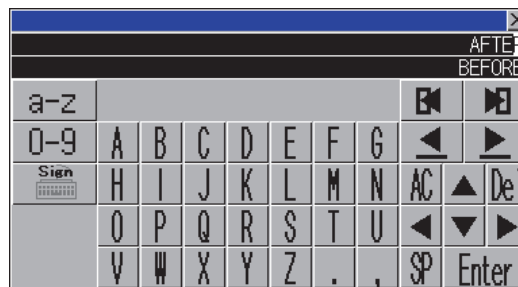



\*1 The input value, current value, and input range are displayed on the key window in that order. Each area can be set to be hidden.

 4.5.5 Settings

## (2) Key window for ASCII characters



Example) key window for ASCII characters (uppercase alphabetic characters)

Item	Description
	Displays the character string currently being input.
	Displays the current value of a device.
	Keys to switch character types sequentially Switches the character types of the key window one by one in sequential order.
	Keys to switch character types directly Switches the character types of the key window as specified by the key. (A-Z: uppercase alphabetic characters/a-z: lowercase alphabetic characters/0-9: numeric characters/Sign: symbols)
	Inputs characters in the object. Keys displayed in a key window differ according to the character type to be selected.
	Moves the input cursor.
	Moves the cursor in the object being input.
	Deletes the character on the cursor.
	Clears the character string currently being input.
	Writes the input character string to a device. (Enter key)
	Closes the key window.

\*1 The character string currently being input and the current value of a device are displayed on the key window in that order. Each area can be set to be hidden.

 4.5.5 Settings

## ■ Key window for GT10

The following explains keys of a standard key window and display items.

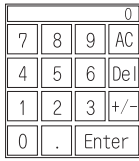

Example) Decimal key window for GT105 □ and GT104 □

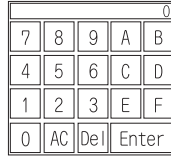

Example) Hexadecimal key window for GT105 □ and GT104 □

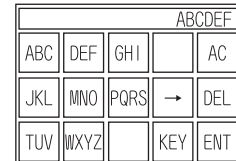

Example) ASCII key window for GT105 □ and GT104 □

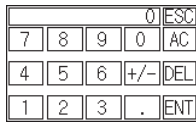

Example) Decimal key window for GT1030 and GT1020)

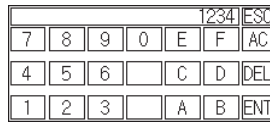

Example) Hexadecimal key window for GT1030 and GT1020

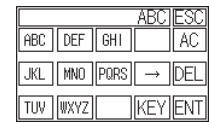

Example) ASCII key window for GT1030 and GT1020

Item	Description
	Displays input values.
	Inputs numeric values or characters.
	Closes the key window.
	Clears all numeric values or characters.
	Clears the least significant digit of input numeric values or characters and shifts all numeric values or characters to the right by one digit.
	Writes the input numeric values or characters to a device. (Enter key)
	Moves the input cursor.
	Switches a button type (alphabet, numeric character, or symbol) every time the button is touched.
	Closes the key window.



### (1) How to input characters with key window for ASCII input

Multiple characters are assigned to one button on a key window for the ASCII input for the GT10. With touching the same button several times, characters to be input are switched.

- When inputting "GOT"

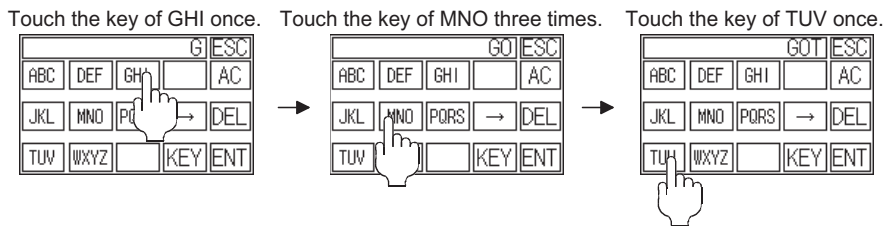

- When inputting "TU"

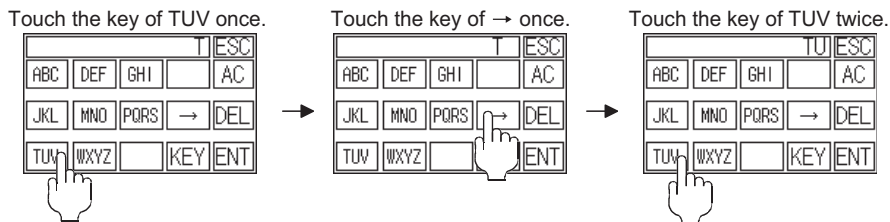

### (2) Display items of key windows for the GT10

Key windows for the GT10 do not display the input range or the button to move the cursor.

**(3) Key window for hexadecimal with GT1020**

With the GT1020, the key window for hexadecimal cannot display all buttons on the same key window. Switch the displays by touching the [A-F] or [0-9] button.

Key window for hexadecimal with GT1020

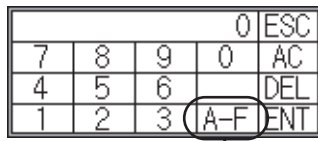

Touching here switches to the key board displaying A to F.

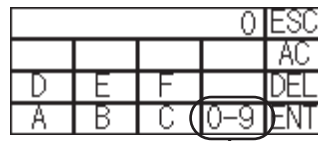

Touching here switches to the key board displaying 0 to 9.

**(4) Key window for hexadecimal in vertical type (Only GT10)**

The key window for hexadecimal in vertical type cannot display all buttons on the same key window. Switch the displays by touching the [A-F] or [0-9] button.

Key window for hexadecimal in vertical display



Touching here switches to the key board displaying A to F.

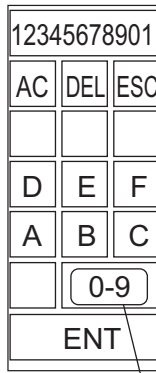

Touching here switches to the key board displaying 0 to 9.

## 4.5.3 How to operate key window

### ■ How to display a key window

A key window appears when the numerical input or the ASCII input is touched on the GOT, or the other cases. For the setting of the key window display, refer to the following.

☞ 4.5.5 Settings

### ■ Basic operation method

In the following procedure, the numerical input function is used to explain key window operation on the GOT as an example.

(The operation is the same as when ASCII input function is used.)

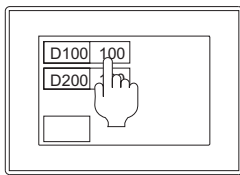

1. Touch the numerical input to input a numeric value.

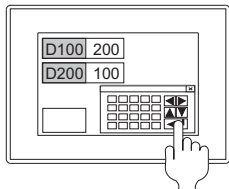

2. In the key window, input the numeric value. After inputting, touch the [Enter] button or the [ENT] button (Enter key). The numeric value is written to a device.

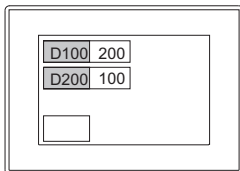

3. The value in the numerical input is updated, and the key window is closed.

## HINT



### Key window position setting

By default, a key window is displayed on the lower-right of the GOT screen. Key window position can be set as follows.

1. Select [Object] → [Window Position] → [Key Window] from the menu.
2. Click the position with a mouse to display a key window.

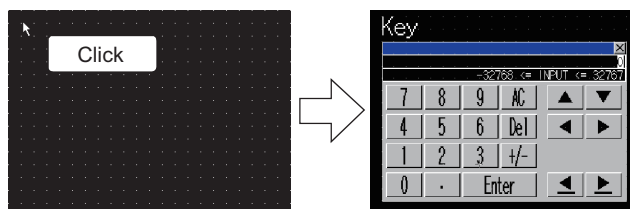

## Method of moving key window

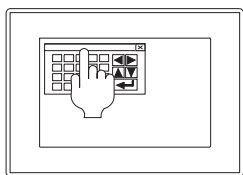

1. If touch the upper part of key window, the bar is highlighted.

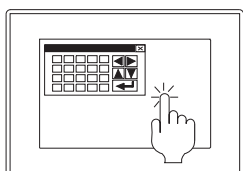

2. Touch the position where the key window is moved within three seconds.  
When the object is touched within less than three seconds, the object does not act.  
With three seconds or more, the movement mode of the key window is canceled.

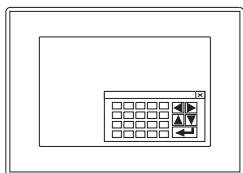

3. The key window moves to the specified position.

### HINT



#### Buzzer volume setting

In the GOT utility or GT Designer3, set whether to beep the buzzer when moving a window.  
For the setting in GT Designer3, refer to the following.

☞ 4.9 GOT Display and Operation Setting

For the setting in the GOT utility, refer to the following.

☞ User's Manual for the GOT used

## 4.5.4 How to create user-created key window

To use a user-created key window, arrange touch switches on a window screen and set the screen as a key window.

### ■ Outline procedure

1. Select [Screen] → [New] → [Window Screen] from the menu and create a window screen.  
By double-clicking [New] for [Window Screen] in the screen tree, the window screen can be created.

☞ 3.7.1 Creating a new screen

2. According to the purpose of using the key window, assign a key code to a key code switch and arrange it on the screen editor of the window screen.

☞ (Functions) 2. TOUCH SWITCH

For the precautions of creating the user-created window, refer to the following.

☞ 4.5.7 Precautions

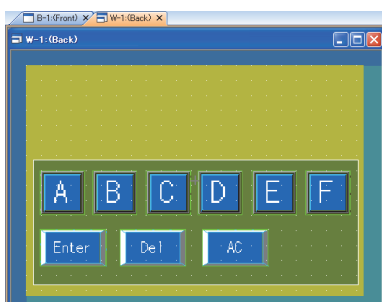

### (1) Utilizing the library

By utilizing the buttons for numerical input or ASCII input in the library, the key windows can be easily set.

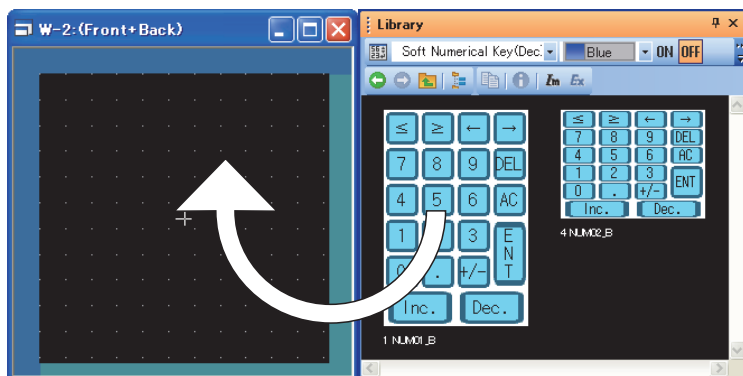

Various touch switches are registered in the library.

For how to use the library, refer to the following.

☞ 6. LIBRARY

### (2) ON shape display of a touch switch

To display the ON shape of a touch switch in a key window when the touch switch is touched, the following settings are required.

- On the [Basic Setting] tab (Key Window) in the [Environmental Setting] dialog box, select [Display the key touch ON shapes when keys are touched (project common)].
- Set [Lamp (Timing to change shape/text)] to [Key Touch State].

For the key window setting, refer to the following.

☞ 4.5.5 ■ Setting for each project



- Configure the setting to use the created window screen as a key window.

4.5.5 Settings

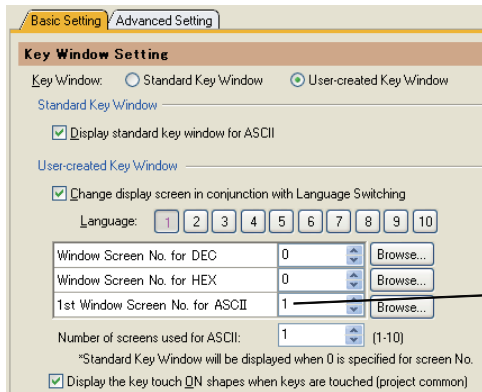

Select a window screen to be used as a key window

- Set the view format and position of input value and input range.

Display of the input value area setting, input range area setting, and previous value area setting

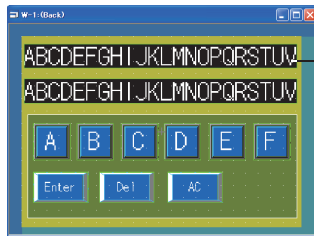

Set input value position and number of digits.

- Check the display image on GT Designer3.

3.11 Viewing Created Screen Image

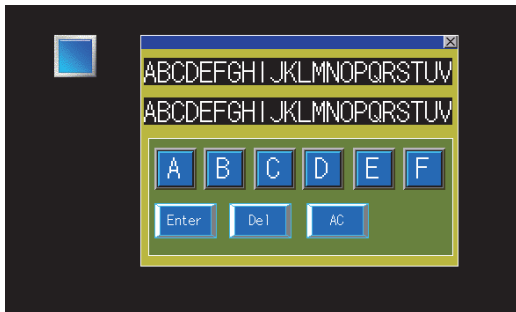

- Set the key window display method, cursor action, and others if required.

4.5.5 Settings

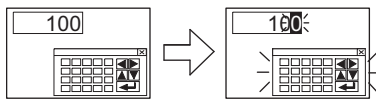

When condition success, cursor and key window are displayed automatically.

Cursor and key window are displayed.

## ■ Display of the input value area setting, input range area setting, and previous value area setting

Set an area for a user-created key window to display a value being input, the input range area, and a previous value before inputting.

The applicable key settings differ according to the GOT type.

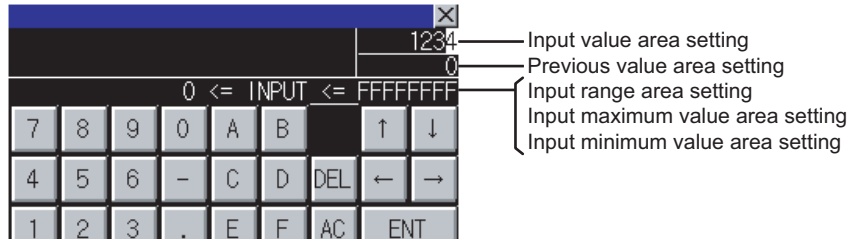

Object	Function	Model
Input value area setting	Displays the value being input.	Gr16 Gr15 Gr14 Gr12 Gr11 Gr10 SoftGOT1000
Input range area setting	<p>Displays the input range.</p> <p>INPUT : Indicates the input value.</p> <p>&lt;: The left side of the inequality is less than the right side.</p> <p>&lt;=: The left side of the inequality is less than or equal to the right side.</p> <p>==: The left side of the inequality is equal to the right side.</p> <p>!=: The left side of the inequality differs from the right side.</p> <p>The number of digits set for the target numerical input object determines the displayed input range.</p> <p>(In the numerical input setting, specifying [Format String] disables [Digits], and the number of # (number signs) is that of the displayed digits.)</p> <p>Example) Numerical input ([Data Type]: [Signed BIN16], [Digits]: 4)</p> <p>Range when [Data Type] is set to [Signed BIN16]</p> <p style="text-align: center;">-32768 &lt;= INPUT &lt;= 32767</p> <p>Range when [Digits] is set to 4</p> <p style="text-align: center;">-999 &lt;= INPUT &lt;= 9999 ← Displayed as the input range.</p> <p>When conditions are set in the [Numerical Input] dialog box ([Input Case] tab), the condition with the smallest number applies to the displayed input range.</p> <p>For the precautions for the input range, refer to the following.</p> <p>☞ 4.5.7 Precautions</p>	Gr16 Gr15 Gr14 Gr12 Gr11 Gr10 SoftGOT1000
Input maximum value area setting	Displays only the maximum value within the input range.	Gr16 Gr15 Gr14 Gr12 Gr11 Gr10 SoftGOT1000
Input minimum value area setting	Displays only the minimum value within the input range.	Gr16 Gr15 Gr14 Gr12 Gr11 Gr10 SoftGOT1000
Previous value area setting	Displays the current value.	Gr16 Gr15 Gr14 Gr12 Gr11 Gr10 SoftGOT1000

1. Select [Object] → [Key Window Object] from the menu, and select an object to be arranged on a window screen as shown below.

- [Input Value Area Setting]
- [Input Range Area Setting]
- [Input Maximum Value Area Setting]
- [Input Minimum Value Area Setting]
- [Previous Value Area Setting]

- Click the position where the object is displayed to complete the object arrangement.

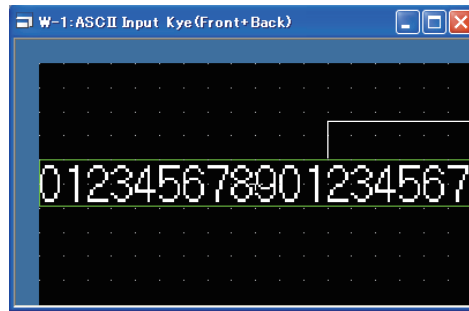

The input value area, input range area, or previous value area is placed by clicking.

- Double-click the arranged objects for the input value area setting, input range area setting, or previous value area setting. The setting dialog box appears.

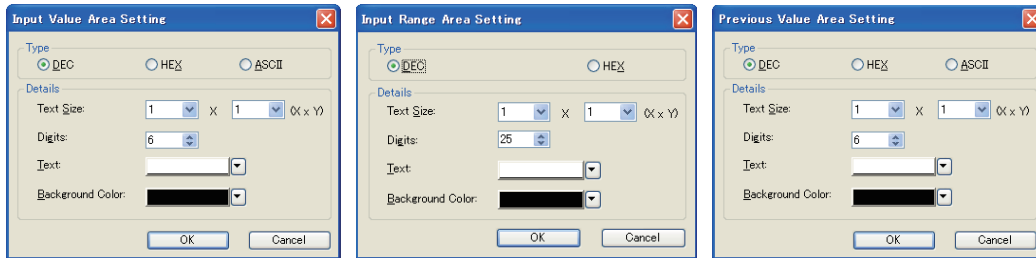

Item	Description		Model
Type	Select the view format of the input value to be displayed. DEC: Select this item when a decimal key window has been created. HEX: Select this item when a hexadecimal key window has been created. ASCII: Select this item when a key window for ASCII input has been created.		
Details	Text Size	Select character size of the input value to be displayed.	
	Digits	<ul style="list-style-type: none"> <li>When setting Input Value Area Set the number of digits for displaying input value. DEC: 1 to 32 digits (1 to 20 digits for GT10) HEX: 1 to 8 digits ASCII: 1 to 100 digits</li> <li>When setting Input Range Area Set the number of digits for displaying input range DEC/HEX: 15 to 78 digits</li> <li>When setting Input Maximum Value and Input Minimum Value Areas Set in the number of digits of the maximum and minimum values. DEC: 1 to 32 digits HEX: 1 to 8 digits</li> <li>When setting the previous value area Set the number of digits for displaying the current value. DEC: 1 to 32 digits HEX: 1 to 8 digits ASCII: 1 to 100 digits</li> </ul>	GT16 GT15 GT14 GT12 GT11 GT10 SoftGT1000
	Text	Select the color of text to be displayed.	
	Background Color	Select the background color of text.	

**POINT**

**Input range area setting**

If a device is specified in a range equation and the device value exceeds the preset number of digits, "?" may be displayed. Specify the input range in consideration of the potential device value with reference to the following example.

Example 1) If  $D100 \leq INPUT \leq D200$

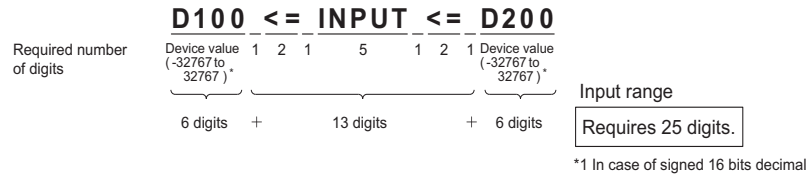

Example 2) If  $D100 < INPUT$

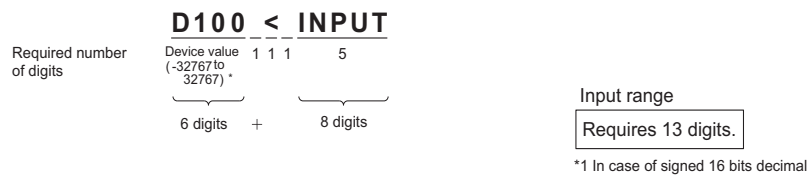

## ■ Display of the input value area, the input range area, and the previous value area on the screens other than the key window

The following objects can be also displayed on the overlap window or the dialog window.

(The following is referred to as the key window object.)

- Input value area
- Input range area
- Input maximum value area
- Input minimum value area
- Previous value area

However, the previous value area cannot be displayed on the dialog window.

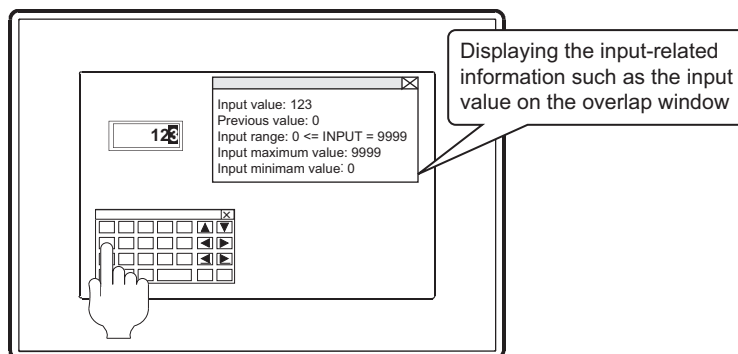

### (1) Screens for displaying the key window objects

The objects can be displayed on the following screens.

- Key window
- Dialog window
- Overlap window

The only one screen is available for displaying the key window objects.

If two or more screens on which the key window objects are arranged are displayed, the key window objects can be displayed only on the first window.

If two or more window screens are displayed at the same time, the key window objects can be displayed only on the highest-priority screen.

Also if the screen on which the key window objects are arranged is displayed by the screen switching, the key window objects can be displayed only on the highest-priority screen.

Display Priority	Display Screen	Remarks
High	Key window	-
	Overlap window 1	When some overlap windows with the same display priority exist, the priority is as follows. <ul style="list-style-type: none"> <li>• When the overlap windows are arranged on the front layer of the basic screen.</li> </ul>
	Overlap window 2	
	Overlap window 3	
Overlap window 4		
Low	Overlap window 5	<ul style="list-style-type: none"> <li>• Basic screen → Overlap window 1 → Overlap window 2 → ...</li> <li>• When the overlap windows are arranged on the back layer of the basic screen.</li> </ul>
		Overlap window 1 → Overlap window 2 → ... → Basic screen

## (2) Setting procedure

1. Configure the setting to display the key window objects on the window screen used as the overlap window.  
For the setting procedure, refer to the following.

 3.7.1 Creating a new screen

2. Arrange the key window objects on the overlap windows.  
The key window object can be set by selecting [Object]→[Key Window Object].  
For the setting procedure, refer to the following.

 ■Display of the input value area setting, input range area setting, and previous value area setting

## (3) Precautions

When the following operations are performed, the key window objects are displayed according to the priority as is the case in the screen switching.

- Security level change
- Language switching
- System language switching
- Station No. switching
- Changing the text code by the text code format control (GS456)

## 4.5.5 Settings

Set a key window to be used for a whole project or for each screen.

### ■ Setting for each project

Select [Common] → [GOT Environmental Setting] → [Key Window] from the menu to display the [Environmental Setting] dialog box.



#### Settings relevant to functions

For the key window settings, some settings are relevant to multiple GOT functions.

For the common settings in a project data, some settings are relevant to multiple GOT functions.

For each setting relevant to the GOT functions, refer to the following.





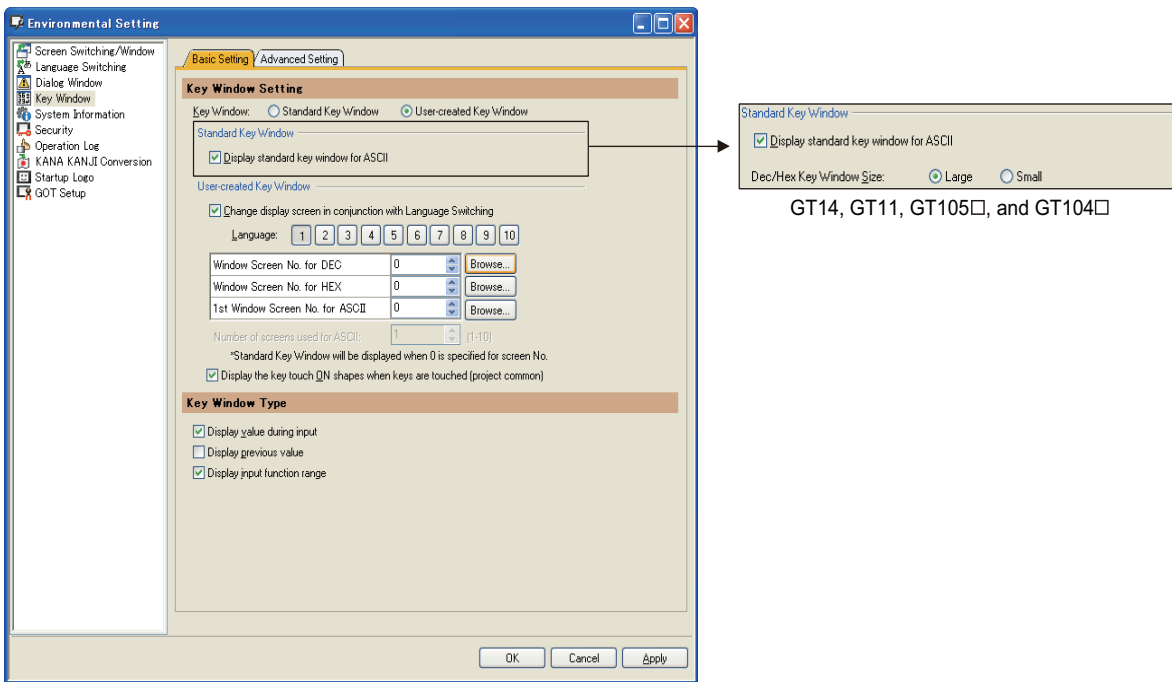



Appendix8 Relevant Settings

#### (1) Basic Setting tab



Item	Description	Model	
Key Window Setting	Key Window	Select the type of the key window to be used. (Standard Key Window/User-created Key Window)	GT16 GT15 GT14 GT12 GT11 GT10 SERGOT1000
	Display standard key window for ASCII	Select this item to display the standard key window at ASCII input.	GT16 GT15 GT14 GT12 GT11 GT10 SERGOT1000
	Dec/Hex Key Window Size	Select this item to select the size of the key window for numeric values. For the GT10, this item is available only for the GT105□ and GT104□.	GT16 GT15 GT14 GT12 GT11 GT10 SERGOT1000

(Continued to next page)

Item	Description		Model
Key Window Setting	Change display screen in conjunction with Language Switching *1	<p>This item is available when [User-created Key Window] is selected for [Key Window].</p> <p>Select this item to change the key window display in synchronization with the value of language switching device. After selecting this item, select the value (1 to 10) of the language switching device for [Language].</p> <p>Set window screens to be displayed in synchronization with each value.</p> <p>When the setting is changed, the color of each value for [Language] is changed.</p>	
	Window Screen No. for DEC	<p>To input a decimal number, set a window screen number displayed as a key window.</p> <p>By clicking the [Browse] button, the window screen can be selected in the [Screen Image List] dialog box.</p>	
	Window Screen No. for HEX	<p>To input a hexadecimal number, set a window screen number displayed as a key window.</p> <p>By clicking the [Browse] button, the window screen can be selected in the [Screen Image List] dialog box.</p>	
	1st Window Screen No. for ASCII	<p>To input a ASCII character, set a window screen number displayed as a key window.</p> <p>Starting with the screen number set for this item, as many screens as set in [Number of screens used for ASCII] are available for key windows for ASCII characters.</p> <p>To display the standard key window, set "0" for the screen number.*2</p> <p>By clicking the [Browse] button, the window screen can be selected in the [Screen Image List] dialog box.</p>	
	Number of screens used for ASCII	<p>Set the number of window screens used for key windows for ASCII characters. (1 to 10)</p> <p>When multiple key windows for ASCII characters are set, the key windows can be switched by the key code switch (key window switching).</p> <p>For details of key code switches, refer to the following.</p> <p> (Functions) 2.9 Setting Key Code Switch</p>	
	Display the key touch ON shapes when keys are touched (project common)	<p>This item can be set per project only.</p> <p> ■Setting for each project</p>	
Key Window Type	Display value during input	<p>Select this item to display the value being input on the key window.</p> <p>To display the input value on a user-created key window, the input value area setting must be arranged on the window screen.</p> <p> 4.5.4 ■Display of the input value area setting, input range area setting, and previous value area setting</p>	
	Display previous value	<p>Select this item to display the value before input.</p> <p>To display the value before input on a user-created key window, the previous value area setting must be arranged on the window screen.</p> <p> 4.5.4 ■Display of the input value area setting, input range area setting, and previous value area setting</p>	
	Display input function range	<p>Select this item to display the input range on a key window.</p> <p>To display the input range on a user-created key window, the input range area setting must be arranged on the window screen.</p> <p> 4.5.4 ■Display of the input value area setting, input range area setting, and previous value area setting</p>	

\*1 In synchronization with the language switching device value, the screen window set for [Language] is displayed as a key window. The following shows the GT Designer3 settings relevant to the language switching actions on the GOT.  
Example) Switching key windows for a decimal number in synchronization with the value of language switching device



• GT Designer3 setting

Select language	DEC key sheet No.	Description
1	10	Window screen 10 is displayed for the key window when the language switching device value is "1".
2	22	Window screen 22 is displayed for the key window when the language switching device value is "2".
3	0	The standard key window is displayed when the language switching device value is "3".
10	47	Window screen 47 is displayed for the key window when the language switching device value is "10".

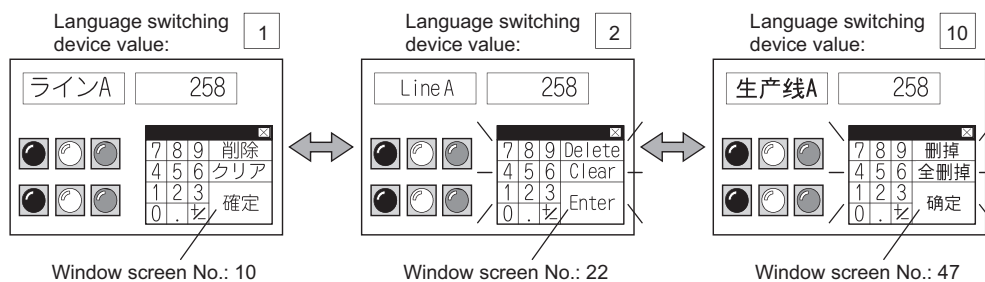

• Language switching on the GOT

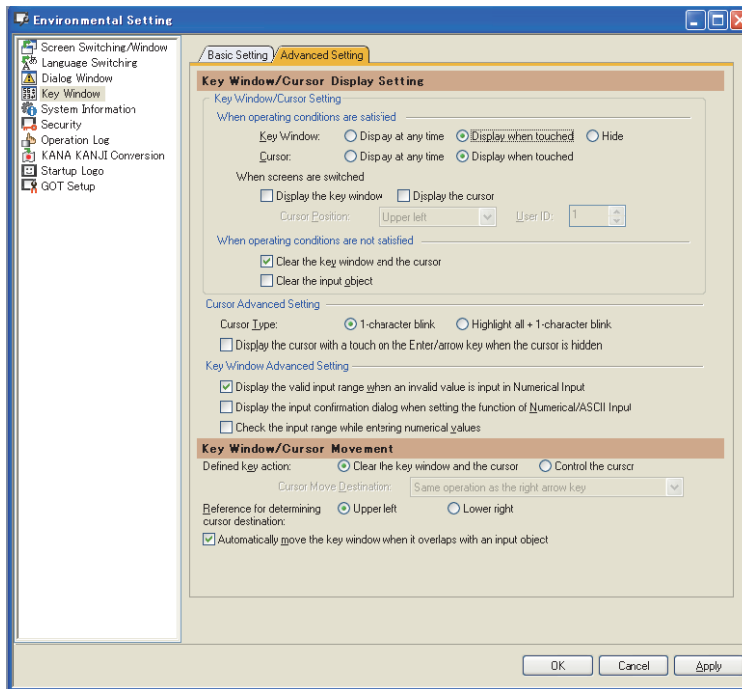

\*2 When setting "0" for the screen number, select [Display standard key window for ASCII]. Otherwise, the key window is not displayed.

(2) Advanced Setting tab



Item	Description	Model
Key Window/Cursor Display Setting	Key Window/Cursor Setting  (a) Key Window/Cursor Setting	gr16 gr15 gr14 gr12 gr11 gr10 SoftGoT1000
	Cursor Advanced Setting  (b) Cursor Advanced Setting	
	Key Window Advanced Setting  (c) Key Window Advanced Setting	gr16 gr15 gr14 gr12 gr11 gr10 SoftGoT1000
Key Window/Cursor Movement	Defined key action	gr16 gr15 gr14 gr12 gr11 gr10 SoftGoT1000
	Reference for determining cursor destination	
	Automatically move the key window when it overlaps with an input object	gr16 gr15 gr14 gr12 gr11 gr10 SoftGoT1000

(a) Key Window/Cursor Setting

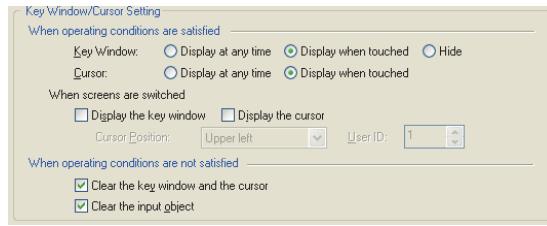

Item	Description	Model
When operating conditions are satisfied	Key Window	Set the action of the key window when operating conditions for the numerical input or ASCII input is satisfied. (Display at any time/Display when touched/ Hide) GT16 GT15 GT14 GT12 GT11 GT10 SoftGOT1000
	Cursor	Set the action of the cursor when operating conditions for the numerical input or ASCII input are satisfied. (Display at any time/Display when touched) GT16 GT15 GT14 GT12 GT11 GT10 SoftGOT1000
	When screens are switched	This item is available when [Display when touched]/ [Hide] is selected for [Key Window], or [Display when touched] is selected for [Cursor]. Set the action of the key window and cursor when switching screens.
	Display the key window	Select this item to display the key window when switching screens. GT16 GT15 GT14 GT12 GT11 GT10 SoftGOT1000
	Display the cursor	Select this item to display the cursor when switching screens. After selecting this item, set [Cursor Position]. Cursor Position: Select the display position of the cursor when switching screens. (Upper left/User ID minimum/ User ID specification) To select [User ID specification], set the user ID for [User ID].
When operating conditions are not satisfied	Clear the key window and the cursor	Select this item to clear the key window and cursor when conditions of the input object are not satisfied.
	Clear the input object	This item is available only when selecting [Clear the key window and the cursor]. Select this item to clear the input object as well as the cursor and key window when conditions of the input object are not satisfied. GT16 GT15 GT14 GT12 GT11 GT10 SoftGOT1000

(b) Cursor Advanced Setting



Item	Description	Model
Cursor Type	Set the action of the cursor to be displayed on the input area. • 1-character blink: Blinks the area for one character in the input area. • Highlight all + 1-character blink: Highlights characters displayed in the input area, and blinks the area for one character. GT16 GT15 GT14 GT12 GT11 GT10 SoftGOT1000	
Display the cursor with a touch on the Enter/arrow key when the cursor is hidden	Select this item to display the cursor with a touch on the enter or arrow key while the cursor is hidden. GT16 GT15 GT14 GT12 GT11 GT10 SoftGOT1000	

(c) Key Window Advanced Setting

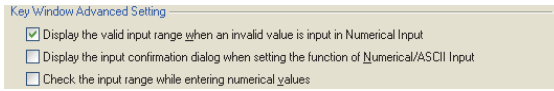

Item	Description	Model
Display the valid input range when an invalid value is input in Numerical Input	Select this item to display the dialog box for the valid input range when an invalid value is input for the numerical input area.	
Display the input confirmation dialog when setting the function of Numerical/ASCII Input	Select this item to display the confirmation dialog box when inputting the numerical input or ASCII input.	gr16 gr15 gr14 gr12 gr11 gr10 SoftGoT1000
Check the input range while entering numerical values	Select this item to check the range while the numeric value is input. Deselecting this item checks the range when the numerical input is completed.	

## ■ Setting for each screen

1. Select a screen editor to set a key window, and select [Screen] → [Screen Property] from the menu to display the [Screen Property] dialog box.
2. Select the [Key Window Basic Setting] tab or the [Key Window Advanced Setting] tab, and set the required items.



### Settings relevant to functions

For the key window settings, some settings are relevant to multiple GOT functions.  
For each setting relevant to the GOT functions, refer to the following.





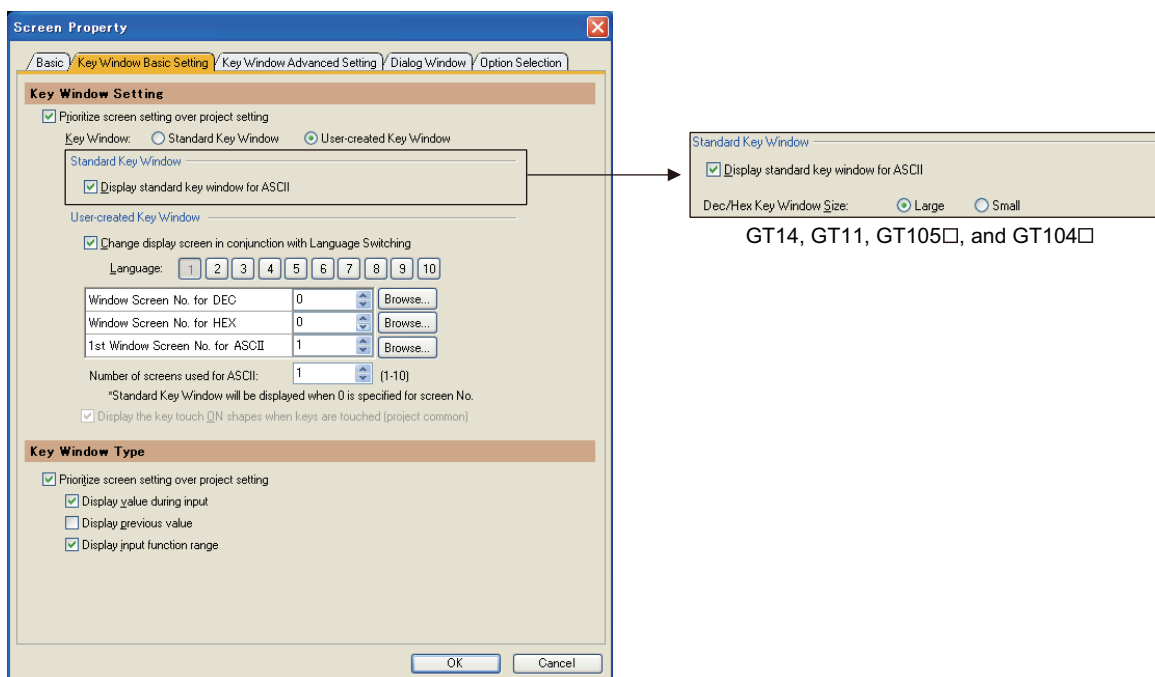





☞ Appendix8 Relevant Settings

### (1) Key Window Basic Setting tab



Item	Description	Model
Key Window Setting	Prioritize screen setting over project setting	Select this item to give the setting for each screen priority over the setting for each project.
	Key Window	This item is available when [Prioritize screen setting over project setting] is selected for [Key Window Setting]. (Standard Key Window/User-created Key Window)
	Display standard key window for ASCII	Select this item to display the standard key window at ASCII input.
	Dec/Hex Key Window Size	Select this item to select the size of the key window for numeric values. For the GT10, this item is available only for the GT105□ and GT104□.
		GT16 GT15 GT14 GT12 GT11 GT10 SerGOT1000
		GT16 GT15 GT14 GT12 GT11 GT10 SerGOT1000
		GT16 GT15 GT14 GT12 GT11 GT10 SerGOT1000

(Continued to next page)

Item	Description		Model
Key Window Setting	Change display screen in conjunction with Language Switching *1	<p>This item is available when [User-created Key Window] is selected for [Key Window].</p> <p>Select this item to change the key window display in synchronization with the value of language switching device. After selecting this item, select the value (1 to 10) of the language switching device for [Language].</p> <p>Set window screens to be displayed in synchronization with each value.</p> <p>When the setting is changed, the color of each value for [Language] is changed.</p>	
	Window Screen No. for DEC	<p>To input a decimal number, set a window screen number displayed as a key window.</p> <p>By clicking the [Browse] button, the window screen can be selected in the [Screen Image List] dialog box.</p>	
	Window Screen No. for HEX	<p>To input a hexadecimal number, set a window screen number displayed as a key window.</p> <p>By clicking the [Browse] button, the window screen can be selected in the [Screen Image List] dialog box.</p>	
	1st Window Screen No. for ASCII	<p>To input a ASCII character, set a window screen number displayed as a key window.</p> <p>Starting with the screen number set for this item, as many screens as set in [Number of screens used for ASCII] are available for key windows for ASCII characters.</p> <p>To display the standard key window, set "0" for the screen number.*2</p> <p>By clicking the [Browse] button, the window screen can be selected in the [Screen Image List] dialog box.</p>	
	Number of screens used for ASCII	<p>Set the number of window screens used for key windows for ASCII characters. (1 to 10)</p> <p>When multiple key windows for ASCII characters are set, the key windows can be switched by the key code switch (key window switching).</p> <p>For details of key code switches, refer to the following.</p> <p> (Functions) 2.9 Setting Key Code Switch</p>	
	Display the key touch ON shapes when keys are touched (project common)	<p>This item can be set per project only.</p> <p> ■Setting for each project</p>	
Key Window Type	Prioritize screen setting over project setting	<p>Select this item to give the setting for each screen priority over the setting for each project.</p>	
	Display value during input	<p>Select this item to display the value being input on the key window.</p> <p>To display the input value on a user-created key window, the input value area setting must be arranged on the window screen.</p> <p> 4.5.4 ■Display of the input value area setting, input range area setting, and previous value area setting</p>	
	Display previous value	<p>Select this item to display the value before input.</p> <p>To display the value before input on a user-created key window, the previous value area setting must be arranged on the window screen.</p> <p> 4.5.4 ■Display of the input value area setting, input range area setting, and previous value area setting</p>	
	Display input function range	<p>Select this item to display the input range on a key window.</p> <p>To display the input range on a user-created key window, the input range area setting must be arranged on the window screen.</p> <p> 4.5.4 ■Display of the input value area setting, input range area setting, and previous value area setting</p>	

\*1 In synchronization with the language switching device value, the screen window set for [Language] is displayed as a key window. The following shows the GT Designer3 settings relevant to the language switching actions on the GOT.  
Example) Switching key windows for a decimal number in synchronization with the value of language switching device

• GT Designer3 setting

Select language	DEC key sheet No.	Description
1	10	Window screen 10 is displayed for the key window when the language switching device value is "1".
2	22	Window screen 22 is displayed for the key window when the language switching device value is "2".
3	0	The standard key window is displayed when the language switching device value is "3".
10	47	Window screen 47 is displayed for the key window when the language switching device value is "10".

• Language switching on the GOT

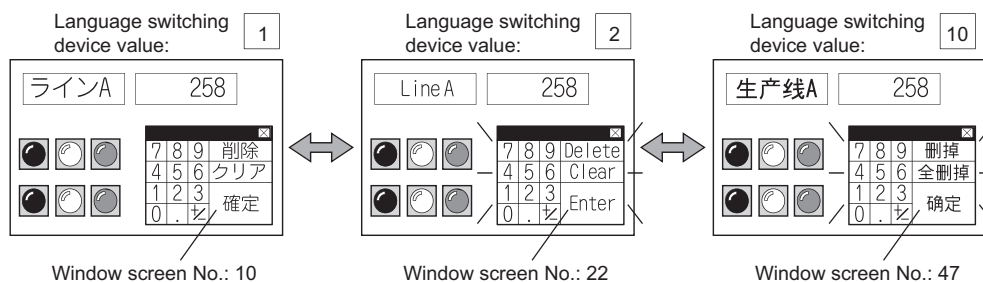

\*2 When setting "0" for the screen number, select [Display standard key window for ASCII]. Otherwise, the key window is not displayed.

(2) Key Window Advanced Setting tab

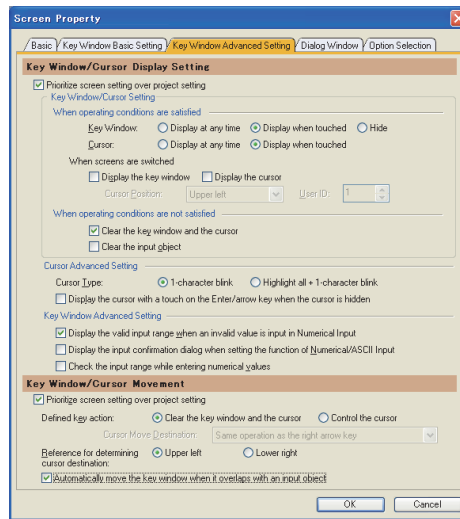

Item	Description	Model	
Key Window/Cursor Display Setting	Prioritize screen setting over project setting	Select this item to give the setting for each screen priority over the setting for each project.	
	Key Window/Cursor Setting	Set the action of the key window and cursor when operating conditions are satisfied or not satisfied. (a) Key Window/Cursor Setting	gr16 gr15 gr14 gr12 gr11 gr10 SoftGoT1000
	Cursor Advanced Setting	Set the action of the cursor. (b) Cursor Advanced Setting	
	Key Window Advanced Setting	Set the action of the key window. (c) Key Window Advanced Setting	gr16 gr15 gr14 gr12 gr11 gr10 SoftGoT1000
Key Window/Cursor Movement	Prioritize screen setting over project setting	Select this item to give the setting for each screen priority over the setting for each project.	
	Defined key action	Set the action of the key window and cursor when touching the enter key. (Clear the key window and the cursor/Control the cursor) Select [Cursor Move Destination] for [Control the cursor]. Cursor Move Destination: Select the position where the cursor moves. (Same operation as the right arrow key/Same operation as the down arrow key/Not move/Move in order of User IDs (not move if it cannot shift)	gr16 gr15 gr14 gr12 gr11 gr10 SoftGoT1000
	Reference for determining cursor destination	Select the reference to determine the position where the cursor moves. (Upper left/Lower right)	
	Automatically move the key window when it overlaps with an input object	Select this item to display the key window without overlapping the key window on an input target object.	gr16 gr15 gr14 gr12 gr11 gr10 SoftGoT1000



(a) Key Window/Cursor Setting

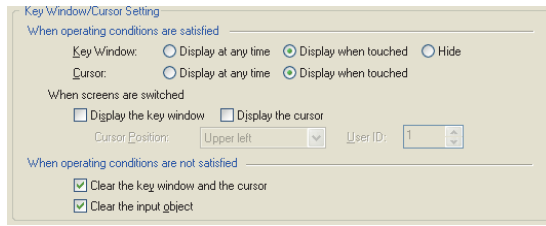

Item	Description	Model
When operating conditions are satisfied	Key Window	Set the action of the key window when operating conditions for the numerical input or ASCII input is satisfied. (Display at any time/Display when touched/ Hide) GT16 GT15 GT14 GT12 GT11 GT10 SoftGOT1000
	Cursor	Set the action of the cursor when operating conditions for the numerical input or ASCII input are satisfied. (Display at any time/Display when touched) GT16 GT15 GT14 GT12 GT11 GT10 SoftGOT1000
	When screens are switched	Set the action of the key window and cursor when switching screens.
	Display the key window	Select this item to display the key window when switching screens.
When operating conditions are not satisfied	Display the cursor	Select this item to display the cursor when switching screens. After selecting this item, set [Cursor Position]. Cursor Position: Select the display position of the cursor when switching screens. (Upper left/User ID minimum/ User ID specification) To select [User ID specification], set the user ID for [User ID]. GT16 GT15 GT14 GT12 GT11 GT10 SoftGOT1000
	Clear the key window and the cursor	Select this item to clear the key window and cursor when conditions of the input object are not satisfied. GT16 GT15 GT14 GT12 GT11 GT10 SoftGOT1000
	Clear the input object	This item is available only when selecting [Clear the key window and the cursor]. Select this item to clear the input object as well as the cursor and key window when conditions of the input object are not satisfied. GT16 GT15 GT14 GT12 GT11 GT10 SoftGOT1000

(b) Cursor Advanced Setting

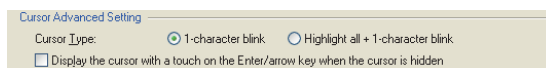

Item	Description	Model
Cursor Type	Set the action of the cursor to be displayed on the input area. • 1-character blink: Blinks the area for one character in the input area. • Highlight all + 1-character blink: Highlights characters displayed in the input area, and blinks the area for one character.	GT16 GT15 GT14 GT12 GT11 GT10 SoftGOT1000
Display the cursor with a touch on the Enter/arrow key when the cursor is hidden	Select this item to display the cursor with a touch on the enter or arrow key while the cursor is hidden.	GT16 GT15 GT14 GT12 GT11 GT10 SoftGOT1000

(c) Key Window Advanced Setting

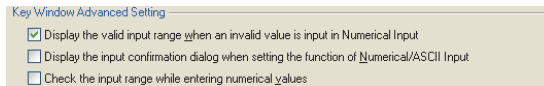

Item	Description	Model
Display the valid input range when an invalid value is input in Numerical Input	Select this item to display the dialog box for the valid input range when an invalid value is input for the numerical input area.	
Display the input confirmation dialog when setting the function of Numerical/ASCII Input	Select this item to display the confirmation dialog box when inputting the numerical input or ASCII input.	gr16 gr15 gr14 gr12 gr11 gr10 SoftGOT1000
Check the input range while entering numerical values	Select this item to check the range while the numeric value is input. Deselecting this item checks the range when the numerical input is completed.	

### 4.5.6 Relevant settings

The key window is available for the relevant settings other than the specific settings. The following shows the functions that are available by relevant settings.

#### ■ GOT environment settings (System information)

Select [Common] → [GOT Environmental Setting] → [System Information] from the menu to display the [Environmental Setting] dialog box.

4.6 System Information Setting

Function	Setting item	Model
Disabling all key inputs (Read device: System signal 1-1.b9)	[System Signal 1-1]	
Notifying the key input (Write device: System signal 2-1.b3)	[System Signal 2-1]	
Notifying that the input is completed (Write device: System signal 2-1.b4)	[System Signal 2-1]	gr16 gr15 gr14 gr12 gr11 gr10 SoftGOT1000
Notifying that the key window is on the screen (Write device: System signal 2-1.b11)	[System Signal 2-1]	
Notifying the user ID of the completed numerical input (Write device)	[Numeric Value Input Number]	
Notifying the key code set on the touched key (Write device)	[Key Code Input]	gr16 gr15 gr14 gr12 gr11 gr10 SoftGOT1000
Notifying the value before the change (32 bits) (Write device)	[Previous Numeric Value Input(32bit)]	gr16 gr15 gr14 gr12 gr11 gr10 SoftGOT1000
Notifying the completed input value (32 bits) (Write device)	[Current Numeric Value Input(32bit)]	gr16 gr15 gr14 gr12 gr11 gr10 SoftGOT1000

#### ■ GOT internal devices

Appendix2 GOT Internal Devices

Function	Setting item	Model
Displaying the confirmation dialog box when the numerical input or ASCII input are completed	GS450.b0	gr16 gr15 gr14 gr12 gr11 gr10 SoftGOT1000
Displaying the confirmation dialog box that notifies the input value for the numerical input is out of range	GS450.b1	gr16 gr15 gr14 gr12 gr11 gr10 SoftGOT1000

## 4.5.7 Precautions

### ■ Precautions for using standard key window and user-created key window

(1) **When the comment window for an alarm is used**

A key window cannot be displayed when details of alarm are displayed on a comment window by using the alarm history display, user alarm display, or system alarm display.

(2) **When the cursor is not displayed on the object targeted for input**

When the cursor is not displayed on the object targeted for input while the key window is displayed, the following constraints apply.

To input a value with the key window, display the cursor on the object targeted for input.

- (a) The key window does not display the input value, the input range, and the previous value.
- (b) Even though the satisfied operating condition status varies while the key window is displayed, the key window remains the same state. (Even though the operating conditions of all the input objects are not satisfied, the key window remains displayed.)

(3) **Input range displayed in the key window for numeric values (Excluding GT10)**

When [Octal] or [Binary] is selected for [Format] in the numerical input setting, the value is input in hexadecimal. Even though the input hexadecimal value is outside the displayable range of the numerical input, the value is input when the value is within the input range.

Example) Numerical input ([Format]: [Octal], [Digits]: 3)

- Displayable range of the numerical input ([Format]: [Octal]): 0 to 777 (octal)
- Input range with the key window (hexadecimal): 0 to FFF (hexadecimal)

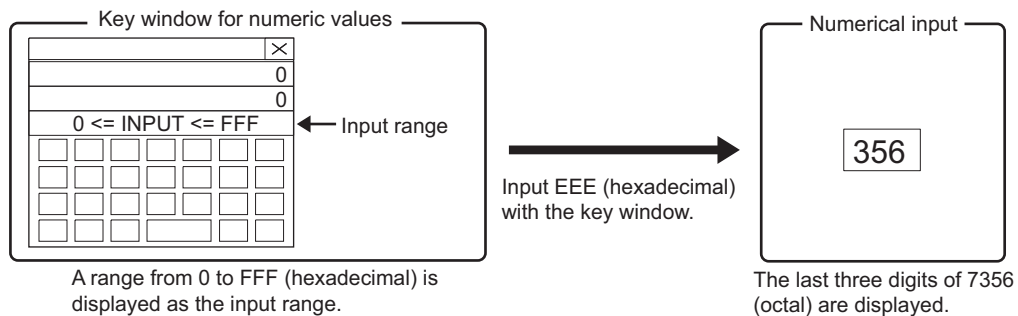

### ■ Precautions for creating user-created key window

(1) **Precautions for using GT10**

Set a touch switch for the [ESC] key. (Key code 001BH (Cancel))

(2) **Objects displayable in a user-created key window**

The following shows the objects displayable in a user-created key window. (Excluding GT10)

Even if the objects other than the following are placed, the GOT cannot display the objects.

Objects displayable in a user-created key window			
• Switch	• key code switch	• Input value area setting	• Input range area setting
• Input maximum value area setting	• Input minimum value area setting	• Previous value area setting	

The GT10 displays the objects other than the above.

For the numerical input and the ASCII input, only displaying them is available on the GT10.

(3) **Limitations on the touch switch**

When a touch switch is placed on a user-created key window, the following limitations apply.

- (a) When a touch switch is [Switch], even though key code actions and any of the other actions are set on the [Action] tab, only the key code actions are executed.
- (b) Place touch switches on the back layer.  
When placing the switches on the front layer, the GOT does not display the touch switches. Additionally, the switches do not operate even when touching the positions that the switches are placed.
- (c) Even though the blink and the object script are set, they do not function.
- (d) Only [Text] is available for [Text Type].  
[Indirect Text(Basic Comment)] and [Comment Group] are not displayed even if they are set.

- (e) Only [KANJI Region] is available for the setting of the [Extended] tab. Other setting items than [KANJI Region] are not available.
- (f) The setting of the [Trigger] tab is not available even if the setting is configured.



**How to create a key window that includes functions the above (2) and (3)**

When creating a key window with a key that includes the above functions, use a normal window screen as a key window without making the settings for displaying the key window.

Example) Normal overlap window used as key window

Example: Normal overlap window used as key window

- Set the objects except Numerical input and ASCII input.

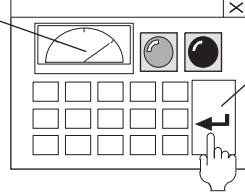

- Turn ON the other device (bit SET) simultaneously with RETURN (000DH).

**(4) Numbers of digits of the numerical input object and the input value area setting object (Excluding GT10)**

For [Digits] in the input value area setting and the numerical input, set the same value.

Failure to do so makes difference between the input range displayed in the key window and the input range that can be entered.

For example) [Digits] of the input range area setting: 4, [Digits] of the numerical input: 6

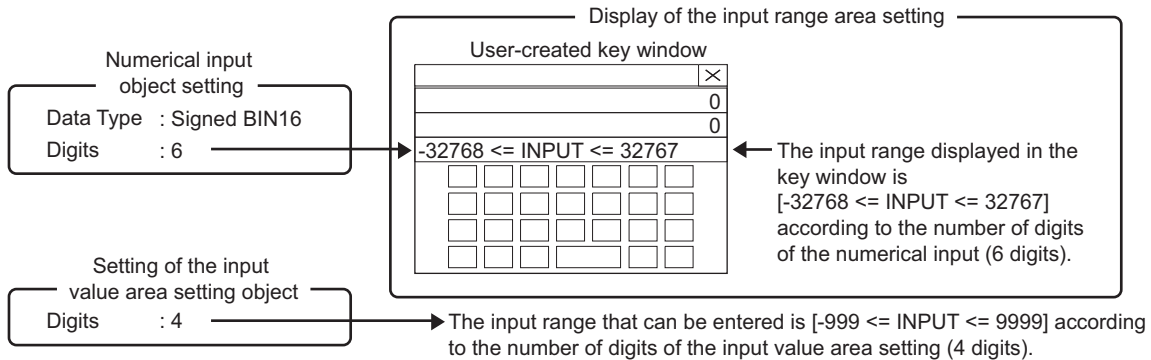

**(5) Number of settings for the input value area setting, input range area setting, or previous value area setting**

Multiple settings of [Input Value Area Setting], [Input Range Area Setting], or [Previous Value Area Setting] are not available for one window screen.

**(6) Superimposing objects**

In a user-created key window, objects cannot be superimposed. (The text on the objects also cannot be superimposed.)

Additionally, the layers are disabled.

**(7) Image display**

In a user-created key window, do not display a JPEG figure data.

Doing so may slow down the reaction speed of the touch switches.

To display an image, use a BMP figure data.

**(8) Size of user-created key window**

The key window size is same with the size of set window screen.

It can be changed by changing the size of window screen.

For changing the size of the window screen, refer to the following.

☞ 3.7 Creating/Opening/Closing Screen

The applicable size of window screen is different according to the status of close key and move key, i.e., whether they are displayed or not.

☞ 2.3.1 Screen specifications for each GOT type

## 4.6 System Information Setting



A device to store system information is set. By setting the device, the GOT can control GOT operations (including the screen closing, disabling key input) by a controller, or notify the GOT status to controllers.

The two types of devices that store system information are shown below.

- Read device: controls GOT operation via controller
- Write device: notifies controller of GOT operation status

### ■ Controlling GOT operations by controllers (Read device)

A controller writes a value to the read device for controlling the GOT operations. Doing so enables the GOT to control the GOT operations.

Example) Turning the GOT to screen save mode forcibly by controller.

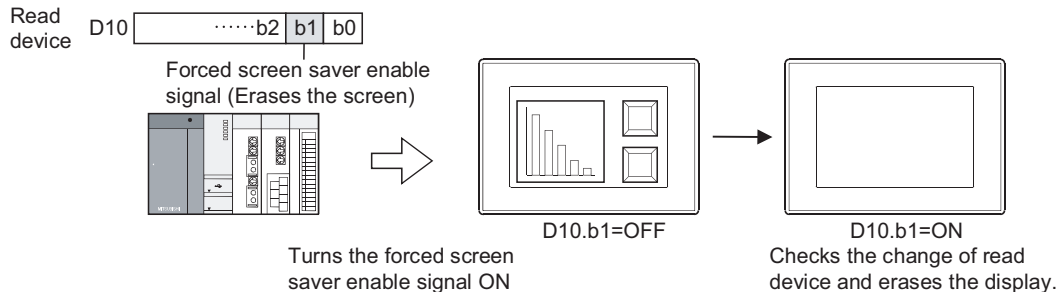

### ■ Notifying the GOT status to controllers (Write device)

The GOT writes a value to the write device for notifying the GOT status. Doing so enables the GOT to notify the GOT status to a controller.

Example) Notifying the base screen No. currently displayed on the GOT to a controller

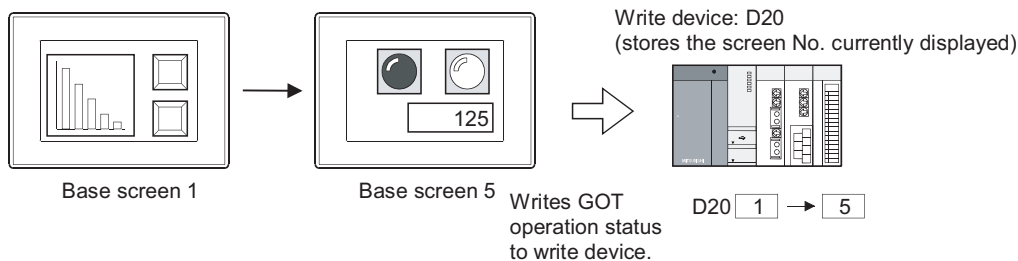

### POINT

#### Monitoring system information device or update timing

The following explains monitoring the read device set in the system information and deciding the timing to update the write device.

Device	Monitoring/update timing
Read device	<p>Monitored at intervals of GOT monitor period.</p> <p>The read device value needs to be longer compared to the interval of GOT monitor period.</p> <p>The monitor period value is stored in the GOT internal device (GS8).</p> <p>👉 Appendix2 GOT Internal Devices</p>
Write device	Updated when the GOT operation status has changed.

## 4.6.1 Settings

Select [Common] → [GOT Environmental Setting] → [System Information] from the menu to display the [Environmental Setting] dialog box.

For the function of the read device and write device for the system information, refer to the following.

 4.6.2 Details of system information





### Settings relevant to functions

For the common settings in a project data, some settings are relevant to multiple GOT functions. For each setting relevant to the GOT functions, refer to the following.

 Appendix8 Relevant Settings

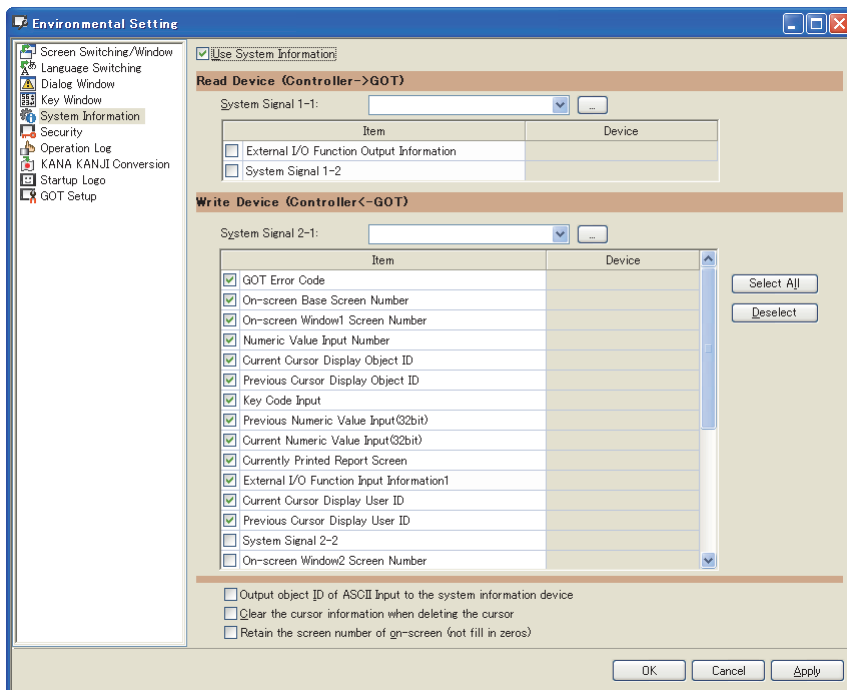
## System Information



Item	Description	Model
Use System Information	Select this item to set a device to store system information.	
Read Device	Set a read device to control the GOT.	
	System Signal 1-1	Set a start device of the read device.
	Item	For the selected items, this item sets the subsequent devices of the device set for [System Signal 1-1] in sequential device order.
	Device	
Write Device	Set a write device to notify the GOT status.	
	System Signal 2-1	Set a start device of the write device.
	Item	For the selected items, this item sets the subsequent devices of the device set for [System Signal 2-1] in sequential device order.
	Device	
		Click this item to select all the items for the write device.
	Click this item to clear all the items for the write device.	

gr16 gr15  
gr14 gr12  
gr11 gr10  
softgot1000

(Continued to next page)

Item	Description	Model
Output object ID of ASCII Input to the system information device	Select this item so that the ASCII input is the output target for the following devices. · Numeric Value Input Read Complete Signal (System Signal 1-1.b4) · Numeric Value Input Signal (System Signal 2-1.b4) · Numeric Value Input Number · Current Cursor Display User ID · Previous Cursor Display User ID	
Clear the cursor information when deleting the cursor	Select this item to store "0" in the following devices when deleting the cursor. · Current Cursor Display Object ID · Previous Cursor Display Object ID · Previous Cursor Display User ID	GT16 GT15 GT14 GT12 GT11 GT10 SENSOR1000
Retain the screen number of on-screen (not fill in zeros)	Select this item to hold the following device values while the screens are switched. ("0" is not stored.) · On-screen Base Screen Number · On-screen Window1 Screen Number · On-screen Window2 Screen Number · On-screen Window3 Screen Number · On-screen Window4 Screen Number · On-screen Window5 Screen Number	

1	OVERVIEW
2	GT Designer3 SPECIFICATIONS
3	GT Designer3 OPERATION
4	COMMON SETTING
5	EDITING AND SETTING FIGURES AND OBJECTS
6	LIBRARY
7	TEMPLATE



## 4.6.2 Details of system information

This section explains the read device and write device of system information.

Signal type		Reference	Signal type		Reference
Read device	System Signal 1-1	(1)	Write device	Current Cursor Display User ID	(13)
	External I/O Function Output Information	(2)		Previous Cursor Display User ID	(14)
	System Signal 1-2	(3)		System Signal 2-2	(15)
Write device	System Signal 2-1	(1)		On-screen Window2 Screen Number	(16)
	GOT Error Code	(2)		Drive A empty capacity information (32bit)	(17)
	On-screen Base Screen Number	(3)		Drive B empty capacity information (32bit)	(18)
	On-screen Window 1 Screen Number	(4)		Drive C empty capacity information (32bit)	(19)
	Numeric Value Input Number	(5)		Drive D empty capacity information (32bit)	(20)
	Current Cursor Display Object ID	(6)		External I/O Function Input Information2	(21)
	Previous Cursor Display Object ID	(7)		On-screen Window3 Screen Number	(22)
	Key Code Input	(8)		On-screen Window4 Screen Number	(23)
	Previous Numeric Value Input (32bit)	(9)		On-screen Window5 Screen Number	(24)
	Current Numeric Value Input (32bit)	(10)	Extended Drive Information (E and subsequent drives)	(25)	
Currently Printed Report Screen	(11)	Drive E empty capacity information (32bit)	(26)		
External I/O Function Input Information1	(12)	System Signal 2-3	(27)		

### Read device

#### (1) System Signal 1-1

Bit No.	Signal name	Description	Model	
b0	Automatic Screen Saver Disable Signal	Turning on this signal disables the screen saver function (turning off the monitor screen display).		
b1	Forced Screen Saver Enable Signal	Turning on this signal forcibly turns the GOT into the screen saver mode.		
b2	Forced Screen Saver Touch-cancel Signal	Turning on this signal disables the screen saver when the screen is touched even during forced screen saving. The operation condition of the Forced screen saver enable signal (System signal 1-1.b1) differs according to on or off of this signal. • ON: Operates at the rising. • OFF: Operates during on.		
b3	Key Code Read Complete Signal	Turning on this signal turns off the Key input signal (System signal 2-1.b3).		
b4	Numeric Value Input Read Complete Signal	Turning on this signal turns off the Numeric value input signal (System signal 2-1.4). This signal is available for the ASCII input when configuring any of the following settings. • Selecting [Output object ID of ASCII Input to the system information device] for the [Environmental Setting] dialog box in [System Information] • Turning on the GOT internal device (GS450.b2) For the GT10, the signal is always used for the numerical input and ASCII input.		
b5	Barcode Input Disable Signal (CH8)	Turning on this signal disables the barcode function for the channel No. 8.		
b6	External device I/O complete signal (CH8)	Turning on this signal turns off the External device I/O signal (CH8) (System signal 2-1.b6).		

(Continued to next page)



Bit No.	Signal name	Description	Model
b7	Backlight OFF Output Signal	<p>Turning on this signal turns on the backlight during screen saving. The backlight behaves differently depending on the setting of [Screen Save Backlight] for the [Environmental Setting] dialog box in [GOT Setup].</p> <ul style="list-style-type: none"> <li>When [Screen Save Backlight] is [OFF] The setting of the utility is preceded. The backlight is not turned on even if this signal is turned off.</li> </ul> <ul style="list-style-type: none"> <li>When [Screen Save Backlight] is [ON] The setting of this signal is preceded. The backlight is turned off when this signal is turned on.</li> </ul>	
b8	Buzzer Threshot Output Signal	<p>Turning on this signal outputs the buzzer three times. The buzzer length can be set by the followings.</p> <ul style="list-style-type: none"> <li>[Display/Operation] tab for the [Environmental Setting] dialog box (GOT Setup)</li> <li> 4.9 GOT Display and Operation Setting</li> <li>Settings relevant to the utility operation</li> <li> User's Manual for the GOT used</li> <li>When [None] is set, the buzzer sound length is the same as [Long].</li> </ul>	
b9	Key-In Disable Signal	Turning on this signal disables all key-input.	
b10	Hard copy setting validate signal	Turning on this signal enables the hard copy output.	
b11	-	Use prohibited	
b12	Hard copy white/black reverse signal	Turning on this signal reverses black and white of the monitor screen at the hard copy output. Reversing black and white is enabled only when the output destination is a printer.	
b13	GOT Error Reset Signal	Turning on this signal processes the followings. <ul style="list-style-type: none"> <li>Storing "0" to the GOT error code storage area (Write Device)</li> <li>Turning off the GOT error detection signal (System signal 2-1, b13)</li> <li>Clearing system alarm messages</li> </ul>	
b14	Buzzer Output Signal	While turning on this signal, the buzzer sound is output. Even if [Buzzer] is set to [None] for the [Display/Operation] tab in the [Environmental Setting] dialog box, the buzzer sound is output.	
b15	Buzzer Oneshot Output Signal	<p>Turning on this signal outputs the buzzer once. The buzzer length can be set by the followings.</p> <ul style="list-style-type: none"> <li>[Display/Operation] tab for the [Environmental Setting] dialog box (GOT Setup)</li> <li> 4.9 GOT Display and Operation Setting</li> <li>Settings relevant to the utility operation</li> <li> User's Manual for the GOT used</li> <li>When [None] is set, the buzzer sound length is the same as [Long].</li> </ul>	

## (2) External I/O Function Output Information

Functions for each signal differ depending on the GOT used.

### (a) GT16 and GT15

Bit No.	Signal name	Description	Model
b0 to b15	Output signal Y0 to YF	With writing data to be output into the bits, external outputs (lamps and relays) can be executed.	gr16 gr15 gr14 gr12 gr11 gr10 SoftGOT1000

### (b) GT11 and GT10

Bit No.	Signal name	Description	Model
b0 to 5	Operation switch LED control signal	Turning on this signal turns on operation switch LEDs (L1 to L6) for the GT11 Handy GOT.	
b6	Grip switch LED control signal	Turning on this signal turns on the grip switch LED. This signal only enables when the following settings are configured in the [Handy GOT] tab for the [Environmental Setting] dialog box. • Selecting [Depend on ON/OFF state of System Signal] for the on or off operation of the grip switch LED Do not use this signal when the above settings are not configured.	gr16 gr15 gr14 gr12 gr11 gr10 SoftGOT1000
b7 to b11	-	Use prohibited	gr16 gr15 gr14 gr12 gr11 gr10 SoftGOT1000
b12	Backlight control enable bit	Available for the GT1030 and GT1020 only. Turning on this signal enables the backlight control (blinking, color specification).	
b13	Backlight blinking	Available for the GT1030 and GT1020 only. Turning on this signal blinks the backlight.	
b14 to b15	Backlight color specification	Available for the GT1030 and GT1020 only. Controls the backlight color. The backlight color differs according to the GOT used. • GT1030 and GT1020 with 3 colors LED backlight (green, red, and orange) b14:OFF and b15:OFF: Not lit b14:OFF and b15:ON: Red b14:ON and b15:OFF: Green b14:ON and b15:ON: Orange • GT1030 and GT1020 with 3 colors LED backlight (white, red, and pink) b14:OFF and b15:OFF: Not lit b14:OFF and b15:ON: Red b14:ON and b15:OFF: White b14:ON and b15:ON: Pink • Other GT10 This signal is invalid.	gr16 gr15 gr14 gr12 gr11 gr10 SoftGOT1000

### (3) System Signal 1-2

Bit No.	Signal name	Description	Model
b0	File Access Error Reset Signal	Turning on this signal resets all the File access error signals (System signal 2-2.b7, b8, b9) in the drive A, B, D, or E. During turning on this signal, the next File access error signal does not turn on.	GT16 GT15 GT14 GT12 GT11 GT10 SoftGOT1000
b1	RFID request signal (CH8)	By turning on this signal, the GOT requests to read the data with the channel No. 8.	
b2	Barcode input disable signal (CH5)	Turning on this signal disables the barcode function for the channel No. 5.	GT16 GT15 GT14 GT12 GT11 GT10 SoftGOT1000
b3	External device I/O complete signal (CH5)	Turning on this signal turns off the External device I/O signal (CH5) (System signal 2-3.b0).	
b4	RFID request signal (CH5)	By turning on this signal, the GOT requests to read the data with the channel No. 5.	
b5	Barcode input disable signal (CH6)	Turning on this signal disables the barcode function for the channel No. 6.	
b6	External device I/O complete signal (CH6)	Turning on this signal turns off the External device I/O signal (CH6)(System signal 2-3.b1).	
b7	RFID request signal (CH6)	By turning on this signal, the GOT requests to read the data with the channel No. 6.	GT16 GT15 GT14 GT12 GT11 GT10 SoftGOT1000
b8	Barcode input disable signal (CH7)	Turning on this signal disables the barcode function for the channel No. 7.	
b9	External device I/O complete signal (CH7)	Turning on this signal turns off the External device I/O signal (CH7)(System signal 2-3.b2).	
b10	RFID request signal (CH7)	By turning on this signal, the GOT requests to read the data with the channel No. 7.	
b11	Enabling RFID control during external authentication signal	Turning on this signal enables the device input/output of the RFID reading results, control signal, and notification signal during the operator authentication by an external authentication device (RFID).	GT16 GT15 GT14 GT12 GT11 GT10 SoftGOT1000
b12	-	Use prohibited	GT16 GT15 GT14 GT12 GT11 GT10 SoftGOT1000
b13	D drive automatic recovery confirmation complete signal	Turning on this signal turns off the D drive automatic recovery signal (System signal 2-2.b13). This signal is not available for the GT1020.	GT16 GT15 GT14 GT12 GT11 GT10 SoftGOT1000
b14	-	Use prohibited	GT16 GT15 GT14 GT12 GT11 GT10 SoftGOT1000
b15	Print abort signal	Turning on this signal aborts printing (printing for the hard copy function or report function) when this signal rises. In response to the abort of printing, the GOT turns off the Printing signal (System Signal 2-2.b15). The user must turn off this signal after confirming that the Printing signal (System Signal 2-2. b15) is turned off.  <div style="display: flex; align-items: center;"> <div style="margin-right: 10px;"> <p>Print abort signal (System Signal 1-2.b15)</p> <p>Printing signal (System Signal 2-2.b15)</p> </div> </div>	GT16 GT15 GT14 GT12 GT11 GT10 SoftGOT1000

## ■ Write device

### (1) System Signal 2-1

Bit No.	Signal name	Description	Model
b0	Screen saving signal	Turns on while the GOT is in screen save mode.	
b1	GOT Ready Signal	Shows the GOT status when the GOT is powered on. <ul style="list-style-type: none"> <li>• ON: Normal</li> <li>• OFF: Abnormal</li> </ul> If this signal does not turn on by resetting the GOT, the hardware error may occur in the GOT. Consult your local Mitsubishi Electric service center or representative.	
b2	-	Use prohibited	
b3	Key Input Signal	Shows whether the key is input or not. <ul style="list-style-type: none"> <li>• ON: The key is input.</li> <li>• OFF: The key is not input.</li> </ul>	
b4	Numeric Value Input Signal	Turns on when a value is input in the numerical input, and the value is completed. Turning on the Numeric value input read complete signal (System signal 1-1.b4) turns off this signal.  ■Read device By setting any of the followings, this signal is available for the ASCII input. (For the GT10, the signal is always used for the numerical input and ASCII input.) <ul style="list-style-type: none"> <li>• Selecting [Output object ID of ASCII Input to the system information device] for the [Environmental Setting] dialog box (System Information)</li> <li>• Turning on the GOT internal device (GS450.b2)</li> </ul> The status of this signal does not change when a value is input to the numerical input for which a user ID is not set. (For the GT10, the status of this signal changes when a value is input to the numerical input for which a user ID is not set.)	gr16 gr15 gr14 gr12 gr11 gr10 SoftGOT1000
b5	Human Sensor Detection Signal	Turns on when the human sensor is detected human motion. This signal turns ON for approx. 60 seconds after GOT startup due to the sensor's characteristic. This signal can be set for the GT1695, GT1685, GT1595, and GT1585.	gr16 gr15 gr14 gr12 gr11 gr10 SoftGOT1000
b6	External device I/O signal (CH8)	Available when the channel No. 8 is used for the barcode function. Turns on when the data read by the barcode reader is stored in the specified device.	gr16 gr15 gr14 gr12 gr11 gr10 SoftGOT1000
		Available when the channel No. 8 is used for the RFID function. Turns on when the data read by the RFID reader/writer is stored in the specified device. (With the dedicated protocol) Turns on when the data transfer to the RFID controller is completed. (With the nonprocedural protocol) Turns off when the External device I/O complete signal (CH8) (System signal 1-1.b6) turns on.	gr16 gr15 gr14 gr12 gr11 gr10 SoftGOT1000
b7	Hard copy output signal	Turns on during printing by the hard copy function.	gr16 gr15 gr14 gr12 gr11 gr10 SoftGOT1000
b8	Report output signal	Turns on during printing by the report function.	gr16 gr15 gr14 gr12 gr11 gr10 SoftGOT1000
b9	-	Use prohibited	
b10	Recipe Processing Signal	Turns on during recipe process (Write/Read operation).	gr16 gr15 gr14 gr12 gr11 gr10 SoftGOT1000
b11	Key window Output Signal	Turns on during displaying the key window.	gr16 gr15 gr14 gr12 gr11 gr10 SoftGOT1000
b12	Hardcopy Sub-signal	Turns on when the number of screen data files (file number) stored in a memory card by using the hard copy function is 9900 to 9999.	gr16 gr15 gr14 gr12 gr11 gr10 SoftGOT1000

(Continued to next page)

Bit No.	Signal name	Description	Model
b13	GOT Error Detection Signal	Turns on when an error occurs in the GOT (error data are stored in the GOT error code).	
b14	Numeric Value Error Detection Signal	Turns on when the value exceeding the input range is stored in the write target device of the numerical input. (This signal is checked when screens are switched.) When no input range formula is preset to the numerical input, detection is not performed.	GT16 GT15 GT14 GT12 GT11 GT10 SoftGOT1000
b15	Printer error detection signal	Turns on when a printer error occurs during printing because of the powered off printer, cable disconnection, no paper, paper jam, and others.	GT16 GT15 GT14 GT12 GT11 GT10 SoftGOT1000

## (2) GOT Error Code

The data of the error occurred in the GOT are stored.  
Not available for the GT10.

## (3) On-screen Base Screen Number

The base screen being displayed is stored.  
The stored screen number is as follows.

Display status	Data format of the screen switching device	
	BIN	BCD
When displaying other than usercreated screens (utility, RGB and others)	-1	Stores the number of the user-created base screen previously displayed
During screen switching	0	
Base screen being displayed	1 to 32767	1 to 9999

## (4) On-screen Window 1 Screen Number

The number of the window screen currently displayed is stored as the overlap window 1.  
The stored screen number is as follows.

Display status	Data format of the screen switching device	
	BIN	BCD
Not displayed or during screen switching	0	
The number of overlap window 1 being displayed	1 to 32767	1 to 9999

Confirm the display status of the superimpose window 1 by the screen switching device.

## (5) Numeric Value Input Number

The user ID number of the numerical input is stored when the input value is determined.  
By setting any of the followings, this signal is available for the ASCII input.

- Selecting [Output object ID of ASCII Input to the system information device] for the [Environmental Setting] dialog box (System Information)
- Turning on the GOT internal device (GS450.b2)

For the GT10, the signal is always used for the numerical input and ASCII input.

## (6) Current Cursor Display Object ID

The object ID No. of the object on which the cursor is currently displayed is stored.  
By setting any of the followings, "0" is stored when the cursor is deleted.

- Selecting [Clear the cursor information when deleting the cursor] for the [Environmental Setting] dialog box (System Information)
- Turning on the GOT internal device (GS450.b3)

## (7) Previous Cursor Display Object ID

The object ID No. of the object on which the cursor is previously displayed is stored.  
By setting any of the followings, "0" is stored when the cursor is deleted.

- Selecting [Clear the cursor information when deleting the cursor] for the [Environmental Setting] dialog box (System Information)
- Turning on the GOT internal device (GS450.b3)

**(8) Key Code Input**

When inputting values with the input key (Touch switch, numerical input, or ASCII input), the specified key code is stored.

When a key code is stored, the Key Input Signal (System Signal 2-1.b3) is turned on.

Not available for the GT10.

**(9) Previous Numeric Value Input (32bit)**

When a value is input in the numerical input, the value before the change (32 bits) is stored.

Effective only for the numerical input object to which the user ID is set.

**(10) Current Numeric Value Input (32bit)**

The input value (32 bits) determined in the numerical input.

Effective only for the numerical input to which the user ID is set.

**(11) Printing report number**

The screen number of the report screen currently printed is stored.

Not available for the GT14, GT12, GT11, and GT10.

**(12) External I/O function/input information 1**

Bit No.	Signal name	Description	Model
b0 to b7	Input signal X0 to X7	Input data are written in the bits. An external input can take up to three seconds to write data in a bit. For avoiding the delay time, use GOT internal devices (GB10 to GB25, GB30 to GB37, GB50 to GB57).	Gr16 Gr15 Gr14 Gr12 Gr11 Gr10 SoftGOT1000
b8	Power status notification signal	Turns on when the power is not supplied to an external I/O device.	
b9 to b15	-	Use prohibited	Gr16 Gr15 Gr14 Gr12 Gr11 Gr10 SoftGOT1000

**(13) Current Cursor Display User ID**

The user ID No. of the object on which the cursor is currently displayed is stored.

By setting any of the followings, this signal is available for the ASCII input.

- Selecting [Output object ID of ASCII Input to the system information device] for the [Environmental Setting] dialog box (System Information)
- Turning on the GOT internal device (GS450.b2)

For the GT10, the signal is always used for the numerical input and ASCII input.

By setting any of the followings, "0" is stored when the cursor is deleted.

- Selecting [Clear the cursor information when deleting the cursor] for the [Environmental Setting] dialog box (System Information)
- Turning on the GOT internal device (GS450.b3)

**(14) Previous Cursor Display User ID**

The user ID No. of the object on which the cursor is previously displayed is stored.

By setting any of the followings, this signal is available for the ASCII input.

- Selecting [Output object ID of ASCII Input to the system information device] for the [Environmental Setting] dialog box (System Information)
- Turning on the GOT internal device (GS450.b2)

For the GT10, the signal is always used for the numerical input and ASCII input.

By setting any of the followings, "0" is stored when the cursor is deleted.

- Selecting [Clear the cursor information when deleting the cursor] for the [Environmental Setting] dialog box (System Information)
- Turning on the GOT internal device (GS450.b3)

## (15) System Signal 2-2

Bit No.	Signal name	Description	Model
b0	Drive A File Accessing Signal	Turns on during file accessing in the drive A.	GT16 GT15 GT14 GT12 GT11 GT10 SoftGOT1000
b1	Drive B File Accessing Signal	Turns on during file accessing in the drive B.	GT16 GT15 GT14 GT12 GT11 GT10 SoftGOT1000
b2	Drive C File Accessing Signal	Turns on during file accessing in the drive C.	GT16 GT15 GT14 GT12 GT11 GT10 SoftGOT1000
b3	Drive D File Accessing Signal	Turns on during file accessing in the drive D. Not available for the GT1020.	GT16 GT15 GT14 GT12 GT11 GT10 SoftGOT1000
b4	Drive A Full Signal	Turns on when the empty capacity of the drive A is less than 1k byte.	GT16 GT15 GT14 GT12 GT11 GT10 SoftGOT1000
b5	Drive B Full Signal	Turns on when the empty capacity of the drive B is less than 1k byte.	GT16 GT15 GT14 GT12 GT11 GT10 SoftGOT1000
b6	Drive D Full Signal	Turns on when the empty capacity of the drive D is less than 1k byte.	GT16 GT15 GT14 GT12 GT11 GT10 SoftGOT1000
b7	Drive A File Access Error Signal	Turns on while an access error with a file in the drive A occurs.	GT16 GT15 GT14 GT12 GT11 GT10 SoftGOT1000
b8	Drive B File Access Error Signal	Turns on while an access error with a file in the drive B occurs.	GT16 GT15 GT14 GT12 GT11 GT10 SoftGOT1000
b9	Drive D File Access Error Signal	Turns on while an access error with a file in the drive D occurs.	GT16 GT15 GT14 GT12 GT11 GT10 SoftGOT1000
b10	-	Use prohibited	
b11	Cursor Displaying Signal	Turns on during displaying the numerical input or ASCII input cursor.	
b12	Built-in Battery Voltage Drop Signal	Turns on when a voltage drop of the GOT built-in battery is detected. The battery backup data is guaranteed within the data backup time after this signal switches ON, however, replace the battery immediately. For the data backup time, refer to the following.  User's Manual for the GOT used	GT16 GT15 GT14 GT12 GT11 GT10 SoftGOT1000
b13	D drive automatic recovery signal	Turns on when the drive D is recovered automatically. Not available for the GT1020.	GT16 GT15 GT14 GT12 GT11 GT10 SoftGOT1000
b14	Backlight Shutoff Detection Signal	Turns on when a blown backlight bulb of the GOT is detected. Not available for the GT104□, GT1030, and GT1020.	GT16 GT15 GT14 GT12 GT11 GT10 SoftGOT1000
b15	Printing signal	Turns on during printing (printing by the hard copy function or report function)	GT16 GT15 GT14 GT12 GT11 GT10 SoftGOT1000

**(16) On-screen Window 2 screen number**

The number of the window screen currently displayed is stored as the overlap window 2.  
The screen number to be stored is as follows.

Display status	Data format of the screen switching device	
	BIN	BCD
Not displayed or during screen switching	0	
The number of overlap window 2 being displayed	1 to 32767	1 to 9999

Confirm the display status of the superimpose window 2 by the screen switching device.

**(17) Drive A empty capacity information (32bit)**

The data for the empty capacity (32 bits) of the drive A is stored. (Unit, byte)  
A 2GB or more of empty capacity cannot be notified.  
When the empty capacity is 2GB or more, the value of 2GB is stored.  
Not available for the GT10.

**(18) Drive B empty capacity information (32bit)**

The data for the empty capacity (32 bits) of the drive B is stored. (Unit, byte)  
A 2GB or more of empty capacity cannot be notified.  
When the empty capacity is 2GB or more, the value of 2GB is stored.  
Not available for the GT14, GT12, GT11, and GT10.

**(19) Drive C empty capacity information (32bit)**

The data for the empty capacity (32 bits) of the drive C is stored. (Unit, byte)  
Not available for the GT10.

**(20) Drive D empty capacity information (32bit)**

The data for the empty capacity (32 bits) of the drive D is stored. (Unit, byte)  
Not available for the GT16, GT15, GT10, and GT SoftGOT1000.

**(21) External I/O function/input information 2**

Bit No.	Signal name	Description	Model
b0 to b7	Input signal X8 to XF	Input data are written in the bits. An external input can take up to three seconds to write data in a bit. For avoiding the delay time, use GOT internal devices (GB10 to GB25, GB30 to GB37, GB50 to GB57).	gr16 gr15 gr14 gr12 gr11 gr10 SoftGOT1000
b8 to b15	-	Use prohibited	gr16 gr15 gr14 gr12 gr11 gr10 SoftGOT1000

**(22) On-screen Window 3 screen number**

The number of the window screen currently displayed is stored as the overlap window 3.  
The screen number to be stored is as follows.

Display status	Data format of the screen switching device	
	BIN	BCD
Not displayed or during screen switching	0	
The number of overlap window 3 being displayed	1 to 32767	1 to 9999

Not available for the GT15, GT14, GT12, GT11, and GT10.



**(23) On-screen Window 4 screen number**

The number of the window screen currently displayed is stored as the overlap window 4.  
The screen number to be stored is as follows.

Display status	Data format of the screen switching device	
	BIN	BCD
Not displayed or during screen switching	0	
The number of overlap window 4 being displayed	1 to 32767	1 to 9999

Not available for the GT15, GT14, GT12, GT11, and GT10.

**(24) On-screen Window 5 screen number**

The number of the window screen currently displayed is stored as the overlap window 5.  
The screen number to be stored is as follows.

Display status	Data format of the screen switching device	
	BIN	BCD
Not displayed or during screen switching	0	
The number of overlap window 5 being displayed	1 to 32767	1 to 9999

Not available for the GT15, GT14, GT12, GT11, and GT10.

**(25) Extended Drive Information (E and subsequent drives)**





Bit No.	Signal name	Description	Model
b0	Drive E File Accessing Signal	Turns on during file accessing in the drive E.	
b1	Drive E Full Signal	Turns on when the empty capacity of the drive E is less than 1k byte.	
b2	Drive E File Access Error Signal	Turns on while an access error with a file in the drive E occurs.	
b3 to b15	-	Use prohibited	

Not available for the GT15, GT12, GT11, GT10, and GT SoftGOT1000.

**(26) Drive E empty capacity information (32bit)**

The data for the empty capacity (32 bits) of the drive E is stored. (Unit, byte)  
Not available for the GT15, GT12, GT11, GT10, and GT SoftGOT1000.

**(27) System Signal 2-3**

Bit No.	Signal name	Description	Model
b0	External device I/O signal (CH5)	Available when the channel No. 5 is used for the barcode function. Turns on when the data read by the barcode reader is stored in the specified device.	
		Available when the channel No. 5 is used for the RFID function. Turns on when the data read by the RFID reader/writer is stored in the specified device. (With the dedicated protocol) Turns on when the data transfer to the RFID controller is completed. (With the nonprocedural protocol) Turns off when the External device I/O complete signal (CH5) (System signal 1-2.b3) turns on.	
b1	External device I/O signal (CH6)	Available when the channel No. 6 is used for the barcode function. Turns on when the data read by the barcode reader is stored in the specified device.	
		Available when the channel No. 6 is used for the RFID function. Turns on when the data read by the RFID reader/writer is stored in the specified device. (With the dedicated protocol) Turns on when the data transfer to the RFID controller is completed. (With the nonprocedural protocol) Turns off when the External device I/O complete signal (CH6) (System signal 1-2.b6) turns on.	
b2	External device I/O signal (CH7)	Available when the channel No. 7 is used for the barcode function. Turns on when the data read by the barcode reader is stored in the specified device.	
		Available when the channel No. 7 is used for the RFID function. Turns on when the data read by the RFID reader/writer is stored in the specified device. (With the dedicated protocol) Turns on when the data transfer to the RFID controller is completed. (With the nonprocedural protocol) Turns off when the External device I/O complete signal (CH7) (System signal 1-2.b9) turns on.	
b3 to b15	-	Use prohibited	

### 4.6.3 Application example

#### Confirm the error occurred in GOT

The code of the error occurred in GOT can be confirmed.  
 The error codes within the range of error code 300 to 699 are displayed.  
 For the details of error code, refer to the following manuals.

User's Manual for the GOT used

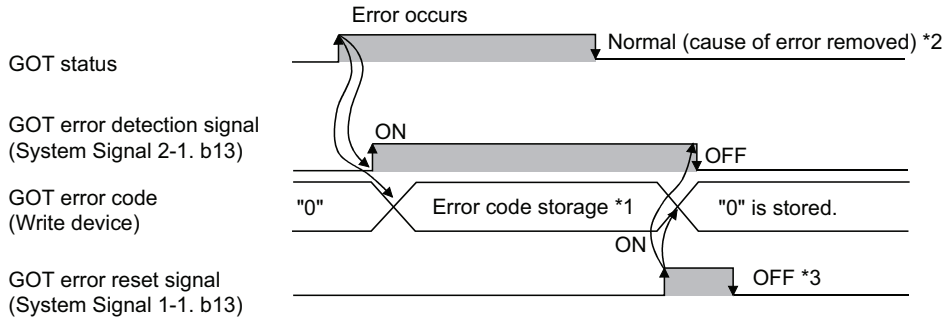

- \*1 When multiple errors occur simultaneously, the latest error code will be stored.
- \*2 The GOT error code (Write device) is not cleared automatically even if removing the error source. Clear the error code by using the GOT error reset signal (System signal 1-1.b13).
- \*3 Check that the GOT error detection signal (System signal 2-1.b13) turns off, and then turn off the GOT error reset signal (System signal 1-1.b13). If the GOT error reset signal (System signal 1-1.b13) turns on, the GOT error code will be reset when an error occurs at the next.



#### Error Reset Method

An error can be reset by using GOT as explained below.  
 When the cause of error is removed, the error can be reset by touching the touch switch.  
 Example) Create the touch switch (bit momentary) that turns on the GOT error reset signal only while the touch switch is touched.

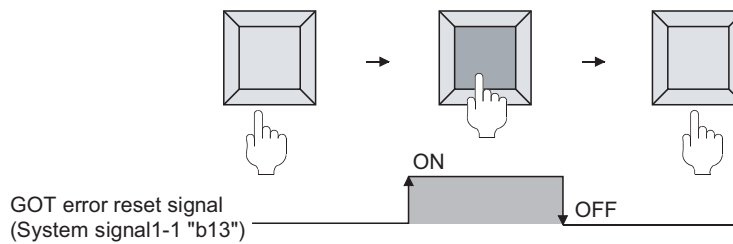

#### Confirm the input key code by input key

The input key code can be confirmed by input key (Touch switch, numerical input, or ASCII input).

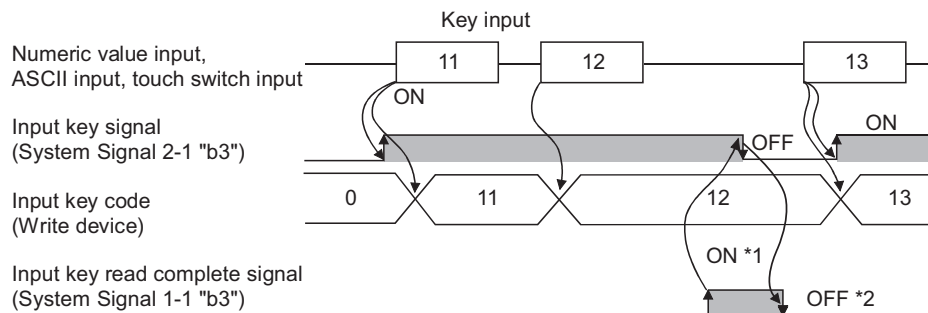

- \*1 When key input is completed, the stored key code is held. When the Key code read complete signal (System signal 1-1.b3) turns on, the Input key signal (System signal 2-1.b3) turns off.
- \*2 Check that the Input key signal (System signal 2-1.b3) turns off, and then turn off the Key code read complete signal (System signal 1-1.b3). If the Key code read complete signal (System signal 1-1.b3) turns on, the stored key code will be reset at the next key input.

## Confirmation of the numeric value input determination timing

The timing of which the input value was determined can be confirmed with the user ID written in the numerical input No.

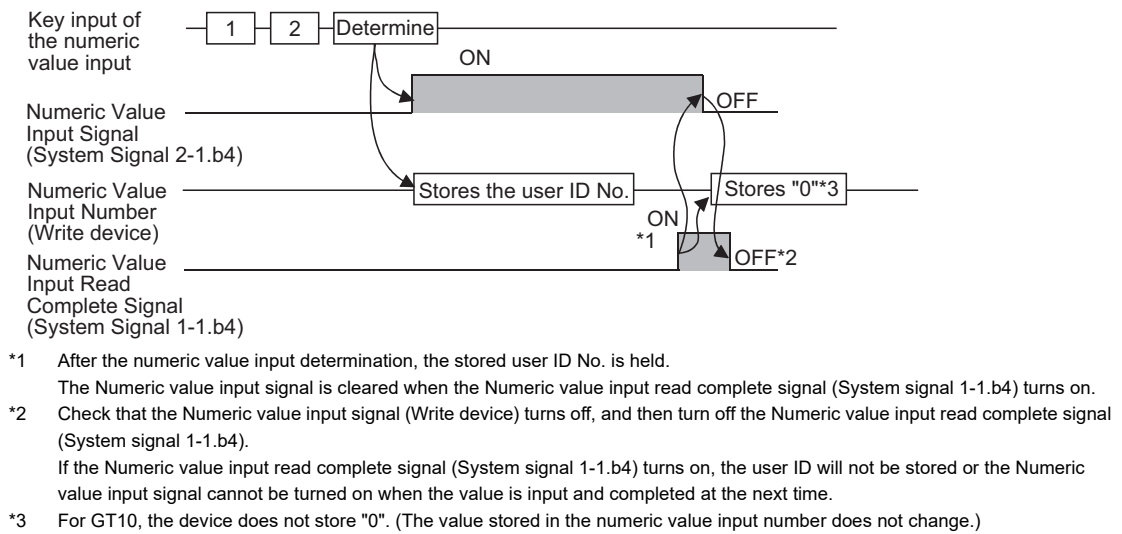

## Confirm cursor's display position

The cursor's display position can be confirmed by writing the data of the object (numeric value input function, ASCII input function) in which cursor is located into the device.

The object information to be written are classified into the following types

- User ID : Can be set to any object.  
Set user ID on setting dialog box of each object.
- Object ID: Automatically set when setting an object with GT Designer3.

Example) Operation example of cursor display

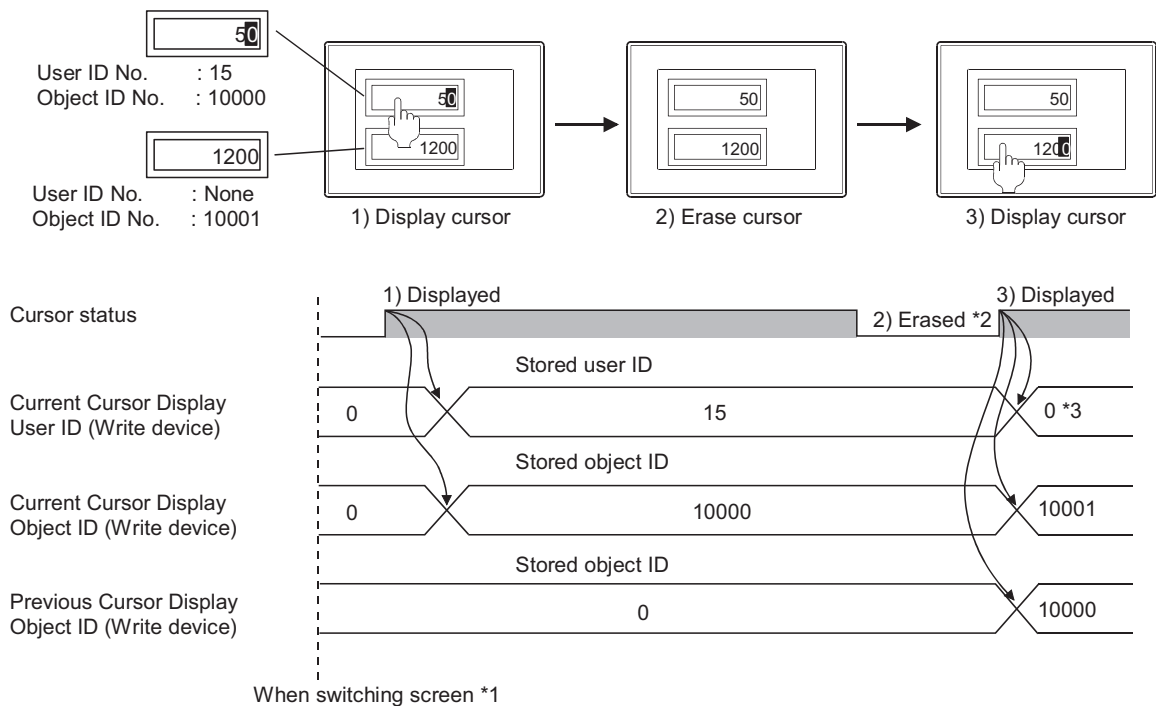

- \*1** If a cursor is not displayed when switching screens, "0" will be stored.
- \*2** The stored user ID and object ID can be held even if a cursor is erased.
- \*3** If a cursor is displayed at the object (numeric input function, ASCII input function) with a user ID unset, the cursor position numeric value input will be "0".
- \*4** The Current or Previous Cursor Display User ID operates with the ASCII input function if the GOT internal device GS450.b2 is switched ON.

## HINT



### (1) How to delete the stored user ID and object ID when a cursor is deleted

Turn on the GOT internal device (monitor common control: GS450.b3) to delete the user ID and object ID when a cursor is deleted. ("0" is stored.)

For details of GOT internal devices, refer to the following.

Appendix2 GOT Internal Devices

### (2) Setting and confirmation of the object ID

Object ID will be set automatically when object is set.

The object ID cannot be changed by user.

#### (a) Method of confirming object ID

Select [View] → [Display Items] → [Object ID] from the menu to display the object ID in an object arranged on the screen editor.

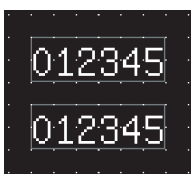

Object ID not displayed



Object ID displayed

#### (b) Methods of changing object ID

If the arranged object is deleted, the object ID will change automatically.

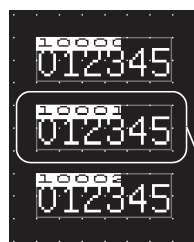

Deleted

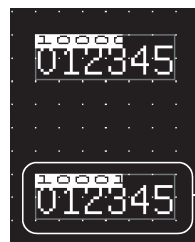

Object ID changes from 10002 to 10001

## ■ Control of Screen Display

### (1) Disable screen saver function

The screen saver function, which is set within the GOT utility, is designed to turn off the screen display if the GOT is not touched within a specified time. This function prevents the screen performance from deteriorating over its operable life.

By turning Automatic screen saver disable signal ON in the system information, the function that is set within the GOT utility (Setup) is disabled

Example 1) Display the monitor screen erased by automatic screen saver function

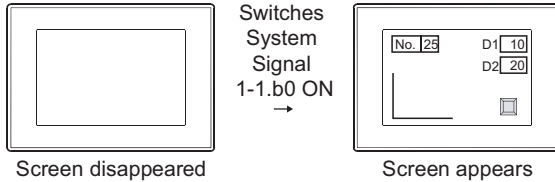

Example 2) Disables screen saver function to start even after the specified period has passed.

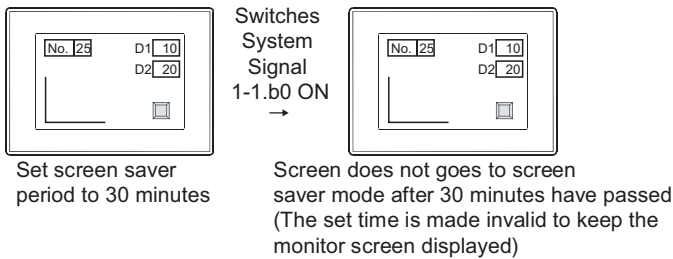

### (2) Erase screen

By turning [Forced screen saver enable signal] ON, the displayed monitor screen can be erased. While the bit is ON, monitor screen will not appear even when the GOT screen is touched.

Example) Erase displayed monitor screen

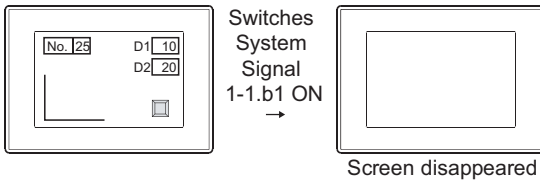

In addition, the monitor screen can be displayed by switching the "Forced Screen Saver Touchcancel Signal" ON and touching the screen to cancel the forced screen saver function started with the "Forced Screen Saver Enabled Signal".

Example) Displaying the monitor screen that is forcibly erased

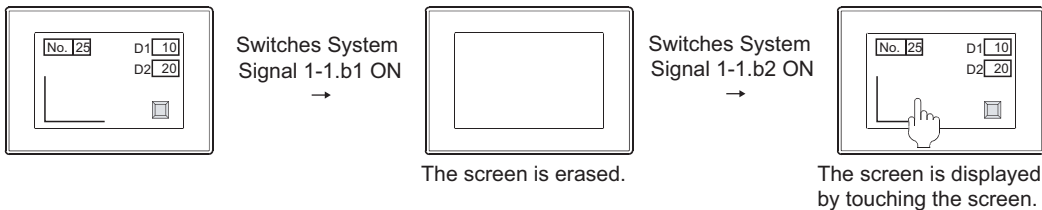

**(3) Display control by human sensor (Specific to GT1695M-X, GT1685M-S, GT1595-X, GT1585V-S and GT1585-S)**

The human sensor is a function that releases the GOT from the screen saving mode without the necessity to touch the GOT.

This function releases the GOT from the screen saving mode when the operator has come closer to the GOT.

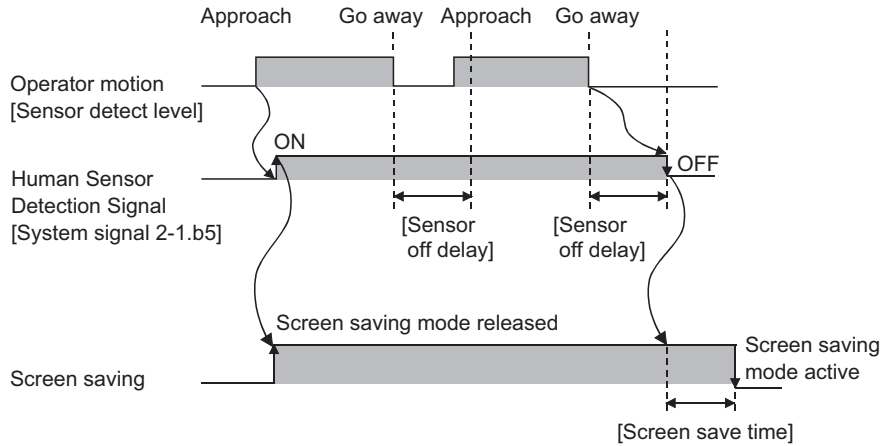

When no operator is not around the GOT for the time set as [Sensor off delay], the Human sensor detection signal (System signal 2-1.b5) turns off.

When the time set as [Screen save time] elapses after the Human sensor detection signal (System signal 2-1.b5) turns off, the GOT enters the screen saving mode.

Make the human sensor settings (including [Sensor detect level] and [Sensor off delay]) using the GOT utility. Refer to the following manual for the GOT utility.

User's Manual for the GOT used

**HINT**

**(1) How to make the settings so that the GOT releases the screen save mode only when human movement is detected**

By disabling the GOT to release the screen save mode with the touch or external operation, the GOT can release the screen save mode only when human movement is detected.

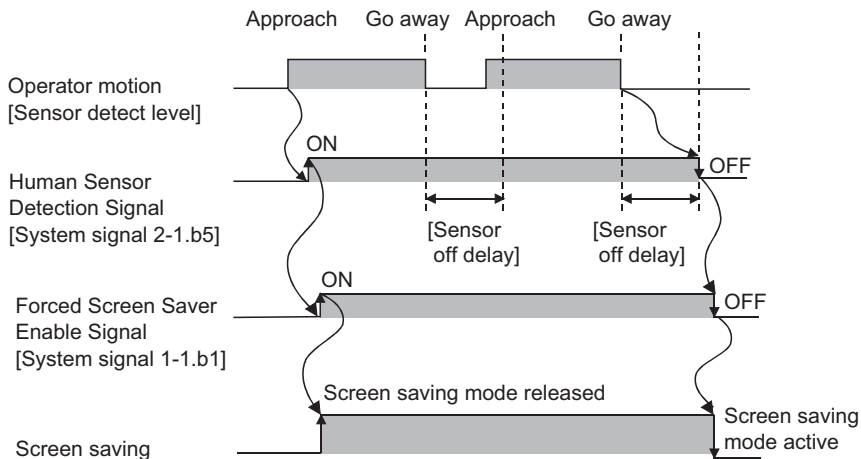

Associate [Human Sensor Detection Signal] with [Forced Screen Saver Enable Signal] in the sequence program to control the screen saving mode.

With this setting, the GOT enters the screen saving mode after the Sensor OFF delay time elapses, regardless of the screen saving time.

**(2) GOT Screen Control**

The following shows the priority among functions that control the screen status (Displayed/ Not displayed):

Priority  
 Low —————> High

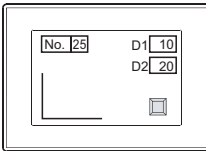
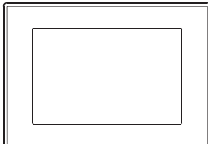
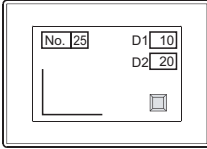
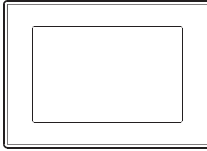
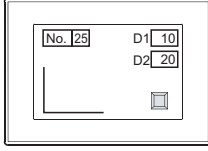
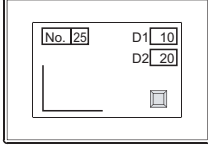
Display Screen	Screen Saver Function (Utility)	Screen Saver Disable Signal	Forced Screen Saver Enable Signal	Forced Screen Saver Touch-cancel Signal
	 With screen saver function	 ON Screen save function of utility is disabled.	 ON Forces the screen to go into the screen saver mode. The screen saver settings, the status of screen saver disable signal and human sensor are irrelevant.	 ON Forcibly cancels the screen saver mode by touching. The status of forced screen saver enable signal is irrelevant.
	 Without screen saver function			





**! WARNING**

- Incorrect operation of the touch switch(s) may lead to a serious accident if the GOT backlight is gone out. When the GOT backlight goes out, the display turns black and causes the monitor screen to appear blank, while the input of the touch switch (s) still remains active. This may confuse an operator in thinking that the display is in "screensaver" mode, who then tries to release the GOT display from this mode by touching the display screen, which may cause a touch switch to operate. Note that the following occurs on the GOT when the backlight goes out.
  - The monitor screen disappears even when the screensaver mode is not set.
  - The monitor screen will not come back on by touching the display, even if the GOT is in screensaver mode.
 The screensaver operation status can be confirmed by the display status of the POWER LED.
  - Lit in green: Power is correctly supplied
  - Lit in orange: Screen saving and backlight off
  - Blinks in orange/green: Blown back light bulb
  - Not lit: Power is not supplied

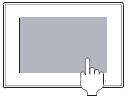
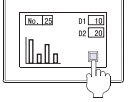
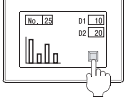

**(4) Relation between screen saver functions and Key-In Disable Signal**

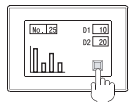
The relation between screen saver functions and Key-In Disable Signal is as follows.

Forced screen saver enable signal	Key-in disable signal	Screen saver function	Screen status
ON	ON/OFF	ON/OFF	The GOT screen goes into the screen saver status.  No response to touching
OFF	ON	ON	When the key-in disable signal turns on, the GOT screen does not go into the screen saver status. When the key-in disable signal turns on while the GOT screen is in the screen saver status, the screen saver status is canceled.  No response to touching
		OFF	The GOT screen does not go into the screen saver status.  No response to touching
	OFF	ON	The GOT screen goes into the screen saver status.   Touch the screen, and then the screen saver status is canceled.
		OFF	The GOT screen does not go into the screen saver status.  Touch the object, and then the object responds to touching.

**4.6.4 Precautions**

■ **Precautions for drawing**

Do not use a special register as a read device or write device, as it is an internal device of which specifications are defined within PLC CPU, and cannot be used as a normal internal device for system information.  
If a special registered is used as described above, GOT may not operate correctly.

■ **Precautions for using system information**

Do not write data to a device set as a write device for the system information directly from a controller.  
Depending on the operation on the GOT and the GOT internal status, the value of a write device may be overwritten with data retained in the GOT.

## 4.7 Security Setting



The security setting is available for objects, the screen display or operation, the upload operation, and the utility operation.

The security setting restricts users.

### ■ Restricting the object and screen display/operation

With setting the security level (0 to 15) per object and screen, the screen display can be changed according to the user's security level.

The authentication method for changing security levels includes the operator authentication and the password authentication.

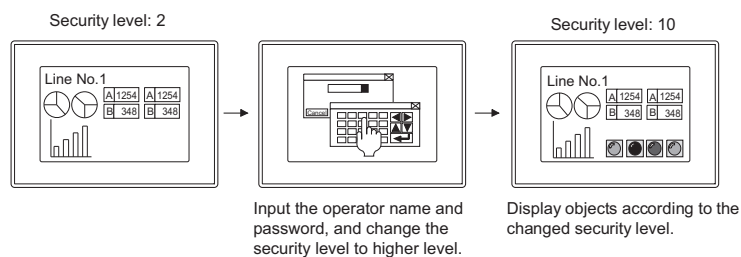

#### Shape or text of a touch switch displayed when the security level of the touch switch is unsatisfied

To a touch switch, the user can set a shape or a text displayed when the touch switch does not operate due to the unsatisfied security level.

For how to set the touch switch, refer to the following.

(Functions) 2. TOUCH SWITCH

#### (1) Operator authentication

The operator authentication is an authentication method with the operator information of the user when the security level is changed.

5.3.5 Security setting

With the operation log function, the user information can be stored as a history.

With setting the automatic logout and the password expiration date, the security can be enhanced.

The operator authentication includes the following the authentication types.

(a) Operator authentication with a password

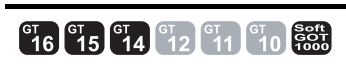

With the operation log function, the user information can be stored as a history.

For using the operator authentication with a password on the GT16, GT15, and GT14, install the extended function OS (Operator authentication) on the GOT.

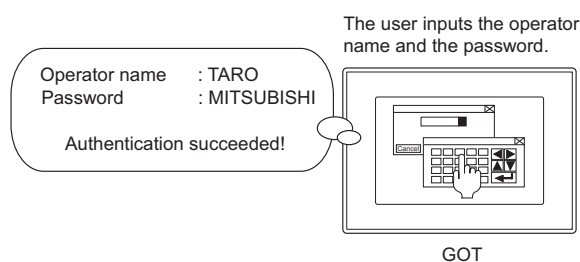

(b) Operator authentication with an external authentication device

GT 16 GT 15 GT 14 GT 12 GT 11 GT 10 Soft GOT 1000

The authentication is executed by the external authentication ID that is input using an external authentication device.

For using the operator authentication with an external authentication device, the following external authentication device can be used.

- RFID controller

For using the operator authentication with an external authentication device on the GT16, GT15, and GT14, install the extended function OSs (Operator authentication, RFID) on the GOT.

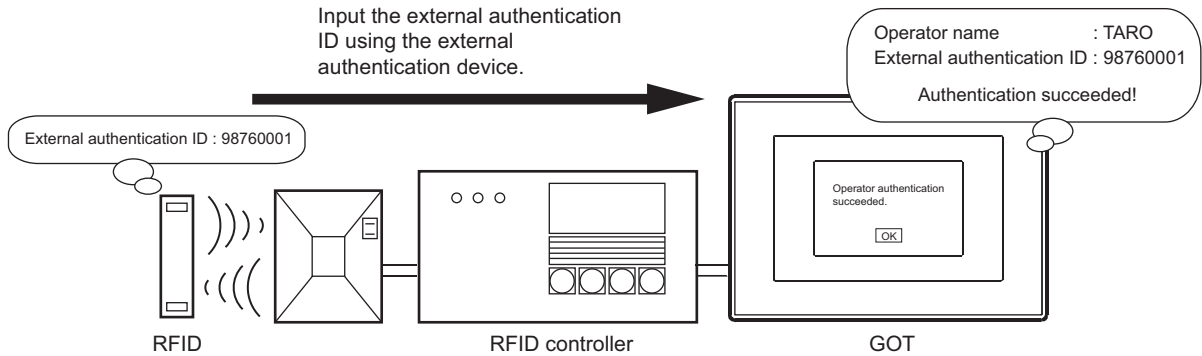

(c) Operator authentication with a fingerprint unit

GT 16 GT 15 GT 14 GT 12 GT 11 GT 10 Soft GOT 1000

The authentication is executed by the external authentication ID identified by the fingerprint information that is input using the fingerprint unit.

Up to 100 pieces of fingerprints authentication information can be registered.

Up to two fingerprints can be registered for a piece of fingerprint authentication information.

For using the operator authentication with the fingerprint unit, install the extended function OS (Operator authentication, Fingerprint Authentication) on the GOT.

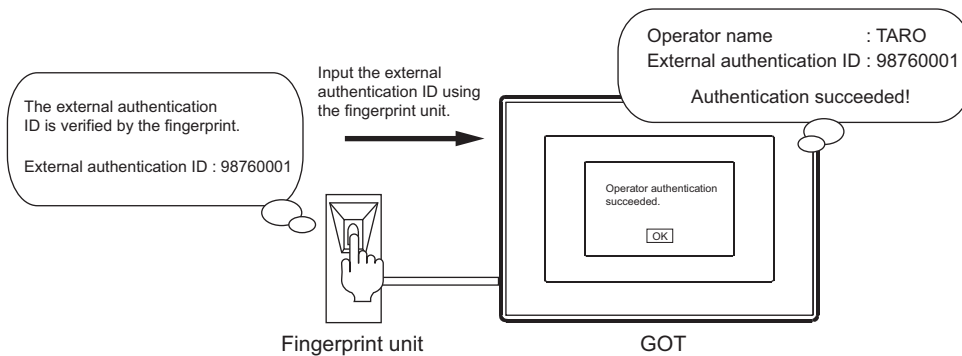

**HINT**

**Auxiliary authentication**

For the operator authentication with an external authentication device or fingerprint unit, the operator authentication may not be properly executed due to a device failure, injured finger or others.

Enable the auxiliary authentication beforehand so that the authentication is executed by switching to the operator authentication with a password.

For setting the auxiliary authentication, refer to the following.

User's Manual for the GOT used

## (2) Password authentication



The security level authentication is an authentication method with a password for each security level when security levels are changed.

☞ 5.3.5 Security setting

### ■ Restricting the read operation



The security authentication restricts the screen data read operation. For details of data transmission operation, refer to the following.

☞ 8. COMMUNICATION WITH GOT

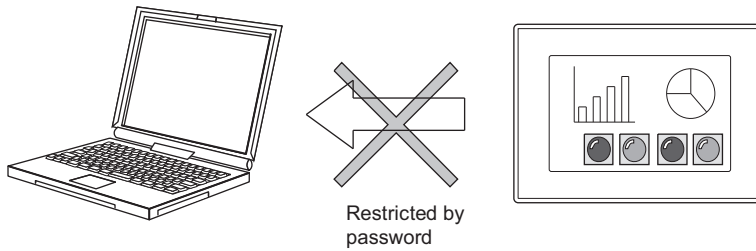

### ■ Restricting the utility operation



When starting the utility, the authentication for security prevents the user from unnecessary utility operations. For details of utility operation, refer to the following manual.

☞ User's Manual for the GOT used

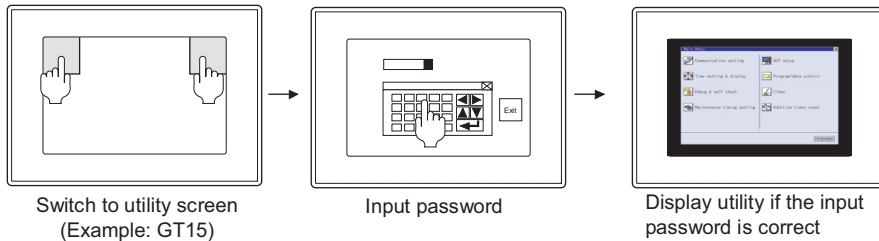

### ■ Restricting parameter setting screen display



When displaying the parameter setting screen of the Q motion monitor or the servo amplifier monitor, the input of a preset password is requested so that inadvertent changing of the parameter settings in the targeted motion controller CPU (Q series)/servo amplifier can be avoided.

For details of the servo amplifier monitor function and the Q motion monitor function, refer to the following manual.

☞ GOT1000 Series User's Manual (Extended Functions, Option Functions) for GT Works3

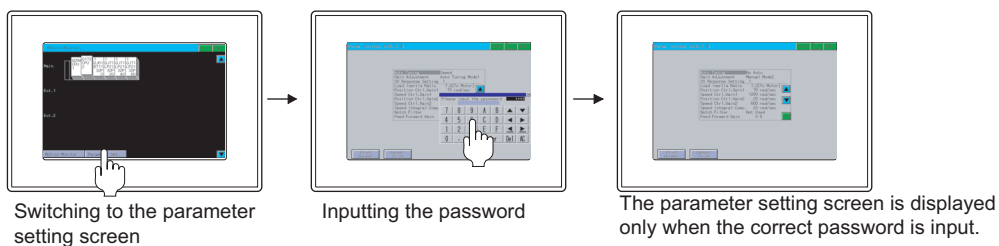

## ■ Restricting the ladder editor

The security authentication can restrict unnecessary ladder editor operations.

The following operations can be restricted.

- Displaying the ladder editor screen
- Operation of the device test

For details of the ladder editor function, refer to the following.

☞ GOT1000 Series User's Manual (Extended Functions, Option Functions) for GT Works3

The ladder editor can be restricted by the authentication with a device, authentication with a password, or authentication with a device and password combined.

Select the authentication method according to the purpose.

### (1) Authentication with an authorization device

While an authorization device of the ladder editor or device test turns on, the operation is permitted.

For the authorization device setting, refer to the following.

☞ 4.7.1 ■ Security Level Authentication tab

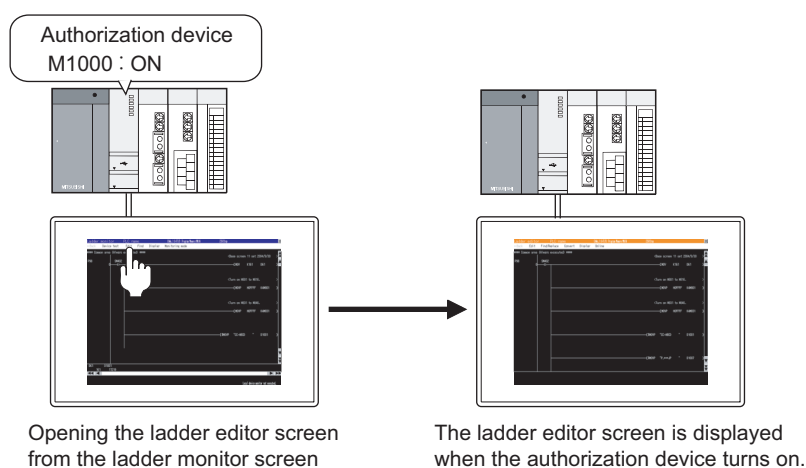

### (2) Authentication with a password

When the input password matches the set password, the operation is permitted.

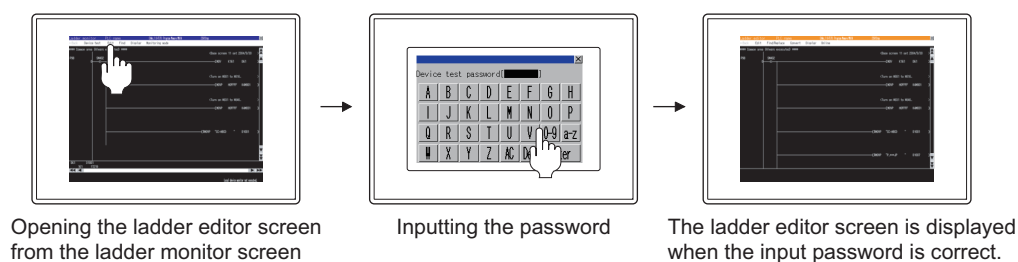

### (3) Authentication with an authorization device and password combined

When the input password matches the set password and an authorization device turns on, the operation is permitted.

For the authorization device setting, refer to the following.

#### 4.7.1 ■ Security Level Authentication tab

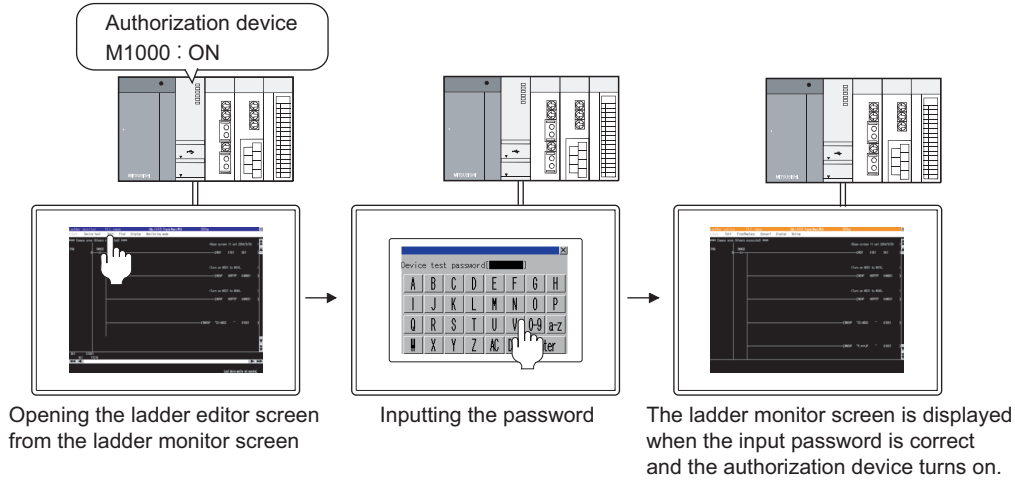

## 4.7.1 Settings

Select [Common] → [GOT Environmental Setting] → [Security] from the menu to display the [Environmental Setting] dialog box.

### ■ Security Level Authentication tab

Select the security level authentication method.

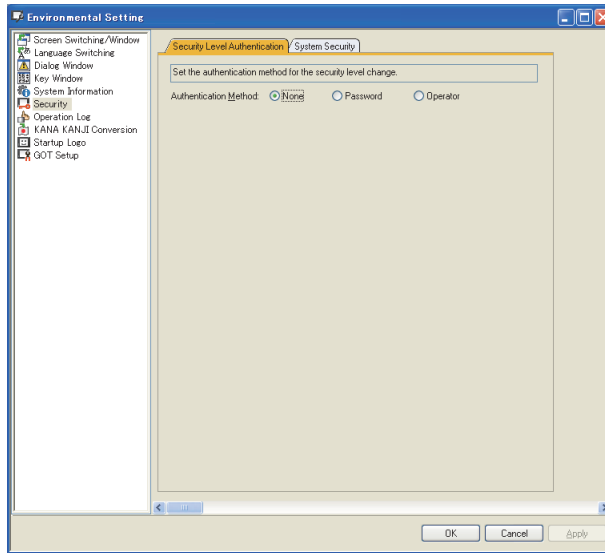





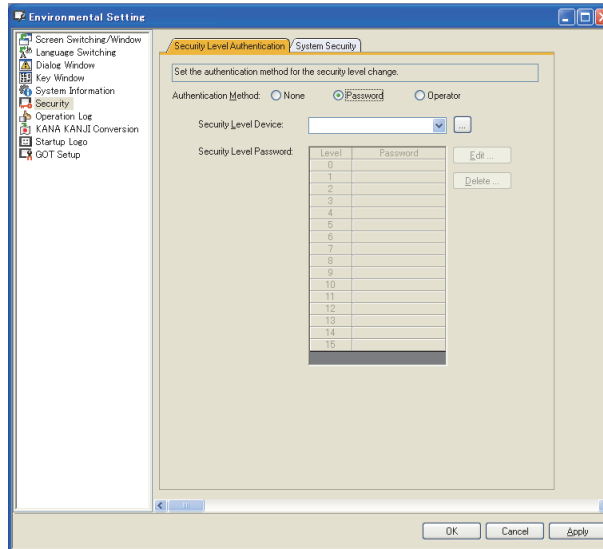

Authentication	Description	Model
None	The security level authentication is not performed.	Gr16 Gr15 Gr14 Gr12 Gr11 Gr10 SoftGOT1000
Password	The security level is changed only with the password.	Gr16 Gr15 Gr14 Gr12 Gr11 Gr10 SoftGOT1000
Operator	The security level is changed with an operator name and a password, or the external authentication ID.	Gr16 Gr15 Gr14 Gr12 Gr11 Gr10 SoftGOT1000

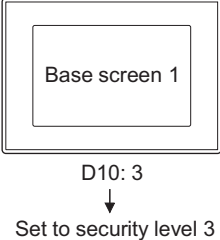
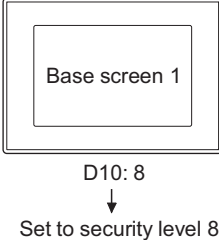
The setting items differ depending on the selected authentication method.  
The setting items for each authentication method are shown in the next page.

## (1) Password authentication



Item	Description	Model
Security Level Device	<p>Set the device to store the security level value for a screen displayed on the GOT. By setting the device, a password for each level for [Security Level Password] can be set. The security level can be changed by changing the level device value from the controller. Example: Level device: D10</p> <div style="display: flex; justify-content: space-around; align-items: center;"> <div style="text-align: center;">  </div> <div style="text-align: center;">  </div> </div> <p>If the level device is not controlled by a controller, set the GOT internal device (GD).</p>	
Security Level Password	<p>Passwords for changing the security level are listed. (Passwords are displayed as [*****].) Select the security level and click the [Edit] button or the [Delete] button to edit or delete the selected security level.</p> <ul style="list-style-type: none"> <li>• Security level 0: The security function is not set.</li> <li>• Security level 1: Low</li> <li style="text-align: center;">↓</li> <li>• Security level 15: High</li> </ul>	<div style="border: 1px solid black; padding: 2px;">             GT16 GT15              GT14 GT12              GT11 GT10              SoftGOT1000           </div>
	<p>For the selected security level, set a new password or edit a password. Set different passwords for each security level. When the password is not set for the selected security level, the [Password] dialog box appears.</p> <p> 4.7.1 nSecurity Level Authentication tab (1) (a) Password dialog box</p> <p>When the password is already set for the selected security level, the [Edit Password] dialog box appears.</p> <p> 4.7.1 nSystem Security tab (1) (b) Edit Password dialog box</p>	
	<p>Click this button to display the [Delete Password] dialog box.</p> <p> 4.7.1 nSystem Security tab (1) (c) Delete Password dialog box</p>	

- (a) Password dialog box  
Enter a password [Password], and click the [OK] button.  
Up to 8 one-byte numeric characters can be entered for the password.

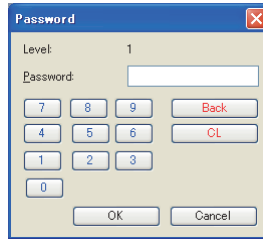

- (b) Edit Password dialog box  
Enter an old password in [Old Password], and enter a new password in [New PasswordNew Password] or [Reentry], and then click the [OK] button.  
Up to 8 one-byte numeric characters can be entered for the password.



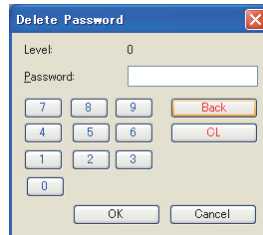

- (c) Delete Password dialog box  
Enter an old password, and click the [OK] button.



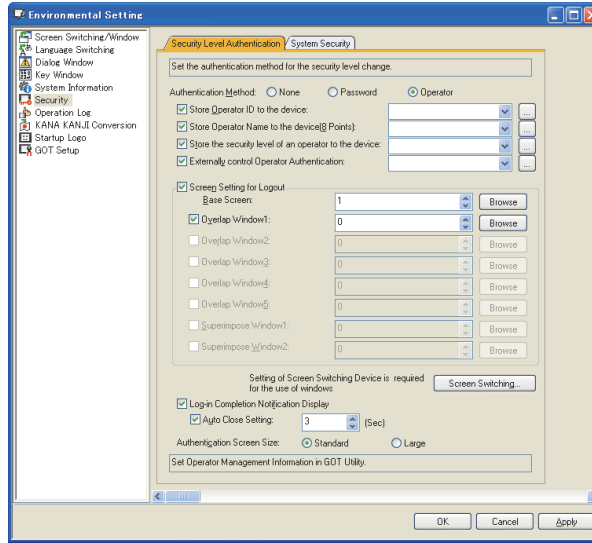

## (2) Operator



Item	Description	Model
Store Operator ID to the device	Select this item to set a device to store an operator ID for a login operator (Operator ID external notification device). Set the operator ID in the operator information management screen of the utility.	
Store Operator Name to the device(8 Points)	Select this item to set a device to store an operator name for a login operator (Operator name external notification device).	
Store the security level of an operator to the device	Select this item to set a device to store a security level for a login operator (Operator level external notification device). Set the security level in the operator information management screen of the utility.	
Externally control Operator Authentication	Select this item to set a device to externally control the operator information (Operator authentication external control device <sup>*1</sup> ). • Settable device: Word device	GT16 GT15 GT14 GT12 GT11 GT10 SoftGOT1000
Screen Setting for Logout	Set a screen displayed when logging out of the GOT. Select each window screen to set a window screen displayed when logging out of the GOT. To set a window screen, set the screen switching device. Timing to display the set screen differs according to operation when logging out of the GOT. • Logging out of the GOT by a touch switch (special function switch) or the automatic logout function After logging out of the GOT, the set screen appears. • Logging out of the GOT by the utility After logging out of the GOT, the utility screen appears. After changing the utility screen to a user-created screen, the set screen appears.	
	Displays [Screen Switching/Window] for the [Environmental Setting] dialog box.  4.2 Screen Switching Device Setting	
Log-in Completion Notification Display	Select this item to display the login completion notification dialog box when logging in the GOT.  Auto Close Setting Select this item to set the time period between displaying the login completion notification dialog box and closing the dialog box. (1 to 60 seconds)	GT16 GT15 GT14 GT12 GT11 GT10 SoftGOT1000
Authentication Screen Size	Select the size for the authentication screen size. (Standard/Large) Not available for the GT1555-Q and the GT1550-Q.	GT16 GT15 GT14 GT12 GT11 GT10 SoftGOT1000

For details of \*1, refer to the following.

## \*1 Operator authentication external control device

Bit No.	Signal name	Description
.b0	Forced logout signal	Turning on this signal forcibly logs out a user currently logging in. The Forced logout signal behaves at the signal rising. Therefore, this signal does not behave even if it is always turned on. Also, without the user login, this signal does not behave even if it is turned on.
.b1 to .b15	-	Use prohibited

### POINT

#### (1) Settings of operator information

Set the operator information, including the operator ID and level, the operator information management screen of the utility.

For the operator information management screen, refer to the following.

 User's Manual for the GOT used

#### (2) Timing to turn off the Forced logout signal

Confirm the completion of logout before turning off the Forced logout signal (.b0).

To confirm the completion of logout, check the value of the operator ID external notification device.

When the device value is "0", logout is completed.

#### (3) Security level after the forced logout

When a user security level becomes lower than the one set for the currently-displaying screen after the Forced logout, each screen behaves as follows.

(a) Base screen

The login screen is displayed.

(b) Window screen





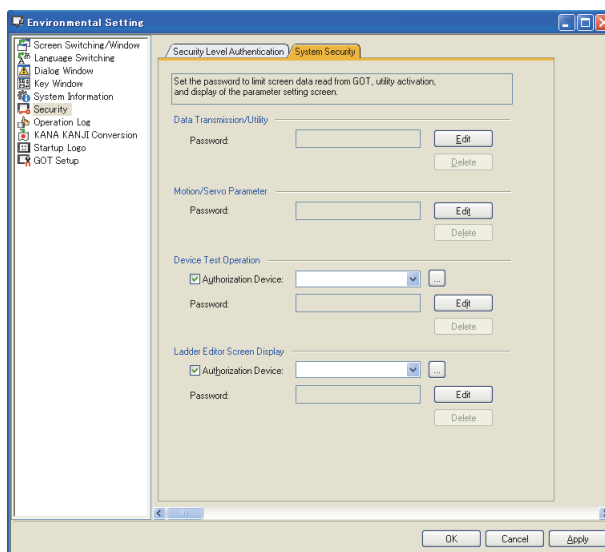

The window screens (overlap windows and superimposed windows) are deleted.

## System Security tab



Item	Description		Model
Data Transmission/Utility		Set a new password or edit a password to restrict reading the GOT screen data and the utility screen display. (The password is displayed as [*****].) When no password is set, the [Password] dialog box appears. (1) Password dialog box When the password is already set, the [Edit Password] dialog box appears. (2) Edit Password dialog box	GT16 GT15 GT14 GT12 GT11 GT10 SoftGOT1000
		Click this button to display the [Delete Password] dialog box. (3) Delete Password dialog box	
Motion/Servo Parameter		Set a new password or edit a password to display the parameter setting screen of the Q motion monitor or the servo amplifier monitor. (The password is displayed as [*****].) When no password is set, the [Password] dialog box appears. (1) Password dialog box When the password is already set, the [Edit Password] dialog box appears. (2) Edit Password dialog box	
		Click this button to display the [Delete Password] dialog box. (3) Delete Password dialog box	
Device Test Operation	Authorization Device	Select this item to set the authorization device for the device test operation. A bit device can be set for the authorization device. ON: Device test operation permitted OFF: Device test operation prohibited 5.3.1 Device setting	GT16 GT15 GT14 GT12 GT11 GT10 SoftGOT1000
		Set a new password or edit a password to permit the device test operation for the ladder editor. The password is displayed as [*****]. When no password is set, the [Password] dialog box appears. (1) Password dialog box When the password is already set, the [Edit Password] dialog box appears. (2) Edit Password dialog box	
		Click this button to display the [Delete Password] dialog box. (3) Delete Password dialog box	
Ladder Editor Screen Display	Authorization Device	Select this item to set the authorization device for the ladder editor screen display. A bit device can be set for the authorization device. ON: Display of ladder editor screen permitted OFF: Display of ladder editor screen prohibited 5.3.1 Device setting	

(Continued to next page)

Item	Description	Model
Ladder Editor Screen Display	 <p>Set a new password or edit a password to permit the ladder editor screen display. The password is displayed as [*****]. When no password is set, the [Password] dialog box appears.   (1) Password dialog box  When the password is already set, the [Edit Password] dialog box appears.   (2) Edit Password dialog box</p>	
	 <p>Click this button to display the [Delete Password] dialog box.   (3) Delete Password dialog box</p>	

### (1) Password dialog box

Enter a password [Password], and click the [OK] button.

For the data transmission/utility and motion/servo parameter, up to 8 one-byte alphanumeric characters can be entered for the password (0 to 9, A to F).

For the device test operation and ladder editor screen display, up to 8 one-byte alphanumeric characters can be entered for the password (0 to 9, A to F, a to z).

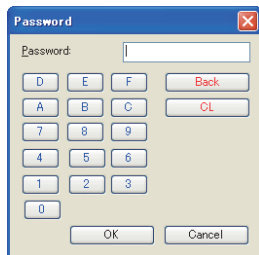

Data transmission/utility, motion/servo parameter

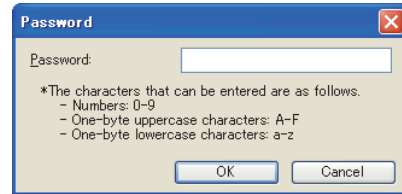

Device test operation, ladder editor screen display

### (2) Edit Password dialog box

Enter an old password in [Old Password], and enter a new password in [New Password] or [Reentry], and then click the [OK] button.

For the data transmission/utility and motion/servo parameter, up to 8 one-byte alphanumeric characters can be entered for the password (0 to 9, A to F).

For the device test operation and ladder editor screen display, up to 8 one-byte alphanumeric characters can be entered for the password (0 to 9, A to F, a to z).

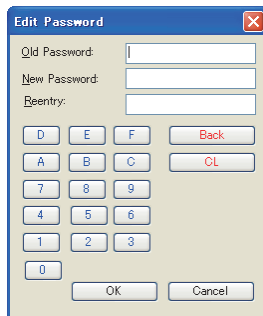

Data transmission/utility, motion/servo parameter

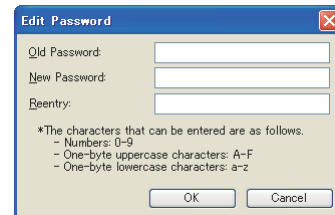

Device test operation, ladder editor screen display

### (3) Delete Password dialog box

Enter an old password, and click the [OK] button.

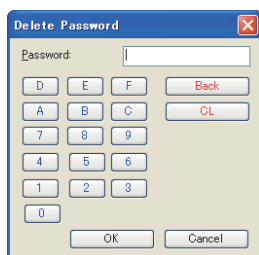

Data transmission/utility, motion/servo parameter

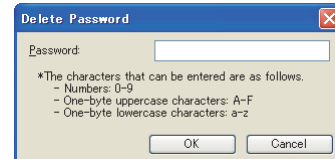



Device test operation, ladder editor screen display

## 4.7.2 Relevant settings

The security function is available for the relevant settings other than the specific settings. The following shows the functions that are available by the relevant settings.00000

### ■ GOT internal devices

 Appendix2 GOT Internal Devices

Function	Setting item	Model
Notifying that the authentication by the external authentication device or fingerprint unit succeeds	GS240.b0	
Notifying that the authentication by the external authentication device or fingerprint unit fails	GS240.b1	
Notifying that the login screen or operator re-authentication screen is being displayed regardless of authentication method.	GS240.b13	
Notifying that the login screen for the external authentication device or fingerprint unit is displayed	GS240.b14	
Notifying that the external authentication ID input key window is displayed	GS240.b15	
Notifying the screen that cannot be displayed because of the insufficient security level	GS241.b1 to b4, b8 to b12	
	GS1241.b0 to b2, b8 to b10	

## 4.7.3 Authentication methods and setting procedures

This section explains the setting procedure for the authentication by the operator authentication and password authentication.

### ■ Operator authentication

Set the information of an operator (Operator information) for the operator authentication.

The operator information can be exported to a memory card or imported with another GOT.

When the operator authentication is set, the operator information (operator name and operator ID) can be stored as a history with the operation log function. (The GT14 does not support the operation log function.)

 (Functions) 23. OPERATION LOG FUNCTION

With setting the following functions, the security can be enhanced.

- Automatic logout function: Automatically logging out of the GOT when the GOT is not operated for a certain period
- Password expiration date: The expiration date can be set for a password.

#### (1) Settings for the operator authentication with the password

Set the following for the password authentication with the password by using GT Designer3 and the GOT/GT SoftGOT1000 utility.

##### (a) Settings with GT Designer3

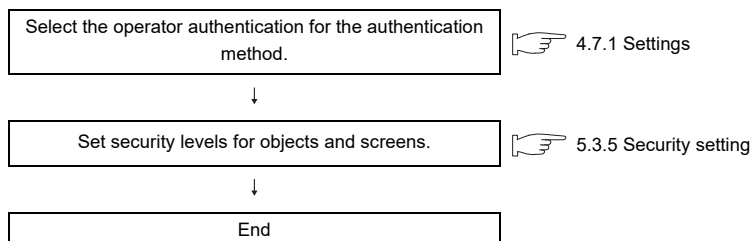

(b) Settings with utility

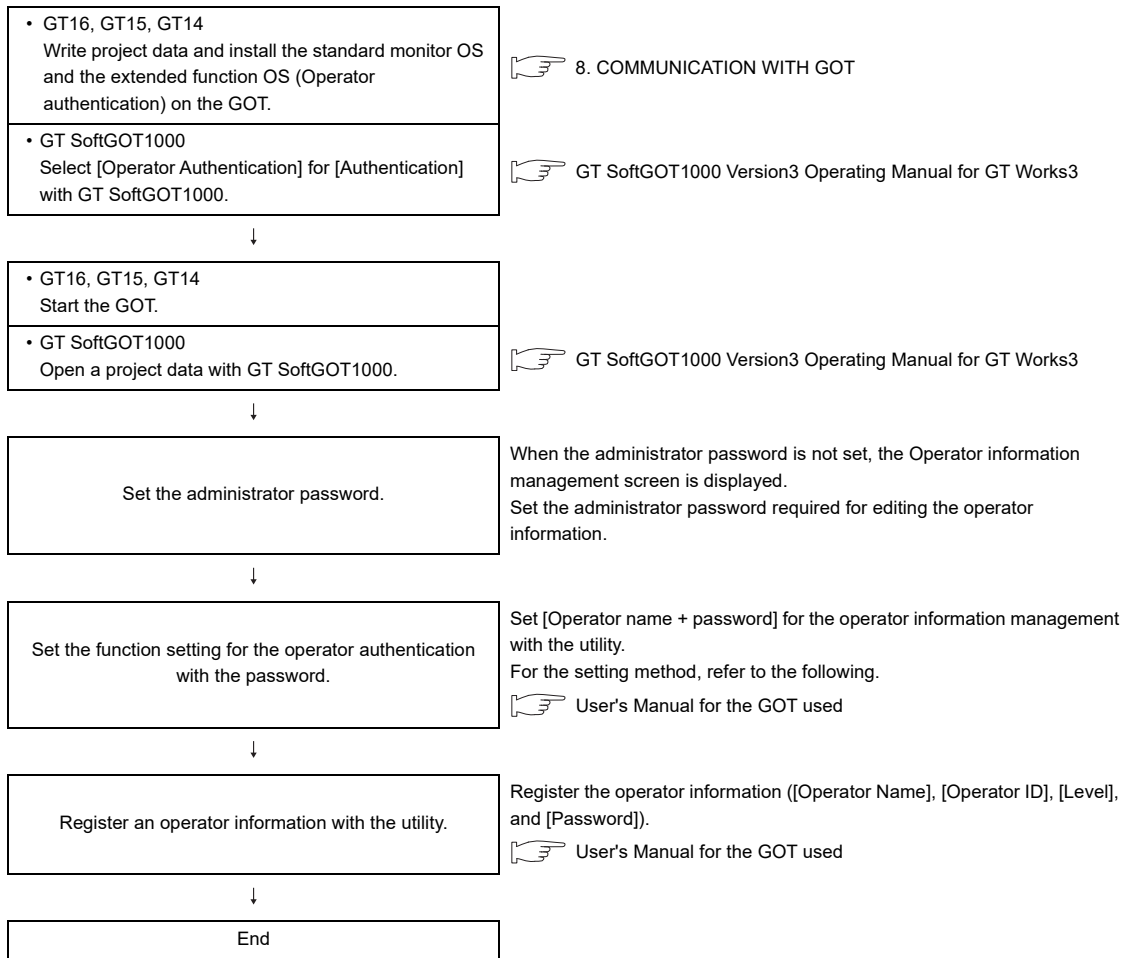

**POINT**

**Login of administrator**

Logging into the GOT with the operator name of administrator cannot be executed.  
Log into the GOT with the operator registered in the utility.

**(2) Settings for the operator authentication with the external authentication device**

Set the following for the operator authentication with the external authentication device by using GT Designer3 and the GOT/GT SoftGOT1000 utility.

(a) Settings with GT Designer3

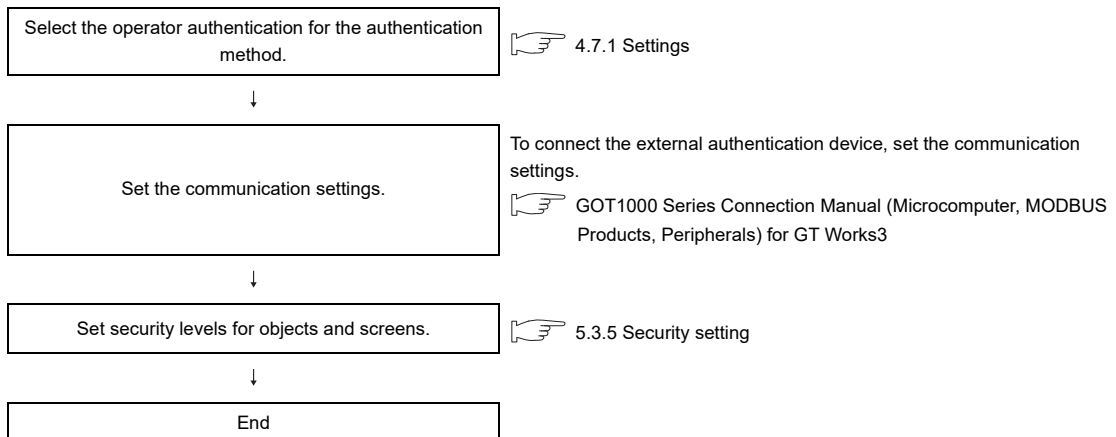

(b) Settings with the utility

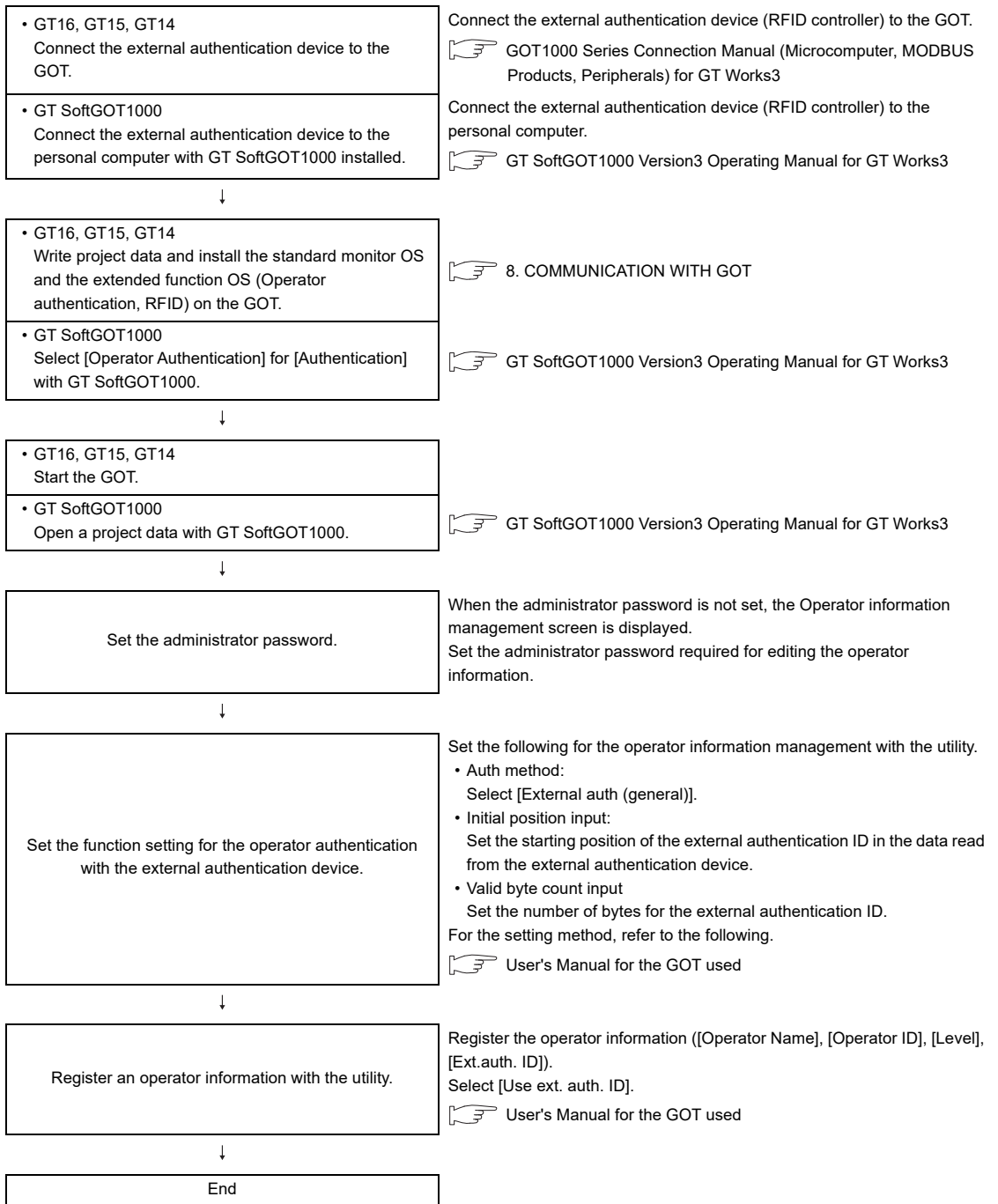

**POINT**

**Registration of external authentication ID**

For using the operator authentication with the external authentication device, register the external authentication ID for the operator information.

For how to register the operator information, refer to the following.

 User's Manual for the GOT used

### (3) Operator authentication with the fingerprint unit

Set the following for the operator authentication with the fingerprint unit by using GT Designer3 and the GOT utility.

#### (a) Settings with GT Designer3

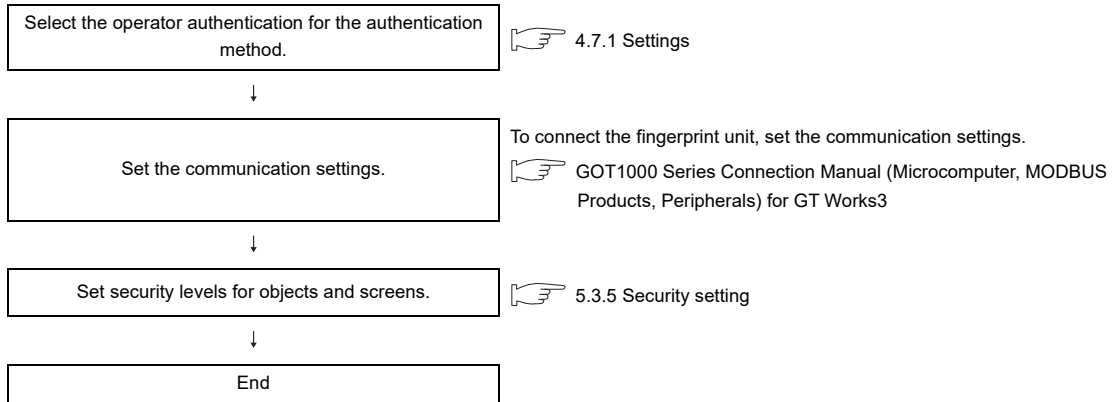

#### (b) Settings with the utility

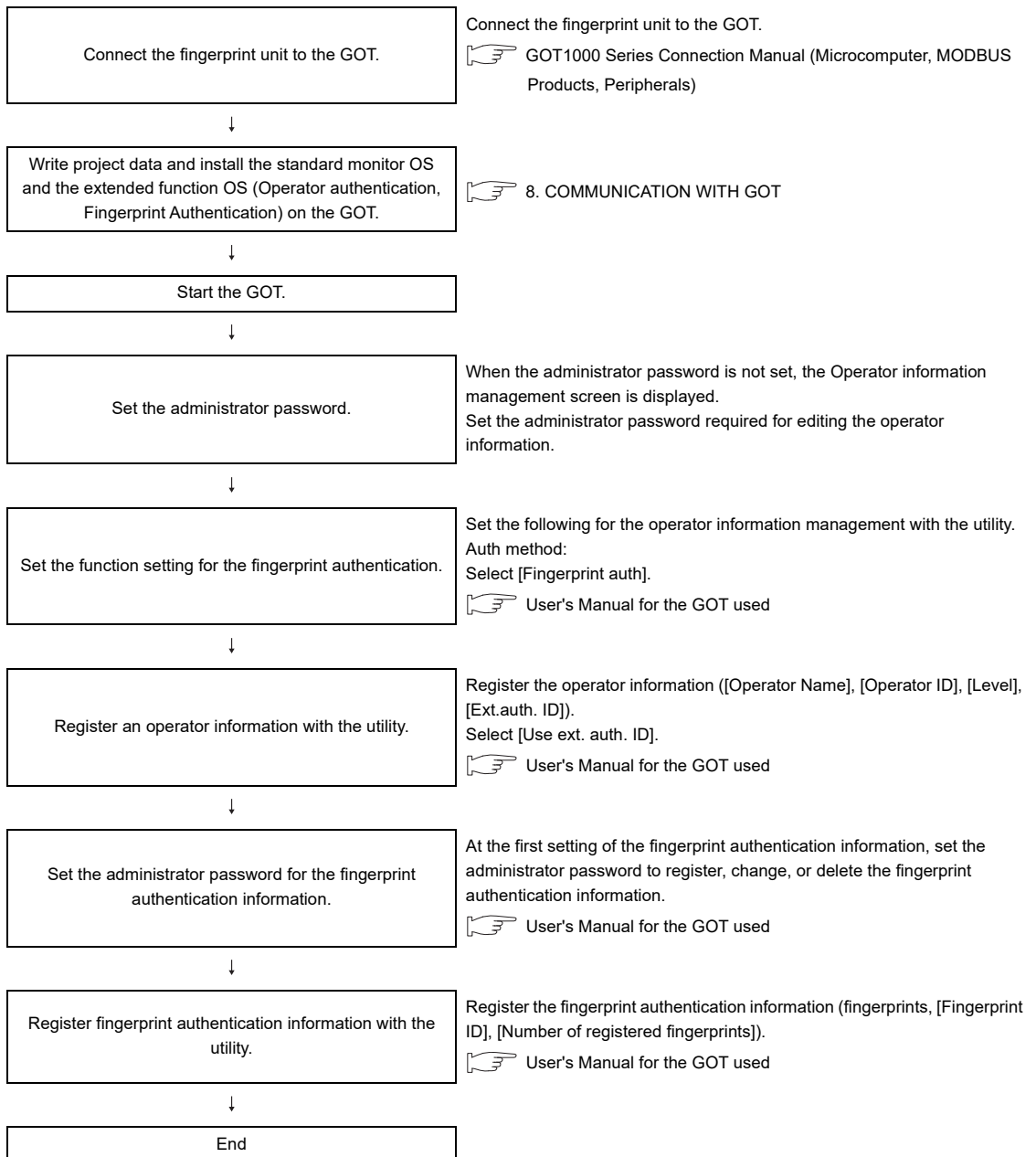



## POINT

### (1) Registration of external authentication ID

For using the operator authentication with the fingerprint unit, register the external authentication ID for the operator information.

For registering the operator information, the number of bytes for the external authentication ID must be 7 bytes or less.

For using the fingerprint authentication, the number of valid bytes for the external authentication ID must be in the range of 4 bytes to 7 bytes.

For how to register the operator information, refer to the following.

 User's Manual for the GOT used

### (2) Setting for fingerprint registration ID

The number of the fingerprint registration ID must be the same as that of the external authentication ID.

For the operator authentication with the fingerprint unit, the user is specified by verifying the fingerprint ID and the external authentication ID.

When the ID number of the fingerprint registration ID and the external authentication ID does not match, the user cannot log into the GOT using the fingerprint authentication.

### (4) Common settings for operator authentication

Set the following for the automatic logout time and the password expiration date.

- Function setting with the utility (automatic logout time, password expiration date)

 User's Manual for the GOT used

### (5) How to change security levels

The security level can be changed on screens for login and logout.

The screens for login and logout can be displayed with touch switches (special function switch) or the utility.

For changing security levels, refer to the following.

 5.3.5 Security setting

## ■ Password authentication

Set passwords for each security level for the password authentication.

### (1) Settings

Set the following for the password authentication on GT Designer3.

- Setting security levels for objects and screens
- Setting passwords for each security level in the [Environmental Setting] dialog box

### (2) How to change security levels

The security level can be changed on a screen for the password input.

The screen for the password input can be displayed with touch switches (special function switch) or the utility.

For changing security levels, refer to the following.

 5.3.5 Security setting

## 4.7.4 GOT operator management information conversion tool

With the GOT operator management information conversion tool, an operator management information file (AUTHINF.G1U) exported from the GOT can be converted into a CSV file.

After the CSV file is edited on the personal computer, the CSV file can be converted into an operator management information file.

By converting the edited CSV file into an operator management information file and importing the file to the GOT, a lot of operator information can be registered, changed, or deleted at a time.

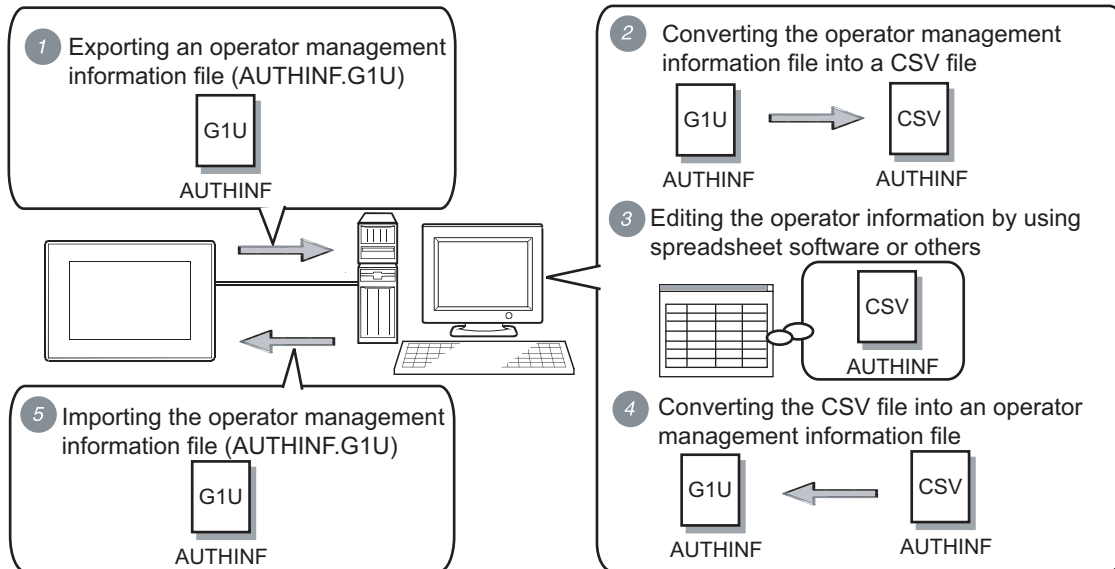

### ■ How to obtain the GOT operator management information conversion tool

Obtain the GOT operator management information conversion tool by one of the following methods.

- (1) Disk5 folder in GT Works3 DVD  
Folder name: OperatorMgrInfoConv  
File name: GTOperatorInfoConv.exe
- (2) Contact your local distributor.

## ■ Operating environment

Item	Description
Model	Personal computer that Windows runs on.
OS(English version) <sup>*1*5</sup>	<ul style="list-style-type: none"> <li>• Microsoft Windows 11 Education (64 bit)<sup>*3</sup></li> <li>• Microsoft Windows 11 Enterprise (64 bit)<sup>*3</sup></li> <li>• Microsoft Windows 11 Pro (64 bit)<sup>*3</sup></li> <li>• Microsoft Windows 11 Home (64 bit)<sup>*3</sup></li> <li>• Microsoft Windows 10 Enterprise (32 bit, 64 bit)<sup>*3</sup></li> <li>• Microsoft Windows 10 Pro (32 bit, 64 bit)<sup>*3</sup></li> <li>• Microsoft Windows 10 Home (32 bit, 64 bit)<sup>*3</sup></li> <li>• Microsoft Windows 8.1 Enterprise (32 bit, 64 bit)<sup>*3*4</sup></li> <li>• Microsoft Windows 8.1 Pro (32 bit, 64 bit)<sup>*3*4</sup></li> <li>• Microsoft Windows 8.1 (32 bit, 64 bit)<sup>*3*4</sup></li> <li>• Microsoft Windows 8 Enterprise (32 bit, 64 bit)<sup>*3*4</sup></li> <li>• Microsoft Windows 8 Pro (32 bit, 64 bit)<sup>*3*4</sup></li> <li>• Microsoft Windows 8 (32 bit, 64 bit)<sup>*3*4</sup></li> <li>• Microsoft Windows 7 Ultimate (32 bit, 64 bit)<sup>*2*3</sup></li> <li>• Microsoft Windows 7 Enterprise (32 bit, 64 bit)<sup>*2*3</sup></li> <li>• Microsoft Windows 7 Professional (32 bit, 64 bit)<sup>*2*3</sup></li> <li>• Microsoft Windows 7 Home Premium (32 bit, 64 bit)<sup>*3</sup></li> <li>• Microsoft Windows 7 Starter (32 bit)</li> <li>• Microsoft Windows Vista Ultimate (32 bit) Service Pack1 or later</li> <li>• Microsoft Windows Vista Enterprise (32 bit) Service Pack1 or later</li> <li>• Microsoft Windows Vista Business (32 bit) Service Pack1 or later</li> <li>• Microsoft Windows Vista Home Premium (32 bit) Service Pack1 or later</li> <li>• Microsoft Windows Vista Home Basic (32 bit) Service Pack1 or later</li> <li>• Microsoft Windows XP Professional (32 bit) Service Pack2 or later</li> <li>• Microsoft Windows XP Home Edition (32 bit) Service Pack2 or later</li> <li>• Microsoft Windows 2000 Professional Service Pack4 or later</li> </ul>
CPU	The system requirements for the above OSs must be met. <sup>*6</sup>
Memory	The system requirements for the above OSs must be met. <sup>*6</sup>
Display	Resolution: SVGA (800×600 dots) or higher
Hard disk space	500 KB or more
Display color	High Color (16 bits) or higher
Other hardware	Use a mouse and a keyboard compatible with the above OSs.

\*1 The following functions are not supported.

- Application start in Windows compatibility mode
- Fast user switching
- Changing your desktop themes (fonts)
- Remote desktop
- DPI setting other than the normal size (For Windows XP and Windows Vista)
- Setting the size of text and illustrations on the screen to any size other than [Small-100%] (for Windows 11, Windows 10, Windows 8.1, Windows 8, and Windows 7)

\*2 Windows XP Mode is not supported.

\*3 The touch feature is not supported.

\*4 Modern UI Style is not supported.

\*5 Operation in a virtual environment such as Hyper-V is not supported.

\*6 For the system requirements for the OSs, refer to the following.

 Microsoft official website

## ■ How to start

Installing GOT operator management information conversion tool is not required.

Copy the execution file (GTOperatorInfoConv.exe) in a folder, and then execute the file in the folder.

1

OVERVIEW

2

GT Designer3  
SPECIFICATIONS

3

GT Designer3  
OPERATION

4

COMMON SETTING

5

EDITING AND  
SETTING FIGURES  
AND OBJECTS

6



LIBRARY

7

TEMPLATE

## ■ Converting an operator management information file



To convert an operator management information file, refer to the following methods.

Method	Description
Conversion with the GOT operator management information conversion tool	Start the GOT operator management information conversion tool to convert the file.  (1) Operation with the GOT operator management information conversion tool
Conversion with a command line	Execute a command on the command prompt to convert the file.  (2) Operation with a command line

### (1) Operation with the GOT operator management information conversion tool

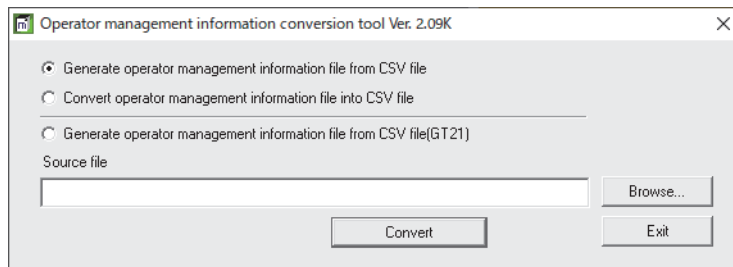
1. Start the GOT operator management information conversion tool.  
The following dialog box appears.



Item	Description
Generate operator management information file from CSV file	Selecting this item and clicking the [Convert] button create an operator management information file from the CSV file specified for [Source file]. At the conversion, an error log file is output.  ■ Information contained in output files (3) Error log file (GTOperatorInfoConv.log)
Convert operator management information file into CSV file	Selecting this item and clicking the [Convert] button convert an operator management information file into the CSV file specified for [Source file].
Generate operator management information file from CSV file(GT21)	This setting is not available for GOT1000 series. This is available for GOT2000 series.
Source file	Specify a path of the conversion source file. By clicking the [Browse] button, the path of the conversion source file can be specified in the [Open CSV file] dialog box.
	Click this button to execute the file conversion.

2. Set the required setting items, and click the [Convert] button to display the [Administrator password entry] dialog box.

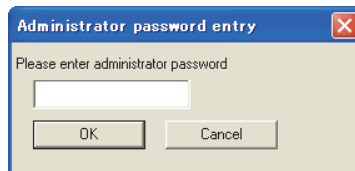

- To create an operator management information file from a CSV file  
Enter the Administrator password, and click the [OK] button to display the [Administrator password re-entry] dialog box.

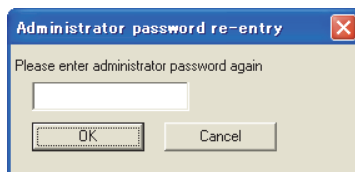

Enter the Administrator password again, and click the [OK] button. The operator management information file (AUTHINF.G1U) is created in the folder where the conversion source file is stored.

- To convert an operator management information file into a CSV file  
Enter the password set for an operator management information file to be converted, and click the [OK] button.  
The CSV file (AUTHINF.CSV) is created in the folder that stores the conversion source file.

**(2) Operation with a command line**

To convert a file with a command line, use version 1.02C or later of the GOT operator management information conversion tool.

The following explains commands according to the format in the table below.

Symbol	Description
[ ]	Indicates that the command can be omitted.

Perform one of the following operations to open Command Prompt.

- Select [Windows System] → [Command Prompt] from the Windows start menu.
- Enter "cmd" in the search box on the taskbar, and run a search.

Command Prompt opens differently depending on the Windows® OS.

(a) Command

Command	Description
GTOperatorInfoConv.exe	Converts an operator management information file. A G1U file is converted into AUTHINF.CSV, and a CSV file is converted into AUTHINF.G1U. The converted file is output to the folder where the conversion source file is stored. After the conversion, another command prompt starts to display the conversion result.

(b) Format

GTOperatorInfoConv.exe filename [password] [/f] [/l] [-c] [/help] [/?]

(c) Option

Option	Description
filename	Specifies the operator management information file to be converted (CSV or G1U) with the full path. If the path contains spaces, enclose the path in double quotation marks (" ").
password	Specifies the administrator password.
/f	If the conversion destination folder already has AUTHINF.CSV or AUTHINF.G1U, the file is overwritten.
/l	Outputs the conversion result to an operator management information conversion log file. The operator management information conversion log file is output to the folder where the conversion source file is stored. If the folder already has AUTHINF.CSV or AUTHINF.G1U, the file is overwritten.  ■ Information contained in output files (2) Operator management information conversion log file (GTOperatorInfoConvResult.txt)
/-c	Does not start the command prompt to display the conversion result.
/help	Displays how to use options on the command prompt.
/?	If these options are specified, the other options are ignored and the conversion is not executed.

## Information contained in output files

The following shows the information contained in the files that are output when an operator management information file is converted.

### (1) CSV file (AUTHINF.CSV)

A CSV file contains the data as shown below.

Set each setting item without changing the order of the items as shown in the tables below.

In the following cases, the data format is invalid and a CSV file is not converted into an operator management information file.

- When any of the setting items is deleted
- When the order of the setting items is changed
- When any of the settings is incorrect

#### (a) Header part

In the header part, configure the common setting for each operator information.

GOT_OPERATOR_AUTHENTICATION_INFO		1)
DATA_VERSION	0	2)
AUTH_TYPE	ID_PASS	3)
PASS_TYPE	ENCRYPTED	4)
AUTO_LOGOUT_TIME	0	5)
PASS_EXP_DATE	20	6)
EXT_AUTH_ID_TOP	0	7)
EXT_AUTH_ID_LEN	7	8)
EXT_UNIT_CH	8	9)

No.	Item	Description
1)	GOT_OPERATOR_AUTHENTICATION_INFO	Keyword to declare that the file is an operator management information file
2)	DATA_VERSION	Set the version of the CSV file. Setting range: 0
3)	AUTH_TYPE	Set the authentication type of the operator authentication. Set any of the following. <ul style="list-style-type: none"> <li>• ID_PASS: Set this item when the authentication type is the operator authentication with the password.</li> <li>• EXT_AUTH: Set this item when the authentication type is the operator authentication with the external authentication device.</li> <li>• EXT_FP: Set this item when the authentication type is the operator authentication with the fingerprint unit.</li> </ul>
4)	PASS_TYPE	Set the password type. Set any of the following. <ul style="list-style-type: none"> <li>• ENCRYPTED: Set this item to specify an encrypted password for [PASSWD] in the data part. Even if an unencrypted password is specified for [PASSWD], the file is correctly converted. For the password encryption, refer to the following. <ul style="list-style-type: none"> <li>☞ ■Precautions for GOT operator management information conversion tool</li> </ul> </li> <li>• PLAIN: Set this item to specify an unencrypted password for [PASSWD] in the data part.</li> </ul>
5)	AUTO_LOGOUT_TIME	Set the automatic logout time. Setting range: 0 (Automatic logout disabled)/1 to 60 (minute)
6)	PASS_EXP_DATE	Set the password expiration. Setting range: 0 (No expiration)/1 to 1000 (day)

(Continued to next page)

No.	Item	Description
7)	EXT_AUTH_ID_TOP	Set the initial position of the external authentication ID. When a CSV file is converted into an operator management information file, 0 is set in the following cases. <ul style="list-style-type: none"> <li>When nothing or invalid value is set</li> <li>When [AUTH_TYPE] (Authentication type) is set to [EXT_FP]</li> </ul> Setting range: 0 to 1998 (byte) The total set value of [EXT_AUTH_ID_TOP] and [EXT_AUTH_ID_LEN] must be 2000 or less. If the total set value exceeds 2000, the file cannot be converted correctly.
8)	EXT_AUTH_ID_LEN	Set the number of bytes for the external authentication ID. When a CSV file is converted into an operator management information file, the set value varies depending on the case as shown below. <ul style="list-style-type: none"> <li>When nothing or invalid value is set: 4</li> <li>When [AUTH_TYPE] (Authentication type) is set to [EXT_FP]: 7</li> </ul> Setting range: 2 to 16 (byte) The total set value of [EXT_AUTH_ID_TOP] and [EXT_AUTH_ID_LEN] must be 2000 or less. If the total set value exceeds 2000, the file cannot be converted correctly.
9)	EXT_UNIT_CH	Set the channel for connecting an external authentication device. Setting range: 8 (CH)

(b) Data part

In the data part, set the individual operator information.

1)	2)	3)	4)	5)	6)	7)
OPE_ID	OPE_NAME	LEVEL	PASSWD	IS_PASSWD_EXP	IS_EXT_AUTH	EXT_AUTH_ID
3	ICHIRO@	5	MITSUBISHI0001	0	1	313233334353637@
2	JIRO@	1	MITSUBISHI0002	0	1	3030303030303136@
1	SABURO@	9	MITSUBISHI0003	1	1	30303039393939@

No.	Item	Description
1)	OPE_ID	Set the operator ID. Setting range: 1 to 32766
2)	OPE_NAME	Set the operator name. Setting range: 1 to 16 one-byte alphanumeric characters (A to Z, a to z, 0 to 9)
3)	LEVEL	Set the security level of the operator. Setting range: 0 to 15
4)	PASSWD	Set the password for the operator. Setting range: 0 to 16 one-byte alphanumeric characters (A to Z, a to z, 0 to 9) Setting range for an unencrypted password. For the password encryption, refer to the following.  ■ Converting an operator management information file
5)	IS_PASSWD_EXP	Set whether to set the password expiration. Setting range: 0 (Without expiration)/1 (With expiration)
6)	IS_EXT_AUTH	Set whether to set the external authentication ID. Setting range: 0 (Without setting)/1 (With setting)
7)	EXT_AUTH_ID	Set the external authentication ID. The number of bytes for the external authentication ID is the value set for [EXT_AUTH_ID_LEN]. The setting method varies depending on the setting for [AUTH_TYPE]. <ul style="list-style-type: none"> <li>When [AUTH_TYPE] is set to [ID_PASS] (Password authentication) The external authentication ID setting is not required. When an operator management information file exported from the GOT is converted into a CSV file, the external authentication ID is displayed with ASCII characters. However, the ID is not recognized.</li> <li>When [AUTH_TYPE] is set to [EXT_AUTH] (External authentication) Set the external authentication ID with hexadecimal numbers.</li> <li>When [AUTH_TYPE] is set to [EXT_FP] (Fingerprint authentication) Set the external authentication ID with decimal numbers.</li> </ul>

**(2) Operator management information conversion log file (GTOperatorInfoConvResult.txt)**

Checking the conversion result is available.

The file is output when the conversion is executed with a command line.

The file is output to the folder where the conversion source file is stored.

```
0 _____ 1)
DayTime=05/19/2011/18:13:19 _____ 2)
ExeCmd=C:\AUTHINF.CSV ***** /f /l _____ 3)
Results=success _____ 4)
Cmnt=Conversion process is completed. _____ 5)
```

No.	Description
1)	Conversion result (0: Normal completion, 1: Abnormal end)
2)	Date and time of conversion
3)	Executed command
4)	Conversion result (success: Conversion completed, failure: Abnormal end)
5)	Message

**(3) Error log file (GTOperatorInfoConv.log)**

Checking the error location (line) in the CSV file and the error cause (error code) is available.

The file is output when a CSV file is converted into a G1U file only.

With no error, the file is not output.

The file is output to the folder where the conversion source file is stored.

If the folder already has the file, the file is overwritten.

```
[RESULT] _____ 1)
Line :ErrorCode ]
1:1001 _____ 2)
12:1000 ]
```

No.	Description
1)	Header part (The character strings are fixed.)
2)	The error line numbers and the error codes are displayed. (Line number: Error code)  ■Error code list



## ■ Error code list

The following shows the errors and the corrective actions corresponding to the error codes output to the error log file and others.

Error code	Error	Corrective action
1000	The file format of the CSV file is invalid. (Any other than the error codes from 1001 to 1016 applies to the file.)	Check if the specified CSV file is correct.
1001	The header data of the CSV file is invalid.	Check if the keyword alignment, the character strings, and the set values in the header part are correct. Correct them as required.
1010	The set value of the operator ID (OPE_ID) is invalid.	Check if the operator ID in the data part is not outside the setting range or is not invalid. Correct the operator ID as required.
1011	The operator name (OPE_NAME) is invalid.	Check if the number of characters of the operator name in the data part is outside the setting range and if the character string does not include invalid characters. Correct the operator name as required.
1012	The set value of the operator security level (LEVEL) is invalid.	Check if the security level in the data part is not outside the setting range or is not invalid. Correct the security level as required.
1013	The set password (PASSWD) is invalid.	Check if the character string and the number of characters of the password are not invalid. For the encrypted password, check if the set character string does not include characters inapplicable to hexadecimal notation. Correct the password as required.
1014	The set value of the setting whether to set the password expiration (IS_PASSWD_EXP) is invalid.	Check if the set value is not invalid. Correct the value as required.
1015	The set value of the setting whether to set the external authentication ID (IS_EXT_AUTH) is invalid.	Check if the set value is not invalid. Correct the value as required.
1016	The set value of the external authentication ID (EXT_AUTH_ID) is invalid.	Check if the set value of the external authentication ID is correct. (Make sure that the set value corresponds to the authentication type set in the header part.) Correct the value as required.
2000	The file format of AUTHINF.G1U is invalid.	Check if the specified AUTHINF.G1U is correct.

## ■ Precautions for GOT operator management information conversion tool

### (1) Precautions for editing a CSV file

#### (a) Password encryption

To encrypt the password ([PASSWD]) of a CSV file edited on the personal computer, execute the following procedures.

1. Create an operator management information file from the CSV file by using the GOT operator management information conversion tool.
2. Convert the created operator management information file into a CSV file to encrypt the password.

#### (b) Displaying an unencrypted password

To set an unencrypted password for [PASSWD], handle the CSV file carefully.

The unencrypted password is displayed as it is.

To not to leak the password, set nothing for [PASSWD] and set the password on the GOT, or encrypt the file by using the method shown in (a) above.

#### (c) How to input a value beginning with zeros

When editing a CSV file by using spreadsheet software, the leading zeros of a value beginning with zeros can be removed.

To input a value beginning with zeros, add @ to the beginning or end of the value.

@ is not recognized as a value during conversion.

### (2) Precautions for converting a file

#### (a) Automatic addition of @

When an operator management information file is converted into a CSV file, @ may automatically be added to the set values of some setting items to not to remove zeros by using spreadsheet software.

When the CSV file is converted into an operator management information file, @ is not recognized as a value. Therefore, deleting @ is not required.

## 4.7.5 Precautions

### ■ Precautions on drawing

#### (1) Operator authentication

- (a) Security level of the screen displayed at logout  
When a security level (1 or more) is set for the screen displayed when logging out of the GOT, the screen for login is displayed after logging out of the GOT.  
Set the security level of 0 for the screen displayed when logging out of the GOT.

☞ 4.7.1 Settings

- (b) When the authentication screen size is set to [Large] for the operator authentication with a password  
When a login or logout touch switch is placed on a screen, do not set the screen script and the status observation function that operate with screen switching for the screen.  
After authentication, the screen that is displayed before login appears again by screen switching.  
Therefore, the screen script and the status observation function may be executed without intention if the functions are set for the screen.

Authentication screen size: [Large]

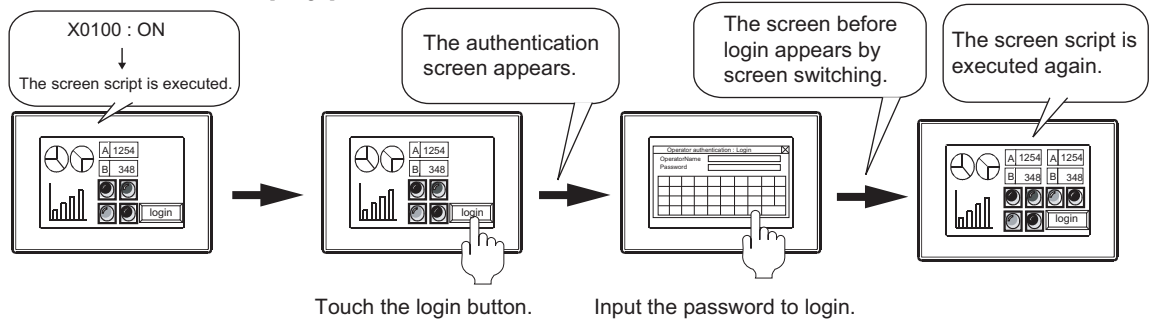

Authentication screen size: [Standard]

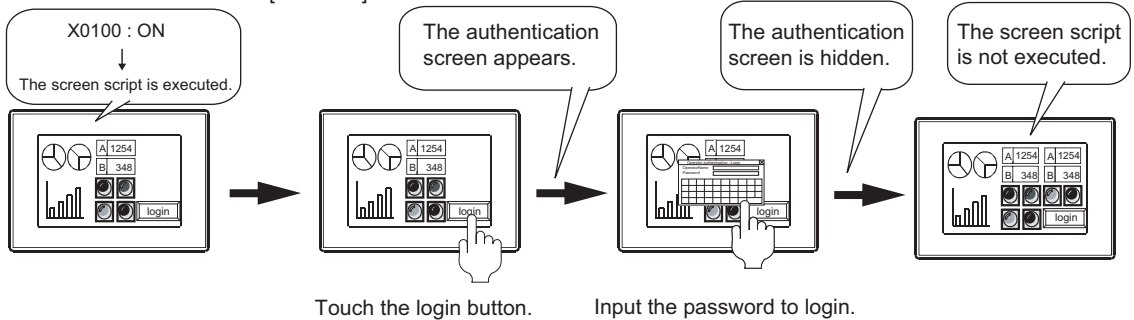

## (2) Password authentication

When the security level device value is changed with the numerical input, the key window used for the value input is deleted after the input is completed, regardless of the following settings.

- Selecting [Clear the key window and the cursor] of [Defined key action] in the [Advanced Setting] tab for the [Environmental Setting] dialog box (Key Window)

When configuring any of the following settings, the key window is redisplayed.

- Selecting [Display when touched] for [Key Window] in the [Advanced Setting] tab for the [Environmental Setting] dialog box or in the [Key Window Advanced Setting] tab for the [Screen Property] dialog box
- Selecting [Display the key window] in the [Advanced Setting] tab for the [Environmental Setting] dialog box or in the [Key Window Advanced Setting] tab for the [Screen Property] dialog box

The cursor position to redisplay the key window is the same position set for [Cursor Position] of [When screens are switched] in the [Advanced Setting] tab for the [Environmental Setting] dialog box (Key Window) or in the [Key Window Advanced Setting] tab for the [Screen Property] dialog box.

 4.5 Key Window Setting

## (3) Using the project security and the data transfer/utility password together

To use the project security, set the data transfer/utility password.

The project security setting cannot be written in the GOT. To protect the project written in the GOT, set the data transfer/utility password.

When the data transfer/utility password is not set, and if the user is under the following conditions, the user cannot write a project in the GOT.

- The project security for a project disables the user to edit the project.
- The project security for each screen disables the user to display or edit any of screens.

For the details of the project security, refer to the following.

 3.14 Securing Project

## ■ Precautions on OS

### (1) Operator authentication

For using the operator authentication with the GT16, GT15, and GT14, the required extended function OS varies according to the authentication type.

Authentication type	Required extended function OS
Operator authentication with password	Operator authentication
Operator authentication with external authentication device	Operator authentication, RFID
Operator authentication with fingerprint unit (GT16 and GT15 only)	Operator authentication, Fingerprint Authentication

### (2) Password authentication

For using the password authentication with the GT16, GT15, and GT14, do not install the extended function OS (Operator authentication) on the GOT.

When the extended function OS (Operator authentication) is installed on the GOT, the password authentication cannot be used.

When the extended function OS (Operator authentication) is already installed on the GOT, delete the OS.

## ■ Precautions for hardware

### (1) Connectable channel No.

To use the operator authentication (with the external authentication device or fingerprint unit), the external authentication device or fingerprint unit can be connected to the RS-232 interface built in the GOT (Channel No.8) only.

Do not set any channel number other than the channel No.8 in the communication settings.

Multiple external authentication devices or fingerprint units cannot be connected to one GOT.

**(2) Temporary measures for failure of the external authentication device**

When the external authentication device or fingerprint unit breaks down for the operator authentication (with the external authentication device or fingerprint unit), changing the authentication type to the operator authentication with the password using the utility is available in an emergency.

To change authentication types, the administrator password is required.

For how to change authentication types, refer to the following.

 User's Manual for the GOT used

**■ Precautions for use**

**(1) Registration of external authentication ID**

To use the operator authentication (with the external authentication device or fingerprint unit), set the external authentication ID for the operator information.

When the external authentication ID is not set, the corresponding user cannot log into the GOT.

When the authentication type is changed from [External auth (general)] to [Fingerprint auth] with the utility, all the external authentication IDs are deleted.

In that case, set the IDs again.

**(2) Registration of fingerprint information**

For the operator authentication (fingerprint authentication), a fingerprint can be registered for multiple fingerprint registration IDs.

Unauthorized login is possible depending on the usage. Before the registration, consider the operational rules for registering fingerprints.

**■ Management of password and external authentication ID**

**(1) Solutions when forgetting the password or external authentication ID**

(a) Operator authentication

Situation	Solution
When forgetting the password of an operator	Delete the operator information with the forgotten password, and register an operator information again.
When forgetting the external authentication ID When losing the external authentication device	<ul style="list-style-type: none"> <li>Operator authentication with the external authentication device Check the operator information on the Operator information management screen, and then set the external authentication ID for the external authentication device again.</li> <li>Operator authentication with the fingerprint unit Check the operator information on the Operator information management screen, and then set the fingerprint registration ID again on the Fingerprint information management screen.</li> </ul>
When forgetting the administrator password or system security password	<ul style="list-style-type: none"> <li>GT16, GT15, GT14 Install CoreOS. When CoreOS is installed, the built-in flash memory of the GOT is formatted. (Each OS, project data, and others are deleted.) Upload data to be backed up to a personal computer and memory card before installing CoreOS. For installing CoreOS, refer to the following.  User's Manual for the GOT used</li> <li>GT SoftGOT1000 Use another module of GT SoftGOT1000. To use GT SoftGOT1000 with the forgotten password, install it again.</li> </ul>

(b) Password authentication

Create a project data again. (Only passwords cannot be reset.)



## 4.8 GOT Startup Logo Setting



The GOT can display a BMP screen at the GOT startup.





The BMP screen specified is displayed at the GOT startup.

### 4.8.1 Settings

Select [Common] → [GOT Environmental Setting] → [Startup Logo] from the menu to display the [Environmental Setting] dialog box.

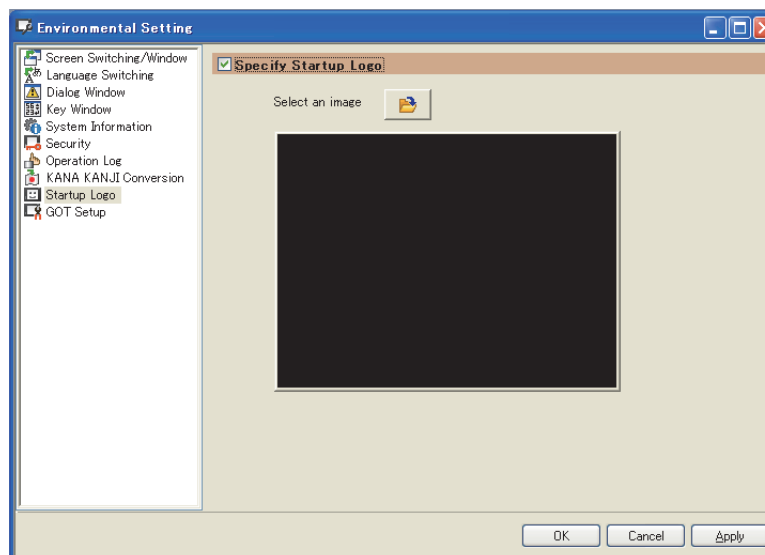
#### ■ Startup logo



Item	Description	Model
Specify Startup Logo	Select this item to set a BMP file to be displayed at the GOT startup. After selecting this item, set a BMP file to be displayed at the GOT startup in [Select an image].	gr16 gr15 gr14 gr12 gr11 gr10 SoftGOT1000
	Select an image Click the  button to display the [Open a file] dialog box. Select the BMP file to display the preview.	



#### Setting the startup logo displaying time

The startup logo displaying time can be set in the following items for the [Environmental Setting] dialog box (GOT Setup).

- [Title Display Time] in the [Display] or [Operation] tab

☞ 4.9 GOT Display and Operation Setting

## 4.8.2 Setting/deleting procedure

### Startup logo setting procedure

#### (1) GT16, GT15, GT14, GT12, GT11, or GT10

1. Set a BMP file to be displayed at the GOT startup in the [Environmental Setting] dialog box (Startup Logo).  
☞ 4.8.1 Settings
2. Select [Startup Logo] in the [GOT Write] tab of the [Communicate with GOT] dialog box, and write the project data in the GOT.  
☞ 8.1.4 Writing and installing on GOT

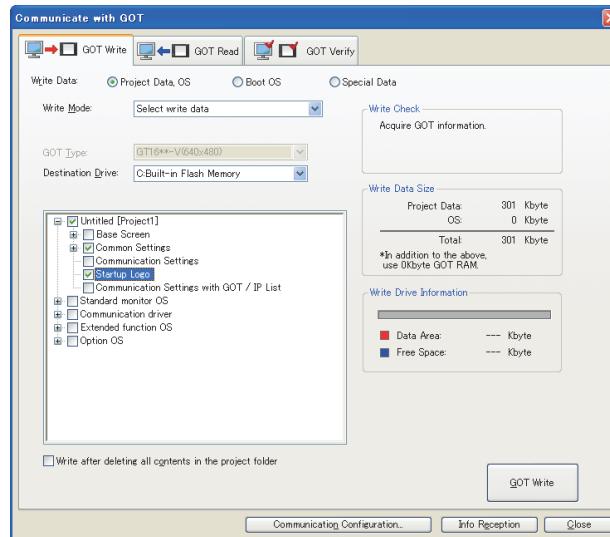

3. The specified BMP file is displayed as the startup logo at the GOT startup.

#### (2) GT SoftGOT1000

1. Set a BMP file to be displayed at the GOT startup in the [Environmental Setting] dialog box (Startup Logo).  
☞ 4.8.1 Settings
2. Start up GT SoftGOT1000, and open the created project data to display the set BMP file at the GOT startup.

## ■ Startup logo deleting procedure

### (1) GT16, GT15, GT14, GT12, GT11, or GT10

#### POINT

##### When the OS boot drive is set to [A:Standard Memory Card]

When the OS boot drive is set to [A:Standard Memory Card], the startup logo cannot be deleted by the method described in (b).

The startup logo can be deleted by the method described in (a) or by writing project data without the startup logo set and the OS into the memory card.

#### (a) How to delete the startup logo when writing the project data to the GOT

1. Clear [Specify Startup Logo] for the [Environmental Setting] dialog box (Startup Logo).  
☞ 4.8.1 Settings
2. Select [Write after deleting all contents in the project folder] in the [GOT Write] tab for the [Communicate with GOT] dialog box, and write the project data with the changed settings to the GOT.  
☞ 8.1.4 Writing and installing on GOT

#### (b) How to delete the startup logo on the drive information

1. Select [Drive Information] in the [GOT Read] tab for the [Communicate with GOT] dialog box.  
☞ 8.1.5 Reading from GOT
2. Select [Startup Logo] in the tree structure, and click the [Delete] button.

### (2) GT SoftGOT1000

Clear [Specify Startup Logo] for the [Environmental Setting] dialog box (Startup Logo).

☞ 4.8.1 Settings

## 4.8.3 Precautions

### ■ Precautions on drawing

#### (1) BMP file screen size and GOT screen size

Use the BMP file screen size smaller than the GOT screen size.

If using the BMP file screen size larger than the GOT screen size, only the portion fitted in the screen is displayed.

#### (2) Number of colors for displaying the startup logo

##### (a) When using GT16, GT15, GT14, GT12, GT11, or GT10

The colors not displayable on the GOT in use are subtracted.

Also, the startup logo is displayed in 256 colors even when the BMP file uses 256 colors or more.

##### (b) When using GT SoftGOT1000

The BMP file used as the startup logo is displayed in the maximum of 65536 colors.



# 4.9 GOT Display and Operation Setting



This setting is available for screen save time, whether to set the clock setting, and the buzzer sound length long or short. The settings can be configured in the utility.

## 4.9.1 Settings

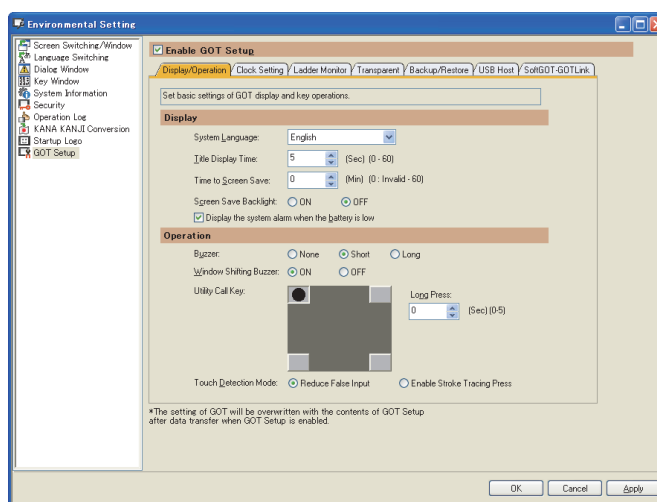

Select → [Common] → [GOT Environmental Setting] → [GOT Setup] to display the [Environmental Setting] dialog box.

### ■ Display/Operation tab

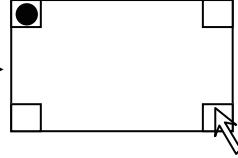

Item	Description	Model
Enable GOT Setup	Select this item to set the display/operation setting, the clock setting, and others for the GOT.	
Display	System Language	Select the language used for the display of system messages, utility and system alarm. (Korean is not available for the GT10.) • Japanese • English • Chinese(Simplified) • Chinese(Traditional) • Korean • German
	Title Display Time	Set the opening screen time when the GOT is started up. (0 to 60 seconds)
	Time to Screen Save	Set the time to turn off the display of the monitor screen by the screen saving function. (0 to 60 minutes)
	Screen Save Backlight	Set whether to turn off the backlight by the screen saving function in synchronization with turning off the display of the monitoring screen. • ON: Does not turn off the backlight. • OFF: Turns off the backlight. This setting behaves differently depending on the setting of the Backlight OFF output signal (System Signal 1-1.b7). 4.6 System Information Setting
Display the system alarm when battery is low	Select this item to display the system alarm when the battery voltage is low.	

(Continued to next page)

Item	Description	Model	
Operation	Buzzer	Set the length of buzzer sound when holding down the button. (None/Short/Long)	<div style="display: flex; flex-direction: column; align-items: flex-end; padding-right: 10px;"> <div style="margin-bottom: 10px;"> <span style="border: 1px solid black; padding: 2px;">gr16</span> <span style="border: 1px solid black; padding: 2px;">gr15</span>  <span style="border: 1px solid black; padding: 2px;">gr14</span> <span style="border: 1px solid black; padding: 2px;">gr12</span>  <span style="border: 1px solid black; padding: 2px;">gr11</span> <span style="border: 1px solid black; padding: 2px;">gr10</span>  <span style="border: 1px solid black; padding: 2px;">SoftGOT1000</span> </div> <div style="margin-bottom: 10px;"> <span style="border: 1px solid black; padding: 2px;">gr16</span> <span style="border: 1px solid black; padding: 2px;">gr15</span>  <span style="border: 1px solid black; padding: 2px;">gr14</span> <span style="border: 1px solid black; padding: 2px;">gr12</span>  <span style="border: 1px solid black; padding: 2px;">gr11</span> <span style="border: 1px solid black; padding: 2px;">gr10</span>  <span style="border: 1px solid black; padding: 2px;">SoftGOT1000</span> </div> <div> <span style="border: 1px solid black; padding: 2px;">gr16</span> <span style="border: 1px solid black; padding: 2px;">gr15</span>  <span style="border: 1px solid black; padding: 2px;">gr14</span> <span style="border: 1px solid black; padding: 2px;">gr12</span>  <span style="border: 1px solid black; padding: 2px;">gr11</span> <span style="border: 1px solid black; padding: 2px;">gr10</span>  <span style="border: 1px solid black; padding: 2px;">SoftGOT1000</span> </div> </div>
	Window Shifting Buzzer	Set whether to sound buzzer or not when moving a window. <ul style="list-style-type: none"> <li>• ON: Beeps the buzzer.</li> <li>• OFF: Does not beep the buzzer.</li> </ul>	
	Utility Call Key	<p>Specify the key area for calling the utility from the monitoring screen. The black circle ● shows that the utility call key is specified in this area.</p> <p>By clicking a square □ area at the four corners of the screen image, the black circle ● is displayed on the clicked square □.</p> <p>By clicking the square □ with the black circle ●, the utility call key specification is canceled.</p> <ul style="list-style-type: none"> <li>• To specify the key area Specify one or two points at the four corners of the screen image. (Only one point for the GT16, GT1595-X, GT14, GT12, GT1020, and GT SoftGOT1000) To change the specified key area to another key area, perform the following procedure.</li> </ul> <div style="display: flex; justify-content: space-around; align-items: center;"> <div style="text-align: center;">  <p>Click the utility call key to be canceled.</p> </div> <div style="text-align: center;">  <p>The clicked area is changed to a square □. Click a square □ to be newly specified as the utility call key.</p> </div> </div> <div style="text-align: center; margin: 10px 0;">↓</div> <div style="text-align: center;">  <p>The clicked area is changed to ●, and the area is set for the new utility call key.</p> </div> <p>When the key area is set at one point, the displayed screen is switched to the utility screen by setting [Long Press].</p> <ul style="list-style-type: none"> <li>• To not to specify the key area Click the square □ with the black circle ● to cancel the utility call key specification.</li> </ul>	
	Long Press	When the key area is set at one point, set the time for [Utility Call Key ] to switch the displayed screen to the utility screen. (0 to 5 seconds) This item is available when only one key area is set.	
	Key Reaction	Set the touch key reaction speed. (Standard./+10ms/+20ms/+40ms/+80ms/+120ms) Configure the setting so that the GOT does not recognize the touch operation with holding down the key during the set time. Doing so can reduce the number of malfunctions when touching the touch panel unnecessarily.	
Touch Detection Mode	For the GT16, GT1595-X, and GT12, incorrect inputs (responses of parts other than the touched part) when more than 2 points are touched simultaneously on the GOT screen can be reduced. Reduce False Input: False Input Reduction: Responses of parts other than the touched part are reduced. Enable Stroke Tracing Press: Responses of parts other than the touched part are not reduced.		

## POINT

### Precautions when specifying a utility call key

When the display position switching is enabled for the advanced alarm popup display and the scrolling alarm display, set one of the following by using [Utility Call Key].

- Setting the position of the utility call key to the upper-right or lower-left corner
- Setting [Long Press] of the utility call key to one or more seconds
- Specifying two points for the utility call key (For the GT16, GT1595-X, GT14, GT12, GT1020, and GT SoftGOT1000, two points cannot be specified.)

If the above setting is not configured, the utility call key and the display position switching area of the advanced alarm popup display and the scrolling alarm display may be overlapped.

If the overlapped area is touched, the utility display takes priority over the display position switching. Therefore, the display positions are not switched.

For the advanced alarm popup display and the scrolling alarm display, refer to the following.

 (Functions) 11.8 Advanced Alarm Popup Display

 (Functions) 11.9 Scrolling Alarm Display

## ■ Clock Setting tab

GT16 GT15 GT14 GT12 GT11 GT10 SoftGOT1000

For how to match the clock data between the GOT and controllers, refer to the following.

 4.9.2 How to match clock data between the GOT and controllers

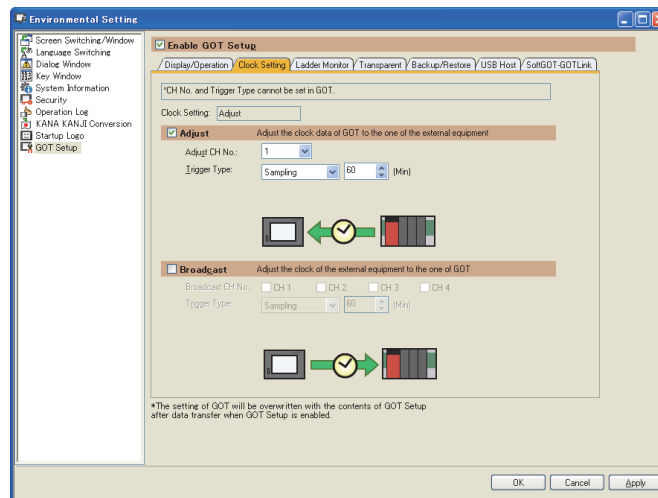

Item	Description	Model
Clock Setting	Displays the management method of a set clock.	GT16 GT15 GT14 GT12 GT11 GT10 SoftGOT1000
Adjust	Select this item to adjust the GOT clock data to a controller clock data.	GT16 GT15 GT14 GT12 GT11 GT10 SoftGOT1000
	<p><b>Adjust CH No.</b></p> <p>Select the channel No. of a controller connected to the GOT to adjust the GOT clock data to the controller.</p>	GT16 GT15 GT14 GT12 GT11 GT10 SoftGOT1000
	<p><b>Trigger Type</b></p> <p>Select the trigger type to adjust the GOT clock data to the controller.</p> <ul style="list-style-type: none"> <li>• Rise: Adjusts the GOT clock data to the controller when the device rises. After selecting this item, set a trigger device.</li> <li>• Fall: Adjusts the GOT clock data to the controller when the device falls. After selecting this item, set a trigger device.</li> <li>• Sampling: Adjusts the GOT clock data to the controller by the sampling cycle. After selecting this item, set the sampling cycle. (1 to 1440 minutes)</li> </ul>	GT16 GT15 GT14 GT12 GT11 GT10 SoftGOT1000

(Continued to next page)

Item	Description	Model
Broadcast	Select this item to adjust a controller clock data to the GOT clock data. This item is not available for the GT1020.	gr16 gr15 gr14 gr12 gr11 gr10 SoftGOT1000
	Broadcast CH No. Select the channel No. of a controller connected to the GOT to adjust the controller clock data to the GOT clock data.	gr16 gr15 gr14 gr12 gr11 gr10 SoftGOT1000
	Trigger Type Select the trigger type to adjust the GOT clock data to the controller. <ul style="list-style-type: none"> <li>Rise: Adjusts the GOT clock data to the controller when the device rises. After selecting this item, set a trigger device.</li> <li>Fall: Adjusts the GOT clock data to the controller when the device falls. After selecting this item, set a trigger device.</li> <li>Sampling: Adjusts the GOT clock data to the controller by the sampling cycle. After selecting this item, set the sampling cycle. (1 to 1440 minutes)</li> </ul>	gr16 gr15 gr14 gr12 gr11 gr10 SoftGOT1000

## Ladder Monitor tab



This setting is not available for the GT1555-Q, and GT1550-Q.

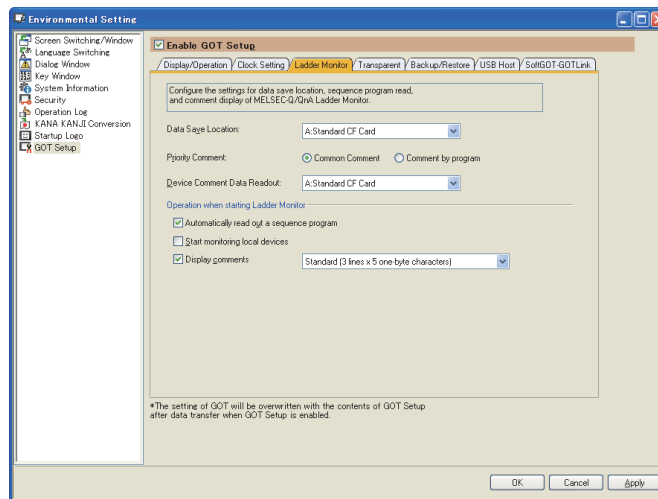



Item	Description	Model
Data Save Location	Set a data save location for the ladder monitor.	gr16 gr15 gr14 gr12 gr11 gr10 SoftGOT1000
Priority Comment	Select the priority comment when a common comment and each program comment are set for one device in the sequence program.	
Device Comment Data Readout	Select the drive to be used for collectively reading device comment data stored in a memory card.	
Automatically read out a sequence program	Select this item to enable the GOT to automatically read the sequence program by a controller when starting the ladder monitor.	
Start monitoring local devices	Select this item to start monitoring local devices when starting the ladder monitor.	
Display comments	Select this item to display comments when starting the ladder monitor. (Standard (3 lines x 5 one-byte characters)/32-character Display (4 lines x 8 one-byte characters))	

## ■ Transparent tab

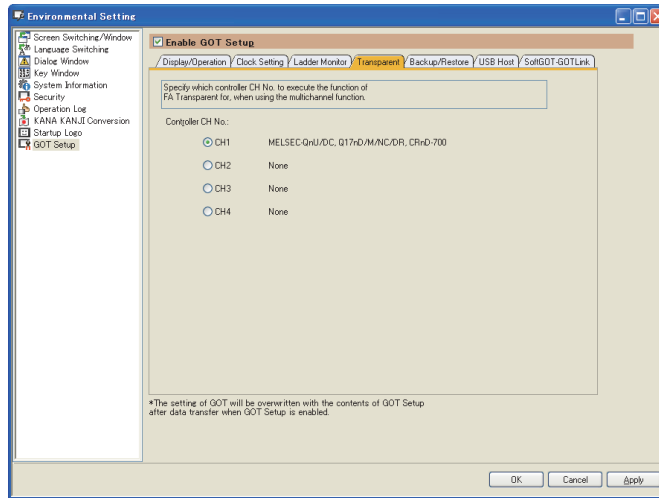
GT 16 GT 15 GT 14 GT 12 GT 11 GT 10 Soft GOT 1000



Item	Description	Model
Controller CH No.	To use the multi-channel function, select the target channel No. for the FA transparent function. For the FA transparent function, refer to the following.  GOT1000 Series Connection Manual (Mitsubishi Electric Products) for GT Works3	

1 OVERVIEW

2 GT Designer3 SPECIFICATIONS

3 GT Designer3 OPERATION

4 COMMON SETTING

5 EDITING AND SETTING FIGURES AND OBJECTS

6 LIBRARY

7 TEMPLATE

## Backup/Restore tab

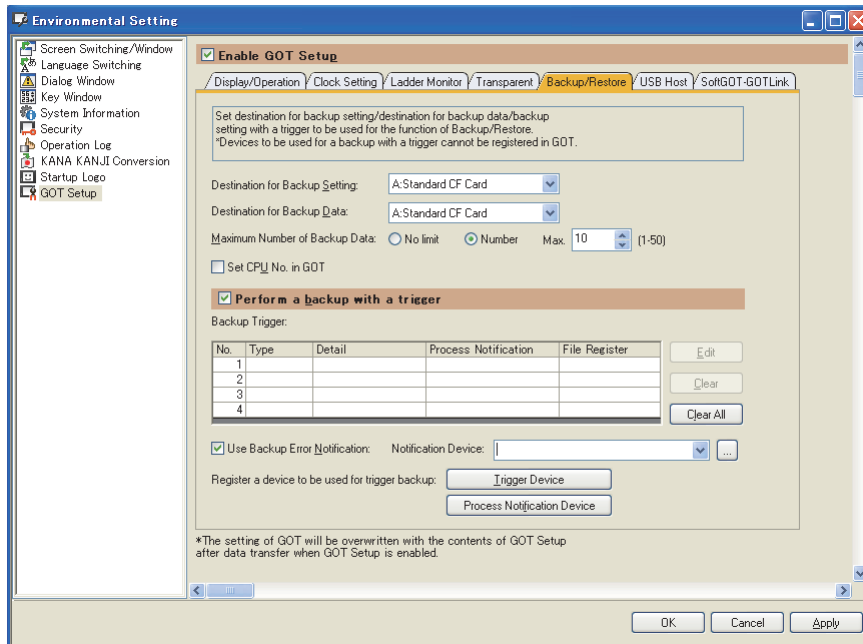

Item	Description	Model
Destination for Backup Setting	Set the storage locations for the backup settings.	
Destination for Backup Data	Set the storage location that the setting data for backups is stored.	
Maximum Number of Backup Data	Select the maximum stored number of the backup data. <ul style="list-style-type: none"> <li>No limit: Backups the data in the specified drive selected for [Destination for Backup Data] up to maximum data capacity.</li> <li>Number: Backups the data up to the set number of the backup data. After selecting this item, set the maximum stored number. (1 to 50)</li> </ul>	
Set CPU No. in GOT	Select this item to enable the specification of the CPU number of the programmable controller targeted for backup. Specify the CPU number at the backup. When the CPU No.is specified in the GOT, the GOT starts to communicate with only one PLC and therefore the network batch backup/restore function on the multiple PLCs cannot be used.	
Perform a backup with a trigger	Select this item to set a backup trigger.	
Backup Trigger	Displays the backup trigger settings in the list. <div style="display: flex; align-items: flex-start;"> <div style="margin-right: 10px;"> <input type="button" value="Edit"/> : Click this button to display the [Trigger Setting] dialog box. The selected backup trigger setting can be edited. </div> <div style="margin-right: 10px;">  (1) Trigger Setting dialog box </div> <div style="margin-right: 10px;"> <input type="button" value="Clear"/> : Click this button to delete the selected backup trigger setting. </div> <div> <input type="button" value="Clear All"/> : Click this button to delete all the trigger settings. </div> </div>	GT16 GT15 GT14 GT12 GT11 GT10 SoftGOT1000
Use Backup Error Notification	Select this item to store the backup trigger number in the notification device if an error occurs during the backup. After selecting this item, set [Notification Device].	
Register a device to be used for trigger backup	<input type="button" value="Trigger Device"/>	Click this button to display the [Device List(Trigger Device)] dialog box. (2) Device List dialog box
	<input type="button" value="Process Notification Device"/>	Click this button to display the [Device List(Process Notification Device)] dialog box. (2) Device List dialog box

(1) Trigger Setting dialog box

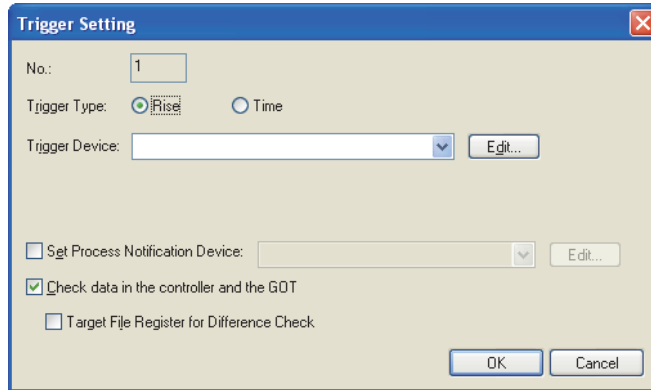

Item	Description	Model	
No.	Displays the editing backup trigger setting ID.		
Trigger Type	Select the trigger type of the backup trigger. <ul style="list-style-type: none"> <li>• Rise: Backups the data when the trigger device rises. Set [Trigger Device].</li> <li>• Time: Backups the data with the time that is specified in the time setting. Set [Time Setting].</li> </ul>	G116 G115 G114 G112 G111 G110 SoftGOT1000	
	Trigger Device		Select the trigger device from devices that is set in the [Device List(Trigger Device)] dialog box. Click the [Edit] button to display the [Device List(Trigger Device)] dialog box. (2) Device List dialog box
	Time Setting		Set the time and days that the GOT executes the backup. Multiple days can be set. Click the [Daily] button to select all days.
Set Process Notification Device	Select this item to select a device to notify that the backup is on processing. Select the process notification device from devices that is set in the [Device List(Trigger Device)] dialog box. Click the [Edit] button to display the [Device List((Process Notification Device)] dialog box. (2) Device List dialog box		
Check data in the controller and the GOT	Select this item to check the data in the controller and the GOT. The file register is not checked.		
	Target File Register for Difference Check	Select this item to check if data stored in file registers are changed when the backup is executed. QCPU User's Manual (Function Explanation, Program Fundamentals) For file registers, refer to the following. QCPU User's Manual (Function Explanation, Program Fundamentals)	

**POINT**









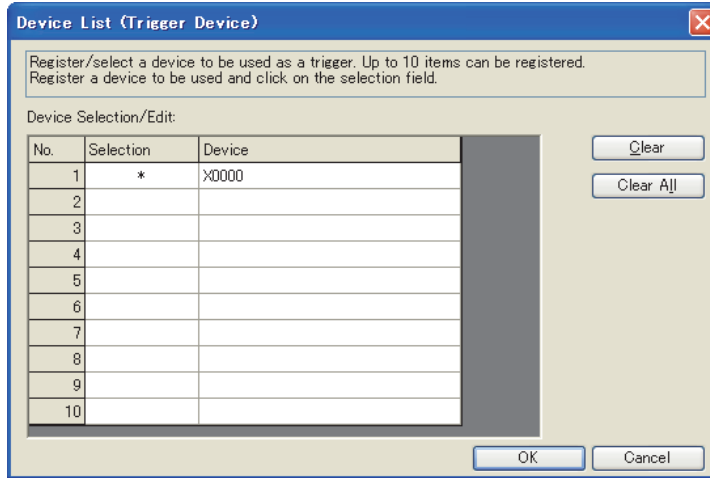

When the project data where [Check data in the controller and the GOT] is not selected is opened in GT Designer3 with the older version than 1.64S, the setting is changed as follows.

- (1) **When the workspace format project or a single file format project (\*.GTW) is opened**  
 [Target File Register for Difference Check] is not selected.
- (2) **When the project data is read from the G1 format file or the GOT**  
 [Target File Register for Difference Check] is selected.

**(2) Device List dialog box**

Set and select devices used as the trigger device or the process notification device.



Item	Description	Model
Selection	Select devices used as the trigger device and the process notification device. Selected devices are displayed with [*]. This item is available only when opening by the [Trigger Setting] dialog box.	
Device	Select devices used as the trigger device and the process notification device. Up to 10 devices can be set.  5.3.1 Device setting	      
	Click this item to delete the clicked No. of settings.	
	Click this item to delete all of settings.	



## ■ USB host tab

GT 16 GT 15 GT 14 GT 12 GT 11 GT 10 Soft GOT 1000

Setting of a USB mouse or USB keyboard actions when using the USB mouse/keyboard function is available.

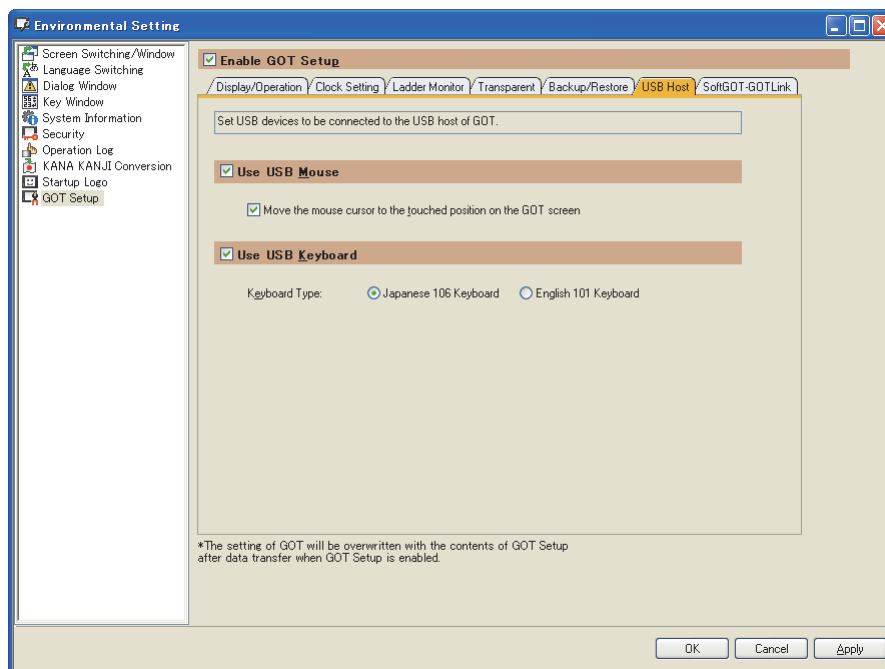

Item	Description		Model
Use USB Mouse	Select this item to enable the USB mouse connected to the USB interface (host) of the GOT.		GT16 GT15 GT14 GT12 GT11 GT10 SoftGOT1000
	Move the mouse cursor to the touched position on the GOT screen	Select this item to move the cursor to the position where the user touched on the GOT screen.	
Use USB Keyboard	Select this item to enable the USB keyboard connected to the USB interface (host) of the GOT.		
	Keyboard Type	Select the keyboard type to be connected to the USB interface (host) of the GOT. (Japanese 106 Keyboard/English 101 Keyboard)	

1 OVERVIEW

2 GT Designer3 SPECIFICATIONS

3 GT Designer3 OPERATION

4 COMMON SETTING

5 EDITING AND SETTING FIGURES AND OBJECTS

6 LIBRARY

7 TEMPLATE

## ■ SoftGOT-GOT Link tab

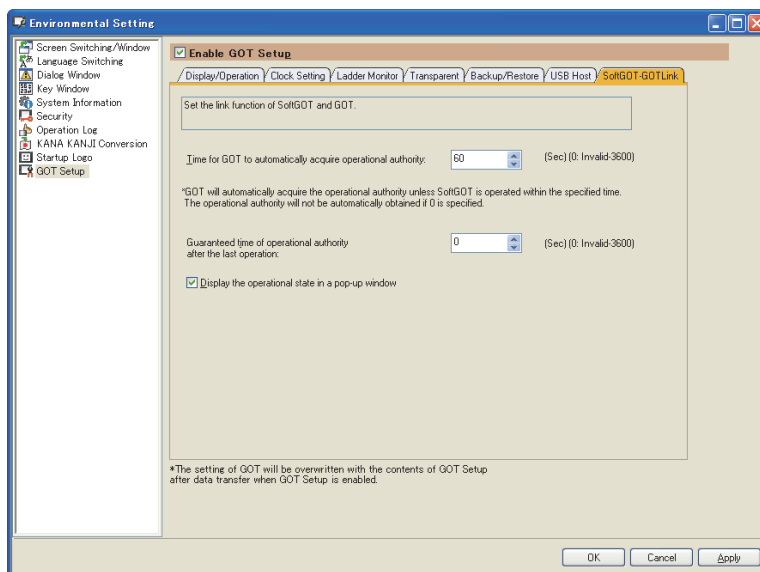

Item	Description	Model
Time for GOT to automatically acquire operational authority	Set the time from when GT SoftGOT1000 is operated after GT SoftGOT1000 obtains the authorization until when the GOT automatically obtains the authorization. (0 to 3600 seconds)	
Guaranteed time of operational authority after the last operation	Set the time to retain the authorization after GT SoftGOT1000 or the GOT obtains the authorization and then GT SoftGOT1000 or the GOT is operated. (0 to 3600 seconds) Until after the set time, GT SoftGOT1000 or the GOT without the authorization cannot obtain the authorization.	gr16 gr15 gr14 gr12 gr11 gr10 SoftGOT1000
Display the operational state in a pop-up window	Select this item to pop up the information of GT SoftGOT1000 or the GOT with the authorization on GT SoftGOT1000 or the GOT without the authorization.	

### POINT

#### Relationship between [Time for GOT to automatically acquire operational authority] and [Guaranteed time of operational authority after the last operation]

With the following settings, [Time for GOT to automatically acquire operational authority] has a higher priority. (After the set time, the GOT automatically obtains the authorization.)

- [Time for GOT to automatically acquire operational authority] is set to one or more seconds.
- [Guaranteed time of operational authority after the last operation] is set to longer than [Time for GOT to automatically acquire operational authority].

## ■ Handy GOT tab



This setting is available only when using the GT1155HS-QSBD and GT1150HS-QLBD.  
For functions and settings relevant to Handy GOT, refer to the following.

GT11 Handy GOT User's Manual

## 4.9.2 How to match clock data between the GOT and controllers

### ■ GOT clock management

GT 16 GT 15 GT 14 GT 12 GT 11 GT 10 Soft GOT 1000

The following types show the GOT clock management method.

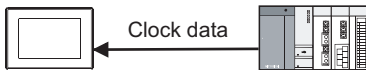
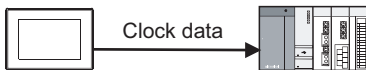
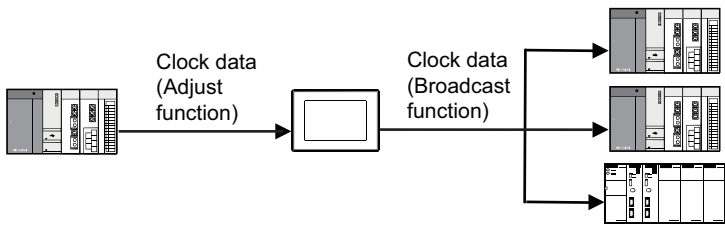
Clock management	Description	Model
Adjust	Adjusts the GOT clock data to the controller clock data. 	
Broadcast	Notifies the controller clock data to the GOT clock data. Not available for the GT1020. 	GT16 GT15 GT14 GT12 GT11 GT10 Soft GOT 1000
Adjust/Broadcast	Uses the adjust function and the broadcast function. 	

#### POINT

##### Controllers available for the adjust function or the broadcast function

Only controllers equipped with a clock are available for the adjust function or the broadcast function. For controllers equipped with a clock and the connection type, refer to the following.

 GOT1000 Series Connection Manual for GT Works3 and a controller used

#### (1) Adjust function

The time of the GOT clock data is adjusted to that of the controller clock data when the GOT is turned on. No battery is required because the GOT does not hold the clock data while the GOT is turned off. To set the controller clock data, refer to the manual of the controller used.

#### (2) Broadcast function

The time of the controller clock data is adjusted to that of the GOT at the timing of triggering. A battery must be installed because the GOT must hold the clock data while the GOT is turned off. To set the GOT clock data, use the utility.

 User's Manual for the GOT used

To use the multi-channel function, the clock data of multiple controllers can be adjusted to the GOT clock data.

#### HINT

##### How to hold the clock data while the GOT is turned off

To hold the GOT clock data while the GOT is turned off, install a battery on the GOT.

**(3) Adjust/Broadcast function**

The following shows an example when using the adjust function and the broadcast function.

- To use the multi-channel function, adjust the clock data of the GOT and multiple controllers to that of one controller.
- Set triggers for the adjust function and the broadcast function, respectively, and use the functions according to the situation.

**■ Changing clock data by using GOT special register (GS)**



The GOT constantly writes clock data into the GOT special register (GS).

The GOT clock data can be changed from the numerical input by using the clock data stored in the GOT special register (GS) and the Time change signal.

**(1) GOT special register (GS)**

**(a) Read device**

Function	Device	Bit number	Description	Model
Time change signal	GS512	b0	Turning on the bit changes the GOT clock data to the data set for the change time (GS513 to GS516).	
Change time	GS513	b8 to b15	lower 2 digits of the year (data format: BCD)	
		b0 to b7	month (data format: BCD)	
	GS514	b8 to b15	day (data format: BCD)	
		b0 to b7	hour (data format: BCD)	
	GS515	b8 to b15	minute (data format: BCD)	
		b0 to b7	second (data format: BCD)	
	GS516	b8 to b15	None	
		b0 to b7	Day of week (data format: BCD) 0: Sunday, 1: Monday, 2: Tuesday, 3: Wednesday, 4: Thursday, 5: Friday, 6: Saturday	

**(b) Write device**

Function	Device	Bit number	Description	Model
Current time	GS650	b8 to b15	lower 2 digits of the year (data format: BCD)	
		b0 to b7	month (data format: BCD)	
	GS651	b8 to b15	day (data format: BCD)	
		b0 to b7	hour (data format: BCD)	
	GS652	b8 to b15	minute (data format: BCD)	
		b0 to b7	second (data format: BCD)	
	GS653	b8 to b15	None	
		b0 to b7	Day of week (data format: BCD) 0: Sunday, 1: Monday, 2: Tuesday, 3: Wednesday, 4: Thursday, 5: Friday, 6: Saturday	

## (2) Changing clock data by using GOT special register

The following shows an example for changing clock data by using the numerical display and numerical input.

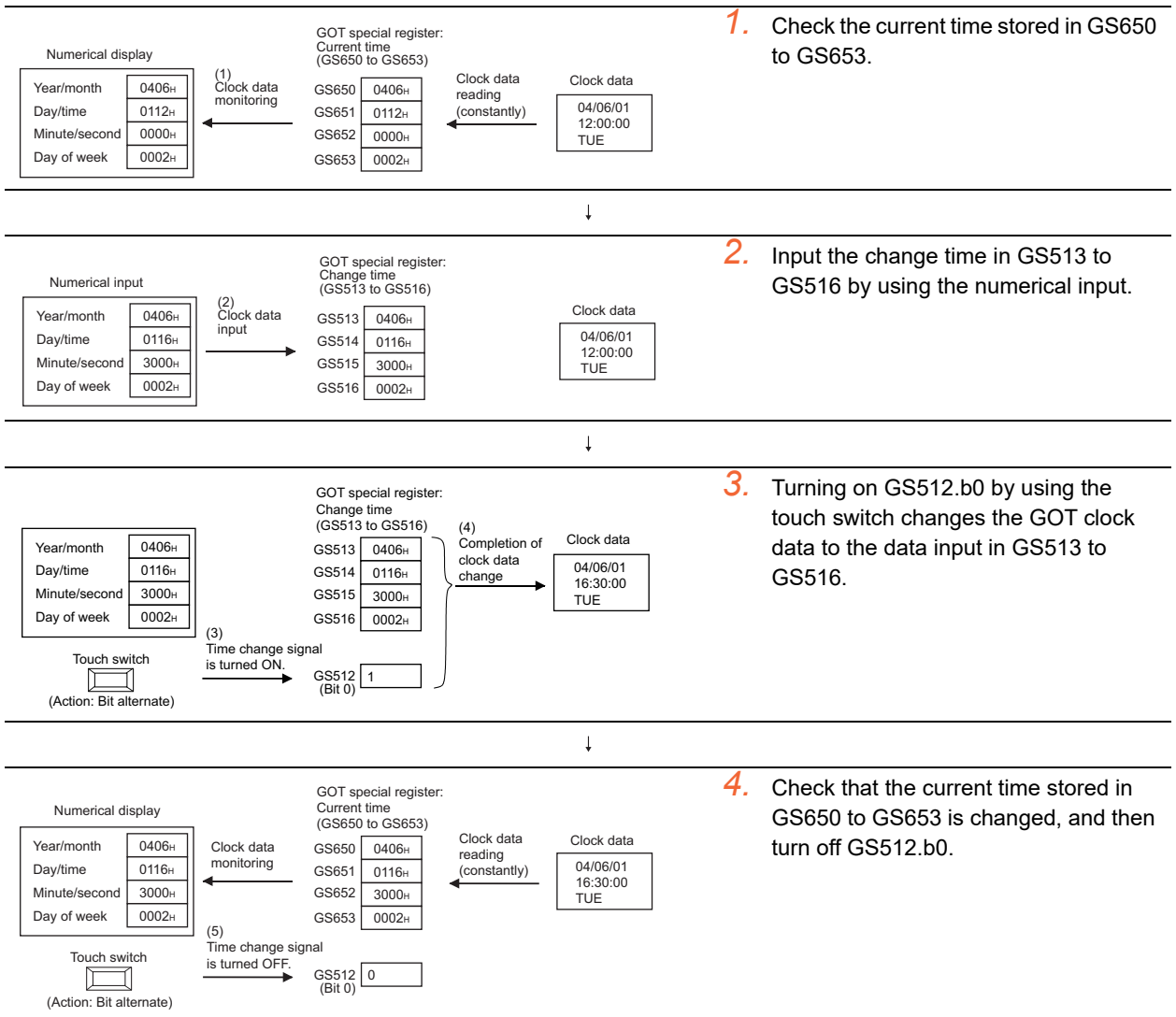

## ■ Adjusting clock data between GT SoftGOT1000 and controller

Because GT SoftGOT1000 uses the clock data of a personal computer, the adjust function and broadcast function are not available.

To adjust the clock data between GT SoftGOT1000 and a controller, the user must adjust the time.

The clock data of GT SoftGOT1000 is always written to a GOT special register (GS).

By writing the clock data stored in a GOT special register (GS) to the controller, the time of the controller can be adjusted to that of GT SoftGOT100.

An example of time adjustment operation is explained below using the method to display the clock data of GT SoftGOT1000 and the controller on the same screen.

Example) When connecting the GT SoftGOT1000 to a QCPU (Q mode)

### (1) Screen image

9h 27' 50", November 1, 2005 Tuesday

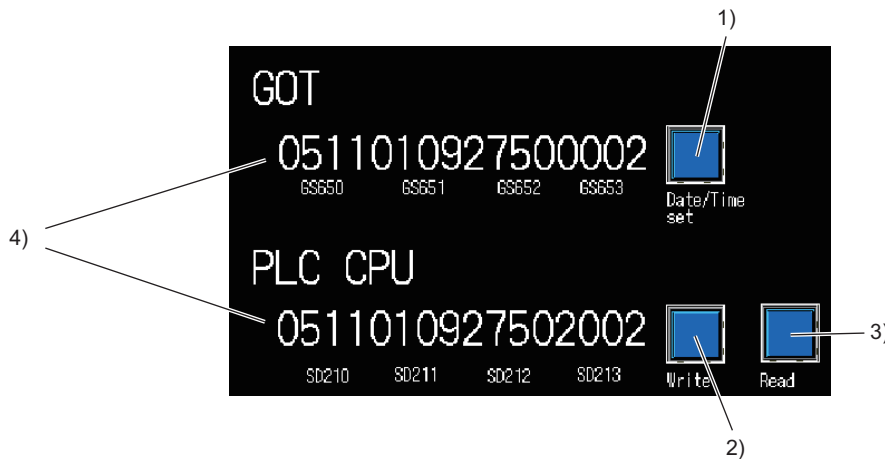





Number	Description
1)	Touching this switch stores the GOT clock data (GS650 to GS653) in the devices (SD210 to SD213) of the controller.
2)	Touching this switch writes the set clock data to the controller.
3)	Touching this switch reads the current clock data from the controller.
4)	Displays the GOT clock data and the controller clock data. Year (lower two digits), Month, Day, Hour, Minute, Seconds, Year (upper two digits) (with GOT, "00" is always displayed), Day of week

### (2) Operation

1. Touch the switch 3) to display the controller clock data in 4).
2. Touch the touch switch 1) to store the GOT clock data (GS650 to GS653) to the devices (SD210 to SD213) in the controller.  
In 4), the values for GS650 to GS653, and SD210 to SD213 are displayed.
3. Touch the touch switch 2) to change the controller clock data.

### (3) Setting details

Item	Object	Description
	Switch	Set the following operations in the [Action] tab. <ul style="list-style-type: none"> <li>• Operation1: word Device: SD210, Data Type: BCD16, [Indirect] of [Type](GS650)</li> <li>• Operation2: word Device: SD211, Data Type: BCD16, [Indirect] of [Type](GS651)</li> <li>• Operation3: word Device: SD212, Data Type: BCD16, [Indirect] of [Type](GS652)</li> <li>• Operation4: word Device: SD213, Data Type:BCD16, [Fixed] of [Type](2000), [Indirect] of [Type](GS653)</li> </ul>
	Bit switch	Set the following items in the [Device] tab. <ul style="list-style-type: none"> <li>• Device: SM213</li> <li>• [Action]: Alternate</li> <li>• [Bit] of [Lamp](SM213)</li> </ul>
	Bit switch	Set the following items in the [Device] tab. <ul style="list-style-type: none"> <li>• Device: SM210</li> <li>• Action: Alternate</li> <li>• [Bit] of [Lamp](SM210)</li> </ul>
	Numerical Input	Set the following items in the [Device/Style] tab. <ul style="list-style-type: none"> <li>• Device: GS650 to GS653</li> <li>• Data Type: BCD16</li> <li>• Unsigned decimal number</li> <li>• Digits: 4</li> <li>• Data type: 2 × 2</li> </ul>
	Numerical Input	Set the following items in the [Device/Style] tab. <ul style="list-style-type: none"> <li>• Device: SD210 to SD213</li> <li>• Data Type: BCD16</li> <li>• Format: Unsigned decimal number</li> <li>• Digits: 4</li> <li>• Size: 2 × 2</li> </ul>

### 4.9.3 Precautions

#### ■ GT Designer3 settings and GOT settings

The items set in [GOT Setup] for the [Environmental Setting] dialog box can be changed with the GOT utility. After changing the settings with the utility, write project data in the GOT. Doing so enables the data set for the [Environmental Setting] dialog box in GT Designer3.

After writing project data to the GOT, change the settings with the utility. Doing so enables the data changed with the utility.

When the project data are read by the GOT, the data set in the utility are reflected.

#### ■ Displaying the utility without the utility call keys

To display the utility without the utility call keys, perform any of the following operations.

- Set a special function switch.  
Place a special function switch, and set [Utility] for [Switch Action].
- Forcibly display the utility by using the GOT.  
The operation method differs according to the GOT used.

GOT	Operation method to forcibly display the utility
GT16, GT1595-X, GT12	Turn on the GOT, and then press the S.MODE switch while [Booting] is displayed at the upper left of the screen.
Models other than the above	Turn on the GOT while touching the upper left of the screen.

To limit the display of the utility, set the password with GT Designer3.

 4.7 Security Setting

## ■ Time setting function and time notification function for network-connected controllers

To display the utility without the utility call keys, perform any of the following operations.

Connection type	Target of time setting function and time notification function
Ethernet connection	Host station
MELSECNET/H connection	Master station
MELSECNET/10 connection	
CC-Link IE Controller Network connection	
CC-Link IE Field Network connection	





## 4.10 Station No. Switching Device Setting



The GOT switches the monitored station numbers by using the station No. switching device.

In a system with the same controlled multiple machines to a network, the multiple machines can be monitored on the same monitor screen by switching the station numbers.

As the number of object to be set can be reduced, the built-in memory of GOT can be saved.

Switching station No. can be carried out for the station No. that can be monitored by GOT.

For more information on station No. that can be monitored by GOT (accessible range), Refer to the following.

☞ GOT1000 Series Connection Manual (Mitsubishi Electric Products) for GT Works3

### Switching station numbers

The GOT monitors a station No. with a value stored in the station No. switching device.

When switching station numbers, objects and figures displayed on the GOT are redrawn.

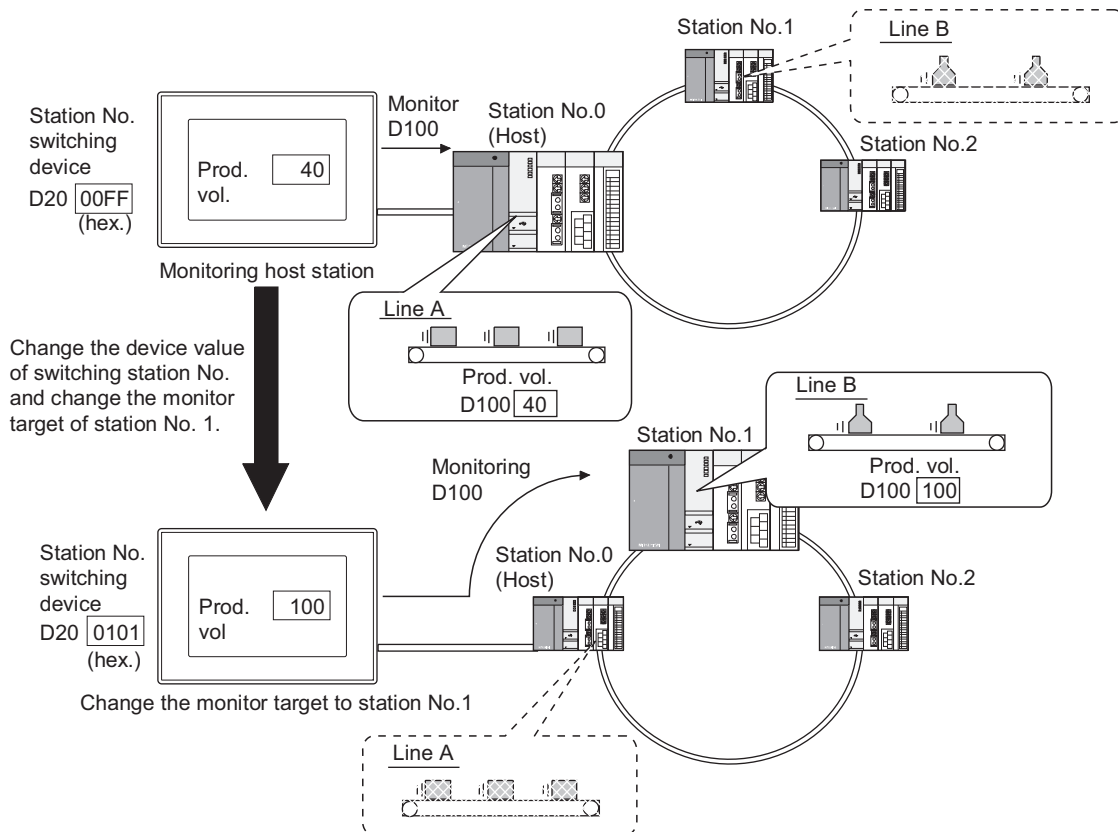

The station No. can be specified in either of the following methods. The station No. is stored into the station No. switching device by the methods.

- Storing a station No. in the station No. switching device
- Switching station numbers with a touch switch (Change Station No, Switch)

### POINT

#### Controllers connected to the GOT and types for specifying station numbers

The types for specifying station numbers differ according to controllers connected to the GOT.

☞ Appendix4 Setting device of each controller

**(1) Storing a station No. in the station No. switching device**

Station No. can be switched if a value is stored in the device for switching station No. as follows:

- When GOT has been incorporated into the data link system (MELSECNET/B, (II)) or CC-Link system

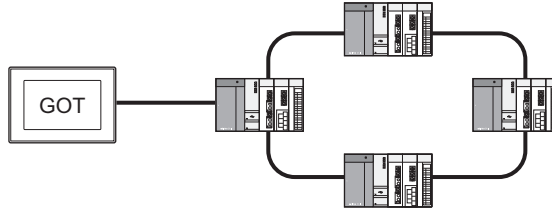

Switching target	Storage value (hexadecimal)
Master station	0000H
Local station (1 to 64)	0001H to 0040H
Station No. set for each object (The same monitor target is set if "Switching station No." has not been set.)	00FEH
Host (connection target) monitor	00FFH

- When the GOT is included in a network system (MELSECNET/H, MELSECNET/10) or Ethernet system

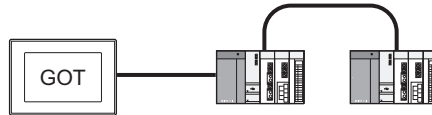

Switching target	Storage value (hexadecimal)
Network No. (1 to 255)	Relation between change target and storage value is as follows:  When monitoring PLC station No: 18, network No.: 1  0112H ├── PLC station No. └── Network No.
PLC station No. (1 to 64)	
Station No. set for each object (The same monitor target is set if "Switching station No." has not been set.)	00FEH
Host station (connection target) monitor	00FFH

**POINT**

**Setting when connecting Ethernet**

For the Ethernet connection, the Ethernet setting is required on GT Designer3.

Refer to the following manual for details of the setting method.

☞ GOT1000 Series Connection Manual for GT Works3 and a controller used

**(2) Switching station numbers with a touch switch (Change Station No, Switch)**

Touch the touch switch dedicated to switching station No. to switch the station No.

☞ (Functions) 2. TOUCH SWITCH

**POINT**

**When using GOT data register (GD) for switching station No. device**

Module connected to station No.0 of network No.0 is monitored until setting the value of switching station No. device (GD) after turning on GOT.

Therefore, the system alarm [402 Communication timeout. Confirm communication pathway or modules.] occurs depending on the connection type.

To not occur the system alarm, create the initial displaying screen and set the value to switching station No. device in the screen.

## 4.10.1 Settings

1. Select [Common] → [Controller Setting] from the menu to display the [Controller Setting] dialog box.
2. Select [Station No. Switching], and set the required items.

### POINT

#### Before setting station No. switching device

To switch station numbers, set whether to enable or disable the function of the switching station No. for each base screen or window screen.

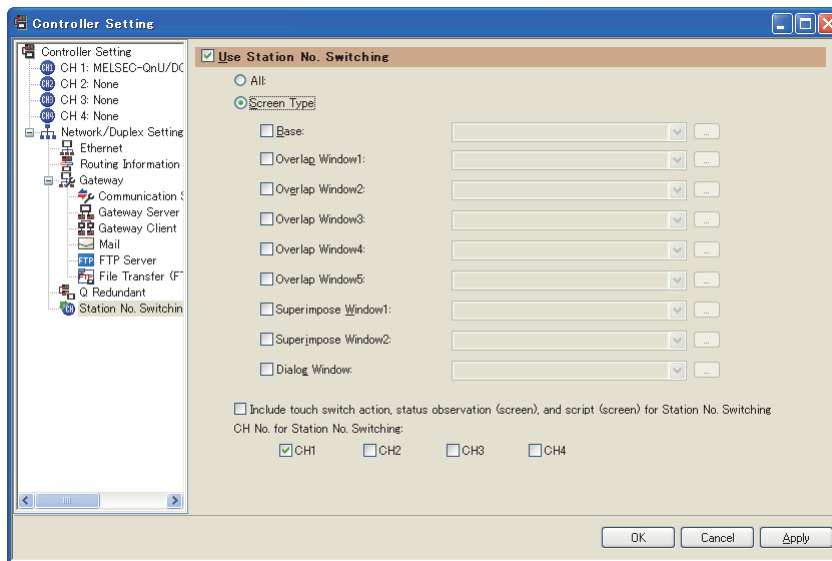

To use the function, select [Switch Station No.] for the [Screen Property] dialog box for each screen.

 3.7 Creating/Opening/Closing Screen

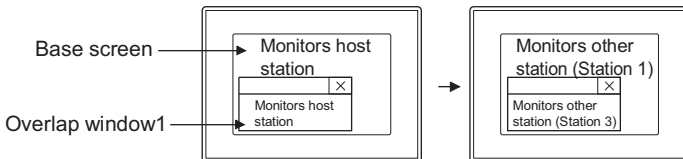

Item	Description	Model	
Use Station No. Switching	Select this item to use the station No. switching device.		
All	Select this item to set the station No. switching device for each project.		
Screen Type	Select this item to set the station No. switching device for each screen. Set the station No. switching device for the selected screen. Example) Monitoring different station numbers between a base screen and an overlap window 1 Example: 		
	Switching station No. device (hexadecimal)		<ul style="list-style-type: none"> <li>● Base screen : 00FFH → : 0101H</li> <li>● Overlap window1 : 00FFH → : 0103H</li> </ul>
	Base		Select this item to set the station No. switching device for the base screen.
	Overlap Window1		Select this item to set the station No. switching device for the overlap window 1.
Overlap Window2	Select this item to set the station No. switching device for the overlap window 2.		

(Continued to next page)

Item	Description		Model
Screen Type	Overlap Window3	Select this item to set the station No. switching device for the overlap window 3.	
	Overlap Window4	Select this item to set the station No. switching device for the overlap window 4.	
	Overlap Window5	Select this item to set the station No. switching device for the overlap window 5.	
	Superimpose Window1	Select this item to set the station No. switching device for the superimpose window 1.	
	Superimpose Window2	Select this item to set the station No. switching device for the superimpose window 2.	
	Dialog Window	Select this item to set the station No. switching device for the dialog window.	
Include touch switch action, status observation (screen), and script (screen) for Station No. Switching	Select this item to be targets a touch switch, status observation (for each screen), and script (for each screen) for switching station numbers.		
CH No. for Station No. Switching	To use the multi-channel function, the selected channels are the target channels for switching station numbers.		

**POINT**

**Actions of the touch switch function, status observation function, or script function**

When using the device of which station No. has been switched to perform all actions of the touch switch function, status observation function, and script function, select [Include touch switch action, status observation (screen), and script (screen) for Station No. Switching].

Object	Function	Monitor/Action object
Touch switch function	ON/OFF figure to display status	Device of which station No. has been switched.
	Device for indirect comment	
	Action at touch	
Status observation function (screen)	Trigger device	Device of which station No. has been switched.
	Action when condition success	Device of which station No. set in GT Designer3
Script function	Screen script, object script	Device of which station No. has been switched.
	Script function monitor device	
	Script function write device	

### 4.10.2 Relevant settings

The station No. switching is available for the relevant settings other than the specific settings. The following shows the function that is available by the relevant settings.

■ **GOT Environmental Setting(Key Window)/Screen Property**

The function can be set in each screen (Screen Property).

Select a screen editor to set a key window, and select [Screen] → [Screen Property] from the menu to display the [Screen Property] dialog box.

 3.7 Creating/Opening/Closing Screen

Function	Setting item	Model
Setting whether to switch station numbers for each screen	[Switch Station No.] on the [Basic] tab	

## 4.10.3 Precautions

### ■ Controller compatible with "Switching station No."

"Station No. switching" is available only when a controller shown below is monitored.

- MELSEC-Q
- MELSEC-L
- MELSEC-QnA
- MELSEC-A
- MELSEC-FX (Only via the Ethernet connection)
- Third party PLCs (Only via the Ethernet connection)
- Temperature controller
- Inverter
- Servo amplifier
- CNC connection
- Robot controller

### ■ Functions not available for switching screen numbers

The devices of the following functions are not compatible with "Switching station No."

GOT monitors the device of the station No. set in each function.

Note that if the object compatible with "Switching station No." has been set in the same screen, GOT will monitor the different station No. depending on the object when carrying out "Switching station No."

- Screen switching function
- Language switching function
- Switching station No. function
- Clock function
- System information function
- Historical data list display<sup>\*5</sup>
- Advanced user alarm observation
- Advanced system alarm observation
- Alarm history display
- Advanced alarm popup display
- User alarm display<sup>\*1</sup>
- Line graph<sup>\*2</sup>
- Trend graph<sup>\*1</sup>
- Scatter graph<sup>\*1</sup>
- Historical Trend Graph<sup>\*5</sup>
- Operation log function
- Logging function
- Recipe function
- Advanced recipe function
- Device data transfer function
- Status observation function<sup>\*3</sup>
- Trigger action function<sup>\*3</sup>
- Time action function
- Script function<sup>\*4</sup>
- Video/RGB display function
- Report function
- Hard copy function
- Gateway function
- MES interface function

\*1 When [Store Memory] is not set, the GOT monitors the device of the station No. set as the switching target.

When [Store Memory] is not set, the GOT monitors the device of the station No. set in the object.

\*2 When [Locus] is not set, the GOT monitors the device of the station No. set as the switching target.

When [Locus] is set, the GOT monitors the device of the station No. set as the object.

\*3 Only when the settings have been made for each project, GOT monitors the device of the station No. set in the object.

GOT monitors the device of the station No. set as the switching target when the settings have been made for each screen.

\*4 The screen script and object script monitor the device of the station No. after switching.

The project script monitors the device of the station No. set at the object.

\*5 Station numbers can be switched other than the logging device.

### ■ Re-drawing the screen after switching station

The screen objects are re-drawn immediately after switching the station No. Thus, the object displaying speed may decrease temporarily.

### ■ Switching station No. during input operation

When inputting a numeric value or ASCII, finish the input operation before switching the station No.

If station No. is switched during inputting operation, the correct data may not be written in the monitored device.

To write a station No. from the controller to a station No. switching device, use the Key window output signal (system signal 2-1. b11), and complete the input operation.

The key window output signal is turned on while the key window is displayed.

### ■ Station No. switching while a dialog window is displayed

In a dialog window, objects operate according to the value of the station No. switching device that is set when the dialog window is displayed.

If the value of the station No. switching device is changed while the dialog window is displayed, the display and operation of the objects on the dialog window are not changed. (The devices for the objects are the same as the devices before the station No. switching.)

# 4.11 Buffer Memory Unit No. Switching Device Setting (Controller Setting)



The GOT switches the monitored buffer memory unit numbers by using the buffer memory unit No. switching device. In a system with the same controlled multiple machines to a network, the multiple machines can be monitored on the same monitor screen by switching the buffer memory unit numbers. As the number of object to be set can be reduced, the built-in memory of GOT can be saved.

Switching buffer memory unit No. can be carried out for the buffer memory that can be monitored by GOT. For more information on buffer memory that can be monitored by GOT (accessible range), refer to the following.

👉 GOT1000 Series Connection Manual (Mitsubishi Electric Products) for GT Works3

## ■ Switching buffer memory unit numbers

The GOT monitors a machine with a value stored in the buffer memory unit No. switching device. When switching buffer memory unit numbers, objects and figures displayed on the GOT are redrawn.

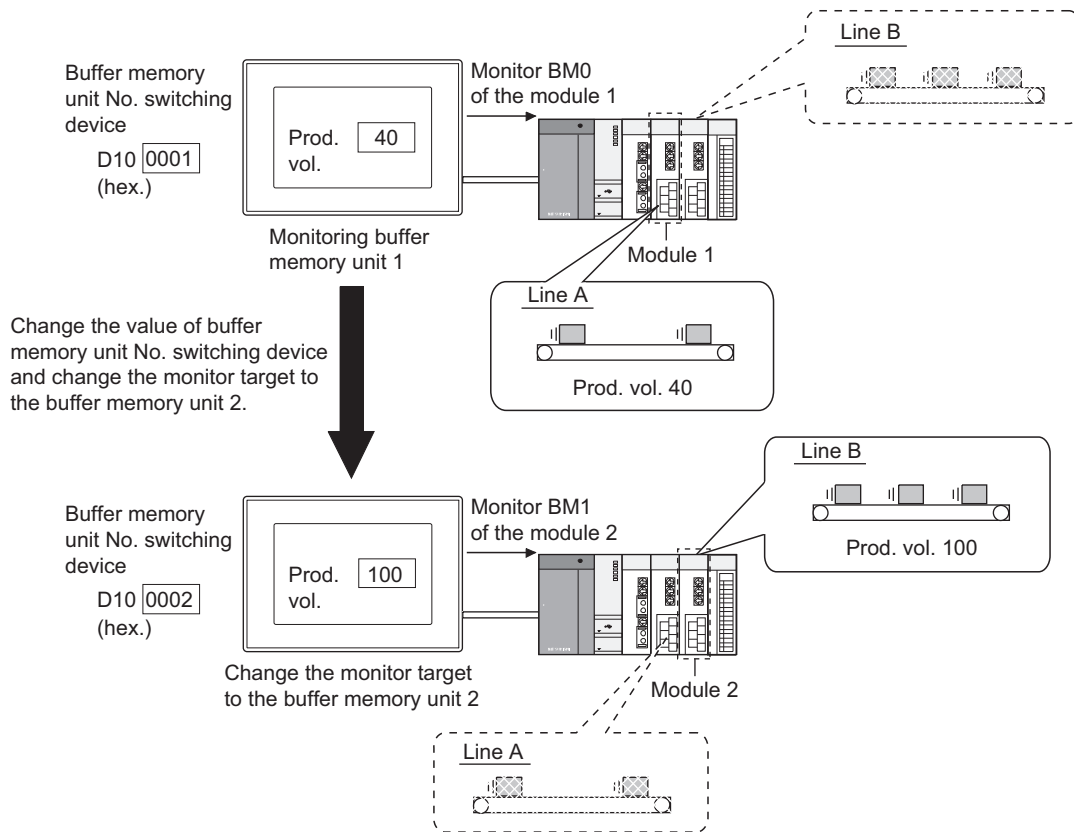

## 4.11.1 Settings

1. Select [Common] → [Controller Setting] from the menu to display the [Controller Setting] dialog box.
2. Select [Buffer Memory Unit No. Switching], and set the required items.

### POINT



#### Before setting buffer memory unit No. switching device

To switch buffer memory unit numbers, set whether to enable or disable the function of the switching buffer memory unit No. for each base screen or window screen.

To use the function, select [Switch buffer memory unit No.] for the [Screen Property] dialog box for each screen.

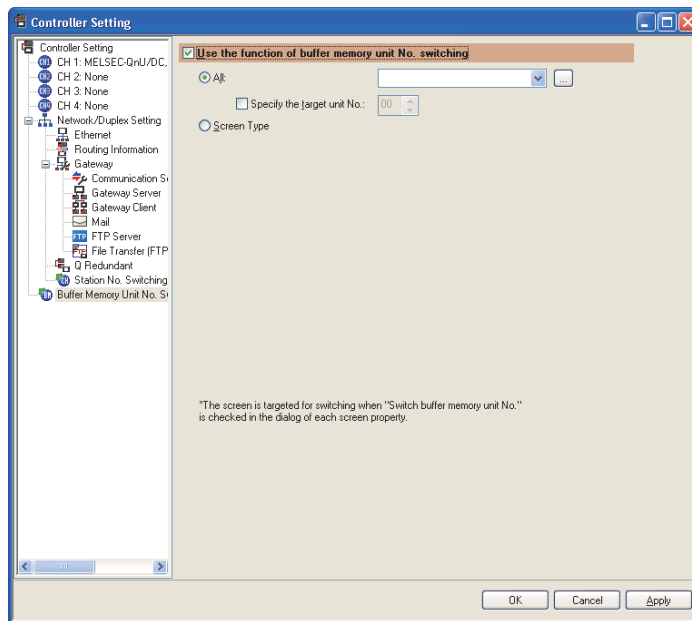
 3.7 Creating/Opening/Closing Screen

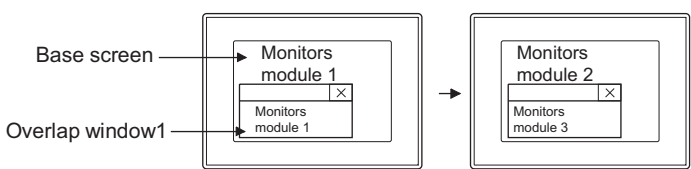

Item	Description	Model
Use the function of buffer memory unit No. switching	Select this item to set the buffer memory unit No. switching device.	
All	Select this item to set the buffer memory unit No. switching device for each project. Select [Specify the target unit No.] to specify the buffer memory unit number for switching.	
Screen Type	Select this item to set the buffer memory unit No. switching device for each screen. Set the buffer memory unit No. switching device for the selected screen. Example) Monitoring different buffer memory units between a base screen and an overlap window 1  Example:  Buffer memory unit No. switching device (hexadecimal) ● Base screen                    D10: 0001H                    → : 0002H ● Overlap window1            D20: 0001H                    → : 0003H	

(Continued to next page)



Item	Description		Model
Screen Type	Base	Select this item to use the buffer memory unit No. switching device for the base screen. To specify the buffer memory unit number, set [Specify] in [Target], and set the unit number.	
	Overlap window1	Select this item to set the buffer memory unit No. switching device for the overlap window 1. To specify the buffer memory unit number, set [Specify] in [Target], and set the unit number.	Gr16 Gr15 Gr14 Gr12 Gr11 Gr10 SerGOT1000
	Overlap window2	Select this item to set the buffer memory unit No. switching device for the overlap window 2. To specify the buffer memory unit number, set [Specify] in [Target], and set the unit number.	
	Overlap window3	Select this item to set the buffer memory unit No. switching device for the overlap window 3. To specify the buffer memory unit number, set [Specify] in [Target], and set the unit number.	
	Overlap window4	Select this item to set the buffer memory unit No. switching device for the overlap window 4. To specify the buffer memory unit number, set [Specify] in [Target], and set the unit number.	Gr16 Gr15 Gr14 Gr12 Gr11 Gr10 SerGOT1000
	Overlap window5	Select this item to set the buffer memory unit No. switching device for the overlap window 5. To specify the buffer memory unit number, set [Specify] in [Target], and set the unit number.	
	Superimpose window1	Select this item to set the buffer memory unit No. switching device for the superimpose window 1. To specify the buffer memory unit number, set [Specify] in [Target], and set the unit number.	
	Superimpose window2	Select this item to set the buffer memory unit No. switching device for the superimpose window 2. To specify the buffer memory unit number, set [Specify] in [Target], and set the unit number.	Gr16 Gr15 Gr14 Gr12 Gr11 Gr10 SerGOT1000
	Dialog Window	Select this item to set the buffer memory unit No. switching device for the dialog window. To specify the buffer memory unit number, set [Specify] in [Target], and set the unit number.	

## 4.11.2 Relevant settings

The buffer memory unit No. switching is available for the relevant settings other than the specific settings. The following shows the function that is available by the relevant settings.

### ■ GOT Environmental Setting (Key Window)/Screen Property

The function can be set in each screen (Screen Property).

Select a screen editor to set a key window, and select [Screen] → [Screen Property] from the menu to display the [Screen Property] dialog box.

 3.7 Creating/Opening/Closing Screen

Function	Setting item	Model
Setting whether to switch buffer memory unit numbers for each screen	[Switch buffer memory unit No.] on the [Basic] tab	Gr16 Gr15 Gr14 Gr12 Gr11 Gr10 SerGOT1000

### 4.11.3 Precautions

---

#### ■ Controller compatible with "Switching buffer memory unit No."

"Buffer memory unit No. switching" is available only when a controller shown below is monitored.

- MELSEC iQ-R series
- MELSEC iQ-F
- MELSEC-Q
- MELSEC-L
- MELSEC-QnA
- MELSEC-A
- CNC connection
- Robot controller

#### ■ Functions not available for switching buffer memory unit numbers

The devices of the following functions are not compatible with "Switching buffer memory unit No."

GOT monitors the device set in each function.

Note that if the object compatible with "Switching buffer memory unit No." has been set in the same screen, GOT will monitor the different buffer memory depending on the object when carrying out "Switching buffer memory unit No."

- Screen switching function
- Switching station No. function
- Clock function
- Historical data list display<sup>\*5</sup>
- Advanced user alarm observation
- Advanced system alarm observation
- Alarm history display
- Advanced alarm popup display
- Line graph<sup>\*2</sup>
- Trend graph<sup>\*1</sup>
- Scatter graph<sup>\*1</sup>
- Historical Trend Graph<sup>\*5</sup>
- Operation log function
- Logging function
- Recipe function
- Advanced recipe function
- Device data transfer function
- Status observation function<sup>\*3</sup>
- Trigger action function<sup>\*3</sup>
- Time action function
- Script function<sup>\*4</sup>
- Video/RGB display function
- Report function
- MES interface function

\*1 When [Store Memory] is not set, the GOT monitors the buffer memory after buffer memory unit No. switching.

When [Store Memory] is set, the GOT monitors the device with the buffer memory set in the object.

\*2 When [Locus] is not set, the GOT monitors the buffer memory after buffer memory unit No. switching.

When [Locus] is set, the GOT monitors the device with the buffer memory set in the object.

\*3 Only when the settings have been made for each project, GOT monitors the buffer memory after buffer memory unit No. switching.

GOT monitors the device with the buffer memory set in the object when the settings have been made for each screen.

\*4 The screen script and object script monitor the buffer memory after buffer memory unit No. switching.

The project script monitors the device with the buffer memory set in the object.

\*5 Buffer memory unit numbers can be switched other than the logging device.

#### ■ Re-drawing the screen after switching buffer memory unit number

The screen objects are re-drawn immediately after switching the buffer memory unit number. Thus, the object displaying speed may decrease temporarily.

# 4.12 Comment Setting



Comments are character strings registered by the user using GT Designer3. Comments can be displayed with objects by registering the objects as a basic comment or a comment group in advance.

Example 1) Displaying comments registered in basic comments by the comment display  
 The comments registered as basic comments are displayed.  
 The comment No. corresponding to the monitored device value is displayed.

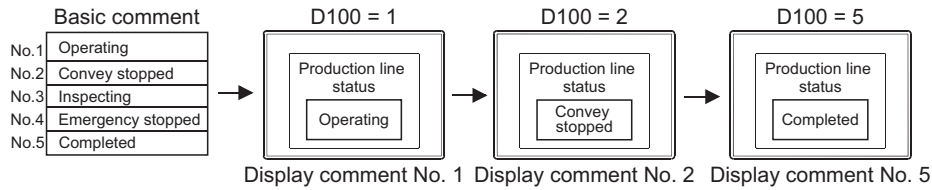

Example 2) Displaying comments registered in a comment group by the comment display  
 The comments registered in comment group are displayed.  
 The comment No. corresponding to the monitored device value is displayed.  
 The column of the comment displayed can be switched by the language switching device.

☞ 4.3 Language Switching Device Setting

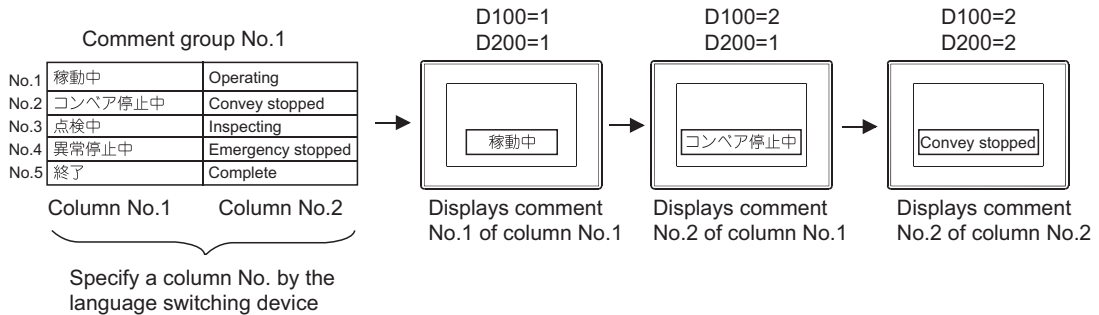

## ■ Specifications of basic comments and comment groups

The following shows the specifications of the basic comment and comment group.

Item	Specifications	
	Basic comment	Comment group
Max. No. of groups	1	Up to 255
Max. No. of comments	Up to 32767	Up to 3276 for each comment group
No. of comment columns	1	10 for each comment group
Title	Change not allowed (Fixed as [Basic Comment])	Can be changed (Up to 32 characters regardless of 1byte or 2byte characters)
KANJI region specification	None (Japan only)	Japan, China (GB) - Mincho, China (Big5) - Gothic
[Edit Comment] dialog box	Up to 10 of basic comments and comment groups can be displayed simultaneously (This number varies depending on the performance of the personal computer used.)	
Applicable object	Touch switch, Comment display, Data list, Alarm history, User alarm display, Report function	Touch switch, Lamp (Bit/Word), Comment display, Advanced user alarm display, Alarm history display, Advanced alarm popup display, Report function
Font	16dot (Standard/HQ Mincho)	12dot (Standard/HQ Mincho/HQ Gothic) 16dot (Standard/HQ Mincho/HQ Gothic)
Comment	Up to 512 characters for each comment regardless of 1byte or 2byte characters	
Type of importable or exportable file	Test file, CSV file, Unicode text file	CSV file, Unicode text file

Up to 32767 comments can be registered.

Comment No.	Comment	Text	Invert	Blink	HQ	Style	Solid
1	LINE A Normal operation	<input type="checkbox"/>	No	None	<input type="checkbox"/>	Regular	<input type="checkbox"/>
2	LINE B Normal operation	<input type="checkbox"/>	No	None	<input type="checkbox"/>	Regular	<input type="checkbox"/>
3	LINE A Emergency stop	<input type="checkbox"/>	No	None	<input type="checkbox"/>	Regular	<input type="checkbox"/>
4	LINE B Emergency stop	<input type="checkbox"/>	No	None	<input type="checkbox"/>	Regular	<input type="checkbox"/>

Basic Comment

Up to 255 groups can be registered.

Up to 32767 comments can be registered.

Column No.	Comment No.	Comment	Text	Invert	Blink	High Quality Font				Style	Solid
						12dot Gothic	12dot Mincho	16dot Gothic	16dot Mincho		
1	1	Aライン提供コンベア停止	<input type="checkbox"/>	No	None	<input type="checkbox"/>	<input type="checkbox"/>	<input type="checkbox"/>	<input type="checkbox"/>	Regular	<input type="checkbox"/>
	2	A-Line supply conveyer stopped.	<input type="checkbox"/>	No	None	<input type="checkbox"/>	<input type="checkbox"/>	<input type="checkbox"/>	<input type="checkbox"/>	Regular	<input type="checkbox"/>
	2	非常停止リミット作動	<input type="checkbox"/>	No	None	<input type="checkbox"/>	<input type="checkbox"/>	<input type="checkbox"/>	<input type="checkbox"/>	Regular	<input type="checkbox"/>
	3	Emergency stop limit switch operate.	<input type="checkbox"/>	No	None	<input type="checkbox"/>	<input type="checkbox"/>	<input type="checkbox"/>	<input type="checkbox"/>	Regular	<input type="checkbox"/>
	3	加工品リミット作動せず	<input type="checkbox"/>	No	None	<input type="checkbox"/>	<input type="checkbox"/>	<input type="checkbox"/>	<input type="checkbox"/>	Regular	<input type="checkbox"/>
	4	Product limit does not operate.	<input type="checkbox"/>	No	None	<input type="checkbox"/>	<input type="checkbox"/>	<input type="checkbox"/>	<input type="checkbox"/>	Regular	<input type="checkbox"/>
	4	加工機-1の油圧低下	<input type="checkbox"/>	No	None	<input type="checkbox"/>	<input type="checkbox"/>	<input type="checkbox"/>	<input type="checkbox"/>	Regular	<input type="checkbox"/>
		Hydraulic pressure of finishing machine 1 is low.	<input type="checkbox"/>	No	None	<input type="checkbox"/>	<input type="checkbox"/>	<input type="checkbox"/>	<input type="checkbox"/>	Regular	<input type="checkbox"/>

Up to 10 columns can be set

Comment Group

## 4.12.1 Displaying the [Comment List] dialog box

### ■ Basic comment

1. Select [Common] → [Comment] → [Open] from the menu to display the [Open Comment Group] dialog box.

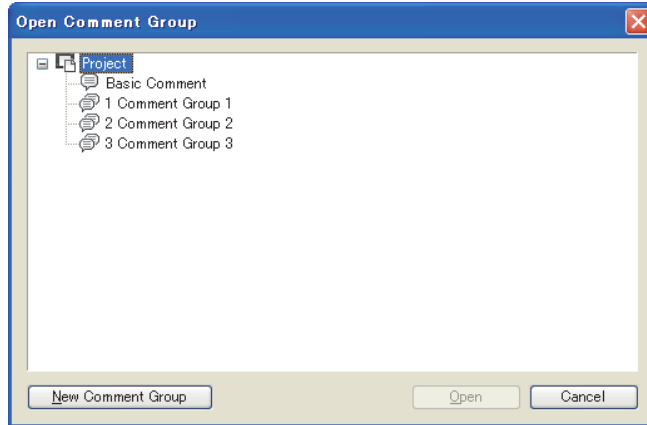

2. Select [Basic Comment], and click the [Open] button to display the [Basic Comment List] dialog box. For operation of the [Basic Comment List] dialog box, refer to the following.

☞ 4.12.2 Basic operations for comment registration

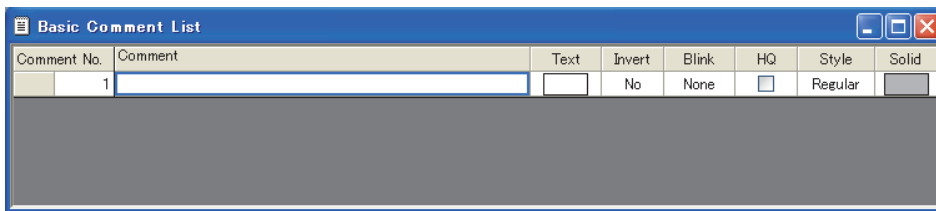

### HINT

#### Operating by the project tree

Double-click [Basic Comment] in the project tree to display the [Comment List] dialog box.

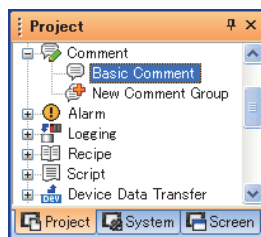

## ■ Comment group

### (1) Creating a new comment group

1. Select [Common] → [Comment] → [New Comment Group] from the menu to display the [Comment Group Property] dialog box.

☞ 4.11.2 ■Basic operations for comment registration (1) Comment Group Property dialog box

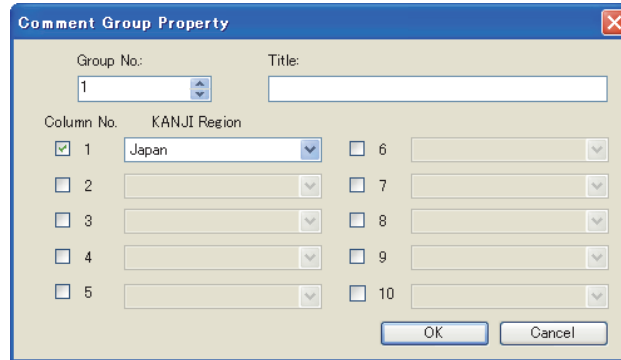

### Operating by the project tree

Double-click [New Comment Group] in the project tree to display the [Comment Group Property] dialog box.

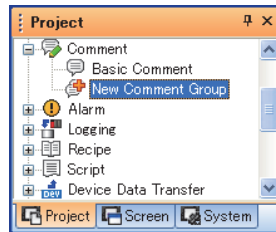

2. Set the required items, and click the [OK] button to display the [Comment List] dialog box. For operation of the [Comment List] dialog box, refer to the following.

☞ 4.12.2 Basic operations for comment registration

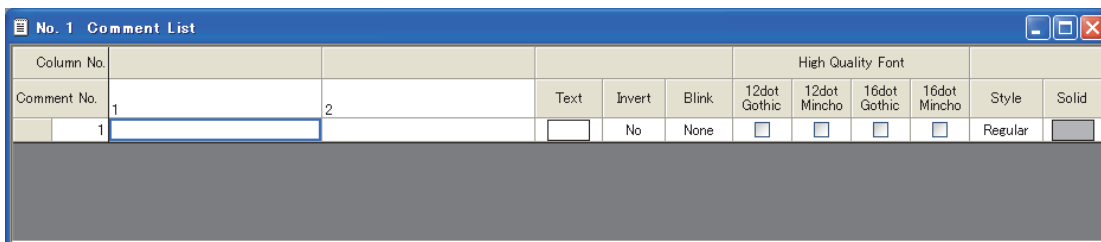

## (2) Displaying a existing comment group

1. Select [Common] → [Comment] → [Open] from the menu to display the [Open Comment Group] dialog box.

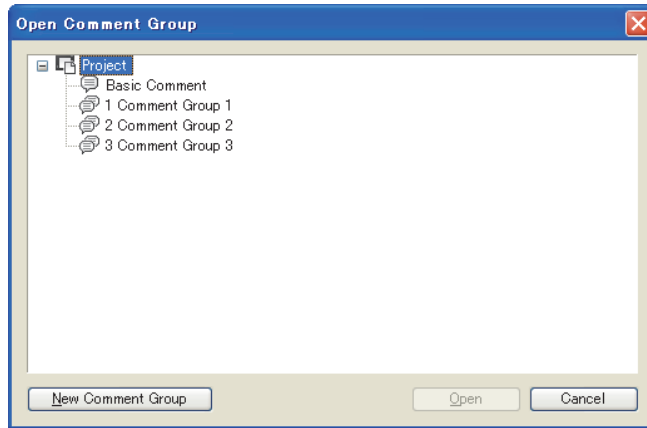

2. Select a comment group to be opened, and click the [OK] button to display the [Comment List] dialog box for the selected comment group.  
For operation of the [Comment List] dialog box, refer to the following.

☞ 4.12.2 Basic operations for comment registration

No. 1 Comment Group 1 Comment List												
Column No.			High Quality Font									
Comment No.	1	2	Text	Invert	Blink	12dot Gothic	12dot Mincho	16dot Gothic	16dot Mincho	Style	Solid	
	1	Aライン提供コンベア停止	A-Line supply conveyer stopped.	<input type="checkbox"/>	No	None	<input type="checkbox"/>	<input type="checkbox"/>	<input type="checkbox"/>	<input type="checkbox"/>	Regular	<input type="checkbox"/>
	2	非常停止リミット作動	Emergency stop limit switch operate.	<input type="checkbox"/>	No	None	<input type="checkbox"/>	<input type="checkbox"/>	<input type="checkbox"/>	<input type="checkbox"/>	Regular	<input type="checkbox"/>
	3	加工品リミット作動せず	Product limit does not operate.	<input type="checkbox"/>	No	None	<input type="checkbox"/>	<input type="checkbox"/>	<input type="checkbox"/>	<input type="checkbox"/>	Regular	<input type="checkbox"/>
	4	加工機-1の油圧低下	Hydraulic pressure of finishing machine 1 is low.	<input type="checkbox"/>	No	None	<input type="checkbox"/>	<input type="checkbox"/>	<input type="checkbox"/>	<input type="checkbox"/>	Regular	<input type="checkbox"/>

## 4.12.2 Basic operations for comment registration

### ■ Basic operations of toolbar (Comment list setting)





Icon	Description	Shortcut key
	Adds a new row.	-
	Inserts a row above the selected row.	-
	Inserts a column on the left of the selected column.	-
	Imports comments from a CSV file or Unicode text file to GT Designer3.	-
	Exports comments from GT Designer3 to a CSV file or Unicode text file.	-
	Displays the [Search] dialog box. (2) Search dialog box	-
	Displays the [Jump] dialog box. (3) Jump dialog box	-
	Displays the [Attribute Setting] dialog box. (4) Attribute Setting dialog box	-
	Select whether to display the comment attribute.	-
	Creates a new comment group.	-
	Displays the [Comment Group Property] dialog box for the selected comment group. (1) Comment Group Property dialog box	-

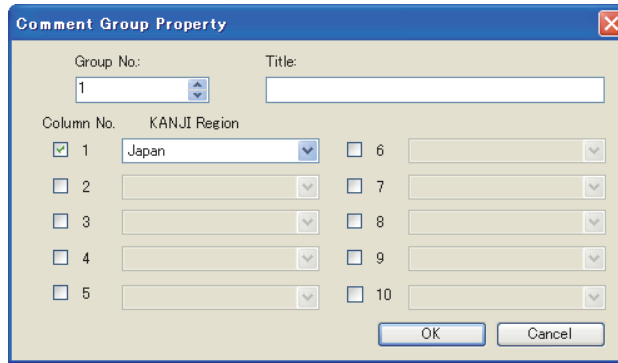

**(1) Comment Group Property dialog box**

Select [Common] → [Comment] → [New Comment Group] from the menu to display the [Comment Group Property] dialog box.



Item	Description	Model
Group No.	Set a group No. of the comment group.	GT16 GT15
Title	Set a title of the comment group (up to 32 characters).	GT14 GT12
Column No.	Select the column No. to set multiple comment columns.	GT11 GT10 SoftGT1000
KANJI Region	<p>Select the kanji region used for each comment.</p> <p> 2.5 Specifications of Applicable Characters</p> <p>Japan: Japanese kanji characters are displayed.</p> <p>China(GB)-Mincho: Chinese characters (simplified) are displayed.</p> <p>China(Big5)-Gothic: Displays traditional Chinese characters.</p> <p>Example: Difference between "Japan" and "China (GB) - Mincho"</p> <div style="display: flex; justify-content: space-around; align-items: center;"> <div style="text-align: center;">  Japan         </div> <div style="text-align: center;">  China (GB) -Mincho         </div> </div>	GT16 GT15 GT14 GT12 GT11 GT10 SoftGT1000

**POINT**

**Kanji region setting**

This setting is necessary when using kanji for each comment column. However, because this is not the language setting, you do not have to change the setting from the default (Japan) if using a language irrelevant to kanji (e.g. English).

Column No.	Comment No.	1	2
	1	Aライン供給コンベア停止。	A-line supply conveyer stopped.
	2	非常停止リミット作動。	Emergency stop limit switch operated.
	3	加工品リミット油圧低下	Product limit switch does not operate.
	4	加工機-1の油圧低下。	Hydraulic pressure of finishing machine 1 is low.

English can be entered and displayed even if the kanji region is set to Japan.

(2) Search dialog box

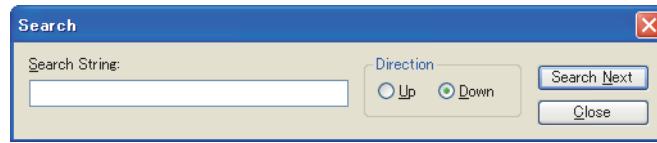

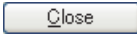
Item	Description	Model
Search Setting	Enter character strings to be searched.	
Direction	Select the search direction.	er16 er15 er14 er12 er11 er10 SoftGot1000
	Searches for the character strings entered in [Search Next].	
	Closes the [Search] dialog box.	

(3) Jump dialog box

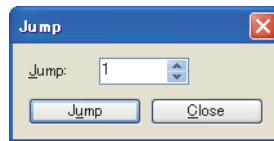

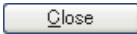

Item	Description	Model
Jump	Specify a jumping target comment No.	
	Changes the row of the comment No. specified in [Jump] to the selected status.	er16 er15 er14 er12 er11 er10 SoftGot1000
	Closes the [Jump] dialog box.	

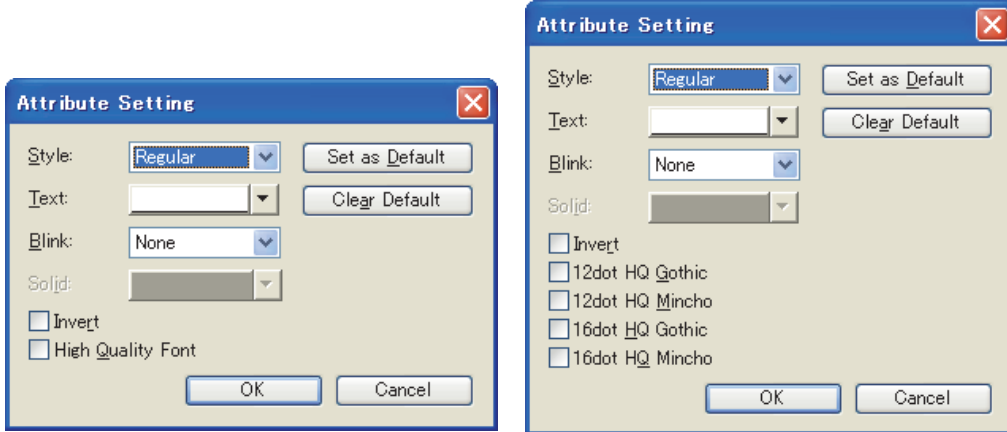
**(4) Attribute Setting dialog box**  
Set comment attributes (e.g. style, text color).



Attribute Setting Dialog box for Basic Comment

Attribute Setting dialog box for Comment Group

Item	Description	Model
Style	Select a style (font) of the comment.  Regular Bold Solid Raised	
Text	Select a color of the comment.	
Blink	Select this item to select how to blink the comment. (None/Low/Middle/High)	
Solid	Select a shadow color when [Solid] or [Raised] is selected for [Style].	
Invert	Select this item to highlight the comment.	
High Quality Font	Select this item to display the comment as the HQ characters.	
12dot Gothic	Select this item to display the comment as the 12-dot HQ Gothic characters. Not available for the GT1020.	
12dot HQ Mincho	Select this item to display the comment as the 12-dot HQ Mincho characters. Not available for the GT1020.	
16dot HQ Gothic	Select this item to display the comment as the 16-dot HQ Gothic characters.	
16dot HQ Mincho	Select this item to display the comment as the 16-dot HQ Mincho characters.	
Set as Default	Click this button to set the changed attributes as a specified setting.	
Clear Default	Click this button to return the changed attributes to the default setting.	





## Basic operation in the project tree

Comments can be managed by the project tree.

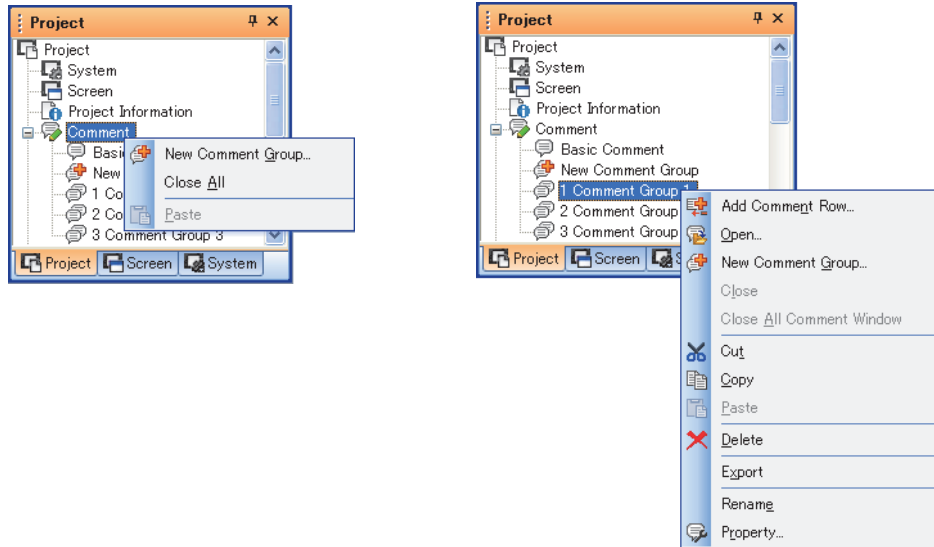
Right-click the items to be operated, the menu appears.

The menu options displayed vary depending on the selected target.



Item	Description	Model
Add Comment Row	Displays the [Comment List] dialog box for the selected basic comment and comment group, and adds a comment row.  ■Comment List dialog box	
Open	Displays the [Comment List] dialog box for the selected comment group.  ■Comment List dialog box	
New Comment Group	Creates a new comment group. After selecting this item, the [Comment Group Property] dialog box appears. Set a group No., title, and KANJI region of a comment group.  ■Basic operations of toolbar (Comment list setting) (1) Comment Group Property dialog box	
Close	Closes the selected [Comment List] dialog box.	
Close All Comment Window	Closes all the displayed [Comment List] dialog box.	gr16 gr15
Close All		gr14 gr12
Cut	Cuts all selected comment groups.	gr11 gr10
Copy	Copies the selected comment group.	SoftGot1000
Paste	Pastes the copied or cut comment group.	
Delete	Deletes the selected comment group.	
Export	Stores the selected basic comments and comment groups in a text file or CSV file.	
Rename	Change the comment group name.	
Property	Select this item to display the [Group Property] dialog box, and change the settings of the group No., title, and KANJI region.  ■Basic operations of toolbar (Comment list setting) (1) Comment Group Property dialog box	

## ■ Comment List dialog box

This dialog box is displayed by operations from the project tree or the [Open Comment Group] dialog box. Add new comments with the toolbar or the menu displayed by right-clicking the mouse.

### (1) Comment List dialog box for Basic Comment

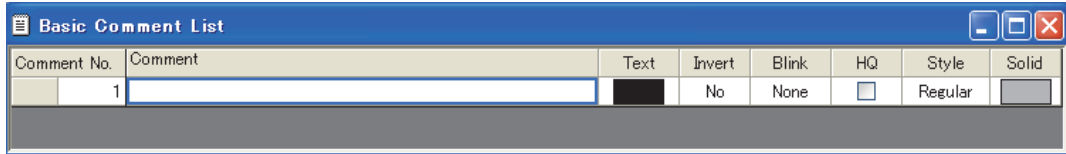

#### (a) Setting items for Basic Comment List

Item	Description	Model
Comment No.	Displays the comment number.	
Comment	Enter a comment.	
Text	Select a display color of the comment.	
Invert	Check this when making the comment highlighted.	
Blink	Specify how the comment is to be blinked (None/Low/Middle/High).	
HQ	Check this when displaying the comment in a HQ font.	GT16 GT15 GT14 GT12 GT11 GT10 SenGT1000
Style	Select a style (font) to display the comment.  Regular Bold Solid Raised	
Solid	Select a shadow color when [Solid] or [Raised] is selected in [Style].	



#### Display of information in the comment column

Point the cursor to a cell in the comment column to display the numbers of characters, digits, and lines of the input comment on the status bar.

- Number of characters: A one-byte or two-byte character is counted as one character, and a line feed is counted as two characters.
- Number of digits: A one-byte character is counted as one digit, and a two-byte character is counted as two digits. The number of digits of the line with the largest number of digits is displayed.
- Number of lines: The number of lines of the comment is displayed. When only a line feed is inserted without characters, the line feed is counted as one line.

(b) Menu displayed by right clicking

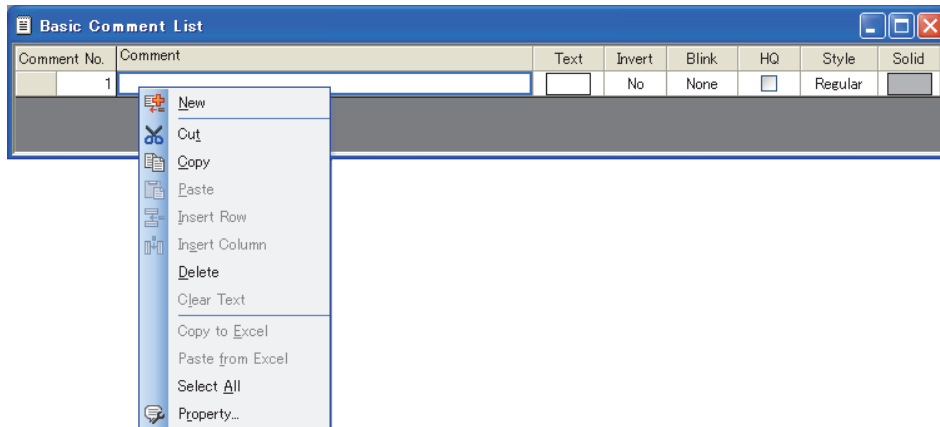

Item	Description	Model
New	Adds a new comment row.	
Cut <sup>*1</sup>	Cuts a comment selected.	
Copy	Copies a comment selected.	
Paste	Pastes a comment copied or cut.	
Insert Row	Inserts a row to the row selected.	
Insert Column	Inserts a column to the selected column. Not available for the [Basic Comment List] dialog box.	
Delete <sup>*1</sup>	Deletes a comment selected.	gr16 gr15 gr14 gr12 gr11 gr10 SoftGo1000
Clear Text	Clears a comment of the row or column selected. <sup>*3</sup>	
Copy to Excel	Copies a comment selected to Excel. Copy a comment in row or column unit. <sup>*3</sup> After copying, paste the comment on Excel.	
Paste from Excel	Pastes a comment selected from Excel. Copy or cut a comment on Excel and paste it on the [Basic Comment List] dialog box.	
Select All	Selects all comments in Basic Comment List.	
Property	Displays the Attribute Setting dialog box of the comment selected. <sup>*2</sup>	

\*1 Disabled for an entire column.

\*2 For the Attribute Setting dialog box, refer to the following.



■ Basic operations of toolbar (Comment list setting) (4) Attribute Setting dialog box

\*3 When selecting a column, select the Comment column.

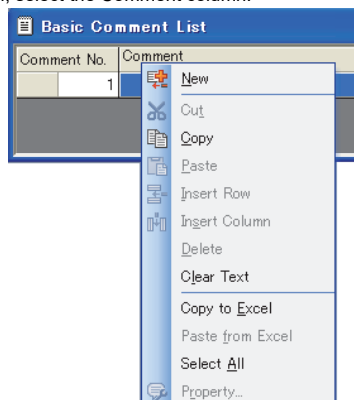

**HINT**

**(1) How to select more than one comment**

If there is more than one comment, all the comments can be selected by the operations below.

- Clicking the left-upper cell ([Comment No.]
- Selecting [Select All] from the menu displayed by right-clicking

**(2) Reusing comments between different projects**

Comments can be pasted to the different project comment with the drop-down menu displayed by right-clicking.

☞ ■ Comment List dialog box (1) (b) Menu displayed by right clicking

**(3) Batch setting of Text, Rev, Blink, High Quality Font, Style or Solid**

You can apply the same setting to all comments simultaneously by selecting a column before making a setting.

Comment No.	Comment	Text	Invert	Blink	HQ	Style	Solid
1	Line A error		No	None	<input type="checkbox"/>	Regular	<input type="checkbox"/>
2	Line B error		No	None	<input type="checkbox"/>	Regular	<input type="checkbox"/>
3	Line C error		No	None	<input type="checkbox"/>	Regular	<input type="checkbox"/>
4	Line D error		No	None	<input type="checkbox"/>	Regular	<input type="checkbox"/>
5	Line E error		No	None	<input type="checkbox"/>	Regular	<input type="checkbox"/>

1. Select a column.

Comment No.	Comment	Text	Invert	Blink	HQ	Style	Solid
1	Line A error		No	None	<input type="checkbox"/>	Regular	<input type="checkbox"/>
2	Line B error		Yes	None	<input type="checkbox"/>	Regular	<input type="checkbox"/>
3	Line C error		No	None	<input type="checkbox"/>	Regular	<input type="checkbox"/>
4	Line D error		No	None	<input type="checkbox"/>	Regular	<input type="checkbox"/>
5	Line E error		No	None	<input type="checkbox"/>	Regular	<input type="checkbox"/>

2. Make a setting with the column selected.



Comment No.	Comment	Text	Invert	Blink	HQ	Style	Solid
1	Line A error		Yes	None	<input type="checkbox"/>	Regular	<input type="checkbox"/>
2	Line B error		No	None	<input type="checkbox"/>	Regular	<input type="checkbox"/>
3	Line C error		No	None	<input type="checkbox"/>	Regular	<input type="checkbox"/>
4	Line D error		No	None	<input type="checkbox"/>	Regular	<input type="checkbox"/>
5	Line E error		No	None	<input type="checkbox"/>	Regular	<input type="checkbox"/>

3. All comments are batch set to the same.

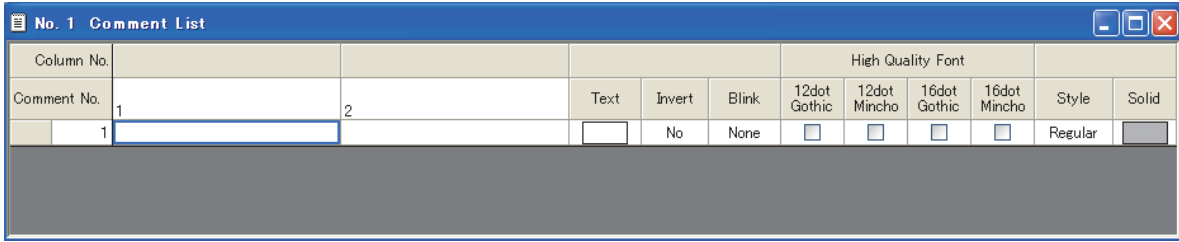
**(2) Comment List dialog box for comment groups**

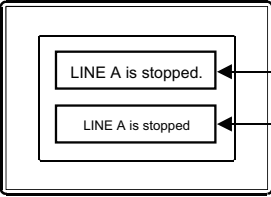

(a) Setting items for Comment List

Item	Description	Model	
Comment No.	Set a comment No.		
Column No.	Set a comment column No.		
Text	Select a color of the comment.		
Invert	Check this when making the comment highlighted.		
Blink	Specify how the comment is to be blinked (None/Low/Middle/High).		
High Quality Font	<p>Check this when displaying the comment in a HQ font.                      This setting enables the GOT to display a comment with the HQ characters for an object.                      (When setting the HQ characters that is not set in the comment list for an object, the comment cannot be displayed as the HQ characters.)                      Example: When comments are registered, only [16dot Gothic] is selected</p>  <p>When the font is specified to 16dot HQ Gothic. The comment is displayed in 16dot HQ Gothic.</p> <p>When the font is specified to 12dot HQ Gothic. The comment is displayed in 12dot regular because 12dot HQ Gothic was not checked in comment registration.</p>		
	12dot Gothic	Check this when displaying the comment in 12-dot HQ Gothic. Not available for the GT1020.	
	12dot Mincho	Check this when displaying the comment in 12-dot HQ Mincho. Not available for the GT1020.	
	16dot Gothic	Check when displaying the comment in 16-dot HQ Gothic.	
	16dot Mincho	Check when displaying the comment in 16-dot HQ Mincho.	
Style	<p>Select a style (font) to display the comment.</p>  <p>Regular Bold Solid Raised</p>		
Solid	Select a shadow color when [Solid] or [Raised] is selected in [Style].		

gr16 gr15  
gr14 gr12  
gr11 gr10  
SoftGOT1000



## HINT

### Display of information in the comment column

Point the cursor to a cell in the comment column to display the numbers of characters, digits, and lines of the input comment on the status bar.

- Number of characters: A one-byte or two-byte character is counted as one character, and a line feed is counted as two characters.
- Number of digits: A one-byte character is counted as one digit, and a two-byte character is counted as two digits. The number of digits of the line with the largest number of digits is displayed.
- Number of lines: The number of lines of the comment is displayed. When only a line feed is inserted without characters, the line feed is counted as one line.

(b) Menu displayed by right clicking

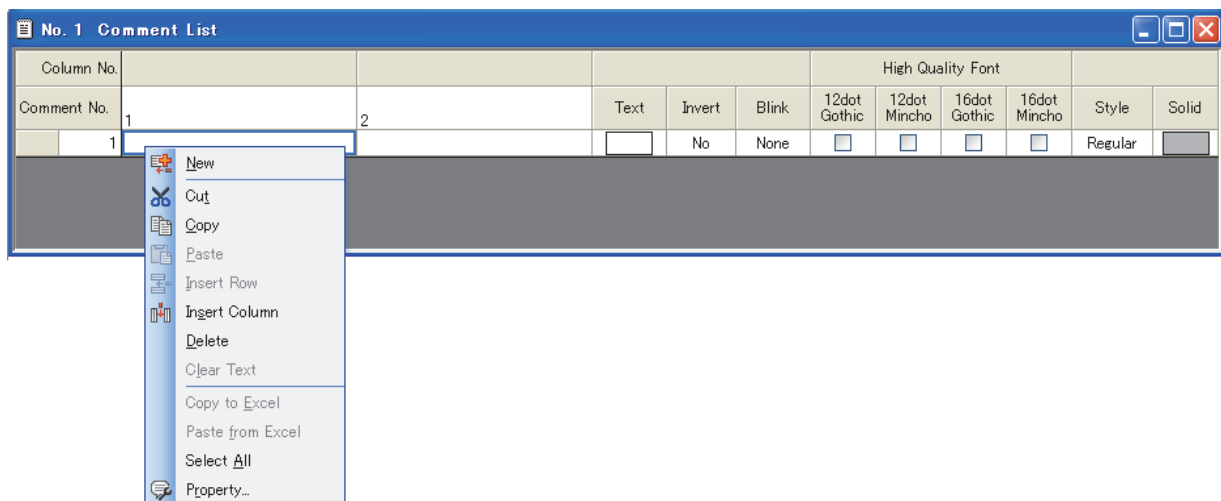

Item	Description	Model
New	Adds a new comment row.	
Cut <sup>*1</sup>	Cuts a comment selected.	
Copy	Copies a comment selected.	
Paste	Pastes a comment copied or cut.	
Insert Row	Inserts a row to the row selected.	
Insert Column	Inserts a column to the row selected.	
Delete <sup>*1</sup>	Deletes a comment selected.	GT16 GT15 GT14 GT12 GT11 GT10 SoftGOT1000
Clear Text	Clears a comment of the row or column selected. <sup>*3</sup>	
Copy to Excel	Copies selected comments to Excel. Copy comments in a row or column unit. <sup>*3</sup> After copying, paste the comments on Excel.	
Paste from Excel	Pastes selected comments from Excel. Copy or cut comments on Excel and paste them on the [Comment List] dialog box.	
Select All	Selects all the comments in the comment list.	
Property	Displays the Attribute Setting dialog box of the comment selected. <sup>*2</sup>	

\*1 Disabled for an entire column.

\*2 For the Attribute Setting dialog box, refer to the following.



■ Basic operations of toolbar (Comment list setting) (4) Attribute Setting dialog box

\*3 When selecting a column, select the Comment column.

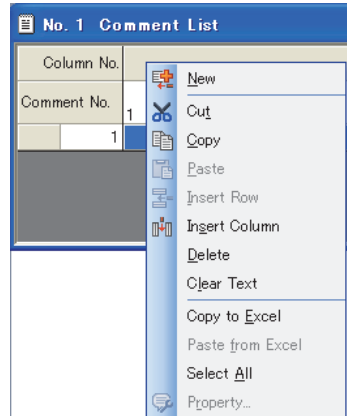

## HINT

### (1) How to select more than one comment

If more than one comment exist, all the comments can be selected by the operation below.

- Clicking the upper-left cell ([Column No.] area)
- Selecting [Select All] from the menu displayed by right-clicking

### (2) Reusing comments between different projects

Comments can be pasted to the different project comment with the drop-down menu displayed by right-clicking.

■ Comment List dialog box (2) (b) Menu displayed by right clicking

### (3) Batch setting of Text, Rev, Blink, High Quality Font, Style or Solid

You can apply the same setting to all comments simultaneously by selecting a column before making a setting.

Column No.		High Quality Font									
Comment No.		Text	Invert	Blink	12dot Gothic	12dot Mincho	16dot Gothic	16dot Mincho	Style	Solid	
1	ラインA異常 Line A error		No	None	<input type="checkbox"/>	<input type="checkbox"/>	<input type="checkbox"/>	<input type="checkbox"/>	Regular	<input type="checkbox"/>	
2	ラインB異常 Line B error		No	None	<input type="checkbox"/>	<input type="checkbox"/>	<input type="checkbox"/>	<input type="checkbox"/>	Regular	<input type="checkbox"/>	
3	ラインC異常 Line C error		No	None	<input type="checkbox"/>	<input type="checkbox"/>	<input type="checkbox"/>	<input type="checkbox"/>	Regular	<input type="checkbox"/>	
4	ラインD異常 Line D error		No	None	<input type="checkbox"/>	<input type="checkbox"/>	<input type="checkbox"/>	<input type="checkbox"/>	Regular	<input type="checkbox"/>	
5	ラインE異常 Line E error		No	None	<input type="checkbox"/>	<input type="checkbox"/>	<input type="checkbox"/>	<input type="checkbox"/>	Regular	<input type="checkbox"/>	

1. Select a column.

Column No.		High Quality Font									
Comment No.		Text	Invert	Blink	12dot Gothic	12dot Mincho	16dot Gothic	16dot Mincho	Style	Solid	
1	ラインA異常 Line A error		No	None	<input type="checkbox"/>	<input type="checkbox"/>	<input type="checkbox"/>	<input type="checkbox"/>	Regular	<input type="checkbox"/>	
2	ラインB異常 Line B error		Yes	None	<input type="checkbox"/>	<input type="checkbox"/>	<input type="checkbox"/>	<input type="checkbox"/>	Regular	<input type="checkbox"/>	
3	ラインC異常 Line C error		No	None	<input type="checkbox"/>	<input type="checkbox"/>	<input type="checkbox"/>	<input type="checkbox"/>	Regular	<input type="checkbox"/>	
4	ラインD異常 Line D error		No	None	<input type="checkbox"/>	<input type="checkbox"/>	<input type="checkbox"/>	<input type="checkbox"/>	Regular	<input type="checkbox"/>	
5	ラインE異常 Line E error		No	None	<input type="checkbox"/>	<input type="checkbox"/>	<input type="checkbox"/>	<input type="checkbox"/>	Regular	<input type="checkbox"/>	

2. Make a setting with the column selected.

Column No.		High Quality Font									
Comment No.		Text	Invert	Blink	12dot Gothic	12dot Mincho	16dot Gothic	16dot Mincho	Style	Solid	
1	ラインA異常 Line A error		Yes	None	<input type="checkbox"/>	<input type="checkbox"/>	<input type="checkbox"/>	<input type="checkbox"/>	Regular	<input type="checkbox"/>	
2	ラインB異常 Line B error		Yes	None	<input type="checkbox"/>	<input type="checkbox"/>	<input type="checkbox"/>	<input type="checkbox"/>	Regular	<input type="checkbox"/>	
3	ラインC異常 Line C error		Yes	None	<input type="checkbox"/>	<input type="checkbox"/>	<input type="checkbox"/>	<input type="checkbox"/>	Regular	<input type="checkbox"/>	
4	ラインD異常 Line D error		Yes	None	<input type="checkbox"/>	<input type="checkbox"/>	<input type="checkbox"/>	<input type="checkbox"/>	Regular	<input type="checkbox"/>	
5	ラインE異常 Line E error		Yes	None	<input type="checkbox"/>	<input type="checkbox"/>	<input type="checkbox"/>	<input type="checkbox"/>	Regular	<input type="checkbox"/>	

3. All comments are batch set to the same.

## 4.12.3 Comment registration

### ■ Register comments displayed by the object functions.

1. Click the comment field of the comment No. to which the comment is to be registered.



2. Enter a comment in the comment text box.



3. Set the display attributes of the comment.

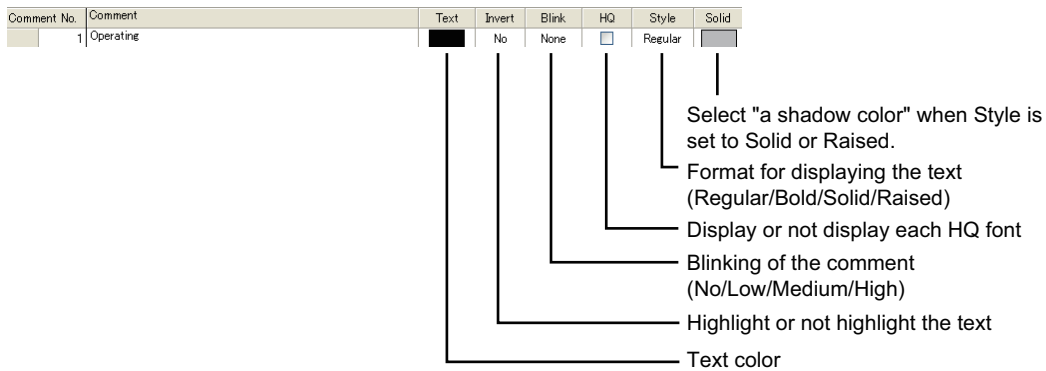

4. After the comment registration, select [Common] → [Comment] → [New Row] from the menu to display the next comment column.

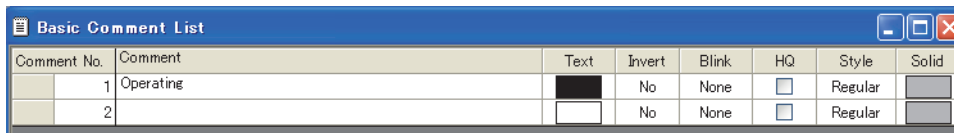

5. When all the comment registration is completed, click the  button to close the [Comment List] dialog box.

## ■ Registering comments as comment group

1. Click the comment field of the comment No. to which the comment is to be registered.

Column No.		High Quality Font								
Comment No.		Text	Invert	Blink	12dot Gothic	12dot Mincho	16dot Gothic	16dot Mincho	Style	Solid
1		<input type="text"/>	No	None	<input type="checkbox"/>	<input type="checkbox"/>	<input type="checkbox"/>	<input type="checkbox"/>	Regular	<input type="checkbox"/>

2. Enter the comment in the comment text box.

Column No.		High Quality Font								
Comment No.		Text	Invert	Blink	12dot Gothic	12dot Mincho	16dot Gothic	16dot Mincho	Style	Solid
1	Line A in operation	<input type="text"/>	No	None	<input type="checkbox"/>	<input type="checkbox"/>	<input type="checkbox"/>	<input type="checkbox"/>	Regular	<input type="checkbox"/>

3. Set the display attributes of the comment.

Column No.		High Quality Font								
Comment No.		Text	Invert	Blink	12dot Gothic	12dot Mincho	16dot Gothic	16dot Mincho	Style	Solid
1	Line A in operation	<input type="text"/>	No	None	<input type="checkbox"/>	<input type="checkbox"/>	<input type="checkbox"/>	<input type="checkbox"/>	Regular	<input type="checkbox"/>

- Select "a shadow color" when Style is set to Solid or Raised.
- Format for displaying the text (Regular/Bold/Solid/Raised)
- Display or not display each HQ font
- Blinking of the text (No/Low/Medium/High)
- Highlight or not highlight the text
- Text color

4. After the comment registration, select [Common] → [Comment] → [New Row] from the menu to display the next comment column.

Column No.		High Quality Font								
Comment No.		Text	Invert	Blink	12dot Gothic	12dot Mincho	16dot Gothic	16dot Mincho	Style	Solid
1	Line A in operation	<input type="text"/>	No	None	<input type="checkbox"/>	<input type="checkbox"/>	<input type="checkbox"/>	<input type="checkbox"/>	Regular	<input type="checkbox"/>
2		<input type="text"/>	No	None	<input type="checkbox"/>	<input type="checkbox"/>	<input type="checkbox"/>	<input type="checkbox"/>	Regular	<input type="checkbox"/>

5. When all the comment registration is completed, click the button to close the [Comment List] dialog box.

**HINT****(1) Creating a multi-line comment**

- (a) To start a new line, press the [Alt] + [Enter] keys at the end of the current line.

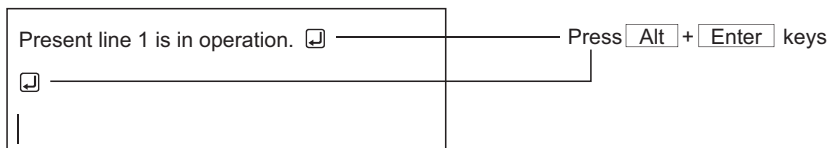

- (b) A comment composed of multiple lines is displayed on the GOT as follows.

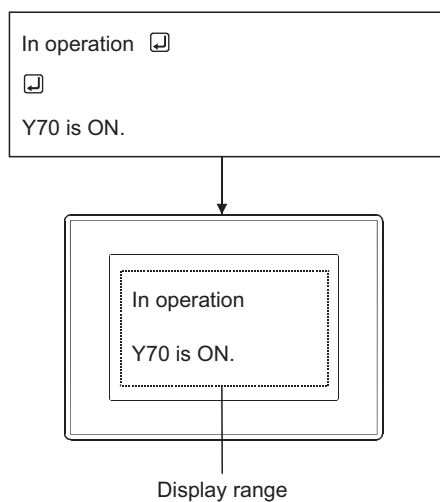
**(2) Creating comments by keyboard**

Because the cursor in the Comment List dialog box moves when the keys shown below are pressed, comments can be entered without using the mouse. (Comment numbers are added by the [Alt] + [N] keys.)

- (a) When a cell is selected
- [→]key: Move to the right cell.
  - [←]key: Move to the left cell.
  - [↑]key: Move to the upper cell.
  - [↓]key: Move to the lower cell.
- (b) When a line is selected
- [→]key: Move to the comment cell in the same line.
  - [←]key: Move to the comment cell in the same line.
  - [↑]key: Move to the comment cell in the upper line.
  - [↓]key: Move to the comment cell in the lower line.

## 4.12.4 Registering comment group columns

1. Display the [Comment List] dialog box.  
☞ 4.12.1 Displaying the [Comment List] dialog box

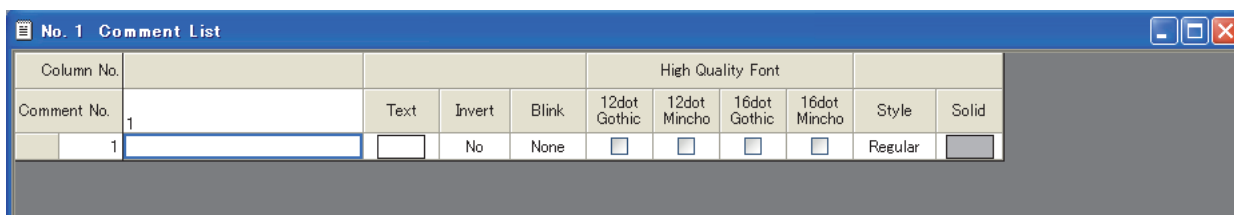

2. Select [Common] → [Comment] → [Comment Group Property] from the menu to display the [Comment Group Property] dialog box.

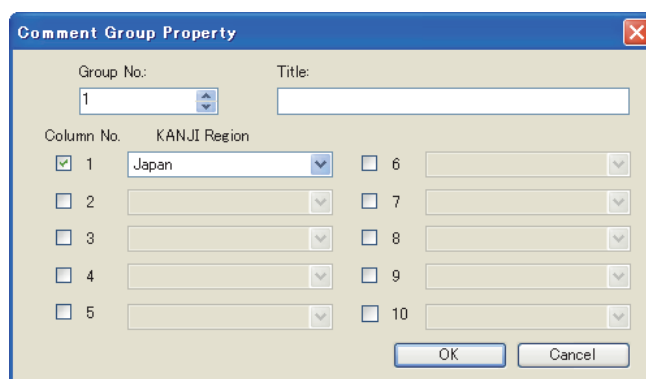

3. Select the column No. to be added, select [KANJI Region], and click the [OK] button.  
The column is registered.

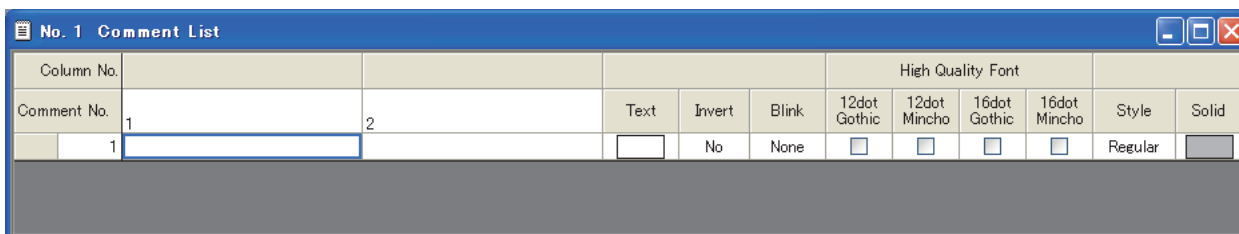

### POINT

#### Registering columns by insert column

By clicking [Common] → [Comment] → [Insert Column] from the menu, a column can be added. However, there are the following restrictions:

##### (1) KANJI Region setting for an added column

The KANJI Region setting for a column added by [Insert Column] is set to [Japan].

The setting for the Kanji region can be changed in the comment group property dialog box.

##### (2) Column No. setting

Because the column No. setting is not available for a column added by [Insert Column], the column No. that is already registered may be changed.

Be careful about this if the language switching device has been set.

☞ 4.3 Language Switching Device Setting

## 4.12.5 Copying or cutting a comment

### ■ Copying or cutting a comment for another comment No.

1. Select a comment row to be copied or cut, and select [Edit] → [Copy] or [Cut] from the menu.

Comment No.	Comment
1	Operating
2	Stopping
3	Lamp OFF

2. Select [Edit] → [Paste] from the menu to display the [Paste Comment] dialog box.

Paste Comment

Destination No.: 1

OK Cancel

3. Set [Destination No.], and click the [OK] button to paste the comment.

Comment No.	Comment
1	Operating
2	Stopping
3	Lamp OFF
4	Lamp OFF

### ■ Copying or cutting a comment for another column

1. Select a comment column to be copied or cut, and select [Edit] → [Copy] or [Cut] from the menu.

Column No.		
Comment No.	1	2
1	Operating	
2	Stopping	
3	Lamp OFF	

2. Select a column where the comment is pasted, and select [Edit] → [Paste] from the menu.

Column No.		
Comment No.	1	2
1	Operating	Operating
2	Stopping	
3	Lamp OFF	

3. The comment is pasted.

Column No.		
Comment No.	1	2
1	Operating	Operating
2	Stopping	Stopping
3	Lamp OFF	Lamp OFF

## ■ Copying/pasting a comment to/from Excel

### (1) Copying to Excel

1. Select a comment row or column to be copied or cut, and select [Copy to Excel] from the menu by right-clicking.

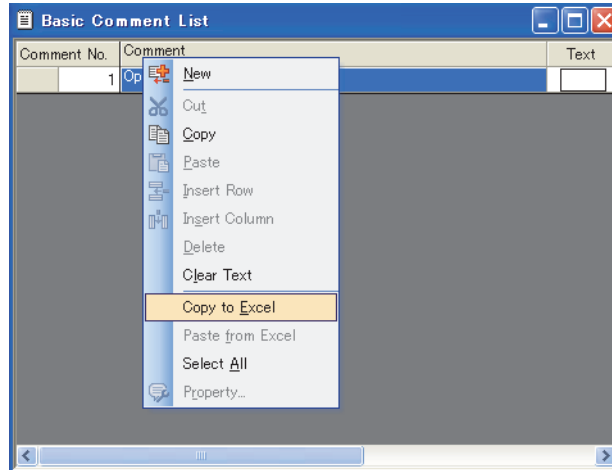

2. Perform the paste operation on the Excel, and the comments are pasted.

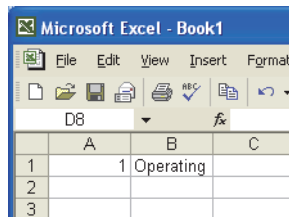

### (2) Pasting from Excel

1. Copy comments on Excel.

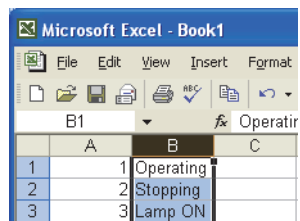

2. Select the comment row or column to be pasted, and select [Paste from Excel] by right-clicking.

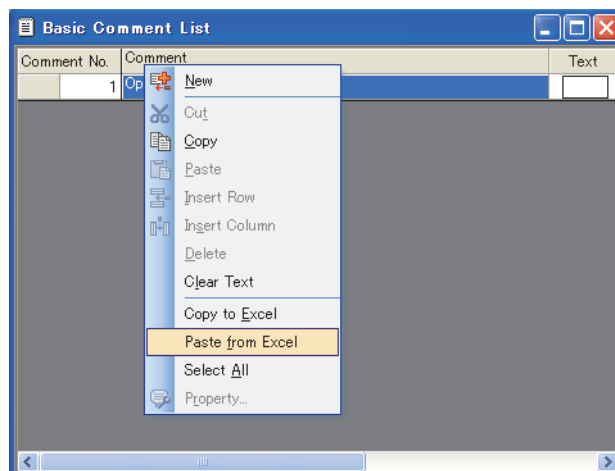



- The comment is pasted.

Comment No.	Comment	Text
1	Operating	
2	Stopping	
3	Lamp OFF	

## POINT

### (1) Copying a comment or comment group in the project tree

By copying a folder of a comment or comment group in the project tree, a basic comment or comment group can be copied.

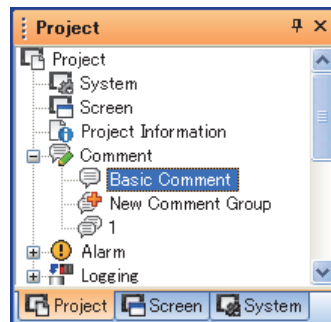

- Select [Copy] from the menu by right-clicking.
- Select [Paste] from the menu by right-clicking.
- Enter a comment group No. and title in the [Comment Group Property] dialog box, and click the [OK] button.

### (2) Copying comments among comment groups

Comments can be copied from the basic comment to a comment group or from comment group No.1 to No.2.

- Select a comment to be copied.
- Select [Copy] from the menu by right-clicking.
- Open the [Comment List] dialog box of the basic comment or the comment group where the comment is pasted. Select [Paste] from the menu by right-clicking to copy the comment.
- When copying the comment for each row, the [Paste Comment] dialog box appears. Set [Destination No.] and click the [OK] button to copy the comment.

### (3) Cutting columns

Columns can be cut only when there are two or more columns in the comment group. For Basic Comment, any column cannot be cut.

### (4) Copying/cutting columns of comment groups

The setting of KANJI Region is also copied/cut.

### (5) In the case that pasting an entire row is disabled

Pasting may be disabled according to the comments of the pasting destination when copying/cutting and paste an entire row.

In such a case, copy/cut the relevant cells one by one or directly input the comment to the pasting destination.

## 4.12.6 Deleting a comment or clearing a text

---

### ■ Deleting comments

This section explains how to delete a comment in a row unit.

When deleting a comment in a column unit, follow the method below.

1. Select a comment to be deleted.

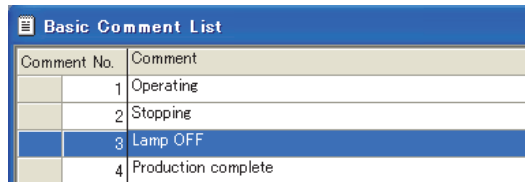

Comment No.	Comment
1	Operating
2	Stopping
3	Lamp OFF
4	Production complete

2. Select [Edit] → [Delete] from the menu to display the confirmation dialog box.

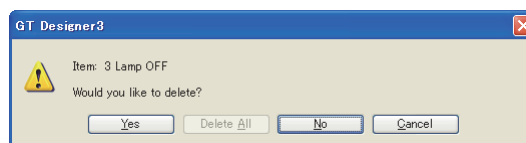

3. Click the [Yes] button to delete the selected comment.

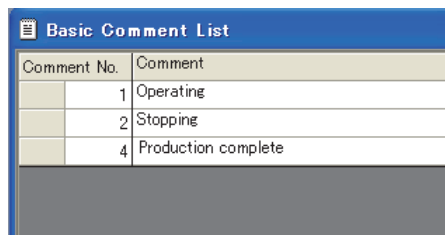

Comment No.	Comment
1	Operating
2	Stopping
4	Production complete

## POINT

### (1) Deletion in the project tree

Comment groups can be deleted in the project tree.

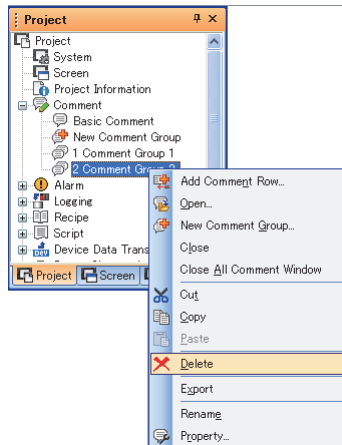

1. Select [Delete] from the menu by right-clicking, the confirmation dialog box appears.
2. Click the [Yes] button, the comment group is deleted.

### (2) Deleting a comment in a column unit

Deleting a comment in a column unit is enabled only for a comment group with two or more columns.

## ■ Clearing texts

The comment texts are cleared in a row or column unit.

1. Select [Clear Text] from the displayed menu.

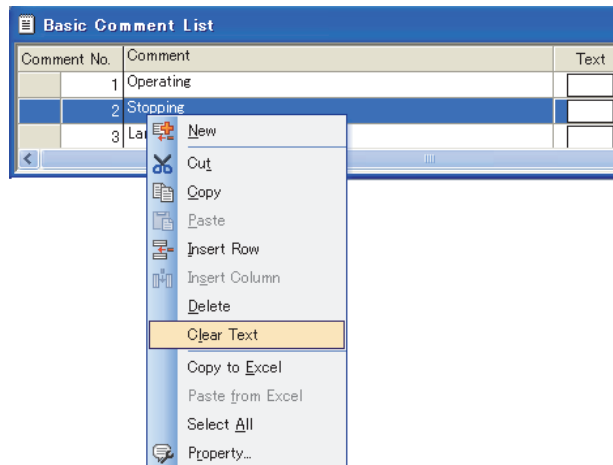

2. Select [Clear Text] from the menu by right-clicking, the texts can be cleared.

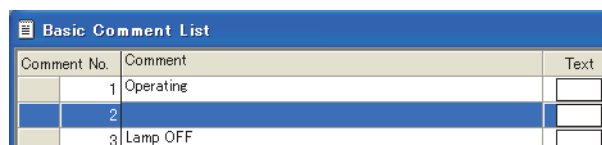

## 4.12.7 Deleting columns in comment group

1. Display the [Comment List] dialog box.  
☞ 4.12.1 Displaying the [Comment List] dialog box

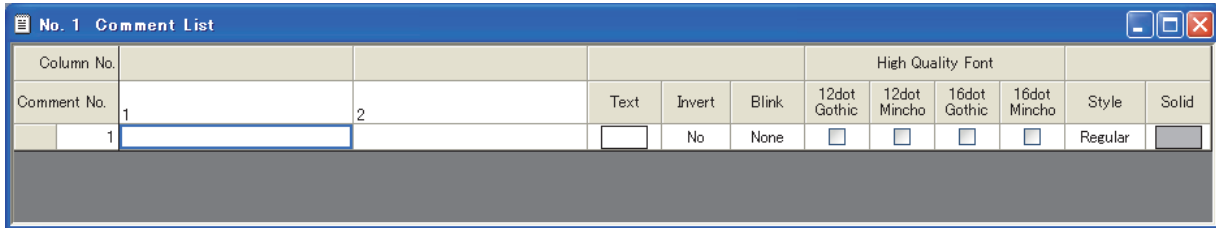

2. Select [Common] → [Comment] → [Comment Group Property] from the menu to display the [Comment Group Property] dialog box.

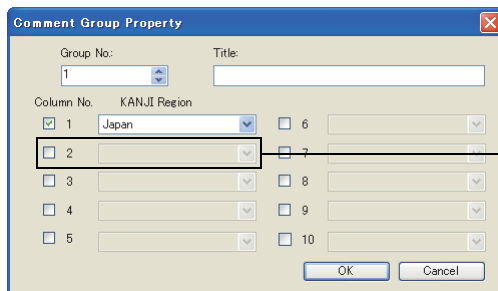

Uncheck the Column No. to delete the column.

3. Uncheck the column No. of the column to be deleted, and click the [OK] button.

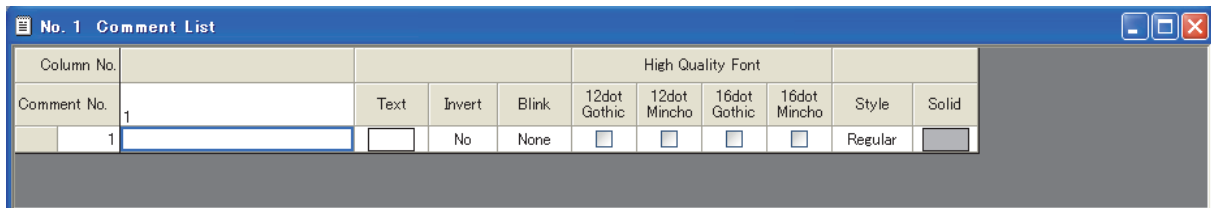

### Deletion of columns

Columns of a comment group can be deleted by the [Comment List] dialog box.

☞ 4.12.6 Deleting a comment or clearing a text

## 4.12.8 Changing comment settings

Change the text, comment No. and display attributes of a registered comment.

1. Select the target comment.

Basic Comment List	
Comment No.	Comment
1	Operating
2	Stopping
3	Lamp OFF
4	Production complete

2. Change the comment settings.

- Basic comment

Comment No.	Comment	Text	Invert	Blink	HQ	Style	Solid
1	Operating		No	None	<input type="checkbox"/>	Regular	

Select "a shadow color" when Style is set to Solid or Raised.  
 Format for displaying the text (Regular/Bold/Solid/Raised)  
 Display or not display each HQ font  
 Blinking of the text (No/Low/Medium/High)  
 Highlight or not highlight the text  
 Text color  
 Comment text  
 Comment No.

- Comment group

Column No.		High Quality Font								Style	Solid
Comment No.		Text	Invert	Blink	12dot Gothic	12dot Mincho	16dot Gothic	16dot Mincho			
1	Line A in operation		No	None	<input type="checkbox"/>	<input type="checkbox"/>	<input type="checkbox"/>	<input type="checkbox"/>	Regular		

Select "a shadow color" when Style is set to Solid or Raised.  
 Format for displaying the text (Regular/Bold/Solid/Raised)  
 Display or not display each HQ font  
 Blinking of the text (No/Low/Medium/High)  
 Highlight or not highlight the text  
 Text color

3. After changing the comment settings, click the  button to close the [Comment List] dialog box.

### POINT

#### Changing settings in the project tree

The settings of a comment group can be changed in the project tree.

1. Select [Property] from the menu by right-clicking to display the [Comment Group Property] dialog box.
2. Change the comment group settings, and click the [OK] button.

## 4.12.9 Saving/Reading comments as file

Registered comments can be saved as a text file (\*.TXT), Unicode text file (\*.TXT), or CSV file (\*.CSV). In addition, the file created by a commercial word-processor or spreadsheet software (text/CSV file) can be read as comments.

Comment No.	Comment	Text	Invert	Blink
1	During preparation		No	None
2	Emergency stop		No	None
3			No	None

GT Designer3

Save  
(Export)  
→  
←  
Read  
(Import)

	A	B	C	D	E	F	G
1			Color	Reverse	Blink	HQ Font	St
2	1	During pre	Blue	No	No	No	Ni
3	2	Emergenc	Red	No	No	No	Ni
4	3		Black	No	No	No	Ni

Commercial word-processor/spreadsheet software

### POINT

#### (1) Operations for adding/overwriting comments when importing them from a file

The comment Nos. in the file to be imported are compared with those that have already registered, and the data are handled as follows:

- If the comment No. is different each other, the comment in the file is added.
- If the comment No. is the same, the comment in the file is overwritten.

	A	B
1		
2	1	Conveyer1 normal operation
3	2	Conveyer2 normal operation
4	3	Conveyer3 normal operation
5	5	Conveyer5 normal operation
6		
7		

CSV file

Import  
→

Comment No.	Comment
1	Conveyer 1 normal
4	Conveyer 2 normal
6	Conveyer 3 normal

GT Designer3

→

Comment No.	Comment	
1	Conveyer 1 in normal operation	— Overwrite
2	Conveyer 2 in normal operation	— Add
3	Conveyer 3 in normal operation	— Add
4	Conveyer 2 normal	
5	Conveyer 5 in normal operation	— Add
6	Conveyer 3 normal	

GT Designer3

Comments can be created efficiently by predetermining each comment No. and sharing the creation by multiple persons.

#### (2) Precautions for exporting comments from GT Designer3

If comments are exported from GT Designer3, all the registered comments are reflected on the file. If the file is overwritten during export, all the comments saved in the past are lost.

### HINT

#### (1) Unicode text file

The Unicode text file is used when importing/exporting comments by the multi-language input function. For the multi-language input function, refer to the following manual.

☞ 9.6 Entering Multiple Languages (Multi-Language Input Function)

#### (2) How to save/read comments in a row or column unit in/from the Excel

Refer to the following for details.

☞ 4.12.5 Copying or cutting a comment

## ■ Saving comments as file (Export)

Save registered comments as a text file, Unicode text file, or CSV file.

1. Select [Common] → [Comment] → [Export] from the menu to display the [Save As] dialog box.

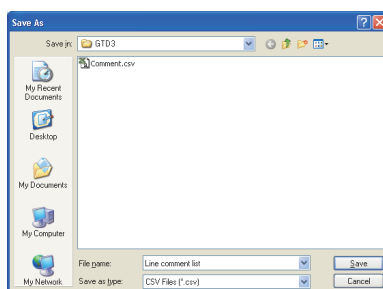

2. Select a file type for [Save as type]. (txt: text file or Unicode text file, csv: CSV file)
3. Enter a file name, select a place to save the file, and click the [Save] button.
4. When the comments writing is completed, click the  button to close the [Comment List] dialog box.

### POINT

#### When multilingual comments are registered

The comment group that includes multilingual comments cannot be saved correctly in a CSV file. Save the comment group in a Unicode text file.

 ■ Reading text file, unicode text file, or CSV file (Import)

### HINT

#### Saving comments in the project tree

To save comments as a file in the project tree, perform the following operations.

1. Select [Export] from the menu by right-clicking.

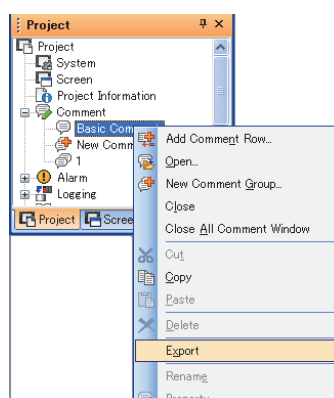



2. The [Save As] dialog box appears. Enter a file name, select a place to save the file, and click the [Save] button.

## ■ Reading text file, unicode text file, or CSV file (Import)

Read a text file, Unicode text file, or CSV file as comments.

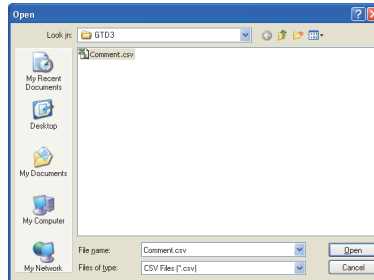
1. Select [Common] → [Comment] → [Import] from the menu to display the [Open] dialog box.



2. Select a file type for [Files of type]. (txt: text file or Unicode text file, csv: CSV file)
3. Select a file to be read, select a place to save the file, and click the [Open] button.
4. If the comments are already registered, a dialog box to confirm overwriting appears. Click the [Yes] button.
5. When the comment reading is completed, click the  button to close the [Comment List] dialog box.





## POINT

### (1) Cautions for saving a file

The edited file must be saved in the text file (\*.txt) format.

### (2) Cautions for entering a comment

Do not enter only a sequence of a double-quotation ["], a comma [,] and a return mark [↵] as a comment text because data will not be imported correctly.

If such a case is identified, correct the comment on the text file, and then import it again.

## HINT

### Writing a multiple-line comment

When writing a multiple-line comment, press the [Enter] key at the end of a line.

When providing a line of space, press the [Enter] key at the line.

```
//1 ↵  
"In operation now ↵  
↵  
Y70 is ON" █
```

The entry of the [ ], [ / ], [ / ], [ / ], and [Enter] key are processed as comment No. 1.

```
//1 ↵ ————— Processed as comment No.1  
"In operation now ↵  
↵  
Y70 is ON ↵  
↵  
X30 is ON" ↵  
250, 0, 0, 1, 1, 42, 16, 5 ↵  
//2 ↵ ————— Processed as comment No.2  
"In stop now" ↵  
150, 1, 3, 1, 1, 11, 11, 1 ↵  
//3 ↵ ————— Processed as comment No.3  
"Operation start", ↵  
101, 0, 1, 0, 1, 15, 15, 1 ↵
```

## ■ CSV format file

When saving or reading comments as a CSV format file, edit them as explained below.

### (1) When editing comments by spreadsheet software

Create each setting item as follows on the spreadsheet.

(The following is an example when Microsoft® Excel is used.)

#### (a) Basic comment

	A	B	C	D	E	F	G	H	I	J	K
1			Color	Reverse	Blink	HQ Font	Style	Solid	Characters	Digits	Lines
2	1	During preparation	Blue	No	None	No	Normal		20	20	1
3	2	Emergency stop Power supply check	Red	No	None	No	Normal		34	18	2
	1)	2)	3)	4)	5)	6)	7)	8)	9)	10)	11)

#### (b) Comment group

Comment Group No.

Column No.

	A	B	C	D	E	F	G	H	I	J	K	L	M	N	O	P	Q	R
1	1			Color	Reverse	Blink	12dot Gothic HQ	12dot Mincho HQ	16dot Gothic HQ	16dot Mincho HQ	Style	Solid	Characters(1)	Digits(1)	Lines(1)	Characters(2)	Digits(2)	Lines(2)
3	1	稼働中	Operating	Blue	No	None	Yes	Yes	Yes	Yes	Normal		3	6	1	9	9	1
4	2	点検中	Inspecting	Green	No	None	Yes	Yes	Yes	Yes	Normal		3	6	1	10	10	1
	1)	2)	3)	4)	5)		6)		7)	8)	9)	10)	11)	9)	10)	11)		

No.	Description
1)	Set the comment number.
2)	Set the comment text.
3)	Set the name or number of the text color. For the numbers corresponding to the colors other than the following: gray, black, blue, dark blue, green, dark green, cyan, dark cyan, red, dark red, magenta, dark magenta, yellow, dark yellow, white, and dark white, select [More Colors] for [Text] in the [Comment List] dialog box, and the check the color list.
4)	Set the reverse video display. (Normal/Reverse)
5)	Set the blink. (No/Low/Middle/High)
6)	Set whether to use the HQ characters. (Yes/No) For the comment group, 12-dot HQ Gothic, 12-dot HQ Mincho, 16-dot HQ Gothic, and 16-dot HQ Mincho can be set respectively.
7)	Set the text style. (Regular/Bold/Solid/Raised)
8)	Set the name or number of the [Solid] color. Set this item as is the case with setting the text color number. This item is enabled when the text style is set to [Solid] or [Raised].
9)	The number of characters of the comment is set. *1 A one-byte or two-byte character is counted as one character, and a line feed is counted as two characters.
10)	The number of digits of the comment is set. *1 A one-byte character is counted as one digit, and a two-byte character is counted as two digits. The number of digits of the line with the largest number of digits is displayed.
11)	The number of lines of the comment is set. *1 The number of lines of the input comment is displayed.

\*1 After the comment file is imported to GT Designer3, the numbers of characters, lines, and digits are automatically calculated and specified according to the comment.  
Even though these data are not input, they are imported.

## (2) When editing comments by text editor

The comment data saved in a CSV file is configured as follows on the text.

### (a) Basic comment

A character string is enclosed with double-quotation marks (" ").

Added if the style is "Solid" or "Raised."

```
, , Color, Reverse, Blink, HQ Font, Style, Solid, Characters, Digits, Lines
1, "During preparation", Blue, No, None, No, Normal, , 18, 18, 1
2, "Line A, supply stop", Red, No, None, No, Solid, Black, 19, 19, 1
```

11 fields delimited by 10 commas (,).  
Commas in a string are recognized as characters.

Comment
Line A, supply stop

### (b) Comment group

Comment group No.

```
1, 1, 1
1, 2, Color, Reverse, Blink, 12dot Gothic HQ, ... , Style, Solid, Characters(1), ... , Digits(2), Lines(2)
1, "稼働中", "Operating", Blue, No, None, Yes, Yes, Yes, Yes, Normal, , 3, 6, 1, 9, 9, 1
2, "点検中", "Inspecting", Green, No, None, Yes, Yes, Yes, Yes, Normal, , 3, 6, 1, 10, 10, 1
```

Comment column No.

## POINT

### Precaution for saving a file

The edited file must be saved in the CSV file (\*.csv) format.

## HINT

### When the display attributes of the comment are not read

If the number of commas and their positions in the CSV file are not correct, the display attributes will not be read. Before reading them, confirm the number of commas and their positions.

## Unicode text file

When saving the comments as a Unicode text file or reading out the comments to GT Designer3, edit the comments as explained below.

### (a) Basic comment

A character string is enclosed with double-quotation marks (" ").

Added if the style is "Solid" or "Raised."

```
→→Color→Reverse→Blink→HQ Font→Style→Solid→Characters→Digits→Lines
1→"Under preparation"→Blue→No→None→No→Normal→17→17→1
2→"Line A, supply stopped"→Red→No→None→No→Solid→Black→22→22→1
```

11 fields delimited by 10 tabs (→).  
Tabs cannot be inserted into any string.

### (b) Comment group

Comment group No.

```
①→1→1
→1→2→Color→Reverse→Blink→12dot Gothic HQ→...→Style→Solid→Characters(1)→Digits(2)→Lines(2)
1→"稼働中"→"Operating"→Blue→No→None→Yes→Yes→Yes→Yes→Normal→3→6→1→9→9→1
2→"点検中"→"Inspecting"→Green→No→None→Yes→Yes→Yes→Yes→Normal→3→6→1→10→10→1
```

Comment column No.

## POINT

### (1) Displayed language

When Unicode text files are edited in multiple languages, comment strings are displayed in the language that the user entered.

Attributes (color, reverse, blink and so on) are displayed in English.

For entering multiple languages, refer to the following manual.

 9.6 Entering Multiple Languages (Multi-Language Input Function)

### (2) Caution for saving the file

The edited file must be saved in the Unicode text file (\*.txt) format.

### (3) Precautions for using Unicode text file

Refer to the following for the precautions when using a Unicode text file.

 Appendix9 Precautions for Using Unicode Text File

## 4.12.11 Precautions

### ■ Maximum number of registerable comments

#### (1) Basic comment

Up to 32767 comments can be registered.

#### (2) Comment group

Up to 255 comment groups can be registered, and each group can include comments of up to 32767 lines × 10 columns.

### ■ Maximum number of characters registerable in a comment

A comment can be created with 1 to 512 characters regardless whether they are one- or two-byte characters. One line feed equals to two characters.

### ■ Character size for displayed comments

Specify the character size for the displayed comments in the dialog box provided for each object setting.



### ■ Display attributes of comments





























Some display attributes set to comments are not available depending on the object function.



For the restriction on the comment display for each object function, refer to the relevant section of each object function.

 GT Designer3 Version1 Screen Design Manual(Functions)

The following list shows the attributes set for the registered comments and each object.

- : Displayed according to the attributes registered with the comment. They can be changed at each object setting.
- : Displayed according to the attributes registered with the comment. They can not be changed at each object setting.
- : The attributes registered by the comment are not displayed. They are set at each object setting.
- - : Not used.

Object	Display attribute					
	Text Color	Reverse	Blink	HQ Font	Style	Solid
Touch Switch	*1	-	-		*1	*1
Lamp (Bit/Word)		-	-			
Data List Display	-	-	-		-	-
Historical Data List Display		-	-			
Comment Display						
Advanced User Alarm Display		-	-			
Alarm History Display	-	-	-	-	-	-
User Alarm Display			-			
Advanced Alarm Popup Display		-	-			

\*1 When [Text] or [Indirect Text (Basic Comment)] is selected for [Text Type]:, when [Comment Group] is selected for [Text Type]:

### ■ HQ font of Chinese (GB, Big5)



#### (1) Chinese (GB) characters

The Chinese (GB) characters will not be displayed in 12dot HQ Gothic or 16dot HQ Gothic setting.

If 12dot HQ Gothic or 16dot HQ Gothic is checked in comment registration, the characters are displayed as 12dot HQ Mincho or 16dot HQ Mincho.

#### (2) Chinese (Big 5) characters

The China (Big 5) characters will not be displayed in 12dot HQ Mincho or 16dot HQ Mincho setting.

If 12dot HQ Mincho or 16dot HQ Mincho is checked in comment registration, the characters are displayed as 12dot HQ Gothic or 16dot HQ Gothic.

## 4.13 Registering Parts



User-created figures are registered as parts.

The registered parts can be displayed as objects for the parts display or the parts movement.

(Objects that can be displayed as parts differ according to how to register parts.)

Example) Parts display

The several kinds of figures can be displayed by changing a monitor device value.

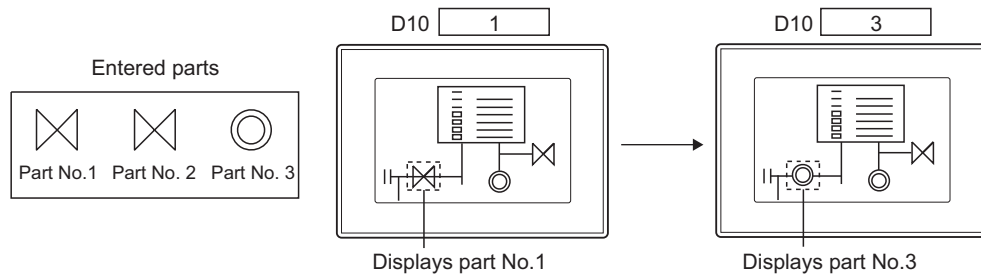

The following two types show how to register parts.

- Registering parts by GT Designer3
- Registering BMP/JPEG files for parts in a memory card

This section explains how to register parts by GT Designer3.

For how to register BMP/JPEG files for parts in a memory card, refer to the following.

 4.14 Registering BMP/JPEG Files for Parts in Memory Card

### ■ How to register parts by GT Designer3

Registering figures as parts by GT Designer3

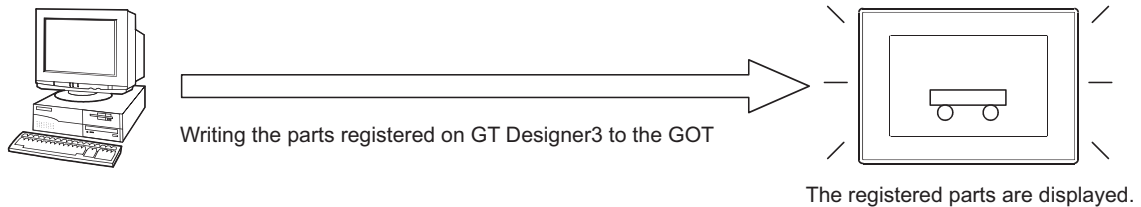

## 4.13.1 Basic operation for registering parts

Parts can be registered or edited by the following screen.

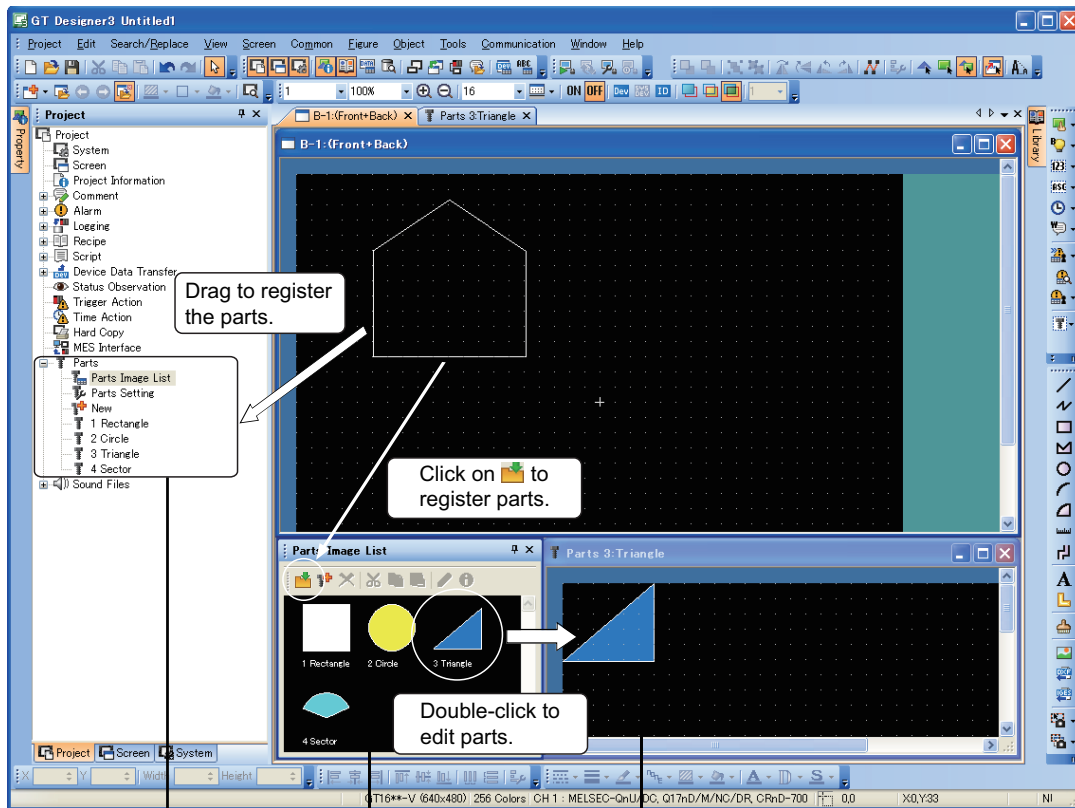

Parts editor

- Registered parts can be edited on the dedicated editor of parts.

Parts image list window

- By clicking , figures can be registered as parts.
- Images of registered figures can be checked.

Project tree

- By dragging figures from the screen editor to the tree, the figures can be registered as parts.
- The parts image list window or the parts editor can be displayed.



### Setting editor background color

The background color of the parts editor can be set in the [Options] dialog box.

 3.5.3 Customizing actions and default value of GT Designer3



## Basic operation for the [Parts Image List] window

Select [Common] → [Parts] → [Parts Image List] from the menu to display the [Parts Image List] window.

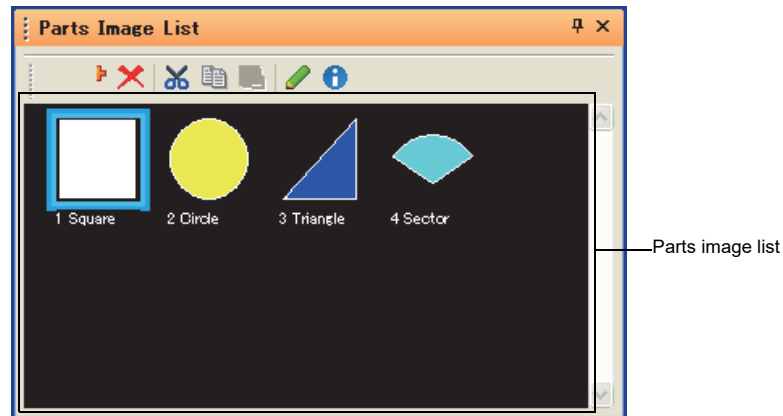

Items	Description	Model
	Register selected figure to parts.	
	Register a new part.	
	Delete the selected parts.	
	Cut the selected parts.	
	Copy the selected parts.	Gr16 Gr15 Gr14 Gr12 Gr11 Gr10 SortGr1000
	Paste the copied or cut parts.	
	Edit the selected parts by the parts editor.	
	Change the selected parts number and name. 4.13.6 Changing part numbers and names	
Parts Image List	Displays the registered parts thumbnail, number, and name.	



### Operating by the project tree

Double-click [Parts Image List] in the project tree to display the [Parts Image List] window.

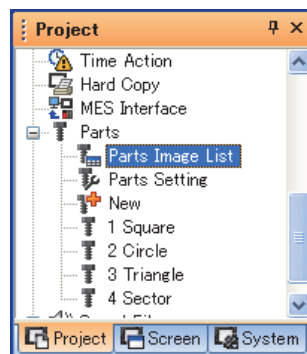

## ■ Basic operation for the project tree

Parts can be managed by the project tree.

By right-clicking the items to be operated, the menu appears.

The items to be displayed differ according to the selected items.

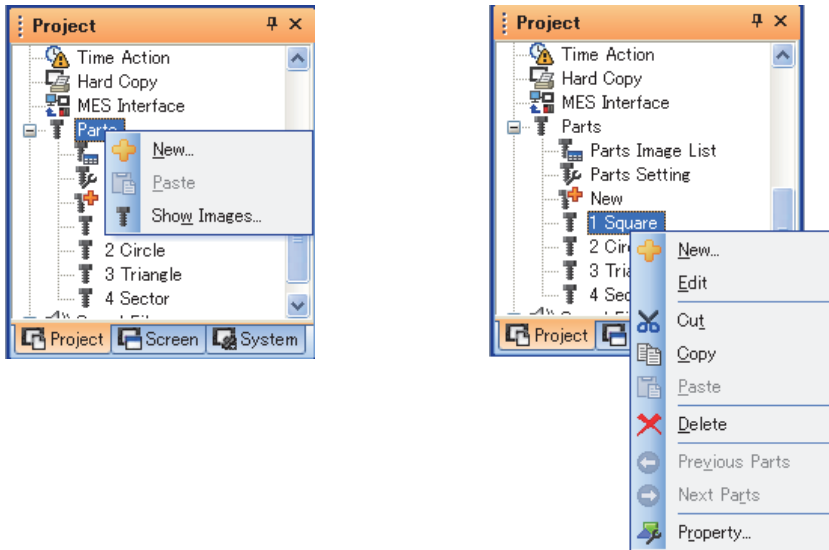



Item	Description	Model
New	Register a new part.	
Edit	The selected parts can be edited by the parts editor.	
Cut	Cut the selected parts.	
Copy	Copy selected parts.	
Paste	Paste the copied or cut parts.	
Delete	Delete the selected parts.	
Previous Parts	The last number of the part before the selected part is displayed on the parts editor. Available only during displaying the parts editor.	Gr16 Gr15 Gr14 Gr12 Gr11 Gr10 SoftGOT1000
Next Parts	The next number of the part currently selected is displayed on the parts editor. Available only during displaying the parts editor.	
Property	Change the selected part number and name. ☞ 4.13.6 Changing part numbers and names	
Show Images	Displays the [Parts Image List] window. ☞ ■Basic operation for the [Parts Image List] window	

## 4.13.2 Registering parts

### ■ How to register figures on the screen editor as parts

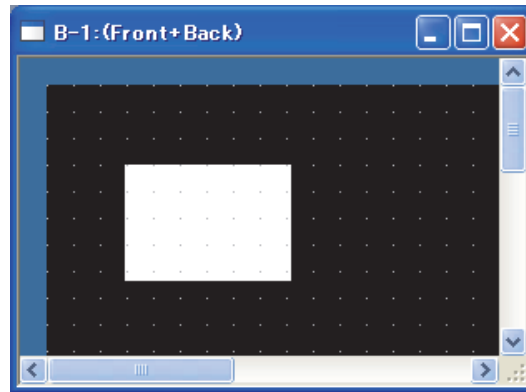
1. Perform one of the following operations.
  - On the screen editor, select a figure to be registered as a part, and click  in the [Parts Image List] window.
  - On the screen editor, right-click a figure to be registered as a part, and select [Register to Parts] from the menu.



2. In the [Parts Property] dialog box, enter [No.] and [Name], and click the [OK] button.  
 4.13.1 ■ Basic operation for the [Parts Image List] window

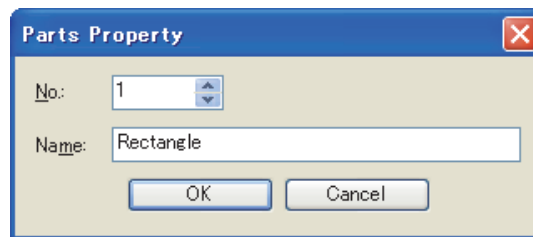

3. The figure is registered as a part.

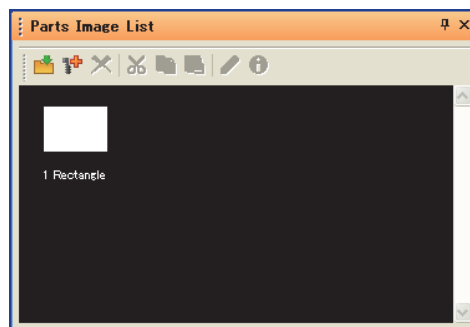



### Operating by the project tree

1. Drag the figure to be registered as a part in the project tree.

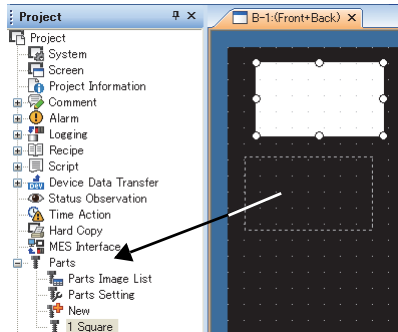

2. In the [Parts Property] dialog box, enter [No.] and [Name], and click the [OK] button.

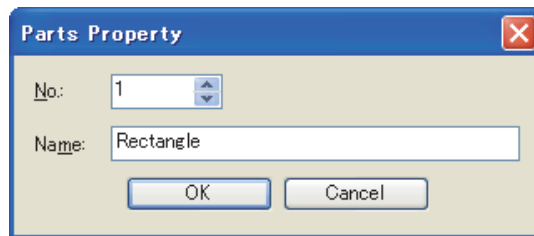

3. The figure is registered as the part.

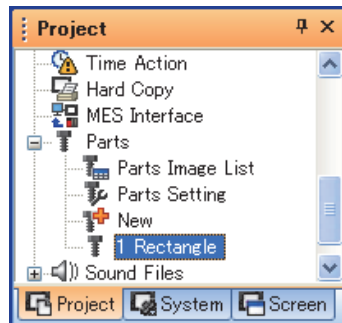

## ■ How to register parts by drawing a figure on the parts editor

1. Click  in the [Parts Image List] window.

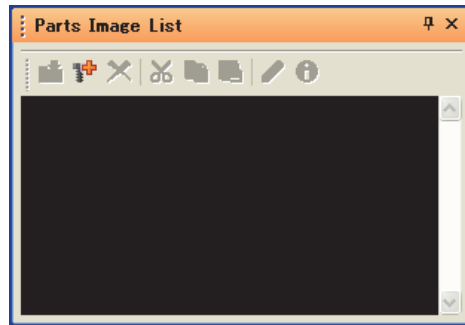

### HINT

#### Operating by the project tree

Double-click [New] in [Parts] in the project tree to display the [Parts Property] dialog box.

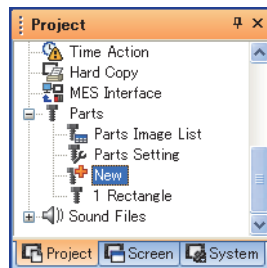

2. In the [Parts Property] dialog box, enter [No.] and [Name], and click the [OK] button.

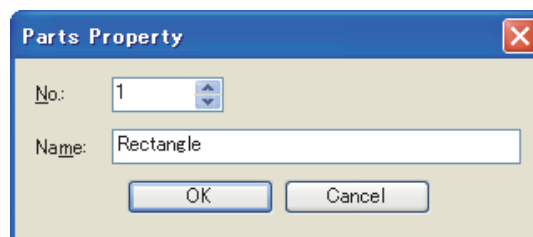

3. In the parts editor, draw a figure to be registered as a part.

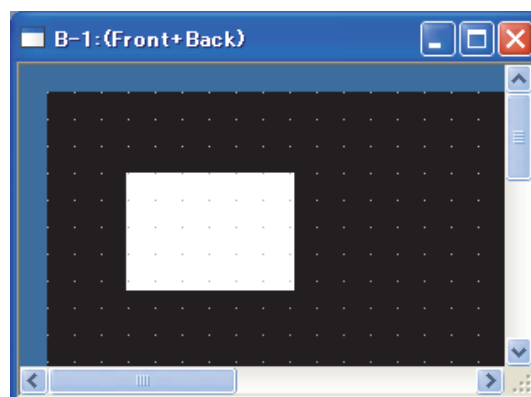

4. After drawing the figure, click the  button to close the parts editor.

**HINT**

**(1) Pasting a figure registered as a part on the screen editor**

- (a) Pasting the figure by the project tree  
Drag the part in the project tree on the screen editor

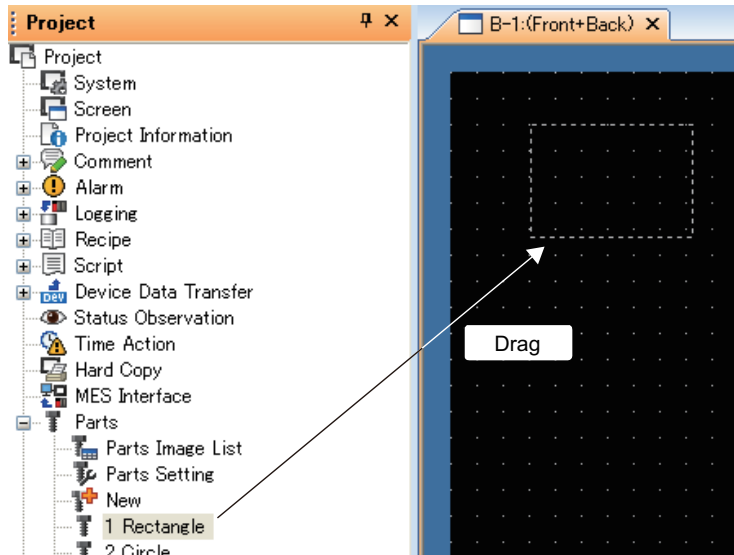

- (b) Pasting the figure by the [Parts Image List] window  
Drag the part in the [Parts Image List] window on the screen editor.

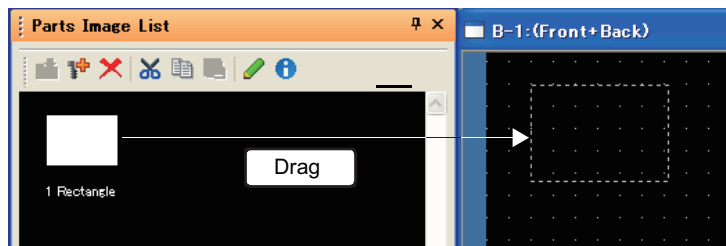

**(2) The figure that can be registered as parts**

The BMP file /JPEG file \*1 /DXF file/IGES file data imported as a figure can also be registered by the same procedure as figures.

\*1 JPEG files can be registered for GT16 and GT15 only.

 (Functions) 1. FIGURES

### 4.13.3 Copying parts

1. In the [Parts Image List] window, select the part to be copied, and click .

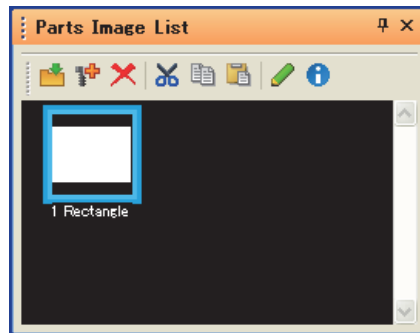

2. Click  to display the [Parts Property] dialog box.

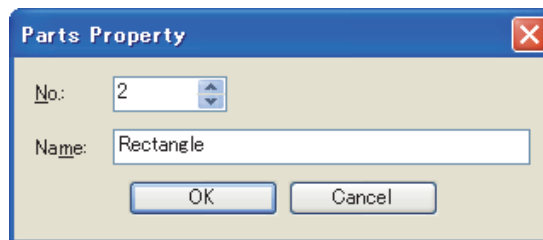

3. Change [No.] and [Name], and click the [OK] button to copy the part.

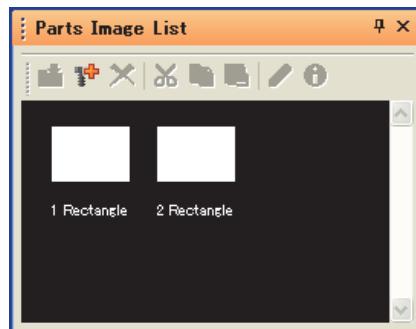



---

### Operating by the project tree

Parts can be copied in the project tree.

 4.13.1 ■ Basic operation for the project tree

#### (1) Copying a part in the project tree

1. Select a part to be copied in the project tree, and select [Copy] from the menu by right-clicking.
2. Select [Paste] from the menu by right-clicking again to display the [Parts Property] dialog box.
3. Change [No.] and [Name], and click the [OK] button to copy the part.

#### (2) Copying multiple parts simultaneously

Multiple parts can be copied in the project tree.

1. Select multiple parts to be copied by any of the following methods.
    - Selecting multiple parts with holding down the [Shift] key
    - Selecting multiple parts with holding down the [Ctrl] key
  2. Select [Copy] from the menu by right-clicking the selected parts.
  3. Select [Paste] from the menu by right-clicking again to display the [Parts Property] dialog box for the copied parts.
  4. Change [No.] and [Name], and click the [OK] button to copy the parts.  
(The [Parts Property] dialog box is displayed for each copied part.)
-



## 4.13.4 Deleting parts

1. In the [Parts Image List] window, select the part to be deleted, and click .

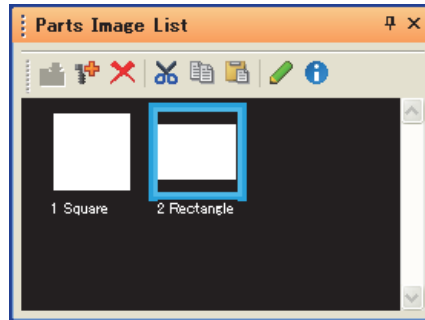

2. In the confirmation dialog box, click the [Yes] button to delete the selected part.

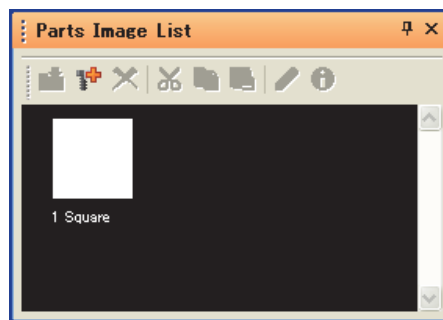

### HINT



#### Operating by the project tree

Parts can be deleted in the project tree.

 4.13.1 ■ Basic operation for the project tree

##### (1) Deleting a part in the project tree

1. Select a part to be deleted in the project tree, and select [Delete] from the menu by right-clicking.
2. In the confirmation dialog box, click the [Yes] button to delete the selected part.

##### (2) Deleting multiple parts simultaneously

Multiple parts can be deleted simultaneously in the project tree.

1. Select multiple parts to be deleted by any of the following methods.
  - Selecting multiple parts with holding down the [Shift] key
  - Selecting multiple parts with holding down the [Ctrl] key
2. Select [Delete] from the menu by right-clicking the selected parts.
3. In the confirmation dialog box, click the [Yes] or [Yes to All] button.
  - [Yes] button: Deletes the selected parts one by one.
  - [Yes to All] button: Deletes all the selected parts.

## 4.13.5 Editing parts

---

1. In the [Parts Image List] window, select the part to be edited, and click .

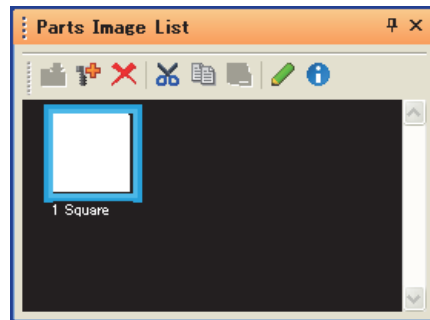

### HINT

#### Operating by the project tree

Select a part to be edited in the project tree, and select [Edit] from the menu by right-clicking to display the parts editor.

 4.13.1 ■ Basic operation for the project tree

---

2. In the parts editor, edit the part.

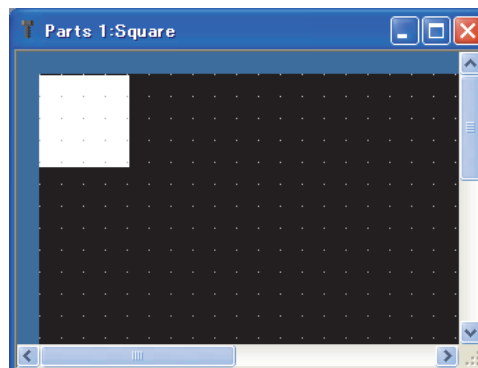

3. After editing the part, click  to close the parts editor.

## 4.13.6 Changing part numbers and names

Registered part numbers and names can be changed.

1. In the [Parts Image List] window, select a part to change the number and name, and click .

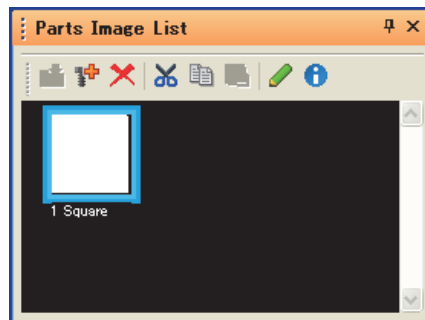

2. In the [Parts Property] dialog box, change [No.] and [Name], and click the [OK] button.

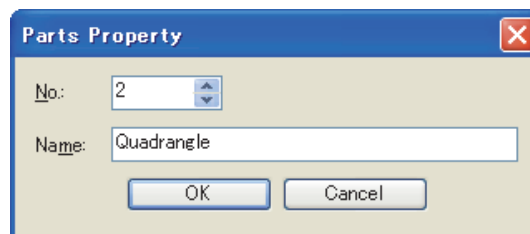

3. The number and name are changed.

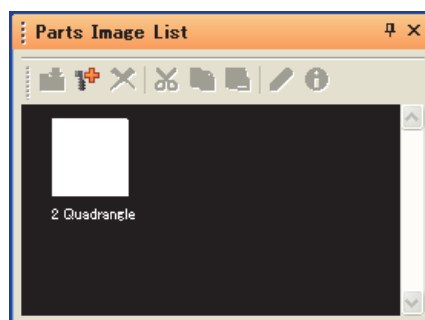

### HINT

#### Operating by the project tree

Part numbers and names can be changed in the project tree.

 4.13.1 ■ Basic operation for the project tree

1. Select a part to change a number and name in the project tree by right-clicking [Property] from the menu.
2. In the [Parts Property] dialog box, change [No.] and [Name], and click the [OK] button to apply the change.

## 4.13.7 Precautions

### ■ Maximum number of Parts that can be registered

Up to 32767 parts can be registered.

### ■ Data capacity required for parts

It is same with memory capacity for drawing figure.

☞ 2.4 Figures and Data Capacity

### ■ Display restrictions for registering figures as parts

#### (1) Line width of figure outline frame

For a figure to be registered as parts, its frame must be drawn in 1-dot line.

If drawn in 2-dot or wider line, it may not appear in actual width on GOT.

However, the frame of 2-dot or wider line can be displayed by following the steps below.

(a) When display with changing the color of figure (figure displayed as mark)

Example) Combine three figures drawn in 1-dot line to make one figure with 3-dot-wide frame.

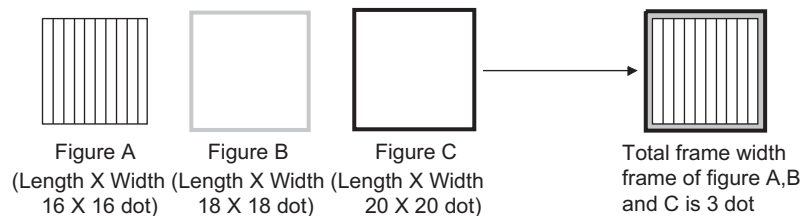

(b) Set a figure drawn in 2-dot or wider line on an unused base screen and display the base screen as parts using parts display function.

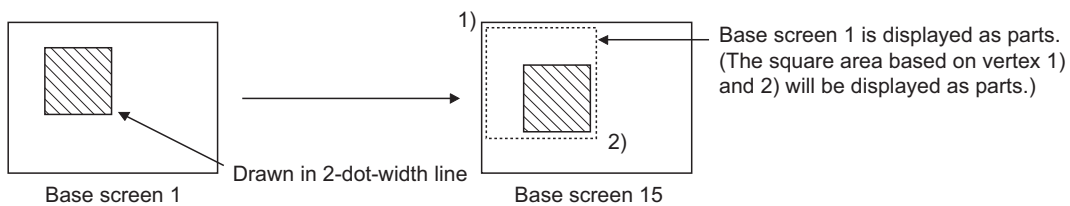

#### (2) Line width (except slant lines)

When the width of a line (except slant lines) to be registered as a part is 2 to 7 dots, the line may not be displayed with the set width on a GOT.

When displaying a 2-dot or more line on a GOT, refer to the following steps.

(a) Creating a rectangle (filled) and dragging the rectangle to change into the shape of a line

(b) Drawing a 2-dot or more line with 1-dot lines

Example) Combine three 1-dot lines and make a part with 3-dot line width.

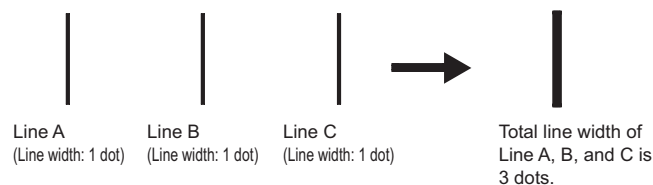

**(3) Changing the color of a figure on the screen (figure marked as a mark)**

The white area of a part displayed as a mark by Parts Display/Parts Movement, can be changed to another color.

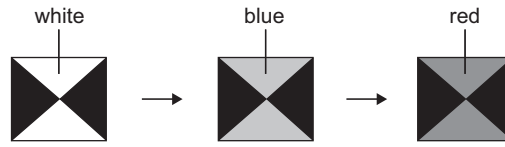

Change the area color from white to other colors.

Register the part displayed as a mark as below.

- Draw the color changing area of the figure in white.
- Do not use any figure read from the BMP/JPEG format file.

The above figure will not change in color even if displayed as a mark.

# 4.14 Registering BMP/JPEG Files for Parts in Memory Card



This section explains how to register BMP/JPEG files for parts in a memory card. For how to register parts by GT Designer3, refer to the following.

☞ 4.13 Registering Parts

## ■ How to register BMP/JPEG files for parts in a memory card

The BMP/JPEG files for parts stored in a memory card (hereinafter referred to as BMP/JPEG file parts) can be displayed as parts in the parts display or parts movement.

By registering parts in the memory card, the size of the project data written in the GOT can be reduced.

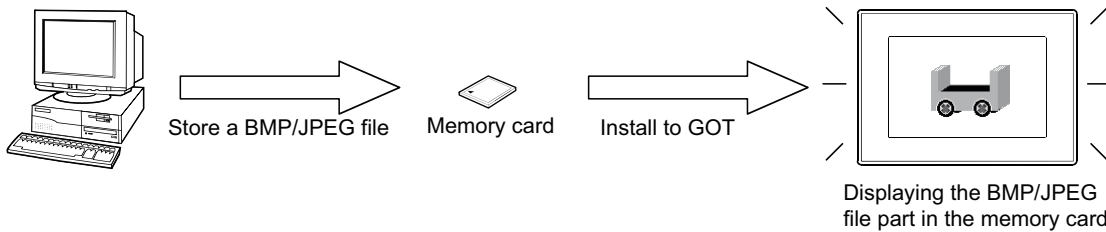

For how to display parts as BMP/JPEG file parts in the memory card by the parts display or parts movement, refer to the following.

☞ (Functions) 21. PARTS DISPLAY, 22.PARTS MOVEMENT

## 4.14.1 Specifications for BMP/JPEG files that can be stored in a memory card and displayed as parts

### ■ How to display BMP/JPEG file parts

Item	BMP/JEPG fils part (object units)	BMP/JEPG fils part (project units)
Overview	Specifying the BMP/JEPG file part stored in the memory card in each object setting of the parts display or the parts movement	Specifying part numbers from 9001 as the numbers used for BMP/JEPG file parts only and displaying the parts for parts display or parts movement
Storage folder name	Any folder name	Fixed
Storage file name	Any file name	Fixed
Available drive	A drive, B drive	A drive
Effective setting range	Object units	Project units
Number of settable parts	Max, 65536	Max, 999
Image	<p>Parts are managed by object.</p>	<p>Parts are managed by project.</p>

## ■ The BMP/JPEG files that can be displayed

### POINT

#### Specification differences between BMP/JPEG files and BMP/JPEG file parts handled by GT Designer3

For the specifications for BMP/JPEG files handled by GT Designer3, refer to the following.

#### 2.4 Figures and Data Capacity

The BMP/JPEG file (BMP/JPEG file part) specifications that can be stored in a memory card differ from the BMP/JPEG file that can be used in GT Designer3 (registered part).

The data registered as parts by GT Designer3 may not be used as BMP/JPEG file parts.

#### (1) BMP file

Item	Description
Data format	The BMP data *1 of 24-bit, 8-bit, 4-bit or 1-bit
Number of colors*2	65536 colors *3, 256 colors, 16 colors or monochrome
Resolution*4	Max.: GT SoftGOT1000: 1600×1200, 1280×1024, 1024×768, 800×600, 640×480 GT1695M-X, GT1595-X: 1024×768 GT1685M-S, GT1675M-S, GT1665M-S, GT1585V-S, GT1585-S, GT1575V-S, GT1575-S: 800×600 GT1675M-V, GT1675-VN, GT1672-VN, GT1665M-V, GT1662-VN, GT1655-V, GT16 Handy GOT, GT1575-V, GT1575-VN, GT1572-VN, GT1565-V, GT1562-VN, GT1555-V, GT12: 640×480 GT1555-Q, GT1550-Q, GT14: 320×240 Min.: 1×1 dot

\*1 The BMP data compressed by compression software cannot be used.

When using the compressed BMP data, the system alarm of [536 Image file error or invalid file format.] occurs.

\*2 For the BMP files stored in the memory card, the number of colors is reduced to the number supported by the GOT in use.

\*3 For the GOT types that allow display in 65536 colors, refer to the following.

 User's Manual for the GOT used

\*4 When specifying an image file larger than the display size of the GOT in use, the system alarm of [536 Image file error or invalid file format.] occurs.

#### (2) JPEG file

Item	Description
File format	JFIF
Data format	Base line
Number of colors*1*2	Full-color, gray-scale
Resolution*3	Max.: GT SoftGOT1000: 1600×1200, 1280×1024, 1024×768, 800×600, 640×480 GT1695M-X, GT1595-X: 1024×768 GT1685M-S, GT1675M-S, GT1665M-S, GT1585V-S, GT1585-S, GT1575V-S, GT1575-S: 800×600 GT1675M-V, GT1675-VN, GT1672-VN, GT1665M-V, GT1662-VN, GT1655-V, GT16 Handy GOT, GT1575-V, GT1575-VN, GT1572-VN, GT1565-V, GT1562-VN, GT1555-V, GT12: 640×480 GT1555-Q, GT1550-Q, GT14: 320×240 Min.: 1×1 dot

\*1 For the JPEG files stored in the memory card, the number of colors is reduced to the number supported by the GOT in use.

\*2 For the GOT types that allow display in 65536 colors, refer to the following.

 User's Manual for the GOT used

\*3 When specifying an image file larger than the display size of the GOT in use, the system alarm of [536 Image file error or invalid file format.] occurs.



**(1) DXF/IGES data**

DXF/IGES files cannot be displayed as parts even when the files are stored in a memory card.  
To use DXF/IGES files as parts, import the files to GT Designer3.

**(2) Time taken to display a BMP/JPEG file part (reference)**

The length of time necessary for a BMP/JPEG file part to be displayed on the GOT screen is indicated below for each GOT type.

Depending on the project data to be used, the time may differ from the time shown below.

GOT Type	Data range of BMP file to be displayed		Time taken to display a part (Reference, sec.)	
	Resolution (dots)	Number of colors (colors)	BMP file part	JPEG file part <sup>*1</sup>
GT1695M-X/GT1595-X	1024×768	24-bit full color	3.2	1.54
		256	1.68	1.55
		Monochrome	0.62	1.52
GT1685M-S/GT1675M-S/ GT1665M-S/GT1585V-S/ GT1585-S/GT1575V-S/ GT1575-S	800×600	24-bit full color	1.16	2.0
		256	0.69	1.86
		Monochrome	0.3 or less	1.95
GT1675M-V/GT1675-VN/ GT1665M-V/GT1655-V/ GT16 Handy GOT/GT1575-V/ GT1565-V/GT16 Handy GOT/ GT12	640×480	24-bit full color <sup>*2</sup>	1.22	0.80
		256	0.82	0.72
		Monochrome	0.3 or less	0.77
GT1575-VN	640×480	256	0.78	0.55
		Monochrome	0.3 or less	0.57
GT1672-VN/GT1662-VN/ GT1572-VN/GT1562-VN	640×480	16	0.78	0.55
		Monochrome	0.3 or less	0.57
GT1555-V	640×480	24-bit full color	1.14	0.61
		256	0.67	0.61
		Monochrome	0.3 or less	0.59
GT1555-Q/GT1455-Q	320×240	24-bit full color <sup>*2</sup>	0.45	0.41
		256	0.40	0.39
		Monochrome	0.32	0.44
GT1550-Q/GT1450-Q	320×240	Monochrome	0.35	0.46
GT SoftGOT1000	1280×1024	24-bit full color	0.62	0.92
		256	0.67	0.8
		Monochrome	0.65	0.78

\*1 Values measured using a JPEG file part, by converting the BMP format into JPEG format.

\*2 For the following GOT types, the number of colors on the GOT screen is reduced to 4096.

- GT1675-VN
- 1555-QSBD



## 4.14.2 Storing BMP/JPEG file parts in a memory card

### ■ Displaying BMP/JPEG files (object units)

1. Create a folder to store a BMP/JPEG file part in the memory card.  
Use a folder name set in each object.

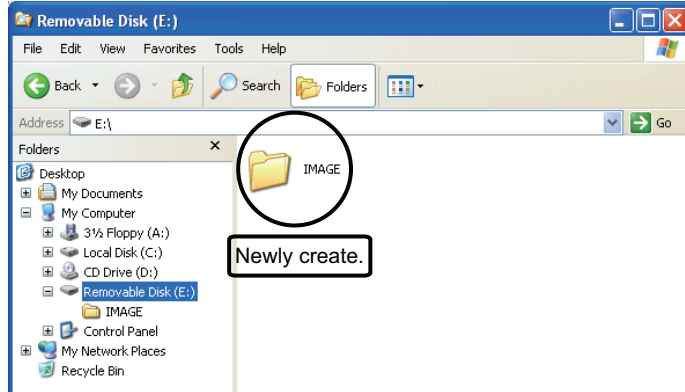

2. Store a BMP/JPEG file to be used as a part in the created folder.  
Use a BMP/JEPG file name that has been set in each object.  
Example) In a case where file name: IMG, part number. : 0123, digits: 4

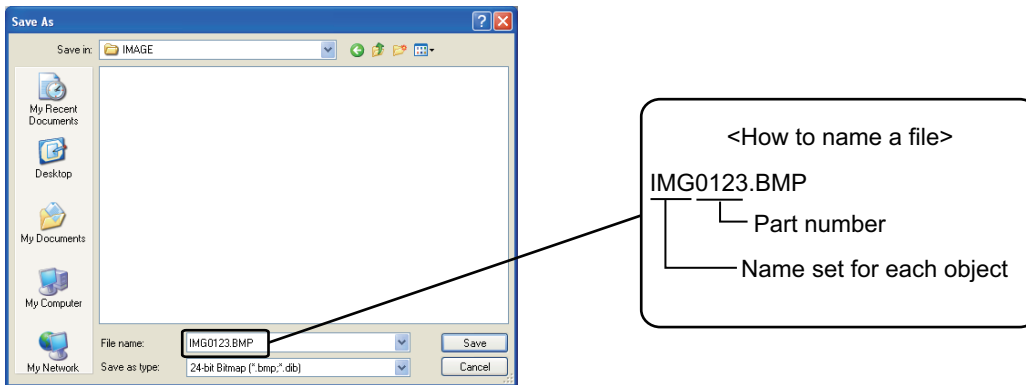

The part number varies depending on the number set for [Digits] in each object.

- 5 digits :00001 to 65535
- 4 digits :0001 to 9999
- 3 digits :001 to 999
- 2 digits :01 to 99
- 1 digits :1 to 9



### 4.14.3 Precautions

#### ■ The size of the BMP/JPEG file parts stored in the CF card

##### (1) Size of the BMP/JPEG file parts stored in the memory card

The BMP/JPEG file parts displayed on the GOT is the same size as the BMP/JPEG file parts stored in the memory card.

Any BMP/JPEG file part larger than the GOT display size cannot be displayed.

The BMP/JPEG file parts in the memory card must be smaller than the display size of the GOT.

- When the BMP/JPEG file part is the same size or smaller than the GOT display size

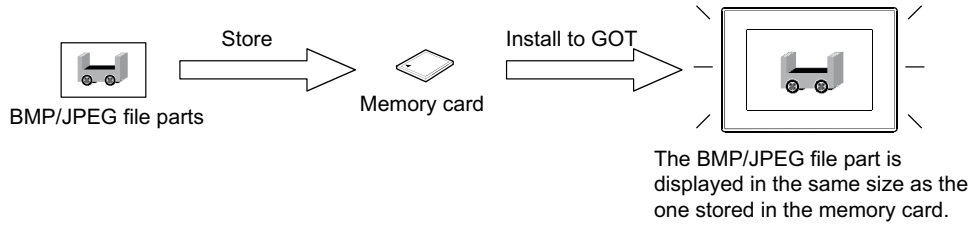

- When the BMP/JPEG file part is larger than the GOT display size

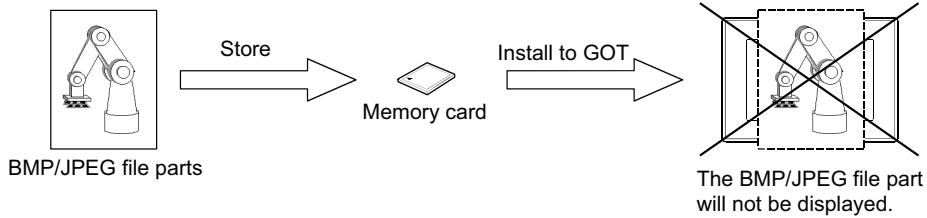



# **EDITING AND SETTING FIGURES AND OBJECTS**

---



# 5. EDITING AND SETTING FIGURES AND OBJECTS

This chapter explains how to arrange, edit and set figures and objects.

## ■ Outline of figures and objects

Both figures and objects are used by arranging on the screen.  
The following shows the features of figures and objects.

### (1) Figure

Used for describing a text or shape.

A figure does not change according to the device or setting value status. Its function is exclusively to display texts or shapes.

For the figures available in GT Designer3 and its setting methods, refer to the following.

 (Functions) 1. FIGURES

### (2) Object

Used for describing a device setting value or text/shape.

Each object has specific functions, and varies according to the device or setting value status.

For the objects available in GT Designer3 and its setting methods, refer to the following.

 2.6 Specifications of Available Functions Set with GT Designer3  
GT Designer3 Version1 Screen Design Manual (Functions)

## 5.1 Arranging Figures and Objects



This chapter explains how to arrange figures and objects.

## ■ Arranging a figure or object while changing its size

1. Select a figure or object to be allocated from the [Figure] or [Object] menu, and switch the mouse pointer to the arrangement mode (+).



2. Move the mouse pointer to the point where the object is to be arranged on the screen editor.

3. Click the position to arrange the object and drag the pointer to any position.

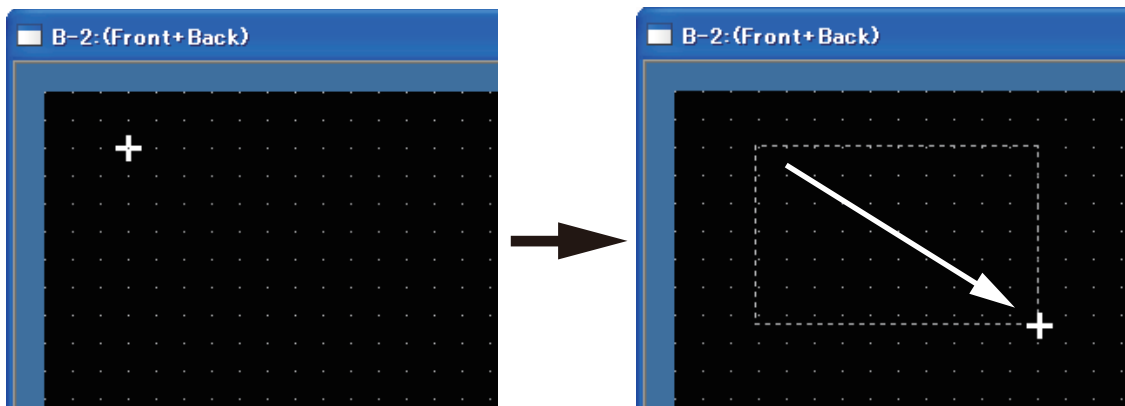

4. Release the mouse button. The object with the size changed is arranged.

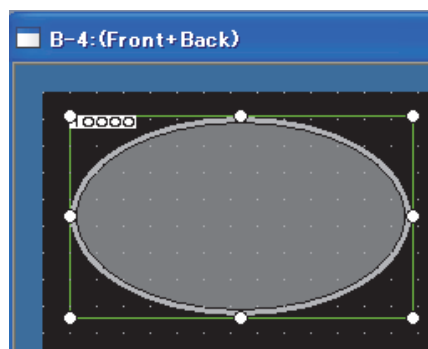

## HINT



### (1) Selecting the figure/object

The figure and object to be arranged on the screen editor can also be selected from the toolbar icon. For how to use the toolbar and icon list, refer to the following.

 3.4 Type of Tool Bars and Short Cut Keys

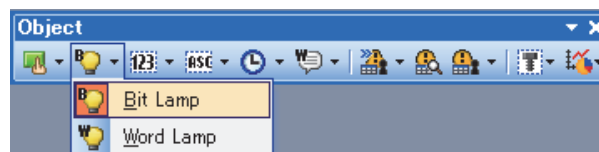

### (2) Operation with the keyboard

1. Select a figure or object, and move the mouse pointer to the point where the figure or object is to be arranged with cursor keys
2. Press the [Enter] key once to change the size. Change the figure or object size with cursor keys.
3. Press the [Enter] key again to arrange the figure or object with the size changed.



## ■ Arranging figures or objects without changing the size

1. Select a figure or object to be allocated from the [Figure] or [Object] menu, and switch the mouse pointer to the arrangement mode (+).

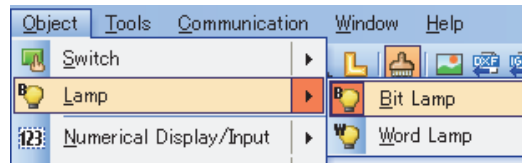

2. Move the mouse pointer to the point where the object is to be arranged on the screen editor.
3. Click the position to arrange the object.  
The object in the default size is arranged.

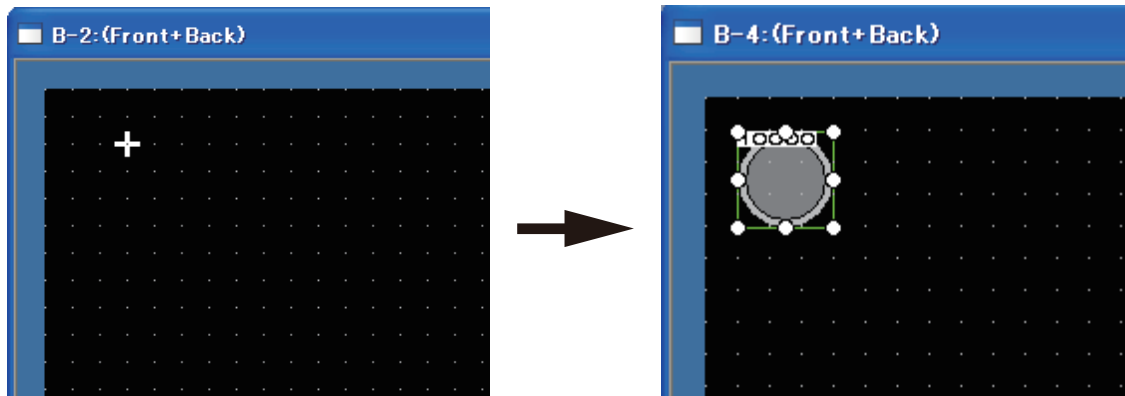

### HINT

#### (1) Selecting figures or objects

The figures or objects to be arranged on the screen editor can also be selected from the icons on the tool bar. For how to use the tool bar and for the list of icons, refer to the following.

 3.4 Type of Tool Bars and Short Cut Keys

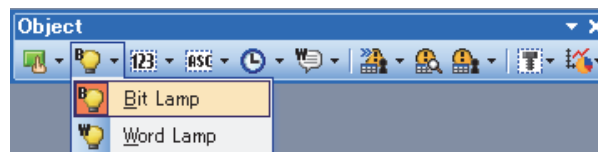

#### (2) Operation by keyboard

1. Select the object and move the mouse pointer with the cursor keys to the point where the object is to be arranged.
2. Press the [Enter] key twice.  
The object in the default size is arranged.

## ■ Arranging from Parts Image List

If the part to be used is previously registered, the part can be selected and arranged on the screen from the Parts Image List.

1. If the Parts Image List is not displayed, select [View] → [Docking Window] → [Parts Image List] from the menu to display the parts image list.



2. Click the object to be arranged from the Parts Image List. Move the mouse pointer on the screen editor, to the position where the object is to be arranged.
3. Click the position to arrange the object. The selected part is arranged.

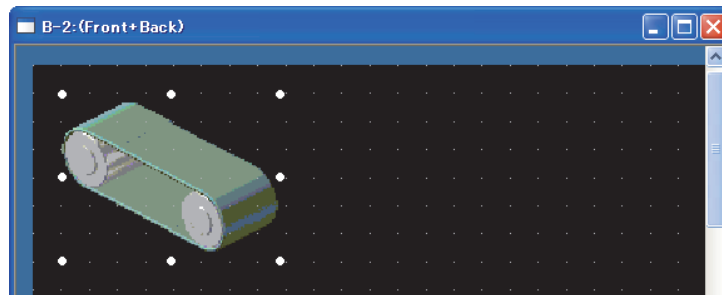

## ■ Changing the operation for figure/object arrangement

Change the operations for arrangement by configuring the following settings on the [Operation] tab of the [Options] dialog box.

- Arranging figures/objects repeatedly.
- Clearing the selection status after arranging figures/objects.
- Displaying the setting dialog box after arranging figures/objects.
- Moving the figures/objects inside the screen display area (Moving to the temporary area by the ALT key)

Select [Tools] → [Option] from the menu to display the [Options] dialog box.

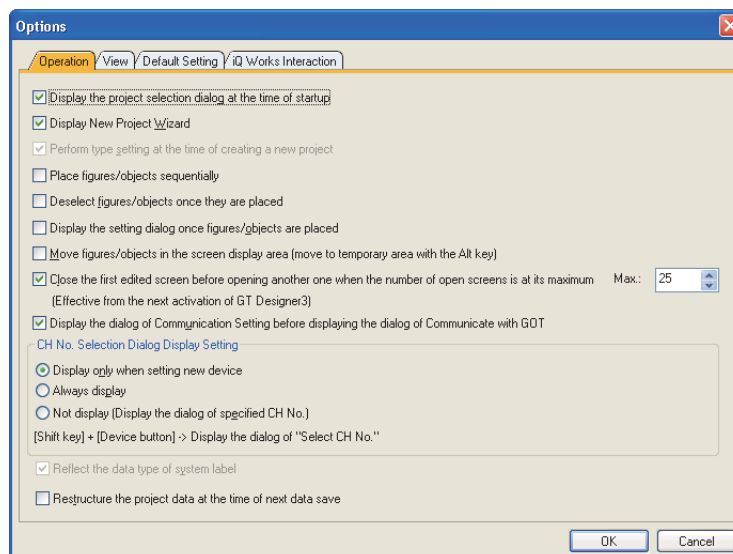

For the setting contents of the Options dialog box, refer to the following.

 3.5.3 Customizing actions and default value of GT Designer3

## 5.2 Editing Figure and Object







This chapter explains how to edit figures and objects.

### 5.2.1 Selecting figure and object

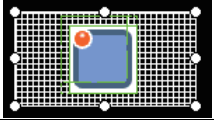
#### ■ Selecting target

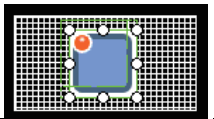
The selection targets for the screen editor can be selected from [Figure], [Object], or [Figure+Object].  
(Default: [Figure+Object])

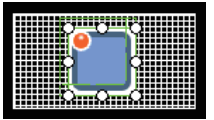
Selection target	Description	Selection operation
Figure	<p>Use this setting when selecting only figures.</p>  <p>Only figures can be selected.</p> <p>When a figure and an object are overlapped, only the figure is displayed.</p> 	<ul style="list-style-type: none"> <li>Select [Edit] → [Object of Selection] → [Figure] from the menu.</li> </ul>
Object	<p>Use this setting when selecting only objects.</p>  <p>Only objects can be selected.</p> <p>When a figure and an object are overlapped, only the object is displayed.</p> 	<ul style="list-style-type: none"> <li>Select [Edit] → [Object of Selection] → [Object] from the menu.</li> </ul>
Figure+Object	<p>Use this setting when selecting figures and objects.</p>  <p>Both figures and objects can be selected.</p>  <p>When a figure and an object are overlapped, the object is displayed with priority.</p> 	<ul style="list-style-type: none"> <li>Select [Edit] → [Object of Selection] → [Figure+Object] from the menu.</li> </ul>

## HINT

### (1) Selecting set overlay screen

When the selecting target is [Object] or [Figure+Object], switch whether to execute or not set overlay screen. Switch with the following operations

- Select [Edit] → [Object of Selection] → [Overlay Screen] from the menu.

### (2) Screens affected by [Object of Selection]

When [Object of Selection] is set, the screens affected by the setting differ according to the displayed screen.

- When a base screen or a window screen is displayed  
The setting of [Object of Selection] affects base screens and window screens.
- When the report screen, the parts editor, or the library editor is displayed  
The setting of [Object of Selection] affects the displayed screen only.

## ■ Selecting figures and objects in the background

Click the part where figures or objects are overlapped while pressing the [Ctrl] key. The selected figure shifts by each click.

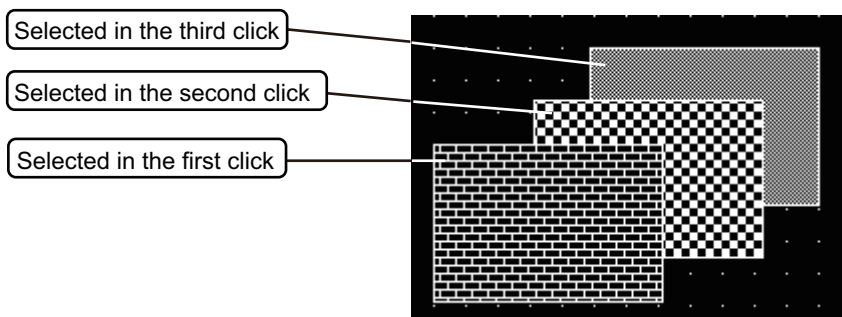

## ■ Selecting multiple figures and objects

### (1) By the drag operation of the mouse

Select the area around the figures or objects by the mouse drag function.

Release the mouse button. Multiple figures and objects in the selected area are selected.

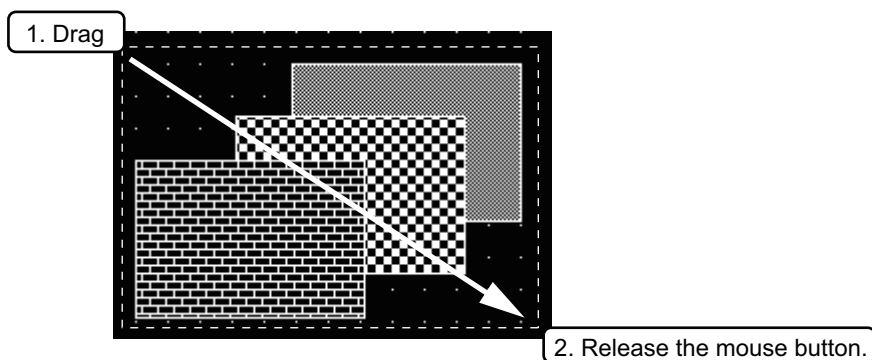

**(2) By the [Shift] key + mouse operation**

Click the figure or object to be selected while pressing the [Shift] key.  
The clicked figure or object is selected.

Multiple selection  
by [Shift] + click

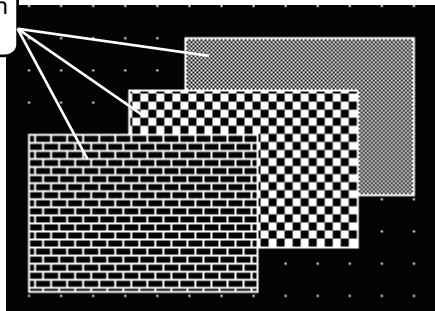

**■ Releasing multiple-selected figures and objects**

Click figures and objects to be released from the multiple selected ones while pressing the [Shift] key.  
The clicked figure or object is released.

Release multiple  
selection by  
[Shift] + click

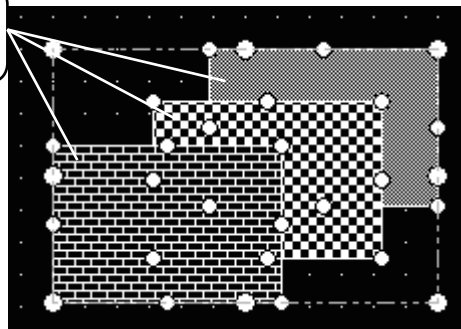

**HINT**





**(1) Selecting figure or object from the data list**

Using the data list, the figures and objects on the screen can be displayed in a list.  
The figure or object selected in the data list is also selected on the screen editor.  
For how to use the data list, refer to the following.

 9.5.3 Selecting overlapped figure (Data view)

## 5.2.2 Editing figure and object

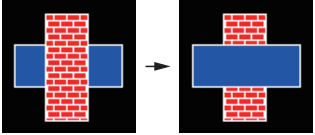
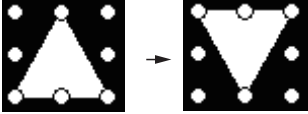
1. Select the figure or object to be edited.
2. Perform the following operations, according to the editing contents.

Function	Description	Operation
Cut	Figures and objects are cut.	<ul style="list-style-type: none"> <li>• Select [Edit] → [Cut] from the menu.</li> </ul>
Copy	Figures and objects are copied.	<ul style="list-style-type: none"> <li>• Select [Edit] → [Copy] from the menu.</li> </ul>
Paste	The cut/copied figures and objects are pasted.	<ul style="list-style-type: none"> <li>• Select [Edit] → [Paste] from the menu.</li> </ul>
Delete	Figures and objects are deleted.	<ul style="list-style-type: none"> <li>• Select [Edit] → [Delete] from the menu.</li> </ul>
Bring to Front or Front Layer /Send to Back or Back Layer	<p>The front-to-back sequence of objects is changed within the screen.</p> <p>(Ex.) The selected objects are changed in front-to-back sequence.</p> 	<ul style="list-style-type: none"> <li>• Select [Edit] → [Stacking Order] → [Move to Front of Front Layer] from the menu.</li> </ul>
	<ul style="list-style-type: none"> <li>• Select [Edit] → [Stacking Order] → [Move to Back of Back Layer] from the menu.</li> </ul>	
Bring to Front of Layer /Sent to Back of Layer	<p>The front-to-back sequence of figures/objects is changed within the same layer.</p> <p>(Ex.) The selected figure is moved to the front.</p> 	<ul style="list-style-type: none"> <li>• Select [Edit] → [Stacking Order] → [Move of Front of Layer] from the menu.</li> </ul>
	<ul style="list-style-type: none"> <li>• Select [Edit] → [Stacking Order] → [Move to Back of Layer] from the menu.</li> </ul>	
Flip Vertical /Flip Horizontal	<p>The selected figure is flipped. (Not available for objects)</p> <p>(Ex.) Flipping selected figure vertically</p> 	<ul style="list-style-type: none"> <li>• Select [Edit] → [Rotate/Flip] → [Flip Vertical] from the menu.</li> <li>• Select [Edit] → [Rotate/Flip] → [Flip Horizontal] from the menu.</li> </ul>
RotateLeft /Rotate Right	<p>Figure is rotated 90 degrees to right/left. (Not available for objects)</p> <p>(Ex.) Rotating selected figure 90 degrees to left</p> 	<ul style="list-style-type: none"> <li>• Select [Edit] → [Rotate/Flip] → [Rotate Left] from the menu.</li> <li>• Select [Edit] → [Rotate/Flip] → [Rotate Right] from the menu.</li> </ul>



### Operation with icons or shortcut keys

The operations above can also be performed with icons on the toolbar or shortcut keys. For the list of toolbar icons and shortcut keys, refer to the following.

 3.4 Type of Tool Bars and Short Cut Keys

## 5.2.3 Grouping multiple figures and objects

The grouping of multiple figures and objects enables users to handle them as a single figure.

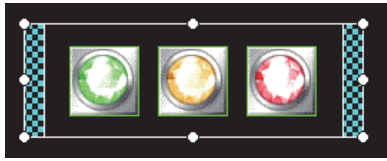

Group

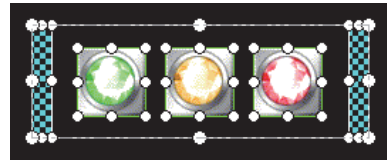

Ungroup

1. Select the figures or objects to be grouped or ungrouped.
2. Perform the following operations, depending on the editing content.

Function	Description	Operation
Group	Multiple figures and objects are grouped.	• Select [Edit] → [Group] from the menu.
Ungroup	Multiple figures and objects are ungrouped.	• Select [Edit] → [Ungroup] from the menu.



### (1) Operation with icons or shortcut keys

The operations above can also be performed with icons on the toolbar or shortcut keys. For the list of toolbar icons and shortcut keys, refer to the following.

 3.4 Type of Tool Bars and Short Cut Keys

### (2) Grouping a template information box, figure, and object

A template information box, a figure, and an object can be grouped. For the conditions of grouping them, refer to the following.

 7.5 Precautions

## 5.2.4 Undo, redo

The edition of figures or objects can be reversed. Also, reversed operations can be re-executed.

### ■ Undo

Select [Edit] → [Undo] from the menu.  
The last action is reversed.

### ■ Redo

Select [Edit] → [Redo] from the menu.  
The operation reversed with [Undo] is re-executed.



### Operation with icons or shortcut keys

The operations above can also be performed with icons on the toolbar or shortcut keys. For the list of toolbar icons and shortcut keys, refer to the following.

 3.4 Type of Tool Bars and Short Cut Keys

## 5.2.5 Aligning figures and objects

Multiple figures and objects can be aligned.

### ■ Aligning in one direction

1. Select the figures or objects to be aligned.
2. Perform the following operations according to the alignment.

Function	Description	Operation
Left	Figures and objects are aligned to the left.	• Select [Edit] → [Align] → [Left] from the menu.
Center (Horizontal)	Figures and objects are aligned at the center in the horizontal direction	• Select [Edit] → [Align] → [Center (Horizontal)] from the menu.
Right	Figures and objects are aligned to the right.	• Select [Edit] → [Align] → [Right] from the menu.
Top	Figures and objects are aligned to the top.	• Select [Edit] → [Align] → [Top] from the menu.
Center (Vertical)	Figures and objects are aligned at the center in the vertical direction	• Select [Edit] → [Align] → [Center (Vertical)] from the menu.
Bottom	Figures and objects are aligned to the bottom.	• Select [Edit] → [Align] → [Bottom] from the menu.
Align Sideways	Figures and objects are equally aligned in the horizontal direction.	• Select [Edit] → [Align] → [Align Sideways] from the menu.
Align Lengthways	Figures and objects are equally aligned in the vertical direction.	• Select [Edit] → [Align] → [Align Lengthways] from the menu.

(Example) Aligning example of figures and objects

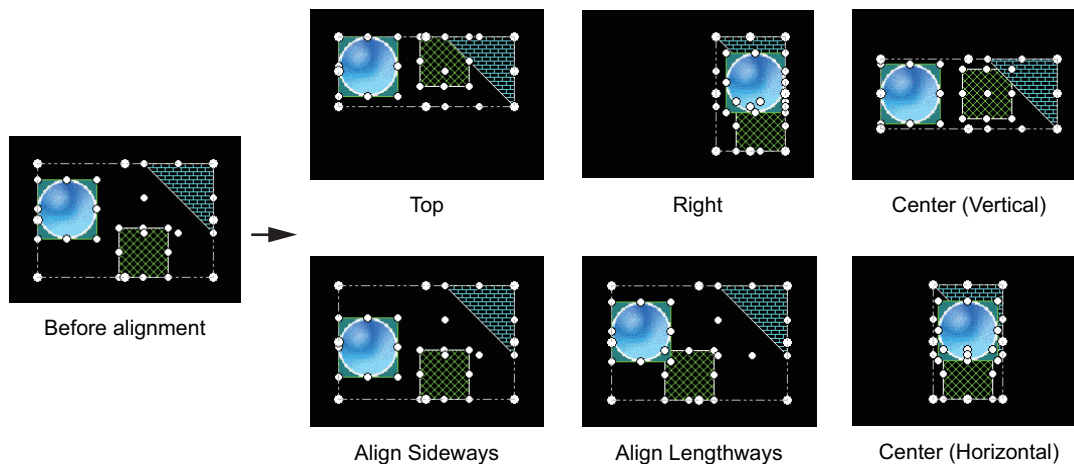

### Operation with toolbar icons

The operations above can also be performed with icons in the toolbar.  
For toolbar icons, refer to the following.

☞ 3.4 Type of Tool Bars and Short Cut Keys



## POINT

### (1) Align Sideways

When [Align Sideways] is selected, the figures and objects are aligned equally based on the top-left coordinates of the leftmost and rightmost figures or objects.

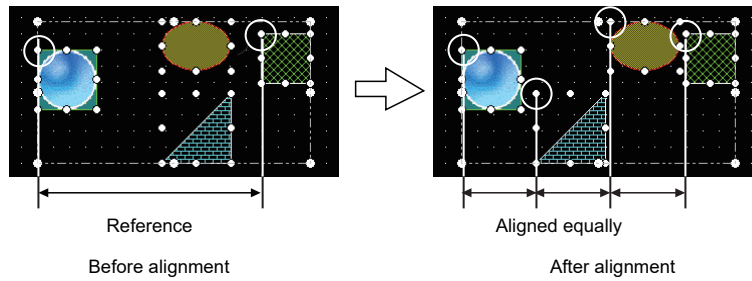

### (2) Align Lengthways

When [Align Lengthways] is selected, the figures and objects are aligned equally based on the top-left coordinates of the uppermost and lowermost figures or objects.

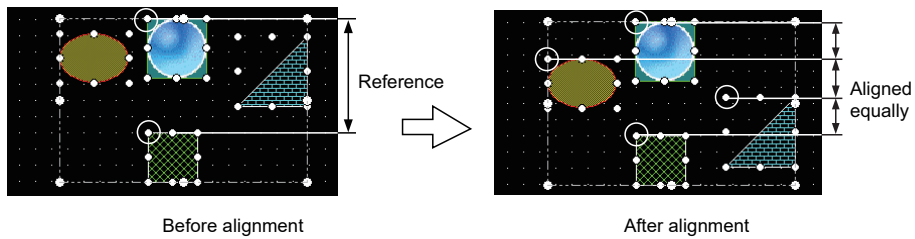

## ■ Alignment in combination of multiple directions

1. Select the figures and objects to be aligned.
2. Select [Edit] → [Align] → [Custom] from the menu.
3. The [Align] dialog box is appears.  
Select the alignment direction and click the [OK] button.

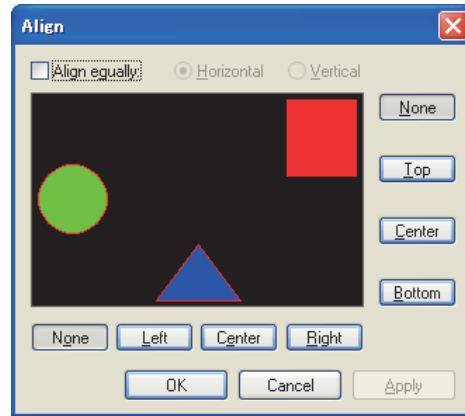

Item	Description	
None	Figures and objects are not aligned to the selected direction.	
Top	Figures and objects are aligned to the top.	
Bottom	Figures and objects are aligned to the bottom.	
Left	Figures and objects are aligned to the left.	
Right	Figures and objects are aligned to the right.	
Center	Figures and objects are aligned at the center of selected direction.	
Align equally	Select this item to align figures equally.	
	Horizontal	Figures and objects are aligned equally in the horizontal direction.
	Vertical	Figures and objects are aligned equally in the vertical direction.

## ■ Alignment using the Guidelines

1. Select [Display] → [Guidelines (auxiliary line)] and any of the following from the menu.

Item	Description
Display	Displays the guideline.
Figure	The guideline is displayed for figures.
Object	The guideline is displayed for objects.
Figure + Object	The guideline is displayed for figures and objects.
Same Type	The guideline is displayed for the same type of data of the selected figure or object.
Custom	Displays the guideline setting dialog box.  (1) [Guidelines (auxiliary line) Setting] dialog box

2. Drag and move the figure or object.  
 The Guidelines is displayed if some display target is placed in the horizontal or vertical direction.  
 Take the Guidelines as a reference and determine the position to move.

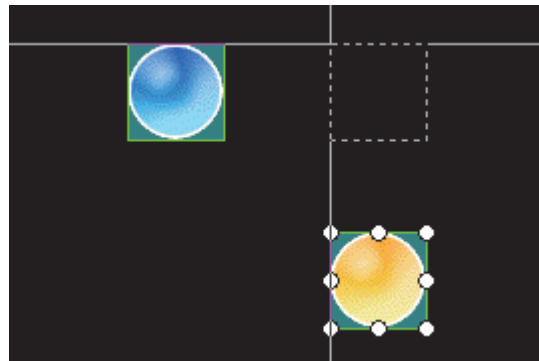

### (1) [Guidelines (auxiliary line) Setting] dialog box

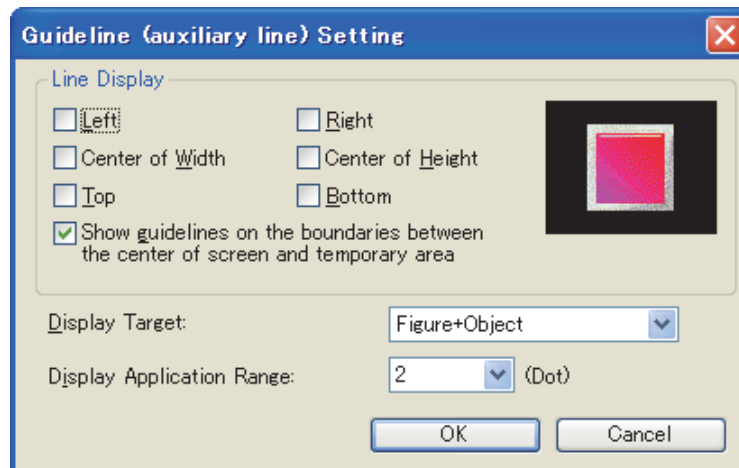

Item	Description	
Line Display	Set the lines to be displayed as Guidelines.	
Display Target	Select the target for the moving figure or object to display the guideline.	
	Figure	The guideline is displayed for figures.
	Object	The guideline is displayed for objects.
	Figure + Object	The guideline is displayed for figures and objects.
Same Type	The guideline is displayed for the same type of data of the selected figure or object.	
Display Application Range	Specify the displaying distance of the figure or object.	



### Precautions for Guidelines

- When [Center of Width] or [Center of Height] is selected, the Guidelines is displayed at the center of the width or height of the display target.
- Grouped figures and objects displays the Guidelines for grouped figures and objects regardless of the contents of the group.
- Guidelines is not displayed in the touch area of touch switches.
- The Guidelines is not displayed when operating the keyboard.

## 5.2.6 Changing attributes of figures and objects

### ■ Changing attributes with property sheet

1. Select [View] → [Docking Window] → [Propertysheet] from the menu.  
After selecting, the property sheet is displayed.

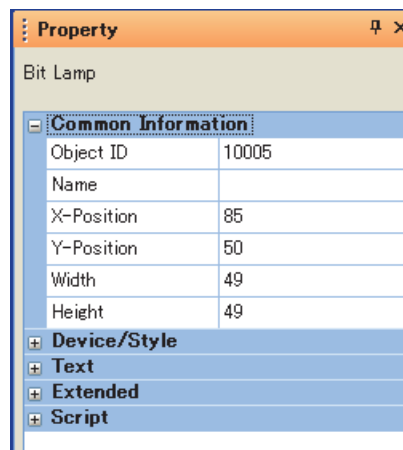

2. Select the figure or object.  
After selecting, the attributes of the selected figure or object are displayed in the property sheet.
3. Change the attributes of the figure or object.  
For how to use the property sheet, refer to the following.

 9.4 Displaying in List and Editing Screen/Figure/Object Settings (Propertysheet)



### (1) Changing attributes of multiple figures/objects in a batch

The type of figures or objects to be changed must be the same.  
Attributes of different types of figures and objects cannot be changed in a batch.  
Also, if different types of figures and objects are grouped, those attributes cannot be changed.  
Ex.) Touch switch and lamp, Bit lamp and word lamp, Circle and rectangle

### (2) Object shape setting

Shapes cannot be set for objects in the property sheet.  
When selecting whether to set or not shapes, set it from the dialog box of each object.

### (3) Width and height of figures and objects

Item	Setting range
Width	1 to 2000
Height	1 to 1600

## ■ Changing attribute with dialog box

1. Double-click the figure or object.
2. The setting dialog box of the figure or object is displayed.  
Change the attributes of the figure or object.  
For how to set the setting dialog box of each figure or object, refer to the following.

 GT Designer3 Version1 Screen Design Manual (Functions)



### How to display the setting dialog box

The setting dialog box of each figure or object can be displayed by the following methods.

- (1) **Display from the right-click menu**  
Select [Setting] from the menu displayed by right-clicking the figure or object.
- (2) **Display from the toolbar menu**  
Select the figure or object, and select [Edit] → [Setting] from the menu.

## 5.2.7 Changing size of figures/objects

### POINT

#### Handle types

When selecting figures or objects, the points displayed around are called handle. Select [Edit] → [Edit Vertices] from the menu to switch the handle type. The following types of handle are available.

#### (1) Size change handle

Use this to change the size of figures or objects

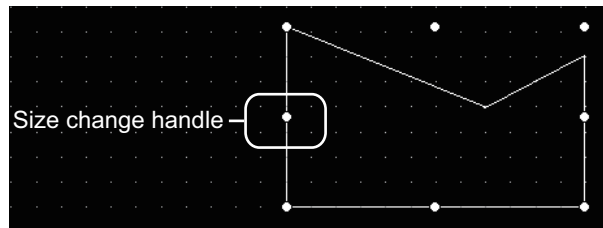

#### (2) Vertex edit handle

Use this to edit the length of specified side of figures or objects.

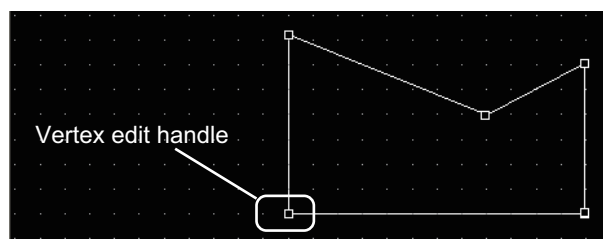

### Scaling up/down figures

The overall size can be scaled up or down.

1. Select the figure.
2. The handle is displayed on the figure.  
When the handle type is vertex edit handle, select [Edit] → [Edit Vertices] from the menu, and switch to the size change handle.
3. Drag the handle, and change the figure size.

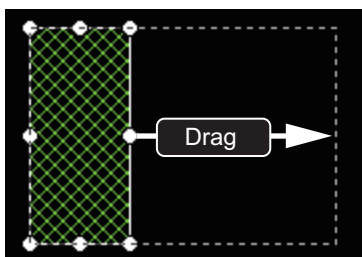

Ex.) Changing vertical and horizontal sizes

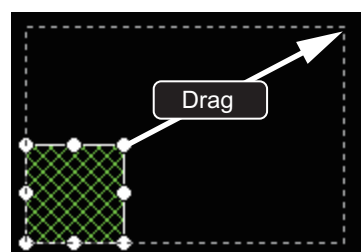

Ex.) Changing vertical and horizontal sizes from corner

## HINT



### (1) Operation in combination with the [Ctrl] key and [Shift] key.

The method for changing the size can be changed by a combined operation of the [Ctrl] and [Shift] keys.

#### (a) When changing sizes without changing the vertical/horizontal ratio

Drag the handle while pressing the [Shift] key.

The figure size can be changed, without changing the vertical/horizontal ratio.

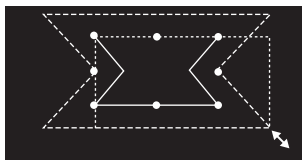

#### (b) When changing the vertical and horizontal sizes from the center

Drag the handle while pressing the [Ctrl] key.

The figure size can be changed to the vertical or horizontal directions from the center.

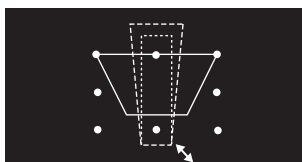

#### (c) When changing sizes from the center without changing the vertical/horizontal ratio

Drag the handle while pressing the [Ctrl] and [Shift] keys.

The figure size can be changed without changing the vertical/horizontal ratio from the center.

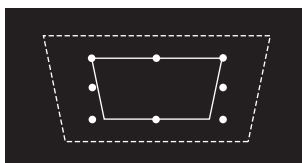

Texts can be resized by performing the operations (a) to (c) above.

However, when high-quality or True Type font is used, the text may not be resized as intended, since they are restricted in the applicable size.

### (2) Changing attribute with dialog box

Multiple figures and objects can also be selected and enlarged or reduced in a batch.

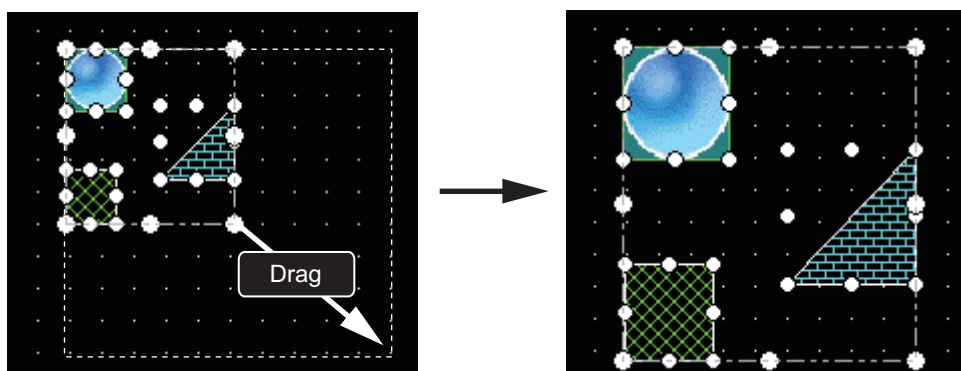

## ■ Editing figure vertex

The length of a specified side can be changed.

1. Select a figure.
2. The handle is displayed on the figure.  
When the handle type is size change handle, select [Edit] → [Edit Vertices] from the menu to switch to the vertex edit handle.
3. Drag the handle, and change the vertex position.  
Ex.) Vertex edit of Line free form

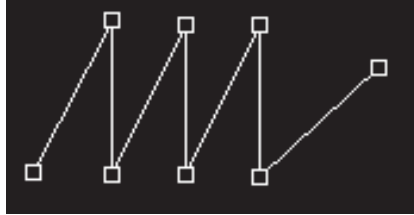

## ■ Enlarging or reducing objects

### (1) Overall size

1. Select an object.
2. The handle is displayed on the object.
3. Drag the handle, and change the object size.

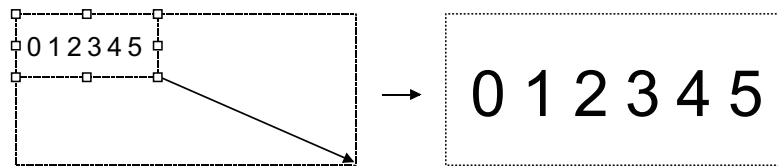

### **Objects whose size cannot be changed by mouse operation.**

Text size can be automatically adjusted to fit a character string by setting Adjust Direct Text Size.  
Refer to the following manual for the target object and setting for Adjust Direct Text Size.



**(2) Text size**

**(a) Text set to an object**

Size of texts other than direct input texts are changed according to the object size changing. The changing details are different according to object types.

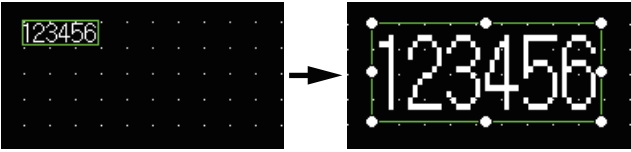
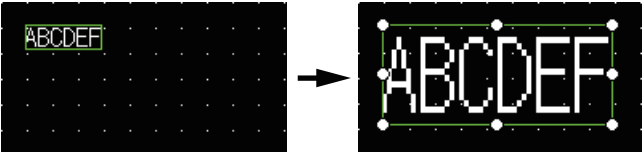
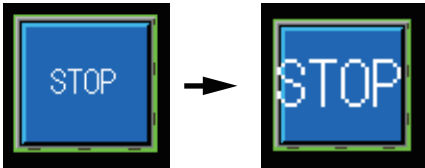
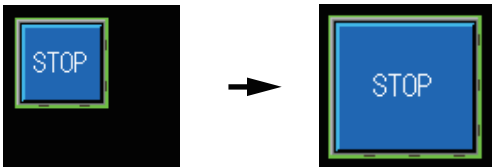
Change of text size	Object	Details of change
Changeable	Numerical display Numerical input	The text size is enlarged 0.5 to 8 times from the original object size. 
	ASCII display ASCII input	The text size is enlarged 0.5 to 8 times from the original object size. 
Unchangeable	Touch switch Lamp (Bit/Word) Alarm list Comment display Data list display Alarm history display Trend graph Line graph Bar graph Statistics graph Scatter graph Panel meter	The text size can be changed by setting text size from the dialog box of each object. The text size is not changed even if the object size is changed, Example: When the text size setting is changed (Touch switch)  Example: When the object size is changed 

**(b) Text set as direct input text**

When [Adjust Direct Text Size] is enabled, the direct input text is automatically enlarged or reduced according to the object size.

Select [Edit] → [Adjust Direct Text Size] from the menu to switch whether to enable or disable the automatic sizing of direct input text.



When [Adjust Direct Text Size] is enabled

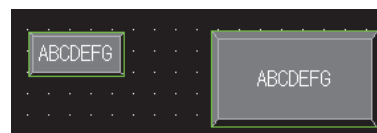

When [Adjust Direct Text Size] is disabled

The Adjust Direct Text Size is available for the following objects.

- Touch switch
- Lamp (Bit/Word)
- Panelmeter

(c) Text set for comment group

The size of text set for comment group is automatically changed then [Adjust Text Size] on the dialog box of each object is enabled.

The font size of texts exceeding the object display frame is automatically adjusted, according to the object display frame.

Also, the minimum font size when adjusting the text can be set at [Minimum Size].

When using high quality fonts, the displayed font may be changed depending of the size after changing.







So, after changing the object size, confirm if the displayed font is not changed.

If the font is changed, adjust the object size to enable the display of the high quality font.

The [Adjust Text Size] is available for the following objects.

- Touch switch
- Lamp (Bit/Word)
- Comment Display
- Advanced Alarm

The following explains operations when [Adjust Text Size] is enabled and disabled.

When the text string is not fit in the display frame	Enabled	Disabled
<p>Display frame</p>  <p>Text string displayed</p> <p>ABCDEF GH</p>	 <p>When the text string is not fit in the display frame, the character size is adjusted automatically so that the text string is fit in the display frame.</p>	 <p>Line feed is performed for the text string.</p>
<p>Display frame</p>  <p>Text string displayed</p> <p>ABCDEF GHIJK</p>	 <p>When the text string is not fit in the display frame even with the set minimum text size, the text string is aligned to the left and overflowed text part are not displayed.</p>	 <p>When the text string is not fit in the display frame even when line feed is performed, the overflowed text part is not displayed.</p>

### (3) Shapes set to objects

Shapes set to objects are enlarged or reduced according to the object.

- (a) Shape with fixed frame width when the object is enlarged (Frame width fixed shape)  
When the object is enlarged or reduced, the frame width does not change.



- (b) Shape with increasing frame width when the object is enlarged  
When the object is enlarged, the frame width is also enlarged.  
When the object is reduced, the frame width is narrowed.



## HINT



### Frame width fixed shape

A frame width fixed shape is included in basic figures and the name of the shape includes [Fixed Width].

Shape:

### (4) Touch area

When changing the size of objects to which shape is set, the size of touch area and shape, and the display position of both may become misaligned.

When the object and shape are not aligned, select the object and perform the following operations to adjust the display position.

- (a) Center the touch area in its shape  
Right-click the object and select [Centering] from the displayed menu.  
The touch area moves to the center of the shape.

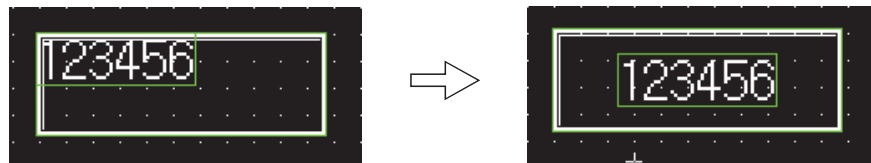

- (b) Edit the touch area and shape separately  
Select the object and then select [Edit] → [Edit Touch Area/Frame Region] → [Edit Touch Area/Frame Region] from the menu.

After selecting, the display position/size of the touch area and shape can be edited separately.

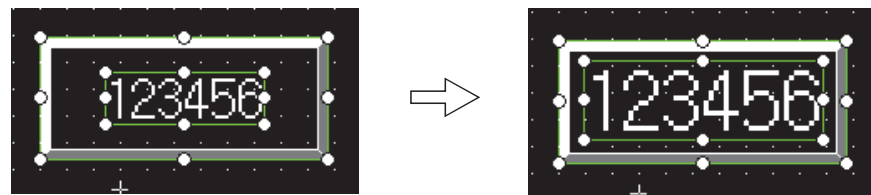

- (c) Matching the touch switch shape and touch area  
Select the touch switch and then select [Edit] → [Edit Touch Area/Frame Region] → [Touch Area Auto Adjustment] from the menu.  
After selecting, the shape and touch area are matched.

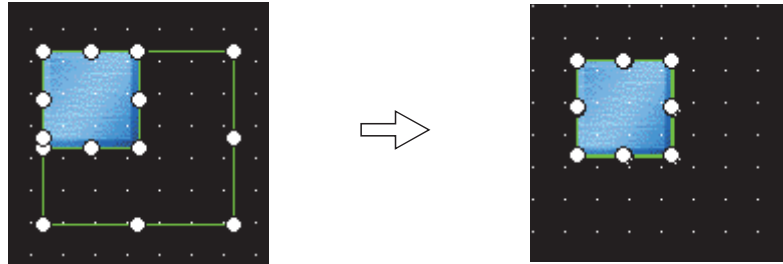

## HINT

### Always adjust the touch area automatically

For matching the shape and touch area always, enable [Constant Touch Area Auto Adjustment].

Select [Edit] → [Edit Touch Area/Frame Region] → [Constant Touch Area Auto Adjustment] from the menu to switch whether to enable or disable the function.

## 5.2.8 Copying figures and objects

Figures or objects can be copied at a time.

1. Select the figure or object to be copied.

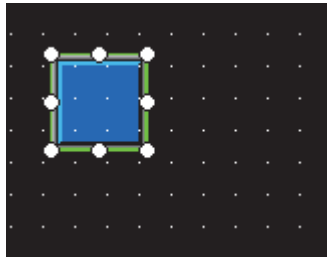

2. Select [Edit] → [Duplicate] from the menu.  
A copy of the selected object is arranged.

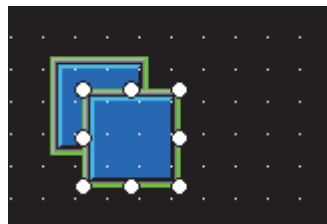

## HINT

### Operation with icons or shortcut keys

The operation above can also be performed with icons on the toolbar or shortcut keys.

For the list of toolbar icons and shortcut keys, refer to the following.

☞ 3.4 Type of Tool Bars and Short Cut Keys

## 5.2.9 Copying figures and objects consecutively

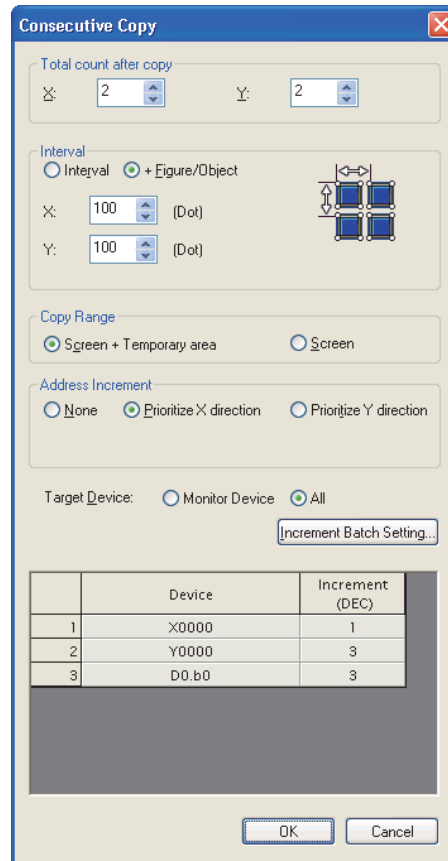

Figures and objects can be copied at a time.

1. Select the desired figure or object for consecutive copies.
2. Select [Edit] → [Consecutive Copy] from the menu.  
The Consecutive Copy dialog box appears.  
After setting the copy details, click the [OK] button to make copies.

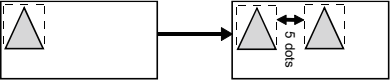
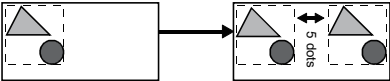
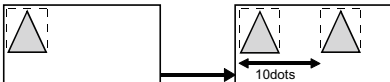
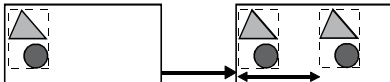
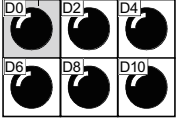

Item	Description
Total count after copy	<p>Set the number of figures (copy source + its copies) that will appear on the screen. For example, when "2" is set, two figures, i.e., the copy source and its one copy appears on the screen.</p> <p>Example) Number is set to X: 3 and Y: 2.</p> <div style="text-align: center;"> <p>Before setting                      After setting</p> </div>
X	Set the number of figures or objects in the X direction (rightward from the copy source). (1 to 100)
Y	Set the number of figures or objects in the Y direction (downward from the copy source). (1 to 100)

(Continued to next page)

Item	Description
Interval	<p>Set the interval (dots) between the copy source and its copies.</p> <ul style="list-style-type: none"> <li>Interval *1 Example) Interval is set to X: 5 dots.</li> </ul> <div style="display: flex; justify-content: space-around;"> <div style="text-align: center;"> <p>When one figure is selected</p>  </div> <div style="text-align: center;"> <p>When multiple figures are selected</p>  </div> </div> <ul style="list-style-type: none"> <li>Figure/Object Example) Interval is set to X: 10 dots.</li> </ul> <div style="display: flex; justify-content: space-around;"> <div style="text-align: center;"> <p>When one figure is selected</p>  </div> <div style="text-align: center;"> <p>When multiple figures are selected</p>  </div> </div>
X	Set the interval (dots) between figures in the X direction (rightward from the copy source). (0 to 100)
Y	Set the interval (dots) between figures in the Y direction (downward from the copy source). (0 to 100)
Address Increment	<p>It is set to offset the device of the object to the device number for the increments when copying a object. For a touch switch, the write device only for the bit/word operation is applicable.</p> <ul style="list-style-type: none"> <li>None : Increment is not performed.</li> <li>Prioritize X direction: Incremented in the X direction (right)</li> <li>Prioritize Y direction: Incremented in the Y direction (down)</li> </ul> <p>After selecting the priority direction, set the device No. increment. Increment(DEC): -10000 to 10000</p> <p>Ex. 1: Priority in the X direction (Number of increments: 2)      Ex. 2: Priority in the Y direction (Number of increments: 2)</p> <div style="display: flex; justify-content: space-around;"> <div style="text-align: center;"> <p>Copy source</p>  <p>Priority is given to the X direction (right).</p> </div> <div style="text-align: center;"> <p>Copy source</p>  <p>Priority is given to the Y direction (down).</p> </div> </div>
Copy Range	Select the copy range from [Screen + Temporary area] and [Screen].
Target Device	<p>Select the devices for consecutive copies.</p> <ul style="list-style-type: none"> <li>Monitor Device Set the number of increments for the monitor device.</li> <li>All Select all the devices to display the applicable devices in the table. To set the number of increments in a batch, select [Increment Batch Setting] and set the number of increments. To set the number of increments for each device, input the number of increments to be set.</li> </ul>

\*1 If a figure/object is copied with 0 interval, the pasted figure/object is overlapped with the source by 1 dot. Set the interval to 1 or more to avoid overlapping of figures or objects.  
Ex.)



Copying with 0 interval.



Copying with the interval of 16

## 5.3 Common Settings of Objects



This chapter describes the items to be set commonly for objects.

### 5.3.1 Device setting



#### ■ Device that can be set by GT Designer3

For details on the device type and setting range, please refer to the following.

- ☞ Appendix2 GOT Internal Devices
- Appendix3 Device of Controllers

#### ■ Device usable for controller monitoring

The device range available for setting by GT Designer3 depends on [Controller Setting]. For details on the controller setting, refer to the following.

- ☞ GOT1000 Series Connection Manual for GT Works3 and a controller used

In addition, the device range set by GT Designer3 may be different with the usable range in controller. GT Designer3 does not check whether the device settings (device name, device No.) are actually available for the target controller.

For the availability, check it as follows:

##### (1) Check when setting the controller

For the device type and setting range available for the controller, refer to the following.

- ☞ User's Manual of the connected controller

##### (2) Check the following when drawing

For the device type and setting range available for setting by GT Designer3, refer to the followings.

- ☞ GOT1000 Series Connection Manual for GT Works3 and a controller used

GT SoftGOT1000 Version3 Operating Manual for GT Works3

##### (3) Check when monitoring

Check the device name and range with the system alarm.

If try to monitor the device name or device range that cannot be used by a controller, a system alarm occurs. (System alarm: "322 Dedicated device is out of range.")



#### Device setting for iQ Works

For iQ Works, system labels can be set instead of setting devices.

For setting the system label, refer to the following.

- ☞ 5.3.2 Label setting

## ■ Settings

Set a device using the setting dialog box provided for each object.

Example: Setting a device to be monitored by "Bit lamp"

1. Click the [...] button on the Device/Style tab. The setting dialog box is displayed.

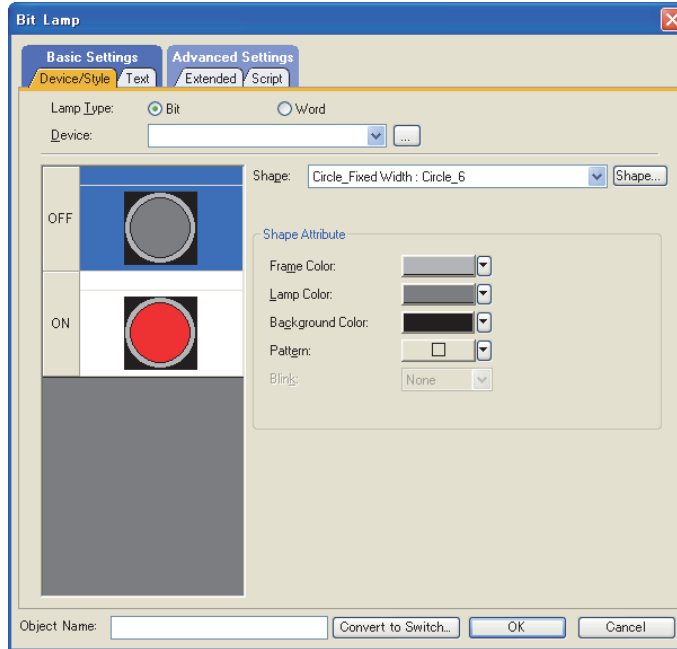

### (1) Direct input of a device

The device can be input directly from the keyboard.

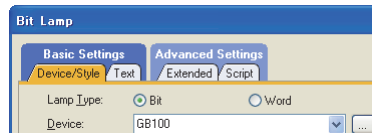

### (2) Select CH No. dialog box

According to the option setting on GT Designer3, the [Select CH No.] dialog box is displayed when the [...] button is clicked.

Click the [...] button in the setting dialog box of each object function while pressing the [Shift] key of the personal computer. The [Select CH No.] dialog box is displayed independently of the option setting.

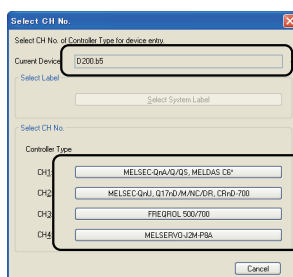

Displays the presently set device.

@ 2 : 1-5 / 2 D200 . b5

Bit position  
Device No.  
Device name  
CPU Machine  
PLC station No.  
NW No.  
Channel No.

Displays the channel No. and type name of the controller.

The display condition of the [Select CH No.] dialog box can be changed using [CH No. Selection Dialog display Setting] in the [Options] dialog box.

To display the [Options] dialog box, select [Tools] → [Option] from the menu.

For how to change the settings, refer to the following.

3.5.3 Customizing actions and default value of GT Designer3



- Click the [...] button, and the [device setting] dialog box is displayed. Select the device to be set and click the [OK] button. The device is set to the object. For the settings of the [device setting] dialog box, refer to the following.

Appendix4 Setting device of each controller

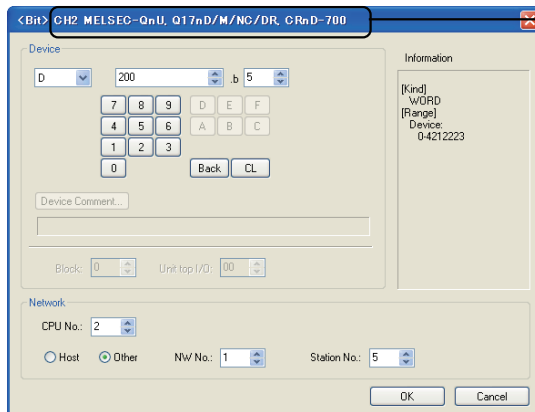

Displays the channel No. and type name of the controller, which are set presently.

Device setting dialog box

## POINT

### (1) Changing the communication settings

After setting a device, do not change the channel setting to None in the communication settings. If changed, the device of the channel No. set to None must be set again.

### (2) Setting of frequently-used device.

Once a device is set, it can be selected from the displayed list for setting from the next time. Maximum 10 device names can be added to the list. If more than 10 devices are kept, the device name will be deleted from the oldest one.

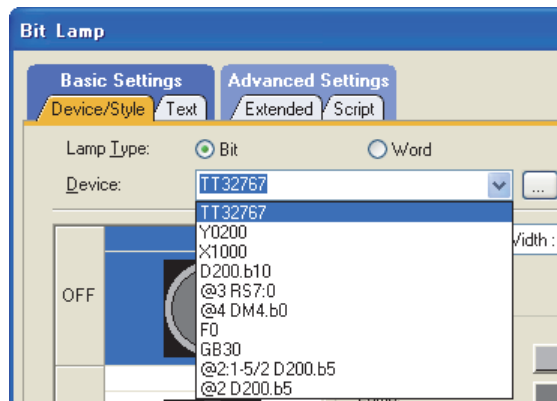

## 5.3.2 Label setting



For iQ Works, system labels can be used instead of setting devices on GT Designer3. The system labels can be registered in the system label database by GT Designer3.



### (1) System label

A system label is a character string with a controller device assigned. The system label can be used among projects in the workspace of iQ Works. The system label cannot be used for other than iQ Works.

### (2) System label database

The system label database is a database to manage system labels. When a workspace is saved in MELSOFT Navigator, a system label database is created in the workspace. When the system label database does not exist in the workspace, system labels cannot be used.

## ■ Conditions for use of system labels

### (1) Conditions for projects

System labels can be used only a workspace saved in MELSOFT Navigator. A system label database is not created for a GT Designer3 project in a workspace created by GT Designer3 (not started from MELSOFT Navigator). Therefore, the system labels cannot be used. To use the system labels, save the GT Designer3 project in a workspace created by MELSOFT Navigator.

### (2) Conditions for GT Designer3 settings

#### (a) GOT type setting

System labels can be used only [Use system labels in conjunction with MELSOFT Navigator] is selected for [GOT Type Setting].

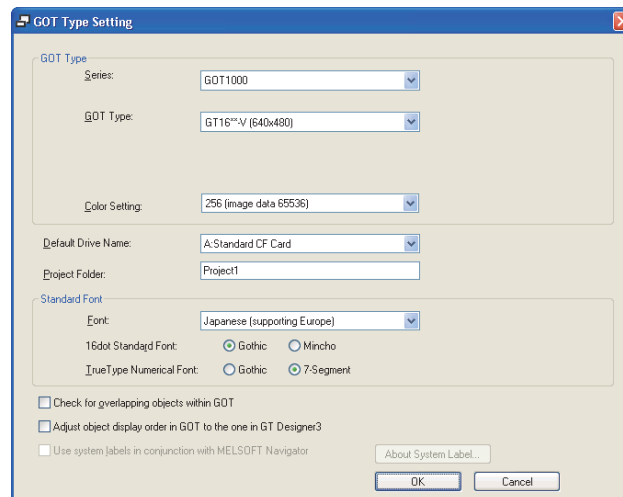

For how to configure the GOT type setting, refer to the following.

 4.1 GOT Type Setting

(b) Controller setting

When any of the following types are not set for [Controller Setting], system labels cannot be used.

Manufacturer	Controller type	Model
MITSUBISHI ELECTRIC	MELSEC-QnU/DC, Q17nD/M/NC/DR, CRnD-700	GT16 GT15 GT14 GT12 GT11 GT10 SoftGOT1000
	MELSEC-QnA/Q/QS, MELDAS C6*	GT16 GT15 GT14 GT12 GT11 GT10 SoftGOT1000
	MELSEC-Q(Multi)/Q-Motion	GT16 GT15 GT14 GT12 GT11 GT10 SoftGOT1000
	MELSEC-L	GT16 GT15 GT14 GT12 GT11 GT10 SoftGOT1000
	MELSEC-FX	GT16 GT15 GT14 GT12 GT11 GT10 SoftGOT1000
	MELSEC-QnU/DC, Q17nD/M/NC/DR	GT16 GT15 GT14 GT12 GT11 GT10 SoftGOT1000
	MELSEC-QnA/Q, MELDAS C6*	GT16 GT15 GT14 GT12 GT11 GT10 SoftGOT1000
	MELSEC-QnU/DC	GT16 GT15 GT14 GT12 GT11 GT10 SoftGOT1000
	MELSEC-QnA/Q	GT16 GT15 GT14 GT12 GT11 GT10 SoftGOT1000
MELSEC-Q(Multi)	GT16 GT15 GT14 GT12 GT11 GT10 SoftGOT1000	

For how to configure the controller setting, refer to the following.

 GOT1000 Series Connection Manual (Mitsubishi Electric Products) for GT Works3

## ■ Applicable system labels

The GOT can use system labels that satisfy the following conditions.

System labels not applicable to the GOT are recognized as incorrect labels.

The incorrect labels can be set for GT Designer3, however the labels cannot be written to the GOT, a memory card, or a USB memory.

### (1) System label name

The GOT can use system labels that satisfy the following conditions.

System labels that do not satisfy the following conditions cannot be set for GT Designer3.

- Regardless of two-byte or one-byte characters, up to 32 characters are set for system labels.
- One-byte kana characters are not used.
- The following one-byte symbols are not used.  
., , , [ , ] , : , ! , " , # , \$ , % , & , ' , ( , ) , \* , + , ; , < , = , > , ? , \ , ^ , ` , { , | , } , ~ , ?
- A system label name is not the same as a device name.
- Reserved characters are not used.

For reserved characters, refer to the following.

 GX Works2 Version1 Operating Manual (Common)

## (2) Registering system labels in a system label database

System labels that are not registered in a system label database are recognized as incorrect labels. For how to register the system labels in the system label database, refer to the following.

- Registering system labels by MELSOFT Navigator

 Help for MELSOFT Navigator

- Registering system labels by GT Designer3

 ■ Registering system labels

## (3) Data types

System labels with the following data types are recognized as incorrect system labels.

Do not set the system labels with the following data types.

- [Time]
- [String]
- [Pointer]
- [FLOAT[Double Precision]]

### HINT



#### Reflecting data type of system labels on GT Designer3 settings

When [Reflect the data type of system label] on the [Operation] tab for the [Options] dialog box is selected, the data type of system label is reflected to GT Designer3 settings.

 3.5.3 Customizing actions and default value of GT Designer3

## (4) Devices assigned to system labels

Assign devices that can be monitored by the GOT to system labels.

The following system labels are recognized as incorrect labels.

- System labels with devices assigned that cannot be monitored by the GOT
- System labels without devices assigned

## ■ System label setting

As well as devices, system labels are set for each object setting dialog box.

System labels can be set by entering a system label name directly, or selecting system labels from the system label list.

### (1) Entering system label name directly

Enter a system label name directly to [Device] for the dialog box of objects or others.

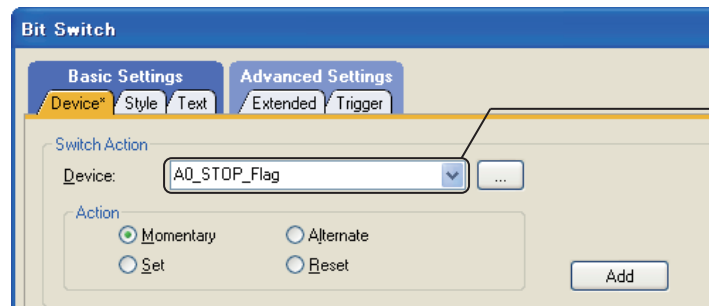

Enter the system label name.

When incorrect label names including a system label name that is not registered in the system label database is entered, ?? is added to just before the system label name.

Check the system label setting, and then configure the setting again, or register the system label in the system label database.

 ■ System label update/check

## (2) Selecting system labels in the system label list

1. Click the [...] button in the setting dialog box of objects and others.  
The [Import System Labels to Project] dialog box appears.  
According to the option setting on GT Designer3, the [Select CH No.] dialog box or the [Device Setting] dialog box for the specified CH No. is displayed.
2. Select a system label in the system label list.
3. Click the [Import] button to set the system label for [Device].

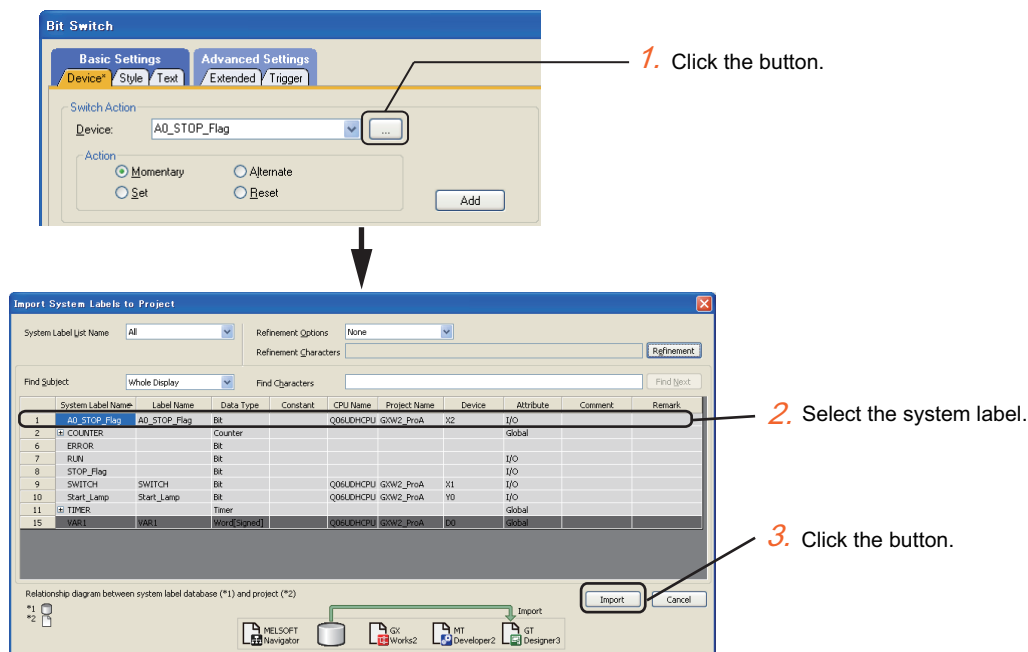

### (1) Select CH No. dialog box

According to the option setting on GT Designer3, the [Select CH No.] dialog box is displayed when the [...] button is clicked.

Click the [...] button in the setting dialog box of each object function while pressing the [Shift] key of the personal computer. The [Select CH No.] dialog box is displayed independently of the option setting.

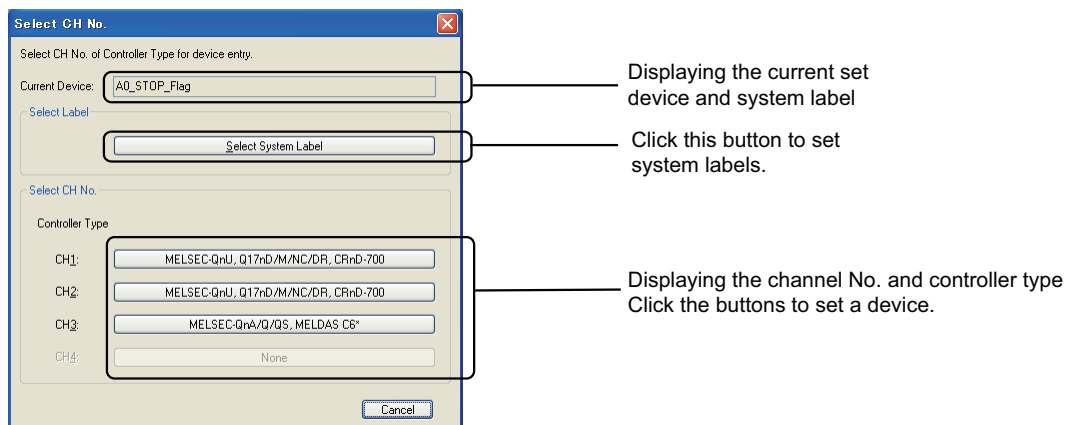

The display condition of the [Select CH No.] dialog box can be changed using [CH No. Selection Dialog display Setting] in the [Options] dialog box.

To display the [Options] dialog box, select [Tools] → [Option] from the menu.

For how to change the settings, refer to the following.

3.5.3 Customizing actions and default value of GT Designer3

## ■ System label update/check

Data of a system label database can be edited by each software for iQ Works.

Therefore, system labels used with GT Designer3 settings may not be updated.

When the system label update/check is executed, GT Designer3 project data are updated by importing data in the system label database. And then the set system labels are checked whether the labels are applicable.

When registering, changing, or deleting data in the system label database by MELSOFT Navigator or others, execute the system label update/check and import the latest system labels.

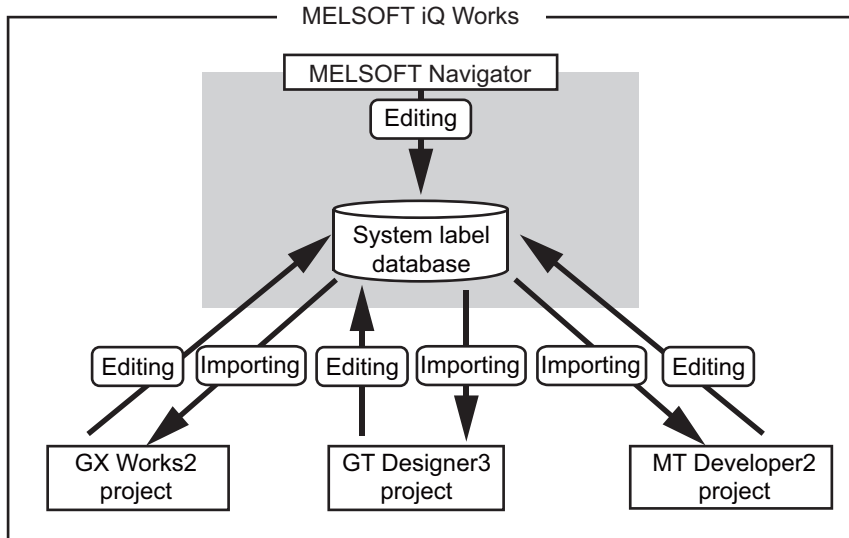

### (1) Operating procedure

1. Select [Tools] → [System Label Update/Check] from the menu to update and/or check system labels.
2. When the system label settings are incorrect, the [System Label Update/Check] dialog box appears. Refer to the following to remove errors.

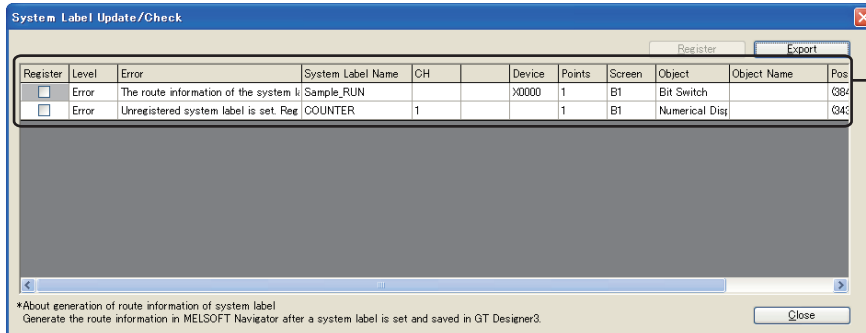

Item	Description	Model
Register	Click this button to register the system label selected for the error list in the system label database. ■ Registering system labels	
Export	Click this button to export the result of the system label update/check. Click this button to display the [Save As] dialog box. Set the save location, file name, and file type, and then save the check result.	gr16 gr15 gr14 gr12 gr11 gr10 softgr1000
Error list	Displays error messages and error occurred system label names and others. For errors, causes, and corrective actions, refer to the following. (3) Error messages To register an unregistered system label in the system label database, select [Register].	

## (2) Automatically executing the system label update/check

To match a project data and another project data, GT Designer3 automatically executes the system label update/check in the following operations.

- Open a GT Designer3 project. (Only when system labels are changed)
- Save a GT Designer3 project.
- Select [Communication] → [Write to GOT], [Transfer to Memory Card], or [Communicate with GT10-LDR] from the menu.
- Select or clear [Use system labels in conjunction with MELSOFT Navigator] for the GOT type setting.
- Start or update GT Simulator3.
- Clear the applicable controller type for the controller setting.

☞ ■Conditions for use of system labels



### (1) System label update notification

When the system labels set for the GT Designer3 project are changed or deleted in the system label database, the system label update notification icon is displayed on the status bar.

Right-click the system label update notification icon, and then select [System Label Update/Check] to update and/or check system labels.

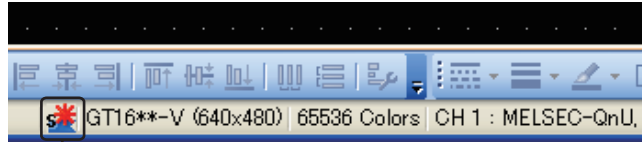

System label update notification icon

### (2) System label update/check when starting GT Designer3

Whether to automatically execute the system label update/check when starting GT Designer3 can be set in the [Options] dialog box.









The [Options] dialog box appears by selecting [Tools] → [Option] from the menu.

For the setting method, refer to the following.

☞ 3.5.3 Customizing actions and default value of GT Designer3

### (3) Error messages

The following table shows the errors, causes, and corrective actions for the system label update/check.

Error	Cause	Corrective action
Controller and this project are not allocated in MELSOFT Navigator. Allocate this project with the controller and save in MELSOFT Navigator.	<ul style="list-style-type: none"> <li>The current used project is not assigned to the system configuration diagram.</li> </ul>	<ul style="list-style-type: none"> <li>Assign the current used project to the controller, and then save the project by MELSOFT Navigator.</li> <li> Help for MELSOFT Navigator</li> </ul>
Device setting of the system label or controller setting of GT Designer3 is incorrect. Check the device setting of the system label and controller setting.	<ul style="list-style-type: none"> <li>A device that cannot be monitored by the GOT is set.</li> <li>The device number of a device set for the system label is out of range or invalid.</li> </ul>	<ul style="list-style-type: none"> <li>Check the device setting of the device assigned to the system label.</li> <li> ■Applicable system labels Appendix3 Device of Controllers Help for MELSOFT Navigator</li> </ul>
	<ul style="list-style-type: none"> <li>A value out of the range is specified for an element of array.</li> <li>A label name of the structure that does not exist is specified.</li> <li>/T, /S, or /C is specified for a system label with the data type other than [Timer], [Counter], and [Retentive Timer].</li> </ul>	<ul style="list-style-type: none"> <li>Check the data type assigned to the system label.</li> <li> Help for MELSOFT Navigator</li> </ul>
	<ul style="list-style-type: none"> <li>A system label with an unavailable channel No. is set.</li> </ul>	<ul style="list-style-type: none"> <li>Check the controller setting for each channel.</li> <li> GOT1000 Series Connection Manual (Mitsubishi Electric Products) for GT Works3</li> </ul>
Unregistered system label is set. Register it in a system label of MELSOFT Navigator.	<ul style="list-style-type: none"> <li>A system label that is set for GT Designer3 does not exist in the system label database.</li> </ul>	<ul style="list-style-type: none"> <li>Register the system label in the system label database.</li> <li> ■Registering system labels</li> </ul>
A system label of unavailable data type is selected. Set the device again.	<ul style="list-style-type: none"> <li>A system label with the data type ([Time], [Pointer], [String], or [FLOAT[Double Precision]]) not available for GT Designer3 is set.</li> </ul>	<ul style="list-style-type: none"> <li>Set a system label with the data type available for GT Designer3 to the device setting.</li> <li> ■Applicable system labels ■System label setting Help for MELSOFT Navigator</li> </ul>
The device of the system label cannot be obtained. Allocate the device to the system label in MELSOFT Navigator.	<ul style="list-style-type: none"> <li>A device of the system label cannot be obtained.</li> </ul>	<ul style="list-style-type: none"> <li>Assign a device to the system label.</li> <li> Help for MELSOFT Navigator</li> </ul>
The routing information of the system label cannot be acquired. Generate the routing information of the system label in MELSOFT Navigator.	<ul style="list-style-type: none"> <li>The route information cannot be obtained with MELSOFT Navigator.</li> <li>The system configuration diagram of MELSOFT Navigator does not match the controller setting of the Designer3 project.</li> </ul>	<ul style="list-style-type: none"> <li>Generate the route information of the system label, and then save a workspace.</li> <li>After saving the workspace, execute the system label update/check again.</li> <li>Generate the route information of the system label by MELSOFT Navigator, and then reflect parameters on the GT Designer3 project.</li> <li> Help for MELSOFT Navigator</li> </ul>



## ■ Registering system labels

The following procedure shows how to register system labels in the system label database by GT Designer3.

1. Enter a system label name to be registered directly to the text box in [Device] for the dialog box of objects.

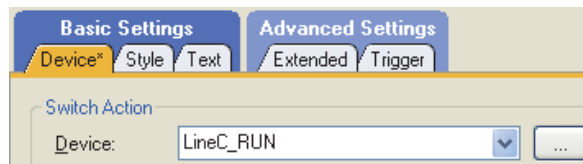

2. Select [Tools] → [System Label Update/Check] from the menu to update and/or check system labels.
3. The error list appears in the [System Label Update/Check] dialog box. Select [Register] to register the target system label in the system label database.
4. Click the [Register] button.

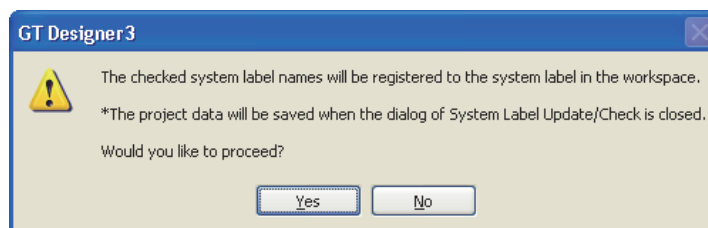
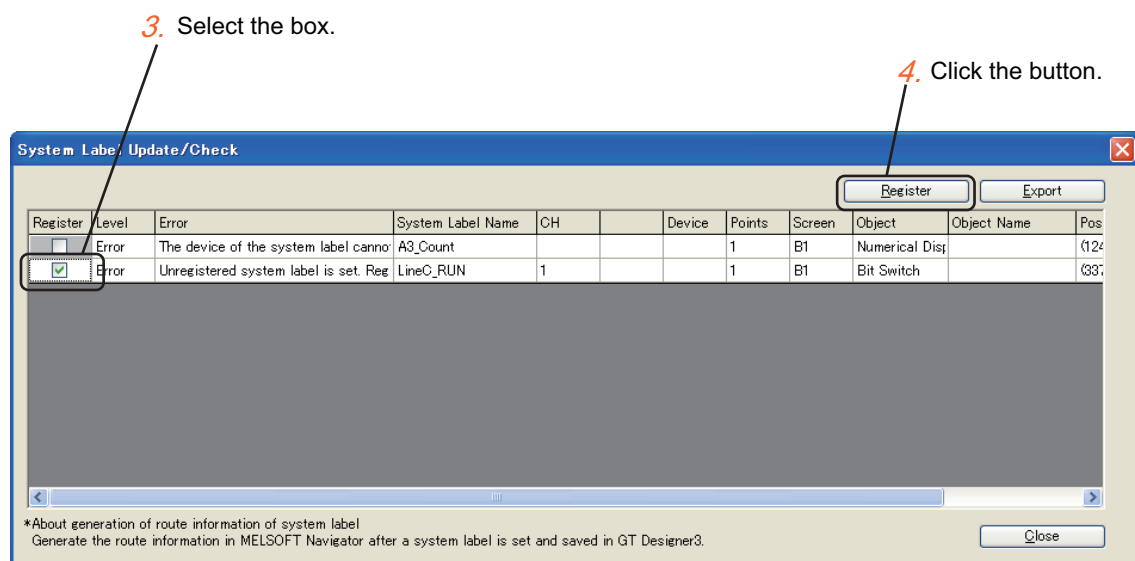

6. Close the [System Label Update/Check] dialog box to automatically save the GT Designer3 project.
7. After registering the system label, update the system label list by MELSOFT Navigator. When the system label list is not updated, the registered data are not reflected in the system label list. For how to operate MELSOFT Navigator, refer to the following.

 Help for MELSOFT Navigator

## ■ Generating route information on GT Designer3

Route information can be generated when all the following conditions are satisfied.

- GT Designer3 is started by using MELSOFT Navigator.
- When the project data is saved, only a route information obtainment error has occurred at the system label update/check.

1. Save the project data.
2. The confirmation dialog box appears.  
Check the contents, and click the [Yes] button to start generating the route information.

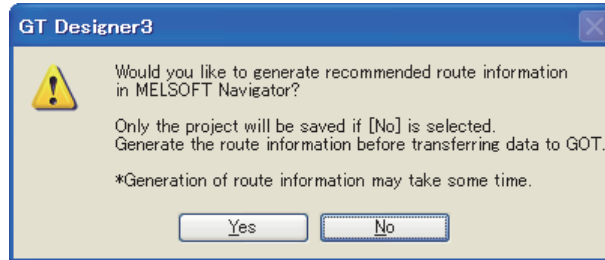

3. The route information is generated, and GT Designer3 is displayed at the front.

The route information is not generated under the following conditions.

- The project data is saved collectively by using MELSOFT Navigator.
- The project data is saved in the save confirmation dialog box displayed when GT Designer3 exits.
- GT Designer3 is started by using MELSOFT Navigator, the GOT type is changed, and then the project data is saved.
- The project data is saved while GT Simulator3 is started by using GT Designer3.
- Generating route information takes 20 minutes or more.

## ■ Precautions

### (1) Changing a system configuration diagram by MELSOFT Navigator

The route information of the system label is manually generated by the system configuration diagram for MELSOFT Navigator.

When changing the system configuration diagram for MELSOFT Navigator, generate the route information again by MELSOFT Navigator.

After generating the route information, reflect parameters with the route information on a GT Designer3 project by MELSOFT Navigator.

For how to operate MELSOFT Navigator, refer to the following.

 [Help for MELSOFT Navigator](#)

### (2) Data type of system labels and data type of devices

When [Reflect the data type of system label] on the [Operation] tab for the [Options] dialog box is selected, the data type of system label is reflected to GT Designer3 settings.

 [3.5.3 Customizing actions and default value of GT Designer3](#)

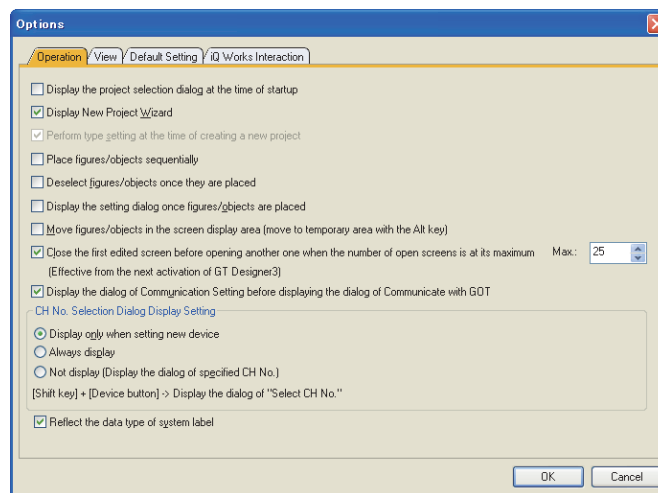

### (3) System label with data type of [Timer], [Counter], and [Retentive Timer]

For a system label with the data type of [Timer], [Counter], and [Retentive Timer], MELSOFT Navigator processes the data as one system label. However, GT Designer3 processes the data as multiple labels.

Data type of system label	Data type of device	Notation of system label	Devices of MELSEC-Q/L/QnA/A	Devices of MELSEC-FX
Timer	Signed BIN16	System label name	Timer (current value) (TN)	Timer (current value) (T)
		System label name/V	-	Timer (set value) (TS)
	Bit	System label name/T	Timer (contact) (TT)	Timer contact (T)
		System label name/C	Timer (coil) (TC)	-
Counter	Signed BIN16	System label name	Counter (current value) (CN)	Counter (current value) (C)
		System label name/V	-	Counter (set value) (CS)
	Bit	System label name/T	Counter (contact) (CT)	Counter contact (C)
		System label name/C	Counter (coil) (CC)	-
Retentive timer	Signed BIN16	System label name	Retentive timer (current value) (SN)	Timer (current value) (T)
		System label name/V	-	Timer (set value) (TS)
	Bit	System label name/S	Retentive timer (contact) (SS)	Timer contact (T)
		System label name/C	Retentive timer (contact) (SC)	-

For details of devices in a controller, refer to the following.

 [Appendix3 Device of Controllers](#)

**(4) Class for system label**

To use a system label with [VAR\_GLOVAL\_CONSTANT] set for the class, use the system label with a bit device assigned. When the system label with other than a bit device assigned, the system label is not applicable to GT Designer3.

**(5) System label names that can be set for consecutive devices**

To set consecutive devices, system label names that are not registered in the system label database cannot be entered.

Enter a system label name that is registered in the system label database.

**(6) When the system label database is inaccessible**

Depending on the version of GT Designer3, the system label database is inaccessible.

If this problem is not solved with the troubleshooting shown in the error message, install the latest version of GT Designer3.

**(7) Updating the system labels used for scripts**

The system labels used for scripts cannot be updated by executing the system label update/check.

When you change system labels using MELSOFT Navigator, update the system labels used for scripts by one of the following methods.

- Click the [Update] button on the [Option] tab in the [Script] dialog.
- Select the script in the [Script File List] dialog, click the [Edit Script] button, and then click the [OK] button in the [Edit Script(script name)] dialog that appears.

 (Functions) 30. SCRIPT FUNCTION

### 5.3.3 Shape setting

Shapes can be set to objects in order to fit its display.

There are two types of shapes: One is set as the external shape for lamps and others. The other is set as frames for numerical display, graph, or others.

Shapes set as external shapes:



Shapes set as frames:

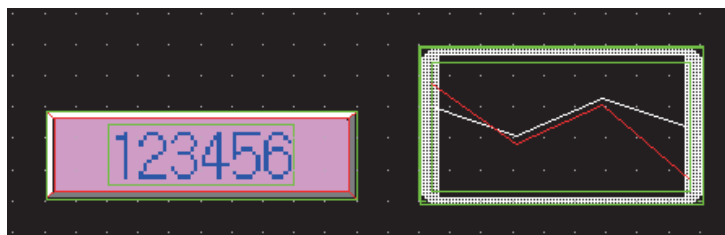

#### ■ Settings

This section explains how to set figures to objects.

1. Display the setting dialog box of each object with either of the following operations.
  - Click an object and select [Edit] → [Setting].
  - Right-click an object and select [Setting].
  - Double-click an object.
2. Select a figure to set as a figure on the [Style] tab.

The following figures can be selected from the [Shape] pull down menu.

  - None
  - Basic figure (5 types)
  - Figure already selected before (5 types)

When selecting figures other than the above, click the [Shape] button.

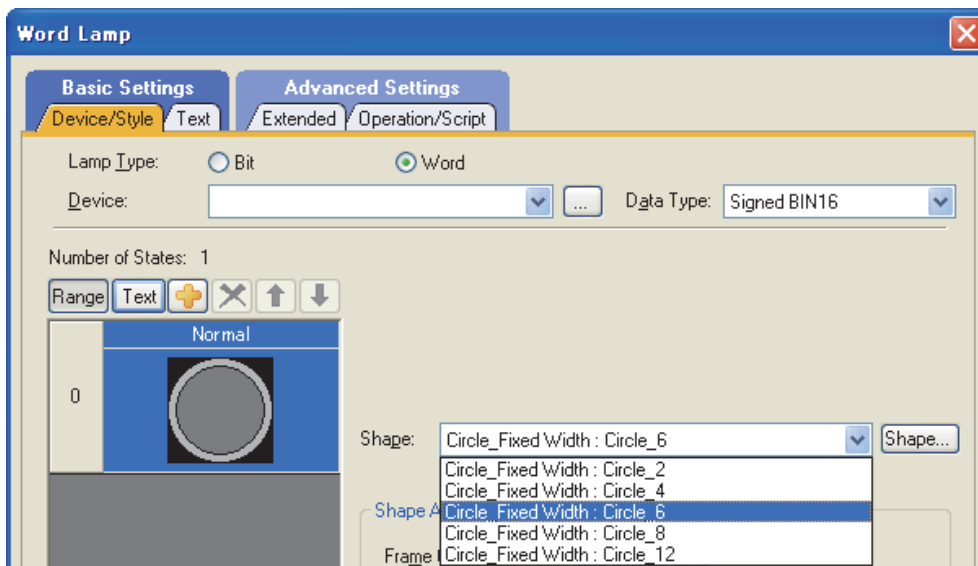

- Click the [Shape] button, and the [Image List] dialog box is displayed. Select the shape to set to an object from the shape image list.

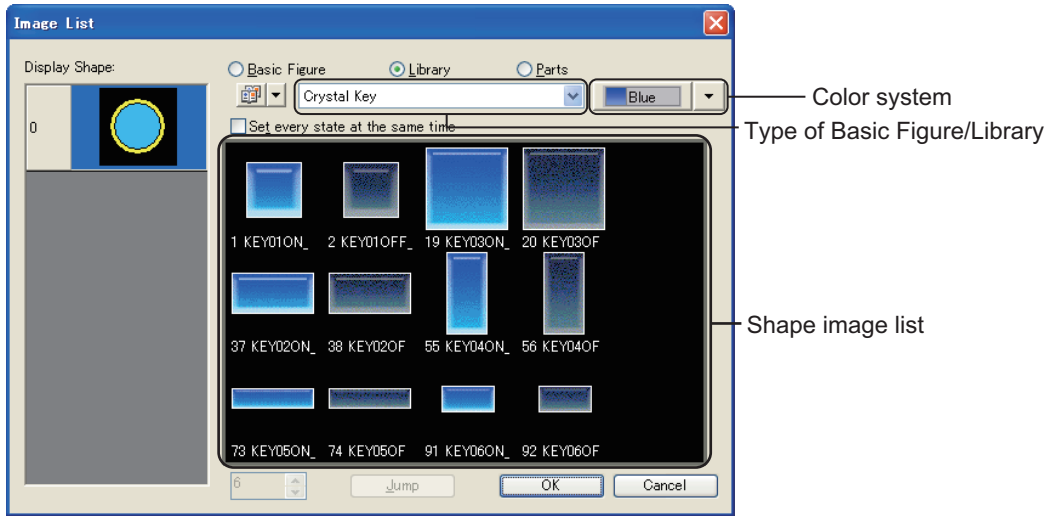

Items	Description
Display Shape	Displays the object images that are displayed in the GOT screen. Select the shapes according to the state, from the shape image list. (For bit switch and bit lamp, images can be selected at the time of switching ON/OFF) Mixed selecting of [Basic Figure], [Library], and [Parts] for one object is not allowed. Select any of [Basic Figure], [Library], or [Parts].
Basic Figure	Select this item when setting basic shapes registered for each project.
Library	Select this item to set shapes registered in the library (My favorites, my library, and system library).
Parts	Select this item when setting shapes registered as parts.
	Select the library type. Only the selected library is displayed on the pull down menu on the right side of the item.
Type of Basic Figure/Library	Select the basic shape type or library type from the pull down menu. After selecting, the shapes of the selected type are displayed in the shape image list.
	Switches the ON or OFF status of the shapes displayed in the shape image list. This setting is available for the bit switch and the bit lamp.
	Click this button to register shapes selected in the shape image list to my favorites or my library.
Color system	Switch the color system of the shape to display in the figure image list. The color system switching of figures or objects can be used only in the system library.
Set OFF and ON at the same time	Select this item to set the same shape for the on and off status, when selecting [Library] or [Parts]. When Basic Figure is selected, different shapes cannot be set to on and off status. (The item is always selected) This item can be set only for bit switch and bit lamp.
Set every state at the same time	Select this item to set the same shape for all states. When [Basic Figure] is selected, different shapes cannot be set to on and off status. (The item is always selected) This item can be set only for bit switch and bit lamp.
Shape image list	Select a shape to set to the object. The selected shape is displayed in [Display Shape].
	Input the number of a shape and click [Jump]. The shape whose number is set is selected in the shape image list. The selected shape is displayed in [Display Shape].

### 5.3.4 State setting

Setting the state, the ON/OFF status of bit device can be changed as well as the color of object shape according to the word device value.

The following states can be set to objects.

- Word device value being monitored by object.
- Any bit device ON/OFF.
- Any word device value.

The types of object to which state can be set and the conditions that can be set to object are listed in the following table.

○ : Applicable × : N/A

Object type	Conditions that can be set for objects		
	Word device value being monitored by object	Selected device	
		Bit device ON/OFF	Word device value
Numerical display Parts display (Word parts) Parts movement (Word parts) Word lamp	○	○	○
Numerical input Data list Comment display (Word comment) Level Panel meter Scatter graph	○	×	○*1

\*1 The word device value being monitored must be set as the condition for display change.

#### (1) Display changes according to the word device value being monitored.

Example) Level display function

- Word device D100 being monitored.

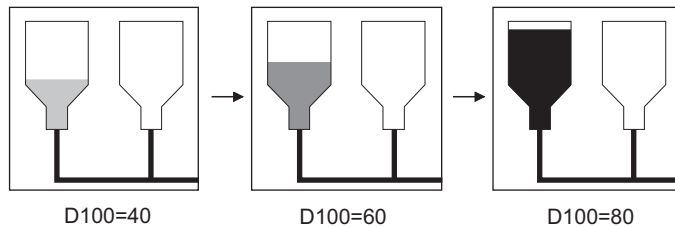

Display color changes according to the word device value being monitored.

#### (2) Display changes according to word device ON/OFF.

Example) Numerical display function

- Bit device D500 (temperature) being monitored
- Bit device M10 (ON in error occurrence) for display changing

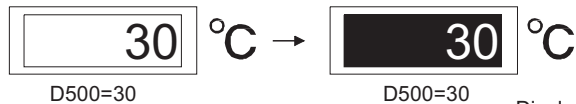

Display changes due to an error occurrence.

#### (3) Display changes according to word device value

Example) Numerical display function

- Word device D500 (production output) being monitored.
- Word device D100 (defective products) for display changing

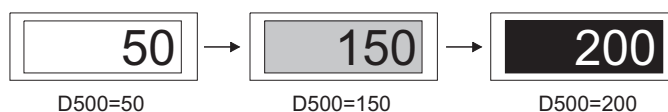

Display changes when the number of defective products exceeds the specified number.

## ■ Display priority

Up to 64 (0 to 63) states can be set to one object.

When display change conditions overlap, the state of the smaller No. is displayed with priority.

[Display priority]

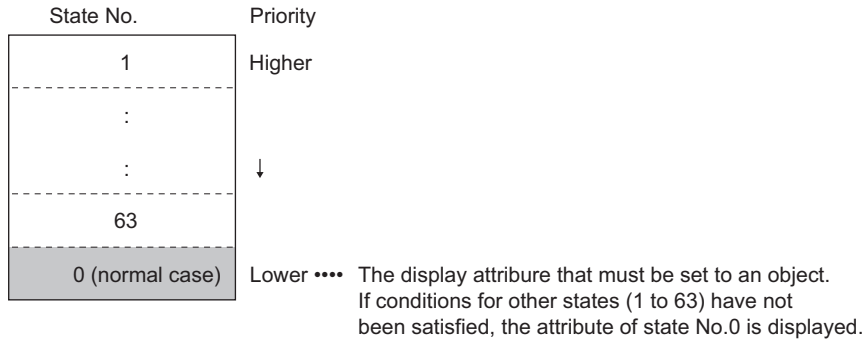

Example: When conditions for displaying state 1 and 2 occur simultaneously.

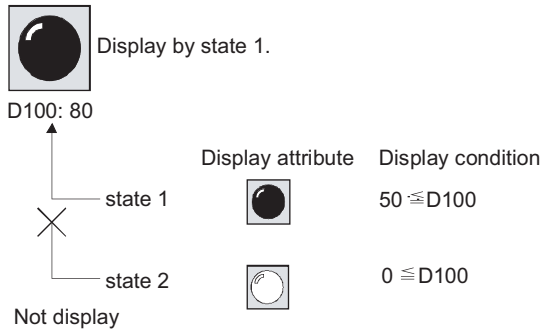

## ■ Setting

1. Open the setting dialog box of the object to set a state.

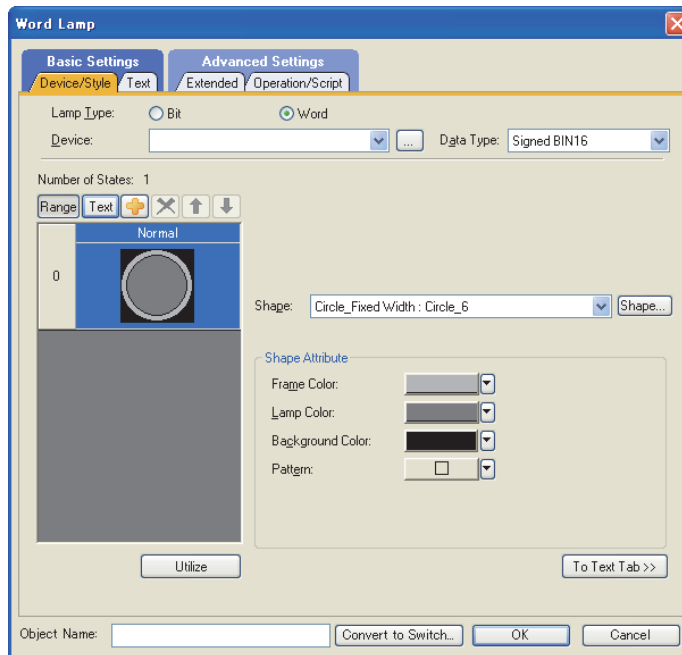



2. Display the following tabs according to the object.

Object	Tab	Reference
Word lamp	<ul style="list-style-type: none"> <li>[Device/Style] tab</li> <li>[Text] tab</li> </ul>	(Functions) 3.2 Setting Word Lamp
Numerical display	<ul style="list-style-type: none"> <li>[Display Case] tab</li> </ul>	(Functions) 5.1 Setting Numerical Display
Numerical input	<ul style="list-style-type: none"> <li>[Input Case] tab</li> <li>[Display Case] tab</li> </ul>	(Functions) 5.2 Setting Numerical Input
Data list display	<ul style="list-style-type: none"> <li>[Style] tab</li> </ul>	(Functions) 7.1 Settings
Comment display (Word comment)	<ul style="list-style-type: none"> <li>[Device/Style] tab</li> <li>[Comment] tab</li> </ul>	(Functions) 10.2 Setting Word Comment
Level	<ul style="list-style-type: none"> <li>[Device/Style] tab</li> </ul>	(Functions) 12.1 Settings
Panel meter	<ul style="list-style-type: none"> <li>[Range] tab</li> </ul>	(Functions) 13.1 Settings
Scatter graph	<ul style="list-style-type: none"> <li>[Point/Line Attribute] tab<sup>*1</sup></li> </ul>	(Functions) 19.1 Settings
Parts display (Word parts)	<ul style="list-style-type: none"> <li>[Device/Style] tab</li> </ul>	(Functions) 21.2 Word Parts Settings
Parts movement (Word parts)	<ul style="list-style-type: none"> <li>[Device/Style] tab</li> </ul>	(Functions) 22.2 Word Parts Settings

\*1 The setting value of [Attribute Switching] is [Signed BIN16] or [BCD16], a preview list is displayed.

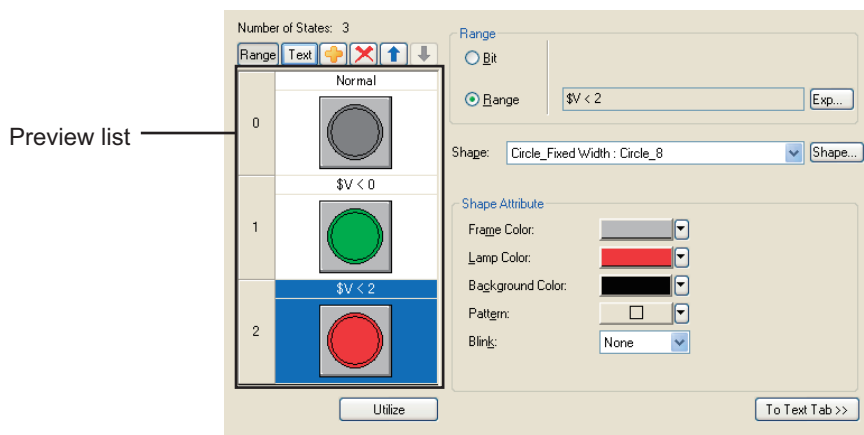

3. The preview list is displayed in each tab.  
Set the states referring to the references above.

Example) Word lamp preview list



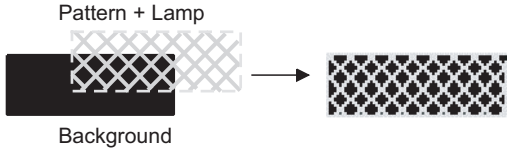

Items	Description	Model
Preview list	Displays status set for each state. Up to 64 states can be set (including the normal case). (state No. 0 indicates the normal case)	
	Creates a new state.	
	Deletes a specified state.	
	Changes the priority of the state.	
	Creates a new state to reuse the setting of the selected state.	
Range	Set conditions to establish each state. <ul style="list-style-type: none"> <li>• Bit:               <ul style="list-style-type: none"> <li>If the set device is turned on or off, the state is established.</li> <li>After checking this item, set a bit device and the condition (on or off) to establish the state.</li> </ul> </li> <li>• Range:               <ul style="list-style-type: none"> <li>When the current value of the specified word device is within the specified range, the state is established.</li> <li>After checking this item, click the [Range] button to specify the condition to establish the state.</li> </ul> </li> </ul> (1) Edit Range dialog box	

(Continued to next page)

Item	Description		Model
Shape Attribute	Frame Color	Select the frame color of the lamp figure.	Gr16 Gr15 Gr14 Gr12 Gr11 Gr10 SoftGOT1000
	Lamp Color	Select the color of the lamp figure. When a figure in the [Library] (Except my favorites) is set for [Shape], the set figure can be changed to the same figure with a different color, by changing the lamp color.	
	Background	Select the pattern and background color of the lamp figure. The selected pattern in the lamp color is displayed on the background color.	
	Pattern	Example: Background :  Pattern :  Lamp :  	
	Blink	Select the blinking pattern of the Lamp. (None/Low/Medium/High)	
	Blink Scope	Select a blink area. (Shape and Text/Shape only)	

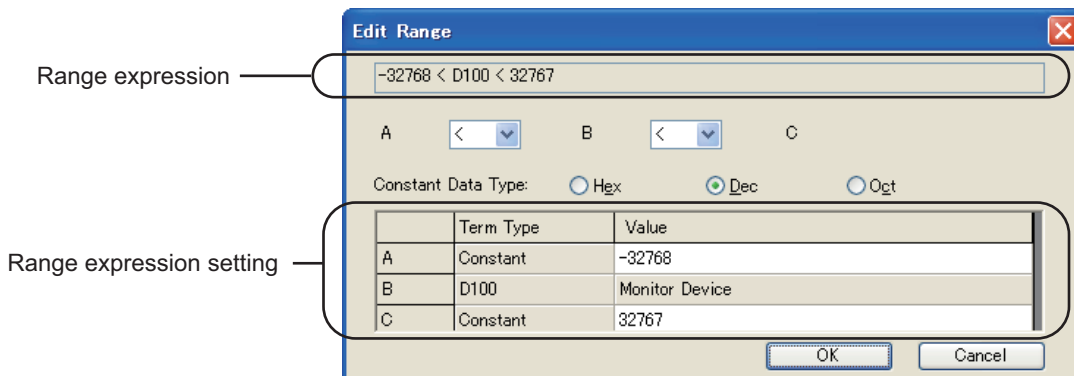
**(1) Edit Range dialog box**



Item	Description		Model
Range expression	Displays the set range expression.		Gr16 Gr15 Gr14 Gr12 Gr11 Gr10 SoftGOT1000
	Set the relational operator of the range expression. < : Left value is smaller than right value == : Left value is equal to right value <= : Left value is smaller than or equal to right value != : Left value is not equal to right value None: Without comparison		
Constant Data Type	When setting the fixed value to each item of the range expression, select the data type of the fixed value. (Hex/Dec/Oct)		
Range expression setting	Term Type	Set the details of each range expression item (A to C). <ul style="list-style-type: none"> <li>• Constant:               <ul style="list-style-type: none"> <li>Select this item when operating with fixed values.</li> <li>Select either of [Hex], [Dec], or [Oct] for [Constant Data Type].</li> </ul> </li> <li>• \$V :               <ul style="list-style-type: none"> <li>Select when operating the value of word device set as the monitoring target or writing target.</li> <li>This item must be set once in an expression.</li> </ul> </li> <li>• Other device:               <ul style="list-style-type: none"> <li>Select this item when operating the word device value.</li> <li>The data type is she same of the monitoring device (\$V).</li> </ul> </li> </ul>	
	Value	Set the setting values of each range expression item (A to C). The setting target varies according to the [Term Type] settings. <ul style="list-style-type: none"> <li>• [Constant]:               <ul style="list-style-type: none"> <li>Set the value.</li> </ul> </li> <li>• [\$V]:               <ul style="list-style-type: none"> <li>The monitor device is set.</li> </ul> </li> <li>• [Other device]:               <ul style="list-style-type: none"> <li>Set the intended device.</li> <li>Click the [...] button to set from the [Device setting] dialog box.</li> </ul> </li> </ul>	

## Example of state setting operation

This section explains the state setting operation with an example of numerical display setting.

- The monitor word device D500 (productivity)
- The word device for display changes D100 (the number of defective goods)

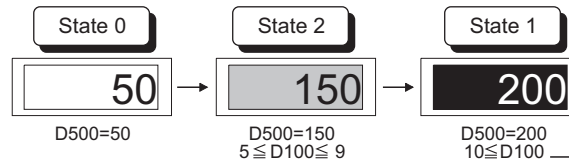

Displaying changes when the number of defective goods exceed the specified number.

### 1. Set the state 0 on the [Device/Style] tab.

The figure setting set on the [Device/Style] tab is displayed except when the conditions set for state 1, 2 are applied.

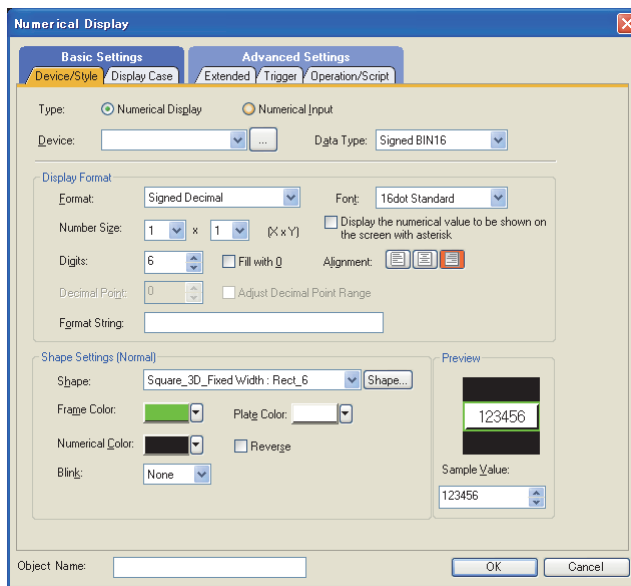

Set the display attribute of state 0.

The figure setting set here is changed when each state is satisfied.

Numerical Color : Black

Blink : None

Reverse : Unchecked

Plate Color : White

### 2. Set state 1 on the [Display Case] tab.

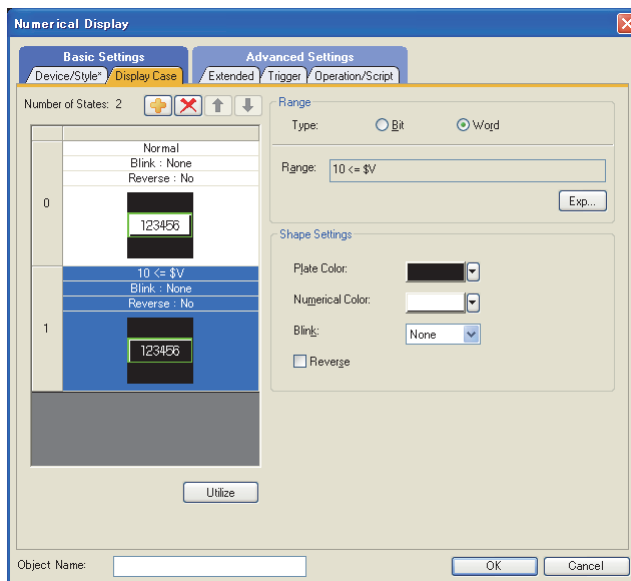

Click the button to create state 1.

Set the conditional expression to display state 1.

Others ( $10 \leq D100$ )

Set the display attribute of state1.

Numerical Color : White

Blink : None

Reverse : Unchecked

Plate Color : Black

3. Set state 2.

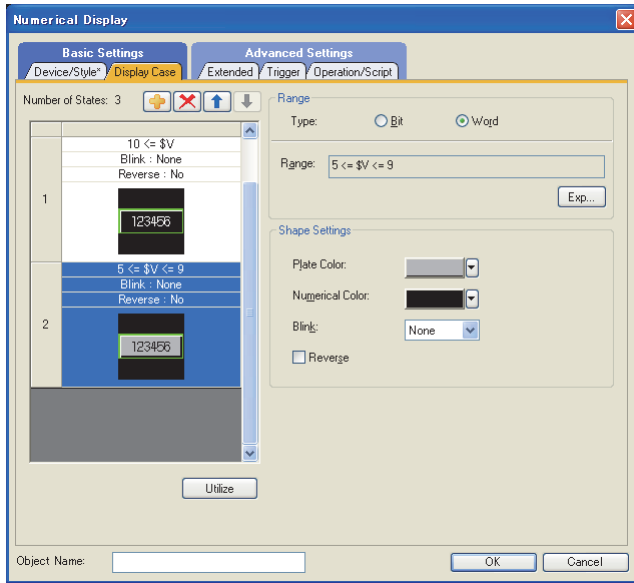

Click the  button to create state 2.  
Set the conditional expression to display state 2.  
Others ( $5 \leq D100 \leq 9$ )  
Set the display attribute of state 2.  
Numerical Color : White  
Blink : None  
Reverse : Unchecked  
Plate Color : Gray Color



**Operations of preview list**

The preview list can also be operated from the right-click menu.

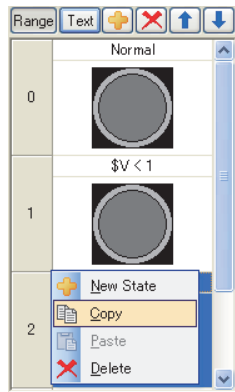

## 5.3.5 Security setting

GT 16 GT 15 GT 14 GT 12 GT 11 GT 10 Soft GOT 1000

This function determines which screen is displayed depending on the security level. The security level can be changed by inputting the password corresponding to each level. The security level (0 to 15) can be set for each screen and object. The security level can be set to each object function (excluding document display), window screen and base screen.

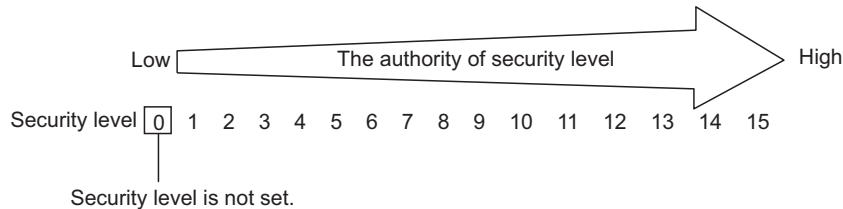

### POINT

#### Authentication method

The authentication method for changing security levels includes the following types.

- Operator authentication
- Security level authentication

For the authentication method, refer to the following.

4.7 Security Setting

### Security function setting

When the security function is used, the following settings are needed.

#### (1) Setting authentication method

Set the authentication type of the security.

Select an authentication method, and then set the settings for the authentication method.

4.7 Security Setting

#### (2) Setting the security level of screen and object

(a) Setting on screen

1. Select the screen to which the security level is set, and select [Screen] → [Screen Property] from the menu.

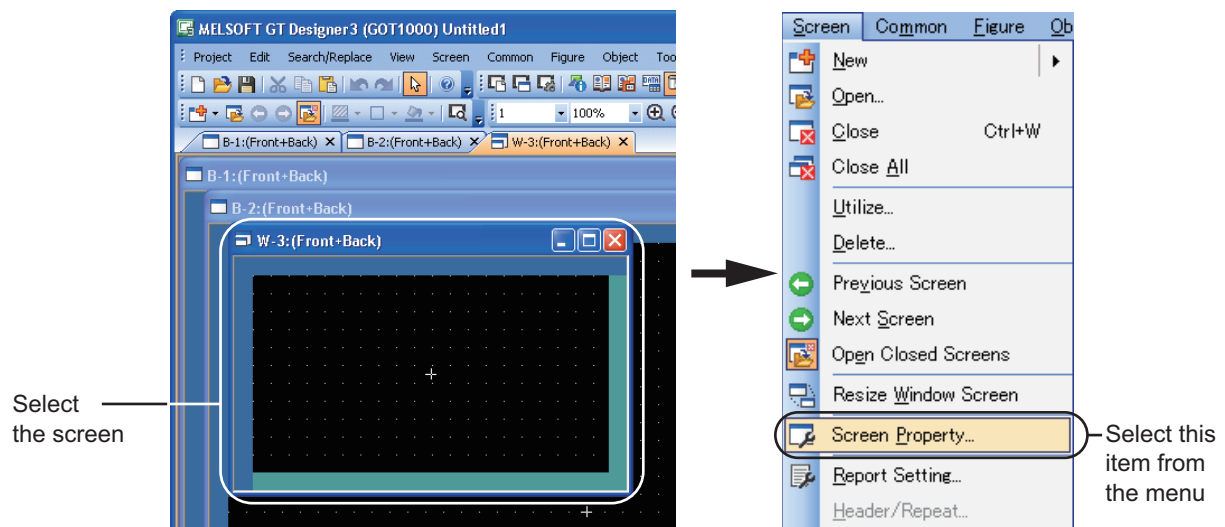

2. The screen property dialog box appears.  
Set the security level (that is set to the screen) in [Security] on the [Basic] tab.

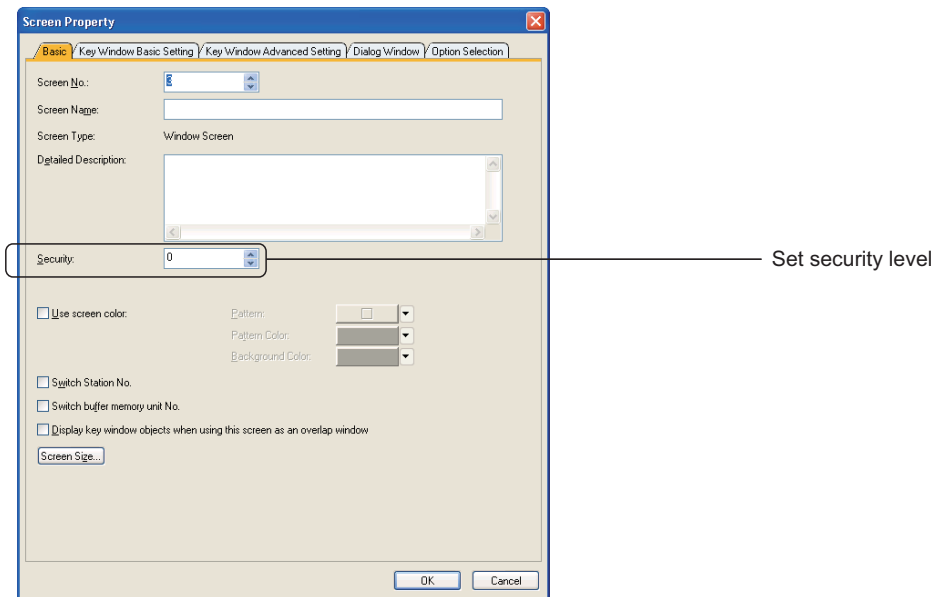

- (b) Setting on object  
Set the security level of the object in the [Extended] tab of the setting dialog box.  
For how to set each object, refer to the following.

 GT Designer3 Version1 Screen Design Manual (Functions)

## ■ Change method of the security level on the GOT

The method for changing security levels differs depending on authentication methods.  
The following shows the method for changing security levels for each authentication method.

### (1) Operator authentication

To change security levels, log out of the GOT and log in the GOT again using an operator name with a different security level.

The screens for login and logout can be displayed with the following.

- Touch a touch switch (special function switch: Log-in/Log-out (Operator Authentication)) for switching to screens for login and logout.
- Display the GOT utility and touch [Login/Logout].

The following shows how to change security levels.

1. The screen for logout is displayed, and then touch the [OK] button.
2. The screen for login is displayed.
3. Log into the GOT as an operator with a different security level.

The method for login varies according to the authentication type.

- Operator authentication by password  
Input the operator name and the password, and then touch [Enter].
- Operator authentication by external authentication device  
Input the external authentication ID using the external authentication device.  
When switching to the operator authentication by password, touch [Password].
- Operator authentication by fingerprint unit  
Press the finger on the fingerprint reader of the fingerprint unit.  
When switching to the operator authentication by password, touch [Password].



### Auxiliary authentication

For the operator authentication with an external authentication device or fingerprint unit, the operator authentication may not be properly executed due to a device failure, injured finger or others.  
Enable the auxiliary authentication beforehand so that the authentication is executed by switching to the operator authentication with a password.

For setting the auxiliary authentication, refer to the following.

 User's Manual for the GOT used

4. To close the screens for login and logout, perform the following operation.  
The operation varies according to the authentication type.

- Operator authentication by password  
Touch [×] at the top-right of the screens for login and logout.
- Operator authentication by external authentication device or fingerprint unit  
Touch [Cancel].



Screen for login  
(Operator authentication by password)

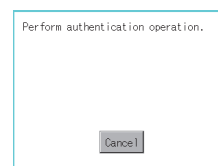

Screen for login  
(Operator authentication by external authentication device or fingerprint unit)

## (2) Password authentication

In order to change the security level, the password of each security level needs to be input on the security level change screen.

Either of the following methods is available to display the security level change screen.

- Touch a touch switch (special function switch: password (security level)) for switching to the security level change screen.

 (Functions) 2.6 Setting Special Function Switch

- Display the GOT utility, and touch the [security level change] button.

 User's Manual for the GOT used

The following indicates how to change the security level.

1. Display the security level change screen.
2. On the security level change screen, enter the password for the target security level and touch the [Enter] key.
3. To close the security level change screen, touch the [×] button at the top-right of the password display window.

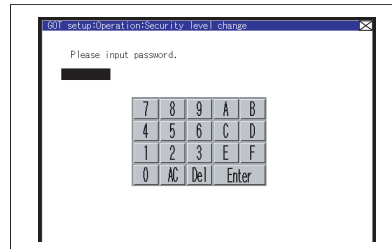

## POINT

### Changing security levels with controllers (Password authentication only)

The level of security is stored in the device storing "security level status" (Level device)

( 4.7 Security Setting)

Current security level can be changed by directly changing the level device value from the controller.

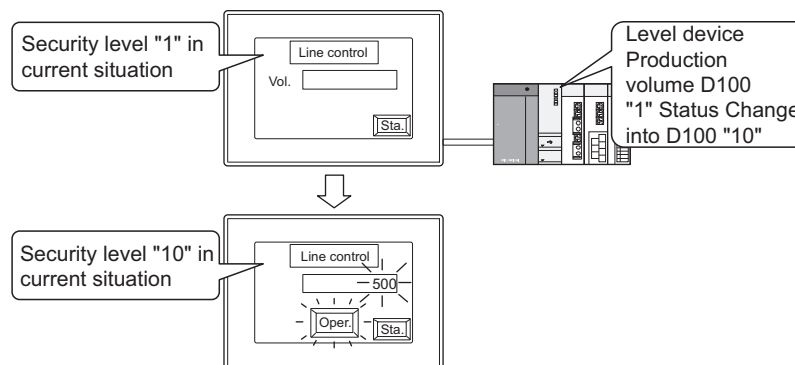

Change the display according to the changed security level.

When the value stored in the level device is set to below the security level for the base screen currently displayed, a screen for changing security levels is displayed.

For returning to the previous screen, input the password for the set security level or higher.



## HINT

### (1) To undo temporarily-raised security level (Password authentication only)

The security level that is increased temporarily for maintenance and inspection tasks can be restored back to its original state easily.

(a) Inform the users of the normal security level password to restore the security level through the normal password input operation.

(b) Create the touch switch for restoring the security level to normal level.

Example) When changing the security level to "0" with the touch switch.

- Level device: D30
- Touch switch: Write "0" into level device D30

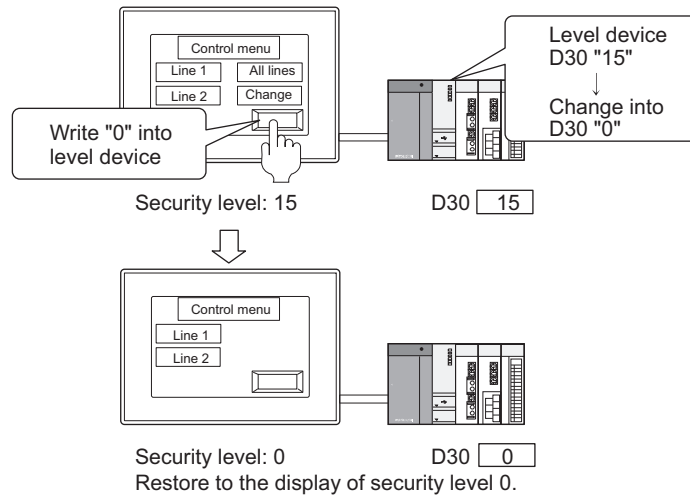

### (2) Forced logout

Turning on the forced logout signal (.b0) of the operator authentication external control device forcibly logs out a user currently logging in.

The forced logout signal behaves at the signal rising. Therefore, this signal does not behave even if it is always turned on.

Also, without the user login, this signal does not behave even if it is turned on.

For the operator authentication external control device setting, refer to the following.

☞ 4.7.1 Settings

## Example of security function

Change the contents that can be operated by each user in the screen for setting plural objects.

The switch action set for the special function switch that is used for changing user's security level varies according to the authentication method.

For special function switches, refer to the following.

### (Functions) 2.6 Setting Special Function Switch

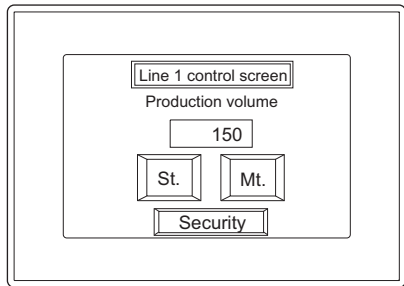

Base screen 1  
Screen design example  
Used objects and security levels

- ..... Display product volume (security level: 4)
- ..... Display product volume condition(Window screen 2) (security level: 4)
- ..... Switch to Mt. screen (base screen 10)(security level: 4)
- ..... Display login/logout screen (Operator authentication), Display password input screen (Security level authentication) (Security level: 0)

Screen example for each security level

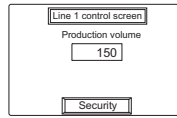

Base screen 1  
(Security level: 0)

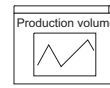

Window screen 2  
(Security level: 8)

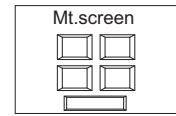

Base screen 10  
(Security level: 15)

○ : Enabled, × : Not enabled

User	User's security level						
Operator	4	○	○	○	○	×	×
Supervisor	8	○	○	○	○	○	×
Maintenance staff	15	○	○	○	○	○	○
Others	0	×	×	×	○	×	×

**(1) Operation example**

**(a) Changing displays and operations of objects with changing security levels**

The following example shows the object display and operation changed from 0 to 4 of the security level.

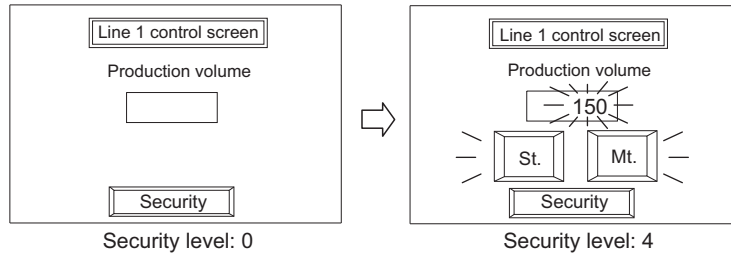

Security level status	Screen	Operation contents
Level 0	<p>Line 1 control screen Production volume Security</p> <p>Base screen 1</p>	<p>The object function on the screen cannot be used, because the security level is in a low status.</p> <ul style="list-style-type: none"> <li>• Base screen 1 (security level 0)</li> <li>• Each object function (security level 4)</li> </ul>
Level 0	<p>Line 1 control screen Production volume Security</p> <p>Base screen 1</p>	<p>Touch a touch switch, and then the screen for changing security levels is displayed.</p> <ul style="list-style-type: none"> <li>• Operator authentication</li> <li>The first touch: Log out of the GOT.</li> <li>The second touch: The screen for login is displayed.</li> <li>• Security level authentication</li> <li>The screen for changing security levels is displayed.</li> </ul> <p>(Hand icon) ■ Change method of the security level on the GOT)</p>
Level 0 ↓ Level 4	<p>Operator authentication by password</p> <p>Operator authentication by external authentication device</p> <p>Operator authentication by fingerprint unit</p> <p>Password authentication</p>	<ul style="list-style-type: none"> <li>• Operator authentication by password: Input the operator name and password of the security level 4 to login.</li> <li>• Operator authentication by external authentication device: Input the external authentication ID of the security level 4 using the external authentication device to login.</li> <li>• Operator authentication by fingerprint unit: Input a fingerprint of the security level 4 user using the fingerprint unit to login.</li> <li>• Password authentication: Input the password, and change the security level into 4.</li> </ul>
	(Continued to next page)	

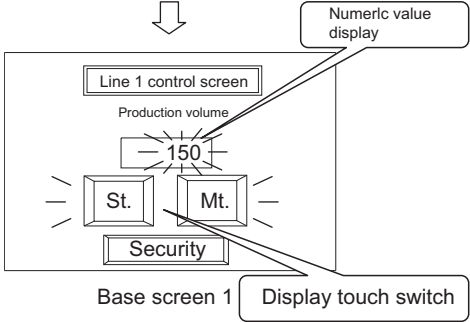
Security level status	Screen	Operation contents
Level 4	<p>(From previous page)</p> 	Display the object function corresponding to security level 4.



**(1) The security level set in the numerical input, the ASCII input and the touch switch**

2 types of security levels (for input and display) can be set in the numerical input, the ASCII input and the touch switch.

Example) When the security level is set in the numerical input function.

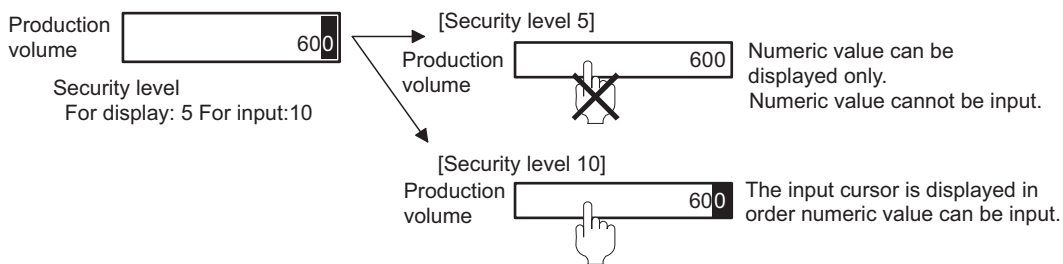

**(2) The movement of the input cursor when setting the security function**

The cursor will move to the currently available numerical input box or ASCII input box, when setting security level respectively in plural numerical input and ASCII input.

Example) Input numeric value when the base screen security level is "2".

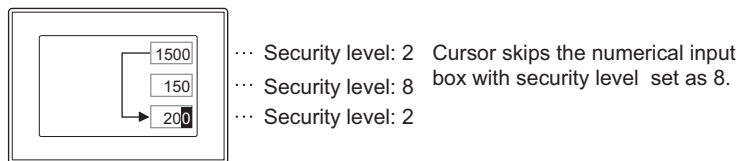

- (b) Displaying window screen with changing security levels  
 The following example shows the object display and operation changed from 4 to 8 of the security level.

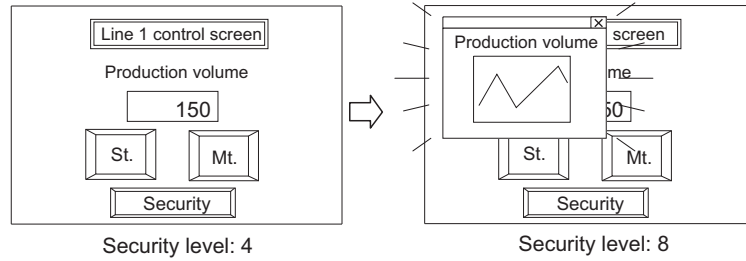

Security level status	Screen	Operation contents
Level 4	<p>Base screen 1</p>	<p>Base screen 1 (security level 4)</p> <p>↓</p> <p>Window screen 2 (security level 8)</p>
Level 4	<p>Base screen 1</p>	<p>Do not display the window screen.</p>
Level 4	<p>Base screen 1</p> <p>(Continued to next page)</p>	<p>Touch a touch switch, and then the screen for changing security levels is displayed.</p> <ul style="list-style-type: none"> <li>Operator authentication:           <ul style="list-style-type: none"> <li>The first touch : Log out of the GOT.</li> <li>The second touch: The screen for login is displayed.</li> </ul> </li> <li>Password authentication:           <ul style="list-style-type: none"> <li>The screen for changing security levels is displayed.</li> </ul> </li> </ul> <p>(Hand icon) ■ Change method of the security level on the GOT)</p>

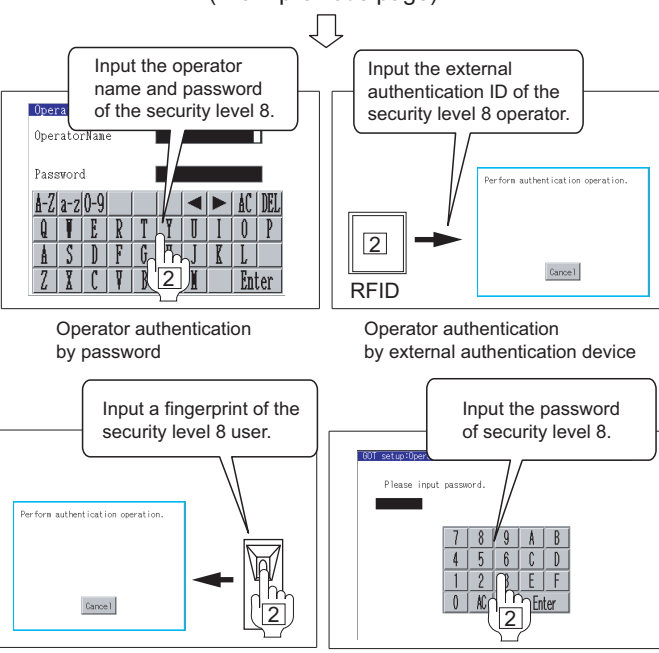
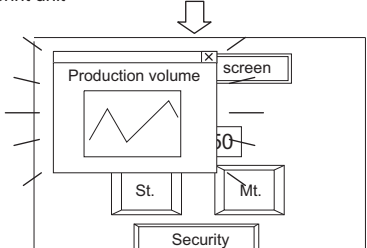
Security level status	Screen	Operation contents
Level 4 ↓ Level 8	<p>(From previous page)</p>  <p>Operator authentication by password</p> <p>Operator authentication by external authentication device</p> <p>Operator authentication by fingerprint unit</p> <p>Password authentication</p>	<ul style="list-style-type: none"> <li>Operator authentication by password: Input the operator name and password of the security level 8 to login.</li> <li>Operator authentication by external authentication device: Input the external authentication ID of the security level 8 using the external authentication device to login.</li> <li>Operator authentication by fingerprint unit: Input a fingerprint of the security level 8 user using the fingerprint unit to login.</li> </ul>
Level 8	 <p>Window screen 2</p>	Display a window screen.

(c) Switching base screen with changing security levels

The following example shows the object display and operation changed from 8 to 15 of the security level.

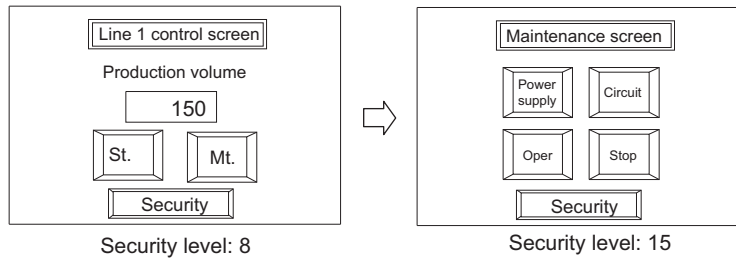

Security level status	Screen	Operation contents
Level 8	<p>Line 1 control screen</p> <p>Production volume</p> <p>150</p> <p>St. Mt.</p> <p>Security</p> <p>Security level: 8</p>	<p>Base screen 1 (security level 8)</p> <p>↓</p> <p>Base screen 10 (security level 15)</p>
Level 8 ↓ Level 15	<p>Input the operator name and password of the security level 15.</p> <p>Operator authentication by password</p> <p>Input the external authentication ID of the security level 15 operator.</p> <p>Operator authentication by external authentication device</p> <p>Input a fingerprint of the security level 15 user.</p> <p>Operator authentication by fingerprint unit</p> <p>Input the password of security level 15.</p> <p>Password authentication</p>	<ul style="list-style-type: none"> <li>Operator authentication by password: The screen for login is displayed automatically. Input the operator name and password of the security level 15 to login.</li> <li>Operator authentication by external authentication device: The screen for login is displayed automatically. Input the external authentication ID of the security level 15 using the external authentication device to login.</li> <li>Operator authentication by fingerprint unit: The screen for login is displayed automatically. Input a fingerprint of the security level 15 user using the fingerprint unit to login.</li> <li>Password authentication: The security level change screen is displayed automatically. Input the password, and change the security level into 15.</li> </ul>
Level 15	<p>Maintenance screen</p> <p>Power supply Circuit</p> <p>Oper Stop</p> <p>Password</p> <p>Base screen 10</p>	<p>Switch to base screen 10</p>

## ■ Precautions

### (1) Precautions for drawing

When the GOT is started up, a screen always appears regardless of the screen security settings and security level.

Make sure to design screens so that the screen without security settings will appear at GOT start up and it will be switched to the screen with security settings by performing screen switching.

### (2) Making a note of the password

The already registered password cannot be checked later. Therefore, always make a note of the password.

When passwords are forgotten, the following operations cannot be executed.

- Changing security levels on the GOT
- Deleting or changing passwords on GT Designer3
- Deleting or changing the operator information on the GOT

For solutions when forgetting passwords, refer to the following.

 4.7.5 Precautions



## 5.3.6 Offset setting

Plural devices can be switched and monitored by setting a single device.  
(In the user alarm display, multiple comments can be switched and displayed by setting a single device.)

Example: When switching and monitoring multiple device statuses by a single device

The value set in the device using the offset (hereinafter referred to as offset device) is added to the device set in each object function.

- Device set in each object function D200, D201, D202

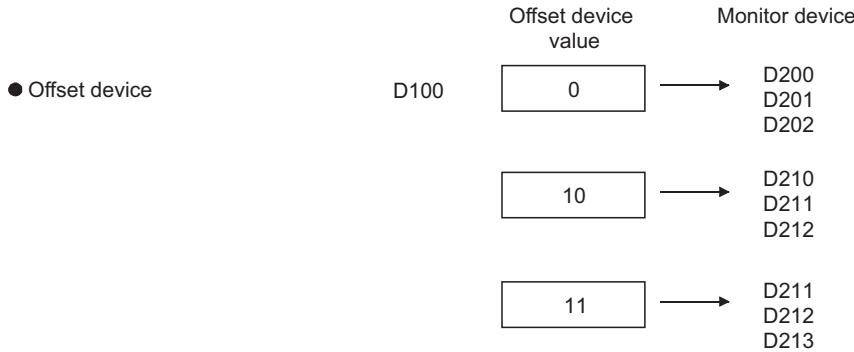

Switch the monitor device according to the value stored in offset device.

This offset is available for the following objects and functions.

- |                      |                    |                                |                      |
|----------------------|--------------------|--------------------------------|----------------------|
| • Touch switch*1     | • Lamp (Bit/Word)  | • Numerical Display            | • Numerical Input    |
| • ASCII Display      | • ASCII Input      | • Data List Display            | • Comment Display    |
| • User alarm display | • Level            | • Panelmeter                   | • Line Graph         |
| • Trend Graph        | • Bar Graph        | • Statistics bar and pie graph | • Scatter Graph      |
| • Parts Display*2    | • Parts Movement*2 | • Script                       | • Status Observation |

\*1 The offset device value is added to the device set in the action setting.

The offset cannot be set for the special function switch.

\*2 The offset cannot be set for the fixed parts.

### ■ Settings

#### (1) Setting offset for object

Set the offset on the [Extended] tab of the setting dialog box of the object.  
For how to configure setting for each object, refer to the following.

 GT Designer3 Version1 Screen Design Manual (Functions)

#### (2) Setting offset for script and status observation

For how to set the offset, refer to the following.

- Script

 (Functions) 30. SCRIPT FUNCTION

- Status observation

 (Functions) 27. STATUS OBSERVATION FUNCTION

## Examples of offset

### (1) Switching and monitoring multiple line statuses with a single numerical display (Numerical display)

 (Functions) 5. NUMERICAL DISPLAY/NUMERICAL INPUT

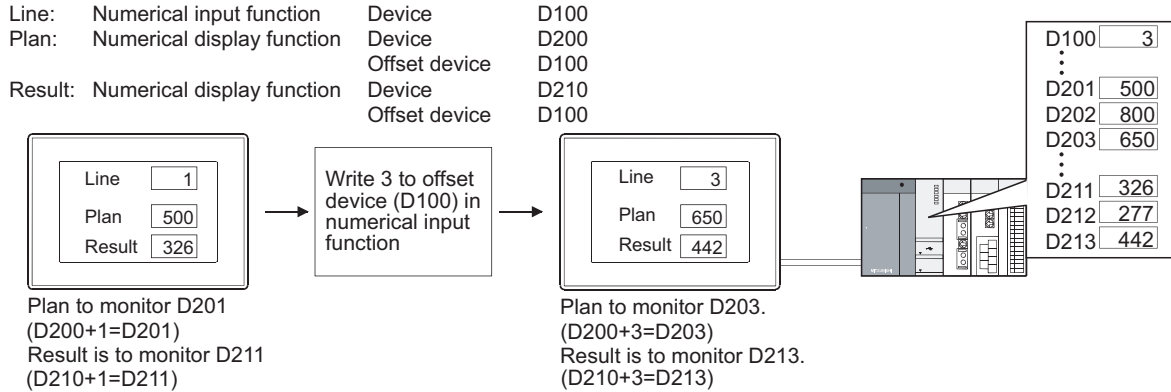

### (2) Switching and displaying multiple comments by a single device (User alarm display)

The offset device value is added to the comment set in the user alarm display.

In a normal user alarm display, bit devices for the number of displayed comments needs to be set. However, by using the offset, multiple comments can be switched and displayed by a single device.

#### (a) Offset of display setting

The offset device value is added to the number of the comment to be displayed.

Head comment No. : 1  
Comment No. offset : D200

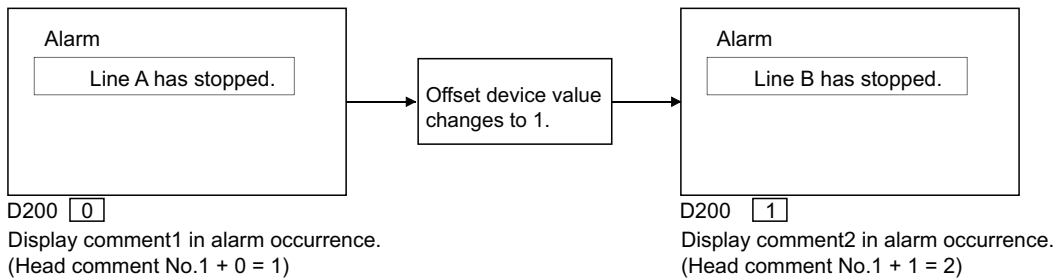

#### (b) Offset of detailed display setting

The offset device value is added to the numbers of comment (comment window), window screen and base screen to be displayed as details.

Detailed display : Comment window  
Detailed No. of alarm device : 1  
Detailed No. offset : D200

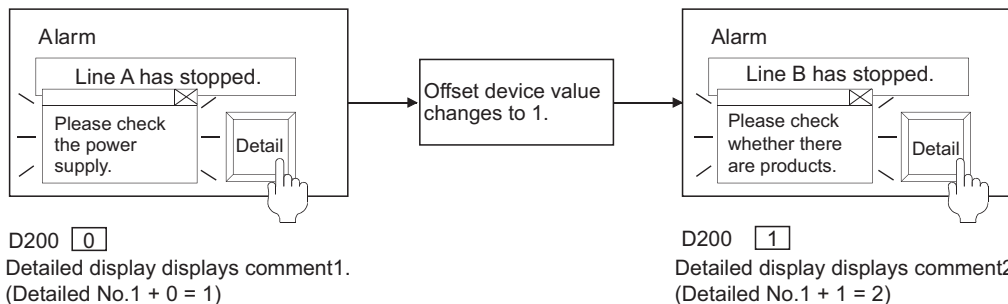

## HINT



### When executing offset of detailed display setting

When executing offset of detailed display setting, the comment for detailed display is changed regardless of the message on user alarm display.

To relate the message to the comment, adjust comment and the message displayed by using offset of display setting.

## ■ Precautions

The following describes the precautions for using the offset.

### (1) Precautions for drawing

- (a) When monitoring the trigger device in sampling by the status observation function  
When offsetting the trigger device in a constant sampling, set the offset sampling longer than the monitor sampling.  
Example) Changing cycle (7 s) of offset device value > Status observation function sampling (5 s)
- (b) Abnormal operation of the status observation cycle setting (e.g. uncollected data by affecting the timing shift)  
If an offset-specified object is arranged on the monitor screen, the condition device for the status observation is delayed. Do not set offset-specified objects on the monitor screen at using the status observation.
- (c) Device setting  
The offset function is not available for the bit device word specification.  
For the word device bit specification, the device No. is offset.

Example)

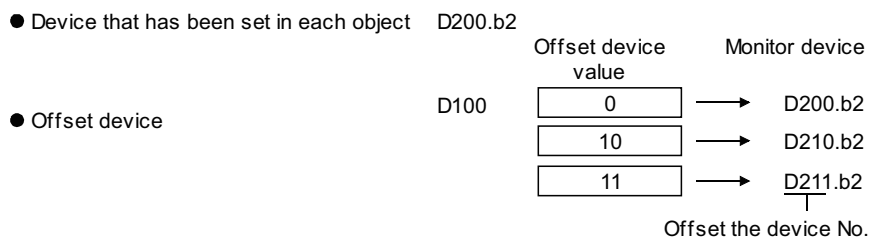

The data format of offset devices is fixed to the signed 16-bit binary data.

### (2) Precautions for use

- (a) Offset value change  
The monitor device will be read as the offset value changes; so do not change the offset value frequently.  
If the offset value is changed frequently, the monitor speed will become low.
- (b) When the offset device No. exceeds the PLC word range trigger  
When the offset device No. exceeds the PLC device range, monitoring and writing will not be executed.  
Error will be displayed in alarm list (system alarm), if it is set in advance.  
When monitoring plural devices with a single graph, the display method is determined by the setting method of monitored device.
  - Trend graph, line graph, bar graph and statistics graph  
When setting the device consecutively: Holds the previous display.  
When setting the device at random: Holds the previous display only when the displaying exceeds word range trigger.  
For the display other than the above, the offset device will be monitored.
  - Scatter graph  
When setting the device consecutively: Holds the previous display.  
When setting the device at random: Holds the previous display.

## 5.3.7 Superimposition setting

Figures or objects can be superimposed in the following methods

- Superimposition using layers
- Superimposition using no layer
- Special superimposition of touch switch, numerical input, and ASCII input

### POINT

#### Screens that display superimposed objects

The screens that display superimposed objects include the base screen, the overlap window, and the superimpose window.

The key window and the dialog window cannot display the superimposed objects.

### ■ Superimposition using layers



Each of the base screen and window screen consists of two layers; front layer and back layer. By arranging objects separately on each layer, the objects can be superimposed.

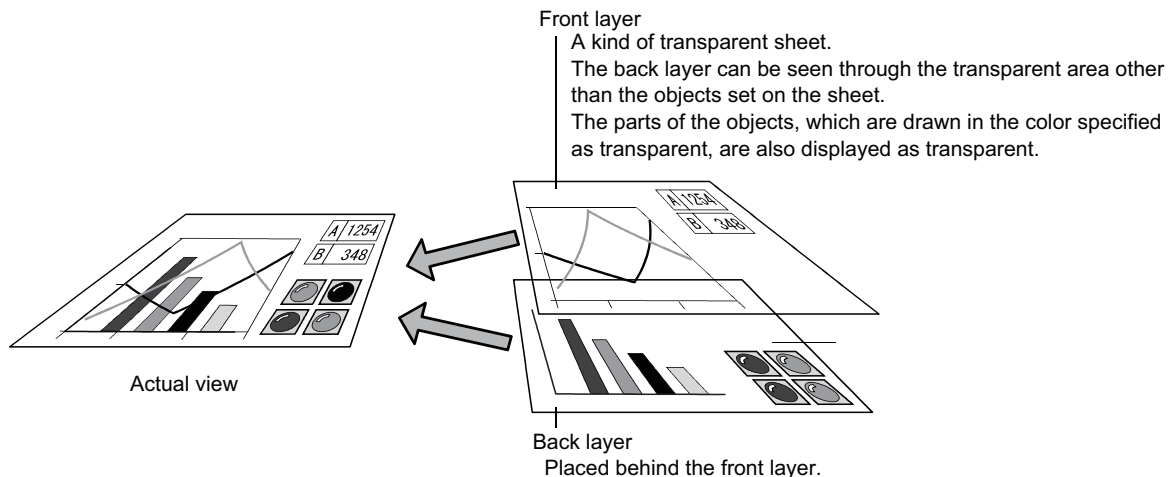

The layers of the window screen can be disabled according to the window screen.

Window screen	Layer setting
Overlap window	The layers are disabled. The figures and the objects on both the layers are processed so that they are on one layer.
Superimpose window	The layers are enabled.
Key window	The layers are disabled. The figures and the objects on both the layers are processed so that they are on one layer.
Dialog window	The layers are disabled. Only the figures and the objects on the back layer are displayed.

#### (1) Figures and objects that can be arranged on each layer

The following shows figures and objects that can be arranged on each layer.

Layer	Figures and objects that can be arranged
Front layer	Figures (Piping figures with lamp attribute only) and objects
Back layer	Figures and objects

**(2) Display order of objects arranged on front and back layers**



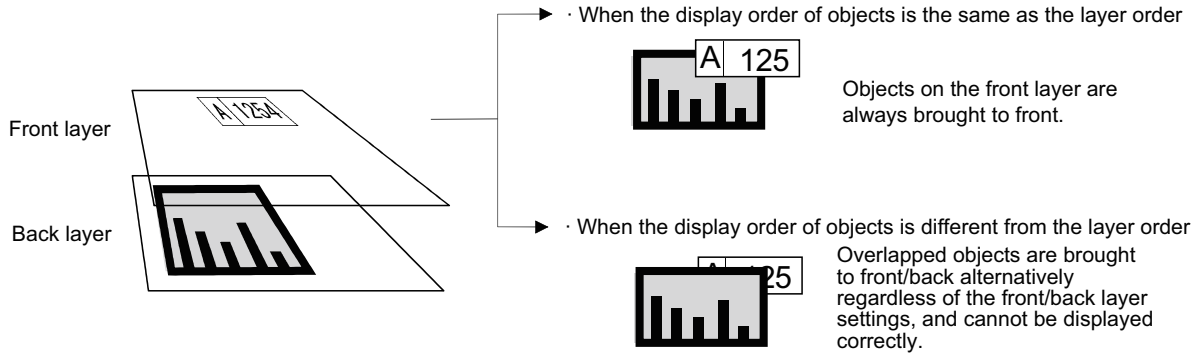

The display order in the GOT of objects arranged on the front and back layers differs depending on the screen type; same as the layer superimposition order or different from it.

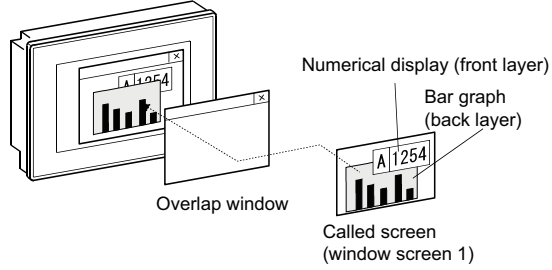

The following shows the display order of objects on each screen.

Screen type	Object display order in the GOT
Base screen	<p>Display order is the same as the layer superimposition order.</p> <p>Numerical display (front layer) Bar graph (back layer)</p> <p>Base screen</p>
Screen called to the base screen by the set overlay screen function	<p>Display order is the same as the layer superimposition order.</p> <p>Numerical display (front layer) Bar graph (back layer)</p> <p>Called screen (window screen 1)</p>
Superimpose window	<p>Display order is the same as the layer superimposition order.</p> <p>Numerical display (front layer) Bar graph (back layer)</p> <p>Superimpose window</p>
Screen called to the superimpose screen by the set overlay screen function	<p>Display order is the same as the layer superimposition order.</p> <p>Numerical display (front layer) Bar graph (back layer)</p> <p>Superimpose window Called screen (window screen 1)</p>
Overlap window	<p>Display order is different from the layer superimposition order.</p> <p>Numerical display (front layer) Bar graph (back layer)</p> <p>Overlap window</p>

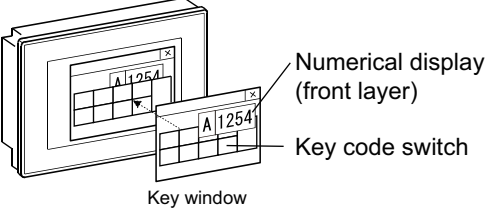
(Continued to next page)

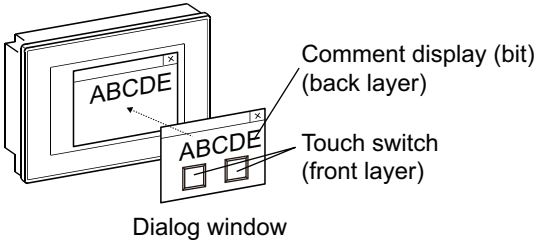
Screen type	Object display order in the GOT
<p>Screen called to the overlap screen by the set overlay screen function</p>	<p>Display order is different from the layer superimposition order.</p>  <p>Overlap window</p> <p>Numerical display (front layer)</p> <p>Bar graph (back layer)</p> <p>Called screen (window screen 1)</p>
<p>Key window</p>	<p>Display order is different from the layer superimposition order.</p> <p> 4.5 Key Window Setting</p>  <p>Key window</p> <p>Numerical display (front layer)</p> <p>Key code switch</p>
<p>Dialog window</p>	<p>Only the back layer is displayed.</p> <p> 4.4 Setting Message to be Displayed on GOT</p>  <p>Dialog window</p> <p>Comment display (bit) (back layer)</p> <p>Touch switch (front layer)</p>



**Set overlay screen function**

For how to use the set overlay screen function, refer to the following.

 10.2 Changing Screen According to Situation (Set Overlay Screen)

### (3) Transparent color

The transparent color settings are specific to the front layer.

The parts of objects arranged on the front layer, which are drawn in the same transparent color as the transparent color of the front layer, are displayed as transparent.

To display some parts of objects as transparent, change the color specified as transparent of the front layer according to the target parts.

(The transparent color is set to dark yellow by default.)

Example) Displaying the bar graph on the back layer through the numerical display.

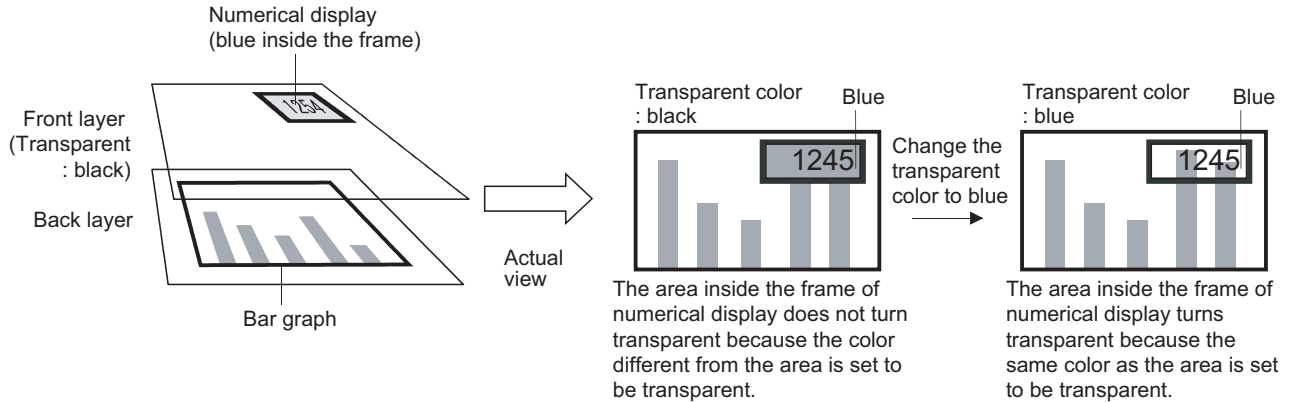

Set the transparent color of the front layer in the [Screen Property] dialog box of the base screen.

For how to configure settings in the [Screen Property] dialog box, refer to the following.

☞ 3.7.1 Creating a new screen

## POINT

### Precautions for inverting an object (display mode: XOR)

The following shows the precautions for inverting an object (display mode: XOR) using the touch switch, numerical display, comment display, and parts display.

#### (1) When arranging an object on the front layer

If no figure or other object is arranged below the target object, the object is inverted to the transparent color of the front layer.

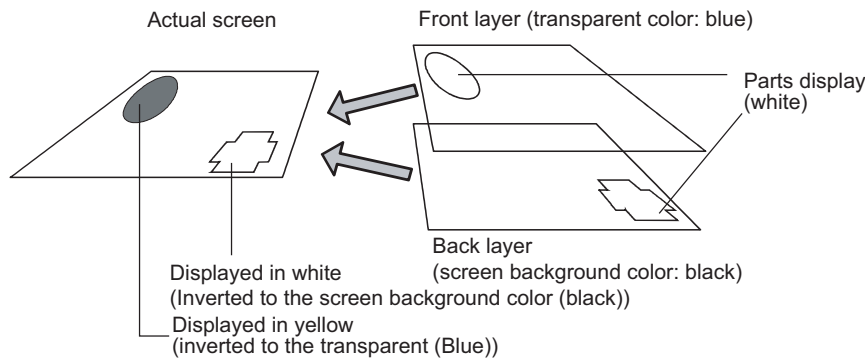

#### (2) When inverting an object to a shape (display mode: XOR)

Arrange the object on the back layer.

#### (4) Precautions

When superimposing multiple screens using the superimpose windows and set overlay screen function, design the screen while paying full attention to the following.

##### (a) Layer settings

Front layers and back layers of screens will be integrated into a single front layer and back layer, respectively, when the screens are overlaid.

Arrange and place objects on each layer so that they will not be overlapped between the integrated front layers or between the integrated back layers.

Overlapped objects may not be displayed or operate correctly.

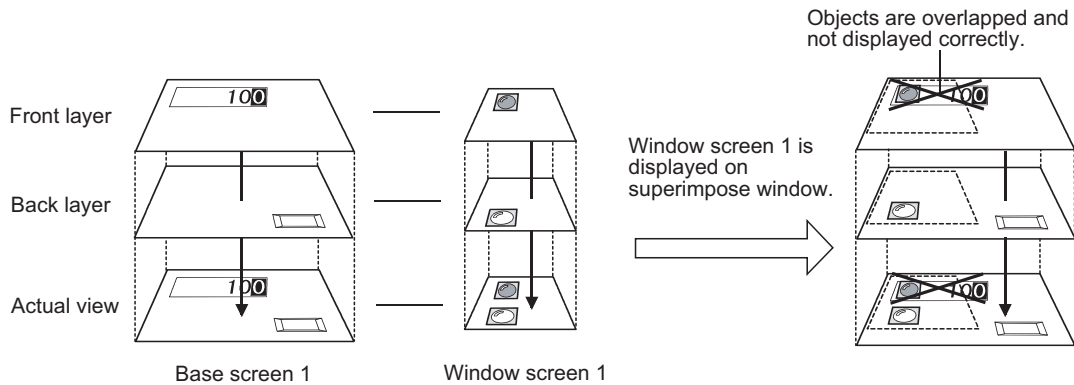

### HINT

#### (1) The object that can be superimposed with another on the same layer

Some of the composite objects set on a single layer can be displayed and operate correctly.

For the object that can be superimposed with another on a single layer, refer to the following.

☞ 5.3.7 ■ Superimposition using no layer

#### (2) How to arrange objects so that the objects on the base screen and those on the superimpose window are not overlapped

##### (a) Check whether the objects are overlapped or not.

Check whether the objects on the base screen and those on the superimpose window are not overlapped each other by previewing the superimpose window.

Preview screen can be displayed by selecting [View] → [Window Preview] → [Custom] from the menu.

##### (b) Rearrange the superimpose window

If objects are overlapped, rearrange the superimpose window by selecting the [Object] → [Window Position] → [Superimpose1] or [Superimpose2] from the menu.



(b) Transparent color settings

The transparent color of called screen is invalid, but that of the basic screen is valid.

The transparent color is based on the corresponding settings of a base screen, as window screen (superimpose window) does not include the settings.

Therefore, set the object colors on the front layer of the called screen considering the transparent color set on the basic screen.

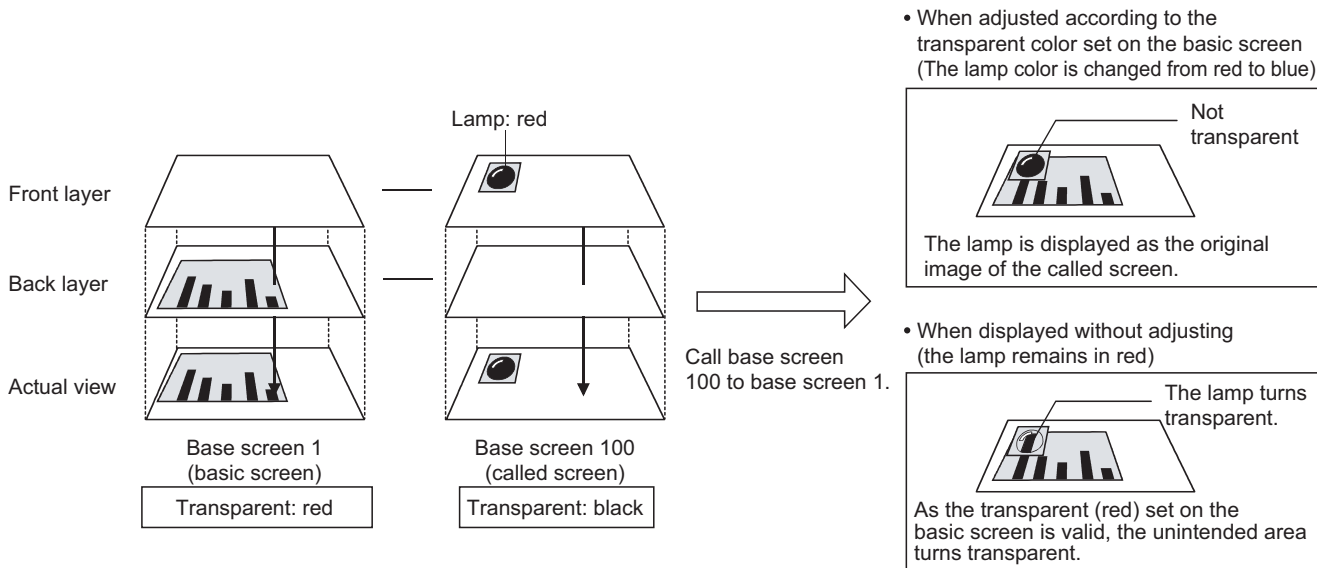

■ Superimposition using no layer



Some objects can be superimposed on the same layer.

The following shows the possible combinations of objects that can be superimposed on the same layer.

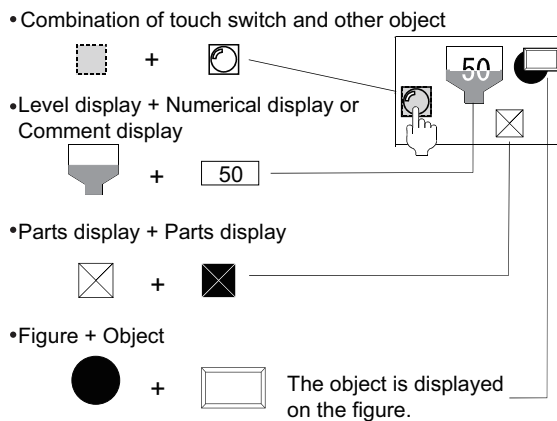

Combination	Reference
Touch switch and other object (Except numerical input and ASCII input)	(1) Superimposition with touch switch
Level and numerical display or comment display	(2) Superimposition with level
Parts display and parts display	(3) Superimposition with parts display

**(1) Superimposition with touch switch**

Touch switches with no figure and text set can be superimposed with other objects.

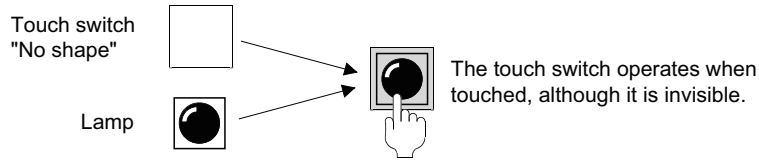

(a) Objects that can be superimposed with touch switch

Objects that can be superimposed with touch switch			
Lamp,	Numerical Display,	ASCII Display,	Data List Display,
Historical data list display,	Date/Time Display,	Comment Display,	Alarm history display*1,
User alarm display*1,	System alarm display,	Level,	Panelmeter,
Line Graph,	Trend Graph,	Bar Graph,	Statistics Bar Graph,
Statistics Pie Graph,	Scatter Graph,	Historical Trend Graph,	Parts Display,
Parts Movement			

\*1 Cannot be superimposed with a touch switch If one touch is enabled for alarm history display or user alarm display. For how to set the alarm history display and user alarm display, refer to the following.

GT Designer3 Version1 Screen Design Manual(Functions)



**Superimposition of touch switch and numerical input or ASCII input**

Arrange the touch switch and the numerical input or ASCII input on different layers to superimpose them. For how to set superimposition using the layer, refer to the following.

5.3.7 ■ Superimposition using layers

(b) Settings for superimposing touch switch and object

When superimposing the touch switch and object, do not configure the following settings.

- Selecting the item other than [None] for [Shape] in the [Style] tab
- When selecting [None] for [Shape] in the [Style] tab, select [Reverse Switch Area].
- Selecting [Text] for [Text Type] on the [Text] tab, and entering text to [Text]

For how to set the touch switch, refer to the following.

(Functions) 2. TOUCH SWITCH

**(2) Superimposition with level**

(a) Objects that can be superimposed with level

Objects that can be superimposed with level
Numerical display, Comment display

(b) Condition for superimposing object with level

One numerical display or comment display can be superimposed with a single level.

(c) Setting example

Example 1: When [Transparent] is selected in [Display Mode] for the numerical display or comment display  
The numeric value and text will be displayed in the original color.  
Suitable for the color-display GOT.

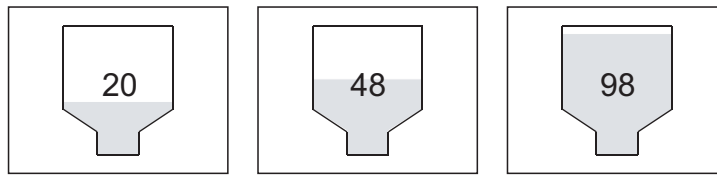

Example 2: When [XOR] is selected in [Display Mode] for the numerical display or comment display  
The area overlapped with the filled color of level will be inverted.  
Suitable for the monochrome-display GOT.

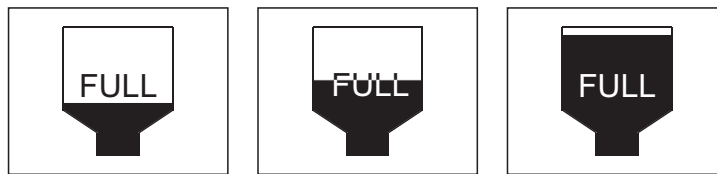

**(3) Superimposition with parts display**

Multiple fixed displays can be superimposed.

Example: Displaying the composite of three parts displays (with [Overwrite] selected for [Display Mode])

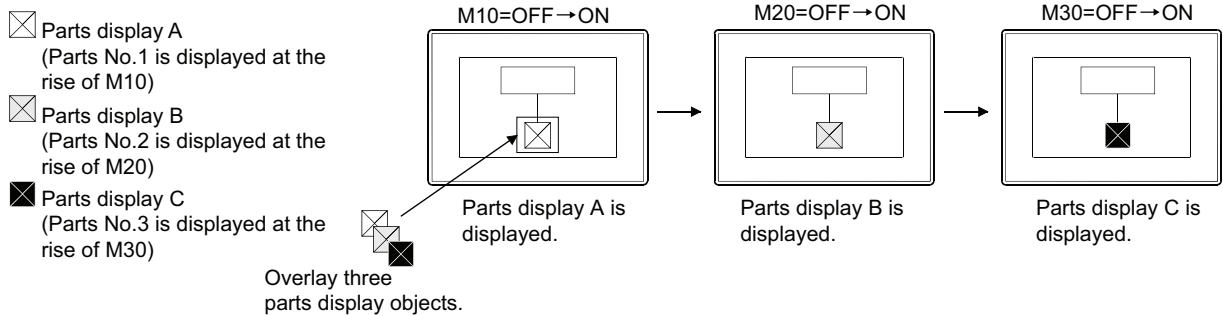

**Special superimposition of touch switch, numerical input, and ASCII input**



Up to 8 objects such as the touch switch set to each screen, numerical input, and ASCII input can be superimposed using the superimpose windows or set overlay screen function.

**(1) How to specially superimpose touch switch, numerical input, and ASCII input**

(a) Superimposition by Superimpose Windows

The superimpose windows are placed in the front of the base screen as a single screen.  
For specifications of the superimpose window, refer to the following.

2.3.1 Screen specifications for each GOT type

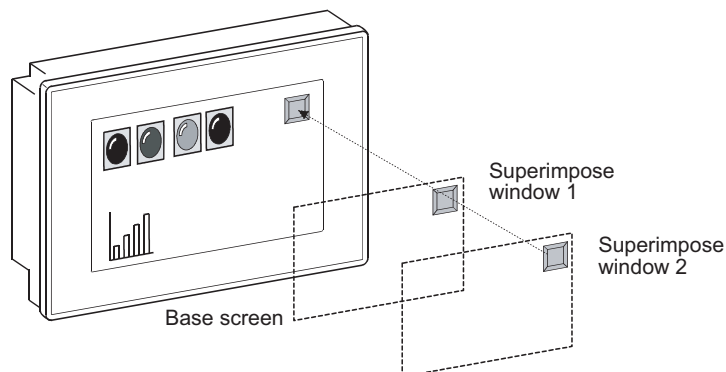

(b) Superimposition by set overlay screen

The set overlay screen function brings other base screens and window screens onto a basic screen (base screen or superimpose window), and superimpose and displays them as a single (composite) screen. For how to set the set overlay screen function, refer to the following.

☞ 10.2 Changing Screen According to Situation (Set Overlay Screen)

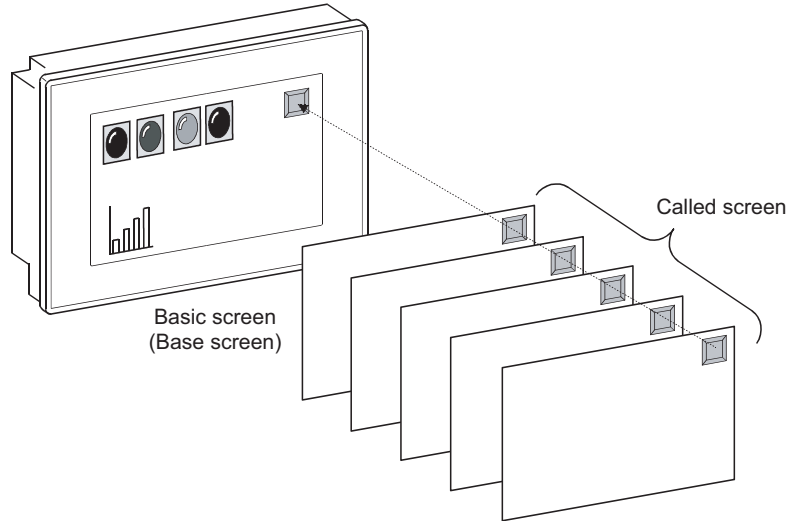

**POINT**

**(1) Setting multiple operations to a single touch switch**

The settings can be easily made, so that a single touch switch operates as several touch switches that are superimposed using superimpose windows or set overlay screen function. For how to set the touch switch, refer to the following.

☞ (Functions) 2. TOUCH SWITCH

Example) Execute three operations by touching once

When superimposing three touch switches by set overlay screen:

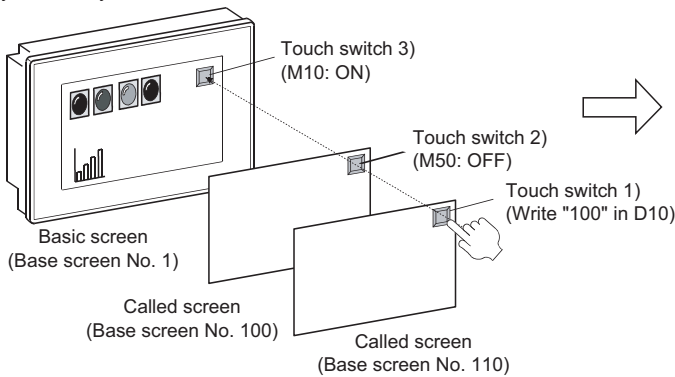

When setting three operations to a touch switch:

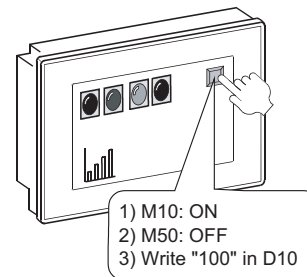

## (2) Precautions for superimposing multiple touch switches

- (a) The superimposed touch switches operate in priority order (From high to low). Therefore, the switch may not operate if touched too short. To confirm the operations of the touch switches, set a lamp, which will turn on when the touch switch with the lowest priority operates.

Lamp for operation check (lit when M10: ON)

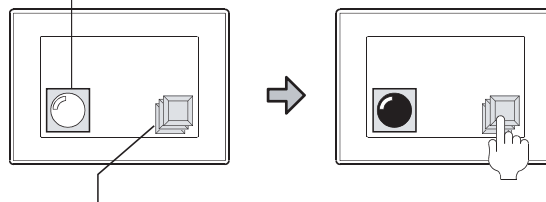

Operation settings of the touch switch with the lowest priority

1) D10

2) M50

3) M10

The lamp will turn on when the touch switch operates.

1) D10

2) M50

3) M10

Add the operation of turning on the bit for operation check (M10).

For the operation priority order of the touch switch, refer to the following.

(Functions) 2. TOUCH SWITCH

- (b) Go to screen switch or touch switch with screen switching setting  
When the above switch is superimposed with any of the following objects, if [When a finger is touched (ON synchronous)] is set for [Action of Go To Screen Switch] in the GOT environmental setting, place the objects as below. Place each object so that the go to screen switch or the touch switch with the screen switching setting operates last.  
Even if any of the following objects is placed so that the object operates after screen switching, the object does not function.

- Touch switch
- Numerical input
- ASCII input

For the operation order of the superimposed objects, refer to the following.

5.3.7 Superimposition setting

- (c) If the simultaneous pressing prohibition key is overlapped with other key, the key does not operate even when touched.

**(2) Operations of superimposed touch switch, numerical input, and ASCII input**

(a) Number of operative objects

Up to 6 of the objects (the touch switch, numerical input, and ASCII input are superimposed) superimposed by the set overlay screen function can operate. When superimpose windows 1 and 2 are additionally used, up to 8 objects can operate.

If objects (touch switch, numerical input, and ASCII input) are set over the above number, they do not operate.

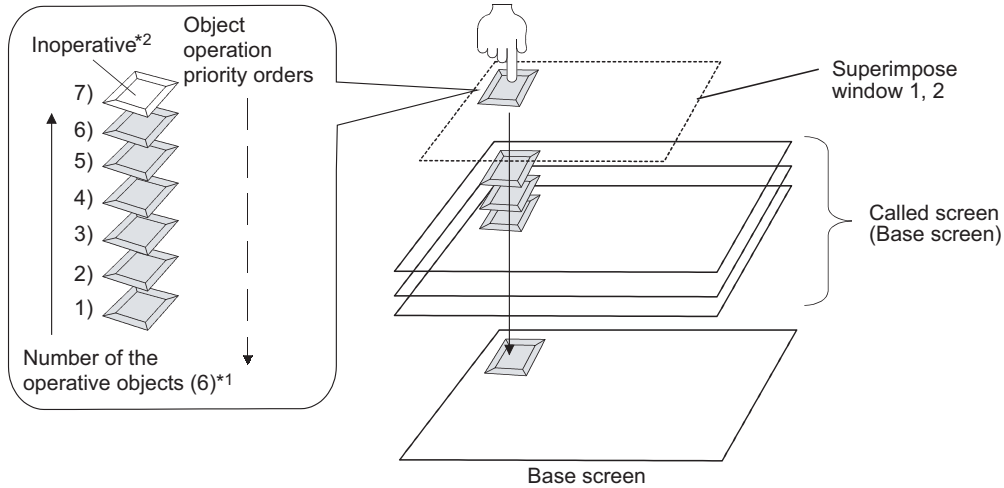

\*1 Up to 8 objects can operate according to the combination of the composite screens.

\*2 When [Display when touched] is selected for the key window operation on the key window [Key Window Advanced Setting] tab of the [Screen Property] dialog box, if multiple objects of numerical input or ASCII input are overlapped, only the first touched and turned valid calls the key window.

Therefore, the following objects do not operate.

(b) Actions of the overlapping key code switches

When different key codes are set for the overlapping key code switches, some of the switches may not function depending on the key code type.

- (c) Priority order based on the combination of composite screens  
The following shows the priority order in which the touch switch, numerical input, and ASCII input can operate, based on the combination of composite screens.

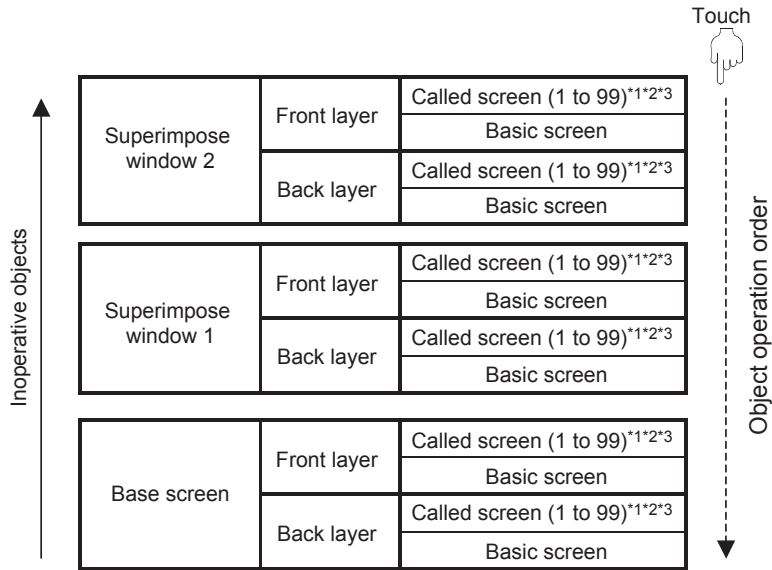

- \*1 The touch switches can operate in the order in which the screens are displayed by the set overlay screen function. For the order in which screens are called by the set overlay screen function, refer to the following.  
 10.2 Changing Screen According to Situation (Set Overlay Screen)
- \*2 The superimposed touch switch, numerical input, and ASCII input operate on up to 99 called screens. If 100 or more screens are called, the touch switch, numerical input, and ASCII input objects set on the called screen of No.100 or higher do not operate.
- \*3 When a numerical input object or an ASCII input object calls the key window, the objects (the touch switch, numerical input, and ASCII input) overlapped under this object do not operate.

- (d) Windows in which layers are disabled  
Layers are disabled in overlap windows, key windows, and dialog windows.

(e) Application example

The following shows the operation range of the touch switch, numerical input, and ASCII input set on multiple screens.

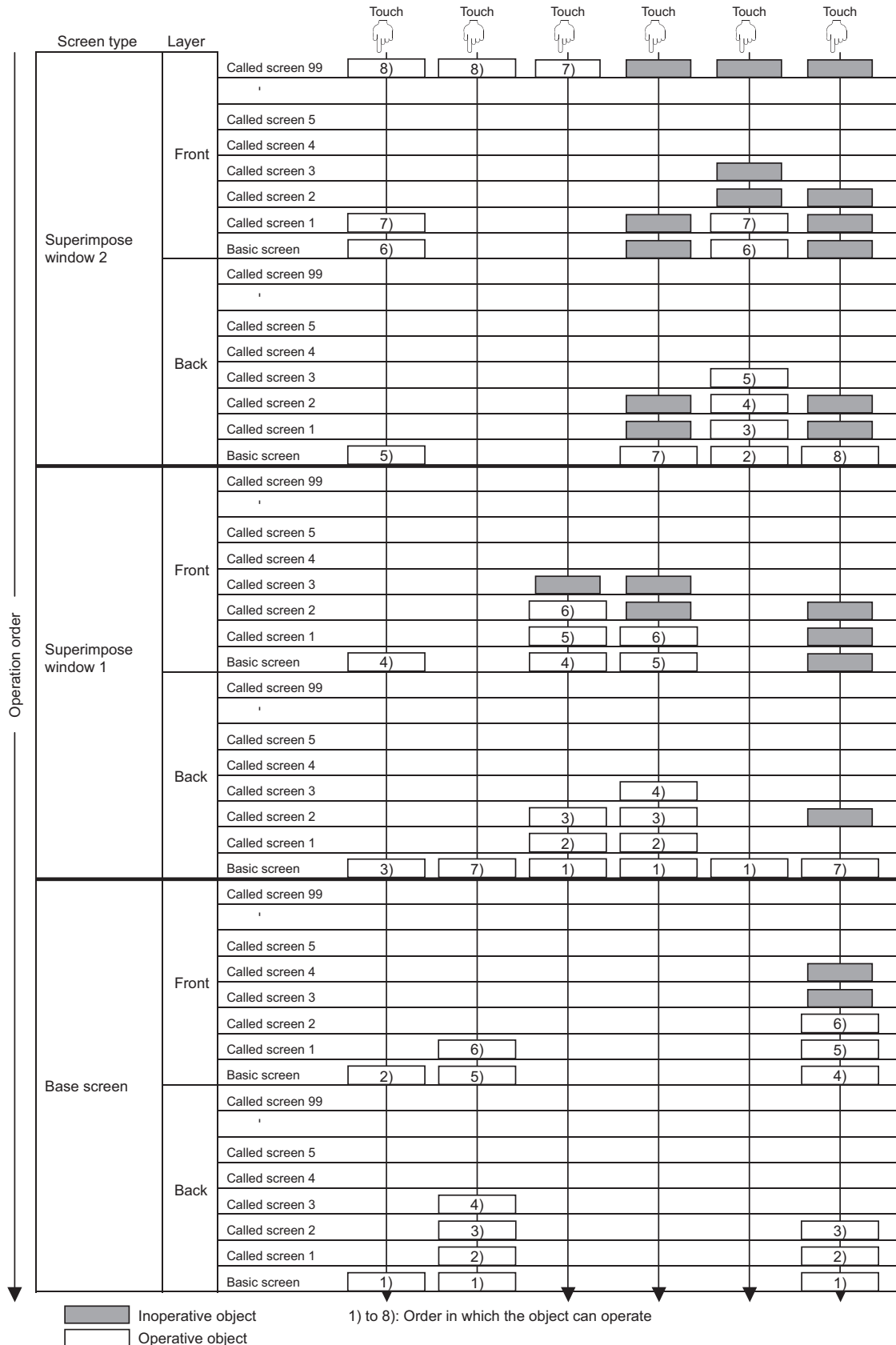

\*1 The No. 1 to 99 shown in the figure above indicate the order of calling the screens to the base screen or window screen. (In the calling order set on GT Designer3).



## 5.3.8 Trigger setting

The following triggers can be set for monitoring and writing operations of each object function.

- (1) **Trigger (for display)**  
Set for the object that monitors device.  
When the trigger is not satisfied, the object will stop device monitor or disappear.
- (2) **Trigger (for write)**  
Set for the object that writes to device.  
When the trigger is not satisfied, the object operation will be disabled and/or the display will be held.
- (3) **Trigger (for script execution)**  
Set for the script function.  
When the trigger is not satisfied, the script is not executed.

Example 1) Only the numerical display functions that are monitoring the production line are displayed.  
Production start signal (line1: M11, line2: M12, line3: M13)

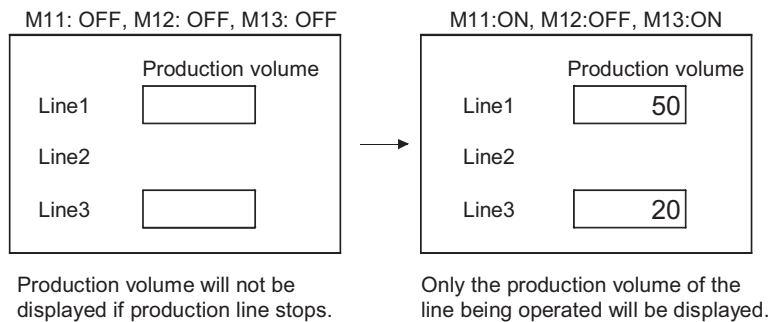

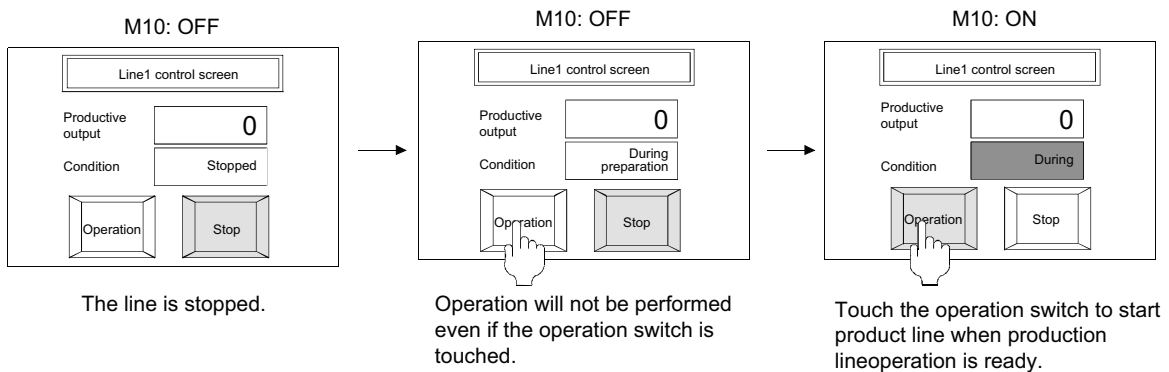

Example 2) Set an interlock device for a touch switch  
Line operation ready signal: M10

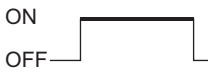

## ■ Applicable conditions and actions

### (1) Triggers (for display and action)

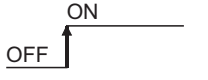
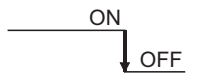
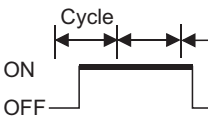
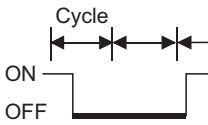
Trigger type	Execution trigger	Actions when condition is satisfied	
		Display condition	Action condition
Ordinary	None	<ul style="list-style-type: none"> <li>The device is monitored at the monitor sampling of the GOT.</li> </ul>	<ul style="list-style-type: none"> <li>The action set to the object can be executed at the monitor sampling of the GOT.</li> </ul>
ON		<ul style="list-style-type: none"> <li>When trigger is satisfied: The device is monitored at the monitor sampling of the GOT.</li> <li>When trigger is not satisfied: Select or not the [Hold Display] item in the display condition setting to choose the display action. Selected: The previous object display is retained. Not selected: The object display is erased.</li> </ul>	<ul style="list-style-type: none"> <li>When trigger is satisfied: The action set to the object can be executed.</li> <li>When trigger is not satisfied: The previous object display is retained. To clear the object display, select [Clear the input object] of the [Advanced Setting] tab for the [Environmental Setting] dialog box (Key Window), or select the [Key Window Advanced Setting] tab of the [Screen Property] dialog box.</li> </ul>
OFF		<ul style="list-style-type: none"> <li>When trigger is satisfied: The device is monitored only once.</li> <li>When trigger is not satisfied: The previous object display is retained. To monitor the device and display the object at screen switching, set [Initial display] in the display condition.</li> </ul>	Not applicable.
Rise		<ul style="list-style-type: none"> <li>When trigger is satisfied: The device is monitored only once.</li> <li>When trigger is not satisfied: The previous object display is retained. To monitor the device and display the object at screen switching, set [Initial display] in the display condition.</li> </ul>	Not applicable.
Fall			
Sampling	Sampling	<ul style="list-style-type: none"> <li>When trigger is satisfied: The device is monitored at each preset sampling. Setting range: 0.1 to 3600 seconds (every 100ms), 1 to 3600 seconds (every one second)</li> <li>When trigger is not satisfied: The previous object display is retained.</li> </ul>	Not applicable.
Range	Word device value	<ul style="list-style-type: none"> <li>When trigger is satisfied: The device is monitored at the monitor sampling of the GOT.</li> <li>When trigger is not satisfied: The previous object display is retained.</li> </ul>	<ul style="list-style-type: none"> <li>When trigger is satisfied: The action set to the object can be executed.</li> <li>When trigger is not satisfied: The previous object display is retained. To clear the object display, select [Clear the input object] of the [Advanced Setting] tab for the [Environmental Setting] dialog box (Key Window), or select the [Key Window Advanced Setting] tab of the [Screen Property] dialog box.</li> </ul>
Bit Trigger	Logical operation result of ON/OFF condition of the set multi bit device	<ul style="list-style-type: none"> <li>When trigger is satisfied: The device is monitored at the monitor sampling of the GOT.</li> <li>When trigger is not satisfied: The previous object display is retained.</li> </ul>	<ul style="list-style-type: none"> <li>When trigger is satisfied: The action set to the object can be executed.</li> <li>When trigger is not satisfied: The previous object display is retained. To clear the object display, select [Clear the input object] of the [Advanced Setting] tab for the [Environmental Setting] dialog box (Key Window), or select the [Key Window Advanced Setting] tab of the [Screen Property] dialog box.</li> </ul>
ON Sampling		<ul style="list-style-type: none"> <li>When trigger is satisfied: The device is monitored at both of the satisfied trigger (the specified device is ON or OFF) and each preset sampling. Setting range: 0.1 to 3600 seconds (every 100ms), 1 to 3600 seconds (every one second)</li> <li>When trigger is not satisfied: The previous object display is retained.</li> </ul>	Not applicable.
OFF Sampling			

(a) Actions of multi bit condition

As trigger, 2 to 8 bit devices and its ON/OFF statuses.

Operate logical AND or logical OR based on the preset ON/OFF status of the multi bit device.

Example) When M10, M11 and M12 are used as the display condition

Area where trigger is satisfied ○ : Trigger satisfied × : Trigger not satisfied

Display condition	M10 is ON	M11 is OFF	M12 is ON	Operation result	
				Logical AND	Logical OR
Upper: ON/OFF status Lower: Satisfied/ Not satisfied	OFF ×	OFF ○	OFF ×	×	○
	ON ○	OFF ○	OFF ×	×	○
	OFF ×	ON ×	OFF ×	×	×
	ON ○	ON ×	OFF ×	×	○
	OFF ×	OFF ○	ON ○	×	○
	ON ○	OFF ○	ON ○	○	○
	OFF ×	ON ×	ON ○	×	○
	ON ○	ON ×	ON ○	×	○

(b) Trigger and display on GOT

In the case of [ON], [OFF], and [Bit Trigger], the GOT does not monitor when the condition is not satisfied. If the trigger is satisfied once and then unsatisfied, the previous display is held.

Example) • Condition: range (D100: 50 to 100) • Display: D500 is numerically displayed

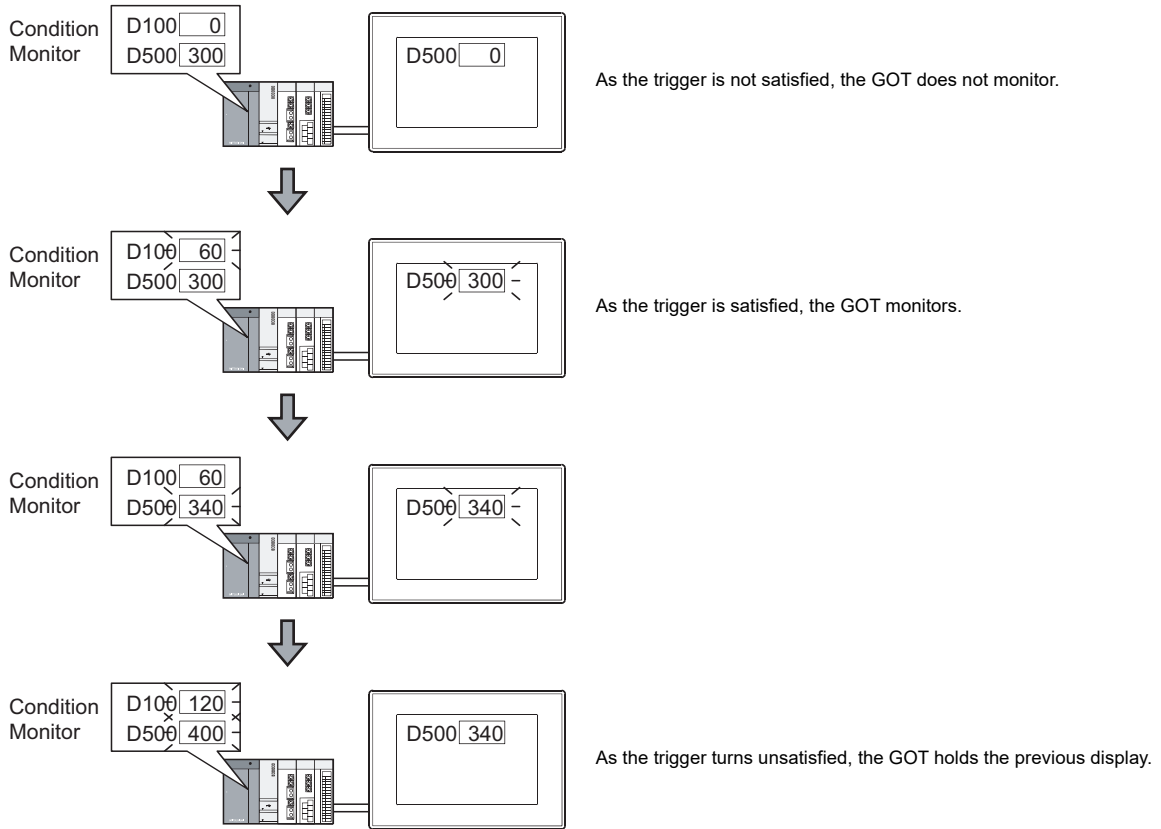

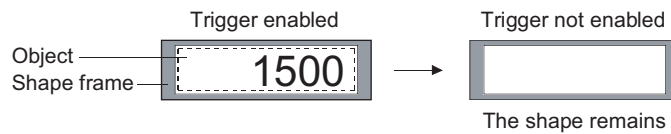

(c) Object placed into shape

In the case of [ON], [OFF], and [Bit Trigger], the object shape remains when the object is erased.

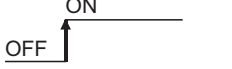
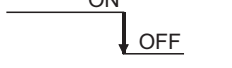
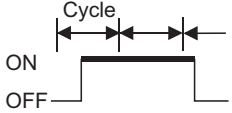
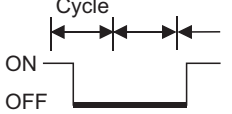

## (2) Triggers for script execution

Trigger type	Execution trigger	Actions when trigger is satisfied
Ordinary	Executed always	
ON	ON OFF 	
OFF	ON OFF 	
Rise	ON OFF 	
Fall	ON OFF 	
Sampling	Sampling	
ON sampling		<ul style="list-style-type: none"> <li>• When the trigger is satisfied: The script is executed.</li> <li>• When the trigger is not satisfied: The script is not executed.</li> </ul>
OFF sampling		
View change	When the object display changes.	
Synchronized display trigger	The same trigger for display as set for object	
Key code input	When the key code below is input. <ul style="list-style-type: none"> <li>• 0008H (the least significant digit is cleared and entire data is shifted right by 1 digit.)</li> <li>• 0088H (the contents being input are cleared.)</li> <li>• 002DH (the code is inverted.)</li> <li>• 002EH (.)</li> <li>• ASCII code, shift JIS, Kanji code</li> </ul>	
At the establishment of input	When the input data is written to a device by key code 000DH.	
Device writing	When the bit SET / word SET is executed by a touch switch.	

## ■ Objects that support trigger condition

The following shows the object types that can be set by a condition.  
The trigger type varies according to object types.

### (1) Trigger (for display)

○ : Applicable × : N/A

Object type	Trigger type						
	Ordinary	ON/OFF	Rise/Fall	Sampling	Range	Bit trigger	ON Sampling/ OFF Sampling
<ul style="list-style-type: none"> <li>• Numerical display</li> <li>• Data list display<sup>*1</sup></li> <li>• ASCII display</li> <li>• Comment display</li> <li>• User alarm display</li> <li>• Parts display<sup>*2</sup></li> <li>• Parts movement<sup>*3</sup></li> <li>• Level display</li> <li>• Line graph</li> <li>• Bar graph</li> <li>• Statistics graph</li> </ul>	○ (Default)	○	○	○	○	○	×
<ul style="list-style-type: none"> <li>• Trend graph</li> <li>• Line graph<sup>*4</sup></li> <li>• Scatter graph</li> </ul>	×	×	○	○ (Default)	×	×	○
<ul style="list-style-type: none"> <li>• User alarm display<sup>*5</sup></li> </ul>	×	×	×	○ (Default)	×	×	×
<ul style="list-style-type: none"> <li>• Advanced alarm display</li> </ul>	○ (Default)	○	×	×	×	×	×
<ul style="list-style-type: none"> <li>• Historical data list display</li> <li>• Historical trend graph</li> </ul>	○ (Default)	×	×	×	×	×	×

\*1 When conditions are not met in the data list, the comment and data are deleted while the frame and title are displayed.

\*2 The displaying condition of the fixed parts display is rise/fall only.

When conditions are not met in the parts display, the object is deleted only when the display mode is set to "replace" ([Hold Display] is not selected).  
In other cases, the fixed parts are displayed.

\*3 When conditions are not met in the parts movement display, the object is displayed if either (or both) of [Locus] in the [Device/Style] tab and [Hold Display] in the [Trigger] tab is specified.

\*4 The trigger for the line graph when [Locus] is selected.

\*5 The trigger for the user alarm display when [Store Memory] is selected.

### (2) Trigger (for write)

○ : Applicable × : N/A

Object type	Trigger type						
	Ordinary	ON/OFF	Rise/Fall	Sampling	Range	Bit trigger	ON Sampling/ OFF Sampling
<ul style="list-style-type: none"> <li>• Touch switch</li> <li>• Numerical input</li> <li>• ASCII input</li> </ul>	○ (Default)	○	×	×	○	○	×
<ul style="list-style-type: none"> <li>• Logging function</li> </ul>	×	×	○ (Default)	○	×	×	○

### (3) Triggers for script execution

○ : Applicable × : N/A

#### (a) Project script and screen script

Object type	Trigger type									
	Ordinary	ON/OFF	Rise/Fall	Sampling	ON sampling/ OFF sampling	View change	Synchron ize display trigger	Key code input	Input fixation	Device writing
<ul style="list-style-type: none"> <li>Project script</li> <li>Screen script</li> </ul>	○	○	○	○	○	×	×	×	×	×

#### (b) Object script

##### • Input object script

Object type	Trigger type									
	Ordinary	ON/OFF	Rise/Fall	Sampling	ON sampling/ OFF sampling	View change	Synchron ize display trigger	Key code input	Input fixation	Device writing
<ul style="list-style-type: none"> <li>Numerical input</li> <li>ASCII input</li> </ul>	○	○	○	○	○	×	×	○	○	×

##### • Display object script

Object type	Trigger type									
	Ordinary	ON/OFF	Rise/Fall	Sampling	ON sampling/ OFF sampling	View change	Synchron ize display trigger	Key code input	Input fixation	Device writing
<ul style="list-style-type: none"> <li>Numerical display</li> <li>Numerical input</li> <li>ASCII display</li> <li>ASCII input</li> <li>Comment display</li> <li>Parts display</li> <li>Parts movement</li> <li>Level display</li> <li>Trend graph</li> <li>Line graph</li> <li>Bar graph</li> <li>Statistics graph</li> <li>Scatter graph</li> </ul>	○	○	○	○	○	○	○	×	×	×
<ul style="list-style-type: none"> <li>Lamp (Bit/Word)</li> <li>Clock display (date display and time display)</li> <li>Panel meter</li> </ul>	○	○	○	○	○	○	×	×	×	×

##### • Switch object script

Object type	Trigger type									
	Ordinary	ON/OFF	Rise/Fall	Sampling	ON sampling/ OFF sampling	View change	Synchron ize display trigger	Key code input	Input fixation	Device writing
<ul style="list-style-type: none"> <li>Touch switch (Switch)</li> </ul>	○	○	○	○	○	×	×	×	×	○

## ■ Settings

Set the trigger on the [Trigger] tab of the setting dialog box for each object.

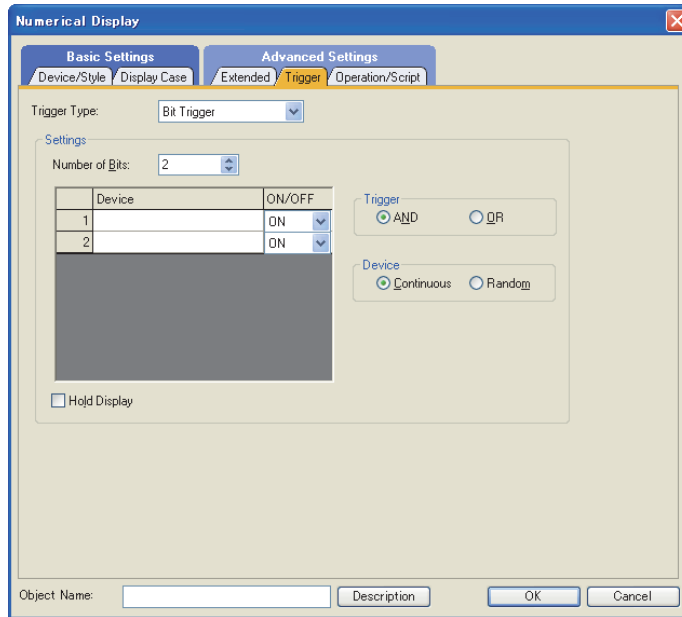

Item	Description	Model	
Trigger Type	Select the trigger for displaying/operating the object. When [Sampling] is selected, the cycle is set in second unit (1 to 3600s). • Ordinary • ON • OFF • Sampling • Range • Rise • Fall • Bit Trigger • ON Sampling • OFF Sampling		
Settings	The setting content differs depending on the trigger type.	gr16 gr15 gr14 gr12 gr11 gr10 SoftGOT1000	
	Ordinary	No setting content.	
	ON	☞ (1) ON/OFF	
	OFF		
	Rise	☞ (2) Rise/Fall	gr16 gr15 gr14 gr12 gr11 gr10 SoftGOT1000
	Fall		
	Sampling	☞ (3) Sampling	gr16 gr15 gr14 gr12 gr11 gr10 SoftGOT1000
	Range	☞ (4) Range	
Bit Trigger	☞ (5) Bit Trigger	gr16 gr15 gr14 gr12 gr11 gr10 SoftGOT1000	
ON Sampling/ OFF Sampling	☞ (6) ON Sampling/OFF Sampling	gr16 gr15 gr14 gr12 gr11 gr10 SoftGOT1000	

### POINT

#### Conditions settable for trigger type for each object

Conditions that can be set for a trigger type differ depending on the used object or the GOT type setting. For conditions settable for a trigger type for each object, refer to the following.

☞ GT Designer3 Version1 Screen Design Manual (Functions)



### (1) ON/OFF

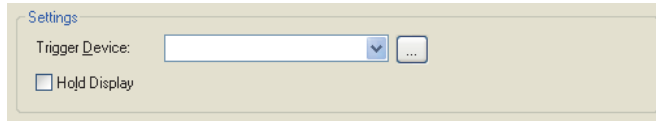

Item	Description	Model
Trigger Device	Click the [...] button to set the device to be a trigger. 5.3.1 Device setting	GT16 GT15 GT14 GT12 GT11 GT10 SRRGT1000
Hold Display	Select this item to hold the object display even when the display condition is not satisfied anymore, after satisfying once. Without this item selected, the object is cleared when the condition is not satisfied. <p><b>Hold display</b> The object display status with satisfying the display condition is held.</p> <p><b>No hold display</b> Clear it as the display condition is not satisfied.</p>	GT16 GT15 GT14 GT12 GT11 GT10 SRRGT1000

### (2) Rise/Fall

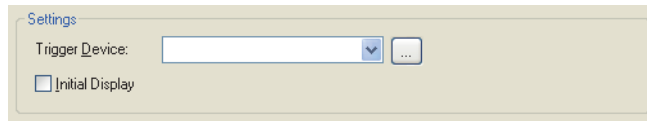

Item	Description	Model
Trigger Device	Click the [...] button to set the device to be a trigger. 5.3.1 Device setting	GT16 GT15 GT14 GT12 GT11 GT10 SRRGT1000
Initial Display	Select this item to monitor and display the device even if the initial condition of the screen switch is not satisfied. <p><b>Initial display</b> The device is monitored and the set value is displayed even when the trigger is not satisfied.</p> <p><b>No initial display</b> Not display when trigger is not satisfied.</p>	GT16 GT15 GT14 GT12 GT11 GT10 SRRGT1000

### (3) Sampling

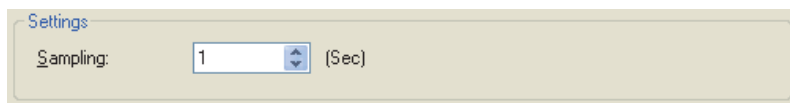

Item	Description	Model
Sampling	Set the cycle for monitoring the trigger device condition. (1 to 3600s)	GT16 GT15 GT14 GT12 GT11 GT10 SRRGT1000

#### (4) Range

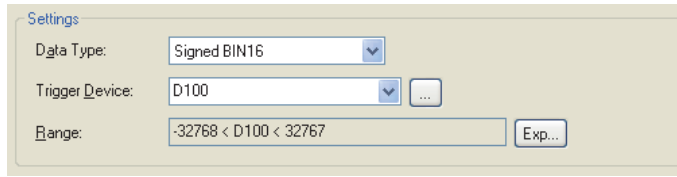

Item	Description	Model
Data Type	Select the data type of word device. Signed BIN : Treats the word device value as a signed binary value. Unsigned BIN : Treats the word device value as an unsigned binary value. Real : Treats the word device value as a floating point type real number.	Gr16 Gr15 Gr14 Gr12 Gr11 Gr10 SoftGOT1000
Trigger Device	Click the [...] button to set the device to be a trigger. 5.3.1 Device setting	
Range	Click the [Exp] button to display the [Edit Range] dialog box. Set the trigger device range. (a) Edit Range dialog box	

(a) Edit Range dialog box

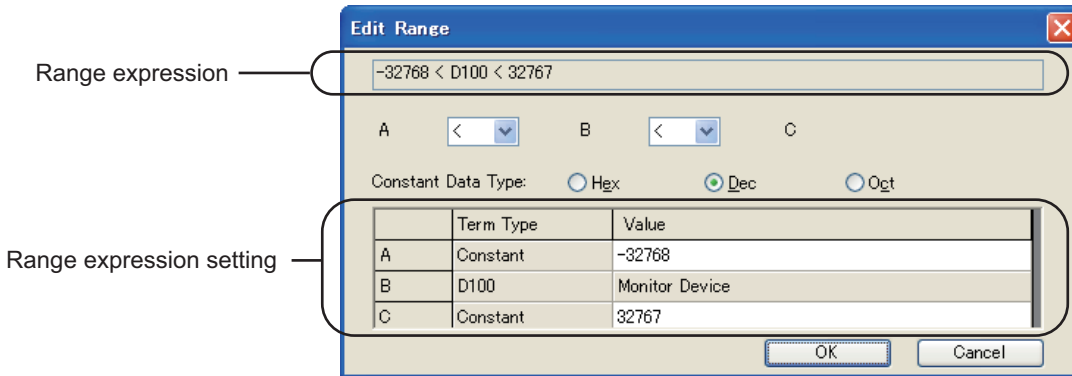

Item	Description	Model
Range expression	Displays the set range expression.	Gr16 Gr15 Gr14 Gr12 Gr11 Gr10 SoftGOT1000
	Set the relational operator of the range expression. < : Left value is smaller than right value == : Left value is equal to right value <= : Left value is smaller than or equal to right value != : Left value is not equal to right value None: Without comparison	
Constant Data Type	When setting the fixed value to each item of the range expression, select the data type of the fixed value. (Hex/Dec/Oct)	

(Continued to next page)

Item	Description		Model
Range expression setting	Term Type	<p>Set the details of each range expression item (A to C).</p> <ul style="list-style-type: none"> <li>• Constant: Select this item when operating with fixed values. Select either of [Hex], [Dec], or [Oct] for [Constant Data Type].</li> <li>• \$V : Select when operating the value of word device set as the monitoring target or writing target. This item must be set once in an expression.</li> <li>• Other device: Set this item when operating the word device value. The data type is she same of the monitoring device (\$V).</li> </ul>	GT16 GT15 GT14 GT12 GT11 GT10 SerGot1000
	Value	<p>Set the setting values of each range expression item (A to C). The setting target varies according to the [Term Type] settings.</p> <ul style="list-style-type: none"> <li>• [Constant]: Set the value.</li> <li>• [\$V]: The monitor device is set.</li> <li>• [Other device]: Set the intended device. Click the [...] button to set from the [Device setting] dialog box.</li> </ul>	

### (5) Bit Trigger

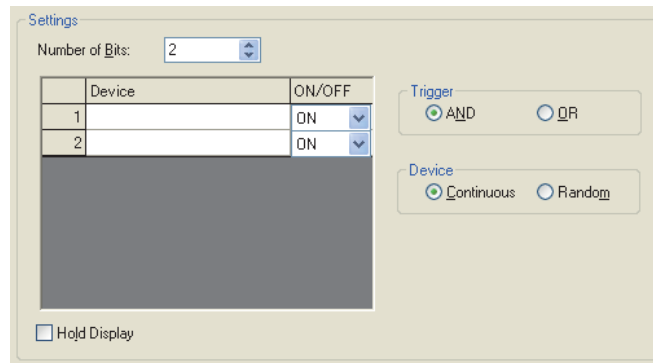

Item	Description	Model
Number of Bits	Specify the number of the multi bit trigger. (1 to 10)	GT16 GT15 GT14 GT12 GT11 GT10 SerGot1000
Device	<p>The devices preset as multi bit trigger are listed. Click the Device bar to display the [...] button. Open the [Device setting] dialog box to set the device.</p> <p> 5.3.1 Device setting</p>	
ON/OFF	Select whether ON or OFF status of bit device will be set as the trigger condition.	
Trigger	<p>Select the definition for multi bit trigger condition.</p> <p>AND : If all triggers that are specified based on the bit device ON/OFF statuses are satisfied, the multi bit trigger is set.</p> <p>OR : If any of the triggers specified based on the bit device ON/OFF statuses are satisfied, the multi bit trigger is set.</p>	
Device	<p>Select the method of setting device.</p> <p>Continuous : Set the specified number of devices continuously starting from the set device automatically.</p> <p>Random : Randomly set the specified number of devices.</p>	

(Continued to next page)

Items	Description	Model
Hold Display	<p>Select this item to hold the object display even when the display condition is not satisfied anymore, after satisfying once. Without this item selected, the object is cleared when the condition is not satisfied.</p> <p>The object display status with satisfying the display condition is held.</p> <p>Clear it as the display condition is not satisfied.</p>	gr16 gr15 gr14 gr12 gr11 gr10 SoftGOT1000

### (6) ON Sampling/OFF Sampling

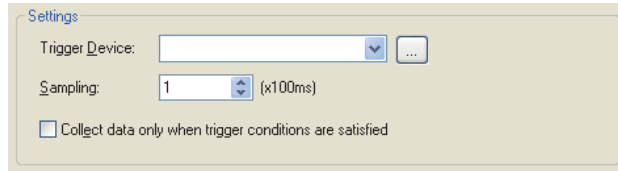

Item	Description	Model
Trigger Device	<p>Click the [...] button to set the word device to be a trigger.</p> 5.3.1 Device setting	gr16 gr15 gr14 gr12 gr11 gr10 SoftGOT1000
Sampling	Set the cycle of monitoring the trigger device condition. (1 to 3600s)	
Collect data only when trigger conditions are satisfied	<p>Select this item to collect the data only when the display condition is satisfied.</p> (Functions) GRAPH, METER	

### ■ Precautions

#### (1) Object of which trigger has been set to sampling

Up to 100 objects can be set on one screen, of which the trigger type was been set to [Sampling].  
In this case, change the trigger type to [Sampling] and adjust the sampling cycle to 2 seconds or longer.

#### (2) Setting of trigger for line graph

When many devices are monitored in line graph form, and the trigger is set to [Ordinary], the object processing may be delayed.

In this case, change the trigger type to [Sampling] and adjust the sampling cycle to 2 seconds or longer.

### 5.3.9 Data operation setting

If data operation function has been set, each object executes the operations set in [Data operation] the preset word device values, and monitors based on the results. Data operation function is applicable to the following objects.

Object name			
Lamp (Bit/Word),	Numerical Display,	Numerical Input*1,	Data List Display,
Historical data list display,	Comment Display,	Level,	Panelmeter,
Line Graph,	Trend Graph,	Bar Graph,	Statistics Bar Graph,
Statistics Pie Graph,	Scatter Graph,	Historical Trend Graph,	Parts Display,
Parts Movement,	Numerical Print		

\*1 If bit mask operation is used for numerical input function, only logical (AND) is applicable. Logical add (OR) and exclusive logical add (XOR) are not applicable.

Example: Data operation is used in numerical display function.  
Monitored device: D101

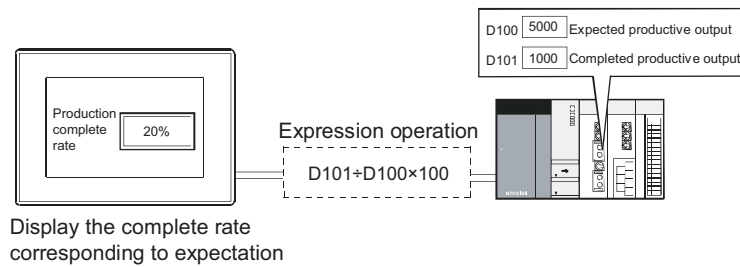

### Bit operation

This function executes operation of the word device value in bit unit.

#### (1) Bit mask

Executes a logical operation of the word device value by the preset pattern value.

- (a) Logical AND (AND)  
The operation result is "1" when the corresponding bits of both the device value and pattern value are "1".  
The operation result is "0" in other cases.
- (b) Logical OR (OR)  
The operation result is "0" when the corresponding bits of both device value and pattern value are "0".  
The operation result is "1" in other cases.
- (c) Exclusive logic XOR (XOR)  
The operation result is "0" when the corresponding bits of device value and pattern value are equivalent;  
"1" when not equivalent.

Example: When logical AND (AND) is operated

Monitor device value	b15	b14	b13	b12	b11	b10	b9	b8	b7	b6	b5	b4	b3	b2	b1	b0
	0	1	0	1	0	1	0	1	0	1	0	1	0	1	0	1
	AND															
Pattern value (Hexadecimal)	b15	b14	b13	b12	b11	b10	b9	b8	b7	b6	b5	b4	b3	b2	b1	b0
	0	0	0	0	1	1	1	1	1	1	1	1	0	0	0	0
	↓															
Operation result	b15	b14	b13	b12	b11	b10	b9	b8	b7	b6	b5	b4	b3	b2	b1	b0
	0	0	0	0	0	1	0	1	0	1	0	1	0	0	0	0

**(2) Bit shift**

Shifts the word device value to the right or left in bit unit to execute an operation on the value.  
(It becomes arithmetic shift when it comes to the signed monitor format of device.)

Example: Shift right for 4 bits

(a) Signed

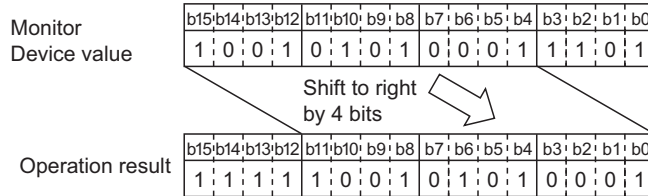

(b) Unsigned

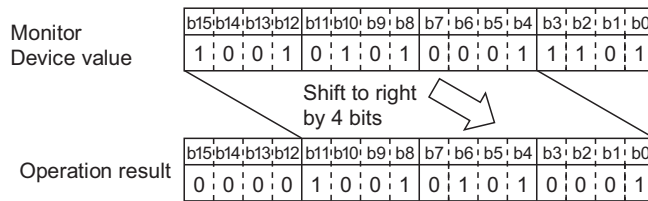

**(3) Data operation**

Executes the preset data operation on the word device value.  
Select and set the data operation format from the 9 types.  
The operation is executed based on the following conditions:

Example:

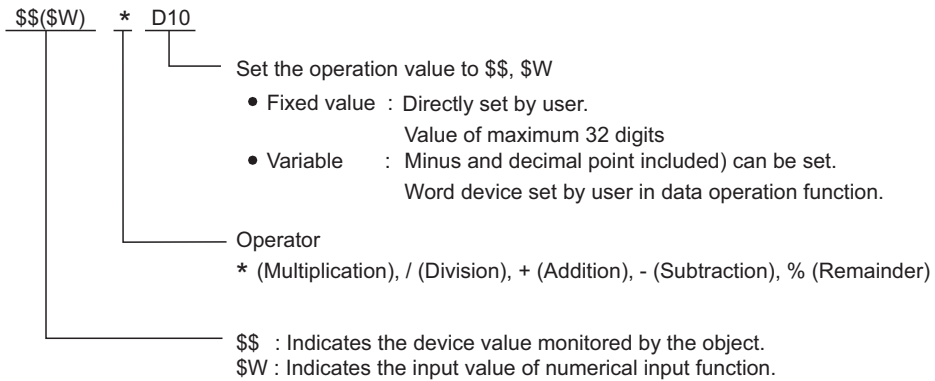

## ■ Procedure for operation processing

The operation processing for device monitoring and numerical inputting is shown as follows.

### (1) When monitoring device

The following shows the order of priority of each processing.

1. Bit mask
2. Bit shift
3. Data operation processing

### (2) When using numerical input function

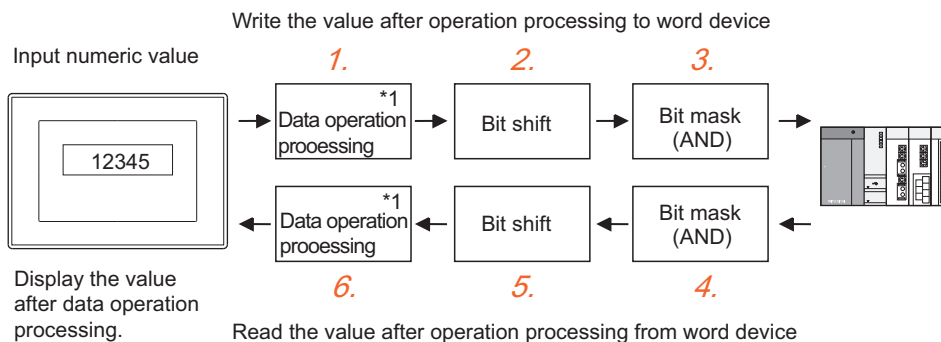

\*1: Other data operations can be set for write destination device during monitoring and writing.

- Write the value after operation processing to word device>

#### 1. Data operation processing

The input value by the preset operation expression for writing device value is calculated.

#### 2. Bit shift

Shifts the input value in the set direction (right / left)

#### 3. Bit mask

Executes bit mask (logical AND) on the input value by the preset value.

To write the bit and mask the remaining, carry out the following.

Operation data

(Write value) = {(Input value) AND (Pattern value)} OR {(Current value) AND (Reverse pattern value)}

Example: Writing 12<sub>H</sub> to the lower two digits of the current value ABCD<sub>H</sub>

Input value (value input by user) : 0012<sub>H</sub>

Current value (value before write) : ABCD<sub>H</sub>

Pattern value (value set by user) : 00FF<sub>H</sub>

Reverse pattern value (value created for GOT operation) : FF00<sub>H</sub>

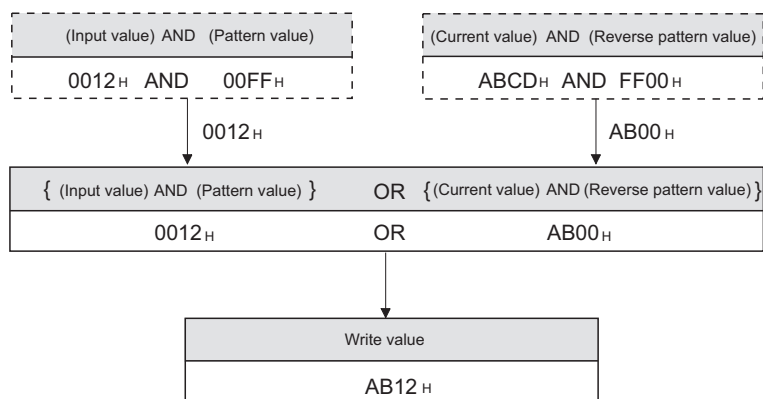

- Read the word device value after operation processing

4. Bit mask  
Executes bit mask (logical (AND) of the device value by the preset pattern value.
5. Bit shift  
Shifts the device value in the reverse direction.
6. Data operation processing  
Calculates and displays the written device value by the preset operation expression for reading device value.

## ■ Settings

The data operation is set on the [Operation/Script] tab of each object.

An example of numerical display is provided here for explanation of the data operation setting.

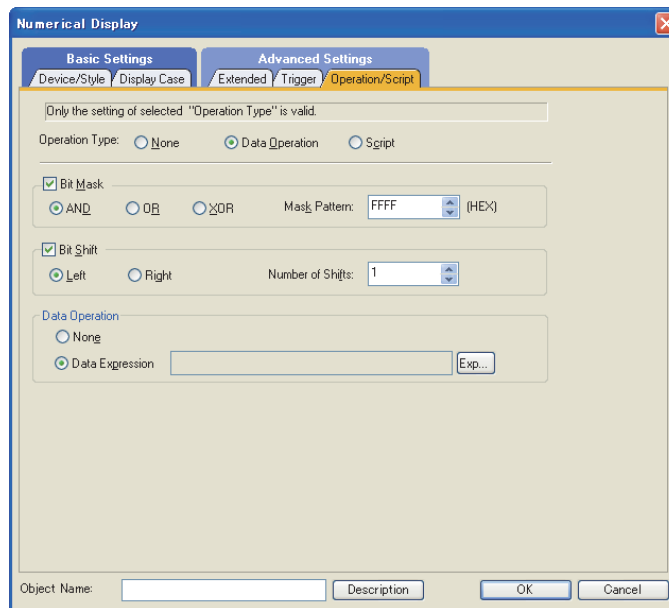

Item	Description	Model
Operation Type	Select the type of operation to be set to the object. None : Select this item when not executing operation. Data Operation : Select this item to execute the operation by data operation. Script : Select this item to execute the operation by script.	
Bit Mask	Select this item to execute the bit mask operation. Select the bit mask type and set the mask pattern value in [Mask Pattern] in hexadecimal format. AND : Executes logical product. OR : Executes logical add. XOR : Executes exclusive logical add. Mask Pattern:At data length of 16 bits (0 to FFFF), at 32 bits (0 to FFFFFFFF) When the data type of the device is [Real], this setting is disabled.	Gr16 Gr15 Gr14 Gr12 Gr11 Gr10 SnrGOT1000
Bit Shift	Select this item to execute the bit shift operation (for monitoring/writing). Select the shift direction and set the number of bits to shift in [Number of Shifts]. Left : Shift left Right : Shift right Number of Shifts:At data length of 16 bits (1 to 15), at 32 bits (1 to 31) When the data type of the device is [Real], this setting is disabled.	
Data Operation	Select whether or not to execute the data operation. None : Select this item when not executing data operation. Data Expression : Select this item when executing data operation. Click the [Exp] button to display the [Edit Data Expression] dialog box. Set the operational expression referring to the following.  (1) Edit data expression dialog box	



**(1) Edit data expression dialog box**

Set the expression for data operation.

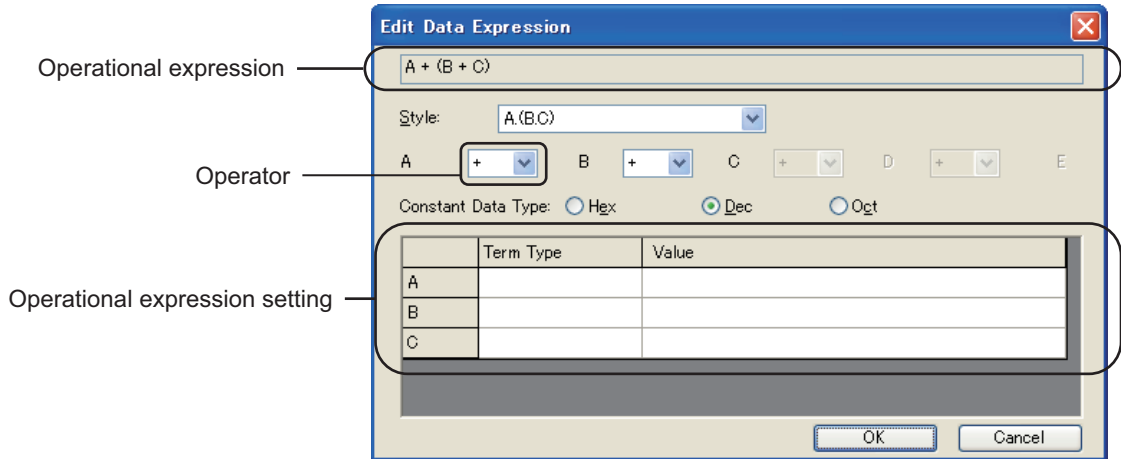

Item	Description	Model
Operational expression	The set operational expression is displayed.	
Style	<p>Set the operational expression format.</p> <p><math>A \cdot B</math> — Fixed value, variable (represented as "\$\$", "SW", respectively; any word device set for operation)</p> <p>— Operator</p> <p>Select from the following 9 types.</p> <p>A, (A · B) · C, ((A · B) · C) · (D · E)</p> <p>A · B, A · ((B · C) · D), (A · B) · ((C · D) · E)</p> <p>A · (B · C), A · (B · (C · D)), ((A · B) · (C · D)) · E</p>	
Operator	<p>Select the operators to connect items of the operational expression.</p> <p>+ : Add * : Multiply % : Remainder*<sup>1</sup></p> <p>- : Subtract / : Divide</p>	
Constant Data Type	When setting fixed value to each item of the operational expression, select the data format of fixed value. (Hex/Dec/Oct)	
Operational expression setting	<p>Set the term type and value of each item of the operational expression.</p> <p><b>Term Type</b></p> <p>Set each item (A to E) of the operational expression.</p> <ul style="list-style-type: none"> <li>Fixed value: Select this item when using fixed value to execute the operation. Select [Constant Data Type] from [Hex], [Dec], and [Oct].</li> <li>\$\$ : Select this item to execute the operation of the word device value that has been set as monitor and write destination. Be sure to set one.</li> <li>Other device: Select this item to execute the operation of the word device value. Data type is the same as the monitor device (\$\$).</li> </ul>	<p>gr16 gr15</p> <p>gr14 gr12</p> <p>gr11 gr10</p> <p>SRGOT1000</p>
	<p><b>Value</b></p> <p>Set the setting value of each item of the operational expression. The target of setting is restricted by on the setting of [Term Type].</p> <ul style="list-style-type: none"> <li>[Constant]: Set the value.</li> <li>[\$\$]: The monitor device is set.</li> <li>[Other Device]: Set the intended device. Click the [...] button to set the device from the [Device] dialog box.</li> </ul>	

\*1 The left value is divided by the right value and the remainder it the result.  
Example: 100 % 3 = 1 (100 / 3 = 33 remainder is 1)



# USING LIBRARY

---



# 6. LIBRARY



Figures, objects, and templates are registered in the library.  
 The registered figures, objects, and templates can be easily pasted on the screen editor.  
 The following items can also be registered in the library.

- Figures and objects created by the user
- Templates with the edited template names and template attribute names, originally in the system library

For the templates in the system library, refer to the following.

☞ 7.1.2 Templates in the system library

## ■ Screen configuration of library

### (1) Library list window

In the library list window, the figures, objects, and templates in the library can be read, and figures, objects, and templates can be registered in the library or edited.

The [Library] window is configured by the toolbar area, library tree area, and library data area.

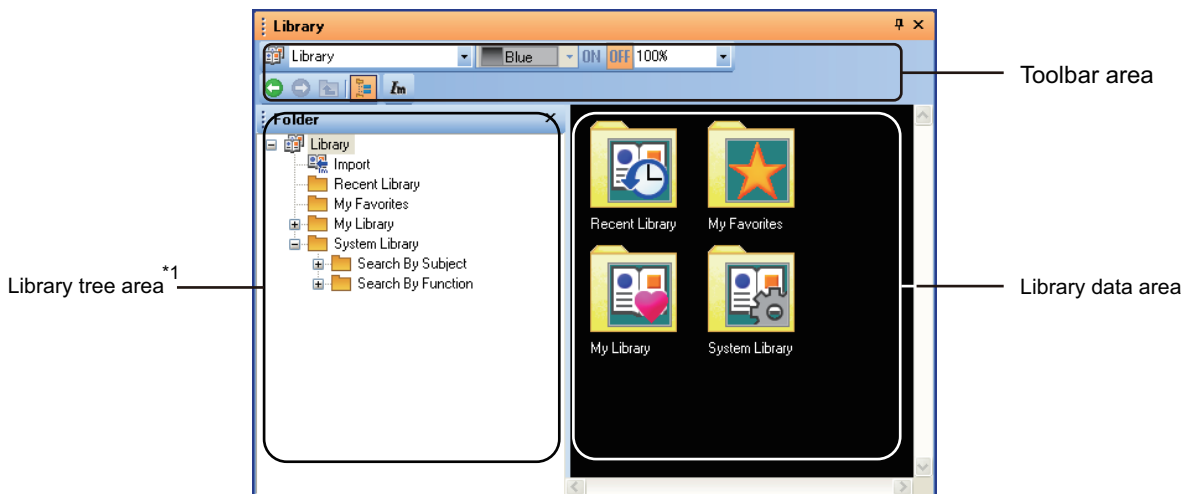

\*1 The library data area is not displayed by default.

### (2) Library data editor

Data are registered in [My Favorites] and [My Library], or data are edited in the library data editor.

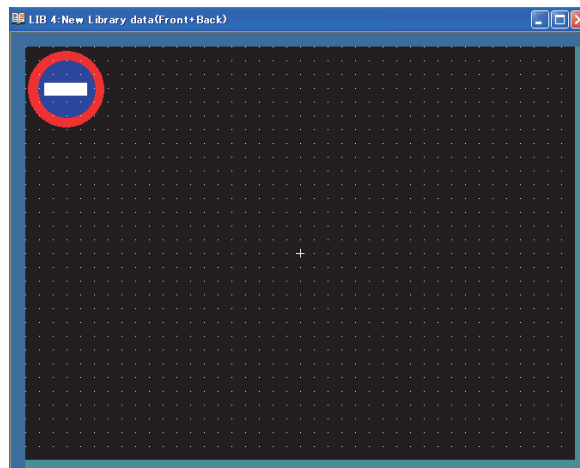

## Library types

The library types are shown as below.

### (1) User-created library

The following items can be registered in the library.

- Figures and objects created by the user
- Templates with the edited template names and template attribute names, originally in the system library

The user-created library types are shown as below.

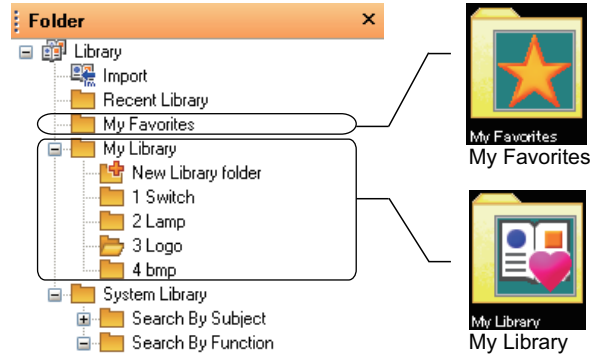

#### (a) My Favorites

Register the commonly-used figures, objects, and templates.

The icons of the figures, objects, and templates in [My Favorites] are added to the [My Favorites] toolbar.



#### (b) My Library

Register the user-created figures, objects, and templates.

When the library folders are classified for each type, it is convenient to use them.

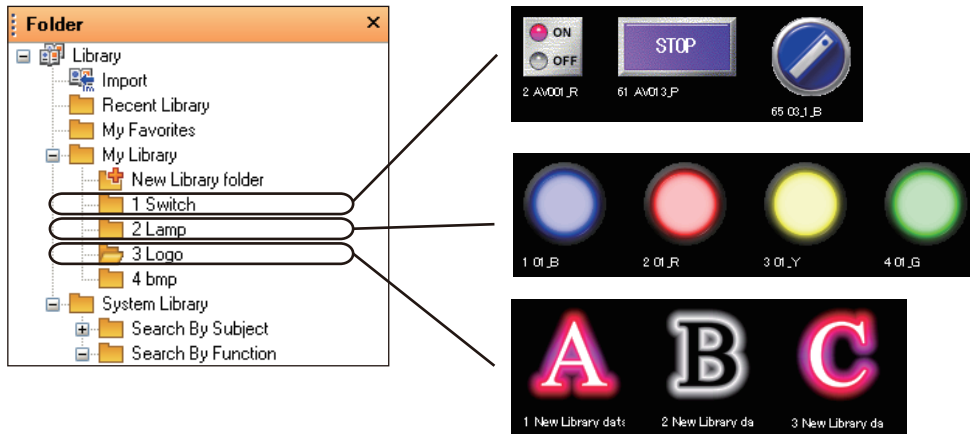

For how to register figures, objects, and templates in [My Favorites] or [My Library], refer to the following.

👉 6.3 Editing User-Created Library

## (2) System Library

Figures, objects, and templates are registered as the library data.

By reading out the registered library data and arranging the data on the screen, figures, objects, and templates can be set.

The library folders or library data in [System Library] cannot be registered, deleted or changed for the attributes.

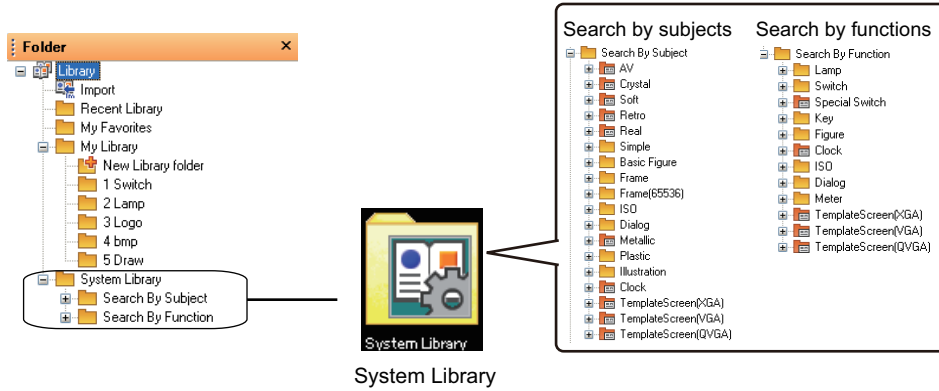

### HINT

#### Search By Subject/Search By Function

Select whether to search for the target figure, object, or template by subject or by function.

Select the method according to the purpose.

The terminal folder for [Search By Subject] stores the same library data as those of the terminal folder for [Search By Function].

## (3) Recent Library

Up to 10 data that are recently used by the user are recorded.

The library data are not directly registered, deleted, or changed for the attributes.

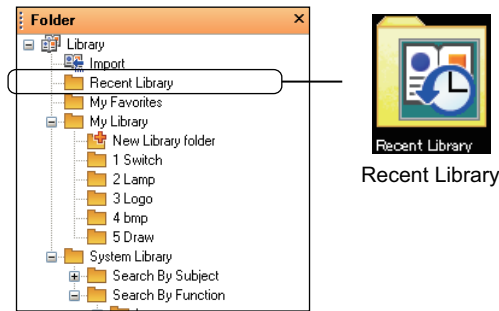

### Maximum library data that can be registered

Up to 250 data can be created in [My Library].

In one library folder, up to 255 library data can be registered.

# 6.1 Operation of Library List

## Library list window

Select [View] → [Docking Window] → [Library List] from the menu to display the library list window.

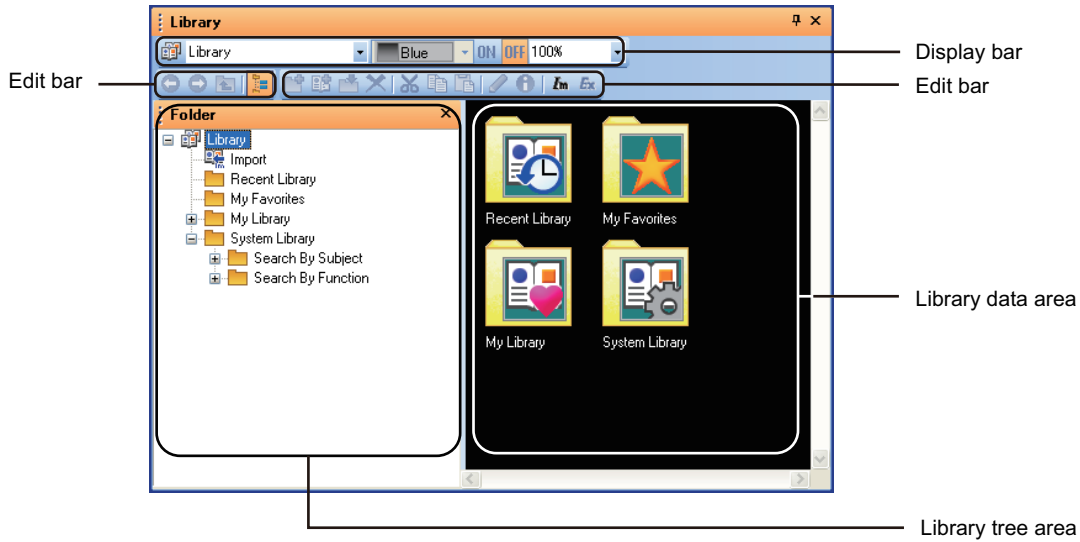

Item	Description	Reference	Model
Display bar	Displays the display status of the library data area.	(1) Display bar	
Movement bar	Moves currently displayed folders.	(2) Movement bar	
Edit bar	Operates the library tree and library data.	(3) Edit bar	gr16 gr15 gr14 gr12 gr11 gr10 SoftGOT1000
Library tree area	Displays the library as the tree structure.	(4) Library tree area	
Library data area	Displays the data of the selected library folder.	(5) Library data area	

### (1) Display bar

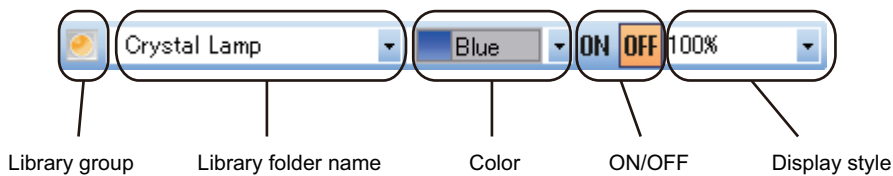

Item	Description	Model
Library group	Select the type of the library to be displayed on the library data area. Select this item to display the library data in the library data area.	
Library folder name	Select a library folder in the library selected for the library group. Select this item to display the selected library folder data in the library data area.	
Color	Switches the figure colors to be displayed on the library data area. Switching the figure and object colors is only available in the system library. • All Color • Blue • Red • Yellow • Green • Orange • Cyan • Purple • Pink • Gray • Gold • Silver • Black • White	gr16 gr15 gr14 gr12 gr11 gr10 SoftGOT1000
ON/OFF	Switches between on and off of figures to be displayed on the library data area.	
Display style	Select the display style of figures displayed on the library data area. • 150%, 100%, 75%, 50%, 25%: Displays the library data with the selected rate. • Thumbnail: Displays the library data with the fixed size. • Detail: Displays the library data and the attribute value with the fixed size.	



## (2) Movement bar



Item	Description		Model
	Back	Opens the previous folder.	GT16 GT15 GT14 GT12 GT11 GT10 SotGOT1000
	Forward	Opens the next folder.	
	Up One Level	Opens the parent folder.	
	Display Tree	Selects whether to display or hide the library tree.	

## (3) Edit bar







Item	Description		Model
	New Library folder	Creates a new library folder.	GT16 GT15 GT14 GT12 GT11 GT10 SotGOT1000
	New Library data	Creates the new library data.	
	Register Data	Registers the library data of the library data editor.	
	Delete	Deletes the library folder or library data.	
	Cut	Cuts the library folder or library data.	
	Copy	Copies the library folder or library data.	
	Paste	Pastes the library folder or library data.	
	Edit Data	Edit the selected library data.	
	Edit Property	Change the selected library data attributes. Displays the property of the library data when the library data in the system library are selected.	
	Import	Imports a library file or image file.	
	Export	Exports a selected library folder.	

**(4) Library tree area**

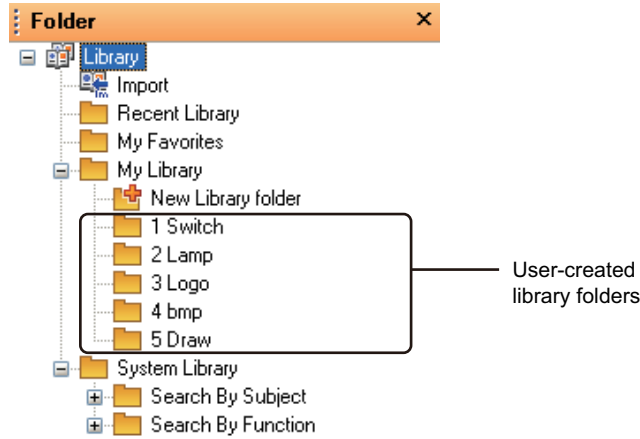
The library tree area enables the GOT to switch between the display and hide of the library tree by clicking the  button.

**(a) Configuration of library tree**



Item	Description		Model
Import	Double-click this item to import a user-created library or image file.  6.3.9 Importing library		
Recent Library	Displays the library data recently used by the user are displayed on the library data area.		
My Favorites	Registers the commonly-used figures, objects, and templates. Opening a folder displays the registered library data on the library data area.		
My Library	New Library Folder	Double-click this item to create a new user-created library folder.	
	User-created library folders	Stores the user-created library data. Any folder name can be set for each library folder.	
System Library	Stores the figures, objects, and templates registered by default. When the library data with a template is stored, the folder icon is  . For the library data with a template, refer to the following.  7.1.2 Templates in the system library		
	Search By Subject	Classifies the library data in different folders according to the appearance differences of figures, objects, and templates. The library data stored in the terminal folder is the same as the folder stored in [Search By Function].	
	Search By Function	Classifies the library data in different folders according to the function differences of figures, objects, and templates. The library data stored in the terminal folder is the same as the folder stored in [Search By Subject].	

**(b) Operation with the movement bar or edit bar**

The library tree can be operated with the icons in the movement bar or edit bar.

 (2) Movement bar

(3) Edit bar

(c) Operation with the right-click

The library tree can be operated with the menu opened by the right-click.

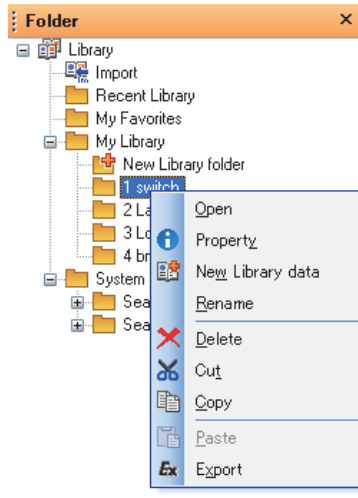

Menu	Description	Model
Open	Displays the library folder data on the library data area.	
Expand	Opens library folders in the library tree by one hierarchy.	
All expand	Opens library folders in the library tree by all hierarchies.	
Reduce	Closes the opened library folders by one hierarchy. Subfolders are not closed.	
All reduce	Closes all the opened library folders. Subfolders are closed.	
New Library folder* <sup>1</sup>	A new library folder is created in [My Library]. The available folder number is assigned to the new created library folder. The folder name is [New Folder].	
Save MyLibrary* <sup>1</sup>	Stores the data for [My Favorites] and [My Library]. ☞ 6.3.7 Saving library	
Load MyLibrary* <sup>1</sup>	Opens a folder for [My Library] created by other project. ☞ 6.3.8 Opening library	
Property	Edit a library folder number and name. ☞ 6.3.6 Changing library attribute Displays the number and name when the system library is selected. (Cannot be changed.)	GT16 GT15 GT14 GT12 GT11 GT10 SOLIGOT1000
New Library Data* <sup>1</sup>	The new library data are created in [My Favorites] and [My Library]. ☞ 6.3.1 Registering library data	
Rename* <sup>1</sup>	Change a library folder name.	
Delete* <sup>1</sup>	Deletes a library folder. ☞ 6.3.4 Deleting library	
Cut* <sup>1</sup>	Cuts a library folder.	
Copy	Copies a library folder.	
Paste* <sup>1</sup>	Pastes the copied library folder.	
Export* <sup>1</sup>	Exports a library folder.	

\*<sup>1</sup> Not available for the system library.

**(5) Library data area**

The library data in the currently selected library folder is displayed.

By switching between on and off display settings of the display bar, the image displayed on the library data area is changed according to the setting.

The library data in the library folder are displayed as shown below.

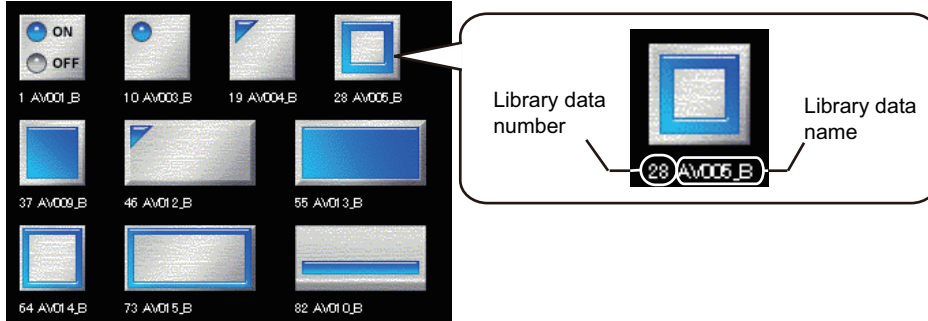

(a) Operation with the movement bar or edit bar

The library tree can be operated with the icons in the movement bar or edit bar.

(2) Movement bar

(3) Edit bar

(b) Operation with the right-click

The library data area can be operated from the menu opened by the right-click.

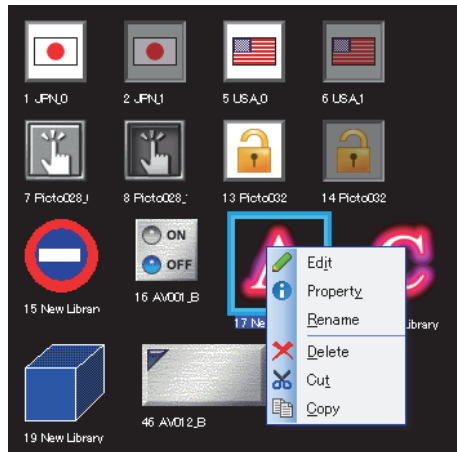

Menu	Description	Model
Edit* <sup>1</sup>	Edit the library data. Select this item to display the library data editor. 6.3.5 Editing library data	<div style="border: 1px solid black; padding: 2px;"> <span style="background-color: black; color: white; padding: 1px;">Gr16</span> <span style="background-color: black; color: white; padding: 1px;">Gr15</span>  <span style="background-color: black; color: white; padding: 1px;">Gr14</span> <span style="background-color: black; color: white; padding: 1px;">Gr12</span>  <span style="background-color: black; color: white; padding: 1px;">Gr11</span> <span style="background-color: black; color: white; padding: 1px;">Gr10</span>  <span style="background-color: black; color: white; padding: 1px;">SoftGOT1000</span> </div>
Property	Edit the library data number and name. 6.3.6 Changing library attribute Select [System Library] to display the number and name. (Cannot be changed.)	
Rename* <sup>1</sup>	Change the library data name.	
Delete* <sup>1</sup>	Deletes the library data. 6.3.4 Deleting library	
Cut* <sup>1</sup>	Cuts the library data.	
Copy	Copies the library data.	
New Library Data* <sup>1</sup>	The new library data are created in [My Favorites] and [My Library]. 6.3.1 Registering library data	
Paste* <sup>1</sup>	Pastes the copied library data.	
Export* <sup>1</sup>	Exports the library data.	

\*<sup>1</sup> Not available for the system library.

## HINT

### (1) Multiple library data selections

By clicking the library data with holding down the [Ctrl] key, multiple library data can be selected. By selecting multiple library data, the library data can be copied, cut, or dragged at one time.

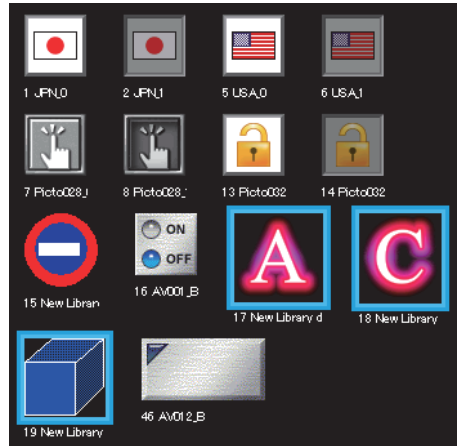

## 6.2 Pasting Figures, Objects and Templates by Library

1. In the library data area, click the library data to be pasted on the screen editor.

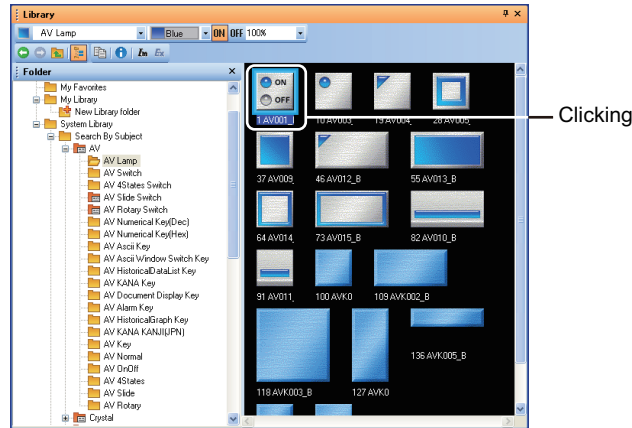

2. Click the position on the screen editor to paste the library data. The library data are pasted on the screen editor.

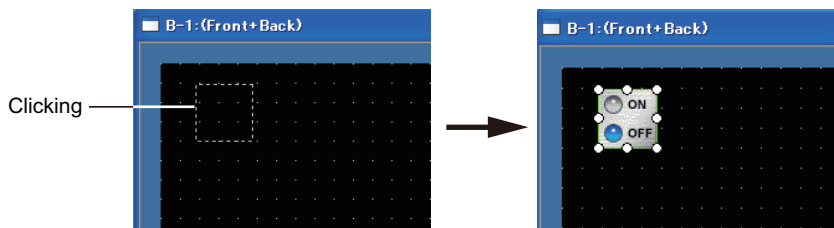

### (1) Pasting the data by [My Favorites]

The figures, objects, and templates registered in [My Favorites] can be pasted by using the [My Favorites] toolbar.

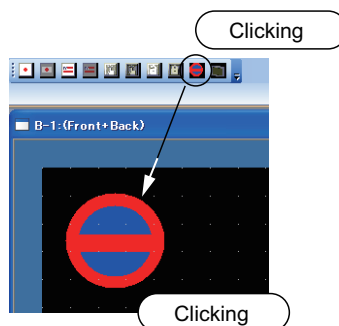

### (2) Changing the data size and pasting the data

After moving the library data on the screen editor, dragging the mouse resizes and arranges the library data.

### (3) Pasting a template

For pasting a template, refer to the following.

➔ 7.2.1 Using a template in the library

## 6.3 Editing User-Created Library

### 6.3.1 Registering library data

#### ■ Creating new library data

1. In the library list window, select a library folder where figures, objects, and templates are registered.

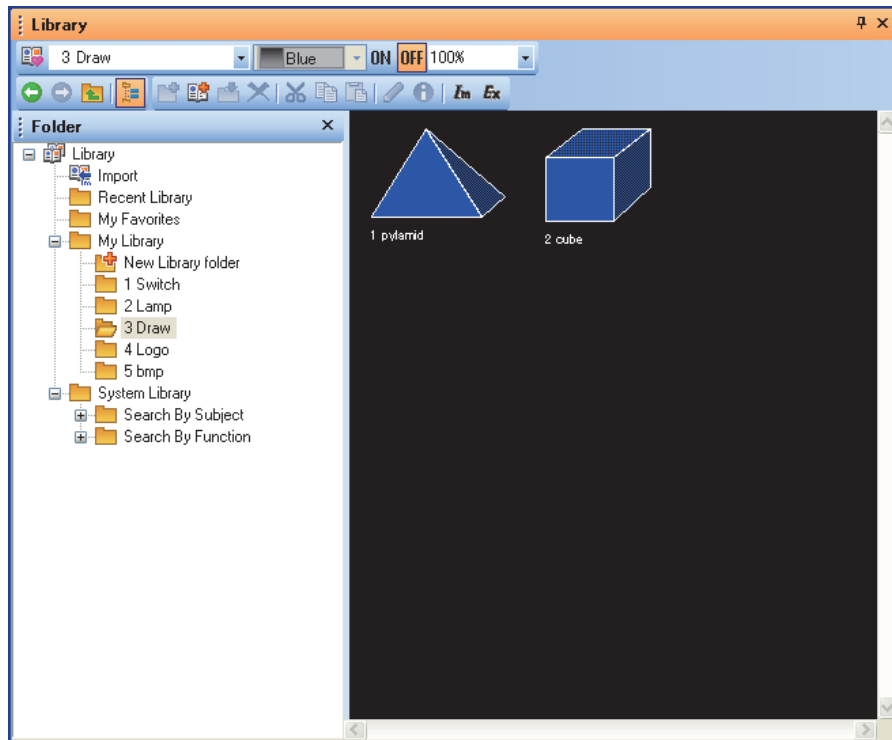

2. Click the  (New Library data) button. Clicking this button creates [New Library data] in the library folder, and the library data editor appears.

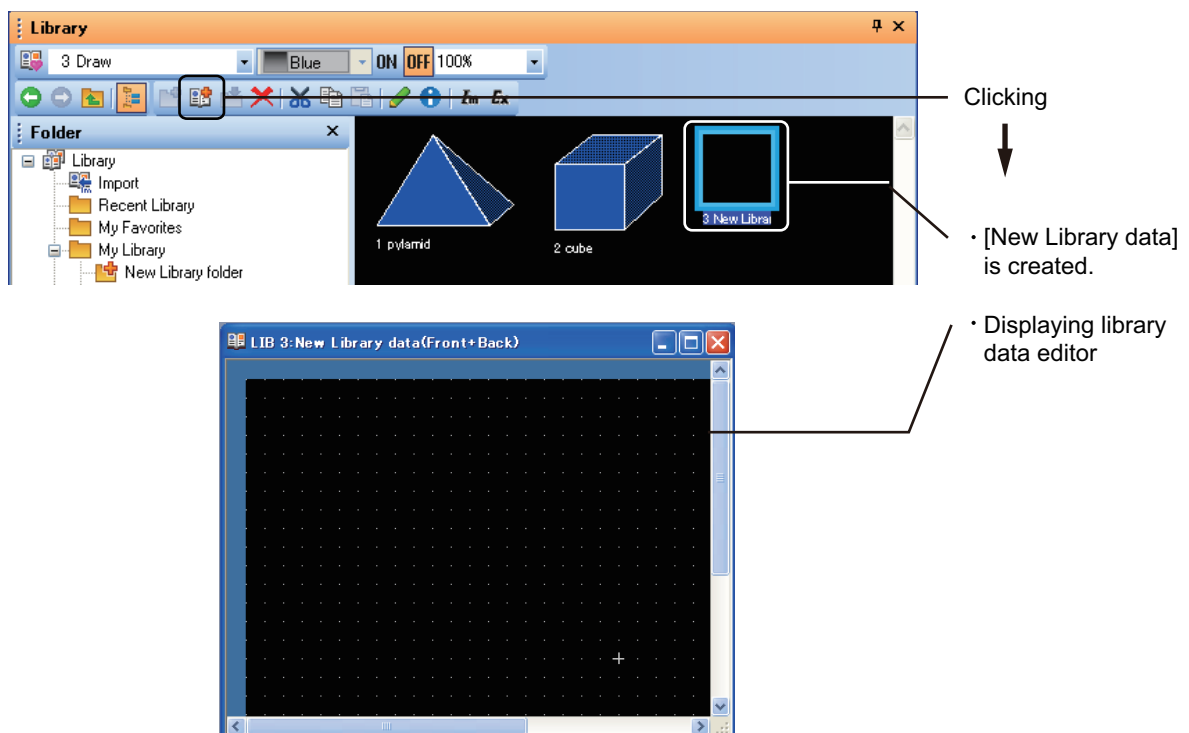

3. Create the library data by arranging or editing figures, objects, and templates on the library data editor.

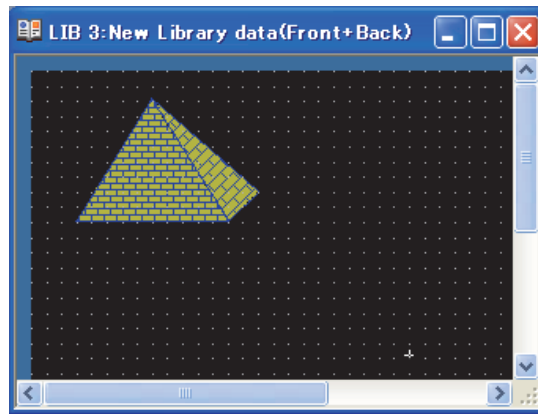

For how to edit the library data, refer to the following.

☞ 6.3.5 Editing library data

4. After creating, click the  button to close the library data editor.
5. To change the library data number and name, refer to the following.

☞ 6.3.6 Changing library attribute

## HINT

### Registration to the library on the screen editor

The figures, the objects, and the templates on the screen editor can be registered to the library by the following methods.

#### (1) Registration to the library by drag operation

Drag a figure, object, or template from the screen editor to the library tree area or the library data area to register the figure, object, or template to the library.

The figure, object, or template can be registered in [My Favorites] or a library folder in [My Library] only.

To register the figure, object, or template in [My Library], create a library folder in [My Library] in advance.

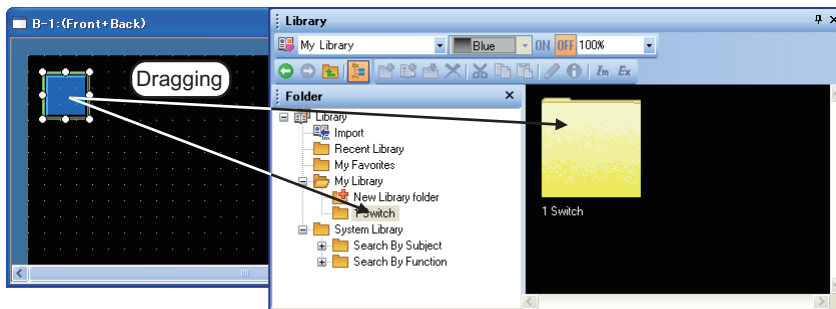

#### (2) Registration to the library by right-click menu

Right-click a figure, object, or template on the screen editor and select [Register to My Favorites] from the menu to register the figure, object, or template to [My Favorites].

The figure, object, or template can be registered in [My Favorites] only.

## ■ Importing library data

The following library data can be created by importing the data.

- Image data (.bmp/.jpg/.jpeg/.jpe)
- Library data in [My Favorites] created by other project

For how to import the library data, refer to the following.

☞ 6.3.9 Importing library



## 6.3.2 Registering shapes for objects in library

1. Display the object setting dialog box.

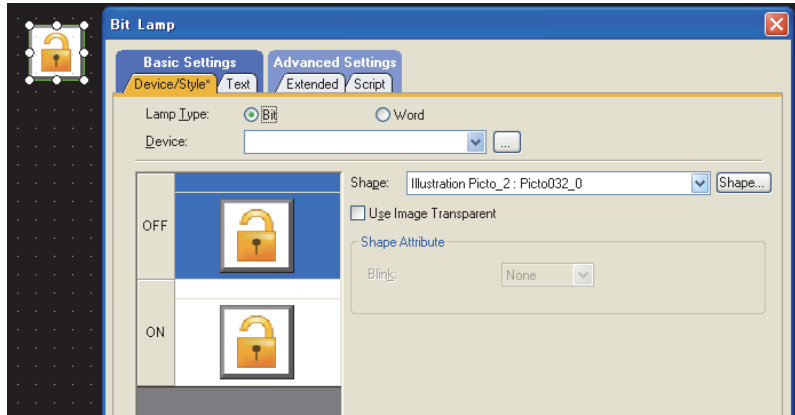

2. Select the shape to be registered in the preview list, and click the [Shape] button. The [Image List] dialog box appears.

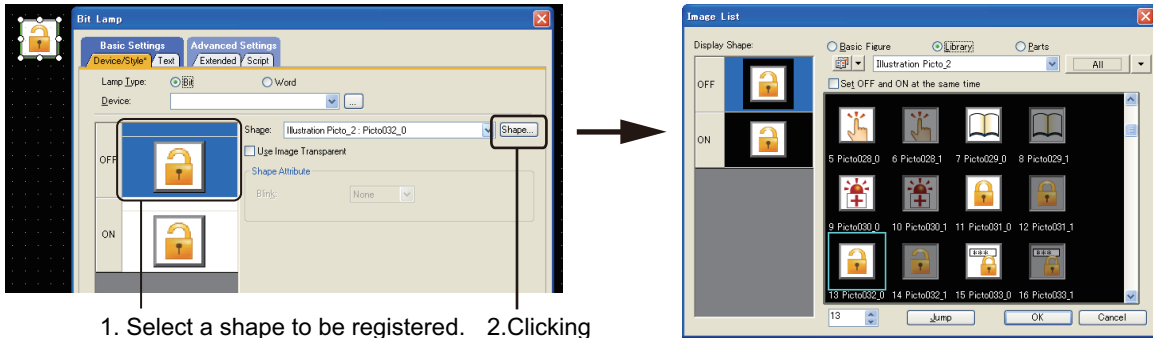

1. Select a shape to be registered. 2. Clicking

3. Select a library folder where the shape is registered. [System Library] cannot be selected for the library folder. Select [My Favorites] or [MyLibrary].
4. In [Display Shape], select the shape to be registered, and click the [Register Here] button.

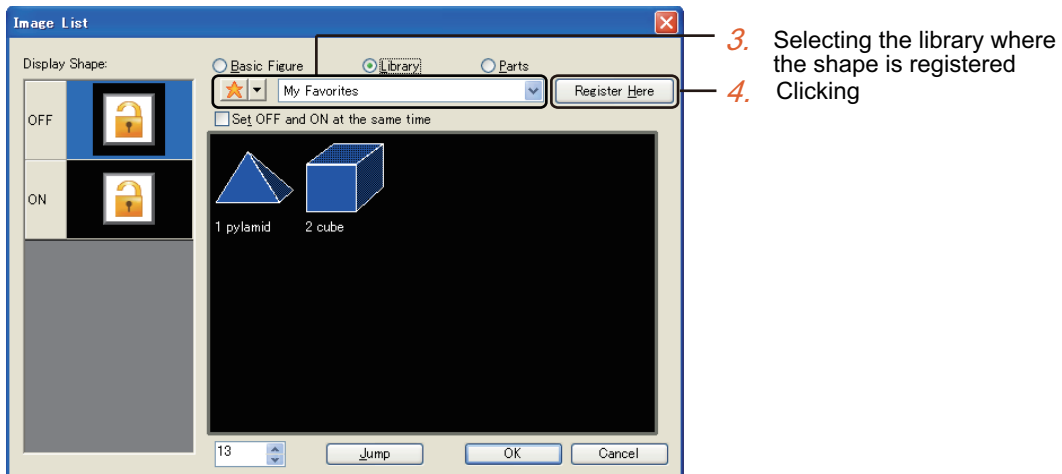

3. Selecting the library where the shape is registered
4. Clicking

5. The [Library Data Property] dialog box appears.  
Enter the library data number and name.

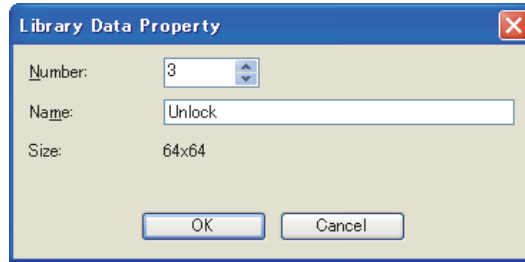

6. The shape is registered in the library folder.

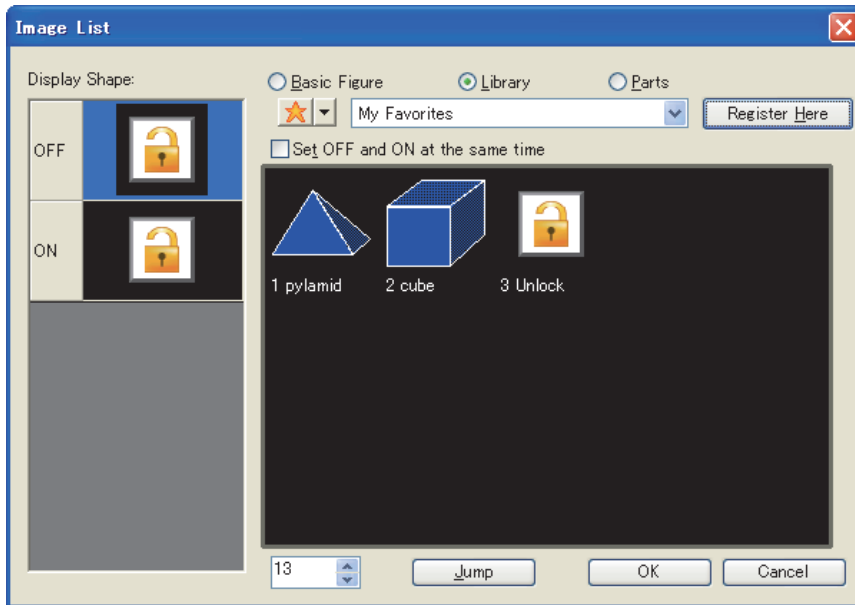

7. To change the library data number and name, refer to the following.

 6.3.6 Changing library attribute



#### **Library registration for objects set for system labels**

System labels can be set for objects, and the objects can be registered in the library.

For system labels with objects registered in the library, the system label update/check is not executed.

Check whether the system labels are updated or not.

### 6.3.3 Copying library

1. Select the library folder or library data to be copied.

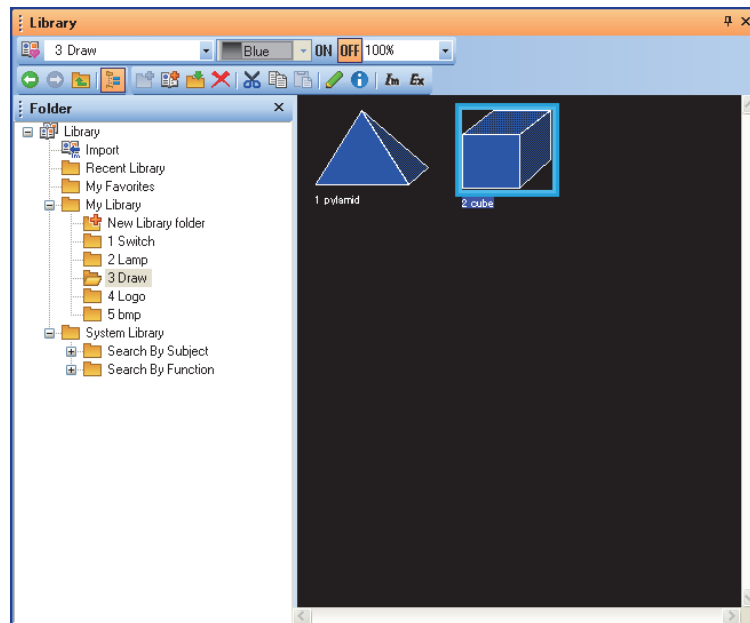

2. Click the  (Copy) button.

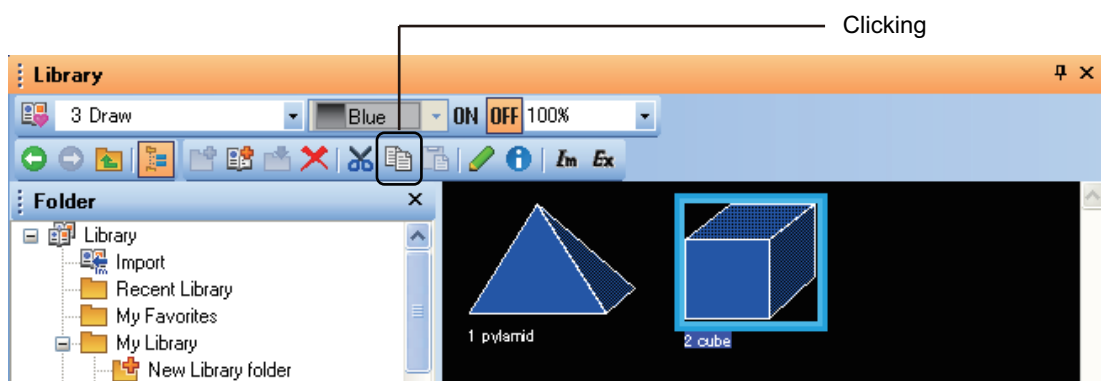

3. Select a folder where the data is pasted, and click the  (Paste) button.

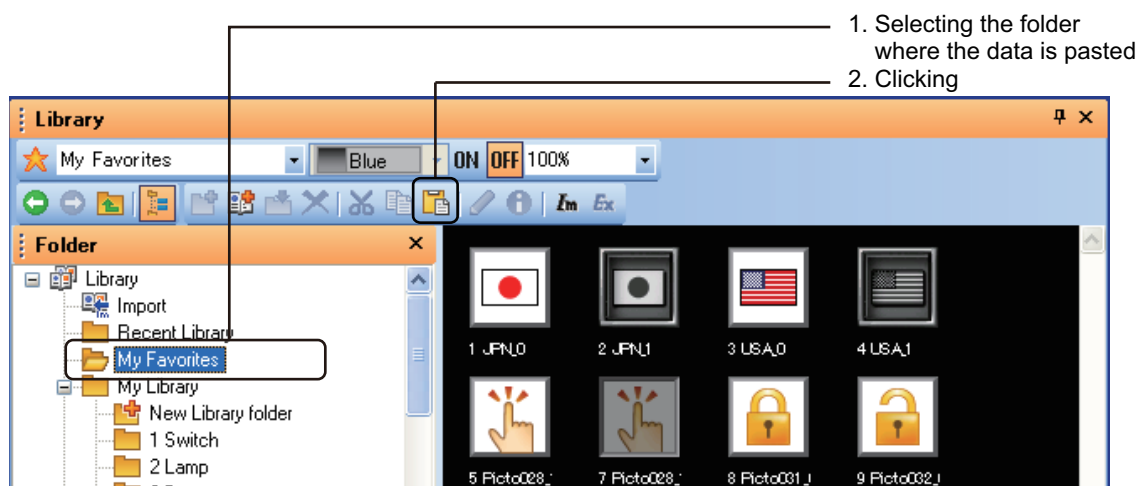

4. The following dialog box appears when the copied data number is the same as the library data number.
- To overwrite the library data, click the [Yes] button.
  - To overwrite all the library data, click the [All Yes] button.
  - To register the copied data as other number, click the [Save as] button and set a new number.
  - To cancel the registration, click the [No] button.
  - To cancel the overwriting of multiple library data, click the [Cancel] button.

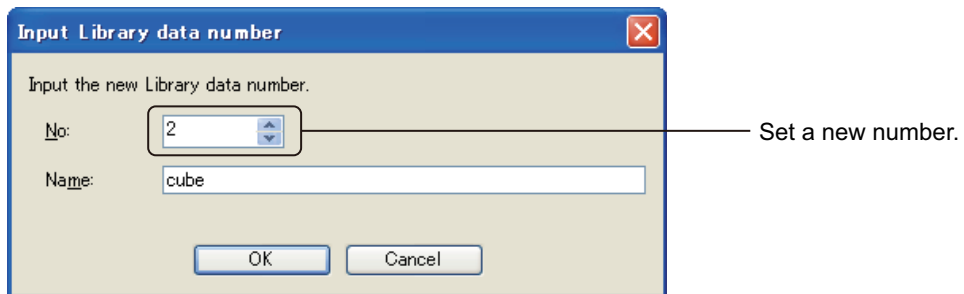
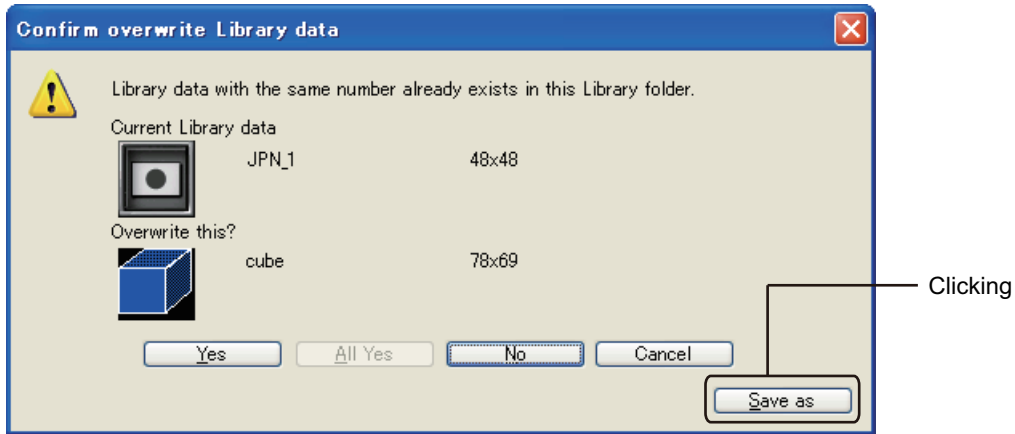

## 6.3.4 Deleting library

1. Select the library folder or library data to be deleted.

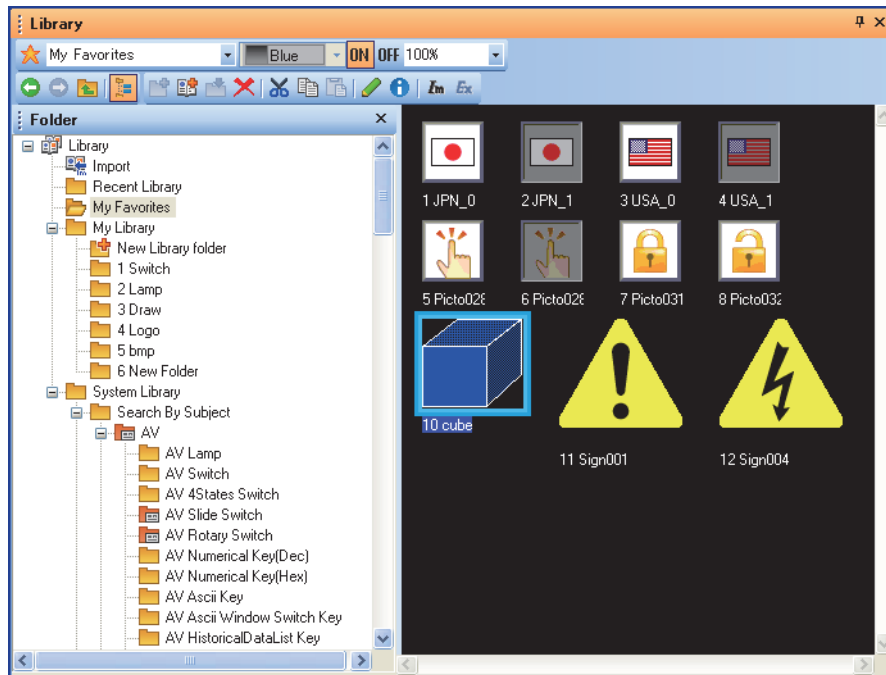

2. Click the  (Delete) button.

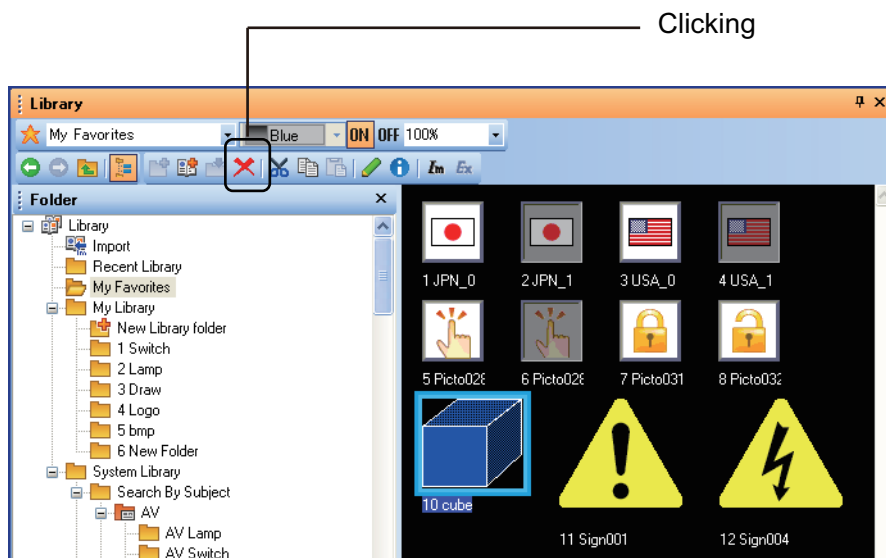

3. In the following dialog box, click the [Yes] button to delete the library folder or library data.

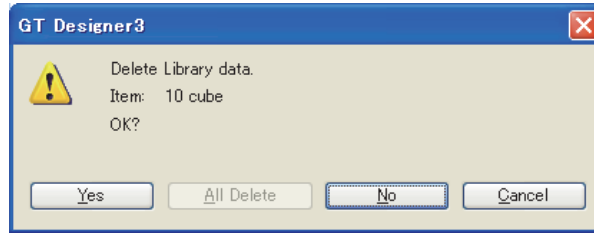

## POINT

### Deleting library folder

Note that deleting the library folder deletes all library data registered in the library.

## 6.3.5 Editing library data

1. Select the library data to be edited.

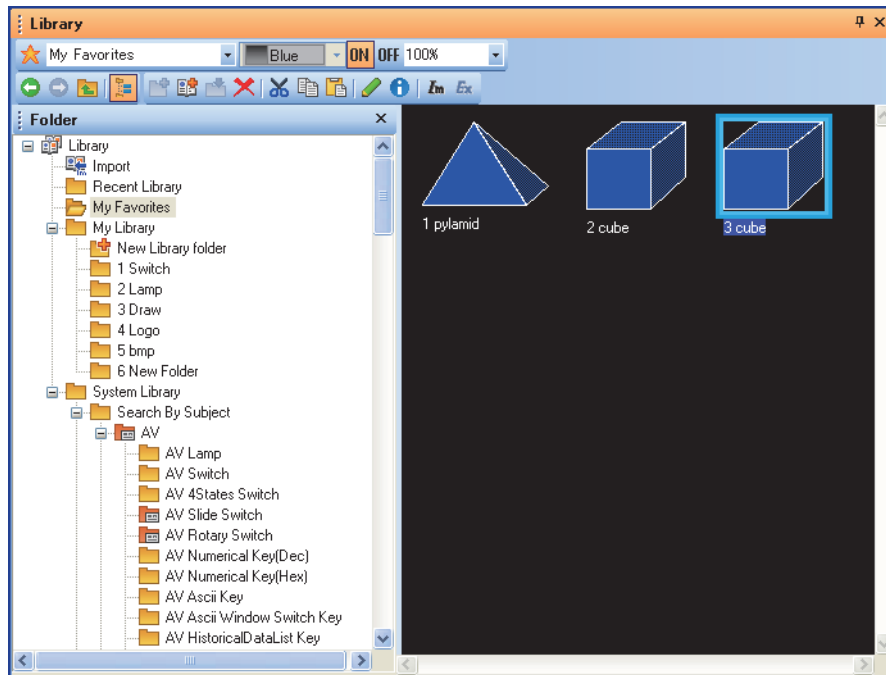

2. Click the  (Edit Data) button.

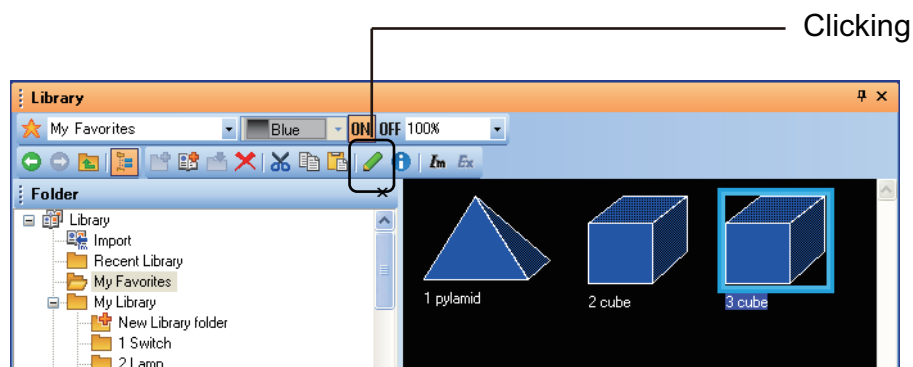

3. The library data editor appears.  
Arrange figures, objects, and templates on the library data editor, and edit the library data.  
The edited data are reflected soon.  
To clear the incorrect edited data, cancel operation by clicking the  (Undo) button before closing the library data editor.  
After closing the library data editor, operation cannot be restored.

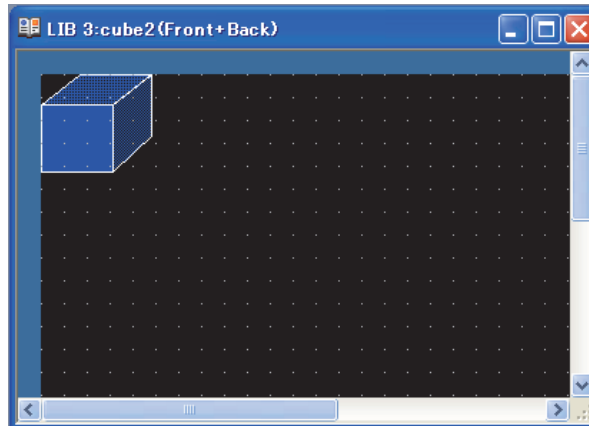

## HINT

### (1) Utilizing library data

The library data can be utilized and edited by the following methods.

#### (a) Copying figures, objects, and templates

Figures and objects on the screen editor can be copied on the library data editor.  
(Moving the figures and objects is not available by drag operation.)

#### (b) Utilizing other library data

Other library data can be pasted on the library data editor.

### (2) Displaying the library data editor with double-click

The library data editor appears by double-clicking the library data in the library data area.

4. After editing the library data, click the  button on the upper-right of the library data editor to close the library data editor.



## 6.3.6 Changing library attribute

1. Select the library folder or library data to change the attribute.

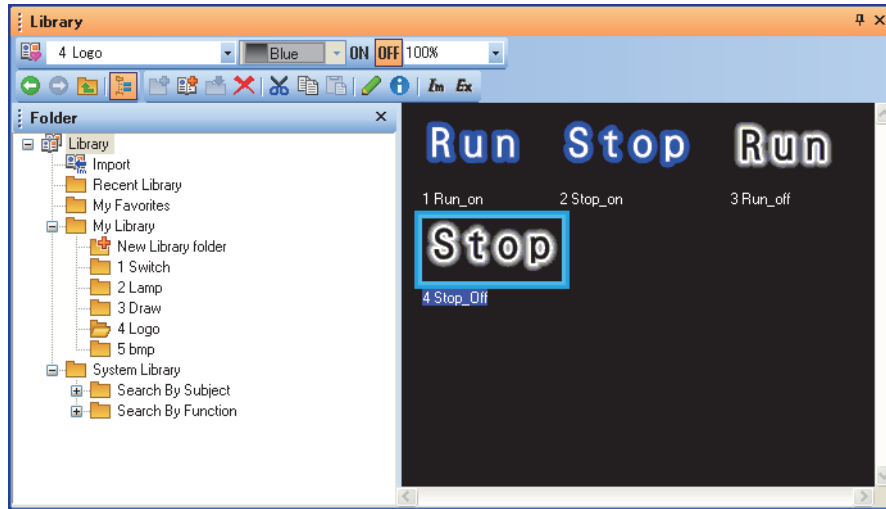

2. Click the  (Edit Property) button.

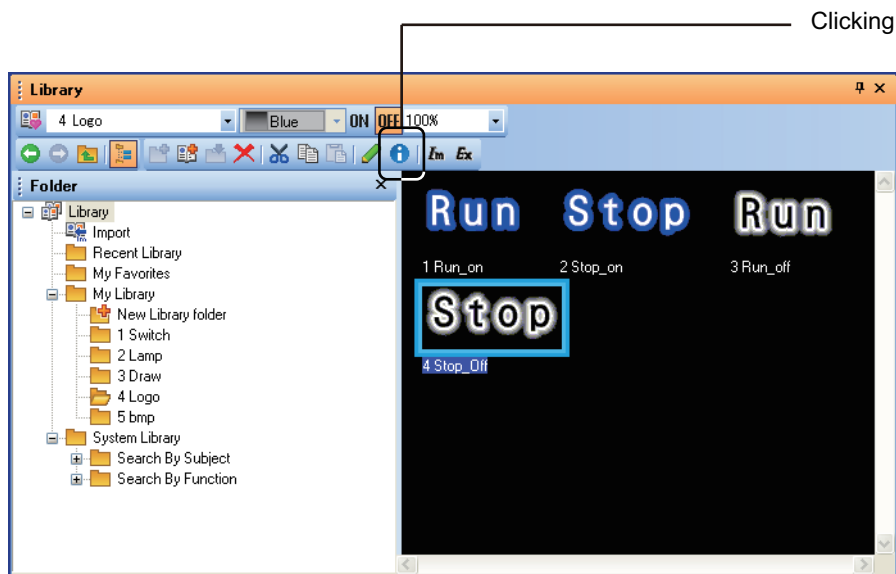

3. The [Library folder Property] dialog box or the [Library data Property] dialog box appears. Set the number and name of the library folder or library data to be changed. After setting, click the [OK] button to change the attribute of the library folder or library data.

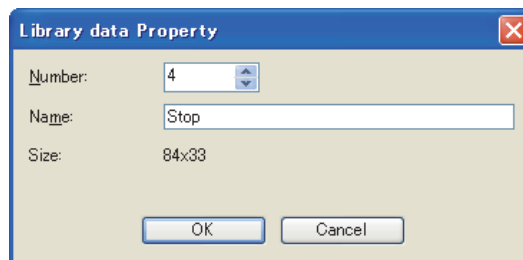

## 6.3.7 Saving library

The data in the user-created library can be saved in a separate folder from the currently used library. Multiple user-created libraries can be stored in the hard disk on the personal computer. The user can use the multiple user-created libraries.

### 6.3.8 Opening library

Copying the user-created library in a personal computer enables the computer to share the library among multiple personal computers.

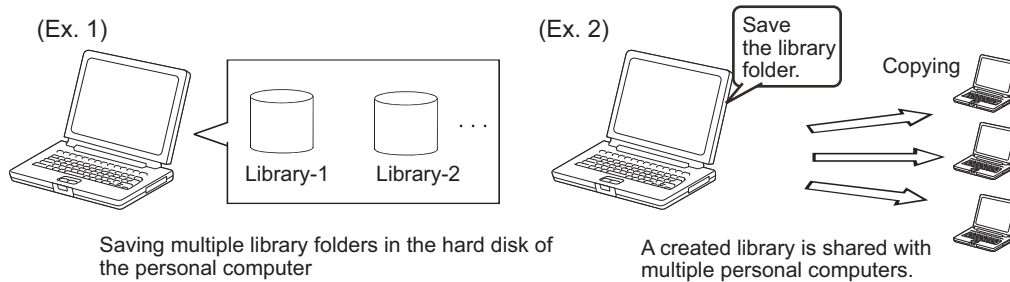

### Overwriting currently used user-created library

Overwriting a project overwrites the currently used user-created library.

## Operating procedure

1. Right-click [My Library], and click [Save MyLibrary] from the menu in the library tree.

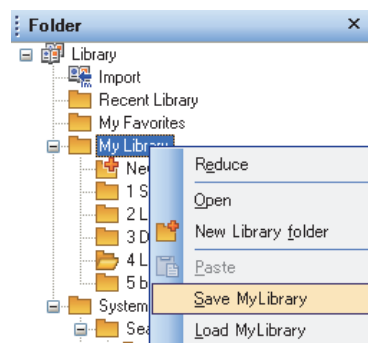

- The [Save Library folder (MyLibrary)] dialog box appears. Click the [Reference] button to specify the location where the data in [My Library] is saved. After the specification, click the [OK] button.

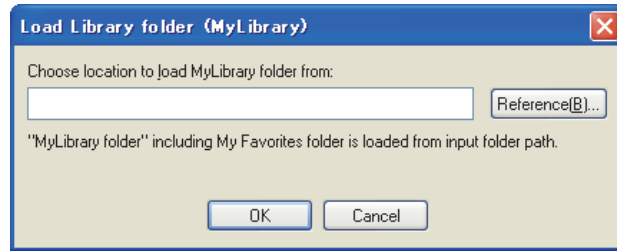

### POINT

#### Saving multiple libraries

The folder name of the user-created library is fixed to [My Library].

To save the data in the same folder among multiple libraries, the data are overwritten. Save the data in each folder.

- The folder for [My Library] is automatically created in the specified folder. The created folder saves the file (\*.mlb) for [MyLibrary].  
The file for [My Favorites] is saved as "000\_My Favorites.mlb".  
The file for [My Library] can be named with the library folder number and name.

Example) Library folder number: 1, Name: abc

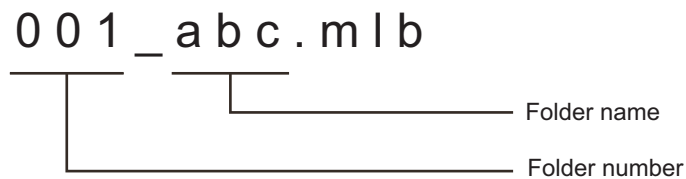

### POINT

#### Saved library file

Do not operate the folder for [My Library] saved in a personal computer (including adding, deleting files, or changing the file name).

Failure to do so may not enable GT Designer3 to read the library correctly.

## 6.3.8 Opening library

By opening a user-created library saved in other project, the library is available for the currently created project. The currently used library is changed to the user-created library saved in other project.

Example) Loading the library of another project to the project being edited

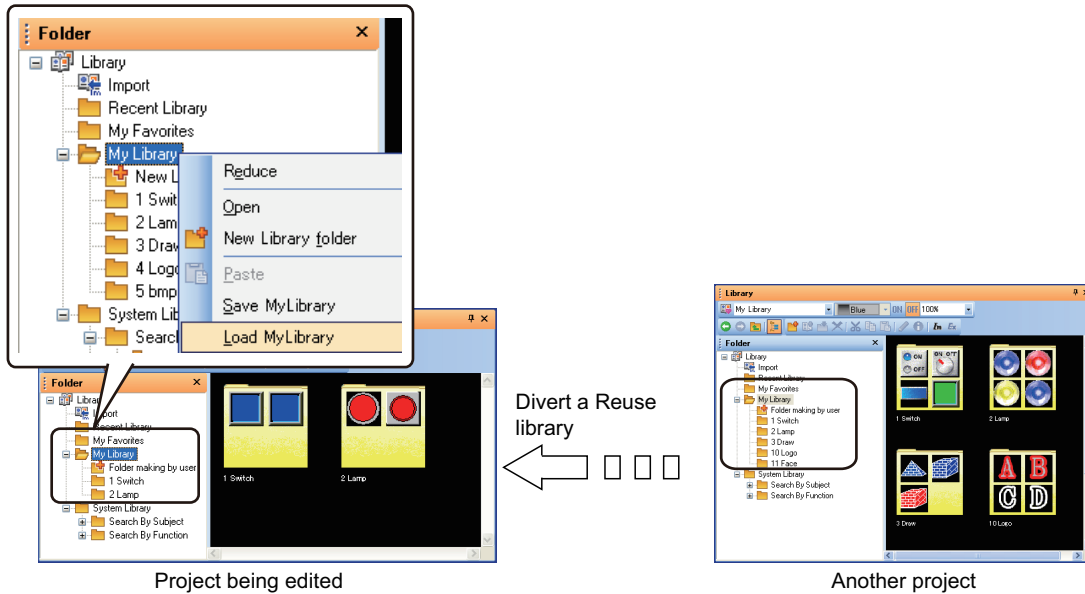

### ■ Operating procedure

1. Right-click [My Library] in the library tree, and select [Load MyLibrary] from the menu.

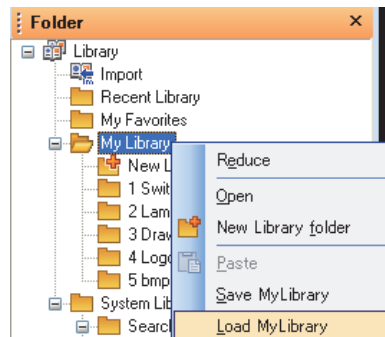

2. While editing the library, the confirmation dialog box appears whether the currently edited library data are saved. To save the data, click the [Yes] button, and not to save the data, click the [No] button.

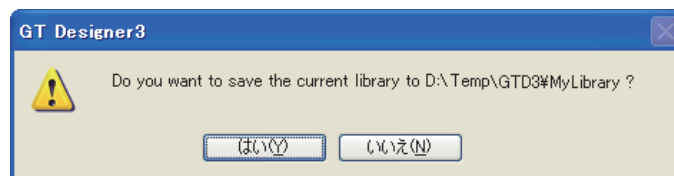

3. The [Load Library folder (MyLibrary)] dialog box appears.

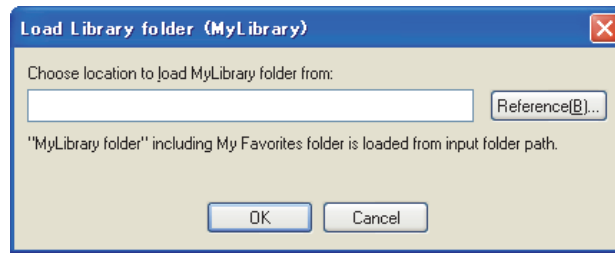

Click the [Reference] button, and specify the folder (one-upper hierarchy folder) that stores the library data (MyLibrary) to be read.

After specifying the folder, click the [OK] button to switch between [My Favorites] and [My Library].

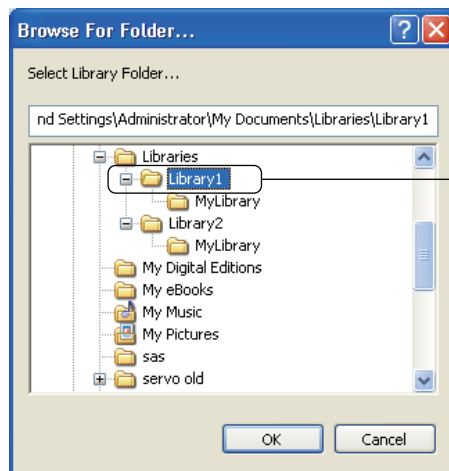

Folder for one-upper hierarchy in [MyLibrary]

## 6.3.9 Importing library

The data in [My Favorites] or [My Library] created in other project can be imported and used. Image files can be imported and registered as library data. The following shows files that can be imported.

- (1) **My library file (.mlb/.lbe)**  
The file is exported by the user-created library.
  - mlb file: Exported by GT Designer3.
  - lbe file: Eexported by GT Designer2.
- (2) **Import library file (.ilb)**  
A file for the system library  
Contact your local distributor.
- (3) **Image file (.bmp/.jpg/.jpeg/jpe)**  
An image file used as library data

### ■ Importing library

1. Click the  (Import) button.

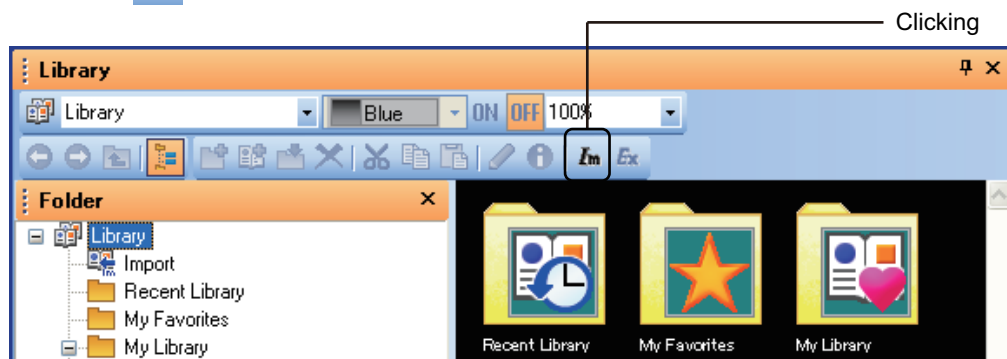

2. Select [MyLibrary Files (\*.mlb;\*.lbe)] or [Import Library Files (\*.ilb)] for the file type of a file to be imported.

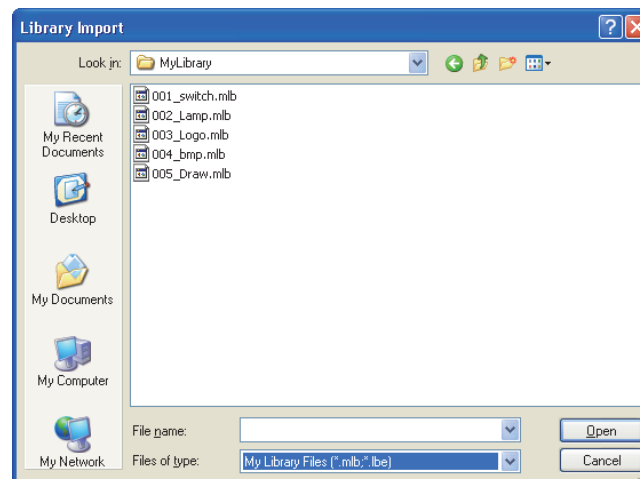

3. Select a file to be imported, and click the [Open] button.

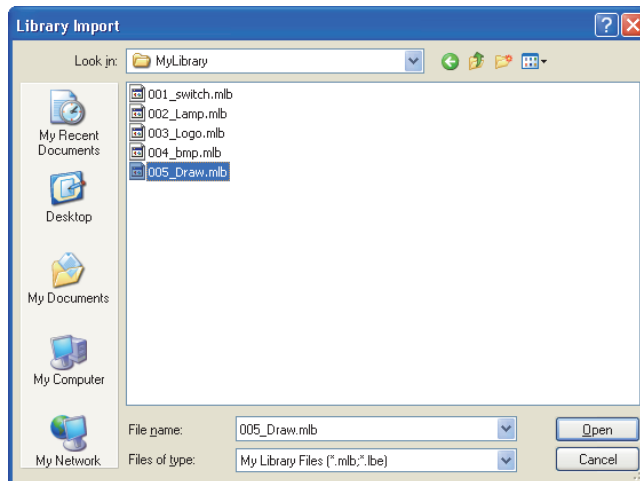

4. The following dialog box appears when the imported library folder number is the same as the library folder number.
  - To overwrite the number, click the [Yes] button.
  - Not to overwrite the number, click the [No] button.
  - To cancel the overwriting of multiple library folder numbers, click the [Cancel] button.
  - To register the imported library folder number as other folder number, click the [Save as] button, and set a new number.

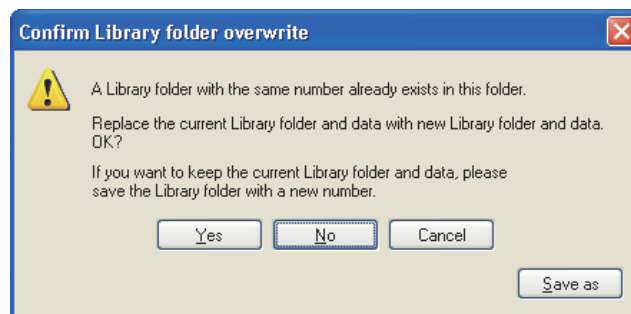

5. My library file is added to [My Library]. Import library file is added to [System Library]. When the folder for [My Favorites] is imported, the folder is automatically assigned to a spare library number. The imported library data are added. The existing library data are not overwritten.

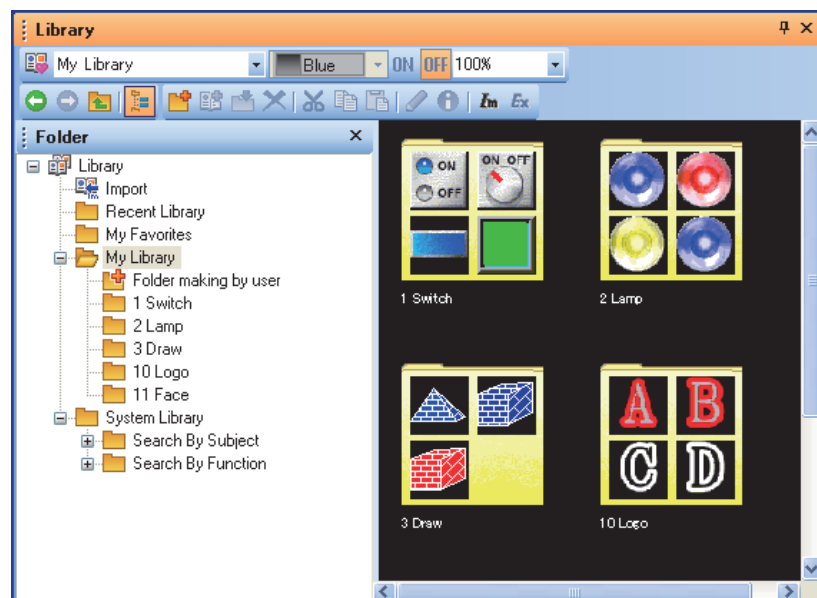

## HINT

### Importing by drag operation

A library file can be imported by drag operation.

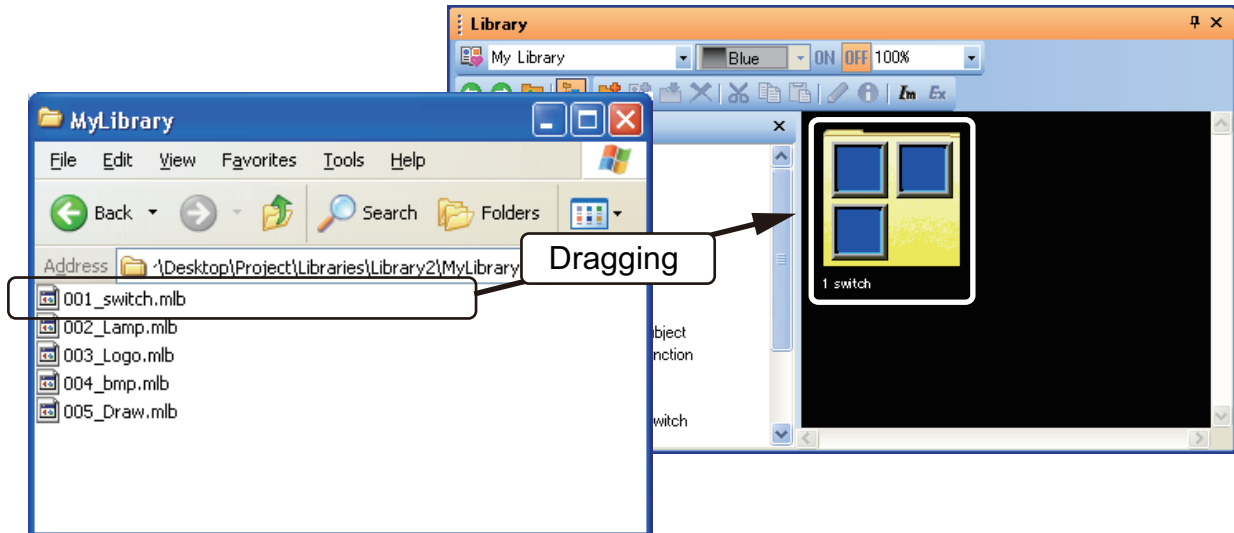

### ■ Importing image data

1. Click the  (Import) button.

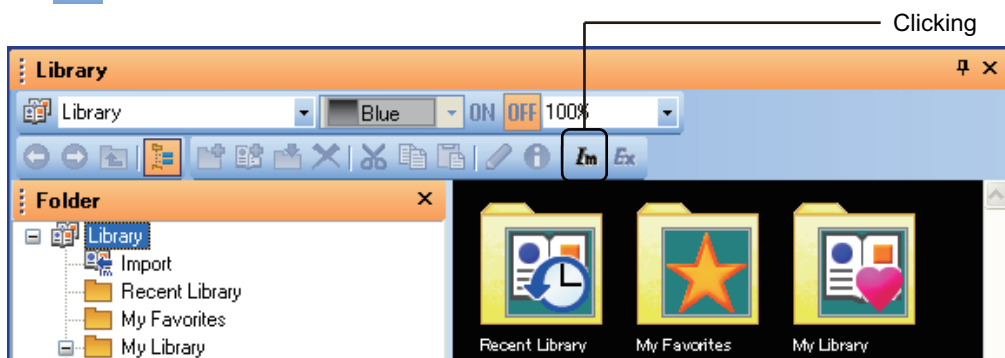

2. Select [Image Files (\*.bmp;\*.jpg;\*.jpeg;\*.jpe)] for the file type of a file to be imported.

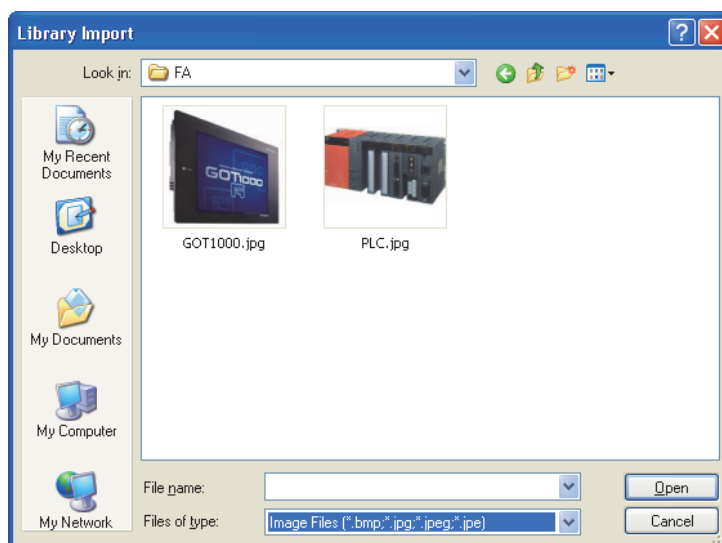



3. Select the file to be imported, and click the [Open] button.

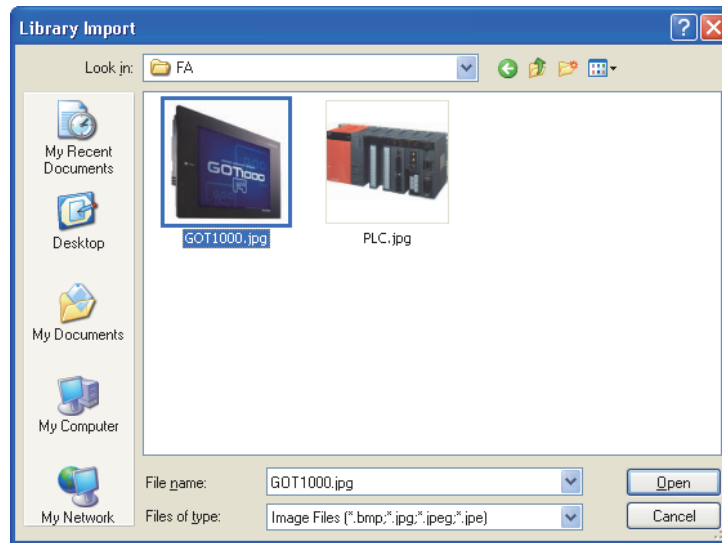

4. The [Choose import folder] dialog box appears. Select the library folder where the image data are saved, and click the [OK] button.

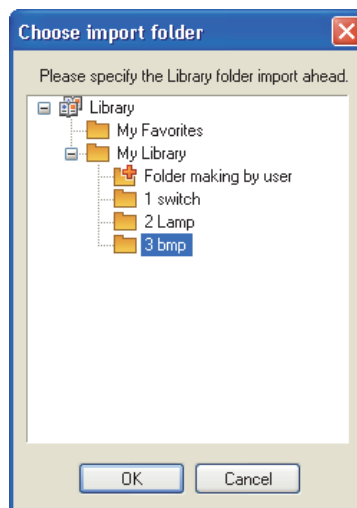

5. The image data are saved in the specified library folder.

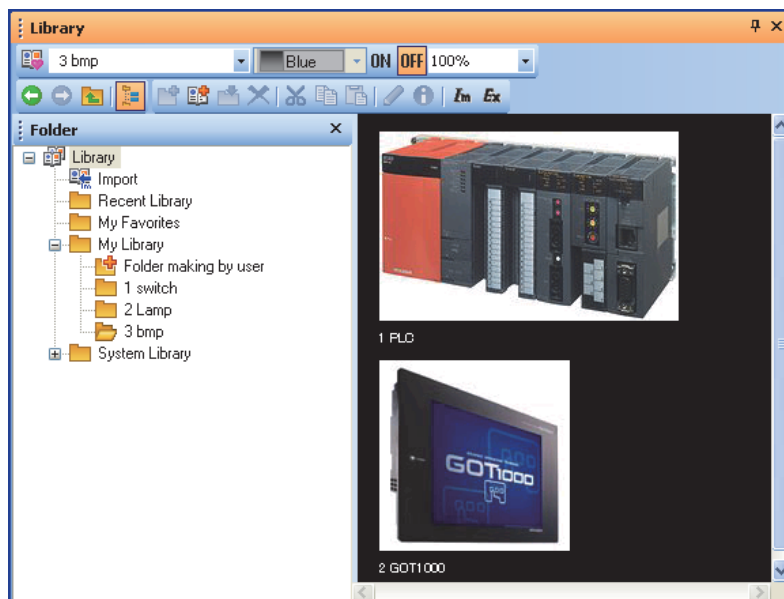

## 6.3.10 Exporting library

The user-created data for [My Library] can be exported, and the library data can be used with other project. The data in [My Favorites] and [System Library] cannot be exported.

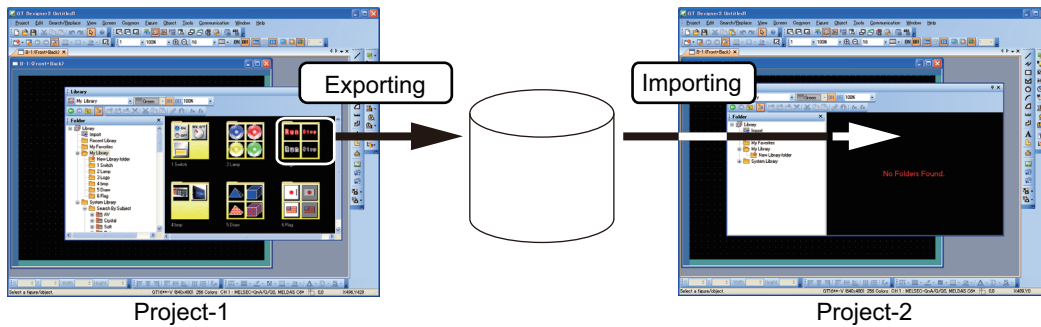

1. In the library tree, select the library data to be exported, and click the **Ex** (Export) button.

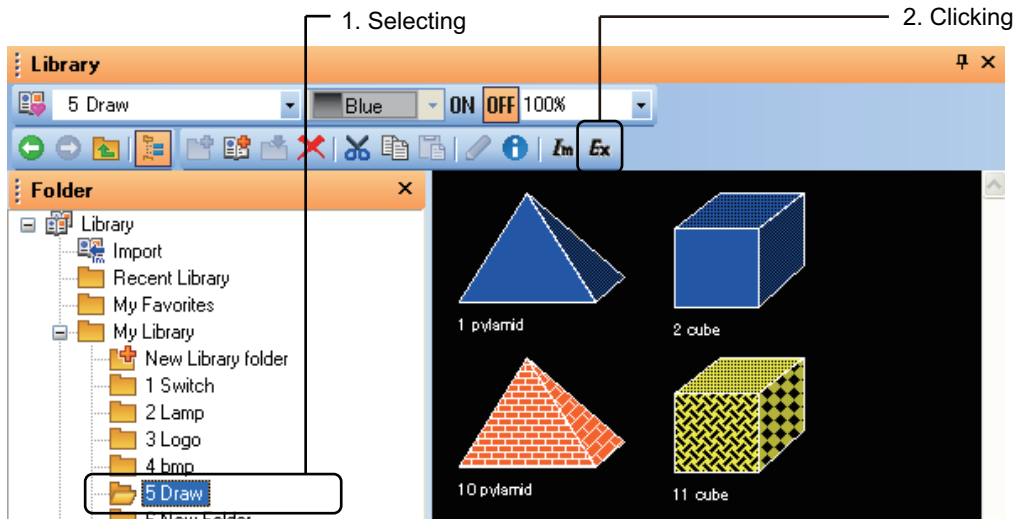

2. The [Library Export] dialog box appears. Set a storage location path and file name, and click the [Save] button.

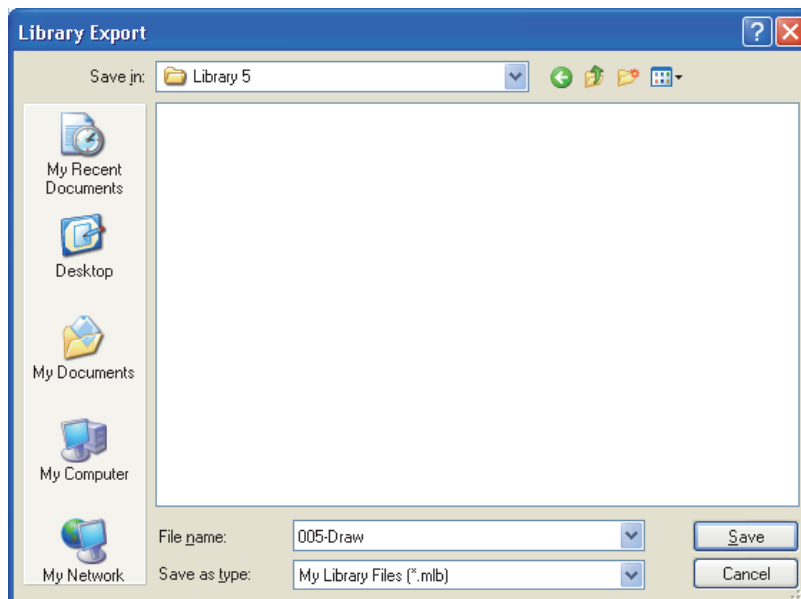

# USING TEMPLATE

---



# 7. TEMPLATE



A template consists of two things as shown below.

- Group of figures and objects on the screen editor
- Attribute information of the above group (Template attribute)

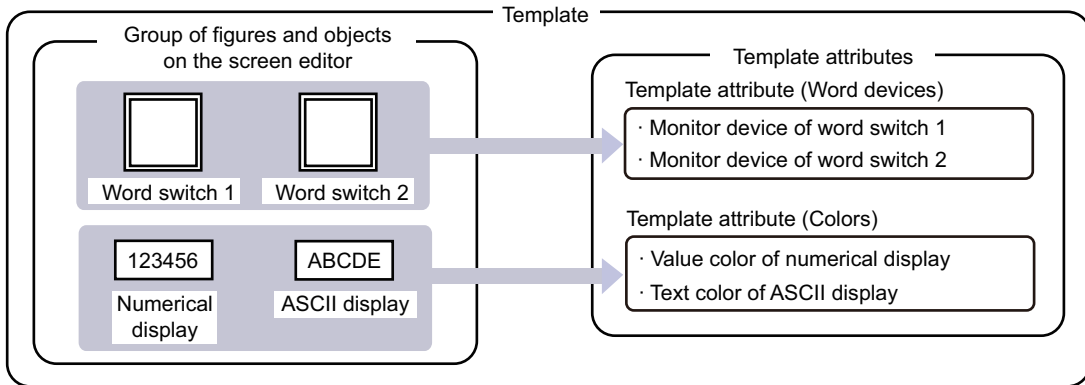

## ■ Creating a screen by using a template

The user can create a screen by using a template registered in the library.

With the template attributes set for a template, the user can check the values set in the related attributes and use the batch edit.

☞ 7.2 Creating a Screen by Using a Template

By registering the edited template in the library, the user can use the template to create another screen.

☞ 7.3.4 Registering a template in the library

## ■ Creating or editing a template

### (1) Creating or editing a template

The user can create a new template or edit an existing template.

By registering the created template in the library, the user can use the template to create another screen.

☞ 7.3 Creating or Editing a Template

### (2) Creating or editing a template attribute

After registering figures and objects in a template, the user can create template attributes. Then, the user can register figure/object attributes to the template attributes or delete the attributes of the figures and the objects registered in the template from the template attributes.

Registering the related attributes to the template attributes enables listing the attributes and changing the setting values collectively.

☞ 7.3.3 Editing a template attribute



### Templates in the system library

The system library has the templates as the library data.

For the templates in the system library, refer to the following.

☞ 7.1.2 Templates in the system library

# 7.1 Specifications

## 7.1.1 Template specifications

### ■ Figures and objects that can be registered in a template

The figures and the objects on the same screen editor can be registered in a template.  
The figures and the objects on a report screen cannot be registered in a template.

### ■ Types of template attribute

The following shows the types of the template attribute.

- Bit (device)
- Word (device)
- Number
- Text
- Color
- Shape
- Font
- Text Size

### ■ Template information boxes on the screen editor

When the screen editor has the figures and the objects that are registered in a template, a template information box is displayed.

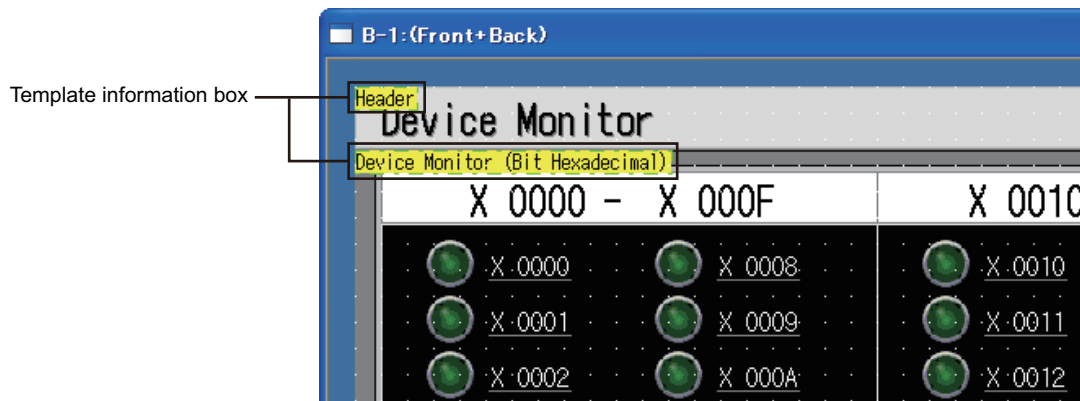

#### (1) Template information box

The template information box shows the template name.

The template information box appears on the screen editor of GT Designer3 only.

The GT Designer3 preview screen, the GT Designer3 data list, and the GOT do not display the template information box.

#### (2) Display setting of template information box

The display/hide setting and the background color setting of the template information box can be changed on the [View] tab in the [Options] dialog box.

The setting of [Device/Object ID Text Color] determines the text color of the template name.

For how to configure the setting in the [Options] dialog box, refer to the following.

 3.5.3 Customizing actions and default value of GT Designer3

#### (3) Manipulations of a template information box

(a) A template information box can be moved like a figure or an object on the screen editor.

To move the figures and the objects that belong to a template information box simultaneously with the box, select the template information box, the figures, and the objects.

Double-click the template information box to select the template information box and all the figures and the objects belonging to the box.

(b) Cutting, copying, duplicating, or consecutively copying the template information box simultaneously cuts, copies, duplicates, or consecutively copies all the figures and the objects belonging to the box.

(c) The template information box cannot be rotated or flipped and cannot be registered as a part.

## 7.1.2 Templates in the system library

The system library registers library data with a template.

Template library data registered in the system library. The user can refer to the library data by the [Search By Function] folder.

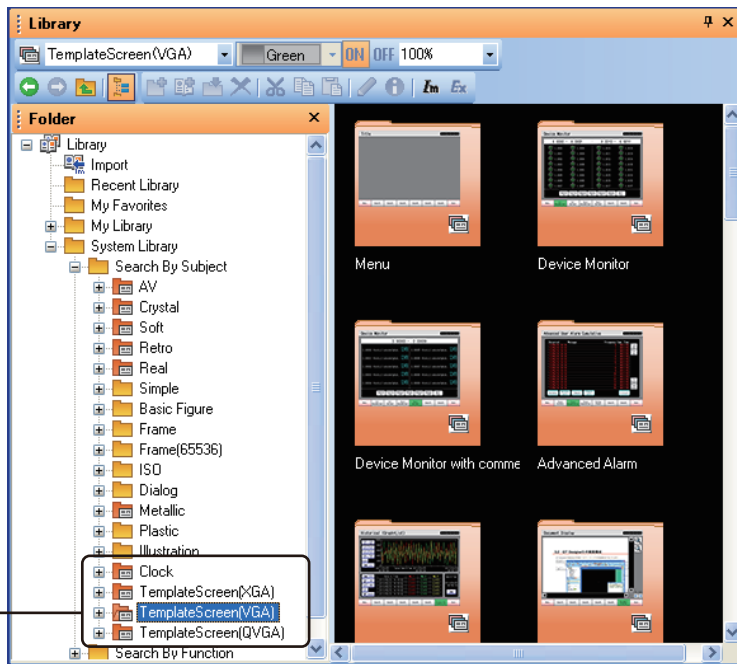

### ■ Default values in a template library data

The default values set in a library data require to be changed according to the settings of the project where the library data is used.

For the default values set in each library data, refer to the following.

☞ ■ List of template library data in the system library

#### (1) GOT internal device used by default

When a GOT internal device is used by default, change the device to a device that is not used in the project where the library data is used.

#### (2) Devices requiring to be changed separately from the property sheet

When a device displayed on the property sheet is used in the other settings that are not displayed on the property sheet, the change of the device on the property sheet is not reflected to the other settings. Check the locations where the device is used by using the device list, and change the device in each location separately.

☞ 9.5.4 Checking devices in use (Device list)

#### (3) Devices that are not displayed on the property sheet

The devices used in only the following cannot be displayed and changed on the property sheet.

- Attributes of figures and objects that are not registered in a template
- Object scripts

To change the devices, check them with the device list and change the devices separately.

☞ 9.5.4 Checking devices in use (Device list)

#### (4) Setting of the go to screen switch

When the default value of [Screen No.] of the go to screen switch differs from the screen number of the base screen where the library data is pasted, change the setting of [Screen No.].

## ■ List of template library data in the system library

The following shows the settings of the template library data in the system library and the settings required for using the library data. (The following items are listed according to the folder configuration of [Search By Subject] in the system library.)

For the operation of using a template, refer to the following.

### 7.2.1 Using a template in the library

	Folder name	Reference
AV	AV Slide Switch	(1) (a)
	AV Rotary Switch	(1) (b)
Crystal	Crystal Slide Switch	(2) (a)
	Crystal Rotary Switch	(2) (b)
Soft	Soft Slide Switch	(3) (a)
	Soft Rotary Switch	(3) (b)
Retro	Retro Slide Switch	(4) (a)
	Retro Rotary Switch	(4) (b)
Real	Real 3Selector Switch	(5) (a)
	Real 3Selector Switch with plate	(5) (b)
	Real Radio Switch	(5) (c)
	Real Radio Switch 2	(5) (d)
Metallic	Metal Radio Switch	(6) (a)
Clock	Analog Clock	(7) (a)
	Clock (Alarm&Historical)	(7) (b)
TemplateScreen (XGA)	Menu	(8) (a)
	Device Monitor	(8) (b)
	Device Monitor with comment	(8) (c)
	Advanced Alarm	(8) (d)
	Historical (Graph+List)	(8) (e)
	Document Display	(8) (f)
	Calendar	(8) (g)
	Clock Data Change	(8) (h)
	# Device Monitor <sup>*1</sup>	(8) (i)
	# Device Monitor with comment <sup>*1</sup>	(8) (j)
	# Advanced Alarm <sup>*1</sup>	(8) (k)
	# Historical (Graph+List) <sup>*1</sup>	(8) (l)
TemplateScreen (VGA)	Menu	(9) (a)
	Device Monitor	(9) (b)
	Device Monitor with comment	(9) (c)
	Advanced Alarm	(8) (d)
	Historical (Graph+List)	(9) (e)
	Document Display	(8) (f)
	Calendar	(8) (g)
	Clock Data Change	(8) (h)
	# Device Monitor <sup>*1</sup>	(9) (i)
	# Device Monitor with comment <sup>*1</sup>	(9) (j)
	# Advanced Alarm <sup>*1</sup>	(8) (k)
	# Historical (Graph+List) <sup>*1</sup>	(9) (l)
	CC-Link Network Monitor	(9) (m)
QD75MH	(9) (n)	

(Continued to next page)



	Folder name	Reference
TemplateScreen (VGA)	QD75M	(9) (o)
	LD77MH4	(9) (p)
	MR-J3-A	(9) (q)
	MR-J4-A	(9) (r)
	FR-A700	(9) (s)
	FR-F700	(9) (t)
	FR-E700	(9) (u)
	FR-D700	(9) (v)
	H-PCP-J (RKC)	(9) (w)
	SDC40A (Azbil)	(9) (x)
	UT152 (YOKOGAWA)	(9) (y)
	LT830 (CHINO)	(9) (z)
	FCR-15A (SHINKO TECHNOS)	(9) (aa)
	PXR5 (Fuji Electric)	(9) (ab)
	Q64TC (MITSUBISHI)	(9) (ac)
TemplateScreen (QVGA)	Menu	(10) (a)
	Device Monitor	(10) (b)
	Advanced Alarm	(8) (d)
	Historical (Graph+List)	(10) (d)
	Calendar	(10) (e)
	Clock Data Change	(8) (h)
	# Device Monitor <sup>*1</sup>	(10) (g)
	# Advanced Alarm <sup>*1</sup>	(8) (k)
	# Historical (Graph+List) <sup>*1</sup>	(10) (i)

\*1 Stores library data excluding templates of [Header] and [Screen Switching&Background] from the library data in the same name of folder without #.

## (1) AV

### (a) AV Slide Switch

Library data		Library data setting/Setting required for the destination project		
No.	Name			
1 to 8	AVSL01_B/R/Y/G/O/LB/P/PK	Library data setting	Used GOT internal device (GB, GD)	<ul style="list-style-type: none"> <li>• GB100 to 103</li> <li>• GDO</li> </ul>
10 to 17	AVSL02_B/R/Y/G/O/LB/P/PK			

### (b) AV Rotary Switch

Library data		Library data setting/Setting required for the destination project		
No.	Name			
1 to 8	AVRO01_B/R/Y/G/O/LB/P/PK	Library data setting	Used GOT internal device (GB, GD)	<ul style="list-style-type: none"> <li>• GB100 to 107</li> <li>• GDO</li> </ul>

1 OVERVIEW  
2 GT Designer3 SPECIFICATIONS  
3 GT Designer3 OPERATION  
4 COMMON SETTING  
5 EDITING AND SETTING FIGURES AND OBJECTS  
6 LIBRARY  
7 TEMPLATE

**(2) Crystal**

(a) Crystal Slide Switch

Library data		Library data setting/Setting required for the destination project		
No.	Name			
1 to 8	CSL01_B/R/Y/G/O/LB/P/PK	Library data setting	Used GOT internal device (GB, GD)	<ul style="list-style-type: none"> <li>• GB100 to 103</li> <li>• GD0</li> </ul>
10 to 17	CSL02_B/R/Y/G/O/LB/P/PK			
19 to 26	CSL12_B/R/Y/G/O/LB/P/PK			
28 to 35	CSL13_B/R/Y/G/O/LB/P/PK			

(b) Crystal Rotary Switch

Library data		Library data setting/Setting required for the destination project		
No.	Name			
1 to 8	CRO14_B/R/Y/G/O/LB/P/PK	Library data setting	Used GOT internal device (GB, GD)	<ul style="list-style-type: none"> <li>• GB100 to 107</li> <li>• GD0</li> </ul>

**(3) Soft**

(a) Soft Slide Switch

Library data		Library data setting/Setting required for the destination project		
No.	Name			
1 to 8	SSL02_B/R/Y/G/O/LB/P/PK	Library data setting	Used GOT internal device (GB, GD)	<ul style="list-style-type: none"> <li>• GB100 to 103</li> <li>• GD0</li> </ul>

(b) Soft Rotary Switch

Library data		Library data setting/Setting required for the destination project		
No.	Name			
1 to 8	SRO05_B/R/Y/G/O/LB/P/PK	Library data setting	Used GOT internal device (GB, GD)	<ul style="list-style-type: none"> <li>• GB100 to 107</li> <li>• GD0</li> </ul>

**(4) Retro**

(a) Retro Slide Switch

Library data		Library data setting/Setting required for the destination project		
No.	Name			
1 to 8	RSL05_B/R/Y/G/O/LB/P/PK	Library data setting	Used GOT internal device (GB, GD)	<ul style="list-style-type: none"> <li>• GB100 to 103</li> <li>• GD0</li> </ul>

(b) Retro Rotary Switch

Library data		Library data setting/Setting required for the destination project		
No.	Name			
1 to 9	RRO07_B/R/Y/G/O/LB/P/PK/GR	Library data setting	Used GOT internal device (GB, GD)	<ul style="list-style-type: none"> <li>• GB100 to 107</li> <li>• GD0</li> </ul>

**(5) Real**

**(a) Real 3Selector Switch**

Library data		Library data setting/Setting required for the destination project		
No.	Name			
1, 9, 17, 25, 33, 41, 49, 57, 65, 89	3Selector01_B/R/ Y/G/O/LB/P/PK/ GR/BK	Library data setting	Used GOT internal device (GB, GD)	<ul style="list-style-type: none"> <li>• GB100 to 102</li> <li>• GD0</li> </ul>
2, 10, 18, 26, 34, 42, 50, 58, 66, 90	3Selector02_B/R/ Y/G/O/LB/P/PK/ GR/BK			

**(b) Real 3Selector Switch with plate**

Library data		Library data setting/Setting required for the destination project		
No.	Name			
1, 9, 17, 25, 33, 41, 49, 57, 65, 89	P_3Selector01_B/ R/Y/G/O/LB/P/PK/ GR/BK	Library data setting	Used GOT internal device (GB, GD)	<ul style="list-style-type: none"> <li>• GB100 to 102</li> <li>• GD0</li> </ul>
2, 10, 18, 26, 34, 42, 50, 58, 66, 90	P_3Selector02_B/ R/Y/G/O/LB/P/PK/ GR/BK			

(c) Real Radio Switch

Library data		Library data setting/Setting required for the destination project		
No.	Name			
3	RASQ01_05	Library data setting	Used GOT internal device (GB, GD)	• GB100 to 104
8	RASQ01_10	Library data setting	Used GOT internal device (GB, GD)	• GB100 to 109
11	RASQ03_03	Library data setting	Used GOT internal device (GB, GD)	• GB100 to 102
12	RASQ03_04	Library data setting	Used GOT internal device (GB, GD)	• GB100 to 103
13	RASQ03_05	Library data setting	Used GOT internal device (GB, GD)	• GB100 to 104
14	RASQ03_06	Library data setting	Used GOT internal device (GB, GD)	• GB100 to 105
15	RASQ03_07	Library data setting	Used GOT internal device (GB, GD)	• GB100 to 106
16	RASQ03_08	Library data setting	Used GOT internal device (GB, GD)	• GB100 to 107
17	RASQ03_09	Library data setting	Used GOT internal device (GB, GD)	• GB100 to 108
18	RASQ03_10	Library data setting	Used GOT internal device (GB, GD)	• GB100 to 109

(d) Real Radio Switch 2

Library data		Library data setting/Setting required for the destination project		
No.	Name			
1	RASI01_03	Library data setting	Used GOT internal device (GB, GD)	• GB100 to 102
2	RASI01_04	Library data setting	Used GOT internal device (GB, GD)	• GB100 to 103
3	RASI01_05	Library data setting	Used GOT internal device (GB, GD)	• GB100 to 104
4	RASI01_06	Library data setting	Used GOT internal device (GB, GD)	• GB100 to 105
5	RASI01_07	Library data setting	Used GOT internal device (GB, GD)	• GB100 to 106
6	RASI01_08	Library data setting	Used GOT internal device (GB, GD)	• GB100 to 107
7	RASI01_09	Library data setting	Used GOT internal device (GB, GD)	• GB100 to 108
8	RASI01_10	Library data setting	Used GOT internal device (GB, GD)	• GB100 to 109

(6) Metallic

(a) Metal Radio Switch

Library data		Library data setting/Setting required for the destination project		
No.	Name			
3	RASQ02_05	Library data setting	Used GOT internal device (GB, GD)	• GB100 to 104
8	RASQ02_10	Library data setting	Used GOT internal device (GB, GD)	• GB100 to 109

## (7) Clock

### (a) Analog Clock

Library data		Library data setting/Setting required for the destination project		
No.	Name			
1/ 2/ 6/ 7/ 11/ 12	ANCL01_1*1/ ANCL01_2*1/ ANCL02_1*1/ ANCL02_2*1/ ANCL03_1*1/ ANCL03_2*1	Library data setting	Used GOT internal device (GB, GD)	• GD9998, GD9999
	Device requiring to be changed separately from the property sheet		• GD9998, GD9999	
	Device that is not displayed on the property sheet		Since some devices are used for only the following, the property sheet does not display the devices. • Object script function	
	Precautions	Do not change the default GOT special registers (GS). Doing so causes the corresponding objects to malfunction.		

\*1 Since the object script is set, the data are not available for the GT12, GT11, and GT10.

### (b) Clock (Alarm&Historical)

Library data		Library data setting/Setting required for the destination project		
No.	Name			
1	CLAH01_1	Precautions		Do not change the default GOT special registers (GS). Doing so causes the corresponding objects to malfunction.
2	CLAH01_2			
3	CLAH01_3			
4	CLAH01_4			
11	CLAH02_1			
12	CLAH02_2			
13	CLAH02_3			
14	CLAH02_4			
51	CLAH01(JPN)_1			
52	CLAH01(JPN)_2			
61	CLAH02(JPN)_1			
62	CLAH02(JPN)_2			

**(8) TemplateScreen (XGA)**

The data are for the XGA GOT.

If the resolution of the used template differs from the resolution of the set GOT type, cancel grouping of the figures and the objects in the template on the screen editor, and change their positions and sizes.

**(a) Menu of TemplateScreen (XGA)**

Library data		Library data setting/Setting required for the destination project	
No.	Name		
1	8-key Horizontal Menu (w/Back)	Setting required for the destination project	Change [Screen No.] of the go to screen switch according to the screen number of the base screen where the library data is pasted.
2	8-key Horizontal Menu (w/o Back)		
3	12-key Vertical Menu (w/Back)		
4	12-key Vertical Menu (w/o Back)		
5	12-key Vertical Menu L (w/Back)		
6	12-key Vertical Menu L (w/o Back)		
7	15-key Main Menu		

**(b) Device Monitor of TemplateScreen (XGA)**

The displayable range of a device is as follows: 0 to 32769 in decimal and 0000 to 7FFF in hexadecimal.

Library data		Library data setting/Setting required for the destination project		
No.	Name			
1	Device Monitor (Bit Hexadecimal)	Library data setting	Used GOT internal device (GB, GD)	• GD990
			Setting of the go to screen switch	The setting is configured for No. 1501 base screen.
2	Device Monitor (Bit Decimal)	Library data setting	Used GOT internal device (GB, GD)	• GB0 to 39 • GD991
			Setting of the go to screen switch	The setting is configured for No. 1502 base screen.
3	Device Monitor (Word Hexadecimal)	Library data setting	Used GOT internal device (GB, GD)	• GD992
			Setting of the go to screen switch	The setting is configured for No. 1503 base screen.
4	Device Monitor (Word Decimal)	Library data setting	Used GOT internal device (GB, GD)	• GD993
			Setting of the go to screen switch	The setting is configured for No. 1504 base screen.

(c) Device Monitor with comment of TemplateScreen (XGA)

The displayable range of a device is as follows: 0 to 32769 in decimal and 0000 to 7FFF in hexadecimal.

Library data		Library data setting/Setting required for the destination project		
No.	Name			
1	Device Monitor (Bit Hexadecimal_w/ comments)	Library data setting	Used GOT internal device (GB, GD)	• GD990
			Setting of the go to screen switch	The setting is configured for No. 1501 base screen.
		Setting required for the destination project	Set the comments in X0000 and contiguous devices to comment No.1 and consecutive comment numbers in comment group No.1.	
2	Device Monitor (Bit Decimal_w/ comments)	Library data setting	Used GOT internal device (GB, GD)	• GB0 to 19 • GD991
			Setting of the go to screen switch	The setting is configured for No. 1502 base screen.
		Setting required for the destination project	Set the comments in GB0 and contiguous devices to comment No.1 and consecutive comment numbers in comment group No.2.	
3	Device Monitor (Word Hexadecimal_w/ comments)	Library data setting	Used GOT internal device (GB, GD)	• GD992
			Setting of the go to screen switch	The setting is configured for No. 1503 base screen.
		Setting required for the destination project	Set the comments in W0000 and contiguous devices to comment No.1 and consecutive comment numbers in comment group No.3.	
4	Device Monitor (Word Decimal_w/ comments)	Library data setting	Used GOT internal device (GB, GD)	• GD993
			Setting of the go to screen switch	The setting is configured for No. 1504 base screen.
		Setting required for the destination project	Set the comments in D0 and contiguous devices to comment No.1 and consecutive comment numbers in comment group No.4.	

(d) Advanced Alarm of TemplateScreen (XGA)

Library data		Library data setting/Setting required for the destination project		
No.	Name			
1	Advanced User Alarm Historical	Library data setting	Setting of the go to screen switch	The setting is configured for No. 1001 base screen.
		Setting required for the destination project	Set the advanced user alarm observation (Alarm ID: 1).	
2	Advanced User Alarm Accumulation	Library data setting	Setting of the go to screen switch	The setting is configured for No. 1002 base screen.
		Setting required for the destination project	Set the advanced user alarm observation (Alarm ID: 1).	
3	Advanced User Alarm Generation	Library data setting	Setting of the go to screen switch	The setting is configured for No. 1003 base screen.
		Setting required for the destination project	Set the advanced user alarm observation (Alarm ID: 1).	
4	Advanced System Alarm	Library data setting	Setting of the go to screen switch	The setting is configured for No. 1004 base screen.
		Setting required for the destination project	Set the advanced system alarm observation.	

(e) Historical (Graph+List) of TemplateScreen (XGA)

Library data		Library data setting/Setting required for the destination project		
No.	Name			
1	Historical Trend Graph (8 pens)	Library data setting	Used GOT internal device (GB, GD)	• GD0 to 7, GD10 to 17, GD20 to 34
			Setting of the go to screen switch	The setting is configured for No. 1101 base screen.
		Setting required for the destination project	Before pasting the data, set the logging (Logging ID: 1).	
		Precautions	Do not change the default GOT special registers (GS). Doing so causes the corresponding objects to malfunction.	
2	Historical Trend Graph (8 pens, simple)	Library data setting	Used GOT internal device (GB, GD)	• GD24 to 31
			Setting of the go to screen switch	The setting is configured for No. 1101 base screen.
		Setting required for the destination project	Before pasting the data, set the logging (Logging ID: 1).	
5	Historical Trend Graph (8 pens-2)	Library data setting	Used GOT internal device (GB, GD)	• GD0 to 7, GD10 to 17, GD20 to 34
			Setting of the go to screen switch	The setting is configured for No. 1101 base screen.
		Setting required for the destination project	Before pasting the data, set the logging (Logging ID: 1).	
		Precautions	Do not change the default GOT special registers (GS). Doing so causes the corresponding objects to malfunction.	
11	Historical Data List (8 columns)	Library data setting	Used GOT internal device (GB, GD)	• GD20 to 22
			Setting of the go to screen switch	The setting is configured for No. 1102 base screen.
		Setting required for the destination project	Before pasting the data, set the logging (Logging ID: 1).	
17	Historical (Graph+List) (8 pens, horizontal)	Library data setting	Used GOT internal device (GB, GD)	• GD20 to 35
			Setting of the go to screen switch	The setting is configured for No. 1103 base screen.
		Setting required for the destination project	Before pasting the data, set the logging (Logging ID: 1).	
19	Historical (Graph+List) (8 pens, vertical)	Library data setting	Used GOT internal device (GB, GD)	• GD20 to 35
			Setting of the go to screen switch	The setting is configured for No. 1103 base screen.
		Setting required for the destination project	Before pasting the data, set the logging (Logging ID: 1).	



(f) Document Display of TemplateScreen (XGA)

Library data		Library data setting/Setting required for the destination project		
No.	Name			
1 to 3	Document Display1/ Document Display2/ Document Display3	Library data setting	Used GOT internal device (GB, GD)	• GD0
			Setting of the go to screen switch	The setting is configured for No. 1201 base screen.
	Setting required for the destination project	Convert document ID No.1 by using Document Converter.		

(g) Calendar of TemplateScreen (XGA)

Library data		Library data setting/Setting required for the destination project			
No.	Name				
1 to 3	Calendar1*1/ Calendar2*1/ Calendar3*1	Library data setting	Used GOT internal device (GB, GD)	• GB40, GB110 • GD0 to 36, GD9998, GD9999	
			Device requiring to be changed separately from the property sheet	• GB110 • GD0 to 36, GD9998, GD9999	
			Device that is not displayed on the property sheet	Since some devices are used for only the following, the property sheet does not display the devices. • Attributes of figures and objects that are not registered in the template • Object script function	
			Setting of the go to screen switch	The setting is configured for No. 1401 base screen.	
		Precautions	The data from year 2008 to 2037 is displayed.		
			Do not change the default GOT special registers (GS). Doing so causes the corresponding objects to malfunction.		
			Do not use this library data for the screen that is first displayed after GOT startup. Depending on the set operation timing of GB40, the current year and month may not be displayed correctly.		

\*1 Since the object script is set, the data are not available for the GT12, GT11, and GT10.

(h) Clock Data Change of TemplateScreen (XGA)

Library data		Library data setting/Setting required for the destination project			
No.	Name				
1	Clock Data Change*1	Library data setting	Used GOT internal device (GB, GD)	• GB40 • GD50 to 55	
			Device requiring to be changed separately from the property sheet	• GD50 to 55	
			Device that is not displayed on the property sheet	Since some devices are used for only the following, the property sheet does not display the devices. • Object script function	
			Setting of the go to screen switch	The setting is configured for No. 1301 base screen.	
		Setting required for the destination project	On the [Clock Setting] tab in the GOT setup of the [Environmental Setting] dialog box, set the trigger device of [Broadcast].([Trigger Type]: [Rise], [Device]: GS512.b0)		
			Precautions	Do not change the default GOT special registers (GS). Doing so causes the corresponding objects to malfunction.	
Do not use this library data for the screen that is first displayed after GOT startup. Depending on the set operation timing of GB40, the current year and month may not be displayed correctly.					

\*1 Since the object script is set, the data are not available for the GT12, GT11, and GT10.

1 OVERVIEW  
2 GT Designer3 SPECIFICATIONS  
3  
4 GT Designer3 OPERATION  
5 COMMON SETTING  
6 EDITING AND SETTING FIGURES AND OBJECTS  
7 LIBRARY TEMPLATE

(i) # Device Monitor of TemplateScreen (XGA)

This folder stores library data excluding templates of [Header] and [Screen Switching&Background] from the library data in the [Device Monitor] folder.

The displayable range of a device is as follows: 0 to 32769 in decimal and 0000 to 7FFF in hexadecimal.

Library data		Library data setting/Setting required for the destination project		
No.	Name			
1	Device Monitor (Bit Hexadecimal)	Library data setting	Used GOT internal device (GB, GD)	• GD990
2	Device Monitor (Bit Decimal)	Library data setting	Used GOT internal device (GB, GD)	• GB0 to 39 • GD991
3	Device Monitor (Word Hexadecimal)	Library data setting	Used GOT internal device (GB, GD)	• GD992
4	Device Monitor (Word Decimal)	Library data setting	Used GOT internal device (GB, GD)	• GD993

(j) # Device Monitor with comment of TemplateScreen (XGA)

This folder stores library data excluding templates of [Header] and [Screen Switching&Background] from the library data in the [Device Monitor with comment] folder.

The displayable range of a device is as follows: 0 to 32769 in decimal and 0000 to 7FFF in hexadecimal.

Library data		Library data setting/Setting required for the destination project		
No.	Name			
1	Device Monitor (Bit Hexadecimal_w/ comments)	Library data setting	Used GOT internal device (GB, GD)	• GD990
		Setting required for the destination project	Set the comments in X0000 and contiguous devices to comment No.1 and consecutive comment numbers in comment group No.1.	
2	Device Monitor (Bit Decimal_w/ comments)	Library data setting	Used GOT internal device (GB, GD)	• GB0 to 19 • GD991
		Setting required for the destination project	Set the comments in GB0 and contiguous devices to comment No.1 and consecutive comment numbers in comment group No.2.	
3	Device Monitor (Word Hexadecimal_w/ comments)	Library data setting	Used GOT internal device (GB, GD)	• GD992
		Setting required for the destination project	Set the comments in W0000 and contiguous devices to comment No.1 and consecutive comment numbers in comment group No.3.	
4	Device Monitor (Word Decimal_w/ comments)	Library data setting	Used GOT internal device (GB, GD)	• GD993
		Setting required for the destination project	Set the comments in D0 and contiguous devices to comment No.1 and consecutive comment numbers in comment group No.4.	

(k) # Advanced Alarm of TemplateScreen (XGA)

This folder stores library data excluding templates of [Header] and [Screen Switching&Background] from the library data in the [Advanced Alarm] folder.

Library data		Library data setting/Setting required for the destination project	
No.	Name		
1	Advanced User Alarm Historical		
2	Advanced User Alarm Accumulation	Setting required for the destination project	Set the advanced user alarm observation (Alarm ID: 1).
3	Advanced User Alarm Generation		
4	Advanced System Alarm	Setting required for the destination project	Set the advanced system alarm observation.

(l) # Historical (Graph+List) of TemplateScreen (XGA)

This folder stores library data excluding templates of [Header] and [Screen Switching&Background] from the library data in the [Historical (Graph+List)] folder.

Library data		Library data setting/Setting required for the destination project	
No.	Name		
1	Historical Trend Graph (8 pens)	Library data setting	Used GOT internal device (GB, GD) • GD0 to 7, GD10 to 17, GD20 to 34
		Setting required for the destination project	Before pasting the data, set the logging (Logging ID: 1).
		Precautions	Do not change the default GOT special registers (GS). Doing so causes the corresponding objects to malfunction.
2	Historical Trend Graph (8 pens, simple)	Library data setting	Used GOT internal device (GB, GD) • GD24 to 31
		Setting required for the destination project	Before pasting the data, set the logging (Logging ID: 1).
5	Historical Trend Graph (8 pens-2)	Library data setting	Used GOT internal device (GB, GD) • GD0 to 7, GD10 to 17, GD20 to 34
		Setting required for the destination project	Before pasting the data, set the logging (Logging ID: 1).
		Precautions	Do not change the default GOT special registers (GS). Doing so causes the corresponding objects to malfunction.
11	Historical Data List (8 columns)	Library data setting	Used GOT internal device (GB, GD) • GD20 to 22
		Setting required for the destination project	Before pasting the data, set the logging (Logging ID: 1).
17	Historical (Graph+List) (8 pens, horizontal)	Library data setting	Used GOT internal device (GB, GD) • GD20 to 35
		Setting required for the destination project	Before pasting the data, set the logging (Logging ID: 1).
19	Historical (Graph+List) (8 pens, vertical)	Library data setting	Used GOT internal device (GB, GD) • GD20 to 35
		Setting required for the destination project	Before pasting the data, set the logging (Logging ID: 1).

**(9) TemplateScreen (VGA)**

The data are for the VGA GOT.

If the resolution of the used template differs from the resolution of the set GOT type, cancel grouping of the figures and the objects in the template on the screen editor, and change their positions and sizes.

**(a) Menu of TemplateScreen (VGA)**

Library data		Library data setting/Setting required for the destination project	
No.	Name		
1	8-key Horizontal Menu (w/Back)	Setting required for the destination project	Change [Screen No.] of the go to screen switch according to the screen number of the base screen where the library data is pasted.
2	8-key Horizontal Menu (w/o Back)		
3	10-key Vertical Menu (w/Back)		
4	10-key Vertical Menu (w/o Back)		
5	10-key Vertical Menu L (w/Back)		
6	10-key Vertical Menu L (w/o Back)		
7	10-key Main Menu		

**(b) Device Monitor of TemplateScreen (VGA)**

The displayable range of a device is as follows: 0 to 32769 in decimal and 0000 to 7FFF in hexadecimal.

Library data		Library data setting/Setting required for the destination project		
No.	Name			
1	Device Monitor (Bit Hexadecimal)	Library data setting	Used GOT internal device (GB, GD)	• GD990
			Setting of the go to screen switch	The setting is configured for No. 1501 base screen.
2	Device Monitor (Bit Decimal)	Library data setting	Used GOT internal device (GB, GD)	• GB0 to 19 • GD991
			Setting of the go to screen switch	The setting is configured for No. 1502 base screen.
3	Device Monitor (Word Hexadecimal)	Library data setting	Used GOT internal device (GB, GD)	• GD992
			Setting of the go to screen switch	The setting is configured for No. 1503 base screen.
4	Device Monitor (Word Decimal)	Library data setting	Used GOT internal device (GB, GD)	• GD993
			Setting of the go to screen switch	The setting is configured for No. 1504 base screen.

**(c) Device Monitor with comment of TemplateScreen (VGA)**

The displayable range of a device is as follows: 0 to 32769 in decimal and 0000 to 7FFF in hexadecimal.

Library data		Library data setting/Setting required for the destination project		
No.	Name			
1	Device Monitor (Bit Hexadecimal_w/ comments)	Library data setting	Used GOT internal device (GB, GD)	• GD990
			Setting of the go to screen switch	The setting is configured for No. 1501 base screen.
		Setting required for the destination project	Set the comments in X0000 and contiguous devices to comment No.1 and consecutive comment numbers in comment group No.1.	
2	Device Monitor (Bit Decimal_w/ comments)	Library data setting	Used GOT internal device (GB, GD)	• GB0 to 9 • GD991
			Setting of the go to screen switch	The setting is configured for No. 1502 base screen.
		Setting required for the destination project	Set the comments in GB0 and contiguous devices to comment No.1 and consecutive comment numbers in comment group No.2.	

(Continued to next page)

Library data		Library data setting/Setting required for the destination project		
No.	Name			
3	Device Monitor (Word Hexadecimal_w/ comments)	Library data setting	Used GOT internal device (GB, GD)	• GD992
			Setting of the go to screen switch	The setting is configured for No. 1503 base screen.
		Setting required for the destination project	Set the comments in W0000 and contiguous devices to comment No.1 and consecutive comment numbers in comment group No.3.	
4	Device Monitor (Word Decimal_w/ comments)	Library data setting	Used GOT internal device (GB, GD)	• GD993
			Setting of the go to screen switch	The setting is configured for No. 1504 base screen.
		Setting required for the destination project	Set the comments in D0 and contiguous devices to comment No.1 and consecutive comment numbers in comment group No.4.	

(d) Advanced Alarm of TemplateScreen (VGA)

For the library data setting and the setting required for the destination project, refer to the following.

 (8) (d) Advanced Alarm of TemplateScreen (XGA)

(e) Historical (Graph+List) of TemplateScreen (VGA)

Library data		Library data setting/Setting required for the destination project		
No.	Name			
1	Historical Trend Graph (3 pens)	Library data setting	Used GOT internal device (GB, GD)	• GD0 to 2, GD10 to 12, GD20 to 34
			Setting of the go to screen switch	The setting is configured for No. 1101 base screen.
		Setting required for the destination project	Before pasting the data, set the logging (Logging ID: 1).	
		Precautions	Do not change the default GOT special registers (GS). Doing so causes the corresponding objects to malfunction.	
2	Historical Trend Graph (3 pens, simple)	Library data setting	Used GOT internal device (GB, GD)	• GD24 to 31
			Setting of the go to screen switch	The setting is configured for No. 1101 base screen.
		Setting required for the destination project	Before pasting the data, set the logging (Logging ID: 1).	
5	Historical Trend Graph (8 pens)	Library data setting	Used GOT internal device (GB, GD)	• GD0 to 7, GD10 to 17, GD20 to 34
			Setting of the go to screen switch	The setting is configured for No. 1101 base screen.
		Setting required for the destination project	Before pasting the data, set the logging (Logging ID: 1).	
		Precautions	Do not change the default GOT special registers (GS). Doing so causes the corresponding objects to malfunction.	
11	Historical Data List (5 columns)	Library data setting	Used GOT internal device (GB, GD)	• GD20 to 22
			Setting of the go to screen switch	The setting is configured for No. 1102 base screen.
		Setting required for the destination project	Before pasting the data, set the logging (Logging ID: 1).	

(Continued to next page)

Library data		Library data setting/Setting required for the destination project		
No.	Name			
17	Historical (Graph+List) (3 pens, horizontal)	Library data setting	Used GOT internal device (GB, GD)	• GD20 to 35
			Setting of the go to screen switch	The setting is configured for No. 1103 base screen.
		Setting required for the destination project	Before pasting the data, set the logging (Logging ID: 1).	
19	Historical (Graph+List) (3 pens, vertical)	Library data setting	Used GOT internal device (GB, GD)	• GD20 to 35
			Setting of the go to screen switch	The setting is configured for No. 1103 base screen.
		Setting required for the destination project	Before pasting the data, set the logging (Logging ID: 1).	

(f) Document Display of TemplateScreen (VGA)

For the library data setting and the setting required for the destination project, refer to the following.

 (8) (f) Document Display of TemplateScreen (XGA)

(g) Calendar of TemplateScreen (VGA)

For the library data setting and the setting required for the destination project, refer to the following.

 (8) (g) Calendar of TemplateScreen (XGA)

(h) Clock Data Change of TemplateScreen (VGA)

For the library data setting and the setting required for the destination project, refer to the following.

 (8) (h) Clock Data Change of TemplateScreen (XGA)

(i) # Device Monitor of TemplateScreen (VGA)

This folder stores library data excluding templates of [Header] and [Screen Switching&Background] from the library data in the [Device Monitor] folder.

The displayable range of a device is as follows: 0 to 32769 in decimal and 0000 to 7FFF in hexadecimal.

Library data		Library data setting/Setting required for the destination project		
No.	Name			
1	Device Monitor (Bit Hexadecimal)	Library data setting	Used GOT internal device (GB, GD)	• GD990
2	Device Monitor (Bit Decimal)	Library data setting	Used GOT internal device (GB, GD)	• GB0 to 19 • GD991
3	Device Monitor (Word Hexadecimal)	Library data setting	Used GOT internal device (GB, GD)	• GD992
4	Device Monitor (Word Decimal)	Library data setting	Used GOT internal device (GB, GD)	• GD993

(j) # Device Monitor with comment of TemplateScreen (VGA)

This folder stores library data excluding templates of [Header] and [Screen Switching&Background] from the library data in the [Device Monitor with comment] folder.

The displayable range of a device is as follows: 0 to 32769 in decimal and 0000 to 7FFF in hexadecimal.

Library data		Library data setting/Setting required for the destination project		
No.	Name			
1	Device Monitor (Bit Hexadecimal_w/ comments)	Library data setting	Used GOT internal device (GB, GD)	• GD990
		Setting required for the destination project	Set the comments in X0000 and contiguous devices to comment No.1 and consecutive comment numbers in comment group No.1.	
2	Device Monitor (Bit Decimal_w/ comments)	Library data setting	Used GOT internal device (GB, GD)	• GB0 to 9 • GD991
		Setting required for the destination project	Set the comments in GB0 and contiguous devices to comment No.1 and consecutive comment numbers in comment group No.2.	
3	Device Monitor (Word Hexadecimal_w/ comments)	Library data setting	Used GOT internal device (GB, GD)	• GD992
		Setting required for the destination project	Set the comments in W0000 and contiguous devices to comment No.1 and consecutive comment numbers in comment group No.3.	
4	Device Monitor (Word Decimal_w/ comments)	Library data setting	Used GOT internal device (GB, GD)	• GD993
		Setting required for the destination project	Set the comments in D0 and contiguous devices to comment No.1 and consecutive comment numbers in comment group No.4.	

(k) # Advanced Alarm of TemplateScreen (VGA)

For the library data setting and the setting required for the destination project, refer to the following.

 (8) (k) # Advanced Alarm of TemplateScreen (XGA)

(l) # Historical (Graph+List) of TemplateScreen (VGA)

This folder stores library data excluding templates of [Header] and [Screen Switching&Background] from the library data in the [Historical (Graph+List)] folder.

Library data		Library data setting/Setting required for the destination project		
No.	Name			
1	Historical Trend Graph (3 pens)	Library data setting	Used GOT internal device (GB, GD)	• GD0 to 2, GD10 to 12, GD20 to 34
		Setting required for the destination project	Before pasting the data, set the logging (Logging ID: 1).	
		Precautions	Do not change the default GOT special registers (GS). Doing so causes the corresponding objects to malfunction.	
2	Historical Trend Graph (3 pens, simple)	Library data setting	Used GOT internal device (GB, GD)	• GD24 to 31
		Setting required for the destination project	Before pasting the data, set the logging (Logging ID: 1).	
5	Historical Trend Graph (8 pens)	Library data setting	Used GOT internal device (GB, GD)	• GD0 to 7, GD10 to 17, GD20 to 34
		Setting required for the destination project	Before pasting the data, set the logging (Logging ID: 1).	
		Precautions	Do not change the default GOT special registers (GS). Doing so causes the corresponding objects to malfunction.	

(Continued to next page)

Library data		Library data setting/Setting required for the destination project		
No.	Name			
11	Historical Data List (5 columns)	Library data setting	Used GOT internal device (GB, GD)	• GD20 to 22
		Setting required for the destination project	Before pasting the data, set the logging (Logging ID: 1).	
17	Historical (Graph+List) (3 pens, horizontal)	Library data setting	Used GOT internal device (GB, GD)	• GD20 to 35
		Setting required for the destination project	Before pasting the data, set the logging (Logging ID: 1).	
19	Historical (Graph+List) (3 pens, vertical)	Library data setting	Used GOT internal device (GB, GD)	• GD20 to 35
		Setting required for the destination project	Before pasting the data, set the logging (Logging ID: 1).	

(m) CC-Link Network Monitor of TemplateScreen (VGA)

Do not change the default link special relays (SB) and link special registers (SW).  
Doing so causes the corresponding objects to malfunction.

Library data		Library data setting/Setting required for the destination project		
No.	Name			
1	Main	Library data setting	Setting of the go to screen switch	The setting is configured for No.10001 base screen.
2	Station Status Monitor1	Library data setting	Used GOT internal device (GB, GD)	• GB40 • GD65001
			Device that is not displayed on the property sheet	Since some devices are used for only the following, the property sheet does not display the devices. • Attributes of figures and objects that are not registered in the template
			Setting of the go to screen switch	The setting is configured for No.10002 base screen.
3	Station Status Monitor2	Library data setting	Used GOT internal device (GB, GD)	• GB40 • GD65001
			Device that is not displayed on the property sheet	Since some devices are used for only the following, the property sheet does not display the devices. • Attributes of figures and objects that are not registered in the template
			Setting of the go to screen switch	The setting is configured for No.10003 base screen.

(n) QD75MH of TemplateScreen (VGA)

Only the start I/O number of the buffer memory set for the BM device can be changed.  
Changing the device numbers causes the corresponding objects to malfunction.

Library data		Library data setting/Setting required for the destination project		
No.	Name			
1	Operation Monitor	Library data setting	Setting of the go to screen switch	The setting is configured for No.12101 base screen.
2	I/O Monitor	Library data setting	Setting of the go to screen switch	The setting is configured for No.12102 base screen.
12	Axis Monitor-1	Library data setting	Setting of the go to screen switch	The setting is configured for No.12103 base screen.
13	Axis Monitor-2	Library data setting	Setting of the go to screen switch	The setting is configured for No.12104 base screen.
14	Axis Monitor-3	Library data setting	Setting of the go to screen switch	The setting is configured for No.12105 base screen.
15	Axis Monitor-4	Library data setting	Setting of the go to screen switch	The setting is configured for No.12106 base screen.
24	Error/Warning History	Library data setting	Setting of the go to screen switch	The setting is configured for No.12107 base screen.



(o) QD75M of TemplateScreen (VGA)

Only the start I/O number of the buffer memory set for the BM device can be changed.  
Changing the device numbers causes the corresponding objects to malfunction.

Library data		Library data setting/Setting required for the destination project		
No.	Name			
1	Operation Monitor	Library data setting	Setting of the go to screen switch	The setting is configured for No.12601 base screen.
2	I/O Monitor	Library data setting	Setting of the go to screen switch	The setting is configured for No.12602 base screen.
12	Axis Monitor-1	Library data setting	Setting of the go to screen switch	The setting is configured for No.12603 base screen.
13	Axis Monitor-2	Library data setting	Setting of the go to screen switch	The setting is configured for No.12604 base screen.
14	Axis Monitor-3	Library data setting	Setting of the go to screen switch	The setting is configured for No.12605 base screen.
15	Axis Monitor-4	Library data setting	Setting of the go to screen switch	The setting is configured for No.12606 base screen.
24	Error/Warning History	Library data setting	Setting of the go to screen switch	The setting is configured for No.12607 base screen.

(p) LD77MH4 of TemplateScreen (VGA)

Only the start I/O number of the buffer memory set for the BM device can be changed.  
Changing the device numbers causes the corresponding objects to malfunction.

Library data		Library data setting/Setting required for the destination project		
No.	Name			
1	Operation Monitor	Library data setting	Setting of the go to screen switch	The setting is configured for No.14101 base screen.
2	I/O Monitor	Library data setting	Setting of the go to screen switch	The setting is configured for No.14102 base screen.
12	Axis Monitor-1	Library data setting	Setting of the go to screen switch	The setting is configured for No.14103 base screen.
13	Axis Monitor-2	Library data setting	Setting of the go to screen switch	The setting is configured for No.14104 base screen.
14	Axis Monitor-3	Library data setting	Setting of the go to screen switch	The setting is configured for No.14105 base screen.
15	Axis Monitor-4	Library data setting	Setting of the go to screen switch	The setting is configured for No.14106 base screen.
24	Error/Warning History	Library data setting	Setting of the go to screen switch	The setting is configured for No.14107 base screen.

(q) MR-J3-A of TemplateScreen (VGA)

Do not change the default devices of the servo amplifier. Doing so causes the corresponding objects to malfunction.

Library data		Library data setting/Setting required for the destination project		
No.	Name			
1	Menu	Library data setting	Setting of the go to screen switch	The setting is configured for No.30001 base screen.
10	Parameter Setting Menu	Library data setting	Setting of the go to screen switch	The setting is configured for No.30010 base screen.
11	Basic Setting Parameter (ROM)	Library data setting	Setting of the go to screen switch	The setting is configured for No.30011 base screen.
12	Gain/Filter Parameter (ROM) (1/2)	Library data setting	Setting of the go to screen switch	The setting is configured for No.30012 base screen.
13	Gain/Filter Parameter (ROM) (2/2)	Library data setting	Setting of the go to screen switch	The setting is configured for No.30013 base screen.
14	Advanced Setting Parameter (ROM) (1/2)	Library data setting	Setting of the go to screen switch	The setting is configured for No.30014 base screen.
15	Advanced Setting Parameter (ROM) (2/2)	Library data setting	Setting of the go to screen switch	The setting is configured for No.30015 base screen.
16	I/O Setting Parameter (ROM)	Library data setting	Setting of the go to screen switch	The setting is configured for No.30016 base screen.
17	Basic Setting Parameter (RAM)	Library data setting	Setting of the go to screen switch	The setting is configured for No.30017 base screen.
18	Gain/Filter Parameter (RAM) (1/2)	Library data setting	Setting of the go to screen switch	The setting is configured for No.30018 base screen.
19	Gain/Filter Parameter (RAM) (2/2)	Library data setting	Setting of the go to screen switch	The setting is configured for No.30019 base screen.
20	Advanced Setting Parameter (RAM) (1/2)	Library data setting	Setting of the go to screen switch	The setting is configured for No.30020 base screen.
21	Advanced Setting Parameter (RAM) (2/2)	Library data setting	Setting of the go to screen switch	The setting is configured for No.30021 base screen.
22	I/O Setting Parameter (RAM)	Library data setting	Setting of the go to screen switch	The setting is configured for No.30022 base screen.
30	Monitor	Library data setting	Setting of the go to screen switch	The setting is configured for No.30030 base screen.
40	Graph	Library data setting	Used GOT internal device (GB, GD)	<ul style="list-style-type: none"> <li>GD1606 to 1609, GD1620 to 1630, GD10001, GD10010, GD10014</li> <li>GB40</li> </ul>
			Device requiring to be changed separately from the property sheet	<ul style="list-style-type: none"> <li>GD1628 to 1630</li> </ul>
			Device that is not displayed on the property sheet	Since some devices are used for only the following, the property sheet does not display the devices. <ul style="list-style-type: none"> <li>Object script function</li> </ul>
			Setting of the go to screen switch	The setting is configured for No.30040 base screen.
		Setting required for the destination project	Before pasting the data, target ST1, ST9, and ST14 for data collection in the logging setting (Logging ID: 1).	
	Precautions	Do not change the set GOT special register (GS). If it is changed, the GOT is not properly operated.		

(Continued to next page)

Library data		Library data setting/Setting required for the destination project		
No.	Name			
50	Diagnosis* <sup>1</sup>	Library data setting	Used GOT internal device (GB, GD)	• GD9998, GD9999, GD60263, GD60264
			Device requiring to be changed separately from the property sheet	• GD9998, GD9999, GD60263, GD60264 • DI0 • DO0
			Setting of the go to screen switch	The setting is configured for No.30050 base screen.
60	Current Alarm	Library data setting	Devices in which template attributes are not registered	• AI0
			Setting of the go to screen switch	The setting is configured for No.30060 base screen.
70	Test	Library data setting	Setting of the go to screen switch	The setting is configured for No.30070 base screen.
71	JOG Operation* <sup>1</sup>	Library data setting	Setting of the go to screen switch	The setting is configured for No.30071 base screen.
72	Positioning Operation* <sup>1</sup>	Library data setting	Setting of the go to screen switch	The setting is configured for No.30072 base screen.
73	Motor-less Operation	Library data setting	Setting of the go to screen switch	The setting is configured for No.30073 base screen.
74	Output Signal (DO) Forced Output	Library data setting	Setting of the go to screen switch	The setting is configured for No.30074 base screen.

\*<sup>1</sup> Since the object script is set, the data are not available for the GT12, GT11, and GT10.

1

OVERVIEW

2

GT Designer3  
SPECIFICATIONS

3

GT Designer3  
OPERATION

4

COMMON SETTING

5

EDITING AND  
SETTING FIGURES  
AND OBJECTS

6

LIBRARY

7

TEMPLATE

## (r) MR-J4-A of TemplateScreen (VGA)

Do not change the default devices of the servo amplifier. Doing so causes the corresponding objects to malfunction.

Library data		Library data setting/Setting required for the destination project		
No.	Name			
1	Menu	Library data setting	Setting of the go to screen switch	The setting is configured for No.30001 base screen.
2	Parameter Setting Menu	Library data setting	Setting of the go to screen switch	The setting is configured for No.30002 base screen.
11	Basic Setting Parameter (ROM) (1/2)	Library data setting	Setting of the go to screen switch	The setting is configured for No.30011 base screen.
12	Basic Setting Parameter (ROM) (2/2)	Library data setting	Setting of the go to screen switch	The setting is configured for No.30012 base screen.
14	Gain&Filter Parameter (ROM) (1/3)	Library data setting	Setting of the go to screen switch	The setting is configured for No.30014 base screen.
15	Gain&Filter Parameter (ROM) (2/3)	Library data setting	Setting of the go to screen switch	The setting is configured for No.30015 base screen.
16	Gain&Filter Parameter (ROM) (3/3)	Library data setting	Setting of the go to screen switch	The setting is configured for No.30016 base screen.
18	Extension Setting1 Parameter (ROM) (1/3)	Library data setting	Setting of the go to screen switch	The setting is configured for No.30018 base screen.
19	Extension Setting1 Parameter (ROM) (2/3)	Library data setting	Setting of the go to screen switch	The setting is configured for No.30019 base screen.
20	Extension Setting1 Parameter (ROM) (3/3)	Library data setting	Setting of the go to screen switch	The setting is configured for No.30020 base screen.
22	I/O Setting Parameter (ROM) (1/2)	Library data setting	Setting of the go to screen switch	The setting is configured for No.30022 base screen.
23	I/O Setting Parameter (ROM) (2/2)	Library data setting	Setting of the go to screen switch	The setting is configured for No.30023 base screen.
25	Extension Setting2 Parameter (ROM)	Library data setting	Setting of the go to screen switch	The setting is configured for No.30025 base screen.
27	Extension Setting3 Parameter (ROM)	Library data setting	Setting of the go to screen switch	The setting is configured for No.30027 base screen.
29	Basic Setting Parameter (RAM) (1/2)	Library data setting	Setting of the go to screen switch	The setting is configured for No.30029 base screen.
30	Basic Setting Parameter (RAM) (2/2)	Library data setting	Setting of the go to screen switch	The setting is configured for No.30030 base screen.
32	Gain&Filter Parameter (RAM) (1/3)	Library data setting	Setting of the go to screen switch	The setting is configured for No.30032 base screen.
33	Gain&Filter Parameter (RAM) (2/3)	Library data setting	Setting of the go to screen switch	The setting is configured for No.30033 base screen.
34	Gain&Filter Parameter (RAM) (3/3)	Library data setting	Setting of the go to screen switch	The setting is configured for No.30034 base screen.

(Continued to next page)

Library data		Library data setting/Setting required for the destination project		
No.	Name			
36	Extension Setting1 Parameter (RAM) (1/3)	Library data setting	Setting of the go to screen switch	The setting is configured for No.30036 base screen.
37	Extension Setting1 Parameter (RAM) (2/3)	Library data setting	Setting of the go to screen switch	The setting is configured for No.30037 base screen.
38	Extension Setting1 Parameter (RAM) (3/3)	Library data setting	Setting of the go to screen switch	The setting is configured for No.30038 base screen.
40	I/O Setting Parameter (RAM) (1/2)	Library data setting	Setting of the go to screen switch	The setting is configured for No.30040 base screen.
41	I/O Setting Parameter (RAM) (2/2)	Library data setting	Setting of the go to screen switch	The setting is configured for No.30041 base screen.
43	Extension Setting2 Parameter (RAM)	Library data setting	Setting of the go to screen switch	The setting is configured for No.30043 base screen.
45	Extension Setting3 Parameter (RAM)	Library data setting	Setting of the go to screen switch	The setting is configured for No.30045 base screen.
51	Monitor	Library data setting	Setting of the go to screen switch	The setting is configured for No.30051 base screen.
61	Diagnosis* <sup>1</sup>	Library data setting	Used GOT internal device (GB, GD)	• GD61001, GD61002, GD61003, GD61004, GD61005
			Device requiring to be changed separately from the property sheet	• GD61001, GD61002, GD61003, GD61004, GD61005 • DI0 • DO0
			Setting of the go to screen switch	The setting is configured for No.30061 base screen.
71	Current Alarm* <sup>1</sup>	Library data setting	Used GOT internal device (GB, GD)	• GD61051, GD61055, GD61056
			Device requiring to be changed separately from the property sheet	• GD61051, GD61055, GD61056 • ALM0
			Device that is not displayed on the property sheet	Since some devices are used for only the following, the property sheet does not display the devices. • Attributes of figures and objects that are not registered in the template
			Setting of the go to screen switch	The setting is configured for No.30071 base screen.
81	Historical Trend Graph* <sup>1</sup>	Library data setting	Used GOT internal device (GB, GD)	• GD61151, GD61159, GD61164, GD61171 to 61185 • GB40
			Device requiring to be changed separately from the property sheet	• GD61183, GD61184, GD61185
			Device that is not displayed on the property sheet	Since some devices are used for only the following, the property sheet does not display the devices. • Object script function
			Setting of the go to screen switch	The setting is configured for No.30081 base screen.
		Setting required for the destination project	Before pasting the data, target ST1, ST9, and ST14 for data collection in the logging setting (Logging ID: 1).	
		Precautions	Do not change the default GOT special registers (GS). Doing so causes the corresponding objects to malfunction.	

(Continued to next page)

Library data		Library data setting/Setting required for the destination project		
No.	Name			
91	Test	Library data setting	Device requiring to be changed separately from the property sheet	<ul style="list-style-type: none"> <li>GD61211.b0, GD61213.b0, GD61251.b0, GD61253.b0, GD61255.b0</li> <li>OM1, OM2, OM4</li> <li>TMIO</li> </ul>
			Setting of the go to screen switch	The setting is configured for No.30091 base screen.
93	JOG Operation* <sup>1</sup>	Library data setting	Device requiring to be changed separately from the property sheet	<ul style="list-style-type: none"> <li>GD61201, GD61203, GD61211.b0, GD61213.b0, GD61251.b0, GD61253.b0, GD61255.b0</li> <li>OM0, OM2, OM4</li> <li>TMIO</li> <li>TMD0, TMD1</li> </ul>
			Setting of the go to screen switch	The setting is configured for No.30093 base screen.
95	Positioning Operation* <sup>1</sup>	Library data setting	Device requiring to be changed separately from the property sheet	<ul style="list-style-type: none"> <li>GD61201, GD61203, GD61205, GD61211.b0, GD61213.b0, GD61251.b0, GD61253.b0, GD61255.b0</li> <li>OM0, OM1, OM4</li> <li>TMIO</li> <li>TMD0, TMD1, TMD2</li> </ul>
			Setting of the go to screen switch	The setting is configured for No.30095 base screen.
99	Output Signal (DO) Forced Output	Library data setting	Device requiring to be changed separately from the property sheet	<ul style="list-style-type: none"> <li>GD61211.b0, GD61213.b0, GD61251.b0, GD61253.b0, GD61255.b0, GD61353.b0 to 61353.b6</li> <li>OM0, OM1, OM2</li> <li>TMIO</li> <li>TMO0</li> </ul>
			Setting of the go to screen switch	The setting is configured for No.30099 base screen.

\*<sup>1</sup> Since the object script is set, the data are not available for the GT12, GT11, and GT10.

(s) FR-A700 of TemplateScreen (VGA)

Do not change the default devices of the inverter. Doing so causes the corresponding objects to malfunction.

Library data		Library data setting/Setting required for the destination project		
No.	Name			
1	Menu	Library data setting	Used GOT internal device (GB, GD)	• GB131 to 135
			Setting of the go to screen switch	The setting is configured for No.10001 base screen.
2	Operation Command/Monitor*1	Library data setting	Used GOT internal device (GB, GD)	• GB131 to 135
			Device requiring to be changed separately from the property sheet	• GB131 to 135 • SP122:0
			Device that is not displayed on the property sheet	Since some devices are used for only the following, the property sheet does not display the devices. • Object script function
			Setting of the go to screen switch	The setting is configured for No.10002 base screen.
		Setting required for the destination project	Before pasting the data, target SP111:0 and SP112:0 for data collection in the logging setting (Logging ID: 1).	
3	Graph	Library data setting	Used GOT internal device (GB, GD)	• GD0, GD2, GD10 to 13 • GB131 to 135
			Setting of the go to screen switch	The setting is configured for No.10003 base screen.
		Setting required for the destination project	Before pasting the data, target SP111:0 and SP112:0 for data collection in the logging setting (Logging ID: 1).	
		Precautions	Do not change the default GOT special registers (GS). Doing so causes the corresponding objects to malfunction.	
4	Parameter1	Library data setting	Setting of the go to screen switch	The setting is configured for No.10004 base screen.
5	Parameter2	Library data setting	Setting of the go to screen switch	The setting is configured for No.10005 base screen.
6	Alarm*1	Library data setting	Used GOT internal device (GB, GD)	• GB131 to 135
			Device requiring to be changed separately from the property sheet	• SP115:0
			Device that is not displayed on the property sheet	Since some devices are used for only the following, the property sheet does not display the devices. • Object script function
			Setting of the go to screen switch	The setting is configured for No.10006 base screen.

\*1 Since the object script is set, the data are not available for the GT12, GT11, and GT10.

(t) FR-F700 of TemplateScreen (VGA)

Do not change the default devices of the inverter. Doing so causes the corresponding objects to malfunction.

Library data		Library data setting/Setting required for the destination project		
No.	Name			
1	Menu	Library data setting	Used GOT internal device (GB, GD)	• GB131 to 135
			Setting of the go to screen switch	The setting is configured for No.10001 base screen.
2	Operation Command/Monitor <sup>*1</sup>	Library data setting	Used GOT internal device (GB, GD)	• GB131 to 135
			Device requiring to be changed separately from the property sheet	• GB131 to 135 • SP122:0
			Device that is not displayed on the property sheet	Since some devices are used for only the following, the property sheet does not display the devices. • Object script function
			Setting of the go to screen switch	The setting is configured for No.10002 base screen.
		Setting required for the destination project	Before pasting the data, target SP111:0 and SP112:0 for data collection in the logging setting (Logging ID: 1).	
3	Graph	Library data setting	Used GOT internal device (GB, GD)	• GD0, GD2, GD10 to 13 • GB131 to 135
			Setting of the go to screen switch	The setting is configured for No.10003 base screen.
		Setting required for the destination project	Before pasting the data, target SP111:0 and SP112:0 for data collection in the logging setting (Logging ID: 1).	
		Precautions	Do not change the default GOT special registers (GS). Doing so causes the corresponding objects to malfunction.	
4	Parameter1	Library data setting	Setting of the go to screen switch	The setting is configured for No.10004 base screen.
5	Parameter2	Library data setting	Setting of the go to screen switch	The setting is configured for No.10005 base screen.
6	Alarm <sup>*1</sup>	Library data setting	Used GOT internal device (GB, GD)	• GB131 to 135
			Device requiring to be changed separately from the property sheet	• SP115:0
			Device that is not displayed on the property sheet	Since some devices are used for only the following, the property sheet does not display the devices. • Object script function
			Setting of the go to screen switch	The setting is configured for No.10006 base screen.

\*1 Since the object script is set, the data are not available for the GT12, GT11, and GT10.



(u) FR-E700 of TemplateScreen (VGA)

Do not change the default devices of the inverter. Doing so causes the corresponding objects to malfunction.

Library data		Library data setting/Setting required for the destination project			
No.	Name				
1	Menu	Library data setting	Used GOT internal device (GB, GD)	• GB131, GB132	
			Setting of the go to screen switch	The setting is configured for No.10001 base screen.	
2	Operation Command/Monitor	Library data setting	Used GOT internal device (GB, GD)	• GB131, GB132	
			Setting of the go to screen switch	The setting is configured for No.10002 base screen.	
		Setting required for the destination project	Before pasting the data, target SP111:0 and SP112:0 for data collection in the logging setting (Logging ID: 1).		
3	Graph	Library data setting	Used GOT internal device (GB, GD)	• GD0, GD2, GD10 to 13 • GB131, GB132	
			Setting of the go to screen switch	The setting is configured for No.10003 base screen.	
		Setting required for the destination project	Before pasting the data, target SP111:0 and SP112:0 for data collection in the logging setting (Logging ID: 1).		
		Precautions	Do not change the default GOT special registers (GS). Doing so causes the corresponding objects to malfunction.		
4	Parameter1	Library data setting	Setting of the go to screen switch	The setting is configured for No.10004 base screen.	
5	Parameter2	Library data setting	Setting of the go to screen switch	The setting is configured for No.10005 base screen.	
6	Alarm*1	Library data setting	Used GOT internal device (GB, GD)	• GB131, GB132	
			Device requiring to be changed separately from the property sheet	• SP115:0	
			Device that is not displayed on the property sheet	Since some devices are used for only the following, the property sheet does not display the devices. • Object script function	
			Setting of the go to screen switch	The setting is configured for No.10006 base screen.	

\*1 Since the object script is set, the data are not available for the GT12, GT11, and GT10.

## (v) FR-D700 of TemplateScreen (VGA)

Do not change the default devices of the inverter. Doing so causes the corresponding objects to malfunction.

Library data		Library data setting/Setting required for the destination project			
No.	Name				
1	Menu	Library data setting	Used GOT internal device (GB, GD)	• GB131, GB132	
			Setting of the go to screen switch	The setting is configured for No.10001 base screen.	
2	Operation Command/Monitor	Library data setting	Used GOT internal device (GB, GD)	• GB131, GB132	
			Setting of the go to screen switch	The setting is configured for No.10002 base screen.	
		Setting required for the destination project	Before pasting the data, target SP111:0 and SP112:0 for data collection in the logging setting (Logging ID: 1).		
3	Graph	Library data setting	Used GOT internal device (GB, GD)	• GD0, GD2, GD10 to 13 • GB131, GB132	
			Setting of the go to screen switch	The setting is configured for No.10003 base screen.	
		Setting required for the destination project	Before pasting the data, target SP111:0 and SP112:0 for data collection in the logging setting (Logging ID: 1).		
		Precautions	Do not change the default GOT special registers (GS). Doing so causes the corresponding objects to malfunction.		
4	Parameter1	Library data setting	Setting of the go to screen switch	The setting is configured for No.10004 base screen.	
5	Parameter2	Library data setting	Setting of the go to screen switch	The setting is configured for No.10005 base screen.	
6	Alarm <sup>*1</sup>	Library data setting	Used GOT internal device (GB, GD)	• GB131, GB132	
			Device requiring to be changed separately from the property sheet	• SP115:0	
			Device that is not displayed on the property sheet	Since some devices are used for only the following, the property sheet does not display the devices. • Object script function	
			Setting of the go to screen switch	The setting is configured for No.10006 base screen.	

\*1 Since the object script is set, the data are not available for the GT12, GT11, and GT10.

(w) H-PCP-J (RKC) of TemplateScreen (VGA)

Do not change the default devices of the temperature controller. Doing so causes the corresponding objects to malfunction.

Library data		Library data setting/Setting required for the destination project		
No.	Name			
1	Monitor	Library data setting	Setting of the go to screen switch	The setting is configured for No.10001 base screen.
		Setting required for the destination project	Before pasting the data, target 0-1 ..0000, 0-1 ..00C8, and 0-1 ..0014 for data collection in the logging setting (Logging ID: 1).	
2	Parameter	Library data setting	Setting of the go to screen switch	The setting is configured for No.10002 base screen.

(x) SDC40A (Azbil) of TemplateScreen (VGA)

Do not change the default devices of the control equipment. Doing so causes the corresponding objects to malfunction.

Library data		Library data setting/Setting required for the destination project		
No.	Name			
1	Monitor	Library data setting	Setting of the go to screen switch	The setting is configured for No.10001 base screen.
		Setting required for the destination project	Before pasting the data, target 0-1 ..506, 0-1 ..1002, and 0-1 ..510 for data collection in the logging setting (Logging ID: 1).	
2	Parameter	Library data setting	Setting of the go to screen switch	The setting is configured for No.10002 base screen.

(y) UT152 (YOKOGAWA) of TemplateScreen (VGA)

Do not change the default devices of the temperature controller. Doing so causes the corresponding objects to malfunction.

Library data		Library data setting/Setting required for the destination project		
No.	Name			
1	Monitor	Library data setting	Setting of the go to screen switch	The setting is configured for No.10001 base screen.
		Setting required for the destination project	Before pasting the data, target 0-1 C1-D0002, 0-1 C1-D0003, and 0-1 C1-D0004 for data collection in the logging setting (Logging ID: 1).	
2	Parameter	Library data setting	Setting of the go to screen switch	The setting is configured for No.10002 base screen.

(z) LT830 (CHINO) of TemplateScreen (VGA)

Do not change the default devices of the controller. Doing so causes the corresponding objects to malfunction.

Library data		Library data setting/Setting required for the destination project		
No.	Name			
1	Monitor	Library data setting	Used GOT internal device (GB, GD)	• GD0, GD2, GD4, GD26 to 29
			Device requiring to be changed separately from the property sheet	• GD0, GD2, GD4
			Setting of the go to screen switch	The setting is configured for No.10001 base screen.
		Setting required for the destination project	Before pasting the data, target 0-1 30101, 0-1 30103, and 0-1 30105 for data collection in the logging setting (Logging ID: 1).	
2	Parameter	Library data setting	Setting of the go to screen switch	The setting is configured for No.10002 base screen.

(aa) FCR-15A (SHINKO TECHNOS) of TemplateScreen (VGA)

Do not change the default devices of the indicating controller. Doing so causes the corresponding objects to malfunction.

Library data		Library data setting/Setting required for the destination project		
No.	Name			
1	Monitor	Library data setting	Used GOT internal device (GB, GD)	• GD0, GD2, GD4, GD10 to 13
			Device requiring to be changed separately from the property sheet	• GD0, GD2, GD4
		Setting of the go to screen switch	The setting is configured for No.10001 base screen.	
		Setting required for the destination project	Before pasting the data, target 0-0 M0/..0080, 0-0 M1/..0001, and 0-0 M0/..0081 for data collection in the logging setting (Logging ID: 1).	
2	Parameter	Library data setting	Setting of the go to screen switch	The setting is configured for No.10002 base screen.

(ab) PXR5 (Fuji Electric) of TemplateScreen (VGA)

Do not change the default devices of the temperature controller. Doing so causes the corresponding objects to malfunction.

Library data		Library data setting/Setting required for the destination project		
No.	Name			
1	Monitor	Library data setting	Setting of the go to screen switch	The setting is configured for No.10001 base screen.
		Setting required for the destination project	Before pasting the data, target 0-1 31001, 0-1 31002, and 0-1 31004 for data collection in the logging setting (Logging ID: 1).	
2	Parameter	Library data setting	Setting of the go to screen switch	The setting is configured for No.10002 base screen.

(ac) Q64TC (MITSUBISHI) of TemplateScreen (VGA)

Do not change the default devices of the temperature controller. Doing so causes the corresponding objects to malfunction.

Library data		Library data setting/Setting required for the destination project		
No.	Name			
1	Monitor	Library data setting	Setting of the go to screen switch	The setting is configured for No.10001 base screen.
		Setting required for the destination project	Before pasting the data, set the following data for data collection in the logging setting. Logging ID1: BM00-9, BM00-34, BM00-13 Logging ID2: BM00-10, BM00-66, BM00-14 Logging ID3: BM00-11, BM00-98, BM00-15 Logging ID4: BM00-12, BM00-130, BM00-16	
2	Graph	Library data setting	Setting of the go to screen switch	The setting is configured for No.10002 base screen.
3	CH1	Library data setting	Used GOT internal device (GB, GD)	• GB40 • GD10 to 12, GD20 to 34
			Device requiring to be changed separately from the property sheet	• GD32 to 34
			Device that is not displayed on the property sheet	Since some devices are used for only the following, the property sheet does not display the devices. • Attributes of figures and objects that are not registered in the template
		Setting of the go to screen switch	The setting is configured for No.10003 base screen.	
		Precautions	Do not change the default GOT special registers (GS). Doing so causes the corresponding objects to malfunction.	

(Continued to next page)

Library data		Library data setting/Setting required for the destination project		
No.	Name			
4	CH2	Library data setting	Used GOT internal device (GB, GD)	<ul style="list-style-type: none"> <li>• GB40</li> <li>• GD40 to 42, GD50 to 64</li> </ul>
			Device requiring to be changed separately from the property sheet	<ul style="list-style-type: none"> <li>• GD62 to 64</li> </ul>
			Device that is not displayed on the property sheet	Since some devices are used for only the following, the property sheet does not display the devices. <ul style="list-style-type: none"> <li>• Attributes of figures and objects that are not registered in the template</li> </ul>
			Setting of the go to screen switch	The setting is configured for No.10004 base screen.
		Precautions	Do not change the default GOT special registers (GS). Doing so causes the corresponding objects to malfunction.	
5	CH3	Library data setting	Used GOT internal device (GB, GD)	<ul style="list-style-type: none"> <li>• GB40</li> <li>• GD70 to 72, GD80 to 94</li> </ul>
			Device requiring to be changed separately from the property sheet	<ul style="list-style-type: none"> <li>• GD92 to 94</li> </ul>
			Device that is not displayed on the property sheet	Since some devices are used for only the following, the property sheet does not display the devices. <ul style="list-style-type: none"> <li>• Attributes of figures and objects that are not registered in the template</li> </ul>
			Setting of the go to screen switch	The setting is configured for No.10005 base screen.
		Precautions	Do not change the default GOT special registers (GS). Doing so causes the corresponding objects to malfunction.	
6	CH4	Library data setting	Used GOT internal device (GB, GD)	<ul style="list-style-type: none"> <li>• GB40</li> <li>• GD100 to 102, GD110 to 124</li> </ul>
			Device requiring to be changed separately from the property sheet	<ul style="list-style-type: none"> <li>• GD122 to 124</li> </ul>
			Device that is not displayed on the property sheet	Since some devices are used for only the following, the property sheet does not display the devices. <ul style="list-style-type: none"> <li>• Attributes of figures and objects that are not registered in the template</li> </ul>
			Setting of the go to screen switch	The setting is configured for No.10006 base screen.
		Precautions	Do not change the default GOT special registers (GS). Doing so causes the corresponding objects to malfunction.	

1	OVERVIEW
2	GT Designer3 SPECIFICATIONS
3	GT Designer3 OPERATION
4	COMMON SETTING
5	EDITING AND SETTING FIGURES AND OBJECTS
6	LIBRARY
7	TEMPLATE

**(10) TemplateScreen (QVGA)**

The data are for the QVGA GOT.

If the resolution of the used template differs from the resolution of the set GOT type, cancel grouping of the figures and the objects in the template on the screen editor, and change their positions and sizes.

**(a) Menu of TemplateScreen (QVGA)**

Library data		Library data setting/Setting required for the destination project	
No.	Name		
1	5-key Horizontal Menu (w/Back)	Setting required for the destination project	Change [Screen No.] of the go to screen switch according to the screen number of the base screen where the library data is pasted.
2	5-key Horizontal Menu (w/o Back)		
3	6-key Vertical Menu (w/Back)		
4	6-key Vertical Menu (w/o Back)		
5	6-key Vertical Menu L (w/Back)		
6	6-key Vertical Menu L (w/o Back)		
7	8-key Main Menu		

**(b) Device Monitor of TemplateScreen (QVGA)**

The displayable range of a device is as follows: 0 to 32769 in decimal and 0000 to 7FFF in hexadecimal.

Library data		Library data setting/Setting required for the destination project		
No.	Name			
1	Device Monitor (Bit Hexadecimal)	Library data setting	Used GOT internal device (GB, GD)	• GD990
			Setting of the go to screen switch	The setting is configured for No. 1501 base screen.
2	Device Monitor (Bit Decimal)	Library data setting	Used GOT internal device (GB, GD)	• GB0 to 9 • GD991
			Setting of the go to screen switch	The setting is configured for No. 1502 base screen.
3	Device Monitor (Word Hexadecimal)	Library data setting	Used GOT internal device (GB, GD)	• GD992
			Setting of the go to screen switch	The setting is configured for No. 1503 base screen.
4	Device Monitor (Word Decimal)	Library data setting	Used GOT internal device (GB, GD)	• GD993
			Setting of the go to screen switch	The setting is configured for No. 1504 base screen.

**(c) Advanced Alarm of TemplateScreen (QVGA)**

For the library data setting and the setting required for the destination project, refer to the following.

 (8) (d) Advanced Alarm of TemplateScreen (XGA)

(d) Historical (Graph+List) of TemplateScreen (QVGA)

Library data		Library data setting/Setting required for the destination project			
No.	Name				
1	Historical Trend Graph (3 pens)	Library data setting	Used GOT internal device (GB, GD)	• GD0 to 2, GD10 to 12, GD20 to 31	
			Setting of the go to screen switch	The setting is configured for No. 1101 base screen.	
		Setting required for the destination project	Before pasting the data, set the logging (Logging ID: 1).		
		Precautions	Do not change the default GOT special registers (GS). Doing so causes the corresponding objects to malfunction.		
2	Historical Trend Graph (3 pens, simple)	Library data setting	Used GOT internal device (GB, GD)	• GD24 to 31	
			Setting of the go to screen switch	The setting is configured for No. 1101 base screen.	
		Setting required for the destination project	Before pasting the data, set the logging (Logging ID: 1).		
11	Historical Data List (5 columns)	Library data setting	Setting of the go to screen switch	The setting is configured for No. 1102 base screen.	
		Setting required for the destination project	Before pasting the data, set the logging (Logging ID: 1).		

(e) Calendar of TemplateScreen (QVGA)

Library data		Library data setting/Setting required for the destination project			
No.	Name				
1	Calendar1*1	Library data setting	Used GOT internal device (GB, GD)	• GB40, GB110 • GD0 to 36, GD9998, GD9999	
			Device requiring to be changed separately from the property sheet	• GB110 • GD0 to 36, GD9998, GD9999	
			Device that is not displayed on the property sheet	Since some devices are used for only the following, the property sheet does not display the devices. • Attributes of figures and objects that are not registered in the template • Object script function	
			Setting of the go to screen switch	The setting is configured for No. 1401 base screen.	
		Precautions	The data from year 2008 to 2037 is displayed. Do not change the default GOT special registers (GS). Doing so causes the corresponding objects to malfunction. Do not use this library data for the screen that is first displayed after GOT startup. Depending on the set operation timing of GB40, the current year and month may not be displayed correctly.		

\*1 Since the object script is set, the data are not available for the GT12, GT11, and GT10.

(f) Clock Data Change of TemplateScreen (QVGA)

For the library data setting and the setting required for the destination project, refer to the following.

 (8) (h) Clock Data Change of TemplateScreen (XGA)

1 OVERVIEW  
2 GT Designer3 SPECIFICATIONS  
3 GT Designer3 OPERATION  
4 COMMON SETTING  
5 EDITING AND SETTING FIGURES AND OBJECTS  
6 LIBRARY  
7 TEMPLATE

(g) # Device Monitor of TemplateScreen (QVGA)

This folder stores library data excluding templates of [Header] and [Screen Switching&Background] from the library data in the [Device Monitor] folder.

The displayable range of a device is as follows: 0 to 32769 in decimal and 0000 to 7FFF in hexadecimal.

Library data		Library data setting/Setting required for the destination project		
No.	Name			
1	Device Monitor (Bit Hexadecimal)	Library data setting	Used GOT internal device (GB, GD)	• GD990
2	Device Monitor (Bit Decimal)	Library data setting	Used GOT internal device (GB, GD)	• GB0 to 9 • GD991
3	Device Monitor (Word Hexadecimal)	Library data setting	Used GOT internal device (GB, GD)	• GD992
4	Device Monitor (Word Decimal)	Library data setting	Used GOT internal device (GB, GD)	• GD993

(h) # Advanced Alarm of TemplateScreen (QVGA)

For the library data setting and the setting required for the destination project, refer to the following.

 (8) (k) # Advanced Alarm of TemplateScreen (XGA)

(i) # Historical (Graph+List) of TemplateScreen (QVGA)

This folder stores library data excluding templates of [Header] and [Screen Switching&Background] from the library data in the [Historical (Graph+List)] folder.

Library data		Library data setting/Setting required for the destination project		
No.	Name			
1	Historical Trend Graph (3 pens)	Library data setting	Used GOT internal device (GB, GD)	• GD0 to 2, GD10 to 12, GD20 to 31
		Setting required for the destination project	Before pasting the data, set the logging (Logging ID: 1).	
		Precautions	Do not change the default GOT special registers (GS). Doing so causes the corresponding objects to malfunction.	
2	Historical Trend Graph (3 pens, simple)	Library data setting	Used GOT internal device (GB, GD)	• GD24 to 31
		Setting required for the destination project	Before pasting the data, set the logging (Logging ID: 1).	
11	Historical Data List (5 columns)	Setting required for the destination project	Before pasting the data, set the logging (Logging ID: 1).	



## 7.2 Creating a Screen by Using a Template

This section explains how to create a screen by using a template.

### 7.2.1 Using a template in the library

#### ■ Before using a template

Some templates require settings (including the settings of the controller and the go to screen switch) in the project where the templates are used.

For the settings required for using the templates in the system library, refer to the following.

 7.1.2 Templates in the system library

To use a template that is edited by the user, check the template settings and configure the setting required for the project.

The following shows the settings required for the project.

#### (1) Controller setting

Before pasting a template, configure the controller setting in the [Controller Setting] dialog box.

 GOT1000 Series Connection Manual for GT Works3 and a controller used

When the pasted template setting does not match the controller setting, the device setting is changed as shown below.

- The device name is changed to the device name in the controller setting.
- When the device in the template setting is invalid for the controller set in the controller setting (For example, the type of the device is nonexistent, and the device is outside the setting range.), the device is displayed as [??].

When a controller that differs from the one set in the template setting is specified, check and set the device again.

#### (2) Common setting

To paste a template containing the advanced user alarm display, the historical trend graph, and others, configure the settings required for the objects in common (including the advanced user alarm observation and the logging).

#### (3) Setting of the go to screen switch

After pasting a template, according to the screen number of the destination base screen, check and set [Screen No.] of the go to screen switch again.

 (Functions) 2.5 Go to screen switch

#### HINT



#### (1) How to check the presence or absence of a template

In [My Library], the library data do not show if they contain a template.

Paste the library data on the screen editor, and check if the template information boxes appear.

 7.1 ■ Template information boxes on the screen editor

#### (2) Template and grouping

To change the position and the size of the figures and the objects on a template, cancel grouping of the figures and the objects.

Doing so does not cancel the registration of the figures and the objects in the template.

The template information box remains displayed.

## ■ Using a template in the library

1. Select [View] → [Docking Window] → [Library List]/[Library List (Template)] from the menu to display the library list window.  
(When [Library List (Template)] is selected, the library list window appears with the [TemplateScreen (VGA)] folder in the system library opened.)  
For how to use the library, refer to the following.

### ☞ 6. LIBRARY

2. In the library list window, click the template library data to be used.
3. Click the screen editor to paste the library data.  
Depending on the pasted data, the [Select CH No.] dialog box can appear.

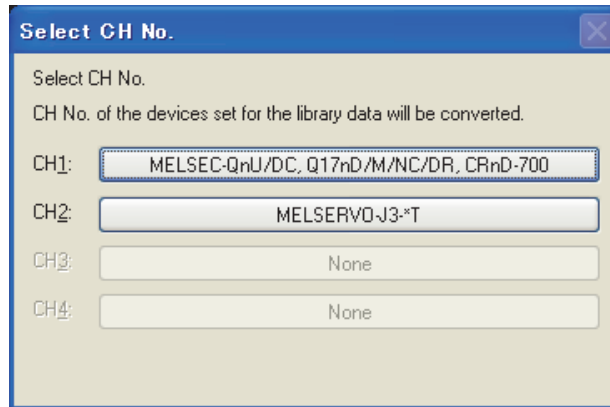

Select the channel of the controller to be monitored.

Depending on the selected channel of controller, the controller devices used in the template are changed as shown below.

- The device names are changed to the corresponding device names set in the selected channel of controller.
- When the devices are invalid for the selected channel of controller (For example, the types of the devices are nonexistent, and the devices are outside the setting range.), the devices are displayed as [??].

When the channel of controller that differs from the one set in the template setting is selected, check and set the devices again.

## 7.2.2 Checking the settings in a template

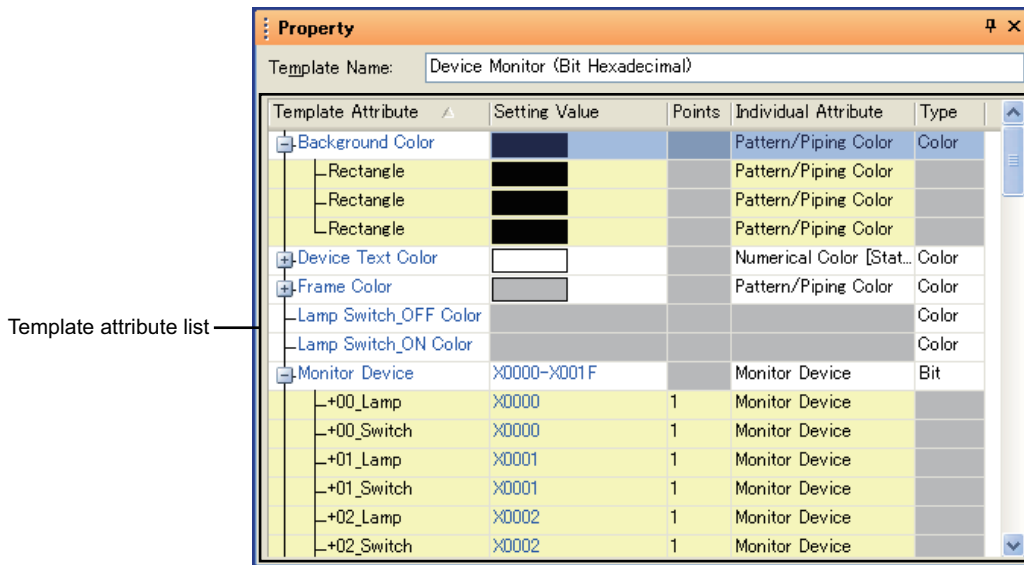

This section explains how to check the attributes of the figures and the objects that are registered in a template.

1. Perform one of the following operations to display the template name and the template attributes on the property sheet. (All the figures and the objects that are registered in the template are selected on the screen editor.)
  - On the screen editor or the data browser, double-click the template information box.
  - On the screen editor, right-click the template information box and select [Display Template Property] from the menu.
  - On the screen editor or the data browser, select the template information box or a figure/object registered in the template, and then on the property sheet, click the [Template Property] button.
2. Check and change the settings in the attributes of the figures and the objects.



Item	Description	Model																				
Template Name	Displays the template name. The template name can be changed. Up to 128 two-byte and one-byte characters can be input.																					
Template attribute list	<p>The template attributes are displayed in a tree view, and the attributes of the figures and the objects are positioned under the template attribute hierarchy.</p> <p>Template attribute rows: Created template attribute</p> <table border="1"> <thead> <tr> <th>Template Attribute</th> <th>Setting Value</th> <th>Points</th> <th>Individual Attribute</th> <th>Type</th> </tr> </thead> <tbody> <tr> <td>Background Color</td> <td></td> <td></td> <td>Pattern/Piping Color</td> <td>Color</td> </tr> <tr> <td>  Rectangle</td> <td></td> <td></td> <td>Pattern/Piping Color</td> <td></td> </tr> <tr> <td>  Rectangle</td> <td></td> <td></td> <td>Pattern/Piping Color</td> <td></td> </tr> </tbody> </table> <p>Figure/object attribute rows: Attributes of the figures or objects belonging to the template attribute</p> <p>Click a column header to sort the list by the column item. The list is sorted in ascending or descending order. If the list is not sorted, the items in the list are displayed in order of the items that are set in [Template Attribute List] in the [Edit Template Attribute] dialog box.</p> <p>Select a row to select the corresponding figure or object on the screen editor. (The handle of the figure or object is displayed in red.)</p> <p>Select a template attribute row to select all the figures and objects that belong to the template attribute on the screen editor. Grouped figures and objects are displayed as shown below.</p> <p>Handle indicating a grouping of figures and objects</p> <p>Handle indicating the selected figure or object</p> <p>Double-click a figure/object attribute row to display the corresponding setting dialog box.</p>	Template Attribute	Setting Value	Points	Individual Attribute	Type	Background Color			Pattern/Piping Color	Color	Rectangle			Pattern/Piping Color		Rectangle			Pattern/Piping Color		<p>GT16 GT15 GT14 GT12 GT11 GT10 SoftGT1000</p>
Template Attribute	Setting Value	Points	Individual Attribute	Type																		
Background Color			Pattern/Piping Color	Color																		
Rectangle			Pattern/Piping Color																			
Rectangle			Pattern/Piping Color																			

(Continued to next page)

Item	Description		Model
Template attribute list	Template Attribute	<p>A template attribute row displays the template attribute name.            The template attribute name can be changed.            Up to 128 two-byte and one-byte characters can be input.            A figure/object attribute row displays the figure type or the object name.            The object name can be changed in the corresponding setting dialog box.            (When [Object Name] is not specified, the object type appears in the corresponding object row.)</p>	
	Setting Value	<p>In a template attribute row, when the template attribute satisfies the conditions for the batch edit, the setting value field is displayed in white.            When the template attribute does not satisfy the conditions, the setting value field is displayed in gray.            A figure/object attribute row displays the setting value of the figure or object.            For the conditions for the batch edit and how to change the setting values, refer to the following.   7.2.3 Changing the setting value in the attribute of a figure or object</p>	
	Points	<p>Displays the number of contiguous devices when [Bit] or [Word] is set for [Type].            Displays the number of consecutive numbers when [Type] is set to [Number] in the figure/object attribute that is affected by the continuous/random setting of the figure/object.</p>	
	Individual Attribute	<p>A template attribute row displays the attribute names of the figures and the objects that belong to the template attribute.            A figure/object attribute row displays the attribute name of the figure or object.            When a condition is set for the figure or object, the attribute name and the condition are displayed.</p>	
	Type	<p>Displays the types of the template attributes.</p>	

## 7.2.3 Changing the setting value in the attribute of a figure or object

The section explains how to change the setting value in the attribute of a figure or object on the property sheet. For how to display the template setting on the property sheet, refer to the following.

 7.2.2 Checking the settings in a template

### POINT

#### (1) Editing a template attribute

For how to edit a template attribute, refer to the following.

 7.3.3 Editing a template attribute

#### (2) Registering a template to the library

By registering a template with the changed setting value of a figure/object attribute, the user can use the template to create another screen. For how to register a template to the library, refer to the following.

 7.3.4 Registering a template in the library

### Batch edit by the type of template attribute

By changing the setting value in a template attribute row on the property sheet, the setting values in the attributes of the figures and objects belonging to the template attribute can be changed in a batch.

The following shows the batch edit patterns by the type.

#### (1) Bit and word

By changing the smallest device number (setting value), the setting values in the attributes of the figures and objects can be changed in a batch with the same space as before the change between the devices.

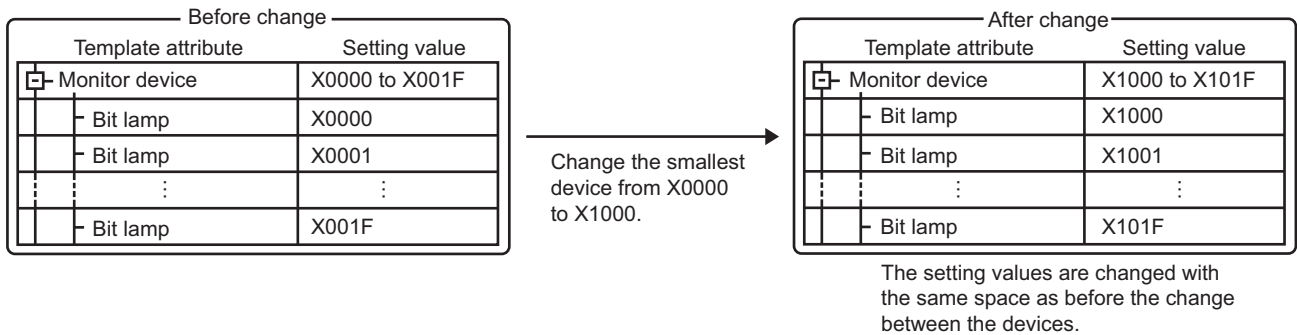

The device names can also be changed in a batch.

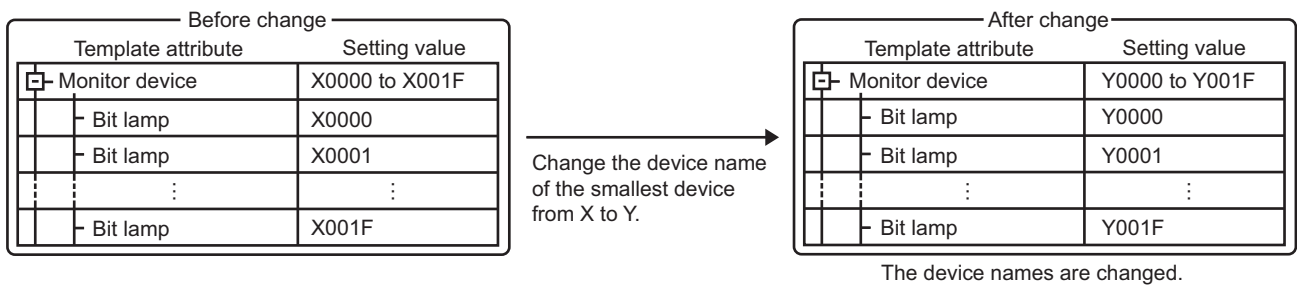

The batch edit is available when the following conditions are satisfied.

- The setting values of all the attributes specify the devices of one controller. The same network number, station number, and CPU number must be set in each device setting.
- The setting values of all the attributes specify the devices with the same device name.

The batch edit is available even though the attributes have different data formats. To change the setting values of all the attributes to one device, change the setting value of each attribute separately.

 ■ Changing the setting values in the figure/object attributes one by one

**(2) Number**

By changing the smallest value (setting value), the setting values in the attributes of the figures and objects can be changed in a batch with the same space as before the change between the values.

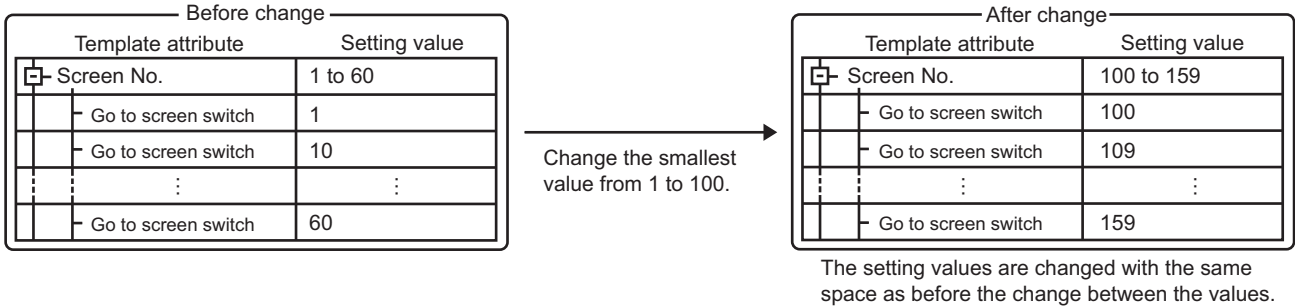

To change the setting values of all the attributes to one value, change the setting values separately.

 ■ Changing the setting values in the figure/object attributes one by one

**(3) Text**

The setting values of all the attributes can be changed to one text in a batch.

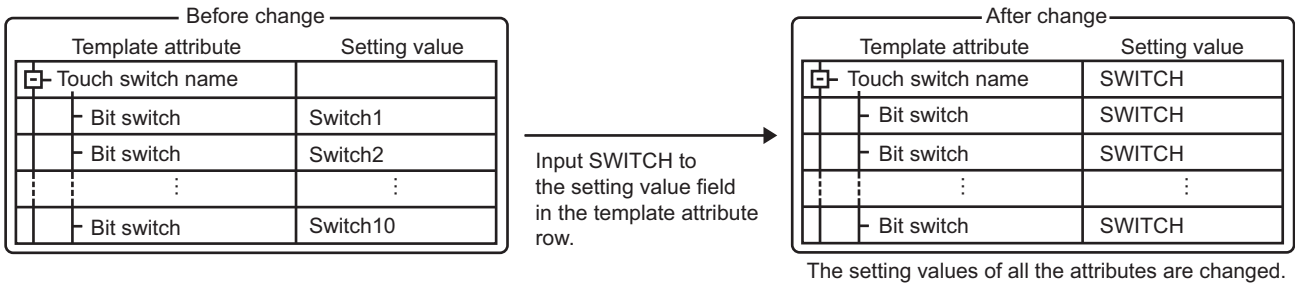

In the setting value field in a template attribute row, the maximum number of characters is the largest maximum number of characters among the figure/object attributes belonging to the template attribute. The setting value fields in the figure/object rows have the maximum number of characters on their own.

**(4) Color**

The setting values of all the attributes can be changed to one color in a batch.

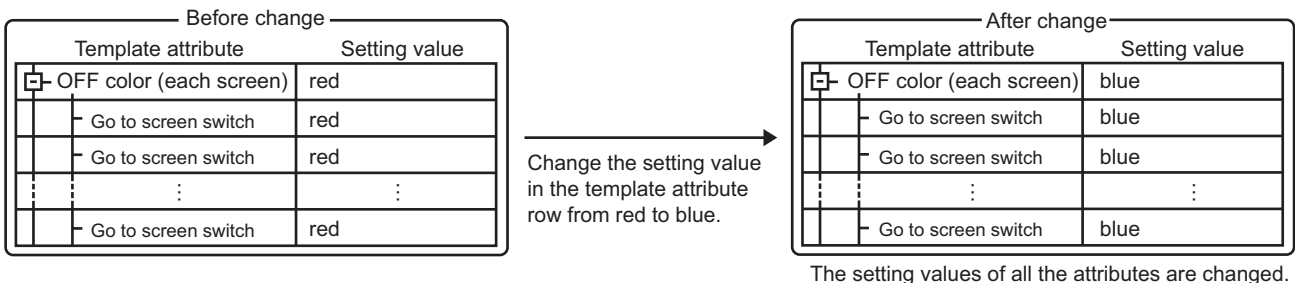

Since the color setting methods differ in the following attributes, the batch edit is not available when a template attribute includes the following attributes.

- Text color of a switch, lamp, and others
- Color of a touch switch and others with a shape selected from the system library (Color system switching)
- Text color of a logo text (Filled effect)

**(5) Shape, font, and text size**

The setting values of all the attributes can be changed to one setting value in a batch.  
 Example) When the type is set to the text size

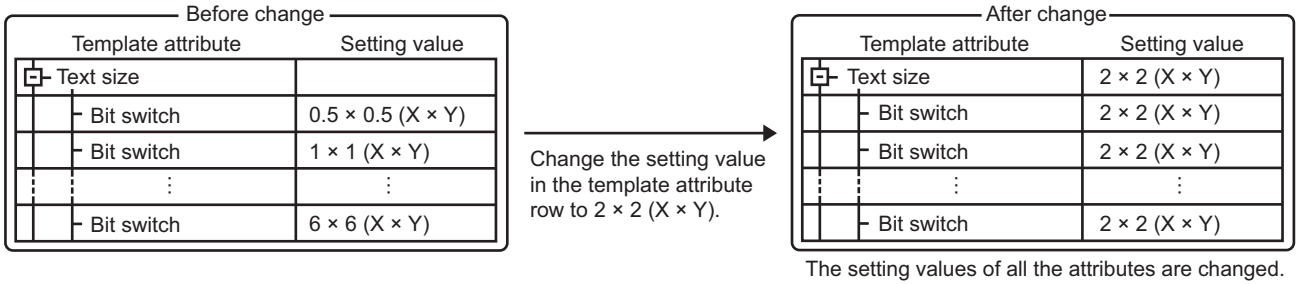

The batch edit is available only when the figure/object attributes have the same setting range.

**■ Procedure of the batch edit**

The following explains an example when the template attribute specifies the word for the type and the figure/object attributes belonging to the template attribute specify the same device name of device.

1. Change the setting value in the template attribute row.

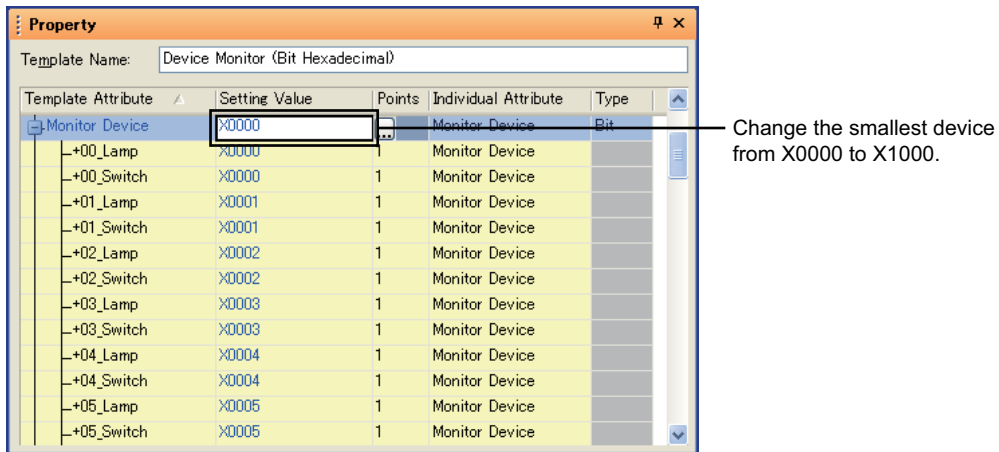

2. The setting values in the figure/object attributes belonging to the template attribute are changed.

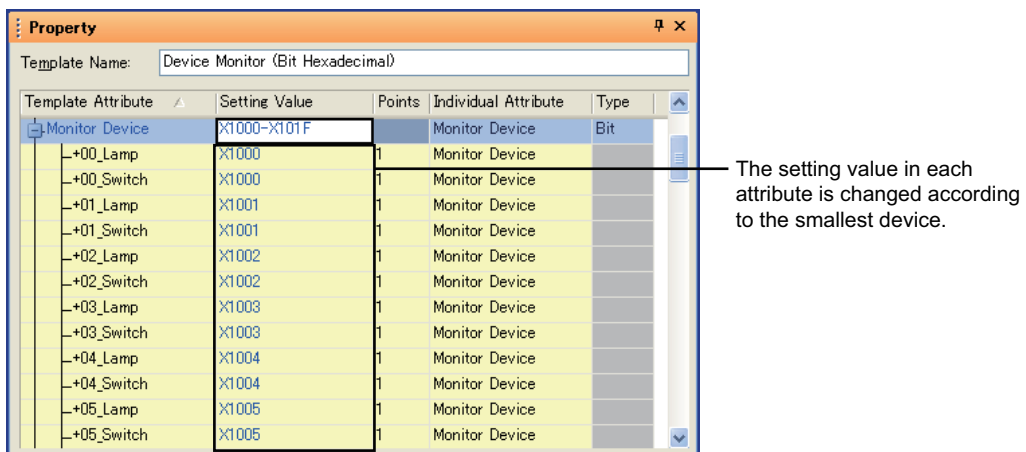

The batch edit processes the setting value outside the input range as an error.  
 The setting values displayed under the error figure/object attribute row are not changed.

## ■ Changing the setting values in the figure/object attributes one by one

By changing the settings in figure/object attribute rows one by one, the setting values can be changed for each figure/object attribute.

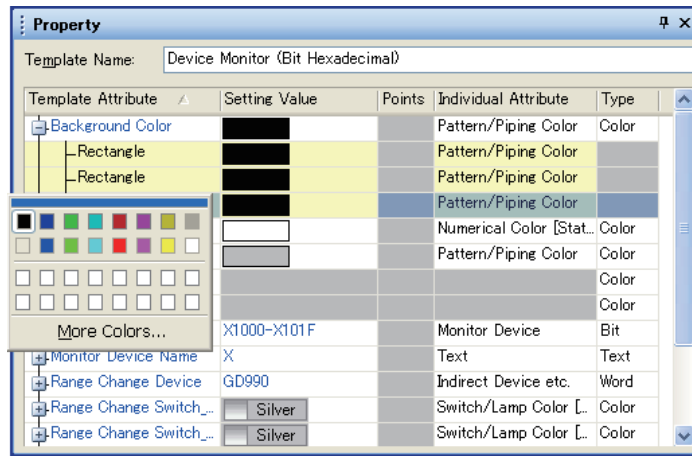

When [Type] is set to [Shape], change the setting value in the [Image List] dialog box. For how to configure the setting in the [Image List] dialog box, refer to the following.

☞ 5.3.3 Shape setting



## 7.3 Creating or Editing a Template

This section explains how to create a template.

### 7.3.1 Registering a figure or object to a template

This section explains how to register a figure or object to a template.

1. On the screen editor, select a figure or object to be registered in a template.
2. Perform one of the following operations to display the [Register To Template] dialog box.
  - Select [Edit] → [Template Registration] → [Register to Template] from the menu.
  - Right-click the figure or object, and select [Template Registration] → [Register to Template] from the menu.
3. Select a template where the figure or object is registered, and click the [OK] button.

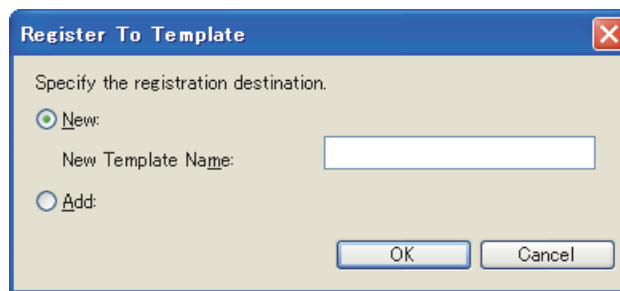

Item	Description	Model									
New	Select this item to register the figure or object to a new template. If the screen editor has no template, this item is not displayed.										
	<table border="1"> <tr> <td>New Template Name</td> <td>Set the name of a new template. Up to 128 two-byte and one-byte characters can be input.</td> </tr> </table>	New Template Name	Set the name of a new template. Up to 128 two-byte and one-byte characters can be input.	<table border="1"> <tr> <td>GT16</td> <td>GT15</td> </tr> <tr> <td>GT14</td> <td>GT12</td> </tr> <tr> <td>GT11</td> <td>GT10</td> </tr> <tr> <td colspan="2">SOPGT1000</td> </tr> </table>	GT16	GT15	GT14	GT12	GT11	GT10	SOPGT1000
New Template Name	Set the name of a new template. Up to 128 two-byte and one-byte characters can be input.										
GT16	GT15										
GT14	GT12										
GT11	GT10										
SOPGT1000											
Add	Select this item to register the figure or object to an existing template. Select an existing template where the figure or object is registered. If the screen editor has no template, this item is not displayed.										

4. The [Edit Template Attribute] dialog box appears.  
Edit the template attributes and click the [OK] button to complete the registration to the template.  
If a new template is created, the screen editor displays the template information box.  
For how to edit the template attributes in the [Edit Template Attribute] dialog box, refer to the following.

 7.3.3 Editing a template attribute

### 7.3.2 Deleting a figure or object from a template

This section explains how to delete a figure or object from a template.

1. On the screen editor, select a figure or object to be deleted from the template.
2. Perform one of the following operations to delete the selected figure or object from the template.
  - Select [Edit] → [Template Registration] → [Deregister from Template] from the menu.
  - Right-click the figure or object, and select [Template Registration] → [Deregister from Template] from the menu.

### 7.3.3 Editing a template attribute

Edit a template attribute in the [Edit Template Attribute] dialog box.

For how to create a template attribute and to register a figure/object attribute, refer to the following.

- Creating a template attribute
- Registering a figure/object attribute to a template attribute
- Deleting a template attribute or deleting a figure/object attribute from a template attribute





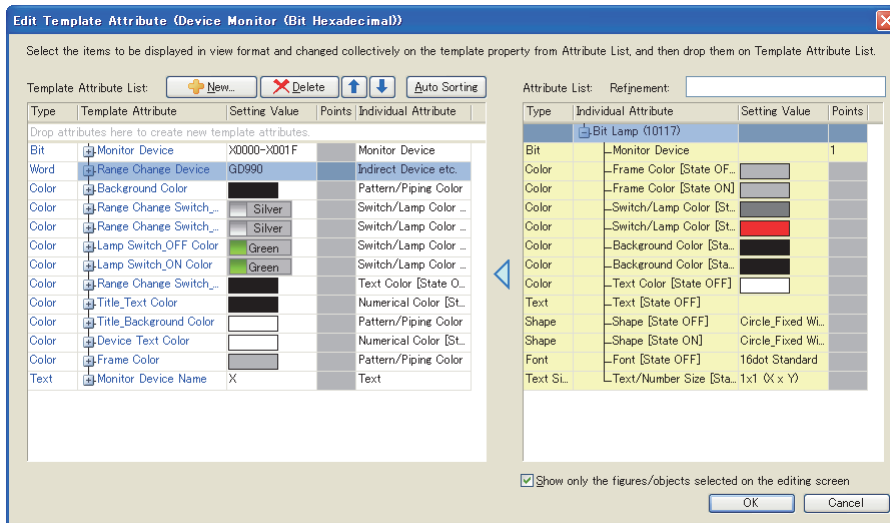

The following shows how to display the [Edit Template Attribute] dialog box.

1. On the screen editor, select the template information box or a figure/object in the template.
2. Perform one of the following operations to display the [Edit Template Attribute] dialog box.
  - Select [Edit] → [Edit Template Attribute] from the menu.
  - Right-click the figure/object, and select [Edit Template Attribute] from the menu.
3. Edit a template attribute and click the [OK] button to confirm changes.



Item	Description	Model																									
Template Attribute List	<p>The registered figure/object attributes are displayed by template attribute in a tree view.</p> <p>Template attribute rows: Created template attribute</p> <table border="1"> <thead> <tr> <th>Type</th> <th>Template Attribute</th> <th>Setting Value</th> <th>Points</th> <th>Individual Attribute</th> </tr> </thead> <tbody> <tr> <td colspan="5">Drop attributes here to create new template attributes.</td> </tr> <tr> <td>Color</td> <td>Title_Background Color</td> <td></td> <td></td> <td>Pattern/Piping Color</td> </tr> <tr> <td></td> <td>Rectangle</td> <td></td> <td></td> <td>Pattern/Piping Color</td> </tr> <tr> <td></td> <td>Rectangle</td> <td></td> <td></td> <td>Pattern/Piping Color</td> </tr> </tbody> </table> <p>Figure/object attribute rows: Attributes of the figures or objects belonging to the template attribute</p> <p>Drag a figure/object attribute from [Attribute List] to [Template Attribute List] to register the attribute in a template attribute.</p> <p>Up to 255 template attributes can be set for one template.</p> <p>Up to 5000 figure/object attributes can be registered in one template attribute.</p> <p>Select a cell to display the cursor and to select its row.</p> <p>Select a row to select the corresponding figure or object on the screen editor. (The handle of the figure or object is displayed in red.)</p> <p>Select a template attribute row to select all the figures and objects that belong to the template attribute on the screen editor.</p> <p>Grouped figures and objects are displayed as shown below.</p> <p>Handle indicating a grouping of figures and objects</p> <p>Handle indicating the selected figure or object</p>	Type	Template Attribute	Setting Value	Points	Individual Attribute	Drop attributes here to create new template attributes.					Color	Title_Background Color			Pattern/Piping Color		Rectangle			Pattern/Piping Color		Rectangle			Pattern/Piping Color	<p>gr16 gr15</p> <p>gr14 gr12</p> <p>gr11 gr10</p> <p>SoftGOT1000</p>
Type	Template Attribute	Setting Value	Points	Individual Attribute																							
Drop attributes here to create new template attributes.																											
Color	Title_Background Color			Pattern/Piping Color																							
	Rectangle			Pattern/Piping Color																							
	Rectangle			Pattern/Piping Color																							

(Continued to next page)

Item	Description		Model
Template Attribute List	Type	Displays the types of the template attributes. The types can be changed. When the type of a template attribute is changed, the figure/object attributes belonging to the template attribute are deleted.	
	Template Attribute	A template attribute row displays the template attribute name. The template attribute name can be changed. Up to 128 two-byte and one-byte characters can be input. A figure/object attribute row displays the figure type or the object name. The object name can be changed in the corresponding setting dialog box. (When [Object Name] is not specified, the object type appears in the corresponding object row.)	
	Setting Value	Displays the set values. The set values cannot be changed.	
	Points	Displays the number of contiguous devices when [Bit] or [Word] is set for [Type]. Displays the number of consecutive numbers when [Type] is set to [Number] in the figure/object attribute that is affected by the continuous/random setting of the figure/object.	
	Individual Attribute	A template attribute row displays the attribute names of the figures and the objects that belong to the template attribute. A figure/object attribute row displays the attribute name of the figure or object. When a condition is set for the figure or object, the attribute name and the condition are displayed.	
	Creates a template attribute. Click this button to display the [Template Attribute] dialog box.  ■Creating a template attribute		
	Deletes the attribute selected in [Template Attribute List] from the list. If a template attribute row is selected, the selected template attribute and the figure/object attributes belonging to the template attribute are deleted. If a figure/object attribute row is selected, the selected figure/object attribute is deleted from its template attribute.		
	Moves up/down the row selected in [Template Attribute List]. The selected template attribute row moves by one template attribute. The selected figure/object attribute row moves by one figure/object attribute. If multiple rows are selected, the selected rows move collectively. If a template attribute row and a figure/object attribute row are selected together, they cannot move.		
	Classifies all the figure/object attributes displayed in [Attribute List] by [Setting Value] and automatically registers the attributes to new template attributes. The batch edit conditions differ according to [Type].		

(Continued to next page)

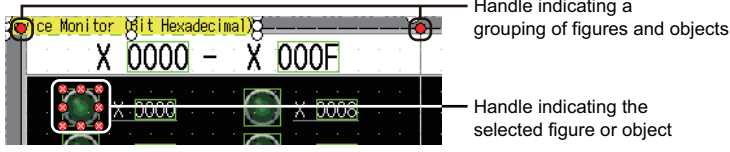
Item	Description	Model																																				
Attribute List	<p>Lists the figures/objects registered in the template or the figures/objects selected on the screen editor for registration to the template.</p> <p>The figure/object attributes that can be registered in template attributes are displayed by figure/object in a tree view.</p> <p>Figure/object row: Figure/object registered in the template or figure/object selected on the screen editor for registration to the template</p> <table border="1" data-bbox="539 421 1034 560"> <thead> <tr> <th>Type</th> <th>Individual Attribute</th> <th>Setting Value</th> <th>Points</th> </tr> </thead> <tbody> <tr> <td></td> <td>Rectangle</td> <td></td> <td></td> </tr> <tr> <td>Color</td> <td>Line Color</td> <td></td> <td></td> </tr> <tr> <td>Color</td> <td>Pattern/Piping Color</td> <td></td> <td></td> </tr> <tr> <td>Color</td> <td>Pattern Background C...</td> <td></td> <td></td> </tr> </tbody> </table> <p>Attribute rows: Figure/object attributes</p> <p>Click a column header to sort the list by the column item.</p> <p>Select a row to select the corresponding figure or object on the screen editor. (The handle of the figure or object is displayed in red.)</p> <p>Grouped figures and objects are displayed as shown below.</p>  <p>The text of a figure/object attribute registered in a template attribute is displayed in gray.</p> <table border="1" data-bbox="507 896 1329 1361"> <thead> <tr> <th>Type</th> <th>Description</th> </tr> </thead> <tbody> <tr> <td>Individual Attribute</td> <td>Displays the types of the figure/object attributes.  A figure/object row displays the figure type, or the object name and the object ID. The object name can be changed in the corresponding setting dialog box. (When [Object Name] is not specified, the object type appears in the corresponding object row.) An attribute row displays the figure/object attribute name. When a condition is set for the figure or object, the attribute name and the condition are displayed.</td> </tr> <tr> <td>Setting Value</td> <td>Displays the values set for the figure/object attributes. The set values cannot be changed.</td> </tr> <tr> <td>Points</td> <td>Displays the number of contiguous devices when [Bit] or [Word] is set for [Type]. Displays the number of consecutive numbers when [Type] is set to [Number] in the figure/object attribute that is affected by the continuous/random setting of the figure/object.</td> </tr> </tbody> </table>	Type	Individual Attribute	Setting Value	Points		Rectangle			Color	Line Color			Color	Pattern/Piping Color			Color	Pattern Background C...			Type	Description	Individual Attribute	Displays the types of the figure/object attributes.  A figure/object row displays the figure type, or the object name and the object ID. The object name can be changed in the corresponding setting dialog box. (When [Object Name] is not specified, the object type appears in the corresponding object row.) An attribute row displays the figure/object attribute name. When a condition is set for the figure or object, the attribute name and the condition are displayed.	Setting Value	Displays the values set for the figure/object attributes. The set values cannot be changed.	Points	Displays the number of contiguous devices when [Bit] or [Word] is set for [Type]. Displays the number of consecutive numbers when [Type] is set to [Number] in the figure/object attribute that is affected by the continuous/random setting of the figure/object.	<div style="text-align: right;"> <table border="1"> <tr><td>gr16</td><td>gr15</td></tr> <tr><td>gr14</td><td>gr12</td></tr> <tr><td>gr11</td><td>gr10</td></tr> <tr><td colspan="2">SoftGOT1000</td></tr> </table> </div>	gr16	gr15	gr14	gr12	gr11	gr10	SoftGOT1000	
Type	Individual Attribute	Setting Value	Points																																			
	Rectangle																																					
Color	Line Color																																					
Color	Pattern/Piping Color																																					
Color	Pattern Background C...																																					
Type	Description																																					
Individual Attribute	Displays the types of the figure/object attributes.  A figure/object row displays the figure type, or the object name and the object ID. The object name can be changed in the corresponding setting dialog box. (When [Object Name] is not specified, the object type appears in the corresponding object row.) An attribute row displays the figure/object attribute name. When a condition is set for the figure or object, the attribute name and the condition are displayed.																																					
Setting Value	Displays the values set for the figure/object attributes. The set values cannot be changed.																																					
Points	Displays the number of contiguous devices when [Bit] or [Word] is set for [Type]. Displays the number of consecutive numbers when [Type] is set to [Number] in the figure/object attribute that is affected by the continuous/random setting of the figure/object.																																					
gr16	gr15																																					
gr14	gr12																																					
gr11	gr10																																					
SoftGOT1000																																						
Refinement	<p>Enter a keyword to narrow down the items displayed in [Attribute List].</p> <p>To narrow down the displayed items with multiple keywords, separate the keywords with one-byte spaces.</p> <p>The keywords are case-insensitive.</p> <p>Up to 128 two-byte and one-byte characters can be input.</p> <p>To cancel the refinement, delete the keywords.</p>																																					
Show only the figures/objects selected on the editing screen	<p>Select this item to display the attributes of the figure or object only selected on the screen editor in [Attribute List].</p> <p>This item is not displayed when a new template is created and the [Edit Template Attribute] dialog box is displayed.</p>																																					



### Operations with a mouse and a keyboard

The following shows operations with a mouse and a keyboard in [Template Attribute List] and [Attribute List].

#### (1) Operations when the data are listed

Operation	Template Attribute List	Attribute List
Arrow (up, down)	Moves the cursor.	Moves up/down the focus.
Arrow (left)		<ul style="list-style-type: none"> <li>When a figure/object row is selected Collapses the selected row. The focus moves up when the selected row is already collapsed.</li> <li>When an attribute row is selected Moves up the focus to the figure/object row.</li> </ul>
Arrow (right)		<ul style="list-style-type: none"> <li>When a figure/object row is selected Expands the selected row. The focus moves down when the selected row is already expanded.</li> <li>When an attribute row is selected Moves down the focus.</li> </ul>
Shift + Arrow (up, down)	Moves the cursor while selecting the row where the cursor is positioned. The destination row of the cursor is also selected.	Moves the focus while selecting the row with the focus. The destination row of the focus is also selected.
+	Expands the selected row.	
-	Collapses the selected row.	
Shift + Plus sign(+)	Expands all the rows in the tree.	
Shift + Minus sign(-)	Collapses all the rows in the tree.	
Home	Moves the cursor to the top row.	Selects the top row.
End	Moves the cursor to the bottom row.	Selects the bottom row.
PageUp	Moves the cursor up one page.	Moves the focus up one page.
PageDown	Moves the cursor down one page.	Moves the focus down one page.
Shift + Home	Selects the rows from the row where the cursor is positioned to the top row.	Selects the rows from the row with the focus to the top row.
Shift + End	Selects the rows from the row where the cursor is positioned to the bottom row.	Selects the rows from the row with the focus to the bottom row.
Shift + PageUp	Selects the rows from the row where the cursor is positioned to the row where the cursor moves up one page.	Selects the rows from the row with the focus to the row where the focus moves up one page.
Shift + PageDown	Selects the rows from the row where the cursor is positioned to the row where the cursor moves down one page.	Selects the rows from the row with the focus to the row where the focus moves down one page.
Ctrl + Space	Selects or deselects a row.	
Ctrl + Left mouse button		
F2	Places the cell at the cursor into edit mode.	-
Drag	<ul style="list-style-type: none"> <li>Drag from [Attribute List] to [Template Attribute List] Registers the dragged figure/object attribute to a template attribute.</li> <li>Drag from [Template Attribute List] to [Attribute List] Deletes the dragged figure/object attribute from the template attribute.</li> </ul>	

#### (2) Operations when the data is edited ([Template Attribute List] only)

[Type] and [Template Attribute] in the template attribute rows can be edited.

Operation	Template Attribute List
Enter	Confirms and ends the edits.
Esc	Cancels and ends the edits.

## ■ Creating a template attribute

1. Click the [New] button to display the [Template Attribute] dialog box.

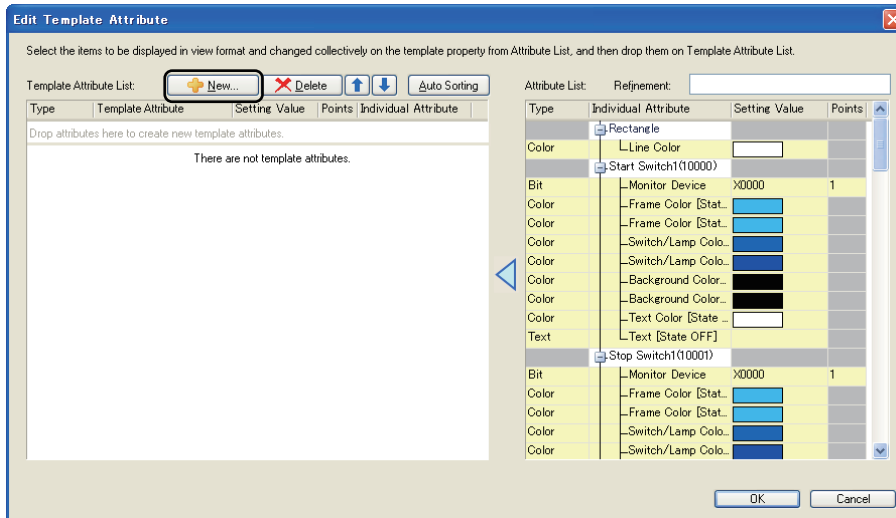

2. Set [Type] and [Template Attribute Name], and click the [OK] button.

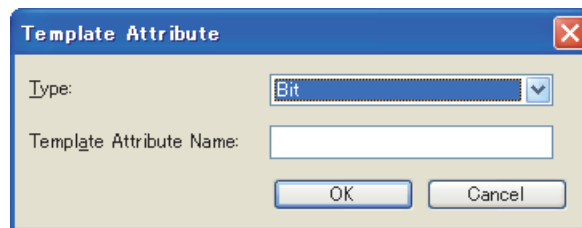

Item	Description	Model
Type	Select the type of the template attribute to be created.	gr16 gr15 gr14 gr12
Template Attribute Name	Set the template attribute name. Up to 128 two-byte and one-byte characters can be input.	gr11 gr10 Softcor1000

3. The template attribute is created in [Template Attribute List].



### Automatically creating template attributes

The [Auto Sorting] button classifies the figure/object attributes in [Attribute List] into new template attributes. Creating the new template attributes and registering the figure/object attributes are automatically performed. Only the figure/object attributes displayed in [Attribute List] are registered in the new template attributes that are created automatically. By using [Refinement] or others, the figure/object attributes affected by [Auto Sorting] can be changed.

## ■ Registering a figure/object attribute to a template attribute

1. In [Attribute List], select a figure/object attribute to be registered to a template attribute, and drag the figure/object attribute to [Template Attribute List].

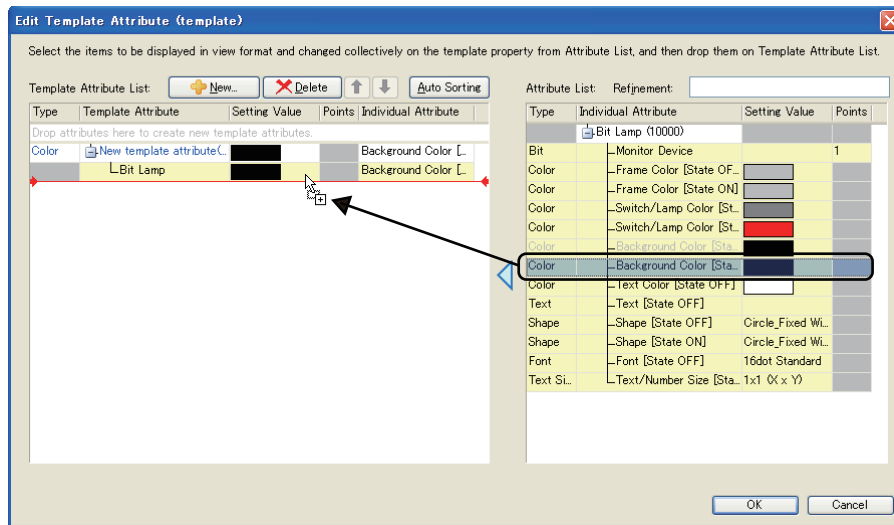

2. The selected figure/object attribute is registered to the template attribute. If the figure/object attribute is dragged to [Drop attributes here to create new template attributes.], a new template attribute is automatically created and the figure/object attribute is registered to the template attribute. The text of a figure/object attribute registered in a template attribute is displayed in gray in [Attribute List].

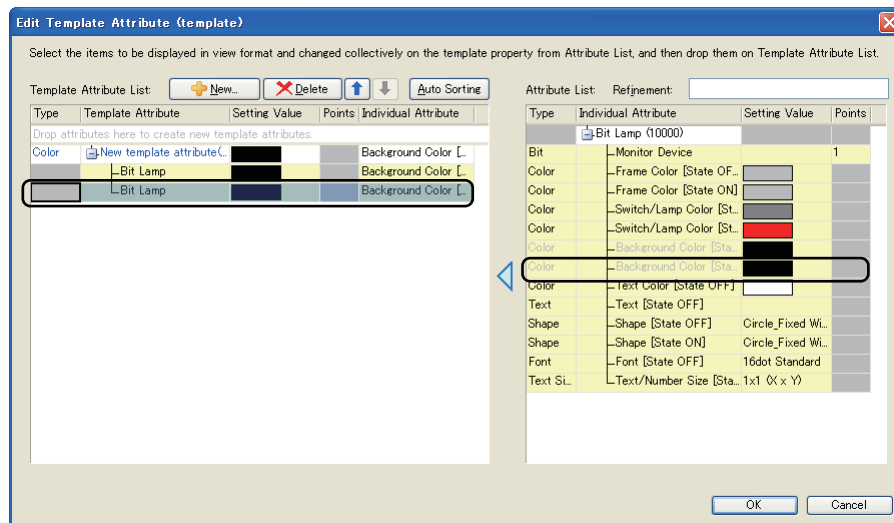

### Batch edit of the setting values for the figure/object attributes

When the figure/object attributes, whose types are the same, are registered in one template attribute, the setting values for the figure/object attributes can be changed in a batch on the property sheet. For the conditions for the batch edit, refer to the following.

➔ 7.2.3 Changing the setting value in the attribute of a figure or object

## ■ Deleting a template attribute or deleting a figure/object attribute from a template attribute

1. In [Template Attribute List], select a template attribute or a figure/object attribute to be deleted, and perform one of the following operations.
  - Click the [Delete] button.
  - Drag the attribute from [Template Attribute List] to [Attribute List].

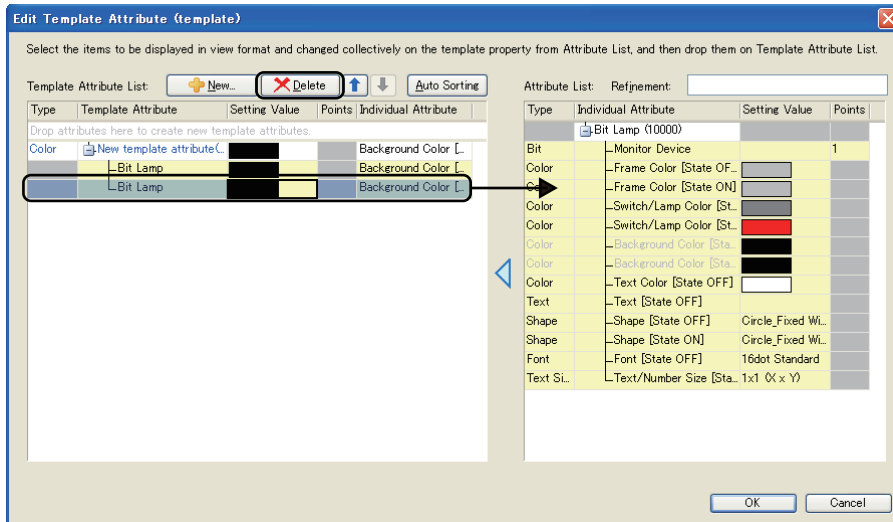

2. The selected attribute is deleted from [Template Attribute List].  
If a template attribute is deleted, the figure/object attributes belonging to the template attribute are also deleted. The text of the figure/object attribute deleted from a template attribute is displayed in black in [Attribute List].

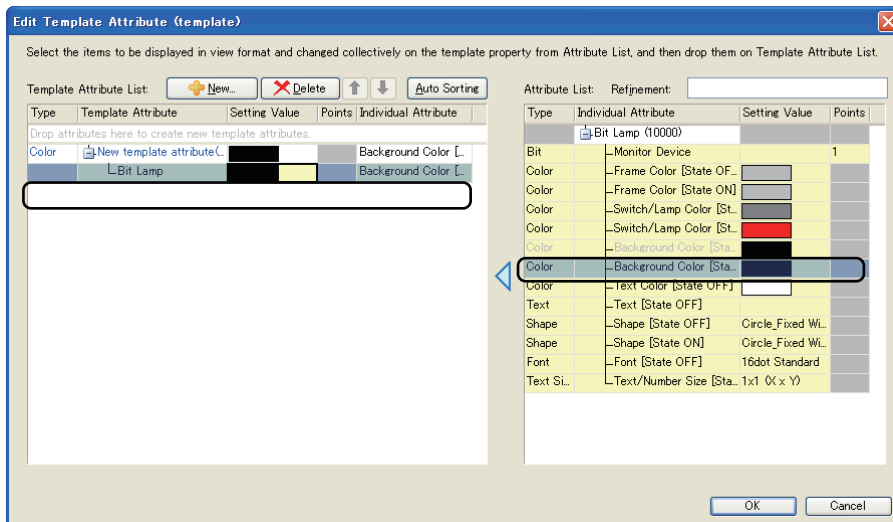



## 7.3.4 Registering a template in the library

This section explains how to register an edited template in the library.

1. Select [View] → [Docking Window] → [Library List] from the menu to display the library list window.
2. In the library list window, display the folder where the template is registered. The template can be registered in library folders of [My Favorites] and [My Library]. To register the template in [My Library], create a library folder in the [My Library] folder.
3. Drag the template information box of the template from the screen editor to the library list window to display the [Library Data Property] dialog box.

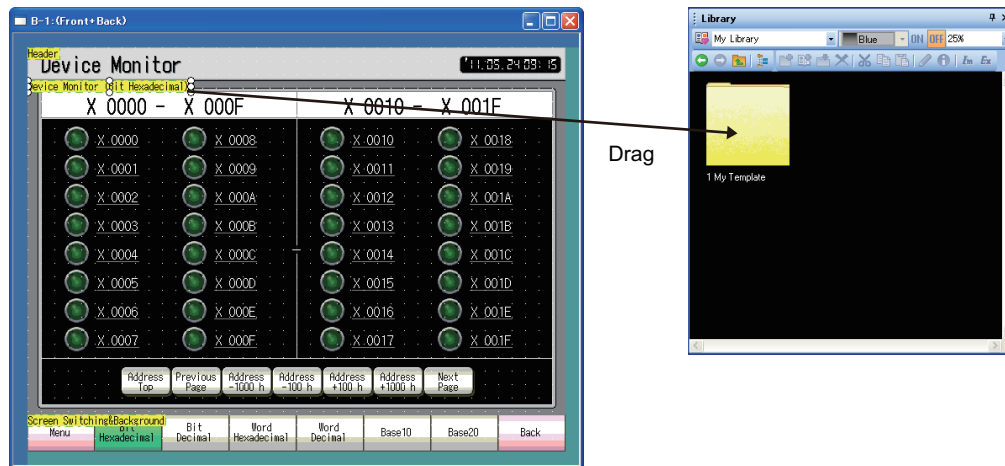

4. In the [Library Data Property] dialog box, set [Number] and [Name], and click the [OK] button to complete the registration of the template in the library. For how to operate the library, refer to the following.

 6.3.1 Registering library data

## 7.4 Deleting a Template

This section explains how to delete a template.

1. On the screen editor, select the template information box to be deleted. When figures and objects are also selected, they are deleted when the template information box is deleted. Double-click the template information box to select the template information box and all the figures and the objects belonging to the box.
2. Perform one of the following operations to delete the template information box.
  - Select [Edit] → [Delete] from the menu.
  - Right-click the template information box, and click [Delete] from the menu.

# 7.5 Precautions

## ■ Precautions for drawing

### (1) Manipulations of the figures and the objects registered in a template

- (a) The figures and the objects registered in a template cannot be registered to another template.
- (b) The figures and the objects registered in a template can be copied and pasted, duplicated, and consecutively copied.  
Note that the copied figures and objects are not registered in the template.
- (c) When a figure or object in the template is cut, deleted, or dragged to another screen, the figure or object is deleted from the template.
- (d) A template information box and a figure/object registered in the template can be grouped in combinations as shown below.

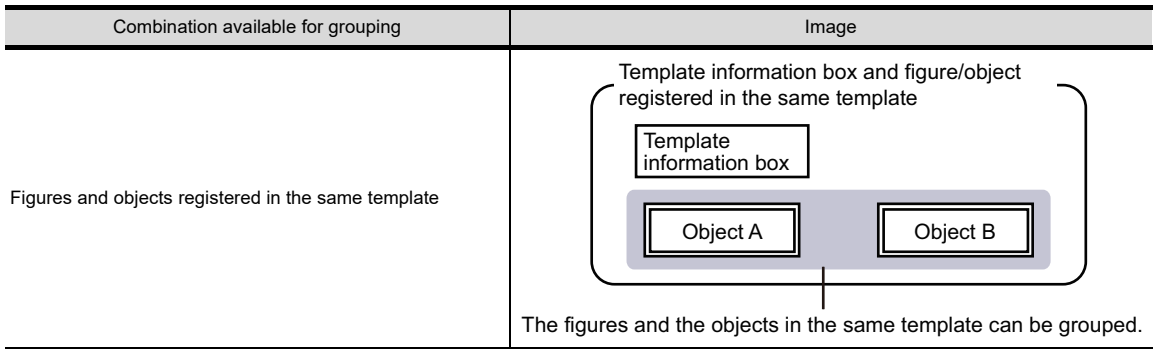

For the method of grouping, refer to the following.

5.2.3 Grouping multiple figures and objects

- (e) The following shows operations when the setting of a figure/object registered in a template is separately changed in the corresponding dialog box.
  - Even though a set item is added in the corresponding dialog box, the added item is not reflected to the template attribute.
  - When a set item, which belongs to the template attribute, is canceled in the corresponding dialog box, the cancelled item is also deleted from the template attribute.
  - When the setting change is canceled by using [Undo], the state of the template attribute also returns to the original state.

### (2) Precautions for using a template

The [Select CH No.] dialog box appears when a template in the system library is used only.

When a template in [My favorites] or [My Library] is used, the dialog box does not appear and the devices are not changed according to the controller setting.

### (3) Precautions for registering a figure to a template

When 10000 or more figures are registered in a template, the following state is made. If the project data is transferred to the GOT or a memory card, the 10001st and later registered figures are deleted from the template.

The GOT or the memory card saves the project data that differs from the project data before the transfer. When you use the project data after the transfer, note the difference between the project data.

# INDEX

<b>[A]</b>	Access control setting..... 3-75	Dialog Window ..... 4-25	GOT Setup ..... 4-115
<b>[B]</b>	Base Screen..... 2-5	Key Window ..... 4-34	Language Switching..... 4-20
	Batch edit..... 9-29	Screen Switching/Window..... 4-10	Security ..... 4-84
	Blank area ..... 3-53	Startup Logo..... 4-112	System Information ..... 4-63
	BMP/JPEG file parts..... 4-192	GOT special register (GS) ..... 2-41,App-17	GOT Type Setting..... 4-3
	BootOS ..... 8-103	Group..... 5-9	GT Designer3 ..... 1-1,3-3
<b>[C]</b>	Category list..... 9-25	Editor tab..... 3-4	Menu bar ..... 3-9
	Change password..... 3-79	Project Tree..... 3-5	Screen editor..... 3-53
	Comment..... 4-141	Screen Tree ..... 3-6	Status Bar ..... 3-3
	Basic comment ..... 4-142	System Tree..... 3-7	Title bar ..... 3-3
	Comment group ..... 4-142	Tool bars ..... 3-10	View Window..... 3-3
	Communication with GOT	GT Simulator3..... 9-50	Guidelines..... 5-13
	Reading from GOT..... 8-43	<b>[I]</b>	
	Verifying with GOT..... 8-49	Import Device Comment of GX Developer ..... 9-9	Import project..... 9-1
	Writing and installing on GOT ..... 8-26	Import Tag of RS Logix5000..... 9-14	<b>[K]</b>
	Controller Type List ..... 3-3	<b>[L]</b>	
<b>[D]</b>	Data check..... 3-70	Language switching device..... 4-20	
	Data operation ..... 5-87	Layer..... 2-13	
	Data size..... 9-47	Layer display..... 3-56	
	Data view..... 9-33	Library..... 6-1	
	Default value..... 3-29	Library List..... 6-4	
	Device..... 2-41,5-25,App-14	Login..... 3-80	
	Controller device ..... 2-41,App-58	<b>[M]</b>	
	GOT internal device ..... 2-41,App-14	Multi-language input function..... 9-44	
	Device for screen switching..... 4-10	<b>[O]</b>	
	Device list ..... 9-34	Object ..... 5-1	
	Docking..... 3-19	Offset ..... 5-59	
	Document Converter ..... 10-3	Operator authentication ..... 4-84,4-91,4-95	
	Document display function ..... 10-1	OS..... 8-95	
<b>[E]</b>	Edit vertices ..... 5-18	Device Data Transfer ..... 8-115	
<b>[F]</b>	Figure ..... 2-14,5-1	Extended function ..... 8-113	
	Font ..... 2-17	Standard monitor OS ..... 8-107	
	HQ font..... 2-20		
	Standard font ..... 2-19		
	Stroke font..... 2-21		
	TrueType font..... 2-20		
	Windows(R) font ..... 2-22		
	Frame ..... 3-60		
<b>[G]</b>	GOT bit register (GB) ..... 2-41,App-14		
	GOT data register (GD)..... 2-41,App-15		
	GOT Environmental Setting		

<b>[P]</b>		
Parts .....	4-177	
Parts image list .....	4-179	
Password authentication .....	4-86,4-89,4-99	
Preview .....	3-61	
Print/File Output.....	3-84	
Print.....	3-85	
Print Common Setting .....	3-90	
Print Preview .....	3-92	
Project data .....	8-120	
Project format .....	2-3	
Compressed file .....	2-3	
G1 format .....	2-3	
GT Designer3 project.....	2-3	
GTD format .....	2-3	
GTE format.....	2-3	
Propertysheet .....	9-20	
<b>[R]</b>		
Redisplay .....	3-56	
Report Screen .....	2-5	
Resource data .....	8-121	
<b>[S]</b>		
Screen display area .....	3-53	
Security		
Restriction of the GOT display/operation		
.....	4-84,5-47	
Securing a project .....	3-72	
Set overlay screen function .....	10-19	
Simulator .....	9-50	
SoftGOT-GOT Link Function .....	10-35	
Special data .....	8-41	
Standard key window .....	4-36	
State .....	5-41	
Station No. switching device.....	4-132,4-134	
Superimposition .....	5-62	
Switching station No. function .....	4-132	
System label .....	2-41,5-28	
System label database .....	5-28	
System label update/check.....	5-32	
System library.....	6-3	
<b>[T]</b>		
Template .....	7-1	
Checking a template .....	7-39	
Creating a template attribute.....	7-50	
Deleting a figure or object from a template .....	7-45	
Deleting a figure/object attribute		
from a template attribute .....	7-52	
Deleting a template .....	7-53	
Deleting a template attribute .....	7-52	
Editing a template .....	7-41	
Registering a figure or object to a template .....	7-45	
Registering a figure/object attribute		
to a template attribute .....	7-51	
Registering a template in the library.....	7-53	
Template information box.....	7-2	
Templates in the system library .....	7-3	
Using a template .....	7-37	
Temporary area .....	3-53	
Text list .....	9-36	
Trigger (for display)/Trigger (for write) .....	5-75	
<b>[U]</b>		
USB Mouse/Keyboard Function .....	10-29	
User Management .....	3-74,3-77	
User-created key window .....	4-42	
User-created library .....	6-2	
My favorites .....	6-2	
My library.....	6-2	
Utility call key .....	4-116	
<b>[V]</b>		
Verify project.....	9-48	
<b>[W]</b>		
Window Position .....	4-13	
Window Screen.....	2-5	
Dialog Window .....	2-5,4-25	
Key Window .....	2-5	
Overlap Window .....	2-5	
Superimpose Window .....	2-5	
Work tree .....	3-5	

## REVISIONS

\* The manual number is given on the left bottom of the back cover.

Print Date	*Manual Number	Revision
Oct., 2009	SH(NA)-080866ENG-A	<p>First Printing: Compatible with GT Works3 Version1.01B</p> <p>The function of the initial communication time-out for GOT Modem Connection Tool will be supported soon.</p>
Nov., 2009	SH(NA)-080866ENG-B	<p>Compatible with GT Works3 Version1.05F</p> <p>The function of the initial communication time-out for GOT Modem Connection Tool is supported.</p> <ul style="list-style-type: none"> <li>• Interaction with iQ Works supported</li> <li>• System label in the device setting supported</li> <li>• System label update/check supported</li> <li>• System label search in the device list supported</li> <li>• Communication between a personal computer and the GOT via a modem supported</li> </ul>
Jan., 2010	SH(NA)-080866ENG-C	<p>Compatible with GT Works3 Version1.10L</p> <ul style="list-style-type: none"> <li>• Remote personal computer operation (Ethernet) supported</li> <li>• Storing the operator information read with RFID to a device at the operator authentication enabled</li> <li>• Auxiliary authentication at the operator authentication with the external authentication device or fingerprint unit supported</li> <li>• Restriction of displaying the ladder editor screen or device test operation screen in the system security setting supported</li> <li>• Forced logout of a login user for the operator authentication supported</li> <li>• USB mouse/keyboard function supported</li> <li>• Ethernet connection with FX CPUs supported</li> <li>• Ethernet connection with OMRON PLCs supported</li> <li>• Ethernet connection with microcomputers supported</li> <li>• Connection with LCPUs supported</li> <li>• MELSEC-L troubleshooting function for the special function switch supported</li> <li>• SoftGOT1000-GOT link function supported</li> </ul>
May, 2010	SH(NA)-080866ENG-D	<p>Compatible with GT Works3 Version1.14Q</p> <ul style="list-style-type: none"> <li>• Windows® 7 supported by GT Works3 Version1</li> <li>• GOT multi-drop connection for the GT16 and GT 15 supported</li> <li>• Character display in smaller size for the user alarm display and alarm history display enabled</li> <li>• OS installation via Ethernet supported</li> <li>• Holding project data and special data during the OS installation supported</li> </ul>

(Continued to next page)

\* The manual number is given on the left bottom of the back cover.

Print Date	*Manual Number	Revision
Jun., 2010	SH(NA)-080866ENG-E	<p>Compatible with GT Works3 Version1.17T</p> <ul style="list-style-type: none"> <li>• GT1675-VN, GT1672-VN, and GT1662-VN supported</li> <li>• Connection with C Controller modules supported</li> <li>• Connection with MELSEC-WS series supported</li> <li>• Connection with IAI robot controllers supported</li> <li>• Connection with SICK safety controllers supported</li> <li>• Connection with PANASONIC servo amplifiers supported</li> <li>• Connection with a serial printer supported</li> <li>• Switching images of shapes according to the status whether or not a touch switch is touched enabled</li> <li>• Motion SFC monitor and log viewer function for special function switch supported</li> <li>• Lamp area supported</li> <li>• Data input by barcode reader or RFID for numerical input or ASCII input enabled</li> <li>• Retaining data in the SRAM user area under power failure for the advanced user alarm, advanced system alarm, and logging function enabled</li> <li>• Editing a device comment for the advanced recipe function enabled</li> <li>• Data browser supported</li> <li>• Importing and exporting the setting of default values for objects enabled</li> <li>• Standard key window for ASCII characters supported</li> <li>• CF card formatting with FAT32 format type enabled</li> <li>• Intensity adjustment of backlight by the GOT special register (GS) enabled</li> </ul>
Oct., 2010	SH(NA)-080866ENG-F	<p>Compatible with GT Works3 Version1.19V</p> <ul style="list-style-type: none"> <li>• Opening a project without a workspace management file and a project management file supported</li> <li>• Overwriting compressed files supported</li> <li>• GB code and KS code for the ASCII display and the ASCII input supported</li> <li>• GB code and KS code of the ASCII display and the ASCII input for the operation log function supported</li> <li>• Switching between a lamp and a switch supported</li> <li>• Selecting whether to execute the system label update/check supported</li> <li>• Channel setting of the MODBUS communication control function supported</li> <li>• Notifying a network number and a station number by the GS devices with the Ethernet connection supported</li> </ul>

(Continued to next page)

\* The manual number is given on the left bottom of the back cover.

Print Date	*Manual Number	Revision
Jan., 2011	SH(NA)-080866ENG-G	<p>Compatible with GT Works3 Version1.23Z</p> <ul style="list-style-type: none"> <li>• Connection with the IAI ROBO CYLINDER supported</li> <li>• Connection with the TOSHIBA Unified Controller nv supported</li> <li>• Connection with the YAMATAKE DMC50 supported</li> <li>• Size range of the TrueType numerical font changed</li> <li>• Type of the device displayed on an object changed</li> <li>• Checking the operations of objects and window screens in the preview window supported</li> <li>• System language switching with the system language switching device supported</li> <li>• Disabling the utility call key setting in the GOT setup enabled</li> <li>• Authorization setting of the SoftGOT-GOT link function in the GOT setup supported</li> <li>• Changing settings of selected multiple objects in the property sheet supported</li> <li>• Batch change of colors in the data browser supported</li> <li>• Notifying a network number and a station number by using the GS devices with the Ethernet connection supported</li> <li>• The GT11 and the GT10 support the transparent setting of an image data.</li> <li>• The special function switch supports displaying screens of the utility.</li> <li>• Displaying the same alarm that has occurred multiple times individually in the alarm history</li> <li>• Fixing the display position of the scrolling alarm display enabled</li> <li>• Display mode for the trend graph supported</li> <li>• Single touch operation on the historical trend graph supported</li> <li>• Saving an operation log at the system language switching supported</li> <li>• Trigger action function supported</li> <li>• The GT11 and the GT10 support storing the time action setting as a file.</li> <li>• [Continuous] and [Separate] of the external control device setting for the time action setting added</li> <li>• The script function supports the file line read function for the file operation function.</li> <li>• The script function supports the string operation function.</li> <li>• Acquiring the touch position color for the RGB display function enabled</li> <li>• GT16 Handy GOT supported</li> </ul>
Apr., 2011	SH(NA)-080866ENG-H	<p>Compatible with GT Works3 Version1.28E</p> <ul style="list-style-type: none"> <li>• GT1655-V supported</li> <li>• [GT165*-V(640×480)] for the GOT type added</li> <li>• Historical data list display supported</li> <li>• The key code supports the operation of the historical data list display.</li> <li>• With the data check, the historical data list display devices are checked.</li> <li>• File transfer function (FTP client) supported</li> <li>• With the GS devices, the control or the status notification of the file transfer function (FTP client) supported</li> <li>• GT Designer3 Help supported</li> <li>• GT SoftGOT1000 supports the barcode function and the RFID function.</li> <li>• Ethernet connection with SIEMENS PLCs supported</li> </ul>

(Continued to next page)

\* The manual number is given on the left bottom of the back cover.

Print Date	*Manual Number	Revision
Jul., 2011	SH(NA)-080866ENG-I	<p>Compatible with GT Works3 Version1.31H</p> <ul style="list-style-type: none"> <li>• GT Works3 Version1 supports the 64-bit version of Windows® 7.</li> <li>• The GOT operator management information conversion tool supports the 64-bit version of Windows® 7.</li> <li>• Document Converter supports the 64-bit version of Windows® 7.</li> <li>• For the GT10, the range of the GOT internal devices (GB and GD) is extended.</li> <li>• The input range displayed on the key window is changed to the input range that can be entered.</li> <li>• ON shape display on the key window supported</li> <li>• Displaying the input comment information in the status bar and the [Edit Comment] dialog box supported</li> <li>• Template supported</li> <li>• The data browser supports searching for common settings and templates.</li> <li>• The data browser supports copying and pasting multiple cells.</li> <li>• Utility operation with the USB mouse or keyboard supported</li> <li>• Multilingualization of special data supported</li> <li>• Exporting and importing the communication parameters for the GT01-RS4-M supported</li> <li>• The setting of [Use the system information of Multidrop] supported</li> <li>• The special function switch supports displaying the motion program (SV43) edit screen.</li> <li>• The advanced user alarm display and the advanced system alarm display support the display position time specification jump.</li> <li>• The comment group setting for the user alarms supported</li> <li>• The number of bars for a bar graph is extended.</li> <li>• The multimedia function supports displaying a video image on a user-created screen.</li> <li>• The RGB display function supports the extended control.</li> <li>• The device ranges for the MELSEC-QnU/DC, Q17nD/M/NC/DR, and CRnD-700 are extended.</li> <li>• CC-Link IE Field Network connection supported</li> <li>• Connection with PANASONIC servo amplifiers (MINAS A5) supported</li> <li>• Connection with YOKOGAWA temperature controllers (UTAdvanced) supported</li> <li>• Converting an operator management information file with a command line supported</li> </ul>
Oct., 2011	SH(NA)-080866ENG-J	<p>Compatible with GT Works3 Version1.37P</p> <ul style="list-style-type: none"> <li>• GT14 supported</li> <li>• GT12 added</li> <li>• The file transfer function (FTP client) supports notifying the numbers of transfer target files and transfer completion files by using the GS devices.</li> <li>• Stopping background processing during the backup/restore function execution by using the GS device supported</li> <li>• VNC® server function supported</li> </ul>

(Continued to next page)



\* The manual number is given on the left bottom of the back cover.

Print Date	*Manual Number	Revision
Jan., 2012	SH(NA)-080866ENG-K	<p>Compatible with GT Works3 Version1.40S</p> <ul style="list-style-type: none"> <li>• Canceling the screen saver when screens are switched supported</li> <li>• For the GT14, GT11, GT105□, and GT104□, selecting the size of the key window for decimal/hexadecimal values supported</li> <li>• Displaying the guidelines (auxiliary lines) on the boundary between the screen display area and the temporary area supported</li> <li>• Creating and editing a template supported</li> <li>• The templates for the XGA and QVGA GOTs are added to the system library.</li> <li>• 5V power supply setting supported</li> <li>• Setting enabled when the touch switch does not operate supported</li> <li>• Data addition and data subtraction settings of the word switch supported</li> <li>• Specifying the logging ID of the historical trend graph by using devices supported</li> <li>• The numbers of settable script symbols and object script symbols are increased.</li> <li>• The device range for MELSEC-QnA/Q/QS,MELDAS C6* is expanded.</li> <li>• Notifying the GOT IP address by using GS devices supported</li> <li>• Disconnecting/connecting a station on the network by using the GS devices supported</li> </ul>
Apr., 2012	SH(NA)-080866ENG-L	<p>Compatible with GT Works3 Version1.45X</p> <ul style="list-style-type: none"> <li>• The project security supports the security for each screen.</li> <li>• Specifying the CPU No. at the backup supported</li> <li>• The screen switching supports specifying the screen number of a screen displayed at the GOT startup and displaying a screen with the screen number incremented by one.</li> <li>• Library data (AV, crystal, soft, retro, real, metallic, and clock) with templates are added to the system library.</li> </ul>
Jun., 2012	SH(NA)-080866ENG-M	<p>Compatible with GT Works3 Version1.54G</p> <ul style="list-style-type: none"> <li>• The company name of Panasonic Electric Works Co., Ltd. is changed to Panasonic Corporation.</li> <li>• The company name of Yamatake Corporation is changed to Azbil Corporation.</li> <li>• The numbers of settable advanced user alarm displays and advanced system alarm displays are changed from 1 to 8.</li> <li>• Some menu names and function names are partially changed.</li> <li>• Generating the route information for MELSOFT Navigator supported</li> <li>• MELSERVO J4-□A supported</li> <li>• The GT14 supports the printer output.</li> <li>• The GT10 supports the hard copy function.</li> <li>• The GT14 supports iQ Works.</li> </ul>
Sep., 2012	SH(NA)-080866ENG-N	<p>Compatible with GT Works3 Version1.58L</p> <ul style="list-style-type: none"> <li>• The GT14 supports the operator authentication.</li> <li>• The offset setting is not available for the special function switch, the parts display (fixed parts), and the parts movement (fixed parts).</li> <li>• Setting the communication timeout time for the file transfer function (FTP client) by using the GS device supported</li> <li>• Retaining the state of the historical trend graph displayed before screen switching by using the GS device supported</li> <li>• The device ranges for [MELSEC-QnU/DC, Q17nD/M/NC/DR, CRnD-700], [MELSEC-QnA/Q/QS, MELDAS C6*], [MELSEC-Q(Multi)/Q-Motion], and [MELSEC-L] are expanded.</li> <li>• Image format available for VNC® the server function added</li> </ul>

(Continued to next page)

\* The manual number is given on the left bottom of the back cover.

Print Date	*Manual Number	Revision
Nov., 2012	SH(NA)-080866ENG-O	Compatible with GT Works3 Version1.63R <ul style="list-style-type: none"> <li>• SAFETY PRECAUTIONS changed</li> <li>• The device range for [MELSEC-QnU/DC, Q17nD/M/NC/DR, CRnD-700] is expanded.</li> <li>• Shortcut keys added</li> </ul>
Feb., 2013	SH(NA)-080866ENG-P	Compatible with GT Works3 Version1.67V <ul style="list-style-type: none"> <li>• Image formats available for the VNC<sup>®</sup> server function added</li> <li>• The template icons to the tool bar added</li> <li>• GT14 supports the Kana-kanji conversion.</li> <li>• GT14 supports the VNC<sup>®</sup> server function.</li> <li>• CNC machining program edit supported</li> <li>• Communication with SIEMENS S7 Ethernet OP supported</li> <li>• The difference check for the file register in the trigger backup supported</li> <li>• Displaying the key window objects on the overlap window supported</li> </ul>
May, 2013	SH(NA)-080866ENG-Q	Compatible with GT Works3 Version1.70Y <ul style="list-style-type: none"> <li>• Batch edit of the network supported</li> </ul>
Jun., 2013	SH(NA)-080866ENG-R	Compatible with GT Works3 Version1.74C <ul style="list-style-type: none"> <li>• The company name of GE Fanuc Automation Corporation is changed to GE Intelligent Platforms.</li> <li>• The company name of Panasonic Corporation is changed to Panasonic Industrial Devices SUNX Co., Ltd.</li> <li>• The company name of Fuji Electric FA Components &amp; Systems Co., Ltd. is changed to FUJI ELECTRIC CO., LTD.</li> <li>• The company name of Fuji Electric Systems Co., Ltd. is changed to FUJI ELECTRIC CO., LTD.</li> <li>• GT Works3 Version1 supports Windows<sup>®</sup> 8.</li> <li>• GOT operator management information conversion tool supports Windows<sup>®</sup> 8.</li> <li>• Document Converter supports Windows<sup>®</sup> 8.</li> <li>• Ethernet connection with KEYENCE KV5000 supported</li> <li>• Displaying the shortcut keys in the menu of the preview window added</li> <li>• Consecutive copies of figures and objects to the function to perform the increment for the devices other than the monitor device supported</li> <li>• Changing the script additional setting when other project data is utilized is added.</li> </ul>
Sep., 2013	SH(NA)-080866ENG-S	Compatible with GT Works3 Version1.100E
Jan., 2014	SH(NA)-080866ENG-T	Compatible with GT Works3 Version1.108N <ul style="list-style-type: none"> <li>• The screen title of GT Designer3 is changed to MELSOFT GT Designer3.</li> <li>• Shortcut keys are partially changed.</li> <li>• [Open] is changed to [Open Project].</li> <li>• The buffer memory unit No. switching function is supported.</li> <li>• The ladder editor (enhanced), SFC monitor (enhanced), and GOT Function Expansion Library (enhanced) are added to the option OS.</li> <li>• The operation log function supports the buffer memory unit No. switching.</li> <li>• The hard copy function supports the constant trigger watch.</li> <li>• Connection with FREQROL-A800, F800 and E700EX supported</li> <li>• Connection with MELSERVO-JE supported</li> <li>• Connection with FX3GA supported</li> </ul>

(Continued to next page)

\* The manual number is given on the left bottom of the back cover.

Print Date	*Manual Number	Revision
Apr., 2014	SH(NA)-080866ENG-U	Compatible with GT Works3 Version1.112S <ul style="list-style-type: none"> <li>• Restructuring project data at the time of next data save supported</li> <li>• Screen switching while the screen is being touched supported</li> <li>• Connection with AB PLC (MicroLogix1400) supported</li> <li>• Device range extension of MicroLogix1000/1200/1400/1500 supported</li> <li>• Indirect station No. specification and all station numbers specification in MODBUS<sup>®</sup> connection supported</li> </ul>
Jun., 2014	SH(NA)-080866ENG-V	Compatible with GT Works3 Version1.117X <ul style="list-style-type: none"> <li>• Connection with MELSEC iQ-R Series and RnMT CPU supported.</li> <li>• The names of communication drivers A/QnA/L/Q CPU, LJ71C24, and QJ71C24 are changed to Serial (MELSEC).</li> </ul>
Jul., 2014	SH(NA)-080866ENG-W	Compatible with GT Works3 Version1.118Y <ul style="list-style-type: none"> <li>• Connection with FUJI PLCs (MICREX-SX SPH3000, SPH2000) supported</li> </ul>
Oct., 2014	SH(NA)-080866ENG-X	Compatible with GT Works3 Version1.122C <ul style="list-style-type: none"> <li>• GT Works3 Version1 is no longer compatible with Windows<sup>®</sup> XP Service Pack2 and Windows<sup>®</sup> 2000.</li> <li>• GT1450-QMBDE and GT1450-QMBD are supported.</li> </ul>
Jan., 2015	SH(NA)-080866ENG-Y	Compatible with GT Works3 Version1.126G <ul style="list-style-type: none"> <li>• Connection with MELSEC iQ-F is supported.</li> <li>• Varieties of the monitor devices of MELSERVO-J4-*A have been increased.</li> <li>• Connection with MELSERVO-J4-*A-RJ is supported.</li> </ul>
Apr., 2015	SH(NA)-080866ENG-Z	Compatible with GT Works3 Version1.130L <ul style="list-style-type: none"> <li>• Serial connection with FUJI PLCs (MICREX-SX SPH3000, SPH2000) is supported.</li> <li>• Varieties of the monitor devices of MELSERVO-J4-*A-RJ have been increased.</li> </ul>
May, 2015	SH(NA)-080866ENG-AA	Compatible with GT Works3 Version1.131M <ul style="list-style-type: none"> <li>• The operating environment of GT Works3 Version1 has been changed.</li> </ul>
Jul., 2015	SH(NA)-080866ENG-AB	Compatible with GT Works3 Version1.136S <ul style="list-style-type: none"> <li>• The ranges of the monitor devices for the MELSEC iQ-R series and RnMT CPU have been extended.</li> <li>• The folder name [MELSOFT Application] displayed in the Windows<sup>®</sup> start menu has been changed to [MELSOFT].</li> </ul>
Oct., 2015	SH(NA)-080866ENG-AC	Compatible with GT Works3 Version1.144A <ul style="list-style-type: none"> <li>• The ranges of the monitor devices for the MELSEC iQ-R series and MELSEC iQ-F series have been extended.</li> </ul>
Dec., 2015	SH(NA)-080866ENG-AD	Compatible with GT Works3 Version1.150G <ul style="list-style-type: none"> <li>• The description of the operating environment for GT Works3 Version1 has been changed.</li> <li>• The description of the operating environment for the GOT operator management information conversion tool has been changed.</li> <li>• The description of the operating environment for Document Converter has been changed.</li> <li>• The description of the operating environment for the multimedia interaction tool has been changed.</li> <li>• The description of SAFETY PRECAUTIONS has been changed.</li> </ul>

(Continued to next page)

\* The manual number is given on the left bottom of the back cover.

Print Date	*Manual Number	Revision
May, 2016	SH(NA)-080866ENG-AE	Compatible with GT Works3 Version1.155M <ul style="list-style-type: none"> <li>• Outputting the MELSOFT iQ AppPortal information file is supported.</li> <li>• GT Works3 Version1 supports Windows® 10.</li> <li>• GOT operator management information conversion tool supports Windows® 10.</li> <li>• Document Converter supports Windows® 10.</li> </ul>
Aug., 2016	SH(NA)-080866ENG-AF	• Partial corrections
Jan., 2017	SH(NA)-080866ENG-AG	• Partial corrections
Jun., 2017	SH(NA)-080866ENG-AH	• Partial corrections
Oct., 2017	SH(NA)-080866ENG-AI	• Partial corrections
Apr., 2018	SH(NA)-080866ENG-AJ	• Partial corrections
Oct., 2019	SH(NA)-080866ENG-AK	• Partial corrections
Jan., 2020	SH(NA)-080866ENG-AL	• Partial corrections
Apr., 2020	SH(NA)-080866ENG-AM	Compatible with GT Works3 Version1.235V <ul style="list-style-type: none"> <li>• GT Works3 Version1 has ended support for Windows® Vista and Windows® XP.</li> <li>• Document Converter has ended support for Windows® Vista and Windows® XP.</li> </ul>
Aug., 2020	SH(NA)-080866ENG-AN	• Partial corrections
Jul., 2021	SH(NA)-080866ENG-AO	• Partial corrections
Apr., 2022	SH(NA)-080866ENG-AP	Compatible with GT Works3 Version1.275M <ul style="list-style-type: none"> <li>• Compatible with Windows® 11</li> </ul>
Jul., 2022	SH(NA)-080866ENG-AQ	• Partial corrections
Apr., 2023	SH(NA)-080866ENG-AR	Compatible with GT Works3 Version1.295H <ul style="list-style-type: none"> <li>• GT Works3 Version1 has ended support for Windows® 8.1, Windows® 8, and Windows® 7.</li> <li>• Document Converter has ended support for Windows® 8.1, Windows® 8, and Windows® 7.</li> </ul>
Jul., 2023	SH(NA)-080866ENG-AS	• Partial corrections

This manual confers no industrial property rights or any other kind, nor does it confer any patent licenses. Mitsubishi Electric Corporation cannot be held responsible for any problems involving industrial property rights which may occur as a result of using the contents noted in this manual.

# **WARRANTY**

Please check the following product warranty details before using this product.

## ■ 1. **Gratis Warranty Term and Gratis Warranty Range**

If any faults or defects (hereinafter "Failure") found to be the responsibility of Mitsubishi occurs during use of the product within the gratis warranty term, the product shall be repaired at no cost via the sales representative or Mitsubishi Service Company. However, if repairs are required onsite at domestic or overseas location, expenses to send an engineer will be solely at the customer's discretion.

Mitsubishi shall not be held responsible for any re-commissioning, maintenance, or testing on-site that involves replacement of the failed module.

### (1) **Gratis Warranty Term**

The gratis warranty term of the product shall be for thirty-six (36) months after the date of purchase or delivery to a designated place.

Note that after manufacture and shipment from Mitsubishi, the maximum distribution period shall be six (6) months, and the longest gratis warranty term after manufacturing shall be forty-two (42) months.

The gratis warranty term of repair parts shall not exceed the gratis warranty term before repairs.

### (2) **Gratis Warranty Range**

- (a) The customer shall be responsible for the primary failure diagnosis unless otherwise specified.  
If requested by the customer, Mitsubishi Electric Corporation or its representative firm may carry out the primary failure diagnosis at the customer's expense.  
The primary failure diagnosis will, however, be free of charge should the cause of failure be attributable to Mitsubishi Electric Corporation.
- (b) The range shall be limited to normal use within the usage state, usage methods, and usage environment, etc., which follow the conditions and precautions, etc., given in the instruction manual, user's manual and caution labels on the product.
- (c) Even within the gratis warranty term, repairs shall be charged in the following cases.
  - Failure occurring from inappropriate storage or handling, carelessness or negligence by the user. Failure caused by the user's hardware or software design.
  - Failure caused by unapproved modifications, etc., to the product by the user.
  - When the Mitsubishi product is assembled into a user's device, Failure that could have been avoided if functions or structures, judged as necessary in the legal safety measures the user's device is subject to or as necessary by industry standards, had been provided.
  - Failure that could have been avoided if consumable parts designated in the instruction manual had been correctly serviced or replaced.
  - Replacing consumable parts such as a battery, backlight, and fuse.
  - Failure caused by external irresistible forces such as fires or abnormal voltages, and Failure caused by force majeure such as earthquakes, lightning, wind and water damage.
  - Failure caused by reasons that could not be predicted by scientific technology standards at the time of shipment from Mitsubishi.
  - Any other failure found not to be the responsibility of Mitsubishi or that admitted not to be so by the user.

## ■ 2. **Onerous repair term after discontinuation of production**

- (1) Mitsubishi shall accept onerous product repairs for seven (7) years after production of the product is discontinued. Discontinuation of production shall be notified with Mitsubishi Technical Bulletins, etc.
- (2) Mitsubishi shall not accept a request for product supply (including spare parts) after production is discontinued.

## ■ 3. **Overseas service**

Overseas, repairs shall be accepted by Mitsubishi's local overseas FA Center.

Note that the repair conditions at each FA Center may differ.

## ■ 4. **Exclusion of loss in opportunity and secondary loss from warranty liability**

Regardless of the gratis warranty term, Mitsubishi shall not be liable for compensation to:

- (1) Damages caused by any cause found not to be the responsibility of Mitsubishi.
- (2) Loss in opportunity, lost profits incurred to the user by Failures of Mitsubishi products.
- (3) Special damages and secondary damages whether foreseeable or not, compensation for accidents, and compensation for damages to products other than Mitsubishi products.
- (4) Replacement by the user, maintenance of on-site equipment, start-up test run and other tasks.

## ■ 5. **Changes in product specifications**

The specifications given in the catalogs, manuals, or technical documents are subject to change without prior notice.

## ■ 6. **Product application**

- (1) In using the Mitsubishi graphic operation terminal, the usage conditions shall be that the application will not lead to a major accident even if any problem or fault should occur in the graphic operation terminal device, and that backup and fail-safe functions are systematically provided outside of the device for any problem or fault.
- (2) The Mitsubishi graphic operation terminal has been designed and manufactured for applications in general industries, etc. Thus, applications in which the public could be affected such as in nuclear power plants and other power plants operated by respective power companies, and applications in which a special quality assurance system is required, such as for Railway companies or Public service shall be excluded from the graphic operation terminal applications.  
In addition, applications in which human life or property could be greatly affected, such as in aircraft, medical, railway applications, incineration and fuel devices, manned transportation equipment, recreation and amusement devices, safety devices, shall also be excluded from the graphic operation terminal.  
Even for the above applications, however, Mitsubishi Electric Corporation may consider the possibility of an application, provided that the customer notifies Mitsubishi Electric Corporation of the intention, the application is clearly defined and any special quality is not required, after the user consults the local Mitsubishi representative.

## Intellectual Property Rights

### ■ Trademarks

GOT is a registered trademark of Mitsubishi Electric Corporation.

Microsoft, Microsoft Access, Excel, SQL Server, Visual Basic, Visual C++, Visual C#, Windows, Windows NT, Windows Server, and Windows Vista are trademarks of the Microsoft group of companies.

Adobe and Adobe Reader are registered trademarks of Adobe Systems Incorporated.

Intel, Intel Core, Pentium, and Celeron are trademarks or registered trademarks of Intel Corporation in the United States and other countries.

MODBUS is a trademark of Schneider Electric SA.

VNC is a registered trademark of RealVNC Ltd. in the United States and other countries.

Other company and product names herein are either trademarks or registered trademarks of their respective owners.

### ■ Copyrights

The screens (screenshots) are used in accordance with the Microsoft Corporation guideline.

This product uses Arphic Mobile Font.

VS-FlexGrid Pro

Copyright © 2003 ComponentOne LLC.

FreeType

Portions of this software are copyright ©2003 The FreeType

Project ([www.freetype.org](http://www.freetype.org)). All rights reserved.



SCREEN DESIGN SOFTWARE

# GT Designer3 Version1

Screen Design Manual **Fundamentals 1/2** Fundamentals 2/2

(For GOT1000 Series)

MODEL	SW1-GTD3-R(DRAW1)-E
MODEL CODE	_____
SH(NA)-080866ENG-AS 1/2(2307)MEE	

## MITSUBISHI ELECTRIC CORPORATION

HEAD OFFICE: TOKYO BLDG., 2-7-3, MARUNOUCHI, CHIYODA-KU, TOKYO 100-8310, JAPAN  
NAGOYA WORKS: 1-14, YADA-MINAMI 5-CHOME, HIGASHI-KU, NAGOYA 461-8670, JAPAN

When exported from Japan, this manual does not require application to the Ministry of Economy, Trade and Industry for service transaction permission.

Specifications subject to change without notice.



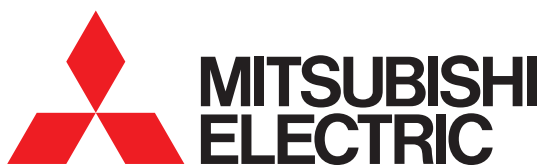

MELSOFT

SCREEN DESIGN SOFTWARE  
**GT Designer3**  
Version1

Screen Design Manual **Fundamentals 1/2** **Fundamentals 2/2**

(For GOT1000 Series)

A grayscale collage background featuring a computer keyboard, a hand holding a mouse, and a detailed view of a Mitsubishi GOT1000 Series operator panel. The operator panel displays a graphical interface with four motor status monitors labeled Motor A, Motor B, Motor C, and Motor D, each showing a gauge and the number 012345. Below the monitors are various control buttons and a message display area.

# GT Designer3



# ● SAFETY PRECAUTIONS ●

(Be sure to read these instructions before using the product)

Before using this product, read this manual and the relevant manuals introduced in this manual carefully and handle the product correctly with full attention to safety.

Note that these precautions apply only to this product.

In this manual, the safety instructions are ranked as "WARNING" and "CAUTION".



**WARNING**

Indicates that incorrect handling may cause hazardous conditions, resulting in death or severe injury.



**CAUTION**

CAUTION Indicates that incorrect handling may cause hazardous conditions, resulting in minor or moderate injury or property damage.

Note that failure to observe the  CAUTION level instructions may also lead to serious results depending on the circumstances.

Be sure to observe the instructions of both levels to ensure personal safety.

Please keep this manual in accessible place and be sure to forward it to the end user.

[Test operation precautions]

## WARNING

- Before testing the operation of a user-created screen (such as turning on or off a bit device, changing the current value of a word device, changing the set value or current value of a timer or counter, and changing the current value of a buffer memory), thoroughly read the manual to fully understand the operating procedure.  
When testing, never change the data of the devices that control the operation essential for the system.  
Faulty output and malfunction may result in an accident.

[Precautions for Remote Control]

## WARNING

- Remote control is available through a network by using GOT functions, including the SoftGOT-GOT link function, the remote personal computer operation function, and the VNC server function.  
If these functions are used to perform remote control of control equipment, the field operator may not notice the remote control, possibly leading to an accident.  
In addition, a communication delay or interruption may occur depending on the network environment, and remote control of control equipment cannot be performed normally in some cases.  
Before using the above functions to perform remote control, fully grasp the circumstances of the field site and ensure safety.

[Design Precautions]

## WARNING

- To maintain the security (confidentiality, integrity, and availability) of the GOT and the system against unauthorized access, DoS<sup>\*1</sup> attacks, computer viruses, and other cyberattacks from unreliable networks and devices via network, take appropriate measures such as firewalls, virtual private networks (VPNs), and antivirus solutions.  
Mitsubishi Electric shall have no responsibility or liability for any problems involving GOT trouble and system trouble by unauthorized access, DoS attacks, computer viruses, and other cyberattacks.  
<sup>\*1</sup> DoS: A denial-of-service (DoS) attack disrupts services by overloading systems or exploiting vulnerabilities, resulting in a denial-of-service (DoS) state.

## CAUTIONS FOR USING THIS SOFTWARE

### (1) Required memory of a personal computer and the free capacity of the hard disk

For required memory and the free capacity of the hard disk, refer to the following.

☞ 2.1 Operating Environment

### (2) Error messages displayed while starting and editing

"Operation will be terminated because of insufficient memory. Would you like to stop?"

If the above message appears, close other running application software or reboot Windows® in order to secure at least 50M bytes of free hard disk space.

### (3) GT Designer3 and the GOT display

(a) Precautions for displaying straight line other than full line (dotted line and others) in bold  
When straight line other than full line is drawn in bold, the line may not be displayed with its actual line width on a personal computer.

However, it will be displayed correctly on GOT. This phenomenon does not mean data problem.

(b) Display of end points of straight line/line freeform/polygon

As shown below, the end points of straight line, line freeform, or polygon is displayed differently between GT Designer3 and the GOT.

GT Designer3



On GOT



(c) Start position for filling patterns

Some filling patterns may be differently displayed. For example, the start position may be different between GT Designer3 and the GOT.

(d) Drawing of different type lines

The length of the dots varies in different dotted lines (for example: the chain lines).

(e) Display of object

- The display position of the scale value displayed in the graph is different between GT Designer3 and the GOT.
- Even if the display-start-line of a comment is set, the comment is displayed from the first line on GT Designer3.

(f) Display magnification

When display magnification is changed, the connected lines or figures may be separated or the filled-paint may be out of outline of the figure. However, if they are displayed correctly on the preview screen (Display magnification: 100%), they will appear correctly on the GOT as well.

Example: When filled-paint is out of the outline.

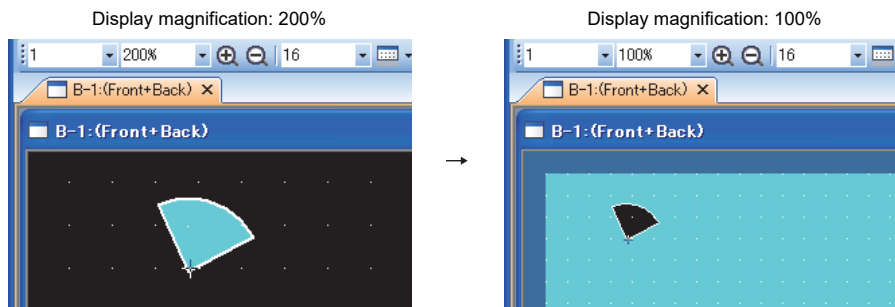

**(4) Restrictions when the color setting is changed to the setting of less colors in the system environment (256 colors → 2 colors)**

- The color palette for setting color will be changed according to the new settings.
- The color on the drawing screen will be kept the same as prior to the change.

If the color setting for a red rectangle-figure is changed to [2(mono)], the red color remains.

- The colors of the image data (BMP file or JPEG file) will be reduced when the project is stored, the screen is closed and that image data is double-clicked.

**(5) When device type is changed**

Confirm the device type when the set bit device is changed from bit device into word device. The device flag may be represented as "??", depending on the settings.

Example: D0.b0 → D0D0.b5 → ??

**(6) OS setting**

Set the font size to [Normal] when setting OS (Windows®) screens.

If the font size is set to other than [Normal], the GT Designer3 dialog box and others cannot be displayed correctly.

# INTRODUCTION

---

Thank you for choosing Mitsubishi Electric Graphic Operation Terminal (Mitsubishi Electric GOT).  
Read this manual and make sure you understand the functions and performance of the GOT thoroughly in advance to ensure correct use.

# CONTENTS

---

## **GT Designer3 Version1 Screen Design Manual (Fundamentals) 1/2**

SAFETY PRECAUTIONS .....	A - 1
CAUTIONS FOR USING THIS SOFTWARE .....	A - 2
INTRODUCTION .....	A - 4
CONTENTS .....	A - 4
MANUALS.....	A - 12
QUICK REFERENCE .....	A - 14
ABBREVIATIONS AND GENERIC TERMS .....	A - 16
HOW TO USE THIS MANUAL.....	A - 21

## **REGARDING GT Designer3**

---

### **1. OVERVIEW**

---

#### **GT Designer3 SPECIFICATIONS**

---

### **2. GT Designer3 SPECIFICATIONS**

---

2.1	Operating Environment.....	2 - 1
2.2	Project Format Handled with GT Designer3 .....	2 - 3
2.3	Types and Number of Creatable Screens .....	2 - 5
2.3.1	Screen specifications for each GOT type .....	2 - 6
2.3.2	Relations of base screen and window screen .....	2 - 11
2.3.3	Layer.....	2 - 13
2.4	Figures and Data Capacity .....	2 - 14
2.5	Specifications of Applicable Characters .....	2 - 17
2.5.1	Fonts.....	2 - 18
2.5.2	KANJI regions.....	2 - 29
2.5.3	Application example.....	2 - 31
2.5.4	Font selection .....	2 - 33
2.5.5	Precautions.....	2 - 34
2.6	Specifications of Available Functions Set with GT Designer3 .....	2 - 35
2.6.1	Specifications.....	2 - 35
2.7	Clock Function Specifications .....	2 - 40
2.8	Supported Devices .....	2 - 41
2.9	Available Numeric Data .....	2 - 43

## GT Designer3 OPERATION

---

### 3. GT Designer3 OPERATION

---

3.1	Starting GT Designer3 .....	3 - 1
3.2	Screen Configuration of GT Designer3 .....	3 - 3
3.2.1	Operating editor tab .....	3 - 4
3.2.2	Operating work tree .....	3 - 5
3.2.3	Operation of screen image list .....	3 - 8
3.3	Menu Configuration .....	3 - 9
3.4	Type of Tool Bars and Short Cut Keys .....	3 - 10
3.5	Customizing Screen Configuration and Toolbars .....	3 - 18
3.5.1	Customizing screen configuration .....	3 - 18
3.5.2	Customizing the toolbars .....	3 - 22
3.5.3	Customizing actions and default value of GT Designer3 .....	3 - 25
3.6	Creating/Editing Project .....	3 - 32
3.6.1	Creating a new project .....	3 - 32
3.6.2	Opening/closing a project .....	3 - 40
3.6.3	Setting the project title .....	3 - 44
3.7	Creating/Opening/Closing Screen .....	3 - 46
3.7.1	Creating a new screen .....	3 - 46
3.7.2	Opening/closing a screen .....	3 - 49
3.8	Basic Operation of Drawing Screen .....	3 - 53
3.8.1	Relation of the screen editor and the screen displayed on the GOT .....	3 - 53
3.8.2	Layer display switching operation .....	3 - 56
3.8.3	Redisplaying the screen editor .....	3 - 56
3.8.4	Selecting the screen editor to be edited .....	3 - 57
3.8.5	Displaying opened screen editors overlapped/aligned .....	3 - 58
3.9	Changing Screen Property .....	3 - 59
3.10	Displaying Frame on Screen Editor .....	3 - 60
3.11	Viewing Created Screen Image .....	3 - 61
3.11.1	Displaying a preview .....	3 - 61
3.11.2	Displaying the window screen preview in the screen editor of the base screen .....	3 - 65
3.12	Copying/Deleting Screen .....	3 - 67
3.12.1	Copying a screen .....	3 - 67
3.12.2	Deleting a screen .....	3 - 69
3.13	Data Check .....	3 - 70
3.14	Securing Project .....	3 - 72
3.14.1	Procedures for setting project security .....	3 - 73
3.14.2	Settings .....	3 - 74
3.14.3	Logging into project .....	3 - 80
3.14.4	Operations after the project security is set .....	3 - 80
3.14.5	Precautions .....	3 - 83
3.15	Printing Project/File Output .....	3 - 84
3.15.1	Print setting .....	3 - 85
3.15.2	Previewing print image .....	3 - 92
3.15.3	Outputting examples .....	3 - 93
3.16	Saving Project .....	3 - 100

3.16.1	Overwriting projects .....	3 - 100
3.16.2	Saving as a new file .....	3 - 101
3.17	Deleting Project .....	3 - 104
3.18	Ending GT Designer3 .....	3 - 104
3.19	How to Use Help .....	3 - 105
3.19.1	Displaying the GT Designer3 Help .....	3 - 105
3.19.2	Displaying PDF manuals .....	3 - 105
3.19.3	Connecting to MITSUBISHI ELECTRIC FA Global Website .....	3 - 107
3.19.4	Confirming GT Designer3 version .....	3 - 107

## COMMON SETTING

---

### 4. COMMON SETTING

---

4.1	GOT Type Setting .....	4 - 3
4.1.1	Settings .....	4 - 3
4.1.2	Precautions .....	4 - 8
4.2	Screen Switching Device Setting .....	4 - 10
4.2.1	Display position of window screen .....	4 - 13
4.2.2	Settings .....	4 - 15
4.2.3	Precautions .....	4 - 19
4.3	Language Switching Device Setting .....	4 - 20
4.3.1	Settings .....	4 - 21
4.3.2	Precautions .....	4 - 23
4.4	Setting Message to be Displayed on GOT .....	4 - 25
4.4.1	Creating a dialog window .....	4 - 26
4.4.2	Settings .....	4 - 28
4.4.3	Precautions .....	4 - 31
4.5	Key Window Setting .....	4 - 34
4.5.1	Key window type .....	4 - 34
4.5.2	Buttons on standard key window and display items .....	4 - 36
4.5.3	How to operate key window .....	4 - 40
4.5.4	How to create user-created key window .....	4 - 42
4.5.5	Settings .....	4 - 49
4.5.6	Relevant settings .....	4 - 60
4.5.7	Precautions .....	4 - 61
4.6	System Information Setting .....	4 - 63
4.6.1	Settings .....	4 - 64
4.6.2	Details of system information .....	4 - 66
4.6.3	Application example .....	4 - 77
4.6.4	Precautions .....	4 - 83
4.7	Security Setting .....	4 - 84
4.7.1	Settings .....	4 - 88
4.7.2	Relevant settings .....	4 - 95
4.7.3	Authentication methods and setting procedures .....	4 - 95
4.7.4	GOT operator management information conversion tool .....	4 - 100
4.7.5	Precautions .....	4 - 108
4.8	GOT Startup Logo Setting .....	4 - 112
4.8.1	Settings .....	4 - 112
4.8.2	Setting/deleting procedure .....	4 - 113



4.8.3	Precautions.....	4 - 114
4.9	GOT Display and Operation Setting .....	4 - 115
4.9.1	Settings.....	4 - 115
4.9.2	How to match clock data between the GOT and controllers .....	4 - 125
4.9.3	Precautions.....	4 - 129
4.10	Station No. Switching Device Setting .....	4 - 132
4.10.1	Settings.....	4 - 134
4.10.2	Relevant settings .....	4 - 135
4.10.3	Precautions.....	4 - 136
4.11	Buffer Memory Unit No. Switching Device Setting (Controller Setting) .....	4 - 137
4.11.1	Settings.....	4 - 138
4.11.2	Relevant settings .....	4 - 139
4.11.3	Precautions.....	4 - 140
4.12	Comment Setting .....	4 - 141
4.12.1	Displaying the [Comment List] dialog box .....	4 - 143
4.12.2	Basic operations for comment registration .....	4 - 146
4.12.3	Comment registration .....	4 - 157
4.12.4	Registering comment group columns .....	4 - 160
4.12.5	Copying or cutting a comment.....	4 - 161
4.12.6	Deleting a comment or clearing a text.....	4 - 164
4.12.7	Deleting columns in comment group .....	4 - 166
4.12.8	Changing comment settings .....	4 - 167
4.12.9	Saving/Reading comments as file .....	4 - 168
4.12.10	Editing comment saved as Text/CSV file .....	4 - 171
4.12.11	Precautions.....	4 - 176
4.13	Registering Parts .....	4 - 177
4.13.1	Basic operation for registering parts.....	4 - 178
4.13.2	Registering parts .....	4 - 181
4.13.3	Copying parts .....	4 - 185
4.13.4	Deleting parts .....	4 - 187
4.13.5	Editing parts.....	4 - 188
4.13.6	Changing part numbers and names .....	4 - 189
4.13.7	Precautions.....	4 - 190
4.14	Registering BMP/JPEG Files for Parts in Memory Card.....	4 - 192
4.14.1	Specifications for BMP/JPEG files that can be stored in a memory card and displayed as parts.....	4 - 192
4.14.2	Storing BMP/JPEG file parts in a memory card.....	4 - 195
4.14.3	Precautions.....	4 - 197

## **EDITING AND SETTING FIGURES AND OBJECTS**

---

### **5. EDITING AND SETTING FIGURES AND OBJECTS**

---

5.1	Arranging Figures and Objects.....	5 - 1
5.2	Editing Figure and Object .....	5 - 5
5.2.1	Selecting figure and object .....	5 - 5
5.2.2	Editing figure and object.....	5 - 8
5.2.3	Grouping multiple figures and objects .....	5 - 9
5.2.4	Undo, redo .....	5 - 9
5.2.5	Aligning figures and objects.....	5 - 10
5.2.6	Changing attributes of figures and objects .....	5 - 14

5.2.7	Changing size of figures/objects .....	5 - 16
5.2.8	Copying figures and objects .....	5 - 22
5.2.9	Copying figures and objects consecutively .....	5 - 23
5.3	Common Settings of Objects .....	5 - 25
5.3.1	Device setting .....	5 - 25
5.3.2	Label setting .....	5 - 28
5.3.3	Shape setting .....	5 - 39
5.3.4	State setting .....	5 - 41
5.3.5	Security setting .....	5 - 47
5.3.6	Offset setting .....	5 - 59
5.3.7	Superimposition setting .....	5 - 62
5.3.8	Trigger setting .....	5 - 75
5.3.9	Data operation setting .....	5 - 87

## USING LIBRARY

---

### 6. LIBRARY

---

6.1	Operation of Library List .....	6 - 4
6.2	Pasting Figures, Objects and Templates by Library .....	6 - 10
6.3	Editing User-Created Library .....	6 - 11
6.3.1	Registering library data .....	6 - 11
6.3.2	Registering shapes for objects in library .....	6 - 13
6.3.3	Copying library .....	6 - 15
6.3.4	Deleting library .....	6 - 17
6.3.5	Editing library data .....	6 - 19
6.3.6	Changing library attribute .....	6 - 21
6.3.7	Saving library .....	6 - 22
6.3.8	Opening library .....	6 - 24
6.3.9	Importing library .....	6 - 26
6.3.10	Exporting library .....	6 - 30

## USING TEMPLATE

---

### 7. TEMPLATE

---

7.1	Specifications .....	7 - 2
7.1.1	Template specifications .....	7 - 2
7.1.2	Templates in the system library .....	7 - 3
7.2	Creating a Screen by Using a Template .....	7 - 37
7.2.1	Using a template in the library .....	7 - 37
7.2.2	Checking the settings in a template .....	7 - 39
7.2.3	Changing the setting value in the attribute of a figure or object .....	7 - 41
7.3	Creating or Editing a Template .....	7 - 45
7.3.1	Registering a figure or object to a template .....	7 - 45
7.3.2	Deleting a figure or object from a template .....	7 - 45
7.3.3	Editing a template attribute .....	7 - 46
7.3.4	Registering a template in the library .....	7 - 53
7.4	Deleting a Template .....	7 - 53
7.5	Precautions .....	7 - 54

## COMMUNICATION WITH GOT

---

### 8. COMMUNICATION WITH GOT

---

8.1	Transferring Data between GOT and Personal Computer .....	8 - 1
8.1.1	Connecting personal computer and GOT with cable .....	8 - 8
8.1.2	Interface setting of the GOT .....	8 - 13
8.1.3	Setting communication .....	8 - 22
8.1.4	Writing and installing on GOT .....	8 - 26
8.1.5	Reading from GOT .....	8 - 43
8.1.6	Verifying with GOT .....	8 - 49
8.2	Transferring Data to Memory Card or USB Memory .....	8 - 51
8.2.1	Transferring project data, OS, and special data to memory card or USB memory.....	8 - 53
8.2.2	Transferring Boot OS to memory card or USB memory .....	8 - 61
8.2.3	Transferring CoreOS to memory card .....	8 - 66
8.3	Transferring Data Using GT10-LDR .....	8 - 69
8.3.1	Preparation for data transfer.....	8 - 69
8.3.2	Connecting cable.....	8 - 74
8.3.3	Setting communication .....	8 - 80
8.3.4	Installing GT10-LDR OS.....	8 - 82
8.3.5	Writing project data and installing OS .....	8 - 84
8.3.6	Obtaining memory information .....	8 - 85
8.3.7	Reading project data .....	8 - 86
8.3.8	Reading resource data .....	8 - 87
8.4	Transferring Data Using GT01-RS4-M .....	8 - 88
8.4.1	Preparation for data transfer.....	8 - 88
8.4.2	Connecting the PC and GT01-RS4-M via USB cable .....	8 - 89
8.4.3	Setting communication .....	8 - 90
8.4.4	Installing OS to GT01-RS4-M.....	8 - 91
8.4.5	Writing communication parameter to GT01-RS4-M .....	8 - 92
8.4.6	Reading communication parameter from GT01-RS4-M .....	8 - 94
8.5	Data Types and Sizes Transferred to the GOT .....	8 - 95
8.5.1	Data types and storage destinations .....	8 - 95
8.5.2	Drive capacity required for data transfer .....	8 - 123
8.6	Error Messages Displayed at Data Transfer.....	8 - 142

## USEFUL FUNCTIONS

---

### 9. USEFUL FUNCTIONS FOR DRAWING

---

9.1	Utilizing Other Project Data .....	9 - 1
9.2	Referring to Device Comment (Importing GX Developer Device Comment) .....	9 - 9
9.3	Importing Tags Created by Third Party Programming Software.....	9 - 14
9.4	Displaying in List and Editing Screen/Figure/Object Settings (Property sheet).....	9 - 20
9.5	Displaying in List and Batch Editing Settings.....	9 - 25
9.5.1	Batch setting and managing figures/objects for each purpose (Category list) .....	9 - 25
9.5.2	Editing attributes of figures/objects and devices in a batch (Batch edit) .....	9 - 29

9.5.3	Selecting overlapped figure (Data view).....	9 - 33
9.5.4	Checking devices in use (Device list).....	9 - 34
9.5.5	Checking text in use (Text list).....	9 - 36
9.5.6	Searching for and editing figures, objects, and others in a project data (Data browser)....	9 - 38
9.6	Entering Multiple Languages (Multi-Language Input Function).....	9 - 44
9.7	Checking Project Data for Errors.....	9 - 46
9.8	Confirming Created Data Size.....	9 - 47
9.9	Verifying Project Data Opened by GT Designer3 with Saved Project Data.....	9 - 48
9.10	Starting Up Simulator (GT Simulator3).....	9 - 50

## 10. USEFUL FUNCTIONS FOR USING GOT

---

10.1	Displaying Documents such as Word and Excel (Document Display).....	10 - 1
10.1.1	Before using the document display function.....	10 - 1
10.1.2	Relevant settings.....	10 - 3
10.1.3	Document conversion using Document Converter.....	10 - 3
10.1.4	Placement and settings.....	10 - 11
10.1.5	Setting items.....	10 - 12
10.1.6	Description on touch switches for document display.....	10 - 15
10.1.7	Precautions.....	10 - 17
10.2	Changing Screen According to Situation (Set Overlay Screen).....	10 - 19
10.3	Switching ON/OFF Device (Test Function).....	10 - 26
10.4	Starting GOT with Memory Card.....	10 - 28
10.5	Operating GOT with USB Mouse/Keyboard (USB Mouse/Keyboard Function).....	10 - 29
10.5.1	Settings.....	10 - 30
10.5.2	Relevant settings.....	10 - 30
10.5.3	Actions.....	10 - 31
10.5.4	Precautions.....	10 - 34
10.6	Synchronizing GT SoftGOT1000 data with GOT data (SoftGOT-GOT Link Function).....	10 - 35

## APPENDICES

---

Appendix1	DATA CAPACITY LIST.....	App - 1
Appendix.1.1	Data Capacity List.....	App - 1
Appendix.1.2	Capacity of Data Stored in a Memory Card.....	App - 10
Appendix.1.3	Capacity of data to be saved in the SRAM user area.....	App - 13
Appendix2	GOT Internal Devices.....	App - 14
Appendix.2.1	GOT bit register (GB).....	App - 14
Appendix.2.2	GOT data register (GD).....	App - 15
Appendix.2.3	GOT special register (GS).....	App - 17
Appendix3	Device of Controllers.....	App - 58
Appendix4	Setting device of each controller.....	App - 192
Appendix5	Key Code List.....	App - 239
Appendix6	Synthesized Colors Available for XOR.....	App - 244
Appendix7	ASCII Code List.....	App - 245
Appendix8	Relevant Settings.....	App - 247
Appendix9	Precautions for Using Unicode Text File.....	App - 284

**INDEX**

---

**REVISIONS**

---

**WARRANTY**

---

**Intellectual Property Rights**

---

## MANUALS

The following table lists the manual relevant to this product.  
Refer to each manual for any purpose.

### ■ Screen creation software manuals

Manual Name	Delivery method	Manual Number
GT Works3 Installation Instructions	Enclosed in product	-
GT Designer3 Version1 Screen Design Manual (Fundamentals) 1/2, 2/2	*1	SH-080866ENG
GT Designer3 Version1 Screen Design Manual (Functions) 1/2, 2/2	*1	SH-080867ENG
GT Simulator3 Version1 Operating Manual for GT Works3	*1	SH-080861ENG
GT Converter2 Version3 Operating Manual for GT Works3	*1	SH-080862ENG

\*1 Contact your local distributor.

### ■ Connection manuals

Manual Name	Delivery method	Manual Number
GOT1000 Series Connection Manual (Mitsubishi Electric Products) for GT Works3	*1	SH-080868ENG
GOT1000 Series Connection Manual (Non-Mitsubishi Electric Products 1) for GT Works3	*1	SH-080869ENG
GOT1000 Series Connection Manual (Non-Mitsubishi Electric Products 2) for GT Works3	*1	SH-080870ENG
GOT1000 Series Connection Manual (Microcomputer, MODBUS Products, Peripherals) for GT Works3	*1	SH-080871ENG
GOT1000 Series Connection Manual ( $\alpha$ 2 Connection) for GT Works3	*1	JY997D39201

\*1 Contact your local distributor.

### ■ Extended and option function manuals

Manual Name	Delivery method	Manual Number
GOT1000 Series Gateway Functions Manual for GT Works3	*1	SH-080858ENG
GOT1000 Series MES Interface Function Manual for GT Works3	*1	SH-080859ENG
GOT1000 Series User's Manual (Extended Functions, Option Functions) for GT Works3	*1	SH-080863ENG

\*1 Contact your local distributor.

### ■ GT SoftGOT1000 manuals

Manual Name	Delivery method	Manual Number
GT SoftGOT1000 Version3 Operating Manual for GT Works3	*1	SH-080860ENG

\*1 Contact your local distributor.

## ■ GT16 manuals

Manual Name	Delivery method	Manual Number
GT16 User's Manual (Hardware)	*1	SH-080928ENG
GT16 User's Manual (Basic Utility)	*1	SH-080929ENG
GT16 Handy GOT User's Manual	*1	JY997D41201 JY997D41202

\*1 Contact your local distributor.

## ■ GT15 manuals

Manual Name	Delivery method	Manual Number
GT15 User's Manual	*1	SH-080528ENG

\*1 Contact your local distributor.

## ■ GT14 manuals

Manual Name	Delivery method	Manual Number
GT14 User's Manual	*1	JY997D44801

\*1 Contact your local distributor.

## ■ GT12 manuals

Manual Name	Delivery method	Manual Number
GT12 User's Manual	*1	SH-080977ENG

\*1 Contact your local distributor.

## ■ GT11 manuals

Manual Name	Delivery method	Manual Number
GT11 User's Manual	*1	JY997D17501
GT11 Handy GOT User's Manual	*1	JY997D20101 JY997D20102

\*1 Contact your local distributor.

## ■ GT10 manuals

Manual Name	Delivery method	Manual Number
GT10 User's Manual	*1	JY997D24701

\*1 Contact your local distributor.

## **QUICK REFERENCE**

### **■ Creating a project**

Obtaining the specifications and operation methods of GT Designer3	GT Designer3 Version1 Screen Design Manual (Fundamentals) 1/2, 2/2
Setting available functions on GT Designer3	
Creating a screen displayed on the GOT	
Obtaining useful functions to increase efficiency of drawing	
Setting details for figures and objects	GT Designer3 Version1 Screen Design Manual (Functions) 1/2, 2/2
Setting functions for the data collection or trigger action	
Setting functions to use peripheral devices	
Simulating a created project on a personal computer	GT Simulator3 Version1 Operating Manual for GT Works3

### **■ Connecting a controller to the GOT**

Obtaining information of Mitsubishi Electric products applicable to the GOT	GOT1000 Series Connection Manual (Mitsubishi Electric Products) for GT Works3
Connecting Mitsubishi Electric products to the GOT	
Connecting multiple controllers to one GOT (Multi-channel function)	
Establishing communication between a personal computer and a controller via the GOT (FA transparent function)	
Obtaining information of Non-Mitsubishi Electric products applicable to the GOT	<ul style="list-style-type: none"> <li>• GOT1000 Series Connection Manual (Non-Mitsubishi Electric Products 1) for GT Works3</li> <li>• GOT1000 Series Connection Manual (Non-Mitsubishi Electric Products 2) for GT Works3</li> </ul>
Connecting Non-Mitsubishi Electric products to the GOT	
Obtaining information of peripheral devices applicable to the GOT	GOT1000 Series Connection Manual (Microcomputer, MODBUS Products, Peripherals) for GT Works3
Connecting peripheral devices including a barcode reader to the GOT	
Connecting α2 with GOT	GOT1000 Series Connection Manual (α2 Connection) for GT Works3

### **■ Transferring data to the GOT**

Writing data to the GOT	GT Designer3 Version1 Screen Design Manual (Fundamentals) 1/2, 2/2
Reading data from the GOT	
Verifying an editing project to a GOT project	



## ■ Others

Obtaining specifications (including part names, external dimensions, and options) of each GOT	<ul style="list-style-type: none"><li>• GT16 User's Manual (Hardware)</li><li>• GT16 Handy GOT User's Manual</li><li>• GT15 User's Manual</li><li>• GT14 User's Manual</li><li>• GT12 User's Manual</li><li>• GT11 User's Manual</li><li>• GT11 Handy GOT User's Manual</li><li>• GT10 User's Manual</li></ul>
Installing the GOT	
Operating the utility	<ul style="list-style-type: none"><li>• GT16 User's Manual (Basic Utility)</li><li>• GT16 Handy GOT User's Manual</li><li>• GT15 User's Manual</li><li>• GT14 User's Manual</li><li>• GT12 User's Manual</li><li>• GT11 User's Manual</li><li>• GT11 Handy GOT User's Manual</li><li>• GT10 User's Manual</li></ul>
Configuring the gateway function	GOT1000 Series Gateway Functions Manual for GT Works3
Configuring the MES interface function	GOT1000 Series MES Interface Function Manual for GT Works3
Configuring the extended function and option function	GOT1000 Series User's Manual (Extended Functions, Option Functions) for GT Works3
Using a personal computer as the GOT	GT SoftGOT1000 Version3 Operating Manual for GT Works3

## ABBREVIATIONS AND GENERIC TERMS

### ■ GOT

Abbreviations and generic terms		Description
GT1695	GT1695M-X	Abbreviation of GT1695M-XTBA, GT1695M-XTBD
GT1685	GT1685M-S	Abbreviation of GT1685M-STBA, GT1685M-STBD
GT1675	GT1675M-S	Abbreviation of GT1675M-STBA, GT1675M-STBD
	GT1675M-V	Abbreviation of GT1675M-VTBA, GT1675M-VTBD
	GT1675-VN	Abbreviation of GT1675-VNBA, GT1675-VNBD
GT1672	GT1672-VN	Abbreviation of GT1672-VNBA, GT1672-VNBD
GT1665	GT1665M-S	Abbreviation of GT1665M-STBA, GT1665M-STBD
	GT1665M-V	Abbreviation of GT1665M-VTBA, GT1665M-VTBD
GT1662	GT1662-VN	Abbreviation of GT1662-VNBA, GT1662-VNBD
GT1655	GT1655-V	Abbreviation of GT1655-VTBD
GT16		Abbreviation of GT1695, GT1685, GT1675, GT1672, GT1665, GT1662, GT1655, GT16 Handy GOT
GT1595	GT1595-X	Abbreviation of GT1595-XTBA, GT1595-XTBD
GT1585	GT1585V-S	Abbreviation of GT1585V-STBA, GT1585V-STBD
	GT1585-S	Abbreviation of GT1585-STBA, GT1585-STBD
GT157□	GT1575V-S	Abbreviation of GT1575V-STBA, GT1575V-STBD
	GT1575-S	Abbreviation of GT1575-STBA, GT1575-STBD
	GT1575-V	Abbreviation of GT1575-VTBA, GT1575-VTBD
	GT1575-VN	Abbreviation of GT1575-VNBA, GT1575-VNBD
	GT1572-VN	Abbreviation of GT1572-VNBA, GT1572-VNBD
GT156□	GT1565-V	Abbreviation of GT1565-VTBA, GT1565-VTBD
	GT1562-VN	Abbreviation of GT1562-VNBA, GT1562-VNBD
GT155□	GT1555-V	Abbreviation of GT1555-VTBD
	GT1555-Q	Abbreviation of GT1555-QTBD, GT1555-QSBD
	GT1550-Q	Abbreviation of GT1550-QLBD
GT15		Abbreviation of GT1595, GT1585, GT157□, GT156□, GT155□
GT145□	GT1455-Q	Abbreviation of GT1455-QTBD, GT1455-QTBD
	GT1450-Q	Abbreviation of GT1450-QMBDE, GT1450-QMBD, GT1450-QLBDE, GT1450-QLBD
GT14		Abbreviation of GT1455-Q, GT1450-Q
GT1275	GT1275-V	Abbreviation of GT1275-VNBA, GT1275-VNBD
GT1265	GT1265-V	Abbreviation of GT1265-VNBA, GT1265-VNBD
GT12		Abbreviation of GT1275, GT1265
GT115□	GT1155-Q	Abbreviation of GT1155-QTBDQ, GT1155-QSBDQ, GT1155-QTBDA, GT1155-QSBDA, GT1155-QTBD, GT1155-QSBD
	GT1150-Q	Abbreviation of GT1150-QLBDQ, GT1150-QLBDA, GT1150-QLBD
GT11		Abbreviation of GT115□, GT11 Handy GOT,
GT105□	GT1055-Q	Abbreviation of GT1055-QSBD
	GT1050-Q	Abbreviation of GT1050-QBBD
GT104□	GT1045-Q	Abbreviation of GT1045-QSBD
	GT1040-Q	Abbreviation of GT1040-QBBD
GT1030		Abbreviation of GT1030-LBD, GT1030-LBD2, GT1030-LBL, GT1030-LBDW, GT1030-LBDW2, GT1030-LBLW, GT1030-LWD, GT1030-LWD2, GT1030-LWL, GT1030-LWDW, GT1030-LWDW2, GT1030-LWLW, GT1030-HBD, GT1030-HBD2, GT1030-HBL, GT1030-HBDW, GT1030-HBDW2, GT1030-HBLW, GT1030-HWD, GT1030-HWD2, GT1030-HWL, GT1030-HWDW, GT1030-HWDW2, GT1030-HWLW
GT1020		Abbreviation of GT1020-LBD, GT1020-LBD2, GT1020-LBL, GT1020-LBDW, GT1020-LBDW2, GT1020-LBLW, GT1020-LWD, GT1020LWD2, GT1020-LWL, GT1020-LWDW, GT1020-LWDW2, GT1020-LWLW
GT10		Abbreviation of GT105□, GT104□, GT1030, GT1020

Abbreviations and generic terms			Description	
GOT1000 Series	Handy GOT	GT16 Handy GOT	GT1665HS-V	Abbreviation of GT1665HS-VTBD
		GT11 Handy GOT	GT1155HS-Q	Abbreviation of GT1155HS-QSBD
			GT1150HS-Q	Abbreviation of GT1150HS-QLBD
	GT SoftGOT1000		Abbreviation of GT SoftGOT1000	
GOT900 Series			Abbreviation of GOT-A900 series, GOT-F900 series	
GOT800 Series			Abbreviation of GOT-800 series	

## ■ Communication unit

Abbreviations and generic terms	Description
Bus connection unit	GT15-QBUS, GT15-QBUS2, GT15-ABUS, GT15-ABUS2, GT15-75QBUSL, GT15-75QBUS2L, GT15-75ABUSL, GT15-75ABUS2L
Serial communication unit	GT15-RS2-9P, GT15-RS4-9S, GT15-RS4-TE
RS-422 conversion unit	GT15-RS2T4-9P, GT15-RS2T4-25P
Ethernet communication unit	GT15-J71E71-100
MELSECNET/H communication unit	GT15-J71LP23-25, GT15-J71BR13
MELSECNET/10 communication unit	GT15-75J71LP23-Z <sup>*1</sup> , GT15-75J71BR13-Z <sup>*2</sup>
CC-Link IE Controller Network communication unit	GT15-J71GP23-SX
CC-Link IE Field Network communication unit	GT15-J71GF13-T2
CC-Link communication unit	GT15-J61BT13, GT15-75J61BT13-Z <sup>*3</sup>
Interface converter unit	GT15-75IF900
Serial multi-drop connection unit	GT01-RS4-M
Connection Conversion Adapter	GT10-9PT5S
RS-232/485 signal conversion adapter	GT14-RS2T4-9P

\*1 A9GT-QJ71LP23 + GT15-75IF900 set

\*2 A9GT-QJ71BR13 + GT15-75IF900 set

\*3 A8GT-J61BT13 + GT15-75IF900 set

## ■ Option unit

Abbreviations and generic terms	Description	
Printer unit	GT15-PRN	
Video/RGB unit	Video input unit	GT16M-V4, GT15V-75V4
	RGB input unit	GT16M-R2, GT15V-75R1
	Video/RGB input unit	GT16M-V4R1, GT15V-75V4R1
	RGB output unit	GT16M-ROUT, GT15V-75ROUT
Multimedia unit	GT16M-MMR	
CF card unit	GT15-CFCD	
CF card extension unit <sup>*1</sup>	GT15-CFEX-C08SET	
External I/O unit	GT15-DIO, GT15-DIOR	
Sound output unit	GT15-SOUT	

\*1 GT15-CFEX + GT15-CFEXIF + GT15-C08CF set.

## ■ Option

Abbreviations and generic terms		Description
Memory card	CF card	GT05-MEM-16MC, GT05-MEM-32MC, GT05-MEM-64MC, GT05-MEM-128MC, GT05-MEM-256MC, GT05-MEM-512MC, GT05-MEM-1GC, GT05-MEM-2GC, GT05-MEM-4GC, GT05-MEM-8GC, GT05-MEM-16GC
	SD card	NZ1MEM-2GBSD, NZ1MEM-4GBSD, NZ1MEM-8GBSD, NZ1MEM-16GBSD, L1MEM-2GBSD, L1MEM-4GBSD
Memory card adaptor		GT05-MEM-ADPC
Option function board		GT16-MESB, GT15-FNB, GT15-QFNB, GT15-QFNB16M, GT15-QFNB32M, GT15-QFNB48M, GT11-50FNB, GT15-MESB48M
Battery		GT15-BAT, GT11-50BAT
Protective Sheet	For GT16	GT16-90PSCB, GT16-90PSGB, GT16-90PSCW, GT16-90PSGW, GT16-80PSCB, GT16-80PSGB, GT16-80PSCW, GT16-80PSGW, GT16-70PSCB, GT16-70PSGB, GT16-70PSCW, GT16-70PSGW, GT16-60PSCB, GT16-60PSGB, GT16-60PSCW, GT16-60PSGW, GT16-50PSCB, GT16-50PSGB, GT16-50PSCW, GT16-50PSGW, GT16-90PSCB-012, GT16-80PSCB-012, GT16-70PSCB-012, GT16-60PSCB-012, GT16-50PSCB-012, GT16H-60PSC
	For GT15	GT15-90PSCB, GT15-90PSGB, GT15-90PSCW, GT15-90PSGW, GT15-80PSCB, GT15-80PSGB, GT15-80PSCW, GT15-80PSGW, GT15-70PSCB, GT15-70PSGB, GT15-70PSCW, GT15-70PSGW, GT15-60PSCB, GT15-60PSGB, GT15-60PSCW, GT15-60PSGW, GT15-50PSCB, GT15-50PSGB, GT15-50PSCW, GT15-50PSGW
	For GT14	GT14-50PSCB, GT14-50PSGB, GT14-50PSCW, GT14-50PSGW
	For GT12	GT11-70PSCB, GT11-65PSCB
	For GT11	GT11-50PSCB, GT11-50PSGB, GT11-50PSCW, GT11-50PSGW, GT11H-50PSC
	For GT10	GT10-50PSCB, GT10-50PSGB, GT10-50PSCW, GT10-50PSGW, GT10-40PSCB, GT10-40PSGB, GT10-40PSCW, GT10-40PSGW, GT10-30PSCB, GT10-30PSGB, GT10-30PSCW, GT10-30PSGW, GT10-20PSCB, GT10-20PSGB, GT10-20PSCW, GT10-20PSGW
Protective cover for oil		GT05-90PCO, GT05-80PCO, GT05-70PCO, GT05-60PCO, GT05-50PCO, GT16-50PCO, GT10-40PCO, GT10-30PCO, GT10-20PCO
USB environmental protection cover		GT16-UCOV, GT16-50UCOV, GT15-UCOV, GT14-50UCOV, GT11-50UCOV
Stand		GT15-90STAND, GT15-80STAND, GT15-70STAND, A9GT-50STAND, GT05-50STAND
Attachment		GT15-70ATT-98, GT15-70ATT-87, GT15-60ATT-97, GT15-60ATT-96, GT15-60ATT-87, GT15-60ATT-77, GT15-50ATT-95W, GT15-50ATT-85
Backlight		GT16-90XLTT, GT16-80SLTT, GT16-70SLTT, GT16-70VLTT, GT16-70VLTTA, GT16-70VLTN, GT16-60SLTT, GT16-60VLTT, GT16-60VLTN, GT15-90XLTT, GT15-80SLTT, GT15-70SLTT, GT15-70VLTT, GT15-70VLTN, GT15-60VLTT, GT15-60VLTN
Multi-color display board		GT15-XHNB, GT15-VHNB
Connector conversion box		GT11H-CNB-37S, GT16H-CNB-42S
Emergency stop sw guard cover		GT11H-50ESCOV, GT16H-60ESCOV
Wall-hanging fitting		GT14H-50ATT
Memory loader		GT10-LDR
Memory board		GT10-50FMB
Panel-mounted USB port extension		GT14-C10EXUSB-4S, GT10-C10EXUSB-5S

## ■ Software

Abbreviations and generic terms		Description
GT Works3		Abbreviation of the SW□DND-GTWK3-E and SW□DND-GTWK3-EA
GT Designer3		Abbreviation of screen drawing software GT Designer3 for GOT1000 series
GT Simulator3		Abbreviation of screen simulator GT Simulator3 for GOT1000/GOT900 series
GT SoftGOT1000		Abbreviation of monitoring software GT SoftGOT1000
GT Converter2		Abbreviation of data conversion software GT Converter2 for GOT1000/GOT900 series
GT Designer2 Classic		Abbreviation of screen drawing software GT Designer2 Classic for GOT900 series
GT Designer2		Abbreviation of screen drawing software GT Designer2 for GOT1000/GOT900 series
iQ Works		Abbreviation of iQ Platform compatible engineering environment MELSOFT iQ Works
MELSOFT Navigator		Generic term for integrated development environment software included in the SW□DNC-IQWK (iQ Platform compatible engineering environment MELSOFT iQ Works)
MELSOFT iQ AppPortal		SW□DND-IQAPL-M type integrated application management software
GX Works3		Abbreviation of SW□DND-GXW3-E and SW□DND-GXW3-EA type programmable controller engineering software
GX Works2		Abbreviation of SW□DNC-GXW2-E and SW□DNC-GXW2-EA type programmable controller engineering software
Controller simulator	GX Simulator3	Abbreviation of GX Works3 with the simulation function
	GX Simulator2	Abbreviation of GX Works2 with the simulation function
	GX Simulator	Abbreviation of SW□D5C-LLT-E(-EV) type ladder logic test tool function software packages (SW5D5C-LLT (-EV) or later versions)
GX Developer		Abbreviation of SW□D5C-GPPW-E(-EV)/SW D5F-GPPW-E type software package
GX LogViewer		Abbreviation of SW□DNN-VIEWER-E type software package
PX Developer		Abbreviation of SW□D5C-FBDQ-E type FBD software package for process control
MT Works2		Abbreviation of motion controller engineering environment MELSOFT MT Works2(SW□DND-MTW2-E)
MT Developer		Abbreviation of SW□RNC-GSV type integrated start-up support software for motion controller Q series
MR Configurator2		Abbreviation of SW□DNC-MRC2-E type Servo Configuration Software
MR Configurator		Abbreviation of MRZJW□-SETUP□E type Servo Configuration Software
FR Configurator		Abbreviation of Inverter Setup Software (FR-SW□-SETUP-WE)
NC Configurator		Abbreviation of CNC parameter setting support tool NC Configurator
FX Configurator-FP		Abbreviation of parameter setting, monitoring, and testing software packages for FX3U-20SSC-H (SW□D5C-FXSSC-E)
FX3U-ENET-L Configuration tool		Abbreviation of FX3U-ENET-L type Ethernet module setting software (SW1D5-FXENETL-E)
FX Configurator-EN		Abbreviation of FX3U-ENET type Ethernet module setting software (SW1D5C-FXENET-E)
RT ToolBox2		Abbreviation of robot program creation software (3D-11C-WINE)
MX Component		Abbreviation of MX Component Version□ (SW□D5C-ACT-E, SW□D5C-ACT-EA)
MX Sheet		Abbreviation of MX Sheet Version□ (SW□D5C-SHEET-E, SW□D5C-SHEET-EA)
CPU Module Logging Configuration Tool		Abbreviation of CPU Module Logging Configuration Tool (SW1DNN-LLUTL-E)

## ■ License key (for GT SoftGOT1000)

Abbreviations and generic terms	Description
License	GT15-SGTKEY-U, GT15-SGTKEY-P

## ■ Others

Abbreviations and generic terms	Description
IAI	Abbreviation of IAI Corporation
AZBIL	Abbreviation of Azbil Corporation (former Yamatake Corporation)
OMRON	Abbreviation of OMRON Corporation
KEYENCE	Abbreviation of KEYENCE CORPORATION
JTEKT ELECTRONICS	Abbreviation of JTEKT ELECTRONICS CORPORATION (formerly KOYO ELECTRONICS INDUSTRIES CO., LTD.)
SHARP	Abbreviation of Sharp Corporation
JTEKT	Abbreviation of JTEKT Corporation
SHINKO	Abbreviation of Shinko Technos Co., Ltd.
CHINO	Abbreviation of CHINO CORPORATION
TOSHIBA	Abbreviation of TOSHIBA CORPORATION
TOSHIBA MACHINE	Abbreviation of TOSHIBA MACHINE CO., LTD.
HITACHI IES	Abbreviation of Hitachi Industrial Equipment Systems Co., Ltd.
HITACHI	Abbreviation of Hitachi, Ltd.
FUJI	Abbreviation of FUJI ELECTRIC CO., LTD.
PANASONIC	Abbreviation of Panasonic Corporation
PANASONIC INDUSTRIAL DEVICES SUNX	Abbreviation of Panasonic Industrial Devices SUNX Co., Ltd.
YASKAWA	Abbreviation of YASKAWA Electric Corporation
YOKOGAWA	Abbreviation of Yokogawa Electric Corporation
ALLEN-BRADLEY	Abbreviation of Allen-Bradley products manufactured by Rockwell Automation, Inc.
GE	Abbreviation of GE Intelligent Platforms
LS ELECTRIC	Abbreviation of LS ELECTRIC Co., Ltd (formerly LS Industrial Systems Co., Ltd.)
MITSUBISHI INDIA	Mitsubishi Electric India Pvt. Ltd.
SCHNEIDER	Abbreviation of Schneider Electric SA
SICK	Abbreviation of SICK AG
SIEMENS	Abbreviation of Siemens AG
RKC	Abbreviation of RKC INSTRUMENT INC.
HIRATA	Abbreviation of Hirata Corporation
MURATEC	Abbreviation of Muratec products manufactured by Muratec Automation Co., Ltd.
PLC	Abbreviation of programmable controller
Temperature controller	Generic term for temperature controller manufactured by each corporation
Indicating controller	Generic term for indicating controller manufactured by each corporation
Control equipment	Generic term for control equipment manufactured by each corporation
CHINO controller	Abbreviation of indicating controller manufactured by CHINO CORPORATION
PC CPU module	Abbreviation of PC CPU Unit manufactured by CONTEC CO., LTD
GOT (server)	Abbreviation of GOTs that use the server function
GOT (client)	Abbreviation of GOTs that use the client function
Windows® font	Abbreviation of TrueType font and OpenType font available for Windows® (Differs from the True Type fonts settable with GT Designer3)
Intelligent function module	Indicates the modules other than the PLC CPU, power supply module and I/O module that are mounted to the base unit
MODBUS® /RTU	Generic term for the protocol designed to use MODBUS® protocol messages on a serial communication
MODBUS® /TCP	Generic term for the protocol designed to use MODBUS® protocol messages on a TCP/IP network

# HOW TO USE THIS MANUAL

The following symbols are used in this manual.

### 4.1 GOT Type Setting

#### 4.1.1 Settings

Select [Common] → [GOT Type Setting] from the menu to display the [GOT Type Setting] dialog box.

**HINT**

**Settings relevant to functions**  
For the common settings in a project data, some settings are relevant to multiple GOT functions.  
For each setting relevant to the GOT functions, refer to the following.

Appendix8 Relevant Settings

Shows whether the GT16, GT15, GT14, GT12, GT11, GT10, and GT SoftGOT1000 are applicable.

- : Applicable
- × : Not applicable

[ ] : Shows the setting item displayed on the software screen or the GOT screen.

**POINT** : Refers to information required for operation.

**HINT** : Refers to information useful for operation.

Shows a chapter, section, relevant manual, or others of relevant information.

- (Fundamentals): GT Designer3 Version1 Screen Design Manual (Fundamentals)
- (Functions): GT Designer3 Version1 Screen Design Manual (Functions)

Shows the operation steps.  
Operate the steps from the step 1.

**Setting for each screen**

- Select a screen editor to set a key window, and select [Screen] → [Screen Property] from the menu to display the [Screen Property] dialog box.
- Select the [Key Window Basic Setting] tab or the [Key Window Advanced Setting] tab, and set the required items.

**HINT**

**Settings relevant to functions**  
For the key window settings, some settings are relevant to multiple GOT functions.  
For each setting relevant to the GOT functions, refer to the following.

Appendix8 Relevant Settings

(1) Key Window Basic Setting tab

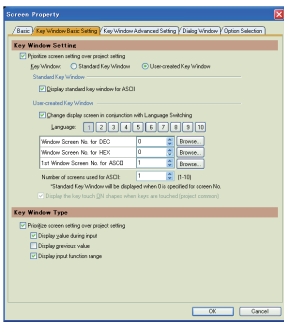

Item	Description	Model
Prioritize screen setting over project setting	Select this item to give the setting for each screen priority over the setting for each project.	gt16, gt15, gt14, gt12, gt11, gt10, gtsoftg1000
Key Window	This item is available when [Prioritize screen setting over project setting] is selected for [Key Window Setting]. (Standard Key Window/User-created Key Window)	gt16, gt15, gt14, gt12, gt11, gt10, gtsoftg1000
Display standard key window for ASCII	Select this item to display the standard key window at ASCII input.	gt16, gt15, gt14, gt12, gt11, gt10, gtsoftg1000
Key Window Setting	This item is available when [User-created Key Window] is	

Shows whether the GT16, GT15, GT14, GT12, GT11, GT10, and GT SoftGOT1000 are applicable.

- Black: Applicable
- Gray: Not applicable

The above is different from the actual page, as it is provided for explanation only.





# COMMUNICATION WITH GOT

---



# 8. COMMUNICATION WITH GOT



## 8.1 Transferring Data between GOT and Personal Computer

This section explains how to transfer data between the GOT and the personal computer.

### ■ Data transfer procedure

Data is transferred in the following procedure.

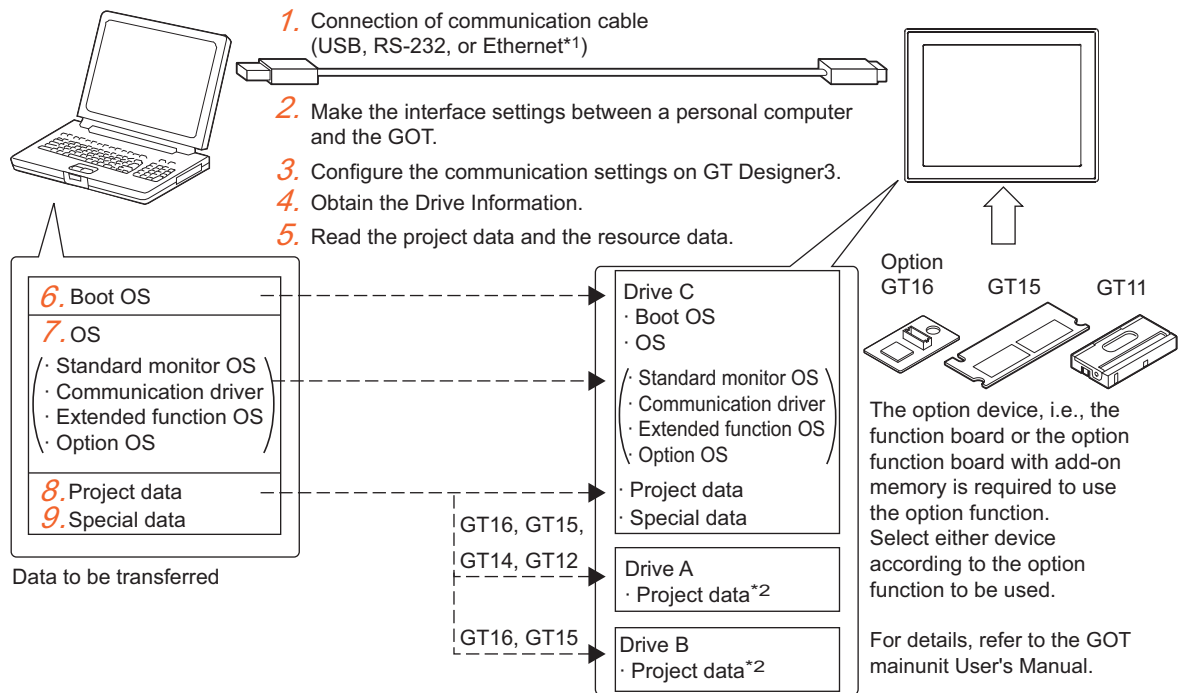

\*1 Connectable to the GT16, GT15, GT1455-QTBDE, GT1450-QLBDE, and GT12 only.

To connect the Ethernet cable to the GT15, the GOT requires the Ethernet communication unit.

\*2 For the GT16 and GT15, the project data can be stored in Drive A or Drive B and started from the drive.

For the GT14 and GT12, the project data can be stored in Drive A and started from the drive.

1. Connect the communication cable.
  - ☞ 8.1.1 Connecting personal computer and GOT with cable
2. Make the interface settings between a personal computer and the GOT.
  - ☞ 8.1.2 Interface setting of the GOT
3. Configure the communication settings on GT Designer3.
  - ☞ 8.1.3 Setting communication
4. Obtain the drive information.
  - ☞ 8.1.5 ■ Reading drive information(GOT to personal computer)

5. Read the project data and resource data from the GOT.
  - Transferring directly the read project data from the GOT to the personal computer
    - ☞ 8.1.5 ■Reading project data (GOT to personal computer)
  - Transferring the read project data to the personal computer via a memory card or a USB memory
    - ☞ 3.6.2 ■Opening GT Designer3 project
  - Transferring the read resource data to the personal computer.
    - ☞ 8.1.5 ■Reading resource data (GOT to personal computer)
  
6. Install the Boot OS on the GOT. (This operation is required at the time of the Boot OS upgrade and the GOT initialization.) (GT16, GT15, GT14, GT12, and GT11)
  - Installing directly the Boot OS on the GOT from the personal computer.
    - ☞ 8.1.4 ■Installing Boot OS (Personal computer to GOT)
  - Installing the Boot OS on the GOT via a memory card or a USB memory
    - ☞ 8.2.2 Transferring Boot OS to memory card or USB memory
  
7. Install the OS (standard monitor OS, communication driver, extended function OS, and option OS) on the GOT.
  - Installing directly the OS on the GOT from the personal computer.
    - ☞ 8.1.4 ■Installing the OS (Personal computer to GOT)
  - Installing the OS on the GOT via a memory card or a USB memory
    - ☞ 8.2.1 Transferring project data, OS, and special data to memory card or USB memory
  
8. Write the project data to the GOT.
  - Writing directly the project data from the personal computer to the GOT.
    - ☞ 8.1.4 ■Writing project data and installing OS (Personal computer to GOT)
  - Writing the project data to the GOT via a memory card or a USB memory
    - ☞ 8.2.1 Transferring project data, OS, and special data to memory card or USB memory
  
9. Write the special data to the GOT. (GT16 and GT15)
  - Writing directly the special data from the personal computer to the GOT.
    - ☞ 8.1.4 ■Writing special data (Personal computer to GOT)
  - Writing the special data to the GOT via a memory card or a USB memory
    - ☞ 8.2.1 Transferring project data, OS, and special data to memory card or USB memory

## ■ Precautions

### (1) Transfer cable

Check if the connector of the cable is securely connected to the one of the GOT and the personal computer.

### (2) Specification of the read destination at read

When [Destination] is specified as a project of GT Designer3, all data in the specified project are deleted. (Even for a partial reading (comment data, etc.), all data in the file are also deleted.)

For details of the read destination, refer to the following.

☞ 8.1.5 Reading from GOT

### (3) Data transfer timing

Communication from the personal computer is not accepted while the message [Booting] or [Booting project data] is on the GOT at power-on.

Transfer the data after the message has gone.

#### (4) GOT operation

In the following cases, the GOT operation is required.

- (a) Transferring the project data to the GT11 via RS-232 cable.  
When the standard I/F-2 (RS-232 interface) is set to other than the host personal computer in the communication settings, change the channel No. of the RS-232 interface to "9" in [Standard I/F Setting] in [Communication Setting] of the GOT.
- (b) Transferring the project data to the GT10.  
When the standard I/F-2 (personal computer connection interface) is set to other than the host personal computer in the communication settings, select the personal computer transfer in the GOT communication settings.

For details of each operation, refer to the following.

 User's Manual for the GOT used

#### (5) When the data storage stores a large number of folders or files

A large number of folders or files in the data storage may decrease file access performance, resulting in a much longer communication time than usual or a communication timeout.

Reduce the number of folders or files in the data storage as necessary.

#### (6) Ethernet transfer (GT16, GT15, GT1455-QTBDE, GT1450-QLBDE, GT1450-QMBDE, and GT12)

Only project data write/read, OS installation, special data write, and resource data read is available with the Ethernet transfer. (The Boot OS cannot be installed.)

Before transferring the data via Ethernet, configure the following settings on the GOT so that communication via Ethernet become available.

- Write the Boot OS and standard monitor OS.
- Configure the setting for the Ethernet download in the communication setting.

For how to check the setting, refer to the following.

 User's Manual for the GOT used

### POINT

#### (1) Precautions for Ethernet transfer operation

- (a) Advance notice of installing the OS and writing project data  
To install the OS and write project data via Ethernet, determine rules of the Ethernet transfer operation including the advance notice to GOT operators.  
Change in the OS and project data without any notice may affect the GOT operation.
- (b) Ensuring of data restoration measures  
If the controller setting is changed when the OS is installed, and when project data is written, the GOT may not communicate with GT Designer3.  
Prepare a memory card or other measures to restore the data on the GOT.

#### (2) Precautions for standard monitor OS major version

If the standard monitor OS major versions between the GOT and GT Designer3 differ, OSes cannot be installed in the GOT via Ethernet.

To install OSs on the GOT, use a USB cable, RS-232 cable, memory card, USB memory, or others.

To confirm the standard monitor OS major version, refer to the following.

 8.5.1 ■Data types and storage destinations (3) Standard monitor OS version

#### (7) Project data write

The project data must have been opened on GT Designer3 to write the project data.

The other data (Boot OS, standard monitor OS, communication driver, extended function OS, and option OS) can be transferred even when the project data has not been opened on GT Designer3.

**(8) Writing, reading, or verifying a project by using the old version of GT Designer3**

When the version of the standard monitor OS and the project data in the GOT are under the following conditions, do not write, read, and verify the project data by using GT Designer3 Version 1.45X or earlier.

- Standard monitor OS:  
Version 05.37.00 or later (GT10: 01.26.00 or later)
- Project data:

The project security is set by using GT Designer3 Version 1.45X or later.

Even if the user tries to write the project data in the GOT, the project data cannot be written.

No error occurs when only the OS is installed in the GOT. However, if the OS and the project data are written in the GOT, an error occurs.

If the project data is read from the GOT, the read data is invalid and does not work correctly.

If the project data is verified, the verification result is incorrect.

**(9) Detailed explanation and category set on the project data or screen**

Detailed explanation and category set on the project data or screen are not written to the GOT.

They are not set when the project data written to the GOT once is read again from the GOT to the personal computer.

**(10) Data within the GOT**

When the data already existing in the GOT is the same as the project data to be written to the GOT (both the project folder name and the project ID are the same), it will be overwritten during write.

Checking [Write after deleting all contents in the project folder] in the [Communicate with GOT] dialog box will allow a new program write after deleting the project data folder.

For installing the Boot OS or OS on the GOT, refer to the following.

 8.1.5 Reading from GOT

**(11) Power saving function of the personal computer**

When data is transferred with the GOT connected, turn off the power saving function of the personal computer and Windows®.

For details of the power saving function setting, refer to the personal computer manual or Windows® Help.

**(12) Installation of the USB driver of another company product**

When installing the USB driver of other company products, the “Confirm File Replace” message of the USB driver file (windrvr6.sys) may be displayed.

When a newer file already exists, click the [No] button to discontinue the overwriting processing.

If the file is overwritten, USB communication between GT Designer3 and the GOT may not be made correctly.

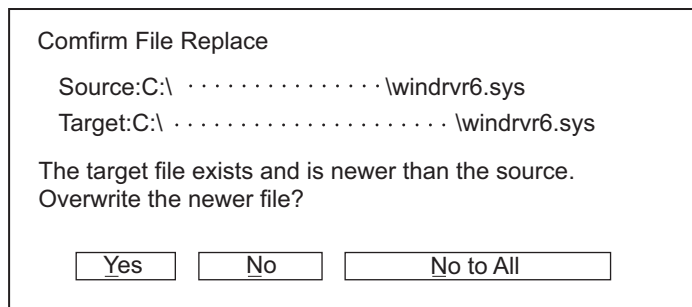

**(13) Precautions for using the USB cable**

- When performing data transfer between the personal computer and the GOT connected via the USB cable, do not set the resume function, suspend function, power-saving function, and standby mode of the personal computer.

For the setting details of the resume function, suspend function, power-saving function, and standby mode, refer to the personal computer manual or Windows® Help.

- If the USB cable is disconnected/reconnected during the data transfer, the GOT is reset or powered off/on, which may result in a unrecoverable communication error.

In this case, perform either of the following operations.

- (a) The Personal Computer will check for a USB connection.  
Please check that MITSUBISHI GOT1000 USB Controller is displayed in the Universal Serial Bus controllers.

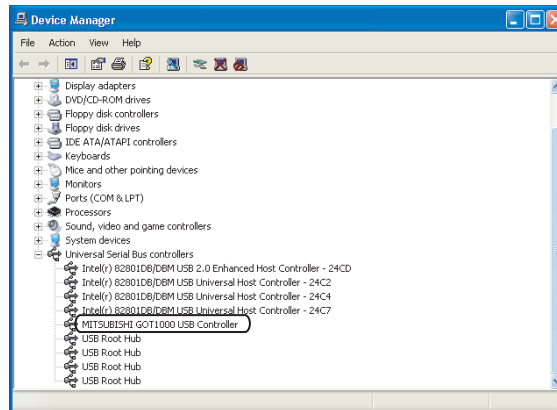

- (b) After disconnecting the USB cable from the GOT for more than 5 seconds, reconnect the cable and restart communication.  
(c) After turning on the GOT again, restart the communication.

**(14) Precautions for communicating with the GOT via modem**

- (a) The setting of GOT Modem Connection Tool, a modem, and the GOT  
When communicating with the GOT via a modem, make sure to set all the communication settings for GOT Modem Connection Tool, a modem, and the GOT correctly.  
If the settings are not configured correctly, communication with the GOT via a modem is not executed.
- (b) The telephone circuit that is not connectable  
Do not connect to the call-waiting circuit.  
Failure to do so disrupts data by an in-coming call or disconnects the circuit automatically.
- (c) Disconnection of the telephone circuit  
When communication with the GOT ends, make sure to disconnect the telephone circuit using GOT Modem Connection Tool or the GOT.  
Otherwise, communication between modems remains connected even if communication between the GOT and GT Designer3 is disconnected.
- (d) Transmission speed of modem  
Configure the setting of the transmission speed between modems same as that of the transmission speed between the personal computer/GOT and a modem.  
If the settings of transmission speed differ, an error may occur at communication.
- (e) Communication via a modem in an incorrect setting  
For communication via a modem, make settings and connections according to the method in the manuals.  
Communication via a modem may be established using a method that is not described in the manuals.  
However, the performance is not guaranteed.
- (f) Confirmation of the initialization command  
Check that the initialization command is correct before executing communication between modems using GOT Modem Connection Tool.  
If the initialization command is incorrect, a modem may automatically disconnect the circuit at data transfer from GT Designer3 even when communication between modems is established.
- (g) Executing a connection test  
When executing a connection test, check that the GOT can send or receive data using both GOT Modem Connection Tool and GT Designer3.
- (h) The Modem initialization signal and the Modem circuit disconnect signal  
Do not turn on the Modem initialization signal (GS448.b0) and the Modem circuit disconnect signal (GS448.b1) in the following cases.  
Even if GS448.b0 and GS448.b1 turn on, the connection between modems cannot be disconnected.
- While the GOT communicates with GX Works2 or GX Developer by using the FA transparent function
  - While the GOT communicates with GT Designer3

- (i) The communication setting between the personal computer/GOT and a modem  
 Configure the communication setting between the personal computer and a modem, and the communication setting between the GOT and a modem before executing communication between modems. Do not change the setting after the setting is configured.  
 The communication port setting for a modem cannot be changed after communication between modems is established.  
 The communication setting on the personal computer and the GOT should be identical.  
 If the communication settings differ, an error may occur at communication.
- (j) Interface between the personal computer and the GOT  
 When [Host(Modem)] is selected in the interface setting between the personal computer and the GOT, do not directly connect the personal computer and the GOT using the RS-232 cable.  
 Communication is not established if the personal computer and the GOT are directly connected.
- (k) Assignment of personnels  
 When communicating with the GOT via a modem, assign personnels both for the personal computer and the GOT to take action for an accident including a circuit fault.

**(15) Communication error that may occur when the PLC is not connected to the GOT**

If the GOT and the PLC are not connected but the relevant connection settings are already made on the GOT, the GOT performs retry communication processing as it cannot communicate with the PLC. If the following operations are performed on GT Designer3 in this status, a communication error may occur (error No.: 8011000a).

- OS installation
- Project data writing
- OS, project data, or resource data deletion
- Drive formatting

For the corrective action, refer to the following.

☞ 8.6 Error Messages Displayed at Data Transfer

**(16) When a communication error occurs**

A communication error, such as a time-out error, may occur due to the communication port settings on the personal computer.

When the port for the Ethernet communication is blocked by the firewall, a communication error occurs.

Disable the firewall or configure the setting to open the port.

Check and change the settings in the following procedure.

The following items may not be present depending on the used personal computer.

1. Select [Start] → [Control Panel] from the menu.

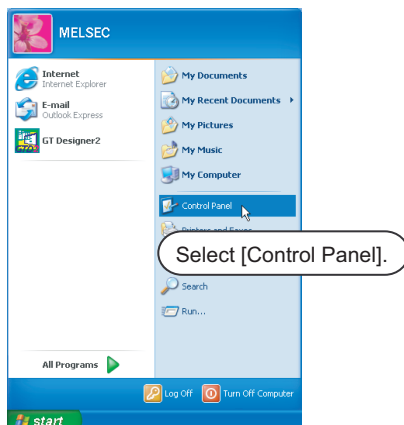



2. Select [Performance and Maintenance] and click the [System] icon.

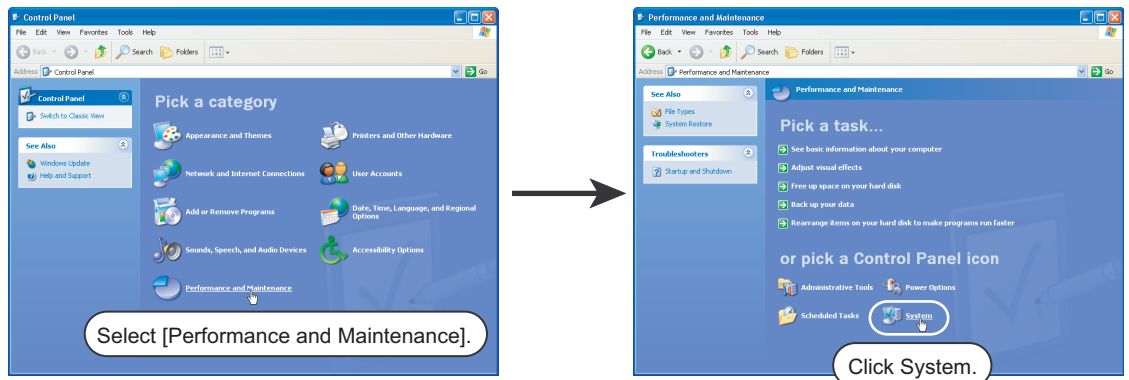

3. The [System Properties] dialog box appears. Click the [Device Manager] button in the [Hardware] tab.

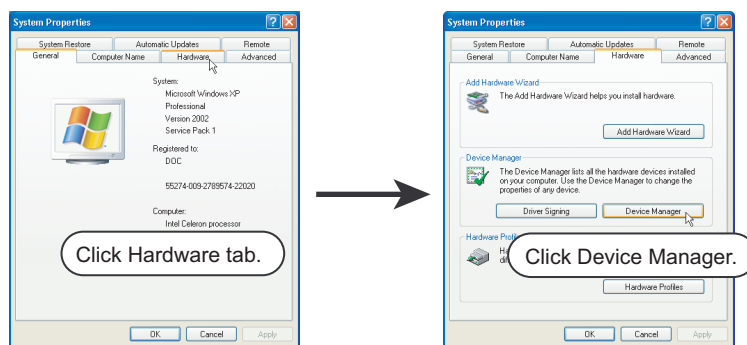

4. Device Manager appears. Select [Ports] and double-click the current [Communications Port] icon. (In the following, an example using the communication port (COM1) is described.)

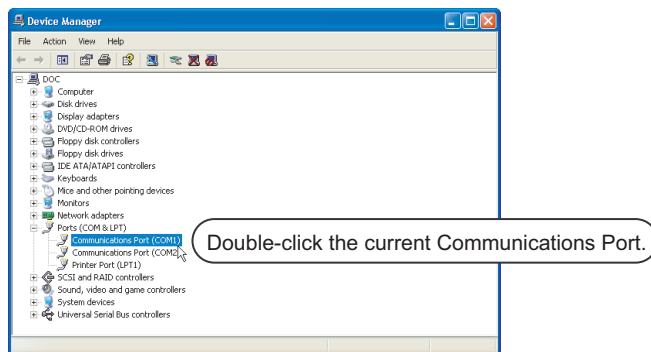

5. The [Communications Port(COM1) Properties] dialog box appears. Click the [Advanced] button in the [Port Settings] tab.

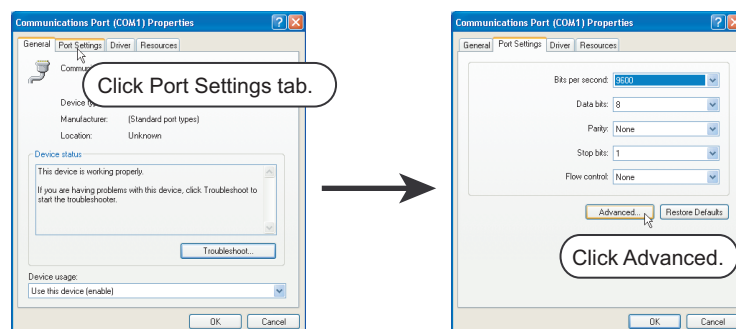

6. The [Advanced Settings for COM1] dialog box appears. Clear [Use FIFO buffers].

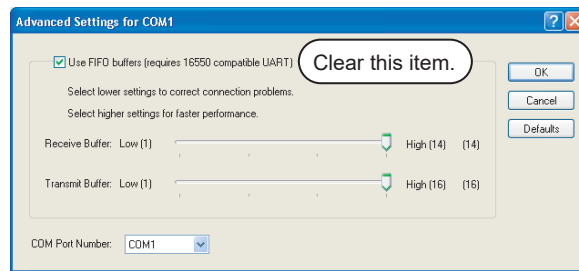

## 8.1.1 Connecting personal computer and GOT with cable

### ■ Connecting personal computer and GOT with USB cable

#### (1) System configuration and applicable cable

The following shows the system configuration and applicable cables to connect the personal computer and the GOT with the USB cable.

##### (a) System configuration

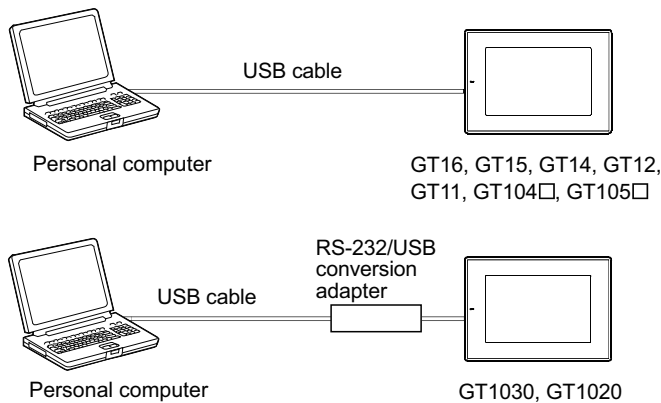

##### (b) USB cable

Model	Manufacturer	Compatible model
GT09-C20USB-5P (A↔mini B type)	Mitsubishi Electric System & Service Co., Ltd.	GT16, GT15, GT14, GT12, GT11, GT105□, GT104□
GT09-C30USB-5P (A↔mini B type)	Mitsubishi Electric System & Service Co., Ltd.	GT16, GT15, GT14, GT12, GT11, GT105□, GT104□, GT1030* <sup>1</sup> , GT1020* <sup>1</sup>

\*1 Use the cable and the RS-232/USB conversion adapter in combination.

##### (c) RS-232/USB conversion adapter

Model	Manufacturer	Compatible model
GT10-RS2TUSB-5S	Mitsubishi Electric	GT1030, GT1020

#### (2) Connecting with the USB cable

Connect the personal computer and the GOT with the USB cable in the following procedure.

1. Connect the A-type connector of a USB cable to the USB port of the personal computer, and the mini B type connector of the cable to the USB interface (Device) of the GOT.  
For the location of the USB interface (Device) on the GOT, refer to the following.

User's Manual for the GOT used

2. Power on the GOT.
3. Only at the first connection, the USB driver is installed to the personal computer automatically.

## POINT

### Warning message displayed when installing the USB driver

When installing the USB driver, [Windows can't verify the publisher of this driver software] is displayed as a warning message.

To continue the USB driver installation, click [Install this driver software anyway].

The [Program Compatibility Assistant] window may be displayed during installation.

In this case, click [This program installed correctly].

## ■ Connecting personal computer and GOT with RS-232 cable

Connect the personal computer and the GOT with the RS-232 cable in the following procedure.

### (1) System configuration and applicable cables

The following shows the system configuration and applicable cables to connect the personal computer and the GOT with the RS-232 cable.

#### (a) System configuration

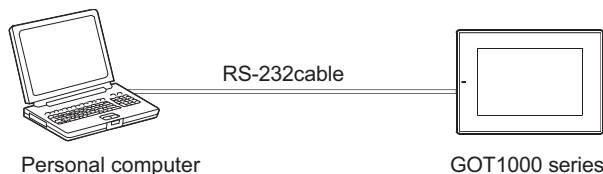

#### (b) RS-232 cable

Model	Manufacturer	Compatible model
GT01-C30R2-9S (9-pin female ↔ 9-pin female)	Mitsubishi Electric	GT16, GT15, GT14, GT12, GT11, GT105□, GT104□
GT01-C30R2-6P (9pin female ↔ 6pin male)	Mitsubishi Electric	Handy GOT, GT1030, GT1020

### (2) Connecting with the RS-232 cable

1. Connect the RS-232 cable to the communication port of the personal computer.
2. Connect the RS-232 cable to the RS-232 connector of the GOT.  
For RS-232 connector of each GOT, refer to the following.

User's Manual for the GOT used

## ■ Connecting personal computer and GOT with Ethernet cable

Connect the personal computer and the GOT with the Ethernet cable in the following procedure.

### (1) System configuration and applicable cable

The following shows the system configuration and the applicable cable to connect the personal computer and the GOT with the Ethernet cable.

#### (a) System configuration

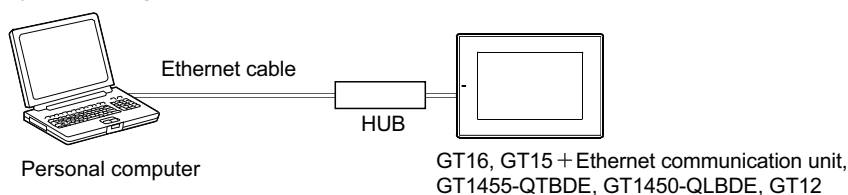

#### (b) Communication unit

Model	Manufacturer	Compatible model
GT15-J71E71-100	Mitsubishi Electric	GT15

#### (c) Ethernet cable

Cable*1	Manufacturer	Compatible model
Shielded twisted pair cable (STP) Unshielded twisted pair cable (UTP) Category 3, 4, and 5	-	GT16*2, GT15, GT1455-QTBDE, GT1450-QLBDE, GT12

\*1 The destination connected with the twisted pair cable varies with the configuration of the applicable Ethernet network system. Connect to the Ethernet module, hub, transceiver, or other system equipment corresponding to the applicable Ethernet network system.  
Use cables, connectors, and hubs that meet the IEEE802.3 10BASE-T/100BASE-TX standard.

\*2 When connecting GT16 of the function version A to an equipment that meets the 10BASE (-T/2/5) standard, use the switching hub and operate in a 10Mbps/100Mbps mixed environment.  
For how to check the function version, refer to the following.

 GT16 User's Manual (Hardware)

## (2) Installing the Ethernet communication unit (GT15)

Install the Ethernet communication unit to the expansion unit installation connector of the GT15.  
For details of the Ethernet communication unit, refer to the following.

 GT15 Ethernet communication unit User's Manual

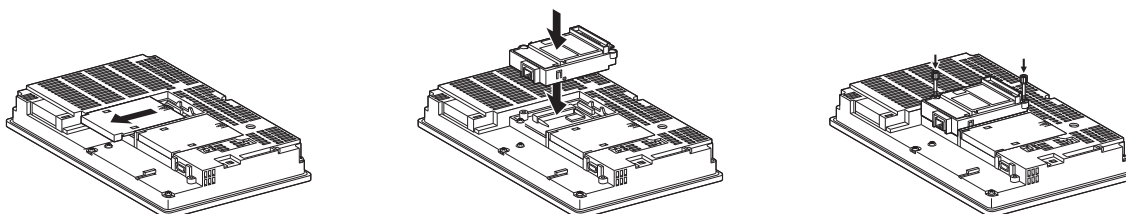

1. Remove the extension unit cover.

2. Push in the Ethernet communication unit.

3. Secure the unit by tightening the installation screw with the specified torque.

## (3) Connecting with the Ethernet cable (GT16, GT15, GT1455-QTBDE, GT1450-QLBDE and GT12)

For the GT16, GT1455-QTBDE, GT1450-QLBDE, and GT12, connect the Ethernet cable to the GOT. For the GT15, connect the Ethernet cable to the Ethernet communication unit.

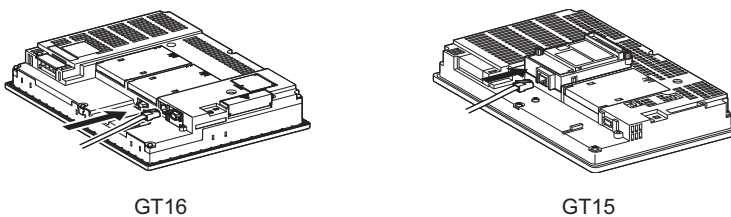

GT16

GT15

### POINT

#### Precautions for installing the unit and connecting the cable

Shut off all phases of the GOT before installing the communication unit or connecting the cable.

## ■ Connecting personal computer and the GOT via modem

Connect a personal computer, a modem, and the GOT using a RS-232 cable.

### (1) System configuration and applicable cable

The following shows a system configuration of connecting a personal computer and the GOT via a modem, and applicable cables.

#### (a) System configuration

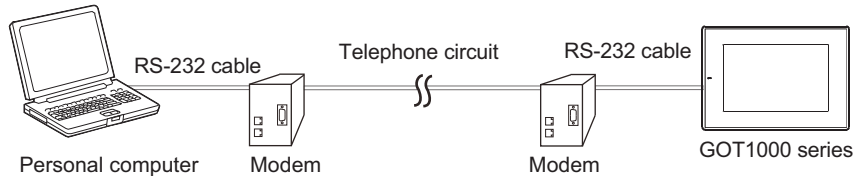

#### (b) Modem and RS-232 cable

The personal computer built-in modem is not applicable.

Applicable RS-232 cable differs depending on a modem type.

For applicable modems and RS-232 cables, refer to Technical News GOT-A-0010 "List of Valid Devices Applicable for GOT1000 Series" separately available, or contact your local distributor.

#### (c) Telephone circuit

Refer to the user's manual for the modem used.

### (2) Connecting with RS-232 cable

Connect a personal computer and a modem, and the GOT and a modem using a RS-232 cable.

#### (a) Connecting personal computer and modem

1. Connect a RS-232 cable to the communication port of a personal computer.
2. Turn on the modem.
3. Connect the RS-232 cable which is connected to the personal computer and the RS-232 connector of the modem.  
For connecting a RS-232 cable to a modem, refer to the following.  
☞ User's manual for the modem used
4. Connect the modem to the telephone circuit.  
For connecting to the telephone circuit, refer to the following.  
☞ User's manual for the modem used

#### (b) Connecting the GOT and modem

1. Connect the RS-232 cable to the RS-232 connector of the GOT.  
For RS-232 connectors of each GOT, refer to the following.  
☞ User's Manual for the GOT used
2. Turn on the modem.
3. Connect the RS-232 cable which is connected to the GOT and the RS-232 connector of the modem.  
For connecting a RS-232 cable to a modem, refer to the following.  
☞ User's manual for the modem used
4. Connect the modem to the telephone circuit.  
For connecting to the telephone circuit, refer to the following.  
☞ User's manual for the modem used

## 8.1.2 Interface setting of the GOT

1. Configure the interface setting between a personal computer and the GOT before executing communication with the GOT.

 ■Interface setting of the GOT

For communication using a USB cable, a RS-232 cable, and an Ethernet cable, the interface setting is completed. Configure the communication setting by referring to the following.

 8.1.3 Setting communication

2. When communicating with the GOT via a modem, initialize the modem of the GOT. For the communication setting between the GOT and a modem, refer to the following.

 User's manual for the modem used

3. Establish communication between modems using GOT Modem Connection Tool.

 ■Establishing communication between modems (GOT Modem Connection Tool)

The interface setting is completed.

Configure the communication setting by referring to the following.

 8.1.3 Setting communication

### ■ Interface setting of the GOT



Select [Common] → [Peripheral Setting] → [PC (Data Transfer)] from the menu.

The setting dialog box appears.

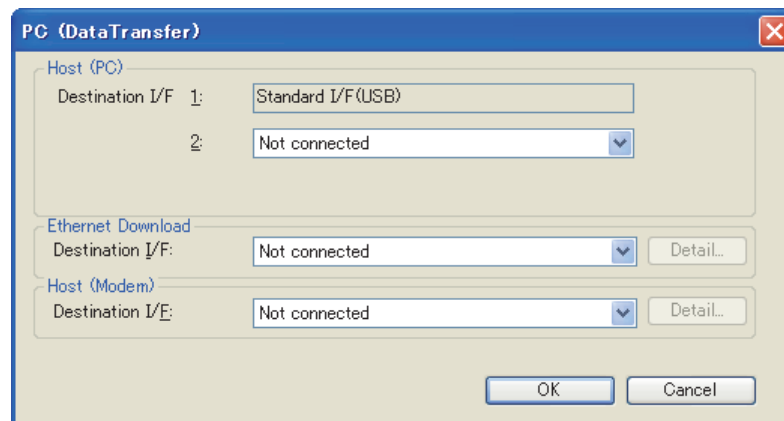
Set the GOT interface used for communication with a personal computer.



Example: GT16

Item	Description	Model
Host (PC)	When the communication is executed with the GOT and a personal computer directly connected, set the GOT interface used for communication with a personal computer.	GT16 GT15 GT14 GT12 GT11 GT10 SoftGOT1000
Ethernet Download	When communicating with the GOT via Ethernet, set the GOT interface used for communication with the personal computer. Click the [Detail] button to display the [Detail Setting] dialog box. Configure the connection setting between a personal computer and the GOT by referring to the following.  (1) Detail setting (Ethernet download)	GT16 GT15 GT14 GT12 GT11 GT10 SoftGOT1000
Host (Modem)	When communicating with the GOT via a modem, set the GOT interface used for communication with the modem. Click the [Detail] button to display the [Detail Setting] dialog box. Configure the connection setting between the modem and the GOT by referring to the following.  (2) Detail setting (host (modem))	GT16 GT15 GT14 GT12 GT11 GT10 SoftGOT1000

**(1) Detail setting (Ethernet download)**

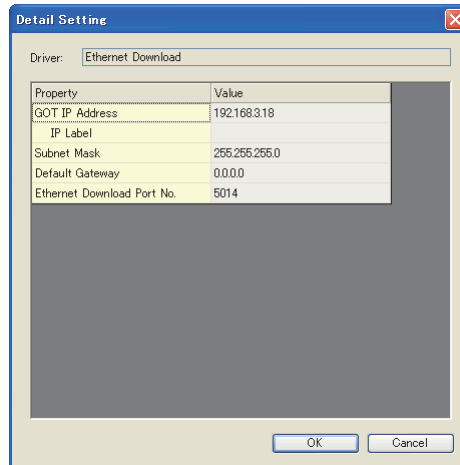

Item	Description	Setting range
GOT IP Address	Set the IP address of the GOT.	0.0.0.0 to 255.255.255.255
IP Label	Set the IP label of the detail setting. The set IP label is registered in the IP label list. 8.1.3 ■ IP Label List	-
Subnet Mask	When the subnetwork is used, set the subnet mask. (Via a router only.) (Default: 255.255.255.0)	0.0.0.0 to 255.255.255.255
Default Gateway	Set the router address of the default gateway to which the GOT is connected. (Via a router only.) (Default: 0.0.0.0)	0.0.0.0 to 255.255.255.255
Ethernet Download Port No.	Set the port No. used by the GOT for Ethernet download. (Default: 5014)	1024 to 65534

**(2) Detail setting (host (modem))**

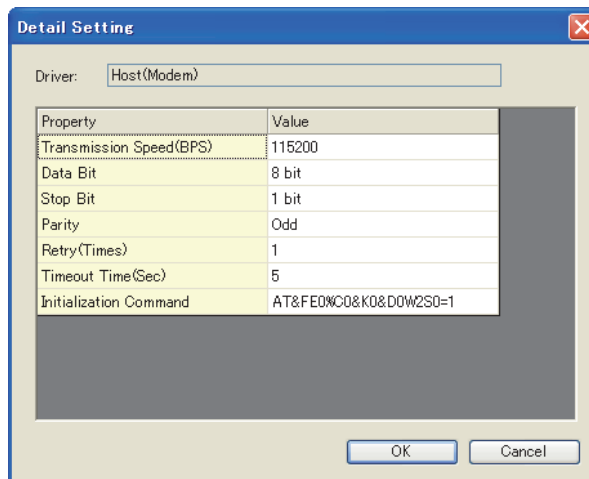

Item	Description	Setting range
Transmission Speed(BPS)	Set the transmission speed at communication. (Default: 115200)	9600/19200/38400/57600/115200
Data Bit	Set the data length at communication. (Default: 8 bit)	7bit/8bit
Stop Bit	Set the stop bit length at communication. (Default: 1 bit)	1bit/2bit

(Continued to next page)



Item	Description	Setting range
Parity	Set the type to check parity at communication. (Default: Odd)	None/Even/Odd
Retry(Times)	Set the number of retries at communication. (Default: 1 time)	1 time
Timeout Time(Sec)	Set the timeout time at communication. (Default: 5 seconds)	5 seconds
Initialization Command	Set AT commands for initializing a modem. (Default: AT&FE0%C0&K0&D0W2S0=1)	Up to 255 one-byte alphanumeric characters*1

\*1 The maximum number of characters of AT commands differs depending on the modem specification. When the maximum number of characters of AT commands applicable for the modem is 255 or less, set the initialization command according to the modem.

## HINT

### AT command

The AT command is the command system to control modems and terminal adapters. When the AT command is used, a personal computer can control modems. For details of the AT command, refer to the user's manual for the modem used.

## POINT

### AT command settings

For communication between the GOT and a personal computer via modems, set the AT commands as shown below.

If the settings are incorrect, the GOT cannot communicate with the personal computer via modems.

- Command echo setting: Disabled (Setting example: E0)
- Result code setting: Enabled (Setting example: Q0)
- Display format of the result code: Word format (Setting example: V1)
- Extended result code setting: Displaying the transmission speed between modems (Setting example: W2)
- DTR signal control: Ignoring the DTR signal and always turning on the signal (Setting example: &D0)
- Flow control for a personal computer: Flow control disabled (Setting example: &K0)
- Data compression function setting: Data compression disabled (Setting example: %C0)
- S register setting: Setting the auto-answer to be enabled, and setting the number of rings required before the modem answers to one (Setting example: S0=1)

## ■ Establishing communication between modems (GOT Modem Connection Tool)

GOT Modem Connection Tool is the software to establish communication between modems by using a personal computer.

To communicate with the GOT via modems, make sure to establish the communication between modems by using GOT Modem Connection Tool, and then connect GT Designer3 to the GOT.

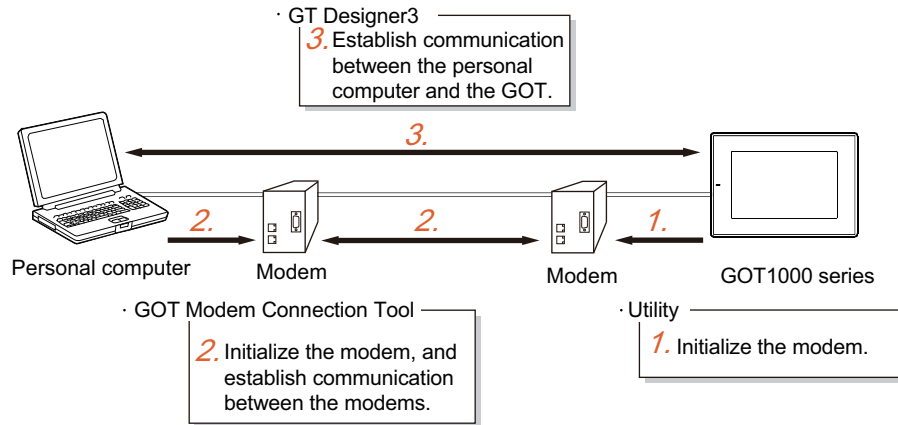

### (1) How to obtain software

Obtain the software with either of the following methods.

- Disk5 folder in GT Works3 DVD  
The stored location of the software is written in ReadmeJ.txt. (File name: GTModemConnector.exe)  
Copy the software on the hard disk of a personal computer, and use the software.
- Contact your local distributor.

### (2) Operating environment

The following shows the operating environment.

Item	Description
OS	Same as the operating environment of GT Designer3 ☞ 2.1 Operating Environment
Computer	Compatible with the operating environment for the above OS.
Hard disk space	2MB or more
Display color	High Color (16 bits) or more
Resolution	Resolution of 800 × 600 dots or more
Others	The mouse and keyboard must be compatible with the above OS. GT Designer3 Version1.06G or more must be installed.

### (3) How to start software

Installing GOT Modem Connection Tool is not required.  
Execute GTModemConnector.exe.

**(4) Establishing communication between modems**

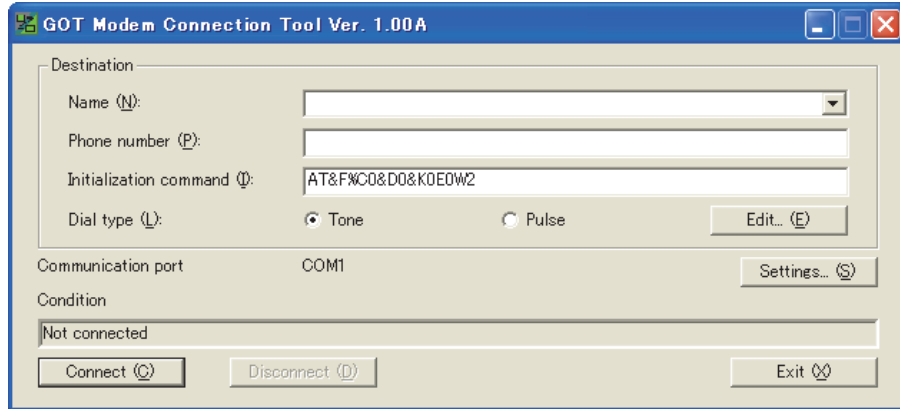

Establish the communication between modems by the following procedure.

1. Execute GTModemConnector.exe, and start GOT Modem Connection Tool.
2. Refer to the following to set a destination to be connected to a modem.

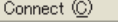
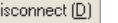

Item	Description	Model
Destination	Set a destination to be connected to a modem. The data of the destination can be entered directly, or can be selected for the destination list.	
	<b>Name</b> Displays the name of the destination registered in the destination list. Select the destination. By selecting the destination, a phone number, initialization command, and dial type registered in the destination list are displayed.	
	<b>Phone number</b> When the destination is selected for [Name], the registered phone number is displayed. When entering the data of the destination directly, enter a phone number with only numerical values. No hyphen is required between the values.	
	<b>Initialization command</b> When the destination is selected for [Name], the registered initialization command is displayed. When entering the data of the destination directly, set AT commands to initialize the modem. For details of AT commands, refer to the following. User's manual for the modem used	   
	<b>Dial type</b> Select the dial type. • Tone: Select this item to dial using the touch-tone circuit. • Pulse: Select this item to dial using the dial circuit.	
	 Click this button to edit the destination list. Click this button to display the [Destination list] dialog box. Refer to the following to edit the destination. (a) Destination list dialog box	
Communication port	Set the communication port to communicate with a personal computer via modems. Click the [Settings] button to display the [Communication settings] dialog box. Refer to the following to set the communication port. (b) Communication settings dialog box	

(Continued to next page)

Item	Description	Model
Condition	Displays the connection status between modems.	
 Connect [C]	Click this button to connect to the modem set to [Destination].	gr16 gr15 gr14 gr12 gr11 gr10 SoftGOT1000
 Disconnect [D]	Click this button to disconnect the connection between modems.	
 Exit [X]	Click this button to exit GOT Modem Connection Tool.	

## HINT

### AT command

The AT command is the command system to control modems and terminal adapters. When the AT command is used, a personal computer can control modems. For details of the AT command, refer to the user's manual for the modem used.

## POINT

### AT command settings

For communication between the GOT and a personal computer via modems, set the AT commands as shown below.

If the settings are incorrect, the GOT cannot communicate with the personal computer via modems.

- Command echo setting: Disabled (Setting example: E0)
- Result code setting: Enabled (Setting example: Q0)
- Display format of the result code: Word format (Setting example: V1)
- Extended result code setting: Displaying the transmission speed between modems (Setting example: W2)
- DTR signal control: Ignoring the DTR signal and always turning on the signal (Setting example: &D0)
- Flow control for a personal computer: Flow control disabled (Setting example: &K0)
- Data compression function setting: Data compression disabled (Setting example: %C0)
- S register setting: Setting the auto-answer to be enabled, and setting the number of rings required before the modem answers to one (Setting example: S0=1)

3. After setting the destination, click the [Connect] button.  
The connection between modems starts.

(a) Destination list dialog box

Register a new destination, or change/delete a destination registered in the destination list.

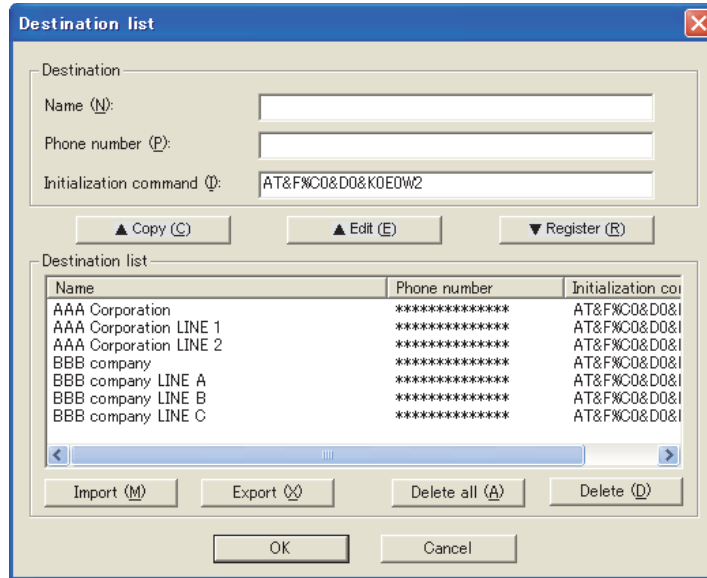

Item	Description	Model
Destination	Set the destination to be registered in the destination list.	
	Name	Set a registered name for the destination.
	Phone number	Set a phone number of the destination with only numerical values. (No hyphen is required.)
	Initialization command	Set AT commands to initialize the modem. For details of AT commands, refer to the following. User's manual for the modem used
	Click this button to copy the destination selected for [Destination list], and copy the selected destination to [Destination]. The selected destination is not deleted from [Destination list]. Use this button to utilize the registered destinations.	
	Click this button to display the destination selected for [Destination list]. The selected destination is deleted from [Destination list]. To restore the deleted destination in [Destination list], click the [Register] button, and register the destination again.	
	Click this button to register the settings entered in [Destination]. When the name entered in [Destination] exists in [Destination list], the settings are not registered.	gr16 gr15 gr14 gr12 gr11 gr10 SoftGot1000
Destination list	Registered destinations are displayed in a list. Up to 500 data of the destination are registered.	
		Click this button to import a destination list. In the [Import destination list (Unicode Text file)] dialog box, select the destination list to be imported.
		Click this button to export a destination list. In the [Export destination list (Unicode Text file)] dialog box, select the destination list to be exported.
		Click this button to delete all the destinations registered in the destination list.
	Click this button to delete the destination selected for the destination list.	

- (b) Communication settings dialog box  
Set the communication method between a personal computer and a modem.

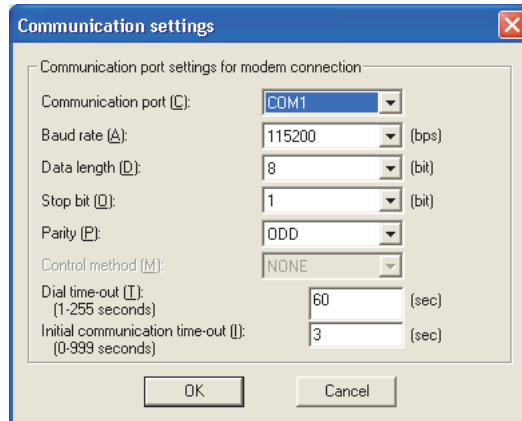

Item	Description	Model
Communication port	Set the communication port of a personal computer connected to the modem. (COM1 to COM63)	gr16 gr15 gr14 gr12 gr11 gr10 SoftGOT1000
Baud rate	Set the transmission speed. (9600/19200/38400/57600/115200)	
Data length	Set the data length. (7 bits/8 bits)	
Stop bit	Set the stop bit length. (1 bit/2 bits)	
Parity	Set the type to check parity. (EVEN/ODD/NONE)	
Control method	Displays the control method for the communication port of the personal computer. (1 to 255 seconds)	
Dial time-out (1-255 seconds)	Set the time required for the dial response to time out. (0 to 999 seconds)	
Initial communication time-out (0-999 seconds)	To use GX Works2 or GX Developer, set the time for the initial communication time-out. (0 to 999 seconds)	

## POINT

### (1) Transmission speed of modem

Configure the setting of the transmission speed between modems same as that of the transmission speed between the personal computer/GOT and a modem.

If the settings of transmission speed differ, an error may occur at communication.

### (2) Initial communication time-out setting

To use the FA transparent function via modems, the initial communication between a PLC and GX Works2/GX Developer may take time, and a time-out may occur.

Set the time for the initial communication time-out longer than the set time.

## (5) Precautions

- (a) Communication between the GOT and GT Designer3  
 For the communication between the GOT and GT Designer3, connect GT Designer3 to the GOT when the connection status is [Communicating] for GOT Modem Connection Tool.  
 If the communication between modems is not established by GOT Modem Connection Tool, the GOT cannot communicate with GT Designer3.
- (b) Unintended disconnection of the telephone circuit  
 When the telephone circuit is disconnected by the following statuses during communication using GOT Modem Connection Tool, the software cannot detect the disconnection.
  - Telephone circuit disconnection with the bad connection
  - Telephone circuit disconnection by the GOT telephone circuit
 In the above cases, the connection status is [Communicating] for GOT Modem Connection Tool.  
 To connect to the telephone circuit again, click the [Disconnect] button, and then click the [Connect] button.
- (c) Destination list import  
 When importing a destination list, the existing destination list is overwritten.  
 To hold the existing destination list, export the list, and then import a new destination list.
- (d) Communication settings between the personal computer/GOT and a modem  
 Configure the communication setting between the personal computer and a modem, and the communication setting between the GOT and a modem before executing the communication between modems. Do not change the setting after the setting is configured.  
 The communication port setting for a modem cannot be changed after the communication between modems is established.  
 The communication setting on the personal computer and the GOT should be identical.  
 If the communication settings differ, an error may occur at communication.
- (e) Disconnection of the telephone circuit  
 When the communication with the GOT ends, make sure to disconnect the telephone circuit using GOT Modem Connection Tool or the GOT.  
 Otherwise, the communication between modems remains connected even if the communication between the GOT and GT Designer3 is disconnected.

## ■ Relevant settings

For communication between the GOT and a personal computer via modems, the relevant settings other than the specific settings are available.

The following shows the functions that are available by the relevant settings.

### (1) GOT internal devices

 Appendix2 GOT Internal Devices

Function	Setting item	Model
Notifying that a modem is during the initialization process	GS248.b0	 SoftGOT1000
Notifying that the modem initialization process is completed	GS248.b1	
Notifying that the circuit connection status of a modem	GS248.b14	
Notifying that the modem initialization process is succeeded or failed	GS248.b15	
Notifying a transmission speed when connecting to the circuit	GS249	
Outputting initialization AT commands to a modem	GS448.b0	
Outputting AT commands for the circuit disconnection to a modem	GS448.b1	
Prohibiting reading data from the GOT via modems	GS448.b12	
Prohibiting writing data to the GOT via modems	GS448.b13	
Prohibiting the modem connection	GS448.b15	

## 8.1.3 Setting communication





Configure the communication setting to transfer data from the personal computer to the GOT.

There are two ways to configure the setting; selecting [Communication Configuration] from the menu to configure the setting in the [Communication Configuration] dialog box, or selecting [Write to GOT], [Read form GOT], or [Verify GOT] from the menu to display the [Communication Configuration] dialog box and configure the setting.

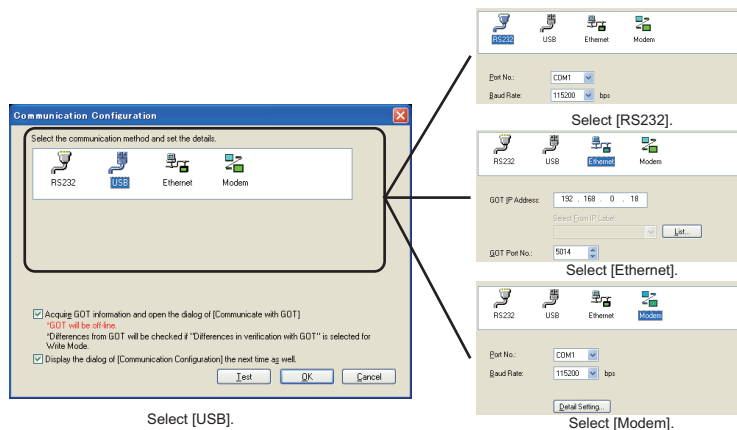
### ■ Communication settings

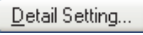

1. Perform either of the following operation.
  - Select [Communication] → [Communication Configuration] from the menu.
  - Select [Communication] → [Write to GOT], [Read form GOT], or [Verify GOT] from the menu.
2. The [Communication Configuration] dialog box appears.



Item	Description
Connection Method	Select the connection method of the personal computer and the GOT. If [RS232], [Ethernet] <sup>1</sup> , or [Modem] <sup>2</sup> is selected, the detail setting is required.
Port No.	Select the communication port of the personal computer connected to the GOT. The valid communication port numbers are displayed. (COM1 to COM63) (Configure this setting when [RS232], or [Modem] is selected.)
Baud Rate	Set the transmission speed to transfer data to the GOT. Set the rate suitable for the personal computer. (Configure this setting when [RS232] or [Modem] is selected.) (Setting range: 115200bps, 57600bps, 38400bps, 19200bps, 9600bps)
	Display the [Detail Setting] dialog box to configure the communication setting between the personal computer and the modem. (Configure this setting when [Modem] is selected.)  ■Detail Setting dialog box
GOT IP Address	Enter the IP address of the GOT. (Enter it when [Ethernet] is selected.)
	Displays the [IP Label List] dialog box to select the IP address from the list of the registered IP address of the GOT. (Configure this setting when [Ethernet] is selected.) For details of the [IP Label List] dialog box, refer to the following.  ■IP Label List
GOT Port No.	Enter the port No. to connect with the GOT. (Enter it when [Ethernet] is selected.)
Acquire GOT information and open the dialog of [Communicate with GOT]	When [Write to GOT], [Read form GOT], or [Verify GOT] is selected from the menu, set whether the information of the connected GOT is obtained or not before the [Communicate with GOT] dialog box is opened.
Display the dialog of [Communication Configuration] the next time as well.	When [Write to GOT], [Read form GOT], or [Verify GOT] is selected from the menu, set display/non-display of the [Communication Configuration] dialog box. The setting can be made when the [Communication Configuration] dialog box is displayed by selecting [Write to GOT], [Read form GOT], or [Verify GOT] from the menu. To display the dialog after the setting of non-display, select [Tools] → [Option] from the menu to display the [Options] dialog box and configure the display setting.

(Continued to next page)



Item	Description
	Performs the Test with the GOT. When [RS232], [USB], or [Modem] is selected, the test is started. When [Ethernet] is selected, the [Test] dialog box appears. For details of the [Test] dialog box, refer to the following.  ■ Test

- \*1 In the Ethernet transfer, only project data write/read, special data write, and resource data read can be performed.
- \*2 For the data transfer via modems, only writing/reading project data and resource data to/from the GOT is available.

### ■ Detail Setting dialog box

To connect a personal computer to the GOT via modems, refer to the following to configure the communication settings between the personal computer and the GOT.

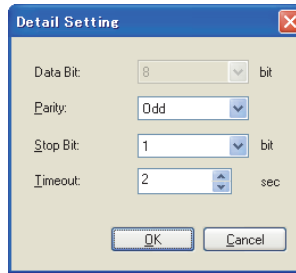

Item	Description
Parity	Set the type to check parity. (Odd/Even/None)
Stop Bit	Set the stop bit length. (1 bit/2 bits)
Timeout	Set the time required for communication to time out. (1 to 90 seconds)

### POINT

**(1) Transmission speed of modem**

Configure the setting of the transmission speed between modems same as that of the transmission speed between the personal computer/GOT and a modem.  
If the settings of transmission speed differ, an error may occur at communication.

**(2) Communication setting when using FA transparent function**

When using the FA transparent function for communication via modems, the communication setting differs according to a controller.  
Configure the setting as shown below.

Controller connected to GOT	Setting item	Setting target				
		GT Designer3	GX Works2 <sup>*1</sup>	GX Developer <sup>*1</sup>	GOT Modem Connection Tool	GOT controller setting
QCPU	Data Bit	8bit				
	Parity	Odd				
	Stop Bit	1bit				
FXCPU	Data Bit	8bit	7bit	8bit		
	Parity	None	Even	None		
	Stop Bit	1bit				

\*1 The communication setting of GX Works2 or GX Developer is set automatically. Therefore, no setting is required.





## ■ IP Label List

In the Ethernet communication, the IP address can be selected from that of GOTs registered in the [IP Label List] dialog box.

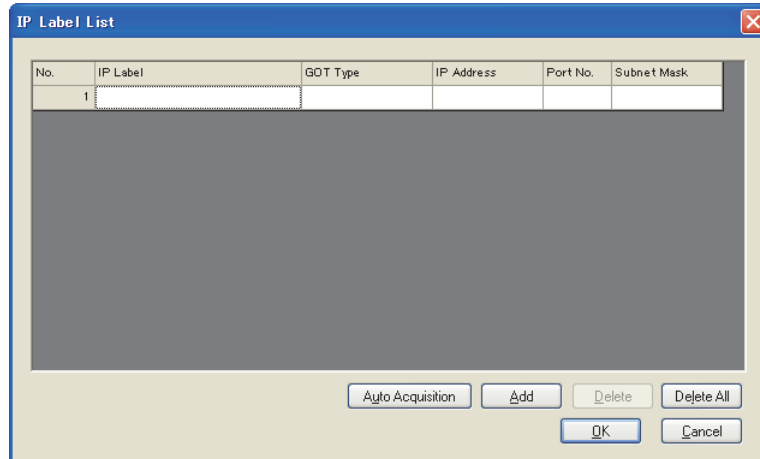
Register the IP address with the following procedure.

1. Click the [List] button in the [Communication Configuration] dialog box.
2. The [IP Label List] dialog box appears.



Item	Description
IP Label	Enter the GOT name.
GOT Type	Select the GOT type.
IP Address	Set the IP address.
Port No.	Set the port No. (Setting range: 1024 to 65534)
Subnet Mask	Set the subnet mask.
 *1	Obtains automatically GOT type, IP address, GOT port No., and subnet mask of GOTs on the network. Obtaining processing of the GOT is stopped when search time (2 seconds) is over, or the list reaches its registration capacity (256). The obtained GOT is registered in the list with the IP Label [New GOT + number].
	Adds a line to be registered to the list.
	Deletes the settings in the selected line.
	Deletes the settings in all lines.

\*1 Only the GT16 can use this function.

### POINT

- (1) **IP Label**  
Duplicate IP Labels cannot be registered.
- (2) **Auto Acquisition**  
To use the auto acquisition, use the same subnet mask to both of the personal computer and GOT.  
The IP address of the GOT on other networks cannot be automatically obtained.
- (3) **Setting the firewall**  
When the port for the Ethernet communication is blocked by the firewall, a communication error occurs.  
Disable the firewall or configure the setting to open the port.

## ■ Test

When performing the communication test of the Ethernet communication, the communication test method can be selected from [PING Test] and [Connection] in the [Test] dialog box.

Perform the test with the following procedure.

1. Click the [Test] button in the [Communication Configuration] dialog box.
2. The [Test] dialog box appears. Click the [PING Test] or [Connection] button to start the communication test. After the communication test is completed, the test result is displayed.

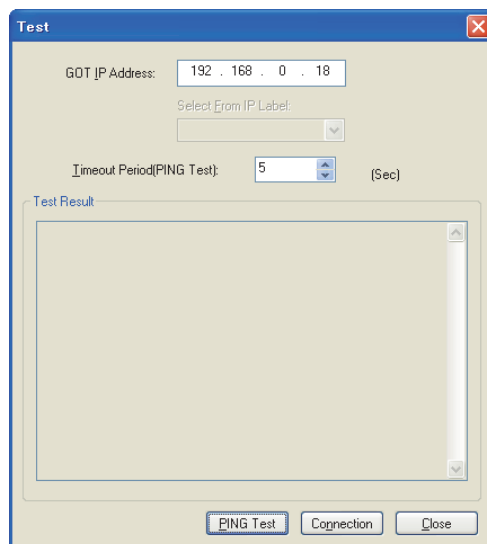

Item	Description
GOT IP Address	Enter the IP address of the GOT.
Select From IP Label	When the IP address is registered in [IP Label List], select it from [IP Label List]. Selection cannot be made when no IP address is registered.
Timeout Period (PING Test)	Set the timeout interval of [PING Test]. (Setting range: 1 to 30 seconds)
Test Result	The result of the communication test is displayed. When [PING Test] or [Connection] is performed again, the result of the previous test is reset.
	Performs the communication test by the specified IP address and PING.
	Checks if the device located at the specified IP address is GOT1000 series.

### POINT

#### Test of the RS232 and USB

Click the [Test] button in the [Communicate with GOT] dialog box to start the communication test. After the communication test is completed, the test result is displayed.

## 8.1.4 Writing and installing on GOT

### ■ Writing project data and installing OS (Personal computer to GOT)

Write the project data and install the OS on the GOT from GT Designer3.

#### POINT

#### (1) When the OS version in the GOT differs from the one of GT Designer3

The following dialog box appears when the OS version of GT Designer3 differs from the one in the GOT.

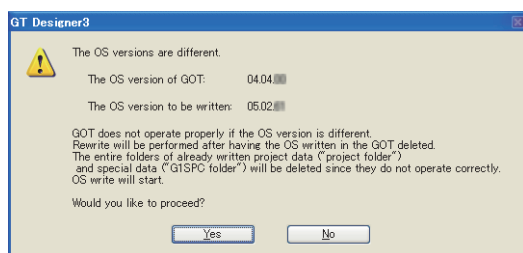

When the standard monitor OS version in the GOT is 05.07.\*\* or earlier, 05.09.\*\*, or 05.10.\*\*

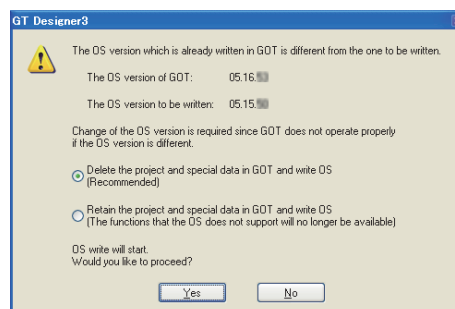

When the standard monitor OS version in the GOT is 05.08.\*\* or 05.11.\*\* or later

The project data does not operate properly when the OS version of GT Designer3 differs from the one in the GOT. Therefore, click the [Yes] button to install the OS.

When installing the OS, the OS in the GOT is deleted once before the OS of GT Designer3 is installed. Therefore, the OS file types and number of OSs in the GOT may change. (When the OS is downgraded, unsupported OSs are deleted.)

To stop the installation, click the [No] button.

#### (2) Precautions for writing the project data

Do not perform the following operations while project data is being written.

- Power off the GOT.
- Press the reset button of the GOT.
- Disconnect the communication cable.
- Turning off the personal computer

Performing the operations listed above during the project data write may stop writing. If writing fails, use the utilities function of the GOT to delete the project data, and then write the project data again.

#### (3) Execution of parameter verification (iQ Works only)

Before writing a project data to the GOT, execute [Verification of System Configuration Information and Parameters] by MELSOFT Navigator to check whether the system configuration diagram and the GT Designer3 controller setting are matched.

When the system configuration diagram does not match the GT Designer3 controller setting, the GOT may not monitor a controller correctly.

For MELSOFT Navigator operation, refer to the following.

 Help for MELSOFT Navigator

**(1) Writing the project data and installing the OS (Personal computer to GOT)**

The following explains how to write the project data and install the OS.

**POINT**

**To make a communication between the GOT and PLC**

The installation of the communication driver and writing of the communication settings are required.

For the installation the communication driver and writing of the communication settings, refer to the following.

GOT1000 Series Connection Manual for GT Works3 and a controller used

1. Select [Communication] → [Communication Configuration] from the menu to configure the communication setting in the [Communication Configuration] dialog box.

For details of the [Communication Configuration] dialog box, refer to the following.

8.1.3 Setting communication

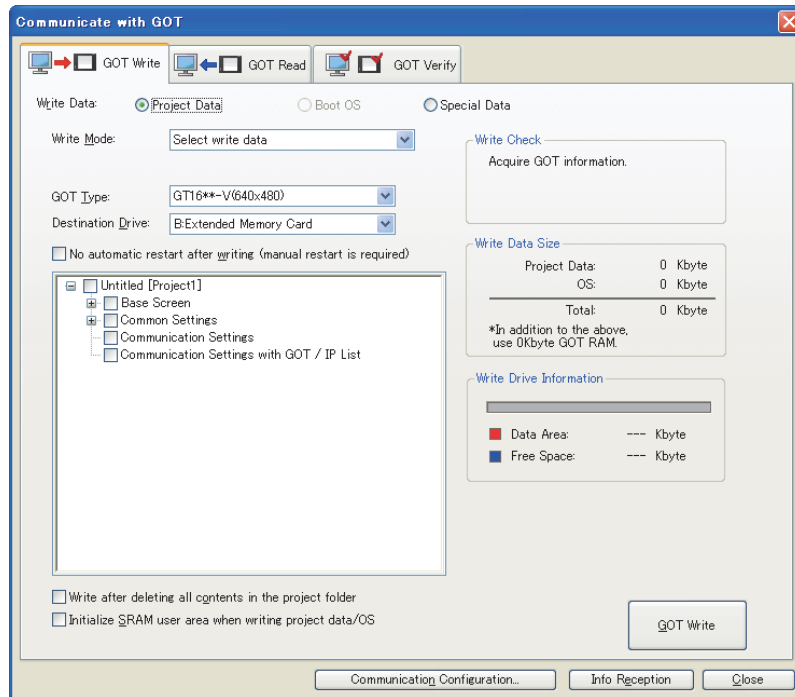

2. Select [Communication] → [Write to GOT] from the menu.  
When system labels are used, the system label update/check is executed.  
If errors exist in the system label settings, the project data cannot be written to the GOT.  
When errors exist in the system label settings, check the settings, and remove the errors.

3. The [GOT Write] tab of the [Communicate with GOT] dialog box appears.  
Configure the setting for the data written to the GOT by referring to the following.





Item	Description
Write Data	<p>Select the data type to be written to the GOT.</p> <ul style="list-style-type: none"> <li>• Project Data, OS: Select this item when writing or installing the project data, standard monitor OS, communication driver, extended function OS, or option OS.</li> <li>• Boot OS: Select this item when writing the Boot OS.</li> <li>• Special Data: Select this item when writing the intelligent module monitor data, Q motion monitor data, or servo amplifier monitor data.</li> </ul>

(Continued to next page)

Item	Description
Write Mode	<p>Select the mode to write the project data and install the OS on the GOT. The display of the [Tree view] check box differs depending on the selected [Write Mode].</p> <ul style="list-style-type: none"> <li>• Difference in verification with GOT For details, refer to the following.  (2) Writing the changed project data (Personal computer to GOT)</li> <li>• Difference after the previous write For details, refer to the following.  (2) Writing the changed project data (Personal computer to GOT)</li> <li>• Project data OS batch write All the project data and OS required by the project data to be written are selected. (Selected items cannot be changed.) The OS is not selected in the following. <ul style="list-style-type: none"> <li>• The stroke font is used for the group comment text set in objects and others.</li> <li>• The ladder monitor function and the SoftGOT-GOT link function in the GOT setup are set.</li> <li>• The backup trigger is not set with the backup/restore function.</li> </ul> </li> <li>• Select write data As no checkbox is selected, select the project data to be written and the OS.</li> </ul>
Include required OS in the project data	<p>When [Difference in verification with GOT] or [Difference after the previous write] is selected in [Write Mode], select this item to install the OS required by the extracted changed data. The setting cannot be made when [Project data OS batch write] or [Select write data] is selected.</p>
GOT Type	<p>The GOT type set in [GOT Type Setting] for project data is displayed.</p> <p>When [GT16**-V(640x480)] is selected for the GOT type, select any of the followings.</p> <ul style="list-style-type: none"> <li>• GT16**-V(640x480): The utility screen, key window, extended function screen, and option function screen are displayed in standard. (Color)</li> <li>• GT16**-VNB*(640x480): The utility screen, key window, extended function screen, and option function screen are displayed in high contrast. (Monochrome) (The GT1672-VN and GT1662-VN are recommended for setting.)</li> </ul> <p>When [GT15**-V(640x480)] is selected for the GOT type, select any of the followings.</p> <ul style="list-style-type: none"> <li>• GT15**-V(640x480): The utility screen, key window, extended function screen, and option function screen are displayed in standard. (Color)</li> <li>• GT15**-VNB*(640x480): The utility screen, key window, extended function screen, and option function screen are displayed in high contrast. (Monochrome) (The GT1575-VN, GT1572-VN, and GT1562-VN are recommended for setting.)</li> </ul>
Destination Drive	<p>Select the GOT drive in which the project data and OS are to be written or installed.</p> <ul style="list-style-type: none"> <li>• For GT16 and GT15 Select the drive from [A:Standard CF Card], [B:Extended Memory Card], or [C:Built-in Flash Memory].</li> <li>• For GT14 Select the drive from [A:Standard SD Card] or [C:Built-in Flash Memory].</li> <li>• For GT12 Select the drive from [A:Standard CF Card] or [C:Built-in Flash Memory].</li> <li>• For GT11 and GT10 The drive is fixed to [C:Built-in Flash Memory].</li> </ul>
No automatic restart after write (manual restart is required)	<p>Prevents the automatic restart of the GOT after the project data is written to the GOT. (The setting can be made only if the GOT is connected to the personal computer with [Ethernet].) As the GOT is in the restart standby status after writing, restart the GOT manually.</p>
Tree view	<p>When the personal computer and the GOT are connected with [Ethernet], the project data is displayed in the tree. When the personal computer and the GOT are connected with [RS232] or [USB], the project data, Standard monitor OS, Communication driver, Extended function OS, and Option OS is displayed in the tree. The OS cannot be installed when a drive other than [C:Built-in Flash Memory] is selected in [Destination Drive]. In this case, only the project data is displayed in the tree.</p>

(Continued to next page)

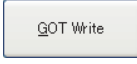
Item	Description
Write after deleting all contents in the project folder	Select this item to delete all the data in the project folder before the data is written to the GOT. Valid if [Project data OS batch write] or [Select write data] is selected in [Write Mode]. This item is always selected when [Project data OS batch write] is selected, and the setting can be changed when [Select write data] is selected.
Initialize SRAM user area when writing project data/OS	Select this item to initialize the SRAM user area when data is written to the GOT.
Write Check	The writing and installation status of the GOT is displayed.
Write Data Size	The size of the data to be written and installed on the GOT is displayed.
Write Drive Information	The information of the drive specified in [Destination Drive] is displayed. In the graph, the data area is shown in red and the free space is shown in blue.
	Displays the [Communication Configuration] dialog box.
	Communicates with the GOT to obtain the information. The obtained information is displayed in [Write Check].
	Writes the project data and installs the OS on the GOT.

## POINT

### Precautions when selecting write data (iQ Works only)

When system labels are written and [System Label] is cleared for target data, system labels are deleted from a target project, and the labels are changed to devices.

The system labels changed to devices cannot be restored.

To hold the system label settings, do not clear [System Label] for the write target data.

When clearing [System Label] for the write target data, check the device setting.

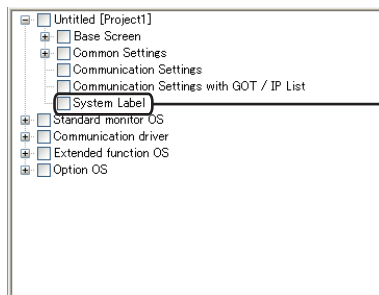

When the box is cleared, system labels are deleted from the project.

4. Click the [GOT Write] button.

When installing the OS, the dialog box appears to check the OS version.

Check the OS version already installed on the GOT and the version which is to be installed from GT Designer3.

At the OS installation, the user can select whether to hold or delete the project data and special data in the GOT when the following standard monitor OS is installed on the GOT.

- Standard monitor OS with version 05.08.\*\*
- Standard monitor OS with version 05.11.\*\* or later

To hold the project data and special data, select [Retain the project and special data in GOT and write OS (The functions that the OS does not support will no longer be available)].

To install the OS, click the [Yes] button. To cancel the OS installation, click the [No] button.

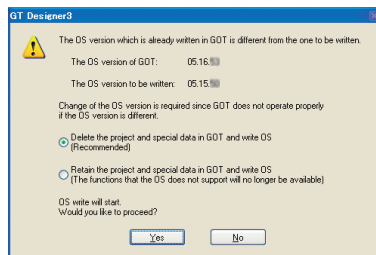

When the OS versions differ between the GOT and GT Designer3

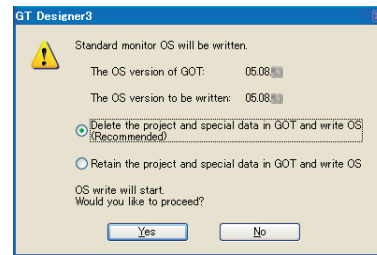

When the OS version in the GOT is the same as the one of GT Designer3



### Holding the project data and special data

To install only the OS, without deleting or changing the project data and special data, select [Retain the project and special data in GOT and write OS (The functions that the OS does not support will no longer be available)].

5. If the following dialog box appears, enter the data transfer/utility password set for the project data in the GOT, and click the [OK] button.

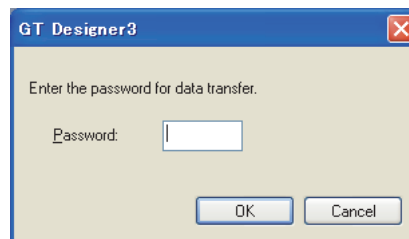

6. When [Delete the project and special data in GOT and write OS (Recommended)] is selected in the step 4. without selecting [Communication Settings] for the data to be written in the step 3., the following dialog box appears.

To hold the controller setting of the GOT, click the [Yes] button.

To delete the controller setting of the GOT, click the [No] button.

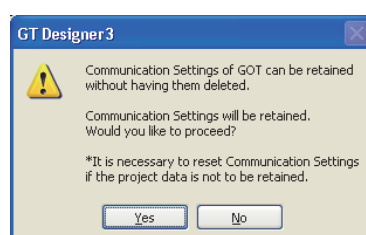



## POINT

### (1) GOT that cannot hold the project data and special data

At the OS installation, the user cannot select whether to hold or delete the project data and special data in the GOT when the following standard monitor OS is installed on the GOT.

- Standard monitor OS with version 05.07.\*\* or earlier
- Standard monitor OS with version 05.09.\*\*
- Standard monitor OS with version 05.10.\*\*

When the standard monitor OS above is installed, the project data and special data are all deleted. It is recommended to back up the project data and special data as necessary.

 8.1.5 Reading from GOT

### (2) Holding the controller setting (at OS installation via Ethernet)

At the OS installation via Ethernet, the GOT may not communicate with GT Designer3 when the controller setting of the GOT is deleted or changed.

Check the controller setting to be written in the GOT, and then delete or change the controller setting of the GOT.

7. The installation of the OS and the project data starts.  
After the installation is completed, the GOT automatically restarts.

### (2) Writing the changed project data (Personal computer to GOT)

Use of this function during project data debugging or editing, only the screens and settings changed since the last write can be selected. The write time can be reduced by writing only the selected items.

1. Select [Communication] → [Communication Configuration] from the menu to configure the Communication Configuration in the [Communication Configuration] dialog box.  
For details of the [Communication Configuration] dialog box, refer to the following.

 8.1.3 Setting communication

2. Select [Communication] → [Write to GOT] from the menu.  
When the If errors exist in the system label settings, the project data cannot be written to the GOT. When errors exist in the system label settings, check the settings, and remove the errors.setting for using system labels is configured, the system label update/check is executed.
3. As the [GOT Write] tab of the [Communicate with GOT] dialog box appears, select [Destination Drive] and set [Write Mode] as follows.  
Select either of [Difference in verification with GOT] or [Difference after the previous write], since the difference to be extracted varies depending on [Write Mode].
  - Difference in verification with GOT  
Only the difference between the project data written in the GOT and that in GT Designer3 is written. The check box of the data changed from the project data written in the GOT is selected in the tree.
  - Difference after the previous write  
Only the difference between the project data previously written and that of GT Designer3 is written. The check box of the data changed from the project data written previously is selected in the tree.

Even if either [Write Mode] is selected, the check boxes of the changed data and the OS required by the project data to be written are selected.

To prevent the OS from being installed, clear [Include required OS in the project data] to clear the selected OS.

For the setting items in the [Communcate with GOT] dialog box, refer to the following.

 (1) Writing the project data and installing the OS (Personal computer to GOT)

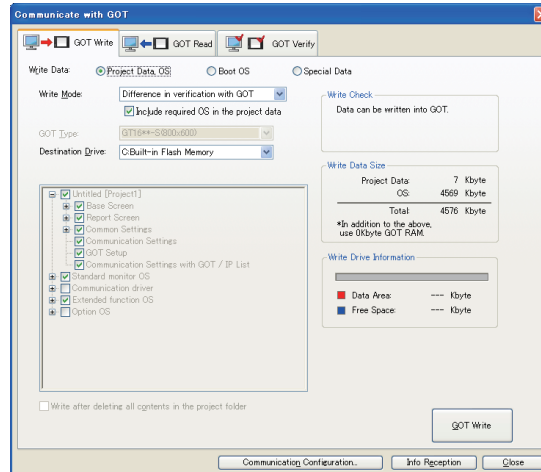

When [Difference in verification with GOT] is selected in [Write Mode].

4. Click the [GOT Write] button to start writing the project data and installing the required OS. If dialog boxes appear, refer to the following.

☞ (1) Writing the project data and installing the OS (Personal computer to GOT)

After the write and installation are completed, the GOT automatically restarts.

## POINT

### Writing the difference

The write history to be the target of [Difference after the previous write] is the write performed from the startup to the exit of GT Designer3.

The previous write history is deleted at the exit of GT Designer3. To write only the difference at the next startup, perform [Difference in verification with GOT].

## ■ Installing the OS (Personal computer to GOT)

When the OS is required for a function which is not included in the project data, select and install only the required OS on the GOT from GT Designer3.

The installing method differs depending on the GOT type.

### POINT

#### (1) When the standard monitor OS is not installed on the GT16, GT15, GT14, GT12, and GT11

If the standard monitor OS is not installed on the GT16, GT15, GT14, GT12 and GT11, depending on the Boot OS version, only the standard monitor OS may be installed on the GT16, GT15, GT14, GT12 and GT11 from GT Designer3.

For such case, install the communication driver and write the optional function after installing the standard monitor OS.

#### (2) Standard monitor OS and Communication driver of the GOT

The standard monitor OS and communication driver are installed on the GT10 by default.

Only the communication driver can be installed from GT Designer3.

#### (3) Data written in the GOT

At the OS installation, the user can select whether to hold or delete the project data and special data in the GOT when the following standard monitor OS is installed on the GOT.

- Standard monitor OS with version 05.08.\*\*
- Standard monitor OS with version 05.11.\*\* or later

When installing the standard monitor OS on the GOT with OS version 05.08.00 or later, the user can select whether to hold or delete the project data and special data in the GOT.

When deleting the project data and special data, it is recommended to back up the project data and special data before the standard monitor OS installation.

Write the project data to a personal computer, memory card, or USB memory.

Write the special data to a memory card or USB memory.

The special data cannot be read to a personal computer.

For reading each data, refer to the following.

 8.1.5 Reading from GOT

#### (4) Precautions for installing the OS

Once the OS is started to be installed, the processing cannot be interrupted.

Do not perform the following operations during the OS installation, as it may disable the GOT from operating.

- Turning off the GOT.
- Pressing the reset button of the GOT.
- Disconnecting the communication cable.
- Turning off the personal computer.

If the GOT has been disabled from operating by any of the above operations during the OS installation, install the OS again in the following procedure.

1. Turn off the GOT.
2. When the memory card is not installed, proceed to step 3.  
When the memory card is installed, turn off the CF/SD card access switch, and remove the memory card.  
While the CF/SD card access LED is on, do not remove the memory card or do not turn off the GOT.
3. Turn on the GOT.
4. As the [Please install the Standard OS] message appears on the GOT, install the standard monitor OS from GT Designer3.  
If the above message does not appear, please contact a service representative.
5. After the standard monitor OS installation is completed, the GOT automatically restarts.

**(1) Installing the OS (Standard monitor OS, communication driver, extended function OS, and option OS) to the GT16, GT15, GT14, GT12, and GT11**

The following shows how to install the OS on the GT16, GT15, GT14, GT12, and GT11.

1. Select [Communication] → [Communication Configuration] from the menu to configure the communication setting in the [Communication Configuration] dialog box.

For details of the [Communication Configuration] dialog box, refer to the following.

 8.1.3 Setting communication

2. Select [Communication] → [Write to GOT] from the menu.

As the [Communicate with GOT] dialog box appears, select [Destination Drive] and set [Include required OS in the project data] to [Select write data].

3. Select the OS required to be installed from the tree.

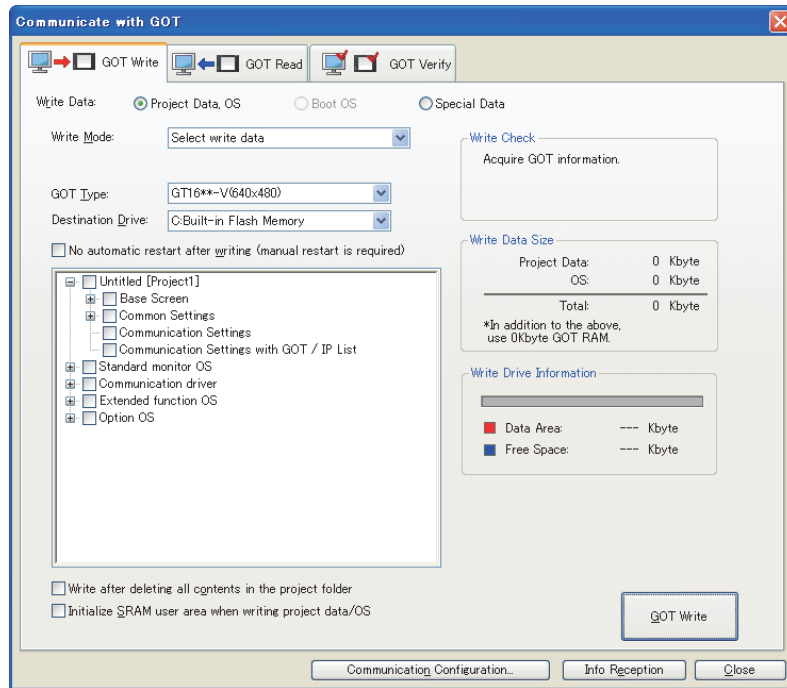

Item	Description
Write Data	Select the type of the data to be written to the GOT. Select [Project Data, OS].
Write Mode	Select the mode to install the OS on the GOT. For details, refer to the following.  ■Writing project data and installing OS (Personal computer to GOT)
Destination Drive	Select the GOT drive in which the OS is to be installed.
Tree view	The project data, Standard monitor OS, Communication driver, Extended function OS, and Option OS are displayed in the tree.
Write Check	The writing and installation status of the GOT is displayed.
Write Data Size	The size of the data to be written to the GOT is displayed.
Write Drive Information	The information of [C:Built-in Flash Memory] is displayed. In the graph, the data area is shown in red and the free space is shown in blue.
Write after deleting all contents in the project folder	Select this item to delete all the data in the project folder before the data is written to the GOT. Valid if [Project data OS batch write] or [Select write data] is selected in [Write Mode]. This item is always selected when [Project data OS batch write] is selected, and the setting can be changed when [Select write data] is selected.
Initialize SRAM user area when writing project data/OS	Select this item to initialize the SRAM user area when data is written to the GOT. (GT16/GT14 only)

(Continued to next page)

Item	Description
Communication Configuration...	Displays the [Communication Configuration] dialog box.
Info Reception	Communicates with the GOT to obtain the information. The obtained information is displayed in [Write Check].
GOT Write	Installs the OS on the GOT.

- Click the [GOT Write] button.  
The OS is started to be installed.  
If dialog boxes appear, refer to the following.

■ Writing project data and installing OS (Personal computer to GOT)  
(1) Writing the project data and installing the OS (Personal computer to GOT)

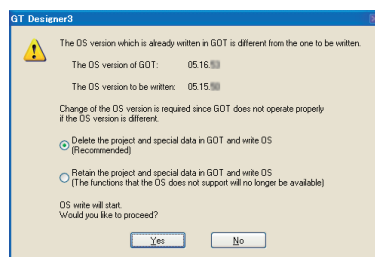

When the OS versions differ between the GOT and GT Designer3

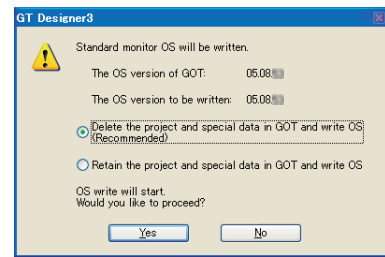

When the OS version in the GOT is the same as the one of GT Designer3

- Installing the OS (Standard monitor OS and communication driver) to the GT10**  
The following shows how to install the OS on the GT10.

- Turn on the power while the down-right corner of the display on the GT10 is touched.

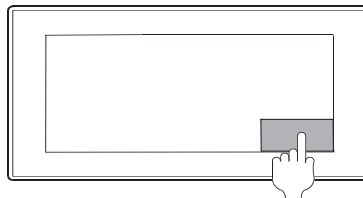

Touch the bottom-right corner.

- The OS installation screen appears.



## POINT

### OS installation screen

The OS can be installed on the following GOT from GT Designer3 without displaying the OS installation screen.

Model	Boot OS version
GT105□, GT104□	Applicable from the first version
GT1030, GT1020	Boot OS version F or later

For how to check the Boot OS version, refer to the following.

 GT10 User's Manual

3. Select [Communication] → [Communication Configuration] from the menu to configure the communication setting in the [Communication Configuration] dialog box.  
For details of the [Communication Configuration] dialog box, refer to the following.

 8.1.3 Setting communication

4. Select [Communication] → [Write to GOT] from the menu.  
As the [GOT Write] tab of the [Communicate with GOT] dialog box is displayed, set [Write Mode] to [Select write data].  
For the setting items in the [Communicate with GOT] dialog box, refer to the following.

 (1) Installing the OS (Standard monitor OS, communication driver, extended function OS, and option OS) to the GT16, GT15, GT14, GT12, and GT11

5. Select the OS required to be installed from the tree.

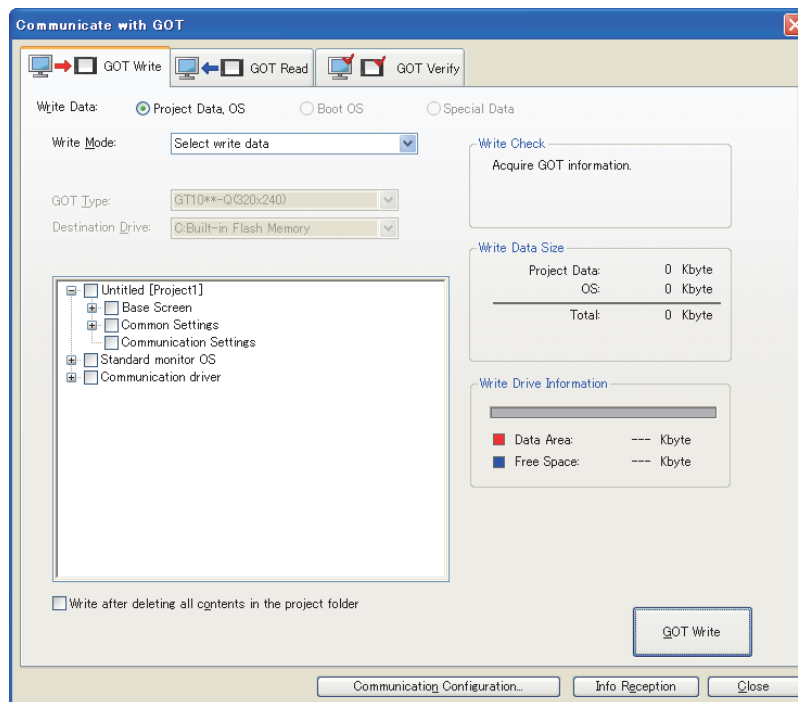

- Click the [GOT Write] button.  
Check the OS version already installed on the GOT and the version which is to be installed from GT Designer3.  
To install, click the [Yes] button.  
To cancel the installation, click the [No] button.

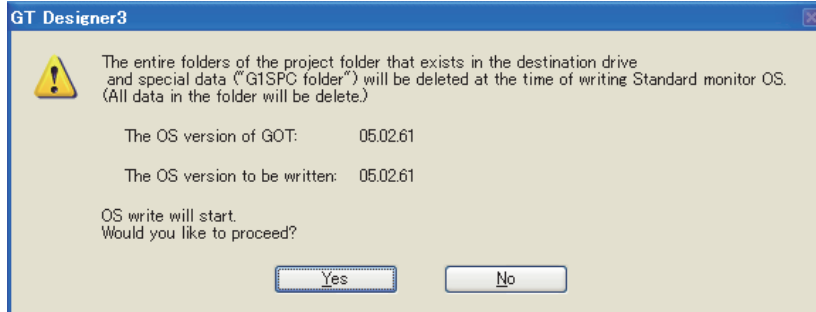

- The OS is started to be installed.  
After the installation is completed, the GOT automatically restarts.

### POINT

#### Selection of the standard monitor OS

It takes a long time to install the entire standard monitor OS of the GT10.  
Select and install the necessary standard monitor OS.

## ■ Installing Boot OS (Personal computer to GOT)



The Boot OS is installed on the GOT by default.

However, the Boot OS needs to be upgraded (installed) to use the function unsupported by the Boot OS version in the GOT.

To return the GOT to the factory-shipped condition, install the Boot OS to initialize it.

### POINT

#### (1) Installing the Boot OS

The Boot OS may not be installed if the GOT is in its factory-shipped condition.

Install the standard monitor OS before starting the Boot OS installation.

#### (2) Overwriting the Boot OS in the GOT with the older version

The Boot OS cannot be overwritten with the older version.

During the Boot OS installation, the Boot OS version in the GOT is compared with the one to be installed for check. If the latter one is older, the installation will be discontinued.

#### (3) Data written in the GOT

When the Boot OS is installed, the project data, OS (standard monitor OS, communication driver, extended function OS, option OS), and special data in the GOT are all deleted.

If the project data backup is required, write the project data to a personal computer, memory card or USB memory before installing the Boot OS.

The special data cannot be written to a personal computer. Therefore, write the special data to a memory card or USB memory.

For reading and writing each data, refer to the following.

 8.1.5 Reading from GOT

#### (4) Precautions when installing the Boot OS

Once the Boot OS is started to be installed, it cannot be interrupted.

Do not perform the following operations during the Boot OS installation, as it may disable the GOT from operating.

- Turning off the GOT.
- Pressing the reset button of the GOT.
- Disconnecting the communication cable.
- Turning off the personal computer.

If the GOT does not operate, please contact a service representative.



The following shows how to install the Boot OS.

1. Select [Communication] → [Communication Configuration] from the menu to configure the communication setting in the [Communication Configuration] dialog box.  
For details of the [Communication Configuration] dialog box, refer to the following.  
 8.1.3 Setting communication
2. Select [Communication] → [Write to GOT] from the menu.  
The [GOT Write] tab of the [Communicate with GOT] dialog box appears.
3. Select [Boot OS] in [Write Data].
4. Check [Procedures for GOT Write and precautions] and click the [GOT Write] button.

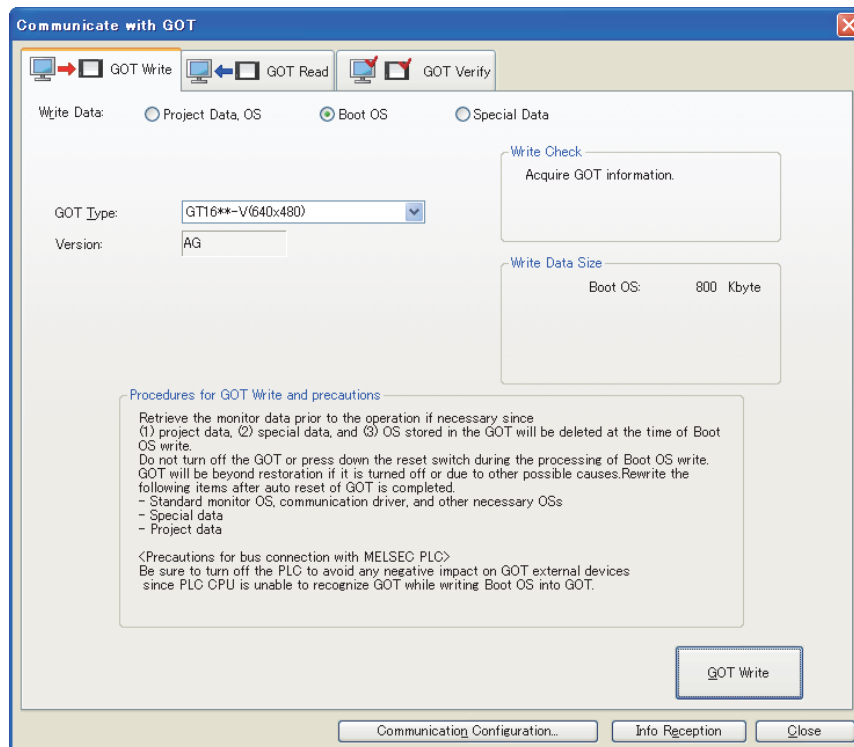

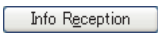
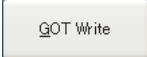
Item	Description
Write Data	Select the type of the data to be written to the GOT. Select [BootOS].
GOT Type	Select the GOT type of the installation destination.
Version	Select the version of the Boot OS to be installed on the GOT.
Procedures for GOT Write and precautions	The procedure and precautions for installing the Boot OS is displayed. Make sure to read them before installing.
Write Check	The installation status of the GOT is displayed.
Write Data Size	The size of the Boot OS to be installed on the GOT is displayed.
	Displays the [Communication Configuration] dialog box.
	Communicates with the GOT to obtain the information. The obtained information is displayed in [Write Check].
	Installs the Boot OS to the GOT.

5. Check the Boot OS version already installed on the GOT and the one which is to be installed from GT Designer3.  
To install, click the [Yes] button.  
To cancel the installation, click the [No] button.

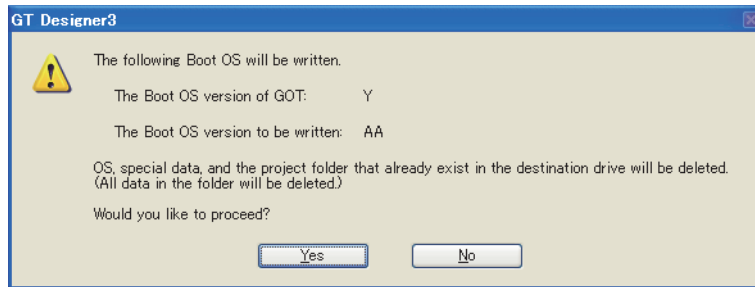

6. The Boot OS is started to be installed.  
After the installation is completed, the GOT automatically restarts. Then, write the project data and special data, and install the OS (standard monitor OS, communication driver, extended function OS, option OS) to the GOT.

## ■ Writing special data (Personal computer to GOT)



The following shows how to write the special data.

1. Select [Communication] → [Communication Configuration] from the menu to configure the communication setting in the [Communication Configuration] dialog box.  
For details of the [Communication Configuration] dialog box, refer to the following.

 8.1.3 Setting communication

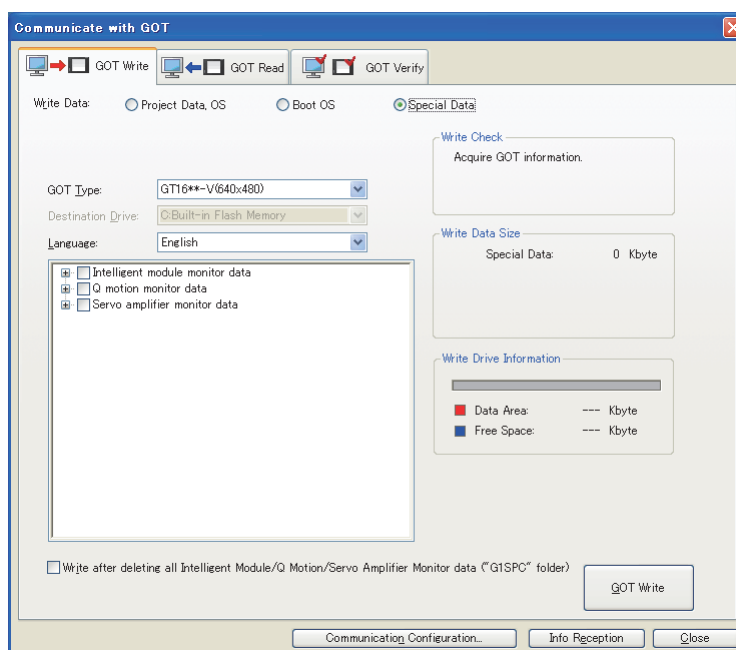
2. Select [Communication] → [Write to GOT] from the menu.  
As the [GOT Write] tab of the [Communicate with GOT] dialog box appears, select [Special Data] in [Write Data].
3. Select the special data to be written from the tree, and click the [GOT Write] button.

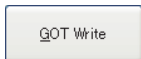

Item	Description
Write Data	Select the type of the data to be written to the GOT. Select [Special Data].
GOT Type	Select the GOT type of the installation destination.
Language	Select the language of the special data.
Tree view	The Intelligent module monitor data, Q motion monitor data, and servo amplifier monitor data, which are in the language selected for [Language], are displayed in the tree view. Select the data to be written to the GOT.
Write after deleting all Intelligent Module/Q Motion/Servo Amplifier Monitor data ("G1SPC" folder)	The intelligent module/Q motion/servo amplifier monitor (G1SPC folder) are deleted before writing data to the GOT.
Write Check	The writing status of the GOT is displayed.
Write Data Size	The size of the data to be written to the GOT is displayed.
Write Drive Information	The information of the drive specified in [Destination Drive] is displayed. In the graph, the free space is shown in red and the data area is shown in blue.
	Displays the [Communication Configuration] dialog box.
	Communicates with the GOT to obtain the information. The obtained information is displayed in [Write Check].
	Writes the special data to the GOT.

## POINT

---

### **Installing the option OS**

When the special data is used, the special data and option OS must be written or installed.  
Write both special data to be used and option OS.

---

## 8.1.5 Reading from GOT

### ■ Reading project data (GOT to personal computer)

When the Boot OS or OS is installed on the GOT, the project data in the GOT are deleted.

To back up the project data, perform read and save the project data in the GOT once into the hard disk of the personal computer or other.

#### POINT

##### (1) When the OS version in the GOT differs from the one of GT Designer3

When the OS version of GT Designer3 differs from the one in the GOT, the read will be performed differently as shown below.

###### (a) When the OS major version in the GOT is older than the one of GT Designer3

The project data can be read by GT Designer3 without any problem.

However, the OS information of the project data will be changed to the version of GT Designer3 in which the project data has been read.

###### (b) When the OS major version in the GOT is newer than the one of GT Designer3

The project data cannot be opened on the GT Designer3, but can be read as the GOT1000 series binary file (\*.G1).

To open this project data, GT Designer3 of the same OS version as the one in the GOT or newer is required.

###### (c) When the OS minor version in the GOT is newer than the one of GT Designer3 (When the major versions are the same)

The project data can be read and opened on GT Designer3. However, note that the unsupported functions are deleted.

It is recommended to read the project data again using GT Designer3 of the same OS version as the one in the GOT or newer

For how to check the OS version in the GOT, refer to the following.

 User's Manual for the GOT used

##### (2) Settings of project data that cannot be read

Even though the GOT reads project data, the GOT cannot read the following utility settings in the data.

Settings of project data that cannot be read		
• Registered data of license management	• Setting of behavior of duplicate IPs	• Human sensor setting
• Intensity adjustment setting	• Contrast adjustment setting	• Key sensitivity/key reaction speed setting <sup>*1</sup>
• Touch panel adjustment setting	• Host station change setting in the Ethernet setting	• Setting to save ladders for the Q/L/QnA ladder monitor

<sup>\*1</sup> The GT10 reads the setting.

When the read project data is used on another GOT, check the utility settings.



The following shows how to read the project data.

1. Select [Communication] → [Communication Configuration] from the menu to configure the communication setting in the [Communication Configuration] dialog box.  
For details of the [Communication Configuration] dialog box, refer to the following.

☞ 8.1.3 Setting communication

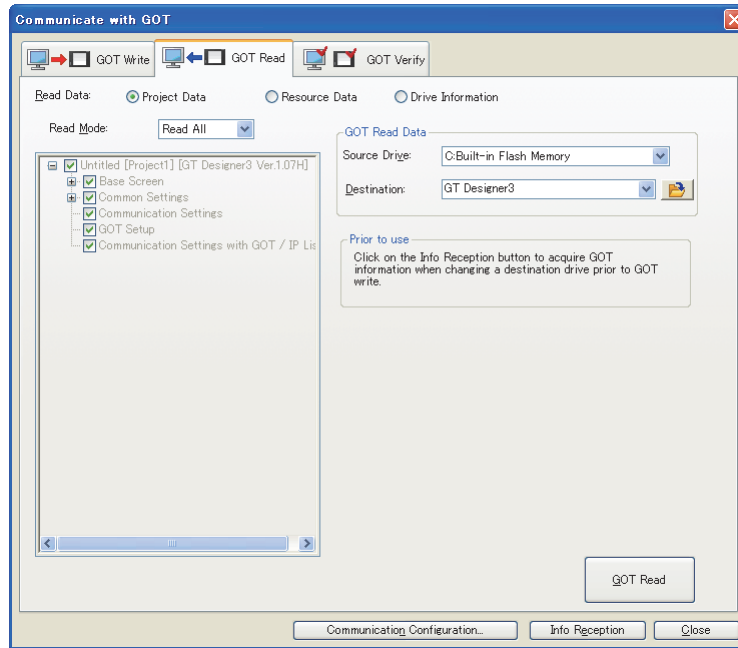
2. Select [Communication] → [Read from GOT] from the menu.  
The [GOT Read] tab of the [Communicate with GOT] dialog box appears.

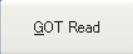

Item	Description
Read Data	Select the type of the data to be read to the GOT. Select [Project Data].
Read Mode	Select the mode to read. When [Read All] is selected, all the data are selected. (Selected items cannot be changed.) When [Preference] is selected, the data to be read are selected in the tree.
Tree view	The project data of the GOT is displayed.
GOT Read Data	In [Source Drive], select the drive to be read. In [Destination], set the save destination of the read data.
Prior to use	Precautions before using are displayed.
	Displays the [Communication Configuration] dialog box.
	Communicates with the GOT to obtain the information. When the project data is not displayed in the tree, click the [Info Reception] button to obtain the project data information from the GOT.
	Reads the project data from the GOT.

## POINT

### Precautions when selecting read data (iQ Works only)

When system labels are read and [System Label] is cleared for target data, system labels are deleted from a target project, and the labels are changed to devices.

The system labels changed to devices cannot be restored.

To hold the system label settings, do not clear [System Label] for the read target data.

When clearing [System Label] for the read target data, check the device setting.

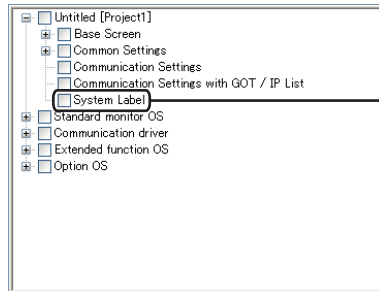

When the box is cleared, system labels are deleted from the project.

3. In [GOT Read Data], select [Source Drive] and set [Destination].
4. Select [Read Mode] to select the project data to be read in the tree, and click the [GOT Read] button.
5. If the following dialog box appears, enter the data transfer/utility password set for the project data in the GOT, and click the [OK] button.

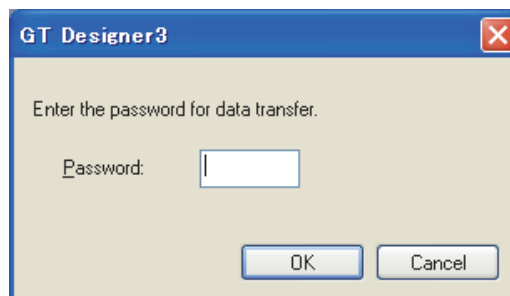

6. The project data is started to be read.

## ■ Reading resource data (GOT to personal computer)



The following shows how to read the resource data.

1. Select [Communication] → [Communication Configuration] from the menu to configure the communication setting in the [Communication Configuration] dialog box.  
For details of the [Communication Configuration] dialog box, refer to the following.

☞ 8.1.3 Setting communication

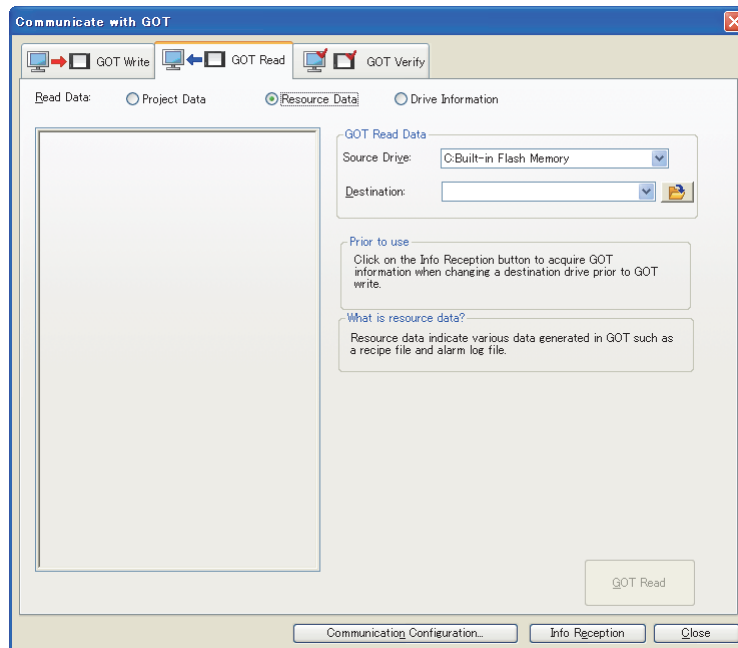
2. Select [Communication] → [Read from GOT] from the menu.  
The [GOT Read] tab of the [Communicate with GOT] dialog box appears.
3. Select [Resource Data] in [Read Data].

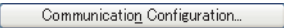

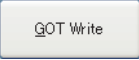
Item	Description
Read Data	Select the type of the data to be read to the GOT. Select [Resource Data].
Tree view	The resource data of the GOT is displayed.
GOT Read Data	In [Source Drive], select the drive to be read. In [Destination], select the save destination of the read data.
Prior to use	Precautions before using are displayed.
What is resource data?	The explanation of the resource data is displayed.
	Displays the [Communication Configuration] dialog box.
	Communicates with the GOT to obtain the information. When the resource data is not displayed in the tree, click the [Info Reception] button to obtain the resource data information from the GOT.
	Reads the resource data from the GOT.



## POINT

### Reading large amounts of resource data

If the memory card has large amount of resource data, the GOT may not obtain the resource data even by clicking the [Info Reception] button.

Therefore, read the data by any of the following methods.

- By using a personal computer or others, read the resource data from the memory card.
- Copy the resource data to a USB memory, and read the resource data from the USB memory by using a personal computer or others. (GT16 only)

 GT16 User's Manual (Basic Utility)

- By using the FTP server function, read the resource data from the memory card installed in the GOT. (GT16 and GT15 only)

 GOT1000 Series Gateway Functions Manual for GT Works3

4. In [GOT Read Data], select [Source Drive] and set [Destination].
5. Select the resource data to be read in the tree view, and click the [GOT Read] button.
6. The resource data is started to be read.

## ■ Reading drive information(GOT to personal computer)



The following shows how to read the drive information.

1. Select [Communication] → [Communication Configuration] from the menu to configure the communication setting in the [Communication Configuration] dialog box.  
For details of the [Communication Configuration] dialog box, refer to the following.

☞ 8.1.3 Setting communication

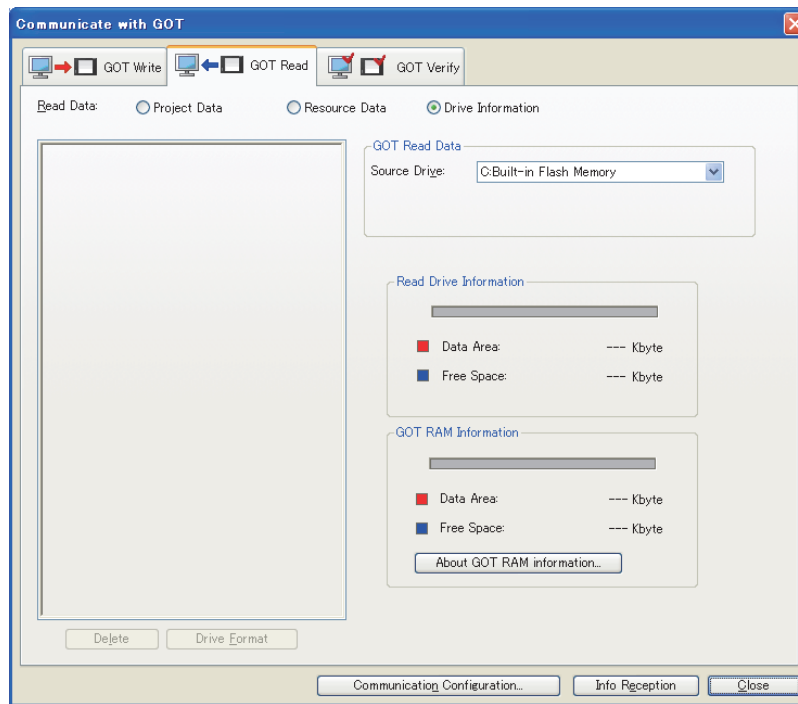
2. Select [Communication] → [Read from GOT] from the menu.  
The [GOT Read] tab of the [Communicate with GOT] dialog box appears.
3. Select [Drive Information] in [Read Data].

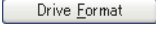

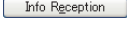
Item	Description
Read Data	Select the type of the data to be read to the GOT. Select [Drive Information].
Tree view	The drive information of the GOT is displayed.
	Deletes data selected in the tree (the Boot OS excluded).
	Initializes a drive selected in [Source Drive]. Available only when [A:Standard Memory Card] or [B:Extended Memory Card] is selected in [Source Drive].
GOT Read Data	Select a drive to be read in [Source Drive].
Read Drive Information	[Data Area] and [Free Space] of a driver selected in [Source Drive] are displayed.
GOT RAM Information	[Data Area] and [Free Space] of the user memory (RAM) are displayed. Click the [About GOT RAM information] button to display the explanation of the GOT RAM information.
	Displays the [Communication Configuration] dialog box.
	Communicates with the GOT to obtain the information. When the drive information is not displayed in the tree, click the [Info Reception] button to obtain the drive information from the GOT.

4. In [GOT Read Data], select [Source Drive] and then click the [Info Reception] button.
5. The drive information is started to be read.

## 8.1.6 Verifying with GOT

### ■ Verifying project data (Personal computer : GOT)

Verify the project data located at the GOT against the one opened by GT Designer3.

The following can be verified.

- Data contents check  
The data contents check checks if the project data have any difference.
- Time stamp check  
The time stamp check checks if the project data have any difference in the update date and time.





The following shows how to verify the project data.

1. Select [Communication] → [Communication Configuration] from the menu to configure the communication setting in the [Communication Configuration] dialog box.  
For details of the [Communication Configuration] dialog box, refer to the following.

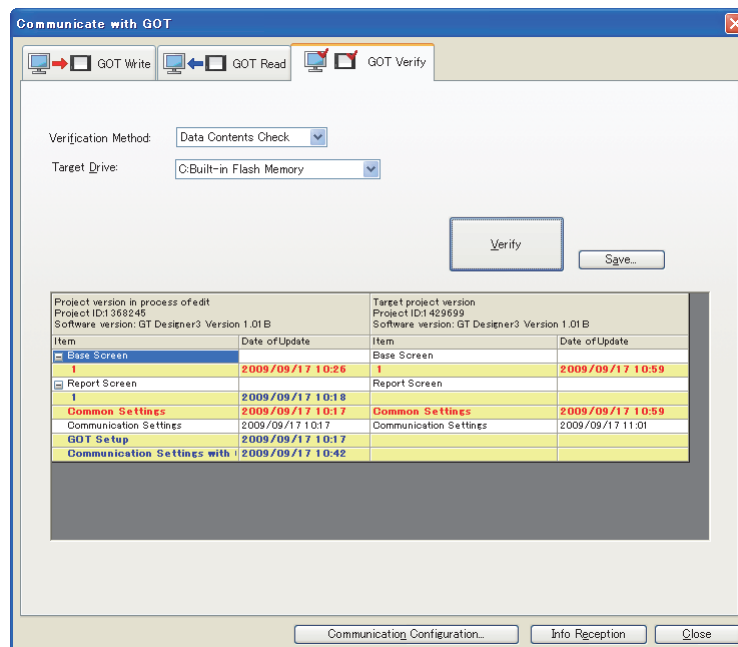
 8.1.3 Setting communication

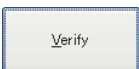
2. Select [Communication] → [Read from GOT] from the menu.  
The [GOT Read] tab of the [Communicate with GOT] dialog box appears.



Item	Description
Verification Method	Select the verification method with the GOT. When [Data Contents Check] is selected, the data is verified by contents. When [Time Stamp Check] is selected, the data is verified by date/time information.
Target Drive	Select the target drive where the project data is verified.
	Verifies with the project data in the GOT.
Verification result	The result of verification is displayed.
	Saves the verification result as a Unicode text file.
	Displays the [Communication Configuration] dialog box.
	Communicates with the GOT to obtain the information.

3. In [Verification Method], select the verification method.
4. In [Target Drive], select the drive where the project data is verified.
5. Click the [Verify] button to display the verification result.

6. To save the verification result, click the [Save] button to specify the save destination.  
The result is saved as a Unicode text file.

## POINT

---

**(1) Time Stamp Check**

When verifying with [Time Stamp Check], the update date/time of the following data is changed to the date/time when the verification is performed.

- Communication settings
- Setup
- MES setting
- Startup logo

**(2) Major versions of GT Designer3 and the project data to be verified**

Even if the major version of GT Designer3 differs from the one of the project data to be verified, the verification is performed.

---

## 8.2 Transferring Data to Memory Card or USB Memory

GT 16 GT 15 GT 14 GT 12 GT 11 GT 10 Soft GOT 1000

This section explains how to transfer data using a memory card or a USB memory. Use of a memory card or a USB memory eliminates the necessity to carry the personal computer and cable when the project is written to multiple GOTs.

### ■ Data transferring procedure

Data is transferred in the following procedure.

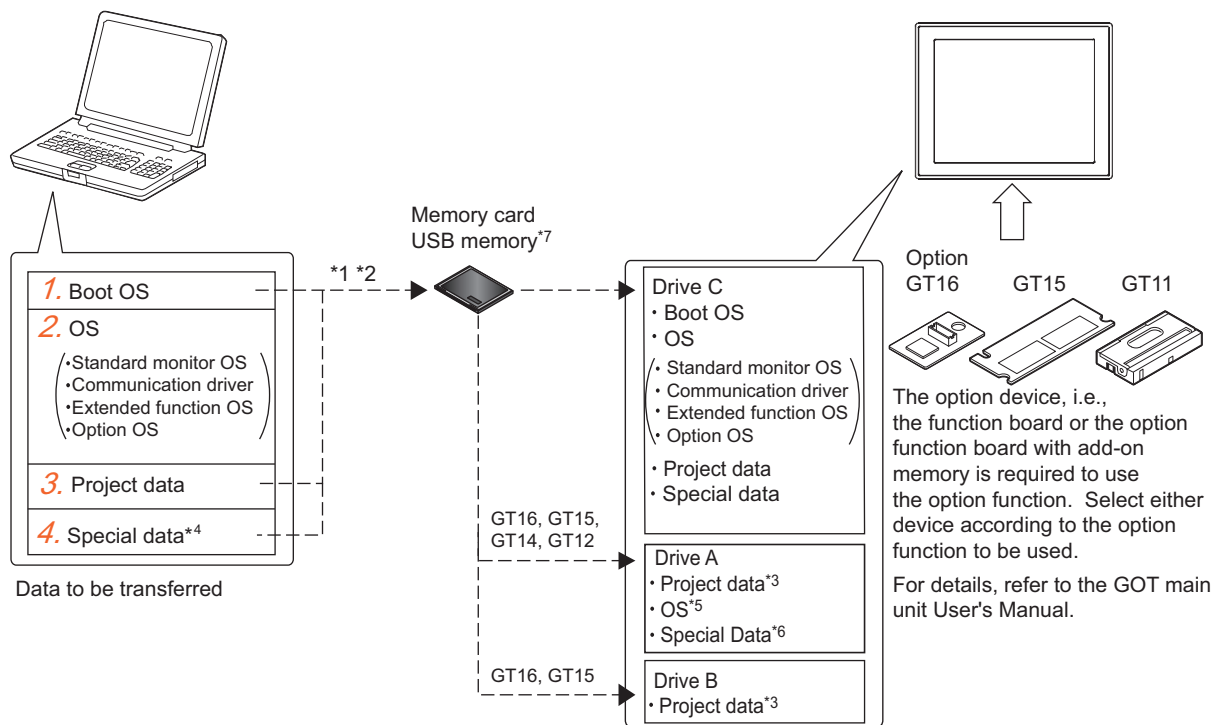

- \*1 Boot OS and OSs (standard monitor OS, communication driver, extended function OS, and option OS), project data, or special data cannot be transferred to the same memory card or USB memory.
- \*2 Depending on the capacity of the memory card or the USB memory used, OSs (Standard monitor OS, communication driver, extended function OS, and option OS), project data, and special data can be transferred simultaneously.
- \*3 The GT16 and GT15 can start from Drive A or Drive B by storing the project data on these drives. For the GT14 and GT12, the project data can be stored in Drive A and started from the drive.
- \*4 For the GT16 and GT15 only.
- \*5 The GT16 and GT15 can start from Drive A by storing the OS on this drive.
- \*6 The GT16 and GT15 can start from Drive A by storing the Special Data on this drive.
- \*7 For the GT16 and GT14 only.

1. Write the Boot OS to the memory card or the USB memory.  
 8.2.2 Transferring Boot OS to memory card or USB memory
2. Write the OSs (standard monitor OS, communication driver, extended function OS, and option OS) to the memory card or the USB memory.  
 8.2.1 Transferring project data, OS, and special data to memory card or USB memory
3. Write the project data to the memory card or the USB memory.  
 8.2.1 Transferring project data, OS, and special data to memory card or USB memory
4. Write the special data to the memory card or the USB memory. (GT16 and GT15)  
 8.2.1 Transferring project data, OS, and special data to memory card or USB memory

## POINT

### Transferring the project data to the memory card or the USB memory

To transfer the project data from the personal computer to the memory card or the USB memory, the project data must be opened on GT Designer3.

Other data can be transferred even if the project data is not open on GT Designer3.

## ■ Precautions

### (1) Detailed explanation and category set on the project or screen

Detailed explanation and category set on the project or screen are not written to the GOT.  
After writing, they are not saved when they are read again from the GOT.

### (2) Transferring the project data to the memory card or the USB memory

Make sure to transfer the project data from GT Designer3 to the memory card the USB memory. When the data is copied using Explorer of the personal computer, the GOT cannot recognize the data in the memory card or the USB memory.

### (3) Data in the GOT and memory card or the USB memory

When the project data of the same name as the write target data has already been within the GOT, the memory card, or the USB memory, write or read it after the folders (G1BOOT, S1SYS, and project data folder) in the GOT, the memory card, or the USB memory are deleted.

### (4) Formatting a memory card or USB memory

Prior to use, make sure to format the memory card or the USB memory in either of the following methods. If any folders and files other than the GOT data exist in the memory card or the USB memory, the OSs and project data may not be transferred to the GOT.

Prior to use, make sure to format the memory card in either of the following methods.

#### (a) Using a personal computer (Memory card and USB memory)

Use a memory card or a USB memory with 32GB or less.

Format the memory card or the USB memory to FAT16 or FAT32.

The availability and the capacity of the memory card or the USB memory differ according to the GOT used.

GOT	Memory card/USB memory
GT16	<ul style="list-style-type: none"><li>When formatting a CF card or a USB memory to FAT16: Up to 2GB</li><li>When formatting a CF card or a USB memory to FAT32: Up to 32GB<sup>*1</sup></li></ul>
GT15, GT12, GT11	<ul style="list-style-type: none"><li>When formatting a CF card to FAT16: Up to 2GB</li><li>When formatting a CF card to FAT32: Not available</li></ul>
GT14	<ul style="list-style-type: none"><li>When formatting a SD card or a USB memory to FAT16: Up to 2GB</li><li>When formatting a SD card or a USB memory to FAT32: Up to 32GB<sup>*1</sup></li></ul>

<sup>\*1</sup> To use a memory card or a USB memory with more than 2GB, refer to (2) in POINT as shown below.

#### (b) For details of the utility menu used for Program/data control (Memory card Format) of the utility menu, refer to the following manual.

 User's Manual for the GOT used

### (5) Access authority of a project when the project security is set

When all of the following conditions are satisfied, the project data cannot be written in a memory card or a USB memory.

- The access level of the user is other than the administrator.
- The data transfer/utility password is not set in the project data.

For the details of the project security, refer to the following.

 3.14 Securing Project

### (6) Time for transferring (writing) to a memory card or a USB memory

The time for transferring data from GT Designer3 to the memory card or the USB memory depends on the environment of the personal computer.

Therefore, more time may be taken depending on the used memory card, the USB memory, and the personal computer OS.

## POINT

### (1) Folders and files in the memory card or the USB memory

When the OS or project data is transferred to the memory card or the USB memory, multiple folders and files are created.

Do not delete or edit these folders and files as they are managed by the GOT.

If they are deleted or edited, the GOT will not operate normally.

### (2) Use condition of a memory card or a USB memory with more than 2GB

The memory card or the USB memory with more than 2GB can be used for the GT16 and the GT14 with the following versions of OS installed.

- BootOS version: 05.09.00AF or later
- Standard monitor OS version: 05.09.00 or later

If the above versions of OSes are not installed, install the OSes to the GOT by using GT Designer3 Version1.15R or later.

If the OS version is earlier than the above OS versions, the memory card or the USB memory with more than 2GB is not recognized correctly.

### (7) If an error occurs when data is written to a memory card

When the setting that encrypts the ~Gtdtmp folder is configured, an error occurs when data is written to a memory card.

Cancel the folder encryption setting.

The ~Gtdtmp folder is stored in the temporary folder of the Windows login account.

## 8.2.1 Transferring project data, OS, and special data to memory card or USB memory

### ■ Writing project data and installing OS (Personal computer to memory card or USB memory to GOT)

Write the project data and installing the OS from GT Designer3 to the memory card or the USB memory.

## POINT

### (1) Using a memory card or a USB memory (GT16)

When writing or reading the project data or OS to a memory card or a USB memory, do not store any other data to the memory card or USB memory.

The other data are all deleted when the project data or OS is written or read.

### (2) Data written in the GOT

When the OS is installed, the project data stored in the project folder in the GOT is deleted.

If the project data backup is required, write the project data to a personal computer, memory card, or USB memory before installing the Boot OS.

### (3) Precautions for installing the OS

The OS installation cannot be interrupted.

Do not do any of the following operations to interrupt the installation, as it may disable the GOT from operating.

- Removing the memory card
- Removing the USB memory
- Turning off the GOT
- Pressing the reset button of the GOT

If the GOT has been disabled from operating due to any of the above operations during the installation, install the Boot OS again by using the 2-point presses installation method provided in the following section.

 8.2.2 Transferring Boot OS to memory card or USB memory

The following shows how to write the project data and install the OS.

**(1) How to write the project data and to install the OS to a memory card or a USB memory**

**POINT**

**To make communication between the GOT and PLC**

The installation of the communication driver and writing the communication settings are required. For the installation of the communication driver and writing of the communication settings, refer to the following.

 GOT1000 Series Connection Manual for GT Works3 and a controller used

1. Select [Communication] → [Transfer to Memory Card] from the menu. When system labels are used, the system label update/check is executed. If an error exist in the system label settings, the project data cannot be written to a memory card or a USB memory. When errors exist in the system label settings, check the settings, and remove the errors.
2. As the [Memory Card Write] tab of the [Communicate with Memory Card] dialog box appears, select the project data to be written and click the [Memory Card Write] button.

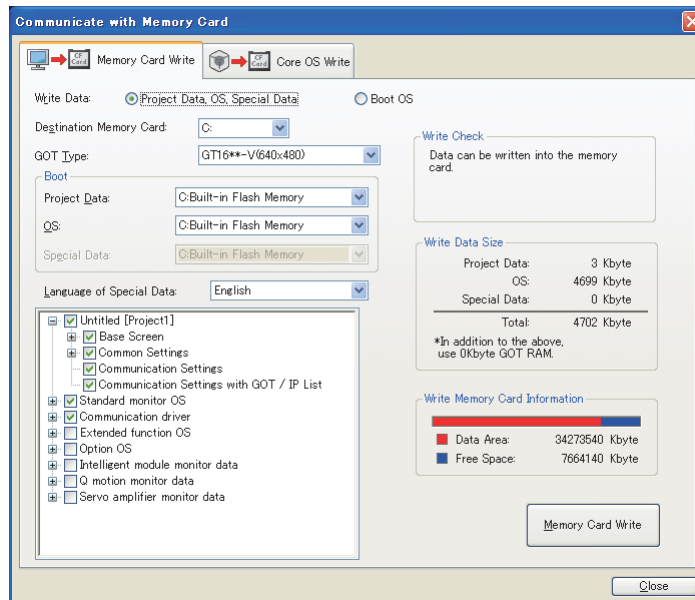

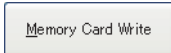
Item	Description
Write Data	Select the type of the data to be written to the memory card or the USB memory. Select [Project Data, OS, Special Data, Boot OS].
Destination Memory Card	Select the memory card drive or the USB memory drive in which the data is to be written.
GOT Type	Select the GOT type of the project data to be written to the memory card or the USB memory.
Boot <sup>*1*2</sup>	Select the Boot drive of the [Project Data] and [OS].
Tree View	The project data, Standard monitor OS, Communication driver, Extended function OS, Option OS, and Special Data are displayed in the tree.
Write Check	The writing status of the memory card or the USB memory is displayed.
Write Data Size	The size of the data to be written to the memory card or the USB memory is displayed.
Write Memory Card Information	The information of the drive specified in [Destination Memory Card] is displayed. In the graph, the data area is shown in red and the free space is shown in blue.
	Writes the project data and OS to the memory card or the USB memory.

\*1 In the GT16, GT15, GT14, and GT12 when [A:Standard Memory Card] is selected for the OS boot drive, the project data and special data in the boot drive are fixed to [A:Standard Memory Card].

\*2 In GT11, the Boot drive for the OS is fixed to [C:Built-in Flash Memory].



3. The project data and the required OS are started to be written.

## POINT

### (1) When [A:Standard Memory Card] is selected for the boot drive

- (a) When [A:Standard Memory Card] is selected in the boot drive, the GOT can start with the standard memory card.  
For details, refer to the following.  
☞ 10.4 Starting GOT with Memory Card
- (b) The communication driver, extended function OS, and option OS that exceed the limit of the user area capacity (C drive) can be used.  
For details, refer to the following.  
☞ 8.5.2 Drive capacity required for data transfer
- (c) To display the startup logo in the memory card, the Boot OS version of [03.09.\*\*.S] or later must be installed on the GOT.  
For how to check the Boot OS version installed on the GOT, refer to the following.  
☞ User's Manual for the GOT used

### (2) Precautions when selecting write data (iQ Works only)

When system labels are written and [System Label] is cleared for target data, system labels are deleted from a target project, and the labels are changed to devices.  
The system labels changed to devices cannot be restored.  
To hold the system label settings, do not clear [System Label] for the write target data.  
When clearing [System Label] for the write target data, check the device setting.

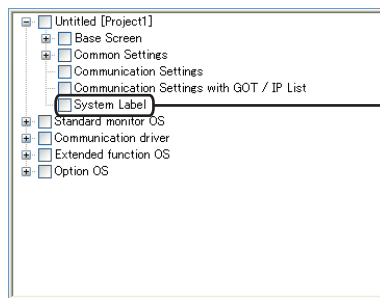

When the box is cleared, system labels are deleted from the project.

### (2) How to write the project data and install the OS on the GOT

The project data and OS can be written and installed on the GOT in either of the following methods.

- Writing and installing while the GOT is turned on
- Writing and installing by the utility (Program/data control) function of the GOT

#### (a) How to write and install while the GOT is turned on

The messages displayed on the GOT during write and installation differ, depending on if the standard monitor OS is installed or not.  
The instructions below are based on the assumption that the standard monitor OS is installed on the GOT.  
If a request message is displayed on the screen, follow the screen's request.  
(If the standard monitor OS and project data is written to the memory card, the project data will be written after the standard monitor OS is installed.)

1. Turn off the GOT and also turn off the CF/SD card access switch.
2. Install the memory card in which the project data is written to the A drive of the GOT.  
(B drive cannot be used for the write.)  
For how to write the project data to the memory card, refer to the following.  
☞ (1) How to write the project data and to install the OS to a memory card or a USB memory  
For how to install the memory card, refer to the following.  
☞ User's Manual for the GOT used

3. Turn on the CF/SD card access switch of the GOT.
4. Turn on the GOT.
  - For GT16, GT1595-X, and GT12  
Turn on the GOT while pressing the GOT installation switch (S.MODE switch) on the rear of the GOT. (The 1-point press installation function)
  - For the GT1585V-S, GT1585-S, GT1575V-S, GT1575-S, GT1575-V, GT1575-VN, GT1572-VN, GT1565-V, GT1555-V, GT1562-VN, GT1555-Q, GT1550-Q, and GT11  
Turn on the GOT while touching the lower and upper portions of the left side of the GOT screen. (The 2-point presses installation function)
  - For GT14  
Turn on the GOT while touching the upper left position on the GOT screen. (The 1-point press installation function)

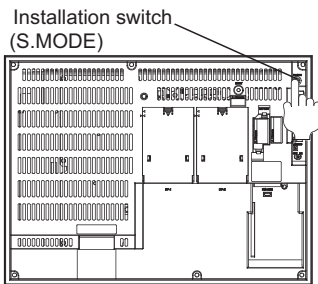

For the GT16, GT1595-X, and GT12

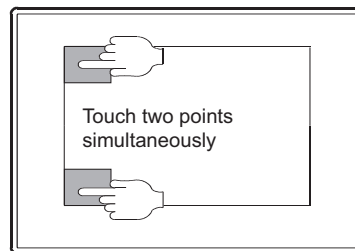

For the GT1585V-S, GT1585-S, GT1575V-S, GT1575-S, GT1575-V, GT1575-VN, GT1572-VN, GT1565-V, GT1562-VN, GT1555-Q, GT1550-Q, and GT11

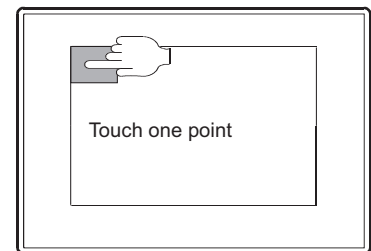

For the GT14

5. As the following screen appears, touch the [OK] button to start downloading (writing) the project data.

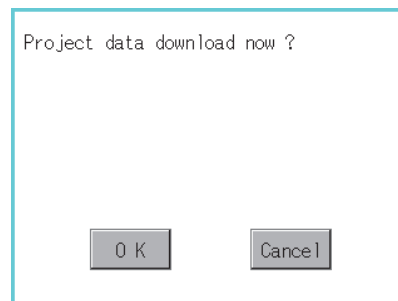

The CF/SD card access LED is on during the installation and download (write). Do not perform the following operations while the CF/SD access LED is on.

- Removing the memory card
- Turning off the CF/SD card access switch
- Turning off the GOT
- Pressing the reset button of the GOT

## POINT

### If the OS version in the GOT differs from the GT Designer3 OS version in which the project data was created

If the OS major version in the GOT differs from the GT Designer3 OS major version in which the project data was created, the project data may not function properly on the OS in the GOT.

Therefore, the appropriate OS installation is recommended when the project data is written to the memory card. However, as the OS is deleted before writing the project data again, the OS file types and numbers of OSs in the GOT can change. (When the OS is downgraded, the unsupported OS is deleted)



Because of the version is not much to current basic OS,GOT aborts down-loading.

OK

6. After the download (write/installation) is completed, the following screen appears. Touch the [OK] button to commence the restart.  
After the GOT is restarted, turn off the CF/SD card access switch of the GOT. Then, check that the CF/SD card access LED is off and remove the memory card from the GOT.

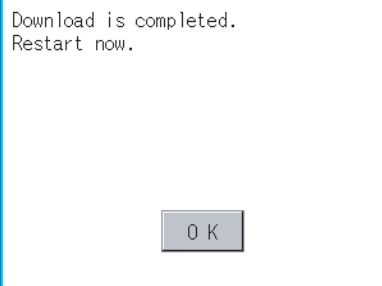

Download is completed.  
Restart now.

OK

- (b) How to write by the utility (Program/data control) function of the GOT  
For how to write, refer to the following.

 User's Manual for the GOT used

## ■ Writing special data (Personal computer to memory card or USB memory to GOT)



The following shows how to write the special data.

### (1) How to write special data to the memory card or the USB memory

1. Select [Communication] → [Transfer to Memory Cord] from the menu.
2. As the [Memory Card Write] tab of the [Communicate with Memory Card] dialog box appears, select the special data to be written and click the [Memory Card Write] button.

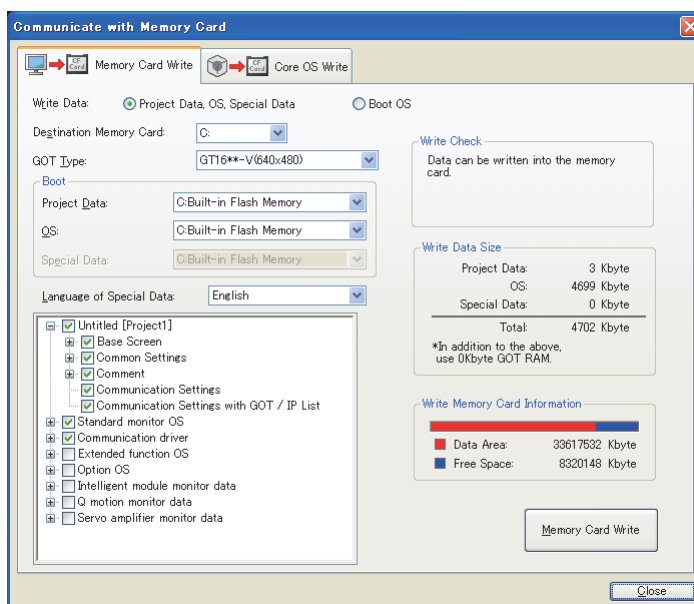

Item	Description
Write Data	Select the type of the data to be written to the memory card or the USB memory. Select [Project Data, OS, Special Data].
Destination Memory Card	Select the drive of the memory card or the USB memory in which the data is to be written.
GOT Type	Select the GOT type of the special data to be written to the memory card or the USB memory.
Boot <sup>*1</sup>	Select the Boot drive of [Project Data] and [OS]. For the boot drive of [Special Data], the drive for [OS] is set.
Language of Special Data	Select the language of the special data.
Tree View	The project data, standard monitor OSs, communication drivers, extended function OSs, option OSs, and special data in the language selected for [Language of Special Data] are displayed in the tree view.
Write Check	The writing status of the memory card or the USB memory is displayed.
Write Data Size	The size of the data to be written to the memory card or the USB memory is displayed.
Write Memory Card Information	The drive information of the drive specified in [Destination Memory Card]. In the graph, the data area is shown in red and the free space is shown in blue.
Memory Card Write	Writes the project data to the memory card or the USB memory.

\*1 When [A:Standard Memory Card] is selected for the boot OS drive, the boot drives for the project data and special data are fixed to [A:Standard Memory Card].

### POINT

#### Installing the option OS

To use the special data, both the special data and the option OS must be installed.  
Write the special data to be used and install the option OS.

## (2) How to write the special data to the GOT

The special data can be written to the GOT in either of the following methods.

- Writing while the GOT is turned on
- Writing by the utility (Program/data control) function of the GOT

### (a) How to write while the GOT is turned on

The messages displayed during the write are based on the assumption that the standard monitor OS is installed on the GOT. If a request message is displayed on the screen, follow the screen's request.

1. Turn off the GOT and turn off the CF card access switch.
2. Insert the memory card in which the special data is written to the A drive of the GOT.  
(B drive cannot be used for the write.)  
For how to write the special data to the memory card, refer to the following.  
☞ (1) How to write the project data and to install the OS to a memory card or a USB memory  
For how to install the memory card, refer to the following.  
☞ User's Manual for the GOT used
3. Turn on the CF card access switch of the GOT.
4. Turn on the GOT.
  - For the GT16 and GT1595-X  
Turn on the GOT while pressing the GOT installation switch (S.MODE switch) on the rear of the GOT. (the 1-point press installation function)
  - For the GT1585V-S, GT1585-S, GT1575V-S, GT1575-S, GT1575-V, GT1575-VN, GT1572-VN, GT1565-V, GT1555-V, GT1562-VN, GT1555-Q, and GT1550-Q  
Turn on the GOT while touching the lower and upper portions of the left side of the GOT screen. (the 2-point presses installation function)

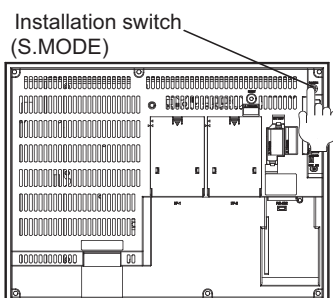

For the GT16□□, and GT1595-X

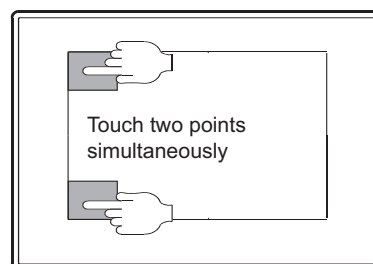

For the GT1585V-S, GT1585-S, GT1575V-S, GT1575-S, GT1575-V, GT1575-VN, GT1572-VN, GT1565-V, GT1562-VN, GT1555-V, GT1555-Q, GT1550-Q and GT11

5. As the following screen appears, touch the [OK] button to start downloading (writing) the special data. If the special data is not written in the memory card, this download (write) processing is not performed.

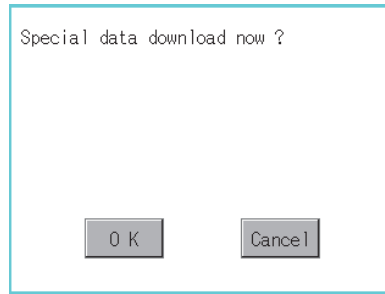

The CF card access LED is lit during the installation and download (write). Do not perform the following operation while the CF card access LED is lit.

- Removing the memory card
- Turning off the CF card access switch
- Turning off the GOT
- Pressing the reset button of the GOT

## POINT

### **If the OS version in the GOT differs from the GT Designer3 OS version in which the special data was created**

If the OS major version in the GOT differs from the GT Designer3 OS major version in which the special data was created, the special data may not function properly on the OS in the GOT.

Therefore, the appropriate OS installation is recommended when the special data is written to the memory card. However, as the OS is deleted before writing the special data again, the OS file types and numbers of OSs in the GOT can change. (When the OS is downgraded, the unsupported OS will be deleted)

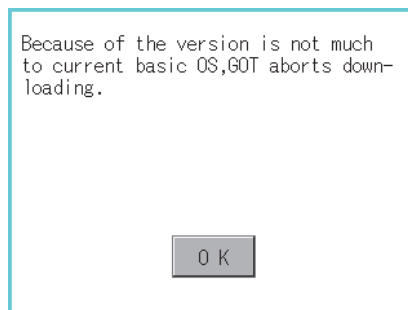

6. After the download (write) is completed, the following screen appears. Touch the [OK] button to commence the startup. After the GOT is restarted, turn off the CF card access switch of the GOT. Then, check that the CF card access LED is off and remove the memory card from the GOT.

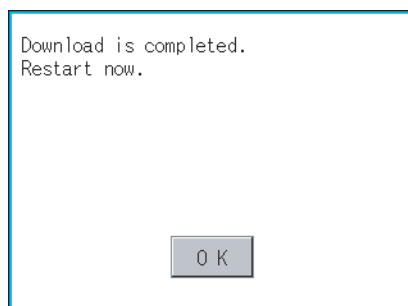

- (b) How to write by the utility (Program/data control) function of the GOT  
For how to write, refer to the following.

 User's Manual for the GOT used

## 8.2.2 Transferring Boot OS to memory card or USB memory

### ■ Installing Boot OS (Personal computer to memory card or USB memory to GOT)

#### POINT

**(1) When using a memory card or a USB memory**

When writing the Boot OS to a memory card or a USB memory, do not store any other data to the memory card or the USB memory.

The other data are all deleted when the Boot OS is written.

**(2) Data written in the GOT**

When the Boot OS is installed, the project data, OS (standard monitor OS, communication driver, extended function OS, and option OS), and special data folder in the GOT are deleted.

If the project data backup is required, write the project data to a personal computer, memory card or USB memory before installing the Boot OS.

As the special data cannot be written to a personal computer, write the special data to a memory card or a USB memory.

For reading each data, refer to the following.

 8.1.5 Reading from GOT

**(3) Precautions for installing the Boot OS on the GOT**

Once the Boot OS is started to be installed, the processing cannot be interrupted.

Do not perform the following operations during the OS installation, as it may disable the GOT from operating.

- Removing the memory card or the USB memory
- Turning off the GOT
- Pressing the reset button of the GOT

If the GOT does not operate, please contact a service representative.

**(4) When the Boot OS versions are different**

During the Boot OS installation, the Boot OS version is checked against the preinstalled one to prevent the newer one from being overwritten. The installation is interrupted when the versions are different (when the Boot OS version in the memory card or the USB memory is older).

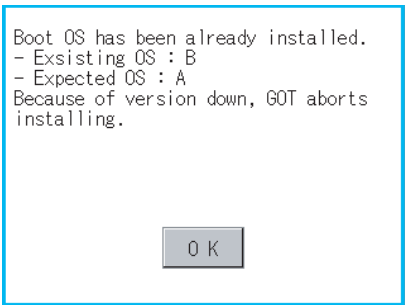

```
Boot OS has been already installed.
- Existing OS : B
- Expected OS : A
Because of version down, GOT aborts
installing.
```

**(5) Initializing the GOT (Returning the GOT to factory-settings)**

Installing the Boot OS returns the GOT to the factory-settings.

Note that when the Boot OS is installed, the project data and OS (standard monitor OS, communication driver, extended function OS, and option OS) in the GOT are deleted.

If the project data backup is required, write the project data to a personal computer, memory card or USB memory before installing the Boot OS.

- To a personal computer  
     ☞ 8.1.5 ■ Reading project data (GOT to personal computer)
- To a memory card or USB memory  
     ☞ User's Manual for the GOT used

The following shows how to install the Boot OS

**(1) How to write the Boot OS to the memory card or USB memory**

1. Select [Communication] → [Transfer to Memory Card] from the menu.
2. The [Memory Card Write] tab of the [Communicate with Memory Card] dialog box appears.
3. Select [Boot OS] in [Write Data].
4. Check [Procedures for GOT Write and precautions] and click the [Memory Card Write] button.

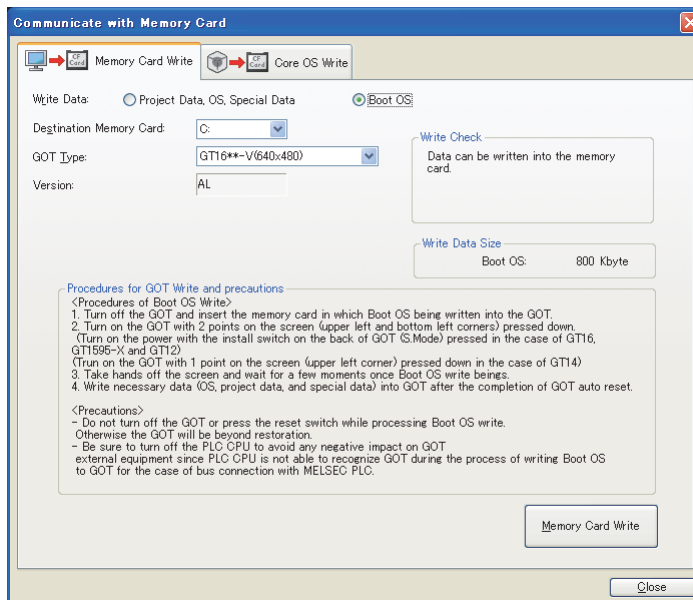

Item	Description
Write Data	Select the type of the data to be written to the memory card or the USB memory. Select [BootOS].
Destination Memory Card	Select the drive of the memory card or the USB memory in which the data is to be written.
GOT Type	Select the GOT type of the Boot OS to be written to the memory card or the USB memory.
Version	The version of the Boot OS to be installed on the GOT is displayed.
Procedures for GOT Write and precautions	The procedure and precautions for writing the Boot OS are displayed. Make sure to read them before writing.
Write Check	The writing status of the memory card or the USB memory is displayed.
Write Data Size	The size of the Boot OS to be written to the memory card or the USB memory is displayed.
Memory Card Write	Writes the Boot OS to the memory card or the USB memory.



## (2) How to install on the GOT

The Boot OS can be installed on the GOT in either of the following methods.

- Installing while the GOT is turned on

For how to install, refer to the following.

☞ (a) How to install while the GOT is turned on

- Installing by the utility (Program/data control) function of the GOT

For how to install, refer to the following.

☞ User's Manual for the GOT used

- (a) How to install while the GOT is turned on

The messages displayed on the GOT during the installation differ depending on the condition of the standard monitor OS installation.

If a message requesting an operation is displayed on the screen, follow the instructions on the screen.

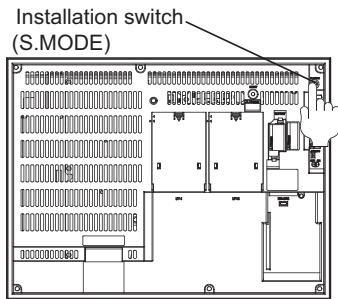

For the GT16, GT1595-X, and GT12

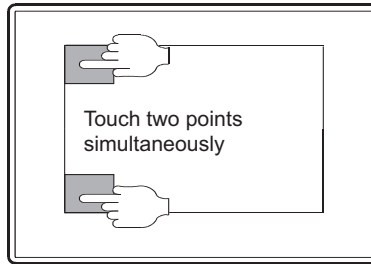

For the GT1585V-S, GT1585-S, GT1575V-S, GT1575-S, GT1575-V, GT1575-VN, GT1572-VN, GT1565-V, GT1562-VN, GT1555-V, GT1555-Q, GT1550-Q and GT11

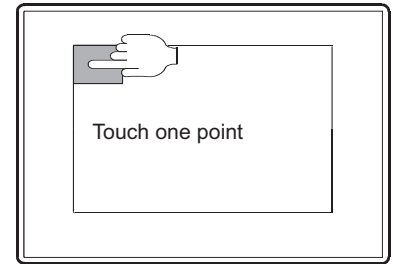

For the GT14

- When installing data with the memory card

1. Turn off the GOT and also turn off the CF/SD card access switch.

2. Insert the memory card in which the Boot OS is written to the A drive of the GOT. (B drive cannot be used for the installation.)

For how to write the Boot OS to the memory card, refer to the following.

☞ (1) How to write the Boot OS to the memory card or USB memory

For how to insert the memory card, refer to the following.

☞ User's Manual for the GOT used

3. Turn on the CF/SD card access switch of the GOT.

4. Turn on the GOT.

- For GT16, GT1595-X, and GT12

Turn on the GOT while pressing the GOT installation switch (S.MODE switch) on the rear of the GOT. (the 1-point press installation function)

- For the GT1585V-S, GT1585-S, GT1575V-S, GT1575-S, GT1575-V, GT1575-VN, GT1572-VN, GT1565-V, GT1555-V, GT1562-VN, GT1555-Q, GT1550-Q, and GT11

Turn on the GOT while touching the lower and upper portions of the left side of the GOT screen. (the 2-point presses installation function)

- For GT14

Turn on the GOT while touching the upper left position on the GOT screen. (The 1-point press installation function)

5. Install the Boot OS on the built-in flash memory (C drive).  
The CF/SD card access LED is on during the installation.  
Do not perform the following operations while the CF/SD card access LED is on.
  - Removing the memory card
  - Turning off the CF/SD card access switch
  - Turning off the GOT
  - Pressing the reset button of the GOT

When Standard monitor OS is not yet installed

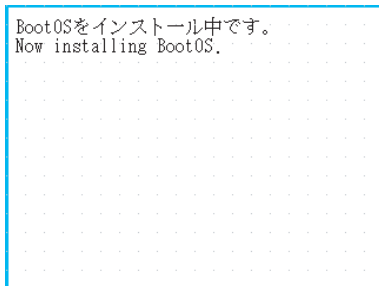

When Standard monitor OS is already installed

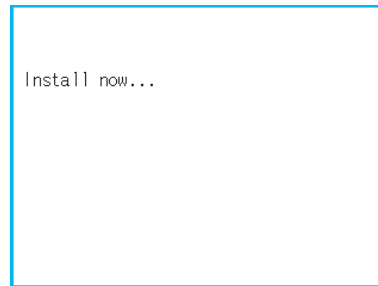

6. After the installation is completed, the GOT automatically restarts.  
(When the standard monitor OS is already installed, touch the [OK] button to restart the GOT.)  
After the GOT is restarted, turn off the CF/SD card access switch of the GOT. Then, check that the CF/SD card access LED is off and remove the memory card from the GOT.
7. Transfer the OS or project data.

- When installing data with the USB memory (GT16, GT14)

1. Turn off the GOT, and install the USB memory where the Boot OS, standard monitor OS, or project data is stored in the USB interface of the GOT.  
The BootOS cannot be stored in the USB memory where the standard monitor OS or project data is stored.
2. Turn on the GOT.
  - For GT16  
Turn on the GOT while pressing the install switch (S.MODE switch) on the back of the GOT. (1-point press installation function)
  - For GT14  
Turn on the GOT while touching the upper left position on the GOT screen. (The 1-point press installation function)
3. The Boot OS and standard monitor OS are installed on the built-in flash memory.  
The USB memory access LED is lit during the installation.  
Do not remove the USB memory or turn off the GOT while the USB memory access LED is lit.

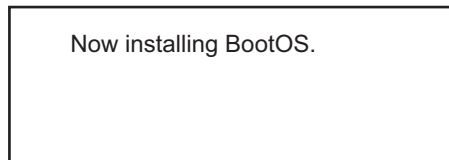

4. After the installation is completed, the GOT automatically restarts.  
(When the standard monitor OS is already installed, the GOT restarts by touching the [OK] button.)

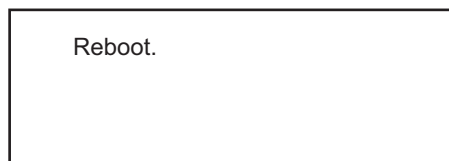

5. After confirming normal restart, confirm that the USB memory access LED is not lit, and remove the USB memory from the USB interface of the GOT.  
For how to remove the USB memory, refer to the following.  
 User's Manual for the GOT used

## 8.2.3 Transferring CoreOS to memory card

---

### ■ Installing CoreOS (personal computer to memory card to GOT)

Install the CoreOS only if the GOT is not in its factory-shipped condition after the reinstallation of the Boot OS. Normally, the installation is not required.

#### POINT

##### (1) Precautions for installing the CoreOS

The installation cannot be interrupted.

Do not perform the following operations during the CoreOS installation, as it may disable the GOT from operating.

- Turning off the GOT
- Pressing the reset button of the GOT
- Turning on the CF/SD card access switch
- Removing the memory card

##### (2) Drive to install the CoreOS

The CoreOS can be installed only on the A drive.

The B drive cannot be used to install the CoreOS.

---

If the GOT is not recovered even after installing the CoreOS, there may be a hardware problem. Please consult your nearest sales office or FA Center, explaining a detailed description.

##### (1) Before installing the CoreOS

###### (a) How to install the CoreOS

The CoreOS can only be installed with the memory card.

It cannot be installed via a USB, RS-232, or Ethernet connection.

###### (b) Applicable memory card

Use a memory card with 32MB or more.

###### (c) BootOS

When the CoreOS is installed, the Boot OS is also automatically installed.

###### (d) When installing the CoreOS

When installing the CoreOS, remove all units mounted on the extended I/F.

For how to remove the unit, refer to the following.

 User's Manual for the GOT used

**(2) How to install the CoreOS**

The following shows how to install the CoreOS.

1. Select [Communication] → [Transfer to Memory Card] from the menu.
2. As the [Memory Card Write] tab of the [Communicate with Memory Card] dialog box appears, select the [Core OS Write] tab.
3. Check [Procedures for GOT Write and precautions] and click the [Memory Card Write] button.

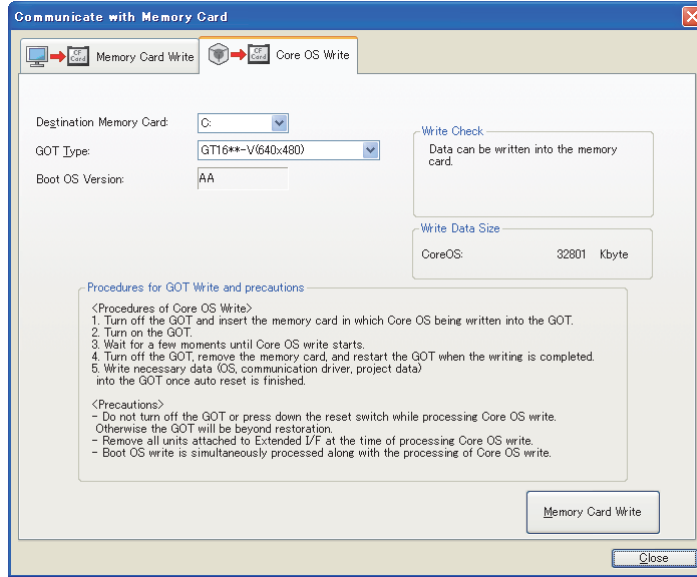

Item	Description
Destination Memory Card	Select the memory card drive in which the data is to be written.
GOT Type	Select the GOT type of the CoreOS to be written to the memory card.
Boot OS Version	The version of the Boot OS to be installed on the GOT.
Procedures for GOT Write and precautions	The procedure and precautions for writing the CoreOS are displayed. Make sure to read them before writing.
Write Check	The writing status of the memory card is displayed.
Write Data Size	The size of the CoreOS to be written to the memory card.
Memory Card Write	Writes the CoreOS to the memory card.

### (3) If the CoreOS cannot be installed



If the CoreOS cannot be installed, check the following items.

If the CoreOS still cannot be installed even after checking these items, there may be a hardware problem.

Please consult your nearest sales office or FA Center, explaining a detailed description.

Item	Contents
Even though the memory card is installed in the GOT, CoreOS cannot be installed.	<ul style="list-style-type: none"><li>• Make sure that the CF/SD card access switch of the GOT is on. If the switch is off, turn on the switch.</li><li>• It is possible that data was not written correctly to the memory card from GT Designer3. Write to the memory card from GT Designer3 again.</li></ul>
The following message is displayed at the GOT. [GOT error. Consult your local sales office.]	The GOT is broken. Please consult your nearest sales office or FA Center, explaining a detailed description.
The following message is displayed at the GOT. [CF card error. Installation will be canceled. Check whether the CF card can be used.]	The memory card has an error. <ul style="list-style-type: none"><li>• Perform the operation again after formatting the memory card.</li><li>• Replace the memory card.</li></ul>
The following message is displayed at the GOT. [Optional unit has been connected to extension I/F slot.]	Turn OFF the GOT and remove the communication unit or others mounted on the extended I/F, and then re-execute the CoreOS installation.
The following message is displayed at the GOT. [GOT type and OS version do not match.]	Re-execute the CoreOS installation with the installation function of CoreOS of the correct model.
The following message is displayed at the GOT. [The version of OS is not acceptable to this GOT.]	Re-execute the CoreOS installation with the installation function of the newer version of CoreOS.
The following message is displayed at the GOT. [Memory card access switch is off.]	Turn on the CF/SD card access switch, and then install the CoreOS again.

### (4) How to install on the GOT

1. Turn off the GOT and turn off the CF/SD card access switch.
2. Insert the memory card in which the CoreOS is written to the A drive of the GOT.  
For how to write the CoreOS to the memory card, refer to the following.  
 (2) How to install the CoreOS  
For how to install the memory card, refer to the following.  
 User's Manual for the GOT used
3. Turn on the CF/SD card access switch of the GOT.
4. Turn on the GOT to display the installation performing screen. Then, turn off the CF/SD access switch to start installing the CoreOS.
5. Install the CoreOS on the built-in flash memory (C drive).  
The CF/SD card access LED is on during the installation.  
Do not perform the following operations while the CF/SD card access LED is on.
  - Removing the memory card
  - Turning on the CF/SD card access switch
  - Turning off the GOT
  - Pressing the reset button of the GOT
6. When the installation is completed, the power LED of the GOT starts to blink. Turn off the GOT, remove the memory card, and then turn on the GOT again.
7. Transfer the OS, project data and special data.

## 8.3 Transferring Data Using GT10-LDR

GT 16 GT 15 GT 14 GT 12 GT 11 GT 10 Soft GOT 1000

### 8.3.1 Preparation for data transfer

The GT105□ and the GT104□ do not support the GT10-LDR.

#### ■ Data transfer procedure

Data is transferred in the following procedure.

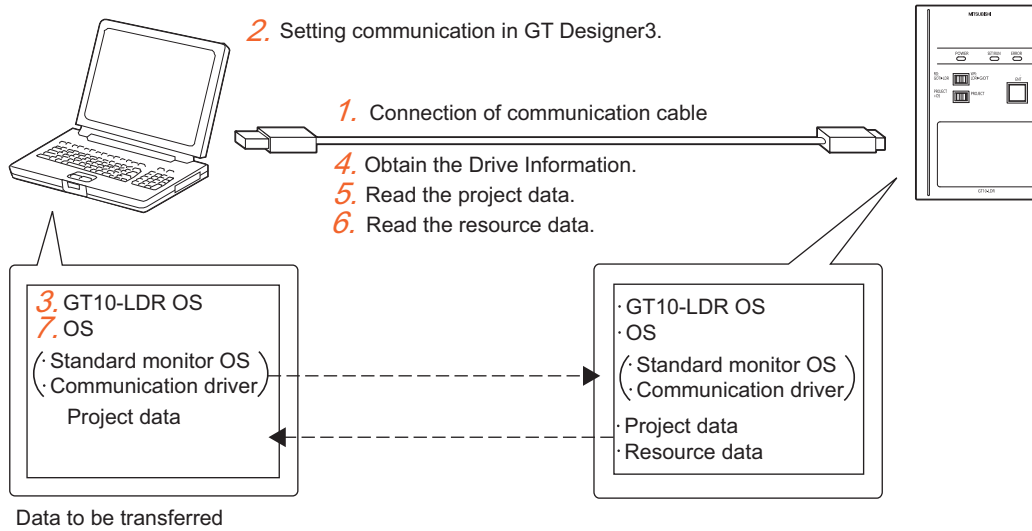

1. Connect the communication cable.  
☞ 8.3.2 Connecting cable
2. Configure the communication setting of GT Designer3.  
☞ 8.3.3 Setting communication
3. Install the GT10-LDR OS.  
☞ 8.3.4 Installing GT10-LDR OS
4. Obtain the built-in memory information.  
☞ 8.3.6 Obtaining memory information
5. Read the project data. (GT10-LDR → personal computer (project))  
☞ 8.3.7 Reading project data
6. Read the resource data. (GT10-LDR → personal computer (resource))  
☞ 8.3.8 Reading resource data
7. Install the OS (standard monitor OS and communication driver) and write the project data. (Personal computer → GT10-LDR (OS/project))  
☞ 8.3.5 Writing project data and installing OS

## ■ Precautions

### (1) Transfer cable

Make sure that the connector of the used USB, RS-232, or Ethernet cable is securely connected to that of the GOT and personal computer.

### (2) Read destination at read

When the read destination is specified as a project file of GT Designer3, all data in the specified project file are deleted. (Even for a partial reading (comment data, etc.), all data in the file are also deleted.)

### (3) Detailed explanation and category set on the project or screen

Detailed explanation and category set on the project or screen are not written to the GT10-LDR. Therefore, they are not saved if they are read again from the GT10-LDR after writing.

### (4) Data within the GT10-LDR

When data is written to the GT10-LDR from GT Designer3, perform writing after all data within the GT10-LDR are deleted.

 8.3.5 Writing project data and installing OS

### (5) Precautions for installing the USB driver of the other company product

When installing the USB driver of the other company product, the "Confirm File Replace" message of the USB driver file (windrvr6.sys) may be displayed.

When a newer file already exists, click the [No] button to discontinue the overwriting processing.

If the file is overwritten, USB communication between GT Designer3 and GT10-LDR may not be made correctly.

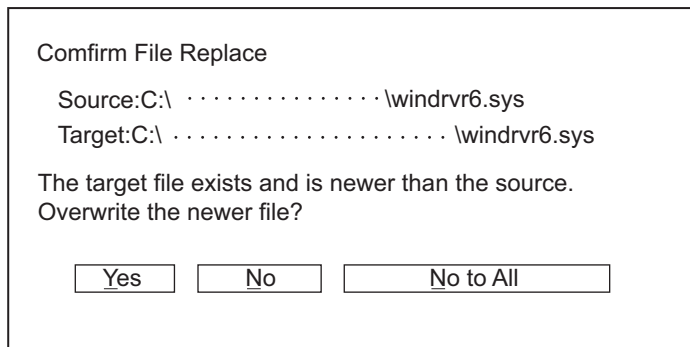



**(6) Precautions for using the USB cable**

- When performing data transfer between the PC and GT10-LDR connected via the USB cable, do not set the resume function, suspend function, power-saving function and standby mode of the PC.  
For the setting details of the resume function, suspend function, power-saving function and standby mode, refer to the PC manual or Windows® Help.
  - If the USB cable is disconnected/reconnected during the data transfer, the GT10-LDR is reset or powered off/on, which may result in an unrecoverable communication error.  
In this case, perform either of the following operations.
- (a) The Personal Computer will check for a USB connection.  
Please check that GT10-LDR is displayed in the Universal Serial Bus controllers and Port (COM/LPT).

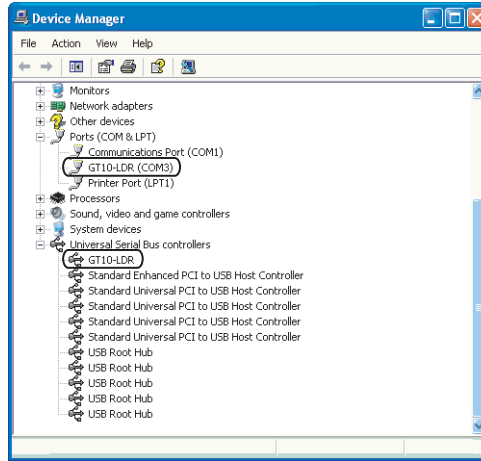

- (b) After disconnecting the USB cable from GT10-LDR for more than 5 seconds, reconnect the cable and restart communication.

**(7) When a communication error has occurred**

A communication error, such as a time-out error, may occur due to the communication port settings on the PC. Check and change the settings in the following procedure.

The following items may not be present depending on the PC used.

1. Select [Start] → [Control Panel] from the menu.

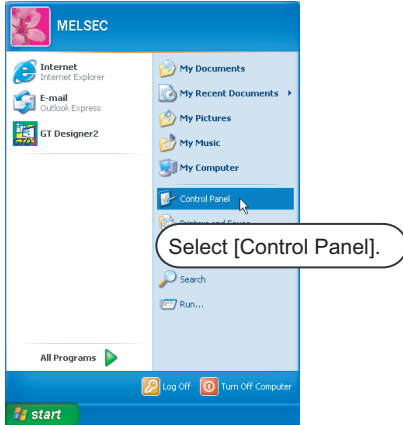

2. Select [Performance and Maintenance] and click the [System] icon.

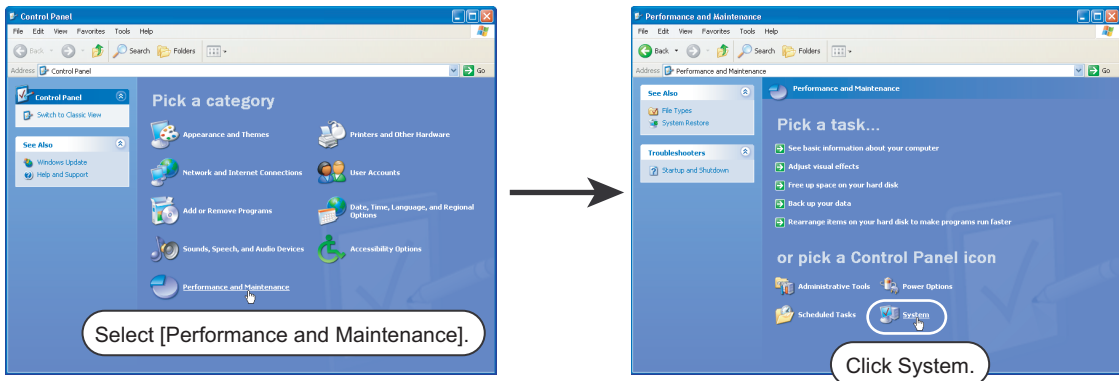

3. As the [System Properties] dialog box appears, click [Device Manager] on the [Hardware] tab.

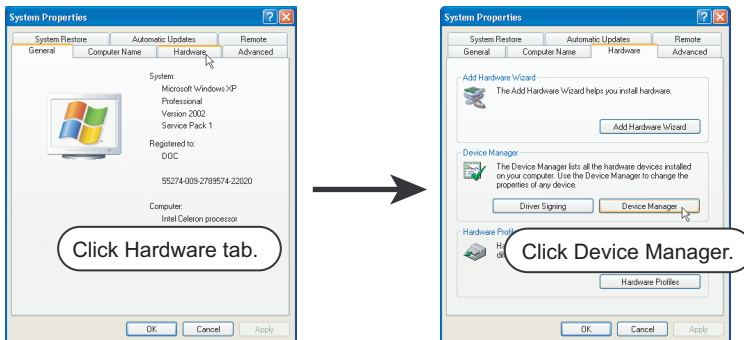

- As Device Manager appears, double-click the current [Communications Port] icon in [Ports]. (In the following, an example using the communication port (COM1) is described.)

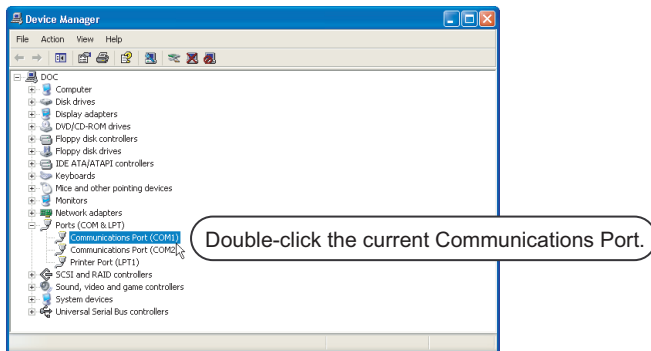

- As the [Communications Port(COM1) Properties] dialog box appears, click the [Advanced] button on the [Port Settings] tab.

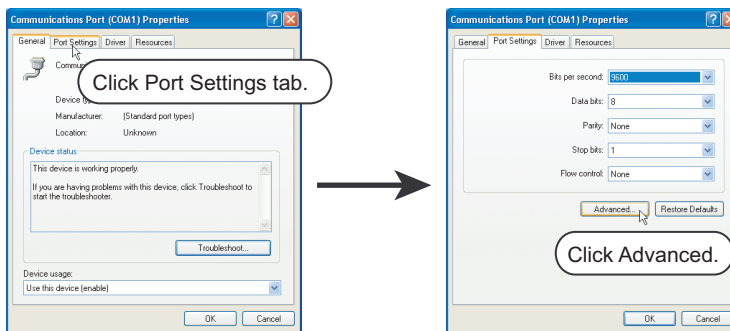

- As the [Advanced Settings for COM1] dialog box appears, clear the [Use FIFO buffers] item.

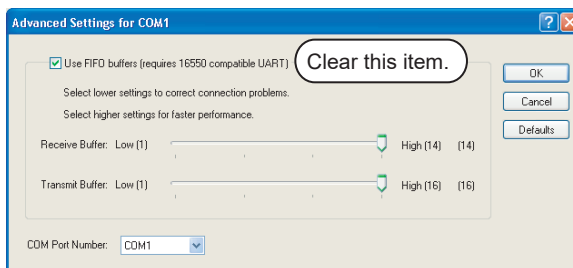

## 8.3.2 Connecting cable

---

Make sure to follow the procedures to securely connect the USB cable to the PC and GT10-LDR.

1. Connect the USB cable to the USB Type-A connector of the PC.
2. Connect the USB cable to the USB connector of the GT10-LDR.  
When the PC and GT10-LDR are USB connected, install the USB driver into the PC.  
Refer to the following for the installation of the USB driver.

### ■ Installing the USB driver

To make the USB communication with the GT10-LDR using the USB cable, the USB driver must be installed.

Windows®	USB driver installation	Necessity of Administrator authority at USB driver installation	Operation during USB driver installation
Windows® 10 (32-bit version, 64-bit version)	Required for each USB connector	Required	Operation required (Refer to next page)

Two USB drivers for the GT10-LDR must be installed.

By referring to the procedure in the following pages, make sure to install two USB drivers.

## (1) USB driver installation

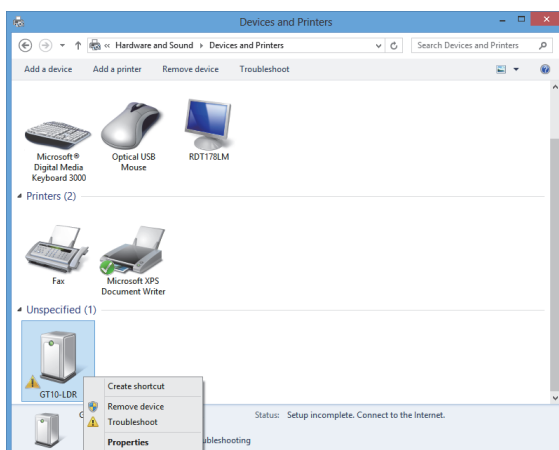
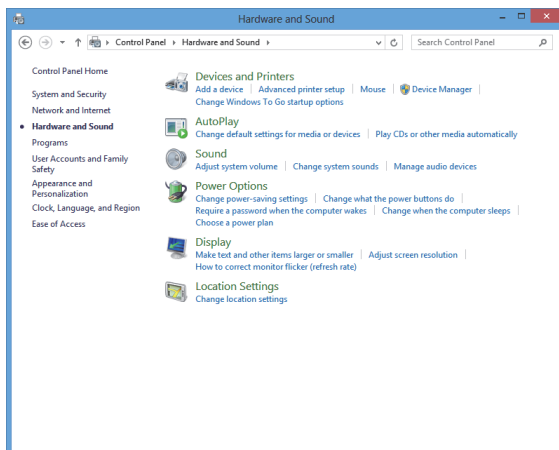
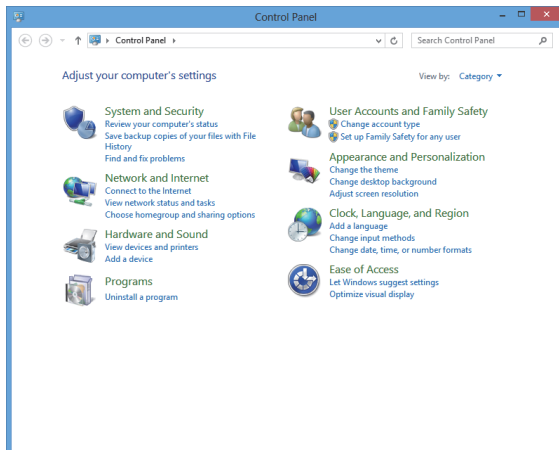

1. Install the USB drivers.  
Select [Hardware and Sound] in [Control Panel].

2. Select [Devices and Printers].

3. Right-click [GT10-LDR], and then select [Properties].

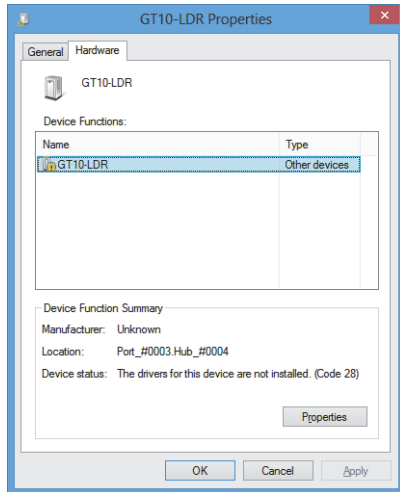

4. The left screen appears. Select the [Hardware] tab, and click the [Properties] button.

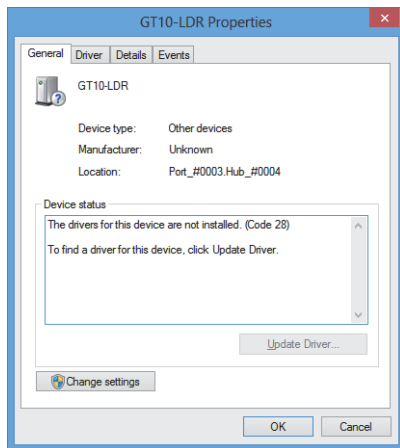

5. The left screen appears. Click the [Change settings] button.

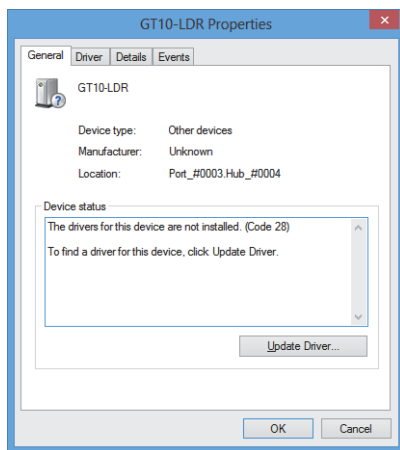

6. Click the [Update Driver] button.



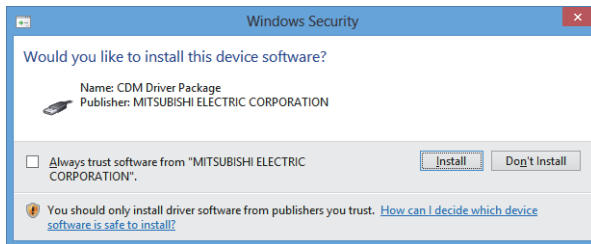
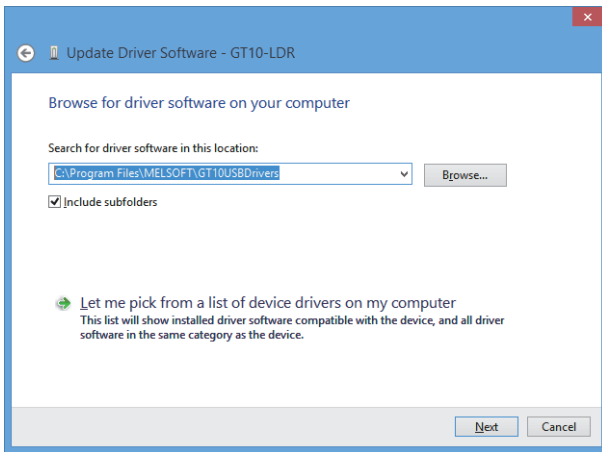
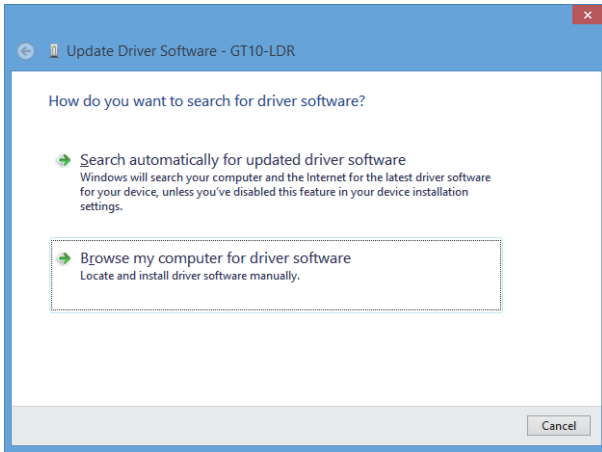

7. The left screen appears.  
Click [Browse my computer for driver software].

8. Specify the following folder, on the install CD of GT Designer3.

MELSOFT\GT10USBDrivers

9. Click [Install] button.  
Clicking this item starts the driver installation.

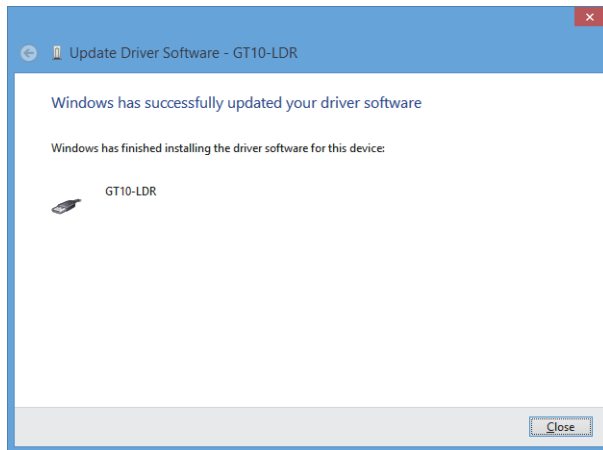

10. When the USB driver installation is completed, click the [Close] button.

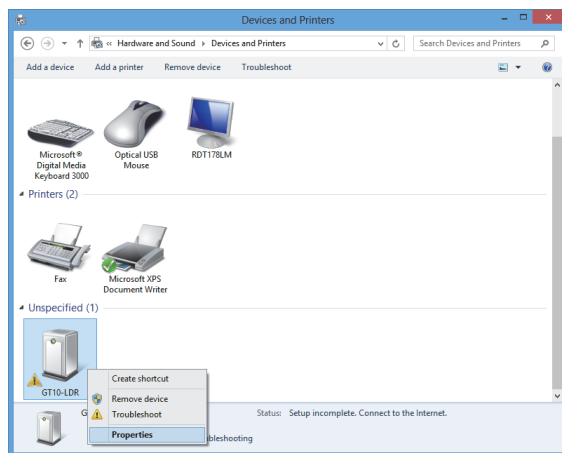

11. Next, install the COM port driver. In [Devices and Printers] in [Control Panel], right-click [GT10-LDR], and then select [Properties].

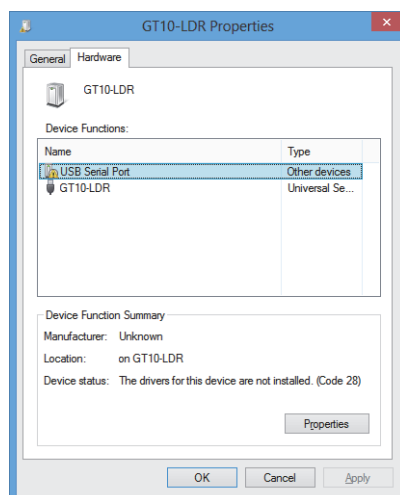

12. The left screen appears. Select the [Hardware] tab. Select [USB Serial Port], and click the [Properties] button. The window shown in step 6 appears. Repeat the steps from 6 to 11 to install the COM port driver.





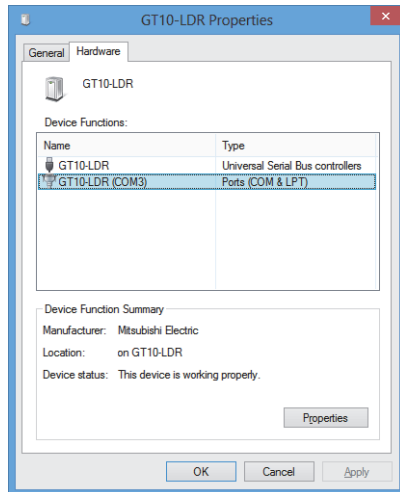

13. Perform the steps from 2 to 4 to open the [GT10-LDR Properties] window. When the following driver is added, the installation is completed.
- GT10-LDR

## POINT

### Confirmation of driver installation

The device manager of Windows® can confirm that the driver is installed properly

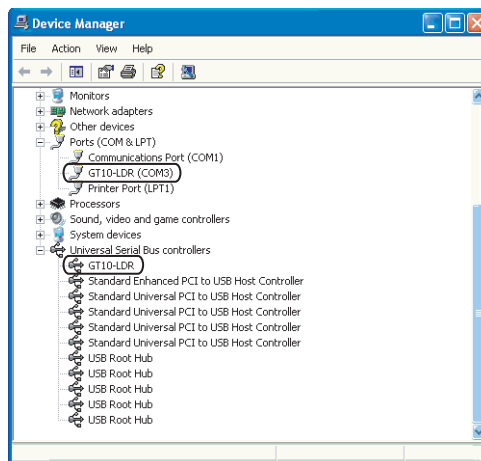

### 8.3.3 Setting communication

The communication setting of the PC, which transfers the data to GT10-LDR.  
Configure the setting in the [Communicate with GT10-LDR] dialog box.

#### ■ Communication setting procedure

1. Select [Communication] → [Communicate with GT10-LDR] from the menu.  
When the GOT type is set to the GT1020 or GT1030, and system labels are used, the system label update/check is executed.  
If errors exist in the system label settings, the GOT cannot communicate with the GT10-LDR.  
When errors exist in the system label settings, check the settings, and remove the errors.
2. As the [Communicate with GT10-LDR] dialog box appears, click the [Communication Configuration] button.
3. The [Communication Configuration] dialog box appears.

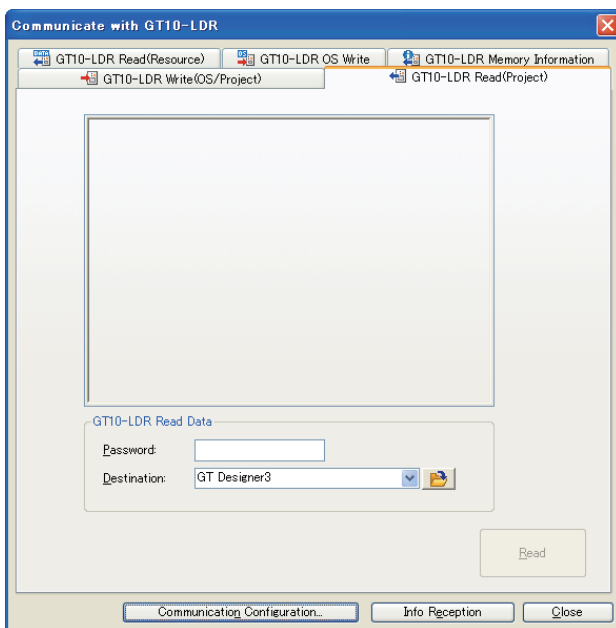

[Communicate with GT10-LDR] dialog box

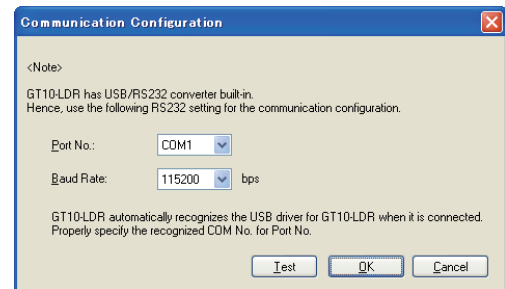

[Communication Configuration] dialog box

Item	Description
Port No.	PC port connected to GT10-LDR is selected. The valid communication port numbers are displayed. (COM1 to COM63) (Select the COM number that USB driver for GT10-LDR recognizes.)
Baud Rate	Set the transmission speeds on the PC and GT10-LDR. The transmission speed setting must be consistent with that of the PC.
	Communication test with GT10-LDR is performed.

## ■ Communication test procedure

1. After the settings in the [Communication Configuration] dialog box are configured, click the [Test] button to start the communication test.
2. The test result is displayed.

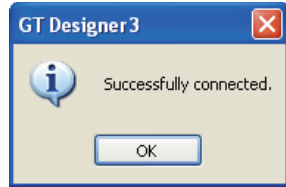

Communication succeeded

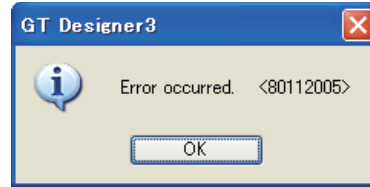

Communication failed

### 8.3.4 Installing GT10-LDR OS

The following explains how to install GT10-LDR OS.

1. Select [Communication] → [Communicate with GT10-LDR] from the menu.  
 When the GOT type is set to the GT1020 or GT1030, and system labels are used, the system label update/check is executed.  
 If errors exist in the system label settings, the GOT cannot communicate with the GT10-LDR.  
 When errors exist in the system label settings, check the settings, and remove the errors.
2. As the [Communicate with GT10-LDR] dialog box appears, select the [GT10-LDR OS Write] tab.
3. Check [Points of caution] and click the [Write] button.

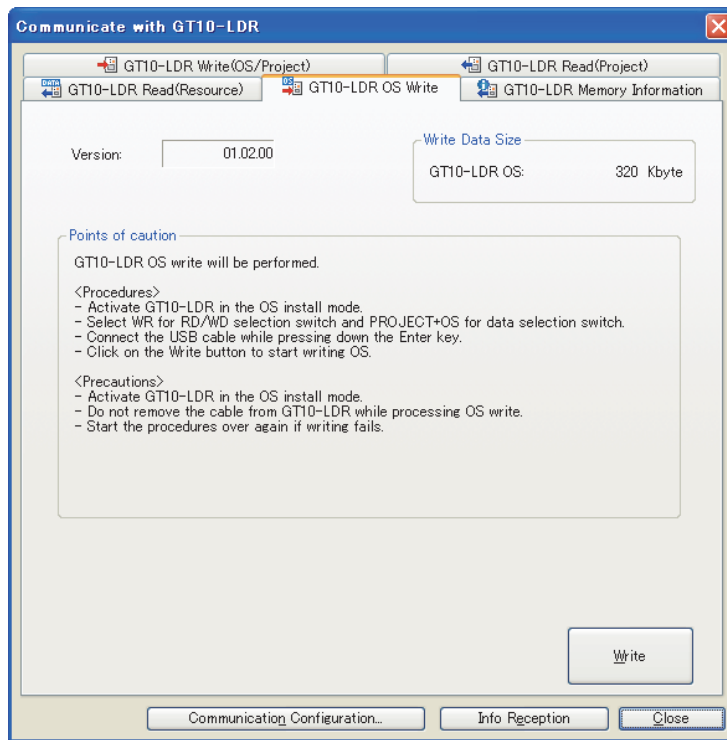

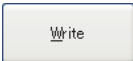
Item	Description
Version	The version of the GT10-LDR OS to be installed on the GT10-LDR is displayed.
Write Data Size	The data size of the GT10-LDR OS to be installed on the GT10-LDR.
Points of caution	The precautions for installing the GT10-LDR OS are displayed. Make sure to read them before installing.
	Installs the GT10-LDR OS on the GT10-LDR.

- Clicking the [Write] button displays the message confirming the installation.  
Click the [Yes] button to start the installation.  
Click the [No] button to cancel the installation.

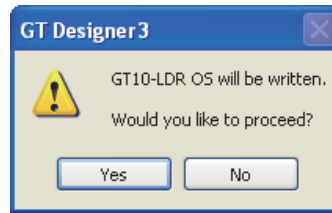

- Clicking the [Yes] button checks the OS version in the GT10-LDR against the GT Designer3 OS version.  
Click the [Yes] button to continue the installation.  
Click the [No] button to cancel the installation.

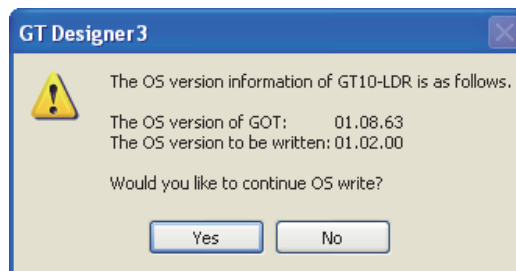

## 8.3.5 Writing project data and installing OS

The following shows how to install the OS and write the project data.

1. Select [Communication] → [Communicate with GT10-LDR] from the menu.  
When the GOT type is set to the GT1020 or GT1030, and system labels are used, the system label update/check is executed.  
If errors exist in the system label settings, the GOT cannot communicate with the GT10-LDR.  
When errors exist in the system label settings, check the settings, and remove the errors.
2. As the [Communicate with GT10-LDR] dialog box appears, select the [GT10-LDR Write(OS/Project)] tab.
3. Select the project data and OS to be written or installed, and click the [Write] button.

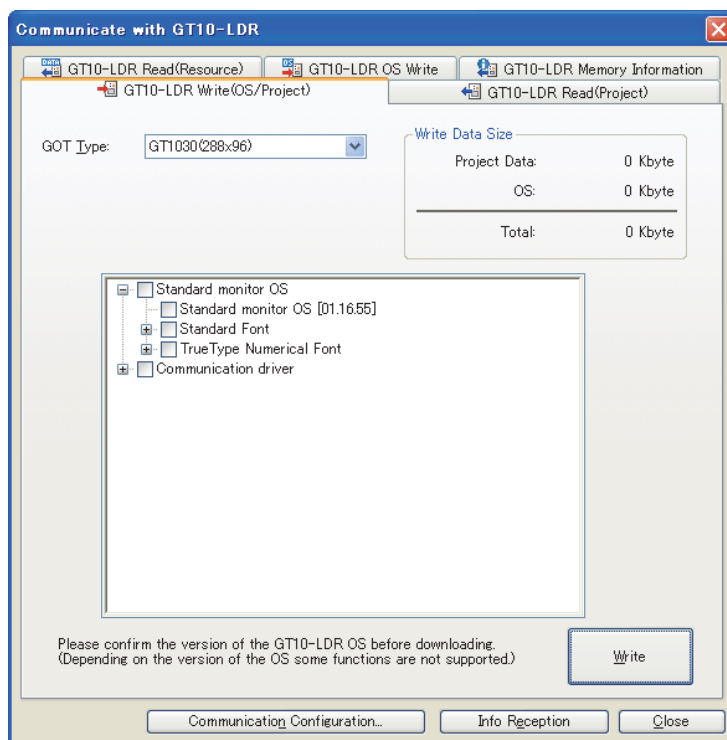

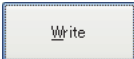

Item	Description
GOT Type	Select the GOT type of the OS and project data to be written or installed on the GT10-LDR. This item can be selected when a project data other than GT10 is opened or the project data has not been created.
Folder	The folder name of the write and installation destination is displayed.
Project ID	The ID of the project data to be written is displayed.
Write Data Size	The size of the OS and project data to be written or installed on the GT10-LDR is displayed.
Tree view	The project data, Standard monitor OS, and Communication driver are displayed in the tree. Select the data to be written.
	Writes the project data and installs the OS on the GT10-LDR.

### 8.3.6 Obtaining memory information

The following explains how to confirm the memory information.

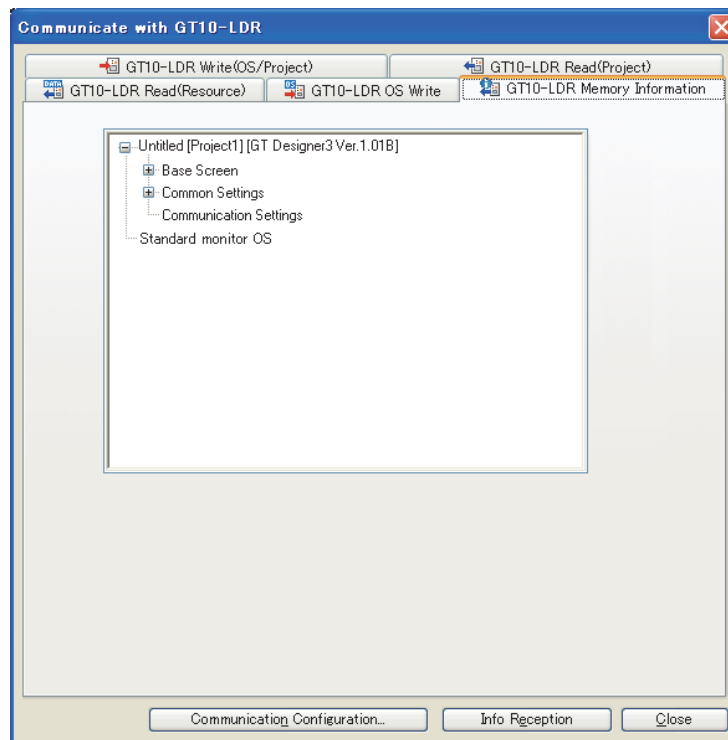
1. Select [Communication] → [Communicate with GT10-LDR] from the menu.  
 When the GOT type is set to the GT1020 or GT1030, and system labels are used, the system label update/check is executed.  
 If errors exist in the system label settings, the GOT cannot communicate with the GT10-LDR.  
 When errors exist in the system label settings, check the settings, and remove the errors.
2. As the [Communicate with GT10-LDR] dialog box appears, select the [GT10-LDR Memory Information] tab.
3. Click the [Info Reception] button to display the data stored in the built-in memory of the GT10-LDR.





Item	Description
Tree view	The project data, OS, and others stored in the built-in memory of the GT10-LDR in the tree.
	Memory information is read out from GT10-LDR.

### 8.3.7 Reading project data

The following shows how to read the project data.

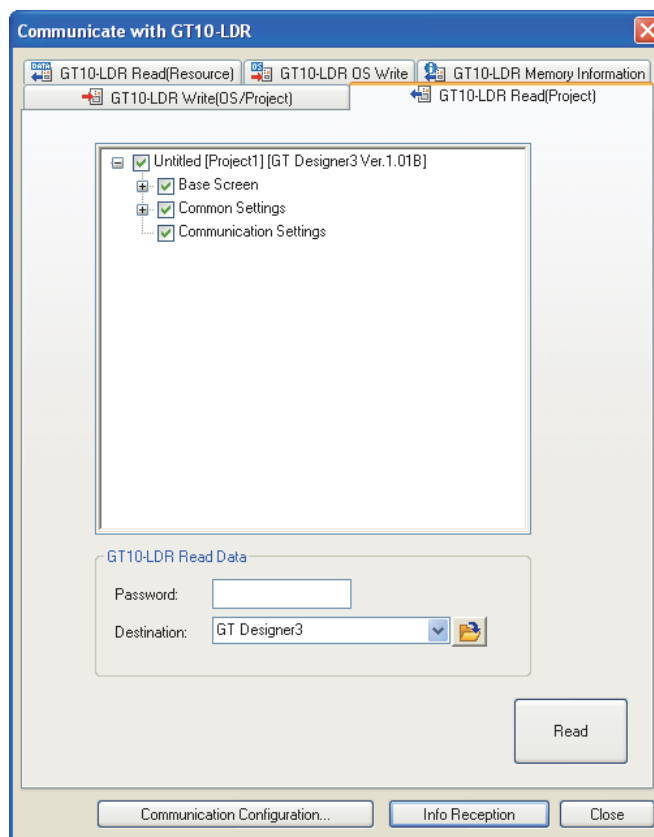
1. Select [Communication] → [Communicate with GT10-LDR] from the menu.  
When the GOT type is set to the GT1020 or GT1030, and system labels are used, the system label update/check is executed.  
If errors exist in the system label settings, the GOT cannot communicate with the GT10-LDR.  
When errors exist in the system label settings, check the settings, and remove the errors.
2. As the [Communicate with GT10-LDR] dialog box appears, select the [GT10-LDR Read(Project)] tab.
3. Click the [Info Reception] button to display the project data written in the GT10-LDR.  
(This operation is not required when the project data of the read target has already been displayed.)
4. Select the data to be read, and click the [Read] button.

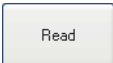

Item	Description
Tree view	Project data stored in the GT10-LDR is displayed in a tree structure.
Password	When a password has been set in the project data stored in the GT10-LDR, enter the password . The entered password is indicated with asterisks (*).
Destination	Set the storage destination of the read project data. (Up to five past specified destinations are held.) When the project data is read with the default (GT Designer3) settings, the read data will be imported to the currently open GT Designer3.
	Reads the built-in memory information from the GT10-LDR.
	Read the items selected*1 in the tree from the GT10-LDR. The reading is interrupted if the read destination has run out of space.

\*1 Items cannot be selected individually, as they are selected by the package acquisition.





### 8.3.8 Reading resource data

The following shows how to read the resource data.

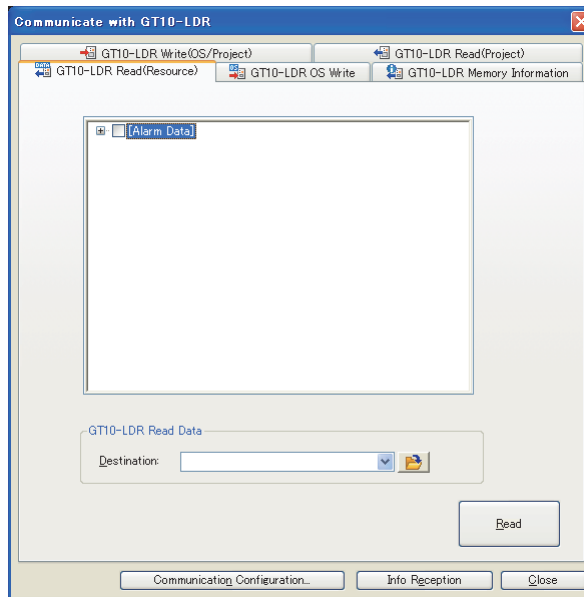
1. Select [Communication] → [Communicate with GT10-LDR] from the menu.  
When the GOT type is set to the GT1020 or GT1030, and system labels are used, the system label update/check is executed.  
If errors exist in the system label settings, the GOT cannot communicate with the GT10-LDR.  
When errors exist in the system label settings, check the settings, and remove the errors.
2. As the [Communicate with GT10-LDR] dialog box appears, select the [GT10-LDR Read(Resource)] tab.
3. Click the [Info Reception] button to display the resource data written in the GT10-LDR.  
(This operation is not required when the resource data of the read target has already been displayed.)
4. Select the data to be read, and click the [Read] button.



Item	Description
Tree View	The list of resource data stored in GT10-LDR is displayed. Select the data to be read.
Destination	Set the storage destination of the read resource data. (Up to five past specified destinations are held.)
	Reads the resource data from the GT10-LDR.
	Reads the items selected in the tree from the GT10-LDR. The reading is interrupted if the read destination has run out of space.

# 8.4 Transferring Data Using GT01-RS4-M

## 8.4.1 Preparation for data transfer

### ■ Data transfer procedure

Data is transferred in the following procedure.

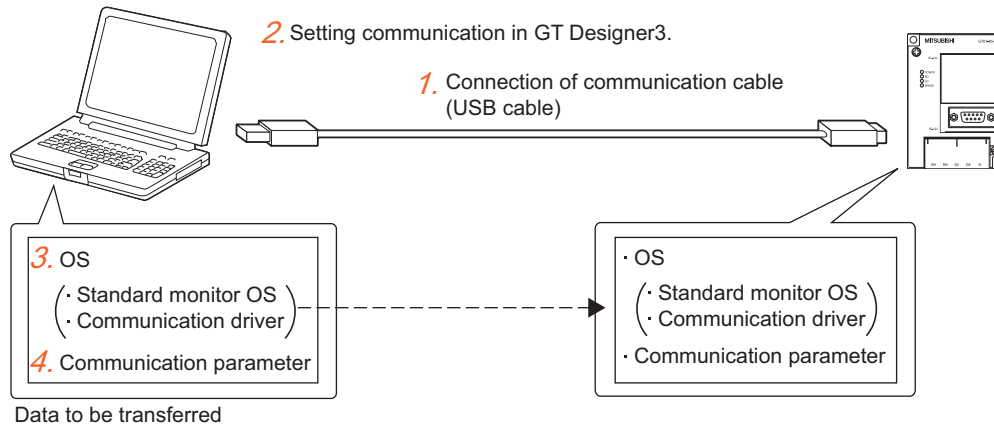

1. Connect the communication cable to the GT01-RS4-M.  
    ☞ 8.4.2 Connecting the PC and GT01-RS4-M via USB cable
2. Configure the communication setting of GT Designer3.  
    ☞ 8.4.3 Setting communication
3. Install the OS on the GT01-RS4-M.  
    ☞ 8.4.4 Installing OS to GT01-RS4-M
4. Write the communication parameter to the GT01-RS4-M.  
    ☞ 8.4.5 Writing communication parameter to GT01-RS4-M
5. Read the communication parameter from the GT01-RS4-M.  
    ☞ 8.4.6 Reading communication parameter from GT01-RS4-M
6. Write the communication driver (multi-drop (slave)) to the GOT.  
    ☞ 8.1.4 Writing and installing on GOT  
    When writing the driver via memory card  
    ☞ 8.2.1 Transferring project data, OS, and special data to memory card or USB memory
7. Write the communication detail settings to the GOT.  
    ☞ 8.1.4 Writing and installing on GOT  
    When writing the settings via memory card  
    ☞ 8.2.1 Transferring project data, OS, and special data to memory card or USB memory  
    For the communication detail settings, refer to the following.  
    ☞ GOT1000 Series Connection Manual for GT Works3 and a controller used

## 8.4.2 Connecting the PC and GT01-RS4-M via USB cable

Follow the procedures to securely connect the USB cable to the GT01-RS4-M and GOT.

1. Connect the USB cable to the USB Type-A connector of the PC.
2. Connect the USB cable to the USB connector of the GT01-RS4-M.  
When the PC and GT01-RS4-M are USB connected, install the USB driver into the PC.  
Refer to the following for the installation of the USB driver.

☞ 8.1.1 Connecting personal computer and GOT with cable

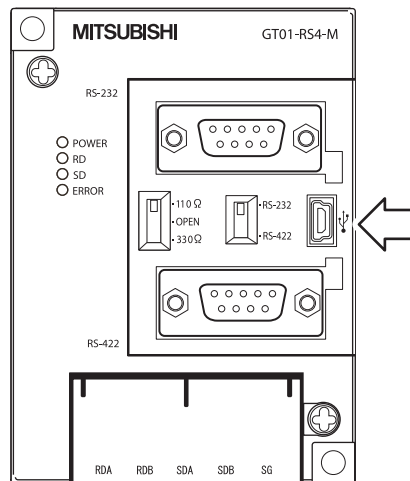

### 8.4.3 Setting communication

Communication settings of the PC, which transfers the data to GT01-RS4-M. To communicate with GT01-RS4-M a dialog box is used for the settings.

#### ■ Communication setting procedure

1. Select [Communication] → [Communicate with GT01-RS4-M] from the menu.
2. As the [Communicate with GT01-RS4-M] dialog box appears, click the [Communication Configuration] button.
3. The [Communication Configuration] dialog box appears.

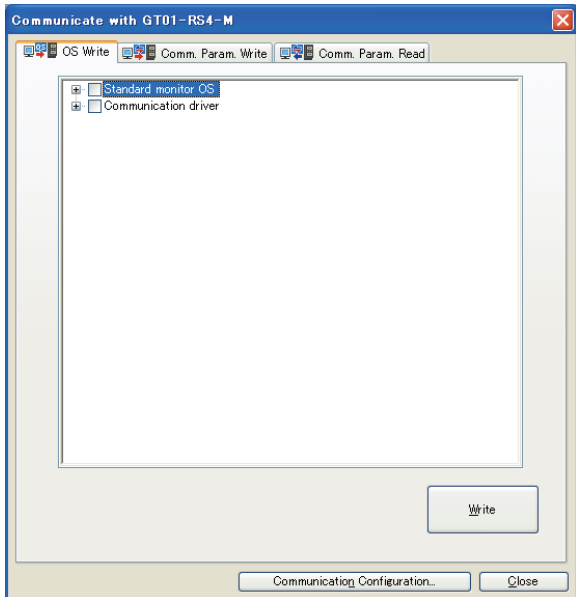

[Communicate with GT10-LDR] dialog box

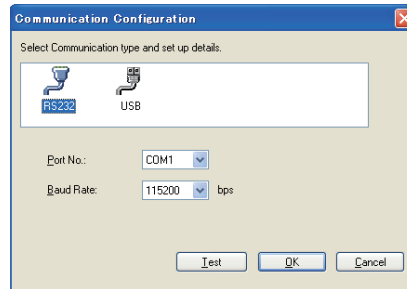

[Communication Configuration] dialog box (RS232)

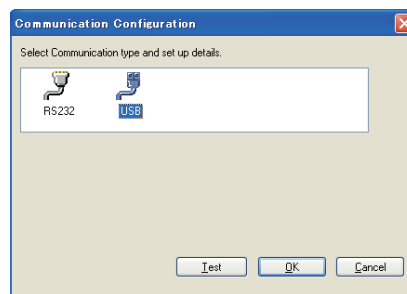

[Communication Configuration] dialog box (USB)

Item	Description
Communication method	Select the method to connect the personal computer with the GT01-RS4-M.
Port No.	PC port connected to GT01-RS4-M is selected. (Configure this setting when connected with RS232.) The valid communication port numbers are displayed. (COM1 to COM63)
Baud Rate	Set the transmission speeds on the PC and GT01-RS4-M. The transmission speed setting must be consistent with that of the PC. (Configure this setting when connected with RS232.)
	Starts the communication test with the GT01-RS4-M.

#### ■ Communication test procedure (RS232, USB)

1. After the settings in the [Communication Configuration] dialog box are completed, click the [Test] button to start the communication test.
2. The test result is displayed.

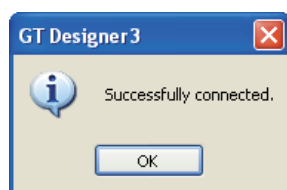

Communication succeeded



Communication failed

## 8.4.4 Installing OS to GT01-RS4-M

### POINT

#### When installing the standard monitor OS and the communication driver

The standard monitor OS and communication driver (MELSEC-FX) are installed in the GT01-RS4-M by default. Typically, the standard monitor OS does not need to be installed. However, install the driver for the connected PLC as a communication driver.

#### ■ How to install the OS (standard monitor OS and communication driver)

1. Select [Communication] → [Communicate with GT01-RS4-M] from the menu.
2. On the [OS Write] tab of the [Communicate with GT01-RS4-M] dialog box, select the OSs to be installed (standard monitor OS and communication driver) and click the [Write] button.

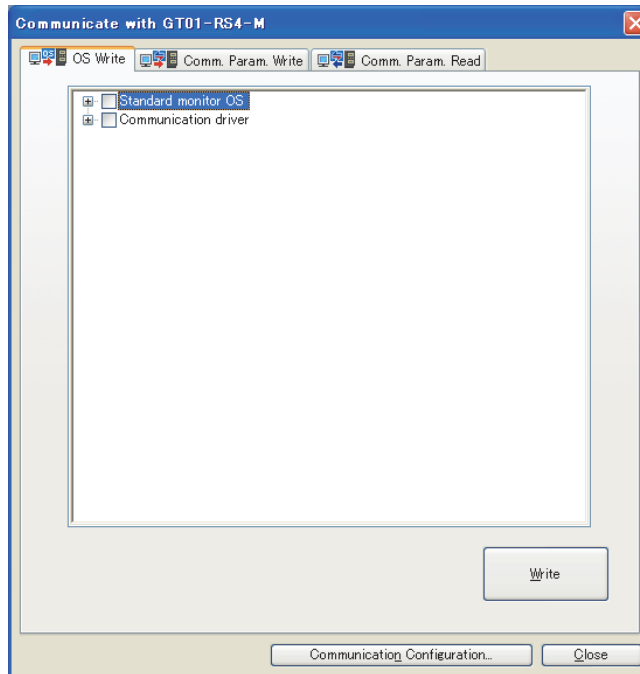

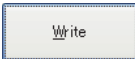
Item	Description
Tree view	The OS (standard monitor OS and communication driver) are shown in the tree. Select the data to be written.
	Installs the OS (standard monitor OS and communication driver) on the GT01-RS4-M.

## 8.4.5 Writing communication parameter to GT01-RS4-M

### How to write the communication parameter

1. Select [Communication] → [Communicate with GT01-RS4-M] from the menu.
2. In the [Communicate with GT01-RS4-M] dialog box, select the [Comm. Param. Write] tab.
3. Check [Points of caution] and click the [Write] button.

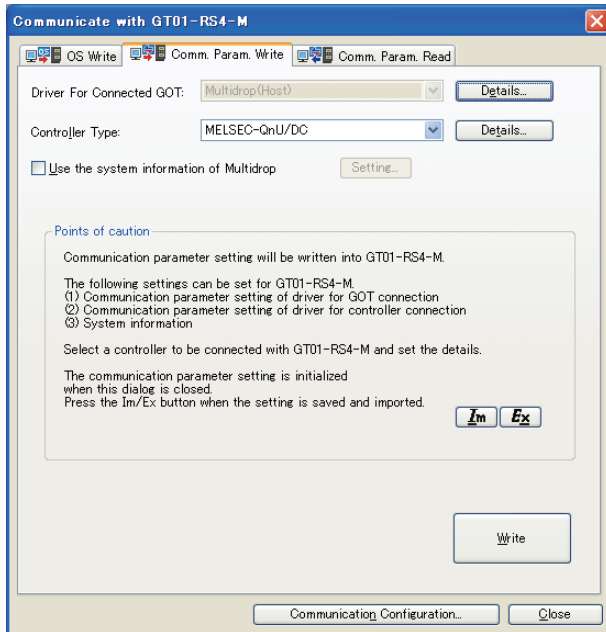

[Communicate with GT01-RS4-M] dialog box

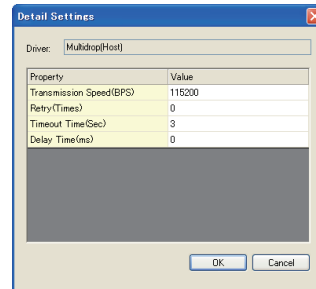

[Details] dialog box  
(For communication with GOT)

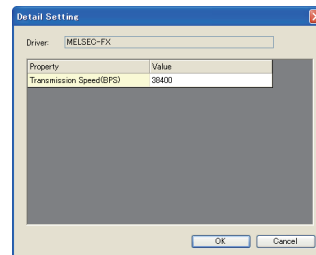

[Details] dialog box  
(For communication with controllers)

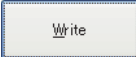
Item	Description
Driver For Connected GOT	Fixed to Multidrop (HOST). Click the [Details] button to configure the communication detail settings of the GT01-RS4-M and the GOT.
Controller Type	Select the controller to be connected. Click the [Details] button to configure the communication detail settings of the controller and the GOT.
Use the system information of Multidrop	Select this item to check the connection status of each GOT connected to the GT01-RS4-M on the controller side. Click the [Setting] button to display the [System Information Setting of Multidrop] dialog box. ☞ (1) System Information Setting of Multidrop dialog box For the setting details, refer to the following. ☞ GOT1000 Series Connection Manual (Mitsubishi Electric Products) for GT Works3
Points of Caution	The precautions for writing the communication parameter are displayed. Make sure to read it before writing. Click the [Im] button or the [Ex] button to import or export the communication parameter setting. For the details, refer to the following. ☞ GOT1000 Series Connection Manual (Mitsubishi Electric Products) for GT Works3
	Writes the communication parameter to the GT01-RS4-M.

(1) **System Information Setting of Multidrop dialog box**

Set the devices that store the connection status of each GOT connected to the GT01-RS4-M.

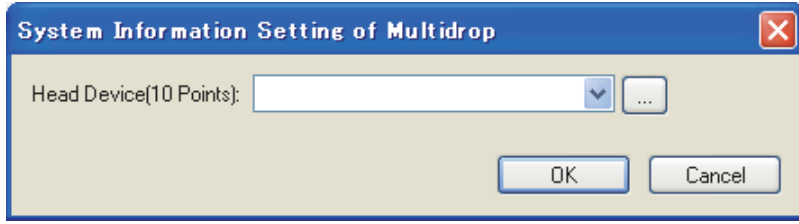



Item	Description
Head Device(10 Points)	Set the device of the controller. (The settable device range is the same as that for the GT10.) Ten devices, starting from the set device, are occupied. A GOT internal device, bit devices specified as a word device, and a system label cannot be set. The devices set with [Head Device(10 Points)] are not available for the device list and the device batch edit.

## 8.4.6 Reading communication parameter from GT01-RS4-M

### ■ How to read the communication parameter

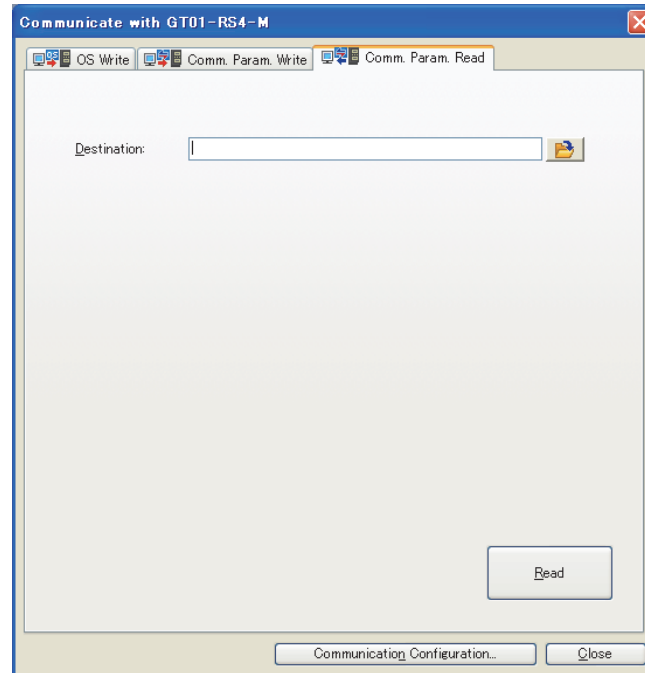
1. Select [Communication] → [Communicate with GT01-RS4-M] from the menu.
2. In the [Communicate with GT01-RS4-M] dialog box, select the [Comm. Param. Read] tab.
3. Set the folder where the communication parameter is to be read, and click the [Read] button.



Item	Description
Destination	Set the folder where the communication parameter is to be read.
	Reads the communication parameter from the GT01-RS4-M.

4. The communication parameter setting file (\*.ini) and the OS information file (\*.txt) are stored in the destination folder.



# 8.5 Data Types and Sizes Transferred to the GOT

## 8.5.1 Data types and storage destinations

### ■ Data types and storage destinations

The following data are in the GOT.

The Boot OS, standard monitor OS, and communication driver are necessary data to operate the GOT and must be installed before the created project data is written to the GOT.

The standard monitor OS and communication driver are preinstalled on the GT10 and do not need to be installed. However, the communication driver may need to be replaced depending on the system configuration. In such a case, install the communication driver.

For the storage destination of each data in each GOT, refer to the following.

#### ■Data storage destinations in the GOT

#### (1) GT16

Data type	Storage destination drive	Reference
BootOS	C: Built-in Flash Memory (system area)	■BootOS
OS	Standard monitor OS	One of the following • A: Standard CF Card • C: Built-in Flash Memory (system area)
	Communication driver (First)	• A: Standard CF Card • C: Built-in Flash Memory (user area)
	Communication driver (From the second)	
Extended function OS Option OS, etc.	■Extended function ■Option function	
Project data	One of the following • A: Standard CF Card • B: Extended Memory Card • C: Built-in Flash Memory (user area)	■Project data
Special data	One of the following • A: Standard CF Card • C: Built-in Flash Memory (user area)	8.1.4 ■Writing special data (Personal computer to GOT)
Resource data	One of the following • A: Standard CF Card • B: Extended Memory Card	■Resource data

**(2) GT15**

Data type		Storage destination drive	Reference
BootOS		C: Built-in Flash Memory (system area)	■BootOS
OS	Standard monitor OS	One of the following • A: Standard CF Card • C: Built-in Flash Memory (system area)	■Standard monitor OS
	Communication driver (First)		■Communication driver
	Communication driver (From the second)	• A: Standard CF Card • C: Built-in Flash Memory (user area)	■Communication driver
	Extended function OS Option OS, etc.		■Extended function ■Option function
Project data		One of the following • A: Standard CF Card • B: Extended Memory Card • C: Built-in Flash Memory (user area)	■Project data
Special data		One of the following • A: Standard CF Card • C: Built-in Flash Memory (user area)	8.1.4 ■Writing special data (Personal computer to GOT)
Resource data		One of the following • A: Standard CF Card • B: Extended Memory Card	■Resource data

**(3) GT14**

Data type		Storage destination drive	Reference
BootOS		C: Built-in Flash Memory (system area)	■BootOS
OS	Standard monitor OS	One of the following • A: Standard SD Card • C: Built-in Flash Memory (system area)	■Standard monitor OS
	Communication driver (First)		■Communication driver
	Communication driver (From the second)	■Extended function ■Option function	
	Extended function OS Option OS, etc.	One of the following • A: Standard SD Card • C: Built-in Flash Memory (system area)	■Project data
Project data			■Project data
Special data		-	-
Resource data		One of the following • A: Standard SD Card • D: Built-in SRAM	■Resource data

**(4) GT12**

Data type		Storage destination drive	Reference
BootOS		C: Built-in Flash Memory (system area)	■BootOS
OS	Standard monitor OS	One of the following • A: Standard CF Card • C: Built-in Flash Memory (system area)	■Standard monitor OS
	Communication driver (First)	C: Built-in Flash Memory (user area)	■Communication driver
	Communication driver (From the second)		
Extended function OS Option OS, etc.		One of the following • A: Standard CF Card • C: Built-in Flash Memory (user area)	■Extended function ■Option function
Project data		One of the following • A: Standard CF Card • C: Built-in Flash Memory (user area)	■Project data
Special data		-	-
Resource data		One of the following • A: Standard CF Card • D: Built-in SRAM	■Resource data

**(5) GT11**

Data type		Storage destination drive	Reference
BootOS		C: Built-in Flash Memory (system area)	■BootOS
OS	Standard monitor OS		■Standard monitor OS
	Communication driver (First)		■Communication driver
	Communication driver (From the second)		
	Extended function OS Option OS, etc.		
Project data		One of the following • A: Standard CF Card • C: Built-in Flash Memory (user area)	■Project data
Special data		-	-
Resource data		One of the following • A: Standard CF Card • D: Built-in SRAM	■Resource data

**(6) GT10**

Data type	Storage destination drive	Reference
BootOS	-	■BootOS
OS	Standard monitor OS	■Standard monitor OS
	Communication driver (First)	C: Built-in Flash Memory (system area) ■Communication driver
	Communication driver (From the second)	- ■Communication driver
	Extended function OS Option OS, etc.	- ■Extended function ■Option function
Project data	C: Built-in Flash Memory (user area)	■Project data
Special data	-	-
Resource data	<ul style="list-style-type: none"> <li>• GT1020</li> <li>C: Built-in Flash Memory</li> <li>• Other than GT1020</li> <li>D: Built-in SRAM</li> </ul>	■Resource data

**POINT**

**(1) Writing the project data and special data**

If the OS (standard monitor OS, communication driver, extended function, and option OS) used by GT Designer3 in writing the project data and special data is newer than the OS installed on the GOT, new functions may be unavailable. Reinstalling the OS on the GOT is recommended when writing the project data and special data to the GOT.

**(2) Installing the OS (standard monitor OS, communication driver, extended function, and option OS)**

Make sure that OS (standard monitor OS, communication driver, extended function OS, option OS) are of the same major version and minor version.

If their version numbers are different, the GOT will not operate.

(Example 1)

Standard monitor OS : [01.00]00 ]  
 Communication driver : [01.00]00 ]  
 Extended function OS : [01.00]00 ]  
 Option OS : [01.00]00 ]

GOT operates.

(Example 2)

Standard monitor OS : [01.00]00 ]  
 Communication driver : [02.00]00 ]  
 Extended function OS : [01.00]00 ]  
 Option OS : [01.00]00 ]

GOT does not operate.

For how to check the OS version, refer to the following.

 ■BootOS (9) Property of OS information

## ■ Data storage destinations in the GOT

The data storage drives change depending on the GOT model.

### (1) GT16

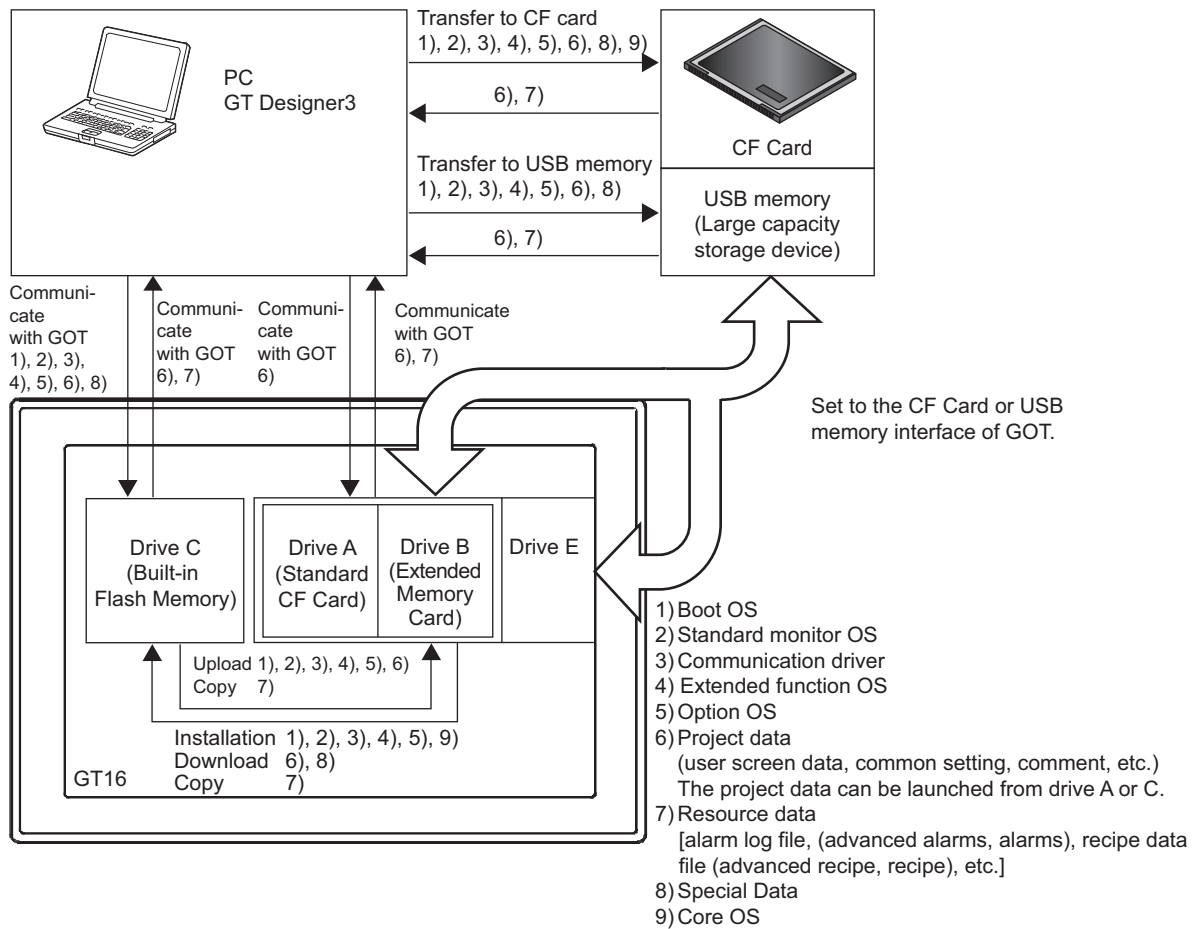

**(2) GT15**

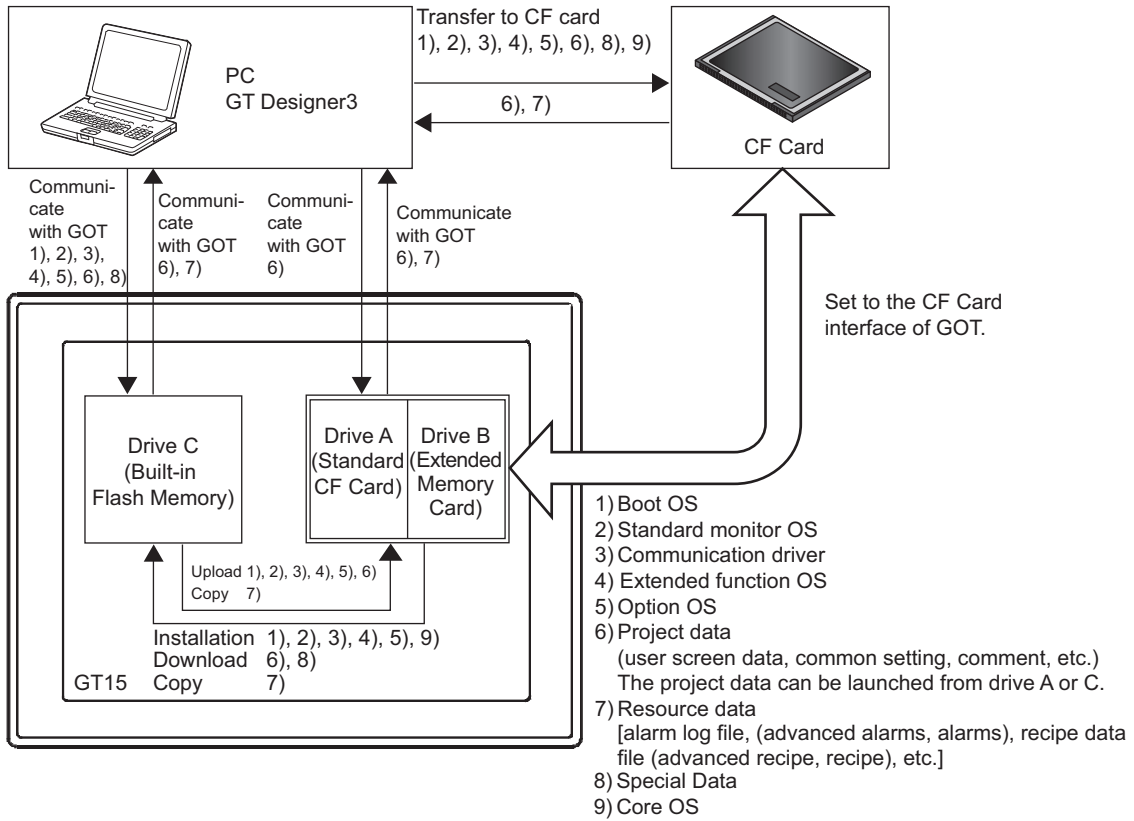

**(3) GT14**

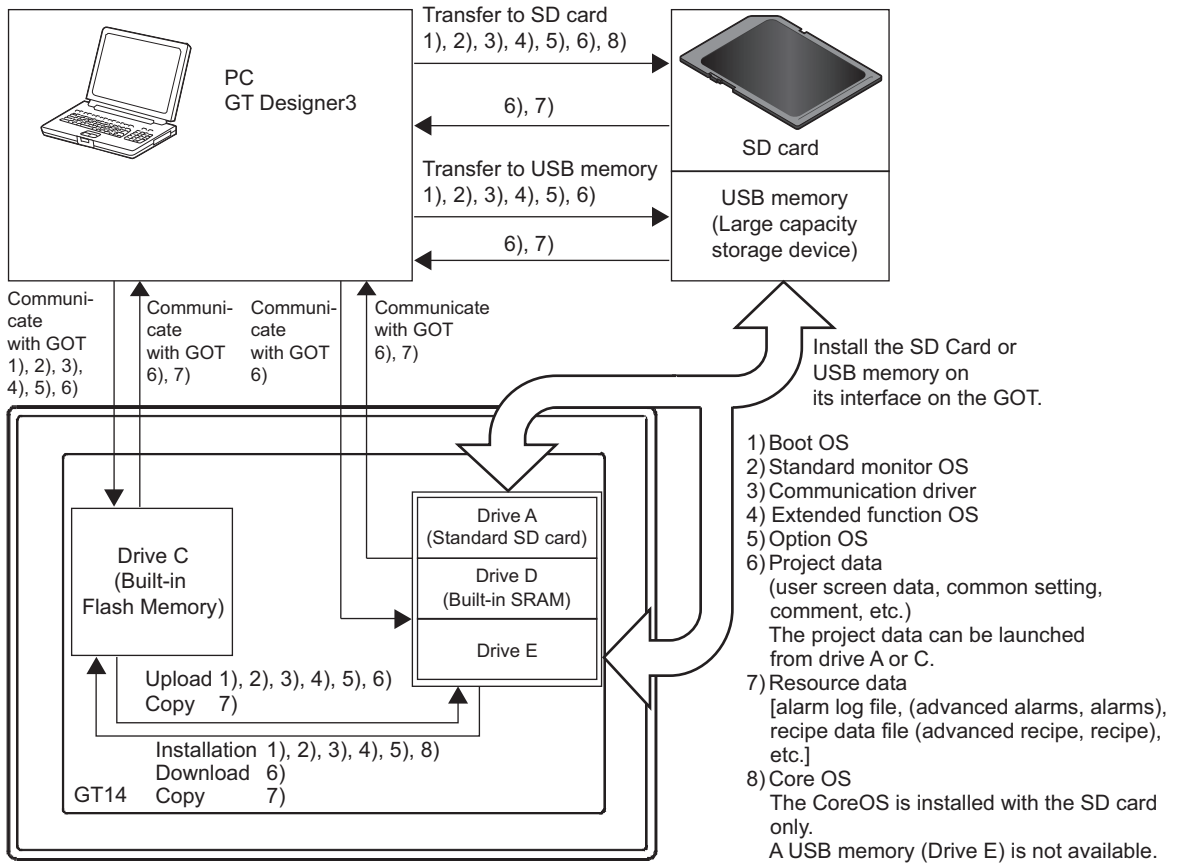

(4) GT12

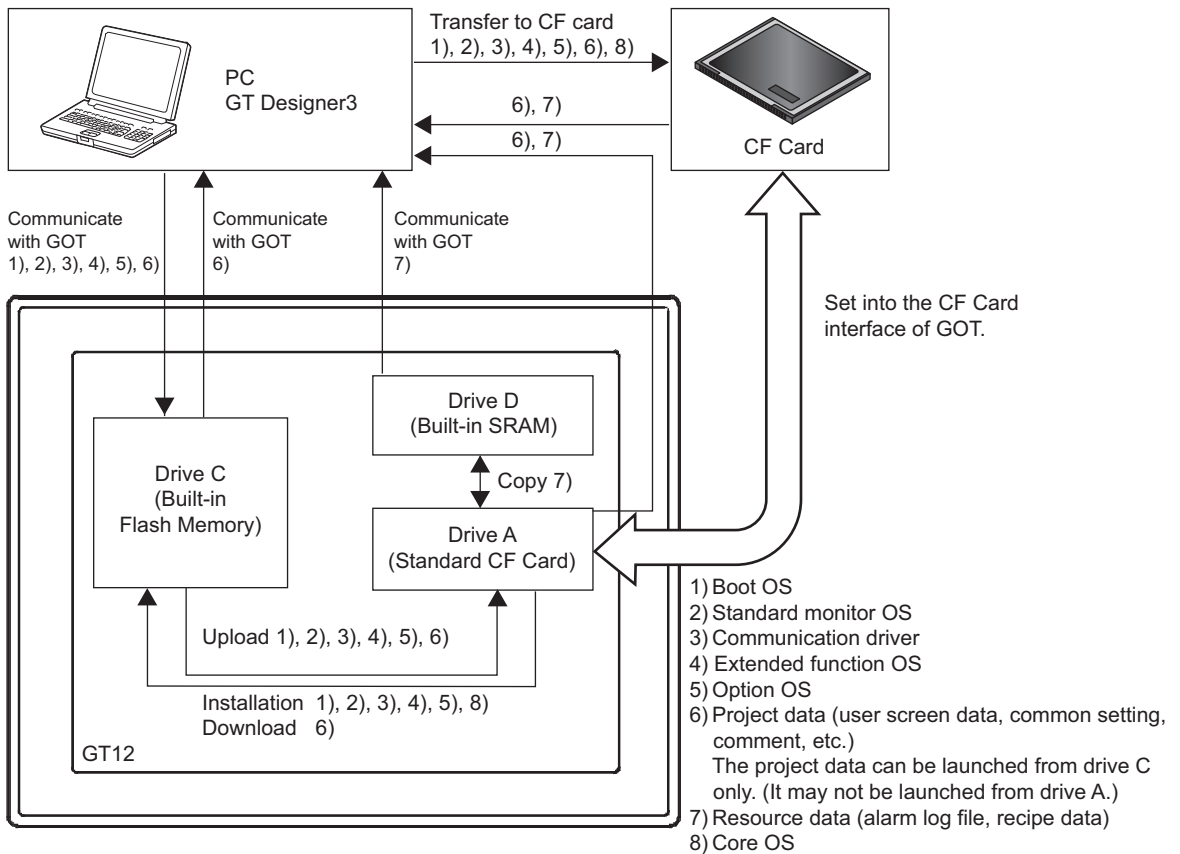

(5) GT11

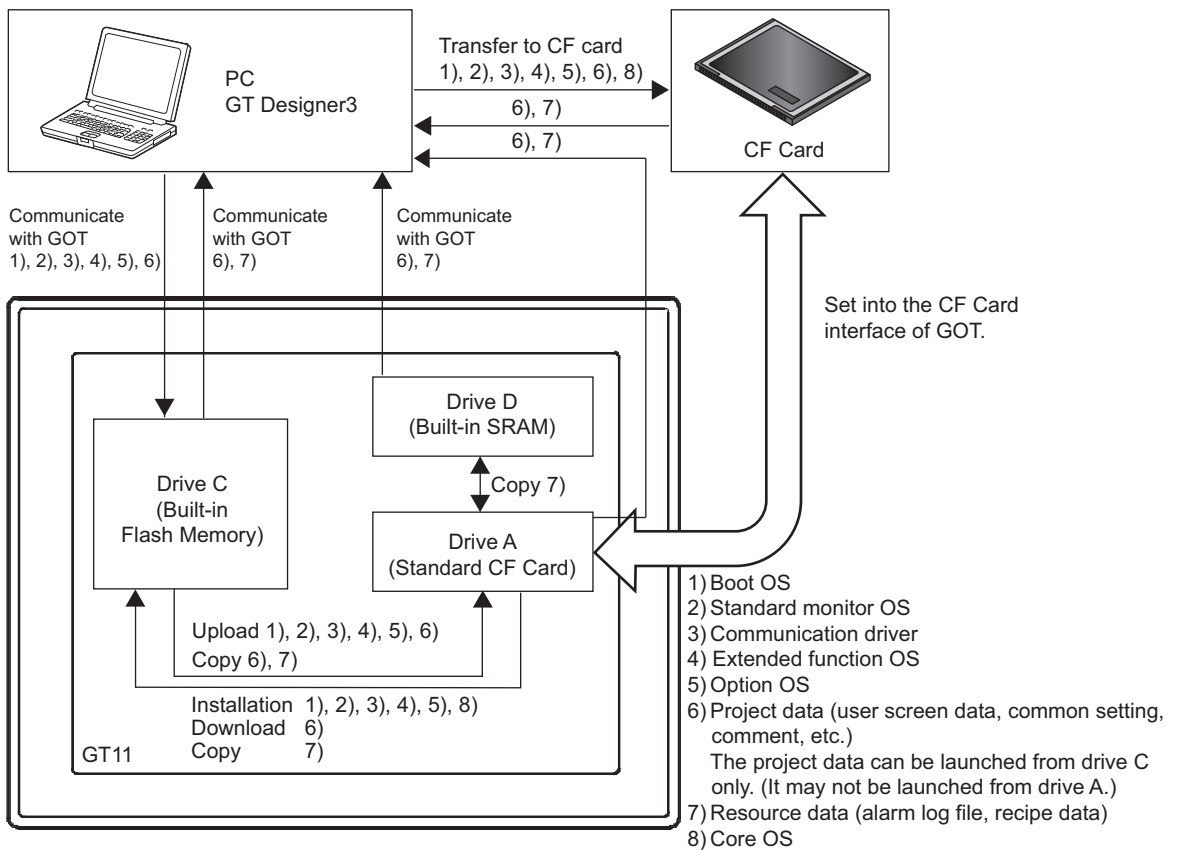

**(6) GT10**

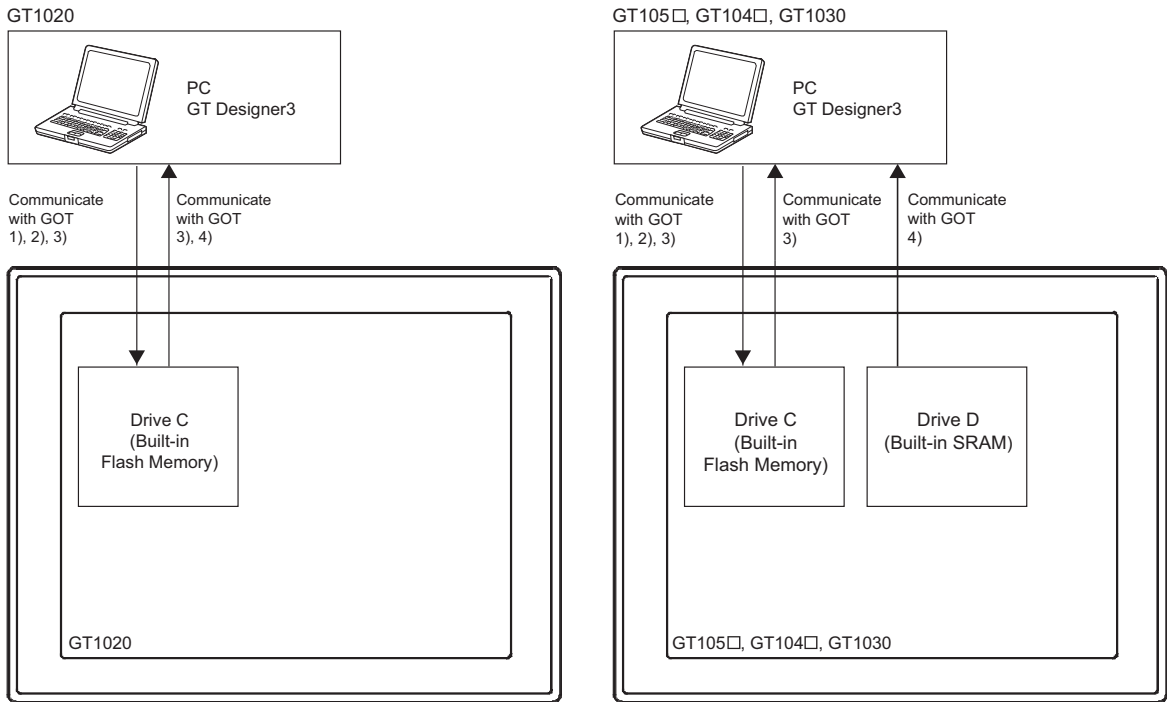

- 1) Standard monitor OS
- 2) Communication driver
- 3) Project data (user screen data, common setting, comment, etc.)
- 4) Resource data (alarm log file, recipe data)



## ■ BootOS

This is the program needed to control GOT hardware, and during communication between GOT and PCs. Boot OS is installed on the GOT at factory shipment. However, if functions not supported by the Boot OS version are used in the GOT, Boot OS must be upgraded (installed). The GOT can be initialized to the factory preset condition by install the Boot OS. (The Boot OS cannot be installed on the GT10.)

### (7) File name and storage destination in GOT

Data type	File name	Storage destination*1
BootOS	G1OSBTOS.OUT	C:\G1BOOT\

\*1 The storage destination folder in the GOT is created when the Boot OS is installed.

### (8) Boot OS version

The version of the Boot OS installed on the GOT can be checked from the property of OS information or rating plate of the GOT. However, if the Boot OS has been updated (installed) by the user, the actual version may differ from the one given on the rating plate. Therefore, it is recommended to check it from the property of OS information. Immediately after purchase of the product, the version may be checked with the rating nameplate.

#### (a) Property of OS information

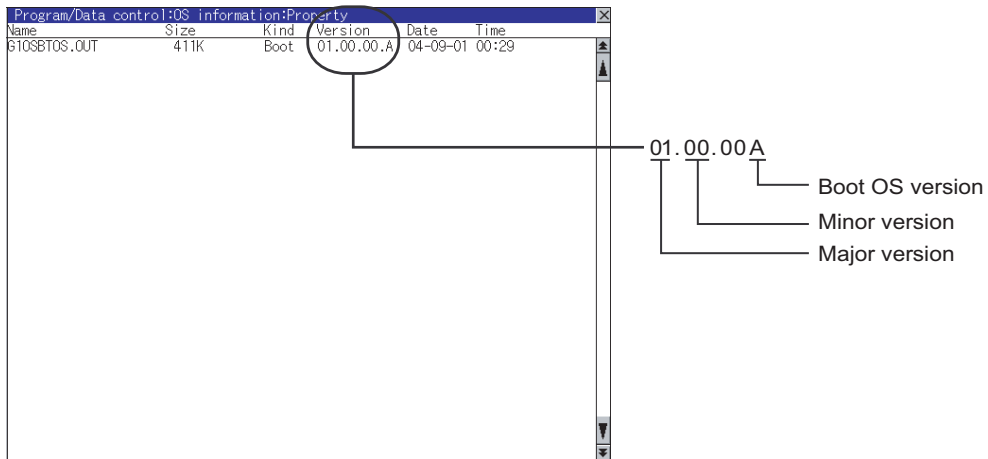

#### (b) Rating plate

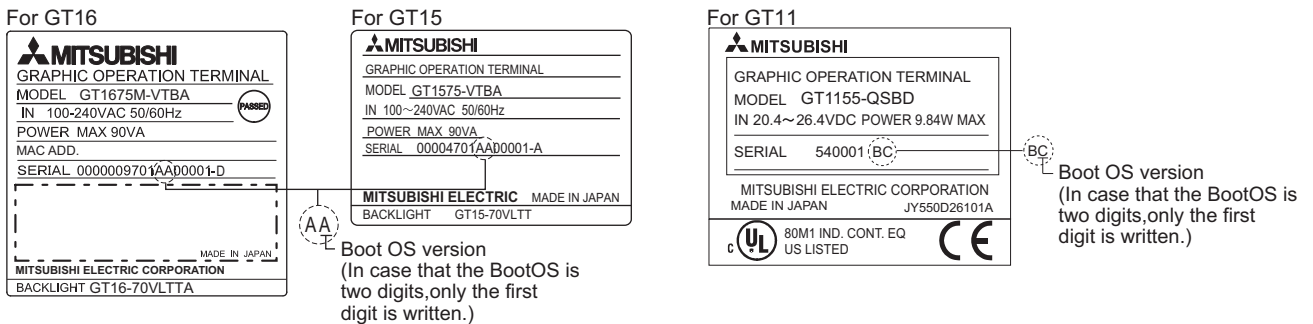

## POINT

### Checking the Boot OS version of the GT10

In the GT10, the Boot OS installed on the GOT at factory shipment cannot be upgraded. However, the Boot OS version of the GOT can be checked. For how to check the Boot OS version of the GT10, refer to the following.

GT10 User's Manual

## (9) Property of OS information

The property of OS information can be displayed by the following operation.  
For details of how to startup and operate the utility, refer to the following.

 User's Manual for the GOT used

1. Touch the utility call key or the special function switch (utility).  
(Touch the above key or switch after installing the standard monitor OS on the GOT from GT Designer3.)

- Using the utility call key

While the user-created screen is being displayed, touch the utility call key to display the main menu.

The utility call key can be set using the GOT's utility screen or GT Designer3.

For the setting method, refer to the following.

 User's Manual for the GOT used

### 4.9 GOT Display and Operation Setting

#### How to display the utility (at factory shipment)

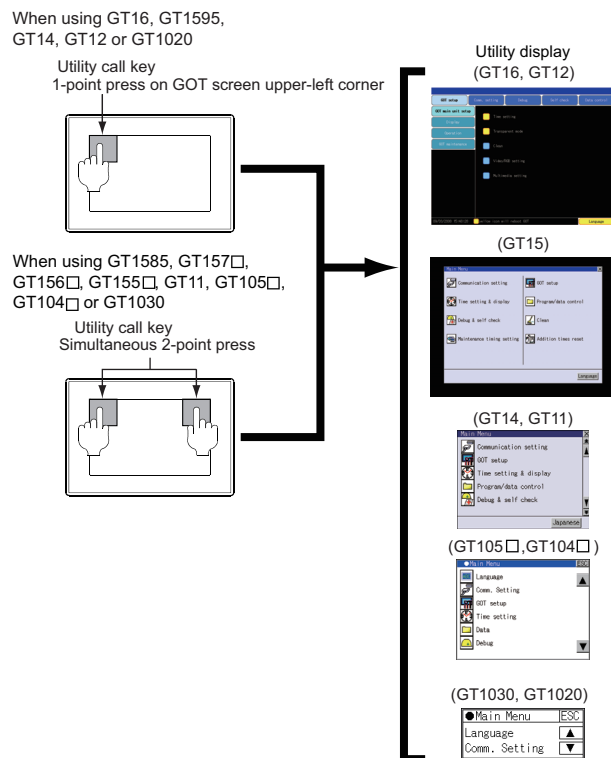

## POINT

### If the Utility Call Key is set in one place

If the [Pressing time] on the utility call key setting screen is set to non-zero value, hold the utility call key continuously until the beeper sounds.

For the utility call key setting, refer to the following.

 User's Manual for the GOT used

- Using the special function switch (Utility)  
 While the user-created screen is being displayed, touch the special function switch (Utility) to display the main menu.  
 For details of the special function switch (Utility), refer to the following.

 (Functions) 2.6 Setting Special Function Switch

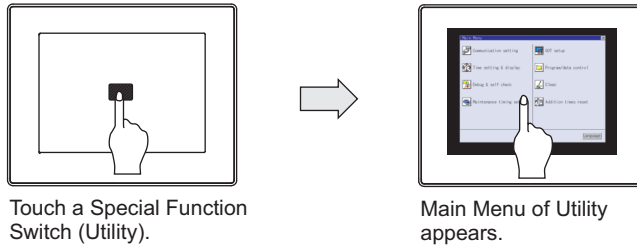

- Display [OS information] from the utility main menu.  
 For details of the operation to display [OS information], refer to the following.

 User's Manual for the GOT used

Utility operation of GT16

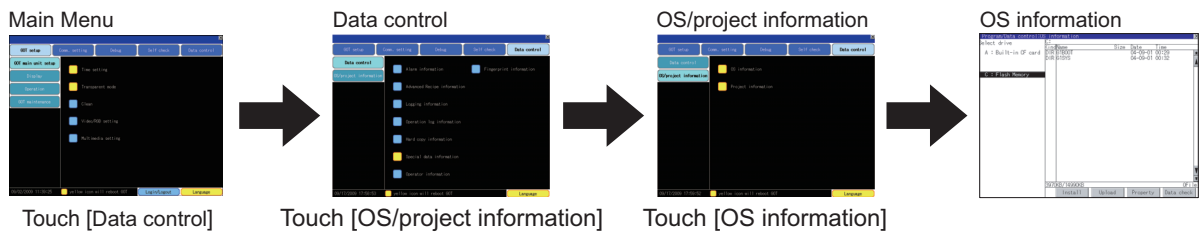

Utility operation of GT15

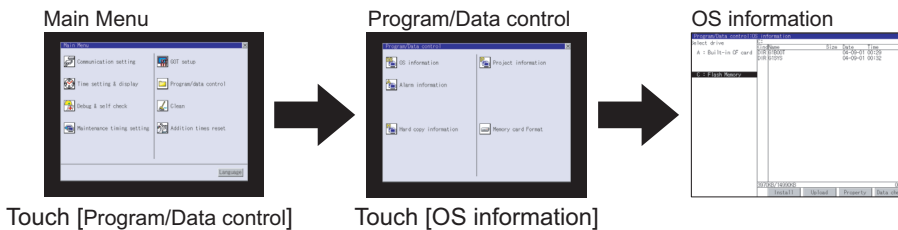

- The [OS information] screen appears.  
 Select a drive in [Select drive]. Then, select a file and touch the [Property] button.

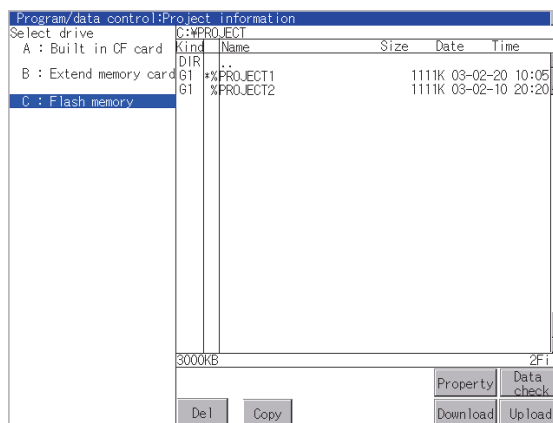

4. The [Property display] screen appears.

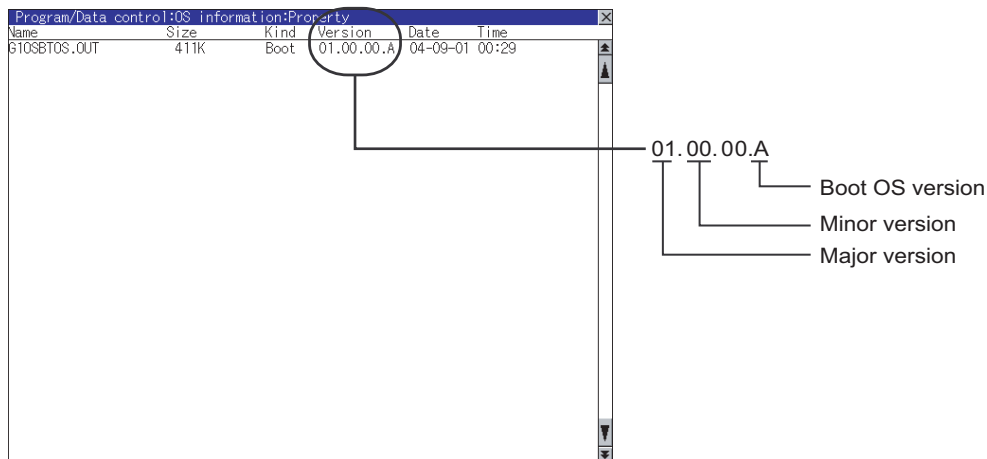

(10) How to install

The Boot OS is installed on the GOT by default. When the upgrade of the Boot OS or initialization of the GOT is required, install the Boot OS.

The Boot OS can be installed in either of the following methods.

- (a) Installing the Boot OS on the GOT using the USB or RS-232 cable
  - ☞ 8.1.4 ■ Installing Boot OS (Personal computer to GOT)
- (b) Installing the Boot OS on the GOT via the memory card of USB memory
  - ☞ 8.2.2 Transferring Boot OS to memory card or USB memory

**POINT**

**Initializing the GOT (Returning the GOT to factory-settings)**

When the Boot OS is installed to initialize the GOT (return the GOT to factory-settings), the OS and project data in the GOT are automatically deleted.

If the project data backup is required, write the project data to a personal computer, memory card or USB memory before installing the Boot OS.

If the GOT is not initialized even after installing the Boot OS, install the CoreOS.

- ☞ 8.2.2 Transferring Boot OS to memory card or USB memory
- 8.2.3 Transferring CoreOS to memory card

## Standard monitor OS

The standard monitor OS includes the standard monitor OS, standard font, standard OS system screen data, and standard OS system screen information.

They are programs that operate the GOT, e.g. interface control, OS/screen data write and installation, OS/project data deletion, touch key control, and screen/guidance display functions.

On the GT10, the standard monitor OS, 12dot (except GT1020) standard font Japanese (supporting Europe), and 16dot standard font (Gothic) are preinstalled.

Check the standard monitor OS version when using the standard font.

### (1) File names that are used by GT16, GT15, GT14, GT12, and GT11 and storage destination folder in GOT

Data type		File name	Storage destination <sup>*1</sup>	
Standard monitor OS	6 × 8 dot Font (ASCII character)	G1OSMONT.OUT	C:\G1SYS\	
	24dot Numerical HQ Font			
	32dot Numerical HQ Font			
Standard Font	Japanese	12dot <sup>*2</sup>		G1F12STG.FON
		16dot (Mincho) <sup>*2</sup>		G1F16STM.FON
		16dot (Gothic) <sup>*2</sup>		G1F16STG.FON
	Japanese (supporting Europe)	12dot <sup>*2</sup>		G1F12SLG.FON
		16dot (Mincho) <sup>*2</sup>		G1F16SLM.FON
		16dot (Gothic) <sup>*2</sup>		G1F16SLG.FON
	Chinese (Simplified)	12dot <sup>*2</sup>		G1F12SGM.FON
		16dot (Mincho) <sup>*2</sup>	G1F16SGM.FON	
	Chinese (Simplified) (supporting Europe)	12dot <sup>*2</sup>	G1F12SBM.FON	
		16dot (Mincho) <sup>*2</sup>	G1F16SBM.FON	
	Chinese (Traditional) (supporting Europe)	12dot <sup>*2</sup>	G1F12SFG.FON	
		16dot (Gothic) <sup>*2</sup>	G1F16SFG.FON	
	True Type Numerical Font Gothic		G1FTTNMG.FON	
True Type Numerical Font 7-seg		G1FTTNM7.FON		
System Screen Data		G1OSMONT.G1		
System Screen Information		G1OSMONT.G1D		

\*1 The storage destination folder in the GOT is created when the standard monitor OS is installed.

\*2 Install the font to be used onto the main body of GOT.

The font to be used on the GOT needs to be the same as standard font in the model setting on GT Designer3.

## (2) File names that are used by GT10 and storage destination folder in GOT

Data type		File name	Storage destination	
Standard monitor OS	6 × 8 dot Font (ASCII character)		-	
	24dot Numerical HQ Font			
	32dot Numerical HQ Font			
Standard Font	Japanese	12dot <sup>*1</sup>		C:
		16dot (Mincho) <sup>*1</sup>		
		16dot (Gothic) <sup>*1</sup>		
	Japanese <sup>*2</sup> (supporting Europe)	12dot		
		16dot (Gothic)		
	Chinese (Simplified)	12dot <sup>*1</sup>		
		16dot (Mincho) <sup>*1</sup>		
	Chinese (Simplified) (supporting Europe)	12dot <sup>*1</sup>		
		16dot (Mincho) <sup>*1</sup>		
	Chinese (Traditional) (supporting Europe)	12dot <sup>*1</sup>		
16dot (Gothic) <sup>*1</sup>				
True Type Numerical Font Gothic				
True Type Numerical Font 7-seg <sup>*3</sup>				

- \*1 Install the font to be used onto the main body of GOT.  
The font to be used on the GOT is required to be the same as the standard font in the GOT type setting on GT Designer3.
- \*2 Standard Font [Japanese (supporting Europe)] is preinstalled on the GT10.  
(12dot Standard font is installed only onto the GT105□, GT104□ and GT1030.)
- \*3 Install this font to the GOT of the Boot OS version [01.11.\*\*.G] or later.

### POINT

#### Installing the standard font

- (1) In the case of 16dot standard font, either Mincho or Gothic can be installed.  
Make sure to install the font specified in the system settings.  
(With the write item in the standard monitor OS cleared, select the font other than the 16dot standard font again. This will select the font specified in the system setting.)
- (2) If the 16dot standard font specified in the system setting differs from the font to be installed on the GOT, the GOT uses the installed font to display.  
The text or object text of the 16dot standard font will look differently from the one drawn on GT Designer3.
- (3) When the standard font Japanese or Chinese (Simplified) is installed, some characters in the European languages (characters with a mark on the top or bottom of the alphabet) are displayed as two-byte characters.  
When Japanese (supporting Europe), Chinese (Simplified) (supporting Europe), or Chinese (Traditional) (supporting Europe) is installed, some characters in the European languages (characters with a mark on the top or bottom of the alphabet) are displayed as one-byte-characters.
- (4) Install the same standard font as that specified in the system setting. If the font language specified in the system setting differs from the standard font to be install on the GOT, note that the text will look differently from the one drawn on GT Designer3, as the GOT uses the installed standard font to display.
- (5) To select German for the language to display in the GOT utility, install the font supporting Europe.
- (6) When the font certified by Chinese government must be displayed, install Chinese (Simplified).
- (7) The TrueType numerical font 7-seg can be used in the GOT of the following Boot OS versions or later.
  - GT16, GT15, GT14, GT12, and GT11: [04.00.00.U]
  - GT10: [01.11.\*\*.G]

## HINT

### Displaying Simplified Chinese or Traditional Chinese

Perform the following three steps to display Simplified Chinese characters or Traditional Chinese characters on the GT16, GT15, or GT14.

- (1) Install the following fonts (Option OS) while installing the OS.

Standard font (China GB) 12-dot characters	The Simplified Chinese (GB) font is a GB2312-encoded font mainly used on mainland China.
Standard font (China GB) 16-dot characters	
Standard font (China Big5) 12-dot characters	The Traditional Chinese (Big5) font is a Big5-encoded font mainly used in Taiwan.
Standard font (China Big5) 16-dot characters	

- (2) Set each shape and object's [KANJI Region] to [China(GB)-Mincho] or [China(Big5)-Gothic].
- (3) Insert the option function board into the GOT. (GT15)  
If the option function board is not inserted (GT15), or if the font (option OS) is not installed, Japanese characters will be displayed.

### (3) Standard monitor OS version

The version of the standard monitor OS installed on the GOT can be checked from the property of OS information of the GOT.

For how to display the property of OS information, refer to the following.

☞ ■BootOS (9) Property of OS information

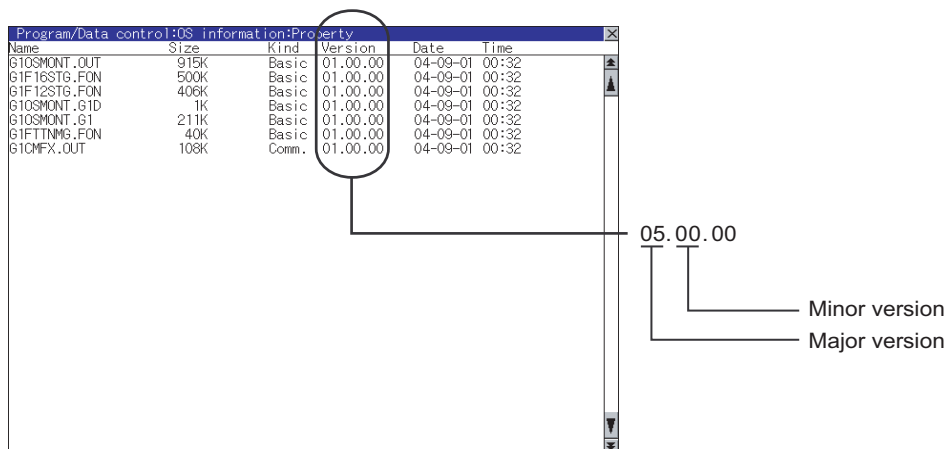

### (4) Installation method

The standard monitor OS has not been installed on the GOT at factory shipment. Therefore, make sure to install it before writing the project data in either of the following methods.

Install the standard monitor OS in either of the following methods.

- (a) Installing the OS on the GOT using the USB or RS-232 cable

☞ 8.1.4 ■Writing project data and installing OS (Personal computer to GOT)

- (b) Installing the OS on the GOT via the memory card or USB memory

☞ 8.2.1 Transferring project data, OS, and special data to memory card or USB memory

## ■ Communication driver

The communication driver performs communication between the GOT and the controller. Always select and install a communication driver that is appropriate for the controller's protocol. Up to four communication drivers can be installed on the GT16, GT15, GT14, GT12, and GT11.

Communication driver (MELSEC-FX) is preinstalled on the GT10.

The following file names in the table are used by the GT16, GT15, GT14, GT12, and GT11.

For details of the connection protocol and controller settings, refer to the following.

 GOT1000 Series Connection Manual for GT Works3 and a controller used

### (1) File names that are used by GT16, GT15, GT14, GT12, and GT11 and storage destination folder in GOT

Connection type		Communication driver name	File name	Storage destination <sup>*1</sup>
Bus connection	QCPU (Q mode)	Bus (Q)	G1CMQBUS.OUT	C:\G1SYS\
	A/QnACPU	Bus (A/QnA)	G1CMABUS.OUT	
Direct CPU connection	A/QnA/L/QCPU	Serial (MELSEC)	G1CMAQDR.OUT	
	FX CPU	MELSEC-FX	G1CMFX.OUT	
	MELSEC-WS	MELSEC-WS	G1CMMWS.OUT	
Computer link connection	L/Q/RCPU	Serial (MELSEC)	G1CMAQDR.OUT	
	QnACPU	AJ71QC24, MELDAS C6*	G1CMQC24.OUT	
	QCPU (A mode), ACPU	AJ71C24/UC24	G1CMC24.OUT	
MELSECNET/H connection (PLC to PLC network)		MELSECNET/H	G1CMNETH.OUT	
MELSECNET/10 connection (PLC to PLC network)		MELSECNET/10	G1CMNET1.OUT	
CC-Link IE Controller Network connection		CC-Link IE Controller Network	G1CMNETG.OUT	
CC-Link IE Field Network connection		CC-Link IE Field Network	G1CMCIEF.OUT	
CC-Link connection (Intelligent device station)		CC-Link Ver.2(ID)	G1CMCCV2.OUT	
		CC-Link(ID)	G1CMCCID.OUT	
CC-Link connection (via G4)		CC-Link(G4)	G1CMCCG4.OUT	
Ethernet connection	L/Q/RCPU	Ethernet(MELSEC), Q17nNC, CRnD-700	G1CME71.OUT	
	FX CPU	Ethernet(FX)	G1CMFXET.OUT	
MODBUS/TCP connection		MODBUS/TCP	G1CMMBTP.OUT	
MODBUS/RTU connection		MODBUS/RTU	G1CMMRTU.OUT	
IAI robot controller connection		IAI X-SEL	G1CMIAIS.OUT	
		IAI ROBO CYLINDER	G1CMIAIC.OUT	
OMRON PLC connection	Serial connection	OMRON SYSMAC	G1CMSMC.OUT	
	Ethernet connection	Ethernet(OMRON)	G1CMOMET.OUT	
KEYENCE PLC connection	Serial connection	KEYENCE KV-700/1000	G1CMKEY.OUT	
	Ethernet connection	Ethernet(KEYENCE)	G1CMKYET.OUT	
KOYO PLC connection		KOYO KOSTAC/DL	G1CMKSTC.OUT	
SHARP PLC connection		SHARP JW	G1CMJW.OUT	
JTEKT PLC connection		JTEKT TOYOPUC-PC	G1CMTOYO.OUT	
TOSHIBA PLC connection	Serial connection	TOSHIBA PROSEC T/V	G1CMPSTC.OUT	
	Ethernet connection	Ethernet(TOSHIBA nv)	G1CMTSNV.OUT	
TOSHIBA MACHINE PLC connection		TOSHIBA MACHINE TCmini	G1CMTCMI.OUT	

(Continued to next page)



Connection type		Communication driver name	File name	Storage destination <sup>*1</sup>
HITACHI IES PLC connection		HITACHI HIDIC H	G1CMHDCH.OUT	C:\G1SYS\
		HITACHI HIDIC H (Protocol2)	G1CMHDC2.OUT	
HITACHI PLC connection		HITACHI S10mini/S10V	G1CMHS10.OUT	
FUJI PLC connection	Serial connection	FUJI MICREX-F	G1CMFMRX.OUT	
		FUJI MICREX-SX SPH	G1CMFMSX.OUT	
	Ethernet connection <sup>*2</sup>	Ethernet (FUJI) ,Gateway	G1CMFMET.OUT	
Panasonic Industrial Devices SUNX PLC connection		Panasonic MEWNET-FP	G1CMMWNT.OUT	
PANASONIC servo amplifier connection		Panasonic MINAS	G1CMPMNS.OUT	
YASKAWA PLC connection	Serial connection	YASKAWA GL/CP9200(SH/H)/CP9300MS	G1CMYGL.OUT	
	Ethernet connection	Ethernet (YASKAWA)	G1CMYKET.OUT	
YOKOGAWA PLC connection	Serial connection	YOKOGAWA FA500/FA-M3/STARDOM	G1CMYGFA.OUT	
	Ethernet connection	Ethernet (YOKOGAWA)	G1CMYGET.OUT	
ALLEN-BRADLEY PLC connection	Serial connection	AB SLC500, AB1: N	G1CMRWSL.OUT	
		AB Micro Logix	G1CMRWML.OUT	
		AB Control/Compact Logix	G1CMRWCL.OUT	
	Ethernet connection	Ethernet	G1CMETIP.OUT	
GE PLC connection		GE (SNP-X)	G1CMGESX.OUT	
LS IS PLC connection		LSIS Master-K	G1CMLSMK.OUT	
SICK safety controller connection		SICK Flexi Soft	G1CMSICK.OUT	
SIEMENS PLC connection	Serial connection	SIEMENS S7-200	G1CMSS72.OUT	
		SIEMENS S7-300/400	G1CMSS7.OUT	
	Ethernet connection	Ethernet(SIEMENS S7)	G1CMS7ET.OUT	
		Ethernet(SIEMENS OP)	G1CMOPET.OUT	
Microcomputer connection	Serial connection	Computer	G1CMMICR.OUT	
	Ethernet connection	Ethernet(MICROCOMPUTER)	G1CMMCET.OUT	
AZBIL control equipment connection		Azbil SDC/DMC	G1CMYTK.OUT	
OMRON temperature controller connection		OMRON THERMAC/INPANEL NEO	G1CMNEO.OUT	
SHINKO indicating controller connection		SHINKO TECHNOS CONTROLLER	G1CMSKTS.OUT	
FUJI temperature controller connection		FUJI PXR/PXG/PXH	G1CMFC.OUT	
YOKOGAWA temperature controller connection		YOKOGAWA GREEN/UT100/UT2000/UTAdvanced	G1CMYGUT.OUT	
RKC temperature controller connection		RKC SR Mini HG (MODBUS)	G1CMRKC.OUT	
CHINO controller connection		CHINO Controllers (MODBUS)	G1CMCNDB.OUT	
Inverter connection		FREQROL 500/700/800, Sensorless servo	G1CMFQRL.OUT	
Servo amplifier connection		MELSERVO-J4,J3,J2S/M,JE	G1CMMSV2.OUT	
GOT multi-drop connection		Multidrop (Slave)	G1CMLDLS.OUT	

\*1 The storage destination folder in the GOT is created when the communication driver is installed.

\*2 Only available to GT16 and GT14.

**(2) File names that are used by GT10 and storage destination folder in GOT**

Connection type	Communication driver name	File name	Storage destination
Direct CPU connection	QnA/L/QCPU	Serial (MELSEC)	-
	A CPU	MELSEC-A	
	FX CPU	MELSEC-FX	
	MELSEC-WS	MELSEC-WS	
Computer link connection	QnA/L/Q/R CPU	Serial (MELSEC)	
	QCPU (A mode), ACPU	AJ71C24/UC24	
CC-Link connection (via G4)		CC-Link (G4)	
MODBUS/RTU connection		MODBUS/RTU	
IAI robot controller connection		IAI X-SEL	
OMRON PLC connection		OMRON SYSMAC	
KEYENCE PLC connection		KEYENCE KV-700/1000	
TOSHIBA MACHINE PLC connection		TOSHIBA MACHINE TCmini	
Panasonic Industrial Devices SUNX PLC connection		Panasonic MEWNET-FP	
YASKAWA PLC connection		YASKAWA MP	
ALLEN-BRADLEY PLC connection	AB SLC500		
	AB Micrologix		
LS IS PLC connection		LSIS Master-K	
SICK safety controller connection		SICK Flexi Soft	
SIEMENS PLC connection		SIEMENS S7-200 SIEMENS S7-300/400	
Microcomputer connection		Computer	
Inverter connection		FREQROL 500/700/800, Sensorless servo	
Servo amplifier connection		MELSERVO-J4,J3,J2S/M,JE	
GOT multi-drop connection		Multidrop (Slave)	

**(3) Installation method**

The communication driver has not been installed on the GT16, GT15, GT14, GT12, and GT11 at factory shipment. Therefore, make sure to install it before writing the project data.

Install the communication driver in either of the following methods.

- (a) Installing the driver on the GOT using the USB or RS-232 cable

 8.1.4 ■ Writing project data and installing OS (Personal computer to GOT)

- (b) Installing the driver on the GOT via the memory card or USB memory

 8.2.1 Transferring project data, OS, and special data to memory card or USB memory

## Extended function

The extended function become available after the extended function OS is installed.

The available number of items in the extended function depends on the version of Boot OS.

### (1) Extended function and necessary OS

Extended function		Extended function OS
System monitor		System monitor
Barcode function		Barcode
RFID function		RFID
Remote personal computer operation (Serial) <sup>*1</sup>		PC Remote Operation(Serial)
Remote personal computer operation (Ethernet) <sup>*1</sup>		PC Remote Operation(Ethernet)
VNC <sup>®</sup> server function		VNC Server
USB mouse/keyboard function		USB Mouse/Keyboard
Report function		Report
Printer	Printer (PictBridge)	Printer(PictBridge)
	Printer (Serial)	Printer(Serial)
Video/RGB display function		Video/RGB
Multimedia function		Multimedia
Device name converter <sup>*2</sup>		Device name converter
Stroke Standard Font	Stroke Font Support Data	Stroke Font Support Data
	Stroke Standard Font (JPN)	Stroke Standard Font(JPN)
	Stroke Standard Font (JPN) (supporting Hangul)	Stroke Standard Font(JPN)(supporting Hangul)
	Stroke Standard Font (China GB)	Stroke Standard Font(China GB)
	Stroke Standard Font (China GB) (supporting Hangul)	Stroke Standard Font(China GB)(supporting Hangul)
Sound output function		Sound Output
External I/O function / Operation panel function		External I/O / Operation Panel
Operator authentication	Password authentication	Operator Authentication
	External authentication	Operator Authentication, RFID
	Fingerprint authentication	Operator Authentication, Fingerprint Authentication
Backup/Restore		Backup/Restore
CNC data I/O		CNC Data I/O, GOT Platform Library
CNC Machining Program Edit		CNC Machining Program Edit, GOT Platform Library
Device data transfer function		Device Data Transfer
MELSEC-L troubleshooting		MELSEC-L Troubleshooting Function
SoftGOT-GOT link function		SoftGOT-GOT Link Function
Log viewer		Log Viewer
File transfer function (FTP client)		File Transfer(FTP Client)

\*1 The driver is required to be installed on the personal computer.  
For details, refer to the following.

 (Functions) 33. REMOTE PERSONAL COMPUTER OPERATION FUNCTION

\*2 When the log files collected by the operation log function are converted to the Unicode text files or CSV text files on the GOT, or the device name is output by the operation log information control function, the device name converter is needed.

## POINT

### Stroke font

- (1) To use the stroke font on the GOT, write the stroke font support data in the extended function and the stroke standard font that corresponds to the language to be displayed. (Example: Select "Stroke Standard Font (JPN)" to display Japanese.)
- (2) To display various Chinese characters that are used in multiple areas, install the stroke standard font and the stroke font in option function that corresponds to the language to be displayed.
- (3) To display Korean (Hangul), select the stroke standard font (supporting Hangul) in the extended function.
- (4) The total amount of OS may differ depending on the combination of Stroke Standard Font in extended function and Stroke Font in option function even when displayable stroke font on the GOT is the same.

### (2) File name and data storage location

Data type		File name	Storage location
System monitor		G1OSSYSM.OUT	C:\G1SYS\
Barcode		G1OSBCD.OUT	
RFID		G1OSRFID.OUT	
PC Remote Operation(Serial)		G1OSRMUS.OUT	
PC Remote Operation(Ethernet)		G1OSPCRA.OUT	
VNC Server		G1OSVNCS.OUT	
USB Mouse/Keyboard		G1OSUSMK.OUT	
Report		G1OSRPT.OUT	
Printer	Printer(PictBridge)	G1OSPRPB.OUT	
	Printer(Serial)	G1OSSPRT.OUT	
Video/RGB		G1OSVRIN.OUT	
Multimedia		G1OSMMR.OUT	
Device name converter		G1OSDEV.OUT	
Stroke Standard Font	Stroke Font Support Data	G1OSSTRK.OUT	
	Stroke Standard Font (JPN)	G1SFRSLG.FON	
	Stroke Standard Font (JPN) (supporting Hangul)	G1SFRSKG.FON	
	Stroke Standard Font (China GB)	G1SFRSBG.FON	
	Stroke Standard Font (China GB) (supporting Hangul)	G1SFRGKG.FON	
Sound Output		G1OSSND.OUT	
External I/O / Operation Panel		G1OSDIO.OUT	
Operator Authentication		G1OSAU.OUT	
Fingerprint Authentication		G1OSFPA.OUT	
Backup/Restore		G1OSBKUP.OUT	
CNC Data I/O		G1OSNCIO.OUT	
CNC Machining Program Edit		G1OSNCED.OUT	
GOT Platform Library		G1OSPTFM.OUT	
Device Data Transfer		G1OSDVMV.OUT	
MELSEC-L Troubleshooting Function		G1OSLCTS.OUT	
SoftGOT-GOT Link Function		G1OSSGLK.OUT	
Log Viewer		G1OSLGVW.OUT	
File Transfer(FTP Client)		G1OSFTPC.OUT	

## ■ Option function

The option function indicates the functions and fonts that are available by installing the option OS or mounting the option function board (including the one with add-on memory) or option function board dedicated to each function. The available number of items in the option function depends on the version of Boot OS.

### (1) Option function, required option function board, and required OS

Option function	Option function board	OS
Multi-channel function	GT16, GT14, GT12 • Not required GT15 • Expansion memory-attached option function board <sup>*1</sup>	The Option OS is not required.
Recipe function	GT16, GT14, GT12, GT10 • Not required GT15 • Option function board or expansion memory-attached option function board <sup>*2</sup> GT11 • Option function board	Option OS • Recipe (Not required for the GT10)
Advanced recipe function	GT16, GT14 • Not required GT15 • Option function board or expansion memory-attached option function board <sup>*2</sup>	Option OS • Advanced Recipe
Logging function	GT16, GT14, GT12 • Not required GT15 • Option function board or expansion memory-attached option function board <sup>*2</sup>	Option OS • Logging
Object script	GT16, GT14 • Not required GT15 • Option function board or expansion memory-attached option function board <sup>*2</sup>	Option OS • Object Script
Operation log function <sup>*3</sup>	GT16 • Not required GT15 • Option function board or expansion memory-attached option function board <sup>*2</sup>	Option OS • Operation Log
Document display function <sup>*3</sup>	GT16 • Not required GT15 • Expansion memory-attached option function board <sup>*1</sup>	Option OS • Document Display
MES Interface function	MES Interface function attached option function board <sup>*4</sup>	Option OS • MES Interface
MELSEC-A ladder monitor	GT16 • Not required GT15 • Option function board or expansion memory-attached option function board <sup>*2</sup>	Option OS • Ladder monitor for MELSEC-A
MELSEC-Q/L/QnA ladder monitor	GT16 • Not required GT15 • Expansion memory-attached option function board <sup>*1</sup>	Option OS • Ladder monitor for MELSEC-Q/L/QnA

(Continued to next page)

Option function	Option function board	OS
MELSEC-FX ladder monitor		Option OS • Ladder monitor for MELSEC-FX
Ladder editor		Option OS • Ladder editor • Ladder editor (enhanced) • GOT Function Expansion Library • GOT Function Expansion Library (enhanced) Extended function OS • GOT Platform Library
Network monitor		Option OS • Network monitor
SFC monitor		Option OS • SFC Monitor • SFC monitor (enhanced) • GOT Function Expansion Library • GOT Function Expansion Library (enhanced) Extended function OS • GOT Platform Library
Motion SFC monitor		Option OS • Motion SFC Monitor Extended function OS • GOT Platform Library
Intelligent module monitor		Option OS • Intelligent module monitor
Q motion monitor		Option OS • Q motion monitor
Servo amplifier monitor		Option OS • Servo amplifier monitor
CNC monitor		Option OS • CNC Monitor
MELSEC-FX list editor <sup>*5</sup>		GT16, GT14, GT12, GT10 • Not required GT15 • Option function board or expansion memory-attached option function board <sup>*2</sup> GT11 • Option function board
MELSEC-A list editor	GT16, GT14, GT12 • Not required GT15 • Option function board or expansion memory-attached option function board <sup>*2</sup> GT11 • Option function board	Option OS • List editor for MELSEC-A
Gateway (Server, Client) function	GT16, GT14 • Not required	Option OS • Gateway(Server, Client)
Gateway (Mail) function	GT15 • Option function board or expansion memory-attached option function board <sup>*2</sup>	Option OS • Gateway(Mail)
Gateway (FTP server) function	GT16, GT14, GT12 • Not required GT15 • Option function board or expansion memory-attached option function board <sup>*2</sup>	Option OS • Gateway(FTP Server)

(Continued to next page)

Option function		Option function board	OS
Standard Font (China: Simplified) (Simplified Chinese [GB] Mincho)		GT16, GT14 • Not required	Option OS • Standard Font(China GB)
Standard Font (China: Big5) (Traditional Chinese) (Big5) (Gothic)		GT15 • Option function board or expansion memory-attached option function board* <sup>2</sup>	Option OS • Standard Font(China Big5)
Standard Font (Japanese)			Option OS • Standard Font(Japanese)
Stroke Font	Stroke Font (JPN)		Option OS • Stroke Font(JPN) Extended function OS • Stroke Font Support Data
	Stroke Font (China GB)	GT16, GT14 • Not required GT15 • Option function board or expansion memory-attached option function board* <sup>2</sup>	Option OS • Stroke Font(China GB) Extended function OS • Stroke Font Support Data
	Stroke Font (China Big5)		Option OS • Stroke Font(China Big5) Extended function OS • Stroke Font Support Data
Kana-kanji conversion function	Kana-kanji conversion	GT15 • Option function board or expansion memory-attached option function board* <sup>2</sup>	Option OS • Kana-kanji conversion
	Kana-kanji conversion (enhanced version)	GT16, GT14 • Not required GT15 • Option function board or expansion memory-attached option function board* <sup>2</sup>	Option OS • Kana-kanji conversion(enhanced version)
Maintenance report function* <sup>6</sup>		GT16 • Not required GT15 • Option function board or expansion memory-attached option function board* <sup>2</sup>	The Option OS is not required.

\*1 The multi-channel function and ladder monitor function for MELSEC-Q/L/QnA cannot be used on the GT15-FNB.

\*2 If the total amount of data stored in the GOT exceeds the capacity of standard memory, use the option function board with add-on memory.

\*3 In addition to the option function board, a memory card is required.

\*4 In the GT15, installing the option OS for MES Interface function requires 8218 KB on the option function board as work memory for MES Interface function in addition to the space required for MES Interface function data (3216KB). Other option functions can be used by inserting the option function board with MES Interface function. For the GT16, use the GT16-MESB.

\*5 In the GT10, only the GT105□ and GT104□ can use this function.

\*6 In addition to the option function board, the battery is required.

## POINT

### Option function board

When using the option function, the option function board is required.

For the precautions of using the option function board, refer to the following.

 Appendix10 Precautions for Option Function Board



### Displaying Simplified Chinese or Traditional Chinese

Perform the following three steps to display Simplified Chinese characters or Traditional Chinese characters on the GT16, GT15, or GT14.

- (1) Install the following fonts (Option OS) while installing the OS.

Standard Font(China GB) 12dot	The Simplified Chinese (GB) font is a GB2312-encoded font mainly used on mainland China.
Standard Font(China GB) 16dot	
Standard Font(China Big5) 12dot	The Traditional Chinese (Big5) font is a Big5-encoded font mainly used in Taiwan.
Standard Font(China Big5) 16dot	

- (2) Set each shape and object's [KANJI Region] to [China(GB)-Mincho] or [China(Big5)-Gothic]. Insert the option function board into the GOT. (GT15)
- (3) If the option function board is not inserted (GT15), or if the font (option OS) is not installed, Japanese characters will be displayed.



## (2) File names and data storage destinations

Data type		File name	Storage destination <sup>*1</sup>
Advanced Recipe		G1OSARCP.OUT	C:\G1SYS\
Logging		G1OSLOG.OUT	
Object Script		G1OSSCR.OUT	
Operation Log		G1OSOPLG.OUT	
KANJI KANJI(JPN)		G1OSFEP.OUT	
KANJI KANJI(JPN)(Enhanced Version)		G1OSFEP2.OUT	
Document Display		G1OSDOCV.OUT	
MES Interface		G1OSMES.OUT	
Ladder monitor for MELSEC-A		G1OSACIR.OUT	
Ladder monitor for MELSEC-Q/L/QnA		G1OSQCIR.OUT	
Ladder monitor for MELSEC-FX		G1OSFCIR.OUT	
Ladder editor		G1OSLDED.OUT	
Ladder editor (enhanced)		G1OSLDED2.OUT	
Network monitor		G1OSNETM.OUT	
Intelligent module monitor		G1OSSPM.OUT	
Q motion monitor		G1OSMTM.OUT	
Servo amplifier monitor		G1OSSVM.OUT	
CNC monitor		G1OSCNM.OUT	
SFC Monitor		G1OSSFC.OUT	
SFC monitor (enhanced)		G1OSSFC2.OUT	
Motion SFC Monitor		G1OSMSFC.OUT	
List editor for MELSEC-FX		G1OSFLST.OUT	
List editor for MELSEC-A		G1OSALST.OUT	
Gateway (Server, Client)		G1OSGWYE.OUT	
Gateway (Mail)		G1OSGWYM.OUT	
Gateway (FTP Server)		G1OSGWYF.OUT	
Recipe		G1OSRECP.OUT	
Standard Font (China GB)	12dot	G1F12GBM.FON	
	16dot	G1F16GBM.FON	
Standard Font (China Big5)	12dot	G1F12BGG.FON	
	16dot	G1F16BGG.FON	
Standard Font (Japanese)	12dot	G1F12JSG.FON	
	16dot	G1F16JSG.FON	
Stroke Font	Stroke Font (JPN)	G1SFRJSG.FON	
	Stroke Font (China GB)	G1SFRGBG.FON	
	Stroke Font (China Big5)	G1SFRBGG.FON	

\*1 The storage destination folder in the GOT is created when the option OS is installed.

## (3) How to install

The option OS such as the recipe function, standard font (China: GB), and standard font (China: Big5) have not been installed on the GOT at factory shipment. Therefore, install them before writing the project data if necessary.

Install the option OS in either of the following methods.

- (a) Installing the option OS on the GOT using the USB or RS-232 cable

 8.1.4 ■ Writing project data and installing OS (Personal computer to GOT)

- (b) Installing the option OS on the GOT via the memory card or USB memory

 8.2.1 Transferring project data, OS, and special data to memory card or USB memory

## ■ Project data

Data for monitor screens created by the user

### (1) File names and data storage destinations

Data type		File name	Storage destination*1
Project data	User screen data (base screen, window screen and advanced recipe*4)	G1PRJCT.G1	<ul style="list-style-type: none"> <li>• GT16, GT15</li> <li>A:\, B:\, C:\(Project Folder*2)\</li> <li>• GT14, GT12, GT11</li> <li>A:\, C:\(Project Folder*2)\</li> <li>• GT10</li> <li>C:\(Project Folder*2)\</li> </ul>
	Parts		
	Comment		
	Common Settings		
	HQ Font*3		
	System label		

\*1 The storage destination folder in the GOT is created when the project data is written.

\*2 Specify the project folder name in [Project Folder] of the [GOT Type Setting] dialog box. (The default setting is Project 1.)

 4.1 GOT Type Setting

\*3 Check HQ Font when the high-quality font has been set for texts or objects (except Numerical Display and Numerical Input). (The font cannot be selected separately.)

\*4 If the file is written after the recipe setting is changed, update the recipe file, too.  
Otherwise the device values will not be read or written according to the settings changed with GT Designer3.  
For details, refer to the following.

 (Functions) 25. RECIPE

### (2) How to write

The project data can be written in either of the following methods.

(a) Writing the data to the GOT using the USB or RS-232 cable or the Ethernet communication unit or cable

 8.1.4 ■ Writing project data and installing OS (Personal computer to GOT)

(b) Writing the data to the GOT via the memory card or USB memory

 8.2.1 Transferring project data, OS, and special data to memory card or USB memory

## Resource data

The Resource data indicates various data generated in the GOT.  
For details of each data, refer to the following.

 GT Designer3 Version1 Screen Design Manual (Functions)

Data type	File name	File format	Storage destination*1	Remarks
Advanced Alarm log file	AAM#####.CSV*2	CSV	• GT16, GT15 A:\, B:\(Path set for each function)	File output by the Advanced Alarm function
	AAM#####.TXT*2	TXT	• GT14, GT12	
	AAM#####.G1A*2*3	Binary file	A:\, D:\	
Alarm log file	ALARMHST.CSV	CSV	• GT16, GT15 A:\, B:\(Path set for each function) • GT14, GT12, GT11 A:\, D:\ • GT105□, GT104□, GT1030 D:\*5 • GT1020 C:\*5	File output by the Alarm History function
	ALARMHST.G1H	Binary file	• GT16, GT15 A:\, B:\(Path set for each function) • GT14, GT12, GT11 A:\, D:\	
Advanced Recipe file	ARP#####.CSV*4	CSV	• GT16, GT15 A:\, B:\(Path set for each function)	File output by the advanced recipe function
	ARP#####.TXT*4	TXT	• GT14	
	ARP#####.G1P*3	Binary file	A:\, D:\	
Recipe data file	RECIP###.CSV*2	CSV	• GT16, GT15 A:\, B:\(Path set for each function) • GT14, GT12, GT11 A:\, D:\ • GT105□, GT104□, GT1030 D:\*5 • GT1020 C:\*5	File output by the recipe function
	RECIP###.G1R	Binary file	• GT14, GT12, GT11 A:\, D:\	
Data log file	LOG###.CSV*2	CSV	• GT16, GT15 A:\, B:\(Path set for each function)	File output by the logging function
	LOG###.TXT*2	TXT	• GT14, GT12	
	LOG###.G1L*2*3	Binary file	A:\, D:\	
Operation log file	OPELOG_YYYYMMDD_ xx.CSV	CSV	• GT16, GT15 A:\, B:\(Path set for each function)	File output by the operating log function
	OPELOG_YYYYMMDD_ xx.TXT	TXT		
	OPELOG_YYYYMMDD_ xx.G1O*3	Binary file		
Screen transition information file	BASEHIST.G1C	Binary file	• GT16, GT15 A:\, B:\(Project Folder) • GT14, GT12, GT11 A:\	File output when the screen switching operation mode is set to the history mode (save)
Operator management information file	AUTHINF.G1U	Binary file	• GT16, GT15, GT14 C:\	File for setting the operator information and setting used for the operator authentication
Fingerprint information administrator file	FINGAUTH.G1F	Binary file	• GT16, GT15 C:\	File for storing the administrator password used for the fingerprint authentication device

(Continued to next page)

Data type	File name	File format	Storage destination <sup>*1</sup>	Remarks
Image file (BMP format)	SNAP####.BMP <sup>*2</sup>	BMP	<ul style="list-style-type: none"> <li>• GT16, GT15</li> <li>A:\, B:\(any path specified in [Common] → [Hard Copy])\</li> </ul>	File output by the hard copy function
Image file (JPEG format)	SNAP####.JPG <sup>*2</sup>	JPEG	<ul style="list-style-type: none"> <li>• GT14</li> <li>A:\, D:\</li> <li>• GT12</li> <li>A:\</li> </ul>	

\*1 The storage destination folder in the GOT is created when the project data is written.

\*2 ### indicates a serial No. of each data type.

The file name can also be specified by the user in the common settings or object settings.

\*3 By using the utility or GT Designer3, a binary file can be converted into a CSV file or a Unicode text file.

\*4 By using the utility or GT Designer3, a CSV file or a Unicode text file can be converted into a binary file.

\*5 In the case that resource data is uploaded with GT Designer3.

## 8.5.2 Drive capacity required for data transfer

The GOT operates by expanding the OS or project data stored in the built-in flash memory (ROM) to the memory for operation (RAM).

For the GT16, GT14, and GT12, since a part of the data is compressed to be stored in the built-in flash memory (ROM), the data size becomes larger when the data is expanded to the memory for operation (RAM).

Boot OS, Standard monitor OS, Communication driver, Extended function OS, Option OS, Special data, Project data and other data are stored in the system area and user area of the drive specified by the GOT.

Regarding the Boot OS, the standard monitor OS and others that are stored in the system area of the C drive, checking the data capacity before installation is not required. (Data stored in the system area differ according to the GOT.)

However, when the GT16, GT15, GT14, and GT12 is used, the extended function OS, the option OS, the communication driver (the second or later communication driver for the GT15) and project data that are stored in the user area are not transferred if the target drive has insufficient space.

Before transferring data (including installing OSs and writing project data), check the free space of the drive where the data is to be stored and the size of data to be transferred to select the transfer destination drive.

### User area capacity

Transfer destination		User area capacity		Remarks
GT16	Drive C (C: Built-in Flash memory)	GT1695M-X, GT1685M-S, GT1675M-S, GT1675M-V, GT1665M-S, GT1665M-V, GT1655-V, GT16 Handy GOT	15MB	The total memory size of Extended function OS, Option OS, Special data, and Communication driver must be smaller than the user area capacity. Download (store) the Project data to Drive A (A: Standard CF Card) or Drive B (B: Extended Memory Card) if user area does not have enough space for Project data, Extended function OS, Option OS, Special data, Communication driver, and buffering.
		GT1675-VN, GT1672-VN, GT1662-VN	11MB	
	Drive A (A: Standard CF Card)	Check the CF card capacity.		
	Drive B (B: Extended Memory Card)	Check the CF card capacity.		
	Drive E (E: USB memory)	Check the USB memory capacity.		
GT15	Drive C (C: Built-in Flash memory)	GT1595-X, GT1585V-S, GT1585-S, GT1575V-S, GT1575-V, GT1565-V, GT1555-V, GT1555-Q, GT1550-Q	9MB	The total memory size of Extended function OS, Option OS, Special data, and the second or later Communication driver must be smaller than the user area capacity. An option function board with add-on memory is necessary if user area does not have enough space for Project data, Extended function OS, Option OS, Special data, Communication driver, and buffering.
		GT1575-VN, GT1572-VN, GT1562-VN	5MB	
	Drive A (A: Standard CF Card)	Check the CF card capacity.		
	Drive B (B: Extended Memory Card)	Check the CF card capacity.		
GT14	Drive C (C: Built-in Flash memory)	9MB (For project data), 5MB (For the extended function and the option OS)		The total memory size of extended function OS and option OS must be smaller than the user area capacity (5MB).
	Drive A (A: Standard SD Card)	Check the SD card capacity.		
GT12	Drive C (C: Built-in Flash memory)	9MB		The project data size is a maximum of 6MB.
	Drive A (A: Standard CF Card)	Check the CF card capacity.		
GT11	Drive C (C: Built-in Flash memory)	3MB		The project data size is a maximum of 3MB.
GT10	Drive C (C: Built-in Flash memory)	GT105□	3MB	The project data size is a maximum of 3MB.
	Drive C (C: Built-in Flash memory)	GT104□	3MB	The project data size is a maximum of 3MB.
	Drive C (C: Built-in Flash memory)	GT1030	1.5MB	The project data size is a maximum of 1.5MB.
	Drive C (C: Built-in Flash memory)	GT1020	512KB	The project data size is a maximum of 512KB.

Each type of data is grouped and shown as a, b, A to F.

Apply the corresponding size when calculating the data size with the following expressions or flow charts.

Data type (GT16)	
a	Extended function OS stored in the ROM
b	Option OS stored in the ROM
A	Extended function OS expanded to the RAM
B	Option OS expanded to the RAM
C	Communication driver
D	Special data
E	Project
F	Buffering area

Data type (GT15)	
A	Extended function OS
B	Option OS
C	Second or later communication driver
D	Special data
E	Project
F	Buffering area

Data type (GT14)	
a	Extended function OS stored in the ROM
b	Option OS stored in the ROM
A	Extended function OS expanded to the RAM
B	Option OS expanded to the RAM
C	Communication driver
E	Project
F	Buffering area

Data type (GT12)	
a	Extended function OS stored in the ROM
b	Option OS stored in the ROM
A	Extended function OS expanded to the RAM
B	Option OS expanded to the RAM
C	Communication driver
E	Project
F	Buffering area

Data size of extended functions  
GT16

Extended function		User area capacity	
		a Built-in flash memory (ROM)	A User memory (RAM)
System monitor		450 KB	692 KB
Barcode		50 KB	84 KB
RFID		50 KB	166 KB
Report		150 KB	235 KB
Printer	Printer(PictBridge)	552 KB	1104 KB
	Printer(Serial)	80KB	200KB
Video/Multimedia	Video/RGB	298 KB	480 KB
	Multimedia	292 KB	1074 KB
PC Remote Operation(Serial)		50 KB	84 KB
PC Remote Operation(Ethernet)		860KB	5130KB
USB Mouse/Keyboard		80KB	200KB
Device name converter		400 KB	800 KB
Stroke Standard Font	Stroke Font Support Data	300 KB	400 KB
	Stroke Standard Font (JPN)	2160 KB	2160 KB
	Stroke Standard Font (JPN) (supporting Hangul)	3175 KB	3175 KB
	Stroke Standard Font (China GB)	1474 KB	1474 KB
	Stroke Standard Font (China GB) (supporting Hangul)	2016 KB	2016 KB
Sound Output		100 KB	200 KB
External I/O / Operation Panel		70 KB	100 KB
Operator Authentication		460 KB	730 KB
Fingerprint Authentication		270 KB	616 KB
Backup/Restore		420 KB	766 KB
CNC Data I/O		210 KB	383 KB
CNC Machining Program Edit		220 KB	738 KB
GOT Platform Library		77 KB	200 KB
Device Data Transfer		50 KB	100 KB
MELSEC-L Troubleshooting Function		340 KB	770 KB
SoftGOT-GOT Link Function		100 KB	200 KB
Log Viewer		1434KB	3882KB
File Transfer(FTP Client)		300KB	1300KB
VNC Server		512KB	8192KB

## GT15

Extended function		A User area capacity
System monitor		746 KB
Barcode		84 KB
RFID		166 KB
PC Remote Operation(Serial)		84 KB
Report		235 KB
Printer	Printer(PictBridge)	1104 KB
	Printer(Serial)	200KB
Video/RGB		512 KB
Device name converter		800 KB
Stroke Standard Font	Stroke Font Support Data	400 KB
	Stroke Standard Font (JPN)	2160 KB
	Stroke Standard Font (JPN) (supporting Hangul)	3175 KB
	Stroke Standard Font (China GB)	1474 KB
	Stroke Standard Font (China GB) (supporting Hangul)	2016 KB
Sound Output		200 KB
External I/O / Operation Panel		100 KB
Operator Authentication		784 KB
Fingerprint Authentication		616 KB
Backup/Restore		820 KB
CNC Data I/O		437 KB
GOT Platform Library		100 KB
Device Data Transfer		100 KB
SoftGOT-GOT Link Function		200 KB
File Transfer(FTP Client)		1300KB

## GT14

Extended function	User area capacity	
	a Built-in flash memory (ROM)	A User memory (RAM)
System monitor	692 KB	692 KB
Barcode	84 KB	84 KB
RFID	166 KB	166 KB
Printer(Serial)	80 KB	200 KB
USB Mouse/Keyboard	200 KB	200 KB
Device name converter	800 KB	800 KB
Stroke Standard Font	Stroke Font Support Data	400 KB
	Stroke Standard Font (JPN)	2160 KB
	Stroke Standard Font (JPN) (supporting Hangul)	3175 KB
	Stroke Standard Font (China GB)	1474 KB
	Stroke Standard Font (China GB) (supporting Hangul)	2016 KB
Operator Authentication	730 KB	730 KB
Backup/Restore	766 KB	766 KB
Device Data Transfer	100 KB	100 KB
File Transfer(FTP Client)	1300 KB	1300 KB
VNC Server	512 KB	2048 KB

## GT12

Extended function	a Built-in flash memory (ROM)
System monitor	450 KB
Barcode	50 KB
RFID	50 KB
Device name converter	400 KB
Backup/Restore	420 KB

## GT11

Extended function	User area capacity
System monitor	0 KB
Barcode	0 KB
RFID	0 KB

Data size of optional functions

GT16

Option function		User area capacity	
		<b>b</b> Built-in flash memory (ROM)	<b>B</b> User memory (RAM)
Standard Font (China GB)	12dot	1280 KB	1280 KB
	16dot		
Standard Font (China Big5)	12dot	1920 KB	1920 KB
	16dot		
Standard Font (Japanese)	12dot	1280 KB	1280 KB
	16dot		
Stroke Font	Stroke Font (JPN)	1037 KB	1037 KB
	Stroke Font (China GB)	1248 KB	1248 KB
	Stroke Font (China Big5)	1680 KB	1680 KB
Recipe		70 KB	100 KB
Advanced Recipe		310 KB	1187 KB
Logging		380 KB	710 KB
KANJI KANJI (JPN) (Enhanced Version)		1242 KB	2774KB
Object Script		180 KB	360 KB
Operation Log		384 KB	1221 KB
Document Display		150 KB	3072 KB
MES Interface		1598 KB	13461 KB
Ladder monitor	Ladder monitor for MELSEC-A	342 KB	674 KB
	Ladder monitor for MELSEC-Q/L/QnA	590 KB	4170 KB
	Ladder monitor for MELSEC-FX	342 KB	674 KB
Ladder editor		2567 KB	8192 KB
Ladder editor (enhanced)		2567 KB	8192 KB
Network monitor		210 KB	370 KB
Intelligent module monitor		390 KB	770 KB
Q motion monitor		390 KB	770 KB
Servo amplifier monitor		390 KB	770 KB
CNC Monitor		390 KB	770 KB
SFC Monitor		442 KB	2108 KB
SFC monitor (enhanced)		442 KB	2108 KB
Motion SFC Monitor		1240KB	12522KB
GOT Function Expansion Library		4729 KB	19381 KB
GOT Function Expansion Library (enhanced)		9458 KB	25840 KB
List editor for MELSEC-A		542 KB	1024 KB
List editor for MELSEC-FX		542 KB	1024 KB
Gateway (Server, Client)		50 KB	100 KB
Gateway (Mail)		50 KB	100 KB
Gateway (FTP Server)		50 KB	84 KB



## GT15

Option function		B User area capacity
Standard Font(China GB)	12dot	1280 KB
	16dot	
Standard Font(China Big5)	12dot	1920 KB
	16dot	
Standard Font(Japanese)	12dot	1280 KB
	16dot	
Stroke Font	Stroke Font (JPN)	1037 KB
	Stroke Font (China GB)	1248 KB
	Stroke Font (China Big5)	1680 KB
Recipe		100 KB
Advanced Recipe		1241 KB
Logging		740 KB
KANA KANJI(JPN)	KANA KANJI(JPN)	1223 KB
	KANA KANJI(JPN)(Enhanced Version)	2774 KB
Object Script		360 KB
Operation Log		1218 KB
Document Display		2048 KB
MES Interface		3196 KB
Ladder monitor	Ladder monitor for MELSEC-A	523 KB
	Ladder monitor for MELSEC-Q/L/QnA	1082 KB
	Ladder monitor for MELSEC-FX	592 KB
Ladder editor		5121 KB
Ladder editor (enhanced)		5121 KB
Network monitor		324 KB
Intelligent module monitor		384 KB
Q motion monitor		607 KB
Servo amplifier monitor		524 KB
CNC Monitor		588 KB
SFC Monitor		1373 KB
SFC monitor (enhanced)		1373 KB
Motion SFC Monitor		2477KB
GOT Function Expansion Library		4729 KB
GOT Function Expansion Library (enhanced)		9458 KB
List editor for MELSEC-A		1058 KB
List editor for MELSEC-FX		1058 KB
Gateway (Server, Client)		100 KB
Gateway (Mail)		100 KB
Gateway (FTP Server)		64 KB

GT14

Option function		User area capacity	
		<b>b</b> Built-in flash memory (ROM)	<b>B</b> User memory (RAM)
Standard Font (China GB)	12dot	1280 KB	1280 KB
	16dot		
Standard Font (China Big5)	12dot	1920 KB	1920 KB
	16dot		
Standard Font (Japanese)	12dot	1280 KB	1280 KB
	16dot		
Stroke Font	Stroke Font (JPN)	1037 KB	1037 KB
	Stroke Font (China GB)	1248 KB	1248 KB
	Stroke Font (China Big5)	1680 KB	1680 KB
Recipe		100 KB	100 KB
Advanced Recipe		1187 KB	1187 KB
Logging		710 KB	710 KB
KANJI(KANJI)(Enhanced Version)		1228 KB	2048 KB
Object Script		360 KB	360 KB
List editor for MELSEC-A		1024 KB	1024 KB
List editor for MELSEC-FX		1024 KB	1024 KB
Gateway (Server, Client)		100 KB	100 KB
Gateway (Mail)		100 KB	100 KB
Gateway (FTP Server)		84 KB	84 KB

GT12

Option function	<b>b</b> Built-in flash memory (ROM)
Recipe	70 KB
Logging	380 KB
List editor for MELSEC-A	542 KB
List editor for MELSEC-FX	542 KB
Gateway (FTP Server)	50 KB

GT11

Option function	User area capacity
Recipe	0 KB
List editor for MELSEC-A	0 KB
List editor for MELSEC-FX	0 KB

**C** Communication driver data size

**GT16**

Communication driver	User area capacity
Bus(Q)	180 KB
Serial (MELSEC)	180 KB
MELSEC-FX	180 KB
MELSECNET/H	200 KB
CC-Link IE Controller Network	200 KB
CC-Link IE Field Network	230 KB
JTEKT TOYOPUC-PC	160 KB
Ethernet (YASKAWA)	160 KB
Computer	230 KB
Ethernet (MICROCOMPUTER)	230 KB
Communication driver other than the above	150 KB

**GT15**

Communication drivers use 150 KB each.

**GT12**

Communication driver	User area capacity
Serial (MELSEC)	180 KB
MELSEC-FX	180 KB
JTEKT TOYOPUC-PC	160 KB
Ethernet (YASKAWA)	160 KB
Computer	230 KB
Ethernet (MICROCOMPUTER)	230 KB
Communication driver other than the above	150 KB

**F** Buffering area size (data size)

Refer to the following manual for the data size of the buffering area size.

 GT Designer3 Version1 Screen Design Manual (Functions)

## ■ Newly transferring data to the GOT

Check whether the following expression is satisfied or not.  
Refer to the following section for the project data size.

 ■ Checking project data size to be written

### ● GT16

The GT16 can store the project data into Drive C or Drive A (A: Standard CF Card).

$$\begin{aligned} \text{User area space (ROM Size)} &> \text{Project } \mathbf{E} + \text{Extended function OS data size } \mathbf{a}^{*1} + \text{Option OS data size } \mathbf{b}^{*1*2} \\ &+ \text{Communication driver data size } \mathbf{C} + \text{Special Data } \mathbf{D} \end{aligned}$$

\*1 Calculate the sizes of Extended function OS and Option OS with the values **a** and **b** which are the sizes when they are stored in the built-in flash memory (ROM).

### ● GT15

The GT15 can store the project data into Drive C or Drive A (A: Standard CF Card).

$$\begin{aligned} \text{User area space} &> \text{Project } \mathbf{E} + \text{Extended function OS data size } \mathbf{A} + \text{Option OS data size } \mathbf{B}^{*2} \\ &+ \text{Second or later Communication driver data size } \mathbf{C} + \text{Special Data } \mathbf{D} \end{aligned}$$

### ● GT14

The GT14 can store the project data into Drive C or Drive A (A: Standard SD Card).

$$\text{User area space} > \text{Project } \mathbf{E} + \text{Extended function OS data size } \mathbf{a}^{*1} + \text{Option OS data size } \mathbf{b}^{*1*2}$$

### ● GT12

The GT12 can store the project data into Drive C or Drive A (A: Standard CF Card).

The GT12 stores project data up to 6MB.

$$\begin{aligned} \text{User area space} &> \text{Project } \mathbf{E} + \text{Extended function OS data size } \mathbf{a} + \text{Option OS data size } \mathbf{b}^{*2} \\ &+ \text{Communication driver data size } \mathbf{C} \end{aligned}$$

### ● GT11 and GT10

The GT11 and GT10 can store the project data into Drive C.

$$\text{User area space } \mathbf{A} > \text{Project}$$

\*1 Calculate the sizes of Extended function OS and Option OS with the values **a** and **b** which are the sizes when they are stored in the built-in flash memory (ROM).

\*2 When the GOT project data created on PX Developer (Ver.1.15 or later) is used, logging function and object script function are required.

Refer to the PX Developer User's Manual for details.

## POINT

### When free space of transfer destination drive is sufficient but the insufficient space message appears

Select [Write after deleting all contents in the project folder] to write all project data.

If the project data backup is required, write the project data to a personal computer, memory card, or USB memory before writing the project data to the GOT.

## Memory for storage (ROM) and memory for operation (RAM)

### (1) GT16

#### (a) Specifications

The GT16 operates by expanding the OS or project data stored in the memory for storage (ROM) to the memory for operation (RAM).

The capacity of the memory for storage (ROM) and the memory for operation (RAM) differs according to the GOT.

GOT	Memory	Capacity
GT1695M-X, GT1685M-S, GT1675M-S, GT1675M-V, GT1665M-S, GT1665M-V, GT1655-V, GT16 Handy GOT	Memory for storage (ROM) (Built-in flash memory, included as standard)	15MB
	Memory for operation (RAM) (User memory, included as standard)	57MB
GT1675-VN, GT1672-VN, GT1662-VN	Memory for storage (ROM) (Built-in flash memory, included as standard)	11MB
	Memory for operation (RAM) (User memory, included as standard)	53MB

If the OS or project data exceeds the capacity of the memory for storage (ROM), the capacity of the ROM can be extended by using a CF card.

Example) GT1675M-V

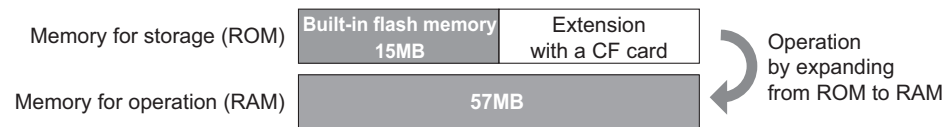

The built-in flash memory corresponds to drive C, and the CF card corresponds to drive A (standard) or drive B (extended).

The memory for operation (RAM) cannot be extended.

If the amount of data expanded to the memory for operation (RAM) exceeds the above capacity, data must be resized by reducing the project data or deleting the unnecessary OS.

For the extended function OS and option OS, the compressed data **a** and **b** are stored in the memory for storage (ROM) and the data size becomes larger as shown by **A** and **B** when they are expanded to the memory for operation (RAM).

The buffering area **F** is an area for storing the resource data such as logging or advanced alarm and uses the memory for operation (RAM). The data size varies depending on the setting.

The stored resource data is stored to the specified storage destination (Drive A or Drive B) when saving to a file is specified by GT Designer3. (The memory for storage (ROM) is not used.)

If the amount of data expanded to the memory for operation (RAM) exceeds the above capacity, data must be resized by reducing the project data or deleting the unnecessary OS.

Example) GT1675M-V

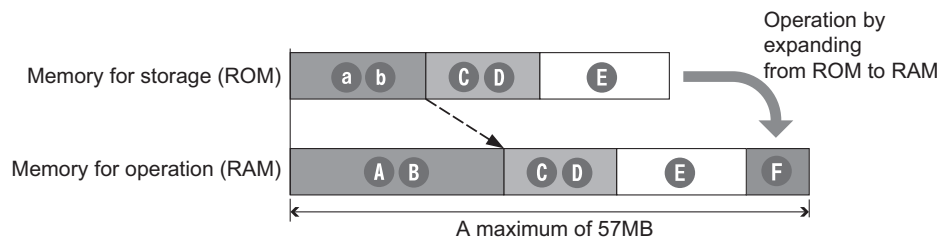

Data type	
<b>a</b>	Extended function OS stored in the ROM
<b>b</b>	Option OS stored in the ROM
<b>A</b>	Extended function OS expanded to the RAM
<b>B</b>	Option OS expanded to the RAM
<b>C</b>	Communication driver
<b>D</b>	Special data
<b>E</b>	Project
<b>F</b>	Buffering area

(b) CF card requirement and capacity

Whether the CF card is required or not and the required capacity of CF card vary depending on the data size.

Select whether to use the CF card and its capacity using the following flow chart.

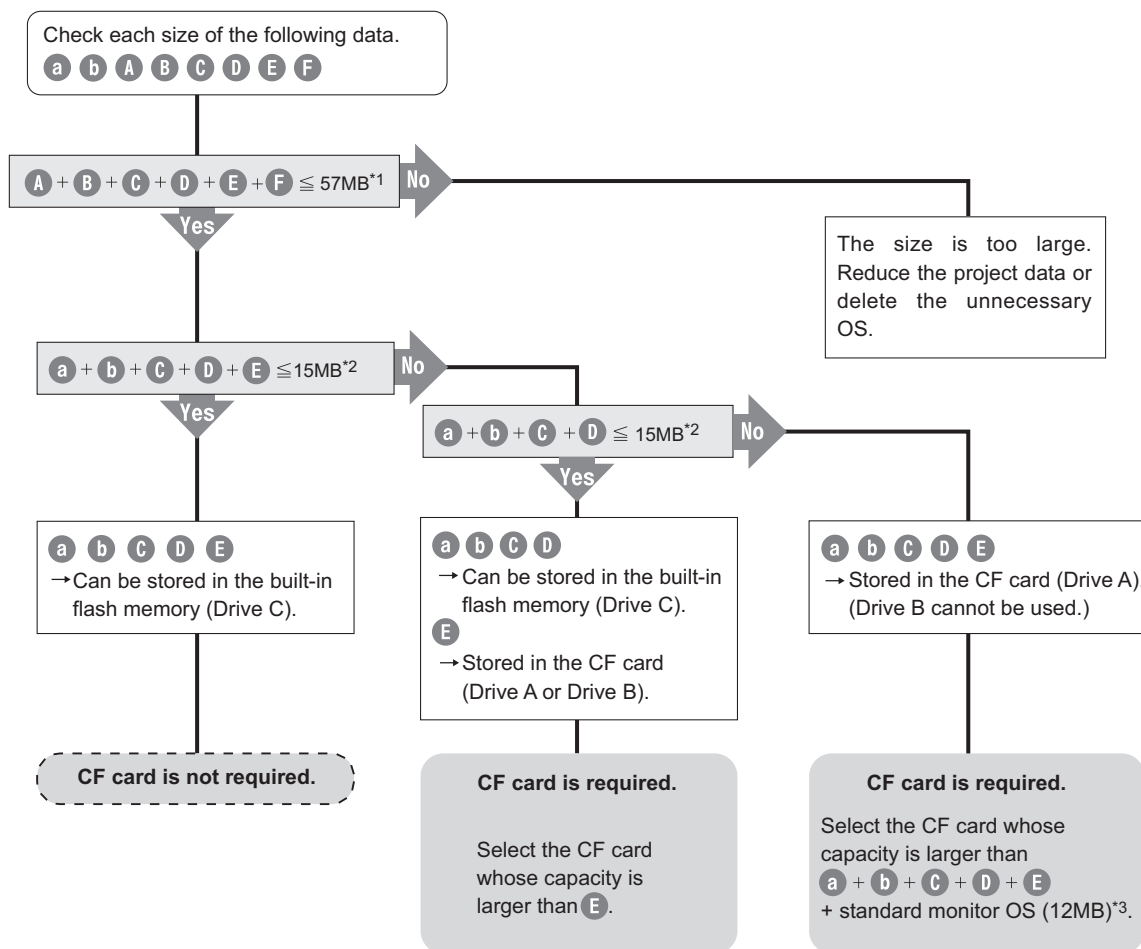

\*1 GT1675-VN, GT1672-VN, GT1662-VN: 53MB

\*2 GT1675-VN, GT1672-VN, GT1662-VN: 11MB

\*3 When the extended function OS and option OS are stored in the CF card (Drive A), the standard monitor OS (standard monitor OS, basic font, etc.) must be stored also in the CF card (Drive A).

(2) GT15

(a) Specifications

The GT15 operates by expanding the OS or project data stored in the memory for storage (ROM) to the memory for operation (RAM).

The capacity of the memory for storage (ROM) and the memory for operation (RAM) differ according to the GOT.

GOT	Memory	Capacity	Maximum capacity (Option function board with add-on memory mounted)
GT1595-X, GT1585V-S, GT1585-S, GT1575V-S, GT1575-V, GT1565-V, GT1555-V, GT1555-Q, GT1550-Q	Memory for storage (ROM) (Built-in flash memory, included as standard)	9MB	-
	Memory for operation (RAM) (Included as standard)	9MB	57MB (When using the GT15-MESB48M)
GT1575-VN, GT1572-VN, GT1562-VN	Memory for storage (ROM) (Built-in flash memory, included as standard)	5MB	-
	Memory for operation (RAM) (Included as standard)	5MB	53MB (When using the GT15-MESB48M)

If the OS or project data exceeds the maximum capacity of the memory for storage (ROM), the capacity of the ROM can be extended by using a CF card and an option function board with add-on memory (GT15-QFNB□M or GT15-MESB48M).

Example) GT1575-V

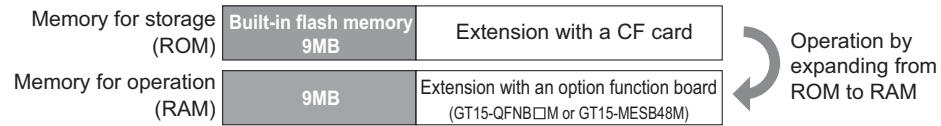

The built-in flash memory corresponds to drive C, and the CF card corresponds to drive A (standard) or drive B (extended).

The memory for operation (RAM) can be extended up to the above capacity by mounting the option function board.

If the amount of data expanded to the memory for operation (RAM) exceeds the above maximum capacity, data must be resized by reducing the project data or deleting the unnecessary OS

The buffering area (F) is an area for storing the resource data such as logging or advanced alarm and uses the memory for operation (RAM). The stored resource data is stored to the specified storage destination (Drive A or Drive B) when saving to a file is specified by GT Designer3. (The memory for storage (ROM) is not used.)

Example) GT1575-V

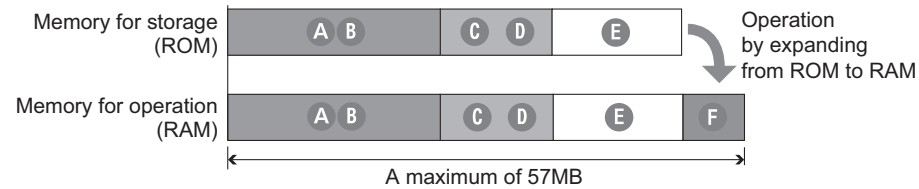

Data type	
(A)	Extended function OS
(B)	Option OS
(C)	Second or later communication driver
(D)	Special data
(E)	Project
(F)	Buffering area

(b) CF card requirement and capacity

Whether the expansion memory-attached option function board or CF card is required or not and the required capacity of expansion memory-attached option function board or CF card vary depending on the data size.

Select whether to use the expansion memory-attached option function board or CF card and their capacity using the following flow chart.

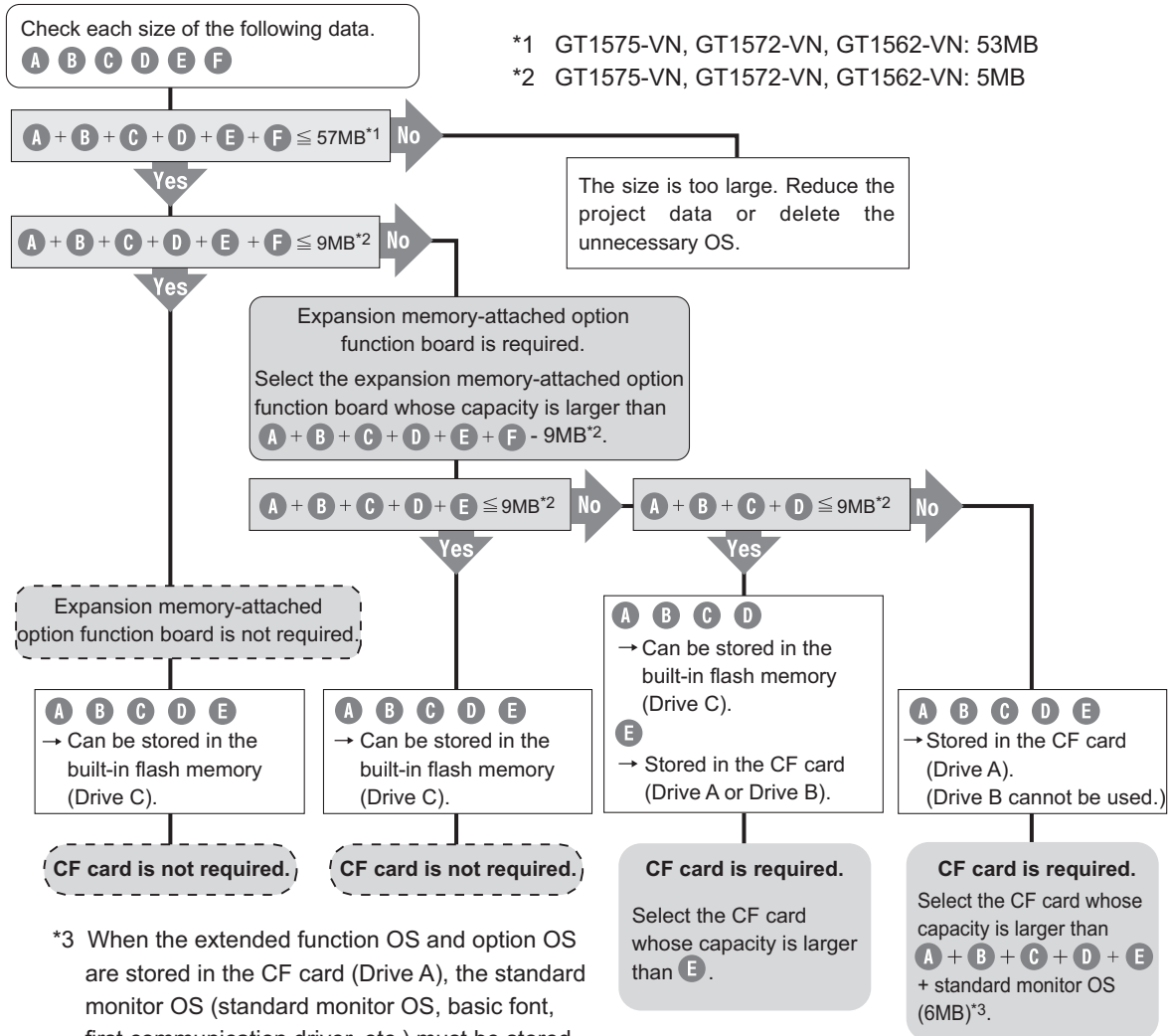



**(3) GT14**

(a) Specifications

The GT14 operates by expanding the OS or project data stored in the memory for storage (ROM) to the memory for operation (RAM).

The capacity of the memory for storage (ROM) and the memory for operation (RAM) differs according to the GOT.

GOT	Memory	Capacity
GT14	Memory for storage (ROM) (Built-in flash memory, included as standard)	9MB (For project data), 5MB (For the extended function and the option OS)
	Memory for operation (RAM) (User memory, included as standard)	9MB (For project data), 20MB (For the extended function and the option OS)

For project data, the memory for storage (ROM) stores 9MB. For the extended function OS and the option OS, the memory for storage (ROM) stores 5MB.

When the capacity of the extended function OS and the option OS exceeds the capacity of the memory for storage (ROM), the ROM capacity can be extended by using a SD card.

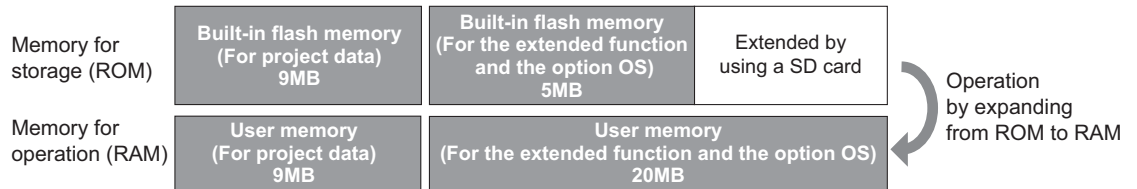

The built-in flash memory uses Drive C, and the SD card uses Drive A (standard).

The memory for operation (RAM) cannot be extended.

If the amount of data expanded in the memory for operation (RAM) exceeds the above maximum capacity, the data must be resized by deleting the unnecessary OS and others.

For the extended function OS and option OS, the compressed data **a** and **b** are stored in the memory for storage (ROM) and the data size becomes larger as shown by **A** and **B** when they are expanded to the memory for operation (RAM).

The buffering area **F** is an area for storing the resource data such as logging or advanced alarm and uses the memory for operation (RAM). The data size varies depending on the setting.

The stored resource data is stored to the specified storage destination (Drive A or Drive D) when saving to a file is specified by GT Designer3. (The memory for storage (ROM) is not used.)

If the amount of data expanded to the memory for operation (RAM) exceeds the above capacity, data must be resized by reducing the project data or deleting the unnecessary OS.

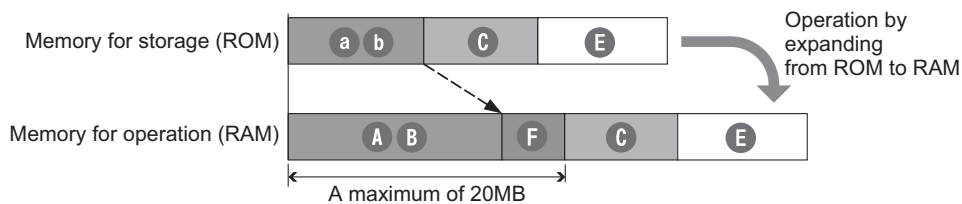

Data type	
<b>a</b>	Extended function OS stored in the ROM
<b>b</b>	Option OS stored in the ROM
<b>A</b>	Extended function OS expanded to the RAM
<b>B</b>	Option OS expanded to the RAM
<b>C</b>	Communication driver
<b>E</b>	Project
<b>F</b>	Buffering area

(b) SD card requirement and capacity

The required capacity of the SD card differs depending on the data size.

Select whether to use the SD card and the capacity of the SD card by using the following flow chart.

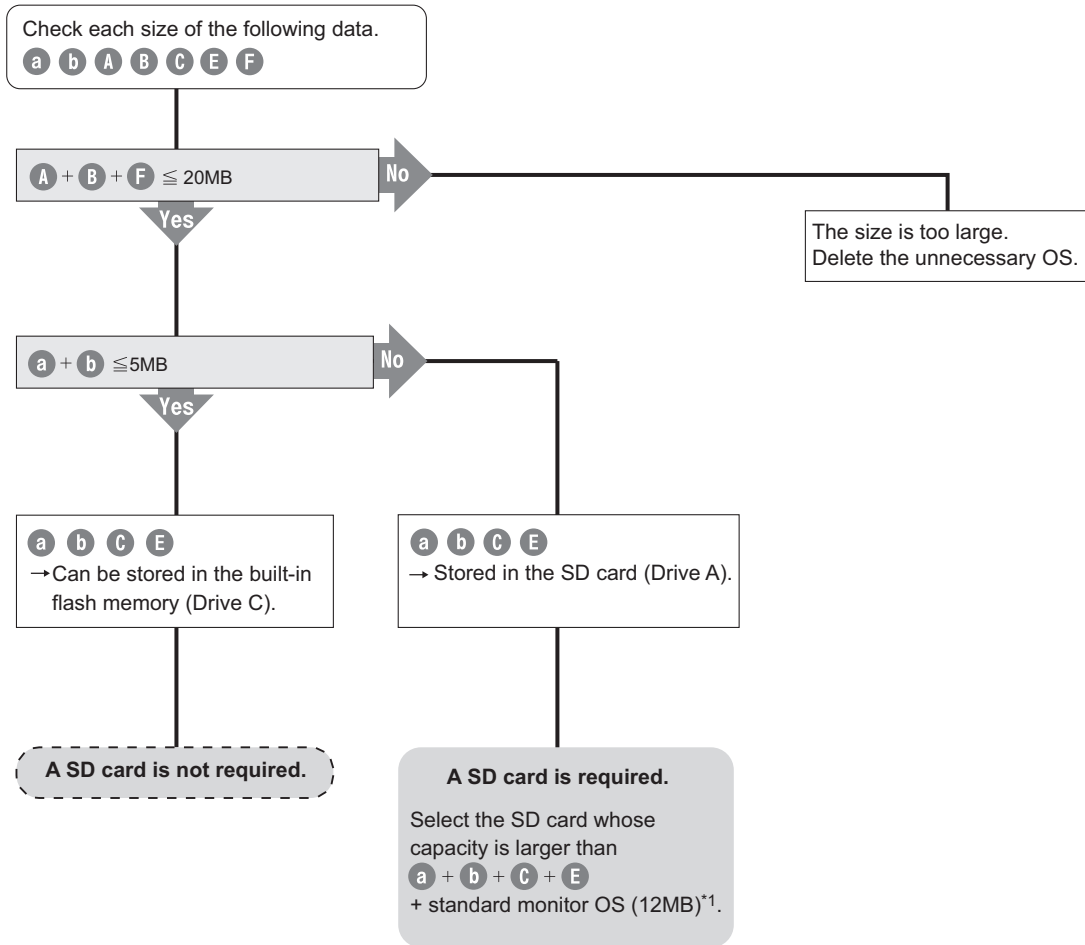

\*1 When the extended function OS and option OS are stored in the SD card (Drive A), the standard monitor OS (including basic font) must be also stored in the SD card (Drive A).

**(4) GT12**

**(a) Specifications**

The GT12 operates by expanding the OS or project data stored in the memory for storage (ROM) to the memory for operation (RAM).

The capacity of the memory for storage (ROM) and the memory for operation (RAM) differs according to the GOT.

GOT	Memory	Capacity
GT12	Memory for storage (ROM) (Built-in flash memory, included as standard)	9MB
	Memory for operation (RAM) (User memory, included as standard)	12MB

The capacity of the memory for storage (ROM) or the CF card available for storing project data is 6MB. The capacity of the memory for storage (ROM) available for storing the project data may be less than 6MB depending on the size of the extended function OS, option OS, and communication driver.

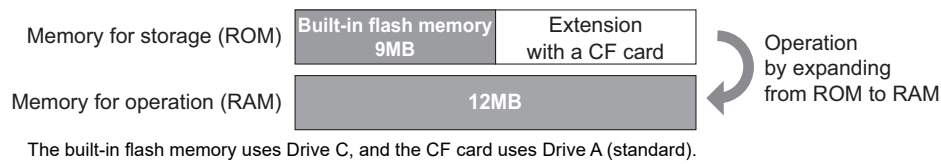

The memory for operation (RAM) cannot be extended.

In the 12MB memory for operation (RAM), 6MB is used for the extended function OS, option OS, and communication driver.

The remaining 6MB is used for the project data and the buffering area.

The buffering area **F** is an area for storing the resource data such as logging or advanced alarm and uses the memory for operation (RAM). The data size varies depending on the setting.

The accumulated resource data is stored in the specified storage destination (Drive A or Drive D) when [File Save] is specified on drawing software. (The memory for storage (ROM) is not used.)

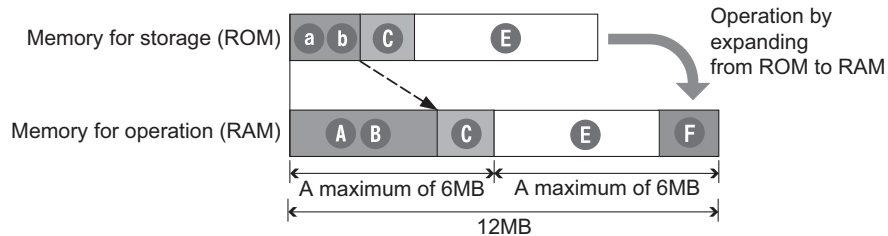

Data type	
<b>a</b>	Extended function OS stored in the ROM
<b>b</b>	Option OS stored in the ROM
<b>A</b>	Extended function OS expanded to the RAM
<b>B</b>	Option OS expanded to the RAM
<b>C</b>	Communication driver
<b>E</b>	Project
<b>F</b>	Buffering area

(b) CF card requirement and capacity

The required capacity of the CF card differs depending on the data size.

Select whether to use the CF card and the capacity of the CF card by using the following flow chart.

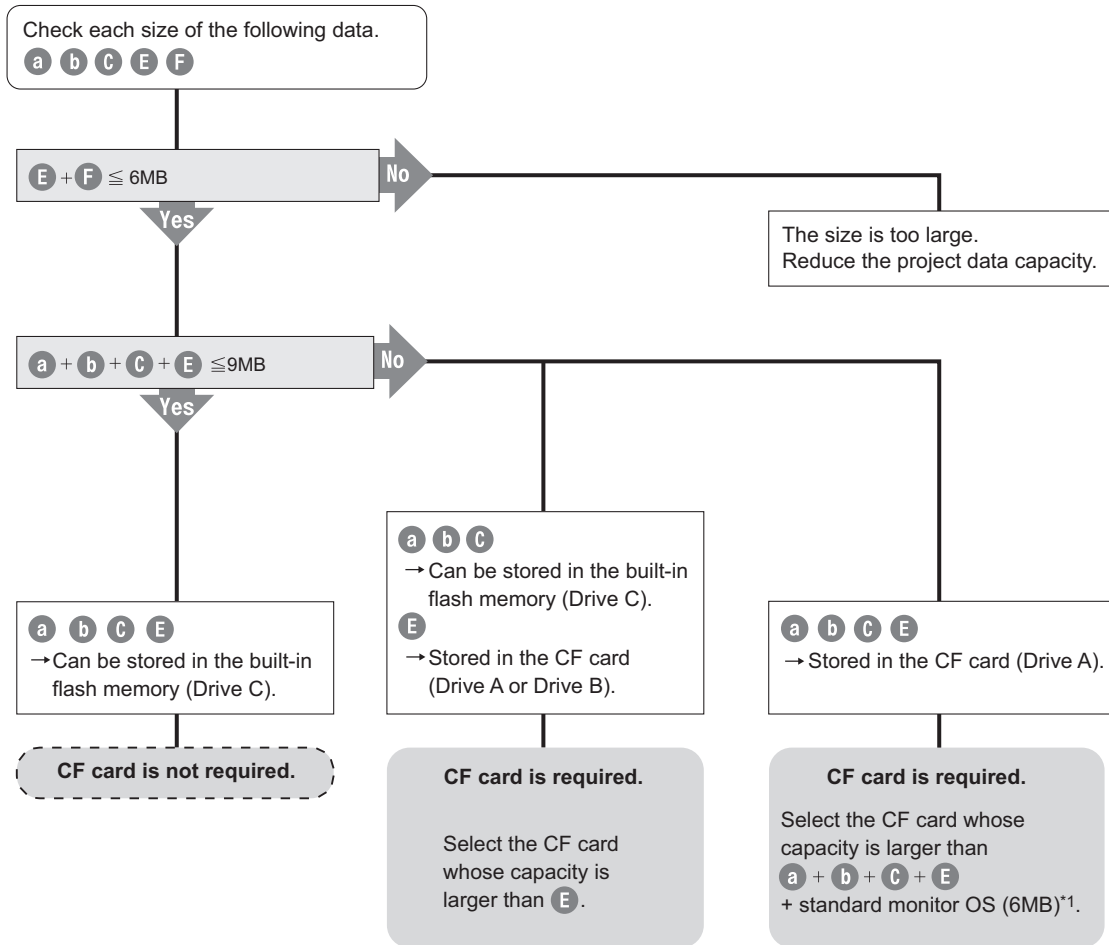

\*1 When the extended function OS and option OS are stored in the CF card (Drive A), the standard monitor OS (including basic font) must be also stored in the CF card (Drive A).

**POINT****Limit to write OS****(1) When the drive of the standard OS in the boot drive is C drive**

Even when the option function board with add-on memory is mounted to the GOT, the total volume of the Communication driver (the second or later one for the GT15), Extended function OS, and Option OS cannot exceed the user area capacity in the C drive.

**(2) When the drive of the standard OS in the boot drive is A drive****(a) GT16**

Since the memory for operation (RAM) is included as standard, the total volume of the Communication driver, Extended function OS, Option OS, project data, special data, and etc. can be up to the max. total capacity.

- Max. RAM capacity

Target models	Max. capacity
GT1695M-X, GT1685M-S, GT1675M-S, GT1675M-V, GT1665M-S, GT1665M-V, GT1655-V, GT16 Handy GOT	57MB
GT1675-VN, GT1672-VN, GT1662-VN	53MB

For details about the capacities of the memory for operation (RAM), refer to the following.

 [GT16 User's Manual \(Hardware\)](#)

**(b) GT15**

When the option function board with add-on memory is mounted to the GOT, the total volume of the second or later Communication driver, Extended function OS, Option OS, project data, special data, and etc. can be up to the max. total capacity when the option function board with add-on memory is used.

- Max. total capacity when option function board with add-on memory is used.

Target models	Max. total capacity
GT1595-X, GT1585V-S, GT1585-S, GT1575V-S, GT1575-V, GT1565-V, GT1555-V, GT1555-Q, GT1550-Q	57MB
GT1575-VN, GT1572-VN, GT1562-VN	53MB

For details about the types and capacities of the option function boards with add-on memory, refer to the following.

 [GT15 User's Manual](#)

**(c) GT14**

The total capacity of the extended function OS and the option OS is up to 20MB of the memory for operation (RAM).

**(d) GT12**

The total capacity of project data is up to 6MB of the memory for operation (RAM).

## ■ When adding a new screen or setting data to the project data in the GOT

Compare the size of the new screen or setting data to be added with the free space of the transfer destination drive.

When transferring the modified existing screen, check them referring to the following.

 ■Newly transferring data to the GOT

Refer to the following section for the size of the new screen or setting data to be added.

 ■Checking project data size to be written (2) Checking the project data size at the time of transfer

Refer to the following section for the free space of the transfer destination drive.

 ■Checking the free space in the user area of the transfer destination

- (1) When the size of the new screen or setting data to be added is less than the free space of the transfer destination drive, the project data can be transferred.
- (2) When the size of the new screen or setting data to be added is greater than the free space of the transfer destination drive, all project data cannot be transferred.  
Reexamine the project data contents and reduce the data size.  
When the project data is written in Drive C on the GT16, GT15, GT14, or GT12, write the data to Drive A (A:Standard Memory Card).

### POINT

**When free space of transfer destination drive is sufficient but the insufficient space message appears**

Select [Write after deleting all contents in the project folder] to write all project data.

If the project data backup is required, write the project data to a personal computer, memory card, or USB memory before writing the project data to the GOT.

## ■ Checking project data size to be written

The project data size can be checked in either of the following methods.

### (1) Check the project data size in advance.

Select [Tools] → [Data Size] → [Project] from the menu to display the [Data Size (Project)] dialog box. Then, check the size.

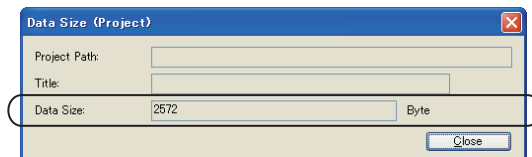

Item	Description
Project Path	Displays the storage destination and file name of the project data in the PC. The path is not displayed when the data has never been saved.
Title	Displays the Project Title. The title is not displayed when no Project Title is specified.
Data Size	Displays the data size of the project.

**(2) Checking the project data size at the time of transfer**

Capacity of each data can be checked in the [GOT Write] tab of the [Communicate with GOT] dialog box or the [Memory Card Write] tab of the [Communicate with Memory Card] dialog box.

For details of each dialog box, refer to the following.

- [Communicate with GOT] dialog box

☞ 8.1.4 Writing and installing on GOT

- [Communicate with Memory Card] dialog box

☞ 8.2.1 Transferring project data, OS, and special data to memory card or USB memory

Select [Project Data] of [Write Data] on the [GOT Write] tab of the [Communicate with GOT] dialog box

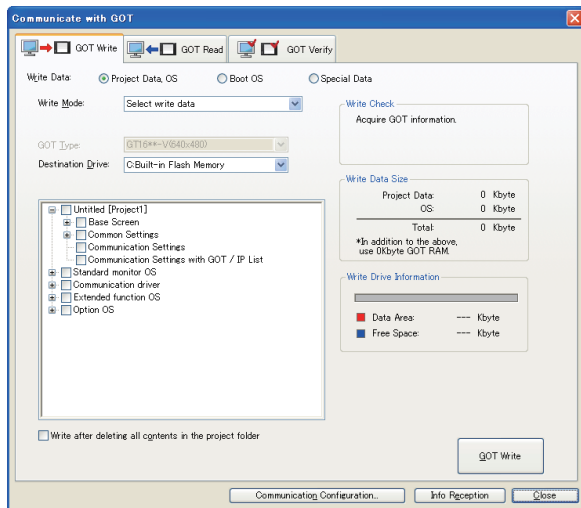

Select [Project Data, OS, Special Data] of [Write Data] on the [Memory Card Write] tab of the [Communicate with Memory Card] dialog box.

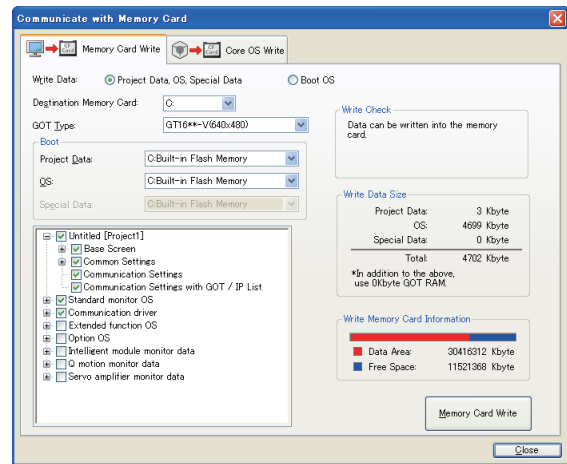

**■ Checking the free space in the user area of the transfer destination**

The free space in the user area of the transfer destination can be checked in the [GOT Read] tab of the [Communicate with GOT] dialog box.

To check it, connect the GOT and the personal computer with the USB cable, RS-232 cable, or Ethernet communication unit or cable.

For details, refer to the following.

☞ 8.1.5 ■ Reading drive information(GOT to personal computer)

8.1.1 Connecting personal computer and GOT with cable

User's Manual for the GOT used

Select [Drive Information] of [Read Data] on the [GOT Read] tab of the [Communicate with GOT] dialog box

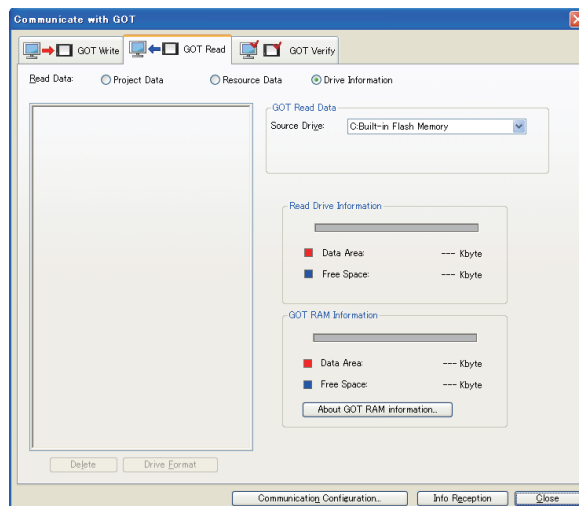

## 8.6 Error Messages Displayed at Data Transfer

If some error occurs when the data is transferred, check the following items.

When the error still occurs after the following items are checked, please consult the nearest sales office or FA Center, and then explain the details of your problem.

### ■ Communication settings

Error No.	Error message	Error definition and cause	Corrective action
-	Invalid communication port is using.	The communication port has not been set.	In [Port No.] of [Communication Configuration], set the port to which the communication cable for the GOT is connected.

### ■ Drive information

Error No.	Error message	Error definition and cause	Corrective action
-	The deleting items is not selected.	The deleting items is not selected.	Select the item to be deleted and reexecute the deletion.

### ■ Boot OS installation → GOT

Error No.	Error message	Error definition and cause	Corrective action
00000132	OS version that is older than the one written in GOT cannot be written. The Boot OS version of GOT: AA The Boot OS version to be written: BB	Boot OS older than the one in the GOT cannot be installed.	Upgrade GT Designer3.
00000133	GOT Type error occurred.	The set [GOT Type] is different from the actual GOT.	Execute the installation again, after selecting the [GOT Type] that is the same as the actual GOT.

### ■ OS installation → GOT

Error No.	Error message	Error definition and cause	Corrective action
00000133	GOT Type error occurred.	The set [GOT Type] is different from the actual GOT.	Execute the installation again, after selecting the [GOT Type] that is the same as the actual GOT.
801f4102	The Standard monitor OS cannot be written in this GOT H/W version. Use the appropriate version of GT Designer3.	The Standard monitor OS of the currently used software cannot be installed, as it is too old and incompatible with the GOT H/W version.	Upgrade GT Designer3.
801f4107	GOT Memory dose not have enough space	The OS cannot be installed as the installation destination drive does not have enough free space.	Select [Drive Information] of [Read Data] in the [GOT Read] tab, and then click the [Info Reception] button to check the GOT information written to the GOT. Delete the functions and data written to the GOT, and install the OS again.
-	The writing items is not selected.	Item to be installed is not selected.	Selecting the target item and execute the installation again.



## ■ Project write → GOT

Error No.	Error message	Error definition and cause	Corrective action
00000133	GOT type error occurred.	The set [GOT Type] is different from the actual GOT.	Execute the write again, after selecting the [GOT Type] that is the same as the GOT.
00000136	The OS version of the current software and the one of the GOT are different. The OS version of GOT: xx The OS version of the software: xx The project data/special data cannot be written if OS versions are different. *OS write cannot be performed via Modem. Perform OS write via Standard CF Card or USB/RS232/Ethernet.	The OS version of the GT Designer3 where the project data was created and the OS version written in the GOT differ.	<ul style="list-style-type: none"> <li>When the project data is written via modem, install the OS of the latest version on the GOT, and then write the project data.</li> <li>Write the project data via USB, RS232, or Ethernet.</li> </ul> When the project data is written via modem, the OS is not installed simultaneously.
801f4107	The possible causes are shown below. <ul style="list-style-type: none"> <li>Memory does not have enough space.</li> <li>Memory card formatted in unsupported form is inserted.</li> </ul>	The project cannot be written as the write destination drive does not have enough free space. When a drive other than Drive C is selected, the GOT does not support the memory card form.	Select [Drive Information] of [Read Data] in the [GOT Read] tab, and then click the [Info Reception] button to check the GOT information written to the GOT. Delete the functions and data written to the GOT, and write the project again. When [C:Built-in Flash Memory] is specified as the write destination on the GT16, GT15, GT14, or GT12, and the memory card is installed in the GOT, the project data write destination can be changed to [A:Standard CF Card] ([A:Standard SD Card] for the GT14).
-	GOT does not operate properly due to the capacity shortage of GOT RAM. Take one of the following measures. <ul style="list-style-type: none"> <li>Increase expansion memory</li> <li>Reduce the project data size</li> <li>Delete unnecessary special data</li> <li>Adjust the buffering area size</li> <li>Delete unnecessary OS data</li> </ul> Would you like to proceed with the writing of the project, special data, and OS?	Though the write destination drive has enough space, the built-in memory and add-on memory of the GOT do not have enough space. Therefore, the written project may not operate correctly.	Adjust the project data size or buffering size (Advanced Alarm). Alternatively, change the add-on memory board for the one with larger capacity.
801f42c5	Communication error Consider the following cause. <ul style="list-style-type: none"> <li>The communication port settings are incorrect.</li> <li>The cable is disconnected or broken.</li> <li>The GOT is Powered OFF.</li> <li>The communication setting of each controller is incorrect.</li> <li>Dialog Window is displayed in GOT.</li> </ul>	The data transfer/utility password is set for the project data in the GOT by using GT Designer3 Version 1.43V or later. When the version of GT Designer3 is earlier than the above version, the password security cannot be removed. Therefore, the project data cannot be written.	Write the project data in the GOT by using the latest version of GT Designer3.

## ■ Project read → Personal computer

Error No.	Error message	Error definition and cause	Corrective action
801f4101	The password is incorrect. Enter the password again.	The entered password is not correct.	Execute the read after entering a correct password.
-	The destination to read is invalid. Set the destination again.	The specified drive, folder or file name is incorrect.	Check if the specified drive, folder name or file name is applicable to the following. <ul style="list-style-type: none"> <li>Check if the specified drive exists.</li> <li>Check if reserved words are used for the folder or file name.</li> <li>Check if incorrect characters are used in the folder or file name.</li> </ul>

## ■ Verify



Error No.	Error message	Error definition and cause	Corrective action
00000133	GOT Type error occurred.	The GOT type of the target project data is inconsistent with the type of the GOT.	Check the GOT type of the project data to be verified.
00000137	The OS written in GOT does not support the verification feature.	The OS installed on the GOT does not support the verification function.	Save the project data in the GOT and reinstall the Standard Monitor OS from GT Designer3.
-	The destination to read is invalid. Set the destination again.	The specified drive, folder name or file name is incorrect.	Check if the specified drive, folder name or file name is applicable to the following. <ul style="list-style-type: none"> <li>• Check if the specified drive exists.</li> <li>• Check if reserved words are used for the folder or file name.</li> <li>• Check if incorrect characters are used in the folder or file name.</li> </ul>
801f4101	GOT information cannot be acquired due to an incorrect password entry. Enter the password again.	The entered password is not correct.	Execute the verification again after entering a correct password.

## ■ Communication

For the precautions of using USB cables and the personal computer settings, refer to the following.

### 8.1.1 Connecting personal computer and GOT with cable

Error No.	Error message	Error definition and cause	Corrective action
00000134	Standard monitor OS is not written. Write Standard monitor OS.	As only the Boot OS is installed on the GOT, communication cannot be made for the purpose other than the OS installation	Install the Standard monitor OS by performing OS installation.
00000135	Communication error occurred. The possible causes are shown below. (1) The GOT is in processing. Wait for 60 seconds and retry. (2) GOT Type does not match Check if connected GOT Type matches. (3) Connection setting does not match. Check if the communication setting of each controller matches.	Communication fails due to one of the following causes. (1) Communication fails because GOT is busy. (2) There is inconsistency in the GOT type. (3) The modem setting is incorrect.	(1) It takes 60 seconds until the GOT completes the process. Wait for 60 seconds before starting communication again. If communication with the GOT fails even after 60 seconds, check the state of the GOT. (2) Check if the type of the connected GOT is correct. (3) Check if the modem setting is set correctly.
80110003	Please check Port NO.	The communication port settings are incorrect.	In [Port No.] of [Communication Configuration], set the port to which the communication cable for the GOT is connected.
80110004	Time out error	The cable is disconnected or broken.	• Check if the cable is connected correctly.
		The GOT does not respond.	• Check if the GOT is powered on. • Using the GOT utility perform the I/O check. • When the USB cable is used, disconnect it from the GOT for more than 5 seconds. • When the USB cable is used, power the GOT off and then on again.
		A communication error has occurred as the communication with the GOT is instable.	For RS-232 communication, change [Baud Rate] of [Communication Configuration] to a value lower than the currently set one.
80110006	The GOT is being accessed by another application.	Communication is disabled as the GOT is communicating with another application.	Check whether the GOT is communicating with another application. When GX Developer is used, check whether the GX Developer monitor screen is open. If open, close the monitor screen or stop monitoring.

Error No.	Error message	Error definition and cause	Corrective action
80110007	Quality of communication signal error. Please check communication settings.	A communication error has occurred as the communication with the GOT is instable.	For RS-232 communication, change [Baud Rate] of [Communication Configuration] to a value lower than the currently set one.
80110008	Please check Baud rate.	The baudrate settings are incorrect.	Set [Baud Rate] of [Communication Configuration] again.
80110009	Send error.	Data cannot be sent to the GOT.	<ul style="list-style-type: none"> <li>When the USB cable is used, disconnect it from the GOT for more than 5 seconds.</li> <li>Cycle the GOT power.</li> </ul>
8011000a 80111101 80112202 80112005 80112208 801f4100	Communication error Consider the following cause. <ul style="list-style-type: none"> <li>The communication port settings are incorrect.</li> <li>The cable is disconnected or broken.</li> <li>The GOT is Powered OFF.</li> <li>The communication setting of each controller is incorrect.</li> <li>Dialog Window is displayed in GOT.</li> </ul>	Communication is disabled as the GOT is processing.	Refer to The communication error that may occur when the PLC is not connected to the GOT <sup>1</sup> .
		The cable is disconnected or broken.	<ul style="list-style-type: none"> <li>Check the communication port.</li> <li>Check if the cable is connected correctly.</li> </ul>
		The GOT does not respond.	<ul style="list-style-type: none"> <li>Check if the GOT is powered on.</li> <li>Using the GOT utility perform the I/O check.</li> </ul>
		When the GOT is connected via a modem, GOT Modem Connection Tool is not active.	<ul style="list-style-type: none"> <li>Start GOT Modem Connection Tool, and then establish the communication between the personal computer and the modem.</li> </ul>
		Communication fails because the dialog window is displayed on the GOT.	<ul style="list-style-type: none"> <li>Close the dialog window on the GOT.</li> </ul>
		The USB cable is disconnected or broken while communicating.	<ul style="list-style-type: none"> <li>Check if the USB cable is connected correctly.</li> </ul>
		The memory card has a large amount of resource data.	<p>Read the resource data by either of the following methods.</p> <p>After reading the resource data, delete the data from the memory card.</p> <ul style="list-style-type: none"> <li>Read the resource data from the memory card using a personal computer or others.</li> <li>Copy the resource data to a USB memory, and read the resource data from the USB memory using a personal computer or others. (GT16 only)</li> </ul> <p> GT16 User's Manual (Basic Utility)</p> <ul style="list-style-type: none"> <li>Use the FTP server function to read the resource data from the memory card installed in the GOT. (GT16 and GT15 only)</li> </ul> <p> GOT1000 Series Gateway Functions Manual for GT Works3</p> <ul style="list-style-type: none"> <li>Format the memory card.</li> </ul>
The memory card is faulty.	The memory card has failed or reached its end of life. Replace the memory card as necessary.		
-	The following Drive is not inserted. X:XXXXXX Please check the installation of Drive.	The specified drive is inaccessible.	Check whether the specified drive has been set.
80112401	Unable to communicate with GOT via Ethernet. The possible causes are shown below. (1) Standard monitor OS is not written in the GOT (2) The Standard monitor OS does not support Ethernet Download function (3) The GOT is not turned on (4) Communication Settings are not properly set (5) GOT IP address is not properly set (6) Incorrect wiring *OS write cannot be performed via Ethernet/Modem. Perform OS write via Standard CF Card or USB/RS232/Ethernet.	Communication between the GOT and Ethernet fails due to one of the following causes. (1) The Standard Monitor OS is not installed on the GOT. (2) The Standard Monitor OS of the GOT does not support the Ethernet download function. (3) The GOT is not turned on. (4) Communication Settings include a fault. (5) The IP address of the GOT is incorrect. (6) Wiring is incorrect.	Check the following. (1) Check if the Standard Monitor OS is installed on the GOT. (2) Check if the Standard Monitor OS of the GOT supports the Ethernet download function. (3) Check if the GOT is turned on. (4) Check if the Communication Settings are correct. (5) Check if the IP address of the GOT is correct. (6) Check if wiring is correct.

Error No.	Error message	Error definition and cause	Corrective action
80112402	Unable to communicate with GOT via Ethernet. The possible causes are shown below. (1) The GOT is communicating with another computer (2) GOT IP address is not properly set (3) GOT Port No. is not properly set	Communication fails because the GOT is communicating with another PC or the specified IP address of the GOT indicates a network device other than the GOT. Communication fails because the GOT port number is incorrect.	Check if the GOT communicates with another PC or if the specified IP address of the GOT indicates a network device other than the GOT. Enter the correct downloading port number where the GOT is connected.
80112405	Please check if both GOT and PC are properly connected together via Ethernet.	Communication fails because the GOT is not connected to the network correctly.	Check if the GOT is connected with the network correctly.
80112406	Unable to communicate with GOT via Ethernet. The possible causes are shown below. (1) The GOT is communicating via USB/RS232/Modem (2) The GOT is not turned on	Communication fails because the GOT is communicating via USB, RS232, or modem, or because the GOT is turned off.	Establish communication via Ethernet, or turn on the GOT.
801f42c4	GOT restricts the communication with Ethernet. Unable to communicate with GOT via Ethernet.	Communication via Ethernet fails because the GOT restricts the communication via Ethernet.	Establish communication by either of the following methods. <ul style="list-style-type: none"> <li>• Enable communication of the GOT with Ethernet.(GS454)</li> </ul>  Appendix.2.3 GOT special register (GS) <ul style="list-style-type: none"> <li>• Establish communication by other method than Ethernet.</li> </ul>

#### **\*1 The communication error that may occur when the PLC is not connected to the GOT**

If the GOT and PLC are not yet connected while the settings of the connection with the PLC have been made on the GOT, the GOT performs retry communication processing as it cannot communicate with the PLC. If any of the following operations is performed from GT Designer3 in this status, a communication error may occur (error No.: 8011000a).

- OS installation
- Project data write
- OS, project data or resource data deletion
- Drive formatting

In this case, take any of the following corrective actions.

#### **(1) Using the utility, set the interface to be connected with the PLC as described below, and perform the operation again from GT Designer3.**

- When connecting the GOT and PLC via the RS-232 interface  
Change the CH No. of the standard interface RS-232 in [Communication setting] of the utility from "1" to "0" or from "1" to "9".
- When connecting the GOT and PLC via bus type connection (GT16, GT15, and GT11 Bus)  
Change the CH No. of the extension interface in [Communication setting] of the utility from "1" to "0".
- When connecting the GOT and PLC via the RS-422 interface (GT16, GT11)  
Change the CH No. of the standard interface RS-422 in [Communication setting] of the utility from "1" to "0".  
When making a communication between the GOT and PLC after connecting with the PLC, return the changed Communication Settings to "1".

#### **(2) Perform the installation by pressing two points on the GOT or using the utility function.**

OS deletion cannot be made by the utility function.

- OS installation or project data write  
Install the OS or write the project data by pressing two points on the GOT, or from [Data control] of the utility.
- Project data/resource data deletion, drive formatting  
Delete project data/resource data or format a drive from [Data control] of the utility.

Refer to the following manual for the utility operation.

 User's Manual for the GOT used

Refer to the following section for installation by pressing two points on the GOT.

 8.2.1 Transferring project data, OS, and special data to memory card or USB memory

## ■ Transfer to memory card (Memory card write)

Error No.	Error message	Error definition and cause	Corrective action
000000c9	Create Folder Error.	The drive in which the memory card is set has not been specified.	Select the drive in which the memory card is set.
		The memory card is write-protected.	Enable the memory card to be written.
-	OS is not selected for Installing.	OS is not selected for Installing.	Select the OS to be installed.



# USEFUL FUNCTIONS

---





# 9. USEFUL FUNCTIONS FOR DRAWING

This chapter explains the useful editing functions of GT Designer3.

## 9.1 Utilizing Other Project Data



It is possible to import a project (source project) into the project being edited (destination project). This function is effective when utilizing multiple project data. Project data from GOT-900 series cannot be utilized.

### ■ How to import data

1. Select [Project] → [Utilize Project] from the menu.
2. The [Utilize Project] dialog box appears. Click the [Browse] button.

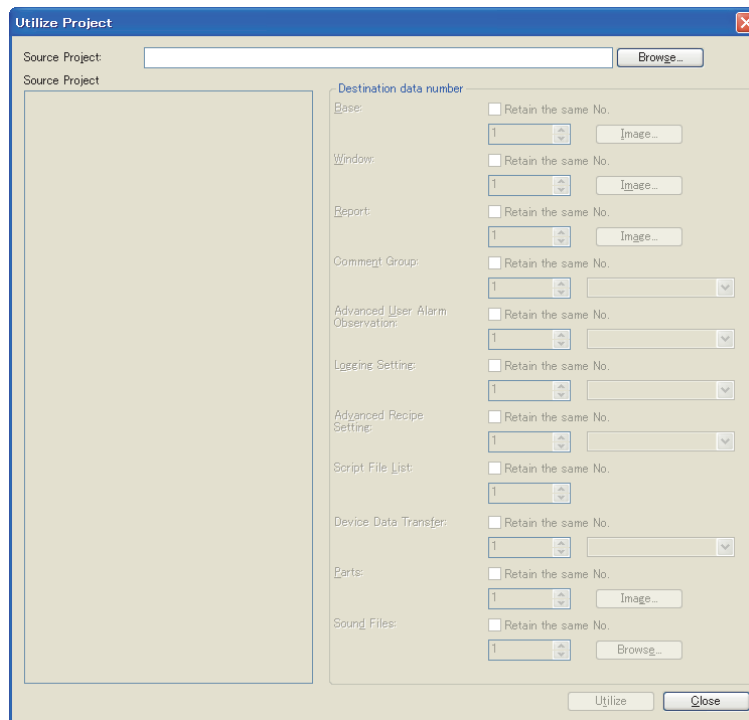

## HINT

### (1) Project specification by direct input

The project can be specified by inputting the path directly in the [Source Project] field.

Source Project: D:\TANK.GTE

### (2) Dialog boxes to be closed before opening other project

Close the [GOT Environmental Setting] dialog box and the [Controller Setting] dialog box before opening other projects.

If the dialog boxes above are opened, the [GOT Environmental Setting] and [Controller Setting] cannot be imported.

(They are not displayed on the [Source Project] tree.)

### 3. The [Select Project] dialog box appears. Select the project to be imported.

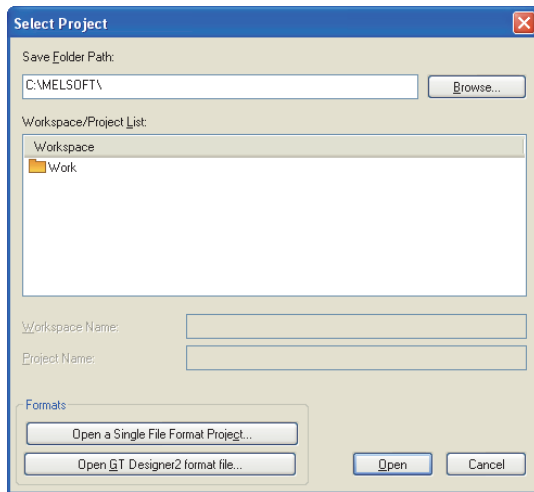

For GT Designer3 project

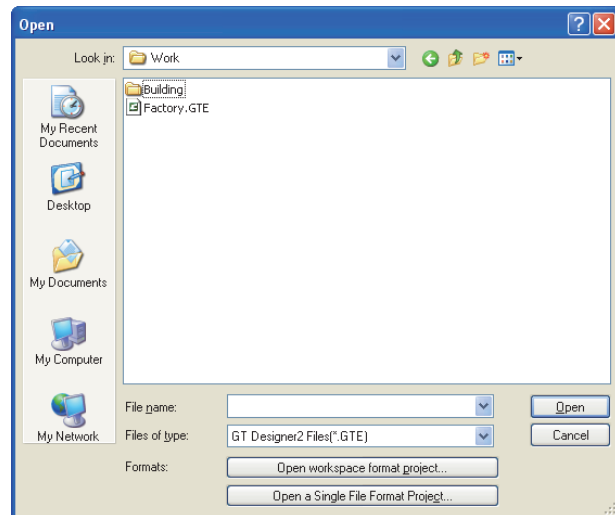

For a single file format project file (\*.GTW)/GT Designer2 format file (\*.GTE)

4. When security is set for the project to be imported, the following dialog box appears. Input the user name and password for the authentication.

3.14 Securing Project

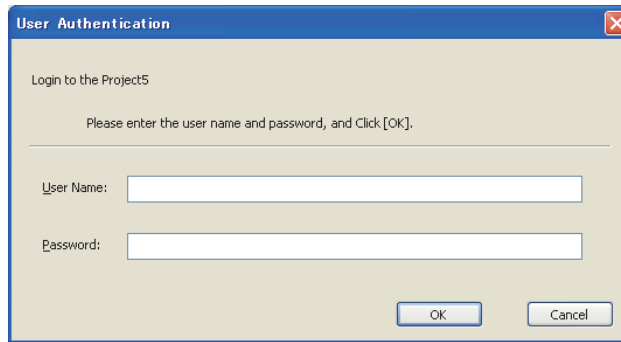

5. Refer to the following to set the [Source Project] and [Destination data number].

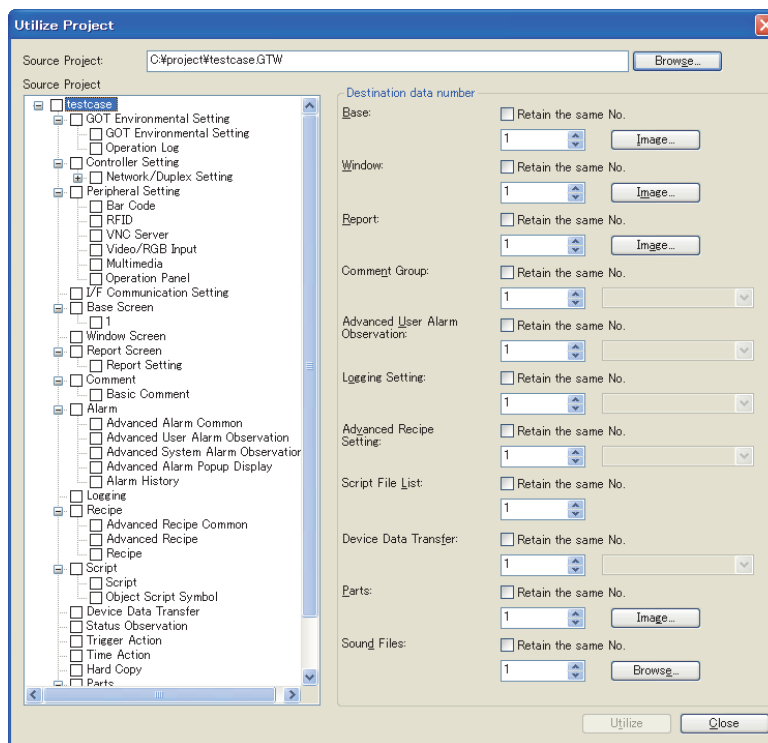

Item	Description	Model	
Source Project	Displays the items to be imported from other projects in a tree. Select the checkbox of the item to be imported.		
Destination data number	Set the numbers that are assigned to the screens and settings imported from other projects. When the numbers are assigned to multiple screens and settings, the set number becomes the first number, and the subsequent numbers are set in the selected intervals. (☞ ■Precautions)		
	Base	Set a new screen number for the imported screen.	
	Window	For using the same screen number used in the previous project, select the [Retain the same No.] item. Click the [Image] button to display a list of the existing screens.	
	Report	When overwriting existing screens, select the screen to be overwritten. When not overwriting screens, click the [Cancel] button and specify a new screen number.	

(Continued to next page)

Item	Description	Model
Destination data number	Commnet Group	gr16 gr15 gr14 gr12 gr11 gr10 SoftGOT1000
	Advanced User Alarm Observation	gr16 gr15 gr14 gr12 gr11 gr10 SoftGOT1000
	Logging Setting	
	Advanced Recipe Setting	gr16 gr15 gr14 gr12 gr11 gr10 SoftGOT1000
	Script File List	gr16 gr15 gr14 gr12 gr11 gr10 SoftGOT1000
	Device Data Tansfer	gr16 gr15 gr14 gr12 gr11 gr10 SoftGOT1000
	Parts	gr16 gr15 gr14 gr12 gr11 gr10 SoftGOT1000
Sound Files	gr16 gr15 gr14 gr12 gr11 gr10 SoftGOT1000	

6. Click the [Utilize] button to start importing the data.  
 When the GOT types of the source project and destination project are different, the following dialog box appears. (☞ ■Precautions)  
 Click the [Yes] button to continue, or the [No] button to cancel the process.

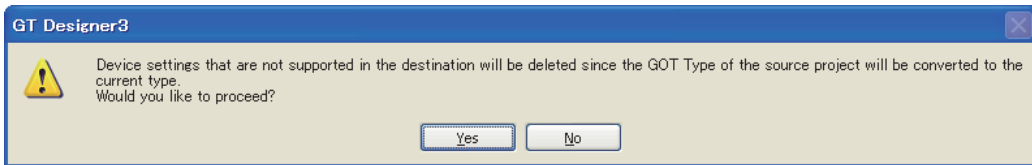

7. When the process is continued, a confirmation dialog box for overwrite appears for each item imported. Confirm the contents of the dialog box, and select whether to overwrite or not.

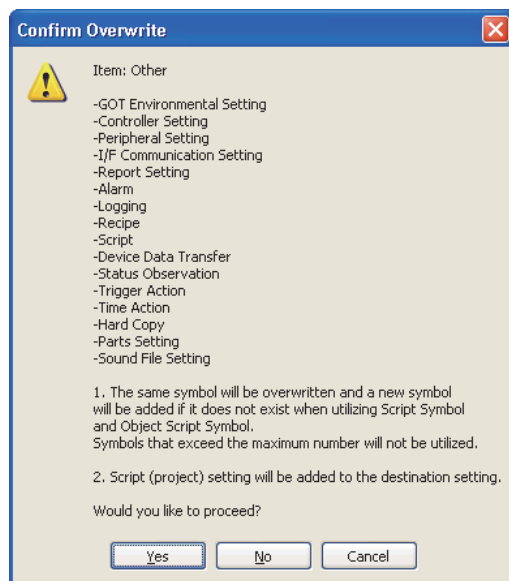

Example: When settings such as [GOT Environmental Setting] are imported.

8. Control returns to the [Utilize Project] dialog box. Click the [Close] button to complete the import. After the import, check the imported data and the relevant settings.

## ■ Precautions

### (1) If the GOT type or controller set for the source project differs from that set for the destination project

- (a) If the GOT type set for the source project differs from that for the destination project, the GOT type of the imported data is changed to the one set for the destination project.  
With this import, some functions may be deleted due to the GOT type incompatibility.
- (b) If the controller set for the source project differs from that for the destination project, the controller of the imported data is changed to the one set for the destination project.  
When the controller setting is changed, depending on the combination of the controllers set in the source and destination projects, the device setting is changed as shown below.
- The device names are changed to the corresponding device names set for the changed controller setting.
  - When the devices are invalid for the controller set in the destination project (For example, the types of the devices are nonexistent, and the devices are outside the setting range.), the devices are displayed as [??].
  - When there is "I/F" that is invalid for the controller set in the destination project, [I/F] and [Driver] of the controller setting in the destination project are displayed as [Not connected].

When the controller setting is changed, check and set the devices again.



### How to avoid the device deletion

The devices to be deleted after the data import, described in (b) above, can be held by executing the following operations.

1. Change [Controller Setting] for the source project to the one for the destination project.
2. The incompatible devices are converted to ??.  
Check the objects converted to ?? in the device list, and set the devices again.
3. Save the modified source project. Then, open the destination project and execute [Utilize Project].

## (2) Importing screens with script set

- (a) When importing screens, the set script is imported simultaneously.  
The imported script is added to the last in the script list in the destination data.  
According to this, the settings of scripts set to the imported screens are changed in conjunction.
- (b) When importing screens, all script symbols are imported.  
If script symbols with the same name already exists, they are overwritten. If no script symbol with the same name exists, the imported ones are added.
- (c) When [Script] is selected in the source data tree, all scripts are imported.  
The imported script is added to the last in the script list in the destination data.

## (3) Importing categories

When the object data is imported to the project in which the corresponding category is not set, the object is registered within the [None] category, even if the category is set in the source project.  
To set the category, create the same category within the destination project in advance, or set the category after the data import.

Example: When the source project has the [Go To Screen Switch] category

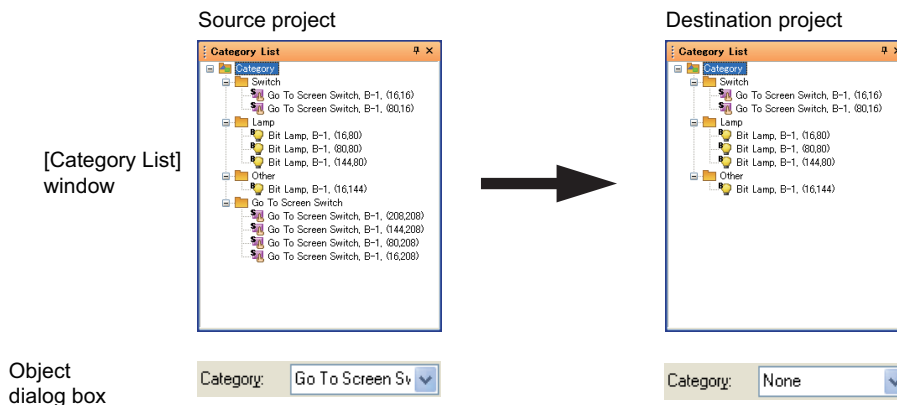

## (4) Importing status observation set to the screen

Status observation set to screens cannot be imported from [Status Observation] of the source project tree.  
To import the status observation set to a screen, import the screen where the status observation is set.  
The status observation is imported simultaneously with the screen.



**(8) Project security with restriction**

The project security restricts importing another project.

 3.14 Securing Project

- (a) When the project security is set in the source project  
GT Designer3 cannot import a screen (display disabled).
- (b) When the project security is set in the destination project  
When the security for a project disables editing the project, the project cannot import another project.  
A screen (edit disabled) cannot be overwritten.  
When a screen (write protected) exists, importing another project is canceled.



## 9.2 Referring to Device Comment (Importing GX Developer Device Comment)



The device comment and the device name created on GX Developer can be checked when setting devices on GT Designer3.

Since devices can be set on GT Designer3 while checking the devices used for the PLC program, errors in the device number setting can be prevented.

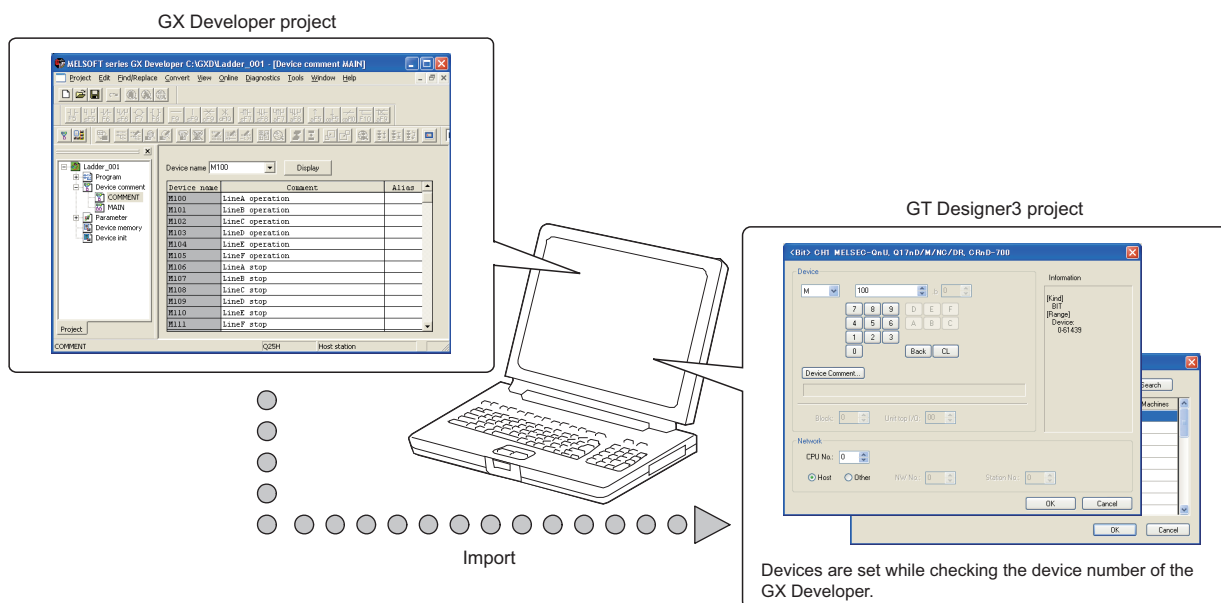

### POINT

- (1) **PLC types available for the device comment check**  
The device comments of GX Developer can be checked only when any of the MITSUBISHI ELECTRIC PLCs is selected for [Controller Type] in the controller setting.
- (2) **Referring to device comments with iQ Works**  
When starting GT Designer3 from MELSOFT Navigator, this function is not available.  
To refer to device comments, start GT Designer3 (not from MELSOFT Navigator).

## ■ Importing the device comments

To refer to devices on GT Designer3, import the device comments of GX Developer with GT Designer3.

1. Select [Project] → [Import GX Developer Device Comment] from the menu.
2. The [Import GX Developer Device Comment] dialog box appears. Specify the device comment file in the project of GX Developer.  
Click the [Delete] button on the [Import GX Developer Device Comment] dialog box to delete the path of the currently specified device comment data.

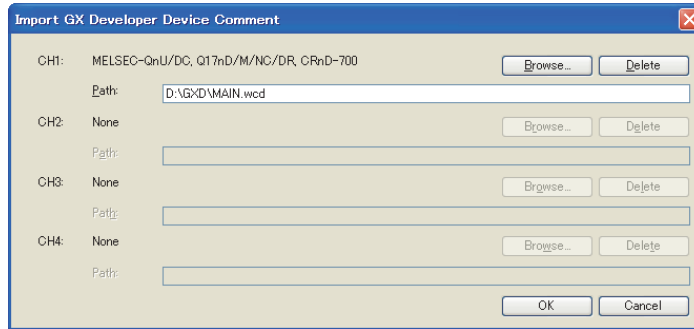

3. Click the [OK] button to complete the import of device comments.

### POINT

#### (1) Device comment data storage destination

The device comment data (\*.wcd) of GX Developer are created in the project data of GX Developer.

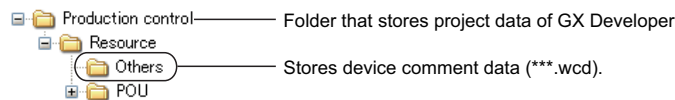

#### (2) GX Developer data used for this function

Only the device comment data (\*.wcd) of the GX Developer is required for this function.  
Other project data of the GX Developer is not required.

#### (3) Modification of device comment on the GX Developer

If the device comment data (\*.wcd) once specified is edited on the GX Developer, it is not updated on GT Designer3.

To update the edition, specify the device comment data (\*.wcd) again.

#### (4) Specified path

The path is stored after the GT Designer3 is completed.

#### (5) Importing a comment from GX Works2 project data

Save the project data containing the comment to be imported in GX Developer format.

The comment cannot be imported from GX Works2 project data.

For how to save GX Works2 project data in GX Developer format, refer to the following.

 GX Works2 Version1 Operating Manual (Common)

## ■ Check method of device comment

The following shows the checking method of device comments.

1. Click the [Device Comment] button in the device settings dialog box of each project.

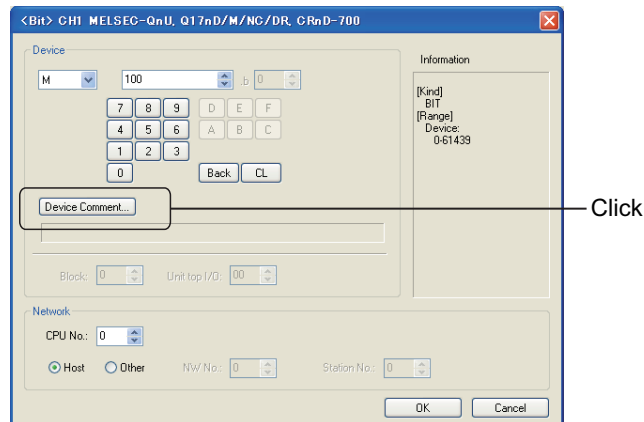

2. The [Device Comment] dialog box appears. A device can be set while checking the Device comment.

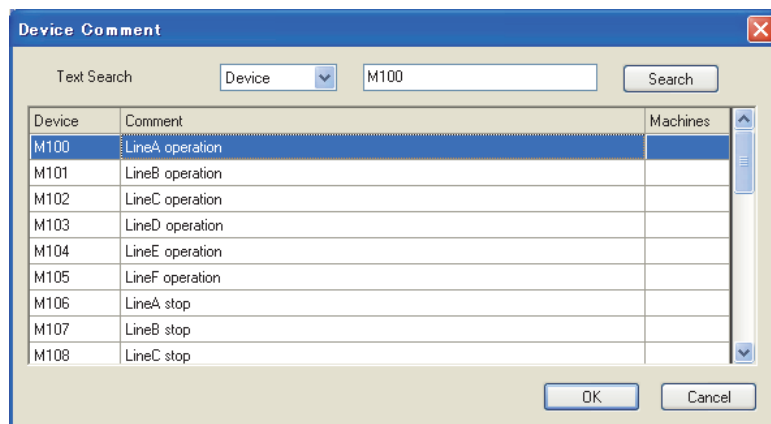

3. After setting, click the [OK] button. The [Device Comment] dialog box closes, and the selected device is set to the Device setting dialog box.

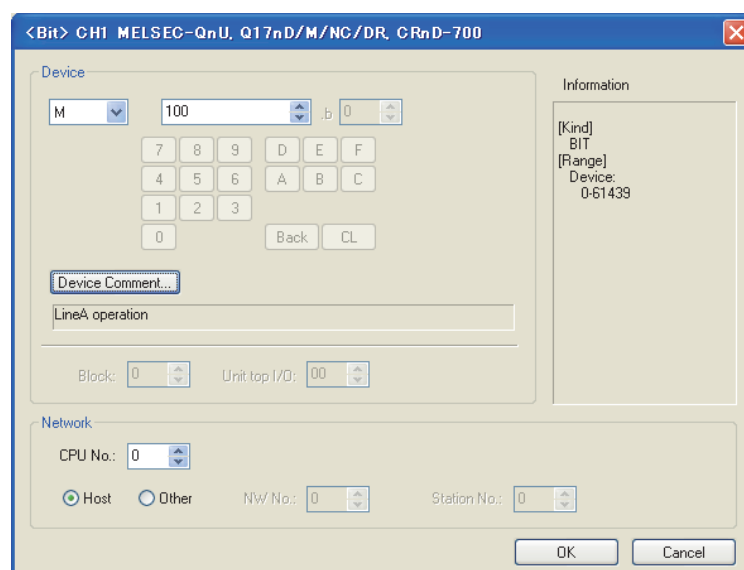



### Search for device

In the [Device Comment] dialog box, search can be performed by device, comment or machines.

#### (1) Search by device No.

After entering the device No. to be searched for, click the [Show] button. This displays the entered device No. at the top of the list.

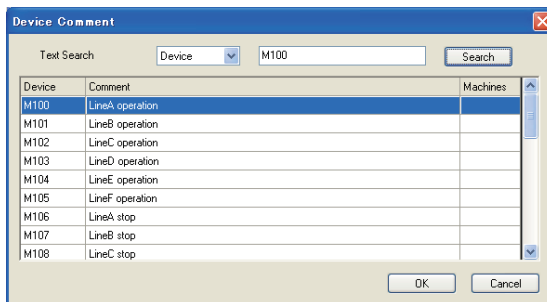
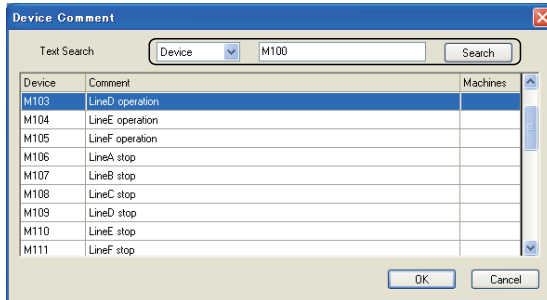

#### (2) Search by Comment/Machines name

After entering the keyword to be searched for, click the [Show] button. This displays comments/machine names including the entered keyword in the list.

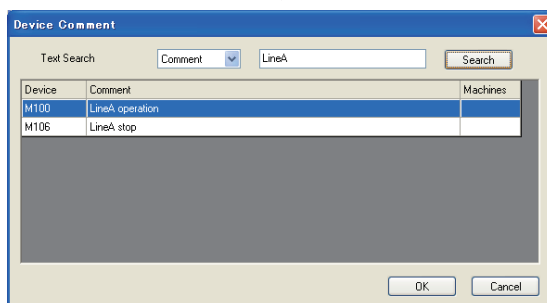
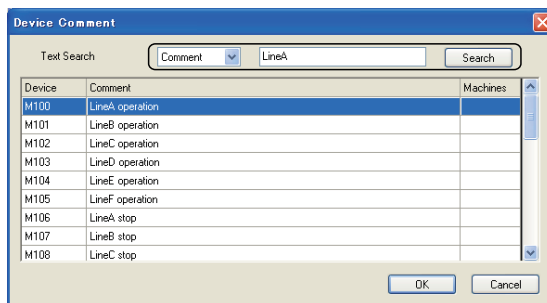

## ■ Precautions

### (1) Project security with restriction

When the project security for a project disables the user to edit the project, devices cannot be imported.  
For the details of the project security, refer to the following.

 3.14 Securing Project

### (2) Devices that cannot be searched for

When any of the following is selected for [Type] in the [Controller Setting] dialog box, the buffer memory devices cannot be searched for in the [Device Comment] dialog box.

- MELSEC-QnU/DC, Q17nD/M/NC/DR, CRnD-700
- MELSEC-QnA/Q/QS, MELDAS C6\*
- MELSEC-Q(Multi)/Q-Motion
- MELSEC-L
- MELSEC-FX
- MELSEC-FX(Ethernet)

# 9.3 Importing Tags Created by Third Party Programming Software



This function enables GT Designer3 to import tag files created by a third party programming software. Tags imported to GT Designer3 can be set as devices.

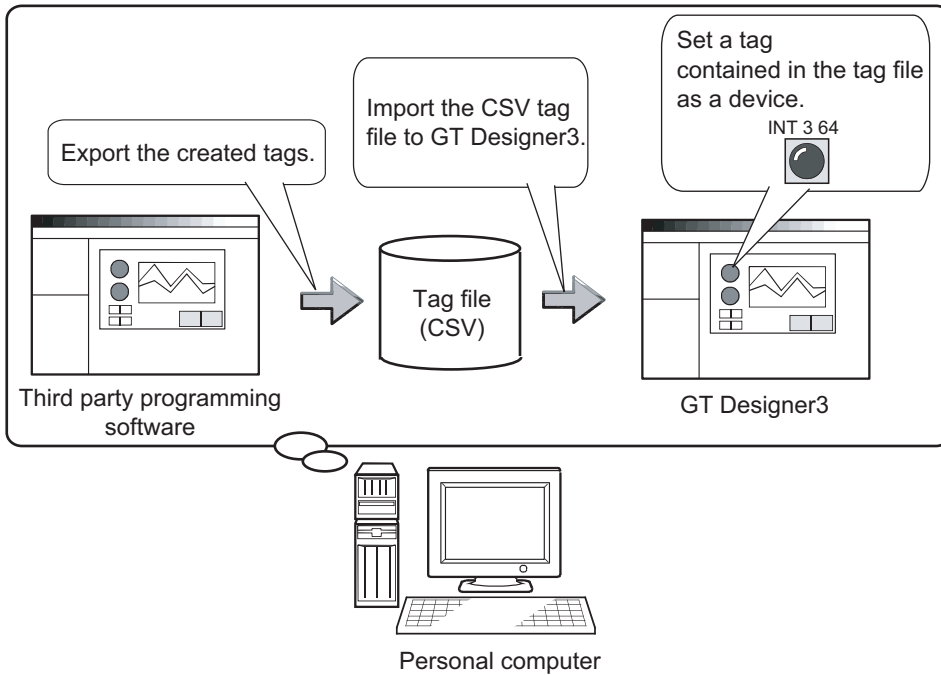

## ■ Specifications

### (1) Applicable PLCs

GT Designer3 can import tag files that are created for the following PLCs.

Type		Model				
ALLENBRADLEY PLC	ControlLogix series	1756-L,	1756-L1M1,	1756-L1M2,	1756-L1M3,	1756-L61, 1756-L62, 1756-L63, 1756-L55M12, 1756-L55M13, 1756-L55M14, 1756-L55M16, 1756-L55M22, 1756-L55M23, 1756-L55M24
	CompactLogix series	1769-L31,	1769-L32E,	1769-L32C,	1769-L35E,	1769-L35CR

### (2) Applicable software

GT Designer3 can import tag files that are created by the following third party programming software.

Manufacturer	Software
Rockwell Automation, Inc. (ALLEN-BRADLEY)	RSLogix5000

### (3) Applicable tag

You can import only controller tags with GT Designer3. Program tags cannot be imported.

## ■ Operating procedures

The following shows the operating procedures to set a tag as a device.

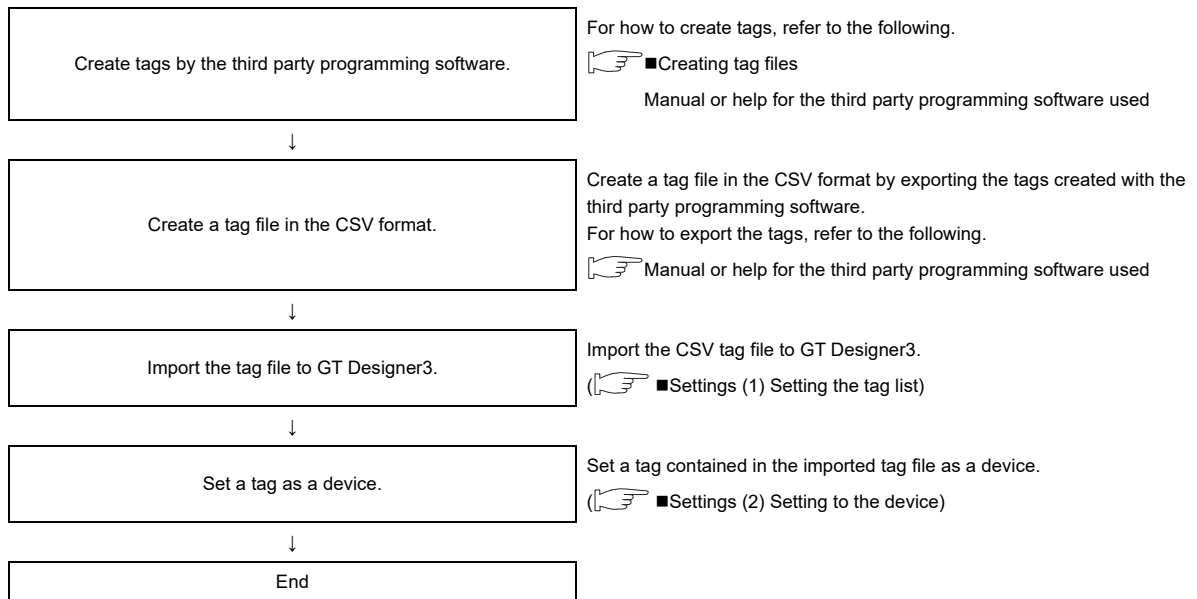

## ■ Creating tag files

Create tag files to be imported to GT Designer3 by the third party programming software.

For how to create tags and tag files by the third party programming software, refer to the following.

☞ Manual or help for the third party programming software used

The following shows requirements to create tag files according to programming software.

### (1) RSLogix5000

- Tag mapping  
Map the created tags.  
The tags without mapping cannot be set as devices with GT Designer3.
- Tag file format  
Create tag files in the CSV format.  
GT Designer3 cannot import tag files in formats other than the CSV format.

(c) Tag file setting

To import a tag file to GT Designer3, the following settings are required for the tag file.  
Set the following fields with RSLogix5000.

Field	Description	Input example
TYPE	Set the type of the target record. Only tag files with the type TAG can be imported by GT Designer3. Setting range: TAG	TAG
SCOPE	Leave blank.	-
NAME	Set the tag name. Setting range: 0 to 40 characters	tagBOOL
DESCRIPTION	Set the comment of the tag in ASCII characters. Setting range: 0 to 120 characters	\$0050\$004C\$0043
DATATYPE	Set the data type and the element number*1 Setting range: INT[0 to 1000]/DINT[0 to 1000]/ REAL[0 to 1000]/BOOL[0 to 32000]	BOOL[10]
SPECIFIER	Leave blank.	-
ATTRIBUTES	Set the tag attribute. Setting range: RADIX PLCMappingFile*2 PLC2Mapping	(PLCMappingFile := 100)

**\*1 Setting range of element number**

Set the element number within the following range.

Element numbers outside the following range cannot be set for the device with GT Designer3.

Data type	Element number range
INT,DINT,REAL	0 to 1000
BOOL	0 to 32000

**\*2 File number of PLCMappingFile**

When the tag attribute is set to PLCMappingFile, set the file number.

The file number must be set within the range from 0 to 999.

File numbers outside the range cannot be set with GT Designer3.

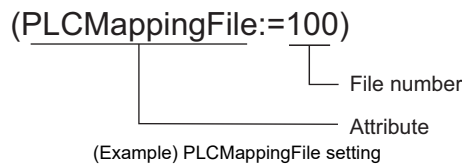



## ■ Settings

### (1) Setting the tag list

Import the tag list to GT Designer3.

1. Select [Project] → [Import RSLogix 5000 Tag] from the menu.
2. The following dialog box appears. Add, delete, or update tag files, and then click the [OK] button.

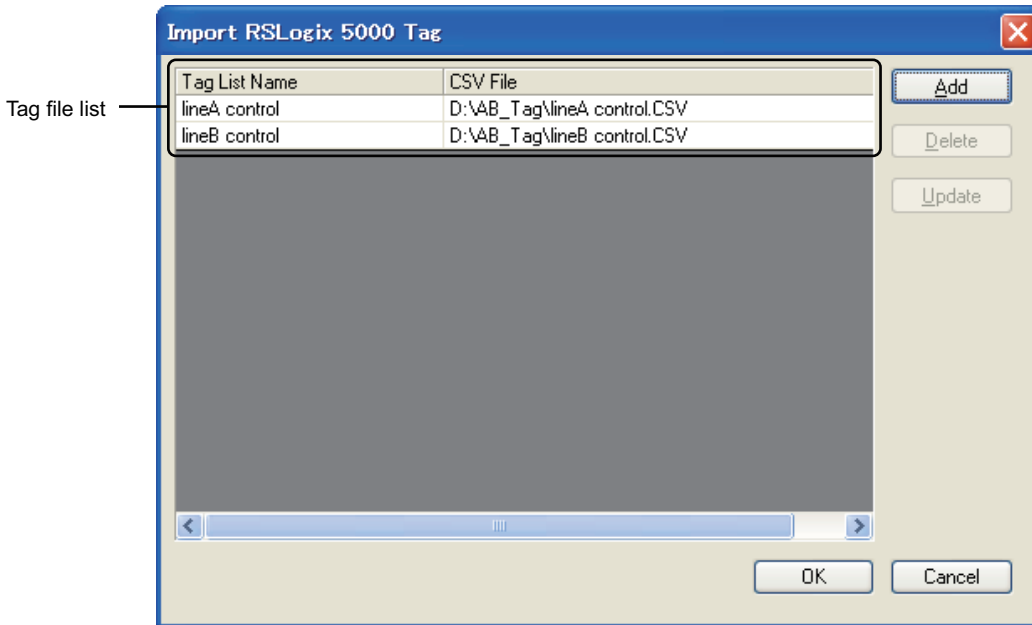

Item	Description	Model
Tag file list	Displays a list of tag files imported to GT Designer3.	
	Tag List Name	Displays the tag file names.
	CSV File	Displays the paths of the tag files.
	Click this button to import a tag file to GT Designer3. Clicking this button displays the [Add Tag List] dialog box. Input the information of the tag file to be added. (a) Add Tag List dialog box	GT16 GT15 GT14 GT12 GT11 GT10 SoftGOT1000
	Click this button to delete the selected tag file.	
	Click this button to update the selected tag file. After selecting a tag file, click this button to display the [Update Tag List] dialog box. Input the latest path of the tag file. (b) Update Tag List dialog box	

(a) Add Tag List dialog box

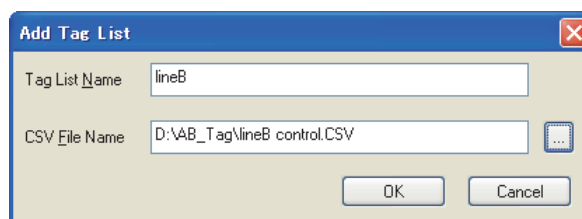

Item	Description
Tag List Name	Input the name of the tag file to be added to the tag file list.
CSV File Name	Input the path of the tag file to be added. Click the [...] button to select the path in the Open dialog box.

(b) Update Tag List dialog box

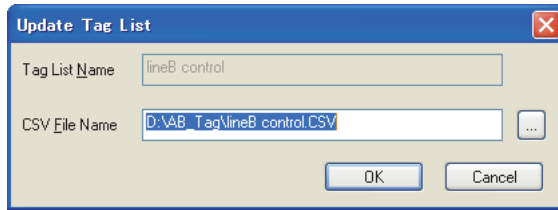

Item	Description
CSV File Name	Input the path of the tag file to be updated. Click the [...] button to select the path in the Open dialog box.

(2) Setting to the device

Set the imported tag to the device.

1. Click the [Tag View] button on the Device dialog box.  
 Appendix4 Setting device of each controller
2. The Tag View dialog box appears.  
 Make the settings referring to the following.

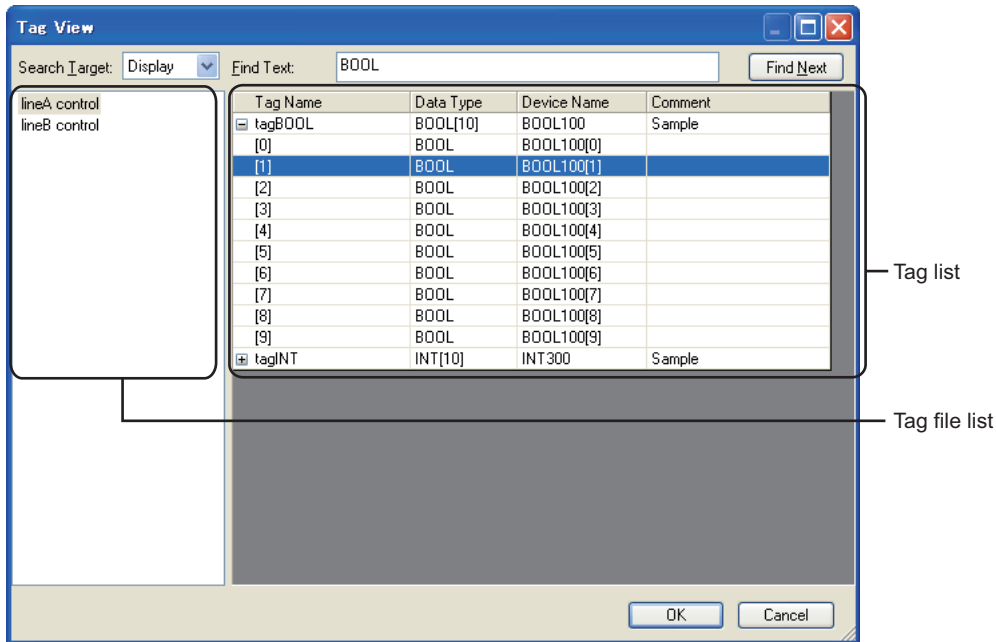

Item	Description	Model
Search Target	Set the items for the tag information to be searched.	
Find Text	Set the character string to be searched. Upper and lower cases are not distinguished.	
Find Next	Click this button to search by the contents set in the search target or find text.	
Tag file list	Tag files imported to GT Designer3 are displayed in a list. Click the tag file name to display the tag file contents on the right.	
Tag View	Displays the tags in the selected tag file in a list. Select a tag and click the [OK] button to set the tag to the device.	
	Tag Name	Displays the tag name. Click the [+] button to display the element number of the tag.
	Data Type	The file type of the tag is displayed.
	Device Name	The device name in GT Designer3 is displayed.
	Comment	The comment set to the tag is displayed.

gr16 gr15  
gr14 gr12  
gr11 gr10  
SongOT1000

## ■ Precautions

### (1) Tag file format

To export tags by the third party programming software, the tags must be exported in CSV files. GT Designer3 cannot import tag files exported in formats other than CSV format.

### (2) Storage location of tag file

After a tag file is imported, if the storage location of the tag file is changed, update the tag file and set the path of the new storage location.

Failure to do so does not display the tag file in the tag file list at the device setting.

### (3) Project security with restriction

When the project security for a project is set for the destination project and the security disables editing the project, a tag file cannot be imported.

For the details of the project security, refer to the following.

 3.14 Securing Project

# 9.4 Displaying in List and Editing Screen/Figure/Object Settings (Propertysheet)



The propertysheet is a window that displays all setting items and details of screens/figures/objects currently selected in a list. Using the propertysheet, the setting details can be checked and changed without opening the dialog box.

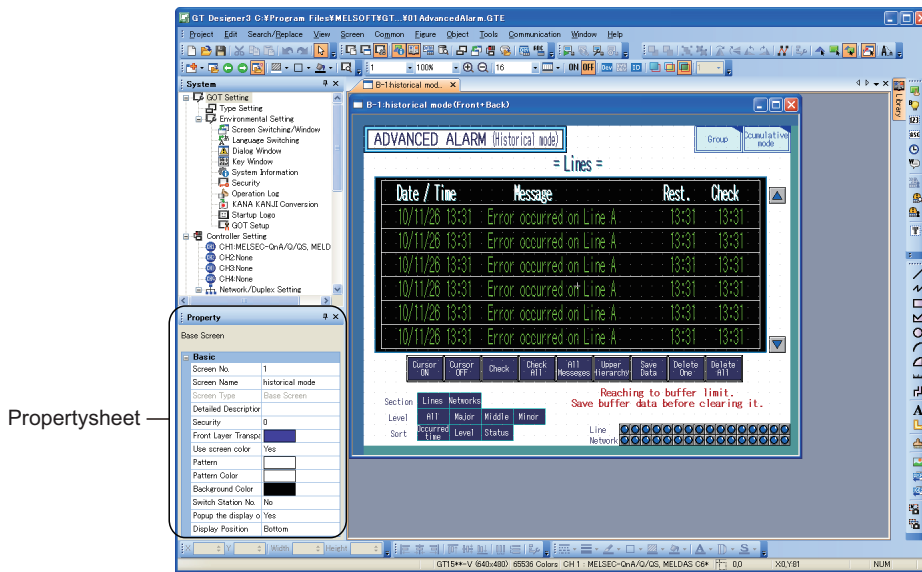

By using the propertysheet, the settings of multiple figures/objects arranged on the same screen can be changed at a time.

(Example) Changing the size of 2 lamps at a time  
Change the [Width] and [Height] to change the size of all selected lamps

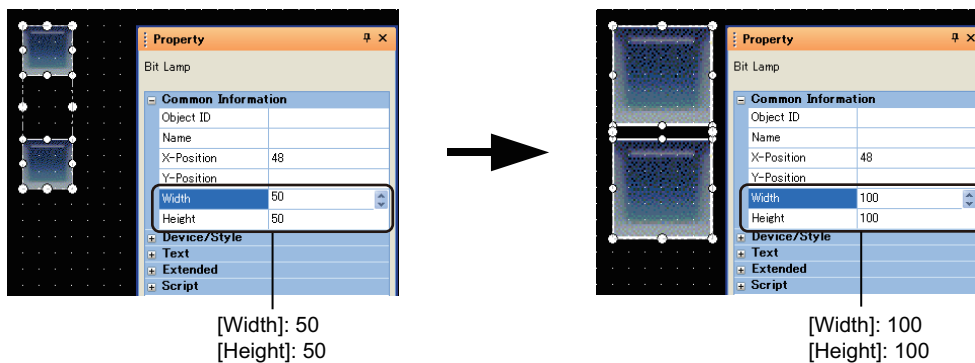

- Attributes that can be changed or set when different types of figures and objects are selected**  
When different types of figures and objects or grouped different types of figures and objects are selected, only some of their attributes can be checked or set. For the attributes that can be checked or set, refer to the following.

☞ ■Precautions

**(2) Displaying a template setting**

On the property sheet, checking and editing the template setting are also available.  
For how to check and edit the template setting, refer to the following.

 7.2 Creating a Screen by Using a Template

**Property sheet operations****(1) Displaying property sheet**

Select [View] → [Docking Window] → [Property sheet] from the menu to switch the display/hide status of the property sheet.

**(2) How to change attributes**

1. Select the screen/figure/object to change the settings.  
Multiple figures/objects can be selected.

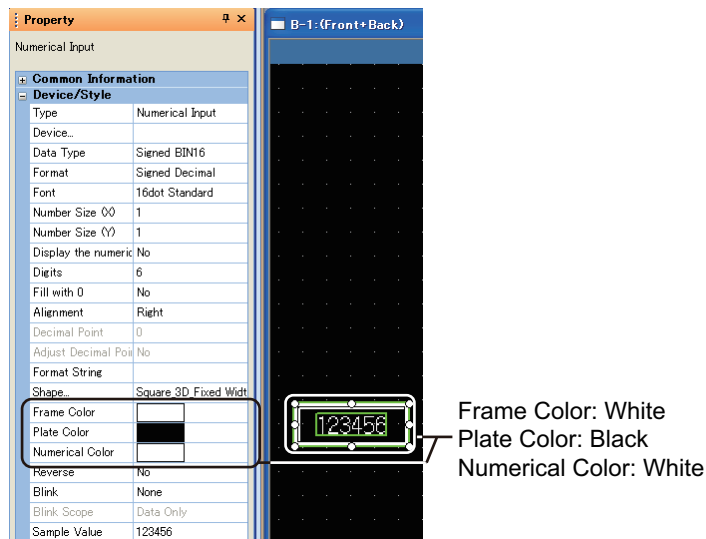

2. The attributes are displayed on the Property sheet. Change the desired attributes.  
Example) Changing the Frame Color, Plate Color, and Numerical Color.

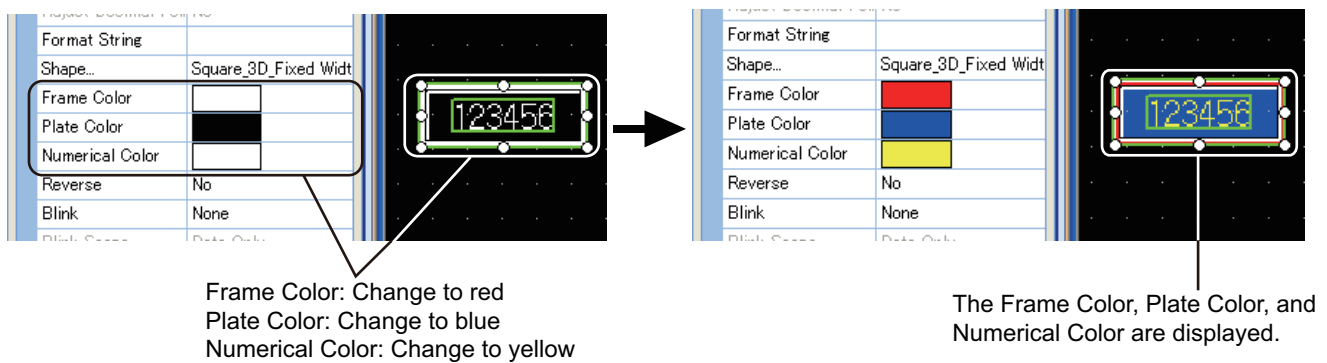
**POINT****Attribute change**

Attributes displayed in the Property sheet correspond to the setting items of the Object or Figure setting dialog box. The attributes (setting items) can be set in the same way as the dialog box is set. For the figure setting items, refer to the following.

 GT Designer3 Version1 Screen Design Manual (Functions)

**(3) How to input setting items**

The input method varies depending on the setting item.

**(a) Direct input**

Set the text/numerical values by direct input.

For the text, multiple lines can be entered/edited by inserting line feeds.

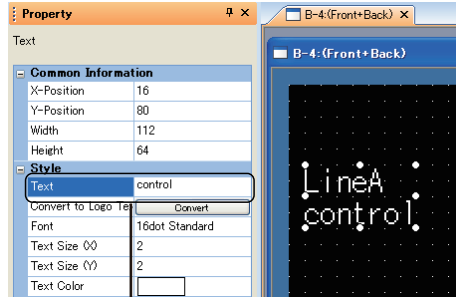

Directly enter.

**(b) Selection from the list**

Select and set the item from the displayed list.

Numerical values and text cannot be directly input.

Select from list box.

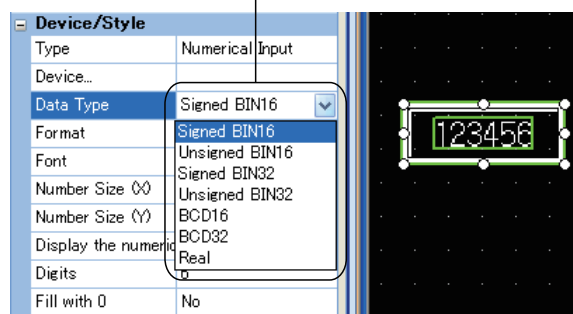

**(c) Selection from the list/Direct input**

Select and set the item from the displayed list.

Values can also be directly input.

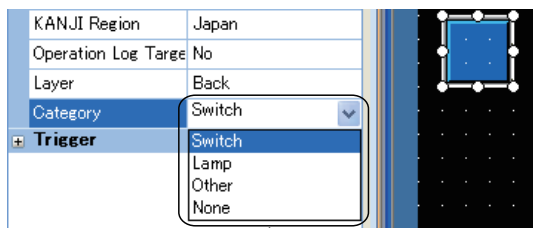

Select the item from the list box.

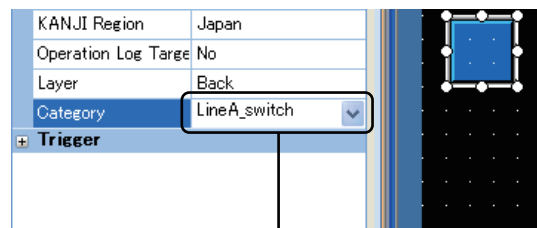

Directly enter the item.

**(d) Numerical input**

Set the values by clicking ▲ / ▼.

Values can also be directly input.

Directly enter a value or click ▲ / ▼.

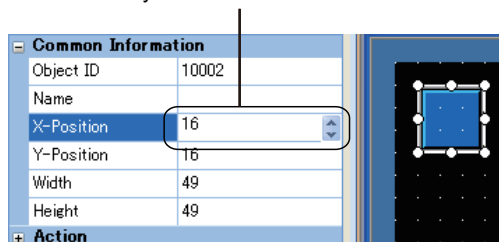

- (e) Input from dialog box  
Click the button, and set the item from the displayed dialog box.

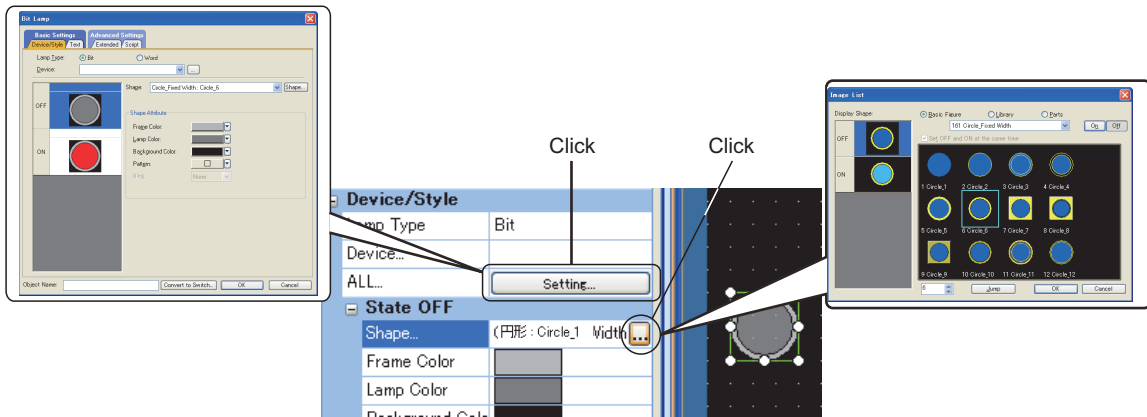

- (f) Color input  
Set the color by clicking the color button in the color palette.

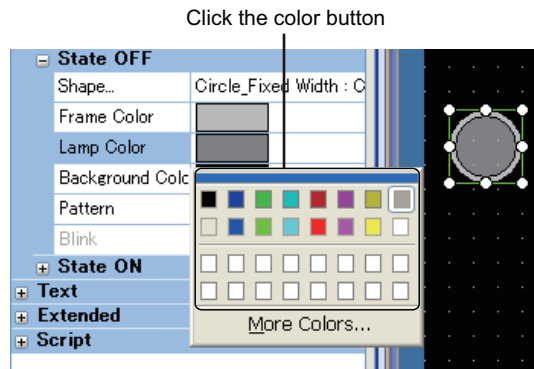

### Setting custom color

When using other than the basic 16 colors, click the [More Colors] button to add custom colors to the color palette.

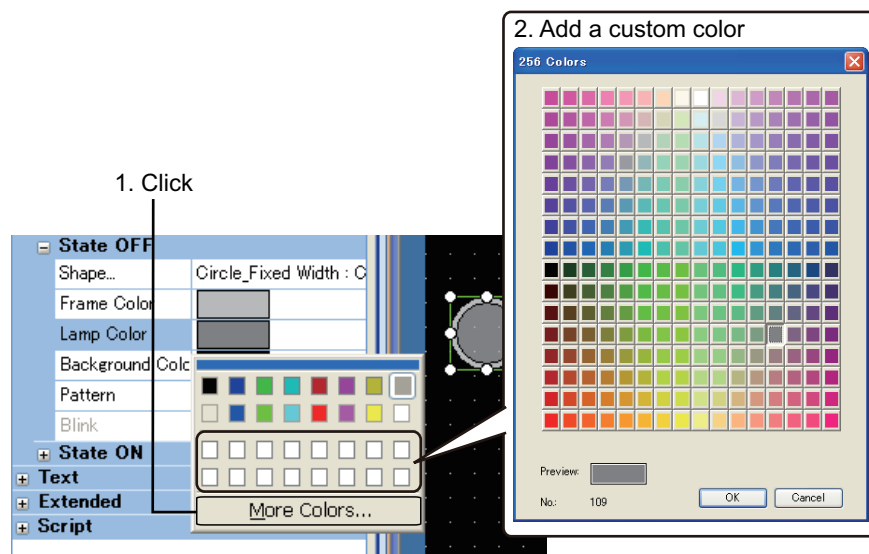

## ■ Precautions

### (1) Checking or setting different types of figures and objects at a time

For different types of figures and objects, some of their attributes can be checked or set by selecting the figures and the objects at a time.

Also, if different types of figures/objects are grouped, they cannot be checked/set at a time.

The attributes that can be checked or set differ according to the subjects selected.

- When the selected subjects include a figure  
The displayed attributes are based on the figure that is placed at the back of the other selected subjects.
- When the selected subjects exclude a figure  
The displayed attributes are based on the object with the minimum object ID.

When the selected subjects have attributes in common, the attributes can be checked or set.

However, if the settable value ranges or selectable options differ between the common attributes, the attributes cannot be checked or set.

### (2) Checking or setting figures/objects on multiple screens

In the property sheet, only figures/objects on the same screen can be checked or set.

Figures/objects on multiple screens cannot be checked nor edited.

### (3) Precautions when changing multiple objects

- (a) When multiple figures/objects are selected, the field of items which setting values are different becomes empty.
- (b) When changing from the property sheet, the setting is reflected to all selected figures/objects.  
Be careful with unintended changes when changing settings from the property sheet.

### (4) Shapes to be set for objects

Setting without [Shape] for objects is not available in the property sheet.

For not setting [Shape] for objects, set from the dialog box of each object.

### (5) Setting range of size

Specify the width in the range of 1 to 2000, and specify the height in the range of 1 to 1600.

If the value out of the range is specified, an error occurs.

### (6) Project security with restriction

When the security for a project disables the user to edit a project, the user cannot edit figures and objects in the property sheet.

Figures and objects on the screen (edit disabled) cannot be edited in the property sheet.

For the details of the project security, refer to the following.

 3.14 Securing Project



# 9.5 Displaying in List and Batch Editing Settings

## 9.5.1 Batch setting and managing figures/objects for each purpose (Category list)



The set figures/objects can be sorted to any of the following categories.

- Switch category
- Lamp category
- Others category
- User-created category

The sorted figures/objects are registered to each category in the category list.

Sorting figures and objects in each category allows management of figures and objects for each purpose.

### (1) Category types

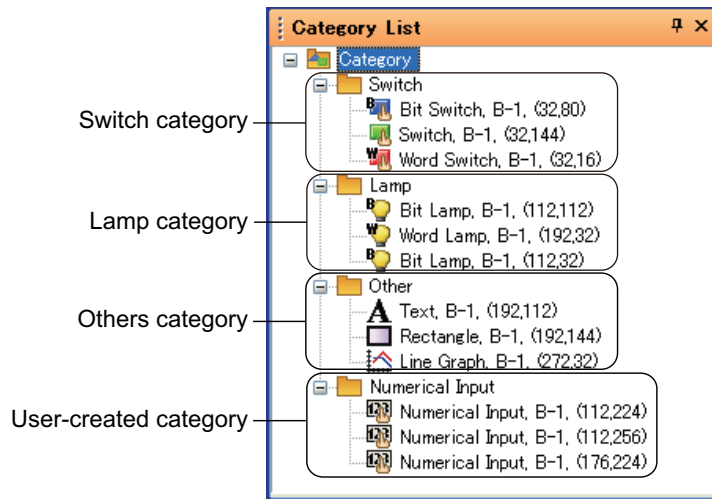

Item	Description
Switch category	Category in which figures/objects set as [Switch] are registered. By default, all touch switches are included.
Lamp category	Category in which figures/objects set as [Lamp] are registered. By default, all lamps are included.
Others category	Category in which figures/objects set as [Others] are registered. By default, figures and objects other than touch switches and lamps are included.
User-created category	User-set category. Figures/objects can be registered for each purpose.

### (2) Batch changing attributes

The device, color, shape, channel No., and network of figures/objects set to objects in the same category can be edited in a batch.

(Example) Batch edit for display color of the bit switch

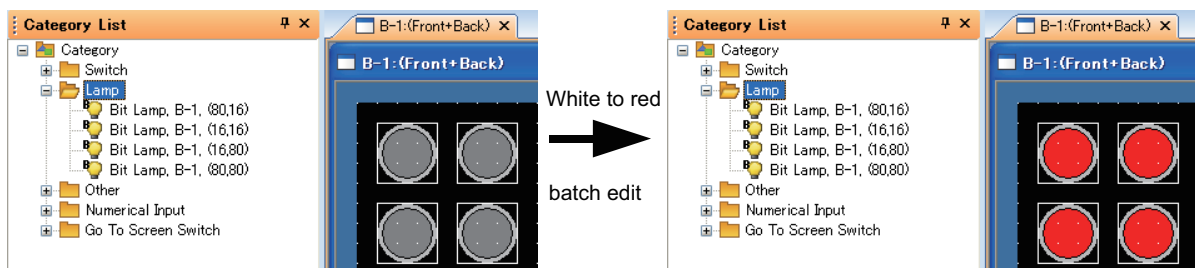

## ■ How to create user-created category

1. Right-click any category in the category list., and select [New Category] from the menu.

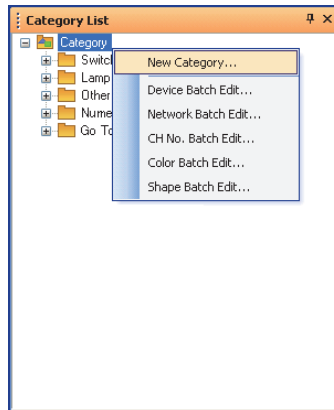

2. The edit category dialog box appears. Enter the category name. After entering the category name, click the [OK] button to close the dialog box.

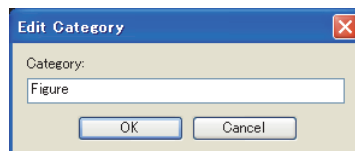

3. The user-created category is added.

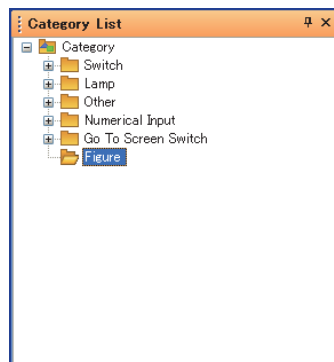

4. Select the figures/objects to be changed from the existing categories, and drag them to the created category. The figures/objects are moved to the created category.

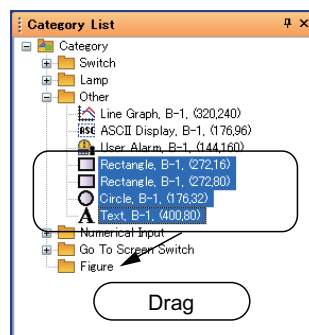

## HINT



### Category registration of figures and objects

Create a user category first. The created user category can be selected when setting the registration location of figures and objects.

Also, the category name can be edited and new user-created category can be created by directly entering the name in the category list box.

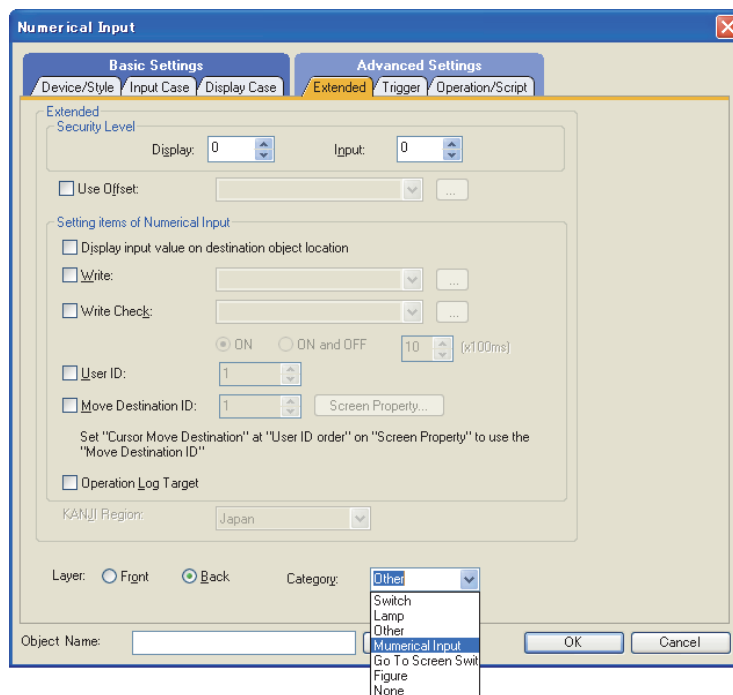

## How to configure batch settings for each category

Figures/objects in the same category can be changed in a batch.

1. Right-click the category for batch change and select the followings.
  - For changing the device : [Device Batch Edit]
  - For changing the color : [Color Batch Edit]
  - For changing the network : [Network Batch Edit]
  - For changing the figure : [Shape Batch Edit]
  - For changing the channel No. : [CH No. Batch Edit]

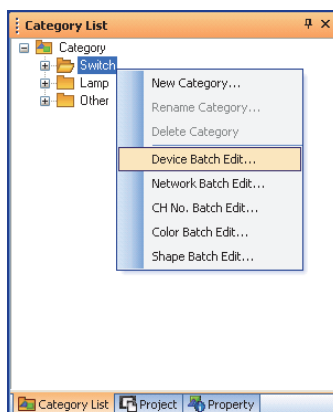

2. The batch change dialog box appears.  
Refer to the following, and configure the batch change settings.



9.5.2 Editing attributes of figures/objects and devices in a batch (Batch edit)

## ■ Precautions

### (1) Figures/objects which are not displayed in the category list.

Figures/objects arranged on closed screens are not displayed in the category list.

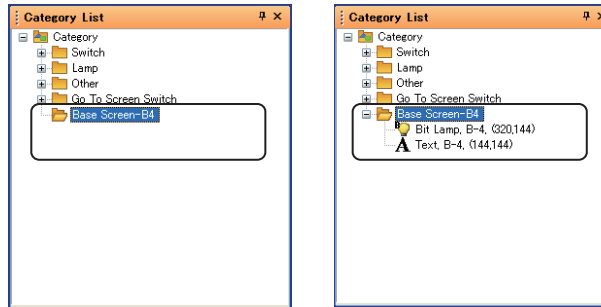

When the base screen 4 is closed

When the base screen 4 is opened

### (2) Registering to multiple categories

A single figure/object cannot be registered into multiple categories.

### (3) Changing multiple attributes

Multiple attributes cannot be batch-changed. (Example: The device and color cannot be batchchanged.)

### (4) Other precautions

Before performing batch editing, refer to the precautions for batch editing.

☞ 9.5.2 Editing attributes of figures/objects and devices in a batch (Batch edit)

### (5) Project security with restriction

When the project security is set, and if the user is under the following conditions, the user cannot change the category in the category list.

- The project security disables the user to edit the project data.
- The security for each screen is set and the access level of the user is other than the administrator.

For the details of the project security, refer to the following.

☞ 3.14 Securing Project

## 9.5.2 Editing attributes of figures/objects and devices in a batch (Batch edit)



Figures, objects, and devices can be changed in a batch.  
The following shows the items which can be batch edited.

- Devices or system labels
- Color
- Shapes used for a lamp or touch switch
- Channel No. (Only for GT16, GT15, GT14 and GT12)

This function is convenient to batch change a device, system label, color, lamp/switch shape, and channel No. of figures or objects arranged on multiple screens.

Also, figures/objects with different types (such as circle and rectangle or touch switch and numerical display) can be batch changed.

The following types of batch edit are available.

Each change method and image after change are shown below.

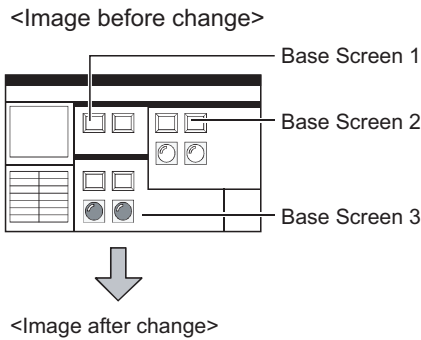

Batch editing all screens  
(Change of color: □ → ■)

Color of objects/figures on all screens (Base Screen 1, Base Screen 2, Base Screen 3) is batch edited.

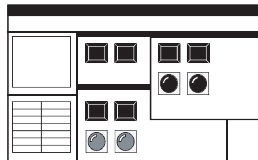

Batch editing screen  
(Change of color: □ → ■)

Color of objects/figures on the editing screen (Base Screen 2) is batch edited.

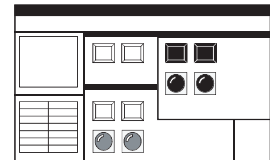

Batch editing specified screens  
(Change of color: □ → ■)

Color of objects/figures on screens for the specified numbers (Base Screen 1 to Base Screen 2) is batch edited.

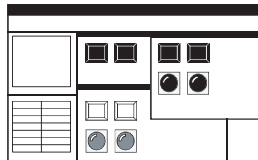

Batch editing each category  
(Change of color: □ → ■)

Color of the specified category (Go To Screen Switch) is batch edited.

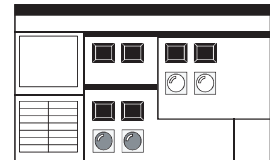

Batch editing selected areas  
(Change of color: □ → ■)

Color of objects/figures on the selected area in the editing screen is batch edited.

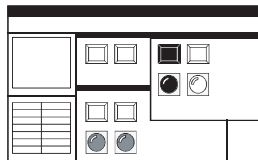

Batch editing common settings  
(Change of device)

Devices (Switching screen device, start trigger device of hard copy, etc.) set in the [Common] settings are batch edited.

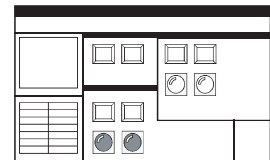

## ■ Operation method

1. Perform either of the following operations.
  - Select [Search/Replace] → [Batch Edit] → [Device]/[Color]/[Network]/[Shape]/[CH No.] from the menu.
  - On the screen editor, select [Batch Edit] → [Device]/[Color]/[Network]/[Shape]/[CH No.] from the right-click menu.
2. The setting dialog box appears. Refer to the following descriptions for setting.

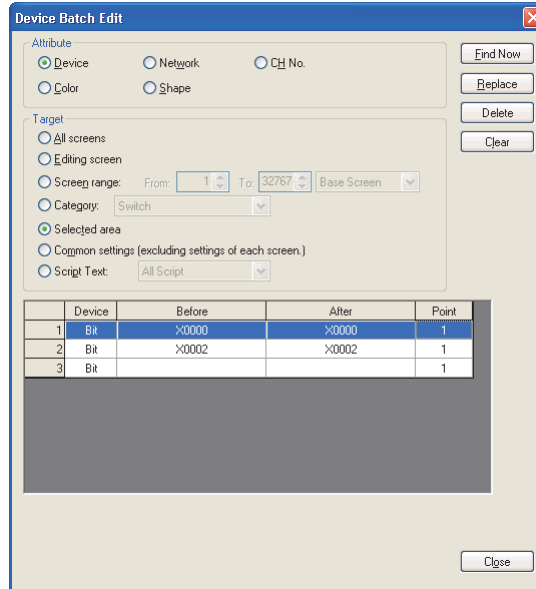

Item	Description	Model
	A device, system label, color, network, shape, or channel No. (GT16, GT15, GT14, and GT12 only) set for a screen and others is searched.	
	Batch edit is performed.	
	Items selected for change are deleted.	
	Items set on the edit list are cleared.	
Attribute	<p>Attribute for batch edit is selected.</p> <ul style="list-style-type: none"> <li>• Device : The device number or system label name is edited in a batch.</li> <li>• Color : The color is edited in a batch.</li> <li>• Network : The network is edited in a batch.</li> <li>• Shape : The figure of a touch switch or lamp is edited.</li> <li>• CH No. : The CH No. is edited in a batch.(GT16, GT15, GT14, and GT12 only)</li> </ul>	
Target	<p>Unit for batch edit is selected.</p> <ul style="list-style-type: none"> <li>• All screens: All screens are the target for batch edit.</li> <li>• Edited screen: The editing screen is the target for batch edit.</li> <li>• Screen range: The specified screen is the target for batch edit. After selection, the range and the type on the screen are specified.</li> <li>• Category: Category is the target for batch edit. After selection, select the category for batch edit.</li> <li>• Selected area: Figures/objects selected on the editing screen are the target for batch edit.</li> <li>• Common settings (excluding settings of each screen.): [Common] are the target for batch edit. The device assigned to object set on each screen is not the target.</li> <li>• Script Text: The script of the target is selected.</li> </ul>	

(Continued to next page)

Item	Description	Model
Edit list	<p>Attributes to be changed are set.</p> <p>When figures are selected by attributes, switch figures and lamp figures can be classified for setting.</p> <p>Before: Device/Color/Network/Shape/CH No.(GT16, GT15, GT14, and GT12 only) before change is selected.</p> <p>After: Device/Color/Network/Shape/CH No.(GT16, GT15, GT14, and GT12 only) after change is selected.</p> <p>Device: Device type (bit/word) is selected for batch edit of device.</p> <p>Point: Points are set for consecutive edit of devices.</p> <p>(In Device No of Objects: M0/New Device No.: M10, set 4. M0 to M3 are changed to M10 to M13.)</p> <p>Default values and names for the network setting in the device batch edit and the network batch edit may be different.</p>	<div style="border: 1px solid black; padding: 2px;"> GT16 GT15  GT14 GT12  GT11 GT10  SoftGoT1000 </div>

## Method of batch edit

An example to change the color of objects or figures set on all screens from black to white is described here.

1. Display the device batch edit dialog box. Select [Color] from [Attribute] and [All screens] from [Target].

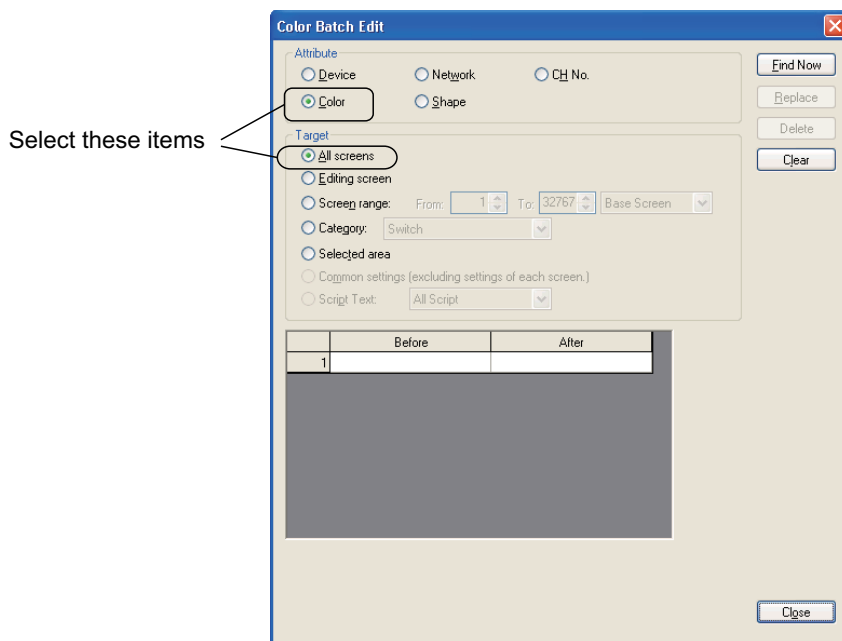

2. Select black from [Before] and white from [After].  
After selecting, click the [Replace] button to change the contents set with black to white.

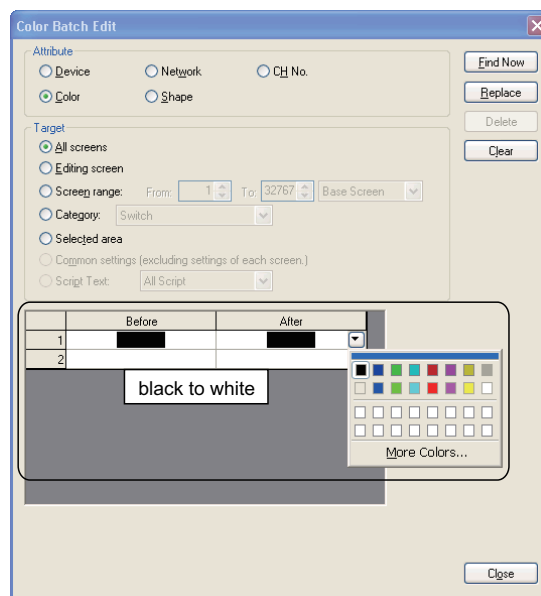



---

**Purpose of the [Find Now] button.**

Click the [Find Now] button to display one of the devices/colors/networks/figures/channel numbers that are used in all screens.

This button is convenient to edit multiple devices/colors/networks/figures/channel numbers in a batch.

---

**■ Precautions****(1) Change of device**

- (a) When the device format (bit device, word device, bit specification for word device) is specified, the device cannot be changed to a different device type.
- (b) The object device with the specified offset device cannot be changed to the word specification for bit device.
- (c) When the head device of the device which is automatically and consecutively set is changed, do not make the data length out of the device range.  
The following operation occurs depending on the device data length.
  - When the data length is 16 bits and the set device is out of the range, the device is not changed.
- (d) When the data length is 32 bits and the set device is out of the range, the area out of the device range is not set. When searching for devices or others, incorrect labels are displayed in the edit list.  
When the following system labels are set to a system label name in [After], devices are not changed.
  - System labels that are not registered in the system label database
  - System labels without devices assigned

**(2) Change of shape**

Changes from Basic Figure to Library and from Library to Basic Figure are not allowed.

**(3) Change of CH No.**

- (a) Batch change of CH No. of devires on the script cannot be performed.
- (b) If a non-existent device is used for the device specified in [After], the device must be assigned again.  
If non-existent device is used for the selected device after CH No. is changed, the device must be assigned again.  
If a non-existent device is used for the selected device after CH No. is changed, [??] is displayed on the setting dialog box for each setting or each object string.

**(4) Project security with restriction**

When the project security disables the user to edit project data, the user cannot change figures, objects, and others in a batch.

When the security for each screen is set, the setting items of the screen (edit disabled) do not appear on the batch edit dialog box.

For the details of the project security, refer to the following.

 3.14 Securing Project



### 9.5.3 Selecting overlapped figure (Data view)



The Data View displays all figures and objects arranged on the screen in a list.  
The listed figures/objects can be double clicked and edited directly.

Check an item for display.

The number of objects is displayed.

Object/Figure names, coordinates, layers and object IDs (objects only) are displayed.

When the figure is a grouped one, its name is preceded by G.

Object/Figure	Object Name	Position	Layer	Object ID
Text		(64,32)-(223,111)	Back	
Bit Switch		(240,40)-(304,10)	Back	10000
Word Lamp		(36,40)-(399,10)	Back	10001
Numerical Display		(64,128)-(207,19)	Back	10002
G1Circle		(432,40)-(512,12)	Back	
G1Circle		(456,64)-(468,96)	Back	

If multiple figures or objects are overlapped, the intended figures or objects can be easily selected and edited.

Figures/objects to change attributes can be easily selected from the data view.

Object/Figure	Object Name	Position	Layer	Object ID
Rotate		(60,115)-(192,128)	Back	
Bit Lamp		(60,115)-(192,128)	Back	10000

#### ■ Operation method

1. Select [View] → [Docking Window] → [Data View] from the menu to display the data view.
2. In the data view, double-click the figure/object to be edited.  
The setting dialog box appears.



#### Individual settings for grouped objects

Using the data view, grouped objects can have individual settings without ungrouping.

## ■ Precautions for the project security

When the security for each screen is set, the setting dialog box of figures and objects on the screen (edit disabled) cannot be opened in the data view.

For the details of the project security, refer to the following.

☞ 3.14 Securing Project

## 9.5.4 Checking devices in use (Device list)



The device list displays the devices and system labels used for the editing screen or the entire project.

Also, refining, jump, and preset file output are available.

This function is convenient for checking or searching devices and system labels in the project/screen being created.

- Bit device tab

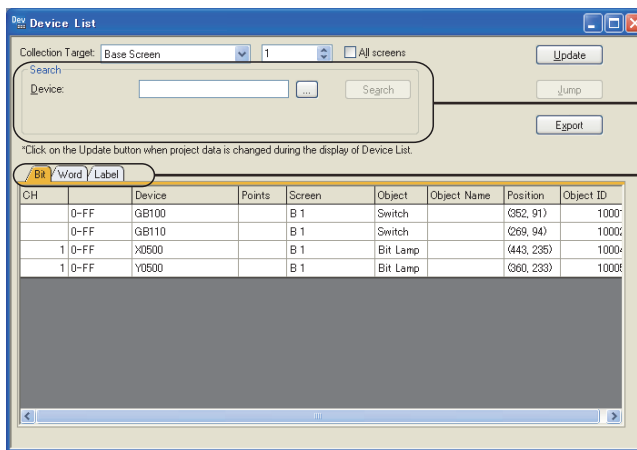

Enter the device to be searched, and click the [Search] button to start the searching.

Click the tab and select the type of the device to be searched.

- Word device tab

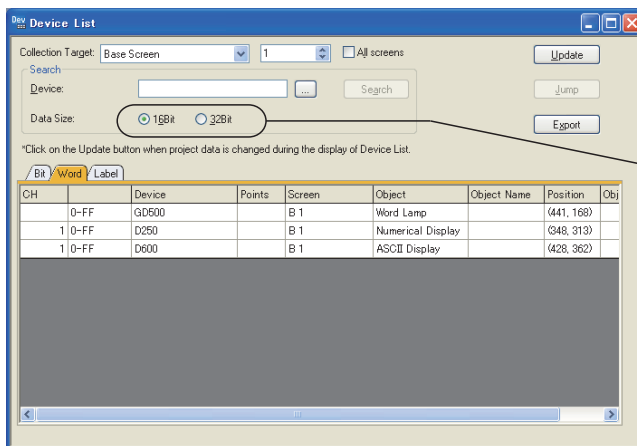

Select the data length according to the device to be searched.

- Label tab

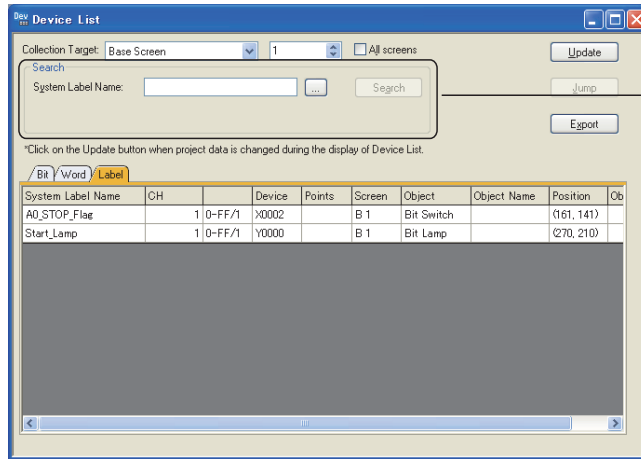

Enter a system label to be searched, and click the [Search] button to start the search.

## ■ Operation method

1. Select [Search/Replace] → [Device List] → [Screen]/[Project]/[Script Text] from the menu.
  - When the [Screen] is selected, the collection target is [Base Screen].
  - When the [Project] is selected, the collection target is [Project (excl. Script Text)].
  - When the [Script Text] is selected, the collection target is the whole script text.
2. The [Device List] dialog box appears. Check the used devices and system labels.

\*mark is displayed when there is data which is not updated.

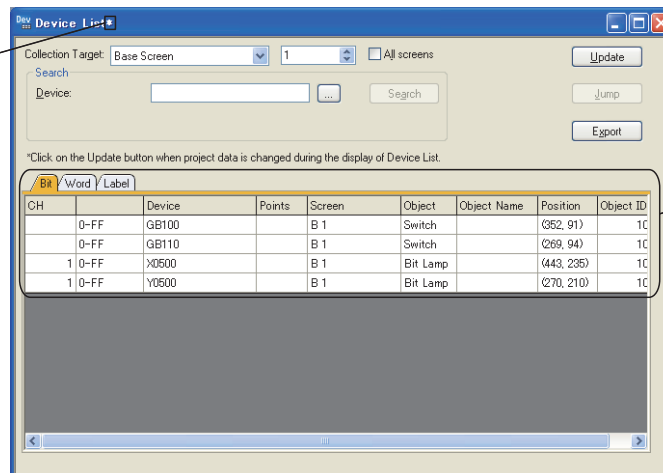

The list of used devices and system labels is displayed.

Item	Description
Collection Target	Select the target to be displayed on the device list. <ul style="list-style-type: none"> <li>• [Project (incl. Script Text)]</li> <li>• [Base Screen],[Windows Screen]</li> <li>• [All Script Text]</li> <li>• [Project/Screen Script Text]</li> <li>• [Project (excl. Script Text)]</li> <li>• [Report Screen]</li> <li>• [Script List]</li> <li>• [Object Script Text]</li> </ul> When the [Project (incl. Script Text)] or [Project (excl. Script Text)] is selected, the screen number and [All screens] check box are disabled.)
Target Screen No.	Specify the screen number to be searched. (1 to 32767; for report screen only, from 1 to 8)
All screens	Select this item to target all screens of the screen type selected in the collection target.
	The list information is updated.
	The specified setting screen is opened, and the object is pointed with a cursor. Jump button is enabled when a line is selected in the list.
	The Device List currently displayed is output to the CSV or Unicode Text file.
	Set a device or system label, and then press the return key or the [Search] button to search the device or system label.

## POINT

### When using the Device List

After the objects on the screen are erased, or the order of the objects are changed, if the Jump is performed without updating the device list, an error that the cursor jumps to the different object may occur.

## HINT

### Cross reference function for MELSOFT Navigator (iQ Works only)

To search a system label used for another project in a workspace, use the cross reference function for MELSOFT Navigator.

 [Help for MELSOFT Navigator](#)

## ■ Precautions for the project security

When the project security disables the user to edit project data, the user cannot change devices in the device list in a batch.

When the security for each screen is set, devices set in the screen (display or edit disabled) do not appear on the device list.

For the details of the project security, refer to the following.

 [3.14 Securing Project](#)

## 9.5.5 Checking text in use (Text list)



The text list displays the directly set text in a list, by the refining setting.

The specific figure or object can be selected by the jump function.

This function is convenient for checking or searching figures/objects in the creating screen/project.

## ■ Operation method

1. Select [Search/Replace] → [Text List] from the menu.

2. The text list window is displayed.

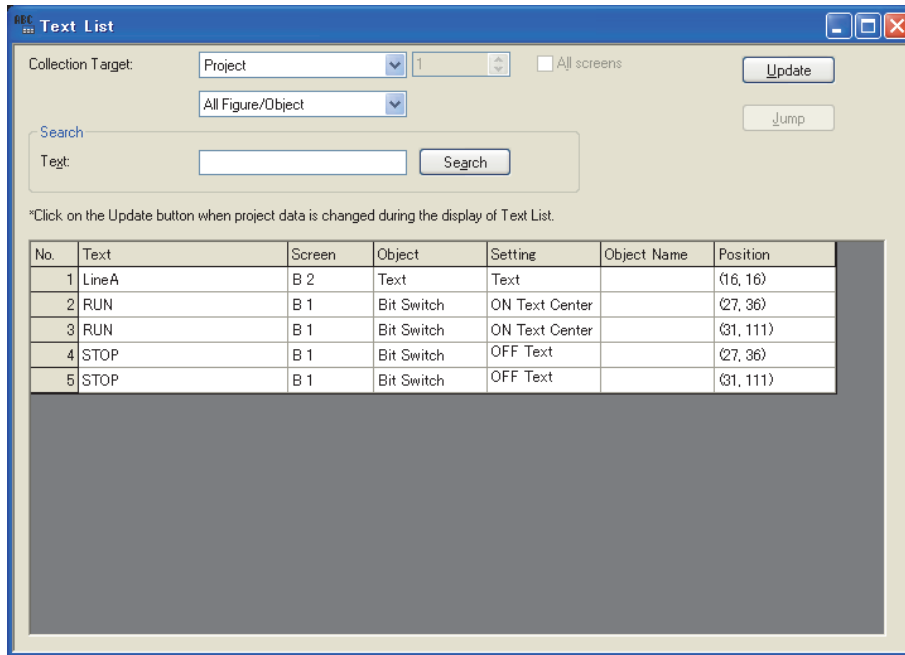

Item	Description
Collection Target	Select the ranges and targets to be displayed in the text list. Range: [Project]/[Base Screen]/[Window Screen]/[Report Screen]/[Parts]/[My Library] Target: [All Figure/Object]/[Text Figure]/[Logo Text Figure]/[Switch]/[Lamp]/[Bit Comment]/[Panelmeter]
Target Screen No.	Specify the screen number to be searched. For [Base Screen], [Window Screen], and [Parts]: Specify the screen number to be searched from 1 to 32767. For [Report Screen]: Specify the screen number from 1 to 8. For [My Library]: Specify the screen number to be searched from 1 to 250.
All screens* <sup>1</sup>	All screens of the Screen Type that are selected in the collection target are the objects.
	The list information is updated.
	The specified setting screen is opened, and the object is pointed with a cursor. Jump button is enabled when a line is selected in the list.
Collection Target 2	The target to be displayed in the list is refined.
	When the device is set, and when the return key or the Find button is pressed, the search is performed.

\*<sup>1</sup> When the [My Library] is selected, the name becomes [All My Library (0: including My Favorites)].

■ **Precautions for the project security**

When the security for each screen is set, texts set in the screen (display disabled) do not appear on the text list. For the details of the project security, refer to the following.

3.14 Securing Project

## 9.5.6 Searching for and editing figures, objects, and others in a project data (Data browser)



The data browser lists the data in a project, including the common settings, figures, and objects.

The scope of figures and objects displayed in the search result list can be narrowed using keywords or display conditions.

The displayed figures and objects can also be edited in the search result list, the [Text Replacement] dialog box, and others.

The data browser comes in handy when the user searches the project for the figures and the objects that match the specified conditions and collectively changes the settings of the figures and the objects.

### POINT

#### Operations that cannot be cancelled with [Undo]

The setting changes made by the following operations cannot be cancelled by selecting [Edit]→[Undo] from the menu.

Before performing the operations, check the settings to be changed.

- Batch edit of texts, devices, and colors
- Changing the settings of the figures and the objects on unopened screen editors
- Changing the common settings

### Operation method



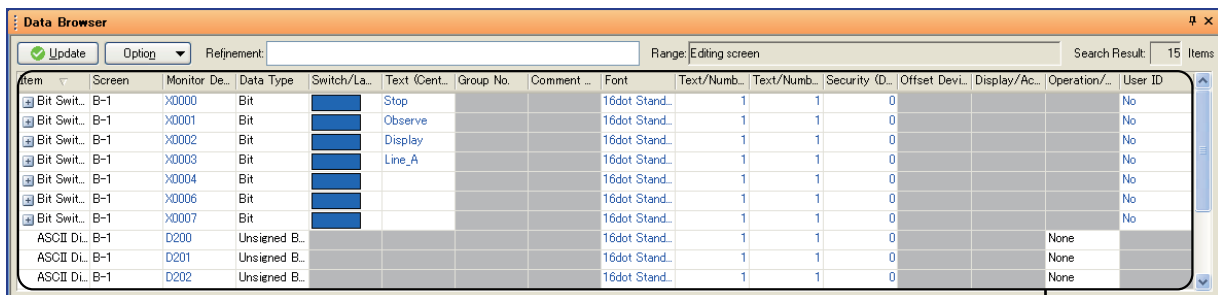

1. Select [View] → [Docking Window] → [Data Browser] from the menu.
2. The data browser appears.  
Search for or edit the data by referring to the following.



Search result list

Item	Description
	<p>Click this button to search the list with the conditions specified in the [Range/Target Setting] dialog box and to display the results in the search result list.</p> <p>The status of the button shows whether the search result list is updated as shown below.</p> <ul style="list-style-type: none"> <li>•  : The search result list is updated.</li> <li>•  : The search result list in not updated.</li> </ul>

(Continued to next page)

Item	Description
<div style="border: 1px solid black; padding: 2px; width: fit-content;">Option ▾</div>	<p>Set the search condition and the display condition for the search result list.</p> <ul style="list-style-type: none"> <li>• Range/Target Setting: Set a range and target for a search when the [Update] button is clicked.  (1) Range/Target Setting dialog box</li> <li>• Display Item Setting: Set the items to be displayed in the search result list.  (2) Display Item List dialog box</li> <li>• Device Batch Edit: Collectively change the devices of figures and objects selected in the search result list.  9.5.2 Editing attributes of figures/objects and devices in a batch (Batch edit)</li> <li>• Text Batch Edit: Collectively change the text strings of figures and objects selected in the search result list.  (3) Text Replacement dialog box</li> <li>• Color Batch Edit Collectively change the colors of figures and objects selected in the search result list.  9.5.2 Editing attributes of figures/objects and devices in a batch (Batch edit)</li> <li>• Export: Export a search result to a CSV/Unicode text file.</li> </ul>
Refinement	Enter a keyword to narrow the scope of a search for all items displayed in the search result list. To search with multiple keywords, separate the keywords with one-byte spaces.
Range	Displays the range of search set in the [Range/Target Setting] dialog box. (All screens/Editing screen/Screen range)
Search Result	Displays the number of items displayed in the search result list.
Search result list	<p>Search results are displayed as a list. The displayed items can be edited in the list. (The characters in a cell that can be edited in the list appears in blue.) Select a cell to display the cursor and to select its row. The selected rows are targeted for the batch edit. The figures and the objects corresponding to the selected rows are also selected on the screen editor.</p>



### (1) Operation by keyboard

The data browser can be operated by a keyboard.

#### (a) Operations when the data are listed

Operation	Function
Arrow (up, down, left, right)	Moves the cursor.
Shift + Arrow (up, down, left, right)	Remains the cell at the cursor selected and moves the cursor. The destination cell is also selected.
+	Expands the selected row.
-	Collapses the selected row.
Shift + Plus sign(+)	Expands all the rows in the tree.
Shift + Minus sign(-)	Collapses all the rows in the tree.
Home	Moves the cursor to the top row.
End	Moves the cursor to the bottom row.
PageUp	Moves the cursor up one page.
PageDown	Moves the cursor down one page.
Shift + Home	Selects the cells from the cursor position to the top row.
Shift + End	Selects the cells from the cursor position to the bottom row.
Shift + PageUP	Selects the cells from the cursor position to the position where the cursor moves one page up.
Shift + PageDown	Selects the cells from the cursor position to the position where the cursor moves one page down.
Tab	Moves the cursor to the next cell.
Shift + Tab	Moves the cursor to the preceding cell.

Operation	Function
Enter	Moves the cursor down one row.
Ctrl + Space	Selects or deselects a row.
Ctrl + C	Copies the value of the cell at the cursor. Selecting multiple cells copies all the values of the selected cells. Placing the cursor in the [Item] column copies the figure or object selected on the screen editor. Selecting multiple cells in the [Item] column copies the figures and the objects selected on only the screen editor displayed at the front. (The figures and the objects on a separate screen editor cannot be copied simultaneously.)
Ctrl + V	Pastes the copied value. (The value outside the setting range of the destination cell cannot be pasted.) When a cell in the [Item] column is copied, the figure or object corresponding to the cell is pasted on the screen editor.
Delete	Clears the value of the selected cell (whose data can be edited in the list only). Enters 0 to the cell where a numeric value should be set.
Back space	Places the cell at the cursor into edit mode. Clears the cell data and places the cell into edit mode when the data can be edited in the list.
F2	Places the cell at the cursor into edit mode.
F3	Displays the setting dialog box corresponding to the selected row.
Character	Places the cell at the cursor into edit mode when the cell data can be edited in the list.

**(2) Operations when the data is edited**

Operation	Function
Enter	Confirms and ends the edits.
Esc	Cancel and ends the edits.
Tab	Confirms the edits and moves the cursor to the next cell.
Shift + Tab	Confirms the edits and moves the cursor to the preceding cell.
Alt + Enter	Starts a new line while characters are entered.



(1) Range/Target Setting dialog box

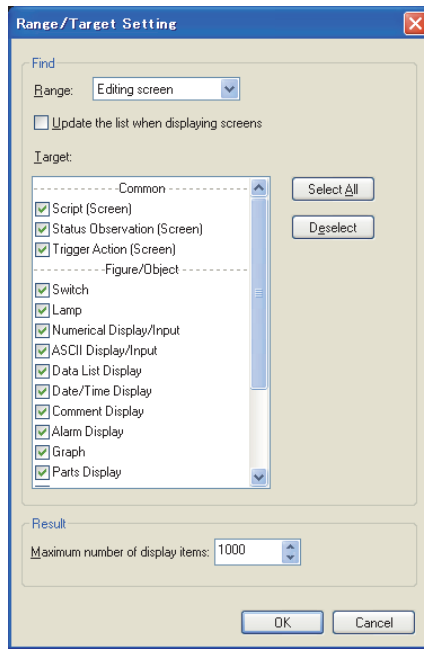

	Item	Description
Find	Range	<p>Set the search range.</p> <ul style="list-style-type: none"> <li>• All screens: Select this item to search all the screens of a project.</li> <li>• Editing screen: Select this item to search only the screens currently being edited.</li> <li>• Screen range: Select this item to search only the specified screens. After selecting this item, select the screen type (Base Screen/Window Screen/Report Screen). Then, set the range of the screen numbers to be searched.</li> </ul>
	Target	<p>Lists the targets to be searched for on the data browser. Select the targets to be searched for.</p>
	Select All	Click this button to select all the items in [Target].
	Deselect	Click this button to clear all the items in [Target].
Result	Maximum number of display items	Set the maximum number of items to be displayed in the search result list.

**(2) Display Item List dialog box**

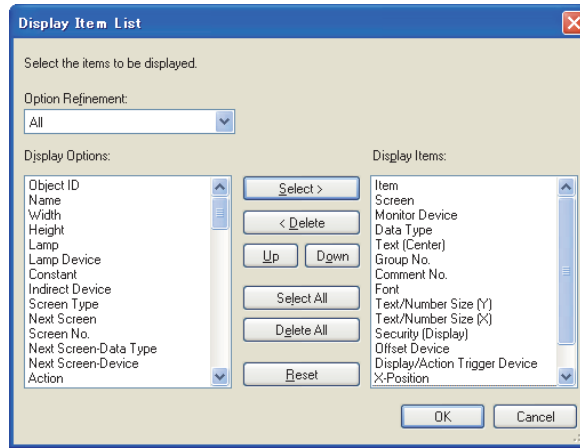

Item	Description
Option Refinement	The setting of [Option Refinement] narrows down the items displayed in [Display Options].
Display Options	Displays the options of items to be displayed in the search result list. These items are not displayed in the search result list. Select an item and click the [Select] button. Then, the selected item is moved to [Display Items]. (The moved items are displayed in the search result list.)
Display Items	Displays the items to be displayed in the search result list. Select an item and click the [Delete] button. Then, the selected item is moved to [Display Options]. (The moved items are not displayed in the search result list.) To change the display order of the selected item, click the [Up] or [Down] button.
	Click this button to move the item selected in [Display Options] to [Display Items].
	Click this button to move the item selected in [Display Items] to [Display Options].
	Click this button to move up or down the selected item in [Display Items].
	Click this button to move all the items in [Display Options] to [Display Items].
	Click this button to move all the items except [Item] in [Display Items] to [Display Options].
	Click this button to reset [Display Items] to its default.



**Display order of items to be displayed**

In the search result list, the items are displayed in order starting from the top set in [Display Items].

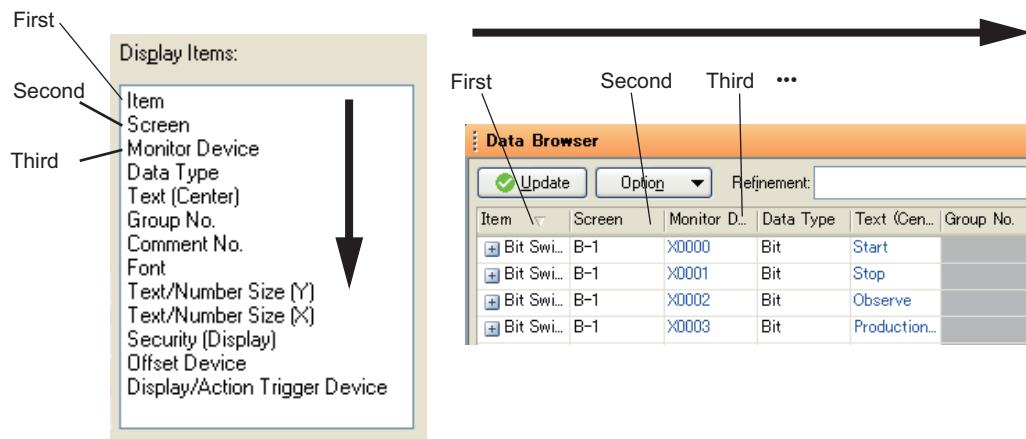

### (3) Text Replacement dialog box

The text strings of the figures and objects selected in the search result list can be collectively changed.

1. Enter the text string to be changed in [Find what], and then enter the new text string in [Replace with].
2. Click the [Replace] button to collectively change the text strings set for the selected figures and objects.

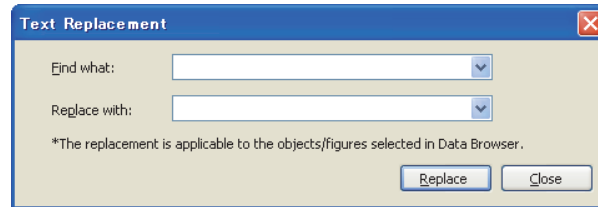

#### Settings that can be collectively changed

Only the texts set in [Text (Center)], [Text (Up)], [Text (Down)], [Text (Left)], and [Text (Right)] for the figures and objects can be collectively changed.

### ■ Precautions

#### (1) Settings that cannot be edited when the screen is closed

Some settings (including the X coordinate, Y coordinate, and logo text) of a figure or an object cannot be edited when the screen with the figure or the object is closed.

To edit the settings in the data browser, open the screen that has the figure or the object, and then edit the settings.

#### (2) Project security with restriction

When the project security disables the user to edit project data, the user cannot change figures, objects, and others in the data browser.

When the security for each screen is set, figures and objects on the screen (display disabled) do not appear on the data browser.

Though figures and objects on the screen (edit disabled) appear on the data browser, the figures and objects cannot be edited and deleted.

For the details of the project security, refer to the following.

 3.14 Securing Project

## 9.6 Entering Multiple Languages (Multi-Language Input Function)



The GOT 1000 series can display Unicode 2.1 characters. The Windows® multi-language function enables to enter various languages on GT Designer3, and their characters can be displayed as they are on the GOT. Characters or comments can also be entered in the various languages and the corresponding screens can be displayed on a single GOT

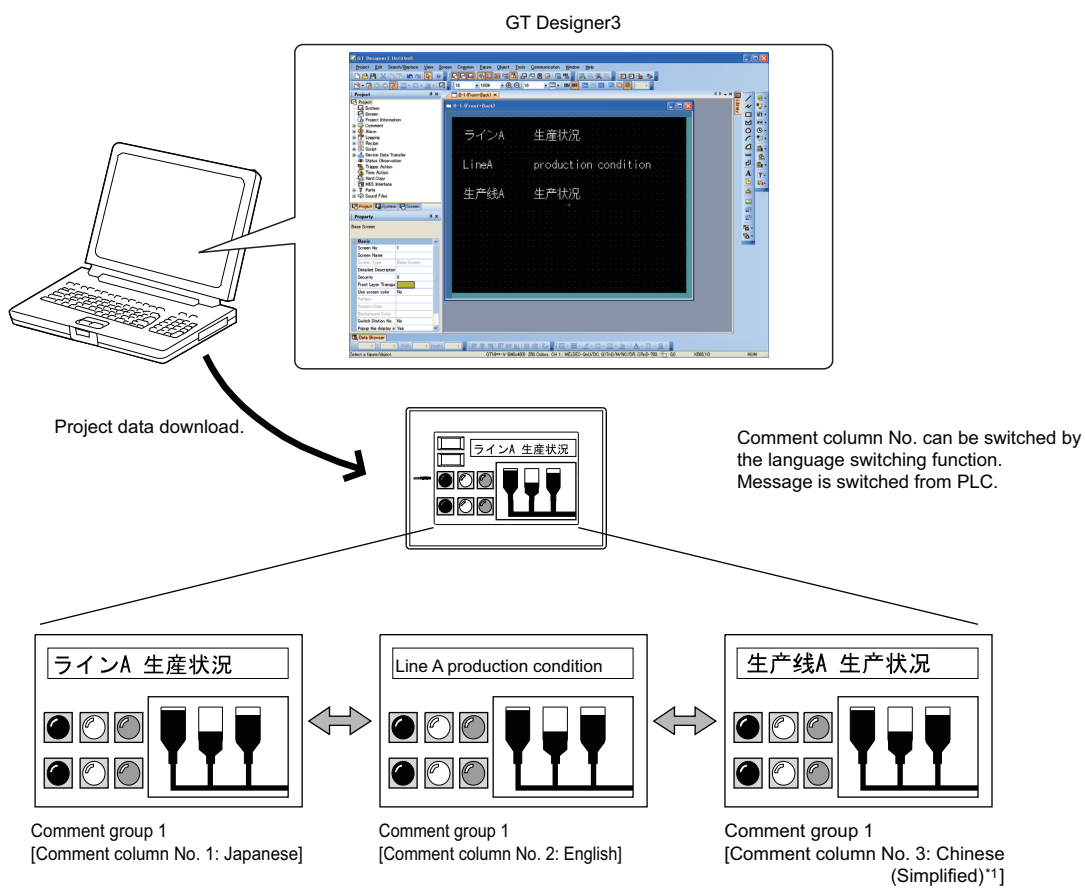

\*1 To display Simplified Chinese characters on the GT16, GT15, and GT14, set the KANJI region to Simplified Chinese, and install an option OS of Simplified Chinese.

### POINT

#### Entering multiple languages

Multiple languages can be entered by the following method

- Use the multi-language function of Windows® to enter.

Multiple languages can be entered on GT Designer3 by using the Windows® multi-language function.

(Windows®-incompatible languages cannot be entered.)

☞ ■Using the Windows(R) multi-language function

## ■ Using the Windows(R) multi-language function

Before entering various languages, the function must be activated in Windows®.  
For details of the Windows® operation method, refer to Windows® Manual/Help.

## ■ Precautions

### (1) Characters which are displayed

GT Designer3 and GOT use Unicode 2.1 fonts to display texts. Therefore, when displaying Simplified Chinese, Traditional Chinese and Korean characters, similar ones may appear instead of the intended ones.



### Displaying Simplified or Traditional Chinese Characters (GT16, GT15, and GT14)

To display Simplified Chinese and Traditional Chinese characters on the GT16, GT15 and GT14, perform the following two actions.

#### (a) Installing fonts

Install the following fonts (Option OS) while installing the OS.

Font	Description
Standard font [China GB] 12-dot characters	The Simplified Chinese (GB) font is a GB2312-encoded font mainly used on mainland China.
Standard font [China GB] 16-dot characters	
Standard font [China Big5] 12-dot characters	The Traditional Chinese (Big5) font is a Big 5-encoded font mainly used in Taiwan.
Standard font [China Big5] 16-dot characters	

#### (b) Set Kanji region

Set each shape and object KANJI region to China (GB)-Mincho or China (Big5)-Gothic.

### (2) Precautions for printing

When [Output to file] is executed for printing, only languages supported by the OS (Windows®) as standard can be output.

### (3) Import/export of comments entered in multiple languages

Use Unicode text files to import/export comments entered in multiple languages.  
Characters may be garbled if a normal text file or CSV file is used.

## 9.7 Checking Project Data for Errors



Project data created on GT Designer3 can be checked for errors.  
For details of the data check method, refer to the following.

 3.13 Data Check

### ■ Data Check Procedure

1. Select [Tools] → [Data Check] from the menu.
2. The Data Check dialog box appears.  
Set the data check items and the target screens.  
After selecting, click the [Check] button to execute the data check.

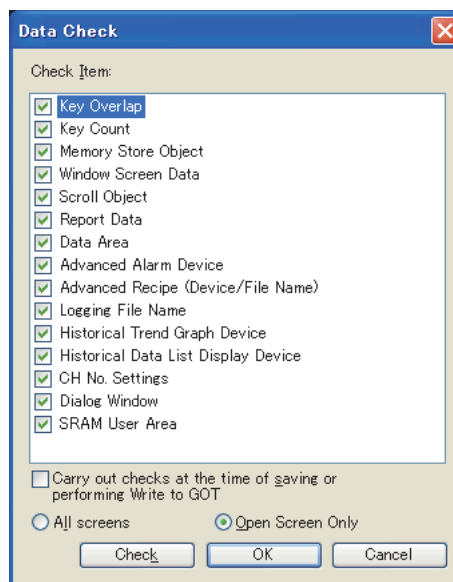

## 9.8 Confirming Created Data Size



Before transferring the monitor data created using GT Designer3 to the GOT, the data size can be confirmed for each screen or the whole project.

### Confirmation method

1. Select [Tools] → [Data Size] → [Screen]/[Project] from the menu.
2. The Data Size (Screen)/Data Size (Project) dialog box appears. Refer to the following to confirm the data size.
  - Screen

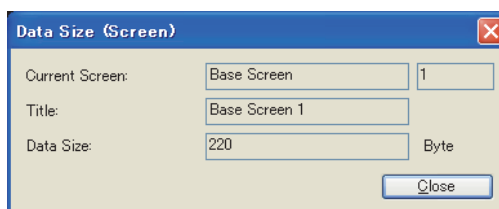

Item	Description
Current Screen	The editing screen type and screen No. are displayed
Title	The screen title is displayed.
Data Size	The screen data size is displayed.

- Project

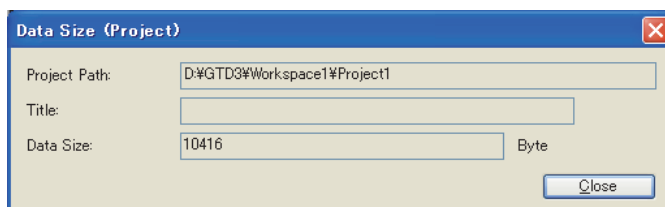

Item	Description
Project Path	The path for the editing project is displayed.
Title	The project title is displayed.
Data Size	The project data size is displayed.

# 9.9 Verifying Project Data Opened by GT Designer3 with Saved Project Data



Project data opened by GT Designer3 can be verified with project data saved on the personal computer.

## ■ Verifying project

1. Click [Project] → [Verify Data] from the menu to display the [Verify Project] dialog box.
2. Set [Target Project] and click the [Browse] button to start the verification.

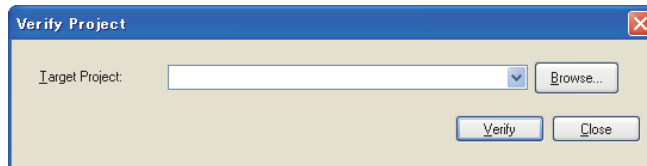

Item	Description	Model
Target Project	Set the file to be verified with the [Browse] button or by direct input. Projects in the following formats can be set as the verification target. <ul style="list-style-type: none"> <li>• GT Designer3 projects</li> <li>• A single file format project (*.GTW)</li> <li>• G1 format (G1 format data created with GT Designer3)</li> </ul>	
	Select the verification target projects. Click this button to display the [Select Project] dialog box or the [Open] dialog box. Select a project to be verified.	
	The verification is started.	
	Closes the [Verify Project] dialog box.	

3. The [Verification Result] dialog box is displayed. Click the [Save] button to save the verification result.

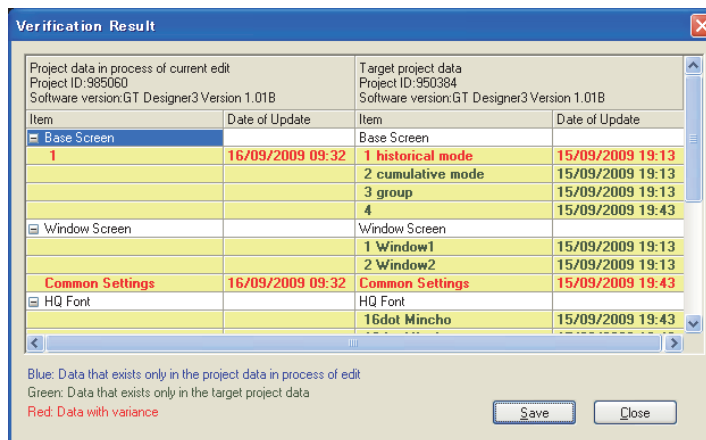

Item	Description	Model
Verification Result	The results of verification are displayed. Items differing between both project data, or existing in only one side, are displayed in light yellow background lines.	

(Continued to next page)



Item	Description	Model
Save	The results of verification are saved in the text format under the specified file name at the specified location. L: Items existing only in the currently editing project data R: Items existing only in the verification target project data D: Items with differences	GT16 GT15 GT14 GT12 GT11 GT10 SBRGT1000
Close	Closes the [Verification Result] dialog box.	

## POINT

### File verification

- (1) Verification between project data with different GOT types is not available.  
Set the same GOT type for project data to be verified.  
For the GOT type settings, refer to the following.  
 4.1 GOT Type Setting
- (2) When the currently used GT Designer3 version differs from the version of GT Designer3 that edited the project data to be verified, a difference may appear in the verification result.
- (3) When HQ font is set, a font not set by the user is displayed.  
Also, when the HQ font to be used is changed, a difference appears in all HQ fonts.
- (4) When a project data to which [Detailed Description] is set on the [Screen Property] dialog box of base/window/report screens is compared with a project data saved by writing from the memory card, or with a project data saved after uploading from GOT using a data transfer tool, a difference may be displayed.
- (5) When the buffering area size is changed, a difference is displayed in the common settings.  
Example)
  - When changing settings in [File Conversion External Control] on the [Advanced Recipe Common Setting] dialog box.
  - When changing settings in [Record Number] on the [Advanced Recipe] dialog box.
- (6) When [I/F], [Driver], or [Detail Setting] on the [Controller Setting] dialog box is changed, a difference is displayed in [Communication Setting].  
When [Controller Type] on the [Controller Setting] dialog box is changed, [Common] becomes mismatched.

## Precautions

### (1) Project security with restriction

When the security for each screen is set, and if the source or destination project used for the verification has a screen (display disabled), the project cannot be verified.  
For the details of the project security, refer to the following.

 3.14 Securing Project

## 9.10 Starting Up Simulator (GT Simulator3)



GT Simulator3 can be started up from GT Designer3 directly.  
For the usage of GT Simulator3, refer to the following.

 GT Simulator3 Version1 Operating Manual for GT Works3

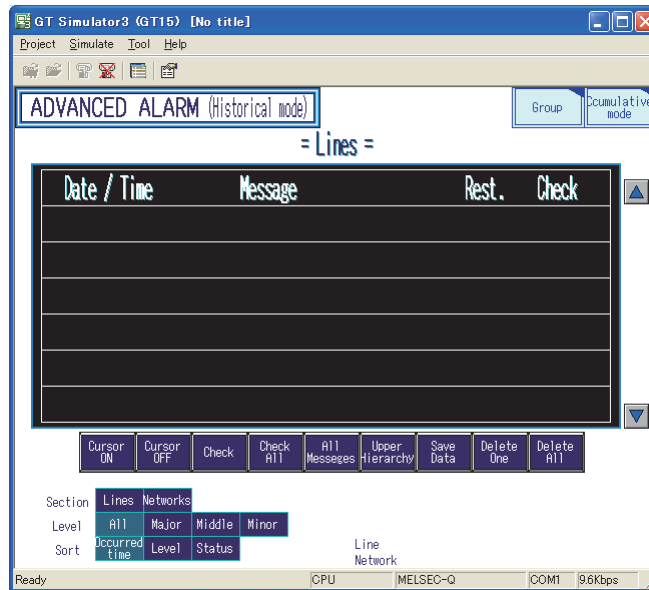

### ■ Operating procedure

Operate GT Simulator3 by selecting the followings from the [Tools] → [Simulator] menu.

- Select [Activate] from the menu to start GT Simulator3.
- Select [Set] from the menu to display the GT Simulator3 setting dialog box.
- Select [Update] from the menu to reflect the editing project to GT Simulator3.
- Select [Exit] from the menu to exit the operating GT Simulator3.



#### Executing the system label update/check (iQ Works only)

When starting GT Simulator3 while system labels are used, the system label update/check is executed.

 5.3.2 Label setting

# 10. USEFUL FUNCTIONS FOR USING GOT

## 10.1 Displaying Documents such as Word and Excel (Document Display)



The document display function displays a document created on a personal computer (such as Microsoft® Word and Microsoft® Excel).

Since a document such as the specifications and manuals can be displayed on the GOT, it is possible to use a document on the troubleshooting screen or display an operation document during monitoring.

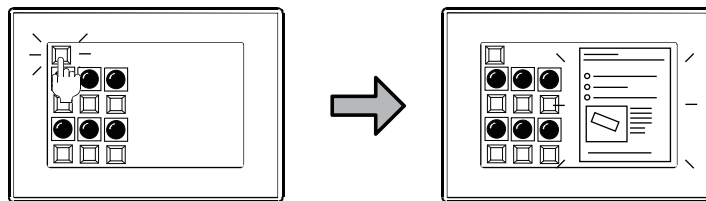

Displays a document that explains such as touch switch operation on the GOT.

### 10.1.1 Before using the document display function

#### ■ Documents that can be displayed

The document display function can display a document created using the following data.

- Microsoft® Word
- Microsoft® Excel
- Microsoft® PowerPoint
- PDF data
- Image file (JPEG, BMP)

## ■ Operation flow to display a document

The following shows the series of operations from document file conversion to storing the converted document file into a CF card.

Document Converter is necessary to convert a document file.

### ☞ 10.1.3 Document conversion using Document Converter

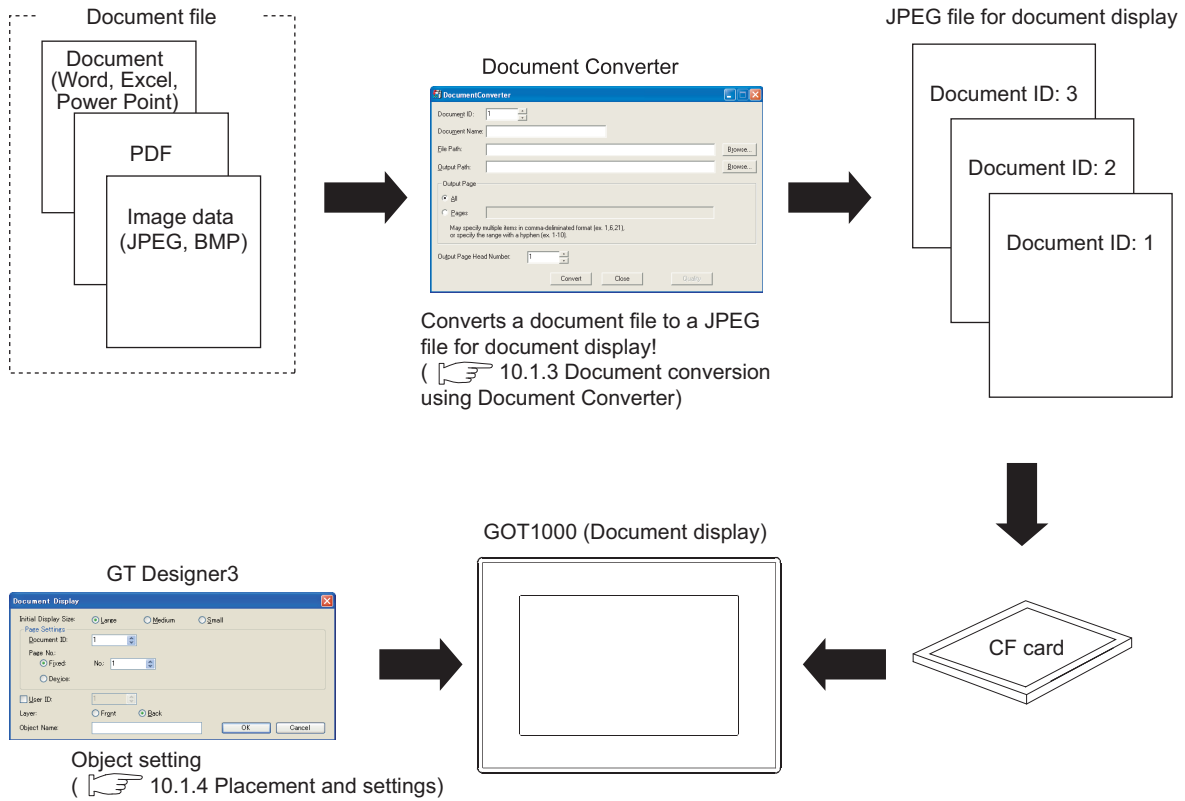

### About sample image used for document display

When GT Designer3 is installed, document display sample image files (following files) are also installed in the folder in which GTD3.exe is stored.

- IMG00000L.JPG (Large size 816×1168)
- IMG00000M.JPG (Medium size 656×928)
- IMG00000S.JPG (Small size 400×584)

For the sample images, preview that shows how they are displayed when the object is arranged is given. (In the preview, the size conforms to the setting for initial display size.)

It is possible to display other image data in preview by replacing the sample images with the desired images. For this purpose, assign the file name of the present sample image to the desired image.

## 10.1.2 Relevant settings

The document display function is available for the relevant settings other than the specific settings. The following shows the functions that are available by the relevant settings.

### ■ GOT internal devices

 Appendix2 GOT Internal Devices

Function	Setting item	Model
Checking if a document is displayed. (Write device)	GS276.b0	

## 10.1.3 Document conversion using Document Converter

The following explains the procedure used for converting the document to be displayed on the GOT by Document Converter and storing the converted document to a CF card.

### ■ Operating environment required for using Document Converter

Item	Description
Model	Personal computer that Windows runs on.
OS(English version) <sup>*3*5</sup>	<ul style="list-style-type: none"> <li>• Microsoft Windows 11 Education (64 bit)<sup>*1*2*4</sup></li> <li>• Microsoft Windows 11 Enterprise (64 bit)<sup>*1*2*4</sup></li> <li>• Microsoft Windows 11 Pro (64 bit)<sup>*1*2*4</sup></li> <li>• Microsoft Windows 11 Home (64 bit)<sup>*1*2*4</sup></li> <li>• Microsoft Windows 10 Enterprise (32 bit, 64 bit)<sup>*1*2*4</sup></li> <li>• Microsoft Windows 10 Pro (32 bit, 64 bit)<sup>*1*2*4</sup></li> <li>• Microsoft Windows 10 Home (32 bit, 64 bit)<sup>*1*2*4</sup></li> </ul>
CPU	<ul style="list-style-type: none"> <li>• Windows 11: 64 bit-compatible processor with dual-core or more or System on a Chip (SoC)<sup>*8</sup></li> <li>• Other than Windows 11: Intel Core 2 Duo Processor 2.0 GHz or more recommended<sup>*8</sup></li> </ul>
Memory	<ul style="list-style-type: none"> <li>• For Windows 11: 4 GB or more recommended</li> <li>• For 64-bit OS other than Windows 11: 2 GB or more recommended</li> <li>• For 32-bit OS other than Windows 11: 1 GB or more recommended</li> </ul>
Display	Resolution SVGA (800×600 dots) or higher
Hard disk space	<ul style="list-style-type: none"> <li>• For installation: 10 MB or more</li> <li>• For execution: 100 MB or more recommended<sup>*6</sup></li> </ul>
Display color	High Color (16 bits) or higher
Other software	To display Help, the following software must be installed. <ul style="list-style-type: none"> <li>• Internet Explorer7 or later recommended</li> </ul>
	The following software must be installed. <ul style="list-style-type: none"> <li>• Ghostscript GPL9.55 (Free software)</li> <li>• PostScript printer driver supplied with Windows<sup>*7</sup></li> <li>• Microsoft Office 2003, Microsoft Office XP, Microsoft Office 2000<sup>*7</sup></li> </ul>
Other hardware	Use the hardware compatible with the above OS. <ul style="list-style-type: none"> <li>• For installation: mouse, keyboard, DVD drive</li> <li>• For execution: mouse, keyboard</li> <li>• For printing: printer</li> </ul>

\*1 For installation, the standard user or administrator account is required.  
To interact GT Designer3 with other MELSOFT applications which are used under the administrator authority, use GT Designer3 under the administrator authority.

\*2 The following functions are not supported.

- Application start in Windows compatibility mode
- Fast user switching
- Changing your desktop themes (fonts)
- Remote desktop
- Setting the size of text and illustrations on the screen to any size other than [Small-100%]

\*3 Operation is not supported in an environment with the text cursor indicator turned on.

- \*4 The touch feature is not supported.
- \*5 Operation in a virtual environment such as Hyper-V is not supported.
- \*6 For execution, the hard disk space for storing the temporary data in conversion is required.  
The required hard disk space is different depending on the document to be converted.  
When the conversion fails, increase the hard disk space and convert the document again.
- \*7 Required to convert a file created with Microsoft Word, Microsoft Excel, or Microsoft PowerPoint.
- \*8 ARM6 and ARM32 are not supported.

## ■ Before using Document Converter

Install the software indicated below before using Document Converter.

- Document Converter (Install it from the GT Works3 DVD (Disk3 folder).)
- Ghostscript GPL8.50 to 9.50<sup>\*2</sup> (Free software)
- PostScript printer driver supplied with Windows<sup>®</sup>\*1
- Microsoft<sup>®</sup> Office<sup>®</sup> 2000, Microsoft<sup>®</sup> Office<sup>®</sup> XP, Microsoft<sup>®</sup> Office<sup>®</sup> 2003<sup>\*1</sup>

\*1 Required to convert a file created with Microsoft<sup>®</sup> Word, Microsoft<sup>®</sup> Excel, or Microsoft<sup>®</sup> PowerPoint.

\*2 Versions 8.50, 8.71, 9.15, and 9.50 of the software are validated by our company.

### (1) Installing Document Converter

For the Document Converter installation procedure, refer to the following manual.

 GT Works3 Version1 Installation Procedure Manual

### (2) Installing Ghost script (free software)

Download Ghost script from the home page indicated below.

<http://www.ghostscript.com/download/gsdnld.html>

(Please note that the web site above is subject to change without notice.)

#### (a) Downloading procedure

The following shows the download procedure for GhostScript GPL9.15 as an example.

1. Select [<http://downloads.ghostscript.com/public/>] at the above website.
2. Select a file applicable to the OS used. ([gs915w32.exe] or [gs915w64.exe])  
Download of the file starts.

#### (b) Installation

1. Double click the downloaded file (.exe) and select [Setup].
2. Select the [Use WindowsTrueType fonts for Chinese, Japanese and korean] item.
3. Select [Install] to execute the installation.

(c) Adding environment variables

When [C:\gs] is set for the installation location, add [C:\gs\\*\*\*\*\bin] and [C:\gs\\*\*\*\*\lib] to the path of the environmental variables.

\*\*\*\*\*: Enter six characters that include the first five characters of the install execution file name and a decimal point. (For gs915w32.exe, input gs9.15.)

Follow the procedure below for setting the environment variables.

1. Select [Start] → [Control Panel] → [System and Security] → [System] from the menu.
2. Click the [Change settings] button in [Computer name, domain, and work group settings].
3. Select the [Advanced] tab and click the [Environment Variables] button.
4. Select [Path] in [System variables], and then click the [Edit] button.

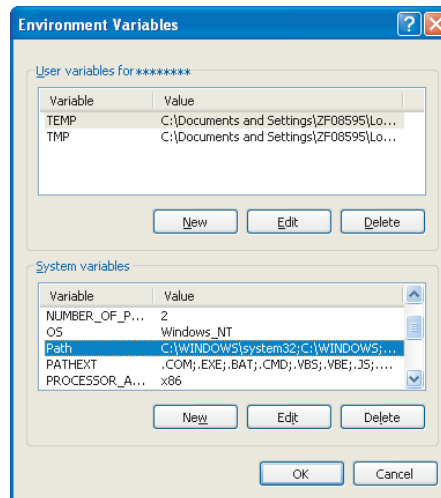

5. Add the path to [Variable value].  
Make sure to separate the existing path and the added path with a semicolon (;).

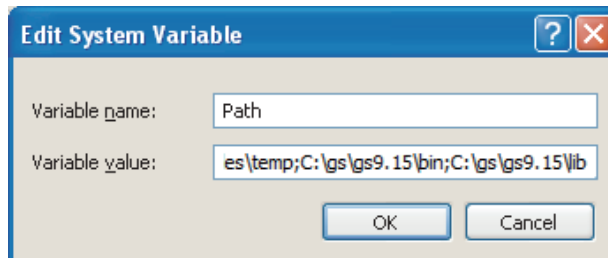

6. Restart the personal computer.

### (3) PostScript printer driver

The following shows how to install the PostScript printer driver.

For details of the operation of Windows<sup>®</sup>, refer to the manual and help information of Windows<sup>®</sup>.

1. Select [Start] → [Control Panel] → [Hardware and Sound] → [Add a printer] from the menu.
2. Click [The printer that I want isn't listed], select [Add a local printer or network printer with manual settings], and click [Next].

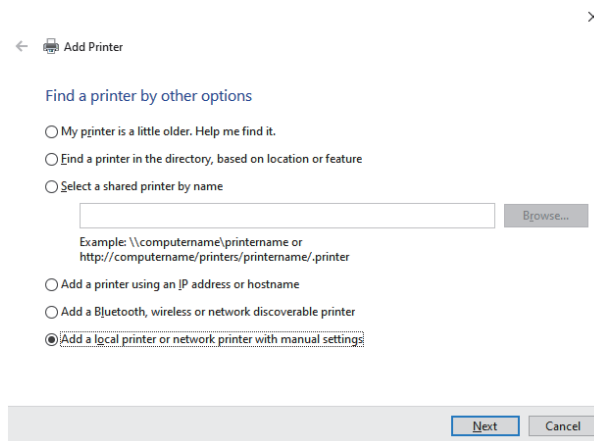
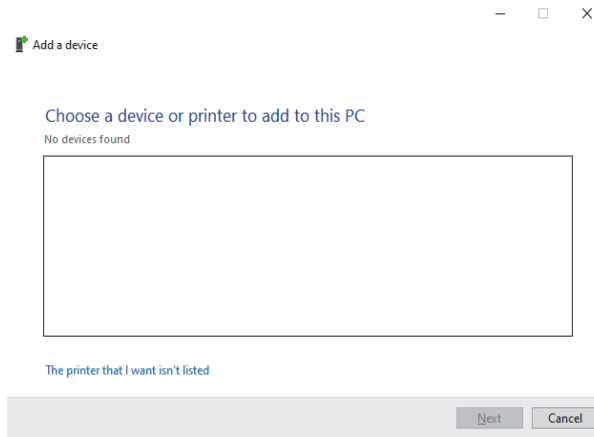

3. Select [FILE: (Print to File)] for [Use an existing port], and click [Next].

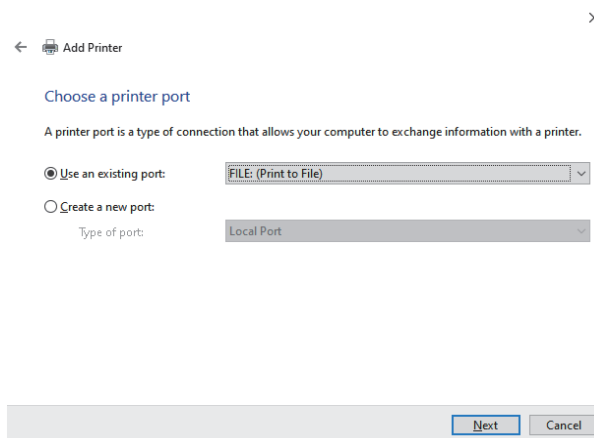



4. Select the PostScript printer driver (manufacturer: Generic, printer: MS Publisher Color Printer) supplied with Windows®, and click [Next].

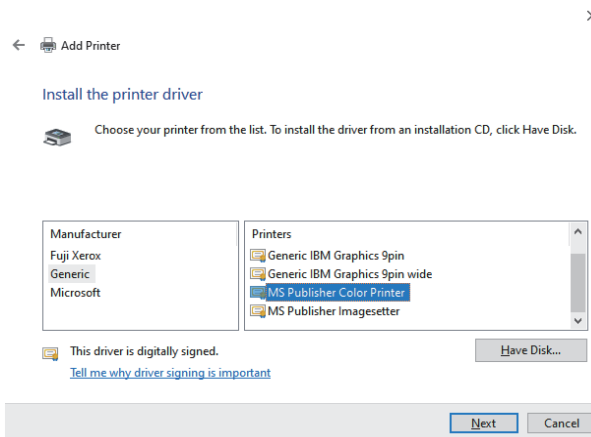

5. Select [Use the driver that is currently installed], and click [Next].

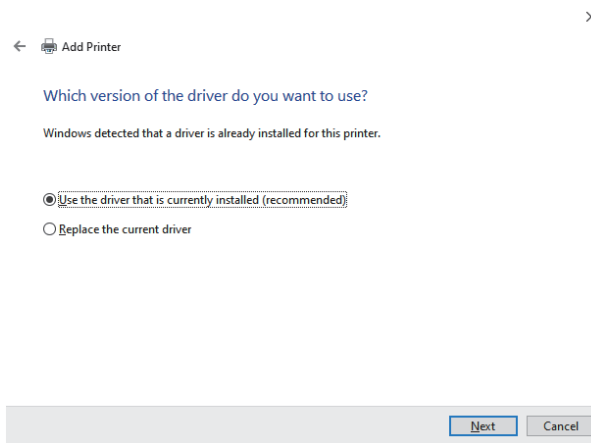

6. Check [Printer name], and click [Next].

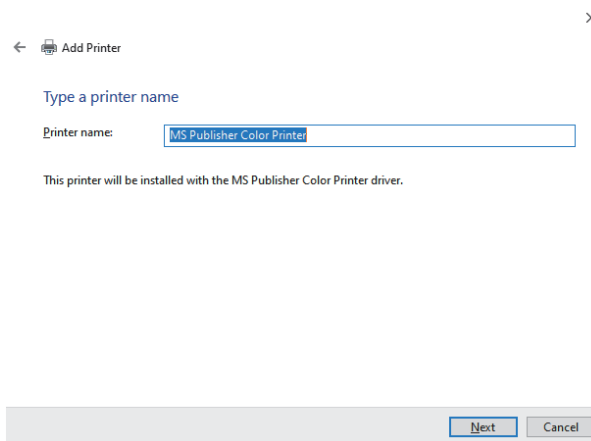

7. Select [Do not share this printer], and click [Next].

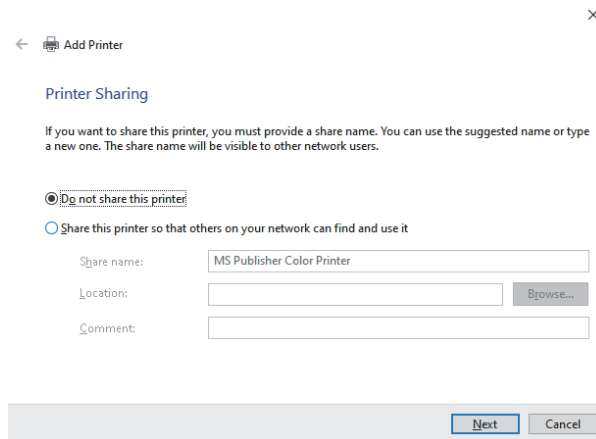



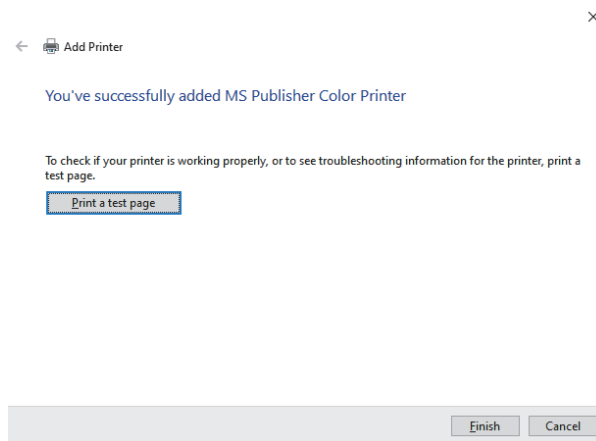

8. Click the [Finish] button.

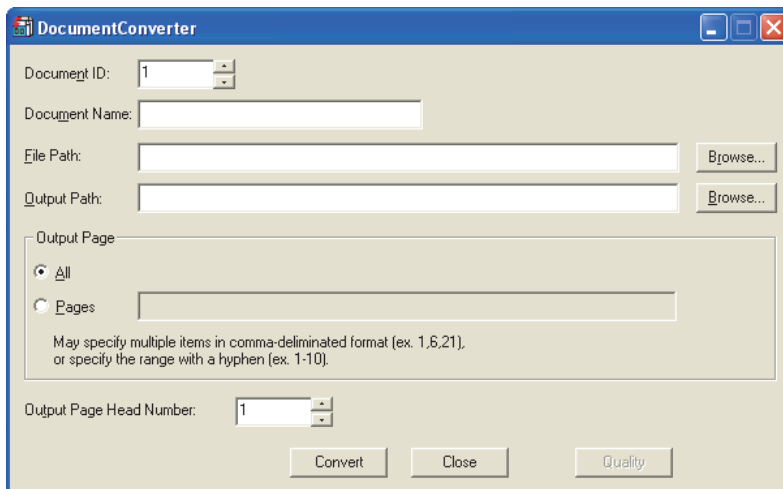

## ■ Converting a document file

1. Start Document Converter.
2. Set the following items and click the [Convert] button. The document conversion starts. After the conversion, three JPEG files (large, middle and small) are created for one page of document.



Item	Description	Model
Document ID	Set the document ID (1 to 255) to be assigned to the document after conversion.	
Document Name	The document name can be changed meeting the purpose. Up to 32 characters can be input.	
File Path	Specify the path name of the file to be converted by clicking the [Browse] button.	
Output Path	Specify the path in the personal computer for outputting the converted file by clicking the [Browse] button. The converted file is output in the following folder structure. \\DOCIMG(Document ID)(Output size: L/M/S)\\IMG****.JPG For the output size, L, M, and S stand for large, middle, and small, respectively. ****: Page number (serial number)  Example) Document ID: 1, output size: L (large) Output path\\DOCIMG\\001\\L\\IMG00001.JPG	GT16 GT15 GT14 GT12 GT11 GT10 SeriGOT1000
Output Page	Specify the pages to be converted. (This is required only for the Word, Excel, PowerPoint and PDF files.)	
Output Page Head Number	Specify the page number to be assigned to the first page of the converted file. (Specify "20" for example to assign Page 20 to the first page.)	
	Starts converting of the document.	
	Exits Document Converter.	GT16 GT15 GT14 GT12 GT11 GT10 SeriGOT1000
	Adjusts the image quality of the converted document.  (1) Quality dialog box (Executable after document conversion)	

## POINT

### (1) JPEG file after conversion

#### (a) JPEG file size

When a document of A4 size is converted, the size of JPEG files (large, middle and small) obtained is as follows.

Large: 816×1168 Middle: 656×928 Small: 400×584

#### (b) Folder structure of JPEG file storage location (DOCIMG) after conversion

Do not change the folder structure of DOCIMG.  
Doing so causes the GOT not to recognize the file.

#### (c) Storing files in CF card

For storing converted files in a CF card, store the DOCIMG folder containing the files in the root directory.  
When the DOCIMG folder is stored in a folder other than the root directory, the GOT does not recognize the files.

**(1) Quality dialog box**

The image quality of the converted document can be adjusted.

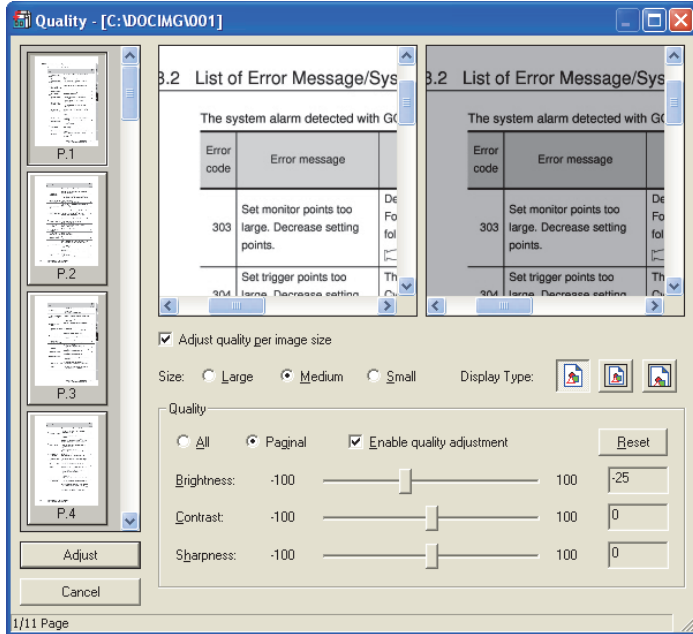

Item	Description	Model
Preview screen	Displays the screen images before and after adjustment. (Left: Before adjustment, Right: After adjustment) Select a page for adjusting image quality on the thumbnail located in the left side of the dialog box.	
Adjust quality per image size	Check this item when adjusting image quality for each image size. (When this item is not selected, the image quality is adjusted for all [Large], [Medium], and [Small] of [Size].) After selecting, select the image size of the image quality adjusting target in [Size].	
Display Type	Select how to display the image in the preview screen.	
Quality	Performs image quality adjustment. It is selectable whether image adjustment is performed for all pages or each page. Clicking the Reset button restores the settings to default values. <ul style="list-style-type: none"> <li>All Select this item when applying the same image quality adjustment for all pages.</li> <li>Paginal Select this item when applying image quality adjustment for each page. After selecting, select the [Enable quality adjustment] item for the image quality adjusting target page and execute image quality adjustment.</li> </ul>	G116 G115 G114 G112 G111 G110 SoftGOT1000
Adjust	Executes the image quality adjustment set. Note that the image quality cannot be restored after execution of image quality adjustment.	
Cancel	Cancels the set image quality adjustment and closes the screen.	

## 10.1.4 Placement and settings

1. Select [Object] → [Document Display] from the menu.
2. Click at the position where the document should be displayed. This completes the arrangement for the document display object.
3. Double click the arranged document display object and the setting dialog box is displayed. make the necessary settings referring to the following.



### Convenient setting

With the property sheet, direct setting of object is allowed on the sheet.

☞ 9.4 Displaying in List and Editing Screen/Figure/Object Settings (Propertysheet)

A document is displayed as follows, depending on the relationship between the size of the object (Object frame) arranged in procedures 1 to 3 and the size of the document to be displayed (Size of the JPEG file converted by Document Converter).

(The shaded area shows the actual area where the document is displayed.)

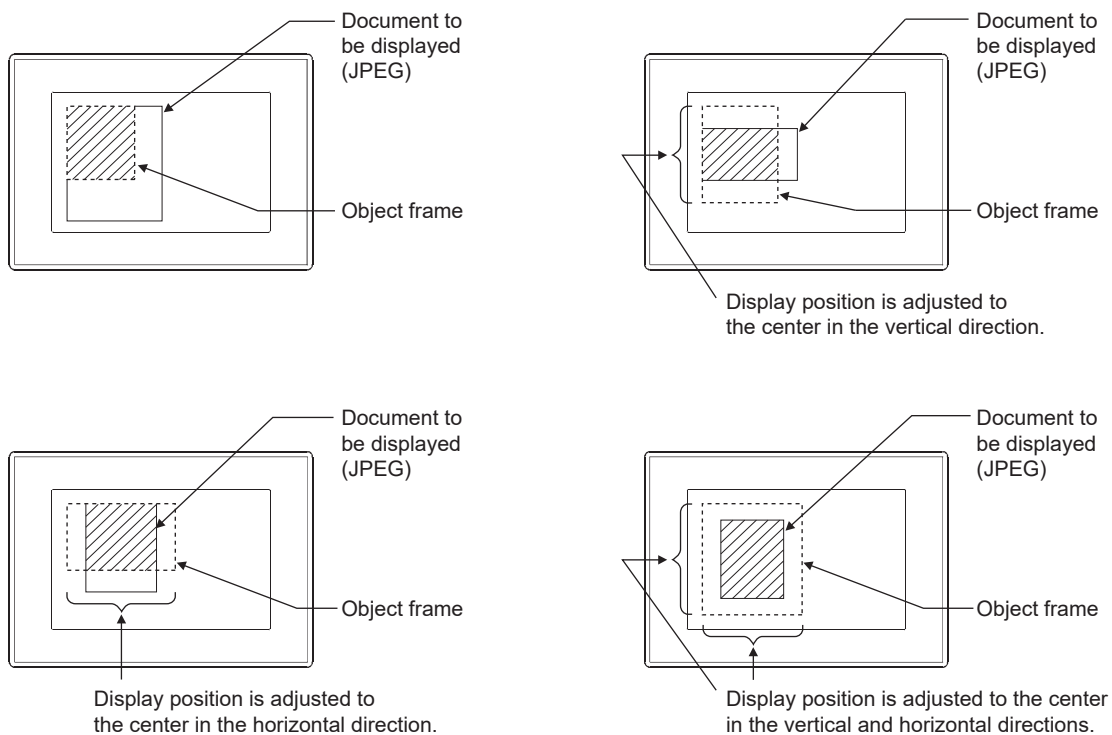

## 10.1.5 Setting items

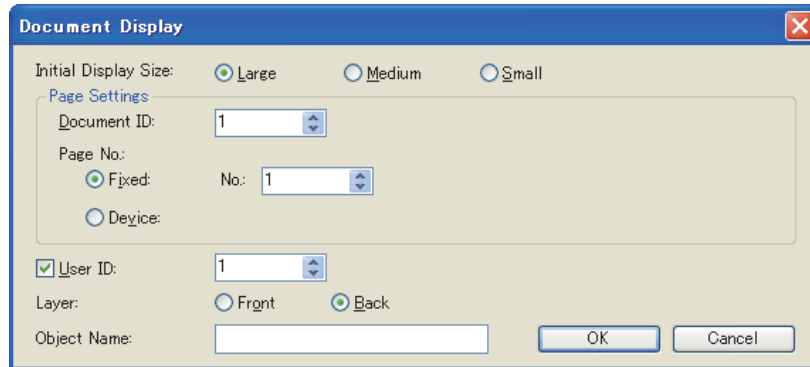

Item	Description	Model
Initial Display Size	Select the size (L / M / S) of the document displayed for the first time when the screen is switched. Large : 816 × 1168 Medium: 656 × 928 Small : 400 × 584	
Page Settings	Document ID* <sup>1</sup> Set the document ID of the document to be displayed when the screen is switched in a fixed value (1 to 255). If a document ID that does not exist in the CF card is set, the document is not displayed.	gr16 gr15 gr14 gr12 gr11 gr10 SoftGOT1000
	Page No. Select the method (Fixed/Device) to set the page number of the document to be displayed when the screen is switched. If a page number that does not exist or "0" is set, document is not displayed. • Fixed: Select this item when setting a page number in a fixed number (0 to 65535). • Device: Select this item to set a page number by specifying a device. After selecting this item, select the data format and set the number device. Select [Unsigned BIN16] or [BCD16] for the data format.	
User ID	Set the user ID (1 to 65535) of document display.* <sup>2</sup>	
Layer	When setting an object without superimposing it, set the object by default (Back). When setting an object with superimposing it, the object has to be set to Front or Back place.  5.3.7 Superimposition setting	
Object Name	The object name being set can be renamed to meet the purpose of use. The changed object name is displayed in the GT Designer3 (in such as Data view and Propertysheet). This Object Name item is displayed in other than the Basic tab. Up to 30 characters can be input.	

For details of \*1 and \*2, refer to the following.

## \*1 User ID

### (1) Cases that require setting of user ID

When there are several objects that are operated by the touch switches of the same key code on the screen, expected action may not be achieved even if a touch switch is touched.

By setting a user ID so that each object has unique ID (user ID), it is made possible to specify the ID (object) to be operated by a touch switch. This enables switch operation as expected.

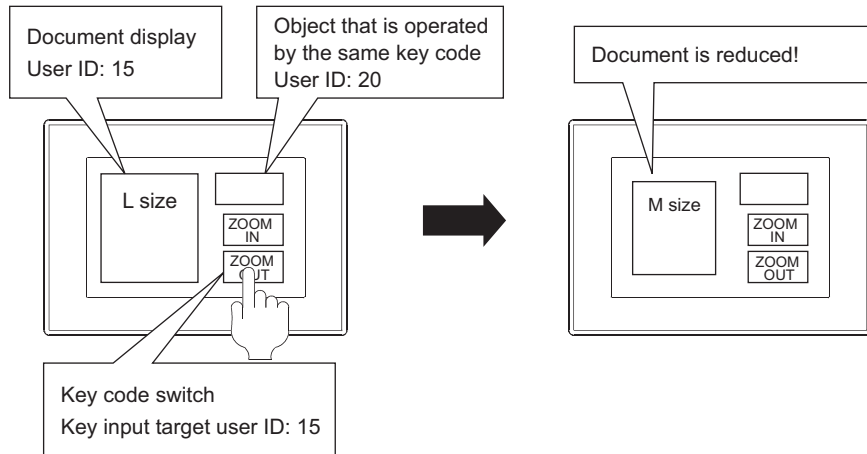

### (2) Setting for a touch switch

Input the user ID set in this user ID setting to [User ID for a key input and data change].  
For details of the switch, refer to the following.

 (Functions) 2.1 Setting Switch

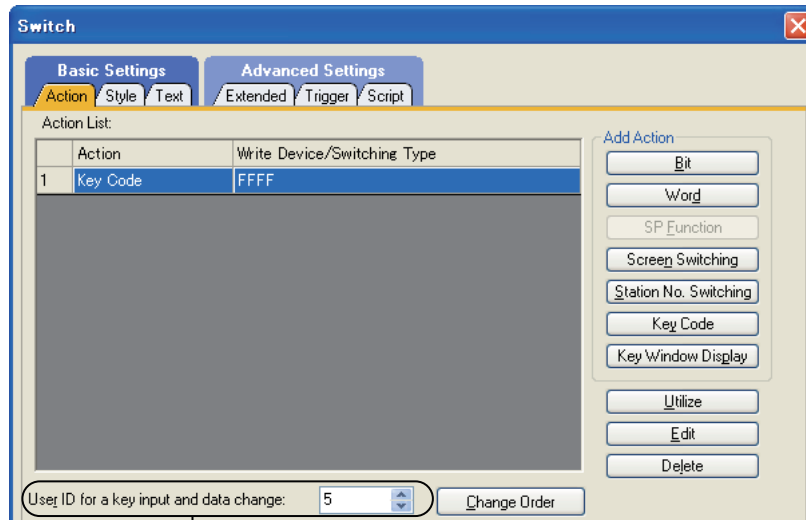

Set the user ID that has been set at the object side.

## \*2 Changing the page by setting a page number

To change the display page of the document, set a page number at the device.

Example) Document ID: 2, Page number setting device: D600

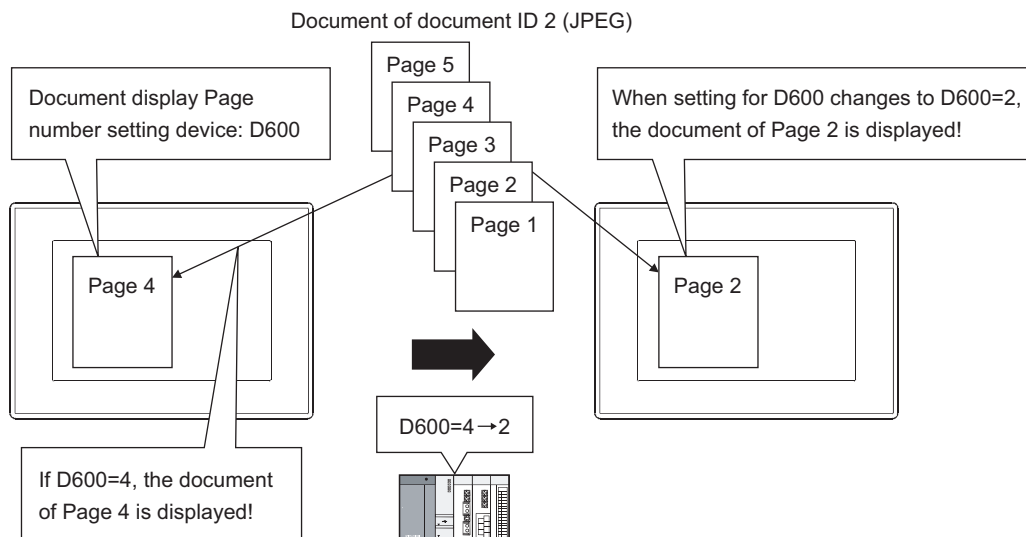
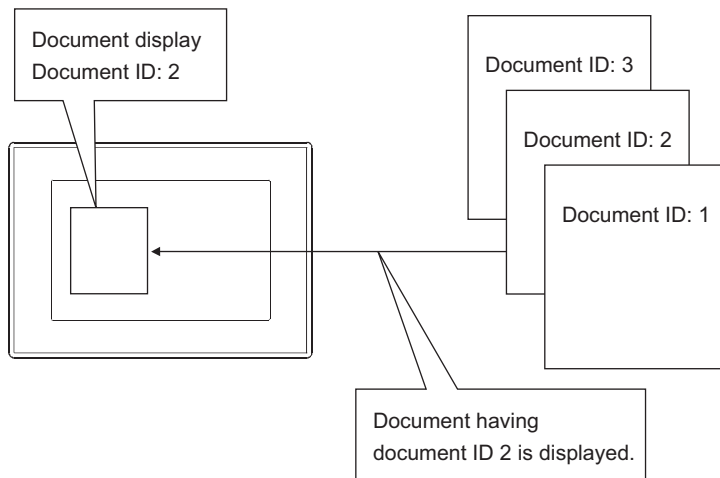

### POINT

#### If a page that does not exist is specified

If a page that does not exist is specified when changing the page of the displayed document, document is not displayed.







In this case, the document display status notification signal (GS276.b0) turns ON.

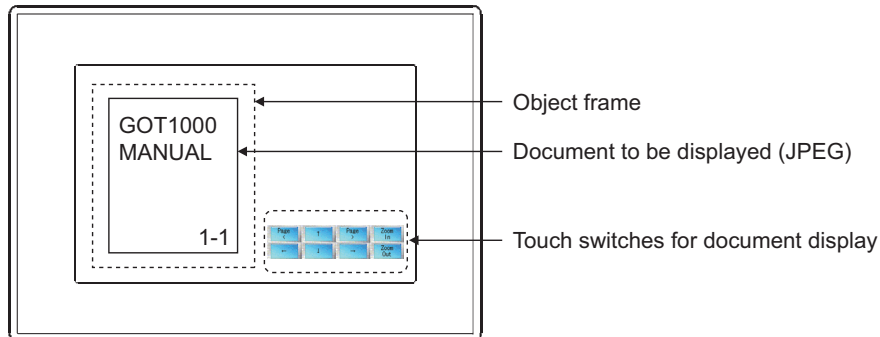

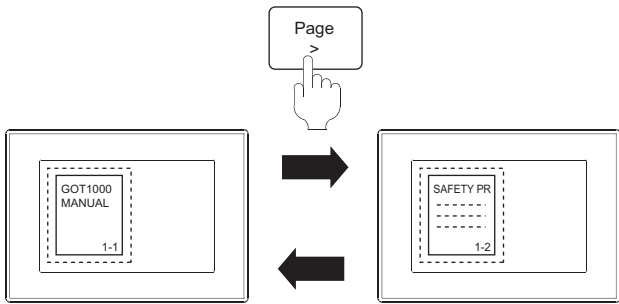



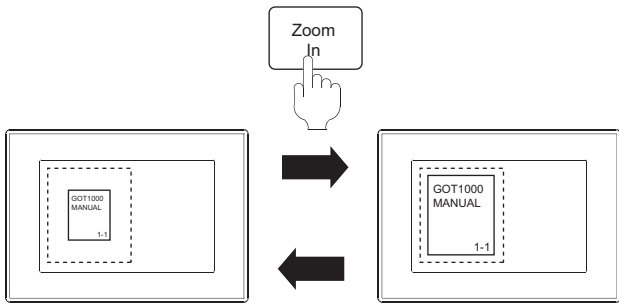

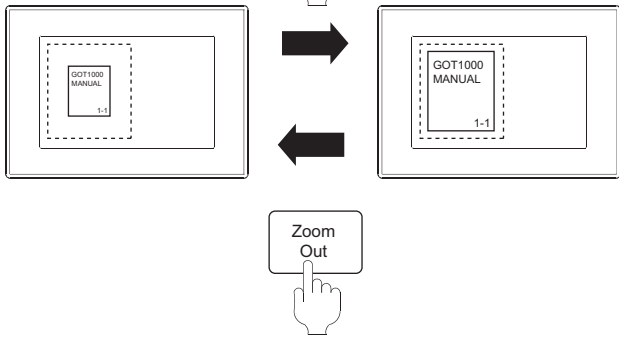



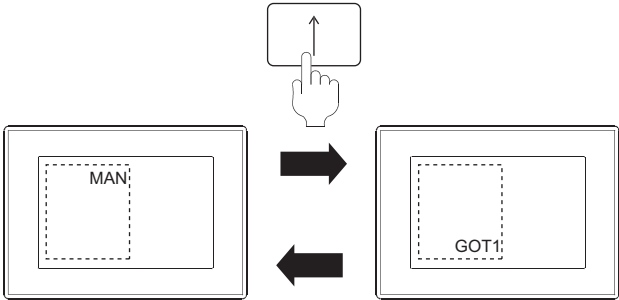

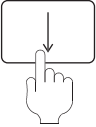
## 10.1.6 Description on touch switches for document display

Touch switches for document display can be read from the library of GT Designer3. Also, text on a touch switch and touch switch shape can be changed by the user as desired. A document display touch switch can be created by setting a key code to a touch switch.

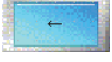
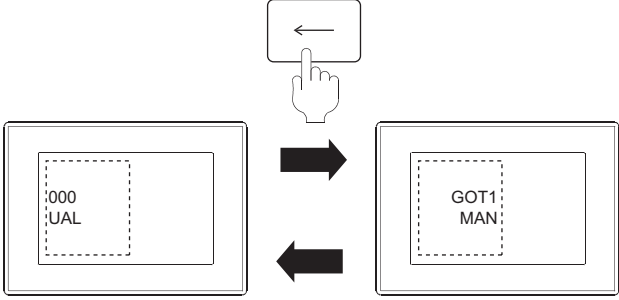

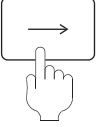
Touch switch	Key code	Description
Next Page 	FFE0 <sub>H</sub>	Advances / returns the document to the next / previous page. 
Previous Page 	FFE1 <sub>H</sub>	When the page number of the document to be displayed is specified using a device, the specified device value is updated in synchronization with the operation of the keys  /  .
Expansion 	FFE2 <sub>H</sub>	Enlarges or contracts the displayed document (in three steps of L / M / S). 
Reduction 	FFE3 <sub>H</sub>	

(Continued to next page)

Touch switch	Key code	Description
<p>Up Scroll</p> 	<p>FFE4<sub>H</sub></p>	<p>Scrolls up / down the displayed document.</p> 
<p>Down Scroll</p> 	<p>FFE5<sub>H</sub></p>	 <p>The  /  key is inoperative when the displayed document is at the upper / lower end, respectively.</p> <p>When the vertical size of the document to be displayed is smaller than the object frame (position is adjusted (centering) in the vertical direction),  and  keys are inoperative.</p>
<p>Left Scroll</p> 	<p>FFE6<sub>H</sub></p>	<p>Scrolls left / right the displayed document.</p> 
<p>Right Scroll</p> 	<p>FFE7<sub>H</sub></p>	 <p>The  /  key is inoperative when the displayed document is at the left / right end, respectively.</p> <p>When the horizontal size of the document to be displayed is smaller than the object frame (position is adjusted (centering) in the horizontal direction),  and  keys are inoperative.</p>

## 10.1.7 Precautions

Precautions to be attended to when using the document display function are indicated below.

### ■ Precautions for drawing

- (1) **Number of objects that can be arranged on one screen**  
Only one document display can be arranged on one screen.
- (2) **Number of objects that can be displayed**  
Multiple document displays cannot operate simultaneously.  
Displaying of another document on an overlap window or a superimpose window or with the set overlay screen function is invalid.

### ■ Precautions for OS

Install the option OS (Document display) to the GOT to use the document display function.

### ■ Precautions for hardware

- (1) **Option function board**  
To use the document display function, the option function board is required according to the GOT.  
The following shows option function boards required for each GOT

GOT	Option function board
GT16	Not required
GT15	GT15-QFNB, GT15-QFNB16M, GT15-QFNB32M, GT15-QFNB48M, GT15-MESB48M

For GOTs with built-in option function boards, refer to the following.

 Appendix10 Precautions for Option Function Board

- (2) **CF card**  
Insert a CF card in the drive specified for [Default Drive Name] in the [GOT Type Setting] dialog box.

 4.1 GOT Type Setting

### ■ Precautions for use

- (1) **If document is not displayed**  
Document display is disabled in the following cases.
  - (a) A CF card is not installed.
  - (b) The CF card access switch is OFF.
  - (c) The document to be displayed does not exist (A document ID or a page number that does not exist has been set)
  - (d) The specified file is not an image file or it is damaged.
  - (e) The image data to be displayed does not satisfy the following conditions.
    - The image resolution is 1240×840 or lower (horizontal), or 840×1240 or lower (vertical)
    - The data size is 960KB or less.

In such cases, system alarm occurs and an error message is displayed.

For details of system alarm, refer to the following manual.

 User's Manual for the GOT used

At the same time, the document display status notification signal (GS276.b0) is turned ON.

 Appendix2 GOT Internal Devices

**(2) About Word, Excel and PowerPoint files**

Files that can be opened and printed on the personal computer in which Microsoft® Office® 2000, Microsoft® Office® XP or Microsoft® Office® 2003 is installed, can be displayed.

**(3) About PDF files**

If the font used in the PDF file is in the following state, display of such PDF file is not possible.

- Font does not exist in the execution environment (on Windows®).
- Font data is not embedded to the PDF file.

In such cases, an error occurs when a file is converted by Document Converter.

For the pages that cannot be converted by Document Converter, use the procedure indicated below to convert them.

1. Convert the document page by selecting [Page] in [Output Page].
2. Check the pages that cannot be converted from the display of an error message.
3. Capture the image of the page that was not converted and save it as an image file (JPEG, BMP).
4. Convert the saved image file (JPEG, BMP) by Document Converter.

# 10.2 Changing Screen According to Situation (Set Overlay Screen)



Other base screens or window screens can be called to be placed on a basic screen and displayed in a single screen by using this function.

Memory capacity when setting the same object onto multiple screens can be saved.

- When not using the set overlay screen function  
Set four touch switches. (2 on production status screen1 and 2 on production status screen2)

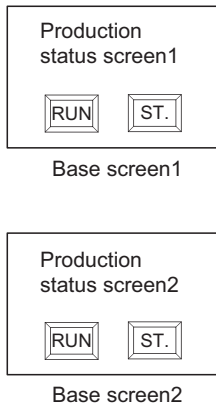

- When using set overlay screen function  
Set two touch switches. (2 on the set overlay screen)  
Touch switch setting is not required for production status screen1 and 2 because these touch switches have already been registered on the called screen.

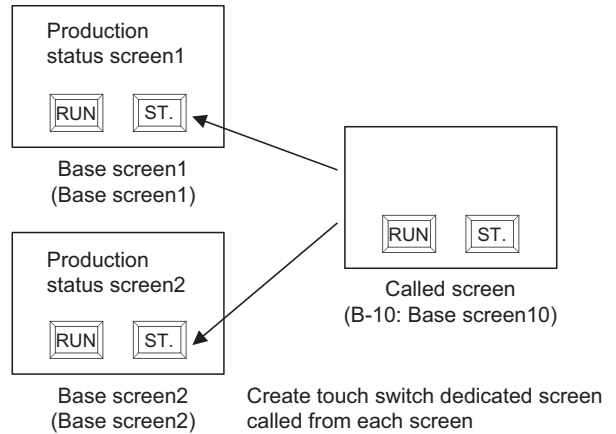

## (1) Multiple called screens can be displayed

Multiple called screens can be displayed on one basic screen.

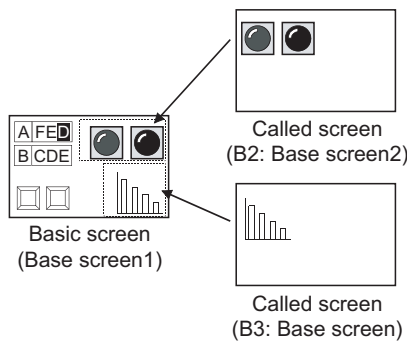

**(2) Up to the 16th nesting can be called**

As up to the 16th nesting can be set, screen setting with high flexibility can be realized.

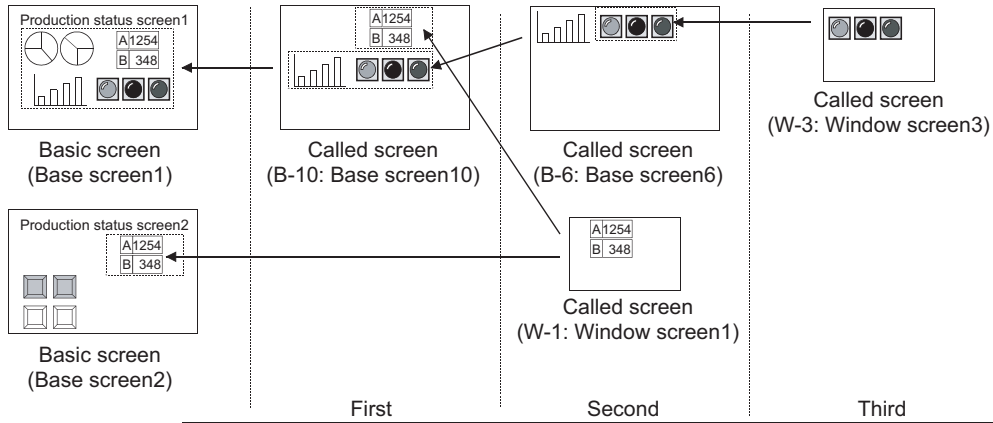

**Relevant settings**

The set overlay screen function is available for the relevant settings other than the specific settings. The following shows the functions that are available by the relevant settings.

**(1) GOT type setting**

Select [Common] → [GOT Type Setting] from the menu to display the [GOT Type Setting] dialog box.

4.1 GOT Type Setting

Function	Setting item	Model
Checking if objects are not overlapping.	[Check for overlapping objects within GOT]	GT16 GT15 GT14 GT12 GT11 GT10 SetGOT1000
Adjusting the order of displaying objects on the GOT to that of the overlapped objects on GT Designer3.	[Adjust object display order in GOT to the one in GT Designer3]	GT16 GT15 GT14 GT12 GT11 GT10 SetGOT1000

**(2) GOT Environmental Setting**

Select [Common] → [GOT Environmental Setting] → [Screen Switching/Windows] from the menu to display the [Environmental Setting] dialog box.

4.2 Screen Switching Device Setting

Function	Setting item	Model
Setting the placement position (Front/Back) of the called screen to the basic screen when calling a screen.	[Place the overlay screen under the basic screen ]	GT16 GT15 GT14 GT12 GT11 GT10 SetGOT1000
Setting the background color of a called screen to enabled or disabled on the basic screen when calling a screen.	[Disable background colors of overlay screen when setting an overlay screen]	GT16 GT15 GT14 GT12 GT11 GT10 SetGOT1000

## ■ Arrangement and settings

1. Select [Object] → [Set Overlay Screen] from the menu.
2. The [Set Overlay Screen] dialog box appears.  
 Select the screens to call up by any of the following methods, and click the [OK] button.
  - Select the screen to call up directly from the screen selection tree
  - Click the [Screen No.] button to display the [Number Specification] dialog box, and set the screen to call up by the screen number.
  - Click the [Image] button to display the [Screen Image List] dialog box, and select the screen to call up from the screen images.

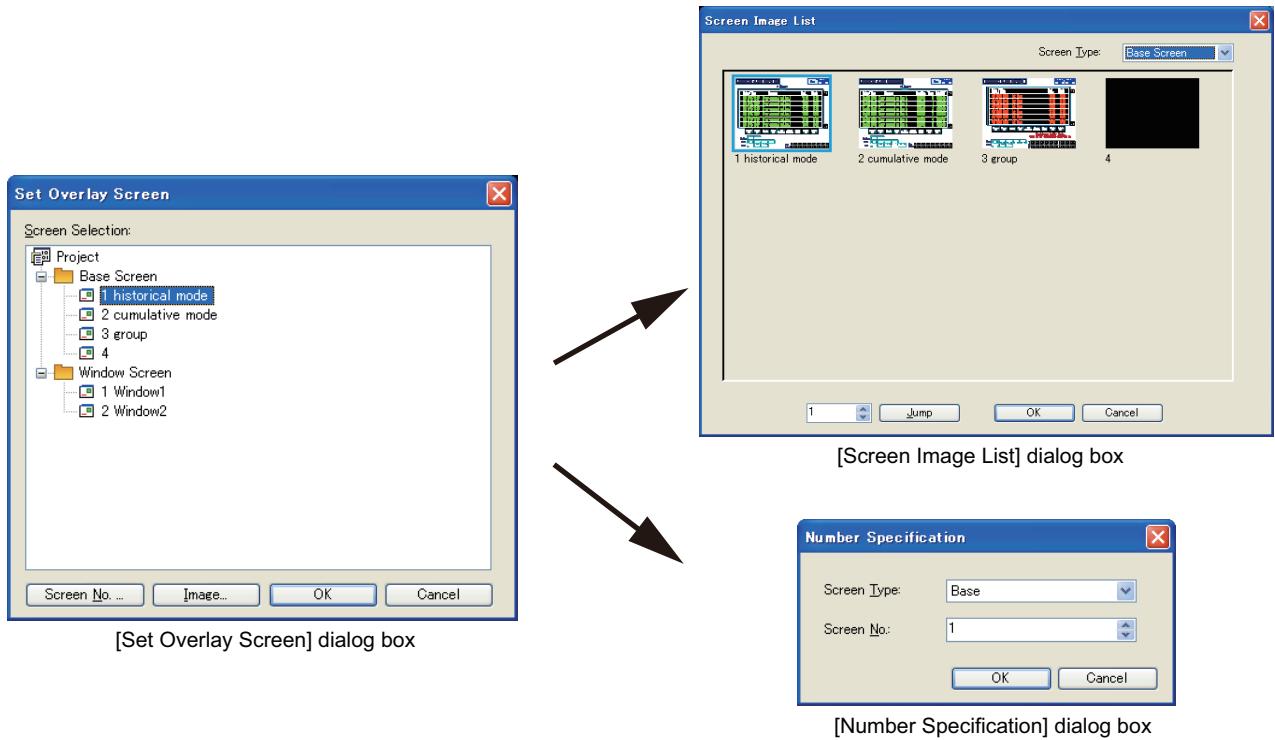

3. Arrange the Set overlay screen on the screen editor.

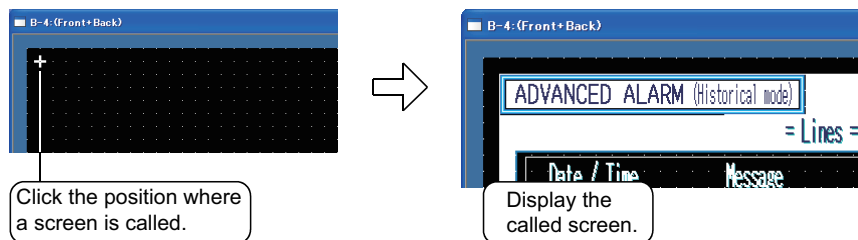

### HINT

**(1) Editing of called screens**

By double-clicking a Set overlay screen arranged on the screen editor, the called screen can be opened to be edited.

**(2) Easy setting method**

The Set overlay screen can also be set by dragging it from the screen tree.

## ■ Check of the settings

The setting contents of Set overlay screen can be checked in the screen tree.  
For details of the screen tree, refer to the following.

 3.2.2 Operating work tree

## ■ Precautions

This section provides the precautions for using the set overlay screen function.

### (1) Screen that can be called

Base screen, window screen (For GT10, only the base screen can be called.)

### (2) Maximum number of called screens (The number of screens that can be called and displayed on the basic screen)

Up to 2047 called screens can be placed (set). (Up to 5 screens for GT10)

### (3) Maximum nesting number (nesting of further call to the called screen)

16 (Excluding the basic screen, up to 1 level for GT10)

### (4) Edit of called screen

(a) The called screen cannot be edited on the basic screen.

Edit must be done on the called screen.

(b) Once the called screen is edited, it will be reflected to all of the basic screens where the edited screen is called.

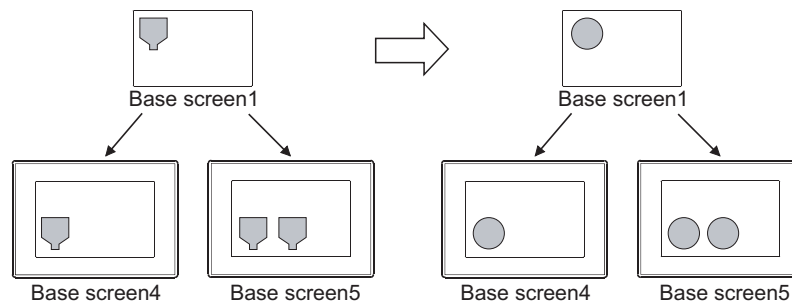

### (5) Displaying figures and objects placed in temporary area

When figures and objects are placed in the temporary area of the called screen, the GOT does not display the objects.

The GOT displays the figures only.



**(6) When cascading shapes/objects**

The following are examples of cascading on the same layer.  
 For the cascading of shapes/objects, refer to the following.

5.3.7 Superimposition setting

(a) Figure data

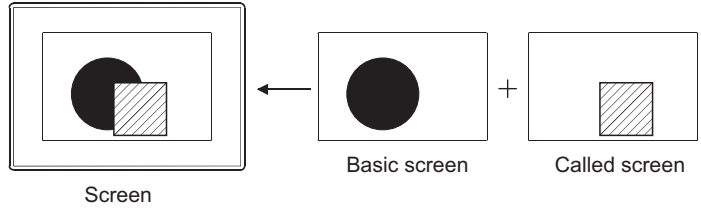

The figure of called screen is displayed in the front.

(b) Object data

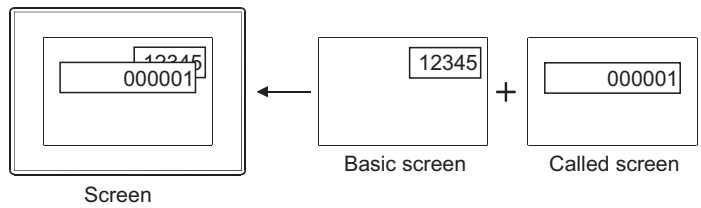

Among the objects of basic screen and called screen, the one whose value is changed will be displayed in the front.

(c) Touch switch

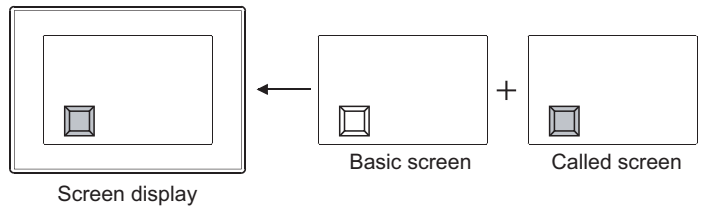

Initially, the touch switch corresponding to the latest screen will be displayed in the front. After, the screen where touch switch trigger has changed will be displayed.

**HINT**

**(1) Overlapping touch switches**

Without using the screen calling, multiple operations can be set to one touch switch.

(Functions) 2.1 Setting Switch

**(2) Screen background**

The background color of the called screen will be displayed in the front.

When the background color and the basic screen shape color are overlapped, the shape will not be displayed.

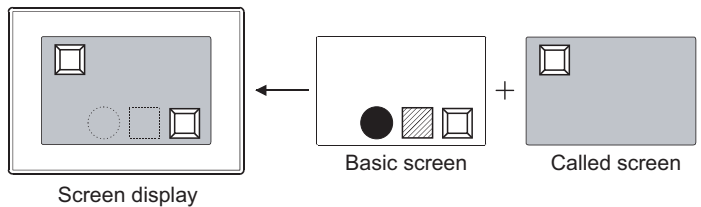

The shape of basic screen will not be displayed.

If no background color is set for the called screen or if "No pattern" is set in "Pattern" of the background color, that of the basic screen is displayed.

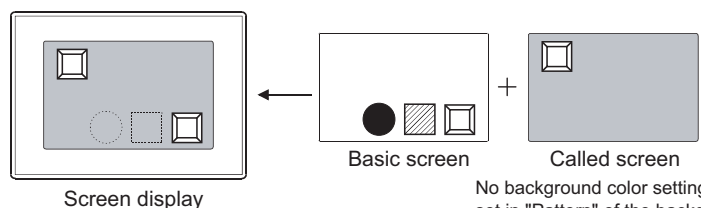

No background color setting or "No pattern" set in "Pattern" of the background color

## POINT

### When the figure is filled with paint

If the paint has been set to the figure on the basic screen and when the figure is overlapped with another on the called screen, the colors may not be displayed correctly.

If this occurs, fill in the figure on the basic screen.

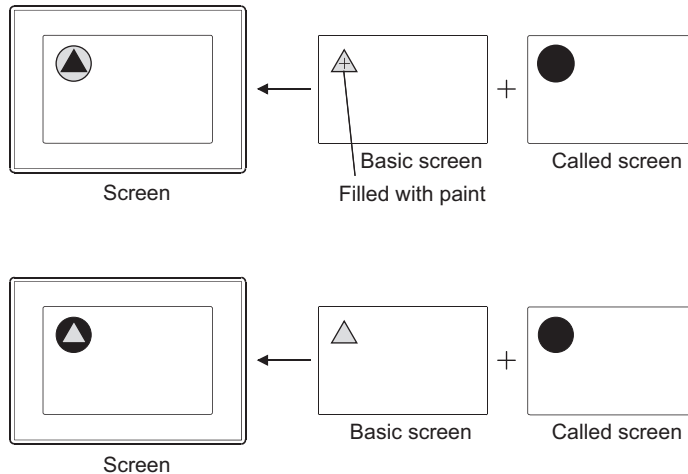

### (7) When exclusive objects (which only one setting is allowed per each screen) are overlapped

Do not cascade such objects created by the data list function and the alarm history function.

Otherwise, the set numbers of objects are displayed, however, they cannot be displayed correctly because of the function restrictions.

### (8) Display/hide called screen according to the security level and nesting of called screen

The security level set in each called screen is valid.

The cautions for security setting in each called screen are as follows.

- The called screen will not be displayed when the security level of the called screen is higher than that of the password input on the basic screen.
- The screen display using the nesting structure cannot be called from the screen with security settings enabled.
- The status observation function and the script function set to the called screen that is not displayed cannot be executed.

Example) Called screens that can be displayed by password of security level2

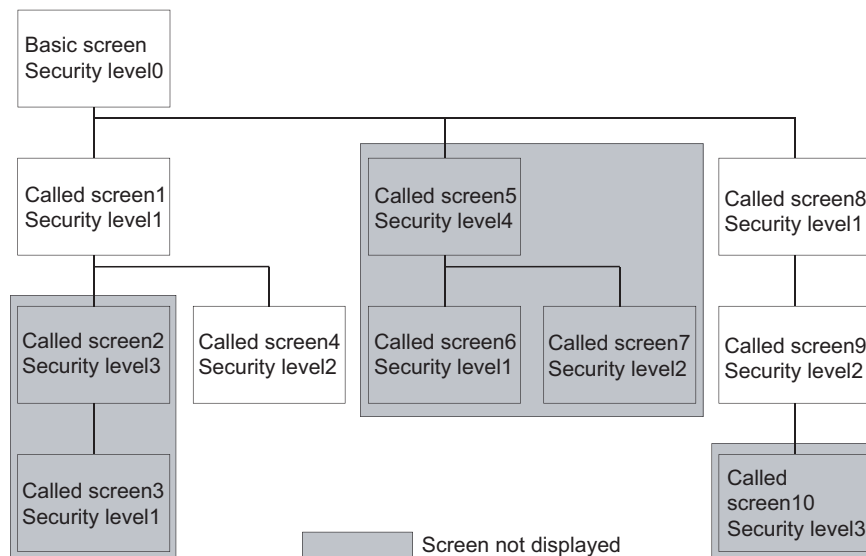

### (9) Displaying order for calling multiple screens

When multiple called screens are set on one screen, they are displayed on the order of setting in GT Designer3 or called screen nesting.

Since the current screen is displayed on the previous screen, the screen with the lowest order will be displayed in the front most.

The following shows the order of precedence for display.

- When multiple called screens are set, they are displayed in the order set in GT Designer3.
- For called screens that have been nested, the screen with deeper nesting is displayed in the front most.
- If the above conditions (a) and (b) are both applied, priority is given to the nested called screen.

Example) When setting multiple called screens including nested called screens ( 1) to 11): Display order)

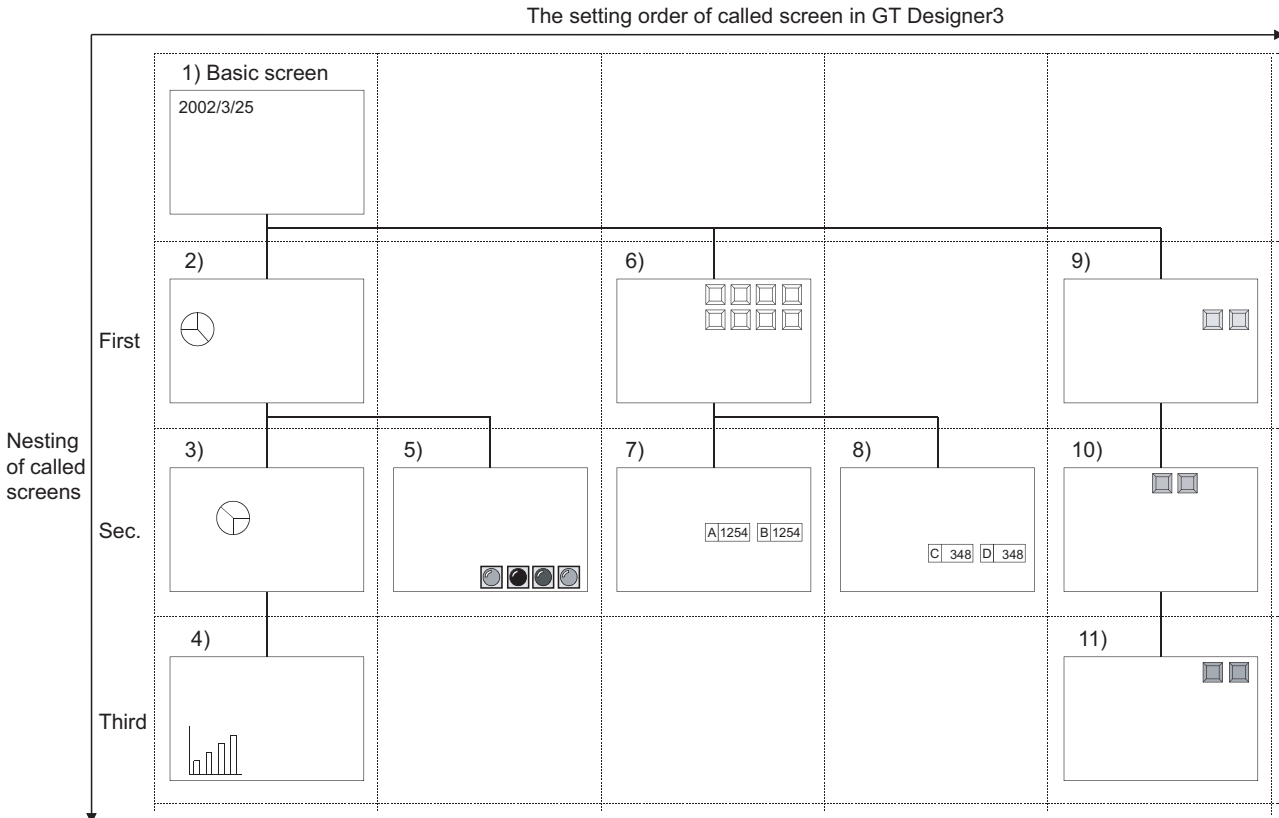

### POINT

#### (1) Security function, status observation function and script function of called screen

The security function, status observation function and script function set for each called screen are processed in the same order as the called screen display.

#### (2) Check methods of nesting and setting order

The nesting can be checked in the screen tree.

☞ 3.2.2 Operating work tree

The set order can be checked in the data view. (Data are displayed in the order of setting in the data view.) Refer to the following manual for the data view.

☞ 9.5.3 Selecting overlapped figure (Data view)

## 10.3 Switching ON/OFF Device (Test Function)



This section explains the test function that displays test window on monitor screen and changes device value. This function is applicable for maintenance and inspection using monitor screen, providing the following functions. Test function provides following operations.

- Bit device ON/OFF
- Change the word device
- Change the set value of timer/counter
- Change the buffer memory

Arrange touch switch (special function switch) to set the test function.

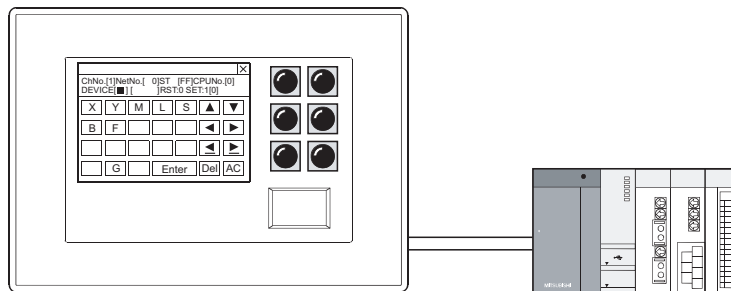

### HINT

#### Test except when the monitor screen is displayed

The test window can be displayed to change the device value, as well when the ladder monitor function or system monitor function is used.

Refer to the following manuals for the test methods of various functions.

GOT1000 Series User's Manual (Extended Functions, Option Functions) for GT Works3

### Method of operating test window

This section explains how to operate the test window.

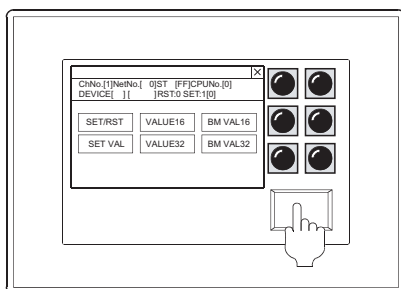

1. Touch the Special Function switch to display the test window.

(Continued to the next page)

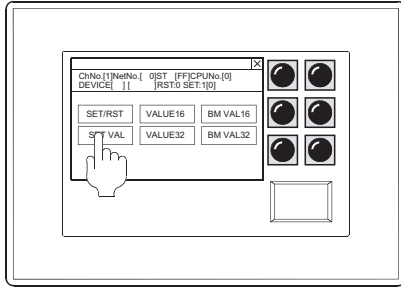

2. Select the device type to be changed
  - SET/RST: Set/reset the bit device.
  - Current value 16/Current value 32: Change the current value of word device.
  - Set value: Change the set value of T.C.
  - BIN Value 16/BIN Value 32: Change the current value of buffer memory.

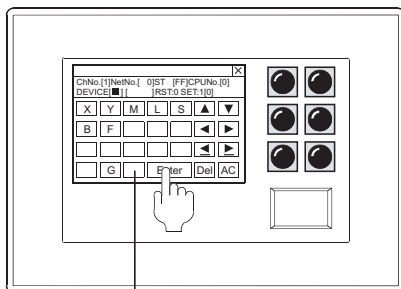

Change keys according to input area.

3. Specify the network No., device and value of the device of which value is to be changed. Change the input area by ◀, ▶ keys.
  - In the case of data link system
    - ChNo.: Set the channel No.of the GOT interface.
    - NetNo.: 0
    - ST: FF (host), 0 (master station), 1 to 64 (local station)
  - In the case of network system
    - ChNo.: Set the channel No.of the GOT interface.
    - NetNo.: 0 (self loop), 1 to 255 (specified loop)
    - ST: FF (host), 0 (control station), 1 to 64 (normal station)
  - Define the value change by the definition key

## ■ Arrangement and settings

Refer to the following section for arrangement and settings of the touch switch.

(Functions) 2. TOUCH SWITCH

## ■ Setting items

Refer to the following section for setting items of the touch switch.

(Functions) 2.6 Setting Special Function Switch

## ■ Precautions

### (1) Precautions for drawing

- (a) Line graph with locus display setting  
Only the GT16 displays the test window on the base screen that has the line graph with the locus display setting.
- (b) Windows that cannot be displayed on the same screen  
The test window and overlap window 2 cannot be displayed on the same screen.

### (2) Precautions for OS

To use the test function, install the extended function OS (System monitor) on the GOT.

### (3) Precautions for use

- (a) Control of the controller control  
Executing test function may affect the control of the controller.  
Make sure to fully confirm the security before executing the test function.

## 10.4 Starting GOT with Memory Card

---



The GOT starts with the simple operation of inserting a memory card into the GOT.

Storing project data and OSs in the memory card enables you to use data exceeding the size of the GOT built-in memory for storing data (ROM). (The maximum data size is the size of the GOT built-in memory for operation (RAM).)

The size of the memory for storing data (ROM) and the memory for operation (RAM), refer to the following.

 8.5.2 Drive capacity required for data transfer

### ■ To start up

1. Select [Communication] → [Transfer to Memory Card] from the menu.  
After selecting, the [Communicate with Memory Card] dialog box appears.
2. In the [Communicate with Memory Card] dialog box, set [A:Standard Memory Card] for the boot OS drive, and transfer the data to a memory card.  
For details of the setting method, refer to the following.

 8.2 Transferring Data to Memory Card or USB Memory

3. Insert the memory card into the GOT to start.  
Refer to the following manual for details of the starting operation.

 User's Manual for the GOT used

### POINT

#### When the GOT is started with the memory card

##### (1) Unavailable operations at GOT start-up with the memory card

When the GOT is started with the memory card, the following operations are not available.

- Installing Boot OS<sup>\*3</sup>
- Installing OS<sup>\*1\*3</sup>
- Writing special data<sup>\*1\*3</sup>
- Writing project data to a drive other than drive A<sup>\*3</sup>
- Deleting in the drive information<sup>\*2\*3</sup>
- Format in the drive information<sup>\*2\*3</sup>

<sup>\*1</sup> Write the data to the memory card again with GT Designer3.

<sup>\*2</sup> Insert the memory card into a personal computer, and perform the operation on the personal computer.

<sup>\*3</sup> Stop starting the GOT with the memory card, and perform the operation again with GT Designer3.

##### (2) Files that must not be deleted

When the GOT is started with the memory card, "GOT1000-STATUS.txt" and "GOT1000-TIME.txt" are created in the card.

Do not delete these files because they are required for the system.

---

## 10.5 Operating GOT with USB Mouse/Keyboard (USB Mouse/Keyboard Function)



GOT operation by connecting a USB mouse or USB keyboard to the GOT is available.

This function is useful when operating small touch switches or entering a large amount of characters.

With the remote personal computer operation (Ethernet), a personal computer on the network can be operated from the GOT by using a mouse or keyboard.

For using and setting the remote personal computer operation, refer to the following.

 (Functions) 33.2 Remote Personal Computer Operation (Ethernet)

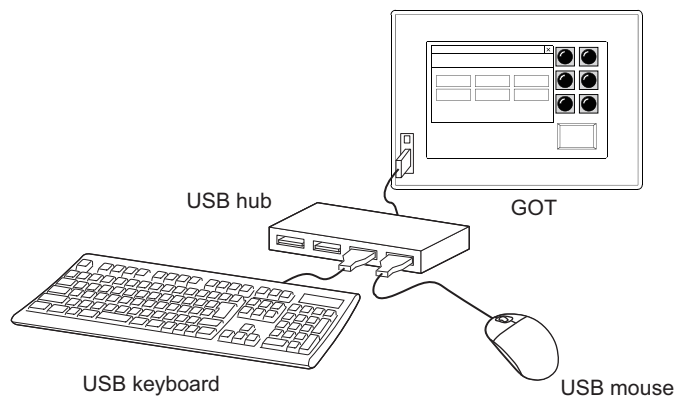

## 10.5.1 Settings

Select [Common] → [GOT Environmental Setting] → [GOT Setup] from the menu to display the [Environmental Setting] dialog box.

Click the [USB Host] tab, and then configure the setting.

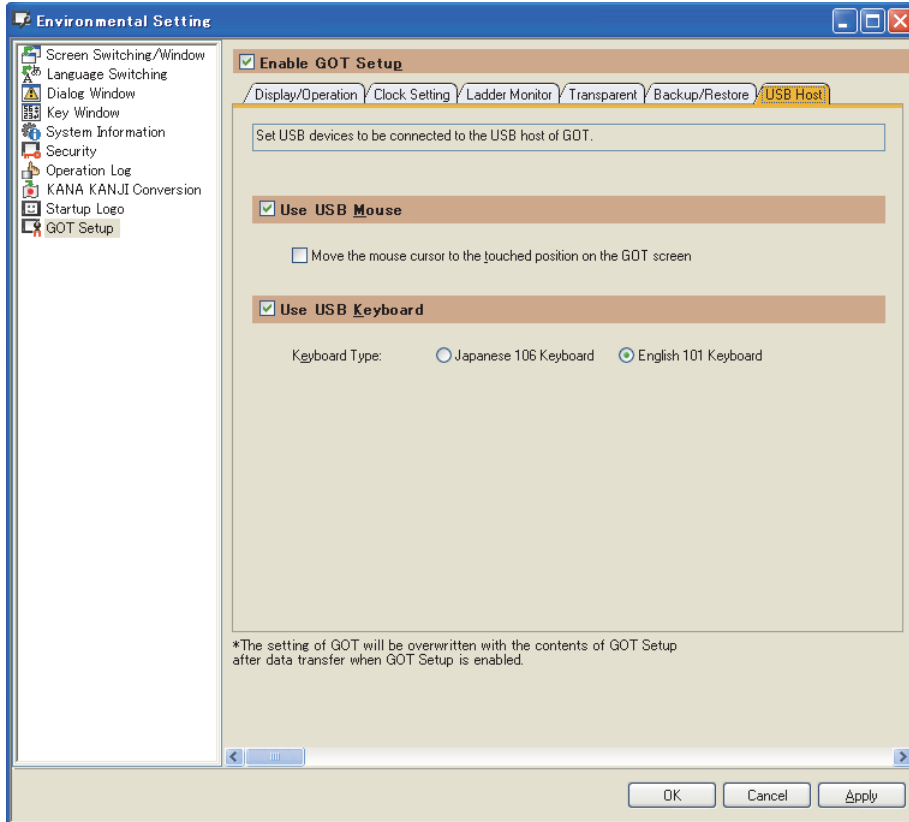

Item	Description		Model
Use USB Mouse	Select this item to enable the USB mouse connected to the USB interface (host) of the GOT.		gr16 gr15 gr14 gr12 gr11 gr10 softGOT1000
	Move the mouse cursor to the touched position on the GOT screen	Select this item to move the cursor to the position where the user touched on the GOT screen.	
Use USB Keyboard	Select this item to enable the USB keyboard connected to the USB interface (host) of the GOT.		
	Keyboard Type	Select the keyboard type to be connected to the USB interface (host) of the GOT. (Japanese 106 Keyboard/English 101 Keyboard)	

## 10.5.2 Relevant settings

The USB mouse/keyboard function is available for the relevant settings other than the specific settings. The following shows the functions that are available by the relevant settings.

### ■ GOT internal devices

Appendix2 GOT Internal Devices

Function	Setting item	Model
Controlling whether to send or not the touch status to the personal computer. (Write device)	GS511.b0	gr16 gr15 gr14 gr12 gr11 gr10 softGOT1000
Notifying the position touched by the user (X-coordinate and Y-coordinate). (Write device)	GS654, GS655	
Notifying whether the screen is touched or not. (Write device)	GS656	



## 10.5.3 Actions

### ■ Specifications

#### (1) System configuration

- (a) Using only USB mouse  
Connect a USB mouse directly to the USB interface (host) of the GOT.

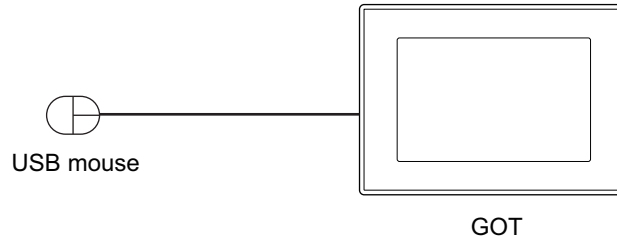

- (b) Using only USB keyboard  
Connect a USB keyboard directly to the USB interface (host) of the GOT.

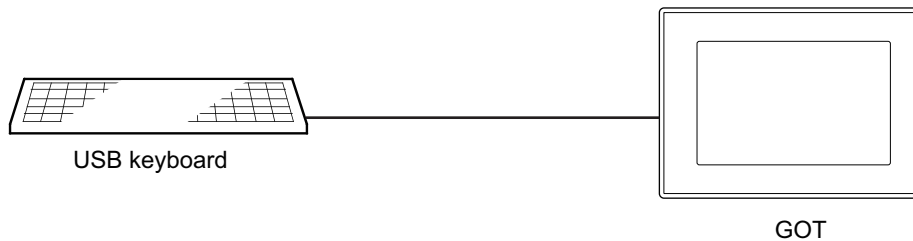

- (c) Using USB mouse and USB keyboard together  
A USB mouse and USB keyboard can be used together by connecting a USB hub to the USB interface (host) of the GOT.  
Also, a USB memory can be used together.

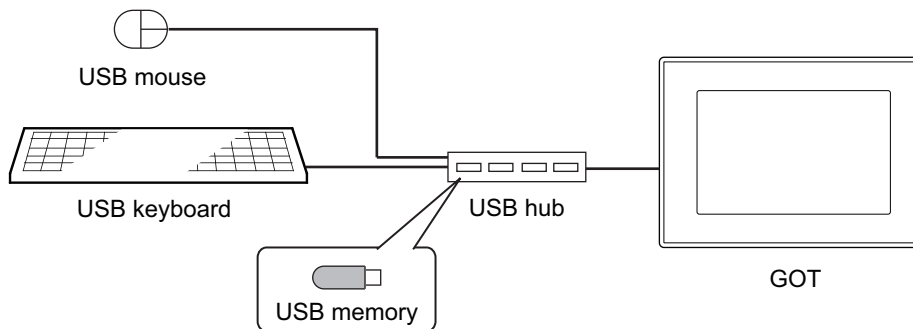

#### (2) Connectable USB mouse, USB keyboard, and USB hub

- (a) USB mouse  
A two-button mouse is available.  
A wheeled mouse and a mouse with more than two buttons can be used as a two-button mouse.  
The mouse wheel and an extra button are not available.  
A mouse with a particular function may not be available depending on the mouse type.
- (b) USB keyboard  
The following keyboards can be used.
- Japanese 106 keyboard
  - English 101 keyboard
- Forward-compatible keyboards, including Japanese 109 keyboard or English 104 keyboard, are also available.  
However, the keys which do not exist on Japanese 106 keyboard and English 101 keyboard are not available.  
Particular keyboards, including a keyboard with hub function, may not be available depending on the keyboard type.

(c) USB hub

A USB version 1.1 compatible USB hub is available.

For applicable USB hubs, refer to Technical News GOT-A-0010 "List of Valid Devices Applicable for GOT1000 Series" separately available, or contact your local distributor.

■ **Available screens, functions, and objects**

**(1) Screens for which a USB mouse and USB keyboard can be used**

A USB mouse and keyboard are available for the following screens.

Screen	Executable operation
Base screen	Operating objects
Overlap window	Operating objects, moving windows, closing windows, and operating a personal computer screen on the GOT displayed by the remote personal computer operation function (Ethernet)
Superimpose window	Operating objects, and operating a personal computer screen on the GOT displayed by the remote personal computer operation function (Ethernet)
Key window	Key input with the keyboard, clicking the buttons, moving windows, and closing windows
Login screen and password authentication screen	Key input with the keyboard
Dialog window	Clicking buttons
Utility (excluding the touch panel adjustment and check)	Clicking buttons

**(2) Functions for which a USB mouse and USB keyboard can be used**

A USB mouse and keyboard are available for the following functions.

- The operator authentication
- The remote personal computer operation function (Serial) (USB mouse only)
- The remote personal computer operation function (Ethernet)

**(3) Objects operable with a USB mouse and USB keyboard**

The following objects can be operated with a USB mouse and USB keyboard.

○: Applicable ✕: Inapplicable

Object	Operation	
	Click	Keyboard input
Touch switch	○	✕
Numerical input, ASCII input	○	○
Advanced alarm display, advanced alarm popup display	○	○
Alarm display, alarm history display	○	○

## ■ USB mouse actions

### (1) Display of mouse cursor

To display the mouse cursor on the screen, enable the USB mouse operation in the [Environmental Setting] dialog box (GOT Setup) and connect the USB mouse to the USB interface (host) of the GOT.

### (2) Action of mouse cursor

The actions of mouse cursor differ on a monitor screen and a personal computer screen on the GOT. For details of the personal computer screen on the GOT, refer to the following.

 (Functions) 33.2 Remote Personal Computer Operation (Ethernet)

Screen	Mouse operation		
	Left-click	Right-click	Drag
Monitor screen	Behaves in the same way as touching a monitor screen.	Inapplicable	Inapplicable
Personal computer screen on the GOT	Behaves in the same way as clicking on a personal computer screen.		Applicable <sup>*1</sup>

<sup>\*1</sup> A dragging is not available on the GOTs of the following versions when setting [Avoid input error] for [Touch detection mode] in [GOT setup] for the utility.

- Hardware versions
  - GT1695M-XTBA: F or earlier
  - GT1695M-XTBD: D or earlier
  - GT1685M-STBA: C or earlier
  - GT1685M-STBD: B or earlier

For confirming hardware versions, refer to the following.

 User's Manual for the GOT used

## ■ USB keyboard actions

On a monitor screen, an input operation to an object with a keyboard is available.

On a personal computer screen on the GOT, an input operation to the personal computer connected to the GOT with a keyboard is available.

### POINT

#### Entering Japanese with USB keyboard

Japanese language cannot be entered with a USB keyboard.

The kana-kanji input by kana-kanji conversion function is available with a touch operation.

### HINT

#### (1) Operation of dialog boxes with a keyboard

Dialog boxes can be also operated with the Esc key or Enter key.

#### (2) Key repeat

For the remote personal computer operation (Ethernet), while holding down a keyboard key, a character on the keyboard key is repeated.

The Ctrl key, Alt key, Shift key, Caps key, and Windows key are excluded.

#### (3) Simultaneous press of the Ctrl key, Alt key, or Windows key with other keys

Pressing the Ctrl key, Alt key, or Windows key simultaneously with other keys is invalid.

## 10.5.4 Precautions

---

### ■ Precautions for drawing

#### (1) USB keyboard setting

Match the setting of [Keyboard Type] in the [Environmental Setting] dialog box (GOT Setup) with the USB keyboard type actually used.

If the setting of the USB keyboard type is different, some characters are incorrectly entered.

 10.5.1 Settings

### ■ Precautions for OS

#### (1) CoreOS

To use the USB mouse/keyboard function, install the Core OS (05.03.00.AC or later) on the GOT.

For confirming the Core OS versions and installing the Core OS, refer to the following.

 User's Manual for the GOT used

#### (2) Extended function OS

To use the USB mouse/keyboard function, install the extended function OS (USB Mouse/Keyboard) on the GOT.

### ■ Precautions for hardware

#### (1) Wheeled mouse and particular mouse

A wheeled mouse and a mouse with more than two buttons can be used as a two-button mouse.

The mouse wheel and an extra button are not available.

A mouse with a particular function may not be available depending on the mouse type.

#### (2) Forward-compatible keyboards with Japanese 106 keyboard/English 101 keyboard, particular keyboards

For forward-compatible keyboards with Japanese 106 keyboard or English 101 keyboard (including Japanese 109 keyboard or English 104 keyboard), the keys which do not exist on Japanese 106 keyboard and English 101 keyboard are not available.

Particular keyboards, including a keyboard with hub function, may not be available depending on the keyboard type.

### ■ Precautions for use

#### (1) Touch operation while clicking

Do not touch a GOT screen while clicking the mouse.

The GOT recognizes two points (the clicked position and touched position) are pressed.

#### (2) Actions of USB keyboard while displaying a personal computer screen on the GOT

While displaying a personal computer screen on the GOT by the remote personal computer operation function (Ethernet), a USB keyboard is available only on the personal computer screen on the GOT.

To use a USB keyboard for an object input and others, close the personal computer screen on the GOT.

## 10.6 Synchronizing GT SoftGOT1000 data with GOT data (SoftGOT-GOT Link Function)



The SoftGOT-GOT link function enables GT SoftGOT1000 to connect the GOT via Ethernet. And then, the function synchronizes GT SoftGOT1000 data with GOT project data and resource data.

When input objects (touch switch, numerical input, and ASCII input) are input or other operation is performed, the simultaneous operation between GT SoftGOT1000 and the GOT must be prevented. The operation must be allowed by either GT SoftGOT1000 or the GOT.

GT SoftGOT1000 can monitor a controller connected to the GOT.

For details of the function including the usage method, refer to the following.

GT SoftGOT1000 Version3 Operating Manual for GT Works3

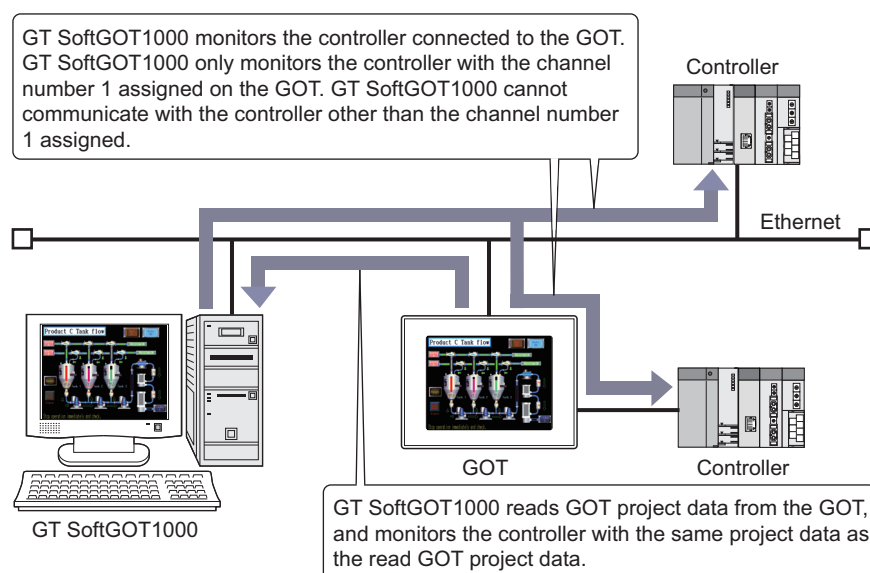

### POINT

**(1) Extended function OS**

To use the SoftGOT-GOT link function, install the extended function OS (SoftGOT-GOT Link Function) on the GOT.

**(2) Settings**

For the SoftGOT-GOT link function settings, refer to the following.

GT SoftGOT1000 Version3 Operating Manual for GT Works3

**(3) System configuration**

For the system configurations for using the SoftGOT-GOT link function, refer to the following.

GT SoftGOT1000 Version3 Operating Manual for GT Works3

## ■ Relevant settings

The SoftGOT-GOT link function is available for the relevant settings other than the specific settings. The following shows the functions that are available by relevant settings.

### (1) GOT internal devices

 Appendix2 GOT Internal Devices

Function	Setting item	Model
Enabling only the GOT to obtain the exclusive authorization (Not available for GT SoftGOT1000)	GS447.b0	
Notifying the communication status between GT SoftGOT1000 and the GOT	GS244.b0	
Notifying the obtaining status of the authorization	GS244.b1	
Notifying that SoftGOT1000 or the GOT is in use	GS244.b2	
Notifying the obtaining status of the exclusive authorization	GS244.b3	
Notifying the display status of the dedicated screen for the utility, the extended function, or the option function	GS244.b4	

# APPENDICES

---





# Appendix1 DATA CAPACITY LIST



## Appendix.1.1 Data Capacity List

The maximum number of settings and the data capacity in the following table are for the case that all items are set as default.

If the data size is increased due to settings of data operation, display method, or others, the available number of settings may decrease.

### ■ Touch switch

 (Functions) 2. TOUCH SWITCH

Function	Data capacity for one function (Bytes)	Models
Switch	120 bytes	
Bit switch	132 bytes	
Word switch	124 bytes	
Go to screen switch	124 bytes	
Change station number switch	124 bytes	
Special function switch	80 bytes	
Key window display switch	124 bytes	
Key code switch	124 bytes	





### ■ Lamp

 (Functions) 3. LAMP

Function	Data capacity for one function (Bytes)	Model
Lamp (Bit lamp)	68 bytes	
Lamp (Word lamp)	56 bytes	
Lamp (Lamp area)	44 bytes	

### ■ Numeric value, text

 (Functions) 5. to 10.

Function	Data capacity for one function (Bytes)	Model
Numerical display	48 bytes	
Numerical input	52 bytes	
ASCII display	44 bytes	
ASCII input	48 bytes	
Data list display	Refer to the following (1)	
Historical data list display	Refer to the following (2)	
Date display	44 bytes	
Time display	44 bytes	
Comment display (Bit comment)	64 bytes	
Comment display (Word comment)	56 bytes	

(Continued to next page)

Function	Data capacity for one function (Bytes)	Model
Comment display (Simple comment)	64 bytes	Gr16 Gr15 Gr14 Gr12 Gr11 Gr10 SoftGot1000
Basic comment	Refer to the following (3)	
Comment group	Refer to the following (4)	

**(1) Data capacity for data list display (Bytes)**

$$60+(NR+1)\times 8+ANC\times 6+RTN\times 2$$

NR: Value of [Columns]

ANC: Value of [Rows]

RTN: Number of title characters per column

**(2) Data capacity for historical data list display (Bytes)**

$$472+(84\times NCOB)+(68\times NCB)+(24\times DR)+(16\times DR\times DC)+(2\times RTN)$$

NCOB: Number of columns that [Device Type] is other than [Bit]

NCB: Number of columns that [Device Type] is [Bit]

DR: Value of [Display Rows]

DC: Value of [Display Columns]

RTN: Number of title characters per column

**(3) Data capacity for basic comment (Bytes)**

$$24+(14\times RC)+(2\times AT)$$

(The value within () will be converted into multiple of 4)

RC: Number of registered comments

AT: Number of whole characters

**(4) Data capacity for comment group (Bytes)**

$$46+(2\times NT)+(4\times NC)+(8\times NR)+(NC\times NR\times (6+2\times NS))$$

NT: Number of characters

NC: Number of lines

NR: Number of columns

NS: Number of average characters of a comment

## Alarm

 (Functions) 11. ALARM

Function	Data capacity for one function (Bytes)	Model
Advanced user alarm display	Refer to the following (1)	Gr16 Gr15 Gr14 Gr12 Gr11 Gr10 SoftGot1000
Advanced system alarm display		
Alarm history display	Refer to the following (2)	Gr16 Gr15 Gr14 Gr12 Gr11 Gr10 SoftGot1000
User alarm list display	44 bytes	
System alarm list display	40 bytes	Gr16 Gr15 Gr14 Gr12 Gr11 Gr10 SoftGot1000
Advanced alarm popup display	Refer to the following (3)	Gr16 Gr15 Gr14 Gr12 Gr11 Gr10 SoftGot1000
Scrolling alarm display	Refer to the following (4)	Gr16 Gr15 Gr14 Gr12 Gr11 Gr10 SoftGot1000

**(1) Data capacity for advanced user alarm display and advanced system alarm display (Bytes)**

$$96 + (\text{DAN} \times 8) + (\text{TN} \times 2) + (\text{DN} \times 8)$$

DAN: Number of display attributes

TN: Number of title characters

DN: Date / Specified number of times

**(2) Data capacity for alarm history (Bytes)**

$$62 + \text{N1} + \text{N2} + \text{N3} + \text{N4}$$

N1: (Number of the following title characters)  $\times 2$

- Occurred • Message • Restored • Checks • Cum. Time • Occur Freq

N2: (Number of the following characters)  $\times 2$

- Occurrence date/time • Restoration date/time • Check date/time

N3: "4" should be added for each of the following setting items

- Text Sprite • Draw Ruled Line • Restored Time • Confirm Time • One Touch

N4: "16" should be added for each of the following setting items

- Figure frame

**POINT**

**Precautions for calculation of N1 and N2**

**(1) Handling of calculated value**

Round the calculated value to a multiple of "4."

Example) If the calculated value is "10"

Use "10"  $\rightarrow$  "12" for calculation.

**(2) Calculation procedure**

Calculate each item.

Example) Occurrence time field: four characters    Message field: five characters

Occurrence time field:  $4 \times 2 = 8$

Message field:  $5 \times 2 = 10 \rightarrow 12$  (Round to a multiple of "4.")

Therefore  $\text{N1} = 8 + 12 = 20$

**(3) Data capacity for advanced alarm popup display (Bytes)**

$$56 + (\text{CPN} \times 8) + (\text{DN} \times 8)$$

CPN: Specified number of comments

DN: Date / Specified number of times

**(4) Data capacity for scrolling alarm display (Bytes)**

$$148 + 28 \times \text{AN} + \text{DON} + \text{O}$$

AN: Alarm points

DON: Setting of the device that stores the number of alarm occurrences (Set: 8, Not set: 0)

O: Setting of the alarm occurrence time (display attributes) (Set: 12, Not set: 0)

## ■ Graph, meter

☞ (Functions) 12. to 20.

Function	Data capacity for one function (Bytes)	Model
Level	52 bytes	Gr16 Gr15 Gr14 Gr12 Gr11 Gr10 SoftGot1000
Panel meter	96 bytes	
Line graph	Refer to the following (1)	
Trend graph	Refer to the following (2)	Gr16 Gr15 Gr14 Gr12
Bar graph	Refer to the following (3)	Gr11 Gr10 SoftGot1000
Statistics bar graph	Refer to the following (4)	
Statistics pie graph		
Scatter graph	Refer to the following (5)	Gr16 Gr15 Gr14 Gr12 Gr11 Gr10 SoftGot1000
Historical trend graph	Refer to the following (6)	Gr16 Gr15 Gr14 Gr12 Gr11 Gr10 SoftGot1000

### (1) Data capacity for line graph (Bytes)

$$48+(4 \times N1)+(12 \times N2)+(8 \times MN)+(32 \times SVN)$$

N1: Number of lines+Number of offset device points+Number of data operation setting items

N2: Number of graph frame settings+Number of clear trigger device points set in the locus+Number of trigger device points set in the trigger

LN: Number of lines

MN: Number of monitored points

SVN: Number of scales

### (2) Data capacity for trend graph (Bytes)

$$48+(4 \times N1)+(12 \times N2)+(32 \times SVN)$$

N1: Number of lines+Number of monitored points+Number of offset device points+Number of data operation setting items

N2: Number of graph frame settings+Number of clear trigger device points set in the locus+Number of trigger device points set in the trigger

SVN: Number of scales

### (3) Data capacity for bar graph (Bytes)

(a) When the number of bars is 8 or less

$$56+(4 \times N1)+(12 \times N2)+(20 \times SVN)$$

(b) When the number of bars is 9 or more

$$96+(4 \times N1)+(12 \times N2)+(20 \times SVN)+DS$$

N1: Number of bars+Number of offset device points+Number of data operation setting items

N2: Number of graph frame settings+Number of clear trigger device points set in the locus+Number of trigger device points set in the trigger

SVN: Number of scales

DS: 4 (when [Continuous] is selected for [Device Setting]) or 32 (when [Random] is selected for [Device Setting])

### (4) Data capacity for statistics bar graph/statistics pie graph (Bytes)

$$36+(4 \times N1)+(12 \times N2)+(20 \times SVN)$$

N1: Number of pieces+Number of offset device points+Number of data operation setting items

N2: Number of graph frame settings+Number of clear trigger device points set in the locus+Number of trigger device points set in the trigger

SVN: Number of scales

**(5) Data capacity for scatter graph (Bytes)**

$$108+4 \times PN \times 2$$

PN: Number of points

**(6) Data capacity for historical trend graph (Bytes)**

$$308+(8 \times N1)+(4 \times N2)+(12 \times SHN)+(20 \times SVN)+(8 \times (EXGN \times LN))+((12+(8 \times LN1)) \times PN)$$

N1: Number of auxiliary lines+Number of extended function settings

N2: Number of horizontal and vertical grid line settings+Number of point attribute settings+Number of line attribute settings+Number of data operation setting items+Number of logging device settings

SHN: Number of graph frame settings

SVN: Number of scales

EXGN: External output setting for each graph

LN: Number of lines

PN: Number of points

**Parts**

 (Functions) 21. to 22.

Function	Data capacity for one function (Bytes)	Model
Parts display (Bit parts)	48 bytes	GT16 GT15 GT14 GT12 GT11 GT10 SoftGOT1000
Parts display (Word parts)	44 bytes	GT16 GT15 GT14 GT12 GT11 GT10 SoftGOT1000
Parts display (Fixed parts)	52 bytes	GT16 GT15 GT14 GT12 GT11 GT10 SoftGOT1000
Parts movement (Bit parts)	60 bytes	GT16 GT15 GT14 GT12 GT11 GT10 SoftGOT1000
Parts movement (Word parts)	56 bytes	GT16 GT15 GT14 GT12 GT11 GT10 SoftGOT1000
Parts movement (Fixed parts)	56 bytes	GT16 GT15 GT14 GT12 GT11 GT10 SoftGOT1000

**Data collection**

 (Functions) 23. to 24.

Function	Data capacity for one function (Bytes)	Model
Operation log	Refer to the following (1)	GT16 GT15 GT14 GT12 GT11 GT10 SoftGOT1000
Logging function	Refer to the following (2)	GT16 GT15 GT14 GT12 GT11 GT10 SoftGOT1000

**(1) Data capacity for operation log (Bytes)**

$$36+2 \times OPIgfn$$

OPIgfn: Number of characters for an operation log file name (full path)

**(2) Data capacity for logging (Bytes)**

- Data capacity for logging to be stored in the user area (C drive+expansion memory):  
The capacity can be confirmed in [Buffering] of the Logging dialog box.









 (Functions) 24. LOGGING FUNCTION

- When the data is stored in a memory card:

 Appendix.1.2 Capacity of Data Stored in a Memory Card

## ■ Recipe

 (Functions) 25. RECIPE

Function	Data capacity for one function (Bytes)	Model
Recipe	Refer to the following (1)	   
Advanced recipe	Refer to the following (2)	   

### (1) Data capacity for recipe (Bytes)

- When the data is stored in the built-in memory:  
 $48 + N_{\text{rnm}} \times 2 + (N_{\text{fom}} \times N_{\text{fam}}) \times 2 + 8$  bytes, shared by recipe  
 N<sub>rnm</sub>: Number of characters of [Recipe Name]  
 N<sub>fom</sub>: Number of characters of folder name  
 N<sub>fam</sub>: Number of characters of file name

- When the data is stored in a memory card:

 Appendix.1.2 Capacity of Data Stored in a Memory Card

### (2) Data capacity for advanced recipe (Bytes)

- Advanced recipe setting capacity to be stored in the built-in flash memory:  
 $96 + N_1 + N_2 + N_3 + N_4 + N_5$

N<sub>1</sub>:  $2 \times (N_{\text{rnm}} + N_{\text{fnm}})$

N<sub>2</sub>:  $12 \times (N_{\text{ir}} + N_{\text{iw}})$

N<sub>3</sub>:  $(8 + 2 \times N_{\text{dcmt}}) \times N_{\text{dev}}$  (When setting device comment.)  
       :  $4 \times N_{\text{dev}}$  (When not setting device comment.)

N<sub>4</sub>:  $28 \times N_{\text{blk}} + 76 \times N_{\text{rec}}$

N<sub>5</sub>:  $(2 \times (N_{\text{bdev}} + N_{\text{wdev}}) + 4 \times N_{\text{dwdev}}) \times N_{\text{recv}}$

N<sub>rnm</sub>: Number of characters of [Recipe Name]

N<sub>fnm</sub>: Number of characters of [File Name]

N<sub>ir</sub>: Points of [Read Trigger]

N<sub>iw</sub>: Points of [Write Trigger]

N<sub>dcmt</sub>: Number of characters of [Device Comment] (The average number of characters of device comments set in each device)

N<sub>recv</sub>: Number of record (only for the record whose attribute has recipe device value)

N<sub>dev</sub>: Points of device ( $N_{\text{bdev}} + N_{\text{wdev}} + N_{\text{dwdev}}$ )

N<sub>bdev</sub>: Points of bit device

N<sub>wdev</sub>: Points of word device (16-bit)

N<sub>dwdev</sub>: Points of word device (32-bit)

N<sub>blk</sub>: Number of block



N<sub>rec</sub>: Number of record

- When the data is stored in a memory card:

 Appendix.1.2 Capacity of Data Stored in a Memory Card

## Trigger action

 (Functions) 26. to 29.

Function	Data capacity for one function (Bytes)	Model
Device data transfer	Refer to the following (1)	
Status observation	Refer to the following (2)	
Trigger action	Refer to the following (3)	
Time action	Refer to the following (4)	

### (1) Data capacity for the device data (Bytes)

Total data capacity of all the device data transfer settings:

$$32+N1+N2(1)+N2(2)+\dots+N2(Ndt)$$

N1:  $Wt+Ws+Wm$

N2:  $36+(2+2 \times Ndtm)+(6+2 \times Ncmt) \times Np+52 \times Nblk$

Wt:  $68+52 \times (Ndt+2)$

Ws:  $76 \times Nend$

Wm:  $68+16 \times Nrd$  (When the device point is set to 1)

:  $80+INT((Ds \times P+3)/4) \times 4$  (When the device point is set to 2 or more)

Ndt: Total number of device data transfer settings

Nend: Total number of device data transfer settings with the external notification device set

Nrd: Total number of blocks with the device point set to 1

INT(): Rounding down numbers of decimal places

Ds: Data type for the selected device type (16-bit device: 2, 32-bit device: 4)

P: Total number of device points

Ndtm: Number of the characters for the device data transfer name set in one device data transfer setting

Ncmt: Total number of the characters for comments set in one device data transfer setting

Np: Total number of device points set in one device data transfer setting

Nblk: Total number of blocks set in one device data transfer setting

### (2) Data capacity for status observation (Bytes)

$$28+WN \times 8+IN \times 8+FN \times 4$$

WN: Number of write points

IN: Number of function points

FN: Fixed

### (3) Data capacity for trigger action (Bytes)

$$12+N \times 76$$

N: Number of settings

### (4) Data capacity for time action (Bytes)



$$26+BA \times 8+WA \times 16(+ 8 \text{ bytes, shared by time action})$$

BA: Bit action

WA: Word action

## Script

 (Functions) 30. SCRIPT FUNCTION

Function	Data capacity for one function (Bytes)	Model
Project script	Refer to the following (1)	
Screen script		
Object script	Refer to the following (2)	

**(1) Data capacity for project script/screen script (Bytes)**

(The memory capacity for script function set in each window will be 0 if the window screen is not displayed.)  
48+(Number of expressions in RPN×8)+(WDN×8)+28+FPN+SCN+FDS

- WDN: Number of write devices
- FPN: Number of file path characters
- SCN: Number of script comment characters
- FDS: File data size

**(2) Memory capacity for object script function (Bytes)**

488×(Number of expressions in RPN×8)+(WDN×8)+STS

- WDN: Number of write devices
- STS: Script text size



**Reversed polish notation**

The reversed polish notation (RPN) is a method to express an operator (+, -, \*, /, and others) after an operand (Numeric value or variable).

Example: In usual expression: 1 + 2, in RPN expression: 1 2 +

**Peripheral connection**

(Functions) 31. to 41.

Function	Data capacity for one function (Bytes)	Model
Barcode	-	gr16 gr15 gr14 gr12 gr11 gr10 SoftGoT1000
RFID	-	gr16 gr15 gr14 gr12 gr11 gr10 SoftGoT1000
Remote personal computer operation function	-	gr16 gr15 gr14 gr12 gr11 gr10 SoftGoT1000
VNC® server function	-	gr16 gr15 gr14 gr12 gr11 gr10 SoftGoT1000
Video display	12 bytes	gr16 gr15 gr14 gr12 gr11 gr10 SoftGoT1000
Multimedia	Refer to the following (1)	gr16 gr15 gr14 gr12 gr11 gr10 SoftGoT1000
Operation panel/External I/O	Refer to the following (2)	gr16 gr15 gr14 gr12 gr11 gr10 SoftGoT1000
RGB display	12 bytes	gr16 gr15 gr14 gr12 gr11 gr10 SoftGoT1000
Report	Refer to the following (3)	gr16 gr15 gr14 gr12 gr11 gr10 SoftGoT1000
Hard copy	Refer to the following (4)	gr16 gr15 gr14 gr12 gr11 gr10 SoftGoT1000

**(1) Data capacity for multimedia function (Bytes)**

36+2×FN

FN: Number of characters of file name in the recording setting



**(2) Data capacity for operation panel function (Bytes)**

$$12+(NPK \times 12)+NA \times (4+DCS)$$

NPK: Number of keys set for the operation panel

NA: Number of operation settings set for keys

DCS: Data capacity of the touch switch set for the operation panel

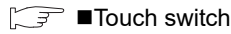

**(3) Data capacity for report function (Bytes)**

$$136+4 \times Nlin+(2 \times Nfnv)+20 \times Nobv+(4+Nchv \times 2) \times Nclv+(36+8 \times Nrv) \times Nprv+(44+8 \times Nrv) \times Npcv$$

For the calculation above, convert the values below to a multiple of 4.

(Example: If the value is "10", assume "12" to calculate.)

Nlin: Number of lines set in the print format of the report setting

Nfnv: Number of characters of file name

Nobv: Total number of objects arranged on the report screen

Nchv: Number of characters

Nclv: Number of lines and characters set

Nrv: Number of data items in the expression

Nprv: Number of numerical prints set

Npcv: Number of comment prints set

**(4) Data capacity for hard copy function (Bytes)**

$$26+(Nfom+Nfam) \times 2$$

Nfom: Number of characters of folder name

Nfam: Number of characters of file name

**Useful functions**

10. USEFUL FUNCTIONS FOR USING GOT

Function	Data capacity for one function (Bytes)	Model
Document display	72 bytes	
Set overlay screen	8 (+8 bytes common to Set overlay screen)	

**Other functions**

GOT1000 Series Gateway Functions Manual for GT Works3

GOT1000 Series MES Interface Function Manual for GT Works3

Function	Data capacity for one function (Bytes)	Model
Gateway	-	
MES interface	Refer to the following (1)	

**(1) Memory capacity for MES interface function (Bytes)**

$$2500+43000 \times COMACT+8000 \times CALACT+2000 \times JOBN+1000 \times HDSKN+150 \times TAGN+150 \times TAGEN+350 \times DTBOJN$$

COMACT: Number of communication a

CALACT: Number of operation actions

JOBN: Number of jobs

HDSKN: Number of handshakes

TAGN: Number of tags

TAGEN: Number of tag components

DTBOJN: Number of database objects

## Appendix.1.2 Capacity of Data Stored in a Memory Card

Some functions store data in a memory card.

The following table shows the capacity of data stored in the memory card for each function.

Function	Data capacity
Advanced user alarm display (byte)	<ul style="list-style-type: none"> <li>Data capacity for G1A files Historical: <math>64+2 \times Nm+2 \times Ng+20 \times Nh</math> Cumulative: <math>64+2 \times Nm+34 \times Ng</math></li> <li>Data capacity for CSV files (In the calculation of the number of characters, count a 1-byte character as 0.5 characters and a 2-byte character as 1 character.) Historical: <math>228+(\text{Nat} \times 2)+(91+(\text{Ncv} \times 2)) \times \text{Nac}</math> Cumulative: <math>258+(\text{Nat} \times 2)+(121+(\text{Ncv} \times 2)) \times \text{Nac}</math></li> <li>Data capacity for Unicode text files Historical: <math>456+(\text{Nat} \times 2)+(182+(\text{Ncv} \times 2)) \times \text{Nac}</math> Cumulative: <math>516+(\text{Nat} \times 2)+(242+(\text{Ncv} \times 2)) \times \text{Nac}</math></li> </ul> <p>Ng: Number of general alarms set Nm: Number of middle alarms set Nh: Max. number of histories (The value set for [Stored Number] of advanced user alarm observation/advanced system alarm observation) Ncv: Average number of comment characters Nac: Number of alarms Nat: Number of alarm name characters (The number of characters set for [Alarm Name] of advanced user alarm observation)</p>
Advanced system alarm display (byte)	<ul style="list-style-type: none"> <li>Data capacity for G1A files Historical: <math>64+2 \times Nm+2 \times Ng+24 \times Nh</math></li> <li>Data capacity for CSV files (In the calculation of the number of characters, count a 1-byte character as 0.5 characters and a 2-byte character as 1 character.) Historical: <math>197+(71+(\text{Ncv} \times 2)) \times \text{Nac}</math></li> <li>Data capacity for Unicode text files Historical: <math>394+(142+(\text{Ncv} \times 2)) \times \text{Nac}</math></li> </ul> <p>Ng: Number of general alarms set Nm: Number of middle alarms set Nh: Max. number of histories (The value set for [Stored Number] of advanced user alarm observation/advanced system alarm observation) Ncv: Average number of comment characters Nac: Number of alarms</p>
Alarm history display (K bytes)	<p>When saving 3072 alarm historical data</p> <p>Cumulative mode (When saved in CSV file): Approx. 97 (Approx. 400) History mode (When saved in CSV file): Approx. 72 (Approx. 360)</p>

(Continued to next page)

Function	Data capacity
Operation log (byte)	<ul style="list-style-type: none"> <li>• G10 file size: <math>40+(N1+N2+\dots+Nm)</math>  N1 to Nm: Size of each log (see below) <ul style="list-style-type: none"> <li>· GOT start-up (12) · Application switching (16) · Time change (16) · System language switching (Max. 28)</li> <li>· Security setting (Max.28) · Screen switching (Max.88) · Station No. switching (16) · Language switching (16),</li> <li>· Bit switch (Max.120) · Word switch (Max.120) · Special Function Switch (Max.108),</li> <li>· Go to screen switch (Max.112) · Change station No. switch (Max.112)</li> <li>· Numerical input (Max.124) · Numerical input (When writing to write device / write check device) (Max.120),</li> <li>· ASCII input (Max.320) · Alarm history (Display, delete, delete all) (Max.108) · Reset (Max.120),</li> <li>· Advanced user alarm display (Display, delete, delete all (Max.108), Reset (Max.120)),</li> <li>· Advanced system alarm display (Max.108) · Object script (Max.120)</li> </ul> </li> <li>• CSV file size: <math>162+(N1+N2+\dots+Nm)</math>  N1 to Nm: Size of each log (see below) <ul style="list-style-type: none"> <li>· GOT start-up (Max.63) · Application switching (Max.98) · Time change (Max.113)</li> <li>· System language switching (Max.86) · Security setting (Max.94) · Screen switching (Max.212)</li> <li>· Station No. switching (Max.87) · Language switching (Max.67) · Bit switch (Max.285)</li> <li>· Word switch (Max.285) · Special Function Switch (Max.226) · Go to screen switch (Max.235)</li> <li>· Change station No. switch (Max.233) · Numerical input (Max.272)</li> <li>· Numerical input (When writing to write device / write check device) (Max.282) · ASCII input (Max.449)</li> <li>· Alarm history (Delete, delete all) (Max.210) · Reset (Max.274)</li> <li>· Advanced user alarm display (Display, delete, delete all (Max.226), Reset (Max.280)),</li> <li>· Advanced system alarm display (Max.230) · Object script (Max.262)</li> </ul> </li> <li>• Unicode text file size: <math>324+(N1+N2+\dots+Nm)</math>  N1 to Nm: Size of each log (see below) <ul style="list-style-type: none"> <li>· GOT start-up (Max.116) · Application switching (Max.152) · Time change (Max.218),</li> <li>· System language switching (Max.156) · Security setting (Max.164) · Screen switching (Max.332)</li> <li>· Station No. switching (Max.142) · Language switching (Max.124) · Bit switch (Max.476)</li> <li>· Word switch (Max.476) · Special Function Switch (Max.366) · Go to screen switch (Max.384),</li> <li>· Change station No. switch (Max.380) · Numerical input (Max.476)</li> <li>· Numerical input (When writing to write device / write check device) (Max.474)</li> <li>· ASCII input (Max.824) · Alarm history (Delete, delete all (Max.350), Reset (Max.466))</li> <li>· Advanced user alarm display (Display, delete, delete all (Max.366), Reset (Max.472)),</li> <li>· Advanced system alarm display (Max.368) · Object script (Max.442)</li> </ul> </li> </ul>
Logging function (byte)	<ul style="list-style-type: none"> <li>• Data capacity for G1L files: <math>100+N1+N2+N3</math>  N1: <math>Nd \times (8+Navedc \times 2)</math>  N2: <math>Nb \times 16</math>  N3: <math>(6+Ndb \times 2+Ndw \times 2+Ndd \times 4) \times (17/16) \times Nalgf</math></li> <li>• Data capacity for CSV files: <math>99 + N1 + N2 \times N3</math>  N1: <math>(Navedc+11) \times Nd</math>  N2: <math>(20+(Ndspl+1) \times Nd)</math>  N3: <math>Nalgf</math></li> <li>• Data capacity for Unicode text files: <math>198 + N1 + N2 \times N3</math>  N1: <math>(Navedc+11) \times Nd \times 2^*1</math>  N2: <math>(20+(Ndspl+1) \times Nd)</math>  N3: <math>Nalgf \times 2</math></li> </ul> <p>Navedc: Average number of device comment characters  Ndb: Number of bit devices  Ndw: Number of 16-bit (word) devices  Ndd: Number of 32-bit (double-word) devices  Nb: Number of device blocks  Ndspl: Number of display digits (When setting the real for the display type: Number of display digits + 5)  Nalgf: Number of logs in a file  Nd: Number of logging devices (Total number of devices set to a device block)</p>
Recipe (byte)	$(149 \times RF)+(9 \times R16)+(14 \times R32)$ RF: Number of recipe files R16: Total number of 16-bit devices in each recipe file R32: Total number of 32-bit devices in each recipe file

(Continued to next page)

Function	Data capacity
Advanced recipe (byte)	<ul style="list-style-type: none"> <li>Data capacity for G1P files: <math>128+N1+N2+N3</math>  <math>128+N1+N2+N3</math>  N1: <math>(8+2 \times \text{Ndcmt}) \times \text{Ndev}</math>  : <math>4 \times \text{Ndev}</math>(When not setting device comment.)  N2: <math>\text{Nblk} \times 12</math>  N3: <math>(80+\text{Ndwsz} \times 2) \times \text{Nrec}</math>  Ndcmt: Number of characters of [Device Comment]  Ndev: Points of device (<math>\text{Nbdev}+\text{Nwdev}+\text{Ndwdev}</math>)  Nbdev: Points of bit device  Nwdev: Points of word device (16-bit)  Ndwdev: Points of word device (32-bit)  Nblk: Number of block  Nrec: Number of record  Ndwsz: Number of word device points (<math>\text{Nbdev}+\text{Nwdev}+\text{Ndwdev} \times 2</math>)</li> <li>Data capacity for CSV data files: <math>164 + N1+N2+N3</math>  N1: <math>\text{Nnm}</math>  N2: <math>(\text{Nbit}+\text{Nwrd}+\text{Ndwrdr}) \times (18+\text{Ndcmt})</math>  N3: <math>\text{Nrec} \times (25+\text{Nbit} \times 2+\text{Nwrd} \times 7+\text{Ndwrdr} \times 12)</math></li> <li>Unicode text file size: above CSV file size <math>\times 2</math></li> </ul> <p>Nnm: Number of characters*<sup>1</sup> of [Recipe Name]  Ndcmt: Number of characters*<sup>1</sup> of [Device Comment]  Ndev: Device Points  Nblk: Block Number  Nrec: Record Number  Nbit: Number of bit device points  Nwrd: Number of 16-bit device points  Ndwrdr: Number of 32-bit device points</p>
Multimedia function* <sup>2</sup>	<ul style="list-style-type: none"> <li>Data capacity of video when recording on the video image screen (K bytes)  Recording size: [640 × 480], frame rate: [15FPS] or [12.5FPS]: <math>2.56+(152 \times \text{RT})</math>  Recording size: [320 × 240], frame rate: [15FPS] or [12.5FPS]: <math>2.56+(50 \times \text{RT})</math>  Recording size: [320 × 240], frame rate: [30FPS] or [25FPS]: <math>2.56+(99 \times \text{RT})</math>  RT: Recording time (Second)</li> <li>Data capacity of video when recording before and after the event (K bytes)  Recording size: [640 × 480], frame rate: [15FPS] or [12.5FPS]: <math>2.56+(152 \times \text{RT})</math>  Recording size: [320 × 240], frame rate: [15FPS] or [12.5FPS]: <math>2.56+(50 \times \text{RT})</math>  Recording size: [320 × 240], frame rate: [30FPS] or [25FPS]: <math>2.56+(99 \times \text{RT})</math>  RT: Recording time (before event) + Recording time (after event) (Second)</li> <li>Video file size for long time recording (M bytes): Number of video files <math>\times 20</math></li> </ul>
Report function (byte)	$(8 \times \text{RN})+48+(8 \times \text{RN}+8) \times \text{CN}$ RN: Number of numerical print and comment print objects set on the report screen CN: Number of data collection times
Hard copy function (K bytes)	<p>Data capacity per screen (The following are reference values.) <math>\times</math> Number of screens to be stored  Data capacity per screen for BMP format</p> <ul style="list-style-type: none"> <li>GT1695M-X, GT1595-X: 65536 colors (2359), 256 colors (787)</li> <li>GT1685M-S, GT1675M-S, GT1665M-S, GT1585V-S, GT1585-S, GT1575V-S, GT1575-S: 65536 colors (1440), 256 colors (481)</li> <li>GT1675M-V, GT1675-VN, GT1665M-V, GT1655-V, GT16 Handy GOT, GT1575-V, GT1565-V: 65536 colors (921), 256 colors (308)</li> <li>GT1575-VN: 256 colors (308)</li> <li>GT1672-VN, GT1662-VN, GT1572-VN, GT1562-VN: 16 colors (308)</li> <li>GT1555-Q: 65536 colors (230), 256 colors (77)</li> <li>GT1550-Q: Monochrome (77)</li> </ul> <p>Data capacity per screen for JPEG format: Depends on the screen contents.</p>
Document display function	Differs depending on the screen contents.
MES interface function (byte)	MES interface execute log file: Up to 524288 (512KB) per file Job execute log file: Up to 1048576 (1MB) per file

\*1 Single/double byte characters are not distinguished.

\*2 Recorded video files are stored in the CF card installed in the multimedia unit.

## Appendix.1.3 Capacity of data to be saved in the SRAM user area

According to functions to be used, data are saved in the SRAM user area.  
The following shows the capacity of data to be saved in the SRAM user area in each function.

Function	Data capacity
Advanced user alarm display	<p>(Round up <math>(200+(2 \times Nm)+\text{alarm data size})</math> to multiples of 64.) <math>\times 2</math></p> <p>Alarm data size:            Cumulative mode: <math>(2 \times Ng)+(32 \times Ng)</math>            Historical mode: <math>(2 \times Ng)+(20 \times Nh)</math>            Collecting no alarms: <math>(2 \times Ng)+(16 \times Ng)</math></p> <p>Nm: Number of middle comment settings            Ng: Number of alarm points            Nh: Number of saved data</p> <p>Round up the calculated value within the parenthesis ( ) to multiples of 4.            Example) Alarm data size when the number of alarm points is 3 for the cumulative mode.  <math>(2 \times Ng)+(32 \times Ng) = 2 \times 3+32 \times 3</math>  <math>= 6 + 186</math>  <math>\rightarrow 8 + 188</math></p>
Advanced system alarm display	<p>(Round up <math>(204+\text{Alarm data size})</math> to multiples of 64.) <math>\times 2</math></p> <p>Alarm data size:            History mode: <math>(24 \times Nh)</math>            Collecting no alarms: <math>(20 \times Nh)</math></p> <p>Nh:            Number of saved data for the historical mode            Number of maximum alarm points collected at one time when collecting no alarms</p>
Logging function	<p>Round up <math>(192+12 \times \text{Number of device blocks}+\text{logging data size} \times \text{Number of stored logs})</math> to multiples of 64.</p> <p>Logging data size:            Round up <math>(4+\text{data size}+(\text{Data size}+16))</math> to multiples of 4.</p> <p>Data size:            Round up <math>(\text{Number of bit devices} \times 2)+(\text{Number of word devices} \times 2)+\text{Number of double word devices} \times 4</math> to multiples of 4.</p>

### POINT

#### (1) Advanced alarm data

If power failure occurs while advanced alarm data are written to the SRAM user area, data in the SRAM user area become invalid. Therefore, the data in the SRAM user area may not be read.

To take measures, advanced alarm data are duplicated and saved in the SRAM user area.

Therefore, the size of data in the SRAM user area is approximately twice the size of data in the buffering area.

#### (2) Data of the logging function

If power failure occurs while logging data are written to the SRAM user area, the data to be written at the power failure are deleted.

To reduce data size, the data are not duplicated.

# Appendix2 GOT Internal Devices

## Appendix.2.1 GOT bit register (GB)

Device	Function	Model
GB0 to GB9	Use prohibited	GT16 GT15 GT14 GT12 GT11 GT10 SotGOT1000
GB10 to GB25	Y0 to YF turn on when the GB devices turn on.	GT16 GT15 GT14 GT12 GT11 GT10 SotGOT1000
GB26 to GB29	Use prohibited	GT16 GT15 GT14 GT12 GT11 GT10 SotGOT1000
GB30 to GB37	ON when X0 to X7 turn on	GT16 GT15 GT14 GT12 GT11 GT10 SotGOT1000
GB38	ON without the power supply	GT16 GT15 GT14 GT12 GT11 GT10 SotGOT1000
GB39	The clock data is stored during GB39 turns on.	GT16 GT15 GT14 GT12 GT11 GT10 SotGOT1000
GB40	Always ON	
GB41	Always OFF	GT16 GT15 GT14 GT12 GT11 GT10 SotGOT1000
GB42	ON when screen switching occurs	GT16 GT15 GT14 GT12 GT11 GT10 SotGOT1000
GB43 to GB49	Use prohibited	
GB50 to GB57	ON when X8 to XF turn on	GT16 GT15 GT14 GT12 GT11 GT10 SotGOT1000
GB58 to GB63	Use prohibited	GT16 GT15 GT14 GT12 GT11 GT10 SotGOT1000
GB64 to GB65535 *1	User area	GT16 GT15 GT14 GT12 GT11 GT10 SotGOT1000

\*1 For the GT105□, GT104□, and GT1030, GB64 to GB1023 are available.  
For the GT1020, GB64 to GB255 are available.

### (1) External output for Y0 to YF (GB10 to GB25)

With the external I/O function, signals are output to an external I/O device when the GB devices turn on. The following shows signal names for each GB device.

GB device	Signal name	GB device	Signal name	GB device	Signal name	GB device	Signal name
GB10	Y0 output	GB14	Y4 output	GB18	Y8 output	GB22	YC output
GB11	Y1 output	GB15	Y5 output	GB19	Y9 output	GB23	YD output
GB12	Y2 output	GB16	Y6 output	GB20	YA output	GB24	YE output
GB13	Y3 output	GB17	Y7 output	GB21	YB output	GB25	YF output

### (2) External input for X0 to X7 and X8 to XF (GB30 to GB37, GB50 to GB57)

With the external I/O function, the GB devices turn on when signals are input with an external I/O device. The following shows signal names for each GB device.

GB device	Signal name	GB device	Signal name	GB device	Signal name	GB device	Signal name
GB30	X0 input	GB34	X4 input	GB50	X8 input	GB54	XC input
GB31	X1 input	GB35	X5 input	GB51	X9 input	GB55	XD input
GB32	X2 input	GB36	X6 input	GB52	XA input	GB56	XE input
GB33	X3 input	GB37	X7 input	GB53	XB input	GB57	XF input

**(3) Without power supply (GB38)**

With the external I/O function, the GB device turns on without the power supply of an external I/O device.

**(4) Clock data storage during ON (GB39)**

With GT10, GD0 to GD6 store the clock data when the GB device turns on.  
The device does not store the clock data when the GB device turns off.

**(5) Always ON (GB40)**

Always ON.

**(6) Always OFF (GB41)**

Always OFF.

**(7) On when screen switching occurs (GB42)**

Turns on when switching of the following screens occurs.

- Base screen
- Overlap window 1, 2, 3, 4, 5
- Superimpose window 1, 2
- When an overlap window is closed by opening a test window, etc. during the overlap window is displayed.

Turn off this signal at user side.



**Actions of always ON (GB40) and always OFF (GB41)**

Always ON (GB40) and always OFF (GB41) in common information 1 (GS0) are always ON (GB40) and always OFF (GB41), respectively.

## Appendix.2.2 GOT data register (GD)

GD devices are listed as follows.

Device	Function
GD0 to GD65535 *1	User area

\*1 For the GT105□, GT104□, and GT1030, GD0 to GD1023 are available.  
For the GT1020, GD0 to GD255 are available.

**(1) Store the clock data in GD device (Only with GT10)**

With GT10, GD0 to GD6 store the clock data when GB39 turns on.  
For the clock function, refer to the following.

4.9 GOT Display and Operation Setting

For details of the each GD device, refer to followings.

GD device	Description
GD0	second (0 to 59)
GD1	minute (0 to 59)
GD2	hour (0 to 23)
GD3	day (1 to 31)
GD4	month (1 to 12)
GD5	year (1980 to 2079)
GD6	day of a week (0 to 6)

GD0 to GD6 cannot be used as an user area during GB39 turns on.  
Set GB39 to off when using GD0 to GD6 as the user area.

**(2) Designation of station No. using GD (only in the case of temperature controller connection, inverter connection and servo amplifier connection)**

If 100 to 115 is set for station No. in the setting of device, a station No. can be designated by the value of GD10 to GD25.

The monitor target station No. can be changed by simply changing a device value.

For the device setting, refer to the following.

☞ 5.3.1 Device setting

(a) When GD is used together with a switching station No. device (GT16, GT15, GT14, and GT12 only)  
The switching station No. device has priority.

(b) When objects that monitor different channel Nos. are arranged on the same screen  
To monitor different station Nos. by individual objects, use GD10 to GD25.  
If switching station No. devices are used, the monitor target station No. can change for an unintended object. (Especially when multiple switching target channel Nos. are set.)

Example: When monitor target channel Nos. of switching station No. device are 1 and 2.

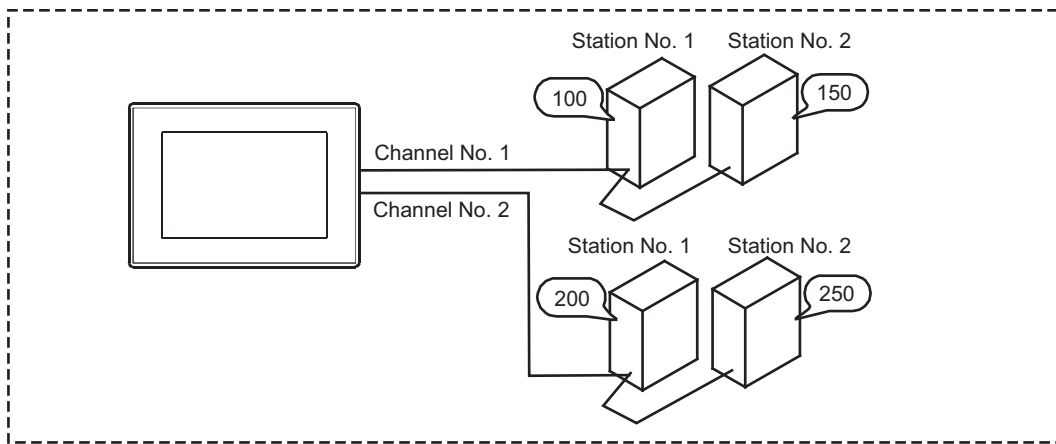

(When switching station No. device is used)

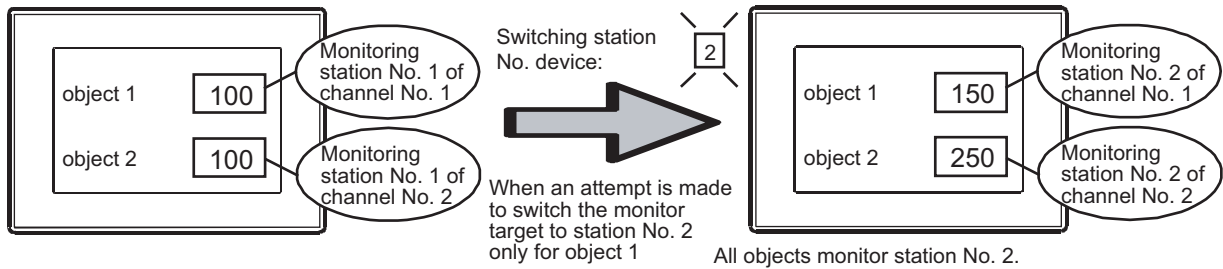

(When GD (GD10 to GD25) is used)

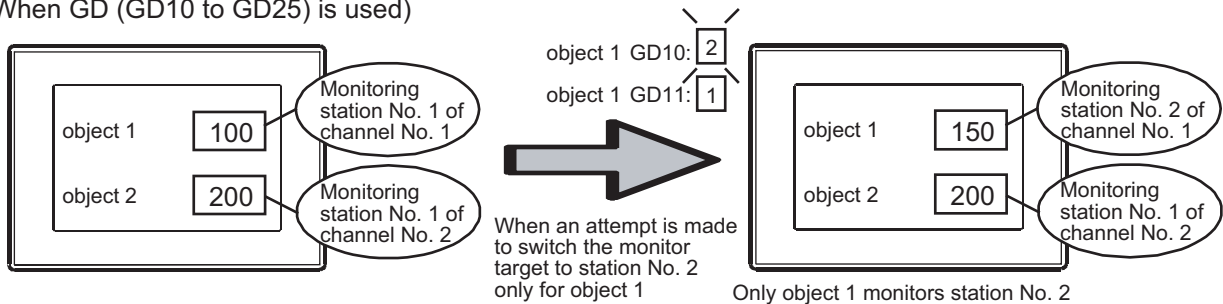





## POINT

### The timing at which station No. changes

The station No. of monitor target changes when a value of GD10 to GD25 is changed.

## Appendix.2.3 GOT special register (GS)

The GOT special register includes the following two types.

Device	Range	Description
Read device	GS384 to GS639, GS1792 to GS2047	The user can control the GOT behavior by writing values.  n Read device
Write device	GS0 to GS383, GS640 to GS1791	The user can control the GOT behavior by writing values.  n Write device

## HINT







### Functions affected by GOT special register

Some GOT special registers affect multiple functions on the GOT.

For the relation between each GOT special register and GOT functions, refer to the following.

 Appendix8 Relevant Settings















### Read device

Device	Function	Reference	Model
GS0 to 383	Write device	n Write device	
GS384	Script common control	(Functions) 30. SCRIPT FUNCTION	
GS385	Script monitoring time		
GS386	Project/screen script initial operation		
GS387	Object script common control	(Functions) 30. SCRIPT FUNCTION	
GS388	Object script monitoring time		
GS389	Object script initial operation		
GS390	File operation function data storage order	(Functions) 30. SCRIPT FUNCTION	
GS391 to 399	Use prohibited	-	
GS400	Gateway common control	GOT1000 Series Gateway Functions Manual for GT Works3	
GS401	FTP communication control		
GS402	FTP communication timeout time		
GS403 to 446	Use prohibited	-	

(Continued to next page)

Device	Function	Reference	Model
GS447	Exclusive authorization control	GT SoftGOT1000 Version3 Operating Manual for GT Works3	gr16 gr15 gr14 gr12 gr11 gr10 SoftGOT1000
GS448	Modem connection control	See (1) below	gr16 gr15 gr14 gr12 gr11 gr10 SoftGOT1000
GS449	Use prohibited	-	gr16 gr15 gr14 gr12 gr11 gr10 SoftGOT1000
GS450	Monitor common control	See (2) below	gr16 gr15 gr14 gr12 gr11 gr10 SoftGOT1000
GS451	Auto screen save time	See (3) below	gr16 gr15 gr14 gr12 gr11 gr10 SoftGOT1000
GS452	Error detection common control	See (4) below	gr16 gr15 gr14 gr12 gr11 gr10 SoftGOT1000
GS453	Use prohibited	-	gr16 gr15 gr14 gr12 gr11 gr10 SoftGOT1000
GS454	Ethernet access control	See (5) below	gr16 gr15 gr14 gr12 gr11 gr10 SoftGOT1000
GS455	Intensity control	See (6) below	gr16 gr15 gr14 gr12 gr11 gr10 SoftGOT1000
GS456	Text code format control	See (7) below	gr16 gr15 gr14 gr12 gr11 gr10 SoftGOT1000
GS457	Pass-through transparent stop control	See (8) below	gr16 gr15 gr14 gr12 gr11 gr10 SoftGOT1000
GS458 to 459	Use prohibited	-	gr16 gr15 gr14 gr12 gr11 gr10 SoftGOT1000
GS460	Conversion start indication	(Functions) 30. SCRIPT FUNCTION	gr16 gr15 gr14 gr12 gr11 gr10 SoftGOT1000
GS461	Conversion devices		
GS462	Conversion source head device No.		
GS463	Conversion destination head device No.		
GS464	Store error value		
GS465 to 499	Use prohibited	-	gr16 gr15 gr14 gr12 gr11 gr10 SoftGOT1000
GS500	GT SoftGOT1000 common control	See (9) below	gr16 gr15 gr14 gr12 gr11 gr10 SoftGOT1000
GS501 to 502	Application start signal	See (10) below	
GS503	GT SoftGOT1000 full screen size (Width)	See (11) below	
GS504	GT SoftGOT1000 full screen size (Height)	See (12) below	
GS505 to 507	Advanced application start signal	See (13) below	
GS508 to 509	Use prohibited	-	gr16 gr15 gr14 gr12 gr11 gr10 SoftGOT1000



(Continued to next page)

Device	Function	Reference	Model
GS510	Device data transfer information	See (14) below	
GS511	Touch status communication control	See (15) below	
GS512	Time change information	4.9.2 ■ Changing clock data by using GOT special register (GS)	
GS513 to 516	Changed time		
GS517	External I/O function notification/control function	See (16) below	
GS518	Sound output cancel control	See (17) below	
GS519	Use prohibited	-	
GS520	Buffering and file access control	See (18) below	
GS521	Trigger backup data send delay	See (19) below	
GS522	Special control during specific function execution	See (20) below	
GS523 to 529	Use prohibited	-	
GS530	Network No. for monitor station disconnected (CH1)	See (21) below	
GS531 to 538	monitor station disconnection (CH1)	See (22) below	
GS539	Channel shutdown control (CH1)	See (23) below	
GS540	Network No. for monitor station disconnected (CH2)	See (21) below	
GS541 to 548	monitor station disconnection (CH2)	See (22) below	
GS549	Channel shutdown control (CH2)	See (23) below	
GS550	Network No. for monitor station disconnected (CH3)	See (21) below	
GS551 to 558	monitor station disconnection (CH3)	See (22) below	
GS559	Channel shutdown control (CH3)	See (23) below	
GS560	Network No. for monitor station disconnected (CH4)	See (21) below	
GS561 to 568	monitor station disconnection (CH4)	See (22) below	
GS569	Channel shutdown control (CH4)	See (23) below	
GS570 to 576	MODBUS communication control function (Common)	See (24) below	
GS577 to 578	Use prohibited	-	
GS579	Channel setting of MODBUS communication control function	See (25) below	

(Continued to next page)

Device	Function	Reference	Model
GS580	Microcomputer connection (serial) extended setting (CH1)	See (26) below	gr16 gr15 gr14 gr12 gr11 gr10 SoftGoT1000
GS581	Microcomputer connection (serial) extended setting (CH2)	See (26) below	gr16 gr15 gr14 gr12 gr11 gr10 SoftGoT1000
GS582	Microcomputer connection (serial) extended setting (CH3)		
GS583	Microcomputer connection (serial) extended setting (CH4)		
GS584 to 589	Use prohibited	-	gr16 gr15 gr14 gr12 gr11 gr10 SoftGoT1000
GS590 to 596	MODBUS communication control function (CH1)	See (24) below	gr16 gr15 gr14 gr12 gr11 gr10 SoftGoT1000
GS597 to 603	MODBUS communication control function (CH2)	See (24) below	gr16 gr15 gr14 gr12 gr11 gr10 SoftGoT1000
GS604 to 610	MODBUS communication control function (CH3)		
GS611 to 617	MODBUS communication control function (CH4)		
GS618 to 629	Use prohibited	-	gr16 gr15 gr14 gr12 gr11 gr10 SoftGoT1000
GS630	Touch position color acquisition ready signal	See (27) below	gr16 gr15 gr14 gr12 gr11 gr10 SoftGoT1000
GS631 to 637	Use prohibited	-	gr16 gr15 gr14 gr12 gr11 gr10 SoftGoT1000
GS638	Maintenance time notification control	See (28) below	gr16 gr15 gr14 gr12 gr11 gr10 SoftGoT1000
GS639	GOT reset control	See (29) below	gr16 gr15 gr14 gr12 gr11 gr10 SoftGoT1000
GS640 to 1023	Write device	■Write device	gr16 gr15 gr14 gr12 gr11 gr10 SoftGoT1000
GS1024 to 1791	Write device	■Write device	gr16 gr15 gr14 gr12 gr11 gr10 SoftGoT1000
GS1792	VNC® server function control	See (30) below	gr16 gr15 gr14 gr12 gr11 gr10 SoftGoT1000
GS1793 to 1823	Use prohibited	-	gr16 gr15 gr14 gr12 gr11 gr10 SoftGoT1000
GS1824	USB drive common information	See (31) below	
GS1825 to 1997	Use prohibited	-	

(Continued to next page)

Device	Function	Reference	Model
GS1998	Full-screen display control signal	See (32) below	
GS1999 to 2006	Video window 1 extended control signal	See (33) below	
GS2009 to 2016	Video window 2 extended control signal		
GS2019 to 2026	Video window 3 extended control signal		
GS2029 to 2036	Video window 4 extended control signal		
GS2039 to 2045	RGB screen extended control signal		
GS2046 to 2047	Use prohibited	-	

### (1) Modem connection control (GS448 (16 bits))



GS448 controls communication between the GOT and a modem.

- b0: Turns on to send the initialization command to the modem.
- b1: Turns on to send the circuit disconnect command to the modem.
- b2 to b11: Must not be used
- b12: While this bit is on, reading project data and resource data from the GOT via modems is prohibited.
- b13: While this bit is on, writing project data and resource data to the GOT via modems is prohibited.
- b14: Must not be used
- b15: While this bit is on, communication between a personal computer and the GOT via modems is prohibited.

### POINT

#### (1) Turning on GS448.b0 during connecting to the circuit

The device disconnects the circuit, and then sends the initialization command.

The device initializes the modem connection status notification (GS248.b14) and the modem circuit connection baud rate (GS249) at the same time.

#### (2) Modem initialization signal and Modem circuit disconnect signal

Do not turn on the Modem initialization signal (GS448.b0) and the Modem circuit disconnect signal (GS448.b1) in the following cases.

Even if GS448.b0 and GS448.b1 turn on, the connection between modems cannot be disconnected.

- While the GOT communicates with GX Works2 or GX Developer by using the FA transparent function
- While the GOT communicates with GT Designer3

## (2) Monitor common control (GS450 (16 bit))

b15	b14	b13	b12	b11 to b9	b8	b7 to b5	b4	b3	b2	b1	b0
-----	-----	-----	-----	-----------	----	----------	----	----	----	----	----

- b0: When it is on, displays a confirm message after numerical/ASCII data are input.
- b1: Controls the displaying methods of the message displayed when an numerical value exceeding the valid range is input.  
Turning on displays a message during input of the numerical value.  
Turning off displays a message after the numerical value is entered.
- b2: Turns on to activate the system signal 1-1.b4 (Numeric value input read complete signal), system signal 2-1.b4 (Numeric value input signal), [Numeric Value Input Number], [Current Cursor Display User ID], and [Previous Cursor Display User ID] on the [Environmental Setting] dialog box (System information) during ASCII input as well.
- b3: Turns on to store "0" in [Current Cursor Display Object ID], [Previous Cursor Display Object ID], [Current Cursor Display User ID], and [Previous Cursor Display User ID] on the [Environmental Setting] dialog box (System information) when a cursor is erased.
- b4: Activates the Kana-kanji conversion function for ASCII input when turned on.
- b5 to b7: Use prohibited
- b8: When it is on, the parts display or parts movement can use a BMP/JPEG file in the memory card as a part. Turning off displays parts registered by GTDesigner3.  
When [Show image files in the memory card at the time of specifying Parts No. 9001-9999] is selected in the [Parts Setting] dialog box, a BMP/JPEG file in the memory card is used as a part regardless of the on/off status of this signal.

 (Functions) 21. PARTS DISPLAY

- b9: When this bit is on, the GOT retains the state of the historical trend graph displayed before screen switching and displays the same graph state after switching back to the graph screen.

 (Functions) 20. HISTORICAL TREND GRAPH

- b10 to b11: Use prohibited
- b12: Controls the timing when the screen/station No. changes by touch switch operation.  
This applies when multiple actions including either of the bit alternate/bit set/bit reset and either of screen switching/station No. switching are set for a touch switch.

 (Functions) 2. TOUCH SWITCH

- b13: When it is on, a memory card stores the history of the screen switching.
- b14: When it is on, the screen switching mode is switched from the previous mode to the history mode.
- b15: Use prohibited

## (3) Auto screen save time (GS451 (16 bit))

Store the time before close (OFF) the monitor screen in screen save function.

Store the value by 1 to 60 (Min).

(To store value higher than 60, store it as 60)

The changed value is validated after canceling screen save when changing value in screen save.

## POINT

### (1) Relationship between GS451 and GOT utility (screen save time)

If value other than 0 is stored in GS451, the screen save time set in GOT utility will be invalidated.

To validate the screen save time of utility, store 0 in GS451.

### (2) The Modem initialization signal and the Modem circuit disconnect signal

Do not turn on the Modem initialization signal (GS448.b0) and the Modem circuit disconnect signal (GS448.b1) in the following cases.

Even if GS448.b0 and GS448.b1 turn on, the connection between modems cannot be disconnected.

- While the GOT communicates with GX Works2 or GT Designer3 by using the FA transparent function
- While the GOT communicates with GT Designer3

**(4) Error detection common control (GS452 (16 bit))**

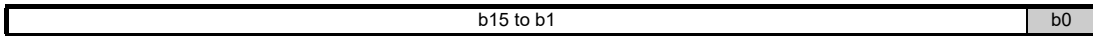

- b0: Turns ON to turn the error detection common information (GS252.b0) OFF.
- b1 to b15: Use prohibited

**(5) Ethernet access control (GS454 (16 bits))**



GS454 controls the OS installation/uninstallation on/from the GOT via Ethernet, or controls the project data write/read to/from the GOT via Ethernet.

- b0: When the bit turns on, OSEs cannot be installed on the GOT via Ethernet.
- b1: When the bit turns on, project data cannot be written to the GOT via Ethernet.
- b2 to 7: Use prohibited
- b8: When the bit turns on, project data cannot be read from the GOT via Ethernet.
- b9 to 15: Use prohibited

**(6) Intensity control (GS455 (16 bits))**

If a value is stored, the intensity of the GOT display section can be adjusted.

This device is valid for the GOT that can adjust the intensity.

The intensity is changed according to the following stored values.

Stored value of GS455	Intensity		Stored value of GS455	Intensity	
	GOT with 8-level intensity adjustment	GOT with 4-level intensity adjustment		GOT with 8-level intensity adjustment	GOT with 4-level intensity adjustment
0	Intensity set in the utility		5	5	3
1	1	1	6	6	
2	2		2	7	7
3	3	4		8	8
4	4			9 or more	Intensity set in the utility

The intensity of the GOT can be confirmed by the intensity notification (GS255).

(19) Intensity notification (GS255 (16 bits))

For the specifications of the GOT display section, refer to the following.

User's Manual for the GOT used

**POINT**

**Setting value changed by the intensity control (GS455)**

The intensity control (GS455) changes the setting value of the intensity temporarily.

If the GOT is turned off after the setting value of the intensity is changed, the value is returned to the value set in the utility.

### (7) Text code format control (GS456 (16 bits))

The text code for the ASCII display and the ASCII input can be changed.

Changing the text code also changes the KANJI region of the kanji characters displayed for the ASCII display and the ASCII input.

The text code is changed according to the following stored values.

Stored value	Text code	KANJI region of displayed kanji characters	Model
0	ASCII code, shift JIS code	Japanese	
1	Shift JIS code	Japanese	
2	ASCII code	Japanese	
3*1	GB code	Simplified Chinese	
4	KS code	Japanese	

\*1 For the GT10, the standard font ([Chinese(Simplified)] or [Chinese(Simplified) (supporting Europe)]) must be version 01.01.00 or later.

The new text code is applied to the GOT screen in any of the following timing.

- Switching screens
- Switching security
- Switching languages
- Switching station numbers

## POINT

### (1) Applied KANJI region

When the font data applicable to the KANJI region of the selected text code is not written in the GOT, the KANJI region of the standard font is applied.

The following is an example when using the GOT that has only Japanese as the standard font (Standard). If the text code is changed to the GB code, the KANJI region of the displayed kanji characters is set to Japanese.

### (2) Precautions for using the ASCII code and GB code

When the GOT has no font supporting European languages, the GOT cannot distinguish between some one-byte and two-byte characters of the ASCII code and GB code correctly.

When using the ASCII code and GB code, write the font supporting European languages to the GOT.

2.5 Specifications of Applicable Characters

### (8) Pass-through transparent stop control (GS457 (16 bits))

When "1" is set at this area, pass-through transparent stop request is performed.

By using this area, the user can expedite recovery from the pass-through transparent recovery waiting status.

This area is effective only when "2" (pass-through mode in operation) is set for FA transparent status (GS256).

0: No stop request

1: Stop request

### (9) GT SoftGOT1000 common control (GS500 (16 bits))

b15 to b2	b1	b0
-----------	----	----

- b0: The dialog box for exiting the GT SoftGOT1000 is displayed when the bit turns ON. The signal turns OFF if exiting is canceled in the displayed dialog box.
- b1: When the bit turns on, GT SoftGOT1000 is displayed in the full screen mode. When the bit turns off, the full screen mode of GT SoftGOT1000 is canceled.
- b2: When the bit turns on, the [File Information in PLC] dialog box is displayed.
- b3 to b15: Use prohibited



**(10) Application start signal (GS501 to GS502 (16 bits))**

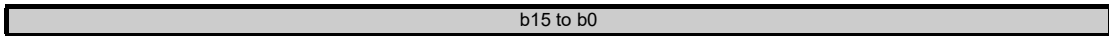

b0 to b15: When a bit turns ON, the application assigned to each bit by the GT SoftGOT1000 runs.

**(11) GT SoftGOT1000 full screen size (Width) (GS503 (16 bits))**

With the full screen mode function of GT SoftGOT1000, set the width of GT SoftGOT1000 monitor screen (320 to 1920 dots).

When the set value is 320 or less, the value is processed as 320. When the set value is 1920 or more, the value is processed as 1920.

**(12) GT SoftGOT1000 full screen size (Height) (GS504 (16 bits))**

With the full screen mode function of GT SoftGOT1000, set the height of GT SoftGOT1000 monitor screen (240 to 1200 dots).

When the set value is 240 or less, the value is processed as 240. When the set value is 1200 or more, the value is processed as 1200.

**(13) Advanced application start signal (GS505, GS506 to 507 (16 bits))**

Using a value in GS505 and any bit from GS506 to 507 starts an application on GT SoftGOT1000.

For setting the devices from GS505 to 507 as a trigger of the application, refer to the following manual.

 GT SoftGOT1000 Version3 Operating Manual for GT Works3

(a) GS505

The device stores a value used for starting the application. (1 to 255)

(b) GS506 to 507

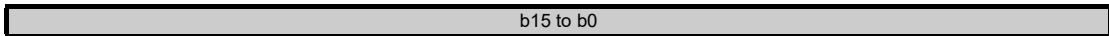

b0 to b15: Turning on any of these bits start the application assigned to each bit according to a value in GS505.

**(14) Device data transfer information (GS510 (16 bits))**



- b0: When the bit turns on, the device stores 0 in the error device data transfer ID (GS642) and the device data transfer error count (GS643).
- b1: When the bit turns on, the device stores 0 in the device data transfer processing time (GS644), the device data transfer min. processing time (GS646), and the device data transfer max. processing time (GS648).
- b2 to b15: Use prohibited

**(15) Touch status communication control (GS511 (16 bits))**

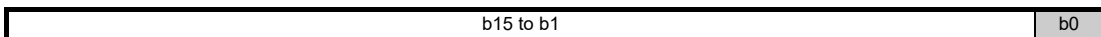

- b0: When the bit turns on, the touch status is output to the personal computer. When the bit turns off, the touch status is not output to the personal computer.
- b1 to b15: Use prohibited

**POINT**

**For using touch status communication control**

For using the touch status communication control, the extended function OS for the remote personal computer operation function is required.

For details of the remote personal computer operation function, refer to the following.

 (Functions) 33. REMOTE PERSONAL COMPUTER OPERATION FUNCTION

### (16) External I/O function notification/control function (GS517 (16 bits))

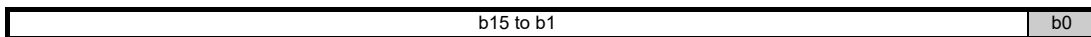

- b0: When b0 turns on, the 128-point input can be executed with the external I/O function. When b0 turns off, the 16-point input can be executed.
- b1 to b15: Use prohibited



#### 128-point input

Without the 128-point input (when the above device turns off), a GOT internal device turns on when the 16-point input is executed with an input terminal.

With the 128-point input (when the above device turns on), a 16-point input with an input terminal is used with a 8-point scan signal.

For connection diagrams of each signal with the external I/O function, refer to the following manual.

GOT1000 Series Connection Manual (Microcomputer, MODBUS Products, Peripherals) for GT Works3

### (17) Sound output cancel control (GS518 (16 bits))



- b0: When the bit turns on, a sound output during play is cancelled.
- b1: When the bit turns on, a sound output during play is cancelled and all sound output requests are cancelled.
- b2 to b15: Use prohibited

### (18) Buffering and file access control (GS520 (16 bits))

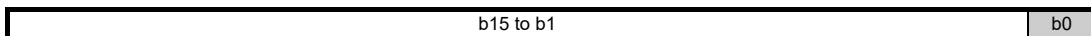

- b0: Turns on to store the whole data in the buffering area in the destination drive at the timing of the rising edge.
- b1 to b15: Use prohibited

### (19) Trigger backup data send delay (GS521 (16 bits))

The backup/restore function can set the delay time for backup communication intervals.

Setting of the delay time can reduce the load of other processes (such as monitoring objects) with the backup process.

The actually time set by the set value is listed as follows.

Set value	Delay time
0	None
1 to 100	Set value × 5(ms)
101 or more	500(ms)



#### Setting of trigger backup data send delay

Backup communication times are longer than a default when the trigger backup data send delay is set.

Set the suitable delay time to match the processing condition of backup function and others (such as monitoring objects).

### (20) Special control during specific function execution (GS522 (16 bits))

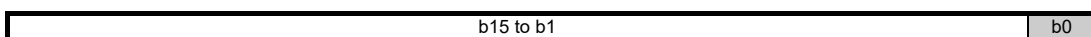

- b0: When the bit turns on, during the backup/restore function execution, processing by the alarm functions, the logging function, and others and device monitoring stop, and only the backup/restore process is executed.
- b1 to b15: Use prohibited

**(21) Network No. for monitor station disconnected (CH1 to CH4) (GS530, GS540, GS550, GS560 (16 bits))**

These devices control the disconnection and the connection of the monitor stations by station.



- b0 to b7: Specify the network number for the station to be disconnected. (0 to 239)  
One network number can be specified per channel.
- b8 to b15: Use prohibited

The devices are enabled only when the following communication drivers are used.

- A/QnA/L/Q CPU, LJ71C24, QJ71C24
- AJ71QC24, MELDAS C6\*
- AJ71C24/UC24
- Bus(A/QnA)
- Bus(Q)
- CC-Link(G4)

Specify the station to be disconnected by using the following GOT special registers.

Turning on the bit corresponding to the station number disconnects the specified station from the GOT. (For the multi-channel connection, the bit of the device corresponding to each channel No.(CH1 to CH4) turns on.)

- 1: Disconnected
- 0: Connected

Device				Station No.															
CH1	CH2	CH3	CH4	b15	b14	b13	b12	b11	b10	b9	b8	b7	b6	b5	b4	b3	b2	b1	b0
GS531	GS541	GS551	GS561	15	14	13	12	11	10	9	8	7	6	5	4	3	2	1	0
GS532	GS542	GS552	GS562	31	30	29	28	27	26	25	24	23	22	21	20	19	18	17	16
GS533	GS543	GS553	GS563	47	46	45	44	43	42	41	40	39	38	37	36	35	34	33	32
GS534	GS544	GS554	GS564	63	62	61	60	59	58	57	56	55	54	53	52	51	50	49	48
GS535	GS545	GS555	GS565	79	78	77	76	75	74	73	72	71	70	69	68	67	66	65	64
GS536	GS546	GS556	GS566	95	94	93	92	91	90	89	88	87	86	85	84	83	82	81	80
GS537	GS547	GS557	GS567	111	110	109	108	107	106	105	104	103	102	101	100	99	98	97	96
GS538	GS548	GS558	GS568	127	126	125	124	123	122	121	120	119	118	117	116	115	114	113	112

**(22) Monitor station disconnection (CH1 to CH4) (GS531 to 538, GS541 to 548, GS551 to 558, GS561 to 568 (16 bits))**

When the bit corresponding to the station No. of the temperature controller, servo amplifier, inverter, IAI robo cylinder, or MODBUS®/RTU equipment turns on, the specified station is disconnected from the GOT. (For the multi-channel connection, the bit of the device corresponding to each channel No. (CH1 to CH4) turns on.)

1: Disconnected

0: Connected

When the GOT is connected to the AZBIL temperature controller (DMC50), the specified station No. of the DMC50 differs from the station numbers of the other models.

The following shows the station numbers for each device.

(a) When connecting models other than the AZBIL temperature controller (DMC50)

Device				Station No.															
CH1	CH2	CH3	CH4	b15	b14	b13	b12	b11	b10	b9	b8	b7	b6	b5	b4	b3	b2	b1	b0
GS531	GS541	GS551	GS561	15	14	13	12	11	10	9	8	7	6	5	4	3	2	1	0
GS532	GS542	GS552	GS562	31	30	29	28	27	26	25	24	23	22	21	20	19	18	17	16
GS533	GS543	GS553	GS563	47	46	45	44	43	42	41	40	39	38	37	36	35	34	33	32
GS534	GS544	GS554	GS564	63	62	61	60	59	58	57	56	55	54	53	52	51	50	49	48
GS535	GS545	GS555	GS565	79	78	77	76	75	74	73	72	71	70	69	68	67	66	65	64
GS536	GS546	GS556	GS566	95	94	93	92	91	90	89	88	87	86	85	84	83	82	81	80
GS537	GS547	GS557	GS567	111	110	109	108	107	106	105	104	103	102	101	100	99	98	97	96
GS538	GS548	GS558	GS568	127	126	125	124	123	122	121	120	119	118	117	116	115	114	113	112

(b) When connecting the AZBIL temperature controller (DMC50)

Device				Station-Sub station															
CH1	CH2	CH3	CH4	b15	b14	b13	b12	b11	b10	b9	b8	b7	b6	b5	b4	b3	b2	b1	b0
GS531	GS541	GS551	GS561	1-15	1-14	1-13	1-12	1-11	1-10	1-9	1-8	1-7	1-6	1-5	1-4	1-3	1-2	1-1	1-0
GS532	GS542	GS552	GS562	2-15	2-14	2-13	2-12	2-11	2-10	2-9	2-8	2-7	2-6	2-5	2-4	2-3	2-2	2-1	2-0
GS533	GS543	GS553	GS563	3-15	3-14	3-13	3-12	3-11	3-10	3-9	3-8	3-7	3-6	3-5	3-4	3-3	3-2	3-1	3-0
GS534	GS544	GS554	GS564	4-15	4-14	4-13	4-12	4-11	4-10	4-9	4-8	4-7	4-6	4-5	4-4	4-3	4-2	4-1	4-0
GS535	GS545	GS555	GS565	5-15	5-14	5-13	5-12	5-11	5-10	5-9	5-8	5-7	5-6	5-5	5-4	5-3	5-2	5-1	5-0
GS536	GS546	GS556	GS566	6-15	6-14	6-13	6-12	6-11	6-10	6-9	6-8	6-7	6-6	6-5	6-4	6-3	6-2	6-1	6-0
GS537	GS547	GS557	GS567	7-15	7-14	7-13	7-12	7-11	7-10	7-9	7-8	7-7	7-6	7-5	7-4	7-3	7-2	7-1	7-0
GS538	GS548	GS558	GS568	8-15	8-14	8-13	8-12	8-11	8-10	8-9	8-8	8-7	8-6	8-5	8-4	8-3	8-2	8-1	8-0

**POINT**

**(1) Error station**

When an error station is disconnected from the GOT, the temperature controller/servo amplifier faulty station information corresponding to the disconnected station turns off.

 (27) Faulty station information (CH1 to CH4) (GS281 to 288, GS301 to 308, GS321 to 328, GS341 to 348 (16 bits))

**(2) Restrictions**

- The GOT cannot disconnect the stations with the station No. 128 or later, or the station No. and the sub station No., "9-0" or later.
- The stations with the station numbers specified on GT Designer3 cannot be disconnected using the device of the temperature controller/servo amplifier monitor station disconnection.

For specifying station numbers, refer to the following.

 GOT1000 Series Connection Manual (Microcomputer, MODBUS Products, Peripherals) for GT Works3

**(23) Channel shutdown control(CH1 to CH4)(GS539, GS549, GS559, GS569 (16 bits))**

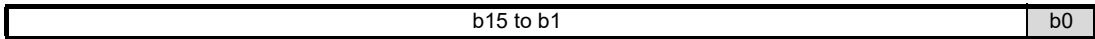

Communication of each channel is prohibited.

When this signal turns on, the channel observation notification information (GS299, GS319, GS339, GS359) for the channel whose communication is prohibited turns off.

 (28) Channel observation notification information (GS299, GS319, GS339, GS359 (16 bits))

- b0: While the bit is on, communication of each channel is prohibited.
- b1 to b15: Use prohibited

8	COMMUNICATION WITH GOT
9	USEFUL FUNCTIONS FOR DRAWING
10	USEFUL FUNCTIONS FOR USING GOT
	APPENDICES

**(24) MODBUS communication control function (GS570 to GS576, GS590 to GS596, GS597 to GS603, GS604 to GS610, GS611 to GS617 (16 bits))**

When some controllers do not comply with the specifications, this function enables the GOT to reduce the communication delay in the MODBUS® network.

For GT SoftGOT1000, GS570 to GS576 and GS590 to GS596 are available only.

When the multi-channel function uses the MODBUS® connection with multiple channels, the target channel can be selected according to the values stored in GS579.

 **(25) Channel setting of MODBUS communication control function (GS579 (16 bits))**

Device					Function
Common	CH1	CH2	CH3	CH4	
GS570.b0	GS590.b0	GS597.b0	GS604.b0	GS611.b0	When the bit turns on, the function code 0FH (Write multiple coils) is not available.
GS570.b1	GS590.b1	GS597.b1	GS604.b1	GS611.b1	When the bit turns on, the function code 10H (Write multiple registers) is not available.
GS570.b2 to b15	GS590.b2 to b15	GS597.b2 to b15	GS604.b2 to b15	GS611.b2 to b15	Use prohibited
GS571	GS591	GS598	GS605	GS612	Set the maximum number of device points (1 to 2000) for a message with the function code 01H (Read coils). When 0 is set, the maximum number of device points is set as shown below. <ul style="list-style-type: none"> <li>• MODBUS/TCP: 1000</li> <li>• MODBUS/RTU: 2000</li> </ul> When values other than the above are set, the maximum number of device points is set to 2000.
GS572	GS592	GS599	GS606	GS613	Set the maximum number of device points (1 to 2000) for a message with the function code 02H (Read input relays). When 0 is set, the maximum number of device points is set as shown below. <ul style="list-style-type: none"> <li>• MODBUS/TCP: 1000</li> <li>• MODBUS/RTU: 2000</li> </ul> When values other than the above are set, the maximum number of device points is set to 2000.
GS573	GS593	GS600	GS607	GS614	Set the maximum number of device points (1 to 125) for a message with the function code 03H (Read holding registers). When the maximum number of device points is set to other than 1 to 125, the maximum number is set to 125.
GS574	GS594	GS601	GS608	GS615	Set the maximum number of device points (1 to 125) for a message with the function code 04H (Read input registers). When the maximum number of device points is set to other than 1 to 125, the maximum number is set to 125.
GS575	GS595	GS602	GS609	GS616	Set the maximum number of device points for a message with the function code 0FH (Write multiple coils). The following shows the setting range of the maximum number of device points. <ul style="list-style-type: none"> <li>• MODBUS/TCP: 1 to 800</li> <li>• MODBUS/RTU: 1 to 1968</li> </ul> When the maximum number of device points is set to 0, the maximum number is set to 800. When values other than the above are set, the maximum number of device points is set to the maximum value.
GS576	GS596	GS603	GS610	GS617	Set the maximum number of device points for a message with the function code 10H (Write multiple registers). The following shows the setting range of the maximum number of device points. <ul style="list-style-type: none"> <li>• MODBUS/TCP: 1 to 100</li> <li>• MODBUS/RTU: 1 to 123</li> </ul> When the maximum number of device points is set to 0, the maximum number is set to 100. When values other than the above are set, the maximum number of device points is set to the maximum value.

## POINT

### (1) Function codes supported by the GOT

For function codes supported by the GOT, refer to the following.

 GOT1000 Series Connection Manual (Microcomputer, MODBUS Products, Peripherals) for GT Works3

### (2) Setting MODBUS communication control function

Set the MODBUS communication control function at the GOT startup with the project script or others. When the setting is changed after the communication starts, the communication error may occur.

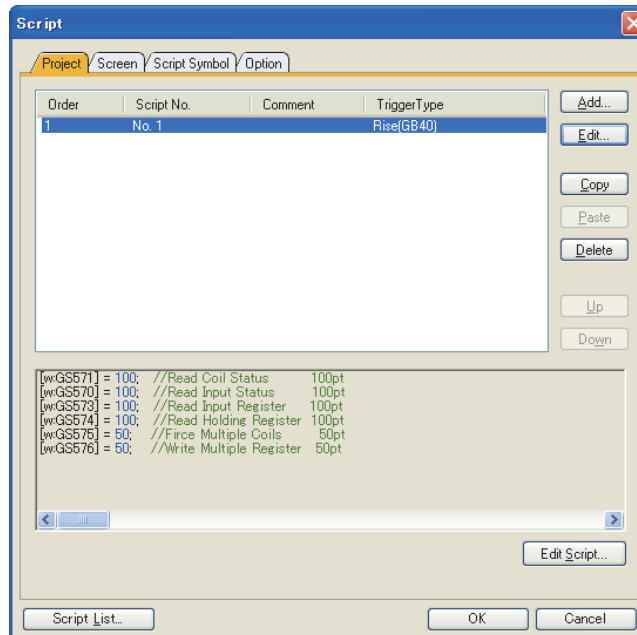

Setting example of project script

### (25) Channel setting of MODBUS communication control function (GS579 (16 bits))



The MODBUS communication control function setting can be selected for each channel.

For GT SoftGOT1000, b0 is available only.

 (24) MODBUS communication control function (GS570 to GS576, GS590 to GS596, GS597 to GS603, GS604 to GS610, GS611 to GS617 (16 bits))

- b0: The MODBUS communication control function for CH1 can be selected.  
Turning on this bit applies the MODBUS communication control function (CH1) (GS590 to GS596).  
Turning off this bit applies the MODBUS communication control function (Common) (GS570 to GS576).
- b1: The MODBUS communication control function for CH2 can be selected.  
Turning on this bit applies the MODBUS communication control function (CH2) (GS597 to GS603).  
Turning off this bit applies the MODBUS communication control function (Common) (GS570 to GS576).
- b2: The MODBUS communication control function for CH3 can be selected.  
Turning on this bit applies the MODBUS communication control function (CH3) (GS604 to GS610).  
Turning off this bit applies the MODBUS communication control function (Common) (GS570 to GS576).
- b3: The MODBUS communication control function for CH4 can be selected.  
Turning on this bit applies the MODBUS communication control function (CH4) (GS611 to GS617).  
Turning off this bit applies the MODBUS communication control function (Common) (GS570 to GS576).
- b4 to b15: Use prohibited

**(26) Microcomputer connection (serial) extended setting (CH1 to CH4) (GS580 to GS583 (16 bits))**

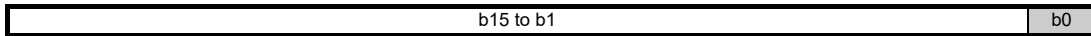

- b0: For the microcomputer connection (serial), when the bit is on and the data format of the message format is the format 12 or 13, communication packets are fully compatible with the Digital Electronics Corporation's memory link method in the communication.

(ON: Fully compatible, OFF: Partly compatible)

For details of the message format of the microcomputer connection (serial), refer to the following.



GOT1000 Series Connection Manual (Microcomputer, MODBUS Products, Peripherals) for GT Works3

- b1 to b15: Use prohibited

**(27) Touch position color acquisition ready signal (GS630 (16 bits))**

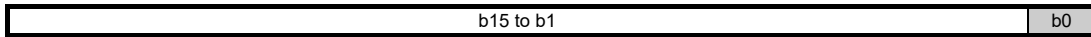

- b0: Turning on the bit makes the GOT be ready for acquiring the color information at the touched position on the GOT screen. In this status, even when an object or others is touched, the object or others does not function.

Turning off the bit without acquiring the color information cancels the status.

- b1 to b15: Use prohibited

**(28) Maintenance time notification cancel control (GS638 (16 bits))**



- b0: Turns on to turn off the first-stage backlight maintenance time notification signal (GS680.b0). While this bit is on, the first-stage backlight maintenance time notification signal (GS680.b0) remains off even if the backlight power on addition time (GS681 (32 bits)) exceeds the backlight maintenance notification time setting specified with a utility.
- b1: Turns on to turn off the first-stage display section maintenance time notification signal (GS680.b1). While this bit is on, the first-stage display section maintenance time notification signal (GS680.b1) remains off even if the display section power ON addition time (GS683 (32 bits)) exceeds the display section maintenance notification time setting specified with a utility.
- b2: Turns on to turn off the first-stage touch key maintenance time notification signal (GS680.b2). While this bit is on, the first-stage touch key maintenance time notification signal (GS680.b2) remains off even if any of the touch key pushing addition times (GS700 to 979) exceeds the touch key maintenance notification count setting specified with a utility.
- b3: Turns on to turn off the first-stage built-in flash memory maintenance time notification signal (GS680.b3). While this bit is on, the first-stage built-in flash memory maintenance timing notification signal (GS680.b3) remains off even if the build in flash memory writing times (GS685 (32 bits)) exceeds the built-in flash memory maintenance notification count setting specified with a utilities.
- b4: Turns on to turn off the second-stage backlight maintenance time notification signal (GS680.b4). While this bit is on, the second-stage backlight maintenance time notification signal (GS680.b4) remains off even if backlight power ON addition time (GS681 (32 bits)) exceeds the backlight maintenance notification time setting specified with a utility.
- b5: Turns on to turn off the second-stage display section maintenance time notification signal (GS680.b5). While this bit is on, the second-stage display section maintenance time notification signal (GS680.b5) remains off even if the backlight power ON addition time (GS683 (32 bits)) exceeds the display section maintenance notification time setting specified with a utility.
- b6: Turns on to turn off the second-stage touch key maintenance time notification signal (GS680.b6). While this bit is on, the second-stage touch key maintenance time notification signal (GS680.b6) remains off even if any of the touch key pushing addition times (GS700 to 979) exceeds the touch key maintenance notification count setting specified with a utility.
- b7: Turns on to turn off the second-stage built-in flash memory maintenance time notification signal (GS680.b7). While this bit is on, the second-stage built-in flash memory maintenance time notification signal (GS680.b7) remains off even if the built-in flash memory writing times (GS685 (32 bits)) exceeds the built-in flash memory maintenance time notification count setting specified with a utility.
- b8 to b15: Use prohibited



## POINT

### Action of maintenance time notification cancel signal upon power-off of GOT

The maintenance time notification cancel signal is reset when the GOT is powered off.

Therefore the maintenance time notification signal deactivated during operation of the maintenance timing notification cancel signal is turned on again when the GOT is powered on.

To keep the maintenance time notification signal off even when the GOT is powered off and then on again, use the state monitoring function or the like to turn on the maintenance time notification cancel signal again.

### (29) GOT reset control (GS639 (16 bits))



- b0 to b13: Use prohibited
- b14: Turns on to exit all the GOT functions. (The GOT power can be turned off safely.)  
Not supported by GT11.
- b15: Turn on to software-rest the GOT at the rising edge timing.

### (30) VNC<sup>®</sup> server function control (GS1792 (16 bits))



- b0: When the bit turns on, the device disables communication from the VNC<sup>®</sup> client.
- b1: When the bit turns on, the device disables operations from the VNC<sup>®</sup> client.
- b2 to b7: Use prohibited
- b8: When the bit turns on, the authorization guarantee time for the VNC<sup>®</sup> server function is disabled.
- b9 to b15: Use prohibited

### (31) USB drive common control (GS1824 (16 bits))

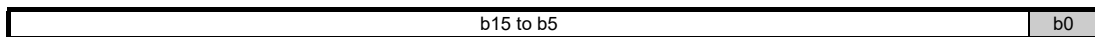

- b0: When the bit turns on, the USB memory connected to the USB interface on the GOT can be removed.
- b5 to b15: Use prohibited

### (32) Full-screen display control signal (GS1998 (16 bits))

When b7 (Extended control signal) of the video/RGB input common device is on, the Full-screen display control signal specifies the video window or the RGB screen to be displayed in full-screen size.

When the signal stores any value other than the following, the GOT does not display the video window or the RGB screen in full-screen size. (The operation is the same as when 0 is stored.)

0: Does not display the video window or the RGB screen in full-screen size. (The size of the video window or the RGB screen corresponds to the setting of each video window or the RGB screen.)

1 to 4: Displays the specified number of video window in full-screen size.

5: Displays the RGB screen in full-screen size.

**(33) Video window extended control signals (video windows 1 to 4) and RGB screen extended control signal (GS1999 to GS2006, GS2009 to GS2016, GS2019 to GS2026, GS2029 to GS2036, GS2039 to GS2045 (16 bits))**











When b7 (Extended control signal) of the video/RGB input common device is on, each signal specifies video windows 1, 2, 3, 4, or the RGB screen.

The default display position of the video window or the RGB screen is the upper left corner of the GOT screen.

Device					Function
Video window 1	Video window 2	Video window 3	Video window 4	RGB screen	
GS1999	GS2009	GS2019	GS2029	-	Specifies the channel No. for the video window displayed. <sup>*1</sup>
GS2000	GS2010	GS2020	GS2030	GS2039	Specifies the display magnification of the video window or the RGB screen. The reference display size (width and height) is specified in the setting of the video window or the RGB screen. <ul style="list-style-type: none"> <li>• 7: 400%</li> <li>• 8: 200%</li> <li>• 0: 100%</li> <li>• 1: 87.5%</li> <li>• 2: 75%</li> <li>• 3: 62.5%</li> <li>• 4: 50%</li> <li>• 5: 37.5%</li> <li>• 6: 25%</li> <li>• Other than the above: 100%</li> </ul>
GS2001	GS2011	GS2021	GS2031	GS2040	Specifies the display size (width) of the video window or the RGB screen in dots as the reference of the display size (width) at 100% magnification. The actual display size (width) of the video window or the RGB screen is enlarged or reduced according to the set display magnification. The video image or the GOT with lower resolution must be specified.
GS2002	GS2012	GS2022	GS2032	GS2041	Specifies the display size (height) of the video window or the RGB screen in dots as the reference of the display size (height) at 100% magnification. The actual display size (height) of the video window or the RGB screen is enlarged or reduced according to the set display magnification. The video image or the GOT with lower resolution must be specified.
GS2003	GS2013	GS2023	GS2033	GS2042	Specifies the display position (X coordinate) of the video window or the RGB screen in dots. The default display position is the upper left corner of the GOT screen. The video image or the GOT with lower resolution must be specified.
GS2004	GS2014	GS2024	GS2034	GS2043	Specifies the display position (Y coordinate) of the video window or the RGB screen in dots. The default display position is the upper left corner of the GOT screen. The video image or the GOT with lower resolution must be specified.
GS2005	GS2015	GS2025	GS2035	GS2044	Specifies the origin point (X coordinate) of the clip area of the video image. The available resolution for the video image must be specified.
GS2006	GS2016	GS2026	GS2036	GS2045	Specifies the origin point (Y coordinate) of the clip area of the video image. The available resolution for the video image must be specified.

\*1 Specifies the channel No. with b14 or b15 (Selection for display/hide of RGB screen) of the video/RGB input common device.

## Write device

Device	Function	Reference	Model
GS0	Common information 1	See (1) below	
GS1	Base screen information	See (2) below	
GS2 to 5	Use prohibited	-	
GS6	CC-Link G4 station No.(CH1)	See (3) below	
	GOT multidrop slave station No. (CH1)	See (4) below	
GS7	1 second binary counter	See (5) below	
GS8	Scan time of monitor	See (6) below	
GS9	Use prohibited	-	
GS10	Scan counter of monitor	See (7) below	
GS11 to 13	Use prohibited	-	
GS14	Script common information	(Functions) 30. SCRIPT FUNCTION	
GS15	Script error pointer		
GS16	Script No.		
GS17	Error code		
:	:		
GS46	Script No.		
GS47	Error code		
GS48	Script execute pointer		
GS49 to 79	Script execute No.		
GS80	Object script common information		
GS81	Object script error point		
GS82	Object script user ID		
GS83	Error code		
:	:		
GS112	Object script user ID		
GS113	Error code		
GS114	Object script error execute pointer		
GS115 to 145	Object script error execute ID		
GS146 to 153	Use prohibited	-	
GS154	File operation function information	(Functions) 30. SCRIPT FUNCTION	

(Continued to next page)

Device	Function	Reference	Model
GS155 to 197	Use prohibited	-	Gr16 Gr15 Gr14 Gr12 Gr11 Gr10 SoftGOT1000
GS198 to 199	GOT IP address notification	See (8) below	Gr16 Gr15 Gr14 Gr12 Gr11 Gr10 SoftGOT1000
GS200 to 229	Gateway common information	GOT1000 Series Gateway Functions Manual for GT Works3	Gr16 Gr15 Gr14 Gr12 Gr11 Gr10 SoftGOT1000
GS230	No. of faulty stations	See (9) below	Gr16 Gr15 Gr14 Gr12
GS231 to 238	Ethernet faulty station information	See (10) below	Gr11 Gr10 SoftGOT1000
GS239	Use prohibited	-	Gr16 Gr15 Gr14 Gr12 Gr11 Gr10 SoftGOT1000
GS240	External authentication status notification	See (11) below	Gr16 Gr15 Gr14 Gr12 Gr11 Gr10 SoftGOT1000
GS241	Insufficient security level	See (12) below	Gr16 Gr15 Gr14 Gr12 Gr11 Gr10 SoftGOT1000
GS242	Use prohibited	-	Gr16 Gr15 Gr14 Gr12 Gr11 Gr10 SoftGOT1000
GS243	Object direct input reception notification	See (13) below	Gr16 Gr15 Gr14 Gr12 Gr11 Gr10 SoftGOT1000
GS244	SoftGOT-GOT link status control/ notification	GT SoftGOT1000 Version3 Operating Manual for GT Works3	Gr16 Gr15 Gr14 Gr12 Gr11 Gr10 SoftGOT1000
GS245 to 247	Use prohibited	-	Gr16 Gr15 Gr14 Gr12 Gr11 Gr10 SoftGOT1000
GS248	Modem connection status notification	See (14)below	Gr16 Gr15 Gr14 Gr12
GS249	Modem circuit connection baud rate	See (15) below	Gr11 Gr10 SoftGOT1000
GS250	Use prohibited	-	Gr16 Gr15 Gr14 Gr12 Gr11 Gr10 SoftGOT1000
GS251	Accessible drive notification	See (16) below	Gr16 Gr15 Gr14 Gr12
GS252	Error detection common information	See (17) below	Gr11 Gr10 SoftGOT1000
GS253	Use prohibited	-	Gr16 Gr15 Gr14 Gr12 Gr11 Gr10 SoftGOT1000
GS254	Ethernet incorrect access notification	See (18) below	Gr16 Gr15 Gr14 Gr12 Gr11 Gr10 SoftGOT1000
GS255	Intensity notification	See (19) below	Gr16 Gr15 Gr14 Gr12 Gr11 Gr10 SoftGOT1000
GS256	FA transparent status	See (20) below	Gr16 Gr15 Gr14 Gr12 Gr11 Gr10 SoftGOT1000

















(Continued to next page)

Device	Function	Reference	Model
GS257	Use prohibited	-	GT16 GT15 GT14 GT12 GT11 GT10 SoftGOT1000
GS258	Printer status information	See (21) below	GT16 GT15 GT14 GT12 GT11 GT10 SoftGOT1000
GS259	Use prohibited	-	GT16 GT15 GT14 GT12 GT11 GT10 SoftGOT1000
GS260	Integer ↔ Real number conversion status	(Functions) 30. SCRIPT FUNCTION	GT16 GT15 GT14 GT12 GT11 GT10 SoftGOT1000
GS261	Integer ↔ Real number conversion error code		
GS262	System alarm GOT error channel No.	See (22) below	GT16 GT15 GT14 GT12 GT11 GT10 SoftGOT1000
GS263	System alarm CPU error channel No.	See (23) below	GT16 GT15 GT14 GT12 GT11 GT10 SoftGOT1000
GS264	System alarm network error channel No.	See (24) below	GT16 GT15 GT14 GT12 GT11 GT10 SoftGOT1000
GS265	SNTP time synchronization setting status	GOT1000 Series MES Interface Function Manual for GT Works3	GT16 GT15 GT14 GT12 GT11 GT10 SoftGOT1000
GS266 to 272	SNTP time query result		
GS273 to 274	Use prohibited	-	GT16 GT15 GT14 GT12 GT11 GT10 SoftGOT1000
GS275	Monitoring interval timeout count	GOT1000 Series MES Interface Function Manual for GT Works3	GT16 GT15 GT14 GT12 GT11 GT10 SoftGOT1000
GS276	Document display status notification	See (25) below	GT16 GT15 GT14 GT12 GT11 GT10 SoftGOT1000
GS277 to 279	Use prohibited	-	GT16 GT15 GT14 GT12 GT11 GT10 SoftGOT1000
GS280	Faulty monitor station signal (CH1)	See (26) below	GT16 GT15 GT14 GT12 GT11 GT10 SoftGOT1000
GS281 to 288	Faulty station information (CH1)	See (27) below	GT16 GT15 GT14 GT12 GT11 GT10 SoftGOT1000
GS289 to 298	Use prohibited	-	GT16 GT15 GT14 GT12 GT11 GT10 SoftGOT1000
GS299	Channel observation notification information (CH1)	See (28) below	GT16 GT15 GT14 GT12 GT11 GT10 SoftGOT1000
GS300	Faulty monitor station signal (CH2)	See (26) below	GT16 GT15 GT14 GT12 GT11 GT10 SoftGOT1000
GS301 to 308	Faulty station information (CH2)	See (27) below	GT16 GT15 GT14 GT12 GT11 GT10 SoftGOT1000
GS309 to 318	Use prohibited	-	GT16 GT15 GT14 GT12 GT11 GT10 SoftGOT1000
GS319	Channel observation notification information (CH2)	See (28) below	GT16 GT15 GT14 GT12 GT11 GT10 SoftGOT1000
GS320	Faulty monitor station signal (CH3)	See (26) below	GT16 GT15 GT14 GT12 GT11 GT10 SoftGOT1000
GS321 to 328	Faulty station information (CH3)	See (27) below	GT16 GT15 GT14 GT12 GT11 GT10 SoftGOT1000
GS329 to 338	Use prohibited	-	GT16 GT15 GT14 GT12 GT11 GT10 SoftGOT1000









(Continued to next page)

Device	Function	Reference	Model
GS339	Channel observation notification information (CH3)	See (28) below	Gr16 Gr15 Gr14 Gr12 Gr11 Gr10 SoftGOT1000
GS340	Faulty monitor station signal (CH4)	See (26) below	
GS341 to 348	Faulty station information (CH4)	See (27) below	
GS349 to 358	Use prohibited	-	Gr16 Gr15 Gr14 Gr12 Gr11 Gr10 SoftGOT1000
GS359	Channel observation notification information (CH4)	See (28) below	Gr16 Gr15 Gr14 Gr12 Gr11 Gr10 SoftGOT1000
GS360	CC-Link G4 station No.(CH1)	See (3) below	Gr16 Gr15 Gr14 Gr12 Gr11 Gr10 SoftGOT1000
	GOT multidrop slave station No. (CH1)	See (4) below	
GS361	CC-Link G4 station No.(CH2)	See (3) below	Gr16 Gr15 Gr14 Gr12 Gr11 Gr10 SoftGOT1000
	GOT multidrop slave station No. (CH2)	See (4) below	
GS362	CC-Link G4 station No.(CH3)	See (3) below	Gr16 Gr15 Gr14 Gr12 Gr11 Gr10 SoftGOT1000
	GOT multidrop slave station No. (CH3)	See (4) below	
GS363	CC-Link G4 station No.(CH4)	See (3) below	Gr16 Gr15 Gr14 Gr12 Gr11 Gr10 SoftGOT1000
	GOT multidrop slave station No. (CH4)	See (4) below	
GS364 to 375	Use prohibited	-	Gr16 Gr15 Gr14 Gr12 Gr11 Gr10 SoftGOT1000
GS376 to 377	GOT network No./station No. notification (CH1)	See (29) below	Gr16 Gr15 Gr14 Gr12 Gr11 Gr10 SoftGOT1000
GS378 to 379	GOT network No./station No. notification (CH2)	See (29) below	Gr16 Gr15 Gr14 Gr12 Gr11 Gr10 SoftGOT1000
GS380 to 381	GOT network No./station No. notification (CH3)	See (29) below	Gr16 Gr15 Gr14 Gr12 Gr11 Gr10 SoftGOT1000
GS382 to 383	GOT network No./station No. notification (CH4)		
GS384 to 639	Read device	■Read device	Gr16 Gr15 Gr14 Gr12 Gr11 Gr10 SoftGOT1000
GS640 to 641	Use prohibited	-	Gr16 Gr15 Gr14 Gr12 Gr11 Gr10 SoftGOT1000
GS642	Error device data transfer ID	See (30) below	Gr16 Gr15 Gr14 Gr12 Gr11 Gr10 SoftGOT1000
GS643	Device data transfer error count	See (31) below	
GS644	Device data transfer processing time	See (32) below	
GS645	Device data transfer ID	See (33) below	
GS646	Device data transfer min. processing time	See (34) below	
GS647	Device data transfer ID (min. processing time)	See (35) below	
GS648	Device data transfer max. processing time	See (36) below	
GS649	Device data transfer ID (max. processing time)	See (37) below	
GS650 to 653	Present time	4.9	Gr16 Gr15 Gr14 Gr12 Gr11 Gr10 SoftGOT1000

(Continued to next page)

Device	Function	Reference	Model
GS654	Touch status external notification (X-coordinate)	See (38) below	
GS655	Touch status external notification (Y-coordinate)	See (39) below	
GS656	Touch status external notification (touch status)	See (40) below	
GS657	Trigger backup processing setting No. notification	See (41) below	
GS658 to 665	Extended external input status notification signal	See (42) below	
GS666 to 667	Use prohibited	-	
GS668	Sound status information	See (43) below	
GS669	Sound file number during play	See (44) below	
GS670	No. of trigger buffer data (GS670)	GOT1000 Series MES Interface Function Manual for GT Works3	
GS671	Trigger buffer overflow count (GS671)		
GS672 to GS675	Trigger buffer overflow flag per job (GS672 to GS675)		
GS676 to GS679	Use prohibited	-	
GS680 *1	Maintenance time notification information	See (45) below	
GS681 to 682 *1	Backlight power ON addition time	See (46) below	
GS683 to 684 *1	Display section power ON addition time	See (47) below	
GS685 to 686 *1	Built-in flash memory writing times	See (48) below	
GS687 to 699	Must not be used	-	
GS700 to 701 *1	Touch key pushing addition times No. 0	See (49) below	
:	:		
GS978 to 979 *1	Touch key pushing addition times No. 139		
GS980	Touch position color acquisition complete signal	See (50) below	
GS981 to 983	Touch position color	See (51) below	
GS984	Authorization guarantee status notification signal	GT SoftGOT1000 Version3 Operating Manual for GT Works3	
GS985 to 986	Use prohibited	-	
GS987	Executing file transfer ID notification	GOT1000 Series Gateway Functions Manual for GT Works3	
GS988	Communicating FTP server ID notification		
GS989	FTP communication error No. notification		

(Continued to next page)

Device	Function	Reference	Model
GS990	FTP communication status notification	GOT1000 Series Gateway Functions Manual for GT Works3	
GS991	FTP transfer target file count notification		
GS992	FTP transfer completion file count notification		
GS993 to 1023	Use prohibited	-	
GS1024	USB drive common information	See (52) below	
GS1025	RGB signal input status notification	See (53) below	
GS1026	RGB signal resolution (horizontal)	See (54) below	
GS1027	RGB signal resolution (vertical)	See (55) below	
GS1028	RGB signal refresh rate	See (56) below	
GS1029 to 1229	Use prohibited	-	
GS1230	VNC <sup>®</sup> server operation status notification	See (57) below	
GS1231 to 1232	Communicating VNC <sup>®</sup> client information notification	See (58) below	
GS1233	VNC <sup>®</sup> server authorization guarantee status notification	See (59) below	
GS1234 to 1240	Use prohibited	-	
GS1241	Insufficient security level notification	See (60) below	
GS1242 to 1791	Use prohibited	-	
GS1792 to 2047	Read device	■ Read device	

\*1 For using the function, the GOT requires a battery.

## (1) Common information1 (GS0 (16 bit))

b15 to b11	b10	b9	b8	b7 to b6	b5	b4	b3	b2	b1	b0
------------	-----	----	----	----------	----	----	----	----	----	----

- b0: Repeats turning ON and OFF for every communication cycle<sup>\*1</sup>. (For channel No. 1)
- b1: Turns ON when the base/window screen is switched and remains ON until a cycle of the on-screen setting processing is complete. (This applies to station No. switching, security level change or language switching.) It is used to check (debug) the screen switch settings.
- b2: Turns ON when the base/window screen is switched and remains ON until a cycle of the status observation processing of the project and the screen display is completed. (This applies to station No. switching, security level change or language switching.) It is used to activate the status observation for once when switching the screen.
- b3: Turns ON while the initial screen is displayed at power-on. It turns off when the base screen is switched over.
- b4: Always ON.
- b5: Always OFF.
- b6 to b7: Use prohibited
- b8: Repeats turning ON and OFF for every communication cycle<sup>\*1</sup>. (For channel No. 2)
- b9: Repeats turning ON and OFF for every communication cycle<sup>\*1</sup>. (For channel No. 3)
- b10: Repeats turning ON and OFF for every communication cycle<sup>\*1</sup>. (For channel No. 4)
- b11 to b15: Use prohibited

\*1 A cycle is the elapsed time for GOT to read the objects on the current screen display and the data set in the common settings.





### Actions of b4 and b5 in common information 1 (GS0)

b4 and b5 in common information 1 (GS0) are always ON (GB40) and always OFF (GB41), respectively.

## (2) Base screen information (GS1 (16 bit))



- b0: Repeats turning ON and OFF for every communication cycle while the base screen is displayed. (For channel No. 1)
- b1: Turns ON when the base/window screen is switched and remains ON until a cycle of the on-screen setting processing is complete. (This applies to station No. switching, security level change or language switching.) It is used to check (debug) the screen switch settings
- b2: Turns ON when the base screen is switched and remains ON until a cycle of the status observation processing of the base screen is completed. (This applies to station No. switching, security level change or language switching.) It is used to activate the status observation for once when the screen is switched over.
- b3 to b7: Use prohibited
- b8: Repeats turning ON and OFF for every communication cycle while the base screen is displayed. (For channel No. 2)
- b9: Repeats turning ON and OFF for every communication cycle while the base screen is displayed. (For channel No. 3)
- b10: Repeats turning ON and OFF for every communication cycle while the base screen is displayed. (For channel No. 4)
- b11 to b15: Use prohibited

## (3) CC-Link G4 station No.(CH1) (GS6 (16 bits))

For the CC-Link connection (via G4 or GT11H(S)-CCL), the station number of the connected AJ65BT-G4-S3, AJ65BT-R2N, or GT11H(S)-CCL is stored when the GOT is powered on.

When the multi-channel function is used, the station No. of channel No. 1 is stored. Station Nos. of channel Nos. 2 to 4 are stored to GS361 to GS363.

## (4) GOT multidrop slave station No. (CH1) (GS6 (16 bits))

For the multidrop connection, the station No. of the connected GOT is stored when the GOT is powered ON.

When the multi-channel function is used, the station No. of channel No. 1 is stored. Station Nos. of channel Nos. 2 to 4 are stored to GS361 to GS363.

## (5) 1 second binary counter (GS7 (16bit))

Starts counting every second immediately after the power is switched on.

Any given value can be written to this counter to start the count from the written value.

The obtained data are stored as binary data.

This is used to check how long the time has elapsed from specific timing (operation, etc.).

## (6) Scan time of monitor (GS8 (16bit))

Stores the time (ms) of a complete processing cycle set on the display screen as binary data.

Data will be updated when all of the processing set on the display screen is complete.

An error of 10 ms may be produced depending on the processing settings.

Also, this does not apply to the objects that have not been processed by the security function.

It is useful for load checking (debugging) of the monitor processing.

## (7) Scan time counter of monitor (GS10 (16bit))

Counts up the number of cycles every time the processing cycle set on the display screen is complete.

Used to check (debug) the number of scan of monitor.

**(8) GOT IP address notification (GS198 to 199 (16 bit))**

These devices store the GOT IP address in hexadecimal.

Example) When the GOT IP address is 192.168.3.18 (Decimal)

GOT IP address : C0. A8. 03. 12 (Hexadecimal)



**(9) No. of faulty stations detection (GS230 (16 bit))**

The number of stations where CPU error was detected is stored.

The station where error occurs can be checked with GS231 to GS238.

☞ (10) Ethernet faulty station information (GS231 to GS238 (16 bits))

When the redundant setting is configured, these GS devices do not operate.



- b0 to b7: Stores the number of faulty stations.
- b8 to b15: Use prohibited

**POINT**

**Monitoring GS230 by numerical display**

When monitoring GS230 by numerical display, etc., perform mask processing using data operation function as below.

☞ 5.3.9 Data operation setting

Example: Setting of numerical display ([Operation/Script] tab)

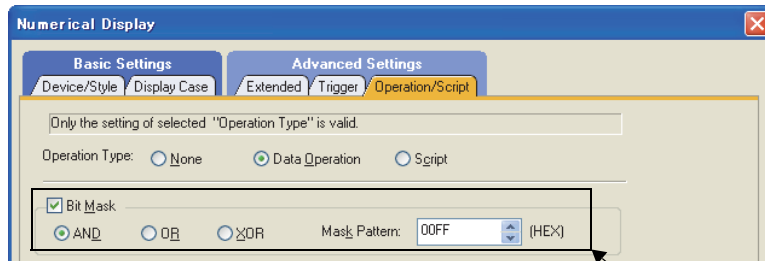

Make setting for mask processing of the upper 8 bits (b15 to b8) of GS230 in Numerical Display.

**(10) Ethernet faulty station information (GS231 to GS238 (16 bits))**

The bit for the Ethernet module with an error turns on.

0: No error

1: Error

When an alarm occurred has restored, the bit turns off.

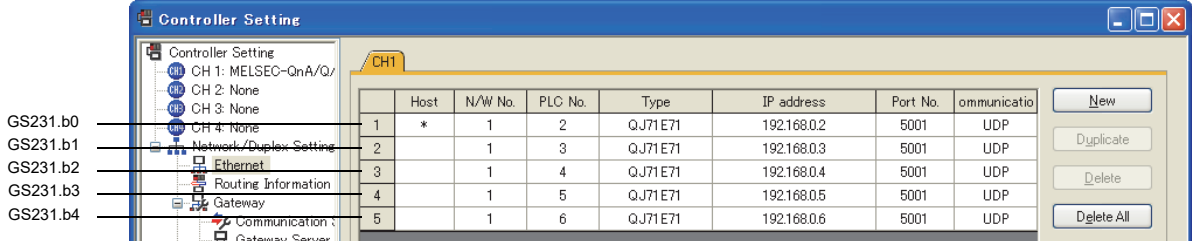

Device	Ethernet Setting No															
	b15	b14	b13	b12	b11	b10	b9	b8	b7	b6	b5	b4	b3	b2	b1	b0
GS231	16	15	14	13	12	11	10	9	8	7	6	5	4	3	2	1
GS232	32	31	30	29	28	27	26	25	24	23	22	21	20	19	18	17
GS233	48	47	46	45	44	43	42	41	40	39	38	37	36	35	34	33
GS234	64	63	62	61	60	59	58	57	56	55	54	53	52	51	50	49
GS235	80	79	78	77	76	75	74	73	72	71	70	69	68	67	66	65
GS236	96	95	94	93	92	91	90	89	88	87	86	85	84	83	82	81
GS237	112	111	110	109	108	107	106	105	104	103	102	101	100	99	98	97
GS238	128	127	126	125	124	123	122	121	120	119	118	117	116	115	114	113

**(11) External authentication status notification (GS240 (16 bits))**

b15	b14	b13	b13 to b2										b1	b0
-----	-----	-----	-----------	--	--	--	--	--	--	--	--	--	----	----

- b0: Turns on when the authentication by an external authentication device or fingerprint unit succeeds. Turns off when the login screen or operator re-authentication screen is displayed regardless of authentication method.
- b1: Turns on when the authentication by an external authentication device or fingerprint unit fails. Turns off when the login screen or operator re-authentication screen is displayed regardless of authentication method.
- b2 to b12: Use prohibited
- b13: Turns on while the login screen or operator re-authentication screen is displayed.
- b14: Turns on when the login screen for the authentication by an external authentication device or fingerprint unit is displayed.
- b15: Turns on when the external authentication ID input key window is displayed.

**POINT**

**Notifying the authentication mode by b13 and b14**

The status of the Operator authentication reception signal and External authentication reception signal notifies the user of the authentication mode currently being accepted.

Operator authentication reception signal (GS240.b13)	External authentication reception signal (GS240.b14)	Authentication mode
OFF	OFF	The operator authentication not accepted
ON	OFF	The password authentication accepted (operator name + password)
ON	ON	The external authentication accepted (external authentication or fingerprint authentication)

This notifies the user of switching to the auxiliary authentication.

**(12) Insufficient security level notification (GS241 (16 bits))**

The bit turns on when the screen cannot be displayed because of the insufficient security level.



- b0: Use prohibited
- b1: Turns on when the overlap window 1 cannot be displayed.
- b2: Turns on when the overlap window 2 cannot be displayed.
- b3: Turns on when the superimpose window 1 cannot be displayed.
- b4: Turns on when the superimpose window 2 cannot be displayed.
- b5 to b7: Use prohibited
- b8: Turns on when a called screen on the base screen cannot be displayed.
- b9: Turns on when a called screen on the overlap window 1 cannot be displayed.
- b10: Turns on when a called screen on the overlap window 2 cannot be displayed.
- b11: Turns on when a called screen on the superimpose window 1 cannot be displayed.
- b12: Turns on when a called screen on the superimpose window 2 cannot be displayed.
- b13 to b15: Use prohibited

b1 to b4 turn off when a screen is displayed.

b1 to b4 turn off when "0" is stored in a screen switching device.

b8 to b12 turn off when a called screen is displayed.

**(13) Object direct input reception notification (GS243 (16 bits))**

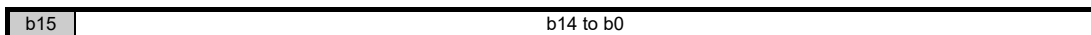

- b0 to b14: Use prohibited
- b15: Turns on while an object is in the ready state for the data read by the barcode reader or RFID to be directly input.

**(14) Modem connection status notification (GS248 (16 bits))**

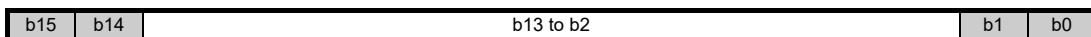

GS248 notifies the connection status between the GOT and a modem.

- b0: Turns on during sending the initialization command of the modem.  
Turns off when the modem initialization is completed, and GS448.b0 turns off.

 (1) Modem connection control (GS448 (16 bits))

- b1: Turns on when the modem initialization is completed.
- b2 to 13: Use prohibited
- b14: Turns on during connecting to the circuit.  
Turns off when disconnecting the circuit.
- b15: Turns on when the modem initialization is failed.

### (15) Modem circuit connection baud rate (GS249 (16 bits))

This device stores the transmission speed during connecting to the circuit via modems.

When the GOT starts up, resets, initializes modems, and disconnects the circuit, this device stores 0.

### (16) Accessible drive notification (GS251 (16 bits))



This device notifies whether the A drive or the B drive is accessible.

- b0: Turns on when data can be read/written from/to the A drive.
- b1: Turns on when data can be read/written from/to the B drive.

### (17) Error detection common information (GS252 (16bit))

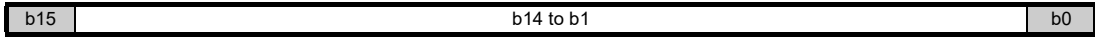

- b0: Turns ON if an error is detected in the alarm information file to be stored when executing memory card storage function by alarm history display.

The alarm information file is not stored into a memory card while this bit is ON.

Turns OFF when the error detection common control (GS452.b0) is turned ON.

Useful for error detection during file storage.

- b1 to b13: Use prohibited

- b14: Turns on when the RGB signal for CH2 is not input.

The bit automatically turns OFF when the RGB signal for CH2 is input.

The bit turns OFF when b14 of the device specified for [Video/RGB Input Common] is turned OFF (to hide the RGB screen for CH2).

For details, refer to the following.

 (Functions) 38. RGB DISPLAY FUNCTION

- b15: Turns on when the RGB signal for CH1 is not input.

The bit automatically turns OFF when the RGB signal for CH1 is input.

The bit turns OFF when b15 of the device specified for [Video/RGB Input Common] is turned OFF (to hide the RGB screen for CH1).

For details, refer to the following.

 (Functions) 38. RGB DISPLAY FUNCTION

### (18) Ethernet incorrect access notification (GS254 (16 bits))



While OSes and project data cannot be written to or read from the GOT by the Ethernet access control (GS454), GS254 notifies the incorrect write or read request send from GT Designer3.

- b0: Turns on when the OS installation prohibition signal (GS454.b0) is on, and when the GOT receives the OS installation request from GT Designer3 via Ethernet.  
When the OS installation prohibition signal (GS454.b0) turns off, the bit turns off.
- b1: Turns on when the Project data write prohibition signal (GS454.b1) is on, and when the GOT receives the project data write request from GT Designer3 via Ethernet.  
When the Project data write prohibition signal (GS454.b1) turns off, the bit turns off.
- b2 to b7: Use prohibited
- b8: Turns on when the Project data read prohibition signal (GS454.b8) is on, and when the GOT receives the project data read request from GT Designer3 via Ethernet.  
When the Project data read prohibition signal (GS454.b8) turns off, the bit turns off.
- b9 to b15: Use prohibited

**(19) Intensity notification (GS255 (16 bits))**

The current intensity of the GOT display section is stored.  
This device is valid for the GOT that can adjust the intensity.  
The following shows the intensity according to the stored value.

Stored value of GS255	Current intensity		Stored value of GS255	Current intensity	
	GOT with 8-level intensity adjustment	GOT with 4-level intensity adjustment		GOT with 8-level intensity adjustment	GOT with 4-level intensity adjustment
1	1	1	5	5	3
2	2	-	6	6	-
3	3	2	7	7	4
4	4	-	8	8	-

For the specifications of the GOT display section, refer to the following.

User's Manual for the GOT used

**(20) FA transparent status (GS256 (16 bits))**

Notifies the status of the FA transparent function.  
The relationship between the stored value and the FA transparent status is as indicated below.

- 0: Ordinary monitoring
- 1: In the transparent mode
- 2: In the pass-through mode

**(21) Printer status information (GS258 (16 bits))**

b15 to b4	b3	b2	b1	b0
-----------	----	----	----	----

- b0: Turns ON when the connection between the printer unit of GOT and the printer is established. Turns OFF when the connection with the printer is shut off.
- b1: Turns ON when a warning level alarm occurs while a printer is connected. Turns OFF after the restoration from the alarm.
- b2: Turns ON when a fatal level alarm occurs while a printer is connected. Turns OFF after the restoration from the alarm.
- b3: Turns ON when the printer gets ready for printing. Stays OFF when the printer is in the preparation status (during warm up, etc.) or during printing. If printing is not possible although this bit is ON, check whether the printing function (hard copy function, etc.) processing has been completed. Whether or not the processing has been completed can be confirmed by checking the hard copy output signal (System Signal 2-1.b7), etc.
- b4 to b15: Use prohibited



**(1) If printing is not possible**

Whether the cause is cable connection error or a problem at the printer can be found by checking this signal (GS258).

Signal status	Cause of Error
GS258.b0: OFF, GS258.b3: OFF	Cable connection error
GS258.b0: ON, GS258.b3: OFF	Although cable is connected correctly, the printer has a problem. (Printer in preparation stage (warming up), during printing, printer error)

**(2) Corrective action at the occurrence of an error**

Refer to the following manuals for the corrective action to be taken after the occurrence of an error.

User's Manual for the GOT used

**(22) System alarm GOT error channel No. (GS262 (16 bits))**

If a system alarm (GOT error) occurs, the corresponding channel No. is stored.  
"0" is stored when the system alarm is cleared.  
With some system alarms, channel numbers are not stored.  
Refer to the following manual for details.

 User's Manual for the GOT used

**(23) System alarm CPU error channel No. (GS263 (16 bits))**

If a system alarm (CPU error) occurs, the corresponding channel No. is stored.  
"0" is stored when the system alarm is cleared.

**(24) System alarm network error channel No. (GS264 (16 bits))**

If a system alarm (network error) occurs, the corresponding channel No. is stored.  
"0" is stored when the system alarm is cleared.

**(25) Document display status notification (GS276 (16 bits))**

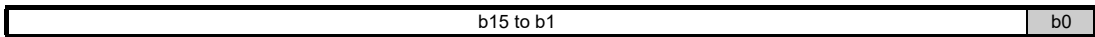

- b0: Turns on in the following cases.
  - There is no display target file.
  - Memory card is not installed.
  - The CF card access switch on the GOT is off.
  - The specified file is not an image file or it is damaged.
  - The bit automatically turns off when the problem above is cleared.
- b1 to b15: Use prohibited

**(26) Faulty monitor station signal (CH1 to CH4) (GS280, GS300, GS320, GS340 (16 bits))**



- b0 to b7: The bits store the number of faulty monitor stations with the Ethernet connection. (Except the Ethernet connection with a microcomputer)
- b8 to b15: Use prohibited

**(27) Faulty station information (CH1 to CH4) (GS281 to 288, GS301 to 308, GS321 to 328, GS341 to 348 (16 bits))**

With the Ethernet connection, temperature controller connection, inverter connection, or servo amplifier connection, the bit corresponding to the station with a communication error turns on.

(For the multi-channel connection, the bit of the device corresponding to each channel No. (CH1 to CH4) turns on.)

0: No error

1: Error

When the error is recovered, the bit turns off.

When the GOT is connected to the AZBIL temperature controller (DMC50), the specified station No. of the DMC50 differs from the station numbers of the other controllers.

The following shows station numbers for each device.

**(a) When connecting other than the AZBIL temperature controller (DMC50)**

The station corresponding to each device differs according to whether the Ethernet connection is used or not.

- With the Ethernet connection: 1 to 128
- With other than the Ethernet connection: 0 to 127

Example) With other than the Ethernet connection

Device				Station No.															
CH1	CH2	CH3	CH4	b15	b14	b13	b12	b11	b10	b9	b8	b7	b6	b5	b4	b3	b2	b1	b0
GS281	GS301	GS321	GS341	15	14	13	12	11	10	9	8	7	6	5	4	3	2	1	0
GS282	GS302	GS322	GS342	31	30	29	28	27	26	25	24	23	22	21	20	19	18	17	16
GS283	GS303	GS323	GS343	47	46	45	44	43	42	41	40	39	38	37	36	35	34	33	32
GS284	GS304	GS324	GS344	63	62	61	60	59	58	57	56	55	54	53	52	51	50	49	48
GS285	GS305	GS325	GS345	79	78	77	76	75	74	73	72	71	70	69	68	67	66	65	64
GS286	GS306	GS326	GS346	95	94	93	92	91	90	89	88	87	86	85	84	83	82	81	80
GS287	GS307	GS327	GS347	111	110	109	108	107	106	105	104	103	102	101	100	99	98	97	96
GS288	GS308	GS328	GS348	127	126	125	124	123	122	121	120	119	118	117	116	115	114	113	112

**(b) When connecting the AZBIL temperature controller (DMC50)**

Device				Station-Sub station															
CH1	CH2	CH3	CH4	b15	b14	b13	b12	b11	b10	b9	b8	b7	b6	b5	b4	b3	b2	b1	b0
GS281	GS301	GS321	GS341	1-15	1-14	1-13	1-12	1-11	1-10	1-9	1-8	1-7	1-6	1-5	1-4	1-3	1-2	1-1	1-0
GS282	GS302	GS322	GS342	2-15	2-14	2-13	2-12	2-11	2-10	2-9	2-8	2-7	2-6	2-5	2-4	2-3	2-2	2-1	2-0
GS283	GS303	GS323	GS343	3-15	3-14	3-13	3-12	3-11	3-10	3-9	3-8	3-7	3-6	3-5	3-4	3-3	3-2	3-1	3-0
GS284	GS304	GS324	GS344	4-15	4-14	4-13	4-12	4-11	4-10	4-9	4-8	4-7	4-6	4-5	4-4	4-3	4-2	4-1	4-0
GS285	GS305	GS325	GS345	5-15	5-14	5-13	5-12	5-11	5-10	5-9	5-8	5-7	5-6	5-5	5-4	5-3	5-2	5-1	5-0
GS286	GS306	GS326	GS346	6-15	6-14	6-13	6-12	6-11	6-10	6-9	6-8	6-7	6-6	6-5	6-4	6-3	6-2	6-1	6-0
GS287	GS307	GS327	GS347	7-15	7-14	7-13	7-12	7-11	7-10	7-9	7-8	7-7	7-6	7-5	7-4	7-3	7-2	7-1	7-0
GS288	GS308	GS328	GS348	8-15	8-14	8-13	8-12	8-11	8-10	8-9	8-8	8-7	8-6	8-5	8-4	8-3	8-2	8-1	8-0



## POINT

### Restrictions

- (1) The GOT cannot detect errors with the station No. 128 or later, or the station No. and the sub station No., "9-0" or later.
- (2) When an error occurs with the station No. specified on GT Designer3, the operation differs according to the controller used.
  - When using other than the AZBIL temperature controller (DMC50)  
When an error occurs with the station No. specified on GT Designer3, the own station No. of the error temperature controller, inverter, or servo amplifier is detected.  
(For example, when the station No. specified on GT Designer3 is "110" and the own station No. of the temperature controller or servo amplifier is "10", the bit for the station No.10 turns on.)
  - When using the AZBIL temperature controller (DMC50)  
When the station No. is specified with the value of the GOT data register (GD), the GOT cannot detect errors.

For specifying station numbers, refer to the following.

 GOT1000 Series Connection Manual for GT Works3 and a controller used

**Dealing with faulty stations**

**(1) The GOT automatically stops monitoring operations of controllers with errors.**

The GOT automatically stops monitoring operations of the faulty station with a communication time-out among controllers so as not to slow monitoring the other stations. (No settings are required.)

The following explains GOT's operations when a communication error occurs with the station No.3.

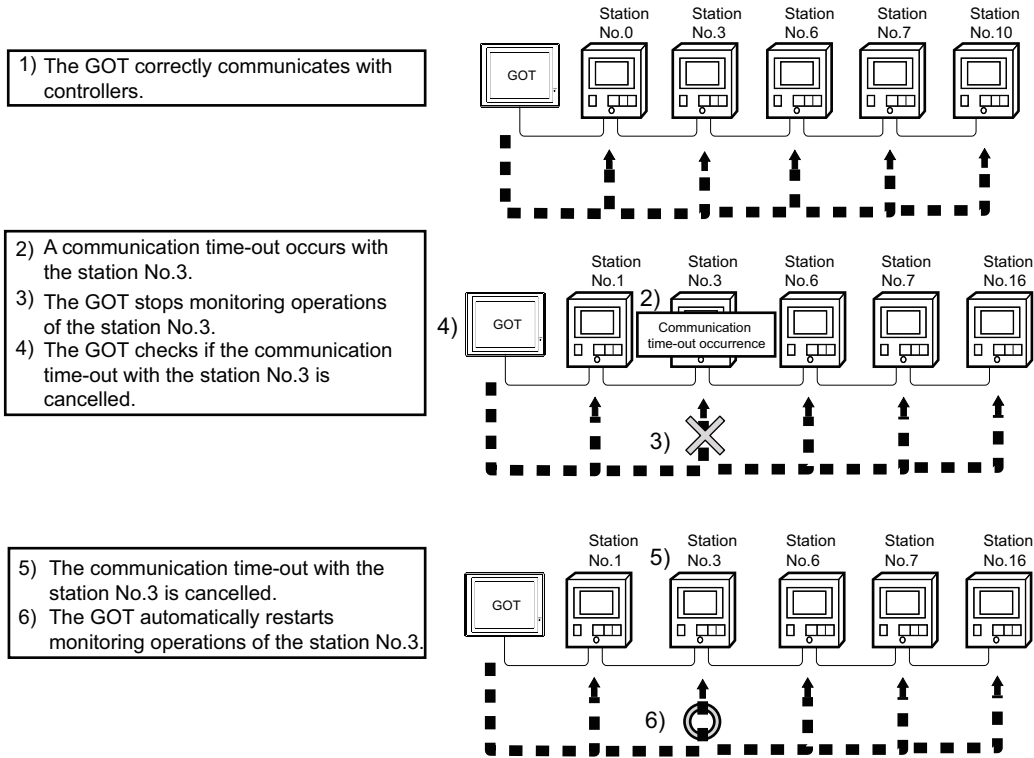

**(2) Disconnecting the temperature controller, servo amplifier, or inverter from the system**

With the temperature controller/servo amplifier/inverter monitor station disconnection (GS531 to GS568), the specified temperature controller, servo amplifier, or inverter can be disconnected from the GOT.

☞ ■Read device (22) Monitor station disconnection (CH1 to CH4) (GS531 to 538, GS541 to 548, GS551 to 558, GS561 to 568 (16 bits))

Therefore, no communication time-out occurs even if the temperature controller, servo amplifier, or inverter is removed for changing units. (No system alarm is displayed on the GOT.)

Depending on the connection type used, the GOT may not monitor the temperature controllers, servo amplifiers, or inverters that follow the controller disconnected.

**(28) Channel observation notification information (GS299, GS319, GS339, GS359 (16 bits))**

b15 to b1	b0
-----------	----

Notifies the communication status of each channel.

- b0: Turns on if a connection error occurs.
- b1 to b15: Use prohibited

**(29) GOT network No./station No. notification (CH1 to CH4) (GS376 to 383 (16 bits))**

When the GOT starts, the devices store a network number and a station number of the GOT connected with the Ethernet connection.

When the GOT is connected with other than the Ethernet connection, the devices store 0.

Device				Description
CH1	CH2	CH3	CH4	
GS376	GS378	GS380	GS382	Network number (1 to 239)
GS377	GS379	GS381	GS383	Station number (1 to 64)

**(30) Error device data transfer ID (GS642 (16 bits))**

The device stores the device data transfer ID with the executed device data if an error occurs during device data transfer.

**(31) Device data transfer error count (GS643 (16 bits))**

The device stores the number of error times with the executed device data during the device data transfer.

(Maximum 65535 times)

When errors occur 65535 times or more, the value remains 65535.

The device data transfer ID with the executed device data is stored in the error device data transfer ID.

**(32) Device data transfer processing time (GS644 (16 bits))**

The device stores the device data transfer processing time for one time. (0 to 60000 (×10ms))

The device stores 60000 (×10ms) when the device data transfer processing time is 600 seconds or more.

**(33) Device data transfer ID (GS645 (16 bits))**

The device stores the device data transfer ID with the executed device data transfer.

**(34) Device data transfer min. processing time (GS646 (16 bits))**

The device stores minimum processing time among all of stored device data transfer processing times (GS644).

(0 to 60000 (×10ms))

**(35) Device data transfer ID (min. processing time) (GS647 (16 bits))**

The device stores the device data transfer ID with the executed device data transfer when GS646 stores a minimum processing time.

**(36) Device data transfer max. processing time (GS648 (16 bits))**

The device stores a maximum processing time among all of stored device data transfer processing times

(GS644). (0 to 60000 (×10ms))

**(37) Device data transfer ID (max. processing time) (GS649 (16 bits))**

The device stores the device data transfer ID with the executed device data when GS648 stores a maximum processing time.

**(38) Touch status external notification (X-coordinate) (GS654 (16 bits))**

The device stores the x-coordinate of touched position when the GOT screen is touched on.

**(39) Touch status external notification (Y-coordinate) (GS655 (16 bits))**

The device stores the y-coordinate of touched position when the GOT screen is touched on.

**(40) Touch status external notification (touch status) (GS656 (16 bits))**

The following values are stored in the device depending on the touched screen types when the GOT screen is touched on.

0: Without touching

1: Touching on the base screen

2: Touching touchable objects on the base screen

11: Touching on the overlap window 1

12: Touching touchable objects on the overlap window 1

21: Touching on the overlap window 2

22: Touching on touchable objects on the overlap window 2

61: Touching on the video window

71: Touching on the key window

81: Touching on the comment window

91: Touching on the popup display

**(41) Trigger backup processing setting No. notification (GS657 (16 bits))**

The GOT notifies users the trigger backup processing status.

The device stores the trigger ID with the executing backup trigger setting during the trigger backup processing.

The device stores 0 when the trigger backup processing is not executed.

**(42) Extended external input status notification signal (GS658 to GS665 (16 bits))**

When the 128-point input can be executed with the external I/O function, the bit for an input scan signal turns on.

When the 128-point input cannot be executed, the GB devices are always off.

To enable the 128-point input, turns on GS517.b0 (external I/O function notification, external I/O control function).

0: Signal OFF

1: Signal ON

The following shows the devices for each bit.

Scan signal	Extended external input status notification signal	External input signal															
		X0	X1	X2	X3	X4	X5	X6	X7	X8	X9	XA	XB	XC	XD	XE	XF
XSCN0	GS658	b0	b1	b2	b3	b4	b5	b6	b7	b8	b9	b10	b11	b12	b13	b14	b15
XSCN1	GS659	b0	b1	b2	b3	b4	b5	b6	b7	b8	b9	b10	b11	b12	b13	b14	b15
XSCN2	GS660	b0	b1	b2	b3	b4	b5	b6	b7	b8	b9	b10	b11	b12	b13	b14	b15
XSCN3	GS661	b0	b1	b2	b3	b4	b5	b6	b7	b8	b9	b10	b11	b12	b13	b14	b15
XSCN4	GS662	b0	b1	b2	b3	b4	b5	b6	b7	b8	b9	b10	b11	b12	b13	b14	b15
XSCN5	GS663	b0	b1	b2	b3	b4	b5	b6	b7	b8	b9	b10	b11	b12	b13	b14	b15
XSCN6	GS664	b0	b1	b2	b3	b4	b5	b6	b7	b8	b9	b10	b11	b12	b13	b14	b15
XSCN7	GS665	b0	b1	b2	b3	b4	b5	b6	b7	b8	b9	b10	b11	b12	b13	b14	b15



**Controlling signal with controllers**

The above signal can be controlled with controllers when the status observation function and the script function are used.

**(43) Sound status information (GS668 (16 bits))**

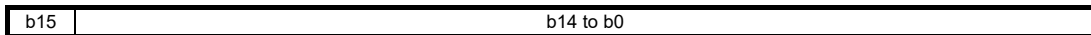

- b0 to b14: Use prohibited
- b15: Turns on with a jack disconnection when the sound output function is used.  
Turns off without a jack disconnection.

**(44) Sound file number during play (GS669 (16 bits))**

A sound file number during play is stored in the device.

When no sound file exists during play, 0 is stored in the device.

**(45) Maintenance time notification information (GS680 (16 bits))**

b15 to b8	b7	b6	b5	b4	b3	b2	b1	b0
-----------	----	----	----	----	----	----	----	----

- b0: Turns on as a first-stage notification if the backlight power on addition time (GS681 (32 bits)) reaches 80% or above of the maintenance notification time setting specified with a utility function.
- b1: Turns on as a first-stage notification if display power on addition time (GS683 (32 bits)) reaches 80% or above of the display section maintenance notification time setting specified with a utility.
- b2: Turns on as a first-stage notification if any of the touch key pushing addition times (GS700 to 979) reaches 80% or above of the touch key maintenance notification count setting specified with a utility.
- b3: Turns on as a first stage notification if the build in flash memory writing times (GS685 (32b bits)) reaches 80% or above of the built-in flash memory maintenance notification count setting specified with a utility.
- b4: Turns on as a second-stage notification if the backlight power on addition time (GS681 (32 bits)) reaches 100% or above of the backlight maintenance notification time setting specified with a utility function.
- b5: Turns on as a second-stage notification if display power on addition time (GS683 (32 bits)) reaches 100% or above of the display section maintenance notification time setting specified with a utility.
- b6: Turns on as a second-stage notification if any of the touch key pushing addition times (GS700 to 979) reaches 100% or above of the touch key maintenance notification count setting specified with a utility.
- b7: Turns on as a second-stage notification if the built-in flash memory writing times (GS685 (32 bits)) reaches the built-in flash memory maintenance notification count setting specified with a utility.
- b8 to b15: Use prohibited

**(46) Backlight power on addition time (GS681 (32 bits))**

The cumulative power-on time of the backlight is stored in binary data.

Unit: hours

**(47) Display power on addition time (GS683 (32 bits))**

The cumulative power-on time of the display section is stored in binary data.

Unit: hours

**(48) Build in flash memory writing times (GS685 (32 bits))**

The cumulative writing times of the built-in flash memory is stored in binary data.

**(49) Touch key pushing addition times No. 0 (GS700 (32 bits)).**

Touch key pushing addition times No. 1 (GS702 (32 bits)) to No. 139 (GS978 (32 bits))

The cumulative pushing times of the touch key is stored in binary data.

The count is taken in each of areas, divided into the size shown below.

Model	Area (dots)	The number of touch keys included in an area
GT1695M-X, GT1595-X	96 × 96	36 pieces
GT1685M-S, GT1675M-S, GT1675M-V, GT1675-VN, GT1672-VN, GT1665M-S, GT1665M-V, GT1662-VN, GT1655-V, GT16 Handy GOT, GT1585V-S, GT1585-S, GT1575V-S, GT1575-S, GT1575-V, GT1575-VN, GT1572-VN, GT1565-V, GT1562-VN, GT1555-V, GT1555-Q, GT1550-Q	80 × 80	25 pieces

The number of times a touch key is pushed is counted in the manner explained below.

- Touching in an area

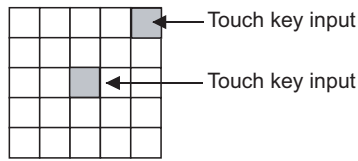

If multiple touch keys are pushed simultaneously in an area, only one count is added.

- Touching four areas

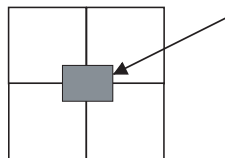

If four areas are touched, the pushing frequency is counted at each area.

Example: Arrangement of the special registers of GOT of the 640×480 dot screen size

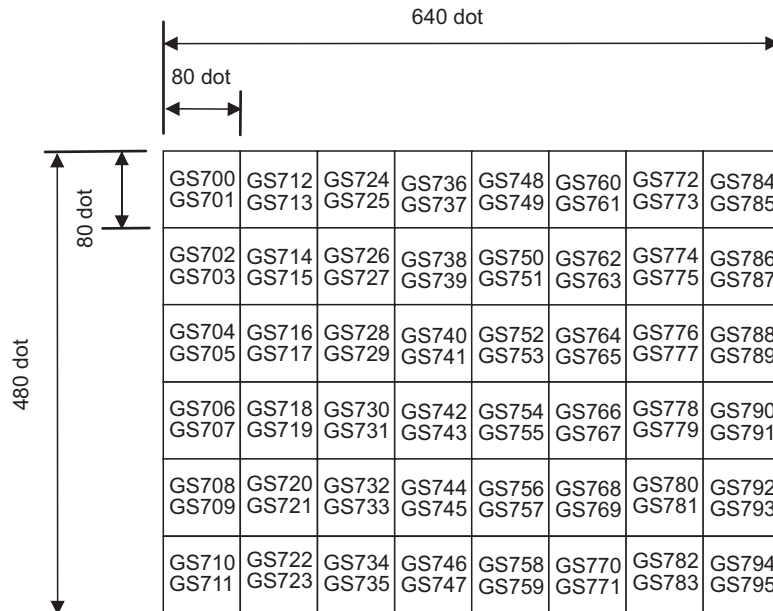

**POINT**

**When the GOT type is changed by the GT Designer3**

When the GOT type is changed to the one having different resolution, the arrangement of special registers of GOT changes. After changing the GOT type, check the GOT special registers.

Example: Differences in GOT special register arrangement between 640x480 dot screen and 800x600 dot screen

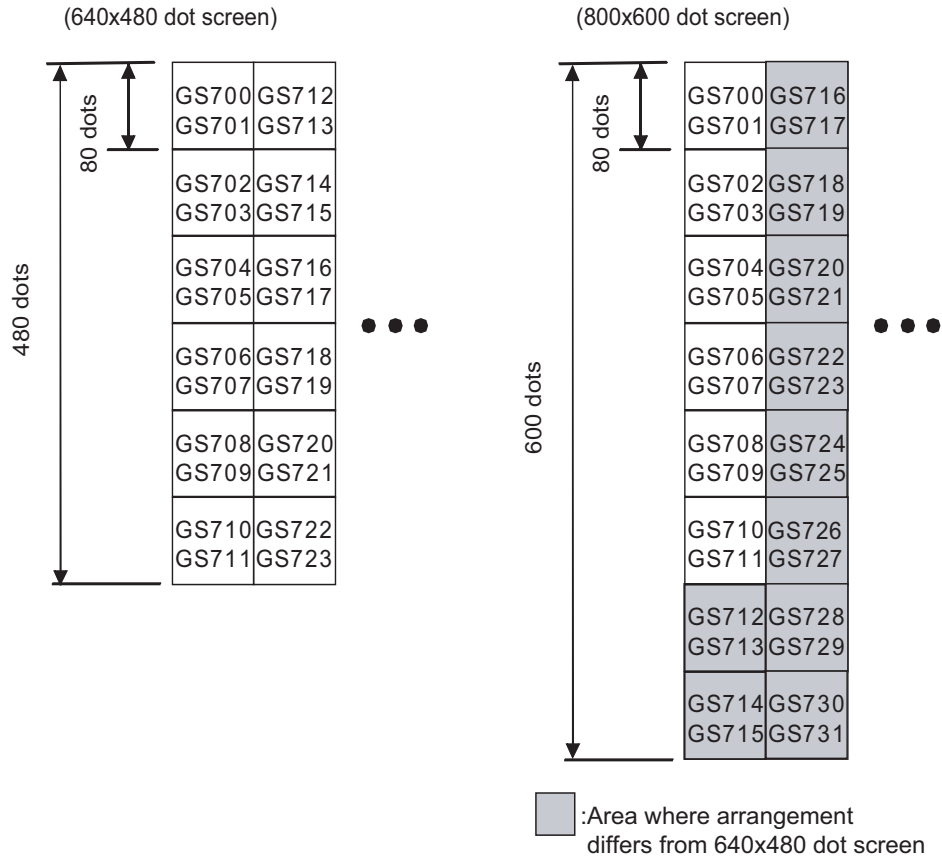

**(50) Touch position color acquisition complete signal (GS980 (16 bits))**

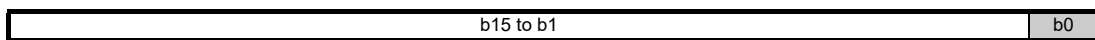

- b0: Turns on when the touch position color (GS981 to 983) stores a value. Turning on the bit cancels the touch position color acquisition ready status. Turning off the Touch position color acquisition ready signal (GS630.b0) turns off the bit.
- b1 to b15: Use prohibited

**(51) Touch position color (GS981 to 983 (16 bits))**

This device notifies the color information at the touched position. The GOT acquires the color information with RGB. The following GOT special register (GS) store the RGB values (0 to 255).

- R: GS981
- G: GS982
- B: GS983

Turning on the Touch position color acquisition ready signal (GS630.b0) stores -1 in R, G, and B. After the signal turns on, the GOT acquires the color information at the first touch and release of the screen.

**(52) USB drive common information (GS1024 (16 bits))**



- b0: Turns on when the USB memory connected to the USB interface on the GOT is ready for removal after the USB drive common control (GS1824.b0) turns on.
- b1 to b7: Use prohibited
- b8: Turns on when the USB memory connected to the USB interface on the GOT is ready for use.
- b9 to b15: Use prohibited

**(53) RGB signal input status notification (GS1025 (16 bits))**

The device notifies the following:

the RGB signal input, supporting the resolution and the refresh rate of the RGB signal or not, and the RGB input unit status.

When the GT16M-R2 is used, the device notifies the input status of the channel set for the input source of the RGB screen.



- b0: Turns on when the RGB signal is input.
- b1: Turns on when the GOT supports the input resolution and refresh rate.
- b2: Turn on when the RGB unit operates normally.
- b3 to b15: Use prohibited

**(54) RGB signal resolution (horizontal) (GS1026 (16 bits))**

When GS1025.b0 turns on, the device stores the horizontal resolution (dots) of the RGB signal.  
When the RGB signal does not exist or the resolution of the signal is unclear, the device stores 0.

**(55) RGB signal resolution (vertical) (GS1027 (16 bits))**

When GS1025.b0 turns on, the device stores the vertical resolution (dots) of the RGB signal.  
When the RGB signal does not exist or the resolution of the signal is unclear, the device stores 0.

**(56) RGB signal refresh rate (GS1028 (16 bits))**

When GS1025.b0 turns on, the device stores the refresh rate (Hz) of the RGB signal.  
When the RGB signal does not exist or the refresh rate of the signal is unclear, the device stores 0.

**(57) VNC® server operation status notification (GS1230 (16 bits))**



- b0: Turns on while the VNC® server communicates with the VNC® client.
- b1: Turns on when the VNC® client is allowed to display the VNC® server screen and to remotely operate the VNC® server.  
Turns off when the VNC® client is allowed to only display the VNC® server screen.
- b2: Turns on when the VNC® client holds the authorization.  
Turns off when the VNC® server holds the authorization.
- b3 to b15: Use prohibited

**(58) Communicating VNC® client information notification (GS1231 to 1232 (16 bits))**

The device stores the IP address of the VNC® client communicating with the VNC® server in hexadecimal.

Example) When the IP address of the VNC® client is 192.168.3.10 (Decimal)

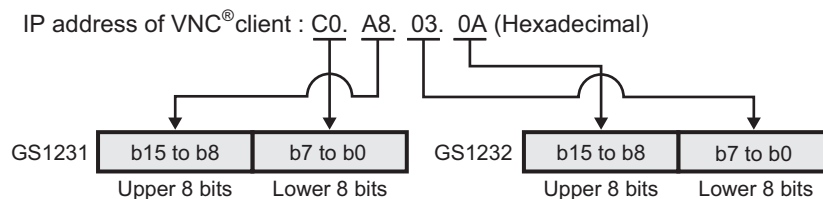

**(59) VNC® server authorization guarantee status notification (GS1233 (16 bits))**

The device stores the remaining authorization guarantee time (second).



### (60) Insufficient security level notification (GS1241 (16 bits))

The bit turns on when the screen cannot be displayed because of the insufficient security level.

b15 to b11	b10	b9	b8	b7 to b3	b2	b1	b0
------------	-----	----	----	----------	----	----	----

- b0: Turns on when the overlap window 3 cannot be displayed.
- b1: Turns on when the overlap window 4 cannot be displayed.
- b2: Turns on when the overlap window 5 cannot be displayed.
- b3 to b7: Use prohibited
- b8: Turns on when a called screen on the overlap window 3 cannot be displayed.
- b9: Turns on when a called screen on the overlap window 4 cannot be displayed.
- b10: Turns on when a called screen on the overlap window 5 cannot be displayed.
- b11 to b15: Use prohibited

## Appendix3 Device of Controllers

---

The device ranges of controller that can be used for GOT are as follows.

Note that the device ranges in the following tables are the maximum values that can be set in GT Designer3.

Since the device specifications may be different depending on the models even though they belongs to the same series of the controller.

Please make setting according to the specifications of the controller actually used.

When a non-existent device or device No. outside the range is specified, other objects may not be monitored.

- ☞ ■MITSUBISHI ELECTRIC PLC, CNC, C Controller module, and motion controllers
- OMRON PLC
- KEYENCE PLC (KEYENCE KV-700/1000/3000/5000)
- KOYO EI PLC (KOYO KOSTAC/DL)
- SHARP PLC (SHARP JW)
- JTEKT PLC (JTEKT TOYOPUC-PC)
- TOSHIBA PLC
- TOSHIBA MACHINE PLC (TOSHIBA MACHINE TCmini)
- HITACHI IES PLC (HITACHI HIDIC H series)
- HITACHI PLC (HITACHI S10mini/S10V)
- FUJI PLC
- PANASONIC INDUSTRIAL DEVICES SUNX PLC (PANASONIC MEWNET-FP)
- YASKAWA PLC
- YOKOGAWA PLC
- ALLEN-BRADLEY PLC
- GE PLC (GE Series 90)
- LS IS PLC (LS Industrial Systems MASTER-K)
- SICK safety controller (SICK Flexi Soft)
- SIEMENS PLC
- IAI robot controller
- Microcomputer connection
- MODBUS(R)
- AZBIL control equipment
- OMRON temperature controller (OMRON THERMAC/INPANEL NEO)
- SHINKO indicating controller (Shinko Technos Controller)
- CHINO controller (CHINO Controllers)
- FUJI temperature controller (FUJI PXR/PXG/PXH)
- YOKOGAWA temperature controller (YOKOGAWA GREEN/UT100/UT2000/UTAdvanced)
- RKC temperature controller (RKC SR Mini HG)
- Inverter (FREQROL 500/700/800 series, Sensorless servo)
- Servo amplifier
- PANASONIC servo amplifier

**HINT** 

**Device setting**

For the device setting methods, see the following section.

 Appendix4 Setting device of each controller

■ MITSUBISHI ELECTRIC PLC, CNC, C Controller module, and motion controllers

(1) MELSEC iQ-R, RnMT

Device name		Setting range	Device No. representation	
Bit device	Input (X)	X0 to X3FFF	Hexadecimal	
	Output (Y)	Y0 to Y3FFF		
	Special relay (SM)	SM0 to SM4095	Decimal	
	Internal relay (M) <sup>*1</sup>	M0 to M161882111		
	Latch relay (L)	L0 to L32767		
	Step relay (S) <sup>*5</sup>	S0 to S16383		
	Link special relay (SB) <sup>*1</sup>	SB0 to SB9A61FFF		Hexadecimal
	Link relay (B) <sup>*1</sup>	B0 to B9A61FFF		
	Safety input relay (SAX)	SAX0 to SAX2FFF		
	Safety output relay (SAY)	SAY0 to SAY2FFF		
	Safety link relay (SAB)	SAB0 to SAB9BFFF		
	Timer <sup>*1</sup>	Contact (TT)	TT0 to TT8993439	Decimal
		Coil (TC)	TC0 to TC8993439	
	Counter <sup>*1</sup>	Contact (CT)	CT0 to CT8993439	
		Coil (CC)	CC0 to CC8993439	
	Retentive timer <sup>*1</sup>	Contact (SS)	SS0 to SS8993439	
		Coil (SC)	SC0 to SC8993439	
	Long timer <sup>*1*2</sup>	Contact (LTT)	LTT0 to LTT2529407	
		Coil (LTC)	LTC0 to LTC2529407	
	Long counter <sup>*1</sup>	Contact (LCT)	LCT0 to LCT4761215	
		Coil (LCC)	LCC0 to LCC4761215	
	Long retentive timer <sup>*1*2</sup>	Contact (LSS)	LSS0 to LSS2529407	
		Coil (LSC)	LSC0 to LSC2529407	
	Annunciator (F)		F0 to F131071	
	Safety internal relay (SAM)		SAM0 to SAM638975	
	Safety timer	Contact (SATT)	SATT0 to SATT35487	
		Coil (SATC)	SATC0 to SATC35487	
	Safety counter	Contact (SACT)	SACT0 to SACT35487	
		Coil (SACC)	SACC0 to SACC35487	
	Safety retentive timer	Contact (SASS)	SASS0 to SASS35487	
Coil (SASC)		SASC0 to SASC35487		
Safety special relay (SASM)		SASM0 to SASM4095		
SFC block (BL)		BL0 to BL319		
Step relay (block)(BLS)		BLS0 to BLS511		
Bit-specified word device (Except timer, counter, and retentive timer)		Setting range of each word device	-	

Device name		Setting range	Device No. representation	
Word device	Data register (D) <sup>*1</sup>	D0 to D10117631	Decimal	
	Link register (W) <sup>*1</sup>	W0 to W9A61FF	Hexadecimal	
	Special data register (SD)	SD0 to SD4095	Decimal	
	Link special register (SW) <sup>*1</sup>	SW0 to SW9A61FF	Hexadecimal	
	Timer (current value) (TN) <sup>*1</sup>	TN0 to TN8993439	Decimal	
	Counter (current value) (CN) <sup>*1</sup>	CN0 to CN8993439		
	Retentive timer (current value) (SN) <sup>*1</sup>	SN0 to SN8993439		
	File register (R)	R0 to R32767		
	Extension file register (ER)	Block		0 to 255
		Device		ER0 to ER32767
	Extension file register (ZR) <sup>*1</sup>	ZR0 to ZR10027007		
	Index register (16 bits) (Z)	Z0 to Z23		
	Buffer memory (G) <sup>*3</sup>	G0 to G65535		
	Ww	Ww0 to Ww1FFF		
	Wr	Wr0 to Wr1FFF		
	Multiple CPU high speed transmission memory (U3E0) <sup>*4</sup>	U3E000000 to U3E012287		
	Multiple CPU high speed transmission memory (U3E1) <sup>*4</sup>	U3E100000 to U3E112287		
	Multiple CPU high speed transmission memory (U3E2) <sup>*4</sup>	U3E200000 to U3E212287		
	Multiple CPU high speed transmission memory (U3E3) <sup>*4</sup>	U3E300000 to U3E312287		
	Safety timer (current value) (SATN)	SATN0 to SATN35487		
	Safety counter(current value) (SACN)	SACN0 to SACN35487		
	Safety retentive(current value) (SASN)	SASN0 to SASN35487		
	Safety data register (SAD)	SAD0 to SAD39935		
Safety special register (SASD)	SASD0 to SASD4095			
Motion device (#)	#0 to #108287			
Safety link register (SAW)	SAW0 to SAW9BFF	Hexadecimal		
Word-specified bit devices (Except timer, long timer, counter, long counter, retentive timer, and long retentive timer)	Setting range of each bit device	-		
Double-word device	Long timer (current value) (LTN) <sup>*1*2</sup>	LTN0 to LTN2529407	Decimal	
	Long counter (current value) (LCN) <sup>*1</sup>	LCN0 to LCN4761215		
	Long retentive timer (current value) (LSN) <sup>*1*2</sup>	LSN0 to LSN2529407		
	Index register (32 bits) (ZZ) <sup>*2</sup>	ZZ0 to ZZ22		
	Index register (32 bits) (LZ)	LZ0 to LZ11		

\*1 For the maximum number of devices when an extended SRAM cassette is installed, refer to the following.

 MELSEC iQ-R CPU Module User's Manual (Application)

\*2 Monitoring or writing is not possible in the continuous device designation mode.

\*3 Only the intelligent function module on the station connected to GOT can be specified.

Set the buffer memory within the address range of the buffer memory existing in the intelligent function module.

\*4 For monitoring the multiple CPU high speed transmission memory, the CPU buffer memory access device (HG) for RCPU is monitored.

The CPU buffer memory access device (G) is not monitored.

\*5 If a bit-specified word device is used in the random read processing, GT SoftGOT1000 or GT Simulator3 uses the value of the bit device in block No. 0 only.

The bit device status depends on the SFC program status (active or inactive). When the SFC program is inactive, the bit device is off (stores 0).

If a step relay (S) is used in the random read processing, specify the relevant step relay (block) (BLS) on GT SoftGOT1000 or GT Simulator3.

(2) MELSEC iQ-F

Device name		Setting range	Device No. representation	
Bit device	Input (X)	X0 to X1777	Hexadecimal	
	Output (Y)	Y0 to Y1777		
	Internal relay (M) <sup>*3</sup>	M0 to M32767	Decimal	
	Latch relay (L)	L0 to L32767		
	Step relay (S)	S0 to S4095		
	Annunciator (F)	F0 to F32767		
	Link relay (B)	B0 to B7FFF		
	Timer	Contact (TT)	TT0 to TT1023	Decimal
		Coil (TC)	TC0 to TC1023	
	Counter	Contact (CT)	CT0 to CT1023	
		Coil (CC)	CC0 to CC1023	
	Long counter	Contact (LCT)	LCT0 to LCT1023	
		Coil (LCC)	LCC0 to LCC1023	
	Special relay (SM)	SM0 to SM9999		
	Retentive timer	Contact (SS)	SS0 to SS1023	
		Coil (SC)	SC0 to SC1023	
	Link special relay (SB)	SB0 to SB7FFF	Hexadecimal	
	Bit-specified word device (Except timer, counter, retentive timer, index register, and buffer memory)		Setting range of each word device	-
	Word device	Data register (D)	D0 to D7999	Decimal
		Special data register (SD)	SD0 to SD11999	
Link register (W)		W0 to W7FFF	Hexadecimal	
Timer (current value) (TN)		TN0 to TN1023	Decimal	
Counter (current value) (CN)		CN0 to CN1023		
Retentive timer (current value) (SN)		SN0 to SN1023		
Link special register (SW)		SW0 to SW7FFF	Hexadecimal	
File register (R) <sup>*1</sup>		R0 to R32767	Decimal	
Index register (16 bits) (Z)		Z0 to Z23		
Buffer memory (G) <sup>*2</sup>		G0 to G262143		
Word-specified bit devices <sup>*3</sup> (Except timer, counter, and retentive timer)		Setting range of each bit device		-
Double-word device	Long counter (current value) (LCN) <sup>*3</sup>	LCN0 to LCN1023	Decimal	
	Index register (32 bits) (LZ)	LZ0 to LZ11		

\*1 Available for the file register of block No. switched with the RSET instruction.

\*2 Only the intelligent function module on the station connected to GOT can be specified.  
Set the buffer memory within the address range of the buffer memory existing in the intelligent function module.

\*3 The device No. must be set in multiples of 16.

(3) MELSEC-QnU/DC, Q17nD/M/NC/DR, CRnD-700\*10

Device name*7*11		Setting range	Device No. representation	
Bit device	Input (X)	X0 to X3FFF	Hexadecimal	
	Output (Y)	Y0 to Y3FFF		
	Internal relay (M)*5	M0 to M61439	Decimal	
	Latch relay (L)	Y0 to Y1FFF		
	Annunciator (F)	F0 to F32767		
	Link relay (B)	B0 to B9FFFF	Hexadecimal	
	Timer*5	Contact (TT)	TT0 to TT32767	Decimal
		Coil (TC)	TC0 to TC32767	
	Counter*5	Contact (CT)	CT0 to CT32767	
		Coil (CC)	CC0 to CC32767	
	Special relay (SM)	SM0 to SM2255		
	Retentive timer*5	Contact (SS)	SS0 to SS32767	
		Coil (SC)	SC0 to SC32767	
	Step relay (S)	S0 to S32767		
	Link special relay (SB)	SB0 to SB7FFF	Hexadecimal	
Bit-specified word device (Except timer, counter, retentive timer, index register, and buffer memory)		Setting range of each word device	-	
Word device	Data register (D)*5	D0 to D4212735	Decimal	
	Special data register (SD)	SD0 to SD2255		
	Link register (W)	W0 to W4047FF	Hexadecimal	
	Timer (current value) (TN)*5	TN0 to TN32767	Decimal	
	Counter (current value) (CN)*5	CN0 to CN32767		
	Retentive timer (current value) (SN)*5	SN0 to SN32767		
	Link special register (SW)	SW0 to SW7FFF	Hexadecimal	
	File register (R)*1*2	R0 to R32767	Decimal	
	Extension file register (ER)*1	Block		0 to 255
		Device		ER0 to ER32767
	Extension file register (ZR)*1*3*8	ZR0 to ZR4184063		
	Index register (Z)	Z0 to Z19		
	Buffer memory (Intelligent function module) (BM)*4	BM0 to BM32767		
	Buffer memory (Intelligent function module) (G)*4	G0 to G65535		
	Ww*9	Ww0 to Ww1FFF	Hexadecimal	
	Wr*9	Wr0 to Wr1FFF		
	Multiple CPU high speed transmission memory (U3E0)	U3E010000 to U3E024335	Decimal	
	Multiple CPU high speed transmission memory (U3E1)	U3E110000 to U3E124335		
Multiple CPU high speed transmission memory (U3E2)	U3E210000 to U3E224335			
Multiple CPU high speed transmission memory (U3E3)	U3E310000 to U3E324335			
Motion device (#)*6*9	#0 to #12287			
Word-specified bit devices*9 (Except timer, counter, retentive timer, and index register)		Setting range of each bit device	-	

- \*1 Do not set a file register by GT Designer3 when executing multiple programs with the file of the file register set at [Use the same file name as the program.] by the PLC parameter of GX Developer.  
Otherwise, read/write at GOT will be erroneous.
- \*2 Available for file register of block No. switched with the RSET instruction.
- \*3 Available for file register of block No. of file name switched with the QDRSET instruction.
- \*4 Only the intelligent function module on the station connected to GOT can be specified.  
Set within the address range of the buffer memory existing in the intelligent function module.
- \*5 Do not use the local device set in a MELSEC-Q system.  
Otherwise normal monitoring is not performed.
- \*6 GT SoftGOT1000 cannot monitor the device.
- \*7 Even though Universal model QCPU processes 64-bit data, the GOT cannot monitor the 64-bit data.
- \*8 ZR1042432 to ZR4184063 cannot be used for GT SoftGOT1000.
- \*9 This is not supported by GT10.
- \*10 For GT11 and GT10, the controller type is as shown below.
  - GT11: MELSEC-QnU/DC,Q17nD/M/NC/DR
  - GT10: MELSEC-QnU/DC
- \*11 To write data to the consecutive devices of a Q172DR(CR750-Q), use the Q172DR(CR750-Q) with firmware version R6b or later.



#### (4) MELSEC-L

Device name		Setting range	Device No. representation	
Bit device	Input (X)	X0 to X1FFF	Hexadecimal	
	Output (Y)	Y0 to Y1FFF		
	Internal relay (M) <sup>*5</sup>	M0 to M61439	Decimal	
	Latch relay (L)	L0 to L32767		
	Annunciator (F)	F0 to F32767		
	Link relay (B)	B0 to BEFFF	Hexadecimal	
	Timer <sup>*5</sup>	Contact (TT)	TT0 to TT32767	Decimal
		Coil (TC)	TC0 to TC32767	
	Counter <sup>*5</sup>	Contact (CT)	CT0 to CT32767	
		Coil (CC)	CC0 to CC32767	
	Special relay (SM)	SM0 to SM2047		
	Retentive timer <sup>*5</sup>	Contact (SS)	SS0 to SS32767	
		Coil (SC)	SC0 to SC32767	
	Step relay (S)	S0 to S8191		
	Link special relay (SB)	SB0 to SB7FF	Hexadecimal	
Bit-specified word device (Except timer, counter, retentive timer, index register, and buffer memory)		Setting range of each word device	-	
Word device	Data register (D) <sup>*5</sup>	D0 to D421887	Decimal	
	Special data register (SD)	SD0 to SD2047		
	Link register (W)	W0 to W66FFF	Hexadecimal	
	Timer (current value) (TN) <sup>*5</sup>	TN0 to TN32767	Decimal	
	Counter (current value) (CN) <sup>*5</sup>	CN0 to CN32767		
	Retentive timer (current value) (SN) <sup>*5</sup>	SN0 to SN32767		
	Link special register (SW)	SW0 to SW7FFF	Hexadecimal	
	File register (R) <sup>*1*2</sup>	R0 to R32767	Decimal	
	Extension file register (ZR) <sup>*1*3</sup>	ZR0 to ZR393215		
	Index register (Z)	Z0 to Z19		
	Buffer memory (Intelligent function module) (BM) <sup>*4</sup>	BM0 to BM32767		
	Buffer memory (Intelligent function module) (G) <sup>*4</sup>	G0 to G65535		
	Ww <sup>*6*7</sup>	Ww0 to Ww7FF	Hexadecimal	
	Wr <sup>*6*7</sup>	Wr0 to Wr7FF		
	Word-specified bit devices <sup>*6</sup> (Except timer, counter, and retentive timer)		Setting range of each bit device	-

\*1 Do not set a file register by GT Designer3 when executing multiple programs with the file of the file register set at [Use the same file name as the program.] by the PLC parameter of GX Developer.

Otherwise, read/write at GOT will be erroneous.

\*2 Available for file register of block No. switched with the RSET instruction.

\*3 Available for file register of block No. of file name switched with the QDRSET instruction.

\*4 Only the intelligent function module on the station connected to GOT can be specified.  
Set within the address range of the buffer memory existing in the intelligent function module.

\*5 Do not use the local device set in a MELSEC-Q system.

Otherwise normal monitoring is not performed. (D32768 or later can be used for data register (D)).

\*6 This is not supported by GT10.

\*7 This cannot be monitored when in GOT multi-drop connection.

(5) MELSEC-QnA/Q/QS, MELDAS C6\*\*12

Device name *6 *7 *11		Setting range	Device No. representation	
Bit device	Input (X)	X0 to X3FFF	Hexadecimal	
	Output (Y)	Y0 to Y3FFF		
	Internal relay (M)*8	M0 to M32767	Decimal	
	Latch relay (L)	L0 to L32767		
	Annunciator (F)	F0 to F32767		
	Link relay (B)	B0 to B7FFF	Hexadecimal	
	Timer*8	Contact (TT)	TT0 to TT32767	Decimal
		Coil (TC)	TC0 to TC32767	
	Counter*8	Contact (CT)	CT0 to CT32767	
		Coil (CC)	CC0 to CC32767	
	Special relay (SM)	SM0 to SM2047		
	Retentive timer*8	Contact (SS)	SS0 to SS32767	
		Coil (SC)	SC0 to SC32767	
	Step relay (S)	S0 to S32767		
	Link special relay (SB)	SB0 to SB7FFF	Hexadecimal	
Bit-specified word device (Except timer, counter, retentive timer, index register, and buffer memory)		Setting range of each word device	-	
Word device	Data register (D)*8	D0 to D32767	Decimal	
	Special data register (SD)	SD0 to SD2047		
	Link register (W)	W0 to W7FFF	Hexadecimal	
	Timer (current value) (TN)*8	TN0 to TN32767	Decimal	
	Counter (current value) (CN)*8	CN0 to CN32767		
	Retentive timer (current value) (SN)*8	SN0 to SN32767		
	Link special register (SW)	SW0 to SW7FFF	Hexadecimal	
	File register (R)*1*2	R0 to R32767	Decimal	
	Extension fill register (ER)*1*9	Block		0 to 255
		Device		R0 to R32767
	Extension file register (ZR)*1*3*8*9	ZR0 to ZR1042431		
	Index register (Z)	Z0 to Z15		
	Buffer memory (Intelligent function module) (BM)*4*9*10	BM0 to BM32767		
	Buffer memory (Intelligent function module) (G)*4*9*10	G0 to G65535		
	Ww*9*10	Ww0 to Ww1FFF	Hexadecimal	
Wr*9*10	Wr0 to Wr1FFF			
Word-specified bit devices*5*9 (Except timer, counter, and retentive timer)		Setting range of each bit device	-	

- \*1 Do not set a file register by GT Designer3 when executing multiple programs with the file of the file register set at [Use the same file name as the program.] by the PLC parameter of GX Developer. (With exceptions of MELSECQnA) Otherwise, read/write at GOT will be erroneous.
- \*2 Available for file register of block No. switched with the RSET instruction.
- \*3 Available for file register of block No. of file name switched with the QDRSET instruction.
- \*4 Only the intelligent function module on the station connected to GOT can be specified. Set within the address range of the buffer memory existing in the intelligent function module.
- \*5 The device No. must be set in multiples of 16.
- \*6 When monitoring MELDAS C6/64, if a word device outside the range is set, the value will be indefinite. If a bit device outside the range is set, the object may not be displayed or the set function may fail to operate. Check the set device using the device list of GT Designer3.

- \*7 Devices used by the MELDAS C6/64 system cannot be used.
- \*8 Do not use the local device set in a MELSEC-Q system.  
Otherwise normal monitoring is not performed.
- \*9 This is not supported by GT10.
- \*10 This cannot be monitored when in GOT multi-drop connection.
- \*11 The GOT can only read data from the device for the QS001CPU.
- \*12 For GT11 and GT10, the controller type is as shown below.
  - GT11: MELSEC-QnA/Q, MELDAS C6\*
  - GT10: MELSEC-QnA/Q

8	COMMUNICATION WITH GOT
9	USEFUL FUNCTIONS FOR DRAWING
10	USEFUL FUNCTIONS FOR USING GOT
	APPENDICES

**(6) MELSEC-Q (Multi)/Q Motion<sup>\*12</sup>**

Device name		Setting range	Device No. representation	
Bit device	Input (X)	X0 to X1FFF	Hexadecimal	
	Output (Y)	Y0 to Y1FFF		
	Internal relay (M) <sup>*11</sup>	M0 to M32767	Decimal	
	Latch relay (L)	L0 to L32767		
	Annunciator (F)	F0 to F32767		
	Link relay (B)	B0 to B7FFF		
	Timer <sup>*11</sup>	Contact (TT)	TT0 to TT32767	Decimal
		Coil (TC)	TC0 to TC32767	
	Counter <sup>*11</sup>	Contact (CT)	CT0 to CT32767	
		Coil (CC)	CC0 to CC32767	
	Special relay (SM) <sup>*7</sup>		SM0 to M2047	
	Retentive timer <sup>*11</sup>	Contact (SS)	SS0 to SS32767	
		Coil (SC)	SC0 to SC32767	
	Step relay (S)		S0 to S32767	
	Link special relay (SB)		SB0 to SB7FF	Hexadecimal
Bit-specified word device (Except timer, counter, retentive timer, index register, and buffer memory)		Setting range of each word device	-	
Word device	Data register (D) <sup>*8*9*11</sup>		Decimal	
	Special data register (SD)			SD0 to SD2047
	Link register (W)		W0 to W7FFF	Hexadecimal
	Timer (current value) (TN) <sup>*11</sup>		TN0 to TN32767	Decimal
	Counter (current value) (CN) <sup>*11</sup>		CN0 to CN32767	
	Retentive timer (current value) (SN) <sup>*11</sup>		SN0 to SN32767	
	Link special register (SW)		SW0 to SW7FF	
	File register (R) <sup>*1*2</sup>		R0 to R32767	Decimal
	Extension file register (ER) <sup>*1*6</sup>	Block	0 to 255	
		Device	R0 to R32767	
	Extension file register (ZR) <sup>*1*3*6</sup>		ZR0 to ZR1042431	
	Index register (Z)		Z0 to Z15	
	Buffer memory (Intelligent function module) (BM) <sup>*4*6</sup>		BM0 to BM32767	
	Buffer memory (Intelligent function module) (G) <sup>*4*6</sup>		G0 to G65535	
	Ww <sup>*6</sup>		Ww0 to Ww7FF	Hexadecimal
Wr <sup>*6</sup>		Wr0 to Wr7FF		
Motion device (#) <sup>*10</sup>		#0 to #8191	Decimal	
Word-specified bit devices <sup>*5*6</sup> (Except timer, counter, and retentive timer)		Setting range of each bit device	-	

(When the QCPU is used)

\*1 to \*5 (2) MELSEC-QnA/Q/QS, MELDAS C6\*

\*6 This is not supported by GT10.

(When the Q Motion is used)

\*7 When setting special internal relay M9000 to M9255, use SM for the device name and set the value subtracted 9000 for the device number (0 to 255).

\*8 The setting range is D9000 to D9255 when setting the special data register.

\*9 D8192 to D8999 and D9256 to D9999 are out of the valid setting range.

- \*10 Monitoring is not available with GT SoftGOT1000.  
(When the QCPU / Q Motion is used)
- \*11 Do not use the local device set in a MELSEC-Q (Multi)/Q Motion system.  
Otherwise normal monitoring is not performed.
- \*12 For GT10, the controller type is [MELSEC-Q(Multi)].

## (7) MELSEC-A

### (a) GT16, GT15, GT14, GT12, GT11, GT SoftGOT1000

Device name		Setting range	Device No. representation	
Bit device	Input (X)	X0 to X1FFF	Hexadecimal	
	Output (Y)	Y0 to Y1FFF		
	Internal relay/Special internal relay (M)	M0 to M32767	Decimal	
	Latch relay (L)	L0 to L32767		
	Annunciator (F)	F0 to F32767		
	Link relay (B)	B0 to B7FFF	Hexadecimal	
	Timer	Contact (TT)	TT0 to TT32767	Decimal
		Coil (TC)	TC0 to TC32767	
	Counter	Contact (CT)	CT0 to CT32767	
		Coil (CC)	CC0 to CC32767	
	Link special relay (SB)	SB0 to SB7FF	Hexadecimal	
Bit-specified word device (Except Index register(Z) and buffer memory)		Setting range of each word device	-	
Word device	Data register/Special data register (D)	D0 to D32767	Decimal	
	Link register (W)	W0 to W7FFF	Hexadecimal	
	Timer (current value) (TN)	TN0 to TN32767	Decimal	
	Counter (current value) (CN)	CN0 to CN32767		
	Link special register (SW)	SW0 to SW7FF	Hexadecimal	
	File register (R)	R0 to R32767	Decimal	
	Extension file register (ER) <sup>*1</sup>	Block		1 to 255
		Device		ER0 to ER32767
	Index register <sup>*2</sup>	(Z)		Z0 to Z15
		(V)		V0 to V6
	Accumulator (A)	A0 to A1		
	Buffer memory (Intelligent function module) (BM) <sup>*3</sup>	BM0 to BM32767	Decimal	
	Ww	Ww0 to Ww7FF	Hexadecimal	
	Wr	Wr0 to Wr7FF		
Word-specified bit devices <sup>*4*5</sup> (Except timer and counter)		Setting range of each bit device	-	

\*1 In the computer link connection, the bit specification writing of the word device to the ER29-0 (block 29 of the extension file register) or later of A3ACPU, A3UCPU, A4UCPU is not available.

When the bit specification writing of the word device is required, use the range of block No. 0 to 28.

\*2 In the computer link connection, writing to the index register (e.g., the touch switch function, numerical input function) is not available.

\*3 Only the intelligent function module on the station connected to GOT can be specified.

Set within the address range of the buffer memory existing in the intelligent function module.

\*4 The device No. must be set in multiples of 16.

\*5 If the special internal relay (M) is converted to the word device, treat 9000 of the device No. as 0 and set in multiples of 16.  
Example: M9000, M9016, M9240

## (b) GT10

Device name		Setting range	Device No. representation	
Bit device	Input (X)	X0 to X1FFF	Decimal	
	Output (Y)	Y0 to Y1FFF		
	Internal relay/Special internal relay (M)	M0 to M9255		
	Latch relay (L)	L0 to L8191		
	Annunciator (F)	F0 to F2047		
	Link relay (B)	B0 to B1FFF	Hexadecimal	
	Timer	Contact (TT)	TT0 to TT2047	Decimal
		Coil (TC)	TC0 to TC2047	
	Counter	Contact (CT)	CT0 to CT1023	
		Coil (CC)	CC0 to CC1023	
Bit-specified word device (Except index register)		Setting range of each word device	-	
Word device	Data register/Special data register (D)	D0 to D9255	Decimal	
	Link register (W)	W0 to W1FFF	Hexadecimal	
	Timer (current value) (TN)	TN0 to TN2047	Decimal	
	Counter (current value) (CN)	CN0 to CN1023		
	File register (R)	R0 to R8191		
	Index register* <sup>1</sup>	(Z)		Z0 to Z6
		(V)		V0 to V6
	Accumulator (A)* <sup>2</sup>	A0 to A1		

\*1 When the computer link connection is used, writing to index registers (such as touch switch function, numerical input function) is disabled.

\*2 With the computer link connection, the GOT cannot read/write data from/to the accumulator.

## (8) MELSEC-FX

Device name		Setting range	Device No. representation	
Bit device	Input (X)	X0 to X377	Octal	
	Output (Y)	Y0 to Y377		
	Auxiliary relay (M)	M0 to M7679	Decimal	
	Special auxiliary relay (M)	M8000 to M8511		
	State (S)	S0 to S4095		
	Timer contact (T)	T0 to T511		
	Counter contact (C)	C0 to C255		
	Bit-specified word device <sup>*1</sup> (Except the timer (set value) and counter (set value))		Setting range of each word device	-
Word device	Data register (D)	D0 to D0999	Decimal	
	RAM file register (D)	D1000 to D7999		
	Special data register (D)	D8000 to D8511		
	Timer (current value) (T)	T0 to T511		
	Counter (current value) (C)	C0 to C255		
	Timer (set value) (TS) <sup>*3*5*8</sup>	TS0 to TS511		
	Counter (set value) (CS) <sup>*4*5*8</sup>	CS0 to CS255		
	Extension register (R)	R0 to R32767		
	Index register (V)	V0 to V7		
	Index register (Z)	Z0 to Z7		
	Buffer memory (Special function units/ blocks)(BM) <sup>*7</sup>	Unit No.		0 to 7 (Indirect specification: 100 to 115)
		Mask		0 1 to 6
		Device		BM0 to BM32767
	Word-specified bit devices <sup>*2*6</sup> (Except the timer contact and counter contact)			Setting range of each bit device

\*1 When executing the touch switch function that has been set during the bit specification of the word device, do not write any data to the word device through the sequence program.

\*2 The device No. must be set in multiples of 16.

\*3 Only 16-bit (1-word) designation is allowed.

\*4 For CS0 to CS199, only 16-bit (1-word) designation is allowed.

For CS200 to CS255, only 32-bit (2-word) designation is allowed.

\*5 Monitoring or writing is not possible in the continuous device designation mode.

In addition, setting values of the timer and counter, which are not used for the program, cannot be monitored. If monitoring is executed, a reading error occurs.

\*6 This is not supported by GT10.

\*7 Can be used only for special blocks or special units compatible with FX<sub>2N</sub>, FX<sub>3U</sub>, and FX<sub>3G</sub>. (Except FX<sub>0N</sub>-3A, FX<sub>2N</sub>-2AD, and FX<sub>2N</sub>-2DA)

\*8 GT SoftGOT1000 and GT Simulator3 cannot monitor the set values.

## POINT

### (1) How to select a keyword protection level

For equipment that is allowed to operate the FX PLC on line, 3 levels of protection level can be set. When performing monitoring or changing settings with any on-line equipment is required, set password with referring to the following.

#### (a) When setting keyword only

Select a protection level by the initial letter of keyword.

All operation protect: Set a keyword with initial letter of "A", "D" to "F", or "0" to "9".

Read/Incorrect write protection: Set a keyword with initial letter of "B".

Incorrect write protect: Set a keyword with initial letter of "C".

#### (b) Set a keyword with initial letter of "C".

Select a protection level by [Registration condition].

### (2) Monitoring availability at each keyword protection level

Device monitoring availability at each keyword protection level is shown in the following.

Item		When registering keyword only			When registering keyword and 2nd keyword			Keyword not registered or protection cancelled
		All operation protect	Read/Incorrect write protection	Incorrect write protect	All on-line operation protect	Read/write protect	Write protect	
Monitoring devices		○	○	○	×	○	○	○
Changing devices	T, C set value and file register (D1000 and the following)	×	×	×	×	○	○	○
	Other than the above	○	○	○	×	○	○	○

### (3) Difference between all online operations prohibition and all operations prohibition

When specifying all online operations prohibited, displaying devices and inputting data with a programming tool or GOT are all prohibited.

When all operations are prohibited, displaying devices and inputting data with the GOT are enabled while all operations using a programming tool are prohibited.

## (9) MELSEC-WS

Device name <sup>*1</sup>		Setting range	Device No. representation
Bit device	Input (I)	I1.1 to I12.8	Decimal+Decimal
	Output (Q)	Q1.1 to Q12.8	
	Logic result (LQ)	LQ0.0 to LQ3.7	
	Logic input (LI)	LI0.0 to LI3.7	
	Bit-specified word device		Setting range of each word device
Word device	Data (byte) (D)	D0 to D99	Decimal
	Data (word) (W)	W0 to W49	
	EFI input(byte) (EI)	EI110 to EI233	Decimal +Decimal +Decimal
	EFI output(byte) (EQ)	EQ10 to EQ22	Decimal+Decimal
	Logic input (byte) (LD)	LD0 to LD3	Decimal
	Logic input (word) (LW)	LW0 to LW1	

\*1 The GOT can only read data from all the devices.



## ■ OMRON PLC

### (1) SYSMAC

	Device name	Setting range	Device No. representation
Bit device	I/O relay/internal auxiliary relay	..000000 to ..614315	Decimal + Hexadecimal
	Data link relay (LR)	LR00000 to LR19915	
	Auxiliary memory relay (AR)	AR00000 to AR95915	
	Holding relay (HR)	HR00000 to HR51115	
	Internal auxiliary relay/Work relay (WR)	WR00000 to WR51115	
	Timer contact (TIM)	TIM0000 to TIM4095	Decimal
	Counter contact (CNT)	CNT0000 to CNT4095	
	Bit-specified word device <sup>*1*4</sup> (Except data link relay, auxiliary memory relay, holding relay, and internal auxiliary relay)	Setting range of each word device	-
Word device	I/O relay / internal auxiliary relay	..0000 to ..6143	Decimal
	Data link relay (LR)	LR000 to LR199	
	Auxiliary memory relay (AR)	AR000 to AR959	
	Holding relay (HR)	HR000 to HR511	
	Internal auxiliary relay/Work relay (WR)	WR000 to WR511	
	Data memory (DM)	DM00000 to DM32767	
	Timer (current value) (TIM) <sup>*3</sup>	TIM0000 to TIM4095	
	Counter (current value) (CNT) <sup>*3</sup>	CNT0000 to CNT4095	
	Extension data memory (EM current bank) <sup>*2</sup>	EM00000 to EM32767	
	Extension data memory (E0 to EC: 13 banks) <sup>*2</sup>	E000000 to E032767 : EC00000 to EC32767	

\*1 When executing the touch switch function that has been set during the bit specification of the word device, do not write to word device through the sequence program.

\*2 Writing or reading the extension data memory using multiple banks is not allowed.

\*3 Timer (current value) and counter (current value) are valid within the range of 0 to 9999.  
(This applies to the 16 bit/32 bit device data.)

\*4 This is not supported by GT10.

**(2) SYSMAC CS/CJ**

Device name		Setting range	Device No. representation
Bit device	I/O relay/internal auxiliary relay	..000000 to ..614315	Decimal + Hexadecimal
	Data link relay (LR)	LR00000 to LR19915	
	Auxiliary memory relay (AR)	AR00000 to AR147115 AR1000000 to AR1153515	
	Holding relay (HR)	HR00000 to HR51115	
	Internal auxiliary relay/Work relay (WR)	WR00000 to WR51115	
	Timer contact (TIM)	TIM0000 to TIM4095	Decimal
	Counter contact (CNT)	CNT0000 to CNT4095	
Bit-specified word device <sup>*1*4</sup> (Except data link relay, auxiliary memory relay, holding relay, and internal auxiliary relay.)		Setting range of each word device	-
Word device	I/O relay / internal auxiliary relay	..0000 to ..6143	Decimal
	Data link relay (LR)	LR000 to LR199	
	Auxiliary memory relay (AR)	AR000 to AR11535	
	Holding relay (HR)	HR000 to HR511	
	Internal auxiliary relay/Work relay (WR)	WR000 to WR511	
	Data memory (DM)	DM00000 to DM32767	
	Timer (current value) (TIM) <sup>*3</sup>	TIM0000 to TIM4095	
	Counter (current value) (CNT) <sup>*3</sup>	CNT0000 to CNT4095	
	Extension data memory (EM current bank) <sup>*2</sup>	EM00000 to EM32767	
	Extension data memory (E0 to E18: 25 banks) <sup>*2</sup>	E000000 to E032767 : E1800000 to EC1832767	

- \*1 When executing the touch switch function that has been set during the bit specification of the word device, do not write to word device through the sequence program.
- \*2 Writing or reading the extension data memory using multiple banks is not allowed.
- \*3 Timer (current value) and counter (current value) are valid within the range of 0 to 9999.  
(This applies to the 16 bit/32 bit device data.)
- \*4 This is not supported by GT10.

## KEYENCE PLC (KEYENCE KV-700/1000/3000/5000)

	Device name	Setting range	Device No. representation
Bit device	Relay (...)	..00000 to ..99915	Decimal
	Internal auxiliary relay (MR)	MR00000 to MR99915	
	Latch relay (LR)	LR00000 to LR99915	
	Control relay (CR)	CR00000 to CR3915	
	Link relay (B) <sup>*2</sup>	B0000 to B3FFF	Hexadecimal
	Work relay (VB) <sup>*2</sup>	VB0000 to VB3FFF	
	Timer (contact) (T) <sup>*1*2</sup>	T0000 to T3999	Decimal
	Counter (contact) (C) <sup>*1*2</sup>	C0000 to C3999	
	High-speed counter comparator (contact) (CTC) <sup>*2*3*6</sup>	CTC0 to CTC3	
Bit-specified word device <sup>*7</sup> (Except the control memory, temporary data memory, work memory, and index register)	Setting range of each word device	-	
Word device	Data memory (DM)	DM00000 to DM65534	Decimal
	Extension data memory (EM)	EM00000 to EM65534	
	Extension data memory 2 (FM)	FM00000 to FM32767	
	File register (ZF)	ZF000000 to ZF032767 ZF032768 to ZF065535 ZF065536 to ZF098303 ZF098304 to ZF131071	
	Link register (W)	W0000 to W3FFF	Hexadecimal
	Control memory (CM)	CM00000 to CM11998	Decimal
	Temporary data memory (TM)	TM000 to TM511	
	Work memory (VM)	VM00000 to VM59999	
	Index register (Z) <sup>*8</sup>	Z1 to Z12	
	Word-specified bit devices <sup>*7</sup> (Except timer (contact), counter (contact), and highspeed counter comparator (contact))	Setting range of each bit device	-
Double-word device	Timer (current value) (TC) <sup>*2*4</sup>	TC0000 to TC3999	Decimal
	Timer (set value) (TS) <sup>*2*4</sup>	TS0000 to TS3999	
	Counter (current value) (CC) <sup>*2*4</sup>	CC0000 to CC3999	
	Counter (set value) (CS) <sup>*2*4</sup>	CS0000 to CS3999	
	High-speed counter (current value) (CTH) <sup>*2*4</sup>	CTH0 to CTH1	
	High-speed counter comparator (set value) (CTC) <sup>*2*4</sup>	CTC0 to CTC3	
	Index register (DZ)	DZ01 to DZ12	
	Digital trimmer (TRM) <sup>*4*5</sup>	TRM0 to TRM7	

\*1 Monitoring or writing is not possible in the continuous device designation mode.

\*2 Monitoring by GOT is possible only when a device is used in the sequence program.

\*3 In writing, only resetting of a contact is possible.

\*4 Only 32-bit (2-word) designation is possible.

\*5 Only reading is possible.

\*6 Reading/writing from/to continuous devices is not possible.

\*7 This is not supported by GT10.

\*8 With KV-3000 and KV-5000, Z devices cannot be specified as 32-bit (2 words) data. Use DZ devices.

## ■ KOYO EI PLC (KOYO KOSTAC/DL)

Device name		Setting range	Device No. representation
Bit device	Input (I) <sup>*5</sup>	I0 to I1777	Octal
	Output (Q) <sup>*5</sup>	Q0 to Q1777	
	Link relay (GI)	GI0 to GI3777	
	Link output (GQ)	GQ0 to GQ3777	
	Internal relay (M)	M0 to M3777	
	Stage (S)	S0 to S1777	
	Timer (T)	T0 to T377	
	Counter (C)	C0 to C377	
	Special relay (SP) <sup>*1</sup>	SP0 to SP777	
Word device	Timer (current value) (R)	R0 to R377	Octal
	Preparatory register (R) <sup>*5</sup>	R400 to R677	
	Special register 1 (R) <sup>*1*5</sup>	R700 to R777	
	Counter (current value) (R) <sup>*3</sup>	R1000 to R1377	
	Data register 1 (R) <sup>*2*5</sup>	R1400 to R7377	
	Special register 2 (R) <sup>*1*4*5</sup>	R7400 to R7777	
	Data register 2 (R) <sup>*5</sup>	R10000 to R36777	
	Special register 3 (R) <sup>*1*5</sup>	R37000 to R37777	
	Link relay (R)	R40000 to R40177	
	Link output (R)	R40200 to R40377	
	Input (R)	R40400 to R40477	
	Output (R)	R40500 to R40577	
	Internal relay (R)	R40600 to R40777	
	Stage (R)	R41000 to R41077	
	Timer (R)	R41100 to R41117	
	Counter (R)	R41140 to R41157	
	Special relay (R)	R41200 to R41237	

\*1 Read-only device for KOSTAC SU series

\*2 The GOT cannot write data to R7377 for the SU-5M and SU-6M.

\*3 For Direct Logic 05 series and Direct Logic 06 series, devices from R1200 to R1377 are used as V-memory 2.

\*4 The GOT cannot write data to devices from R7766 to R7774 (calendar area).

\*5 The device names differ according to the series.

The following shows the device names for each series.

KOSTAC SU series, PZ series	Direct Logic 05 series, Direct Logic 06 series	Direct Logic 205 series
Input	Input relay	Input
Output	Output relay	Output
Preparatory register	V-memory 1	Data register 1
Special register 1	System parameter 1	System parameter 1
Data register 1	V-memory 2	Data register 2
Special register 2	System parameter 2	System parameter 2
Data register 2	V-memory 3	Data register 3
Special register 3	System parameter 4	System parameter 4

## ■ SHARP PLC (SHARP JW)

Device name		Setting range	Device No. representation	
Bit device	I/O relay	..00000 to ..15777 ..20000 to ..75777	Octal	
	Timer (Contact) (T)	T0000 to T1777		
	Counter (Contact) (C)	C0000 to C1777		
	Bit-specified word device	Setting range of each word device	-	
Word device	Timer (Current value) (T)	T0000 to T1777	Octal	
	Counter (Current value) (C)	C0000 to C1777		
	Register (09 to E7)			09000 to 09776
				19000 to 19776
				29000 to 29776
				39000 to 39776
				49000 to 49776
				59000 to 59776
				69000 to 69776
				79000 to 79776
				89000 to 89776
				99000 to 99776
				E0000 to E0776
				E1000 to E1776
				E2000 to E2776
				E3000 to E3776
				E4000 to E4776
				E5000 to E5776
				E6000 to E6776
		E7000 to E7776		
File register (1 to 7)	1000000 to 1177776 2000000 to 2177776 3000000 to 3177776 4000000 to 4177776 5000000 to 5177776 6000000 to 6177776 7000000 to 7177776			

## ■ JTEKT PLC (JTEKT TOYOPUC-PC)

Device name		Setting range	Device No. representation
Bit device	Input (X) <sup>*1</sup>	X000 to X7FF	Hexadecimal
	Output (Y) <sup>*1</sup>	Y000 to Y7FF	
	Link relay (L)	L000 to L7FF	
	Internal relay (M)	M000 to M7FF	
	Keep relay (K)	K000 to K2FF	
	Edge detection (P)	P000 to P1FF	
	Timer (T) <sup>*1</sup>	T000 to T1FF	
	Counter (C) <sup>*1</sup>	C000 to C1FF	
	Special relay (V)	V000 to V0FF	
	Extended input (EX) <sup>*1</sup>	EX000 to EX7FF	
	Extended output (EY) <sup>*1</sup>	EY000 to EY7FF	
	Extended internal relay (EM)	EM0000 to EM1FFF	
	Extended keep-relay (EK)	EK000 to EKFFF	
	Extended special relay (EV)	EV000 to EVFFF	
	Extended timer (ET) <sup>*1</sup>	ET000 to ET7FF	
	Extended counter (EC) <sup>*1</sup>	EC000 to EC7FF	
	Extended link relay (EL)	EL0000 to EL1FFF	
	Extended edge detection (EP)	EP000 to EPFFF	
	Extended input 2 (GX) <sup>*1*3</sup>	GX0000 to GXFFFF	
	Extended output 2 (GY) <sup>*1*3</sup>	GY0000 to GYFFFF	
Extended internal relay (GM) <sup>*3</sup>	GM0000 to GMFFFF		
Bit-specified word device (Except the extended buffer register and setup value register)	Setting range of each word device		
Word device	Data register (D)	D0000 to D2FFF	Hexadecimal
	Link register (R)	R0000 to R07FF	
	Current value register (N)	N0000 to N01FF	
	Special register (S)	S0000 to S03FF	
	File register (B)	B0000 to B1FFF	
	Extended present value register (EN)	EN0000 to EN07FF	
	Extended setup value register (H)	H0000 to H07FF	
	Extended special register (ES)	ES0000 to ES07FF	
	Extended data register (U)	U0000 to U7FFF	
	Extended buffer register (EB) <sup>*3</sup>	EB00000 to EB07FFF EB08000 to EB0FFFF EB10000 to EB17FFF EB18000 to EB1FFFF	
	Setup value register (TCS) <sup>*2</sup>	TCS0000 to TCS01FF	
	Word-specified bit devices	Setting range of each bit device	

\*1 Overlapped device designation of an input (X, EX, GX) and an output (Y, EY, GY), or a timer (T, ET) and a counter (C, EC) is not allowed. (Example: X0000 and Y0000, EX0000 and EY0000)

\*2 To store a setting value of T (timer) or C (counter), use TCS.  
Setting value of a timer and a counter is stored in TCS. (TCS cannot be used if a timer or a counter is not in a program.)

\*3 GX, GY, GM and EB can be used only in the PC3JG separate mode.  
Access to GX, GY, GM and EB through a link module is not possible.

## ■ TOSHIBA PLC

### (1) Unified Controller nv

Device name		Setting range	Device No. representation
Bit device	External input (X)	X000000 to X16383F	Decimal + Hexadecimal
	External output (Y)	Y000000 to Y16383F	
	Internal relay (R)	R00000 to R8191F	
	Input variable (I)	I000000 to I16383F	
	Output variable (Q)	Q000000 to Q16383F	
	Special relay (S)	S00000 to S1023F	
Word device	External input (XW)	XW0 to XW16383	Decimal
	External output (YW)	YW0 to YW16383	
	Internal relay (RW)	RW0 to RW8191	
	Special relay (SW)	SW0 to SW1023	
	Data register (D)	D0 to D8191	Decimal
	File register (F)	F0 to F32767	
	Input variable (IW)	IW0 to IW16383	
	Output variable (QW)	QW0 to QW16383	
	User global (UG)	UG0 to UG262143	

### (2) PROSEC T/V

Device name		Setting range	Device No. representation
Bit device	External input (X)	X0000 to X511F	Hexadecimal
	External output (Y)	Y0000 to Y511F	
	Internal relay (R) <sup>*6</sup>	R0000 to R4095F	
	Special relay (S) <sup>*6</sup>	S0000 to S511F	
	Link register relay (Z)	Z0000 to Z999F	
	Link relay (L)	L0000 to L255F	
	Timer (Contact) (T) <sup>*1</sup>	T0 to T999	Decimal
	Counter (Contact) (C) <sup>*1</sup>	C0 to C511	
Bit-specified word device <sup>*2*6</sup> (Except external input, external output, internal relay, special relay, link relay, timer, and counter)		Setting range of each word device	-
Word device	External input (XW)	XW0 to XW511	Decimal
	External output (YW)	YW0 to YW511	
	Internal relay (RW) <sup>*5*7</sup>	RW0 to RW4095	
	Special relay (SW) <sup>*7</sup>	SW0 to SW511	
	Link relay (LW)	LW0 to LW255	
	Timer (Current value) (T) <sup>*1</sup>	T0 to T999	
	Counter (Current value) (C) <sup>*1</sup>	C0 to C511	
	Data register (D) <sup>*3*5*7</sup>	D0 to D8191	
	Link register (W)	W0 to W2047	
	File register (F) <sup>*4</sup>	F0 to F32767	

(PROSEC T series)

- \*1 Write of the timer (contact)/(current value), counter (contact)/(current value) is executed after having been read by GOT. Therefore, do not edit it in the sequence program during this period.
- \*2 As bit specification of a word device is performed after the GOT reads the value, do not change the value in the sequence program during this period.
- \*3 When the mode switch on the CPU module has been set to "P-RUN", writing to D0000 through D4095 is disabled.
- \*4 Extension file register is not supported.

(PROSEC V series)

- \*2 As bit specification of a word device is performed after the GOT reads the value, do not change the value in the sequence program during this period.
- \*5 RW0000 and D0000 indicate the same data register in the same region although they are shown in different notations.
- \*6 For bit data, the conversion from the address notation for the TOSHIBA PLC to that for the GOT is shown as follows.  
Address notation for TOSHIBA PLC  $\div$  16 = Word address (Quotient)...Bit address (Remainder)

Address notation for TOSHIBA PLC	Address notation for GOT	Conversion
S8191	S511 E (Decimal) (Hexadecimal)	8191 $\div$ 16 = 511...15
R65535	R4095 E (Decimal) (Hexadecimal)	65535 $\div$ 16 = 4095...15

- \*7 For word data, the conversion from the address notation for the TOSHIBA PLC to that for the GOT is shown as follows.

Data format	Address notation for TOSHIBA PLC	Address notation for GOT
16 bit data	DW10	D10
32 bit data	(Integer) DD10 (Calculate the device No. in 32-bit unit)	D20
	(Real number) DF10 (Calculate the device No. in 32-bit unit)	D20



## ■ TOSHIBA MACHINE PLC (TOSHIBA MACHINE TCmini)

	Device name	Setting range	Device No. representation
Bit device	Input relay 1 (X)	X000 to XF7F	Hexadecimal + Octal + Hexadecimal
	Input relay 2 (I)	I000 to IF7F	
	Output relay 1 (Y)	Y000 to YF7F	
	Output relay 2 (O)	O000 to OF7F	
	Internal relay (R)	R000 to R77F	
	Extended internal relay 1 (GR)	GR000 to GRF7F	
	Extended internal relay 2 (H)	H000 to HF7F	
	Extended internal relay 3 (J)	J000 to JF7F	
	Extended internal relay 4 (K)	K000 to KF7F	
	Timer contact (T)	T000 to T77F	
	Counter contact (C)	C000 to C77F	
	Shift relay (S)	S000 to S07F	
	Latch relay (L)	L000 to L07F	
	Edge relay (E)	E000 to E77F	
	Special aux relay (A)	A000 to A16F	
Word device	Input register 1 (XW)	XW00 to XWF7	Hexadecimal + Octal
	Input register 2 (IW)	IW00 to IWF7	
	Output register 1 (YW)	YW00 to YWF7	
	Output register 2 (OW)	OW00 to OWF7	
	Internal register (RW)	RW00 to RW77	
	Extended internal register 1 (GW)	GW00 to GWF7	
	Extended internal register 2 (HW)	HW00 to HWF7	
	Extended internal register 3 (JW)	JW00 to JWF7	
	Extended internal register 4 (KW)	KW00 to KWF7	
	Timer contact register (TW)	TW00 to TW77	
	Counter contact register (CW)	CW00 to CW77	
	Shift register (SW)	SW00 to SW07	
	Latch register (LW)	LW00 to LW07	
	Edge register (EW)	EW00 to EW77	
	Special aux register (AW)	AW00 to AW16	
	Generic register 1 (D)	D000 to DF7F	Hexadecimal + Octal + Hexadecimal
	Generic register 2 (B)	B000 to BF7F	
	Generic register 3 (U)	U000 to UF7F	
	Generic register 4 (M)	M000 to MF7F	
	Generic register 5 (Q)	Q000 to QF7F	
Timer/Counter current value (P)	P000 to P77F		
Timer/Counter set value (V)	V000 to V77F		

## ■ HITACHI IES PLC (HITACHI HIDIC H series)

	Device name	Setting range	Device No. representation
Bit device	External input (X)	X00000 to X05A95	Hexadecimal + Decimal
	External output (Y)	Y00000 to Y05A95	
	Remote external input (X)	X10000 to X49995	Decimal
	Remote external output (Y)	Y10000 to Y49995	
	1st CPU link (L)	L0000 to L3FFF	Hexadecimal
	2nd CPU link (L1)	L10000 to L13FFF	
	Data area (M)	M0000 to M3FFF	
	On-delay timer (TD) <sup>*1</sup>	TD0 to TD255	Decimal
	Single-shot timer (SS) <sup>*1</sup>	SS0 to SS255	
	Watchdog timer (WDT) <sup>*1</sup>	WDT0 to WDT255	
	Monostable timer (MS) <sup>*1</sup>	MS0 to MS255	
	Retentive timer (TMR) <sup>*1</sup>	TMR0 to TMR255	
	Up counter (CU) <sup>*1</sup>	CU0 to CU511	
	Ring counter (RCU) <sup>*1</sup>	RCU0 to RCU511	
	Up/Down counter (CT) <sup>*1</sup>	CT0 to CT511	Hexadecimal
	Bit internal output (R)	R0 to R7BF	
	Rising edge detection (DIF) <sup>*1</sup>	DIF0 to DIF511	
	Falling edge detection (DFN) <sup>*1</sup>	DFN0 to DFN511	
	Bit-specified word device (Except external input, external output, remote external input, remote external output, first CPU link, second CPU link, and data area)	Setting range of each word device	-
Word device	External input (WX)	WX0000 to WX05A7	Hexadecimal + Decimal
	External output (WY)	WY0000 to WY05A7	
	Remote external input (WX)	WX1000 to WX4997	Decimal
	Remote external output (WY)	WY1000 to WY4997	
	First CPU link (WL)	WL000 to WL3FF	Hexadecimal
	Second CPU link (WL1)	WL1000 to WL13FF	
	Data area (WM)	WM000 to WM3FF	
	Timer/Counter (Elapsed value) (TC) <sup>*1</sup>	TC0 to TC511	Decimal
	Word internal output (WR)	WR000 to WR3FF	Hexadecimal

\*1 The same number cannot be used repeatedly.

\*2 Do not set device outside the range.

If the set device is outside the range, the object set by the device within the range cannot be displayed.

## ■ HITACHI PLC (HITACHI S10mini/S10V)

Device name		Setting range	Device No. representation
Bit device	External input (X)	X000 to XFFF	Hexadecimal
	External output (Y)	Y000 to YFFF	
	Internal register (R)	R000 to RFFF	
	Keep relay (K)	K000 to KFFF	
	Extended internal register (M)	M000 to MFFF	
	Extended internal register (A)	A000 to AFFF	
	On-delay timer (T)	T000 to T1FF	
	On-shot timer (U)	U000 to U0FF	
	Up-down counter (C)	C00 to CFF	
	Global link register (GL) <sup>*6</sup>	GL000 to GLFFF	
	Event register (E)	E000 to EFFF	
	System register (S) <sup>*1</sup>	S000 to SBFF	
	Transfer register (J)	J000 to JFFF	
	Receive register (Q)	Q000 to QFFF	
Bit-specified word device (Except the external input, external output, internal register, extended internal register, keep relay, ondelay timer, one-shot timer, up-down counter, global link register, event register, system register, transfer register, and receive register)		Setting range of each word device	-

(Continued to next page)

Device name		Setting range	Device No. representation
Word device	External input (XW)	XW000 to XWFF0	Hexadecimal
	External output (YW)	YW000 to YWFF0	
	Internal register (RW)	RW000 to RWFF0	
	Extended internal register (MW)	MW000 to MWFF0	
	Extended internal register (AW)	AW000 to AWFF0	
	Keep relay (KW)	KW000 to KWFF0	
	On-delay timer (TW)	TW000 to TW1F0	
	On-shot timer (UW)	UW000 to UW0F0	
	Up-down counter (CW)	CW00 to CWF0	
	Global link register (GW)	GW000 to GWFF0	
	Event register (EW)	EW000 to EWFF0	
	System register (SW) <sup>*1</sup>	SW000 to SWBF0	
	Transfer register (JW)	JW000 to JWFF0	
	Receive register (QW)	QW000 to QWFF0	
	On-delay timer (current value) (TC) <sup>*2</sup>	TC000 to TC1FF	
	On-delay timer (set value) (TS) <sup>*2</sup>	TS000 to TS1FF	
	One-shot timer (current value) (UC) <sup>*2</sup>	UC000 to UC0FF	
	One-shot timer (set value) (US) <sup>*2</sup>	US000 to US0FF	
	Up-down counter (current value) (CC) <sup>*2</sup>	CC00 to CCFF	
	Up-down counter (set value) (CS) <sup>*2</sup>	CS00 to CSFF	
Function data register (DW) <sup>*4*5</sup>	DW000 to DWFFF	Hexadecimal	
Function work register (FW) <sup>*4*5</sup>	FW000 to FWBFF		
Extended function work register (LWW) <sup>*4*5</sup>	LWW0000 to LWWFFFF		
Backup work register (LXW) <sup>*5</sup>	LXW0000 to LXW3FFF		
Double-word device	Long-word work register (LLL) <sup>*3</sup>	LLL0000 to LLL1FFF	Hexadecimal
	Backup Long-word work register (LML) <sup>*3*4</sup>	LML0000 to LML1FFF	
	Floating-point work register (LF) <sup>*3</sup>	LF0000 to LF1FFF	
	Backup single-precision floating-point work register (LG) <sup>*3</sup>	LG0000 to LG1FFF	

\*1 Only reading is possible.

\*2 Only 16-bit (1-word) specification is possible.

\*3 Only 32-bit (2-word) specification is possible.

\*4 When it is used with bit specification (bit specification of word device), the offset function cannot be used.

\*5 When bit specification (bit specification of word device) is performed, the uppermost bit is b0 and the lowermost bit is b15.

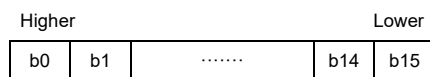

\*6 Device "GL" corresponds to device "G" of the PLU CPU.

# ■ FUJI PLC

## (1) FUJI MICREX-F

	Device name	Setting range	Device No. representation
Bit device	I/O relay (B)	B0000 to B511F	Decimal + Hexadecimal
	Auxiliary relay (M)	M0000 to M511F	
	Keep relay (K)	K0000 to K063F	
	Special relay (F) <sup>*1</sup>	F0000 to F125F	
	Annunciator relay (A)	A0000 to A045F	
	Differential relay (D)	D0000 to D063F	
	Link memory (L)	L0000 to L511F	
	Timer output (0.01s) (T)	T000 to T511	Decimal
	Timer output (0.1s) (T)	T512 to T999	
	Counter output (C)	C000 to C511	
	Bit-specified word device <sup>*5</sup> (Except the I/O relay, auxiliary relay, keep relay, special relay, annunciator relay, differential relay, and link memory)	Setting range of each word device	-
Word device	I/O relay (WB)	WB000 to WB511	Decimal
	Auxiliary relay (WM)	WM000 to WM511	
	Keep relay (WK)	WK000 to WK063	
	Special relay (WF) <sup>*1</sup>	WF000 to WF125	
	Annunciator relay (WA)	WA000 to WA045	
	Differential relay (WD)	WD000 to WD063	
	Link memory (WL)	WL000 to WL511	
	Direct access (W24) <sup>*6*7</sup>	W24 :0000 to W24 :0255	
	User file (W30) <sup>*4*6*7</sup> User file (W31) <sup>*4*6*7</sup> : User file (W108) <sup>*4*6*7</sup> User file (W109) <sup>*4*6*7</sup>	W30 :0000 to W30 :4095 W31 :0000 to W31 :4095 : W108 :0000 to W108 :4095 W109 :0000 to W109 :4095	
	Double-word device	Data memory (BD) <sup>*2</sup>	
Timer set value (0.01s) (TS) <sup>*2*3</sup>		TS0 to TS511	
Timer current value (0.01s) (TR) <sup>*2*3</sup>		TR0 to TR511	
Timer current value (0.1s) (W9) <sup>*2*3</sup>		W9 :0000 to W9 :0487	
Counter set value (CS) <sup>*2*3</sup>		CS0 to CS511	
Counter current value (CR) <sup>*2*3</sup>		CR0 to CR511	

\*1 Only reading is possible.

\*2 Only 32-bit (2-word) specification is possible.

\*3 Decimal points are not displayed.

\*4 When reading/writing data from/to a user file, set SI data for the data format of the PLC CPU, and 16 bits for the data length on GT Designer3.

With any setting other than the above, the PLC does not operate normally.

Data format of the PLC CPU	Setting on GT Designer3
SI (Binary 16-bit length)	Data length of devices: 16 bits
DI (Binary 32-bit length)	None
BD (8-digit BCD)	None

\*5 As bit specification of a word device is performed after the GOT reads the value, do not change the value in the sequence program during this period.

- \*6 When it is used with bit specification (bit specification of word device), the offset function cannot be used.
- \*7 When bit specification (bit specification of word device) is performed, the uppermost bit is b0 and the lowermost bit is b15.

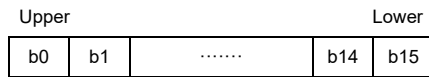

**(2) FUJI MICREX-SX SPH**

	Device name	Setting range	Device No. representation
Bit device	Bit-specified word device*1	Setting range of each word device	-
Word device	Non-retain memory (M)*2*3	M0000 to M2097151	Decimal
	Retain memory (L)*2*3	L0000 to L2097151	
	System memory (SM)*2*3	SM000 to SM511	

- \*1 As bit specification of a word device is performed after the GOT reads the value, do not change the value in the sequence program during this period.
- \*2 When it is used with bit specification (bit specification of word device), the offset function cannot be used.
- \*3 When bit specification (bit specification of word device) is performed, the uppermost bit is b0 and the lowermost bit is b15.

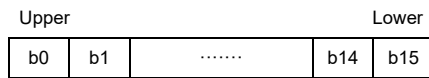

## ■ PANASONIC INDUSTRIAL DEVICES SUNX PLC (PANASONIC MEWNET-FP)

Device name		Setting range <sup>*1</sup>	Device No. representation	
Bit device	Input relay (X) <sup>*2*3</sup>	X0000 to X511F	Hexadecimal + Decimal	
	Output relay (Y) <sup>*3</sup>	Y0000 to Y511F		
	Internal relay (R)	R0000 to R886F		
	Special relay (R) <sup>*2</sup>	R9000 to R911F		
	Link relay (L) <sup>*5</sup>	L0000 to L639F		
	Timer contact (T) <sup>*2*4</sup>	T0 to T3071	Decimal	
	Counter contact (C) <sup>*2*4</sup>	C0 to C3071		
	Bit-specified word device <sup>*7</sup> (Except input relay, output relay, internal relay, special relay, and link relay)		Setting range of each word device	-
Word device	Input relay (WX) <sup>*2</sup>	WX000 to WX511	Decimal	
	Output relay (WY)	WY000 to WY511		
	Internal relay (WR)	WR000 to WR886		
	Special relay (WR) <sup>*2</sup>	WR900 to WR911		
	Link relay (WL)	WL000 to WL639		
	Timer/Counter (Elapsed value) (EV) <sup>*4</sup>	EV0 to EV3071		
	Timer/Counter (Set value) (SV) <sup>*4</sup>	SV0 to SV3071		
	Data register (DT)	DT0 to DT10239		
	Special data register (DT)	DT0 to DT32764 DT90000 to DT90511		
	Link register (LD) <sup>*5</sup>	LD0 to LD8447		
	File register (FL) <sup>*5*6</sup>	FL0 to FL32764		
	Word-specified bit devices <sup>*7</sup> (Except the timer contact and counter contact)			Setting range of each bit device

\*1 The above device range is for the case where FP10SH is used.

For Fp0, FP1, FP2, FP3, FP5, FP-10(S), or FP-M, device ranges are different in individual CPUs.

\*2 Writing to device is not allowed.

\*3 Only those devices that have been assigned to I/O contacts by peripheral software can be used.

\*4 The device points of the timer and counter differs depending on the head numbers of the counter set by the value of the system register (No. 5).

\*5 This device does not exist in FP0, FP1, and FP-M.

\*6 When FP2SH is used, only one bank of 32765 × 3 banks can be monitored.

\*7 This is not supported by GT10.

## ■ YASKAWA PLC

### (1) YASKAWA GL/PROGIC8

Device name		Setting range	Device No. representation
Bit device	Coil (O) <sup>*5</sup>	O1 to O63424	Decimal
	Input relay (I) <sup>*6*7</sup>	I1 to I63424	
	Link coil (D)	D1 to D2048	
		D10001 to D12048 D20001 to D22048	
Bit-specified word device		Setting range of each word device	-
Word device	Input register (Z) <sup>*1*7</sup>	Z1 to Z31840	Decimal
	Holding register (W) <sup>*2*4</sup>	W1 to W28291	
		SW1 to SW28291	
	Link register (R, SR) <sup>*4</sup>	R1 to R2048	
		R10001 to R12048 R20001 to R22048	
		SR1 to SR2048	
		SR10001 to SR12048 SR20001 to SR22048	
Constant register (K) <sup>*3</sup>	K1 to K4096		
Word-specified bit devices (Except coil and input relay)		Setting range of each bit device	-

\*1 Change the input register "30001 to 30512" to "Z1 to Z512" for setting. (When set in default)

\*2 Change the holding register "40001 to 49999" to "W1 to W9999" for setting. (When set in default)

\*3 Change the constant register "31001 to 35096" to "K1 to K4096" for setting. (When set in default)

\*4 SR and SW indicate registers (virtual register) compatible to the data format where internal data of PLC is displayed using R or W. The following shows the difference between the display values of SR, SW and those of R, W corresponding to the values of PLC internal data.

PLC internal data (16 bit)	SR, SW	R, W
9999	9999	9999
1001	1001	1001
1000	1000	1000
999	999	999
0	0	0
-1	-1	32769
-999	-999	33767
-1000	-1000	33768
-1001	-1001	33769
-9999	-9999	42767

\*5 The internal coil N1 to N1536 can be set as O513 to O2048.

However, setting must not exceed O1 to O512 and O513 to O2048.

\*6 Change the input relay "10001 to 14096" to "I1 to I4096" for setting. (When set in default)

\*7 Only reading is possible.



**(2) YASKAWA CP9200SH/MP900**

Device name		Setting range	Device No. representation
Bit device	Coil (MB) <sup>*1</sup>	MB000000 to MB32767F	Decimal + hexadecimal
	Input relay (IB)	IB0000 to IBFFFF	Hexadecimal
	Bit-specified word device <sup>*2</sup> (Except coil and input relay)	Setting range of each word device	-
Word device	Input register (IW)	IW0000 to IW7FFF	Hexadecimal
	Holding register (MW)	MW0 to MW32767	Decima
	Coid (MB) <sup>*2</sup>	MB0 to MB32767	Decima
	Input relay (IB) <sup>*2</sup>	IB000 to IBFFF	Hexadecimal
	Word-specified bit devices	Setting range of each bit device	-

\*1 MB40960 to MB32767F is available for MP-940 only.

\*2 This is not supported by GT10.

**(3) YASKAWA CP9200(H)**

Device name		Setting range	Device No. representation
Bit device	Coil (OB) <sup>*3</sup>	OB000 to OB7FF	Hexadecimal
	Input relay (IB) <sup>*3</sup>	IB000 to IB7FF	
	Bit-specified word device	Setting range of each word device	-
Word device	Input register (IW)	IW00 to IW7F	Hexadecimal
	Output register (OW)	OW00 to OW7F	
	Data register (DW, ZD) <sup>*1</sup>	DW0 to DW2047	Decimal
		ZD0 to ZD2047	
	Common register (MW) <sup>*2</sup>	MW0 to MW7694	
Word-specified bit devices	Setting range of each bit device	-	

\*1 Setting is available only when CP-9200 is used.

\*2 To use data registers of CPU #1 during operation of CP-9200, copy them to MW0 to 7694.

\*3 During operation of CP-9200H, specify the reference No. and quantities so that they do not cover both OB\*\*\* and IB\*\*\*.

**(4) YASKAWA CP9300MS(MC compatible)**

Device name		Setting range	Device No. representation
Bit device	Coil (OB)	OB0 to OB1023	Decimal
	Input relay (IB)	IB0 to IB1023	
	Bit-specified word device	Setting range of each word device	-
Word device	Input register (I)	I0 to I63	Decimal
	Data register (OM)	M0 to M2047	
	Output register (o)	o0 to o63	
	Word-specified bit devices	Setting range of each bit device	-

**(5) YASKAWA MP2000/MP900/CP9200SH**

Device name		Setting range	Device No. representation
Bit device	Coil(MB)	MB000000 to MB65534F	Decimal + Hexadecimal
	Input relay(IB) <sup>*1</sup>	IB00000 to IB7FFFF	Hexadecimal
	Bit-specified word device <sup>*2*3</sup>	Setting range of each word device	-
Word device	Input register(IW) <sup>*1</sup>	IW0000 to IW7FFF	Hexadecimal
	Holding register(MW)	MW0 to MW65534	Decimal
	Word-specified bit devices <sup>*2</sup>	Setting range of each bit device	-

\*1 Only reading is possible.

\*2 This is not supported by GT10.

\*3 For the CP-317, only reading is possible for the word device (MW) with the bit specification.

## ■ YOKOGAWA PLC

### POINT

#### (1) When using YOKOGAWA PLC FA-M3

When YOKOGAWA PLC FA-M3 is used, the usable device range differs depending on the PLC model selected by the GT Designer3.

Since [YOKOGAWA STARDOM/FA-M3] has a larger number of devices that can be set than [YOKOGAWA FA500/FA-M3 ], select [YOKOGAWA STARDOM/FA-M3] for setting a large number of devices.

#### (2) Devices to be set for an object

If a device outside the setting range is set for an object, the value display at the object is indefinite (no error is displayed for system alarm).

A device to be set for an object must be in the device range of YOKOGAWA PLC.

For the device range of YOKOGAWA PLC, refer to the manual below.

 Manual of YOKOGAWA PLC

#### (1) YOKOGAWA FA500/FA-M3

	Device name	Setting range	Device No. representation
Bit device	Input relay (X) <sup>*1</sup>	X00201 to X71664	Decimal
	Output relay (Y)	Y00201 to Y71664	
	Internal relay (I)	I1 to I65536	
	Link relay (L)	L1 to L71024	
	Common relay (E)	E1 to E4096	
	Special relay (M) <sup>*3</sup>	M1 to M9984	
	Timer (TU) <sup>*2</sup>	TU1 to TU3072	
	Counter (CU) <sup>*2</sup>	CU1 to CU3072	
	Bit-specified word device (Except the timer and counter)	Setting range of each word device	
Word device	Timer (TP)	TP1 to TP3072	Decimal
	Timer (TS) <sup>*1</sup>	TS1 to TS3072	
	Counter (CP)	CP1 to CP3072	
	Counter (CS) <sup>*1</sup>	CS1 to CS3072	
	File register (B)	B1 to B262144	
	Data register (D)	D1 to D8192	
	Common register (R)	R1 to R4096	
	Index register (V)	V1 to V256	
	Link register (W)	W1 to W71024	
	Special register (Z) <sup>*3</sup>	Z1 to Z512	
	Word-specified bit devices (Except the timer and counter)	Setting range of each bit device	

\*1 Writing is not possible.

\*2 Writing to continuous devices is not possible.

\*3 Reading/writing from/to continuous devices is not possible.

(2) YOKOGAWA STARDOM/FA-M3

Device name		Setting range	Device No. representation
Bit device	Input relay (X) <sup>*1</sup>	X00201 to X71664	Decimal
	Output relay (Y)	Y00201 to Y71664	
	Internal relay (I) <sup>*4</sup>	I1 to I65535	
	Link relay (L)	L00001 to L08192 L10001 to L18192 L20001 to L28192 L30001 to L38192 L40001 to L48192 L50001 to L58192 L60001 to L68192 L70001 to L78192	
	Shared relay (E)	E1 to E4096	
	Special relay (M) <sup>*3</sup>	M1 to M9984	
	Timer (TU) <sup>*2</sup>	TU1 to TU3072	
	Counter (CU) <sup>*2</sup>	CU1 to CU3072	
	Bit-specified word device (Except the timer and counter)	Setting range of each word device	
	Word device	Timer (TP)	
Timer (TS) <sup>*1</sup>		TS1 to TS3072	
Counter (CP)		CP1 to CP3072	
Counter (CS) <sup>*1</sup>		CS1 to CS3072	
Filer register (B) <sup>*5</sup>		B1 to B262144	
Data register (D)		D1 to D65535	
Shared register (R)		R1 to R4096	
Index register (V)		V1 to V256	
Link register (W)		W00001 to W08192 W10001 to W18192 W20001 to W28192 W30001 to W38192 W40001 to W48192 W50001 to W58192 W60001 to W68192 W70001 to W78192	
Special register (Z) <sup>*3</sup>		Z1 to Z1024	
Word-specified bit devices (Except the timer and counter)	Setting range of each bit device		

\*1 Writing is not possible.

\*2 Writing to continuous devices is not possible.

\*3 Reading/writing from/to continuous devices is not possible.

\*4 With STARDOM, FA-M3 (F3SP59 only), if communications that include the maximum device number (32767 or 65535) occurs, system alarm "322 Dedicated device is out of range. Confirm device range." may be detected.  
If such system alarm is detected, do not use the last 15 bits.

\*5 With STARDOM, do not use B32768 or later. If used, correct monitoring is disabled.

## ■ ALLEN-BRADLEY PLC

### (1) AB SLC500

Device name		Setting range	Device No. representation
Bit device	Bit (B)	B3:0/0 to B3:255/15 B10:0/0 to B255:255/15	Decimal
	Timer (Timing bit) (T) <sup>*2</sup>	T4:0/14(TT) to T4:255/14(TT) T10:0/14(TT) to T255:255/14(TT)	
	Timer (Completion bit) (T) <sup>*2</sup>	T4:0/13(DN) to T4:255/13(DN) T10:0/13(DN) to T255:255/13(DN)	
	Counter (Up counter) (C) <sup>*2</sup>	C5:0/15(CU) to C5:255/15(CU) C10:0/15(CU) to C255:255/15(CU)	
	Counter (Down counter) (C) <sup>*2</sup>	C5:0/14(CD) to C5:255/14(CD) C10:0/14(CD) to C255:255/14(CD)	
	Counter (Completion bit) (C)	C5:0/13(DN) to C5:255/13(DN) C10:0/13(DN) to C255:255/13(DN)	
	Integer (N) <sup>*3</sup>	N7:0 to N7:255 N10:0 to N255:255	
Word device	Bit (B) <sup>*3</sup>	B3:0 to B3:255 B10:0 to B255:255	Decimal
	Timer (Set value) (T) <sup>*1*2</sup>	T4:0.1(PRE) to T4:255.1(PRE) T10:0.1(PRE) to T255:255.1(PRE)	
	Timer (Current value) (T) <sup>*1*2</sup>	T4:0.2(ACC) to T4:255.2(ACC) T10:0.2(ACC) to T255:255.2(ACC)	
	Counter (Set value) (C) <sup>*1*2</sup>	C5:0.1(PRE) to C5:255.1(PRE) C10:0.1(PRE) to C255:255.1(PRE)	
	Counter (Current value) (C) <sup>*1*2</sup>	C5:0.2(ACC) to C5:255.2(ACC) C10:0.2(ACC) to C255:255.2(ACC)	
	Integer (N) <sup>*1</sup>	N7:0 to N7:255 N10:0 to N255:255	

\*1 Writing on the device is not allowed for 32-bit data.

\*2 Monitoring or writing cannot be done in the continuous device designation mode.

\*3 This is not supported by GT10.

**(2) AB MicroLogix1000/1200/1400/1500 Series**

Device name		Setting range	Device No. representation
Bit device	Input (I)	I:0.0/0 to I:16.7/15	Decimal
	Output (O)	O:0.0/0 to O:16.7/15	
	Bit (B)	B3:0/0 to B255:255/15	
	Timer (Timing bit) (T) <sup>*3</sup>	T3:0/14(TT) to T255:255/14(TT)	
	Timer (Completion bit) (T) <sup>*3</sup>	T3:0/13(DN) to T255:255/13(DN)	
	Counter (Up counter) (C) <sup>*3</sup>	C3:0/15(CU) to C255:255/15(CU)	
	Counter (Down counter) (C) <sup>*3</sup>	C3:0/14(CD) to C255:255/14(CD)	
	Counter (Completion bit) (C) <sup>*3</sup>	C3:0/13(DN) to C255:255/13(DN)	
	Integer (N) <sup>*4</sup>	N3:0/0 to N255:255/15	
Word device	Input (I)	I:0.0 to I:16.7	Decimal
	Output (O)	O:0.0 to O:16.7	
	Bit (B) <sup>*4</sup>	B3:0 to B255:255	
	Timer (Set value) (T) <sup>*1*3</sup>	T3:0.1(PRE) to T255:255.1(PRE)	
	Timer (Current value) (T) <sup>*1*3</sup>	T3:0.2(ACC) to T255:255.2(ACC)	
	Counter (Set value) (C) <sup>*1*3</sup>	C3:0.1(PRE) to C255:255.1(PRE)	
	Counter (Current value) (C) <sup>*1*3</sup>	C3:0.2(ACC) to C255:255.2(ACC)	
	Integer (N) <sup>*1</sup>	N3:0 to N255:255	
Double-word device	32bit integer(L) <sup>*2</sup>	L3:0 to L3:255 L255:0 to L255:255	Decimal
	32bit float (F) <sup>*2</sup>	F3:0 to F3:255 F255:0 to F255:255	

- \*1 Writing on the device is not allowed for 32 bit data.
- \*2 Writing on the device is not allowed for 16 bit data.
- \*3 Monitoring or writing cannot be done in the continuous device designation mode.
- \*4 This is not supported by GT10.

**(3) AB MicroLogix1000/1200/1500 Series (Device extended)**

For details of this communication driver, contact our company.

**(4) AB Control/CompactLogix**

Device name		Setting range	Device No. representation
Bit device	Bit data (BOOL)	BOOL0[0] to BOOL999[31999]	Decimal
Word device	Word data (INT)	INT0[0] to INT999[999]	Decimal
Double-word device	Double word data (DINT) <sup>*1</sup>	DINT0[0] to DINT999[999]	Decimal
	Floating point data (REAL) <sup>*1</sup>	REAL0[0] to REAL999[999]	

- \*1 Only 32-bit (2-word) specification is possible.

## ■ GE PLC (GE Series 90)

	Device name	Setting range	Device No. representation
Bit device	input (I)	I00001 to I12288	Decimal
	output (Q)	Q00001 to Q12288	
	internal (M)	M00001 to M12288	
	temporary (T)	T001 to T256	
	system status (S)	S001 to S128	
	system status (SA)	SA001 to SA128	
	system status (SB)	SB001 to SB128	
	system status (SC)	SC001 to SC128	
	global data (G)	G0001 to G7680	
	Bit-specified word device	Setting range of each word device	
Word device	system register (R)	R00001 to R32640	Decimal
	analog input register (AI)	AI0001 to AI32640	
	analog output register (AQ)	AQ0001 to AQ32640	
	Word-specified bit devices <sup>*1</sup>	Setting range of each bit device	

\*1 Word access of system status(S) is enabled for reading only.

## ■ LS IS PLC (LS Industrial Systems MASTER-K)

	Device name	Setting range	Device No. representation
Bit device	I/O relay (P)	P0000 to P063F	Decimal + Hexadecimal
	Auxiliary relay (M)	M0000 to M191F	
	Keep relay (K)	K0000 to K031F	
	Link relay (L)	L0000 to L063F	
	Special relay (F) <sup>*1</sup>	F0000 to F063F	
	Timer contact (T)	T0 to T255	Decimal
	Counter contact (C)	C0 to C255	
Word device	I/O relay (P)	P000 to P063	Decimal
	Auxiliary relay (M)	M000 to M191	
	Keep relay (K)	K000 to K031	
	Link relay (L)	L000 to L063	
	Special relay (F) <sup>*1</sup>	F000 to F063	
	Timer current value (T)	T0 to T255	
	Counter current value (C)	C0 to C255	
	Step controller (S)	S0 to S99	
Data register (D)	D0 to D9999		

\*1 Only reading is possible.

## ■ SICK safety controller (SICK Flexi Soft)

Device name *1		Setting range	Device No. representation
Bit device	Input (I)	I1.1 to I12.8	Decimal+Decimal
	Output (Q)	Q1.1 to Q12.8	
	Logic result (LQ)	LQ0.0 to LQ3.7	
	Logic input (LI)	LI0.0 to LI3.7	
	Bit-specified word device	Setting range of each word device	
Word device	Data (byte) (D)	D0 to D99	Decimal
	Data (word) (W)	W0 to W49	
	EFI input (byte) (EI)	EI110 to EI233	Decimal +Decimal +Decimal
	EFI output (byte) (EQ)	EQ10 to EQ22	Decimal+Decimal
	Logic input (byte) (LD)	LD0 to LD3	Decimal
	Logic input (word) (LW)	LW0 to LW1	

\*1 The GOT can only read data from all the devices.

## ■ SIEMENS PLC

### (1) SIEMENS S7-300/400 series

Device name		Setting range	Device No. representation	
Bit device	Input relay (I)	I0000 to I5117	Decimal	
	Output relay (Q)	Q0000 to Q5117		
	Bit memory (M)	M00000 to M20477		
	Bit-specified word device (Except input relay, output relay, bit memory, timer, and counter)	Setting range of each word device		-
Word device	Input relay (IW)	IW0 to IW510	Decimal	
	Output relay (QW)	QW0 to QW510		
	Bit memory (MW)	MW0 to MW2046		
	Timer (Current value) (T)*1	T0 to T511		
	Counter (Current value) (C)	C0 to C511		
	Data register (DB)	DB1.DBW0 to DB1.DBW65534		
		DB2.DBW0 to DB2.DBW65534		
		.		
		.		
		DB4094.DBW0 to DB4094.DBW65534		
	DB4095.DBW0 to DB4095.DBW65534			

\*1 Monitoring or writing cannot be done in the continuous device designation mode.



## (2) SIEMENS S7-200 series

	Device name	Setting range	Device No. representation
Bit device	variable memory (V)	V0 to V51197	Decimal
	Input relay (I)	I0 to I77	
	Output relay (Q) <sup>*3</sup>	Q0 to Q77	
	Bit Memory (M)	M0 to M317	
	special memory (SM)	SM0 to SM1947	
	Timer (T) <sup>*1</sup>	T0 to T255	
	Counter (C) <sup>*1</sup>	C0 to C255	
	sequence control relay (S)	S0 to S317	
Word device	variable memory (VW)	VW0 to VW5118	Decimal
	Input relay (IW)	IW0 to IW6	
	Output relay (QW) <sup>*3</sup>	QW0 to QW6	
	analog input (AIW) <sup>*1</sup>	AIW0 to AIW30	
	analog output (AQW) <sup>*3</sup>	AQW0 to AQW30	
	Bit memory (MW)	MW0 to MW30	
	special memory (SMW)	SMW0 to SMW192	
	Timer (T) <sup>*4</sup>	T0 to T255	
	Counter (CW) <sup>*4</sup>	C0 to C255	
	sequence control relay (SW)	SW0 to SW30	
Double-word device	High-speed counter (HC) <sup>*2</sup>	HC0 to HC2	Decimal

\*1 Only reading is possible.

\*2 Only reading 32-bit data (two-word data) is possible.

\*3 Only writing while the programmable controller runs is possible.

\*4 Reading and writing only 16-bit data (one-word data) are possible.

### (3) SIEMENS S7(Ethernet)

Device name		Setting range	Device No. representation
Bit device	Input relay (I)	I0000 to I1277	Decimal
	Output relay (Q)	Q0000 to Q1277	
	Bit memory (M)	M0000 to M2557	
	Bit-specified word device (Except input relay, output relay, bit memory, timer, and counter)	Setting range of each word device	-
Word device	Input relay (IW)	IW0 to IW126	Decimal
	Output relay (QW)	QW0 to QW126	
	Bit memory (MW)	MW0 to MW254	
	Timer (Current value) (T) <sup>*1</sup>	T0 to T255	
	Counter (Current value) (C) <sup>*1</sup>	C0 to C255	
	Data register (DB)	DB1.DBW0 to DB1.DBW2046	
		DB2.DBW0 to DB2.DBW2046	
		.	
.			
.			
	DB254.DBW0 to DB254.DBW2046		
	DB255.DBW0 to DB255.DBW2046		

\*1 Monitoring or writing cannot be done in the continuous device designation mode.

#### (4) SIEMENS OP(Ethernet)

Device name		Setting range	Device No. representation	
Bit device	Variable memory (V)	V0 to V102397	Decimal	
	Input relay (I)	I0 to I655357		
	Output relay (Q) <sup>*3</sup>	Q0 to Q655357		
	Bit memory (M)	M0 to M655357		
	Bit-specified word device (Except variable memory, except input relay, output relay, bit memory, timer, and counter)	Setting range of each word device	-	
Word device	Variable memory (VW)	VW0 to VW10238	Decimal	
	Input relay (IW)	IW0 to IW65534		
	Output relay (QW) <sup>*3</sup>	QW0 to QW65534		
	Bit memory (MW)	MW0 to MW65534		
	Timer (Current value) (T) <sup>*1*2*4</sup>	T0 to T65535		
	Counter (Current value) (C) <sup>*1*2*4</sup>	C0 to C65535		
	Data register (DB)	DB1.DBW0 to DB1.DBW65534		
		DB2.DBW0 to DB2.DBW65534		
		.		
		.		
.				
	DB4094.DBW0 to DB4094.DBW65534			
	DB4095.DBW0 to DB4095.DBW65534			

\*1 The data format to be entered in Timer (T) and Counter (C) depends on the PLC types.

\*2 S7-1200 is not applied to Timer (T) and Counter (C).

\*3 Only writing while the programmable controller runs is possible.

\*4 Reading and writing only 16-bit data (one-word data) are possible.

## ■ IAI robot controller

### (1) IAI ROBO CYLINDER

Device name		Setting range	Device No. representation
Bit device	Status (S)	S0000 to SFFFF	Hexadecimal
	Bit-specified word device* <sup>1</sup>	Setting range of each word device	-
Word device	Registers (R)	R0000 to RFFFF	Hexadecimal

\*1 The GT10 cannot specify a word device with a bit.

#### (a) Status (S)

The following shows the status settings and the definitions.

Status	Definition	Symbol
0000 to 00FF	- (Reserved for the system)	-
0100	EMG status	EMGS
0101	Safety speed enabled status	SFTY
0102	Controller ready status	PWR
0103	Servo ON status	SV
0104	Missed work in push-motion operation	PSFL
0105	Major failure status	ALMH
0106	Minor failure status	ALML
0107	Absolute error status	ABER
0108	Brake forced-release status	BKRL
0109	Use prohibited	-
010A	Pause status	STP
010B	HomingHome return status	HEND
010C	Positioning completionPosition complete status	PEND
010D to 010F	Use prohibited	-
0110	Use prohibited	-
0111	Use prohibited	-
0112	Load output judgment status	LOAD
0113	Torque level status	TRQS
0114	Teaching mode status	MODS
0115	Position-data load command status	TEAC
0116	Jog+ status	JOG+
0117	Jog- status	JOG-
0118	Completed PositionPosition complete 7	PE7
0119	Completed PositionPosition complete 6	PE6
011A	Completed PositionPosition complete 5	PE5
011B	Completed PositionPosition complete 4	PE4
011C	Completed PositionPosition complete 3	PE3
011D	Completed PositionPosition complete 2	PE2
011E	Completed PositionPosition complete 1	PE1
011F	Completed PositionPosition complete 0	PE0

(Continued to next page)

Status	Definition	Symbol
0120	Emergency stop status	EMGP
0121	Motor voltage low status	MPIV
0122	Operation mode status	RMDS
0123	Use prohibited	-
0124	HomingHome return status	GHMS
0125	Push-motion operation in progress	PUSH
0126	Excitation detection status	PSNS
0127	PIO/Modbus switching status	PMSS
0128	Use prohibited	-
0129	Use prohibited	-
012A	Moving signal	MOVE
012B to 012F	Use prohibited	-
0130 to 0136	Use prohibited	-
0137	Completed position numberPosition complete number status bit 256	PM256
0138	Completed position numberPosition complete number status bit 128	PM128
0139	Completed position numberPosition complete number status bit 64	PM64
013A	Completed position numberPosition complete number status bit 32	PM32
013B	Completed position numberPosition complete number status bit 16	PM16
013C	Completed position numberPosition complete number status bit 8	PM8
013D	Completed position numberPosition complete number status bit 4	PM4
013E	Completed position numberPosition complete number status bit 2	PM2
013F	Completed position numberPosition complete number status bit 1	PM1
0140	Use prohibited	-
0141	Limit sensor output monitor 2	LS2
0142	Limit sensor output monitor 1	LS1
0143	Limit sensor output monitor 0	LS0
0144 to 0146	Use prohibited	-
0147	Position zone output monitor	ZP
0148 to 014D	Use prohibited	-
014E	Zone output monitor 2	Z2
014F	Zone output monitor 1	Z1
0150 to 015F	PIO connector pin number 20A(IN15) to PIO connector pin number 5A(IN0)	-
0160 to 016F	PIO connector pin number 16B(OUT15) to PIO connector pin number 1B(OUT0)	-
0170	Use prohibited	-
0171	Command pulse NP signal status	NP
0172	Use prohibited	-
0173	Command pulse PP signal status	PP

(Continued to next page)

Status	Definition	Symbol
0174 to 0175	Use prohibited	-
0176	Use prohibited	-
0177	Mode switch status	MDSW
0178	Use prohibited	-
0179 to 017B	Use prohibited	-
017C	Home-check sensor monitor	HMCK
017D	Overtravel sensor	OT
017E	Creep sensor	CREP
017F	Limit sensor	LS
0180 to 03FF	- (Reserved for the system)	-
0400	EMG operation specification	EMG
0401	Safety speed command	SFTY
0402	Use prohibited	-
0403	Servo ON command	SON
0404 to 0406	Use prohibited	-
0407	Alarm reset command	ALRS
0408	Brake forced-release command	BKRL
0409	Use prohibited	-
040A	Pause command	STP
040B	HomeingHome return command	HOME
040C	Positioning start command	CSTR
040D to 040F	Use prohibited	-
0410	Use prohibited	-
0411	Jog/inch switching	JISL
0412 to 0413	Use prohibited	-
0414	Teaching mode command	MOD
0415	Position data load command	TEAC
0416	Jog+ command	JOG+
0417	Jog- command	JOG-
0418	Start position 7	ST7
0419	Start position 6	ST6
041A	Start position 5	ST5
041B	Start position 4	ST4
041C	Start position 3	ST3
041D	Start position 2	ST2
041E	Start position 1	ST1
041F	Start position 0	ST0
0420 to 0426	Use prohibited	-
0427	PIO/Modbus switching specification	PMSL
0428 to 042B	Use prohibited	-
042C	Deceleration stop	STOP
042D to 042F	Use prohibited	-
0430 to 0436	Use prohibited	-
0437	Position command bit 256	PC256

(Continued to next page)

Status	Definition	Symbol
0438	Position command bit 128	PC128
0439	Position command bit 64	PC64
043A	Position command bit 32	PC32
043B	Position command bit 16	PC16
043C	Position command bit 8	PC8
043D	Position command bit 4	PC4
043E	Position command bit 2	PC2
043F	Position command bit 1	PC1
0440 to FFFF	- (Reserved for the system)	-

## (b) Registers (R)

The following shows the register settings and the definitions.

Registers	Definition	Symbol
0000 to 0CFF	- (Reserved for the system)	-
0D00	Device control register 1	DRG1
0D01	Device control register 2	DRG2
0D03	Position number specification register	POSR
0D04 to 0FFF	- (Reserved for the system)	-
1000 to 3FFF	Target position	PCMD
	In-position bandPositioning band	INP
	Speed command	VCMD
	Individual zone boundary +	ZNMP
	Individual zone boundary -	ZNLP
	Acceleration command	ACMD
	Deceleration command	DCMD
	Push-current limiting value	PPOW
	Load current threshold	LPOW
Control flag specification	CTLF	
4000 to 8FFF	- (Reserved for the system)	-
9000	Current position monitor	PNOW
9002	Present alarm code query	ALMC
9003	Input port query	DIPM
9004	Output port monitor query	DOPM
9005	Device status 1 query	DSS1
9006	Device status 2 query	DSS2
9007	Expanded device status query	DSSE
9008	System status query	STAT
900A	Current speed monitor	VNOW
900C	Current ampere monitor	CNOW
900E	Deviation monitor	DEVI
9010	System timer query	STIM
9012	Special input port query	SIPM
9013	Zone status query	ZONS
9014	Completed position numberPosition complete number status query	POSS

(Continued to next page)

Registers	Definition	Symbol
9015 to 97FF	- (Reserved for the system)	-
9800	Position movement command register	POSR
9801 to 98FF	- (Reserved for the system)	-
9900	Target position coordinate specification register	PCMD
9902	In-position bandPositioning band specification register	INP
9904	Speed specification register	VCMD
9906	Acceleration/deceleration speed specification register	ACMD
9907	Push-current limiting value	PPOW
9908	Control flag specification register	CTLF
9909 to FFFF	- (Reserved for the system)	-

## (2) IAI X-SELController

Device name		Setting range	Device No. representation	
Bit device	Input Port (IP) <sup>*1</sup>	IP000 to IP299	Decimal	
	Output Port (OP)	OP300 to OP599		
	Flag (FG)	FG000:600 to FG000:899 FG001:900 to FG001:999 : FG128:900 to FG128:999		
	Point Data Clear (PCLR) <sup>*2*6</sup>	PCLR0001 to PCLR4E20	Hexadecimal	
Word device	Point Data Total Count (PDT) <sup>*1</sup>	PDT0	Decimal	
	String (STR) <sup>*3</sup>	STR000:300 to STR000:998 STR001:001 to STR001:299 : STR128:001 to STR128:299		
	Axis Status (AXST) <sup>*1</sup>	AXST00 to AXST2F		
	Scara Axis Status 0 (Base coordinate system) (SAXS0) <sup>*1</sup>	SAXS000 to SAXS0FF	Hexadecimal	
	Scara Axis Status 1 (Selected work coordinate system) (SAXS1) <sup>*1</sup>	SAXS100 to SAXS1FF		
	Scara Axis Status 2 (Reserved for system use) (SAXS2) <sup>*1</sup>	SAXS200 to SAXS2FF		
	Scara Axis Status 3 (Each axis system) (SAXS3) <sup>*1</sup>	SAXS300 to SAXS3FF		
	Version 0 (Main CPU application/) (VR0) <sup>*1</sup>	VR00:0 to VR00:F : VR0F:0 to VR0F:F		
	Version 1 (Main CPU core) (VR1) <sup>*1</sup>	VR10:0 to VR10:F : VR1F:0 to VR1F:F		
	Version 2 (Driver CPU) (VR2) <sup>*1</sup>	VR20:0 to VR20:F : VR2F:0 to VR2F:F		
	Version 3 (Mount SIO) (VR3) <sup>*1</sup>	VR30:0 to VR30:F : VR3F:0 to VR3F:F		
	Program Status (PGST) <sup>*1*4</sup>	PGST000 to PGST511		Decimal
	System Status (SYST) <sup>*1</sup>	SYST0 to SYST6		
	Program Control (PRG) <sup>*2</sup>	PRG000 to PRG128		

(Continued to next page)



	Device name	Setting range	Device No. representation
Word device	Alarm Reset (AR) <sup>*2</sup>	AR0	Decimal
	Software Reset (SR) <sup>*2,5</sup>	SR0	
	Drive-Source Recovery (DSR) <sup>*2</sup>	DSR0	
	Operation-Pause Reset (OPR) <sup>*2</sup>	OPR0	
	Servo (SV) <sup>*7</sup>	SV0 to SV2	
	Write to Flash ROM (FRW) <sup>*7</sup>	FRW0 to FRW1	
Double-word device	Coordinate Affiliate Data 0 (Work coordinate system definition data) (CD0) <sup>*1</sup>	CD000:0 to CD000:F : CD0FF:0 to CD0FF:F	Hexadecimal
	Coordinate Affiliate Data 1 (Tool coordinate system definition data) (CD1) <sup>*1</sup>	CD100:0 to CD100:F : CD1FF:0 to CD1FF:F	
	Integer (INT)	INT000:0200 to INT000:1299 INT001:0001 to INT001:1099 : INT128:0001 to INT128:1099	Decimal
	Real (RL)	RL000:0300 to RL000:1399 RL001:0100 to RL001:1199 : RL128:0100 to RL128:1199	
	Error Detail 0 (System error) (ER0) <sup>*1</sup>	ER000:000:00 to ER0FF:000:FF : ER000:FFF:00 to ER0FF:FFF:FF	Hexadecimal
	Error Detail 1 (Axis-specific error) (ER1) <sup>*1</sup>	ER100:000:00 to ER1FF:000:FF : ER100:FFF:00 to ER1FF:FFF:FF	
	Error Detail 2 (Program-specific error) (ER2) <sup>*1</sup>	ER200:000:00 to ER2FF:000:FF : ER200:FFF:00 to ER2FF:FFF:FF	
	Error Detail 3 (Error in error list record) (ER3) <sup>*1</sup>	ER300:000:00 to ER3FF:000:FF : ER300:FFF:00 to ER3FF:FFF:FF	
	Error Detail 4 (Reserved for system use) (ER4) <sup>*1</sup>	ER400:000:00 to ER4FF:000:FF : ER400:FFF:00 to ER4FF:FFF:FF	
	Error Detail 5 (Reserved for system use) (ER5) <sup>*1</sup>	ER500:000:00 to ER5FF:000:FF : ER500:FFF:00 to ER5FF:FFF:FF	
	Error Detail 6 (Reserved for system use) (ER6) <sup>*1</sup>	ER600:000:00 to ER6FF:000:FF : ER600:FFF:00 to ER6FF:FFF:FF	
	Error Detail 7 (Reserved for system use) (ER7) <sup>*1</sup>	ER700:000:00 to ER7FF:000:FF : ER700:FFF:00 to ER7FF:FFF:FF	
	Point Data Total Count (PD) <sup>*7</sup>	PD00 to PD9E	
	Simple Interference Check Zone Data (SD) <sup>*1</sup>	SD01:0 to SD01:F : SDFF:0 to SDFF:F	

\*1 The GOT can only read data from the device.

\*2 The GOT can only write data to the device.

\*3 The following restrictions are applied depending on the program number.

- When the program number is 000, the variable number can be only even numbers.
- When the program number is 001 to 128, the variable number can be only odd numbers.

- \*4 For the program control device, the command to be sent differs depending on the write data.  
Write data other than the followings are processed as an internal error of GOT.
  - Write data 0: Program Exit Command (0 × 254)
  - Write data 1: Program Execution Command (0 × 253)
  - Write data 2: Program Pause Command(0 × 255)
  - Write data 3: Program 1 Step Execution Command (0 × 256)
  - Write data 4: Program Restart Command (0 × 257)
- \*5 When performing software reset, a no response error is displayed after a non-communicating period of ten and several seconds, and then the communication is resumed.
- \*6 For the word address, the value is specified only when the last digit is 1.
- \*7 For the device whose obtained data No.0 is a command trigger, a request is sent to the controller when the Write or Read is input to the command trigger.  
It is not sent when the Clear is input.

## ■ Microcomputer connection

### (1) GT16, GT15, GT14, GT12, GT11, GT SoftGOT1000

Device name		Setting range	Device No. representation
Bit device	Internal relay (M)	M0 to M2047	Decimal
	Special relay (SM)	SM0 to SM63	
	Latch relay (L)	L0 to L2047	
	Bit-specified word device	Setting range of each word device	
Word device	Data register (D)	D0 to D4095	Decimal
	Link special register (SD)	SD0 to SD15	
	File register (R)	R0 to R4095	
	Word-specified bit devices	Setting range of each bit device	

\*1 The host is not allowed to write to/read from GB and GD devices.

### (2) GT10

Device name		Setting range	Device No. representation
Bit device	Internal relay (M)	M0 to M2047	Decimal
	Special relay (SM)	SM0 to SM63	
	Latch relay (L)	L0 to L2047	
	Bit-specified word device	Setting range of each word device	
Word device	Data register (D)	D0 to D511	Decimal
	Link special register (SD)	SD0 to SD15	
	File register (R)	R0 to R4095	

\*1 The host is not allowed to write to/read from GB and GD devices.

## ■ MODBUS(R)

Device name		Setting range	Device No. representation
Bit device	Coils (0)	000001 to 065536	Decimal
	Discretes input (1) <sup>*1</sup>	100001 to 165536	
	Bit-specified word device	Setting range of each word device	-
Word device	Input registers (3) <sup>*1</sup>	300001 to 365536	Decimal
	Holding registers (4)	400001 to 465536	
	Extension file register (6)	File No.: 0 to 104 600000 to 609999	

\*1 Only reading is possible.

## ■ AZBIL control equipment

### (1) SDC/DMC series

Device name		Setting range	Device No. representation
Bit device	Bit-specified word device	Setting range of each word device	-
Word device	Data (...) <sup>*1</sup>	..273 to ..31243	Decimal

\*1 Only 16-bit (1-word) designation is possible.

### (2) DMC50

Device name		Setting range	Device No. representation
Double-word device	Network Addresses (NA) <sup>*1</sup>	0000 to FFFF	Hexadecimal
	Parameter Addresses (PA) <sup>*1</sup>	00000 to FFFFF	Hexadecimal

\*1 Only 32-bit (2-word) designation is possible.

#### (a) Network Addresses (NA)

The following shows the network address settings and definitions.

Network Addresses	Definition
0000	Network Addresses

(b) Parameter Addresses (PA)

The following shows the parameter address settings and definitions.

Parameter Addresses	Definition
001	H/W Information
002	Date and Time Setup
021	AI Setup (High resolution type:standard inputs)
022	AI Setup (Special type)
023	AI Setup (High resolution type:option inputs)
041	AUX-IN Setup
045	AO Setup
061	DO Setup
071	TP Setup
0A1	ME20X Communication Setup
0A2	
0A3	
0C1	System Status
0C5	AI Alarm Log
0C3	Date and Time Display
0C4	System Alarm Log
0C6	AUX-IN Alarm Log
0E1	AI Status
0E2	AUX-IN Status
0E3	AO Status
0E5	DI Status
0E6	DO Status
0E7	TP Status
0E8	Zener Barrier Adjustment Counts
0F1	Present ME20X Communication Setup
0F2	
0F3	
103	Memory Usage Monitor
201	PID_A Options
202	PID_A Constants
203	PID_A Monitor
211	PID_CAS Options
212	PID_CAS Constants (master)
213	PID_CAS Constants (slave)
214	PID_CAS Monitor
234	Ra_PID Options
235	Ra_PID Constants
236	Ra_PID Monitor
241	UP_PID Options
242	UP_PID Constants
243	UP_PID Monitor
301	TBL/TBR Setup

(Continued to next page)

Parameter Addresses	Definition
C00	Pattern Setup
C01 to C63	Segment Setup
CF1	Pattern FB Monitor
801 to 9FF	Type label defined by the user

### ■ OMRON temperature controller (OMRON THERMAC/INPANEL NEO)

	Device name	Setting range	Device No. representation
Bit device	Status (S) <sup>*1</sup>	S0000 to S0031 S0100 to S0131	Decimal
Word device	Operation command (A) <sup>*2</sup>	A0000 to A000C	Hexadecimal
Double-word device	Variable area 0 (C0) <sup>*1*3</sup>	C00000 to C00006 C00100 to C00106	Decimal + Hexadecimal
	Variable area 1 (C1) <sup>*3</sup>	C10000 to C1001C C10100 to C1011C	
	Variable area 3 (C3) <sup>*3</sup>	C30000 to C3003E C30100 to C3013E	

\*1 Only reading is possible.

\*2 Only writing is possible.  
Numerical input cannot be used.  
Use a word switch for writing.

\*3 Only 32-bit (2-word) designation is possible.

### ■ SHINKO indicating controller (Shinko Technos Controller)

	Device name	Setting range	Device No. representation
Bit device	Bit-specified word device <sup>*1</sup>	Setting range of each word device	-
Word device	Data item (..)	..0001 to ..7901	Hexadecimal

\*1 As bit specification of a word device is performed after the GOT reads the value, do not change the value with the indicating controller during this period.

■ CHINO controller (CHINO Controllers)

Device name		Setting range	Device No. representation
Bit device	Digital parameter (0)	00001 to 09999	Decimal
	Digital input data (1) <sup>*1</sup>	10001 to 19999	
Word device	Analog input data (3) <sup>*1</sup>	30001 to 39999	Decimal
	Analog parameter (4)	40001 to 49999	

\*1 Only reading is possible.

## ■ FUJI temperature controller (FUJI PXR/PXG/PXH)

Device name		Setting range	Device No. representation
Bit device	Bit data (0)	00001 to 00001	Decimal
	Bit data (1) <sup>*1</sup>	10001 to 10016	
	Bit-specified word device	Setting range of each word device	-
Word device	Word data (3) <sup>*1</sup>	30001 to 31398	Decimal
	Word data (4)	40001 to 43776	

\*1 Only reading is possible.

## ■ YOKOGAWA temperature controller (YOKOGAWA GREEN/UT100/UT2000/UTAdvanced)

Device name		Setting range	Device No. representation
Bit device	Internal relay (I)	I0001 to I7072	Decimal
	Bit-specified word device <sup>*1</sup>	Setting range of each word device	-
Word device	Data register (D) <sup>*1</sup>	D0001 to D9000	Decimal
	File register (B) <sup>*1*2</sup>	B0001 to B1600	
	Word-specified bit devices	Setting range of each bit device	-

\*1 Only 16-bit (1-word) specification is possible.

\*2 Only UP750 and UP550 are available.

## ■ RKC temperature controller (RKC SR Mini HG)

Device name		Setting range	Device No. representation
Bit device	Bit-specified word device	Setting range of each word device	-
Word device	Data (..)	..0000 to ..FFFF	Hexadecimal

## ■ Inverter (FREQROL 500/700/800 series, Sensorless servo)



### Inverter data

For details of parameters, etc., refer to the following manual.

Manual of the inverter being used

Device name*4		Setting range	Device No. representation
Bit device	Inverter status monitor (RS)*3	RS0:0 to RS15:31 RS0:100 to RS15:115	Decimal
	Run command (WS)*5*6	WS0:0 to WS15:31 WS0:100 to WS15:115	
Word device	Alarm definition (A)*2*3	A0:0 to A7:31 A0:100 to A7:115	Decimal
	Parameter (Pr)*1*2	Pr0:0 to Pr1500:31 Pr0:100 to Pr1500:115	
	Programmed operation (PG)*1*2	PG0:0 to PG89:31 PG0:100 to PG89:115	
	Special parameter (SP)*2*5*6	SP108:0 to SP127:31 SP108:100 to SP127:115	

\*1 When creating the screen, designate only either of programmed operation (PG) device or parameter (Pr) device.

Do no designate both PG (PG0 to PG89) and Pr (Pr900 to Pr905) devices.

\*2 Only 16-bit (1-word) designation is possible.

\*3 Only reading is possible.

\*4 The GOT cannot read or write data from/to consecutive devices.

For details of \*5, \*6, refer to the following.

### \*5 Precautions for PU operation mode

When the GOT is connected to the PU connector and the operation mode is set to the PU operation mode, the multi-speed operation (W3 to W7, SP121, SP122) cannot be used.

For using the multi-speed operation, follow either of the operations as below.

- Connect the GOT to the RS-485 terminal and set the operation mode to the NET operation mode (Computer link operation mode), and then operate the inverter.
- Change the motor speed with the set frequency (SP109, SP110), and then operate the inverter with the forward or reverse rotation (WS1, WS2, SP121, SP122).

### \*6 Precautions for WS devices

- Only writing is possible for WS devices.

More than one WS cannot turn on at once. (Except the turned on WS device, the other WS devices turn off.)

The bits of SP122 (word device) are assigned to WS0 to WS7, and the bits of SP121 (word device) are assigned to WS8 to WS15.

When more than one WS turns on at once, convert the values for the bit devices that are assigned to the word device into values for the word device. Write the converted values into SP122 or SP121.

- Setting the High speed operation command (WS5), Middle speed operation command (WS4), and Low speed operation command (WS3)

When setting the above commands, write values to device SP122 as necessary.

As shown in the figure below, each operation mode is assigned to a bit of device SP122.

The following shows an example of setting the Forward rotation command (WS1) and Low speed operation command (WS3).



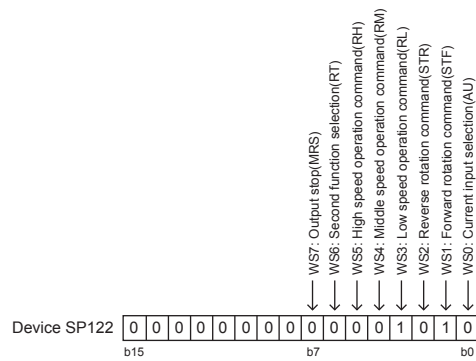

Write 1 to the bits of device SP122 that correspond to the Forward rotation command (WS1) and Low speed operation command (WS3).

In this example, device SP122 must store 000AH.

Convert 000AH to a decimal value (10), and then write 10 to device SP122.

- Setting the JOG operation command (WS8), Selection of automatic restart after instantaneous power failure command (WS9), Start self-holding selection command (WS10), and Reset command (WS11)

When setting the above commands, write values to device SP121 as necessary.

As shown in the figure below, each operation mode is assigned to a bit of device SP121.

The following shows an example of setting the Reset command (WS11).

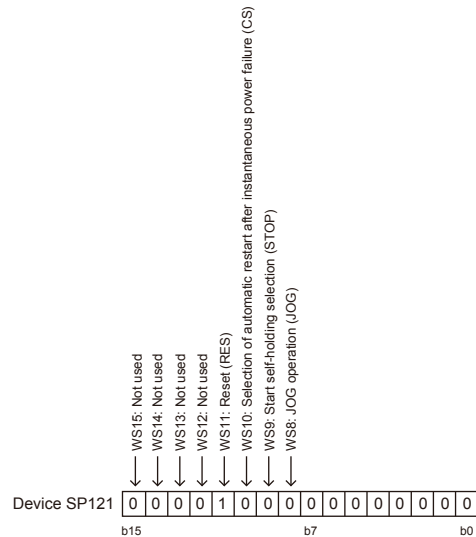

Write 1 to the bit of device SP121 that corresponds to the Reset command (WS11).

In this example, device SP121 must store 0800H.

Convert 0800H to a decimal value (2048), and then write 2048 to device SP121.

- When using a WS device, [Alternate] of a bit switch cannot be used. Use [Momentary], [Set], and [Reset] for bit switch actions.

The following shows correspondences between virtual inverter devices used in the GOT and data of the inverter.

**(1) Inverter status monitor**

The settable devices differ according to the inverter used.

For the settable devices of each inverter, refer to the following.

Manual of the inverter being used

Example) When using the FREQROL-A700 series

Device name	Description <sup>*1</sup>
RS0	Inverter running (RUN)
RS1	Forward rotation (STF)
RS2	Reverse rotation (STR)
RS3	Up to frequency (SU)
RS4	Overload (OL)
RS5	Instantaneous power failure (IPF)
RS6	Frequency detection (FU)
RS7	Alarm occurrence
RS8	-
RS9	-
RS10	-
RS11	-
RS12	-
RS13	-
RS14	-
RS15	Alarm occurrence

<sup>\*1</sup> The parameters may be changed for the inverter.  
To use the devices, check the parameters and set the parameters as required.

 Manual of the inverter being used

## (2) Run command

The settable devices differ according to the inverter used.

For the settable devices of each inverter, refer to the following.

 Manual of the inverter being used

Example) When using the FREQROL-A700 series

Device name	Description <sup>*1</sup>
WS0	Current input selection (AU)
WS1	Forward rotation (STF)
WS2	Reverse rotation (STR)
WS3	Low speed operation (RL) (Current input selection (AU) for FREQROL-F500 series)
WS4	Middle speed operation (RM)
WS5	High speed operation (RH)
WS6	Second function selection (RT)
WS7	Output stop (MRS)
WS8 <sup>*2</sup>	JOG operation (JOG)
WS9 <sup>*2</sup>	Selection of automatic restart after instantaneous power failure (CS)
WS10 <sup>*2</sup>	Start self-holding selection (STOP)
WS11 <sup>*2</sup>	Reset (RES)
WS12	-
WS13	-
WS14	-
WS15	-

<sup>\*1</sup> The parameters may be changed for the inverter.  
To use the devices, check the parameters and set the parameters as required.

 Manual of the inverter used

<sup>\*2</sup> Write a value to parameter Pr.185, Pr.186, Pr.188, or Pr.189 that corresponds to a signal within parentheses.  
Doing so issues the corresponding run command (WS8 to WS11).  
For the details of the inverter parameters, refer to the following.

 Manual of the inverter used

### (3) Alarm definition

Device name*1	Description
A0	Second alarm in past
A1	Latest alarm
A2	Fourth alarm in past
A3	Third alarm in past
A4	Sixth alarm in past
A5	Fifth alarm in past
A6	Eighth alarm in past
A7	Seventh alarm in past

\*1 Only reading is possible for A0 to A7.  
These devices cannot be used for a write object (numerical input etc.).

### (4) Parameters

The numbers of virtual devices for inverter (parameter (Pr)), used by GOT, correspond to the inverter parameter numbers.

For the inverter parameters, refer to the following.

 Manual of the inverter being used

## POINT

#### (1) Monitoring Pr.37

The GOT cannot monitor the parameter (Pr.37) of FREQROL-E500/S500(E)/F500J/D700/F700PJ/E700.

#### (2) When setting [8888] or [9999] to inverter parameter (Pr)

[8888] and [9999] designate special function.

To set these numbers from GOT, designate a number as shown below.

Setting at inverter	Value to be set at GOT
8888	65520
9999	65535

#### (3) Precautions for setting calibration parameter (Pr900 to Pr905)

When setting a calibration parameter (Pr900 to Pr905), it is necessary to set the value below for extension second parameter (SP108), depending on the device number to be used and the inverter model.

Value to be set to extension second parameter (SP108)	Description
H00	Offset / gain
H01	Analog
H02	Analog value at terminal

## (5) Program operation

The devices below correspond to the parameters (Pr.201 to Pr.230) of FREQROL-A500 series.

Device name	Description
PG0 to PG9	Program set 1 (running frequency)
PG10 to PG19 <sup>*1</sup>	Program set 1 (time)
PG20 to PG29	Program set 1 (rotation direction)
PG30 to PG39	Program set 2 (running frequency)
PG40 to PG49 <sup>*1</sup>	Program set 2 (time)
PG50 to PG59	Program set 2 (rotation direction)
PG60 to PG69	Program set 3 (running frequency)
PG70 to PG79 <sup>*1</sup>	Program set 3 (time)
PG80 to PG89	Program set 3 (rotation direction)

\*1 To set the start time (PG10 to PG19, PG40 to PG49, PG70 to PG79), set hour or minute in the upper 8 bits, and minute or second in the lower 8 bits.

Example) To set 13 hour 35 minute

Time to be set	13 H	35 M	Remark
Convert "hour" and "minute" into hexadecimal.	H0D	H23	HEX
Combine upper and lower 8-bit values.	Input H0D23 or 3363.		-

## (6) Special parameters

The numbers of inverter virtual devices (SP) used for the GOT correspond to instruction code of the inverter communication function.

For instruction details, and values to be read and written, refer to the following,

 Manual of the inverter used

Device name	Description	Instruction code	
		Read	Write
SP108	Second parameter changing	6CH	ECH
SP109 <sup>*1</sup>	Set frequency (RAM)	6DH	EDH
SP110 <sup>*1</sup>	Set frequency (RAM, E <sup>2</sup> PROM)	6EH	EEH
SP111 <sup>*1</sup>	Output frequency	6FH	-
SP112	Output current	70H	-
SP113	Output voltage	71H	-
SP114	Special monitor	72H	-
SP115	Special monitor selection No.	73H	F3H
SP116	Alarm definition all clear	-	F4H
	Latest alarm, second alarm in past	74H	-
SP117	Third alarm in past, fourth alarm in past	75H	-
SP118	Fifth alarm in past, sixth alarm in past	76H	-
SP119	Seventh alarm in past, eighth alarm in past	77H	-
SP121	Inverter status monitor (extended)	79H	F9H
	Run command (extend)		
SP122	Inverter status monitor	7AH	-
	Run command	-	FAH
SP123	Communication mode	7BH	FBH
SP124	All parameter clear	-	FBH
SP125	Inverter reset	-	FDH
SP127	Link parameter extended setting	7FH	FFH

- \*1 GOT cannot monitor SP109 to SP111 if the conditions below are satisfied at the same time.  
(Only FREQROL-E500/S500(E)/F500J/D700/F700PJ/E700 series)
  - Pr37 ≠ 0
  - SP127 = 1
- \*2 Only reading is possible for SP111 to SP114.  
These devices cannot be used for write objects (such as numerical input).
- \*3 Only writing is possible for SP124 and SP125.  
These devices cannot be used for read object.
- \*4 If the GOT is connected to the PU port of the FREQROL-A500/E500/F500 (excluding the FREQROL-F500J), the mode of the inverter is [External operation mode.] when the power is turned on.  
When changing parameters from the GOT, change the value of SP123 to "2" (PU operation mode) in advance.

## ■ Servo amplifier

### POINT

#### (1) Monitoring servo amplifier

Carefully read the manual of servo amplifier to be connected and fully understand the operating procedures before monitoring.

Before operation, check the parameter settings. Improper settings may cause some machines to perform unexpected operation.

The parameter settings must not be changed excessively. Operation will be insatiable.

#### (2) Parameters with \* in front of it's abbreviated name

For the parameter with \* in front of it's abbreviated name, powering off the servo amplifier after setting then on makes the parameter valid.

#### (3) Data length for setting virtual devices for servo amplifier

Set the following data length for setting devices.

- PRM, ST, AL, PA, PB, PC, PD, POS, SPD, ACT, DCT, DWL, AUX: 16 bits or 32 bits (depends on the data of servo amplifier)
- DI, DO, TMI, TMO, TMD: 32 bits

If the above data length was not set, data would not be set to the servo amplifier correctly or the GOT can not monitor normally.

##### (a) Monitoring

- When the 16-bit data is handled as 32-bit data, the upper 16 bits are displayed as 0.
- When the 32-bit data is handled as 16-bit data, the lower 16 bits only are displayed as 0.

##### (b) Writing

The GOT writes within the range of data length set. Note that the servo amplifier responds correctly while the written data is invalid in the servo amplifier side when the written data is outside the range of values which can be set by the servo amplifier.

#### (4) Memory area for writing parameters

Parameters are written to RAM or E<sup>2</sup>PROM of servo amplifier.

##### (a) When written to RAM

Remember that written parameters are cleared when power supply to the servo amplifier is turned off.

##### (b) When written to E<sup>2</sup>PROM

Written parameters are not cleared even when power supply to the servo amplifier is turned off. However, there are limits in the number of writing to E<sup>2</sup>PROM.

If the data is frequently updated (more than once in an hour), write the parameters to the RAM.

For details, refer to the manual of the servo amplifier used.



#### Data of servo amplifier

Refer to the following manual for parameters.

 Manual of the servo amplifier used

**(1) MELSERVO-J2M-P8A**

Device name*2		Setting range available	Device No. representation
Bit device	Servo amplifier request (SP)*3	SP1 to SP2	Decimal
	Operation mode selection (OM)*3	OM0 to OM4	
Word device	Basic parameter/expansion parameter (PRM)*1	PRM0 to PRM29 PRM1000 to PRM1029	Decimal
	Status display (ST)	ST0 to ST2	
	Alarm (AL)	AL0 AL11 to AL13 AL200 to AL205 AL210 to AL215 AL230 to AL235	
	External input (DI)	DI0 to DI2	
	External output (DO)	DO0 to DO1	
Double-word device	Forced output of signal pin (for test operation) (TMO)*3	TMO0	Decimal

- \*1 Use PRM0 to PRM29 when writing parameters to the servo amplifier RAM.  
PRM1000 to PRM1029 are used when writing parameters to E<sup>2</sup>PROM of the servo amplifier.
- \*2 The GOT cannot read or write data from/to consecutive devices.  
For details of \*3, refer to the following.

**\*3 Precautions for SP, OM, and TMO devices**

- (a) For bit devices  
Only writing is possible.  
[Alternate] of a bit switch cannot be used.  
Use [Momentary], [Set], and [Reset] for bit switch actions.
- (b) For word device and double-word device  
Only writing is possible.  
Numerical input cannot be used.  
Use a word switch for writing.
- Servo amplifier request

Device name	Item	Symbol
SP1	Current alarm clear	-
SP2	Alarm history clear	-

- Operation mode selection

Device name	Item	Symbol
OM0	Normal mode (not test operation mode)	-
OM4	Output signal (DO) forced output	-

- Basic parameter/expansion parameter

Device name	Item	Symbol*2
PRM0, PRM1000	Serial communication function selection, alarm history clear	*BPS
PRM1, PRM1001	Regenerative brake option selection	*REG
PRM2, PRM1002	Function selection 1	*OP1

(Continued to next page)

Device name	Item	Symbol* <sup>2</sup>
PRM3, PRM1003	Analog monitor 1 output	MD1
PRM4, PRM1004	Analog monitor 2 output	MD2
PRM5, PRM1005	Analog monitor 3 output	MD3
PRM6, PRM1006	Analog monitor 1 offset	MO1
PRM7, PRM1007	Analog monitor 2 offset	MO2
PRM8, PRM1008	Analog monitor 3 offset	MO3
PRM9, PRM1009	Function selection 2	*OP2
PRM10, PRM1010	Interface unit serial communication number selection	*ISN
PRM11, PRM1011	1slot serial communication station number selection	*DSN1
PRM12, PRM1012	2slot serial communication station number selection	*DSM2
PRM13, PRM1013	3slot serial communication station number selection	*DSM3
PRM14, PRM1014	4slot serial communication station number selection	*DSN4
PRM15, PRM1015	5slot serial communication station number selection	*DSN5
PRM16, PRM1016	6slot serial communication station number selection	*DSN6
PRM17, PRM1017	7slot serial communication station number selection	*DSN7
PRM18, PRM1018	8slot serial communication station number selection	*DSN8
PRM19, PRM1019	Parameter write inhibit	*BLK
PRM20, PRM1020	Serial communication time-out selection	SIC
PRM21 to PRM29, PRM1021 to PRM1029	For manufacturer setting	-

\*<sup>2</sup> For the parameters prefixed by an asterisk (\*), setting becomes effective when the power is turned off once and back on after setting the parameter data.

- Status display

Device name	Item	Symbol
ST0	Regenerative load ratio	-
ST1	Bus voltage	-
ST2	Peak bus voltage	-

- Alarm

Device name	Item	Symbol
AL0	Current alarm number	-
AL11	Servo status when alarm occurs regenerative load factor	-
AL12	Servo status when alarm occurs bus voltage	-
AL13	Servo status when alarm occurs peak bus voltage	-
AL200	Alarm number from alarm history most recent alarm	-
AL201	Alarm number from alarm history first alarm in past	-
AL202	Alarm number from alarm history second alarm in past	-
AL203	Alarm number from alarm history third alarm in past	-
AL204	Alarm number from alarm history fourth alarm in past	-
AL205	Alarm number from alarm history fifth alarm in past	-
AL210	Alarm occurrence time in alarm history most recent alarm	-
AL211	Alarm occurrence time in alarm history first alarm in past	-
AL212	Alarm occurrence time in alarm history second alarm in past	-
AL213	Alarm occurrence time in alarm history third alarm in past	-

(Continued to next page)

Device name	Item	Symbol
AL214	Alarm occurrence time in alarm history fourth alarm in past	-
AL215	Alarm occurrence time in alarm history fifth alarm in past	-
AL230	Detailed alarm from alarm history most recent alarm	-
AL231	Detailed alarm from alarm history first alarm in past	-
AL232	Detailed alarm from alarm history second alarm in past	-
AL233	Detailed alarm from alarm history third alarm in past	-
AL234	Detailed alarm from alarm history fourth alarm in past	-
AL235	Detailed alarm from alarm history fifth alarm in past	-

• External I/O signal

Device name	Item	Symbol
DI0	External input pin statuses CN1A/CN1B	-
DI1	External input pin statuses CN5	-
DI2	External input pin statuses CN4A/CN4B	-
DO0	External output pin statuses CN1A/CN1B	-
DO1	External output pin statuses CN4A/CN4B	-

• Forced output of signal pin (for test operation)

Device name	Item	Symbol
TMO0	Forced output of signal pin	-

## (2) MELSERVO-J2M-\*DU

Device name <sup>*2</sup>		Setting range	Device No. representation
Bit device	Servo amplifier request (SP) <sup>*3</sup>	SP0 to SP6	Decimal
	Operation mode selection (OM) <sup>*3</sup>	OM0 to OM4	
	Instruction demand (for test operation) (TMB) <sup>*3</sup>	TMB0 to TMB1	
Word device	Basic parameter/expansion parameter (PRM) <sup>*1</sup>	PRM0 to PRM84 PRM1000 to PRM1084	Decimal
	Status display (ST)	ST0 to ST10	
	Alarm (AL)	AL0 AL11 to AL21 AL200 to AL205 AL210 to AL215 AL230 to AL235	
Double-word device	Input signal for test operation (for test operation) (TMI) <sup>*3</sup>	TMI0	Decimal
	Forced output of signal pin (for test operation) (TMO) <sup>*3</sup>	TMO0	
	Set data (for test operation) (TMD) <sup>*3</sup>	TMD0 to TMD2	

\*1 Use PRM0 to PRM84 when writing parameters to the servo amplifier RAM.

PRM1000 to PRM1084 are used when writing parameters to E<sup>2</sup>PROM of the servo amplifier.

\*2 The GOT cannot read or write data from/to consecutive devices.

For details of \*3, refer to the following.



### \*3 Precautions for SP, OM, TMB, TMI, TMO, and TMD devices

- (a) For bit devices  
Only writing is possible.  
[Alternate] of a bit switch cannot be used.  
Use [Momentary], [Set], and [Reset] for bit switch actions.
- (b) For word device and double-word device  
Only writing is possible.  
Numerical input cannot be used.  
Use a word switch for writing.

The following shows correspondences between virtual devices for servo amplifier and data of the servo amplifier used with the GOT.

- Servo amplifier request

Device name	Item	Symbol
SP0	Status display data clear	-
SP1	Current alarm clear	-
SP2	Alarm history clear	-
SP3	External input signal prohibited	-
SP4	External output signal prohibited	-
SP5	External input signal resumed	-
SP6	External output signal resumed	-

- Operation mode selection

Device name	Item	Symbol
OM0	Normal mode (not test operation mode)	-
OM1	JOG operation	-
OM2	Positioning operation	-
OM3	Motorless operation	-
OM4	Output signal (DO) forced output	-

- Instruction demand (for test operation)

Device name	Item	Symbol
TMB0	Clears acceleration/deceleration time constant (test mode)	-
TMB1	Temporary stop command (test mode)	-

- Basic parameter/expansion parameter

Device name	Item	Symbol <sup>*1</sup>
PRM0, PRM1000	For manufacturer setting	-
PRM1, PRM1001	Function selection 1	*OP1
PRM2, PRM1002	Auto tuning	ATU
PRM3, PRM1003	CMX Electronic gear numerator (Command pulse multiplying factor numerator)	CMX
PRM4, PRM1004	Electronic gear denominator (Command pulse multiplying factor denominator)	CDV
PRM5, PRM1005	In-position range	INP
PRM6, PRM1006	Position loop gain 1	PG1
PRM7, PRM1007	Position command acceleration/deceleration time constant (position smoothing)	PST
PRM8 to PRM15, PRM1008 to PRM1015	For manufacturer setting	-
PRM16, PRM1016	Alarm history clear	*BPS

(Continued to next page)

Device name	Item	Symbol* <sup>1</sup>
PRM17 to PRM18, PRM1017 to PRM1018	For manufacturer setting	-
PRM19, PRM1019	DRU parameter block	*BLK
PRM20, PRM1020	Function selection 2	*OP2
PRM21, PRM1021	Function selection 3 (Command pulse selection)	*OP3
PRM22, PRM1022	Function selection 4	*OP4
PRM23, PRM1023	Feed forward gain	FFC
PRM24, PRM1024	Zero speed	ZSP
PRM25 to PRM26, PRM1025 to PRM1026	For manufacturer setting	-
PRM27, PRM1027	Encoder output pulses	*ENR
PRM28, PRM1028	Internal torque limit 1	TL1
PRM29 to PRM32, PRM1029 to PRM1032	For manufacturer setting	-
PRM33, PRM1033	Electromagnetic brake sequence output	MBR
PRM34, PRM1034	Ratio of load inertia moment to servo motor inertia moment	GD2
PRM35, PRM1035	Position loop gain 2	PG2
PRM36, PRM1036	Speed loop gain 1	VG1
PRM37, PRM1037	Speed loop gain 2	VG2
PRM38, PRM1038	Speed integral compensation	VIC
PRM39, PRM1039	Speed differential compensation	VDC
PRM40 to PRM41, PRM1040 to PRM1041	For manufacturer setting	-
PRM42, PRM1042	Input signal selection 1	*DI1
PRM43 to PRM50, PRM1043 to PRM1050	For manufacturer setting	-
PRM51, PRM1051	Function selection 6	*OP6
PRM52 to PRM53, PRM1052 to PRM1053	For manufacturer setting	-
PRM54, PRM1054	Function selection 9	*OP9
PRM55, PRM1055	Function selection A	*OPA
PRM56 to PRM57, PRM1056 to PRM1057	For manufacturer setting	-
PRM58, PRM1058	Machine resonance suppression filter 1	NH1
PRM59, PRM1059	Machine resonance suppression filter 2	NH2
PRM60, PRM1060	Low-pass filter, adaptive vibration suppression control	LPF
PRM61, PRM1061	Ratio of load inertia moment to servo motor inertia moment 2	GD2B
PRM62, PRM1062	Position control gain 2 changing ratio	PG2B
PRM63, PRM1063	Speed control gain 2 changing ratio	VG2B
PRM64, PRM1064	Speed integral compensation changing ratio	VICB
PRM65, PRM1065	Gain changing selection	*CDP
PRM66, PRM1066	Gain changing condition	CDS
PRM67, PRM1067	Gain changing time constant	CDT
PRM68, PRM1068	For manufacturer setting	-
PRM69, PRM1069	Command pulse multiplying factor numerator 2	CMX2
PRM70, PRM1070	Command pulse multiplying factor numerator 3	CMX3
PRM71, PRM1071	Command pulse multiplying factor numerator 4	CMX4
PRM72 to PRM75, PRM1072 to PRM1075	For manufacturer setting	-
PRM76, PRM1076	Internal torque limit 2	TL2
PRM77 to PRM84, PRM1077 to PRM1084	For manufacturer setting	-

\*1 For the parameters prefixed by an asterisk (\*), setting becomes effective when the power is turned off once and back on after setting the parameter data.

- Status display

Device name	Item	Symbol
ST0	Cumulative feedback pulses	-
ST1	Servo motor speed	-
ST2	Droop pulses	-
ST3	Cumulative command pulses	-
ST4	Command pulse frequency	-
ST5	Effective load ratio	-
ST6	Peak load ratio	-
ST7	Instantaneous torque	-
ST8	Within one-revolution position	-
ST9	ABS counter	-
ST10	Load inertia moment ratio	-

- Alarm

Device name	Item	Symbol
AL0	Current alarm number	-
AL11	Servo status when alarm occurs cumulative feedback pulses	-
AL12	Servo status when alarm occurs servo motor speed	-
AL13	Servo status when alarm occurs droop pulses	-
AL14	Servo status when alarm occurs cumulative command pulses	-
AL15	Servo status when alarm occurs command pulse frequency	-
AL16	Servo status when alarm occurs effective load ratio	-
AL17	Servo status when alarm occurs peak load ratio	-
AL18	Servo status when alarm occurs instantaneous torque	-
AL19	Servo status when alarm occurs within one-revolution position	-
AL20	Servo status when alarm occurs ABS counter	-
AL21	Servo status when alarm occurs load inertia moment ratio	-
AL200	Alarm number from alarm history most recent alarm	-
AL201	Alarm number from alarm history first alarm in past	-
AL202	Alarm number from alarm history second alarm in past	-
AL203	Alarm number from alarm history third alarm in past	-
AL204	Alarm number from alarm history fourth alarm in past	-
AL205	Alarm number from alarm history fifth alarm in past	-
AL210	Alarm occurrence time in alarm history most recent alarm	-
AL211	Alarm occurrence time in alarm history first alarm in past	-
AL212	Alarm occurrence time in alarm history second alarm in past	-
AL213	Alarm occurrence time in alarm history third alarm in past	-
AL214	Alarm occurrence time in alarm history fourth alarm in past	-
AL215	Alarm occurrence time in alarm history fifth alarm in past	-
AL230	Detailed alarm from alarm history most recent alarm	-
AL231	Detailed alarm from alarm history first alarm in past	-
AL232	Detailed alarm from alarm history second alarm in past	-
AL233	Detailed alarm from alarm history third alarm in past	-
AL234	Detailed alarm from alarm history fourth alarm in past	-
AL235	Detailed alarm from alarm history fifth alarm in past	-

- Input signal for test operation (for test operation)

Device name	Item	Symbol
TMI0	Input signal for test operation	-

- Forced output of signal pin (for test operation)

Device name	Item	Symbol
TMO0	Forced output of signal pin	-

- Set data (for test operation)

Device name	Item	Symbol
TMD0	Writes the speed (test mode)	-
TMD1	Writes the acceleration/deceleration time constant (test mode)	-
TMD2	Writes the moving distance in pulses (test mode)	-

### (3) MELSERVO-J2S-\*A

Device name <sup>*2</sup>		Setting range	Device No. representation
Bit device	Servo amplifier request (SP) <sup>*3</sup>	SP0 to SP6	Decimal
	Operation mode selection (OM) <sup>*3</sup>	OM0 to OM4	
	Instruction demand (for test operation) (TMB) <sup>*3</sup>	TMB0 to TMB1	
Word device	Basic parameter/expansion parameter (PRM) <sup>*1</sup>	PRM0 to PRM84 PRM1000 to PRM1084	Decimal
	Status display (ST)	ST0 to ST14	
	Alarm (AL)	AL0 to AL1 AL11 to AL25 AL200 to AL205 AL210 to AL215 AL230 to AL235	
	External input (DI)	DI0	
	External output (DO)	DO0	
	Double-word device	Input signal for test operation (for test operation) (TMI) <sup>*3</sup>	
Forced output of signal pin (for test operation) (TMO) <sup>*3</sup>	TMO0		
Set data (for test operation) (TMD) <sup>*3</sup>	TMD0 to TMD2		

- \*1 Use PRM0 to PRM84 when writing parameters to the servo amplifier RAM.  
PRM1000 to PRM1084 are used when writing parameters to E<sup>2</sup>PROM of the servo amplifier.
- \*2 The GOT cannot read or write data from/to consecutive devices.  
For details of \*3, refer to the following.

#### **\*3 Precautions for SP, OM, TMB, TMI, TMO, and TMD devices**

- (a) For bit devices  
Only writing is possible.  
[Altmate] of a bit switch cannot be used.  
Use [Momentary], [Set], and [Reset] for bit switch actions.
- (b) For word device and double-word device  
Only writing is possible.  
Numerical input cannot be used.  
Use a word switch for writing.

The following shows correspondences between virtual devices for servo amplifier and data of the servo amplifier used with the GOT.

- Servo amplifier request

Device name	Item	Symbol
SP0	Status display data clear	-
SP1	Current alarm clear	-
SP2	Alarm history clear	-
SP3	External input signal prohibited	-
SP4	External output signal prohibited	-
SP5	External input signal resumed	-
SP6	External output signal resumed	-

- Operation mode selection

Device name	Item	Symbol
OM0	Normal mode (not test operation mode)	-
OM1	JOG operation	-
OM2	Positioning operation	-
OM3	Motorless operation	-
OM4	Output signal (DO) forced output	-

- Instruction demand (for test operation)

Device name	Item	Symbol
TMB0	Clears the acceleration/deceleration time constant	-
TMB1	Temporary stop command	-

- Basic parameter/expansion parameter

Device name	Item	Symbol <sup>*1</sup>
PRM0, PRM1000	Control mode, regenerative brake option selection	*STY
PRM1, PRM1001	Function selection 1	*OP1
PRM2, PRM1002	Auto tuning	ATU
PRM3, PRM1003	Electronic gear numerator	CMX
PRM4, PRM1004	Electronic gear denominator	CDV
PRM5, PRM1005	In-position range	INP
PRM6, PRM1006	Position loop gain 1	PG1
PRM7, PRM1007	Position command acceleration/deceleration time constant	PST
PRM8, PRM1008	Internal speed command1/limit1	SC1
PRM9, PRM1009	Internal speed command2/limit2	SC2
PRM10, PRM1010	Internal speed command3/limit3	SC3
PRM11, PRM1011	Acceleration time constant	STA
PRM12, PRM1012	Deceleration time constant	STB
PRM13, PRM1013	S-pattern acceleration/deceleration time constant	STC
PRM14, PRM1014	Torque command time constant	TQC
PRM15, PRM1015	Station number setting	*SNO
PRM16, PRM1016	Serial communication function selection, alarm history clear	*BPS
PRM17, PRM1017	Analog monitor output	MOD
PRM18, PRM1018	Status display selection	*DMD
PRM19, PRM1019	Parameter block	*BLK
PRM20, PRM1020	Function selection 2	*OP2
PRM21, PRM1021	Function selection 3 (Command pulse selection)	*OP3
PRM22, PRM1022	Function selection 4	*OP4
PRM23, PRM1023	Feed forward gain	FFC
PRM24, PRM1024	Zero speed	ZSP
PRM25, PRM1025	Analog speed command maximum speed/limit maximum speed	VCM
PRM26, PRM1026	Analog torque command maximum output	TLC
PRM27, PRM1027	Encoder output pulses	*ENR

(Continued to next page)

Device name	Item	Symbol *1
PRM28, PRM1028	Internal torque limit 1	TL1
PRM29, PRM1029	Analog speed command offset/limit offset	VCO
PRM30, PRM1030	Analog torque command offset/limit offset	TLO
PRM31, PRM1031	Analog monitor 1 offset	MO1
PRM32, PRM1032	Analog monitor 2 offset	MO2
PRM33, PRM1033	Electromagnetic brake sequence output	MBR
PRM34, PRM1034	Ratio of load inertia moment to servo motor inertia moment	GD2
PRM35, PRM1035	Position loop gain 2	PG2
PRM36, PRM1036	Speed loop gain 1	VG1
PRM37, PRM1037	Speed loop gain 2	VG2
PRM38, PRM1038	Speed integral compensation	VIC
PRM39, PRM1039	Speed differential compensation	VDC
PRM40, PRM1040	For manufacturer setting	-
PRM41, PRM1041	Input signal automatic ON selection	*DIA
PRM42, PRM1042	Input signal selection 1	*DI1
PRM43, PRM1043	Input signal selection 2 (CN1B-5)	*DI2
PRM44, PRM1044	Input signal selection 3 (CN1B-14)	*DI3
PRM45, PRM1045	Input signal selection 4 (CN1A-8)	*DI4
PRM46, PRM1046	Input signal selection 5 (CN1B-7)	*DI5
PRM47, PRM1047	Input signal selection 6 (CN1B-8)	*DI6
PRM48, PRM1048	Input signal selection 7 (CN1B-9)	*DI7
PRM49, PRM1049	Output signal selection 1	*DO1
PRM50, PRM1050	For manufacturer setting	-
PRM51, PRM1051	Function selection 6	*OP6
PRM52, PRM1052	For manufacturer setting	-
PRM53, PRM1053	Function selection 8	*OP8
PRM54, PRM1054	Function selection 9	*OP9
PRM55, PRM1055	Function selection A	*OPA
PRM56, PRM1056	Serial communication time-out selection	SIC
PRM57, PRM1057	For manufacturer setting	-
PRM58, PRM1058	Machine resonance suppression filter 1	NH1
PRM59, PRM1059	Machine resonance suppression filter 2	NH2
PRM60, PRM1060	Low-pass filter, adaptive vibration suppression control	LPF
PRM61, PRM1061	Ratio of load inertia moment to servo motor inertia moment 2	GD2B
PRM62, PRM1062	Position control gain 2 changing ratio	PG2B
PRM63, PRM1063	Speed control gain 2 changing ratio	VG2B
PRM64, PRM1064	Speed integral compensation changing ratio	VICB
PRM65, PRM1065	Gain changing selection	*CDP
PRM66, PRM1066	Gain changing condition	CDS
PRM67, PRM1067	Gain changing time constant	CDT
PRM68, PRM1068	For manufacturer setting	-
PRM69, PRM1069	Command pulse multiplying factor numerator 2	CMX2
PRM70, PRM1070	Command pulse multiplying factor numerator 3	CMX3

(Continued to next page)

Device name	Item	Symbol <sup>*1</sup>
PRM71, PRM1071	Command pulse multiplying factor numerator 4	CMX4
PRM72, PRM1072	Internal speed command4/limit4	SC4
PRM73, PRM1073	Internal speed command5/limit5	SC5
PRM74, PRM1074	Internal speed command6/limit6	SC6
PRM75, PRM1075	Internal speed command7/limit7	SC7
PRM76, PRM1076	Internal torque limit 2	TL2
PRM77 to PRM84, PRM1077 to PRM1084	For manufacturer setting	-

\*1 For the parameters prefixed by an asterisk (\*), setting becomes effective when the power is turned off once and back on after setting the parameter data.

- Status display

Device name	Item	Symbol
ST0	Cumulative feedback pulses	-
ST1	Servo motor speed	-
ST2	Droop pulses	-
ST3	Cumulative command pulses	-
ST4	Command pulse frequency	-
ST5	Analog speed command voltage/limit voltage	-
ST6	Analog torque command voltage/limit voltage	-
ST7	Regenerative load ratio	-
ST8	Effective load ratio	-
ST9	Peak load ratio	-
ST10	Instantaneous torque	-
ST11	Within one-revolution position	-
ST12	ABS counter	-
ST13	Load inertia moment ratio	-
ST14	Bus voltage	-

- Alarm

Device name	Item	Symbol
AL0	Current alarm number	-
AL1	Detailed data of current alarms	-
AL11	Servo status when alarm occurs cumulative feedback pulses	-
AL12	Servo status when alarm occurs servo monitor speed	-
AL13	Servo status when alarm occurs droop pulses	-
AL14	Servo status when alarm occurs cumulative command pulses	-
AL15	Servo status when alarm occurs command pulse frequency	-
AL16	Servo status when alarm occurs analog speed command voltage/limit voltage	-
AL17	Servo status when alarm occurs analog torque command voltage/limit voltage	-
AL18	Servo status when alarm occurs regenerative load ratio	-
AL19	Servo status when alarm occurs effective load ratio	-
AL20	Servo status when alarm occurs peak load ratio	-
AL21	Servo status when alarm occurs instantaneous torque	-
AL22	Servo status when alarm occurs within one-revolution position	-

(Continued to next page)



Device name	Item	Symbol
AL23	Load inertia moment ratio ABS counter	-
AL24	Servo status when alarm occurs load inertia moment ratio	-
AL25	Servo status when alarm occurs bus voltage	-
AL200	Alarm number from alarm history most recent alarm	-
AL201	Alarm number from alarm history first alarm in past	-
AL202	Alarm number from alarm history second alarm in past	-
AL203	Alarm number from alarm history third alarm in past	-
AL204	Alarm number from alarm history fourth alarm in past	-
AL205	Alarm number from alarm history fifth alarm in past	-
AL210	Alarm occurrence time in alarm history most recent alarm	-
AL211	Alarm occurrence time in alarm history first alarm in past	-
AL212	Alarm occurrence time in alarm history second alarm in past	-
AL213	Alarm occurrence time in alarm history third alarm in past	-
AL214	Alarm occurrence time in alarm history fourth alarm in past	-
AL215	Alarm occurrence time in alarm history fifth alarm in past	-
AL230	Detailed alarm from alarm history most recent alarm	-
AL231	Detailed alarm from alarm history first alarm in past	-
AL232	Detailed alarm from alarm history second alarm in past	-
AL233	Detailed alarm from alarm history third alarm in past	-
AL234	Detailed alarm from alarm history fourth alarm in past	-
AL235	Detailed alarm from alarm history fifth alarm in past	-

- External I/O signal

Device name	Item	Symbol
DI0	External input pin statuses	-
DO0	External output pin statuses	-

- Input signal for test operation (for test operation)

Device name	Item	Symbol
TMIO	Input signal status for test operation	-

- Forced output of signal pin (for test operation)

Device name	Item	Symbol
TMO0	Forced output status of signal pin	-

- Set data (for test operation)

Device name	Item	Symbol
TMD0	Writes the speed (test mode)	-
TMD1	Writes the acceleration/deceleration time constant (test mode)	-
TMD2	Writes the moving distance in pulses (test mode)	-

**(4) MELSERVO-J2S-\*CP**

Device name*3		Setting range	Device No. representation
Bit device	Servo amplifier request (SP)*5	SP0 to SP6	Decimal
	Operation mode selection (OM)*5	OM0 to OM4	
	Instruction demand (for test operation) (TMB)*5	TMB0 to TMB1	
Word device	Basic parameter/expansion parameter (PRM)*1	PRM0 to PRM90 PRM1000 to PRM1090	Decimal
	Status display (ST)	ST0 to ST16	
	Alarm (AL)	AL0 to AL1 AL11 to AL27 AL200 to AL205 AL210 to AL215 AL230 to AL235	
	External input (DI)*4	DI0 to DI2	
	External output (DO)	DO0 to DO1	
	Point table (position) (POS)*2	POS1 to POS31 POS1001 to POS1031	
	Point table (speed) (SPD)*2	SPD1 to SPD31 SPD1001 to SPD1031	
	Point table (acceleration time constant) (ACT)*2	ACT1 to ACT31 ACT1001 to ACT1031	
	Point table (deceleration time constant) (DCT)*2	DCT1 to DCT31 DCT1001 to DCT1031	
	Point table (dwell) (DWL)*2	DWL1 to DWL31 DWL1001 to DWL1031	
	Point table (auxiliary function) (AUX)*2	AUX1 to AUX31 AUX1001 to AUX1031	
Double-word device	Input signal for test operation (for test operation) (TMI)*5	TMI0	Decimal
	Forced output of signal pin (for test operation) (TMO)*5	TMO0	
	Set data (for test operation) (TMD)*5	TMD0 to TMD2	

- \*1 Use PRM0 to PRM90 when writing parameters to the servo amplifier RAM.  
PRM1000 to PRM1090 are used when writing parameters to E<sup>2</sup>PROM of the servo amplifier.
- \*2 When writing to a point table, use the area of 1001 to 1031 (E<sup>2</sup>PROM area) of POS, SPD, ACT, DCT, DWL, or AUX.  
If writing to the area of 1 to 31 (RAM area) of POS, SPD, ACT, DCT, DWL, or AUX, the value is not reflected.
- \*3 The GOT cannot read or write data from/to consecutive devices.
- \*4 Only reading is available for DI0 to DI1.  
For details of \*5, refer to the following.

**\*5 Precautions for SP, OM, TMB, TMI, TMO, and TMD devices**

- (a) For bit devices  
Only writing is possible.  
[Altimate] of a bit switch cannot be used.  
Use [Momentary], [Set], and [Reset] for bit switch actions.
- (b) For word device and double-word device  
Only writing is possible.  
Numerical input cannot be used.  
Use a word switch for writing.

The following shows correspondences between virtual devices for servo amplifier and data of the servo amplifier used with the GOT.

- Servo amplifier request

Device name	Item	Symbol
SP0	Status display data clear	-
SP1	Current alarm clear	-
SP2	Alarm history clear	-
SP3	External input signal prohibited	-
SP4	External output signal prohibited	-
SP5	External input signal resumed	-
SP6	External output signal resumed	-

- Operation mode selection

Device name	Item	Symbol
OM0	Normal mode (not test operation mode)	-
OM1	JOG operation	-
OM2	Positioning operation	-
OM3	Motorless operation	-
OM4	Output signal (DO) forced output	-

- Instruction demand (for test operation)

Device name	Item	Symbol
TMB0	Clears the acceleration/deceleration time constant	-
TMB1	Temporary stop command	-

- Basic parameter/expansion parameter

Device name	Item	Symbol*1
PRM0, PRM1000	Command system/regenerative brake option selection	*STY
PRM1, PRM1001	Feeding function selection	*FTY
PRM2, PRM1002	Function selection 1	*OP1
PRM3, PRM1003	Auto tuning	ATU
PRM4, PRM1004	Electronic gear numerator	*CMX
PRM5, PRM1005	Electronic gear denominator	*CDV
PRM6, PRM1006	In-position range	INP
PRM7, PRM1007	Position loop gain 1	PG1
PRM8, PRM1008	Home position return type	*ZTY
PRM9, PRM1009	Home position return speed	ZRF
PRM10, PRM1010	Creep speed	CRF
PRM11, PRM1011	Home position shift distance	ZST
PRM12, PRM1012	Rough match output range	CRP
PRM13, PRM1013	Jog speed	JOG
PRM14, PRM1014	S-pattern acceleration/deceleration time constant	*STC
PRM15, PRM1015	Station number setting	*SNO

(Continued to next page)

Device name	Item	Symbol*1
PRM16, PRM1016	Serial communication function selection, alarm history clear	*BPS
PRM17, PRM1017	Analog monitor output	MOD
PRM18, PRM1018	Status display selection	*DMD
PRM19, PRM1019	Parameter block	*BLK
PRM20, PRM1020	Function selection 2	*OP2
PRM21, PRM1021	For manufacturer setting	-
PRM22, PRM1022	Function selection 4	*OP4
PRM23, PRM1023	Serial communication time-out selection	SIC
PRM24, PRM1024	Feed forward gain	FFC
PRM25, PRM1025	Override offset	VCO
PRM26, PRM1026	Torque limit offset	TLO
PRM27, PRM1027	Encoder output pulses	*ENR
PRM28, PRM1028	Internal torque limit 1	TL1
PRM29, PRM1029	Internal torque limit 2	TL2
PRM30, PRM1030	Backlash compensation	*BKC
PRM31, PRM1031	Analog monitor 1 offset	MO1
PRM32, PRM1032	Analog monitor 2 offset	MO2
PRM33, PRM1033	Electromagnetic brake sequence output	MBR
PRM34, PRM1034	Ration of load inertia moment to servo motor inertia moment	GD2
PRM35, PRM1035	Position control gain 2	PG2
PRM36, PRM1036	Speed control gain 1	VG1
PRM37, PRM1037	Speed control gain 2	VG2
PRM38, PRM1038	Speed integral compensation	VIC
PRM39, PRM1039	Speed differential compensation	VDC
PRM40 to PRM41, PRM1040 to PRM1041	For manufacturer setting	-
PRM42, PRM1042	Home position return position data	*ZPS
PRM43, PRM1043	Moving distance after proximity dog	DCT
PRM44, PRM1044	Stopper type home position return stopper time	ZTM
PRM45, PRM1045	Stopper type home position return torque limit value	ZTT
PRM46, PRM1046	Software limit +	*LMP
PRM47, PRM1047		
PRM48, PRM1048	Software limit -	*LMN
PRM49, PRM1049		
PRM50, PRM1050	Position range output address +	*LPP
PRM51, PRM1051		
PRM52, PRM1052	Position range output address -	*LNP
PRM53, PRM1053		
PRM54, PRM1054	For manufacturer setting	-
PRM55, PRM1055	Function selection 6	*OP6
PRM56, PRM1056	For manufacturer setting	-
PRM57, PRM1057	Function selection 8	*OP8
PRM58, PRM1058	Function selection 9	*OP9
PRM59, PRM1059	Function selection A	*OPA
PRM60, PRM1060	For manufacturer setting	-

(Continued to next page)

Device name	Item	Symbol*1
PRM61, PRM1061	Machine resonance suppression filter 1	NH1
PRM62, PRM1062	Machine resonance suppression filter 2	NH2
PRM63, PRM1063	Low-pass filter/adaptive vibration suppression control	LPF
PRM64, PRM1064	Ratio of load inertia moment to servo motor inertia moment 2	GD2B
PRM65, PRM1065	Position control gain 2 changing ratio	PG2B
PRM66, PRM1066	Speed control gain 2 changing ratio	VG2B
PRM67, PRM1067	Speed integral compensation changing ratio	VICB
PRM68, PRM1068	Gain changing selection	*CDP
PRM69, PRM1069	Gain changing condition	CDS
PRM70, PRM1070	Gain changing time constant	CDT
PRM71 to PRM90, PRM1071 to PRM1090	For manufacturer setting	-

\*1 For the parameters prefixed by an asterisk (\*), setting becomes effective when the power is turned off once and back on after setting the parameter data.

- Status display

Device name	Item	Symbol
ST0	Current position	-
ST1	Command position	-
ST2	Command remaining distance	-
ST3	Point table No.	-
ST4	Cumulative feedback pulses	-
ST5	Servo motor speed	-
ST6	Droop pulses	-
ST7	Override	-
ST8	Torque limit voltage	-
ST9	Regenerative load ratio	-
ST10	Effective load ratio	-
ST11	Peak load ratio	-
ST12	Instantaneous torque	-
ST13	Within one-revolution position	-
ST14	ABS counter	-
ST15	Load inertia moment ratio	-
ST16	Bus voltage	-

- Alarm

Device name	Item	Symbol
AL0	Current alarm number	-
AL1	Detailed data of current alarms	-
AL11	Servo status when alarm occurs current position	-
AL12	Servo status when alarm occurs command position	-
AL13	Servo status when alarm occurs command remaining distance	-
AL14	Servo status when alarm occurs point table No.	-
AL15	Servo status when alarm occurs cumulative feedback pulses	-
AL16	Servo status when alarm occurs servo motor speed	-
AL17	Servo status when alarm occurs droop pulses	-

(Continued to next page)

Device name	Item	Symbol
AL18	Current alarm number	-
AL19	Detailed data of current alarms	-
AL20	Servo status when alarm occurs current position	-
AL21	Servo status when alarm occurs command position	-
AL22	Servo status when alarm occurs command remaining distance	-
AL23	Servo status when alarm occurs point table No.	-
AL24	Servo status when alarm occurs cumulative feedback pulses	-
AL25	Servo status when alarm occurs servo motor speed	-
AL26	Servo status when alarm occurs droop pulses	-
AL27	Current alarm number	-
AL200	Detailed data of current alarms	-
AL201	Servo status when alarm occurs current position	-
AL202	Servo status when alarm occurs command position	-
AL203	Servo status when alarm occurs command remaining distance	-
AL204	Alarm number from alarm history fourth alarm in past	-
AL205	Alarm number from alarm history fifth alarm in past	-
AL210	Alarm occurrence time in alarm history most recent alarm	-
AL211	Alarm occurrence time in alarm history first alarm in past	-
AL212	Alarm occurrence time in alarm history second alarm in past	-
AL213	Alarm occurrence time in alarm history third alarm in past	-
AL214	Alarm occurrence time in alarm history fourth alarm in past	-
AL215	Alarm occurrence time in alarm history fifth alarm in past	-
AL230	Detailed alarm from alarm history most recent alarm	-
AL231	Detailed alarm from alarm history first alarm in past	-
AL232	Detailed alarm from alarm history second alarm in past	-
AL233	Detailed alarm from alarm history third alarm in past	-
AL234	Detailed alarm from alarm history fourth alarm in past	-
AL235	Detailed alarm from alarm history fifth alarm in past	-

- External I/O signal

Device name	Item	Symbol
DI0	Input device statuses	-
DI1	External input pin statuses	-
DI2	Statuses of input devices switched on through communication	-
DO0	Output device statuses	-
DO1	External output pin statuses	-

- Point table (position)

Device name	Item	Symbol
POS1 to POS31, POS1001 to POS1031	Point table (position) No. 1 to No. 31	-
SPD1 to SPD31, SPD1001 to SPD1031	Point table (speed) No. 1 to No. 31	-
ACT1 to ACT31, ACT1001 to ACT1031	Point table (acceleration time constant) No. 1 to No. 31	-
DCT1 to DCT31, DCT1001 to DCT1031	Point table (deceleration time constant) No. 1 to No. 31	-
DWL1 to DWL31, DWL1001 to DWL1031	Point table (dwell) No. 1 to No. 31	-
AUX1 to AUX31, AUX1001 to AUX1031	Point table (auxiliary function) No. 1 to No. 31	-

- Input signal for test operation (for test operation)

Device name	Item	Symbol
TMI0	Input signal for test operation	-

- Forced output of signal pin (for test operation)

Device name	Item	Symbol
TMO0	Forced output of signal pin	-

- Set data (for test operation)

Device name	Item	Symbol
TMD0	Writes the speed (test mode)	-
TMD1	Writes the acceleration/deceleration time constant (test mode)	-
TMD2	Writes the moving distance in pulses (test mode)	-

**(5) MELSERVO-J2S-\*CL**

Device name*2		Setting range	Device No. representation
Bit device	Servo amplifier request (SP)*5	SP0 to SP6	Decimal
	Operation mode selection (OM)*5	OM0 to OM4	
	Instruction demand (for test operation) (TMB)*5	TMB0 to TMB1	
Word device	Basic parameter/expansion parameter (PRM)*1	PRM0 to PRM90 PRM1000 to PRM1090	Decimal
	Status display (ST)	ST0 to ST17	
	Alarm (AL)	AL0 to AL1 AL11 to AL28 AL200 to AL205 AL210 to AL215 AL230 to AL235	
	External input (DI)*4	DI0 to DI2	
	External output (DO)	DO0 to DO1	
	Current position latch data (LD)	LD1	
Double-word device	The value of the general-purpose register (Rx) (RR)*3	RR1 to RR4 RR1001 to RR1004	Decimal
	The value of the general-purpose register (Dx) (RD)	RD1 to RD4	
	Input signal for test operation (for test operation) (TMI)*5	TMI0	
	Forced output of signal pin (for test operation) (TMO)*5	TMO0	
	Set data (for test operation) (TMD)*5	TMD0 to TMD2	

- \*1 PRM0 to PRM90 are used when writing parameters to the servo amplifier RAM.  
PRM1000 to PRM1090 are used when writing parameters to E2PROM with the servo amplifier.
- \*2 The GOT cannot read or write data from/to consecutive devices.
- \*3 Use the integer number when writing parameters to Rx.
- \*4 Only reading is available for DI0 to DI1.  
For details of \*5, refer to the following.

**\*5 Precautions for SP, OM, TMB, TMI, TMO, and TMD devices**

- (a) For bit devices  
Only writing is possible.  
[Alternate] of a bit switch cannot be used.  
Use [Bit], [Set], and [Reset] for bit switch actions.
- (b) For word device and double-word device  
Only writing is possible.  
Numerical input cannot be used.  
Use a word switch for writing.



The following shows correspondences between virtual devices for servo amplifier and data of the servo amplifier used with the GOT.

- Servo amplifier request

Device name	Item	Symbol
SP0	Status display data clear	-
SP1	Current alarm clear	-
SP2	Alarm history clear	-
SP3	External input signal prohibited	-
SP4	External output signal prohibited	-
SP5	External input signal resumed	-
SP6	External output signal resumed	-

- Operation mode selection

Device name	Item	Symbol
OM0	Normal mode (not test operation mode)	-
OM1	JOG operation	-
OM2	Positioning operation	-
OM3	Motorless operation	-
OM4	Output signal (DO) forced output	-

- Instruction demand (for test operation)

Device name	Item	Symbol
TMB0	Clears the acceleration/deceleration time constant	-
TMB1	Temporary stop command	-

- Basic parameter/expansion parameter

Device name	Item	Symbol <sup>*1</sup>
PRM0, PRM1000	Command system/regenerative brake option selection	*STY
PRM1, PRM1001	Feeding function selection	*FTY
PRM2, PRM1002	Function selection 1	*OP1
PRM3, PRM1003	Auto tuning	ATU
PRM4, PRM1004	Electronic gear numerator	*CMX
PRM5, PRM1005	Electronic gear denominator	*CDV
PRM6, PRM1006	In-position range	INP
PRM7, PRM1007	Position loop gain 1	PG1
PRM8, PRM1008	Home position return type	*ZTY
PRM9, PRM1009	Home position return speed	ZRF
PRM10, PRM1010	Creep speed	CRF
PRM11, PRM1011	Home position shift distance	ZST
PRM12, PRM1012	For manufacturer setting	-
PRM13, PRM1013	Jog speed	JOG
PRM14, PRM1014	S-pattern acceleration/deceleration time constant	*STC
PRM15, PRM1015	Station number setting	*SNO

(Continued to next page)

Device name	Item	Symbol <sup>*1</sup>
PRM16, PRM1016	Serial communication function selection, alarm history clear	*BPS
PRM17, PRM1017	Analog monitor output	MOD
PRM18, PRM1018	Status display selection	*DMD
PRM19, PRM1019	Parameter block	*BLK
PRM20, PRM1020	Function selection 2	*OP2
PRM21, PRM1021	For manufacturer setting	-
PRM22, PRM1022	Function selection 4	*OP4
PRM23, PRM1023	Serial communication time-out selection	SIC
PRM24, PRM1024	Feed forward gain	FFC
PRM25, PRM1025	Override offset	VCO
PRM26, PRM1026	Torque limit offset	TLO
PRM27, PRM1027	Encoder output pulses	*ENR
PRM28, PRM1028	Internal torque limit 1	TL1
PRM29, PRM1029	Internal torque limit 2	TL2
PRM30, PRM1030	Backlash compensation	*BKC
PRM31, PRM1031	Analog monitor 1 offset	MO1
PRM32, PRM1032	Analog monitor 2 offset	MO2
PRM33, PRM1033	Electromagnetic brake sequence output	MBR
PRM34, PRM1034	Ration of load inertia moment to servo motor inertia moment	GD2
PRM35, PRM1035	Position control gain 2	PG2
PRM36, PRM1036	Speed control gain 1	VG1
PRM37, PRM1037	Speed control gain 2	VG2
PRM38, PRM1038	Speed integral compensation	VIC
PRM39, PRM1039	Speed differential compensation	VDC
PRM40, PRM1040	JOG operation acceleration/deceleration time constant	JTC
PRM41, PRM1041	Home position return operation acceleration/deceleration time constant	ZTS
PRM42, PRM1042	Home position return position data	*ZPS
PRM43, PRM1043	Moving distance after proximity dog	DCT
PRM44, PRM1044	Stopper type home position return stopper time	ZTM
PRM45, PRM1045	Stopper type home position return torque limit value	ZTT
PRM46, PRM1046	Software limit +	*LMP
PRM47, PRM1047		
PRM48, PRM1048	Software limit -	*LMN
PRM49, PRM1049		
PRM50, PRM1050	Position range output address +	*LPP
PRM51, PRM1051		
PRM52, PRM1052	Position range output address -	*LNP
PRM53, PRM1053		
PRM54, PRM1054	For manufacturer setting	-
PRM55, PRM1055	Function selection 6	*OP6
PRM56, PRM1056	For manufacturer setting	-
PRM57, PRM1057	Function selection 8	*OP8
PRM58, PRM1058	Function selection 9	*OP9
PRM59, PRM1059	Function selection A	*OPA
PRM60, PRM1060	For manufacturer setting	-

(Continued to next page)

Device name	Item	Symbol*1
PRM61, PRM1061	Machine resonance suppression filter 1	NH1
PRM62, PRM1062	Machine resonance suppression filter 2	NH2
PRM63, PRM1063	Low-pass filter, adaptive vibration suppression control	LPF
PRM64, PRM1064	Ratio of load inertia moment to Servo motor inertia moment 2	GD2B
PRM65, PRM1065	Position control gain 2 changing ratio	PG2B
PRM66, PRM1066	Speed control gain 2 changing ratio	VG2B
PRM67, PRM1067	Speed integral compensation changing ratio	VICB
PRM68, PRM1068	Gain changing selection	*CDP
PRM69, PRM1069	Gain changing condition	CDS
PRM70, PRM1070	Gain changing time constant	CDT
PRM71 to PRM73, PRM1071 to PRM1073	For manufacturer setting	-
PRM74, PRM1074	OUT1 output time selection	OUT1
PRM75, PRM1075	OUT2 output time selection	OUT2
PRM76, PRM1076	OUT3 output time selection	OUT3
PRM77, PRM1077	Selected to program input polarity selection 1	SYC1
PRM78 to PRM90, PRM1078 to PRM1090	For manufacturer setting	-

\*1 For the parameter with \* in front of its abbreviated name, powering off the servo amplifier after setting then on makes the parameter valid.

- Status display

Device name	Item	Symbol
ST0	Current position	-
ST1	Command position	-
ST2	Command remaining distance	-
ST3	Program Number	-
ST4	Step Number	-
ST5	Cumulative feedback pulses	-
ST6	Servo motor speed	-
ST7	Droop pulses	-
ST8	Override	-
ST9	Torque limit voltage	-
ST10	Regenerative load ratio	-
ST11	Effective load ratio	-
ST12	Peak load ratio	-
ST13	Instantaneous torque	-
ST14	Within one-revolution position	-
ST15	ABS counter	-
ST16	Load inertia moment ratio	-
ST17	Bus voltage	-

- Alarm

Device name	Item	Symbol
AL0	Current alarm number	-
AL1	Detailed data of current alarms	-
AL11	Servo status when alarm occurs Current position	-

(Continued to next page)

Device name	Item	Symbol
AL12	Servo status when alarm occurs Command position	-
AL13	Servo status when alarm occurs Command remaining distance	-
AL14	Servo status when alarm occurs Program Number	-
AL15	Servo status when alarm occurs Step Number	-
AL16	Servo status when alarm occurs Cumulative feedback pulses	-
AL17	Servo status when alarm occurs Servo motor speed	-
AL18	Servo status when alarm occurs Droop pulses	-
AL19	Servo status when alarm occurs Override	-
AL20	Servo status when alarm occurs Torque limit voltage	-
AL21	Servo status when alarm occurs Regenerative load ratio	-
AL22	Servo status when alarm occurs Effective load ratio	-
AL23	Servo status when alarm occurs Peak load ratio	-
AL24	Servo status when alarm occurs Instantaneous torque	-
AL25	Servo status when alarm occurs Within one-revolution position	-
AL26	Servo status when alarm occurs ABS counter	-
AL27	Servo status when alarm occurs Load inertia moment ratio	-
AL28	Servo status when alarm occurs Bus voltage	-
AL200	Alarm number from Alarm History most recent alarm	-
AL201	Alarm number from Alarm History first alarm in past	-
AL202	Alarm number from Alarm History second alarm in past	-
AL203	Alarm number from Alarm History third alarm in past	-
AL204	Alarm number from Alarm History fourth alarm in past	-
AL205	Alarm number from Alarm History fifth alarm in past	-
AL210	Alarm occurrence time in alarm history most recent alarm	-
AL211	Alarm occurrence time in alarm history first alarm in past	-
AL212	Alarm occurrence time in alarm history second alarm in past	-
AL213	Alarm occurrence time in alarm history third alarm in past	-
AL214	Alarm occurrence time in alarm history fourth alarm in past	-
AL215	Alarm occurrence time in alarm history fifth alarm in past	-
AL230	Detailed alarm from Alarm History most recent alarm	-
AL231	Detailed alarm from Alarm History first alarm in past	-
AL232	Detailed alarm from Alarm History second alarm in past	-
AL233	Detailed alarm from Alarm History third alarm in past	-
AL234	Detailed alarm from Alarm History fourth alarm in past	-
AL235	Detailed alarm from Alarm History fifth alarm in past	-

• External I/O signal

Device name	Item	Symbol
DI0	Input device statuses	-
DI1	External input pin statuses	-
DI2	Statuses of input devices switched on through communication	-
DO0	Output device statuses	-
DO1	External output pin statuses	-

- Current position latch data

Device name	Item	Symbol
LD1	Current position latch data	-

- The value of the general-purpose register (Rx)

Device name	Item	Symbol
RR1, RR1001	The value of the general-purpose register (R1)	-
RR2, RR1002	The value of the general-purpose register (R2)	-
RR3, RR1003	The value of the general-purpose register (R3)	-
RR4, RR1004	The value of the general-purpose register (R4)	-

- The value of the general-purpose register (Dx)

Device name	Item	Symbol
RD1	The value of the general-purpose register (D1)	-
RD2	The value of the general-purpose register (D2)	-
RD3	The value of the general-purpose register (D3)	-
RD4	The value of the general-purpose register (D4)	-

- Input signal for test operation (for test operation)

Device name	Item	Symbol
TMI0	Input signal for test operation	-

- Forced output of signal pin (for test operation)

Device name	Item	Symbol
TMO0	Forced output of signal pin	-

- Set data (for test operation)

Device name	Item	Symbol
TMD0	Writes the speed (test mode)	-
TMD1	Writes the acceleration/deceleration time constant (test mode)	-
TMD2	Writes the moving distance in pulses (test mode)	-

**(6) MELSERVO-J3-\*A**

Device name*2		Setting range	Device No. representation
Bit device	Servo amplifier request (SP)*4	SP0 to SP6	Decimal
	Operation mode selection (OM)*4	OM0 to OM4	
	Instructin demand (for test operation) (TMB)*4	TMB1 to TMB6	
Word device	Basic setting parameter (PA)*1	PA1 to PA19 PA1001 to PA1019	Decimal
	Gain filter parameter (PB)*1	PB1 to PB45 PB1001 to PB1045	
	Extension setting parameter (PC)*1	PC1 to PC50 PC1001 to PC1050	
	I/O setting parameter (PD)*1	PD1 to PD30 PD1001 to PD1030	
	Status display (ST)	ST0 to ST14	
	Alarm (AL)	AL0 to AL1 AL11 to AL25 AL200 to AL205 AL210 to AL215 AL230 to AL235	
	External input (DI)*3	DI0 to DI12	
	External output (DO)	DO0 to DO1	
Double-word device	Input signal for test operation (for test operation) (TMI)*3	TMI0	Decimal
	Forced output of signal pin (for test operation) (TMO)*4	TMO0	
	Set data (for test operation) (TMD)*4	TMD0 to TMD1 TMD3	

\*1 1 to 50 of PA, PB, PC, and PD are used when writing data to the servo amplifier RAM.

1001 to 1050 of PA, PB, PC, and PD are used when writing data to E<sup>2</sup>PROM of the servo amplifier.

\*2 The GOT cannot read or write data from/to consecutive devices.

\*3 Only reading is available for DI0 to DI1.

For details of \*4, refer to the following.

**\*4 Precautions for SP, OM, TMB, TMI, TMO, and TMD devices**

- (a) For bit devices  
Only writing is possible.  
[Alternate] of a bit switch cannot be used.  
Use [Momentary], [Set], and [Reset] for bit switch actions.
- (b) For word device and double-word device  
Only writing is possible.  
Numerical input cannot be used.  
Use a word switch for writing.

The following shows correspondences between virtual devices for servo amplifier and data of the servo amplifier used with the GOT.

- Servo amplifier request

Device name	Item	Symbol
SP0	Status display data clear	-
SP1	Current alarm clear	-
SP2	Alarm history clear	-
SP3	External input signal prohibited	-
SP4	External output signal prohibited	-
SP5	External input signal resumed	-
SP6	External output signal resumed	-

- Operation mode selection

Device name	Item	Symbol
OM0	Normal mode (not test operation mode)	-
OM1	JOG operation	-
OM2	Positioning operation	-
OM3	Motorless operation	-
OM4	Output signal (DO) forced output	-

- Instruction demand (for test operation)

Device name	Item	Symbol
TMB1	Temporary stop command	-
TMB2	Test operation (positioning operation) start command	-
TMB3	Forward rotation direction	-
TMB4	Reverse rotation direction	-
TMB5	Restart for remaining distance	-
TMB6	Remaining distance clear	-

- Basic setting paramete

Device name	Item	Symbol <sup>*1</sup>
PA1, PA1001	Control mode	*STY
PA2, PA1002	Regenerative brake option	*REG
PA3, PA1003	Absolute position detection system	*ABS
PA4, PA1004	Function selection A-1	*AOP1
PA5, PA1005	Number of command input pulses per revolution	*FBP
PA6, PA1006	Electronic gear numerator (command pulse multiplying factor numerator)	CMX
PA7, PA1007	Electronic gear denominator (command pulse multiplying factor denominator)	CDV
PA8, PA1008	Auto tuning mode	ATU
PA9, PA1009	Auto tuning response	RSP
PA10, PA1010	In-position range	INP
PA11, PA1011	Forward torque limit	TLP
PA12, PA1012	Reverses torque limit	TLN
PA13, PA1013	Command pulse input form	*PLSS
PA14, PA1014	Rotation direction selection	*POL
PA15, PA1015	Encoder output pulses	*ENR
PA16 to PA18, PA1016 to PA1018	For manufacturer setting	-
PA19, PA1019	Parameter block	*BLK

\*1 For the parameters prefixed by an asterisk (\*), setting becomes effective when the power is turned off once and back on after setting the parameter data.



- Gain filter parameter

Device name	Item	Symbol*1
PB1, PB1001	Adaptive tuning mode (Adaptive filter II)	FILT
PA2, PB1002	Vibration suppression control filter tuning mode (Advanced vibration suppression control)	VRFT
PB3, PB1003	Position command acceleration/deceleration time constant (position smoothing)	PST
PB4, PB1004	Feed forward gain	FFC
PB5, PB1005	For manufacturer setting	-
PB6, PB1006	Ratio of load inertia moment to servo motor inertia moment	GD2
PB7, PB1007	Model control gain	PG1
PB8, PB1008	Position loop gain	PG2
PB9, PB1009	Speed loop gain	VG2
PB10, PB1010	Speed integral compensation	VIC
PB11, PB1011	Speed differential compensation	VDC
PB12, PB1012	For manufacturer setting	-
PB13, PB1013	Machine resonance suppression filter 1	NH1
PB14, PB1014	Notch form selection 1	NHQ1
PB15, PB1015	Machine resonance suppression filter 2	NH2
PB16, PB1016	Notch form selection 2	NHQ2
PB17, PB1017	For manufacturer setting	-
PB18, PB1018	Low-pass filter setting	LPF
PB19, PB1019	Vibration suppression control vibration frequency setting	VRF1
PB20, PB1020	Vibration suppression control resonance frequency setting	VRF2
PB21 to PB22, PB1021 to PB1022	For manufacturer setting	-
PB23, PB1023	Low-pass filter selection	VFBF
PB24, PB1024	Slight vibration suppression control selection	*MVS
PB25, PB1025	Function selection B-1	*BOP1
PB26, PB1026	Gain changing selection	*CDP
PB27, PB1027	Gain changing condition	CDL
PB28, PB1028	Gain changing time constant	CDT
PB29, PB1029	Ratio of load inertia moment to servo motor inertia moment at changing gain	GD2B
PB30, PB1030	Position loop gain at changing gain	PG2B
PB31, PB1031	Speed loop gain at changing gain	VG2B
PB32, PB1032	Speed integral compensation at changing gain	VICB
PB33, PB1033	Vibration suppression control vibration frequency setting for changing gain	VRF1B
PB34, PB1034	Vibration suppression control vibration resonance setting for changing gain	VRF2B
PB35 to PB45, PB1035 to PB1045	For manufacturer setting	-

\*1 For the parameters prefixed by an asterisk (\*), setting becomes effective when the power is turned off once and back on after setting the parameter data.

• Extension setting parameter

Device name	Item	Symbol* <sup>1</sup>
PC1, PC1001	Acceleration time constant	STA
PC2, PC1002	Deceleration time constant	STB
PC3, PC1003	S-pattern acceleration/deceleration time constant	STC
PC4, PC1004	Torque command time constant	TQC
PC5, PC1005	Internal speed command 1 / limit 1	SC1
PC6, PC1006	Internal speed command 2 / limit 2	SC2
PC7, PC1007	Internal speed command 3 / limit 3	SC3
PC8, PC1008	Internal speed command 4 / limit 4	SC4
PC9, PC1009	Internal speed command 5 / limit 5	SC5
PC10, PC1010	Internal speed command 6 / limit 6	SC6
PC11, PC1011	Internal speed command 7 / limit 7	SC7
PC12, PC1012	Analog speed command maximum speed / limit maximum speed	VCM
PC13, PC1013	Analog torque command maximum output	TLC
PC14, PC1014	Analog monitor 1 output	MOD1
PC15, PC1015	Analog monitor 2 output	MOD2
PC16, PC1016	Electromagnetic brake sequence output	MBR
PC17, PC1017	Zero speed	ZSP
PC18, PC1018	Alarm history clear	*BPS
PC19, PC1019	Encoder output pulse selection	*ENRS
PC20, PC1020	Station number. setting	*SNO
PC21, PC1021	Communication function selection	*SOP
PC22, PC1022	Function selection C-1	*COP1
PC23, PC1023	Function selection C-2	*COP2
PC24, PC1024	Function selection C-3	*COP3
PC25, PC1025	For manufacturer setting	-
PC26, PC1026	Function selection C-5	*COP5
PC27 to PC29, PC1027 to PC1029	For manufacturer setting	-
PC30, PC1030	Acceleration time constant 2	STA2
PC31, PC1031	Deceleration time constant 2	STB2
PC32, PC1032	Command pulse multiplying factor numerator 2	CMX2
PC33, PC1033	Command pulse multiplying factor numerator 3	CMX3
PC34, PC1034	Command pulse multiplying factor numerator 4	CMX4
PC35, PC1035	Internal torque limit 2	TL2
PC36, PC1036	Status display selection	*DMD
PC37, PC1037	Analog speed command offset / limit offset	VCO
PC38, PC1038	Analog torque command offset / limit offset	TPO
PC39, PC1039	Analog monitor 1 offset	MO1
PC40, PC1040	Analog monitor 2 offset	MO2
PC41 to PC50, PC1041 to PC1050	For manufacturer setting	-

\*1 For the parameters prefixed by an asterisk (\*), setting becomes effective when the power is turned off once and back on after setting the parameter data.

- I/O setting parameter

Device name	Item	Symbol*1
PD1, PD1001	Input signal automatic ON selection 1	*DIA1
PD2, PD1002	For manufacturer setting	-
PD3, PD1003	Input signal device selection 1 (CN1-15)	*DI1
PD4, PD1004	Input signal device selection 2 (CN1-16)	*DI2
PD5, PD1005	Input signal device selection 3 (CN1-17)	*DI3
PD6, PD1006	Input signal device selection 4 (CN1-18)	*DI4
PD7, PD1007	Input signal device selection 5 (CN1-19)	*DI5
PD8, PD1008	Input signal device selection 6 (CN1-41)	*DI6
PD9, PD1009	For manufacturer setting	-
PD10, PD1010	Input signal device selection 8 (CN1-43)	*DI8
PD11, PD1011	Input signal device selection 9 (CN1-44)	*DI9
PD12, PD1012	Input signal device selection 10 (CN1-45)	*DI10
PD13, PD1013	Output signal device selection 1 (CN1-22)	*DO1
PD14, PD1014	Output signal device selection 2 (CN1-23)	*DO2
PD15, PD1015	Output signal device selection 3 (CN1-24)	*DO3
PD16, PD1016	Output signal device selection 4 (CN1-25)	*DO4
PD17, PD1017	For manufacturer setting	-
PD18, PD1018	Output signal device selection 6 (CN1-49)	*DO6
PD19, PD1019	Response level setting	*DIF
PD20, PD1020	Function selection D-1	*DOP1
PD21, PD1021	For manufacturer setting	-
PD22, PD1022	Function selection D-3	*DOP3
PD23, PD1023	For manufacturer setting	-
PD24, PD1024	Function selection D-5	*DOP5
PD25 to PD30, PD1025 to PD1030	For manufacturer setting	-

\*1 For the parameters prefixed by an asterisk (\*), setting becomes effective when the power is turned off once and back on after setting the parameter data.

- Status display

Device name	Item	Symbol
ST0	Cumulative feedback pulses	-
ST1	Servo motor speed	-
ST2	Drift pulses	-
ST3	Cumulative command pulses	-
ST4	Command pulse frequency	-
ST5	Analog speed command voltage/limit voltage	-
ST6	Analog torque command voltage/limit voltage	-
ST7	Regenerative load ratio	-
ST8	Effective load ratio	-
ST9	Peak load ratio	-
ST10	Instantaneous torque	-
ST11	Within one-revolution position	-
ST12	ABS counter	-
ST13	Load inertia moment ratio	-
ST14	Bus voltage	-

- Alarm

Device name	Item	Symbol
AL0	Current alarm number	-
AL1	Detailed data of current alarms	-
AL11	Servo status when alarm occurs cumulative feedback pulses	-
AL12	Servo status when alarm occurs servo monitor speed	-
AL13	Servo status when alarm occurs droop pulses	-
AL14	Servo status when alarm occurs cumulative command pulses	-
AL15	Servo status when alarm occurs command pulse frequency	-
AL16	Servo status when alarm occurs analog speed command voltage/limit voltage	-
AL17	Servo status when alarm occurs analog torque command voltage/limit voltage	-
AL18	Servo status when alarm occurs regenerative load ratio	-
AL19	Servo status when alarm occurs effective load ratio	-
AL20	Servo status when alarm occurs peak load ratio	-
AL21	Servo status when alarm occurs instantaneous torque	-
AL22	Servo status when alarm occurs within one-revolution position	-
AL23	Load inertia moment ratio ABS counter	-
AL24	Servo status when alarm occurs load inertia moment ratio	-
AL25	Servo status when alarm occurs bus voltage	-
AL200	Alarm number from alarm history most recent alarm	-
AL201	Alarm number from alarm history first alarm in past	-
AL202	Alarm number from alarm history second alarm in past	-
AL203	Alarm number from alarm history third alarm in past	-
AL204	Alarm number from alarm history fourth alarm in past	-
AL205	Alarm number from alarm history fifth alarm in past	-
AL210	Alarm occurrence time in alarm history most recent alarm	-
AL211	Alarm occurrence time in alarm history first alarm in past	-
AL212	Alarm occurrence time in alarm history second alarm in past	-
AL213	Alarm occurrence time in alarm history third alarm in past	-
AL214	Alarm occurrence time in alarm history fourth alarm in past	-
AL215	Alarm occurrence time in alarm history fifth alarm in past	-
AL230	Detailed alarm from alarm history most recent alarm	-
AL231	Detailed alarm from alarm history first alarm in past	-
AL232	Detailed alarm from alarm history second alarm in past	-
AL233	Detailed alarm from alarm history third alarm in past	-
AL234	Detailed alarm from alarm history fourth alarm in past	-
AL235	Detailed alarm from alarm history fifth alarm in past	-

- External input

Device name	Item	Symbol
DI0	Input device statuses	-
DI1	External input pin statuses	-
DI2	Statuses of input devices switched on through communication	-

- External output

Device name	Item	Symbol
DO0	Output device statuses	-
DO1	External output pin statuses	-

- Input signal for test operation (for test operation)

Device name	Item	Symbol
TMI0	Input signal for test operation	-

- Forced output of signal pin (for test operation)

Device name	Item	Symbol
TMO0	Forced output of signal pin	-

- Set data (for test operation)

Device name	Item	Symbol
TMD0	Writes the speed (test mode)	-
TMD1	Writes the acceleration/deceleration time constant (test mode)	-
TMD2	For manufacturer setting	-
TMD3	Writes the moving distance (test mode)	-

**(7) MELSERVO-J3-\*T**

Device name <sup>*5</sup>		Setting range	Device No. representation
Bit device	Servo amplifier request (SP) <sup>*6</sup>	SP0 to SP6	Decimal
	Operation mode selection (OM) <sup>*6</sup>	OM0 to OM5	
	Instruction demand (for test operation) (TMB) <sup>*6</sup>	TMB1 to TMB6	
Word device	Basic setting parameter (PA) <sup>*1</sup>	PA1 to PA19 PA1001 to PA1019	Decimal
	Gain filter parameter (PB) <sup>*1</sup>	PB1 to PB45 PB1001 to PB1045	
	Extension setting parameter (PC) <sup>*1</sup>	PC1 to PC50 PC1001 to PC1050	
	Extension setting parameter(PD) <sup>*1</sup>	PD1 to PD30 PD1001 to PD1030	
	Option unit parameter (PO) <sup>*1</sup>	PO1 to PO35 PO1001 to PO1035	
	Status display (ST) <sup>*4</sup>	ST0 to ST17	
	Alarm (AL) <sup>*4</sup>	AL0 to AL1 AL11 to AL28 AL200 to AL205 AL210 to AL215 AL230 to AL235	
	External input (DI) <sup>*7</sup>	DI0 to DI7	
	External output (DO) <sup>*4</sup>	DO0 to DO4	
	Point table (position) (POS) <sup>*2</sup>	POS1 to POS255 POS1001 to POS1255	
	Point table (speed) (SPD) <sup>*2</sup>	SPD1 to SPD255 SPD1001 to SPD1255	
	Point table (acceleration time constant) (ACT) <sup>*2</sup>	ACT1 to ACT255 ACT1001 to ACT1255	
	Point table (deceleration time constant) (DCT) <sup>*2</sup>	DCT1 to DCT255 DCT1001 to DCT1255	
	Point table (dwell) (DWL) <sup>*2</sup>	DWL1 to DWL255 DWL1001 to DWL1255	
	Point table (auxiliary function) (AUX) <sup>*2</sup>	AUX1 to AUX255 AUX1001 to AUX1255	
Point table (M code) (MCD) <sup>*2 *3</sup>	MCD1 to MCD255 MCD1001 to MCD1255		
Double-word device	Input signal for test operation (for test operation) (TMI) <sup>*6</sup>	TMI0 to TMI2	Decimal
	Forced output of signal pin (for test operation) (TMO) <sup>*6</sup>	TMO0 to TMO1	
	Set data (for test operation) (TMD) <sup>*6</sup>	TMD0 to TMD1 TMD3	

\*1 Use 1 to 50 of PA, PB, PC, PD, and PO when the GOT writes data to RAM of the servo amplifier.

Use 1001 to 1050 of PA, PB, PC, PD, and PO when the GOT write data to E<sup>2</sup>PROM of the servo amplifier.

\*2 When the GOT writes data to point tables, use 1001 to 1255 of POS, SPD, ACT, DCT, DWL, AUX, and MCD (E<sup>2</sup>PROM area).

\*3 MCD cannot be used as a real number.

\*4 The GOT can only read data from the device.

\*5 The GOT cannot read or write from/to consecutive devices.

For details of \*6, refer to the following.

\*7 For DI0 to DI4, the GOT can only read data from devices.

**\*6 Precautions for SP, OM, TMB, TMI, TMO, and TMD devices**

- (a) For bit devices  
Only writing is possible.  
[Alternate] of a bit switch cannot be used.  
Use [Momentary], [Set], and [Reset] for bit switch actions.
- (b) For word device and double-word device  
Only writing is possible.  
Numerical input cannot be used.  
Use a word switch for writing.

The following shows correspondences between virtual devices for servo amplifier and data of the servo amplifier used with the GOT.

- Servo amplifier request

Device name	Item	Symbol
SP0	Status display data clear	-
SP1	Current alarm clear	-
SP2	Alarm history clear	-
SP3	External input signal prohibited	-
SP4	External output signal prohibited	-
SP5	External input signal resumed	-
SP6	External output signal resumed	-

- Operation mode selection

Device name	Item	Symbol
OM0	Normal mode (not test operation mode)	-
OM1	JOG operation	-
OM2	Positioning operation	-
OM3	Motorless operation	-
OM4	Output signal (DO) forced output	-
OM5	One step sending	-

- Instruction demand (for test operation)

Device name	Item	Symbol
TMB1	Temporary stop command	-
TMB2	Test operation (positioning operation) start command	-
TMB3	Forward rotation direction	-
TMB4	Reverse rotation direction	-
TMB5	Restart for remaining distance	-
TMB6	Remaining distance clear	-

• Basic setting parameter

Device name	Item	Symbol <sup>*1</sup>
PA1, PA1001	Control mode	*STY
PA2, PA1002	Regenerative brake option	*REG
PA3, PA1003	Absolute position detection system	*ABS
PA4, PA1004	Function selection A-1	*AOP1
PA5, PA1005	Feeding function selection	*FTY
PA6, PA1006	Electronic gear numerator	*CMX
PA7, PA1007	Electronic gear denominator	*CDV
PA8, PA1008	Auto tuning mode	ATU
PA9, PA1009	Auto tuning response	RSP
PA10, PA1010	In-position range	INP
PA11, PA1011	Forward torque limit	TLP
PA12, PA1012	Reverses torque limit	TLN
PA13, PA1013	For manufacturer setting	-
PA14, PA1014	Rotation direction selection	*POL
PA15, PA1015	Encoder output pulses	*ENR
PA16 to PA18, PA1016 to PA1018	For manufacturer setting	-
PA19, PA1019	Parameter block	*BLK

\*1 For the parameters prefixed by an asterisk (\*), setting becomes effective when the power is turned off once and back on after setting the parameter data.



- Gain filter parameter

Device name	Item	Symbol*1
PB1, PB1001	Adaptive tuning mode (Adaptive filter II)	FILT
PA2, PB1002	Vibration suppression control filter tuning mode (advanced vibration suppression control)	VRFT
PB3, PB1003	For manufacturer setting	-
PB4, PB1004	Feed forward gain	FFC
PB5, PB1005	For manufacturer setting	-
PB6, PB1006	Ratio of load inertia moment to servo motor inertia moment	GD2
PB7, PB1007	Model control gain	PG1
PB8, PB1008	Position loop gain	PG2
PB9, PB1009	Speed loop gain	VG2
PB10, PB1010	Speed integral compensation	VIC
PB11, PB1011	Speed differential compensation	VDC
PB12, PB1012	For manufacturer setting	-
PB13, PB1013	Machine resonance suppression filter 1	NH1
PB14, PB1014	Notch form selection 1	NHQ1
PB15, PB1015	Machine resonance suppression filter 2	NH2
PB16, PB1016	Notch form selection 2	NHQ2
PB17, PB1017	For manufacturer setting	-
PB18, PB1018	Low-pass filter setting	LPF
PB19, PB1019	Vibration suppression control vibration frequency setting	VRF1
PB20, PB1020	Vibration suppression control resonance frequency setting	VRF2
PB21 to PB22, PB1021 to PB1022	For manufacturer setting	-
PB23, PB1023	Low-pass filter selection	VFBF
PB24, PB1024	Slight vibration suppression control selection	*MVS
PB25, PB1025	For manufacturer setting	-
PB26, PB1026	Gain changing selection	*CDP
PB27, PB1027	Gain changing condition	CDL
PB28, PB1028	Gain changing time constant	CDT
PB29, PB1029	Gain changing, Ratio of load inertia moment to servo motor inertia moment	GD2B
PB30, PB1030	Gain changing, Position loop gain	PG2B
PB31, PB1031	Gain changing, Speed loop gain	VG2B
PB32, PB1032	Gain changing, Speed integral compensation	VICB
PB33, PB1033	Gain changing, Vibration suppression control vibration frequency setting	VRF1B
PB34, PB1034	Gain changing, Vibration suppression control resonance frequency setting	VRF2B
PB35 to PB45, PB1035 to PB1045	For manufacturer setting	-

\*1 For the parameters prefixed by an asterisk (\*), setting becomes effective when the power is turned off once and back on after setting the parameter data.

• Extension setting parameter

Device name	Item	Symbol* <sup>1</sup>
PC1, PC1001	For manufacturer setting	-
PC2, PC1002	Home position return type	*ZTY
PC3, PC1003	Direction of home position return	*ZDIR
PC4, PC1004	Home position return speed	ZRF
PC5, PC1005	Creep speed	CRF
PC6, PC1006	Home position shift distance	ZST
PC7, PC1007	Home position return position data	*ZPS
PC8, PC1008	Moving distance after proximity dog	DCT
PC9, PC1009	Hold time home position return hold time	ZTM
PC10, PC1010	Hold time home position return torque limit value	ZTT
PC11, PC1011	Rough match output range	CRP
PC12, PC1012	Jog speed	JOG
PC13, PC1013	S-pattern acceleration/deceleration time constant	*STC
PC14, PC1014	Backlash compensation	*BKC
PC15, PC1015	For manufacturer setting	-
PC16, PC1016	Electromagnetic brake sequence output	MBR
PC17, PC1017	Zero speed	ZSP
PC18, PC1018	Alarm history clear	*BPS
PC19, PC1019	Encoder output pulse selection	*ENRS
PC20, PC1020	Station number. setting	*SNO
PC21, PC1021	communication function selection	*SOP
PC22, PC1022	Function selection C-1	*COP1
PC23, PC1023	For manufacturer setting	-
PC24, PC1024	Function selection C-3	*COP3
PC25, PC1025	For manufacturer setting	-
PC26, PC1026	Function selection C-5	*COP5
PC27, PC1027	For manufacturer setting	-
PC28, PC1028	Function selection C-7	*COP7
PC29 to PC30, PC1029 to PC1030	For manufacturer setting	-
PC31, PC1031	Software limit + Low	LMPL
PC32, PC1032	Software limit + High	LMPH
PC33, PC1033	Software limit - Low	LMNL
PC34, PC1034	Software limit - High	LMNH
PC35, PC1035	Internal torque limit2	TL2
PC36, PC1036	Status display selection	*DMD
PC37, PC1037	Position range output address + Low	*LPPL
PC38, PC1038	Position range output address + High	*LPPH
PC39, PC1039	Position range output address - Low	*LNPL
PC40, PC1040	Position range output address - High	*LNPH
PC41 to PC50, PC1041 to PC1050	For manufacturer setting	-

\*1 For the parameters prefixed by an asterisk (\*), setting becomes effective when the power is turned off once and back on after setting the parameter data.

- I/O setting parameter

Device name	Item	Symbol <sup>*1</sup>
PD1, PD1001	Input signal automatic ON selection 1	*DIA1
PD2, PD1002	For manufacturer setting	-
PD3, PD1003	Input signal automatic ON selection 3	*DIA3
PD4, PD1004	Input signal automatic ON selection 4	*DIA4
PD5, PD1005	For manufacturer setting	-
PD6, PD1006	Input signal device selection 2 (CN6-2)	*DI2
PD7, PD1007	Input signal device selection 3 (CN6-3)	*DI3
PD8, PD1008	Input signal device selection 4 (CN6-4)	*DI4
PD9, PD1009	Output signal device selection 1 (CN6-14)	*DO1
PD10, PD1010	Output signal device selection 2 (CN6-15)	*DO2
PD11, PD1011	Output signal device selection 3 (CN6-16)	*DD3
PD12 to PD15, PD1012 to PD1015	For manufacturer setting	-
PD16, PD1016	Input polarity selection	*DIAB
PD17 to PD18, PD1017 to PD1018	For manufacturer setting	-
PD19, PD1019	Response level setting	*DIF
PD20, PD1020	Function selection D-1	*DOP1
PD21, PD1021	For manufacturer setting	-
PD22, PD1022	Function selection D-3	*DOP3
PD23, PD1023	For manufacturer setting	-
PD24, PD1024	Function selection D-5	*DOP5
PD25 to PD30, PD1025 to PD1030	For manufacturer setting	-

\*1 For the parameters prefixed by an asterisk (\*), setting becomes effective when the power is turned off once and back on after setting the parameter data.

- Option unit parameter

Device name	Item	Symbol
PO1, PO1001	For manufacturer setting	-
PO2, PO1002	MR-J3-D01 Input signal device selection 1 (CN10-21, 26)	*ODI1
PO3, PO1003	MR-J3-D01 Input signal device selection 2 (CN10-27, 28)	*ODI2
PO4, PO1004	MR-J3-D01 Input signal device selection 3 (CN10-29, 30)	*ODI3
PO5, PO1005	MR-J3-D01 Input signal device selection 4 (CN10-31, 32)	*ODI4
PO6, PO1006	MR-J3-D01 Input signal device selection 5 (CN10-33, 34)	*ODI5
PO7, PO1007	MR-J3-D01 Input signal device selection 6 (CN10-35, 36)	*ODI6
PO8, PO1008	MR-J3-D01 Output signal device selection 1 (CN10-46, 47)	*ODO1
PO9, PO1009	MR-J3-D01 Output signal device selection 2 (CN10-48, 49)	*ODO2
PO10, PO1010	Function selection 0-1	*OOP1
PO11, PO1011	For manufacturer setting	-
PO12, PO1012	Function selection 0-3	*OOP3
PO13, PO1013	MR-J3-D01 Analog monitor 1 output	MOD1
PO14, PO1014	MR-J3-D01 Analog monitor 2 output	MOD2
PO15, PO1015	MR-J3-D01 Analog monitor 1 offset	M01
PO16, PO1016	MR-J3-D01 Analog monitor 2 offset	M02
PO17 to 20, PO1017 to PO1020	For manufacturer setting	-

(Continued to next page)

Device name	Item	Symbol
PO21, PO1021	MR-J3-D01 Override offset	VCO
PO22, PO1022	MR-J3-D01 Analog torque limitation offset	TLO
PO23 to 35, PO102 to PO1035	For manufacturer setting	-

- Status display

Device name	Item	Symbol
ST0	Current position	-
ST1	Command position	-
ST2	Command remaining distance	-
ST3	Point table No.	-
ST4	Cumulative feedback pulses	-
ST5	Servo motor speed	-
ST6	Droop pulses	-
ST7	Override voltage	-
ST8	Override	-
ST9	Analog torque command voltage/limit voltage	-
ST10	Regenerative load ratio	-
ST11	Effective load ratio	-
ST12	Peak load ratio	-
ST13	Instantaneous torque	-
ST14	Within one-revolution position	-
ST15	ABS counter	-
ST16	Load inertia moment ratio	-
ST17	Bus voltage	-

• Alarm

Device name	Item	Symbol
AL0	Current alarm number	-
AL1	Detailed data of current alarms	-
AL11	Servo status when alarm occurs, Current position	-
AL12	Servo status when alarm occurs, Command position	-
AL13	Servo status when alarm occurs, Command remaining distance	-
AL14	Servo status when alarm occurs, Point table No.	-
AL15	Servo status when alarm occurs, Cumulative feedback pulses	-
AL16	Servo status when alarm occurs, Servo motor speed	-
AL17	Servo status when alarm occurs, Droop pulses	-
AL18	Servo status when alarm occurs, Override voltage	-
AL19	Servo status when alarm occurs, Override	-
AL20	Servo status when alarm occurs, Analog torque limit voltage	-
AL21	Servo status when alarm occurs, Regenerative load ratio	-
AL22	Servo status when alarm occurs, Effective load ratio	-
AL23	Servo status when alarm occurs, Peak load ratio	-
AL24	Servo status when alarm occurs, Instantaneous torque	-
AL25	Servo status when alarm occurs, Within one-revolution position	-
AL26	Servo status when alarm occurs, ABS counter	-
AL27	Servo status when alarm occurs, Load inertia moment ratio	-
AL28	Servo status when alarm occurs, Bus voltage	-
AL200	Alarm number from alarm history, Most recent alarm	-
AL201	Alarm number from alarm history, First alarm in past	-
AL202	Alarm number from alarm history, Second alarm in past	-
AL203	Alarm number from alarm history, Third alarm in past	-
AL204	Alarm number from alarm history, Fourth alarm in past	-
AL205	Alarm number from alarm history, Fifth alarm in past	-
AL210	Alarm occurrence time in alarm history, Most recent alarm	-
AL211	Alarm occurrence time in alarm history, First alarm in past	-
AL212	Alarm occurrence time in alarm history, Second alarm in past	-
AL213	Alarm occurrence time in alarm history, Third alarm in past	-
AL214	Alarm occurrence time in alarm history, Fourth alarm in past	-
AL215	Alarm occurrence time in alarm history, Fifth alarm in past	-
AL230	Detailed alarm from alarm history, Most recent alarm	-
AL231	Detailed alarm from alarm history, First alarm in past	-
AL232	Detailed alarm from alarm history, Second alarm in past	-
AL233	Detailed alarm from alarm history, Third alarm in past	-
AL234	Detailed alarm from alarm history, Fourth alarm in past	-
AL235	Detailed alarm from alarm history, Fifth alarm in past	-

- External input

Device name	Item	Symbol
DI0	Input device statuses 1	-
DI1	Input device statuses 2	-
DI2	Input device statuses 3	-
DI3	External input pin statuses 1	-
DI4	External input pin statuses 2	-
DI5	Statuses of input devices switched on through communication 1	-
DI6	Statuses of input devices switched on through communication 2	-
DI7	Statuses of input devices switched on through communication 3	-

- External output

Device name	Item	Symbol
DO0	Output device statuses 1	-
DO1	Output device statuses 2	-
DO2	Output device statuses 3	-
DO3	External output pin statuses 1	-
DO4	External output pin statuses 2	-

- Point table (position)

Device name	Item	Symbol
POS1 to POS255, POS1001 to POS1255	Point table (position) No.1 to 255	-
SPD1 to SPD255, SPD1001 to SPD1255	Point table (speed) No.1 to 255	-
ACT1 to ACT255, ACT1001 to ACT1255	Point table (acceleration time constant) No.1 to 255	-
DCT1 to DCT255, DCT1001 to DCT1255	Point table (deceleration time constant) No.1 to 255	-
DWL1 to DWL255, DWL1001 to DWL1255	Point table (dwell) (DWL) No.1 to 255	-
AUX1 to AUX255, AUX1001 to AUX1255	Point table (auxiliary function) No.1 to 255	-
MCD1 to MCD255, MCD1001 to MCD1255	Point table (M code) No.1 to 255	-

- Input signal for test operation (for test operation)

Device name	Item	Symbol
TMI0	Input signal for test operation 1	-
TMI1	Input signal for test operation 2	-
TMI2	Input signal for test operation 3	-

- Forced output of signal pin (for test operation)

Device name	Item	Symbol
TMO0	Forced output from signal pin (CN6)	-
TMO1	Forced output from signal pin (CN10)	-

- Set data (for test operation)

Device name	Item	Symbol
TMD0	Writes the speed (test mode)	-
TMD1	Writes the acceleration/deceleration time constant (test mode)	-
TMD3	Writes the moving distance (test mode)	-

(8) MELSERVO-J4-\*A, -JE-\*A

	Device name <sup>*2</sup>	Setting range	Device No. representation
Bit device	Servo amplifier request (SP) <sup>*6</sup>	SP0 to SP6	Decimal
	Operation mode selection (OM) <sup>*6</sup>	OM0 to OM2 OM4 to OM5	
	Instruction demand (for test operation) (TMB) <sup>*6</sup>	TMB1 to TMB6	
	One-touch tuning instruction (OTI) <sup>*5</sup>	OTI0 to OTI5	
Word device	Basic setting parameter (PA) <sup>*1</sup>	PA1 to PA32 PA1001 to PA1032	Decimal
	Gain filter parameter (PB) <sup>*1</sup>	PB1 to PB64 PB1001 to PB1064	
	Extension setting parameter (PC) <sup>*1</sup>	PC1 to PC80 PC1001 to PC1080	
	I/O setting parameter (PD) <sup>*1</sup>	PD1 to PD48 PD1001 to PD1048	
	Extension setting No.2 parameter (PE) <sup>*1</sup>	PE1 to PE64 PE1001 to PE1064	
	Extension setting No.3 parameter (PF) <sup>*1</sup>	PF1 to PF48 PF1001 to PF1048	
	Linear servo motor/DD motor setting parameters (PL) <sup>*1</sup>	PL1 to PL48 PL1001 to PL1048	
	Status display (ST) <sup>*3</sup>	ST0 to ST41	
	Alarm (Current alarm J3A compatible) (AL) <sup>*3</sup>	AL0 to AL1 AL11 to AL25	
	Alarm (Alarm history J3A compatible) (AL) <sup>*3</sup>	AL200 to AL205 AL210 to AL215 AL230 to AL235	
	Alarm (Current alarm J4A extend) (ALM) <sup>*3</sup>	ALM0 to ALM1 ALM11 to ALM52	
	Alarm (Alarm history J4A extend) (ALM) <sup>*3</sup>	ALM200 to ALM215 ALM220 to ALM235 ALM240 to ALM255	
	Machine diagnosis data (MD) <sup>*3</sup>	MD0 to MD11	
	One-touch tuning data (OTS) <sup>*3</sup>	OTS0 to OTS3	
	External input (DI) <sup>*4</sup>	DI0 to DI2	
	External output (DO) <sup>*3</sup>	DO0 to DO1	
Double-word device	Life Diagnosis (ALD) <sup>*3</sup>	ALD0 to ALD1	Decimal
	Input signal for test operation (for test operation) (TMI) <sup>*6</sup>	TMI0	
	Forced output of signal pin (for test operation) (TMO) <sup>*6</sup>	TMO0	
	Set data (for test operation) (TMD) <sup>*6</sup>	TMD0 to TMD1 TMD3	

- \*1 Use 1 to 80 of PA, PB, PC, PD, PE, PF, and PL when the GOT writes data to the RAM of a servo amplifier.  
Use 1001 to 1080 of PA, PB, PC, PD, PE, PF, and PL when the GOT writes data to the E<sup>2</sup>PROM of a servo amplifier.
- \*2 The GOT cannot read or write data from/to consecutive devices.
- \*3 The GOT can only read data from the device.
- \*4 Only reading is available for DI0 to DI1.
- \*5 The GOT can only write data to the device.
- For details of \*6, refer to the following.

**\*6 Precautions for SP, OM, TMB, TMI, TMO, and TMD devices**

- (a) For bit devices  
Only writing is possible.  
[Alternate] of a bit switch cannot be used.  
Use [Momentary], [Set], and [Reset] for bit switch actions.
- (b) For word device and double-word device  
Only writing is possible.  
Numerical input cannot be used.  
Use a word switch for writing.

The following shows correspondences between virtual devices for servo amplifier and data of the servo amplifier used with the GOT.

- Servo amplifier request

Device name	Item	Symbol
SP0	Status display data clear	-
SP1	Current alarm clear	-
SP2	Alarm history clear	-
SP3	External input signal prohibited	-
SP4	External output signal prohibited	-
SP5	External input signal resumed	-
SP6	External output signal resumed	-

- Operation mode selection

Device name	Item	Symbol
OM0	Normal mode (not test operation mode)	-
OM1	JOG operation	-
OM2	Positioning operation	-
OM4	Output signal (DO) forced output	-

- Instruction demand (for test operation)

Device name	Item	Symbol
TMB1	Temporary stop command	-
TMB2	Test operation (positioning operation) start command	-
TMB3	Forward rotation direction	-
TMB4	Reverse rotation direction	-
TMB5	Restart for remaining distance	-
TMB6	Remaining distance clear	-

- One-touch tuning instruction

Device name	Item	Symbol
OTI0	One-touch tuning start command(Basic mode)	-
OTI1	One-touch tuning start command(High mode)	-
OTI2	One-touch tuning start command(Low mode)	-
OTI3	One-touch tuning stop command	-
OTI4	Return to initial value	-
OTI5	Return to value before adjustment	-



- Basic setting parameter

Device name	Item	Symbol*1
PA1, PA1001	Operation mode	*STY
PA2, PA1002	Regenerative brake option	*REG
PA3, PA1003*2	Absolute position detection system	*ABS
PA4, PA1004	Function selection A-1	*AOP1
PA5, PA1005	Number of command input pulses per revolution	*FBP
PA6, PA1006	Electronic gear numerator (command pulse multiplication numerator)	CMX
PA7, PA1007	Electronic gear denominator (command pulse multiplication denominator)	CDV
PA8, PA1008	Auto tuning mode	ATU
PA9, PA1009	Auto tuning response	RSP
PA10, PA1010	In-position range	INP
PA11, PA1011	Forward rotation torque limit	TLP
PA12, PA1012	Reverse rotation torque limit	TLN
PA13, PA1013	Command pulse input form	*PLSS
PA14, PA1014	Rotation direction selection	*POL
PA15, PA1015	Encoder output pulses	*ENR
PA16, PA1016	Encoder output pulses 2	*ENR2
PA17 to PA18, PA1017 to PA1018	For manufacturer setting	-
PA19, PA1019	Parameter writing inhibit	*BLK
PA20, PA1020	Tough drive setting	*TDS
PA21, PA1021	Function selection A-3	*AOP3
PA22, PA1022	For manufacturer setting	-
PA23, PA1023	Drive recorder arbitrary alarm trigger setting	DRAT
PA24, PA1024	Function selection A-4	*AOP4
PA25, PA1025	One-touch tuning - Overshoot permissible level	OTHOV
PA26, PA1026*2	Function selection A-5	*AOP5
PA26 to PA32, PA1026 to PA1032	For manufacturer setting	-

\*1 For the parameters prefixed by an asterisk (\*), setting becomes effective when the power is turned off once and back on after setting the parameter data.

\*2 MELSERVO-JE is equal to MELSERVO-J4; however, their parameters are different in functioning. When using a MELSERVO-JE series servo amplifier, refer to the following.

 Technical manual for MELSERVO-JE series servo amplifiers

- Gain filter parameter

Device name	Item	Symbol*1
PB1, PB1001	Adaptive tuning mode (Adaptive filter II)	FILT
PB2, PB1002	Vibration suppression control tuning mode (advanced vibration suppression control II)	VRFT
PB3, PB1003	Position command acceleration/deceleration time constant (position smoothing)	PST
PB4, PB1004	Feed forward gain	FFC
PB5, PB1005	For manufacturer setting	-
PB6, PB1006	Load to motor inertia ratio	GD2
PB7, PB1007	Model loop gain	PG1
PB8, PB1008	Position loop gain	PG2

(Continued to next page)

Device name	Item	Symbol*1
PB9, PB1009	Speed loop gain	VG2
PB10, PB1010	Speed integral compensation	VIC
PB11, PB1011	Speed differential compensation	VDC
PB12, PB1012	Overshoot amount compensation	OVA
PB13, PB1013	Machine resonance suppression filter 1	NH1
PB14, PB1014	Notch shape selection 1	NHQ1
PB15, PB1015	Machine resonance suppression filter 2	NH2
PB16, PB1016	Notch shape selection 2	NHQ2
PB17, PB1017	Shaft resonance suppression filter	NHF
PB18, PB1018	Low-pass filter setting	LPF
PB19, PB1019	Vibration suppression control 1 - Vibration frequency	VRF11
PB20, PB1020	Vibration suppression control 1 - Resonance frequency	VRF12
PB21, PB1021	Vibration suppression control 1 - Vibration frequency dumping	VRF13
PB22, PB1022	Vibration suppression control 1 - Resonance frequency dumping	VRF14
PB23, PB1023	Low-pass filter selection	VFBF
PB24, PB1024	Slight vibration suppression control	*MVS
PB25, PB1025	Function selection B-1	*BOP1
PB26, PB1026	Gain switching function	*CDP
PB27, PB1027	Gain switching condition	CDL
PB28, PB1028	Gain switching time constant	CDT
PB29, PB1029	Load to motor inertia ratio after gain switching	GD2B
PB30, PB1030	Position loop gain after gain switching	PG2B
PB31, PB1031	Speed loop gain after gain switching	VG2B
PB32, PB1032	Speed integral compensation after gain switching	VICB
PB33, PB1033	Vibration suppression control 1 - Vibration frequency after gain switching	VRF1B
PB34, PB1034	Vibration suppression control 1 - Resonance frequency after gain switching	VRF2B
PB35, PB1035	Vibration suppression control 1 - Vibration frequency dumping after gain switching	VRF3B
PB36, PB1036	Vibration suppression control 1 - Resonance frequency dumping after gain switching	VRF4B
PB37 to PB44, PB1037 to PB1044	For manufacturer setting	-
PB45, PB1045	Command notch filter	CNHF
PB46, PB1046	Machine resonance suppression filter 3	NH3
PB47, PB1047	Notch shape selection 3	NHQ3
PB48, PB1048	Machine resonance suppression filter 4	NH4
PB49, PB1049	Notch shape selection 4	NHQ4
PB50, PB1050	Machine resonance suppression filter 5	NH5
PB51, PB1051	Notch shape selection 5	NHQ5
PB52, PB1052	Vibration suppression control 2 - Vibration frequency	VRF21
PB53, PB1053	Vibration suppression control 2 - Resonance frequency	VRF22
PB54, PB1054	Vibration suppression control 2 - Vibration frequency dumping	VRF23

(Continued to next page)

Device name	Item	Symbol* <sup>1</sup>
PB55, PB1055	Vibration suppression control 2 - Resonance frequency dumping	VRF24
PB56, PB1056	Vibration suppression control 2 - Vibration frequency after gain switching	VRF21B
PB57, PB1057	Vibration suppression control 2 - Resonance frequency after gain switching	VRF22B
PB58, PB1058	Vibration suppression control 2 - Vibration frequency dumping after gain switching	VRF23B
PB59, PB1059	Vibration suppression control 2 - Resonance frequency dumping after gain switching	VRF24B
PB60, PB1060	Model loop gain after gain switching	PG1B
PB61 to PB64, PB1061 to PB1064	For manufacturer setting	-

\*<sup>1</sup> For the parameters prefixed by an asterisk (\*), setting becomes effective when the power is turned off once and back on after setting the parameter data.

- Extension setting parameter

Device name	Item	Symbol* <sup>1</sup>
PC1, PC1001	Acceleration time constant	STA
PC2, PC1002	Deceleration time constant	STB
PC3, PC1003	S-pattern acceleration/deceleration time constant	STC
PC4, PC1004	Torque command time constant	TQC
PC5, PC1005	Internal speed command 1 / limit 1	SC1
PC6, PC1006	Internal speed command 2 / limit 2	SC2
PC7, PC1007	Internal speed command 3 / limit 3	SC3
PC8, PC1008	Internal speed command 4 / limit 4	SC4
PC9, PC1009	Internal speed command 5 / limit 5	SC5
PC10, PC1010	Internal speed command 6 / limit 6	SC6
PC11, PC1011	Internal speed command 7 / limit 7	SC7
PC12, PC1012	Analog speed command maximum speed / limit maximum speed	VCM
PC13, PC1013	Analog torque command maximum output	TLC
PC14, PC1014	Analog monitor output 1	MOD1
PC15, PC1015	Analog monitor output 2	MOD2
PC16, PC1016	Electromagnetic brake sequence output	MBR
PC17, PC1017	Zero speed	ZSP
PC18, PC1018	Alarm history clear	*BPS
PC19, PC1019	Encoder output pulse selection	*ENRS
PC20, PC1020* <sup>2</sup>	Station number setting	*SNO
PC21, PC1021* <sup>2</sup>	Communication function selection	*SOP
PC22, PC1022	Function selection C-1	*COP1
PC23, PC1023	Function selection C-2	*COP2
PC24, PC1024	Function selection C-3	*COP3
PC25, PC1025	For manufacturer setting	-
PC26, PC1026	Function selection C-5	*COP5
PC27, PC1027* <sup>2</sup>	Function selection C-6	*COP6
PC28 to PC29, PC1028 to PC1029	For manufacturer setting	-
PC30, PC1030	Acceleration time constant 2	STA2

(Continued to next page)

Device name	Item	Symbol <sup>*1</sup>
PC31, PC1031	Deceleration time constant 2	STB2
PC32, PC1032	Command input pulse multiplication numerator 2	CMX2
PC33, PC1033	Command input pulse multiplication numerator 3	CMX3
PC34, PC1034	Command input pulse multiplication numerator 4	CMX4
PC35, PC1035	Internal torque limit 2	TL2
PC36, PC1036	Status display selection	*DMD
PC37, PC1037	Analog speed command offset / limit offset	VCO
PC38, PC1038	Analog torque command offset / limit offset	TPO
PC39, PC1039	Analog monitor 1 offset	MO1
PC40, PC1040	Analog monitor 2 offset	MO2
PC41 to PC42, PC1041 to PC1042	For manufacturer setting	-
PC43, PC1043	Error excessive alarm detection level	ERZ
PC44 to PC50, PC1044 to PC1050	For manufacturer setting	-
PC51, PC1051	Forced stop deceleration time constant	RSBR
PC52 to PC53, PC1052 to PC1053	For manufacturer setting	-
PC54, PC1054	Vertical axis freefall prevention compensation amount	RSUP1
PC55 to PC59, PC1055 to PC1059	For manufacturer setting	-
PC60, PC1060	Function selection C-D	*COPD
PC61 to PC80, PC1061 to PC1080	For manufacturer setting	-

\*1 For the parameters prefixed by an asterisk (\*), setting becomes effective when the power is turned off once and back on after setting the parameter data.

\*2 MELSERVO-JE is equal to MELSERVO-J4; however, their parameters are different in functioning. When using a MELSERVO-JE series servo amplifier, refer to the following.

 Technical manual for MELSERVO-JE series servo amplifiers

- I/O setting parameter

Device name	Item	Symbol <sup>*1</sup>
PD1, PD1001	Input signal automatic on selection 1	*DIA1
PD2, PD1002	For manufacturer setting	-
PD3, PD1003	Input device selection 1L	*DI1L
PD4, PD1004	Input device selection 1H	*DI1H
PD5, PD1005 <sup>*2</sup>	Input device selection 2L	*DI2L
PD6, PD1006 <sup>*2</sup>	Input device selection 2H	*DI2H
PD7, PD1007 <sup>*2</sup>	Input device selection 3L	*DI3L
PD8, PD1008 <sup>*2</sup>	Input device selection 3H	*DI3H
PD9, PD1009 <sup>*2</sup>	Input device selection 4L	*DI4L
PD10, PD1010 <sup>*2</sup>	Input device selection 4H	*DI4H
PD11, PD1011	Input device selection 5L	*DI5L
PD12, PD1012	Input device selection 5H	*DI5H
PD13, PD1013	Input device selection 6L	*DI6L
PD14, PD1014	Input device selection 6H	*DI6H
PD15 to PD16, PD1015 to PD1016	For manufacturer setting	-
PD17, PD1017	Input device selection 8L	*DI8L
PD18, PD1018	Input device selection 8H	*DI8H
PD19, PD1019	Input device selection 9L	*DI9L

(Continued to next page)

Device name	Item	Symbol*1
PD20, PD1020	Input device selection 9H	*DI9H
PD21, PD1021*2	Input device selection 10L	*DI10L
PD22, PD1022*2	Input device selection 10H	*DI10H
PD23, PD1023*2	Output device selection 1	*DO1
PD24, PD1024	Output device selection 2	*DO2
PD25, PD1025	Output device selection 3	*DO3
PD26, PD1026*2	Output device selection 4	*DO4
PD27, PD1027	For manufacturer setting	-
PD28, PD1028	Output device selection 6	*DO6
PD29, PD1029	Input filter setting	*DIF
PD30, PD1030	Function selection D-1	*DOP1
PD31, PD1031	For manufacturer setting	-
PD32, PD1032	Function selection D-3	*DOP3
PD33, PD1033	For manufacturer setting	-
PD34, PD1034	Function selection D-5	*DOP5
PD35 to PD48, PD1035 to PD1048	For manufacturer setting	-

\*1 For the parameters prefixed by an asterisk (\*), setting becomes effective when the power is turned off once and back on after setting the parameter data.

\*2 MELSERVO-JE is equal to MELSERVO-J4; however, their parameters are different in functioning. When using a MELSERVO-JE series servo amplifier, refer to the following.

 Technical manual for MELSERVO-JE series servo amplifiers

- Extension setting No.2 parameter

Device name	Item	Symbol
PE1 to PE40, PE1001 to PE1040	For manufacturer setting	-
PE41, PE1041	Function selection E-3	EOP3
PE42 to PE64, PE1042 to PE1064	For manufacturer setting	-

- Extension setting No.3 parameter

Device name	Item	Symbol
PF1 to PF8, PF1001 to PF1008	For manufacturer setting	-
PF9, PF1009*1	Function selection F-5	*FOP5
PF10 to PF14, PF1010 to PF1014	For manufacturer setting	-
PF15, PF1015*1	Electronic dynamic brake operating time	DBT
PF16 to PF20, PF1016 to PF1020	For manufacturer setting	-
PF21, PF1021	Drive recorder switching time setting	DRT
PF22, PF1022	For manufacturer setting	-
PF23, PF1023	Vibration tough drive - Oscillation detection level	OSCL1
PF24, PF1024	Vibration tough drive function selection	OSCL2
PF25, PF1025	Instantaneous power failure tough drive - Detection time	CVAT
PF26 to PF30, PF1026 to PF1030	For manufacturer setting	-
PF31, PF1031	Machine diagnosis function - Friction judgment speed	FRIC
PF32 to PF48, PF1032 to PF1048	For manufacturer setting	-

\*1 MELSERVO-JE is equal to MELSERVO-J4; however, their parameters are different in functioning. When using a MELSERVO-JE series servo amplifier, refer to the following.

 Technical manual for MELSERVO-JE series servo amplifiers

- Linear servo motor/DD motor setting parameters

Device name	Item	Symbol
PL1, PL1001	Linear servo motor/DD motor function selection 1	*LIT1
PL2, PL1002	Linear encoder resolution - Numerator	*LIM
PL3, PL1003	Linear encoder resolution - Denominator	*LID
PL4, PL1004	Linear servo motor/DD motor function selection 2	*LIT2
PL5, PL1005	Position deviation error detection level	LB1
PL6, PL1006	Speed deviation error detection level	LB2
PL7, PL1007	Torque/thrust deviation error detection level	LB3
PL8, PL1008	Linear servo motor/DD motor function selection 3	*LIT3
PL9, PL1009	Magnetic pole detection voltage level	LPWM
PL10 to PL16, PL1010 to PL1016	For manufacturer setting	-
PL17, PL1017	Magnetic pole detection - Minute position detection method - Function selection	LTSTS
PL18, PL1018	Magnetic pole detection - Minute position detection method - Identification signal amplitude	IDLV
PL19 to PL48, PL1019 to PL1048	For manufacturer setting	-

- Status display

Device name	Item	Symbol
ST0	Cumulative feedback pulse	-
ST1	Servo motor speed	-
ST2	Droop pulse	-
ST3	Cumulative command pulse	-
ST4	Command pulse frequency	-
ST5	Analog speed command voltage/limit voltage	-
ST6	Analog torque command voltage/limit voltage	-
ST7	Regenerative load ratio	-
ST8	Effective load ratio	-
ST9	Peak load ratio	-
ST10	Instantaneous torque	-
ST11	Within one-revolution position (1 pulse unit)	-
ST12	ABS counter	-
ST13	Load inertia moment ratio	-
ST14	Bus voltage	-
ST15 to ST31	For manufacturer setting	-
ST32	Internal temperature of encoder	-
ST33	Setting time	-
ST34	Oscillation detection frequency	-
ST35	Number of tough drives	-
ST36 to ST39	For manufacturer setting	-
ST40	Unit power consumption 1 (increment of 1 W)	-
ST41	Unit total power consumption 1 (increment of 1 Wh)	-

- Alarm (compatible with MELSERVO-J3-\*A)

Device name	Item	Symbol
AL0	Current alarm number	-
AL1*1	Detailed data of current alarms	-
AL11	Servo status when alarm occurs Cumulative feedback pulses	-
AL12	Servo status when alarm occurs Servo motor speed	-
AL13	Servo status when alarm occurs Droop pulses	-
AL14	Servo status when alarm occurs cumulative command pulses	-
AL15	Servo status when alarm occurs command pulse frequency	-
AL16	Servo status when alarm occurs analog speed command voltage/limit voltage	-
AL17	Servo status when alarm occurs analog torque command voltage/limit voltage	-
AL18	Servo status when alarm occurs regenerative load ratio	-
AL19	Servo status when alarm occurs effective load ratio	-
AL20	Servo status when alarm occurs peak load ratio	-
AL21	Servo status when alarm occurs Instantaneous torque	-
AL22	Servo states when alarm occurs Within one-revolution position (1 pulse unit)	-
AL23	Servo status when alarm occurs ABS counter	-
AL24	Servo status when alarm occurs load inertia moment ratio	-
AL25	Servo status when alarm occurs Bus voltage	-
AL200	Alarm number from Alarm History most recent alarm	-
AL201	Alarm number from Alarm History first alarm in past	-
AL202	Alarm number from Alarm History second alarm in past	-
AL203	Alarm number from Alarm History third alarm in past	-
AL204	Alarm number from Alarm History fourth alarm in past	-
AL205	Alarm number from Alarm History fifth alarm in past	-
AL210	Alarm occurrence time in alarm history most recent alarm	-
AL211	Alarm occurrence time in alarm history first alarm in past	-
AL212	Alarm occurrence time in alarm history second alarm in past	-
AL213	Alarm occurrence time in alarm history third alarm in past	-
AL214	Alarm occurrence time in alarm history fourth alarm in past	-
AL215	Alarm occurrence time in alarm history fifth alarm in past	-
AL230	Detailed alarm from alarm history most recent alarm	-
AL231	Detailed alarm from alarm history first alarm in past	-
AL232	Detailed alarm from alarm history second alarm in past	-
AL233	Detailed alarm from alarm history third alarm in past	-
AL234	Detailed alarm from alarm history fourth alarm in past	-
AL235	Detailed alarm from alarm history fifth alarm in past	-

\*1 MELSERVO-JE is equal to MELSERVO-J4; however, their parameters are different in functioning. When using a MELSERVO-JE series servo amplifier, refer to the following.

 Technical manual for MELSERVO-JE series servo amplifiers

- Alarm (extended for MELSERVO-J4-\*A)

Device name	Item	Symbol
ALM0	Current alarm number	-
ALM1 <sup>*1</sup>	Detailed data of current alarms	-
ALM11	Servo status when alarm occurs Cumulative feedback pulses	-
ALM12	Servo status when alarm occurs Servo motor speed	-
ALM13	Servo status when alarm occurs Droop pulses	-
ALM14	Servo status when alarm occurs cumulative command pulses	-
ALM15	Servo status when alarm occurs command pulse frequency	-
ALM16	Servo status when alarm occurs analog speed command voltage/limit voltage	-
ALM17	Servo status when alarm occurs analog torque command voltage/limit voltage	-
ALM18	Servo status when alarm occurs regenerative load ratio	-
ALM19	Servo status when alarm occurs effective load ratio	-
ALM20	Servo status when alarm occurs peak load ratio	-
ALM21	Servo status when alarm occurs Instantaneous torque	-
ALM22	Servo states when alarm occurs Within one-revolution position (1 pulse unit)	-
ALM23	Servo status when alarm occurs ABS counter	-
ALM24	Servo status when alarm occurs load inertia moment ratio	-
ALM25	Servo status when alarm occurs Bus voltage	-
ALM26 to ALM42	For manufacturer setting	-
ALM43	Servo states when alarm occurs Internal temperature of encoder	-
ALM44	Servo states when alarm occurs Setting time	-
ALM45	Servo states when alarm occurs Oscillation detection frequency	-
ALM46	Servo states when alarm occurs Number of tough drives	-
ALM47 to ALM50	For manufacturer setting	-
ALM51	Servo states when alarm occurs Unit power consumption 1 (increment of 1 W)	-
ALM52	Servo states when alarm occurs Unit total power consumption 1 (increment of 1 Wh)	-
ALM200	Alarm number from Alarm History most recent alarm	-
ALM201	Alarm number from Alarm History 1st alarm in past	-
ALM202	Alarm number from Alarm History 2nd alarm in past	-
ALM203	Alarm number from Alarm History 3rd alarm in past	-
ALM204	Alarm number from Alarm History 4th alarm in past	-
ALM205	Alarm number from Alarm History 5th alarm in past	-
ALM206	Alarm number from Alarm History 6th alarm in past	-
ALM207	Alarm number from Alarm History 7th alarm in past	-
ALM208	Alarm number from Alarm History 8th alarm in past	-
ALM209	Alarm number from Alarm History 9th alarm in past	-
ALM210	Alarm number from Alarm History 10th alarm in past	-
ALM211	Alarm number from Alarm History 11th alarm in past	-
ALM212	Alarm number from Alarm History 12th alarm in past	-

(Continued to next page)



Device name	Item	Symbol
ALM213	Alarm number from Alarm History 13th alarm in past	-
ALM214	Alarm number from Alarm History 14th alarm in past	-
ALM215	Alarm number from Alarm History 15th alarm in past	-
ALM220	Alarm occurrence time in alarm history most recent alarm	-
ALM221	Alarm occurrence time in alarm history 1st alarm in past	-
ALM222	Alarm occurrence time in alarm history 2nd alarm in past	-
ALM223	Alarm occurrence time in alarm history 3rd alarm in past	-
ALM224	Alarm occurrence time in alarm history 4th alarm in past	-
ALM225	Alarm occurrence time in alarm history 5th alarm in past	-
ALM226	Alarm occurrence time in alarm history 6th alarm in past	-
ALM227	Alarm occurrence time in alarm history 7th alarm in past	-
ALM228	Alarm occurrence time in alarm history 8th alarm in past	-
ALM229	Alarm occurrence time in alarm history 9th alarm in past	-
ALM230	Alarm occurrence time in alarm history 10th alarm in past	-
ALM231	Alarm occurrence time in alarm history 11th alarm in past	-
ALM232	Alarm occurrence time in alarm history 12th alarm in past	-
ALM233	Alarm occurrence time in alarm history 13th alarm in past	-
ALM234	Alarm occurrence time in alarm history 14th alarm in past	-
ALM235	Alarm occurrence time in alarm history 15th alarm in past	-
ALM240* <sup>1</sup>	Detailed alarm from Alarm History most recent alarm	-
ALM241* <sup>1</sup>	Detailed alarm from Alarm History 1st alarm in past	-
ALM242* <sup>1</sup>	Detailed alarm from Alarm History 2nd alarm in past	-
ALM243* <sup>1</sup>	Detailed alarm from Alarm History 3rd alarm in past	-
ALM244* <sup>1</sup>	Detailed alarm from Alarm History 4th alarm in past	-
ALM245* <sup>1</sup>	Detailed alarm from Alarm History 5th alarm in past	-
ALM246* <sup>1</sup>	Detailed alarm from Alarm History 6th alarm in past	-
ALM247* <sup>1</sup>	Detailed alarm from Alarm History 7th alarm in past	-
ALM248* <sup>1</sup>	Detailed alarm from Alarm History 8th alarm in past	-
ALM249* <sup>1</sup>	Detailed alarm from Alarm History 9th alarm in past	-
ALM250* <sup>1</sup>	Detailed alarm from Alarm History 10th alarm in past	-
ALM251* <sup>1</sup>	Detailed alarm from Alarm History 11th alarm in past	-
ALM252* <sup>1</sup>	Detailed alarm from Alarm History 12th alarm in past	-
ALM253* <sup>1</sup>	Detailed alarm from Alarm History 13th alarm in past	-
ALM254* <sup>1</sup>	Detailed alarm from Alarm History 14th alarm in past	-
ALM255* <sup>1</sup>	Detailed alarm from Alarm History 15th alarm in past	-

\*1 MELSERVO-JE is equal to MELSERVO-J4; however, their parameters are different in functioning. When using a MELSERVO-JE series servo amplifier, refer to the following.

 Technical manual for MELSERVO-JE series servo amplifiers

- Machine diagnosis data

Device name	Item	Symbol
MD0	Machine diagnosis data parameter number	-
MD1	Machine diagnosis data shift judgment(test mode)	-
MD2	Machine diagnosis data status	-
MD3	Machine diagnosis data coulomb friction torque in positive direction	-
MD4	Machine diagnosis data friction torque at rated speed in positive direction	-
MD5	Machine diagnosis data coulomb friction torque in negative direction	-
MD6	Machine diagnosis data friction torque at rated speed in negative direction	-
MD7	Machine diagnosis data oscillation frequency(moter is stopped)	-
MD8	Machine diagnosis data vibration level(moter is stopped)	-
MD9	Machine diagnosis data oscillation frequency(moter is operating)	-
MD10	Machine diagnosis data vibration level(moter is operating)	-
MD11	Machine diagnosis data rated speed	-

- One-touch tuning data

Device name	Item	Symbol
OTS0	One-touch tuning status confirmation	-
OTS1	Error code list	-
OTS2	Setting time	-
OTS3	Overshoot amount	-

- External input

Device name	Item	Symbol
DI0	Input device statuses	-
DI1	External input pin statuses	-
DI2	Statuses of input devices switched on through communication	-

- External output

Device name	Item	Symbol
DO0	Output device statuses	-
DO1	External output pin statuses	-

- Life Diagnosis

Device name	Item	Symbol
ALD0	Cumulative power-on time	-
ALD1	Number of inrush current switching times	-

- Input signal for test operation (for test operation)

Device name	Item	Symbol
TMI0	Input signal for test operation	-

- Forced output of signal pin (for test operation)

Device name	Item	Symbol
TMO0	Forced output of signal pin	-

- Set data (for test operation)

Device name	Item	Symbol
TMD0	Writes the speed (test mode)	-
TMD1	Writes the acceleration/deceleration time constant (test mode)	-
TMD3	Writes the moving distance (test mode)	-

**(9) MELSERVO-J4-\*A-RJ**

Device name*3		Setting range	Device No. representation
Bit device	Servo amplifier request (SP)*9	SP0 to SP6	Decimal
	Operation mode selection (OM)*9	OM0 to OM2 OM4 to OM5	
	Instruction demand (for test operation) (TMB)*9	TMB1 to TMB6	
	One-touch tuning instruction (OTI)*1	OTI0 to OTI5	
Word device	Basic setting parameter (PA)*2	PA1 to PA32 PA1001 to PA1032	Decimal
	Gain filter parameter (PB)*2	PB1 to PB64 PB1001 to PB1064	
	Extension setting parameter (PC)*2	PC1 to PC80 PC1001 to PC1080	
	I/O setting parameter (PD)*2	PD1 to PD48 PD1001 to PD1048	
	Extension setting No.2 parameter (PE)*2	PE1 to PE64 PE1001 to PE1064	
	Extension setting No.3 parameter (PF)*2	PF1 to PF48 PF1001 to PF1048	
	Option unit parameter (PO)*2	PO1 to PO32 PO1001 to PO1032	
	Linear servo motor/DD motor setting parameters (PL)*2	PL1 to PL48 PL1001 to PL1048	
	Positioning control parameters (PT)*2	PT1 to PT48 PT1001 to PT1048	
	Status display (ST)*4	ST0 to ST48	
	Alarm (Current alarm J3A compatible) (AL)*4	AL0 to AL1 AL11 to AL25	
	Alarm (Alarm history J3A compatible) (AL)*4	AL200 to AL205 AL210 to AL215 AL230 to AL235	
	Alarm (Current alarm J4A extend) (ALM)*4	ALM0 to ALM1 ALM11 to ALM59	
	Alarm (Alarm history J4A extend) (ALM)*4	ALM200 to ALM215 ALM220 to ALM235 ALM240 to ALM255	
	Point table (position) (POS)*5	POS1 to POS255 POS1001 to POS1255	
	Point table (speed) (SPD)*5	SPD1 to SPD255 SPD1001 to SPD1255	
	Point table (acceleration time constant) (ACT)*5	ACT1 to ACT255 ACT1001 to ACT1255	
	Point table (deceleration time constant) (DCT)*5	DCT1 to DCT255 DCT1001 to DCT1255	
	Point table (dwell) (DWL)*5	DWL1 to DWL255 DWL1001 to DWL1255	
	Point table (auxiliary function) (AUX)*5	AUX1 to AUX255 AUX1001 to AUX1255	
Point table (M code) (MCD)*5*6	MCD1 to MCD255 MCD1001 to MCD1255		
Machine diagnosis data (MD)*4	MD0 to MD11		

(Continued to next page)

Device name <sup>*3</sup>		Setting range	Device No. representation
Word device	One-touch tuning data (OTS) <sup>*4</sup>	OTS0 to OTS3	Decimal
	External input (DI) <sup>*7</sup>	DI0 to DI6	
	External output (DO) <sup>*4</sup>	DO0 to DO4	
Double-word device	Current position latch data (LD) <sup>*4</sup>	LD0 to LD1	Decimal
	General-purpose register (Rx) (RR) <sup>*8</sup>	RR1 to RR4 RR1001 to RR1004	
	General-purpose register (Dx) (RD)	RD1 to RD4	
	Life Diagnosis (ALD) <sup>*4</sup>	ALD0 to ALD1	
	Input signal for test operation (for test operation) (TMI) <sup>*9</sup>	TMI0 to TMI2	
	Forced output of signal pin (for test operation) (TMO) <sup>*9</sup>	TMO0	
	Set data (for test operation) (TMD) <sup>*9</sup>	TMD0 to TMD1 TMD3	

\*1 The GOT can only write data to the device.

\*2 Use 1 to 80 of PA, PB, PC, PD, PE, PF, PL, PO, and PT when the GOT writes data to RAM of the servo amplifier.

Use 1001 to 1080 of PA, PB, PC, PD, PE, PF, PL, PO, and PT when the GOT writes data to E<sup>2</sup>PROM of the servo amplifier.

\*3 The GOT cannot read or write data from /to consecutive devices.

\*4 The GOT can only read data from the device.

\*5 When the GOT writes data to point tables, use 1001 to 1255 of POS, SPD, ACT, DCT, DWL, AUX, and MCD (E<sup>2</sup>PROM area).

\*6 MCD cannot be used as a real number.

\*7 Only reading is available for DI0 to DI3.

\*8 Use the integer number when writing parameters to Rx.

For details of \*9, refer to the following.

**\*9 The following shows the precautions for SP, OM, TMB, TMI, TMO and TMD devices.**

- (a) For bit devices  
Only writing is possible.  
[Alternate] of a bit switch cannot be used.  
Use [Momentary], [Set], and [Reset] for bit switch actions.
- (b) For word device and double-word device  
Only writing is possible.  
Numerical input cannot be used.  
Use a word switch for writing.

The following shows correspondences between virtual devices for servo amplifier and data of the servo amplifier used with the GOT.

- Servo amplifier request

Device name	Item	Symbol
SP0	Status display data clear	-
SP1	Current alarm clear	-
SP2	Alarm history clear	-
SP3	External input signal prohibited	-
SP4	External output signal prohibited	-
SP5	External input signal resumed	-
SP6	External output signal resumed	-

- Operation mode selection

Device name	Item	Symbol
OM0	Normal mode (not test operation mode)	-
OM1	JOG operation	-
OM2	Positioning operation	-
OM4	Output signal (DO) forced output	-
OM5	Single-step feed operation	-

- Instruction demand (for test operation)

Device name	Item	Symbol
TMB1	Temporary stop command (test mode)	-
TMB2	Test operation (positioning operation) start command.	-
TMB3	Forward rotation direction	-
TMB4	Reverse rotation direction	-
TMB5	Restart for remaining distance	-
TMB6	Remaining distance clear	-

- One-touch tuning instruction

Device name	Item	Symbol
OTI0	One-touch tuning start command(Basic mode)	-
OTI1	One-touch tuning start command(High mode)	-
OTI2	One-touch tuning start command(Low mode)	-
OTI3	One-touch tuning stop command	-
OTI4	Return to initial value	-
OTI5	Return to value before adjustment	-

- Basic setting parameter

Device name	Item	Symbol <sup>*1</sup>
PA1, PA1001	Operation mode	*STY
PA2, PA1002	Regenerative brake option	*REG
PA3, PA1003	Absolute position detection system	*ABS
PA4, PA1004	Function selection A-1	*AOP1
PA5, PA1005	Number of command input pulses per revolution	*FBP
PA6, PA1006	Electronic gear numerator (command pulse multiplication numerator)/Number of gear teeth on machine side	*CMX
PA7, PA1007	Electronic gear denominator (command pulse multiplication denominator)/Number of gear teeth on servo motor side	*CDV
PA8, PA1008	Auto tuning mode	ATU
PA9, PA1009	Auto tuning response	RSP
PA10, PA1010	In-position range	INP
PA11, PA1011	Forward rotation torque limit/positive direction thrust limit	TLP
PA12, PA1012	Reverse rotation torque limit/negative direction thrust limit	TLN
PA13, PA1013	Command pulse input form	*PLSS
PA14, PA1014	Rotation direction selection/travel direction selection	*POL
PA15, PA1015	Encoder output pulses	*ENR
PA16, PA1016	Encoder output pulses 2	*ENR2

(Continued to next page)

Device name	Item	Symbol*1
PA17, PA1017	Servo motor series setting	*MSR
PA18, PA1018	Servo motor type setting	*MTY
PA19, PA1019	Parameter writing inhibit	*BLK
PA20, PA1020	Tough drive setting	*TDS
PA21, PA1021	Function selection A-3	*AOP3
PA22, PA1022	For manufacturer setting	-
PA23, PA1023	Drive recorder arbitrary alarm trigger setting	DRAT
PA24, PA1024	Function selection A-4	AOP4
PA25, PA1025	One-touch tuning - Overshoot permissible level	OTHOV
PA26, PA1026	Function selection A-5	*AOP5
PA27 to PA32, PA1027 to PA1032	For manufacturer setting	-

\*1 For the parameters prefixed by an asterisk (\*), setting becomes effective when the power is turned off once and back on after setting the parameter data.

- Gain filter parameter

Device name	Item	Symbol*1
PB1, PB1001	Adaptive tuning mode (Adaptive filter II)	FILT
PB2, PB1002	Vibration suppression control tuning mode (advanced vibration suppression control II)	VRFT
PB3, PB1003	Position command acceleration/deceleration time constant (position smoothing)	PST
PB4, PB1004	Feed forward gain	FFC
PB5, PB1005	For manufacturer setting	-
PB6, PB1006	Load to motor inertia ratio/load to motor mass ratio	GD2
PB7, PB1007	Model loop gain	PG1
PB8, PB1008	Position loop gain	PG2
PB9, PB1009	Speed loop gain	VG2
PB10, PB1010	Speed integral compensation	VIC
PB11, PB1011	Speed differential compensation	VDC
PB12, PB1012	Overshoot amount compensation	OVA
PB13, PB1013	Machine resonance suppression filter 1	NH1
PB14, PB1014	Notch shape selection 1	NHQ1
PB15, PB1015	Machine resonance suppression filter 2	NH2
PB16, PB1016	Notch shape selection 2	NHQ2
PB17, PB1017	Shaft resonance suppression filter	NHF
PB18, PB1018	Low-pass filter setting	LPF
PB19, PB1019	Vibration suppression control 1 - Vibration frequency	VRF11
PB20, PB1020	Vibration suppression control 1 - Resonance frequency	VRF12
PB21, PB1021	Vibration suppression control 1 - Vibration frequency dumping	VRF13
PB22, PB1022	Vibration suppression control 1 - Resonance frequency dumping	VRF14
PB23, PB1023	Low-pass filter selection	VFBF
PB24, PB1024	Slight vibration suppression control	*MVS
PB25, PB1025	Function selection B-1	*BOP1
PB26, PB1026	Gain switching function	*CDP

(Continued to next page)

Device name	Item	Symbol <sup>*1</sup>
PB27, PB1027	Gain switching condition	CDL
PB28, PB1028	Gain switching time constant	CDT
PB29, PB1029	Load to motor inertia ratio/load to motor mass ratio after gain switching	GD2B
PB30, PB1030	Position loop gain after gain switching	PG2B
PB31, PB1031	Speed loop gain after gain switching	VG2B
PB32, PB1032	Speed integral compensation after gain switching	VICB
PB33, PB1033	Vibration suppression control 1 - Vibration frequency after gain switching	VRF1B
PB34, PB1034	Vibration suppression control 1 - Resonance frequency after gain switching	VRF2B
PB35, PB1035	Vibration suppression control 1 - Vibration frequency dumping after gain switching	VRF3B
PB36, PB1036	Vibration suppression control 1 - Resonance frequency dumping after gain switching	VRF4B
PB37 to PB44, PB1037 to PB1044	For manufacturer setting	-
PB45, PB1045	Command notch filter	CNHF
PB46, PB1046	Machine resonance suppression filter 3	NH3
PB47, PB1047	Notch shape selection 3	NHQ3
PB48, PB1048	Machine resonance suppression filter 4	NH4
PB49, PB1049	Notch shape selection 4	NHQ4
PB50, PB1050	Machine resonance suppression filter 5	NH5
PB51, PB1051	Notch shape selection 5	NHQ5
PB52, PB1052	Vibration suppression control 2 - Vibration frequency	VRF21
PB53, PB1053	Vibration suppression control 2 - Resonance frequency	VRF22
PB54, PB1054	Vibration suppression control 2 - Vibration frequency dumping	VRF23
PB55, PB1055	Vibration suppression control 2 - Resonance frequency dumping	VRF24
PB56, PB1056	Vibration suppression control 2 - Vibration frequency after gain switching	VRF21B
PB57, PB1057	Vibration suppression control 2 - Resonance frequency after gain switching	VRF22B
PB58, PB1058	Vibration suppression control 2 - Vibration frequency dumping after gain switching	VRF23B
PB59, PB1059	Vibration suppression control 2 - Resonance frequency dumping after gain switching	VRF24B
PB60, PB1060	Model loop gain after gain switching	PG1B
PB61 to PB64, PB1061 to PB1064	For manufacturer setting	-

\*1 For the parameters prefixed by an asterisk (\*), setting becomes effective when the power is turned off once and back on after setting the parameter data.

- Extension setting parameter

Device name	Item	Symbol <sup>*1</sup>
PC1, PC1001	JOG operation acceleration time constant/Acceleration time constant 1	STA
PC2, PC1002	JOG operation deceleration time constant/Deceleration time constant 1	STB
PC3, PC1003	S-pattern acceleration/deceleration time constant	*STC

(Continued to next page)



Device name	Item	Symbol*1
PC4, PC1004	Torque command time constant/thrust command time constant	TQC
PC5, PC1005	Automatic operation speed 1	SC1
PC6, PC1006	Automatic operation speed 2	SC2
PC7, PC1007	Manual operation speed 1	SC3
PC8, PC1008	Internal speed command 4 / limit 4	SC4
PC9, PC1009	Internal speed command 5 / limit 5	SC5
PC10, PC1010	Internal speed command 6 / limit 6	SC6
PC11, PC1011	Internal speed command 7 / limit 7	SC7
PC12, PC1012	Analog speed / limit command - Maximum speed	VCM
PC13, PC1013	Analog torque command maximum output	TLC
PC14, PC1014	Analog monitor output 1	MOD1
PC15, PC1015	Analog monitor output 2	MOD2
PC16, PC1016	Electromagnetic brake sequence output	MBR
PC17, PC1017	Zero speed	ZSP
PC18, PC1018	Alarm history clear	*BPS
PC19, PC1019	Encoder output pulse selection	*ENRS
PC20, PC1020	Parameter block	*SNO
PC21, PC1021	RS-422 communication function selection	*SOP
PC22, PC1022	Function selection C-1	*COP1
PC23, PC1023	Function selection C-2	*COP2
PC24, PC1024	Function selection C-3	*COP3
PC25, PC1025	For manufacturer setting	-
PC26, PC1026	Function selection C-5	*COP5
PC27, PC1027*2	Function selection C-6	*COP6
PC28 to PC29, PC1028 to PC1029	For manufacturer setting	-
PC30, PC1030	Home position return acceleration time constant/ Acceleration time constant 2	STA2
PC31, PC1031	Home position return deceleration time constant/ Deceleration time constant 2	STB2
PC32, PC1032	Command input pulse multiplication numerator 2	CMX2
PC33, PC1033	Command input pulse multiplication numerator 3	CMX3
PC34, PC1034	Command input pulse multiplication numerator 4	CMX4
PC35, PC1035	Internal torque limit 2/internal thrust limit 2	TL2
PC36, PC1036	Status display selection	*DMD
PC37, PC1037	Analog speed command offset / limit offset	VCO
PC38, PC1038	Analog torque command offset / limit offset	TPO
PC39, PC1039	Analog monitor 1 offset	MO1
PC40, PC1040	Analog monitor 2 offset	MO2
PC41 to PC42, PC1041 to PC1042	For manufacturer setting	-
PC43, PC1043	Error excessive alarm detection level	ERZ
PC44, PC1044	Function selection C-9	*COP9
PC45, PC1045	Function selection C-A	*COPA
PC46 to PC50, PC1046 to PC1050	For manufacturer setting	-
PC51, PC1051	Forced stop deceleration time constant	RSBR
PC52 to PC53, PC1052 to PC1053	For manufacturer setting	-

(Continued to next page)

Device name	Item	Symbol <sup>*1</sup>
PC54, PC1054	Vertical axis freefall prevention compensation amount	RSUP1
PC55 to PC59, PC1055 to PC1059	For manufacturer setting	-
PC60, PC1060	Function selection C-D	*COPD
PC61 to PC80, PC1061 to PC1080	For manufacturer setting	-

\*1 For the parameters prefixed by an asterisk (\*), setting becomes effective when the power is turned off once and back on after setting the parameter data.

- I/O setting parameter

Device name	Item	Symbol <sup>*1</sup>
PD1, PD1001	Input signal automatic on selection 1	*DIA1
PD2, PD1002	For manufacturer setting	-
PD3, PD1003	Input device selection 1L	*DI1L
PD4, PD1004	Input device selection 1H	*DI1H
PD5, PD1005	Input device selection 2L	*DI2L
PD6, PD1006	Input device selection 2H	*DI2H
PD7, PD1007	Input device selection 3L	*DI3L
PD8, PD1008	Input device selection 3H	*DI3H
PD9, PD1009	Input device selection 4L	*DI4L
PD10, PD1010	Input device selection 4H	*DI4H
PD11, PD1011	Input device selection 5L	*DI5L
PD12, PD1012	Input device selection 5H	*DI5H
PD13, PD1013	Input device selection 6L	*DI6L
PD14, PD1014	Input device selection 6H	*DI6H
PD15 to PD16, PD1015 to PD1016	For manufacturer setting	-
PD17, PD1017	Input device selection 8L	*DI8L
PD18, PD1018	Input device selection 8H	*DI8H
PD19, PD1019	Input device selection 9L	*DI9L
PD20, PD1020	Input device selection 9H	*DI9H
PD21, PD1021	Input device selection 10L	*DI10L
PD22, PD1022	Input device selection 10H	*DI10H
PD23, PD1023	Output device selection 1	*DO1
PD24, PD1024	Output device selection 2	*DO2
PD25, PD1025	Output device selection 3	*DO3
PD26, PD1026	Output device selection 4	*DO4
PD27, PD1027	For manufacturer setting	-
PD28, PD1028	Output device selection 6	*DO6
PD29, PD1029	Input filter setting	*DIF
PD30, PD1030	Function selection D-1	*DOP1
PD31, PD1031	Function selection D-2	*DOP2
PD32, PD1032	Function selection D-3	*DOP3
PD33, PD1033	Function selection D-4	*DOP4
PD34, PD1034	Function selection D-5	*DOP5
PD35 to PD40, PD1035 to PD1040	For manufacturer setting	-
PD41, PD1041	Input signal automatic on selection 3	*DIA3
PD42, PD1042	Input signal automatic on selection 4	*DIA4

(Continued to next page)

Device name	Item	Symbol*1
PD43, PD1043	Input device selection 11L	*DI11L
PD44, PD1044	Input device selection 11H	*DI11H
PD45, PD1045	Input device selection 12L	*DI12L
PD46, PD1046	Input device selection 12H	*DI12H
PD47, PD1047	IOutput device selection 7	*DO7
PD48, PD1048	For manufacturer setting	-

\*1 For the parameters prefixed by an asterisk (\*), setting becomes effective when the power is turned off once and back on after setting the parameter data.

- Extension setting No.2 parameter

Device name	Item	Symbol*1
PE1, PE1001	Fully closed loop function selection 1	*FCT1
PE2, PE1002	For manufacturer setting	-
PE3, PE1003	Fully closed loop function selection 2	*FCT2
PE4, PE1004	Fully closed loop control - Feedback pulse electronic gear 1 - Numerator	*FBN
PE5, PE1005	Fully closed loop control - Feedback pulse electronic gear 1 - Denominator	*FBD
PE6, PE1006	Fully closed loop control - Speed deviation error detection level	BC1
PE7, PE1007	Fully closed loop control - Position deviation error detection level	BC2
PE8, PE1008	Fully closed loop dual feedback filter	DUF
PE9, PE1009	For manufacturer setting	-
PE10, PE1010	Fully closed loop function selection 3	FCT3
PE11 to PE33, PE1011 to PE1033	For manufacturer setting	-
PE34, PE1034	Fully closed loop control - Feedback pulse electronic gear 2 - Numerator	*FBN2
PE35, PE1035	Fully closed loop control - Feedback pulse electronic gear 2 - Denominator	*FBD2
PE36 to PE40, PE1036 to PE1040	For manufacturer setting	-
PE41, PE1041	Function selection E-3	EOP3
PE42 to PE64, PE1042 to PE1064	For manufacturer setting	-

\*1 For the parameters prefixed by an asterisk (\*), setting becomes effective when the power is turned off once and back on after setting the parameter data.

- Extension setting No.3 parameter

Device name	Item	Symbol*1
PF1 to PF8, PF1001 to PF1008	For manufacturer setting	-
PF9, PF1009	Function selection F-5	*FOP5
PF10 to PF14, PF1010 to PF1014	For manufacturer setting	-
PF15, PF1015	Electronic dynamic brake operating time	DBT
PF16 to PF20, PF1016 to PF1020	For manufacturer setting	-
PF21, PF1021	Drive recorder switching time setting	DRT
PF22, PF1022	For manufacturer setting	-
PF23, PF1023	Vibration tough drive - Oscillation detection level	OSCL1
PF24, PF1024	Vibration tough drive function selection	OSCL2

(Continued to next page)

Device name	Item	Symbol <sup>*1</sup>
PF25, PF1025	SEMI-F47 function - Instantaneous power failure detection time	CVAT
PF26 to PF30, PF1026 to PF1030	For manufacturer setting	-
PF31, PF1031	Machine diagnosis function - Friction judgement speed	FRIC
PF32 to PF33, PF1032 to PF1033	For manufacturer setting	-
PF34, PF1034	RS-422 communication function selection 3	*SOP3
PF35 to PF48, PF1035 to PF1048	For manufacturer setting	-

\*1 For the parameters prefixed by an asterisk (\*), setting becomes effective when the power is turned off once and back on after setting the parameter data.

- Option unit parameter

Device name	Item	Symbol <sup>*1</sup>
PO1 to PO11, PO1001 to PO1011	For manufacturer setting	-
PO12, PO1012	Function selection O-3	*OOP3
PO13 to PO32, PO1013 to PO1032	For manufacturer setting	-

\*1 For the parameters prefixed by an asterisk (\*), setting becomes effective when the power is turned off once and back on after setting the parameter data.

- Linear servo motor/DD motor setting parameters

Device name	Item	Symbol <sup>*1</sup>
PL1, PL1001	Linear servo motor/DD motor function selection 1	*LIT1
PL2, PL1002	Linear encoder resolution - Numerator	*LIM
PL3, PL1003	Linear encoder resolution - Denominator	*LID
PL4, PL1004	Linear servo motor/DD motor function selection 2	*LIT2
PL5, PL1005	Position deviation error detection level	LB1
PL6, PL1006	Speed deviation error detection level	LB2
PL7, PL1007	Torque/thrust deviation error detection level	LB3
PL8, PL1008	Linear servo motor/DD motor function selection 3	*LIT3
PL9, PL1009	Magnetic pole detection voltage level	LPWM
PL10 to PL16, PL1010 to PL1016	For manufacturer setting	-
PL17, PL1017	Magnetic pole detection - Minute position detection method - Function selection	LTSTS
PL18, PL1018	Magnetic pole detection - Minute position detection method - Identification signal amplitude	IDLV
PL19 to PL48, PL1019 to PL1048	For manufacturer setting	-

\*1 For the parameters prefixed by an asterisk (\*), setting becomes effective when the power is turned off once and back on after setting the parameter data.

- Positioning control parameters

Device name	Item	Symbol <sup>*1</sup>
PT1, PT1001	Command mode selection	*CTY
PT2, PT1002	Function selection T-1	*TOP1
PT3, PT1003	Feeding function selection	*FTY
PT4, PT1004	Home position return type	*ZTY
PT5, PT1005	Home position return speed	ZRF
PT6, PT1006	Creep speed	CRF
PT7, PT1007	Home position shift distance	ZST

(Continued to next page)

Device name	Item	Symbol*1
PT8, PT1008	Home position return position data	*ZPS
PT9, PT1009	Travel distance after proximity dog	DCT
PT10, PT1010	Stopper type home position return stopper time	ZTM
PT11, PT1011	Stopper type home position return torque limit value	ZTT
PT12, PT1012	Rough match output range	CRP
PT13, PT1013	JOG operation	JOG
PT14, PT1014	Backlash compensation	*BKC
PT15, PT1015	Software limit +(Low)	LMPL
PT16, PT1016	Software limit +(High)	LMPH
PT17, PT1017	Software limit -(Low)	LMNL
PT18, PT1018	Software limit -(High)	LMNH
PT19, PT1019	Position range output address +(Low)	*LPPL
PT20, PT1020	Position range output address +(High)	*LPPH
PT21, PT1021	Position range output address -(Low)	*LNPL
PT22, PT1022	Position range output address -(High)	*LNPH
PT23, PT1023	OUT1 output setting time	OUT1
PT24, PT1024	OUT2 output setting time	OUT2
PT25, PT1025	OUT3 output setting time	OUT3
PT26, PT1026	Function selection T-2	*TOP2
PT27, PT1027	Operation mode selection	*ODM
PT28, PT1028	Number of stations per rotation	*STN
PT29, PT1029	Function selection T-3	*TOP3
PT30 to PT33, PT1030 to PT1033	For manufacturer setting	-
PT34, PT1034	Point table/program default	*PDEF
PT35 to PT37, PT1035 to PT1037	For manufacturer setting	-
PT38, PT1038	Function selection T-7	*TOP7
PT39, PT1039	Torque limit delay time	INT
PT40, PT1040	Station home position shift distance	*SZS
PT41, PT1041	Home position return inhibit selection	ORP
PT42, PT1042	Digital override minimum multiplication	*OVM
PT43, PT1043	Digital override pitch width	*OVS
PT44 to PT48, PT1044 to PT1048	For manufacturer setting	-

\*1 For the parameters prefixed by an asterisk (\*), setting becomes effective when the power is turned off once and back on after setting the parameter data.

- Status display

Device name	Item	Symbol
ST0	Cumulative feedback pulses	-
ST1	Servo motor speed	-
ST2	Droop pulses	-
ST3	Cumulative command pulses	-
ST4	Command pulse frequency	-
ST5	Analog speed command voltage/Analog speed limit voltage	-
ST6	Analog torque limit voltage/Analog torque command voltage	-

(Continued to next page)

Device name	Item	Symbol
ST7	Regenerative load ratio	-
ST8	Effective load ratio	-
ST9	Peak load ratio	-
ST10	Instantaneous torque	-
ST11	Position within one-revolution	-
ST12	ABS counter	-
ST13	Load to motor inertia ratio	-
ST14	Bus voltage	-
ST15	Load-side cumulative feedback pulses	-
ST16	Load-side droop pulses	-
ST17	Load-side encoder information 1	-
ST18	Load-side encoder information 2	-
ST19 to ST21	For manufacturer setting	-
ST22	Temperature of servo motor thermistor	-
ST23	Servo motor-side cumulative feedback pulses (before gear)	-
ST24	Electrical angle	-
ST25 to ST29	For manufacturer setting	-
ST30	Servo motor-side/load-side position deviation	-
ST31	Servo motor-side/load-side speed deviation	-
ST32	Encoder inside temperature	-
ST33	Settling time	-
ST34	Oscillation detection frequency	-
ST35	Number of tough drive operations	-
ST36 to ST39	For manufacturer setting	-
ST40	Unit power consumption	-
ST41	Unit total power consumption	-
ST42	Current position	-
ST43	Command position	-
ST44	Command remaining distance	-
ST45	Point table No./Program No./Station position No.	-
ST46	Step No.	-
ST47	Analog override voltage	-
ST48	Override level	-

• Alarm (MELSERVO-J3-\*A compatible)

Device name	Item	Symbol
AL0	Current alarm number	-
AL1	Detailed data of current alarms	-
AL11	Servo status when alarm occurs Cumulative feedback pulses	-
AL12	Servo status when alarm occurs Servo motor speed	-
AL13	Servo status when alarm occurs Droop pulses	-
AL14	Servo status when alarm occurs cumulative command pulses	-
AL15	Servo status when alarm occurs command pulse frequency	-

(Continued to next page)

Device name	Item	Symbol
AL16	Servo status(alarm) analog speed command voltage/limit voltage	-
AL17	Servo status(alarm) analog torque command voltage/limit voltage	-
AL18	Servo status when alarm occurs regenerative load ratio	-
AL19	Servo status when alarm occurs effective load ratio	-
AL20	Servo status when alarm occurs peak load ratio	-
AL21	Servo status when alarm occurs Instantaneous torque	-
AL22	Servo status(alarm) Within one-revolution position(1 pulse unit)	-
AL23	Servo status when alarm occurs ABS counter	-
AL24	Servo status when alarm occurs load inertia moment ratio	-
AL25	Servo status when alarm occurs Bus voltage	-
AL200	Alarm number from Alarm History most recent alarm	-
AL201	Alarm number from Alarm History first alarm in past	-
AL202	Alarm number from Alarm History second alarm in past	-
AL203	Alarm number from Alarm History third alarm in past	-
AL204	Alarm number from Alarm History fourth alarm in past	-
AL205	Alarm number from Alarm History fifth alarm in past	-
AL210	Alarm occurrence time in alarm history most recent alarm	-
AL211	Alarm occurrence time in alarm history first alarm in past	-
AL212	Alarm occurrence time in alarm history second alarm in past	-
AL213	Alarm occurrence time in alarm history third alarm in past	-
AL214	Alarm occurrence time in alarm history fourth alarm in past	-
AL215	Alarm occurrence time in alarm history fifth alarm in past	-
AL230	Detailed alarm from Alarm History most recent alarm	-
AL231	Detailed alarm from Alarm History first alarm in past	-
AL232	Detailed alarm from Alarm History second alarm in past	-
AL233	Detailed alarm from Alarm History third alarm in past	-
AL234	Detailed alarm from Alarm History fourth alarm in past	-
AL235	Detailed alarm from Alarm History fifth alarm in past	-

- Alarm (extended for MELSERVO-J4-\*A)

Device name	Item	Symbol
ALM0	Current alarm number	-
ALM1	Detailed data of current alarms	-
ALM11	Servo status(alarm) Cumulative feedback pulses	-
ALM12	Servo status(alarm) Servo motor speed	-
ALM13	Servo status(alarm) Droop pulses	-
ALM14	Servo status(alarm) cumulative command pulses	-
ALM15	Servo status(alarm) command pulse frequency	-
ALM16	Servo status(alarm) analog speed command voltage/limit voltage	-
ALM17	Servo status(alarm) analog torque command voltage/limit voltage	-
ALM18	Servo status(alarm) regenerative load ratio	-
ALM19	Servo status(alarm) effective load ratio	-

(Continued to next page)

Device name	Item	Symbol
ALM20	Servo status(alarm) peak load ratio	-
ALM21	Servo status(alarm) Instantaneous torque	-
ALM22	Servo status(alarm) Within one-revolution position(1 pulse unit)	-
ALM23	Servo status(alarm) ABS counter	-
ALM24	Servo status(alarm) load inertia moment ratio	-
ALM25	Servo status(alarm) Bus voltage	-
ALM26	Servo status(alarm) Load-side cumulative feedback pulses	-
ALM27	Servo status(alarm) Load-side droop pulses	-
ALM28	Servo status(alarm) Load-side encoder information 1	-
ALM29	Servo status(alarm) Load-side encoder information 2	-
ALM30 to ALM32	For manufacturer setting	-
ALM33	Servo status(alarm) Temperature of servo motor thermistor	-
ALM34	Servo status(alarm) Servo motor-side cumulative feedback pulses (before gear)	-
ALM35	Servo status(alarm) Electrical angle	-
ALM36 to ALM40	For manufacturer setting	-
ALM41	Servo status(alarm) Servo motor-side/load-side position deviation	-
ALM42	Servo status(alarm) Servo motor-side/load-side speed deviation	-
ALM43	Servo status(alarm) Internal temperature of encoder	-
ALM44	Servo status(alarm) Setting time	-
ALM45	Servo status(alarm) Oscillation detection frequency	-
ALM46	Servo status(alarm) Number of tough drives	-
ALM47 to ALM50	For manufacturer setting	-
ALM51	Servo status(alarm) Unit power consumption	-
ALM52	Servo status(alarm) Unit total power consumption	-
ALM53	Servo status(alarm) Current position	-
ALM54	Servo status(alarm) Command position	-
ALM55	Servo status(alarm) Command remaining distance	-
ALM56	Servo status(alarm) Point table No./Program No./Station position No.	-
ALM57	Servo status(alarm) Step No.	-
ALM58	Servo status(alarm) Analog override voltage	-
ALM59	Servo status(alarm) Override level	-
ALM200	Alarm number from Alarm History most recent alarm	-
ALM201	Alarm number from Alarm History 1st alarm in past	-
ALM202	Alarm number from Alarm History 2nd alarm in past	-
ALM203	Alarm number from Alarm History 3rd alarm in past	-
ALM204	Alarm number from Alarm History 4th alarm in past	-
ALM205	Alarm number from Alarm History 5th alarm in past	-
ALM206	Alarm number from Alarm History 6th alarm in past	-
ALM207	Alarm number from Alarm History 7th alarm in past	-
ALM208	Alarm number from Alarm History 8th alarm in past	-
ALM209	Alarm number from Alarm History 9th alarm in past	-

(Continued to next page)



Device name	Item	Symbol
ALM210	Alarm number from Alarm History 10th alarm in past	-
ALM211	Alarm number from Alarm History 11th alarm in past	-
ALM212	Alarm number from Alarm History 12th alarm in past	-
ALM213	Alarm number from Alarm History 13th alarm in past	-
ALM214	Alarm number from Alarm History 14th alarm in past	-
ALM215	Alarm number from Alarm History 15th alarm in past	-
ALM220	Alarm occurrence time in alarm history most recent alarm	-
ALM221	Alarm occurrence time in alarm history 1st alarm in past	-
ALM222	Alarm occurrence time in alarm history 2nd alarm in past	-
ALM223	Alarm occurrence time in alarm history 3rd alarm in past	-
ALM224	Alarm occurrence time in alarm history 4th alarm in past	-
ALM225	Alarm occurrence time in alarm history 5th alarm in past	-
ALM226	Alarm occurrence time in alarm history 6th alarm in past	-
ALM227	Alarm occurrence time in alarm history 7th alarm in past	-
ALM228	Alarm occurrence time in alarm history 8th alarm in past	-
ALM229	Alarm occurrence time in alarm history 9th alarm in past	-
ALM230	Alarm occurrence time in alarm history 10th alarm in past	-
ALM231	Alarm occurrence time in alarm history 11th alarm in past	-
ALM232	Alarm occurrence time in alarm history 12th alarm in past	-
ALM233	Alarm occurrence time in alarm history 13th alarm in past	-
ALM234	Alarm occurrence time in alarm history 14th alarm in past	-
ALM235	Alarm occurrence time in alarm history 15th alarm in past	-
ALM240	Detailed alarm from Alarm History most recent alarm	-
ALM241	Detailed alarm from Alarm History 1st alarm in past	-
ALM242	Detailed alarm from Alarm History 2nd alarm in past	-
ALM243	Detailed alarm from Alarm History 3rd alarm in past	-
ALM244	Detailed alarm from Alarm History 4th alarm in past	-
ALM245	Detailed alarm from Alarm History 5th alarm in past	-
ALM246	Detailed alarm from Alarm History 6th alarm in past	-
ALM247	Detailed alarm from Alarm History 7th alarm in past	-
ALM248	Detailed alarm from Alarm History 8th alarm in past	-
ALM249	Detailed alarm from Alarm History 9th alarm in past	-
ALM250	Detailed alarm from Alarm History 10th alarm in past	-
ALM251	Detailed alarm from Alarm History 11th alarm in past	-
ALM252	Detailed alarm from Alarm History 12th alarm in past	-
ALM253	Detailed alarm from Alarm History 13th alarm in past	-
ALM254	Detailed alarm from Alarm History 14th alarm in past	-
ALM255	Detailed alarm from Alarm History 15th alarm in past	-

- Point table

Device name	Item	Symbol
POS1 to POS255, POS1001 to POS1255	Point table (position) No.1 to No.255	-
SPD1 to SPD255, SPD1001 to SPD1255	Point table (speed) No.1 to No.255	-
ACT1 to ACT255, ACT1001 to ACT1255	Point table (acceleration time constant) No.1 to No.255	-
DCT1 to DCT255, DCT1001 to DCT1255	Point table (deceleration time constant) No.1 to No.255	-
DWL1 to DWL255, DWL1001 to DWL1255	Point table (dwell) No.1 to No.255	-
AUX1 to AUX255, AUX1001 to AUX1255	Point table (auxiliary function) No.1 to No.255	-
MCD1 to MCD255, MCD1001 to MCD1255	Point table (M code) No.1 to No.255	-

- Machine diagnosis data

Device name	Item	Symbol
MD0	Machine diagnosis data parameter number	-
MD1	Machine diagnosis data shift judgment(test mode)	-
MD2	Machine diagnosis data status	-
MD3	Machine diagnosis data coulomb friction torque in positive direction	-
MD4	Machine diagnosis data friction torque at rated speed in positive direction	-
MD5	Machine diagnosis data coulomb friction torque in negative direction	-
MD6	Machine diagnosis data friction torque at rated speed in negative direction	-
MD7	Machine diagnosis data oscillation frequency(moter is stopped)	-
MD8	Machine diagnosis data vibration level(moter is stopped)	-
MD9	Machine diagnosis data oscillation frequency(moter is operating)	-
MD10	Machine diagnosis data vibration level(moter is operating)	-
MD11	Machine diagnosis data rated speed	-

- One-touch tuning data

Device name	Item	Symbol
OTS0	One-touch tuning status confirmation	-
OTS1	Error code list	-
OTS2	Setting time	-
OTS3	Overshoot amount	-

- External input

Device name	Item	Symbol
DI0	Input device statuses 1	-
DI1	Input device statuses 2	-
DI2	Input device statuses 3	-
DI3	External input pin statuses	-
DI4	Statuses of input devices switched on through communication 1	-
DI5	Statuses of input devices switched on through communication 2	-
DI6	Statuses of input devices switched on through communication 3	-

- External output

Device name	Item	Symbol
DO0	Output device statuses 1	-
DO1	Output device statuses 2	-
DO2	Output device statuses 3	-
DO3	Output device statuses 4	-
DO4	External output pin statuses	-

- Current position latch data

Device name	Item	Symbol
LD0	Position data unit	-
LD1	Current position latch data	-

- General-purpose register (Rx)

Device name	Item	Symbol
RR1, RR1001	General purpose register (R1) value	-
RR2, RR1002	General purpose register (R2) value	-
RR3, RR1003	General purpose register (R3) value	-
RR4, RR1004	General purpose register (R4) value	-

- General-purpose register (Dx)

Device name	Item	Symbol
RD1	General purpose register (D1) value	-
RD2	General purpose register (D2) value	-
RD3	General purpose register (D3) value	-
RD4	General purpose register (D4) value	-

- Life Diagnosis

Device name	Item	Symbol
ALD0	Cumulative power-on time	-
ALD1	Number of inrush current switching times	-

- Input signal for test operation (for test operation)

Device name	Item	Symbol
TMI0	Input signal for test operation 1	-
TMI1	Input signal for test operation 2	-
TMI2	Input signal for test operation 3	-

- Forced output of signal pin (for test operation)

Device name	Item	Symbol
TMO0	Forced output from signal pin	-

- Set data (for test operation)

Device name	Item	Symbol
TMD0	Writes the speed(test mode)	-
TMD1	Writes the acceleration/deceleration time constant (test mode)	-
TMD3	Writes the moving distance (test mode)	-

## ■ PANASONIC servo amplifier

### (1) PANASONIC MINAS-A4

Device name <sup>*1</sup>		Setting range	Device No. representation
Bit device	Status (STS) <sup>*2</sup>	STS0 to STS7	Decimal
	Input signal (INP) <sup>*2</sup>	INP0 to INP31	
	Output signal (OTP) <sup>*2</sup>	OTP0 to OTP47	
	Absolute encoder (Status) (AEST) <sup>*2</sup>	AEST0 to AEST15	
	Writing of parameter to EEPROM (EPRW) <sup>*3</sup>	EPRW0	
	Clear of user alarm history (in EEPROM as well) (ALHC) <sup>*3</sup>	ALHC0	
	Alarm clear (ALMC) <sup>*3</sup>	ALMC0	
Absolute clear (ABSC) <sup>*3</sup>	ABSC0		
Word device	Status (Control modes) (STCM) <sup>*2</sup>	STCM0	Decimal
	Present speed (SPD) <sup>*2</sup>	SPD0	
	Present torque output (TRQ) <sup>*2</sup>	TRQ0	
	Absolute encoder (Encoder ID) (AEID) <sup>*2</sup>	AEID0	
	Absolute encoder (Multi-turn data) (AEMD) <sup>*2</sup>	AEMD0	
	Parameter (PRM)	PRM0000 to PRM007F	Hexadecimal
	Present alarm data (ALM) <sup>*2</sup>	ALM0	Decimal
	User alarm history (ALHI) <sup>*2</sup>	ALHI1 to ALHI14	
	User parameter (MIN. value) (PRMN) <sup>*2</sup>	PRMN0000 to PRMN007F	Hexadecimal
	User parameter (MAX. value) (PRMX) <sup>*2</sup>	PRMX0000 to PRMX007F	
User parameter (Property) (PRPR) <sup>*2</sup>	PRPR0000 to PRPR007F		
Double-word device	Feedback pulse counter (FBPC) <sup>*2</sup>	FBPC0	Decimal
	Present deviation counter (DVC) <sup>*2</sup>	DVC0	
	Absolute encoder (Single turn data) (AESD) <sup>*2</sup>	AESD0	
	External scale deviation and sum of pulses (ESA) <sup>*2</sup>	ESA0 to ESA1	

\*1 The GOT cannot read or write data from/to consecutive devices.

\*2 Only reading is possible.

\*3 Only writing is possible.

**(2) PANASONIC MINAS-A5**

Device name <sup>*1</sup>		Setting range	Device No. representation
Bit device	Status (STS) <sup>*2</sup>	STS0 to STS7	Decimal
	Input signal (INP) <sup>*2</sup>	INP0 to INP31	
	Output signal (OTP) <sup>*2</sup>	OTP0 to OTP47	
	Absolute encoder (Status) (AEST) <sup>*2</sup>	AEST0 to AEST15	
	Writing of parameter to EEPROM (EPRW) <sup>*3</sup>	EPRW0	
	Clear of user alarm history (in EEPROM as well) (ALHC) <sup>*3</sup>	ALHC0	
	Alarm clear (ALMC) <sup>*3</sup>	ALMC0	
	Absolute clear (ABSC) <sup>*3</sup>	ABSC0	
Word device	Status (Control modes) (STCM) <sup>*2</sup>	STCM0	Decimal
	Present speed (SPD) <sup>*2</sup>	SPD0	
	Present torque output (TRQ) <sup>*2</sup>	TRQ0	
	Absolute encoder (Encoder ID) (AEID) <sup>*2</sup>	AEID0	
	Absolute encoder (Multi-turn data) (AEMD) <sup>*2</sup>	AEMD0	
	Present alarm data (ALM) <sup>*2</sup>	ALM0	
	Present alarm data (Sub number) (ALMS) <sup>*2</sup>	ALMS0	
	User alarm history (ALHI) <sup>*2</sup>	ALHI1 to ALHI14	
	User alarm history (Sub number) (ALHS) <sup>*2</sup>	ALHS1 to ALHS14	
	User parameter (Class.0, Property) (PRPR0) <sup>*3</sup>	PRPR00 to PRPR017	
	User parameter (Class.1, Property) (PRPR1) <sup>*3</sup>	PRPR10 to PRPR127	
	User parameter (Class.2, Property) (PRPR2) <sup>*3</sup>	PRPR20 to PRPR223	
	User parameter (Class.3, Property) (PRPR3) <sup>*3</sup>	PRPR30 to PRPR329	
	User parameter (Class.4, Property) (PRPR4) <sup>*3</sup>	PRPR40 to PRPR442	
	User parameter (Class.5, Property) (PRPR5) <sup>*3</sup>	PRPR50 to PRPR535	
User parameter (Class.6, Property) (PRPR6) <sup>*3</sup>	PRPR60 to PRPR639		

(Continued to next page)

Device name <sup>*1</sup>	Setting range	Device No. representation
Parameter (Class.0) (PRM0)	PRM00 to PRM017	Decimal
Parameter (Class.1) (PRM1)	PRM10 to PRM127	
Parameter (Class.2) (PRM2)	PRM20 to PRM223	
Parameter (Class.3) (PRM3)	PRM30 to PRM329	
Parameter (Class.4) (PRM4)	PRM40 to PRM442	
Parameter (Class.5) (PRM5)	PRM50 to PRM535	
Parameter (Class.6) (PRM6)	PRM60 to PRM639	
User parameter (Class.0, MIN.value) (PRMN0) <sup>*2</sup>	PRMN00 to PRMN017	
User parameter (Class.1, MIN.value) (PRMN1) <sup>*2</sup>	PRMN10 to PRMN127	
User parameter (Class.2, MIN.value) (PRMN2) <sup>*2</sup>	PRMN20 to PRMN223	
User parameter (Class.3, MIN.value) (PRMN3) <sup>*2</sup>	PRMN30 to PRMN329	
User parameter (Class.4, MIN.value) (PRMN4) <sup>*2</sup>	PRMN40 to PRMN442	
User parameter (Class.5, MIN.value) (PRMN5) <sup>*2</sup>	PRMN50 to PRMN535	
User parameter (Class.6, MIN.value) (PRMN6) <sup>*2</sup>	PRMN60 to PRMN639	
User parameter (Class.0, MAX.value) (PRMX0) <sup>*2</sup>	PRMX00 to PRMX017	
User parameter (Class.1, MAX.value) (PRMX1) <sup>*2</sup>	PRMX10 to PRMX127	
User parameter (Class.2, MAX.value) (PRMX2) <sup>*2</sup>	PRMX20 to PRMX223	
User parameter (Class.3, MAX.value) (PRMX3) <sup>*2</sup>	PRMX30 to PRMX329	
User parameter (Class.4, MAX.value) (PRMX4) <sup>*2</sup>	PRMX40 to PRMX442	
User parameter (Class.5, MAX.value) (PRMX5) <sup>*2</sup>	PRMX50 to PRMX535	
User parameter (Class.6, MAX.value) (PRMX6) <sup>*2</sup>	PRMX60 to PRMX639	
Feedback pulse counter (FBPC) <sup>*2</sup>	FBPC0	
Present deviation counter (DVC) <sup>*2</sup>	DVC0	
Absolute encoder (Single turn data) (AESD) <sup>*2</sup>	AESD0	
External scale deviation and sum of pulses (ESA) <sup>*2</sup>	ESA0 to ESA1	

\*1 The GOT cannot read or write data from/to consecutive devices.

\*2 Only reading is possible.

\*3 Only writing is possible.

Double-word device

# Appendix4 Setting device of each controller

## Mitsubishi Electric PLC

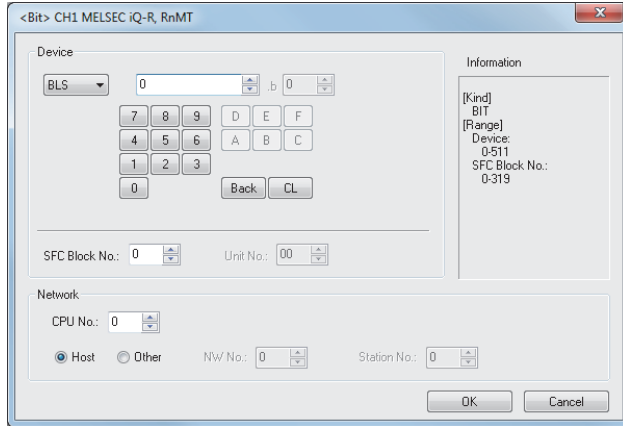

MELSEC iQ-R, RnMT

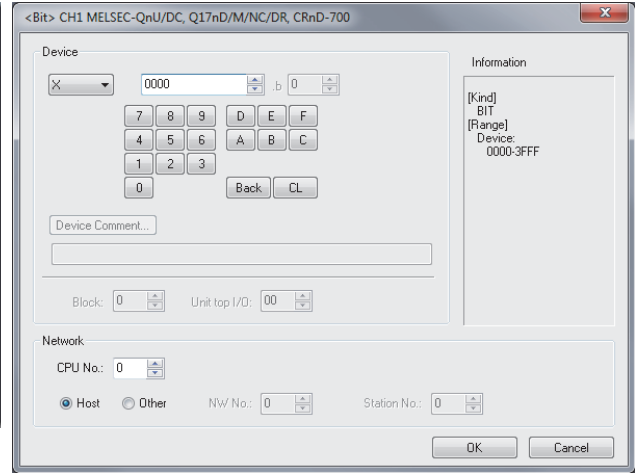

MELSEC-QnU/DC, Q17nD/M/NC/DR, CRnD-700

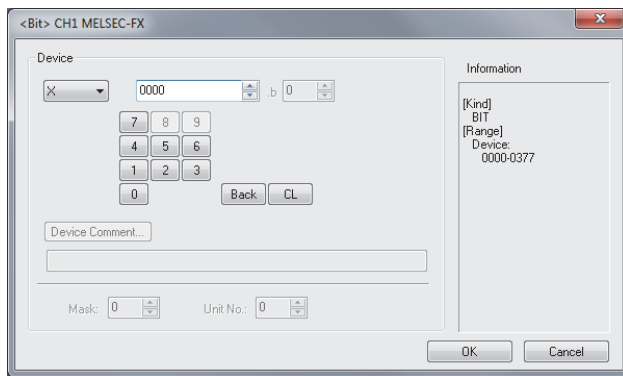

MELSEC-FX

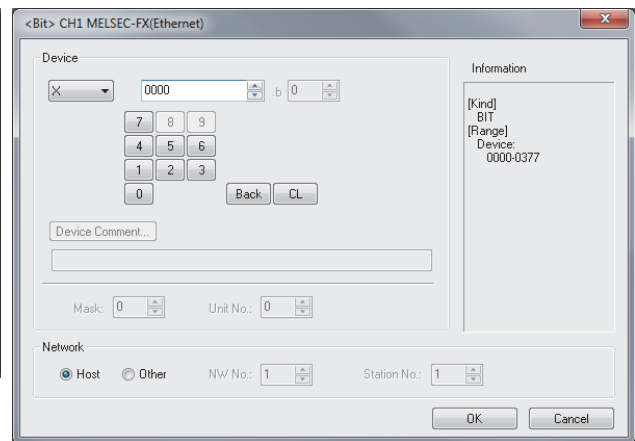

MELSEC-FX(Ethernet)

Item	Description	Model	
Device	Set the device name, device number, and bit number. The bit number can be set when performing the bit specification of word device. When setting the buffer memory, set the buffer memory address in the space for the device number.	<div style="border: 1px solid black; padding: 2px; display: inline-block;">                     G116 G115                      G114 G112                      G111 G110                      SoftGOT1000                 </div>	
	<div style="border: 1px solid gray; padding: 2px; display: inline-block;">Device Comment...</div> Reading the device comment data created by GX Developer and confirming the device comment/device name is available during device setting. For how to use the device comment reference, refer to the following. 9.2 Referring to Device Comment (Importing GX Developer Device Comment)		
	SFC Block No.		Can be set only when a step relay (block) (BLS) is selected. Set the block number of the step relay (block).
	Block		It can be set when the extended file register (ER) is selected. Set the block number of the extended file register.
	Unit top I/O		It can be set when the buffer memory (BM) is selected. Set the start I/O number of the buffer memory for the intelligent function module. Set the first 2 digits of the 3-digit start I/O number.
	Mask		Set this item when using the buffer memory of the FX CPU. Set the mask type when only the specific bit of the buffer memory is monitored or written. (4) Mask type setting

(Continued to next page)



Item	Description		Model
Device	Unit No.	<ul style="list-style-type: none"> <li>For MELSEC iQ-R, RnMT, MELSEC iQ-F, MELSEC-QnU/DC, Q17nD/M/NC/DR, CRnD-700, MELSEC-QnA/Q/QS, MELDAS C6*, MELSEC-Q(Multi)/Q-Motion, and MELSEC-L Set this item when using the buffer memory (G). Set the start I/O number of the buffer memory for the intelligent function module. Set the first 2 digits of the 3-digit start I/O number.</li> <li>For MELSEC-FX(Ethernet) Set this item when using the buffer memory of the FX CPU. Set the unit number of special function units or special function blocks to be monitored or written.</li> </ul>  (5) Unit number setting (for MELSEC-FX(Ethernet))	GT16 GT15 GT14 GT12 GT11 GT10 SoftGOT1000
Information	Displays the type and setting range of the device selected in [Device].		
Network		Set the station number of the controller to be monitored.	
	CPU No.	Set the CPU No. of the controller.	
	Host	Select this when monitoring the host controller.	
	Other	Select this when monitoring other controller. Then, set the station number and network number of the controller to be monitored. NW No. : Set the network No. Station No. : Set the station No.	GT16 GT15 GT14 GT12 GT11 GT10 SoftGOT1000

### (1) Setting CPU No.

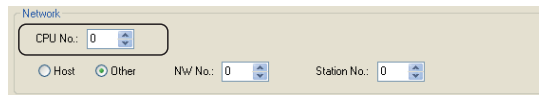

- (a) When monitoring single CPU system  
Set the CPU No. to "0".
- (b) When monitoring multiple CPU system  
Set [CPU No.] between "0" and "4" in the network setting when monitoring a multiple CPU system.  
When [CPU No.] is set to "0", the monitoring target differs depending on the connection method.

Connection method		Monitoring target
• Direct CPU connection	• Ethernet connection (when using the Ethernet port built in the CPU)	Connected PLC CPU
• Bus connection	• Computer link connection	Control CPU
• MELSECNET connection	• Ethernet connection (when using the Ethernet module)	
• CC-Link connection		

- (c) When bus-connected by GT SoftGOT1000, which is installed on the PC CPU module  
Do not set [CPU No.] to "0".  
When [CPU No.] is set to "0", GT SoftGOT1000 cannot monitor the PC CPU module although the module is set as a monitoring target.

### (2) When monitoring link relay (B) and link register (W) assigned in link parameter and network parameter

Set device link relay (B) and link register (W) running cyclic communication as [Host].  
If it is set as [Other] in the network setting, the cyclic transmission will be changed to the transient transmission irrespective of the network type, resulting in delay of the object display.

**(3) Setting device by inputting directly from keyboard**

When setting it by inputting directly from the keyboard, set the items as follows:

(a) Devices other than the buffer memory (BM, G) and the step relay (block) (BLS)

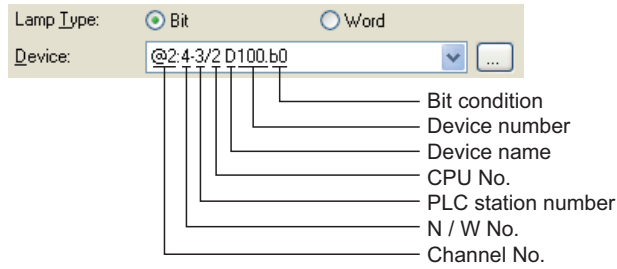

(b) Buffer memory (BM)

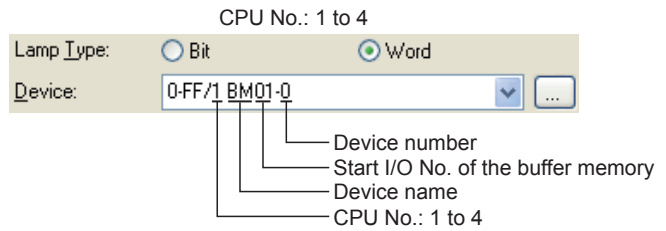
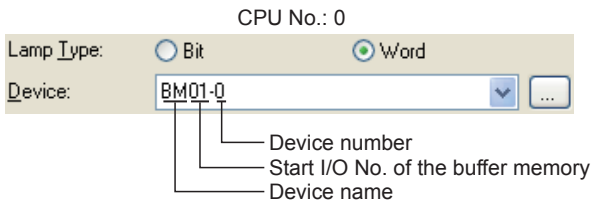

(c) Buffer memory (G)

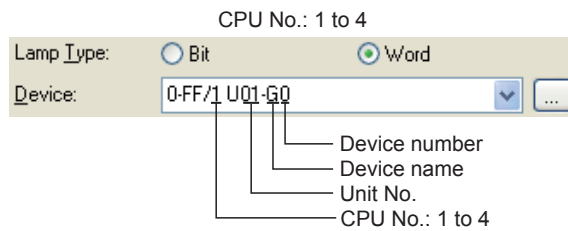
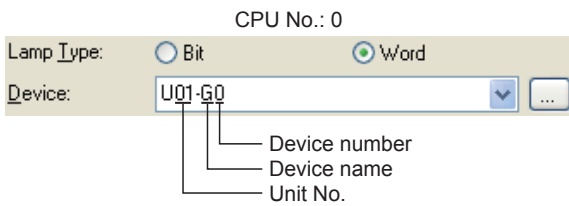

(d) Step relay (block)(BLS)

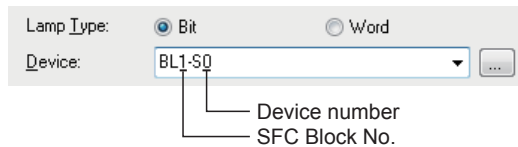

**(4) Mask type setting**

Set the mask type when only the specific bit of the buffer memory is monitored or written.

**(a) Mask type "0"**

The buffer memory value is monitored or written.

**(b) Mask type "1"**

- 16 bits

Only b0 to b3 of the buffer memory is monitored or written.

Example:

When monitoring BM0=4321H with the mask type "1", the monitored value=0001H.

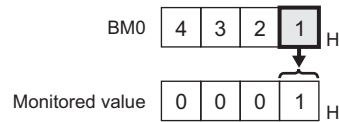

When writing the input value (4321H) to BM0=0000H with the mask type "1", BM0=0001H.

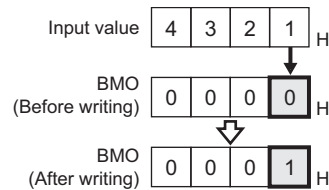

- 32 bits

Only b0 to b3 and b16 to b19 of the buffer memory is monitored or written.

Example:

When monitoring BM0=87654321H with the mask type "1", the monitored value=00050001H.

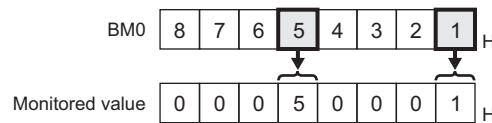

When writing the input value (87654321H) to BM0=00000000H with the mask type "1", BM0=00050001H.

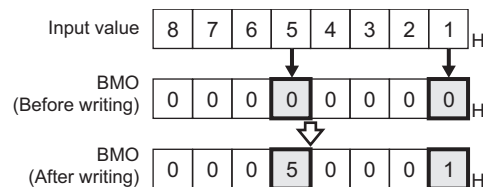
**(c) Mask type "2"**

- 16 bits

Only b4 to b7 of the buffer memory is monitored or written.

Example:

When monitoring BM0=4321H with the mask type "2", the monitored value=0002H.

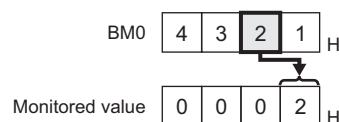

When writing the input value (4321H) to BM0=0000H with the mask type "2", BM0=0010H.

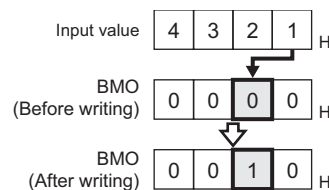

- 32 bits

Only b4 to b7 and b20 to b23 of the buffer memory is monitored or written.

Example:

When monitoring BM0=87654321H with the mask type "2", the monitored value=00060002H.

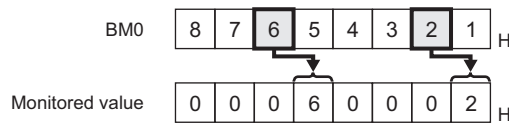

When writing the input value (87654321H) to BM0=00000000H with the mask type "2", BM0=00500010H.

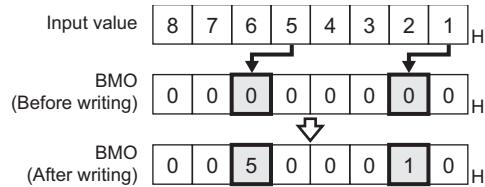

(d) Mask type "3"

- 16 bits

Only b8 to b11 of the buffer memory is monitored or written.

Example:

When monitoring BM0=4321H with the mask type "3", the monitored value=0003H.

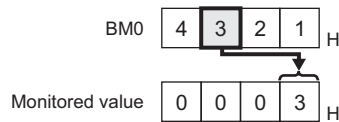

When writing the input value (4321H) to BM0=0000H with the mask type "3", BM0=0100H.

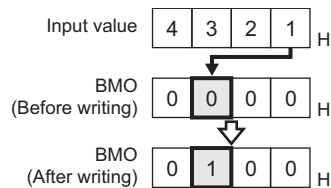

- 32 bits

Only b8 to b11 and b28 to b31 of the buffer memory is monitored or written.

Example:

When monitoring BM0=87654321H with the mask type "3", the monitored value=00070003H.

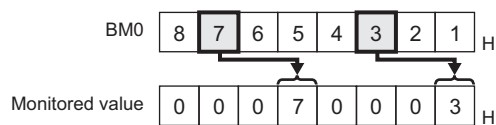

When writing the input value (87654321H) to BM0=00000000H with the mask type "3", BM0=00050001H.

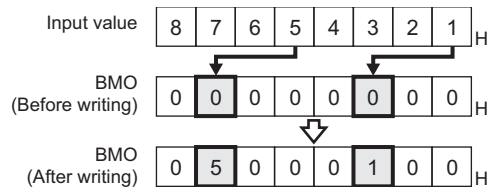

## (e) Mask type "4"

- 16 bits

Only b12 to b15 of the buffer memory is monitored or written.

Example:

When monitoring BM0=4321H with the mask type "4", the monitored value=0004H.

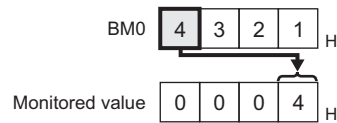

When writing the input value (4321H) to BM0=0000H with the mask type "4", BM0=1000H.

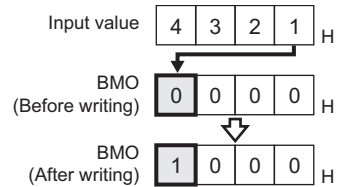

- 32 bits

Only b12 to b15 and b28 to 31 of the buffer memory is monitored or written.

Example:

When monitoring BM0=87654321H with the mask type "4", the monitored value=00080004H.

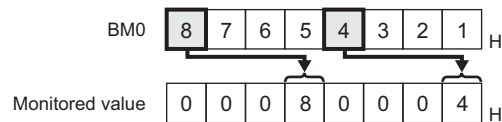

When writing the input value (87654321H) to BM0=00000000H with the mask type "4", BM0=50001000H.

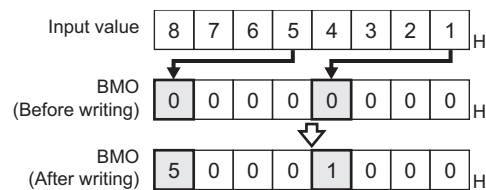

## (f) Mask type "5"

- 16 bits

Only b0 to b7 of the buffer memory is monitored or written.

Example:

When monitoring BM0=4321H with the mask type "5", the monitored value=0021H.

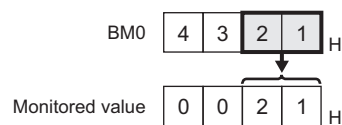

When writing the input value (4321H) to BM0=0000H with the mask type "5", BM0=0021H.

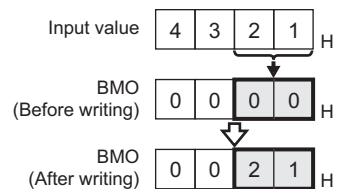

- 32 bits

Only b0 to b7 and b13 to b16 of the buffer memory is monitored or written.

Example:

When monitoring BM0=87654321H with the mask type "5", the monitored value=00650021H.

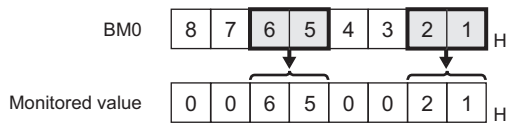

When writing the input value (87654321H) to BM0=00000000H with the mask type "5", BM0=00650021H.

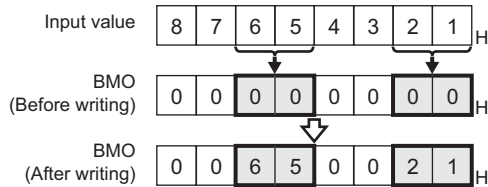

(g) Mask type "6"

- 16 bits

Only b8 to b15 of the buffer memory is monitored or written.

Example:

When monitoring BM0=4321H with the mask type "6", the monitored value=0043H.

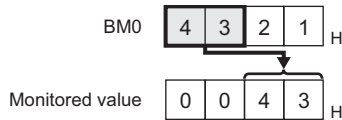

When writing the input value (4321H) to BM0=0000H with the mask type "6", BM0=2100H.

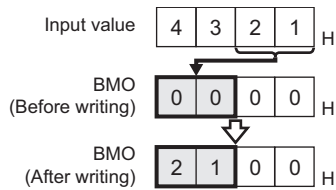

- 32 bits

Only b8 to b15 and b24 to 31 of the buffer memory is monitored or written.

Example:

When monitoring BM0=87654321H with the mask type "6", the monitored value=00870043H.

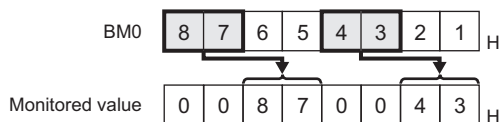

When writing the input value (87654321H) to BM0=00000000H with the mask type "6", BM0=65002100H.

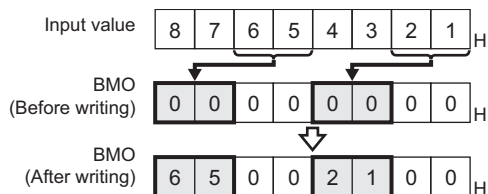

## (5) Unit number setting (for MELSEC-FX(Ethernet))

Set the unit number of special function units or special function blocks to be monitored or written. The unit number (No.0 to No.7) is assigned to the units or blocks in order of distance from the main unit. For details of the unit number, refer to the following.

 User's Manual (Hardware) of MELSEC-FX

### (a) Direct specification

When setting devices, directly specify the unit number (No.0 to No.7) of special function units or special function blocks to be monitored or written.

### (b) Indirect specification

When setting devices, indirectly specify the unit number of special function units or special function blocks to be monitored or written using the 16-bit GOT internal registers (GD10 to GD25).

When specifying the unit number at 100 to 115 on GT Designer3, the value of device corresponding to the unit number (GD10 to GD25) is the unit number of the special function unit or special function block.

Unit No.	Corresponding device	Setting range
100	GD10	0 to 7 If setting a value outside the range above, a device range error occurs. If setting the unit number which does not exist, a communication timeout error occurs.
101	GD11	
:	:	
114	GD24	
115	GD25	

## (6) MELSEC-WS

### (a) Device settings of MELSEC-WS

- Input (I), Output(Q)

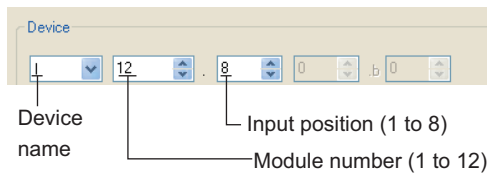

- Logic result (LQ), Logic input (LI)

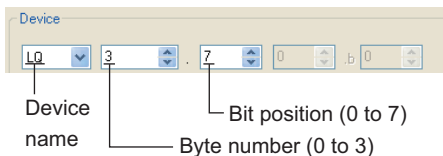

- EFI input (EI)

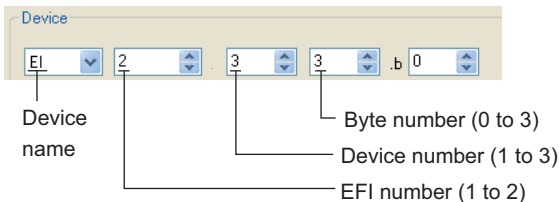

- EFI output (EQ)

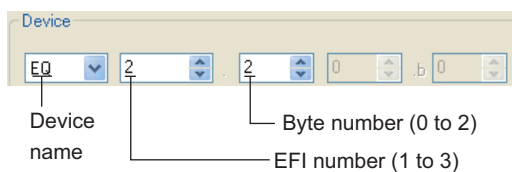

- (b) Engineering software for MELSEC-WS and device representation of GT Designer3  
 The engineering software for MELSEC-WS and the device representation of GT Designer3 are different.  
 Set the device by referring to the following table.

Device name	GT Designer3	Engineering software for MELSEC-WS
I <sup>*1</sup>	I□□.△ □□(1-12(Dec)): Module number △(1-8): Input position	▲▲▲▲[□□].I△ ▲▲▲▲: I/O model name (such as XTIO) □□ (1-12(Dec)): Module number △ (1-8): Input position
Q <sup>*1</sup>	Q□□.△ □□ (1-12(Dec)): Module number △ (1-8): Output position	▲▲▲▲[□□].Q△ ▲▲▲▲: I/O model name (such as XTIO) □□ (1-12(Dec)): Module number △ (1-8): Output position
LQ <sup>*1</sup>	LQ□.△ □ (0-3): Byte number △ (0-7): Bit position	▲▲□.△ ▲▲: "Result" □ (0-3): Byte number △ (0-7): Bit position
LI <sup>*1</sup>	LI□.△ □ (0-3): Byte number △ (0-7): Bit position	▲▲▲▲[0].□.△ ▲▲▲▲: CPU type (CPU0, CPU1) □ (0-3): Byte number △ (0-7): Bit position
EI <sup>*1</sup>	EIO□△ ○ (1-2): EFI number □ (1-3): Device number △ (0-3): Byte number	▲▲▲▲[0].EFI○:□, Byte △ ▲▲▲▲: CPU type (CPU0, CPU1) ○ (1-2): EFI number □ (1-3): Device number △ (0-3): Byte number
EQ <sup>*1</sup>	EQ○△ △ (1-2): EFI number ○ (0-2): Byte number	▲▲▲▲[0].EFI○:1, Byte △ ▲▲▲▲: CPU type (CPU0, CPU1) ○ (1-2): EFI number △ (0-2): Byte number
D	D△ △ (0-99(Dec)): Byte number	RS232 data (Safety controller to RS232)
W	W△ △ (0-49(Dec)): Word number Word virtualization of D device W0= (D1(Upper bits), D0(Lower bits))	GOT independent device (Not available)
LD	LD△ △ (0-3): Byte number	RS232 data (Safety controller to RS232)
LW	LW△ △ (0-1): Word number Word virtualization of LD device LW0= (LD1(Upper bits), LD0(Lower bits))	GOT independent device (Not available)

<sup>\*1</sup> When the mapping position is changed by the MELSEC-WS engineering software, a mismatch occurs between virtual devices on GOT and MELSEC-WS mapping devices.  
 When mapping is changed, use D devices or LD devices.



(c) When using offset specification

When setting devices using the offset function, the device values are as follows.

• Input (I)

Offset	+0	+1	+2	+3	+4	+5	+6	+7	+8 to +15
+0	I1.1	I1.2	I1.3	I1.4	I1.5	I1.6	I1.7	I1.8	Fixed to 0 (OFF)
+16	I2.1	I2.2	I2.3	I2.4	I2.5	I2.6	I2.7	I2.8	
+32	I3.1	I3.2	I3.3	I3.4	I3.5	I3.6	I3.7	I3.8	
+48	I4.1	I4.2	I4.3	I4.4	I4.5	I4.6	I4.7	I4.8	
+64	I5.1	I5.2	I5.3	I5.4	I5.5	I5.6	I5.7	I5.8	
+80	I6.1	I6.2	I6.3	I6.4	I6.5	I6.6	I6.7	I6.8	
+90	I7.1	I7.2	I7.3	I7.4	I7.5	I7.6	I7.7	I7.8	
+112	I8.1	I8.2	I8.3	I8.4	I8.5	I8.6	I8.7	I8.8	
+128	I9.1	I9.2	I9.3	I9.4	I9.5	I9.6	I9.7	I9.8	
+144	I10.1	I10.2	I10.3	I10.4	I10.5	I10.6	I10.7	I10.8	
+160	I11.1	I11.2	I11.3	I11.4	I11.5	I11.6	I11.7	I11.8	
+176	I12.1	I12.2	I12.3	I12.4	I12.5	I12.6	I12.7	I12.8	
+192	Device range error								

• Output (Q)

Offset	+0	+1	+2	+3	+4	+5	+6	+7	+8 to +15
+0	Q1.1	Q1.2	Q1.3	Q1.4	Q1.5	Q1.6	Q1.7	Q1.8	Fixed to 0 (OFF)
+16	Q2.1	Q2.2	Q2.3	Q2.4	Q2.5	Q2.6	Q2.7	Q2.8	
+32	Q3.1	Q3.2	Q3.3	Q3.4	Q3.5	Q3.6	Q3.7	Q3.8	
+48	Q4.1	Q4.2	Q4.3	Q4.4	Q4.5	Q4.6	Q4.7	Q4.8	
+64	Q5.1	Q5.2	Q5.3	Q5.4	Q5.5	Q5.6	Q5.7	Q5.8	
+80	Q6.1	Q6.2	Q6.3	Q6.4	Q6.5	Q6.6	Q6.7	Q6.8	
+90	Q7.1	Q7.2	Q7.3	Q7.4	Q7.5	Q7.6	Q7.7	Q7.8	
+112	Q8.1	Q8.2	Q8.3	Q8.4	Q8.5	Q8.6	Q8.7	Q8.8	
+128	Q9.1	Q9.2	Q9.3	Q9.4	Q9.5	Q9.6	Q9.7	Q9.8	
+144	Q10.1	Q10.2	Q10.3	Q10.4	Q10.5	Q10.6	Q10.7	Q10.8	
+160	Q11.1	Q11.2	Q11.3	Q11.4	Q11.5	Q11.6	Q11.7	Q11.8	
+176	Q12.1	Q12.2	Q12.3	Q12.4	Q12.5	Q12.6	Q12.7	Q12.8	
+192	Device range error								

• Logic result (LQ)

Offset	+0	+1	+2	+3	+4	+5	+6	+7
+0	LQ0.0	LQ0.1	LQ0.2	LQ0.3	LQ0.4	LQ0.5	LQ0.6	LQ0.7
+8	LQ1.0	LQ1.1	LQ1.2	LQ1.3	LQ1.4	LQ1.5	LQ1.6	LQ1.7
+16	LQ2.0	LQ2.1	LQ2.2	LQ2.3	LQ2.4	LQ2.5	LQ2.6	LQ2.7
+24	LQ3.0	LQ3.1	LQ3.2	LQ3.3	LQ3.4	LQ3.5	LQ3.6	LQ3.7
+32	Device range error							

- EFI input (EI)

Offset	+0	+1	+2	+3	+8 to +15
+0	EI110	EI111	EI112	EI113	Fixed to 0
+16	EI120	EI121	EI122	EI123	
+32	EI130	EI131	EI132	EI133	
+48 : +240	Fixed to 0				
+256	EI210	EI211	EI212	EI213	
+272	EI220	EI221	EI222	EI223	Device range error
+288	EI230	EI231	EI232	EI233	
+302	Device range error				

- EFI output (EQ)

Offset	+0	+1	+2	+3 to +15
+0	EQ10	EQ11	EQ12	Fixed to 0
+16 : +240	Fixed to 0			
+256	EQ20	EQ21	EQ22	
+302	Device range error			

## ■ OMRON PLC

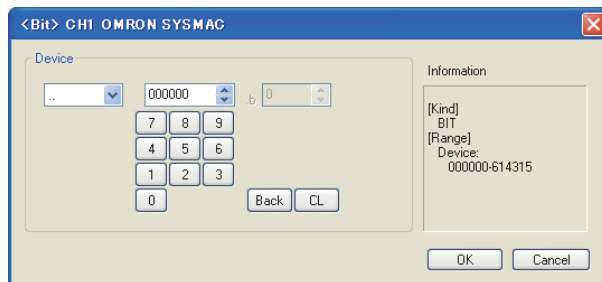

OMRON SYSMAC

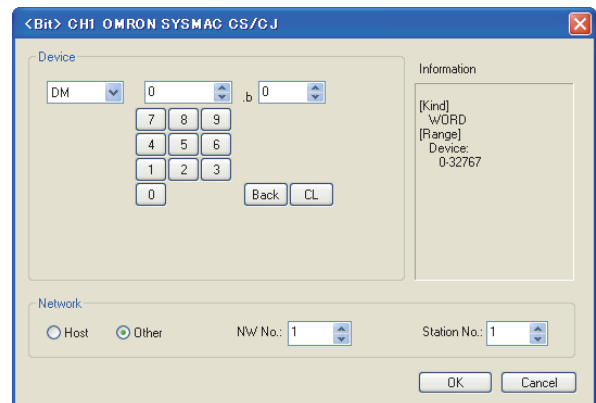

OMRON SYSMAC CS/CJ

Item	Description		Model
Device	Set the device name, device number, and bit number. The bit number can be set when performing the bit specification of word device.		GT16 GT15 GT14 GT12 GT11 GT10 SoftGoT1000
Information	Displays the type and setting range of the device selected in [Device].		
Network	Host	Select this when monitoring the host controller.	GT16 GT15 GT14 GT12 GT11 GT10 SoftGoT1000
	Other	Select this when monitoring other controller. Then, set the station number and network number of the controller to be monitored. NW No. : Set the network No. Station No. : Set the station No.	

## KEYENCE PLC

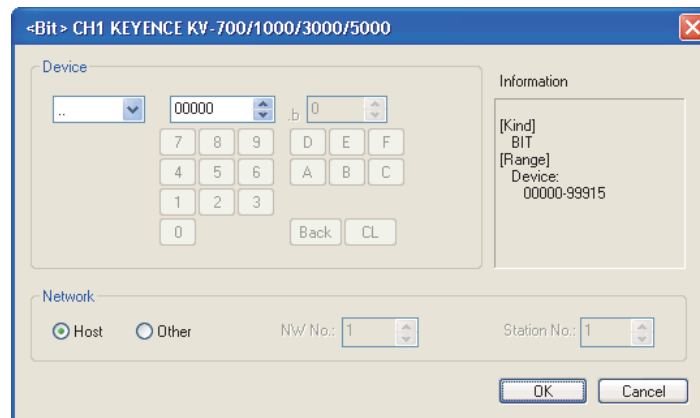

Item	Description	Model		
Device	Set the device name, device number, and bit number. The bit number can be set when performing the bit specification of word device.	GT16 GT15 GT14 GT12 GT11 GT10		
Information	Displays the type and setting range of the device selected in [Device].	SoftGOT1000		
Network	Set the station number of the controller to be monitored.	GT16 GT15 GT14 GT12 GT11 GT10 SoftGOT1000		
	<table border="1"> <tr> <td>Host</td> <td>Select this when monitoring the host controller.</td> </tr> <tr> <td>Other</td> <td>Select this when monitoring other controller. Then, set the station number and network number of the controller to be monitored. NW No. : Set the network No. Station No. : Set the station No.</td> </tr> </table>		Host	Select this when monitoring the host controller.
Host	Select this when monitoring the host controller.			
Other	Select this when monitoring other controller. Then, set the station number and network number of the controller to be monitored. NW No. : Set the network No. Station No. : Set the station No.			

- (1) How to set relays (.), internal auxiliary relays (MR), latch relays (LR) and control relays (CR)  
Make settings for these devices by a channel number and a bit position.

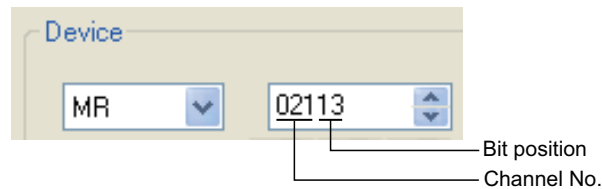

## KOYO EI PLC

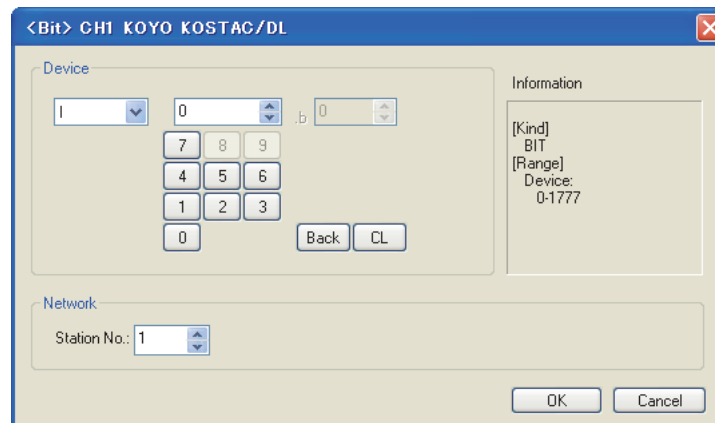

Item	Description	Model
Device	Set the device name, device number, and bit number. The bit number can be set when performing the bit specification of word device.	GT16 GT15 GT14 GT12 GT11 GT10
Information	Displays the type and setting range of the device selected in [Device].	SoftGOT1000
Network	Set the monitor target of the set device.	GT16 GT15 GT14 GT12 GT11 GT10 SoftGOT1000
	Station No.	

## SHARP PLC

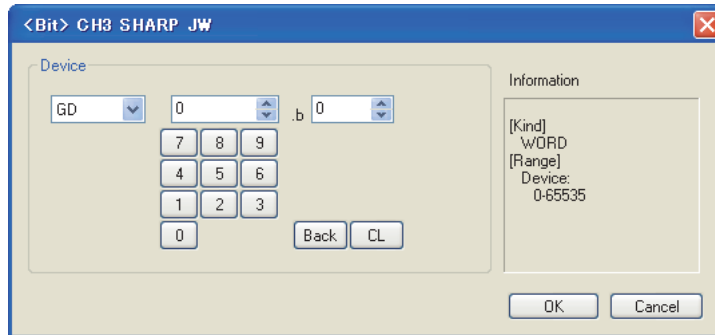

Item	Description	Model
Device	Set the device name, device number, and bit number. The bit number can be set when performing the bit specification of word device.	Gr16 Gr15 Gr14 Gr12 Gr11 Gr10 SoftGr1000
Information	Displays the type and setting range of the device selected in [Device].	

### (1) Device setting when setting a register or memory as a word device

#### (a) Registers

Set the type (first 2 digits) and the address.

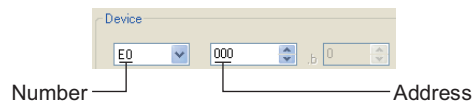

#### (b) File register

Set the file number and the address.

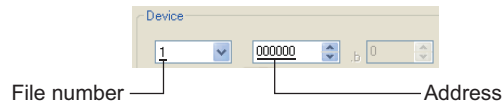

### (2) Device setting when setting a register or memory as a word device

#### (a) I/O relay

Set a combination of the device address (multiple of 16) + bit address format (fixed to 0).

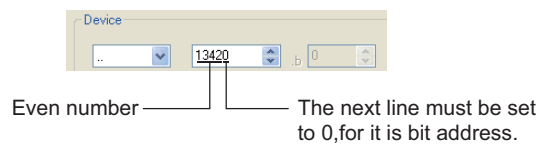

#### (b) Registers and file register

Set the device address (multiple of 16).

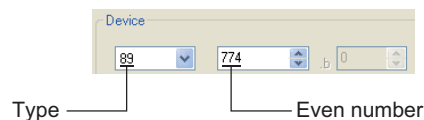

**(3) Monitoring the timer (T) and the counter (C)**

(a) Address setting

Make sure not to set the same address range for the timer (T) and the counter (C).

Even if the address ranges are overlapped, GOT will display no error.

GOT monitors them according to the address instead of the device name.

Therefore, if the device invalid for the SHARP PLC side parameter is set by GT Designer3, GOT will monitor other device (the device corresponding to the set device address range).

Example)

Content in SHARP PLC parameter setting  
T0000 to T1000  
C1001 to C1777

Content in GT Designer3 parameter setting

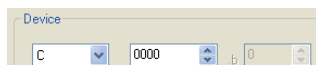

Even if GT Designer3 is set to "C0000", GOT will monitor "T0000".

(b) Contact writing into timer (T) and counter (C)

Writing the contact for the timer (T) and counter (C) can only be done while the CPU is in RUN (while the timer and counter is in operation).

**JTEKT PLC**

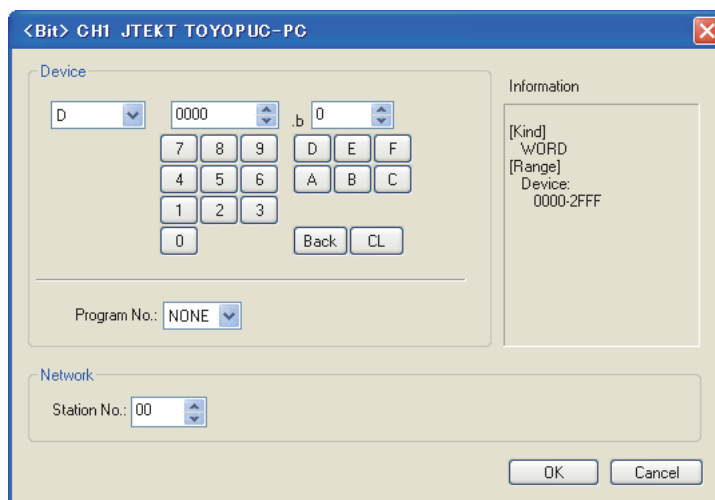

Item	Description	Model
Device	Set the device name, device number, and bit number. The bit number can be set when performing the bit specification of word device.	GT16 GT15 GT14 GT12 GT11 GT10 SoftGOT1000
	Program No. Sets the number of the program for which the device is set.	
Information	Displays the type and setting range of the device selected in [Device].	
Network	Sets the monitoring target for the set device.	
	Station No. Select the station No. when monitoring the PLC of the specified station No. (octal)	

**(1) About program number setting (when PC3JG or PC3J is used)**

Setting of a program number is allowed for the following devices.

Internal relay (M), keep relay (K), link relay (L), special relay (V), edge detection (P), timer (T), counter (C), data register (D), link register (R), special register (S), current value register (N)

## TOSHIBA PLC

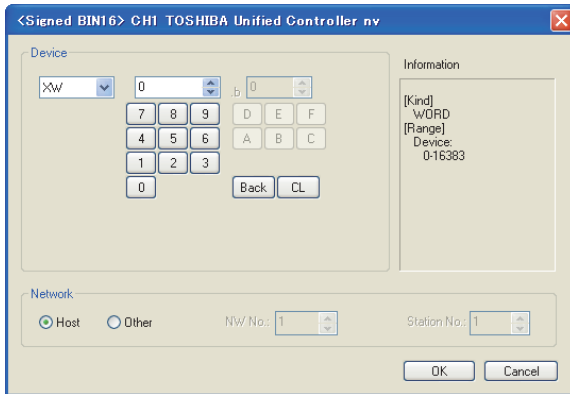

TOSHIBA Unified Controller nv

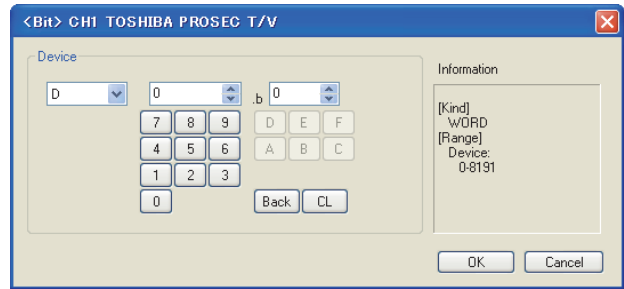

TOSHIBA PROSEC T/V

Item	Description	Model			
Device	Set the device name, device number, and bit number. The bit number can be set when performing the bit specification of word device.	GT16 GT15 GT14 GT12 GT11 GT10 SoftGOT1000			
Information	Displays the type and setting range of the device selected in [Device].				
Network	Set the station number of the controller to be monitored.				
	<table border="1"> <tr> <td>Host</td> <td>Select this when monitoring the host controller.</td> </tr> <tr> <td>Other</td> <td>Select [Other] for monitoring the controller set as the other station. After selecting the item, set the station No. of the controller to be monitored. NW No. : Set the network No. Station No. : Set the station No.</td> </tr> </table>	Host	Select this when monitoring the host controller.	Other	Select [Other] for monitoring the controller set as the other station. After selecting the item, set the station No. of the controller to be monitored. NW No. : Set the network No. Station No. : Set the station No.
Host	Select this when monitoring the host controller.				
Other	Select [Other] for monitoring the controller set as the other station. After selecting the item, set the station No. of the controller to be monitored. NW No. : Set the network No. Station No. : Set the station No.				

### (1) Device setting when setting a relay as a bit device

Set the device using the format of word address (DEC) + bit address (HEX).

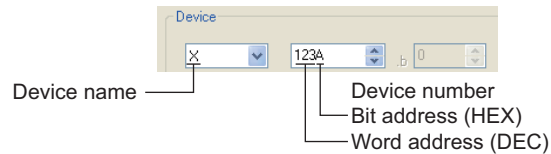

### (2) Device setting when setting a relay as a word device

Set the device using the format of word address (DEC).

For the device name, set the bit device name with "W".

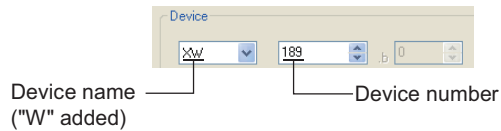

### (3) Notation of device address (when using PROSEC V series)

The notation of device address setting is different between the TOSHIBA PLC peripheral software and GOT. Refer to the following for details.

☞ Appendix2 GOT Internal Devices

## ■ TOSHIBA MACHINE PLC

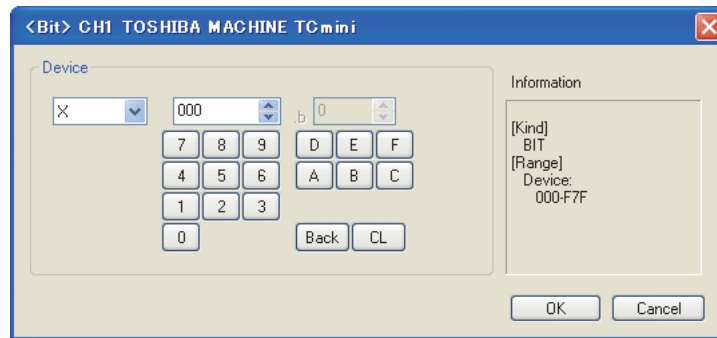

Item	Description	Model
Device	Set the device name, device number, and bit number. The bit number can be set when performing the bit specification of word device.	GT16 GT15 GT14 GT12 GT11 GT10
Information	Displays the type and setting range of the device selected in [Device].	SetGT1000

- (1) **Device setting when setting a relay address or word register address as a bit device**  
 Set the device using the format of rack No. (HEX) + module position (OCT) + terminal No. (HEX).

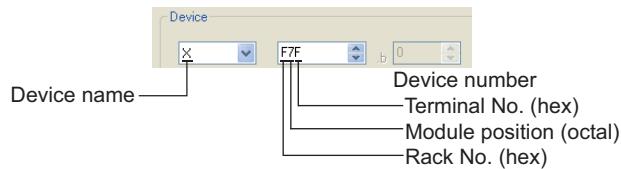

- (2) **Device setting when setting a relay address as a word device**  
 Set the device using the format of rack No. (HEX) + module position (OCT).  
 For the device name, set the bit device name with "W".

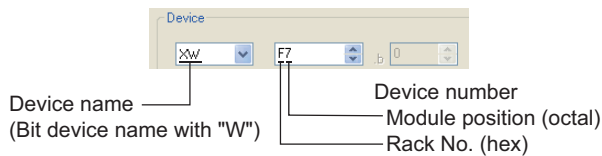

## ■ HITACHI IES PLC

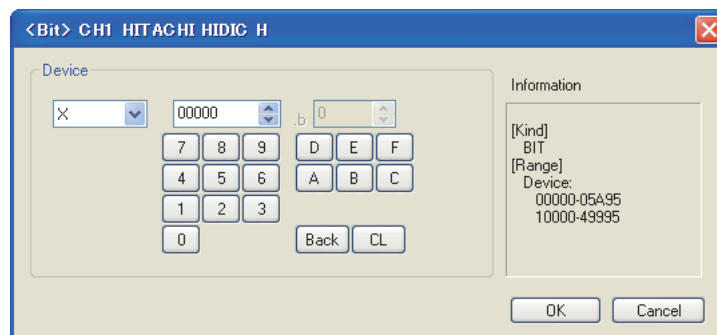

Item	Description	Model
Device	Set the device name, device number, and bit number. The bit number can be set when performing the bit specification of word device.	GT16 GT15 GT14 GT12 GT11 GT10
Information	Displays the type and setting range of the device selected in [Device].	SetGT1000

**(1) When specifying an external I/O device**

(a) When setting a bit device

Set the device using the format of module No. + slot No. + module bit No.

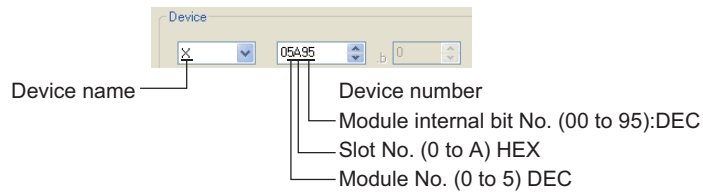

(b) When setting a word device

Set the device using the format of module No. + slot No. + module bit No.

For the device name, set the bit device name with "W".

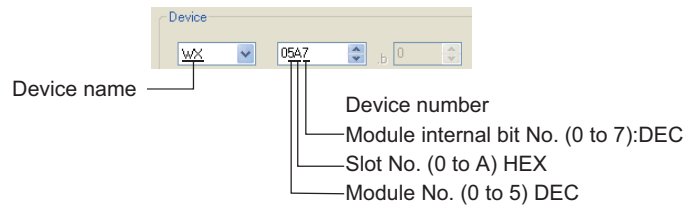

**(2) Device setting when specifying an external I/O device**

(a) When setting a bit device

Set the device using the format of remote master station + remote slave station + slot No. + module bit No.

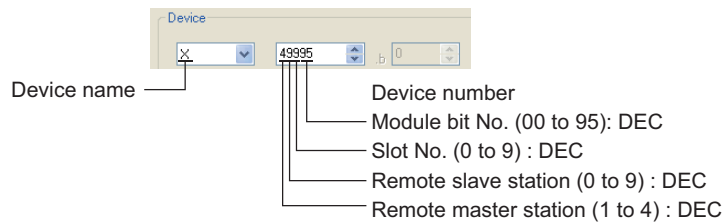

(b) When setting a word device.

Set the device using the format of remote master station + remote slave station + slot No. + module bit No.

For device name setting, enter "W" before the bit device name.

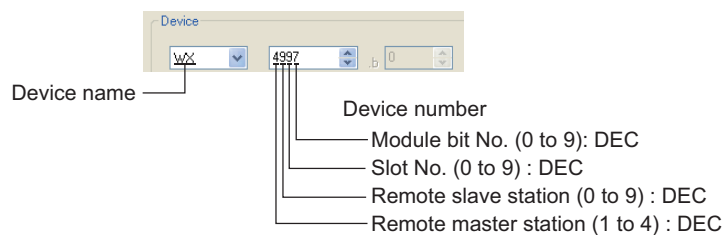



## ■ HITACHI PLC

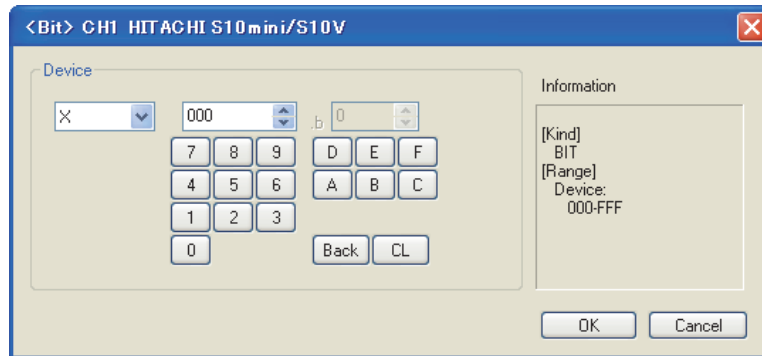

Item	Description	Model
Device	Set the device name, device number, and bit number. The bit number can be set when performing the bit specification of word device. The uppermost bit is b0 and the lowermost bit is b15.	GT16 GT15 GT14 GT12 GT11 GT10 SoftGoT1000
Information	Displays the type and setting range of the device selected in [Device].	

### (1) Device setting when setting a bit device

Set the device using the format of address (word unit) + bit position (0 to F).

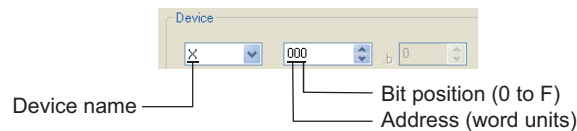

### (2) When setting a word device

For external input (XW), external output (YW), internal register (RW), extended internal register (MW, AW), keep relay (KW), on-delay timer (TW), one-shot timer (UW), up-down counter (CW), global link register (GW), event register (EW), system register (SW), transfer register (JW), and receive register (QW), set as follows.

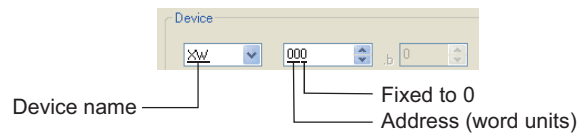

## ■ FUJI PLC

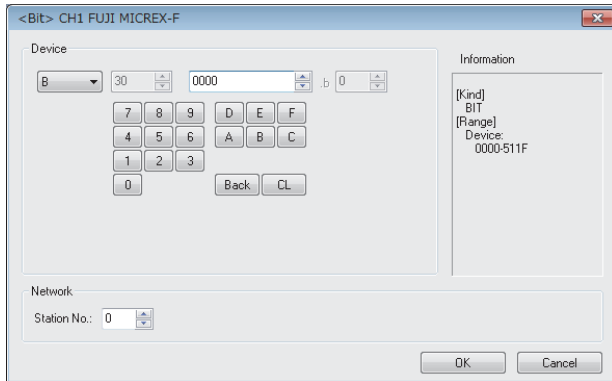

FUJI MICREX-F

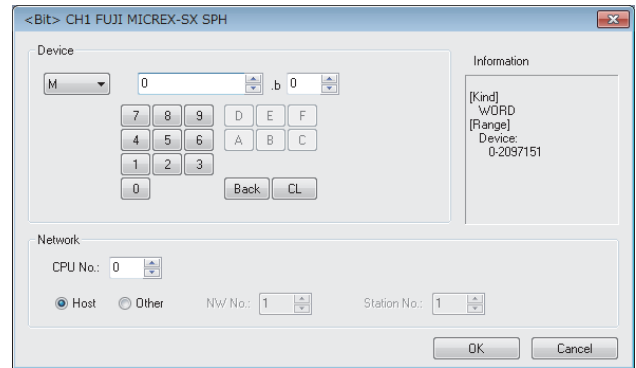

FUJI MICREX-SX SPH

Item	Description	Model	
Device	Set the device name, device number, and bit number. The bit number can be set when performing the bit specification of word device. The uppermost bit is b0 and the lowermost bit is b15.	Gr16 Gr15 Gr14 Gr12 Gr11 Gr10 SoftGOT1000	
Information	Displays the type and setting range of the device selected in [Device].		
Network	Set the monitor target of the set device.		
	Station No.	Set this item when monitoring the PLC of the specified station No.	
	CPU No.	Set the CPU No. of the controller.	
	Host	Select this when monitoring the host controller.	Gr16 Gr15 Gr14 Gr12 Gr11 Gr10 SoftGOT1000
Other	Select this when monitoring other controller. Then, set the station number and network number of the controller to be monitored. NW No. : Set the network No. Station No. : Set the station No.		

### (1) Device setting when setting a bit device

#### (a) FUJI MICREX-F

Set the device using the format of word number (DEC) + bit position (0 to F (HEX)).

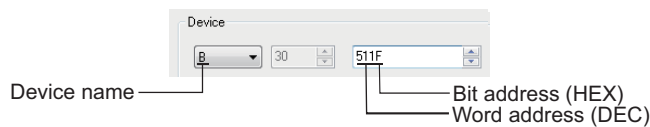

#### (b) FUJI MICREX-SX SPH

Set a bit-specified word device.

### (2) Device setting when setting a word device

#### (a) FUJI MICREX-F

For direct access (W24) and under file (W30 to W109, W9), set as follows.

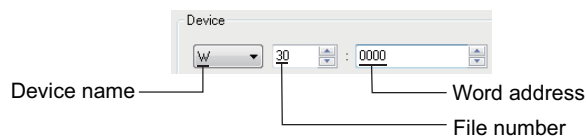

#### (b) FUJI MICREX-SX SPH

Set the device number.

## ■ PANASONIC INDUSTRIAL DEVICES SUNX PLC

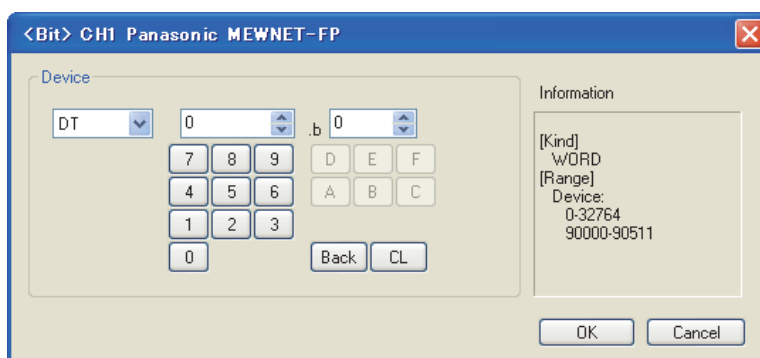

Item	Description	Model
Device	Set the device name, device number, and bit number. The bit number can be set when performing the bit specification of word device.	GT16 GT15 GT14 GT12 GT11 GT10
Information	Displays the type and setting range of the device selected in [Device].	SoftGoT1000

### (1) Device setting when setting a contact as a bit device

Set the device using the format of word address (DEC) + bit address (HEX).

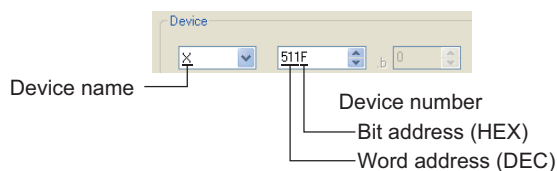

### (2) Device setting when setting a contact as a word device

Set the device number.

"W" is added to the device name, and the bit address is not included.

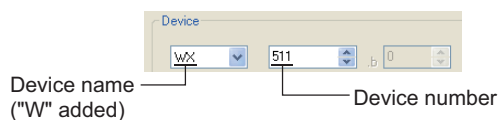

## ■ YASKAWA PLC

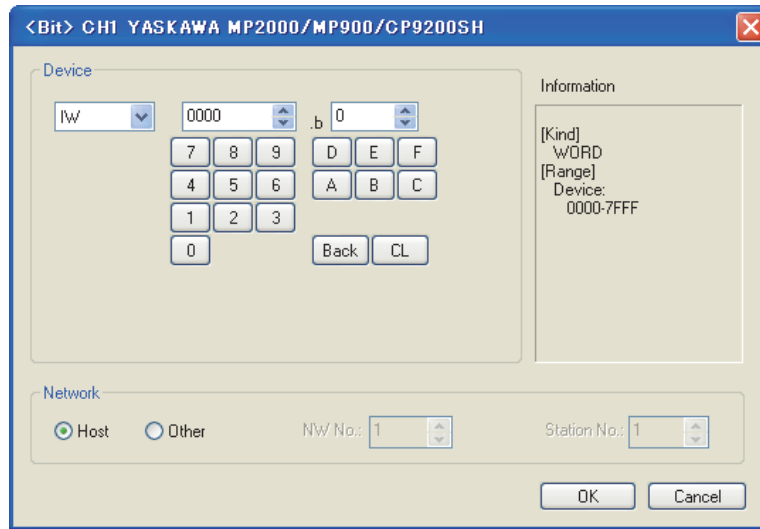

Item	Description	Model		
Device	Set the device name, device number, and bit number. The bit number can be set when performing the bit specification of word device.	GT16 GT15 GT14 GT12 GT11 GT10 SoftGT1000		
Information	Displays the type and setting range of the device selected in [Device].			
Network	Set the station No. of the controller to be monitored.	GT16 GT15 GT14 GT12 GT11 GT10 SoftGT1000		
	<table border="1"> <tr> <td>Host</td> <td>Select [Host] for monitoring the controller set as the host station.</td> </tr> <tr> <td>Other</td> <td>Select [Other] for monitoring the controller set as the other station. After selecting the item, set the station No. of the controller to be monitored. NW No. : Set the network No. Station No. : Set the station No.</td> </tr> </table>		Host	Select [Host] for monitoring the controller set as the host station.
Host	Select [Host] for monitoring the controller set as the host station.			
Other	Select [Other] for monitoring the controller set as the other station. After selecting the item, set the station No. of the controller to be monitored. NW No. : Set the network No. Station No. : Set the station No.			

### (1) Device setting when using CP-9200SH, CP-9300MS, MP-920, or MP-930

Set the coil device (MB) as follows:

#### (a) When setting a link and coil as a bit device

Set the device using the format of word address (DEC) + bit position (HEX).

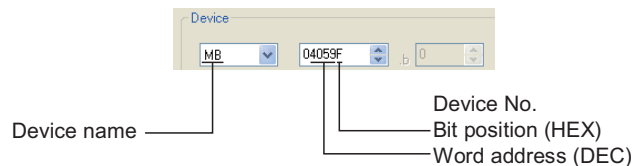

#### (b) When setting a register as a word device

Set the device using the format of word address (DEC).

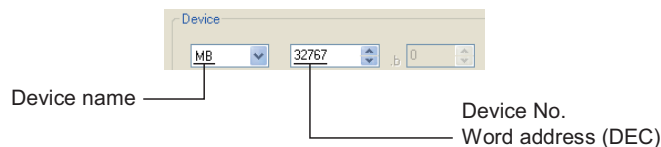





## ■ YOKOGAWA PLC

Item	Description	Model	
Device	Set the device name, device number, and bit number. The bit number can be set when performing the bit specification of word device.		
	File number    Set the file number.		
Information	Displays the type and setting range of the device selected in [Device].		
Network	Set the station No. of the controller to be monitored.		
	Host		Select [Host] for monitoring the controller set as the host station.
	Other		Select [Other] for monitoring the controller set as the other station. After selecting the item, set the station No. of the controller to be monitored. NW No.    : Set the network No. Station No. : Set the station No.

## ■ ALLEN-BRADLEY PLC

Item	Description	Model
Device	Set the device name, device number, and bit number. The bit number can be set when performing the bit specification of word device.	
Information	Displays the type and setting range of the device selected in [Device].	

(Continued to next page)

Item	Description	Model		
	Click this button to set the device by selecting a tag file read to GT Designer3.  9.3 Importing Tags Created by Third Party Programming Software			
Network	Set the station number of the PLC connected to the specified device.			
	<table border="1"> <tr> <td>Host</td> <td>Select this when monitoring the host PLC.</td> </tr> <tr> <td>Other</td> <td>           Select this when monitoring the other PLC.            Then, set the station number of the PLC to be monitored.            NW No. : Set the network No.            Station No. : Set the station No.         </td> </tr> </table>		Host	Select this when monitoring the host PLC.
Host	Select this when monitoring the host PLC.			
Other	Select this when monitoring the other PLC. Then, set the station number of the PLC to be monitored. NW No. : Set the network No. Station No. : Set the station No.			



### Device settings for ALLEN-BRADLEY PLC

The ALLEN-BRADLEY PLC device addressing consists of a file and element.

#### (1) Device setting when using AB SLC500 or AB Micro Logix

(a) When setting a bit address as a bit device

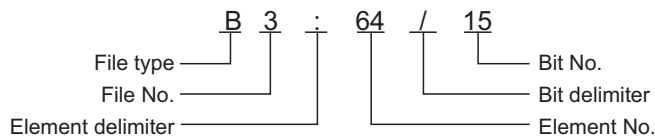

• Setting by GT Designer3

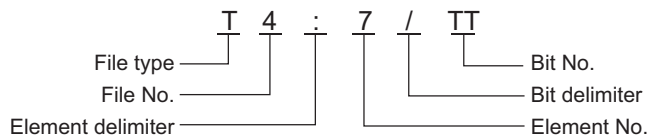
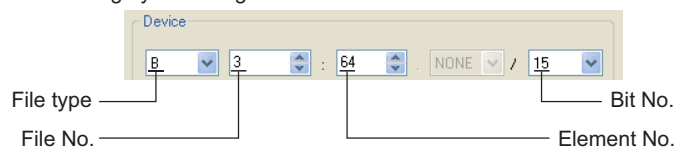

• Setting by GT Designer3

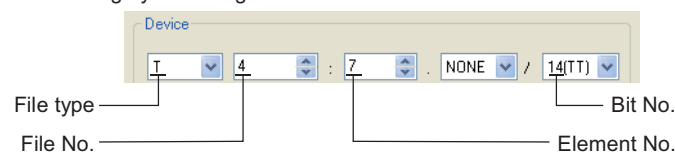

(b) When setting an element address as a word device

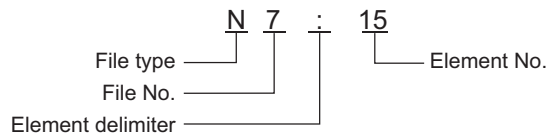

• Setting by GT Designer3

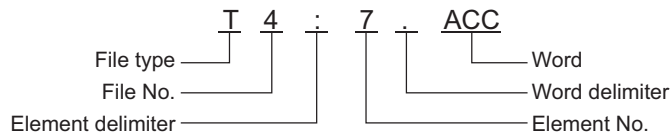
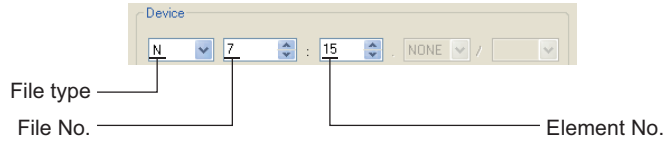

• Setting by GT Designer3

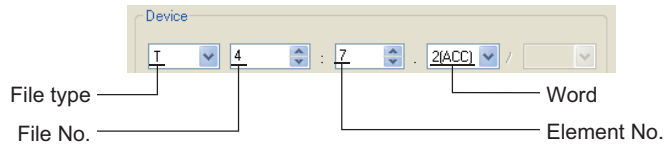

(2) Device setting when using AB Control/CompactLogix

(a) When setting a bit address as a bit device

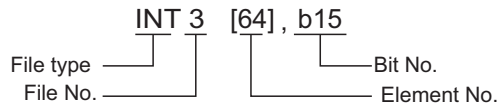

• Setting by GT Designer3

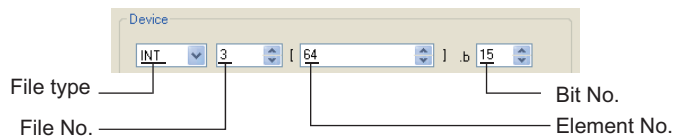

(b) When setting an element address as a word device

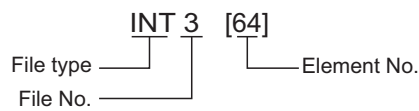

• Setting by GT Designer3

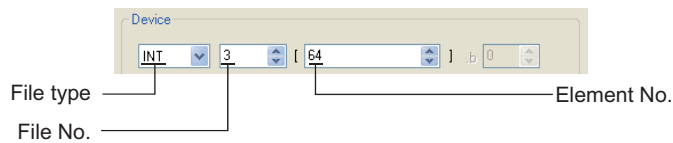

## ■ GE PLC

Item	Description	Model
Device	Set the device name, device number, and bit number. The bit number can be set when performing the bit specification of word device.	gr16 gr15 gr14 gr12 gr11 gr10 SoftGOT1000
Information	Displays the type and setting range of the device selected in [Device].	
Network	Set the monitor target of the set device.	
	Station No.	Set this item when monitoring the PLC of the specified station No.

## ■ LS IS PLC

Item	Description	Model
Device	Set the device name, device number, and bit number. The bit number can be set when performing the bit specification of word device.	gr16 gr15 gr14 gr12 gr11 gr10 SoftGOT1000
Information	Displays the type and setting range of the device selected in [Device].	
Network	Set the monitor target of the set device.	
	Station No.	Monitors the temperature controller of the specified station No. 0 to 31 : To monitor the PLC of the specified station No. 100 to 115 : To specify the station No. of the PLC to be monitored by the value of GOT data register (GD). <sup>*1</sup>



\*1 The relation between station No. of PLC and GOT data register is as follows.

Station No.	GOT data register (GD)	Setting range
100	GD10	0 to 31 (If setting a value outside the range above, a device range error occurs.)
101	GD11	
⋮	⋮	
114	GD24	
115	GD25	

### (1) Device setting when setting a bit device

Set the bit device using the decimal number (three digits) and the hexadecimal number.

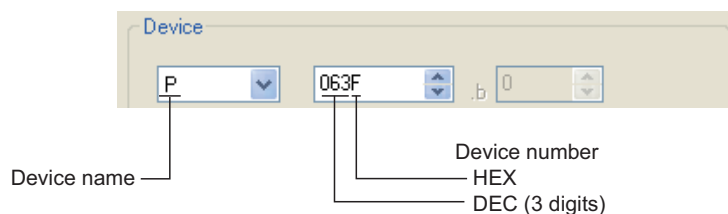

## ■ SICK safety controller

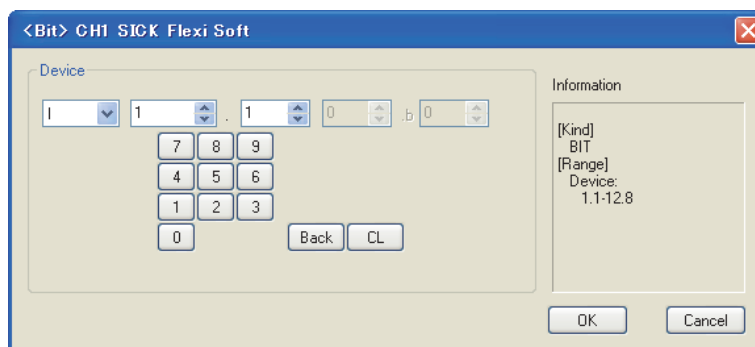

Item	Description	Model
Device	Set the device name, device number, and bit number. The bit number can be set only by specifying the bit of word device.	Gr16 Gr15 Gr14 Gr12 Gr11 Gr10
Information	Displays the device type and its setting range selected in [Device].	SoftGOT1000

The device setting method is the same as that of MELSEC-WS series.

To set a device, refer to the following.

- ☞ ■ MITSUBISHI ELECTRIC PLC, CNC, C Controller module, and motion controllers (9) MELSEC-WS

## ■ SIEMENS PLC (S7-300/400, S7(Ethernet), OP(Ethernet))

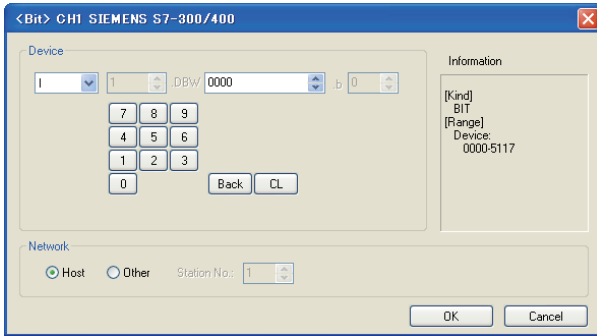

SIEMENS S7-300/400

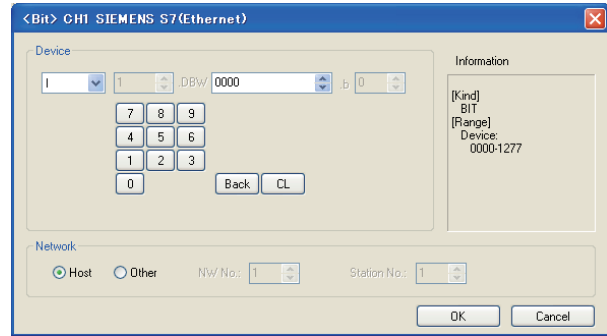

SIEMENS S7(Ethernet)

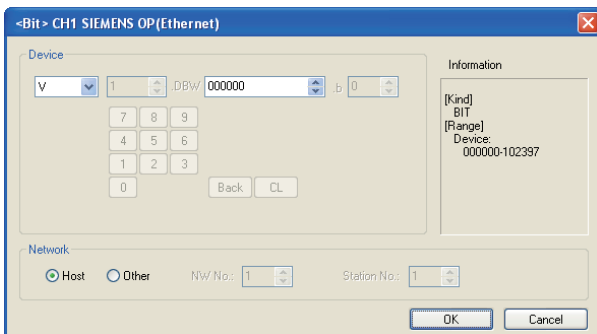

SIEMENS OP(Ethernet)

Item	Description	Model			
Device	Set the device name, device number, and bit number. The bit number can be set when performing the bit specification of word device.	G116 G115 G114 G112 G111 G110 SoftGOT1000			
Information	Displays the type and setting range of the device selected in [Device].				
Network	Set the monitor target of the set device.				
	<table border="0"> <tr> <td>Host</td> <td>Select this item to monitor the controller specified as the host station in the GOT utility (setup).</td> </tr> <tr> <td>Other</td> <td>Select this item to monitor a controller other than the one specified as the host station.  <ul style="list-style-type: none"> <li>For SIEMENS S7-300/400 Set the MPI address of the controller monitored.</li> <li>For SIEMENS S7(Ethernet), SIEMENS OP(Ethernet) Set the network number and the station number of the controller monitored.</li> </ul> </td> </tr> </table>	Host	Select this item to monitor the controller specified as the host station in the GOT utility (setup).	Other	Select this item to monitor a controller other than the one specified as the host station. <ul style="list-style-type: none"> <li>For SIEMENS S7-300/400 Set the MPI address of the controller monitored.</li> <li>For SIEMENS S7(Ethernet), SIEMENS OP(Ethernet) Set the network number and the station number of the controller monitored.</li> </ul>
Host	Select this item to monitor the controller specified as the host station in the GOT utility (setup).				
Other	Select this item to monitor a controller other than the one specified as the host station. <ul style="list-style-type: none"> <li>For SIEMENS S7-300/400 Set the MPI address of the controller monitored.</li> <li>For SIEMENS S7(Ethernet), SIEMENS OP(Ethernet) Set the network number and the station number of the controller monitored.</li> </ul>				

### (1) Device setting when setting a bit memory as a bit device

Set the device using the format of byte address (DEC) + bit address (0 to 7)

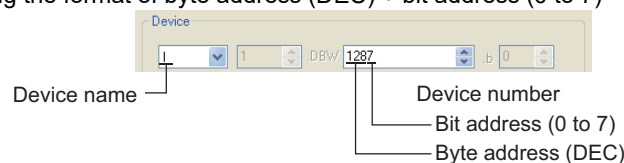

### (2) Device setting when setting a bit memory as a word device

Set it with device number.

For the device name, set the bit memory device name with "W".

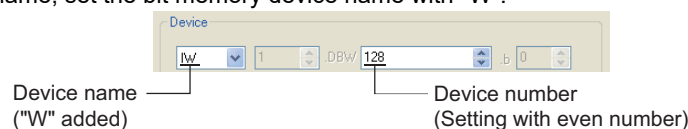

### (3) Device setting when setting a data register

Set the device using the format of data block (DB) + data word (DW).

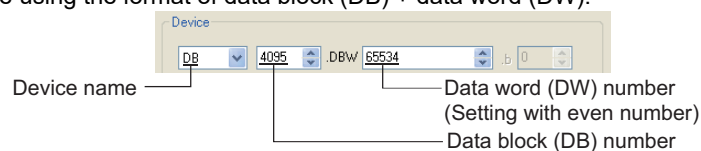

**(4) Precautions for setting device**

- (a) Notation system of bit memory

The difference in bit memory notation between GOT and PLC is as follows:

Notation of GOT	Notation of PLC
Q0007	Q0.7

- (b) Preparation for setting data register

It is necessary to define the data block using a peripheral software and sequence program, before using a data register.

Setting more than one data block cannot be done for the data register.

- (c) Object to which timer (current value) (T) cannot be set

For the timer (current value) (T), only one device can be set for the write target.

Therefore, multiple devices, such as, using the recipe function, etc., cannot be used.

- (d) Notation method of the data registers with the bit specification

The notation of the data registers with the bit specification differs between the GOT and the PLC.

The following shows the correspondence table.

Notation in GOT	Notation in PLC
DB1.DBW0.b0	DB1.DBX1.0
DB1.DBW0.b1	DB1.DBX1.1
:	:
DB1.DBW0.b7	DB1.DBX1.7
DB1.DBW0.b8	DB1.DBX0.0
:	:
DB1.DBW0.b15	DB1.DBX0.7
DB1.DBW2.b0	DB1.DBX3.0
:	:
DB1.DBW2.b7	DB1.DBX3.7
DB1.DBW2.b8	DB1.DBX2.0
:	:
DB1.DBW2.b15	DB1.DBX2.7
:	:

**■ SIEMENS PLC (S7-200 series)**

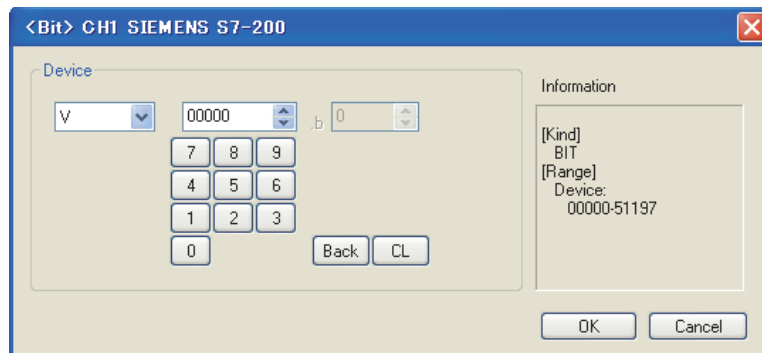

Item	Description	Model
Device	Set the device name, device number, and bit number. The bit number can be set when performing the bit specification of word device.	Gr16 Gr15 Gr14 Gr12 Gr11 Gr10
Information	Displays the type and setting range of the device selected in [Device].	SoftGOT1000

**(5) When setting bit device (excluding timer and counter)**

Make settings for bit devices by byte address (decimal) and bit address (0 to 7).

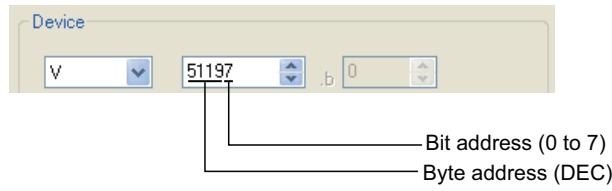

**IAI robot controller**

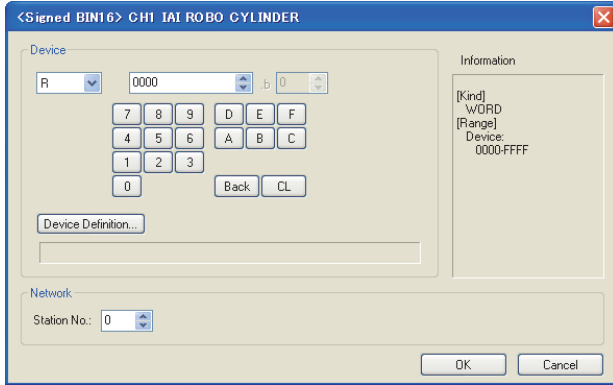

IAI ROBO CYLINDER

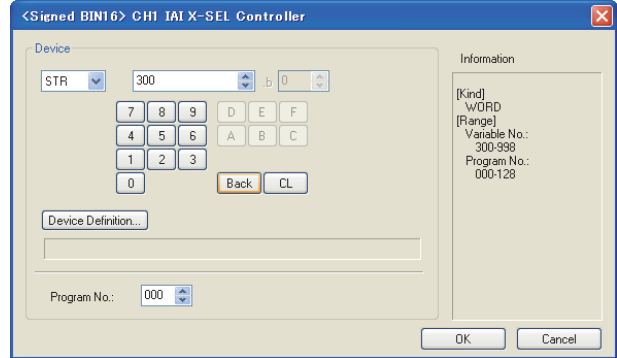

IAI X-SEL Controller

Item	Description		Model
Device	Set the device name, device number, and bit number. The bit number can be set only when specifying the bit of word device.		G116 G115 G114 G112 G111 G110 SoftGOT1000
	Device Definition...	Device definition can be checked.	
	Program No.	Set the number of the program for which the device is used.	
Device No.	Set the number of the program for which the device is used.		
Network	Station No.	The GOT monitors the robo cylinder with the specified station No. 0 to 15: Specify the station No. of the robo cylinder to be monitored. 100 to 115: With the value of the GOT data register (GD), specify the station No. of the robo cylinder to be monitored.*1	
Information	Displays the device type and setting range which are selected in [Device].		

\*1 The relation between the station No. of the robo cylinder and the GOT data register is as follows.

Station No.	GOT data register (GD)	Setting range
100	GD10	0 to 15 (If setting a value out of the range above, a timeout error occurs.)
101	GD11	
:	:	
114	GD24	
115	GD25	

### (1) Flag device setting

FG000 : 600

Flag number:  
Global area (600 to 899)  
Local area (900 to 999)

Program No.:

Program number:  
Global area (000)  
Local area (001 to 128)

### (2) String device setting

STR000 : 300

Variable number:  
Global area (300 to 998 (only even))  
Local area (001 to 299 (only odd))

Program No.:

Program number:  
Global area (000)  
Local area (001 to 128)

### (3) Version device setting

VR 0 0 : 0

Obtained data:

0: Model code	5: Time (day)
1: Unit code	6: Time (hour)
2: Version number	7: Time (min)
3: Time (year)	8: Time (sec)
4: Time (month)	9 to F: Reserved for system use

Device No.:

Device number (0 to F)

VR0

Unit type (0 to 3)  
0= Main CPU application / 1 = Main CPU core  
/ 2= Driver CPU / 3 = Mount SIO

### (4) Axis Status device setting

AXST00

Obtained data:

AXST00 to AXST05: Single-axis status

00: Axis status

- Bit 7 (Reserved for system use)
- Bit 6 (Reserved for system use)
- Bit 5 (Push error detection): 0 = Not detected / 1 = Detected
- Bit 4 (Operation command successful completion):  
0 = Not yet complete / 1 = Completed successfully
- \* Can be used only for completion check after an operation command.
- Bit 3 (Servo): 0 = OFF / 1 = ON
- Bit 1-2 (Origin return): 0 = Not yet performed  
/ 1 = Returning to origin / 2 = Completed
- Bit 0 (Servo axis in use): 0 = Not in use  
/ 1 = In use (moving, etc.)

\* "Servo axis in use" indicates that a given task has the right to use the applicable axis.  
Therefore, this bit will turn ON in the following conditions:

- When an operation command involving axis movement is in progress (including when an axis is moving)
- Servo is starting up from an OFF state
- Servo is shutting down from an ON state (excluding emergency stop)
- Operation axis is paused

01: Axis sensor input status

- Bit 3 (Reserved for system use)
- Bit 2 (Origin sensor): 0 = OFF / 1 = ON
- Bit 1 (Overrun sensor): 0 = OFF / 1 = ON
- Bit 0 (Creep sensor): 0 = OFF / 1 = ON

02: Axis error code

- 03: Encoder status
- Bit 7 (Battery alarm (BA))
- Bit 6 (Battery error (BE))
- Bit 5 (Multi-rotation error (ME))
- Bit 4 (Reserved for system use)
- Bit 3 (Counter overflow (OF))
- Bit 2 (Count error (CE))
- Bit 1 (Full absolute status (FS))
- Bit 0 (Overspeed (OS))
- 04: Current position (L) unit (0.001mm)  
Indicates the lower 16 bits of the current position in
- 05: Current position (H) unit (0.001mm)  
Indicates the upper 16 bits of the current position in
- AXST06 to AXST11: Double axes status
- AXST42 to AXST47: Eight axes status

## (5) Scara Axis Status device setting

SAXS 0 00

00

Obtained data:

00: Work coordinate system selection number  
 01: Tool coordinate system selection number  
 02: Common axis status  
 Bit 7 (Reserved for system use)  
 Bit 6 (Reserved for system use)  
 Bit 5 (Reserved for system use)  
 Bit 4 (Reserved for system use)  
 Bit 2-3 (Scara axis current position coordinate system type):  
   0 = Base coordinate system  
   / 1 = Selected work coordinate system  
   / 2 = Reserved for system use / 3 = Each axis system  
 Bit 0-1: (Scara axis current arm system):  
   0 = Right arm system / 1 = Left arm system  
   / 2 = Indeterminable / 3 = Reserved for system use

03: Axis pattern

Bit	-	7	6	5	4	3	2	1	0
-----	---	---	---	---	---	---	---	---	---

1st axis  
 8th axis  
 Reserved for system use

04 to 09: Single-axis status

04: Axis status  
 Bit 7 (Reserved for system use)  
 Bit 6 (Reserved for system use)  
 Bit 5 (Push error detection): 0 = Not detected / 1 = Detected  
 Bit 4 (Operation command successful completion):  
   0 = Not yet complete / 1 = Completed successfully  
 \* Can be used only for completion check after an operation command.(For positioning that includes any of the X, Y and R axes, be sure to check completion for all of the X, Y and R axes.)  
 Bit 3 (Servo): 0 = OFF / 1 = ON  
 Bit 1-2 (Origin return): 0 = Not yet performed  
   / 1 = Returning to origin / 2 = Completed  
 Bit 0 (Servo axis in use): 0 = Not in use  
   / 1 = In use (moving, etc.)  
 \* "Servo axis in use" indicates that a given task has the right to use the applicable axis. Therefore, this bit will turn ON in the following conditions:  
 - When an operation command involving axis movement is in progress (including when an axis is moving)  
 - Servo is starting up from an OFF state  
 - Servo is shutting down from an ON state (excluding emergency stop)  
 - Operation axis is paused

05: Axis sensor input status

Bit 3 (Reserved for system use)  
 Bit 2 (Origin sensor): 0 = OFF / 1 = ON  
 Bit 1 (Overrun sensor): 0 = OFF / 1 = ON  
 Bit 0 (Creep sensor): 0 = OFF / 1 = ON

06: Axis error code

07: Encoder status  
 Bit 7 (Battery alarm (BA))  
 Bit 6 (Battery error (BE))  
 Bit 5 (Multi-rotation error (ME))  
 Bit 4 (Reserved for system use)  
 Bit 3 (Counter overflow (OF))  
 Bit 2 (Count error (CE))  
 Bit 1 (Full absolute status (FS))  
 Bit 0 (Overspeed (OS))

08: Current position (L) unit (0.001mm or 0.001deg)

Indicates the lower 16 bits of the current position in Hex.

09: Current position (H) unit (0.001mm or 0.001deg)

Indicates the upper 16 bits of the current position in Hex.

0A to 0E: Double axes status

2E to 33: Eight axes status

34 to FF: Reserved for system use

SAXS0

Unit type (0 to F)

Bit 3 (Reserved for system use) Fixed to 0  
 Bit 2 (Reserved for system use) Fixed to 0  
 Bit 0-1 (Scara axis current position type):  
   0 = Base coordinate system  
   / 1 = Selected work coordinate system  
   / 2 = Reserved for system use / 3 = Each axis system

## (6) Program Status device setting

PGST 000

000

Obtained data:

000 to 003: Program number 1 status  
 000: Status  
 Bit 3 (Reserved for system use)  
 Bit 2 (Reserved for system use)  
 Bit 1 (Reserved for system use)  
 Bit 0 (Start): 0 = Not started / 1 = Started  
 001: Execution program step number  
 002: Program-dependent error code  
 003: Error occurrence step number

004 to 007: Program number 2 status

:

508 to 511: Program number 128 status

## (7) System Status device setting

SYST 0  b

Obtained data:

- 0: System mode  
0 = Indeterminable / 1 = AUTO mode / 2 = MANUAL mode / 3 = Slave update mode / 4 = Core update mode
- 1 Critical level system error number
- 2: Latest system error number
- 3: System status byte 1  
Bit 7 (Reserved for system use)  
Bit 6 (Battery voltage error status) : 0 = No error / 1 = Error  
Bit 5 (Battery voltage low warning status): 0 = No low / 1 = Low  
Bit 4 (Power error status): 0 = Normal / 1 = Error  
Bit 3 (Emergency stop switch status):  
0 = No emergency stop / 1 = Emergency stop
- Bit 2 (Safety gate status): 0 = CLOSE / 1 = OPEN  
\* X-SEL (P/Q Series) (Multi axes/Scara)/SSEL/ASEL/PSEL: Enable switch (Deadman switch / Enable switch) status is indicated.
- Bit 1 (TP enable switch status): 0 = ON / 1 = OFF  
\* X-SEL (P/Q Series) (Multi axes/Scara)/SSEL/ASEL/PSEL: This bit is disabled (fixed to 0).
- Bit 0 (Operation mode switch status): 0 = AUTO / 1 = MANUAL

- 4: System status byte 2  
Bit 7 (Reserved for system use)  
Bit 6 (Reserved for system use)  
Bit 5 (Program run status): 0 = Not run / 1 = Running  
Bit 4 (Restart wait status): 0 = Not waiting / 1 = Waiting  
Bit 3 (I/O interlock status): 0 = No interlock / 1 = Interlock  
Bit 2 (Servo interlock status): 0 = No interlock / 1 = Interlock  
Bit 1 (Slave parameter writing status):  
0 = Not writing / 1 = Writing
- Bit 0 (Application data flash ROM write status):  
0 = Not writing/erasing / 1 = Writing/erasing
- \* When the core program is in operation (Application update mode), only Bit 0 is enabled. Data for System mode, Critical level system error number, Latest system error number, System status byte 1, System status byte 3 and System status byte 4 is disabled.
- 5: System status byte 3  
Bit 7 (Reserved for system use)  
Bit 6 (Reserved for system use)  
Bit 5 (Reserved for system use)  
Bit 4 (Operation mode):  
0 = Program mode / 1 = Position mode
- Bit 3 (Reserved for system use)
- Bit 2 (System ready status): 0 = Not ready / 1 = Ready
- Bit 1 (System operation status):  
0 = Not operating in AUTO mode / 1 = Operating in AUTO mode
- Bit 0 (Drive-source cutoff status): 0 = Not cut off / 1 = Cut off
- 6: System status byte 4  
Reserved for system use

## (8) Coordinate Affiliate Data device setting

CD 0 00 : 0  b

Obtained data:

- 0: X axis coordinate offset
- 1: Y axis coordinate offset
- 2: Z axis coordinate offset
- 3: R axis coordinate offset
- 4 to F: Reserved for system use

Definition Data No.:

Coordinate system definition data number (00 to FF)  
Work/tool coordinate system definition data number (0 to)

CD0

- Type 1 (0 to 1)  
0 = Work coordinate system definition data  
/ 1 = Tool coordinate system definition data

## (9) Servo device setting

SV 0  b

Obtained data:

- 0: Command trigger  
1 = Write / 4 = Clear
- 1: Axis pattern
- 2: Operation type
- Bit 3 (Reserved for system use) Fixed to 0
- Bit 2 (Reserved for system use) Fixed to 0
- Bit 1 (Reserved for system use) Fixed to 0
- Bit 0 (Servo ON/OFF): 0 = OFF / 1 = ON

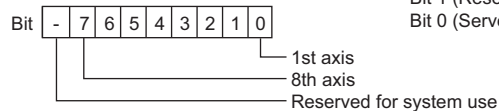

**(10) Write to Flash ROM device setting**

FRW 0

b

Obtained data  
 0 : Command trigger  
 1=Write/  
 1 : Reserved for system use

**(11) Integer device setting**

INT000 : 0200

b

Variable number:  
 Global area (0200 to 0299,1200 to 1299)  
 Local area (0001 to 0099,1001 to 1099)

Program No.:

Program number:  
 Global area (000)  
 Local area (001 to 128)

**(12) Real device setting**

RL000 : 0300

b

Variable number:  
 Global area (0300 to 0399,1300 to 1399)  
 Local area (0100 to 0199,1100 to 1199)

Program No.:

Program number:  
 Global area (000)  
 Local area (001 to 128)

**(13) Error Detail (0 to 7) device setting**

ER0 00 : 000 : 00

b

Obtained data:  
 00: Error number  
 01: Detail information 1  
 Other than system-down level error: Program number  
 (Error source is indicated if the step number is not 0.)  
 System-down level error: System down type  
 02: Detail information 2  
 Other than system-down level error: Step number  
 (Error source)  
 System-down level error: System down error code  
 03: Detail information 3  
 Other than system-down level error: Axis number  
 System-down level error: System down information 1

Reserved:

Reserved for system use

Type2:

Type 2 (0 to FF)  
 System error: 0 = Critical level error / 1 = Latest error  
 Axis-specific error: Axis number  
 Program-specific error: Program number  
 Error in error list record: Record number (1 to )

ER0

Type 1  
 0 = System error / 1 = Axis-specific error  
 / 2 = Program-specific error  
 / 3 = Error in error list record  
 / 4 or later = Reserved for system use

04: Detail information 4  
 Other than system-down level error: Point number  
 (Negative value at interpolation point)  
 System-down level error: System down information 2  
 05: Detail information 5  
 06: Detail information 6  
 07: Detail information 7  
 08: Detail information 8  
 09: Message bytes  
 0A: Message 1 (4 bytes)  
 10: Message 2 (4 bytes)  
 :  
 49: Message 64 (4 bytes)  
 50 to FF: Reserved for system use



### (14) Point Data device setting

PD 00

00  b

Obtained data:

- 00: Command trigger
- 01: Starting point number
- 02: Number of point data
- 03 to 0F: Point data 1
- 03: Point number
- 04: Axis pattern
- 05: Acceleration unit (0.01G)
- 06: Deceleration unit (0.01G)
- 07: Speed unit (mm/sec)
- 08 to 0F: Position data unit (0.001 mm)
- 08: 1st axis position data
- :
- 0F: 8th axis position data
- 10 to 1C: Point data 2
- :
- 92 to 9E: Point data 12

### (15) Simple Interference Check Zone Data device setting

SD 01 : 0

0  b

Obtained data:

- 0: Effective axis pattern
- 1 to 4: Simple interference check zone definition coordinate  
1 unit (0.001 mm (R axis: 0.001 deg))
- 1: X-axis definition coordinate
- 2: Y-axis definition coordinate
- 3: Z-axis definition coordinate
- 4: R-axis definition coordinate
- 5 to 8: Simple interference check zone definition coordinate  
2 unit (0.001 mm (R axis: 0.001 deg))
- 9: Physical output port number or global flag number for output upon entry
- A: Entry error type specification
- 0 = No error handling / 1 = Message-level error
- / 2 = Operation-cancellation level error
- B to F: Reserved for system use

Definition Data No.: 01

Definition data number (1 to FF)

## Microcomputer

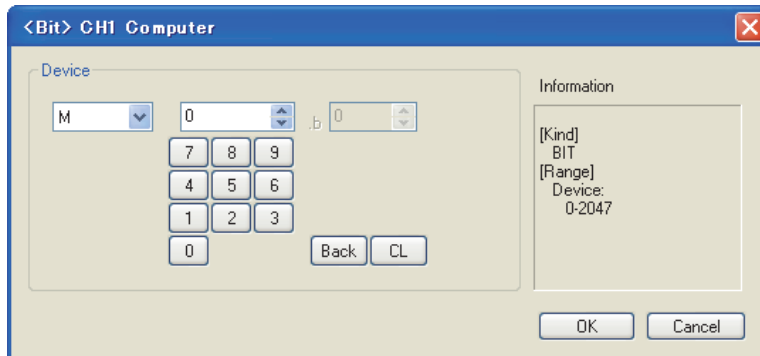

Item	Description	Model
Device	Set the device name, device number, and bit number. The bit number can be set when performing the bit specification of word device.	GT16 GT15 GT14 GT12 GT11 GT10
Information	Displays the type and setting range of the device selected in [Device].	SERVO1000

## ■ MODBUS® connection

Item	Description		Model
Device	Set the device name, device number, and bit number. The bit number can be set when performing the bit specification of word device.		
	File No.	Set the file No. It can be set only when "6" is selected in [Device].	
Information	Displays the type and setting range of the device selected in [Device].		
Network	Set the station number of the controller to be monitored.		
	Host	Select this when monitoring the host controller.	
	Other	<ul style="list-style-type: none"> <li>• GT16, GT15, GT14, GT12 Select this when monitoring the other controllers. Then, set the station number and network number of the controller to be monitored. NW No. : For the MODBUS®/RTU connection, set "1". MODBUS®/TCP connection, set the network No. Station No. : Set the station No. 0: Monitors the controllers of all the station numbers. 1 to 247: Monitors the controller of the specified station No. 248 to 254: Monitors the controller of the station No. specified by GOT data register (GD).<sup>*1</sup> 255: Monitors the host controller.</li> <li>• GT11, GT10 Select this item when monitoring the controller set as the other station. After selecting this item, set the station No. of the controller to be monitored. Station No. : Set the station No. 0: Monitors the controllers of all the station numbers. 1 to 247: Monitors the controller of the specified station No. 248 to 254: Monitors the controller of the station No. specified by GOT data register (GD).<sup>*1</sup> 255: Monitors the host controller.</li> </ul>	

\*1 The relation between the station No. of controllers and the GOT data register is as follows.

Station No.	GOT data register (GD)	Setting range
248	GD10	0 to 255 (If setting a value outside the range above, a device range error occurs.)
249	GD11	
:	:	
253	GD15	
254	GD16	

## ■ OMRON temperature controller

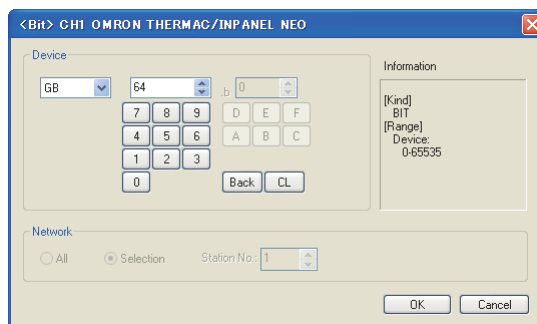

Item	Description	Model					
Device	Set the device name, device number, and bit number. The bit number can be set when performing the bit specification of word device.						
Information	Displays the type and setting range of the device selected in [Device].						
Network	Set the monitor target of the set device.						
	<table border="0"> <tr> <td style="text-align: center;">All</td> <td>Select this when writing data to all temperature controllers. During monitoring, the temperature controller of station No. 1 is monitored. (When writing the data in numerical input, data is written to all connected temperature controllers during input, and the temperature controller of station No. 1 is monitored during other than input (i.e. display).)</td> <td style="text-align: center;"> </td> </tr> <tr> <td style="text-align: center;">Selection</td> <td>Select this when monitoring the temperature controller of the specified station No. After selecting "Selection", set the station No. in the range indicated below. 0 to 99 : To monitor the temperature controller of the specified station No. 100 to 115 : To specify the station No. of the temperature controller to be monitored by the value of GOT data register (GD).<sup>*1</sup></td> <td></td> </tr> </table>	All	Select this when writing data to all temperature controllers. During monitoring, the temperature controller of station No. 1 is monitored. (When writing the data in numerical input, data is written to all connected temperature controllers during input, and the temperature controller of station No. 1 is monitored during other than input (i.e. display).)		Selection	Select this when monitoring the temperature controller of the specified station No. After selecting "Selection", set the station No. in the range indicated below. 0 to 99 : To monitor the temperature controller of the specified station No. 100 to 115 : To specify the station No. of the temperature controller to be monitored by the value of GOT data register (GD). <sup>*1</sup>	
All	Select this when writing data to all temperature controllers. During monitoring, the temperature controller of station No. 1 is monitored. (When writing the data in numerical input, data is written to all connected temperature controllers during input, and the temperature controller of station No. 1 is monitored during other than input (i.e. display).)						
Selection	Select this when monitoring the temperature controller of the specified station No. After selecting "Selection", set the station No. in the range indicated below. 0 to 99 : To monitor the temperature controller of the specified station No. 100 to 115 : To specify the station No. of the temperature controller to be monitored by the value of GOT data register (GD). <sup>*1</sup>						

\*1 The relation between station No. of PLC and GOT data register is as follows.

Station No.	GOT data register (GD)	Setting range
100	GD10	0 to 99 (If setting a value outside the range above, a device range error occurs.)
101	GD11	
:	:	
114	GD24	
115	GD25	

### (1) Device setting when setting status (S)

Make settings for status by a channel number and a bit position.

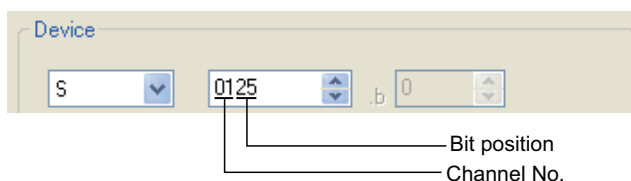

### (2) Device setting when setting variable area (0), variable area (1), and variable area (2)

Make setting for variable areas by a channel number and address.

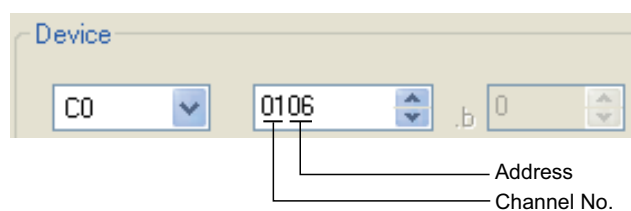

## ■ SHINKO indicating controller

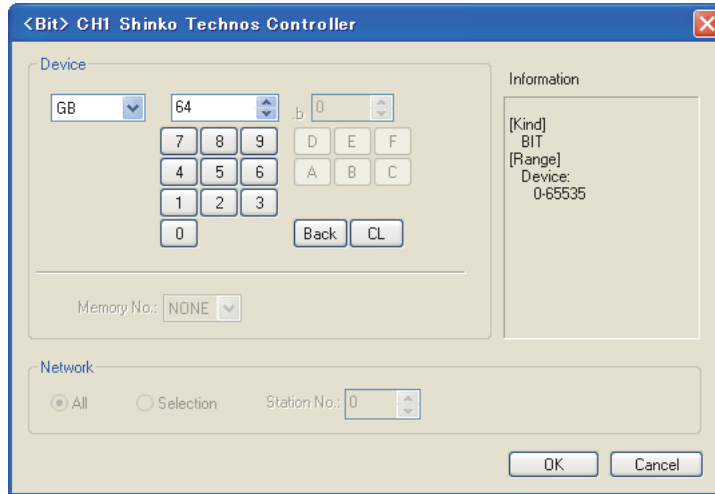

Item	Description	Model
Device	Set the device name, device number, and bit number. The bit number can be set when performing the bit specification of word device.	
	Memory No.*1 Set the memory number (None, 0 to 7) of the device to be monitored.	
Information	Displays the type and setting range of the device selected in [Device].	
Network	Set the monitor target of the set device.	gr16 gr15 gr14 gr12 gr11 gr10 SoftGOT1000
	All Select this item when writing data to all the indicating controllers connected. During a monitoring, the indicating controller set for [Host Address] of the communication detail setting is monitored. (When inputting data with the numerical input function, the data is written to all the connected indicating controllers during input; the indicating controller that is set for [Host Address] is monitored during other than input (display).)	
	Selection Select this item when monitoring the indicating controller of the station No. specified. After selecting, set the station No. of the indicating controller in the following range. 0 to 94 : The indicating controller of the station No. specified is monitored. 95 : Same as the setting of [All]. 100 to 115 : Specify the station No. of the indicating controller to be monitored with the GOT data register (GD).*2	

\*1 The device name is displayed as follows when the memory number (0 to 7) is set.

Memory No.	Displayed device name
None	Device Number
0	M0/Device Number
1	M1/Device Number
2	M2/Device Number
3	M3/Device Number
4	M4/Device Number
5	M5/Device Number
6	M6/Device Number
7	M7/Device Number

\*2 The relation between station No. of indicating controller and GOT data register is as follows.

Station No.	GOT data register (GD)	Setting range
100	GD10	0 to 94 (If setting a value outside the range above, a device range error occurs.)
101	GD11	
:	:	
114	GD24	
115	GD25	

## ■ CHINO controller

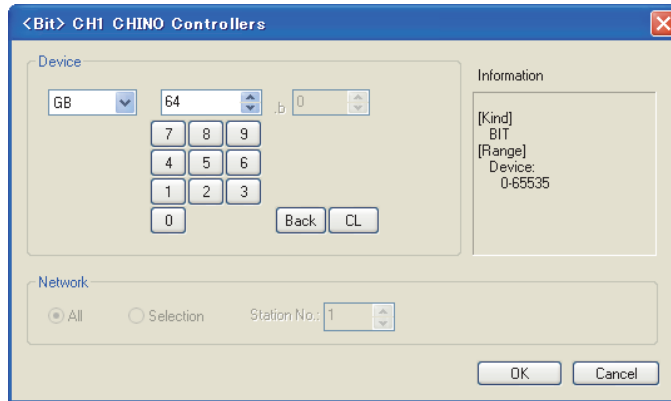

Item	Description	Model			
Device	Set the device name, device number, and bit number. The bit number can be set when performing the bit specification of word device.				
Information	Displays the type and setting range of the device selected in [Device].				
Network	Sets the monitoring target for the set device.				
	<table border="0"> <tr> <td style="vertical-align: top;">All</td> <td>Select the item when data are written in all the connected controllers. The controller set for [Host Address] of the communication detail settings is monitored. (When inputting data with the numerical input function, data is written to all the connected controllers during input. The controller set for [Host Address] is monitored during other than input (display).)</td> <td rowspan="2" style="vertical-align: middle;">           gr16 gr15            gr14 gr12            gr11 gr10            SerGOT1000         </td> </tr> <tr> <td style="vertical-align: top;">Selection</td> <td>Select the item when the controller with the specified station No. is monitored. Select the item, and then set the station No. for the controller in the following range. 1 to 99 : The controller with the specified station No. is monitored. 100 to 115 : Specify the station No. for the controller to be monitored with a GOT data register (GD).*1</td> </tr> </table>	All	Select the item when data are written in all the connected controllers. The controller set for [Host Address] of the communication detail settings is monitored. (When inputting data with the numerical input function, data is written to all the connected controllers during input. The controller set for [Host Address] is monitored during other than input (display).)	gr16 gr15 gr14 gr12 gr11 gr10 SerGOT1000	Selection
All	Select the item when data are written in all the connected controllers. The controller set for [Host Address] of the communication detail settings is monitored. (When inputting data with the numerical input function, data is written to all the connected controllers during input. The controller set for [Host Address] is monitored during other than input (display).)	gr16 gr15 gr14 gr12 gr11 gr10 SerGOT1000			
Selection	Select the item when the controller with the specified station No. is monitored. Select the item, and then set the station No. for the controller in the following range. 1 to 99 : The controller with the specified station No. is monitored. 100 to 115 : Specify the station No. for the controller to be monitored with a GOT data register (GD).*1				

\*1 The relation between station No. of controller and GOT data register is as follows.

Station No.	GOT data register (GD)	Setting range
100	GD10	0 to 99 (If setting a value outside the range above, a device range error occurs.)
101	GD11	
:	:	
114	GD24	
115	GD25	

### (1) Device setting

Devices are set with reference numbers.

For parameters corresponding to each reference number, refer to the manual of the controller to be used.

## ■ FUJI temperature controller

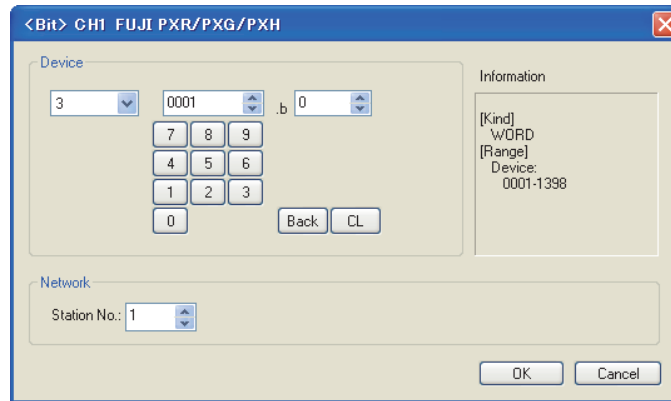

Item	Description	Model
Device	Set the device name, device number, and bit number. The bit number can be set when performing the bit specification of word device.	
Information	Displays the type and setting range of the device selected in [Device]. (Bit/Word)	
Network	Set the monitor target of the set device.	gr16 gr15 gr14 gr12 gr11 gr10 SoftGOT1000
	Station No. Monitors the temperature controller of the specified station number. 1 to 119, 216 to 255 : Monitors the temperature controller of the specified station number. 200 to 215 : The station number of the temperature controller to be monitored is specified by the value of the data register (GD) of the GOT.*1	

\*1 The relation between station No. of temperature controller and GOT data register is as follows

Station No.	GOT data register (GD)	Setting range
200	GD10	1 to 255 (If setting a value outside the range above, a device range error occurs.)
201	GD11	
:	:	
214	GD24	
215	GD25	

### (1) Device setting

Devices are set with the coil and register numbers of the temperature controller.

For the relation between the numbers and parameters etc. (such as an address map of coil/register number and a parameter), refer to the manual of the temperature controller to be used.

## AZBIL control equipment

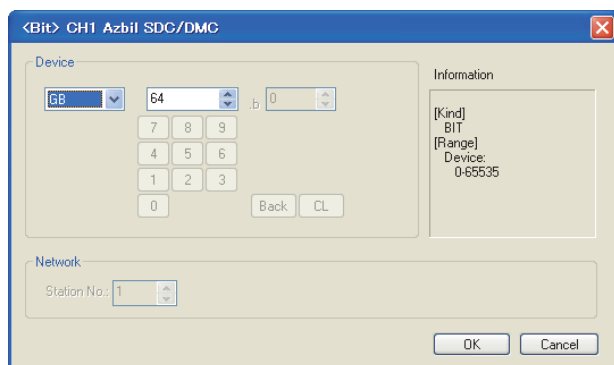

Azbil SDC/DMC

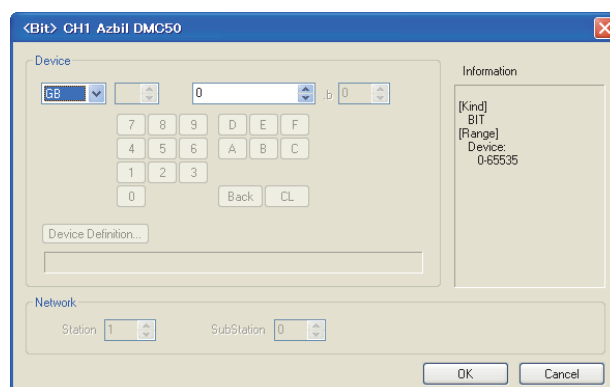

Azbil DMC50

Item	Description	Model		
Device	Set the device name, device number, and bit number. The bit number can be set when performing the bit specification of word device.			
	<input type="button" value="Device Definition..."/> Device definitions can be checked or set.			
Information	Displays the type and setting range of the device selected in [Device].			
Network	Set the monitor target of the set device.			
	<table border="1"> <tr> <td>Station No.</td> <td>The GOT monitors the control equipment with the specified station No. • Azbil SDC/DMC 0 to 127: Specify the station No. of the control equipment to be monitored. 200 to 215: With the value of the GOT data register (GD), specify the station No. of the control equipment to be monitored.*1</td> </tr> <tr> <td></td> <td>• Azbil DMC50 1 to 15: Specify the station No. of the COM module or the control equipment to be monitored. 100 to 115: With the value of the GOT data register (GD), specify the station No. of the COM module or the control equipment to be monitored, and specify the sub station No. of the control equipment.*2</td> </tr> </table>		Station No.	The GOT monitors the control equipment with the specified station No. • Azbil SDC/DMC 0 to 127: Specify the station No. of the control equipment to be monitored. 200 to 215: With the value of the GOT data register (GD), specify the station No. of the control equipment to be monitored.*1
Station No.	The GOT monitors the control equipment with the specified station No. • Azbil SDC/DMC 0 to 127: Specify the station No. of the control equipment to be monitored. 200 to 215: With the value of the GOT data register (GD), specify the station No. of the control equipment to be monitored.*1			
	• Azbil DMC50 1 to 15: Specify the station No. of the COM module or the control equipment to be monitored. 100 to 115: With the value of the GOT data register (GD), specify the station No. of the COM module or the control equipment to be monitored, and specify the sub station No. of the control equipment.*2			
	<table border="1"> <tr> <td>SubStation</td> <td>Specify the sub station No. of the control equipment connected to the COM module specified in [Station]. (0 to 15) When [SubStation] is specified to 0, the GOT monitors the COM module or the control equipment specified in [Station].</td> </tr> </table>	SubStation	Specify the sub station No. of the control equipment connected to the COM module specified in [Station]. (0 to 15) When [SubStation] is specified to 0, the GOT monitors the COM module or the control equipment specified in [Station].	
SubStation	Specify the sub station No. of the control equipment connected to the COM module specified in [Station]. (0 to 15) When [SubStation] is specified to 0, the GOT monitors the COM module or the control equipment specified in [Station].			

\*1 The relation between the station No. of the control equipment and the GOT data register is as follows.

Station No.	GOT data register (GD)	Setting range
200	GD10	0 to 127 (If setting a value outside the range above, a device range error occurs.)
201	GD11	
:	:	
214	GD24	
215	GD25	

\*2 In the value of GD10 to 25, the upper 8 bits are set for the station No., and the lower 8 bits are set for the sub station No.  
The setting of [SubStation] is disabled.

The relation between the station No. of the control equipment and the GOT data register is as follows.

Station No.	GOT data register (GD)	Setting range
100	GD10	0x0000 to 0xFFFF
101	GD11	
:	:	
114	GD24	
115	GD25	

Example: When [Station] is set to 100

The value of GD10 determines the temperature controller to be monitored.

GD10 = 0x010A

(Upper 8 bits) 0x01 → Station No.: 1

(Lower 8 bits) 0x0A → Sub station No.: 10

## POINT

---

### (1) Station No. and sub station No. of AZBIL DMC50

The station No. and the sub station No. set for the AZBIL DMC50 are equivalent to the network No. and the station No. set for the MITSUBISHI ELECTRIC PLC, respectively.

To set the temperature controller to be monitored, set both the station No. and the sub station No.

### (2) Restrictions for the faulty station information and the temperature controller/servo amplifier monitor station disconnection

When the DMC50 is used, the GOT only monitors some stations.

For the details of the station numbers of the DMC50 to be monitored, refer to the following.

 Appendix.2.3 GOT special register (GS) ■Read device

---



## ■ YOKOGAWA temperature controller

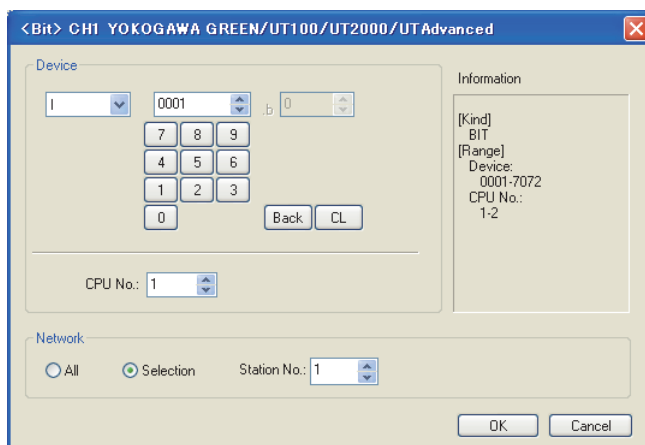

Item	Description	Model
Device	Set the device name, device number, and bit number. The bit number can be set when performing the bit specification of word device.	
	CPU No.* <sup>2</sup> Set the CPU No. (1, 2) of the device to be monitored. When device B is selected, the CPU No. is fixed to 1.	
Information	Displays the setting range available for the device selected in [Device].	
Network	Set the monitor target of the set device.	
	<p>All</p> <p>Select this item when writing data to all the temperature controllers connected. When bit specification of word device is performed, data are written to the indicating controller of the station No. set for [Host Address] of the communication detail settings. Monitoring and writing with bit specification of word device are performed only for the station No. set for [Host Address]. (When inputting data with the numerical input function, the data is written to all the connected temperature controller that is set for [Host Address] is monitored during other than input (display).)</p>	
	<p>Selection</p> <p>Set is item when monitoring the temperature controller of the specification No. After selecting, set the station No. of the temperature controller in the following range. 0 to 99 : The temperature controller of the station No. specified is monitored. 100 to 115 : Specify the station No. of the temperature controller to be monitored with the GOT data register (GD)<sup>*1</sup></p>	

\*1 The relation between station No. of temperature controller and GOT data register is as follows.

Station No.	GOT data register (GD)	Setting range
100	GD10	0 to 99 (If setting a value outside the range above, a device range error occurs.)
101	GD11	
:	:	
114	GD24	
115	GD25	

\*2 When there is no setting for the CPU No. in the communication settings on the temperature controller side, set the CPU No. on the GOT side to 1 (default).

## ■ RKC temperature controller

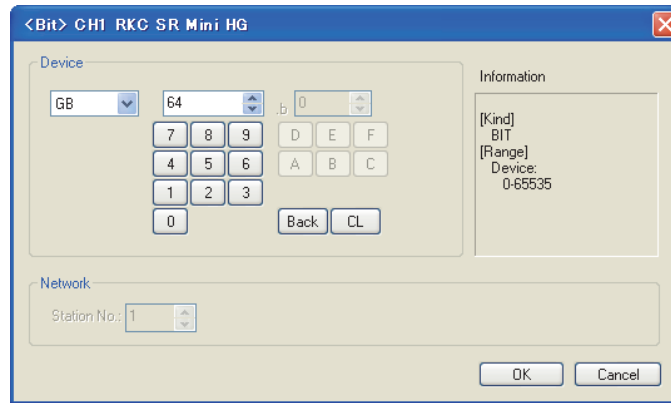

Item	Description	Model
Device	Set the device name, device number, and bit number. The bit number can be set when performing the bit specification of word device.	
Information	Displays the type and setting range of the device selected in [Device].	
Network	Set the monitor target of the set device.	G116 G115 G114 G112 G111 G110 SoftGOT1000
	Station No. Monitors the temperature controller of the specified station No. 0 to 99 : To monitor the temperature controller of the specified station No. 100 to 115 : To specify the station No. of the temperature controller to be monitored by the value of GOT data register (GD).*1	

\*1 The relation between station No. of temperature controller and GOT data register is as follows.

Station No.	GOT data register (GD)	Setting range
100	GD10	0 to 99 (If setting a value outside the range above, a device range error occurs.)
101	GD11	
:	:	
114	GD24	
115	GD25	

### (1) Device setting

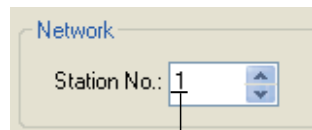

- Set by a value of "unit address + 1".
- For unit address 0: Set "1".
  - For unit address F: Set "16".

## ■ Inverter

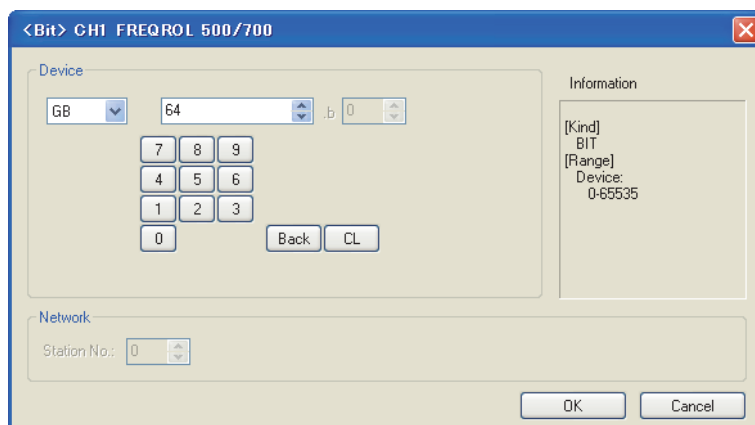





Item	Description	Model
Device	Set the device name, device number, and bit number. The bit number can be set when performing the bit specification of word device.	
	Station No. Monitors the Inverter of the specified station No. 0 to 31 : To monitor the Inverter of the specified station No. 100 to 115 : To specify the station No. of the Inverter to be monitored by the value of GOT data register (GD). <sup>*1</sup>	
Information	Displays the type and setting range of the device selected in [Device].	

\*1 The relation between station No. of inverter and GOT data register is as follows.

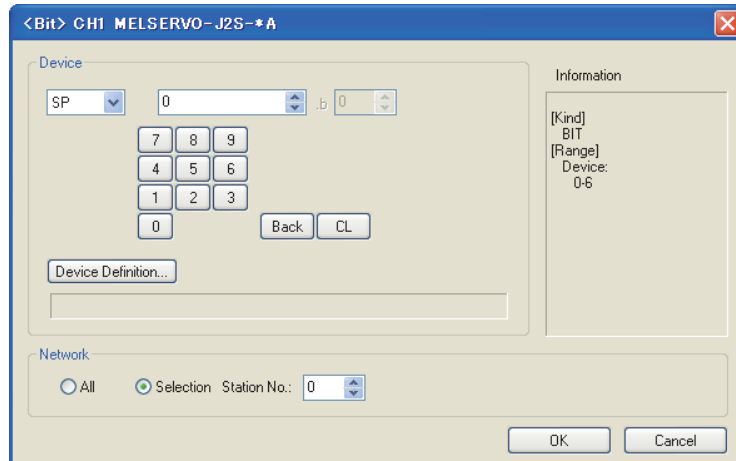
Station No.	GOT data register (GD)	Setting range
100	GD10	0 to 31 (If setting a value outside the range above, a device range error occurs.)
101	GD11	
:	:	
114	GD24	
115	GD25	

## ■ MITSUBISHI ELECTRIC servo amplifier



Item	Description	Model
Device	Set the device name, device number, and bit number. The bit number can be set when performing the bit specification of word device.	
	 <p>Clicking the button displays the dialog box indicating the correspondence between the GOT virtual device for a servo amplifier and the definition of servo amplifier. If select an item on the displayed dialog box, the definition of the servo amplifier is displayed in the text box below.</p> <p> (a) Device Definition dialog box</p>	
Information	Displays the type and setting range of the device selected in [Device].	
Network	Set the monitor target of the set device.	
	<p>All</p> <p>Select this item when writing data to all servo amplifiers connected. During a monitoring, the servo amplifier of Station No. 0 is monitored. When inputting data by Numerical Input, the data is written to all servo amplifiers connected during inputting; the servo amplifier of Station No. 0 is monitored during other than inputting (displaying).</p> <p>Selection Station No.</p> <p>Select this item when monitoring the servo amplifier of the Station No. specified. After selecting, set station numbers of servo amplifiers in the following range. 0 to 31 : The servo amplifier of the Station No. specified will be monitored. 100 to 115 : Specify the Station No. of the servo amplifier to be monitored with a GOT data register (GD).<sup>*1</sup></p>	

For details of \*1, refer to the following.

Station No.	GOT data register (GD)	Setting range
100	GD10	0 to 31 (If setting a value out of the range above, a timeout error occurs.)
101	GD11	
:	:	
114	GD24	
115	GD25	

(a) Device Definition dialog box

When setting a device in the Device dialog box and click the [Device Definition] button, the correspondence between the GOT virtual device for a servo amplifier and the definition of the servo amplifier is displayed.

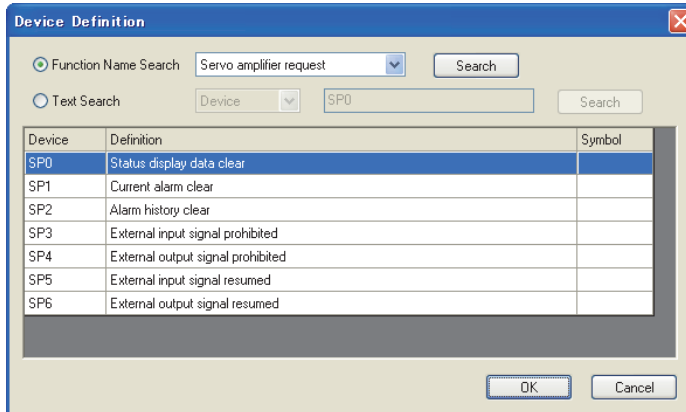

The device can be searched with the servo definition or other items on this dialog box to set a device.

1. Select a key item for searching.
  - Function Name Search: Select this item to search by a function name.
  - Text Search: Select this item to search by a character string. (Device, definition, or symbol)
2. Enter a function name, device, definition, or symbol by which the searching is performed.
3. After entering, click the [Search] button.  
As the items that match to the specified condition are displayed, select the device to be set.
4. Click the [OK] button to reflect the device selected in step 4 to the Device dialog box.

**POINT**

**When selecting [All] in the Network setting**

The network No. 0 and Station No. FF are displayed on Device List and when printing.

(Device List screen)

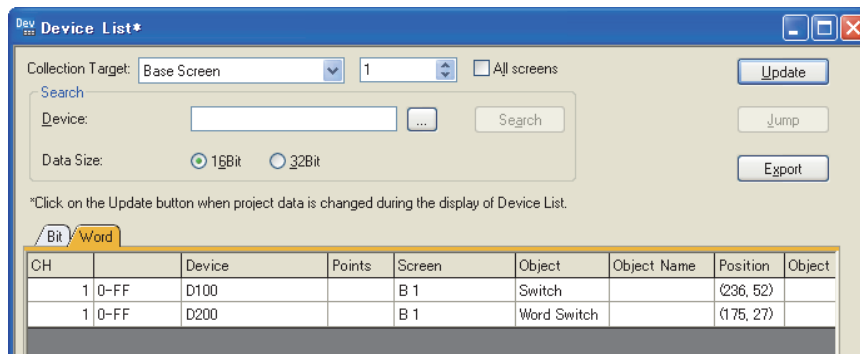

## ■ PANASONIC servo amplifier

Item	Description	Model
Device	Set the device name, device number, and bit number. The bit number can be set only when specifying the bit of word device.	gr16 gr15 gr14 gr12 gr11 gr10 SoftGOT1000
Information	Displays the device type and setting range which are selected in [Device].	
Network	Set the monitor target of the set device.	
	Station No.	Set this item when monitoring the servo amplifier of the specified station No.

# Appendix5 Key Code List

## (1) List of key code for numerical input and ASCII input

Key	Key code(H)	Key	Key code(H)	Key	Key code(H)	Key	Key code(H)
SP	0020H	@	0040H	`	0060H	←	0081H
!	0021H	A	0041H	a	0061H	↑	0082H
”	0022H	B	0042H	b	0062H	↓	0083H
#	0023H	C	0043H	c	0063H	(Clear)	0088H
\$	0024H	D	0044H	d	0064H		
%	0025H	E	0045H	e	0065H		
&	0026H	F	0046H	f	0066H		
,	0027H	G	0047H	g	0067H		
(	0028H	H	0048H	h	0068H		
)	0029H	I	0049H	i	0069H		
*	002AH	J	004AH	j	006AH		
+	002BH	K	004BH	k	006BH		
,	002CH	L	004CH	l	006CH		
-	002DH	M	004DH	m	006DH		
.	002EH	N	004EH	n	006EH		
/	002FH	O	004FH	o	006FH		
0	0030H	P	0050H	p	0070H		
1	0031H	Q	0051H	q	0071H		
2	0032H	R	0052H	r	0072H		
3	0033H	S	0053H	s	0073H		
4	0034H	T	0054H	t	0074H		
5	0035H	U	0055H	u	0075H		
6	0036H	V	0056H	v	0076H		
7	0037H	W	0057H	w	0077H		
8	0038H	X	0058H	x	0078H		
9	0039H	Y	0059H	y	0079H		
:	003AH	Z	005AH	z	007AH		
;	003BH	[	005BH	{	007BH		
<	003CH	\	005CH		007CH		
=	003DH	]	005DH	}	007DH		
>	003EH	^	005EH	~	007EH		
?	003FH	_	005FH	→	0080H		

## (2) List of key code for objects

### (a) Key code for numerical input

Key code <sup>(H)</sup>	Application	Operation Timing <sup>*1</sup>
0008H	Deletes the least signification digit and shifts the entire digits to the right by one.	ON action
000DH	Write to the destination device (Execute)/Move the cursor	OFF action
001BH	Cancel	OFF action
002DH	"±" (sign inversion)	ON action
002EH	"."	ON action
0030H to 0046H	Input value	ON action
0080H	Move cursor to right	OFF action
0081H	Move cursor to left	OFF action
0082H	Move cursor upward	OFF action
0083H	Move cursor downward	OFF action
0088H	Clear input numeric values	ON action
0090H	Move cursor to right within object	ON action
0091H	Move cursor to left within object	ON action
0092H	User ID ascending order movement of cursor	OFF action
0093H	User ID descending order movement of cursor	OFF action
FFFAH	Increment	ON action
FFFBH	Decrement	ON action

\*1 ON action for the GT10

### (b) Key code for ASCII input

Key code <sup>(H)</sup>	Application	Operation Timing <sup>*1</sup>
0008H	Deletes the first character and shifts the entire characters to the right by one character.	ON action
000DH	Write to the destination device (Execute)/Move the cursor	OFF action
001BH	Cancel	OFF action
ASCII code	Input characters	ON action
0080H	Move cursor to right	OFF action
0081H	Move cursor to left	OFF action
0082H	Move cursor upward	OFF action
0083H	Move cursor downward	OFF action
0084H	Kanji conversion	ON action
0085H	Previous choice	ON action
0086H	Next choice/Conversion	ON action
0087H	Select/No conversion/Select next word	ON action
0088H	Clear input numeric values	ON action
0089H	Select previous word	ON action
0090H	Move cursor to right within object/Lengthen the word length	ON action
0091H	Move cursor to left within object/Shorten the word length	ON action
0092H	User ID ascending order movement of cursor	OFF action
0093H	User ID descending order movement of cursor	OFF action
0094H	Switches key windows (Next)	ON action
0095H	Switches key windows (Previous)	ON action
009CH	Switches key windows (Indirection)	ON action

\*1 ON action for the GT10



## (c) Key code for data list display

Key code <sup>(H)</sup>	Application	Operation Timing <sup>*1</sup>
00F2H	Scroll up by one line	ON action
00F3H	Scroll down by one line	ON action

\*1 ON action for the GT10

## (d) List of key code for historical data list display

Key code <sup>(H)</sup>	Application	Operation Timing <sup>*1</sup>
FFD0H	Jump to the top of the list	ON action
FFD1H	Jump to the bottom of the list	ON action
FFD2H	Scroll the list by one cell to the left	ON action
FFD3H	Scroll the list by one cell to the right	ON action
FFD4H	Move display position to the specified time	ON action
FFD5H	Scroll the list by one page to the left	ON action
FFD6H	Scroll the list by one page to the right	ON action
FFEFH	Latest Data	ON action
FFF0H	Show cursor	ON action
FFF1H	Hide cursor	ON action
FFF2H	List Cursor Up	ON action
FFF3H	List Cursor Down	ON action
FFF4H	List Displacement Scroll Up	ON action
FFF5H	List Displacement Scroll Down	ON action
FFF6H	List Page Scroll Up	ON action
FFF7H	List Page Scroll Down	ON action

\*1 ON action for the GT10

## (e) Key code for user alarm display and system alarm display

Key code <sup>(H)</sup>	Application	Operation Timing <sup>*1</sup>
00F2H	Scroll up by one line	ON action
00F3H	Scroll down by one line	ON action
FFB0H	Show cursor	ON action
FFB1H	Hide cursor	ON action
FFB2H	Move cursor upward (Move to previous page when cursor is hidden.)	ON action
FFB3H	Move cursor downward (Move to next page when cursor is hidden.)	ON action
FFB8H	Display detail information	ON action
FFBCH	Display ladder	OFF action
FFBDH	Display ladder (Ladder Editor)	OFF action

\*1 ON action for the GT10

## (f) Key code for alarm history function

Key code <sup>(H)</sup>	Application	Operation Timing <sup>*1</sup>
FFB0H	Show cursor	ON action
FFB1H	Hide cursor	ON action
FFB2H	Move cursor upward (Move to previous page when cursor is hidden.)	ON action
FFB3H	Move cursor downward (Move to next page when cursor is hidden.)	ON action
FFB4H	Display date/time of selected data	ON action
FFB5H	Display date/time of all data	ON action
FFB6H	Clear the selected alarm data	ON action
FFB7H	Clear all alarm data	ON action
FFB8H	Display detail /Move to the lower hierarchy	ON action
FFB9H	Reset the selected alarm data	ON action
FFBBH	Store to Memory Card	ON action
FFBCH	Display ladder	OFF action
FFBDH	Display ladder (Ladder Editor)	OFF action

\*1 ON action for the GT10

## (g) Key code for advanced alarm display

Key code <sup>(H)</sup>	Application	Operation Timing <sup>*1</sup>
FFB0H	Show cursor	ON action
FFB1H	Hide cursor	ON action
FFB2H	Move cursor up	ON action
FFB3H	Move cursor down	ON action
FFB4H	Display date/time of selected data	ON action
FFB5H	Display date/time of all data	ON action
FFB6H	Clear the selected alarm data	ON action
FFB7H	Clear all alarm data	ON action
FFB8H	Move to the lower hierarchy (Display detail)	ON action
FFB9H	Reset the specified device	ON action
FFBBH	Store to Memory Card	ON action
FFBCH	Display ladder	OFF action
FFBDH	Display ladder (Ladder Editor)	OFF action
FFBEH	Move display position to the specified time	ON action
FFC2H	Move to the upper hierarchy	ON action

\*1 ON action for the GT10

(h) Key code for historical trend graph

Key code <sup>(H)</sup>	Application	Operation Timing <sup>*1</sup>
FFD4H	Move display position to the specified time	ON action
FFEFH	Latest Data	ON action
FFF0H	Show cursor	ON action
FFF1H	Hide cursor	ON action
FFF2H	Graph Cursor Next	ON action
FFF3H	Graph Cursor Previous	ON action
FFF4H	Graph next	ON action
FFF5H	Graph previous	ON action
FFF6H	Graph next page scroll	ON action
FFF7H	Graph previous page scroll	ON action
FFF8H	Time axis expansion	ON action
FFF9H	Time axis reduction	ON action

\*1 ON action for the GT10

(i) Key code for document display function

Key code <sup>(H)</sup>	Application	Operation Timing <sup>*1</sup>
FFD8H	Display the list of the keyword candidates	ON action
FFD9H	Display switching (Group display/Developed display)	ON action
FFDAH	Keyword search (Descending order)	ON action
FFDBH	Keyword search (Ascending order)	ON action
FFDCH	Move cursor up	ON action
FFDDH	Move cursor down	ON action
FFDEH	Scroll the upper page (Keyword list)	ON action
FFDFH	Scroll the bottom page (Keyword list)	ON action
FFE0H	Next page	ON action
FFE1H	Previous page	ON action
FFE2H	Expansion	ON action
FFE3H	Reduction	ON action
FFE4H	Up scroll	ON action
FFE5H	Down scroll	ON action
FFE6H	Left scroll	ON action
FFE7H	Right scroll	ON action

\*1 ON action for the GT10

# Appendix6 Synthesized Colors Available for XOR

The following table indicates the colors and corresponding numbers available when using the parts display function XOR drawing mode

When using the XOR for any colors other than the following, confirm them in the preview of GT Designer3.

	Black 0	Blue 3	Red 224	Purple 227	Green 28	Cyan 31	Yellow 252	White 255	Dark blue 2	Dark red 160	Dark purple 162	Dark green 20	Dark cyan 22	Dark yellow 180	Gray 182	Dark white 109
Black 0	Black 0	Blue 3	Red 224	Purple 227	Green 28	Cyan 31	Yellow 252	White 255	Dark blue 2	Dark red 160	Dark purple 162	Dark green 20	Dark cyan 22	Dark yellow 180	Gray 182	Dark white 109
Blue 3	Blue 3	Black 0	Purple 227	Red 224	Cyan 31	Green 28	White 255	Yellow 252	- 1	- 163	- 161	- 23	- 21	- 183	- 181	- 110
Red 224	Red 224	Purple 227	Black 0	Blue 3	Yellow 252	White 255	Green 28	Cyan 31	- 226	- 64	- 66	- 244	- 246	- 84	- 86	- 141
Purple 227	Purple 227	Red 224	Blue 3	Black 0	White 255	Yellow 252	Cyan 31	Green 28	- 225	- 67	- 65	- 247	- 245	- 87	- 85	- 142
Green 28	Green 28	Cyan 31	Yellow 252	White 255	Black 0	Blue 3	Red 224	Purple 227	- 30	- 188	- 190	- 8	- 10	- 168	- 170	- 113
Cyan 31	Cyan 31	Green 28	White 255	Yellow 252	Blue 3	Black 0	Purple 227	Red 224	- 29	- 191	- 189	- 11	- 7	- 171	- 169	- 114
Yellow 252	Yellow 252	White 255	Green 28	Cyan 31	Red 224	Purple 227	Black 0	Blue 3	- 254	- 92	- 94	- 232	- 234	- 72	- 74	- 145
White 255	White 255	Yellow 252	Cyan 31	Green 28	Purple 227	Red 224	Blue 3	Black 0	- 253	- 95	- 93	- 235	- 233	- 75	- 73	- 146
Dark blue 2	Dark blue 2	- 1	- 226	- 225	- 30	- 29	- 254	- 253	Black 0	Dark purple 162	Dark red 160	Dark cyan 22	Dark green 20	Gray 182	Dark yellow 180	- 111
Dark red 160	Dark red 160	- 163	- 64	- 67	- 188	- 191	- 92	- 95	Dark purple 162	Black 0	Dark blue 2	Dark yellow 180	Gray 182	Dark green 20	Dark cyan 22	- 205
Dark purple 162	Dark purple 162	- 161	- 66	- 65	- 190	- 189	- 94	- 93	Dark red 160	Dark blue 2	Black 0	Gray 182	Dark yellow 180	Dark cyan 22	Dark green 20	- 207
Dark green 20	Dark green 20	- 23	- 244	- 247	- 8	- 11	- 232	- 235	Dark cyan 22	Dark yellow 180	Gray 182	Black 0	Dark blue 2	Dark red 160	Dark purple 162	- 121
Dark cyan 22	Dark cyan 22	- 21	- 246	- 245	- 10	- 7	- 234	- 233	Dark green 20	Gray 182	Dark yellow 180	Dark blue 2	Black 0	Dark purple 162	Dark red 160	- 123
Dark yellow 180	Dark yellow 180	- 183	- 84	- 87	- 168	- 171	- 72	- 75	Gray 182	Dark green 20	Dark cyan 22	Dark red 160	Dark purple 162	Black 0	Dark blue 2	- 217
Gray 182	Gray 182	- 181	- 86	- 85	- 170	- 169	- 74	- 73	Dark yellow 180	Dark cyan 22	Dark green 20	Dark purple 162	Dark red 160	Dark blue 2	Black 0	- 219
Dark white 109	Dark white 109	- 110	- 141	- 142	- 113	- 114	- 145	- 146	- 111	- 205	- 207	- 121	- 123	- 217	- 219	Dark black 0

## POINT

### XOR synthesis

The XOR synthesis function creates a color by combining two colors.

For created colors, refer to the above table.

# Appendix7 ASCII Code List

ASCII code list is shown below. (The blanks represent control code.)  
 0xA1 to 0xDF can be displayed only when the GOT's system language is Japanese.

	0	1	2	3	4	5	6	7	8	9	A	B	C	D	E	F
0			(SP)	0	@	P	`	p				ー	タ	ミ		
1			!	1	A	Q	a	q			。	ア	チ	ム		
2			"	2	B	R	b	r			「	イ	ツ	メ		
3			#	3	C	S	c	s			」	ウ	テ	モ		
4			\$	4	D	T	d	t			、	エ	ト	ヤ		
5			%	5	E	U	e	u			・	オ	ナ	ユ		
6			&	6	F	V	f	v			ヲ	カ	ニ	ヨ		
7			'	7	G	W	g	w			ア	キ	ヌ	ラ		
8			(	8	H	X	h	x			イ	ク	ネ	リ		
9			)	9	I	Y	i	y			ウ	ケ	ノ	ル		
A			*	:	J	Z	j	z			エ	コ	ハ	レ		
B			+	:	K	[	k	{			オ	サ	ヒ	ロ		
C			,	<	L	\	l				ヤ	シ	フ	ワ		
D			-	=	M	]	m	}			ユ	ス	ヘ	ン		
E			.	>	N	^	n	~			ヨ	セ	ホ	°		
F			/	?	O	_	o				ッ	ソ	マ	°		



# Appendix8 Relevant Settings

---

Some of the contents in the settings common to each project affect multiple functions of GT Designer3. The following shows the relation between each common setting item and functions of GT Designer3.

- ☞ ■GOT type setting
  - GOT environment setting (Screen switching/Windows)
  - GOT environment setting (Key window)
  - Screen property
  - GOT environment setting: System information
  - Parts setting
  - Sound file setting
  - GOT special register (GS)

## ■ GOT type setting

○ : Relevant - : Irrelevant

Item	Operation log function	Parts movement	Parts display	Historical trend graph	Statistics bar/Statistics pie/Scatter graph	Line/Trend/Bar graph	Panel meter	Level	Scrolling alarm display	Alarm history display	System alarm display	User alarm display	Advanced alarm popup display (System alarm)	Advanced alarm popup display (User alarm)	Advanced system alarm display	Advanced user alarm display	Comment display	Date display/Time display	Historical data list display	Data list	ASCII input	ASCII display	Numerical input	Numerical display	Lamp	Touch switch
Check for overlapping objects within GOT	-	-	○	○	○	○	○	○	-	○	○	○	-	-	○	○	○	○	○	○	○	○	○	○	○	○
Adjust object display order in GOT to the one in GT Designer3	-	-	○	○	○	○	○	○	-	○	○	○	-	-	○	○	○	○	○	○	○	○	○	○	○	○

## ■ GOT environment setting (Screen switching/Windows)

○ : Relevant - : Irrelevant

Item	Operation log function	Parts movement	Parts display	Historical trend graph	Statistics bar/Statistics pie/Scatter graph	Line/Trend/Bar graph	Panel meter	Level	Scrolling alarm display	Alarm history display	System alarm display	User alarm display	Advanced alarm popup display (System alarm)	Advanced alarm popup display (User alarm)	Advanced system alarm display	Advanced user alarm display	Comment display	Date display/Time display	Historical data list display	Data list	ASCII input	ASCII display	Numerical input	Numerical display	Lamp	Touch switch
Disable background colors of overlay screen when setting an overlay screen	-	-	-	-	-	-	-	-	-	-	-	-	-	-	-	-	-	-	-	-	-	-	-	-	-	-
Place the overlay screen under the basic screen	-	-	-	-	-	-	-	-	-	-	-	-	-	-	-	-	-	-	-	-	-	-	-	-	-	-
Operation Timing	-	-	-	-	-	-	-	-	-	-	-	-	-	-	-	-	-	-	-	-	-	-	-	-	○	-



○ : Relevant - : Irrelevant

Key windows	-	-
Station No. switching function	-	-
MES interface function	-	-
Gateway function	-	-
Test function	-	-
Document display function	-	-
Set overlay screen function	○	○
Sound output function	-	-
Hardcopy function	-	-
Report function	-	-
RGB display function	-	-
Operation panel/External I/O function	-	-
Multimedia function	-	-
Video display function	-	-
VNC® server function	-	-
Remote personal computer operation (Ethernet)	-	-
Remote personal computer operation (Serial)	-	-
RFID function	-	-
Barcode function	-	-
Script function	-	-
Time action function	-	-
Trigger action function	-	-
Status observation function	-	-
Device data transfer function	-	-
Advanced recipe function	-	-
Recipe function	-	-
Logging function	-	-
Item	-	-
Check for overlapping objects within GOT	-	-
Adjust object display order in GOT to the one in GT Designer3	-	-

○ : Relevant - : Irrelevant

Key windows	-	-
Station No. switching function	-	-
MES interface function	-	-
Gateway function	-	-
Test function	-	-
Document display function	-	-
Set overlay screen function	○	○
Sound output function	-	-
Hardcopy function	-	-
Report function	-	-
RGB display function	-	-
Operation panel/External I/O function	-	-
Multimedia function	-	-
Video display function	-	-
VNC® server function	-	-
Remote personal computer operation (Ethernet)	-	-
Remote personal computer operation (Serial)	-	-
RFID function	-	-
Barcode function	-	-
Script function	-	-
Time action function	-	-
Trigger action function	-	-
Status observation function	-	-
Device data transfer function	-	-
Advanced recipe function	-	-
Recipe function	-	-
Logging function	-	-
Item	-	-
Disable background colors of overlay screen when setting an overlay screen	-	-
Place the overlay screen under the basic screen	-	-
Operation Timing	-	-

## ■ GOT environment setting (Key window)

### (1) Advanced Setting tab

○ : Relevant - : Irrelevant

Item	Operation log function	Parts movement	Parts display	Historical trend graph	Statistics bar/Statistics pie/Scatter graph	Line/Trend/Bar graph	Panel meter	Level	Scrolling alarm display	Alarm history display	System alarm display	User alarm display	Advanced alarm popup display (System alarm)	Advanced alarm popup display (User alarm)	Advanced system alarm display	Advanced user alarm display	Comment display	Date display/Time display	Historical data list display	Data list	ASCII input	ASCII display	Numerical input	Numerical display	Lamp	Touch switch
Key Window	-	-	-	-	-	-	-	-	-	-	-	-	-	-	-	-	-	-	-	-	○	-	-	-	-	
Cursor	-	-	-	-	-	-	-	-	-	-	-	-	-	-	-	-	-	-	-	-	○	-	-	-	-	
When screens are switched	-	-	-	-	-	-	-	-	-	-	-	-	-	-	-	-	-	-	-	-	○	-	-	-	-	
Cursor Position	-	-	-	-	-	-	-	-	-	-	-	-	-	-	-	-	-	-	-	-	○	-	-	-	-	
Clear the key window and the cursor	-	-	-	-	-	-	-	-	-	-	-	-	-	-	-	-	-	-	-	-	○	-	-	-	-	
Clear the input object	-	-	-	-	-	-	-	-	-	-	-	-	-	-	-	-	-	-	-	-	○	-	-	-	-	
Cursor Type	-	-	-	-	-	-	-	-	-	-	-	-	-	-	-	-	-	-	-	-	○	-	-	-	-	
Display the cursor with a touch on the Enter/arrow key when the cursor is hidden	-	-	-	-	-	-	-	-	-	-	-	-	-	-	-	-	-	-	-	-	○	-	-	-	-	
Display the valid input range when an invalid value is input in Numerical Input	-	-	-	-	-	-	-	-	-	-	-	-	-	-	-	-	-	-	-	-	○	-	-	-	-	
Display the input confirmation dialog when setting the function of Numerical/ ASCII Input	-	-	-	-	-	-	-	-	-	-	-	-	-	-	-	-	-	-	-	-	○	-	-	-	-	
Check the input range while entering numerical values	-	-	-	-	-	-	-	-	-	-	-	-	-	-	-	-	-	-	-	-	○	-	-	-	-	
Defined key action	-	-	-	-	-	-	-	-	-	-	-	-	-	-	-	-	-	-	-	-	○	-	-	-	-	

○ : Relevant - : Irrelevant

Item	Key windows	Station No. switching function	MES interface function	Gateway function	Test function	Document display function	Set overlay screen function	Sound output function	Hardcopy function	Report function	RGB display function	Operation panel/External I/O function	Multimedia function	Video display function	VNC® server function	Remote personal computer operation (Ethernet)	Remote personal computer operation (Serial)	RFID function	Barcode function	Script function	Time action function	Trigger action function	Status observation function	Device data transfer function	Advanced recipe function	Recipe function	Logging function
Key Window	○	-	-	-	-	-	-	-	-	-	-	-	-	-	-	-	-	-	-	-	-	-	-	-	-	-	-
Cursor	○	○	○	○	○	○	○	○	○	○	○	○	○	○	○	○	○	○	○	○	○	○	○	○	○	○	○
When screens are switched	○	○	○	○	○	○	○	○	○	○	○	○	○	○	○	○	○	○	○	○	○	○	○	○	○	○	○
Cursor Position	○	○	○	○	○	○	○	○	○	○	○	○	○	○	○	○	○	○	○	○	○	○	○	○	○	○	○
Clear the key window and the cursor	○	○	○	○	○	○	○	○	○	○	○	○	○	○	○	○	○	○	○	○	○	○	○	○	○	○	○
Clear the input object	○	○	○	○	○	○	○	○	○	○	○	○	○	○	○	○	○	○	○	○	○	○	○	○	○	○	○
Cursor Type	○	○	○	○	○	○	○	○	○	○	○	○	○	○	○	○	○	○	○	○	○	○	○	○	○	○	○
Display the cursor with a touch on the Enter/arrow key when the cursor is hidden	○	○	○	○	○	○	○	○	○	○	○	○	○	○	○	○	○	○	○	○	○	○	○	○	○	○	○
Display the valid input range when an invalid value is input in Numerical Input	○	○	○	○	○	○	○	○	○	○	○	○	○	○	○	○	○	○	○	○	○	○	○	○	○	○	○
Display the input confirmation dialog when setting the function of Numerical/ASCII Input	○	○	○	○	○	○	○	○	○	○	○	○	○	○	○	○	○	○	○	○	○	○	○	○	○	○	○
Check the input range while entering numerical values	○	○	○	○	○	○	○	○	○	○	○	○	○	○	○	○	○	○	○	○	○	○	○	○	○	○	○
Defined key action	○	○	○	○	○	○	○	○	○	○	○	○	○	○	○	○	○	○	○	○	○	○	○	○	○	○	○

## ■ Screen property

### (1) Basic tab

○ : Relevant - : Irrelevant

Item	Operation log function	Parts movement	Parts display	Historical trend graph	Statistics bar/Statistics pie/Scatter graph	Line/Trend/Bar graph	Panel meter	Level	Scrolling alarm display	Alarm history display	System alarm display	User alarm display	Advanced alarm popup display (System alarm)	Advanced alarm popup display (User alarm)	Advanced system alarm display	Advanced user alarm display	Comment display	Date display/Time display	Historical data list display	Data list	ASCII input	ASCII display	Numerical input	Numerical display	Lamp	Touch switch	
Switch Station No.	.	.	.	.	.	.	.	.	.	.	.	.	.	.	.	.	.	.	.	.	.	.	.	.	.	.	.
Pop up the display of advanced alarm	.	.	.	.	.	.	.	.	.	.	.	.	○	○	.	.	.	.	.	.	.	.	.	.	.	.	.
Display alarm flow	.	.	.	.	.	.	.	○	.	.	.	.	.	.	.	.	.	.	.	.	.	.	.	.	.	.	
Backlight	.	.	.	.	.	.	.	.	.	.	.	.	.	.	.	.	.	.	.	.	.	.	.	.	.	.	
Blink Backlight	.	.	.	.	.	.	.	.	.	.	.	.	.	.	.	.	.	.	.	.	.	.	.	.	.	.	

### (2) Advanced Setting tab

○ : Relevant - : Irrelevant

Item	Operation log function	Parts movement	Parts display	Historical trend graph	Statistics bar/Statistics pie/Scatter graph	Line/Trend/Bar graph	Panel meter	Level	Scrolling alarm display	Alarm history display	System alarm display	User alarm display	Advanced alarm popup display (System alarm)	Advanced alarm popup display (User alarm)	Advanced system alarm display	Advanced user alarm display	Comment display	Date display/Time display	Historical data list display	Data list	ASCII input	ASCII display	Numerical input	Numerical display	Lamp	Touch switch
Prioritize screen setting over project setting	.	.	.	.	.	.	.	.	.	.	.	.	.	.	.	.	.	.	.	.	.	○	.	.	.	.
Key Window	.	.	.	.	.	.	.	.	.	.	.	.	.	.	.	.	.	.	.	.	.	○	○	○	○	.
Cursor	.	.	.	.	.	.	.	.	.	.	.	.	.	.	.	.	.	.	.	.	.	○	○	○	○	.
When screens are switched	.	.	.	.	.	.	.	.	.	.	.	.	.	.	.	.	.	.	.	.	.	○	○	○	○	.
Cursor Position	.	.	.	.	.	.	.	.	.	.	.	.	.	.	.	.	.	.	.	.	.	○	○	○	○	.
Clear the key window and the cursor	.	.	.	.	.	.	.	.	.	.	.	.	.	.	.	.	.	.	.	.	.	○	○	○	○	.
Clear the input object	.	.	.	.	.	.	.	.	.	.	.	.	.	.	.	.	.	.	.	.	.	○	○	○	○	.
Cursor Type	.	.	.	.	.	.	.	.	.	.	.	.	.	.	.	.	.	.	.	.	.	○	○	○	○	.
Display the input confirmation dialog when setting the function of Numerical/ ASCII Input	.	.	.	.	.	.	.	.	.	.	.	.	.	.	.	.	.	.	.	.	.	○	.	.	.	.
Check the input range while entering numerical values	.	.	.	.	.	.	.	.	.	.	.	.	.	.	.	.	.	.	.	.	.	○	.	.	.	.
Defined key action	.	.	.	.	.	.	.	.	.	.	.	.	.	.	.	.	.	.	.	.	.	○	.	.	.	.
Reference for determining cursor destination	.	.	.	.	.	.	.	.	.	.	.	.	.	.	.	.	.	.	.	.	.	○	.	.	.	.
Automatically move the key window when it overlaps with an input object	.	.	.	.	.	.	.	.	.	.	.	.	.	.	.	.	.	.	.	.	.	○	.	.	.	.

○ : Relevant - : Irrelevant

Item	Key windows	Station No. switching function	MES interface function	Gateway function	Test function	Document display function	Set overlay screen function	Sound output function	Hardcopy function	Report function	RGB display function	Operation panel/External I/O function	Multimedia function	Video display function	VNC® server function	Remote personal computer operation (Ethernet)	Remote personal computer operation (Serial)	RFID function	Barcode function	Script function	Time action function	Trigger action function	Status observation function	Device data transfer function	Advanced recipe function	Recipe function	Logging function	
Switch Station No.	.	○	.	.	.	.	.	.	.	.	.	.	.	.	.	.	.	.	.	.	.	.	.	.	.	.	.	.
Popup the display of advanced alarm	.	.	.	.	.	.	.	.	.	.	.	.	.	.	.	.	.	.	.	.	.	.	.	.	.	.	.	.
Display alarm flow	.	.	.	.	.	.	.	.	.	.	.	.	.	.	.	.	.	.	.	.	.	.	.	.	.	.	.	.
Backlight	.	.	.	.	.	.	.	.	.	.	.	.	.	.	.	.	.	.	.	.	.	.	.	.	.	.	.	.
Blink Backlight	.	.	.	.	.	.	.	.	.	.	.	.	.	.	.	.	.	.	.	.	.	.	.	.	.	.	.	.

○ : Relevant - : Irrelevant

Item	Key windows	Station No. switching function	MES interface function	Gateway function	Test function	Document display function	Set overlay screen function	Sound output function	Hardcopy function	Report function	RGB display function	Operation panel/External I/O function	Multimedia function	Video display function	VNC® server function	Remote personal computer operation (Ethernet)	Remote personal computer operation (Serial)	RFID function	Barcode function	Script function	Time action function	Trigger action function	Status observation function	Device data transfer function	Advanced recipe function	Recipe function	Logging function	
Prioritize screen setting over project setting	○	.	.	.	.	.	.	.	.	.	.	.	.	.	.	.	.	.	.	.	.	.	.	.	.	.	.	.
Key Window	○	.	.	.	.	.	.	.	.	.	.	.	.	.	.	.	.	.	.	.	.	.	.	.	.	.	.	.
Cursor	○	.	.	.	.	.	.	.	.	.	.	.	.	.	.	.	.	.	.	.	.	.	.	.	.	.	.	.
When screens are switched	○	.	.	.	.	.	.	.	.	.	.	.	.	.	.	.	.	.	.	.	.	.	.	.	.	.	.	.
Cursor Position	○	.	.	.	.	.	.	.	.	.	.	.	.	.	.	.	.	.	.	.	.	.	.	.	.	.	.	.
Clear the key window and the cursor	○	.	.	.	.	.	.	.	.	.	.	.	.	.	.	.	.	.	.	.	.	.	.	.	.	.	.	.
Clear the input object	○	.	.	.	.	.	.	.	.	.	.	.	.	.	.	.	.	.	.	.	.	.	.	.	.	.	.	.
Cursor Type	.	.	.	.	.	.	.	.	.	.	.	.	.	.	.	.	.	.	.	.	.	.	.	.	.	.	.	.
Display the input confirmation dialog when setting the function of Numerical/ASCII Input	○	.	.	.	.	.	.	.	.	.	.	.	.	.	.	.	.	.	.	.	.	.	.	.	.	.	.	.
Check the input range while entering numerical values	○	.	.	.	.	.	.	.	.	.	.	.	.	.	.	.	.	.	.	.	.	.	.	.	.	.	.	.
Defined key action	○	.	.	.	.	.	.	.	.	.	.	.	.	.	.	.	.	.	.	.	.	.	.	.	.	.	.	.
Reference for determining cursor destination	○	.	.	.	.	.	.	.	.	.	.	.	.	.	.	.	.	.	.	.	.	.	.	.	.	.	.	.
Automatically move the key window when it overlaps with an input object	○	.	.	.	.	.	.	.	.	.	.	.	.	.	.	.	.	.	.	.	.	.	.	.	.	.	.	.

## GOT environment setting: System information

○ : Relevant - : Irrelevant

System Signal 1-1 (Read device)		Operation log function	Parts movement	Parts display	Historical trend graph	Statistics bar/Statistics pie/Scatter graph	Line/Trend/Bar graph	Panel meter	Level	Scrolling alarm display	Alarm history display	System alarm display	User alarm display	Advanced alarm popup display (System alarm)	Advanced alarm popup display (User alarm)	Advanced system alarm display	Advanced user alarm display	Comment display	Date display/Time display	Historical data list display	Data list	ASCII input	ASCII display	Numerical input	Numerical display	Lamp	Touch switch
Bit No.	Description																										
b0	Automatic Screen Saver Disable Signal	-	-	-	-	-	-	-	-	-	-	-	-	-	-	-	-	-	-	-	-	-	-	-	-	-	-
b1	Forced Screen Saver Enable Signal	-	-	-	-	-	-	-	-	-	-	-	-	-	-	-	-	-	-	-	-	-	-	-	-	-	-
b2	Forced Screen Saver Touch-cancel Signal	-	-	-	-	-	-	-	-	-	-	-	-	-	-	-	-	-	-	-	-	-	-	-	-	-	-
b3	Key Code Read Complete Signal	-	-	-	-	-	-	-	-	-	○	-	-	-	-	-	-	-	-	-	-	-	-	-	-	-	-
b4	Numeric Value Input Read Complete Signal	-	-	-	-	-	-	-	-	-	-	-	-	-	-	-	○	-	-	-	-	-	-	-	-	-	-
b5	Barcode Input Disable Signal (CH8)	-	-	-	-	-	-	-	-	-	-	-	-	-	-	-	-	-	-	-	-	-	-	-	-	-	-
b6	External device I/O complete signal (CH8)	-	-	-	-	-	-	-	-	-	-	-	-	-	-	-	-	-	-	-	-	-	-	-	-	-	-
b7	Backlight OFF Output Signal	-	-	-	-	-	-	-	-	-	-	-	-	-	-	-	-	-	-	-	-	-	-	-	-	-	-
b8	Buzzer Threshot Output Signal	-	-	-	-	-	-	-	-	-	-	-	-	-	-	-	-	-	-	-	-	-	-	-	-	-	-
b9	Key-In Disable Signal	○	-	-	-	-	-	-	-	-	○	-	-	-	-	-	-	-	-	-	-	-	-	-	-	-	-
b10	Hard copy setting validate signal	-	-	-	-	-	-	-	-	-	-	-	-	-	-	-	-	-	-	-	-	-	-	-	-	-	-
b12	Hard copy white/black reverse signal	-	-	-	-	-	-	-	-	-	-	-	-	-	-	-	-	-	-	-	-	-	-	-	-	-	-
b13	GOT Error Reset Signal	-	-	-	-	-	-	-	-	-	-	○	-	-	-	-	-	-	-	-	-	-	-	-	-	-	-
b14	Buzzer Output Signal	-	-	-	-	-	-	-	-	-	-	-	-	-	-	-	-	-	-	-	-	-	-	-	-	-	-
b15	Buzzer Oneshot Output Signal	-	-	-	-	-	-	-	-	-	-	-	-	-	-	-	-	-	-	-	-	-	-	-	-	-	-

○ : Relevant - : Irrelevant

System Signal (Read device)		Operation log function	Parts movement	Parts display	Historical trend graph	Statistics bar/Statistics pie/Scatter graph	Line/Trend/Bar graph	Panel meter	Level	Scrolling alarm display	Alarm history display	System alarm display	User alarm display	Advanced alarm popup display (System alarm)	Advanced alarm popup display (User alarm)	Advanced system alarm display	Advanced user alarm display	Comment display	Date display/Time display	Historical data list display	Data list	ASCII input	ASCII display	Numerical input	Numerical display	Lamp	Touch switch
Bit No.	Description																										
External input and output function/output information (GT16, GT15)		-	-	-	-	-	-	-	-	-	-	-	-	-	-	-	-	-	-	-	-	-	-	-	-	-	-
External input and output function/output information (GT11, GT10)		-	-	-	-	-	-	-	-	-	-	-	-	-	-	-	-	-	-	-	-	-	-	-	-	-	-
b0 to b5	Operation switch LED control signal	-	-	-	-	-	-	-	-	-	-	-	-	-	-	-	-	-	-	-	-	-	-	-	-	-	-
b6	Grip switch LED control signal	-	-	-	-	-	-	-	-	-	-	-	-	-	-	-	-	-	-	-	-	-	-	-	-	-	-

○ : Relevant - : Irrelevant

System Signal 1-1 (Read device)		Key windows	Station No. switching function	MES interface function	Gateway function	Test function	Document display function	Set overlay screen function	Sound output function	Hardcopy function	Report	RGB display function	Operation panel/External I/O function	Multimedia function	Video display function	VNC® server function	Remote personal computer operation (Ethernet)	Remote personal computer operation (Serial)	RFID function	Barcode function	Script function	Time action function	Trigger action function	Status observation function	Device data transfer function	Advanced recipe function	Recipe function	Logging function
Bit No.	Description																											
b0	Automatic Screen Saver Disable Signal	-	-	-	-	-	-	-	-	-	-	-	-	-	-	-	-	-	-	-	-	-	-	-	-	-	-	-
b1	Forced Screen Saver Enable Signal	-	-	-	-	-	-	-	-	-	-	-	-	-	-	-	-	-	-	-	-	-	-	-	-	-	-	-
b2	Forced Screen Saver Touch-cancel Signal	-	-	-	-	-	-	-	-	-	-	-	-	-	-	-	-	-	-	-	-	-	-	-	-	-	-	-
b3	Key Code Read Complete Signal	-	-	-	-	-	-	-	-	-	-	-	-	-	-	-	-	-	-	-	-	-	-	-	-	-	-	-
b4	Numeric Value Input Read Complete Signal	-	-	-	-	-	-	-	-	-	-	-	-	-	-	-	-	-	-	-	-	-	-	-	-	-	-	-
b5	Barcode Input Disable Signal (CH8)	-	-	-	-	-	-	-	-	-	-	-	-	-	-	-	-	-	○	○	-	-	-	-	-	-	-	-
b6	External device I/O complete signal (CH8)	-	-	-	-	-	-	-	-	-	-	-	-	-	-	-	-	-	○	○	-	-	-	-	-	-	-	-
b7	Backlight OFF Output Signal	-	-	-	-	-	-	-	-	-	-	-	-	-	-	-	-	-	-	-	-	-	-	-	-	-	-	-
b8	Buzzer Threeshot Output Signal	-	-	-	-	-	-	-	-	-	-	-	-	-	-	-	-	-	-	-	-	-	-	-	-	-	-	-
b9	Key-In Disable Signal	-	-	-	-	-	-	-	-	-	-	-	-	-	-	-	-	-	-	-	-	-	-	-	-	-	-	○
b10	Hard copy setting validate signal	-	-	-	-	-	-	-	-	-	-	-	-	-	-	-	-	-	-	-	-	-	-	-	-	-	-	-
b12	Hard copy white/black reverse signal	-	-	-	-	-	-	-	-	-	○	-	-	-	-	-	-	-	-	-	-	-	-	-	-	-	-	-
b13	GOT Error Reset Signal	-	-	-	-	-	-	-	-	-	-	-	-	-	-	-	-	-	-	-	-	-	-	-	-	-	-	-
b14	Buzzer Output Signal	-	-	-	-	-	-	-	-	-	-	-	-	-	-	-	-	-	-	-	-	-	-	-	-	-	-	-
b15	Buzzer Oneshot Output Signal	-	-	-	-	-	-	-	-	-	-	-	-	-	-	-	-	-	-	-	-	-	-	-	-	-	-	-

○ : Relevant - : Irrelevant

System Signal (Read device)		Key windows	Station No. switching function	MES interface function	Gateway function	Test function	Document display function	Set overlay screen function	Sound output function	Hardcopy function	Report function	RGB display function	Operation panel/External I/O function	Multimedia function	Video display function	VNC® server function	Remote personal computer operation (Ethernet)	Remote personal computer operation (Serial)	RFID function	Barcode function	Script function	Time action function	Trigger action function	Status observation function	Device data transfer function	Advanced recipe function	Recipe function	Logging function
Bit No.	Description																											
External input and output function/output information (GT16, GT15)		-	-	-	-	-	-	-	-	-	-	-	○	-	-	-	-	-	-	-	-	-	-	-	-	-	-	-
External input and output function/output information (GT11, GT10)		-	-	-	-	-	-	-	-	-	-	-	-	-	-	-	-	-	-	-	-	-	-	-	-	-	-	-
b0 to b5	Operation switch LED control signal	-	-	-	-	-	-	-	-	-	-	-	-	-	-	-	-	-	-	-	-	-	-	-	-	-	-	-
b6	Grip switch LED control signal	-	-	-	-	-	-	-	-	-	-	-	-	-	-	-	-	-	-	-	-	-	-	-	-	-	-	-

○ : Relevant - : Irrelevant

System Signal 1-2 (Read device)		Operation log function	Parts movement	Parts display	Historical trend graph	Statistics bar/Statistics pie/Scatter graph	Line/Trend/Bar graph	Panel meter	Level	Scrolling alarm display	Alarm history display	System alarm display	User alarm display	Advanced alarm popup display (System alarm)	Advanced alarm popup display (User alarm)	Advanced system alarm display	Advanced user alarm display	Comment display	Date display/Time display	Historical data list display	Data list	ASCII input	ASCII display	Numerical input	Numerical display	Lamp	Touch switch
Bit No.	Description																										
b0	File Access Error Reset Signal	-	-	-	-	-	-	-	-	-	-	-	-	-	-	-	-	-	-	-	-	-	-	-	-	-	-
b1	RFID request signal (CH8)	-	-	-	-	-	-	-	-	-	-	-	-	-	-	-	-	-	-	-	-	-	-	-	-	-	-
b2	Barcode input disable signal (CH5)	-	-	-	-	-	-	-	-	-	-	-	-	-	-	-	-	-	-	-	-	-	-	-	-	-	-
b3	External device I/O complete signal (CH5)	-	-	-	-	-	-	-	-	-	-	-	-	-	-	-	-	-	-	-	-	-	-	-	-	-	-
b4	RFID request signal (CH5)	-	-	-	-	-	-	-	-	-	-	-	-	-	-	-	-	-	-	-	-	-	-	-	-	-	-
b5	Bar code input disable signal (CH6)	-	-	-	-	-	-	-	-	-	-	-	-	-	-	-	-	-	-	-	-	-	-	-	-	-	-
b6	External device I/O complete signal (CH6)	-	-	-	-	-	-	-	-	-	-	-	-	-	-	-	-	-	-	-	-	-	-	-	-	-	-
b7	RFID request signal (CH6)	-	-	-	-	-	-	-	-	-	-	-	-	-	-	-	-	-	-	-	-	-	-	-	-	-	-
b8	Bar code input disable signal (CH7)	-	-	-	-	-	-	-	-	-	-	-	-	-	-	-	-	-	-	-	-	-	-	-	-	-	-
b9	External device I/O complete signal (CH7)	-	-	-	-	-	-	-	-	-	-	-	-	-	-	-	-	-	-	-	-	-	-	-	-	-	-
b10	RFID request signal (CH7)	-	-	-	-	-	-	-	-	-	-	-	-	-	-	-	-	-	-	-	-	-	-	-	-	-	-
b11	Enabling RFID control during external authentication signal	-	-	-	-	-	-	-	-	-	-	-	-	-	-	-	-	-	-	-	-	-	-	-	-	-	-
b13	D drive automatic recovery confirmation complete signal	-	-	-	-	-	-	-	-	-	-	-	-	-	-	-	-	-	-	-	-	-	-	-	-	-	-
b15	Print abort signal	-	-	-	-	-	-	-	-	-	-	-	-	-	-	-	-	-	-	-	-	-	-	-	-	-	-

○ : Relevant - : Irrelevant

System Signal 2-1 (Write device)		Operation log function	Parts movement	Parts display	Historical trend graph	Statistics bar/Statistics pie/Scatter graph	Line/Trend/Bar graph	Panel meter	Level	Scrolling alarm display	Alarm history display	System alarm display	User alarm display	Advanced alarm popup display (System alarm)	Advanced alarm popup display (User alarm)	Advanced system alarm display	Advanced user alarm display	Comment display	Date display/Time display	Historical data list display	Data list	ASCII input	ASCII display	Numerical input	Numerical display	Lamp	Touch switch
Bit No.	Description																										
b0	Screen saving signal	-	-	-	-	-	-	-	-	-	-	-	-	-	-	-	-	-	-	-	-	-	-	-	-	-	-
b1	GOT Ready Signal	-	-	-	-	-	-	-	-	-	-	-	-	-	-	-	-	-	-	-	-	-	-	-	-	-	-
b3	Key Input Signal	○	-	-	-	-	-	-	-	-	-	-	-	-	-	-	-	-	-	-	-	-	-	-	-	-	-
b4	Numeric Value Input Signal	-	-	-	-	-	-	-	-	-	-	-	-	-	-	-	-	-	-	-	-	-	-	-	-	-	-
b5	Human Sensor Detection Signal	-	-	-	-	-	-	-	-	-	-	-	-	-	-	-	-	-	-	-	-	-	-	-	-	-	-
b6	External device I/O signal (CH8)	-	-	-	-	-	-	-	-	-	-	-	-	-	-	-	-	-	-	-	-	-	-	-	-	-	-
b7	Hard copy output signal	-	-	-	-	-	-	-	-	-	-	-	-	-	-	-	-	-	-	-	-	-	-	-	-	-	-
b8	Report output signal	-	-	-	-	-	-	-	-	-	-	-	-	-	-	-	-	-	-	-	-	-	-	-	-	-	-
b10	Recipe Processing Signal	-	-	-	-	-	-	-	-	-	-	-	-	-	-	-	-	-	-	-	-	-	-	-	-	-	-
b11	Key window Output Signal	-	-	-	-	-	-	-	-	-	-	-	-	-	-	-	-	-	-	-	-	-	-	-	-	-	-
b12	Hardcopy Sub-signal	-	-	-	-	-	-	-	-	-	-	-	-	-	-	-	-	-	-	-	-	-	-	-	-	-	-
b13	GOT Error Detection Signal	-	-	-	-	-	-	-	-	-	-	-	-	-	-	-	-	-	-	-	-	-	-	-	-	-	-
b14	Numeric Value Error Detection Signal	-	-	-	-	-	-	-	-	-	-	-	-	-	-	-	-	-	-	-	-	-	-	-	-	-	-
b15	Printer error detection signal	-	-	-	-	-	-	-	-	-	-	-	-	-	-	-	-	-	-	-	-	-	-	-	-	-	-



○ : Relevant - : Irrelevant

System Signal 1-2 (Read device)																												
Bit No.	Description	Key windows	Station No. switching function	MES interface function	Gateway function	Test function	Document display function	Set overlay screen function	Sound output function	Hardcopy function	Report function	RGB display function	Operation panel/External I/O function	Multimedia function	Video display function	VNC® server function	Remote personal computer operation (Ethernet)	Remote personal computer operation (Serial)	RFID function	Barcode function	Script function	Time action function	Trigger action function	Status observation function	Device data transfer function	Advanced recipe function	Recipe function	Logging function
b0	File Access Error Reset Signal	-	-	-	-	-	-	-	-	-	-	-	-	-	-	-	-	-	-	-	-	-	-	-	-	-	-	-
b1	RFID request signal (CH8)	-	-	-	-	-	-	-	-	-	-	-	-	-	-	-	-	-	○	-	-	-	-	-	-	-	-	-
b2	Barcode input disable signal (CH5)	-	-	-	-	-	-	-	-	-	-	-	-	-	-	-	-	-	-	○	-	-	-	-	-	-	-	-
b3	External device I/O complete signal (CH5)	-	-	-	-	-	-	-	-	-	-	-	-	-	-	-	-	-	○	○	-	-	-	-	-	-	-	-
b4	RFID request signal (CH5)	-	-	-	-	-	-	-	-	-	-	-	-	-	-	-	-	-	○	-	-	-	-	-	-	-	-	-
b5	Barcode input disable signal (CH6)	-	-	-	-	-	-	-	-	-	-	-	-	-	-	-	-	-	-	○	-	-	-	-	-	-	-	-
b6	External device I/O complete signal (CH6)	-	-	-	-	-	-	-	-	-	-	-	-	-	-	-	-	-	○	○	-	-	-	-	-	-	-	-
b7	RFID request signal (CH6)	-	-	-	-	-	-	-	-	-	-	-	-	-	-	-	-	-	○	-	-	-	-	-	-	-	-	-
b8	Barcode input disable signal (CH7)	-	-	-	-	-	-	-	-	-	-	-	-	-	-	-	-	-	-	○	-	-	-	-	-	-	-	-
b9	External device I/O complete signal (CH7)	-	-	-	-	-	-	-	-	-	-	-	-	-	-	-	-	-	○	○	-	-	-	-	-	-	-	-
b10	RFID request signal (CH7)	-	-	-	-	-	-	-	-	-	-	-	-	-	-	-	-	-	○	-	-	-	-	-	-	-	-	-
b11	Enabling RFID control during external authentication signal	-	-	-	-	-	-	-	-	-	-	-	-	-	-	-	-	-	-	-	-	-	-	-	-	-	-	-
b13	D drive automatic recovery confirmation complete signal	-	-	-	-	-	-	-	-	-	-	-	-	-	-	-	-	-	-	-	-	-	-	-	-	○	-	-
b15	Print abort signal	-	-	-	-	-	-	-	-	-	-	-	-	-	-	-	-	-	-	-	-	-	-	-	-	-	-	-

○ : Relevant - : Irrelevant

System Signal 2-1 (Write device)																												
Bit No.	Description	Key windows	Station No. switching function	MES interface function	Gateway function	Test function	Document display function	Set overlay screen function	Sound output function	Hardcopy function	Report function	RGB display function	Operation panel/External I/O function	Multimedia function	Video display function	VNC® server function	Remote personal computer operation (Ethernet)	Remote personal computer operation (Serial)	RFID function	Barcode function	Script function	Time action function	Trigger action function	Status observation function	Device data transfer function	Advanced recipe function	Recipe function	Logging function
b0	Screen saving signal	-	-	-	-	-	-	-	-	-	-	-	-	-	-	-	-	-	-	-	-	-	-	-	-	-	-	-
b1	GOT Ready Signal	-	-	-	-	-	-	-	-	-	-	-	-	-	-	-	-	-	-	-	-	-	-	-	-	-	-	-
b3	Key Input Signal	-	-	-	-	-	-	-	-	-	-	-	-	-	-	-	-	-	-	-	-	-	-	-	-	-	-	-
b4	Numeric Value Input Signal	-	-	-	-	-	-	-	-	-	-	-	-	-	-	-	-	-	-	-	-	-	-	-	-	-	-	-
b5	Human Sensor Detection Signal	-	-	-	-	-	-	-	-	-	-	-	-	-	-	-	-	-	-	-	-	-	-	-	-	-	-	-
b6	External device I/O signal (CH8)	-	-	-	-	-	-	-	-	-	-	-	-	-	-	-	-	-	-	○	○	-	-	-	-	-	-	-
b7	Hard copy output signal	-	-	-	-	-	-	-	-	-	-	-	-	-	-	-	-	-	-	-	-	-	-	-	-	-	-	-
b8	Report output signal	-	-	-	-	-	-	-	-	-	-	-	-	-	-	-	-	-	-	-	-	-	-	-	-	-	-	-
b10	Recipe Processing Signal	-	-	-	-	-	-	-	-	-	-	-	-	-	-	-	-	-	-	-	-	-	-	-	-	○	-	-
b11	Key window Output Signal	-	-	-	-	-	-	-	-	-	-	-	-	-	-	-	-	-	-	-	-	-	-	-	-	-	-	-
b12	Hardcopy Sub-signal	-	-	-	-	-	-	-	-	-	-	-	-	-	-	-	-	-	-	-	-	-	-	-	-	-	-	-
b13	GOT Error Detection Signal	-	-	-	-	-	-	-	-	-	-	-	-	-	-	-	-	-	-	-	-	-	-	-	-	-	-	-
b14	Numeric Value Error Detection Signal	-	-	-	-	-	-	-	-	-	-	-	-	-	-	-	-	-	-	-	-	-	-	-	-	-	-	-
b15	Printer error detection signal	-	-	-	-	-	-	-	-	-	-	-	-	-	-	-	-	-	-	-	-	-	-	-	-	-	-	-

○ : Relevant - : Irrelevant

System Signal (Write device)		Operation log function	Parts movement	Parts display	Historical trend graph	Statistics bar/Statistics pie/Scatter graph	Line/Trend/Bar graph	Panel meter	Level	Scrolling alarm display	Alarm history display	System alarm display	User alarm display	Advanced alarm popup display (System alarm)	Advanced alarm popup display (User alarm)	Advanced system alarm display	Advanced user alarm display	Comment display	Date display/Time display	Historical data list display	Data list	ASCII input	ASCII display	Numerical input	Numerical display	Lamp	Touch switch
Bit No.	Description																										
	GOT Error Code	-	-	-	-	-	-	-	-	-	-	-	-	○	-	-	-	-	-	-	-	-	-	-	-	-	-
	On-screen Base Screen Number	-	-	-	-	-	-	-	-	-	-	-	-	-	-	-	-	-	-	-	-	-	-	-	-	-	-
	On-screen Window 1 Screen Number	-	-	-	-	-	-	-	-	-	-	-	-	-	-	-	-	-	-	-	-	-	-	-	-	-	-
	Numeric Value Input Number	-	-	-	-	-	-	-	-	-	-	-	-	-	-	-	-	-	-	-	-	○	-	-	-	-	-
	Current Cursor Display Object ID	-	-	-	-	-	-	-	-	-	-	-	-	-	-	-	-	-	-	-	-	○	-	-	-	-	-
	Previous Cursor Display Object ID	-	-	-	-	-	-	-	-	-	-	-	-	-	-	-	-	-	-	-	-	○	-	-	-	-	-
	Key Code Input	-	-	-	-	-	-	-	-	-	-	-	-	-	-	-	-	-	-	-	-	○	-	-	-	-	-
	Previous Numeric Value Input (32bit)	-	-	-	-	-	-	-	-	-	-	-	-	-	-	-	-	-	-	-	-	-	○	-	-	-	-
	Current Numeric Value Input (32bit)	-	-	-	-	-	-	-	-	-	-	-	-	-	-	-	-	-	-	-	-	-	○	-	-	-	-
	Printing report number	-	-	-	-	-	-	-	-	-	-	-	-	-	-	-	-	-	-	-	-	-	-	-	-	-	-
	External I/O function/input information 1	-	-	-	-	-	-	-	-	-	-	-	-	-	-	-	-	-	-	-	-	-	-	-	-	-	-
	Current Cursor Display User ID	-	-	-	-	-	-	-	-	-	-	-	-	-	-	-	-	-	-	-	-	-	○	-	-	-	-
	Previous Cursor Display User ID	-	-	-	-	-	-	-	-	-	-	-	-	-	-	-	-	-	-	-	-	-	○	-	-	-	-

○ : Relevant - : Irrelevant

System Signal 2-2 (Write device)		Operation log function	Parts movement	Parts display	Historical trend graph	Statistics bar/Statistics pie/Scatter graph	Line/Trend/Bar graph	Panel meter	Level	Scrolling alarm display	Alarm history display	System alarm display	User alarm display	Advanced alarm popup display (System alarm)	Advanced alarm popup display (User alarm)	Advanced system alarm display	Advanced user alarm display	Comment display	Date display/Time display	Historical data list display	Data list	ASCII input	ASCII display	Numerical input	Numerical display	Lamp	Touch switch
Bit No.	Description																										
b0	Drive A File Accessing Signal	-	-	-	-	-	-	-	-	-	-	-	-	-	-	-	-	-	-	-	-	-	-	-	-	-	-
b1	Drive B File Accessing Signal	-	-	-	-	-	-	-	-	-	-	-	-	-	-	-	-	-	-	-	-	-	-	-	-	-	-
b2	Drive C File Accessing Signal	-	-	-	-	-	-	-	-	-	-	-	-	-	-	-	-	-	-	-	-	-	-	-	-	-	-
b3	Drive D File Accessing Signal	-	-	-	-	-	-	-	-	-	-	-	-	-	-	-	-	-	-	-	-	-	-	-	-	-	-
b4	Drive A Full Signal	-	-	-	-	-	-	-	-	-	-	-	-	-	-	-	-	-	-	-	-	-	-	-	-	-	-
b5	Drive B Full Signal	-	-	-	-	-	-	-	-	-	-	-	-	-	-	-	-	-	-	-	-	-	-	-	-	-	-
b6	Drive D Full Signal	-	-	-	-	-	-	-	-	-	-	-	-	-	-	-	-	-	-	-	-	-	-	-	-	-	-
b7	Drive A File Access Error Signal	-	-	-	-	-	-	-	-	-	-	-	-	-	-	-	-	-	-	-	-	-	-	-	-	-	-
b8	Drive B File Access Error Signal	-	-	-	-	-	-	-	-	-	-	-	-	-	-	-	-	-	-	-	-	-	-	-	-	-	-
b9	Drive D File Access Error Signal	-	-	-	-	-	-	-	-	-	-	-	-	-	-	-	-	-	-	-	-	-	-	-	-	-	-
b11	Cursor Displaying Signal	-	-	-	-	-	-	-	-	-	-	-	-	-	-	-	-	-	-	-	-	-	○	-	-	-	-
b12	Built-in Battery Voltage Drop Signal	-	-	-	-	-	-	-	-	-	-	-	-	-	-	-	-	-	-	-	-	-	-	-	-	-	-
b13	D drive automatic recovery signal	-	-	-	-	-	-	-	-	-	-	-	-	-	-	-	-	-	-	-	-	-	-	-	-	-	-
b14	Backlight Shutoff Detection Signal	-	-	-	-	-	-	-	-	-	-	-	-	-	-	-	-	-	-	-	-	-	-	-	-	-	-
b15	Printing signal	-	-	-	-	-	-	-	-	-	-	-	-	-	-	-	-	-	-	-	-	-	-	-	-	-	-

○ : Relevant - : Irrelevant

System Signal (Write device)		Key windows	Station No. switching function	MES interface function	Gateway function	Test function	Document display function	Set overlay screen function	Sound output function	Hardcopy function	Report function	RGB display function	Operation panel/External I/O function	Multimedia function	Video display function	VNC® server function	Remote personal computer operation (Ethernet)	Remote personal computer operation (Serial)	RFID function	Barcode function	Script function	Time action function	Trigger action function	Status observation function	Device data transfer function	Advanced recipe function	Recipe function	Logging function
Bit No.	Description																											
	GOT Error Code	-	-	-	-	-	-	-	-	-	-	-	-	-	-	-	-	-	-	-	-	-	-	-	-	-	-	-
	On-screen Base Screen Number	-	-	-	-	-	-	-	-	-	-	-	-	-	-	-	-	-	-	-	-	-	-	-	-	-	-	-
	On-screen Window 1 Screen Number	-	-	-	-	-	-	-	-	-	-	-	-	-	-	-	-	-	-	-	-	-	-	-	-	-	-	-
	Numeric Value Input Number	-	-	-	-	-	-	-	-	-	-	-	-	-	-	-	-	-	-	-	-	-	-	-	-	-	-	○
	Current Cursor Display Object ID	-	-	-	-	-	-	-	-	-	-	-	-	-	-	-	-	-	-	-	-	-	-	-	-	-	-	○
	Previous Cursor Display Object ID	-	-	-	-	-	-	-	-	-	-	-	-	-	-	-	-	-	-	-	-	-	-	-	-	-	-	○
	Key Code Input	-	-	-	-	-	-	-	-	-	-	-	-	-	-	-	-	-	-	-	-	-	-	-	-	-	-	○
	Previous Numeric Value Input (32bit)	-	-	-	-	-	-	-	-	-	-	-	-	-	-	-	-	-	-	-	-	-	-	-	-	-	-	○
	Current Numeric Value Input (32bit)	-	-	-	-	-	-	-	-	-	-	-	-	-	-	-	-	-	-	-	-	-	-	-	-	-	-	○
	Printing report number	-	-	-	-	-	-	-	-	-	○	-	-	-	-	-	-	-	-	-	-	-	-	-	-	-	-	-
	External I/O function/input information 1	-	-	-	-	-	-	-	-	-	-	-	○	-	-	-	-	-	-	-	-	-	-	-	-	-	-	-
	Current Cursor Display User ID	-	-	-	-	-	-	-	-	-	-	-	-	-	-	-	-	-	-	-	-	-	-	-	-	-	-	-
	Previous Cursor Display User ID	-	-	-	-	-	-	-	-	-	-	-	-	-	-	-	-	-	-	-	-	-	-	-	-	-	-	-

○ : Relevant - : Irrelevant

System Signal 2-2 (Write device)		Key windows	Station No. switching function	MES interface function	Gateway function	Test function	Document display function	Set overlay screen function	Sound output function	Hardcopy function	Report function	RGB display function	Operation panel/External I/O function	Multimedia function	Video display function	VNC® server function	Remote personal computer operation (Ethernet)	Remote personal computer operation (Serial)	RFID function	Barcode function	Script function	Time action function	Trigger action function	Status observation function	Device data transfer function	Advanced recipe function	Recipe function	Logging function
Bit No.	Description																											
b0	Drive A File Accessing Signal	○	○	○	-	-	-	-	-	-	○	○	-	-	-	-	-	-	-	-	-	-	-	-	-	-	-	-
b1	Drive B File Accessing Signal	○	○	○	-	-	-	-	-	-	○	○	-	-	-	-	-	-	-	-	-	-	-	-	-	-	-	-
b2	Drive C File Accessing Signal	-	-	-	-	-	-	-	-	-	-	-	-	-	-	-	-	-	-	-	-	-	-	-	-	-	-	-
b3	Drive D File Accessing Signal	-	-	○	-	-	-	-	-	-	-	-	-	-	-	-	-	-	-	-	-	-	-	-	-	-	-	-
b4	Drive A Full Signal	○	○	○	-	-	-	-	-	-	○	○	-	-	-	-	-	-	-	-	-	-	-	-	-	-	-	-
b5	Drive B Full Signal	○	○	○	-	-	-	-	-	-	○	○	-	-	-	-	-	-	-	-	-	-	-	-	-	-	-	-
b6	Drive D Full Signal	-	○	-	-	-	-	-	-	-	-	-	-	-	-	-	-	-	-	-	-	-	-	-	-	-	-	-
b7	Drive A File Access Error Signal	○	○	○	-	-	-	-	-	-	○	○	-	-	-	-	-	-	-	-	-	-	-	-	-	-	-	-
b8	Drive B File Access Error Signal	○	○	○	-	-	-	-	-	-	○	○	-	-	-	-	-	-	-	-	-	-	-	-	-	-	-	-
b9	Drive D File Access Error Signal	-	○	-	-	-	-	-	-	-	-	-	-	-	-	-	-	-	-	-	-	-	-	-	-	-	-	-
b11	Cursor Displaying Signal	-	-	-	-	-	-	-	-	-	-	-	-	-	-	-	-	-	-	-	-	-	-	-	-	-	-	-
b12	Built-in Battery Voltage Drop Signal	-	-	-	-	-	-	-	-	-	-	-	-	-	-	-	-	-	-	-	-	-	-	-	-	-	-	-
b13	D drive automatic recovery signal	-	○	-	-	-	-	-	-	-	-	-	-	-	-	-	-	-	-	-	-	-	-	-	-	-	-	-
b14	Backlight Shutoff Detection Signal	-	-	-	-	-	-	-	-	-	-	-	-	-	-	-	-	-	-	-	-	-	-	-	-	-	-	-
b15	Printing signal	-	-	-	-	-	-	-	-	-	○	○	-	-	-	-	-	-	-	-	-	-	-	-	-	-	-	-

○ : Relevant - : Irrelevant

System Signal (Write device)		Operation log function	Parts movement	Parts display	Historical trend graph	Statistics bar/Statistics pie/Scatter graph	Line/Trend/Bar graph	Panel meter	Level	Scrolling alarm display	Alarm history display	System alarm display	User alarm display	Advanced alarm popup display (System alarm)	Advanced alarm popup display (User alarm)	Advanced system alarm display	Advanced user alarm display	Comment display	Date display/Time display	Historical data list display	Data list	ASCII input	ASCII display	Numerical input	Numerical display	Lamp	Touch switch
Bit No.	Description																										
	On-screen Window 2 screen number	-	-	-	-	-	-	-	-	-	-	-	-	-	-	-	-	-	-	-	-	-	-	-	-	-	-
	Drive A empty capacity information (32bit)	-	-	-	-	-	-	-	-	○	-	-	-	-	-	-	-	-	-	-	-	-	-	-	-	-	-
	Drive B empty capacity information (32bit)	-	-	-	-	-	-	-	-	○	-	-	-	-	-	-	-	-	-	-	-	-	-	-	-	-	-
	Drive C empty capacity information (32bit)	-	-	-	-	-	-	-	-	-	-	-	-	-	-	-	-	-	-	-	-	-	-	-	-	-	-
	Drive D empty capacity information (32bit)	-	-	-	-	-	-	-	-	-	-	-	-	-	-	-	-	-	-	-	-	-	-	-	-	-	-
	External I/O function/input information 2	-	-	-	-	-	-	-	-	-	-	-	-	-	-	-	-	-	-	-	-	-	-	-	-	-	-
	On-screen Window 3 screen number	-	-	-	-	-	-	-	-	-	-	-	-	-	-	-	-	-	-	-	-	-	-	-	-	-	-
	On-screen Window 4 screen number	-	-	-	-	-	-	-	-	-	-	-	-	-	-	-	-	-	-	-	-	-	-	-	-	-	-
	On-screen Window 5 screen number	-	-	-	-	-	-	-	-	-	-	-	-	-	-	-	-	-	-	-	-	-	-	-	-	-	-
	Extended Drive Information (E and subsequent drives)	-	-	-	-	-	-	-	-	-	-	-	-	-	-	-	-	-	-	-	-	-	-	-	-	-	-
	Drive E empty capacity information (32bit)	-	-	-	-	-	-	-	-	-	-	-	-	-	-	-	-	-	-	-	-	-	-	-	-	-	-

○ : Relevant - : Irrelevant

System Signal 2-3 (Write device)		Operation log function	Parts movement	Parts display	Historical trend graph	Statistics bar/Statistics pie/Scatter graph	Line/Trend/Bar graph	Panel meter	Level	Scrolling alarm display	Alarm history display	System alarm display	User alarm display	Advanced alarm popup display (System alarm)	Advanced alarm popup display (User alarm)	Advanced system alarm display	Advanced user alarm display	Comment display	Date display/Time display	Historical data list display	Data list	ASCII input	ASCII display	Numerical input	Numerical display	Lamp	Touch switch
Bit No.	Description																										
b0	External device I/O signal (CH5)	-	-	-	-	-	-	-	-	-	-	-	-	-	-	-	-	-	-	-	-	-	-	-	-	-	-
b1	External device I/O signal (CH6)	-	-	-	-	-	-	-	-	-	-	-	-	-	-	-	-	-	-	-	-	-	-	-	-	-	-
b2	External device I/O signal (CH7)	-	-	-	-	-	-	-	-	-	-	-	-	-	-	-	-	-	-	-	-	-	-	-	-	-	-

○ : Relevant - : Irrelevant

Item	Operation log function	Parts movement	Parts display	Historical trend graph	Statistics bar/Statistics pie/Scatter graph	Line/Trend/Bar graph	Panel meter	Level	Scrolling alarm display	Alarm history display	System alarm display	User alarm display	Advanced alarm popup display (System alarm)	Advanced alarm popup display (User alarm)	Advanced system alarm display	Advanced user alarm display	Comment display	Date display/Time display	Historical data list display	Data list	ASCII input	ASCII display	Numerical input	Numerical display	Lamp	Touch switch	
An object ID is output to the system information device at ASCII input.	-	-	-	-	-	-	-	-	-	-	-	-	-	-	-	-	-	-	-	-	○	-	-	-	-	-	-
When the cursor is deleted, the cursor information is cleared.	-	-	-	-	-	-	-	-	-	-	-	-	-	-	-	-	-	-	-	-	-	○	-	-	-	-	-
When the screen is switched, On-screen Number (System Information) is maintained. (Zero is not written.)	-	-	-	-	-	-	-	-	-	-	-	-	-	-	-	-	-	-	-	-	-	-	-	-	-	-	

○ : Relevant - : Irrelevant

System Signal (Write device)		Key windows	Station No. switching function	MES interface function	Gateway/function	Test function	Document display function	Set overlay screen function	Sound output function	Hardcopy function	Report function	RGB display function	Operation panel/External I/O function	Multimedia function	Video display function	VNC® server function	Remote personal computer operation (Ethernet)	Remote personal computer operation (Serial)	RFID function	Barcode function	Script function	Time action function	Trigger action function	Status observation function	Device data transfer function	Advanced recipe function	Recipe function	Logging function
Bit No.	Description																											
	On-screen Window 2 screen number	-	-	-	-	-	-	-	-	-	-	-	-	-	-	-	-	-	-	-	-	-	-	-	-	-	-	-
	Drive A empty capacity information (32bit)	○	-	-	-	-	-	-	-	-	○	-	-	-	-	-	-	-	-	-	-	-	-	-	-	○	-	-
	Drive B empty capacity information (32bit)	○	○	-	-	-	-	-	-	○	-	-	-	-	-	-	-	-	-	-	-	-	-	-	-	○	-	-
	Drive C empty capacity information (32bit)	-	-	-	-	-	-	-	-	-	-	-	-	-	-	-	-	-	-	-	-	-	-	-	-	-	-	-
	Drive D empty capacity information (32bit)	-	-	-	-	-	-	-	-	-	-	-	-	-	-	-	-	-	-	-	-	-	-	-	-	-	-	-
	External I/O function/input information 2	-	-	-	-	-	-	-	-	-	-	○	-	-	-	-	-	-	-	-	-	-	-	-	-	-	-	-
	On-screen Window 3 screen number	-	-	-	-	-	-	-	-	-	-	-	-	-	-	-	-	-	-	-	-	-	-	-	-	-	-	-
	On-screen Window 4 screen number	-	-	-	-	-	-	-	-	-	-	-	-	-	-	-	-	-	-	-	-	-	-	-	-	-	-	-
	On-screen Window 5 screen number	-	-	-	-	-	-	-	-	-	-	-	-	-	-	-	-	-	-	-	-	-	-	-	-	-	-	-
	Extended Drive Information (E and subsequent drives)	-	-	-	-	-	-	-	-	-	-	-	-	-	-	-	-	-	-	-	-	-	-	-	-	-	-	-
	Drive E empty capacity information (32bit)	-	-	-	-	-	-	-	-	-	-	-	-	-	-	-	-	-	-	-	-	-	-	-	-	-	-	-

○ : Relevant - : Irrelevant

System Signal 2-3 (Write device)		Key windows	Station No. switching function	MES interface function	Gateway/function	Test function	Document display function	Set overlay screen function	Sound output function	Hardcopy function	Report function	RGB display function	Operation panel/External I/O function	Multimedia function	Video display function	VNC® server function	Remote personal computer operation (Ethernet)	Remote personal computer operation (Serial)	RFID function	Barcode function	Script function	Time action function	Trigger action function	Status observation function	Device data transfer function	Advanced recipe function	Recipe function	Logging function
Bit No.	Description																											
b0	External device I/O signal (CH5)	-	-	-	-	-	-	-	-	-	-	-	-	-	-	-	-	-	○	○	○	○	-	-	-	-	-	-
b1	External device I/O signal (CH6)	-	-	-	-	-	-	-	-	-	-	-	-	-	-	-	-	-	-	○	○	○	-	-	-	-	-	-
b2	External device I/O signal (CH7)	-	-	-	-	-	-	-	-	-	-	-	-	-	-	-	-	-	-	○	○	○	-	-	-	-	-	-

○ : Relevant - : Irrelevant

Item	Key windows	Station No. switching function	MES interface function	Gateway/function	Test function	Document display function	Set overlay screen function	Sound output function	Hardcopy function	Report function	RGB display function	Operation panel/External I/O function	Multimedia function	Video display function	VNC® server function	Remote personal computer operation (Ethernet)	Remote personal computer operation (Serial)	RFID function	Barcode function	Script function	Time action function	Trigger action function	Status observation function	Device data transfer function	Advanced recipe function	Recipe function	Logging function
An object ID is output to the system information device at ASCII input.	-	-	-	-	-	-	-	-	-	-	-	-	-	-	-	-	-	-	-	-	-	-	-	-	-	-	-
When the cursor is deleted, the cursor information is cleared.	-	-	-	-	-	-	-	-	-	-	-	-	-	-	-	-	-	-	-	-	-	-	-	-	-	-	-
When the screen is switched, On-screen Number (System Information) is maintained. (Zero is not written.)	-	-	-	-	-	-	-	-	-	-	-	-	-	-	-	-	-	-	-	-	-	-	-	-	-	-	-

## ■ Parts setting

○ : Relevant - : Irrelevant

Item	Operation log function	Parts movement	Parts display	Historical trend graph	Statistics bar/Statistics pie/Scatter graph	Line/Trend/Bar graph	Panel meter	Level	Scrolling alarm display	Alarm history display	System alarm display	User alarm display	Advanced alarm popup display (System alarm)	Advanced alarm popup display (User alarm)	Advanced system alarm display	Advanced user alarm display	Comment display	Date display/Time display	Historical data list display	Data list	ASCII input	ASCII display	Numerical input	Numerical display	Lamp	Touch switch
Show overlapping areas of shapes in XOR when Display Mode of Parts Display is XOR.	-	-	○	-	-	-	-	-	-	-	-	-	-	-	-	-	-	-	-	-	-	-	-	-	-	-
Show image files in the memory card at the time of specifying Parts No. 9001-9999	-	○	○	-	-	-	-	-	-	-	-	-	-	-	-	-	-	-	-	-	-	-	-	-	-	-

## ■ Sound file setting

○ : Relevant - : Irrelevant

Item	Operation log function	Parts movement	Parts display	Historical trend graph	Statistics bar/Statistics pie/Scatter graph	Line/Trend/Bar graph	Panel meter	Level	Scrolling alarm display	Alarm history display	System alarm display	User alarm display	Advanced alarm popup display (System alarm)	Advanced alarm popup display (User alarm)	Advanced system alarm display	Advanced user alarm display	Comment display	Date display/Time display	Historical data list display	Data list	ASCII input	ASCII display	Numerical input	Numerical display	Lamp	Touch switch
Use a sound file for touch key tone	-	-	-	-	-	-	-	-	-	-	-	-	-	-	-	-	-	-	-	-	-	-	-	-	○	-
Give top priority to sound output of a switch	-	-	-	-	-	-	-	-	-	-	-	-	-	-	-	-	-	-	-	-	-	-	-	-	-	○

○ : Relevant - : Irrelevant

Key windows	-	-
Station No. switching function	-	-
MES interface function	-	-
Gateway function	-	-
Test function	-	-
Document display function	-	-
Set overlay screen function	-	-
Sound output function	-	-
Hardcopy function	-	-
Report function	-	-
RGB display function	-	-
Operation panel/External I/O function	-	-
Multimedia function	-	-
Video display function	-	-
VNC® server function	-	-
Remote personal computer operation (Ethernet)	-	-
Remote personal computer operation (Serial)	-	-
RFID function	-	-
Barcode function	-	-
Script function	-	-
Time action function	-	-
Trigger action function	-	-
Status observation function	-	-
Device data transfer function	-	-
Advanced recipe function	-	-
Recipe function	-	-
Logging function	-	-
Item	-	-
Show overlapping areas of shapes in XOR when Display Mode of Parts Display is XOR.	-	-
Show image files in the memory card at the time of specifying Parts No. 9001-9999	-	-

○ : Relevant - : Irrelevant

Key windows	-	-
Station No. switching function	-	-
MES interface function	-	-
Gateway function	-	-
Test function	-	-
Document display function	-	-
Set overlay screen function	○	○
Sound output function	-	-
Hardcopy function	-	-
Report function	-	-
RGB display function	-	-
Operation panel/External I/O function	-	-
Multimedia function	-	-
Video display function	-	-
VNC® server function	-	-
Remote personal computer operation (Ethernet)	-	-
Remote personal computer operation (Serial)	-	-
RFID function	-	-
Barcode function	-	-
Script function	-	-
Time action function	-	-
Trigger action function	-	-
Status observation function	-	-
Device data transfer function	-	-
Advanced recipe function	-	-
Recipe function	-	-
Logging function	-	-
Item	-	-
Use a sound file for touch key tone	-	-
Give top priority to sound output of a switch	-	-

# ■ GOT special register (GS)

○ : Relevant - : Irrelevant

Bit No.	Item	Touch switch	Lamp	Numerical display	Numerical input	ASCII display	ASCII input	Data list	Historical data list display	Date display/Time display	Comment display	Advanced user alarm display	Advanced system alarm display	Advanced alarm popup display (User alarm)	Advanced alarm popup display (System alarm)	User alarm display	System alarm display	Alarm history display	Scrolling alarm display	Level	Panel meter	Line/Trend/Bar graph	Statistics bar/Statistics pie/Scatter graph	Historical trend graph	Parts display	Parts movement	Operation log function
Common information1 (GS0)		-	-	-	-	-	-	-	-	-	-	-	-	-	-	-	-	-	-	-	-	-	-	-	-	-	-
b0	CH No. 1 communication cycle signal	-	-	-	-	-	-	-	-	-	-	-	-	-	-	-	-	-	-	-	-	-	-	-	-	-	-
b1	Screen switching complete signal	-	-	-	-	-	-	-	-	-	-	-	-	-	-	-	-	-	-	-	-	-	-	-	-	-	-
b2	Screen initial scan complete signal	-	-	-	-	-	-	-	-	-	-	-	-	-	-	-	-	-	-	-	-	-	-	-	-	-	-
b3	Initial screen displaying signal	-	-	-	-	-	-	-	-	-	-	-	-	-	-	-	-	-	-	-	-	-	-	-	-	-	-
b4	Always ON signal	-	-	-	-	-	-	-	-	-	-	-	-	-	-	-	-	-	-	-	-	-	-	-	-	-	-
b5	Always OFF signal	-	-	-	-	-	-	-	-	-	-	-	-	-	-	-	-	-	-	-	-	-	-	-	-	-	-
b8	CH No. 2 communication cycle signal	-	-	-	-	-	-	-	-	-	-	-	-	-	-	-	-	-	-	-	-	-	-	-	-	-	-
b9	CH No. 3 communication cycle signal	-	-	-	-	-	-	-	-	-	-	-	-	-	-	-	-	-	-	-	-	-	-	-	-	-	-
b10	CH No. 4 communication cycle signal	-	-	-	-	-	-	-	-	-	-	-	-	-	-	-	-	-	-	-	-	-	-	-	-	-	-
Base screen information (GS1)		-	-	-	-	-	-	-	-	-	-	-	-	-	-	-	-	-	-	-	-	-	-	-	-	-	-
b0	Base screen CH No. 1 communication cycle signal	-	-	-	-	-	-	-	-	-	-	-	-	-	-	-	-	-	-	-	-	-	-	-	-	-	-
b1	Base screen switching complete signal	-	-	-	-	-	-	-	-	-	-	-	-	-	-	-	-	-	-	-	-	-	-	-	-	-	-
b2	Base screen initial scan complete signal	-	-	-	-	-	-	-	-	-	-	-	-	-	-	-	-	-	-	-	-	-	-	-	-	-	-
b8	Base screen CH No. 2 communication cycle signal	-	-	-	-	-	-	-	-	-	-	-	-	-	-	-	-	-	-	-	-	-	-	-	-	-	-
b9	Base screen CH No. 3 communication cycle signal	-	-	-	-	-	-	-	-	-	-	-	-	-	-	-	-	-	-	-	-	-	-	-	-	-	-
b10	Base screen CH No. 4 communication cycle signal	-	-	-	-	-	-	-	-	-	-	-	-	-	-	-	-	-	-	-	-	-	-	-	-	-	-
CC-Link G4 station No. (CH1)		-	-	-	-	-	-	-	-	-	-	-	-	-	-	-	-	-	-	-	-	-	-	-	-	-	-
GOT multidrop slave station No. (CH1)		GS6	-	-	-	-	-	-	-	-	-	-	-	-	-	-	-	-	-	-	-	-	-	-	-	-	-
1 second binary counter (GS7)		-	-	-	-	-	-	-	-	-	-	-	-	-	-	-	-	-	-	-	-	-	-	-	-	-	-
Scan time of monitor (GS8)		-	-	-	-	-	-	-	-	-	-	-	-	-	-	-	-	-	-	-	-	-	-	-	-	-	-
Scan counter of monitor (GS10)		-	-	-	-	-	-	-	-	-	-	-	-	-	-	-	-	-	-	-	-	-	-	-	-	-	-
Script common information (GS14)		-	-	-	-	-	-	-	-	-	-	-	-	-	-	-	-	-	-	-	-	-	-	-	-	-	-
b0	Script error occurrence signal	-	-	-	-	-	-	-	-	-	-	-	-	-	-	-	-	-	-	-	-	-	-	-	-	-	-
b7	Script BCD error occurrence signal	-	-	-	-	-	-	-	-	-	-	-	-	-	-	-	-	-	-	-	-	-	-	-	-	-	-
b8	Script zero division error occurrence signal	-	-	-	-	-	-	-	-	-	-	-	-	-	-	-	-	-	-	-	-	-	-	-	-	-	-
b12	Script communication error occurrence signal	-	-	-	-	-	-	-	-	-	-	-	-	-	-	-	-	-	-	-	-	-	-	-	-	-	-
Script error pointer (GS15)		-	-	-	-	-	-	-	-	-	-	-	-	-	-	-	-	-	-	-	-	-	-	-	-	-	-
Script error data (GS16 to 47)		-	-	-	-	-	-	-	-	-	-	-	-	-	-	-	-	-	-	-	-	-	-	-	-	-	-
Script execute pointer (GS48)		-	-	-	-	-	-	-	-	-	-	-	-	-	-	-	-	-	-	-	-	-	-	-	-	-	-
Script execute No. (GS49 to 79)		-	-	-	-	-	-	-	-	-	-	-	-	-	-	-	-	-	-	-	-	-	-	-	-	-	-
Object script common information (GS80)		-	-	-	-	-	-	-	-	-	-	-	-	-	-	-	-	-	-	-	-	-	-	-	-	-	-
b0	Object script error occurrence signal	-	-	-	-	-	-	-	-	-	-	-	-	-	-	-	-	-	-	-	-	-	-	-	-	-	-
b7	Object script BCD error occurrence signal	-	-	-	-	-	-	-	-	-	-	-	-	-	-	-	-	-	-	-	-	-	-	-	-	-	-
b8	Object script zero division error occurrence signal	-	-	-	-	-	-	-	-	-	-	-	-	-	-	-	-	-	-	-	-	-	-	-	-	-	-
b12	Object script communication error occurrence signal	-	-	-	-	-	-	-	-	-	-	-	-	-	-	-	-	-	-	-	-	-	-	-	-	-	-
Object script error pointer (GS81)		-	-	-	-	-	-	-	-	-	-	-	-	-	-	-	-	-	-	-	-	-	-	-	-	-	-



○ : Relevant - : Irrelevant

Bit No.	Item	Logging function	Recipe function	Advanced recipe function	Device data transfer function	Status observation function	Trigger action function	Time action function	Script function	Barcode function	RFID function	Remote personal computer operation (Serial)	Remote personal computer operation (Ethernet)	VNC® server function	Video display function	Multimedia function	Operation panel/External I/O function	RGB display function	Report function	Hardcopy function	Sound output function	Set overlay screen function	Document display function	Test function	Gateway function	MES interface function	Station No. switching function	Key windows
Common information1 (GS0)		-	-	-	-	-	-	-	-	-	-	-	-	-	-	-	-	-	-	-	-	-	-	-	-	-	-	-
b0	CH No. 1 communication cycle signal	-	-	-	-	-	-	-	-	-	-	-	-	-	-	-	-	-	-	-	-	-	-	-	-	-	-	-
b1	Screen switching complete signal	-	-	-	-	-	-	-	-	-	-	-	-	-	-	-	-	-	-	-	-	-	-	-	-	-	-	-
b2	Screen initial scan complete signal	-	-	-	-	○	-	-	-	-	-	-	-	-	-	-	-	-	-	-	-	-	-	-	-	-	-	-
b3	Initial screen displaying signal	-	-	-	-	-	-	-	-	-	-	-	-	-	-	-	-	-	-	-	-	-	-	-	-	-	-	-
b4	Always ON signal	-	-	-	-	-	-	-	-	-	-	-	-	-	-	-	-	-	-	-	-	-	-	-	-	-	-	-
b5	Always OFF signal	-	-	-	-	-	-	-	-	-	-	-	-	-	-	-	-	-	-	-	-	-	-	-	-	-	-	-
b8	CH No. 2 communication cycle signal	-	-	-	-	-	-	-	-	-	-	-	-	-	-	-	-	-	-	-	-	-	-	-	-	-	-	-
b9	CH No. 3 communication cycle signal	-	-	-	-	-	-	-	-	-	-	-	-	-	-	-	-	-	-	-	-	-	-	-	-	-	-	-
b10	CH No. 4 communication cycle signal	-	-	-	-	-	-	-	-	-	-	-	-	-	-	-	-	-	-	-	-	-	-	-	-	-	-	-
Base screen information (GS1)		-	-	-	-	-	-	-	-	-	-	-	-	-	-	-	-	-	-	-	-	-	-	-	-	-	-	-
b0	Base screen CH No. 1 communication cycle signal	-	-	-	-	-	-	-	-	-	-	-	-	-	-	-	-	-	-	-	-	-	-	-	-	-	-	-
b1	Base screen switching complete signal	-	-	-	-	-	-	-	-	-	-	-	-	-	-	-	-	-	-	-	-	-	-	-	-	-	-	-
b2	Base screen initial scan complete signal	-	-	-	-	○	-	-	-	-	-	-	-	-	-	-	-	-	-	-	-	-	-	-	-	-	-	-
b8	Base screen CH No. 2 communication cycle signal	-	-	-	-	-	-	-	-	-	-	-	-	-	-	-	-	-	-	-	-	-	-	-	-	-	-	-
b9	Base screen CH No. 3 communication cycle signal	-	-	-	-	-	-	-	-	-	-	-	-	-	-	-	-	-	-	-	-	-	-	-	-	-	-	-
b10	Base screen CH No. 4 communication cycle signal	-	-	-	-	-	-	-	-	-	-	-	-	-	-	-	-	-	-	-	-	-	-	-	-	-	-	-
CC-Link G4 station No. (CH1)		-	-	-	-	-	-	-	-	-	-	-	-	-	-	-	-	-	-	-	-	-	-	-	-	-	-	-
GOT multidrop slave station No. (CH1)		GS6	-	-	-	-	-	-	-	-	-	-	-	-	-	-	-	-	-	-	-	-	-	-	-	-	-	-
1 second binary counter (GS7)		-	-	-	-	-	-	-	-	-	-	-	-	-	-	-	-	-	-	-	-	-	-	-	-	-	-	-
Scan time of monitor (GS8)		-	-	-	-	-	-	-	-	-	-	-	-	-	-	-	-	-	-	-	-	-	-	-	-	-	-	-
Scan counter of monitor (GS10)		-	-	-	-	-	-	-	-	-	-	-	-	-	-	-	-	-	-	-	-	-	-	-	-	-	-	-
Script common information (GS14)		-	-	-	-	-	-	-	○	-	-	-	-	-	-	-	-	-	-	-	-	-	-	-	-	-	-	-
b0	Script error occurrence signal	-	-	-	-	-	-	-	○	-	-	-	-	-	-	-	-	-	-	-	-	-	-	-	-	-	-	-
b7	Script BCD error occurrence signal	-	-	-	-	-	-	-	○	-	-	-	-	-	-	-	-	-	-	-	-	-	-	-	-	-	-	-
b8	Script zero division error occurrence signal	-	-	-	-	-	-	-	○	-	-	-	-	-	-	-	-	-	-	-	-	-	-	-	-	-	-	-
b12	Script communication error occurrence signal	-	-	-	-	-	-	-	○	-	-	-	-	-	-	-	-	-	-	-	-	-	-	-	-	-	-	-
Script error pointer (GS15)		-	-	-	-	-	-	-	○	-	-	-	-	-	-	-	-	-	-	-	-	-	-	-	-	-	-	-
Script error data (GS16 to 47)		-	-	-	-	-	-	-	○	-	-	-	-	-	-	-	-	-	-	-	-	-	-	-	-	-	-	-
Script execute pointer (GS48)		-	-	-	-	-	-	-	○	-	-	-	-	-	-	-	-	-	-	-	-	-	-	-	-	-	-	-
Script execute No. (GS49 to 79)		-	-	-	-	-	-	-	○	-	-	-	-	-	-	-	-	-	-	-	-	-	-	-	-	-	-	-
Object script common information (GS80)		-	-	-	-	-	-	-	○	-	-	-	-	-	-	-	-	-	-	-	-	-	-	-	-	-	-	-
b0	Object script error occurrence signal	-	-	-	-	-	-	-	○	-	-	-	-	-	-	-	-	-	-	-	-	-	-	-	-	-	-	-
b7	Object script BCD error occurrence signal	-	-	-	-	-	-	-	○	-	-	-	-	-	-	-	-	-	-	-	-	-	-	-	-	-	-	-
b8	Object script zero division error occurrence signal	-	-	-	-	-	-	-	○	-	-	-	-	-	-	-	-	-	-	-	-	-	-	-	-	-	-	-
b12	Object script communication error occurrence signal	-	-	-	-	-	-	-	○	-	-	-	-	-	-	-	-	-	-	-	-	-	-	-	-	-	-	-
Object script error pointer (GS81)		-	-	-	-	-	-	-	○	-	-	-	-	-	-	-	-	-	-	-	-	-	-	-	-	-	-	-

○ : Relevant - : Irrelevant

Bit No.	Item	Touch switch	Lamp	Numerical display	Numerical Input	ASCII display	ASCII Input	Data list	Historical data list display	Date display/Time display	Comment display	Advanced user alarm display	Advanced system alarm display	Advanced alarm popup display (User alarm)	Advanced alarm popup display (System alarm)	User alarm display	System alarm display	Alarm history display	Scrolling alarm display	Level	Panel meter	Line/Trend/Bar graph	Statistics bar/Statistics pie/Scatter graph	Historical trend graph	Parts display	Parts movement	Operation log function
	Object script error data (GS82 to GS113)	-	-	-	-	-	-	-	-	-	-	-	-	-	-	-	-	-	-	-	-	-	-	-	-	-	-
	Object script error execute pointer (GS114)	-	-	-	-	-	-	-	-	-	-	-	-	-	-	-	-	-	-	-	-	-	-	-	-	-	-
	Object script error execute ID (GS115 to GS145)	-	-	-	-	-	-	-	-	-	-	-	-	-	-	-	-	-	-	-	-	-	-	-	-	-	-
	File operation function information (GS154)	-	-	-	-	-	-	-	-	-	-	-	-	-	-	-	-	-	-	-	-	-	-	-	-	-	-
b0	File operation function execution notification	-	-	-	-	-	-	-	-	-	-	-	-	-	-	-	-	-	-	-	-	-	-	-	-	-	-
b15	File operation function error occurrence	-	-	-	-	-	-	-	-	-	-	-	-	-	-	-	-	-	-	-	-	-	-	-	-	-	-
	GOT IP address notification (GS198 to GS199)	-	-	-	-	-	-	-	-	-	-	-	-	-	-	-	-	-	-	-	-	-	-	-	-	-	-
	Gateway common information (GS200)	-	-	-	-	-	-	-	-	-	-	-	-	-	-	-	-	-	-	-	-	-	-	-	-	-	-
b0	Mail send function ready signal	-	-	-	-	-	-	-	-	-	-	-	-	-	-	-	-	-	-	-	-	-	-	-	-	-	-
b1	FTP server function ready signal	-	-	-	-	-	-	-	-	-	-	-	-	-	-	-	-	-	-	-	-	-	-	-	-	-	-
b2	FTP server function log-in signal	-	-	-	-	-	-	-	-	-	-	-	-	-	-	-	-	-	-	-	-	-	-	-	-	-	-
b3	Server function ready signal	-	-	-	-	-	-	-	-	-	-	-	-	-	-	-	-	-	-	-	-	-	-	-	-	-	-
b4	Client function ready signal	-	-	-	-	-	-	-	-	-	-	-	-	-	-	-	-	-	-	-	-	-	-	-	-	-	-
b11	Mail send function error occurrence signal	-	-	-	-	-	-	-	-	-	-	-	-	-	-	-	-	-	-	-	-	-	-	-	-	-	-
b14	Server function error occurrence signal	-	-	-	-	-	-	-	-	-	-	-	-	-	-	-	-	-	-	-	-	-	-	-	-	-	-
b15	Client function error occurrence signal	-	-	-	-	-	-	-	-	-	-	-	-	-	-	-	-	-	-	-	-	-	-	-	-	-	-
	Mail send function error counter (GS201)	-	-	-	-	-	-	-	-	-	-	-	-	-	-	-	-	-	-	-	-	-	-	-	-	-	-
	Mail send function error code (GS202)	-	-	-	-	-	-	-	-	-	-	-	-	-	-	-	-	-	-	-	-	-	-	-	-	-	-
	Mail send function error occurrence date and time (GS203 to 205)	-	-	-	-	-	-	-	-	-	-	-	-	-	-	-	-	-	-	-	-	-	-	-	-	-	-
	Mail send function send source (GS206)	-	-	-	-	-	-	-	-	-	-	-	-	-	-	-	-	-	-	-	-	-	-	-	-	-	-
	Server function error counter (GS210)	-	-	-	-	-	-	-	-	-	-	-	-	-	-	-	-	-	-	-	-	-	-	-	-	-	-
	Server function error code (GS211)	-	-	-	-	-	-	-	-	-	-	-	-	-	-	-	-	-	-	-	-	-	-	-	-	-	-
	Server function error occurrence date and time (GS212 to 214)	-	-	-	-	-	-	-	-	-	-	-	-	-	-	-	-	-	-	-	-	-	-	-	-	-	-
	Server function error client (GS215 to 216)	-	-	-	-	-	-	-	-	-	-	-	-	-	-	-	-	-	-	-	-	-	-	-	-	-	-
	Server function error counter (GS220)	-	-	-	-	-	-	-	-	-	-	-	-	-	-	-	-	-	-	-	-	-	-	-	-	-	-
	Client function error code (GS221)	-	-	-	-	-	-	-	-	-	-	-	-	-	-	-	-	-	-	-	-	-	-	-	-	-	-
	Client function error occurrence date and time (GS222 to 224)	-	-	-	-	-	-	-	-	-	-	-	-	-	-	-	-	-	-	-	-	-	-	-	-	-	-
	Client function error server (GS225 to 226)	-	-	-	-	-	-	-	-	-	-	-	-	-	-	-	-	-	-	-	-	-	-	-	-	-	-
	No. of faulty stations (GS230)	-	-	-	-	-	-	-	-	-	-	-	-	-	-	-	-	-	-	-	-	-	-	-	-	-	-
	Ethernet faulty station information (GS231 to 238)	-	-	-	-	-	-	-	-	-	-	-	-	-	-	-	-	-	-	-	-	-	-	-	-	-	-
	External authentication status notification (GS240)	-	-	-	-	-	-	-	-	-	-	-	-	-	-	-	-	-	-	-	-	-	-	-	-	-	-
b0	External authentication success signal	-	-	-	-	-	-	-	-	-	-	-	-	-	-	-	-	-	-	-	-	-	-	-	-	-	-
b1	External authentication failure signal	-	-	-	-	-	-	-	-	-	-	-	-	-	-	-	-	-	-	-	-	-	-	-	-	-	-
b13	Operator authentication reception signal	-	-	-	-	-	-	-	-	-	-	-	-	-	-	-	-	-	-	-	-	-	-	-	-	-	-
b14	External authentication reception signal	-	-	-	-	-	-	-	-	-	-	-	-	-	-	-	-	-	-	-	-	-	-	-	-	-	-

○ : Relevant - : Irrelevant

Bit No.	Item	Logging function	Recipe function	Advanced recipe function	Device data transfer function	Status observation function	Trigger action function	Time action function	Script function	Barcode function	RFID function	Remote personal computer operation (Serial)	Remote personal computer operation (Ethernet)	VNC® server function	Video display function	Multimedia function	Operation panel/External I/O function	RGB display function	Report function	Hardcopy function	Sound output function	Set overlay screen function	Document display function	Test function	Gateway function	MES interface function	Station No. switching function	Key windows
	Object script error data (GS82 to GS113)	-	-	-	-	-	-	-	○	-	-	-	-	-	-	-	-	-	-	-	-	-	-	-	-	-	-	-
	Object script error execute pointer (GS114)	-	-	-	-	-	-	-	○	-	-	-	-	-	-	-	-	-	-	-	-	-	-	-	-	-	-	-
	Object script error execute ID (GS115 to GS145)	-	-	-	-	-	-	-	○	-	-	-	-	-	-	-	-	-	-	-	-	-	-	-	-	-	-	-
	File operation function information (GS154)	-	-	-	-	-	-	-	○	-	-	-	-	-	-	-	-	-	-	-	-	-	-	-	-	-	-	-
b0	File operation function execution notification	-	-	-	-	-	-	-	○	-	-	-	-	-	-	-	-	-	-	-	-	-	-	-	-	-	-	-
b15	File operation function error occurrence	-	-	-	-	-	-	-	○	-	-	-	-	-	-	-	-	-	-	-	-	-	-	-	-	-	-	-
	GOT IP address notification (GS198 to GS199)	-	-	-	-	-	-	-	-	-	-	-	-	-	-	-	-	-	-	-	-	-	-	-	-	-	-	-
	Gateway common information (GS200)	-	-	-	-	-	-	-	-	-	-	-	-	-	-	-	-	-	-	-	-	-	-	-	○	-	-	-
b0	Mail send function ready signal	-	-	-	-	-	-	-	-	-	-	-	-	-	-	-	-	-	-	-	-	-	-	-	○	-	-	-
b1	FTP server function ready signal	-	-	-	-	-	-	-	-	-	-	-	-	-	-	-	-	-	-	-	-	-	-	-	○	-	-	-
b2	FTP server function log-in signal	-	-	-	-	-	-	-	-	-	-	-	-	-	-	-	-	-	-	-	-	-	-	-	○	-	-	-
b3	Server function ready signal	-	-	-	-	-	-	-	-	-	-	-	-	-	-	-	-	-	-	-	-	-	-	-	○	-	-	-
b4	Client function ready signal	-	-	-	-	-	-	-	-	-	-	-	-	-	-	-	-	-	-	-	-	-	-	-	○	-	-	-
b11	Mail send function error occurrence signal	-	-	-	-	-	-	-	-	-	-	-	-	-	-	-	-	-	-	-	-	-	-	-	○	-	-	-
b14	Server function error occurrence signal	-	-	-	-	-	-	-	-	-	-	-	-	-	-	-	-	-	-	-	-	-	-	-	○	-	-	-
b15	Client function error occurrence signal	-	-	-	-	-	-	-	-	-	-	-	-	-	-	-	-	-	-	-	-	-	-	-	○	-	-	-
	Mail send function error counter (GS201)	-	-	-	-	-	-	-	-	-	-	-	-	-	-	-	-	-	-	-	-	-	-	-	○	-	-	-
	Mail send function error code (GS202)	-	-	-	-	-	-	-	-	-	-	-	-	-	-	-	-	-	-	-	-	-	-	-	○	-	-	-
	Mail send function error occurrence date and time (GS203 to 205)	-	-	-	-	-	-	-	-	-	-	-	-	-	-	-	-	-	-	-	-	-	-	-	○	-	-	-
	Mail send function send source (GS206)	-	-	-	-	-	-	-	-	-	-	-	-	-	-	-	-	-	-	-	-	-	-	-	○	-	-	-
	Server function error counter (GS210)	-	-	-	-	-	-	-	-	-	-	-	-	-	-	-	-	-	-	-	-	-	-	-	○	-	-	-
	Server function error code (GS211)	-	-	-	-	-	-	-	-	-	-	-	-	-	-	-	-	-	-	-	-	-	-	-	○	-	-	-
	Server function error occurrence date and time (GS212 to 214)	-	-	-	-	-	-	-	-	-	-	-	-	-	-	-	-	-	-	-	-	-	-	-	○	-	-	-
	Server function error client (GS215 to 216)	-	-	-	-	-	-	-	-	-	-	-	-	-	-	-	-	-	-	-	-	-	-	-	○	-	-	-
	Server function error counter (GS220)	-	-	-	-	-	-	-	-	-	-	-	-	-	-	-	-	-	-	-	-	-	-	-	○	-	-	-
	Client function error code (GS221)	-	-	-	-	-	-	-	-	-	-	-	-	-	-	-	-	-	-	-	-	-	-	-	○	-	-	-
	Client function error occurrence date and time (GS222 to 224)	-	-	-	-	-	-	-	-	-	-	-	-	-	-	-	-	-	-	-	-	-	-	-	○	-	-	-
	Client function error server (GS225 to 226)	-	-	-	-	-	-	-	-	-	-	-	-	-	-	-	-	-	-	-	-	-	-	-	○	-	-	-
	No. of faulty stations (GS230)	-	-	-	-	-	-	-	-	-	-	-	-	-	-	-	-	-	-	-	-	-	-	-	-	-	-	-
	Ethernet faulty station information (GS231 to 238)	-	-	-	-	-	-	-	-	-	-	-	-	-	-	-	-	-	-	-	-	-	-	-	-	-	-	-
	External authentication status notification (GS240)	-	-	-	-	-	-	-	-	-	○	-	-	-	-	-	-	-	-	-	-	-	-	-	-	-	-	-
b0	External authentication success signal	-	-	-	-	-	-	-	-	○	-	-	-	-	-	-	-	-	-	-	-	-	-	-	-	-	-	-
b1	External authentication failure signal	-	-	-	-	-	-	-	-	○	-	-	-	-	-	-	-	-	-	-	-	-	-	-	-	-	-	-
b13	Operator authentication reception signal	-	-	-	-	-	-	-	-	○	-	-	-	-	-	-	-	-	-	-	-	-	-	-	-	-	-	-
b14	External authentication reception signal	-	-	-	-	-	-	-	-	○	-	-	-	-	-	-	-	-	-	-	-	-	-	-	-	-	-	-

8 COMMUNICATION WITH GOT  
 9 USEFUL FUNCTIONS FOR DRAWING  
 10 USEFUL FUNCTIONS FOR USING GOT  
 APPENDICES

○ : Relevant - : Irrelevant

Bit No. S	Item	Touch switch	Lamp	Numerical display	Numerical Input	ASCII display	ASCII Input	Data list	Historical data list display	Date display/Time display	Comment display	Advanced user alarm display	Advanced system alarm display (User alarm)	Advanced alarm popup display (System alarm)	Advanced alarm popup display (User alarm)	User alarm display	System alarm display	Alarm history display	Scrolling alarm display	Panel meter	Line/Trend/Bar graph	Statistics bar/Statistics pie/Scatter graph	Historical trend graph	Parts display	Parts movement	Operation log function
b15	External authentication ID input reception signal	-	-	-	-	-	-	-	-	-	-	-	-	-	-	-	-	-	-	-	-	-	-	-	-	-
	Insufficient security level notification (GS241)	-	-	-	-	-	-	-	-	-	-	-	-	-	-	-	-	-	-	-	-	-	-	-	-	-
b1	Insufficient screen security level notification signal (Overlap window 1)	-	-	-	-	-	-	-	-	-	-	-	-	-	-	-	-	-	-	-	-	-	-	-	-	-
b2	Insufficient screen security level notification signal (Overlap window 2)	-	-	-	-	-	-	-	-	-	-	-	-	-	-	-	-	-	-	-	-	-	-	-	-	-
b3	Insufficient screen security level notification signal (Superimpose window 1)	-	-	-	-	-	-	-	-	-	-	-	-	-	-	-	-	-	-	-	-	-	-	-	-	-
b4	Insufficient screen security level notification signal (Superimpose window 2)	-	-	-	-	-	-	-	-	-	-	-	-	-	-	-	-	-	-	-	-	-	-	-	-	-
b8	Insufficient called screen security level notification signal (Base screen)	-	-	-	-	-	-	-	-	-	-	-	-	-	-	-	-	-	-	-	-	-	-	-	-	-
b9	Insufficient called screen security level notification signal (Overlap window 1)	-	-	-	-	-	-	-	-	-	-	-	-	-	-	-	-	-	-	-	-	-	-	-	-	-
b10	Insufficient called screen security level notification signal (Overlap window 2)	-	-	-	-	-	-	-	-	-	-	-	-	-	-	-	-	-	-	-	-	-	-	-	-	-
b11	Insufficient called screen security level notification signal (Superimpose window 1)	-	-	-	-	-	-	-	-	-	-	-	-	-	-	-	-	-	-	-	-	-	-	-	-	-
b12	Insufficient called screen security level notification signal (Superimpose window 2)	-	-	-	-	-	-	-	-	-	-	-	-	-	-	-	-	-	-	-	-	-	-	-	-	-
	Object direct input reception notification (GS243)	-	-	-	○	-	○	-	-	-	-	-	-	-	-	-	-	-	-	-	-	-	-	-	-	-
b15	Object direct input reception notification signal	-	-	-	○	-	○	-	-	-	-	-	-	-	-	-	-	-	-	-	-	-	-	-	-	-
	SoftGOT-GOT link status control/ notification (GS244)	-	-	-	-	-	-	-	-	-	-	-	-	-	-	-	-	-	-	-	-	-	-	-	-	-
b0	Communication status notification signal	-	-	-	-	-	-	-	-	-	-	-	-	-	-	-	-	-	-	-	-	-	-	-	-	-
b1	Obtaining authorization notification signal	-	-	-	-	-	-	-	-	-	-	-	-	-	-	-	-	-	-	-	-	-	-	-	-	-
b2	GT SoftGOT1000/GOT identification signal	-	-	-	-	-	-	-	-	-	-	-	-	-	-	-	-	-	-	-	-	-	-	-	-	-
b3	Obtaining exclusive authorization notification signal	-	-	-	-	-	-	-	-	-	-	-	-	-	-	-	-	-	-	-	-	-	-	-	-	-
b4	System screen displaying notification signal	-	-	-	-	-	-	-	-	-	-	-	-	-	-	-	-	-	-	-	-	-	-	-	-	-
	Modem connection status notification (GS248)	-	-	-	-	-	-	-	-	-	-	-	-	-	-	-	-	-	-	-	-	-	-	-	-	-
b0	Modem initializing notification signal	-	-	-	-	-	-	-	-	-	-	-	-	-	-	-	-	-	-	-	-	-	-	-	-	-
b1	Modem initialization complete notification signal	-	-	-	-	-	-	-	-	-	-	-	-	-	-	-	-	-	-	-	-	-	-	-	-	-
b14	Modem circuit connecting notification signal	-	-	-	-	-	-	-	-	-	-	-	-	-	-	-	-	-	-	-	-	-	-	-	-	-
b15	Modem initialization error notification signal	-	-	-	-	-	-	-	-	-	-	-	-	-	-	-	-	○	-	-	-	-	-	-	-	-
	Modem circuit connection baud rate (GS249)	-	-	-	-	-	-	-	-	-	-	-	-	-	-	-	-	-	-	-	-	-	-	-	-	-
	Accessible drive notification (GS251)	-	-	-	-	-	-	-	-	-	-	-	-	-	-	-	-	-	-	-	-	-	-	-	-	-
b0	Accessible A drive signal	-	-	-	-	-	-	-	-	-	-	-	-	-	-	-	-	-	-	-	-	-	-	-	-	-
b1	Accessible B drive signal	-	-	-	-	-	-	-	-	-	-	-	-	-	-	-	-	-	-	-	-	-	-	-	-	-
	Error detection common information (GS252)	-	-	-	-	-	-	-	-	-	-	-	-	-	-	-	-	○	-	-	-	-	-	-	-	-

○ : Relevant - : Irrelevant

Bit No S	Item	Logging function	Recipe function	Advanced recipe function	Device data transfer function	Status observation function	Trigger action function	Time action function	Script function	Barcode function	RFID function	Remote personal computer operation (Serial)	Remote personal computer operation (Ethernet)	VNC® server function	Video display function	Multimedia function	Operation panel/External I/O function	RGB display function	Report function	Hardcopy function	Sound output function	Set overlay screen function	Document display function	Test function	Gateway function	MES interface function	Station No. switching function	Key windows
b15	External authentication ID input reception signal	-	-	-	-	-	-	-	-	-	-	-	-	-	-	-	-	-	-	-	-	-	-	-	-	-	-	-
Insufficient security level notification (GS241)		-	-	-	-	-	-	-	-	-	-	-	-	-	-	-	-	-	-	-	-	-	-	-	-	-	-	-
b1	Insufficient screen security level notification signal (Overlap window 1)	-	-	-	-	-	-	-	-	-	-	-	-	-	-	-	-	-	-	-	-	-	-	-	-	-	-	-
b2	Insufficient screen security level notification signal (Overlap window 2)	-	-	-	-	-	-	-	-	-	-	-	-	-	-	-	-	-	-	-	-	-	-	-	-	-	-	-
b3	Insufficient screen security level notification signal (Superimpose window 1)	-	-	-	-	-	-	-	-	-	-	-	-	-	-	-	-	-	-	-	-	-	-	-	-	-	-	-
b4	Insufficient screen security level notification signal (Superimpose window 2)	-	-	-	-	-	-	-	-	-	-	-	-	-	-	-	-	-	-	-	-	-	-	-	-	-	-	-
b8	Insufficient called screen security level notification signal (Base screen)	-	-	-	-	-	-	-	-	-	-	-	-	-	-	-	-	-	-	-	-	-	-	-	-	-	-	-
b9	Insufficient called screen security level notification signal (Overlap window 1)	-	-	-	-	-	-	-	-	-	-	-	-	-	-	-	-	-	-	-	-	-	-	-	-	-	-	-
b10	Insufficient called screen security level notification signal (Overlap window 2)	-	-	-	-	-	-	-	-	-	-	-	-	-	-	-	-	-	-	-	-	-	-	-	-	-	-	-
b11	Insufficient called screen security level notification signal (Superimpose window 1)	-	-	-	-	-	-	-	-	-	-	-	-	-	-	-	-	-	-	-	-	-	-	-	-	-	-	-
b12	Insufficient called screen security level notification signal (Superimpose window 2)	-	-	-	-	-	-	-	-	-	-	-	-	-	-	-	-	-	-	-	-	-	-	-	-	-	-	-
Object direct input reception notification (GS243)		-	-	-	-	-	-	-	-	○	○	-	-	-	-	-	-	-	-	-	-	-	-	-	-	-	-	-
b15	Object direct input reception notification signal	-	-	-	-	-	-	-	-	○	○	-	-	-	-	-	-	-	-	-	-	-	-	-	-	-	-	-
SoftGOT-GOT link status control/ notification (GS244)		-	-	-	-	-	-	-	-	-	-	-	-	-	-	-	-	-	-	-	-	-	-	-	-	-	-	-
b0	Communication status notification signal	-	-	-	-	-	-	-	-	-	-	-	-	-	-	-	-	-	-	-	-	-	-	-	-	-	-	-
b1	Obtaining authorization notification signal	-	-	-	-	-	-	-	-	-	-	-	-	-	-	-	-	-	-	-	-	-	-	-	-	-	-	-
b2	GT SoftGOT1000/GOT identification signal	-	-	-	-	-	-	-	-	-	-	-	-	-	-	-	-	-	-	-	-	-	-	-	-	-	-	-
b3	Obtaining exclusive authorization notification signal	-	-	-	-	-	-	-	-	-	-	-	-	-	-	-	-	-	-	-	-	-	-	-	-	-	-	-
b4	System screen displaying notification signal	-	-	-	-	-	-	-	-	-	-	-	-	-	-	-	-	-	-	-	-	-	-	-	-	-	-	-
Modem connection status notification (GS248)		-	-	-	-	-	-	-	-	-	-	-	-	-	-	-	-	-	-	-	-	-	-	-	-	-	-	-
b0	Modem initializing notification signal	-	-	-	-	-	-	-	-	-	-	-	-	-	-	-	-	-	-	-	-	-	-	-	-	-	-	-
b1	Modem initialization complete notification signal	-	-	-	-	-	-	-	-	-	-	-	-	-	-	-	-	-	-	-	-	-	-	-	-	-	-	-
b14	Modem circuit connecting notification signal	-	-	-	-	-	-	-	-	-	-	-	-	-	-	-	-	-	-	-	-	-	-	-	-	-	-	-
b15	Modem initialization error notification signal	-	-	-	-	-	-	-	-	-	-	-	-	-	-	-	-	-	-	-	-	-	-	-	-	-	-	-
Modem circuit connection baud rate (GS249)		-	-	-	-	-	-	-	-	-	-	-	-	-	-	-	-	-	-	-	-	-	-	-	-	-	-	-
Accessible drive notification (GS251)		-	-	-	-	-	-	-	-	-	-	-	-	-	-	-	-	-	-	-	-	-	-	-	-	-	-	-
b0	Accessible A drive signal	-	-	-	-	-	-	-	-	-	-	-	-	-	-	-	-	-	-	-	-	-	-	-	-	-	-	-
b1	Accessible B drive signal	-	-	-	-	-	-	-	-	-	-	-	-	-	-	-	-	-	-	-	-	-	-	-	-	-	-	-
Error detection common information (GS252)		-	-	-	-	-	-	-	-	-	-	-	-	-	-	-	-	-	○	-	-	-	-	-	-	-	-	-

8 COMMUNICATION WITH GOT  
 9 USEFUL FUNCTIONS FOR DRAWING  
 10 USEFUL FUNCTIONS FOR USING GOT  
 APPENDICES

○ : Relevant - : Irrelevant

Bit No. S	Item	Touch switch	Lamp	Numerical display	Numerical input	ASCII display	ASCII input	Data list	Historical data list display	Date display/Time display	Comment display	Advanced user alarm display	Advanced system alarm display	Advanced alarm popup display (User alarm)	Advanced alarm popup display (System alarm)	User alarm display	System alarm display	Alarm history display	Scrolling alarm display	Level	Panel meter	Line/Trend/Bar graph	Statistics bar/Statistics pie/Scatter graph	Historical trend graph	Parts display	Parts movement	Operation log function
	Ethernet incorrect access notification (GS254)	-	-	-	-	-	-	-	-	-	-	-	-	-	-	-	-	-	-	-	-	-	-	-	-	-	-
b0	OS incorrect installation notification signal	-	-	-	-	-	-	-	-	-	-	-	-	-	-	-	-	-	-	-	-	-	-	-	-	-	-
b1	Project data incorrect write notification signal	-	-	-	-	-	-	-	-	-	-	-	-	-	-	-	-	-	-	-	-	-	-	-	-	-	-
b8	Project data incorrect read notification signal	-	-	-	-	-	-	-	-	-	-	-	-	-	-	-	-	-	-	-	-	-	-	-	-	-	-
	Intensity notification (GS255)	-	-	-	-	-	-	-	-	-	-	-	-	-	-	-	-	-	-	-	-	-	-	-	-	-	-
	FA transparent status (GS256)	-	-	-	-	-	-	-	-	-	-	-	-	-	-	-	-	-	-	-	-	-	-	-	-	-	-
	Printer status information (GS258)	-	-	-	-	-	-	-	-	-	-	-	-	-	-	-	-	-	-	-	-	-	-	-	-	-	-
b0	Printer connection notification signal	-	-	-	-	-	-	-	-	-	-	-	-	-	-	-	-	-	-	-	-	-	-	-	-	-	-
b1	Warning error occurrence notification signal	-	-	-	-	-	-	-	-	-	-	-	-	-	-	-	-	-	-	-	-	-	-	-	-	-	-
b2	Fatal error occurrence notification signal	-	-	-	-	-	-	-	-	-	-	-	-	-	-	-	-	-	-	-	-	-	-	-	-	-	-
b3	Print enable/disable status notification signal	-	-	-	-	-	-	-	-	-	-	-	-	-	-	-	-	-	-	-	-	-	-	-	-	-	-
	Integer ↔ Real number conversion status (GS260)	-	-	-	-	-	-	-	-	-	-	-	-	-	-	-	-	-	-	-	-	-	-	-	-	-	-
b14	Integer ↔ Real number conversion error occurrence signal	-	-	-	-	-	-	-	-	-	-	-	-	-	-	-	-	-	-	-	-	-	-	-	-	-	-
b15	Integer ↔ Real number conversion complete signal	-	-	-	-	-	-	-	-	-	-	-	-	-	-	-	-	-	-	-	-	-	-	-	-	-	-
	Integer ↔ Real number conversion error code (GS261)	-	-	-	-	-	-	-	-	-	-	-	-	-	-	-	-	-	-	-	-	-	-	-	-	-	-
	System alarm GOT error channel No. (GS262)	-	-	-	-	-	-	-	-	-	-	-	○	-	○	-	○	-	-	-	-	-	-	-	-	-	-
	System alarm CPU error channel No. (GS263)	-	-	-	-	-	-	-	-	-	-	-	○	-	○	-	○	-	-	-	-	-	-	-	-	-	-
	System alarm network error channel No. (GS264)	-	-	-	-	-	-	-	-	-	-	-	○	-	○	-	○	-	-	-	-	-	-	-	-	-	-
	SNTP time synchronization setting status (GS265)	-	-	-	-	-	-	-	-	-	-	-	-	-	-	-	-	-	-	-	-	-	-	-	-	-	-
	SNTP time query result (GS266 to 272)	-	-	-	-	-	-	-	-	-	-	-	-	-	-	-	-	-	-	-	-	-	-	-	-	-	-
	Monitoring interval timeout count (GS275)	-	-	-	-	-	-	-	-	-	-	-	-	-	-	-	-	-	-	-	-	-	-	-	-	-	-
	Document display status notification (GS276)	-	-	-	-	-	-	-	-	-	-	-	-	-	-	-	-	-	-	-	-	-	-	-	-	-	-
	Faulty monitor station signal (CH1) (GS280)	-	-	-	-	-	-	-	-	-	-	-	-	-	-	-	-	-	-	-	-	-	-	-	-	-	-
	Faulty station information (CH1) (GS281 to 288)	-	-	-	-	-	-	-	-	-	-	-	-	-	-	-	-	-	-	-	-	-	-	-	-	-	-
	Channel observation notification information (CH1) (GS299)	-	-	-	-	-	-	-	-	-	-	-	-	-	-	-	-	-	-	-	-	-	-	-	-	-	-
	Faulty monitor station signal (CH2) (GS300)	-	-	-	-	-	-	-	-	-	-	-	-	-	-	-	-	-	-	-	-	-	-	-	-	-	-
	Faulty station information (CH2) (GS301 to 308)	-	-	-	-	-	-	-	-	-	-	-	-	-	-	-	-	-	-	-	-	-	-	-	-	-	-
	Channel observation notification information (CH2) (GS319)	-	-	-	-	-	-	-	-	-	-	-	-	-	-	-	-	-	-	-	-	-	-	-	-	-	-
	Faulty monitor station signal (CH3) (GS320)	-	-	-	-	-	-	-	-	-	-	-	-	-	-	-	-	-	-	-	-	-	-	-	-	-	-
	Faulty station information (CH3) (GS321 to 328)	-	-	-	-	-	-	-	-	-	-	-	-	-	-	-	-	-	-	-	-	-	-	-	-	-	-
	Channel observation notification information (CH3) (GS339)	-	-	-	-	-	-	-	-	-	-	-	-	-	-	-	-	-	-	-	-	-	-	-	-	-	-
	Faulty monitor station signal (CH4) (GS340)	-	-	-	-	-	-	-	-	-	-	-	-	-	-	-	-	-	-	-	-	-	-	-	-	-	-

○ : Relevant - : Irrelevant

Bit No. S	Item	Logging function	Recipe function	Advanced recipe function	Device data transfer function	Status observation function	Trigger action function	Time action function	Script function	Barcode function	RFID function	Remote personal computer operation (Serial)	Remote personal computer operation (Ethernet)	VNC® server function	Video display function	Multimedia function	Operation panel/External I/O function	RGB display function	Report function	Hardcopy function	Sound output function	Set overlay screen function	Document display function	Test function	Gateway function	MES interface function	Station No. switching function	Key windows
	Ethernet incorrect access notification (GS254)	-	-	-	-	-	-	-	-	-	-	-	-	-	-	-	-	-	-	-	-	-	-	-	-	-	-	-
b0	OS incorrect installation notification signal	-	-	-	-	-	-	-	-	-	-	-	-	-	-	-	-	-	-	-	-	-	-	-	-	-	-	-
b1	Project data incorrect write notification signal	-	-	-	-	-	-	-	-	-	-	-	-	-	-	-	-	-	-	-	-	-	-	-	-	-	-	-
b8	Project data incorrect read notification signal	-	-	-	-	-	-	-	-	-	-	-	-	-	-	-	-	-	-	-	-	-	-	-	-	-	-	-
	Intensity notification (GS255)	-	-	-	-	-	-	-	-	-	-	-	-	-	-	-	-	-	-	-	-	-	-	-	-	-	-	-
	FA transparent status (GS256)	-	-	-	-	-	-	-	-	-	-	-	-	-	-	-	-	-	-	-	-	-	-	-	-	-	-	-
	Printer status information (GS258)	-	-	-	-	-	-	-	-	-	-	-	-	-	-	-	-	-	-	-	-	-	-	-	-	-	-	-
b0	Printer connection notification signal	-	-	-	-	-	-	-	-	-	-	-	-	-	-	-	-	-	○	○	-	-	-	-	-	-	-	-
b1	Warning error occurrence notification signal	-	-	-	-	-	-	-	-	-	-	-	-	-	-	-	-	-	○	○	-	-	-	-	-	-	-	-
b2	Fatal error occurrence notification signal	-	-	-	-	-	-	-	-	-	-	-	-	-	-	-	-	-	○	○	-	-	-	-	-	-	-	-
b3	Print enable/disable status notification signal	-	-	-	-	-	-	-	-	-	-	-	-	-	-	-	-	-	○	○	-	-	-	-	-	-	-	-
	Integer ↔ Real number conversion status (GS260)	-	-	-	-	-	-	-	-	-	-	-	-	-	-	-	-	-	-	-	-	-	-	-	-	-	-	-
b14	Integer ↔ Real number conversion error occurrence signal	-	-	-	-	-	-	-	-	-	-	-	-	-	-	-	-	-	-	-	-	-	-	-	-	-	-	-
b15	Integer ↔ Real number conversion complete signal	-	-	-	-	-	-	-	-	-	-	-	-	-	-	-	-	-	-	-	-	-	-	-	-	-	-	-
	Integer ↔ Real number conversion error code (GS261)	-	-	-	-	-	-	-	○	-	-	-	-	-	-	-	-	-	-	-	-	-	-	-	-	-	-	-
	System alarm GOT error channel No. (GS262)	-	-	-	-	-	-	-	-	-	-	-	-	-	-	-	-	-	-	-	-	-	-	-	-	-	-	-
	System alarm CPU error channel No. (GS263)	-	-	-	-	-	-	-	-	-	-	-	-	-	-	-	-	-	-	-	-	-	-	-	-	-	-	-
	System alarm network error channel No. (GS264)	-	-	-	-	-	-	-	-	-	-	-	-	-	-	-	-	-	-	-	-	-	-	-	-	-	-	-
	SNTP time synchronization setting status (GS265)	-	-	-	-	-	-	-	-	-	-	-	-	-	-	-	-	-	-	-	-	-	-	-	-	○	-	-
	SNTP time query result (GS266 to 272)	-	-	-	-	-	-	-	-	-	-	-	-	-	-	-	-	-	-	-	-	-	-	-	-	○	○	-
	Monitoring interval timeout count (GS275)	-	-	-	-	-	-	-	-	-	-	-	-	-	-	-	-	-	-	-	-	-	-	-	○	-	-	-
	Document display status notification (GS276)	-	-	-	-	-	-	-	-	-	-	-	-	-	-	-	-	-	-	-	-	-	○	-	-	-	-	-
	Faulty monitor station signal (CH1) (GS280)	-	-	-	-	-	-	-	-	-	-	-	-	-	-	-	-	-	-	-	-	-	-	-	-	-	-	-
	Faulty station information (CH1) (GS281 to 288)	-	-	-	-	-	-	-	-	-	-	-	-	-	-	-	-	-	-	-	-	-	-	-	-	-	-	-
	Channel observation notification information (CH1) (GS299)	-	-	-	-	-	-	-	-	-	-	-	-	-	-	-	-	-	-	-	-	-	-	-	-	-	-	-
	Faulty monitor station signal (CH2) (GS300)	-	-	-	-	-	-	-	-	-	-	-	-	-	-	-	-	-	-	-	-	-	-	-	-	-	-	-
	Faulty station information (CH2) (GS301 to 308)	-	-	-	-	-	-	-	-	-	-	-	-	-	-	-	-	-	-	-	-	-	-	-	-	-	-	-
	Channel observation notification information (CH2) (GS319)	-	-	-	-	-	-	-	-	-	-	-	-	-	-	-	-	-	-	-	-	-	-	-	-	-	-	-
	Faulty monitor station signal (CH3) (GS320)	-	-	-	-	-	-	-	-	-	-	-	-	-	-	-	-	-	-	-	-	-	-	-	-	-	-	-
	Faulty station information (CH3) (GS321 to 328)	-	-	-	-	-	-	-	-	-	-	-	-	-	-	-	-	-	-	-	-	-	-	-	-	-	-	-
	Channel observation notification information (CH3) (GS339)	-	-	-	-	-	-	-	-	-	-	-	-	-	-	-	-	-	-	-	-	-	-	-	-	-	-	-
	Faulty monitor station signal (CH4) (GS340)	-	-	-	-	-	-	-	-	-	-	-	-	-	-	-	-	-	-	-	-	-	-	-	-	-	-	-

8 COMMUNICATION WITH GOT  
 9 USEFUL FUNCTIONS FOR DRAWING  
 10 USEFUL FUNCTIONS FOR USING GOT  
 APPENDICES

○ : Relevant - : Irrelevant

Bit No. S	Item	Touch switch	Lamp	Numerical display	Numerical Input	ASCII display	ASCII Input	Data list	Historical data list display	Date display/Time display	Comment display	Advanced user alarm display	Advanced system alarm display	Advanced alarm popup display (User alarm)	Advanced alarm popup display (System alarm)	User alarm display	System alarm display	Alarm history display	Scrolling alarm display	Level	Panel meter	Line/Trend/Bar graph	Statistics bar/Statistics pie/Scatter graph	Historical trend graph	Parts display	Parts movement	Operation log function
	Faulty station information (CH4) (GS341 to 348)	-	-	-	-	-	-	-	-	-	-	-	-	-	-	-	-	-	-	-	-	-	-	-	-	-	-
	Channel observation notification information (CH4) (GS359)	-	-	-	-	-	-	-	-	-	-	-	-	-	-	-	-	-	-	-	-	-	-	-	-	-	-
	CC-Link G4 station No.(CH1)	GS360	-	-	-	-	-	-	-	-	-	-	-	-	-	-	-	-	-	-	-	-	-	-	-	-	-
	GOT multidrop slave station No. (CH1)		-	-	-	-	-	-	-	-	-	-	-	-	-	-	-	-	-	-	-	-	-	-	-	-	-
	CC-Link G4 station No.(CH2)	GS361	-	-	-	-	-	-	-	-	-	-	-	-	-	-	-	-	-	-	-	-	-	-	-	-	-
	GOT multidrop slave station No. (CH2)		-	-	-	-	-	-	-	-	-	-	-	-	-	-	-	-	-	-	-	-	-	-	-	-	-
	CC-Link G4 station No.(CH3)	GS362	-	-	-	-	-	-	-	-	-	-	-	-	-	-	-	-	-	-	-	-	-	-	-	-	-
	GOT multidrop slave station No. (CH3)		-	-	-	-	-	-	-	-	-	-	-	-	-	-	-	-	-	-	-	-	-	-	-	-	-
	CC-Link G4 station No.(CH4)	GS363	-	-	-	-	-	-	-	-	-	-	-	-	-	-	-	-	-	-	-	-	-	-	-	-	-
	GOT multidrop slave station No. (CH4)		-	-	-	-	-	-	-	-	-	-	-	-	-	-	-	-	-	-	-	-	-	-	-	-	-
	GOT network No./station No. notification (GS376 to 383)		-	-	-	-	-	-	-	-	-	-	-	-	-	-	-	-	-	-	-	-	-	-	-	-	-
	Script common control (GS384)		-	-	-	-	-	-	-	-	-	-	-	-	-	-	-	-	-	-	-	-	-	-	-	-	-
b0	Script error clear signal		-	-	-	-	-	-	-	-	-	-	-	-	-	-	-	-	-	-	-	-	-	-	-	-	-
b1	Script retry signal		-	-	-	-	-	-	-	-	-	-	-	-	-	-	-	-	-	-	-	-	-	-	-	-	-
	Script monitoring time (GS385)		-	-	-	-	-	-	-	-	-	-	-	-	-	-	-	-	-	-	-	-	-	-	-	-	-
	Project/screen script initial operation (GS386)		-	-	-	-	-	-	-	-	-	-	-	-	-	-	-	-	-	-	-	-	-	-	-	-	-
	Object script common control (GS387)		-	-	-	-	-	-	-	-	-	-	-	-	-	-	-	-	-	-	-	-	-	-	-	-	-
	Object script monitoring time (GS388)		-	-	-	-	-	-	-	-	-	-	-	-	-	-	-	-	-	-	-	-	-	-	-	-	-
	Object script initial operation (GS389)		-	-	-	-	-	-	-	-	-	-	-	-	-	-	-	-	-	-	-	-	-	-	-	-	-
	File operation function data storage order (GS390)		-	-	-	-	-	-	-	-	-	-	-	-	-	-	-	-	-	-	-	-	-	-	-	-	-
	Gateway common control (GS400)		-	-	-	-	-	-	-	-	-	-	-	-	-	-	-	-	-	-	-	-	-	-	-	-	-
b2	Forced FTP server function logout signal		-	-	-	-	-	-	-	-	-	-	-	-	-	-	-	-	-	-	-	-	-	-	-	-	-
b8	FTP server function binary resource file visualize signal		-	-	-	-	-	-	-	-	-	-	-	-	-	-	-	-	-	-	-	-	-	-	-	-	-
b11	Mail send function error clear signal		-	-	-	-	-	-	-	-	-	-	-	-	-	-	-	-	-	-	-	-	-	-	-	-	-
b14	Server function error clear signal		-	-	-	-	-	-	-	-	-	-	-	-	-	-	-	-	-	-	-	-	-	-	-	-	-
b15	Client function error clear signal		-	-	-	-	-	-	-	-	-	-	-	-	-	-	-	-	-	-	-	-	-	-	-	-	-
	FTP communication control(GS401)		-	-	-	-	-	-	-	-	-	-	-	-	-	-	-	-	-	-	-	-	-	-	-	-	-
b0	FTP communication error clear signal		-	-	-	-	-	-	-	-	-	-	-	-	-	-	-	-	-	-	-	-	-	-	-	-	-
	FTP communication timeout time(GS402)		-	-	-	-	-	-	-	-	-	-	-	-	-	-	-	-	-	-	-	-	-	-	-	-	-
	Exclusive authorization control (GS447)		-	-	-	-	-	-	-	-	-	-	-	-	-	-	-	-	-	-	-	-	-	-	-	-	-
b0	Exclusive authorization control signal		-	-	-	-	-	-	-	-	-	-	-	-	-	-	-	-	-	-	-	-	-	-	-	-	-
	Modem connection control (GS448)		-	-	-	-	-	-	-	-	-	-	-	-	-	-	-	-	-	-	-	-	-	-	-	-	-
b0	Modem initialization signal		-	-	-	-	-	-	-	-	-	-	-	-	-	-	-	-	-	-	-	-	-	-	-	-	-
b1	Modem circuit disconnect signal		-	-	-	-	-	-	-	-	-	-	-	-	-	-	-	-	-	-	-	-	-	-	-	-	-
b12	Modem connection read prohibition signal		-	-	-	-	-	-	-	-	-	-	-	-	-	-	-	-	-	-	-	-	-	-	-	-	-
b13	Modem connection write prohibition signal		-	-	-	-	-	-	-	-	-	-	-	-	-	-	-	-	-	-	-	-	-	-	-	-	-
b15	Modem connection prohibition signal		-	-	-	-	-	-	-	-	-	-	-	-	-	-	-	-	-	-	-	-	-	-	-	-	-



○ : Relevant - : Irrelevant

Bit No. S	Item	Logging function	Recipe function	Advanced recipe function	Device data transfer function	Status observation function	Trigger action function	Time action function	Script function	Barcode function	RFID function	Remote personal computer operation (Serial)	Remote personal computer operation (Ethernet)	VNC® server function	Video display function	Multimedia function	Operation panel/External I/O function	RGB display function	Report function	Hardcopy function	Sound output function	Set overlay screen function	Document display function	Test function	Gateway function	MES interface function	Station No. switching function	Key windows
	Faulty station information (CH4) (GS341 to 348)	-	-	-	-	-	-	-	-	-	-	-	-	-	-	-	-	-	-	-	-	-	-	-	-	-	-	-
	Channel observation notification information (CH4) (GS359)	-	-	-	-	-	-	-	-	-	-	-	-	-	-	-	-	-	-	-	-	-	-	-	-	-	-	-
	CC-Link G4 station No.(CH1)	-	-	-	-	-	-	-	-	-	-	-	-	-	-	-	-	-	-	-	-	-	-	-	-	-	-	-
	GOT multidrop slave station No. (CH1)	-	-	-	-	-	-	-	-	-	-	-	-	-	-	-	-	-	-	-	-	-	-	-	-	-	-	-
	CC-Link G4 station No.(CH2)	-	-	-	-	-	-	-	-	-	-	-	-	-	-	-	-	-	-	-	-	-	-	-	-	-	-	-
	GOT multidrop slave station No. (CH2)	-	-	-	-	-	-	-	-	-	-	-	-	-	-	-	-	-	-	-	-	-	-	-	-	-	-	-
	CC-Link G4 station No.(CH3)	-	-	-	-	-	-	-	-	-	-	-	-	-	-	-	-	-	-	-	-	-	-	-	-	-	-	-
	GOT multidrop slave station No. (CH3)	-	-	-	-	-	-	-	-	-	-	-	-	-	-	-	-	-	-	-	-	-	-	-	-	-	-	-
	CC-Link G4 station No.(CH4)	-	-	-	-	-	-	-	-	-	-	-	-	-	-	-	-	-	-	-	-	-	-	-	-	-	-	-
	GOT multidrop slave station No. (CH4)	-	-	-	-	-	-	-	-	-	-	-	-	-	-	-	-	-	-	-	-	-	-	-	-	-	-	-
	GOT network No./station No. notification (GS376 to 383)	-	-	-	-	-	-	-	-	-	-	-	-	-	-	-	-	-	-	-	-	-	-	-	-	-	-	-
	Script common control (GS384)	-	-	-	-	-	-	-	○	-	-	-	-	-	-	-	-	-	-	-	-	-	-	-	-	-	-	-
b0	Script error clear signal	-	-	-	-	-	-	-	○	-	-	-	-	-	-	-	-	-	-	-	-	-	-	-	-	-	-	-
b1	Script retry signal	-	-	-	-	-	-	-	○	-	-	-	-	-	-	-	-	-	-	-	-	-	-	-	-	-	-	-
	Script monitoring time (GS385)	-	-	-	-	-	-	-	○	-	-	-	-	-	-	-	-	-	-	-	-	-	-	-	-	-	-	-
	Project/screen script initial operation (GS386)	-	-	-	-	-	-	-	○	-	-	-	-	-	-	-	-	-	-	-	-	-	-	-	-	-	-	-
	Object script common control (GS387)	-	-	-	-	-	-	-	○	-	-	-	-	-	-	-	-	-	-	-	-	-	-	-	-	-	-	-
	Object script monitoring time (GS388)	-	-	-	-	-	-	-	○	-	-	-	-	-	-	-	-	-	-	-	-	-	-	-	-	-	-	-
	Object script initial operation (GS389)	-	-	-	-	-	-	-	○	-	-	-	-	-	-	-	-	-	-	-	-	-	-	-	-	-	-	-
	File operation function data storage order (GS390)	-	-	-	-	-	-	-	○	-	-	-	-	-	-	-	-	-	-	-	-	-	-	-	-	-	-	-
	Gateway common control (GS400)	-	-	-	-	-	-	-	-	-	-	-	-	-	-	-	-	-	-	-	-	-	-	-	○	-	-	-
b2	Forced FTP server function logout signal	-	-	-	-	-	-	-	-	-	-	-	-	-	-	-	-	-	-	-	-	-	-	-	○	-	-	-
b8	FTP server function binary resource file visualize signal	-	-	-	-	-	-	-	-	-	-	-	-	-	-	-	-	-	-	-	-	-	-	-	○	-	-	-
b11	Mail send function error clear signal	-	-	-	-	-	-	-	-	-	-	-	-	-	-	-	-	-	-	-	-	-	-	-	○	-	-	-
b14	Server function error clear signal	-	-	-	-	-	-	-	-	-	-	-	-	-	-	-	-	-	-	-	-	-	-	-	○	-	-	-
b15	Client function error clear signal	-	-	-	-	-	-	-	-	-	-	-	-	-	-	-	-	-	-	-	-	-	-	-	○	-	-	-
	FTP communication control(GS401)	-	-	-	-	-	-	-	-	-	-	-	-	-	-	-	-	-	-	-	-	-	-	-	○	-	-	-
b0	FTP communication error clear signal	-	-	-	-	-	-	-	-	-	-	-	-	-	-	-	-	-	-	-	-	-	-	-	○	-	-	-
	FTP communication timeout time(GS402)	-	-	-	-	-	-	-	-	-	-	-	-	-	-	-	-	-	-	-	-	-	-	-	○	-	-	-
	Exclusive authorization control (GS447)	-	-	-	-	-	-	-	-	-	-	-	-	-	-	-	-	-	-	-	-	-	-	-	-	-	-	-
b0	Exclusive authorization control signal	-	-	-	-	-	-	-	-	-	-	-	-	-	-	-	-	-	-	-	-	-	-	-	-	-	-	-
	Modem connection control (GS448)	-	-	-	-	-	-	-	-	-	-	-	-	-	-	-	-	-	-	-	-	-	-	-	-	-	-	-
b0	Modem initialization signal	-	-	-	-	-	-	-	-	-	-	-	-	-	-	-	-	-	-	-	-	-	-	-	-	-	-	-
b1	Modem circuit disconnect signal	-	-	-	-	-	-	-	-	-	-	-	-	-	-	-	-	-	-	-	-	-	-	-	-	-	-	-
b12	Modem connection read prohibition signal	-	-	-	-	-	-	-	-	-	-	-	-	-	-	-	-	-	-	-	-	-	-	-	-	-	-	-
b13	Modem connection write prohibition signal	-	-	-	-	-	-	-	-	-	-	-	-	-	-	-	-	-	-	-	-	-	-	-	-	-	-	-
b15	Modem connection prohibition signal	-	-	-	-	-	-	-	-	-	-	-	-	-	-	-	-	-	-	-	-	-	-	-	-	-	-	-

8 COMMUNICATION WITH GOT  
 9 USEFUL FUNCTIONS FOR DRAWING  
 10 USEFUL FUNCTIONS FOR USING GOT  
 APPENDICES

○ : Relevant - : Irrelevant

Bit No. S	Item	Touch switch	Lamp	Numerical display	Numerical input	ASCII display	ASCII input	Data list	Historical data list display	Date display/Time display	Comment display	Advanced user alarm display	Advanced system alarm display	Advanced alarm popup display (User alarm)	Advanced alarm popup display (System alarm)	User alarm display	System alarm display	Alarm history display	Scrolling alarm display	Panel meter	Line/Trend/Bar graph	Statistics bar/Statistics pie/Scatter graph	Historical trend graph	Parts display	Parts movement	Operation log function
Monitor common control (Write device) (GS450)		-	-	-	-	-	-	-	-	-	-	-	-	-	-	-	-	-	-	-	-	-	-	-	-	-
b0	Base screen initial scan complete signal	-	-	-	○	-	○	-	-	-	-	-	-	-	-	-	-	-	-	-	-	-	-	-	-	-
b1	Numeric input range check setting signal	-	-	-	○	-	-	-	-	-	-	-	-	-	-	-	-	-	-	-	-	-	-	-	-	-
b2	Ascii input system information output setting	-	-	-	-	-	○	-	-	-	-	-	-	-	-	-	-	-	-	-	-	-	-	-	-	-
b3	Cursor deleted system information clear setting	-	-	-	○	-	○	-	-	-	-	-	-	-	-	-	-	-	-	-	-	-	-	-	-	-
b4	Kana-kanji conversion authorization certification	○	-	-	-	-	-	-	-	-	-	-	-	-	-	-	-	-	-	-	-	-	-	-	-	-
b8	Memory card image file display setting signal	-	-	-	-	-	-	-	-	-	-	-	-	-	-	-	-	-	-	-	-	-	-	○	○	-
b9	Historical trend graph display mode signal	-	-	-	-	-	-	-	-	-	-	-	-	-	-	-	-	-	-	-	-	-	○	-	-	-
b12	Touch switch operation timing (Screen/station no. switch) setting signal	○	-	-	-	-	-	-	-	-	-	-	-	-	-	-	-	-	-	-	-	-	-	-	-	-
b13	Screen switch memory card save function setting signal	○	-	-	-	-	-	-	-	-	-	-	-	-	-	-	-	-	-	-	-	-	-	-	-	-
b14	Touch switch upper hierarchy operation mode setting signal	○	-	-	-	-	-	-	-	-	-	-	-	-	-	-	-	-	-	-	-	-	-	-	-	-
Auto screen save time (GS451)		-	-	-	-	-	-	-	-	-	-	-	-	-	-	-	-	-	-	-	-	-	-	-	-	-
Error detection common control (GS452)		-	-	-	-	-	-	-	-	-	-	-	-	-	-	-	-	-	○	-	-	-	-	-	-	-
Ethernet access control (GS454)		-	-	-	-	-	-	-	-	-	-	-	-	-	-	-	-	-	-	-	-	-	-	-	-	-
b0	OS installation prohibition signal	-	-	-	-	-	-	-	-	-	-	-	-	-	-	-	-	-	-	-	-	-	-	-	-	-
b1	Project data write prohibition signal	-	-	-	-	-	-	-	-	-	-	-	-	-	-	-	-	-	-	-	-	-	-	-	-	-
b8	Project data read prohibition signal	-	-	-	-	-	-	-	-	-	-	-	-	-	-	-	-	-	-	-	-	-	-	-	-	-
Intensity control (GS455)		-	-	-	-	-	-	-	-	-	-	-	-	-	-	-	-	-	-	-	-	-	-	-	-	-
Text code format control (GS456)		-	-	-	-	○	○	-	-	-	-	-	-	-	-	-	-	-	-	-	-	-	-	-	-	-
Pass-through transparent stop control (GS457)		-	-	-	-	-	-	-	-	-	-	-	-	-	-	-	-	-	-	-	-	-	-	-	-	-
Conversion start indication (GS460)		-	-	-	-	-	-	-	-	-	-	-	-	-	-	-	-	-	-	-	-	-	-	-	-	-
b0 to b7	Integer ↔ Real number conversion method	-	-	-	-	-	-	-	-	-	-	-	-	-	-	-	-	-	-	-	-	-	-	-	-	-
b15	Integer ↔ Real number conversion start signal	-	-	-	-	-	-	-	-	-	-	-	-	-	-	-	-	-	-	-	-	-	-	-	-	-
Conversion devices (GS461)		-	-	-	-	-	-	-	-	-	-	-	-	-	-	-	-	-	-	-	-	-	-	-	-	-
Conversion source head device No. (GS462)		-	-	-	-	-	-	-	-	-	-	-	-	-	-	-	-	-	-	-	-	-	-	-	-	-
Conversion destination head device No. (GS463)		-	-	-	-	-	-	-	-	-	-	-	-	-	-	-	-	-	-	-	-	-	-	-	-	-
Store error value (GS464)		-	-	-	-	-	-	-	-	-	-	-	-	-	-	-	-	-	-	-	-	-	-	-	-	-
GT SoftGOT1000 common control (GS500)		-	-	-	-	-	-	-	-	-	-	-	-	-	-	-	-	-	-	-	-	-	-	-	-	-
b0	GT SoftGOT1000 exit confirmation signal	-	-	-	-	-	-	-	-	-	-	-	-	-	-	-	-	-	-	-	-	-	-	-	-	-
b1	GT SoftGOT1000 full screen mode switching signal	-	-	-	-	-	-	-	-	-	-	-	-	-	-	-	-	-	-	-	-	-	-	-	-	-
b2	PLC file display signal	-	-	-	-	-	-	-	-	-	-	-	-	-	-	-	-	-	-	-	-	-	-	-	-	-
Application start signal (GS501, GS502)		-	-	-	-	-	-	-	-	-	-	-	-	-	-	-	-	-	-	-	-	-	-	-	-	-
GT SoftGOT1000 full screen size (Width) (GS503)		-	-	-	-	-	-	-	-	-	-	-	-	-	-	-	-	-	-	-	-	-	-	-	-	-
GT SoftGOT1000 full screen size (Height) (GS504)		-	-	-	-	-	-	-	-	-	-	-	-	-	-	-	-	-	-	-	-	-	-	-	-	-
Advanced application start signal (GS505 to 507)		-	-	-	-	-	-	-	-	-	-	-	-	-	-	-	-	-	-	-	-	-	-	-	-	-

○ : Relevant - : Irrelevant

Bit No. S	Item	Logging function	Recipe function	Advanced recipe function	Device data transfer function	Status observation function	Trigger action function	Time action function	Script function	Barcode function	RFID function	Remote personal computer operation (Serial)	Remote personal computer operation (Ethernet)	VNC® server function	Video display function	Multimedia function	Operation panel/External I/O function	RGB display function	Report function	Hardcopy function	Sound output function	Set overlay screen function	Document display function	Test function	Gateway function	MES interface function	Station No. switching function	Key windows
	Monitor common control (Write device) (GS450)	-	-	-	-	-	-	-	-	-	-	-	-	-	-	-	-	-	-	-	-	-	-	-	-	-	-	-
b0	Base screen initial scan complete signal	-	-	-	-	-	-	-	-	-	-	-	-	-	-	-	-	-	-	-	-	-	-	-	-	-	-	○
b1	Numeric input range check setting signal	-	-	-	-	-	-	-	-	-	-	-	-	-	-	-	-	-	-	-	-	-	-	-	-	-	-	○
b2	Ascii input system information output setting	-	-	-	-	-	-	-	-	-	-	-	-	-	-	-	-	-	-	-	-	-	-	-	-	-	-	-
b3	Cursor deleted system information clear setting	-	-	-	-	-	-	-	-	-	-	-	-	-	-	-	-	-	-	-	-	-	-	-	-	-	-	-
b4	Kana-kanji conversion authorization certification	-	-	-	-	-	-	-	-	-	-	-	-	-	-	-	-	-	-	-	-	-	-	-	-	-	-	-
b8	Memory card image file display setting signal	-	-	-	-	-	-	-	-	-	-	-	-	-	-	-	-	-	-	-	-	-	-	-	-	-	-	-
b9	Historical trend graph display mode signal	-	-	-	-	-	-	-	-	-	-	-	-	-	-	-	-	-	-	-	-	-	-	-	-	-	-	-
b12	Touch switch operation timing (Screen/station no. switch) setting signal	-	-	-	-	-	-	-	-	-	-	-	-	-	-	-	-	-	-	-	-	-	-	-	-	-	-	-
b13	Screen switch memory card save function setting signal	-	-	-	-	-	-	-	-	-	-	-	-	-	-	-	-	-	-	-	-	-	-	-	-	-	-	-
b14	Touch switch upper hierarchy operation mode setting signal	-	-	-	-	-	-	-	-	-	-	-	-	-	-	-	-	-	-	-	-	-	-	-	-	-	-	-
	Auto screen save time (GS451)	-	-	-	-	-	-	-	-	-	-	-	-	-	-	-	-	-	-	-	-	-	-	-	-	-	-	-
	Error detection common control (GS452)	-	-	-	-	-	-	-	-	-	-	-	-	-	-	-	-	-	-	-	-	-	-	-	-	-	-	-
	Ethernet access control (GS454)	-	-	-	-	-	-	-	-	-	-	-	-	-	-	-	-	-	-	-	-	-	-	-	-	-	-	-
b0	OS installation prohibition signal	-	-	-	-	-	-	-	-	-	-	-	-	-	-	-	-	-	-	-	-	-	-	-	-	-	-	-
b1	Project data write prohibition signal	-	-	-	-	-	-	-	-	-	-	-	-	-	-	-	-	-	-	-	-	-	-	-	-	-	-	-
b8	Project data read prohibition signal	-	-	-	-	-	-	-	-	-	-	-	-	-	-	-	-	-	-	-	-	-	-	-	-	-	-	-
	Intensity control (GS455)	-	-	-	-	-	-	-	-	-	-	-	-	-	-	-	-	-	-	-	-	-	-	-	-	-	-	-
	Text code format control (GS456)	○	-	-	-	-	-	-	-	-	-	-	-	-	-	-	-	-	-	-	-	-	-	-	-	-	-	-
	Pass-through transparent stop control (GS457)	-	-	-	-	-	-	-	-	-	-	-	-	-	-	-	-	-	-	-	-	-	-	-	-	-	-	-
	Conversion start indication (GS460)	-	-	-	-	-	-	-	-	-	-	-	-	-	-	-	-	-	-	-	-	-	-	-	-	-	-	-
b0 to b7	Integer ↔ Real number conversion method	-	-	-	-	-	-	-	○	-	-	-	-	-	-	-	-	-	-	-	-	-	-	-	-	-	-	-
b15	Integer ↔ Real number conversion start signal	-	-	-	-	-	-	-	○	-	-	-	-	-	-	-	-	-	-	-	-	-	-	-	-	-	-	-
	Conversion devices (GS461)	-	-	-	-	-	-	-	○	-	-	-	-	-	-	-	-	-	-	-	-	-	-	-	-	-	-	-
	Conversion source head device No. (GS462)	-	-	-	-	-	-	-	○	-	-	-	-	-	-	-	-	-	-	-	-	-	-	-	-	-	-	-
	Conversion destination head device No. (GS463)	-	-	-	-	-	-	-	○	-	-	-	-	-	-	-	-	-	-	-	-	-	-	-	-	-	-	-
	Store error value (GS464)	-	-	-	-	-	-	-	○	-	-	-	-	-	-	-	-	-	-	-	-	-	-	-	-	-	-	-
	GT SoftGOT1000 common control (GS500)	-	-	-	-	-	-	-	-	-	-	-	-	-	-	-	-	-	-	-	-	-	-	-	-	-	-	-
b0	GT SoftGOT1000 exit confirmation signal	-	-	-	-	-	-	-	-	-	-	-	-	-	-	-	-	-	-	-	-	-	-	-	-	-	-	-
b1	GT SoftGOT1000 full screen mode switching signal	-	-	-	-	-	-	-	-	-	-	-	-	-	-	-	-	-	-	-	-	-	-	-	-	-	-	-
b2	PLC file display signal	-	-	-	-	-	-	-	-	-	-	-	-	-	-	-	-	-	-	-	-	-	-	-	-	-	-	-
	Application start signal (GS501, GS502)	-	-	-	-	-	-	-	-	-	-	-	-	-	-	-	-	-	-	-	-	-	-	-	-	-	-	-
	GT SoftGOT1000 full screen size (Width) (GS503)	-	-	-	-	-	-	-	-	-	-	-	-	-	-	-	-	-	-	-	-	-	-	-	-	-	-	-
	GT SoftGOT1000 full screen size (Height) (GS504)	-	-	-	-	-	-	-	-	-	-	-	-	-	-	-	-	-	-	-	-	-	-	-	-	-	-	-
	Advanced application start signal (GS505 to 507)	-	-	-	-	-	-	-	-	-	-	-	-	-	-	-	-	-	-	-	-	-	-	-	-	-	-	-

8  
COMMUNICATION WITH GOT  
9  
USEFUL FUNCTIONS FOR DRAWING  
10  
USEFUL FUNCTIONS FOR USING GOT  
APPENDICES

○ : Relevant - : Irrelevant

Bit No. S	Item	Touch switch	Lamp	Numerical display	Numerical Input	ASCII display	ASCII Input	Data list	Historical data list display	Date display/Time display	Comment display	Advanced user alarm display	Advanced system alarm display	Advanced alarm popup display (User alarm)	Advanced alarm popup display (System alarm)	User alarm display	System alarm display	Alarm history display	Scrolling alarm display	Level	Panel meter	Line/Trend/Bar graph	Statistics bar/Statistics pie/Scatter graph	Historical trend graph	Parts display	Parts movement	Operation log function
	Device data transfer information (GS510)	-	-	-	-	-	-	-	-	-	-	-	-	-	-	-	-	-	-	-	-	-	-	-	-	-	-
b0	Device data transfer error clear signal	-	-	-	-	-	-	-	-	-	-	-	-	-	-	-	-	-	-	-	-	-	-	-	-	-	-
b1	Device data transfer processing time clear signal	-	-	-	-	-	-	-	-	-	-	-	-	-	-	-	-	-	-	-	-	-	-	-	-	-	-
	Touch status communication control (GS511)	-	-	-	-	-	-	-	-	-	-	-	-	-	-	-	-	-	-	-	-	-	-	-	-	-	-
b0	Touch status communication control signal	-	-	-	-	-	-	-	-	-	-	-	-	-	-	-	-	-	-	-	-	-	-	-	-	-	-
	Time change information (GS512)	-	-	-	-	-	-	-	-	-	-	-	-	-	-	-	-	-	-	-	-	-	-	-	-	-	○
	Changed time (GS513 to 516)	-	-	-	-	-	-	-	-	-	-	-	-	-	-	-	-	-	-	-	-	-	-	-	-	-	○
	External I/O function notification/control function (GS517)	-	-	-	-	-	-	-	-	-	-	-	-	-	-	-	-	-	-	-	-	-	-	-	-	-	-
	Sound output cancel control (GS518)	○	-	-	-	-	-	-	-	-	-	-	-	-	-	-	-	-	-	-	-	-	-	-	-	-	-
b0	Sound output cancel signal during play	○	-	-	-	-	-	-	-	-	-	-	-	-	-	-	-	-	-	-	-	-	-	-	-	-	-
b1	All sound output cancel signal	○	-	-	-	-	-	-	-	-	-	-	-	-	-	-	-	-	-	-	-	-	-	-	-	-	-
	Buffering and file access control (GS520)	-	-	-	-	-	-	-	-	-	○	○	○	○	-	-	-	-	-	-	-	-	-	-	-	-	-
	Trigger backup data send delay (GS521)	-	-	-	-	-	-	-	-	-	-	-	-	-	-	-	-	-	-	-	-	-	-	-	-	-	-
	Special control during specific function execution (GS522)	○	○	○	○	○	○	○	○	○	○	○	○	○	○	○	○	○	○	○	○	○	○	○	○	○	○
b0	Background processing stop signal	○	○	○	○	○	○	○	○	○	○	○	○	○	○	○	○	○	○	○	○	○	○	○	○	○	○
	Network No. for monitor station disconnected (CH1) (GS530)	-	-	-	-	-	-	-	-	-	-	-	-	-	-	-	-	-	-	-	-	-	-	-	-	-	-
	Temperature controller/servo amplifier/inverter monitor station disconnection (CH1) (GS531 to 538)	-	-	-	-	-	-	-	-	-	-	-	-	-	-	-	-	-	-	-	-	-	-	-	-	-	-
	Channel shutdown control (CH1) (GS539)	-	-	-	-	-	-	-	-	-	-	-	-	-	-	-	-	-	-	-	-	-	-	-	-	-	-
	Network No. for monitor station disconnected (CH2) (GS540)	-	-	-	-	-	-	-	-	-	-	-	-	-	-	-	-	-	-	-	-	-	-	-	-	-	-
	Temperature controller/servo amplifier/inverter monitor station disconnection (CH2) (GS541 to 548)	-	-	-	-	-	-	-	-	-	-	-	-	-	-	-	-	-	-	-	-	-	-	-	-	-	-
	Channel shutdown control (CH2) (GS549)	-	-	-	-	-	-	-	-	-	-	-	-	-	-	-	-	-	-	-	-	-	-	-	-	-	-
	Network No. for monitor station disconnected (CH3) (GS550)	-	-	-	-	-	-	-	-	-	-	-	-	-	-	-	-	-	-	-	-	-	-	-	-	-	-
	Temperature controller/servo amplifier/inverter monitor station disconnection (CH3) (GS551 to 558)	-	-	-	-	-	-	-	-	-	-	-	-	-	-	-	-	-	-	-	-	-	-	-	-	-	-
	Channel shutdown control (CH3) (GS559)	-	-	-	-	-	-	-	-	-	-	-	-	-	-	-	-	-	-	-	-	-	-	-	-	-	-
	Network No. for monitor station disconnected (CH4) (GS560)	-	-	-	-	-	-	-	-	-	-	-	-	-	-	-	-	-	-	-	-	-	-	-	-	-	-
	Temperature controller/servo amplifier/inverter monitor station disconnection (CH4) (GS561 to 568)	-	-	-	-	-	-	-	-	-	-	-	-	-	-	-	-	-	-	-	-	-	-	-	-	-	-
	Channel shutdown control (CH4) (GS569)	-	-	-	-	-	-	-	-	-	-	-	-	-	-	-	-	-	-	-	-	-	-	-	-	-	-
	MODBUS communication control function (Common) (GS570 to 576)	-	-	-	-	-	-	-	-	-	-	-	-	-	-	-	-	-	-	-	-	-	-	-	-	-	-
	Channel setting of MODBUS communication control function (GS579)	-	-	-	-	-	-	-	-	-	-	-	-	-	-	-	-	-	-	-	-	-	-	-	-	-	-
b0	MODBUS communication control function (CH1) signal	-	-	-	-	-	-	-	-	-	-	-	-	-	-	-	-	-	-	-	-	-	-	-	-	-	-
b1	MODBUS communication control function (CH2) signal	-	-	-	-	-	-	-	-	-	-	-	-	-	-	-	-	-	-	-	-	-	-	-	-	-	-
b2	MODBUS communication control function (CH3) signal	-	-	-	-	-	-	-	-	-	-	-	-	-	-	-	-	-	-	-	-	-	-	-	-	-	-
b3	MODBUS communication control function (CH4) signal	-	-	-	-	-	-	-	-	-	-	-	-	-	-	-	-	-	-	-	-	-	-	-	-	-	-

○ : Relevant - : Irrelevant

Bit No. S	Item	Logging function	Recipe function	Advanced recipe function	Device data transfer function	Status observation function	Trigger action function	Time action function	Script function	Barcode function	RFID function	Remote personal computer operation (Serial)	Remote personal computer operation (Ethernet)	VNC® server function	Video display function	Multimedia function	Operation panel/External I/O function	RGB display function	Report function	Hardcopy function	Sound output function	Set overlay screen function	Document display function	Test function	Gateway function	MES interface function	Station No. switching function	Key windows
	Device data transfer information (GS510)	-	-	-	-	-	-	-	-	-	-	-	-	-	-	-	-	-	-	-	-	-	-	-	-	-	-	-
b0	Device data transfer error clear signal	-	-	-	○	-	-	-	-	-	-	-	-	-	-	-	-	-	-	-	-	-	-	-	-	-	-	-
b1	Device data transfer processing time clear signal	-	-	-	○	-	-	-	-	-	-	-	-	-	-	-	-	-	-	-	-	-	-	-	-	-	-	-
	Touch status communication control (GS511)	-	-	-	-	-	-	-	-	-	-	○	○	-	-	-	-	-	-	-	-	-	-	-	-	-	-	-
b0	Touch status communication control signal	-	-	-	-	-	-	-	-	-	-	○	○	-	-	-	-	-	-	-	-	-	-	-	-	-	-	-
	Time change information (GS512)	-	-	-	-	-	-	-	-	-	-	-	-	-	-	-	-	-	-	-	-	-	-	-	-	-	-	-
	Changed time (GS513 to 516)	-	-	-	-	-	-	-	-	-	-	-	-	-	-	-	-	-	-	-	-	-	-	-	-	-	-	-
	External I/O function notification/control function (GS517)	-	-	-	-	-	-	-	-	-	-	-	-	-	-	-	○	-	-	-	-	-	-	-	-	-	-	-
	Sound output cancel control (GS518)	-	-	-	-	○	-	○	-	-	-	-	-	-	-	-	-	-	-	-	-	○	-	-	-	-	-	-
b0	Sound output cancel signal during play	-	-	-	-	○	-	○	-	-	-	-	-	-	-	-	-	-	-	-	-	○	-	-	-	-	-	-
b1	All sound output cancel signal	-	-	-	-	○	-	○	-	-	-	-	-	-	-	-	-	-	-	-	-	○	-	-	-	-	-	-
	Buffering and file access control (GS520)	○	-	-	-	-	-	-	-	-	-	-	-	-	-	-	-	-	-	-	-	-	-	-	-	-	-	-
	Trigger backup data send delay (GS521)	-	-	-	-	-	-	-	-	-	-	-	-	-	-	-	-	-	-	-	-	-	-	-	-	-	-	-
	Special control during specific function execution (GS522)	○	○	○	○	○	○	○	○	-	-	-	-	-	-	-	-	-	-	-	-	-	-	-	-	-	-	-
b0	Background processing stop signal	○	○	○	○	○	○	○	○	-	-	-	-	-	-	-	-	-	-	-	-	-	-	-	-	-	-	-
	Network No. for monitor station disconnected (CH1) (GS530)	-	-	-	-	-	-	-	-	-	-	-	-	-	-	-	-	-	-	-	-	-	-	-	-	-	-	-
	Temperature controller/servo amplifier/inverter monitor station disconnection (CH1) (GS531 to 538)	-	-	-	-	-	-	-	-	-	-	-	-	-	-	-	-	-	-	-	-	-	-	-	-	-	-	-
	Channel shutdown control (CH1) (GS539)	-	-	-	-	-	-	-	-	-	-	-	-	-	-	-	-	-	-	-	-	-	-	-	-	-	-	-
	Network No. for monitor station disconnected (CH2) (GS540)	-	-	-	-	-	-	-	-	-	-	-	-	-	-	-	-	-	-	-	-	-	-	-	-	-	-	-
	Temperature controller/servo amplifier/inverter monitor station disconnection (CH2) (GS541 to 548)	-	-	-	-	-	-	-	-	-	-	-	-	-	-	-	-	-	-	-	-	-	-	-	-	-	-	-
	Channel shutdown control (CH2) (GS549)	-	-	-	-	-	-	-	-	-	-	-	-	-	-	-	-	-	-	-	-	-	-	-	-	-	-	-
	Network No. for monitor station disconnected (CH3) (GS550)	-	-	-	-	-	-	-	-	-	-	-	-	-	-	-	-	-	-	-	-	-	-	-	-	-	-	-
	Temperature controller/servo amplifier/inverter monitor station disconnection (CH3) (GS551 to 558)	-	-	-	-	-	-	-	-	-	-	-	-	-	-	-	-	-	-	-	-	-	-	-	-	-	-	-
	Channel shutdown control (CH3) (GS559)	-	-	-	-	-	-	-	-	-	-	-	-	-	-	-	-	-	-	-	-	-	-	-	-	-	-	-
	Network No. for monitor station disconnected (CH4) (GS560)	-	-	-	-	-	-	-	-	-	-	-	-	-	-	-	-	-	-	-	-	-	-	-	-	-	-	-
	Temperature controller/servo amplifier/inverter monitor station disconnection (CH4) (GS561 to 568)	-	-	-	-	-	-	-	-	-	-	-	-	-	-	-	-	-	-	-	-	-	-	-	-	-	-	-
	Channel shutdown control (CH4) (GS569)	-	-	-	-	-	-	-	-	-	-	-	-	-	-	-	-	-	-	-	-	-	-	-	-	-	-	-
	MODBUS communication control function (Common) (GS570 to 576)	-	-	-	-	-	-	-	-	-	-	-	-	-	-	-	-	-	-	-	-	-	-	-	-	-	-	-
	Channel setting of MODBUS communication control function (GS579)	-	-	-	-	-	-	-	-	-	-	-	-	-	-	-	-	-	-	-	-	-	-	-	-	-	-	-
b0	MODBUS communication control function (CH1) signal	-	-	-	-	-	-	-	-	-	-	-	-	-	-	-	-	-	-	-	-	-	-	-	-	-	-	-
b1	MODBUS communication control function (CH2) signal	-	-	-	-	-	-	-	-	-	-	-	-	-	-	-	-	-	-	-	-	-	-	-	-	-	-	-
b2	MODBUS communication control function (CH3) signal	-	-	-	-	-	-	-	-	-	-	-	-	-	-	-	-	-	-	-	-	-	-	-	-	-	-	-
b3	MODBUS communication control function (CH4) signal	-	-	-	-	-	-	-	-	-	-	-	-	-	-	-	-	-	-	-	-	-	-	-	-	-	-	-

8 COMMUNICATION WITH GOT  
 9 USEFUL FUNCTIONS FOR DRAWING  
 10 USEFUL FUNCTIONS FOR USING GOT  
 APPENDICES

○ : Relevant - : Irrelevant

Bit No. S	Item	Touch switch	Lamp	Numerical display	Numerical Input	ASCII display	ASCII Input	Data list	Historical data list display	Date display/Time display	Comment display	Advanced user alarm display	Advanced system alarm display	Advanced alarm popup display (User alarm)	Advanced alarm popup display (System alarm)	User alarm display	System alarm display	Alarm history display	Scrolling alarm display	Level	Panel meter	Line/Trend/Bar graph	Statistics bar/Statistics pie/Scatter graph	Historical trend graph	Parts display	Parts movement	Operation log function
	Microcomputer connection (serial) extended setting (CH1) (GS580)	-	-	-	-	-	-	-	-	-	-	-	-	-	-	-	-	-	-	-	-	-	-	-	-	-	-
b0	Digital compatible signal	-	-	-	-	-	-	-	-	-	-	-	-	-	-	-	-	-	-	-	-	-	-	-	-	-	-
	Microcomputer connection (serial) extended setting (CH2) (GS581)	-	-	-	-	-	-	-	-	-	-	-	-	-	-	-	-	-	-	-	-	-	-	-	-	-	-
b0	Digital compatible signal	-	-	-	-	-	-	-	-	-	-	-	-	-	-	-	-	-	-	-	-	-	-	-	-	-	-
	Microcomputer connection (serial) extended setting (CH3) (GS582)	-	-	-	-	-	-	-	-	-	-	-	-	-	-	-	-	-	-	-	-	-	-	-	-	-	-
b0	Digital compatible signal	-	-	-	-	-	-	-	-	-	-	-	-	-	-	-	-	-	-	-	-	-	-	-	-	-	-
	Microcomputer connection (serial) extended setting (CH4) (GS583)	-	-	-	-	-	-	-	-	-	-	-	-	-	-	-	-	-	-	-	-	-	-	-	-	-	-
b0	Digital compatible signal	-	-	-	-	-	-	-	-	-	-	-	-	-	-	-	-	-	-	-	-	-	-	-	-	-	-
	MODBUS communication control function (CH1) (GS590 to 596)	-	-	-	-	-	-	-	-	-	-	-	-	-	-	-	-	-	-	-	-	-	-	-	-	-	-
	MODBUS communication control function (CH2) (GS597 to 603)	-	-	-	-	-	-	-	-	-	-	-	-	-	-	-	-	-	-	-	-	-	-	-	-	-	-
	MODBUS communication control function (CH1) (GS604 to 610)	-	-	-	-	-	-	-	-	-	-	-	-	-	-	-	-	-	-	-	-	-	-	-	-	-	-
	MODBUS communication control function (CH1) (GS611 to 617)	-	-	-	-	-	-	-	-	-	-	-	-	-	-	-	-	-	-	-	-	-	-	-	-	-	-
	Touch position color acquisition ready signal (GS630)	-	-	-	-	-	-	-	-	-	-	-	-	-	-	-	-	-	-	-	-	-	-	-	-	-	-
	Maintenance time notification cancel control (GS638)	-	-	-	-	-	-	-	-	-	-	-	-	-	-	-	-	-	-	-	-	-	-	-	-	-	-
b0, b4	Backlight maintenance time notification cancel signal	-	-	-	-	-	-	-	-	-	-	-	-	-	-	-	-	-	-	-	-	-	-	-	-	-	-
b1, b5	Display section maintenance time notification cancel signal	-	-	-	-	-	-	-	-	-	-	-	-	-	-	-	-	-	-	-	-	-	-	-	-	-	-
b2, b6	Touch key maintenance time notification cancel signal	-	-	-	-	-	-	-	-	-	-	-	-	-	-	-	-	-	-	-	-	-	-	-	-	-	-
b3, b7	Build-in flash memory maintenance time notification cancel signal	-	-	-	-	-	-	-	-	-	-	-	-	-	-	-	-	-	-	-	-	-	-	-	-	-	-
	GOT reset control (GS639)	-	-	-	-	-	-	-	-	-	-	-	-	-	-	-	-	-	-	-	-	-	-	-	-	-	-
	Error device data transfer ID (GS642)	-	-	-	-	-	-	-	-	-	-	-	-	-	-	-	-	-	-	-	-	-	-	-	-	-	-
	Device data transfer error count (GS643)	-	-	-	-	-	-	-	-	-	-	-	-	-	-	-	-	-	-	-	-	-	-	-	-	-	-
	Device data transfer processing time (GS644)	-	-	-	-	-	-	-	-	-	-	-	-	-	-	-	-	-	-	-	-	-	-	-	-	-	-
	Device data transfer ID (GS645)	-	-	-	-	-	-	-	-	-	-	-	-	-	-	-	-	-	-	-	-	-	-	-	-	-	-
	Device data transfer min. processing time (GS646)	-	-	-	-	-	-	-	-	-	-	-	-	-	-	-	-	-	-	-	-	-	-	-	-	-	-
	Device data transfer ID (min. processing time) (GS647)	-	-	-	-	-	-	-	-	-	-	-	-	-	-	-	-	-	-	-	-	-	-	-	-	-	-
	Device data transfer max. processing time (GS648)	-	-	-	-	-	-	-	-	-	-	-	-	-	-	-	-	-	-	-	-	-	-	-	-	-	-
	Device data transfer ID (max. processing time) (GS649)	-	-	-	-	-	-	-	-	-	-	-	-	-	-	-	-	-	-	-	-	-	-	-	-	-	-
	Present time (GS650 to 653)	-	-	-	-	-	-	-	-	-	-	-	-	-	-	-	-	-	-	-	-	-	-	-	-	-	-
	Touch status external notification (X-coordinate) (GS654)	-	-	-	-	-	-	-	-	-	-	-	-	-	-	-	-	-	-	-	-	-	-	-	-	-	-
	Touch status external notification (Y-coordinate) (GS655)	-	-	-	-	-	-	-	-	-	-	-	-	-	-	-	-	-	-	-	-	-	-	-	-	-	-
	Touch status external notification (touch status) (GS656)	-	-	-	-	-	-	-	-	-	-	-	-	-	-	-	-	-	-	-	-	-	-	-	-	-	-
	Trigger backup processing setting No. notification (GS657)	-	-	-	-	-	-	-	-	-	-	-	-	-	-	-	-	-	-	-	-	-	-	-	-	-	-
	Extended external input status notification signal (GS658 to GS665)	-	-	-	-	-	-	-	-	-	-	-	-	-	-	-	-	-	-	-	-	-	-	-	-	-	-
	Sound status information (GS668)	-	-	-	-	-	-	-	-	-	-	-	-	-	-	-	-	-	-	-	-	-	-	-	-	-	-
b15	Jack disconnection notification signal	-	-	-	-	-	-	-	-	-	-	-	-	-	-	-	-	-	-	-	-	-	-	-	-	-	-

○ : Relevant - : Irrelevant

Bit No. S	Item	Logging function	Recipe function	Advanced recipe function	Device data transfer function	Status observation function	Trigger action function	Time action function	Script function	Barcode function	RFID function	Remote personal computer operation (Serial)	Remote personal computer operation (Ethernet)	VNC® server function	Video display function	Multimedia function	Operation panel/External I/O function	RGB display function	Report function	Hardcopy function	Sound output function	Set overlay screen function	Document display function	Test function	Gateway function	MES interface function	Station No. switching function	Key windows
	Microcomputer connection (serial) extended setting (CH1) (GS580)	-	-	-	-	-	-	-	-	-	-	-	-	-	-	-	-	-	-	-	-	-	-	-	-	-	-	-
b0	Digital compatible signal	-	-	-	-	-	-	-	-	-	-	-	-	-	-	-	-	-	-	-	-	-	-	-	-	-	-	-
	Microcomputer connection (serial) extended setting (CH2) (GS581)	-	-	-	-	-	-	-	-	-	-	-	-	-	-	-	-	-	-	-	-	-	-	-	-	-	-	-
b0	Digital compatible signal	-	-	-	-	-	-	-	-	-	-	-	-	-	-	-	-	-	-	-	-	-	-	-	-	-	-	-
	Microcomputer connection (serial) extended setting (CH3) (GS582)	-	-	-	-	-	-	-	-	-	-	-	-	-	-	-	-	-	-	-	-	-	-	-	-	-	-	-
b0	Digital compatible signal	-	-	-	-	-	-	-	-	-	-	-	-	-	-	-	-	-	-	-	-	-	-	-	-	-	-	-
	Microcomputer connection (serial) extended setting (CH4) (GS583)	-	-	-	-	-	-	-	-	-	-	-	-	-	-	-	-	-	-	-	-	-	-	-	-	-	-	-
b0	Digital compatible signal	-	-	-	-	-	-	-	-	-	-	-	-	-	-	-	-	-	-	-	-	-	-	-	-	-	-	-
	MODBUS communication control function (CH1) (GS590 to 596)	-	-	-	-	-	-	-	-	-	-	-	-	-	-	-	-	-	-	-	-	-	-	-	-	-	-	-
	MODBUS communication control function (CH2) (GS597 to 603)	-	-	-	-	-	-	-	-	-	-	-	-	-	-	-	-	-	-	-	-	-	-	-	-	-	-	-
	MODBUS communication control function (CH1) (GS604 to 610)	-	-	-	-	-	-	-	-	-	-	-	-	-	-	-	-	-	-	-	-	-	-	-	-	-	-	-
	MODBUS communication control function (CH1) (GS611 to 617)	-	-	-	-	-	-	-	-	-	-	-	-	-	-	-	-	-	-	-	-	-	-	-	-	-	-	-
	Touch position color acquisition ready signal (GS630)	-	-	-	-	-	-	-	-	-	-	-	-	-	-	-	-	○	-	-	-	-	-	-	-	-	-	-
	Maintenance time notification cancel control (GS638)	-	-	-	-	-	-	-	-	-	-	-	-	-	-	-	-	-	-	-	-	-	-	-	-	-	-	-
b0, b4	Backlight maintenance time notification cancel signal	-	-	-	-	-	-	-	-	-	-	-	-	-	-	-	-	-	-	-	-	-	-	-	-	-	-	-
b1, b5	Display section maintenance time notification cancel signal	-	-	-	-	-	-	-	-	-	-	-	-	-	-	-	-	-	-	-	-	-	-	-	-	-	-	-
b2, b6	Touch key maintenance time notification cancel signal	-	-	-	-	-	-	-	-	-	-	-	-	-	-	-	-	-	-	-	-	-	-	-	-	-	-	-
b3, b7	Build-in flash memory maintenance time notification cancel signal	-	-	-	-	-	-	-	-	-	-	-	-	-	-	-	-	-	-	-	-	-	-	-	-	-	-	-
	GOT reset control (GS639)	-	-	-	-	-	-	-	-	-	-	-	-	-	-	-	-	-	-	-	-	-	-	-	-	-	-	-
	Error device data transfer ID (GS642)	-	-	-	○	-	-	-	-	-	-	-	-	-	-	-	-	-	-	-	-	-	-	-	-	-	-	-
	Device data transfer error count (GS643)	-	-	-	○	-	-	-	-	-	-	-	-	-	-	-	-	-	-	-	-	-	-	-	-	-	-	-
	Device data transfer processing time (GS644)	-	-	-	○	-	-	-	-	-	-	-	-	-	-	-	-	-	-	-	-	-	-	-	-	-	-	-
	Device data transfer ID (GS645)	-	-	-	○	-	-	-	-	-	-	-	-	-	-	-	-	-	-	-	-	-	-	-	-	-	-	-
	Device data transfer min. processing time (GS646)	-	-	-	○	-	-	-	-	-	-	-	-	-	-	-	-	-	-	-	-	-	-	-	-	-	-	-
	Device data transfer ID (min. processing time) (GS647)	-	-	-	○	-	-	-	-	-	-	-	-	-	-	-	-	-	-	-	-	-	-	-	-	-	-	-
	Device data transfer max. processing time (GS648)	-	-	-	○	-	-	-	-	-	-	-	-	-	-	-	-	-	-	-	-	-	-	-	-	-	-	-
	Device data transfer ID (max. processing time) (GS649)	-	-	-	○	-	-	-	-	-	-	-	-	-	-	-	-	-	-	-	-	-	-	-	-	-	-	-
	Present time (GS650 to 653)	-	-	-	-	-	-	-	-	-	-	-	-	-	-	-	-	-	-	-	-	-	-	-	-	-	-	-
	Touch status external notification (X-coordinate) (GS654)	-	-	-	-	-	-	-	-	-	-	○	○	-	-	-	-	-	-	-	-	-	-	-	-	-	-	-
	Touch status external notification (Y-coordinate) (GS655)	-	-	-	-	-	-	-	-	-	-	○	○	-	-	-	-	-	-	-	-	-	-	-	-	-	-	-
	Touch status external notification (touch status) (GS656)	-	-	-	-	-	-	-	-	-	-	○	○	-	-	-	-	-	-	-	-	-	-	-	-	-	-	-
	Trigger backup processing setting No. notification (GS657)	-	-	-	-	-	-	-	-	-	-	-	-	-	-	-	-	-	-	-	-	-	-	-	-	-	-	-
	Extended external input status notification signal (GS658 to GS665)	-	-	-	-	-	-	-	-	-	-	-	-	-	-	-	○	-	-	-	-	-	-	-	-	-	-	-
	Sound status information (GS668)	-	-	-	-	-	-	-	-	-	-	-	-	-	-	-	-	-	-	-	-	○	-	-	-	-	-	-
b15	Jack disconnection notification signal	-	-	-	-	-	-	-	-	-	-	-	-	-	-	-	-	-	-	-	-	○	-	-	-	-	-	-

8 COMMUNICATION WITH GOT  
 9 USEFUL FUNCTIONS FOR DRAWING  
 10 USEFUL FUNCTIONS FOR USING GOT  
 APPENDICES

○ : Relevant - : Irrelevant

Bit No. S	Item	Touch switch	Lamp	Numerical display	Numerical input	ASCII display	ASCII input	Data list	Historical data list display	Date display/Time display	Comment display	Advanced user alarm display	Advanced system alarm display	Advanced alarm popup display (User alarm)	Advanced alarm popup display (System alarm)	User alarm display	System alarm display	Alarm history display	Scrolling alarm display	Level	Panel meter	Line/Trend/Bar graph	Statistics bar/Statistics pie/Scatter graph	Historical trend graph	Parts display	Parts movement	Operation log function
	Sound file number during play (GS669)	-	-	-	-	-	-	-	-	-	-	-	-	-	-	-	-	-	-	-	-	-	-	-	-	-	
	No. of trigger buffer data (GS670)	-	-	-	-	-	-	-	-	-	-	-	-	-	-	-	-	-	-	-	-	-	-	-	-	-	
	Trigger buffer overflow count (GS671)	-	-	-	-	-	-	-	-	-	-	-	-	-	-	-	-	-	-	-	-	-	-	-	-	-	
	Trigger buffer overflow flag per job (GS672 to GS675)	-	-	-	-	-	-	-	-	-	-	-	-	-	-	-	-	-	-	-	-	-	-	-	-	-	
	Maintenance time notification information (GS680)	-	-	-	-	-	-	-	-	-	-	-	-	-	-	-	-	-	-	-	-	-	-	-	-	-	
b0, b4	Backlight maintenance time notification signal	-	-	-	-	-	-	-	-	-	-	-	-	-	-	-	-	-	-	-	-	-	-	-	-	-	
b1, b5	Display section maintenance time notification signal	-	-	-	-	-	-	-	-	-	-	-	-	-	-	-	-	-	-	-	-	-	-	-	-	-	
b2, b6	Touch key maintenance time notification signal	-	-	-	-	-	-	-	-	-	-	-	-	-	-	-	-	-	-	-	-	-	-	-	-	-	
b3, b7	Built-in flash memory maintenance time notification signal	-	-	-	-	-	-	-	-	-	-	-	-	-	-	-	-	-	-	-	-	-	-	-	-	-	
	Backlight power ON addition time (GS681, 682)	-	-	-	-	-	-	-	-	-	-	-	-	-	-	-	-	-	-	-	-	-	-	-	-	-	
	Display section power ON addition time (GS683, 684)	-	-	-	-	-	-	-	-	-	-	-	-	-	-	-	-	-	-	-	-	-	-	-	-	-	
	Built-in flash memory writing times (GS685, 686)	-	-	-	-	-	-	-	-	-	-	-	-	-	-	-	-	-	-	-	-	-	-	-	-	-	
	Touch key pushing addition times No.0 (GS700, 701) to No.139 (GS978, 979)	-	-	-	-	-	-	-	-	-	-	-	-	-	-	-	-	-	-	-	-	-	-	-	-	-	
	Touch position color acquisition complete signal (GS980)	-	-	-	-	-	-	-	-	-	-	-	-	-	-	-	-	-	-	-	-	-	-	-	-	-	
	Touch position color (GS981 to 983)	-	-	-	-	-	-	-	-	-	-	-	-	-	-	-	-	-	-	-	-	-	-	-	-	-	
	Authorization guarantee status notification signal (GS984)	-	-	-	-	-	-	-	-	-	-	-	-	-	-	-	-	-	-	-	-	-	-	-	-	-	
	Executing file transfer ID notification(GS987)	-	-	-	-	-	-	-	-	-	-	-	-	-	-	-	-	-	-	-	-	-	-	-	-	-	
	Communicating FTP server ID notification(GS988)	-	-	-	-	-	-	-	-	-	-	-	-	-	-	-	-	-	-	-	-	-	-	-	-	-	
	FTP communication error No. notification(GS989)	-	-	-	-	-	-	-	-	-	-	-	-	-	-	-	-	-	-	-	-	-	-	-	-	-	
	FTP communication status notification(GS990)	-	-	-	-	-	-	-	-	-	-	-	-	-	-	-	-	-	-	-	-	-	-	-	-	-	
b0	File writing notification signal	-	-	-	-	-	-	-	-	-	-	-	-	-	-	-	-	-	-	-	-	-	-	-	-	-	
b1	File reading notification signal	-	-	-	-	-	-	-	-	-	-	-	-	-	-	-	-	-	-	-	-	-	-	-	-	-	
b2	FTP server connection mode notification signal	-	-	-	-	-	-	-	-	-	-	-	-	-	-	-	-	-	-	-	-	-	-	-	-	-	
b14	Warning notification signal	-	-	-	-	-	-	-	-	-	-	-	-	-	-	-	-	-	-	-	-	-	-	-	-	-	
b15	FTP communication error notification signal	-	-	-	-	-	-	-	-	-	-	-	-	-	-	-	-	-	-	-	-	-	-	-	-	-	
	FTP transfer target file count notification (GS991)	-	-	-	-	-	-	-	-	-	-	-	-	-	-	-	-	-	-	-	-	-	-	-	-	-	
	FTP transfer completion file count notification (GS992)	-	-	-	-	-	-	-	-	-	-	-	-	-	-	-	-	-	-	-	-	-	-	-	-	-	
	USB drive common information (GS1024)	-	-	-	-	-	-	-	-	-	-	-	-	-	-	-	-	-	-	-	-	-	-	-	-	-	
	RGB signal input status notification (GS1025)	-	-	-	-	-	-	-	-	-	-	-	-	-	-	-	-	-	-	-	-	-	-	-	-	-	
	RGB signal resolution (horizontal) (GS1026)	-	-	-	-	-	-	-	-	-	-	-	-	-	-	-	-	-	-	-	-	-	-	-	-	-	
	RGB signal resolution (vertical) (GS1027)	-	-	-	-	-	-	-	-	-	-	-	-	-	-	-	-	-	-	-	-	-	-	-	-	-	
	RGB signal refresh rate (GS1028)	-	-	-	-	-	-	-	-	-	-	-	-	-	-	-	-	-	-	-	-	-	-	-	-	-	
	VNC® server operation status notification (GS1230)	-	-	-	-	-	-	-	-	-	-	-	-	-	-	-	-	-	-	-	-	-	-	-	-	-	
b0	VNC® client communication status notification signal	-	-	-	-	-	-	-	-	-	-	-	-	-	-	-	-	-	-	-	-	-	-	-	-	-	



○ : Relevant - : Irrelevant

Bit No. S	Item	Logging function	Recipe function	Advanced recipe function	Device data transfer function	Status observation function	Trigger action function	Time action function	Script function	Barcode function	RFID function	Remote personal computer operation (Serial)	Remote personal computer operation (Ethernet)	VNC® server function	Video display function	Multimedia function	Operation panel/External I/O function	RGB display function	Report function	Hardcopy function	Sound output function	Set overlay screen function	Document display function	Test function	Gateway function	MES interface function	Station No. switching function	Key windows
	Sound file number during play (GS669)	-	-	-	-	-	-	-	-	-	-	-	-	-	-	-	-	-	-	-	-	○	-	-	-	-	-	-
	No. of trigger buffer data (GS670)	-	-	-	-	-	-	-	-	-	-	-	-	-	-	-	-	-	-	-	-	-	-	-	-	○	-	-
	Trigger buffer overflow count (GS671)	-	-	-	-	-	-	-	-	-	-	-	-	-	-	-	-	-	-	-	-	-	-	-	-	○	-	-
	Trigger buffer overflow flag per job (GS672 to GS675)	-	-	-	-	-	-	-	-	-	-	-	-	-	-	-	-	-	-	-	-	-	-	-	-	○	-	-
	Maintenance time notification information (GS680)	-	-	-	-	-	-	-	-	-	-	-	-	-	-	-	-	-	-	-	-	-	-	-	-	-	-	-
b0, b4	Backlight maintenance time notification signal	-	-	-	-	-	-	-	-	-	-	-	-	-	-	-	-	-	-	-	-	-	-	-	-	-	-	-
b1, b5	Display section maintenance time notification signal	-	-	-	-	-	-	-	-	-	-	-	-	-	-	-	-	-	-	-	-	-	-	-	-	-	-	-
b2, b6	Touch key maintenance time notification signal	-	-	-	-	-	-	-	-	-	-	-	-	-	-	-	-	-	-	-	-	-	-	-	-	-	-	-
b3, b7	Built-in flash memory maintenance time notification signal	-	-	-	-	-	-	-	-	-	-	-	-	-	-	-	-	-	-	-	-	-	-	-	-	-	-	-
	Backlight power ON addition time (GS681, 682)	-	-	-	-	-	-	-	-	-	-	-	-	-	-	-	-	-	-	-	-	-	-	-	-	-	-	-
	Display section power ON addition time (GS683, 684)	-	-	-	-	-	-	-	-	-	-	-	-	-	-	-	-	-	-	-	-	-	-	-	-	-	-	-
	Built-in flash memory writing times (GS685, 686)	-	-	-	-	-	-	-	-	-	-	-	-	-	-	-	-	-	-	-	-	-	-	-	-	-	-	-
	Touch key pushing addition times No.0 (GS700, 701) to No.139 (GS978, 979)	-	-	-	-	-	-	-	-	-	-	-	-	-	-	-	-	-	-	-	-	-	-	-	-	-	-	-
	Touch position color acquisition complete signal (GS980)	-	-	-	-	-	-	-	-	-	-	-	-	-	-	-	-	○	-	-	-	-	-	-	-	-	-	-
	Touch position color (GS981 to 983)	-	-	-	-	-	-	-	-	-	-	-	-	-	-	-	-	○	-	-	-	-	-	-	-	-	-	-
	Authorization guarantee status notification signal (GS984)	-	-	-	-	-	-	-	-	-	-	-	-	-	-	-	-	-	-	-	-	-	-	-	-	-	-	-
	Executing file transfer ID notification(GS987)	-	-	-	-	-	-	-	-	-	-	-	-	-	-	-	-	-	-	-	-	-	-	-	○	-	-	-
	Communicating FTP server ID notification(GS988)	-	-	-	-	-	-	-	-	-	-	-	-	-	-	-	-	-	-	-	-	-	-	-	○	-	-	-
	FTP communication error No. notification(GS989)	-	-	-	-	-	-	-	-	-	-	-	-	-	-	-	-	-	-	-	-	-	-	-	○	-	-	-
	FTP communication status notification(GS990)	-	-	-	-	-	-	-	-	-	-	-	-	-	-	-	-	-	-	-	-	-	-	-	○	-	-	-
b0	File writing notification signal	-	-	-	-	-	-	-	-	-	-	-	-	-	-	-	-	-	-	-	-	-	-	-	○	-	-	-
b1	File reading notification signal	-	-	-	-	-	-	-	-	-	-	-	-	-	-	-	-	-	-	-	-	-	-	-	○	-	-	-
b2	FTP server connection mode notification signal	-	-	-	-	-	-	-	-	-	-	-	-	-	-	-	-	-	-	-	-	-	-	-	○	-	-	-
b14	Warning notification signal	-	-	-	-	-	-	-	-	-	-	-	-	-	-	-	-	-	-	-	-	-	-	-	○	-	-	-
b15	FTP communication error notification signal	-	-	-	-	-	-	-	-	-	-	-	-	-	-	-	-	-	-	-	-	-	-	-	○	-	-	-
	FTP transfer target file count notification (GS991)	-	-	-	-	-	-	-	-	-	-	-	-	-	-	-	-	-	-	-	-	-	-	-	○	-	-	-
	FTP transfer completion file count notification (GS992)	-	-	-	-	-	-	-	-	-	-	-	-	-	-	-	-	-	-	-	-	-	-	-	○	-	-	-
	USB drive common information (GS1024)	-	-	-	-	-	-	-	-	-	-	-	-	-	-	-	-	-	-	-	-	-	-	-	-	-	-	-
	RGB signal input status notification (GS1025)	-	-	-	-	-	-	-	-	-	-	-	-	-	-	-	-	○	-	-	-	-	-	-	-	-	-	-
	RGB signal resolution (horizontal) (GS1026)	-	-	-	-	-	-	-	-	-	-	-	-	-	-	-	-	○	-	-	-	-	-	-	-	-	-	-
	RGB signal resolution (vertical) (GS1027)	-	-	-	-	-	-	-	-	-	-	-	-	-	-	-	-	○	-	-	-	-	-	-	-	-	-	-
	RGB signal refresh rate (GS1028)	-	-	-	-	-	-	-	-	-	-	-	-	-	-	-	-	○	-	-	-	-	-	-	-	-	-	-
	VNC® server operation status notification (GS1230)	-	-	-	-	-	-	-	-	-	-	-	-	○	-	-	-	-	-	-	-	-	-	-	-	-	-	-
b0	VNC® client communication status notification signal	-	-	-	-	-	-	-	-	-	-	-	-	○	-	-	-	-	-	-	-	-	-	-	-	-	-	-

8  
COMMUNICATION WITH GOT  
9  
USEFUL FUNCTIONS FOR DRAWING  
10  
USEFUL FUNCTIONS FOR USING GOT  
APPENDICES

○ : Relevant - : Irrelevant

Bit No. S	Item	Touch switch	Lamp	Numerical display	Numerical Input	ASCII display	ASCII Input	Data list	Historical data list display	Date display/Time display	Comment display	Advanced user alarm display	Advanced system alarm display	Advanced alarm popup display (User alarm)	Advanced alarm popup display (System alarm)	User alarm display	System alarm display	Alarm history display	Scrolling alarm display	Panel meter	Line/Trend/Bar graph	Statistics bar/Statistics pie/Scatter graph	Historical trend graph	Parts display	Parts movement	Operation log function
b1	VNC® client operation mode notification signal	-	-	-	-	-	-	-	-	-	-	-	-	-	-	-	-	-	-	-	-	-	-	-	-	-
b2	Authorized equipment notification signal	-	-	-	-	-	-	-	-	-	-	-	-	-	-	-	-	-	-	-	-	-	-	-	-	-
	Communicating VNC® client information notification (GS1231, 1232)	-	-	-	-	-	-	-	-	-	-	-	-	-	-	-	-	-	-	-	-	-	-	-	-	-
	VNC® server authorization guarantee status notification (GS1233)	-	-	-	-	-	-	-	-	-	-	-	-	-	-	-	-	-	-	-	-	-	-	-	-	-
	Insufficient security level notification (GS1241)	-	-	-	-	-	-	-	-	-	-	-	-	-	-	-	-	-	-	-	-	-	-	-	-	-
	VNC® server function control (GS1792)	-	-	-	-	-	-	-	-	-	-	-	-	-	-	-	-	-	-	-	-	-	-	-	-	-
b0	VNC® client communication control signal	-	-	-	-	-	-	-	-	-	-	-	-	-	-	-	-	-	-	-	-	-	-	-	-	-
b1	VNC® client operation control signal	-	-	-	-	-	-	-	-	-	-	-	-	-	-	-	-	-	-	-	-	-	-	-	-	-
b8	Authorization guarantee time cancel signal	-	-	-	-	-	-	-	-	-	-	-	-	-	-	-	-	-	-	-	-	-	-	-	-	-
	USB drive common control (GS1824)	-	-	-	-	-	-	-	-	-	-	-	-	-	-	-	-	-	-	-	-	-	-	-	-	-
	Full-screen display control signal (GS1998)	-	-	-	-	-	-	-	-	-	-	-	-	-	-	-	-	-	-	-	-	-	-	-	-	-
	Video window 1 extended control signal (GS1999 to GS2006)	-	-	-	-	-	-	-	-	-	-	-	-	-	-	-	-	-	-	-	-	-	-	-	-	-
	Video window 2 extended control signal (GS2009 to GS2016)	-	-	-	-	-	-	-	-	-	-	-	-	-	-	-	-	-	-	-	-	-	-	-	-	-
	Video window 3 extended control signal (GS2019 to GS2026)	-	-	-	-	-	-	-	-	-	-	-	-	-	-	-	-	-	-	-	-	-	-	-	-	-
	Video window 4 extended control signal (GS2029 to GS2036)	-	-	-	-	-	-	-	-	-	-	-	-	-	-	-	-	-	-	-	-	-	-	-	-	-
	RGB screen extended control signal (GS2039 to GS2045)	-	-	-	-	-	-	-	-	-	-	-	-	-	-	-	-	-	-	-	-	-	-	-	-	-

○ : Relevant - : Irrelevant

Bit No. S	Item	Logging function	Recipe function	Advanced recipe function	Device data transfer function	Status observation function	Trigger action function	Time action function	Script function	Barcode function	RFID function	Remote personal computer operation (Serial)	Remote personal computer operation (Ethernet)	VNC® server function	Video display function	Multimedia function	Operation panel/External I/O function	RGB display function	Report function	Hardcopy function	Sound output function	Set overlay screen function	Document display function	Test function	Gateway function	MES interface function	Station No. switching function	Key windows
b1	VNC® client operation mode notification signal	-	-	-	-	-	-	-	-	-	-	-	-	○	-	-	-	-	-	-	-	-	-	-	-	-	-	-
b2	Authorized equipment notification signal	-	-	-	-	-	-	-	-	-	-	-	-	○	-	-	-	-	-	-	-	-	-	-	-	-	-	-
	Communicating VNC® client information notification (GS1231, 1232)	-	-	-	-	-	-	-	-	-	-	-	-	○	-	-	-	-	-	-	-	-	-	-	-	-	-	-
	VNC® server authorization guarantee status notification (GS1233)	-	-	-	-	-	-	-	-	-	-	-	-	○	-	-	-	-	-	-	-	-	-	-	-	-	-	-
	Insufficient security level notification (GS1241)	-	-	-	-	-	-	-	-	-	-	-	-	-	-	-	-	-	-	-	-	-	-	-	-	-	-	-
	VNC® server function control (GS1792)	-	-	-	-	-	-	-	-	-	-	-	-	○	-	-	-	-	-	-	-	-	-	-	-	-	-	-
b0	VNC® client communication control signal	-	-	-	-	-	-	-	-	-	-	-	-	○	-	-	-	-	-	-	-	-	-	-	-	-	-	-
b1	VNC® client operation control signal	-	-	-	-	-	-	-	-	-	-	-	-	○	-	-	-	-	-	-	-	-	-	-	-	-	-	-
b8	Authorization guarantee time cancel signal	-	-	-	-	-	-	-	-	-	-	-	-	○	-	-	-	-	-	-	-	-	-	-	-	-	-	-
	USB drive common control (GS1824)	-	-	-	-	-	-	-	-	-	-	-	-	-	-	-	-	-	-	-	-	-	-	-	-	-	-	-
	Full-screen display control signal (GS1998)	-	-	-	-	-	-	-	-	-	-	-	-	-	○	-	○	-	-	-	-	-	-	-	-	-	-	-
	Video window 1 extended control signal (GS1999 to GS2006)	-	-	-	-	-	-	-	-	-	-	-	-	-	○	-	-	-	-	-	-	-	-	-	-	-	-	-
	Video window 2 extended control signal (GS2009 to GS2016)	-	-	-	-	-	-	-	-	-	-	-	-	-	○	-	-	-	-	-	-	-	-	-	-	-	-	-
	Video window 3 extended control signal (GS2019 to GS2026)	-	-	-	-	-	-	-	-	-	-	-	-	-	○	-	-	-	-	-	-	-	-	-	-	-	-	-
	Video window 4 extended control signal (GS2029 to GS2036)	-	-	-	-	-	-	-	-	-	-	-	-	-	○	-	-	-	-	-	-	-	-	-	-	-	-	-
	RGB screen extended control signal (GS2039 to GS2045)	-	-	-	-	-	-	-	-	-	-	-	-	-	○	-	○	-	-	-	-	-	-	-	-	-	-	-

8 COMMUNICATION WITH GOT  
 9 USEFUL FUNCTIONS FOR DRAWING  
 10 USEFUL FUNCTIONS FOR USING GOT  
 APPENDICES

## Appendix9 Precautions for Using Unicode Text File

---

The following describes precautions to be attended to when using the Unicode text file that has been imported/exported by GT Designer3.

### ■ How to store Unicode text file

To use the exported and edited Unicode text file again, store it in the Unicode text file format (\*.txt).  
The character code applicable to Unicode text file is Unicode (file format: UTF16 LittleEndian).

### ■ Displaying Unicode text file

To display the Unicode text file on a personal computer or others, use a software compatible to the Unicode.  
If the software used to display the Unicode text file is not compatible to the Unicode, the file may not be displayed correctly.

### ■ Displaying Unicode text file with Microsoft® Excel

To open a Unicode text file that contains a comment of multiple lines by the Microsoft® Excel, drag the Unicode text file to the Microsoft® Excel.

If the Unicode text file is opened in other methods, it may not be displayed in the Microsoft® Excel correctly.

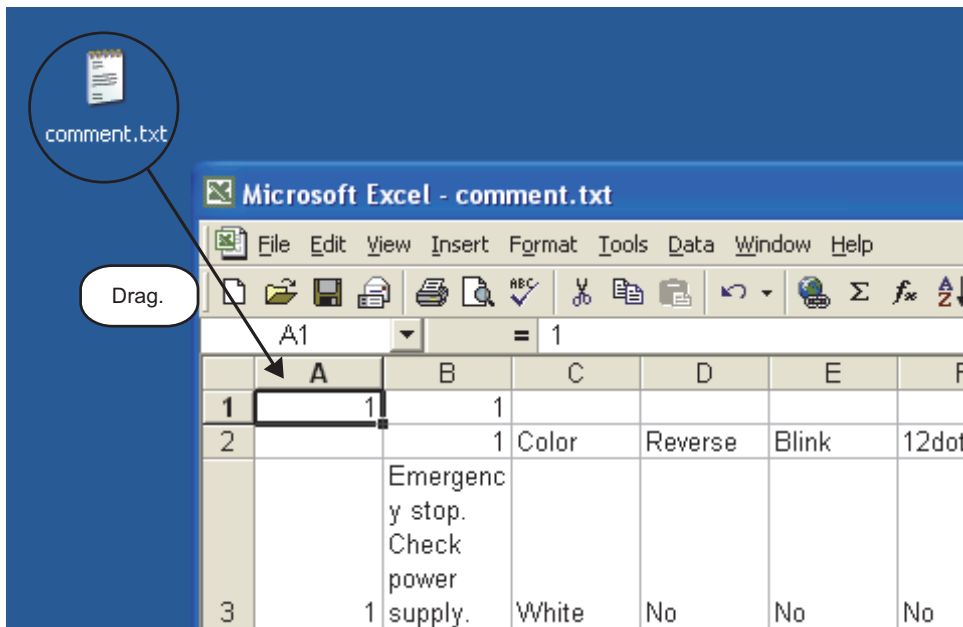

# Appendix10 Precautions for Option Function Board



The following shows the option function boards used for each GOT.

GOT	Option function board
GT16	GT16-MESB
GT15	GT15-FNB, GT15-QFNB, GT15-QFNB16M, GT15-QFNB32M, GT15-QFNB48M, GT15-MESB48M
GT14	Not necessary
GT12	Not necessary
GT11	GT11-50FNB
GT10	Not necessary

An option function board (GT15-FNB or GT11-50FNB) is built in the following GOTs.

GOT	Model	Description <sup>*1</sup>
GT15	All models	Function version D or later
	GT1155-QTBDQ, GT1155-QTBDA, GT1155-QSBDQ, GT1155-QSBDA, GT1150-QLBDQ, GT1150-QLBDA	
GT11	GT1155-QTBD	Hardware Version A or later
	GT1155HS-QSBD, GT1150HS-QLBD	Hardware Version B or later
	GT1155-QSBD, GT1150-QLBD	Hardware Version C or later

\*1 For how to check function versions and hardware versions, refer to the following manuals.

User's Manual for the GOT used

When using the above GOTs, the option functions operated with the GT15-FNB or GT11-50FNB can be used without installing any additional option function board.

For using functions operated with the GT16-MESB, GT15-QFNB (□M), or GT15-MESB48M, and for adding more memory to the GT15, install an applicable option function board.

For option function boards required for each option function, refer to the following.

GOT1000 Series User's Manual (Extended Functions, Option Functions) for GT Works3

An additional option function board can be installed on the GOT with a built-in option function board. (However, an option function board inapplicable to the GOT cannot be used. For example, the board for the GT15 cannot be installed on the GT16.)



# INDEX

- [A]**
  - Access control setting..... 3-75
- [B]**
  - Base Screen..... 2-5
  - Batch edit..... 9-29
  - Blank area ..... 3-53
  - BMP/JPEG file parts..... 4-192
  - BootOS ..... 8-103
- [C]**
  - Category list..... 9-25
  - Change password..... 3-79
  - Comment..... 4-141
    - Basic comment ..... 4-142
    - Comment group ..... 4-142
  - Communication with GOT
    - Reading from GOT..... 8-43
    - Verifying with GOT..... 8-49
    - Writing and installing on GOT ..... 8-26
  - Controller Type List ..... 3-3
- [D]**
  - Data check..... 3-70
  - Data operation ..... 5-87
  - Data size..... 9-47
  - Data view..... 9-33
  - Default value..... 3-29
  - Device..... 2-41,5-25,App-14
    - Controller device ..... 2-41,App-58
    - GOT internal device ..... 2-41,App-14
  - Device for screen switching..... 4-10
  - Device list ..... 9-34
  - Docking..... 3-19
  - Document Converter ..... 10-3
  - Document display function ..... 10-1
- [E]**
  - Edit vertices ..... 5-18
- [F]**
  - Figure ..... 2-14,5-1
  - Font ..... 2-17
    - HQ font..... 2-20
    - Standard font ..... 2-19
    - Stroke font..... 2-21
    - TrueType font..... 2-20
    - Windows(R) font ..... 2-22
  - Frame ..... 3-60
- [G]**
  - GOT bit register (GB) ..... 2-41,App-14
  - GOT data register (GD)..... 2-41,App-15
  - GOT Environmental Setting
    - Dialog Window ..... 4-25
    - GOT Setup ..... 4-115
    - Key Window ..... 4-34
    - Language Switching..... 4-20
    - Screen Switching/Window..... 4-10
    - Security ..... 4-84
    - Startup Logo..... 4-112
    - System Information ..... 4-63
  - GOT special register (GS) ..... 2-41,App-17
  - GOT Type Setting..... 4-3
  - Group..... 5-9
  - GT Designer3 ..... 1-1,3-3
    - Editor tab..... 3-4
    - Menu bar ..... 3-9
    - Project Tree..... 3-5
    - Screen editor..... 3-53
    - Screen Tree ..... 3-6
    - Status Bar ..... 3-3
    - System Tree..... 3-7
    - Title bar ..... 3-3
    - Tool bars ..... 3-10
    - View Window..... 3-3
  - GT Simulator3..... 9-50
  - Guidelines..... 5-13
- [I]**
  - Import Device Comment of GX Developer ..... 9-9
  - Import project..... 9-1
  - Import Tag of RS Logix5000..... 9-14
- [K]**
  - KANJI regions..... 2-29
- [L]**
  - Language switching device..... 4-20
  - Layer..... 2-13
  - Layer display..... 3-56
  - Library ..... 6-1
  - Library List ..... 6-4
  - Login ..... 3-80
- [M]**
  - Multi-language input function..... 9-44
- [O]**
  - Object ..... 5-1
  - Offset ..... 5-59
  - Operator authentication ..... 4-84,4-91,4-95
  - OS..... 8-95
    - Device Data Transfer ..... 8-115
    - Extended function ..... 8-113
    - Standard monitor OS ..... 8-107

<b>[P]</b>		
Parts .....	4-177	
Parts image list .....	4-179	
Password authentication .....	4-86,4-89,4-99	
Preview .....	3-61	
Print/File Output.....	3-84	
Print.....	3-85	
Print Common Setting .....	3-90	
Print Preview .....	3-92	
Project data .....	8-120	
Project format .....	2-3	
Compressed file .....	2-3	
G1 format .....	2-3	
GT Designer3 project.....	2-3	
GTD format .....	2-3	
GTE format.....	2-3	
Propertysheet .....	9-20	
<b>[R]</b>		
Redisplay .....	3-56	
Report Screen .....	2-5	
Resource data .....	8-121	
<b>[S]</b>		
Screen display area .....	3-53	
Security		
Restriction of the GOT display/operation		
.....	4-84,5-47	
Securing a project .....	3-72	
Set overlay screen function .....	10-19	
Simulator .....	9-50	
SoftGOT-GOT Link Function .....	10-35	
Special data .....	8-41	
Standard key window .....	4-36	
State .....	5-41	
Station No. switching device.....	4-132,4-134	
Superimposition.....	5-62	
Switching station No. function .....	4-132	
System label .....	2-41,5-28	
System label database .....	5-28	
System label update/check.....	5-32	
System library.....	6-3	
<b>[T]</b>		
Template.....	7-1	
Checking a template .....	7-39	
Creating a template attribute.....	7-50	
Deleting a figure or object from a template .....	7-45	
Deleting a figure/object attribute		
from a template attribute .....	7-52	
Deleting a template .....	7-53	
Deleting a template attribute .....	7-52	
Editing a template .....	7-41	
Registering a figure or object to a template .....	7-45	
Registering a figure/object attribute		
to a template attribute .....	7-51	
Registering a template in the library.....	7-53	
Template information box.....	7-2	
Templates in the system library .....	7-3	
Using a template .....	7-37	
Temporary area .....	3-53	
Text list .....	9-36	
Trigger (for display)/Trigger (for write) .....	5-75	
<b>[U]</b>		
USB Mouse/Keyboard Function .....	10-29	
User Management .....	3-74,3-77	
User-created key window .....	4-42	
User-created library .....	6-2	
My favorites .....	6-2	
My library.....	6-2	
Utility call key .....	4-116	
<b>[V]</b>		
Verify project.....	9-48	
<b>[W]</b>		
Window Position .....	4-13	
Window Screen.....	2-5	
Dialog Window .....	2-5,4-25	
Key Window .....	2-5	
Overlap Window .....	2-5	
Superimpose Window .....	2-5	
Work tree .....	3-5	



## REVISIONS

\* The manual number is given on the left bottom of the back cover.

Print Date	*Manual Number	Revision
Oct., 2009	SH(NA)-080866ENG-A	<p>First Printing: Compatible with GT Works3 Version1.01B</p> <p>The function of the initial communication time-out for GOT Modem Connection Tool will be supported soon.</p>
Nov., 2009	SH(NA)-080866ENG-B	<p>Compatible with GT Works3 Version1.05F</p> <p>The function of the initial communication time-out for GOT Modem Connection Tool is supported.</p> <ul style="list-style-type: none"> <li>• Interaction with iQ Works supported</li> <li>• System label in the device setting supported</li> <li>• System label update/check supported</li> <li>• System label search in the device list supported</li> <li>• Communication between a personal computer and the GOT via a modem supported</li> </ul>
Jan., 2010	SH(NA)-080866ENG-C	<p>Compatible with GT Works3 Version1.10L</p> <ul style="list-style-type: none"> <li>• Remote personal computer operation (Ethernet) supported</li> <li>• Storing the operator information read with RFID to a device at the operator authentication enabled</li> <li>• Auxiliary authentication at the operator authentication with the external authentication device or fingerprint unit supported</li> <li>• Restriction of displaying the ladder editor screen or device test operation screen in the system security setting supported</li> <li>• Forced logout of a login user for the operator authentication supported</li> <li>• USB mouse/keyboard function supported</li> <li>• Ethernet connection with FX CPUs supported</li> <li>• Ethernet connection with OMRON PLCs supported</li> <li>• Ethernet connection with microcomputers supported</li> <li>• Connection with LCPUs supported</li> <li>• MELSEC-L troubleshooting function for the special function switch supported</li> <li>• SoftGOT1000-GOT link function supported</li> </ul>
May, 2010	SH(NA)-080866ENG-D	<p>Compatible with GT Works3 Version1.14Q</p> <ul style="list-style-type: none"> <li>• Windows® 7 supported by GT Works3 Version1</li> <li>• GOT multi-drop connection for the GT16 and GT 15 supported</li> <li>• Character display in smaller size for the user alarm display and alarm history display enabled</li> <li>• OS installation via Ethernet supported</li> <li>• Holding project data and special data during the OS installation supported</li> </ul>

(Continued to next page)

\* The manual number is given on the left bottom of the back cover.

Print Date	*Manual Number	Revision
Jun., 2010	SH(NA)-080866ENG-E	<p>Compatible with GT Works3 Version1.17T</p> <ul style="list-style-type: none"> <li>• GT1675-VN, GT1672-VN, and GT1662-VN supported</li> <li>• Connection with C Controller modules supported</li> <li>• Connection with MELSEC-WS series supported</li> <li>• Connection with IAI robot controllers supported</li> <li>• Connection with SICK safety controllers supported</li> <li>• Connection with PANASONIC servo amplifiers supported</li> <li>• Connection with a serial printer supported</li> <li>• Switching images of shapes according to the status whether or not a touch switch is touched enabled</li> <li>• Motion SFC monitor and log viewer function for special function switch supported</li> <li>• Lamp area supported</li> <li>• Data input by barcode reader or RFID for numerical input or ASCII input enabled</li> <li>• Retaining data in the SRAM user area under power failure for the advanced user alarm, advanced system alarm, and logging function enabled</li> <li>• Editing a device comment for the advanced recipe function enabled</li> <li>• Data browser supported</li> <li>• Importing and exporting the setting of default values for objects enabled</li> <li>• Standard key window for ASCII characters supported</li> <li>• CF card formatting with FAT32 format type enabled</li> <li>• Intensity adjustment of backlight by the GOT special register (GS) enabled</li> </ul>
Oct., 2010	SH(NA)-080866ENG-F	<p>Compatible with GT Works3 Version1.19V</p> <ul style="list-style-type: none"> <li>• Opening a project without a workspace management file and a project management file supported</li> <li>• Overwriting compressed files supported</li> <li>• GB code and KS code for the ASCII display and the ASCII input supported</li> <li>• GB code and KS code of the ASCII display and the ASCII input for the operation log function supported</li> <li>• Switching between a lamp and a switch supported</li> <li>• Selecting whether to execute the system label update/check supported</li> <li>• Channel setting of the MODBUS communication control function supported</li> <li>• Notifying a network number and a station number by the GS devices with the Ethernet connection supported</li> </ul>

(Continued to next page)

\* The manual number is given on the left bottom of the back cover.

Print Date	*Manual Number	Revision
Jan., 2011	SH(NA)-080866ENG-G	<p>Compatible with GT Works3 Version1.23Z</p> <ul style="list-style-type: none"> <li>• Connection with the IAI ROBO CYLINDER supported</li> <li>• Connection with the TOSHIBA Unified Controller nv supported</li> <li>• Connection with the YAMATAKE DMC50 supported</li> <li>• Size range of the TrueType numerical font changed</li> <li>• Type of the device displayed on an object changed</li> <li>• Checking the operations of objects and window screens in the preview window supported</li> <li>• System language switching with the system language switching device supported</li> <li>• Disabling the utility call key setting in the GOT setup enabled</li> <li>• Authorization setting of the SoftGOT-GOT link function in the GOT setup supported</li> <li>• Changing settings of selected multiple objects in the property sheet supported</li> <li>• Batch change of colors in the data browser supported</li> <li>• Notifying a network number and a station number by using the GS devices with the Ethernet connection supported</li> <li>• The GT11 and the GT10 support the transparent setting of an image data.</li> <li>• The special function switch supports displaying screens of the utility.</li> <li>• Displaying the same alarm that has occurred multiple times individually in the alarm history</li> <li>• Fixing the display position of the scrolling alarm display enabled</li> <li>• Display mode for the trend graph supported</li> <li>• Single touch operation on the historical trend graph supported</li> <li>• Saving an operation log at the system language switching supported</li> <li>• Trigger action function supported</li> <li>• The GT11 and the GT10 support storing the time action setting as a file.</li> <li>• [Continuous] and [Separate] of the external control device setting for the time action setting added</li> <li>• The script function supports the file line read function for the file operation function.</li> <li>• The script function supports the string operation function.</li> <li>• Acquiring the touch position color for the RGB display function enabled</li> <li>• GT16 Handy GOT supported</li> </ul>
Apr., 2011	SH(NA)-080866ENG-H	<p>Compatible with GT Works3 Version1.28E</p> <ul style="list-style-type: none"> <li>• GT1655-V supported</li> <li>• [GT165*-V(640×480)] for the GOT type added</li> <li>• Historical data list display supported</li> <li>• The key code supports the operation of the historical data list display.</li> <li>• With the data check, the historical data list display devices are checked.</li> <li>• File transfer function (FTP client) supported</li> <li>• With the GS devices, the control or the status notification of the file transfer function (FTP client) supported</li> <li>• GT Designer3 Help supported</li> <li>• GT SoftGOT1000 supports the barcode function and the RFID function.</li> <li>• Ethernet connection with SIEMENS PLCs supported</li> </ul>

(Continued to next page)

\* The manual number is given on the left bottom of the back cover.

Print Date	*Manual Number	Revision
Jul., 2011	SH(NA)-080866ENG-I	<p>Compatible with GT Works3 Version1.31H</p> <ul style="list-style-type: none"> <li>• GT Works3 Version1 supports the 64-bit version of Windows® 7.</li> <li>• The GOT operator management information conversion tool supports the 64-bit version of Windows® 7.</li> <li>• Document Converter supports the 64-bit version of Windows® 7.</li> <li>• For the GT10, the range of the GOT internal devices (GB and GD) is extended.</li> <li>• The input range displayed on the key window is changed to the input range that can be entered.</li> <li>• ON shape display on the key window supported</li> <li>• Displaying the input comment information in the status bar and the [Edit Comment] dialog box supported</li> <li>• Template supported</li> <li>• The data browser supports searching for common settings and templates.</li> <li>• The data browser supports copying and pasting multiple cells.</li> <li>• Utility operation with the USB mouse or keyboard supported</li> <li>• Multilingualization of special data supported</li> <li>• Exporting and importing the communication parameters for the GT01-RS4-M supported</li> <li>• The setting of [Use the system information of Multidrop] supported</li> <li>• The special function switch supports displaying the motion program (SV43) edit screen.</li> <li>• The advanced user alarm display and the advanced system alarm display support the display position time specification jump.</li> <li>• The comment group setting for the user alarms supported</li> <li>• The number of bars for a bar graph is extended.</li> <li>• The multimedia function supports displaying a video image on a user-created screen.</li> <li>• The RGB display function supports the extended control.</li> <li>• The device ranges for the MELSEC-QnU/DC, Q17nD/M/NC/DR, and CRnD-700 are extended.</li> <li>• CC-Link IE Field Network connection supported</li> <li>• Connection with PANASONIC servo amplifiers (MINAS A5) supported</li> <li>• Connection with YOKOGAWA temperature controllers (UTAdvanced) supported</li> <li>• Converting an operator management information file with a command line supported</li> </ul>
Oct., 2011	SH(NA)-080866ENG-J	<p>Compatible with GT Works3 Version1.37P</p> <ul style="list-style-type: none"> <li>• GT14 supported</li> <li>• GT12 added</li> <li>• The file transfer function (FTP client) supports notifying the numbers of transfer target files and transfer completion files by using the GS devices.</li> <li>• Stopping background processing during the backup/restore function execution by using the GS device supported</li> <li>• VNC® server function supported</li> </ul>

(Continued to next page)

\* The manual number is given on the left bottom of the back cover.

Print Date	*Manual Number	Revision
Jan., 2012	SH(NA)-080866ENG-K	<p>Compatible with GT Works3 Version1.40S</p> <ul style="list-style-type: none"> <li>• Canceling the screen saver when screens are switched supported</li> <li>• For the GT14, GT11, GT105□, and GT104□, selecting the size of the key window for decimal/hexadecimal values supported</li> <li>• Displaying the guidelines (auxiliary lines) on the boundary between the screen display area and the temporary area supported</li> <li>• Creating and editing a template supported</li> <li>• The templates for the XGA and QVGA GOTs are added to the system library.</li> <li>• 5V power supply setting supported</li> <li>• Setting enabled when the touch switch does not operate supported</li> <li>• Data addition and data subtraction settings of the word switch supported</li> <li>• Specifying the logging ID of the historical trend graph by using devices supported</li> <li>• The numbers of settable script symbols and object script symbols are increased.</li> <li>• The device range for MELSEC-QnA/Q/QS,MELDAS C6* is expanded.</li> <li>• Notifying the GOT IP address by using GS devices supported</li> <li>• Disconnecting/connecting a station on the network by using the GS devices supported</li> </ul>
Apr., 2012	SH(NA)-080866ENG-L	<p>Compatible with GT Works3 Version1.45X</p> <ul style="list-style-type: none"> <li>• The project security supports the security for each screen.</li> <li>• Specifying the CPU No. at the backup supported</li> <li>• The screen switching supports specifying the screen number of a screen displayed at the GOT startup and displaying a screen with the screen number incremented by one.</li> <li>• Library data (AV, crystal, soft, retro, real, metallic, and clock) with templates are added to the system library.</li> </ul>
Jun., 2012	SH(NA)-080866ENG-M	<p>Compatible with GT Works3 Version1.54G</p> <ul style="list-style-type: none"> <li>• The company name of Panasonic Electric Works Co., Ltd. is changed to Panasonic Corporation.</li> <li>• The company name of Yamatake Corporation is changed to Azbil Corporation.</li> <li>• The numbers of settable advanced user alarm displays and advanced system alarm displays are changed from 1 to 8.</li> <li>• Some menu names and function names are partially changed.</li> <li>• Generating the route information for MELSOFT Navigator supported</li> <li>• MELSERVO J4-□A supported</li> <li>• The GT14 supports the printer output.</li> <li>• The GT10 supports the hard copy function.</li> <li>• The GT14 supports iQ Works.</li> </ul>
Sep., 2012	SH(NA)-080866ENG-N	<p>Compatible with GT Works3 Version1.58L</p> <ul style="list-style-type: none"> <li>• The GT14 supports the operator authentication.</li> <li>• The offset setting is not available for the special function switch, the parts display (fixed parts), and the parts movement (fixed parts).</li> <li>• Setting the communication timeout time for the file transfer function (FTP client) by using the GS device supported</li> <li>• Retaining the state of the historical trend graph displayed before screen switching by using the GS device supported</li> <li>• The device ranges for [MELSEC-QnU/DC, Q17nD/M/NC/DR, CRnD-700], [MELSEC-QnA/Q/QS, MELDAS C6*], [MELSEC-Q(Multi)/Q-Motion], and [MELSEC-L] are expanded.</li> <li>• Image format available for VNC® the server function added</li> </ul>

(Continued to next page)

\* The manual number is given on the left bottom of the back cover.

Print Date	*Manual Number	Revision
Nov., 2012	SH(NA)-080866ENG-O	Compatible with GT Works3 Version1.63R <ul style="list-style-type: none"> <li>• SAFETY PRECAUTIONS changed</li> <li>• The device range for [MELSEC-QnU/DC, Q17nD/M/NC/DR, CRnD-700] is expanded.</li> <li>• Shortcut keys added</li> </ul>
Feb., 2013	SH(NA)-080866ENG-P	Compatible with GT Works3 Version1.67V <ul style="list-style-type: none"> <li>• Image formats available for the VNC<sup>®</sup> server function added</li> <li>• The template icons to the tool bar added</li> <li>• GT14 supports the Kana-kanji conversion.</li> <li>• GT14 supports the VNC<sup>®</sup> server function.</li> <li>• CNC machining program edit supported</li> <li>• Communication with SIEMENS S7 Ethernet OP supported</li> <li>• The difference check for the file register in the trigger backup supported</li> <li>• Displaying the key window objects on the overlap window supported</li> </ul>
May, 2013	SH(NA)-080866ENG-Q	Compatible with GT Works3 Version1.70Y <ul style="list-style-type: none"> <li>• Batch edit of the network supported</li> </ul>
Jun., 2013	SH(NA)-080866ENG-R	Compatible with GT Works3 Version1.74C <ul style="list-style-type: none"> <li>• The company name of GE Fanuc Automation Corporation is changed to GE Intelligent Platforms.</li> <li>• The company name of Panasonic Corporation is changed to Panasonic Industrial Devices SUNX Co., Ltd.</li> <li>• The company name of Fuji Electric FA Components &amp; Systems Co., Ltd. is changed to FUJI ELECTRIC CO., LTD.</li> <li>• The company name of Fuji Electric Systems Co., Ltd. is changed to FUJI ELECTRIC CO., LTD.</li> <li>• GT Works3 Version1 supports Windows<sup>®</sup> 8.</li> <li>• GOT operator management information conversion tool supports Windows<sup>®</sup> 8.</li> <li>• Document Converter supports Windows<sup>®</sup> 8.</li> <li>• Ethernet connection with KEYENCE KV5000 supported</li> <li>• Displaying the shortcut keys in the menu of the preview window added</li> <li>• Consecutive copies of figures and objects to the function to perform the increment for the devices other than the monitor device supported</li> <li>• Changing the script additional setting when other project data is utilized is added.</li> </ul>
Sep., 2013	SH(NA)-080866ENG-S	Compatible with GT Works3 Version1.100E
Jan., 2014	SH(NA)-080866ENG-T	Compatible with GT Works3 Version1.108N <ul style="list-style-type: none"> <li>• The screen title of GT Designer3 is changed to MELSOFT GT Designer3.</li> <li>• Shortcut keys are partially changed.</li> <li>• [Open] is changed to [Open Project].</li> <li>• The buffer memory unit No. switching function is supported.</li> <li>• The ladder editor (enhanced), SFC monitor (enhanced), and GOT Function Expansion Library (enhanced) are added to the option OS.</li> <li>• The operation log function supports the buffer memory unit No. switching.</li> <li>• The hard copy function supports the constant trigger watch.</li> <li>• Connection with FREQROL-A800, F800 and E700EX supported</li> <li>• Connection with MELSERVO-JE supported</li> <li>• Connection with FX3GA supported</li> </ul>

(Continued to next page)

\* The manual number is given on the left bottom of the back cover.

Print Date	*Manual Number	Revision
Apr., 2014	SH(NA)-080866ENG-U	Compatible with GT Works3 Version1.112S <ul style="list-style-type: none"> <li>• Restructuring project data at the time of next data save supported</li> <li>• Screen switching while the screen is being touched supported</li> <li>• Connection with AB PLC (MicroLogix1400) supported</li> <li>• Device range extension of MicroLogix1000/1200/1400/1500 supported</li> <li>• Indirect station No. specification and all station numbers specification in MODBUS<sup>®</sup> connection supported</li> </ul>
Jun., 2014	SH(NA)-080866ENG-V	Compatible with GT Works3 Version1.117X <ul style="list-style-type: none"> <li>• Connection with MELSEC iQ-R Series and RnMT CPU supported.</li> <li>• The names of communication drivers A/QnA/L/Q CPU, LJ71C24, and QJ71C24 are changed to Serial (MELSEC).</li> </ul>
Jul., 2014	SH(NA)-080866ENG-W	Compatible with GT Works3 Version1.118Y <ul style="list-style-type: none"> <li>• Connection with FUJI PLCs (MICREX-SX SPH3000, SPH2000) supported</li> </ul>
Oct., 2014	SH(NA)-080866ENG-X	Compatible with GT Works3 Version1.122C <ul style="list-style-type: none"> <li>• GT Works3 Version1 is no longer compatible with Windows<sup>®</sup> XP Service Pack2 and Windows<sup>®</sup> 2000.</li> <li>• GT1450-QMBDE and GT1450-QMBD are supported.</li> </ul>
Jan., 2015	SH(NA)-080866ENG-Y	Compatible with GT Works3 Version1.126G <ul style="list-style-type: none"> <li>• Connection with MELSEC iQ-F is supported.</li> <li>• Varieties of the monitor devices of MELSERVO-J4-*A have been increased.</li> <li>• Connection with MELSERVO-J4-*A-RJ is supported.</li> </ul>
Apr., 2015	SH(NA)-080866ENG-Z	Compatible with GT Works3 Version1.130L <ul style="list-style-type: none"> <li>• Serial connection with FUJI PLCs (MICREX-SX SPH3000, SPH2000) is supported.</li> <li>• Varieties of the monitor devices of MELSERVO-J4-*A-RJ have been increased.</li> </ul>
May, 2015	SH(NA)-080866ENG-AA	Compatible with GT Works3 Version1.131M <ul style="list-style-type: none"> <li>• The operating environment of GT Works3 Version1 has been changed.</li> </ul>
Jul., 2015	SH(NA)-080866ENG-AB	Compatible with GT Works3 Version1.136S <ul style="list-style-type: none"> <li>• The ranges of the monitor devices for the MELSEC iQ-R series and RnMT CPU have been extended.</li> <li>• The folder name [MELSOFT Application] displayed in the Windows<sup>®</sup> start menu has been changed to [MELSOFT].</li> </ul>
Oct., 2015	SH(NA)-080866ENG-AC	Compatible with GT Works3 Version1.144A <ul style="list-style-type: none"> <li>• The ranges of the monitor devices for the MELSEC iQ-R series and MELSEC iQ-F series have been extended.</li> </ul>
Dec., 2015	SH(NA)-080866ENG-AD	Compatible with GT Works3 Version1.150G <ul style="list-style-type: none"> <li>• The description of the operating environment for GT Works3 Version1 has been changed.</li> <li>• The description of the operating environment for the GOT operator management information conversion tool has been changed.</li> <li>• The description of the operating environment for Document Converter has been changed.</li> <li>• The description of the operating environment for the multimedia interaction tool has been changed.</li> <li>• The description of SAFETY PRECAUTIONS has been changed.</li> </ul>

(Continued to next page)

\* The manual number is given on the left bottom of the back cover.

Print Date	*Manual Number	Revision
May, 2016	SH(NA)-080866ENG-AE	Compatible with GT Works3 Version1.155M <ul style="list-style-type: none"> <li>• Outputting the MELSOFT iQ AppPortal information file is supported.</li> <li>• GT Works3 Version1 supports Windows® 10.</li> <li>• GOT operator management information conversion tool supports Windows® 10.</li> <li>• Document Converter supports Windows® 10.</li> </ul>
Aug., 2016	SH(NA)-080866ENG-AF	• Partial corrections
Jan., 2017	SH(NA)-080866ENG-AG	• Partial corrections
Jun., 2017	SH(NA)-080866ENG-AH	• Partial corrections
Oct., 2017	SH(NA)-080866ENG-AI	• Partial corrections
Apr., 2018	SH(NA)-080866ENG-AJ	• Partial corrections
Oct., 2019	SH(NA)-080866ENG-AK	• Partial corrections
Jan., 2020	SH(NA)-080866ENG-AL	• Partial corrections
Apr., 2020	SH(NA)-080866ENG-AM	Compatible with GT Works3 Version1.235V <ul style="list-style-type: none"> <li>• GT Works3 Version1 has ended support for Windows® Vista and Windows® XP.</li> <li>• Document Converter has ended support for Windows® Vista and Windows® XP.</li> </ul>
Aug., 2020	SH(NA)-080866ENG-AN	• Partial corrections
Jul., 2021	SH(NA)-080866ENG-AO	• Partial corrections
Apr., 2022	SH(NA)-080866ENG-AP	Compatible with GT Works3 Version1.275M <ul style="list-style-type: none"> <li>• Compatible with Windows® 11</li> </ul>
Jul., 2022	SH(NA)-080866ENG-AQ	• Partial corrections
Apr., 2023	SH(NA)-080866ENG-AR	Compatible with GT Works3 Version1.295H <ul style="list-style-type: none"> <li>• GT Works3 Version1 has ended support for Windows® 8.1, Windows® 8, and Windows® 7.</li> <li>• Document Converter has ended support for Windows® 8.1, Windows® 8, and Windows® 7.</li> </ul>
Jul., 2023	SH(NA)-080866ENG-AS	• Partial corrections

This manual confers no industrial property rights or any other kind, nor does it confer any patent licenses. Mitsubishi Electric Corporation cannot be held responsible for any problems involving industrial property rights which may occur as a result of using the contents noted in this manual.



# **WARRANTY**

Please check the following product warranty details before using this product.

## ■ 1. **Gratis Warranty Term and Gratis Warranty Range**

If any faults or defects (hereinafter "Failure") found to be the responsibility of Mitsubishi occurs during use of the product within the gratis warranty term, the product shall be repaired at no cost via the sales representative or Mitsubishi Service Company. However, if repairs are required onsite at domestic or overseas location, expenses to send an engineer will be solely at the customer's discretion.

Mitsubishi shall not be held responsible for any re-commissioning, maintenance, or testing on-site that involves replacement of the failed module.

### (1) **Gratis Warranty Term**

The gratis warranty term of the product shall be for thirty-six (36) months after the date of purchase or delivery to a designated place.

Note that after manufacture and shipment from Mitsubishi, the maximum distribution period shall be six (6) months, and the longest gratis warranty term after manufacturing shall be forty-two (42) months.

The gratis warranty term of repair parts shall not exceed the gratis warranty term before repairs.

### (2) **Gratis Warranty Range**

- (a) The customer shall be responsible for the primary failure diagnosis unless otherwise specified.  
If requested by the customer, Mitsubishi Electric Corporation or its representative firm may carry out the primary failure diagnosis at the customer's expense.  
The primary failure diagnosis will, however, be free of charge should the cause of failure be attributable to Mitsubishi Electric Corporation.
- (b) The range shall be limited to normal use within the usage state, usage methods, and usage environment, etc., which follow the conditions and precautions, etc., given in the instruction manual, user's manual and caution labels on the product.
- (c) Even within the gratis warranty term, repairs shall be charged in the following cases.
  - Failure occurring from inappropriate storage or handling, carelessness or negligence by the user. Failure caused by the user's hardware or software design.
  - Failure caused by unapproved modifications, etc., to the product by the user.
  - When the Mitsubishi product is assembled into a user's device, Failure that could have been avoided if functions or structures, judged as necessary in the legal safety measures the user's device is subject to or as necessary by industry standards, had been provided.
  - Failure that could have been avoided if consumable parts designated in the instruction manual had been correctly serviced or replaced.
  - Replacing consumable parts such as a battery, backlight, and fuse.
  - Failure caused by external irresistible forces such as fires or abnormal voltages, and Failure caused by force majeure such as earthquakes, lightning, wind and water damage.
  - Failure caused by reasons that could not be predicted by scientific technology standards at the time of shipment from Mitsubishi.
  - Any other failure found not to be the responsibility of Mitsubishi or that admitted not to be so by the user.

## ■ 2. **Onerous repair term after discontinuation of production**

- (1) Mitsubishi shall accept onerous product repairs for seven (7) years after production of the product is discontinued. Discontinuation of production shall be notified with Mitsubishi Technical Bulletins, etc.
- (2) Mitsubishi shall not accept a request for product supply (including spare parts) after production is discontinued.

## ■ 3. **Overseas service**

Overseas, repairs shall be accepted by Mitsubishi's local overseas FA Center.

Note that the repair conditions at each FA Center may differ.

## ■ 4. **Exclusion of loss in opportunity and secondary loss from warranty liability**

Regardless of the gratis warranty term, Mitsubishi shall not be liable for compensation to:

- (1) Damages caused by any cause found not to be the responsibility of Mitsubishi.
- (2) Loss in opportunity, lost profits incurred to the user by Failures of Mitsubishi products.
- (3) Special damages and secondary damages whether foreseeable or not, compensation for accidents, and compensation for damages to products other than Mitsubishi products.
- (4) Replacement by the user, maintenance of on-site equipment, start-up test run and other tasks.

## ■ 5. **Changes in product specifications**

The specifications given in the catalogs, manuals, or technical documents are subject to change without prior notice.

## ■ 6. **Product application**

- (1) In using the Mitsubishi graphic operation terminal, the usage conditions shall be that the application will not lead to a major accident even if any problem or fault should occur in the graphic operation terminal device, and that backup and fail-safe functions are systematically provided outside of the device for any problem or fault.
- (2) The Mitsubishi graphic operation terminal has been designed and manufactured for applications in general industries, etc. Thus, applications in which the public could be affected such as in nuclear power plants and other power plants operated by respective power companies, and applications in which a special quality assurance system is required, such as for Railway companies or Public service shall be excluded from the graphic operation terminal applications.  
In addition, applications in which human life or property could be greatly affected, such as in aircraft, medical, railway applications, incineration and fuel devices, manned transportation equipment, recreation and amusement devices, safety devices, shall also be excluded from the graphic operation terminal.  
Even for the above applications, however, Mitsubishi Electric Corporation may consider the possibility of an application, provided that the customer notifies Mitsubishi Electric Corporation of the intention, the application is clearly defined and any special quality is not required, after the user consults the local Mitsubishi representative.

## Intellectual Property Rights

### ■ Trademarks

GOT is a registered trademark of Mitsubishi Electric Corporation.

Microsoft, Microsoft Access, Excel, SQL Server, Visual Basic, Visual C++, Visual C#, Windows, Windows NT, Windows Server, and Windows Vista are trademarks of the Microsoft group of companies.

Adobe and Adobe Reader are registered trademarks of Adobe Systems Incorporated.

Intel, Intel Core, Pentium, and Celeron are trademarks or registered trademarks of Intel Corporation in the United States and other countries.

MODBUS is a trademark of Schneider Electric SA.

VNC is a registered trademark of RealVNC Ltd. in the United States and other countries.

Other company and product names herein are either trademarks or registered trademarks of their respective owners.

### ■ Copyrights

The screens (screenshots) are used in accordance with the Microsoft Corporation guideline.

This product uses Arphic Mobile Font.

VS-FlexGrid Pro

Copyright © 2003 ComponentOne LLC.

FreeType

Portions of this software are copyright ©2003 The FreeType

Project ([www.freetype.org](http://www.freetype.org)). All rights reserved.



SCREEN DESIGN SOFTWARE

# GT Designer3 Version1

Screen Design Manual **Fundamentals 1/2** **Fundamentals 2/2**

(For GOT1000 Series)

MODEL	SW1-GTD3-R(DRAW1)-E
MODEL CODE	_____
SH(NA)-080866ENG-AS 2/2(2307)MEE	

## MITSUBISHI ELECTRIC CORPORATION

HEAD OFFICE: TOKYO BLDG., 2-7-3, MARUNOUCHI, CHIYODA-KU, TOKYO 100-8310, JAPAN  
NAGOYA WORKS: 1-14, YADA-MINAMI 5-CHOME, HIGASHI-KU, NAGOYA 461-8670, JAPAN

When exported from Japan, this manual does not require application to the Ministry of Economy, Trade and Industry for service transaction permission.

Specifications subject to change without notice.