

# VECTOR INVERTER FR-V500 INSTRUCTION MANUAL (BASIC)

**FR-V520-1.5K to 55K**

**FR-V540-1.5K to 55K**

Thank you for choosing this Mitsubishi Electric Vector Inverter.

If this is the first time for you to use the FR-V500 series, please read through this Instruction Manual (basic) carefully to use the inverter safely.

When you are going to use the inverter for higher-leveled applications, please request the separately available FR-V500 Instruction Manual (detailed) [IB(NA)-0600131E] from where you purchased the inverter or a Mitsubishi Electric sales representative.

## Contents

<b>1</b>	<b>OUTLINE</b> .....	1
	1.1 Basic configuration and connection of peripheral devices.....	2
	1.2 Structure .....	4
<b>2</b>	<b>INSTALLATION AND WIRING</b> .....	6
	2.1 Installation of the inverter .....	6
	2.2 Connection diagram, encoder cable, PU connector .....	7
	2.3 Setting the motor .....	20
	2.4 Precautions for use of the vector inverter .....	22
<b>3</b>	<b>RUN AND OPERATION</b> .....	23
	3.1 Checks prior to test run .....	23
	3.2 Basic operation (Speed setting, run, speed meter adjustment).....	23
	3.3 Names and functions of the control panel .....	27
<b>4</b>	<b>CONTROL</b> .....	33
	4.1 Speed control operation .....	33
	4.2 Torque control operation .....	38
	4.3 Position control operation .....	44
	4.4 Control mode switchover timing .....	45
	4.5 Easy gain tuning .....	47
	4.6 Online auto tuning .....	50
	4.7 Biases and gains of speed setting terminals (Pr. 902 to Pr. 905, Pr. 917 to Pr. 920).....	51
<b>5</b>	<b>PARAMETERS</b> .....	54
	5.1 Function list (Simple mode parameters).....	54
	5.2 Function list (Extended function parameters).....	58
<b>6</b>	<b>ERRORS AND PROTECTIVE FUNCTIONS</b> .....	74
	6.1 Errors (Alarms) .....	74
	6.2 Correspondences between digital and actual characters .....	84
	6.3 Resetting the inverter .....	84
	6.4 Troubleshooting .....	85
<b>7</b>	<b>PRECAUTIONS FOR MAINTENANCE AND INSPECTION</b> .....	96
	7.1 Check items .....	96
	7.2 Replacement of parts .....	98
	7.3 Inverter replacement.....	100
	7.4 Measurement of main circuit voltages, currents and powers .....	101
<b>8</b>	<b>SPECIFICATIONS</b> .....	103
	8.1 Model specifications .....	103
	8.2 Common specifications .....	106
	8.3 Outline dimension drawings .....	107

1

2

3

4

5

6

7

8

This Instruction Manual (basic) provides handling information and precautions for use of the equipment. Please forward this Instruction Manual (basic) to the end user.

**This section is specifically about safety matters**

Do not attempt to install, operate, maintain or inspect the inverter until you have read through the Instruction Manual and appended documents carefully and can use the equipment correctly. Do not use the inverter until you have a full knowledge of the equipment, safety information and instructions. In this Instruction Manual, the safety instruction levels are classified into "WARNING" and "CAUTION".



**WARNING**

Assumes that incorrect handling may cause hazardous conditions, resulting in death or severe injury.



**CAUTION**

Assumes that incorrect handling may cause hazardous conditions, resulting in medium or slight injury, or may cause physical damage only.

Note that even the **CAUTION** level may lead to a serious consequence according to conditions. Please follow the instructions of both levels because they are important to personnel safety.

**1. Electric Shock Prevention**



**WARNING**

- While power is on or when the inverter is running, do not open the front cover. You may get an electric shock.
- Do not run the inverter with the front cover or wiring cover removed. Otherwise, you may access the exposed high-voltage terminals or the charging part of the circuitry and get an electric shock.
- Even If power is off, do not remove the front cover except for wiring or periodic inspection. You may access the charged inverter circuits and get an electric shock.
- Before starting wiring or inspection, check to make sure that the inverter power indicator lamp is off, wait for at least 10 minutes after the power supply has been switched off, and check that there are no residual voltage using a tester or the like. The capacitor is charged with high voltage for some time after power off and it is dangerous.
- This inverter must be earthed (grounded). Earthing (Grounding) must conform to the requirements of national and local safety regulations and electrical codes. (NEC section 250, IEC 536 class 1 and other applicable standards).
- Any person who is involved in wiring or inspection of this equipment should be fully competent to do the work.
- Always install the inverter before wiring. Otherwise, you may get an electric shock or be injured.
- Perform setting dial and key operations with dry hands to prevent an electric shock.
- Do not subject the cables to scratches, excessive stress, heavy loads or pinching. Otherwise, you may get an electric shock.
- Do not change the cooling fan while power is on. It is dangerous to change the cooling fan while power is on.

**2. Fire Prevention**



**CAUTION**

- Install the inverter on an incombustible wall without holes, etc. Mounting it to or near combustible material can cause a fire.
- If the inverter has become faulty, switch off the inverter power. A continuous flow of large current could cause a fire.
- When a brake resistor is used, use an alarm signal to switch power off. Otherwise, the brake resistor will overheat abnormally due to a brake transistor or other fault, resulting in a fire.
- Do not connect a resistor directly to the DC terminals P, N. This could cause a fire.

**3. Injury Prevention**



**CAUTION**

- Apply only the voltage specified in the instruction manual to each terminal to prevent damage etc.
- Ensure that the cables are connected to the correct terminals. Otherwise damage etc. may occur.
- Always make sure that polarity is correct to prevent damage etc.
- While power is on and for some time after power-off, do not touch the inverter or brake resistor as they are hot and you may get burnt.

**4. Additional Instructions**

Also note the following points to prevent an accidental failure, injury, electric shock, etc.

**1) Transportation and installation**



**CAUTION**

- When carrying products, use correct lifting gear to prevent injury.
- Do not stack the inverter boxes higher than the number recommended.
- Ensure that installation position and material can withstand the weight of the inverter. Install according to the information in the instruction manual.
- Do not operate if the inverter is damaged or has parts missing.
- When carrying the inverter, do not hold it by the front cover; it may fall off or fail.
- Do not stand or rest heavy objects on the inverter.
- Check the inverter mounting orientation is correct.
- Prevent screws, wire fragments, other conductive bodies, oil or other flammable substances from entering the inverter.
- Do not drop the inverter, or subject it to impact
- Use the inverter under the following environmental conditions:

Environment	Ambient temperature	-10°C to +50°C (non-freezing)
	Ambient humidity	90%RH or less (non-condensing)
	Storage temperature	-20°C to +65°C*
	Ambience	Indoors (free from corrosive gas, flammable gas, oil mist, dust and dirt)
	Altitude, vibration	Maximum 1000m above sea level for standard operation. After that derate by 3% for every extra 500m up to 2500m (91%). 5.9m/s <sup>2</sup> or less

\*Temperature applicable for a short time, e.g. in transit.

## 2) Wiring

### CAUTION

- Do not fit capacitive equipment such as power factor correction capacitor, surge suppressor or radio noise filter (option FR-BIF) to the inverter output side.
- The connection orientation of the output cables (terminals U, V, W) to the motor will affect the direction of rotation of the motor.

## 3) Trial run

### CAUTION

- Check all parameters, and ensure that the machine will not be damaged by a sudden start-up.

## 4) Operation

### WARNING

- When you have chosen the retry function, stay away from the equipment as it will restart suddenly after an alarm stop.
- Since the [STOP] key is valid only when functions are set (refer to page 62) provide a circuit and switch separately to make an emergency stop (power off, mechanical brake operation for emergency stop, etc).
- Make sure that the start signal is off before resetting the inverter alarm. A failure to do so may restart the motor suddenly.
- The load used should be a three-phase induction motor only. Connection of any other electrical equipment to the inverter output may damage the equipment.
- Do not modify the equipment.
- Do not perform parts removal which is not instructed in this manual. Doing so may lead to fault or damage of the inverter.

### CAUTION

- The electronic thermal relay function does not guarantee protection of the motor from overheating.
- Do not use a magnetic contactor on the inverter input for frequent starting/stopping of the inverter.
- Use a noise filter to reduce the effect of electromagnetic interference. Otherwise nearby electronic equipment may be affected.
- Take measures to suppress harmonics. Otherwise power supply harmonics from the inverter may heat/damage the power capacitor and generator.
- When a 400V class motor is inverter-driven, please use an insulation-enhanced motor or measures taken to suppress surge voltages. Surge voltages attributable to the wiring constants may occur at the motor terminals, deteriorating the insulation of the motor.
- When parameter clear or all clear is performed, each parameter returns to the factory setting. Each parameter returns to the factory setting.
- The inverter can be easily set for high-speed operation. Before changing its setting, fully examine the performances of the motor and machine.
- In addition to the inverter's holding function, install a holding device to ensure safety.
- Before running an inverter which had been stored for a long period, always perform inspection and test operation. In addition to the inverter's holding function, install a holding device to ensure safety.

## 5) Emergency stop

### CAUTION

- Provide a safety backup such as an emergency brake which will prevent the machine and equipment from hazardous conditions if the inverter fails.
- When the breaker on the inverter input side trips, check for the wiring fault (short circuit), damage to internal parts of the inverter, etc. Identify the cause of the trip, then remove the cause and power on the breaker.
- When the protective function is activated, take the appropriate corrective action, then reset the inverter, and resume operation.

## 6) Maintenance, inspection and parts replacement

### CAUTION

- Do not carry out a megger (insulation resistance) test on the control circuit of the inverter.

## 7) Disposing of the inverter

### CAUTION

- Treat as industrial waste.

## 8) General instructions

Many of the diagrams and drawings in this Instruction Manual (basic) show the inverter without a cover, or partially open. Never operate the inverter in this manner. Always replace the cover and follow this Instruction Manual (basic) when operating the inverter.

### <Abbreviations>

DU: Control panel (FR-DU04-1)

PU: Control panel (FR-DU04-1) and parameter unit (FR-PU04V)

Inverter: Mitsubishi vector inverter FR-V500 series

FR-V500: Mitsubishi vector inverter FR-V500 series

Pr.: Parameter number

PU operation: Operation using the PU (FR-DU04-1/FR-PU04V)

External operation: Operation using the control circuit signals

Combined operation: Operation using both the PU (FR-DU04-1/FR-PU04V) and external operation

### <Trademarks>

CC-Link is a registered trademark of CC-Link Partner Association.

Other company and product names herein are the trademarks or registered trademarks of their respective owners.

# 1 OUTLINE

## Harmonic Suppression Guideline

All models of general-purpose inverters used by specific consumers are covered by "Harmonic suppression guideline for consumers who receive high voltage or special high voltage".

(For further details, refer to  Instruction Manual (detailed).)

## Product check and name of parts

Unpack the inverter and check the capacity plate on the front cover and the rating plate on the inverter side face to ensure that the product agrees with your order, an accessory L-shaped jumper (Refer to page 15 for connection method.) is included, and the inverter is intact.

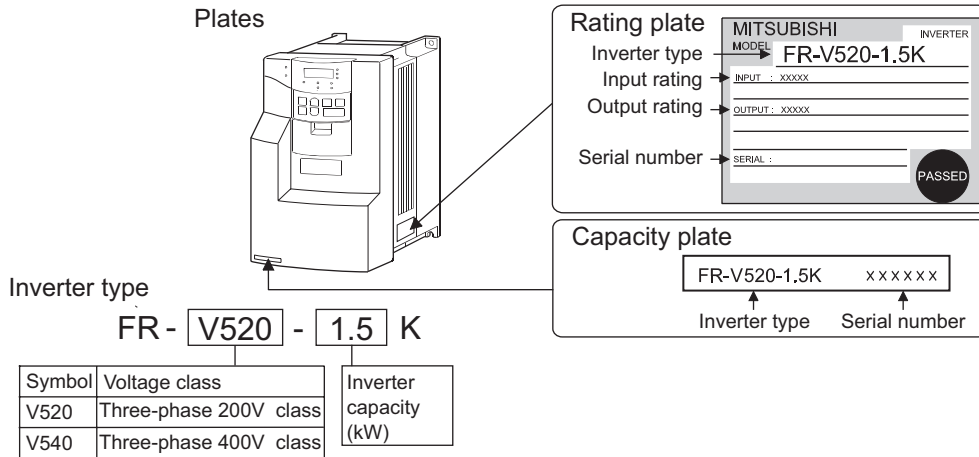

Terminal 5 dedicated L-shaped jumper × 1 (supplied)

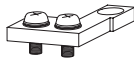

### (1) Front view

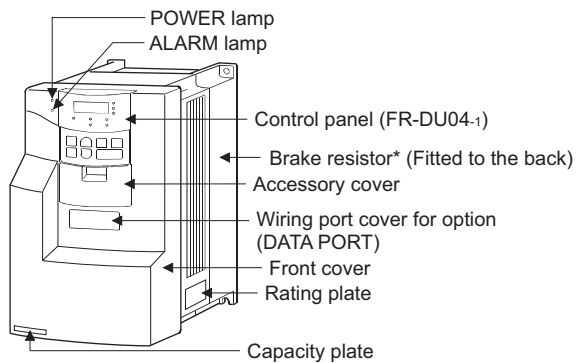

### (2) Without front cover

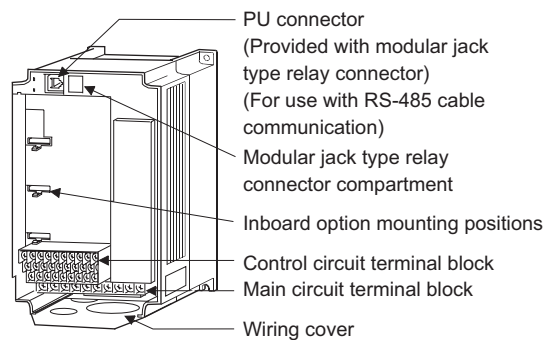

\*The 5.5K or less inverter is equipped with a built-in brake resistor and the 15K or less inverter is equipped with a built-in brake transistor.

## 1.1 Basic configuration and connection of peripheral devices

### 1.1.1 Basic configuration

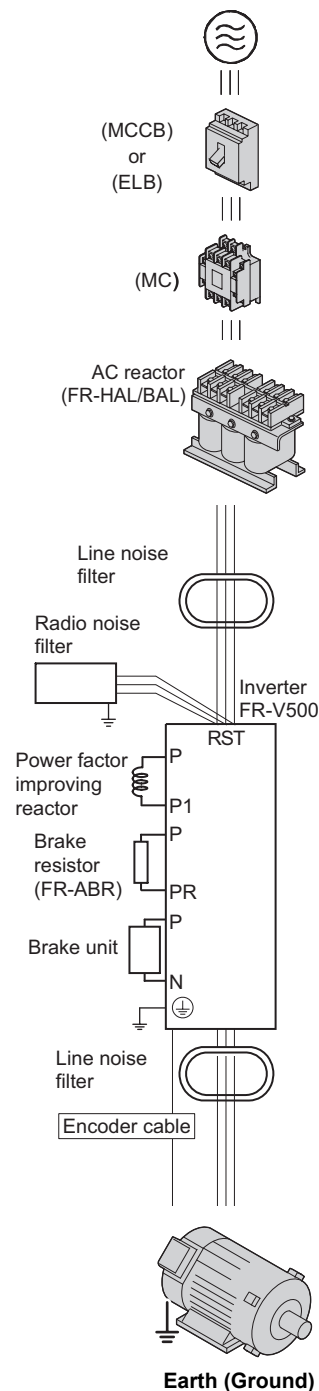

#### Power supply

Use within the permissible power supply specifications of the inverter. (Refer to page 103.)

#### Moulded case circuit breaker (MCCB) or earth leakage circuit breaker (ELB)

The breaker must be selected carefully since an in-rush current flows in the inverter at power-on. (Refer to page 3.)

#### Magnetic contactor

Install the magnetic contactor to ensure safety. (For details, refer to the Instruction Manual (detailed).) Do not use this magnetic contactor to start and stop the inverter. Doing so will cause the inverter life to be shortened. (Refer to page 3.)

#### Power factor improving reactor

A reactor (option) should be used when the power factor is to be improved or when the inverter is installed near a large power supply system (1000kVA or more and wiring distance is within 10m). The inverter may be damaged if you do not use reactors. Make selection carefully. (Refer to page 3.)

- DC reactor (FR-HEL/BEL), AC reactor (FR-HAL/BAL)

(Caution) Remove the jumpers across terminals P-P1 to connect to the DC reactor.

#### Noise filter

Install a noise filter to reduce the electromagnetic noise generated from the inverter.

- Line noise filter (FR-BSF01) (FR-BLF)  
Effective in the range from about 1MHz to 10MHz. When more wires are passed through, a more effective result can be obtained. (Note that the number of wires run through is limited when fitting to the output side.)
- Radio noise filter (FR-BIF)  
Effective in reducing the noises in the AM radio frequency band. Dedicated filter for the input side.

#### Inverter

The life of the inverter is influenced by ambient temperature. The ambient temperature should be as low as possible within the permissible range. This must be noted especially when the inverter is installed in an enclosure. (Refer to page 6.)  
Wrong wiring might lead to damage of the inverter. The control signal lines must be kept fully away from the main circuit to protect them from noise. (Refer to page 7.)

#### Brake resistor

(Caution) Remove the jumpers across terminals PR-PX to connect to the inverter.

- Set "1" in Pr. 30 "regenerative function selection".
- Set Pr. 70 "special regenerative brake duty" as follows:  
7.5K or less . . . . 10%  
11K or more . . . . 6%

#### Brake unit

(Caution) Remove the jumpers across terminals PR-PX to connect to the inverter.

#### Power regeneration common converter (FR-CV)

(Caution) Remove the jumpers across terminals R-R1 and S-S1.

- For a terminal to be connected to the RDYB signal of the FR-CV, set "10" (X10 signal) in any of Pr. 180 to Pr. 183 and Pr. 187 (input terminal function selection).
- Set "2" in Pr. 30 "regenerative function selection".
- Select the converter one rank higher in capacity than the inverter.  
Selection example: FR-V520-7.5K→FR-CV-11K, FR-V520-15K→FR-CV-18.5K (When connecting two inverters to one FR-CV, the capacity is 11K + 18.5K = 29.5K. Therefore, select FR-CV-30K.)

#### Motor

- Dedicated motor (Refer to page 103.)

This is a highly environmentally-resistant motor based on a totally-enclosed squirrel-cage induction motor designed for the vector inverter. Select the motor that matches the inverter capacity.

#### Encoder

For the encoder dedicated motor, refer to page 12.

#### Devices connected to the output

Do not install a power factor correction capacitor, surge suppressor or radio noise filter (FR-BIF option) on the output side of the inverter.

When installing a moulded case circuit breaker on the output side of the inverter, contact each manufacturer for selection of the moulded case circuit breaker.

#### Earth (Ground)

To prevent an electric shock, always earth (ground) the motor and inverter. For reduction of induction noise from the power line of the inverter, it is recommended to wire the earth (ground) cable by returning it to the earth (ground) terminal of the inverter.

(For details of noise reduction techniques, refer to the Instruction Manual (detailed).)

### CAUTION

- Do not fit capacitive equipment such as power factor correction capacitor, radio noise filter (FR-BIF option) or surge suppressor to the output side of the inverter. This will cause the inverter to trip or the capacitor and surge suppressor to be damaged. If any of the above devices are connected, immediately remove them. (If the FR-BIF radio noise filter is connected, switching power off during motor operation may result in "E.UVT". In this case, connect the radio noise filter on the primary side of the magnetic contactor.)
- Electromagnetic wave interference  
The input/output (main circuit) of the inverter includes high frequency components, which may interfere with the communication devices (such as AM radios) used near the inverter. In this case, install the FR-BIF optional radio noise filter (for use on the input side only) or FR-BSF01 or FR-BLF line noise filter to minimize interference.
- For details of peripheral devices, refer to manuals of each option and peripheral devices.

### 1.1.2 Selection of peripheral devices

Check the motor applicable to the inverter you purchased. Appropriate peripheral devices need to be selected according to the motor capacity. Refer to the list below and prepare appropriate peripheral devices.

#### 200V class

Motor Output (kW) *1	Applicable Inverter Type	Moulded Case Circuit Breaker (MCCB) or Earth Leakage Circuit Breaker (ELB)*1*2)		Power Factor Improving AC Reactor	Power Factor Improving DC Reactor	Magnetic Contactor (MC)
		Standard	With power factor improving reactor			
1.5	FR-V520-1.5K	30AF 15A	30AF 15A	FR-HAL/BAL-1.5K	FR-HEL/BEL-1.5K	S-N10
2.2	FR-V520-2.2K	30AF 20A	30AF 15A	FR-HAL/BAL-2.2K	FR-HEL/BEL-2.2K	S-N10
3.7	FR-V520-3.7K	30AF 30A	30AF 30A	FR-HAL/BAL-3.7K	FR-HEL/BEL-3.7K	S-N20, N21
5.5	FR-V520-5.5K	50AF 50A	50AF 40A	FR-HAL/BAL-5.5K	FR-HEL/BEL-5.5K	S-N25
7.5	FR-V520-7.5K	100AF 60A	50AF 50A	FR-HAL/BAL-7.5K	FR-HEL/BEL-7.5K	S-N35
11	FR-V520-11K	100AF 75A	100AF 75A	FR-HAL/BAL-11K	FR-HEL/BEL-11K	S-N50
15	FR-V520-15K	225AF 125A	100AF 100A	FR-HAL/BAL-15K	FR-HEL/BEL-15K	S-N65
18.5	FR-V520-18.5K	225AF 150A	225AF 125A	FR-HAL/BAL-22K	FR-HEL/BEL-18.5K	S-N80
22	FR-V520-22K	225AF 175A	225AF 150A	FR-HAL/BAL-22K	FR-HEL/BEL-22K	S-N95
30	FR-V520-30K	225AF 225A	225AF 175A	FR-HAL/BAL-30K	FR-HEL/BEL-30K	S-N125
37	FR-V520-37K	400AF 250A	225AF 225A	FR-HAL/BAL-37K	FR-HEL/BEL-37K	S-N150
45	FR-V520-45K	400AF 300A	400AF 300A	FR-HAL/BAL-45K	FR-HEL/BEL-45K	S-N180
55	FR-V520-55K	400AF 400A	400AF 350A	FR-HAL/BAL-55K	FR-HEL/BEL-55K	S-N220

#### 400V class

Motor Output (kW) *1	Applicable Inverter Type	Moulded Case Circuit Breaker (MCCB) or Earth Leakage Circuit Breaker (ELB)*1*2)		Power Factor Improving AC Reactor	Power Factor Improving DC Reactor	Magnetic Contactor (MC)
		Standard	With power factor improving reactor			
1.5	FR-V540-1.5K	30AF 10A	30AF 10A	FR-HAL/BAL-H1.5K	FR-HEL/BEL-H1.5K	S-N10
2.2	FR-V540-2.2K	30AF 15A	30AF 10A	FR-HAL/BAL-H2.2K	FR-HEL/BEL-H2.2K	S-N10
3.7	FR-V540-3.7K	30AF 20A	30AF 15A	FR-HAL/BAL-H3.7K	FR-HEL/BEL-H3.7K	S-N20, N21
5.5	FR-V540-5.5K	30AF 30A	30AF 20A	FR-HAL/BAL-H5.5K	FR-HEL/BEL-H5.5K	S-N20, N21
7.5	FR-V540-7.5K	30AF 30A	30AF 30A	FR-HAL/BAL-H7.5K	FR-HEL/BEL-H7.5K	S-N20, N21
11	FR-V540-11K	50AF 50A	50AF 40A	FR-HAL/BAL-H11K	FR-HEL/BEL-H11K	S-N25
15	FR-V540-15K	100AF 60A	50AF 50A	FR-HAL/BAL-H15K	FR-HEL/BEL-H15K	S-N35
18.5	FR-V540-18.5K	100AF 75A	100AF 60A	FR-HAL/BAL-H22K	FR-HEL/BEL-H18.5K	S-N50
22	FR-V540-22K	100AF 100A	100AF 75A	FR-HAL/BAL-H22K	FR-HEL/BEL-H22K	S-N50
30	FR-V540-30K	225AF 125A	100AF 100A	FR-HAL/BAL-H30K	FR-HEL/BEL-H30K	S-N65
37	FR-V540-37K	225AF 150A	225AF 125A	FR-HAL/BAL-H37K	FR-HEL/BEL-H37K	S-N80
45	FR-V540-45K	225AF 175A	225AF 150A	FR-HAL/BAL-H45K	FR-HEL/BEL-H45K	S-N95
55	FR-V540-55K	225AF 200A	225AF 175A	FR-HAL/BAL-H55K	FR-HEL/BEL-H55K	S-N125

\*1 Select the MCCB according to the inverter power supply capacity.

Install one MCCB per inverter.

For installations in the United States or Canada, use the fuse certified by the UL and cUL.

(Refer to page 115.)

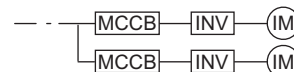

\*2 When the breaker on the inverter primary side trips, check for the wiring fault (short circuit), damage to internal parts of the inverter, etc. Identify the cause of the trip, then remove the cause and power on the breaker.

## 1.2 Structure

### 1.2.1 Removal and reinstallation of the front cover

FR-V520-1.5K to 7.5K, FR-V540-1.5K to 5.5K

#### ● Removal

- 1) Hold both sides of the front cover top and push the front cover down.
- 2) Hold down the front cover and pull it toward you to remove.  
(The front cover may be removed with the PU (FR-DU04-1/FR-PU04V) on.)

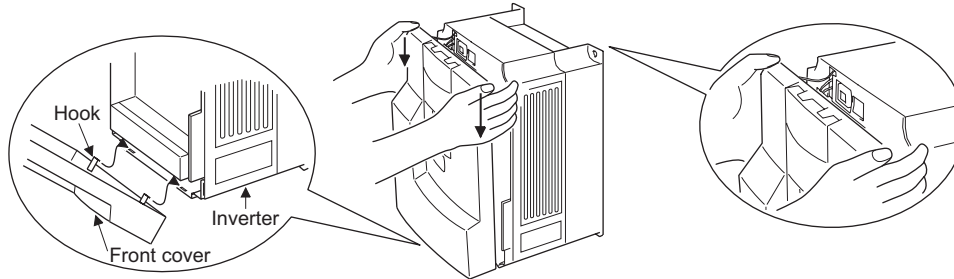

#### ● Reinstallation

- 1) Insert the hooks at the bottom of the front cover into the sockets of the inverter.
- 2) Using the hooks as supports, securely press the front cover against the inverter.

#### CAUTION

When the control panel is fitted to the removed front cover, reinstall the front cover after removing the control panel.

FR-V520-11K, 15K, FR-V540-7.5K to 18.5K

#### ● Removal

- 1) Remove the installation screw at the top of the front cover.
- 2) Hold both ends of the front cover top.
- 3) Pull the front cover toward you to remove.  
(The front cover may be removed with the control panel attached.)

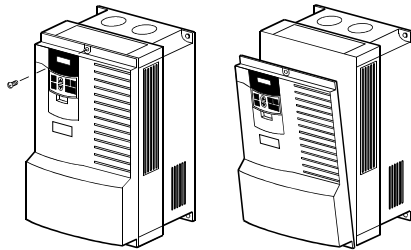

#### ● Reinstallation

- 1) Insert the hooks at the front cover bottom into the sockets of the inverter.
- 2) Using the hooks as supports, securely press the front cover against the inverter.
- 3) Fix the front cover with the top screw.

#### CAUTION

When the control panel is fitted to the removed front cover, reinstall the front cover after removing the control panel.

FR-V520-18.5K to 55K, FR-V540-22K to 55K

#### ● Removal

- 1) Remove the installation screws at the top of the front cover.

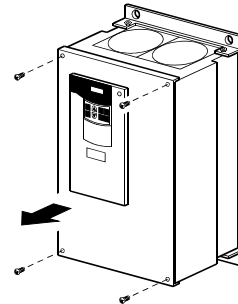

#### ● Reinstallation

- 1) Fix the front cover with the installation screws.

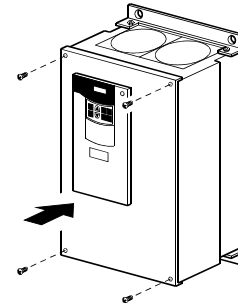

#### REMARKS

The 45K and 55K have two front covers, which are fixed with eight screws.

#### CAUTION

1. Fully make sure that the front cover has been reinstalled securely.
2. The same serial number is printed on the capacity plate of the front cover and the rating plate of the inverter. Before reinstalling the front cover, check the serial numbers to ensure that the cover removed is reinstalled to the inverter from where it was removed.

**REMARKS**

- Removal of the wiring port cover for option (DATA PORT)  
Push the DATA PORT from the back of the front cover to remove before fitting the communication option.

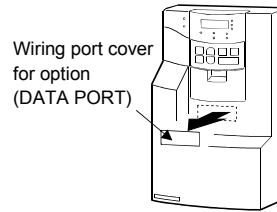

**1.2.2 Removal and reinstallation of the control panel**

To ensure safety, remove and reinstall the control panel after powering off.

● **Removal**

Hold down the top button of the control panel and pull the control panel toward you to remove.

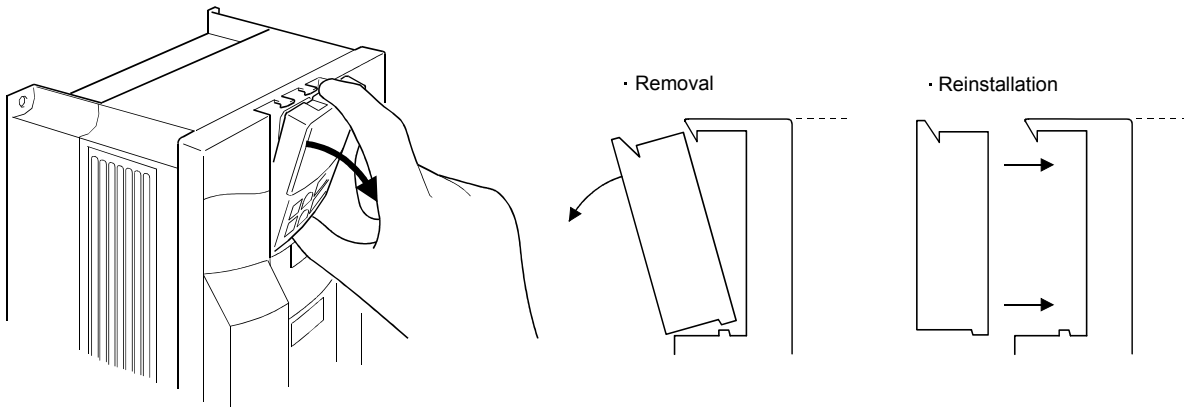

When reinstalling the control panel, insert it straight and reinstall it securely.

● **Reinstallation using the connection cable**

- 1) Remove the control panel.
- 2) Disconnect the modular jack type relay connector. (Place the disconnected modular jack type relay connector in the modular jack type relay connector compartment.)

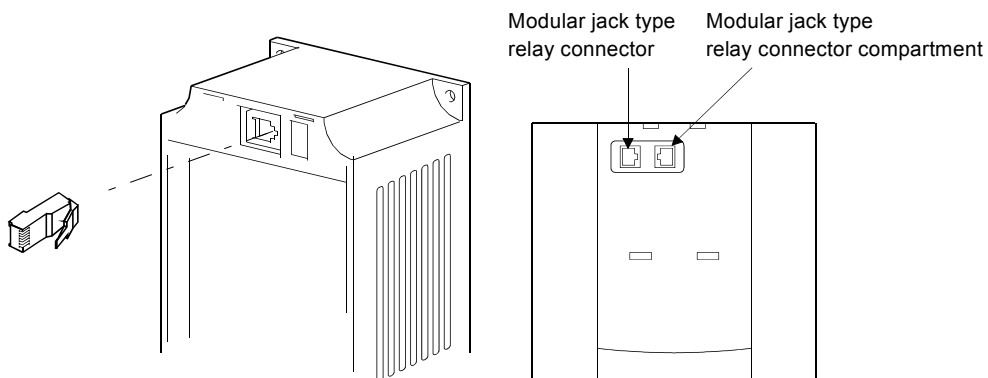

- 3) Securely plug one end of the connection cable into the PU connector of the inverter and the other end into the control panel. (Refer to page 19 for the connection cable.)

**CAUTION**

Install the control panel only when the front cover is on the inverter.



## 2 INSTALLATION AND WIRING

### 2.1 Installation of the inverter

- Install the inverter under the following conditions.

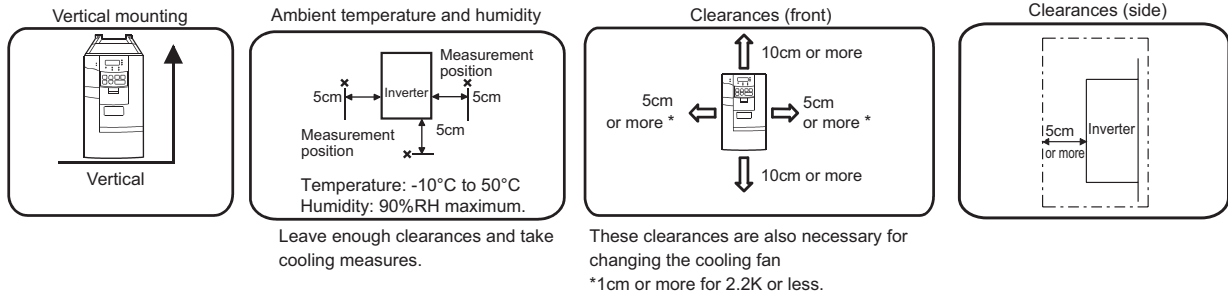

- The inverter consists of precision mechanical and electronic parts. Never install or handle it in any of the following conditions as doing so could cause an operation fault or failure.

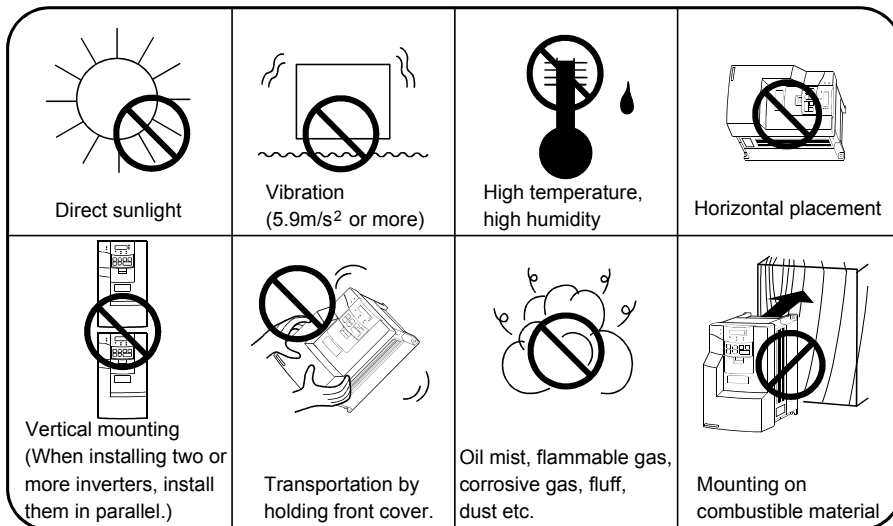

- Wiring cover and handling (15K or less for the 200V class, 18.5K or less for the 400V class)

- 1) When cable conduits are not connected  
Cut the protective bushes of the wiring cover with nippers or a cutter before running the cables.
- 2) When cable conduits are connected  
Remove the corresponding protective bushes and connect the cable conduits.

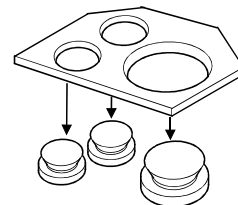
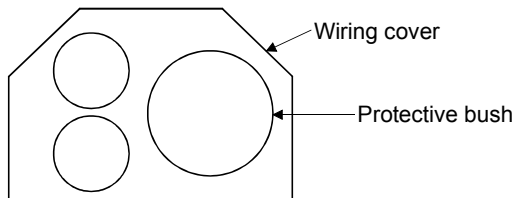

### WARNING

- Do not remove the protective bushes when cable conduits are not connected. Otherwise, the cable sheathes may be scratched by the wiring cover edges, resulting in a short circuit or earth (ground) fault.

## 2.2 Connection diagram, encoder cable, PU connector

### 2.2.1 Connection diagram

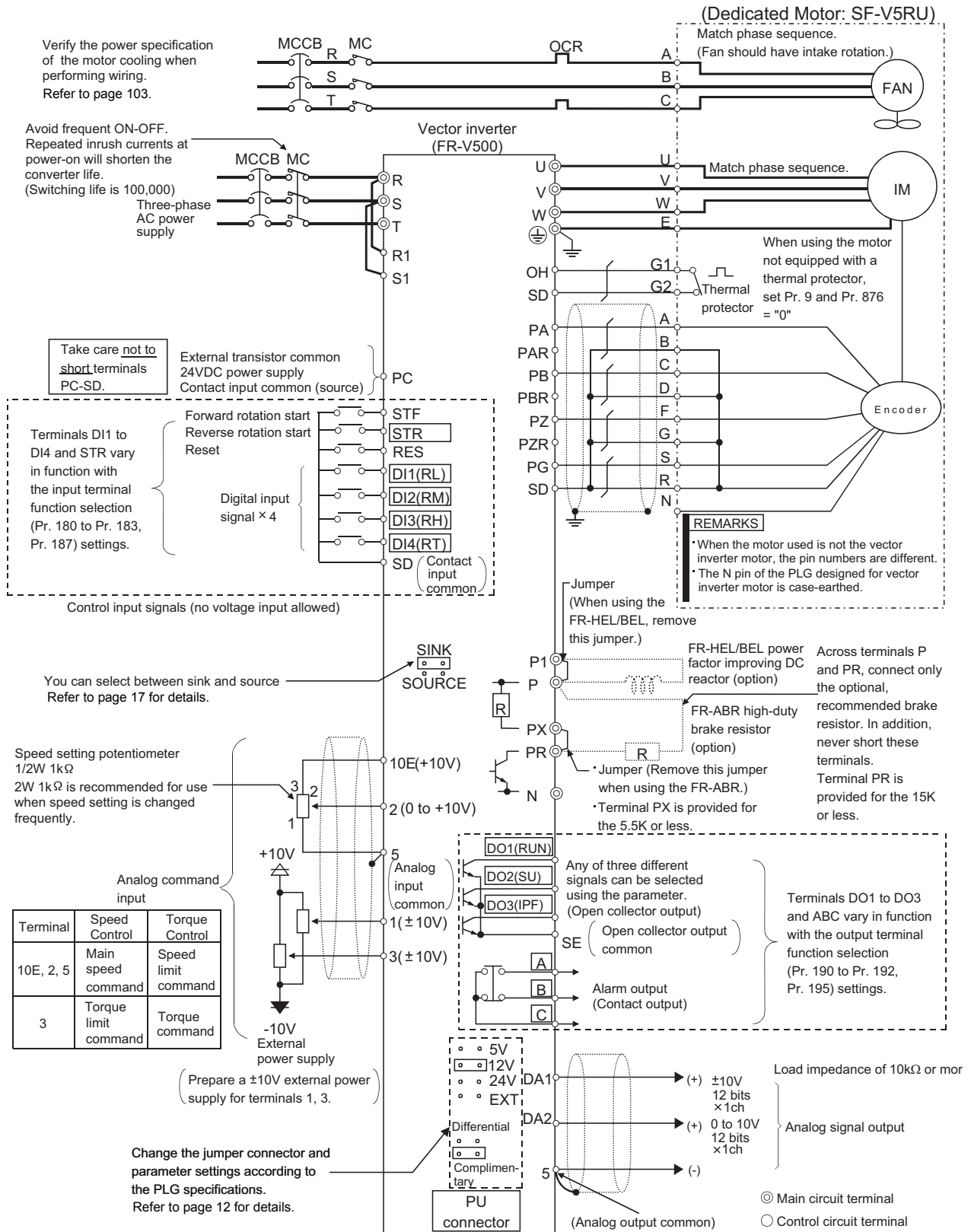

#### CAUTION

- To prevent a malfunction caused by noise, separate the signal cables more than 10cm (3.94 inches) from the power cables.
- During wiring, do not leave wire offcuts in the inverter. Wire offcuts can cause an alarm, failure or malfunction. Always keep the inverter clean. When drilling mounting holes in an enclosure etc., take care not to allow chips and other foreign matter to enter the inverter.

## 2.2.2 Main circuit terminal specifications

### (1) Specification of main circuit terminal

Terminal Symbol	Terminal Name	Description
R, S, T	AC power input	Connect to the commercial power supply. Keep these terminals open when using the high power factor converter (FR-HC) or power regeneration common converter (FR-CV).
U, V, W	Inverter output	Connect a three-phase squirrel-cage motor or Mitsubishi dedicated motor.
R1, S1	Power supply for control circuit	Connected to the AC power supply terminals R and S. To retain the alarm display and alarm output or when using the high power factor converter (FR-HC) or power regeneration common converter (FR-CV), remove the jumpers from terminals R-R1 and S-S1 and apply external power to these terminals. Do not turn off the power supply for control circuit (R1, S1) with the main circuit power (R, S, T) on. Doing so may damage the inverter. The circuit should be configured so that the main circuit power (R, S, T) is also turned off when the power supply for control circuit (R1, S1) is off. 15K or less: 60VA, 18.5K to 55K: 80VA
P, PR	Brake resistor connection	Disconnect the jumper from terminals PR-PX (5.5K or less) and connect the optional brake resistor (FR-ABR) across terminals P-PR. For the 15K or less, connecting the resistor further provides regenerative braking power.
P, N	Brake unit connection	Connect the optional FR-BU type brake unit, BU type brake unit, power regeneration common converter (FR-CV) or high power factor converter (FR-HC).
P, P1	DC reactor connection	Disconnect the jumper from terminals P-P1 and connect the optional DC reactor (FR-HEL/BEL).
PR, PX	Built-in brake circuit connection	When the jumper is connected across terminals PX-PR (factory setting), the built-in brake circuit is valid. (Provided for the 5.5K or less.)
	Earth (Ground)	For earthing (grounding) the inverter chassis. Must be earthed (grounded).

#### CAUTION

- The inverter will be damaged if power is applied to the inverter output terminals (U, V, W). Never perform such wiring.
- When connecting the dedicated external brake resistor (FR-ABR), remove jumpers across terminals PR-PX (5.5K or less).  
Set "1" in Pr. 30 "regenerative function selection".  
Set Pr. 70 "special regenerative brake duty" as follows:  
7.5K or less . . . . . 10%  
11K or more . . . . . 6%  
Refer to the Instruction Manual (detailed) for details.
- When connecting the brake unit (FR-BU, BU type), remove jumpers across terminals PR-PX (5.5K or less). Refer to the Instruction Manual (detailed) for details.

**(2) Terminal arrangement of the main circuit terminal**

In the main circuit of the inverter, the terminals are arranged as shown below:

**200V class**

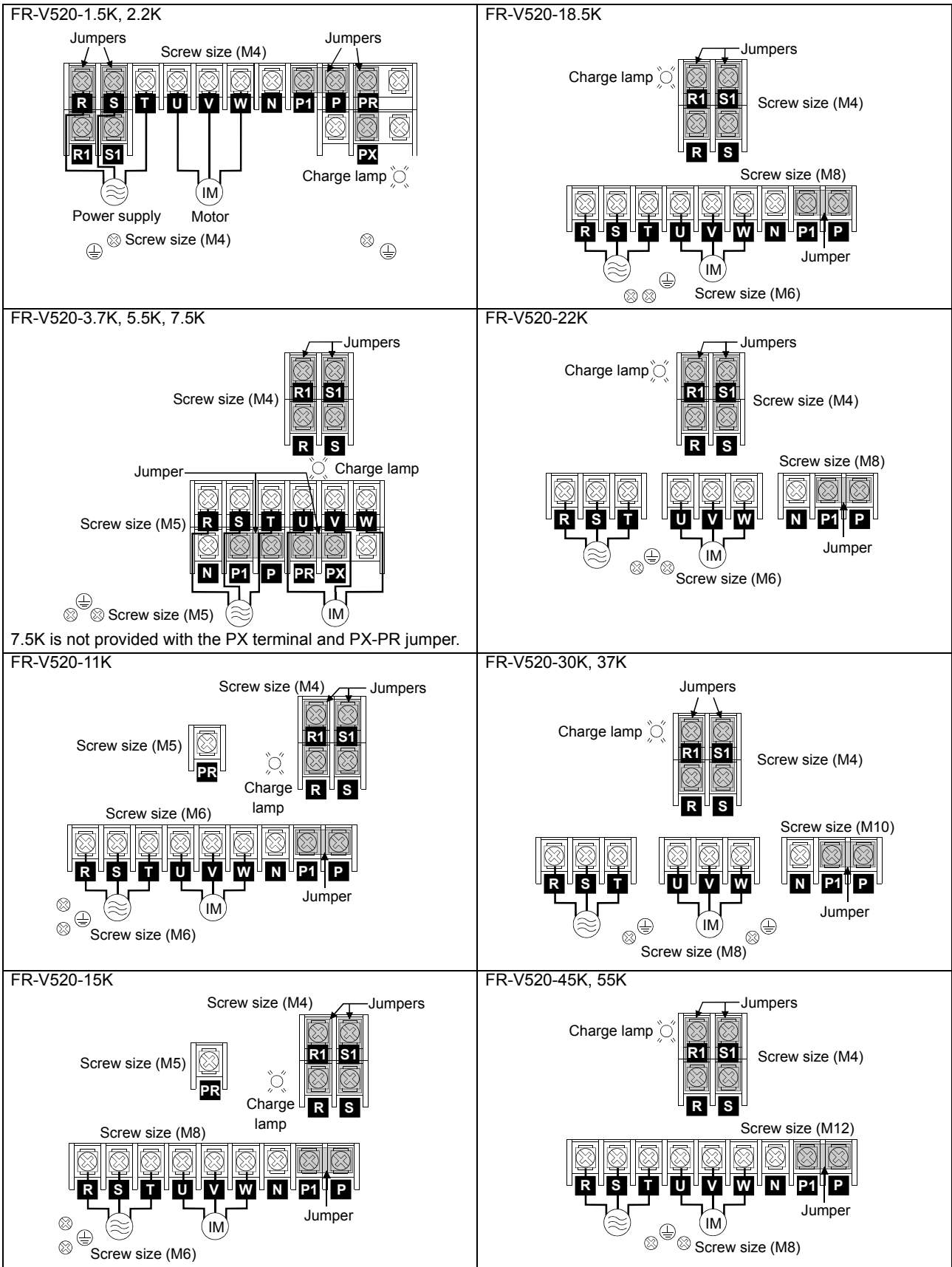

# Connection diagram, encoder cable, PU connector

## 400V class

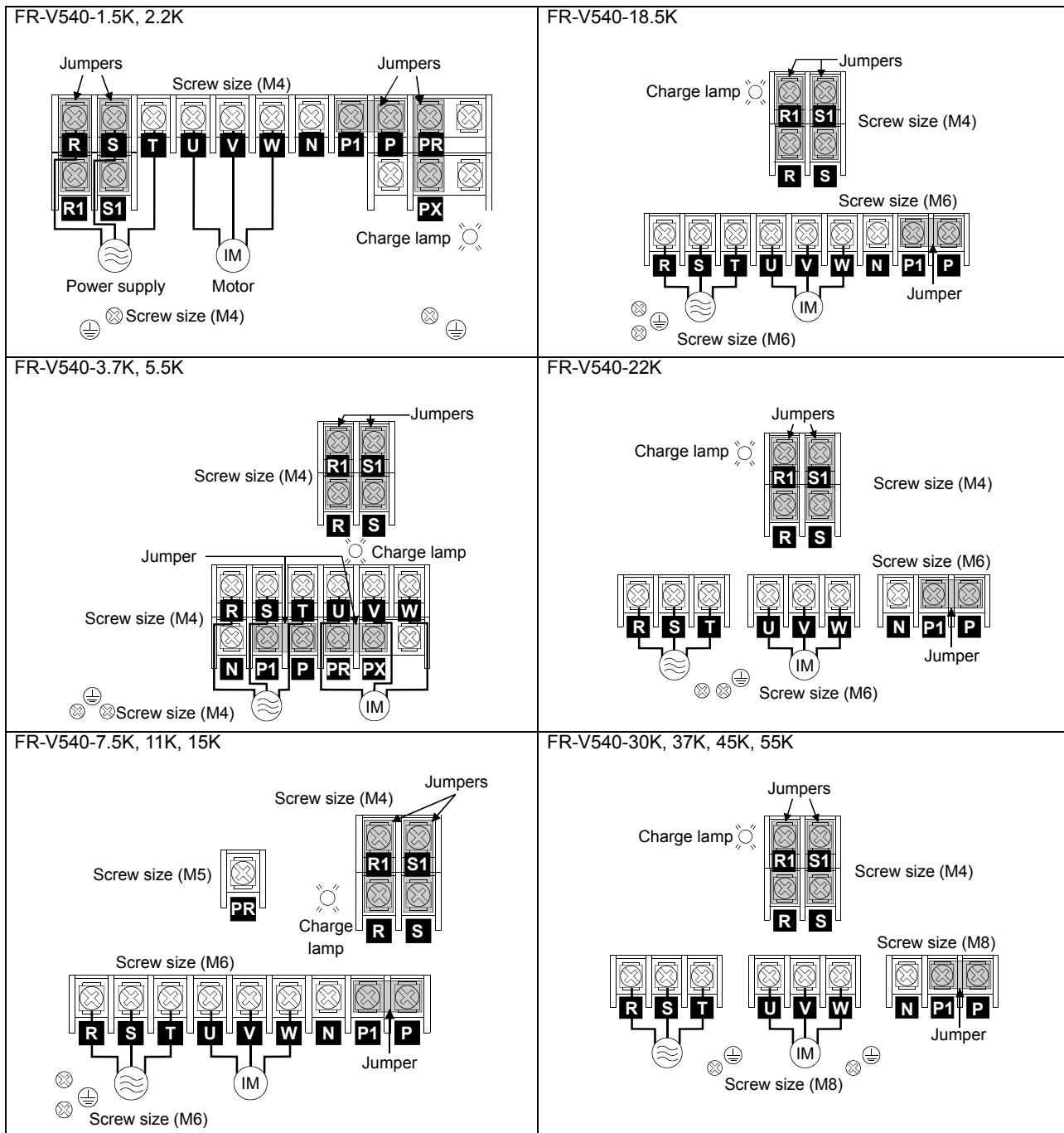

### CAUTION

- Make sure the power cables are connected to the R, S, T of the inverter. Never connect the power cable to the U, V, W of the inverter. (Phase need not be matched.)
- Connect the motor to U, V, W. At this time, turning on the forward rotation switch (signal) rotates the motor in the counterclockwise direction when viewed from the motor shaft.

### (3) Cables and wiring length

Select the recommended cable size to ensure that a voltage drop will be 2% max.

If the wiring distance between the inverter and motor is long, the motor torque will decrease due to the voltage drop of the main circuit cable especially at high-frequency output. The encoder signal will also be affected by the voltage drop.

The following selection example assumes the wiring length of 20m.

#### 200V class (When input power supply is 220V)

Applicable Inverter Type	Terminal Screw Size	Tightening Torque N·m	Crimping Terminals		HIV Cables				PVC Cables	
					mm <sup>2</sup>		AWG		mm <sup>2</sup>	
					R, S, T	U, V, W	R, S, T	U, V, W	R, S, T	U, V, W
FR-V520-1.5K, 2.2K	M4	1.5	2-4	2-4	2	2	14	14	2.5	2.5
FR-V520-3.7K	M5	2.5	3.5-5	3.5-5	3.5	3.5	12	12	6	4
FR-V520-5.5K	M5	2.5	5.5-5	5.5-5	5.5	5.5	10	10	10	6
FR-V520-7.5K	M5	2.5	14-5	8-5	14	8	6	8	16	10
FR-V520-11K	M6	4.4	14-6	14-6	14	14	6	6	25	16
FR-V520-15K	M8	7.8	22-8	22-8	22	22	4	4	35	25
FR-V520-18.5K, 22K	M8	7.8	38-8	38-8	38	38	2	2	50	35
FR-V520-30K	M10	14.7	60-10	60-10	60	60	1/0	1/0	70	70
FR-V520-37K	M10	14.7	100-10	100-10	100	100	4/0	4/0	120	95
FR-V520-45K	M12	24.5	100-12	100-12	100	100	4/0	4/0	150	120
FR-V520-55K	M12	24.5	150-12	150-12	150	150	MCM300	MCM300	240	185

#### 400V class (When input power supply is 440V)

Applicable Inverter Type	Terminal Screw Size	Tightening Torque N·m	Crimping Terminals		HIV Cables				PVC Cables	
					mm <sup>2</sup>		AWG		mm <sup>2</sup>	
					R, S, T	U, V, W	R, S, T	U, V, W	R, S, T	U, V, W
FR-V540-1.5K to 3.7K	M4	1.5	2-4	2-4	2	2	14	14	2.5	2.5
FR-V540-5.5K	M4	1.5	3.5-4	2-4	3.5	2	12	14	4	2.5
FR-V540-7.5K	M6	4.4	3.5-6	3.5-6	3.5	3.5	12	12	4	4
FR-V540-11K	M6	4.4	5.5-6	5.5-6	5.5	5.5	10	10	6	6
FR-V540-15K	M6	4.4	14-6	8-6	14	8	6	8	10	10
FR-V540-18.5K	M6	4.4	14-6	8-6	14	8	6	8	16	16
FR-V540-22K	M6	4.4	22-6	14-6	22	14	4	6	25	16
FR-V540-30K	M8	7.8	22-8	22-8	22	22	4	4	25	25
FR-V540-37K	M8	7.8	38-8	22-8	38	22	2	4	50	35
FR-V540-45K	M8	7.8	38-8	38-8	38	38	2	2	50	35
FR-V540-55K	M8	7.8	60-8	60-8	60	60	1/0	1/0	70	70

The line voltage drop can be calculated by the following formula:

$$\text{Line voltage drop [V]} = \frac{\sqrt{3} \times \text{cable resistance}[\text{m}\Omega/\text{m}] \times \text{wiring distance}[\text{m}] \times \text{current}[\text{A}]}{1000}$$

Use a larger diameter cable when the wiring distance is long or when it is desired to decrease the voltage drop (torque reduction) in the low speed range.

#### CAUTION

- Tighten the terminal screw to the specified torque.  
A screw that has been tighten too loosely can cause a short circuit or malfunction.  
A screw that has been tighten too tightly can cause a short circuit or malfunction due to the unit breakage.
- The crimping terminals recommended for use to wire the power supply and motor are those provided with insulation sleeves.

### (4) Wiring length

- The wiring length should be 100m maximum. (during vector control)

#### CAUTION

- Especially for long-distance wiring, the inverter may be affected by a charging current caused by the stray capacitances of the wiring, leading to a malfunction of the overcurrent protective function or a malfunction or fault of the equipment connected on the secondary side. If fast response current limit malfunctions when fast response current limit function is made valid, disable fast response current limit. (Refer to Pr.156 "stall prevention operation selection".)

### (5) Cable gauge for the control circuit power

- Cable gauge: 0.75mm<sup>2</sup> to 2mm<sup>2</sup>
- Tightening torque: 1.5N·m

## Connection diagram, encoder cable, PU connector

### 2.2.3 Encoder connection cable (FR-V5CBL)

When using a dedicated motor (SF-V5RU series), use an encoder cable (FR-V5CBL) for connection.

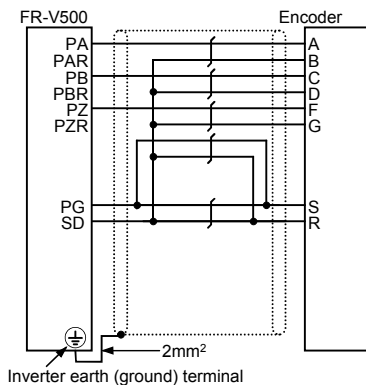
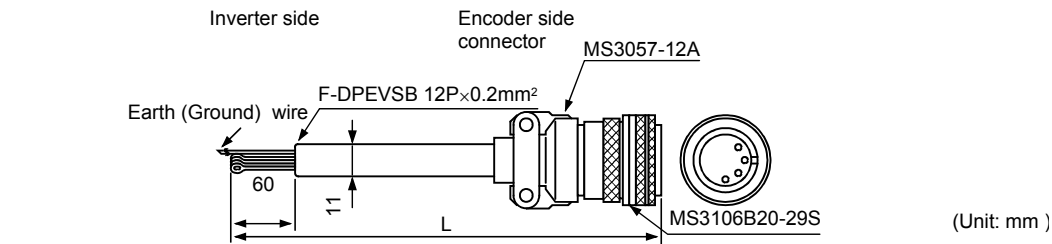

Type	Length L (m)	Remarks
FR-V5CBL5	5	Standard product
FR-V5CBL15	15	
FR-V5CBL30	30	

Contact us separately for other lengths.

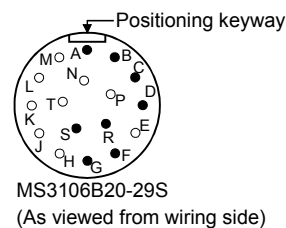

### 2.2.4 Setting the encoder

When a dedicated encoder cable (FR-V5CBL) is used, a setting change may not be required.

#### CAUTION

Make setting correctly.

Fitting the jumper connector to the position exceeding the power specification results in an encoder failure. Fitting the jumper connector to the position below the power specification results in an encoder malfunction.

#### (1) Setting the power supply specification of the encoder and pulse output type

Switch the position of the jumper connector on the back surface of the control circuit terminal block according to the encoder specification. (Refer to page 17 for removal and installation of the control circuit terminal block.)

#### CAUTION

- Encoder power supply jumper connector

The jumper connector is fitted to 12V when shipped from the factory. Switch its position according to power supply specification.

#### REMARKS

Since the specification of the encoder of the conventional motors (SF-VR, SF-JR with encoder) is 5V, fit the jumper connector to 5V.

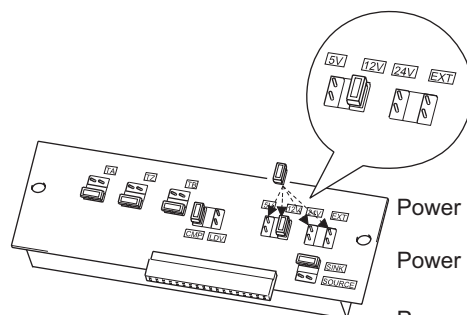

Power supply voltage is 5V

Power supply voltage is 12V

Power supply voltage is 24V

Power supply voltage is external

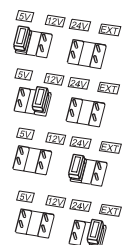

● **Encoder output circuit jumper connector**

The jumper connector is fitted to complimentary when shipped from the factory. Switch its position according to output circuit.

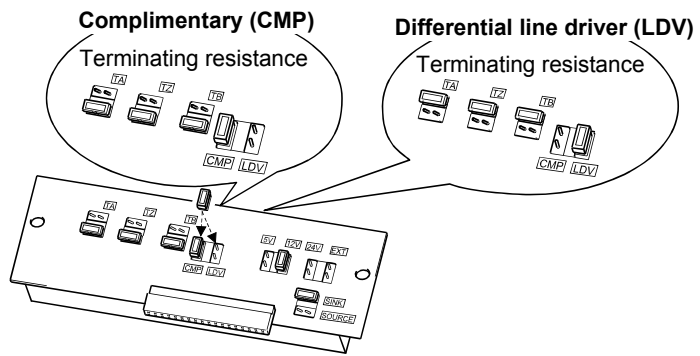

**(2) Setting the number of encoder pulses and encoder rotation direction**

Set the following parameters according to the encoder specification.

Parameter	Name	Factory Setting	Setting Range	Remarks
851	Number of encoder pulses	2048	0 to 4096	These parameters are extended function parameters. Set "1" in Pr.160 "extended function selection"
852	Encoder rotation direction	1	0, 1	

- The rotation direction of the encoder is displayed on the operation status indication (FWD,REV) of the control panel.

Pr. 852 Setting	Rotation direction of the encoder
0	<p>Encoder</p> <p>Forward rotation is clockwise rotation when viewed from A.</p>
1 (factory setting)	<p>Encoder</p> <p>Forward rotation is counterclockwise rotation when viewed from A.</p>

**REMARKS**

- The number of encoder pulses should be between 1000 and 4096.

- When using a conventional motor and an encoder cable (FR-VCBL/FR-JCBL), refer to the Instruction Manual (detailed).



## 2.2.5 Control circuit terminal specifications

### (1) Specification of control circuit terminal

Type	Terminal Symbol	Terminal Name	Description
Contact input	STF	Forward rotation start	Turn on the STF signal to start forward rotation and turn it off to stop.
	STR	Reverse rotation start	Turn on the STR signal to start reverse rotation and turn it off to stop. The function of the terminals changes according to the input terminal function selection (Pr. 187) setting. Refer to page 65 for details.
	DI1 to DI4	Digital input terminals 1 to 4	The terminal functions vary with the input terminal function selection (Pr. 180 to Pr. 183) settings. Refer to page 65 for details.
	OH	Thermal relay protector input	Temperature sensor terminal input for motor overheat protection. OHT error occurs when terminals OH and SD are open.
	RES	Reset	Used to reset alarm output provided when protective circuit is activated. By setting Pr. 75 "reset selection", reset input possible or reset input possible only during protective circuit operation can be selected. Turn on the RES signal for more than 0.1s, then turn it off.
	SD	Contact input common (sink)	Common to the contact input. Common output terminal for 24VDC 0.1A power supply (PC terminal). Isolated from terminals 5 and SE.
	PC	24VDC power supply and external transistor common, contact input common (source)	When connecting a transistor output (open collector output), such as a programmable controller, connect the external power supply common for transistor output to this terminal to prevent a malfunction caused by a sneak current. PC-SD can be used as a 24VDC, 0.1A power supply. Note that this connection does not prevent undesirable currents. When source logic has been selected, this terminal serves as a contact input common.
Input signals Speed setting	10E	Speed setting power supply	10VDC, permissible load current 10mA
	2	Speed setting (voltage)	By entering 0 to 10VDC, the maximum output speed is reached at 10V and I/O are proportional. Acts as a speed command terminal for speed control or as a speed limit for torque control. Input resistance 10kΩ, maximum permissible voltage 20V.
	3	Torque setting terminal	Acts as a torque setting signal for torque control or a torque limit signal for speed control and position control. Acts as an input terminal when torque bias function by external analog is selected. 0 to ±10VDC input, input resistance 10kΩ, maximum permissible voltage ±20VDC
	1	Multi-function setting terminal	Since this is a multi-function selection terminal, its function varies with the Pr. 868 "terminal 1 function assignment" setting. The function of this terminal is factory-set to adding auxiliary of speed setting terminal of terminal 2. Refer to Pr. 868 "terminal 1 function assignment" in the Instruction Manual (detailed). 0 to ±10VDC input, input resistance 10kΩ, maximum permissible voltage ±20V
	5	Speed setting common	Speed setting signal (terminal 2, 1 or 3) common terminal. Isolated from terminals SD and SE. Do not earth (ground).
Encoder signal	PA	A-phase signal input terminal	A-, B- and Z-phase signals are input from the encoder. The jumper connector is factory-set to complimentary. Thus, the encoder need not be connected to PAR, PBR, and PZR.
	PAR	A-phase inverted signal input terminal	
	PB	B-phase signal input terminal	
	PBR	B-phase inverted signal input terminal	
	PZ	Z-phase signal input terminal	
	PZR	Z-phase inverted signal input terminal	
	PG	Encoder power supply terminal (Positive side)	Power supply for encoder. You can switch the power supply between 5 (5.5), 12 and 24VDC. You can also switch to external power supply. The jumper connector is factory-set to 12VDC. (Refer to page 12.)
SD	Power supply earth (ground) terminal	Common terminal for the encoder power supply. Isolated from terminals 5 and SE. Do not earth (ground).	

Type	Terminal Symbol	Terminal Name	Description	
Output signals	Contact	A, B, C	Alarm output 1 changeover contact output indicates that the inverter protective function activated and the output stopped. 230VAC 0.3A, 30VDC 0.3A. Alarm: discontinuity across B-C (continuity across A-C), Normal: continuity across B-C (discontinuity across A-C). The function of the terminals changes according to the output terminal function selection (Pr. 195) setting. Refer to page 65 for details.	
		Open collector	DO1 to DO3	Digital output terminals 1 to 3 Permissible load 24VDC 0.1A The terminal functions vary with the output terminal function selection (Pr. 190 to Pr. 192) settings. Refer to page 65 for details.
	SE		Open collector output common Common terminal for terminals DO1, DO2 and DO3. Isolated from terminals SD and 5.	
	Analog	DA1	Analog signal output One selected from the monitoring items, such as the speed, is output.* The output signal is proportional to the magnitude of the corresponding monitoring item.	Factory setting of output item: Speed monitoring, output signal 0 to ±10VDC, permissible load current 1mA
		DA2	Analog signal output	
		5	Analog signal output common Common terminal for DA1 and DA2. Isolated from terminals SD and SE. Do not earth (ground).	Factory setting of output item: Speed monitoring, output signal 0 to 10VDC, permissible load current 1mA
Communication	RS-485	PU connector	With the PU connector, communication can be made through RS-485. • Conforming standard : EIA-485 (RS-485) • Transmission format : Multidrop link • Communication speed : Maximum 19200bps • Overall length : 500m	

\* Not output during inverter reset.

**REMARKS**

For the input terminal function switchover timing, refer to page 45.

**(2) Control circuit terminal layout**

Terminal screw size : M3.5  
Tightening torque : 1.2N·m  
When connecting three or more control cables to the terminal 5, connect the accessory terminal 5 dedicated L-shaped jumper to the terminal 5.  
In this case no cable should be connected to the screw in the  part.

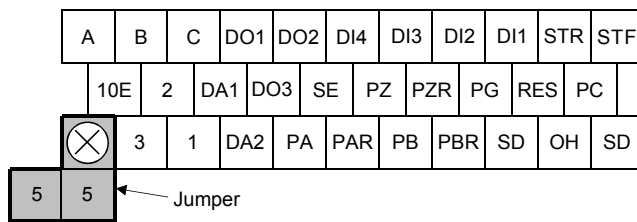

**(3) Wiring instructions**

- 1) Terminals 5, SD and SE are common to the I/O signals and isolated from each other. Do not earth (ground) these terminals. Avoid connecting the terminal SD and 5 and the terminal SE and 5.
- 2) Use shielded or twisted cables for connection to the control circuit terminals and run them away from the main and power circuits (including the 200V relay sequence circuit).
- 3) Since the control circuit input signals are micro currents, use two or more parallel micro signal contacts or a twin contact to prevent a contact fault.
- 4) It is recommended to use the cables of 0.75mm<sup>2</sup> gauge for connection to the control circuit terminals. If the cable gauge used is 1.25mm<sup>2</sup> or more, the front cover may be lifted when there are many cables running or the cables are run improperly, resulting in an control panel or parameter unit contact fault.
- 5) The maximum wiring length should be 30m.

## Connection diagram, encoder cable, PU connector

### (4) Connecting the control circuit to a power supply separately from the main circuit

If the magnetic contactor (MC) in the inverter power supply is opened when the protective circuit is operated, the inverter control circuit power is lost and the alarm output signal cannot be kept on. To keep the alarm signal on terminals R1 and S1 are available. In this case, connect the power supply terminals R1 and S1 of the control circuit to the primary side of the MC.

#### • Model FR-V520-1.5K, 2.2K, FR-V540-1.5K, 2.2K

##### <Connection procedure>

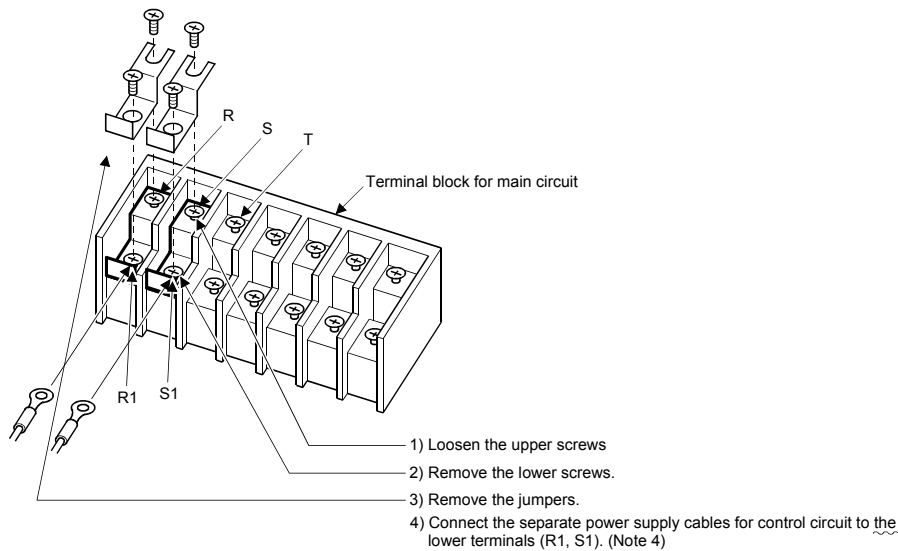

#### • Model FR-V520-3.7K to 55K, FR-V540-3.7K to 55K

##### <Connection procedure>

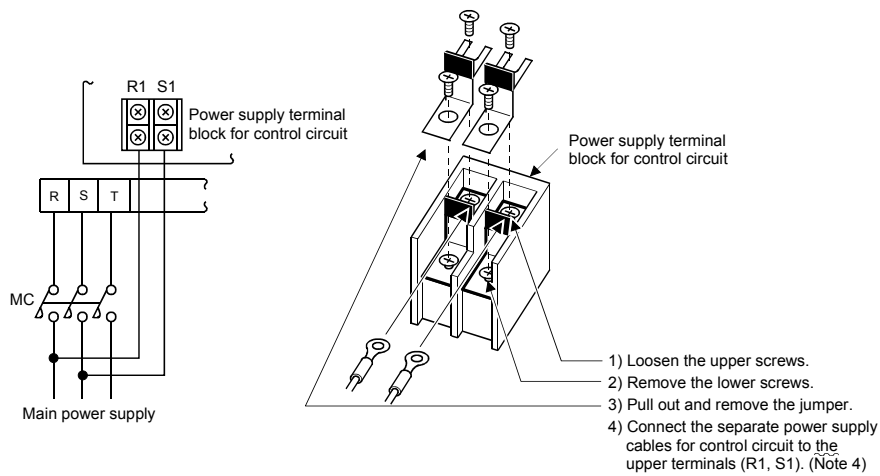

### CAUTION

1. When the main circuit power (R, S, T) is on, do not switch off the control power (terminals R1, S1). Otherwise the inverter may be damaged.
2. When using a separate power supply, the jumpers across R-R1 and S-S1 must be removed. Otherwise the inverter may be damaged.
3. For a different power supply system, which takes the power of the control circuit from other than the primary side of the MC, the voltage should be equal to the main circuit voltage.
4. For the FR-V520-3.7K to 55K, FR-V540-3.7K to 55K, the power supply cables must not be connected to the lower terminals. If connected, the inverter may be damaged.
5. Supplying power to only the R1 and S1 terminals and entering the start signal will result in an error indication (E.OC1).

**(5) Changing the control logic**

The input signals are factory set to sink logic (SINK).

To change the control logic, the jumper connector on the back of the control circuit terminal block must be moved to the other position.

(The output signals may be used in either the sink or source logic independently of the jumper connector position.)

- 1) Loosen the two mounting screws in both ends of the control circuit terminal block. (The screws cannot be removed.) Pull down the terminal block from the back of the control circuit terminals.

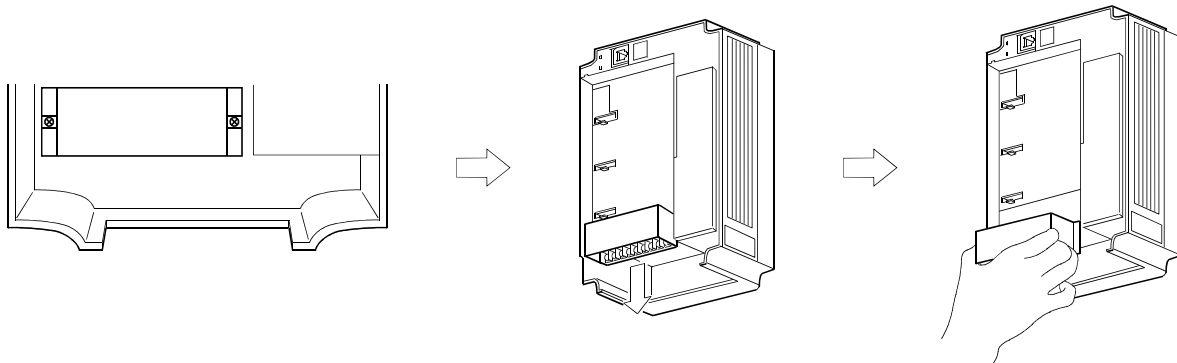

- 2) Fit the jumper connector from the sink logic (SINK) position on the back surface of the control circuit terminal block to the source logic (SOURCE) position to change to the source logic.

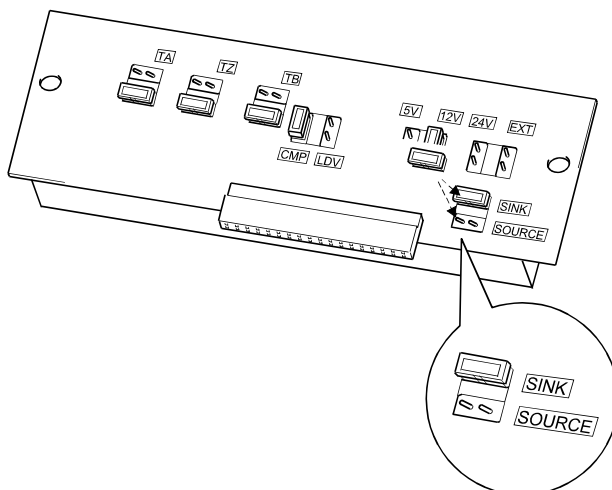

- 3) Using care not to bend the pins of the inverter's control circuit connector, reinstall the control circuit terminal block and fix it with the mounting screws.

**CAUTION**

1. Make sure that the control circuit connector is fitted correctly.
2. While power is on, never disconnect the control circuit terminal block.
3. The sink-source logic change-over jumper connector must be fitted in only one of those positions. If it is fitted in both positions at the same time, the inverter may be damaged.

# Connection diagram, encoder cable, PU connector

## 4) Sink logic type and source logic type

- In sink logic, a signal switches on when a current flows from the corresponding signal input terminal. Terminal SD is common to the contact input signals. Terminal SE is common to the open collector output signals.
- In source logic, a signal switches on when a current flows into the corresponding signal input terminal. Terminal PC is common to the contact input signals. Terminal SE is common to the open collector output signals.

### ● Current flow concerning the RUN signal when sink logic is selected

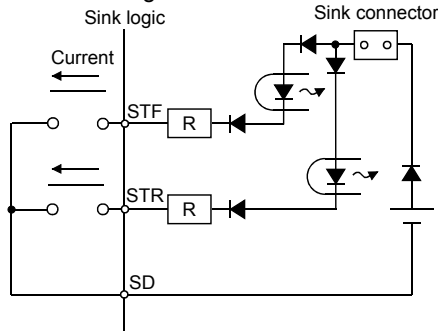

### ● Current flow concerning the RUN signal when source logic is selected

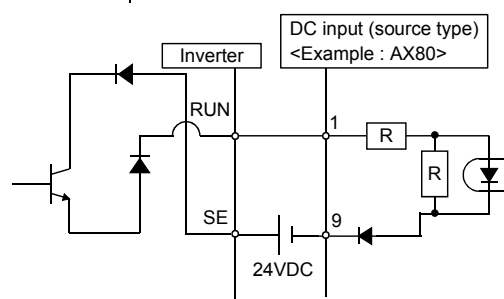
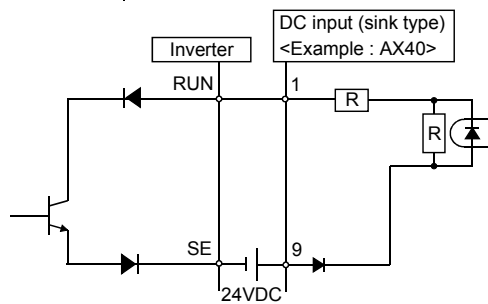
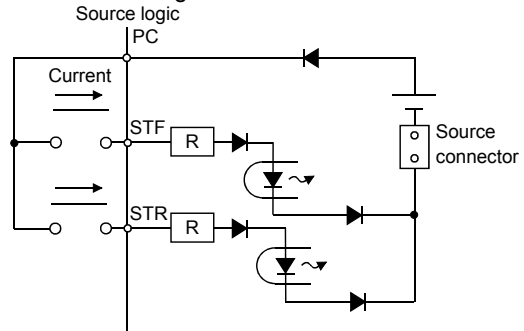

### ● When using an external power supply for transistor output

<p>• Sink logic type Use terminal PC as a common terminal to prevent a malfunction caused by undesirable current. (Do not connect terminal SD of the inverter with terminal 0V of the external power supply. When using terminals PC-SD as a 24VDC power supply, do not install a power supply in parallel in the outside of the inverter. Doing so may cause a malfunction due to undesirable current.)</p>	<p>• Source logic type Use terminal SD as a common terminal to prevent a malfunction caused by undesirable current.</p>
--	---

## 2.2.6 Connection to the PU connector

### (1) When connecting the control panel or parameter unit using a connection cable

#### <Recommended connection cable>

- Parameter unit connection cable (FR-CB2□□) (option) or the following connector and cable available on the market
- Connector : RJ45 connector  
Example: 5-554720-3 of Tyco Electronics Corporation
- Cable : Cable conforming to EIA568 (e.g. 10BASE-T cable)  
Example: SGLPEV-T 0.5mm x 4P(twisted pair cable, 4 pairs) of Mitsubishi Cable Industries, LTD.
- Maximum wiring length : 20m

### (2) For computer link communication

Using the PU connector, you can perform communication operation from a personal computer etc. When the PU connector is connected with a personal, FA or other computer by a communication cable, a user program can run and monitor the inverter or read and write to parameters.



Refer to the Instruction Manual (detailed) for details.

- Conforming Standard : EIA-485 (RS-485)
- Transmission form : Multidrop link
- Communication speed : Maximum 19200bps
- Overall length : 500m

#### CAUTION

**Do not connect the PU connector to the computer's LAN board, FAX modem socket or telephone connector. The product could be damaged due to differences in electrical specifications.**

## 2.2.7 Earthing (Grounding) precautions

- Leakage currents flow in the inverter. To prevent an electric shock, the inverter and motor must be earthed (grounded). Earthing (Grounding) must conform to the requirements of national and local safety regulations and electrical codes. (NEC section 250, IEC 536 class 1 and other applicable standards.)
- Use the dedicated earth (ground) terminal to earth (ground) the inverter. (Do not use the screw in the case, chassis, etc.)  
Use a tinned\* crimping terminal to connect the earth (ground) cable. Tighten the screw, taking care not to break its threads.  
\*Plating should not include zinc.
- Use the thickest possible earth (ground) cable. Use the cable whose size is equal to or greater than that indicated below, and minimize the cable length. The earthing (grounding) point should be as near as possible to the inverter.

Motor Capacity	Earth (Ground) Cable Gauge	
	200V class	400V class
2.2kW or less	2 (2.5)	2 (2.5)
3.7kW	3.5 (4)	2 (2.5)
5.5kW, 7.5kW	5.5 (6)	3.5 (4)
11kW, 15kW	14 (16)	8 (10)
18.5kW to 37kW	22 (25)	14 (16)
45kW, 55kW	38 (35)	22 (25)

For use as a product compliant with the Low Voltage Directive, use PVC cable whose size is indicated within parentheses.

- Earth (Ground) the motor on the inverter side using one wire of the 4-core cable.

### 2.3 Setting the motor

This inverter is factory-set to run the dedicated motor (SF-V5RU (1500r/min series) with encoder)

0	SF-JR	Inverter internal constants
10	SF-HRCA	Inverter internal constants

(It is not necessary to reset the inverter if you use the dedicated motor (SF-V5RU (1500r/min series) with encoder) (only when inverter capacity = motor capacity).)

#### POINT

The parameter below is extended mode parameter. Set "1" in Pr. 160 "extended function selection".

#### 2.3.1 Dedicated motor (SF-V5RU (1500r/min series))

Check that the Pr.71 "applied motor" (extended mode) setting is "30" (SF-V5RU) (factory setting value).

#### 2.3.2 Motor one rank lower than the dedicated motor (SF-V5RU (1500r/min series))

Set the parameter shown below.

Parameter	Name	Factory Setting	Setting Range
80	Motor capacity	Inverter capacity	0.4kW to 55kW

REMARKS



When using a conventional motor (SF-VR, SF-JR) or other motors, refer to the Instruction Manual (detailed).

<At-a-glance guide to setting the motor>

No.	Item	Parameter, Jumper Connector, Terminal	Description	Dedicated Motor		Standard Motor					Constant-torque Motor (with encoder)		
				Mitsubishi		Mitsubishi				Other manufacturer (with encoder)	Mitsubishi		Other manufacturer
				SF-V5RU 1500r/min series	SF-VR-5.5kW to 45kW	SF-JR (with encoder)		SF-HR (with encoder)	Others (with encoder)		SF-HRCA (4P) (with encoder)	SF-JRCA (with encoder)	
		(2, 4, 6P)-2.2kW to 55kW	(4P)-1.5kW or less										
1	Motor setting	Pr. 71 setting		30	30	0	20	3 to 8	3 to 8	3 to 8	10	13 to 18	13 to 18
2	Offline tuning			Not required *	Not required *	Not required *	Not required *	Required	Required	Required	Not required *	Required	Required
3	Capacity setting	Pr. 80 setting	1 : 1	INV capacity	INV capacity	INV capacity	INV capacity	INV capacity	INV capacity	INV capacity	INV capacity	INV capacity	INV capacity
			1 rank lower	Motor capacity	Motor capacity	Motor capacity	Motor capacity	Motor capacity	Motor capacity	Motor capacity	Motor capacity	Motor capacity	Motor capacity
4	Number of encoder pulses	Pr. 851 setting		2048	1000	1024	1024	1024	(*2)	(*2)	1024	1024	(*2)
5	Encoder rotation direction	Pr. 852 setting		1	1	1	1	1	(*2)	(*2)	1	1	(*2)
6	Encoder power supply specification	Encoder power supply jumper connector on the back of the control terminal	Power supply specification	12V	5V	5V	5V	5V	(*2)	(*2)	5V	5V	(*2)
7	Encoder output type		Output circuit	Terminating resistance	Complimentary	Differential	Differential	Differential	Differential	(*2)	(*2)	Differential	Differential
				No	Yes	Yes	Yes	Yes	(*2)	(*2)	Yes	Yes	(*2)
8	Electronic thermal relay	Pr. 9 setting		0	0	Rated motor current	Rated motor current	Rated motor current	(*2)	(*2)	Rated motor current	Rated motor current	(*2)
9	Thermal protector input	Across OH-SD		Connect to the thermal	Connect to the thermal	Open	Open	Open	(*2)	(*2)	Open	Open	(*2)
		Pr. 876 setting		1	1	0	0	0	(*2)	(*2)	0	0	(*2)

CAUTION

1. Set number of motor poles in Pr.81.
2. Make setting according to the motor used.
3. The half-tone screened cells are factory set.
4. Check the power supply specification of encoder and change a jumper connector.
5. \*:Perform offline auto tuning (mode without rotation) for the wiring length to be reflected on the control when exercising magnetic flux observer and the wiring length is long (30m or longer as reference).

<When using other manufacturers' motors>

Offline auto tuning (rotation mode) is necessary. Perform offline auto tuning with the motor alone before connecting a load. If higher torque accuracy is required, perform online auto tuning next.

? Offline auto tuning

- ☞ The inverter measures necessary motor circuit constant and stores it to improve low speed torque.

? Online auto tuning

- ☞ High torque accuracy corresponding to the motor temperature variation is available.



## 2.4 Precautions for use of the vector inverter

The FR-V500 series is a highly reliable product, but incorrect peripheral circuit making or operation/handling method may shorten the product life or damage the product.

Before starting operation, always recheck the following items.

- (1) Use insulation-sleeved crimping terminals for the power supply and motor cables.
- (2) The inverter will be damaged if power is applied to the inverter output terminals (U, V, W).
- (3) After wiring, wire offcuts must not be left in the inverter.  
Wire offcuts can cause an alarm, fault or malfunction. Always keep the inverter clean.  
When drilling mounting holes in an enclosure etc., take care not to allow chips and other foreign matter to enter the inverter.
- (4) Wire the cables of the recommended size to make a voltage drop 2% or less.  
If the wiring distance is long between the inverter and motor, a main circuit cable voltage drop will cause the motor torque to decrease especially at the output of a high frequency.  
Refer to page 11 for the recommended wire sizes.
- (5) The overall wiring length should be 100m maximum.  
Especially for long distance wiring, the fast response current limit function may be reduced or the equipment connected to the secondary side may malfunction or become faulty under the influence of a charging current due to the stray capacity of the wiring. Therefore, note the overall wiring length.
- (6) Electromagnetic wave interference  
The input/output (main circuit) of the inverter includes high frequency components, which may interfere with the communication devices (such as AM radios) used near the inverter. In this case, install the optional FR-BIF radio noise filter (for use on the input side only) or FR-BSF01 or FR-BLF line noise filter to minimize interference.
- (7) Do not install a power factor correction capacitor, surge suppressor or radio noise filter (FR-BIF option) on the output side of the inverter.  
This will cause the inverter to trip or the capacitor and surge suppressor to be damaged. If any of the above devices is installed, immediately remove it. (When the FR-BIF radio noise filter is connected, switching power off during motor operation may result in E. UVT. In this case, connect the radio noise filter in the primary side of the magnetic contactor.)
- (8) Before starting wiring or other work after the inverter is operated, wait for at least 10 minutes after the power supply has been switched off, and check that there are no residual voltage using a tester or the like. The capacitor is charged with high voltage for some time after power off and it is dangerous.
- (9) A short circuit or earth (ground) fault in the inverter output side may damage the inverter modules.
  - Fully check the insulation resistance of the circuit prior to inverter operation since repeated short circuits caused by peripheral circuit inadequacy or an earth (ground) fault caused by wiring inadequacy or reduced motor insulation resistance may damage the inverter modules.
  - Fully check the to-earth (ground) insulation and inter-phase insulation of the inverter secondary side before power on. Especially for an old motor or use in hostile atmosphere, securely check the motor insulation resistance etc.
- (10) Do not use the inverter power supply side magnetic contactor to start/stop the inverter.  
Always use the start signal (turn on/off terminals STF, STR-SD) to start/stop the inverter. (Refer to page 7.)
- (11) Across the P and PR terminals, connect only an external regenerative brake discharge resistor.  
Do not connect a mechanical brake.
- (12) Do not apply a voltage higher than the permissible voltage to the inverter I/O signal circuits.  
Contact to the inverter I/O signal circuits or opposite polarity may damage the I/O devices. Especially check the wiring to prevent the speed setting potentiometer from being connected incorrectly to short terminals 10E-5.
- (13) Use of single-phase power supply  
Do not use single-phase power input.
- (14) Precautions for use of any motor other than the vector control dedicated motor (SF-V5RU, SF-VR) and standard motor with encoder (SF-JR)
  - a) Vector control cannot be exercised without encoder.
  - b) Connect the encoder to the backlash-free motor shaft.
- (15) Since the rated voltage differs from the commercial power supply voltage, the Mitsubishi dedicated motor cannot perform bypass operation.

SF-V5RU	3.7kW or less	170V
	5.5kW or more	160V
SF-V5RUH	3.7kW or less	340V
	5.5kW or more	320V

# 3 RUN AND OPERATION

## 3.1 Checks prior to test run

### Installation check

Check that the inverter is installed correctly in a correct place. (Refer to page 6.)

### Wiring check

Check that wiring is correct. (Refer to page 7.)

## 3.2 Basic operation (Speed setting, run, speed meter adjustment)

### 3.2.1 Setting the speed and running the motor

#### (1) Choosing PU operation mode (operation from the control panel (FR-DU04-1)) and running at 150r/min

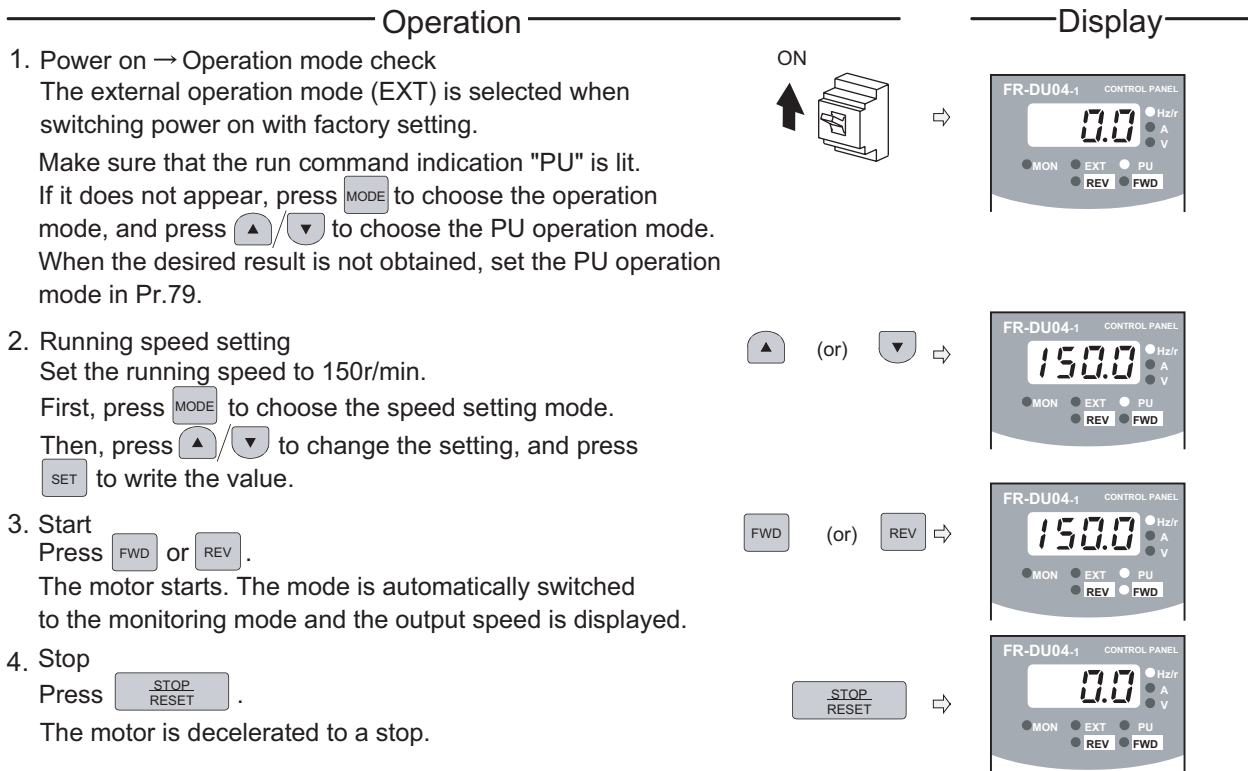

### REMARKS

- The running speed can be changed by changing the preset speed during operation following the steps 2 and 3 above.
- For monitor display changes by **MODE**, refer to page 28.
- To select the PU operation mode in Pr.79 "operation mode selection", set "1" in the parameter. Refer to page 56 for details.

## Basic operation (Speed setting, run, speed meter adjustment)

### ● PU jog operation

Hold down **FWD** or **REV** to perform operation, and release it to stop.

1) Set Pr. 15 "jog speed setting" and Pr. 16 "jog acceleration/deceleration time".

2) Set PU jog operation. (Press **MODE** to select the operation mode and press **▲**/**▼** to switch to PU jog operation.)

3) Hold down the **FWD** or **REV** key to perform operation.

(If the motor remains stopped, check Pr. 13 "starting speed". The motor will not start if its setting is lower than the starting speed.)

#### REMARKS

- If the motor does not rotate ⇒
  - Checking the encoder jumper connector (Refer to page 12.)
  - Checking the phase sequence of the encoder cable (Refer to page 12.)
  - For other cases, refer to Troubleshooting on page 85.
- When you want to set the speed to higher than 1500r/min, set Pr. 1 "maximum speed". (Refer to page 55.)

## (2) Choosing external operation mode (operation using external speed setting potentiometer and external start signals)

### ● Running at 1500 r/min

- Run command: start signals connected outside
- Speed setting: speed setting potentiometer connected outside

#### Operation

#### Display

#### 1. Power on → Operation mode check

The external operation (EXT) is selected when switching power on with factory setting. Make sure that the run command indication "EXT" is lit.

If it does not appear, press **MODE** to choose the operation mode, and press **▲**/**▼** to choose the external (EXT) operation mode.

When the desired result is not obtained, set the external operation mode in Pr.79.

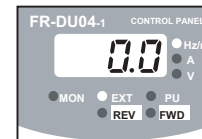
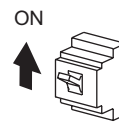

#### 2. Start

Turn on the start switch (STF or STR).

The operation status indication FWD or REV flickers.

#### CAUTION

**The motor does not start if both the forward and reverse rotation switches are turned on. If both switches are turned on during operation, the motor decelerates to a stop.**

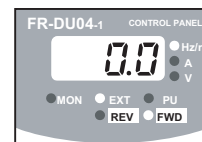
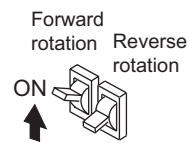

#### 3. Acceleration → Constant speed

Slowly turn the potentiometer (speed setting potentiometer) connected to across terminals 2-5 full clockwise.

The speed shown on the display increases gradually to 1500r/min.

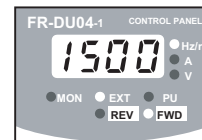
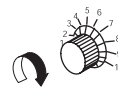

#### 4. Deceleration

Slowly turn the potentiometer (speed setting potentiometer) connected to across terminals 2-5 full counterclockwise.

The speed shown on the display decreases gradually to 0r/min.

The motor stops running.

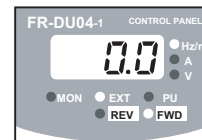

#### 5. Stop

Turn off the start switch (STF or STR).

#### CAUTION

When Pr. 75 "PU stop selection" = "14 to 17",

**STOP** is valid.

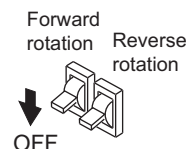

#### REMARKS

- The running speed of the external potentiometer can be adjusted in Pr. 902 and Pr. 903 (bias and gain of the speed setting terminal). (Refer to page 51.)
- For monitor display changes by **MODE**, refer to page 28.
- To select the external operation mode in Pr. 79 "operation mode selection", set "2" in the parameter. Refer to page 56 for details.

● **External jog operation**

Keep the start switch (STF or STR) on to perform operation, and turn it off to stop.

- 1) Set Pr. 15 "jog speed setting" and Pr. 16 "jog acceleration/deceleration time".
- 2) Select the external operation mode.
- 3) Switch on the jog signal. Keep the start switch (STF or STR) on to perform operation.  
Assign the terminal used for the jog signal in any of Pr. 180 to Pr. 183 and Pr. 187 (input terminal function selection). (Refer to page 65.)

**(3) Choosing external/PU combined operation mode 1 (operation using the external start signal and control panel)**

● **When setting the start signals from outside inverter (e.g. switches or relays) and the running speed from the control panel (Pr. 79 = 3)**

- Run command: start signal connected outside
- Speed setting: ▲/▼ of PU or multi-speed command (multi-speed command has priority)  
For multi-speed command, refer to Pr.4 to Pr.6 on page 54.

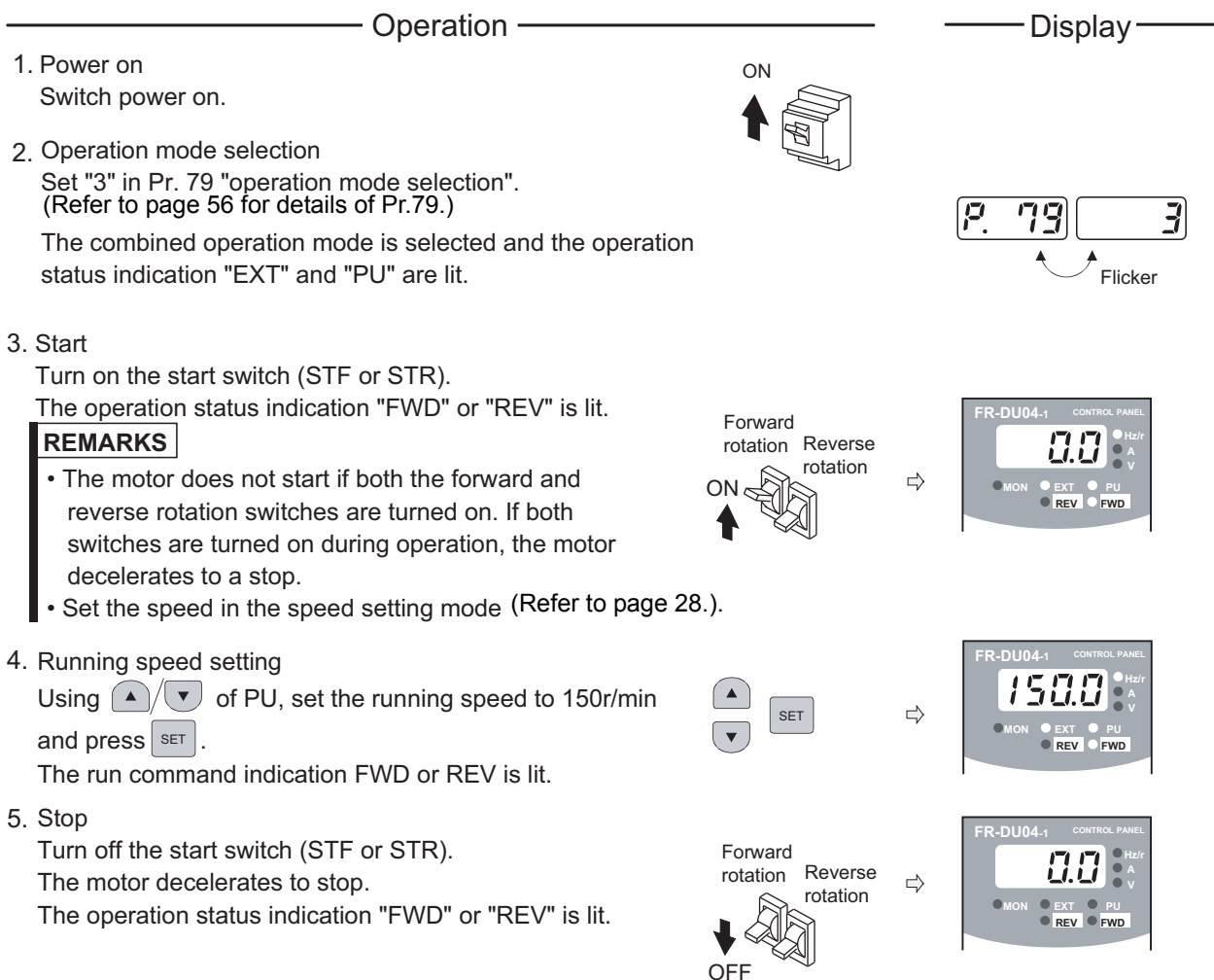

**CAUTION**

When Pr. 75 "PU stop selection" = "14 to 17",

 is valid.

**REMARKS**

When setting the start signal from the PU and speed setting signal from outside inverter, set "4" (combined operation mode 2) in Pr.79 "operation mode selection".















## Basic operation (Speed setting, run, speed meter adjustment)

### 3.2.2 Adjustment (calibration) of speed meter (meter)

**Changing example** At the preset speed of 1500r/min, make adjustment so that the meter (analog meter) deflects to full-scale. Calibrate the DA1 terminal ( $\pm 10V$ ). (in PU operation mode)

#### POINT

- Pr. 900 "DA1 terminal calibration" can be read by setting "1" (extended function parameter enable) in Pr. 160 "extended function selection".
- Set Pr. 900 "DA1 terminal calibration".
- Set any of "1 to 3, 5 to 12, 17, 18, 21, 32 to 34 and 36" in Pr. 54 "DA1 terminal function selection" to output a signal to the terminal DA1. (Refer to page 60)

Operation	Display
1. Press  to operate the inverter. (It is not necessary to connect a motor.)	
2. Press  to select the parameter setting mode.	 ⇒ 
3. Display the present running speed by pressing  to read Pr. 900.	 ⇒ 
4. Press  or  to adjust the meter pointer to a predetermined position. (Depending on the setting, it may take some time until the pointer moves.)	 (Analog voltage meter)
<b>REMARKS</b>	
1. Pressing  to start reverse rotation operation will move the meter pointer reversely (in the negative direction).	
2. The terminal DA1 output will also keep displaying the monitor when the inverter stops due to an alarm.	
5. Press  for about 1.5s. This completes the setting.	 Flicker ... Parameter setting complete!!
6. Press  to stop the inverter.	

#### CAUTION

1. When the speed meter is connected across terminals DA1-5 to monitor the speed, the output of terminal DA1 is saturated if the maximum output speed reaches or exceeds 1500r/min, with the factory setting unchanged. Hence, the setting of Pr. 55 "speed monitoring reference" must be changed to the maximum output speed. (Refer to page 60.)
2. Terminal DA2 can be adjusted in Pr. 901
3. For operation from the parameter unit (FR-PU04V), refer to the instruction manual of the FR-PU04V.

#### REMARKS

- For monitor display changes by , refer to page 28.
- Calibration can be made also during external operation.

### 3.3 Names and functions of the control panel

With the control panel (FR-DU04-1), you can perform operation, set the speed, monitor the run command display, set parameters, display an error, and copy parameters.

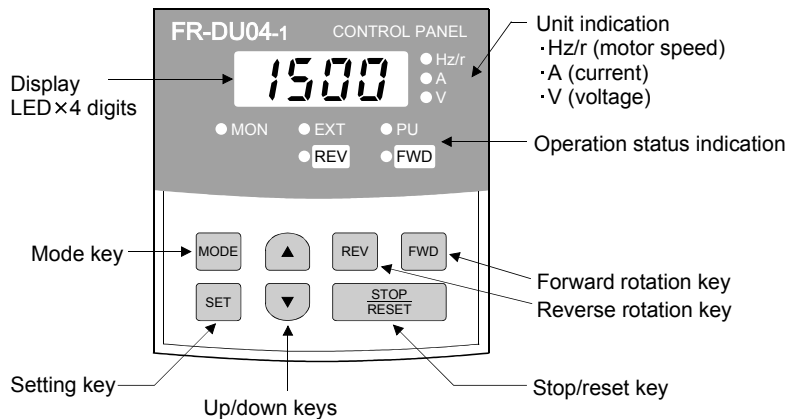

**REMARKS**

The ON of the LED is indicated by ○, and OFF by ●.

● Key indication

Key	Description
	Select the operation mode or setting mode.
	Determine the speed or parameter setting.
	<ul style="list-style-type: none"> <li>Used to increase or decrease the running speed consecutively. Hold down this key to change the speed.</li> <li>Press this key in the setting mode to change the parameter setting consecutively.</li> </ul>
	Forward rotation command key.
	Reverse rotation command key.
	<ul style="list-style-type: none"> <li>Used to stop operation.</li> <li>Used to reset the inverter when the protective function (major fault) is activated to stop the output.</li> </ul>

● Unit indication, operation status indication

Indication	Description
Hz/r	Lit to indicate the output speed.
A	Lit to indicate the current.
V	Lit to indicate the voltage.
MON	Lit in the monitor display mode.
PU	Lit in the PU operation mode.
EXT	Lit in the external operation mode.
FWD	Flickers during forward rotation.
REV	Flickers during reverse rotation.

### 3.3.1 Monitor display changed by pressing

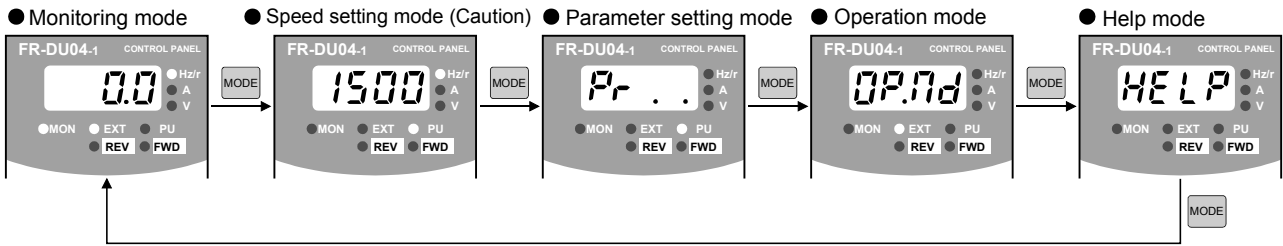

**CAUTION**



The speed setting mode appears only when the operation mode is the PU operation mode.

### 3.3.2 Monitoring

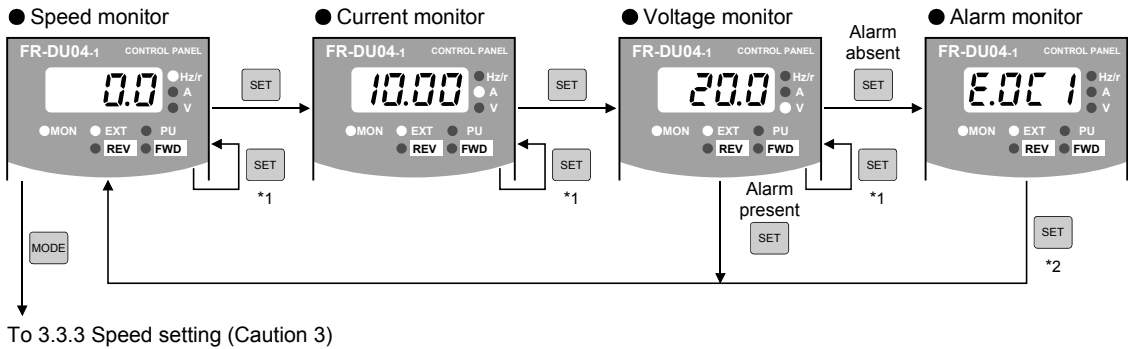
- Run command indications in the monitoring mode  
EXT is lit to indicate external operation.  
PU is lit to indicate PU operation.  
Both EXT and PU are lit to indicate PU/external combined operation.
- The monitor display can also be changed during operation.



**CAUTION**



1. Hold down  marked \*1 for more than 1.5s to change the current monitor to the power-on monitor.
2. Hold down  marked \*2 for more than 1.5s to display the last four errors including the latest one.
3. In the external operation mode, it shifts to the parameter setting mode.

### 3.3.3 Speed setting

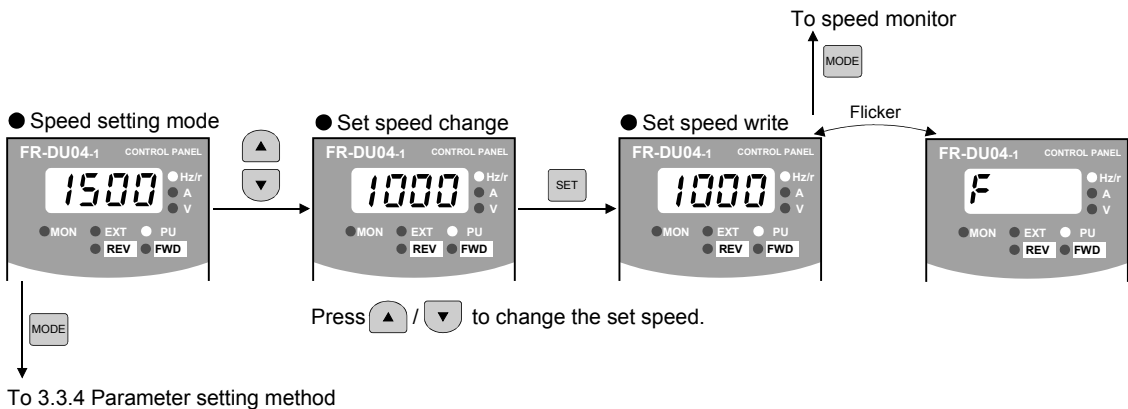
- Used to set the running speed in the PU operation mode.



### 3.3.4 Parameter setting method (Example: Method to enable extended function parameters)

- A parameter value may either be set by updating its parameter number or setting the value digit-by-digit using  .

- To write the setting, change it and press  for 1.5s.

Example: To change the Pr. 160 "extended function selection" setting from "0" (extended function parameter invalid) to "1" (extended function parameter valid) (Refer to page 56 for details of Pr. 160.)

Press  to choose the "parameter setting mode".

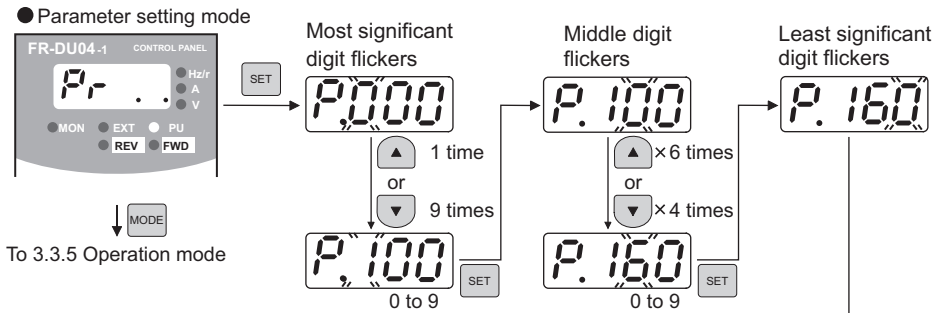

To 3.3.5 Operation mode

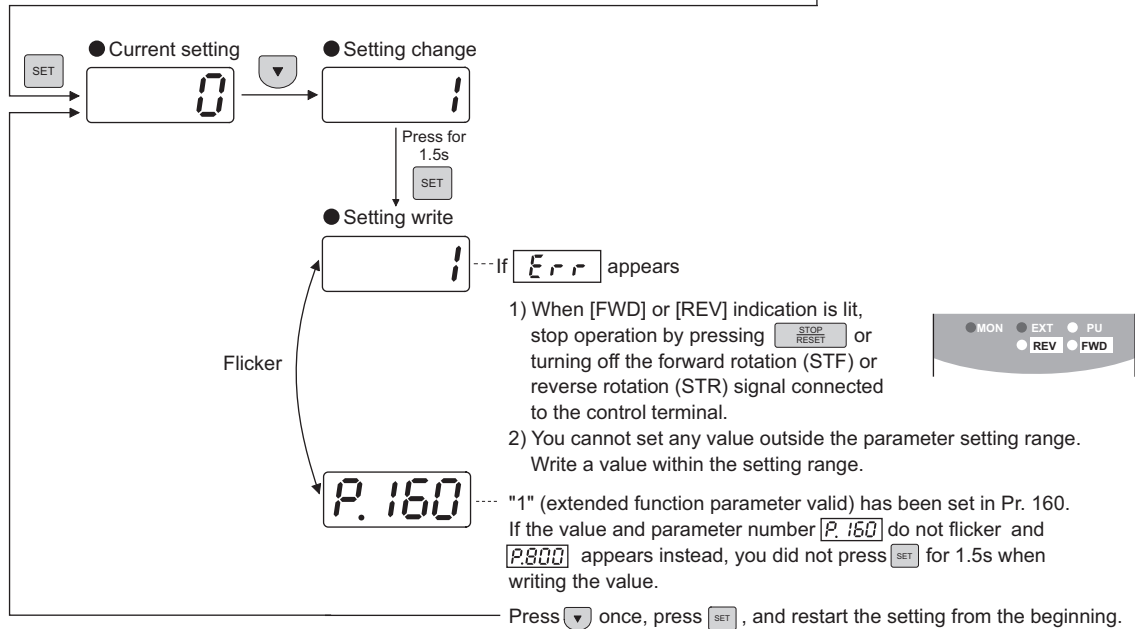

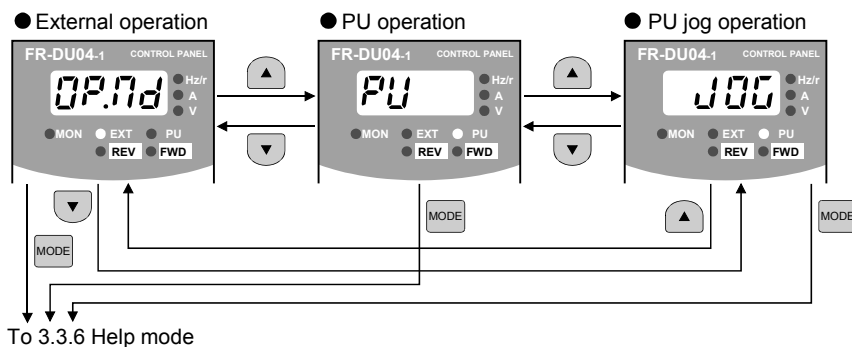

### 3.3.5 Operation mode



#### REMARKS

If one operation mode cannot be switched to another, check the following items.

- External input signals ..... Make sure that the STF and STR signals are off.
- Parameter setting ..... Check the Pr. 79 setting.

When the Pr. 79 "operation mode selection" setting is "0" (factory setting), the inverter is placed in the external operation mode at input power-on. At this time, press  on the control panel twice and press  (press  when the parameter unit (FR-PU04V) is used) to switch to the PU operation mode. For the other values (1 to 8), the operation mode is limited accordingly.



### 3.3.6 Help mode

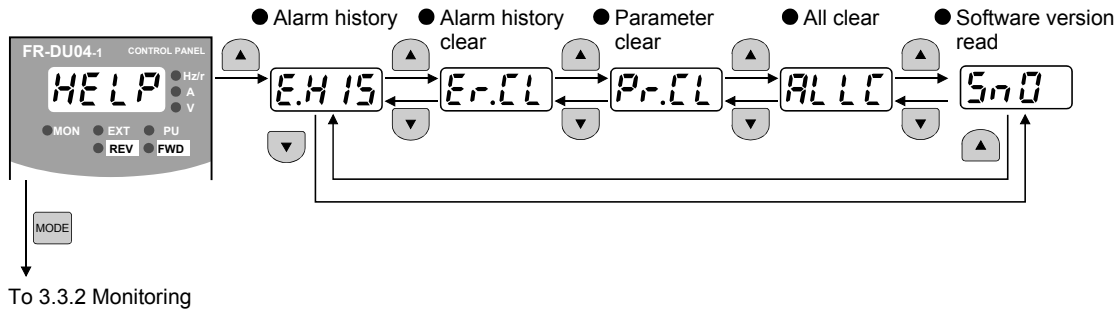

#### (1) Alarm history

Four past alarms can be displayed with / . ("." is appended to the latest alarm.)

When no alarm exists, is displayed.

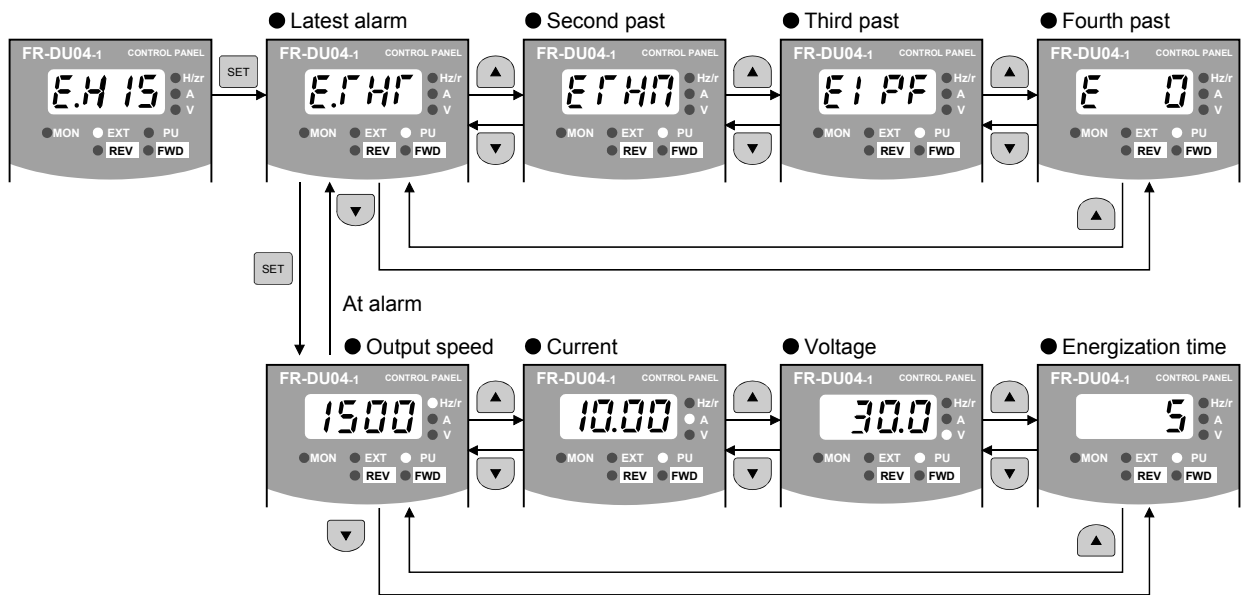

#### (2) Alarm history clear

Clears all alarm history.

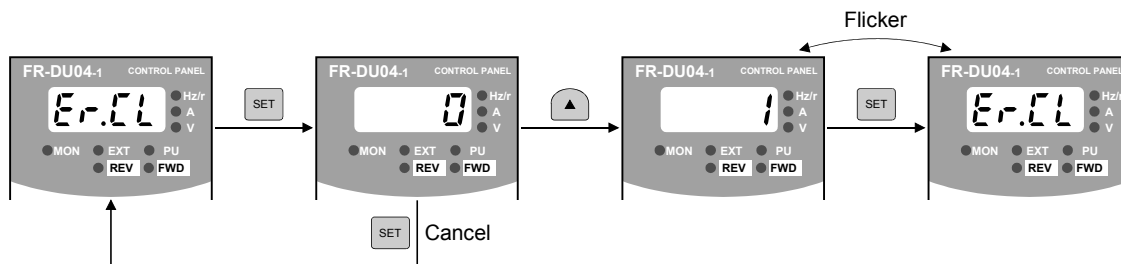

**(3) Parameter clear**

Initializes the parameter values to the factory settings. The calibration values are not initialized.  
 (Parameter values are not cleared by setting "1" in Pr. 77 "parameter write disable selection".)

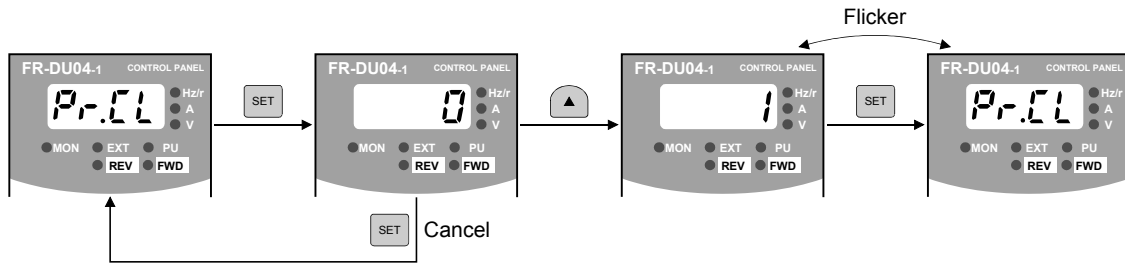

**REMARKS**

Pr. 75, Pr. 82, Pr. 90 to Pr. 94, Pr. 96, Pr. 145, Pr. 171, Pr. 180 to Pr. 183, Pr. 187, Pr. 190 to Pr. 192, Pr. 195, Pr. 496, Pr. 497, Pr. 819, Pr. 849, Pr. 868, Pr. 880, Pr. 890 to Pr. 892, Pr. 900 to Pr. 905, Pr. 917 to Pr. 920, and Pr. 991 are not initialized.

**(4) All clear**

Initializes the parameter values and calibration values to the factory settings.  
 (Parameter values are not cleared by setting "1" in Pr. 77 "parameter write disable selection".)

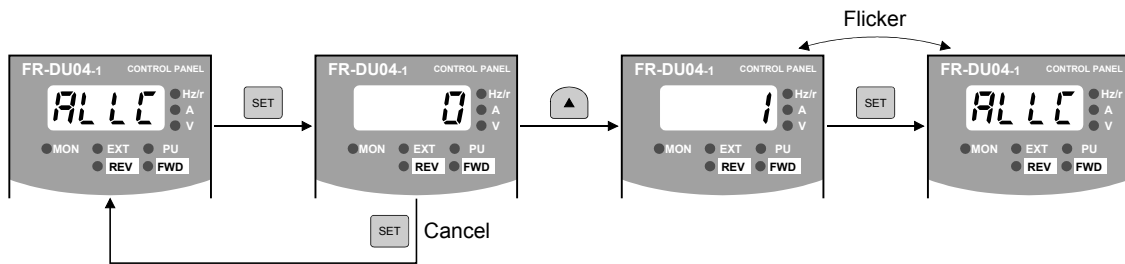

**REMARKS**

Pr. 75, Pr. 145, Pr. 171, Pr. 496, Pr. 497 and Pr. 891 are not initialized.

### 3.3.7 Copy mode

By using the control panel (FR-DU04-1), the parameter values can be copied to another inverter (only the FR-V500 series).

#### 1) Operating procedure

After reading the parameter values from the copy source inverter, connect the control panel to the copy destination inverter, and write the parameter values.

After writing the parameter values to the copy destination inverter, always reset the inverter, e.g. switch power off once, before starting operation.

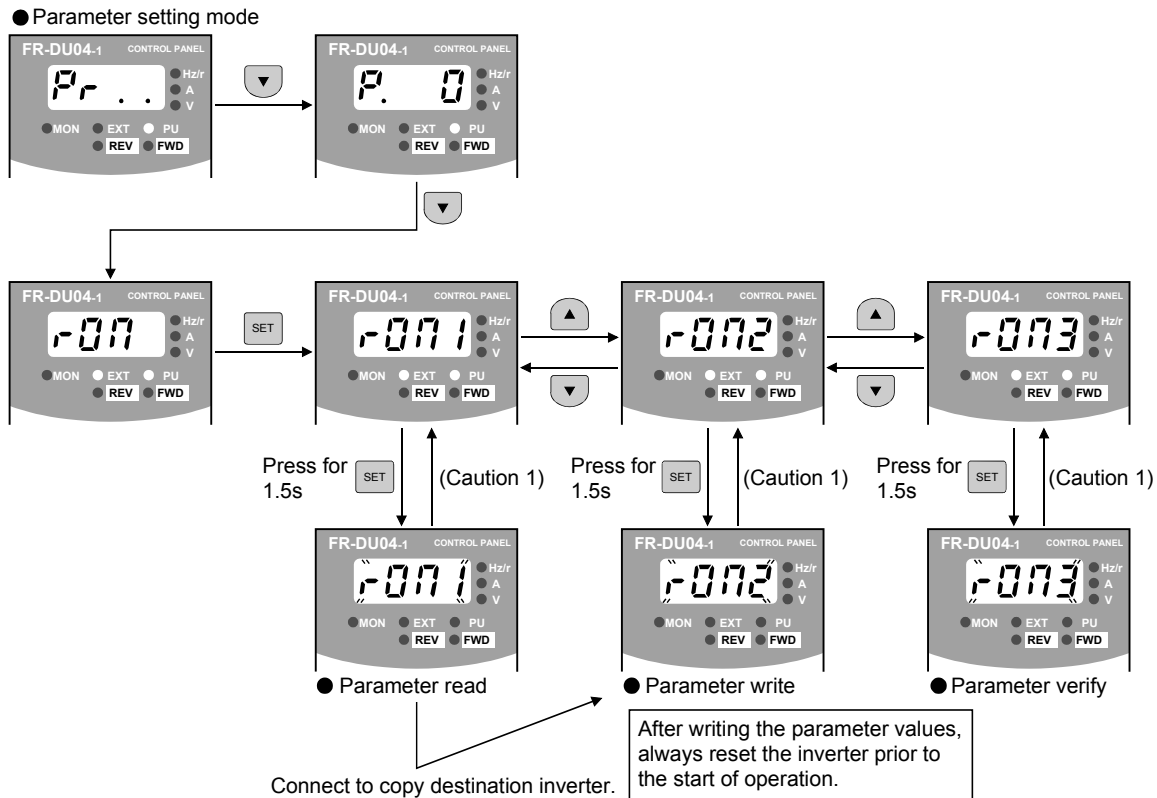

#### CAUTION

1. While the copy function is being activated, the monitor display flickers. The display returns to the lit-up state on completion of the copy function.
2. If a read error occurs during parameter read, "read error (E.rE1)" is displayed.
3. If a write error occurs during parameter write, "write error (E.rE2)" is displayed.
4. If a data discrepancy occurs during parameter verify, the corresponding parameter number and "verify error (E.rE3)" are displayed alternately. If the directly preset speed or jog speed setting differs, "verify error (E.rE3)" flickers. Press  to ignore this display and continue verify.
5. When the copy destination inverter is not the FR-V500, "model error (E.rE4)" is displayed.

Reference: It is recommended to perform parameter read after completion of parameter setting. (When performing auto tuning, it is recommended to perform read after completion of auto tuning.) When the inverter has been changed, performing parameter write from the control panel fitted to a new inverter completes parameter setup.

# 4 CONTROL

This inverter can control a motor under speed, torque or position control. (As required, set "1" (extended function parameters valid) in Pr. 160 "extended function selection".)

Refer to page 29 for the setting method of Pr. 160 "extended function selection" and to page 56 for details. (Since the factory setting of Pr. 77 is "0", perform parameter write in the PU mode or during a stop.)

## 4.1 Speed control operation

### 4.1.1 Speed control

Speed control is exercised to match the speed command and actual motor speed.

Speed response ..... Maximum 800rad/s by internal processing and maximum 300rad/s (without adaptive magnetic flux observer) by analog input signal are available (motor speed response to the speed command).

### 4.1.2 Operation transition

- Turning on the start signal increases the speed up to the preset speed according to the acceleration time.
- Turning off the start signal decreases the speed according to the deceleration time. When the speed has decreased down to the DC brake operation speed, operation changes to 0 speed control or servo lock. (Refer to Pr. 802 "pre-excitation selection" on page 70.)

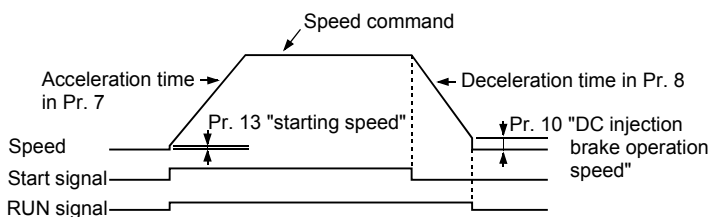

#### REMARKS

- When the RT signal is off, Pr. 7 and Pr. 8 are acceleration time and deceleration time.
- When the RT signal is on, Pr. 44 and Pr. 45 (second acceleration/deceleration time) are acceleration/deceleration time.
- Pr. 44 and Pr. 45 are valid when the RT signal is on, and Pr. 110 and Pr. 111 (third acceleration/deceleration time) are valid when the X9 signal is on. When both the RT and X9 are on, Pr. 110 and Pr. 111 are valid.

### 4.1.3 Setting procedure

Perform secure wiring. (Refer to page 7.)

Set the encoder. (Refer to page 12.)

Set the motor to be used. (Refer to page 20.)  
Refer to page 20 if the motor is one rank lower.

It is not necessary to set the encoder and motor when using the dedicated motor (SF-V5RU).

Set any of "0 (speed control), 2 (speed-torque switchover), 4 (speed-position switchover)" in Pr. 800 "control method selection" to make speed control valid. The parameter is factory-set to 0 (speed control). (Refer to page 57.)

Set the run command. (Refer to page 34.)

**Test run (Refer to page 23.)**

As required

- 1) Gain adjustment (Refer to page 47.)  
<Perform easy gain tuning.>
- 2) Set the torque limit value (Refer to page 34.)

Set the speed limit during torque control.

## Speed control operation

### 4.1.4 Run command setting

#### (1) Forward and reverse rotation commands (terminals STF, STR)

- 1) Command from the control panel (FR-DU04-1): Turn on  or  (Refer to page 23.).
- 2) External command: Turn the forward/reverse rotation signal (terminal STF, STR) on. (Refer to page 24.)  
(Turning both terminals STF and STR on or off will give a stop command.)

#### REMARKS

Use Pr. 79 "operation mode selection" to change the operation mode between control panel (PU) and external command (EXT). (Refer to page 56.)

#### (2) Speed command

- 1) Control panel (FR-DU04-1) speed setting (Refer to page 23.)

#### REMARKS

Use Pr. 79 "operation mode selection" to change the run command between control panel (PU) and external command (EXT). (Refer to page 56.)

- 2) External analog command (terminal 2 (or terminal 1))  
Give a speed command using the analog signal input to terminal 2 (or terminal 1).

#### REMARKS

- Set Pr. 73 "speed setting signal" to change between the main speed and override of terminal 2.  
(  Refer to the Instruction Manual (detailed)).
- For the adjustment of bias/gain of analog signal, set terminal 2 in Pr. 902 "speed setting terminal 2 bias" or Pr. 903 "speed setting terminal 2 gain". (Refer to page 51.)
- The function of terminal 1 changes according to the setting of Pr. 868 "terminal 1 function selection". For the factory set function of terminal 1, refer to the Instruction Manual (detailed). The function of this terminal is factory-set to adding auxiliary of the speed setting signal of terminal 2.
- Set the adjustment of bias/gain of terminal 1 in Pr. 902 "speed setting terminal 2 bias" or Pr. 903 "speed setting terminal 2 gain".

- 3) Multi-speed commands

The external signals (RH, RM, RL) may also be used to give speed command.  
(The terminals are factory-set as follows. DI1 = RH, DI2 = RM, DI3 = RL)

#### REMARKS

- The RH, RM and RL signals are assigned to terminals DI1 to DI4 and STR using Pr. 180 to Pr. 183 and Pr. 187 (input terminal function selection).
- Speed control has the following priority:  
maximum setting > Jog > speed jump > minimum setting > 12 bit digital (FR-A5AX) / 16 bit digital (FR-V5AH) > multi-speed > option high-resolution output (FR-V5AX) > PID control > analog input

### CAUTION

**When the speed command is to be given using the analog command (terminal 2), turn off the external signals (RH, RM, RL). If any of external signals (RH, RM, RL) is on, the multi-speed commands are made valid.**

### 4.1.5 Torque limit

Select the setting method of output torque limit during speed control from among the external analog input terminal "3" or "1" (Pr. 868 "terminal 1 function selection" = "2") or parameter settings using Pr. 810 "torque limit input method selection".

Torque limit is factory-set to exercise by parameter settings, and the limit level is 150%.

Parameter	Name	Factory Setting	Description
803	Constant power range torque characteristic selection	0	0: Motor output is made constant (torque is reduced) 1: Torque is made constant You can select whether the torque limit in the constant power range to be constant torque limit or constant output limit. (Refer to page 41.)
810	Torque limit input method selection	0	0: Internal torque limit (torque limit by parameter settings) (Refer to page 35) 1: External torque limit (torque limit using the terminal 3, 1 and 6 (option FR-V5AX)) With the upper limit of torque limit as set in Pr. 22, Pr. 812, Pr. 813 and Pr. 814, the analog input from the terminal 3 input is used as the torque limit value on the driving side within the Pr. 22 setting range. When regenerative torque limit is assigned to the terminal 1 or option's terminal 6 on the regenerative side, the analog input from the terminal 1 or terminal 6 is used as the torque limit.

Parameter	Name	Factory Setting	Description
22	Torque limit level	150	Set the torque limit level in % for speed control or position control so that the output torque does not exceed the predetermined value. (0 to 400%) When Pr. 810 = 0, 1st quadrant Pr. 22 2nd quadrant Pr. 812 3rd quadrant Pr. 813 4th quadrant Pr. 814
811	Set resolution switchover	0	The setting increments of Pr. 22 "torque limit level" and Pr. 812 to Pr. 817 (torque limit level) and the speed from the communication can be changed. 0: Torque limit 0.1% increments; Speed from the communication 1r/min increments 1: Torque limit 0.1% increments; Speed from the communication 0.1r/min increments 10: Torque limit 0.01% increments; Speed from the communication 1r/min increments 11: Torque limit 0.01% increments; Speed from the communication 0.1r/min increments
812	Torque limit level (regeneration)	9999	Set the torque limit level in % for regeneration. (0 to 400%) Valid for regeneration when Pr. 810 = 0. 9999: Restricted to the Pr. 22 value.
813	Torque limit level (3rd quadrant)	9999	Set the torque limit level in % for 3rd quadrant. (0 to 400%) Valid for reverse rotation driving when Pr. 810 = 0. 9999: Restricted to the Pr. 22 value.
814	Torque limit level (4th quadrant)	9999	Set the torque limit level in % for 4th quadrant. (0 to 400%) Valid for reverse rotation regeneration when Pr. 810 = 0. 9999: Restricted to the Pr. 22 value.
815	Torque limit level 2	9999	When the TL signal is on, the Pr. 815 value is a torque limit value regardless of Pr. 810. Set the torque limit level in % for all operations. (0 to 400%) Valid when the TL terminal (torque limit selection) input is provided. 9999: According to the Pr. 22 value.
816	Acceleration torque limit level	9999	Set the torque limit value for acceleration. 9999: Same torque limit as at constant speed
817	Deceleration torque limit level	9999	Set the torque limit value for deceleration. 9999: Same torque limit as at constant speed

**(1) Torque limit level**

1) When Pr. 810 = 0  
In the factory setting, limit is made on all quadrants on the Pr. 22 torque limit level. When you want to set the level on a quadrant basis, change the corresponding parameter value.

2) When Pr. 810 = 1  
With the upper limit of torque limit as set in Pr. 22, the analog input from the terminal 3 input is used as the torque limit value within the Pr. 22 setting range. When the torque limit function is selected in the regenerative mode with the terminal 1 selected, the input from the terminal 1 is used as the torque limit on the regenerative side. (Pr. 868 = 2)

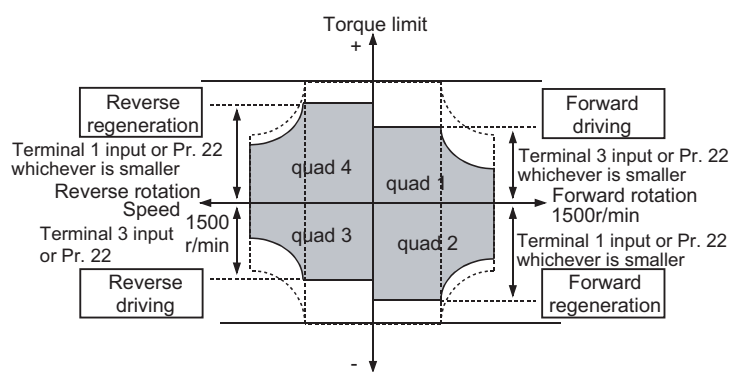
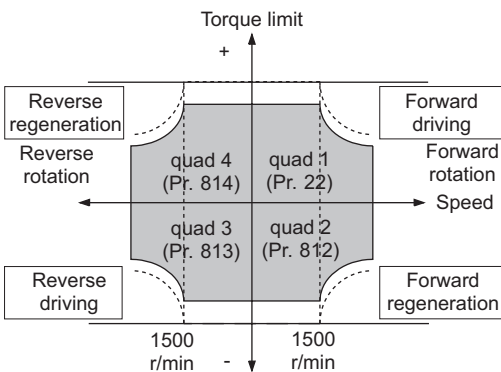

## Speed control operation

### (2) Second torque limit level

- When the TL signal is on, the Pr. 815 value is a torque limit value regardless of the setting in Pr. 810.

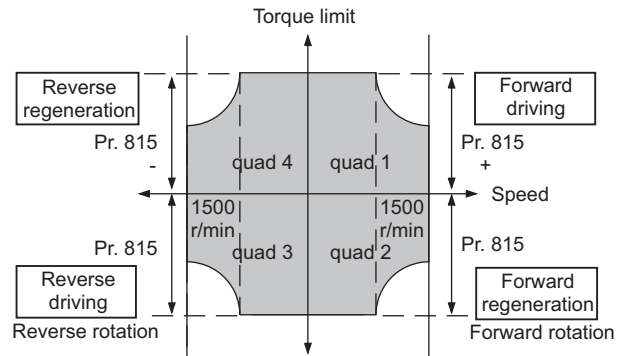

#### Related parameters

TL signal terminal assignment ⇒ Set "26" in any of Pr. 180 to Pr. 183 and Pr. 187 (input terminal function selection). (Refer to page 65)

#### REMARKS

- When an analog signal is used to make external torque limit, refer to page 51 for calibration of the terminal 3 (Pr. 904 "torque command terminal 3 bias" and Pr. 905 "torque command terminal 3 gain").
- When an analog signal is used to make regenerative torque limit from the terminal 1, perform calibration of the terminal 1. (Pr. 919 "terminal 1 bias (torque/magnetic flux)", Pr. 920 "terminal 1 gain (torque/magnetic flux)") Refer to page 51.

### (3) Torque limits during acceleration and deceleration

You can set torque limits during acceleration and deceleration individually.

The following chart shows torque limits according to the settings of Pr. 816 "acceleration torque limit level" and Pr. 817 "deceleration torque limit level".

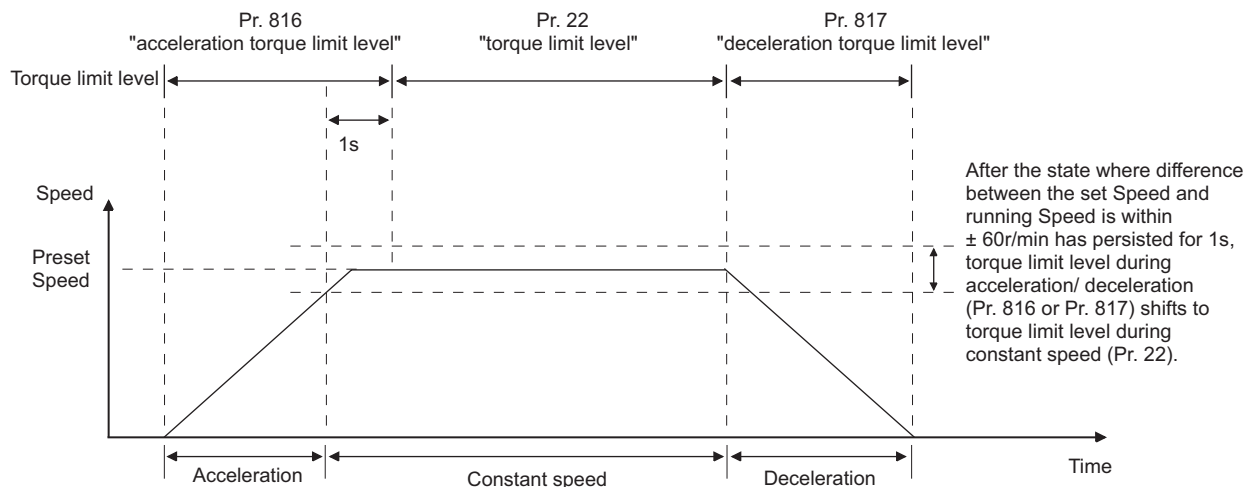

### (4) Setting increments switchover of the torque limit level (Pr. 811)

- By setting "10, 11" in Pr. 811 "set resolution switchover", the setting increments of Pr. 22 "torque limit level" and Pr. 812 to Pr. 817 (torque limit level) can be switched to 0.01%.

#### REMARKS

- The internal resolution of the torque limit is 0.024% ( $100/2^{12}$ ) and the fraction less than the resolution is rounded off.
- When the torque limit setting increments have been changed (0.1% ⇔ 0.01%), reset is necessary because the settings of Pr. 22 and Pr. 812 to Pr. 817 are multiplied by 1/10 (ten times).  
For example, when 10 (0.01%) set in Pr. 811 is changed to 1 (0.1%) with Pr. 22 = 150.00%, Pr. 22 = 1500.0% and the maximum torque is 400%.
- Refer to the Instruction Manual (detailed) for switchover of speed setting increments.

**(5) Change the torque characteristics in the constant power range (Pr. 803)**

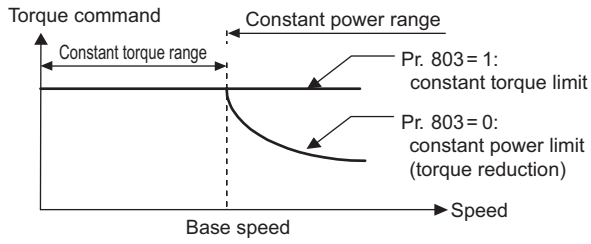

- You can select whether the torque limit in the constant power range be constant torque limit (setting is "1") or constant power limit (initial setting is "0"), using Pr. 803 "constant power range torque characteristic selection" under torque limit operation.

**4.1.6 Gain adjustment**

As a simple tuning method, the Pr. 819 "easy gain tuning" function is available. (Refer to page 47.)

**REMARKS**

- For fine adjustment of gain, refer to the Instruction Manual (detailed))
- Manual gain adjustment (Pr. 820, Pr. 821, Pr. 830, Pr. 831)
- Speed feed forward control and model adaptive speed control are also available.



## 4.2 Torque control operation

### 4.2.1 Torque control

Torque control is exercised to develop torque as set in the torque command. The motor speed becomes constant when the motor output torque and load torque are balanced. For torque control, therefore, the speed is determined by the load.

For torque control, the motor gains speed as the motor output torque becomes greater than the motor load. Here, set the speed limit value so that the motor speed does not increase too high. The speed limit value is set in the following method. When speed limit is not set, the speed limit value setting is regarded as 0r/min to disable torque control.

(Torque control is disabled under speed limit. (Speed control is performed.))

### 4.2.2 Operation transition

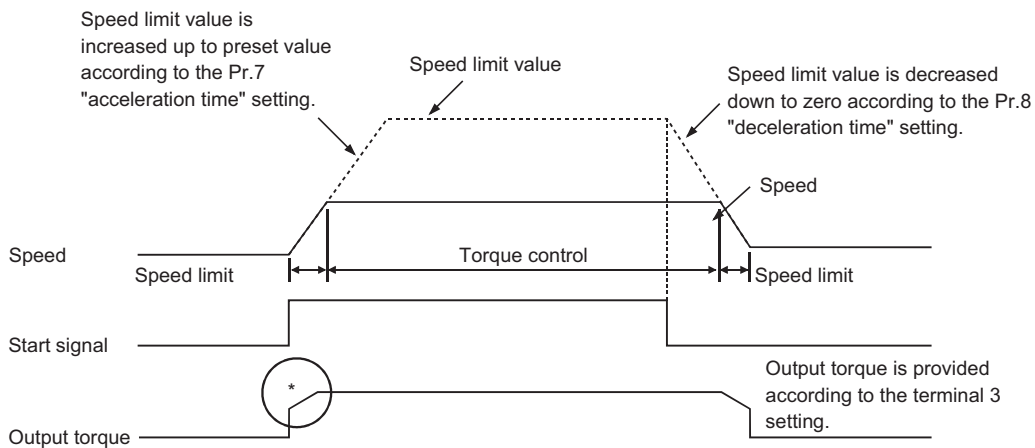

\* Speed control is performed during speed limit. (thus, torque according to the command is not developed)

#### REMARKS

When the load is smaller than torque command, the speed increases up to the speed limit value.

#### ● When "0" is set in Pr. 7 or Pr. 8 "acceleration/deceleration time"

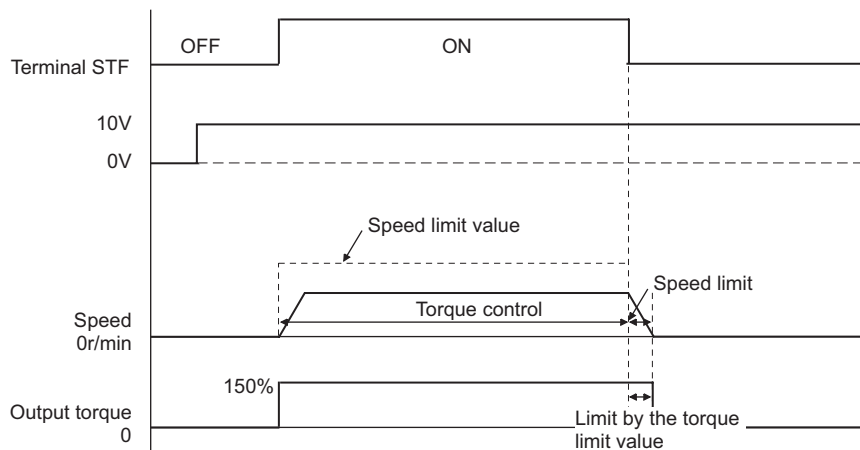

**(1) I/O signals**

The following table indicates the operations of the signals.

Signal	Terminal Name		Remarks
Start signal	External operation	STF, STR signal	Start and stop are the same as under speed control. A stop is made when the STF and STR signals are both on.
	PU operation	Forward or reverse rotation from PU04V or DU04-1	
Torque command	As set in the torque command source selection parameter.		Input torque command.
Speed limit	As set in the speed limit selection parameter.		Display SL and output OL signal during speed limit.

**(2) Operation example (Pr. 804 = 0)**

Torque control is enabled if the actual speed is less than the speed limit value.

When the actual speed reaches or exceeds the speed limit value, speed limit operation starts, torque control is stopped, and speed control (proportional control) starts.

The following shows the operations in response to the analog input command from the terminal 3.

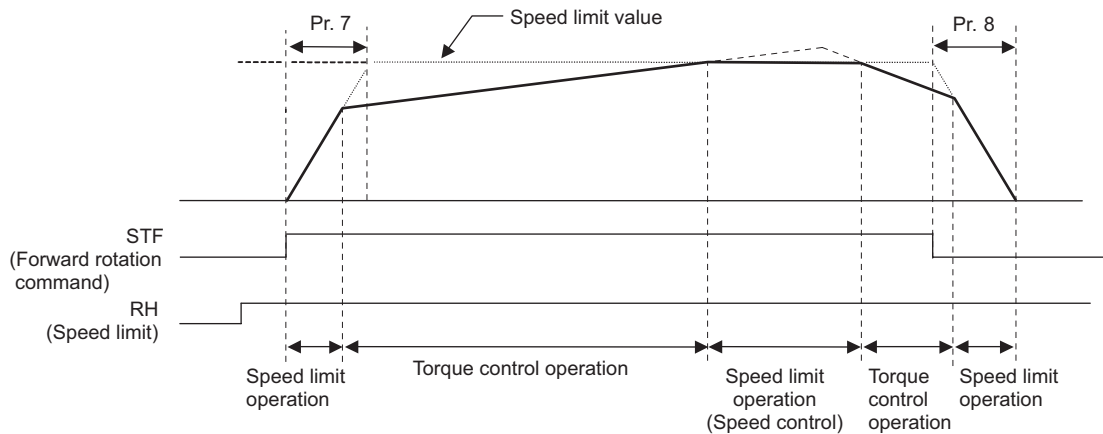

- 1) When STF is turned on, the speed limit value is increased according to the time set in Pr. 7.
- 2) Torque control operation is performed when the actual speed is less than the speed limit value.
- 3) When the STF start signal is turned off, the speed limit value is decreased according to the time set in Pr. 8.
- 4) For torque control, the actual speed becomes constant when the torque command and load torque are balanced.
- 5) The motor torque developing direction is determined by the combination of the torque command input polarity and start signal as indicated in the following table.

Torque Command Polarity	Torque Developing Direction (Mode)	
	STF signal ON	STR signal ON
Positive torque command	Forward rotation direction (forward rotation driving/reverse rotation regeneration)	Reverse rotation direction (forward rotation regeneration/reverse rotation driving)
Negative torque command	Reverse rotation direction (forward rotation regeneration/reverse rotation driving)	Forward rotation direction (forward rotation driving/reverse rotation regeneration)

**REMARKS**

When speed limit operation starts, speed control is exercised to enable internal torque limit (Pr. 22 "torque limit level" (factory setting)). Speed control may not be returned to torque control in this case. Torque limit be set to external torque limit (terminals 3, 1 and 6 (option FR-V5AX)).

(Refer to Pr. 803 "constant power range torque characteristic selection" (page 34).)

## Torque control operation

### 4.2.3 Setting procedure

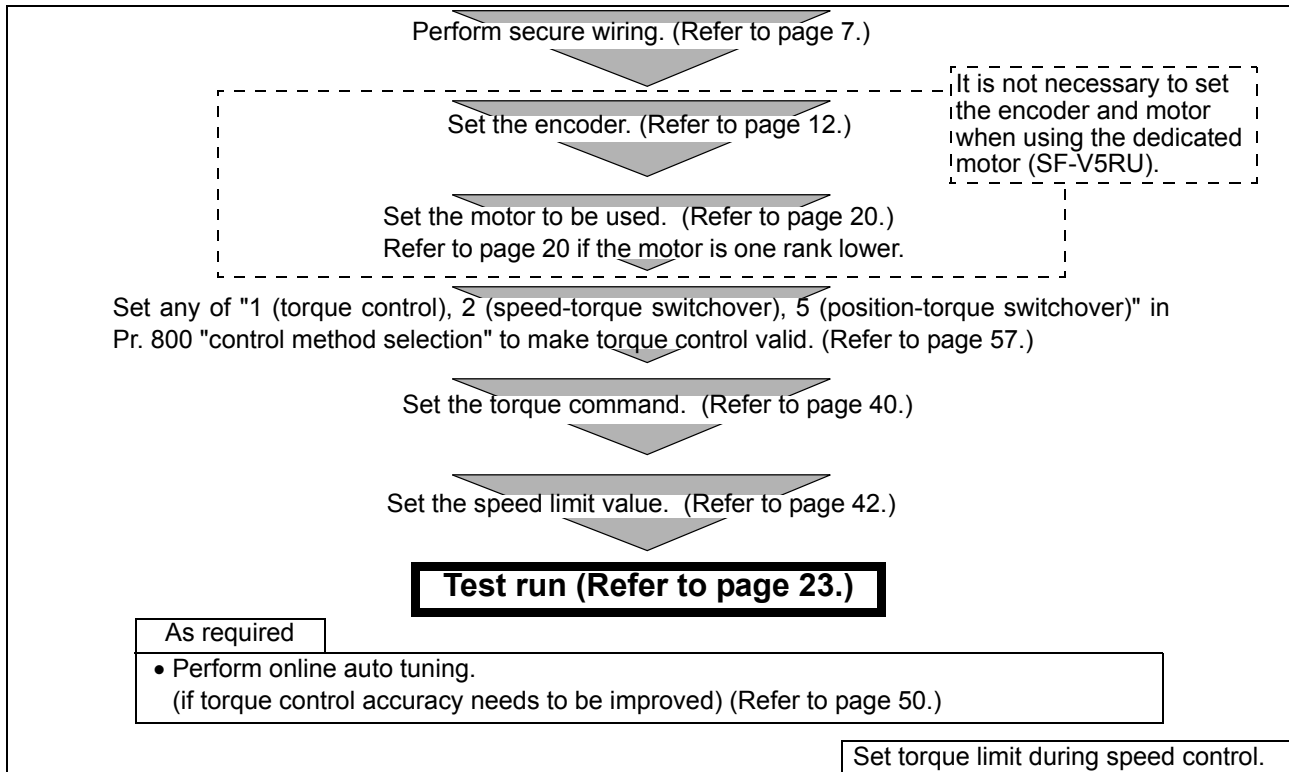

### 4.2.4 Torque command source selection

Using Pr. 804 "torque command source selection", set the method by which the torque command will be given. The torque command is factory set to the torque command connected across terminals 3-5.

(This parameter is an extended function parameter. Set "1" in Pr.160 "extended function selection".)

Parameter	Name	Factory Setting	Setting Range		
804	Torque command source selection	0	0	Terminal 3 analog input	As set in Pr. 807.
			1	Digital input from parameter Pr. 805 or Pr. 806 setting (-400% to 400%)	
			2	Pulse train command input (FR-V5AP) Refer to the instruction manual of the option "FR-V5AP" for details.	
			3	Torque command RWw1(FR-A5NC) from the CC-Link, torque command can be set in the range of 600 to 1400% in the setting increments of 1%. Refer to the instruction manual of the option "FR-A5NC" for details.	The Pr. 808 and Pr. 809 settings are speed limit regardless of the Pr. 807 setting.
			4	Torque command from the option (digital) (FR-V5AH, FR-A5AX) Refer to the instruction manual of the option "FR-V5AH, FR-A5AX" for details.	As set in Pr. 807.
			5	Set in torque command RWw1 (FR-A5NC) from the CC-Link a value in two's complement in 0.01% increments.*1 Input in device RWw1 a two's complement value as a torque command value from the CC-Link.	The Pr. 808 and Pr. 809 settings are speed limit regardless of the Pr. 807 setting.
			6	A value is set in Pr. 805 or Pr. 806 in two's complement in 0.01% increments. Set a two's complement value as a torque command to be set in Pr. 805 or Pr. 806 from the CC-Link. The setting range is from 600 to 1400 in 1% increments setting if parameter is set from the PU04V and DU04.	As set in Pr. 807.

\*1 The speed limit value for Pr. 804 = "5" is the same as when Pr. 807 "speed limit selection" = "1" (speed limit using Pr. 808, Pr. 809) even if the setting is "0".  
The speed setting command is given under speed/position control even when Pr. 804 = "5".  
For RWw1, torque setting can be made only under torque control. During speed control, the value is input as speed command even when Pr. 804 = 5.

●16bit two's complement

Torque command	-327.68%	-100%	-50%	-25%	0%	25%	50%	100%	327.67%
	-32768	-10000	-5000	-2500	0000	2500	5000	10000	32767
Hexadecimal	8000H	D8F0H	EC78H	F63CH	0	09C4H	1388H	2710H	7FFFH
Decimal	32768	55536	60536	63036	0	2500	5000	10000	32767

**CAUTION**

- The internal resolution of the torque command is 0.024% ( $100/2^{12}$ ) and the fraction less than the resolution is rounded off.
- The range of torque setting is from -327.68% to 327.67%. (-400% to 400% when shipped from the factory)
- A negative value can not be input from the control panel DU04-01 and parameter unit PU04V, a value can not be set in 0.01% increments. The setting range is from 600 to 1400% and setting increments is 1% increments. When the value set from the CC-Link is read from the PU04V or DU04-01, the value is also converted to 600 to 1400 for display.

**4.2.5 Torque command setting**

● Torque command selection

The figure below shows how to give the torque command in the constant power range (extended function parameter).

Parameter	Name	Factory Setting	Setting Range
803	Constant power range torque characteristic selection	0	0, 1

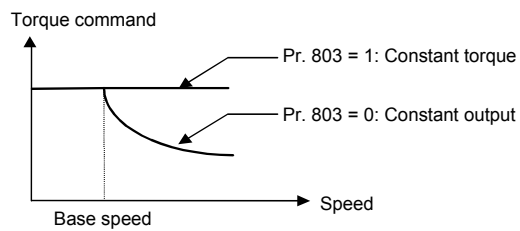

(1) Calibration of torque command terminal 3

Refer to the chart on the right for the relationship between torque setting input voltage and output torque. The torque setting input signal is in proportion to the output torque. Note that the motor-developed torque varies with the motor temperature.

Use Pr. 904 and Pr. 905 to adjust bias/gain of the terminal 3. (Refer to page 51.)

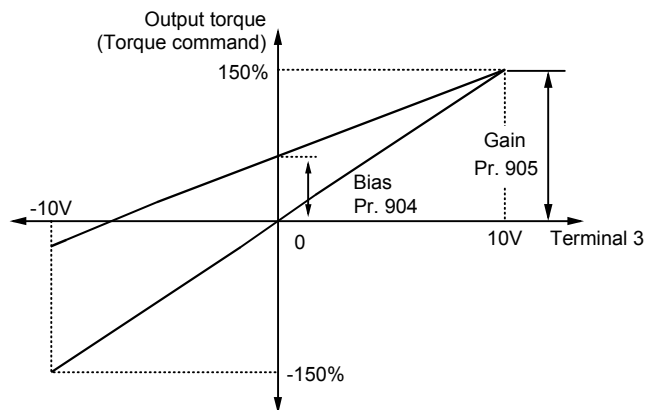

# Torque control operation

## 4.2.6 Speed limit

Set the speed limit value to prevent the motor from over speeding due to a smaller load torque than the torque command value.

Parameter	Name	Factory Setting	Setting Range
807	Speed limit selection	0	0, 1, 2
808	Forward rotation speed control	1500r/min	0 to 3600r/min
809	Reverse rotation speed control	9999	0 to 3600r/min, 9999

Select the speed limit input method using Pr. 807.

Pr. 807 Setting	Speed Limit Input Method	Operation
0 (factory setting)	Same method as speed setting for speed control	<ul style="list-style-type: none"> <li>• Speed setting from the control panel</li> <li>• External analog command (terminal 1, 2)</li> <li>• Multi-speed command</li> <li>• Option (FR-V5AX etc.)</li> <li>• For both PU and external operations, the speed limit changes according to the acceleration/deceleration time. (Refer to page 43)</li> </ul>
1	Pr. 808 Forward rotation speed limit Pr. 809 Reverse rotation speed limit	<p>According to the rotation direction, set the speed limit in forward and reverse rotation directions individually. When the reverse rotation speed limit is 9999, the setting is the same as that of the torque limit in forward rotation direction.</p> <p>(Refer to the Instruction Manual (detailed).)</p>
2	Forward/reverse rotation speed limit (analog polarity switchover speed limit) (terminal 1 analog input)	<p>The analog voltage of the terminal 1 input is used to make speed limit. For 0 to 10V input, set the forward rotation speed limit. (The reverse rotation speed limit is Pr. 1 "maximum speed".) For -10 to 0V input, set the reverse rotation speed limit. (The forward rotation speed limit is Pr. 1 "maximum speed".) The maximum speed of both the forward and reverse rotations is Pr. 1 "maximum speed". When terminal 1 input is selected, set "5" in Pr. 868 "terminal 1 function assignment".</p> <p>Use Pr. 917 or Pr. 918 to calibrate the terminal 1.</p> <p>(Refer to the Instruction Manual (detailed).)</p>

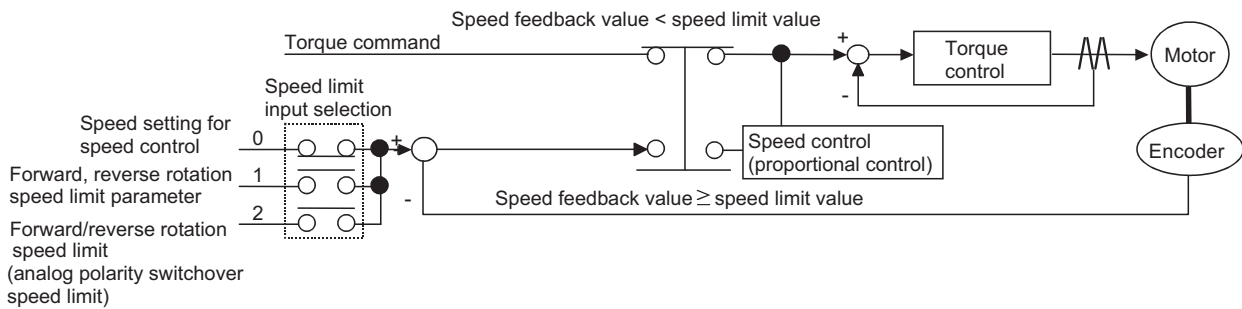

**(1) When Pr. 807 = 0**

The speed command value during speed control acts as a speed limit level. At this time, according to the acceleration/deceleration time set in Pr. 7 "acceleration time" and Pr. 8 "deceleration time", the limit level is increased from 0r/min upon start, and when the start signal turns off, the speed limit level is decreased from the then speed limit level to the DC injection brake operation speed in Pr. 10 to a stop. The speed limit level at this time is shown on the right.

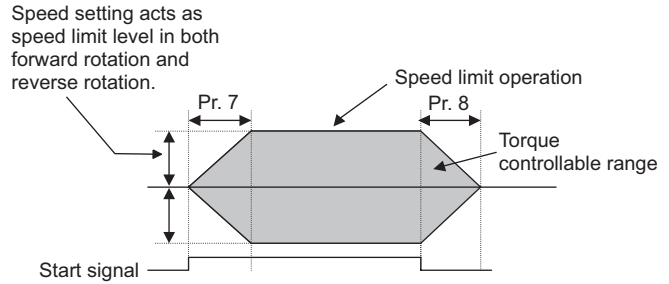

1) External analog speed limit (terminal 1, 2)

The analog signal (0 to +10V (±10V)) input to terminal 2 (or terminal 1) is used to give a speed limit command.

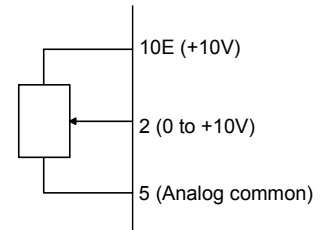

**REMARKS**

- Set Pr. 73 "speed setting signal" to change between the main speed and override of terminal 2.  
( Refer to the Instruction Manual (detailed).)
- If the above speed limit command is greater than Pr. 1 "maximum speed", the speed limit value is regarded as the Pr. 1 "maximum speed" value. If the speed limit command is smaller than Pr. 2 "minimum speed", the speed limit value is regarded as the Pr. 2 "minimum speed". Similarly when the speed limit command is smaller than Pr. 13 "starting speed", the speed limit value is 0r/min.
- Set the speed limit of terminal 1 using Pr. 868 "terminal 1 function selection".  
( Refer to the Instruction Manual (detailed).)

2) Speed limit on multi-speeds

The speed limit command can also be set for the external signals (RH, RM, RL).  
(The terminals are factory-set as follows. DI1 = RH, DI2 = RM, DI3 = RL)

**REMARKS**

The RH, RM and RL signals are assigned to terminals DI1 to DI4 using Pr. 180 to Pr. 183 and Pr. 187 (input terminal function selection).

**CAUTION**

**When speed limit is to be made using the analog command (terminal 2), turn off the external signals (RH, RM, RL). If any of external signals (RH, RM, RL) is on, multi-speed limits are made valid.**

**REMARKS**

- Changing the terminal assignment using Pr. 180 to Pr. 183 and Pr. 187 (input terminal function selection) may affect the other functions. Make setting after checking the functions of the corresponding terminals.
- If the value set in Pr. 187 is other than "9999", the external command cannot be used to perform reverse rotation operation. To start reverse rotation, set "9999" (factory setting) in Pr. 187 to make the STR signal of terminal STR valid.
- When the above speed limit command is greater than the Pr. 1 "maximum speed" value, the speed limit value is the Pr. 1 "maximum speed" value, and when the speed limit command is less than the Pr. 2 "minimum speed" value, the speed limit value is the Pr. 2 "minimum speed" value. When the speed limit command is less than the Pr. 13 "starting speed" value, the speed limit value is 0r/min.
- When external speed limit is to be made using analog, calibrate the terminal 2 (terminal 1). Refer to Pr. 902 "speed setting terminal 2 bias" and Pr. 903 "speed setting terminal 2 gain". Refer to Pr. 902 "speed setting terminal 2 bias" and Pr. 903 "speed setting terminal 2 gain" for the terminal 1. (Refer to page 51.)

**(2) For Pr. 807 = "1 or 2", refer to the Instruction Manual (detailed).**

**4.2.7 Torque control accuracy improvement**

To eliminate the temperature drift of torque under torque control, change the Pr. 95 "online auto tuning" setting to "2". (Refer to page 50.)

For torque control, easy gain tuning has no effect.

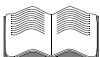

When an unfavorable phenomenon such as torque pulsation occurs or when you want to exhibit the best performance according to the machine, refer to the Instruction Manual (detailed) to perform a manual gain adjustment (Pr. 824 to Pr. 827).

## **4.3 Position control operation**

---

On this inverter, you can use parameter and pulse inputs to exercise position control.

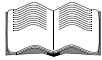

Refer to the Instruction Manual (detailed) for details.

### **4.3.1 Position command from parameter setting**

Position control is exercised using the position feed amounts set in Pr. 465 to Pr. 494.

### **4.3.2 Position command from PLC**

Position control is exercised by connecting the PLC, such as the MELSEC-Q series PLC positioning module (QD75), and the positioning control option (FR-V5AP) to the inverter.

### **4.3.3 Position command from SSCNET**

Position control is exercised by connecting the motion controller and the SSCNET communication option (FR-V5NS) to the inverter.

## 4.4 Control mode switchover timing

Depending on a parameter setting change or whether the MC terminal turns on/off, the control mode switches at the following timing.

Switchover Pattern	Switchover Operation
Speed ↔ Torque	The mode can be changed any time independently of whether the motor is at a stop or running or the DC brake (servo lock) is operating.
Speed ↔ Position	The mode can be changed when the speed is equal to or lower than the low speed detection level.
Position ↔ Torque	When the speed is higher than the low speed detection level, changing the MC signal during rotation will not switch the control mode to the other, and as soon as the speed falls to or below Pr. 865 "low speed detection level", the control mode is changed according to the terminal status.

⟨Example: Speed ↔ Position, when Pr. 800 = 4⟩

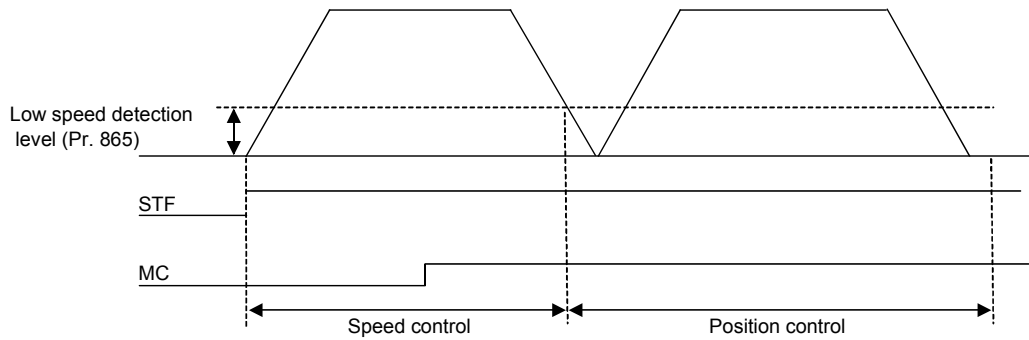

- Terminals and terminal functions changed by control mode switchover  
The terminal functions vary with the control mode as indicated in the following table.

Classification	Description									
	Pr.800 setting	0	1	2		3	4		5	
	Terminal name	Speed control	Torque control	MC signal		Position control	MC signal		MC signal	
				ON	OFF		ON	OFF	ON	OFF
Speed control				Torque control	Speed control		Position control	Position control	Torque control	
Contact input signal	STF	Forward rotation command	←	←	←	←	←	←	←	
	STR	Reverse rotation command	←	←	←	←	←	←	←	
	DI1	Multi-function input 1	←	←	←	←	←	←	←	
	DI2	Multi-function input 2	←	←	←	←	←	←	←	
	DI3	Multi-function input 3	←	←	←	←	←	←	←	
Contact output	ABC	Alarm contact	←	←	←	←	←	←	←	
	DO1	Multi-function output 1	←	←	←	←	←	←	←	
Open collector output	DO2	Multi-function output 2	←	←	←	←	←	←	←	
	DO3	Multi-function output 3	←	←	←	←	←	←	←	
	Analog input	2	Speed command	Speed limit	Speed command	Speed limit	Invalid	Speed command	Invalid	Invalid
1*		Speed command auxiliary	Speed limit auxiliary	Speed command	Speed limit	Invalid	Speed command	Invalid	Invalid	Speed limit
3		Torque limit	Torque command	Torque limit	Torque command	Torque limit	Torque limit	Torque limit	Torque limit	Torque command



## Control mode switchover timing

Classification	Description									
	Pr.800 setting	0	1	2		3	4		5	
	Terminal name	Speed control	Torque control	MC signal		Position control	MC signal		MC signal	
				ON	OFF		ON	OFF	ON	OFF
Speed control				Torque control	Speed control		Position control	Position control	Torque control	
Analog output	DA1	Multi-function monitor 1	←	←		←	←		←	
	DA2	Multi-function monitor 2	←	←		←	←		←	

\*: Assumes that the Pr. 868 value is the factory setting.

### Related parameters

- DI1 to DI4, STR terminal function selection ⇒ Pr. 180 to Pr. 183, Pr. 187 (input terminal function selection). (Refer to page 65.)
- DO1 to DO3, ABC terminal function selection ⇒ Pr. 190 to Pr. 192, Pr. 195 (output terminal function selection). (Refer to page 65.)
- Terminal 1 function selection ⇒ Pr. 868 "terminal 1 function assignment" (Refer to the Instruction Manual (detailed).)
- Terminal 1, 2, 3 bias/gain adjustment ⇒ Pr. 902 to Pr. 905, Pr. 917, Pr. 918 (bias/gain adjustment) (Refer to page 51.)
- DA1, DA2 terminal function selection ⇒ Pr. 54, Pr. 158 (DA1, DA2 function selection) (Refer to page 60 (DA1) and page 64 (DA2).)
- DA1, DA2 terminal calibration ⇒ Pr. 900, Pr. 901 (DA1, DA2 terminal calibration) (Refer to page 26.)
- MC signal terminal assignment ⇒ Set "26" to any of DI1 to DI4 and STR using any of Pr. 180 to Pr. 183 and Pr. 187 (input terminal function selection). (Refer to page 65.)
- Control method selection ⇒ Pr. 800 (Refer to page 57.)

## 4.5 Easy gain tuning

The ratio of the load inertia to the motor inertia (load inertia moment ratio) is estimated in real time from the torque command and speed during motor operation to automatically set the optimum gains for speed control/ position control from that ratio and response level setting.

### 4.5.1 Parameter

Parameter	Name	Factory Setting	Setting Range	Remarks
818	Easy gain tuning response level setting	2	1 to 15	Set the response level. 1: Slow response to 15: Fast response
819	Easy gain tuning selection	0	0, 1, 2	0: No tuning 1: With load estimation, with gain calculation 2: Manual load input (Pr. 880), with gain calculation

### 4.5.2 Easy gain tuning execution procedure

#### (1) Setting the response level in Pr. 818 "easy gain tuning response level setting"

Refer to the diagram on the right and set the response level.

Increasing the value will improve trackability to the command, but too high value will generate vibration. The relationship between the setting and response level are shown on the right.

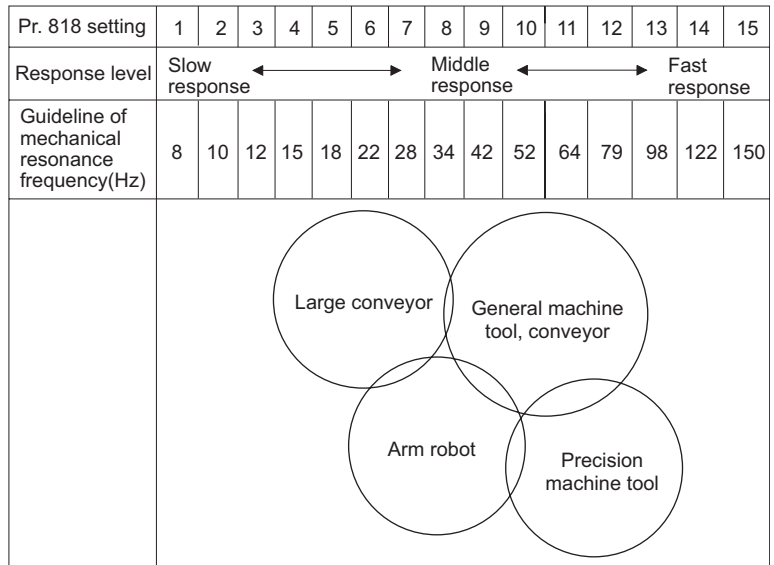

#### (2) Setting easy gain tuning enable in Pr. 819 "easy gain tuning selection"

Pr. 819 Setting	Description
0 (factory setting)	<ul style="list-style-type: none"> <li>Easy gain tuning is invalid.</li> <li>None of the load inertia ratio, position control gain and speed control gain values are updated.</li> </ul>
1	<ul style="list-style-type: none"> <li>Easy gain tuning is valid.</li> <li>Each control gain is automatically set from the load inertia ratio estimated during acceleration/ deceleration operation and the Pr. 818 "easy gain tuning response level setting" value.</li> <li>Pr. 880 "load inertia ratio" is used as the initial value of the load inertia ratio for tuning. Estimated value is set in Pr. 880 during tuning.</li> </ul>
2	<ul style="list-style-type: none"> <li>Used when the load inertia ratio cannot be estimated well due to load disturbance and such or when the load inertia ratio is known in advance, for example. At this time, the load inertia ratio is not estimated and each control gain is automatically set from the Pr. 880 "load inertia ratio" setting (factory setting: 7) and Pr. 818 "easy gain tuning response level setting" value.</li> </ul>

#### CAUTION

- Performing easy gain tuning with larger inertia than the specified value during vector control may cause malfunction such as hunting. In addition, when the motor shaft is fixed with servo lock or position control, bearing may be damaged. To prevent these, make gain adjustment by manual input without performing easy gain tuning.

#### (3) Start signal

Press **FWD** or **REV** to estimate the load inertia ratio or calculate gain any time.  
(The run command for external operation is the STF or STR signal.)

#### REMARKS

When "1 or 2" is set in Pr. 819 "easy gain tuning selection" and then returned to "0", tuning results which are automatically set in each parameter remain unchanged.

### 4.5.3 Precautions for easy gain tuning

#### (1) Checking the Pr. 800 "control method selection" value

Easy gain tuning is valid **only for the speed control/position control mode under vector control with encoder.**

It is invalid for torque control and V/F control.

Pr. 800 Setting	Drive System	Control Mode	Easy Gain Tuning
0	Vector control with encoder	Speed control	Valid
1		Torque control	Invalid
2		Speed-torque switchover	When speed is selected: Valid When torque is selected: Invalid
3		Position control	Valid
4		Speed-position switchover	Valid
5		Position-torque switchover	When position is selected: Valid When torque is selected: Invalid
9	Vector control test operation		Invalid
20	V/F control	Speed control	Invalid

#### (2) Load inertia ratio estimation limit conditions

When "1" is set in Pr. 819 "easy gain tuning selection", the load inertia ratio may not be estimated well, e.g. it takes a long time for estimation, if the following conditions are not satisfied.

- Time taken for acceleration/deceleration to reach 1500r/min is 5s or less.
- Speed is 150r/min or more.
- Acceleration/deceleration torque is 10% or more of the rated torque.
- Abrupt disturbance is not applied during acceleration/deceleration.
- Load inertia ratio is about 30 times or less.
- No gear backlash nor belt looseness is found.

### 4.5.4 Automatically set parameters by easy gain tuning

Parameter	Name	Factory Setting	Setting Range	Remarks
422	Position loop gain	1	0 to 150	Valid during position control (1/s)
820	Speed control P gain 1	60%	0 to 1000%	100%:200rad/s
821	Speed control integration time	0.333s	0 to 10s	
828	Model speed control gain	60%	0 to 1000%	Valid during model adaptive control
880	Load inertia ratio	7	0, 1 to 200 times	Setting value when easy gain tuning load estimation is performed Inertia ratio with load only (with reference to the inertia ratio of Mitsubishi motors )

#### REMARKS

Operation when the first or second function is selected

Load inertia estimation and gain calculation are performed only when the RT terminal is off. The gain calculated is also reflected only on these parameters. When the RT terminal is on, both the inertia estimation value and gain remain unchanged from the previous values.

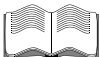

When some adjustments are required after executing easy gain tuning due to disturbance and such, perform fine adjustment (adjustment of Pr. 820, Pr. 821) by manual input. (Set "0" (without gain tuning) in Pr. 819 "easy gain tuning".)

If the fast responsiveness to the speed command is desired, consider exercising speed feed forward control or model adaptive speed control. Refer to the Instruction Manual (detailed) for details.

### 4.5.5 Easy gain tuning-related parameter operation

Refer to the following table for the parameter/gain read/write operation using Pr. 819 "easy gain tuning selection".

		Pr. 819 = 0 Without tuning	Pr. 819 = 1 With inertia estimation, with gain calculation	Pr. 819 = 2 Inertia as set in Pr. 880, with gain calculation
Pr. 880 "load inertia"	Read	Setting is displayed.	Inertia estimation result is displayed from the RAM.	Setting is displayed.
	Write	Setting can be changed.	Load inertia estimation result is written. (Write is enabled only during a stop.)	Setting can be changed.
Timing of writing load inertia ratio and control gains into E <sup>2</sup> PROM	—	Not written	<ul style="list-style-type: none"> <li>•Every hour after power-on</li> <li>•When the Pr. 819 setting is changed to other than "1".</li> <li>•When the vector control mode is changed to other drive systems due to the Pr. 800 "control method selection" setting change.</li> </ul>	<ul style="list-style-type: none"> <li>•When the Pr. 819 setting is changed to "2"</li> <li>•When Pr. 880 "load inertia ratio" or Pr. 818 "easy gain tuning response level setting" is changed</li> </ul>
Control gains (Pr. 820, Pr. 821, Pr. 828, Pr. 422)	Read	Settings are displayed.	Gain calculation results (RAM) are displayed.	Settings are displayed.
	Write	Settings can be changed.	Write disabled (operation error)	Write disabled (operation error)

**CAUTION**

**RAM data is erased when the power is not supplied or the inverter is reset.**

## 4.6 Online auto tuning

Excellent torque accuracy is provided by temperature compensation even if the secondary resistance value of the motor varies with the rise in the motor temperature.

### 4.6.1 Parameters

- For the motor with encoder, set "2" in Pr. 95 "online auto tuning selection".

Parameter	Name	Factory Setting	Setting Range	Remarks
95	Online auto tuning selection	0	0, 1, 2	0: No online auto tuning 1: Start time tuning (at start-up) 2: Adaptive magnetic flux observer (normal)

### 4.6.2 Pr. 95 = "1" (start time tuning)

The current at a start is detected to compensate for the secondary resistance of the motor so that excellent characteristics are provided regardless of the change in value of the secondary resistance of the motor with the rise of the motor temperature.

#### CAUTION

- Perform offline auto tuning in the rotation mode before performing online auto tuning with start time tuning. Data needs to be calculated. Refer to the Instruction Manual (detailed) for offline auto tuning.
- For using start time tuning in vertical lift applications, examine the utilization of a brake sequence for the brake opening timing at a start. Though the tuning ends in about a maximum of 500ms after a start, torque is not provided fully during that period. Therefore, note that there may be a possibility of gravity drop.

#### REMARKS

To prevent delay at starting, X28 function which provides tuning before start signal input is available. (Refer to the Instruction Manual (detailed).)

### 4.6.3 Pr. 95 = "2" (normal tuning)/adaptive magnetic flux observer

This function is effective for optimum speed estimation and torque accuracy improvement when using the motor with encoder.

The current flowing in the motor and the inverter output voltage are used to estimate/observe the magnetic flux in the motor.

The magnetic flux of the motor is always detected with high accuracy so that excellent characteristics are provided regardless of the change in the temperature of the secondary resistance.

Set "2" when exercising vector control with encoder.

#### CAUTION

- For the SF-V5RU, SF-JR (with encoder) or SF-HRCA (with encoder), it is not necessary to perform offline auto tuning to select adaptive magnetic flux observer. (Note that it is necessary to perform offline auto tuning (non-rotation mode) for the wiring length resistance to be reflected on the control when the wiring length is long (30m or longer as reference).)  
For offline auto tuning, refer to the Instruction Manual (detailed).

#### REMARKS

- Online auto tuning of the start time tuning does not operate if the MRS is input, if the preset speed is less than the starting speed (Pr. 13), or if the starting conditions of the inverter are not satisfied, e.g. inverter error.
- Online auto tuning of the start time tuning does not operate during deceleration or at a restart during DC brake operation.
- Invalid for jog operation.
- The RUN signal is not output during online auto tuning of the start time tuning. The RUN signal turns on at a start.
- If the period from an inverter stop to a restart is within 4s, online auto tuning of the start time tuning is performed but the tuning results are not reflected.
- Automatic restart after instantaneous power failure overrides when automatic restart after instantaneous power failure is selected.
- Zero current detection and output current detection are valid during online auto tuning.

## 4.7 Biases and gains of speed setting terminals (Pr. 902 to Pr. 905, Pr. 917 to Pr. 920)

Adjust the biases and gains of the speed setting terminal 2, torque command terminal 3 and multi-function terminal 1.

The "bias" and "gain" functions are designed to adjust the relationship between the 0 to 10V input signal, which is externally input for the setting of output speed, torque or magnetic flux.

Parameter	Name	Factory Setting (*2)		Setting Range		Remarks
902	Speed setting terminal 2 bias	0V	0r/min	0 to 10V	0 to 3600r/min	Extended mode
903	Speed setting terminal 2 gain	10V	1500r/min	0 to 10V	0 to 3600r/min	
904	Torque command terminal 3 bias	0V	0%	0 to 10V	0 to 400%	
905	Torque command terminal 3 gain	10V	150%	0 to 10V	0 to 400%	
917	Terminal 1 bias (speed *1)	0V	0r/min	0 to 10V	0 to 3600r/min	
918	Terminal 1 gain (speed *1)	10V	1500r/min	0 to 10V	0 to 3600r/min	
919	Terminal 1 bias (torque/magnetic flux)	0V	0%	0 to 10V	0 to 400%	
920	Terminal 1 gain (torque/magnetic flux)	10V	150%	0 to 10V	0 to 400%	

\*1 For calibration of forward/reverse rotation limit, PID control deviation and measured value.

\*2 Factory settings may differ because of calibration parameters.

Parameter	Calibration Terminal	Speed Command/Speed Limit (Pr. 807, Pr. 868, Pr. 73)			Forward/ Reverse Rotation Speed Limit	Torque			Magnetic Flux	PID Control (Pr. 128 to Pr. 134)		
		Speed (main speed+ auxiliary)	Compensation input	Override		Magnetic flux command	Torque limit (Pr. 810)	Torque command (Pr. 804)		Torque bias (Pr. 840)	Magnetic command	Deviation
902	terminal 2 (+terminal 1)	●	●	● (terminal 1)						●		
903												
904	terminal 3 only					●	●	●				
905												
917	terminal 1 only				● (Pr. 868)					●		●
918												
919						● (regenerative torque limit (Pr. 868))			● (Pr. 868)			
920												

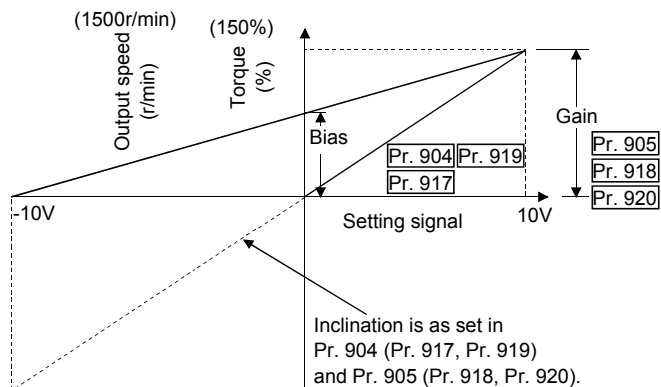
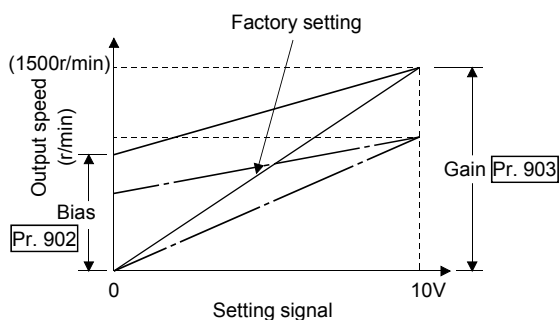

### CAUTION

Torque command bias and gain can not be set by applying an external negative setting signal to the torque command terminal 3 or 1.

**Biases and gains of speed setting terminals**  
**(Pr. 902 to Pr. 905, Pr. 917 to Pr. 920)**

**<Setting>**



There are the following three methods to adjust the speed setting voltage bias and gain.

- 1) Method to adjust any point by application of a voltage to across terminals 2(1)(3) - 5
- 2) Method to adjust any point without application of a voltage to across terminals 2(1)(3) - 5
- 3) Method that does not adjust the bias voltage

**(Example) Pr. 903 "speed setting terminal 2 gain"**

**(Pr. 902 to Pr. 920 can be adjusted in the similar manner.)**

**<Adjustment procedure>** Using the speed setting signal from the control panel (FR-DU04-1) to make speed setting

<p>(1) Power on (monitoring mode)</p>  <p><b>REMARKS</b> ON of the LED is indicated by ○, and OFF by ●.</p>	<p>(2) Choose the PU operation mode.</p> <p>1) Press <b>MODE</b> to make sure that the inverter is in the PU operation mode. (LED of PU is lit.) (Refer to page 28 for monitor transition.)</p> <p>● Operation mode (PU operation mode)</p> 
--	--

2) Set 1 (PU operation mode) in Pr. 79 "operation mode selection". (Refer to page 56.)  
 Example: To change the external operation mode (Pr. 79 = 2) to the PU operation mode (Pr. 79 = 1)

Press **MODE** to choose the "parameter setting mode".

● Parameter setting mode

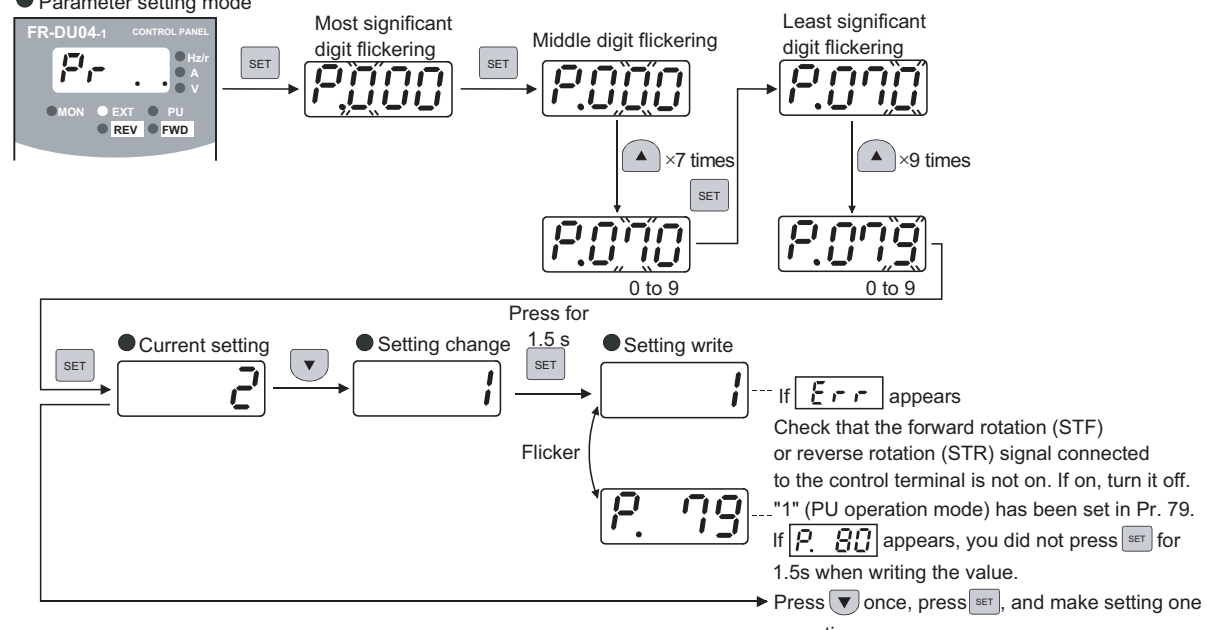

Press for

- Current setting
- Setting change 1.5 s
- Setting write

If **Err** appears  
 Check that the forward rotation (STF) or reverse rotation (STR) signal connected to the control terminal is not on. If on, turn it off.

... "1" (PU operation mode) has been set in Pr. 79.  
 If **P. 80** appears, you did not press **SET** for 1.5s when writing the value.

Press **▼** once, press **SET**, and make setting one more time.

(3) Read Pr. 903 to display the currently set gain speed.

● Parameter setting mode

Press **MODE** to choose the "parameter setting mode".

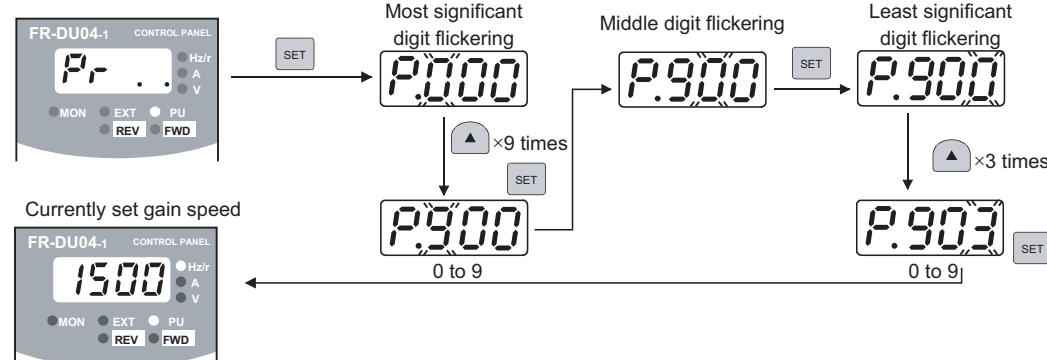

Currently set gain speed

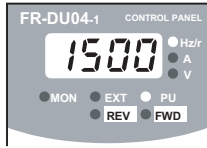

(4) Set the gain speed in Pr. 903 and display the analog voltage value across terminals 2-5 in %.  
 (To change to 1000r/min)

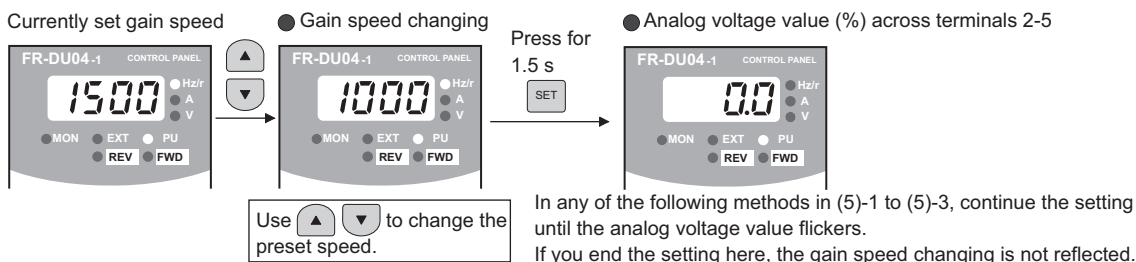

- When not adjusting the gain voltage → To (5)-1
- When adjusting any point by application of voltage → To (5)-2
- When adjusting any point without application of voltage → To (5)-3

(5)-1 Method to adjust only the gain speed and not to adjust the voltage

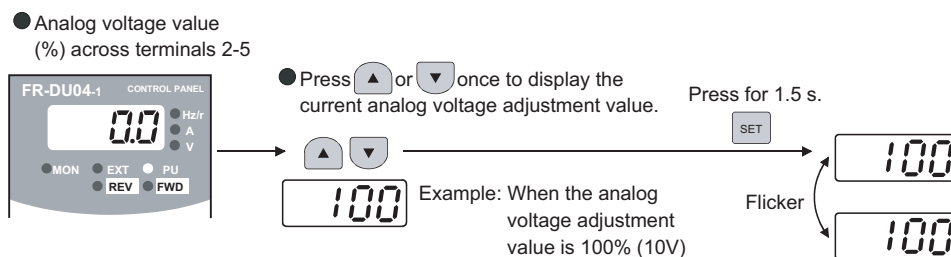

(5)-2 Method to adjust any point by application of voltage to across terminals 2-5 (e.g. applied from external potentiometer)

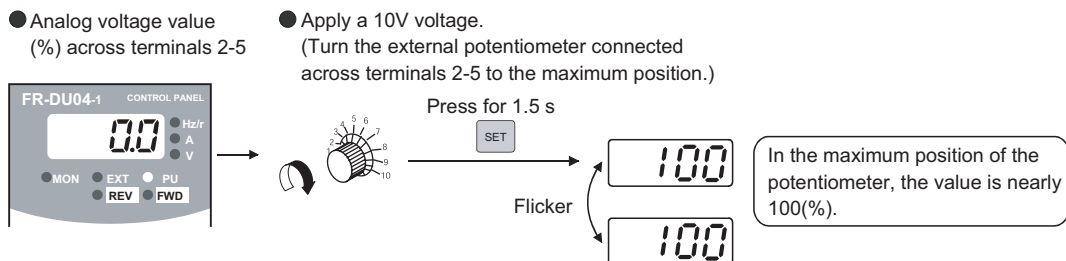

(5)-3 Method to adjust any point without application of voltage to across terminals 2-5 (To change from 80% to 100%)

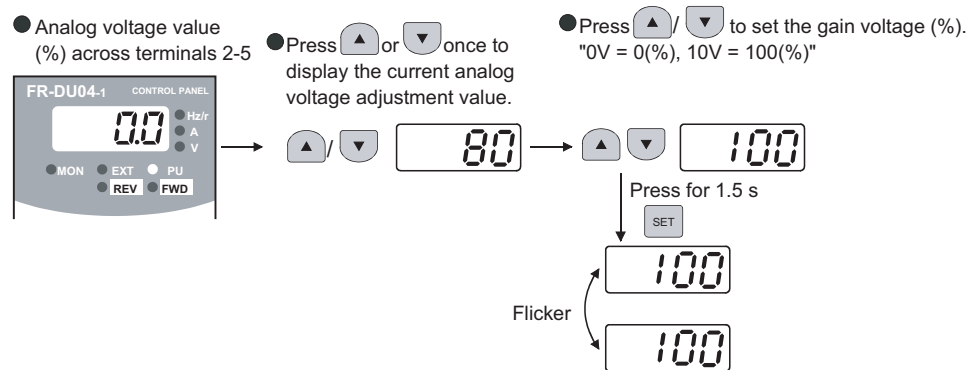

(6) Pressing **SET** shifts to the next parameter.

(7) Re-set the Pr. 79 "operation mode selection" value according to the operation mode being used.

**CAUTION**

1. Changing the Pr. 903 or Pr. 905 (gain adjustment) value will not change the Pr. 20 "acceleration/ deceleration reference speed" value. (Refer to page 58 for Pr. 20.) The input of terminal 1 (speed setting auxiliary input) is added to the speed setting signal.
2. For the operating procedure using the parameter unit (FR-PU04V), refer to the FR-PU04V instruction manual.
3. When applying voltage for calibration, the difference of the set input voltage of bias and gain should be 5% or more. If the difference is 5% or less, a setting error will occur.

**⚠ CAUTION**

⚠ Take care when setting any value other than "0" as the bias speed at 0V. Even if a speed command is not given, merely turning on the start signal will start the motor at the preset speed.



# 5 PARAMETERS

## 5.1 Function list (Simple mode parameters)

### 5.1.1 Simple mode parameter list

Function	Parameter	Name	Setting Range	Minimum Setting Increments	Factory Setting	Reference Page	Customer Setting	At-a-glance Guide to Functions		
								<ul style="list-style-type: none"> <li>• O: Usable function</li> <li>• x: Unusable function</li> <li>• *: Functions that can be used for parameter-set position feed forward function</li> </ul>		
								Vector Control		
			Speed control	Torque control	Position control					
Basic functions	1	Maximum speed	0 to 3600r/min	1r/min	1500r/min	55		○	○	○
	2	Minimum speed	0 to 3600r/min	1r/min	0r/min	55		○	○	x
	4	Multi-speed setting (high speed)	0 to 3600r/min	1r/min	1500r/min	55		○	○	x*
	5	Multi-speed setting (middle speed)	0 to 3600r/min	1r/min	750r/min	55		○	○	x*
	6	Multi-speed setting (low speed)	0 to 3600r/min	1r/min	150r/min	55		○	○	x*
	7	Acceleration time	0 to 3600s/ 0 to 360s	0.1s/0.01s	5s/15s (1.5K to 5.5K /7.5K to 55K)	55		○	○	x*
	8	Deceleration time	0 to 3600s/ 0 to 360s	0.1s/0.01s	5s/15s (1.5K to 5.5K /7.5K to 55K)	55		○	○	x*
	Operation selection functions	72	PWM frequency selection	1 to 6	1	1	55		○	○
77		Parameter write disable selection	0,1,2	1	0	55		○	○	○
79		Operation mode selection	0 to 4,6 to 8	1	0	56		○	○	○
Auto tuning	95	Online auto tuning selection	0,1,2	1	0	50		○	○	○
Additional function	160	Extended function selection	0,1	1	0	56		○	○	○
Operation selection function	800	Control system selection	0 to 5, 9, 20	1	0	57		○	○	○
Control system functions	818	Easy gain tuning response level setting	1 to 15	1	2	47		○	x	○
	819	Easy gain tuning selection	0,1,2	1	0	47		○	x	○

#### REMARKS

By setting "1" in Pr. 160 "extended function selection", the extended function parameters are made valid. (Refer to page 56).

**5.1.2 Explanation of simple mode parameters**

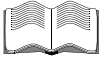

Refer to the separately available Instruction Manual (detailed) for details.

**Pr. 1 "maximum speed", Pr. 2 "minimum speed"**

- You can clamp the upper and lower limits of the output speed.

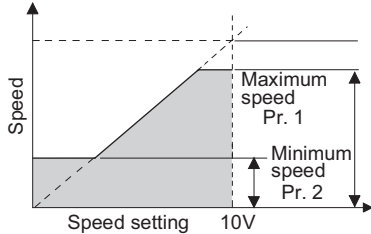

**CAUTION**

**Note that when you have set the minimum speed, merely turning on the start signal will start the motor at the preset speed, without the input of the speed command, according to the acceleration time setting.**

**Pr. 4 "multi-speed setting (high speed)"  
Pr. 5 "multi-speed setting (middle speed)"  
Pr. 6 "multi-speed setting (low speed)"**

- You can select any speed (RH, RM, RL) by simply switching the external contact signal.

	RH	RM	RL
High speed	ON	OFF	OFF
Middle speed	OFF	ON	OFF
Low speed	OFF	OFF	ON

- You can also set each speed to any value within the range of 0 to 3600r/min during inverter operation.
- Using the extended function, you can set up to 15 speeds.

Refer to the Instruction Manual (detailed) for the setting method.

**Pr. 7 "acceleration time", Pr. 8 "deceleration time"**

- The time taken to reach the Pr. 20 acceleration/deceleration reference speed (factory-set to 1500r/min) from 0r/min is set as the acceleration time, and the time taken to reach 0r/min from the Pr. 20 (factory-set to 1500r/min) speed is set as the deceleration time.

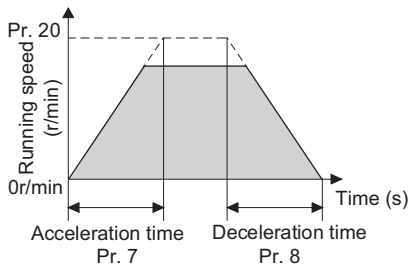

**Pr. 72 "PWM frequency selection"**

- You can change the motor sound.

Setting	Carrier Frequency
1 (factory setting)	2.25kHz
2	4.5kHz
3	6.75kHz
4	9kHz
5	11.25kHz
6	13.5kHz

**REMARKS**

- Increasing the value reduces the sound level but increases noise and leakage currents.
- Set or "1" in Pr. 240 "Soft-PWM control" to decrease motor noises. Refer to page 66 for Pr. 240 "Soft-PWM control".

**Pr. 77 "parameter write disable selection"**

- You can select whether write to various parameters can be performed or not. Use this function to prevent parameter values from being rewritten by misoperation.

Setting	Description
0	Parameter write can be performed. (Write is enabled only during a stop in the PU operation mode.)
1	Parameter write cannot be performed. (Write to Pr. 22, Pr. 75, Pr. 77 and Pr. 79 "operation mode selection" is enabled.)
2	Write during operation is enabled.



**REMARKS**

- Parameters below are write-enabled during operation even when Pr. 77 = "0".  
Pr. 4 to Pr. 6, Pr. 22, Pr. 24 to Pr. 27, Pr. 52 to Pr. 56, Pr. 75, Pr. 77, Pr. 129, Pr. 130, Pr. 133, Pr. 134, Pr. 158, Pr. 160, Pr. 232 to Pr. 240, Pr. 496, Pr. 497, Pr. 805, Pr. 806, Pr. 866, Pr. 900, Pr. 901 and Pr. 990.
- Parameters below are write-enabled even when Pr. 77 = "1".  
Pr. 22, Pr. 75, Pr. 77 and Pr. 79
- Parameters below are write-disabled during operation even when Pr. 77 = "2".  
Pr. 60, Pr. 71, Pr. 72, Pr. 79, Pr. 80 to Pr. 84, Pr. 90 to Pr. 96, Pr. 180 to Pr. 183, Pr. 187, Pr. 190 to Pr. 192, Pr. 195, Pr. 450, Pr. 451, Pr. 453, Pr. 454, Pr. 800, Pr. 819, Pr. 849, Pr. 851, Pr. 852 Pr. 859 and Pr. 868

## Function list (Simple mode parameters)

### Pr. 79 "operation mode selection"

- The inverter operation mode can be changed as desired between operation using external signals (external operation), operation from the PU (FR-DU04-1/FR-PU04V), combined operation of PU operation and external operation (external/PU combined operation), and computer link operation (when the FR-A5NR option is used).

Pr. 79 Setting	Function		
0	At power-on, the inverter is placed in the external operation mode. Operation can be performed by switching between PU and external operation.		
1	PU operation mode		
2	External operation mode		
3	External/PU combined operation mode 1	Speed command Set from the PU (FR-DU04-1/FR-PU04V) (direct setting, ▲/▼) or external signal input (multi-speed setting only)	Start command External signal input (terminal STF, STR)
		Speed command	Start command
4	External/PU combined operation mode 2	External signal input (terminal 2, 1, jog, multi-speed selection)	Input from the PU (FR-DU04-1/FR-PU04V) (start command using  ,  )
		Speed command	Start command
6	Switchover mode Switchover between PU operation, and external operation, and computer link operation (when the FR-A5NR or any other communication option is used) can be done while running.		
7	External operation mode (PU operation interlock) X12 signal ON.....May be switched to PU operation mode (output stop during external operation) X12 signal OFF .....Switching to PU operation mode inhibited		
8	Operation mode switching by the external signal (disallowed during operation) X16 signal ON.....Switched to external operation mode X16 signal OFF .....Switched to PU operation mode		

- Refer to the Instruction Manual (detailed) for details.

### Pr. 95 "online auto tuning selection"

- Refer to page 50 for details.

### Pr. 160 "extended function display selection"

- Set this parameter to display/set the extended function parameters.

Setting	Description
0	Only the simple mode parameters are displayed.
1	All parameters are displayed.

#### REMARKS

Refer to page 58 for the parameters (extended function parameters) available when "1" is set in Pr. 160 "extended function display selection".

**Pr. 800 "control method selection"**

- Select the inverter control system such as speed control, torque control or position control.

Setting	Drive System	Control Method	Remarks
0 (factory setting)	Vector control with encoder	Speed control	Factory setting
1		Torque control	—
2		Speed control-torque control switchover	MC ON: Torque control MC OFF: Speed control
3		Position control	—
4		Speed control-position control switchover	MC ON: Position control MC OFF: Speed control
5		Position control-torque control switchover	MC ON: Torque control MC OFF: Position control
9	Vector control test operation		
20	V/F control	Speed control	—

- If "9" is set in Pr. 800, speed control test operation can be performed even when the motor is not connected. The speed calculation value changes to track the speed command and the transition can be checked with the control panel and analog signal output at DA1 and DA2.

**CAUTION**

- When supplying power only across R1-S1, E.OC1 (overcurrent at acceleration) occurs when the start signal turns on.
- Since current is not detected and voltage is not output, monitors related to current and voltage such as output current and output voltage, etc. and output signals do not function.
- For speed calculation, speed is calculated in consideration of Pr. 880 "load inertia ratio".

**Related parameters**

MC signal terminal assignment ⇒ Set "26" in any of Pr. 180 to Pr. 183 and Pr. 187 (input terminal function selection). (Refer to page 65.)

**REMARKS**

Set the control method selection of the second motor in Pr. 451 "second motor control method selection". Refer to the Instruction Manual (detailed) for details.

**Pr. 818 "easy gain tuning response level setting", Pr. 819 "easy gain tuning"**

- Refer to page 47 for details.

## 5.2 Function list (Extended function parameters)

Refer to page 54 for the function list of simple mode parameters.

The extended function parameters are made valid by setting "1" in Pr. 160 "extended function selection".

(Refer to page 29 for the setting method and to the Instruction Manual (detailed) for details.)

Function	Parameter	Name	Outline	Factory Setting	Customer Setting	At-a-glance Guide to Functions			
						Vector Control			
						Speed control	Torque control	Position control	
Basic functions	0	Torque boost (manual)	Made valid for V/F control. 0 to 30%	4%/3%/2% (3.7K or less/5.5K, 7.5K/11K or more)		×	×	×	
	1	Maximum speed	0 to 3600r/min	1500r/min		○	○	○	
	2	Minimum speed	0 to 3600r/min	0r/min		○	○	×	
	3	Base frequency	Made valid for V/F control. 10 to 200Hz	60Hz		×	×	×	
	4	Multi-speed setting (high speed)	0 to 3600r/min	1500r/min		○	○	×*	
	5	Multi-speed setting (middle speed)	0 to 3600r/min	750r/min		○	○	×*	
	6	Multi-speed setting (low speed)	0 to 3600r/min	150r/min		○	○	×*	
	7	Acceleration time	0 to 3600s/ 0 to 360s	5s/15s (5.5 K or less / 7.5K or more)		○	○	×*	
	8	Deceleration time	0 to 3600s/ 0 to 360s	5s/15s (5.5 K or less / 7.5K or more)		○	○	×*	
	9	Electronic thermal O/L relay	When providing overheat protection for the motor with the external thermal relay (if the dedicated motor SF-V5RU is used), input the external signal across the terminal OH-SD and set the setting value to "0". The electronic thermal O/L relay will not operate. 0 to 500A	0A		○	○	○	
Standard operation functions	10	DC injection brake operation speed	Set the stopping accuracy of positioning operation or the like according to the load by adjusting the speed (0 to 1500r/min, 9999), time (0 to 0.5s) and voltage (0 to 30%) that are used to operate the braking torque at a motor stop for V/F control. (For vector control, these functions follow pre-excitation selection at not more than the speed in Pr. 10.)	15r/min		○	○	×	
	11	DC injection brake operation time		0.5s		○	○	×	
	12	DC injection brake voltage		4%/2% (7.5K or less/11K or more)		×	×	×	
	13	Starting speed		Set the speed at a start. 0 to 1500r/min	15r/min		○	○	×
	15	Jog speed setting		Speed command (0 to 1500r/min) and acceleration/deceleration inclination (0 to 3600s/ 0 to 360s) for jog operation.	150r/min		○	○	×
	16	Jog acceleration/ deceleration time			0.5s		○	○	×
Operation selection functions	17	MRS input selection	0: Turning MRS on stops output, 2: Turning MRS off stops output	0		○	○	○	
	19	Base frequency voltage	Made valid for V/F control. Represents the magnitude of the output voltage at the base frequency (Pr. 3). 8888: 95% of power supply voltage 9999: Same as power supply voltage 0 to 1000V, 8888, 9999	9999		×	×	×	
	20	Acceleration/ deceleration reference speed	Represents the speed to be referenced to increase or decrease the speed from or to 0r/min in the time preset as the acceleration (Pr. 7) or deceleration time (Pr. 8). 1 to 3600r/min	1500r/min		○	○	×*	
	21	Acceleration/ deceleration time increments	0: 0.1s increments, 1: 0.01s increments	0		○	○	×*	
	22	Torque limit level	You can set the level of torque limit. 0 to 400%	150%		○	×	○	

Function	Parameter	Name	Outline	Factory Setting	Customer Setting	At-a-glance Guide to Functions																						
						* : Functions that can be used for parameter-set position control																						
						Speed control	Torque control	Position control																				
Operation selection functions	24	Multi-speed setting (speed 4)	By setting a value other than "9999", set speeds 4 to 7. ON/OFF of the contact signals (RH, RM, RL signals) are combined to change the running speed in stages. <table border="1" style="margin: 10px auto;"> <thead> <tr> <th></th> <th>RH</th> <th>RM</th> <th>RL</th> </tr> </thead> <tbody> <tr> <td>Speed 4</td> <td>OFF</td> <td>ON</td> <td>ON</td> </tr> <tr> <td>Speed 5</td> <td>ON</td> <td>OFF</td> <td>ON</td> </tr> <tr> <td>Speed 6</td> <td>ON</td> <td>ON</td> <td>OFF</td> </tr> <tr> <td>Speed 7</td> <td>ON</td> <td>ON</td> <td>ON</td> </tr> </tbody> </table>		RH	RM	RL	Speed 4	OFF	ON	ON	Speed 5	ON	OFF	ON	Speed 6	ON	ON	OFF	Speed 7	ON	ON	ON	9999		○	○	×*
		RH		RM	RL																							
	Speed 4	OFF		ON	ON																							
	Speed 5	ON		OFF	ON																							
	Speed 6	ON	ON	OFF																								
	Speed 7	ON	ON	ON																								
	25	Multi-speed setting (speed 5)		9999		○	○	×*																				
	26	Multi-speed setting (speed 6)		9999		○	○	×*																				
	27	Multi-speed setting (speed 7)	0 to 3600r/min, 9999	9999		○	○	×*																				
	28	Multi-speed input compensation	The multiple speeds can be increased or overridden for compensation. 0: Without compensation 1: With compensation	0		○	○	×																				
	29	Acceleration/deceleration pattern	Determines the frequency changing pattern for acceleration/deceleration. 0: Linear acceleration/deceleration 1: S-pattern acceleration/deceleration A 2: S-pattern acceleration/deceleration B 3: Backlash measures acceleration/deceleration 4: S-pattern acceleration/deceleration C	0		○	○	×																				
	30	Regenerative function selection	Set when using the FR-ABR, FR-HC or FR-CV option for frequent start/stop operation. 0: Internal brake resistor, brake unit 1: Brake resistor (FR-ABR) 2: High power factor converter (FR-HC), power regeneration common converter (FR-CV)	0		○	○	○																				
31	Speed jump 1A	Set the speed ranges you want to avoid during constant-speed operation to avoid resonance with the machine. 0 to 3600r/min, 9999	9999		○	○	×																					
32	Speed jump 1B		9999		○	○	×																					
33	Speed jump 2A		9999		○	○	×																					
34	Speed jump 2B		9999		○	○	×																					
35	Speed jump 3A		9999		○	○	×																					
36	Speed jump 3B		9999		○	○	×																					
Display function	37	Speed display	Display the machine speed and output speed. 0: Output speed 1 to 9998: Machine speed at the Pr. 505 set speed operation	0		○	○	○																				
Output terminal functions	41	Up-to-speed sensitivity	You can adjust the output signal on/off range when the output speed reaches the running speed. 0 to 100%	10%		○	×	×																				
	42	Speed detection	You can adjust the speed detected. 0 to 3600r/min	300r/min		○	○	○																				
	43	Speed detection for reverse rotation	You can change the speed detection level for forward or reverse rotation in vertical lift, transfer and other applications. 0 to 3600r/min, 9999	9999		○	○	○																				
Second functions	44	Second acceleration/deceleration time	Second function of the acceleration/deceleration time set in Pr. 7, Pr. 8. 0 to 3600s/0 to 360s	5s		○	○	×*																				
	45	Second deceleration time	Second function of the deceleration time set in Pr. 8. 0 to 3600s/0 to 360s, 9999	9999		○	○	×*																				
Output terminal functions	50	Second speed detection	Set the speed at which the FB2 signal is output. 0 to 3600r/min	750r/min		○	○	○																				



## Function list (Extended function parameters)

Function	Parameter	Name	Outline	Factory Setting	Customer Setting	At-a-glance Guide to Functions		
						* : Functions that can be used for parameter-set position control		
						Speed control	Torque control	Position control
Display functions	52	DU/PU main display data selection	You can select the DU/PU main display data. 0, 100: Speed, output current, output voltage, alarm display 5: Preset speed 6: Output frequency 7: Motor torque 8: Converter output voltage 9: Regenerative brake duty 10: Electronic thermal relay function load factor 11: Output current peak value 12: Converter output voltage peak value 17: Load meter 18: Motor excitation current 19: Position pulse 20: Cumulative energization time 23: Actual operation time 24: Motor load factor 32: Torque command 33: Torque current command 34: Motor output 35: Feedback pulse 38: Trace status	0		○	○	○
	53	PU level display data selection	You can select the PU level display data. 0: No monitor 1: Speed 2: Output current 3: Output voltage 5: Preset speed 6: Output frequency 7: Motor torque 8: Converter output voltage 9: Regenerative brake duty 10: Electronic thermal relay function load factor 11: Output current peak value 12: Converter output voltage peak value 17: Load meter 18: Motor excitation current	1		○	○	○
Display functions	54	DA1 terminal function selection	You can select the monitor output DA1 data. 1: Speed 2: Output current 3: Output voltage 5: Preset speed 6: Output frequency 7: Motor torque 8: Converter output voltage 9: Regenerative brake duty 10: Electronic thermal relay function load factor 11: Output current peak value 12: Converter output voltage peak value 17: Load meter 18: Motor excitation current 21: Reference output 32: Torque command 33: Torque current command 34: Motor output 36: Torque monitor (driving/regenerative polarity switching)	1		○	○	○
	55	Speed monitoring reference	You can set the reference value of speed monitoring. 0 to 3600/min	1500r/min		○	○	○
	56	Current monitoring reference	You can set the reference value of current monitoring. 0 to 500A	Rated inverter current		○	○	○
Automatic restart	57	Restart coasting time	When power is restored after an instantaneous power failure, you can start the inverter without stopping the motor (in a coasting status). When this time (Pr. 57) elapses after power was restored, the inverter begins to restart. When you set "9999", the inverter will not restart. Generally, setting of "0" does not pose a problem, but the time can be adjusted (0, 0.1 to 5s, 9999) according to the magnitude of the load.	9999		○	○	×
	58	Restart cushion time	When the restart coasting time (Pr. 57) elapses, the output voltage is risen gradually. Set this cushion time (Pr. 58) (0 to 60s). Normally, you can perform operation with the factory settings, but you can adjust them according to the load magnitude. (Pr. 58 is valid only during V/F control)	1.0s		×	×	×
Additional function	59	Remote setting function selection	You can make remote setting of the speed when the control panel is located away from the control box. 0: None 1: With remote setting function, with frequency setting storage function 2: With remote setting function, without frequency setting storage function 3: With remote setting function, without frequency setting storage function (Turning STF/STR off clears remote setting)	0		○	○	×
Operation selection functions	60	Intelligent mode selection	Set when using the brake sequence control. 0: Normal operation mode 7: Brake sequence mode (With mechanical brake opening completion signal input) 8: Brake sequence mode (Without mechanical brake opening completion signal input)	0		○	×	×

Function	Parameter	Name	Outline	Factory Setting	Customer Setting	At-a-glance Guide to Functions																																																									
						* : Functions that can be used for parameter-set position control																																																									
						Speed control	Torque control	Position control																																																							
Operation selection functions	65	Retry selection	You can select alarms for a retry to be made when the protective function is activated. 0:E.OC1 to 3, E.OV1 to 3, E.THM, E.THT, E.IPF, E.UVT, E.BF, E.GF, E.OHT, E.OLT, E.OPT, E.OP1 to 3, E.PE, E.OS, E.OSD, E.OD, E.MB1 to 7 1:E.OC1 to 3 2:E.OV1 to 3 3:E.OC1 to 3, E.OV1 to 3 4:E.OC1 to 3, E.OV1 to 3, E.IPF, E.UVT, E.BF, E.GF, E.OLT, E.OPT, E.OP1 to 3, E.PE, E.OS, E.OSD, E.OD, E. MB1 to 7 5:E.OC1, E.OC3	0		○	○	×																																																							
	67	Number of retries at alarm occurrence	You can set the number of retries to be made when the protective function is activated. 0: Retry not made. 1 to 10: Without alarm output during retry operation 101 to 110: With alarm output during retry operation	0		○	○	×																																																							
	68	Retry waiting time	You can set the waiting time from activation of the protective function to a retry. 0 to 10s	1s		○	○	×																																																							
	69	Retry count display erasure	You can display the cumulative number of successful restarts made by retries when the protective function was activated. 0: Clears the number of successful restarts made by retries.	0		○	○	×																																																							
	70	Special regenerative brake duty	Set to increase the regenerative brake duty when the FR-ABR option is used. 0 to 15%(1.5K or less), 0 to 30%(2.2K or more)	0%		○	○	○																																																							
	71	Applied motor	Set the motor to be used. 0, 3 to 8, 10, 13 to 18, 20, 23, 24, 30, 33, 34	30		○	○	○																																																							
	<table border="1"> <thead> <tr> <th>Setting</th> <th>Motor</th> <th>Control Constants</th> </tr> </thead> <tbody> <tr> <td>0</td> <td rowspan="8">Standard motor (SF-JR etc.)</td> <td>Inverter internal constants</td> </tr> <tr> <td>3</td> <td>Offline auto tuning</td> </tr> <tr> <td>4</td> <td>Offline auto tuning data utilization</td> </tr> <tr> <td>5</td> <td>Star connection direct input</td> </tr> <tr> <td>6</td> <td>Delta connection direct input</td> </tr> <tr> <td>7</td> <td>Star connection direct input + offline auto tuning</td> </tr> <tr> <td>8</td> <td>Delta connection direct input + offline auto tuning</td> </tr> <tr> <td>10</td> <td rowspan="8">Constant-torque motor (SF-HRCA etc.)</td> <td>Inverter internal constants</td> </tr> <tr> <td>13</td> <td>Offline auto tuning</td> </tr> <tr> <td>14</td> <td>Offline auto tuning data utilization</td> </tr> <tr> <td>15</td> <td>Star connection direct input</td> </tr> <tr> <td>16</td> <td>Delta connection direct input</td> </tr> <tr> <td>17</td> <td>Star connection direct input + offline auto tuning</td> </tr> <tr> <td>18</td> <td>Delta connection direct input + offline auto tuning</td> </tr> <tr> <td>20</td> <td rowspan="4">SF-JR(4P)-1.5kW or less</td> <td>Inverter internal constants</td> </tr> <tr> <td>23</td> <td>Offline auto tuning</td> </tr> <tr> <td>24</td> <td>Offline auto tuning data utilization</td> </tr> <tr> <td>30 (factory setting)</td> <td rowspan="4">SF-V5RU vector control inverter motor (including SF-VR type motor)</td> <td>Inverter internal constants</td> </tr> <tr> <td>33</td> <td>Offline auto tuning</td> </tr> <tr> <td>34</td> <td>Offline auto tuning data utilization</td> </tr> </tbody> </table>								Setting	Motor	Control Constants	0	Standard motor (SF-JR etc.)	Inverter internal constants	3	Offline auto tuning	4	Offline auto tuning data utilization	5	Star connection direct input	6	Delta connection direct input	7	Star connection direct input + offline auto tuning	8	Delta connection direct input + offline auto tuning	10	Constant-torque motor (SF-HRCA etc.)	Inverter internal constants	13	Offline auto tuning	14	Offline auto tuning data utilization	15	Star connection direct input	16	Delta connection direct input	17	Star connection direct input + offline auto tuning	18	Delta connection direct input + offline auto tuning	20	SF-JR(4P)-1.5kW or less	Inverter internal constants	23	Offline auto tuning	24	Offline auto tuning data utilization	30 (factory setting)	SF-V5RU vector control inverter motor (including SF-VR type motor)	Inverter internal constants	33	Offline auto tuning	34	Offline auto tuning data utilization								
Setting	Motor	Control Constants																																																													
0	Standard motor (SF-JR etc.)	Inverter internal constants																																																													
3		Offline auto tuning																																																													
4		Offline auto tuning data utilization																																																													
5		Star connection direct input																																																													
6		Delta connection direct input																																																													
7		Star connection direct input + offline auto tuning																																																													
8		Delta connection direct input + offline auto tuning																																																													
10		Constant-torque motor (SF-HRCA etc.)	Inverter internal constants																																																												
13	Offline auto tuning																																																														
14	Offline auto tuning data utilization																																																														
15	Star connection direct input																																																														
16	Delta connection direct input																																																														
17	Star connection direct input + offline auto tuning																																																														
18	Delta connection direct input + offline auto tuning																																																														
20	SF-JR(4P)-1.5kW or less		Inverter internal constants																																																												
23		Offline auto tuning																																																													
24		Offline auto tuning data utilization																																																													
30 (factory setting)		SF-V5RU vector control inverter motor (including SF-VR type motor)	Inverter internal constants																																																												
33	Offline auto tuning																																																														
34	Offline auto tuning data utilization																																																														
72	PWM frequency selection		1 to 6	1		○	○	○																																																							
73	Speed setting signal	You can set the input specifications of terminals 1 and 2 and whether to use the override function or not.	0		○	○	×																																																								
<table border="1"> <thead> <tr> <th rowspan="2">Pr. 73 Setting</th> <th rowspan="2">Control Mode</th> <th colspan="2">Function</th> <th rowspan="2">Terminal 1 (0 to ±10V)</th> <th rowspan="2">Terminal 2 (0 to 10V)<sup>3</sup></th> </tr> <tr> <th>Override</th> <th>Polarity reversible</th> </tr> </thead> <tbody> <tr> <td>0</td> <td rowspan="4">Speed control</td> <td>×</td> <td>×</td> <td>Addition auxiliary<sup>*1</sup> Speed command</td> <td>Main speed setting</td> </tr> <tr> <td>4</td> <td>○<sup>*2</sup></td> <td>×</td> <td>Main speed setting</td> <td>Override signal</td> </tr> <tr> <td>10</td> <td>×</td> <td>○</td> <td>Addition auxiliary<sup>*1</sup> Speed command</td> <td>Main speed setting</td> </tr> <tr> <td>14</td> <td>○<sup>*2</sup></td> <td>○</td> <td>Main speed setting</td> <td>Override signal</td> </tr> <tr> <td>0</td> <td rowspan="4">Torque control</td> <td>×</td> <td>×</td> <td>Addition auxiliary Speed limit</td> <td>Speed limit</td> </tr> <tr> <td>4</td> <td>○<sup>*4</sup></td> <td>×</td> <td>Speed limit</td> <td>Override signal</td> </tr> <tr> <td>10</td> <td>×</td> <td>×</td> <td>Addition auxiliary Speed limit</td> <td>Speed limit</td> </tr> <tr> <td>14</td> <td>○<sup>*4</sup></td> <td>×</td> <td>Speed limit</td> <td>Override signal</td> </tr> <tr> <td>0, 4, 10, 14</td> <td>Position control</td> <td colspan="2">No function</td> <td>No function</td> <td>No function</td> </tr> </tbody> </table>								Pr. 73 Setting	Control Mode	Function		Terminal 1 (0 to ±10V)	Terminal 2 (0 to 10V) <sup>3</sup>	Override	Polarity reversible	0	Speed control	×	×	Addition auxiliary <sup>*1</sup> Speed command	Main speed setting	4	○ <sup>*2</sup>	×	Main speed setting	Override signal	10	×	○	Addition auxiliary <sup>*1</sup> Speed command	Main speed setting	14	○ <sup>*2</sup>	○	Main speed setting	Override signal	0	Torque control	×	×	Addition auxiliary Speed limit	Speed limit	4	○ <sup>*4</sup>	×	Speed limit	Override signal	10	×	×	Addition auxiliary Speed limit	Speed limit	14	○ <sup>*4</sup>	×	Speed limit	Override signal	0, 4, 10, 14	Position control	No function		No function	No function
Pr. 73 Setting	Control Mode	Function								Terminal 1 (0 to ±10V)	Terminal 2 (0 to 10V) <sup>3</sup>																																																				
		Override						Polarity reversible																																																							
0	Speed control	×						×	Addition auxiliary <sup>*1</sup> Speed command	Main speed setting																																																					
4		○ <sup>*2</sup>						×	Main speed setting	Override signal																																																					
10		×						○	Addition auxiliary <sup>*1</sup> Speed command	Main speed setting																																																					
14		○ <sup>*2</sup>						○	Main speed setting	Override signal																																																					
0	Torque control	×						×	Addition auxiliary Speed limit	Speed limit																																																					
4		○ <sup>*4</sup>						×	Speed limit	Override signal																																																					
10		×	×	Addition auxiliary Speed limit	Speed limit																																																										
14		○ <sup>*4</sup>	×	Speed limit	Override signal																																																										
0, 4, 10, 14	Position control	No function		No function	No function																																																										
<p><sup>*1</sup> The value of terminal 1 (speed setting auxiliary input) is added to the main speed setting signal of terminal 2.</p> <p><sup>*2</sup> When override has been selected, terminal 1 acts as the main speed setting and terminal 2 acts as the override signal (50 to 150% at 0 to 10V).</p> <p><sup>*3</sup> When "30" or "31" is set in Pr. 128, terminal 2 acts as the PID set point function.</p> <p><sup>*4</sup> When override has been selected, terminal 1 acts as speed limit and terminal 2 acts as the override signal.</p>																																																															



## Function list (Extended function parameters)

Function	Parameter	Name	Outline	Factory Setting	Customer Setting	At-a-glance Guide to Functions O: Usable function ×: Unusable function *: Functions that can be used for parameter-set position control				
						Vector Control				
						Speed control	Torque control	Position control		
Operation selection functions	75	Reset selection/ disconnected PU detection/PU stop selection	You can select the reset input acceptance, disconnected PU detection function and PU stop function.		14	○	○	○		
			<b>Pr. 75 Setting</b>	<b>Reset Selection</b>					<b>Disconnected PU Detection</b>	<b>PU Stop Selection</b>
			0	Reset input is always enabled.					If the PU is disconnected, operation will be continued.	Pressing  decelerates the motor to a stop only in the PU operation mode.
			1	Reset input is enabled only when the protective function is activated.					When the PU is disconnected, the inverter output is shut off.	
2			Reset input is always enabled.	If the PU is disconnected, operation will be continued.					Pressing  decelerates the motor to a stop in any of the PU, external and communication operation modes.	
3			Reset input is enabled only when the protective function is activated.	When the PU is disconnected, the inverter output is shut off.						
14			Reset input is always enabled.	If the PU is disconnected, operation will be continued.						
15	Reset input is enabled only when the protective function is activated.	When the PU is disconnected, the inverter output is shut off.								
16	Reset input is always enabled.									
17	Reset input is enabled only when the protective function is activated.									
	77	Parameter write disable selection	0,1,2	0		○	○	○		
	78	Reverse rotation prevention selection	This function can prevent reverse rotation fault resulting from the incorrect input of the start signal. 0: Both forward rotation and reverse rotation enabled, 1: Reverse rotation disabled, 2: Forward rotation disabled	0		○	○	○		
	79	Operation mode selection	0 to 4,6 to 8	0		○	○	○		
Motor constant	80	Motor capacity	Set the motor capacity. 0.4kW to 55kW	Inverter capacity		○	○	○		
	81	Number of motor poles	Set the number of motor poles. 2,4,6	4		○	○	○		
	82	Motor excitation current (no load current)	Used for tuning data utilization or direct input.	9999		○	○	○		
	83	Rated motor voltage	Set the rated motor voltage. 0 to 1000V	200V/ 400V		○	○	○		
	84	Rated motor frequency	Set the rated motor frequency. 10 to 200Hz	60Hz		○	○	○		
	90	Motor constant R1	Used for tuning data utilization or direct input.	9999		○	○	○		
	91	Motor constant R2		9999		○	○	○		
	92	Motor constant L1		9999		○	○	○		
	93	Motor constant L2		9999		○	○	○		
	94	Motor constant X		9999		○	○	○		
	95	Online auto tuning selection	0,1,2	0		○	○	○		
	96	Auto tuning setting/status	Perform motor auto tuning when a motor other than SF-V5RU,SF-VR,SF-JR or SF-HRCA is used. 0,1,101	0		○	○	○		
Third functions	110	Third acceleration/ deceleration time	Third function of acceleration/deceleration time set in Pr. 7, Pr. 8 0 to 3600/0 to 360s	5s		○	○	×*		
	111	Third deceleration time	Third function of deceleration time set in Pr. 8 0 to 3600/0 to 360s, 9999	9999		○	○	×*		
Output terminal functions	116	Third speed detection	Set the speed at which the FB3 signal is output. 0 to 3600r/min	1500r/min		○	○	○		

Function	Parameter	Name	Outline	Factory Setting	Customer Setting	At-a-glance Guide to Functions		
						* : Functions that can be used for parameter-set position control		
						Speed control	Torque control	Position control
Communication functions	117	Communication station number	Station number setting for performing communication operation from the PU connector using a computer link. 0 to 31: Specify the station number of the inverter.	0		○	○	○
	118	Communication speed	48:4800bps 96:9600bps 192:19200bps	192		○	○	○
	119	Stop bit length/data length	0: Stop bit length 1 bit/data length 8 1: Stop bit length 2 bits/data length 8 10: Stop bit length 1 bit/data length 7 11: Stop bit length 2 bits/data length 7	1		○	○	○
	120	Parity check presence/absence	0: None 1: With odd parity check 2: With even parity check	2		○	○	○
	121	Number of communication retries	Set the permissible number of retries at data receive error occurrence. When you set "9999", the inverter will not make an alarm stop if a communication error occurs. 0 to 10, 9999	1		○	○	○
	122	Communication check time interval	Set the communication check time interval. If communication continues for longer than the set time, the inverter will come to an alarm stop. 0: No communication 0.1 to 999.8s: Communication check time interval 9999: Check stop When making communication, set any value other than 0 as the communication check time interval.	0		○	○	○
	123	Waiting time setting	Set the waiting time between data transmission to the inverter and response. 0 to 150ms 9999: Make setting using communication data.	9999		○	○	○
	124	CR/LF selection	0: Without CR/LF, 1: With CR/without LF, 2: With CR/LF  <b>CAUTION</b> <b>After setting the parameter, make a reset. The setting is reflected after the reset is made. (Pr. 117 to Pr. 120, Pr. 123, Pr. 124)</b>	1		○	○	○
PID control	128	PID action selection	Select the action of PID control. 10, 11, 30, 31	10		○	×	×
	129	PID proportional band	Set the proportional band for PID control. 0.1 to 1000%, 9999	100%		○	×	×
	130	PID integral time	Set the integral time for PID control. 0.1 to 3600s, 9999	1s		○	×	×
	131	Upper limit	Set the upper limit value for PID control. 0 to 100%, 9999	9999		○	×	×
	132	Lower limit	Set the lower limit value for PID control. 0 to 100%, 9999	9999		○	×	×
	133	PID action set point for PU operation	Set the PID action set point value for PU operation. 0 to 100%	0%		○	×	×
	134	PID differential time	Set the PID differential time for PID control. 0.01 to 10s, 9999	9999		○	×	×
Backlash	140	Backlash acceleration stopping speed	Used for measures against the backlash of reduction gear, etc. Acceleration stopping speed (0 to 3600r/min) Acceleration stopping time (0 to 360s) Deceleration stopping speed (0 to 3600r/min) Deceleration stopping time (0 to 360s)	30r/min		○	○	×
	141	Backlash acceleration stopping time		0.5s		○	○	×
	142	Backlash deceleration stopping speed		30r/min		○	○	×
	143	Backlash deceleration stopping time		0.5s		○	○	×
Display functions	144	Speed setting switchover	Set the number of motor poles when displaying the motor speed. When Pr. 37 = 0 0, 2, 4, 6, 8, 10	0		○	○	○
	145	Parameter for the option (FR-PU04V)						
Current detection	150	Output current detection level	Set when outputting the output current detection signal. 0 to 200% (Pr. 150) 0 to 10s (Pr. 151)	150%		○	○	○
	151	Output current detection period		0		○	○	○
	152	Zero current detection level	Set when outputting the zero current detection signal. 0 to 200.0% (Pr. 152) 0 to 1s (Pr. 153)	5.0%		○	○	○
	153	Zero current detection period		0.5s		○	○	○

## Function list (Extended function parameters)

Function	Parameter	Name	Outline	Factory Setting	Customer Setting	At-a-glance Guide to Functions																																																																																																													
						* : Functions that can be used for parameter-set position control																																																																																																													
						Speed control	Torque control	Position control																																																																																																											
Sub functions	156	Stall prevention operation selection	<p>You can make setting to prevent the inverter from an overcurrent trip (prevent the fast response current limit from being activated) and/or set the OL signal output delay if stall prevention is activated by an overcurrent or an excessive current flows due to sudden fluctuation of load, ON-OFF of the running inverter output side or the like.</p> <table border="1"> <thead> <tr> <th rowspan="2">Setting</th> <th>Fast Response Current Limit</th> <th>OL Signal Output</th> </tr> <tr> <th>○: Activated ●: Not activated</th> <th>○: Operation continued ●: Operation not continued</th> </tr> </thead> <tbody> <tr><td>0</td><td>○</td><td>○</td></tr> <tr><td>1</td><td>●</td><td>○</td></tr> <tr><td>2</td><td>○</td><td>○</td></tr> <tr><td>3</td><td>●</td><td>○</td></tr> <tr><td>4</td><td>○</td><td>○</td></tr> <tr><td>5</td><td>●</td><td>○</td></tr> <tr><td>6</td><td>○</td><td>○</td></tr> <tr><td>7</td><td>●</td><td>○</td></tr> <tr><td>8</td><td>○</td><td>○</td></tr> <tr><td>9</td><td>●</td><td>○</td></tr> <tr><td>10</td><td>○</td><td>○</td></tr> <tr><td>11</td><td>●</td><td>○</td></tr> <tr><td>12</td><td>○</td><td>○</td></tr> <tr><td>13</td><td>●</td><td>○</td></tr> <tr><td>14</td><td>○</td><td>○</td></tr> <tr><td>15</td><td>●</td><td>-*</td></tr> <tr><td>16</td><td>○</td><td>●</td></tr> <tr><td>17</td><td>●</td><td>●</td></tr> <tr><td>18</td><td>○</td><td>●</td></tr> <tr><td>19</td><td>●</td><td>●</td></tr> <tr><td>20</td><td>○</td><td>●</td></tr> <tr><td>21</td><td>●</td><td>●</td></tr> <tr><td>22</td><td>○</td><td>●</td></tr> <tr><td>23</td><td>●</td><td>●</td></tr> <tr><td>24</td><td>○</td><td>●</td></tr> <tr><td>25</td><td>●</td><td>●</td></tr> <tr><td>26</td><td>○</td><td>●</td></tr> <tr><td>27</td><td>●</td><td>●</td></tr> <tr><td>28</td><td>○</td><td>●</td></tr> <tr><td>29</td><td>●</td><td>●</td></tr> <tr><td>30</td><td>○</td><td>●</td></tr> <tr><td>31</td><td>●</td><td>-*</td></tr> <tr><td>100</td><td>Driving Regeneration</td><td>○ -*</td></tr> <tr><td>101</td><td>Driving Regeneration</td><td>● ○ -*</td></tr> </tbody> </table> <p>* Since both fast response current limit and stall prevention are not activated, OL signal and E.OLT are not output.</p>	Setting	Fast Response Current Limit	OL Signal Output	○: Activated ●: Not activated	○: Operation continued ●: Operation not continued	0	○	○	1	●	○	2	○	○	3	●	○	4	○	○	5	●	○	6	○	○	7	●	○	8	○	○	9	●	○	10	○	○	11	●	○	12	○	○	13	●	○	14	○	○	15	●	-*	16	○	●	17	●	●	18	○	●	19	●	●	20	○	●	21	●	●	22	○	●	23	●	●	24	○	●	25	●	●	26	○	●	27	●	●	28	○	●	29	●	●	30	○	●	31	●	-*	100	Driving Regeneration	○ -*	101	Driving Regeneration	● ○ -*	1		○	○	○
	Setting	Fast Response Current Limit	OL Signal Output																																																																																																																
○: Activated ●: Not activated		○: Operation continued ●: Operation not continued																																																																																																																	
0	○	○																																																																																																																	
1	●	○																																																																																																																	
2	○	○																																																																																																																	
3	●	○																																																																																																																	
4	○	○																																																																																																																	
5	●	○																																																																																																																	
6	○	○																																																																																																																	
7	●	○																																																																																																																	
8	○	○																																																																																																																	
9	●	○																																																																																																																	
10	○	○																																																																																																																	
11	●	○																																																																																																																	
12	○	○																																																																																																																	
13	●	○																																																																																																																	
14	○	○																																																																																																																	
15	●	-*																																																																																																																	
16	○	●																																																																																																																	
17	●	●																																																																																																																	
18	○	●																																																																																																																	
19	●	●																																																																																																																	
20	○	●																																																																																																																	
21	●	●																																																																																																																	
22	○	●																																																																																																																	
23	●	●																																																																																																																	
24	○	●																																																																																																																	
25	●	●																																																																																																																	
26	○	●																																																																																																																	
27	●	●																																																																																																																	
28	○	●																																																																																																																	
29	●	●																																																																																																																	
30	○	●																																																																																																																	
31	●	-*																																																																																																																	
100	Driving Regeneration	○ -*																																																																																																																	
101	Driving Regeneration	● ○ -*																																																																																																																	
	157	OL signal output timer	Set whether to output the overload alarm signal (OL signal) immediately or after a preset period of time when an overload status has occurred. 0 to 25s, 9999	0s		○	○	○																																																																																																											
Display functions	158	DA2 terminal function selection	Select the monitor output DA2 data. 1: Speed 2: Output current 3: Output voltage 5: Preset speed 6: Output frequency 7: Motor torque 8: Converter output voltage 9: Regenerative brake duty 10: Electronic thermal relay function load factor 11: Output current peak value 12: Converter output voltage peak value 17: Load meter 18: Motor excitation current 21: Reference output 32: Torque command 33: Torque current command 34: Motor output 36: Torque monitor (driving/regenerative polarity switching)	1		○	○	○																																																																																																											
	160	Extended function selection	0,1	0		○	○	○																																																																																																											
Automatic restart after instantaneous power failure	162	Automatic restart after instantaneous power failure selection	Valid during V/F control (The setting value "10" is valid for vector control also.) You can select the method for automatic restart after instantaneous power failure. 0: With speed search 1: Without speed search 10: Speed search initiated per start	0		×	×	×																																																																																																											
	163	First cushion time for restart		0s		×	×	×																																																																																																											
	164	First cushion voltage for restart	Set the first cushion time for restart (0 to 20s), first cushion voltage for restart (0 to 100%) and restart current limit level (0 to 200%) when a slight overload status has occurred at an automatic restart after instantaneous power failure.	0%		×	×	×																																																																																																											
	165	Restart current limit level		150%		×	×	×																																																																																																											

Function	Parameter	Name	Outline	Factory Setting	Customer Setting	At-a-glance Guide to Functions		
						* : Functions that can be used for parameter-set position control		
						Speed control	Torque control	Position control
Maintenance functions	168	Maker setting parameters. Do not set.						
	169	Maker setting parameters. Do not set.						
Initial monitor	171	Actual operation hour meter clear	You can clear the actual operation hour meter.	0		○	○	○
Terminal assignment functions	180	DI1 terminal function selection	You can select the following input signals. 0: RL (multi-speed low-speed run command) → Pr. 180 factory setting 1: RM (multi-speed middle-speed run command) → Pr. 181 factory setting 2: RH (multi-speed high-speed run command) → Pr. 182 factory setting 3: RT (second function selection) → Pr. 183 factory setting 5: JOG (jog operation selection) 8: REX (multi-speed 15 speeds selection) 9: X9 (third function selection) 10: X10 (FR-HC,FR-CV connection (inverter run enable signal)) 11: X11 (FR-HC connection (instantaneous power failure detection)) 12: X12 (PU operation external interlock) 14: X14 (PID control valid) 15: BRI (brake release completion signal) 16: X16 (PU operation-external operation switchover) 20: X20 (S-pattern acceleration/deceleration C switching terminal) 22: X22 (orientation command) 23: LX (pre-excitation/servo on) 24: MRS(output stop) 25: STOP (start self-holding selection) 26: MC (control mode switching) 27: TL (torque limit selection) 28: X28 (start time tuning)	0		○	○	○
	181	DI2 terminal function selection	10: X10 (FR-HC,FR-CV connection (inverter run enable signal)) 11: X11 (FR-HC connection (instantaneous power failure detection)) 12: X12 (PU operation external interlock) 14: X14 (PID control valid) 15: BRI (brake release completion signal) 16: X16 (PU operation-external operation switchover) 20: X20 (S-pattern acceleration/deceleration C switching terminal) 22: X22 (orientation command) 23: LX (pre-excitation/servo on) 24: MRS(output stop) 25: STOP (start self-holding selection) 26: MC (control mode switching) 27: TL (torque limit selection) 28: X28 (start time tuning)	1		○	○	○
	182	DI3 terminal function selection	15: BRI (brake release completion signal) 16: X16 (PU operation-external operation switchover) 20: X20 (S-pattern acceleration/deceleration C switching terminal) 22: X22 (orientation command) 23: LX (pre-excitation/servo on) 24: MRS(output stop) 25: STOP (start self-holding selection) 26: MC (control mode switching) 27: TL (torque limit selection) 28: X28 (start time tuning)	2		○	○	○
	183	DI4 terminal function selection	24: MRS(output stop) 25: STOP (start self-holding selection) 26: MC (control mode switching) 27: TL (torque limit selection) 28: X28 (start time tuning)	3		○	○	○
	187	STR terminal function selection	42: X42 (torque bias selection 1) 43: X43 (torque bias selection 2) 44: X44 (P control selection (P/PI control switching)) 9999: No function (STR when set in Pr. 187)	9999		○	○	○
Terminal assignment functions	190	DO1 terminal function selection	You can select the following output signals. 0 (positive logic) → Pr. 190 factory setting, 100 (negative logic): RUN (inverter running) 1 (positive logic) → Pr. 191 factory setting, 101 (negative logic): SU (up to speed) 2 (positive logic) → Pr. 192 factory setting, 102 (negative logic): IPF (instantaneous power failure or undervoltage) 3 (positive logic), 103 (negative logic) : OL (overload warning) 4 (positive logic), 104 (negative logic) : FU (output speed detection) 5 (positive logic), 105 (negative logic) : FU2 (second output speed detection) 6 (positive logic), 106 (negative logic) : FU3 (third output speed detection) 7 (positive logic), 107 (negative logic) : RBP (regenerative brake prealarm) 8 (positive logic), 108 (negative logic) : THP (electronic thermal relay function prealarm) 10 (positive logic), 110 (negative logic) : PU (PU operation mode) 11 (positive logic), 111 (negative logic) : RY (inverter operation ready) 12 (positive logic), 112 (negative logic) : Y12 (output current detection) 13 (positive logic), 113 (negative logic) : Y13 (zero current detection) 14 (positive logic), 114 (negative logic) : FDN (PID lower limit) 15 (positive logic), 115 (negative logic) : FUP (PID upper limit) 16 (positive logic), 116 (negative logic) : RL (PID forward/reverse rotation output) 20 (positive logic), 120 (negative logic) : BOF (brake opening request) 25 (positive logic), 125 (negative logic) : FAN (fan failure output) 26 (positive logic), 126 (negative logic) : FIN (heatsink overheat prealarm) 27 (positive logic), 127 (negative logic) : ORA (orientation completion) 30 (positive logic), 130 (negative logic) : Y30 (forward rotation output) 31 (positive logic), 131 (negative logic) : Y31 (reverse rotation output) 32 (positive logic), 132 (negative logic) : Y32 (regenerative status output) 33 (positive logic), 133 (negative logic) : RY2 (operation ready 2) 34 (positive logic), 134 (negative logic) : LS (low speed output) 35 (positive logic), 135 (negative logic) : TU (torque detection) 36 (positive logic), 136 (negative logic) : Y36 (in-position) 37 (positive logic), 137 (negative logic) : MT (maintenance timer output) 39 (positive logic), 139 (negative logic) : Y39 (start time tuning completion) 40 (positive logic), 140 (negative logic) : Y40:(trace status) 41 (positive logic), 141 (negative logic) : FB (speed detection) 42 (positive logic), 142 (negative logic) : FB2 (second speed detection) 43 (positive logic), 143 (negative logic) : FB3 (third speed detection) 44 (positive logic), 144 (negative logic) : RUN2 (second inverter operating) 96 (positive logic), 196 (negative logic) : REM (remote output) 97 (positive logic), 197 (negative logic) : ER (minor fault output 2) 98 (positive logic), 198 (negative logic) : LF (minor fault output) 99 (positive logic) → Pr. 195 factory setting, 199 (negative logic): ABC (alarm output) 9999: No function	0		○	○	○
	191	DO2 terminal function selection	10 (positive logic), 110 (negative logic) : PU (PU operation mode) 11 (positive logic), 111 (negative logic) : RY (inverter operation ready) 12 (positive logic), 112 (negative logic) : Y12 (output current detection) 13 (positive logic), 113 (negative logic) : Y13 (zero current detection) 14 (positive logic), 114 (negative logic) : FDN (PID lower limit) 15 (positive logic), 115 (negative logic) : FUP (PID upper limit) 16 (positive logic), 116 (negative logic) : RL (PID forward/reverse rotation output) 20 (positive logic), 120 (negative logic) : BOF (brake opening request) 25 (positive logic), 125 (negative logic) : FAN (fan failure output) 26 (positive logic), 126 (negative logic) : FIN (heatsink overheat prealarm) 27 (positive logic), 127 (negative logic) : ORA (orientation completion) 30 (positive logic), 130 (negative logic) : Y30 (forward rotation output) 31 (positive logic), 131 (negative logic) : Y31 (reverse rotation output) 32 (positive logic), 132 (negative logic) : Y32 (regenerative status output) 33 (positive logic), 133 (negative logic) : RY2 (operation ready 2) 34 (positive logic), 134 (negative logic) : LS (low speed output) 35 (positive logic), 135 (negative logic) : TU (torque detection) 36 (positive logic), 136 (negative logic) : Y36 (in-position) 37 (positive logic), 137 (negative logic) : MT (maintenance timer output) 39 (positive logic), 139 (negative logic) : Y39 (start time tuning completion) 40 (positive logic), 140 (negative logic) : Y40:(trace status) 41 (positive logic), 141 (negative logic) : FB (speed detection) 42 (positive logic), 142 (negative logic) : FB2 (second speed detection) 43 (positive logic), 143 (negative logic) : FB3 (third speed detection) 44 (positive logic), 144 (negative logic) : RUN2 (second inverter operating) 96 (positive logic), 196 (negative logic) : REM (remote output) 97 (positive logic), 197 (negative logic) : ER (minor fault output 2) 98 (positive logic), 198 (negative logic) : LF (minor fault output) 99 (positive logic) → Pr. 195 factory setting, 199 (negative logic): ABC (alarm output) 9999: No function	1		○	○	○
	192	DO3 terminal function selection	27 (positive logic), 127 (negative logic) : ORA (orientation completion) 30 (positive logic), 130 (negative logic) : Y30 (forward rotation output) 31 (positive logic), 131 (negative logic) : Y31 (reverse rotation output) 32 (positive logic), 132 (negative logic) : Y32 (regenerative status output) 33 (positive logic), 133 (negative logic) : RY2 (operation ready 2) 34 (positive logic), 134 (negative logic) : LS (low speed output) 35 (positive logic), 135 (negative logic) : TU (torque detection) 36 (positive logic), 136 (negative logic) : Y36 (in-position) 37 (positive logic), 137 (negative logic) : MT (maintenance timer output) 39 (positive logic), 139 (negative logic) : Y39 (start time tuning completion) 40 (positive logic), 140 (negative logic) : Y40:(trace status) 41 (positive logic), 141 (negative logic) : FB (speed detection) 42 (positive logic), 142 (negative logic) : FB2 (second speed detection) 43 (positive logic), 143 (negative logic) : FB3 (third speed detection) 44 (positive logic), 144 (negative logic) : RUN2 (second inverter operating) 96 (positive logic), 196 (negative logic) : REM (remote output) 97 (positive logic), 197 (negative logic) : ER (minor fault output 2) 98 (positive logic), 198 (negative logic) : LF (minor fault output) 99 (positive logic) → Pr. 195 factory setting, 199 (negative logic): ABC (alarm output) 9999: No function	2		○	○	○
	195	A,B,C terminal function selection	41 (positive logic), 141 (negative logic) : FB (speed detection) 42 (positive logic), 142 (negative logic) : FB2 (second speed detection) 43 (positive logic), 143 (negative logic) : FB3 (third speed detection) 44 (positive logic), 144 (negative logic) : RUN2 (second inverter operating) 96 (positive logic), 196 (negative logic) : REM (remote output) 97 (positive logic), 197 (negative logic) : ER (minor fault output 2) 98 (positive logic), 198 (negative logic) : LF (minor fault output) 99 (positive logic) → Pr. 195 factory setting, 199 (negative logic): ABC (alarm output) 9999: No function	99		○	○	○

## Function list (Extended function parameters)

Function	Parameter	Name	Outline	Factory Setting	Customer Setting	At-a-glance Guide to Functions																																															
						* : Functions that can be used for parameter-set position control																																															
						Speed control	Torque control	Position control																																													
Multi-speed operation	232	Multi-speed setting (speed 8)	By setting any value other than "9999", set speeds 8 to 15. This function is designed to change the running speed in stages by changing the ON/OFF combination of the contact signals (RH, RM, RL, REX signals). <table border="1" style="margin: 10px auto;"> <thead> <tr> <th></th> <th>RH</th> <th>RM</th> <th>RL</th> <th>REX</th> </tr> </thead> <tbody> <tr> <td>Speed 8</td> <td>OFF</td> <td>OFF</td> <td>OFF</td> <td>ON</td> </tr> <tr> <td>Speed 9</td> <td>OFF</td> <td>OFF</td> <td>ON</td> <td>ON</td> </tr> <tr> <td>Speed 10</td> <td>OFF</td> <td>ON</td> <td>OFF</td> <td>ON</td> </tr> <tr> <td>Speed 11</td> <td>OFF</td> <td>ON</td> <td>ON</td> <td>ON</td> </tr> <tr> <td>Speed 12</td> <td>ON</td> <td>OFF</td> <td>OFF</td> <td>ON</td> </tr> <tr> <td>Speed 13</td> <td>ON</td> <td>OFF</td> <td>ON</td> <td>ON</td> </tr> <tr> <td>Speed 14</td> <td>ON</td> <td>ON</td> <td>OFF</td> <td>ON</td> </tr> <tr> <td>Speed 15</td> <td>ON</td> <td>ON</td> <td>ON</td> <td>ON</td> </tr> </tbody> </table>		RH	RM	RL	REX	Speed 8	OFF	OFF	OFF	ON	Speed 9	OFF	OFF	ON	ON	Speed 10	OFF	ON	OFF	ON	Speed 11	OFF	ON	ON	ON	Speed 12	ON	OFF	OFF	ON	Speed 13	ON	OFF	ON	ON	Speed 14	ON	ON	OFF	ON	Speed 15	ON	ON	ON	ON	9999		○	○	×*
		RH		RM	RL	REX																																															
	Speed 8	OFF		OFF	OFF	ON																																															
	Speed 9	OFF		OFF	ON	ON																																															
	Speed 10	OFF		ON	OFF	ON																																															
	Speed 11	OFF		ON	ON	ON																																															
	Speed 12	ON		OFF	OFF	ON																																															
	Speed 13	ON		OFF	ON	ON																																															
	Speed 14	ON		ON	OFF	ON																																															
Speed 15	ON	ON	ON	ON																																																	
233	Multi-speed setting (speed 9)	9999		○	○	×*																																															
234	Multi-speed setting (speed 10)	9999		○	○	×*																																															
235	Multi-speed setting (speed 11)	9999		○	○	×*																																															
236	Multi-speed setting (speed 12)	9999		○	○	×*																																															
237	Multi-speed setting (speed 13)	9999		○	○	×*																																															
238	Multi-speed setting (speed 14)	9999		○	○	×*																																															
239	Multi-speed setting (speed 15)	9999		○	○	×*																																															
Sub functions	240	Soft-PWM setting	You can select to exercise Soft-PWM control and long wiring mode. When Soft-PWM control is made valid, you can change the metallic tone of motor sound into an unoffending complex tone. Surge voltage is suppressed in the long wiring mode regardless of the wiring length between the inverter and motor. (When operating a 400V motor with wiring length of 40m or more, select long wiring mode.) 0: Soft-PWM control invalid, long wiring mode invalid 1: Soft-PWM control valid (when Pr. 72 = "1 or 2"), long wiring mode invalid 10: Soft-PWM control invalid, long wiring mode valid (carrier frequency is 2.25Hz *) 11: Soft-PWM control valid, long wiring mode valid (carrier frequency is 2.25Hz *) *The Pr.72 "PWM frequency selection" setting is made invalid.	10		○	○	○																																													
	244	Cooling fan operation selection	You can control the operation of the cooling fan built in the inverter. 0: The fan is always operated at power-on of the inverter. 1: The fan is always on while the inverter is running. During a stop, the inverter status is monitored and the fan switches on-off according to the temperature.	0		○	○	○																																													
Stop selection function	250	Stop selection	Set to allow the motor to be coasted to a stop by turning off the start command during V/F or speed control. 0 to 100s: Coasting to stop 9999: Deceleration to stop	9999		○	○	×																																													
Operation selection function	251	Output phase failure protection selection	You can disable the output phase failure protection function that stops the inverter output if one of the inverter output side (load side) three phases (U, V, W) opens. 0: Without output phase failure protection 1: With output phase failure protection	1		○	○	○																																													
Additional functions	252	Override bias	When you selected the override in Pr. 73, you can adjust the override bias (0 to 200%) and override gain (0 to 200%).	50%		○	○	×																																													
	253	Override gain		150%		○	○	×																																													
Power failure stop functions	261	Power failure stop selection	You can select the stopping method at a power failure. 0: Coasting to stop, inverter output shutoff 1: Inverter is decelerated to a stop.	0		○	○	×																																													
	262	Subtracted speed at deceleration start	0 to 600r/min	90r/min		○	○	×																																													
	263	Subtraction starting speed	0 to 3600r/min, 9999	1500r/min		○	○	×																																													
	264	Power-failure deceleration time 1	0 to 3600/0 to 360s	5s		○	○	×																																													
	265	Power-failure deceleration time 2	0 to 3600/0 to 360s, 9999	9999		○	○	×																																													
	266	Power-failure deceleration time switchover speed	0 to 3600r/min	1500r/min		○	○	×																																													
Brake sequence	278	Brake opening speed	Set when outputting the operation timing signal of the mechanical brake in vertical lift applications. (When speed control (invalid for V/F control) is selected) 0 to 900r/min (Pr. 278) 0 to 200% (Pr. 279) 0 to 2s (Pr. 280) 0 to 5s (Pr. 281) 0 to 900r/min (Pr. 282) 0 to 5s (Pr. 283) 0, 1 (Pr. 284) 0 to 900r/min, 9999 (Pr. 285)	20r/min		○	×	×																																													
	279	Brake opening current		130%		○	×	×																																													
	280	Brake opening current detection time		0.3s		○	×	×																																													
	281	Brake operation time at start		0.3s		○	×	×																																													
	282	Brake operation speed		25r/min		○	×	×																																													
	283	Brake operation time at stop		0.3s		○	×	×																																													
	284	Deceleration detection function selection		0		○	×	×																																													
	285	Overspeed detection speed		9999		○	×	×																																													

Function	Parameter	Name	Outline	Factory Setting	Customer Setting	At-a-glance Guide to Functions		
						* : Functions that can be used for parameter-set position control		
						Speed control	Torque control	Position control
Droop	286	Droop gain	Set when providing a drooping characteristic for the speed in proportion to the load torque. 0 to 100% (Pr. 286) 0.00 to 1.00s (Pr. 287) (Pr. 288) 0: Without droop operation during acceleration/deceleration 1: Without droop operation during acceleration/deceleration (Speed command after droop is zero limited) 2: With droop operation during acceleration/deceleration (Speed command after droop is not zero limited)	0%		O	x	x
	287	Droop filter time constant		0.3s		O	x	x
	288	Droop function activation selection		0		O	x	x
Additional function	342	E <sup>2</sup> PROM write selection	0:E <sup>2</sup> PROM 1:RAM	0		O	O	O
Orientation	350	Stop position command selection	For the stop position command, either the internal stop position command or the external stop position command using external signals may be selected. 0:Internal stop position command 1:External stop position command (6 bit data when the FR-V5AX is fitted ) 2:External stop position command (12 bit data when the FR-A5AX is fitted ) 3:External stop position command (16 bit data when the FR-V5AH is fitted ) 9999:Orientation control invalid	9999		O	x	x
	351	Orientation switchover speed	Decrease the motor speed to the set value during the orientation command is valid. 0 to 1000r/min	200r/min		O	x	x
	356	Internal stop position command	When "0" is set in Pr. 350 "stop position command selection", the internal position command is activated and the setting value of Pr. 356 becomes a stop position. 0 to 16383	0		O	x	x
	357	In-position zone	Set the in-position zone at a stop of the orientation. 0 to 8192	11		O	x	x
	360	External position command selection	When "1" is set in Pr. 350 "stop position command selection", the external position command is activated and the setting value of Pr. 360 becomes a stop position. 0: External position command invalid 1: 4096 per rotation with the FR-A5AX, 64 per rotation with the FR-V5AX 2 to 127: The external stop position command may be used to set up to 128 stop positions at regular intervals.	0		O	x	x
	361	Position shift	The stop position is a position obtained by adding the setting value of Pr. 361 to the position command. You can make fine adjustments to a stop position. 0 to 16383	0		O	x	x
	362	Orientation position loop gain	Adjust at a stop of the orientation 0.1 to 100	10		O	x	x
Control method function	374	Overspeed detection level	Overspeed occurs if the motor speed exceeds the preset speed. 0 to 4200r/min	3450 r/min		O	O	O
S-pattern C	380	Acceleration S-pattern 1	You can set X20 in any of Pr. 180 to 183 and Pr. 187, and set an S pattern by turning it on/off. Set an S pattern in Pr. 380 to Pr. 383. 0 to 50%	0%		O	O	x
	381	Deceleration S-pattern 1		0%		O	O	x
	382	Acceleration S-pattern 2		0%		O	O	x
	383	Deceleration S-pattern 2		0%		O	O	x
Orientation	393	Orientation selection	0,1,2,10,11,12	0		O	x	x
	396	Orientation speed gain (P term)	0 to 1000	60		O	x	x
	397	Orientation speed integral time	0 to 20.0s	0.333		O	x	x
	398	Orientation speed gain (D term)	0 to 100.0%	1		O	x	x
	399	Orientation deceleration ratio	0 to 1000	20		O	x	x
Additional function	408	Motor thermistor selection	When using a thermistor interface with the FR-V5AX connected, use Pr.408 to select a motor type. It can be set only when used with the FR-V5AX. 0:SF-V5RU□□□□□□T 1:SF-V5RU□□□□□□A	0		O	O	O

## Function list (Extended function parameters)

Function	Parameter	Name	Outline	Factory Setting	Customer Setting	At-a-glance Guide to Functions		
						* : Functions that can be used for parameter-set position control		
						Speed control	Torque control	Position control
Torque control	419	Position command source selection	Select the position command source for position control. 0, 1 0: Conditional position feed function by contact input 1: Position command by pulse train input (when the FR-V5AP is fitted).	0		×	×	○
	420	Command pulse scaling factor numerator	Set the electronic gear. Pr. 420 is a numerator and Pr. 421 is a denominator. 0 to 32767	1		×	×	○
	421	Command pulse scaling factor denominator		1		×	×	○
	422	Position loop gain	Set the gain of the position loop. 0 to 150s <sup>-1</sup>	25s <sup>-1</sup>		×	×	○
	423	Position feed forward gain	Function to cancel a delay caused by the droop pulses of the deviation counter. 0 to 100%	0%		×	×	○
	424	Position command acceleration/ deceleration time constant	Used when rotation has become unsmooth at a large electronic gear ratio (about 10 times or more) and low speed. 0 to 50s	0s		×	×	○
	425	Position feed forward command filter	Enters the primary delay filter in response to the feed forward command. 0 to 5s	0s		×	×	○
	426	In-position width	The in-position signal turns on when the droop pulses become less than the setting. 0 to 32767 pulses	100 pulses		×	×	○
	427	Excessive level error	An error becomes excessive when the droop pulses exceed the setting. 0 to 400K pulses, 9999	40K pulses		×	×	○
430	Pulse monitor selection	0 to 5, 9999	9999		×	×	○	
Second motor	450	Second applied motor	0, 10, 30, 9999	9999		×	×	×
	451	Second motor control method selection	Select the method of controlling the second motor. 20, 9999	9999		×	×	×
	452	Second electronic thermal O/L relay	Set the electronic thermal relay function value of the second motor. 0 to 500A, 9999	9999		×	×	×
	453	Second motor capacity	Set the capacity of the second motor. 0.4 to 55kW	Inverter capacity		×	×	×
	454	Number of second motor poles	Set the number of poles of the second motor. 2, 4, 6	4		×	×	×

Function	Parameter	Name	Outline	Factory Setting	Customer Setting	At-a-glance Guide to Functions		
						* : Functions that can be used for parameter-set position control		
						Speed control	Torque control	Position control
Position control	464	Digital position control sudden stop deceleration time	Set the time until the inverter stops when the forward rotation (reverse rotation) command is turned off with the position feed forward function. 0 to 360.0s	0		x	x	○
	465	First position feed amount lower 4 digits	Parameters for setting position feed data for parameter-based position control.	0		x	x	○
	466	First position feed amount upper 4 digits		0		x	x	○
	467	Second position feed amount lower 4 digits		0		x	x	○
	468	Second position feed amount upper 4 digits		0		x	x	○
	469	Third position feed amount lower 4 digits		0		x	x	○
	470	Third position feed amount upper 4 digits		0		x	x	○
	471	Fourth position feed amount lower 4 digits		0		x	x	○
	472	Fourth position feed amount upper 4 digits		0		x	x	○
	473	Fifth position feed amount lower 4 digits		0		x	x	○
	474	Fifth position feed amount upper 4 digits		0		x	x	○
	475	Sixth position feed amount lower 4 digits		0		x	x	○
	476	Sixth position feed amount upper 4 digits		0		x	x	○
	477	Seventh position feed amount lower 4 digits		0		x	x	○
	478	Seventh position feed amount upper 4 digits		0		x	x	○
	479	Eighth position feed amount lower 4 digits		0		x	x	○
	480	Eighth position feed amount upper 4 digits		0		x	x	○
	481	Ninth position feed amount lower 4 digits		0		x	x	○
	482	Ninth position feed amount upper 4 digits		0		x	x	○
	483	Tenth position feed amount lower 4 digits		0		x	x	○
	484	Tenth position feed amount upper 4 digits		0		x	x	○
	485	Eleventh position feed amount lower 4 digits		0		x	x	○
	486	Eleventh position feed amount upper 4 digits		0		x	x	○
	487	Twelfth position feed amount lower 4 digits		0		x	x	○
	488	Twelfth position feed amount upper 4 digits		0		x	x	○
	489	Thirteenth position feed amount lower 4 digits		0		x	x	○
	490	Thirteenth position feed amount upper 4 digits		0		x	x	○
	491	Fourteenth position feed amount lower 4 digits		0		x	x	○
	492	Fourteenth position feed amount upper 4 digits		0		x	x	○
	493	Fifteenth position feed amount lower 4 digits		0		x	x	○
494	Fifteenth position feed amount upper 4 digits	0			x	x	○	
Remote output	495	Remote output selection	You can turn on/off the inverter output. 0: Non-latch 1: Latch	0		○	○	○
	496	Remote output data 1	You can set the output signal data of the inverter. 0 to 4095	0		○	○	○
	497	Remote output data 2		0		○	○	○

No.	Setting Range	Selection Method				Position Feed Speed
		REX	RH	RM	RL	
465	0 to 9999	OFF	ON	OFF	OFF	High speed, Pr. 4
466	0 to 9999	OFF	OFF	ON	OFF	Middle speed, Pr. 5
467	0 to 9999	OFF	OFF	OFF	ON	Low speed, Pr. 6
468	0 to 9999	OFF	OFF	ON	ON	Speed 4, Pr. 24
469	0 to 9999	OFF	ON	OFF	ON	Speed 5, Pr. 25
470	0 to 9999	OFF	ON	ON	OFF	Speed 6, Pr. 26
471	0 to 9999	OFF	ON	ON	ON	Speed 7, Pr. 27
472	0 to 9999	ON	OFF	OFF	OFF	Speed 8, Pr. 232
473	0 to 9999	ON	OFF	OFF	ON	Speed 9, Pr. 233
474	0 to 9999	ON	OFF	ON	OFF	Speed 10, Pr. 234
475	0 to 9999	ON	OFF	ON	ON	Speed 11, Pr. 235
476	0 to 9999	ON	ON	OFF	OFF	Speed 12, Pr. 236
477	0 to 9999	ON	ON	OFF	ON	Speed 13, Pr. 237
478	0 to 9999	ON	ON	ON	OFF	Speed 14, Pr. 238
479	0 to 9999	ON	ON	ON	ON	Speed 15, Pr. 239



## Function list (Extended function parameters)

Function	Parameter	Name	Outline	Factory Setting	Customer Setting	At-a-glance Guide to Functions		
						* : Functions that can be used for parameter-set position control		
						Vector Control		
						Speed control	Torque control	Position control
Additional function	505	Speed setting reference	Reference speed for Pr. 37. 1 to 3600r/min	1500r/min		○	○	○
	<b>Operation selection functions</b>							
	800	Control method selection	0 to 5, 9, 20	0		○	○	○
	801	Torque characteristic selection	You can select the torque characteristic when choosing the motor provided with encoder. 0: Cycle 1: Continuous	1		○	○	○
	802	Pre-excitation selection	You can select either zero speed control or servo lock by turning on the LX signal (pre-excitation/servo on). 0: Zero speed control 1: Servo lock	0		○	×	○
	803	Constant power range torque characteristic selection	You can select how to provide a torque command in the constant power range. 0: Constant output reference 1: Constant torque reference	0		○	○	○
	804	Torque command source selection	Select the torque command source. 0: Terminal 3 analog input 1: Digital input from parameter (Pr. 805, Pr. 806) 2: Pulse train command input (when the FR-V5AP is fitted) 3: Torque command RWw1(FR-A5NC) from the CC-Link, torque command can be set in the range of 600 to 1400% in the setting increments of 1%. 4: Digital input from option (when the FR-V5AH or FR-A5AX is fitted) 5: Set in torque command RWw1 (FR-A5NC) from the CC-Link a value in two's complement in 0.01% increments. 6: A value is set in Pr. 805 or Pr. 806 in two's complement in 0.01% increments.	0		×	○	×
	805	Torque command value (RAM)	You can set the torque command value in the parameter. (RAM) 600 to 1400%	1000%		×	○	×
	806	Torque command value (RAM, E <sup>2</sup> PROM)	You can set the torque command value in the parameter. (RAM, E <sup>2</sup> PROM) 600 to 1400%	1000%		×	○	×
	807	Speed limit selection	You can select the speed limit command input for torque control. 0: Same as speed setting for speed control 1: Control limits for individual rotation directions 2: Terminal 1 analog input	0		×	○	×
	808	Forward rotation speed limit	Set the speed limit in forward rotation direction individually according to the rotation direction. 0 to 3600r/min	1500r/min		×	○	×
	809	Reverse rotation speed limit	Set the speed limit in reverse rotation direction individually according to the rotation direction. 0 to 3600r/min, 9999	9999		×	○	×
<b>Control method functions</b>								
	810	Torque limit input method selection	Set whether to make torque limit using internal parameter values or analog voltage. (0: Internal, 1: External)	0		○	×	○
	811	Set resolution switchover	By setting Pr. 811 "set resolution switchover", the setting increments of the speed from the communication, Pr. 22 "torque limit level" and Pr. 812 to Pr. 817 (torque limit level) can be switched. 0: Speed setting 1r/min increments (communication), torque limit 0.1% increments (Pr. 22, Pr. 812 to 817) 1: Speed setting 0.1r/min increments (communication), torque limit 0.1% increments (Pr. 22, Pr. 812 to 817) 10: Speed setting 1r/min increments (communication), torque limit 0.01% increments (Pr. 22, Pr. 812 to 817) 11: Speed setting 0.1r/min increments (communication), torque limit 0.01% increments (Pr. 22, Pr. 812 to 817)	0		○	○	○
	812	Torque limit level (regeneration)	0 to 400%, 9999	9999		○	×	○
	813	Torque limit level (3rd quadrant)	0 to 400%, 9999	9999		○	×	○
	814	Torque limit level (4th quadrant)	0 to 400%, 9999	9999		○	×	○
	815	Torque limit level 2	Second function of the torque limit level. Made valid when the RT terminal is on. 0 to 400%, 9999	9999		○	×	○
	816	Acceleration torque limit level	Set the torque limit value during acceleration. 0 to 400%, 9999	9999		○	×	○
	817	Deceleration torque limit level	Set the torque limit value during deceleration. 0 to 400%, 9999	9999		○	×	○
	818	Easy gain tuning response level setting	1 to 15	2		○	×	○
	819	Easy gain tuning selection	0,1,2	0		○	×	○
	820	Speed control P gain 1	Set the proportional gain for speed control. (Increasing the value improves trackability in response to a speed command change and reduces speed variation with disturbance.) 0 to 1000%	60%		○	×	○
	821	Speed control integral time 1	Set the integral time during speed control. (Decrease the value to shorten the time taken for returning to the original speed if speed variation with disturbance occurs.) 0 to 20s	0.333s		○	×	○

Function	Parameter	Name	Outline	Factory Setting	Customer Setting	At-a-glance Guide to Functions		
						* : Functions that can be used for parameter-set position control		
						Speed control	Torque control	Position control
Control method functions	822	Speed setting filter 1	Set the primary delay filter for the analog voltage-based speed setting. 0 to 5s	0s		○	○	×
	823	Speed detection filter 1	Set the primary delay filter for the speed feedback. 0 to 0.1s	0.001s		○	○	○
	824	Torque control P gain 1	Set the proportional gain for the current control of the q and d axes. (Increasing the value improves trackability in response to a current command change and reduces current variation with disturbance.) 0 to 200%	100%		○	○	○
	825	Torque control integral time 1	Set the integral time for the current control of the q and d axes. (Decreasing the value shortens the time taken to return to the original torque if current variation with disturbance occurs.) 0 to 500ms	5ms		○	○	○
	826	Torque setting filter 1	Set the primary delay filter for the analog voltage (terminal 3)-based torque command value. (Also valid for the torque limit from the terminal 3 during speed control.) 0 to 5s	0s		○	○	○
	827	Torque detection filter 1	Set the primary delay filter for the current feedback. 0 to 0.1s	0s		○	○	○
	828	Model speed control gain	0 to 1000%	60%		○	×	○
	830	Speed control P gain 2	Second function of Pr. 820 (valid when RT terminal is on) 0 to 1000%, 9999	9999		○	×	○
	831	Speed control integral time 2	Second function of Pr. 821 (valid when RT terminal is on) 0 to 20s, 9999	9999		○	×	○
	832	Speed setting filter 2	Second function of Pr. 822 (valid when RT terminal is on) 0 to 5s, 9999	9999		○	○	×
	833	Speed detection filter 2	Second function of Pr. 823 (valid when RT terminal is on) 0 to 0.1s, 9999	9999		○	○	○
	834	Torque control P gain 2	Second function of Pr. 824 (valid when RT terminal is on) 0 to 200%, 9999	9999		○	○	○
	835	Torque control integral time 2	Second function of Pr. 825 (valid when RT terminal is on) 0 to 500ms, 9999	9999		○	○	○
	836	Torque setting filter 2	Second function of Pr. 826 (valid when RT terminal is on) 0 to 5s, 9999	9999		○	○	○
	837	Torque detection filter 2	Second function of Pr. 827 (valid when RT terminal is on) 0 to 0.1s, 9999	9999		○	○	○
Torque biases	840	Torque bias selection	The torque bias function is designed to quicken the rise of torque at a motor start. You can set the then output torque using the parameters or analog signals. 0: 3 internal parameters, 1 to 3: External analog input, 9999	9999		○	×	×
	841	Torque bias 1	Set the torque bias values when you chose internal parameter-based torque bias selection. Assign X42 (torque bias selection 1) and X43 (torque bias selection 2) to the input terminals.	9999		○	×	×
	842	Torque bias 2	600 to 1400%	9999		○	×	×
	843	Torque bias 3	1) Pr. 841 when X42 is on and X43 is off, 2) Pr. 842 when X42 is off and X43 is on, 3) Pr. 843 when X42 is on and X43 is on	9999		○	×	×
	844	Torque bias filter	You can slow the rise of torque for the torque command. A primary delay filter time constant. 0 to 5s, 9999	9999		○	×	×
	845	Torque bias operation time	Set the time until the set torque of the torque bias amount is generated. 0 to 5s, 9999	9999		○	×	×
	846	Torque bias balance compensation	Set the torque balance with the balance weight. 0 to 10V, 9999	9999		○	×	×
	847	Fall-time torque bias terminal 3 bias	When you set 1 or 2 in Pr. 840, set the bias value of the torque bias at the time of fall from the load input from the terminal 3. 0 to 400%, 9999	9999		○	×	×
848	Fall-time torque bias terminal 3 gain	When you set 1 or 2 in Pr. 840, set the gain value of the torque bias at the time of fall from the load input from the terminal 3. 0 to 400%, 9999	9999		○	×	×	
Additional functions	849	Analog input off set adjustment	When speed command by analog input is set, create the range where the motor remains stop to prevent malfunction at very low speed. 0 to 200%	100%		○	○	×
	851	Number of encoder pulses	Set the number of pulses of the encoder. 0 to 4096	2048		○	○	○

## Function list (Extended function parameters)

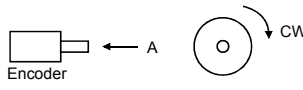
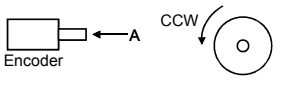
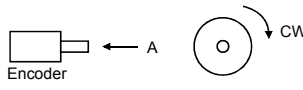
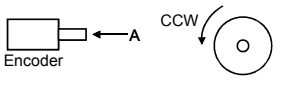
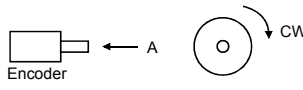
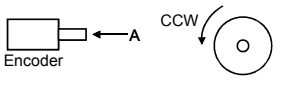
Function	Parameter	Name	Outline	Factory Setting	Customer Setting	At-a-glance Guide to Functions																										
						* : Functions that can be used for parameter-set position control																										
						Speed control	Torque control	Position control																								
Additional functions	852	Encoder rotation direction	Set the rotation direction of the encoder.	1		○	○	○																								
			<table border="1"> <thead> <tr> <th>Pr. 852 Setting</th> <th>Relationship between the motor and encoder</th> </tr> </thead> <tbody> <tr> <td>0</td> <td>  <p>Forward rotation is clockwise rotation when viewed from A.</p> </td> </tr> <tr> <td>1 (Factory setting)</td> <td>  <p>Forward rotation is counterclockwise rotation when viewed from A.</p> </td> </tr> </tbody> </table>						Pr. 852 Setting	Relationship between the motor and encoder	0	 <p>Forward rotation is clockwise rotation when viewed from A.</p>	1 (Factory setting)	 <p>Forward rotation is counterclockwise rotation when viewed from A.</p>																		
	Pr. 852 Setting	Relationship between the motor and encoder																														
	0	 <p>Forward rotation is clockwise rotation when viewed from A.</p>																														
	1 (Factory setting)	 <p>Forward rotation is counterclockwise rotation when viewed from A.</p>																														
	854	Excitation ratio	Set the excitation ratio under no load. 0 to 100%	100%		○	○	○																								
	859	Torque current	Use for utilization of the tuning data or direct input.	9999		○	○	○																								
	862	Notch filter frequency	You can use the mechanical resonance speed to make this setting to reduce the response level of the mechanical resonance frequency band, avoiding mechanical resonance. 0 to 31	0		○	×	○																								
	863	Notch filter depth	Set the depth at which the gain of the mechanical resonance frequency set in Pr. 862 is lowered. 0 to 3	0		○	×	○																								
864	Torque detection	You can make setting to output a signal if the motor torque exceeds the predetermined value. 0 to 400%	150%		○	○	○																									
865	Low speed detection	You can make setting to output a signal if the speed has fallen to or below the preset low speed. 0 to 3600r/min	45r/min		○	○	○																									
866	Torque monitoring reference	Set the reference for the motor torque or load meter torque monitoring output (DA1 or other analog output). 0 to 400%	150%		○	○	○																									
867	DA1 output filter	Set the primary delay filter for the DA1 analog output. 0 to 5s	0.05s		○	○	○																									
Terminal assignment functions	868	Terminal 1 function selection	You can change the setting of the multi-function analog terminal (terminal 1).	0		○	○	○																								
			<table border="1"> <thead> <tr> <th>Setting</th> <th>Speed Control</th> <th>Torque Control</th> <th>Position Control</th> </tr> </thead> <tbody> <tr> <td>0</td> <td>Speed setting auxiliary</td> <td>Speed limit auxiliary</td> <td>No function</td> </tr> <tr> <td>1</td> <td>Magnetic flux command</td> <td>Magnetic flux command</td> <td>Magnetic flux command</td> </tr> <tr> <td>2</td> <td>Regenerative torque limit</td> <td>No function</td> <td>Regenerative torque limit</td> </tr> <tr> <td>5</td> <td>No function</td> <td>Forward/reverse rotation speed limit (analog polarity switchover speed limit)</td> <td>No function</td> </tr> <tr> <td>9999</td> <td>No function</td> <td>No function</td> <td>No function</td> </tr> </tbody> </table>						Setting	Speed Control	Torque Control	Position Control	0	Speed setting auxiliary	Speed limit auxiliary	No function	1	Magnetic flux command	Magnetic flux command	Magnetic flux command	2	Regenerative torque limit	No function	Regenerative torque limit	5	No function	Forward/reverse rotation speed limit (analog polarity switchover speed limit)	No function	9999	No function	No function	No function
			Setting						Speed Control	Torque Control	Position Control																					
			0						Speed setting auxiliary	Speed limit auxiliary	No function																					
			1						Magnetic flux command	Magnetic flux command	Magnetic flux command																					
2	Regenerative torque limit	No function	Regenerative torque limit																													
5	No function	Forward/reverse rotation speed limit (analog polarity switchover speed limit)	No function																													
9999	No function	No function	No function																													
870	Speed deviation level	If the difference between speed command value and speed exceeds the setting of the speed deviation level (Pr. 870) for longer than the setting of the speed deviation time (Pr. 871), speed deviation excessive "E.OSD" is displayed and the motor stops. 0 to 1500r/min, 9999	9999		○	×	×																									
871	Speed deviation time	<p style="text-align: center;"><b>CAUTION</b></p> <p style="text-align: center;"><b>Use this function when a difference in speed will constitute a hindrance. It is independent of torque control.</b></p>	12s		○	×	×																									
873	Speed limit	0 to 3600r/min	600r/min		○	×	×																									
874	OLT level setting	Set the load level of the motor at which OLT alarm. 0 to 200%	150%		○	×	○																									
Operation selection functions	875	Fault definition	You can classify faults into a minor fault and major faults according to the alarms, and make setting to select between immediate output shutoff and output shutoff after deceleration to stop. 0: Immediate output shutoff 1: Output shutoff after deceleration to stop (Immediate output shutoff other than OHT and THM)	0		○	○	×																								
	876	Thermal relay protector input	When using the motor provided with encoder, you can input the contact signal of a thermal relay etc. to terminal OH to provide motor protection against overheat. 0: None 1: Thermal relay input available	1		○	○	○																								

Function	Parameter	Name	Outline	Factory Setting	Customer Setting	At-a-glance Guide to Functions		
						* : Functions that can be used for parameter-set position control		
						Speed control	Torque control	Position control
Control method functions	877	Speed feed forward control/model adaptive speed control selection	Select speed feed forward control (which improves the motor trackability in response to a speed command change (during acceleration/deceleration)) or model adaptive speed control (that can adjust speed trackability and motor disturbance torque response level individually). (0: No selection, 1: Speed feed forward control, 2: model adaptive speed control)	0		○	×	○
	878	Speed feed forward filter	Set the primary delay filter for the speed feed forward result calculated using the speed command and load inertia ratio. 0 to 1s	0s		○	×	○
	879	Speed feed forward torque limit	Limits the maximum value of the speed feed forward torque. 0 to 400%	150%		○	×	○
	880	Load inertia ratio	Set the load inertia ratio. Inertia ratio found by easy gain turning. 0, 1 to 200 times	7		○	×	○
	881	Speed feed forward gain	Set the feed forward calculation result as a gain. 0 to 1000%	0%		○	×	○
Maintenance functions	890	Maintenance output set time	When cumulative operation time of the inverter Pr. 891 "maintenance output timer" has elapsed the time set in Pr. 890 "maintenance output set time", maintenance output [MT] is displayed. Set "0" in Pr. 892 to turn the MT display off. (Used for warning that the capacitor life is reached, for example.) Pr. 890:0 to 9998, 9999: No setting Pr. 891:0 to 9998 Pr. 892:0	9999		○	○	○
	891	Maintenance output timer		0		○	○	○
	892	Maintenance output signal clear		0		○	○	○
Calibration functions	900	DA1 terminal calibration	For calibration of external meter			○	○	○
	901	DA2 terminal calibration	For calibration of external meter			○	○	○
	902	Speed setting terminal 2 bias	You can set the magnitude of the output in response to the speed setting signal (0-10VDC) as desired. 0 to 10V, 0 to 3600r/min	0V, 0r/min		○	○	○
	903	Speed setting terminal 2 gain	You can set the magnitude of the output in response to the speed setting signal (0-10VDC) as desired. 0 to 10V, 0 to 3600r/min	10V, 1500r/min		○	○	○
	904	Torque command terminal 3 bias	You can set the magnitude of the output in response to the torque setting signal (0±10VDC) as desired. 0 to 10V, 0 to 400%	0V, 0%		○	○	○
	905	Torque command terminal 3 gain	You can set the magnitude of the output in response to the torque setting signal (0±10VDC) as desired. 0 to 10V, 0 to 400%	10V, 150%		○	○	○
	917	Terminal 1 bias (Speed)	You can set the magnitude of the output in response to the terminal 1 analog setting signal (0±10VDC) as desired. 0 to 10V, 0 to 3600r/min	0V, 0r/min		○	○	○
	918	Terminal 1 gain (Speed)		10V, 1500r/min		○	○	○
	919	Terminal 1 bias (torque/magnetic flux)	You can set the magnitude of output (torque/magnetic flux) in response to the terminal 1 analog set signal (0 ±10VDC) as desired. 0 to 10V, 0 to 400%	0V, 0%		○	○	○
920	Terminal 1 gain (torque/magnetic flux)	You can set the magnitude of output (torque/magnetic flux) in response to the terminal 1 analog set signal (0 ±10VDC) as desired. 0 to 10V, 0 to 400%	10V, 150%		○	○	○	
Additional functions	990	PU buzzer control	You can control the "beep" sound produced when any key of the parameter unit is pressed. 0: Without sound 1: With sound	1		○	○	○
	991	Parameter for the option (FR-PU04V)						

# 6 ERRORS AND PROTECTIVE FUNCTIONS

## 6.1 Errors (Alarms)

When an alarm occurs in the inverter, the protective function is activated bringing the inverter to an alarm stop and the PU display automatically changes to any of the following error (alarm) indications.

If the fault does not correspond to any of the following errors or if you have any other problem, please contact your sales representative or distributor.

- Retention of alarm output signal..... When the alarm output signal holding protective function is activated, opening the magnetic contactor (MC) provided on the inverter's power supply side will cause the control power of the inverter to be lost and the alarm output not to be held.
- Alarm indication..... When the alarm display protective function is activated, the control panel display section is changed automatically.
- Resetting method ..... When the resetting method protective function is activated, the inverter output stop status is held, and the inverter cannot restart unless it is reset. To reset, switch power off once, then on again, or turn on the RES signal for more than 0.1s.  
If the RES signal is kept on, "Err." appears (flickers) to indicate that the inverter is in a reset status.
- When any protective function is activated, take the appropriate corrective action, then reset the inverter, and resume operation.

### 6.1.1 Major faults

When the protective function is activated, the inverter output is shut off and an alarm is output.

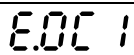
<b>Control Panel Indication</b>	E.OC1		FR-PU04V	OC During Acc
<b>Name</b>	Overcurrent shut-off during acceleration (*1)			
<b>Description</b>	<ul style="list-style-type: none"> <li>• When the inverter output current reaches or exceeds approximately 200% of the rated inverter current during acceleration, the protective circuit is activated to stop the inverter output.</li> <li>• Power is supplied to only the R1 and S1 terminals. This indication also appears when the start signal is entered.</li> </ul>			
<b>Check point</b>	<ul style="list-style-type: none"> <li>• Check for sudden acceleration.</li> <li>• Check for long descending acceleration time of lift applications</li> <li>• Check for output short circuit.</li> <li>• Check that main circuit power (R, S, T) is supplied.</li> </ul>			
<b>Corrective action</b>	<ul style="list-style-type: none"> <li>• Decrease the acceleration time.</li> <li>• Supply main circuit power (R, S, T).</li> </ul>			

<b>Control Panel Indication</b>	E.OC2		FR-PU04V	Stedy Spd OV
<b>Name</b>	Overcurrent shut-off during constant speed (*1)			
<b>Description</b>	When the inverter output current reaches or exceeds approximately 200% of the rated inverter current during constant speed operation, the protective circuit is activated to stop the inverter output.			
<b>Check point</b>	<ul style="list-style-type: none"> <li>• Check for sudden load change.</li> <li>• Check for output short circuit.</li> </ul>			
<b>Corrective action</b>	Keep load stable.			

\*1: E. OC3 appears if the overcurrent shutoff occurs during positioning.

Control Panel Indication	E.OC3	<b>E.OC3</b>	FR-PU04V	OC During Dec
Name	Overcurrent shut-off during deceleration			
Description	When the inverter output current reaches or exceeds approximately 200% of the rated inverter current during deceleration (other than acceleration or constant speed), the protective circuit is activated to stop the inverter output.			
Check point	<ul style="list-style-type: none"> <li>• Check for sudden speed reduction.</li> <li>• Check for output short circuit.</li> <li>• Check for too fast operation of the motor's mechanical brake.</li> </ul>			
Corrective action	<ul style="list-style-type: none"> <li>• Increase the deceleration time.</li> <li>• Check the mechanical brake operation.</li> </ul>			

Control Panel Indication	E.OV1	<b>E.OV1</b>	FR-PU04V	OV During Acc
Name	Regenerative overvoltage shut-off during acceleration (*2)			
Description	If regenerative energy causes the inverter's internal main circuit DC voltage to reach or exceed the specified value, the protective circuit is activated to stop the inverter output. The circuit may also be activated by a surge voltage produced in the power supply system.			
Check point	Check for too slow acceleration.(i.e. during descending acceleration with lifting load)			
Corrective action	<ul style="list-style-type: none"> <li>• Decrease the acceleration time.</li> <li>• Use the brake unit or power regeneration common converter (FR-CV) as required.</li> </ul>			

Control Panel Indication	E.OV2	<b>E.OV2</b>	FR-PU04V	Stedy Spd OV
Name	Regenerative overvoltage shut-off during constant speed (*2)			
Description	If regenerative energy causes the inverter's internal main circuit DC voltage to reach or exceed the specified value, the protective circuit is activated to stop the inverter output. The circuit may also be activated by a surge voltage produced in the power supply system.			
Check point	Check for sudden load change.			
Corrective action	<ul style="list-style-type: none"> <li>• Keep load stable.</li> <li>• Use the brake unit or power regeneration common converter (FR-CV) as required.</li> </ul>			

\*2: E. OV3 appears if the over voltage shutoff occurs during positioning.

Control Panel Indication	E.OV3	<b>E.OV3</b>	FR-PU04V	OV During Dec
Name	Regenerative overvoltage shut-off during deceleration or stop			
Description	If regenerative energy causes the inverter's internal main circuit DC voltage to reach or exceed the specified value, the protective circuit is activated to stop the inverter output. The circuit may also be activated by a surge voltage produced in the power supply system.			
Check point	Check for sudden speed reduction.			
Corrective action	<ul style="list-style-type: none"> <li>• Increase the deceleration time. (Set the deceleration time that meets the moment of inertia of the load)</li> <li>• Decrease the braking duty.</li> <li>• Use the brake unit or power regeneration common converter (FR-CV) as required.</li> </ul>			

Control Panel Indication	E.THM	<b>E.THM</b>	FR-PU04V	Motor Overload
Name	Motor overload shut-off (electronic overcurrent protection (electronic thermal relay function)) (*3)			
Description	The electronic thermal relay function built in the inverter detects motor overheat due to overload or reduced cooling capability during low-speed operation to stop the inverter output. When running a multi-pole motor or two or more motors during V/F control, provide a thermal relay in the inverter output side since such motor(s) cannot be protected. Protection against burnout due to motor temperature rise			
Check point	Check the motor for use under overload.			
Corrective action	<ul style="list-style-type: none"> <li>• Reduce the load weight.</li> <li>• For a constant-torque motor, set the constant-torque motor in Pr. 71 "applied motor".</li> </ul>			

## Errors (Alarms)

<b>Control Panel Indication</b>	E.THT	<i>E.THT</i>	FR-PU04V	Inv. Overload
<b>Name</b>	Inverter overload shut-off (electronic thermal relay function) (*3)			
<b>Description</b>	If a current not less than 150% of the rated output current flows and overcurrent shut-off does not occur (200% or less), inverse-time characteristics cause the electronic thermal relay function to be activated to stop the inverter output in order to protect the output transistors. Protection of output transistors against overheat.			
<b>Check point</b>	Check the motor for use under overload.			
<b>Corrective action</b>	Reduce the load weight.			

\*3. Resetting the inverter initializes the internal thermal integrated data of the electronic thermal relay function.

<b>Control Panel Indication</b>	E.IPF	<i>E.IPF</i>	FR-PU04V	Inst. Pwr. Loss
<b>Name</b>	Instantaneous power failure (*4)			
<b>Description</b>	If a power failure occurs for longer than 15ms (this also applies to inverter input shut-off), the instantaneous power failure protective function is activated to stop the inverter output in order to prevent the control circuit from malfunctioning. At this time, the alarm warning output contacts open (across terminals B-C) and close (across terminals A-C). If a power failure persists for longer than 100ms, the alarm warning output is not provided, and the inverter restarts if the start signal is on upon power restoration. (The inverter continues operating if an instantaneous power failure is within 15ms.)			
<b>Check point</b>	Find the cause of instantaneous power failure occurrence.			
<b>Corrective action</b>	<ul style="list-style-type: none"> <li>• Remedy the instantaneous power failure.</li> <li>• Prepare a backup power supply for instantaneous power failure.</li> <li>• Set the function of automatic restart after instantaneous power failure (Pr. 57). (Refer to page 60.)</li> </ul>			

\*4: When an instantaneous power failure occurs, the alarm display and alarm output are not provided, but the inverter performs protective operation to prevent a fault from occurring in itself. In some operating status (load magnitude, acceleration/deceleration time setting, etc.), overcurrent or other protection may be activated upon power restoration.

<b>Control Panel Indication</b>	E.UVT	<i>E.UVT</i>	FR-PU04V	Under Voltage
<b>Name</b>	Undervoltage			
<b>Description</b>	If the power supply voltage of the inverter decreases, the control circuit will not perform normal functions. In addition, the motor torque will be insufficient and/or heat generation will increase. To prevent this, if the power supply voltage reduces below about 150V (300V for the 400V class), this function stops the inverter output. When a jumper is not connected across P-P1, the undervoltage protective function is activated.			
<b>Check point</b>	<ul style="list-style-type: none"> <li>• Check for start of large-capacity motor.</li> <li>• Check that a jumper or DC reactor is connected across terminals P-P1.</li> </ul>			
<b>Corrective action</b>	<ul style="list-style-type: none"> <li>• Check the power supply system equipment such as power supply.</li> <li>• Connect a jumper or DC reactor across terminals P-P1.</li> </ul>			

<b>Control Panel Indication</b>	E.FIN	<i>E.FIN</i>	FR-PU04V	H/Sink O/Temp
<b>Name</b>	Fin overheat			
<b>Description</b>	If the heatsink overheats, the temperature sensor is actuated to stop the inverter output.			
<b>Check point</b>	<ul style="list-style-type: none"> <li>• Check for too high ambient temperature.</li> <li>• Check for heatsink clogging.</li> <li>• Check that the cooling fan is stopped.</li> </ul>			
<b>Corrective action</b>	<ul style="list-style-type: none"> <li>• Set the ambient temperature to within the specifications.</li> <li>• Replace the cooling fan.</li> </ul>			

<b>Control Panel Indication</b>	E.BE	<i>E.be</i>	FR-PU04V	Br. Cct. Fault
<b>Name</b>	Brake transistor alarm detection			
<b>Description</b>	This function stops the inverter output if an alarm occurs in the brake circuit, e.g. damaged brake transistors. <u>In this case, the inverter must be powered off immediately.</u>			
<b>Check point</b>	<ul style="list-style-type: none"> <li>• Reduce the load inertia.</li> <li>• Check that the frequency of using the brake is proper.</li> <li>• Check that the brake resistor selected is correct.</li> </ul>			
<b>Corrective action</b>	Replace the inverter.			

<b>Control Panel Indication</b>	E.GF	<i>E.GF</i>	FR-PU04V	Ground Fault
<b>Name</b>	Output side earth (ground) fault overcurrent			
<b>Description</b>	This function stops the inverter output if an earth (ground) fault overcurrent flows due to an earth (ground) fault that occurred in the inverter's output (load) side.			
<b>Check point</b>	Check for an earth (ground) fault in the motor and connection cable.			
<b>Corrective action</b>	Remedy the earth (ground) fault portion.			

<b>Control Panel Indication</b>	E.OHT	<i>E.OHT</i>	FR-PU04V	OH Fault
<b>Name</b>	External thermal relay operation			
<b>Description</b>	If the external thermal relay provided for motor overheat protection, or the internally mounted temperature relay in the motor, etc. switches on (contacts open), the inverter output is stopped. Even if the relay contacts are reset automatically, the inverter will not restart unless it is reset.			
<b>Check point</b>	Check for motor overheating.			
<b>Corrective action</b>	Reduce the load and operating duty.			

<b>Control Panel Indication</b>	E.OLT	<i>E.OLT</i>	FR-PU04V	Still Prev STP (OL shown during stall prevention operation)
<b>Name</b>	Motor overload			
<b>Description</b>	For V/F control, the stall prevention function is activated if the current flow in the motor exceeds 150% (factory setting) of the inverter rated current, an alarm stop is made if the status that the output frequency is lowered at 0Hz persists for 3s. For speed/position control, if the torque limit is activated under high load, the motor stalls to the speed less than the low speed detection (Pr. 865) value, and an alarm stop is made if the status that the output torque is more than the OLT level setting (Pr. 874) value persists for 3s. This function is not activated for torque control.			
<b>Check point</b>	<ul style="list-style-type: none"> <li>• Check the motor for use under overload.</li> <li>• Check that the low speed detection (Pr. 865) and OLT level setting (Pr. 874) values are correct. (Check the stall prevention operation level (Pr. 22) setting if V/F control is exercised.)</li> </ul>			
<b>Corrective action</b>	<ul style="list-style-type: none"> <li>• Reduce the load weight.</li> <li>• Change the stall prevention operation level (Pr. 22), low speed detection (Pr. 865) and OLT level setting (Pr. 874) values. (Check the stall prevention operation level (Pr. 22) setting if V/F control is exercised.)</li> </ul>			

<b>Control Panel Indication</b>	E.OPT	<i>E.OPT</i>	FR-PU04V	Option Fault
<b>Name</b>	Option alarm			
<b>Description</b>	Stops the inverter output when two or more communication options are mounted. (*5) When the high power factor converter (FR-HC) or power regeneration common converter (FR-CV) is connected, this alarm appears if an AC power supply is connected to the R, S, T terminals accidentally.			
<b>Check point</b>	<ul style="list-style-type: none"> <li>• Check that the number of communication options mounted is one.</li> <li>• When the high power factor converter (FR-HC) or power regeneration common converter (FR-CV) is connected, check that an AC power supply is not connected to the R, S, T terminals.</li> <li>• When the parameter set is for the option use, the option is not fitted nor connected securely.</li> </ul>			
<b>Corrective action</b>	<ul style="list-style-type: none"> <li>• Mount only one communication option.</li> <li>• Check the Pr. 30 setting and wiring.</li> <li>• Check the Pr. 419 and Pr. 804 settings.</li> <li>• When the high power factor converter (FR-HC) or power regeneration common converter (FR-CV) is connected, connecting an AC power supply to the R, S, T terminals may damage the inverter. Please contact your sales representative.</li> </ul>			

\*5: The FR-A5NR (relay output/computer link) allows one more communication option to be fitted. In this case, only relay output is usable and computer link is unusable.



## Errors (Alarms)

Control Panel Indication	E.OP1 to OP3	<i>E.OP1 to OP3</i>	FR-PU04V	Option slot alarm 1 to 3
Name	Option slot alarm (1 to 3 indicate the option slot numbers.)			
Description	Stops the inverter output if a functional error (e.g. communication line error of the communication option or contact fault of the plug-in option other than the communication option) occurs in the plug-in option fitted to the corresponding slot.			
Check point	<ul style="list-style-type: none"> <li>• Check for a wrong option function setting and operation.</li> <li>• Check that the plug-in option is plugged into the connector securely.</li> <li>• Check for a break in the communication cable.</li> <li>• Check that the termination resistor is fitted properly.</li> <li>• Check that the option card is normal.</li> </ul>			
Corrective action	<ul style="list-style-type: none"> <li>• Check the option function setting, etc.</li> <li>• Connect the plug-in option securely.</li> </ul>			

Control Panel Indication	E. 1 to E. 3	<i>E. 1 to E. 3</i>	FR-PU04V	Fault 1 to Fault 3
Name	Option alarm			
Description	Stops the inverter output if a contact fault or the like of the connector between the inverter and communication option occurs.			
Check point	Check that the communication option is plugged into the connector securely. (1 to 3 indicate the option slot numbers.)			
Corrective action	<ul style="list-style-type: none"> <li>• Connect the plug-in option securely.</li> <li>• Please contact your sales representative.</li> </ul>			

Control Panel Indication	E.PE	<i>E. PE</i>	FR-PU04V	Corrupt Memry
Name	Parameter storage device alarm			
Description	Appears when an error occurred in the stored parameters. (E <sup>2</sup> PROM fault)			
Check point	Check for too many number of parameter write times.			
Corrective action	<ul style="list-style-type: none"> <li>• Please contact your sales representative.</li> <li>• When performing parameter write frequently for communication purposes, set "1" in Pr. 342 to enable RAM write. Note that powering off returns the inverter to the status before RAM write.</li> </ul>			

Control Panel Indication	E.PUE	<i>E.PUE</i>	FR-PU04V	PU Leave Out
Name	PU disconnection			
Description	<ul style="list-style-type: none"> <li>• This function stops the inverter output if communication between the inverter and PU is suspended, e.g. the control panel or parameter unit is disconnected, when "2", "3", "16" or "17" was set in Pr. 75 "reset selection/disconnected PU detection/PU stop selection".</li> <li>• This function stops the inverter output if the number of successive communication errors is greater than the permissible number of retries when the Pr. 121 value is other than "9999" for RS-485 communication from the PU connector. This function also stops the inverter output if communication is broken for the period of time set in Pr. 122.</li> </ul>			
Check point	<ul style="list-style-type: none"> <li>• Check for loose fitting of the FR-DU04-1 or FR-PU04V.</li> <li>• Check the Pr. 75 setting.</li> </ul>			
Corrective action	Fit the FR-DU04-1 or FR-PU04V securely.			

Control Panel Indication	E.RET	<i>E. RET</i>	FR-PU04V	Retry No Over
Name	Retry count excess			
Description	If operation cannot be resumed properly within the number of retries set, this function stops the inverter output.			
Check point	Find the cause of alarm occurrence.			
Corrective action	Eliminate the cause of the error preceding this error indication.			

Control Panel Indication	E.LF	<i>E. LF</i>	FR-PU04V	ELF
Name	Output phase failure			
Description	This function stops the inverter output if one of the three phases (U, V, W) on the inverter's output side (load side) opens.			
Check point	<ul style="list-style-type: none"> <li>• Check the wiring (Check the motor for a fault.)</li> <li>• Check that the capacity of the motor used is not smaller than that of the inverter.</li> </ul>			
Corrective action	<ul style="list-style-type: none"> <li>• Wire the cables properly.</li> <li>• Check the Pr. 251 "output phase failure protection selection" setting.</li> </ul>			

Control Panel Indication	E.CPU	<i>E.CPU</i>	FR-PU04V	CPU Fault
Name	CPU error			
Description	Stops the inverter output if the communication error of the built-in CPU occurs.			
Check point	—			
Corrective action	Please contact your sales representative.			

Control Panel Indication	E. 6	<i>E. 6</i>	FR-PU04V	Fault 6
	E. 7	<i>E. 7</i>		Fault 7
Name	CPU error			
Description	If the arithmetic operation of the peripheral circuit of the built-in CPU does not end within the predetermined period or if an error exists in the receive data of the built-in CPU, the inverter self-determines it as an alarm and stops the output.			
Check point	Check for devices producing excess electrical noises around the inverter.			
Corrective action	<ul style="list-style-type: none"> <li>• Connect devices securely.</li> <li>• Take measures against noises if there are devices producing excess electrical noises around the inverter.</li> <li>• Please contact your sales representative.</li> </ul>			

Control Panel Indication	E.P24	<i>EP24</i>	FR-PU04V	E.P24
Name	24VDC power output short circuit			
Description	<p>When the 24VDC power output from the PC terminal is shorted, this function shuts off the power output.</p> <p>At this time, all external contact inputs switch off. The inverter cannot be reset by entering the RES signal. To reset it, use the control panel or switch power off, then on again.</p> <p>When the 24VDC power for encoder is shorted, this function shuts off the power output.</p>			
Check point	<ul style="list-style-type: none"> <li>• Check for a short circuit in the PC terminal output.</li> <li>• Check for wrong wiring.</li> <li>• Check for a loose connector. Check that the cables are short-circuited.</li> </ul>			
Corrective action	<ul style="list-style-type: none"> <li>• Remedy the short circuit portion.</li> <li>• Connect the cables securely. Change the cables.</li> </ul>			

Control Panel Indication	E.P12	<i>EP 12</i>	FR-PU04V	E.P12
Name	12VDC power output short circuit			
Description	When the 12VDC power for encoder is shorted, this function shuts off the power output.			
Check point	<ul style="list-style-type: none"> <li>• Check for wrong wiring.</li> <li>• Check for a loose connector. Check for a break in the cable.</li> </ul>			
Corrective action	Connect the cables securely. Change the cables.			

Control Panel Indication	E.CTE	<i>E.CTE</i>	FR-PU04V	—
Name	Control panel power supply short circuit			
Description	<p>When the control panel power supply (P5S of the PU connector) is shorted, this function shuts off the power output. At this time, the control panel (parameter unit) cannot be used and RS-485 communication from the PU connector cannot be made. To reset, enter the RES signal or switch power off, then on again.</p> <p>When the 5VDC power for encoder is shorted, this function shuts off the power output.</p>			
Check point	<ul style="list-style-type: none"> <li>• Check for a short circuit in the PU connector cable. Check for a loose connector.</li> <li>• Check that cables are not short-circuited.</li> <li>• Check for wrong wiring.</li> </ul>			
Corrective action	<ul style="list-style-type: none"> <li>• Check the PU and cable.</li> <li>• Connect the cable securely. Change the cable.</li> </ul>			

## Errors (Alarms)

<b>Control Panel Indication</b>	<b>E.MB1 to 7</b>	<b>E.MB1 to 7</b>	<b>FR-PU04V</b>	<b>—</b>
<b>Name</b>	Brake sequence error			
<b>Description</b>	<ul style="list-style-type: none"> <li>The inverter output is stopped when a sequence error occurs during use of the brake sequence function (Pr. 278 to Pr. 285).</li> <li>If (detection frequency) - (output frequency) &gt; Pr. 285 under vector control, E.MB1 occurs and the inverter output is stopped.</li> </ul>			
<b>Check point</b>	Find the cause of alarm occurrence.			
<b>Corrective action</b>	Check the set parameters and perform wiring properly.			

<b>Control Panel Indication</b>	<b>E.OS</b>	<b>E. OS</b>	<b>FR-PU04V</b>	<b>Overspeed occurrence</b>
<b>Name</b>	Overspeed occurrence			
<b>Description</b>	Indicates that the motor speed has exceeded the overspeed setting level.			
<b>Check point</b>	<ul style="list-style-type: none"> <li>Check that the Pr. 374 "overspeed detection level" value is correct.</li> <li>Check that the number of encoder pulses differ from the actual number of encoder pulses.</li> </ul>			
<b>Corrective action</b>	<ul style="list-style-type: none"> <li>Set the Pr. 374 "overspeed detection level" value correctly.</li> <li>Set the correct number of encoder pulses in Pr. 851.</li> </ul>			

<b>Control Panel Indication</b>	<b>E.OSD</b>	<b>E.OSd</b>	<b>FR-PU04V</b>	<b>Excessive speed deflection</b>
<b>Name</b>	Speed deviation excess detection			
<b>Description</b>	Stops the inverter output if the motor speed is increased or decreased under the influence of the load etc. during vector control and cannot be controlled in accordance with the speed command value.			
<b>Check point</b>	<ul style="list-style-type: none"> <li>Check that the Pr. 870 "speed deviation level" and Pr. 871 "speed deviation time" values are correct.</li> <li>Check for sudden load change.</li> <li>Check that the number of encoder pulses differ from the actual number of encoder pulses.</li> </ul>			
<b>Corrective action</b>	<ul style="list-style-type: none"> <li>Set the Pr. 870 "speed deviation level" and Pr. 871 "speed deviation time" values correctly.</li> <li>Keep load stable.</li> <li>Set the correct number of encoder pulses in Pr. 851.</li> </ul>			

<b>Control Panel Indication</b>	<b>E.ECT</b>	<b>E.ECT</b>	<b>FR-PU04V</b>	<b>No encoder signal</b>
<b>Name</b>	Signal loss detection			
<b>Description</b>	Stops the inverter output if the encoder signal is shut off.			
<b>Check point</b>	<ul style="list-style-type: none"> <li>Check for the encoder signal loss.</li> <li>Check that the encoder specifications are correct.</li> <li>Check for a loose connector.</li> <li>Check that the jumper connector of the rear of the control terminal is correctly set.</li> </ul>			
<b>Corrective action</b>	<ul style="list-style-type: none"> <li>Remedy the break in the cable.</li> <li>Use the encoder that meets the specifications.</li> <li>Make connection securely.</li> <li>Set the jumper connector of the rear of the control terminal correctly. (Refer to page 12.)</li> </ul>			

<b>Control Panel Indication</b>	<b>E.OD</b>	<b>E. Od</b>	<b>FR-PU04V</b>	<b>Excessive position error</b>
<b>Name</b>	Position error large			
<b>Description</b>	Indicates that the difference between the position command and position feedback exceeded the reference.			
<b>Check point</b>	<ul style="list-style-type: none"> <li>Check that the position detecting encoder mounting orientation matches the parameter.</li> <li>Check that the load is not large.</li> <li>Check that the Pr. 427 "excessive level error" and Pr. 851 "number of encoder pulses" values are correct.</li> </ul>			
<b>Corrective action</b>	<ul style="list-style-type: none"> <li>Check the parameters.</li> <li>Reduce the load weight.</li> <li>Set the Pr. 427 "excessive level error" and Pr. 851 "number of encoder pulses" values correctly.</li> </ul>			

Control Panel Indication	E.ECA	<i>E.ECA</i>	FR-PU04V	No encoder A signal
Name	Orientation encoder no-signal			
Description	The encoder pulse for the FR-V5AM or FR-A5AP is not input.			
Check point	<ul style="list-style-type: none"> <li>• Check that the FR-V5AM or FR-A5AP is connected correctly.</li> <li>• Check for a loose connector.</li> <li>• Check for a break in the cable.</li> <li>• Check for a detector fault.</li> </ul>			
Corrective action	<ul style="list-style-type: none"> <li>• Make connection securely.</li> <li>• Change the cable.</li> <li>• Replace the detector.</li> </ul>			

Control Panel Indication	E.EP	<i>E.EP</i>	FR-PU04V	E.EP
Name	Encoder mis-wiring detection			
Description	The rotation command of the inverter differs from the actual motor rotation direction detected from the encoder during offline auto tuning.			
Check point	<ul style="list-style-type: none"> <li>• Check for mis-wiring of the encoder cable.</li> <li>• Check for wrong setting of Pr. 852 "encoder rotation direction".</li> </ul>			
Corrective action	<ul style="list-style-type: none"> <li>• Perform connection and wiring securely.</li> <li>• Change the Pr. 852 "encoder rotation direction" value.</li> </ul>			

### 6.1.2 Minor fault

If the protective function is activated, the output is not shut off. You can also output a minor fault signal by making parameter setting. (Set "98" in any of Pr. 190 to Pr. 192 and Pr. 195 (output terminal function selection). Refer to page 65.)

Control Panel Indication	FN	<i>F<sub>n</sub></i>	FR-PU04V	Fan Failure
Name	Fan fault			
Description	For the inverter that contains a cooling fan, <i>F<sub>n</sub></i> appears on the control panel when the cooling fan stops due to a fault or different operation from the setting of Pr. 244 "cooling fan operation selection".			
Check point	Check the cooling fan for a fault.			
Corrective action	Replace the fan.			

### 6.1.3 Warnings



When the protective function is activated, the output is not shut off.

Control Panel Indication	OL	<i>OL</i>	FR-PU04V	OL
Name	Stall prevention (overcurrent)			
Description	V/F control	Output if the inverter output current exceeds torque limit level(*6). (Refer to page 34.).		
	Speed control	<ul style="list-style-type: none"> <li>• Output if the output torque exceeds the torque limit level (*6).</li> </ul>		
	Position control	<ul style="list-style-type: none"> <li>• Output if the encoder setting is wrong.</li> </ul>		
Check point	<ul style="list-style-type: none"> <li>• Check the motor for use under overload.</li> <li>• The acceleration/deceleration time may vary during V/F control. Check that the Pr. 0 "torque boost" setting is not higher than required.</li> <li>• Check that the Pr. 851 "number of encoder pulses" and Pr. 852 "encoder rotation direction" values are correct.</li> </ul>			
Corrective action	<ul style="list-style-type: none"> <li>• Increase the operation level using torque limit level (analog input or parameter input).</li> <li>• Check for the Pr. 851 "number of encoder pulses" and Pr. 852 "encoder rotation direction" values.</li> </ul>			

\*6: Torque limit level can be set using Pr. 22 "torque limit level" as desired. (150% with the factory setting)

Control Panel Indication	oL	<i>oL</i>	FR-PU04V	oL
Name	Stall prevention (overvoltage)			
Description	During deceleration	If the regenerative energy of the motor becomes excessive to exceed the brake capability, this function stops the decrease in frequency to prevent overvoltage shut-off. As soon as the regenerative energy has reduced, deceleration resumes.		
Check point	Check for sudden speed reduction.			
Corrective action	The deceleration time may change. Increase the deceleration time using Pr. 8 "deceleration time".			

## Errors (Alarms)

<b>Control Panel Indication</b>	PS	<i>PS</i>	FR-PU04V	PS
<b>Name</b>	PU stop			
<b>Description</b>	Appears when a stop was made by pressing of the control panel  or parameter unit (FR-PU04V) during operation in the external operation mode with the Pr. 75 "reset selection/PU stop selection" setting.			
<b>Check point</b>	Check for a stop made by pressing  of the control panel during external operation.			
<b>Corrective action</b>	Refer to page 83.			
<b>Control Panel Indication</b>	RB	<i>rb</i>	FR-PU04V	RB
<b>Name</b>	Regenerative brake prealarm			
<b>Description</b>	Appears if the regenerative brake duty reaches or exceeds 85% of the Pr. 70 "special regenerative brake duty" value. If the regenerative brake duty reaches 100%, a regenerative overvoltage (E. OV_) occurs.			
<b>Check point</b>	<ul style="list-style-type: none"> <li>• Check that the brake resistor duty is not high.</li> <li>• Check that the Pr. 30 "regenerative function selection" and Pr. 70 "special regenerative brake duty" values are correct.</li> </ul>			
<b>Corrective action</b>	<ul style="list-style-type: none"> <li>• Increase the deceleration time.</li> <li>• Check the Pr. 30 "regenerative function selection" and Pr. 70 "special regenerative brake duty" values.</li> </ul>			
<b>Control Panel Indication</b>	TH	<i>TH</i>	FR-PU04V	TH
<b>Name</b>	Electronic thermal relay function prealarm			
<b>Description</b>	Appears if the cumulative value of the electronic thermal relay function reaches or exceeds 85% of the preset level. If it reaches 100% of the preset level, a motor overload shutoff (E. THM) occurs.			
<b>Check point</b>	Check for large load or sudden acceleration.			
<b>Corrective action</b>	Reduce the load weight or the number of operation times.			
<b>Control Panel Indication</b>	MT	<i>MT</i>	FR-PU04V	MT
<b>Name</b>	Maintenance signal output			
<b>Description</b>	Indicates that the cumulative operation time of the inverter has reached a given time.			
<b>Check point</b>	Check that Pr. 890 "maintenance output set time" has been set. (A short time has been set.)			
<b>Corrective action</b>	After checking the energization time, write "0" to Pr. 892 "maintenance output signal clear".			
<b>Control Panel Indication</b>	SL	<i>SL</i>	FR-PU04V	SL
<b>Name</b>	Speed limit indication (speed limit)			
<b>Description</b>	Output if the speed limit level is exceeded during torque control.			
<b>Check point</b>	<ul style="list-style-type: none"> <li>• Check that the torque command is not larger than required.</li> <li>• Check that the speed limit level is not low.</li> </ul>			
<b>Corrective action</b>	Decrease the torque command. Increase the speed limit level.			
<b>Control Panel Indication</b>	Err.	<i>Err.</i>		
<b>Description</b>	This alarm appears if: <ul style="list-style-type: none"> <li>• The RES signal is on;</li> <li>• You attempted to make parameter setting in the external operation mode;</li> <li>• You attempted to change the operation mode during operation;</li> <li>• You attempted to set any parameter value outside its setting range;</li> <li>• The PU and inverter cannot make normal communication;</li> <li>• You attempted to make parameter setting during operation (when signal STF or STR is on);</li> <li>• You attempted to make parameter setting when Pr. 77 "parameter write disable selection" has been set to disable parameter write; or</li> <li>• The main circuit power is turned on when the control circuit power (R1, S1) and the main circuit power (R, S, T) are connected to a separate power. It is not a fault.</li> </ul>			
<b>Corrective action</b>	Perform run and operation securely.			

### 6.1.4 How to recover from PU stop error (PS)

#### (1) Restarting method when stop was made by pressing from control panel (Method of restarting from indication)

- 1) After the motor has decelerated to a stop, turn off the STF or STR signal.
- 2) Press  twice\* to display *OPnd*.

**CAUTION**

When Pr. 79 = 3, press  three times to display *PU*. Then press  to proceed to 3).



(\*For monitor screen) ... Refer to page 28 for details of the monitor display provided by pressing .

- 3) Press .
- 4) Turn on the STF or STR signal.

**REMARKS**

- If the reset signal (RES) is provided during operation, the inverter shuts off its output while it is reset, the internal thermal integrated value of the electronic thermal relay function and the number of retries are reset, and the motor coasts.
- The Pr. 75 value can be set any time. This value does not return to the initial value if parameter (all) clear is executed.
- When the motor is stopped from the PU, *PS* and *00* are displayed alternately. An alarm output is not provided.

#### (2) Restarting method when stop was made by pressing from parameter unit

- 1) After the motor has decelerated to a stop, turn off the STF or STR signal.
- 2) Press  .  
.....(Recovery from  )
- 3) Turn on the STF or STR signal.

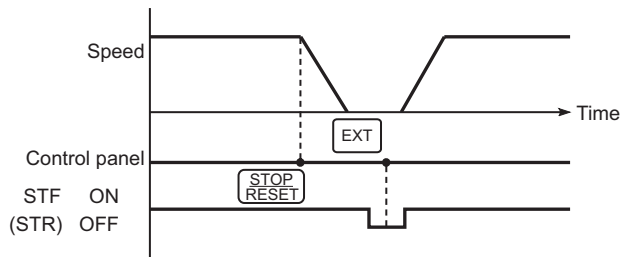

Example of stop and restart during external operation

Alternatively, you can make a restart by making a power-on reset or resetting the inverter using the reset terminal of the inverter.

**REMARKS**

- If the reset signal (RES) is provided during operation, the inverter shuts off its output while it is reset, the data of the electronic thermal relay function and the number of retries are reset, and the motor coasts.
- To make a restart, confirm that the PU is connected and then reset the inverter.
- The Pr. 75 value can be set any time. This value does not return to the initial value if parameter (all) clear is executed.
- When the motor is stopped from the PU, *PS* is displayed. An alarm output is not provided.
- Since *PS* is not an inverter error, the inverter can not be reset with .

 **CAUTION**

 Do not reset the inverter with the start signal input.  
Doing so will start the inverter immediately after it has recovered from the error, causing hazard.

## 6.2 Correspondences between digital and actual characters

There are the following correspondences between the actual alphanumeric characters and the digital characters displayed on the control panel.

Actual	Digital
0	0
1	1
2	2
3	3
4	4
5	5
6	6
7	7
8	8
9	9

Actual	Digital
A	A
B	b
C	C
D	d
E	E
F	F
G	G
H	H
I	I
J	J
L	L

Actual	Digital
M	m
N	n
O	O
o	o
P	P
S	S
T	T
U	U
V	V
r	r
-	-

## 6.3 Resetting the inverter

The inverter can be reset by performing any of the following operations. Note that the internal thermal integrated value of the electronic thermal relay function and the number of retries are cleared (erased) by resetting the inverter. Recover about 1s after reset is cancelled.

Operation 1: Using the control panel, press  to reset the inverter.

(Enabled only when the inverter protective function (major fault) is activated. (Refer to page 74 for major faults.))

Operation 2: Switch power off once, then switch it on again.

Operation 3: Turn on the reset signal (RES) for more than 0.1s.

## 6.4 Troubleshooting

**POINT**

If the cause is still unknown after every check, it is recommended to initialize the parameters (return to factory setting) then re-set the required parameter values and check again. (Refer to page 31 for parameter all clear.)

6.4.1	Motor does not rotate at the commanded speed . . . . .	85
6.4.2	Motor generates abnormal noise . . . . .	85
6.4.3	Motor does not rotate . . . . .	86
	(1) Vector control . . . . .	86
	(2) V/F control . . . . .	88
6.4.4	Motor generates heat abnormally . . . . .	89
6.4.5	Motor hunts . . . . .	90
	(1) Speed control . . . . .	90
6.4.6	Machine operates unstably . . . . .	91
	(1) Speed control . . . . .	91
6.4.7	Speed command does not match motor speed . . . . .	92
	(1) Speed control . . . . .	92
6.4.8	Motor rotates but speed does not change . . . . .	93
	(1) Speed control . . . . .	93
6.4.9	Torque control is not exercised normally . . . . .	94
	(1) Torque control . . . . .	94

### 6.4.1 Motor does not rotate at the commanded speed

### 6.4.2 Motor generates abnormal noise

It would appear that the motor runs in reverse to the starting command when the vector control is not exercised properly due to the inverse rotation direction of the motor and encoder.

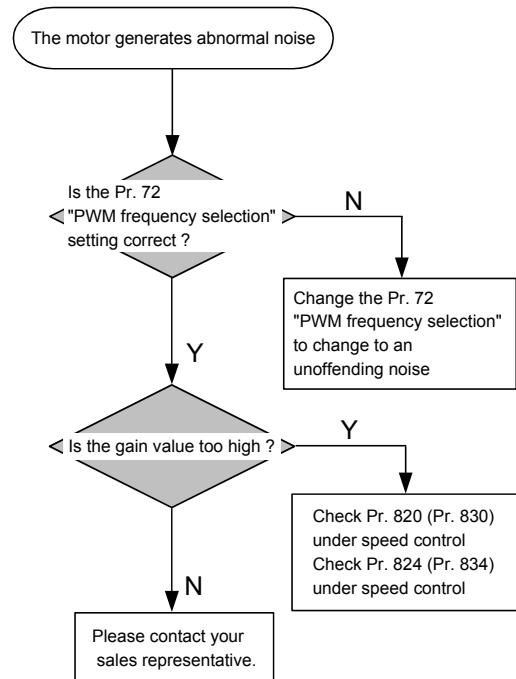
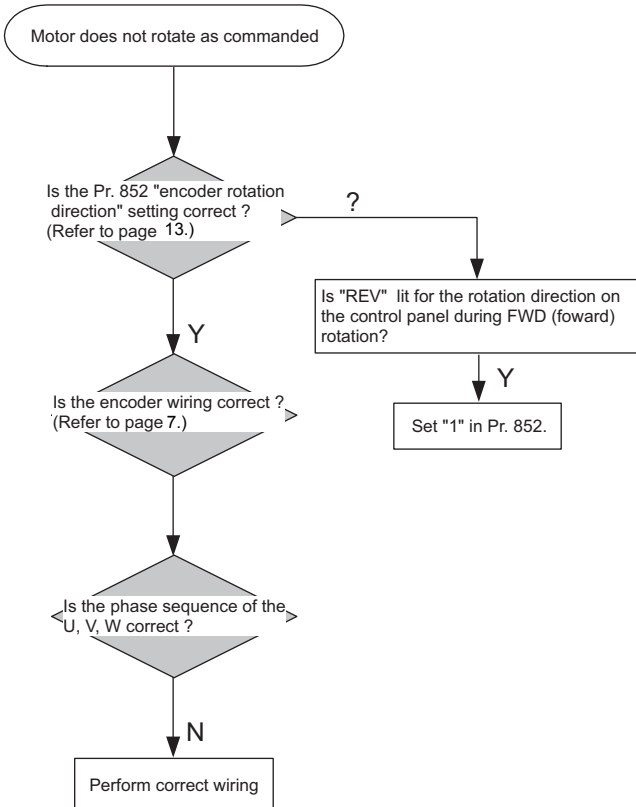



6.4.3 Motor does not rotate

(1) Vector control

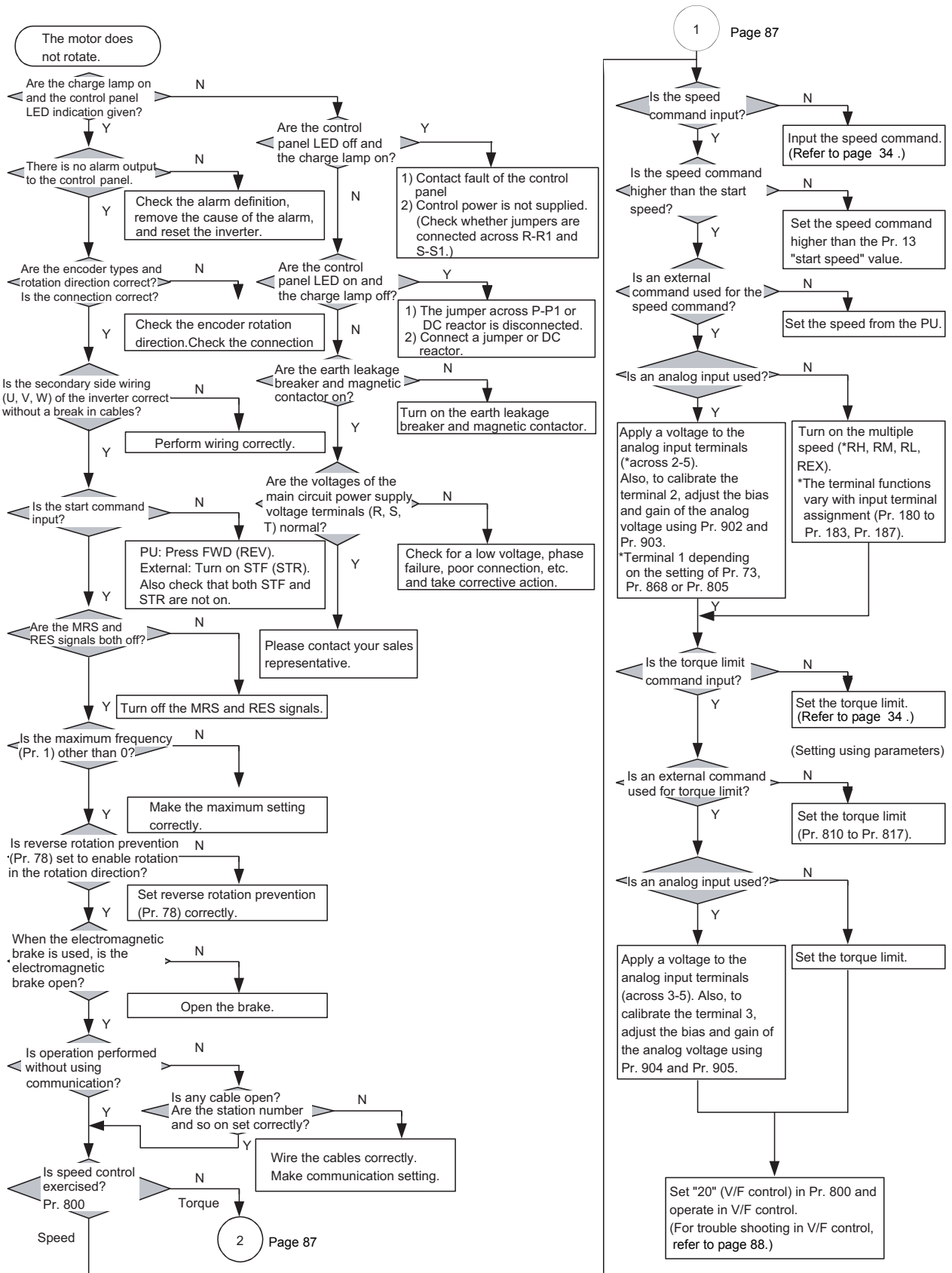

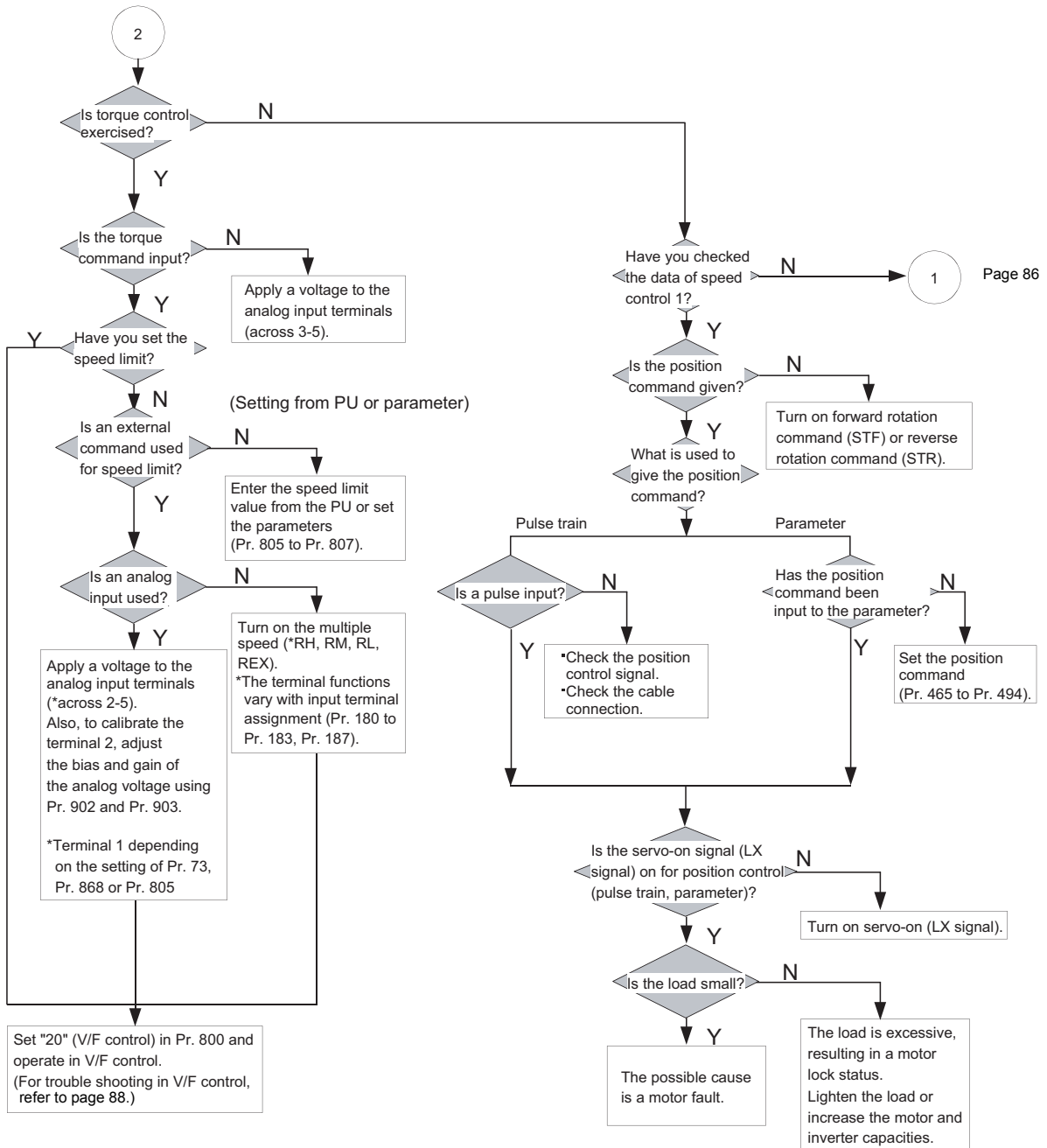

## (2) V/F control

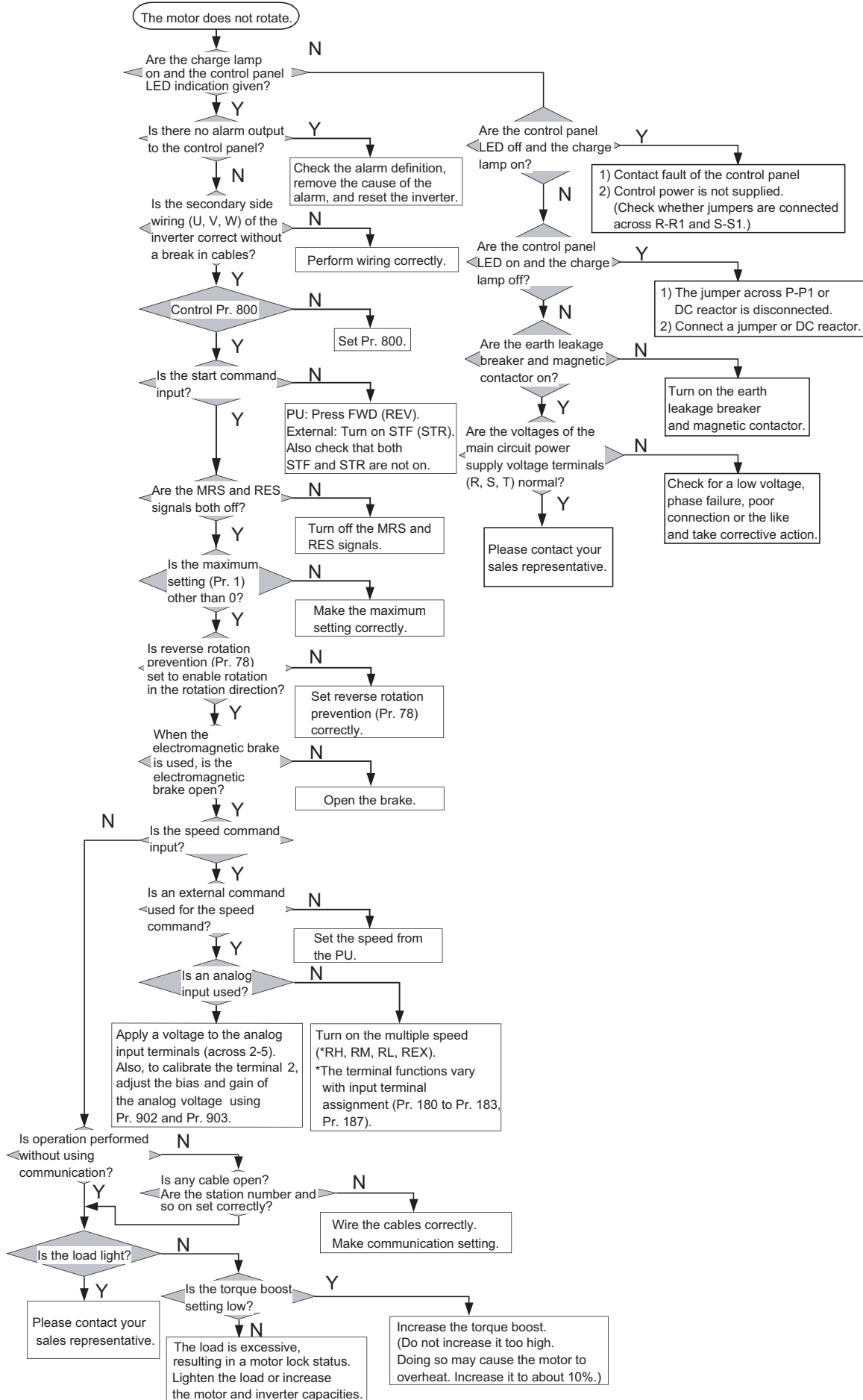

6.4.4 Motor generates heat abnormally

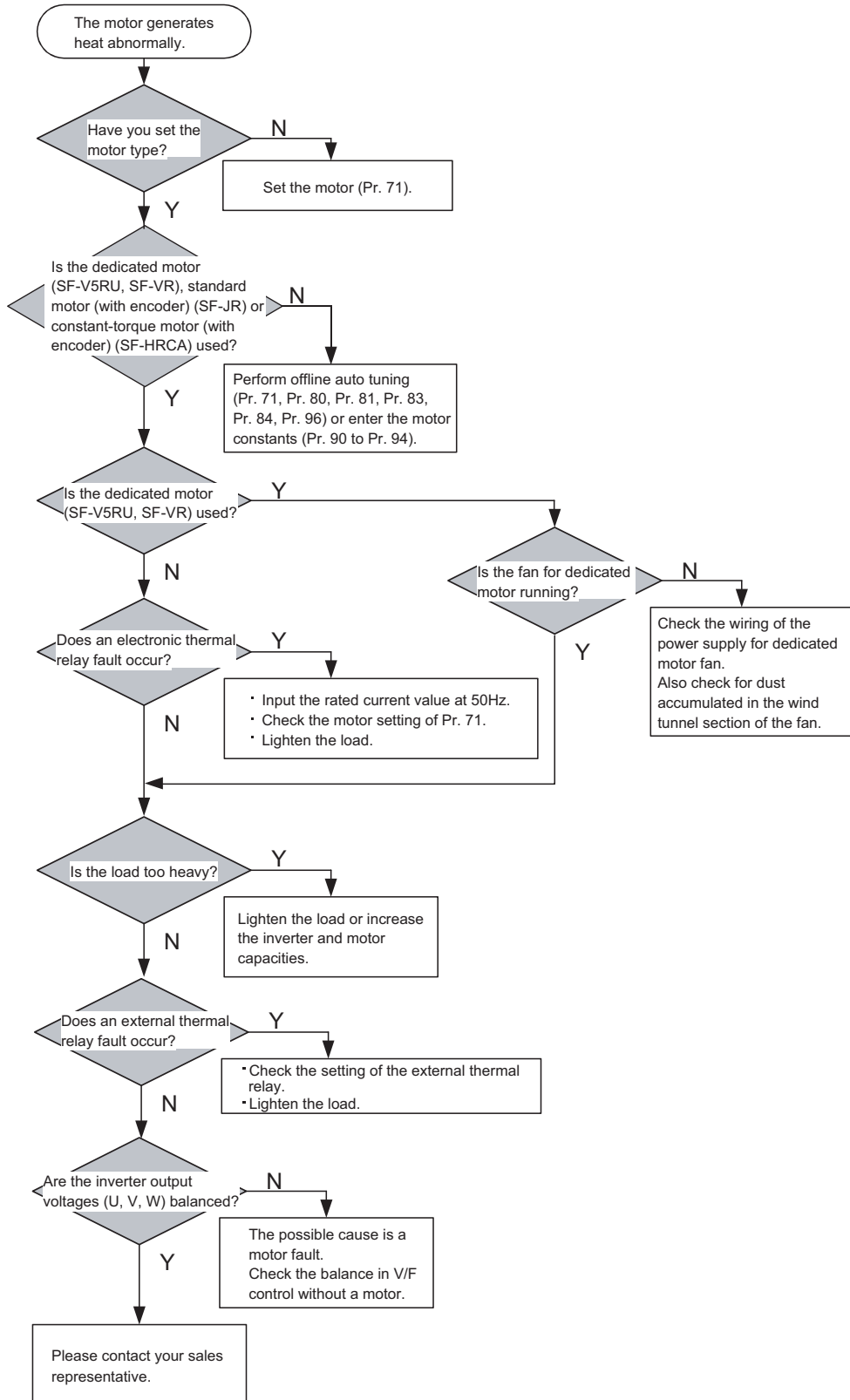

6.4.5 Motor hunts

(1) Speed control

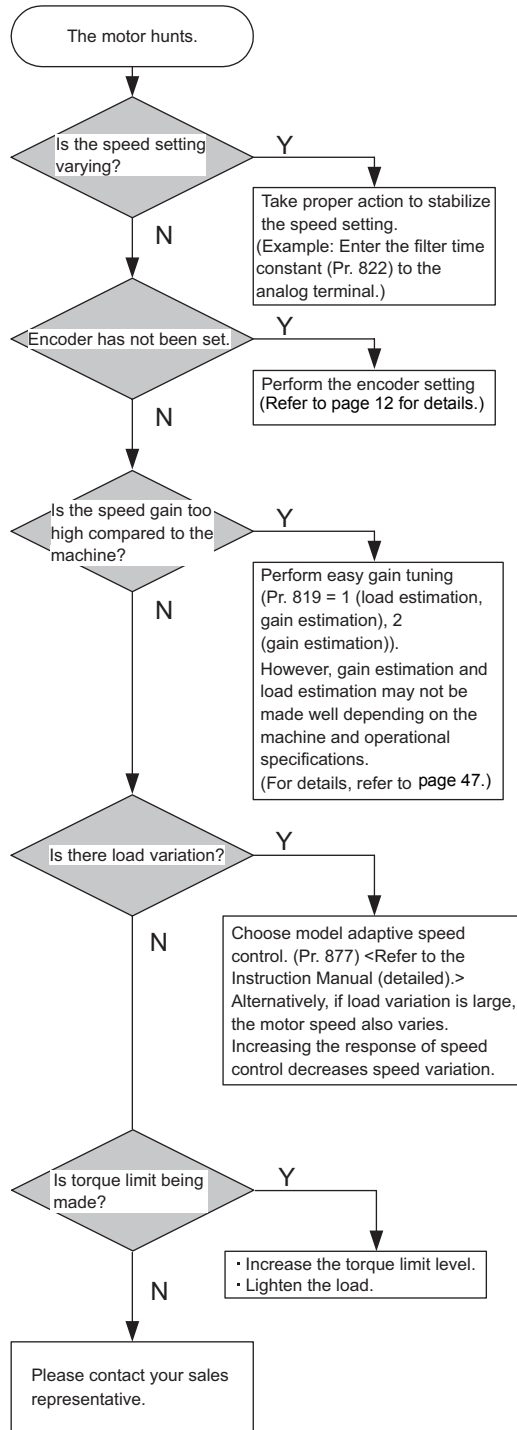

6.4.6 Machine operates unstably

(1) Speed control

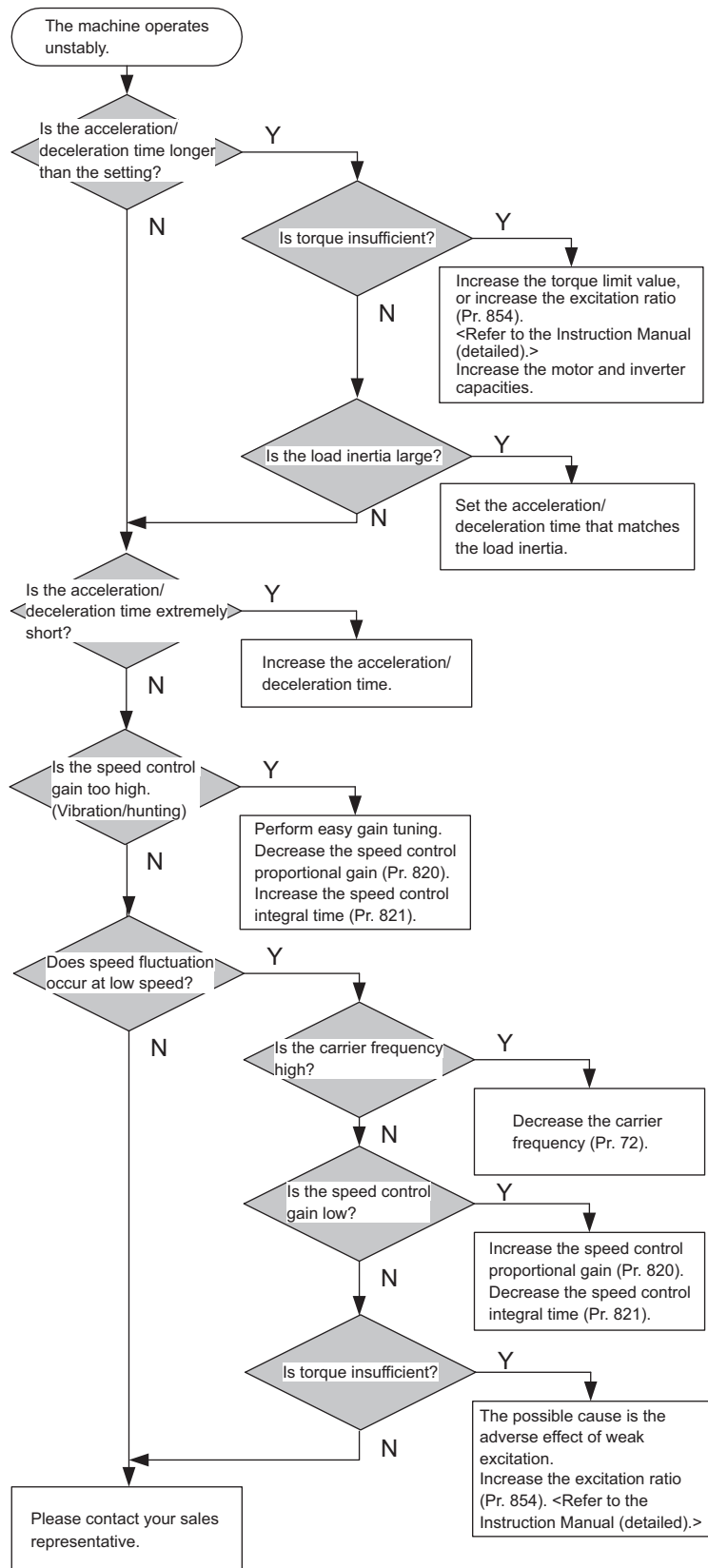

### 6.4.7 Speed command does not match motor speed

#### (1) Speed control

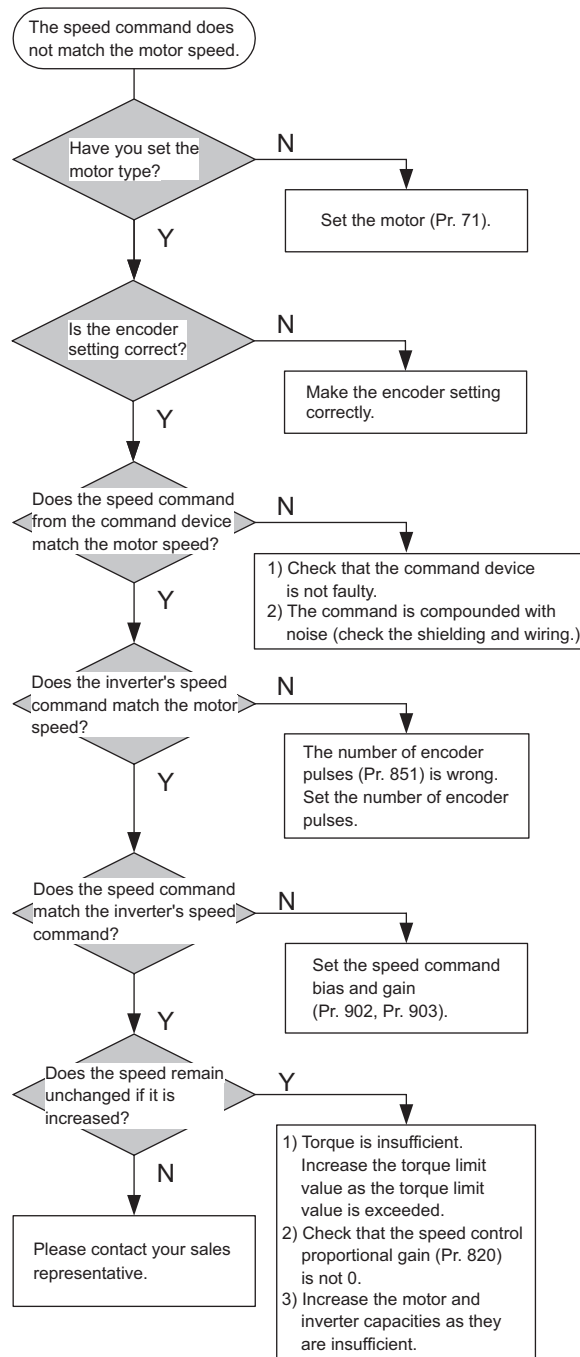

6.4.8 Motor rotates but speed does not change

(1) Speed control

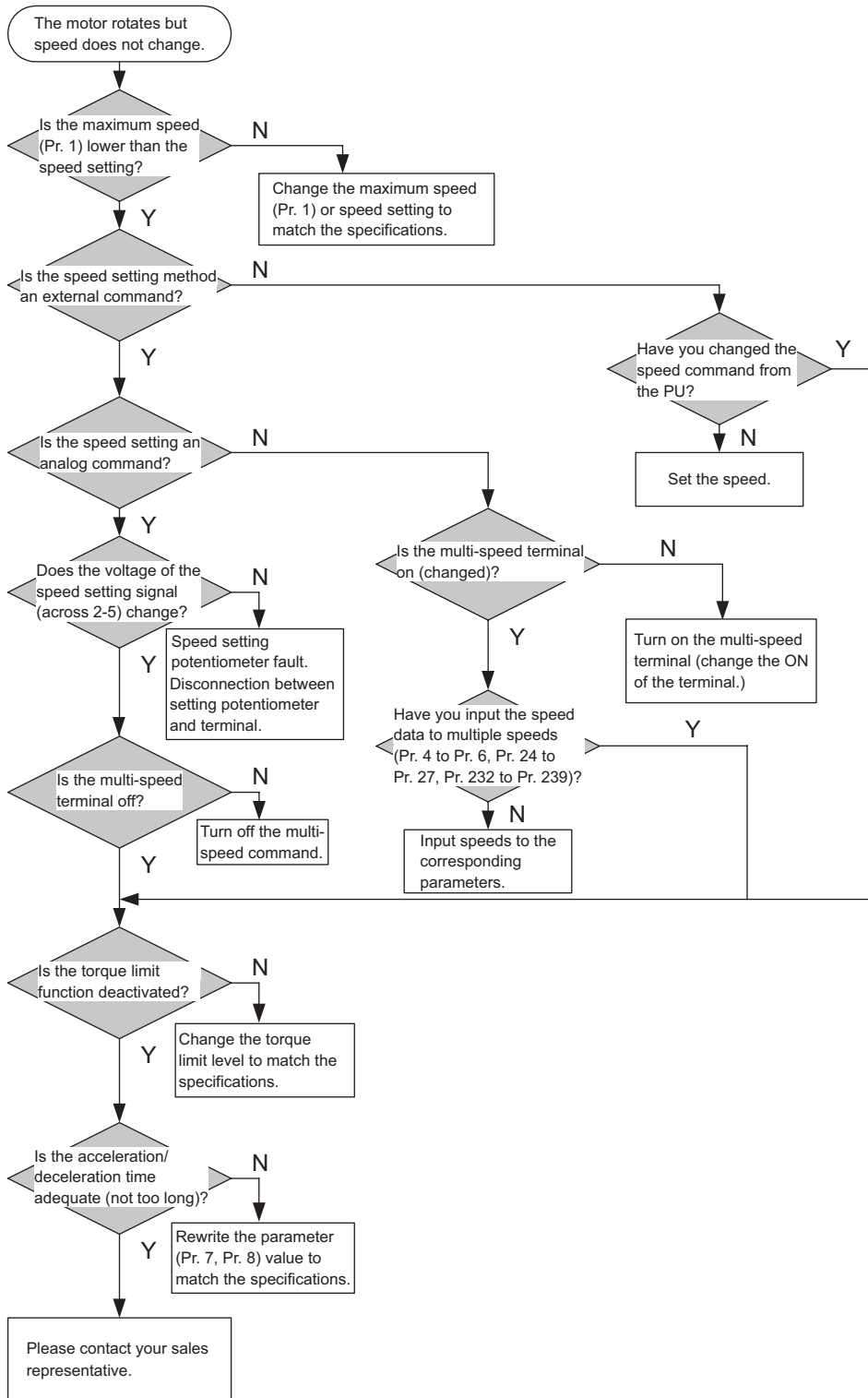



6.4.9 Torque control is not exercised normally

(1) Torque control

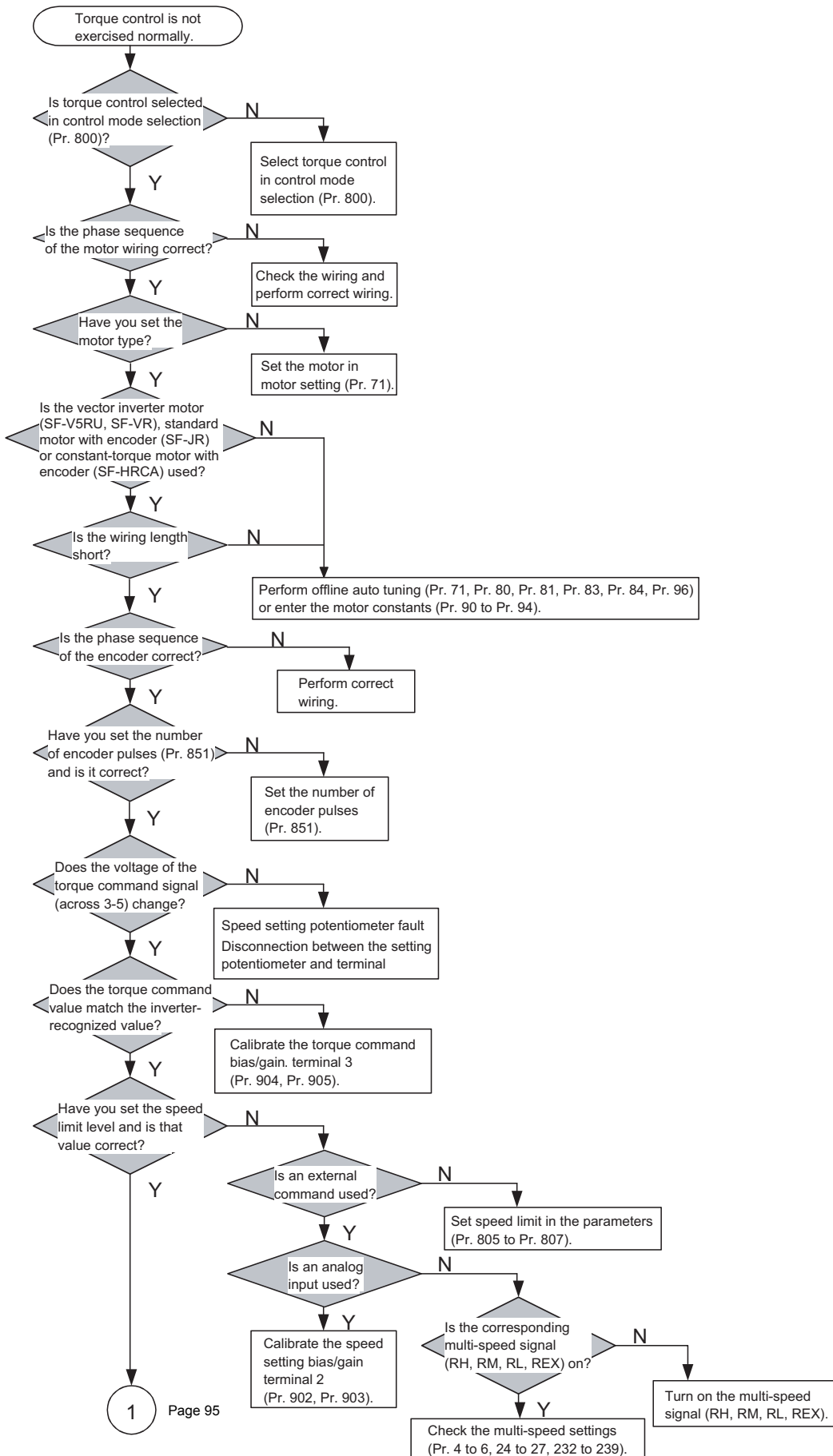

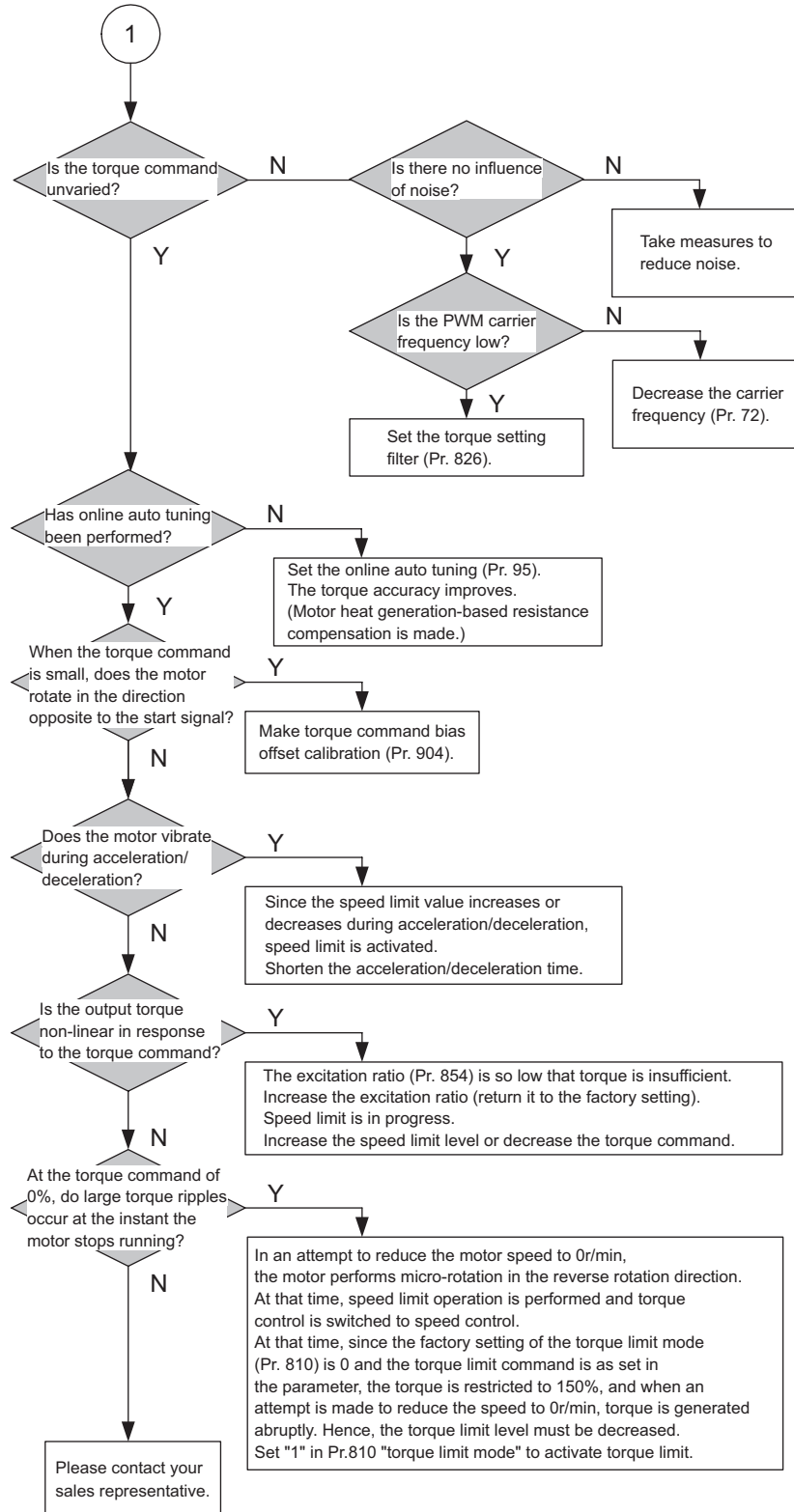

# 7 PRECAUTIONS FOR MAINTENANCE AND INSPECTION

The inverter is a static unit mainly consisting of semiconductor devices. Daily inspection must be performed to prevent any fault from occurring due to the adverse effects of the operating environment, such as temperature, humidity, dust, dirt and vibration, changes in the parts with time, service life, and other factors.

## ● Precautions for maintenance and inspection

For some short time after the power is switched off, a high voltage remains in the smoothing capacitor. When accessing the inverter for inspection, switch power off, wait for more than 10 minutes, and then make sure that the voltage across the main circuit terminals P-N of the inverter is not more than 30VDC using a tester, etc.

## 7.1 Check items

### 7.1.1 Daily inspection

Basically, check for the following faults during operation.

- 1) Motor operation fault
- 2) Improper installation environment
- 3) Cooling system fault
- 4) Unusual vibration and noise
- 5) Unusual overheat and discoloration

During operation, check the inverter input voltages using a tester.

### 7.1.2 Periodic inspection

Check the areas inaccessible during operation and requiring periodic inspection. For periodic inspection, consult us.

- 1) Cooling system fault : Clean the air filter, etc.
- 2) Tightening check and retightening : The screws and bolts may become loose due to vibration, temperature changes, etc. Check and tighten them.  
Tighten them according to the specified tightening torque. (Refer to page 11.)
- 3) Check the conductors and insulating materials for corrosion and damage.
- 4) Measure insulation resistance.
- 5) Check and change the cooling fan and relay.

## ● Daily and periodic inspection

Area of Inspection	Inspection Item	Description	Interval			Method	Criterion	Instrument	Customer's check
			Daily	Periodic*					
				1 year	2 years				
General	Surrounding environment	Check ambient temperature, humidity, dust, dirt, etc.	○			Measure 5cm away from the inverter. (Refer to page 6.)	Ambient temperature: -10°C to +50°C, non-freezing. Ambient humidity: 90% or less, non-condensing.	Thermometer, hygrometer, recorder	
	Overall unit	Check for unusual vibration and noise.	○			Visual and auditory checks.	No fault.		
	Power supply voltage	Check that the main circuit voltages are normal.	○			Measure voltages across the inverter terminal block R, S and T phases.	Within permissible AC (DC) voltage fluctuation (refer to page 103)	Tester, digital multimeter	

Area of Inspection	Inspection Item	Description	Interval			Method	Criterion	Instrument	Customer's check
			Daily	Periodic*					
				1 year	2 years				
Main circuit	General	(1) Check with megger (across main circuit terminals and earth (ground) terminal). (2) Check for loose screws and bolts. (3) Check for overheat traces on the parts. (4) Clean.		<input type="radio"/>	<input type="radio"/>	(1) Disconnect all cables from the inverter and measure across terminals R, S, T, U, V, W and earth (ground) terminal with megger. (2) Retighten. (3) Visual check.	(1) 5MΩ or more. (2), (3) No fault.	500VDC class megger	
	Conductors, cables	(1) Check conductors for distortion. (2) Check cable sheaths for breakage.		<input type="radio"/>	<input type="radio"/>	(1), (2) Visual check.	(1), (2) No fault.		
	Terminal block	Check for damage.		<input type="radio"/>		Visual check	No fault		
	Relay	(1) Check for chatter during operation. (2) Check for rough surface on contacts.		<input type="radio"/>	<input type="radio"/>	(1) Auditory check. (2) Visual check.	(1), (2) No fault.		
	Resistor	(1) Check for crack in resistor insulation. (2) Check for break in the cable.		<input type="radio"/>	<input type="radio"/>	(1) Visual check. Cement resistance, wire-wound resistor. (2) Disconnect one end and measure with tester.	(1) No fault. (2) Indication		
Control circuit Protective circuit	Operation check	(1) Check balance of output voltages across phases with the inverter operated alone. (2) Perform sequence protective operation test to ensure no fault in protective and display circuits.		<input type="radio"/>	<input type="radio"/>	(1) Measure voltages across the inverter output terminals U-V-W. (2) Simulatively short or open the protective circuit output terminals of the inverter.	(1) Phase-to-phase voltage balance within 4V (8V) for 200V (400V). (2) Fault must occur because of sequence.	Digital multimeter, rectifier type voltmeter	
Cooling system	Cooling fan	(1) Check for unusual vibration and noise. (2) Check for loose connection.	<input type="radio"/>	<input type="radio"/>	<input type="radio"/>	(1) Turn by hand with power off. (2) Visual check.	No unusual vibration and noise.		
Display	Display	(1) Check for LED lamp blown. (2) Clean.	<input type="radio"/>	<input type="radio"/>	<input type="radio"/>	(1) Lamps indicate indicator lamps on panel. (2) Clean with rag.	(1) Check that lamps are lit.		
	Meter	Check that reading is normal.	<input type="radio"/>			Check the readings of the meters on the panel.	Must satisfy specified and management values.	Voltmeter, ammeter, etc.	
Motor	General	(1) Check for unusual vibration and noise. (2) Check for unusual odor.	<input type="radio"/>	<input type="radio"/>	<input type="radio"/>	(1) Auditory, sensory, visual checks. (2) Check for unusual odor due to overheat, damage, etc.	(1), (2) No fault.		
	Insulation resistance	Check with megger (across terminals and earth (ground) terminal).			<input type="radio"/>	Disconnect cables from U, V, W (including motor cables).	5MΩ or more.	500V megger	

\* Values in parentheses indicate those for 400V class.

\*Consult us for periodic inspection.

## Replacement of parts

### ● Cleaning

Always run the inverter in a clean status.

When cleaning the inverter, gently wipe dirty areas with a soft cloth immersed in neutral detergent or ethanol.

#### CAUTION

**Do not use solvent, such as acetone, benzene, toluene and alcohol, as they will cause the inverter surface paint to peel off.**

## 7.2 Replacement of parts

The inverter consists of many electronic parts such as semiconductor devices.

The following parts may deteriorate with age because of their structures or physical characteristics, leading to reduced performance or fault of the inverter. For preventive maintenance, the parts must be replaced periodically.

Part Name	Standard Replacement Interval	Description
Cooling fan	2 to 3 years	Replace (as required)
Main circuit smoothing capacitor	10 years	Replace (as required)
On-board smoothing capacitor	10 years	Replace the board (as required).
Relays	—	Replace as required.

#### CAUTION

**For parts replacement, consult the nearest Mitsubishi FA Center.**

### (1) Cooling fan

The cooling fan is used to cool heat-generating parts such as the main circuit semiconductors. The life of the cooling fan bearing is usually 10,000 to 35,000 hours. Hence, the cooling fan must be replaced every 2 to 3 years if the inverter is run continuously. When unusual noise and/or vibration is noticed during inspection, the cooling fan must be replaced immediately.

Inverter Model No.	Fan type	Units	
V520	1.5K, 2.2K	MMF-06D24ES BKO-CA1027H11	1
	3.7K to 7.5K	MMF-08C24ES-RM1 BKO-CA1321H01	2
	11K to 18.5K	MMF-09B24TS-RM1 BKO-CA1322H01	2
	22K, 30K	MMF-12D24DS-RM1 BKO-CA1323H01	2
	37K to 55K		3
V540	1.5K, 2.2K	MMF-06D24ES BKO-CA1027H11	1
	3.7K, 5.5K	MMF-08C24ES-RM1 BKO-CA1321H01	2
	7.5K to 18.5K	MMF-09B24TS-RM1 BKO-CA1322H01	2
	22K	MMF-12D24DS-RM1 BKO-CA1323H01	2
	30K to 55K		3

● **Removal**

- 1) Remove the front cover and wiring cover. (Refer to page 4.)

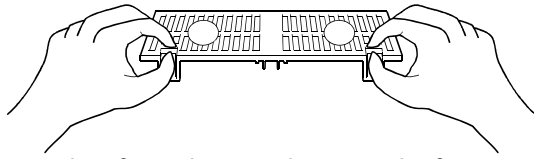

- 2) Push the catches from above and remove the fan cover.
- 3) Disconnect the fan connectors.
- 4) Remove the fan.

● **Reinstallation**

- 1) After confirming the orientation of the fan, reinstall the fan so that the arrow on the left of "AIR FLOW" faces up.

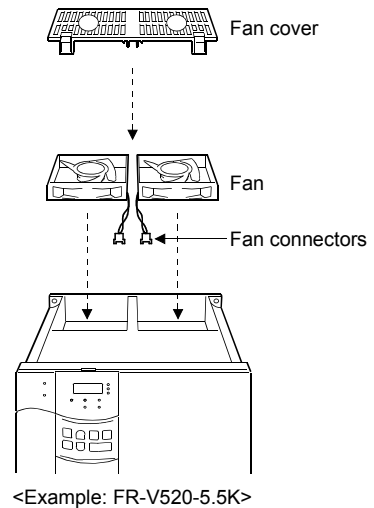
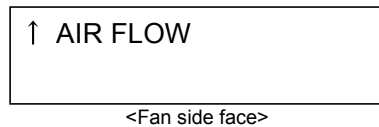

**CAUTION**  
**Installing the fan in the opposite air flow direction can cause the inverter life to be shorter.**

- 2) Reconnect the fan connectors.  
When wiring, use care to avoid the cables being caught by the fan.
- 3) Reinstall the fan cover.

**(2) Smoothing capacitors**

A large-capacity aluminum electrolytic capacitor is used for smoothing in the main circuit DC section, and an aluminum electrolytic capacitor is used for stabilizing the control power in the control circuit. Their characteristics are deteriorated by the adverse effects of ripple currents, etc. The replacement intervals greatly vary with the ambient temperature and operating conditions. When the inverter is operated in air-conditioned, normal environment conditions, replace the capacitors about every 10 years.

The appearance criteria for inspection are as follows:

- 1) Case: Check the side and bottom faces for expansion
- 2) Sealing plate: Check for remarkable warp and extreme crack.
- 3) Check for external crack, discoloration, fluid leakage, etc. Judge that the capacitor has reached its life when the measured capacitance of the capacitor reduced below 80% of the rating.

**(3) Relays**

To prevent a contact fault, etc., relays must be replaced according to the cumulative number of switching times (switching life).

### 7.3 Inverter replacement

---

The inverter can be replaced with the control circuit wiring kept connected. Before replacement, remove the screws in the wiring cover of the inverter.

- 1) Remove the mounting screws in both ends of the control circuit terminal block.
- 2) Pull down the terminal block from behind the control circuit terminals.

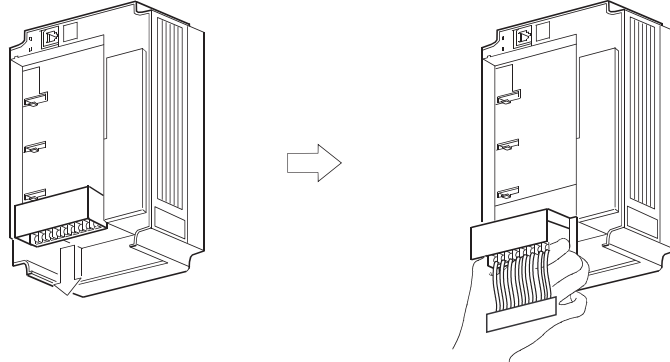

- 3) When installing the terminal block to a new inverter, exercise care not to bend the pins of the control circuit terminal block connector.

---

#### **CAUTION**

---

**Before starting inverter replacement, switch power off, wait for more than 10 minutes, and then check the voltage with a tester and such to ensure safety.**

---

## 7.4 Measurement of main circuit voltages, currents and powers

### 7.4.1 Insulation resistance test using megger

- 1) Before performing the insulation resistance test on the external circuit, disconnect the cables from all terminals of the inverter so that the test voltage is not applied to the inverter.
- 2) For the continuity test of the control circuit, use a tester (high resistance range) and do not use the megger or buzzer.
- 3) For the inverter, conduct the insulation resistance test on the main circuit only as shown below and do not perform the test on the control circuit. (Use a 500VDC megger.)

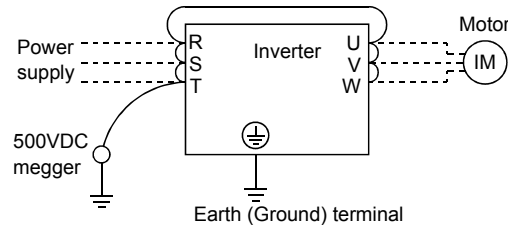

### 7.4.2 Pressure test

Do not conduct a pressure test. Deterioration may occur.

#### ● Measurement of voltages and currents

Since the voltages and currents on the inverter power supply and output sides include harmonics, measurement data depends on the instruments used and circuits measured.

When instruments for commercial frequency are used for measurement, measure the following circuits with the instruments given on the next page.

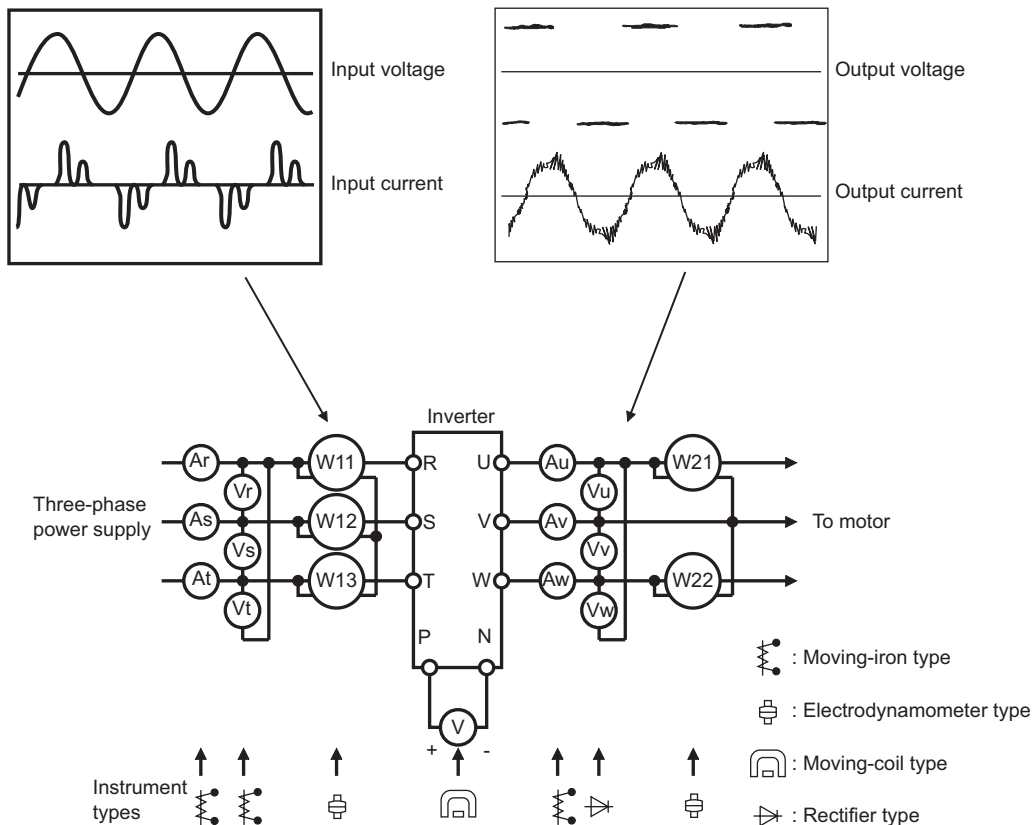

**Examples of Measuring Points and Instruments**

#### CAUTION

**Use an FFT to measure the output voltage accurately.**

**A tester or general measuring instrument cannot measure accurately.**



## Measurement of main circuit voltages, currents and powers

### Measuring Points and Instruments

Item	Measuring Point	Measuring Instrument	Remarks (Reference Measurement Value)	
Power supply voltage V1	Across R-S, S-T and T-R	Moving-iron type AC voltmeter	Commercial power supply Within permissible AC voltage fluctuation (Refer to page 106)	
Power supply side current I1	R, S and T line currents	Moving-iron type AC ammeter		
Power supply side power P1	At R, S and T, and across R-S, S-T and T-R	Electrodynamic type single-phase wattmeter	P1 = W11 + W12 + W13 (3-wattmeter method)	
Power supply side power factor Pf1	Calculate after measuring power supply voltage, power supply side current and power supply side power. $Pf_1 = \frac{P_1}{\sqrt{3}V_1 \times I_1} \times 100\%$			
Output side voltage V2	Across U-V, V-W and W-U	Rectifier type AC voltmeter (Caution 1) (Moving-iron type cannot measure)	Difference between the phases is within $\pm 1\%$ of the maximum output voltage.	
Output side current I2	U, V and W line currents	Moving-iron type AC ammeter (Caution 2)	Difference between the phases is 10% or lower of the rated inverter current.	
Output side power P2	At U, V and W, and across U-V and V-W	Electrodynamic type single-phase wattmeter	P2 = W21 + W22 2-wattmeter method (or 3-wattmeter method)	
Output side power factor Pf2	Calculate in similar manner to power supply side power factor. $Pf_2 = \frac{P_2}{\sqrt{3}V_2 \times I_2} \times 100\%$			
Converter output	Across P-N	Moving-coil type (such as tester)	Inverter LED display is lit. 1.35×V1	
Speed setting signal (Torque setting signal)	Across 2(+)-5	Moving-coil type (Tester and such may be used) (Internal resistance: 50kΩ or larger)	0 to 10VDC	"5" is common.
	Across 1(+)-5		0 to $\pm 10$ VDC	
	Across 3(+)-5		0 to $\pm 10$ VDC	
Frequency setting power supply	Across 10E(+)-5		10VDC	
Speed meter signal	Across DA1(+)-5		$\pm 10$ VDC at maximum speed (without speed meter)	
	Across DA2(+)-5		Approx. 10VDC at maximum speed (without speed meter)	
Start signal Select signal	Across STF, STR, DI1, DI2, DI3, DI4(+)-SD			When open 20 to 30VDC ON voltage: 1V or less
Alarm signal	Across A-C Across B-C	Moving-coil type (such as tester)	Continuity check <Normal> <Abnormal> Across A-C: Discontinuity Continuity Across B-C: Continuity Discontinuity	

#### CAUTION

1. Use an FFT to measure the output voltage accurately. A tester or general measuring instrument cannot measure accurately.
2. When the carrier frequency exceeds 5kHz, do not use this instrument since using it may increase eddy-current losses produced in metal parts inside the instrument, leading to burnout. In this case, use an approximately effective value type instrument.

# 8 SPECIFICATIONS

## 8.1 Model specifications

### ● 200V class (for use with the Mitsubishi dedicated motor [SF-V5RU (1500r/min series)])

Type FR-V520-□□K		1.5	2.2	3.7	5.5	7.5	11	15	18.5	22	30	37	45	55	
Applied motor capacity (kW)		1.5	2.2	3.7	5.5	7.5	11	15	18.5	22	30	37	45	55	
Output	Rated capacity (kVA) (Caution 1)	3.1	4.5	6.9	9.8	13.0	18.7	25.2	30.4	35.8	43.8	58.1	68.5	91.0	
	Rated current (A)	9.0	13.0	20.0	28.5	37.5	54	72.8	88	103.5	126.5	168	198	264	
	Overload current rating (Caution 2)	150% 60s, 200% 0.5s (inverse-time characteristics)													
	Regenerative braking torque	Max. value/ permissible duty	100% torque/3%ED (Caution 3) (Caution 7)				100% torque/ 2%ED (Caution 3) (Caution 7)		20% torque/continuous (Caution 7)						
Power supply	Rated input AC voltage, frequency	Three-phase, 200V to 220V 50Hz, 200 to 240V 60Hz						Three-phase, 200 to 220V 50Hz, 200 to 230V 60Hz							
	Permissible AC voltage fluctuation	170 to 242V 50Hz, 170 to 264V 60Hz						170 to 242V 50Hz, 170 to 253V 60Hz							
	Permissible frequency fluctuation	±5%													
	Instantaneous voltage drop immunity	Operation continues at 165V or higher voltage. If the rated voltage drops to lower than 165V, 15ms operation continues.													
	Power supply capacity (kVA) (Caution 4)	5.0	6.5	10	14	19	23	33	39	48	57	77	90	123	
Protective structure (JEM 1030)		Enclosed type (IP20) (Caution 5)						Open type (IP00)							
Cooling system		Forced air cooling													
Approx. mass (kg)		3.5	3.5	6.0	6.0	6.0	14.0	14.0	21.0	30.0	40.0	40.0	55.0	58.0	
Dedicated motor	Motor type (Caution 8)		SF-V5RU 1K	SF-V5RU 2K	SF-V5RU 3K	SF-V5RU 5K	SF-V5RU 7K	SF-V5RU 11K	SF-V5RU 15K	SF-V5RU 18K	SF-V5RU 22K	SF-V5RU 30K	SF-V5RU 37K	SF-V5RU 45K	SF-V5RU 55K
	Rated output (kW)		1.5	2.2	3.7	5.5	7.5	11	15	18.5	22	30	37	45	55
	Rated torque (N·m)		9.55	14.1	23.6	35.0	47.7	70.0	95.5	118	140	191	235	286	350
	Maximum torque 150% 60s (N·m)		14.3	21.1	35.4	52.4	71.6	105	143	176	211	287	353	429	525
	Rated speed (r/min)		1500												
	Maximum speed (r/min)		3000 (Caution 6)												2400
	Frame No.		90L	100L	112M	132S	132M	160M	160L	180M	180M	200L	200L	200L	225S
	Moment of inertia J (X10 <sup>-4</sup> kg·m <sup>2</sup> )		67.5	105	175	275	400	750	875	1725	1875	3250	3625	3625	6850
	Noise (Caution 11)		75dB or less									80dB or less			85dB or less
	Cooling fan (with thermal protector)	Voltage	Single-phase 200V/50Hz Single-phase 200 to 230V/60Hz						Three-phase 200V/50Hz Three-phase 200 to 230V/60Hz						
		Input (50Hz/60Hz) (Caution 9)	36/55W (0.26/0.32A)			22/28W (0.11/0.13A)			55/71W (0.37/0.39A)			100/156W (0.47/0.53A)			85/ 130W (0.46/ 0.52A)
	Ambient temperature, humidity		-10 to +40°C (non-freezing), 90%RH or less (non-condensing)												
	Structure (Protective structure)		Totally enclosed forced draft system (Motor: IP44, cooling fan: IP23S) (Caution 10)												
	Detector		Encoder 2048P/R, A phase, B phase, Z phase +12VDC power supply												
	Equipment		Encoder, thermal relay protector, fan												
Heat resistance class		F													
Vibration rank		V10													
Approx. weight (kg)		24	33	41	52	62	99	113	138	160	238	255	255	320	
Dedicated Encoder cable	Resolution		2048 pulse/rev												
	Power supply voltage		12VDC±10%												
	Current consumption		90mA												
	Output signal form		A, B phases (90° phase shift) Z phase: 1 pulse/rev												
	Output circuit		Complimentary (constant voltage output matched by emitter follow)												
Output voltage		"H" level: Power supply voltage 9V or more (I <sub>OH</sub> : -20mA), "L" level: Power supply voltage 3V or less (I <sub>OL</sub> : 20mA)													

### CAUTION

- The rated output capacity indicated assumes that the output voltage is 200V.
- The % value of the overload current rating indicated is the ratio of the overload current to the inverter's rated output current. For repeated duty, allow time for the inverter and motor to return to or below the temperatures under 100% load.
- The short-time rating is 5s.
- The power supply capacity varies with the value of the power supply side inverter impedance (including those of the input reactor and cables).
- Open type (IP00) when the plug-in option is fitted after removal of the option wiring port cover.
- You can run the 3.7kW or less dedicated motor at the maximum speed of 3600r/min, consult us when you want to run the motor at higher than 3000r/min.
- With the dedicated external brake resistor FR-ABR (option), the 1.5K to 7.5K and 11K to 15K will achieve the performance of 100% torque/10%ED and 100% torque/6%ED respectively.
- If the motor is one rank lower in capacity than the inverter, it can be used by setting Pr. 80 "motor capacity" and Pr. 81 "number of motor poles". Other manufacturers' motors and special motors can be used by performing online auto tuning.
- Power (current) at 50Hz/60Hz.
- Since a motor with brake has a window for gap check, the protective structure of both the cooling fan section and brake section is IP20. S of IP23S is an additional code indicating the condition that protection from water intrusion is established only when a cooling fan is not operating.
- The value when high carrier frequency is set (Pr. 72 = 6, Pr. 240 = 0).

## Model specifications

### ● 400V class (for use with the dedicated motor [SF-V5RUH (1500r/min series)])

Type FR-V540-[]K	1.5	2.2	3.7	5.5	7.5	11	15	18.5	22	30	37	45	55	
<b>Inverter</b>														
Applied motor capacity (kW)	1.5	2.2	3.7	5.5	7.5	11	15	18.5	22	30	37	45	55	
Output	Rated capacity (kVA) (Caution 1)	3.1	4.5	6.9	10.0	12.8	19.0	24.6	30.4	35.8	46.3	59.5	68.5	91.0
	Rated current (A)	4.5	6.5	10.0	14.5	18.5	27.5	35.5	44	51.8	67	86	99	132
	Overload current rating (Caution 2)	150% 60s, 200% 0.5s (inverse-time characteristics)												
	Regenerative braking torque	100% torque/2%ED (Caution 3) (Caution 7)						20% torque/continuous (Caution 7)						
Power supply	Rated input AC voltage, frequency	Three-phase, 380V to 480V 50Hz/60Hz												
	Permissible AC voltage fluctuation	323 to 528V 50Hz/60Hz												
	Permissible frequency fluctuation	±5%												
	Instantaneous voltage drop immunity	Operation continues at 330V or higher voltage. If the rated voltage drops to lower than 330V, 15ms operation continues.												
	Power supply capacity (kVA)(Caution 4)	5.0	6.5	10	14	19	23	33	39	48	57	77	90	123
Protective structure (JEM 1030)	Enclosed type (IP20) (Caution 5)								Open type (IP00)					
Cooling system	Forced air cooling													
Approx. mass (kg)	3.5	3.5	6.0	6.0	14.0	14.0	14.0	14.0	24.0	35.0	35.0	50.0	52.0	
<b>Dedicated motor</b>														
Motor type (Caution 8)	SF-V5RU H1K	SSF-V5RU H2K	SF-V5RU H3K	SF-V5RU H5K	SF-V5RU H7K	SF-V5RU H11K	SF-V5RU H15K	SF-V5RU H18K	SF-V5RU H22K	SF-V5RU H30K	SF-V5RU H37K	SF-V5RU H45K	SF-V5RU H55K	
Rated output (kW)	1.5	2.2	3.7	5.5	7.5	11	15	18.5	22	30	37	45	55	
Rated torque (N·m)	9.55	14.1	23.6	35.0	47.7	70.0	95.5	118	140	191	235	286	350	
Maximum torque 150% 60s (N·m)	14.3	21.1	35.4	52.4	71.6	105	143	176	211	287	353	429	525	
Rated speed (r/min)	1500													
Maximum speed (r/min)	3000 (Caution 6)												2400	
Frame No.	90L	100L	112M	132S	132M	160M	160L	180M	180M	200L	200L	200L	225S	
Moment of inertia J (X10 <sup>-4</sup> kg·m <sup>2</sup> )	67.5	105	175	275	400	750	875	1725	1875	3250	3625	3625	6850	
Noise (Caution 11)	75dB or less									80dB or less			85dB or less	
Cooling fan (With thermal protector)	Voltage	Single-phase 200V/50Hz Single-phase 200 to 230V/60Hz					Three-phase 380 to 400V/50Hz Three-phase 400 to 460V/60Hz							
	Input (Caution 9)	36/55W (0.26/0.32A)			22/28W (0.11/0.13A)		55/71W (0.19/0.19A)			100/156W (0.27/0.3A)			85/ 130W (0.23/ 0.26A)	
Ambient temperature, humidity	-10 to +40°C (non-freezing), 90%RH or less (non-condensing)													
Structure (Protective structure)	Totally enclosed forced draft system (Motor: IP44, cooling fan: IP23S) (Caution 10)													
Detector	Encoder 2048P/R, A phase, B phase, Z phase +12VDC power supply													
Equipment	Encoder, thermal relay protector, fan													
Heat resistance class	F													
Vibration rank	V10													
Approx. weight (kg)	24	33	41	52	62	99	113	138	160	238	255	255	320	
<b>Dedicated encoder cable</b>														
Resolution	2048 pulse/rev													
Power supply voltage	12VDC±10%													
Current consumption	90mA													
Output signal form	A, B phases (90° phase shift) Z phase: 1 pulse/rev													
Output circuit	Complimentary (constant voltage output matched by emitter follow)													
Output voltage	"H" level: Power supply voltage 9V or more (I <sub>OH</sub> : -20mA), "L" level: Power supply voltage 3V or less (I <sub>OL</sub> : 20mA)													

### CAUTION

- The rated output capacity indicated assumes that the output voltage is 400V.
- The % value of the overload current rating indicated is the ratio of the overload current to the inverter's rated output current. For repeated duty, allow time for the inverter and motor to return to or below the temperatures under 100% load.
- The short-time rating is 5s.
- The power supply capacity varies with the value of the power supply side inverter impedance (including those of the input reactor and cables).
- Open type (IP00) when the plug-in option is fitted after removal of the option wiring port cover.
- You can run the 3.7kW or less dedicated motor at the maximum speed of 3600r/min, consult us when you want to run the motor at higher than 3000r/min.
- With the dedicated external brake resistor FR-ABR-H (option), the 1.5K to 7.5K and 11K to 15K will achieve the performance of 100% torque/10%ED and 100% torque/6%ED respectively.
- If the motor is one rank lower in capacity than the inverter, it can be used by setting Pr. 80 "motor capacity" and Pr. 81 "number of motor poles". Other manufacturers' motors and special motors can be used by performing online auto tuning.
- Power (current) at 50Hz/60Hz.
- Since a motor with brake has a window for gap check, the protective structure of both the cooling fan section and brake section is IP20. S of IP23S is an additional code indicating the condition that protection from water intrusion is established only when a cooling fan is not operating.
- The value when high carrier frequency is set (Pr. 72 = 6, Pr. 240 = 0).

● **Combination with a vector control dedicated motor**

Refer to the table below when using with a vector control dedicated motor.

- Combination with the SF-V5RU

Voltage		200V class			400V class		
Rated speed		1500r/min					
Base frequency		50Hz					
Maximum speed		3000r/min					
Motor capacity	Motor frame number	Motor type	Inverter type	Motor frame number	Motor type	Inverter type	
1.5kW	90L	SF-V5RU1K	FR-V520-1.5K	90L	SF-V5RUH1K	FR-V540-1.5K	
2.2kW	100L	SF-V5RU2K	FR-V520-2.2K	100L	SF-V5RUH2K	FR-V540-2.2K	
3.7kW	112M	SF-V5RU3K	FR-V520-3.7K	112M	SF-V5RUH3K	FR-V540-3.7K	
5.5kW	132S	SF-V5RU5K	FR-V520-5.5K	132S	SF-V5RUH5K	FR-V540-5.5K	
7.5kW	132M	SF-V5RU7K	FR-V520-7.5K	132M	SF-V5RUH7K	FR-V540-7.5K	
11kW	160M	SF-V5RU11K	FR-V520-11K	160M	SF-V5RUH11K	FR-V540-11K	
15kW	160L	SF-V5RU15K	FR-V520-15K	160L	SF-V5RUH15K	FR-V540-15K	
18.5kW	180M	SF-V5RU18K	FR-V520-18.5K	180M	SF-V5RUH18K	FR-V540-18.5K	
22kW	180M	SF-V5RU22K	FR-V520-22K	180M	SF-V5RUH22K	FR-V540-22K	
30kW	200L*2	SF-V5RU30K	FR-V520-30K	200L*2	SF-V5RUH30K	FR-V540-30K	
37kW	200L*2	SF-V5RU37K	FR-V520-37K	200L*2	SF-V5RUH37K	FR-V540-37K	
45kW	200L*2	SF-V5RU45K	FR-V520-45K	200L*2	SF-V5RUH45K	FR-V540-45K	
55kW	225S*1	SF-V5RU55K	FR-V520-55K	225S*1	SF-V5RUH55K	FR-V540-55K	

- Combination with the SF-V5RU1, 3, 4 and SF-THY

		SF-V5RU□1 (1:2)			SF-V5RU□3 (1:3)			SF-V5RU□4 (1:4)		
Voltage		200V class								
Rated speed		1000r/min			1000r/min			500r/min		
Base frequency		33.33Hz			33.33Hz			16.6Hz		
Maximum speed		2000r/min			3000r/min			2000r/min		
Motor capacity	Motor frame number	Motor type	Inverter type	Motor frame number	Motor type	Inverter type	Motor frame number	Motor type	Inverter type	
1.5kW	100L	SF-V5RU1K1	FR-V520-1.5K	112M	SF-V5RU1K3	FR-V520-2.2K	132M	SF-V5RU1K4	FR-V520-2.2K	
2.2kW	112M	SF-V5RU2K1	FR-V520-2.2K	132S	SF-V5RU2K3	FR-V520-2.2K	160M	SF-V5RU2K4	FR-V520-3.7K	
3.7kW	132S	SF-V5RU3K1	FR-V520-3.7K	132M	SF-V5RU3K3	FR-V520-3.7K	160L	SF-V5RU3K4	FR-V520-5.5K	
5.5kW	132M	SF-V5RU5K1	FR-V520-5.5K	160M	SF-V5RU5K3	FR-V520-5.5K	180L	SF-V5RU5K4	FR-V520-7.5K	
7.5kW	160M	SF-V5RU7K1	FR-V520-7.5K	160L	SF-V5RU7K3	FR-V520-11K	200L	SF-V5RU7K4	FR-V520-11K	
11kW	160L	SF-V5RU11K1	FR-V520-11K	180M	SF-V5RU11K3	FR-V520-15K	225S	SF-V5RU11K4	FR-V520-15K	
15kW	180M	SF-V5RU15K1	FR-V520-15K	180L	SF-V5RU15K3	FR-V520-15K	225S	SF-V5RU15K4	FR-V520-18.5K	
18.5kW	180L	SF-V5RU18K1	FR-V520-18.5K	200L	SF-V5RU18K3	FR-V520-22K	—	—	—	
22kW	200L	SF-V5RU22K1	FR-V520-22K	200L	SF-V5RU22K3	FR-V520-22K	—	—	—	
30kW	200L*3	SF-V5RU30K1	FR-V520-30K	225S*1	SF-V5RU30K3	FR-V520-37K	—	—	—	
37kW	225S	SF-V5RU37K1	FR-V520-37K	—	—	—	—	—	—	
45kW	—	—	—	—	—	—	—	—	—	
55kW	—	—	—	—	—	—	—	—	—	

400V class of SF-V5RU1, 3, 4 are developed upon receipt of order.

\*1 The maximum speed is 2400r/min.

\*2 80% output in the high-speed range. (The output is reduced when the speed is 2400r/min or more.)

\*3 90% output in the high-speed range. (The output is reduced when the speed is 1000r/min or more.)

## 8.2 Common specifications

Control specifications	Control method		Soft-PWM control or high carrier frequency sine-wave PWM control can be selected. Vector control or V/F control can be selected.			
	Control mode		Speed control torque control, position control			
	Speed setting resolution	Analog input	0.03% of the maximum set speed			
		Digital input	0.003% to the maximum setting (minimum setting 0.1r/min)			
	Acceleration/deceleration time		0 to 3600s (0.1s increments)			
	Acceleration/deceleration pattern		Linear, S pattern (3 types) or backlash measures acceleration/deceleration can be selected.			
	Torque limit level		Torque limit value can be set (0 to 400% variable)			
	Input signals	Analog setting signal	Terminal No.	Setting Range	Speed Control	Torque Control
			2	0 to 10V (resolution 0.03%)	Main speed setting	Speed limit
			1	0 to ±10V (resolution 0.05%)	Auxiliary speed setting/magnetic flux command/regenerative torque limit	Speed limit compensation/magnetic flux command/forward/reverse rotation speed limit (analog polarity switchover speed limit)
3			0 to ±10V (resolution 0.05%)	Torque limit/Torque bias	Torque command	
Option (FR-V5AX)		6	0 to ±10V (resolution 0.003%)	Main speed setting (at this time, terminal 2 is invalid)/torque limit	Speed limit (at this time, terminal 2 is invalid)/Torque command (at this time, terminal 3 is invalid)	
Contact signal		3 fixed function terminals		Forward rotation command, alarm reset, external thermal relay		
		5 function terminals		Selection can be made from reverse rotation command, multi-speed setting (max. 15 speeds), remote setting, jog operation (Caution 1), second function selection, third function selection, output stop, start signal self-holding, pre-excitation, control mode switchover, torque limit selection, start time tuning, S pattern switchover, PID control terminal, orientation command, break opening completion signal, PU operation/external operation switchover, torque bias selection 1, torque bias selection 2, P control selection, servo on, HC connection, and PU/external interlock.		
Option (FR-V5AX)		6 multi-function terminals				
Inverter		Output signals	Contact signal		1 changeover contact (230VAC 0.3A, 30VDC 0.3A)	
	Open collector signal		3 multi-function terminals			
	Option (FR-V5AY)		3 multi-function terminals			
	Option (FR-V5AM)		1 multi-function terminal			
	Option (FR-A5AY)		7 multi-function terminals			
	Analog output		0 to ±10V 12 bits ×1CH 0 to 10V 12 bits ×1CH			
	Option (FR-A5AY)		0 to 10V 10 bits × 1CH 0 to 20mA 10 bits × 1CH			
	Encoder pulse output option (FR-V5AY)		A phase, B phase, Z phase (A and B phases can be divided) Open collector/differential line driver.			
	Operational functions		Maximum/minimum speed setting, speed jump, external thermal relay input selection, polarity reversible operation, override function, automatic restart after instantaneous power failure operation, forward/reverse rotation prevention, operation mode selection, offline auto tuning function, online auto tuning function, easy gain tuning, computer link operation, remote setting, brake sequence, second function, third function, multi-speed operation, coasting to stop, power failure stop, PID control, speed feed forward, model adaptive speed control, master/slave, torque bias, 12-bit digital command (FR-A5AX option), 16-bit digital command (FR-A5AH option), pulse train input (FR-A5AP option), motor thermistor interface (FR-V5AX option)			
	Display		Parameter unit (FR-DU04-1/FR-PU04V)		Selection can be made from speed, output current, output voltage, preset speed, output frequency, motor torque, converter output voltage, regenerative brake duty, electronic thermal relay function load factor, output current peak value, converter output voltage peak value, input terminal status (Caution 4), output terminal status (Caution 4), load meter, motor excitation current, position pulse, cumulative energization time, actual operation time, motor load factor, torque command, torque current command, feedback pulse, motor output, trace status.	
Alarm definition		Alarm definition is displayed when protective function is activated. 8 past alarm definitions are stored. (Only 4 alarm definitions are displayed on the control panel.)				
Protective functions		Overcurrent shut-off (during acceleration, deceleration, constant speed), regenerative overvoltage shut-off (acceleration, deceleration, constant speed), undervoltage, instantaneous power failure, overload shut-off (electronic thermal relay function), brake transistor alarm (Caution 2), earth (ground) fault current, power output short circuit (12/24VDC/control panel), stall prevention, external thermal relay, heatsink overheat, fan fault, option alarm, parameter error, PU disconnection, encoder no-signal, speed deviation large, overspeed, position error large, CPU error, encoder phase error, output phase failure, retry count excess, brake sequence error				
Environment	Ambient temperature		-10°C to +50°C(non-freezing)			
	Ambient humidity		90%RH or less (non-condensing)			
	Storage temperature (Caution 3)		-20°C to +65°C			
	Atmosphere		Indoor use. (No corrosive gas, flammable gas, oil mist, dust and dirt)			
Altitude, vibration		Maximum 1,000m above sea level, 5.9m/s <sup>2</sup> or less				

### CAUTION

1. Jog operation may also be performed from the control panel (FR-DU04-1) or the parameter unit (FR-PU04V).
2. Not provided for the FR-V520-18.5K to 55K, FR-V540-18.5K to 55K that do not have a built-in brake circuit.
3. Temperature applicable for a short period in transit, etc.
4. Not provided for the control panel (FR-DU04-1).

### 8.3 Outline dimension drawings

#### 8.3.1 Inverter outline dimension drawings

- FR-V520-1.5K, 2.2K
- FR-V540-1.5K, 2.2K

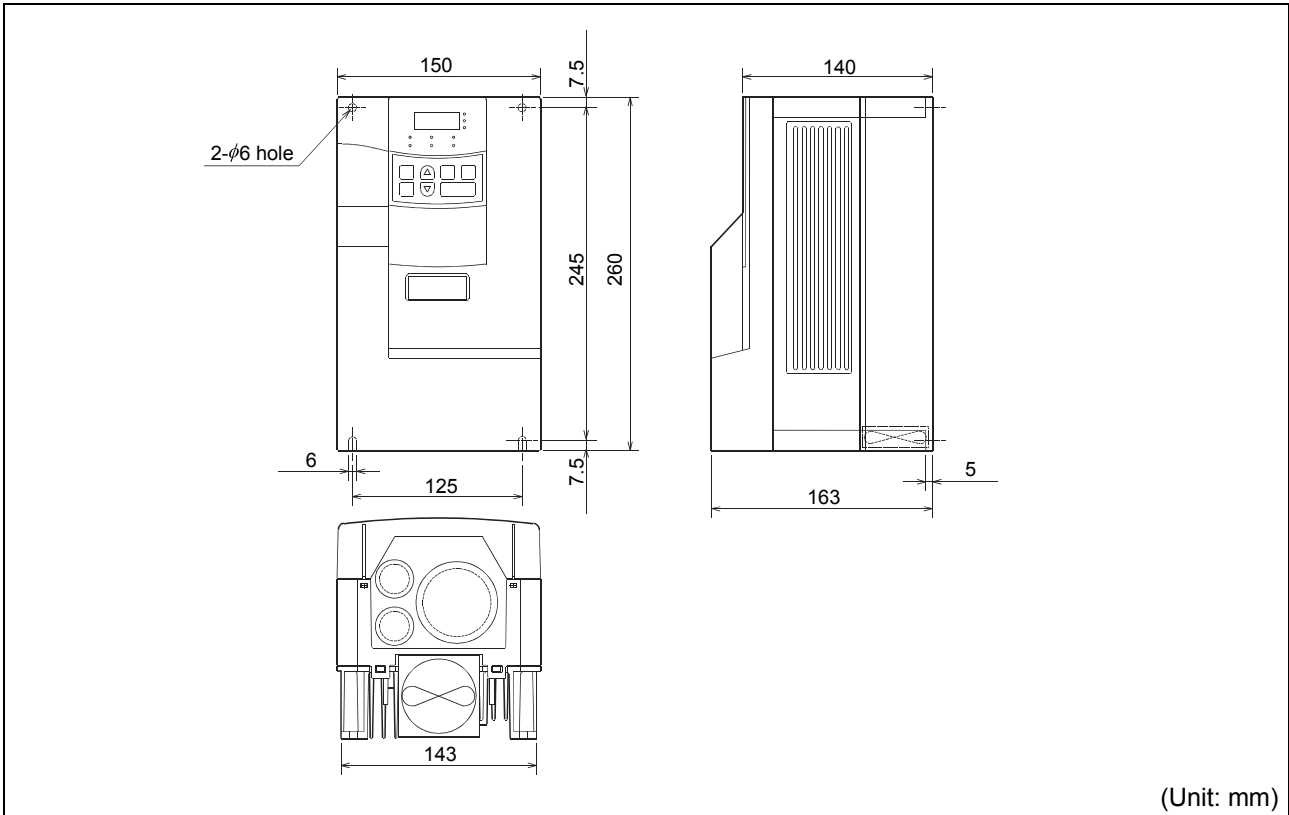

- FR-V520-3.7K, 5.5K, 7.5K
- FR-V540-3.7K, 5.5K

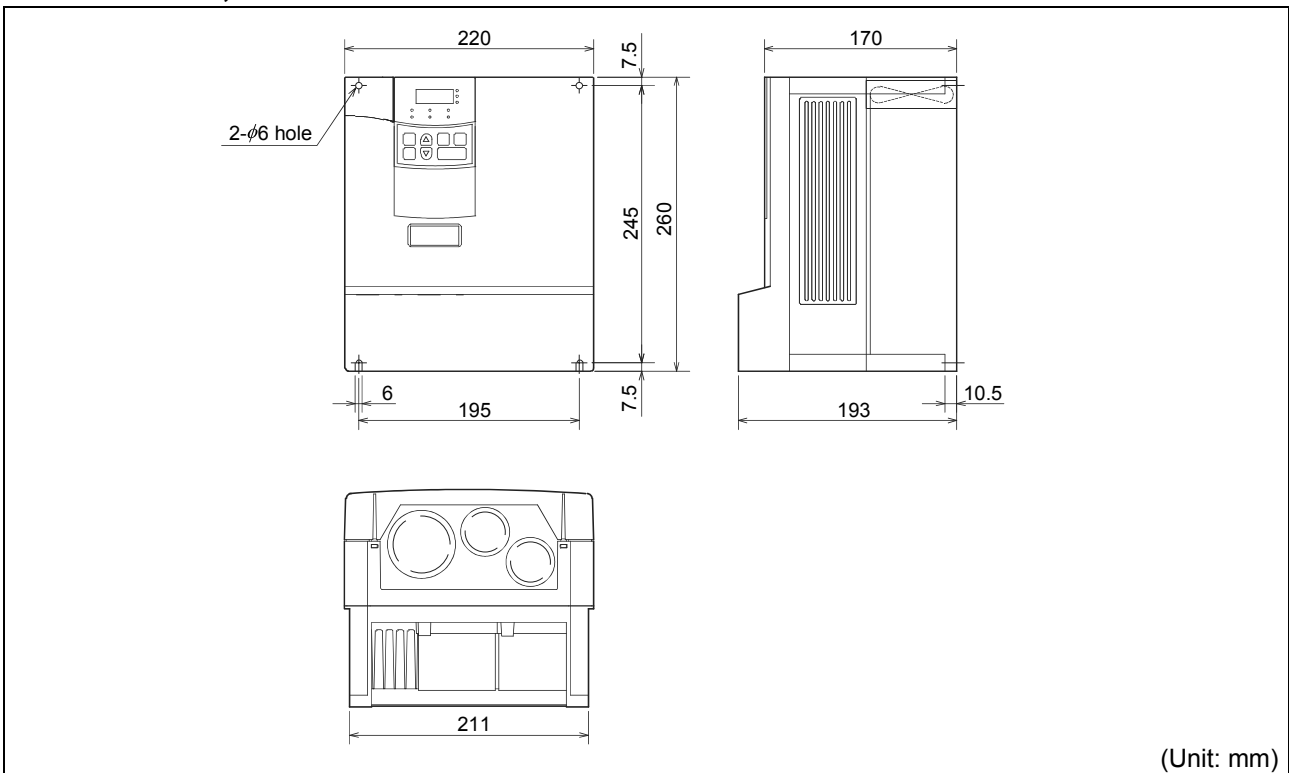

## Outline dimension drawings

●FR-V520-11K, 15K

●FR-V540-7.5K, 11K, 15K, 18.5K

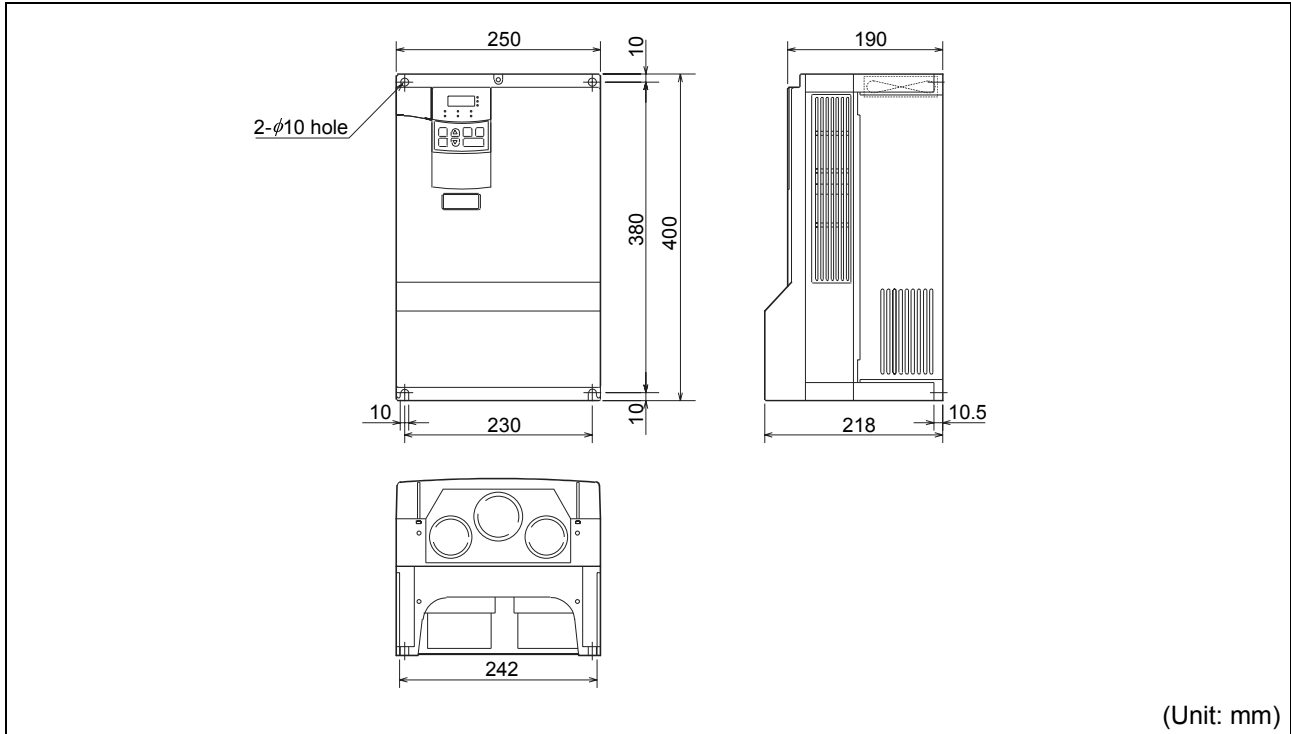

●FR-V520-18.5K

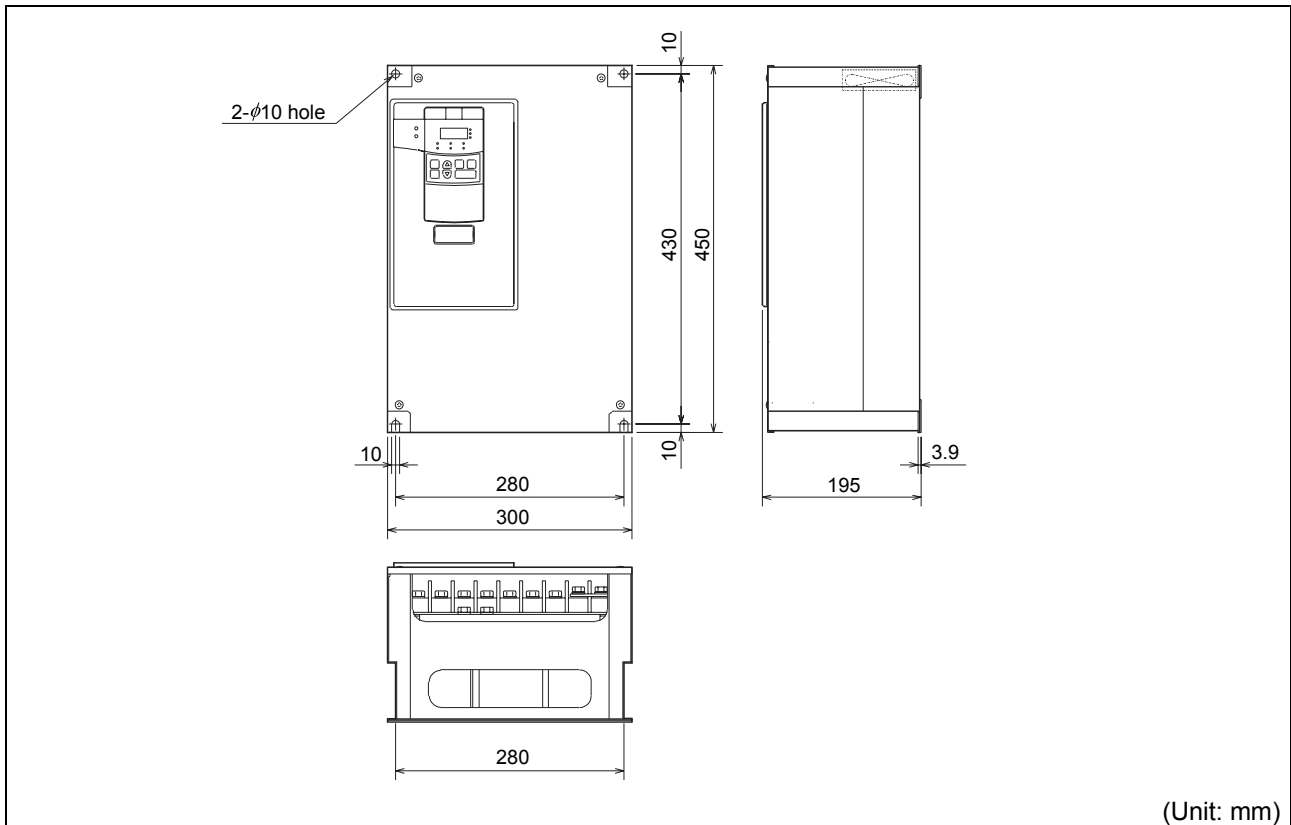

- FR-V520-22K, 30K, 37K
- FR-V540-22K, 30K, 37K

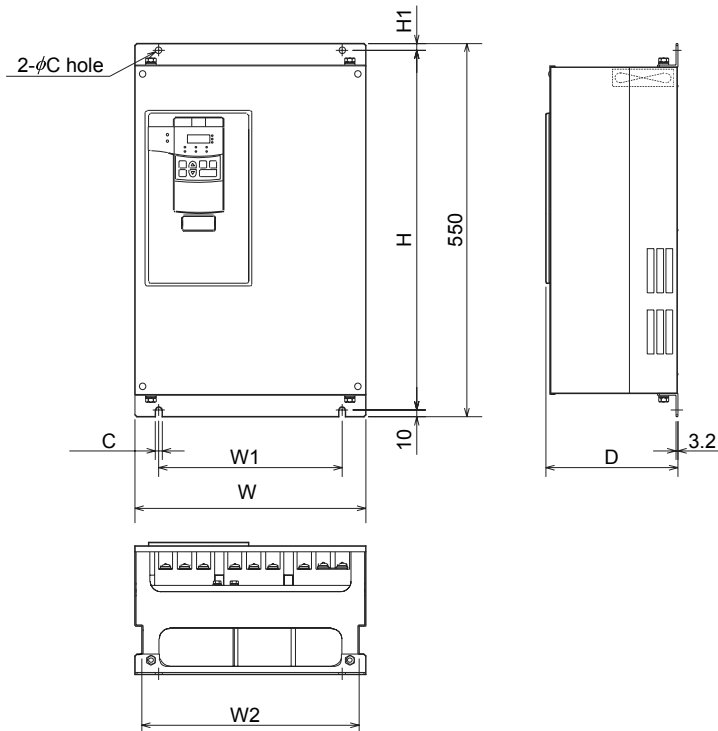

●200V class

Inverter Type	W	W1	W2	H	H1	D	C
FR-V520-22K	340	270	320	530	10	195	10
FR-V520-30K,37K	450	380	430	525	15	250	12

●400V class

Inverter Type	W	W1	W2	H	H1	D	C
FR-V540-22K	340	270	320	530	10	195	10
FR-V540-30K,37K	450	380	430	525	15	250	12

(Unit: mm)

- FR-V520-45K, 55K
- FR-V540-45K, 55K

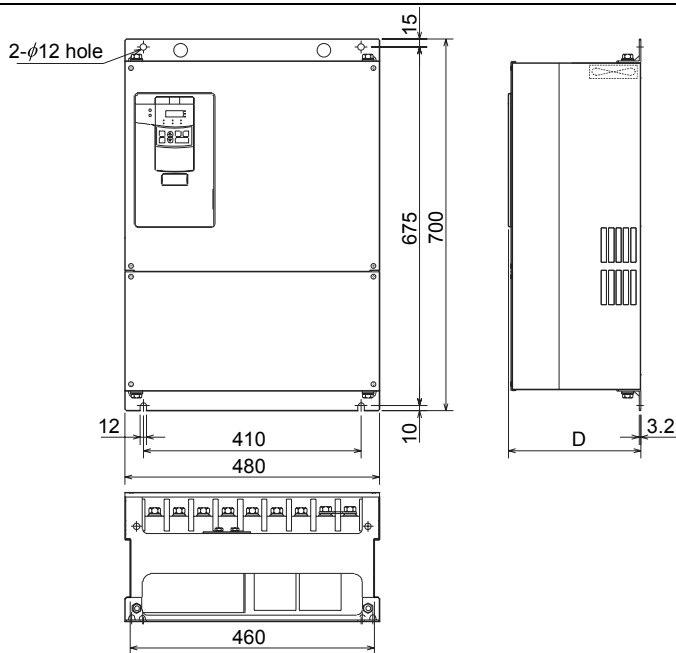

●200V class

Inverter Type	D
FR-V520-45K	250
FR-V520-55K	270

●400V class

Inverter Type	D
FR-V540-45K	250
FR-V540-55K	270

(Unit: mm)



# Outline dimension drawings

## 8.3.2 Dedicated motor outline dimension drawings

### Dedicated motor outline dimension drawings (standard horizontal type)

**Frame Number 90L**  
**SF-V5RU(H) 1K**

**Frame Number 100L, 112M, 132S, 132M**  
**SF-V5RU(H) 2K, 3K, 5K, 7K**

**Frame Number 160M, 160L, 180M, 180L**  
**SF-V5RU(H) 11K, 15K, 18K, 22K**

**Frame Number 200L, 225S**  
**SF-V5RU(H) 30K, 37K, 45K, 55K**

Make sure to earth the earth terminal of the frame installation foot as well as the earth terminal in the terminal box.

### Dimensions table

(Unit: mm)

SF-V5RU K (kW)	SF-V5RU K1 (kW)	SF-V5RU K3 (kW)	SF-V5RU K4 (kW)	Frame No.	Mass (kg)	Motor																		Terminal Screw Size							
						A	B	C	D	E	F	H	I	KA	KG	KL(KP)	L	M	ML	N	XB	Q	QK	R	S	T	U	W	U,V,W	A,B,C	G1,G2
1	—	—	—	90L	24	256.5	114	90	183.6	70	62.5	198	—	53	65	220(210)	425	175	—	150	56	—	—	188.5	24j6	7	4	8	M6	M4	M4
2	1	—	—	100L	33	284	128	100	207	80	70	203.5	230	65	78	231	477	200	212	180	63	60	45	193	28j6	7	4	8	M6	M4	M4
3	2	1	—	112M	41	278	135	112	228	95	70	226	253	69	93	242	478	230	242	180	70	60	45	200	28j6	7	4	8	M6	M4	M4
5	3	2	—	132S	52	303	152	132	266	108	70	265	288	75	117	256	542	256	268	180	89	80	63	239	38k6	8	5	10	M6	M4	M4
7	5	3	1	132M	62	322	171	132	266	108	89	265	288	94	117	256	580	256	268	218	89	80	63	258	38k6	8	5	10	M6	M4	M4
11	7	5	2	160M	99	412	198	160	318	127	105	316	367	105	115	330	735	310	—	254	108	—	—	323	42k6	8	5	12	M8	M4	M4
15	11	7	3	160L	113	434	220	160	318	127	127	316	367	127	115	330	779	310	—	298	108	—	—	345	42k6	8	5	12	M8	M4	M4
18	—	—	—	180M	138	438.5	225.5	180	363	139.5	120.5	359	410	127	139	352	790	335	—	285	121	—	—	351.5	48k6	9	5.5	14	M8	M4	M4
22	15	11	—	180L	160	457.5	242.5	180	363	139.5	139.5	359	410	146	139	352	828	335	—	323	121	—	—	370.5	55m6	10	6	16	M8	M4	M4
30	—	—	7	200L	238	483.5	267.5	200	406	159	152.5	401	—	145	487	(546)	909	390	—	361	133	—	—	425.5	60m6	—	—	—	M10	M4	M4
30, 45	22, 30	18, 22	—	200L	255	483.5	267.5	200	406	159	152.5	401	—	145	487	(592)	932	428	—	342	149	—	—	432	65m6	—	—	—	M10	M4	M4
55	37	30	11, 15	225S	320	500	277	225	446	178	143	446	—	145	533	(592)	932	428	—	342	149	—	—	432	65m6	—	—	—	M10	M4	M4

- Note) 1. Install the motor on the floor and use it with the shaft horizontal.  
 2. Leave an enough clearance between the fan suction port and wall to ensure adequate cooling. Also, check that the ventilation direction of a fan is from the opposite load side to the load side.  
 3. The size difference of top and bottom of the shaft center height is 0.5.  
 4. The 400V class motor has -H at the end of its type name.

Dedicated motor outline dimension drawings (standard horizontal type with brake)

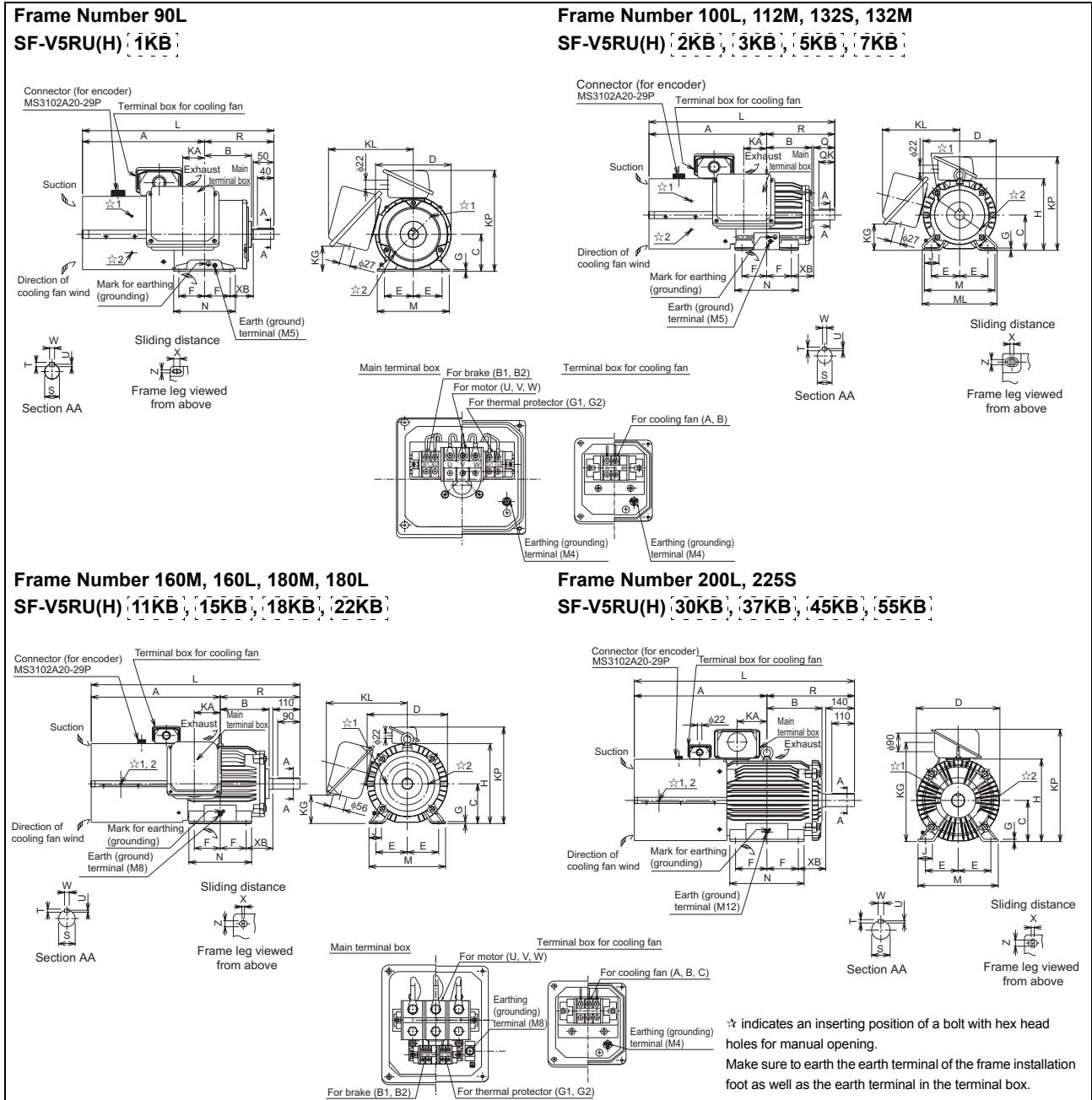

Dimensions table

(Unit: mm)

SF-V5RU KB (kW)	SF-V5RU KB1 (kW)	SF-V5RU KB3 (kW)	SF-V5RU KB4 (kW)	Frame No.	Mass (kg)	Motor																			Shaft End										Terminal Screw Size			
						A	B	C	D	E	F	G	H	I	J	KA	KD	KG	KL	KP	L	M	ML	N	X	XB	Z	Q	QK	R	S	T	U	W	U/VW	A8,G	G1,G2	B1,B2
1	—	—	—	90L	29	296.5	114	90	183.6	70	62.5	4	—	—	53	27	65	220	245	465	175	—	150	15	56	9	50	40	168.5	246	7	4	8	M6	M4	M4	M4	
2	1	—	—	100L	46	333.5	128	100	207	80	70	6.5	—	—	40	65	27	78	231	265	526.5	200	212	180	4	63	12	60	45	193	286	7	4	8	M6	M4	M4	M4
3	2	1	—	112M	53	355	135	112	228	95	70	6.5	—	—	40	69	27	93	242	290	555	230	242	180	4	70	12	60	45	200	286	7	4	8	M6	M4	M4	M4
5	3	2	—	132S	70	416	152	132	266	108	70	6.5	—	—	40	75	27	117	256	329	655	256	268	180	4	89	12	80	63	239	386	8	5	10	M6	M4	M4	M4
7	5	3	1	132M	80	435	171	132	266	108	89	6.5	—	—	40	94	27	117	256	329	693	256	268	218	4	89	12	80	63	258	386	8	5	10	M6	M4	M4	M4
11	7	5	2	160M	140	522.5	198	160	318	127	105	8	—	—	50	105	56	115	330	391	845.5	310	—	254	4	108	14.5	110	90	323	426	8	5	12	M8	M4	M4	M4
15	11	7	3	160L	155	544.5	220	160	318	127	127	8	—	—	50	127	56	115	330	391	889.5	310	—	298	4	108	14.5	110	90	345	426	8	5	12	M8	M4	M4	M4
18	—	—	—	180M	185	588.5	225.5	180	363	139.5	120.5	8	—	—	50	127	56	139	352	428	920	335	—	285	4	121	14.5	110	90	351.5	486	9	5.5	14	M8	M4	M4	M4
22	15	11	—	180M	215	644.5	267.5	200	406	159	152.5	11	—	—	70	145	90	487	—	546	1070	390	—	361	4	133	18.5	140	110	425.5	606	11	7	18	M10	M4	M4	M4
30	—	—	7	200L	305	644.5	267.5	200	406	159	152.5	11	—	—	70	145	90	487	—	546	1070	390	—	361	4	133	18.5	140	110	425.5	606	11	7	18	M10	M4	M4	M4
30, 45	22, 30	18, 22	—	200L	330	644.5	267.5	200	406	159	152.5	11	—	—	70	145	90	487	—	546	1070	390	—	361	4	133	18.5	140	110	425.5	606	11	7	18	M10	M4	M4	M4
55	37	30	11, 15	225S	395	659	277	225	446	178	143	11	—	—	70	145	90	533	—	592	1091	428	—	342	4	149	18.5	140	110	432	656	11	7	18	M10	M4	M4	M4

- Note) 1. Install the motor on the floor and use it with the shaft horizontal.  
 2. Leave an enough clearance between the fan suction port and wall to ensure adequate cooling. Also, check that the ventilation direction of a fan is from the opposite load side to the load side.  
 3. The size difference of top and bottom of the shaft center height is  $\pm 0.5$ .  
 4. The 400V class motor has -H at the end of its type name.  
 5. Since a brake power device is a stand-alone, install it inside the enclosure. (This device should be arranged at the customer side.)

# Outline dimension drawings

## Dedicated motor outline dimension drawings (flange type)

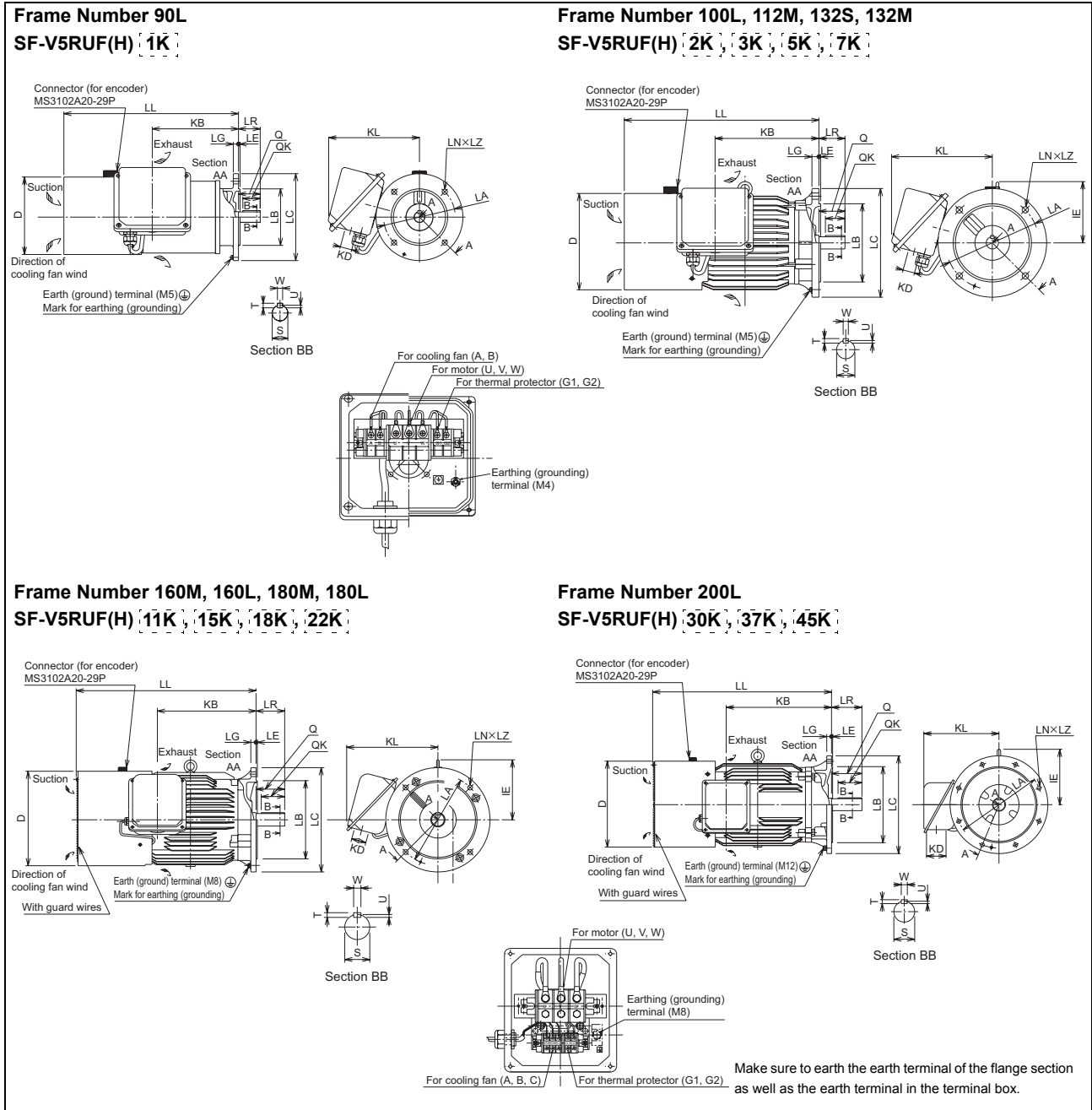

### Dimensions table

(Unit: mm)

SF-V5RU KF (kW)	SF-V5RU KF1 (kW)	SF-V5RU KF3 (kW)	SF-V5RU KF4 (kW)	Flange Number	Frame No.	Mass (kg)	Motor																Shaft End						Terminal Screw Size	
							D	IE	KB	KD	KL	LA	LB	LC	LE	LG	LL	LN	LZ	LR	Q	QK	S	T	U	W	U,V,W	A,B,C	G1,G2	
1	—	—	—	FF165	90L	26.5	183.6	—	198.5	27	220	165	130j6	200	3.5	12	402	4	12	50	50	40	24j6	7	4	8	M6	M4	M4	
2	1	—	—	FF215	100L	37	207	130	213	27	231	215	180j6	250	4	16	432	4	14.5	60	60	45	28j6	7	4	8	M6	M4	M4	
3	2	1	—	FF215	112M	46	228	141	239	27	242	215	180j6	250	4	16	448	4	14.5	60	60	45	28j6	7	4	8	M6	M4	M4	
5	3	2	—	FF285	132S	65	266	156	256	27	256	265	230j6	300	4	20	484	4	14.5	80	80	63	38k6	8	5	10	M6	M4	M4	
7	5	3	1	FF285	132M	70	266	156	294	27	256	265	230j6	300	4	20	522	4	14.5	80	80	63	38k6	8	5	10	M6	M4	M4	
11	7	5	2	FF300	160M	110	318	207	318	56	330	300	250j6	350	5	20	625	4	18.5	110	110	90	42k6	8	5	12	M8	M4	M4	
15	11	7	3	FF300	160L	125	318	207	362	56	330	300	250j6	350	5	20	669	4	18.5	110	110	90	42k6	8	5	12	M8	M4	M4	
18	—	—	—	FF350	180M	160	363	230	378.5	56	352	350	300j6	400	5	20	690	4	18.5	110	110	90	48k6	9	5.5	14	M8	M4	M4	
22	15	11	—	FF350	180L	185	363	230	416.5	56	352	350	300j6	400	5	20	728	4	18.5	110	110	90	55m6	10	6	16	M8	M4	M4	
—	18	15	5	FF350	180L	225	363	230	416.5	56	352	350	300j6	400	5	20	728	4	18.5	110	110	90	55m6	10	6	16	M8	M4	M4	
30	—	—	7	FF400	200L	270	406	255	485	90	346	400	350j6	450	5	22	823.5	8	18.5	140	140	110	60m6	11	7	18	M10	M4	M4	
37, 45	22, 30	18, 22	—	FF400	200L	290	406	255	485	90	346	400	350j6	450	5	22	823.5	8	18.5	140	140	110	60m6	11	7	18	M10	M4	M4	

- Note) 1. Install the motor on the floor and use it with the shaft horizontal.  
For use under the shaft, the protection structure of the cooling fan is IP20.
- Leave an enough clearance between the fan suction port and wall to ensure adequate cooling.  
Also, check that the ventilation direction of a fan is from the opposite load side to the load side.
  - The size difference of top and bottom of the shaft center height is  $\pm 0.5$ .
  - The 400V class motor has -H at the end of its type name.

Dedicated motor outline dimension drawings (flange type with brake)

**Frame Number 90L**  
**SF-V5RUF(H) [1KB]**

**Frame Number 100L, 112M, 132S, 132M**  
**SF-V5RUF(H) [2KB] [3KB] [5KB] [7KB]**

**Frame Number 160M, 160L**  
**SF-V5RUF(H) [11KB] [15KB]**

☆ indicates an inserting position of a bolt with hex head holes for manual opening.

Make sure to earth the earth terminal of the flange section as well as the earth terminal in the terminal box.

Dimensions table

(Unit: mm)

SF-V5RU KFB Output (kW)	SF-V5RU KFB1 Output (kW)	SF-V5RU KFB3 Output (kW)	SF-V5RU KFB4 Output (kW)	Flange Number	Frame No.	Mass (kg)	Motor													Shaft End					Terminal Screw Size					
							D	KB	KD	KL	KP	LA	LB	LC	LE	LG	LL	LN	LZ	LR	Q	QK	S	T	U	W	U,V,W	A,B,C	B1,B2	G1,G2
1	—	—	—	FF165	90L	31.5	183.6	198.5	27	220	155	165	130j6	200	3.5	12	442	4	12	50	50	40	24j6	7	4	8	M6	M4	M4	M4
2	1	—	—	FF215	100L	50	207	213	27	231	165	215	180j6	250	4	16	481.5	4	14.5	60	60	45	28j6	7	4	8	M6	M4	M4	M4
3	2	1	—	FF215	112M	58	228	239	27	242	178	215	180j6	250	4	16	525	4	14.5	60	60	45	28j6	7	4	8	M6	M4	M4	M4
5	3	2	—	FF265	132S	83	266	256	27	256	197	265	230j6	300	4	20	597	4	14.5	80	80	63	38k6	8	5	10	M6	M4	M4	M4
7	5	3	1	FF265	132M	88	266	294	27	256	197	265	230j6	300	4	20	635	4	14.5	80	80	63	38k6	8	5	10	M6	M4	M4	M4
11	7	5	2	FF300	160M	151	318	318	56	330	231	300	250j6	350	5	20	735.5	4	18.5	110	110	90	42k6	8	5	12	M8	M4	M4	M4
15	11	7	3	FF300	160L	167	318	362	56	330	231	300	250j6	350	5	20	779.5	4	18.5	110	110	90	42k6	8	5	12	M8	M4	M4	M4

- Note) 1. Install the motor on the floor and use it with the shaft horizontal.  
 For use under the shaft, the protection structure of the cooling fan is IP20.  
 2. Leave an enough clearance between the fan suction port and wall to ensure adequate cooling.  
 Also, check that the ventilation direction of a fan is from the opposite load side to the load side.  
 3. The size difference of top and bottom of the shaft center height is  $\pm 0.5$ .  
 4. The 400V class motor has -H at the end of its type name.  
 5. Since a brake power device is a stand-alone, install it inside the enclosure.  
 (This device should be arranged at the customer side.)

# APPENDICES

## Appendix 1 Instructions for Compliance with the European Directives

(The products conforming to the Low Voltage Directive carry the CE mark.)

### (1) EMC Directive

- 1) Our view of vector inverters for the EMC Directive  
A vector inverter is a component designed for installation in a control box and for use with the other equipment to control the equipment/device. Therefore, we understand that the EMC Directive does not apply directly to vector inverters. For this reason, we do not place the CE mark on the vector inverters. (The CE mark is placed on inverters in accordance with the Low Voltage Directive.) The European power drive manufacturers' organization (CEMEP) also holds this point of view.
- 2) Compliance  
We understand that the vector inverters are not covered directly by the EMC Directive. However, the EMC Directive applies to machines/equipment into which vector inverters have been incorporated, and these machines and equipment must carry the CE marks. Hence, we prepared the European Standard-compliant noise filters and the technical information "EMC Installation Guidelines" (information number BCN-A21041-202) so that machines and equipment incorporating vector inverters may conform to the EMC Directive more easily.
- 3) Excerpts from the installation method  
It is recommended to mainly use the following methods to install an inverter:
  - \* Use the inverter with an European Standard-compliant noise filter.
  - \* For wiring between the inverter and motor, use shielded cables or run them in a metal piping and earth (ground) the cables on the inverter and motor sides with the shortest possible distance.
  - \* Insert line noise filters and ferrite cores into the power and control lines as required.
 Full information including the European Standard-compliant noise filter specifications are written in the technical information "EMC Installation Guidelines" (information number BCN-A21041-202). Please contact your sales representative.

### (2) Low Voltage Directive

- 1) Our view of vector inverters for the Low Voltage Directive  
Vector inverters are covered by the Low Voltage Directive (Compliant with Standard EN 50178).
- 2) Compliance  
We have self-declared our inverters to be compliant with the Low Voltage Directive and place the CE mark on the inverters.
- 3) Excerpts from instructions
  - \* In the 400V class inverters, the rated input voltage range is three-phase, 380V to 415V, 50/60Hz.
  - \* Earth (Ground) the equipment securely. Do not use an earth leakage circuit breaker as an electric shock protector without earthing (grounding) the equipment.
  - \* Wire the earth terminal independently. (Do not connect two or more cables to one terminal.)
  - \* Use the wire sizes given on pages 19 and 11 under the following conditions:
    - Ambient temperature: 40°C maximum
    - Wire installation: 200V, 15kW or less, with conduits  
200V, 18.5kW or more, on wall without ducts or conduits  
400V, 18.5kW or less, with conduits  
400V, 22kW or more, on wall without ducts or conduits
 If conditions are different, select the appropriate wires according to EN60204, ANNEX C, TABLE 5.
  - \* Use the moulded case circuit breaker and magnetic contactor that conform to the EN or IEC Standard.
  - \* Use the breaker of type B (breaker that can detect both AC and DC). If not, provide double or enhanced insulation between the inverter and other equipment, or put a transformer between the main power supply and inverter.
  - \* Use the inverter under the conditions of overvoltage category II and contamination level 2 or lower specified set forth in IEC664.
    - (a) To meet the overvoltage category II, insert an EN or IEC Standard-compliant insulating transformer or surge absorber in the input of the inverter.
    - (b) To meet the contamination level 2, install the inverter in a control box protected against ingress of water, oil, carbon, dust, etc. (IP54 or higher).
  - \* In the input and output of the inverter, use cables of the type and size set forth in EN60204 Appendix C.
  - \* The operating capacity of the relay outputs (terminal symbols A, B, C) should be 30VDC, 0.3A.  
(The relay outputs are basically isolated from the inverter internal circuits.)
  - \* Control circuit terminals on pages 7 are safely isolated from the main circuit.
  - \* Environment

	During Operation	In Storage	During Transportation
Ambient temperature	-10°C to +50°C	-20°C to +65°C	-20°C to +65°C
Humidity	90%RH or less	90%RH or less	90%RH or less
Altitude	1000m	1000m	10,000m

Details are given in the technical information "Low Voltage Directive Conformance Guide" (information number BCN-A21041-203). Please contact your sales representative.

## Appendix2 Instructions for UL and cUL

(Conformance Standard UL 508C, CSA C22.2 No. 14)

### (1) Installation

The FR-V500 is UL-listed as a product for use in an enclosure. Design an enclosure so that the ambient temperature, humidity and atmosphere of the inverter will satisfy the specifications. (Refer to page 6.)

#### Branch circuit protection

For installation in the United States, branch circuit protection must be provided in accordance with the National Electrical Code and any applicable local codes.

For installation in Canada, branch circuit protection must be provided in accordance with the Canada Electrical Code and any applicable provincial codes.

### (2) Wiring of power supply and motor

For wiring the input (R, S, T) and output (U, V, W) terminals of the inverter, use the UL-recognized copper wires (rated at 75°C) and round crimping terminals. To crimp the crimping terminals, use the crimping tool recommended by the terminal maker.

### (3) Short circuit ratings

- 200V class  
Suitable For Use in A Circuit Capable of Delivering Not More Than 100kA rms Symmetrical Amperes, 264V Maximum.
- 400V class  
Suitable For Use in A Circuit Capable of Delivering Not More Than 100kA rms Symmetrical Amperes, 528V Maximum.

### (4) Motor overload protection

These inverters provide solid state motor overload protection.

Set parameter 9 using the following instructions (Pr. 9 "electronic thermal O/L relay").

Parameter	Name	Factory Setting	Setting Range	Remarks
9	Electronic thermal O/L relay	0	0 to 500A	Extended mode
452	Second electronic thermal O/L relay	9999	0 to 500A, 9999	Extended mode 9999: Without second electronic thermal relay function
876	Thermal relay protector input	1	0, 1	Extended mode

### <Setting>

- When not using an external thermal relay, set the rated current value [A] of the motor in Pr. 9 (Pr. 452) to make the electronic thermal relay function valid.  
(Normally set the rated current value at 50Hz. When the rated current value of 50Hz is not indicated on the name plate, set the value obtained from multiplying the rated current value of 60Hz by 1.1.)
- Setting "0" in Pr. 9 (Pr. 452) deactivates the electronic thermal relay function (motor protective function). (The inverter's output transistor protective function is activated.)
- When using a Mitsubishi constant-torque motor
  - Set "10" in Pr. 71 "applied motor" to select the 100% continuous torque characteristic in the low speed range.
  - Set the rated current of the motor in Pr. 9 "electronic thermal O/L relay".
- The electronic thermal relay function of the second motor (Pr. 452 "second electronic thermal O/L relay" is made valid by: Turning on the RT signal; and Setting other than 9999 in Pr. 450.  
(The value set in Pr. 9 is valid when Pr. 452 = 9999.)
- Use Pr. 876 to select with or without an external thermal relay.

### CAUTION

- When two or more motors are connected to the inverter under V/F control, they cannot be protected by the electronic thermal relay function. Install an external thermal relay to each motor.
- When a difference between the inverter and motor capacities is large and the setting is small, the protective characteristics of the electronic thermal relay function will be deteriorated. In this case, use an external thermal relay.
- A special motor cannot be protected by the electronic thermal relay function. Use an external thermal relay.

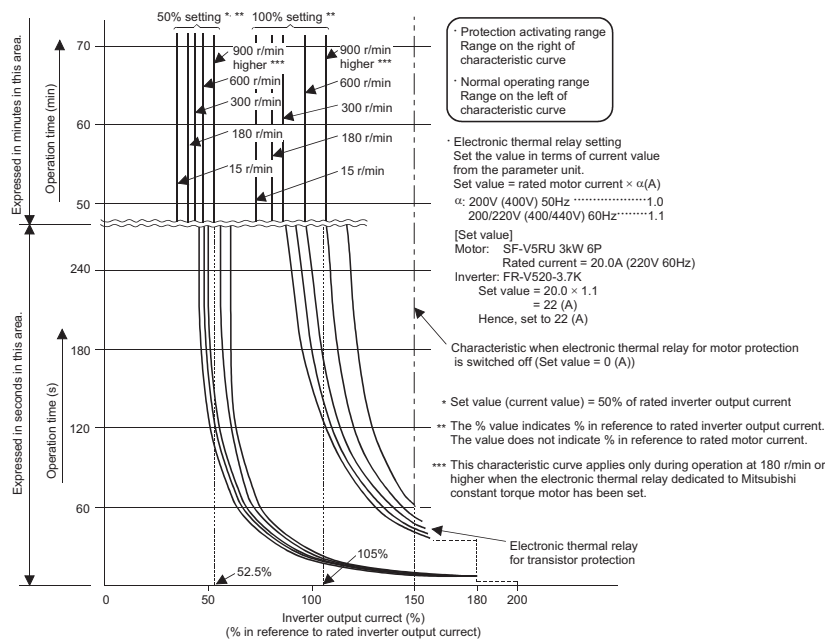

REVISIONS

\* The manual number is given on the bottom left of the back cover.

Print Date	* Manual Number	Revision
Oct., 2001	IB(NA)-0600064-A	First edition
Mar., 2002	IB(NA)-0600064-B	<p><b>Addition</b></p> <p>Three-phase 400V power input specifications</p>
Sep., 2002	IB(NA)-0600064-C	<p><b>Partial additions</b></p> <ul style="list-style-type: none"> <li>• Addition of "28" to the setting range of Pr. 180 to Pr.183, Pr.187(input terminal function selection)</li> <li>• Addition of "39, 139" to the setting range of Pr. 190 to Pr.192, Pr.195(output terminal function selection)</li> <li>• Addition of "2" to the setting range of Pr. 288 "droop function operation selection"</li> <li>• Addition of "9999" to the setting range of Pr. 427 "excessive level error"</li> <li>• Instructions for Compliance with the European Directives</li> <li>• Instructions for Compliance with U.S and Canadian Electrical Codes</li> </ul>
Nov., 2003	IB(NA)-0600064-D	<ul style="list-style-type: none"> <li>• Error correction</li> </ul> <p><b>Addition</b></p> <ul style="list-style-type: none"> <li>• SF-V5RU</li> </ul>
Nov., 2006	IB(NA)-0600064-E	<p><b>Addition</b></p> <ul style="list-style-type: none"> <li>• Pr.408 "motor thermistor selection"</li> <li>• Pr.505 "speed setting reference"</li> <li>• Addition of "9" to the setting range of Pr. 800 "control method selection".</li> <li>• Addition of "5, 6" to the setting range of Pr. 804 "torque command source selection".</li> <li>• Pr.811 "set resolution switchover"</li> </ul> <p><b>Partial modifications</b></p> <ul style="list-style-type: none"> <li>• Settings of Pr.3 "base frequency" and Pr. 84 "rated motor frequency" were changed to "10 to 200Hz"</li> <li>• Short circuit ratings (Instructions for UL and cUL compliance)</li> </ul>

 **For Maximum Safety**

- Mitsubishi vector inverters are not designed or manufactured to be used in equipment or systems in situations that can affect or endanger human life.
- When considering this product for operation in special applications such as machinery or systems used in passenger transportation, medical, aerospace, atomic power, electric power, or submarine repeating applications, please contact your nearest Mitsubishi sales representative.
- Although this product was manufactured under conditions of strict quality control, you are strongly advised to install safety devices to prevent serious accidents when it is used in facilities where breakdowns of the product are likely to cause a serious accident.
- Please do not use this product for loads other than three-phase induction motors.