



VECTOR INVERTER

-INSTRUCTION MANUAL-

ETHERNET COMMUNICATION OPTION

FR-V5NE-E

Thank you for choosing the Mitsubishi inverter option unit.

This instruction manual gives handling information and precautions for use of this equipment. Incorrect handling might cause an unexpected fault. Before using the equipment, please read this manual carefully to use the equipment to its optimum.

Please forward this manual to the end user.

This section is specifically about safety matters

Do not attempt to install, operate, maintain or inspect this product until you have read through this instruction manual and appended documents carefully and can use the equipment correctly. Do not use this product until you have a full knowledge of the equipment, safety information and instructions.

In this instruction manual, the safety instruction levels are classified into "WARNING" and "CAUTION".



Assumes that incorrect handling may cause hazardous conditions, resulting in death or severe injury.



Assumes that incorrect handling may cause hazardous conditions, resulting in medium or slight injury, or may cause physical damage only.

Note that the CAUTION level may lead to a serious consequence according to conditions. Please follow the instructions of both levels because they are important to personnel safety.

SAFETY INSTRUCTIONS

1. Electric Shock Prevention

WARNING

- While power is on or when the inverter is running, do not open the front cover. You may get an electric shock.
- Do not run the inverter with the front cover removed. Otherwise, you may access the exposed high-voltage terminals and charging part and get an electric shock.
- Even if power is off, do not remove the front cover except for wiring or periodic inspection. You may access the charged inverter circuits and get an electric shock.
- Before starting wiring or inspection, switch power off, wait for more than 10 minutes, and check for no residual voltage with a tester or the like.

 **WARNING**

- Any person who is involved in the wiring or inspection of this equipment should be fully competent to do the work.
- Always install the option unit before wiring. Otherwise, you may get an electric shock or be injured.
- Handle this option unit with dry hands to prevent an electric shock.
- Do not subject the cables to scratches, excessive stress, heavy loads or pinching. Otherwise, you may get an electric shock.

2. Injury Prevention

 **CAUTION**

- While power is on or for some time after power-off, do not touch the inverter as it is hot and you may get burnt.

3. Additional instructions

Also note the following points to prevent an accidental failure, injury, electric shock, etc.:

(1) Transportation and mounting

 **CAUTION**

- Do not install or operate the option unit if it is damaged or has parts missing.
- Do not stand or rest heavy objects on the product.
- Check that the mounting orientation is correct.
- Prevent screws, metal fragments or other conductive bodies or oil or other flammable substance from entering the inverter.

(2) Test operation and adjustment

 **CAUTION**

- Before starting operation, confirm and adjust the parameters. A failure to do so may cause some machines to make unexpected motions.

(3) Usage



WARNING

- Do not modify the equipment.



CAUTION

- When parameter clear or all parameter clear is performed, each parameter returns to the factory setting. Re-set the required parameters before starting operation.
- For prevention of damage due to static electricity, touch nearby metal before touching this product to eliminate static electricity from your body.

(4) Maintenance, inspection and parts replacement



CAUTION

- Do not test the equipment with a megger (measure insulation resistance).

(5) Disposal



CAUTION

- Treat as industrial waste.

(6) General instruction

All illustrations given in this manual may have been drawn with covers or safety guards removed to provide in-depth description. Before starting operation of the product, always return the covers and guards into original positions as specified and operate the equipment in accordance with the manual.

CONTENTS

1.PRE-OPERATION INSTRUCTIONS	1
1.1 Unpacking and Product Confirmation	1
1.2 Packing Confirmation	1
1.3 Structure	2
2.INSTALLATION	3
2.1 Pre-Installation Instructions.....	3
2.2 Installation	3
2.3 Removal.....	5
3. OPERATION OVERVIEW	6
3.1 System Configuration.....	6
3.2 Cable Specification	7
3.3 Precautions for System Configuration	7
3.4 General Procedure.....	8
4. INVERTER SETTING	9
4.1 Communication Parameter List.....	9
4.1.1 Parameters	10
4.2 Inverter Operation Mode	11
5. FUNCTION OVERVIEW	12
5.1 Software Specifications.....	13
5.1.1 Software configuration	13
6. SOFTWARE START AND SCREEN DESCRIPTION	14

6.1	Software Start	14
6.1.1	Login	14
6.2	Main Screen	15
6.2.1	Functions	16
6.2.2	Parameter setting.....	16
6.2.3	Parameter No and range	16
6.2.4	Parameter setting button.....	16

7. PARAMETER SETTING **17**

7.1	Parameter Setting on All List Format Page.....	18
7.2	Parameter Setting on Functional List Format Page	19
7.3	Parameter Setting on Individual List Format Page	21
7.4	Parameter Setting on Basic Settings Page.....	23
7.5	DA1/DA2 Calibration.....	25
7.6	Bias/Gain of Speed Setting Voltage (Current)	26

8. PARAMETER FUNCTION BUTTONS **29**

8.1	Change List.....	29
8.2	Parameter Initialization	30
8.3	Block Read/Block Write	31
8.4	Save.....	32
8.5	Upload and Change Value Display	33

9. MONITORING **34**

9.1	Monitor List	34
9.2	Data Display.....	35
9.3	Meter Display	37
9.4	Oscilloscope.....	39
9.5	Alarm History	43

10. DIAGNOSTICS	44
10.1 VFD Status.....	44
10.2 Diagnostics	45
11. MAIL SETTING	46
12.ERROR CODES	47
12.1 Error Code Lists	47
APPENDIX	48
Inverter Operation Mode	48

MEMO

1. PRE-OPERATION INSTRUCTIONS

1.1 Unpacking and Product Confirmation

Take the option unit out of the package, check the unit name, and confirm that the product is as you ordered and intact.

This product is an inboard option unit designed for exclusive use in the Mitsubishi FR-V500 series vector inverter. Before using it, check the type and SERIAL number of the inverter.

- SERIAL number check
 - This product may be used with the FR-V500 series manufactured in and after July 2002. Any of the models may be used with this unit if its SERIAL number indicated on the rating plate and package has "O27OOOOOO" or later version. For details on the SERIAL number, please contact your sales representative.

SERIAL is made up of 1 version symbol, 1 alphabet letter or numeric character indicating month, and 7 numeric characters indicating year and control number as shown below. (Only the first three digits of the control number are printed on the package.)

Symbol Year Month Control number
SERIAL number

1.2 Packing Confirmation

Make sure that the package includes the following

- Instruction manual 1
- Mounting screws M3 × 10 2 (Refer to page 3.)
- Ferrite core 1 (Refer to page 6.)
- Dedicated option cover 1 (Refer to page 3.)

- Windows is a registered trademark of Microsoft Corporation in the United States and other countries.
- Netscape Communications is a registered trademark of Netscape Communications Corporation.
- Internet Explorer is a registered trademark of Microsoft Corporation in the United States and other countries.
- Ethernet is a registered trademark of Xerox Co. Ltd.
- No part of this manual may be copied or reproduced without the permission of Mitsubishi Electric Corporation.
- Other product and company names herein may be either trademarks or registered trademarks of their respective owners.

1.3 Structure

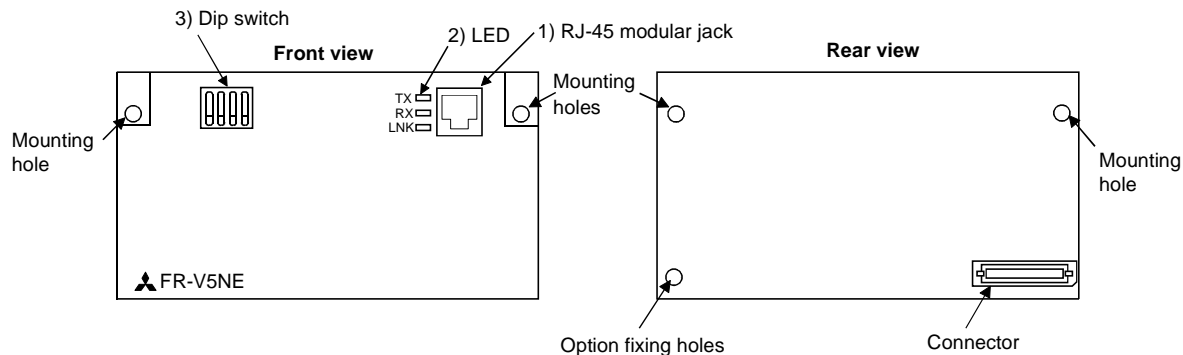

Name		Function	
1)	RJ-45 modular jack	Connect the 10BASE-T cable for Ethernet communication to make communication with a personal computer.	
2)	LED	TX	Lit during send operation.
		RX	Lit during receive operation.
		LNK	Indicate the connection status of the Ethernet cable, option board, etc. Lit when they are properly connected.
3)	Dip Switch	Switches set by the manufacturer. Do not change. (All switches are factory-set to the LOW side. Check for correct setting.)	

2.INSTALLATION

2.1 Pre-Installation Instructions

Make sure that the input power of the inverter is off.

 **CAUTION**

 **With input power on, do not install or remove the option unit. Otherwise, the inverter and option unit may be damaged.**

2.2 Installation

- (1) Remove the inverter front cover referring to the inverter manual.
- (2) Install the option unit to Slot 3.
- (3) Insert the option unit connector into the Slot 3 connector of the inverter securely. At this time, also insert the option fixing holes securely.
Refer to the following diagram for the position of Slot 3. Push the option unit securely into the option fixing hook.
- (4) Fix the two right and left places of the option unit to the inverter securely with the accessory mounting screws. If the screw holes do not line-up, the connector may not have been inserted securely. Check for insecure insertion.
- (5) Remove the option wiring port cover (DATA PORT) from the inverter front cover by pushing it from the back of the front cover, then fit the dedicated option cover on the front cover and reinstall the front cover.

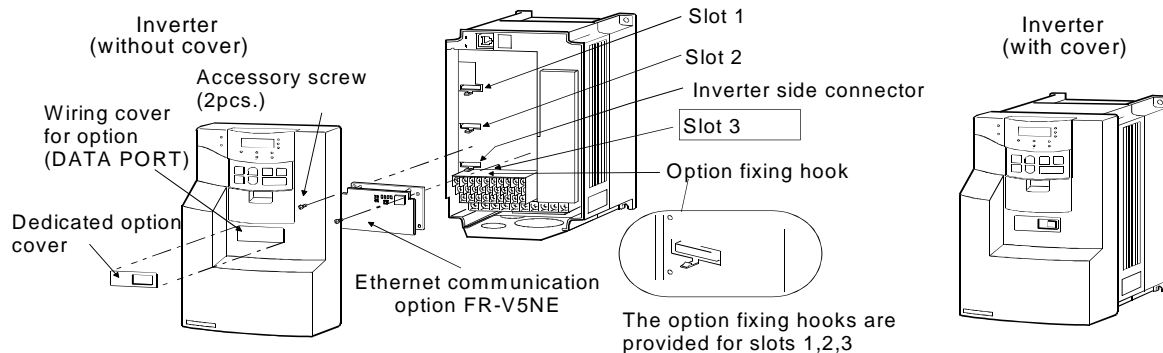

⚠ CAUTION

⚠ When installing the inverter front cover, the cables to the inverter's control circuit terminals and option terminals should be routed properly in the wiring space to prevent them from being caught between the inverter and its cover.

2.3 Removal

- (1) How to remove the control circuit terminal block
Loosen the two mounting screws in both ends of the control circuit terminal block. (The screws cannot be removed.) Pull down the terminal block from the back of the control circuit terminals by one hand.

terminal block fixing screw

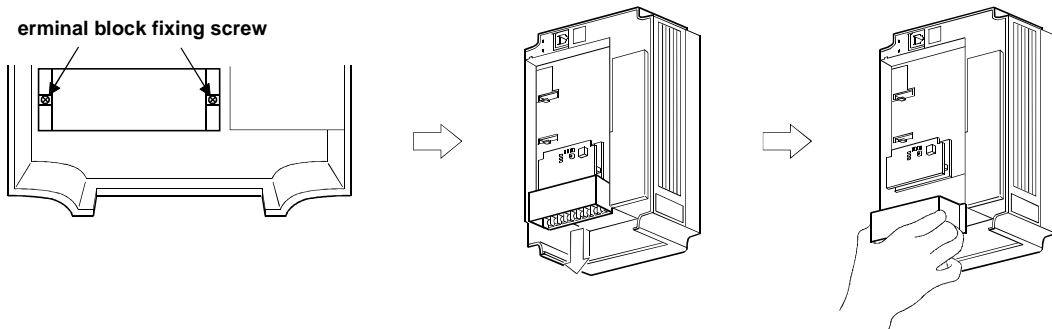

- (2) After removing two screws on the right and left places, hold the option unit and pull the lower part upward as shown below. (The option unit is attached with the inverter hooks.)

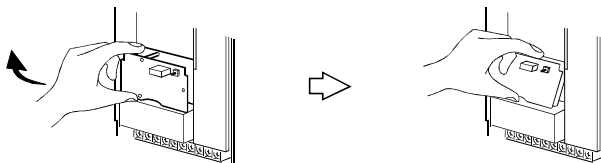

3. OPERATION OVERVIEW

By fitting the Ethernet communication option (FR-V5NE) to the FR-V500 series inverter, you can perform parameter setting, monitoring, diagnostics and mail send/receive efficiently via a LAN using a Web browser.

3.1 System Configuration

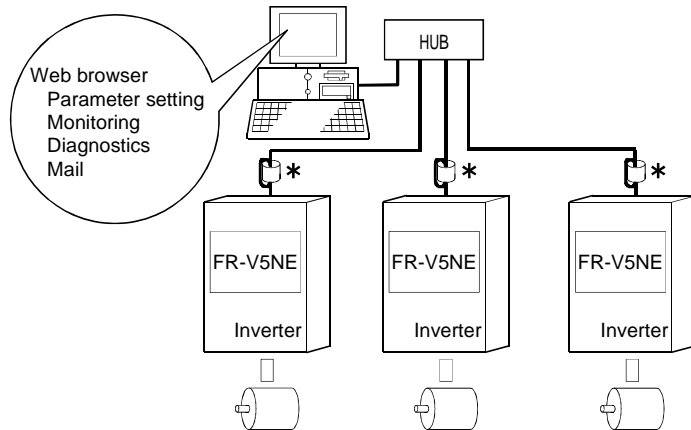

Operating environment

Web browser:

Netscape Communicator Ver. 6.0 or later
or Internet Explorer Ver. 5.5 or later

(When using Windows 2000, Netscape
Communicator Ver. 4.7 or later is compatible.)

OS: Windows operating system under which
the Web browser runs

CAUTION

You cannot construct a network where a
router is located on the host network.

Screen: Resolution 800 x 600 or more, color
display of 256 or more display color

*Use enclosed ferrite cores to prevent noises from
the inverter from affecting Ethernet communication.
Wind the ferrite core around the LAN cable one
time.

CAUTION

When the inverter installed on a cart, etc. is
affected by vibration, perform wiring in such a way
that the ferrite cores are secured.

3.2 Cable Specification

Connect the option unit (FR-V5NE) to the Ethernet using the LAN cable indicated below.

Cable used: Use cables whose category is TPCC3 (Twisted Pair Communication Cable for LAN Category 3) or higher and shape is UTP(Unshielded Twisted Pair). (according to the 10BASE-T(IEEE802.3) standard)

Maximum wiring length: The maximum length between HUB and card is 100m. (according to the 10BASE-T(IEEE802.3) standard)

3.3 Precautions for System Configuration

- 1) Access to the Internet must be fully safeguarded.
Consult the network access provider, Internet service provider or network manager (person who does network planning, IP address management, etc.).
We have no liability for any system problems that occur at the time of access to the Internet.
- 2) Pr. 466 "password" (Refer to page 10.) is the password used only to log in to the inverter, and does not prevent illegal access completely. Take other preventive measures when safety must be secured.

3.4 General Procedure

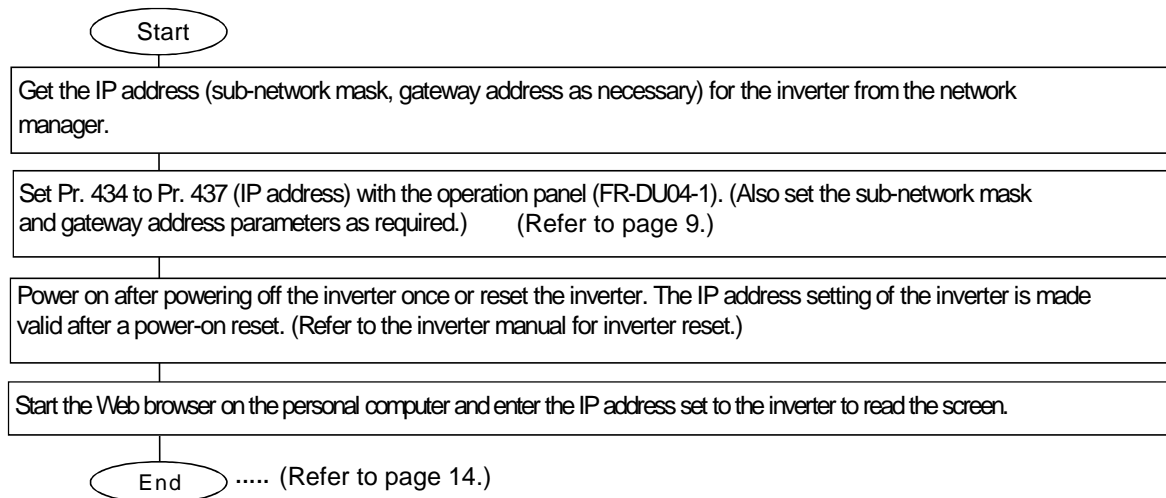

4. INVERTER SETTING

4.1 Communication Parameter List

Fitting the FR-V5NE to the inverter enables the following parameters to be set. Use the PU (FR-DU04-1/FR-PU04V) to set them.

You cannot make access from the personal computer without setting the following parameters.

For the addresses, consult the network manager (person who does network planning, IP address management, etc.).

POINT

The IP address setting of the inverter is valid after a power-on reset. After setting the following parameters, make an inverter reset once. (Making PU reset or terminal reset also makes the setting valid.)

- When using the PU for setting, select the PU operation mode.

Parameter Number	Name	Factory Setting	Setting Range	Minimum Setting Increments
434	IP address 1	0	0 to 255	1
435	IP address 2	0	0 to 255	1
436	IP address 3	0	0 to 255	1
437	IP address 4	0	0 to 255	1
438	Sub-network mask 1	0	0 to 255	1
439	Sub-network mask 2	0	0 to 255	1
440	Sub-network mask 3	0	0 to 255	1
441	Sub-network mask 4	0	0 to 255	1
442	Gateway address 1	0	0 to 255	1
443	Gateway address 2	0	0 to 255	1
444	Gateway address 3	0	0 to 255	1
445	Gateway address 4	0	0 to 255	1
446	Password	0	0 to 9999	1

4.1.1 Parameters

(1) Pr. 434 to Pr. 437 (IP address)

Set the IP address of the FR-V5NE. (Set the IP address that was assigned by the sub-network manager.)

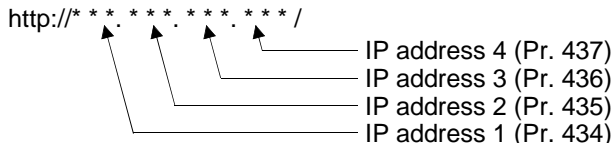

(2) Pr. 438 to Pr. 441 (sub-network mask)

Set these parameters when there is an address block (sub-network) where the IP address of the FR-V5NE belongs.

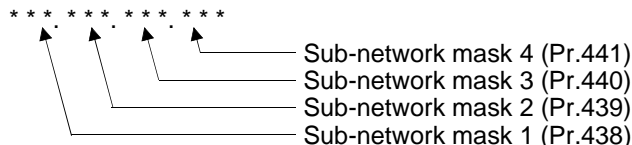

(3) Pr. 442 to Pr. 445 (gateway address)

Set the address when the network of a different host is used.

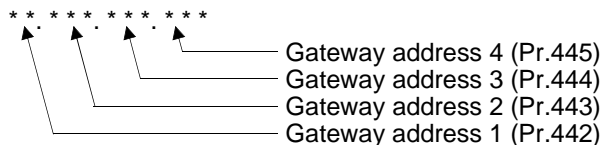

(4) Pr. 446 "password"

Set the password in four digits. Use it when logging in to the inverter.

4.2 Inverter Operation Mode

Change the operation mode to the network operation mode to write, initialize, or reset parameters with the FR-V5NE. When changing to the network operation mode, set "0, 2, 6, 7, or 8" in Pr. 79 to change to the external operation mode. (It is not necessary to set Pr. 79 in the factory-set condition. Parameter reading and monitoring with Ethernet software can be performed in any operation mode.)

- (1) Switch over with Ethernet software
After starting of Ethernet software, select network operation mode by the operation mode switching button. (Refer to page 15.)
- (2) Pr. 340 "link startup mode selection"
Power on the inverter in the network operation mode with "1" set in Pr. 340. (Refer to page 50.)

REMARKS

Refer to Appendix " Inverter operation mode" for the inverter operation mode.

5. FUNCTION OVERVIEW

You can perform the following functions efficiently using the Web browser of the personal computer.

Parameter setting function	All list format	Displays the names, setting ranges and factory settings of all parameters in a list format so that the parameters are read or written.
	Function-by-function list format	Displays the parameters on a function-by-function basis so that the parameters are read or written.
	Individual list format	Lists the user-selected parameters so that the parameters are read or written.
	Simple setting	Sets the parameters automatically when you enter the items necessary for operation, e.g. motor capacity and rated current, without a need to know the specific parameters.
Monitoring	Data display	Displays the data and maximum values of the items, which were selected to be monitored, at fixed intervals.
	Meter display	Displays the monitor data and maximum values of the items, which were selected to be monitored, in the form of analog meters.
	Oscilloscope	Samples and graphs data.
	Alarm history	Batch-displays the alarm history.
Diagnostics	VFD status	Monitors the output current, output voltage, etc. at fixed intervals and displays them as values or %.
	Diagnostics	Displays the definition of the latest alarm and the output speed, current, voltage and energization time at alarm occurrence.
Mail		Sends the alarm definition by mail when an alarm occurs.

5.1 Software Specifications

5.1.1 Software configuration

In Ethernet communication, the software consists of the applet program, servlet program and inverter communication program as shown below. **Start operation after enabling JavaScript on the used Web browser.**

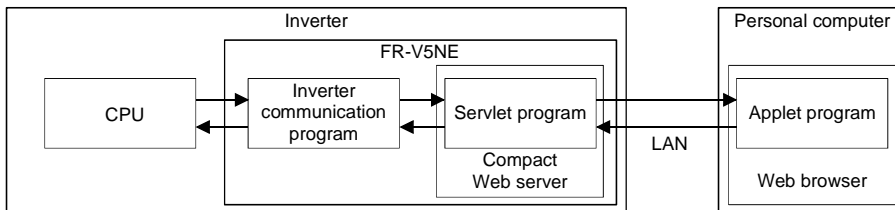

- (1) Applet program
Runs on the Web browser of the computer.
Specifying the URL of the FR-V5NE on the Web browser of the personal computer loads the applet program (Java program) from the compact Web server of the FR-V5NE to the Web browser of the personal computer.
By GUI operation, the applet program sends a data request to, or receives data from, the servlet program of the FR-V5NE via the HTTP connection.
- (2) Servlet program
Runs on the compact Web server of the FR-V5NE.
This program receives a data request from the applet program, sends data to the applet program, requests the inverter communication program to perform inverter operation, or receives data from the inverter program, via the HTTP connection.
- (3) Inverter communication program
Communicates with the inverter CPU.
This program receives a data request from the servlet program, sends data to the servlet program, reads or writes the inverter parameters, or receives monitor data, for example.

6. SOFTWARE START AND SCREEN DESCRIPTION

6.1 Software Start

Start the Ethernet software by specifying the IP address of the FR-V5NE that was set in the parameters (Pr.434 to Pr.437) from the Web browser of the personal computer.

Enter the IP address into the Address field of the Web browser (Internet Explorer or Netscape Communicator) to open the title screen of the Ethernet software.



CAUTION

- At power-on or restart of the inverter, it will take several minutes to start the software. Starting time varies depending on the line condition.
- Note that clicking a browser change button will restart the V5NE.

6.1.1 Login

(1) Login dialog

Specifying the IP address (address set in Pr.434 to Pr.437) of the inverter (FR-V5NE) displays the title screen of the software.

Enter your user name and password.

User name..... Enter "freqrol".

Password..... Enter the password that was set in Pr. 446 of the inverter (FR-V5NE).

(Enter it in four digits. (Example: "0123"))



Login dialog

CAUTION

The setting of the inverter's IP address is made valid after a power-on reset.

6.2 Main Screen

When you login, the following screen appears.

5) → **FREQROL for Java (1.0) - Microsoft Internet Explorer**

File Edit View Favorites Tools Help

Back Forward Stop Refresh Home Search Favorites History Mail Print

Address http://10.97.39.54

1) → **FREQROL** 2) → EXT 3) → LNK EXT MITSUBISHI

6) → All list Format Functional List Format Individual List Format Basic Settings

7) → Parameter No Range

No	Name	Min. Setting	Unit	Factory Setting	Present Setting	Updated Val
0	Torque boost	0.1%		4.0		
				1500		
10	DC injection brake operation S					
11	DC injection brake operation time	0.1s		0.5		
12	DC injection brake voltage	0.1%		4.0		
13	Starting speed	0.1r/min		15.0		
15	Jog speed	0.1r/min		150.0		
16	Jog Acc/Dec time	0.1 / 0.01s		0.5		
17	MRS input selection	1		0		
19	Base frequency voltage	0.1V		9999		
20	Base frequency speed	1.0r/min		1000		

8) → Change List Pr Init Blk Read Read Blk Write Write Save Upload Chg Val Disp

4) → INFORMATION

CAUTION

Normally it takes 2 to 3 list to start the software. However, starting time varies depending on the line condition.

6.2.1 Functions

	Name	Description
1)	Function screen switchover	Used to switch between the function (parameter setting, monitoring, diagnostics, mail) displays.
2)	Operation mode switchover	Used to switch between the operation modes (EXT, LNK). (Refer to page 48 for operation mode of the inverter.) EXT: External operation mode LNK: Network operation mode (Ethernet communication mode) (Note) will result in an error in the PU operation mode
3)	Operation mode indication	Indicates the current operation mode. EXT: External operation, PU: PU operation, EXT JOG: external JOG operation, PU JOG: PU JOG operation, LNK: Network operation mode (Ethernet communication mode), PU EXT: PU-external combined operation. (Note) The operation mode will not be changed, if the PU and such other than Ethernet software was used to change the operation mode.
4)	Information	Shows the current condition, e.g. input error. (Refer to page 47 for error indications.)
5)	Software version	The software version is displayed on the title label of the Web browser.

6.2.2 Parameter setting

	Name	Description	Refer to Page
6)	All List Format	Used to display all parameters.	18
	Functional List Format	Used to display specific parameters on a function-by-function basis.	19
	Individual List Format	Used to list the frequently used parameters or necessary parameters freely.	21
	Basic Settings	Used to set the operation specifications roughly without a need to know the specific parameters.	23

6.2.3 Parameter No and range

	Name	Description
7)	Parameter No	Shows the parameter number of the selected parameter.
	Range	Shows the setting range of the selected parameters.

6.2.4 Parameter setting button

Refer to page 18 for details of the parameter setting button 8)

7. PARAMETER SETTING

Set the parameters.

Refer to the inverter manual for details of the parameters.

After changing any parameter value(s), click 8) [Blk Write] or 9) [Write] to store it (them) into the inverter. (Refer to page 18.)

REMARKS

1. Write can be inhibited by setting "1" in Pr. 77 "parameter write disable selection".
2. Write the set values to the inverter and initialize parameters in the [LINK] operation mode. Writing is invalid in any other operation modes except for certain parameters.
Refer to the inverter manual for parameters of the inverter. (Refer to page 16 for operation mode switch-over.)

7.1 Parameter Setting on All List Format Page

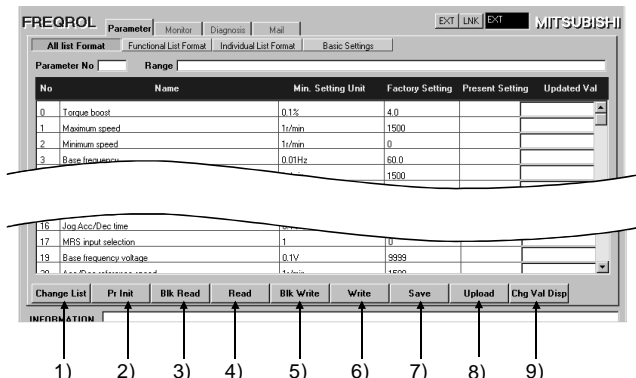

Display all parameters of the inverter being connected.

- (1) Click the Updated Val field on the row of the parameter you want to change.
- (2) Enter the value within the setting range and press  to confirm your entry.
- (3) Click [6] Write] to store the value into the inverter.

REMARKS

1. Two or more parameter values can also be changed at once. To block-write new values to the inverter, click [5] Blk Write].
2. When the Updated Val field has [Click], refer to page 25 or 26.

No.	Name	Description	Reference Page
1)	Change List	Used to list the parameters that have been changed from the factory settings.	29
2)	Pr Init	Used to initialize the parameters to the factory settings.	30
3)	Blk Read	Used to read all parameters in the list from the inverter.	31
4)	Read	Used to read the parameter selected in the list from the inverter.	æ
5)	Blk Write	Used to write all values entered in the Updated Val field of the list to the inverter.	31
6)	Write	Used to write the new parameter value selected in the list to the inverter.	æ
7)	Save	Used to save the parameter list data into a file.	32
8)	Upload	Used to upload the list data saved in the file.	33
9)	Chg Val Disp	Used to reflect the uploaded data on the Updated Val field after uploading.	33

7.2 Parameter Setting on Functional List Format Page

FREQROL EXT LNK EXT MITSUBISHI

Parameter Monitor Diagnosis Mail

All list Format **Functional List Format** Individual List Format Basic Settings

Parameter No Range

Motor	S Settings	Acc/Dec	Protection	Monitor
Brake	Terminal Alloc	V/F Control	Calibration	Option
Sp Running	S. Control	Trq. Control	P. Control	

No	Name	Min. Setting	Unit	Factory Setting	Present Setting	Updated Val
0	Torque boost(Manual)	0.1%		4.0		
3	Base frequency	0.01Hz		60.0		
19	Base frequency Voltage	0.1V		9999		
71	Applied motor	1		30		
80	Motor capacity	0.01kW		2.2		
81	Number of motor poles	1		4		
82	Motor excitation current(no load current)	0.01		9999		
83	Rated motor voltage	0.1V		200.0		
84	Rated motor frequency	0.01Hz		60.0		
90	Motor constant R1	0.01		9999		
91	Motor constant R2	0.01		9999		
92	Motor constant L1	0.01		9999		
93	Motor constant L2	0.01		9999		
94	Motor constant X	0.01		9999		
95	Online auto tuning selection	1		0		

Change List Pr Init Blk Read Read Blk Write Write Save Upload Chg Val Disp

INFORMATION

This page displays specific parameters on a function-by-function basis from among a number of available parameters. Refer to page 18 for the way to change the parameter values.

●Function button outline

Motor	Used to display the parameter list related to motor setting.
S Settings	Used to display the parameter list related to speed setting.
Acc/Dec	Used to display the parameter list related to acceleration/deceleration operation.
Protection	Used to display the parameter list related to the protective functions.
Monitor	Used to display the parameter list related to the monitor functions.
Brake	Used to display the parameter list related to brake operation.
Terminal Alloc	I/O terminal function selection
V/F Control	Used to display the parameter list that is made valid for V/F control.
Calibration	Used to display the parameter lists that are available to adjust the biases and gains of the DA1/DA2, AM/FM, and 1, 2, 3 terminals. (Refer to pages 25, 26)
Option	Used to display the parameter list related to option unit fitting.
Sp Running	Used to display the parameter list related to the other functions that are not covered by the function buttons.
S. Control	Used to display the parameter list related to speed control.
Trq. Control	Used to display the parameter list related to torque control.
P. Control	Used to display the parameter list related to position control.

7.3 Parameter Setting on Individual List Format Page

This page can be used to list the frequently used parameters or necessary parameters freely. Refer to page 31 for write to the inverter.

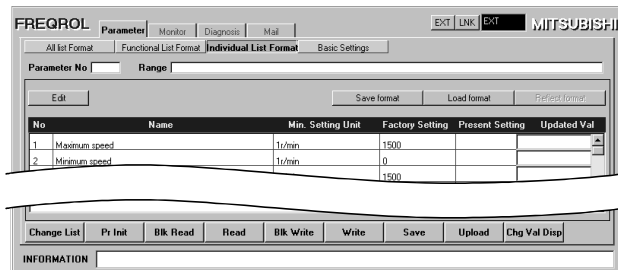

- (1) Creation of individual list
Click [1] Edit], choose the list-registered parameter, and click [2] Add] to move it to the Individual List side. Clicking [OK] registers it to the Individual List format page and returns to the Individual List format page.

REMARKS

Clicking [Cancel] returns to the Individual List format without registering the parameter.
Clicking [Delete] returns to the Parameter List side and clicking [OK] further deletes the parameter from the Individual List format page.

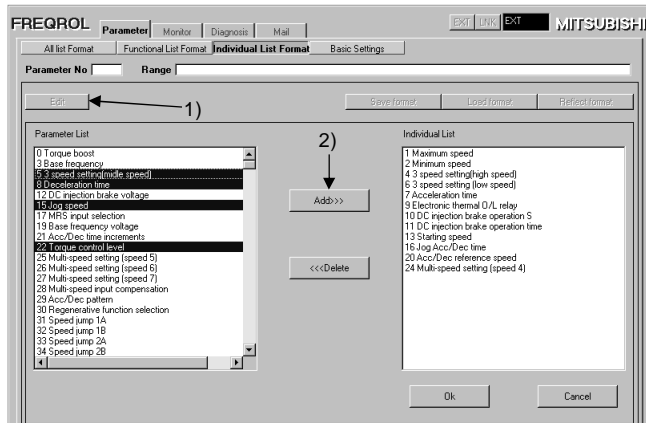

- (2) Save in the Individual List
 Save parameter No. currently displayed in the individual list in the file.
 Click [Save format] to save a file.

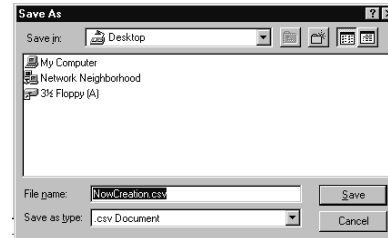

- (3) Display the individual list
 (load/ reflection)
 Click [Format upload] to load the file saved with [Save format] and click [Reflect format] to display the list.

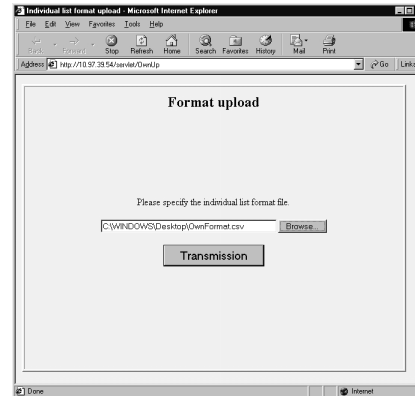

REMARKS

A file is saved in the CSV format.

7.4 Parameter Setting on Basic Settings Page

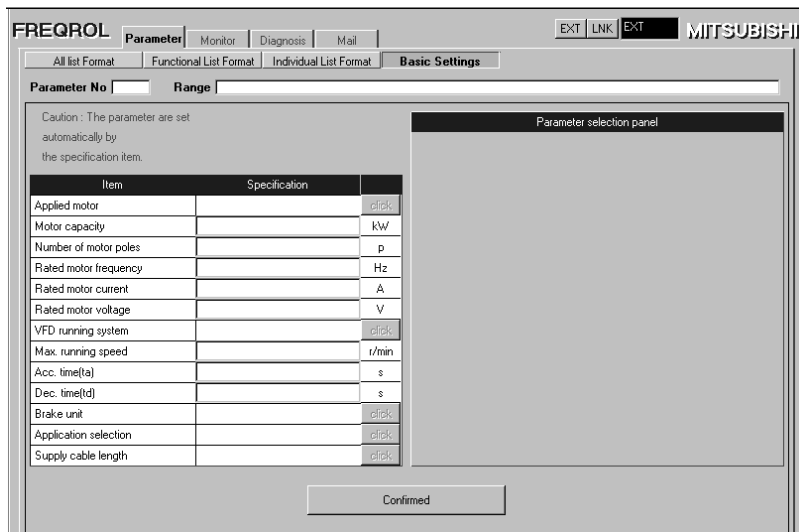

You can set the operation specifications roughly without a need to know the specific parameters. Refer to page 31 for write to the inverter.

- (1) Set all items. (For [Click], make selection from the choices on the right side.)

REMARKS

An error is displayed if the entered value is outside the setting range.

- (2) Clicking [Confirmed] sets the parameters automatically and displays the parameter list.

REMARKS

You can also change the parameter values on this page. (Refer to page 18.)

FREQROL Parameter Monitor Diagnosis Mail EXT LNK EXT mitsubishi

All list Format Functional List Format Individual List Format Basic Settings

Parameter No Range

Pre. page

No	Name	Min. Setting Unit	Factory Setting	Present Setting	Updated Val
0	Torque boost	0.1%	4.0		1.3
3	Base frequency	0.01Hz	60.0	59.0	60.0
7	Acceleration time	0.1 / 0.01s	5.0		125.0
8	Deceleration time	0.1 / 0.01s	5.0		125.0
9	Electronic thermal O/L relay	0.01A	0.0		0.0
13	Starting speed	0.1r/min	15.0		150.0
30	Regenerative function selection	1	0		
70	Special regenerative brake duty	0.1%			
71	Applied motor	1	30		30
78	REV rotation prevention selection	1	0		0
80	Motor capacity	0.01kW	1.5		
81	Number of motor poles	1	4		4
83	Rated motor voltage	0.1V	200.0		
84	Rated motor frequency	0.01Hz	60.0		

Change List Pr Init Blk Read Read Blk Write Write Save Upload Chg Val Disp

Click [Pre. page] to return to the previous page (Basic Settings page).

7.5 DA1/DA2 Calibration

Pressing [Click] in the Change Value field of Pr. 900 or Pr. 901 on the parameter setting page displays the following page. For details, refer to the inverter manual (detailed "calibration function") and make setting.

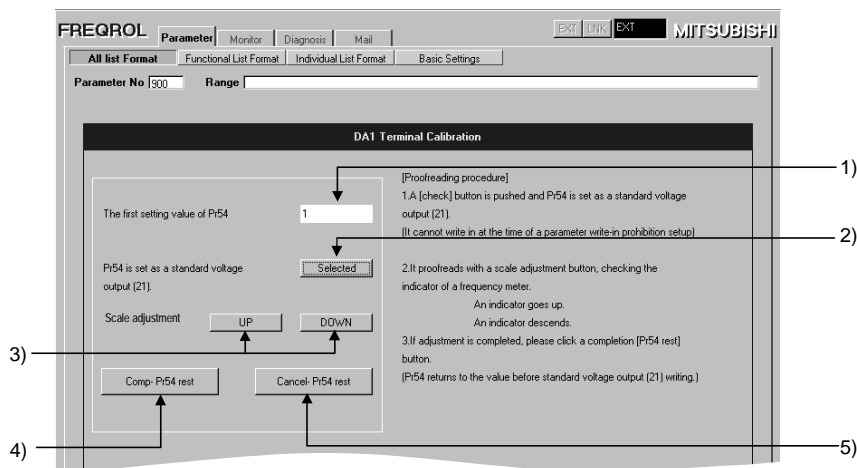

No.	Name	Description
1)	DA1/DA2 setting	Shows the Pr. 54/Pr. 158 setting.
2)	Selected	Used to set "21 (reference voltage output)" in Pr. 54/Pr. 158.
3)	Scale adjustment	For calibration. Press the UP button to start upward calibration or the DOWN button to start downward calibration.
4)	Comp-Pr54 reset	Complete DA1/DA2 calibration after writing the calibration value into the inverter. (Return the Pr. 54/Pr. 158 setting to the value changing to "21".)
5)	Cancel-Pr54 reset	Complete DA1/DA2 calibration without writing the calibration value into the inverter. (Return the Pr. 54/Pr. 158 setting to the value changing to "21".)

7.6 Bias/Gain of Speed Setting Voltage (Current)

Pressing [Click] in the Change Value field of any of Pr. 902 to Pr. 905 and Pr. 917 to Pr. 920 on the parameter setting page displays the following page. For details, refer to the inverter manual (basic) and make setting.

(1) Choose the adjusting method from the following ones.

- Calibration without application of voltage.
- Calibration with application of voltage (Refer to page 27.)
- Calibration at any point without application of voltage (Refer to page 28.)

Choose the adjusting method "Without the voltage source" (1) and set the Setting Speed (2). Clicking the "OK" button writes the speed to the inverter.

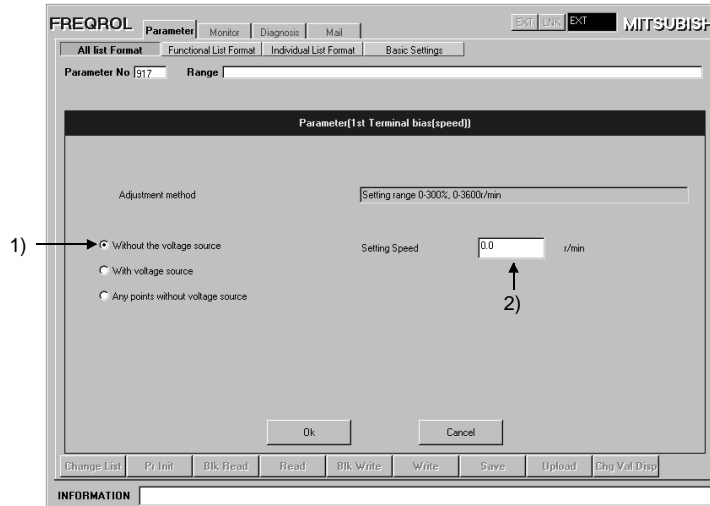

PARAMETER SETTING

(2) Calibration with application of voltage

Choosing the adjusting method "With the voltage source" (1)) monitors the Present Setting Voltage (3)). Set the Setting Speed (2)) and adjust the external potentiometer on the basis of the currently set voltage monitor. Clicking the "OK" button writes the current volume setting voltage to the inverter.

FREQROL Parameter Monitor Diagnosis Mail EXT LNK EXT MITSUBISHI

All list Format Functional List Format Individual List Format Basic Settings

Parameter No 917 Range

Parameter(1st Terminal bias(speed))

Adjustment method Setting range 0-300%, 0-3600r/min

Without the voltage source

With voltage source

Any points without voltage source

2) → Setting Speed 0.0 r/min

3) → Present Setting Voltage 0.0 % Update

Ok Cancel

Change List Pr Init Blk Read Read Blk Write Write Save Upload Chg Val Disp

INFORMATION

(3) Calibration at any point without application of voltage

Choose the adjusting method "Any points without voltage source" (1)) and set the Setting Speed (2)) and Setting Voltage (3)). Clicking the "OK" button writes the setting speed and current volume setting voltage to the inverter.

FREQROL **Parameter** Monitor Diagnosis Mail EXT LINK EXT MITSUBISHI

All list Format Functional List Format Individual List Format Basic Settings

Parameter No [917] Range

Parameter[1st Terminal bias(speed)]

Adjustment method Setting range 0-300%, 0-3600r/min

Without the voltage source
 With voltage source
 Any points without voltage source

2) → Setting Speed 0.0 r/min

3) → Setting Voltage %

Ok Cancel

Change List Pr. Init Bk Read Read Bk Write Write Save Upload Chg Val Disp

INFORMATION

8. PARAMETER FUNCTION BUTTONS

8.1 Change List

Clicking [Change List] displays the following screen.



The parameters whose values have been changed from the factory setting are displayed. Click [OK] to return to the parameter list.

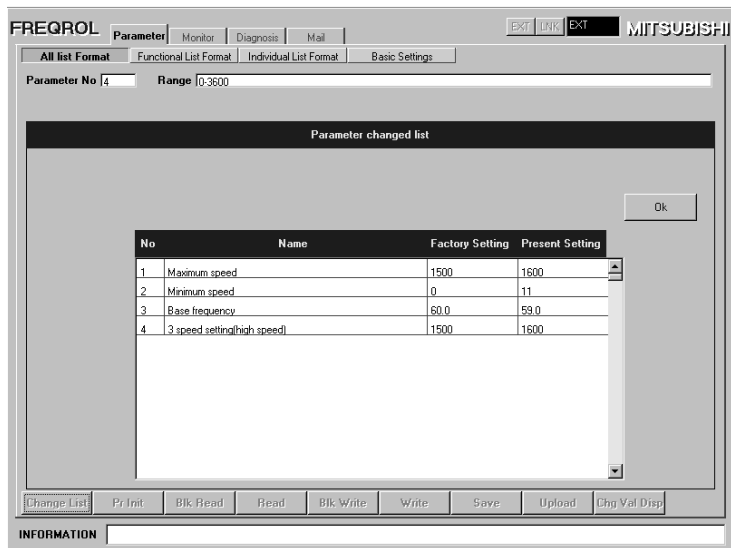

8.2 Parameter Initialization

Clicking [Pr Init] initializes the parameters.



The parameters can be initialized by "Parameter Clear" or "All Clear".

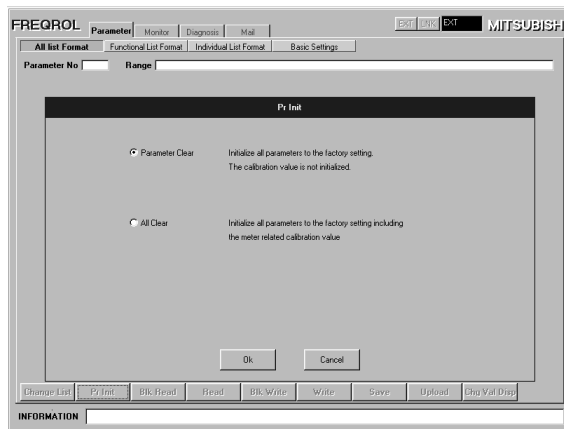

CAUTION

- Clicking "parameter clear" or "All clear" erases the IP addresses (Pr. 434 to Pr. 437)

8.3 Block Read/Block Write

Clicking [Blk Read] or [Blk Write] reads or writes data and displays the progress.

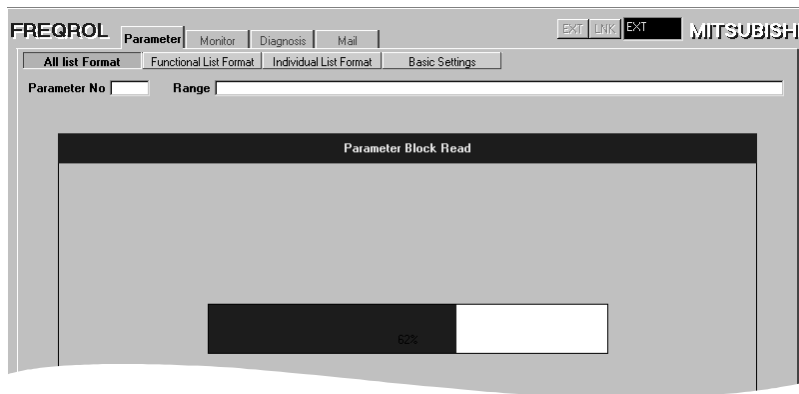

CAUTION

- Clicking the [Cancel] button during read/write displays in the parameter list only the parameter values that have been read/written until then.
- Use [Read] or [Write] to read or write the parameter values individually from or to the inverter.

8.4 Save

Used to save parameter No., parameter setting (in the present setting column), and unit in the parameter list. Save can be performed on the "All List Format", "Functional List Format" or "Basic Settings 2" page of the parameter setting screen.

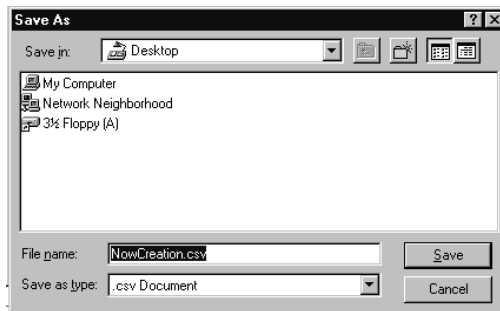

REMARKS

- A file is saved in the CSV format.
You can edit the CSV format file using spreadsheet software, and the like.
After this file has been edited, it cannot be returned to the inverter.
- When no value is displayed in the present setting cell, the setting value at an inverter startup (reset) or at the last batch reading is saved

8.5 Upload and Change Value Display

Used to read the parameter list file saved and display on the change value field. Upload can be performed on the "All List Format", "Functional List Format", "Individual List" or "Basic Settings 2" page of the parameter setting screen.

After uploading, click [Chg Val Disp] to reflect the uploaded data on the Updated Val field.

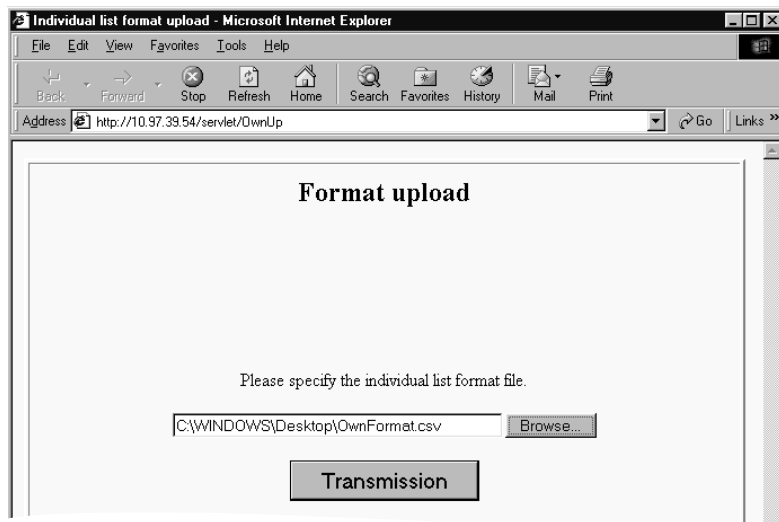

9. MONITORING

9.1 Monitor List

The following items can be monitored on the data display, meter display, oscilloscope and VFD status screens.

(○.....Can be monitored, ×.....Cannot be monitored)

Monitor Name	Data Display	Meter Display	Oscilloscope	VFD Status
Speed (r/min) *3	○	○ (Pr. 55(3600r/min))*4	○	×
Output current (A) *3	○	○ (Pr. 56(rated current))*4	○	○ (Pr. 56(rated current))*4
Output voltage (V) *3	○	○ (400V/800V)*4	○	○ (Pr. 83(200V/400V))*4
Set speed (r/min)	○	○ (Pr. 55(3600r/min))*4	○	×
Output frequency (Hz)	○	○ (120 Hz)*4	○	×
Motor torque (%)	○	○ (Pr. 866(300%))*4	○	×
Converter output voltage (V)	○	○ (500V/900V)*4	○	○ (400V/800V)*4
Regenerative brake duty (%)	○	○	○	○
Electronic thermal protection load factor (%)	○	○ (100%)*4	○	○
Input terminal	○	×	○*1	×
Output terminal	○	×	○*2	×
Load meter (%)	○	○ (Pr. 866(100%))*4	○	×
Motor excitation current (A)	○	○ (Pr. 56(rated current))*4	○	×
Position pulse	○	×	×	×
Energization time (Hr)	○	×	×	○
Operation time (Hr)	○	×	×	○
Motor load factor (%)	○	×	×	×
Torque command (%)	○	○ (Pr. 866(100%))*4	○	×
Torque current command (%)	○	○ (Pr. 866(100%))*4	○	×
Motor output (kW)	○	○ (rated motor capacity)*4	○	×
Feedback pulse	○	×	×	×
Trace status	○	×	×	×

*1 Select the input terminal of the oscilloscope from among DO1, DO2, DO3 and ABC.

*2 Select the output terminal of the oscilloscope from among STF, STR, RES, D11, D12, D13, D14 and OH.

*3 If an inverter alarm occurs during monitoring, each monitor holds the value at an alarm occurrence.

*4 Values in parenthesis indicate full scale values.

9.2 Data Display

Up to four different signals are displayed as numerical values in real time.
The input and output states of the control terminals can also be monitored.

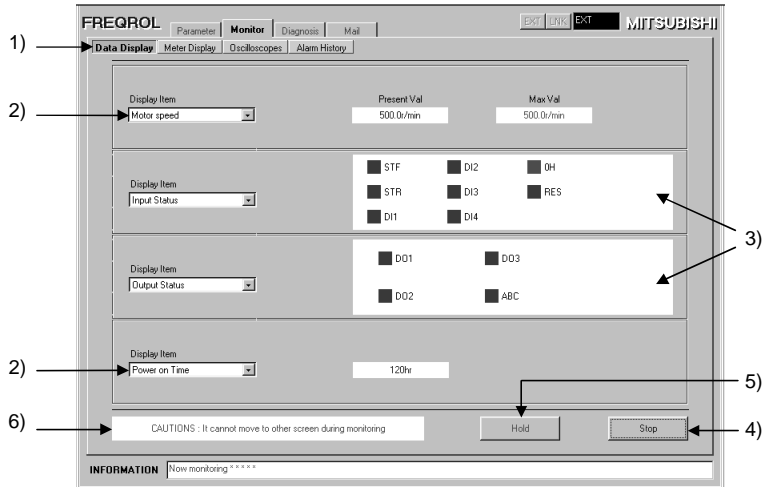

No.	Name	Description
1)	Monitor function switchover	Used to switch between the monitor functions (data display, meter display, oscilloscope, alarm history).
2)	Monitor item	Choosing the item to be monitored displays the status, the current value and maximum value, etc. of the monitor item. The maximum value is cleared when the monitoring is stopped.
3)	Input/output status	Shows the ON/OFF states of the input/output status. (ON: red, OFF: gray)
4)	Start/Stop	Used to start monitoring. During monitoring, this button acts as the "Stop" button.
5)	Hold/On Hold	Used to hold the data being monitored. Valid only during monitoring. During hold, this button acts as the "On Hold" button, and clicking it cancels hold.
6)	Alarm display	<p>Displays alarm descriptions when an alarm occurs in the inverter during monitoring.</p>  <p>REMARKS</p> <p>You can see the detailed information on alarms in "Alarm history" on page 43. For inverter alarm details, refer to the inverter manual.</p>

REMARKS

- Different signals for data display are updated every 5s.
- It can not move to other screen during monitoring.

9.3 Meter Display

Up to four different signals are displayed as meters at regular time intervals.

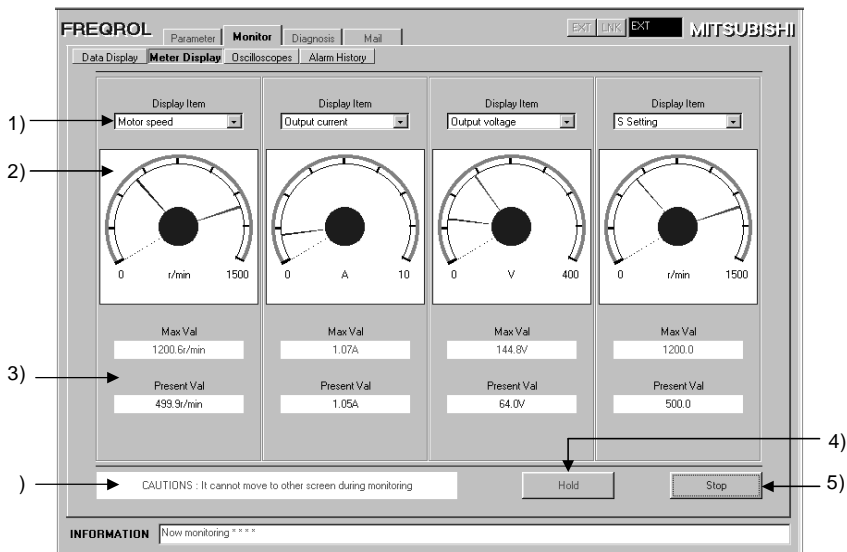

No.	Name	Description
1)	Display item	Select the item to be monitored.
2)	Meter display	The monitor value is displayed as a meter (current value... black, maximum value... red). The full-scale value of the meter can be changed by entering a new value directly.
3)	Monitor value	The current value and maximum value of the monitor item are displayed. The maximum value is cleared when the monitoring is stopped. (Refer to page 34 page for the full scale value.)
4)	Start/Stop	Used to start monitoring. During monitoring, this button acts as the "Stop" button.
5)	Hold/On Hold	Used to hold the data being monitored. Valid only during monitoring. During hold, this button acts as the "On Hold" button, and clicking it cancels hold.
6)	Alarm display	Displays alarm descriptions when an alarm occurs in the inverter during monitoring.

REMARKS

- Data is collected every 5 to 6s. (Note that time differs depending on the line conditions.)
- It can not move to other screen during monitoring.

9.4 Oscilloscope

Up to four different signals, which have been received from the inverter in advance, are displayed on the personal computer screen as waveforms.

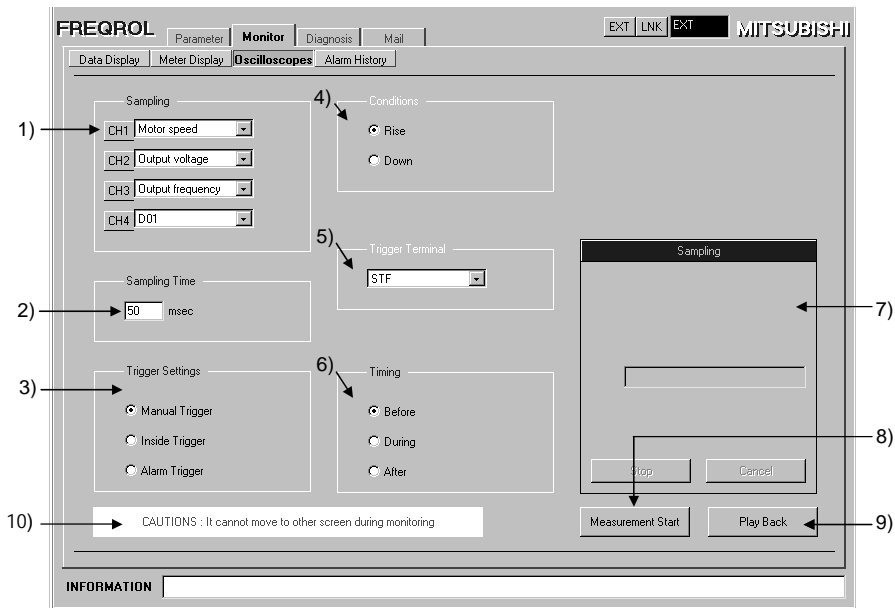

No.	Name	Description
1)	Sampling item	Select the item to be sampled. <Sampling item> Refer to the Monitor List (Refer to page 34.)
2)	Sampling time	Enter the sampling interval. (50 to 30000ms)
3)	Trigger selection	Choose the external or internal trigger. External trigger Data sampling starts after start of measurement. Internal trigger Depending on trigger condition and timing. Alarm trigger Alarm occurrence is used as a trigger.
4)	Trigger condition	Select whether sampling will be started on the leading edge or trailing edge of the trigger terminal signal.
5)	Trigger terminal	Select the trigger terminal from the following items. STF, STR, RES, DI1, DI2, DI3, DI4, OH, D01, D02, D03, ABC
6)	Trigger timing	Choose the timing for trigger waiting. Before 10240 pieces of data before establishment of trigger are displayed. During 5120 pieces of data before establishment of trigger and 5120 pieces after establishment are displayed. After 10240 pieces of data after establishment of trigger are displayed.
7)	Status panel	Shows the status during sampling.
8)	Measurement start	Used to start measurement.
9)	Monitor	Used to monitor the measured data.
10)	Alarm display	Displays alarm descriptions when an alarm occurs in the inverter during monitoring.

(1) The following status panel appears at start of sampling.

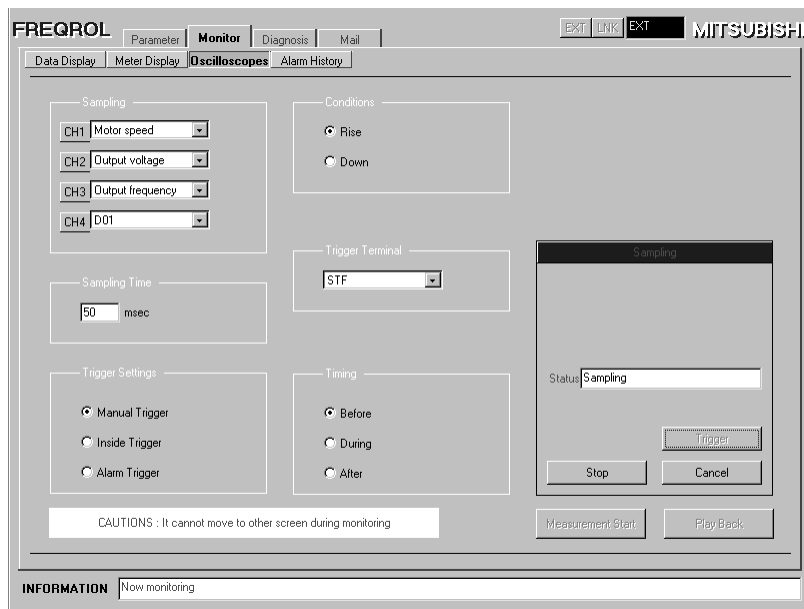

(2) Clicking [Play Back] after sampling displays the following screen.

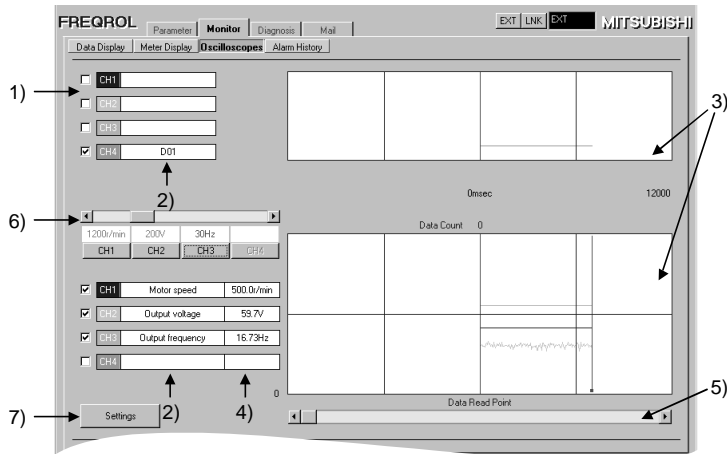

No.	Name	Description
1)	Data waveform selection	Used to display or hide the data waveform.
2)	Data name	Shows the input/output data name.
3)	Data waveform	Shows the input/output data waveform of the monitor item.
4)	Current value	Shows the center value in the waveform display region.
5)	Scroll bar	Used to scroll the waveform left to right.
6)	Vertical scale knob	Used to change the vertical scale of the monitored waveform.*
7)	Settings	Used to return to the oscilloscope screen 1.

*The full scale value of the speed is the Pr. 55 setting. Change the Pr. 55 setting to change the speed to 1500r/min or higher.

9.5 Alarm History

Past eight alarms history can be displayed.

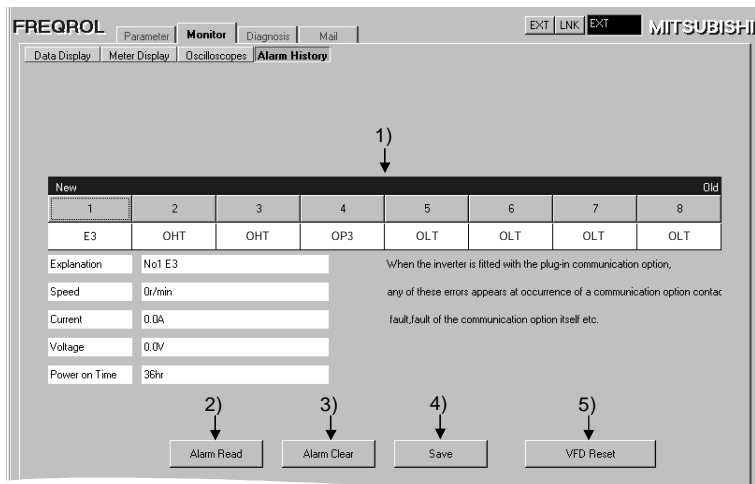

No.	Name	Description
1)	Alarm History	Used to display past eight alarms. Displays the name of alarm selected and output speed, output current, output voltage and power on time below.
2)	Alarm Read	Used to read the alarm history from the inverter.
3)	Alarm Clear	Used to clear the alarm history of the inverter.
4)	Save	Used to save the alarm information into a file. (saved in a text format)
5)	VFD Reset	Used to reset the inverter. Made valid in the [LINK] mode. (Refer to page 16.)

10. DIAGNOSTICS

The output current, output voltage and other data are monitored at fixed intervals.

10.1 VFD Status

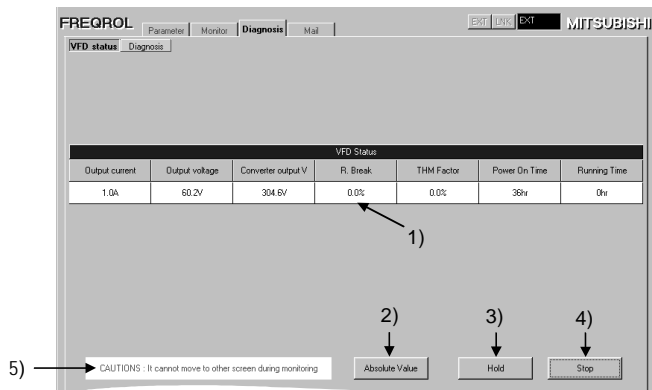

No.	Name	Description
1)	Monitor Value	Shows the monitor value.
2)	Absolute Value/%	Used to switch the monitor display unit of the output current, output voltage or DC bus voltage between the absolute value unit and %. When the display unit is the absolute value, this button acts as the "%" button, and when the display unit is %, this button acts as the "Absolute Value" button. (Note) For % display, full scale value is displayed as 100%. (Refer to page 34 for full scale value.)
3)	Hold/On Hold	Used to hold the data being monitored. Valid only during monitoring. During hold, this button acts as the "On Hold" button, and clicking it cancels hold. Monitoring is also performed during hold.
4)	Monitor Start/Stop	Used to start monitoring. During monitoring, this button acts as the "monitor stop" button.
5)	Alarm Display	Displays alarm descriptions when an alarm occurs in the inverter during monitoring.

10.2 Diagnostics

Various status at inverter error occurrences can be displayed.

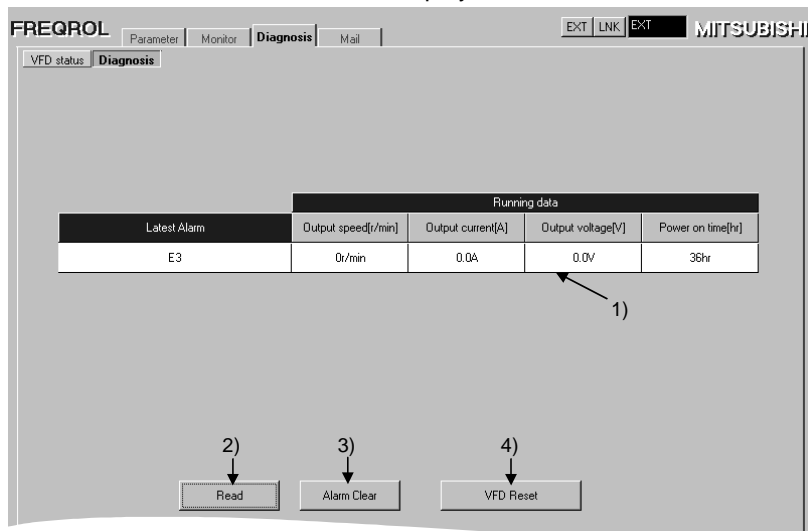

No.	Name	Description
1)	Alarm History	Shows the latest alarm and the output speed, output current, output voltage and energization time at alarm occurrence.
2)	Read	Used to read the latest alarm from the inverter.
3)	Alarm Clear	Used to clear the alarm history of the inverter.
4)	VFD Reset	Used to reset the inverter. Made invalid in the [LINK] mode. (Refer to page 16.)

11. MAIL SETTING

At the occurrence of an inverter alarm, its definition is sent to the preset mail address.

Mail is sent when the protective function of the inverter is activated, and the alarm definition, speed, output current, output time and energization time at that time are sent.

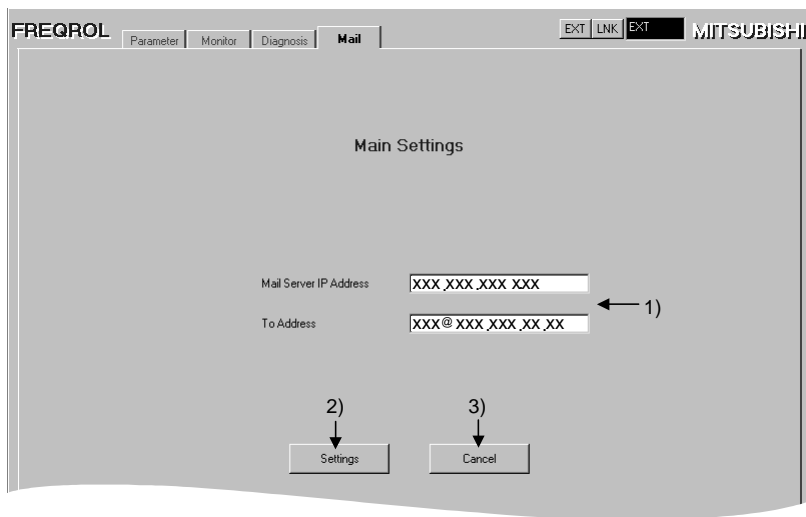

No.	Name	Description
1)	Main Settings	Enter the IP address of the mail server and the mail address of the transmission destination.
2)	Settings	Used to set the mail server and mail address settings in the inverter. (Save in the E ² PROM)
3)	Cancel	Used to cancel the setting.

12.ERROR CODES

12.1 Error Code Lists

When an error occurs, following error codes are displayed in the Information column 4) in the screen on page 15).

(1) Error codes related to an inverter error

Error Code (HEX)	Error Name	Definition
17(11H)	Outside parameter range	Data outside the setting range was specified for the running frequency (running speed), parameter write or the like.
18(12H)	Operation mode error	The present operation mode is not allowed to perform. Change the operation modes.
19(13H)	Running	The inverter is running.
20(14H)	Parameter write disable	Parameter write is inhibited.
22(16H)	No parameters	There are no parameters or related parameters have not been set.
23(17H)	No options	The preset option is not connected to the inverter.
24(18H)	Narrow error	There is no difference between analog value settings of Pr. 902 (Pr. 904) and Pr. 903 (Pr. 905).
26(1AH)	Instruction code error	A non-existing instruction code was sent to the inverter.
33(21H)	Running in present mode	Mode change etc. cannot be made since the inverter is running in the present operation mode.
34(22H)	With STF	Mode change etc. cannot be made since the forward rotation command is entered.
35(23H)	With STR	Mode change etc. cannot be made since the reverse rotation command is entered.
36(24H)	Operation mode specified	Cannot be executed in the present operation mode.
37(25H)	Pr. 75 specified	Since Pr. 75 is specified, inverter reset cannot be executed.

APPENDIX

Inverter Operation Mode

(1) Operation mode switching conditions

Before switching the operation mode, check that:

- 1) The inverter is at a stop;
- 2) Both the STF and STR signals are off; and
- 3) The Pr. 79 "operation mode selection" setting is correct.

(For setting, use the inverter's operation panel or optional parameter unit.)

Pr. 79 Setting	Operation Mode Selection	Switching to Network Operation Mode
0	PU or external operation	Disallowed when the PU mode is selected. Allowed when the external mode is selected.
1	PU operation	Disallowed
2	External operation	Allowed
3, 4	External/PU combined operation	Disallowed
5	Program operation	Disallowed
6	Switch-over	Allowed
7	External operation (PU operation interlock)	Allowed only in the external operation mode when the PU interlock signal (X12) is on.
8	PU or external (signal switching)	Allowed only in the external operation mode (X16 on).

REMARKS

When making a parameter setting using the Ethernet software, the operation mode needs to be switched to the network operation mode. Set any of "0, 2, 6, 8" in Pr. 79 "operation mode selection" when changing the operation mode to the network operation mode. (Refer to the inverter manual for details of Pr. 79.)

(2) Operation mode switching method

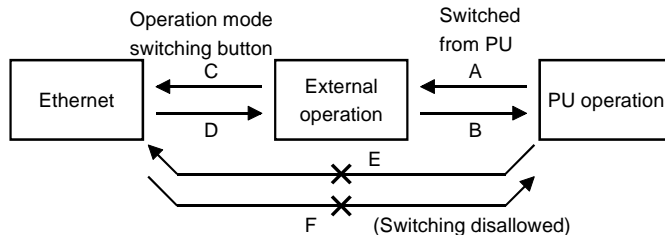

Symbol	Switching Type	Switching Method
A	PU operation → External operation	Operate the external operation key on the PU.
B	External operation → PU operation	Operate the PU operation key on the PU.
C	External operation → Network operation	Operate the operation mode switching button on the PC screen. (Refer to page 16.)
D	Network operation → External operation	Operate the operation mode switching button on the PC screen. (Refer to page 16.)
E	PU operation → Network operation	Switching disallowed. Allowed if external operation is selected in A and network operation is then selected in C. *1
F	Network operation → PU operation	Switching disallowed. Allowed if external operation is selected in D and PU operation is then selected in B. *1

*1 In the switch-over mode (Pr. 79 = 6), switching in E and F is allowed.

CAUTION

- When "1" is set in Pr. 340 "link startup mode selection", the operation mode is network operation at power on or inverter reset.
- When setting "1" in Pr. 340, the initial settings (station number setting, etc.) of the inverter must be made without fail.

(3) Pr. 340 "link startup mode selection"

You can select the operation mode at power-on or automatic restart after instantaneous power failure.

When choosing the network operation mode, set "1" in Pr. 340.

After the link has started, you can write the parameter value using software.

Pr. 340 Setting	Operation Mode		Mode at Power-on or Automatic Restart after Instantaneous Power Failure
	Pr.79		
0 (Factory setting)	0	PU or external operation	External operation mode
	1	PU operation	PU operation mode
	2	External operation	External operation mode
	3	External/PU combined operation	The running speed is set in the PU operation mode and the start signal in the external operation mode.
	4	External/PU combined operation	The running speed is set in the external operation mode and the start signal in the PU operation mode.
	6	Switchover	External operation mode The operation mode is switched over with the operation continued.
	7	PU operation interlock	X12 signal ON External operation mode (Can be switched to the PU operation mode using the parameter unit.) X12 signal OFF..... External operation mode
	8	Operation mode external signal switchover	X16 signal ON External operation mode X16 signal OFF..... PU operation mode

Pr. 340 Setting	Operation Mode		Mode at Power-on or Automatic Restart after Instantaneous Power Failure
	Pr.79		
1(2) *	0	PU or network operation	Network operation mode (Switchover using software is not needed.)
	1	PU operation	PU operation mode
	2	Network operation	Network operation mode (Switchover using software is not needed.)
	3	External/PU combined operation	The running speed is set in the PU operation mode and the start signal in the external operation mode.
	4	External/PU combined operation	The running speed is set in the external operation mode and the start signal in the PU operation mode.
	6	Switchover	Network operation mode The operation mode is switched over with the operation continued. For details, refer to the inverter manual.
	7	PU operation interlock	X12 signal ON PU operation mode (Can be switched to the external operation mode using a program.) X12 signal OFF..... External operation mode
	8	Operation mode external signal switchover	X16 signal ON Network operation mode (Can be switched to the external operation mode using a program.) X16 signal OFF..... PU operation mode

REMARKS

The Pr. 340 setting can be changed from the PU independently of the operation mode.

(4) Pr. 338 "operation command source", Pr. 339 "speed command source"

In the network operation mode, commands from the external terminals and network variables are as listed below:

POINT

Selecting external for operation command source (Pr. 338=1) enables the forward rotation command, reverse rotation command, etc. from the external terminal even in the NET mode.

Control location selection	Pr. 338 "operation control command source"	0: NET	0: NET	1: External	1: External	REMARKS	
	Pr. 339 "speed command source"	0: NET	1: External	0: NET	1: External		
Fixed functions (Functions equivalent to terminals)	Forward rotation command (STF)	—	—	External	External		
	Reverse rotation command (STR)	—	—	External	External		
	Reset (RES)	Combined	Combined	Combined	Combined		
	External thermal relay (OH)	External	External	External	External		
	Network operation speed	—	—	—	—		
	2	—	External	—	External		
	1	Speed setting auxiliary	Compensation	External	Compensation	External	
		Magnetic flux command/regeneration torque restriction	External	External	External	External	
	3	External	External	External	External		

Control location selection	Pr. 338 "operation control command source"		0: NET	0: NET	1: External	1: External	REMARKS
	Pr. 339 "speed command source"		0: NET	1: External	0: NET	1: External	
Selective functions Pr. 180 to Pr. 183, Pr. 187 settings *1	0	Low-speed operation command, Remote setting (setting clear) (RL)	—	External	—	External	Pr. 59 ≠ 0: Remote setting
	1	Middle-speed operation command, Remote setting (deceleration) (RM)	—	External	—	External	
	2	High-speed operation command, Remote setting (acceleration) (RH)	—	External	—	External	
	3	Second function selection (RT)	—	—	External	External	
	5	Jog operation selection (JOG)	—	—	External	External	
	8	15-speed selection (REX)	—	External	—	External	
	9	Third function (X9)	—	—	External	External	
	10	FR-HC connection, FR-CV connection (inverter operation enable) (X10)	External	External	External	External	
	11	FR-HC connection (instantaneous power failure detection) (X11)	External	External	External	External	
	12	PU operation external interlock (X12)	External	External	External	External	
	14	PID control enable terminal (X14)	—	External	—	External	
	Selective functions Pr. 180 to Pr. 183, Pr. 187 settings *1	15	Brake sequence opening completion signal (BRI)	—	—	External	External
16		PU-external operation switchover (X16)	External	External	External	External	
20		S-pattern acceleration/deceleration C switchover (X20)	—	—	External	External	
22		Orientation command(X22)	—	—	External	External	
23		Pre-excitation/servo ON (LX)	—	—	External	External	
24		Output stop (MRS)	External	External	External	External	*2
25		Start self-holding selection (STOP)	—	—	External	External	
26		Control mode changing (MC)	—	—	External	External	
27		Torque restriction selection (TL)	—	—	External	External	
42		Torque bias selection 1 (X42)	—	—	External	External	
43		Torque bias selection 2 (X43)	—	—	External	External	
44	P control selection (P/PI control switchover) (X44)	—	—	External	External		

- External : Control by signal from external terminal is only valid.
NET : Control from network is only valid.
Combined : Control from both external terminal and network is valid.
— : Control from both external terminal and network is invalid.
Compensation : Control by signal from external terminal is only valid if Pr. 28 "multi-speed input compensation" setting is 1.

CAUTION

1. For details of Pr. 180 to Pr. 183, Pr. 187 (input terminal function selection), refer to the inverter manual.
2. When the MRS signal is assigned for both network and external, the output stop command is as indicated in the following table.

Network	External	Output Stop Command	
		Pr.17="0"	Pr.17="2"
ON	ON	Output stopped	Output not stopped
ON	OFF	Output stopped	Output stopped
OFF	ON	Output stopped	Output stopped
OFF	OFF	Output not stopped	Output stopped

(5) Inverter Reset

Which resetting method is allowed or not allowed in each operation mode is described below.

Resetting Method		Operation Mode		
		Network operation	External operation	PU operation
Ethernet software	Inverter reset (command request network variable) •The inverter can be reset any time.	Allowed	Disallowed	Disallowed
Turn on the signal across terminals RES-SD.		Allowed	Allowed	Allowed
Power off the inverter.		Allowed	Allowed	Allowed

CAUTION

1. The inverter can not be reset using the Ethernet software (PC) at a communication line fault.
2. Resetting the inverter in the network operation mode places it in the external operation mode. To resume network operation, therefore, the operation mode must be switched to the network operation again. (This switchover is not needed when "1" is set in Pr. 304 "link startup mode selection". Refer to page 51.)
3. During an inverter reset, communication is interrupted about 1 to 2 mins.

MEMO

REVISIONS

*The manual number is given on the bottom left of the back cover.

Print Date	*Manual Number	Revision
August, 2002	IB(NA)-0600108E-A	First edition