



INVERTER

Option unit

FR-PU07

FR-PU07BB

INSTRUCTION MANUAL

Parameter unit

PRE-OPERATION INSTRUCTIONS **1**

FUNCTIONS **2**

FUNCTION MENU **3**

OPERATION **4**

CHECK FIRST WHEN YOU
HAVE A TROUBLE **5**

SPECIFICATIONS **6**

Thank you for choosing the Mitsubishi Electric inverter option unit.

This instruction manual gives handling information and precautions for use of this equipment. Incorrect handling might cause an unexpected fault. Before using the equipment, please read this manual carefully to use the equipment to its optimum. Please forward this manual to the end user.

This section is specifically about safety matters

Do not attempt to install, operate, maintain or inspect this product until you have read through this instruction manual and appended documents carefully and can use the equipment correctly. Do not use this product until you have a full knowledge of the equipment, safety information and instructions. In this instruction manual, the safety instruction levels are classified into "WARNING" and "CAUTION".

WARNING

Assumes that incorrect handling may cause hazardous conditions, resulting in death or severe injury.

CAUTION

Assumes that incorrect handling may cause hazardous conditions, resulting in medium or slight injury, or may cause physical damage only.

Note that the  CAUTION level may lead to a serious consequence according to conditions. Please follow the instructions of both levels because they are important to personnel safety.

SAFETY INSTRUCTIONS

1. Electric Shock Prevention

WARNING

- While the inverter power is ON, do not open the front cover. Do not run the inverter with the front cover removed. Otherwise you may access the exposed high voltage terminals or the charging part of the circuitry and get an electric shock.
- Before starting wiring or inspection, check that the operation panel indicator is OFF, wait for at least 10 minutes after the power supply has been switched OFF, and check that there are no residual voltage using a tester or the like. The capacitor is charged with high voltage for some time after power OFF and it is dangerous.
- Any person who is involved in the wiring or inspection of this equipment should be fully competent to do the work.
- Always install the inverter before wiring. Otherwise, you may get an electric shock or be injured.
- Operate the keys with dry hands to prevent an electric shock.

2. Additional Instructions

To prevent injury, damage or product failure, please note the following points.

(1) Transportation and mounting

CAUTION

- Do not install and operate the parameter unit (FR-PU07/FR-PU07BB) if it is damaged or has parts missing.
- Do not stand or rest heavy objects on this equipment.
- Check the inverter mounting orientation is correct.
- The parameter unit (FR-PU07/FR-PU07BB) is a precision device. Do not drop it or subject it to impact.
- Use the inverter under the following environmental conditions:

Environment	Surrounding air temperature	-10°C to +50°C (non-freezing)
	Ambient humidity	90%RH or less (non-condensing)
	Storage temperature	-20°C to +65°C*
	Ambience	Indoors (free from corrosive gas, flammable gas, oil mist, dust and dirt)
	Altitude, vibration	Maximum 1000m above seal level, 5.9m/s ² or less at 10 to 55Hz (directions of X, Y, Z axes)

*Temperatures applicable for a short time, e.g. in transit.

- If halogens (including fluorine, chlorine, bromine, and iodine) contained in fumigants for wood packages enter this product, the product may be damaged. Prevent the entry of fumigant residuals or use an alternative method such as heat disinfection. Note that sterilization or disinfection of wood packages should be performed before packing the product.

(2) Test operation and adjustment

CAUTION

- Before starting operation, confirm and adjust the parameters. A failure to do so may cause some machines to make unexpected motions.

(3) Usage

WARNING

- Since pressing  key may not stop output depending on the function setting status, provide a circuit and switch separately to make an emergency stop (power OFF, mechanical brake operation for emergency stop, etc).
- Make sure that the start signal is off before resetting the inverter alarm. A failure to do so may restart the motor suddenly.
- Do not modify the equipment.
- Do not perform parts removal which is not instructed in this manual. Doing so may lead to fault or damage of the inverter.

CAUTION

- When parameter clear or all parameter clear is performed, each parameter returns to the factory setting. Re-set the required parameters before starting operation.

(4) Corrective actions for alarm

CAUTION

- Provide safety backup devices, such as an emergency brake, to protect machines and equipment from hazard if the parameter unit (FR-PU07/FR-PU07BB) becomes faulty.

(5) Disposal

 CAUTION
<ul style="list-style-type: none">• Treat as industrial waste.

(6) General instruction

<p>All illustrations given in this manual may have been drawn with covers or safety guards removed to provide in-depth description. Before starting operation of the product, always return the covers and guards into original positions as specified and operate the equipment in accordance with the manual.</p>

3. Safety Precautions for Alkaline Battery

When using an alkaline battery, read the instruction manuals carefully before using them.

4. Safety Precautions for Nickel Metal Hydride Battery

When using a nickel metal hydride battery and charger, read the instruction manuals carefully before using them.

— CONTENTS —

INTRODUCTION	1
<hr/>	
1 PRE-OPERATION INSTRUCTIONS	2
<hr/>	
1.1 Supporting inverter models	2
1.2 Unpacking and Product Confirmation	4
1.2.1 Unpacking confirmation	4
1.2.2 Appearance and parts identification	5
1.2.3 Explanation of keys	7
1.3 Installation and Removal of FR-PU07	9
1.3.1 Direct installation to the inverter	9
1.3.2 Removal from the inverter	10
1.3.3 Installation using the connection cable (FR-CB2)	11
1.3.4 Removal when the connection cable (FR-CB2) is used	15
1.4 Connection and Removal of FR-PU07BB	16
1.4.1 Before using FR-PU07BB in the battery mode	16
1.4.2 Instructions for the FR-PU07BB (battery mode)	18
1.4.3 Connection using the optional connection cable (FR-CB2)	19
1.4.4 Removal when the connection cable (FR-CB2) is used	22
1.5 Parameters to be Checked First	23
1.5.1 PU display language selection (Pr. 145)	23
1.5.2 PU buzzer control (Pr. 990)	24

1.5.3	PU contrast adjustment (Pr. 991)	24
-------	----------------------------------	----

2 FUNCTIONS **25**

2.1	Monitoring Function	25
2.1.1	Display overview	25
2.1.2	Using "SHIFT" to change the main monitor	28
2.1.3	Setting the power-ON monitor (the first priority monitor)	29
2.1.4	Using "READ" to change the main monitor	30
2.1.5	Using the parameter to change the monitor (Pr. 52)	31
2.2	Frequency Setting	33
2.2.1	Direct setting	33
2.2.2	Step setting	34
2.2.3	Precautions for frequency setting	35
2.3	Setting and Changing the Parameter Values	36
2.3.1	Specifying the parameter number to change the set value	36
2.3.2	Selecting the parameter from functional list to change the set value	37
2.3.3	Selecting the parameter from parameter list to change the set value	39
2.3.4	Selecting the parameter from User List to change the set value	40
2.3.5	Precautions for setting write	41
2.4	User Group Function	42
2.4.1	Registering the parameters to user group	43
2.4.2	Deleting the parameters from user group	44
2.4.3	Confirming the parameters registered to user group	44
2.5	Calibration of the Meter (Frequency Meter)	45

2.5.1	Calibration of the FM terminal	45
2.5.2	Calibration of the AM terminal	46
2.6	Adjustment of the Frequency Setting Signals "Bias" and "Gain"	49
2.6.1	Adjustment procedure	49
3	FUNCTION MENU	56
<hr/>		
3.1	Overview of Function Menu	56
3.1.1	Function menu	56
3.1.2	Function menu transition	58
3.2	Operation Procedures for Functions	62
3.2.1	Monitor function	62
3.2.2	Selection of PU operation (direct input).....	63
3.2.3	Selection of the PU Jog operation mode	64
3.2.4	Parameters	65
3.2.5	Parameter clear	68
3.2.6	Alarm history.....	70
3.2.7	Alarm clear	71
3.2.8	Inverter reset	72
3.2.9	Troubleshooting	73
3.2.10	Terminal assignment (Selectop).....	77
3.2.11	Option	78
3.2.12	Multiple copies.....	79
3.3	Other Precautions	85
3.3.1	Precautions for parameter unit operation	85

4	OPERATION	86
4.1	How to Select the Operation Mode	86
4.1.1	Switching from External operation mode [EXT] to PU operation mode [PU]	86
4.1.2	Switching from PU operation mode [PU] to External operation mode [EXT]	86
4.1.3	Switching to the External / PU combined operation mode	87
4.2	How to Operate PU Operation	88
4.2.1	Normal operation	88
4.2.2	PU Jog operation	89
4.3	Combined Operation (Operation Using External Input Signals and PU)	90
4.3.1	Entering the start signal from outside and setting the running frequency from the PU (Pr. 79 = 3)	90
4.3.2	Entering the running frequency from outside and making start and stop from the PU (Pr. 79 = 4)	91
4.3.3	Entering the start signal and multi-speed signal from outside and setting multiple speeds from the parameter unit	92
5	CHECK FIRST WHEN YOU HAVE A TROUBLE	93
5.1	Troubleshooting	93
6	SPECIFICATIONS	95
6.1	Standard Specifications	95
6.2	Outline Drawing and Panel Cutting Drawing	97
6.2.1	FR-PU07 outline dimension drawings	97
6.2.2	FR-PU07BB outline dimension drawings	98

Appendix 1 Disposing of the equipment in the EU countries	99
Appendix 2 Instructions for UL and cUL	100
Appendix 3 Restricted Use of Hazardous Substances in Electronic and Electrical Products	101

INTRODUCTION

This product is a unit for setting inverter functions (parameters) and has the following features.

- An operation panel can be removed and a parameter unit can be connected.
- Setting such as direct input method with a numeric keypad, operation status indication, and help function are usable.
- Eight languages can be displayed.
- Parameter setting values of maximum of three inverters can be stored.

REMARKS

Features only for FR-PU07BB

- Parameter check and setting change are available without connecting a power supply to the inverter.
- Since the shape is specially designed for portable use, it is easy to work with FR-PU07BB in hand.

CAUTION

To use a parameter unit with battery pack (FR-PU07BB) outside Japan, order a "FR-PU07BB-L" (parameter unit type indicated on the package has L at the end).

Since batteries may conflict with laws in countries to be used (new EU Directive on batteries and accumulators, etc.), batteries are not enclosed with an FR-PU07BB.

The parameter unit screen displays in this instruction manual are examples used with the FR-A700 series.

1 PRE-OPERATION INSTRUCTIONS

1.1 Supporting inverter models

- FR-PU07/FR-PU07BB supporting models

Model	FR-PU07	FR-PU07BB *4
A800/F800 series	○ *3, *4	○ *3
E800 series *1 (except for the FR-E800-(SC)E)	○ (FR-PU07 manufactured in August 2020 or later)*3, *4	○ (FR-PU07BB manufactured in August 2020 or later)*3
A700 series	○	○ (FR-PU07BB manufactured in January 2008 or later) *6
F700 series	○	○ (FR-PU07BB manufactured in January 2009 or later)*6
F700P series	○	○
F700PJ series	○ *4	× *5
E700 series	○ *4	○ (FR-PU07BB manufactured in July 2007 or later)*7
D700/E700EX/D700-G series	○ *4	× *5
500 series *2	○ *3, *4	×

○: supported ×: not supported

- *1 FR-E800 inverters manufactured in May 2020 or later are compatible with the FR-PU07/FR-PU07BB.
- *2 The FR-A500/F500/E500/S500(E) series are included.
- *3 Some parameter names displayed are different from those of the FR-PU07.
- *4 The FR-PU07 can not be directly installed to the inverter unit.
- *5 The battery mode is not available. Functions other than the battery mode are the same as those of FR-PU07.
- *6 If a product assembled before the above date is connected when the inverter power is OFF, "MITSUBISHI" appears on the liquid crystal display screen and it is inoperative. If connected when the inverter power is ON, "PU07BB COMPATIBILITY ERROR " appears on the screen and it is inoperative.

- *7 If a product assembled before the above date is connected, "PU07BB/COMPATIBILITY/ERROR" appears on the liquid crystal display screen and it is inoperative regardless of ON/OFF of the inverter power.

●SERIAL number

For product assembled date, check the SERIAL number indicated on the inverter rating plate or package. For the location of the rating plate and how to check the SERIAL number, refer to Instruction Manual of the inverter.

1.2 Unpacking and Product Confirmation

Take the parameter unit out of the package, check the unit name, and confirm that the product is as you ordered and intact.

1.2.1 Unpacking confirmation

Check the enclosed items.

- FR-PU07

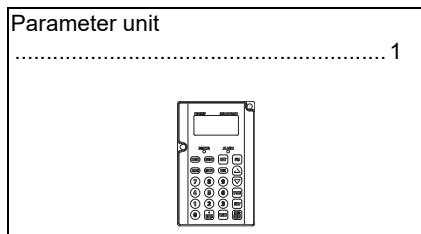

- FR-PU07BB

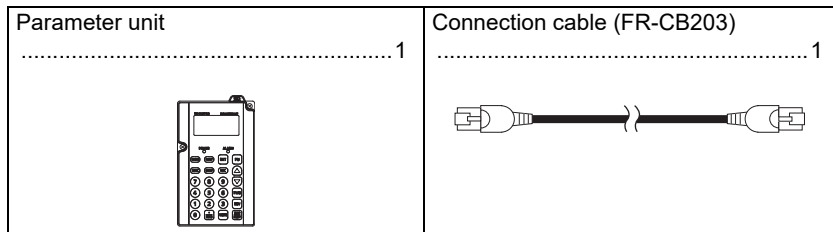

* Batteries are not enclosed. Please prepare them separately.

1.2.2 Appearance and parts identification



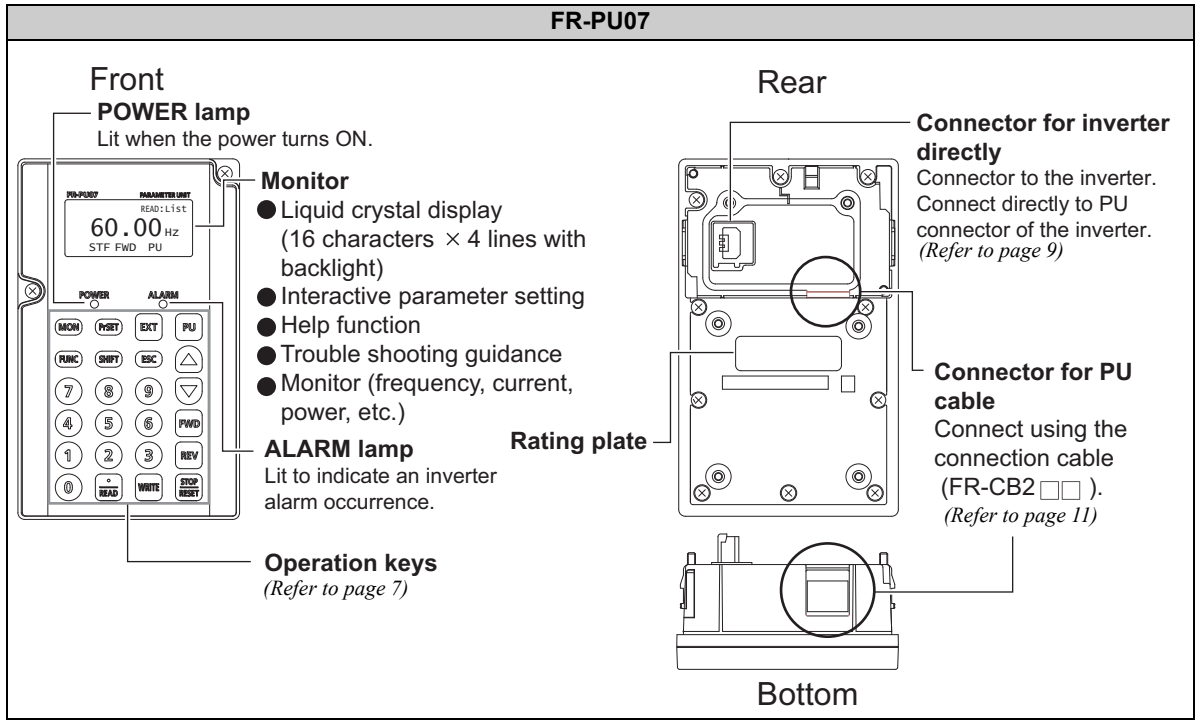



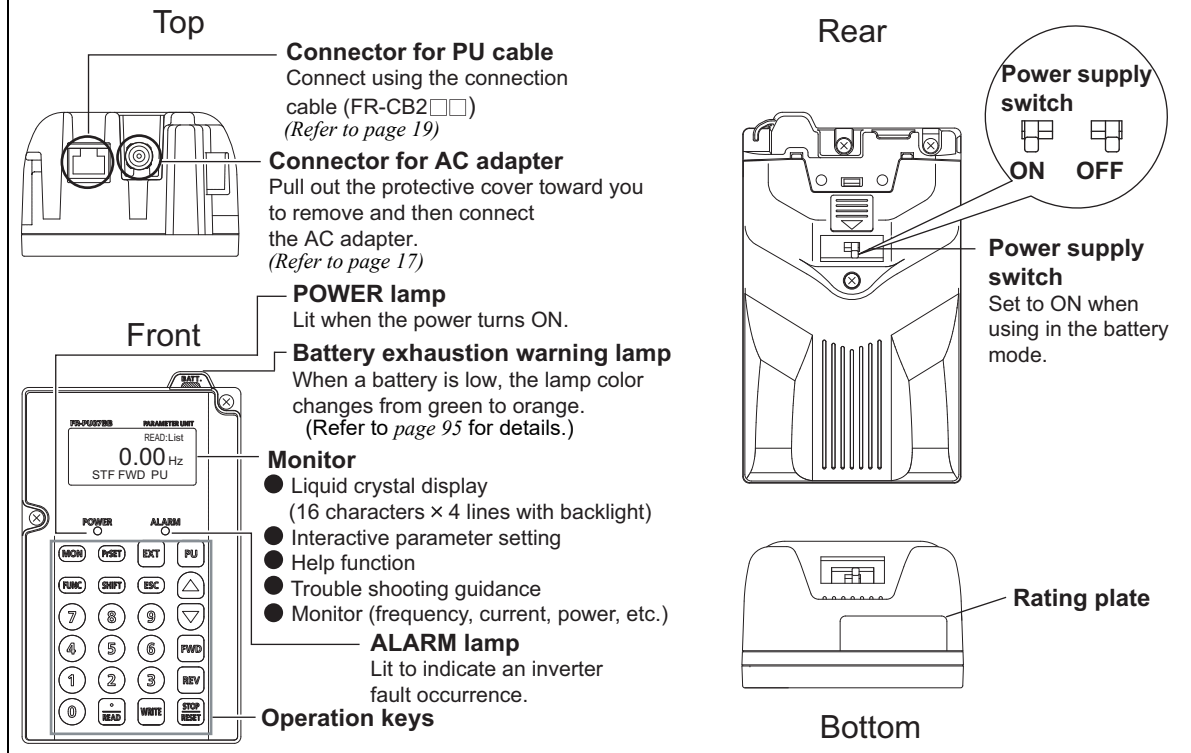

Unpack the parameter unit, check the name plate on the back, and make sure that the product has not been damaged before using.





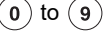

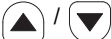
FR-PU07BB



1.2.3 Explanation of keys

Key	Description
	Used to select the parameter setting mode. Press to select the parameter setting mode.
	Used to display the first priority screen. Used to display the output frequency when making an initial setting.
	Operation cancel key.
	Used to display the function menu. A variety of functions can be used on the function menu.
	Used to shift to the next item in the setting or monitoring mode.
	Used to enter a frequency, parameter number or set value.
	Used to select the External operation mode.
	Used to select the PU operation mode to display the frequency setting screen.
	<ul style="list-style-type: none"> · Used to keep on increasing or decreasing the running frequency. Hold down to change the frequency. · Press either of these keys on the parameter setting mode screen to change the parameter setting value sequentially. · On the selecting screen, these keys are used to move the cursor. · Hold down  and press either of these keys to advance or return the display screen one page.

7 Unpacking and Product Confirmation

Key	Description
	Forward rotation command key.
	Reverse rotation command key.
	<ul style="list-style-type: none">· Stop command key.· Used to reset the inverter when a fault occurs.
	<ul style="list-style-type: none">· Used to write a set value in the setting mode.· Used as a clear key in the all parameter clear or alarm history clear mode.
	<ul style="list-style-type: none">· Used as a decimal point when entering numerical value.· Used as a parameter number read key in the setting mode.· Used as an item select key on the menu screen such as parameter list or monitoring list.· Used as an alarm definition display key in the alarm history display mode.· Used as a command voltage read key in the calibration mode.

CAUTION

- Do not use a sharp-pointed tool to push the keys.
- Do not press your fingers against the display.

1.3 Installation and Removal of FR-PU07

FR-PU07 can be directly installed to the FR-A700/F700(P) series inverters.

To ensure safety, install or remove the FR-PU07 only after switching the power of the inverter OFF.

1.3.1 Direct installation to the inverter

- (1) Remove the operation panel (FR-DU07).
- (2) Insert the parameter unit straight and fit it securely.
- (3) Tighten the two screws on the parameter unit to fix the unit to the inverter.

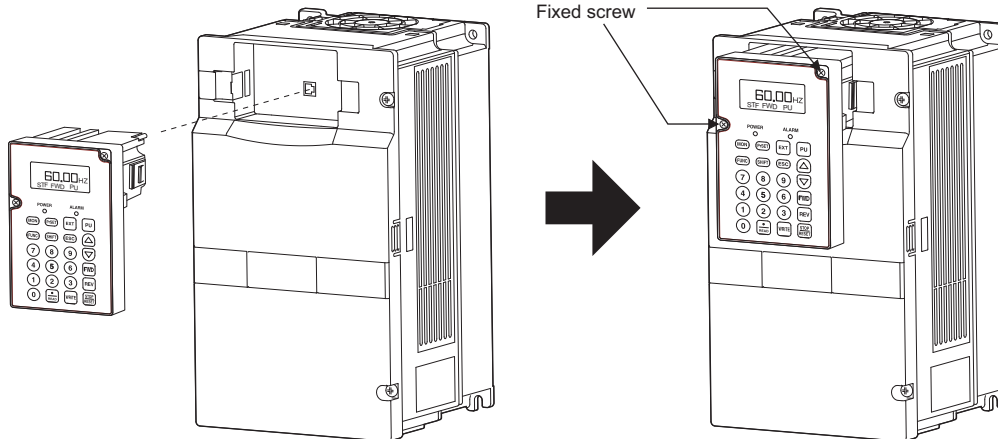

1.3.2 Removal from the inverter

Loosen the fixed screws, hold down the right and left hooks of the FR-PU07, and then pull the parameter unit toward you.

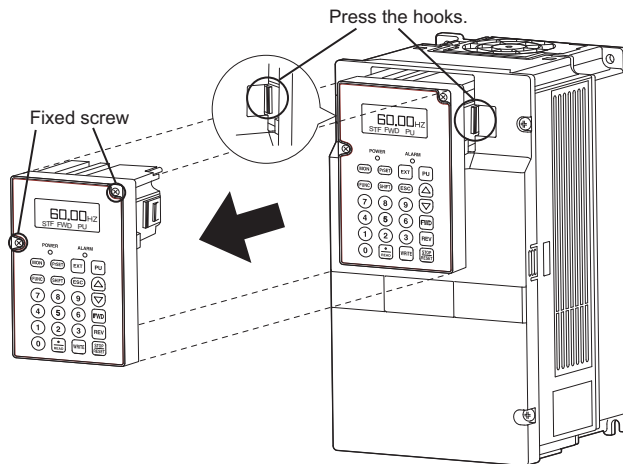

1.3.3 Installation using the connection cable (FR-CB2)

•For the FR-A700/FR-F700(P)/FR-A800/FR-F800

- (1) Remove the operation panel.
- (2) Securely insert one end of connection cable into the PU connector of the inverter and the other end into the connection connector of FR-PU07 along the guides until the stoppers are fixed.

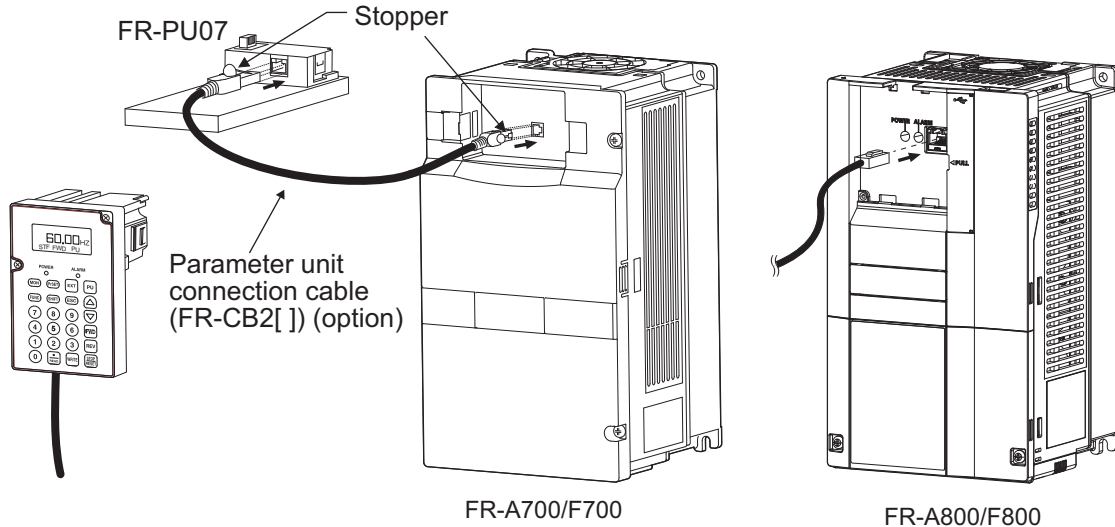

CAUTION

Do not start operation with the inverter front cover removed.

7 Installation and Removal of FR-PU07

- For the FR-E800 (except for the FR-E800-(SC)E)
 - (1) Remove the inverter front cover. (For details on how to remove the front cover, refer to the Instruction Manual of the inverter.)
 - (2) Securely insert one end of the connection cable into the PU connector of the inverter and the other end into the connection connector of the FR-PU07 along the guides until the stoppers are fixed.
 - (3) Install the inverter front cover.

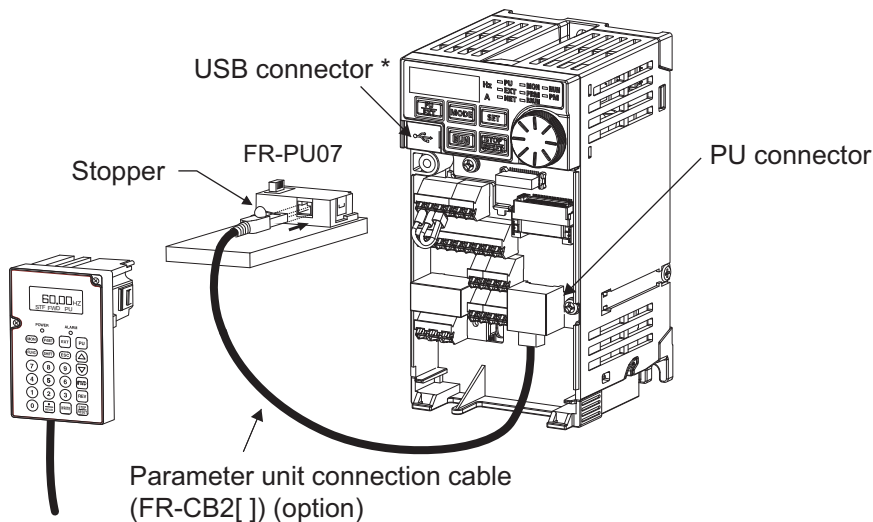

* The PU connector is disabled during USB bus power connection.

CAUTION

Do not start operation with the inverter front cover removed.

Do not connect the parameter unit to the Ethernet port of the FR-E800-E or FR-E800-SCE inverter. Doing so may damage the inverter.

•For FR-E700/FR-E700EX

- (1) Open the PU connector cover.
- (2) Securely insert one end of connection cable into the PU connector of the inverter and the other end into the connection connector of FR-PU07 along the guides until the stoppers are fixed.

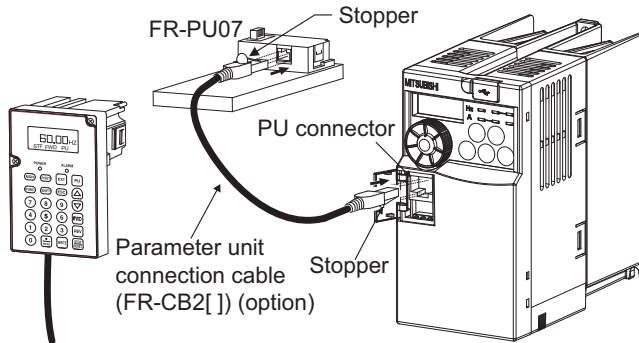

CAUTION

Do not start operation with the inverter front cover removed.

REMARKS

For details of the connection cable (FR-CB2), refer to the connection cable (FR-CB2) instruction manual.

•For FR-F700PJ/FR-D700/FR-D700-G

- (1) Remove the inverter front cover. (For the removal of the front cover, refer to the inverter manual.)
- (2) Securely insert one end of connection cable into the PU connector of the inverter and the other end into the connection connector of FR-PU07 along the guides until the stoppers are fixed.
- (3) Install the inverter front cover.

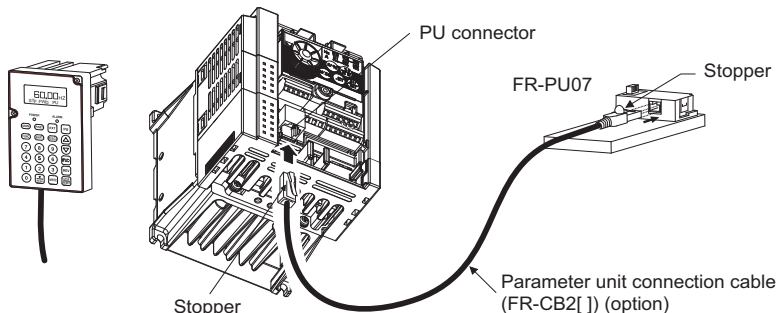

CAUTION

Do not start operation with the inverter front cover removed.

REMARKS

For details of the connection cable (FR-CB2), refer to the connection cable (FR-CB2) instruction manual.

1.3.4 Removal when the connection cable (FR-CB2) is used

Hold down the tab (stopper) at the cable end and gently pull the plug.

1.4 Connection and Removal of FR-PU07BB

1.4.1 Before using FR-PU07BB in the battery mode

For the power supply of FR-PU07BB, a battery and an AC adapter are available.

(1) When using a battery

- 1) Loosen the screw of the FR-PU07BB rear side.
- 3) Place batteries as shown below.

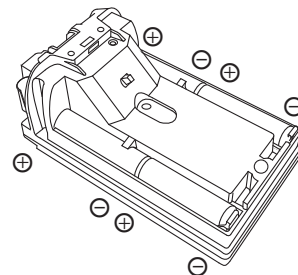
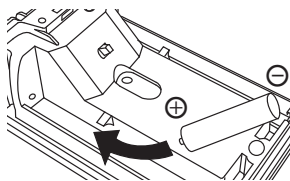
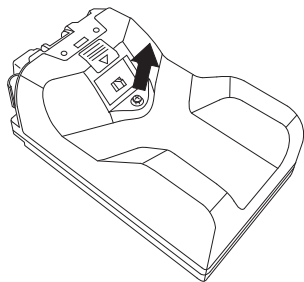

- 2) Pushing the hook, slide the cover in the direction of arrow to open.

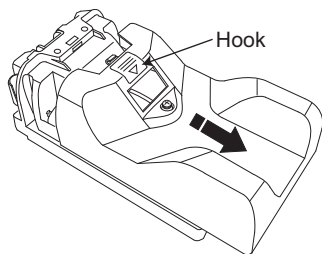

- 4) Close the cover and tighten the screw.

REMARKS

- Use commercially available AA nickel metal hydride batteries or AA alkaline batteries (four pieces).
- Batteries are not enclosed. Please prepare them separately.
- Do not use batteries that have been dropped or otherwise received an impact. Battery leakage may occur. Discard the batteries.

(2) When using an AC adapter

Output specifications	Rated voltage	5.0 VDC \pm 5%
	Rated current	2 A or more
	Polarity	Center positive
	Plug	JEITA RC-5320A compliant

- 1) Pull out the protective cover toward you to remove and then insert the output plug of an AC adapter into the AC adapter connector.
- 2) Connect the AC adapter to a AC power supply.

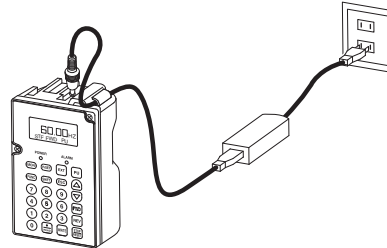
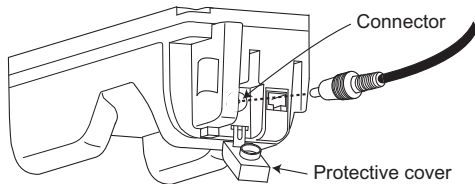

1

REMARKS

- Disconnection of the connector can be prevented by catching the cable with the hook of the parameter unit.
- When using a rechargeable battery, use the rechargeable battery charged with the charger specified by the battery manufacturer. Battery charging is not available with FR-PU07BB even when using an AC adapter.
- If batteries are left in the FR-PU07BB when using an AC adapter, batteries may become discharged.



1.4.2 Instructions for the FR-PU07BB (battery mode)

(1) Functions available when using in the battery mode

	Description	Remarks
Parameter change	<ul style="list-style-type: none"> Parameter read Parameter write 	<ul style="list-style-type: none"> Parameter read/write for plug-in option can be done in battery mode independently of whether the plug-in option is mounted or not.
Functions of the function menu	<ul style="list-style-type: none"> For monitor, only frequency setting monitor is available PU Operation (Only switching between PU/PU Jog modes is available, not operational) Parameter (list, initial value, changed value, read) Parameter clear Read/clear of the fault history Inverter reset Troubleshooting Read of software version Output terminal monitor Frequency direct setting Copy/verification function 	<ul style="list-style-type: none"> Monitor value other than frequency setting monitor is always "0". The ON/OFF status of the input/output signal for the terminal assignment monitor cannot be displayed. Option fitting status monitor cannot be displayed.

(2) FM/AM calibration parameter (*Pr:900, Pr:901*) cannot be set (calibrated).

(3) For following calibration parameters, only the adjusting method without application of analog voltage (current) is available.

Pr:902 to Pr:905, Pr:917 to Pr:920, Pr:932, Pr:933

The parameters may or may not be available depending on the inverter. For details, refer to the instruction manual of each inverter.

(4) Operation by the FR-E800/E700 series operation panel is invalid.

Only PRM LED of the operation panel lit at this time.

(5) Do not use the FR Configurator/FR Configurator2. FR Configurator/FR Configurator2 may not function properly.

1.4.3 Connection using the optional connection cable (FR-CB2)

•For the FR-A700/FR-F700(P)/FR-A800/FR-F800

- (1) Remove the operation panel.
- (2) Insert one end of connection cable securely into the PU connector of the inverter and the other end into the connection connector of FR-PU07BB along the cable guides until the stoppers are fixed.
- (3) When using in the battery mode, turn ON the power supply switch of FR-PU07BB.
ALARM lamp of the inverter flickers in the battery mode.

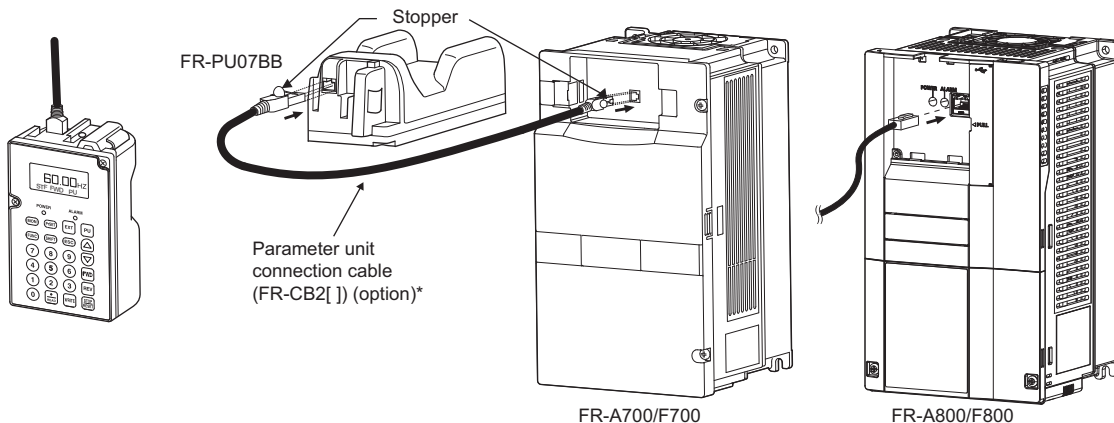

* A connection cable (FR-CB203 (wiring length is 3m)) is enclosed. The cable length when using a connection cable other than the enclosed should be 3m maximum.

CAUTION

- Do not start operation with the inverter front cover removed.
- Do not subject the connection cables to scratches, excessive stress, heavy loads or pinching.

● For the FR-E800 (except for the FR-E800-(SC)E)

- (1) Remove the inverter front cover. (For details on how to remove the front cover, refer to the Instruction Manual of the inverter.)
- (2) Securely insert one end of the connection cable into the PU connector of the inverter and the other end into the connection connector of the FR-PU07BB along the guides until the stoppers are fixed.
- (3) Install the inverter front cover.
- (4) When using in the battery mode, turn ON the power supply switch of FR-PU07BB.

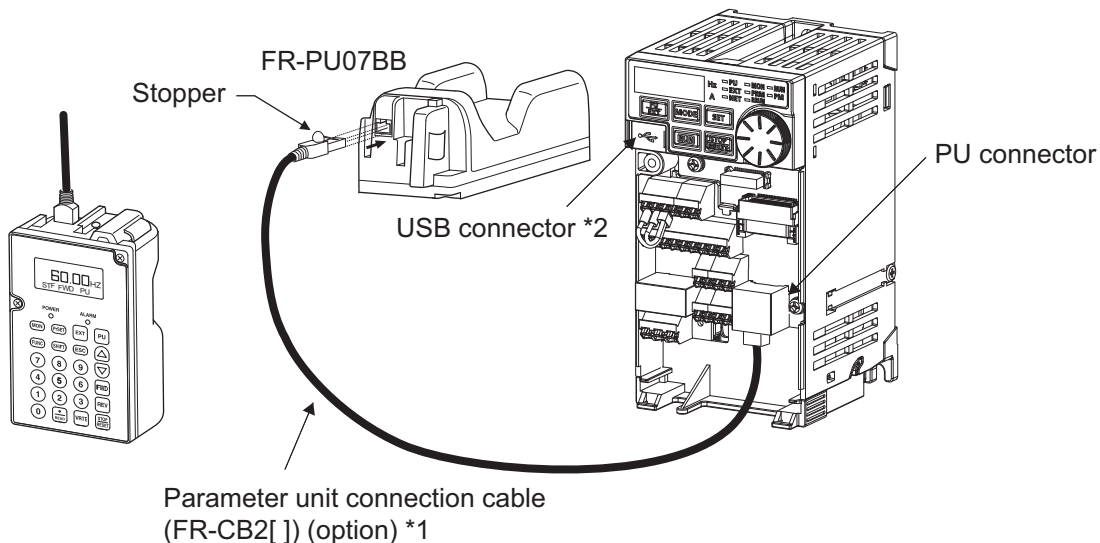

- *1 A connection cable (FR-CB203 (wiring length is 3m)) is enclosed. The cable length when using a connection cable other than the enclosed should be 3m maximum.
- *2 The PU connector is disabled during USB bus power connection.

CAUTION

- Do not start operation with the inverter front cover removed.
 - Do not subject the connection cables to scratches, excessive stress, heavy loads or pinching.
 - Do not connect the parameter unit to the Ethernet port of the FR-E800-E or FR-E800-SCE inverter. Doing so may damage the inverter.
-

• For the FR-E700

- (1) Open the PU cover of the inverter.
- (2) Insert one end of connection cable securely into the PU connector of the inverter and the other end into the connection connector of FR-PU07BB along the cable guides until the stoppers are fixed.
- (3) When using in the battery mode, turn ON the power supply switch of FR-PU07BB.

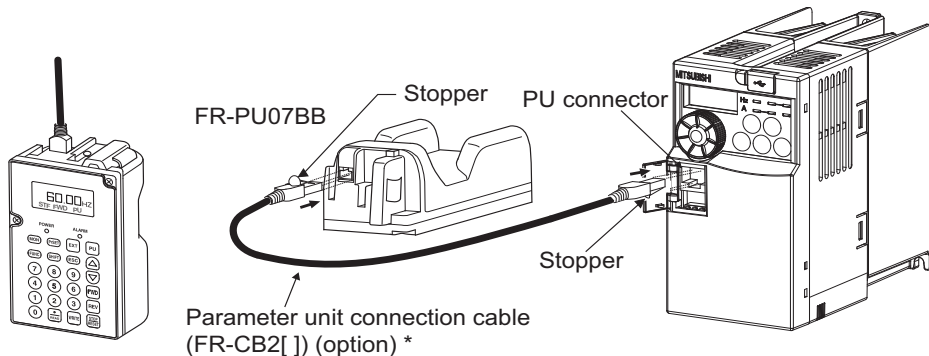

* A connection cable (FR-CB203 (wiring length is 3m)) is enclosed. The cable length when using a connection cable other than the enclosed should be 3m maximum.

CAUTION

- Do not start operation with the inverter front cover removed.
- Do not subject the connection cables to scratches, excessive stress, heavy loads or pinching.

1.4.4 Removal when the connection cable (FR-CB2) is used

Hold down the tab (stopper) at the cable end and gently pull the plug.

1.5 Parameters to be Checked First

Change the following parameter settings as required.
For the changing procedures, refer to *page 36*.

1.5.1 PU display language selection (Pr. 145)

By setting the *Pr. 145 PU display language selection* value, you can select the language displayed on the parameter unit.

<i>Pr. 145 Setting</i>	Display Language
0	Japanese
1	English
2	German
3	French
4	Spanish
5	Italian
6	Swedish
7	Finnish

1.5.2 PU buzzer control (Pr. 990)

By setting the *Pr. 990 PU buzzer control* value, you can select to either generate or mute the "beep" which sounds when you press any of the parameter unit keys.

<i>Pr. 990</i> Setting	Description
0	No buzzer sound
1 (initial value)	Buzzer sound generated

REMARKS

- Inverter alert faults with beep sounds when this parameter is set to activate the buzzer.

1.5.3 PU contrast adjustment (Pr. 991)

By setting the *Pr. 991 PU contrast adjustment* value, you can adjust the contrast for the display panel of the parameter unit.

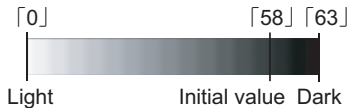
<i>Pr. 991</i> Setting	Description
0 to 63	

2 FUNCTIONS

2.1 Monitoring Function

2.1.1 Display overview

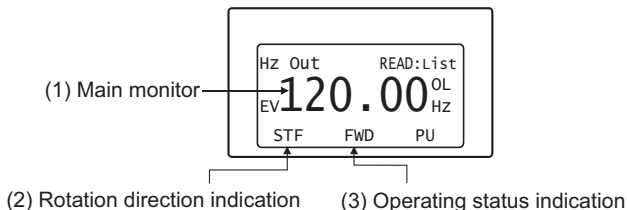

(1) Main monitor

Shows the output frequency (Hz Out), output current (I Out), output voltage (V Out), alarm history and other monitor data.

- Using **(SHIFT)** to change to the next screen (*Refer to page 28*)
- Using **(FUNC)** to change to the next screen (*Refer to page 62*)
- Using the parameter "PU main display data selection" (*Refer to page 31*)

(2) Rotation direction indication

Display the direction (forward rotation/reverse rotation) of the start command.

STF : Forward rotation

STR : Reverse rotation

--- : No command or both STF and STR ON

(3) Operating status indication

Display the running status of the inverter.

STOP : During stop

FWD : During forward rotation

REV : During reverse rotation

JOGf : During Jog forward rotation

JOGr : During Jog reverse rotation

ALAR : At fault occurrence

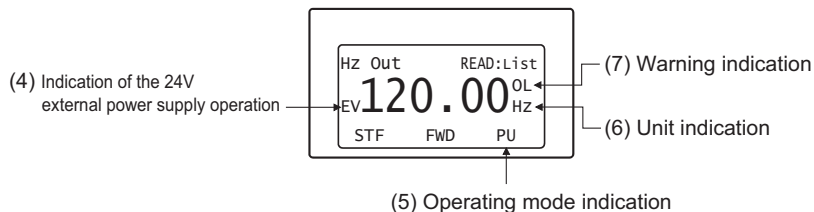

(4) Indication of the 24V external power supply operation

Appears during the 24V external power supply operation (only for the inverters that support the 24V external power supply operation)

(5) Operation mode indication

Displays the status of the operation mode.

- EXT : External operation mode
- PU : PU operation mode
- EXTj : External Jog mode
- PUj : PU Jog mode
- NET : Network operation mode
- PU+E : External/PU combined operation mode

(6) Unit indication

Shows the unit of the main monitor.

(7) Warning indication

Displays an inverter warning.

The warning type varies with the inverter model. Refer to the inverter instruction manual for details. Nothing is displayed when there is no inverter warning.

REMARKS

- Standby mode function
When FR-PU07BB gets into the standby mode, the backlight of the parameter unit turns OFF, and POWER LED remains lit.
<Switching conditions>
 - When the FR-PU07BB is left in the power-ON status for one minute without connecting to the inverter.
 - When FR-PU07BB is connected to the inverter and the inverter remains in the reset status for one minute.<Recovery conditions>
 - When FR-PU07BB is connected to the inverter.
 - When the reset of the inverter connected to FR-PU07BB is canceled.

2.1.2 Using (SHIFT) to change the main monitor

When "0" (initial value) is set in the Pr. 52 DU/PU main display data selection, simply pressing (SHIFT) calls 6 different monitor screens in sequence.

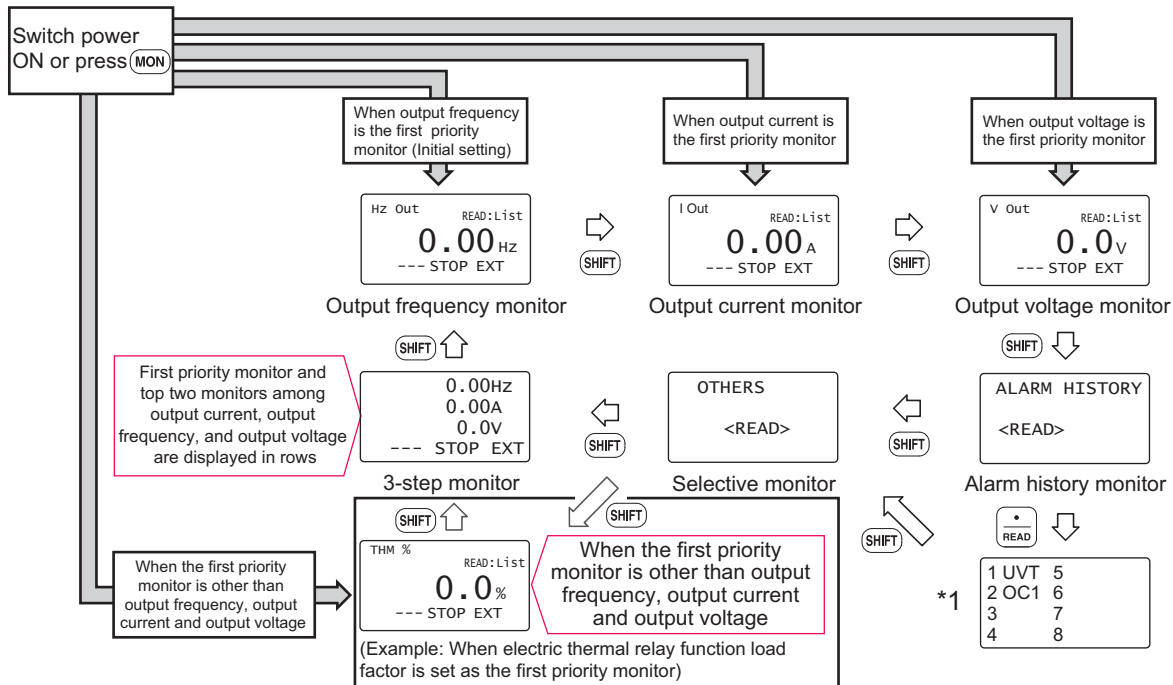

*1 When the inverter stores 10 fault records, the fault history monitor screen is displayed as follows. For the maximum number of storable fault records, refer to the Instruction Manual of each inverter.

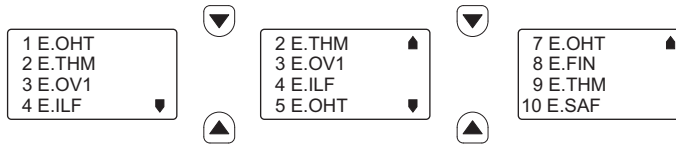

2.1.3 **Setting the power-ON monitor (the first priority monitor)**

Set the monitor which appears first when power is switched ON or **MON** is pressed.











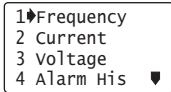

- When you press **WRITE** during any monitor screen other than ALARM HISTORY being displayed, that screen is set as the power-ON screen and will be displayed first.



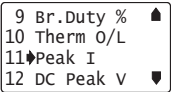

2.1.4 Using to change the main monitor

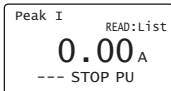
Press  to display the monitoring list while the main monitor is displayed.

Select a monitor from the monitoring list to change the main monitor.

Example: Select the output current peak value monitor.

1	Press  . The parameter unit is in the monitoring mode.	
2	Press  . The monitoring list appears.	
3	Press  /  to move the cursor to "Peak I". Hold down  and press  or  to shift one screen.	
4	Press  . *1 The output current peak is displayed.	
5	Press  . *2 The screen in step 4) is set as the first priority monitor.	Subsequently press  to call another monitor screen.

- *1 The selected monitor is not set as the first priority monitor yet when only  was pressed. Hence, the selected monitor is erased from memory as soon as the power is switched OFF or another operation mode is selected. In this case, the item must be selected again. When you press  to select the first priority screen, the selected item is stored in memory.
- *2 Pressing  sets the selected "output current peak" to be displayed in the first priority monitor when switched to the monitoring mode from other operation modes. To give first priority to another monitor screen, press  with that monitor screen being displayed. (Refer to page 29)

REMARKS

- The setting can be also made from the function menu. For details refer to page 56.
- When "Current monitor" or "Power monitor" is selected, note that any current or power not more than 5% of the rated inverter current cannot be detected and displayed.
 Example: When a small motor is rotated with a large-capacity inverter (a 0.4kW motor is used with a 55kW inverter), the power monitor keeps displaying 0kW and is inoperative.

2.1.5 Using the parameter to change the monitor (Pr. 52)

To change the third monitor (output voltage monitor), set *Pr. 52 DU/PU main display data selection*.

(Note that setting "17" (load meter), "18" (Motor excitation current), and "24" (Motor load ratio) change the output current monitor.

"Output voltage monitor" monitor displays from the first priority monitor using **SHIFT**.

REMARKS

The monitor items depend on the inverter. For the monitor items and descriptions, refer to the instruction manual of each inverter.

Factory setting

* The monitor displayed at powering ON is the first priority monitor. Refer to *page 29* for the setting method of the first priority monitor.

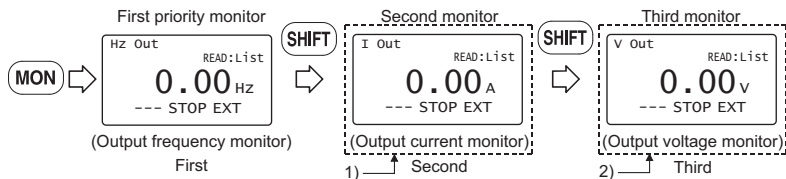

1) For the set value of "17, 18, 24", their monitors are displayed at the second monitor instead of output current monitor.

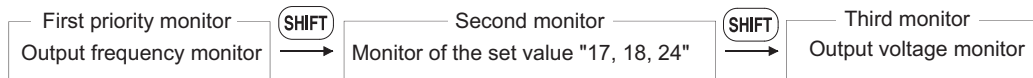

2) For the set value of "19 to 23, 25……", their monitors are displayed at the third monitor instead of output voltage monitor.



REMARKS

The setting range of *Pr. 52 DU/PU main display data selection* differs according to the inverter. Refer to the inverter instruction manual for details.

2.2 Frequency Setting

The frequency in PU operation mode and External/PU combined operation mode (*Pr. 79* = "3") can be set.

REMARKS

When changing the operation mode from External operation mode to PU operation mode, operation mode can not be changed if the external starting signal (STF or STR) is ON.

2.2.1 Direct setting

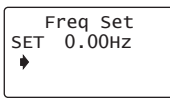
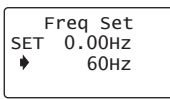
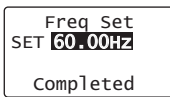

Directly enter a frequency setting using (0) to (9).

- Operation procedure (Changing from 0Hz setting to 60Hz setting)





1	Press PU . The frequency setting screen appears.	
2	Press (6) and (0). Enter 60Hz.	
3	Press WRITE . The 60Hz setting is complete.	

- * If you entered an incorrect value, press (ESC) to return to the pre-entry state.

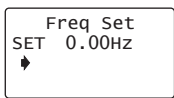

2.2.2 Step setting

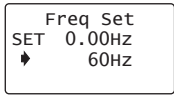
Change frequency continuously using  / .

You can change the frequency only while you press  / . Since the frequency changes slowly at first, this setting can be used for fine adjustment.

1	Press  . The frequency setting screen appears.	
2	Press  /  to enter a desired value (60.00Hz). You can set any value between the maximum frequency (<i>Pr: 1</i>) and minimum frequency (<i>Pr: 2</i>).	
3	Press  . The 60Hz setting is complete.	

REMARKS

Change of frequency can be made during operation by the step setting. However, pressing  /  at monitor mode may cause actual set frequency to be higher/lower from the indicated frequency on the monitor. When performing the step setting at monitor mode, make sure that output frequency is following the set frequency.

2.2.3 Precautions for frequency setting

- 1) Pr. 79 Operation mode selection must have been set to switch to the PU operation. (Refer to the inverter instruction manual for details of Pr. 79 .)
- 2) In the monitor mode, you cannot make the direct setting (Refer to page 33) to set the running frequency.

Perform the step setting (Refer to page 34) and press , or press  to display the frequency setting screen before frequency setting.

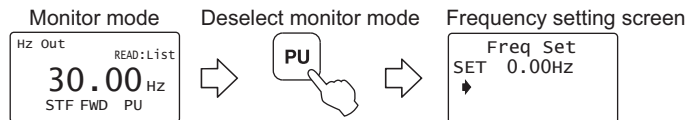



2.3 Setting and Changing the Parameter Values

Using the FR-PU07/FR-PU07BB allows you to read the parameter of inverter or change the set value easily. Refer to the inverter instruction manual for details of the parameters.

2.3.1 Specifying the parameter number to change the set value

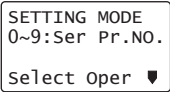
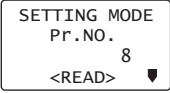
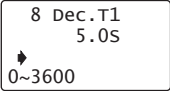
Example: When changing 5s to 180s at the Pr. 8
Deceleration time setting

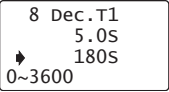
1	<p>Press PU.</p> <p>The frequency setting screen appears, and operation mode changes to PU operation mode.</p> <p>(You need not press PU when the parameter unit is already in the PU operation mode.)</p>	
2	<p>Press PrSET.</p> <p>The parameter unit is in the parameter setting mode.</p>	
3	<p>Press 8.</p> <p>Enter the desired parameter number.</p>	
4	<p>Press READ.</p> <p>The present setting appears.</p>	

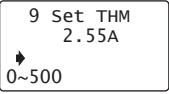
5	<p>(1) Direct setting</p> <p>Press 1 8 0.*</p> <p>Enter the desired value.</p> <p>Or</p> <p>(2) Step setting</p> <p>Press ▲ ▼.</p> <p>Display "180" using ▲ ▼.</p>	
6	<p>Press WRITE.</p> <p>The set value is changed.</p>	
7	<p>Press SHIFT to display the next parameter.</p>	

* If you entered an incorrect value, press **ESC** to return to the pre-entry state.

2.3.2 Selecting the parameter from functional list to change the set value

Example: When changing 5s to 180s at the *Pr. 8 Deceleration time* setting

1	<p>Press PU.</p> <p>The frequency setting screen appears, and operation mode changes to PU operation mode.</p>	
2	<p>Press PrSET.</p> <p>The parameter unit is in the parameter setting mode.</p>	
3	<p>Select the screen using and move the cursor to "Appl.Grp".</p>	
4	<p>Press READ.</p> <p>The function list appears.</p>	
5	<p>Select a function. Point the cursor to "Acc.Dec" using .</p>	

6	<p>Press READ.</p> <p>A function list regarding acceleration/deceleration is displayed.</p>	
7	<p>Select a function.</p> <p>Using , point the cursor to "Acc1/Dec1 T".</p>	
8	<p>Press READ.</p> <p>A parameter list regarding acceleration/deceleration time is displayed.</p>	
9	<p>When moving the cursor to "Dec.T1" using and pressing READ, the present set value is called.</p>	

2

7 Setting and Changing the Parameter Values

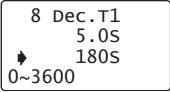
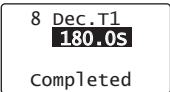
10	<p>(1) Direct setting Press 1 8 0. *</p> <p>Enter the desired value.</p> <p>Or</p> <p>(2) Step setting Press ▲ ▼.</p> <p>Display "180" using ▲ ▼.</p>	 <p>8 Dec.T1 5.0S ↓ 180S 0~3600</p>
11	<p>Press WRITE.</p> <p>The set value is changed.</p>	 <p>8 Dec.T1 180.0S Completed</p>
12	<p>Press SHIFT to display the next parameter.</p>	

* If **ESC** is pressed when an incorrect setting value is input, the display returns to the list display "8".



REMARKS

The FR-PU07 does not support the functional list for the FR-A800/F800/E800 series inverters.

2.3.3 Selecting the parameter from parameter list to change the set value

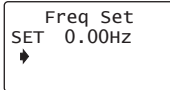
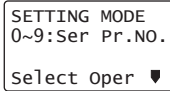
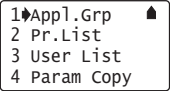
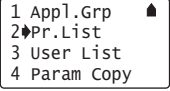
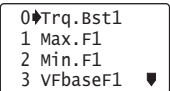
Example: When changing 5s to 180s at the Pr. 8 Deceleration time setting

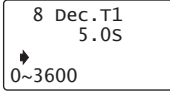
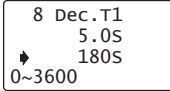
1	<p>Press PU.</p> <p>The frequency setting screen appears, and operation mode changes to PU operation mode.</p>	
2	<p>Press PrSET.</p> <p>The parameter unit is in the parameter setting mode.</p>	
3	<p>Change the screen using ▼.</p>	
4	<p>Select a parameter list.</p> <p>Using ▲▼, point the cursor to "Pr.List".</p>	
5	<p>Press READ.</p> <p>Select the parameter list.</p> <p>The list of the parameters can be read appears.</p>	

6	<p>Select the parameter.</p> <p>When moving the cursor using ▲▼ and pressing READ at "Dec.T1", the present set value is called.</p>	
7	<p>(1) Direct setting</p> <p>Press 1 8 0. *</p> <p>Enter the desired value.</p> <p>Or</p> <p>(2) Step setting</p> <p>Press ▲▼.</p> <p>Display "180" using ▲▼.</p>	
8	<p>Press WRITE.</p> <p>The set value is changed.</p>	
9	<p>Press SHIFT to display the next parameter.</p>	



* If **ESC** is pressed when an incorrect setting value is input, the display returns to the list display "5".

2.3.4 Selecting the parameter from User List to change the set value

If a parameter is registered to User List, the parameter can be read from User List and changed. (For registering the user group, refer to *page 42*.)

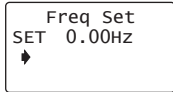
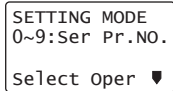
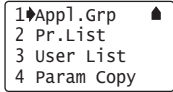
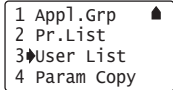
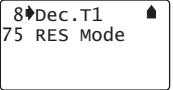
Example: When changing 5s to 180s at the *Pr: 8 Deceleration time* setting

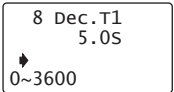
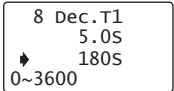
1	<p>Press PU.</p> <p>The frequency setting screen appears, and operation mode changes to PU operation mode.</p>	
2	<p>Press PrSET.</p> <p>The parameter unit is in the parameter setting mode.</p>	
3	<p>Change the screen using ▼.</p>	
4	<p>Select a User List.</p> <p>Using ▲▼, point the cursor to "User List".</p>	
5	<p>Press READ.</p> <p>The list of the parameters registered to User List appears.</p>	

6	<p>Select the parameter.</p> <p>When moving the cursor using ▲▼ and pressing READ at "Dec.T1", the present set value is called.</p>	
7	<p>(1) Direct setting</p> <p>Press 1 8 0. *</p> <p>Enter the desired value.</p> <p>Or</p> <p>(2) Step setting</p> <p>Press ▲▼.</p> <p>Display "180" using ▲▼.</p>	
8	<p>Press WRITE.</p> <p>The set value is changed.</p>	
9	<p>Press SHIFT to display the next parameter.</p>	

* If **ESC** is pressed when an incorrect setting value is input, the display returns to the list display "5".

2.3.5 Precautions for setting write

- Perform parameter setting change during an inverter stop basically in the PU operation mode or combined operation mode. The parameter setting can not be changed in the External operation mode or during inverter operation. (Read is performed independently of the operation mode.) Note that some parameters can be written even in the External operation mode or during operation. Therefore, refer to the inverter manual.
- As *Pr. 77 Parameter write selection* = "0" in the initial setting, parameter can be written only during an inverter stop. (Read is allowed even during operation.) Note that some parameters can be written always. Refer to the inverter manual for details of *Pr. 77*.
- In addition to the above case, setting write cannot be performed when:
 - 1) The parameter number selected does not exist in the parameter list; or
 - 2) The value entered is outside the setting range.
- When write cannot be performed and the "Setting Err." appears, press **ESC** and make setting once more. (Example: For *Pr. 7 Acceleration time*)

```
7 Acc.T1
Setting Error
20000S
<ESC>
```

2.4 User Group Function

- User group function is a function to display only parameters necessary for setting.
- Among all parameters, maximum 16 parameters can be registered to the user group. When "1" is set in *Pr. 160*, only parameters registered in the user group can be accessed for reading and writing. (The parameters not registered to the user group cannot be read.)

REMARKS

The function may or may not be available depending on the inverter. Refer to *the Instruction Manual of the inverter* for details.

2.4.1 Registering the parameters to user group

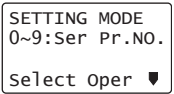
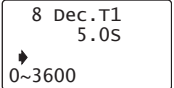
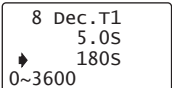
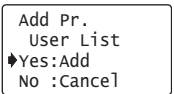
1	<p>Press PrSET.</p> <p>The parameter unit is in the parameter setting mode.</p>	
2	<p>Read the parameters. Enter the parameter number to be registered to the user group with the number keys and press READ to read the parameter setting.</p>	
3	<p>Set the parameters. When changing the set value, enter a new value with the number keys and press WRITE to write. When not changing the setting value, press WRITE to display the setting completion screen.</p>	
4	<p>Press WRITE.</p> <p>The selecting screen appears.</p>	

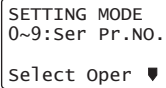
5	<p>Register. When moving the cursor to "YES" and pressing WRITE, the registration is executed.</p>	
6	<p>The parameter setting screen appears. To continue parameter registration, repeat the operation from step 2.</p>	

2.4.2 Deleting the parameters from user group

1	Press PrSET . The parameter unit is in the parameter setting mode.	SETTING MODE 0~9:Ser Pr.NO. Select Oper ▾
2	Select "User List". Using ▲/▼ , point the cursor to "3 User List" and press READ .	1 Appl.Grp ▲ 2 Pr.List 3♦User List 4 Param Copy
3	Select the parameter to be deleted. Using ▲/▼ , point the cursor to the parameter to be deleted and press WRITE .	1 Max.F1 2 Min.F1 3♦VFbaseF1 ▾ 7 Acc.T1
4	Delete. The screen of delete confirmation appears. When pointing the cursor to "Yes" and pressing WRITE , the parameter is deleted.	Delete Pr. User List ♦Yes:Delete No :Cancel

5	To continue deleting parameter, repeat the operation from step 3.	1♦Max.F1 2 Min.F1 7 Acc.T1 8 Dec.T1 ▾
---	---	--

2.4.3 Confirming the parameters registered to user group

1	Press PrSET . The parameter unit is in the parameter setting mode.	SETTING MODE 0~9:Ser Pr.NO. Select Oper ▾
2	Select "User List". Using ▲/▼ , point the cursor to "3 User List" and press READ .	1 Appl.Grp ▲ 2 Pr.List 3♦User List 4 Param Copy
3	Read the parameter. You can confirm the parameters registered to the user group.	1 Max.F1 2 Min.F1 3♦VFbaseF1 7 Acc.T1 ▾

REMARKS

If the parameter is not registered to the user group, "User List Setting Err." will be displayed. Press **ESC** to return to the screen of step 1.

2.5 Calibration of the Meter (Frequency Meter)

The functions vary with the inverter. (Refer to the inverter instruction manual for details of the parameters.)

2.5.1 Calibration of the FM terminal



Parameter

Pr. 900 FM terminal calibration
Pr. 54 FM terminal function selection
Pr. 55 Frequency monitoring reference

This section provides the way to calibrate the full-scale of meter connected to terminal FM using the parameter unit.

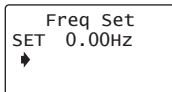
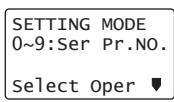
- Calibrating the meter at the running frequency of 60Hz

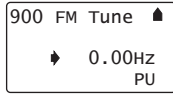
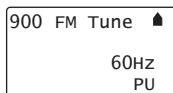
1	<p>Press PU.</p> <p>The frequency setting screen appears, and operation mode changes to PU operation mode.</p>	
2	<p>Press PrSET.</p> <p>The parameter unit is in the parameter setting mode.</p>	

3	<p>Enter 9 0 0 and press READ.</p> <p>The preset frequency is displayed.</p>	
4	<p>Enter 6 0 and press WRITE.</p> <p>60Hz is set.</p>	
5	<p>Press FWD.</p> <p>Forward rotation is performed at 60Hz. You need not connect the motor.</p>	
6	<p>Using ▲/▼, adjust the meter pointer to a predetermined position. The meter pointer moves. (It takes a long time before the pointer moves.)</p>	

7 Calibration of the Meter (Frequency Meter)

7	Press WRITE . Calibration is complete.	900 FM Tune Completed <MONITOR>
8	Press MON to return to the main monitor screen.	Hz Out READ: List 60.00 Hz STF FWD PU

REMARKS

When FR-PU07BB is used in the battery mode (the inverter power is OFF), this parameter cannot be set (calibrated).

2.5.2 Calibration of the AM terminal

Parameter

Pr. 901 AM terminal calibration
Pr. 158 AM terminal function selection
Pr. 55 Frequency monitoring reference
Pr. 56 Current monitoring reference

This section provides a way to calibrate the meter connected to terminal AM using the parameter unit.

(1) Calibration procedure 1

(Example: To calibrate the meter at the running frequency of 60Hz)

1	Press PU . The frequency setting screen appears, and operation mode changes to PU operation mode.	Freq Set SET 0.00Hz ↓
2	Press PrSET . The parameter unit is in the parameter setting mode.	SETTING MODE 0~9:Ser Pr.NO. Select Oper ↓
3	Enter 9 0 1 and press READ . The preset frequency is displayed.	901 AM Tune Run Inverter ↓ 0.00Hz PU

4	Enter 6 0 and press WRITE . 60Hz is set.	901 AM Tune Run Inverter 60Hz PU
5	Press FWD . Forward rotation is performed at 60Hz. You need not connect the motor.	901 AM Tune MntrF 60.00Hz ▶▶▶▶ <WRITE>PU
6	Using ▲ / ▼ , adjust the meter pointer to a predetermined position. The meter pointer moves. (It takes a long time before the pointer moves.)	
7	Press WRITE . Calibration is complete.	901 AM Tune Completed <MONITOR>
8	Press MON to return to the main monitor screen.	Hz Out READ:List 60.00 Hz STF FWD PU



(2) When calibrating output current

For the output current or another item, which does not easily point 100% value during operation, adjust the reference voltage output, then select the item to be displayed.

1	Press PU . The frequency setting screen appears, and operation mode changes to PU operation mode.	Freq Set SET 0.00Hz ▶
2	Press PrSET . The parameter unit is in the parameter setting mode.	SETTING MODE 0~9:Ser Pr.NO. Select Oper ▼
3	Enter 1 5 8 and press READ . The present <i>Pr: 158</i> setting appears.	158 AM set 1 ▶
4	Enter 2 1 and press WRITE . The setting of reference voltage output is complete.	158 AM set 21 Completed
5	Press PrSET . The parameter unit is in the parameter setting mode.	SETTING MODE 0~9:Ser Pr.NO. Select Oper ▼

2

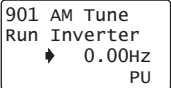
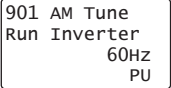
7 Calibration of the Meter (Frequency Meter)

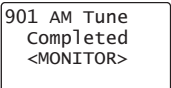
6	<p>Enter 9 0 1 and press READ.</p> <p>The present Pr: 901 setting appears.</p>	
7	<p>Enter 6 0 and press WRITE.</p> <p>The setting of maximum running frequency is complete.</p>	
8	<p>Press FWD.</p> <p>Forward rotation is performed at 60Hz. You need not connect the motor to make adjustment.</p>	
9	<p>Using ▲/▼, adjust the voltage across terminals AM-5 and press WRITE.</p> <p>Setting is complete. The output voltage displayed is the value at 100% output. This voltage is not stored if you do not press WRITE.</p>	

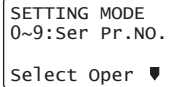
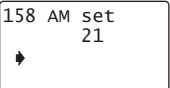
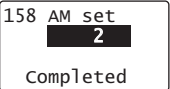
10	<p>Press PrSET.</p> <p>The parameter unit is in the parameter setting mode.</p>	
11	<p>Enter 1 5 8 and press READ.</p> <p>The present Pr: 158 setting appears.</p>	
12	<p>Enter 2 and press WRITE.</p> <p>The setting of output current is complete. The output current for 10VDC is the setting value of Pr: 56 <i>Current monitoring reference</i> (initial value: rated inverter current).</p>	

REMARKS

When FR-PU07BB is used in the battery mode (the inverter power is OFF), this parameter cannot be set (calibrated).

2.6 Adjustment of the Frequency Setting Signals "Bias" and "Gain"

The functions vary with the inverter model. (Refer to the inverter instruction manual for details of the functions.)

2.6.1 Adjustment procedure

There are three ways to adjust the bias and gain of the frequency setting voltage (current).

- (1) Adjust only the bias and gain frequencies and not adjust the voltage (current) (*Refer to page 50*)
- (2) Adjust any point by applying a voltage across terminals 2-5 (starting a current across terminals 4-5) (*Refer to page 52*)
- (3) Adjust any point without a voltage being applied across terminals 2-5 (without a current being applied across terminals 4-5) (*Page 54*)

REMARKS

When using FR-PU07BB in the battery mode, only Adjustment procedure (3) is available for the following calibration parameters.

Pr.902 to Pr.905, Pr.917 to Pr.920, Pr.932, Pr.933

The parameters may or may not be available depending on the inverter. For details, refer to the instruction manual of each inverter.

Parameter

Pr. 902 Terminal 2 frequency setting bias frequency

Pr. 903 Terminal 2 frequency setting gain

Pr. 904 Terminal 4 frequency setting bias frequency

Pr. 905 Terminal 4 frequency setting gain

7 Adjustment of the Frequency Setting Signals "Bias" and "Gain"

- (1) Adjust only the bias and gain frequencies and not adjust the voltage
- Setting of the frequency setting voltage bias

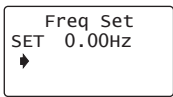
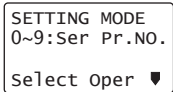
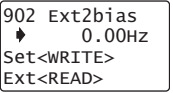
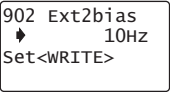
1	Press PU . The frequency setting screen appears, and operation mode changes to PU operation mode.	
2	Press PrSET . The parameter unit is in the parameter setting mode.	
3	Enter 9 0 2 and press READ . The present Pr. 902 setting appears.	
4	Enter 1 0 . Voltage need not be applied across terminals 2-5.	

5 Press **WRITE**.
 The bias frequency is set at 10Hz.

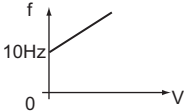

If the voltage is being applied across terminals 2- 5 at this time, the bias setting is as shown above.



Adjustment of the Frequency Setting Signals "Bias" and "Gain"

• Setting of the frequency setting voltage gain

6	Press SHIFT . The present setting appears.	903 Ext2gain ♦ 60.00Hz Set<WRITE> Ext<READ>
7	Enter 5 0 . Voltage need not be applied across terminals 2-5.	903 Ext2gain ♦ 50Hz Set<WRITE>
8	Press WRITE . The bias frequency is set at 50Hz. At this time, set the gain on the assumption that the 5V (10V) in the inverter is the set voltage.	903 Ext2gain 50.00Hz Completed

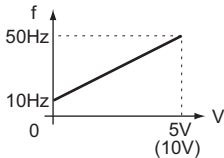

The adjustment of the frequency setting voltage bias and gain is complete.

REMARKS

- The current input (*Pr. 904*) can also be adjusted using a similar procedure.
- The *Pr. 903 Terminal 2 frequency setting gain* remains unchanged if the *Pr. 20 Acceleration/deceleration reference frequency setting* is changed.

7 Adjustment of the Frequency Setting Signals "Bias" and "Gain"

- (2) Adjust any point by application of voltage to across terminals 2-5
- Setting of the frequency setting voltage bias

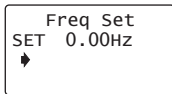
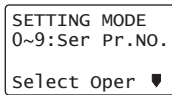
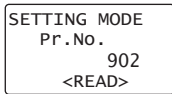
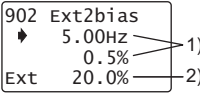
1	<p>Press PU.</p> <p>The frequency setting screen appears, and operation mode changes to PU operation mode.</p>	
2	<p>Press PrSET.</p> <p>The parameter unit is in the parameter setting mode.</p>	
3	<p>Enter 9 0 2.</p>	
4	<p>Press READ twice.</p> <p>The present <i>Pr. 902</i> setting appears.</p> <p>When the set voltage is changed, the % value also changes.</p> <p>This example assumes that a 1V voltage is applied.</p> <p>The value selected in <i>Pr. 73</i> (5V in this example) is 100%.</p>	 <ol style="list-style-type: none"> 1) The previous setting is displayed. 2) The present set voltage across terminals 2-5 is displayed in %.

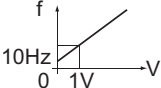
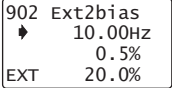
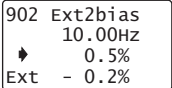
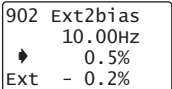
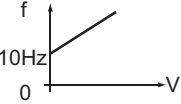
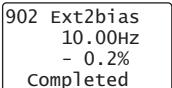
5	<p>Enter 1 0.</p> <p>Set the bias frequency at 10Hz.</p> 	
6	<p>Press WRITE.</p> <p>The cursor (▶) moves to the set voltage.</p>	
7	<p>Apply a 0V voltage.</p> <p>In this example, 0V is applied as 10Hz is set for 0V.</p> <p>(Indicated % on the right changes.)</p>	
8	<p>Press WRITE.</p> <p>The bias frequency is set at 10Hz for 0V input.</p> <p>Setting is completed as shown below:</p> 	 <p>0.0% of analog input value may not be displayed in some cases.</p>

Adjustment of the Frequency Setting Signals "Bias" and "Gain"

• Setting of the frequency setting voltage gain

9	<p>Press (SHIFT), then ($\frac{\cdot}{\text{READ}}$).</p> <p>The present <i>Pr. 903</i> setting appears.</p> <p>When the set voltage is changed, the % value also changes.</p> <p>The value selected in <i>Pr. 73</i> (5V in this example) is 100%.</p>	<div style="border: 1px solid black; padding: 5px;"> <p>903 Ext2gain ♦ 60.00Hz 97.1% Ext 80.0%</p> </div> <p>1) The previous setting is displayed. 2) The present set voltage across terminals 2-5 is displayed in %.</p>
10	<p>Enter (5) (0).</p>	<div style="border: 1px solid black; padding: 5px;"> <p>903 Ext2gain ♦ 50Hz 97.1% Ext 80.0%</p> </div>
11	<p>Press (WRITE).</p> <p>The cursor (▶) moves to the set voltage.</p>	<div style="border: 1px solid black; padding: 5px;"> <p>903 Ext2gain 50.00Hz ♦ 97.1% Ext 80.0%</p> </div>
12	<p>Apply a 5V voltage.</p> <p>In this example, 5V is applied to set 50Hz for 5V input.</p>	<div style="border: 1px solid black; padding: 5px;"> <p>903 Ext2gain 50.00Hz ♦ 97.1% Ext 80.0%</p> </div>

13

Press **(WRITE)**.

The gain frequency is set at 50Hz for 5V input. Setting is completed as shown below:

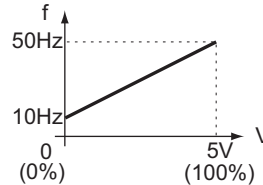

903 Ext2gain
 50.00Hz
 99.6%
 Completed

The value displayed may not be just 100.0% in some cases.

The adjustment of the frequency setting voltage bias and gain is complete.

REMARKS

- The current input (*Pr. 904*, *Pr. 905*) can also be adjusted using a similar procedure.
- The *Pr. 903 Terminal 2 frequency setting gain* remains unchanged even if the *Pr. 20 Acceleration/deceleration reference frequency setting* is changed.
- A narrow calibration (command) value set using *Pr. 902* and *Pr. 903* (*Pr. 904* and *Pr. 905*) will result in "Incr // P" and disable write.

2

7 Adjustment of the Frequency Setting Signals "Bias" and "Gain"

(3) Adjust any point without application of voltage to across terminals 2-5

• Setting of the frequency setting voltage bias

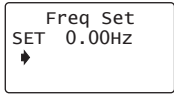
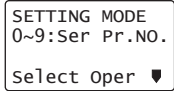
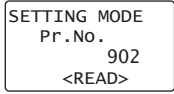
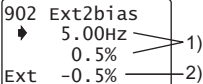
1	<p>Press PU.</p> <p>The frequency setting screen appears, and operation mode changes to PU operation mode.</p>	
2	<p>Press PrSET.</p> <p>The parameter unit is in the parameter setting mode.</p>	
3	<p>Enter 9 0 2.</p>	
4	<p>Press READ twice.</p> <p>The present <i>Pr. 902</i> setting appears.</p> <p>When the set voltage is changed, the % value also changes.</p> <p>The value selected in <i>Pr. 73</i> (5V in this example) is 100%.</p>	 <p>1) The previous setting is displayed.</p> <p>2) The present set voltage across terminals 2-5 is displayed in %.</p>

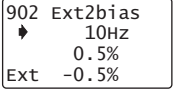
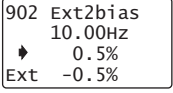
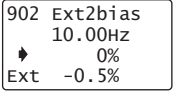
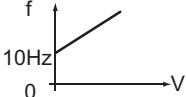
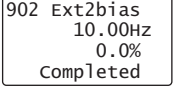
5	<p>Enter 1 0.</p> <p>Set the bias frequency at 10Hz.</p>	
6	<p>Press WRITE.</p> <p>The cursor (➡) moves to the set voltage.</p> <p>Voltage need not be applied across terminals 2-5.</p>	
7	<p>Enter 0.</p> <p>Input 0V to set bias.</p>	
8	<p>Press WRITE.</p> <p>The bias frequency is set at 10Hz.</p> <p>Setting is completed as shown below:</p> 	

Adjustment of the Frequency Setting Signals "Bias" and "Gain"

• Setting of the frequency setting voltage gain

9	<p>Press SHIFT, then READ.</p> <p>The present <i>Pr. 903</i> setting value appears.</p> <p>When the set voltage is changed, the % value also changes.</p> <p>The value selected in <i>Pr. 73</i> (5V in this example) is 100%.</p>	<div style="border: 1px solid black; padding: 5px;"> <p>903 Ext2gain 60.00Hz 97.1% Ext 80.0%</p> </div> <p>1) —> 60.00Hz 2) —> 80.0%</p> <p>1) The previous setting is displayed. 2) The present set voltage across terminals 2-5 is displayed in %.</p>
10	<p>Enter 5 0.</p> <p>Set the gain frequency at 50Hz.</p>	<div style="border: 1px solid black; padding: 5px;"> <p>903 Ext2gain 50Hz 97.1% Ext 80.0%</p> </div>
11	<p>Press WRITE.</p> <p>The cursor (➡) moves to the set voltage.</p> <p>Voltage need not be applied across terminals 2-5.</p>	<div style="border: 1px solid black; padding: 5px;"> <p>903 Ext2gain 50.00Hz 97.1% Ext 80.0%</p> </div>
12	<p>Enter 1 0 0.</p> <p>Input 5V to set gain.</p>	<div style="border: 1px solid black; padding: 5px;"> <p>903 Ext2gain 50.00Hz 100.0% Ext 80.0%</p> </div>

13

Press **WRITE**.

The gain frequency is set at 50Hz.

Setting is completed as shown below:

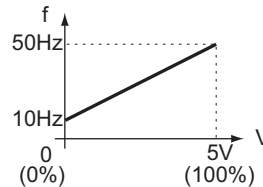

903 Ext2gain
 50.00Hz
 100.0%
 Completed

The adjustment of the frequency setting voltage bias and gain is complete.

REMARKS

- The current input (*Pr. 904, Pr. 905*) can also be adjusted using a similar procedure.
- The *Pr. 903 Terminal 2 frequency setting gain* remains unchanged even if the *Pr. 20 Acceleration/deceleration reference frequency setting* is changed.
- A narrow calibration (command) value set using *Pr. 902 and Pr. 903 (Pr. 904 and Pr. 905)* will result in "Incr I/P" and disable write.

2

3 FUNCTION MENU

3.1 Overview of Function Menu

Press **(FUNC)** in any operation mode to call the function menu, on which you can perform various functions.

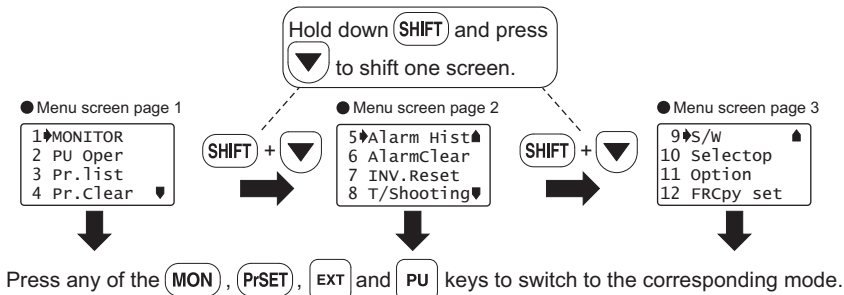

3.1.1 Function menu

Function Menu	Description		Refer To
1. MONITOR	FR-PU07	The monitor list appears, and you can change from one monitor to another and set the first priority monitor.	Page 62
	FR-PU07BB battery mode	Monitor is available. (However, the monitored value other than the value of the frequency setting monitor is displayed as 0.)	
2. PU Oper	FR-PU07	You can select the PU operation mode via direct input (direct setting with the number keys) or select the Jog operation mode from the PU, and displays how to operate the keys.	Page 63
	FR-PU07BB battery mode	The PU operation mode and the PU Jog operation mode can be switched. (The operation is not available.)	

Function Menu	Description		Refer To
3. Pr.List	The parameter menu appears, and you can perform "parameter setting", "list display", "parameter change list display" and "initial value list display".		<i>Page 65</i>
4. Pr.Clear	The parameter clear menu appears, and you can perform "parameter clear" and "all clear".		<i>Page 68</i>
5. Alarm Hist	This function is used to check details of the past faults stored in the inverter.		<i>Page 70</i>
6. AlarmClear	This function clears all the fault (alarm) history.		<i>Page 71</i>
7. Inv.Reset	This function resets the inverter.		<i>Page 72</i>
8. T/Shooting	The inverter displays the cause of mismatch between inverter operation and control/setting or the cause of an inverter fault.		<i>Page 72</i>
9. S/W	This function displays the software control number of the inverter.		-
10. Selectop	FR-PU07	This function displays the signals assigned to the I/O terminals of the control circuit and the ON/OFF states of the signals.	<i>Page 77</i>
	FR-PU07BB battery mode	This function displays the signals assigned to the I/O terminals of the control circuit. The ON/OFF states of the input signal are not displayed.	
11. Option	FR-PU07	This function displays the option fitting states of the option connectors 1 to 3.	<i>Page 78</i>
	FR-PU07BB battery mode	Option cannot be displayed since it cannot be recognized.	
12. FRCpy set	The function can perform the "parameter copy" (read, write, verification).		<i>Page 79</i>

REMARKS

The functions vary with the inverter model and may be invalid for some inverters.

3.1.2 Function menu transition

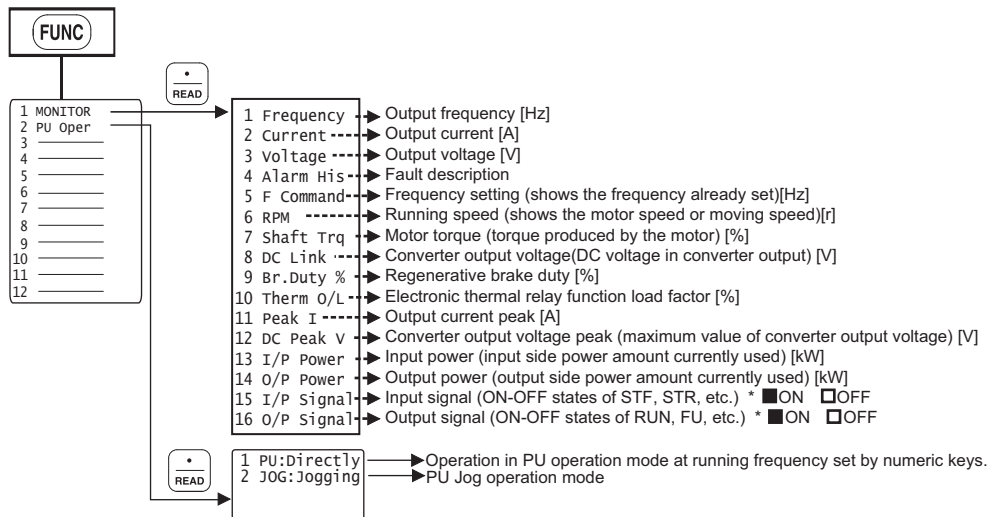

REMARKS

The functions vary with the inverter model and may be invalid for some inverters.

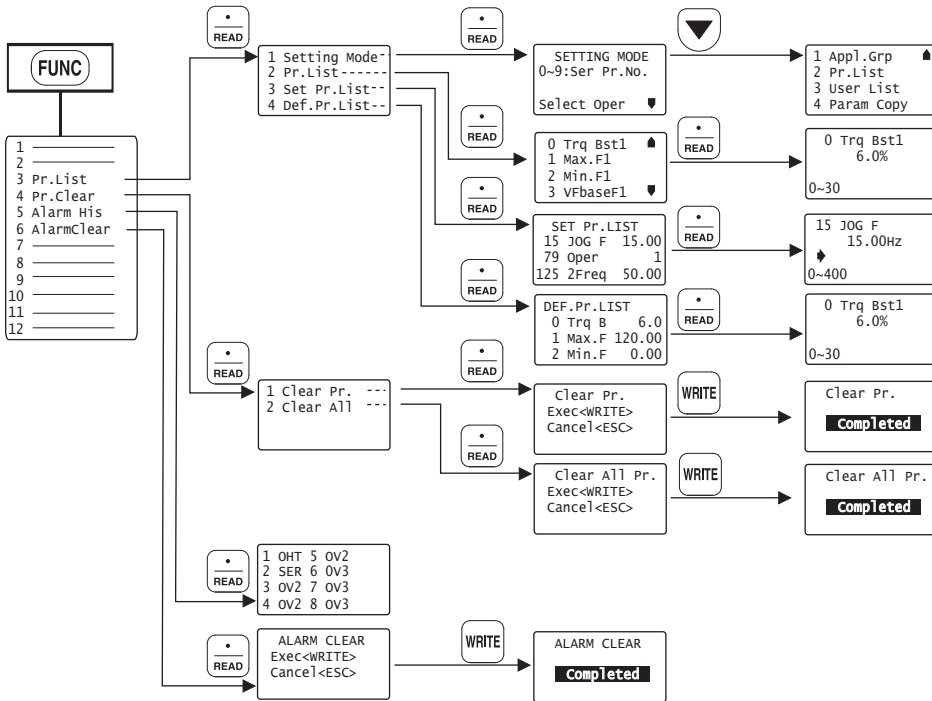

7 Overview of Function Menu

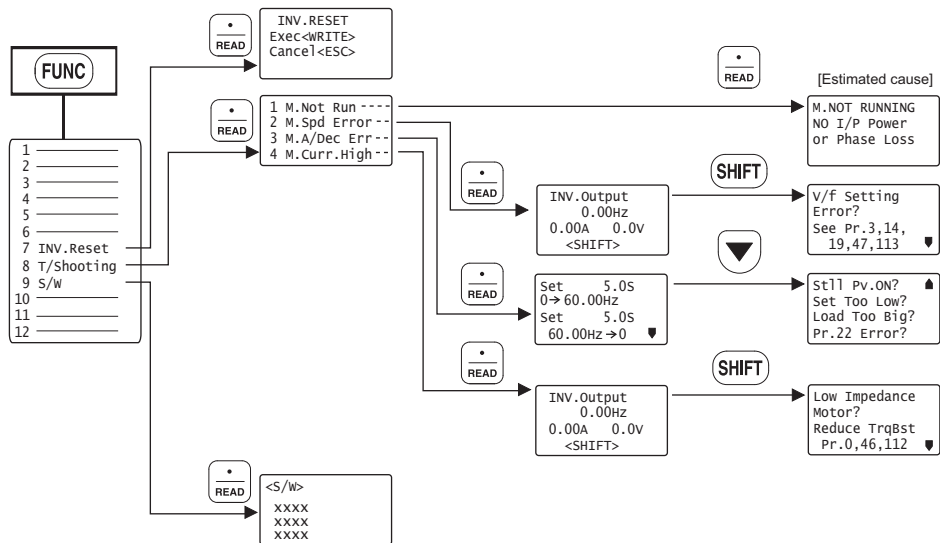

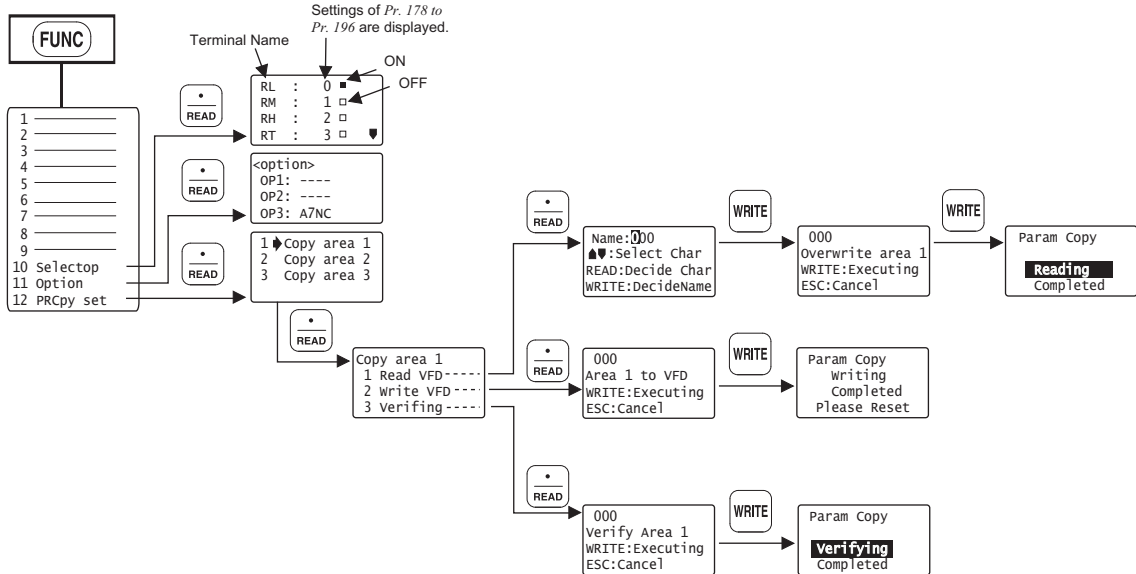









3.2 Operation Procedures for Functions

3.2.1 Monitor function

The monitoring list appears and you can change from one monitor screen to another and set the first priority screen.

1	Press FUNC . The function menu is called.	
2	Make sure that the cursor is located at "1 MONITOR". If not, move the cursor with  /  .	1 MONITOR 2 PU Oper 3 Pr.List 4 Pr.Clear ▼
3	Press  . The monitoring list is called.	1 Frequency 2 Current 3 Voltage 4 Alarm His ▼
4	Press  or  to move the cursor to the desired item. Hold down SHIFT and press  /  to shift one screen.	1 Frequency 2 Current 3 Voltage 4 Alarm His ▼

5	Press  . The monitor screen selected by the cursor appears. Press  to give the first priority to this monitor screen.	I Out READ>List 0.00 A --- STOP PU
----------	---	--



REMARKS

- The monitoring list can be called only with pressing  in the monitoring mode. (Refer to page 30)
- "4 Alarm His" can not be set to the first priority monitor.
- When FR-PU07BB is used in the battery mode (the inverter power is OFF), only frequency setting monitor is available. (The monitor value other than frequency setting monitor is always "0".)
- Some monitoring items are not displayed depending on the connected inverter. To check the available monitoring items, refer to the setting range of Pr.52 DU/PU main display data selection of the inverter.

3.2.2 Selection of PU operation (direct input)

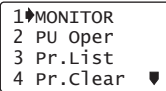
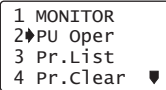
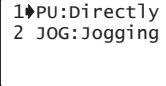
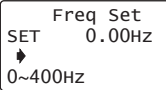
You can select the PU operation mode to set PU operation frequency.

1	Press FUNC . The function menu is called.	
2	Using ▼ , move the cursor to "2 PU Oper".	
3	Press READ . The menu on the right appears.	
4	Make sure that the cursor is located at "1 PU: Directly". If not, move the cursor with ▲/▼ .	
5	Press READ . The PU operation mode is selected and the frequency setting screen appears.	

6	Enter the set frequency using 0 to 9 and press WRITE . The frequency setting is complete.	
7	Press FWD/REV to perform forward or reverse rotation with the set frequency.	

REMARKS

- Press **PU** to call the frequency setting screen any time.

3.2.3 Selection of the PU Jog operation mode

You can select the PU Jog operation mode to set PU jog frequency.

1	Press FUNC . The function menu is called.	<div style="border: 1px solid black; padding: 5px;"> <p>1 MONITOR 2 PU Oper 3 Pr.List 4 Pr.Clear ▾</p> </div>
2	Using ▼ , move the cursor to "2 PU Oper".	<div style="border: 1px solid black; padding: 5px;"> <p>1 MONITOR 2 PU Oper 3 Pr.List 4 Pr.Clear ▾</p> </div>
3	Press READ . The menu on the right appears.	<div style="border: 1px solid black; padding: 5px;"> <p>1 PU Directly 2 JOG: Jogging</p> </div>
4	Using ▼ , move the cursor to "2 JOG: Jogging".	<div style="border: 1px solid black; padding: 5px;"> <p>1 PU Directly 2 JOG: Jogging</p> </div>
5	Press READ . The PU Jog operation mode is selected, and the frequency setting screen appears.	<div style="border: 1px solid black; padding: 5px;"> <p>PU/JOG SET 0.00Hz ▾</p> </div>

6	Enter the set frequency using 0 to 9 and press WRITE . The PU Jog frequency setting is complete.	<div style="border: 1px solid black; padding: 5px;"> <p>PU/JOG SET 5.00Hz Completed</p> </div>
7	Hold down FWD/REV to perform forward or reverse rotation with the PU Jog set frequency.	<div style="border: 1px solid black; padding: 5px;"> <p>Hz Out READ:List 5.00 Hz STR JOGr PUj</p> </div>

REMARKS

- Press **SHIFT** to call the PU Jog frequency setting screen any time after pressing **PU**.

3.2.4 Parameters

When selecting the parameter on the function menu, the parameter menu is displayed, and you can perform the following operations for the parameters.

	Display	Description
1	Setting Mode	Switches to the parameter setting mode to read and write the parameter setting.
2	Pr. List	Displays the parameters list. You can select the parameter from the list to read and write the parameter setting.
3	Set Pr. List	Lists the parameters whose setting is changed from initial value. You can select the parameter from the list to read and write the parameter setting.
4	Def.Pr. List	Displays the parameters and initial value list. You can select the parameter from the list to read and write the parameter setting.

(1) "1 Setting Mode"

1	Press FUNC . The function menu is called.	<div style="border: 1px solid black; padding: 5px;"> 1 MONITOR 2 PU Oper 3 Pr.List 4 Pr.Clear ▾ </div>
2	Using ▼ , move the cursor to "3 Pr. List".	<div style="border: 1px solid black; padding: 5px;"> 1 MONITOR 2 PU Oper 3 ▸ Pr.List 4 Pr.Clear ▾ </div>
3	Press READ . The parameter menu appears.	<div style="border: 1px solid black; padding: 5px;"> 1 Setting Mode 2 Pr.List 3 Set Pr.List 4 Def.Pr.List </div>
4	Press READ . The parameter unit switches to the setting mode. Refer to <i>page 36</i> to set the parameters.	<div style="border: 1px solid black; padding: 5px;"> SETTING MODE 0~9:Ser Pr.NO. Select Oper ▾ </div>







(2) "2 Pr.List"

1	Call the parameter menu similarly to above steps 1 to 3.	<div style="border: 1px solid black; padding: 5px;"> 1 Setting Mode 2 Pr.List 3 Set Pr.List 4 Def.Pr.List </div>
----------	--	---

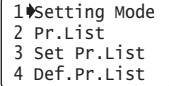
2	Using ▼ , move the cursor to "2 Pr. List".	<div style="border: 1px solid black; padding: 5px;"> 1 Setting Mode 2 ▸ Pr.List 3 Set Pr.List 4 Def.Pr.List </div>
3	Press READ . The parameter menu appears.	
4	Press ▲ / ▼ to move the cursor to the desired parameter. Press SHIFT and ▼ together to shift to the next page.	<div style="border: 1px solid black; padding: 5px;"> 0 ▸ Trq Bst1 ▲ 1 Max.F1 2 Min.F1 3 VfbaseF1 ▾ </div>
5	Press READ . The parameter indicated by the cursor is read, and the parameter unit is in the parameter setting mode. Refer to <i>page 36</i> to set the parameters.	<div style="border: 1px solid black; padding: 5px;"> 0 Trq Bst1 6.0% ▾ 0~30 </div>

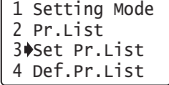

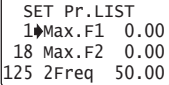

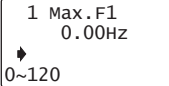

Press **SHIFT** to move to the next parameter.

(3) Display of "3 Set Pr.List"

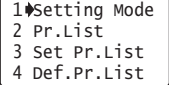
1	Call the parameter menu similarly to steps 1 to 3 of <i>page 66</i> .	
2	Using  /  , move the cursor to "3 Set Pr. List".	
3	Press  . The change list appears. When the parameter has been changed from the initial value, the new value is displayed.	
4	Press  . The parameter indicated by the cursor is read, and the parameter unit is in the parameter setting mode. Refer to <i>page 36</i> to set the parameters.	

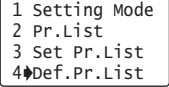
(4) Display of "4 Def.Pr.List"

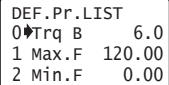
The initial values of parameters are displayed.

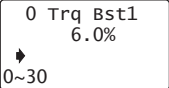
1	Call the parameter menu similarly to steps 1 to 3 of <i>page 66</i> .	
2	Using  /  , move the cursor to "4 Def. Pr. List".	
3	Press  . The initial value list appears.	
4	Press  . The parameter indicated by the cursor is read, and the parameter unit is in the parameter setting mode. Refer to <i>page 36</i> to set the parameters.	

3.2.5 Parameter clear

You can perform the "parameter clear" and "all parameter clear".

Switch to the PU operation mode before performing any operation.







- Clear Pr. Returns (initializes) the parameters to the factory settings with the exception of the some parameters (*Pr. 75* and calibration values in *Pr. 900 to 905*).
- Clear All..... Initializes all parameters with the exception of *Pr. 75*.

(1) Parameter clear

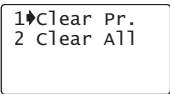
1	Press FUNC . The function menu is called.	<div style="border: 1px solid black; padding: 5px;"> 1♦MONITOR 2 PU Oper 3 Pr.List 4 Pr.Clear ▼ </div>
2	Using ▲ / ▼ , move the cursor to "4 Pr. Clear".	<div style="border: 1px solid black; padding: 5px;"> 1 MONITOR 2 PU Oper 3 Pr.List 4♦Pr.Clear ▼ </div>
3	Press READ . The parameter menu appears.	<div style="border: 1px solid black; padding: 5px;"> 1♦Clear Pr. 2 Clear All </div>
4	Select the "Clear Pr." Using ▲ / ▼ , move the cursor to "1" and press the READ .	<div style="border: 1px solid black; padding: 5px;"> 1♦Clear Pr. 2 Clear All </div>

5	"Clear Pr." is selected, and the confirmation screen for clearing execution is displayed.	<div style="border: 1px solid black; padding: 10px; text-align: center;"> Clear Pr. Exec<WRITE> Cancel<ESC> </div>
6	Press WRITE . The parameters are initialized. When canceling the initialization, press ESC on the confirmation screen.	<div style="border: 1px solid black; padding: 10px; text-align: center;"> Clear Pr. Completed </div>

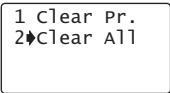
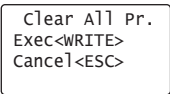
(2) All parameter clear

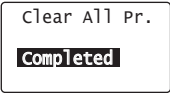
1	<p>Call the parameter menu similarly to steps 1 to 3 of <i>page 68</i>.</p>	
2	<p>Select the "Clear All".</p> <p>Using /, move the cursor to "2 Clear All" and press the .</p>	
3	<p>"Clear All" is selected, and the confirmation screen for clearing execution is displayed.</p>	
4	<p>Press .</p> <p>The parameters are initialized.</p> <p>When canceling the initialization, press  on the confirmation screen.</p>	

3.2.6 Alarm history

This function is used to check details of the past faults stored in the inverter.







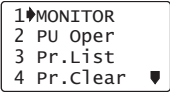

1	Press FUNC . The function menu is called.	<div style="border: 1px solid black; padding: 5px;"> 1 MONITOR 2 PU Oper 3 Pr.List 4 Pr.Clear </div>
2	Using ▲ / ▼ , move the cursor to "5 Alarm His". Hold down SHIFT and press ▲ / ▼ to shift one screen.	<div style="border: 1px solid black; padding: 5px;"> 5 Alarm His ▲ 6 AlarmClear 7 INV.Reset 8 T/Shooting ▼ </div>
3	Press READ . The fault history appears. (Screen shown for the inverter that stores 8 fault records)*1	<div style="border: 1px solid black; padding: 5px;"> 1 OHT 5 OV2 2 SER 6 OV3 3 OV2 7 OV3 4 OV2 8 OV3 </div>
4	Press READ . The running frequency at fault occurrence is displayed.	<div style="border: 1px solid black; padding: 5px;"> LATEST ERR OH Fault 0.00Hz ▼ </div>

5	Press ▼ . The output current, output voltage and cumulative energization time at fault occurrence is displayed.	<div style="border: 1px solid black; padding: 5px;"> LATEST ERR ▲ 0.00A 0.0V 7hr </div>
6	Press READ when displaying the operation mode for fault occurrence in steps 4 and 5 to display the operation data for the preceding fault occurrence.	<div style="border: 1px solid black; padding: 5px;"> 2nd Prev.ERR PU Leave Out 0.00Hz ▼ </div>

*1 For the maximum number of storable fault records, refer to the Instruction Manual of each inverter.

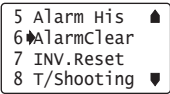
3.2.7 Alarm clear

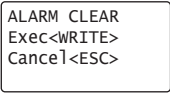
Clears all the fault history.

1	<p>Press FUNC.</p> <p>The function menu is called.</p>	
2	<p>Using  / , move the cursor to "6 AlarmClear".</p> <p>Hold down SHIFT and press  /  to shift one screen.</p>	
3	<p>Press .</p> <p>"AlarmClear" is selected, and the confirmation screen for clearing is displayed.</p>	
4	<p>Press WRITE.</p> <p>The fault history is cleared. When canceling the clear, press ESC on the confirmation screen.</p>	

3.2.8 Inverter reset

Resets the inverter.

1	<p>Press FUNC.</p> <p>The function menu is called.</p>	<pre> 1 MONITOR 2 PU Oper 3 Pr.List 4 Pr.Clear </pre>
2	<p>Using ▲/▼, move the cursor to "7 INV. Reset".</p> <p>Hold down SHIFT and press ▲/▼ to shift one screen.</p>	<pre> 5 Alarm His 6 AlarmClear 7 INV.Reset 8 T/Shooting </pre>
3	<p>Press READ.</p> <p>"INV. Reset" is selected, and the confirmation screen for reset is displayed.</p>	<pre> INV.RESET Exec<WRITE> Cancel<ESC> </pre>
4	<p>Press WRITE.</p> <p>The inverter is reset, and the parameter unit switches to the monitoring mode.</p> <p>When canceling the inverter reset, press ESC on the confirmation screen.</p>	<pre> Hz Out READ:List 0.00 Hz --- STOP EXT </pre>

REMARKS

- If the inverter's protective function is activated to bring the inverter to trip (output shutoff), execute the inverter reset only by pressing **STOP RESET**.
- A similar reset operation may also be performed by switching power ON again or by switching the RES signal ON. (Refer to the inverter instruction manual for details.)

3.2.9 Troubleshooting

If the inverter appears to operate improperly, perform the following operation to display the most likely cause of the fault. (Different screens are displayed depending on the inverter model.)

This operation may also be performed during inverter operation (PU operation, External operation) or during trip (protection activated).

1	<p>Press FUNC.</p> <p>The function menu is called.</p>	<div style="border: 1px solid black; padding: 5px;"> <p>1 MONITOR 2 PU Oper 3 Pr.List 4 Pr.Clear ▾</p> </div>
2	<p>Using ▲/▼, move the cursor to "8 T/Shooting".</p> <p>Hold down SHIFT and press ▲/▼ to shift one screen.</p>	<div style="border: 1px solid black; padding: 5px;"> <p>5 Alarm His ▲ 6 AlarmClear 7 INV.Reset 8 T/Shooting ▾</p> </div>
3	<p>Press READ.</p> <p>The fault menu appears.</p>	<div style="border: 1px solid black; padding: 5px;"> <p>1 M.Not Run 2 M.Spd Error 3 M.A/Dec Err 4 M.Curr.High</p> </div>
4	<p>Press ▲ or ▼ to move the cursor to the desired item.</p>	<div style="border: 1px solid black; padding: 5px;"> <p>1 M.Not Run 2 M.Spd Error 3 M.A/Dec Err 4 M.Curr.High</p> </div>

5	<p>Press READ.</p> <p>The estimated cause of the fault is displayed. (Refer to page 74)</p>	<div style="border: 1px solid black; padding: 5px;"> <p>M.SPEED ERROR SetF>Max.F1/F2 60.00Hz Pr.1/18</p> </div>
----------	--	---

Troubleshooting guidance

1) M.NOT RUNNING (Motor does not run)

M.NOT RUNNING
ALARM
Indicated
<SHIFT>

The protective function is activated to bring the inverter to trip.
Press **(SHIFT)** to display the cause of the trip.

M.NOT RUNNING
Max. Fl<StartF
Pr. 1 Pr. 13

The inverter cannot start because the inverter starting frequency (*Pr. 13*) is higher than the maximum frequency (*Pr. 1*).

M.NOT RUNNING
NO I/P Power
or Phase Loss

The inverter's main circuit power has decreased or a phase in the power supply is lost. Check the power supply.

M.NOT RUNNING
EnableFR Set
See Pr. 78

The inverter cannot start because you attempted to run the motor in the direction in which forward or reverse rotation is inhibited as set in *Pr. 78*.

M.NOT RUNNING
STF, STR
both are OFF
or ON

Both start signals STF and STR are ON or OFF.

M.NOT RUNNING
Current Limit
Activated
<SHIFT>

The inverter cannot start since the current limit function is activated. Press **(SHIFT)** to display the estimated cause that the current limit function was activated.

M.NOT RUNNING
MRS is ON

MRS signal is ON.

M.NOT RUNNING
Under
PID Control

The inverter does not start because the inverter need not start the motor as a result of the arithmetic operation of PID control.

M.NOT RUNNING
SetF<StartF
Pr. 13

The inverter starting frequency (*Pr. 13*) setting is higher than the frequency currently set.

M.NOT RUNNING
CS is OFF
See Pr. 57

The inverter will not restart since the automatic restart after instantaneous power failure select signal CS is OFF. It is estimated that an instantaneous power failure has occurred or the inverter in the commercial power supply switch-over operation mode.

M.NOT RUNNING
AU is OFF

The current input select signal AU remains OFF. (not ON)

M.NOT RUNNING
NO Command
From PU

Neither of **(FWD)** and **(REV)** are pressed in the PU operation mode.

2) M.SPEED ERROR

(Speed does not match the running frequency setting)

M. SPEED ERROR SetF>MaxF1/F2 60.00 Hz Pr.1/18	Since the running frequency setting is higher than the maximum frequency (Pr. 1) setting, the running frequency remains at the maximum frequency.
M. SPEED ERROR SetF<MinF1 60.00Hz Pr.2	Since the running frequency setting is lower than the minimum frequency (Pr. 2) setting, the running frequency has been increased to the minimum frequency.
M. SPEED ERROR Fjump Working See Pr. 31-36 SetF= 60.00Hz	Since the running frequency setting is within the frequency jump setting range (Pr. 31 to 36), the running frequency has jumped.
M. SPEED ERROR Current Limit Activated <SHIFT>	The current limit function was activated and forced the running frequency to reduce. Press (SHIFT) to display the cause that the current limit function was activated.
M. SPEED ERROR Under PI-Control	As a result of arithmetic operation of PID control, the running frequency differs from the set value.

3) M.A/Dec Err

(Actual acceleration/deceleration time is longer than the Pr. 7/Pr. 8 setting)

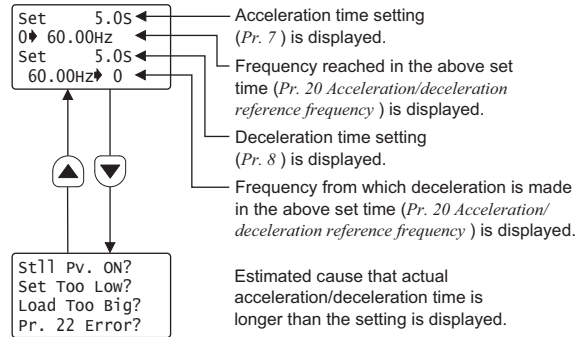

4) M.Curr.High (Inverter output current is larger than normal)

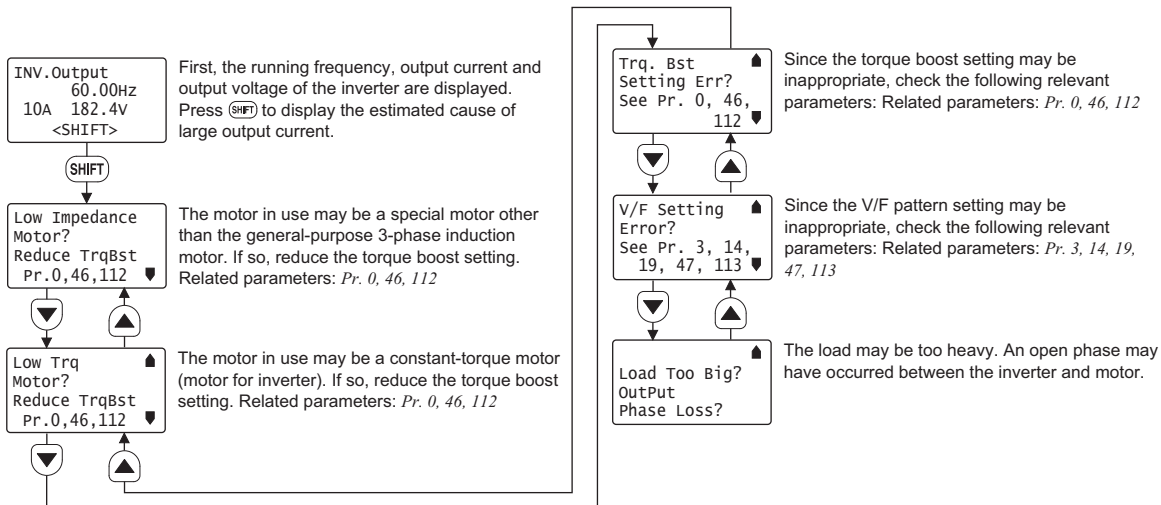

REMARKS

<When the fault could not be identified>

When the cause of the fault is not specified even after performing the operation mentioned above, the current running frequency, output current and output voltage at the point are displayed on the screen.

Press **(SHIFT)** to display the estimated cause related.

INV. Output
60.00Hz
0.00A 182.8V
<SHIFT>

3.2.10 Terminal assignment (Selectop)

The signals assigned to the control circuit terminals and their ON-OFF state are displayed.

If the plug-in options FR-A8AY, FR-A8AR, FR-A7AY, and FR-A7AR are mounted, the terminal state of the plug-in option can be also confirmed.

1	Press FUNC . The function menu is called.	<pre> 1 MONITOR 2 PU Oper 3 Pr.List 4 Pr.Clear </pre>
2	Using ▲ / ▼ , move the cursor to "10 Selectop". Hold down SHIFT and press ▲ / ▼ to shift one screen.	<pre> 9 S/W 10 Selectop 11 Option 12 PRcPy set </pre>
3	Press READ . The signals assigned to the control circuit terminals and their ON-OFF states are displayed.	<pre> RL : 0 □ RM : 1 □ RH : 2 □ RT : 3 □ </pre>

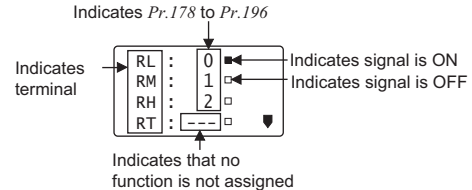

REMARKS

- When FR-PU07BB is used in the battery mode, the ON/OFF state of the input signal for the terminal assignment monitor are not displayed.

3.2.11 Option

Displays what options are fitted to the option connectors.

1	<p>Press FUNC.</p> <p>The function menu is called.</p>	<pre> 1 MONITOR 2 PU Oper 3 Pr.List 4 Pr.Clear </pre>
2	<p>Using ▲/▼, move the cursor to "11 Option".</p> <p>Hold down SHIFT and press ▲/▼ to shift one screen.</p>	<pre> 9 S/W 10 Selectop 11 Option 12 PRCpy set </pre>
3	<p>Press READ.</p> <p>Numbers OP1 to OP3 correspond to numbers 1 to 3 of the option slot on the inverter side.</p> <p>For the inverter with only one option slot, mounted option is displayed next to OP1.</p> <p>The plug-in option which is mounted on the inverter is displayed.</p>	<pre> <option> OP1: ---- OP2: ---- OP3: A7NC </pre>

CAUTION

Option fitting status monitor is not available in battery mode.

3.2.12 Multiple copies

(1) Copying the parameter settings

Inverter parameter settings can be read. The settings of a maximum of three inverters can be stored in FR-PU07(In case of the A800/F800/E800 (except for the FR-E800-(SC)E) series, parameter settings of one inverter can be stored.). You can also copy the stored parameter settings to another inverter of the same series.

Confirm for setting

- Is the *Pr. 77* setting of the copy destination inverter correct? → Set "0 or 2" in *Pr. 77*.
 - Is the inverter of the copy destination the same series as that of the copy source? → Select the inverter of the same series.
- Example: ○ FR-A720-0.4K → FR-A720-0.75K Parameters can be copied only to the same series inverters.
 × FR-A720-0.4K → FR-F720-0.75K

CAUTION

Turning power OFF during parameter copy (read, write) as below, processing is not completely ended.

Perform parameter copy again.

- Turn OFF the inverter power.
- The FR-PU07BB (battery mode) power is OFF or battery exhaustion.
- Remove the FR-PU07 from the inverter.
- Pull out the PU cable.

7 Operation Procedures for Functions

- Reading the parameter settings of the inverter and storing them to FR-PU07.

1	Connect the FR-PU07 to the copy source inverter.
2	<p>Press FUNC.</p> <p>The function menu appears.</p> <div style="border: 1px solid black; padding: 5px; width: fit-content;"> 1 MONITOR 2 PU Oper 3 Pr.List 4 Pr.Clear </div>
3	<p>Select the "PRCpy set".</p> <p>Using ▲/▼, move the cursor to "12 PRCpy set" and press READ.</p> <div style="border: 1px solid black; padding: 5px; width: fit-content;"> 9 S/W 10 Selectop 11 Option 12 PRCpy set </div>
4	<p>Select the copy area.</p> <p>The copy area selection screen is displayed. Then, move the cursor to any one of 1 to 3 and press READ.</p> <p>(Parameter settings of each inverter (three inverters in total) can be copied to the area 1, 2 or 3.)</p> <p>The copy area is fixed to the copy area 1 for the FR-A800/F800/E800 series inverters.</p> <div style="border: 1px solid black; padding: 5px; width: fit-content;"> 1 Copy area 1 2 Copy area 2 3 Copy area 3 </div>

5	<p>Select the "READ".</p> <p>Using ▲/▼, move the cursor to "1 Read VFD" and press READ.</p> <div style="border: 1px solid black; padding: 5px; width: fit-content;"> Copy area 1 1 Read VFD 2 Write VFD 3 Verifying </div>
6	<p>Give a name.</p> <p>You can name each of copy areas 1 to 3. Select the characters with ▲/▼ and set them with READ.</p> <p>Press WRITE to set the name for the area.</p> <div style="border: 1px solid black; padding: 5px; width: fit-content;"> Name: 012 Select Char READ: Decide Char WRITE: DecideName </div>
7	<p>Write to the copy area of FR-PU07.</p> <p>The screen for confirming the overwriting of the data in the FR-PU07 is displayed.</p> <div style="border: 1px solid black; padding: 5px; width: fit-content;"> 012 Overwrite area 1 WRITE: Executing ESC: Cancel </div>
8	<p>Press WRITE.</p> <p>The parameter settings of the inverter are stored.</p> <p>When canceling, press ESC.</p> <div style="border: 1px solid black; padding: 5px; width: fit-content;"> Param Copy Reading Completed </div>

- Writing the parameter setting stored in FR-PU07 to the inverter

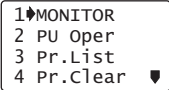
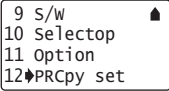
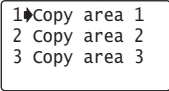
1	<p>Connect the FR-PU07 to the copy destination inverter.</p> <ul style="list-style-type: none"> • Is the PU operation mode selected? → If not, press PU to select the PU operation mode. • Is the inverter stopped? → If it is running, press STOP RESET to stop it. 	
2	<p>Press FUNC.</p> <p>The function menu appears.</p>	
3	<p>Select the "PRCpy set".</p> <p>Using ▲/▼, move the cursor to "12 PRCpy set" and press READ.</p>	
4	<p>Select the copy area.</p> <p>Point the cursor to the copy area that stores the parameter settings to be written to the inverter, and press READ.</p>	

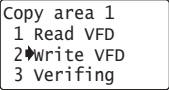
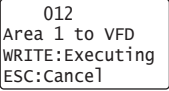
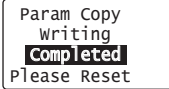
5	<p>Select the "WRITE".</p> <p>Using ▲/▼, point the cursor to "2 Write VFD" and press READ.</p>	
6	<p>Writing the parameter settings is selected, and the confirmation screen for writing is displayed.</p>	
7	<p>Press WRITE.</p> <p>The parameter settings stored in the FR-PU07 are copied to the copy destination inverter.</p>	
8	<p>Reset the inverter. (Refer to page 72)</p>	

REMARKS

- Overwriting the data of the FR-PU07 deletes the previous data.
- The parameter settings of three inverters can be stored in areas 1 to 3. When the FR-PU07 is used with the FR-A800/F800/E800 series inverters, parameter settings of one inverter can be stored in the area 1.
- When the area 1 stores parameter settings of an FR-A800/F800 inverter, the parameter settings of another inverter (except for an FR-A800, FR-F800, or FR-E800 inverter) can be stored in the area 3.
- When the area 1 stores parameter settings of an FR-A800/F800 inverter, storing parameter settings of another inverter in the area 2 will delete the parameter settings stored in the area 1.
- When the area 1 stores the parameter settings of an FR-E800 inverter, storing the parameter settings of another inverter in the area 2 or 3 will delete the parameter settings stored in the area 1.
- Read and write cannot be stopped during execution.
- If power is switched OFF, parameter data stored in the parameter unit remains unerased.

(2) Verifying the parameters







All the parameter settings stored in the FR-PU07 are verified with those which are stored in the inverter.



REMARKS

Verification cannot be performed between different inverter series.

1	Refer to <i>page 80</i> and copy the parameter settings of the verify source inverter to the FR-PU07.				
2	Connect the FR-PU07 to the inverter to be verified.				
3	Press FUNC . The function menu appears. <table border="1" style="margin-left: 20px; width: 150px;"> <tr><td>1 MONITOR</td></tr> <tr><td>2 PU Oper</td></tr> <tr><td>3 Pr.List</td></tr> <tr><td>4 Pr.Clear</td></tr> </table>	1 MONITOR	2 PU Oper	3 Pr.List	4 Pr.Clear
1 MONITOR					
2 PU Oper					
3 Pr.List					
4 Pr.Clear					

4	Select the "multiple copies". Using ▲ / ▼ , move the cursor to "12 PRCpy set" and press + / READ .	<table border="1" style="width: 150px;"> <tr><td>9 S/W</td></tr> <tr><td>10 Selectop</td></tr> <tr><td>11 Option</td></tr> <tr><td>12 PRCpy set</td></tr> </table>	9 S/W	10 Selectop	11 Option	12 PRCpy set
9 S/W						
10 Selectop						
11 Option						
12 PRCpy set						

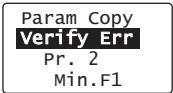
<p>5</p>	<p>Select the copy area. Point the cursor to the copy area that stores the parameter settings required verification, and press .</p>	<div style="border: 1px solid black; padding: 5px;"> <p>1  Copy area 1 2 Copy area 2 3 Copy area 3</p> </div>
<p>6</p>	<p>Select the "Verifying". Using /, point the cursor to "3 Verifying" to press .</p>	<div style="border: 1px solid black; padding: 5px;"> <p>Copy area 1 1 Read VFD 2 Write VFD 3  Verifying</p> </div>
<p>7</p>	<p>Verification of the parameter settings is selected, and the confirmation screen for verification is displayed.</p>	<div style="border: 1px solid black; padding: 5px;"> <p>012 Verify Area 1 WRITE:Executing ESC:Cancel</p> </div>
<p>8</p>	<p>Press .</p> <p>Start verification of parameter settings stored in the FR-PU07 and parameter settings of the inverter.</p>	<div style="border: 1px solid black; padding: 5px;"> <p>Param Copy</p> <p>Verifying Please wait</p> </div>

9	If an error is detected during verification, the corresponding <i>Pr.</i> is shown. Note that only "Verify Err" will be displayed if an incorrect value has been entered directly (f setting) or set in either <i>Pr. 173</i> or <i>Pr. 174</i> .	
10	Press 0 . When verification is stopped with verification error, press 0 to continue verification.	
11	Verification is complete.	

3.3 Other Precautions

3.3.1 Precautions for parameter unit operation

Note the following items when operating the parameter unit to prevent setting from being disabled or incorrect values from being entered.

- **Precautions for the digit count and decimal point of input value**

The maximum number of input digits is six including a decimal point. If you enter a value in excess of 6 digits, the most significant digit is ignored.

12345.6 → ■2345.6
(Input) ↑ Ignored

4 OPERATION

4.1 How to Select the Operation Mode

4.1.1 Switching from External operation mode [EXT] to PU operation mode [PU]

Confirmation

Make sure that the external input signal (STF, STR) is OFF.

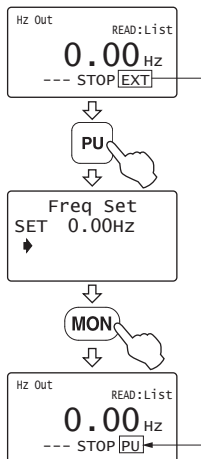

Pressing **[PU]** switches to the PU operation mode and changes the operation mode indication to [PU].

4.1.2 Switching from PU operation mode [PU] to External operation mode [EXT]

Confirmation

Make sure that the external input signal (STF, STR) is OFF and that the operation command indication is "- - -".

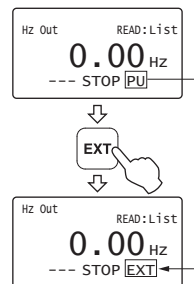

Pressing **[EXT]** switches to the External operation mode and changes the operation mode indication to [EXT].

4.1.3 Switching to the External / PU combined operation mode

Changing the *Pr. 79 Operation mode selection* setting to "3" or "4" switches to the External / PU combined operation mode. "PU+E" is displayed in the operation mode indication position.

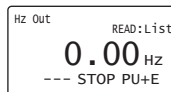

The relationship between the running frequency and the start signal is as indicated in the following table.

Pr. 79 Setting	Description	
	Running frequency setting	Start signal
3	Parameter unit · Direct setting and / key setting External signal input · Multi-speed selection (<i>Pr. 4 to Pr. 6, Pr. 24 to Pr. 27</i>) · 4 to 20mADC across terminals 4-5	External signal input · Terminal STF · Terminal STR
4	External signal input · 0 to 5/10VDC across terminals 2-5 · 4 to 20mADC across terminals 4-5 · Multi-speed selection (<i>Pr. 4 to Pr. 6, Pr. 24 to Pr. 27</i>) · JOG frequency (<i>Pr. 15</i>)	Parameter unit · ·

REMARKS

If the operation mode cannot be switched properly, check the following:

- Make sure that the external input signal is OFF. If it is ON, the operation mode (STF or STR signal) cannot be switched properly.
- Confirm the *Pr. 79 Operation mode selection* setting.
(Refer to *page 86* and *the inverter instruction manual*)

4.2 How to Operate PU Operation

4.2.1 Normal operation

During motor operation, the speed can be changed by simply executing Step 2.

Step	Operation Procedure	Image
1	Switch power ON. Make sure that the monitor appears.	
2	Set the running frequency. Set the running frequency using direct setting or step setting. (Refer to page 33)	
3	Press FWD or REV . The motor starts running. The parameter unit automatically enters the monitoring mode and shows the output frequency.	

Step	Operation Procedure	Image
4	Press STOP RESET . The motor is decelerated to a stop.	

REMARKS

- When performing PU operation to run the motor, pressing the start key (**FWD** or **REV**) after setting the running frequency switches to monitor mode automatically.
- When FR-PU07BB is used in the battery mode (the inverter power is OFF), the operation is not available.

4.2.2 PU Jog operation

Hold down **FWD** or **REV** to perform operation, and release it to stop.

Jog operation cannot be performed in the following cases:

- During motor operation
- The *Pr. 15 Jog frequency* is less than the *Pr. 13 Starting frequency*.

Example: To operate at the PU Jog running frequency of 8Hz

Step	Operation Procedure	Image
1	Switch to the PU operation mode. If the operation mode indication is not [PU], refer to <i>page 86</i> and switch to the PU operation mode.	
2	The frequency for Jog operation can be set with <i>Pr. 15 Jog frequency</i> and the acceleration/deceleration time with <i>Pr. 16 Jog acceleration/deceleration time</i> both in the parameter unit. (Refer to <i>page 36</i> for the parameter setting method.) <Initial value> · <i>Pr. 15</i> 5Hz · <i>Pr. 16</i> 0.5s	



Step	Operation Procedure	Image
3	Press PU , then SHIFT . The PU Jog operation mode is selected, and the PU Jog frequency setting screen appears on the display. To change the frequency, enter the value and press WRITE .	
4	Press FWD or REV . The display changes to the monitor screen. Hold down the key to perform operation and release it to stop.	
5	Press PU . The inverter exits from the Jog operation mode and returns to the ordinary PU operation mode.	

REMARKS

- The Jog operation mode may also be selected from **FUNC**. (Refer to *page 64*)
- When FR-PU07BB is used in the battery mode (the inverter power is OFF), the operation is not available.

4.3 Combined Operation (Operation Using External Input Signals and PU)

4.3.1 Entering the start signal from outside and setting the running frequency from the PU (Pr. 79 = 3)

The external frequency setting signals and  and  of the parameter unit are not accepted.

Stop with  is valid when Pr. 75 Reset selection/disconnected PU detection/PU stop selection = "14 to 17".

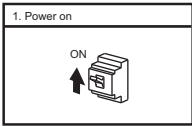
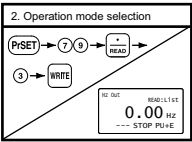
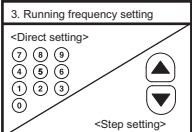
Step	Operation Procedure	Image
1	Switch the power ON.	
2	Set "3" in Pr. 79 Operation mode selection. The External/PU combined operation mode is selected and the operation mode indication on the display changes to "PU + E".	
3	Set the running frequency. Set the running frequency using direct setting or step setting. (Refer to page 33)	

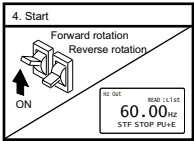
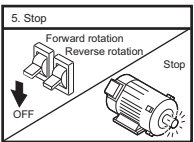
Step	Operation Procedure	Image
4	Set the start switch (STF or STR) to ON. The operation command indication changes to "STF" or "STR" and the operation status indication changes to the output (FWD or REV) indication. · If the forward and reverse rotation switches are both set to ON, the inverter will not start. Also, if these switches are both set to ON during operation, the motor is decelerated to a stop.	
5	Set the start switch (STF or STR) to OFF. The motor stops running.	

REMARKS

- When FR-PU07BB is used in the battery mode (the inverter power is OFF), the operation is not available.

4.3.2 Entering the running frequency from outside and making start and stop from the PU (Pr. 79 = 4)

Step	Operation Procedure	Image
1	Switch the power ON.	<p>1. Power on</p> <p>ON</p>
2	Set "4" in Pr. 79 Operation mode selection. The External/PU combined operation mode is selected and the operation mode indication on the display changes to "PU + E".	<p>2. Operation mode selection</p> <p>PrSET → 7 → 9 → READ → 4 → WRITE</p> <p>0.00 Hz --- STOP PU+E</p>
3	Enter the external frequency command. Select the multi-speed signal or turn the frequency setting potentiometer.	<p>3. Running frequency</p> <p>High speed Middle speed Low speed</p> <p>ON</p>

Step	Operation Procedure	Image
4	Press FWD or REV of the parameter unit. The motor starts running, and the state of the output frequency is shown on the display. ·The starting terminals (STF, STR) of the inverter are invalid. ·The inverter may also be started by pressing the PU FWD or REV and then inputting the frequency command.	<p>4. Start</p> <p>FWD (or) REV</p> <p>60.00 Hz STF STOP PU+E</p>
5	Press STOP RESET of the parameter unit. The motor is decelerated to a stop.	<p>5. Stop</p> <p>STOP RESET</p> <p>Stop</p>

REMARKS

- When FR-PU07BB is used in the battery mode (the inverter power is OFF), the operation is not available.

4.3.3 Entering the start signal and multi-speed signal from outside and setting multiple speeds from the parameter unit

Step	Operation Procedure	Image
1	Switch the power ON.	
2	Select the multi-speed signal required for operation. Switch the RH, RM or RL signal ON.	
3	Set the start switch (STF or STR signal) to ON. The operation command indication changes to "STF" or "STR", the operation status indication changes to the output (FWD or REV) indication, and the motor starts running. · If the forward and reverse rotation switches are both set to ON, the inverter will not start. Also, if these switches are both set to ON during operation, the motor is decelerated to a stop.	

Step	Operation Procedure	Image
4	Change the multi-speed frequency during operation from the parameter unit. When high speed has been selected (RH signal ON), changing the <i>Pr: 4 Multi-speed setting (high speed)</i> value varies the speed. · The other multiple-speed settings not being used may also be changed during operation.	
5	Switch off the multi-speed signal (RH, RM or RL signal) and set the start switch (STF or STR signal) to OFF. The motor stops running.	

REMARKS

- When FR-PU07BB is used in the battery mode (the inverter power is OFF), the operation is not available.

5 CHECK FIRST WHEN YOU HAVE A TROUBLE

5.1 Troubleshooting

If a fault occurs and the inverter fails to operate properly, locate the cause of the fault and take proper corrective action by referring to the troubleshooting below. If the corresponding information is not found in the table, the inverter has problem, or the component parts are damaged, contact your sales representative.

Status	Possible causes	Check point	Corrective action
The LCD or backlight of the parameter unit does not light.	Connection fault of the parameter unit	Check that the parameter unit is connected properly. Or check that the PU cable is inserted far into the PU connector.	Check the connection of the parameter unit and the PU cable.
	The setting of <i>Pr. 991 PU contrast adjustment</i> is changed from the initial value.	Check the <i>Pr. 991</i> setting.	Return the <i>Pr. 991</i> setting to the initial value using the operation panel.
	The inverter is in the standby status.	Check whether the PU cable is disconnected.	Check the connection of the PU cable.
		Check whether the RES signal of the inverter is ON.	Turn OFF the RES signal of the inverter.
	Battery exhaustion of FR-PU07BB, disconnection of the AC adapter	Check whether the battery of FR-PU07BB is run down.	Change the battery.
		Check whether the AC adapter is disconnected.	Check for connection of the AC adapter.

Status	Possible causes	Check point	Corrective action
The "MITSUBISHI" display remains on and it will not accept operation.	During inverter reset	Check whether RES signal is ON	Turn OFF the RES signal.
	Connection fault of a cable or connector	Check that no cable damage nor connection fault of a connector is found.	Replacement of a cable Check for a connector connection
	FR-PU07BB was connected to an incompatible inverter. <i>(Refer to page 2 for compatible models.)</i>	Check the manufacture date of inverters. Check the SERIAL number indicated on the inverter rating plate or package.	—
The "PU07BB/COMPATIBILITY/ERROR" display remains on and it will not accept operation.	FR-PU07BB was connected to an incompatible inverter. <i>(Refer to page 2 for compatible models.)</i>	Check the manufacture date of inverters. Check the SERIAL number indicated on the inverter rating plate or package.	—
FR-PU07BB cannot be operated in the battery mode.	Battery exhaustion of FR-PU07BB, disconnection of the AC adapter	Check whether the battery of FR-PU07BB is run down.	Change the battery.
		Check whether the AC adapter is disconnected.	Check for connection of the AC adapter.

6 SPECIFICATIONS

6.1 Standard Specifications

Item	Specifications	
	FR-PU07	FR-PU07BB
Surrounding air temperature	-10°C to +50°C (non-freezing) *1	
Ambient humidity	90%RH or less (non-condensing)	
Storage temperature	-20°C to +65°C *2	
Ambience	Indoors (free from corrosive gas, flammable gas, oil mist, dust and dirt)	
Altitude, vibration	Maximum 1000m above sea level for standard operation. 5.9m/s ² or less at 10 to 55Hz (directions of X, Y, Z axes)	
Power supply	Power is supplied from the inverter.	Power is supplied from the inverter, a battery or an AC adapter.
Connection	Installed to the inverter or connected to the inverter by the cable.	Connected by the dedicated cable.
Display	LCD (liquid crystal display, 16 characters 4 lines)	
Data retention	Onboard EEPROM	
Number of write times	Maximum 100,000 times	
Protective structure	UL type 1 *3	—
Mass	Approx. 200g	Approx. 300g (not including the battery weight)

*1 At the low temperatures of less than about 0°C, the liquid crystal display (LCD) may be slower in operation.
At high temperatures, the LCD life may become shorter.

*2 Temperatures applicable for a short time, e.g. in transit.

*3 UL Type 1 Enclosure - Suitable for Installation in a Compartment Handling Conditioned Air (Plenum)

CAUTION

- Do not expose the liquid crystal screen to direct sunlight.
- During transportation, avoid applying load to the liquid crystal display.

• FR-PU07BB dedicated specifications

Item	Specifications				
Battery life *		Alkaline battery			
		A800/ F800	E800	A700/ F700(P)	E700
	Battery life	Approx. 90 min	Approx. 260 min	Approx. 90 min	Approx. 260 min
	Battery exhaustion warning lamp color changing start time From green to orange (at lowering of battery power)	Approx. 50 min before			
		Nickel metal hydride battery			
		A800/ F800	E800	A700/ F700(P)	E700
	Battery life	Approx. 120 min	Approx. 340 min	Approx. 120 min	Approx. 340 min
	Battery exhaustion warning lamp color changing start time From green to orange (at lowering of battery power)	Approx. 10 min before			

* The battery life is a reference value. It differs depending on the battery and the usage.

6.2 Outline Drawing and Panel Cutting Drawing

6.2.1 FR-PU07 outline dimension drawings

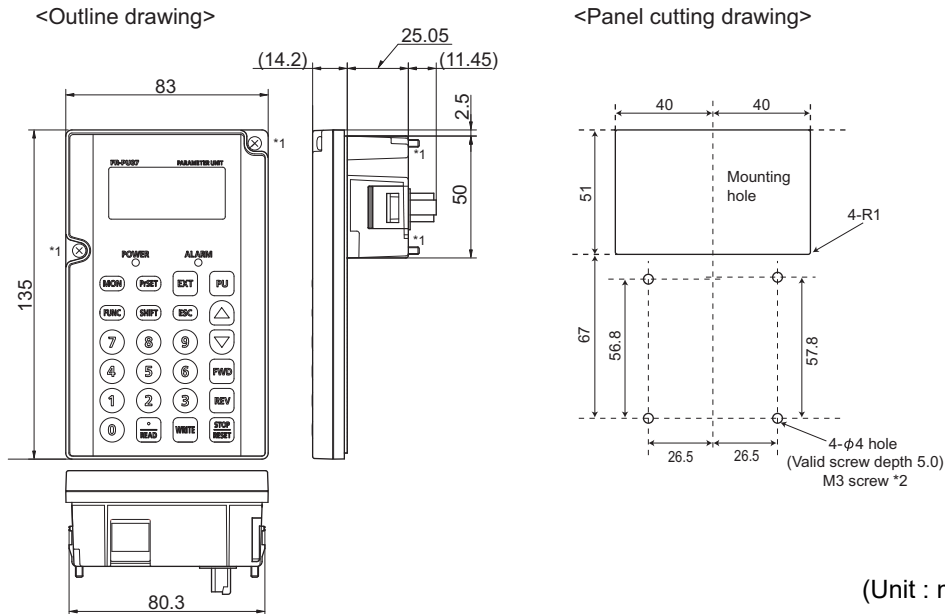

- *1 When installing the FR-PU07 on the enclosure, etc., remove screws for fixing the FR-PU07 to the inverter or fix the screws to the FR-PU07 with M3 nuts.
- *2 Select the installation screws of which length will not exceed the effective depth of the installation screws threads.

6.2.2 FR-PU07BB outline dimension drawings

<Outline drawing>

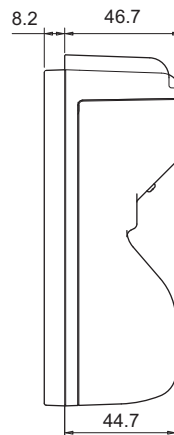
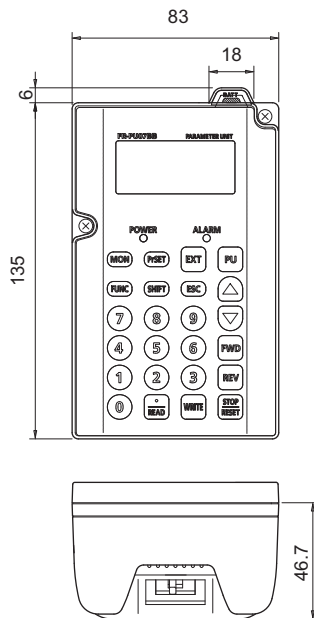

* FR-PU07BB cannot be installed to the enclosure and such.

(Unit: mm)

Appendix 1 Disposing of the equipment in the EU countries

- The symbol shown below, which is printed on the product for EU countries, means that electric and electronic equipment, at their end-of-life, should be disposed of separately from your household waste.
- Please, dispose of this equipment at your local community waste collection/recycling centre if it is to be disposed of in EU countries.
- In the European Union, there are separate collection systems for used electrical and electronic product.
- Please, help us to conserve the environment we live in.

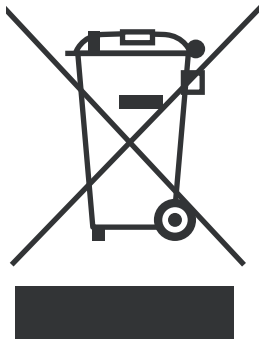

Note: This symbol is for EU countries only.

This symbol is according to the directive 2006/66/EC Article 20 Information for end-users, Article 21 Labelling, and Annex II.



Appendix 2 Instructions for UL and cUL

(Standard to comply with: UL 508C, CSA C22.2 No.14)

The FR-PU07 have been approved as parameter display accessory for a UL type1 enclosure that is suitable for Installation in a Compartment Handling Conditioned Air (Plenum).

The FR-PU07 is to be used only with the following UL listed inverter models.

Parameter Unit	Applicable Inverter Models
FR-PU07	FR-A800, FR-F800, FR-E800, FR-E700, FR-D700, FR-A700 and FR-F700

Appendix 3 Restricted Use of Hazardous Substances in Electronic and Electrical Products

The mark of restricted use of hazardous substances in electronic and electrical products is applied to the product as follows based on the “Management Methods for the Restriction of the Use of Hazardous Substances in Electrical and Electronic Products” of the People's Republic of China.

电器电子产品有害物质限制使用标识要求



本产品中所含有的有害物质的名称、含量、含有部件如下表所示。

• 产品中所含有害物质的名称及含量

部件名称*2	有害物质*1					
	铅(Pb)	汞(Hg)	镉(Cd)	六价铬(Cr(VI))	多溴联苯(PBB)	多溴二苯醚(PBDE)
电路板组件（包括印刷电路板及其构成的零部件，如电阻、电容、集成电路、连接器等）、电子部件	×	○	×	○	○	○
金属壳体、金属部件	×	○	○	○	○	○
树脂壳体、树脂部件	○	○	○	○	○	○
螺丝、电线	○	○	○	○	○	○

上表依据SJ/T11364的规定编制。

○：表示该有害物质在该部件所有均质材料中的含量均在GB/T26572规定的限量要求以下。

×：表示该有害物质在该部件的至少一种均质材料中的含量超出GB/T26572规定的限量要求。

*1 即使表中记载为 ×，根据产品型号，也可能会有有害物质的含量为限制值以下的情况。

*2 根据产品型号，一部分部件可能不包含在产品中。

REVISIONS

*The manual number is given on the bottom left of the back cover.

Revision Date	*Manual Number	Revision
Aug. 2005	IB(NA)-0600240ENG-A	First edition
May 2007	IB(NA)-0600240ENG-B	<div style="border: 1px solid black; padding: 2px;">Addition</div> <ul style="list-style-type: none"> · FR-PU07BB · Disposing of the equipment in EU countries
Mar. 2008	IB(NA)-0600240ENG-C	<ul style="list-style-type: none"> · Partial changes
Jan. 2009	IB(NA)-0600240ENG-D	<div style="border: 1px solid black; padding: 2px;">Addition</div> <ul style="list-style-type: none"> · FR-D700 series · FR-F700 series
Oct. 2014	IB(NA)-0600240ENG-E	<div style="border: 1px solid black; padding: 2px;">Addition</div> <ul style="list-style-type: none"> · Appendix 3 Instructions for UL and cUL
Dec. 2014	IB(NA)-0600240ENG-F	<div style="border: 1px solid black; padding: 2px;">Modification</div> <ul style="list-style-type: none"> · Appendix 3 Instructions for UL and cUL
Sep. 2015	IB(NA)-0600240ENG-G	<div style="border: 1px solid black; padding: 2px;">Modification</div> <ul style="list-style-type: none"> · Display overview · Instructions for use in combination with the FR-A800/F800 series inverter
May 2020	IB(NA)-0600240ENG-H	<div style="border: 1px solid black; padding: 2px;">Addition</div> <ul style="list-style-type: none"> · FR-E800 series (except for the FR-E800-E and FR-E800-SCE inverters)

INVERTER

mitsubishi electric corporation

HEAD OFFICE: TOKYO BUILDING 2-7-3, MARUNOUCHI, CHIYODA-KU, TOKYO 100-8310, JAPAN

IB(NA)-0600240ENG-H(2005) MEE

Printed in Japan

Specifications subject to change without notice.