



# INVERTER

Plug-in option

# FR-A7NF

# INSTRUCTION MANUAL

---

*FL remote communication  
function*

---

PRE-OPERATION INSTRUCTIONS

1

INSTALLATION

2

WIRING

3

INVERTER SETTING

4

FL REMOTE COMMUNICATION  
FUNCTION

5

CYCLIC TRANSMISSION

6

MESSAGE TRANSMISSION

7

DESCRIPTION AND CORRECTIVE  
ACTION OF FAULT INDICATION

8

TROUBLESHOOTING

9

Thank you for choosing this Mitsubishi Electric Inverter plug-in option.

This Instruction Manual gives handling information and precautions for use of this equipment. Incorrect handling might cause an unexpected fault. Before using the equipment, please read this manual carefully to use the equipment to its optimum. Please forward this manual to the end user.

## This section is specifically about safety matters

Do not attempt to install, operate, maintain or inspect this product until you have read through this Instruction Manual and appended documents carefully and can use the equipment correctly. Do not use this product until you have a full knowledge of the equipment, safety information and instructions.

In this Instruction Manual, the safety instruction levels are classified into "WARNING" and "CAUTION".



### WARNING

Incorrect handling may cause hazardous conditions, resulting in death or severe injury.



### CAUTION

Incorrect handling may cause hazardous conditions, resulting in medium or slight injury, or may cause only material damage.

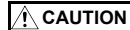

The **CAUTION** level may even lead to a serious consequence according to conditions. Both instruction levels must be followed because these are important to personal safety.

## SAFETY INSTRUCTIONS

### 1. Electric Shock Prevention



### WARNING

- While the inverter power is ON, do not remove the front cover or the wiring cover. Do not run the inverter with the front cover or the wiring cover removed. Otherwise you may access the exposed high voltage terminals or the charging part of the circuitry and get an electric shock.
- Even if power is OFF, do not remove the front cover except for wiring or periodic inspection. You may accidentally touch the charged inverter circuits and get an electric shock.
- Before wiring or inspection, power must be switched OFF. To confirm that, LED indication of the operation panel must be checked. (It must be OFF.) Any person who is involved in wiring or inspection shall wait for at least 10 minutes after the power supply has been switched OFF and check that there are no residual voltage using a tester or the like. The capacitor is charged with high voltage for some time after power OFF, and it is dangerous.
- Any person who is involved in wiring or inspection of this equipment shall be fully competent to do the work.
- The plug-in option must be installed before wiring. Otherwise, you may get an electric shock or be injured.
- Do not touch the plug-in option or handle the cables with wet hands. Otherwise you may get an electric shock.
- Do not subject the cables to scratches, excessive stress, heavy loads or pinching. Otherwise you may get an electric shock.

## 2. Injury Prevention

### CAUTION

- The voltage applied to each terminal must be the ones specified in the Instruction Manual. Otherwise burst, damage, etc. may occur.
- The cables must be connected to the correct terminals. Otherwise burst, damage, etc. may occur.
- Polarity must be correct. Otherwise burst, damage, etc. may occur.
- While power is ON or for some time after power-OFF, do not touch the inverter as they will be extremely hot. Doing so can cause burns.

## 3. Additional Instructions

Also the following points must be noted to prevent an accidental failure, injury, electric shock, etc.

### 1) Transportation and mounting

### CAUTION

- Do not install or operate the plug-in option if it is damaged or has parts missing.
- Do not stand or rest heavy objects on the product.
- The mounting orientation must be correct.
- Foreign conductive objects must be prevented from entering the inverter. That includes screws and metal fragments or other flammable substances such as oil.

### 2) Trial run

### CAUTION

- Before starting operation, each parameter must be confirmed and adjusted. A failure to do so may cause some machines to make unexpected motions.

## 3) Usage

### WARNING

- Do not modify the equipment.
- Do not perform parts removal which is not instructed in this manual. Doing so may lead to fault or damage of the inverter.

### CAUTION

- Static electricity in your body must be discharged before you touch the product. Otherwise the product may be damaged.

## 4) Maintenance, inspection and parts replacement

### CAUTION

- Do not test the equipment with a megger (measure insulation resistance).

## 5) Disposal

### CAUTION

- This inverter plug-in option must be treated as industrial waste.

## 6) General instruction

Many of the diagrams and drawings in this Instruction Manual show the inverter without a cover or partially open for explanation. Never operate the inverter in this manner. The cover must be reinstalled and the instructions in the inverter manual must be followed when operating the inverter.

# — CONTENTS —

<b>1</b>	<b>PRE-OPERATION INSTRUCTIONS</b>	<b>1</b>
<b>1.1</b>	<b>Inverter model</b> .....	<b>1</b>
<b>1.2</b>	<b>Unpacking and product confirmation</b> .....	<b>2</b>
1.2.1	Product confirmation.....	2
1.2.2	SERIAL check .....	3
<b>1.3</b>	<b>Parts</b> .....	<b>8</b>
<b>1.4</b>	<b>LED status</b> .....	<b>9</b>
1.4.1	Device status LED (DEV), remote status LED (RMT) .....	10
1.4.2	Transmitting (TX)/receiving (RX) LED .....	11
1.4.3	Communication set status LED (CHG).....	11
<b>1.5</b>	<b>Specifications</b> .....	<b>12</b>
1.5.1	Inverter option specifications .....	12
1.5.2	Communication specifications .....	12
<b>2</b>	<b>INSTALLATION</b>	<b>13</b>
<b>2.1</b>	<b>Pre-installation instructions</b> .....	<b>13</b>
<b>2.2</b>	<b>Installation of the communication option LED display cover</b> .....	<b>14</b>
<b>2.3</b>	<b>Installation procedure</b> .....	<b>15</b>
<b>2.4</b>	<b>Node address setting</b> .....	<b>17</b>
<b>3</b>	<b>WIRING</b>	<b>18</b>
<b>3.1</b>	<b>Connection to network</b> .....	<b>18</b>
<b>3.2</b>	<b>Cable specifications</b> .....	<b>19</b>
<b>3.3</b>	<b>Precautions for system configuration</b> .....	<b>19</b>
<b>3.4</b>	<b>Wiring</b> .....	<b>20</b>

<b>4</b>	<b>INVERTER SETTING</b>	<b>22</b>
<b>4.1</b>	<b>Parameter list</b>	<b>22</b>
<b>4.2</b>	<b>Operation mode setting</b>	<b>26</b>
4.2.1	Operation mode indication	26
4.2.2	Operation mode switchover method	27
<b>4.3</b>	<b>Selection of control source for the Network operation mode</b>	<b>32</b>
<b>4.4</b>	<b>Operation at communication error occurrence</b>	<b>34</b>
4.4.1	Operation selection at communication error occurrence (Pr. 501, Pr. 502)	34
4.4.2	Fault and measures	36
<b>4.5</b>	<b>Inverter reset</b>	<b>38</b>
<b>4.6</b>	<b>Frequency and speed conversion specifications</b>	<b>39</b>
<b>5</b>	<b>FL REMOTE COMMUNICATION FUNCTION</b>	<b>40</b>
<b>5.1</b>	<b>Functions</b>	<b>40</b>
5.1.1	Output from the inverter to the network	40
5.1.2	Input to the inverter from the network	41
<b>5.2</b>	<b>Types of data communication</b>	<b>42</b>
<b>6</b>	<b>CYCLIC TRANSMISSION</b>	<b>43</b>
<b>6.1</b>	<b>Common memory</b>	<b>44</b>
6.1.1	Common memory area 1	46
6.1.2	Common memory area 2	47
<b>6.2</b>	<b>Output data (master to inverter)</b>	<b>50</b>
6.2.1	Control input command	51
6.2.2	Set frequency	53
<b>6.3</b>	<b>Input data (inverter to master)</b>	<b>54</b>
6.3.1	Inverter status monitor	55

6.3.2	Fault code.....	57
6.3.3	Life/warning .....	57
6.3.4	Output frequency monitor .....	59
6.3.5	Output current monitor.....	59
<b>7</b>	<b>MESSAGE TRANSMISSION</b>	<b>60</b>
<b>7.1</b>	<b>Error response at word block read/write .....</b>	<b>63</b>
<b>7.2</b>	<b>Word block read/write .....</b>	<b>64</b>
7.2.1	Virtual address space of word block read/write .....	65
7.2.2	Product information .....	66
7.2.3	Operation mode.....	68
7.2.4	Inverter status.....	69
7.2.5	Set frequency .....	70
7.2.6	Inverter monitor .....	71
7.2.7	Parameter.....	74
7.2.8	Calibration parameters .....	76
7.2.9	Fault record .....	78
<b>7.3</b>	<b>Network parameter read.....</b>	<b>84</b>
<b>7.4</b>	<b>Log data read .....</b>	<b>87</b>
<b>7.5</b>	<b>Log data clear.....</b>	<b>90</b>
<b>7.6</b>	<b>Profile read .....</b>	<b>91</b>
<b>7.7</b>	<b>Message loopback.....</b>	<b>95</b>
<b>8</b>	<b>DESCRIPTION AND CORRECTIVE ACTION OF FAULT INDICATION</b>	<b>96</b>
<b>9</b>	<b>TROUBLESHOOTING</b>	<b>97</b>
	<b>APPENDIX</b>	<b>99</b>

MEMO

# 1 PRE-OPERATION INSTRUCTIONS

## 1.1 Inverter model

The inverter model, 55K and 75K stated in this Instruction Manual differs according to each -NA, -EC, -CH(T) versions. Refer to the following correspondence table for each inverter model. (*Refer to the Instruction Manual of each inverter for the inverter model.*)

For example, "for the 75K or higher" indicates "for the FR-A740-01440-NA or higher" in the case of FR-A740 of NA version.

		NA	EC	CH
F700	FR-F720(P)-55K	FR-F720-02330-NA	—	—
	FR-F720(P)-75K	FR-F720-03160-NA	—	—
	FR-F740(P)-55K	FR-F740-01160-NA	FR-F740-01160-EC	FR-F740-55K-CH(T)
	FR-F740(P)-75K	FR-F740-01800-NA	FR-F740-01800-EC	FR-F740-S75K-CH(T)
A700	FR-A720-55K	FR-A720-02150-NA	—	—
	FR-A720-75K	FR-A720-02880-NA	—	—
	FR-A740-55K	FR-A740-01100-NA	FR-A740-01800-EC	FR-A740-55K-CHT
	FR-A740-75K	FR-A740-01440-NA	FR-A740-02160-EC	FR-A740-75K-CHT





## 1.2 Unpacking and product confirmation

Take the plug-in option out of the package, check the product name, and confirm that the product is as you ordered and intact.

This product is a plug-in option for the FR-A700/F700(P) series inverter.

### 1.2.1 Product confirmation

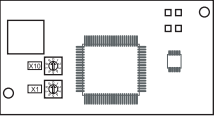
Check the enclosed items.

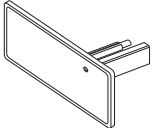
<p>Plug-in option ..... 1</p> 	<p>Mounting screw (M3 × 6mm) ..... 2 (Refer to page 15.)</p> 	<p>Hex-head screw for option mounting (5.5mm) ..... 1 (Refer to page 15.)</p> 	<p>Communication option LED display cover ..... 1 (Refer to page 14.)</p> 
---	--	---	---



## 1.2.2 SERIAL check

The plug-in option is compatible with the inverter having the following SERIAL or later.  
Check the SERIAL indicated on the inverter rating plate or package.

- SERIAL check

Refer to the inverter manual for the location of the rating plate.

### Rating plate example

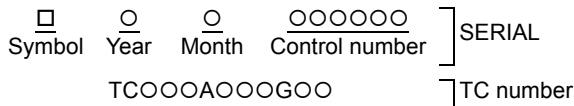

The SERIAL consists of one symbol, two characters indicating production year and month, and six characters indicating control number.  
The last digit of the production year is indicated as the Year, and the Month is indicated by 1 to 9, X (October), Y (November), or Z (December.)

### (1) PU/NET operation switchover (X65 signal) specification

The inverters with the following SERIAL are operated in the PU/NET operation switchover (X65 signal) specification when connected with FR-A7NF.

- FR-A700 series

Model	SERIAL
FR-A720-□□(-NA), FR-A740-□□(-NA)(-EC)(-CHT), FR-CA70-EC, FR-CA70-ECT	□7X○○○○○○ to □03○○○○○○

- FR-F700 series Japanese specification

Model	SERIAL
FR-F720-0.75K to 110K, FR-F740-0.75K to 560K	□91○○○○○○ or later

Regardless of their SERIAL, all FR-F700P series inverters are operated with the PU operation interlock (X12 signal) specification.

## **7** PRE-OPERATION INSTRUCTIONS

---

- FR-F700 series NA specification

<b>Model</b>	<b>SERIAL</b>
FR-F720-00046 to 04750-NA, FR-F740-00023 to 12120-NA	□91000000 or later

- FR-F700 series EC specification

<b>Model</b>	<b>SERIAL</b>
FR-F740-00023 to 00620-EC, FR-CF70-EC, FR-CF70-ECT	□95000000 or later

- FR-F700 series CHT specification

<b>Model</b>	<b>SERIAL</b>
FR-F740-0.75K to 55K-CHT, FR-F740-S75K to S630K-CHT	□93000000 or later



## (2) PU operation interlock (X12 signal) specification

The FR-F700P series and the inverters with the following TC and SERIAL are operated in the PU operation interlock (X12 signal) specification when connected with FR-A7NF.

- FR-A700 series Japanese and NA specification

Model	SERIAL
FR-A720-□□ (-NA) FR-A740-□□ (-NA)	□04○○○○○○

1

**REMARKS**

- The following table shows the operation mode switching specifications of the FR-A700 series inverters with the FR-A7NF. The specification depends on a combination of both SERIALs. Check the board of the FR-A7NF for its version and the SERIAL.

FR-A7NF		SERIAL of the FR-A700 series inverter	
Version	SERIAL	□7X○○○○○○ to □03○○○○○○	□04○○○○○○ or later
A	□03○○○ or earlier	PU/NET operation switchover (X65 signal) specification	PU/NET operation switchover (X65 signal) specification
B	□04○○○ or later	PU/NET operation switchover (X65 signal) specification	PU operation interlock (X12 signal) specification

FR-A7NF SERIAL example

□    ○    ○    ○○○

Symbol   Year   Month   Control number

The SERIAL consists of one symbol, two characters indicating production year and month, and three characters indicating control number. The last digit of the production year is indicated as the Year, and the Month is indicated by 1 to 9, X (October), Y (November), or Z (December.)

- Refer to chapter 4 or later for the differences between the PU/NET operation switchover (X65 signal) specification and the PU operation interlock (X12 signal) specification.

● FR-A700 series EC specification

Model	TC number	SERIAL
FR-A740-00023 to 00052-EC	TC000A000G70	C000000000 or later
	TC000A000G80	A000000000 or later
FR-A740-00083/00126-EC	TC000A000G70	C000000000 or later
	TC000A000G80	B000000000 or later
FR-A740-00170/00250-EC	TC000A000G70	Y000000000 or later
	TC000A000G80	Z000000000 or later
FR-A740-00310/00380-EC	TC000A000G70	Z000000000 or later
	TC000A000G80	B000000000 or later
FR-A740-00470/00620-EC	TC000A000G70	Y000000000 or later
	TC000A000G80	Z000000000 or later
FR-CA70-EC (Control unit)	TC000A000G70	V000000000 or later
	TC000A000G80	E000000000 or later
FR-CA70-ECT (Control unit)	TC000A000G70	S000000000 or later
	TC000A000G80	E000000000 or later



● FR-A700 series CHT specification

Model	TC number	SERIAL
FR-A740-0.4K to 1.5K-CHT	TC000A000G70	A000000000 or later
	TC000A000G80	Y000000000 or later
FR-A740-2.2K/3.7K-CHT	TC000A000G70	A000000000 or later
	TC000A000G80	Z000000000 or later
FR-A740-5.5K/7.5K-CHT	TC000A000G70	W000000000 or later
	TC000A000G80	X000000000 or later
FR-A740-11K/15K-CHT	TC000A000G70	X000000000 or later
	TC000A000G80	Z000000000 or later
FR-A740-18.5/22K-CHT	TC000A000G70	W000000000 or later
	TC000A000G80	X000000000 or later
FR-A740-30K to 45K-CHT	TC000A000G70	X000000000 or later
	TC000A000G80	V000000000 or later
FR-A740-55K-CHT	TC000A000G70	W000000000 or later
	TC000A000G80	V000000000 or later
FR-A740-75K/90K-CHT	TC000A000G70	V000000000 or later
	TC000A000G80	F000000000 or later
FR-A740-110K-CHT	TC000A000G70	X000000000 or later
	TC000A000G80	G000000000 or later
FR-A740-132K-CHT	TC000A000G70	W000000000 or later
	TC000A000G80	G000000000 or later
FR-A740-160K/185K-CHT	TC000A000G70	W000000000 or later
FR-A740-220K to 280K-CHT	TC000A000G70	V000000000 or later
FR-A740-315K/355K-CHT	TC000A000G70	U000000000 or later
FR-A740-400K to 500K-CHT	TC000A000G70	R000000000 or later

## 1.3 Parts

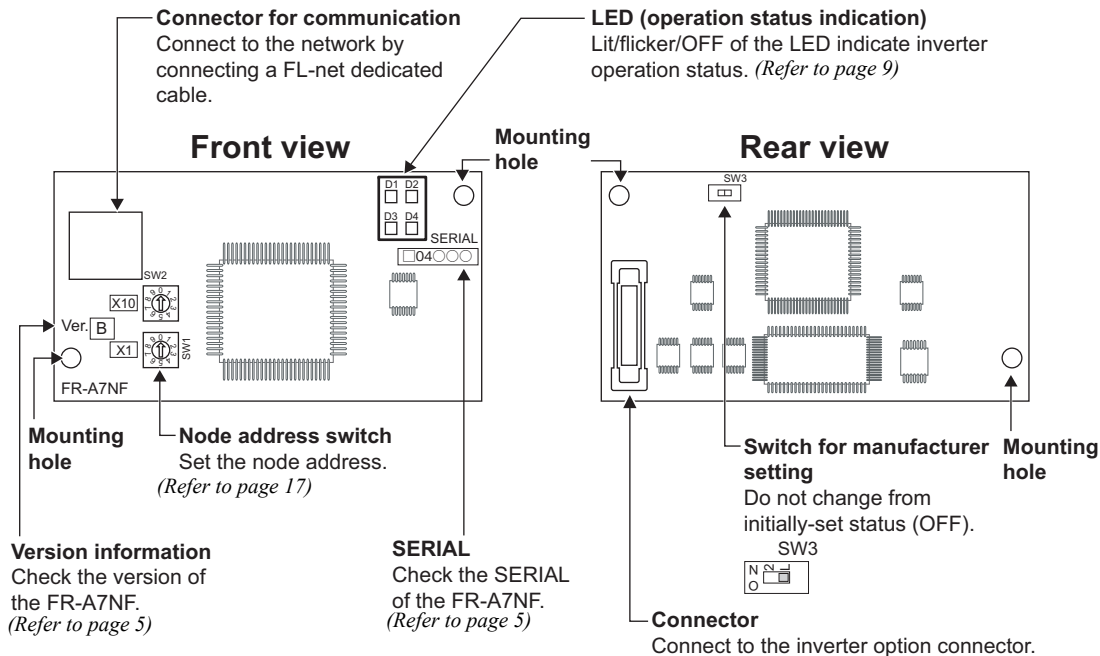



## 1.4 LED status

Each LED indicates the operating status of the option unit and network according to the indication status.

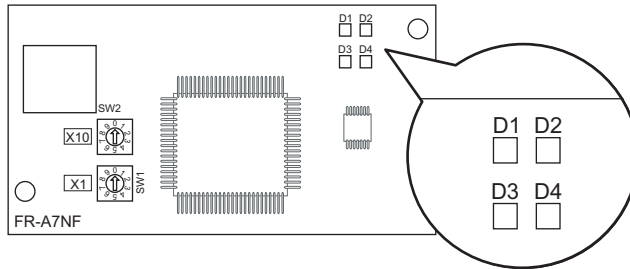

- D1: Communication set status LED (CHG)
- D2: Device status LED (DEV)
- D3: Reception/transmission LED (TX/RX)
- D4: Remote status LED (RMT)



### 1.4.1 Device status LED (DEV), remote status LED (RMT)

LED Status		Node Status	Description
DEV	RMT		
<input type="checkbox"/>	<input type="checkbox"/>	Power is OFF	The inverter power is OFF.
<input checked="" type="checkbox"/>	<input type="checkbox"/>	Hardware fault	<ul style="list-style-type: none"> <li>· Node address is out of range (other than 1 to 64).</li> <li>· Optional board fault</li> <li>· When mounted to the inverter which is not compatible with the FR-A7NF (Refer to <i>page 3</i> for the inverter which is compatible with the FR-A7NF)</li> <li>· When a contact fault occurs in an option connector between the inverter and communication option.</li> </ul>
<input type="checkbox"/>	<input type="checkbox"/>	FL remote network is not connected	Although hardware is normal, it is not connected to the FL remote network.
<input type="checkbox"/>	<input type="checkbox"/>	FL remote network at a remote stop	It is correctly set to connect to the FL remote network and waiting for remote I/O control.
		FL remote network during remote connection processing	Although remote I/O control started, initial processing is in progress.
		Master is not present	When the master is disconnected from FL remote network.
<input type="checkbox"/>	<input type="checkbox"/>	FL remote network during remote operation	During remote I/O control
<input type="checkbox"/>	<input checked="" type="checkbox"/>	Own node is disconnected	When the own node is disconnected from FL remote network.



LED Status		Node Status	Description
DEV	RMT		
<input type="checkbox"/>	<input checked="" type="checkbox"/> ↔ <input type="checkbox"/>	Setting error	Although it is connected to the FL remote, setting error is found. (When the slave is not the one the master is expected.)
<input type="checkbox"/>	<input checked="" type="checkbox"/>	Duplicate node	When node address is duplicate with other node address

:OFF,  : red is lit,  : green is lit,  ↔  :red is flickering,  ↔  : green is flickering,  
 ↔  : red and green are alternately flickering

### 1.4.2 Transmitting (TX)/receiving (RX) LED

LED Status		Node Status	Description
<input type="checkbox"/>			
<input type="checkbox"/>		Transmitting (TX)/receiving (RX)	Flickers at high speed during continuous transmitting/receiving

:OFF,  : green is lit

### 1.4.3 Communication set status LED (CHG)

LED Status		Node Status	Description
<input type="checkbox"/>			
<input checked="" type="checkbox"/> ↔ <input type="checkbox"/>		Communication setting is changed	The red LED flickers when the applied setting and the node address switch setting differ. The setting value of the node address switch is applied by re-powering ON the inverter in this status, then communication setting status LED turns OFF.

:OFF,  ↔  : red is flickering

## 1.5 Specifications

### 1.5.1 Inverter option specifications

<b>Power supply</b>	Supplied from the inverter
<b>Type</b>	Inverter plug-in option (can be mounted/dismounted to/from the inverter front face)
<b>FL-net dedicated cable</b>	<i>Refer to page 19</i>

### 1.5.2 Communication specifications



<b>Maximum number of connectable inverters</b>	64 units maximum
<b>Communication speed</b>	Auto negotiation (auto detection) (10Mbps/100Mbps)
<b>Topology</b>	<ul style="list-style-type: none"> <li>· Star (connection with a hub in the center)</li> <li>· Star bus (connection with multiple hubs)</li> </ul>
<b>Communication distance</b>	<ul style="list-style-type: none"> <li>· Between node ↔ hub: 100m maximum (Node indicate master and inverters.)</li> <li>· Between hubs: 100m maximum</li> <li>· Overall length: 2000m maximum</li> </ul>
<b>Electrical interface</b>	Conforms to IEEE802.3u (conforms to CSMA/CD)
<b>Transmission protocol</b>	FL remote
<b>Node address setting</b>	Can be set with node address switch ( <i>Refer to page 17</i> ). The setting is applied to IP address as well. (192.168.250.node address)
<b>I/O points</b>	Input 64 points, output 64 points

## 2 INSTALLATION

### 2.1 Pre-installation instructions

Make sure that the input power of the inverter is OFF.

#### CAUTION

-  **With input power ON, do not install or remove the plug-in option. Otherwise, the inverter and plug-in option may be damaged.**
-  **Static electricity in your body must be discharged before you touch the product. Otherwise the product may be damaged.**

### 2.2 Installation of the communication option LED display cover

Mount the cover for displaying the operation status indication LED for the communication option on the inverter front cover.

- 1) Cut off hooks on the rear of the inverter front cover with nipper, etc. and open a window for fitting the LED display cover.

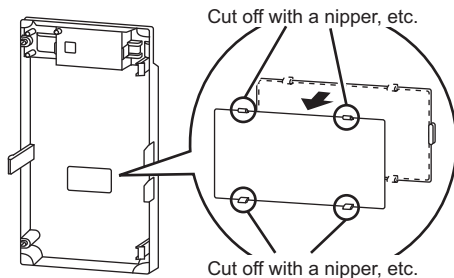

- 2) Fit the communication option LED display cover to the front of the inverter front cover and push it into until fixed with hooks.

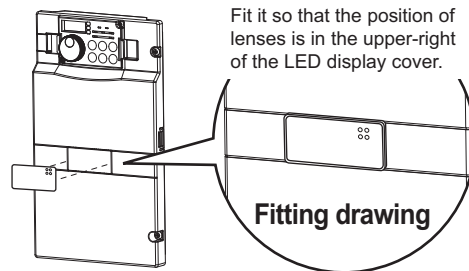

#### ⚠ CAUTION

⚠ Take caution not to hurt your hand and such with portions left by cutting hooks of the rear of the front cover.

## 2.3 Installation procedure

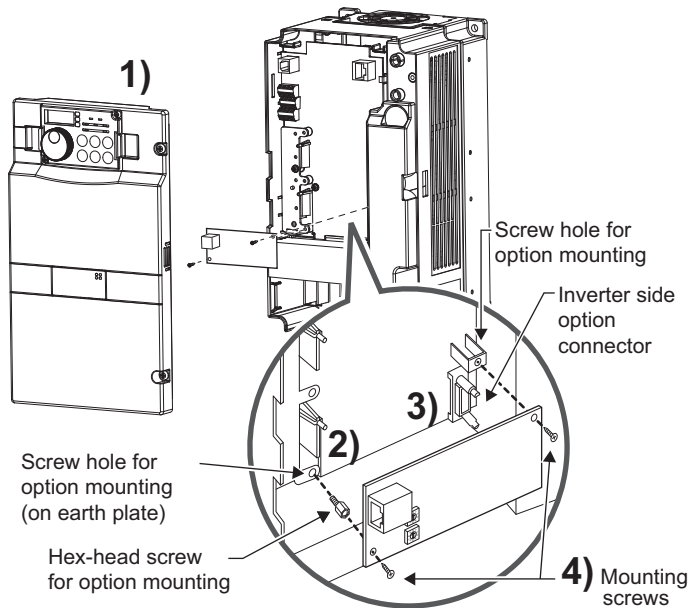

- 1) Remove the inverter front cover.
- 2) Mount the hex-head screw for option mounting into the inverter screw hole (on earth plate) (size 5.5mm, tightening torque 0.56N·m to 0.75N·m).
- 3) Securely fit the connector of the plug-in option to the inverter connector along the guides.
- 4) Securely fix the both right and left sides of the plug-in option to the inverter with the accessory mounting screws. (Tightening torque 0.33N·m to 0.40N·m)  
If the screw holes do not line up, the connector may not have been plugged securely. Check for loose plugging.

2

### REMARKS

- Remove a plug-in option after removing two screws on both left and right sides. (The plug-in option is easily removed if the control circuit terminal block is removed before.)

## CAUTION

- One of "E. 1 to E. 3" (option fault) appears when the inverter cannot recognize the option because it is improperly mounted, etc. One of the faults also appears when an incompatible option is mounted to the inverter. Different indication will appear according to the mounted position (connector 1, 2, or 3).
- For an inverter having several option connectors, use the bottom connector to mount the option.

If it is connected to a connector other than the bottom connector, "E. 1" or "E. 2" (option fault) will appear and its operation will be disabled. Different indication will appear according to the mounted position (connector 1 or 2).

- The number of option connectors differs by the model. The table below shows how the fault indication differs according to the number of connectors and their positions.

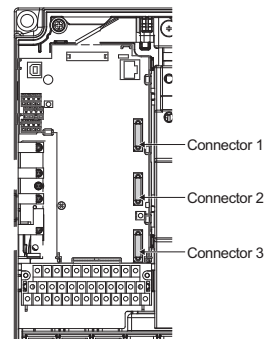

Example of FR-A700

Number of option connectors	3		2		1	
Mounting position and fault indication	Connector 1 (top connector)	E. 1	Connector 1 (top connector)	E. 1	Connector 1	E. 1
	Connector 2 (middle connector)	E. 2	Connector 2 (bottom connector)	E. 2	—	—
	Connector 3 (bottom connector)	E. 3	—	—	—	—

(Refer to *Chapter 1 of the inverter's Instruction Manual* for the number of option connectors.)

- Take caution not to drop a hex-head screw for option mounting or mounting screw during mounting and removal.
- Pull out the option straight to remove. Otherwise, the connector may be damaged.





## 2.4 Node address setting

Set the node address between "1 to 64" using node address switches on the FR-A7NF (Refer to page 8).

The setting is applied when the power turns OFF once, then ON again.

Set the arrow (↑) of the corresponding switches to the number to set a desired address.

● Setting example

<p>Node address 1: Set the "↑" of X10(SW1) to "0" and the "↑" of X1(SW2) to "1".</p>	 	<p>Node address 26: Set the "↑" of X10(SW1) to "2" and the "↑" of X1(SW2) to "6".</p>	 
--	--	---	--

2

### CAUTION

- Set the node address switch to the switch number position correctly. If the switch is set between numbers, normal data communication can not be established.

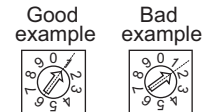

- If the node address switch is set to a value other than "1 to 64", it is invalid due to outside of setting range. In this case, DEV LED of the option is lit red and E.OPT appears on the operation panel of the inverter.
- You cannot set the same node address to other devices on the network. (Doing so disables proper communication.)
- Set the inverter node address before switching ON the inverter and do not change the setting while power is ON. Otherwise you may get an electric shock.
- Changes in the node address setting are applied only at the next power-ON. Therefore, if the node address setting is changed, make sure to power OFF and ON the inverter power.



# 3 WIRING

## 3.1 Connection to network

- (1) Be sure to check the following before connecting the inverter to the network.
  - Check that the FR-A7NF is correctly mounted to the inverter. (*Refer to page 15*)
  - Check that the correct node address is set. (*Refer to page 17*)
  - Check that the FL-net dedicated cable is correctly connected to the FR-A7NF. (*Refer to page 19*)
- (2) System configuration

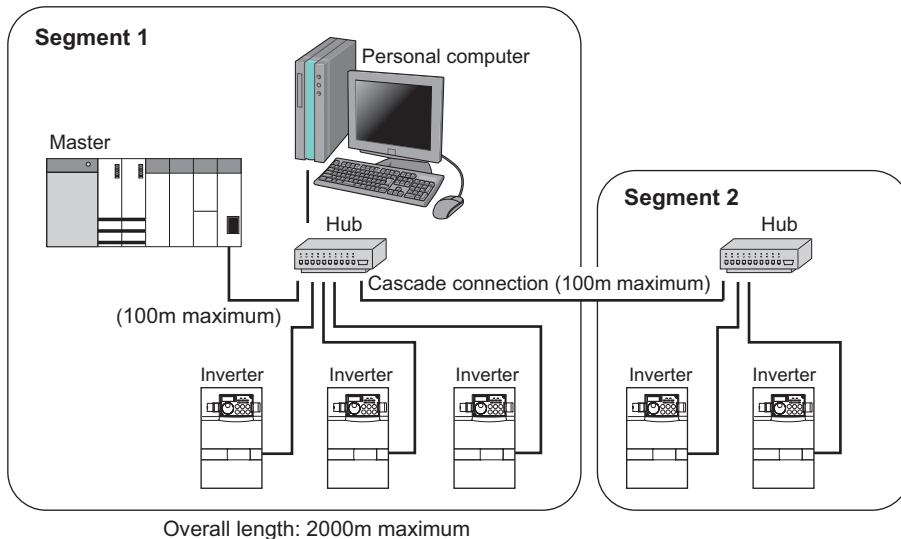

### 3.2 Cable specifications

Connect the FR-A7NF option unit to the FL remote network using the FL-net dedicated cable below.

Cables : TPCC5 or more (Twisted Pair Communication Cable for LAN Category 5)  
 For the shape, use STP (Shielded Twisted Pair) (according to the 100BASE-TX(IEEE802.3u) standard)

Maximum wiring length: 100m maximum between hub and inverter.  
 (according to the 100BASE-TX (IEEE802.3u) standard)

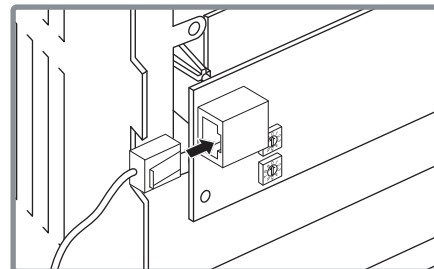

3

#### REMARKS

- FL-net dedicated cable...recommended product (as of February 2015)

Type	Cable Length (m)	Maker
FLG-S-000*1	1m to 100m	Shinwa Co., Ltd.
(Example: when the cable length is 1m) FLG-S-010		

\*1 The cable length is indicated in the brackets (FLG-S-010 for 1m length, FLG-S-1000 for 100m length).

### 3.3 Precautions for system configuration

Enough safety measures are necessary when installing the FL-net dedicated cable and connecting to the FL remote network.

Consult the network provider and network administrator (person in charge of network planning and IP address management) including terminal treatment of connection cable, construction of trunk cable, etc. We are not responsible for system troubles from connecting to the FL remote network.

### 3.4 Wiring

For wiring of the inverter which has one front cover, route wires between the control circuit terminal block and front cover. If cables can not be routed between the control circuit terminal block and front cover (about 7mm), remove a hook of the front cover and use a space become available.

For wiring of the inverter which has front cover 1 and 2, use the space on the left side of the control circuit terminal block.

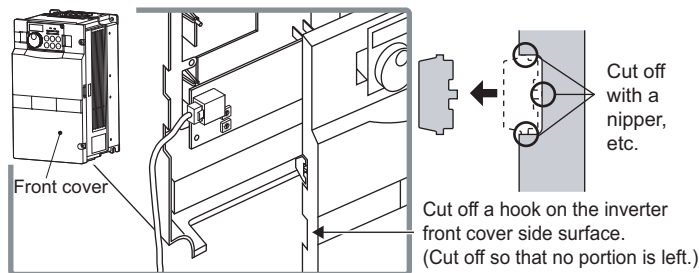

**Inverter which has one front cover**

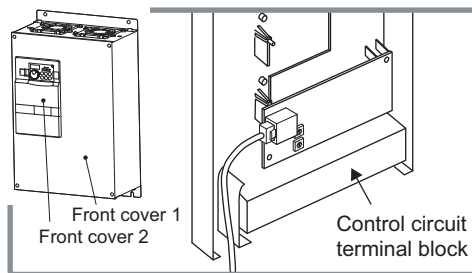



**Inverter which has front cover 1 and 2**

#### REMARKS

- When the hook of the inverter front cover is cut off for wiring, the protective structure (JEM1030) changes to open type (IP00).

 **CAUTION**

-  **Do not connect the parameter unit (FR-PU07, etc.) to the FR-A7NF communication connector. Doing so will damage the option.**
-  **When performing wiring using the space between the inverter front cover and control circuit terminal block, take care not to subject the cable to stress.**
-  **After wiring, wire offcuts must not be left in the inverter. They may cause an error, failure or malfunction.**

# 4 INVERTER SETTING

## 4.1 Parameter list

The following parameters are used for the communication option (FR-A7NF).

For the parameter details, which depend on the applicable model of the inverter, refer to the Instruction Manual (Detailed) of the inverter.

Parameter Number	Name	Setting Range	Minimum Setting Increments	Initial Value	Refer to Page
501*	Communication error occurrence count display	0	1	0	34

\* Parameters which can be displayed when the plug-in option (FR-A7NF) is mounted.

●Parameters whose functions are always the same

When the FR-A7NF is mounted to the inverter, following parameter functions are always the same.

(Changed setting is invalid even if the setting value is changed.)

Parameter Number	Name	Setting	Function	Refer to Page
79	Operation mode selection	0 *3	Network operation mode	27
		7 *4	PU operation interlock	27
180	RL terminal function selection	0	Low-speed operation command	—*2
181	RM terminal function selection	1	Middle-speed operation command	—*2
182	RH terminal function selection	2	High-speed operation command	—*2
183	RT terminal function selection	3	Second function selection	—*2
184	AU terminal function selection	4*3	— (no function)	—*2
		9999*4		
185	JOG terminal function selection	5*3	— (no function)	—*2
		9999*4		
186	CS terminal function selection	6*3	— (no function)	—*2
		9999*4		
187	MRS terminal function selection	24	Output stop	—*2
188	STOP terminal function selection	25*3	— (no function)	—*2
		9999*4		
189	RES terminal function selection	65*3	PU/NET operation switchover	—*2
		12*4	PU operation interlock	—*2
190	RUN terminal function selection	0	Inverter running	—*2
191	SU terminal function selection	1	Up to frequency	—*2
192	IPF terminal function selection	2	Instantaneous power failure/undervoltage	—*2
193	OL terminal function selection	3	Overload alarm	—*2
194	FU terminal function selection	4	Output frequency detection	—*2
195	ABC1 terminal function selection	99	Fault output	—*2
196	ABC2 terminal function selection	9999	— (no function)	—*2

Parameter Number	Name	Setting	Function	Refer to Page
338	Communication operation command source	0	Operation command source communication	32
339	Communication speed command source	0	Speed command source communication	32
340	Communication startup mode selection	0*3	Started in Network operation mode. Operation mode can be changed between the PU operation mode and Network operation mode from the operation panel.	27
		10*4		
342	Communication EEPROM write selection	0	Parameter values written by communication are written to the EEPROM and RAM.	—*2
500 *1	Communication error execution waiting time	0	There is no waiting time since the communication line fault occurrence until communication error (0s). Note that actual time depends on the detection time on FL remote network.	—*2
502 *1	Stop mode selection at communication error	0*3	The inverter decelerates to stop at communication fault occurrence, when provide a fault output.	35
		1*4		
550	NET mode operation command source selection	9999	Automatic communication option recognition Normally, control source of the RS-485 terminal is valid. When a communication option is mounted, the control source of the communication option is valid.	—*2
551	PU mode operation command source selection	2	Selects the PU connector as the PU operation mode operation source.	—*2

\*1 Parameters which can be displayed when the plug-in option (FR-A7NF) is mounted.

\*2 Refer to the inverter manual for details.

\*3 This setting is for the inverters with the PU/NET operation switchover (X65 signal) specification.



- \*4 This setting is for the inverters with the PU operation interlock (X12 signal) specification.  
The X12 signal is valid only when it is input via FL remote communication. (*Refer to page 52*) (It is invalid when input from a control circuit terminal of the inverter.)

**REMARKS**

- Functions that use terminal AU, JOG, CS, or STOP are not available. Also, signals not listed in the table cannot be assigned to the I/O terminals.



## 4.2 Operation mode setting

Powering ON the inverter with the communication option (FR-A7NF) mounted starts the inverter in Network operation mode.

- (1) Network operation [NET] ... Controls the inverter with instructions from the network via the communication option.  
Functions of *Pr.79* and *Pr.340* are always the same when the FR-A7NF is mounted.
- (2) PU operation [PU]..... Controls the inverter from the key of the operation panel (FR-DU07) mounted on the inverter or parameter unit (FR-PU07/FR-PU04).
- (3) External operation [EXT] ... Controls the inverter by switching ON/OFF external signals connected to the control circuit terminals of the inverter.  
(The operation mode can not be changed to External operation mode when the FR-A7NF is mounted.)

### 4.2.1 Operation mode indication

FR-DU07

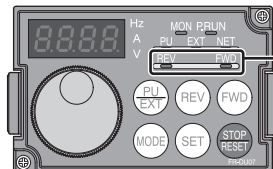

Operation mode indication  
(The inverter operates according to the LED lit mode.)  
PU: PU operation mode  
EXT: External operation mode \*1  
NET: Network operation mode \*2

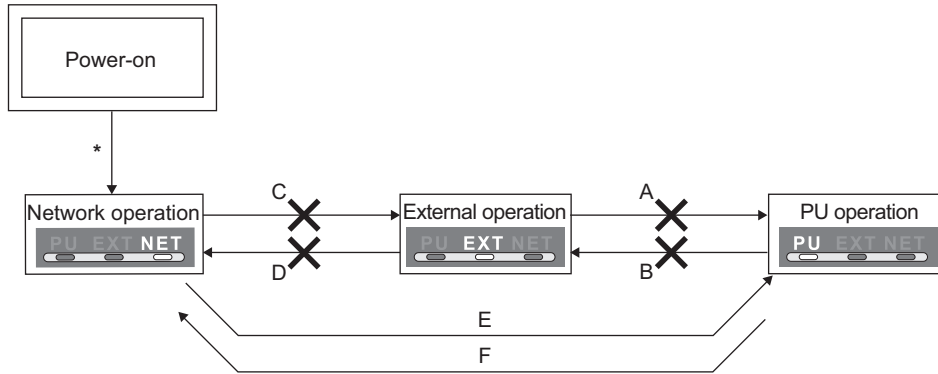

\*1 The operation mode can not be changed to External operation mode when the FR-A7NF is mounted.  
\*2 "NET" is displayed when the FR-A7NF is mounted.

### 4.2.2 Operation mode switchover method



\* When powering ON the inverter with the FR-A7NF mounted, the inverter starts in Network operation mode.

## ● Operation mode switchover

Symbol	Switchover Type	Switchover Method
A	External operation → PU operation	The operation mode can not be switched in power-ON status. After powering OFF the inverter, remove the FR-A7NF, then power ON the inverter again. Then, press the  of the PU (FR-DU07/FR-PU07/FR-PU04).
B	PU operation → External operation	The operation mode can not be switched in power-ON status. After powering OFF the inverter, remove the FR-A7NF, then power ON the inverter again.
C	Network operation → External operation	
D	External operation → Network operation	The operation mode can not be switched in power-ON status. After powering OFF the inverter, mount the FR-A7NF to the option connector (option connector 3 for FR-A700 series), then power ON the inverter again.
E	Network operation → PU operation	Turn ON the PU/NET operation switchover signal. (Refer to page 29) *1
		Turn ON the X12 signal (Bit11), which gives operation commands through FL remote communication, and press  on the PU (FR-DU07/FR-PU07/FR-PU04). (Refer to page 30) *2
F	PU operation → Network operation	Turn OFF the PU/NET operation switchover signal. (Refer to page 29) *1
		Turn OFF the X12 signal (Bit11), which gives operation commands through FL remote communication. (Refer to page 30) *2

\*1 This setting is for the inverters with the PU/NET operation switchover (X65 signal) specification.

\*2 This setting is for the inverters with the PU operation interlock (X12 signal) specification.

(1) Operation mode switching by the PU/NET operation switchover signal (X65)

Combination of the FL remote communication control input command (PU/NET signal) (*refer to page 51*) and the external terminal RES (X65 signal) determines ON/OFF of the PU/NET operation switchover signal and the operation mode as shown in the below table.

Note that operation mode can be changed only during a stop (during a motor stop, start command (STF, STR) is OFF).

<b>FL remote communication control input command (PU/NET signal)</b>	<b>OFF</b>	<b>ON</b>	<b>OFF</b>	<b>ON</b>
<b>RES terminal of external terminal (X65 signal)</b>	<b>OFF</b>	<b>OFF</b>	<b>ON</b>	<b>ON</b>
PU/NET operation switchover signal (Operation mode)	OFF (NET)	ON (PU)	ON (PU)	ON (PU)

PU: PU operation mode  
NET: Net work operation mode

**REMARKS**

- Refer to *page 3* for the inverters compatible with the PU/NET operation switchover (X65 signal) specification.

### (2) Operation mode switching by the PU operation interlock signal (X12)

PU operation interlock is a function that forcefully changes the operation mode to the Network operation mode at turn-OFF of the X12 signal (Bit 11), which gives operation commands through FL remote communication.

This function prevents the operation mode from being accidentally unswitched from the PU operation mode. If the operation mode left unswitched from the PU operation mode, the inverter does not reply to the commands sent through FL remote communication.

X12 signal	Function/Operation	
	Operation mode	Parameter write
ON	Operation mode (PU, NET) switching is enabled Output stop during Network operation	Parameter write is enabled (depending on <i>Pr. 77 Parameter write selection</i> and each parameter write conditions. Refer to the <i>Inverter Manual</i> for details.)
OFF	Forcibly switched to Network operation mode Network operation is enabled Switching to the PU operation mode is disabled	Parameter write is disabled (Note that the <i>Pr.297</i> setting is available when <i>Pr.296</i> ≠ "9999.")

#### REMARKS

- Refer to *page 5* for the inverters compatible with the PU operation interlock (X12 signal) specification.

<Function/operation changed by switching ON-OFF the X12 signal>

Operating Condition		X12 Signal	Operation Mode	Operating Status	Switching to PU Operation Mode
Operation mode	Status				
PU	During stop	ON → OFF *1	Network *2	If Network operation frequency setting and start signal are entered, operation is performed in that status.	Disallowed
	Running	ON → OFF *1			Disallowed
Network	During stop	OFF → ON		During stop	Allowed
		ON → OFF			Disallowed
	Running	OFF → ON		During operation → output stop	Disallowed
		ON → OFF		Output stop → operation	Disallowed

\*1 The operation mode switches to the Network operation mode independently of whether the start signal (STF, STR) is ON or OFF. Therefore, the motor is run in the Network operation mode when the X12 signal is turned OFF with either of STF and STR ON.

\*2 At fault occurrence, pressing of the operation panel resets the inverter.

4

**CAUTION**

- If the X12 signal is ON, the operation mode cannot be switched to the PU operation mode when the start signal (STF, STR) is ON.
- The X12 signal is valid only when it is input via FL remote communication. (The X12 signal is invalid when it is input from a control circuit terminal of the inverter.)
- When the FR-A7NF is mounted, *Pr.79 Operation mode selection* and *Pr.340 Communication startup mode selection* settings are invalid.

## 4.3 Selection of control source for the Network operation mode

- As control sources, there are operation command source that controls signals related to the start command and function selection of the inverter and speed command source that controls signals related to frequency setting.
- Commands from external terminal and communication are as listed below when the FR-A7NF is mounted.

Operation command		Operation valid location	Remarks	
Running frequency from communication		NET	—	
Fixed functions (Functions equivalent to terminals)	Terminal 2	—	—	
	Terminal 4	—	—	
	Terminal 1	Compensation	—	
	Terminal RL	Low-speed operation command/ remote setting clear	NET	Pr. 59 = "0" (multi-speed) Pr. 59 = "1, 2" (remote)
	Terminal RM	Middle-speed operation command/ remote setting deceleration	NET	
	Terminal RH	High-speed operation command/ remote setting acceleration	NET	
	Terminal RT	Second function selection	NET	—
	Terminal RES (X12)*2	PU operation interlock	NET	—
	Terminal RES (X65)*1	PU/NET operation switchover *3	Combined	—
	Terminal MRS	Output stop	Combined	—



Operation command			Operation valid location	Remarks
Operation command through FL remote communication	STF signal	Forward rotation command	NET	—
	STR signal	Reverse rotation command	NET	—
	RL signal	Low-speed operation command	NET	Pr. 59 = "0" (multi-speed) Pr. 59 = "1, 2" (remote)
	RM signal	Middle-speed operation command	NET	
	RH signal	High-speed operation command	NET	
	RT signal	Second function selection	NET	—
	X12 signal *2	PU operation interlock	NET	—
	MRS signal	Output stop	NET	—
	PU/NET signal *1	PU/NET operation switchover *3	NET	—
	Error reset	Error reset	NET	—

- \*1 This setting and signal are for the inverters with the PU/NET operation switchover (X65 signal) specification.  
 \*2 This setting and signal are for the inverters with the PU operation interlock (X12 signal) specification.  
 \*3 Functions of "RES terminal (X65 signal) of external terminal" and "FL remote communication control input command (PU/NET signal)" are the same.

[Explanation of table]

- NET :Control from network is only valid  
 Combined :Operation from either external terminal or communication is valid.  
 — :Operation from either external terminal or computer is invalid.  
 Compensation :Control by signal from external terminal is only valid if Pr. 28 Multi-speed input compensation setting is "1".

**CAUTION**

- The settings of Pr. 338 Communication operation command source and Pr. 339 Communication speed command source are invalid when used with the FR-A7NF.



## 4.4 Operation at communication error occurrence

### 4.4.1 Operation selection at communication error occurrence (Pr. 501, Pr. 502)

You can select operations at communication error occurrences by setting *Pr. 501* and *Pr. 502* under network operation.

#### (1) Display and erasure of communication error occurrence count

The cumulative number of communication error occurrences can be indicated.

Writing "0" to *Pr.501 Communication error occurrence count display* erases this cumulative count.

Parameter Number	Name	Setting Range	Minimum Setting Increments	Initial Value
501	Communication error occurrence count display	0	1	0

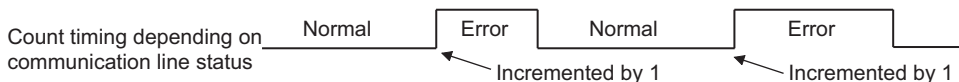

At the point of communication line error occurrence, *Pr. 501 Communication error occurrence count display* is incremented by 1.

The cumulative count of communication error occurrences is counted from 0 to 65535. When the count exceeds 65535, the displayed value is cleared and the counting starts over from 0 again.

### CAUTION

- The communication error count occurrence is stored into RAM temporarily. Since this data is stored in EEPROM at one-hour intervals, performing power-ON reset or inverter may cause the *Pr. 501* data to be the value stored in EEPROM the last time depending on the reset timing.

**(2) Inverter operation at communication error occurrence**

If a communication line error or an error of the option unit itself occurs when the FR-A7NF is mounted, the inverter operates in the same manner as when *Pr. 502 Stop mode selection at communication error = "1"* regardless of setting value of *Pr. 502*.

**●Operation at error occurrence**

Error Definition	Operation	Indication	Fault Output
Communication line	Decelerated to stop	E.OP1, E.OP2 or E.OP3 lit after stop	Provided after stop
Communication option itself	Decelerated to stop	E.1, E.2 or E.3 lit after stop	Provided after stop

**●Operation at error removal**

Error Definition	Operation	Indication	Fault Output
Communication line	Kept stopped	E.OP1, E.OP2 or E.OP3 kept lit	Kept provided
Communication option itself	Kept stopped	E.1, E.2 or E.3 kept lit	Kept provided

4

**CAUTION**

- A communication line error [E.OP1 (fault data: HA1), E.OP2 (fault data:HA2), E.OP3 (fault data: HA3)] is an error that occurs on the communication line, and an error of the communication option unit itself [E. 1 (fault data: HF1), E. 2 (fault data:HF2), E. 3 (fault data: HF3)] is a communication circuit error in the option.
- The fault output indicates fault output signal (terminal ABC1) or fault bit output.
- When the setting was made to provide a fault output, the fault record is stored into the faults history. (The fault record is written to the faults history when a fault output is provided.)  
 When no fault output is provided, the error record overwrites the fault indication of the faults history temporarily, but is not stored.  
 After the error is removed, the fault record is reset and returns to the ordinary monitor, and the faults history returns to the preceding fault indication.
- The deceleration time is the ordinary deceleration time setting (e.g. *Pr. 8, Pr. 44, Pr. 45*).

## 4.4.2 Fault and measures

(1) The inverter operates as follows at fault occurrences.

Fault Location	Status		Operation Mode		
			Network Operation	External Operation	PU Operation
Inverter	Inverter operation		<b>Inverter trip</b>	Inverter trip	Inverter trip
	Data communication		<b>Continued</b>	Continued	Continued
Communication line	Inverter operation		<b>Decelerated to stop</b>	Continued	Continued
	Data communication		<b>Stop</b>	Stop	Stop
Communication option	Communication option connection error	Inverter operation	<b>Decelerated to stop</b>	Inverter trip *	Inverter trip *
		Data communication	<b>Continued</b>	Continued	Continued
	Error of communication option itself	Inverter operation	<b>Decelerated to stop</b>	Continued	Continued
		Data communication	<b>Stop</b>	Stop	Stop

\* Depends on the Pr. 502 setting

(2) Measures at fault occurrences

Fault Indication	Fault Definition	Measures
E.OP1, E.OP2, E.OP3	Communication option fault	<ul style="list-style-type: none"> <li>· Check that a cable is not disconnected from the communication connector.</li> <li>· Check that a cable between own node and other nodes (including switching hub) is not disconnected.</li> </ul>
E.OPT	Option fault	Check the node address setting. <i>(Refer to page 17)</i> If an option board becomes faulty, contact your sales representative.
E.1, E.2, E.3		<ul style="list-style-type: none"> <li>· Mount the communication option to the lowest option connector. <i>(Refer to page 15)</i></li> <li>· Mount a communication option to the inverter compatible with the FR-A7NF. <i>(Refer to page 3)</i></li> <li>· Check the connection between the inverter and option unit for poor contact, etc. and remove the cause of the error. <i>(Refer to page 15)</i></li> </ul>

\* When faults other than the above are displayed, refer to *the inverter manual* and remove the cause of the fault.

## 4.5 Inverter reset

### ●Operation conditions of inverter reset

Which resetting method is allowed or not in each operation mode is described below.

Resetting Method		Operation Mode		
		Network Operation	External Operation	PU Operation
Reset from the network	Inverter reset	Not allowed *1	Not allowed *3	Not allowed
	Error reset at inverter fault (Refer to page 51) *2	Allowed	Not allowed *3	Not allowed
Input the RES signal via a control circuit terminal of the inverter. *4		Enabled	Enabled	Enabled
Switch OFF inverter power		Enabled	Enabled	Enabled
Reset from the PU/DU	Inverter reset	Enabled	Enabled	Enabled
	Reset at inverter fault	Enabled	Enabled	Enabled

\*1 Inverter reset via Network is invalid.

\*2 Reset can be made only when the protective function of the inverter is activated.

\*3 As the FR-A7NF is not mounted, reset from network can not be performed.

\*4 Set "62 (RES signal)" in Pr. 178 STF terminal function selection or Pr. 179 STR terminal function selection to assign the function to a terminal.

### CAUTION

- When E.OP1, E.OP2 or E.OP3 (communication line error) has occurred, reset cannot be made from the network. Reset the inverter by making a power-ON reset, resetting with RES signal, etc.
- The inverter can not be controlled for about 1s after release of a reset command .
- At reset execution, the inverter resets, but the FR-A7NF continues communication.
- At occurrence of E.1, E.2 or E.3 (Option fault), reset can not be performed from the network. Reset the inverter by making a power-ON reset, resetting with RES signal, etc.



## 4.6 Frequency and speed conversion specifications

When setting or monitoring a frequency through the FR-A7NF, the frequency is set or monitored in 0.01Hz increments regardless of the *Pr. 37 Speed display* setting. When setting or monitoring a speed through the FR-A7NF, the speed is calculated with *Pr.144 Speed setting switchover* as shown below.

Speed setting, monitoring (1r/min increments) = frequency × 120 / number of motor poles (*Pr. 144\**)

\* When *Pr. 144* = "102 to 110," the formula is calculated with the value of (*Pr. 144* - 100). When *Pr. 144* ="0," the formula is calculated with 4 poles.

### REMARKS

- Refer to *the Instruction Manual of the inverter* for details of *Pr. 37* and *Pr. 144*.

# 5 FL REMOTE COMMUNICATION FUNCTION

## 5.1 Functions

### 5.1.1 Output from the inverter to the network

Main items to be output from the inverter (FR-A7NF) to the network and their descriptions are explained below. (○: with function, ×: without function)

Item	Description	Cyclic Transmission	Message Transmission	Refer to Page
Inverter monitor	Monitor various items such as inverter output current and output voltage.	×	○	71
Inverter status	Monitors the output signal of the inverter.	○	○	55, 69
Operation mode read	Reads the operation mode of the inverter.	×	○	68
Output frequency read	Monitors the output frequency of the inverter.	○	○	59, 71
Parameter read	Reads parameter settings of the inverter.	×	○	74
Fault description	Monitors the fault history of the inverter.	×	○	78

#### REMARKS

- Refer to the *inverter manual* for functions controllable from the network in each operation mode.



### 5.1.2 Input to the inverter from the network

Main items which can be commanded from the network to the inverter and their descriptions are explained below. (○: with function, ×: without function)

Item	Description	Cyclic Transmission	Message Transmission	Refer to Page
Run command	Sets the control input command such as forward rotation signal (STF) and reverse rotation signal (STR).	○	×	51
Frequency setting	Sets the running frequency of the inverter.	○	×	53
Parameter write *	Sets parameters of the inverter.	×	○	74
Faults history batch clear	Clears the fault of the inverter.	×	○	78

\* Parameter write is available only for the inverter with the PU operation interlock (X12 signal) specification while the X12 signal (bit 11), which gives operation commands through FL remote communication, is ON.

#### REMARKS

- Refer to the *inverter manual* for functions controllable from the network in each operation mode.



## 5.2 Types of data communication

FL remote data communication supports "cyclic transmission" which transmits data periodically (*refer to page 43*) and "message transmission" which transmits data non-periodically (*refer to page 60*).

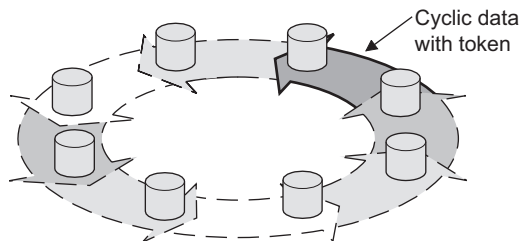

Cyclic transmission

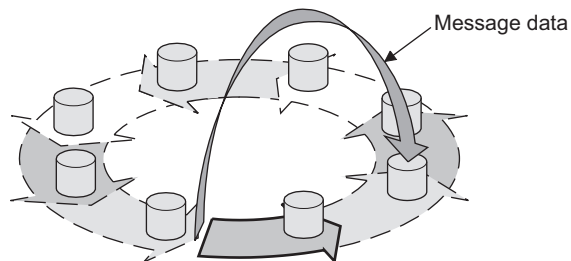

Cyclic transmission + message transmission

## 6 CYCLIC TRANSMISSION

Cyclic transmission transmits data periodically. Each node shares data through common memory. (Refer to *page 44* for common memory.)

Data of I/O area is updated periodically by cyclic transmission.

The master controls the inverter by setting run command (control input command, set frequency, etc.) in the output data area.

The inverter sets the inverter status (output frequency, output current, various signals, etc.) in the input data area and sends it to the master.

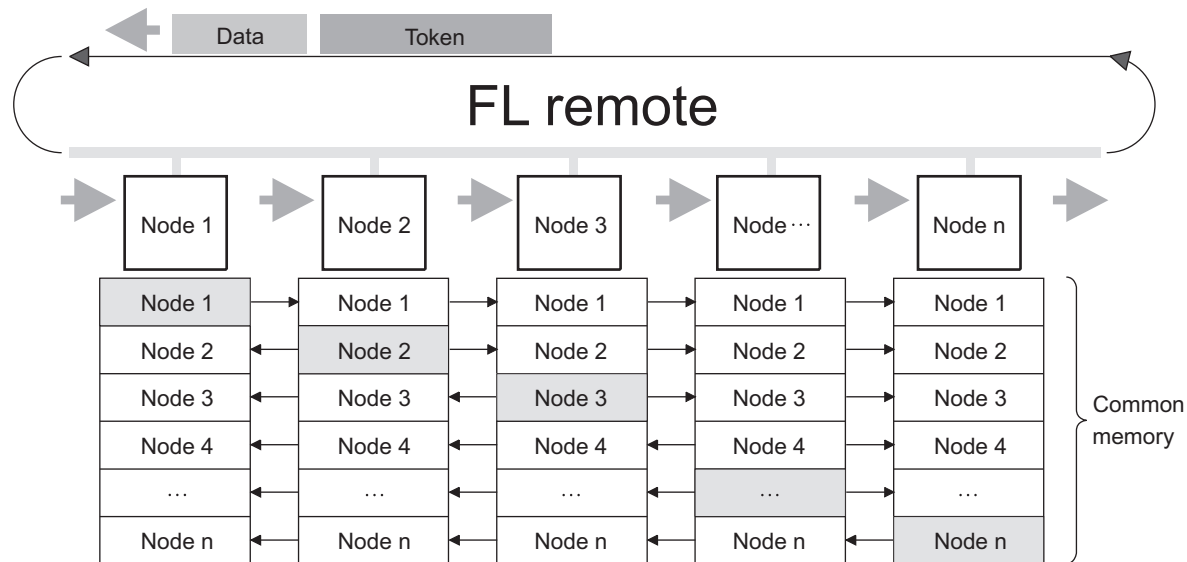

## 6.1 Common memory

Concept of common memory is stated below.

- (1) The common memory is used as a shared memory between nodes which perform cyclic transmission.
- (2) The common memory has two areas which are "common memory area 1" and "common memory area 2".

Common memory area 1 is I/O data area. Common memory area 2 is the control information area. Two different areas can be assigned to each node.

- (3) When the area each node sends exceed the transmission size (1024 byte) by one frame, data is transmitted by multiple frames.
- (4) When receiving data which are divided into multiple frames as (3), common memory is not updated until all frames sent from one node are received. Synchronism per node unit is guaranteed.
- (5) Entire network has an area of 8k bit (0.5k word) + 8k word = 8.5k word.

The maximum send data capacity per one node is 8.5k word. (Note that one word is 2 byte.)

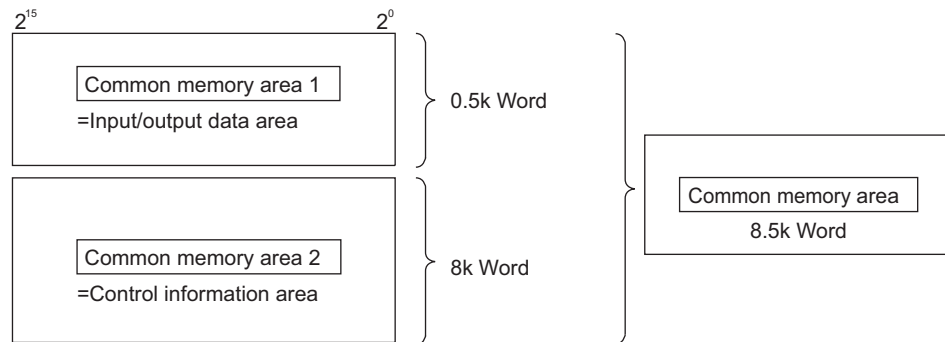

- (6) Among common memory, both common memory area 1 and common memory 2 can be set as a transmission area of one node as desired within the maximum area.
- (7) Each node on FL remote network can share the same data in the whole system by broadcasting data at a constant period. In addition, each node has own transmission area which does not overlap each other to exchange data. (For common memory function, the transmission area assigned to one node is a receive area for other nodes.)

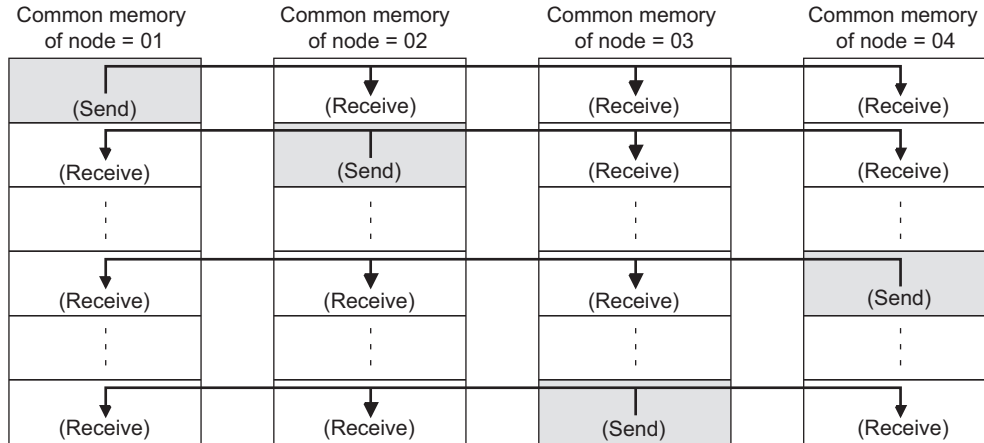

## 6.1.1 Common memory area 1

	Size	Description	Refer to Page
Input data (Inverter→master)	256 words (512 byte)	Data to be sent from inverter to master (4 words). The data includes inverter status, output frequency, etc.	54
Output data (Master→inverter)	256 words (512 byte)	Data to be sent from master to inverter (4 words). The data includes start command, frequency command, etc.	50

	Virtual address (byte boundary)	Applications		
		Address (word boundary)	Size (word boundary)	Description (Number in parentheses indicates node address)
Input data (Inverter→master)	H00000000	0	4	Input data (#1)
	H00000008	4	4	Input data (#2)
	H00000010	8	4	Input data (#3)
	:			
	H000001F0	248	4	Input data (#63)
	H000001F8	252	4	Input data (#64)
Output data (Master→inverter)	H00000200	256	4	Output data (#1)
	H00000208	260	4	Output data (#2)
	H00000210	264	4	Output data (#3)
	:			
	H000003F0	504	4	Output data (#63)
	H000003F8	508	4	Output data (#64)

\* When accessing a message, the access size should be the size stated in the table above.

### REMARKS

- When node status is other than "during FL remote network remote operation", all output data is changed to "0".  
(Refer to *page 10* for change of the setting.)
- When transmitting a message, common memory area 1 and 2 are read only. (*Refer to page 65*)



## 6.1.2 Common memory area 2

	Size
Control information (inverter→master)	1024 word (2048 byte)
Control information (master→inverter)	1024 word (2048 byte)

	Virtual address (byte boundary)	Applications		
		Address (word boundary)	Size (word boundary)	Description (Number in parentheses indicates node address.)
(1) Control information (inverter→master)	H00000400	0	1	Slave status (#)
	H00000402	1	1	Actual status slave type (#1)
	H00000404	2	14	Simple setting check area (#1)
	:			
	H00000BE0	1008	1	Slave status (#64)
	H00000BE2	1009	1	Actual status slave type (#64)
	H00000BE4	1010	14	Simple setting check area (#64)
(2) Control information (master→inverter)	H00000C00	1024	1	Remote control area (#1)
	H00000C02	1025	1	Expected slave type (#1)
	H00000C04	1026	14	Simple setting area (#1)
	:			
	H000013E0	2032	1	Remote control area (#64)
	H000013E2	2033	1	Expected slave type (#64)
	H000013E4	2034	14	Simple setting area (#64)

\* When accessing a message, the access size should be the size stated in the table above.

### REMARKS

- When sending a message, common memory area 1 and 2 are read only. (Refer to page 65)

## (1) Control information (inverter→master)

<Slave status>

Value	Slave status
0	FL remote network is not connected
1	FL remote network remote at a stop
2	FL remote network remote connection processing
3	FL remote network remote operating
4	Master is not present
5	Own node is disconnected
6	Setting error

<Actual slave type>

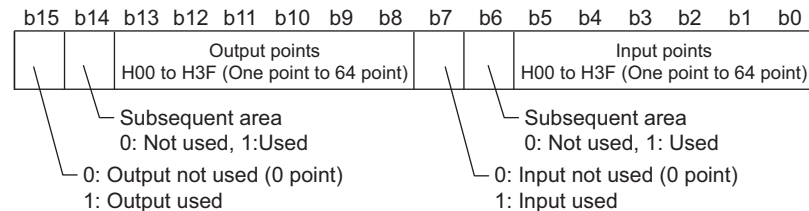

<Simple setting check area>

Not used. (Displays data imported in the simple setting area set from the master.)

**(2) Control information (master→inverter)**

&lt;Remote control area&gt;

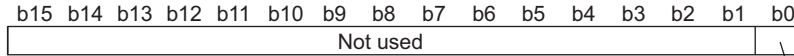

Remote control flag  
0: Remote control stop  
1: Remote control start

&lt;Expected slave type&gt;

Refer to *page 48* for <Actual slave type>

&lt;Simple setting check area&gt;

Not used



## 6.2 Output data (master to inverter)

[Master output area (from master → inverter)]

Word	Address (word boundary) (n: node address)	Applications															
		Bit	15	14	13	12	11	10	9	8	7	6	5	4	3	2	1
0	$4(n-1)+256$	Control input command ( <i>Refer to page 51</i> )															
1	$4(n-1)+257$	— (not used)															
2	$4(n-1)+258$	Set frequency (0.01 Hz increments) ( <i>Refer to page 53</i> )															
3	$4(n-1)+259$	— (not used)															

## 6.2.1 Control input command

Set control input command such as forward and reverse rotation commands.

Bit	Signal	Description			Related Parameter																
0	STF signal	Forward rotation command	<table border="1"> <thead> <tr> <th>Bit0</th> <th>Bit1</th> <th>Command</th> </tr> </thead> <tbody> <tr> <td>Forward rotation: 0</td> <td>Reverse rotation: 0</td> <td>Stop command</td> </tr> <tr> <td>Forward rotation: 1</td> <td>Reverse rotation: 0</td> <td>Forward rotation command</td> </tr> <tr> <td>Forward rotation: 0</td> <td>Reverse rotation: 1</td> <td>Reverse rotation command</td> </tr> <tr> <td>Forward rotation: 1</td> <td>Reverse rotation: 1</td> <td>Stop command</td> </tr> </tbody> </table>			Bit0	Bit1	Command	Forward rotation: 0	Reverse rotation: 0	Stop command	Forward rotation: 1	Reverse rotation: 0	Forward rotation command	Forward rotation: 0	Reverse rotation: 1	Reverse rotation command	Forward rotation: 1	Reverse rotation: 1	Stop command	—
			Bit0	Bit1	Command																
Forward rotation: 0	Reverse rotation: 0	Stop command																			
Forward rotation: 1	Reverse rotation: 0	Forward rotation command																			
Forward rotation: 0	Reverse rotation: 1	Reverse rotation command																			
Forward rotation: 1	Reverse rotation: 1	Stop command																			
1	STR signal	Reverse rotation command																			
2	RL signal*1	<i>Pr. 59 = 0 (initial value)</i>		Low-speed operation command	Pr. 4 to Pr. 6, Pr. 24 to Pr. 27																
		<i>Pr. 59 = 1, 2 *4</i>		Remote setting (setting clear)	Pr. 59																
		<i>Pr. 270 = 1 *5</i>		Stop-on contact selection 0	Pr. 270, Pr. 275, Pr. 276																
3	RM signal*1	<i>Pr. 59 = 0 (initial value)</i>		Middle-speed operation command	Pr. 4 to Pr. 6, Pr. 24 to Pr. 27																
		<i>Pr. 59 = 1, 2 *4</i>		Remote setting (deceleration)	Pr. 59																
4	RH signal*1	<i>Pr. 59 = 0 (initial value)</i>		High-speed operation command	Pr. 4 to Pr. 6, Pr. 24 to Pr. 27																
		<i>Pr. 59 = 1, 2 *4</i>		Remote setting (acceleration)	Pr. 59																
5	RT signal*1	0: second function selection invalid, 1: second function selection valid			Pr. 44 to Pr. 51																
		<i>Pr. 270 = 1 *5</i>		Stop-on contact selection 1	Pr. 270, Pr. 275, Pr. 276																
6 to 8	— (not used)	(Always 0)			—																

Bit	Signal	Description		Related Parameter
9	MRS signal *1	Output stop	0: output shut off cancel, 1: output shut off	Pr.17
10	— (not used)	(Always 0)		—
11	PU/NET signal *1, *2	PU/NET operation switchover	0: Network operation mode, 1: PU operation mode (Refer to <i>page 29</i> for details)	—
	X12 signal *1, *3	PU operation interlock ( <i>Refer to page 30</i> )		—
		Bit11	Function/Operation	
		Operation mode	Parameter write	
	0	Forcibly switched to Network operation mode Network operation is enabled Switching to the PU operation mode is disabled	Parameter write is disabled (Note that the <i>Pr.297</i> setting is available when <i>Pr.296</i> ≠ "9999.")	—
	1	Operation mode (PU, NET) switching is enabled Output stop during Network operation	Parameter write is enabled (depending on <i>Pr. 77 Parameter write selection</i> and each parameter write conditions. Refer to the <i>Inverter Manual</i> for details.)	—
12 to 14	— (not used)	(Always 0)		—
15	Error reset	Resets the inverter when the setting of Bit15 is changed from 0 to 1 at occurrence of inverter error. Resetting the inverter resets the fault and initializes the inverter status. (FL remote communication continues.)		—

\*1 Signals of the Bit2 to Bit5, Bit9, and Bit11 can not be changed. Even when changed using *Pr.178 to Pr.183, Pr.187 and Pr.189*, the settings are invalid. Refer to the *inverter manual* for details of *Pr. 178 to Pr.183, Pr.187 and Pr.189*.

\*2 This setting is for the inverters with the PU/NET operation switchover (X65 signal) specification.

\*3 This setting is for the inverters with the PU operation interlock (X12 signal) specification.



- \*4 When *Pr. 59 Remote function selection* = "1" or "2", the functions of the RL, RM and RH signals are changed as given in the table.
- \*5 When *Pr. 270 Stop-on contact/load torque high-speed frequency control selection* = "1", functions of RL and RT signals are changed as in the table. (The setting is available for the FR-A700 series.)

#### REMARKS

- The values of each bit, "0" and "1," indicate "OFF" and "ON."

### 6.2.2 Set frequency

The set frequency can be set in 0.01Hz increments.

Bit	Range	Unit
0 to 15	0.00Hz to 400.00Hz	0.01Hz

Example:

If you want to set 120.00Hz, set 12000, which is the value multiplied by 100.

#### REMARKS

- Regardless of the *Pr. 37 Speed display* setting, the value is always set in frequency (Hz).

### 6.3 Input data (inverter to master)

[Master input area (inverter → master)]

Word	Address (word boundary) (n: node address)	Applications																
		Bit	15	14	13	12	11	10	9	8	7	6	5	4	3	2	1	0
0	$4(n-1)+0$	Inverter status monitor (Refer to page 55)																
1	$4(n-1)+1$	Life/warning (Refer to page 57)								Fault code (Refer to page 57)								
2	$4(n-1)+2$	Output frequency monitor (Refer to page 59)																
3	$4(n-1)+3$	Output current monitor (Refer to page 59)																



### 6.3.1 Inverter status monitor

Monitors the output signal of the inverter from the network.

Bit	Signal	Description			Related parameter									
0	During forward rotation	<table border="1"> <thead> <tr> <th>Bit0</th> <th>Bit1</th> <th>Operation</th> </tr> </thead> <tbody> <tr> <td>Forward rotation: 0</td> <td>Reverse rotation: 0</td> <td>During stop</td> </tr> <tr> <td>Forward rotation: 1</td> <td>Reverse rotation: 0</td> <td>During forward rotation</td> </tr> </tbody> </table>			Bit0	Bit1	Operation	Forward rotation: 0	Reverse rotation: 0	During stop	Forward rotation: 1	Reverse rotation: 0	During forward rotation	—
		Bit0	Bit1	Operation										
Forward rotation: 0	Reverse rotation: 0	During stop												
Forward rotation: 1	Reverse rotation: 0	During forward rotation												
<table border="1"> <tbody> <tr> <td>Forward rotation: 0</td> <td>Reverse rotation: 1</td> <td>During reverse running</td> </tr> <tr> <td>Forward rotation: 1</td> <td>Reverse rotation: 1</td> <td>Not used</td> </tr> </tbody> </table>			Forward rotation: 0	Reverse rotation: 1	During reverse running	Forward rotation: 1	Reverse rotation: 1	Not used						
Forward rotation: 0	Reverse rotation: 1	During reverse running												
Forward rotation: 1	Reverse rotation: 1	Not used												
1	During reverse running	<table border="1"> <tbody> <tr> <td>Forward rotation: 0</td> <td>Reverse rotation: 1</td> <td>During reverse running</td> </tr> <tr> <td>Forward rotation: 1</td> <td>Reverse rotation: 1</td> <td>Not used</td> </tr> </tbody> </table>			Forward rotation: 0	Reverse rotation: 1	During reverse running	Forward rotation: 1	Reverse rotation: 1	Not used	—			
		Forward rotation: 0	Reverse rotation: 1	During reverse running										
Forward rotation: 1	Reverse rotation: 1	Not used												
2	RUN signal *1	Inverter running	When the inverter output frequency reaches or exceeds <i>Pr.13 Starting frequency</i> , the value changes to "1".		—									
3	SU signal *1	Reached the frequency	When the output frequency reaches the set frequency, the value changes to "1".		Pr. 41									
4	IPF signal *1	Instantaneous power failure/ undervoltage	When an instantaneous power failure or undervoltage protection activates, the value changes to "1".		Pr. 57									
5	OL signal *1	Overload alarm	While stall prevention function is activated, the value changes to "1".		Pr. 22, Pr. 23, Pr. 66									
6	FU signal *1	Output frequency detection	When the output frequency reaches the frequency set in <i>Pr. 42</i> ( <i>Pr. 43</i> for reverse rotation), the value changes to "1".		Pr. 42, Pr. 43									
7	ALM signal *1	Fault	When the inverter protective function is activated to stop the output (fault), the value changes to "1".		—									
8,9	— (not used)	(Always 0)			—									

Bit	Signal	Description		Related parameter
10	— (not used) <sup>*2</sup>	(Always 0)		—
	Edit signal <sup>*3</sup>	Edit enabled	0: Parameter change disabled (X12 signal = "0") 1: Parameter change enabled (X12 signal = "1")	—
11	NET signal	0: Command (run command/speed command) can not be given through network 1: Command (run command/speed command) can be given through network		—
12	Y12 signal	Output current detection	When the output current is higher than the <i>Pr.150</i> setting and persists for longer than the time set in <i>Pr.151</i> , the value changes to "1".	Pr. 150, Pr. 151
13	Y13 signal	Zero current detection	When the output current is lower than the <i>Pr.152</i> setting and persists for longer than the time set in <i>Pr.153</i> , the value changes to "1".	Pr. 152, Pr. 153
14	READY signal	Reset cancel	0: Inverter resetting/starting after power is turned ON 1: Reset canceling	—
15	— (not used)	(Always 0)		—

\*1 Signals of the Bit2 to Bit7 can not be changed. Even if signals are changed using *Pr.190 to Pr.195*, settings are invalid.

Refer to the inverter manual for details of *Pr. 190 to Pr. 195*.

\*2 This setting is for the inverters with the PU/NET operation switchover (X65 signal) specification.

\*3 This setting is for the inverters with the PU operation interlock (X12 signal) specification.

## REMARKS

· The values of each bit, "0" and "1," indicate "OFF" and "ON."



### 6.3.2 Fault code

Description of an alarm that occurred in the inverter can be read.

Bit	Name	Description
0 to 7	Fault code	When a fault occurs in the inverter, fault code is displayed. (Refer to page 82)

### 6.3.3 Life/warning

Whether the control circuit capacitor, main circuit capacitor, cooling fan, and each parts of the inrush current limit circuit have reached the life warning output level or not can be checked.

Bit	Name	Description
8	Control circuit capacitor life	0: without warning, 1: with warning The control circuit capacitor life is calculated from the energization time and temperature according to the operating status, and is counted down from 100%. A warning is output when the control circuit capacitor life falls below 10%. (The setting value goes back to 0 when the part is replaced.)
9	Main circuit capacitor life	0: without warning, 1: with warning On the assumption that the main circuit capacitor capacitance at factory shipment is 100%, the capacitor life is checked every time measurement is made. A warning is output when the measured value falls below 85%. The life check of the main circuit capacitor can be performed by measuring at the maintenance time, etc. After setting "1" in Pr. 259 Main circuit capacitor life measuring, switch OFF power once, then ON again to check that Pr. 259 = "3" (measuring completion). (The setting value goes back to 0 when the part is replaced.)



Bit	Name	Description
10	Cooling fan life	0: without warning, 1: with warning This function detects that the cooling fan speed falls 50% or below and outputs a warning. (The setting value goes back to 0 when the part is replaced.)
11	Inrush current limit circuit life	0: without warning, 1: with warning Counts the number of contact (relay, contactor, thyristor) ON times and counts down every 100% (0 times) to 1%/10,000 times. Outputs a warning when the speed reaches 10% (900000 times). (The setting value goes back to 0 when the part is replaced.)
12	FIN signal (Heatsink overheat pre-alarm)	0: without warning, 1: with warning Output when the heatsink temperature reaches about 85% of the heatsink overheat protection providing temperature.
13	Alarms	0: without display, 1: with display
14	— (not used)	(Always 0)
15	Y95 signal (maintenance timer)	0: normal, 1: maintenance timer has elapsed When the <i>Pr. 503 Maintenance timer</i> setting has elapsed the time (100h increments) set in <i>Pr.504 Maintenance timer alarm output set time</i> , the value changes to 1. (Turn ON Y95 signal.) When <i>Pr. 504</i> = "9999", no function is selected.

## REMARKS

- The values of each bit, "0" and "1," indicate "OFF" and "ON."



### 6.3.4 Output frequency monitor

The output frequency of the inverter can be monitored in 0.01Hz increments.

Bit	Range	Unit
0 to 15	0.00Hz to 400.00Hz	0.01Hz

Example:

If the monitor value is 120.00Hz, 12000 (the value multiplied by 100) is displayed.

#### REMARKS

- Regardless of the *Pr. 37 Speed display* setting, the value is always displayed in frequency (Hz).

### 6.3.5 Output current monitor

The output current of the inverter can be monitored in 0.1A increments.

Bit	Range	Unit
0 to 15	0.0A to 3276.7A	0.1A

- \* For the 55K or lower, increments of output current monitor are rounded from 0.01A increments to 0.1A increments. (The inverter model, 55K and 75K differ according to -NA and -EC versions. (*Refer to page 1*))

## 7 MESSAGE TRANSMISSION

Message transmission is a non-periodic data communication method to communicate to a specified node when send request is given.

Basic function of message transmission is as follows.

- (1) When a node receives a token, one frame can be sent before sending cyclic frame.
- (2) The message frame size which can be sent at a time is 1024 byte maximum.

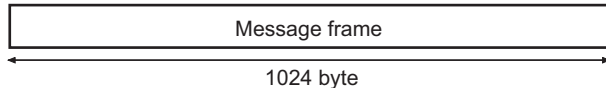

- (3) This method applies algorithm which controls refresh time not exceeding refresh cycle permissible time.
- (4) Two transmission functions are available. One is "one-to-one message transmission" to send to specified nodes, and another is "one-to-n message transmission" to send to all nodes.



- (5) · For "one-to-one message transmission", whether the other node has received data correctly or not is checked.
- For "one-to-n message transmission", response is not given after receipt of a message.

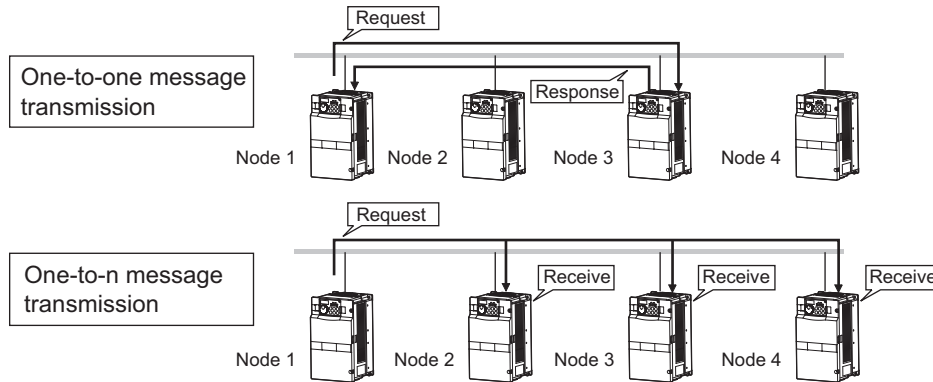

Following functions are provided with a message transmission.

<b>Function</b>	<b>Description</b>	<b>Refer to Page</b>
Word block read/write	Performs data read/write per word unit (one address 16 bits) to the virtual address space (32-bit address space) of other node from the network.	64
Network parameter read	Reads network parameter information of other node from network.	84
Log data read	Reads log information of other node from network.	87
Log data clear	Clears log information ( <i>Refer to page 87</i> ) of other node from network.	90
Profile read	Reads system parameter of device profile of other node from network.	91
Message loopback	Returns message data received then performs message communication test of device.	95



## 7.1 Error response at word block read/write

Error response may be received when reading/writing the product information of connected Mitsubishi inverter.

In such a case, error code is attached to the data portion.

The list of error code is shown below.

Error code	Description	REMARKS
H0010	Address error	<ul style="list-style-type: none"> <li>· Odd address was specified.</li> <li>· Accessed address not defined.</li> </ul>
H0020	Size error	<ul style="list-style-type: none"> <li>· Write size was other than one word.</li> </ul>
H0030	Data error	<ul style="list-style-type: none"> <li>· A value outside the data area was specified.</li> <li>· The range of calibration was too narrow.</li> </ul>
H0040	Write disable error	<ul style="list-style-type: none"> <li>· Attempted to write to monitor data.</li> <li>· Attempted to write to a parameter during an operation.*1</li> <li>· Attempted to write to a write-prohibited parameter.*2</li> </ul>
H0060	During reset	<ul style="list-style-type: none"> <li>· Accessed during inverter reset.</li> </ul>

\*1 When the inverter with the PU/NET operation switchover (X65 signal) specification is used.

\*2 When the inverter with the PU operation interlock (X12 signal) specification is used.

## 7.2 Word block read/write

Performs data read/write per word unit (one address 16-bit unit) to the virtual address space (32 bit address space) of other node from the network.

### (1) Word block read

Item		Data Portion					
Request		Not applicable					
Response	Normal response	<table border="1"> <thead> <tr> <th>Offset</th> <th>Bit 15 to Bit 0</th> </tr> </thead> <tbody> <tr> <td>+0 :</td> <td>Virtual address space (Refer to <i>page 65</i> for details)</td> </tr> </tbody> </table>	Offset	Bit 15 to Bit 0	+0 :	Virtual address space (Refer to <i>page 65</i> for details)	
	Offset	Bit 15 to Bit 0					
+0 :	Virtual address space (Refer to <i>page 65</i> for details)						
Error response	<table border="1"> <thead> <tr> <th>Offset</th> <th>Bit 15 to Bit 0</th> </tr> </thead> <tbody> <tr> <td>+0</td> <td>Error code (Refer to <i>page 63</i>)</td> </tr> </tbody> </table>	Offset	Bit 15 to Bit 0	+0	Error code (Refer to <i>page 63</i> )		
Offset	Bit 15 to Bit 0						
+0	Error code (Refer to <i>page 63</i> )						

### (2) Word block write\*

Item		Data Portion					
Request		<table border="1"> <thead> <tr> <th>Offset</th> <th>Bit15 to Bit0</th> </tr> </thead> <tbody> <tr> <td>+0 :</td> <td>Virtual address space (Refer to <i>page 65</i> for details)</td> </tr> </tbody> </table>	Offset	Bit15 to Bit0	+0 :	Virtual address space (Refer to <i>page 65</i> for details)	
Offset	Bit15 to Bit0						
+0 :	Virtual address space (Refer to <i>page 65</i> for details)						
Response	Normal response	Not applicable					
	Error response	<table border="1"> <thead> <tr> <th>Offset</th> <th>Bit 15 to Bit 0</th> </tr> </thead> <tbody> <tr> <td>+0</td> <td>Error code (Refer to <i>page 63</i>)</td> </tr> </tbody> </table>	Offset	Bit 15 to Bit 0	+0	Error code (Refer to <i>page 63</i> )	
Offset	Bit 15 to Bit 0						
+0	Error code (Refer to <i>page 63</i> )						

\* When the inverter with the PU/NET operation switchover (X65 signal) specification is used, word block write is available only for the faults history batch clear.



## 7.2.1 Virtual address space of word block read/write

Virtual address (byte boundary)	Applications				Message Access		Refer to Page
	Address (word boundary)	Size (word boundary)	Description	Read	Write		
H00000000	Common memory area 1	0 to 511	512	Input/output data	○	×	46
H00000400	Common memory area 2	0 to 1023	1024	Control information (inverter→master)	○	×	47
H00000C00		1024 to 2047	1024	Control information (master→inverter)	○	×	
H00001400		2048 to 8191	6144	Control information (blank)	×	×	
H10000000	Information of individual products	0 to 71	72	Product information	○	×	66
H100000C8		100 to 100	1	Operation mode	○	×	68
H100000DC		110 to 110	1	Inverter status	○	×	69
H100000F0		120 to 121	2	Set frequency	○	×	70
H10000190		200 to 299	100	Inverter monitor	○	×	71
H100007D0		1000 to 1999	1000	Parameter	○	○*	74
H100016AC		2902 to 2939	38	Calibration parameters	○	○*	76
H10001770		3000 to 3899	900	Fault description	○	○	78

\* Writing of parameters / calibration parameters is available only for the inverter with PU operation interlock (X12 signal) specification while the X12 signal (bit 11), which gives operation commands through FL remote communication, is ON.



## 7.2.2 Product information

Product information (the inverter model, inverter capacity, etc) can be read.

Virtual address (byte boundary)	Applications			Message Access	
	Address (word boundary)	Size (word boundary)	Description	Read	Write
H10000000	0	50	Maker name: MITSUBISHI ELECTRIC CORPORATION	○	×
H10000064	50	20	Product name: FR-A700 or FR-F700(P)	○	×
H1000008C	70	1	Inverter capacity : in 0.1kW increments	○	×

\* When accessing a message, the access size should be the size stated in the table above.

<Word block read (maker name)>

Item		Data Portion		
Request		Not applicable		
Response	Normal response	Returns "MITSUBISHI ELECTRIC CORPORATION". The rest are the characters for space.		
		<b>Offset</b>	<b>Bit 15 to Bit 8</b>	<b>Bit 7 to Bit 0</b>
		+0	Second character	First character
		+1	Fourth character	Third character
		:		
	+49	Hundredth character	Ninety ninth character	
Error response		<b>Offset</b>	<b>Bit 15 to Bit 0</b>	
		+0	Error code ( <i>Refer to page 63</i> )	



<Word block read (product name)>

Item		Data Portion															
Request		Not applicable															
Response	Normal response	<p>For the 200V class FR-A700, "FR-A720" is returned. The rest are the characters for space.</p> <table border="1"> <thead> <tr> <th>Offset</th> <th>Bit 15 to Bit 8</th> <th>Bit 7 to Bit 0</th> </tr> </thead> <tbody> <tr> <td>+0</td> <td>Second character</td> <td>First character</td> </tr> <tr> <td>+1</td> <td>Fourth character</td> <td>Third character</td> </tr> <tr> <td>:</td> <td></td> <td></td> </tr> <tr> <td>+19</td> <td>Fortieth character</td> <td>Thirty ninth character</td> </tr> </tbody> </table>	Offset	Bit 15 to Bit 8	Bit 7 to Bit 0	+0	Second character	First character	+1	Fourth character	Third character	:			+19	Fortieth character	Thirty ninth character
	Offset	Bit 15 to Bit 8	Bit 7 to Bit 0														
+0	Second character	First character															
+1	Fourth character	Third character															
:																	
+19	Fortieth character	Thirty ninth character															
Error response	<table border="1"> <thead> <tr> <th>Offset</th> <th>Bit 15 to Bit 0</th> </tr> </thead> <tbody> <tr> <td>+0</td> <td>Error code (<i>Refer to page 63</i>)</td> </tr> </tbody> </table>	Offset	Bit 15 to Bit 0	+0	Error code ( <i>Refer to page 63</i> )												
Offset	Bit 15 to Bit 0																
+0	Error code ( <i>Refer to page 63</i> )																

<Word block read (inverter capacity)>

Item		Data Portion																				
Request		Not applicable																				
Response	Normal response	<p>Inverter capacity is returned.</p> <table border="1"> <thead> <tr> <th>Offset</th> <th>Bit 15 to Bit 0</th> <th>Inverter Capacity</th> <th>Value</th> </tr> </thead> <tbody> <tr> <td>+0</td> <td>Inverter Capacity</td> <td>0.4kW</td> <td>4</td> </tr> <tr> <td></td> <td></td> <td>0.75kW</td> <td>7</td> </tr> <tr> <td>:</td> <td></td> <td></td> <td></td> </tr> <tr> <td></td> <td></td> <td>630kW</td> <td>6300</td> </tr> </tbody> </table>	Offset	Bit 15 to Bit 0	Inverter Capacity	Value	+0	Inverter Capacity	0.4kW	4			0.75kW	7	:						630kW	6300
	Offset	Bit 15 to Bit 0	Inverter Capacity	Value																		
+0	Inverter Capacity	0.4kW	4																			
		0.75kW	7																			
:																						
		630kW	6300																			
Error response	<table border="1"> <thead> <tr> <th>Offset</th> <th>Bit 15 to Bit 0</th> </tr> </thead> <tbody> <tr> <td>+0</td> <td>Error code (<i>Refer to page 63</i>)</td> </tr> </tbody> </table>	Offset	Bit 15 to Bit 0	+0	Error code ( <i>Refer to page 63</i> )																	
Offset	Bit 15 to Bit 0																					
+0	Error code ( <i>Refer to page 63</i> )																					

### 7.2.3 Operation mode

The operation mode of the inverter can be read from the network.

Virtual address (byte boundary)	Applications			Message Access	
	Address (word boundary)	Size (word boundary)	Description	Read	Write
H100000C8	100	1	Operation mode	○	×

\* When accessing a message, the access size should be the size stated in the table above.

<Word block read (operation mode)>

Item		Data Portion				
Request		Not applicable				
Response	Normal response	Operation mode is returned.				
		<b>Offset</b>	<b>Bit 15 to Bit 0</b>		<b>Operation mode</b>	<b>Value</b>
		+0	Operation mode		PU operation	H0001
					PUJOG operation	H0003
				Network operation	H0004	
	Error response	<b>Offset</b>	<b>Bit 15 to Bit 0</b>			
		+0	Error code ( <i>Refer to page 63</i> )			



## 7.2.4 Inverter status

Monitors the output signal of the inverter from network.

Virtual address (byte boundary)	Applications			Message Access	
	Address (word boundary)	Size (word boundary)	Description	Read	Write
H100000DC	110	1	Inverter status	○	×

\* When accessing a message, the access size should be the size stated in the table above.

<Word block read (inverter status)>

Item		Data Portion	
Request		Not applicable	
Response	Normal response	Inverter status is returned. (Refer to <i>page 55</i> for details)	
		<b>Offset</b>	<b>Bit 15 to Bit 0</b>
	+0	Inverter status	
	Error response	<b>Offset</b>	<b>Bit 15 to Bit 0</b>
+0		Error code ( <i>Refer to page 63</i> )	

### 7.2.5 Set frequency

Set frequency can be read from RAM or EEPROM in 0.01Hz increments.

Virtual address (byte boundary)	Applications			Message Access	
	Address (word boundary)	Size (word boundary)	Description	Read	Write
H10000F0	120	1	Set frequency (EEPROM/RAM)	○	×
H10000F2	121	1	Set frequency (RAM)	○	×

\* When accessing a message, the access size should be the size stated in the table above.

<Word block read (set frequency (EEPROM/RAM))>

<Word block read (set frequency (RAM))>

Item		Data Portion	
Request		Not applicable	
Response	Normal response	Set frequency is returned. H0000 to HFFFF (0.01Hz increments)	
		Offset	Bit 15 to Bit 0
		+0	Set frequency
Error response		Offset	Bit 15 to Bit 0
		+0	Error code ( <i>Refer to page 63</i> )

#### REMARKS

- Regardless of the *Pr. 37 Speed display* setting, the value is always displayed in frequency (Hz).

## 7.2.6 Inverter monitor

Inverter monitored value can be read.

<Word block read (inverter monitor)>

Item		Data Portion	
Request		Not applicable	
Response	Normal response	Inverter monitor value is returned.	
		<b>Offset</b>	<b>Bit 15 to Bit 0</b>
	+0	Inverter monitor value ( <i>Refer to page 72</i> )	
	Error response	<b>Offset</b>	<b>Bit 15 to Bit 0</b>
+0		Error code ( <i>Refer to page 63</i> )	

Inverter monitor value of each monitor is as in the table below. Refer to the *inverter manual* for details of each monitor. (When accessing a message, the access size should be 2 byte (1 word).)

Code number	Description	Unit
H10000190	Output frequency *11, *12	0.01Hz
H10000192	Output current *12	0.01A/0.1A *1
H10000194	Output voltage *12	0.1V
H10000198	Set frequency	0.01Hz
H1000019A	Running speed	1
H1000019C	Motor torque *2	0.1%
H1000019E	Converter output voltage	0.1V
H100001A0	Regenerative brake duty	0.1%
H100001A2	Electronic thermal relay function load factor	0.1%
H100001A4	Output current peak value	0.01A/0.1A *1
H100001A6	Converter output voltage peak value	0.1V
H100001A8	Input power	0.01kW/0.1kW *1
H100001AA	Output power	0.01kW/0.1kW *1
H100001AC	Input terminal status *6	—
H100001AE	Output terminal status *7	—
H100001B0	Load meter	0.1%
H100001B2	Motor excitation current *2	0.01A/0.1A *1
H100001B4	Position pulse *2, *5	—
H100001B6	Cumulative energization time	1h
H100001BA	Orientation status *2, *5	—
H100001BC	Actual operation time	1h
H100001BE	Motor load factor	0.1%
H100001C0	Cumulative power	1kWh

Code number	Description	Unit
H100001CE	Torque command *2	0.1%
H100001D0	Torque current command *2	0.1%
H100001D2	Motor output *2	0.01kW/ 0.1kW *1
H100001D4	Feedback pulse *2, *5	—
H100001EA	Motor temperature monitor output *2	1°C
H100001F2	Power saving effect	Variable according to parameters
H100001F4	Cumulative saving power	Variable according to parameters
H100001F6	PID set point	0.1%
H100001F8	PID measured value	0.1%
H100001FA	PID deviation	0.1%
H10000202	Option input terminal status *2, *8	—
H10000204	Option input terminal status 2 *2, *9	—
H10000206	Option output terminal status *2, *10	—
H10000214	PID measured value 2 *4	0.1%
H10000228	Cumulative power (lower 16 bits) *3	1kWh
H1000022A	Cumulative power (upper 16 bits) *3	1kWh
H1000022C	Cumulative power (lower 16 bits) *3	0.01kW/0.1kW *1
H1000022E	Cumulative power (upper 16 bits) *3	0.01kW/0.1kW *1
H10000230	BACnet reception status *4	1
H10000232	BACnet token pass counter *4	1



Code number	Description	Unit
H10000234	BACnet valid APDU counter *4	1
H10000236	BACnet communication error counter *4	1

Code number	Description	Unit
H10000238	Terminal CA output level *4	—
H1000023A	Terminal AM output level *4	—

- \*1 Differ according to capacities. (55K or lower/75K or higher)  
The inverter model, 55K and 75K differ according to -NA and -EC versions. (Refer to page 1.)
- \*2 These items can be monitored with the FR-A700 series only.
- \*3 These items can be monitored with the FR-F700P series only.
- \*4 These items can be monitored with the FR-F700-NA series only.
- \*5 Monitoring is enabled only when the FR-A7AP is mounted.
- \*6 Input terminal monitor details
- b15 b0
- |   |   |   |   |    |     |      |     |     |    |    |    |    |    |     |     |
|---|---|---|---|----|-----|------|-----|-----|----|----|----|----|----|-----|-----|
| - | - | - | - | CS | RES | STOP | MRS | JOG | RH | RM | RL | RT | AU | STR | STF |
|---|---|---|---|----|-----|------|-----|-----|----|----|----|----|----|-----|-----|
- \*7 Output terminal monitor details
- b15 b0
- |   |   |   |   |   |   |   |   |   |   |      |      |    |    |     |    |     |
|---|---|---|---|---|---|---|---|---|---|------|------|----|----|-----|----|-----|
| - | - | - | - | - | - | - | - | - | - | ABC2 | ABC1 | FU | OL | IPF | SU | RUN |
|---|---|---|---|---|---|---|---|---|---|------|------|----|----|-----|----|-----|
- \*8 Details of option input terminal monitor 1 (input terminal status of FR-A7AX)—all terminals are OFF when an option is not fitted.
- b15 b0
- |     |     |     |     |     |     |    |    |    |    |    |    |    |    |    |    |
|-----|-----|-----|-----|-----|-----|----|----|----|----|----|----|----|----|----|----|
| X15 | X14 | X13 | X12 | X11 | X10 | X9 | X8 | X7 | X6 | X5 | X4 | X3 | X2 | X1 | X0 |
|-----|-----|-----|-----|-----|-----|----|----|----|----|----|----|----|----|----|----|
- \*9 Details of option input terminal monitor 2 (input terminal status of FR-A7AX)—all terminals are OFF when an option is not fitted.
- b15 b0
- |   |   |   |   |   |   |   |   |   |   |   |   |   |   |   |   |    |
|---|---|---|---|---|---|---|---|---|---|---|---|---|---|---|---|----|
| - | - | - | - | - | - | - | - | - | - | - | - | - | - | - | - | DY |
|---|---|---|---|---|---|---|---|---|---|---|---|---|---|---|---|----|
- \*10 Details of option output terminal monitor (output terminal status of FR-A7AY/A7AR)—all terminals are OFF when an option is not fitted.
- b15 b0
- |   |   |   |   |   |   |   |     |     |     |    |    |    |    |    |    |    |
|---|---|---|---|---|---|---|-----|-----|-----|----|----|----|----|----|----|----|
| - | - | - | - | - | - | - | RA3 | RA2 | RA1 | Y6 | Y5 | Y4 | Y3 | Y2 | Y1 | Y0 |
|---|---|---|---|---|---|---|-----|-----|-----|----|----|----|----|----|----|----|
- \*11 When a value other than "9999" is set in Pr.430 under position control (Pr.800 = "3"), pulse monitor is selected. (FR-A700 series only)
- \*12 The monitor value is retained when an inverter fault occurs. Resetting the fault clears the retained value.



## 7.2.7 Parameter

Inverter parameters can be read or written through the network.  
Refer to the *inverter manual* for details of the parameters.

Virtual address (byte boundary)	Applications			Message Access	
	Address (word boundary)	Size (word boundary)	Description	Read	Write
H100007D0	1000	1	<i>Pr. 0</i>	○	○*1
H100007D2	1001	1	<i>Pr. 1</i>	○	○*1
H100007D4	1002	1	<i>Pr. 2</i>	○	○*1
:					
H10000F9C	1998	1	<i>Pr. 998</i>	○	○*1
H10000F9E	1999	1	<i>Pr. 999</i>	○	○*1

\*1 Reading is available only for the inverters with the PU operation interlock (X12 signal) specification.

\*2 When accessing a message, the access size should be the size stated in the table above.



## &lt;Word block read (parameter)&gt;

Item		Data Portion			
Request		Not applicable			
Response	Normal response	Specified parameter values return.			
		<table border="1"> <thead> <tr> <th>Offset</th> <th>Bit 15 to Bit 0</th> </tr> </thead> <tbody> <tr> <td>+0</td> <td>Parameter value</td> </tr> </tbody> </table>	Offset	Bit 15 to Bit 0	+0
	Offset	Bit 15 to Bit 0			
	+0	Parameter value			
Error response	<table border="1"> <thead> <tr> <th>Offset</th> <th>Bit 15 to Bit 0</th> </tr> </thead> <tbody> <tr> <td>+0</td> <td>Error code (<i>Refer to page 63</i>)</td> </tr> </tbody> </table>	Offset	Bit 15 to Bit 0	+0	Error code ( <i>Refer to page 63</i> )
	Offset	Bit 15 to Bit 0			
+0	Error code ( <i>Refer to page 63</i> )				

## &lt;Word block write (parameter)&gt;

Item		Data Portion				
Request		Specified parameter values are written.				
		<table border="1"> <thead> <tr> <th>Offset</th> <th>Bit 15 to Bit 0</th> </tr> </thead> <tbody> <tr> <td>+0</td> <td>Parameter value</td> </tr> </tbody> </table>	Offset	Bit 15 to Bit 0	+0	Parameter value
Offset	Bit 15 to Bit 0					
+0	Parameter value					
Response	Normal response	Not applicable				
	Error response	<table border="1"> <thead> <tr> <th>Offset</th> <th>Bit 15 to Bit 0</th> </tr> </thead> <tbody> <tr> <td>+0</td> <td>Error code (<i>Refer to page 63</i>)</td> </tr> </tbody> </table>	Offset	Bit 15 to Bit 0	+0	Error code ( <i>Refer to page 63</i> )
		Offset	Bit 15 to Bit 0			
+0	Error code ( <i>Refer to page 63</i> )					

**REMARKS**

- Parameters can be written while the X12 signal (Bit11), which gives operation commands through FL remote communication, is ON. (*Refer to page 51*) (Note that the *Pr:77* setting cannot be written through FL remote communication.)

## 7.2.8 Calibration parameters

Calibration parameters of the inverter can be read or written through the network. Refer to the *inverter manual* for details of each calibration parameters.

Virtual address (byte boundary)	Applications			Message Access	
	Address (word boundary)	Size (word boundary)	Description	Read	Write
H100016AC	2902	1	<i>Pr. 902</i>	○	○*1
:					
H100016F6	2939	1	<i>Pr. 939</i>	○	○*1

\*1 Writing of parameters / calibration parameters is available only for the inverter with PU operation interlock (X12 signal) specification while the X12 signal (bit 11), which gives operation commands through FL remote communication, is ON.

\*2 When accessing a message, the access size should be the size stated in the table above.

<Word block read (calibration parameter)>

Item		Data Portion	
Request		Not applicable	
Response	Normal response	Specified calibration parameter values is returned.	
		<b>Offset</b>	<b>Bit 15 to Bit 0</b>
	+0	Calibration parameter value	
	Error response	<b>Offset</b>	<b>Bit 15 to Bit 0</b>
+0		Error code ( <i>Refer to page 63</i> )	

&lt;Word block write (calibration parameter)&gt;

Item		Data Portion	
Request		Specified calibration parameter values are written.	
		<b>Offset</b>	<b>Bit 15 to Bit 0</b>
		+0	Calibration parameter value
Response	Normal response	Not applicable	
	Error response	<b>Offset</b>	<b>Bit 15 to Bit 0</b>
		+0	Error code ( <i>Refer to page 63</i> )

## 7.2.9 Fault record

Faults history can be monitored up to eight past faults occurred in the inverter.

Virtual address (byte boundary)	Applications			Message Access		
	Address (word boundary)	Size (word boundary)	Description	Read	Write	
H10001770	3000	1	Faults history batch clear	×	○	
H10001838	3100 to 3899	800	Past eight faults history	○	×	
H10001838	3100	1	Latest faults history	○	×	
H1000183A	3101	3		Fault display	○	×
H10001840	3104	1		Output frequency at fault occurrence	○	×
H10001842	3105	1		Output current at fault occurrence	○	×
H10001844	3106	1		Output voltage at fault occurrence	○	×
H10001846	3107	1		Energization time at fault occurrence	○	×
H10001848	3108	2		(blank)	×	×
H1000184C	3110	90		Fault name	○	×
:						
H10001DB0	3800	1	Past eight faults history	○	×	
H10001DB2	3801	3		Fault display	○	×
H10001DB8	3804	1		Output frequency at fault occurrence	○	×
H10001DBA	3805	1		Output current at fault occurrence	○	×
H10001DBC	3806	1		Output voltage at fault occurrence	○	×
H10001DBE	3807	1		Energization time at fault occurrence	○	×
H10001DC0	3808	2		(blank)	×	×
H10001DC4	3810	90		Fault name	○	×

\* When accessing a message, the access size should be the size stated in the table above.



## &lt;Word block write (faults history batch clear)&gt;

Item		Data Portion				
Request		Faults history can be cleared.				
		<table border="1"> <thead> <tr> <th>Offset</th> <th>Bit 15 to Bit 0</th> </tr> </thead> <tbody> <tr> <td>+0</td> <td>Any*</td> </tr> </tbody> </table>	Offset	Bit 15 to Bit 0	+0	Any*
		Offset	Bit 15 to Bit 0			
+0	Any*					
* Any value is set.						
Response	Normal response	Not applicable				
	Error response	<table border="1"> <thead> <tr> <th>Offset</th> <th>Bit 15 to Bit 0</th> </tr> </thead> <tbody> <tr> <td>+0</td> <td>Error code (<i>Refer to page 63</i>)</td> </tr> </tbody> </table>	Offset	Bit 15 to Bit 0	+0	Error code ( <i>Refer to page 63</i> )
Offset	Bit 15 to Bit 0					
+0	Error code ( <i>Refer to page 63</i> )					

## &lt;Word block read (fault code)&gt;

Item		Data Portion			
Request		Not applicable			
Response	Normal response	Fault code is returned.			
		<table border="1"> <thead> <tr> <th>Offset</th> <th>Bit 15 to Bit 0</th> </tr> </thead> <tbody> <tr> <td>+0</td> <td>Fault code (<i>Refer to page 82</i>)</td> </tr> </tbody> </table>	Offset	Bit 15 to Bit 0	+0
	Offset	Bit 15 to Bit 0			
	+0	Fault code ( <i>Refer to page 82</i> )			
Error response	<table border="1"> <thead> <tr> <th>Offset</th> <th>Bit 15 to Bit 0</th> </tr> </thead> <tbody> <tr> <td>+0</td> <td>Error code (<i>Refer to page 63</i>)</td> </tr> </tbody> </table>	Offset	Bit 15 to Bit 0	+0	Error code ( <i>Refer to page 63</i> )
	Offset	Bit 15 to Bit 0			
+0	Error code ( <i>Refer to page 63</i> )				

<Word block read (fault display)>

Item		Data Portion		
Request		Not applicable		
Response	Normal response	Fault display (5 characters) is returned as a character string. <i>(Refer to page 82)</i> The rest one character is space character.		
		<b>Offset</b>	<b>Bit 15 to Bit 8</b>	<b>Bit 7 to Bit 0</b>
		+0	Second character	First character
		+1	Fourth character	Third character
	+2	Sixth character (space character)	Fifth character	
Error response		<b>Offset</b>	<b>Bit 15 to Bit 0</b>	
		+0	Error code <i>(Refer to page 63)</i>	

<Word block read (output frequency at fault occurrence (0.01Hz increments), output current (0.01A/0.1A increments\*), output voltage (0.1V), energization time (1h increments))>

Item		Data Portion			
Request		Not applicable			
Response	Normal response	Output frequency, output current, output voltage, and energization time at fault occurrence is returned.			
		<b>Offset</b>	<b>Bit 15 to Bit 0</b>		
		+0	Data at fault occurrence		
	Error response		<b>Offset</b>	<b>Bit 15 to Bit 0</b>	
			+0	Error code <i>(Refer to page 63)</i>	

\* Differ according to capacities. (55K or lower/75K or higher)  
The inverter model, 55K and 75K differ according to -NA and -EC versions. *(Refer to page 1)*



<Word block read (fault name)>

Item		Data Portion		
Request		Not applicable		
Response	Normal response	Fault name is returned in a character string. The rest are space characters. <i>(Refer to page 82)</i>		
		<b>Offset</b>	<b>Bit 15 to Bit 8</b>	<b>Bit 7 to Bit 0</b>
		+0	Second character	First character
		+1	Fourth character	Third character
		:		
	+89	One hundred eightieth character	One hundred seventy-ninth character	
Error response		<b>Offset</b>	<b>Bit 15 to Bit 0</b>	
		+0	Error code <i>(Refer to page 63)</i>	



## ●Fault code

Refer to the *inverter manual* for details of faults record.

Fault code *1	Fault Indication	Fault name
H0000	—	No fault
H0010	E.OC1	Overcurrent shut-off during acceleration
H0011	E.OC2	Overcurrent shut-off during constant speed
H0012	E.OC3	Overcurrent shut-off during deceleration or stop
H0020	E.OV1	Regenerative overvoltage shut-off during acceleration
H0021	E.OV2	Regenerative overvoltage shut-off during constant speed
H0022	E.OV3	Regenerative overvoltage shut-off during deceleration or stop
H0030	E.THT	Inverter overload shut-off (electronic thermal relay function)
H0031	E.THM	Motor overload shut-off (electronic thermal relay function)
H0040	E.FIN	Fin overheat
H0050	E.IPF	Instantaneous power failure
H0051	E.UVT	Undervoltage
H0052	E.ILF	Input phase failure
H0060	E.OLT	Stall prevention

Fault code *1	Fault Indication	Fault name
H0061*2	E.SOT	Loss of synchronism detection
H0070	E.BE	Brake transistor fault detection
H0080	E.GF	Output side earth (ground) fault overcurrent
H0081	E.LF	Output phase failure
H0090	E.OHT	External thermal relay operation
H0091	E.PTC	PTC thermistor operation
H00A0	E.OPT	Option fault
H00A1	E.OP1	Communication option fault
H00A2	E.OP2	Communication option fault
H00A3	E.OP3	Communication option fault
H00B0	E.PE	Parameter storage device fault
H00B1	E.PUE	PU disconnection
H00B2	E.RET	Retry count excess
H00B3	E.PE2	Parameter storage device fault
H00C0	E.CPU	CPU error
H00C1	E.CTE	Operation panel power supply short circuit, RS-485 terminal power supply short circuit
H00C2	E.P24	24VDC power output short circuit
H00C4	E.CDO	Output current detection value exceeded



Fault code *1	Fault Indication	Fault name
H00C5	E.IOH	Inrush current limit circuit fault
H00C6	E.SER	Communication error (inverter)
H00C7	E.AIE	Analog input error
H00C8	E.USB	USB communication error
H00D0	E.OS	Overspeed occurrence
H00D1	E.OSD	Speed deviation excess detection
H00D2	E.ECT	No encoder signal
H00D3	E.OD	Excessive position error
H00D5	E.MB1	Brake sequence error
H00D6	E.MB2	Brake sequence error
H00D7	E.MB3	Brake sequence error
H00D8	E.MB4	Brake sequence error
H00D9	E.MB5	Brake sequence error
H00DA	E.MB6	Brake sequence error
H00DB	E.MB7	Brake sequence error
H00DC	E.EP	Encoder phase error

Fault code *1	Fault Indication	Fault name
H00E6	E.PID	PID signal fault
H00F1	E.1	Option1 fault
H00F2	E.2	Option2 fault
H00F3	E.3	Option3 fault
H00F5	E.5	CPU error
H00F6*2	E.6	
H00F7	E.7	Opposite rotation deceleration error
H00FB	E.11	
H00FD	E.13	Internal circuit error
Other than above	E.□□	Error (Contact your sales representative)

\*1 Fault code size of cyclic transmission is 1 byte.

The lower two digits of fault code are displayed.

\*2 Reading is available only for the inverters with the PU operation interlock (X12 signal) specification.

## REMARKS

- Available faults differ by inverter model. For the details, refer to *the Instruction Manual of the inverter*.

## 7.3 Network parameter read

With this function, network parameter information of other node is read from network.

Item		Data Portion				
Request		Not applicable				
Response	Normal response	<b>Offset</b>	<b>Bit 15 to Bit 8</b>	<b>Bit 7 to Bit 0</b>	<b>Remarks</b>	
		+0	Second character	First character	Node name Character string of "FR-A700" or "FR-F700(P)" is stored. In the reset places, space characters are set.	
		+1	Fourth character	Third character		
		+2	Sixth character	Fifth character		
		+3	Eighth character	Seventh character		
		+4	Tenth character	Ninth character	Vender name Character string of "MELCO" is stored. In the reset places, space characters are set.	
		+5	Second character	First character		
		+6	Fourth character	Third character		
		+7	Sixth character	Fifth character		
		+8	Eighth character	Seventh character	Manufacturer model name Character string of "FR-A7NF" is stored. In the reset places, space characters are set.	
		+9	Tenth character	Ninth character		
		+10	Second character	First character		
		+11	Fourth character	Third character		
		+12	Sixth character	Fifth character		
		+13	Eighth character	Seventh character		
		+14	Tenth character	Ninth character		
		+15	First address of region 1			
		+16	Size of region 1			4 words always
		+17	First address of region 2			
+18	Size of region 2					
+19	(spare)	Token monitoring time out time		10ms always		



Item		Data Portion													
Response	Normal response	Offset	Bit 15 to Bit 8	Bit 7 to Bit 0	Remarks										
		+20	(spare)	Minimum permissible clearance	1.0ms always										
		+21	(spare)	Link status	<i>Refer to page 86</i>										
		+22	(spare)	Protocol	H80 always										
		+23	Higher-layer status		<i>Refer to page 86</i>										
		+24	Refresh cycle permissible time setting		0 to 65535ms Refresh cycle permissible time (120% value of the time the token circulates one ring) of own node.										
		+25	Refresh cycle measured value (current value)		0 to 65535ms										
		+26	Refresh cycle measured value (maximum value)		Measured value (current value, maximum value, minimum value) of one cycle of own node.										
		+27	Refresh cycle measured value (minimum value)												
	Error response	<table border="1"> <thead> <tr> <th>Offset</th> <th colspan="4">Bit 15 to Bit 0</th> </tr> </thead> <tbody> <tr> <td>+0</td> <td colspan="4">Error code (<i>Refer to page 63</i>)</td> </tr> </tbody> </table>					Offset	Bit 15 to Bit 0				+0	Error code ( <i>Refer to page 63</i> )		
Offset		Bit 15 to Bit 0													
+0	Error code ( <i>Refer to page 63</i> )														

## <Link status>

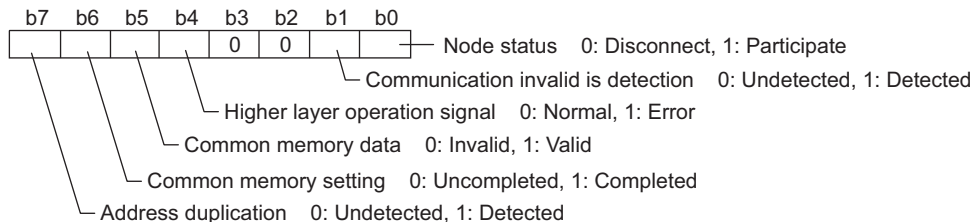

## <Higher-layer status>

The inverter periodically creates "higher layer status" based on "slave control status of FL remote" and "inverter status". In addition, the inverter reports the "higher layer status" to the master (FA link layer) periodically.

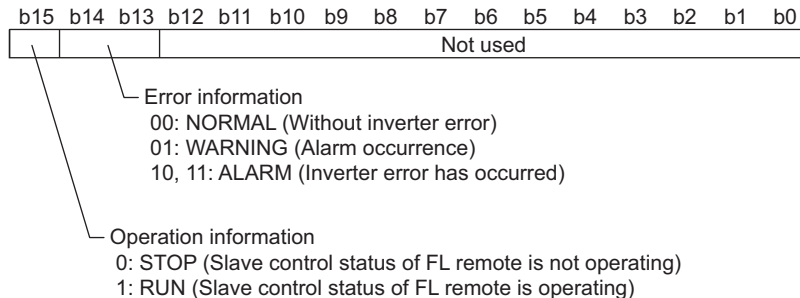



## 7.4 Log data read

With this function, log information of other node is read from network.

Item		Data Portion		
Request		Not applicable		
Response	Normal response	Offset	Bit 7 to Bit 0	Remarks
		+0	The number of communication socket transmitting times	
		+4	The number of communication socket transmitting error times	
		+8	The number of Ethernet transmitting error times	
		+12 to +20	—	
		+24	The number of communication socket receiving times	
		+28	The number of communication socket receiving error times	
		+32	The number of Ethernet receiving error times	
		+36 to +44	—	
		+48	The number of token transmitting times	
		+52	The number of cyclic frame transmitting times	
		+56	The number of 1:1 message transmitting times	
		+60	The number of 1:n message transmitting times	
		+64, +68	—	
		+72	The number of token receiving times	
		+76	The number of cyclic frame receiving times	
		+80	The number of 1:1 message receiving times	
		+84	The number of 1:n message receiving times	
+88, +92	—			
+96	The number of cyclic transmission receiving error times			
+100	The number of cyclic address size error times			
+104	The number of cyclic CBN error times			

Item		Data Portion		
Response	Normal response	<b>Offset</b>	<b>Bit 7 to Bit 0</b>	<b>Remarks</b>
		+108	The number of cyclic TBN error times	
		+112	The number of cyclic BSIZE error times	
		+116 to +140	—	
		+144	The number of message transmission retransmitting times	
		+148	The number of message transmission retransmitting over times	
		+152 to +164	—	
		+168	The number of message transmission receiving error times	
		+172	The number of message sequence version error times	
		+176	The number of message sequence retransmitting recognition times	
		+180 to +188	—	
		+192	The number of ACK error times	
		+196	The number of ACK sequence version error times	
		+200	The number of ACK sequence number error times	
		+204	The number of ACK node number error times	
		+208	The number of ACK TCD error times	
		+212 to +236	—	
		+240	The number of token multiplexing recognition times	
		+244	The number of token destroyed times	
		+248	The number of token reissued times	
+252 to +260	—			
+264	The number of token hold time out times			



Item		Data Portion		
Response	Normal response	<b>Offset</b>	<b>Bit 7 to Bit 0</b>	<b>Remarks</b>
		+268	The number of token monitoring time out times	
		+272 to +284	—	
		+288	Total operation times	
		+292	The number of frame waiting status times	
		+296	Entry time	
		+300	The number of times disconnected	
		+304	The number of disconnected times due to skip	
		+308	The number of recognition times of other node disconnected	
		+312 to +332	—	
		+336 to +364	List of participation recognized node	
		+368 to +508	—	
		Error response	<b>Offset</b>	<b>Bit 15 to Bit 0</b>
	+0		Error code ( <i>Refer to page 63</i> )	

**REMARKS**

- Ethernet is a registered trademark of Fuji Xerox Corporation in Japan.



## 7.5 Log data clear

Clears log information (*Refer to page 87*) of other node from network.

Item		Data Portion	
Request		Not applicable	
Response	Normal response	Not applicable	
	Error response	<b>Offset</b>	<b>Bit 15 to Bit 0</b>
		+0	Error code ( <i>Refer to page 63</i> )



## 7.6 Profile read

With this function, system parameter of device profile of other node is read from network.

Item		Data Portion	
Request		Not applicable	
Response	Normal response	<b>Offset</b>	<b>Bit 15 to Bit 0</b>
		+0 :	Read data (see the table below for details)
	Error response	<b>Offset</b>	<b>Bit 15 to Bit 0</b>
		+0	Error code ( <i>Refer to page 63</i> )

**●SYSPARA**

Parameter Name	Name character		Data Type	Parameter description	
	Length	Character		Length	Character
Device profile common specification version	6	"COMVER"	INTEGER	1	1
System parameter recognition character	2	"ID"	PrintableString	7	"SYSPARA"
System parameter change number	3	"REV"	INTEGER	1	0
System parameter change date	7	"REVDATE"	[INTEGER], 2, (0001-9999), [INTEGER], 1, (01-12), [INTEGER], 1, (01-31)	2 1 1	(Example) 2007 (Example) 5 (Example) 31
Device type	10	"DVCATEGORY"	PrintableString	3	"INV"
Vender name	6	"VENDOR"	PrintableString	10	"MELCO "
Product type name	7	"DVMODEL"	PrintableString	10	"FR-A7NF "



## ●INVPARA

Parameter Name	Name Character		Data Type	Parameter Description	
	Length	Character		Length	Character
Device specific parameter distinguishing characters	2	"ID"	PrintableString	7	"DEVPARA"
MAC address	10	"MACADDRESS"	INTEGER	6	MAC address (6 byte) (Example) 08 00 70 46 D0 00
Firmware version (Inverter)	7	"INV VER"	PrintableString	5	ROM number (Example) 7972*
Firmware version (option)	7	"OPT VER"	PrintableString	5	ROM number (Example) 8015*

### Arrangement of transfer syntax data (coded)

Identifier	Length	Description																																																															
30	81AA	<table border="1"> <thead> <tr> <th>Identifier</th> <th>Length</th> <th>Description</th> </tr> </thead> <tbody> <tr> <td>30</td> <td>6F</td> <td> <table border="1"> <thead> <tr> <th>Identifier</th> <th>Length</th> <th>Description</th> </tr> </thead> <tbody> <tr><td>13</td><td>06</td><td>"COMVER"</td></tr> <tr><td>02</td><td>01</td><td>1</td></tr> <tr><td>13</td><td>02</td><td>"ID"</td></tr> <tr><td>13</td><td>07</td><td>"SYSPARA"</td></tr> <tr><td>13</td><td>03</td><td>"REV"</td></tr> <tr><td>02</td><td>01</td><td>0</td></tr> <tr><td>13</td><td>07</td><td>"REVDATE"</td></tr> </tbody> </table> </td> </tr> <tr> <td>30</td> <td>0A</td> <td> <table border="1"> <thead> <tr> <th>Identifier</th> <th>Length</th> <th>Description</th> </tr> </thead> <tbody> <tr><td>02</td><td>02</td><td>07D7</td></tr> <tr><td>02</td><td>01</td><td>05</td></tr> <tr><td>02</td><td>01</td><td>1F</td></tr> </tbody> </table> </td> </tr> <tr> <td>13</td> <td>0A</td> <td>"DVCATEGORY"</td> </tr> <tr> <td>13</td> <td>03</td> <td>"INV"</td> </tr> <tr> <td>13</td> <td>06</td> <td>"VENDOR"</td> </tr> <tr> <td>13</td> <td>0A</td> <td>"MELCO "</td> </tr> <tr> <td>13</td> <td>07</td> <td>"DVMODEL"</td> </tr> <tr> <td>13</td> <td>0A</td> <td>"FR-A7NF "</td> </tr> </tbody> </table>	Identifier	Length	Description	30	6F	<table border="1"> <thead> <tr> <th>Identifier</th> <th>Length</th> <th>Description</th> </tr> </thead> <tbody> <tr><td>13</td><td>06</td><td>"COMVER"</td></tr> <tr><td>02</td><td>01</td><td>1</td></tr> <tr><td>13</td><td>02</td><td>"ID"</td></tr> <tr><td>13</td><td>07</td><td>"SYSPARA"</td></tr> <tr><td>13</td><td>03</td><td>"REV"</td></tr> <tr><td>02</td><td>01</td><td>0</td></tr> <tr><td>13</td><td>07</td><td>"REVDATE"</td></tr> </tbody> </table>	Identifier	Length	Description	13	06	"COMVER"	02	01	1	13	02	"ID"	13	07	"SYSPARA"	13	03	"REV"	02	01	0	13	07	"REVDATE"	30	0A	<table border="1"> <thead> <tr> <th>Identifier</th> <th>Length</th> <th>Description</th> </tr> </thead> <tbody> <tr><td>02</td><td>02</td><td>07D7</td></tr> <tr><td>02</td><td>01</td><td>05</td></tr> <tr><td>02</td><td>01</td><td>1F</td></tr> </tbody> </table>	Identifier	Length	Description	02	02	07D7	02	01	05	02	01	1F	13	0A	"DVCATEGORY"	13	03	"INV"	13	06	"VENDOR"	13	0A	"MELCO "	13	07	"DVMODEL"	13	0A	"FR-A7NF "
Identifier	Length	Description																																																															
30	6F	<table border="1"> <thead> <tr> <th>Identifier</th> <th>Length</th> <th>Description</th> </tr> </thead> <tbody> <tr><td>13</td><td>06</td><td>"COMVER"</td></tr> <tr><td>02</td><td>01</td><td>1</td></tr> <tr><td>13</td><td>02</td><td>"ID"</td></tr> <tr><td>13</td><td>07</td><td>"SYSPARA"</td></tr> <tr><td>13</td><td>03</td><td>"REV"</td></tr> <tr><td>02</td><td>01</td><td>0</td></tr> <tr><td>13</td><td>07</td><td>"REVDATE"</td></tr> </tbody> </table>	Identifier	Length	Description	13	06	"COMVER"	02	01	1	13	02	"ID"	13	07	"SYSPARA"	13	03	"REV"	02	01	0	13	07	"REVDATE"																																							
Identifier	Length	Description																																																															
13	06	"COMVER"																																																															
02	01	1																																																															
13	02	"ID"																																																															
13	07	"SYSPARA"																																																															
13	03	"REV"																																																															
02	01	0																																																															
13	07	"REVDATE"																																																															
30	0A	<table border="1"> <thead> <tr> <th>Identifier</th> <th>Length</th> <th>Description</th> </tr> </thead> <tbody> <tr><td>02</td><td>02</td><td>07D7</td></tr> <tr><td>02</td><td>01</td><td>05</td></tr> <tr><td>02</td><td>01</td><td>1F</td></tr> </tbody> </table>	Identifier	Length	Description	02	02	07D7	02	01	05	02	01	1F																																																			
Identifier	Length	Description																																																															
02	02	07D7																																																															
02	01	05																																																															
02	01	1F																																																															
13	0A	"DVCATEGORY"																																																															
13	03	"INV"																																																															
13	06	"VENDOR"																																																															
13	0A	"MELCO "																																																															
13	07	"DVMODEL"																																																															
13	0A	"FR-A7NF "																																																															
30	39	<table border="1"> <thead> <tr> <th>Identifier</th> <th>Length</th> <th>Description</th> </tr> </thead> <tbody> <tr><td>13</td><td>02</td><td>"ID"</td></tr> <tr><td>13</td><td>07</td><td>"DEVPARA"</td></tr> <tr><td>13</td><td>0A</td><td>"MACADDRESS"</td></tr> <tr><td>02</td><td>06</td><td>(6 byte data)</td></tr> <tr><td>13</td><td>07</td><td>"INV VER"</td></tr> <tr><td>13</td><td>05</td><td>(5 byte data)</td></tr> <tr><td>13</td><td>07</td><td>"OPT VER"</td></tr> <tr><td>13</td><td>05</td><td>(5 byte data)</td></tr> </tbody> </table>	Identifier	Length	Description	13	02	"ID"	13	07	"DEVPARA"	13	0A	"MACADDRESS"	02	06	(6 byte data)	13	07	"INV VER"	13	05	(5 byte data)	13	07	"OPT VER"	13	05	(5 byte data)																																				
Identifier	Length	Description																																																															
13	02	"ID"																																																															
13	07	"DEVPARA"																																																															
13	0A	"MACADDRESS"																																																															
02	06	(6 byte data)																																																															
13	07	"INV VER"																																																															
13	05	(5 byte data)																																																															
13	07	"OPT VER"																																																															
13	05	(5 byte data)																																																															

\* Identifier 13 indicates PrintableString type, identifier 02 indicates INTEGER type.

## 7.7 Message loopback

Perform communication test of device by returning message data received.

Item		Data Portion	
Request		<b>Offset</b>	<b>Bit 15 to Bit 0</b>
		+0 :	Any data up to 1024 byte.
Response	Normal response	<b>Offset</b>	<b>Bit 15 to Bit 0</b>
		+0 :	Same data as request data is sent.

## 8 DESCRIPTION AND CORRECTIVE ACTION OF FAULT INDICATION

Description and countermeasure for the fault indication are stated below.

### (1) Fault

When a fault occurs, the inverter trips and a fault signal is output.

When the protective function is activated, refer to the inverter manual to take the appropriate countermeasure and reset the inverter to perform operation again.

<b>Operation panel indication</b>	<b>E.OPT</b>		<b>FR-PU04</b> <b>FR-PU07</b>	<b>Option Fault</b>
<b>Name</b>	Option fault			
<b>Description</b>	Appears when node address is out of range (other than 1 to 64) or not correctly set.			
<b>Check Point</b>	<ul style="list-style-type: none"> <li>· Check that node address is within the range of 1 to 64.</li> <li>· Check that the node address switch is not set between numbers.</li> </ul>			
<b>Corrective Action</b>	<ul style="list-style-type: none"> <li>· Set the node address within the range of 1 to 64. <i>(Refer to page 17)</i></li> <li>· Set the node address switch to the number position correctly. <i>(Refer to page 17)</i></li> <li>· If the problem still persists after taking the above measure, please contact your sales representative.</li> </ul>			

# 9 TROUBLESHOOTING

If a fault occurs and the inverter fails to operate properly, locate the cause of the fault and take proper corrective action by referring to the troubleshooting below. If the corresponding information is not found in the table, the inverter has problem, or the component parts are damaged, contact your sales representative.

Display		Possible Causes	Check Point	Countermeasure
Operation panel of inverter	LED of the FR-A7NF *			
E.1 E.2 E.3	DEV (D2) <input type="checkbox"/> RMT (D4) <input type="checkbox"/>	Internal error of the FR-A7NF firmware.	—	Please contact your sales representative.
	DEV (D2) <input checked="" type="checkbox"/> RMT (D4) <input type="checkbox"/>	The FR-A7NF is mounted to the inverter which is not compatible.	Check that the inverter is compatible with the FR-A7NF. <i>(Refer to page 3)</i>	Mount the FR-A7NF to the inverter which is compatible.
		Communication between the inverter and communication option can not be made.	Check that a contact fault is not occurred in an option connector between the inverter and communication option.	Switch the inverter power OFF and remount the FR-A7NF.
E.OPT	DEV (D2) <input checked="" type="checkbox"/> RMT (D4) <input type="checkbox"/>	Node address is out of range (other than 1 to 64)	Check that the node address setting is within the range (1 to 64)	Set the node address within the range (1 to 64) <i>(Refer to page 17)</i>
		Node address is not correctly set.	Check that the node address switch is not set between numbers.	Set the node address switch to the number position correctly. <i>(Refer to page 17)</i>
		Optional board fault	—	Please contact your sales representative.



Display		Possible Causes	Check Point	Countermeasure
Operation panel of inverter	LED of the FR-A7NF *			
E.OP1 E.OP2 E.OP3	DEV (D2) <input type="checkbox"/> RMT (D4) <input type="checkbox"/>	The inverter is not participated in FL remote network and communication between the FR-A7NF and switching hub is disconnected.	Check that no break in the cable between the FR-A7NF and switching hub.	Make sure to connect the cable between the FR-A7NF and switching hub.
	DEV (D2) <input type="checkbox"/> RMT (D4) <input checked="" type="checkbox"/> ↔ <input type="checkbox"/>	After the inverter participated in FL remote network, communication between the FR-A7NF and switching hub is disconnected.		
0.00	DEV (D2) <input type="checkbox"/> RMT (D4) <input type="checkbox"/>	FL remote network communication is not established.	Check that node address setting of the inverter and slave station setting of the master are the same.	Set the node address of the inverter and slave station of the master to the same setting.

: Off, : Red is lit, : Green is lit,  ↔ : Red is flickering

\* Refer to *page 9* for the LED indications.

# APPENDIX

## Restricted Use of Hazardous Substances in Electronic and Electrical Products

The mark of restricted use of hazardous substances in electronic and electrical products is applied to the product as follows based on the "Management Methods for the Restriction of the Use of Hazardous Substances in Electrical and Electronic Products" of the People's Republic of China.

电器电子产品有害物质限制使用标识要求



本产品中所含有的有害物质的名称、含量、含有部件如下表所示。

- 产品中所含有害物质的名称及含量

部件名称*2	有害物质*1					
	铅(Pb)	汞(Hg)	镉(Cd)	六价铬(Gr(VI))	多溴联苯(PBB)	多溴二苯醚(PBDE)
电路板组件（包括印刷电路板及其构成的零部件，如电阻、电容、集成电路、连接器等）、电子部件	×	○	×	○	○	○
金属壳体、金属部件	×	○	○	○	○	○
树脂壳体、树脂部件	○	○	○	○	○	○
螺丝、电线	○	○	○	○	○	○

上表依据SJ/T11364的规定编制。

○：表示该有害物质在该部件所有均质材料中的含量均在GB/T26572规定的限量要求以下。

×：表示该有害物质在该部件的至少一种均质材料中的含量超出GB/T26572规定的限量要求。

\*1 即使表中记载为×，根据产品型号，也可能会有有害物质的含量为限制值以下的情况。

\*2 根据产品型号，一部分部件可能不包含在产品中。

## REVISIONS

\*The manual number is given on the bottom left of the back cover.

Print Date	*Manual Number	Revision
Jan. 2008	IB(NA)-0600328ENG-A	First edition
Jun. 2009	IB(NA)-0600328ENG-B	<div style="border: 1px solid black; display: inline-block; padding: 2px;">Addition</div> Compatible with the FR-F700 series
Nov. 2010	IB(NA)-0600328ENG-C	<div style="border: 1px solid black; display: inline-block; padding: 2px;">Addition</div> ·Compatible with the FR-F700P series ·PU operation interlock (X12 signal) specification
Nov. 2011	IB(NA)-0600328ENG-D	<div style="border: 1px solid black; display: inline-block; padding: 2px;">Modification</div> ·Screw tightening torque of the plug-in option
May. 2017	IB(NA)-0600328ENG-E	<div style="border: 1px solid black; display: inline-block; padding: 2px;">Addition</div> ·Restricted Use of Hazardous Substances in Electronic and Electrical Products

INVERTER

**MITSUBISHI ELECTRIC CORPORATION**

HEAD OFFICE: TOKYO BUILDING 2-7-3, MARUNOUCHI, CHIYODA-KU, TOKYO 100-8310, JAPAN

IB(NA)-0600328ENG-E(1705) MEE

Printed in Japan

Specifications subject to change without notice.