

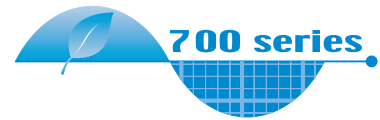

**mitsubishi  
electric**



# **INVERTER FR-A701**

## **INSTRUCTION MANUAL (Applied)**

# **FR-A721-5.5K to 55K FR-A741-5.5K to 55K**



**OUTLINE**

**1**

**WIRING**

**2**

**PRECAUTIONS FOR USE  
OF THE INVERTER**

**3**

**PARAMETERS**

**4**

**PROTECTIVE FUNCTIONS**

**5**

**PRECAUTIONS FOR  
MAINTENANCE AND INSPECTION**

**6**

**SPECIFICATIONS**

**7**

Thank you for choosing this Mitsubishi Inverter.

This Instruction Manual (Applied) provides instructions for advanced use of the FR-A701 series inverters.

Incorrect handling might cause an unexpected fault. Before using the inverter, always read this instruction manual and the instruction manual [IB-0600331ENG] packed with the product carefully to use the equipment to its optimum.

**This section is specifically about safety matters**

Do not attempt to install, operate, maintain or inspect the inverter until you have read through the Instruction Manual and appended documents carefully and can use the equipment correctly. Do not use this product until you have a full knowledge of the equipment, safety information and instructions.

In this Instruction Manual, the safety instruction levels are classified into "WARNING" and "CAUTION".

**⚠ WARNING** Incorrect handling may cause hazardous conditions, resulting in death or severe injury.

**⚠ CAUTION** Incorrect handling may cause hazardous conditions, resulting in medium or slight injury, or may cause only material damage.

The **⚠ CAUTION** level may even lead to a serious consequence according to conditions. Both instruction levels must be followed because these are important to personal safety.

**1. Electric Shock Prevention**

**⚠ WARNING**

- While power is ON or when the inverter is running, do not open the front cover. Otherwise you may get an electric shock.
- Do not run the inverter with the front cover or wiring cover removed. Otherwise you may access the exposed high-voltage terminals or the charging part of the circuitry and get an electric shock.
- Even if power is OFF, do not remove the front cover except for wiring or periodic inspection. You may accidentally touch the charged inverter circuits and get an electric shock.
- Before wiring or inspection, power must be switched OFF. To confirm that, LED indication of the operation panel must be checked. (It must be OFF.) Any person who is involved in wiring or inspection shall wait for at least 10 minutes after the power supply has been switched OFF and check that there are no residual voltage using a tester or the like. The capacitor is charged with high voltage for some time after power OFF, and it is dangerous.
- This inverter must be earthed (grounded). Earthing (grounding) must conform to the requirements of national and local safety regulations and electrical code (NEC section 250, IEC 536 class 1 and other applicable standards). A neutral-point earthed (grounded) power supply for 400V class inverter in compliance with EN standard must be used.
- Any person who is involved in wiring or inspection of this equipment shall be fully competent to do the work.
- The inverter must be installed before wiring. Otherwise you may get an electric shock or be injured.
- Setting dial and key operations must be performed with dry hands to prevent an electric shock.
- Do not subject the cables to scratches, excessive stress, heavy loads or pinching. Otherwise you may get an electric shock.
- Do not change the cooling fan while power is ON. It is dangerous to change the cooling fan while power is ON.
- Do not touch the printed circuit board or handle the cables with wet hands. Otherwise you may get an electric shock.
- When measuring the main circuit capacitor capacity, the DC voltage is applied to the motor for 1s at powering OFF. Never touch the motor terminal, etc. right after powering OFF to prevent an electric shock.

**2. Fire Prevention**

**⚠ CAUTION**

- Inverter must be installed on a nonflammable wall without holes (so that nobody touches the inverter heatsink on the rear side, etc.). Mounting it to or near flammable material can cause a fire.
- If the inverter has become faulty, the inverter power must be switched OFF. A continuous flow of large current could cause a fire.

**3. Injury Prevention**

**⚠ CAUTION**

- The voltage applied to each terminal must be the ones specified in the Instruction Manual. Otherwise burst, damage, etc. may occur.
- The cables must be connected to the correct terminals. Otherwise burst, damage, etc. may occur.
- Polarity must be correct. Otherwise burst, damage, etc. may occur.
- While power is ON or for some time after power-OFF, do not touch the inverter as they will be extremely hot. Doing so can cause burns.

**4. Additional Instructions**

Also the following points must be noted to prevent an accidental failure, injury, electric shock, etc.

**(1) Transportation and Mounting**

**⚠ CAUTION**

- The product must be transported in correct method that corresponds to the weight. Failure to do so may lead to injuries.
- Do not stack the boxes containing inverters higher than the number recommended.
- The product must be installed to the position where withstands the weight of the product according to the information in the Instruction Manual.
- Do not install or operate the inverter if it is damaged or has parts missing.
- When carrying the inverter, do not hold it by the front cover or setting dial; it may fall off or fail.
- Do not stand or rest heavy objects on the product.
- The inverter mounting orientation must be correct.
- Foreign conductive objects must be prevented from entering the inverter. That includes screws and metal fragments or other flammable substance such as oil.
- As the inverter is a precision instrument, do not drop or subject it to impact.
- The inverter must be used under the following environment. Otherwise the inverter may be damaged.

Environment	Surrounding air temperature	-10°C to +50°C (non-freezing)
	Ambient humidity	90%RH or less (non-condensing)
	Storage temperature	-20°C to +65°C *1
	Atmosphere	Indoors (free from corrosive gas, flammable gas, oil mist, dust and dirt)
	Altitude/vibration	Maximum 1,000m above sea level for standard operation. 5.9m/s <sup>2</sup> or less at 10 to 55Hz (directions of X, Y, Z axes)

\*1 Temperature applicable for a short time, e.g. in transit.

**(2) Wiring**

**⚠ CAUTION**

- Do not install a power factor correction capacitor or surge suppressor/capacitor type filter on the inverter output side. These devices on the inverter output side may be overheated or burn out.
- The connection orientation of the output cables U, V, W to the motor affects the rotation direction of the motor.

### (3) Trial run

#### ⚠ CAUTION

- Before starting operation, each parameter must be confirmed and adjusted. A failure to do so may cause some machines to make unexpected motions.

### (4) Usage

#### ⚠ WARNING

- Any person must stay away from the equipment when the retry function is set as it will restart suddenly after trip.
- Since pressing  key may not stop output depending on the function setting status, separate circuit and switch that make an emergency stop (power OFF, mechanical brake operation for emergency stop, etc.) must be provided.
- OFF status of the start signal must be confirmed before resetting the inverter fault. Resetting inverter alarm with the start signal ON restarts the motor suddenly.
- The inverter must be used for three-phase induction motors. Connection of any other electrical equipment to the inverter output may damage the equipment.
- Performing pre-excitation (LX signal and X13 signal) under torque control (Real sensorless vector control) may start the motor running at a low speed even when the start command (STF or STR) is not input. The motor may also run at a low speed when the speed limit value = 0 with a start command input. It must be confirmed that the motor running will not cause any safety problem before performing pre-excitation.
- Do not modify the equipment.
- Do not perform parts removal which is not instructed in this manual. Doing so may lead to fault or damage of the product.

#### ⚠ CAUTION

- The electronic thermal relay function does not guarantee protection of the motor from overheating. It is recommended to install both an external thermal and PTC thermistor for overheat protection.
- Do not use a magnetic contactor on the inverter input for frequent starting/stopping of the inverter. Otherwise the life of the inverter decreases.
- The effect of electromagnetic interference must be reduced by using a noise filter or by other means. Otherwise nearby electronic equipment may be affected.
- When driving a 400V class motor by the inverter, the motor must be an insulation-enhanced motor or measures must be taken to suppress surge voltage. Surge voltage attributable to the wiring constants may occur at the motor terminals, deteriorating the insulation of the motor.
- When parameter clear or all parameter clear is performed, the required parameters must be set again before starting operations because all parameters return to the initial value.
- The inverter can be easily set for high-speed operation. Before changing its setting, the performances of the motor and machine must be fully examined.
- Stop status cannot be hold by the inverter's brake function. In addition to the inverter's brake function, a holding device must be installed to ensure safety.
- Before running an inverter which had been stored for a long period, inspection and test operation must be performed.
- For prevention of damage due to static electricity, nearby metal must be touched before touching this product to eliminate static electricity from your body.

### (5) Emergency stop

#### ⚠ CAUTION

- A safety backup such as an emergency brake must be provided to prevent hazardous condition to the machine and equipment in case of inverter failure.
- When the breaker on the inverter input side trips, the wiring must be checked for fault (short circuit), and internal parts of the inverter for a damage, etc. The cause of the trip must be identified and removed before turning ON the power of the breaker.
- When any protective function is activated, appropriate corrective action must be taken, and the inverter must be reset before resuming operation.

### (6) Maintenance, inspection and parts replacement

#### ⚠ CAUTION

- Do not carry out a megger (insulation resistance) test on the control circuit of the inverter. It will cause a failure.

### (7) Disposal

#### ⚠ CAUTION

- The inverter must be treated as industrial waste.

#### General instruction

Many of the diagrams and drawings in this Instruction Manual show the inverter without a cover or partially open for explanation. Never operate the inverter in this manner. The cover must be always reinstalled and the instruction in this Instruction Manual must be followed when operating the inverter.

# CONTENTS

<b>1</b>	<b>OUTLINE</b>	<b>1</b>
1.1	Product checking and parts identification .....	2
1.2	Inverter and peripheral devices .....	3
1.2.1	Peripheral devices .....	4
1.3	Method of removal and reinstallation of the front cover .....	5
1.4	Installation of the inverter and enclosure design .....	7
1.4.1	Inverter installation environment .....	7
1.4.2	Cooling system types for inverter enclosure .....	10
1.4.3	Inverter placement .....	11
<b>2</b>	<b>WIRING</b>	<b>13</b>
2.1	Terminal connection diagram .....	14
2.2	Main circuit terminal specifications .....	15
2.2.1	Specification of main circuit terminal .....	15
2.2.2	Terminal arrangement of the main circuit terminal, power supply and the motor wiring .....	16
2.2.3	Cables and wiring length .....	18
2.2.4	When connecting the control circuit and the main circuit separately to the power supply .....	21
2.3	Control circuit specifications .....	22
2.3.1	Control circuit terminals .....	22
2.3.2	Changing the control logic .....	25
2.3.3	Control circuit terminal layout .....	27
2.3.4	Wiring instructions .....	27
2.3.5	When connecting the operation panel using a connection cable .....	28
2.3.6	RS-485 terminal block .....	28
2.3.7	Communication operation .....	29
2.4	Connection of motor with encoder (vector control) .....	30
<b>3</b>	<b>PRECAUTIONS FOR USE OF THE INVERTER</b>	<b>37</b>
3.1	EMC and leakage currents .....	38
3.1.1	Leakage currents and countermeasures .....	38
3.1.2	EMC measures .....	40
3.1.3	Power supply harmonics .....	42
3.1.4	Harmonic suppression guideline .....	42
3.2	Power-off and magnetic contactor (MC) .....	44
3.3	Inverter-driven 400V class motor .....	45



<b>3.4</b>	<b>Precautions for use of the inverter .....</b>	<b>46</b>
<b>3.5</b>	<b>Failsafe of the system which uses the inverter .....</b>	<b>48</b>
<b>4</b>	<b>PARAMETERS .....</b>	<b>51</b>
<hr/>		
<b>4.1</b>	<b>Operation panel (FR-DU07) .....</b>	<b>52</b>
4.1.1	Parts of the operation panel (FR-DU07) .....	52
4.1.2	Basic operation (factory setting) .....	53
4.1.3	Changing the parameter setting value .....	54
4.1.4	Setting dial push .....	54
<b>4.2</b>	<b>Parameter list .....</b>	<b>55</b>
4.2.1	Parameter list .....	55
<b>4.3</b>	<b>Control mode .....</b>	<b>71</b>
4.3.1	What is vector control? .....	72
4.3.2	Change the control method (Pr. 80, Pr. 81, Pr. 451, Pr. 800) .....	75
<b>4.4</b>	<b>Speed control by Real sensorless vector control, vector control .....</b>	<b>79</b>
4.4.1	Setting procedure of Real sensorless vector control (speed control) .....	81
4.4.2	Setting procedure of vector control (speed control) .....	82
4.4.3	Torque limit level setting for speed control (Pr. 22, Pr. 803, Pr. 810 to Pr. 817, Pr. 858, Pr. 868, Pr. 874) .....	83
4.4.4	To perform high accuracy/fast response operation (gain adjustment of Real sensorless vector control and vector control) (Pr. 818 to Pr. 821, Pr. 830, Pr. 831, Pr. 880) .....	88
4.4.5	Speed feed forward control, model adaptive speed control (Pr. 828, Pr. 877 to Pr. 881) .....	95
4.4.6	Torque biases (Pr. 840 to Pr. 848) .....	97
4.4.7	Prevent the motor from overrunning (Pr. 285, Pr. 853, Pr. 873) .....	100
4.4.8	Notch filter (Pr. 862, Pr. 863) .....	101
<b>4.5</b>	<b>Torque control by Real sensorless vector control, vector control .....</b>	<b>102</b>
4.5.1	Torque control .....	102
4.5.2	Setting procedure of Real sensorless vector control (torque control) .....	106
4.5.3	Setting procedure of vector control (torque control) .....	107
4.5.4	Torque command (Pr. 803 to Pr. 806) .....	108
4.5.5	Speed limit (Pr. 807 to Pr. 809) .....	110
4.5.6	Gain adjustment of torque control (Pr. 824, Pr. 825, Pr. 834, Pr. 835) .....	113
<b>4.6</b>	<b>Position control by vector control .....</b>	<b>115</b>
4.6.1	Position control .....	115
4.6.2	Conditional position feed function by contact input (Pr. 419, Pr. 464 to Pr. 494) .....	117
4.6.3	Position control (Pr. 419, Pr. 428 to Pr. 430) by inverter pulse train input .....	120

4.6.4	Setting of the electronic gear (Pr. 420, Pr. 421, Pr. 424)	122
4.6.5	Setting of positioning adjustment parameter (Pr. 426, Pr. 427)	123
4.6.6	Gain adjustment of position control (Pr. 422, Pr. 423, Pr. 425)	124
4.6.7	Trouble shooting for when position control is not exercised normally	126
<b>4.7</b>	<b>Adjustment of Real sensorless vector control, vector control</b>	<b>127</b>
4.7.1	Speed detection filter and torque detection filter (Pr. 823, Pr. 827, Pr. 833, Pr. 837)	127
4.7.2	Excitation ratio (Pr. 854)	128
<b>4.8</b>	<b>Adjust the output torque (current) of the motor</b>	<b>129</b>
4.8.1	Manual torque boost (Pr. 0, Pr. 46, Pr. 112)	129
4.8.2	Advanced magnetic flux vector control (Pr. 71, Pr. 80, Pr. 81, Pr. 89, Pr. 450, Pr. 451, Pr. 453, Pr. 454, Pr. 569, Pr. 800)	131
4.8.3	Slip compensation (Pr. 245 to Pr. 247)	134
4.8.4	Stall prevention operation (Pr. 22, Pr. 23, Pr. 48, Pr. 49, Pr. 66, Pr. 114, Pr. 115, Pr. 148, Pr. 149, Pr. 154, Pr. 156, Pr. 157, Pr. 858, Pr. 868)	135
<b>4.9</b>	<b>Limiting the output frequency</b>	<b>140</b>
4.9.1	Maximum/minimum frequency (Pr. 1, Pr. 2, Pr. 18)	140
4.9.2	Avoiding mechanical resonance points (Frequency jump) (Pr. 31 to Pr. 36)	141
<b>4.10</b>	<b>V/F pattern</b>	<b>142</b>
4.10.1	Base frequency, voltage (Pr. 3, Pr. 19, Pr. 47, Pr. 113)	142
4.10.2	Load pattern selection (Pr. 14)	144
4.10.3	Elevator mode (automatic acceleration/deceleration) (Pr. 61, Pr. 64, Pr. 292)	146
4.10.4	Adjustable 5 points V/F (Pr. 71, Pr. 100 to Pr. 109)	147
<b>4.11</b>	<b>Frequency setting by external terminals</b>	<b>148</b>
4.11.1	Multi-speed setting operation (Pr. 4 to Pr. 6, Pr. 24 to Pr. 27, Pr. 232 to Pr. 239)	148
4.11.2	Jog operation (Pr. 15, Pr. 16)	150
4.11.3	Input compensation of multi-speed and remote setting (Pr. 28)	152
4.11.4	Remote setting function (Pr. 59)	152
<b>4.12</b>	<b>Setting of acceleration/deceleration time and acceleration/deceleration pattern</b>	<b>155</b>
4.12.1	Setting of the acceleration and deceleration time (Pr. 7, Pr. 8, Pr. 20, Pr. 21, Pr. 44, Pr. 45, Pr. 110, Pr. 111)	155
4.12.2	Starting frequency and start-time hold function (Pr. 13, Pr. 571)	157
4.12.3	Acceleration/deceleration pattern (Pr. 29, Pr. 140 to Pr. 143, Pr. 380 to Pr. 383, Pr. 516 to Pr. 519)	158
4.12.4	Shortest acceleration/deceleration and optimum acceleration/deceleration (automatic acceleration/deceleration) (Pr. 61 to Pr. 63, Pr. 292, Pr. 293)	162
<b>4.13</b>	<b>Selection and protection of a motor</b>	<b>165</b>
4.13.1	Motor protection from overheat (Electronic thermal relay function) (Pr. 9, Pr. 51)	165

4.13.2	Applied motor (Pr. 71, Pr. 450).....	169
4.13.3	Offline auto tuning (Pr. 71, Pr. 80 to Pr. 84, Pr. 90 to Pr. 94, Pr. 96, Pr. 450, Pr. 453 to Pr. 463, Pr. 684, Pr. 859, Pr. 860) .....	171
4.13.4	Online auto tuning (Pr. 95, Pr. 574) .....	181
<b>4.14</b>	<b>Motor brake and stop operation .....</b>	<b>185</b>
4.14.1	DC injection brake and zero speed control, servo lock (LX signal, X13 signal, Pr. 10 to Pr. 12, Pr. 802, Pr. 850) .....	185
4.14.2	Stop selection (Pr. 250) .....	189
4.14.3	Stop-on contact control function (Pr. 6, Pr. 48, Pr. 270, Pr. 275, Pr. 276) .....	190
4.14.4	Brake sequence function (Pr. 278 to Pr. 285, Pr. 292).....	193
4.14.5	Orientation control (Pr. 350 to Pr. 366, Pr. 369, Pr. 393, Pr. 396 to Pr. 399) .....	196
<b>4.15</b>	<b>Function assignment of external terminal and control .....</b>	<b>207</b>
4.15.1	Input terminal function selection (Pr. 178 to Pr. 189) .....	207
4.15.2	Inverter output shutoff signal (MRS signal, Pr. 17).....	210
4.15.3	Condition selection of function validity by the second function selection signal (RT) and third function selection signal (X9) (RT signal, X9 signal, Pr. 155).....	211
4.15.4	Start signal operation selection (STF, STR, STOP signal, Pr. 250) .....	212
4.15.5	Magnetic flux decay output shutoff signal (X74 signal) .....	214
4.15.6	Output terminal function selection (Pr. 190 to Pr. 196).....	215
4.15.7	Detection of output frequency (SU, FU, FU2 , FU3, FB, FB2, FB3, LS signal, Pr. 41 to Pr. 43, Pr. 50, Pr. 116, Pr. 865) .....	222
4.15.8	Output current detection function (Y12 signal, Y13 signal, Pr. 150 to Pr. 153, Pr. 166, Pr. 167) .....	224
4.15.9	Detection of output torque (TU signal, Pr. 864).....	225
4.15.10	Remote output function (REM signal, Pr. 495 to Pr. 497) .....	226
<b>4.16</b>	<b>Monitor display and monitor output signal .....</b>	<b>227</b>
4.16.1	Speed display and speed setting (Pr. 37, Pr. 144, Pr. 505, Pr. 811).....	227
4.16.2	DU/PU, FM, AM terminal monitor display selection (Pr. 52, Pr. 54, Pr. 158, Pr. 170, Pr. 171, Pr. 268, Pr. 563, Pr. 564, Pr. 891) .....	229
4.16.3	Reference of the terminal FM (pulse train output) and AM (analog voltage output) (Pr. 55, Pr. 56, Pr. 291, Pr. 866, Pr. 867) .....	236
4.16.4	Terminal FM, AM calibration (Calibration parameter C0 (Pr. 900), C1 (Pr. 901)).....	240
<b>4.17</b>	<b>Operation selection at power failure and instantaneous power failure.....</b>	<b>243</b>
4.17.1	Automatic restart after instantaneous power failure/flying start (Pr. 57, Pr. 58, Pr. 162 to Pr. 165, Pr. 299, Pr. 611).....	243
4.17.2	Power failure-time deceleration-to-stop function (Pr. 261 to Pr. 266, Pr. 294 ) .....	247
<b>4.18</b>	<b>Operation setting at fault occurrence .....</b>	<b>250</b>
4.18.1	Retry function (Pr. 65, Pr. 67 to Pr. 69) .....	250
4.18.2	Fault code output selection (Pr. 76).....	252
4.18.3	Input/output phase loss protection selection (Pr. 251, Pr. 872).....	253

4.18.4	Overspeed detection (Pr. 374) .....	253
4.18.5	Encoder signal loss detection (Pr. 376) .....	253
4.18.6	Fault definition (Pr. 875) .....	254
<b>4.19</b>	<b>Energy saving operation and energy saving monitor .....</b>	<b>255</b>
4.19.1	Energy saving control (Pr. 60) .....	255
4.19.2	Energy saving monitor (Pr. 891 to Pr. 899) .....	256
<b>4.20</b>	<b>Motor noise, EMI measures .....</b>	<b>261</b>
4.20.1	PWM carrier frequency and Soft-PWM control (Pr. 72, Pr. 240) .....	261
<b>4.21</b>	<b>Frequency/torque setting by analog input (terminal 1, 2, 4) .....</b>	<b>262</b>
4.21.1	Function assignment of analog input terminal (Pr. 858, Pr. 868) .....	262
4.21.2	Analog input selection (Pr. 73, Pr. 267) .....	263
4.21.3	Analog input compensation (Pr. 73, Pr. 242, Pr. 243, Pr. 252, Pr. 253) .....	267
4.21.4	Response level of analog input and noise elimination (Pr. 74, Pr. 822, Pr. 826, Pr. 832, Pr. 836, Pr. 849) .....	269
4.21.5	Bias and gain of frequency setting voltage (current) (Pr. 125, Pr. 126, Pr. 241, C2(Pr. 902) to C7(Pr. 905), C12(Pr. 917) to C15(Pr. 918)) .....	271
4.21.6	Bias and gain of torque (magnetic flux) setting voltage (current) (Pr. 241, C16(Pr. 919) to C19(Pr. 920), C38 (Pr. 932) to C41 (Pr. 933)) .....	277
<b>4.22</b>	<b>Misoperation prevention and parameter setting restriction .....</b>	<b>282</b>
4.22.1	Reset selection/disconnected PU detection/PU stop selection (Pr. 75) .....	282
4.22.2	Parameter write selection (Pr. 77) .....	284
4.22.3	Reverse rotation prevention selection (Pr. 78) .....	285
4.22.4	Display of applied parameters and user group function (Pr. 160, Pr. 172 to Pr. 174) .....	285
4.22.5	Password function (Pr. 296, Pr. 297) .....	287
<b>4.23</b>	<b>Selection of operation mode and operation location .....</b>	<b>290</b>
4.23.1	Operation mode selection (Pr. 79) .....	290
4.23.2	Operation mode at power on (Pr. 79, Pr. 340) .....	298
4.23.3	Start command source and frequency command source during communication operation (Pr. 338, Pr. 339, Pr. 550, Pr. 551) .....	299
<b>4.24</b>	<b>Communication operation and setting .....</b>	<b>305</b>
4.24.1	Wiring and configuration of PU connector .....	305
4.24.2	Wiring and arrangement of RS-485 terminals .....	307
4.24.3	Initial settings and specifications of RS-485 communication (Pr. 117 to Pr. 124, Pr. 331 to Pr. 337, Pr. 341, Pr. 549) .....	310
4.24.4	Communication EEPROM write selection (Pr. 342) .....	311
4.24.5	Mitsubishi inverter protocol (computer link communication) .....	312
4.24.6	Modbus-RTU communication specifications (Pr. 331, Pr. 332, Pr. 334, Pr. 343, Pr. 539, Pr. 549) .....	324
4.24.7	USB communication (Pr. 547, Pr. 548) .....	337

<b>4.25</b>	<b>Special operation and frequency control .....</b>	<b>338</b>
4.25.1	PID control (Pr. 127 to Pr. 134, Pr. 575 to Pr. 577).....	338
4.25.2	Bypass-inverter switchover function (Pr. 57, Pr. 58, Pr. 135 to Pr. 139, Pr. 159).....	346
4.25.3	Load torque high speed frequency control (Pr. 4, Pr. 5, Pr. 270 to Pr. 274) .....	351
4.25.4	Droop control (Pr. 286 to Pr. 288) .....	354
4.25.5	Frequency setting by pulse train input (Pr. 291, Pr. 384 to Pr. 386).....	356
4.25.6	Encoder feedback control (Pr. 144, Pr. 285, Pr. 359, Pr. 367 to Pr. 369) .....	359
4.25.7	Regeneration avoidance function (Pr. 665, Pr. 882 to Pr. 886).....	361
<b>4.26</b>	<b>Useful functions .....</b>	<b>363</b>
4.26.1	Cooling fan operation selection (Pr. 244) .....	363
4.26.2	Display of the life of the inverter parts (Pr. 255 to Pr. 259).....	364
4.26.3	Maintenance timer alarm (Pr. 503, Pr. 504) .....	367
4.26.4	Current average value monitor signal (Pr. 555 to Pr. 557).....	368
4.26.5	Free parameter (Pr. 888, Pr. 889) .....	370
<b>4.27</b>	<b>Setting of the parameter unit and operation panel.....</b>	<b>371</b>
4.27.1	PU display language selection (Pr. 145) .....	371
4.27.2	Operation panel frequency setting/key lock selection (Pr. 161) .....	371
4.27.3	Buzzer control (Pr. 990).....	373
4.27.4	PU contrast adjustment (Pr. 991) .....	373
<b>4.28</b>	<b>Parameter clear .....</b>	<b>374</b>
<b>4.29</b>	<b>All parameter clear.....</b>	<b>375</b>
<b>4.30</b>	<b>Parameter copy and parameter verification .....</b>	<b>376</b>
4.30.1	Parameter copy .....	376
4.30.2	Parameter verification.....	377
<b>4.31</b>	<b>Check and clear of the faults history .....</b>	<b>378</b>
<b>5</b>	<b>PROTECTIVE FUNCTIONS .....</b>	<b>381</b>
<b>5.1</b>	<b>Reset method of protective function .....</b>	<b>382</b>
<b>5.2</b>	<b>List of fault or alarm display .....</b>	<b>383</b>
<b>5.3</b>	<b>Causes and corrective actions .....</b>	<b>384</b>
<b>5.4</b>	<b>Correspondences between digital and actual characters .....</b>	<b>399</b>
<b>5.5</b>	<b>Check first when you have a trouble .....</b>	<b>400</b>
5.5.1	Motor does not start.....	400
5.5.2	Motor or machine is making abnormal acoustic noise.....	402
5.5.3	Inverter generates abnormal noise.....	402

5.5.4	Motor generates heat abnormally .....	403
5.5.5	Motor rotates in the opposite direction .....	403
5.5.6	Speed greatly differs from the setting .....	403
5.5.7	Acceleration/deceleration is not smooth .....	404
5.5.8	Motor current is too large .....	404
5.5.9	Speed does not accelerate .....	405
5.5.10	Motor and machine vibrate .....	405
5.5.11	Speed varies during operation .....	406
5.5.12	Operation mode is not changed properly .....	407
5.5.13	Operation panel (FR-DU07) display is not operating .....	407
5.5.14	Power lamp is not lit .....	407
5.5.15	Unable to write parameter setting .....	407

## **6 PRECAUTIONS FOR MAINTENANCE AND INSPECTION 409**

---

### **6.1 Inspection item..... 410**

6.1.1	Daily inspection .....	410
6.1.2	Periodic inspection .....	410
6.1.3	Daily and periodic inspection .....	411
6.1.4	Display of the life of the inverter parts .....	412
6.1.5	Checking the inverter and converter modules .....	412
6.1.6	Cleaning .....	413
6.1.7	Replacement of parts .....	413

### **6.2 Measurement of main circuit voltages, currents and powers ..... 416**

6.2.1	Measurement of powers .....	418
6.2.2	Measurement of voltages and use of PT .....	418
6.2.3	Measurement of currents .....	419
6.2.4	Use of CT and transducer .....	419
6.2.5	Measurement of inverter input power factor .....	419
6.2.6	Measurement of converter output voltage (across terminals P/+ and N/-) .....	420
6.2.7	Measurement of inverter output frequency .....	420
6.2.8	Insulation resistance test using megger .....	420
6.2.9	Pressure test .....	420

## **7 SPECIFICATIONS 421**

---

### **7.1 Rating..... 422**

7.1.1	Inverter rating .....	422
7.1.2	Motor rating .....	423

### **7.2 Common specifications ..... 424**

<b>7.3</b>	<b>Outline dimension drawings .....</b>	<b>425</b>
7.3.1	Inverter outline dimension drawings .....	425
7.3.2	Dedicated motor outline dimension drawings .....	430
<b>7.4</b>	<b>Installation of the heatsink portion outside the enclosure for use .....</b>	<b>434</b>
7.4.1	Protrusion of heatsink .....	434

---



---

**APPENDICES** **437**

<b>Appendix 1</b>	<b>Main differences and compatibilities with the FR-A700 series .....</b>	<b>438</b>
<b>Appendix 2</b>	<b>Control mode-based parameter (function) correspondence table and instruction code list .....</b>	<b>439</b>
<b>Appendix 3</b>	<b>Specification change .....</b>	<b>456</b>
Appendix 3-1	SERIAL number check .....	456
Appendix 3-2	Changed functions .....	456



# 1 OUTLINE

---

This chapter describes the basic "OUTLINE" for use of this product.

Always read the instructions before using the equipment.

---

1.1	Product checking and parts identification .....	2
1.2	Inverter and peripheral devices .....	3
1.3	Method of removal and reinstallation of the front cover .....	5
1.4	Installation of the inverter and enclosure design .....	7

<Abbreviations>	
DU .....	Operation panel (FR-DU07)
PU .....	Operation panel (FR-DU07) and parameter unit (FR-PU04/FR-PU07)
Inverter .....	Mitsubishi inverter FR-A701 series
FR-A701 .....	Mitsubishi inverter FR-A701 series
Pr. ....	Parameter Number (Number assigned to function)
PU operation.....	Operation using the PU (FR-DU07/FR-PU04/FR-PU07).
External operation .....	Operation using the control circuit signals
Combined operation .....	Combined operation using the PU (FR-DU07/FR-PU04/FR-PU07) and external operation.
Mitsubishi standard motor .....	SF-JR
Mitsubishi constant-torque motor .....	SF-HRCA
Vector dedicated motor.....	SF-V5RU
<Trademarks>	
<ul style="list-style-type: none"> <li>• Microsoft and Visual C++ are registered trademarks of Microsoft Corporation in the United States and/or other countries.</li> <li>• LonWORKS® is a registered trademark of Echelon Corporation in the U.S.A and other countries.</li> <li>• DeviceNet® is a registered trademark of ODVA (Open DeviceNet Vender Association, Inc.).</li> <li>• Other company and product names herein are the trademarks and registered trademarks of their respective owners.</li> </ul>	





# 1.1 Product checking and parts identification

Unpack the inverter and check the capacity plate on the front cover and the rating plate on the inverter side face to ensure that the product agrees with your order and the inverter is intact.

## • Inverter Model

FR - A721 - 5.5 K

Symbol	Voltage Class
A721	Three-phase 200V class
A741	Three-phase 400V class

Represents inverter capacity (kW)

Cooling fan (Refer to page 414)

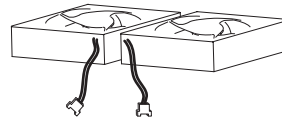

Fan cover (Refer to page 414)

Fan block (Refer to page 414)

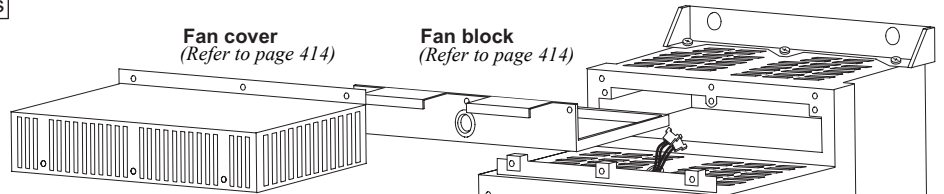

USB connector (Refer to page 337)  
PU connector (Refer to page 24)

RS-485 terminals (Refer to page 307)

Connector for plug-in option connection (Refer to the Instruction Manual of options.)  
There are three connection connectors and they are called connector 1, connector 2, and connector 3 from the top.

Voltage/current input switch (Refer to page 14, 263)  
AU/PTC switchover switch (Refer to page 168)

Control circuit terminal block (Refer to page 22)

Main circuit terminal block (Refer to page 15)

Charge lamp  
Lit when power is supplied to the main circuit (Refer to page 15)

Front cover (Refer to page 5)

Operation panel (FR-DU07) (Refer to page 52)



Power lamp  
Lit when the control circuit (R1/L11, S1/L21) is supplied with power.

Alarm lamp  
Lit when the inverter is in the alarm status (major fault).

Capacity plate

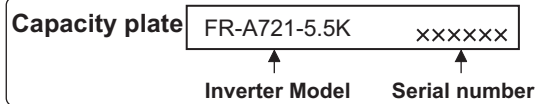

Rating plate

## • Accessory

### • Eyebolt for hanging the inverter

Capacity	Eyebolt size	Quantity
11K, 15K	M8	2
18.5K to 30K	M10	2
37K to 55K	M12	2



\* The 5.5K and 7.5K are not provided with eyebolts.

### Rating plate

MITSUBISHI INVERTER  
MODEL → FR-A721-5.5K  
Applied motor capacity → POWER : XXXXX  
INPUT : XXXXX  
Input rating → OUTPUT : XXXXX  
Output rating → SERIAL :  
Serial number

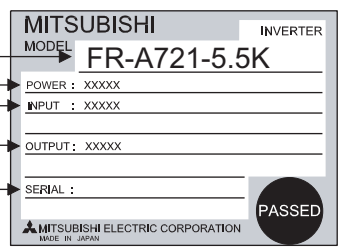

## REMARKS

For removal and reinstallation of covers, refer to page 5.

Harmonic suppression guideline (when inverters are used in Japan)

All models of general-purpose inverters used by specific consumers are covered by "Harmonic suppression guideline for consumers who receive high voltage or special high voltage". (For details, refer to page 42.)

## 1.2 Inverter and peripheral devices



**Three-phase AC power supply**  
Use within the permissible power supply specifications of the inverter.  
(Refer to page 422)



**Moulded case circuit breaker (MCCB) or earth leakage circuit breaker (ELB), fuse**  
The breaker must be selected carefully since an in-rush current flows in the inverter at power on.  
(Refer to page 4)



**Magnetic contactor (MC)**  
Install the magnetic contactor to ensure safety. Do not use this magnetic contactor to start and stop the inverter. Doing so will cause the inverter life to be shorten.  
(Refer to page 44)

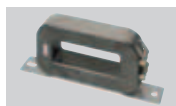

**EMC filter (ferrite core) (FR-BLF)**  
Install a noise filter to reduce the electromagnetic noise generated from the inverter. Effective in the range from about 1MHz to 10MHz. When more wires are passed through, a more effective result can be obtained. The total number of wires passed through should be 4T or more.

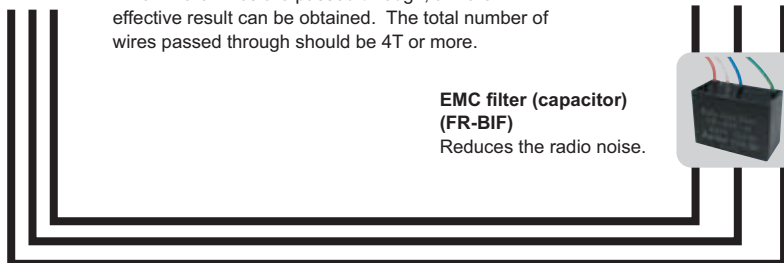

**EMC filter (capacitor) (FR-BIF)**  
Reduces the radio noise.

### USB connector

A personal computer and an inverter can be connected with a USB (Ver1. 1) cable.  
(Refer to page 337)

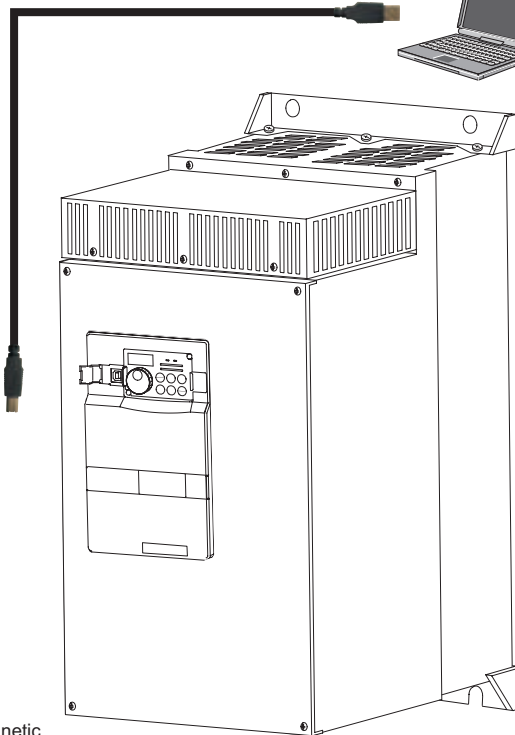

### Inverter (FR-A701)

The life of the inverter is influenced by surrounding air temperature. The surrounding air temperature should be as low as possible within the permissible range. This must be noted especially when the inverter is installed in an enclosure. (Refer to page 7)  
Wrong wiring might lead to damage of the inverter. The control signal lines must be kept fully away from the main circuit to protect them from noise. (Refer to page 14)

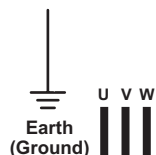

### EMC filter (ferrite core) (FR-BLF)

Install a noise filter to reduce the electromagnetic noise generated from the inverter. Effective in the range from about 1MHz to 10MHz. A wire should be wound four turns at a maximum.

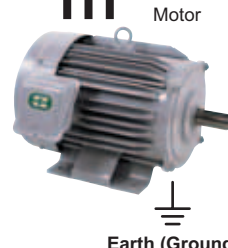

### Devices connected to the output

Do not install a power factor correction capacitor, surge suppressor or radio noise filter on the output side of the inverter. When installing a moulded case circuit breaker on the output side of the inverter, contact each manufacturer for selection of the moulded case circuit breaker.

### Earth (Ground)

To prevent an electric shock, always earth (ground) the motor and inverter.

 : Install these options as required.

## CAUTION

- Do not install a power factor correction capacitor, surge suppressor or radio noise filter on the inverter output side. This will cause the inverter to trip or the capacitor, and surge suppressor to be damaged. If any of the above devices are connected, immediately remove them.
- This inverter has a built-in AC reactor (FR-HAL) and a circuit type specified in Harmonic suppression guideline in Japan is three-phase bridge (capacitor smoothed) and with reactor (AC side). (Refer to page 42) Do not use an AC reactor (FR-HAL) of a stand-alone option except following purpose. (Note that overload protection of the converter may operate when a thyristor load is connected in the power supply system. To prevent this, always install an optional stand-alone AC reactor (FR-HAL).) A DC reactor (FR-HEL) can not be connected to the inverter.
- Electromagnetic wave interference  
The input/output (main circuit) of the inverter includes high frequency components, which may interfere with the communication devices (such as AM radios) used near the inverter. In this case, connecting a capacitor type filter will reduce electromagnetic wave interference.
- Refer to the instruction manual of each option and peripheral devices for details of peripheral devices.



### 1.2.1 Peripheral devices

Check the inverter model of the inverter you purchased. Appropriate peripheral devices must be selected according to the capacity. Refer to the following list and prepare appropriate peripheral devices:

#### 200V class

Motor Output (kW) <sup>*1</sup>	Applicable Inverter Model	Breaker Selection <sup>*2</sup>	Input Side Magnetic Contactor <sup>*3</sup>
5.5	FR-A721-5.5K	40A	S-N20, N21
7.5	FR-A721-7.5K	50A	S-N25
11	FR-A721-11K	75A	S-N35
15	FR-A721-15K	100A	S-N50
18.5	FR-A721-18.5K	125A	S-N50
22	FR-A721-22K	150A	S-N65
30	FR-A721-30K	175A	S-N80
37	FR-A721-37K	225A	S-N125
45	FR-A721-45K	300A	S-N150
55	FR-A721-55K	350A	S-N180

#### 400V class

Motor Output (kW) <sup>*1</sup>	Applicable Inverter Model	Breaker Selection <sup>*2</sup>	Input Side Magnetic Contactor <sup>*3</sup>
5.5	FR-A741-5.5K	20A	S-N11, N12
7.5	FR-A741-7.5K	30A	S-N20, N21
11	FR-A741-11K	40A	S-N20, N21
15	FR-A741-15K	50A	S-N20, N21
18.5	FR-A741-18.5K	60A	S-N25
22	FR-A741-22K	75A	S-N25
30	FR-A741-30K	100A	S-N50
37	FR-A741-37K	125A	S-N50
45	FR-A741-45K	150A	S-N65
55	FR-A741-55K	175A	S-N80

\*1 Selections for use of the Mitsubishi 4-pole standard motor with power supply voltage of 200VAC/400VAC 50Hz.

\*2 Select the MCCB according to the inverter power supply capacity.

Install one MCCB per inverter.

For the use in the United States or Canada, provide the appropriate UL and cUL listed Class RK5 or Class T type fuse or UL 489 molded case circuit breaker (MCCB) that is suitable for branch circuit protection.

(Refer to instruction manual (basic).)

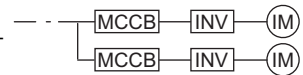

\*3 Magnetic contactor is selected based on the AC-1 class. The electrical durability of magnetic contactor is 500,000 times. When the magnetic contactor is used for emergency stop during motor driving, the electrical durability is 25 times.

When using the MC for emergency stop during motor driving or using on the motor side during commercial-power supply operation, select the MC with class AC-3 rated current for the motor rated current.

#### CAUTION

- When the inverter capacity is larger than the motor capacity, select an MCCB and a magnetic contactor according to the inverter model and cable according to the motor output.
- When the breaker on the inverter input side trips, check for the wiring fault (short circuit), damage to internal parts of the inverter, etc. Identify the cause of the trip, then remove the cause and power on the breaker.

## 1.3 Method of removal and reinstallation of the front cover

### •Removal of the operation panel

- 1) Loosen the two screws on the operation panel.  
(These screws cannot be removed.)
- 2) Push the left and right hooks of the operation panel and pull the operation panel toward you to remove.

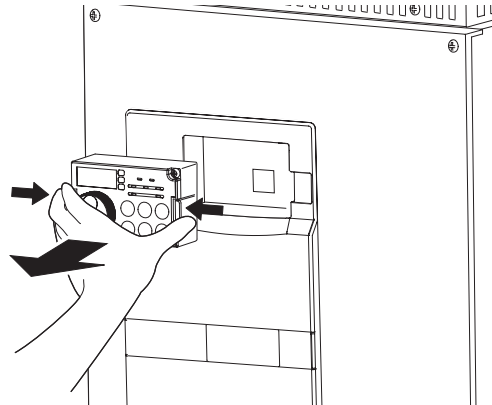
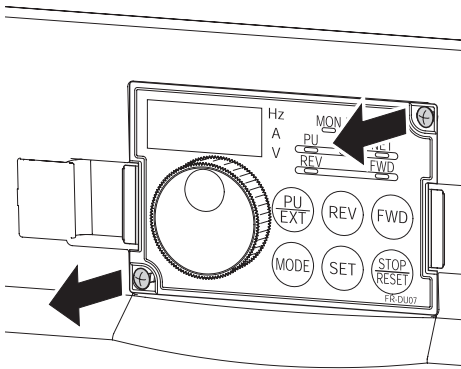

When reinstalling the operation panel, insert it straight to reinstall securely and tighten the fixed screws of the operation panel.

### •Removal of the front cover

- 1) Remove installation screws on the front cover 1 to remove the front cover 1.
- 2) Loosen the installation screws of the front cover 2.

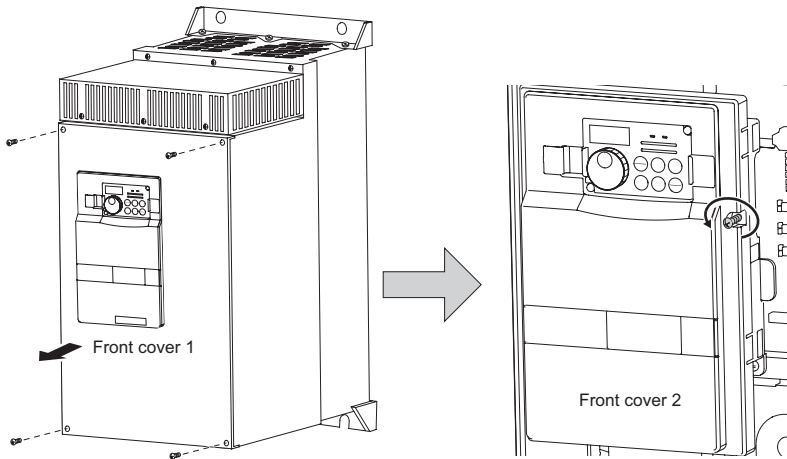

- 3) Pull the front cover 2 toward you to remove by pushing an installation hook on the right side using left fixed hooks as supports.

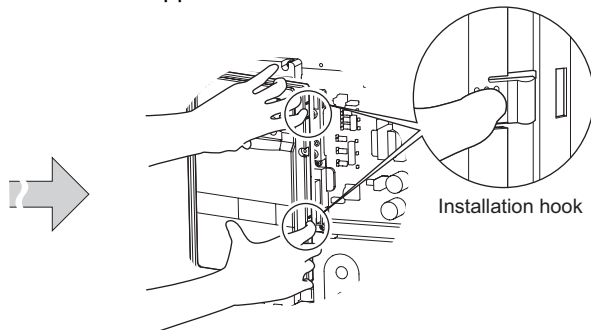

•Reinstallation of the front cover

- 1) Insert the two fixed hooks on the left side of the front cover 2 into the sockets of the inverter.
- 2) Using the fixed hooks as supports, securely press the front cover 2 against the inverter. (Although installation can be done with the operation panel mounted, make sure that a connector is securely fixed.)

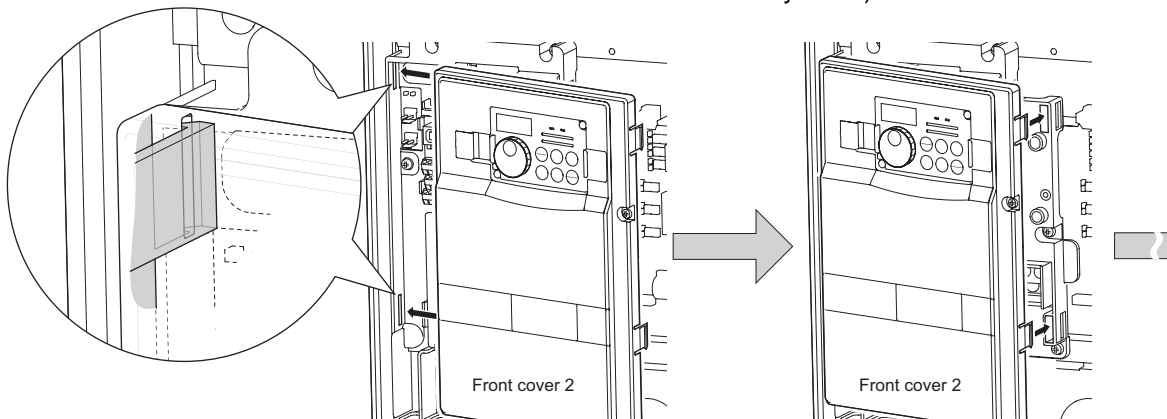

- 3) Fix the front cover 2 with the installation screws.
- 4) Fix the front cover 1 with the installation screws.

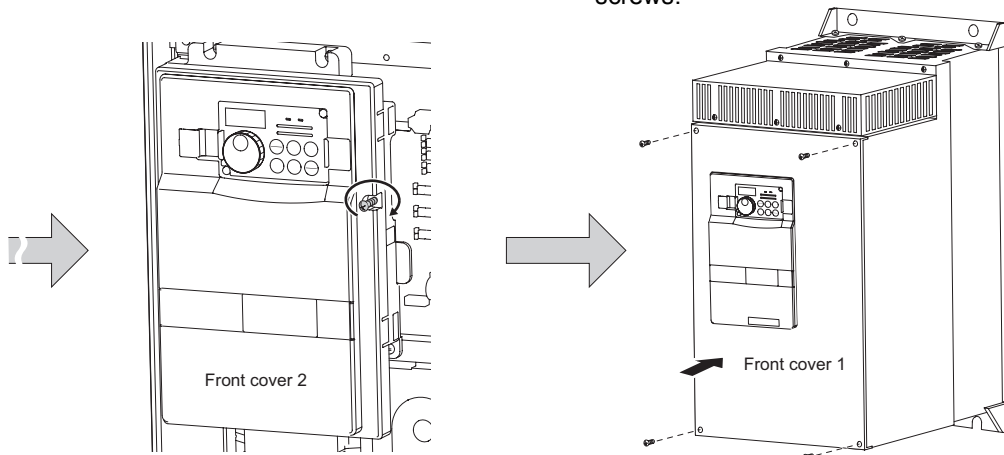

**REMARKS**

- For the 55K, the front cover 1 is separated into two parts.

**CAUTION**

1. Fully make sure that the front cover has been reinstalled securely. Always tighten the installation screws of the front cover.
2. The same serial number is printed on the capacity plate of the front cover and the rating plate of the inverter. Before reinstalling the front cover, check the serial numbers to ensure that the cover removed is reinstalled to the inverter from where it was removed.

## 1.4 Installation of the inverter and enclosure design

When an inverter enclosure is to be designed and manufactured, heat generated by contained equipment, etc., the environment of an operating place, and others must be fully considered to determine the enclosure structure, size and equipment layout. The inverter unit uses many semiconductor devices. To ensure higher reliability and long period of operation, operate the inverter in the ambient environment that completely satisfies the equipment specifications.

### 1.4.1 Inverter installation environment

The inverter consists of precision mechanical and electronic parts. Never install or handle it in any of the following conditions as doing so could cause an operation fault or failure.

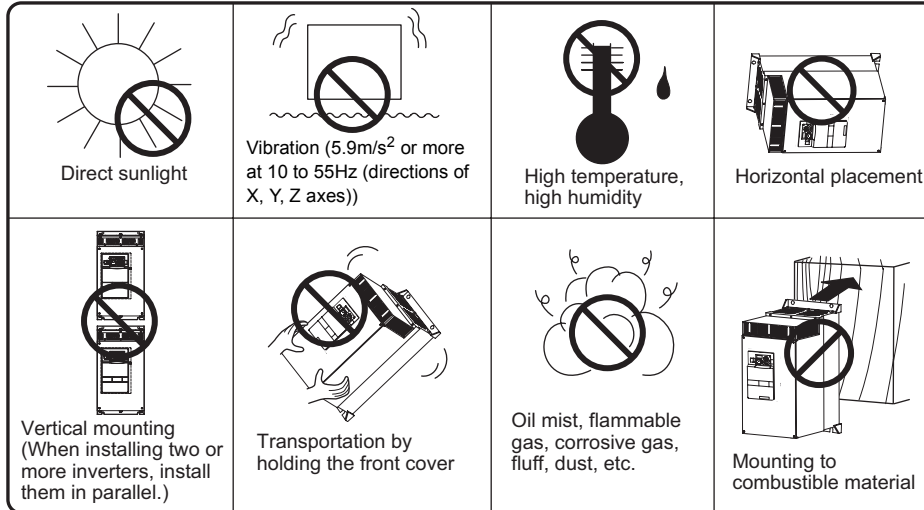

As the inverter installation environment should satisfy the standard specifications indicated in the following table, operation in any place that does not meet these conditions not only deteriorates the performance and life of the inverter, but also causes a failure. Refer to the following points and take adequate measures.

**Environmental standard specifications of inverter**

Item	Description
Surrounding air temperature	-10°C to +50°C (non-freezing)
Ambient humidity	90% RH maximum (non-condensing)
Atmosphere	Free from corrosive and explosive gases, dust and dirt
Maximum Altitude	1,000m or less
Vibration	5.9m/s <sup>2</sup> or less at 10 to 55Hz (directions of X, Y, Z axes)



## **(1) Temperature**

The permissible surrounding air temperature of the inverter is between -10°C and +50°C. Always operate the inverter within this temperature range. Operation outside this range will considerably shorten the service lives of the semiconductors, parts, capacitors and others. Take the following measures so that the surrounding air temperature of the inverter falls within the specified range.

### 1) Measures against high temperature

- Use a forced ventilation system or similar cooling system. (*Refer to page 10.*)
- Install the enclosure in an air-conditioned electrical chamber.
- Block direct sunlight.
- Provide a shield or similar plate to avoid direct exposure to the radiated heat and wind of a heat source.
- Ventilate the area around the enclosure well.

### 2) Measures against low temperature

- Provide a space heater in the enclosure.
- Do not power off the inverter. (Keep the start signal of the inverter off.)

### 3) Sudden temperature changes

- Select an installation place where temperature does not change suddenly.
- Avoid installing the inverter near the air outlet of an air conditioner.
- If temperature changes are caused by opening/closing of a door, install the inverter away from the door.

## **(2) Humidity**

Normally operate the inverter within the 45 to 90% range of the ambient humidity. Too high humidity will pose problems of reduced insulation and metal corrosion. On the other hand, too low humidity may produce a spatial electrical breakdown. The insulation distance specified in JEM1103 "Control Equipment Insulator" is defined as humidity 45 to 85%.

### 1) Measures against high humidity

- Make the enclosure enclosed, and provide it with a hygroscopic agent.
- Take dry air into the enclosure from outside.
- Provide a space heater in the enclosure.

### 2) Measures against low humidity

What is important in fitting or inspection of the unit in this status is to discharge your body (static electricity) beforehand and keep your body from contact with the parts and patterns, besides blowing air of proper humidity into the enclosure from outside.

### 3) Measures against condensation

Condensation may occur if frequent operation stops change the in-enclosure temperature suddenly or if the outside-air temperature changes suddenly.

Condensation causes such faults as reduced insulation and corrosion.

- Take the measures against high humidity in 1).
- Do not power off the inverter. (Keep the start signal of the inverter off.)

## **(3) Dust, dirt, oil mist**

Dust and dirt will cause such faults as poor contact of contact points, reduced insulation or reduced cooling effect due to moisture absorption of accumulated dust and dirt, and in-enclosure temperature rise due to clogged filter.

In the atmosphere where conductive powder floats, dust and dirt will cause such faults as malfunction, deteriorated insulation and short circuit in a short time.

Since oil mist will cause similar conditions, it is necessary to take adequate measures.

### Countermeasures

- Place in a totally enclosed enclosure.  
Take measures if the in-enclosure temperature rises. (*Refer to page 10.*)
- Purge air.  
Pump clean air from outside to make the in-enclosure pressure higher than the outside-air pressure.

#### **(4) Corrosive gas, salt damage**

If the inverter is exposed to corrosive gas or to salt near a beach, the printed board patterns and parts will corrode or the relays and switches will result in poor contact.

In such places, take the measures given in Section (3).

#### **(5) Explosive, flammable gases**

As the inverter is non-explosion proof, it must be contained in an explosion proof enclosure.

In places where explosion may be caused by explosive gas, dust or dirt, an enclosure cannot be used unless it structurally complies with the guidelines and has passed the specified tests. This makes the enclosure itself expensive (including the test charges).

The best way is to avoid installation in such places and install the inverter in a non-hazardous place.

#### **(6) Highland**

Use the inverter at the altitude of within 1000m.

If it is used at a higher place, it is likely that thin air will reduce the cooling effect and low air pressure will deteriorate dielectric strength.

#### **(7) Vibration, impact**

The vibration resistance of the inverter is up to  $5.9\text{m/s}^2$  at 10 to 55Hz frequency (directions of X, Y, Z axes) and 1mm amplitude.

Vibration or impact, if less than the specified value, applied for a long time may make the mechanism loose or cause poor contact to the connectors.

Especially when impact is imposed repeatedly, caution must be taken as the part pins are likely to break.

Countermeasures

- Provide the enclosure with rubber vibration isolators.
- Strengthen the structure to prevent the enclosure from resonance.
- Install the enclosure away from sources of vibration.



### 1.4.2 Cooling system types for inverter enclosure

From the enclosure that contains the inverter, the heat of the inverter and other equipment (transformers, lamps, resistors, etc.) and the incoming heat such as direct sunlight must be dissipated to keep the in-enclosure temperature lower than the permissible temperatures of the in-enclosure equipment including the inverter.

The cooling systems are classified as follows in terms of the cooling calculation method.

- 1) Cooling by natural heat dissipation from the enclosure surface (Totally enclosed type)
- 2) Cooling by heat sink (Aluminum heatsink, etc.)
- 3) Cooling by ventilation (Forced ventilation type, pipe ventilation type)
- 4) Cooling by heat exchanger or cooler (Heat pipe, cooler, etc.)

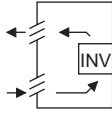
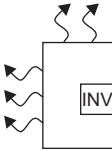
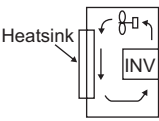
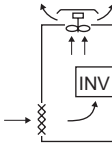
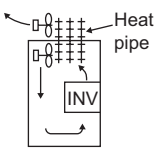
Cooling System		Enclosure Structure	Comment
Natural cooling	Natural ventilation (Enclosed, open type)		Low in cost and generally used, but the enclosure size increases as the inverter capacity increases. For relatively small capacities.
	Natural ventilation (Totally enclosed type)		Being a totally enclosed type, the most appropriate for hostile environment having dust, dirt, oil mist, etc. The enclosure size increases depending on the inverter capacity.
Forced cooling	Heatsink cooling		Having restrictions on the heatsink mounting position and area, and designed for relative small capacities.
	Forced ventilation		For general indoor installation. Appropriate for enclosure downsizing and cost reduction, and often used.
	Heat pipe		Totally enclosed type for enclosure downsizing.

### 1.4.3 Inverter placement

#### (1) Installation of the Inverter

Installation on the enclosure

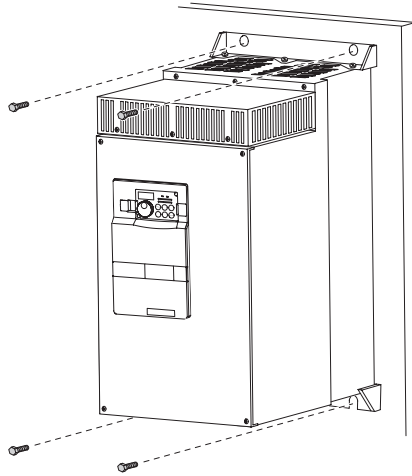

**CAUTION**

- When encasing multiple inverters, install them in parallel as a cooling measure.
- Install the inverter vertically.

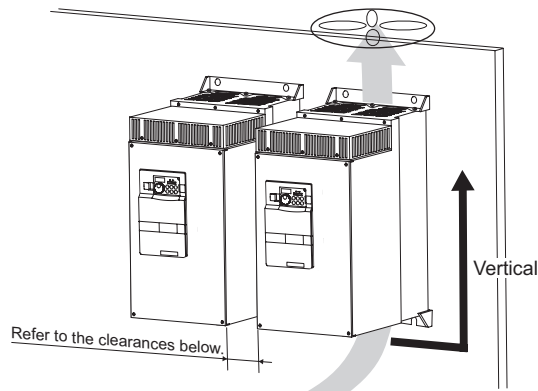

#### (2) Clearances around the inverter

To ensure ease of heat dissipation and maintenance, leave at least the shown clearances around the inverter. At least the following clearances are required under the inverter as a wiring space, and above the inverter as a heat dissipation space.

Surrounding air temperature and humidity

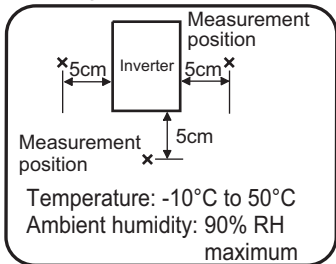

Leave enough clearances and take cooling measures.

Clearances (front)

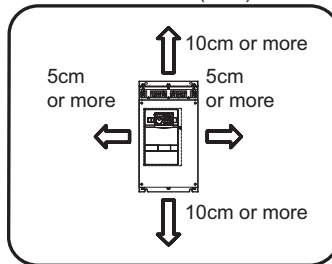

Clearances (side)

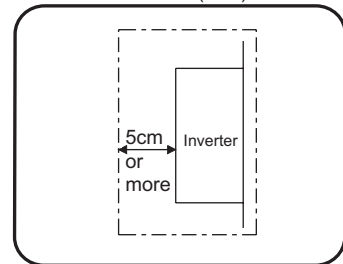

**REMARKS**

For replacing the cooling fan, 30cm of space is necessary in front of the inverter. Refer to *page 414* for fan replacement.

#### (3) Inverter mounting orientation

Mount the inverter on a wall as specified. Do not mount it horizontally or any other way.

**(4) Above the inverter**

Heat is blown up from inside the inverter by the small fan built in the unit. Any equipment placed above the inverter should be heat resistant.

**(5) Arrangement of multiple inverters**

When multiple inverters are placed in the same enclosure, generally arrange them horizontally as shown in the figure below (a). When it is inevitable to arrange them vertically to minimize space, take such measures as to provide guides since heat from the bottom inverters can increase the temperatures in the top inverters, causing inverter failures.

When mounting multiple inverters, fully take caution not to make the surrounding air temperature of the inverter higher than the permissible value by providing ventilation and increasing the enclosure size.

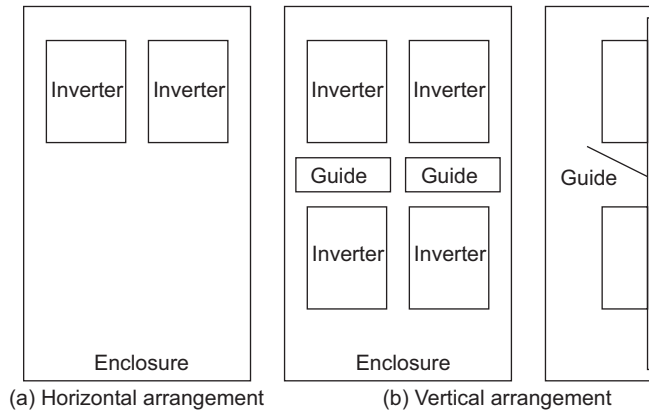

**Arrangement of multiple inverters**

**(6) Placement of ventilation fan and inverter**

Heat generated in the inverter is blown up from the bottom of the unit as warm air by the cooling fan. When installing a ventilation fan for that heat, determine the place of ventilation fan installation after fully considering an air flow. (Air passes through areas of low resistance. Make an airway and airflow plates to expose the inverter to cool air.)

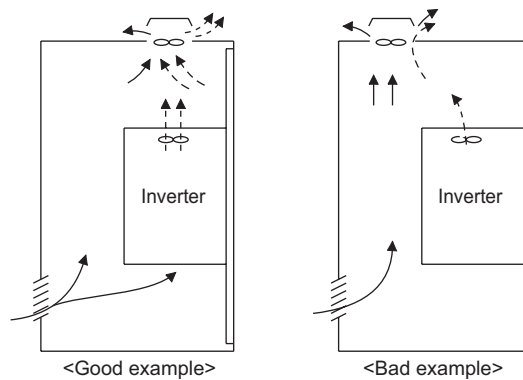

**Placement of ventilation fan and inverter**

# 2 WIRING

---

This chapter describes the basic "WIRING" for use of this product.

Always read the instructions before using the equipment.

---

2.1	Terminal connection diagram .....	14
2.2	Main circuit terminal specifications.....	15
2.3	Control circuit specifications.....	22
2.4	Connection of motor with encoder (vector control) .	30

1

2

3

4

5

6

7



## 2.1 Terminal connection diagram

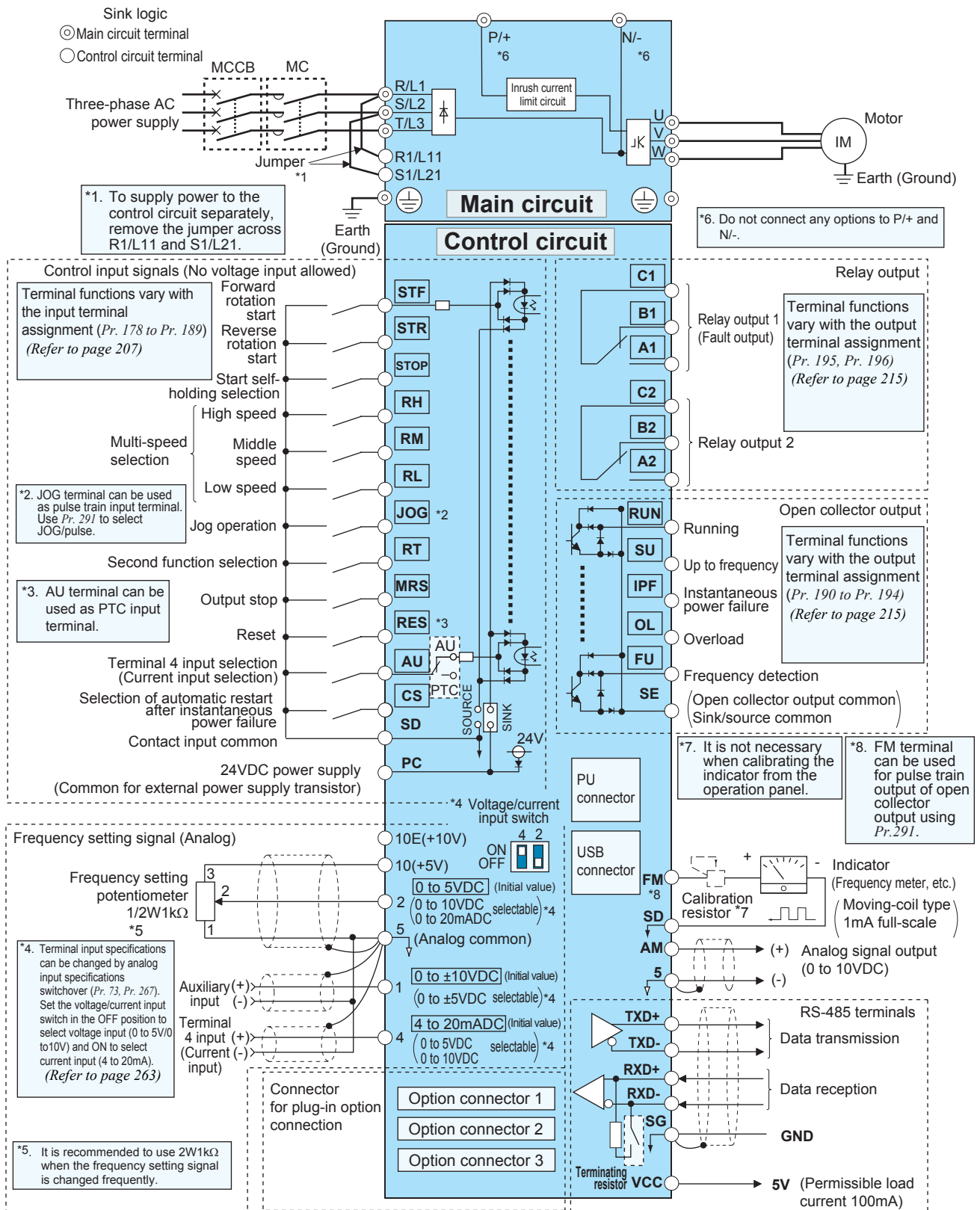

### CAUTION

- To prevent a malfunction due to noise, keep the signal cables more than 10cm away from the power cables. Also separate the main circuit wire of the input side and the output side.
- After wiring, wire offcuts must not be left in the inverter. Wire offcuts can cause an alarm, failure or malfunction. Always keep the inverter clean. When drilling mounting holes in an enclosure etc., take care not to allow chips and other foreign matter to enter the inverter.
- Set the voltage/current input switch correctly. Different setting may cause a fault, failure or malfunction.

## 2.2 Main circuit terminal specifications

### 2.2.1 Specification of main circuit terminal

Terminal Symbol	Terminal Name	Description
R/L1, S/L2, T/L3	AC power input	Connect to the commercial power supply.
U, V, W	Inverter output	Connect a three-phase squirrel-cage motor.
R1/L11, S1/L21	Power supply for control circuit	<p>Connected to the AC power supply terminals R/L1 and S/L2. To retain the fault display and fault output, remove the jumpers from terminals R/L1-R1/L11 and S/L2-S1/L21 and apply external power to these terminals. Do not turn off the power supply for control circuit (R1/L11, S1/L21) with the main circuit power (R/L1, S/L2, T/L3) on. Doing so may damage the inverter. The circuit should be configured so that the main circuit power (R/L1, S/L2, T/L3) is also turned off when the power supply for control circuit (R1/L11, S1/L21) is off.</p> <p>The following power supply capacities are required to supply power separately from R1/L11 and S1/L21: 90VA for 15K or lower, 100VA for 18.5K or higher</p>
P/+, N/-	DC terminal	Do not connect any options.
	Earth (Ground)	For earthing (grounding) the inverter chassis. Must be earthed (grounded).



## 2.2.2 Terminal arrangement of the main circuit terminal, power supply and the motor wiring

### 200V class

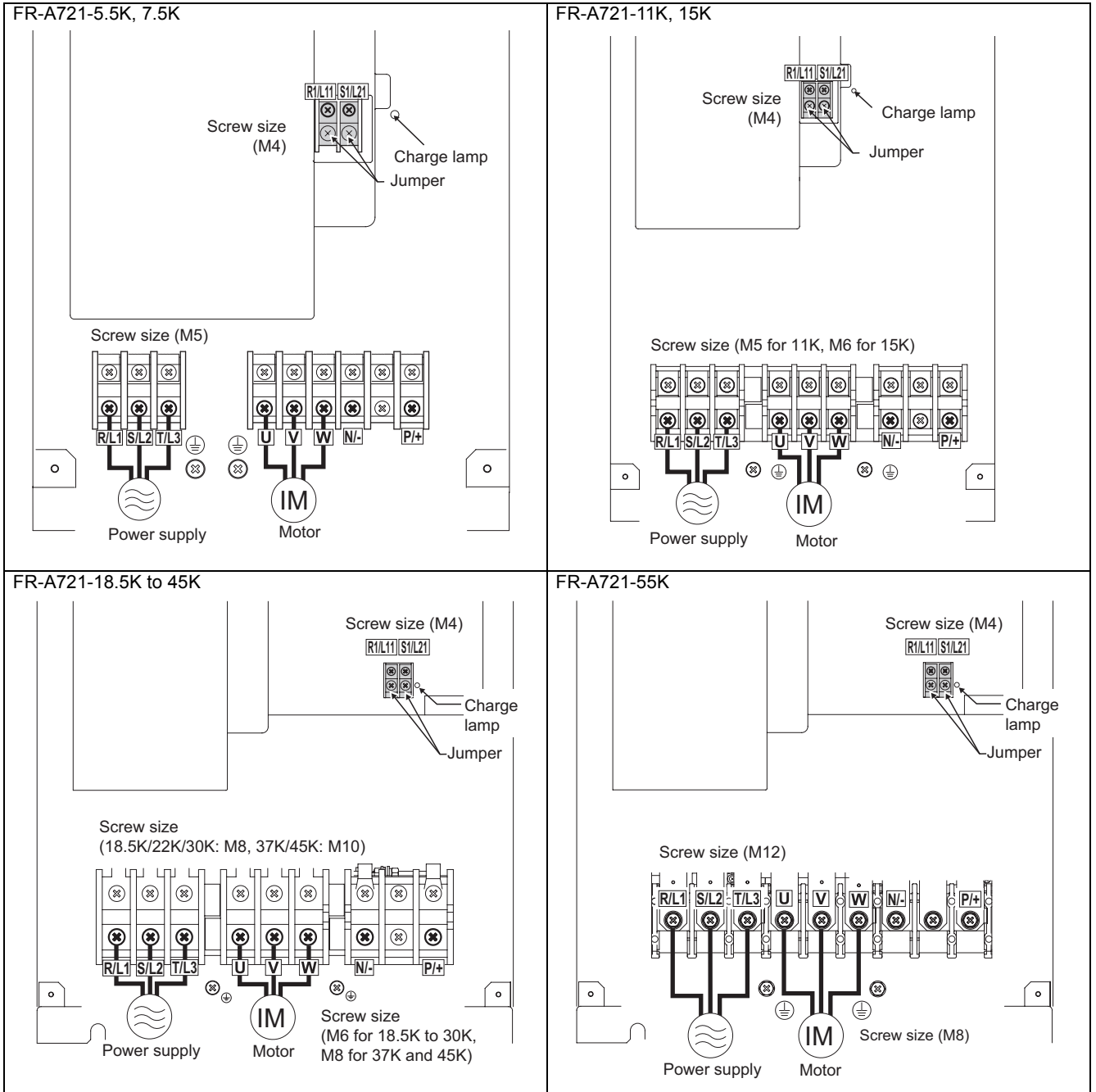



400V class

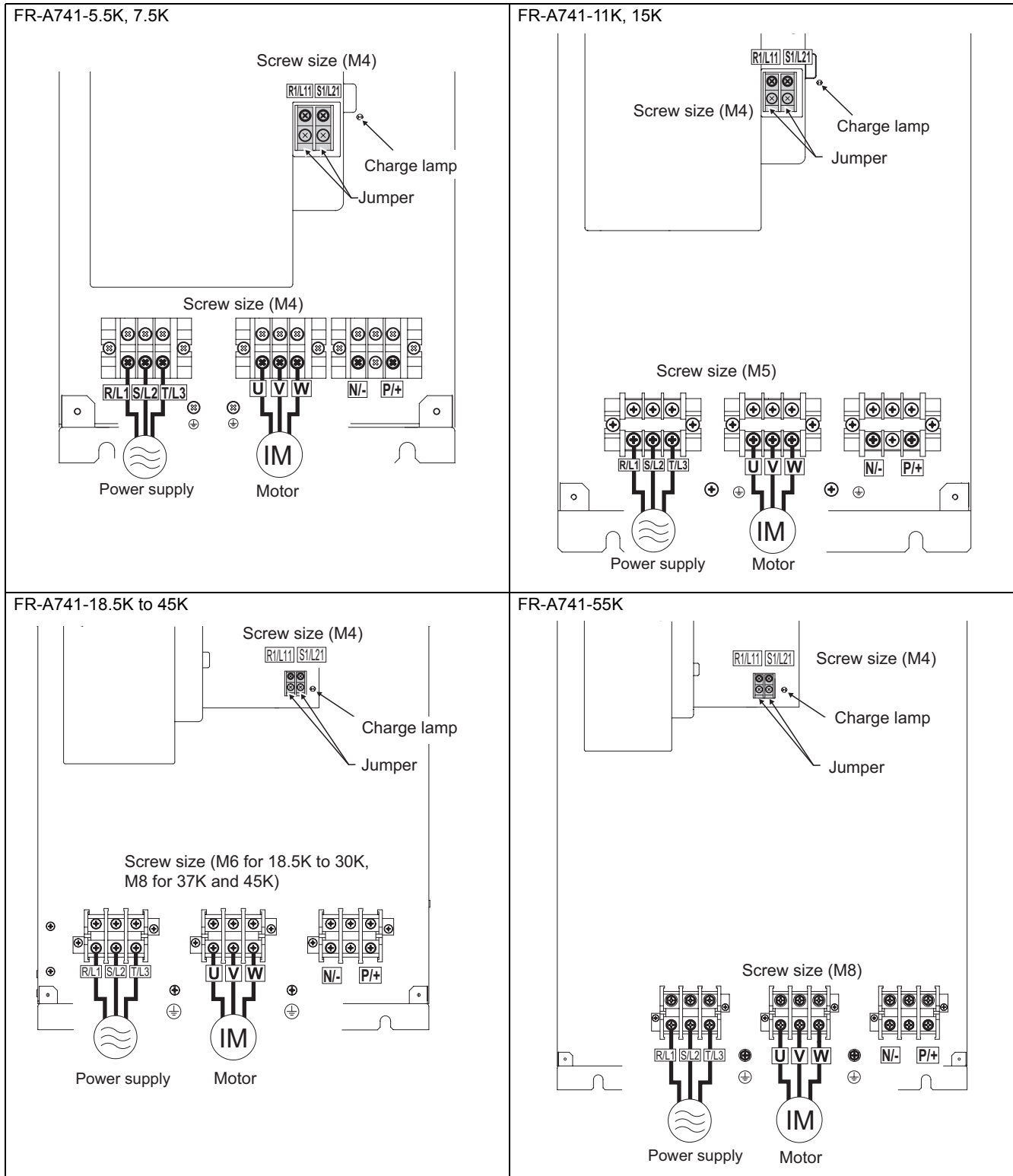

**CAUTION**

- The power supply cables must be connected to R/L1, S/L2, T/L3. (Phase sequence needs not to be matched.) Never connect the power cable to the U, V, W of the inverter. Doing so will damage the inverter.
- Connect the motor to U, V, W. At this time, turning ON the forward rotation switch (signal) rotates the motor in the counterclockwise direction when viewed from the motor shaft.





### 2.2.3 Cables and wiring length

#### (1) Applicable cable size

Select the recommended cable size to ensure that a voltage drop will be 2% or less.

If the wiring distance is long between the inverter and motor, a main circuit cable voltage drop will cause the motor torque to decrease especially at the output of a low frequency.

The following table indicates a selection example for the wiring length of 20m.

#### 200V class (when input power supply is 220V)

Applicable Inverter Model	Terminal Screw Size *4	Tightening Torque N·m	Crimping Terminal		Cable Sizes							
					HIV, etc. (mm <sup>2</sup> ) *1			AWG/MCM *2		PVC, etc. (mm <sup>2</sup> ) *3		
			R/L1, S/L2, T/L3	U, V, W	R/L1, S/L2, T/L3	U, V, W	Earthing cable	R/L1, S/L2, T/L3	U, V, W	R/L1, S/L2, T/L3	U, V, W	Earthing cable
FR-A721-5.5K	M5	2.5	5.5-5	5.5-5	5.5	5.5	5.5	10	10	6	6	6
FR-A721-7.5K	M5	2.5	14-5	8-5	14	8	5.5	6	8	16	10	16
FR-A721-11K	M5	2.5	14-5	14-5	14	14	14	6	6	16	16	16
FR-A721-15K	M6	4.4	22-6	22-6	22	22	14	4	4	25	25	16
FR-A721-18.5K	M8(M6)	7.8	38-8	38-8	38	38	22	2	2	35	35	25
FR-A721-22K	M8(M6)	7.8	38-8	38-8	38	38	22	2	2	35	35	25
FR-A721-30K	M8(M6)	7.8	60-8	60-8	60	60	22	1/0	1/0	50	50	25
FR-A721-37K	M10(M8)	14.7	80-10	80-10	80	80	22	3/0	3/0	70	70	35
FR-A721-45K	M10(M8)	14.7	100-10	100-10	100	100	38	4/0	4/0	95	95	50
FR-A721-55K	M12(M8)	24.5	100-12	100-12	100	100	38	4/0	4/0	95	95	50

\*1 The cable size is that of the cable (HIV cable (600V class 2 vinyl-insulated cable) etc.) with continuous maximum permissible temperature of 75°C. Assumes that the surrounding air temperature is 50°C or less and the wiring distance is 20m or less.

\*2 The recommended cable size is that of the cable (THHW cable) with continuous maximum permissible temperature of 75°C. Assumes that the surrounding air temperature is 40°C or less and the wiring distance is 20m or less.  
(Selection example for use mainly in the United States.)

\*3 For the 15K or lower, the recommended cable size is that of the cable (PVC cable) with continuous maximum permissible temperature of 70°C. Assumes that the surrounding air temperature is 40°C or less and the wiring distance is 20m or less.  
For the 18.5K or higher, the recommended cable size is that of the cable (XLPE cable) with continuous maximum permissible temperature of 90°C. Assumes that the surrounding air temperature is 40°C or less and wiring is performed in an enclosure.  
(Selection example for use mainly in Europe.)

\*4 The terminal screw size indicates the terminal size for R/L1, S/L2, T/L3, U, V, W, and a screw for earthing (grounding).  
A screw for earthing (grounding) of the 18.5K or higher is indicated in ( ).

#### 400V class (when input power supply is 440V)

Applicable Inverter Model	Terminal Screw Size *4	Tightening Torque N·m	Crimping Terminal		Cable Sizes							
					HIV, etc. (mm <sup>2</sup> ) *1			AWG/MCM *2		PVC, etc. (mm <sup>2</sup> ) *3		
			R/L1, S/L2, T/L3	U, V, W	R/L1, S/L2, T/L3	U, V, W	Earthing Cable	R/L1, S/L2, T/L3	U, V, W	R/L1, S/L2, T/L3	U, V, W	Earthing Cable
FR-A741-5.5K	M4	1.5	2-4	2-4	2	2	3.5	12	14	2.5	2.5	4
FR-A741-7.5K	M4	1.5	5.5-4	5.5-4	3.5	3.5	3.5	12	12	4	4	4
FR-A741-11K	M5	2.5	5.5-5	5.5-5	5.5	5.5	8	10	10	6	6	10
FR-A741-15K	M5	2.5	8-5	8-5	8	8	8	8	8	10	10	10
FR-A741-18.5K	M6	4.4	14-6	8-6	14	8	14	6	8	16	10	16
FR-A741-22K	M6	4.4	14-6	14-6	14	14	14	6	6	16	16	16
FR-A741-30K	M6	4.4	22-6	22-6	22	22	14	4	4	25	25	16
FR-A741-37K	M8	7.8	22-8	22-8	22	22	14	4	4	25	25	16
FR-A741-45K	M8	7.8	38-8	38-8	38	38	22	1	2	50	50	25
FR-A741-55K	M8	7.8	60-8	60-8	60	60	22	1/0	1/0	50	50	25

\*1 The cable size is that of the cable (HIV cable (600V class 2 vinyl-insulated cable) etc.) with continuous maximum permissible temperature of 75°C. Assumes that the surrounding air temperature is 50°C or less and the wiring distance is 20m or less.

\*2 For the 45K or lower, the recommended cable size is that of the cable (THHW cable) with continuous maximum permissible temperature of 75°C. Assumes that the surrounding air temperature is 40°C or less and the wiring distance is 20m or less.  
For the 55K, the recommended cable size is that of the cable (THHN cable) with continuous maximum permissible temperature of 90°C. Assumes that the surrounding air temperature is 40°C or less and wiring is performed in an enclosure.  
(Selection example for use mainly in the United States.)

\*3 For the 45K or lower, the recommended cable size is that of the cable (PVC cable) with continuous maximum permissible temperature of 70°C. Assumes that the ambient temperature is 40°C or less and the wiring distance is 20m or less.  
For the 55K, the recommended cable size is that of the cable (XLPE cable) with continuous maximum permissible temperature of 90°C. Assumes that the ambient temperature is 40°C or less and wiring is performed in an enclosure.  
(Selection example for use mainly in Europe.)

The line voltage drop can be calculated by the following formula:

$$\text{Line voltage drop [V]} = \frac{\sqrt{3} \times \text{wire resistance [m}\Omega/\text{m]} \times \text{wiring distance [m]} \times \text{current [A]}}{1000}$$

Use a larger diameter cable when the wiring distance is long or when it is desired to decrease the voltage drop (torque reduction) in the low speed range.

**CAUTION**

- Tighten the terminal screw to the specified torque.  
A screw that has been tighten too loosely can cause a short circuit or malfunction.
- A screw that has been tighten too tightly can cause a short circuit or malfunction due to the unit breakage.
- Use crimping terminals with insulation sleeve to wire the power supply and motor.

**(2) Notes on earthing (grounding)**

- Always earth (ground) the motor and inverter.

1) Purpose of earthing (grounding)

Generally, an electrical apparatus has an earth (ground) terminal, which must be connected to the ground before use.

An electrical circuit is usually insulated by an insulating material and encased. However, it is impossible to manufacture an insulating material that can shut off a leakage current completely, and actually, a slight current flow into the case. The purpose of earthing (grounding) the case of an electrical apparatus is to prevent operator from getting an electric shock from this leakage current when touching it.

To avoid the influence of external noises, this earthing (grounding) is important to audio equipment, sensors, computers and other apparatuses that handle low-level signals or operate very fast.

2) Earthing (grounding) methods and earthing (grounding) work

As described previously, earthing (grounding) is roughly classified into an electrical shock prevention type and a noise-affected malfunction prevention type. Therefore, these two types should be discriminated clearly, and the following work must be done to prevent the leakage current having the inverter's high frequency components from entering the malfunction prevention type earthing (grounding):

- (a) If possible, use (I) independent earthing (grounding) in figure below for the inverter. If independent earthing (grounding) is not available, use (II) joint earthing (grounding) in the figure below which the inverter is connected with the other equipment at an earthing (grounding) point. The (III) common earthing (grounding) as in the figure below, which inverter shares a common earth (ground) cable with the other equipment, must be avoided.

A leakage current including many high frequency components flows in the earth (ground) cables of the inverter and inverter-driven motor. Therefore, use the independent earthing (grounding) and separated the earthing (grounding) cable of the inverter from equipments sensitive to EMI.

In a high building, it may be effective to use the EMI prevention type earthing (grounding) connecting to an iron structure frame, and electric shock prevention type earthing (grounding) with the independent earthing (grounding) together.

- (b) This inverter must be earthed (grounded). Earthing (Grounding) must conform to the requirements of national and local safety regulations and electrical codes. (NEC section 250, IEC 536 class 1 and other applicable standards).

Use a neutral-point earthed (grounded) power supply for 400V class inverter in compliance with EN standard.

- (c) Use the thickest possible earth (ground) cable. The earth (ground) cable should be of not less than the size indicated in the table on the previous page.
- (d) The grounding point should be as near as possible to the inverter, and the ground wire length should be as short as possible.
- (e) Run the earth (ground) cable as far away as possible from the I/O wiring of equipment sensitive to noises and run them in parallel in the minimum distance.

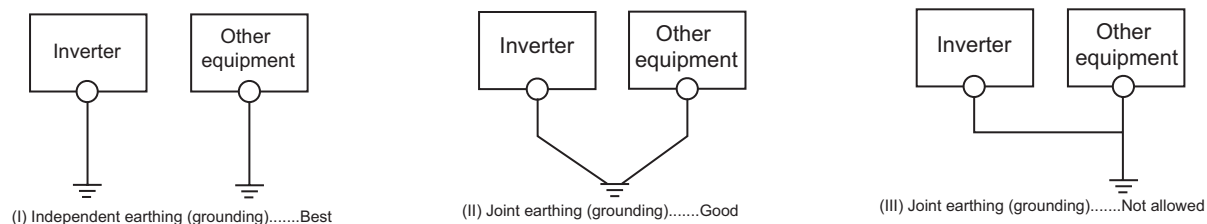



### (3) Total wiring length

The overall wiring length for the connection to a single motor or multiple motors should be within 500m.  
(The wiring length should be within 100m for the operation under vector control.)

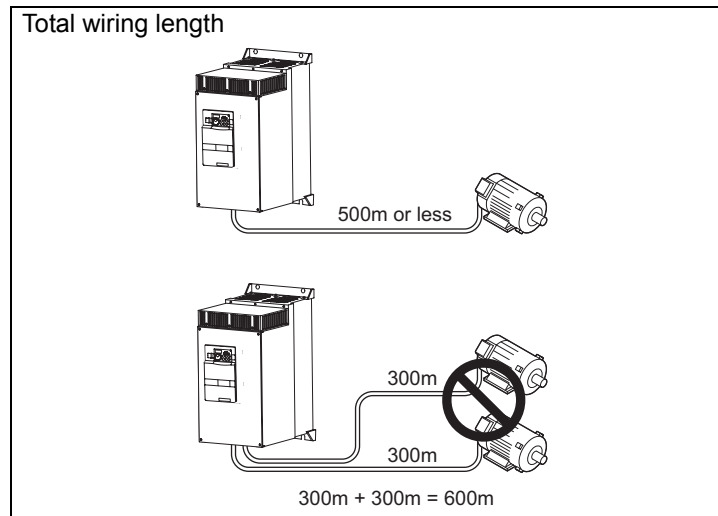

When driving a 400V class motor by the inverter, surge voltages attributable to the wiring constants may occur at the motor terminals, deteriorating the insulation of the motor.  
Refer to *page 45* for measures against deteriorated insulation.

---

#### CAUTION

---

- Especially for long-distance wiring, the inverter may be affected by a charging current caused by the stray capacitances of the wiring, leading to a malfunction of the overcurrent protective function or fast response current limit function or a malfunction or fault of the equipment connected on the inverter output side. If fast response current limit function malfunctions, disable this function. (For *Pr. 156 Stall prevention operation selection, refer to page 135*.)
  - For explanation of the surge voltage suppression filter (FR-ASF-H/FR-BMF-H) and sine wave filter (MT-BSL/BSC), refer to the manual of each option.
  - Do not connect a surge voltage suppression filter (FR-ASF-H/FR-BMF-H) during the operation under vector control.
- 

### (4) Cable size of the control circuit power supply (terminal R1/L11, S1/L21)

- Terminal screw size: M4
- Cable size: 0.75mm<sup>2</sup> to 2mm<sup>2</sup>
- Tightening torque: 1.5N·m

**2.2.4 When connecting the control circuit and the main circuit separately to the power supply**

<Connection diagram>

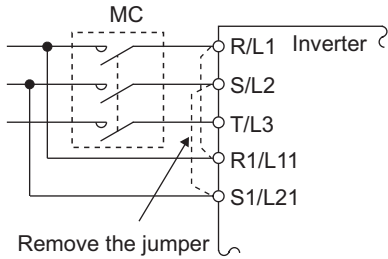

When fault occurs, opening of the electromagnetic contactor (MC) on the inverter power supply side results in power loss in the control circuit, disabling the fault output signal retention. Terminals R1/L11 and S1/L21 are provided to hold a fault signal. In this case, connect the power supply terminals R1/L11 and S1/L21 of the control circuit to the input side of the MC. Do not connect the power cable to incorrect terminals. Doing so may damage the inverter.

- 1) Remove the upper screws.
- 2) Remove the lower screws.
- 3) Pull the jumper toward you to remove.
- 4) Connect the separate power supply cable to the **upper terminals (R1/L11, S1/L21).**

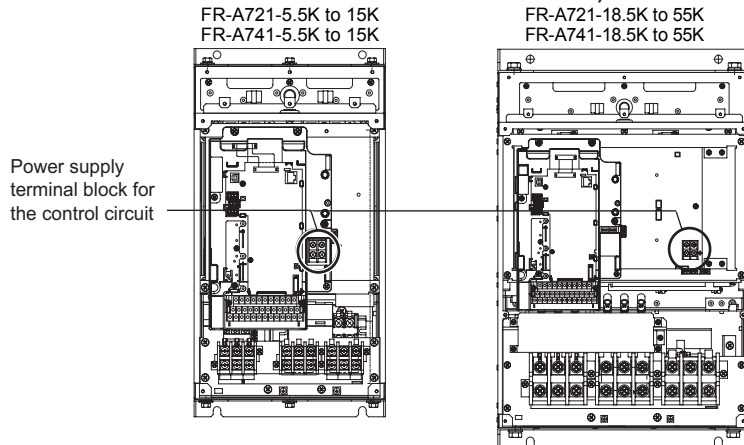
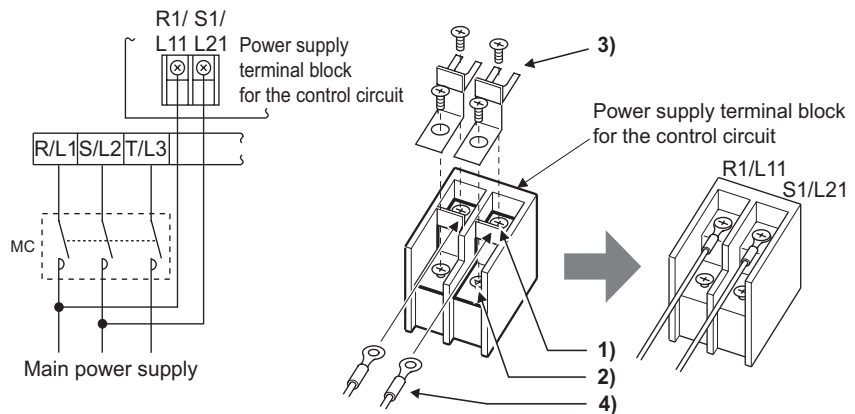

**CAUTION**

- Do not turn off the control power (terminals R1/L11 and S1/L21) with the main circuit power (R/L1, S/L2, T/L3) on. Doing so may damage the inverter. Make up a circuit which will switch off the main circuit power supply terminals R/L1, S/L2, T/L3 when the control circuit power supply terminals R1/L11, S1/L21 are switched off.
- Be sure to use the inverter with the jumpers across terminals R/L1 and R1/L11 and across terminals S/L2 and S1/L21 removed when supplying power from other sources. The inverter may be damaged if you do not remove the jumper.
- The voltage should be the same as that of the main control circuit when the control circuit power is supplied from other than the input side of the MC.
- When separate power is supplied from R1/L11 and S1/L21, the power capacity necessary for the 15K or lower is 90VA, for the 18.5K or higher is 100VA.
- If the main circuit power is switched OFF (for 0.1s or more) then ON again, the inverter resets and a fault output will not be held.



## 2.3 Control circuit specifications

### 2.3.1 Control circuit terminals

□ indicates that terminal functions can be selected using Pr. 178 to Pr. 196 (I/O terminal function selection) (Refer to page 207.)

#### (1) Input signals

Type	Terminal Symbol	Terminal Name	Description		Rated Specifications	Refer to page	
Contact input	STF	Forward rotation start	Turn ON the STF signal to start forward rotation and turn it OFF to stop.	When the STF and STR signals are turned ON simultaneously, the stop command is given.	Input resistance 4.7kΩ Voltage at opening: 21 to 27VDC Contacts at short-circuited: 4 to 6mADC	207	
	STR	Reverse rotation start	Turn ON the STR signal to start reverse rotation and turn it OFF to stop.				
	STOP	Start self-holding selection	Turn ON the STOP signal to self-hold the start signal.			207	
	RH, RM, RL	Multi-speed selection	Multi-speed can be selected according to the combination of RH, RM and RL signals.			207	
	JOG	Jog mode selection	Turn ON the JOG signal to select Jog operation (initial setting) and turn ON the start signal (STF or STR) to start Jog operation.		Input resistance 2kΩ Contacts at short-circuited: 8 to 13mADC	207	
		Pulse train input	JOG terminal can be used as pulse train input terminal. To use as pulse train input terminal, the Pr. 291 setting needs to be changed. (maximum input pulse: 100kulses/s)				
	RT	Second function selection	Turn ON the RT signal to select second function. When the second function such as "second torque boost" and "second V/F (base frequency)" are set, turning on the RT signal selects these functions.		Input resistance 4.7kΩ Voltage at opening: 21 to 27VDC Contacts at short-circuited: 4 to 6mADC	207	
	MRS	Output stop	Turn ON the MRS signal (20ms or more) to stop the inverter output. Use to shut off the inverter output when stopping the motor by electromagnetic brake.				207
	RES	Reset	Used to reset fault output provided when fault occurs. Turn ON the RES signal for more than 0.1s, then turn it OFF. Initial setting is for reset always. By setting Pr. 75, reset can be set to enabled only at fault occurrence. Recover about 1s after reset is cancelled.				207
	AU	Terminal 4 input selection	Terminal 4 is valid only when the AU signal is turned ON. (The frequency setting signal can be set between 4 and 20mADC.) Turning the AU signal ON makes terminal 2 (voltage input) invalid.		Input resistance 4.7kΩ Voltage at opening: 21 to 27VDC Contacts at short-circuited: 4 to 6mADC	263	
		PTC input	AU terminal is used as PTC input terminal (thermal protection of the motor). When using it as PTC input terminal, set the AU/PTC switch to PTC.				168
	CS	Selection of automatic restart after instantaneous power failure	When the CS signal is left ON, the inverter restarts automatically at power restoration. Note that restart setting is necessary for this operation. In the initial setting, a restart is disabled. (Refer to Pr. 57 Restart coasting time in page 243)		—	—	
	SD	Contact input common (sink) (initial setting)	Common terminal for contact input terminal (sink logic) and terminal FM.				
		External transistor common (source)	When connecting the transistor output (open collector output), such as a programmable controller, when source logic is selected, connect the external power supply common for transistor output to this terminal to prevent a malfunction caused by undesirable currents.				
24VDC power supply common		Common output terminal for 24VDC 0.1A power supply (PC terminal). Isolated from terminals 5 and SE.					
PC	External transistor common (sink) (initial setting)	When connecting the transistor output (open collector output), such as a programmable controller, when sink logic is selected, connect the external power supply common for transistor output to this terminal to prevent a malfunction caused by undesirable currents.		Power supply voltage range 19.2 to 28.8VDC Permissible load current 100mA	26		
	Contact input common (source)	Common terminal for contact input terminal (source logic).					
	24VDC power supply	Can be used as 24VDC 0.1A power supply.					



Type	Terminal Symbol	Terminal Name	Description	Rated Specifications	Refer to page	
Frequency setting	10E	Frequency setting power supply	When connecting the frequency setting potentiometer at an initial status, connect it to terminal 10.	10VDC±0.4V Permissible load current 10mA	263	
	10		Change the input specifications of terminal 2 when connecting it to terminal 10E. (Refer to Pr. 73 Analog input selection.)	5.2VDC±0.2V Permissible load current 10mA	263	
	2	Frequency setting (voltage)	Inputting 0 to 5VDC (or 0 to 10V, 0 to 20mA) provides the maximum output frequency at 5V (10V, 20mA) and makes input and output proportional. Use Pr. 73 to switch from among input 0 to 5VDC (initial setting), 0 to 10VDC, and 0 to 20mA. Set the voltage/current input switch in the ON position to select current input (0 to 20mA). *1	Voltage input: Input resistance 10kΩ ± 1kΩ Maximum permissible voltage 20VDC	263	
	4	Frequency setting (current)	Inputting 4 to 20mADC (or 0 to 5V, 0 to 10V) provides the maximum output frequency at 20mA makes input and output proportional. This input signal is valid only when the AU signal is ON (terminal 2 input is invalid). Use Pr. 267 to switch from among input 4 to 20mA (initial setting), 0 to 5VDC, and 0 to 10VDC. Set the voltage/current input switch in the OFF position to select voltage input (0 to 5V/0 to 10V). *1 Use Pr. 858 to switch terminal functions.	Current input: Input resistance 245Ω ± 5Ω Maximum permissible current 30mA		263
	1	Frequency setting auxiliary	Inputting 0 to ±5 VDC or 0 to ±10VDC adds this signal to terminal 2 or 4 frequency setting signal. Use Pr. 73 to switch between the input 0 to ±5VDC and 0 to ±10VDC (initial setting). Use Pr. 868 to switch terminal functions.	Input resistance 10kΩ ± 1kΩ Maximum permissible voltage ± 20VDC		
	5	Frequency setting common	Common terminal for frequency setting signal (terminal 2, 1 or 4) and analog output terminal AM. Do not earth (ground).	—	263	

\*1 Set Pr. 73, Pr. 267, and a voltage/current input switch correctly, then input an analog signal in accordance with the setting. Applying a voltage signal with voltage/current input switch ON (current input is selected) or a current signal with switch OFF (voltage input is selected) could cause component damage of the inverter or analog circuit of signal output devices. (For details, refer to page 263.)

## (2) Output signals

Type	Terminal Symbol	Terminal Name	Description	Rated Specifications	Refer to page
Relay	A1, B1, C1	Relay output 1 (alarm output)	1 changeover contact output indicates that the inverter protective function has activated and the output stopped. Fault: No conduction between B and C (conduction between A and C) Normal: Conduction between B and C (No conduction between A and C)	Contact capacity: 230VAC 0.3A (Power factor=0.4) 30VDC 0.3A	215
	A2, B2, C2	Relay output 2	1 changeover contact output		215



Type	Terminal Symbol	Terminal Name	Description	Rated Specifications	Refer to page	
Open collector	RUN	Inverter running	Switched low when the inverter output frequency is equal to or higher than the starting frequency (initial value 0.5Hz). Switched high during stop or DC injection brake operation. *1	Permissible load 24VDC (27VDC maximum) 0.1A (A voltage drop is 2.8V maximum when the signal is on.) *1 Low is when the open collector output transistor is ON (conducts). High is when the transistor is OFF (does not conduct).	215	
	SU	Up to frequency	Switched low when the output frequency reaches within the range of $\pm 10\%$ (initial value) of the set frequency. Switched high during acceleration/ deceleration and at a stop. *1		Alarm code (4 bits) output (Refer to page 252)	215
	OL	Overload warning	Switched low when stall prevention is activated by the stall prevention function. Switched high when stall prevention is cancelled. *1			215
	IPF	Instantaneous power failure	Switched low when an instantaneous power failure and under voltage protections are activated. *1			215
	FU	Frequency detection	Switched low when the inverter output frequency is equal to or higher than the preset detected frequency and high when less than the preset detected frequency. *1			215
	SE	Open collector output common	Common terminal for terminals RUN, SU, OL, IPF, FU		—	—
Pulse	FM	For meter	Select one e.g. output frequency from monitor items. Not output during inverter reset. The output signal is proportional to the magnitude of the corresponding monitoring item. To set a full-scale value for monitoring the output frequency and the output current, set Pr. 56 and Pr.158.	Output item: Output frequency (initial setting)	Permissible load current 2mA 1440pulses/s at 60Hz	229
		NPN open collector output		Signals can be output from the open collector terminals by setting Pr. 291.	Maximum output pulse: 50kpulses/s Permissible load current : 80mA	356
Analog	AM	Analog signal output		Output item: Output frequency (initial setting)	Output signal 0 to 10VDC Permissible load current 1mA (load impedance 10k $\Omega$ or more) Resolution 8 bit	229

### (3) Communication

Type	Terminal Symbol	Terminal Name	Description	Refer to page	
RS-485	—	PU connector	With the PU connector, communication can be made through RS-485. (for connection on a 1:1 basis only) . Conforming standard : EIA-485 (RS-485) . Transmission format : Multidrop link . Communication speed : 4800 to 38400bps . Overall length : 500m	305	
	RS-485 terminals	TXD+	Inverter transmission terminal	With the RS-485 terminals, communication can be made through RS-485. Conforming standard : EIA-485 (RS-485) Transmission format : Multidrop link Communication speed : 300 to 38400bps Overall length : 500m	307
		TXD-			
		RXD+	Inverter reception terminal		
		RXD-			
SG	Earth (Ground)				
USB	—	USB connector	The FR Configurator can be used by connecting the inverter to the personal computer through USB. Interface:Conforms to USB1.1 Transmission speed:12Mbps Connector:USB B connector (B receptacle)	337	

### 2.3.2 Changing the control logic

The input signals are set to sink logic (SINK) when shipped from the factory.

To change the control logic, the jumper connector on the back of the control circuit terminal block must be moved to the other position.

(The output signals may be used in either the sink or source logic independently of the jumper connector position.)

1) Loosen the two installation screws in both ends of the control circuit terminal block. (These screws cannot be removed.)

Pull down the terminal block from behind the control circuit terminals.

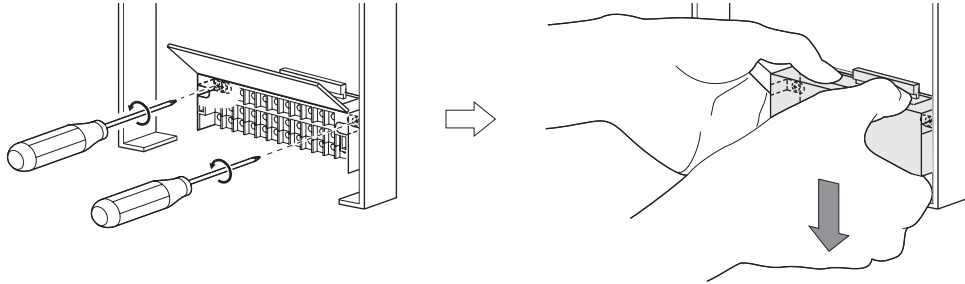

2) Change the jumper connector set to the sink logic (SINK) on the rear panel of the control circuit terminal block to source logic (SOURCE).

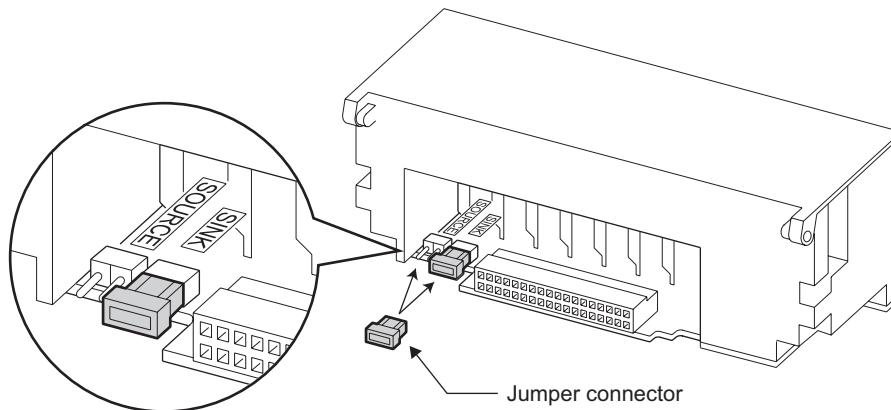

3) Using care not to bend the pins of the inverter's control circuit connector, reinstall the control circuit terminal block and fix it with the mounting screws.

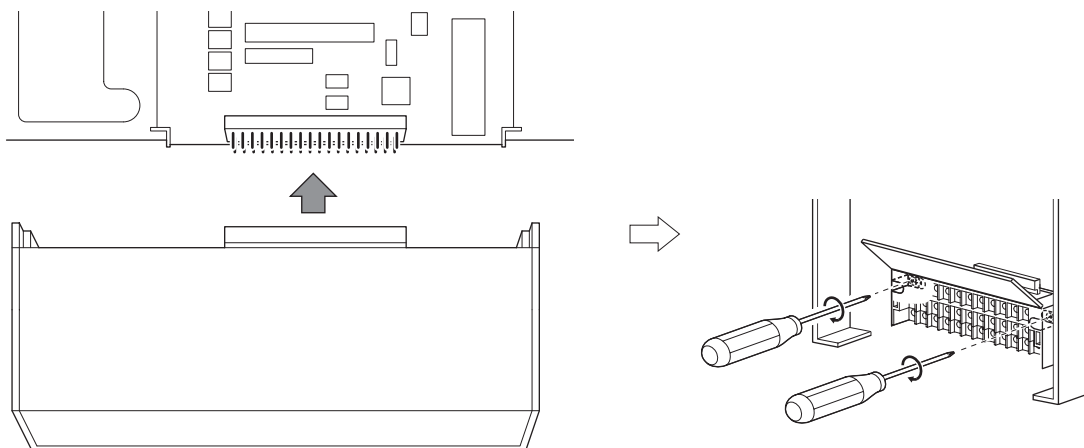

#### CAUTION

1. Make sure that the control circuit connector is fitted correctly.
2. While power is ON, never disconnect the control circuit terminal block.





4) Sink logic and source logic

- In sink logic, a signal switches ON when a current flows from the corresponding signal input terminal. Terminal SD is common to the contact input signals. Terminal SE is common to the open collector output signals.
- In source logic, a signal switches ON when a current flows into the corresponding signal input terminal. Terminal PC is common to the contact input signals. Terminal SE is common to the open collector output signals.

● Current flow concerning the input/output signal when sink logic is selected

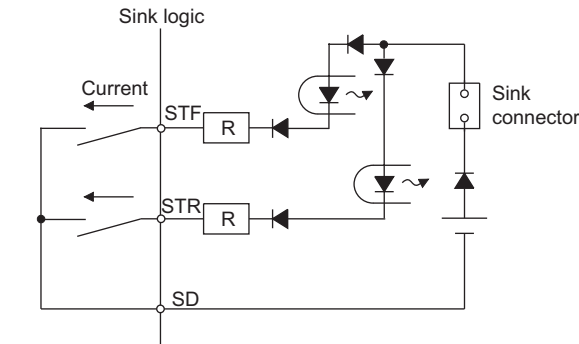

● Current flow concerning the input/output signal when source logic is selected

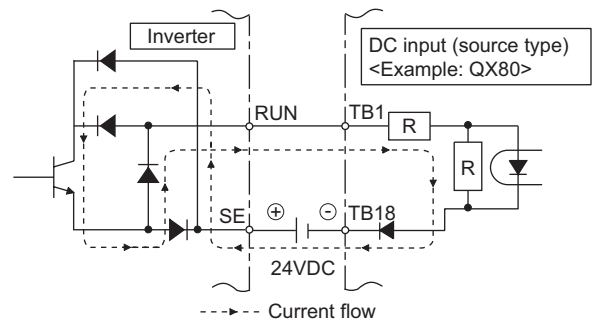
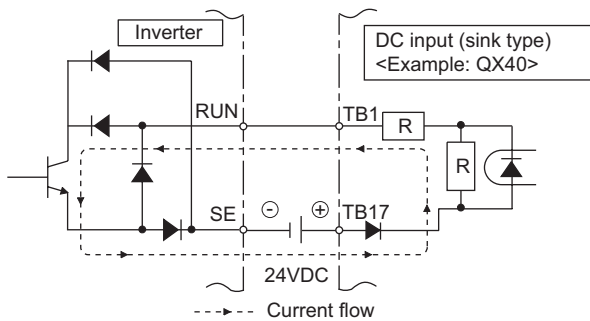
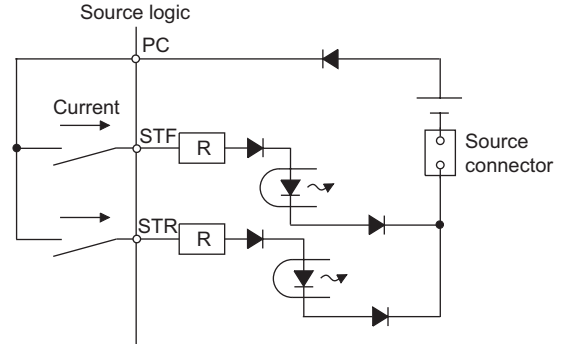

● When using an external power supply for transistor output

· Sink logic type  
Use terminal PC as a common terminal, and perform wiring as shown below. (Do not connect terminal SD of the inverter with terminal 0V of the external power supply. When using terminals PC and SD as a 24VDC power supply, do not install a power supply in parallel in the outside of the inverter. Doing so may cause a malfunction due to undesirable currents.)

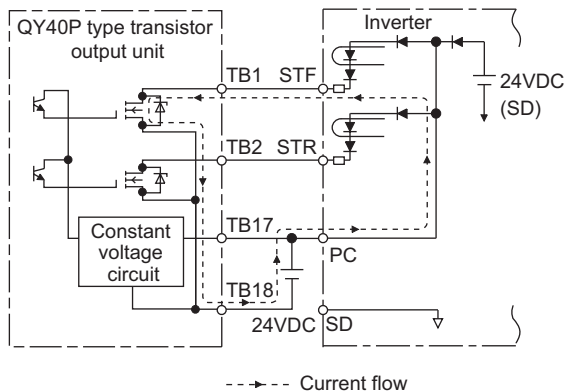

· Source logic type  
Use terminal SD as a common terminal, and perform wiring as shown below. (Do not connect terminal PC of the inverter with terminal +24V of the external power supply. When using terminals PC and SD as a 24VDC power supply, do not install an external power supply in parallel with the inverter. Doing so may cause a malfunction in the inverter due to undesirable currents.)

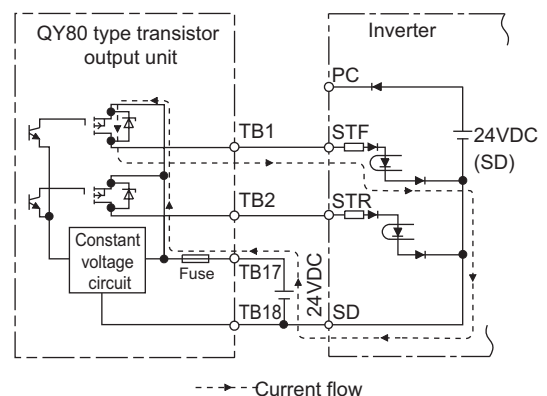

### 2.3.3 Control circuit terminal layout

Terminal screw size: M3.5

Tightening torque: 1.2N·m

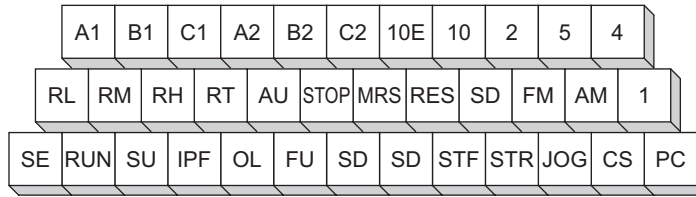

#### (1) Common terminals of the control circuit (SD, 5, SE)

Terminals SD, 5, and SE are all common terminals (0V) for I/O signals and are isolated from each other. Do not earth (ground) these terminals.

Avoid connecting the terminal SD and 5 and the terminal SE and 5.

Terminal SD is a common terminal for the contact input terminals (STF, STR, STOP, RH, RM, RL, JOG, RT, MRS, RES, AU, CS) and frequency output signal (FM).

The open collector circuit is isolated from the internal control circuit by photocoupler.

Terminal 5 is a common terminal for frequency setting signal (terminal 2, 1 or 4) and analog output terminal AM.

It should be protected from external noise using a shielded or twisted cable.

Terminal SE is a common terminal for the open collector output terminal (RUN, SU, OL, IPF, FU).

The contact input circuit is isolated from the internal control circuit by photocoupler.

#### (2) Signal inputs by contactless switches

The contacted input terminals of the inverter (STF, STR, STOP, RH, RM, RL, JOG, RT, MRS, RES, AU, CS) can be controlled using a transistor instead of a contacted switch as shown on the right.

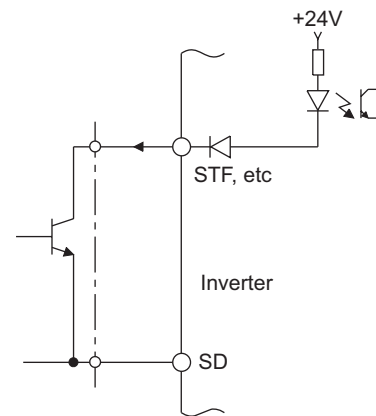

External signal input using transistor

### 2.3.4 Wiring instructions

- 1) It is recommended to use the cables of 0.75mm<sup>2</sup> gauge for connection to the control circuit terminals. If the cable gauge used is 1.25mm<sup>2</sup> or more, the front cover may be lifted when there are many cables running or the cables are run improperly, resulting in an operation panel contact fault.
- 2) The wiring length should be 30m(200m for terminal FM) maximum.
- 3) Use two or more parallel micro-signal contacts or twin contacts to prevent a contact faults when using contact inputs since the control circuit input signals are micro-currents.

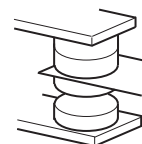

Micro signal contacts

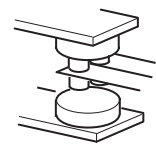

Twin contacts

- 4) Use shielded or twisted cables for connection to the control circuit terminals and run them away from the main and power circuits (including the 200V relay sequence circuit).
- 5) Do not apply a voltage to the contact input terminals (e.g. STF) of the control circuit.
- 6) Always apply a voltage to the fault output terminals (A, B, C) via a relay coil, lamp, etc.



### 2.3.5 When connecting the operation panel using a connection cable

Having an operation panel on the enclosure surface is convenient. With a connection cable, you can mount the operation panel (FR-DU07) to the enclosure surface, and connect it to the inverter.

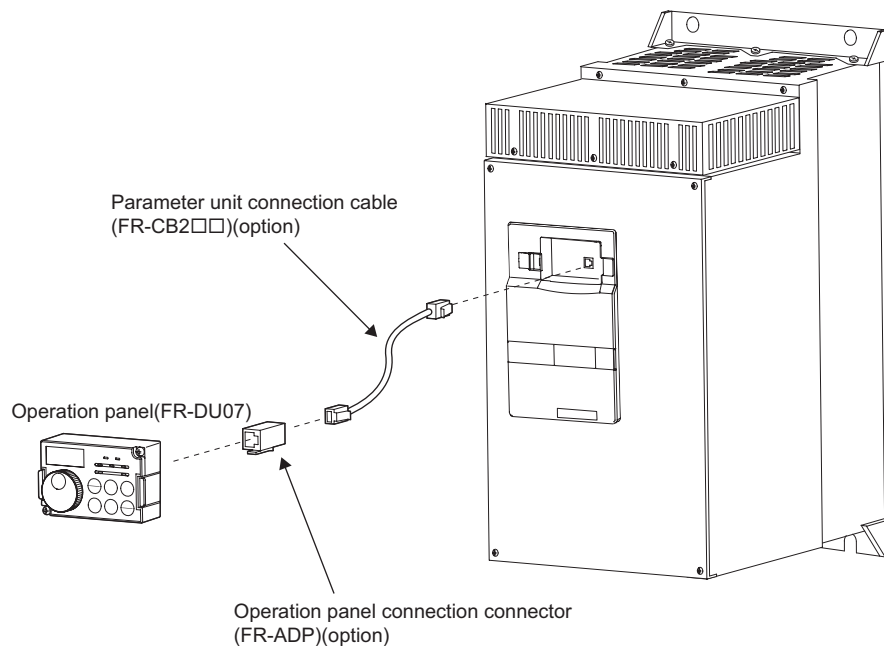

#### CAUTION

Do not connect the PU connector to the computer's LAN port, FAX modem socket or telephone connector. The inverter and machine could be damaged due to differences in electrical specifications.

#### REMARKS

- Refer to *page 5* for removal method of the operation panel.
- Overall wiring length when the operation panel is connected: 20m maximum
- Refer to the following when fabricating the cable on the user side.  
Commercially available product examples (as of January 2010)

	Product	Type	Manufacturer
1)	Communication cable	SGLPEV-T (Cat5e/300m) 24AWG × 4P	Mitsubishi Cable Industries, Ltd.
2)	RJ-45 connector	5-554720-3	Tyco Electronics

- The inverter can be connected to the computer and FR-PU04/FR-PU07.

### 2.3.6 RS-485 terminal block

- Conforming standard: EIA-485(RS-485)
- Transmission format: Multidrop link
- Communication speed: MAX 38400bps
- Overall length: 500m
- Connection cable: Twisted pair cable (4 pairs)

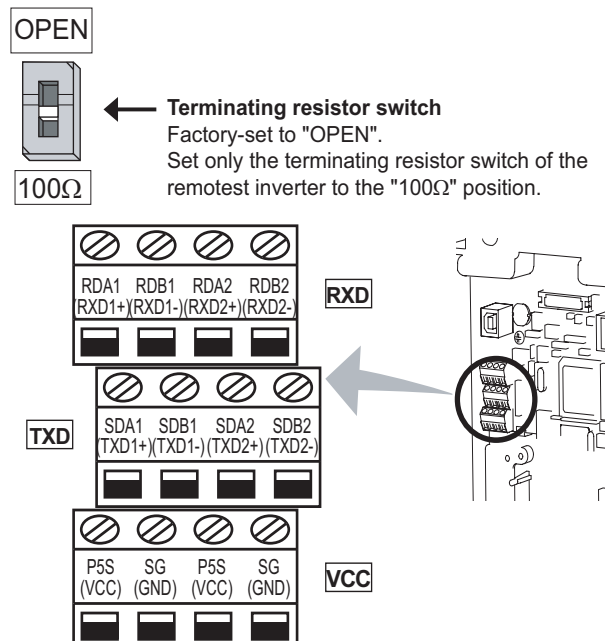



### 2.3.7 Communication operation

Using the PU connector or RS-485 terminal, you can perform communication operation from a personal computer etc. When the PU connector is connected with a personal, FA or other computer by a communication cable, a user program can run and monitor the inverter or read and write to parameters.

For the Mitsubishi inverter protocol (computer link operation), communication can be performed with the PU connector and RS-485 terminal.

For the Modbus-RTU protocol, communication can be performed with the RS-485 terminal.

For further details, refer to page 305.

## 2.4 Connection of motor with encoder (vector control)

Orientation control and encoder feedback control, and speed control, torque control and position control by full-scale vector control operation can be performed using a motor with encoder and a plug-in option FR-A7AP.

### (1) Structure of the FR-A7AP

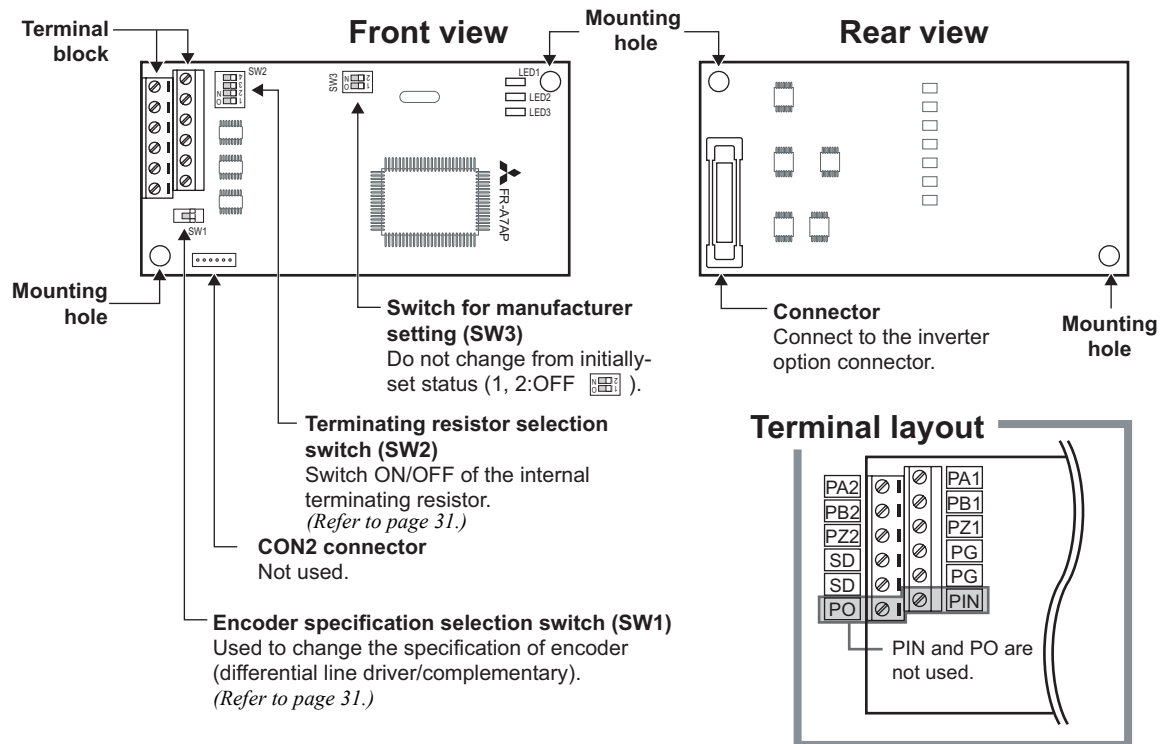

### (2) Terminals of the FR-A7AP

Terminal	Terminal Name	Description
PA1	Encoder A-phase signal input terminal	A-, B- and Z-phase signals are input from the encoder.
PA2	Encoder A-phase inverse signal input terminal	
PB1	Encoder B-phase signal input terminal	
PB2	Encoder B-phase inverse signal input terminal	
PZ1	Encoder Z-phase signal input terminal	
PZ2	Encoder Z-phase inversion signal input terminal	
PG	Encoder power supply (positive side) input terminal	Input terminal for the encoder power supply. Connect the external power supply (5V, 12V, 15V, 24V) and the encoder power cable.
SD	Encoder power supply ground terminal	
PIN	Not used.	
PO		

(3) Switches of the FR-A7AP

- Encoder specification selection switch (SW1)  
Select either differential line driver or complementary  
It is initially set to the differential line driver. Switch its position according to output circuit.
- Terminating resistor selection switch (SW2)  
Select ON/OFF of the internal terminating resistor. Set the switch to ON (initial status) when an encoder output type is differential line driver and set to OFF when complementary.  
ON : with internal terminating resistor (initial status)  
OFF : without internal terminating resistor

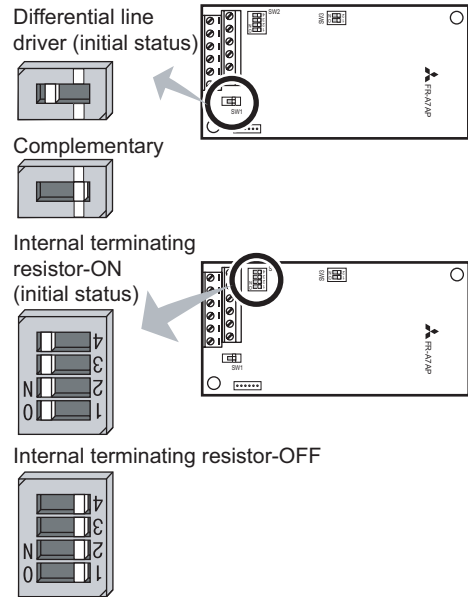

**REMARKS**

- Set all switches to the same setting (ON/OFF).
- If the encoder output type is differential line driver, set the terminating resistor switch to the "OFF" position when sharing the same encoder with other unit (NC (numerical controller), etc.) or a terminating resistor is connected to other unit.

• Motor used and switch setting

Motor		Encoder Specification Selection Switch (SW1)	Terminating Resistor Selection Switch (SW2)	Power Specifications *2
Mitsubishi standard motor with encoder Mitsubishi high efficiency motor with encoder	SF-JR	Differential	ON	5V
	SF-HR	Differential	ON	5V
	Others	*1	*1	*1
Mitsubishi constant-torque motor with encoder	SF-JRCA	Differential	ON	5V
	SF-HRCA	Differential	ON	5V
	Others	*1	*1	*1
Vector control dedicated motor	SF-V5RU	Complimentary	OFF	12V
Other manufacturer motor with encoder	-	*1	*1	*1

\*1 Set according to the motor (encoder) used.

\*2 Choose a power supply (5V/12V/15V/24V) for encoder according to the encoder used.

**CAUTION**

SW3 switch is for manufacturer setting. Do not change the setting.

• Encoder specification

Item	Encoder for SF-JR/HR/JRCA/HRCA	Encoder for SF-V5RU
Resolution	1024 Pulse/Rev	2048 Pulse/Rev
Power supply voltage	5VDC±10%	12VDC±10%
Current consumption	150mA	150mA
Output signal form	A, B phases (90° phase shift) Z phase: 1 pulse/rev	A, B phases (90° phase shift) Z phase: 1 pulse/rev
Output circuit	Differential line driver 74LS113 equivalent	Complimentary
Output voltage	H level: 2.4V or more L level: 0.5V or less	H level: "Power supply for encoder-3V" or more L level: 3V or less

**CAUTION**

Encoder with resolution of 1000 to 4096 pulse/rev is recommended.

(4) Encoder Cable

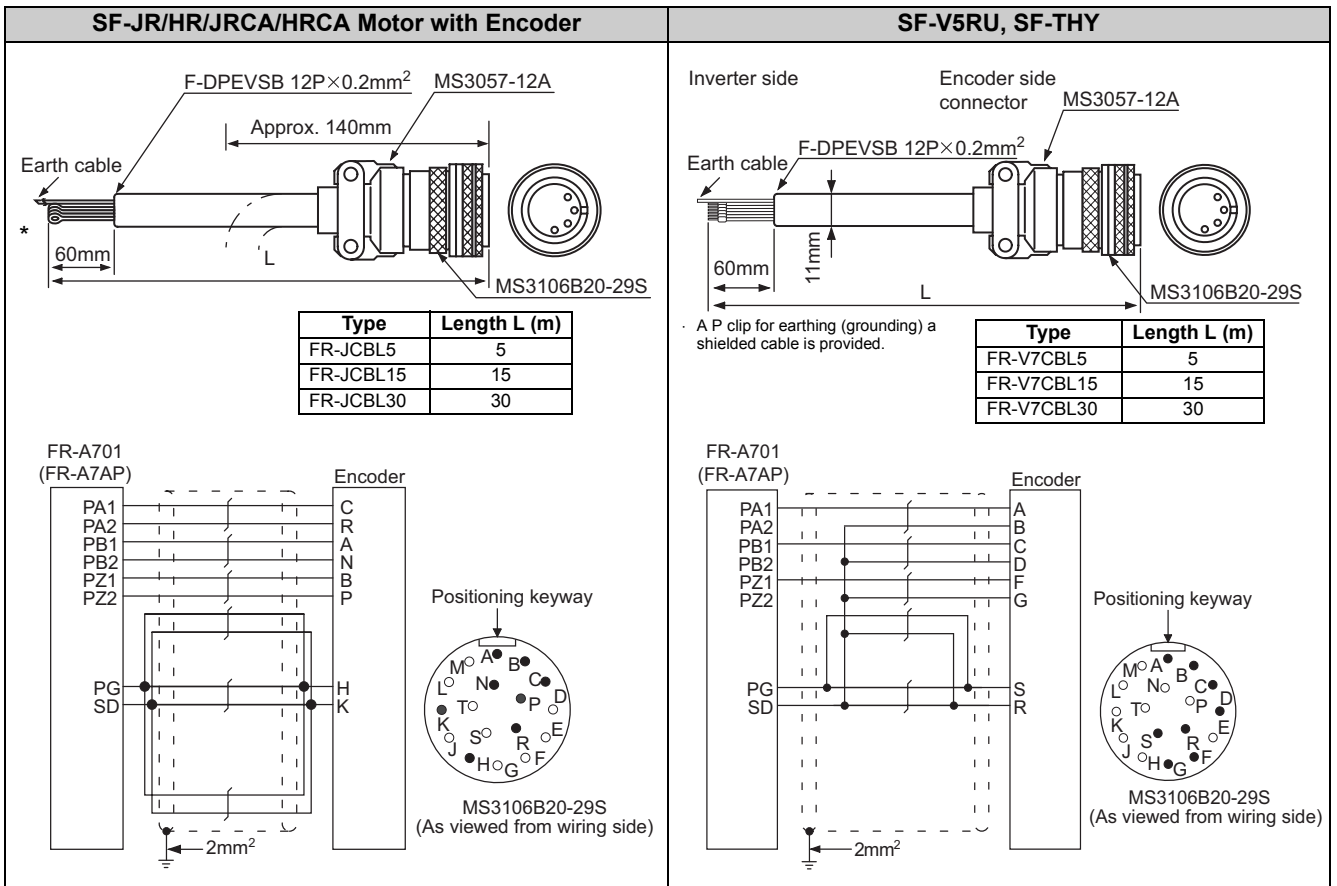

\* As the terminal block of FR-A7AP is an insertion type, earthing cables need to be modified. (See below)

- When using the dedicated encoder cable (FR-JCBL, FR-V5CBL, etc.) for the conventional motor, cut the crimping terminal of the encoder cable and strip its sheath to make its cables loose.

Also, protect the shielded cable of the twisted pair shielded cable to ensure that it will not make contact with the conductive area.

Wire the stripped wire after twisting it to prevent it from becoming loose. In addition, do not solder it.



Use a blade terminal as necessary.

**REMARKS**

**Information on blade terminals**

Commercially available product examples (as of January 2010)

- Phoenix Contact Co.,Ltd.

Terminal Screw Size	Wire Size (mm <sup>2</sup> )	Blade Terminal Model		Blade terminal crimping tool
		with insulation sleeve	without insulation sleeve	
M2	0.3, 0.5	Al 0,5-6WH	A 0,5-6	CRIMPFOX 6

- NICHIFU Co.,Ltd.

Terminal Screw Size	Wire Size (mm <sup>2</sup> )	Blade terminal product number	Insulation product number	Blade terminal crimping tool
M2	0.3 to 0.75	BT 0.75-7	VC 0.75	NH 67

When using the blade terminal (without insulation sleeve), use care so that the twisted wires do not come out.



**Connection terminal compatibility table**

Motor	SF-V5RU, SF-THY	SF-JR/HR/JRCA/HRCA (with Encoder)
<b>Encoder cable</b>	<b>FR-V7CBL</b>	<b>FR-JCBL</b>
FR-A7AP terminal		
PA1	PA	PA
PA2	Keep this open.	PAR
PB1	PB	PB
PB2	Keep this open.	PBR
PZ1	PZ	PZ
PZ2	Keep this open.	PZR
PG	PG	5E
SD	SD	AG2

(5) Wiring

- Speed control

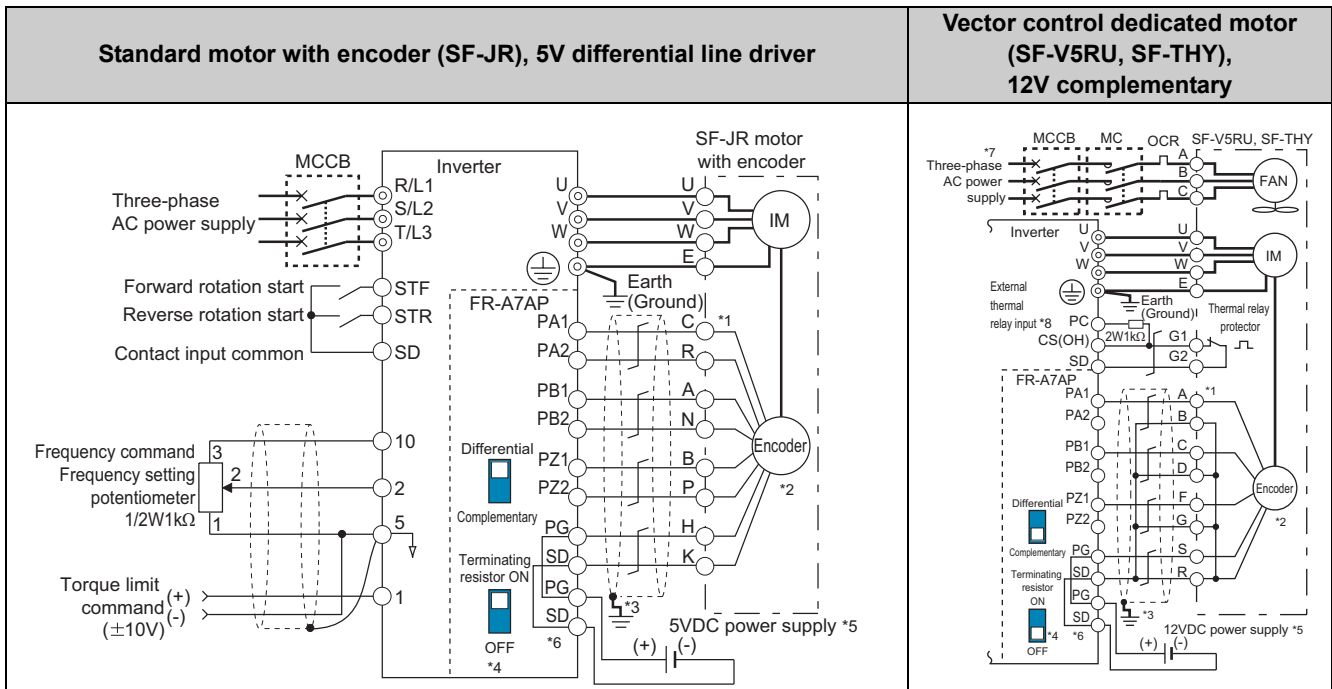

- Torque control

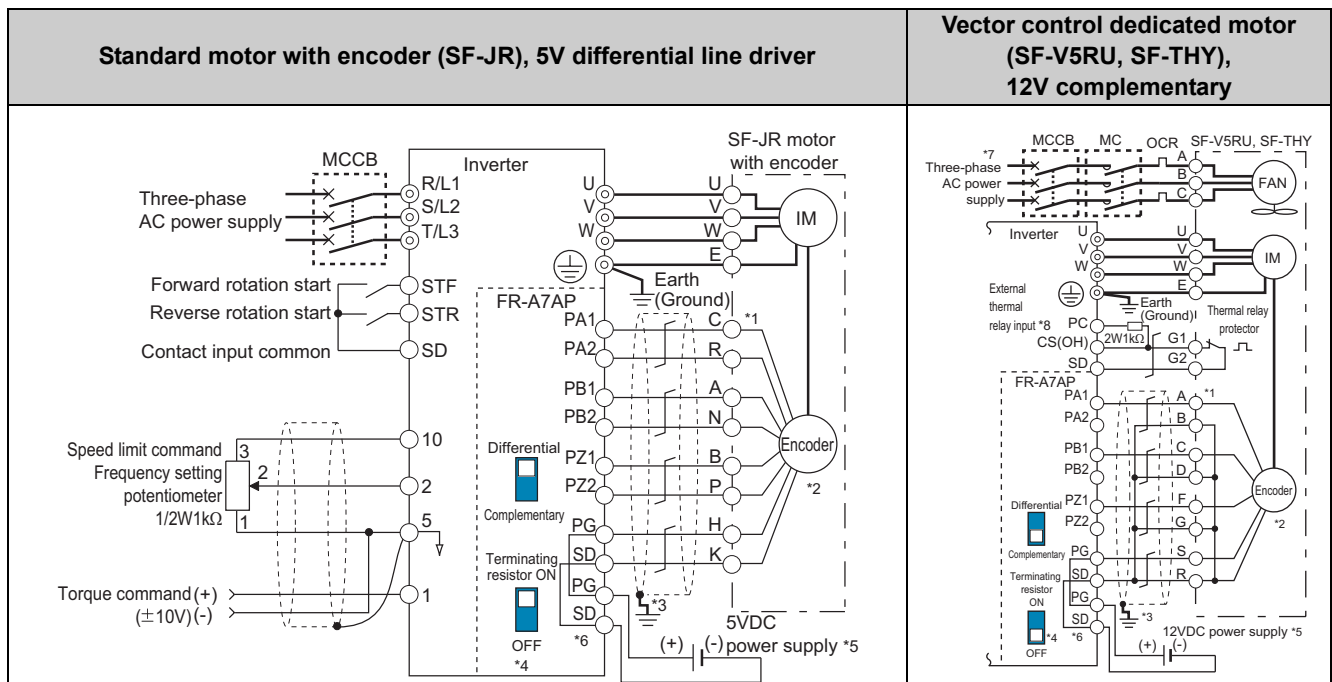



- Position control

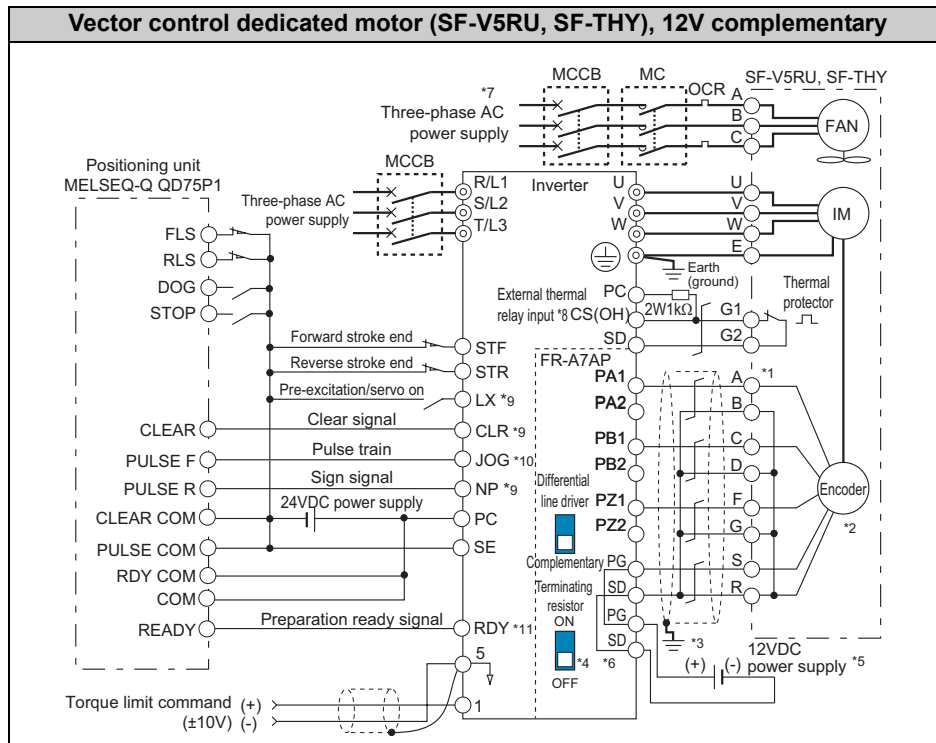

- \*1 The pin number differs according to the encoder used.  
Speed control, torque control, and position control by pulse train input are properly performed without the connection of the Z-phase.
- \*2 Connect the encoder so that there is no looseness between the motor and motor shaft. Speed ratio should be 1:1.
- \*3 Earth (Ground) the shielded cable of the encoder cable to the enclosure with a P clip, etc. (Refer to page 35.)
- \*4 For the complementary, set the terminating resistor selection switch to off position. (Refer to page 31.)
- \*5 A separate power supply of 5V/12V/15V/24V is necessary according to the encoder power specification.
- \*6 For terminal compatibility of the FR-JCBL, FR-V7CBL and FR-A7AP, refer to page 33.
- \*7 For the fan of the 7.5kW or less dedicated motor, the power supply is single phase. (200V/50Hz, 200 to 230V/60Hz)
- \*8 Assign OH (external thermal input) signal to the terminal CS. (Set "7" in Pr. 186 )  
Connect a 2W1kΩ resistor between the terminal PC and CS (OH). Install the resistor pushing against the bottom part of the terminal block so as to avoid a contact with other cables.  
*Refer to page 207 for details of Pr. 186 CS terminal function selection.*
- \*9 Assign the function using Pr. 178 to Pr. 184, Pr. 187 to Pr. 189 (input terminal function selection).
- \*10 When position control is selected, terminal JOG function is invalid and the simple position pulse train input terminal becomes valid.
- \*11 Assign the function using Pr. 190 to Pr. 194 (output terminal function selection).

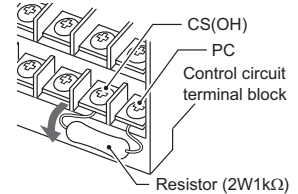

(6) Instructions for encoder cable wiring

- Use twisted pair shield cables (0.2mm<sup>2</sup> or larger) to connect the FR-A7AP and position detector. Cables to terminals PG and SD should be connected in parallel or be larger in size according to the cable length.  
To protect the cables from noise, run them away from any source of noise (e.g. the main circuit and power supply voltage).

Wiring Length	Parallel Connection	Cable gauge	Larger-Size Cable
Within 10m	At least two cables in parallel	0.2mm <sup>2</sup>	0.4mm <sup>2</sup> or larger
Within 20m	At least four cables in parallel		0.75mm <sup>2</sup> or larger
Within 100m *	At least six cables in parallel		1.25mm <sup>2</sup> or larger

\* When differential line driver is set and a wiring length is 30m or more

The wiring length can be extended to 100m by slightly increasing the power by 5V (approx. 5.5V) using six or more cables with gauge size of 0.2mm<sup>2</sup> in parallel or a cable with gauge size of 1.25mm<sup>2</sup> or more. Note that the voltage applied should be within power supply specifications of encoder.

- To reduce noise of the encoder cable, earth (ground) the encoder shielded cable to the enclosure (as near as the inverter) with a P clip or U clip made of metal.

Earthing (grounding) example using a P clip

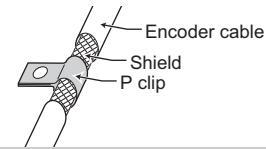

**REMARKS**

- For details of the optional encoder dedicated cable (FR-JCBL/FR-V7CBL), refer to page 32.
- The FR-V7CBL is provided with a P clip for earthing (grounding) shielded cable.

(7) Parameter for encoder (Pr. 359, Pr. 369)

Parameter Number	Name	Initial Value	Setting Range	Description
359	Encoder rotation direction	1	0	<p>Forward rotation is clockwise rotation when viewed from A.</p>
			1	<p>Forward rotation is counterclockwise rotation when viewed from A.</p>
369	Number of encoder pulses	1024	0 to 4096	Set the number of encoder pulses output. Set the number of pulses before it is multiplied by 4.

The above parameters can be set when the FR-A7AP (option) is mounted.

(8) Motor for vector control and parameter setting

Motor Name	Pr. 9 Electronic thermal O/L relay	Pr. 71 Applied motor	Pr. 80 Motor capacity	Pr. 81 Number of motor poles	Pr. 359 Encoder rotation direction	Pr. 369 Number of encoder pulses	
Mitsubishi standard motor	SF-JR	Motor rated current	<b>0</b>	Motor capacity	Number of motor poles	<b>1</b>	<b>1024</b>
	SF-HR	Motor rated current	<b>40</b>	Motor capacity	Number of motor poles	<b>1</b>	<b>1024</b>
	Others	Motor rated current	3 *1	Motor capacity	Number of motor poles	*2	*2
Mitsubishi constant-torque motor	SF-JRCA 4P	Motor rated current	<b>1</b>	Motor capacity	<b>4</b>	<b>1</b>	<b>1024</b>
	SF-HRCA	Motor rated current	<b>50</b>	Motor capacity	Number of motor poles	<b>1</b>	<b>1024</b>
	Others	Motor rated current	13 *1	Motor capacity	Number of motor poles	*2	*2
Mitsubishi vector control dedicated motor	SF-V5RU (1500r/min series)	0 *3	<b>30</b>	Motor capacity	<b>4</b>	<b>1</b>	<b>2048</b>
	SF-V5RU (except for 1500r/min series)	0 *3	13 *1	Motor capacity	<b>4</b>	<b>1</b>	<b>2048</b>
	SF-THY	0 *3	33 *1	Motor capacity	<b>4</b>	<b>1</b>	<b>2048</b>
Other manufacturer's standard motor	—	Motor rated current	3 *1	Motor capacity	Number of motor poles	*2	*2
Other manufacturer's constant-torque motor	—	Motor rated current	13 *1	Motor capacity	Number of motor poles	*2	*2

Values in the bolded frame are initial values.

- \*1 Offline auto tuning is necessary. (Refer to page 171)
- \*2 Set this parameter according to the motor (encoder) used.
- \*3 Use thermal protector input provided with the motor.

◆ Parameters referred to ◆

- Vector control (speed control) Refer to page 81.
- Vector control (torque control) Refer to page 107.
- Vector control (position control) Refer to page 115.
- Orientation control Refer to page 196.
- Encoder feedback control Refer to page 359.

- (9) Combination with a vector control dedicated motor  
 Refer to the table below when using with a vector control dedicated motor.

- Combination with the SF-V5RU

Voltage		200V class			400V class		
Rated speed		1500r/min					
Base frequency		50Hz					
Maximum speed		3000r/min					
Motor capacity	Motor frame number	Motor model	Inverter model	Motor frame number	Motor model	Inverter model	
3.7kW	112M	SF-V5RU3K	FR-A721-5.5K	—	—	—	
5.5kW	132S	SF-V5RU5K	FR-A721-7.5K	132S	SF-V5RUH5K	FR-A741-7.5K	
7.5kW	132M	SF-V5RU7K	FR-A721-11K	132M	SF-V5RUH7K	FR-A741-11K	
11kW	160M	SF-V5RU11K	FR-A721-15K	160M	SF-V5RUH11K	FR-A741-15K	
15kW	160L	SF-V5RU15K	FR-A721-18.5K	160L	SF-V5RUH15K	FR-A741-18.5K	
18.5kW	180M	SF-V5RU18K	FR-A721-22K	180M	SF-V5RUH18K	FR-A741-22K	
22kW	180M	SF-V5RU22K	FR-A721-30K	180M	SF-V5RUH22K	FR-A741-30K	
30kW	200L *2	SF-V5RU30K	FR-A721-37K	200L *2	SF-V5RUH30K	FR-A741-37K	
37kW	200L *2	SF-V5RU37K	FR-A721-45K	200L *2	SF-V5RUH37K	FR-A741-45K	
45kW	200L *2	SF-V5RU45K	FR-A721-55K	200L *2	SF-V5RUH45K	FR-A741-55K	

- Combination with the SF-V5RU1, 3, 4 and SF-THY

Voltage		SF-V5RU□1 (1:2)			SF-V5RU□3 (1:3)			SF-V5RU□4 (1:4)		
Rated speed		1000r/min			1000r/min			500r/min		
Base frequency		33.33Hz			33.33Hz			16.6Hz		
Maximum speed		2000r/min			3000r/min			2000r/min		
Motor capacity	Motor frame number	Motor model	Inverter model	Motor frame number	Motor model	Inverter model	Motor frame number	Motor model	Inverter model	
3.7kW	132S	SF-V5RU3K1	FR-A721-5.5K	132M	SF-V5RU3K3	FR-A721-5.5K	160L	SF-V5RU3K4	FR-A721-7.5K	
5.5kW	132M	SF-V5RU5K1	FR-A721-7.5K	160M	SF-V5RU5K3	FR-A721-7.5K	180L	SF-V5RU5K4	FR-A721-7.5K	
7.5kW	160M	SF-V5RU7K1	FR-A721-11K	160L	SF-V5RU7K3	FR-A721-11K	200L	SF-V5RU7K4	FR-A721-11K	
11kW	160L	SF-V5RU11K1	FR-A721-15K	180M	SF-V5RU11K3	FR-A721-15K	225S	SF-V5RU11K4	FR-A721-15K	
15kW	180M	SF-V5RU15K1	FR-A721-18.5K	180L	SF-V5RU15K3	FR-A721-18.5K	225S	SF-V5RU15K4	FR-A721-22K	
18.5kW	180L	SF-V5RU18K1	FR-A721-22K	200L	SF-V5RU18K3	FR-A721-22K	250MD	SF-THY	FR-A721-22K	
22kW	200L	SF-V5RU22K1	FR-A721-30K	200L	SF-V5RU22K3	FR-A721-30K	280MD	SF-THY	FR-A721-30K	
30kW	200L*3	SF-V5RU30K1	FR-A721-37K	225S*1	SF-V5RU30K3	FR-A721-37K	280MD	SF-THY	FR-A721-37K	
37kW	225S	SF-V5RU37K1	FR-A721-45K	250MD*1	SF-THY	FR-A721-45K	280MD	SF-THY	FR-A721-45K	
45kW	250MD	SF-THY	FR-A721-55K	250MD*1	SF-THY	FR-A721-55K	280MD	SF-THY	FR-A721-55K	

Models surrounded by black borders and 400V class are developed upon receipt of order.

\*1 The maximum speed is 2400r/min.

\*2 80% output in the high-speed range. (The output is reduced when the speed is 2400r/min or more.)

\*3 90% output in the high-speed range. (The output is reduced when the speed is 1000r/min or more.)

# **3 PRECAUTIONS FOR USE OF THE INVERTER**

---

This chapter explains the "PRECAUTIONS FOR USE OF THE INVERTER" for use of this product.

Always read the instructions before using the equipment.

---

3.1	EMC and leakage currents.....	38
3.2	Power-off and magnetic contactor (MC).....	44
3.3	Inverter-driven 400V class motor .....	45
3.4	Precautions for use of the inverter .....	46
3.5	Failsafe of the system which uses the inverter .....	48

1

2

3

4

5

6

7



## 3.1 EMC and leakage currents

### 3.1.1 Leakage currents and countermeasures

Capacitances exist between the inverter I/O cables, other cables and earth and in the motor, through which a leakage current flows. Since its value depends on the static capacitances, carrier frequency, etc., low acoustic noise operation at the increased carrier frequency of the inverter will increase the leakage current. Therefore, take the following measures. Select the earth leakage circuit breaker according to its rated sensitivity current, independently of the carrier frequency setting.

#### (1) To-earth (ground) leakage currents

Leakage currents may flow not only into the inverter's own line but also into the other lines through the earth (ground) cable, etc. These leakage currents may operate earth (ground) leakage circuit breakers and earth leakage relays unnecessarily.

- Suppression technique

- If the carrier frequency setting is high, decrease the *Pr. 72 PWM frequency selection* setting. Note that motor noise increases. Selecting *Pr. 240 Soft-PWM operation selection* makes the sound inoffensive.
- By using earth leakage circuit breakers designed for harmonic and surge suppression in the inverter's own line and other line, operation can be performed with the carrier frequency kept high (with low noise).

- To-earth (ground) leakage currents

- Take caution as long wiring will increase the leakage current. Decreasing the carrier frequency of the inverter reduces the leakage current.
- Increasing the motor capacity increases the leakage current. The leakage current of the 400V class is larger than that of the 200V class.

#### (2) Line-to-line leakage currents

Harmonics of leakage currents flowing in static capacitances between the inverter output cables may operate the external thermal relay unnecessarily. When the wiring length is long (50m or more) for the 400V class small-capacity model (7.5K or lower), the external thermal relay is likely to operate unnecessarily because the ratio of the leakage current to the rated motor current increases.

- Line-to-line leakage current data example (200V class)

Motor Capacity (kW)	Rated Motor Current(A)	Leakage Currents(mA)	
		Wiring length 50m	Wiring length 100m
3.7	12.8	440	630
5.5	19.4	490	680
7.5	25.6	535	725

- Motor SF-JR 4P
- Carrier frequency: 14.5kHz
- Used wire: 2mm<sup>2</sup>, 4cores Cabtyre cable

\*The leakage currents of the 400V class are about twice as large.

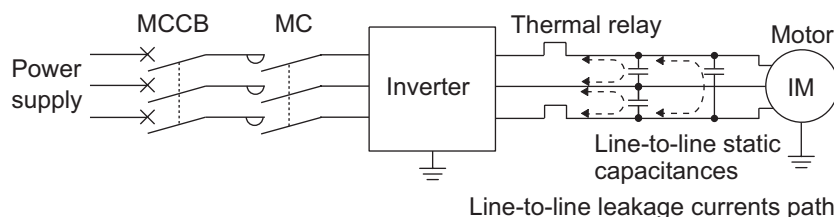

- Measures

- Use *Pr. 9 Electronic thermal O/L relay*.
- If the carrier frequency setting is high, decrease the *Pr. 72 PWM frequency selection* setting. Note that motor noise increases. Selecting *Pr. 240 Soft-PWM operation selection* makes the sound inoffensive. To ensure that the motor is protected against line-to-line leakage currents, it is recommended to use a temperature sensor to directly detect motor temperature.

- Installation and selection of moulded case circuit breaker

Install a moulded case circuit breaker (MCCB) on the power receiving side to protect the wiring of the inverter input side. Select the MCCB according to the inverter input side power factor (which depends on the power supply voltage, output frequency and load). Especially for a completely electromagnetic MCCB, one of a slightly large capacity must be selected since its operation characteristic varies with harmonic currents. (Check it in the data of the corresponding breaker.) As an earth leakage circuit breaker, use the Mitsubishi earth leakage circuit breaker designed for harmonics and surge suppression.

### (3) Selection of rated sensitivity current of earth leakage circuit breaker

When using the earth leakage circuit breaker with the inverter circuit, select its rated sensitivity current as follows, independently of the PWM carrier frequency:

- Breaker designed for harmonic and surge suppression  
 Rated sensitivity current:  
 $I_{\Delta n} \geq 10 \times (I_{g1} + I_{gn} + I_{gi} + I_{g2} + I_{gm})$
  - Standard breaker  
 Rated sensitivity current:  
 $I_{\Delta n} \geq 10 \times \{I_{g1} + I_{gn} + I_{gi} + 3 \times (I_{g2} + I_{gm})\}$
- $I_{g1}$ ,  $I_{g2}$ : Leakage currents in wire path during commercial power supply operation  
 $I_{gn}$ : Leakage current of inverter input side noise filter  
 $I_{gm}$ : Leakage current of motor during commercial power supply operation  
 $I_{gi}$ : Leakage current of inverter unit

Example of leakage current of cable path per 1km during the commercial power supply operation when the CV cable is routed in metal conduit (200V 60Hz)

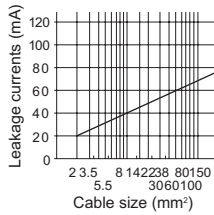

Leakage current example of three-phase induction motor during the commercial power supply operation (200V 60Hz)

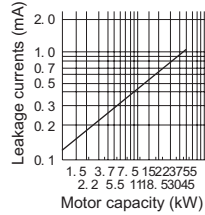

Example of leakage current per 1km during the commercial power supply operation when the CV cable is routed in metal conduit

(Three-phase three-wire delta connection 400V/60Hz)

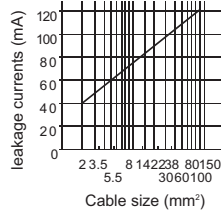

Leakage current example of three-phase induction motor during the commercial power supply operation

(Totally-enclosed fan-cooled type motor 400V/60Hz)

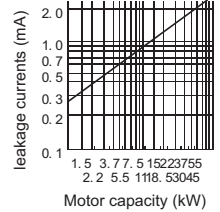

For "Δ" connection, the amount of leakage current is approx. 1/3 of the above value.

<Example>

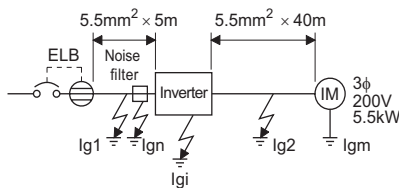

	Breaker Designed for Harmonic and Surge Suppression	Standard Breaker
Leakage current $I_{g1}$ (mA)	$33 \times \frac{5m}{1000m} = 0.17$	
Leakage current $I_{gn}$ (mA)	0 (without noise filter)	
Leakage current $I_{gi}$ (mA)	1	
Leakage current $I_{g2}$ (mA)	$33 \times \frac{40m}{1000m} = 1.32$	
Motor leakage current $I_{gm}$ (mA)	0.29	
Total leakage current (mA)	2.78	6.00
Rated sensitivity current (mA) ( $\geq I_g \times 10$ )	30	100

#### CAUTION

- Install the earth leakage circuit breaker (ELB) on the input side of the inverter.
- In the Δ connection earthed-neutral system, the sensitivity current is blunt against an earth (ground) fault in the inverter output side. Earthing (Grounding) must conform to the requirements of national and local safety regulations and electrical codes. (NEC section 250, IEC 536 class 1 and other applicable standards)  
 Use a neutral-point earthed (grounded) power supply for 400V class inverter in compliance with EN standard.
- When the breaker is installed on the output side of the inverter, it may be unnecessarily operated by harmonics even if the effective value is less than the rating. In this case, do not install the breaker since the eddy current and hysteresis loss will increase, leading to temperature rise.
- The following models are standard breakers...BV-C1, BC-V, NVB, NV-L, NV-G2N, NV-G3NA and NV-2F earth leakage relay (except NV-ZHA), NV with AA neutral wire open-phase protection  
 The other models are designed for harmonic and surge suppression...NV-C/NV-S/MN series, NV30-FA, NV50-FA, BV-C2, earth leakage alarm breaker (NF-Z), NV-ZHA, NV-H



### 3.1.2 EMC measures

Some electromagnetic noises enter the inverter to malfunction it and others are radiated by the inverter to malfunction peripheral devices. Though the inverter is designed to have high immunity performance, it handles low-level signals, so it requires the following basic techniques. Also, since the inverter chops outputs at high carrier frequency, that could generate electromagnetic noises. If these electromagnetic noises cause peripheral devices to malfunction, EMI measures should be taken to suppress noises. These techniques differ slightly depending on EMI paths.

1) Basic techniques

- Do not run the power cables (I/O cables) and signal cables of the inverter in parallel with each other and do not bundle them.
- Use twisted shield cables for the detector connecting and control signal cables and connect the sheathes of the shield cables to terminal SD.
- Earth (Ground) the inverter, motor, etc. at one point.

2) Techniques to reduce electromagnetic noises that enter and malfunction the inverter (Immunity measures))

When devices that generate many electromagnetic noises (which use magnetic contactors, magnetic brakes, many relays, for example) are installed near the inverter and the inverter may be malfunctioned by electromagnetic noises, the following measures must be taken:

- Provide surge suppressors for devices that generate many electromagnetic noises to suppress electromagnetic noises.
- Fit data line filters (*page 41*) to signal cables.
- Earth (Ground) the shields of the detector connection and control signal cables with cable clamp metal.

3) Techniques to reduce electromagnetic noises that are radiated by the inverter to malfunction peripheral devices (EMI measures)

Inverter-generated electromagnetic noises are largely classified into those radiated by the cables connected to the inverter and inverter main circuits (I/O), those electromagnetically and electrostatically induced to the signal cables of the peripheral devices close to the main circuit power supply, and those transmitted through the power supply cables.

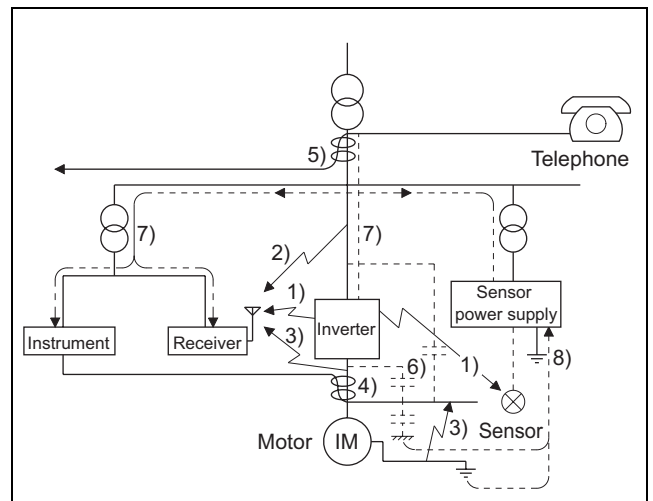
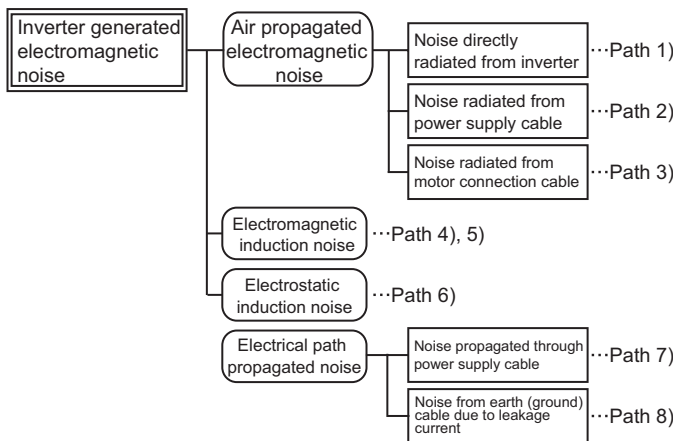

Propagation Path	Measures
1) 2) 3)	<p>When devices that handle low-level signals and are liable to malfunction due to electromagnetic noises, e.g. instruments, receivers and sensors, are contained in the enclosure that contains the inverter or when their signal cables are run near the inverter, the devices may be malfunctioned by air-propagated electromagnetic noises. The following measures must be taken:</p> <ol style="list-style-type: none"> <li>(1) Install easily affected devices as far away as possible from the inverter.</li> <li>(2) Run easily affected signal cables as far away as possible from the inverter and its I/O cables.</li> <li>(3) Do not run the signal cables and power cables (inverter I/O cables) in parallel with each other and do not bundle them.</li> <li>(4) Insert common mode filters into I/O and capacitors between the input lines to suppress cable-radiated noises.</li> <li>(5) Use shield cables as signal cables and power cables and run them in individual metal conduits to produce further effects.</li> </ol>
4) 5) 6)	<p>When the signal cables are run in parallel with or bundled with the power cables, magnetic and static induction noises may be propagated to the signal cables to malfunction the devices and the following measures must be taken:</p> <ol style="list-style-type: none"> <li>(1) Install easily affected devices as far away as possible from the inverter.</li> <li>(2) Run easily affected signal cables as far away as possible from the I/O cables of the inverter.</li> <li>(3) Do not run the signal cables and power cables (inverter I/O cables) in parallel with each other and do not bundle them.</li> <li>(4) Use shield cables as signal cables and power cables and run them in individual metal conduits to produce further effects.</li> </ol>
7)	<p>When the power supplies of the peripheral devices are connected to the power supply of the inverter in the same line, inverter-generated noises may flow back through the power supply cables to malfunction the devices. In such a case, installing the common mode filter (FR-BLF) to the power cables (output cable) of the inverter will prevent malfunction.</p>
8)	<p>When a closed loop circuit is formed by connecting the peripheral device wiring to the inverter, leakage currents may flow through the earth (ground) cable of the inverter to malfunction the device. In such a case, disconnection of the earth (ground) cable of the device may cause the device to operate properly.</p>

● **Data line filter**

Data line filter is effective as an EMC measure. Provide a data line filter for the detector cable, etc.

● **EMC measures**

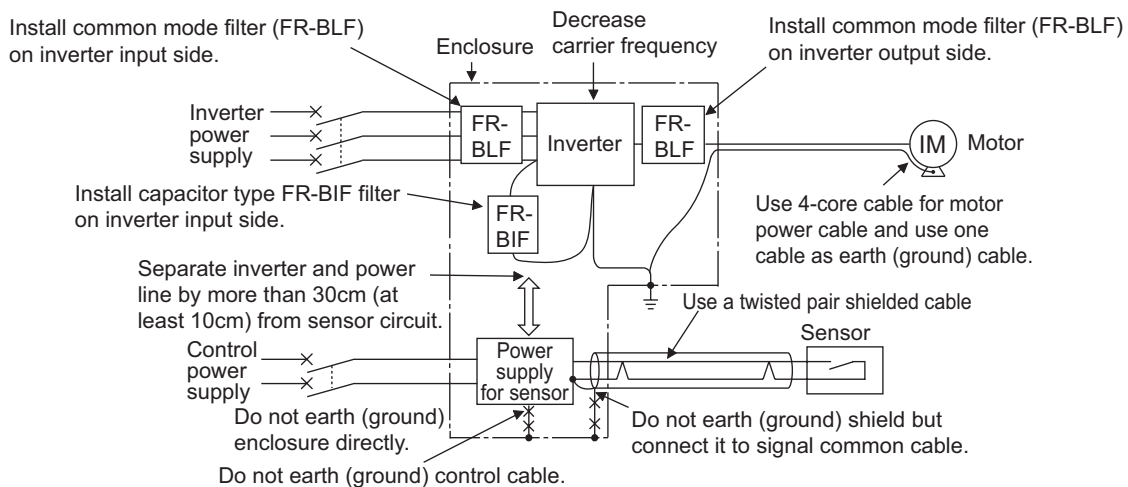

**REMARKS**

For compliance with the EU EMC Directive, refer to the *Instruction Manual (Basic)*.





### 3.1.3 Power supply harmonics

The inverter may generate power supply harmonics from its converter circuit to affect the power generator, power capacitor etc. Power supply harmonics are different from noise and leakage currents in source, frequency band and transmission path. Take the following countermeasure suppression techniques.

This inverter has a built-in AC reactor (FR-HAL) and a circuit type specified in Harmonic suppression guideline in Japan is three-phase bridge (capacitor smoothed) and with reactor (AC side).

### 3.1.4 Harmonic suppression guideline

Harmonic currents flow from the inverter to a power receiving point via a power transformer. The harmonic suppression guideline was established to protect other consumers from these outgoing harmonic currents.

The three-phase 200V input specifications 3.7kW or less are previously covered by "Harmonic suppression guideline for household appliances and general-purpose products" and other models are covered by "Harmonic suppression guideline for consumers who receive high voltage or special high voltage". However, the general-purpose inverter has been excluded from the target products covered by "Harmonic suppression guideline for household appliances and general-purpose products" in January 2004. Later, this guideline was repealed on September 6, 2004. All capacities of all models are now target products of "Harmonic suppression guideline for consumers who receive high voltage or special high voltage" (hereinafter referred to as "Guideline for specific consumers").

"Guideline for specific consumers"

This guideline sets forth the maximum values of harmonic currents outgoing from a high-voltage or especially high-voltage consumer who will install, add or renew harmonic generating equipment. If any of the maximum values is exceeded, this guideline requires that consumer to take certain suppression measures.

**Table 1 Maximum Values of Outgoing Harmonic Currents per 1kW Contract Power**

Received Power Voltage	5th	7th	11th	13th	17th	19th	23rd	Over 23rd
6.6kV	3.5	2.5	1.6	1.3	1.0	0.9	0.76	0.70
22kV	1.8	1.3	0.82	0.69	0.53	0.47	0.39	0.36
33kV	1.2	0.86	0.55	0.46	0.35	0.32	0.26	0.24

#### (1) Application of the harmonic suppression guideline for specific consumers

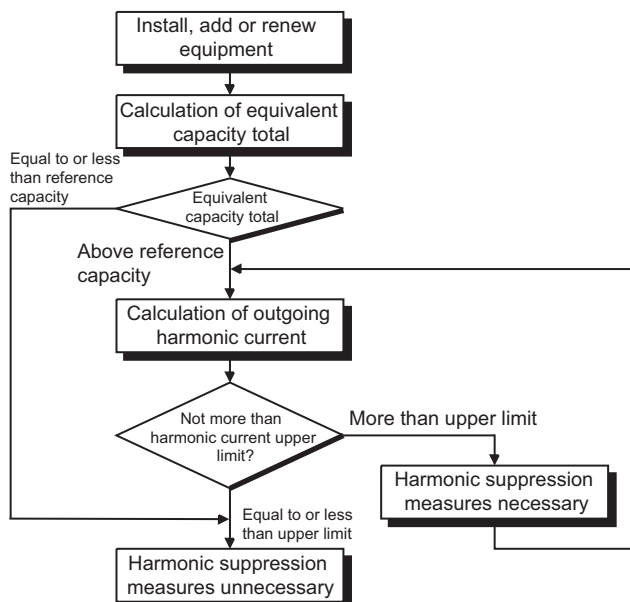

**Table 2 Conversion factors for FR-A701 series**

Class	Circuit Type		Conversion Factor (Ki)
3	Three-phase bridge (Capacitor smoothing)	With reactor (AC side)	K32 = 1.8

**Table 3 Equivalent Capacity Limits**

Received Power Voltage	Reference Capacity
6.6kV	50kVA
22/33kV	300kVA
66kV or more	2000kVA

**Table 4 Harmonic content (Values of the fundamental current is 100%)**

Reactor	5th	7th	11th	13th	17th	19th	23rd	25th
Used (AC side)	38	14.5	7.4	3.4	3.2	1.9	1.7	1.3

1) Calculation of equivalent capacity P0 of harmonic generating equipment

The "equivalent capacity" is the capacity of a 6-pulse converter converted from the capacity of consumer's harmonic generating equipment and is calculated with the following equation. If the sum of equivalent capacities is higher than the limit in Table 3, harmonics must be calculated with the following procedure:

$$P0 = \sum (Ki \times Pi) \text{ [kVA]}$$

Ki: Conversion factor(According to Table 2)

Pi: Rated capacity of harmonic generating equipment\* [kVA]

i : Number indicating the conversion circuit type

\* Rated capacity: Determined by the capacity of the applied motor and found in Table 5. It should be noted that the rated capacity used here is used to calculate generated harmonic amount and is different from the power supply capacity required for actual inverter drive.

2) Calculation of outgoing harmonic current

Outgoing harmonic current = fundamental wave current (value converted from received power voltage) × operation ratio × harmonic content

- Operation ratio: Operation ratio = actual load factor × operation time ratio during 30 minutes
- Harmonic content: Found in Table 4.

**Table 5 Rated capacities and outgoing harmonic currents of inverter-driven motors**

Applied Motor (kW)	Rated Current (A)		Fundamental Wave Current Converted from 6.6kV (mA)	Rated Capacity (kVA)	Outgoing Harmonic Current Converted from 6.6kV (mA) (With reactor, 100% operation ratio)							
	200V	400V			5th	7th	11th	13th	17th	19th	23rd	25th
5.5	19.1	9.55	579	6.77	220.0	83.96	42.85	19.69	18.53	11.00	9.843	7.527
7.5	25.6	12.8	776	9.07	294.9	112.5	57.42	26.38	24.83	14.74	13.19	10.09
11	36.9	18.5	1121	13.1	426.0	162.5	82.95	38.11	35.87	21.30	19.06	14.57
15	49.8	24.9	1509	17.6	573.4	218.8	111.7	51.31	48.29	28.67	25.65	19.62
18.5	61.4	30.7	1860	21.8	706.8	269.7	137.6	63.24	59.52	35.34	31.62	24.18
22	73.1	36.6	2220	25.9	843.6	321.9	164.3	75.48	71.04	42.18	37.74	28.86
30	98.0	49.0	2970	34.7	1129	430.7	219.8	101.0	95.04	56.43	50.49	38.61
37	121	60.4	3660	42.8	1391	530.7	270.8	124.4	117.1	69.54	62.22	47.58
45	147	73.5	4450	52.1	1691	645.3	329.3	151.3	142.4	84.55	75.65	57.85
55	180	89.9	5450	63.7	2071	790.3	403.3	185.3	174.4	103.6	92.65	70.85

3) Harmonic suppression technique requirement

If the outgoing harmonic current is higher than the maximum value per 1kW (contract power) × contract power, a harmonic suppression technique is required.

4) Harmonic suppression techniques

No.	Item	Description
1	Installation of power factor improving capacitor	When used with a series reactor, the power factor improving capacitor has an effect of absorbing harmonic currents.
2	Transformer multi-phase operation	Use two transformers with a phase angle difference of 30° as in $\lambda - \Delta$ , $\Delta - \Delta$ combination to provide an effect corresponding to 12 pulses, reducing low-degree harmonic currents.
3	Passive filter (AC filter)	A capacitor and a reactor are used together to reduce impedances at specific frequencies, producing a great effect of absorbing harmonic currents.
4	Active filter	This filter detects the current of a circuit generating a harmonic current and generates a harmonic current equivalent to a difference between that current and a fundamental wave current to suppress a harmonic current at a detection point, providing a great effect of absorbing harmonic currents.

## 3.2 Power-off and magnetic contactor (MC)

### (1) Inverter input side magnetic contactor (MC)

On the inverter input side, it is recommended to provide an MC for the following purposes.

( Refer to page 4 for selection.)

- 1) To release the inverter from the power supply when the fault occurs or when the drive is not functioning (e.g. emergency stop operation).
- 2) To prevent any accident due to an automatic restart at restoration of power after an inverter stop made by a power failure
- 3) To separate the inverter from the power supply to ensure safe maintenance and inspection work

The inverter's input side MC is used for the above purpose, select class JEM1038-AC3MC for the inverter input side current when making an emergency stop during normal operation.

#### REMARKS

Since repeated inrush currents at power on will shorten the life of the converter circuit (switching life is about 500,000 times.), frequent starts and stops of the MC must be avoided. Turn ON/OFF the inverter start controlling terminals (STF, STR) to run/stop the inverter.

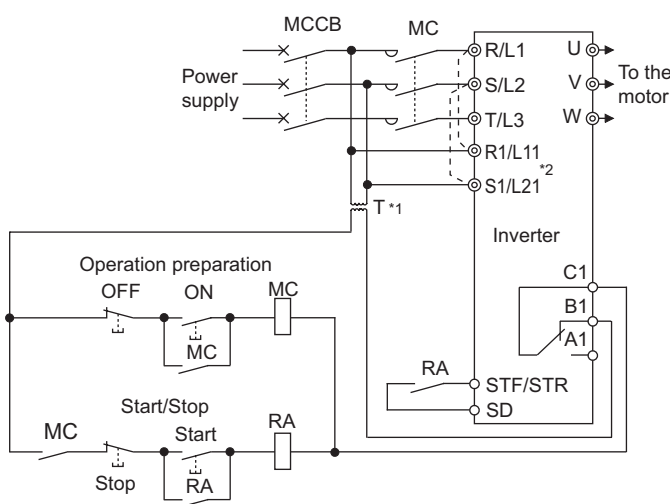

#### • Inverter start/stop circuit example

As shown on the left, always use the start signal (ON or OFF of STF (STR) signal) to make a start or stop. (Refer to page 212)

\*1 When the power supply is 400V class, install a step-down transformer.

\*2 Connect the power supply terminals R1/L11, S1/L21 of the control circuit to the input side of the MC to hold an alarm signal when the inverter's protective circuit is activated. At this time, remove jumpers across terminals R/L1-R1/L11 and S/L2-S1/L21. (Refer to page 21 for removal of the jumper.)

### (2) Handling of the inverter output side magnetic contactor

Switch the magnetic contactor between the inverter and motor only when both the inverter and motor are at a stop. When the magnetic contactor is turned ON while the inverter is operating, overcurrent protection of the inverter and such will activate. When an MC is provided to switch to a commercial power supply, for example, it is recommended to use bypass-inverter switchover function Pr. 135 to Pr. 139 (Refer to page 346).



### 3.3 Inverter-driven 400V class motor

In the PWM type inverter, a surge voltage attributable to wiring constants is generated at the motor terminals. Especially for a 400V class motor, the surge voltage may deteriorate the insulation. When the 400V class motor is driven by the inverter, consider the following measures:

#### ●Measures

It is recommended to take either of the following measures:

- (1) Rectifying the motor insulation and limiting the PWM carrier frequency according to the wiring length  
For the 400V class motor, use an insulation-enhanced motor.  
Specifically,
  - 1)Specify the "400V class inverter-driven insulation-enhanced motor".
  - 2)For the dedicated motor such as the constant-torque motor and low-vibration motor, use the "inverter-driven, dedicated motor".
  - 3)Set *Pr. 72 PWM frequency selection* as indicated below according to the wiring length

	Wiring Length		
	50m or less	50m to 100m	exceeding 100m
<i>Pr. 72 PWM frequency selection</i>	15 (14.5kHz) or less	9 (9kHz) or less	4 (4kHz) or less

- (2) Suppressing the surge voltage on the inverter side  
Connect the surge voltage suppression filter (FR-ASF-H/FR-BMF-H) on the inverter output side.

#### CAUTION

- For details of *Pr. 72 PWM frequency selection*, refer to page 261.
- For explanation of surge voltage suppression filter (FR-ASF-H/FR-BMF-H), refer to the manual of each option.
- Do not perform Real sensorless vector control and vector control with a surge voltage suppression filter (FR-ASF-H) connected.
- A surge voltage suppression filter (FR-ASF-H/FR-BMF-H) can be used under V/F control and Advanced magnetic flux vector control.



### 3.4 Precautions for use of the inverter

The FR-A701 series is a highly reliable product, but incorrect peripheral circuit making or operation/handling method may shorten the product life or damage the product.

Before starting operation, always recheck the following items.

- (1) **Use crimping terminals with insulation sleeve to wire the power supply and motor.**
- (2) **Application of power to the output terminals (U, V, W) of the inverter will damage the inverter. Never perform such wiring.**
- (3) **After wiring, wire offcuts must not be left in the inverter.**  
Wire offcuts can cause an alarm, failure or malfunction. Always keep the inverter clean. When drilling mounting holes in an enclosure etc., take care not to allow chips and other foreign matter to enter the inverter.
- (4) **Use cables of the size to make a voltage drop 2% maximum.**  
If the wiring distance is long between the inverter and motor, a main circuit cable voltage drop will cause the motor torque to decrease especially at the output of a low frequency.  
Refer to *page 18* for the recommended cable sizes.
- (5) **The overall wiring length should be within 500m with unshielded wires (within 100m for the operation under vector control or when using shielded wires).**  
Especially for long distance wiring, the fast-response current limit function may decrease or the equipment connected to the output side may malfunction or become faulty under the influence of a charging current due to the stray capacity of the wiring. Therefore, note the overall wiring length. (*Refer to page 20.*)
- (6) **Electromagnetic wave interference**  
The input/output (main circuit) of the inverter includes high frequency components, which may interfere with the communication devices (such as AM radios) used near the inverter. In this case, connecting a capacitor type filter will reduce electromagnetic wave interference.
- (7) **Do not install a power factor correction capacitor, surge suppressor or capacitor type filter on the inverter output side.**  
This will cause the inverter to trip or the capacitor, and surge suppressor to be damaged. If any of the above devices is installed, immediately remove it.
- (8) **For some short time after the power is switched off, a high voltage remains in the smoothing capacitor.**  
When accessing the inverter for inspection, wait for at least 10 minutes after the power supply has been switched off, and then make sure that the voltage across the main circuit terminals P/+ -N/- of the inverter is not more than 30VDC using a tester, etc. The capacitor is charged with high voltage for some time after power off and it is dangerous.
- (9) **A short circuit or earth (ground) fault on the inverter output side may damage the inverter modules.**
  - Fully check the insulation resistance of the circuit prior to inverter operation since repeated short circuits caused by peripheral circuit inadequacy or an earth (ground) fault caused by wiring inadequacy or reduced motor insulation resistance may damage the inverter modules.
  - Fully check the to-earth (ground) insulation and inter-phase insulation of the inverter output side before power-on. Especially for an old motor or use in hostile atmosphere, securely check the motor insulation resistance etc.
- (10) **Do not use the inverter input side magnetic contactor to start/stop the inverter.**  
Since repeated inrush currents at power ON will shorten the life of the converter circuit (switching life is about 500,000 times), frequent starts and stops of the MC must be avoided.  
Always use the start signal (ON/OFF of STF and STR signals) to start/stop the inverter. (*Refer to page 44*)
- (11) **Do not apply a voltage higher than the permissible voltage to the inverter I/O signal circuits.**  
Application of permissible voltage to the inverter I/O signal circuit and incorrect polarity may damage the I/O terminal. Especially check the wiring to prevent the speed setting potentiometer from being connected incorrectly to short terminals 10E-5.
- (12) **Provide electrical and mechanical interlocks for MC1 and MC2 which are used for bypass operation.**

When the wiring is incorrect or if there is an electronic bypass circuit as shown on the right, the inverter will be damaged by leakage current from the power supply due to arcs generated at the time of switch-over or chattering caused by a sequence error.

(Commercial operation can not be performed with the vector dedicated motor (SF-V5RU, SF-THY).)

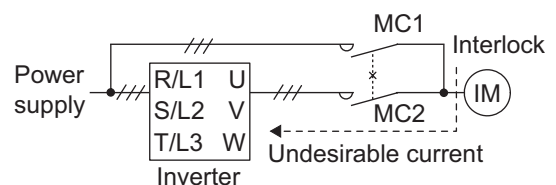



- (13) If the machine must not be restarted when power is restored after a power failure, provide a magnetic contactor in the inverter's input side and also make up a sequence which will not switch on the start signal.**  
If the start signal (start switch) remains on after a power failure, the inverter will automatically restart as soon as the power is restored.
- (14) Inverter input side magnetic contactor (MC)**  
On the inverter input side, connect an MC for the following purposes. (Refer to page 4 for selection.)
- 1) To release the inverter from the power supply when a fault occurs or when the drive is not functioning (e.g. emergency stop operation). For example, MC avoids overheat or burnout of the brake resistor when heat capacity of the resistor is insufficient or brake regenerative transistor is damaged with short while connecting an optional brake resistor.
  - 2) To prevent any accident due to an automatic restart at restoration of power after an inverter stop made by a power failure
  - 3) To separate the inverter from the power supply to ensure safe maintenance and inspection work.  
The inverter's input side MC is used for the above purpose, select class JEM1038-AC3 MC for the inverter input side current when making an emergency stop during normal operation.
- (15) Handling of inverter output side magnetic contactor**  
Switch the magnetic contactor between the inverter and motor only when both the inverter and motor are at a stop. When the magnetic contactor is turned ON while the inverter is operating, overcurrent protection of the inverter and such will activate. When MC is provided for switching to the commercial power supply, for example, switch it ON/OFF after the inverter and motor have stopped.
- (16) A motor with encoder is necessary for vector control. In addition, connect the encoder directly to the backlash-free motor shaft. (An encoder is not necessary for Real sensorless vector control.)**
- (17) Countermeasures against inverter-generated EMI**  
If electromagnetic noise generated from the inverter causes frequency setting signal to fluctuate and motor rotation speed to be unstable when changing motor speed with analog signal, the following countermeasures are effective.
- Do not run the signal cables and power cables (inverter I/O cables) in parallel with each other and do not bundle them.
  - Run signal cables as far away as possible from power cables (inverter I/O cables).
  - Use shield cables as signal cables.
  - Install a ferrite core on the signal cable (Example: ZCAT3035-1330 TDK).
- (18) Instructions for overload operation**  
When performing an operation of frequent start/stop with the inverter, rise/fall in the temperature of the transistor element of the inverter will repeat due to a continuous flow of large current, shortening the life from thermal fatigue. Since thermal fatigue is related to the amount of current, the life can be increased by reducing current at locked condition, starting current, etc. Decreasing current may increase the life. However, decreasing current will result in insufficient torque and the inverter may not start. Therefore, choose the inverter which has enough allowance for current (up to 2 rank larger in capacity).
- (19) Make sure that the specifications and rating match the system requirements.**



### 3.5 Failsafe of the system which uses the inverter

When a fault occurs, the inverter trips to output a fault signal. However, a fault output signal may not be output at an inverter fault occurrence when the detection circuit or output circuit fails, etc. Although Mitsubishi assures best quality products, provide an interlock which uses inverter status output signals to prevent accidents such as damage to machine when the inverter fails for some reason and at the same time consider the system configuration where failsafe from outside the inverter, without using the inverter, is enabled even if the inverter fails.

(1) Interlock method which uses the inverter status output signals

By combining the inverter status output signals to provide an interlock as shown below, an inverter alarm can be detected.

No.	Interlock Method	Check Method	Used Signals	Refer to Page
1)	Inverter protective function operation	Operation check of an alarm contact Circuit error detection by negative logic	Fault output signal (ALM signal)	215
2)	Inverter running status	Operation ready signal check	Operation ready signal (RY signal)	215
3)	Inverter running status	Logic check of the start signal and running signal	Start signal (STF signal, STR signal) Running signal (RUN signal)	207
4)	Inverter running status	Logic check of the start signal and output current	Start signal (STF signal, STR signal) Output current detection signal (Y12 signal)	207, 215

1) Check by the output of the inverter fault signal

When the fault occurs and trips the inverter, the fault output signal (ALM signal) is output (ALM signal is assigned to terminal A1B1C1 in the initial setting).

Check that the inverter functions properly.

In addition, negative logic can be set (on when the inverter is normal, off when the fault occurs).

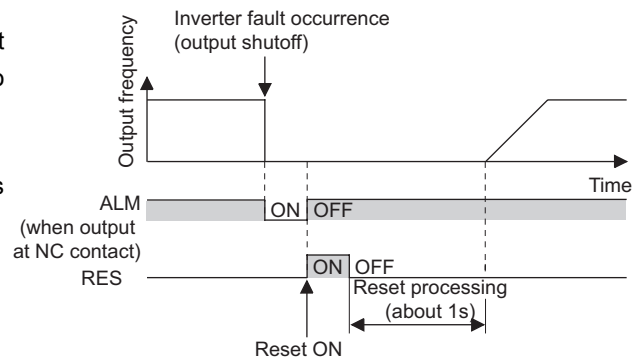

2) Checking the inverter operating status by the inverter operation ready completion signal

Operation ready signal (RY signal) is output when the inverter power is ON and the inverter becomes operative.

Check if the RY signal is output after powering on the inverter.

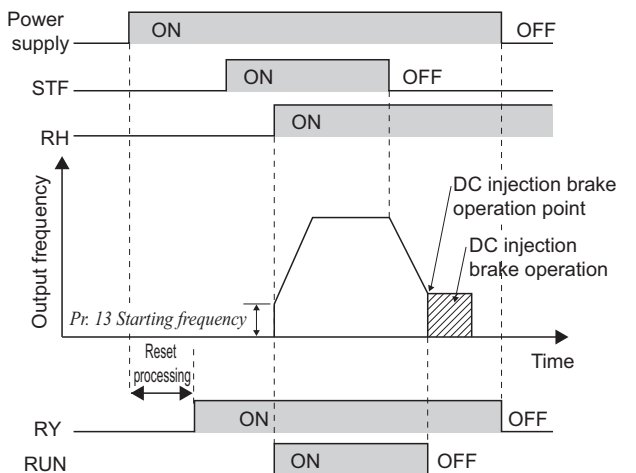

3) Checking the inverter operating status by the start signal input to the inverter and inverter running signal.

The inverter running signal (RUN signal) is output when the inverter is running (RUN signal is assigned to terminal RUN in the initial setting).

Check if RUN signal is output when inputting the start signal to the inverter (forward signal is STF signal and reverse signal is STR signal). For logic check, note that RUN signal is output for the period from the inverter decelerates until output to the motor is stopped, configure a sequence considering the inverter deceleration time

4) Checking the motor operating status by the start signal input to the inverter and inverter output current detection signal. The output current detection signal (Y12 signal) is output when the inverter operates and currents flows in the motor. Check if Y12 signal is output when inputting the start signal to the inverter (forward signal is STF signal and reverse signal is STR signal). Note that the current level at which Y12 signal is output is set to 150% of the inverter rated current in the initial setting, it is necessary to adjust the level to around 20% using no load current of the motor as reference with *Pr. 150 Output current detection level*.

For logic check, as same as the inverter running signal (RUN signal), the inverter outputs for the period from the inverter decelerates until output to the motor is stopped, configure a sequence considering the inverter deceleration time.

Output Signal	Pr. 190 to Pr. 196 Setting	
	Positive logic	Negative logic
ALM	99	199
RY	11	111
RUN	0	100
Y12	12	112

- When using various signals, assign functions to *Pr.190 to Pr. 196 (output terminal function selection)* referring to the table on the left.

**CAUTION**

- Changing the terminal assignment using *Pr. 190 to Pr. 196 (output terminal function selection)* may affect the other functions. Set parameters after confirming the function of each terminal.

(2) Backup method outside the inverter

Even if the interlock is provided by the inverter status signal, enough failsafe is not ensured depending on the failure status of the inverter itself. For example, when the inverter CPU fails, even if the interlock is provided using the inverter fault output signal, start signal and RUN signal output, there is a case where a fault output signal is not output and RUN signal is kept output even if an inverter fault occurs.

Provide a speed detector to detect the motor speed and current detector to detect the motor current and consider the backup system such as checking up as below according to the level of importance of the system.

1) Start signal and actual operation check

Check the motor running and motor current while the start signal is input to the inverter by comparing the start signal to the inverter and detected speed of the speed detector or detected current of the current detector. Note that the motor current runs as the motor is running for the period until the motor stops since the inverter starts decelerating even if the start signal turns OFF. For the logic check, configure a sequence considering the inverter deceleration time. In addition, it is recommended to check the three-phase current when using the current detector.

2) Command speed and actual operation check

Check if there is no gap between the actual speed and commanded speed by comparing the inverter speed command and detected speed of the speed detector.

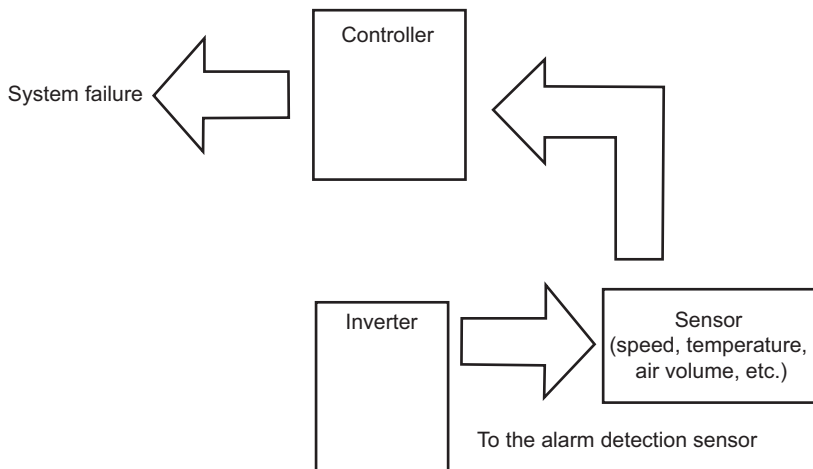



# MEMO

# 4 PARAMETERS

---

This chapter explains the "PARAMETERS" for use of this product.

Always read this instructions before use.

---

The following marks are used to indicate the controls as below.

 ...V/F control

 ...Advanced magnetic flux vector control

 ...Real sensorless vector control

 ...Vector control

(Parameters without any mark are valid for all control.)

1

2

3

4

5

6

7



## 4.1 Operation panel (FR-DU07)

### 4.1.1 Parts of the operation panel (FR-DU07)

**Operation mode indicator**  
 PU: Lit to indicate PU operation mode.  
 EXT: Lit to indicate External operation mode.  
 NET: Lit to indicate Network operation mode.

**Unit indicator**  
 · Hz: Lit to indicate frequency.  
 · A: Lit to indicate current.  
 · V: Lit to indicate voltage.  
 (Flicker when the set frequency monitor is displayed.)

**Rotation direction indicator**  
 FWD: Lit during forward rotation  
 REV: Lit during reverse rotation  
 Lit: Forward/reverse operation  
 Flickering: When the frequency command is not given even if the forward/reverse command is given. When the MRS signal is input.

**Monitor indicator**  
 Lit to indicate monitoring mode.

**Monitor (4-digit LED)**  
 Shows the frequency, parameter number, etc.

**Setting dial**  
 (Setting dial: Mitsubishi inverter dial)  
 Used to change the frequency setting and parameter settings.

**Mode switchover**  
 Used to change each setting mode.

**Operation mode switchover**  
 Used to switch between the PU and External operation mode.  
 When using External operation mode (operation using a separately connected frequency setting potentiometer and start signal), press this key to light up the EXT indicator. (Change the Pr.79 setting to use the combined mode.)  
 PU: PU operation mode  
 EXT: External operation mode

**Rotation direction indicator**  
 FWD: Lit during forward rotation  
 REV: Lit during reverse rotation  
 Lit: Forward/reverse operation  
 Flickering: When the frequency command is not given even if the forward/reverse command is given. When the MRS signal is input.

**Monitor indicator**  
 Lit to indicate monitoring mode.

**No function**

**Start command forward rotation**

**Start command reverse rotation**

**Stop operation**  
 Used to stop Run command. Fault can be reset when protective function is activated (fault).

**Used to set each setting.**  
 If pressed during operation, monitor changes as below;

Running frequency → Output current → Output voltage \*

\* Energy saving monitor is displayed when the energy saving monitor of Pr. 52 is set.



### 4.1.2 Basic operation (factory setting)

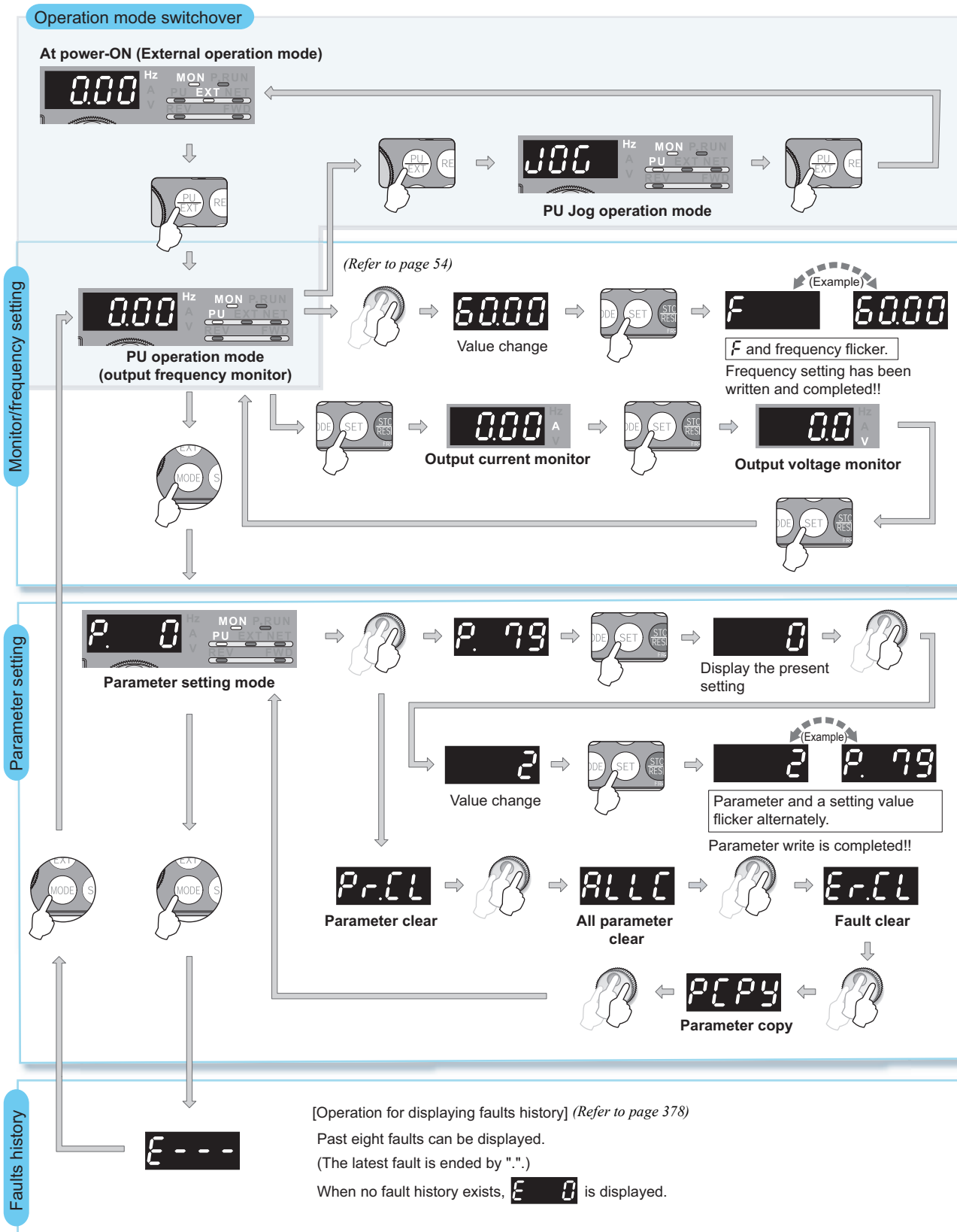



### 4.1.3 Changing the parameter setting value

**Changing example** Change the Pr. 1 Maximum frequency.

Operation	Display
1. Screen at power-ON The monitor display appears.	
2. Press  to choose the PU operation mode.	PU indicator is lit. 
3. Press  to choose the parameter setting mode.	
4. Turn  until P. 1 (Pr. 1) appears.	
5. Press  to read the currently set value. "120.0"(initial value) appears.	
6. Turn  to change it to the set value "60.00".	
7. Press  to set.	

**Flicker ... Parameter setting complete!!**

- By turning , you can read another parameter.
- Press to show the setting again.
- Press twice to show the next parameter.
- Press twice to return the monitor to frequency monitor.

? **Er-1** to **Er-4** are displayed ... Why?

- Er-1 appears. .... Write disable error
- Er-2 appears. .... Write error during operation
- Er-3 appears. .... Calibration error
- Er-4 appears. .... Mode designation error

For details refer to page 384.

#### REMARKS

The number of digits displayed on the operation panel (FR-DU07) is four.  
If the values to be displayed have five digits or more including decimal places, the fifth or later numerals can not be displayed nor set.

(Example) When Pr. 1

When 60Hz is set, 60.00 is displayed.

When 120Hz is set, 120.0 is displayed and second decimal place is not displayed nor set.

### 4.1.4 Setting dial push

Push the setting dial ( ) to display the set frequency currently set.

## 4.2 Parameter list

### 4.2.1 Parameter list

For simple variable-speed operation of the inverter, the initial setting of the parameters may be used as they are. Set the necessary parameters to meet the load and operational specifications. Parameter setting, change and check can be made from the operation panel (FR-DU07).

#### REMARKS

- ◎ indicates simple mode parameters. (initially set to extended mode)
- The shaded parameters in the table allow its setting to be changed during operation even if "0" (initial value) is set in *Pr. 77 Parameter write selection*.
- Refer to the appendix 4 (page 439) for instruction codes for communication and availability of parameter clear, all clear, and parameter copy of each parameter.
- Parameters with **Var.UP** have different specifications according to the date assembled. *Refer to page 456 to check the SERIAL number.*

Function	Parameter	Name	Setting Range	Minimum Setting Increments	Initial Value	Refer to Page	Customer Setting
Basic functions	◎ 0	Torque boost	0 to 30%	0.1%	3/2% *1	129	
	◎ 1	Maximum frequency	0 to 120Hz	0.01Hz	120Hz	140	
	◎ 2	Minimum frequency	0 to 120Hz	0.01Hz	0Hz	140	
	◎ 3	Base frequency	0 to 400Hz	0.01Hz	60Hz	142	
	◎ 4	Multi-speed setting (high speed)	0 to 400Hz	0.01Hz	60Hz	148	
	◎ 5	Multi-speed setting (middle speed)	0 to 400Hz	0.01Hz	30Hz	148	
	◎ 6	Multi-speed setting (low speed)	0 to 400Hz	0.01Hz	10Hz	148	
	◎ 7	Acceleration time	0 to 3600/360s	0.1/0.01s	5/15s *1	155	
	◎ 8	Deceleration time	0 to 3600/360s	0.1/0.01s	5/15s *1	155	
DC injection brake	◎ 9	Electronic thermal O/L relay	0 to 500A	0.01A	Rated inverter current	165	
	10	DC injection brake operation frequency	0 to 120Hz, 9999	0.01Hz	3Hz	185	
	11	DC injection brake operation time	0 to 10s, 8888	0.1s	0.5s	185	
—	12	DC injection brake operation voltage	0 to 30%	0.1%	4/2% *1	185	
	13	Starting frequency	0 to 60Hz	0.01Hz	0.5Hz	157	
—	14	Load pattern selection	0 to 5	1	0	144	
Jog operation	15	Jog frequency	0 to 400Hz	0.01Hz	5Hz	150	
	16	Jog acceleration/deceleration time	0 to 3600/360s	0.1/0.01s	0.5s	150	
—	17	MRS input selection	0, 2, 4	1	0	210	
—	18	High speed maximum frequency	120 to 400Hz	0.01Hz	120Hz	140	
—	19	Base frequency voltage	0 to 1000V, 8888, 9999	0.1V	9999	142	
Acceleration/ deceleration times	20	Acceleration/deceleration reference frequency	1 to 400Hz	0.01Hz	60Hz	155	
	21	Acceleration/deceleration time increments	0, 1	1	0	155	
Stall prevention	22	Stall prevention operation level (torque limit level)	0 to 400%	0.1%	150%	135	
	23	Stall prevention operation level compensation factor at double speed	0 to 200%, 9999	0.1%	9999	135	
Multi-speed setting	24 to 27	Multi-speed setting (4 speed to 7 speed)	0 to 400Hz, 9999	0.01Hz	9999	148	
—	28	Multi-speed input compensation selection	0, 1	1	0	152	
—	29	Acceleration/deceleration pattern selection	0 to 5	1	0	158	
Frequency jump	31	Frequency jump 1A	0 to 400Hz, 9999	0.01Hz	9999	141	
	32	Frequency jump 1B	0 to 400Hz, 9999	0.01Hz	9999	141	
	33	Frequency jump 2A	0 to 400Hz, 9999	0.01Hz	9999	141	
	34	Frequency jump 2B	0 to 400Hz, 9999	0.01Hz	9999	141	
	35	Frequency jump 3A	0 to 400Hz, 9999	0.01Hz	9999	141	
	36	Frequency jump 3B	0 to 400Hz, 9999	0.01Hz	9999	141	



Function	Parameter	Name	Setting Range	Minimum Setting Increments	Initial Value	Refer to Page	Customer Setting
—	37	Speed display	0, 1 to 9998	1	0	227	
Frequency detection	41	Up-to-frequency sensitivity	0 to 100%	0.1%	10%	222	
	42	Output frequency detection	0 to 400Hz	0.01Hz	6Hz	222	
	43	Output frequency detection for reverse rotation	0 to 400Hz, 9999	0.01Hz	9999	222	
Second functions	44	Second acceleration/deceleration time	0 to 3600/360s	0.1/0.01s	5s	155	
	45	Second deceleration time	0 to 3600/360s, 9999	0.1/0.01s	9999	155	
	46	Second torque boost	0 to 30%, 9999	0.1%	9999	129	
	47	Second V/F (base frequency)	0 to 400Hz, 9999	0.01Hz	9999	142	
	48	Second stall prevention operation current	0 to 220%	0.1%	150%	135	
	49	Second stall prevention operation frequency	0 to 400Hz, 9999	0.01Hz	0Hz	135	
	50	Second output frequency detection	0 to 400Hz	0.01Hz	30Hz	222	
51	Second electronic thermal O/L relay	0 to 500A, 9999	0.01A	9999	165		
Monitor functions	52 Ver.UP	DU/PU main display data selection	0, 5 to 8, 10 to 14, 17 to 20, 22 to 25, 32 to 35, 50 to 57, 65, 66, 100	1	0	229	
	54	FM terminal function selection	1 to 3, 5 to 8, 10 to 14, 17, 18, 21, 24, 32 to 34, 50, 52, 53	1	1	229	
	55	Frequency monitoring reference	0 to 400Hz	0.01Hz	60Hz	236	
	56	Current monitoring reference	0 to 500A	0.01A	Rated inverter current	236	
Automatic restart	57	Restart coasting time	0, 0.1 to 5s, 9999	0.1s	9999	243	
	58	Restart cushion time	0 to 60s	0.1s	1s	243	
—	59	Remote function selection	0 to 3	1	0	152	
—	60	Energy saving control selection	0, 4	1	0	255	
Automatic acceleration/ deceleration	61	Reference current	0 to 500A, 9999	0.01A	9999	146, 162	
	62	Reference value at acceleration	0 to 220%, 9999	0.1%	9999	162	
	63	Reference value at deceleration	0 to 220%, 9999	0.1%	9999	162	
	64	Starting frequency for elevator mode	0 to 10Hz, 9999	0.01Hz	9999	146	
—	65	Retry selection	0 to 5	1	0	250	
—	66	Stall prevention operation reduction starting frequency	0 to 400Hz	0.01Hz	60Hz	135	
Retry	67	Number of retries at fault occurrence	0 to 10, 101 to 110	1	0	250	
	68	Retry waiting time	0 to 10s	0.1s	1s	250	
	69	Retry count display erase	0	1	0	250	
—	71	Applied motor	0 to 8, 13 to 18, 30, 33, 34, 40, 43, 44, 50, 53, 54	1	0	131, 169	
—	72	PWM frequency selection	0 to 15	1	2	261	
—	73	Analog input selection	0 to 7, 10 to 17	1	1	263, 267	
—	74	Input filter time constant	0 to 8	1	1	269	
—	75	Reset selection/disconnected PU detection/PU stop selection	0 to 3, 14 to 17	1	14	282	
—	76	Fault code output selection	0 to 2	1	0	252	
—	77	Parameter write selection	0 to 2	1	0	284	
—	78	Reverse rotation prevention selection	0 to 2	1	0	285	
—	© 79	Operation mode selection	0 to 4, 6, 7	1	0	290, 298	



Function	Parameter	Name	Setting Range	Minimum Setting Increments	Initial Value	Refer to Page	Customer Setting
Motor constants	80	Motor capacity	0.4 to 55kW, 9999	0.01kW	9999	131, 171	
	81	Number of motor poles	2, 4, 6, 8, 10, 12, 14, 16, 18, 20, 9999	1	9999	131, 171	
	82	Motor excitation current	0 to 500A, 9999	0.01A	9999	171	
	83	Rated motor voltage	0 to 1000V	0.1V	200V/400V <sup>-4</sup>	171	
	84	Rated motor frequency	10 to 120Hz	0.01Hz	60Hz	171	
	89	Speed control gain (magnetic flux vector)	0 to 200%, 9999	0.1%	9999	131	
	90	Motor constant (R1)	0 to 50Ω, 9999	0.001Ω	9999	171	
	91	Motor constant (R2)	0 to 50Ω, 9999	0.001Ω	9999	171	
	92	Motor constant (L1)	0 to 50Ω (0 to 1000mH), 9999	0.001Ω (0.1mH)	9999	171	
	93	Motor constant (L2)	0 to 50Ω (0 to 1000mH), 9999	0.001Ω (0.1mH)	9999	171	
	94	Motor constant (X)	0 to 500Ω (0 to 100%), 9999	0.01Ω (0.1%)	9999	171	
	95	Online auto tuning selection	0 to 2	1	0	181	
	96	Auto tuning setting/status	0, 1, 101	1	0	171	
Adjustable 5 points V/F	100	V/F1(first frequency)	0 to 400Hz, 9999	0.01Hz	9999	147	
	101	V/F1(first frequency voltage)	0 to 1,000V	0.1V	0V	147	
	102	V/F2(second frequency)	0 to 400Hz, 9999	0.01Hz	9999	147	
	103	V/F2(second frequency voltage)	0 to 1,000V	0.1V	0V	147	
	104	V/F3(third frequency)	0 to 400Hz, 9999	0.01Hz	9999	147	
	105	V/F3(third frequency voltage)	0 to 1,000V	0.1V	0V	147	
	106	V/F4(fourth frequency)	0 to 400Hz, 9999	0.01Hz	9999	147	
	107	V/F4(fourth frequency voltage)	0 to 1,000V	0.1V	0V	147	
	108	V/F5(fifth frequency)	0 to 400Hz, 9999	0.01Hz	9999	147	
109	V/F5(fifth frequency voltage)	0 to 1,000V	0.1V	0V	147		
Third functions	110	Third acceleration/deceleration time	0 to 3600/360s, 9999	0.1/0.01s	9999	155	
	111	Third deceleration time	0 to 3600/360s, 9999	0.1/0.01s	9999	155	
	112	Third torque boost	0 to 30%, 9999	0.1%	9999	129	
	113	Third V/F (base frequency)	0 to 400Hz, 9999	0.01Hz	9999	142	
	114	Third stall prevention operation current	0 to 220%	0.1%	150%	135	
	115	Third stall prevention operation frequency	0 to 400Hz	0.01Hz	0	135	
	116	Third output frequency detection	0 to 400Hz	0.01Hz	60Hz	222	
PU connector communication	117	PU communication station number	0 to 31	1	0	310	
	118	PU communication speed	48, 96, 192, 384	1	192	310	
	119	PU communication stop bit length	0, 1, 10, 11	1	1	310	
	120	PU communication parity check	0 to 2	1	2	310	
	121	Number of PU communication retries	0 to 10, 9999	1	1	310	
	122	PU communication check time interval	0, 0.1 to 999.8s, 9999	0.1s	9999	310	
	123	PU communication waiting time setting	0 to 150ms, 9999	1	9999	310	
	124	PU communication CR/LF selection	0 to 2	1	1	310	
—	Ⓒ 125	Terminal 2 frequency setting gain frequency	0 to 400Hz	0.01Hz	60Hz	271	
—	Ⓒ 126	Terminal 4 frequency setting gain frequency	0 to 400Hz	0.01Hz	60Hz	271	





Function	Parameter	Name	Setting Range	Minimum Setting Increments	Initial Value	Refer to Page	Customer Setting
PID operation	127	PID control automatic switchover frequency	0 to 400Hz, 9999	0.01Hz	9999	338	
	128	PID action selection	10, 11, 20, 21, 50, 51, 60, 61	1	10	338	
	129	PID proportional band	0.1 to 1000%, 9999	0.1%	100%	338	
	130	PID integral time	0.1 to 3600s, 9999	0.1s	1s	338	
	131	PID upper limit	0 to 100%, 9999	0.1%	9999	338	
	132	PID lower limit	0 to 100%, 9999	0.1%	9999	338	
	133	PID action set point	0 to 100%, 9999	0.01%	9999	338	
	134	PID differential time	0.01 to 10.00s, 9999	0.01s	9999	338	
Bypass	135	Electronic bypass sequence selection	0, 1	1	0	346	
	136	MC switchover interlock time	0 to 100s	0.1s	1s	346	
	137	Start waiting time	0 to 100s	0.1s	0.5s	346	
	138	Bypass selection at a fault	0, 1	1	0	346	
	139	Automatic switchover frequency from inverter to bypass operation	0 to 60Hz, 9999	0.01Hz	9999	346	
Backlash measures	140	Backlash acceleration stopping frequency	0 to 400Hz	0.01Hz	1Hz	158	
	141	Backlash acceleration stopping time	0 to 360s	0.1s	0.5s	158	
	142	Backlash deceleration stopping frequency	0 to 400Hz	0.01Hz	1Hz	158	
	143	Backlash deceleration stopping time	0 to 360s	0.1s	0.5s	158	
—	144	Speed setting switchover	0, 2, 4, 6, 8, 10, 102, 104, 106, 108, 110	1	4	227	
PU	145	PU display language selection	0 to 7	1	0	371	
Current detection	148	Stall prevention level at 0V input	0 to 220%	0.1%	150%	135	
	149	Stall prevention level at 10V input	0 to 220%	0.1%	200%	135	
	150	Output current detection level	0 to 220%	0.1%	150%	224	
	151	Output current detection signal delay time	0 to 10s	0.1s	0s	224	
	152	Zero current detection level	0 to 220%	0.1%	5%	224	
	153	Zero current detection time	0 to 1s	0.01s	0.5s	224	
—	154	Voltage reduction selection during stall prevention operation	0, 1	1	1	135	
—	155	RT signal function validity condition selection	0, 10	1	0	211	
—	156	Stall prevention operation selection	0 to 31, 100, 101	1	0	135	
—	157	OL signal output timer	0 to 25s, 9999	0.1s	0s	135	
—	158	AM terminal function selection	1 to 3, 5 to 8, 10 to 14, 17, 18, 21, 24, 32 to 34, 50, 52, 53	1	1	229	
—	159	Automatic switchover frequency range from bypass to inverter operation	0 to 10Hz, 9999	0.01Hz	9999	346	
—	© 160	User group read selection	0, 1, 9999	1	0	285	
—	161	Frequency setting/key lock operation selection	0, 1, 10, 11	1	0	371	
Automatic restart functions	162	Automatic restart after instantaneous power failure selection	0 to 2, 10 to 12	1	0	243	
	163	First cushion time for restart	0 to 20s	0.1s	0s	243	
	164	First cushion voltage for restart	0 to 100%	0.1%	0%	243	
	165	Stall prevention operation level for restart	0 to 220%	0.1%	150%	243	
Current detection	166	Output current detection signal retention time	0 to 10s, 9999	0.1s	0.1s	224	
	167	Output current detection operation selection	0, 1	1	0	224	



Function	Parameter	Name	Setting Range	Minimum Setting Increments	Initial Value	Refer to Page	Customer Setting
—	168	Parameter for manufacturer setting. Do not set.					
—	169						
Cumulative monitor clear	170 <b>Ver.UP</b>	Watt-hour meter clear	0, 2, 10, 9999	1	9999	229	
	171	Operation hour meter clear	0, 9999	1	9999	229	
User group	172	User group registered display/batch clear	9999, (0 to 16)	1	0	285	
	173	User group registration	0 to 999, 9999	1	9999	285	
	174	User group clear	0 to 999, 9999	1	9999	285	
Input terminal function assignment	178	STF terminal function selection	0 to 9, 12 to 20, 22 to 28, 42 to 44, 60, 62, 64 to 69, 74, 9999	1	60	207	
	179	STR terminal function selection	0 to 9, 12 to 20, 22 to 28, 42 to 44, 61, 62, 64 to 69, 74, 9999	1	61	207	
	180	RL terminal function selection	0 to 9, 12 to 20, 22 to 28, 42 to 44, 62, 64 to 69, 74, 9999	1	0	207	
	181	RM terminal function selection		1	1	207	
	182	RH terminal function selection		1	2	207	
	183	RT terminal function selection		1	3	207	
	184	AU terminal function selection	0 to 9, 12 to 20, 22 to 28, 42 to 44, 62 to 69, 74, 9999	1	4	207	
	185	JOG terminal function selection	0 to 9, 12 to 20, 22 to 28, 42 to 44, 62, 64 to 69, 74, 9999	1	5	207	
	186	CS terminal function selection		1	6	207	
	187	MRS terminal function selection		1	24	207	
188	STOP terminal function selection	1		25	207		
189	RES terminal function selection	1		62	207		
Output terminal function assignment	190	RUN terminal function selection	0 to 6, 8, 10 to 20, 25 to 28, 30 to 36, 39, 41 to 47, 64, 70, 84, 90 to 99,	1	0	215	
	191	SU terminal function selection		1	1	215	
	192	IPF terminal function selection	100 to 106, 108, 110 to 116, 120, 125 to 128, 130 to 136, 139, 141 to 147, 164, 170, 184, 190 to 199, 9999	1	2	215	
	193	OL terminal function selection		1	3	215	
	194	FU terminal function selection		1	4	215	
	195	ABC1 terminal function selection	0 to 6, 8, 10 to 20, 25 to 28, 30 to 36, 39, 41 to 47, 64, 70, 84, 90, 91, 94 to 99, 100 to 106, 108, 110 to 116, 120, 125 to 128, 130 to 136, 139, 141 to 147, 164, 170, 184, 190, 191, 194 to 199, 9999	1	99	215	
	196	ABC2 terminal function selection	1	9999	215		
Multi-speed setting	232 to 239	Multi-speed setting (8 speed to 15 speed)	0 to 400Hz, 9999	0.01Hz	9999	148	
—	240	Soft-PWM operation selection	0, 1	1	1	261	
—	241	Analog input display unit switchover	0, 1	1	0	271	
—	242	Terminal 1 added compensation amount (terminal 2)	0 to 100%	0.1%	100%	267	
—	243	Terminal 1 added compensation amount (terminal 4)	0 to 100%	0.1%	75%	267	
—	244	Cooling fan operation selection	0, 1	1	1	363	



Function	Parameter	Name	Setting Range	Minimum Setting Increments	Initial Value	Refer to Page	Customer Setting	
Slip compensation	245	Rated slip	0 to 50%, 9999	0.01%	9999	134		
	246	Slip compensation time constant	0.01 to 10s	0.01s	0.5s	134		
	247	Constant-power range slip compensation selection	0, 9999	1	9999	134		
—	250	Stop selection	0 to 100s, 1000 to 1100s 8888, 9999	0.1s	9999	189		
—	251	Output phase loss protection selection	0, 1	1	1	253		
Frequency compensation function	252	Override bias	0 to 200%	0.1%	50%	267		
	253	Override gain	0 to 200%	0.1%	150%	267		
Life check	255	Life alarm status display	(0 to 15)	1	0	364		
	256	Inrush current limit circuit life display	(0 to 100%)	1%	100%	364		
	257	Control circuit capacitor life display	(0 to 100%)	1%	100%	364		
	258	Main circuit capacitor life display	(0 to 100%)	1%	100%	364		
	259	Main circuit capacitor life measuring	0, 1	1	0	364		
Power failure stop	261	Power failure stop selection	0, 1, 2, 11, 12	1	0	247		
	262	Subtracted frequency at deceleration start	0 to 20Hz	0.01Hz	3Hz	247		
	263	Subtraction starting frequency	0 to 120Hz, 9999	0.01Hz	60Hz	247		
	264	Power-failure deceleration time 1	0 to 3600/360s	0.1/0.01s	5s	247		
	265	Power-failure deceleration time 2	0 to 3600s/360s, 9999	0.1/0.01s	9999	247		
	266	Power failure deceleration time switchover frequency	0 to 400Hz	0.01Hz	60Hz	247		
—	267	Terminal 4 input selection	0 to 2	1	0	263		
—	268	Monitor decimal digits selection	0,1, 9999	1	9999	229		
—	269	Parameter for manufacturer setting. Do not set.						
—	270	Stop-on contact/load torque high-speed frequency control selection	0 to 3	1	0	190, 351		
Load torque high speed frequency control	271	High-speed setting maximum current	0 to 220%	0.1%	50%	351		
	272	Middle-speed setting minimum current	0 to 220%	0.1%	100%	351		
	273	Current averaging range	0 to 400Hz, 9999	0.01Hz	9999	351		
	274	Current averaging filter time constant	1 to 4000	1	16	351		
Stop-on contact control	275	Stop-on contact excitation current low-speed multiplying factor	0 to 1000%, 9999	0.1%	9999	190		
	276	PWM carrier frequency at stop-on contact	0 to 9, 9999	1	9999	190		



Function	Parameter	Name	Setting Range	Minimum Setting Increments	Initial Value	Refer to Page	Customer Setting
Brake sequence function	278	Brake opening frequency	0 to 30Hz	0.01Hz	3Hz	193	
	279	Brake opening current	0 to 220%	0.1%	130%	193	
	280	Brake opening current detection time	0 to 2s	0.1s	0.3s	193	
	281	Brake operation time at start	0 to 5s	0.1s	0.3s	193	
	282	Brake operation frequency	0 to 30Hz	0.01Hz	6Hz	193	
	283	Brake operation time at stop	0 to 5s	0.1s	0.3s	193	
	284	Deceleration detection function selection	0, 1	1	0	193	
	285	Overspeed detection frequency (Speed deviation excess detection frequency)	0 to 30Hz, 9999	0.01Hz	9999	100, 193	
Droop control	286	Droop gain	0 to 100%	0.1%	0%	354	
	287	Droop filter time constant	0 to 1s	0.01s	0.3s	354	
	288	Droop function activation selection	0 to 2, 10, 11	1	0	354	
—	291	Pulse train I/O selection	0, 1, 10, 11, 20, 21, 100	1	0	236, 356	
—	292	Automatic acceleration/deceleration	0, 3, 5 to 8, 11	1	0	146, 162, 193	
—	293	Acceleration/deceleration separate selection	0 to 2	1	0	162	
—	294	UV avoidance voltage gain	0 to 200%	0.1%	100%	247	
Password function	296 Ver.UP	Password lock level	0 to 6, 99, 100 to 106, 199, 9999	1	9999	287	
	297 Ver.UP	Password lock/unlock	(0 to 5), 1000 to 9998, 9999	1	9999	287	
—	299	Rotation direction detection selection at restarting	0, 1, 9999	1	0	243	
RS-485 communication	331	RS-485 communication station number	0 to 31(0 to 247)	1	0	310	
	332	RS-485 communication speed	3, 6, 12, 24, 48, 96, 192, 384	1	96	310	
	333	RS-485 communication stop bit length	0, 1, 10, 11	1	1	310	
	334	RS-485 communication parity check selection	0 to 2	1	2	310	
	335	RS-485 communication retry count	0 to 10, 9999	1	1	310	
	336	RS-485 communication check time interval	0 to 999.8s, 9999	0.1s	0s	310	
	337	RS-485 communication waiting time setting	0 to 150ms, 9999	1	9999	310	
	338	Communication operation command source	0, 1	1	0	299	
	339	Communication speed command source	0 to 2	1	0	299	
	340	Communication startup mode selection	0, 1, 2, 10, 12	1	0	298	
	341	RS-485 communication CR/LF selection	0 to 2	1	1	310	
	342	Communication EEPROM write selection	0, 1	1	0	311	
343	Communication error count	—	1	0	324		



Function	Parameter	Name	Setting Range	Minimum Setting Increments	Initial Value	Refer to Page	Customer Setting
Orientation control	350 *2	Stop position command selection	0, 1, 9999	1	9999	196	
	351 *2	Orientation speed	0 to 30Hz	0.01Hz	2Hz	196	
	352 *2	Creep speed	0 to 10Hz	0.01Hz	0.5Hz	196	
	353 *2	Creep switchover position	0 to 16383	1	511	196	
	354 *2	Position loop switchover position	0 to 8191	1	96	196	
	355 *2	DC injection brake start position	0 to 255	1	5	196	
	356 *2	Internal stop position command	0 to 16383	1	0	196	
	357 *2	Orientation in-position zone	0 to 255	1	5	196	
	358 *2	Servo torque selection	0 to 13	1	1	196	
	359 *2	Encoder rotation direction	0, 1	1	1	196	
	360 *2	16 bit data selection	0 to 127	1	0	196	
	361 *2	Position shift	0 to 16383	1	0	196	
	362 *2	Orientation position loop gain	0.1 to 100	0.1	1	196	
	363 *2	Completion signal output delay time	0 to 5s	0.1s	0.5s	196	
	364 *2	Encoder stop check time	0 to 5s	0.1s	0.5s	196	
	365 *2	Orientation limit	0 to 60s, 9999	1s	9999	196	
366 *2	Recheck time	0 to 5s, 9999	0.1s	9999	196		
Encoder feedback	367 *2	Speed feedback range	0 to 400Hz, 9999	0.01Hz	9999	359	
	368 *2	Feedback gain	0 to 100	0.1	1	359	
	369 *2	Number of encoder pulses	0 to 4096	1	1024	196, 359	
	374	Overspeed detection level	0 to 400Hz	0.01Hz	140Hz	253	
	376 *2	Encoder signal loss detection enable/disable selection	0, 1	1	0	253	
S-pattern acceleration/ deceleration C	380	Acceleration S-pattern 1	0 to 50%	1%	0	158	
	381	Deceleration S-pattern 1	0 to 50%	1%	0	158	
	382	Acceleration S-pattern 2	0 to 50%	1%	0	158	
	383	Deceleration S-pattern 2	0 to 50%	1%	0	158	
Pulse train input	384	Input pulse division scaling factor	0 to 250	1	0	356	
	385	Frequency for zero input pulse	0 to 400Hz	0.01Hz	0	356	
	386	Frequency for maximum input pulse	0 to 400Hz	0.01Hz	60Hz	356	
Orientation control	393 *2	Orientation selection	0 to 2	1	0	196	
	396 *2	Orientation speed gain (P term)	0 to 1000	1	60	196	
	397 *2	Orientation speed integral time	0 to 20s	0.001s	0.333s	196	
	398 *2	Orientation speed gain (D term)	0 to 100	0.1	1	196	
	399 *2	Orientation deceleration ratio	0 to 1000	1	20	196	
Position control	419 *2	Position command source selection	0 to 2	1	0	117, 120	
	Ver. UP						
	420 *2	Command pulse scaling factor numerator	0 to 32767	1	1	122	
	421 *2	Command pulse scaling factor denominator	0 to 32767	1	1	122	
	422 *2	Position loop gain	0 to 150s <sup>-1</sup>	1s <sup>-1</sup>	25s <sup>-1</sup>	124	
	423 *2	Position feed forward gain	0 to 100%	1%	0	124	
	424 *2	Position command acceleration/ deceleration time constant	0 to 50s	0.001s	0s	122	
	425 *2	Position feed forward command filter	0 to 5s	0.001s	0s	124	
	426 *2	In-position width	0 to 32767pulse	1	100	123	
	427 *2	Excessive level error	0 to 400K, 9999	1K	40K	123	
	428 *2	Command pulse selection	0 to 5	1	0	120	
429 *2	Clear signal selection	0, 1	1	1	120		
430 *2	Pulse monitor selection	0 to 5, 9999	1	9999	120		



Function	Parameter	Name	Setting Range	Minimum Setting Increments	Initial Value	Refer to Page	Customer Setting
Second motor constants	450	Second applied motor	0 to 8, 13 to 18, 30, 33, 34, 40, 43, 44, 50, 53, 54, 9999	1	9999	131, 169	
	451	Second motor control method selection	10, 11, 12, 20, 9999	1	9999	131	
	453	Second motor capacity	0.4 to 55kW, 9999	0.01kW	9999	131	
	454	Number of second motor poles	2, 4, 6, 8, 10, 9999	1	9999	131	
	455	Second motor excitation current	0 to 500A, 9999	0.01A	9999	171	
	456	Rated second motor voltage	0 to 1000V	0.1V	200/400V*4	171	
	457	Rated second motor frequency	10 to 120Hz	0.01Hz	60Hz	171	
	458	Second motor constant (R1)	0 to 50Ω, 9999	0.001Ω	9999	171	
	459	Second motor constant (R2)	0 to 50Ω, 9999	0.001Ω	9999	171	
	460	Second motor constant (L1)	0 to 50Ω (0 to 1000mH), 9999	0.001Ω (0.1mH)	9999	171	
	461	Second motor constant (L2)	0 to 50Ω (0 to 1000mH), 9999	0.001Ω (0.1mH)	9999	171	
	462	Second motor constant (X)	0 to 500Ω (0 to 100%), 9999	0.01Ω (0.1%)	9999	171	
	463	Second motor auto tuning setting/status	0, 1, 101	1	0	171	
Conditional position feed function	464 *2	Digital position control sudden stop deceleration time	0 to 360.0s	0.1s	0	117	
	465 *2	First position feed amount lower 4 digits	0 to 9999	1	0	117	
	466 *2	First position feed amount upper 4 digits	0 to 9999	1	0	117	
	467 *2	Second position feed amount lower 4 digits	0 to 9999	1	0	117	
	468 *2	Second position feed amount upper 4 digits	0 to 9999	1	0	117	
	469 *2	Third position feed amount lower 4 digits	0 to 9999	1	0	117	
	470 *2	Third position feed amount upper 4 digits	0 to 9999	1	0	117	
	471 *2	Fourth position feed amount lower 4 digits	0 to 9999	1	0	117	
	472 *2	Fourth position feed amount upper 4 digits	0 to 9999	1	0	117	
	473 *2	Fifth position feed amount lower 4 digits	0 to 9999	1	0	117	
	474 *2	Fifth position feed amount upper 4 digits	0 to 9999	1	0	117	
	475 *2	Sixth position feed amount lower 4 digits	0 to 9999	1	0	117	
	476 *2	Sixth position feed amount upper 4 digits	0 to 9999	1	0	117	
	477 *2	Seventh position feed amount lower 4 digits	0 to 9999	1	0	117	
	478 *2	Seventh position feed amount upper 4 digits	0 to 9999	1	0	117	
	479 *2	Eighth position feed amount lower 4 digits	0 to 9999	1	0	117	
	480 *2	Eighth position feed amount upper 4 digits	0 to 9999	1	0	117	
	481 *2	Ninth position feed amount lower 4 digits	0 to 9999	1	0	117	
	482 *2	Ninth position feed amount upper 4 digits	0 to 9999	1	0	117	
	483 *2	Tenth position feed amount lower 4 digits	0 to 9999	1	0	117	
	484 *2	Tenth position feed amount upper 4 digits	0 to 9999	1	0	117	
	485 *2	Eleventh position feed amount lower 4 digits	0 to 9999	1	0	117	
	486 *2	Eleventh position feed amount upper 4 digits	0 to 9999	1	0	117	
	487 *2	Twelfth position feed amount lower 4 digits	0 to 9999	1	0	117	
	488 *2	Twelfth position feed amount upper 4 digits	0 to 9999	1	0	117	
	489 *2	Thirteenth position feed amount lower 4 digits	0 to 9999	1	0	117	
490 *2	Thirteenth position feed amount upper 4 digits	0 to 9999	1	0	117		
491 *2	Fourteenth position feed amount lower 4 digits	0 to 9999	1	0	117		
492 *2	Fourteenth position feed amount upper 4 digits	0 to 9999	1	0	117		
493 *2	Fifteenth position feed amount lower 4 digits	0 to 9999	1	0	117		
494 *2	Fifteenth position feed amount upper 4 digits	0 to 9999	1	0	117		
Remote output	495	Remote output selection	0, 1, 10, 11	1	0	226	
	496	Remote output data 1	0 to 4095	1	0	226	
	497	Remote output data 2	0 to 4095	1	0	226	
Maintenance	503	Maintenance timer	0 (1 to 9998)	1	0	367	
	504	Maintenance timer alarm output set time	0 to 9998, 9999	1	9999	367	
—	505	Speed setting reference	1 to 120Hz	0.01Hz	60Hz	227	



Function	Parameter	Name	Setting Range	Minimum Setting Increments	Initial Value	Refer to Page	Customer Setting
S-pattern acceleration/ deceleration D	516	S-pattern time at a start of acceleration	0.1 to 2.5s	0.1s	0.1s	158	
	517	S-pattern time at a completion of acceleration	0.1 to 2.5s	0.1s	0.1s	158	
	518	S-pattern time at a start of deceleration	0.1 to 2.5s	0.1s	0.1s	158	
	519	S-pattern time at a completion of deceleration	0.1 to 2.5s	0.1s	0.1s	158	
—	539	Modbus-RTU communication check time interval	0 to 999.8s, 9999	0.1s	9999	324	
USB	547	USB communication station number	0 to 31	1	0	337	
	548	USB communication check time interval	0 to 999.8s, 9999	0.1s	9999	337	
Communication	549	Protocol selection	0, 1	1	0	324	
	550	NET mode operation command source selection	0, 1, 9999	1	9999	299	
	551	PU mode operation command source selection	1 to 3	1	2	299	
Current average value monitor	555	Current average time	0.1 to 1.0s	0.1s	1s	368	
	556	Data output mask time	0.0 to 20.0s	0.1s	0s	368	
	557	Current average value monitor signal output reference current	0 to 500A	0.01A	Rated inverter current	368	
—	563	Energization time carrying-over times	(0 to 65535)	1	0	229	
—	564	Operating time carrying-over times	(0 to 65535)	1	0	229	
Second motor constants	569	Second motor speed control gain	0 to 200%, 9999	0.1%	9999	131	
	571	Holding time at a start	0.0 to 10.0s, 9999	0.1s	9999	157	
—	574	Second motor online auto tuning	0, 1	1	0	181	
PID control	575	Output interruption detection time	0 to 3600s, 9999	0.1s	1s	338	
	576	Output interruption detection level	0 to 400Hz	0.01Hz	0Hz	338	
	577	Output interruption cancel level	900 to 1100%	0.1%	1000%	338	
—	611	Acceleration time at a restart	0 to 3600s, 9999	0.1s	5s	243	
—	665	Regeneration avoidance frequency gain	0 to 200%	0.1%	100%	361	
—	684	Tuning data unit switchover	0, 1	1	0	171	
—	800	Control method selection	0 to 5, 9 to 12, 20	1	20	75, 131	
—	802 *2	Pre-excitation selection	0, 1	1	0	185	
Torque command	803	Constant power range torque characteristic selection	0, 1	1	0	83, 108	
	804	Torque command source selection	0 to 6	1	0	108	
	805	Torque command value (RAM)	600 to 1400%	1%	1000%	108	
	806	Torque command value (RAM,EEPROM)	600 to 1400%	1%	1000%	108	
Speed limit	807	Speed limit selection	0 to 2	1	0	110	
	808	Forward rotation speed limit	0 to 120Hz	0.01Hz	60Hz	110	
	809	Reverse rotation speed limit	0 to 120Hz, 9999	0.01Hz	9999	110	





Function	Parameter	Name	Setting Range	Minimum Setting Increments	Initial Value	Refer to Page	Customer Setting
Torque limit	810	Torque limit input method selection	0, 1	1	0	83	
	811	Set resolution switchover	0, 1, 10, 11	1	0	83, 227	
	812	Torque limit level (regeneration)	0 to 400%, 9999	0.1%	9999	83	
	813	Torque limit level (3rd quadrant)	0 to 400%, 9999	0.1%	9999	83	
	814	Torque limit level (4th quadrant)	0 to 400%, 9999	0.1%	9999	83	
	815	Torque limit level 2	0 to 400%, 9999	0.1%	9999	83	
	816	Torque limit level during acceleration	0 to 400%, 9999	0.1%	9999	83	
Easy gain tuning	817	Torque limit level during deceleration	0 to 400%, 9999	0.1%	9999	83	
	818	Easy gain tuning response level setting	1 to 15	1	2	88	
Adjustment function	819	Easy gain tuning selection	0 to 2	1	0	88	
	820	Speed control P gain 1	0 to 1000%	1%	60%	88	
	821	Speed control integral time 1	0 to 20s	0.001s	0.333s	88	
	822	Speed setting filter 1	0 to 5s, 9999	0.001s	9999	269	
	823 *2	Speed detection filter 1	0 to 0.1s	0.001s	0.001s	127	
	824	Torque control P gain 1	0 to 200%	1%	100%	113	
	825	Torque control integral time 1	0 to 500ms	0.1ms	5ms	113	
	826	Torque setting filter 1	0 to 5s, 9999	0.001s	9999	269	
	827	Torque detection filter 1	0 to 0.1s	0.001s	0s	127	
	828	Model speed control gain	0 to 1000%	1%	60%	95	
	830	Speed control P gain 2	0 to 1000%, 9999	1%	9999	88	
	831	Speed control integral time 2	0 to 20s, 9999	0.001s	9999	88	
	832	Speed setting filter 2	0 to 5s, 9999	0.001s	9999	269	
	833 *2	Speed detection filter 2	0 to 0.1s, 9999	0.001s	9999	127	
	834	Torque control P gain 2	0 to 200%, 9999	1%	9999	113	
	835	Torque control integral time 2	0 to 500ms, 9999	0.1ms	9999	113	
	Torque bias	836	Torque setting filter 2	0 to 5s, 9999	0.001s	9999	269
837		Torque detection filter 2	0 to 0.1s, 9999	0.001s	9999	127	
840 *2		Torque bias selection	0 to 3, 9999	1	9999	97	
841 *2		Torque bias 1	600 to 1400%, 9999	1%	9999	97	
842 *2		Torque bias 2	600 to 1400%, 9999	1%	9999	97	
843 *2		Torque bias 3	600 to 1400%, 9999	1%	9999	97	
844 *2		Torque bias filter	0 to 5s, 9999	0.001s	9999	97	
845 *2		Torque bias operation time	0 to 5s, 9999	0.01s	9999	97	
Additional function	846 *2	Torque bias balance compensation	0 to 10V, 9999	0.1V	9999	97	
	847 *2	Fall-time torque bias terminal 1 bias	0 to 400%, 9999	1%	9999	97	
	848 *2	Fall-time torque bias terminal 1 gain	0 to 400%, 9999	1%	9999	97	
	849	Analog input offset adjustment	0 to 200%	0.1%	100%	269	
	850	Brake operation selection	0 to 2	1	0	185	
	Ver. UP						
	853 *2	Speed deviation time	0 to 100s	0.1s	1s	100	
	854	Excitation ratio	0 to 100%	1%	100%	128	
	858	Terminal 4 function assignment	0, 1, 4, 9999	1	0	262	
	859	Torque current	0 to 500A, 9999	0.01A	9999	171	
Indication function	860	Second motor torque current	0 to 500A, 9999	0.01A	9999	171	
	862	Notch filter time constant	0 to 60	1	0	101	
	863	Notch filter depth	0 to 3	1	0	101	
	864	Torque detection	0 to 400%	0.1%	150%	225	
	865	Low speed detection	0 to 400Hz	0.01Hz	1.5Hz	222	
	866	Torque monitoring reference	0 to 400%	0.1%	150%	236	
	867	AM output filter	0 to 5s	0.01s	0.01s	236	





Function	Parameter	Name	Setting Range	Minimum Setting Increments	Initial Value	Refer to Page	Customer Setting
—	868	Terminal 1 function assignment	0 to 6, 9999	1	0	262	
Protective Functions	872	Input phase loss protection selection	0, 1	1	1	253	
	873 *2	Speed limit	0 to 120Hz	0.01Hz	20Hz	100	
	874	OLT level setting	0 to 200%	0.1%	150%	83	
	875	Fault definition	0, 1	1	0	254	
Control method functions	877	Speed feed forward control/model adaptive speed control selection	0 to 2	1	0	95	
	878	Speed feed forward filter	0 to 1s	0.01s	0s	95	
	879	Speed feed forward torque limit	0 to 400%	0.1%	150%	95	
	880	Load inertia ratio	0 to 200 times	0.1	7	88, 95	
	881	Speed feed forward gain	0 to 1000%	1%	0%	95	
Regeneration avoidance function	882	Regeneration avoidance operation selection	0 to 2	1	0	361	
	883	Regeneration avoidance operation level	300 to 800V	0.1V	380/760VDC *4	361	
	884	Regeneration avoidance at deceleration detection sensitivity	0 to 5	1	0	361	
	885	Regeneration avoidance compensation frequency limit value	0 to 10Hz, 9999	0.01Hz	6Hz	361	
	886	Regeneration avoidance voltage gain	0 to 200%	0.1%	100%	361	
Free parameters	888	Free parameter 1	0 to 9999	1	9999	370	
	889	Free parameter 2	0 to 9999	1	9999	370	
Energy saving monitor	891	Cumulative power monitor digit shifted times	0 to 4, 9999	1	9999	256	
	892	Load factor	30 to 150%	0.1%	100%	256	
	893	Energy saving monitor reference (motor capacity)	0.1 to 55kW	0.01kW	Inverter rated capacity	256	
	894	Control selection during commercial power supply operation	0 to 3	1	0	256	
	895	Power saving rate reference value	0, 1, 9999	1	9999	256	
	896	Power unit cost	0 to 500, 9999	0.01	9999	256	
	897	Power saving monitor average time	0, 1 to 1000h, 9999	1h	9999	256	
	898	Power saving cumulative monitor clear	0, 1, 10, 9999	1	9999	256	
	899	Operation time rate (estimated value)	0 to 100%, 9999	0.1%	9999	256	



Function	Parameter	Name	Setting Range	Minimum Setting Increments	Initial Value	Refer to Page	Customer Setting
Calibration parameters	<b>C0 (900)</b> *3	FM terminal calibration	—	—	—	240	
	<b>C1 (901)</b> *3	AM terminal calibration	—	—	—	240	
	<b>C2 (902)</b> *3	Terminal 2 frequency setting bias frequency	0 to 400Hz	0.01Hz	0Hz	271	
	<b>C3 (902)</b> *3	Terminal 2 frequency setting bias	0 to 300%	0.1%	0%	271	
	<b>125 (903)</b> *3	Terminal 2 frequency setting gain frequency	0 to 400Hz	0.01Hz	60Hz	271	
	<b>C4 (903)</b> *3	Terminal 2 frequency setting gain	0 to 300%	0.1%	100%	271	
	<b>C5 (904)</b> *3	Terminal 4 frequency setting bias frequency	0 to 400Hz	0.01Hz	0Hz	271	
	<b>C6 (904)</b> *3	Terminal 4 frequency setting bias	0 to 300%	0.1%	20%	271	
	<b>126 (905)</b> *3	Terminal 4 frequency setting gain frequency	0 to 400Hz	0.01Hz	60Hz	271	
	<b>C7 (905)</b> *3	Terminal 4 frequency setting gain	0 to 300%	0.1%	100%	271	
Calibration parameters	<b>C12 (917)</b> *3	Terminal 1 bias frequency (speed)	0 to 400Hz	0.01Hz	0Hz	271	
	<b>C13 (917)</b> *3	Terminal 1 bias (speed)	0 to 300%	0.1%	0%	271	
	<b>C14 (918)</b> *3	Terminal 1 gain frequency (speed)	0 to 400Hz	0.01Hz	60Hz	271	
	<b>C15 (918)</b> *3	Terminal 1 gain (speed)	0 to 300%	0.1%	100%	271	
	<b>C16 (919)</b> *3	Terminal 1 bias command (torque/magnetic flux)	0 to 400%	0.1%	0%	277	
	<b>C17 (919)</b> *3	Terminal 1 bias (torque/magnetic flux)	0 to 300%	0.1%	0%	277	
	<b>C18 (920)</b> *3	Terminal 1 gain command (torque/magnetic flux)	0 to 400%	0.1%	150%	277	
	<b>C19 (920)</b> *3	Terminal 1 gain (torque/magnetic flux)	0 to 300%	0.1%	100%	277	
	<b>C38 (932)</b> *3	Terminal 4 bias command (torque/magnetic flux)	0 to 400%	0.1%	0%	277	
	<b>C39 (932)</b> *3	Terminal 4 bias (torque/magnetic flux)	0 to 300%	0.1%	20%	277	
	<b>C40 (933)</b> *3	Terminal 4 gain command (torque/magnetic flux)	0 to 400%	0.1%	150%	277	
<b>C41 (933)</b> *3	Terminal 4 gain (torque/magnetic flux)	0 to 300%	0.1%	100%	277		
—	<b>989</b>	Parameter for manufacturer setting. Do not set.					
PU	<b>990</b>	PU buzzer control	0, 1	1	1	373	
	<b>991</b>	PU contrast adjustment	0 to 63	1	58	373	
Clear parameters	<b>Pr. CL</b>	Parameter clear	0, 1	1	0	374	
	<b>ALLC</b>	All parameter clear	0, 1	1	0	375	
	<b>Er.CL</b>	Faults history clear	0, 1	1	0	378	
	<b>PCPY</b>	Parameter copy	0 to 3	1	0	376	

\*1 Differ according to capacities. (7.5K or lower/11K or higher)

\*2 Setting can be made only when the FR-A7AP/FR-A7AL is mounted.

\*3 The parameter number in parentheses is the one for use with the parameter unit (FR-PU04/FR-PU07).

\*4 Differs according to the voltage class. (200V class/400V class)

## Parameters according to purposes

<b>4.3</b>	<b>Control mode</b>	<b>71</b>
4.3.1	What is vector control?.....	72
4.3.2	Change the control method (Pr. 80, Pr. 81, Pr. 451, Pr. 800).....	75
<b>4.4</b>	<b>Speed control by Real sensorless vector control, vector control</b>	<b>79</b>
4.4.1	Setting procedure of Real sensorless vector control (speed control) .....	81
4.4.2	Setting procedure of vector control (speed control) .....	82
4.4.3	Torque limit level setting for speed control (Pr. 22, Pr. 803, Pr. 810 to Pr. 817, Pr. 858, Pr. 868, Pr. 874) .....	83
4.4.4	To perform high accuracy/fast response operation (gain adjustment of Real sensorless vector control and vector control) (Pr. 818 to Pr. 821, Pr. 830, Pr. 831, Pr. 880) .....	88
4.4.5	Speed feed forward control, model adaptive speed control (Pr. 828, Pr. 877 to Pr. 881) .....	95
4.4.6	Torque biases (Pr. 840 to Pr. 848) .....	97
4.4.7	Prevent the motor from overrunning (Pr. 285, Pr. 853, Pr. 873) .....	100
4.4.8	Notch filter (Pr. 862, Pr. 863) .....	101
<b>4.5</b>	<b>Torque control by Real sensorless vector control, vector control</b>	<b>102</b>
4.5.1	Torque control .....	102
4.5.2	Setting procedure of Real sensorless vector control (torque control) .....	106
4.5.3	Setting procedure of vector control (torque control) .....	107
4.5.4	Torque command (Pr. 803 to Pr. 806) .....	108
4.5.5	Speed limit (Pr. 807 to Pr. 809) .....	110
4.5.6	Gain adjustment of torque control (Pr. 824, Pr. 825, Pr. 834, Pr. 835) .....	113
<b>4.6</b>	<b>Position control by vector control</b>	<b>115</b>
4.6.1	Position control .....	115
4.6.2	Conditional position feed function by contact input (Pr. 419, Pr. 464 to Pr. 494) .....	117
4.6.3	Position control (Pr. 419, Pr. 428 to Pr. 430) by inverter pulse train input .....	120
4.6.4	Setting of the electronic gear (Pr. 420, Pr. 421, Pr. 424) .....	122
4.6.5	Setting of positioning adjustment parameter (Pr. 426, Pr. 427) .....	123
4.6.6	Gain adjustment of position control (Pr. 422, Pr. 423, Pr. 425) .....	124
4.6.7	Trouble shooting for when position control is not exercised normally .....	126
<b>4.7</b>	<b>Adjustment of Real sensorless vector control, vector control</b>	<b>127</b>
4.7.1	Speed detection filter and torque detection filter (Pr. 823, Pr. 827, Pr. 833, Pr. 837) .....	127
4.7.2	Excitation ratio (Pr. 854) .....	128
<b>4.8</b>	<b>Adjust the output torque (current) of the motor</b>	<b>129</b>
4.8.1	Manual torque boost (Pr. 0, Pr. 46, Pr. 112) .....	129
4.8.2	Advanced magnetic flux vector control (Pr. 71, Pr. 80, Pr. 81, Pr. 89, Pr. 450, Pr. 451, Pr. 453, Pr. 454, Pr. 569, Pr. 800) .....	131
4.8.3	Slip compensation (Pr. 245 to Pr. 247) .....	134
4.8.4	Stall prevention operation (Pr. 22, Pr. 23, Pr. 48, Pr. 49, Pr. 66, Pr. 114, Pr. 115, Pr. 148, Pr. 149, Pr. 154, Pr. 156, Pr. 157, Pr. 858, Pr. 868).....	135
<b>4.9</b>	<b>Limiting the output frequency</b>	<b>140</b>
4.9.1	Maximum/minimum frequency (Pr. 1, Pr. 2, Pr. 18).....	140
4.9.2	Avoiding mechanical resonance points (Frequency jump) (Pr. 31 to Pr. 36).....	141
<b>4.10</b>	<b>V/F pattern</b>	<b>142</b>
4.10.1	Base frequency, voltage (Pr. 3, Pr. 19, Pr. 47, Pr. 113).....	142
4.10.2	Load pattern selection (Pr. 14) .....	144
4.10.3	Elevator mode (automatic acceleration/deceleration) (Pr. 61, Pr. 64, Pr. 292) .....	146
4.10.4	Adjustable 5 points V/F (Pr. 71, Pr. 100 to Pr. 109).....	147
<b>4.11</b>	<b>Frequency setting by external terminals</b>	<b>148</b>
4.11.1	Multi-speed setting operation (Pr. 4 to Pr. 6, Pr. 24 to Pr. 27, Pr. 232 to Pr. 239).....	148
4.11.2	Jog operation (Pr. 15, Pr. 16).....	150
4.11.3	Input compensation of multi-speed and remote setting (Pr. 28) .....	152
4.11.4	Remote setting function (Pr. 59) .....	152
<b>4.12</b>	<b>Setting of acceleration/deceleration time and acceleration/deceleration pattern</b>	<b>155</b>
4.12.1	Setting of the acceleration and deceleration time (Pr. 7, Pr. 8, Pr. 20, Pr. 21, Pr. 44, Pr. 45, Pr. 110, Pr. 111).....	155
4.12.2	Starting frequency and start-time hold function (Pr. 13, Pr. 571).....	157

4.12.3	Acceleration/deceleration pattern (Pr. 29, Pr. 140 to Pr. 143, Pr. 380 to Pr. 383, Pr. 516 to Pr. 519).....	158
4.12.4	Shortest acceleration/deceleration and optimum acceleration/deceleration (automatic acceleration/deceleration) (Pr. 61 to Pr. 63, Pr. 292, Pr. 293) .....	162
<b>4.13</b>	<b>Selection and protection of a motor</b>	<b>165</b>
4.13.1	Motor protection from overheat (Electronic thermal relay function) (Pr. 9, Pr. 51).....	165
4.13.2	Applied motor (Pr. 71, Pr. 450) .....	169
4.13.3	Offline auto tuning (Pr. 71, Pr. 80 to Pr. 84, Pr. 90 to Pr. 94, Pr. 96, Pr. 450, Pr. 453 to Pr. 463, Pr. 684, Pr. 859, Pr. 860) .....	171
4.13.4	Online auto tuning (Pr. 95, Pr. 574) .....	181
<b>4.14</b>	<b>Motor brake and stop operation</b>	<b>185</b>
4.14.1	DC injection brake and zero speed control, servo lock (LX signal, X13 signal, Pr. 10 to Pr. 12, Pr. 802, Pr. 850).....	185
4.14.2	Stop selection (Pr. 250).....	189
4.14.3	Stop-on contact control function (Pr. 6, Pr. 48, Pr. 270, Pr. 275, Pr. 276) .....	190
4.14.4	Brake sequence function (Pr. 278 to Pr. 285, Pr. 292) .....	193
4.14.5	Orientation control (Pr. 350 to Pr. 366, Pr. 369, Pr. 393, Pr. 396 to Pr. 399) .....	196
<b>4.15</b>	<b>Function assignment of external terminal and control</b>	<b>207</b>
4.15.1	Input terminal function selection (Pr. 178 to Pr. 189).....	207
4.15.2	Inverter output shutoff signal (MRS signal, Pr. 17) .....	210
4.15.3	Condition selection of function validity by the second function selection signal (RT) and third function selection signal (X9) (RT signal, X9 signal, Pr. 155) .....	211
4.15.4	Start signal operation selection (STF, STR, STOP signal, Pr. 250).....	212
4.15.5	Magnetic flux decay output shutoff signal (X74 signal).....	214
4.15.6	Output terminal function selection (Pr. 190 to Pr. 196) .....	215
4.15.7	Detection of output frequency (SU, FU, FU2, FU3, FB, FB2, FB3, LS signal, Pr. 41 to Pr. 43, Pr. 50, Pr. 116, Pr. 865).....	222
4.15.8	Output current detection function (Y12 signal, Y13 signal, Pr. 150 to Pr. 153, Pr. 166, Pr. 167).....	224
4.15.9	Detection of output torque (TU signal, Pr. 864).....	225
4.15.10	Remote output function (REM signal, Pr. 495 to Pr. 497).....	226
<b>4.16</b>	<b>Monitor display and monitor output signal</b>	<b>227</b>
4.16.1	Speed display and speed setting (Pr. 37, Pr. 144, Pr. 505, Pr. 811) .....	227
4.16.2	DU/PU, FM, AM terminal monitor display selection (Pr. 52, Pr. 54, Pr. 158, Pr. 170, Pr. 171, Pr. 268, Pr. 563, Pr. 564, Pr. 891).....	229
4.16.3	Reference of the terminal FM (pulse train output) and AM (analog voltage output) (Pr. 55, Pr. 56, Pr. 291, Pr. 866, Pr. 867).....	236
4.16.4	Terminal FM, AM calibration (Calibration parameter C0 (Pr. 900), C1 (Pr. 901)).....	240
<b>4.17</b>	<b>Operation selection at power failure and instantaneous power failure</b>	<b>243</b>
4.17.1	Automatic restart after instantaneous power failure/flying start (Pr. 57, Pr. 58, Pr. 162 to Pr. 165, Pr. 299, Pr. 611) .....	243
4.17.2	Power failure-time deceleration-to-stop function (Pr. 261 to Pr. 266, Pr. 294).....	247
<b>4.18</b>	<b>Operation setting at fault occurrence</b>	<b>250</b>
4.18.1	Retry function (Pr. 65, Pr. 67 to Pr. 69).....	250
4.18.2	Fault code output selection (Pr. 76) .....	252
4.18.3	Input/output phase loss protection selection (Pr. 251, Pr. 872) .....	253
4.18.4	Overspeed detection (Pr. 374).....	253
4.18.5	Encoder signal loss detection (Pr. 376) .....	253
4.18.6	Fault definition (Pr. 875).....	254
<b>4.19</b>	<b>Energy saving operation and energy saving monitor</b>	<b>255</b>
4.19.1	Energy saving control (Pr. 60) .....	255
4.19.2	Energy saving monitor (Pr. 891 to Pr. 899).....	256
<b>4.20</b>	<b>Motor noise, EMI measures</b>	<b>261</b>
4.20.1	PWM carrier frequency and Soft-PWM control (Pr. 72, Pr. 240).....	261
<b>4.21</b>	<b>Frequency/torque setting by analog input (terminal 1, 2, 4)</b>	<b>262</b>
4.21.1	Function assignment of analog input terminal (Pr. 858, Pr. 868).....	262
4.21.2	Analog input selection (Pr. 73, Pr. 267) .....	263
4.21.3	Analog input compensation (Pr. 73, Pr. 242, Pr. 243, Pr. 252, Pr. 253) .....	267

4.21.4	Response level of analog input and noise elimination (Pr. 74, Pr. 822, Pr. 826, Pr. 832, Pr. 836, Pr. 849).....	269
4.21.5	Bias and gain of frequency setting voltage (current) (Pr. 125, Pr. 126, Pr. 241, C2(Pr. 902) to C7(Pr. 905), C12(Pr. 917) to C15(Pr. 918)).....	271
4.21.6	Bias and gain of torque (magnetic flux) setting voltage (current) (Pr. 241, C16(Pr. 919) to C19(Pr. 920), C38 (Pr. 932) to C41 (Pr. 933)) .....	277
<b>4.22</b>	<b>Misoperation prevention and parameter setting restriction</b>	<b>282</b>
4.22.1	Reset selection/disconnected PU detection/PU stop selection (Pr. 75).....	282
4.22.2	Parameter write selection (Pr. 77).....	284
4.22.3	Reverse rotation prevention selection (Pr. 78).....	285
4.22.4	Display of applied parameters and user group function (Pr. 160, Pr. 172 to Pr. 174).....	285
4.22.5	Password function (Pr. 296, Pr. 297) .....	287
<b>4.23</b>	<b>Selection of operation mode and operation location</b>	<b>290</b>
4.23.1	Operation mode selection (Pr. 79) .....	290
4.23.2	Operation mode at power on (Pr. 79, Pr. 340).....	298
4.23.3	Start command source and frequency command source during communication operation (Pr. 338, Pr. 339, Pr. 550, Pr. 551) .....	299
<b>4.24</b>	<b>Communication operation and setting</b>	<b>305</b>
4.24.1	Wiring and configuration of PU connector.....	305
4.24.2	Wiring and arrangement of RS-485 terminals.....	307
4.24.3	Initial settings and specifications of RS-485 communication (Pr. 117 to Pr. 124, Pr. 331 to Pr. 337, Pr. 341, Pr. 549) .....	310
4.24.4	Communication EEPROM write selection (Pr. 342).....	311
4.24.5	Mitsubishi inverter protocol (computer link communication) .....	312
4.24.6	Modbus-RTU communication specifications (Pr. 331, Pr. 332, Pr. 334, Pr. 343, Pr. 539, Pr. 549).....	324
4.24.7	USB communication (Pr. 547, Pr. 548).....	337
<b>4.25</b>	<b>Special operation and frequency control</b>	<b>338</b>
4.25.1	PID control (Pr. 127 to Pr. 134, Pr. 575 to Pr. 577).....	338
4.25.2	Bypass-inverter switchover function (Pr. 57, Pr. 58, Pr. 135 to Pr. 139, Pr. 159) .....	346
4.25.3	Load torque high speed frequency control (Pr. 4, Pr. 5, Pr. 270 to Pr. 274) .....	351
4.25.4	Droop control (Pr. 286 to Pr. 288) .....	354
4.25.5	Frequency setting by pulse train input (Pr. 291, Pr. 384 to Pr. 386) .....	356
4.25.6	Encoder feedback control (Pr. 144, Pr. 285, Pr. 359, Pr. 367 to Pr. 369) .....	359
4.25.7	Regeneration avoidance function (Pr. 665, Pr. 882 to Pr. 886) .....	361
<b>4.26</b>	<b>Useful functions</b>	<b>363</b>
4.26.1	Cooling fan operation selection (Pr. 244).....	363
4.26.2	Display of the life of the inverter parts (Pr. 255 to Pr. 259) .....	364
4.26.3	Maintenance timer alarm (Pr. 503, Pr. 504).....	367
4.26.4	Current average value monitor signal (Pr. 555 to Pr. 557).....	368
4.26.5	Free parameter (Pr. 888, Pr. 889).....	370
<b>4.27</b>	<b>Setting of the parameter unit and operation panel</b>	<b>371</b>
4.27.1	PU display language selection (Pr. 145).....	371
4.27.2	Operation panel frequency setting/key lock selection (Pr. 161) .....	371
4.27.3	Buzzer control (Pr. 990) .....	373
4.27.4	PU contrast adjustment (Pr. 991).....	373
<b>4.28</b>	<b>Parameter clear</b>	<b>374</b>
<b>4.29</b>	<b>All parameter clear</b>	<b>375</b>
<b>4.30</b>	<b>Parameter copy and parameter verification</b>	<b>376</b>
4.30.1	Parameter copy.....	376
4.30.2	Parameter verification .....	377
<b>4.31</b>	<b>Check and clear of the faults history</b>	<b>378</b>

## 4.3 Control mode

V/F control (initial setting), Advanced magnetic flux vector control, Real sensorless vector control and vector control are available with this inverter.

### (1) V/F Control

- It controls frequency and voltage so that the ratio of frequency (F) to voltage (V) is constant when changing frequency.

### (2) Advanced magnetic flux vector control

- This control divides the inverter output current into an excitation current and a torque current by vector calculation and makes voltage compensation to flow a motor current which meets the load torque.

#### POINT

If the following conditions are not satisfied, select V/F control since malfunction such as insufficient torque and uneven rotation may occur.

- The motor capacity should be equal to or one rank lower than the inverter capacity.
- Motor to be used is any of Mitsubishi standard motor (SF-JR 3.7kW or higher), high efficiency motor (SF-HR 3.7kW or higher) or Mitsubishi constant torque motor (SF-JRCA 4P, SF-HRCA 3.7kW or higher). When using a motor other than the above (other manufacturer's motor, etc.), perform offline auto tuning without fail.
- Single-motor operation (one motor run by one inverter) should be performed.
- Wiring length from inverter to motor should be within 30m. (Perform offline auto tuning in the state where wiring work is performed when the wiring length exceeds 30m.)

### (3) Real sensorless vector control

- By estimating the motor speed, speed control and torque control with more advanced current control function are enabled. When high accuracy and fast response is necessary, select the Real sensorless vector control and perform offline auto tuning and online auto tuning.
- This control can be applied to the following applications.
  - To minimize the speed fluctuation even at a severe load fluctuation
  - To generate low speed torque
  - To prevent machine from damage due to too large torque (torque limit)
  - To perform torque control

#### POINT

If the following conditions are not satisfied, select V/F control since malfunction such as insufficient torque and uneven rotation may occur.

- The motor capacity should be equal to or one rank lower than the inverter capacity.
- Perform offline auto tuning without fail. Offline auto tuning is necessary under Real sensorless vector control even when the Mitsubishi motor is used.
- Single-motor operation (one motor run by one inverter) should be performed.

### (4) Vector control

- When the FR-A7AP/FR-A7AL (option) is mounted, full-scale vector control operation can be performed using a motor with encoder. Fast response/high accuracy speed control (zero speed control, servo lock), torque control, and position control can be performed.
- What is vector control?  
Excellent control characteristics when compared to V/F control and other control techniques, achieving the control characteristics equal to those of DC machines.  
It is suitable for applications below.
  - To minimize the speed fluctuation even at a severe load fluctuation
  - To generate low speed torque
  - To prevent machine from damage due to too large torque (torque limit)
  - To perform torque control or position control
  - Servo-lock torque control which generates torque at zero speed (i.e. status of motor shaft = stopped)

#### POINT

If the conditions below are not satisfied, malfunction such as insufficient torque and uneven rotation may occur.

- The motor capacity should be equal to or one rank lower than the inverter capacity.
- Motor to be used is any of Mitsubishi standard motor with encoder (SF-JR), high efficiency motor with encoder (SF-HR) or Mitsubishi constant torque motor with encoder (SF-JRCA 4P, SF-HRCA 3.7kW or more) or vector control dedicated motor (SF-V5RU). When using a motor other than the above (other manufacturer's motor), perform offline auto tuning without fail.
- Single-motor operation (one motor run by one inverter) should be performed.
- Wiring length from inverter to motor should be within 30m. (Perform offline auto tuning in the state where wiring work is performed when the wiring length exceeds 30m.)



### 4.3.1 What is vector control?

Vector control is one of the control techniques for driving an induction motor. To help explain vector control, the fundamental equivalent circuit of an induction motor is shown below:

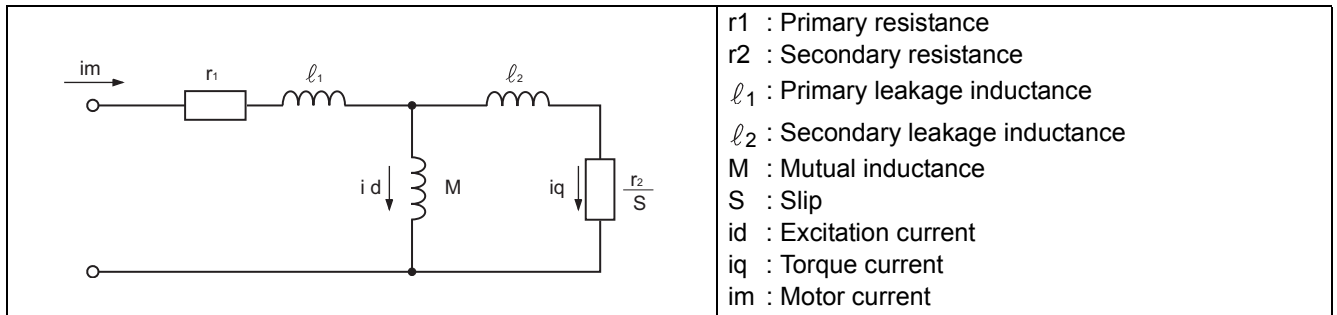

In the above diagram, currents flowing in the induction motor can be classified into a current  $i_d$  (excitation current) for making a magnetic flux in the motor and a current  $i_q$  (torque current) for causing the motor to develop a torque.

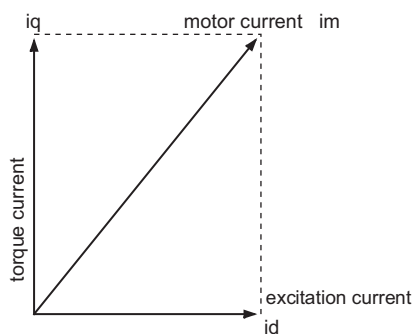

In vector control, the voltage and output frequency are calculated to control the motor so that the excitation current and torque current (as shown in the left figure) flow to the optimum as described below:

- (1) The excitation current is controlled to place the internal magnetic flux of the motor in the optimum status.
- (2) Derive the torque command value so that the difference between the motor speed command and the actual speed (speed estimated value for Real sensorless vector control) obtained from the encoder connected to the motor shaft is zero. Torque current is controlled so that torque as set in the torque command is developed.

Motor-generated torque ( $T_M$ ), slip angular velocity ( $\omega_s$ ) and the motor's secondary magnetic flux ( $\phi_2$ ) can be found by the following calculation:

$$T_M \propto \phi_2 \cdot i_q$$

$$\phi_2 = M \cdot i_d$$

$$\omega_s = \frac{r_2}{L_2} \cdot \frac{i_q}{i_d}$$

where,  $L_2$  = secondary inductance

$$L_2 = l_2 + M$$

Vector control provides the following advantages:

- (1) Excellent control characteristics when compared to V/F control and other control techniques, achieving the control characteristics equal to those of DC machines.
- (2) Applicable to fast response applications with which induction motors were previously regarded as difficult to use. Applications requiring a wide variable-speed range from extremely low speed to high speed, frequent acceleration/deceleration operations, continuous four-quadrant operations etc.
- (3) Allows torque control.
- (4) Allows servo-lock torque control which generates a torque at zero speed (i.e. status of motor shaft = stopped). (Cannot be performed under Real sensorless vector control.)



Block diagram of Real sensorless vector control

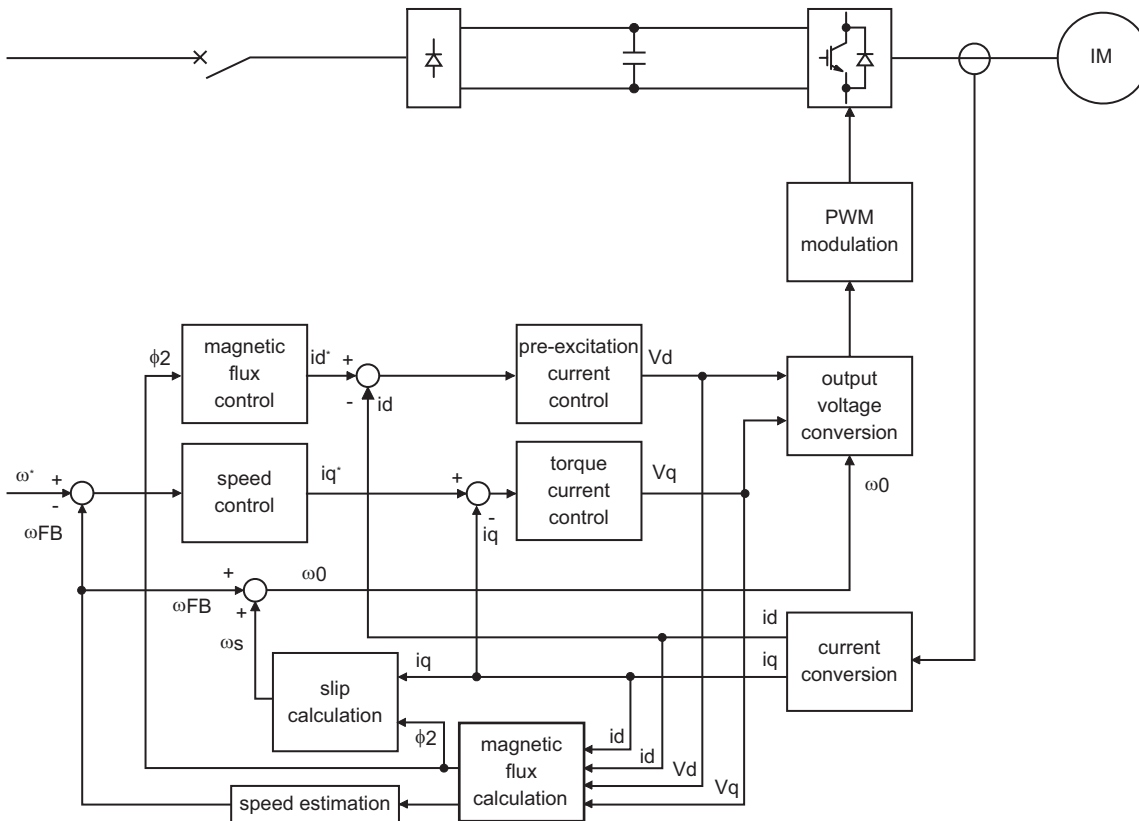

Block diagram of vector control

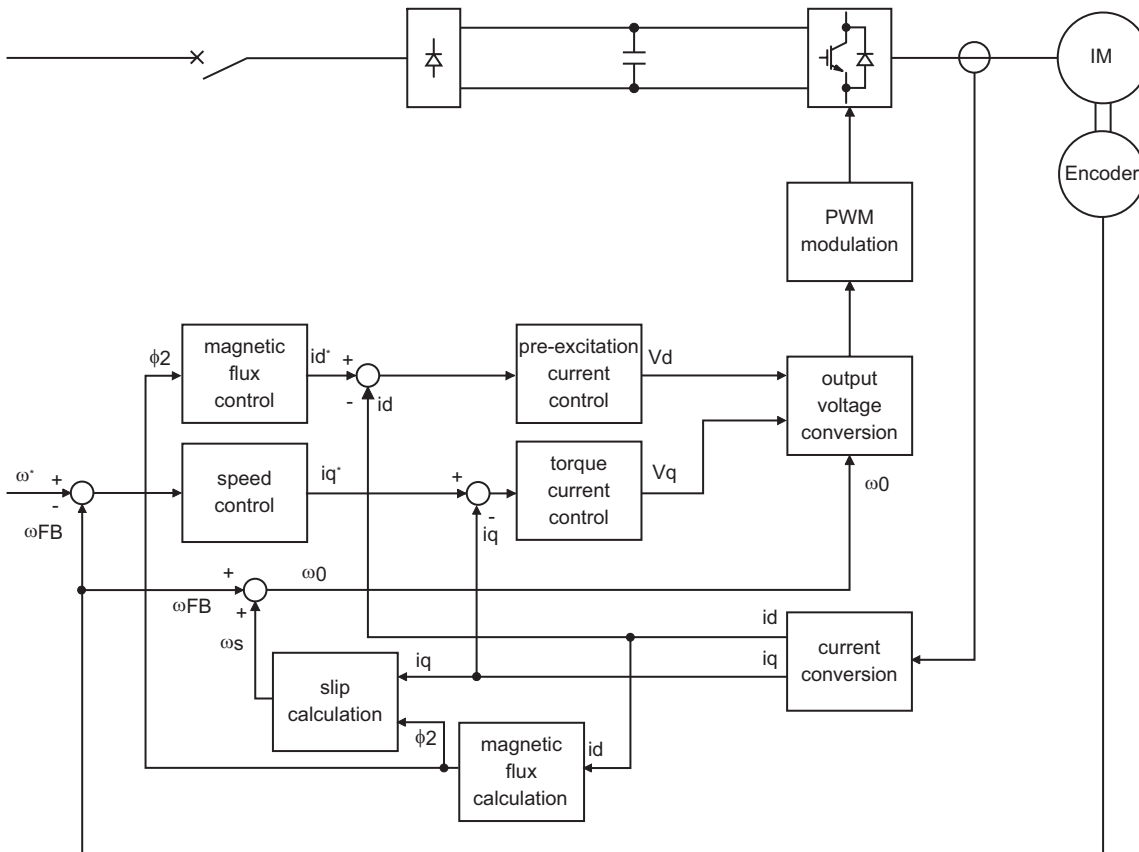





- (1) Speed control  
Speed control operation is performed to zero the difference between the speed command ( $\omega^*$ ) and actual rotation detection value ( $\omega_{FB}$ ). At this time, the motor load is found and its result is transferred to the torque current controller as a torque current command ( $i_q^*$ ).
- (2) Torque current control  
A voltage ( $V_q$ ) is calculated to start a current ( $i_q^*$ ) which is identical to the torque current command ( $i_q$ ) found by the speed controller.
- (3) Magnetic flux control  
The magnetic flux ( $\phi_2$ ) of the motor is derived from the excitation current ( $i_d$ ). The excitation current command ( $i_d^*$ ) is calculated to use that motor magnetic flux ( $\phi_2$ ) as a predetermined magnetic flux.
- (4) Excitation current control  
A voltage ( $V_d$ ) is calculated to start a current ( $i_d$ ) which is identical to the excitation current command ( $i_d^*$ ) found by magnetic flux control.
- (5) Output frequency calculation  
Motor slip ( $\omega_s$ ) is calculated on the basis of the torque current value ( $i_q$ ) and magnetic flux ( $\phi_2$ ). The output frequency ( $\omega_0$ ) is found by adding that slip ( $\omega_s$ ) to the feedback ( $\omega_{FB}$ ) found by a feedback from the encoder.

The above results are used to make PWM modulation and run the motor.

### 4.3.2 Change the control method (Pr. 80, Pr. 81, Pr. 451, Pr. 800)

Set when selecting the Advanced magnetic flux vector control, Real sensorless vector control or vector control. Select a control mode from speed control mode, torque control mode and position control mode under Real sensorless vector control or vector control. The initial value is V/F control.

- Select a control method using Pr. 800 (Pr. 451) Control method selection .
- Each control method can be switched using a method switching signal (MC).

Parameter Number	Name	Initial Value	Setting Range	Description	
80	Motor capacity	9999	0.4 to 55kW	Set the applied motor capacity.	
			9999	V/F control	
81	Number of motor poles	9999	2, 4, 6, 8, 10	Set the number of motor poles.	
			12, 14, 16, 18, 20	X18 signal-ON: V/F control	Set 10 + number of motor poles
			9999	V/F control	
800	Control method selection	20	0 to 5	Vector control	
			9	Vector control test operation	
			10, 11, 12	Real sensorless vector control	
			20	V/F control (Advanced magnetic flux vector control)	
451	Second motor control method selection	9999	10, 11, 12	Real sensorless vector control	
			20, 9999	V/F control (Advanced magnetic flux vector control)	

#### (1) Setting of the motor capacity and the number of motor poles (Pr. 80, Pr. 81)

- Motor specifications (the motor capacity and the number of motor poles) must be set to select Advanced magnetic flux vector control, Real sensorless vector control or vector control.
- Set the motor capacity (kW) in Pr. 80 Motor capacity and set the number of motor poles in Pr. 81 Number of motor poles.

#### REMARKS

- Setting number of motor poles in Pr. 81 changes the Pr. 144 Speed setting switchover setting automatically. (Refer to page 227.)

#### (2) Selection of control method and control mode

- Select the inverter control method for V/F control, Advanced magnetic flux vector control (speed control), Real sensorless vector control (speed control, torque control) and vector control (speed control, torque control, and position control).

Pr. 80, Pr. 81 Setting	Pr. 800 Setting	Pr. 451 Setting	Control Method	Control Mode	Remarks
Other than 9999	0	—	Vector control	Speed control	—
	1	—		Torque control	—
	2	—		Speed control-torque control switchover	MC ON: Torque control MC OFF: Speed control
	3	—		Position control	—
	4	—		Speed control-position control switchover	MC ON: Position control MC OFF: Speed control
	5	—		Position control-torque control switchover	MC ON: Torque control MC OFF: Position control
	9	—		Vector control test operation	
	10	—	Real sensorless vector control	Speed control	—
	11	—		Torque control	—
	12	—		Speed control-torque control switchover	MC ON: Torque control MC OFF: Speed control
	20 (Pr. 800 initial value)	—	Advanced magnetic flux vector control	Speed control	—
—	9999 (Pr. 451 initial value)	V/F control, Advanced magnetic flux vector control			
9999	—*	V/F control			

\* Control method is V/F control regardless of the setting value of Pr. 800 when "9999" is set in Pr. 80 Motor capacity or Pr. 81 Number of motor poles.



### (3) Vector control test operation (Pr. 800 = "9")

- Speed control test operation can be performed even when the motor is not connected. The speed calculation value changes to track the speed command and the transition can be checked with the operation panel and analog signal output at FM and AM.

#### CAUTION

- Since current is not detected and voltage is not output, monitors related to current and voltage such as output current and output voltage, etc. and output signals do not function.
- For speed calculation, speed is calculated in consideration of Pr. 880 Load inertia ratio.

### (4) Control method switching by external terminals (RT signal, X18 signal)

- The switching of the control method (V/F control, Advanced magnetic flux vector control, Real sensorless vector control and vector control) by the external terminal may be made in either of the following two ways: switching by the second function selection signal (RT), or V/F switching signal (X18).
- Two types of control method can be switched with the RT signal by setting the type of motor to be used as second motor in Pr. 450 Second applied motor and control method of the motor in Pr. 451 Second motor control method selection. Turn on the RT signal to select the second function.
- For switching by the X18 signal, setting "12, 14, 16, 18, 20" in Pr. 81 Number of motor poles and turning the X18 signal on switches the currently selected control method (Advanced magnetic flux vector control, Real sensorless vector control and vector control) to V/F control. In this case, use this signal only for changing the control method of one motor since second function as electronic thermal relay characteristic, etc. can not be changed. (Use the RT signal to change the second function.)

For the terminal used for X18 signal input, set "18" in any of Pr. 178 to Pr. 189 (input terminal function selection) to assign the function.

First Motor Control Method	Second Motor Control Method (RT signal is on)	Pr. 450 Setting	Pr. 453, Pr. 454 Setting	Pr. 451 Setting
V/F control	V/F control	9999	—	—
	Advanced magnetic flux vector control	Other than 9999	9999	—
	Real sensorless vector control		Other than 9999	20, 9999 10 to 12
Advanced magnetic flux vector control Real sensorless vector control Vector control	Same control as the first motor *1	9999	—	—
	V/F control	Other than 9999	9999	—
	Advanced magnetic flux vector control		Other than 9999	20, 9999 10 to 12
	Real sensorless vector control			

\*1 V/F control is selected when "12, 14, 16, 18, 20" is set in Pr. 81 and the X18 signal is on. When the X18 signal is not assigned, turning the RT signal on selects V/F control as the RT signal shares this function.

#### REMARKS

- The RT signal is assigned to the terminal RT in the initial setting. By setting "3" in any of Pr. 178 to Pr. 189 (input terminal function selection), you can assign the RT signal to the other terminal.
- The RT signal acts as the second function selection signal and makes the other second functions valid. (Refer to page 211.)
- The control method could be changed by external terminals (RT signal, X18 signal) while the inverter is stopped. If a signal is switched during the operation, the control method changes after the inverter stops.

**(5) Switching the control method from the external terminal (MC signal)**

- When "12 (2)" is set in *Pr. 800 (Pr. 451)*, speed control is selected when the control mode switching signal (MC) is off, and torque control is selected when the signal is on under Real sensorless vector control and vector control. Switching between speed control and torque control is always enabled.

Under vector control, speed control/position control switchover and torque control/position control switchover can be made by setting "4, 5" in *Pr. 800*. For the terminal used for MC signal input, set "26" in any of *Pr. 178 to Pr. 189 (input terminal function selection)* to assign the function.

- When an analog input terminal (terminal 1,4) is used for torque limit, torque command, etc., terminal functions also switch as below if control mode is switched.

- Terminal 1 function according to control

<i>Pr. 868</i> Setting	Real Sensorless Vector Control ( <i>Pr. 800 = 12</i> ), Vector Control ( <i>Pr. 800 = 2</i> )	
	Speed control (MC signal-OFF)	Torque control (MC signal-ON)
0 (initial value)	Speed setting auxiliary	Speed limit auxiliary
1	Magnetic flux command	Magnetic flux command
2	Regenerative torque limit ( <i>Pr. 810 = 1</i> )	—
3	—	Torque command ( <i>Pr. 804 = 0</i> )
4	Torque limit ( <i>Pr. 810 = 1</i> )	Torque command ( <i>Pr. 804 = 0</i> )
5	—	Forward reverse speed limit ( <i>Pr. 807 = 2</i> )
6	—	—
9999	—	—

<i>Pr. 868</i> Setting	Vector Control ( <i>Pr. 800 = 4</i> )	
	Speed control (MC signal-OFF)	Position control (MC signal-ON)
0 (initial value)	Speed setting auxiliary	—
1	Magnetic flux command	Magnetic flux command
2	Regenerative torque limit ( <i>Pr. 810 = 1</i> )	Regenerative torque limit ( <i>Pr. 810 = 1</i> )
3	—	—
4	Torque limit ( <i>Pr. 810 = 1</i> )	Torque limit ( <i>Pr. 810 = 1</i> )
5	—	—
6	Torque bias	—
9999	—	—

<i>Pr. 868</i> Setting	Vector Control ( <i>Pr. 800 = 5</i> )	
	Position control (MC signal-OFF)	Torque control (MC signal-ON)
0 (initial value)	—	Speed setting auxiliary
1	Magnetic flux command	Magnetic flux command
2	Regenerative torque limit ( <i>Pr. 810 = 1</i> )	—
3	—	Torque command ( <i>Pr. 804 = 0</i> )
4	Torque limit ( <i>Pr. 810 = 1</i> )	Torque command ( <i>Pr. 804 = 0</i> )
5	—	Forward reverse speed limit ( <i>Pr. 807 = 2</i> )
6	—	—
9999	—	—



- Terminal 4 function according to control

Pr. 858 Setting	Real Sensorless Vector Control (Pr. 800 = 12), Vector Control (Pr. 800 = 2)	
	Speed control (MC signal-OFF)	Torque control (MC signal-ON)
0 (initial value)	Speed command (AU signal-ON)	Speed limit (AU signal-ON)
1	Magnetic flux command	Magnetic flux command
4	Torque limit (Pr. 810 = 1)	—
9999	—	—

Pr. 858 Setting	Vector Control (Pr. 800 = 4)	
	Speed control (MC signal-OFF)	Position control (MC signal-ON)
0 (initial value)	Speed command (AU signal-ON)	—
1	Magnetic flux command	Magnetic flux command
4	Torque limit (Pr. 810 = 1)	Torque limit (Pr. 810 = 1)
9999	—	—

Pr. 858 Setting	Vector Control (Pr. 800 = 5)	
	Position control (MC signal-OFF)	Torque control (MC signal-ON)
0 (initial value)	—	Speed limit (AU signal-ON)
1	Magnetic flux command	Magnetic flux command
4	Torque limit (Pr. 810 = 1)	—
9999	—	—

— :No function

#### REMARKS

- Switching between speed control and torque control is always enabled independently of whether the motor is at a stop or running or the DC injection brake operation (pre-excitation).
- During motor operation, speed control/position control switchover and torque control/position control switchover is made when frequency drops to the Pr. 865 Low speed detection.

#### CAUTION

- Changing the terminal assignment using Pr. 178 to Pr. 189 (input terminal function selection) may affect the other functions. Set parameters after confirming the function of each terminal.

#### ◆ Parameters referred to ◆

Advanced magnetic flux vector control Refer to page 131  
 Real sensorless vector control, vector control (speed control) Refer to page 79  
 Real sensorless vector control, vector control (torque control) Refer to page 102  
 Vector control (position control) Refer to page 115  
 Pr. 178 to Pr. 189 (input terminal function selection) Refer to page 207  
 Pr. 450 Second applied motor Refer to page 169  
 Pr. 804 Torque command source selection Refer to page 108  
 Pr. 807 Speed limit selection Refer to page 110  
 Pr. 810 Torque limit input method selection Refer to page 83  
 Pr. 858 Terminal 4 function assignment, Pr. 868 Terminal 1 function assignment Refer to page 262

## 4.4 Speed control by Real sensorless vector control, vector control

Purpose	Parameter that should be Set	Refer to Page
To perform torque limit during speed control	Torque limit	Pr. 22, Pr. 803, Pr. 810, Pr. 812 to Pr. 817, Pr. 858, Pr. 868, Pr. 874
Gain adjustment of speed control	Easy gain tuning Gain adjustment	Pr. 818 to Pr. 821, Pr. 830, Pr. 831, Pr. 880
To enhance the trackability of the motor in response to a speed command change	Speed feed forward control, model adaptive speed control	Pr. 828, Pr. 877 to Pr. 881
Stabilize the speed detection signal	Speed detection filter	Pr. 823, Pr. 833
Accelerates the rise of the torque at a start	Torque bias	Pr. 840 to Pr. 848
Avoid mechanical resonance	Notch filter	Pr. 862, Pr. 863

Speed control is exercised to match the speed command and actual motor speed.

### (1) Control block diagram

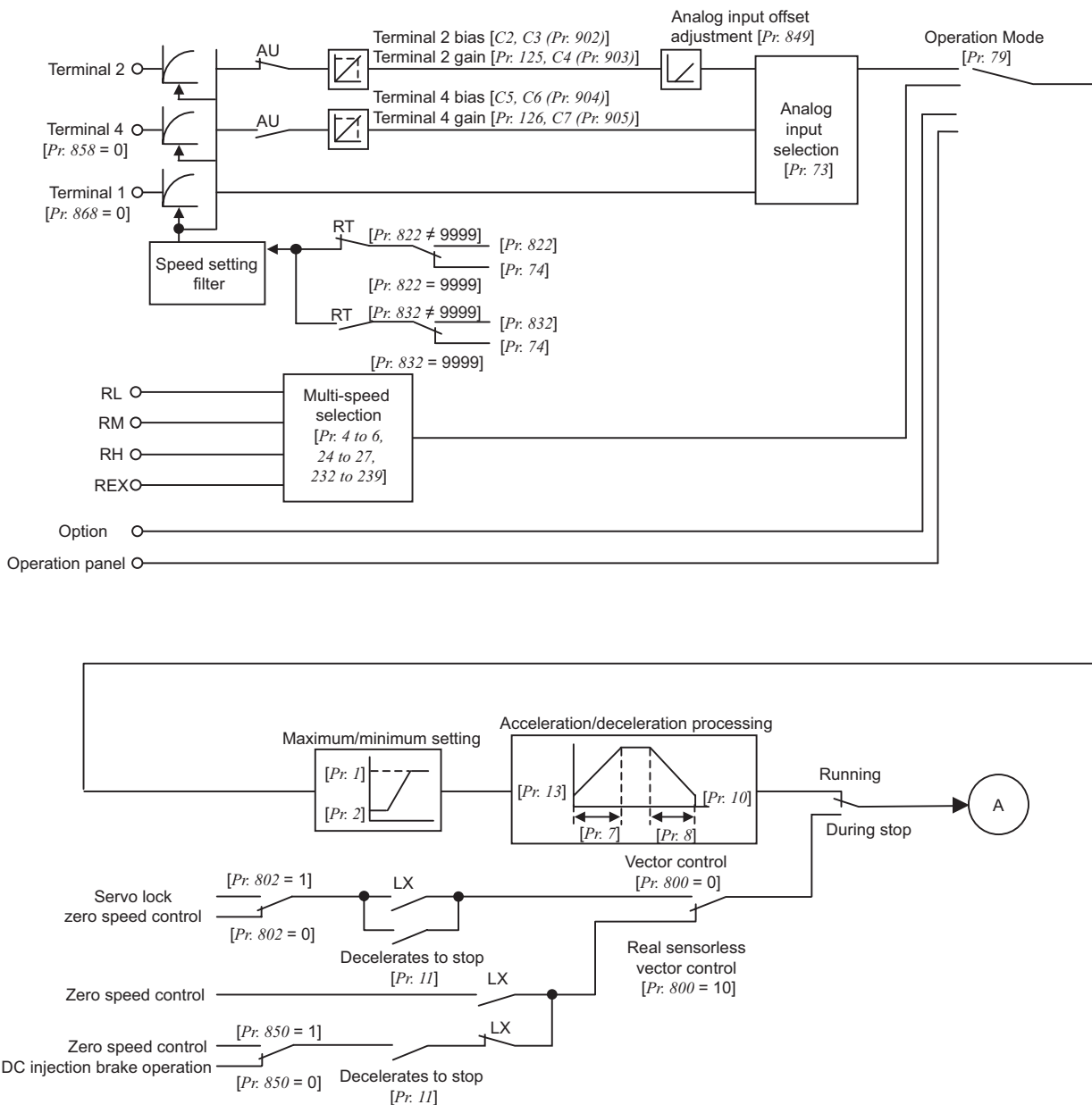

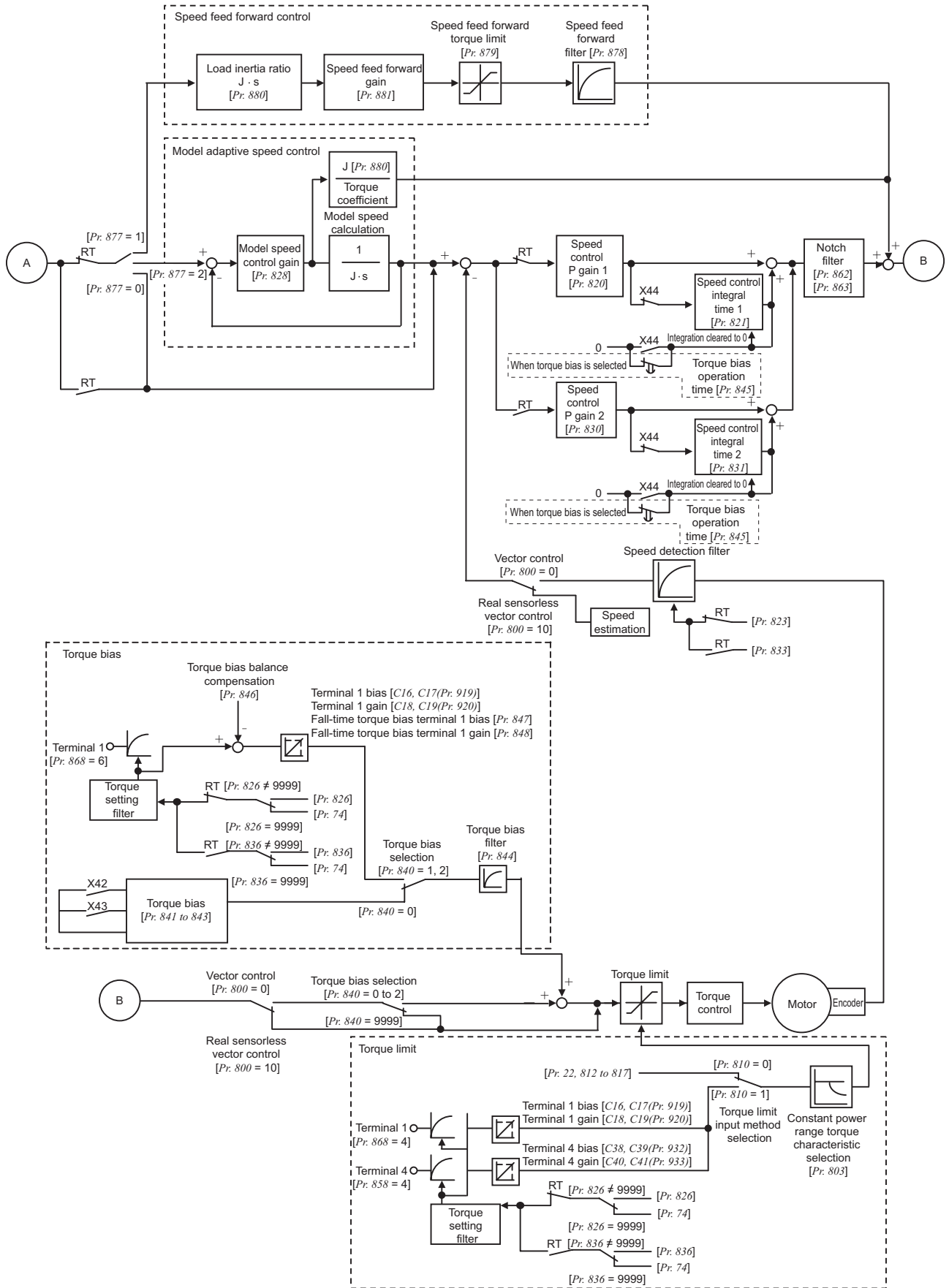

#### 4.4.1 Setting procedure of Real sensorless vector control (speed control) Sensorless

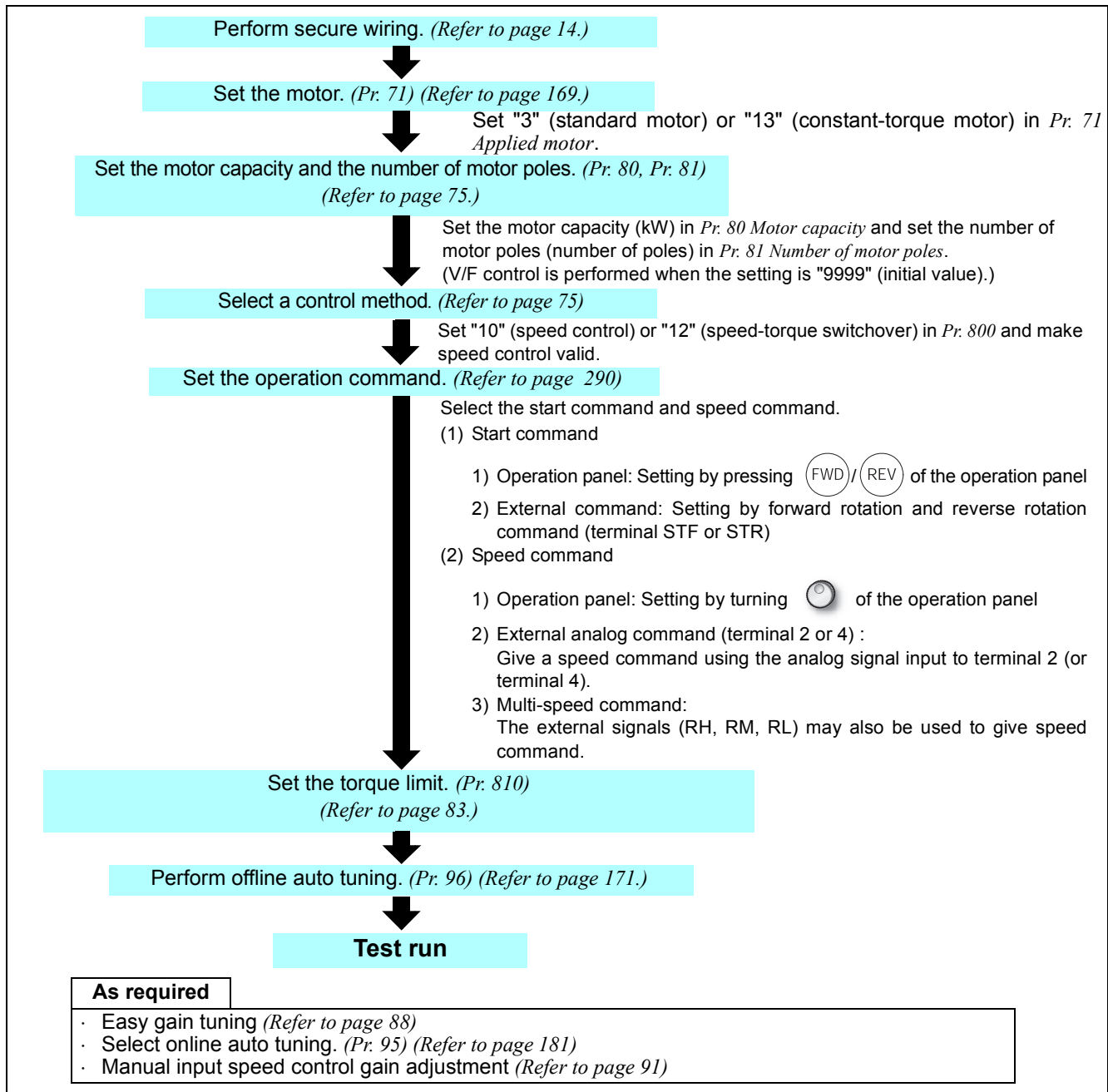

#### CAUTION

- Make sure to perform offline auto tuning before performing Real sensorless vector control.
- Speed command setting range is 0 to 120Hz for Real sensorless vector control.
- The carrier frequencies are selectable from among 2k, 6k, 10k, 14kHz for Real sensorless vector control.
- Torque control can not be performed in the low speed (approx. 10Hz or less) regeneration range and with light load at low speed (approx. 20% or less of rated torque at approx. 5Hz or less). Choose vector control.
- Performing pre-excitation (LX signal and X13 signal) under torque control may start the motor running at a low speed even when the start command (STF or STR) is not input. The motor may run also at a low speed when the speed limit value = 0 with a start command input. Perform pre-excitation after making sure that there will be no problem in safety if the motor runs.
- Do not switch between the STF (forward rotation command) and STR (reverse rotation command) during operation under torque control. Overcurrent trip (E.OCC) or opposite rotation deceleration fault (E.11) occurs.
- When the inverter is likely to start during motor coasting under Real sensorless vector control, set to make frequency search of automatic restart after instantaneous power failure valid (Pr. 57 ≠ "9999", Pr. 162 = "10").
- Enough torque may not be generated in the ultra-low speed range less than approx. 2Hz when performing Real sensorless vector control.

The guideline of speed control range is as shown below.

Driving:	1:200 (2, 4, 6 poles)	Can be used at 0.3Hz or more at rated 60Hz
	1:30 (8, 10 poles)	Can be used at 2Hz or more at rated 60Hz
Regeneration:	1:12 (2 to 10 poles)	Can be used at 5Hz or more at rated 60Hz





4.4.2 Setting procedure of vector control (speed control) Vector

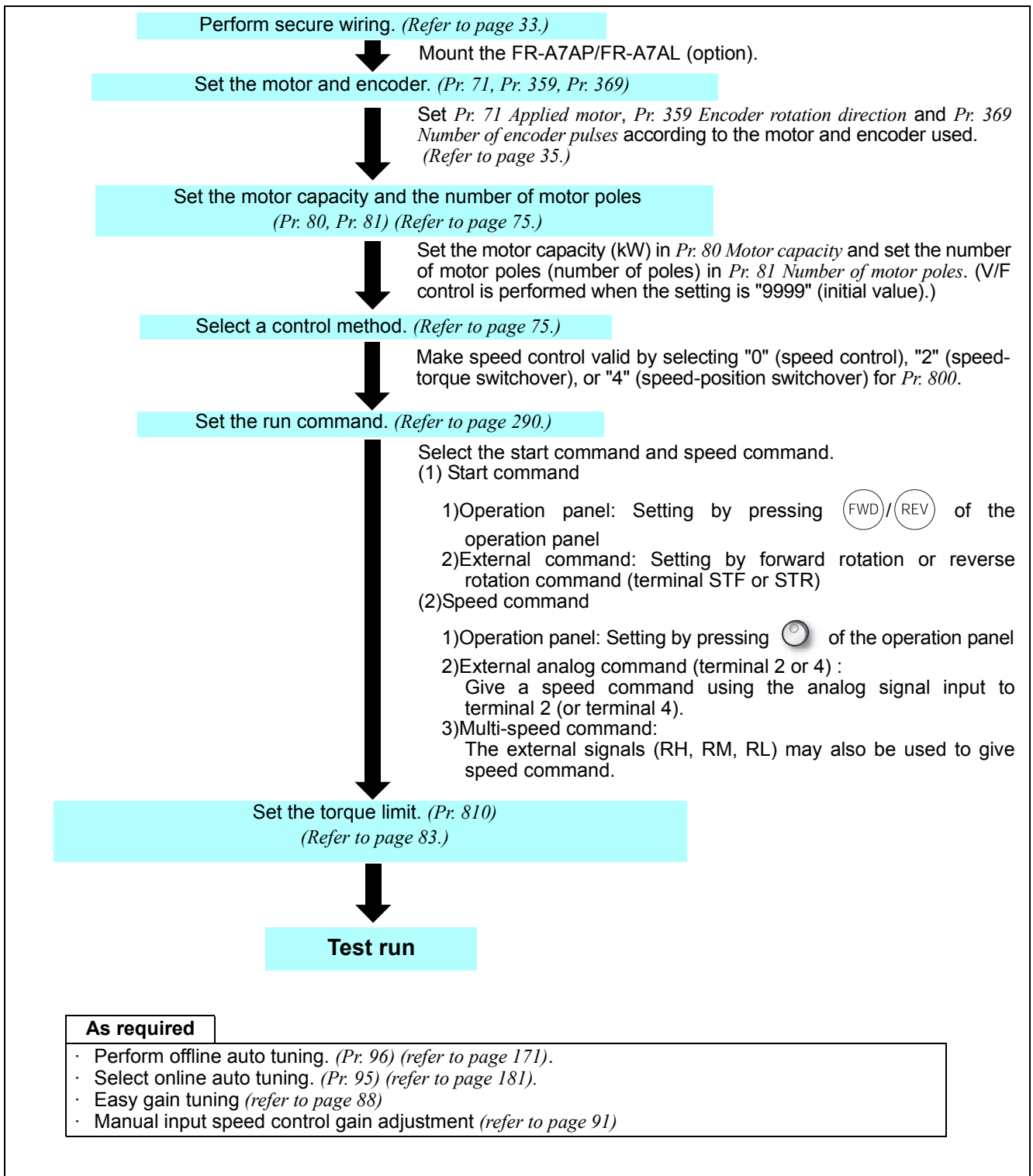

**CAUTION**

- Speed command setting range is 0 to 120Hz for vector control.
- The carrier frequencies are selectable among 2k, 6k, 10k, and 14kHz for vector control.



### 4.4.3 Torque limit level setting for speed control

(Pr. 22, Pr. 803, Pr. 810 to Pr. 817, Pr. 858, Pr. 868, Pr. 874) Sensorless Vector

This function limits the output torque to the predetermined value during speed control under Real sensorless vector control or vector control.

- Set the torque limit level within the range 0 to 400% in Pr. 22.  
When the TL signal is turned on, torque limit level 2 is activated.
- You can select whether the torque limit level is set using parameters or analog input terminals (terminal 1, 4).  
In addition, you can set torque limit level for forward (power driving/regeneration) and reverse (power driving/regeneration) operation individually.

Parameter Number	Name	Initial Value	Setting Range	Description	
22*	Stall prevention operation level (torque limit level)	150%	0 to 400%	Set the torque limit level in % on the assumption that the rated torque is 100%	
157	OL signal output timer	0s	0 to 25s	Set the output start time of the OL signal output when torque limit is activated.	
			9999	Without the OL signal output	
803	Constant power range torque characteristic selection	0	0	Constant motor output limit	
			1	Constant torque limit	
810	Torque limit input method selection	0	0	Internal torque limit (torque limit by parameter settings)	
			1	External torque limit (torque limit by terminal 1, 4)	
811	Set resolution switchover	0		Speed setting and running speed monitor increments from the PU, RS-485 communication or communication option.	
			0	1r/min	Torque limit setting increments Pr. 22, Pr. 812 to Pr. 817
			1	0.1r/min	
			10	1r/min	0.01%
11	0.1r/min				
812	Torque limit level (regeneration)	9999	0 to 400%	Set the torque limit level for forward rotation regeneration.	
			9999	Limit at the value of Pr. 22 or analog terminal	
813	Torque limit level (3rd quadrant)	9999	0 to 400%	Set the torque limit level for reverse rotation driving.	
			9999	Limit at the value of Pr. 22 or analog terminal	
814	Torque limit level (4th quadrant)	9999	0 to 400%	Set the torque limit level for reverse rotation regeneration.	
			9999	Limit at the value of Pr. 22 or analog terminal	
815	Torque limit level 2	9999	0 to 400%	When the torque limit selection (TL) signal is on, the Pr. 815 value is a torque limit value regardless of Pr. 810.	
			9999	The torque limit set to Pr. 810 is valid.	
816	Torque limit level during acceleration	9999	0 to 400%	Set the torque limit value during acceleration.	
			9999	Same torque limit as at constant speed	
817	Torque limit level during deceleration	9999	0 to 400%	Set the torque limit value during deceleration.	
			9999	Same torque limit as at constant speed	
858	Terminal 4 function assignment	0	0, 4, 9999	When "4" is set in, the torque limit can be changed with a signal to terminal 4.	
868	Terminal 1 function assignment	0	0, 2 to 5, 9999	When "4" is set in, the torque limit can be changed with a signal to terminal 1.	
874	OLT level setting	150%	0 to 200%	This function can make an inverter trip if the torque limit is activated to stall the motor. Set the output at which an inverter trip is made.	

\* This parameter allows its setting to be changed during operation in any operation mode even if "0 (initial value) or 1" is set in Pr. 77 Parameter write selection.

#### CAUTION

Under Real sensorless vector control, the lower limit of torque limit level is set 30% if the value less than 30% is input.



**(1) Torque limit block diagram**

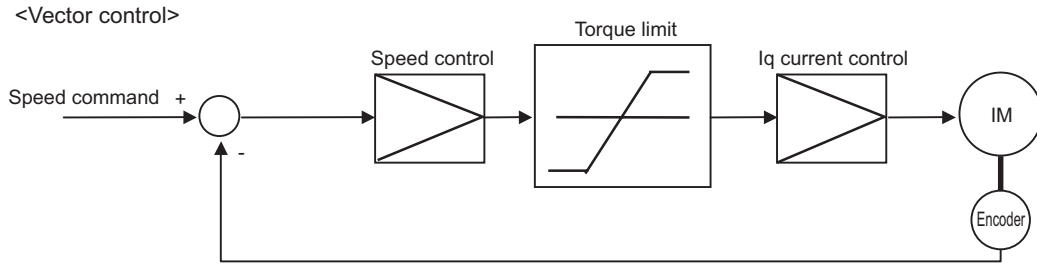

**(2) Selection of torque limit input method (Pr. 810)**

- Set Pr. 810 Torque limit input method selection to select the method to limit output torque during speed control. Torque limit by parameter setting is initially set.

Parameter Number	Setting Range	Torque Limit Input Method	Description
810	0 (initial value)	Internal torque limit	Parameter-set torque limit operation is performed. Changing the torque limit parameter value by communication enables torque limit to be input by communication.
	1	External torque limit	Torque limit using analog voltage (current) to terminal 1 or terminal 4 is enabled.

**(3) Torque limit level by parameter setting (Pr. 810 = "0", Pr. 812 to Pr. 814 )**

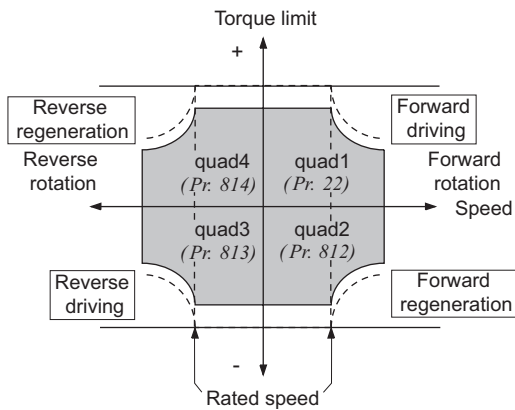

- In the initial setting, limit is made on all quadrants on the Pr. 22 Stall prevention operation level (torque limit level) .
- When you want to set the level on a quadrant basis, set the torque limit level in Pr. 812 Torque limit level (regeneration), Pr. 813 Torque limit level (3rd quadrant), Pr. 814 Torque limit level (4th quadrant).  
When "9999" is set, Pr. 22 is the torque limit level.

**(4) Torque limit level by analog input (terminal 1, 4) (Pr. 810 = "1", Pr. 858, Pr. 868 )**

- With the upper limit of torque limit as set in Pr. 22, the analog input from terminal 1 input is used as the torque limit value within the Pr. 22 setting range.
- When torque limit value is input from terminal 1, set "4" in Pr. 868 Terminal 1 function assignment. When torque limit value is input from terminal 4, set "4" in Pr. 858 Terminal 4 function assignment.  
When Pr. 858 = "4" and Pr. 868 = "2," torque is limited by analog input to terminal 1 for regeneration and to terminal 4 for driving.
- Torque limit by analog input can be calibrated using calibration parameter C16 (Pr. 919) to C19 (Pr. 920), C38 (Pr. 932) to C41 (Pr. 933) . (Refer to page 277)

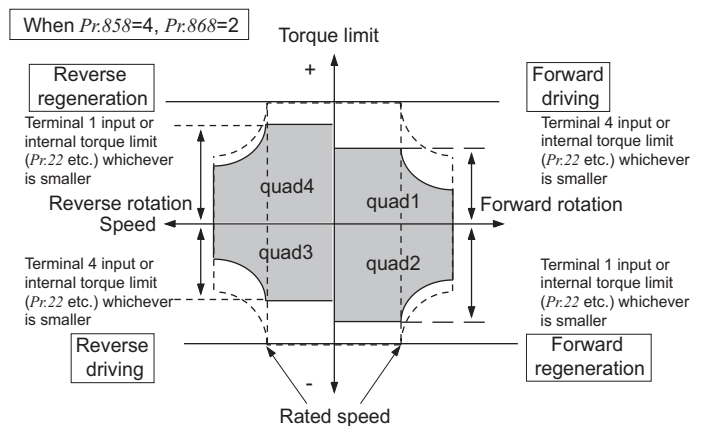
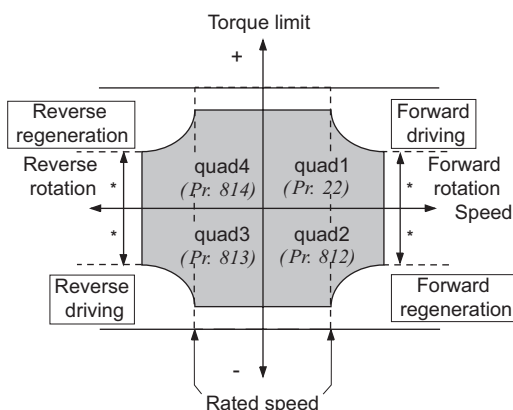

\* Analog input (terminal 1, 4) or internal torque control (Pr. 22 etc.) whichever is smaller



● Terminal 1, 4 function according to control (— : without function)

Pr. 858 Setting *1	Pr. 868 Setting *2	Real Sensorless Vector Control (Speed Control)		
		Terminal 4 function	Terminal 1 function	
0 (initial value)	0 (initial value)	Speed command (AU signal-ON)	Speed setting auxiliary	
	1 *4		Magnetic flux command	
	2		—	
	3		—	
	4		Torque limit (Pr. 810 = 1)	
	5		—	
	6 *4		Torque bias (Pr. 840 = 1 to 3)	
	9999		—	
1 *4	0 (initial value)	Magnetic flux command	Speed setting auxiliary	
	1 *4	— *3	Magnetic flux command	
	2	Magnetic flux command	—	
	3		—	
	4		Torque limit (Pr. 810 = 1)	
	5		—	
	6 *4		Torque bias (Pr. 840 = 1 to 3)	
	9999		—	
4 *2	0 (initial value)		Torque limit (Pr. 810 = 1)	Speed setting auxiliary
	1 *4		Torque limit (Pr. 810 = 1)	Magnetic flux command
	2	Driving torque limit (Pr. 810 = 1)		
	3	Regenerative torque limit (Pr. 810 = 1)		
	4	— *3		
	5	—		
	6 *4	Torque bias (Pr. 840 = 1 to 3)		
	9999	—		
9999	—	—		—

- \*1 When the Pr. 868 setting is other than "0", other functions of terminal 1 (auxiliary input, override function, PID control) do not function.
- \*2 When the Pr. 858 setting is other than "0", PID control and speed command from terminal 4 do not function even if the AU signal turns on.
- \*3 When "1" (magnetic flux command) or "4" (torque limit) is set in both Pr. 858 and Pr. 868, function of terminal 1 has higher priority and terminal 4 has no function.
- \*4 Setting is valid only when exercising vector control with the FR-A7AP/FR-A7AL (option).

### (5) Second torque limit level (TL signal, Pr. 815)

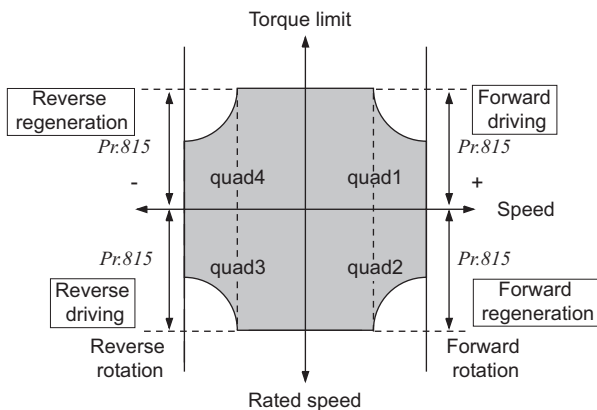

- For Pr. 815 Torque limit level 2, the Pr. 815 value is a torque limit value regardless of Pr. 810 Torque limit input method selection when the torque limit selection signal (TL) is on.
- Set "27" in Pr. 178 to Pr. 189 (input terminal function selection) to assign a function to the TL signal.

#### CAUTION

· Changing the terminal assignment using Pr. 178 to Pr. 189 (input terminal function selection) may affect the other functions. Set parameters after confirming the function of each terminal.



**(6) Set a torque limit value during acceleration and deceleration individually (Pr. 816, Pr. 817)**

- You can set torque limit during acceleration and deceleration individually. The following chart shows torque limit according to the settings of Pr. 816 Torque limit level during acceleration and Pr. 817 Torque limit level during deceleration.

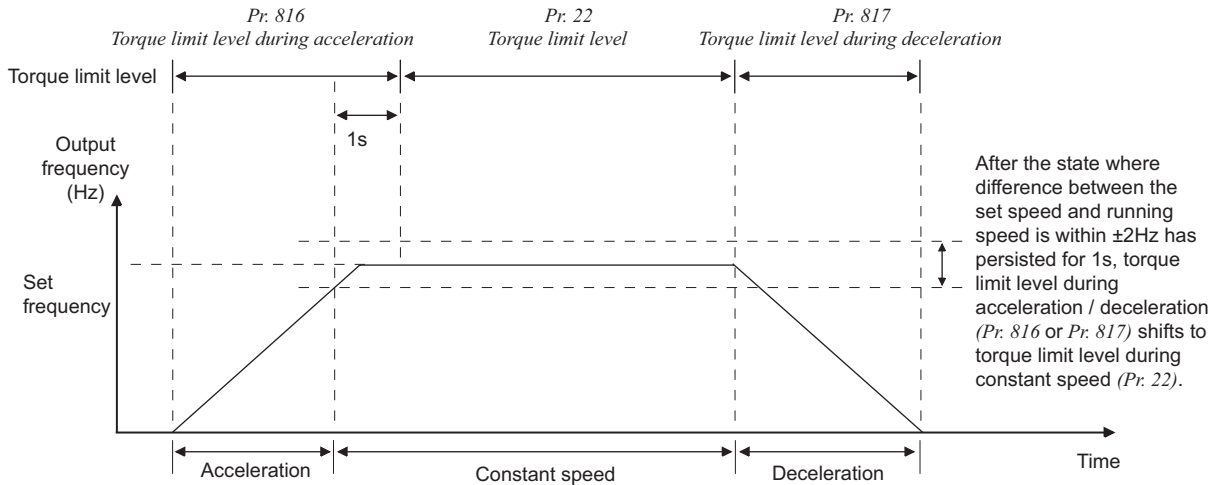

**(7) Setting increments switchover of the torque limit level (Pr. 811)**

- By setting "10, 11" in Pr. 811 Set resolution switchover, the setting increments of Pr. 22 Torque limit level and Pr. 812 to Pr. 817 (torque limit level) can be switched to 0.01%.

**REMARKS**

- The internal resolution of the torque limit is 0.024% ( $100/2^{12}$ ) and the fraction less than the resolution is rounded off.
- When the torque limit setting increments have been changed (0.1% ↔ 0.01%), reset is necessary because the settings of Pr. 22 and Pr. 812 to Pr. 817 are multiplied by 1/10 (ten times). For example, when 10 (0.01%) set in Pr. 811 is changed to 1 (0.1%) with Pr. 22 = 150.00%, Pr. 22 = 1500.0% and the maximum torque is 400%.
- The fraction less than the resolution equivalent to 0.1% is rounded off even if "10 or 11" is set in Pr. 811 when Real sensorless vector control is selected.
- Refer to page 227 for switchover of speed setting increments.

**(8) Change the torque characteristics in the constant power range (Pr. 803)**

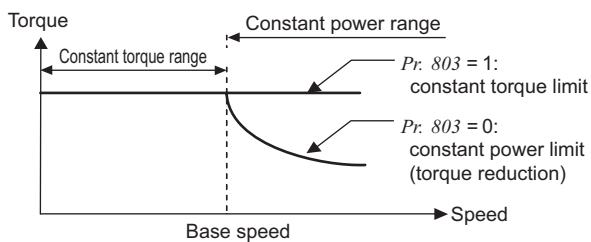

- You can select whether the torque limit in the constant power range be constant torque limit (setting is "1") or constant power limit (initial setting is "0"), using Pr. 803 Constant power range torque characteristic selection under torque limit operation.

**(9) Trip when torque limit is activated (Pr. 874)**

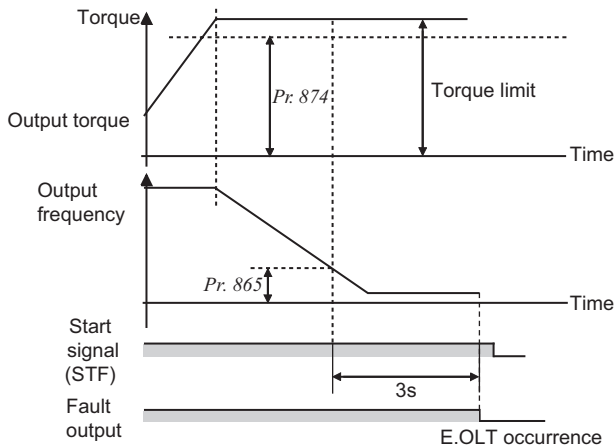

- This function can cause a trip if the torque limit is activated to stall the motor.
- The motor stalls if the torque limit is activated under a high load applied during speed control or position control. At this time, if the motor speed is lower than the speed set in Pr. 865 *Low speed detection* and also the output torque exceeds the level set in Pr. 874 *OLT level setting* for 3s, it is regarded as a stop effected by stall prevention and E. OLT is output, resulting in a trip.

**REMARKS**

- If the frequency has fallen to 0.5Hz by stall prevention operation and remains for 3s under V/F control and Advanced magnetic flux vector control, a fault (E.OLT) appears and trip the inverter. In this case, this function is activated regardless of Pr. 874 . This fault is not provided under torque control.

**(10) Stall prevention operation signal output and output timing adjustment (OL signal, Pr. 157)**

- When the output torque exceeds the torque limit level and torque limit is activated, the stall prevention operation signal (OL signal) turns ON for longer than 100ms. When the output torque falls to or below the torque limit level, the output signal turns OFF.
- Use Pr. 157 *OL signal output timer* to set whether the OL signal is output immediately or after a preset period of time.
- This operation is also performed when the regeneration avoidance function  $\sigma L$  (overvoltage stall) is executed.

Pr. 157 Setting	Description
0 (initial value)	Output immediately
0.1 to 25	Output after the set time (s) has elapsed
9999	Not output

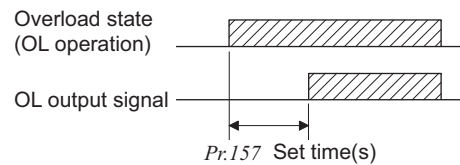

**REMARKS**

- The OL signal is assigned to the terminal OL in the initial setting. The OL signal can also be assigned to the other terminal by setting "3 (positive logic) or 103 (negative logic)" to any of Pr. 190 to Pr. 196 (*output terminal function selection*).

**CAUTION**

- When speed control is performed, a fault (E.OLT) is displayed and the inverter output is stopped if frequency drops to the Pr. 865 *Low speed detection* (initial value is 1.5Hz) setting by torque limit operation and the output torque exceeds Pr. 874 *OLT level setting* (initial value is 150%) setting and remains for more than 3s.
- When terminal assignment is changed using Pr. 190 to Pr. 196 (*output terminal function selection*), the other functions may be affected. Set parameters after confirming the function of each terminal.

**◆Parameters referred to◆**

- Pr. 22 *Stall prevention operation level* Refer to page 135
- Pr. 178 to Pr. 189 (*input terminal function selection*) Refer to page 207
- Pr. 840 *Torque bias selection* Refer to page 97
- Pr. 865 *Low speed detection* Refer to page 222



**4.4.4 To perform high accuracy/fast response operation (gain adjustment of Real sensorless vector control and vector control) (Pr. 818 to Pr. 821, Pr. 830, Pr. 831, Pr. 880)** Sensorless Vector

The ratio of the load inertia to the motor inertia (load moment of inertia) is estimated in real time from the torque command and speed during motor operation by vector control. As optimum gain of speed control and position control are automatically set from the load inertia ratio and response level, time and effort of making gain adjustment are reduced. (Easy gain tuning)

When the load inertia ratio cannot be estimated due to load fluctuation or Real sensorless vector control is exercised, control gain is automatically set by manually inputting the load inertia ratio.

Make a manual input adjustment when vibration, noise or any other unfavorable phenomenon occurs due to large load inertia or gear backlash, for example, or when you want to exhibit the best performance that matches the machine.

Parameter Number	Name	Initial Value	Setting Range	Description
818	Easy gain tuning response level setting	2	1 to 15	Set the response level. 1: Slow response to 15: Fast response
819	Easy gain tuning selection	0	0	Without easy gain tuning
			1	With load estimation, with gain calculation (valid only during vector control)
			2	With load (Pr. 880) manual input, gain calculation
820	Speed control P gain 1	60%	0 to 1000%	Set the proportional gain for speed control. (Increasing the value improves trackability in response to a speed command change and reduces speed variation with disturbance.)
821	Speed control integral time 1	0.333s	0 to 20s	Set the integral time during speed control. (Decrease the value to shorten the time taken for returning to the original speed if speed variation with disturbance occurs.)
830	Speed control P gain 2	9999	0 to 1000%	Second function of Pr. 820 (valid when RT signal is on)
			9999	No function
831	Speed control integral time 2	9999	0 to 20s	Second function of Pr. 821 (valid when RT signal is on)
			9999	No function
880	Load inertia ratio	7 times	0 to 200 times	Set the load inertia ratio to the motor.



**(1) Block diagram of easy gain tuning function**

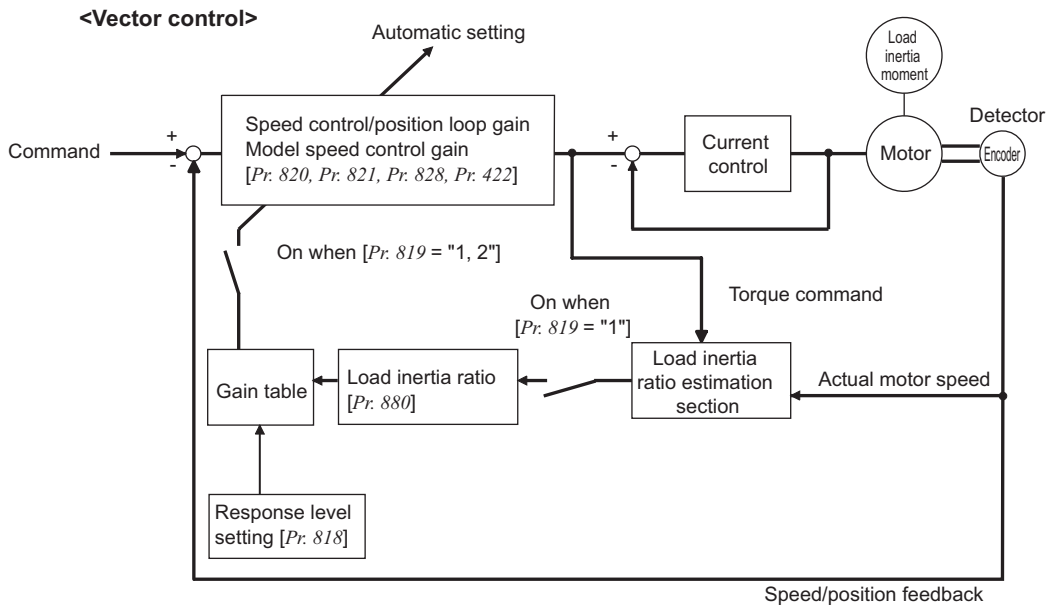

**(2) Easy gain tuning execution procedure (Pr. 819 = "1" load inertia ratio automatic estimation)**

Easy gain tuning (load inertia ratio automatic estimation) is valid only in the speed control or position control mode under vector control. It is invalid under torque control, V/F control, Advanced magnetic flux vector control and Real sensorless vector control.

- 1) Set the response level using *Pr. 818 Easy gain tuning response level setting*. Refer to the diagram on the right and set the response level. Increasing the value will improve trackability to the command, but too high value will generate vibration. The relationship between the setting and response level are shown on the right.

Pr. 818 setting	1	2	3	4	5	6	7	8	9	10	11	12	13	14	15
Response level	Slow response			Middle response						Fast response					
Guideline of mechanical resonance frequency (Hz)	8	10	12	15	18	22	28	34	42	52	64	79	98	122	150

- 2) Each control gain is automatically set from the load inertia ratio estimated during acceleration/deceleration operation and the *Pr. 818 Easy gain tuning response level setting* value. *Pr. 880 Load inertia ratio* is used as the initial value of the load inertia ratio for tuning. Estimated value is set in *Pr. 880* during tuning. The load inertia ratio may not be estimated well, e.g. it takes a long time for estimation, if the following conditions are not satisfied.
  - Time taken for acceleration/deceleration to reach 1500r/min is 5s or less.
  - Speed is 150r/min or more.
  - Acceleration/deceleration torque is 10% or more of the rated torque.
  - Abrupt disturbance is not applied during acceleration/deceleration.
  - Load inertia ratio is approx. 30 times or less.
  - No gear backlash nor belt looseness is found.
- 3) Press **FWD** or **REV** to estimate the load inertia ratio or calculate gain any time. (The operation command for external operation is the STF or STR signal.)





### (3) Easy gain tuning execution procedure (Pr. 819 = "2" load inertia manual input)

Easy gain tuning (load inertia ratio manual input) is valid only in the speed control mode under Real sensorless vector control or in the speed control or position control mode under vector control.

- 1) Set the load inertia ratio to the motor in Pr. 880 Load inertia ratio.
- 2) Set "2" (with easy gain tuning) in Pr. 819 Easy gain tuning selection. Then, Pr. 820 Speed control P gain 1 and Pr. 821 Speed control integral time 1 are automatically set by gain calculation.  
Operation is performed in a gain adjusted status from the next operation.
- 3) Perform a test run and set the response level in Pr. 818 Easy gain tuning response level setting. Increasing the value will improve trackability to the command, but too high value will generate vibration. (When "2" (parameter write enabled during operation) is set in Pr. 77 Parameter write selection, response level adjustment can be made during operation.)

#### REMARKS

- When "1 or 2" is set in Pr. 819 and then returned the Pr. 819 setting to "0" after tuning is executed, tuning results which are set in each parameter remain unchanged.
- When good tuning accuracy is not obtained after executing easy gain tuning due to disturbance and such, perform fine adjustment by manual input. Set "0" (without easy gain tuning) in Pr. 819.

### (4) Parameters automatically set by easy gain tuning

The following table indicates the relationship between easy gain tuning function and gain adjustment parameter.

	Easy Gain Tuning Selection (Pr. 819) Setting		
	0	1	2
Load inertia ratio (Pr. 880)	Manual input	a) Inertia estimation result (RAM) by easy gain tuning is displayed. b) Set the value in the following cases: <ul style="list-style-type: none"> <li>• Every hour after power-ON</li> <li>• When a value other than "1" is set in Pr. 819</li> <li>• When vector control is changed to other control (V/F control etc.) using Pr. 800</li> </ul> c) Write is enabled only during a stop (manual input)	Manual input
Speed control P gain 1 (Pr. 820) Speed control integral time 1 (Pr. 821) Model speed control gain (Pr. 828) Position loop gain (Pr. 422)	Manual input	a) Tuning result (RAM) is displayed. b) Set the value in the following cases: <ul style="list-style-type: none"> <li>• Every hour after power-on</li> <li>• When a value other than "1" is set in Pr. 819</li> <li>• When vector control is changed to other control (V/F control etc.) using Pr. 800</li> </ul> c) Write (manual input) disabled	a) Gain is calculated when "2" is set in Pr. 819 and the result is set in the parameter. b) When the value is read, the tuning result (parameter setting value) is displayed. c) Write (manual input) disabled

#### CAUTION

- Performing easy gain tuning with larger inertia than the specified value during vector control may cause malfunction such as hunting. In addition, when the motor shaft is fixed with servo lock or position control, bearing may be damaged. To prevent these, make gain adjustment by manual input without performing easy gain tuning.



### (5) Manual input speed control gain adjustment

- Make adjustment when any of such phenomena as unusual machine vibration/noise, low response level and overshoot has occurred.

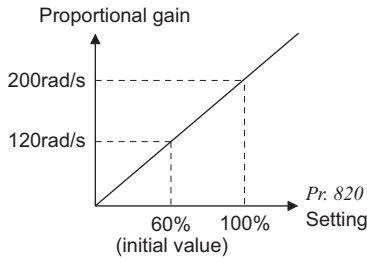

- The response speed of a motor is equivalent to 120rad/s when *Pr.820 Speed control P gain 1* = "60% (initial setting)." Increasing the setting value improves the response level, but setting too large of a gain will produce vibration and/or unusual noise.
- Decreasing the *Pr. 821 Speed control integral time 1* shortens the return time taken at a speed change. However, a too short time will generate an overshoot.

- When there is load inertia, the actual speed gain is as given below.

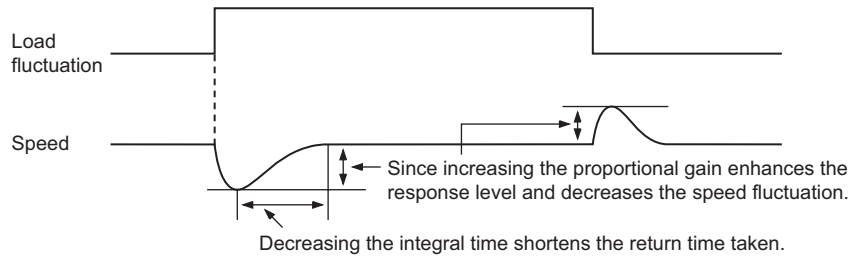

$$\text{Actual speed gain} = \text{speed gain of motor without load} \times \frac{JM}{JM+JL}$$

JM: Inertia of the motor  
JL: Motor shaft-equivalent load inertia

- Adjustment procedures are as below:

- 1) Check the conditions and simultaneously change the *Pr. 820* value.
- 2) If you cannot make proper adjustment, change the *Pr. 821* value and repeat step 1).

No.	Phenomenon/ Condition	Adjustment Method
1	Load inertia is large	Set the <i>Pr. 820</i> and <i>Pr. 821</i> values a little higher.
		<i>Pr. 820</i> When a speed rise is slow, increase the value 10% by 10% until just before vibration/noise is produced, and set about 0.8 to 0.9 of that value.
		<i>Pr. 821</i> If an overshoot occurs, double the value until an overshoot does not occur, and set about 0.8 to 0.9 of that value.
2	Vibration/noise generated from mechanical system	Set the <i>Pr. 820</i> value a little lower and the <i>Pr. 821</i> value a little higher.
		<i>Pr. 820</i> Decrease the value 10% by 10% until just before vibration/noise is not produced, and set about 0.8 to 0.9 of that value.
3	Slow response	<i>Pr. 821</i> If an overshoot occurs, double the value until an overshoot does not occur, and set about 0.8 to 0.9 of that value.
		Set the <i>Pr. 820</i> value a little higher.
4	Long return time (response time)	<i>Pr. 820</i> When a speed rise is slow, increase the value 5% by 5% until just before vibration/noise is produced, and set about 0.8 to 0.9 of that value.
		Set the <i>Pr. 821</i> value a little lower.
5	Overshoot or unstable phenomenon occurs.	Decrease the <i>Pr. 821</i> value by half until just before an overshoot or the unstable phenomenon does not occur, and set about 0.8 to 0.9 of that value.
		Set the <i>Pr. 821</i> value a little higher.
		Increase the <i>Pr. 821</i> value double by double until just before an overshoot or the unstable phenomenon does not occur, and set about 0.8 to 0.9 of that value.

#### REMARKS

- When making manual input gain adjustment, set "0" (without easy gain tuning) (initial value) in *Pr. 819 Easy gain tuning selection*.
- *Pr. 830 Speed control P gain 2* and *Pr. 831 Speed control integral time 2* are valid when the RT terminal is switched on. Make adjustments in the same way as *Pr. 820* and *Pr. 821*.



### (6) When using a multi-pole motor (8 poles or more)

Specially when using a multi-pole motor with more than 8 poles under Real sensorless vector control or vector control, adjust Pr. 820 Speed control P gain 1 and Pr. 824 Torque control P gain 1 according to the motor referring to the following methods.

- For Pr. 820 Speed control P gain 1, increasing the setting value improves the response level, but a too large gain will produce vibration and/or unusual noise.
- For Pr. 824 Torque control P gain 1, note that a too low value will produce current ripples, causing the motor to generate sound synchronizing the cycle of current ripples.

#### Adjustment method

No.	Phenomenon/Condition	Adjustment Method
1	The motor rotation is unstable in the low speed range.	Set a higher value in Pr. 820 Speed control P gain 1 according to the motor inertia. Since the self inertia of a multi-pole motor tends to become large, make adjustment to improve the unstable phenomenon, then make fine adjustment in consideration of the response level using that setting as reference. In addition, when performing vector control with encoder, gain adjustment according to the inertia can be easily done using easy gain tuning (Pr. 819 = 1).
2	Speed trackability is poor.	Set a higher value in Pr. 820 Speed control P gain 1.
3	Speed variation at the load fluctuation is large.	Increase the value 10% by 10% until just before vibration or unusual noise is produced, and set about 0.8 to 0.9 of that value. If you cannot make proper adjustment, increase the value of Pr. 821 Speed control integral time 1 double by double and make adjustment of Pr. 820 again.
4	Torque becomes insufficient or torque ripple occurs at starting or in the low speed range under Real sensorless vector control.	Set the speed control gain a little higher. (same as No. 1) If the problem still persists after gain adjustment, increase Pr. 13 Starting frequency or set the acceleration time shorter if the inverter is starting to avoid continuous operation in the ultra low speed range.
5	Unusual motor and machine vibration, noise or overcurrent occurs.	Set a lower value in Pr. 824 Torque control P gain 1.
6	Overcurrent or overspeed (E.OS) occurs at a start under Real sensorless vector control.	Decrease the value 10% by 10% until just before the phenomenon is improved, and set about 0.8 to 0.9 of that value.

### (7) P/PI switchover (X44 signal)

- By turning the P/PI control switching signal (X44) on/off during speed control operation under Real sensorless vector control or vector control, you can select whether to add the integral time (I) or not when performing gain adjustment with P gain and integral time.  
When the X44 signal is off..... PI control  
When the X44 signal is on..... P control
- For the terminal used for X44 signal input, set "44" in any of Pr. 178 to Pr. 189 (input terminal function selection) to assign the function.

[Function block diagram]

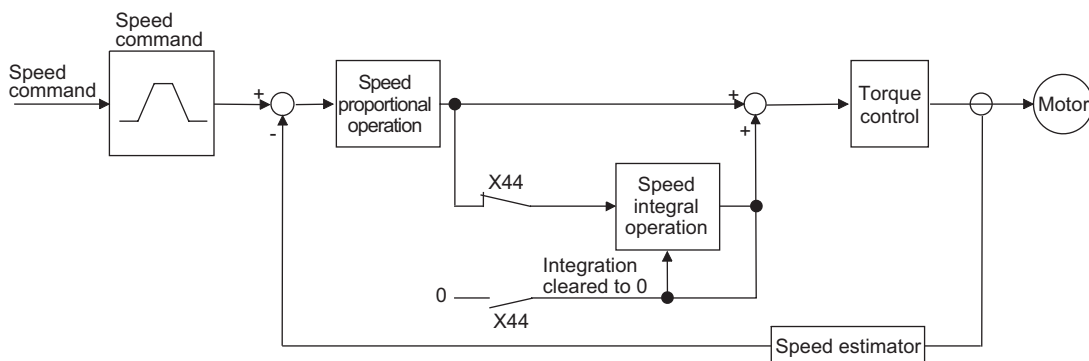

#### CAUTION

- Changing the terminal assignment using Pr. 178 to Pr. 189 (input terminal function selection) may affect the other functions. Set parameters after confirming the function of each terminal.

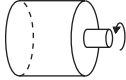
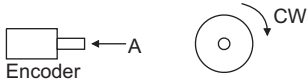
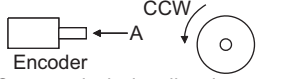
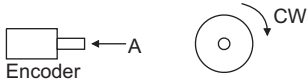
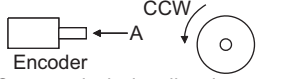
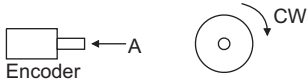
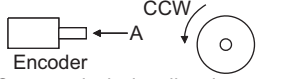

(8) Troubleshooting (speed)

	Phenomenon	Cause	Countermeasures						
1	Motor does not rotate. (Vector control)	(1) The motor wiring is wrong  (2) Encoder specifications (encoder specification selection switch (FR-A7AP/FR-A7AL (option))) are wrong  (3) The encoder wiring is wrong.          (4) The Pr. 369 Number of encoder pulses setting and the number of encoder used are different.  (5) Encoder power specifications are wrong. Or, power is not input.	(1) Wiring check Select V/F control (set "9999" in Pr. 80 or Pr. 81 ) and check the rotation direction of the motor. For the SF-V5RU (1500r/min series), set "160V (320V)" in Pr. 19 Base frequency voltage, and set "50Hz" in Pr. 3 Base frequency.   When the forward rotation signal is input, the motor running in the counterclockwise direction as viewed from the motor shaft is normal. (If it runs in the clockwise direction, the phase sequence of the inverter output side wiring is incorrect.)  (2) Check the encoder specifications. Check the encoder specifications selection switch (FR-A7AP/FR-A7AL (option)) of differential/complementary  (3) Check that FWD is displayed when running the motor in the counter-clockwise direction from outside during a stop of the inverter with vector control setting. If REV is displayed, the encoder phase sequence is wrong. Perform the correct wiring or match the Pr. 359 Encoder rotation direction.  <table border="1" data-bbox="874 913 1417 1301"> <thead> <tr> <th>Pr. 359 Setting</th> <th>Relationship between the Motor and Encoder</th> </tr> </thead> <tbody> <tr> <td>0</td> <td>   Clockwise direction as viewed from A is forward rotation               </td> </tr> <tr> <td>1 (Initial value)</td> <td>   Counter clockwise direction as viewed from A is forward rotation               </td> </tr> </tbody> </table>  (4) The motor will not run if the parameter setting is smaller than the number of encoder pulses used. Set the Pr. 369 Number of encoder pulses correctly.  (5) Check the power specifications (5V/12V/15V/24V) of encoder and input the external power supply.	Pr. 359 Setting	Relationship between the Motor and Encoder	0	 Clockwise direction as viewed from A is forward rotation	1 (Initial value)	 Counter clockwise direction as viewed from A is forward rotation
Pr. 359 Setting	Relationship between the Motor and Encoder								
0	 Clockwise direction as viewed from A is forward rotation								
1 (Initial value)	 Counter clockwise direction as viewed from A is forward rotation								
2	Motor does not run at correct speed. (Speed command does not match actual speed)	(1) The speed command from the command device is incorrect. The speed command is compounded with noise.  (2) The speed command value does not match the inverter-recognized value.  (3) The number of encoder pulses setting is incorrect.	(1) Check that a correct speed command comes from the command device. Decrease Pr. 72 PWM frequency selection.  (2) Readjust speed command bias/gain Pr. 125, Pr. 126, C2 to C7 and C12 to C15.  (3) Check the setting of Pr. 369 Number of encoder pulses. (vector control)						
3	Speed does not rise to the speed command.	(1) Insufficient torque. Torque limit is actuated.  (2) Only P (proportional) control is selected.	(1) -1 Increase the torque limit value. (Refer to torque limit of speed control on page 83 ) (1) -2 Insufficient capacity  (2) When the load is heavy, speed deviation will occur under P (proportional) control. Select PI control.						



	Phenomenon	Cause	Countermeasures
4	Motor speed is unstable.	(1) The speed command varies. (2) Insufficient torque. (3) The speed control gains do not match the machine. (mechanical resonance)	(1) -1 Check that a correct speed command comes from the command device. (Take measures against noises.) (1) -2 Decrease <i>Pr. 72 PWM frequency selection</i> . (1) -3 Increase <i>Pr. 822 Speed setting filter 1</i> . (Refer to page 269) (2) Increase the torque limit value. (Refer to torque limit of speed control on page 83) (3) -1 Perform easy gain tuning. (Refer to page 89) (3) -2 Adjust <i>Pr. 820, Pr. 821</i> . (Refer to page 91) (3) -3 Perform speed feed forward/model adaptive speed control.
5	Motor or machine hunts (vibration/noise is produced).	(1) The speed control gain is high. (2) The torque control gain is high. (3) The motor wiring is wrong.	(1) -1 Perform easy gain tuning. (Refer to page 89) (1) -2 Decrease <i>Pr. 820</i> and increase <i>Pr. 821</i> . (1) -3 Perform speed feed forward control and model adaptive speed control. (2) Decrease the <i>Pr. 824</i> value. (3) Check the wiring
6	Acceleration/deceleration time does not match the setting.	(1) Insufficient torque. (2) Large load inertia.	(1) -1 Increase the torque limit value. (Refer to torque limit of speed control on page 83) (1) -2 Perform speed feed forward control. (2) Set the acceleration/deceleration time that meets the load.
7	Machine operation is unstable.	(1) The speed control gains do not match the machine. (2) Slow response because of improper acceleration/ deceleration time of the inverter.	(1) -1 Perform easy gain tuning. (Refer to page 89) (1) -2 Adjust <i>Pr. 820, Pr. 821</i> . (Refer to page 91) (1) -3 Perform speed feed forward control and model adaptive speed control. (2) Change the acceleration/deceleration time to an optimum value.
8	Speed fluctuates at low speed.	(1) Adverse effect of high carrier frequency. (2) Low speed control gain.	(1) Decrease <i>Pr. 72 PWM frequency selection</i> . (2) Increase <i>Pr. 820 Speed control P gain 1</i> .

### 4.4.5 Speed feed forward control, model adaptive speed control (Pr. 828, Pr. 877 to Pr. 881) Sensorless Vector

- By making parameter setting, select the speed feed forward control or model adaptive speed control. The speed feed forward control enhances the trackability of the motor in response to a speed command change. The model adaptive speed control enables individual adjustment of speed trackability and motor disturbance torque response.

Parameter Number	Name	Initial Value	Setting Range	Description
828	Model speed control gain	60%	0 to 1000%	Set the gain for model speed controller.
877	Speed feed forward control/model adaptive speed control selection	0	0	Normal speed control is exercised.
			1	Speed feed forward control is exercised.
			2	Model adaptive speed control is enabled.
878	Speed feed forward filter	0s	0 to 1s	Set the primary delay filter for the speed feed forward result calculated using the speed command and load inertia ratio.
879	Speed feed forward torque limit	150%	0 to 400%	Limits the maximum value of the speed feed forward torque.
880	Load inertia ratio	7 times	0 to 200 times	Set the load inertia ratio to the motor.
881	Speed feed forward gain	0%	0 to 1000%	Set the feed forward calculation result as a gain.

**POINT**

When model adaptive speed control is selected, the data obtained from easy gain tuning is used for Pr. 828 Model speed control gain. Perform easy gain tuning also (simultaneously). (Refer to page 88)

#### (1) Speed feed forward control (Pr. 877 = "1")

- Calculate required torque in response to the acceleration/deceleration command for the inertia ratio set in Pr. 880 and generate torque immediately.
- When the speed feed forward gain is 100%, the calculation result of the speed feed forward is reflected as-is.
- If the speed command changes suddenly, large torque is generated due to the speed feed forward calculation. The maximum value of the speed feed forward is limited using Pr. 879.
- Using Pr.878, the speed feed forward result can be dulled by the primary delay filter.

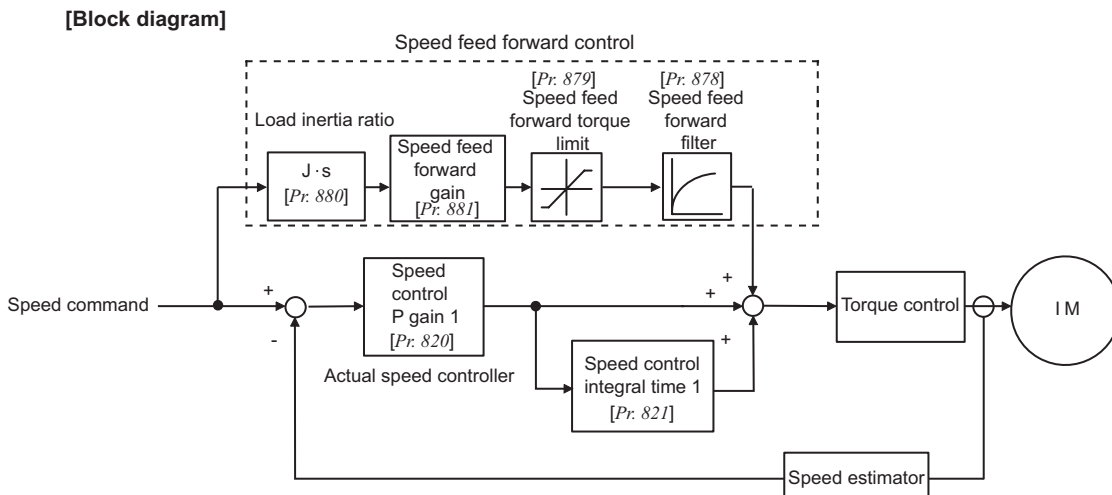

**(2) Model adaptive speed control (Pr. 877 = "2")**

- The motor's model speed is calculated to feed back the model side speed controller. This model speed is also used as the actual speed controller command.
  - The inertia ratio in Pr. 880 is used for calculation of the torque current command value given by the model side speed controller.
  - The torque current command value of the model side speed controller is added to the output of the actual speed controller, and the result is used as the iq current control input.
- Pr. 828 is used for model side speed control (P control), and the first gain in Pr. 820 is used for the actual speed controller. The model adaptive speed control is valid for the first motor only.
- When Pr. 877 = 2, switching to the second motor handles the second motor as Pr. 877 = 0.

[Block diagram]

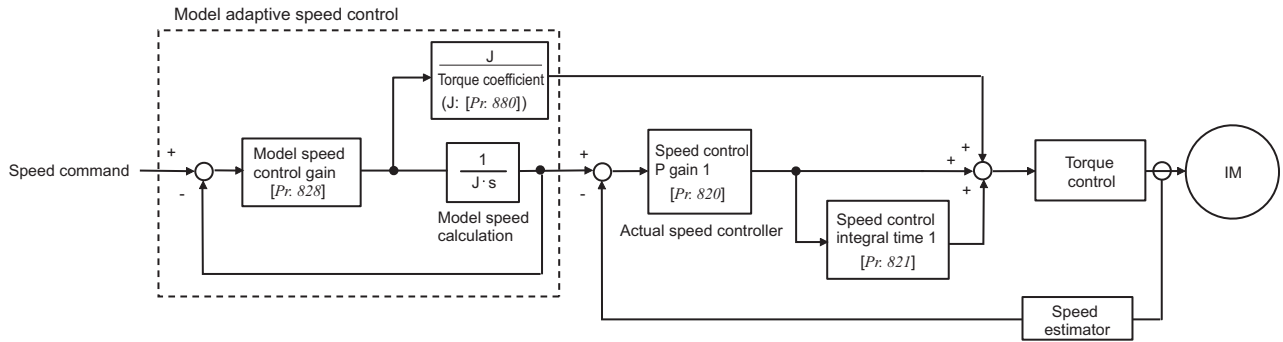

**CAUTION**

The adequate gain value for the model and actual loop parts are set according to the response setting of easy gain tuning under model adaptive speed control. To increase the response level, the Pr. 818 Easy gain tuning response level setting needs to be changed (increased).

**(3) Combination of easy gain tuning**

The following table indicates the relationships between the speed feed forward/model adaptive speed control and easy gain tuning function.

	Easy Gain Tuning Selection (Pr. 819) Setting		
	0	1	2
Load inertia ratio (Pr. 880)	Manual input	Inertia ratio estimation value found by easy gain tuning is displayed. Manual input enabled only during a stop.	Manual input
Speed control P gain 1 (Pr. 820)	Manual input	Tuning results are displayed. Write disabled	Tuning results are displayed. Write disabled
Speed control integral time 1 (Pr. 821)	Manual input	Tuning results are displayed. Write disabled	Tuning results are displayed. Write disabled
Model speed control gain (Pr. 828)	Manual input	Tuning results are displayed. Write disabled	Tuning results are displayed. Write disabled
Speed feed forward gain (Pr. 881)	Manual input	Manual input	Manual input

◆Parameters referred to◆

Pr. 820 Speed control P gain 1, Pr. 830 Speed control P gain 2 (Refer to page 88)  
Pr. 821 Speed control integral time 1, Pr. 831 Speed control integral time 2 (Refer to page 88)

**4.4.6 Torque biases (Pr. 840 to Pr. 848)** Vector

This function accelerates the rise of the torque at a start. Adjust the torque at a motor start using the contact signals or analog signals .

Parameter Number	Name	Initial Value	Setting Range	Description
840	Torque bias selection	9999	0	Set the torque bias amount with the contact signal (X42, X43) using Pr. 841 to Pr. 843.
			1	Set the terminal 1-based torque bias amount as desired in C16 to C19 . (in the case a cage goes up when a motor runs reversely)
			2	Set the terminal 1-based torque bias amount as desired in C16 to C19 . (in the case a cage goes up when a motor runs forward)
			3	The terminal 1-based torque bias amount can be set automatically in C16 to C19, Pr. 846 according to the load.
			9999	Without torque bias, rated torque 100%
841	Torque bias 1	9999	600 to 999%	Negative torque bias amount (-400% to -1%)
842	Torque bias 2		1000 to 1400%	Positive torque bias amount (0% to 400%)
843	Torque bias 3		9999	Without torque bias setting
844	Torque bias filter	9999	0 to 5s	Time until torque rises.
			9999	Same operation as when 0s is set.
845	Torque bias operation time	9999	0 to 5s	Time for maintaining torque equivalent to the torque bias amount.
			9999	Same operation as when 0s is set.
846	Torque bias balance compensation	9999	0 to 10V	Set the voltage under balanced load.
			9999	Same operation as when 0V is set.
847	Fall-time torque bias terminal 1 bias	9999	0 to 400%	Set the bias value of the torque command.
			9999	Same as at a rise time (C16, C17 (Pr. 919)).
848	Fall-time torque bias terminal 1 gain	9999	0 to 400%	Set the gain value of the torque command.
			9999	Same as at a rise time (C18, C19 (Pr. 920)).

The above parameters can be set when the FR-A7AP/FR-A7AL (option) is mounted.

**(1) Block diagram**

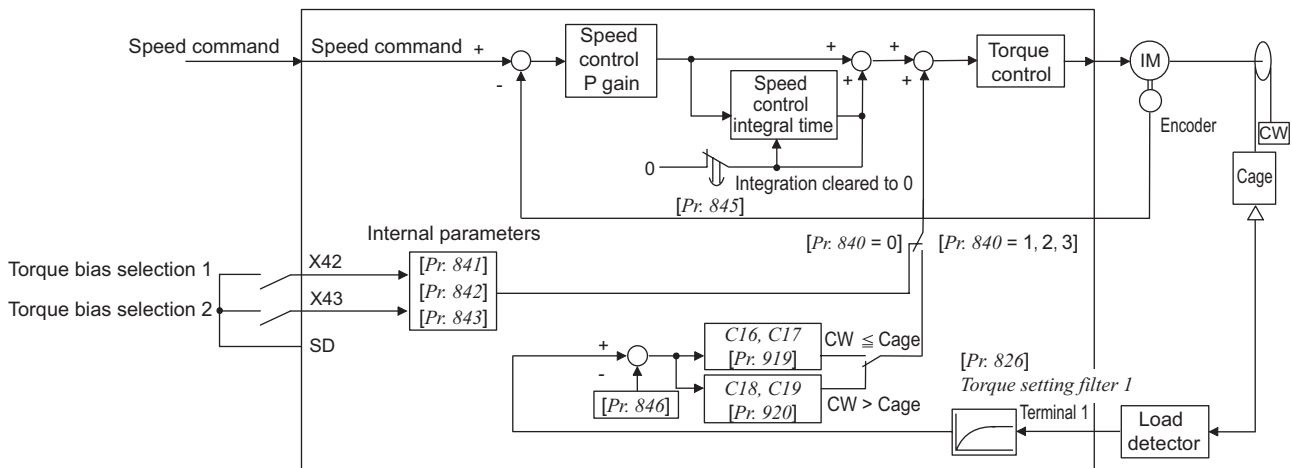





### (2) Setting torque bias amount with the contact input (Pr. 840 = "0")

- Select the torque bias amount in the table below according to the combination of contact signals.
- Set "42" in Pr. 178 to Pr. 189 (input terminal function selection) for the terminal used for X42 signal input and set "43" for the terminal used for X43 signal input to assign functions.

Torque Bias Selection 1 (X42)	Torque Bias Selection 2 (X43)	Torque Bias Amount
OFF	OFF	0%
ON	OFF	Pr. 841 -400% to +400% (setting value : 600 to 1400%)
OFF	ON	Pr. 842 -400% to +400% (setting value : 600 to 1400%)
ON	ON	Pr. 843 -400% to +400% (setting value : 600 to 1400%)

Example) when Pr. 841 = 1025, 25%    when Pr. 842 = 975, -25%    when Pr. 843 = 925, -75%

#### CAUTION

Changing the terminal assignment using Pr. 178 to Pr. 189 (input terminal function selection) may affect the other functions. Set parameters after confirming the function of each terminal.

### (3) Setting torque bias amount with terminal 1 (Pr. 840 = "1, 2")

- Calculate torque bias from the load input to terminal 1 as shown in the diagram below and provide torque bias.
- To set torque bias amount by the voltage input to terminal 1, set "6" in Pr. 868 Terminal 1 function assignment.

Pr. 840 Setting	Rise (Motor Forward Rotation)	Fall (Motor Reverse Rotation)
1		
2		

**(4) Setting torque bias amount with terminal 1 (Pr. 840 = "3")**

- C16 Terminal 1 bias command (torque/magnetic flux), C17 Terminal 1 bias (torque/magnetic flux), C18 Terminal 1 gain command (torque/magnetic flux), C19 Terminal 1 gain (torque/magnetic flux), and Pr. 846 Torque bias balance compensation can be set automatically according to the load.
- To set torque bias amount by the voltage input to terminal 1, set "6" in Pr. 868 Terminal 1 function assignment.

· Setting C16, C17 (Pr. 919) , C18, C19 (Pr. 920)

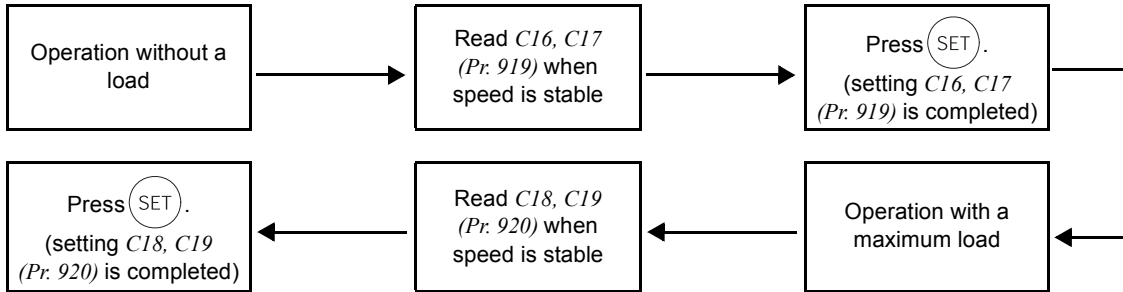

· Setting Pr. 846

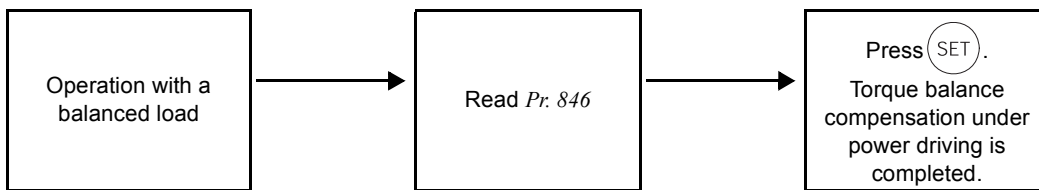

**CAUTION**

When starting torque bias operation after completion of automatic setting, set "1 or 2" in Pr. 840.

**(5) Torque bias operation**

- When a value other than 9999 is set in Pr. 844 Torque bias filter, you can slow the rise of torque. At this time, the torque rises according to the time constant of the primary delay filter.
- Set the time for output torque be maintained with the torque bias command value alone in Pr. 845 Torque bias operation time.

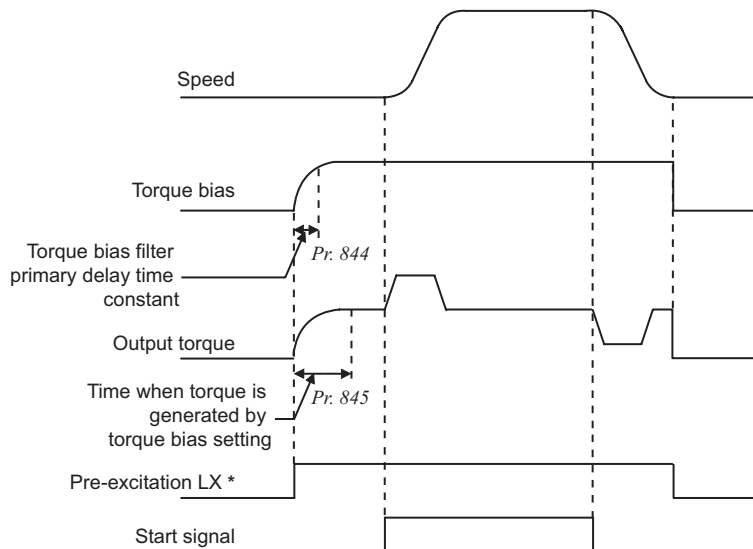

\* When pre-excitation is not made, the torque bias functions simultaneously with the start signal.

**CAUTION**

- When torque bias is valid and "6" is set in Pr. 868 , terminal 1 serves as torque command not as frequency setting auxiliary. When override compensation is set by Pr. 73 and terminal 1 acts as main speed, no main speed (main speed = 0Hz) is selected.
- Changing the terminal assignment using Pr. 178 to Pr. 189 (input terminal function selection) may affect the other functions. Set parameters after confirming the function of each terminal.

**Reference parameters**

- Pr. 73 Analog input selection Refer to page 263.
- Pr. 178 to Pr. 189 (input terminal function selection) Refer to page 207.
- C16 to C19 (torque setting voltage (current) bias and gain) Refer to page 277.



#### 4.4.7 Prevent the motor from overrunning (Pr. 285, Pr. 853, Pr. 873) Vector

This function prevents the motor from overrunning when the load torque is too large and incorrect number of encoder is set.

Parameter Number	Name	Initial Value	Setting Range	Description
285	Speed deviation excess detection frequency *1	9999	9999	Without speed deviation excessive
			0 to 30Hz	If the difference (absolute value) between the speed command value and actual speed during speed control under vector control exceeds the Pr. 285 Speed deviation excess detection frequency for more than the time set in Pr. 853 Speed deviation time, speed deviation excessive occurs and inverter fault (E. OSD) appears, resulting in a trip.
853 *2	Speed deviation time	1.0s	0 to 100s	
873 *2	Speed limit	20Hz	0 to 120Hz	Frequency is limited at the set frequency + Pr. 873.

\*1 Acts as overspeed detection frequency under encoder feed back operation. (Refer to page 193)

\*2 This parameter can be set when the FR-A7AP/FR-A7AL (option) is mounted.

##### (1) Speed deviation excessive (Pr. 285, Pr. 853)

When the deviation between the set frequency and actual speed is large, e.g. too large load torque, this function can cause the inverter to provide a speed deviation excessive fault (E.OSD) and come to a trip.

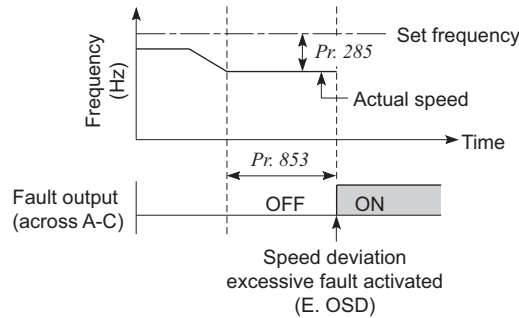

##### (2) Speed limit (Pr. 873)

This function prevents the motor from overrunning when the setting of number of encoder pulses and the actual number differ.

When the setting of number of encoder pulses is smaller than the actual number, the motor may increase its speed. To prevent this, restrict the output frequency with frequency (obtained by adding the set frequency and Pr. 873 ).

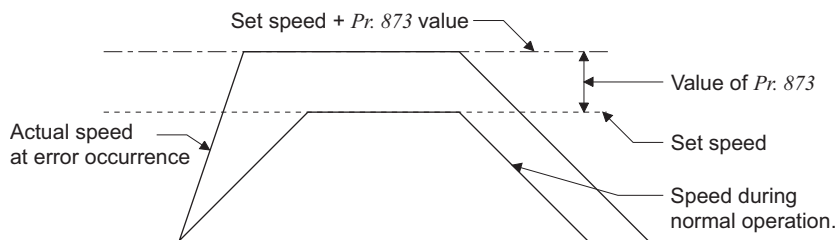

#### CAUTION

- If automatic restart after instantaneous power failure (Pr. 57 ≠ 9999) is selected when the setting of number of encoder pulses is smaller than the actual number, the output speed is limited with the synchronous speed obtained by adding the maximum setting (Pr. 1) and Pr. 873 setting.
- When speed limit function is activated due to regenerative torque limit, output torque may suddenly decrease. In addition, output phase loss (E.LF) may occur when speed limit function is activated during pre-excitation.

When the setting of number of encoder pulses are correct, it is recommended to set a maximum value (120Hz) in Pr. 873.

#### Reference parameters

Pr. 285 Overspeed detection frequency Refer to page 193.

#### 4.4.8 Notch filter (Pr. 862, Pr. 863) Sensorless Vector

You can reduce the response level of speed control in the resonance frequency band of the mechanical system to avoid mechanical resonance.

Parameter Number	Name	Initial Value	Setting Range	Description
862	Notch filter time constant	0	0 to 60	Refer to the following table
863	Notch filter depth	0	0 to 3	0 (deep) → 3 (shallow)

##### (1) Pr. 862 Notch filter time constant

- If you do not know the mechanical resonance frequency, decrease notch frequency gradually from the highest value. The point at which the smallest vibration is generated is the notch frequency setting.
- Machine characteristic can be obtained beforehand with machine analyzer by FR Configurator. Necessary notch frequency can be determined from this.

Setting	0	1	2	3	4	5	6	7	8	9
Frequency	Invalid	1000	500	333.3	250	200	166.7	142.9	125	111.1
Setting	10	11	12	13	14	15	16	17	18	19
Frequency	100	90.9	83.3	76.9	71.4	66.7	62.5	58.8	55.6	52.6
Setting	20	21	22	23	24	25	26	27	28	29
Frequency	50	47.6	45.5	43.5	41.7	40	38.5	37	35.7	34.5
Setting	30	31	32	33	34	35	36	37	38	39
Frequency	33.3	32.3	31.3	30.3	29.4	28.6	27.8	27.0	26.3	25.6
Setting	40	41	42	43	44	45	46	47	48	49
Frequency	25.0	24.4	23.8	23.3	22.7	22.2	21.7	21.3	20.8	20.4
Setting	50	51	52	53	54	55	56	57	58	59
Frequency	20.0	19.6	19.2	18.9	18.5	18.2	17.9	17.5	17.2	16.9
Setting	60									
Frequency	16.7									

##### (2) Pr. 863 Notch filter depth

- The notch filter with deeper depth has an effect on minimizing mechanical resonance. However, large vibration may be generated adversely due to substantial phase delay. Make adjustment of notch depth in order of the shallower depth.

Setting	3	2	1	0
Depth	Shallow	→	←	Deep
Gain	-4dB	-8dB	-14dB	-40dB



## 4.5 Torque control by Real sensorless vector control, vector control

Purpose	Parameter that must be Set		Refer to Page
Selection of torque command source and setting of torque command value	Torque command	Pr. 803 to Pr. 806	108
Prevent the motor overspeed	Speed limit	Pr. 807 to Pr. 809	110
Improve torque control accuracy	Gain adjustment for torque control	Pr. 824, Pr. 825, Pr. 834, Pr. 835	113
Stabilize the torque detection signal	Torque detection filter	Pr. 827, Pr. 837	127

### 4.5.1 Torque control

- Torque control is exercised to develop torque as set in the torque command.
- The motor speed becomes constant when the motor output torque and load torque are balanced.  
For torque control, therefore, the speed is determined by the load.
- For torque control, the motor gains speed as the motor output torque becomes greater than the motor load.  
To prevent overspeed, set the speed limit value so that the motor speed does not increase too high.  
(Torque control is disabled under speed limit since speed control is exercised.)
- When speed limit is not set, the speed limit value setting is regarded as 0Hz to disable torque control.

#### (1) Block diagram

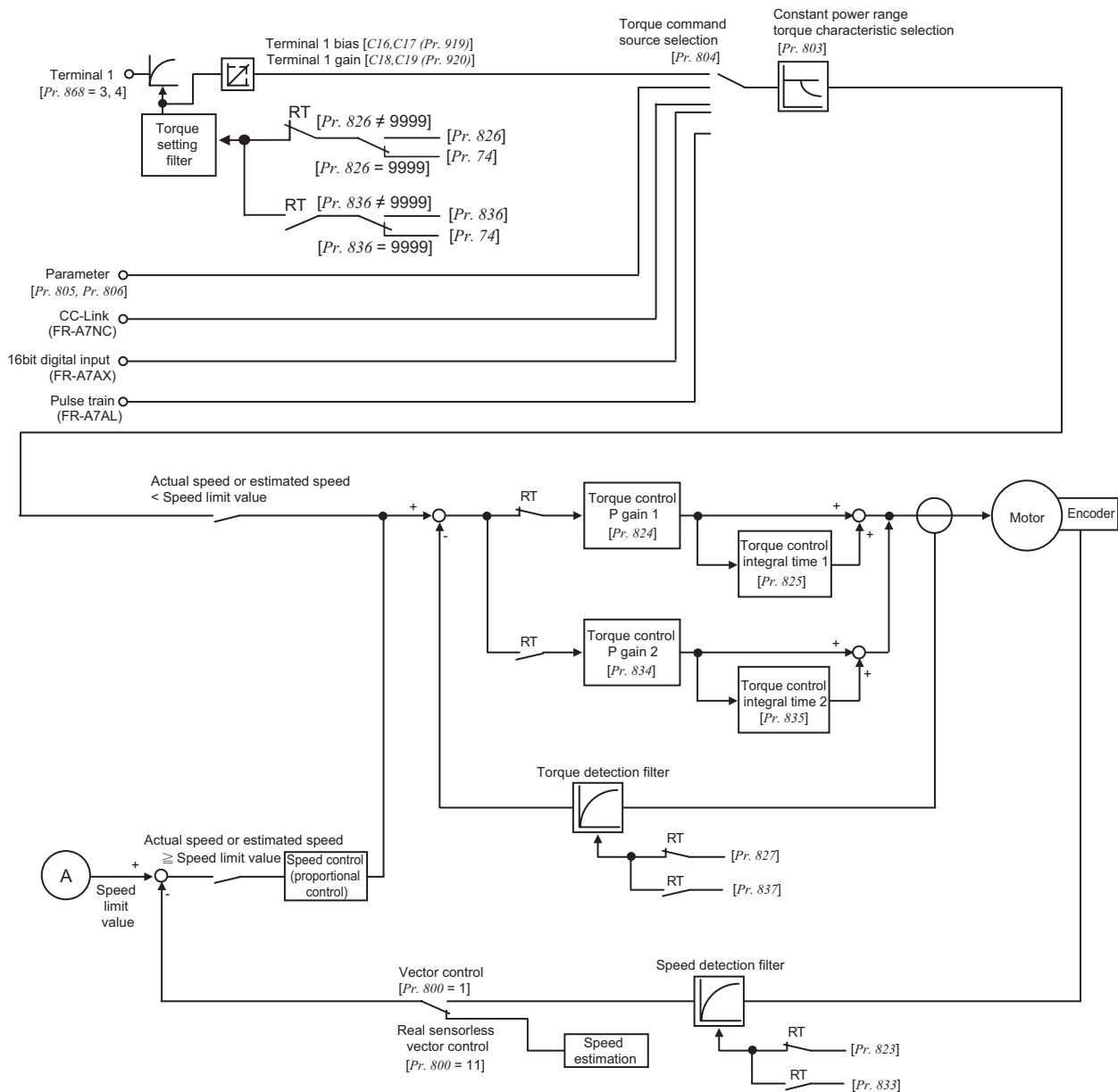

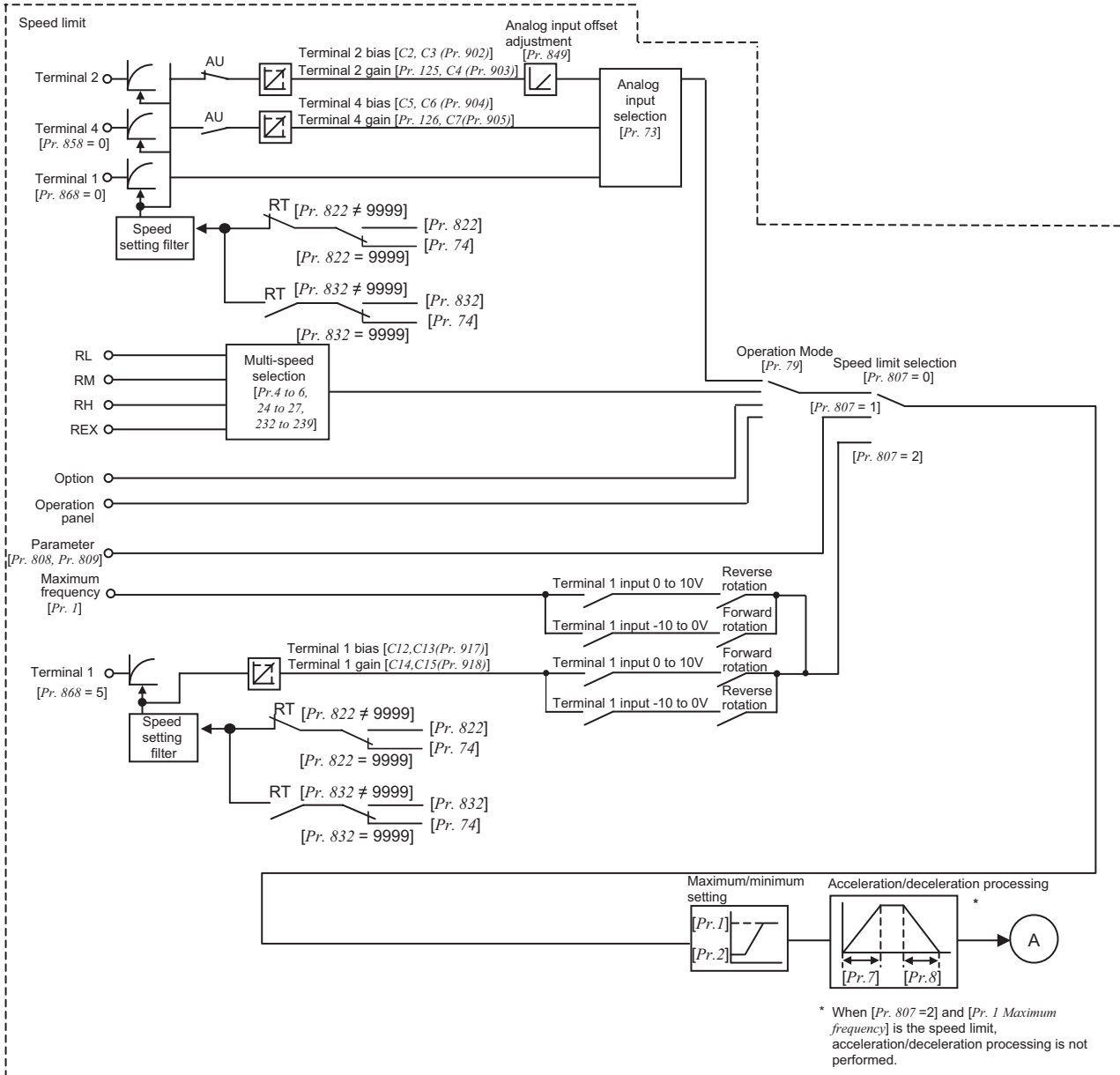



## (2) Operation transition

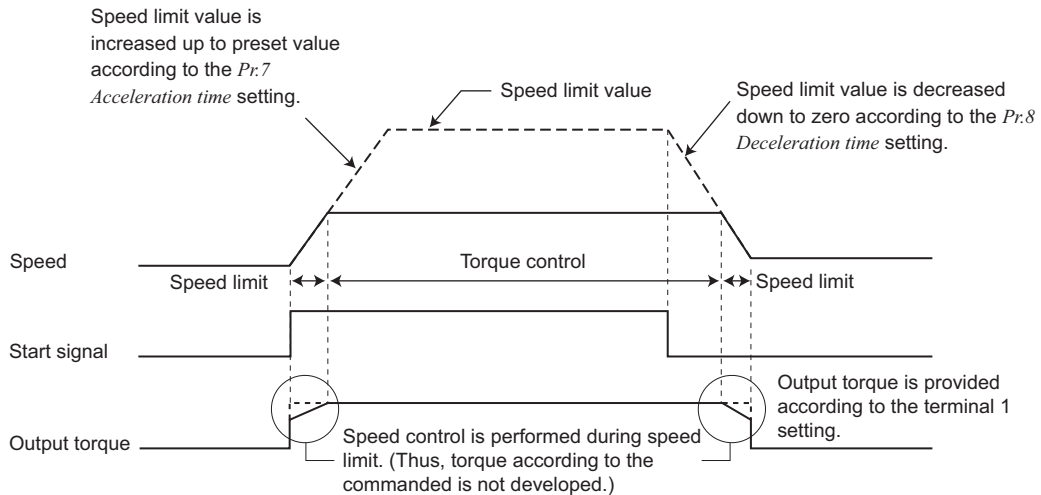

- When "0" is set in Pr. 7 or Pr. 8, speed control is exercised upon powering off a start signal and the output torque is limited at the torque limit value.

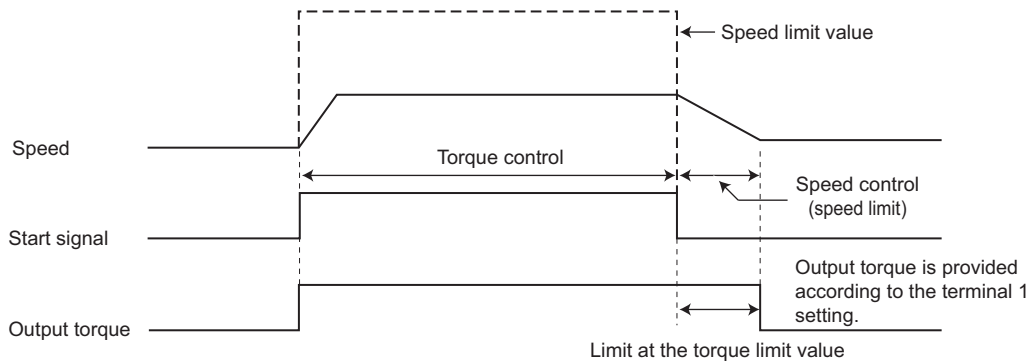

Item	Description	
Start signal	External operation	STF, STR signal
	PU operation	(FWD) and (REV) of FR-DU07, FR-PU07 or FR-PU04
Torque command	Select the input method of torque command and input the torque command.	
Speed limit	Select the input method of speed limit and input the speed limit value.	

**(3) Operation example (when Pr. 804 = "0")**

Torque control is enabled if the actual speed is less than the speed limit value.  
 When the actual speed reaches or exceeds the speed limit value, speed limit operation starts, torque control is stopped, and speed control (proportional control) starts.  
 The following shows the operations in response to the analog input command from terminal 1.

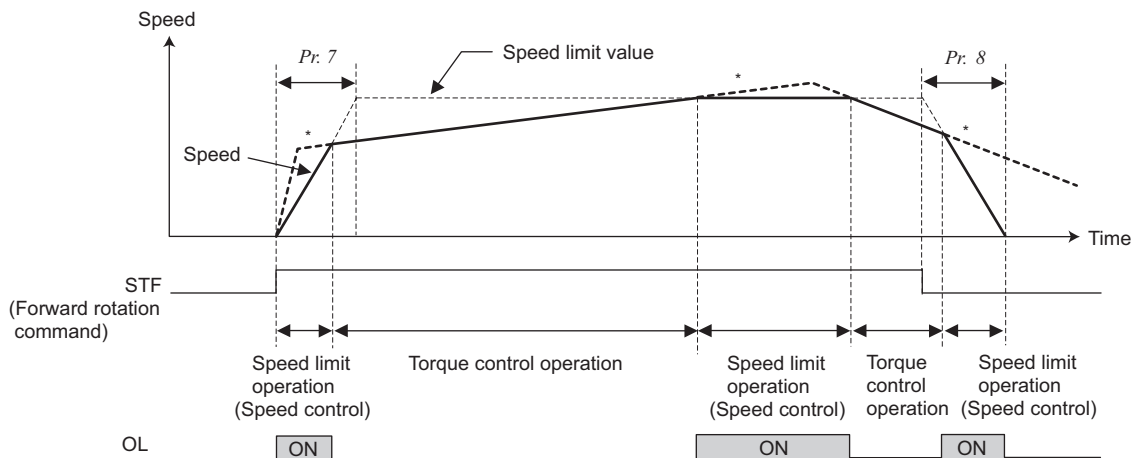

\*When the speed limit activates, torque according to the commanded is not developed.

- 1) When STF signal is turned on, the speed limit value is increased according to the time set in Pr. 7 .
- 2) Speed control operation is performed if the actual speed rises to or above the speed limit value.
- 3) When the STF signal is turned off, the speed limit value is decreased according to the time set in Pr. 8 .
- 4) For torque control, the actual speed becomes constant when the torque command and load torque are balanced.
- 5) The motor torque developing direction is determined by the combination of the torque command input polarity and start signal as indicated in the following table.

Torque Command Polarity	Torque Developing Direction	
	STF signal ON	STR signal ON
Positive torque command	Forward rotation direction (forward rotation driving/reverse rotation regeneration)	Reverse rotation direction (forward rotation regeneration/reverse rotation driving)
Negative torque command	Reverse rotation direction (forward rotation regeneration/reverse rotation driving)	Forward rotation direction (forward rotation driving/reverse rotation regeneration)

**REMARKS**

- When speed limit operation starts, speed control is exercised to enable internal torque limit (Pr. 22 torque limit level) (initial value). Speed control may not be returned to torque control in this case. Torque limit be set to external torque limit (terminal 1, 4). (Refer to page 83.)
- Undervoltage avoidance function (Pr. 261 = "11, 12") of power-failure deceleration stop function is invalid under torque control. When Pr. 261 = "11 (12)", the inverter operates in the same manner as when "1 (2)" is set in Pr. 261.
- Set linear acceleration/deceleration (Pr. 29 = "0 (initial value)") when torque control is exercised. When acceleration/ deceleration patterns other than the linear acceleration/deceleration are selected, the protective function of the inverter may function. (Refer to page 158)

**CAUTION**

- Performing pre-excitation (LX signal and X13 signal) under torque control (Real sensorless vector control) may start the motor running at a low speed even when the start command (STF or STR) is not input. The motor may run also at a low speed when the speed limit value = 0 with a start command input. Perform pre-excitation after making sure that there will be no problem in safety if the motor runs.





#### 4.5.2 Setting procedure of Real sensorless vector control (torque control) Sensorless

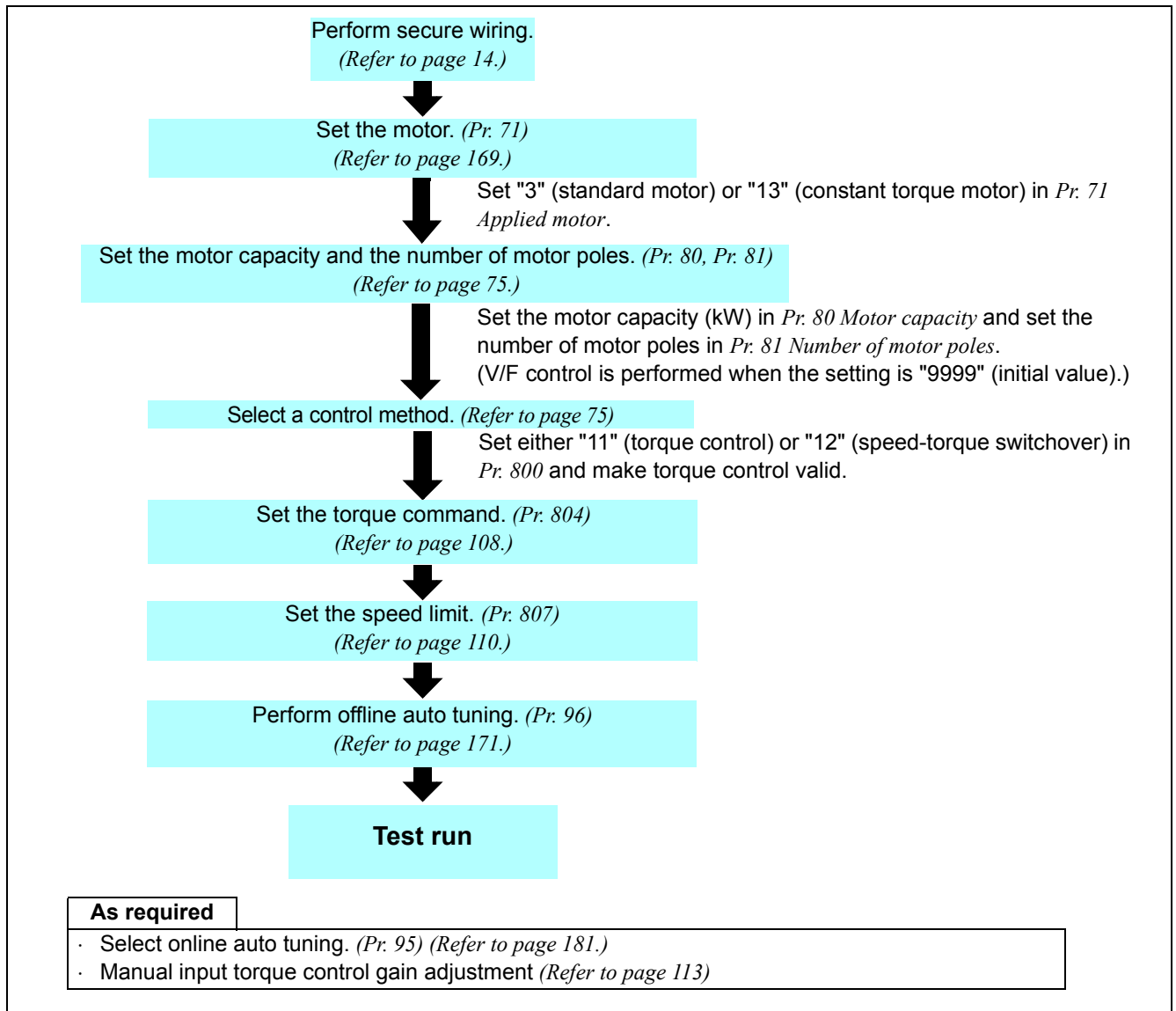

#### CAUTION

- Make sure to perform offline auto tuning before performing Real sensorless vector control.
- The carrier frequencies are selectable from among 2k, 6k, 10k, 14kHz for Real sensorless vector control.
- Torque control can not be performed in the low speed (approx. 10Hz or less) regeneration range and with light load at low speed (approx. 20% or less of rated torque at approx. 5Hz or less). Choose vector control.
- Performing pre-excitation (LX signal and X13 signal) under torque control may start the motor running at a low speed even when the start command (STF or STR) is not input. The motor may run also at a low speed when the speed limit value = 0 with a start command input. Perform pre-excitation after making sure that there will be no problem in safety if the motor runs.
- Do not switch between the STF (forward rotation command) and STR (reverse rotation command) during operation under torque control. Overcurrent trip (E.OC□) or opposite rotation deceleration error (E.11) occurs.
- When the inverter is likely to start during motor coasting under Real sensorless vector control, set to make frequency search of automatic restart after instantaneous power failure valid (Pr. 57 ≠ "9999", Pr. 162 = "10").
- Enough torque may not be generated in the ultra-low speed range less than approx. 2Hz when performing Real sensorless vector control.

The guideline of speed control range is as shown below.

Driving:	1:200 (2, 4, 6 poles)	Can be used at 0.3Hz or more at rated 60Hz
	1:30 (8, 10 poles)	Can be used at 2Hz or more at rated 60Hz
Regeneration:	1:12 (2 to 10 poles)	Can be used at 5Hz or more at rated 60Hz

### 4.5.3 Setting procedure of vector control (torque control) Vector

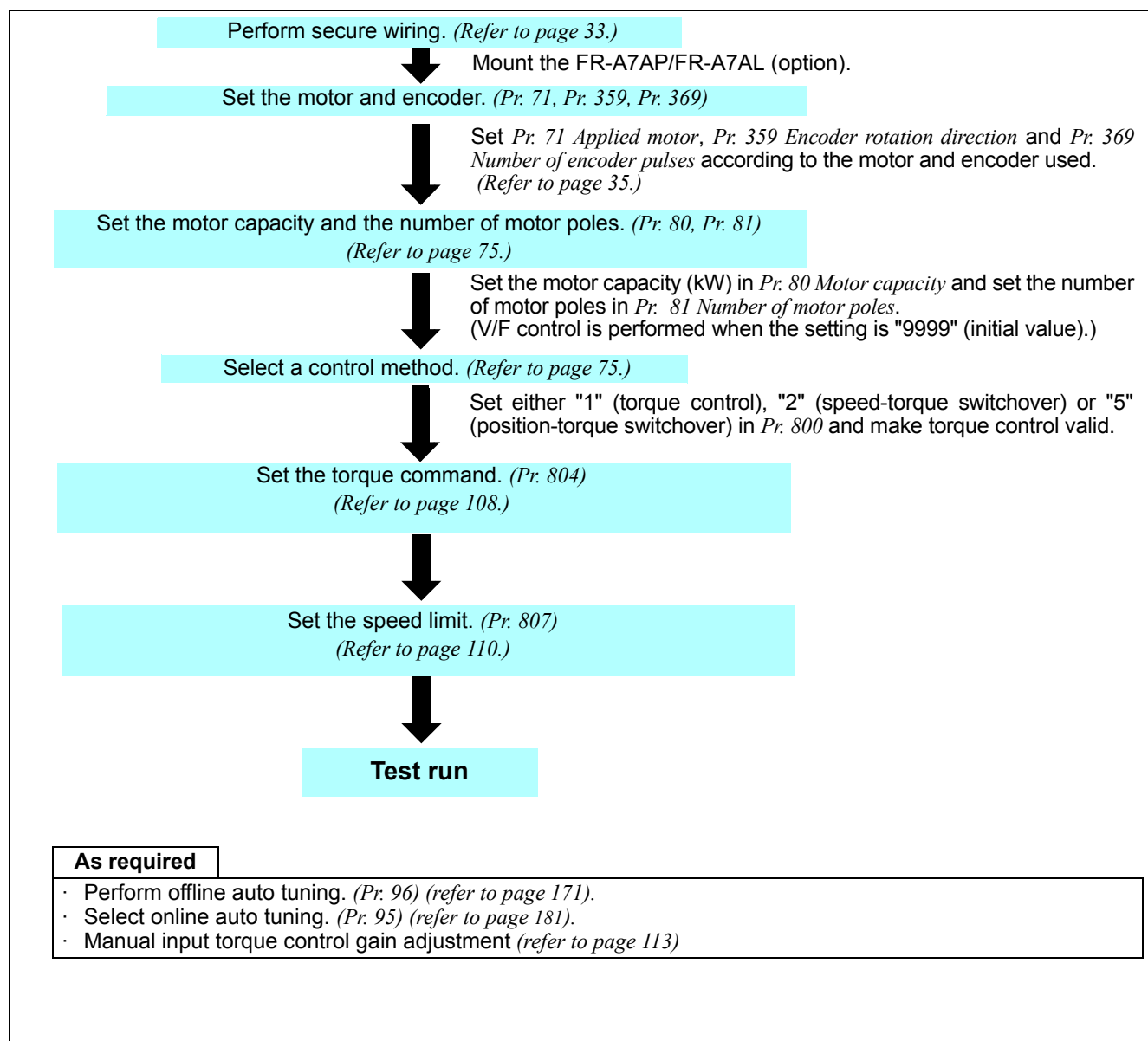

**CAUTION**

· The carrier frequencies are selectable among 2k, 6k, 10k, and 14kHz for vector control.



4.5.4 Torque command (Pr. 803 to Pr. 806) Sensorless Vector

Torque command source for torque control can be selected.

Parameter Number	Name	Initial Value	Setting Range	Description		
803	Constant power range torque characteristic selection	0	0	Constant motor output command	Select the torque command in the constant power range by torque command setting.	
			1	Constant torque command		
804	Torque command source selection	0	0	Torque command input		Speed limit input method
				Torque command by terminal1 analog input (Refer to page 277)		
			1	Torque command by parameter setting (Pr. 805 or Pr. 806) (-400% to 400%)		As set in Pr. 807.
			2	Torque command by pulse train input (FR-A7AL)		
			3	Torque command by parameter setting (Pr. 805 or Pr. 806) (-400% to 400%)	Torque command with using CC-Link communication (FR-A7NC) Setting from the remote resistor can be made. (-400% to 400%)	
			4	12 bit/16 bit digital input (FR-A7AX)		As set in Pr. 807.
			5	Torque command by parameter setting (Pr. 805 or Pr. 806) (Set from communication other than CC-Link communication : -400% to 400%) (Set from CC-Link communication : -327.68% to 327.67%)	Torque command with using CC-Link communication (FR-A7NC) Setting from the remote resistor can be made. (-327.68% to 327.67%)	The Pr. 808 and Pr. 809 settings are speed limit regardless of the Pr. 807 setting.
6	—	As set in Pr. 807.				
805*	Torque command value (RAM)	1000 %	600 to 1400%	Writes the torque command value to the RAM. On the assumption that 1000% is 0%, the torque command is set by an offset from 1000%.		
806*	Torque command value (RAM,EEPROM)	1000 %	600 to 1400%	Writes the torque command value to the RAM and EEPROM. On the assumption that 1000% is 0%, the torque command is set by an offset from 1000%.		

\* This parameter allows its setting to be changed during operation in any operation mode even if "0 (initial value) or 1" is set in Pr. 77 Parameter write selection.

(1) Control block diagram

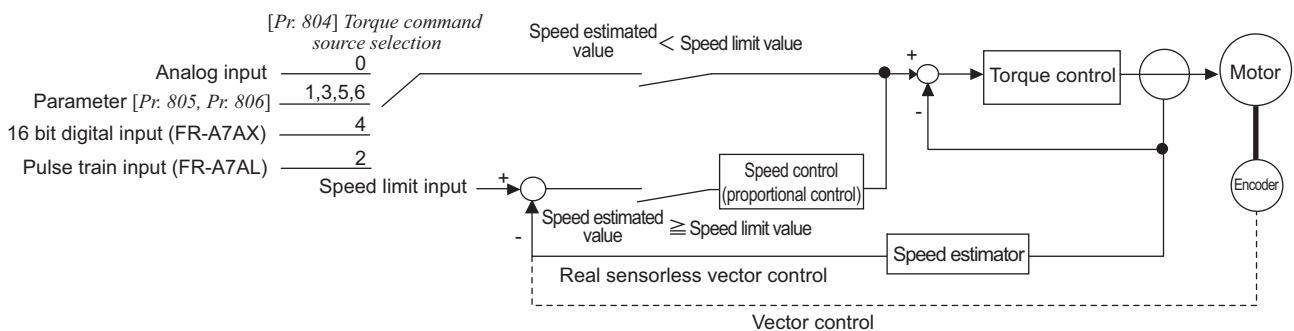

(2) Torque command (Pr. 804 = "0" (initial value)) by analog input (terminal 1)

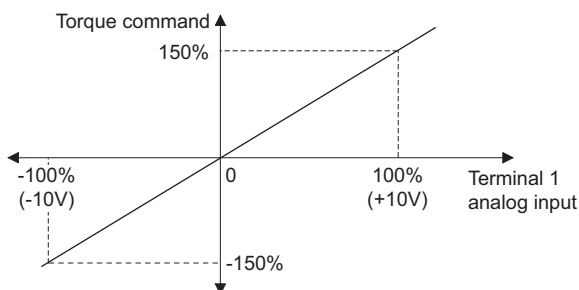

- Torque command is given by voltage (current) input to terminal 1.
- When torque command is input from terminal 1, set "3 or 4" in Pr. 868 Terminal 1 function assignment.
- Torque command by analog input can be calibrated using calibration parameter C16 (Pr. 919) to C19 (Pr. 920). (Refer to page 277)

**(3) Torque command using parameters (Pr. 804 = "1")**

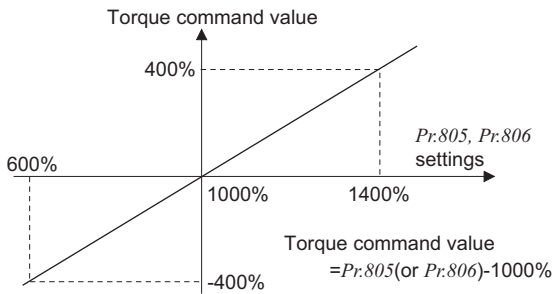

- Torque command value can be set by setting Pr. 805 Torque command value (RAM) or Pr. 806 Torque command value (RAM,EEPROM) .
- For Pr. 805 or Pr. 806, the torque command is set by an offset from 1000% on the assumption that 1000% is 0%. The relationship between the Pr. 805 or Pr. 806 setting and actual torque command value at this time is shown on the left.
- When changing the torque command frequently, write to Pr. 805. Performing frequent parameter write to Pr. 806 will shorten the life of the EEPROM.

**REMARKS**

- When torque command is set in Pr. 805 (RAM), powering off the inverter will erase the changed parameter values. Therefore, the parameter value available when power is switched on again is the value set in Pr. 806 (EEPROM).

**CAUTION**

- When giving a torque command by parameter setting, set the speed limit value to an appropriate value to prevent overspeed. (Refer to page 110.)

**(4) Torque command by pulse train input (Pr.804 = "2")**

Torque command is set by pulse train input from FR-A7AL (plug-in option).  
FR-A7AL needs to be installed for this function.

**REMARKS**

For details of the setting with the FR-A7AL, refer to the FR-A7AL instruction manual.

**(5) Torque command by CC-Link communication (Pr. 804 = "3, 5, 6")**

- Writing a value to Pr. 805 or Pr. 806 using the FR-A7NC (communication option) sets the torque command value.
- When "3 or 5" is set in Pr.804, torque command can be set in remote register RWw1 or RWwC using the FR-A7NC (communication option).
- By setting "5, 6" in Pr.804, the range of torque command setting from FR-A7NC (communication option) is set from -327.68% to 327.67% (0.01% increments).

Pr. 804 Setting	Torque Command Source	Setting Range	Increments
1	Torque command by parameter setting (Pr. 805 or Pr. 806)	600 to 1400 (-400% to 400%)	1%
3	Torque command by parameter setting (Pr. 805 or Pr. 806)	600 to 1400 (-400% to 400%)	1%
	Torque command from remote resistor (RWw1 or RWwC) with using CC-Link communication (FR-A7NC)		
5	Torque command by parameter setting (Pr. 805 or Pr. 806) without using CC-Link communication (FR-A7NC)	600 to 1400 (-400% to 400%)	1%
	Torque command by parameter setting (Pr. 805 or Pr. 806) with using CC-Link communication (FR-A7NC)	-32768 to 32767 (two's complement) (-327.68% to 327.67%)	0.01%
	Torque command from remote resistor (RWw1 or RWwC) with using CC-Link communication (FR-A7NC)	-32768 to 32767 (two's complement) (-327.68% to 327.67%)	0.01%
6	Torque command by parameter setting (Pr. 805 or Pr. 806) without using CC-Link communication (FR-A7NC)	600 to 1400 (-400% to 400%)	1%
	Torque command by parameter setting (Pr. 805 or Pr. 806) with using CC-Link communication (FR-A7NC)	-32768 to 32767 (two's complement) (-327.68% to 327.67%)	0.01%

**REMARKS**

For details of the setting with the FR-A7NC, refer to the FR-A7NC instruction manual.

**(6) Torque command by 16-bit digital input (Pr. 804 = 4)**

- Give a torque command by 16-bit or 12-bit digital input using FR-A7AX (plug-in option).

**REMARKS**

For details of the setting with the FR-A7AX, refer to the FR-A7AX instruction manual.



**(7) Change the torque characteristics in the constant power (Pr. 803)**

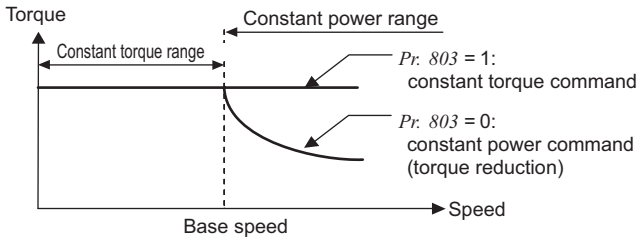

Due to the motor characteristics, torque is reduced at or above the base frequency. Set "1" in Pr. 803 Constant power range torque characteristic selection when you want to keep the torque to be constant even at or above the base frequency.

◆ Parameters referred to ◆

Pr. 868 Terminal 1 function assignment Refer to page 83.  
 Calibration parameter C16 (Pr. 919) to C19 (Pr. 920) (terminal 1 bias, gain torque) Refer to page 277

**4.5.5 Speed limit (Pr. 807 to Pr. 809)** Sensorless Vector

Set the speed limit value to prevent overspeed of the motor in case the load torque becomes less than the torque command value, etc. during torque control operation.

Parameter Number	Name	Initial Value	Setting Range	Description
807	Speed limit selection	0	0	Use the speed command value during speed control as speed limit.
			1	According to Pr. 808 and Pr. 809, set the speed limit in forward and reverse rotation directions individually.
			2	Forward/reverse rotation speed limit The analog voltage of the terminal 1 input is used to make speed limit. The speed limit of the forward rotation and reverse rotation is switched according to the polarity.
808	Forward rotation speed limit	60Hz	0 to 120Hz	Set the speed limit for the forward rotation direction.
809	Reverse rotation speed limit	9999	0 to 120Hz	Set the speed limit of the reverse rotation side.
			9999	As set in Pr. 808.

**(1) Control block diagram**

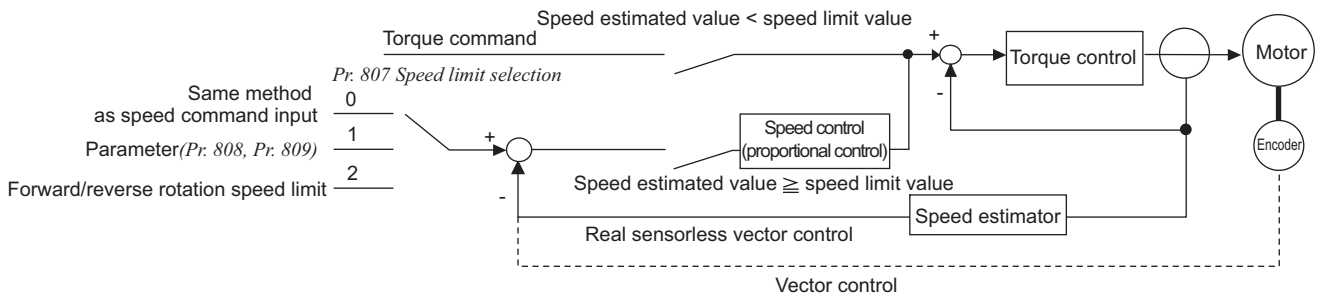

**(2) Use the speed command for speed control (Pr. 807 = "0" initial value)**

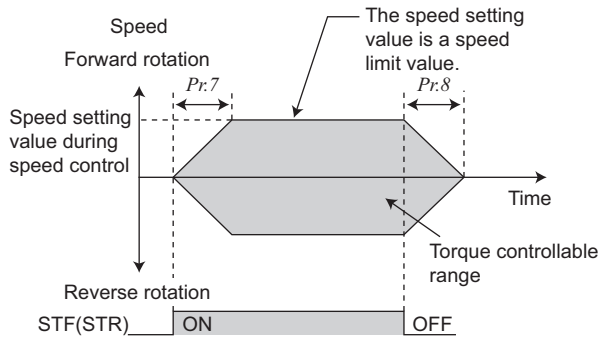

- Set the speed limit in the same method as speed setting for speed control (speed setting by the PU (FR-DU07/FR-PU07/FR-PU04), multi-speed setting, options, etc.)
- According to the acceleration time set in Pr. 7 Acceleration time, the limit level is increased from 0Hz upon turning ON of the start signal, and when the start signal turns off, the speed limit level is decreased from the then speed limit level to the DC injection brake operation speed in Pr. 10 to a stop in accordance with the deceleration time set in Pr. 8 Deceleration time.

**REMARKS**

- When the above speed limit command is greater than the Pr. 1 Maximum frequency value, the speed limit value is the Pr. 1 Maximum frequency value, and when the speed limit command is less than the Pr. 2 Minimum frequency value, the speed limit value is the Pr. 2 Minimum frequency value. Similarly when the speed limit command is smaller than Pr. 13 Starting frequency, the speed limit value is 0Hz.
- When speed limit is set by analog input, perform calibration of the analog input terminal 1, 2 and 4. (Refer to page 277.)

**CAUTION**

When speed limit is set by the analog command (terminal 1,2,4), turn off the external signals (RH, RM, RL). If any of external signals (RH, RM, RL) is on, multi-speed limits are valid.

**(3) Set the forward rotation and reverse rotation individually (Pr. 807 = "1")**

Set the speed limit during forward rotation using Pr. 808 Forward rotation speed limit and the speed limit during reverse rotation using Pr. 809 Reverse rotation speed limit.

The speed during forward and reverse rotation is limited at the setting value of Pr. 808 when "9999" (initial value) is set in Pr. 809.

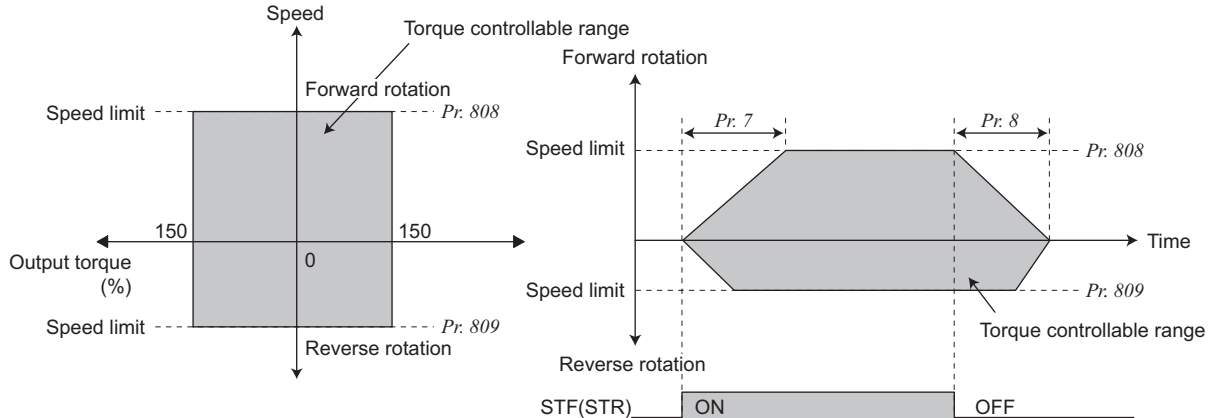



#### (4) Forward rotation/reverse rotation speed limit (Pr. 807 = "2")

- When making a speed limit using analog input from terminal 1, the speed limit of the forward and reverse rotation can be switched according to the polarity of voltage.
- Forward/reverse rotation speed limit is valid when Pr. 868 Terminal 1 function assignment = "5".
- For 0 to 10V input, set the forward rotation speed limit. The reverse rotation speed limit at this time is the value of Pr.1 Maximum frequency.
- For -10 to 0V input, set the reverse rotation speed limit. The forward rotation speed limit at this time is the value of Pr. 1 Maximum frequency .
- The maximum speed of both the forward and reverse rotations is Pr. 1 Maximum frequency .

●When terminal 1 input is "-10 to 0V"

●When terminal 1 input is "0 to 10V"

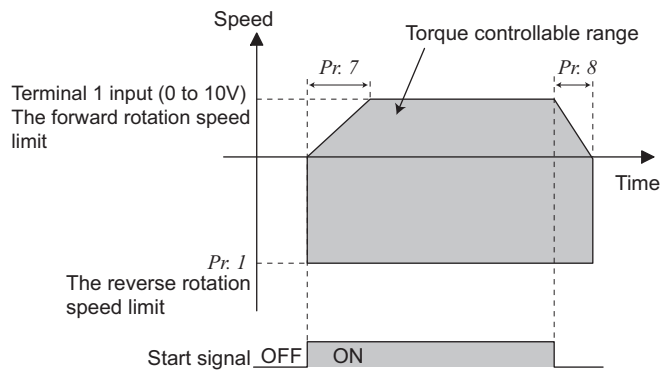
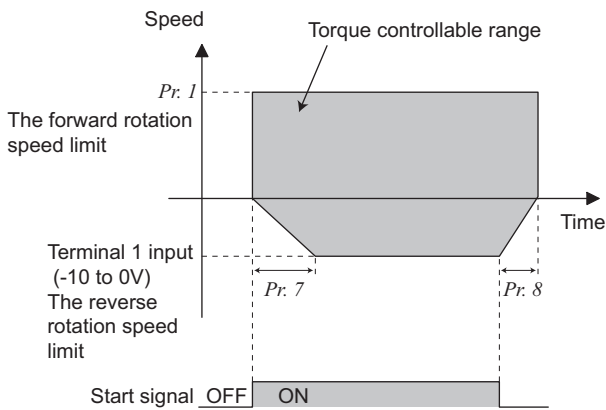
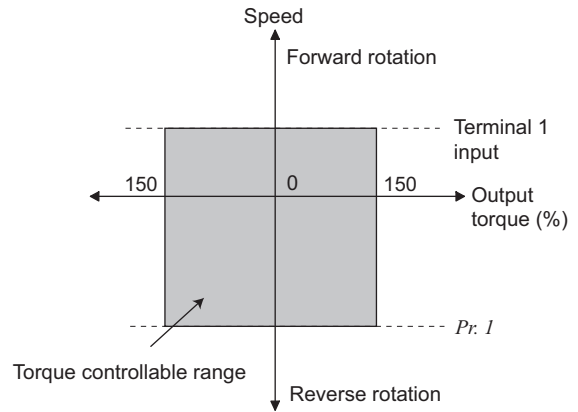
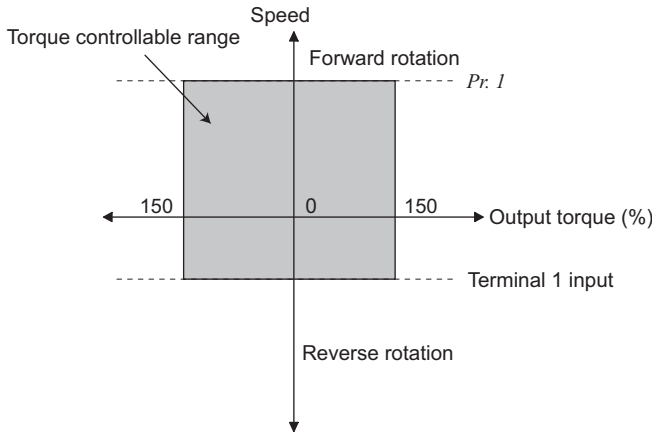

#### REMARKS

- When making speed limit from terminal 1, make calibration of terminal 1. (Refer to page 277.)

#### CAUTION

When the actual speed reaches or exceeds the speed limit value, torque control is switched to speed control to prevent overspeed.

**SL** (SL) appears on the operation panel during speed limit operation and the OL signal is output.

#### ◆Parameters referred to◆

- Pr. 1 Maximum frequency, Pr. 2 Minimum frequency Refer to page 140
- Pr. 7 Acceleration time, Pr. 8 Deceleration time Refer to page 155
- Pr. 13 Starting frequency Refer to page 157
- Pr. 4 to Pr. 6, Pr. 24 to Pr. 27, Pr. 232 to Pr. 239 (Multi-speed operation) Refer to page 148
- Pr. 868 Terminal 1 function assignment Refer to page 262
- Pr. 125, Pr. 126, C2 to C7, C12 to C15 (frequency setting voltage (current) bias/gain) Refer to page 271

#### 4.5.6 Gain adjustment of torque control (Pr. 824, Pr. 825, Pr. 834, Pr. 835) Sensorless Vector

Although stable operation is possible with the initial value, make adjustment when any of such phenomena as unusual motor and machine vibration/noise and overcurrent has occurred.

Parameter Number	Name	Initial Value	Setting Range	Description
824	Torque control P gain 1	100%	0 to 200%	Set the current loop proportional gain. 100% is equivalent to 2000rad/s.
825	Torque control integral time 1	5ms	0 to 500ms	Set the current loop integral compensation time.
834	Torque control P gain 2	9999	0 to 200%	Set the current loop proportional gain when the RT signal is on.
			9999	Without torque control P gain 2 function
835	Torque control integral time 2	9999	0 to 500ms	Set the current loop integral compensation time when the RT signal is on.
			9999	Without torque control integral time 2 function

##### (1) Adjustment of current loop proportional (P) gain

- For general adjustment, make setting within the range 50 to 200% as a guideline.
- Set the proportional gain for torque control.
- Increasing the value improves trackability in response to a current command change and reduces current variation with disturbance. However, a too large gain will cause instability, generating harmonic torque pulsation.

##### (2) Adjustment of current control integral time

- Set the integral time of current control during torque control.
- A small value enhances the torque response level, but a too small value will cause current fluctuation.
- Decreasing the value shortens the time taken to return to the original torque if current variation with disturbance occurs.

##### (3) Use multiple gains

- When you want to change the gain according to applications, switch multiple motors with one inverter, etc., use *Torque control P gain 2* and *Torque control integral time 2*.
- *Pr. 834 Torque control P gain 2* and *Pr. 835 Torque control integral time 2* are valid when the RT signal is ON.

#### REMARKS

- The RT signal acts as the second function selection signal and makes the other second functions valid. (Refer to page 211.)
- The RT signal is assigned to the terminal RT in the initial setting. By setting "3" in any of *Pr. 178 to Pr. 189 (input terminal function selection)*, you can assign the RT signal to the other terminal.





#### (4) Adjustment procedure

Make adjustment when any of such phenomena as unusual motor and machine vibration/noise/current and overcurrent has occurred.

1) Check the conditions and simultaneously change the *Pr. 824* value.

2) If you cannot make proper adjustment, change the *Pr. 825* value and repeat step 1).

Adjustment Method	
Set <i>Pr. 824</i> a little lower and <i>Pr. 825</i> a little higher. First lower <i>Pr. 824</i> and check the motor for unusual vibration/noise and overcurrent. If the problem still persists, increase <i>Pr. 825</i> .	
<i>Pr. 824</i>	Decrease the value 10% by 10% until just before unusual noise and current are improved, and set about 0.8 to 0.9 of that value. Note that a too low value will produce current ripples, causing the motor to generate sound synchronizing the cycle of current ripples.
<i>Pr. 825</i>	Increase the current value double by double until just before an unusual noise and current does not occur, and set about 0.8 to 0.9 of that value. Note that taking a too long time will produce current ripples, causing the motor to generate sound synchronizing the cycle of current ripples.

#### (5) Troubleshooting (Torque)

	Phenomenon	Cause	Countermeasures
1	Torque control is not exercised normally.	(1) The phase sequence of the motor or encoder wiring is wrong. (2) The <i>Pr. 800 Control method selection</i> setting is improper. (3) The speed limit value is not input. (4) The torque command varies. (5) The torque command does not match the inverter-recognized value. (6) Torque variation due to the change in the motor temperature.	(1) Check the wiring. (Refer to page 14) (2) Check the <i>Pr. 800</i> setting. (Refer to page 75) (3) Set the speed limit value. (If the speed limit value is not input, the motor will not rotate since the speed limit value is regarded as 0Hz.) (4)-1 Check that the command device gives a correct torque command. (4)-2 Decrease <i>Pr. 72 PWM frequency selection</i> . (4)-3 Increase <i>Pr. 826 Torque setting filter 1</i> (5) Recalibrate <i>C16 Terminal 1 bias command (torque/magnetic flux)</i> , <i>C17 Terminal 1 bias (torque/magnetic flux)</i> , <i>C18 Terminal 1 gain command (torque/magnetic flux)</i> , <i>C19 Terminal 1 gain (torque/magnetic flux)</i> . (Refer to page 277) (6) Select magnetic flux observer by setting <i>Pr. 95 Online auto tuning selection</i> . (Refer to page 181)
2	When the torque command is small, the motor rotates in the direction opposite to the start signal.	The offset calibration of the torque command does not match.	Recalibrate <i>C16 Terminal 1 bias command (torque/magnetic flux)</i> and <i>C17 Terminal 1 bias (torque/magnetic flux)</i> . (Refer to page 277)
3	Normal torque control cannot be exercised during acceleration/deceleration. The motor vibrates.	The speed limit is activated. (When <i>Pr. 807</i> = "0, 2", the speed limit may be activated since the speed limit value changes with the setting of the acceleration/deceleration time in <i>Pr. 7</i> and <i>Pr. 8</i> .)	Reduce the acceleration/deceleration time. Or, set the acceleration/deceleration time to "0". (The speed limit during acceleration/deceleration depends on the speed limit during the constant speed.)
4	Output torque is not linear in response to the torque command.	Insufficient torque.	Return the excitation ratio in <i>Pr. 854</i> to the initial value.

#### ◆Parameters referred to◆

*Pr. 72 PWM frequency selection* Refer to page 261  
*Pr. 178 to Pr. 189 (input terminal function selection)* Refer to page 207  
*Pr. 800 Control method selection* Refer to page 75  
*Pr. 807 Speed limit selection* Refer to page 110  
*C16 to C19 (torque setting voltage (current) bias and gain)* Refer to page 277



## 4.6 Position control by vector control

Purpose	Parameter that must be Set		Refer to Page
Conditional position control by parameter setting	Position command by parameter	Pr. 419, Pr. 464 to Pr. 494	117
Position control by pulse train input of the inverter	Position command by conditional pulse train	Pr. 419, Pr. 428 to Pr. 430	120
Adjust the gear ratio of motor and machine	Setting the electronic gear	Pr. 420, Pr. 421, Pr. 424	122
Setting of positioning adjustment parameter	In-position width Excessive level error	Pr. 426, Pr. 427	123
Improve position control accuracy	Gain adjustment of position control	Pr. 422, Pr. 423, Pr. 425	124

### 4.6.1 Position control Vector

- In the position control, the speed command is calculated so that the difference between command pulse (or parameter setting) and the number of feedback pulses from the encoder is zero in order to run the motor.
- This inverter can perform simple position feed by contact input, position control by inverter simple pulse input, and position control by FR-A7AL pulse train input.

#### (1) Setting procedure

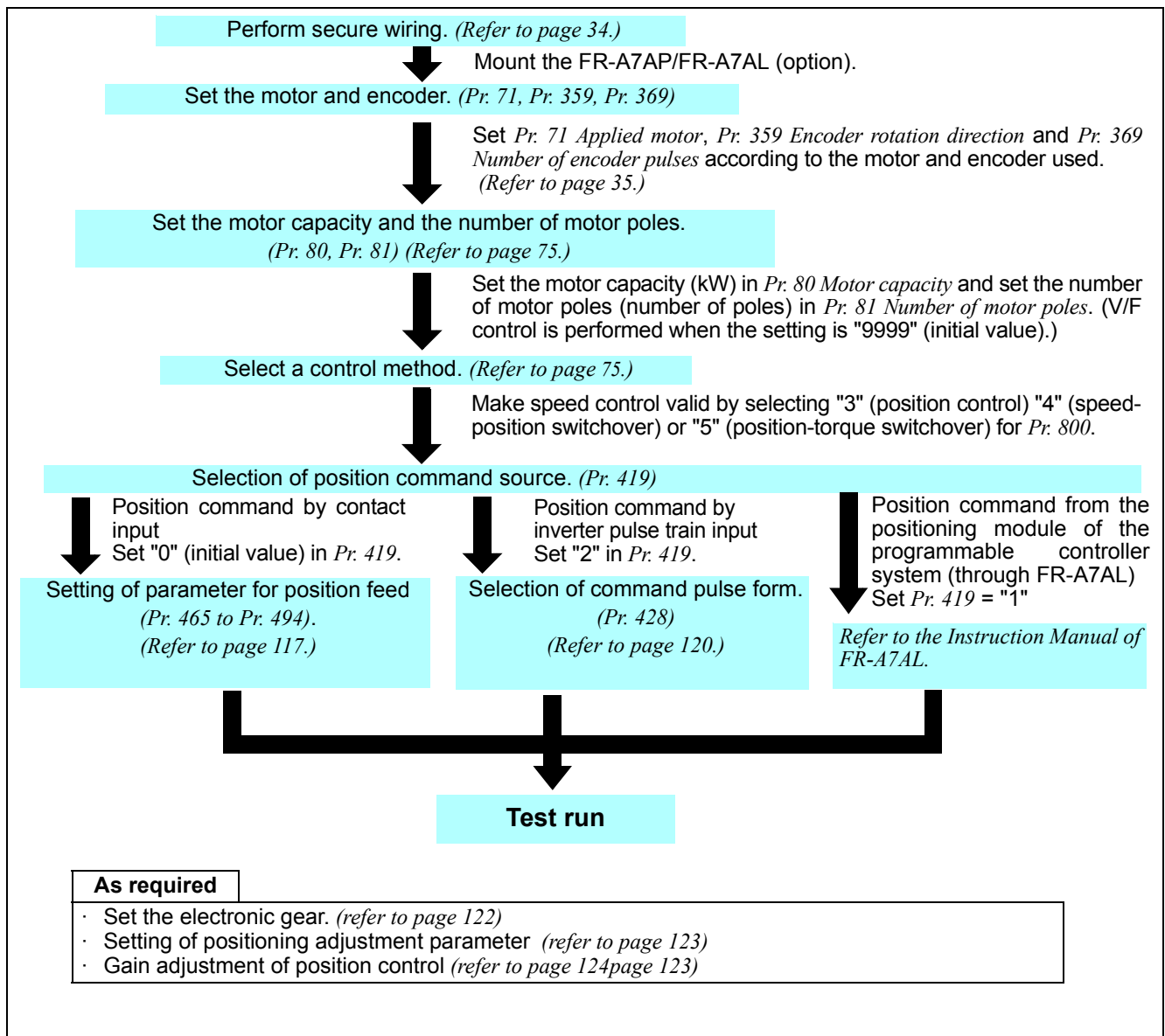

#### CAUTION

- The carrier frequencies are selectable among 2k, 6k, 10k, and 14kHz for vector control.



**(2) Control block diagram**

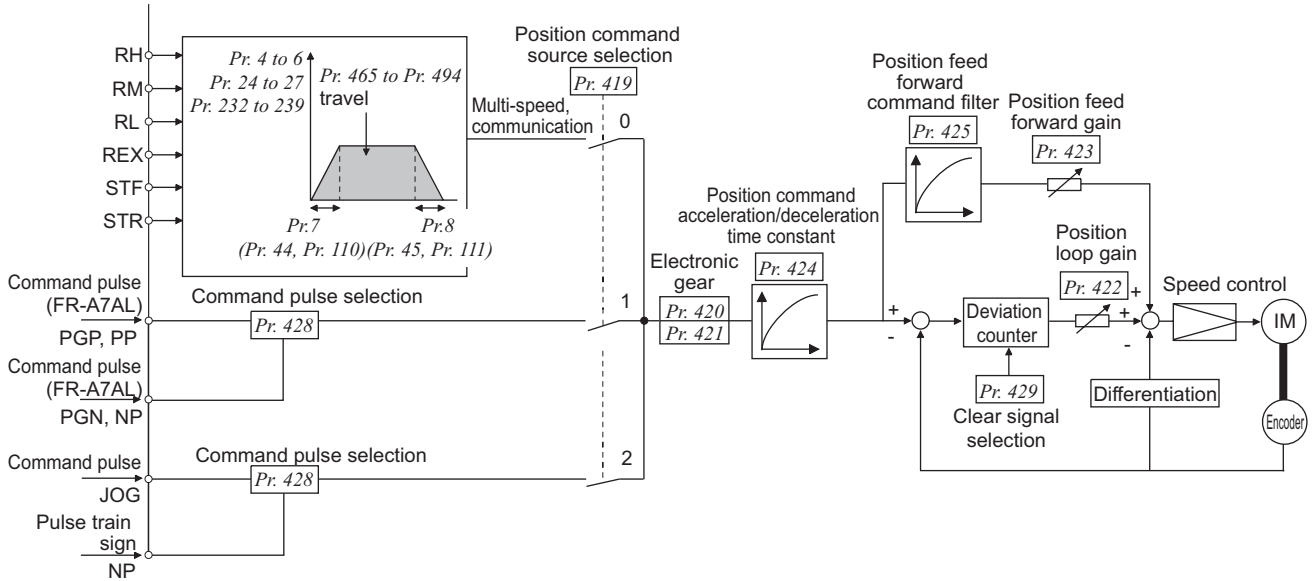

**(3) Example of operation**

The speed command given to rotate the motor is calculated to zero the difference between the number of internal command pulse train pulses (when Pr. 419 = 0, the number of pulses set by parameter (Pr. 465 to Pr. 494) is changed to the command pulses in the inverter) and the number of pulses fed back from the motor end encoder.

- 1) When a pulse train is input, pulses are accumulated in the deviation counter and these droop pulses act as position control pulses to give the speed command.
- 2) As soon as the motor starts running under the speed command of the inverter, the encoder generates feed back pulses and the droop of the deviation counter is counted down. The deviation counter maintains a given droop pulse value to keep the motor running.
- 3) When the command pulse input stops, the droop pulses of the deviation counter decrease, reducing the speed. The motor stops when there are no droop pulses.
- 4) When the number of droop pulses has fallen below the value set in Pr. 426 In-position width , it is regarded as completion of positioning and the in-position signal (Y36) turns on.

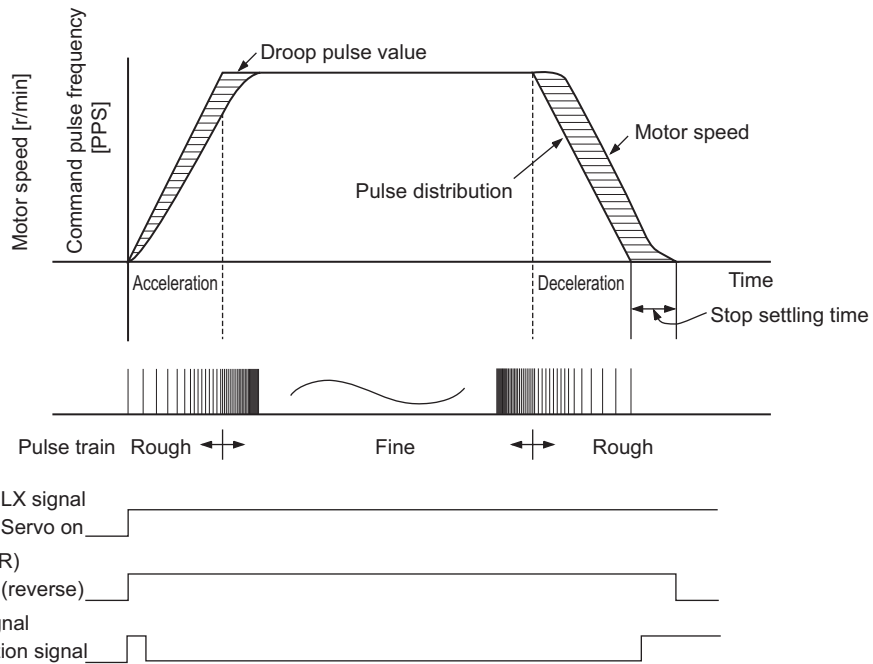

- For conditional position control function by contact input, the STF and STR terminals provide the forward (reverse) command signal. The motor can run only in the direction where the forward (reverse) signal is on. Turning the STF signal off does not run the motor forward and turning the STR signal off does not run the motor reverse.
- The pulse train is rough during acceleration and coarse at the maximum speed. During deceleration the pulse train is rough and at last there are no pulses. The motor stops shortly after the command pulses stop. This time lag is necessary for maintaining the stop accuracy and called stop settling time.

**REMARKS**

- For the servo on signal (LX), set "23" in Pr. 178 to Pr. 189 (input terminal function selection) to assign the function.
- For the in-position signal (Y36), set "36" in Pr. 190 to Pr. 196 (output terminal function selection) to assign the function.

**CAUTION**

Changing the terminal function using any of Pr. 178 to Pr. 189, 190 to Pr. 196 may affect the other functions. Set parameters after confirming the function of each terminal.

## ◆Parameters referred to◆

- Pr. 178 to Pr. 189 (input terminal function selection) Refer to page 207  
 Pr. 190 to Pr. 196 (output terminal function selection) Refer to page 215

**4.6.2 Conditional position feed function by contact input (Pr. 419, Pr. 464 to Pr. 494)**

Vector

Inputting the number of pulses (positions) in the parameters and setting multi-speed and forward (reverse) commands enable position control. The motor does not return to the home position with this conditional position feed function .

Parameter Number	Name	Initial Value	Setting Range	Description
419	Position command source selection	0	0	Conditional position control function by contact input. (position command by parameter settings)
			1 <b>Ver. UP</b>	Pulse train position command from the positioning module of the programmable controller system (when FR-A7AL is installed)
			2	Conditional pulse train position command by inverter pulse train input
464	Digital position control sudden stop deceleration time	0s	0 to 360.0s	Set the time until the inverter stops when the forward rotation (reverse rotation) command is turned off with the position feed forward function.

Parameter Number	Name	Initial Value	Setting Range	Selection Method (OFF: ×, ON: ○)				Position Feed Frequency
				REX	RH	RM	RL	
465	First position feed amount lower 4 digits	0	0 to 9999	×	○	×	×	High speed (Pr. 4)
466	First position feed amount upper 4 digits	0	0 to 9999					
467	Second position feed amount lower 4 digits	0	0 to 9999	×	×	○	×	Middle speed (Pr. 5)
468	Second position feed amount upper 4 digits	0	0 to 9999					
469	Third position feed amount lower 4 digits	0	0 to 9999	×	×	×	○	Low speed (Pr. 6)
470	Third position feed amount upper 4 digits	0	0 to 9999					
471	Fourth position feed amount lower 4 digits	0	0 to 9999	×	×	○	○	4 speed (Pr. 24)
472	Fourth position feed amount upper 4 digits	0	0 to 9999					
473	Fifth position feed amount lower 4 digits	0	0 to 9999	×	○	×	○	5 speed (Pr. 25)
474	Fifth position feed amount upper 4 digits	0	0 to 9999					
475	Sixth position feed amount lower 4 digits	0	0 to 9999	×	○	○	×	6 speed (Pr. 26)
476	Sixth position feed amount upper 4 digits	0	0 to 9999					



Parameter Number	Name	Initial Value	Setting Range	Selection Method (OFF: ×, ON: ○)				Position Feed Frequency
				REX	RH	RM	RL	
477	Seventh position feed amount lower 4 digits	0	0 to 9999	×	○	○	○	7 speed (Pr. 27)
478	Seventh position feed amount upper 4 digits	0	0 to 9999					
479	Eighth position feed amount lower 4 digits	0	0 to 9999	○	×	×	×	8 speed (Pr. 232)
480	Eighth position feed amount upper 4 digits	0	0 to 9999					
481	Ninth position feed amount lower 4 digits	0	0 to 9999	○	×	×	○	9 Speed (Pr. 233)
482	Ninth position feed amount upper 4 digits	0	0 to 9999					
483	Tenth position feed amount lower 4 digits	0	0 to 9999	○	×	○	×	10 speed (Pr. 234)
484	Tenth position feed amount upper 4 digits	0	0 to 9999					
485	Eleventh position feed amount lower 4 digits	0	0 to 9999	○	×	○	○	11 speed (Pr. 235)
486	Eleventh position feed amount upper 4 digits	0	0 to 9999					
487	Twelfth position feed amount lower 4 digits	0	0 to 9999	○	○	×	×	12 speed (Pr. 236)
488	Twelfth position feed amount upper 4 digits	0	0 to 9999					
489	Thirteenth position feed amount lower 4 digits	0	0 to 9999	○	○	×	○	13 speed (Pr. 237)
490	Thirteenth position feed amount upper 4 digits	0	0 to 9999					
491	Fourteenth position feed amount lower 4 digits	0	0 to 9999	○	○	○	×	14 speed (Pr. 238)
492	Fourteenth position feed amount upper 4 digits	0	0 to 9999					
493	Fifteenth position feed amount lower 4 digits	0	0 to 9999	○	○	○	○	15 speed (Pr. 239)
494	Fifteenth position feed amount upper 4 digits	0	0 to 9999					

The above parameters can be set when the FR-A7AP/FR-A7AL (option) is mounted.

**Ver. UP** ..... Specifications differ according to the date assembled. Refer to page 456 to check the SERIAL number.



## (1) Setting of position feed amount by parameter

- Set position feed amount in *Pr. 465 to Pr. 494*.
- The feed amount set in each parameter is selected by multi-speed terminal (RH, RM, RL, REX).
- Set (encoder resolution × speed × 4 times) for position feed amount.
- For example, the formula for stopping the motor after 100 rotations using the FR-V5RU is as follows:

$$2048 \text{ (pulse/rev)} \times 100 \text{ (speed)} \times 4 = 819200 \text{ (feed amount)}$$

To set 819200 for the first position feed amount, divide the value into upper four digits and lower four digits and set 81 (decimal) in *Pr. 466* (upper) and 9200 (decimal) in *Pr. 465* (lower).

## (2) Position command operation by parameter

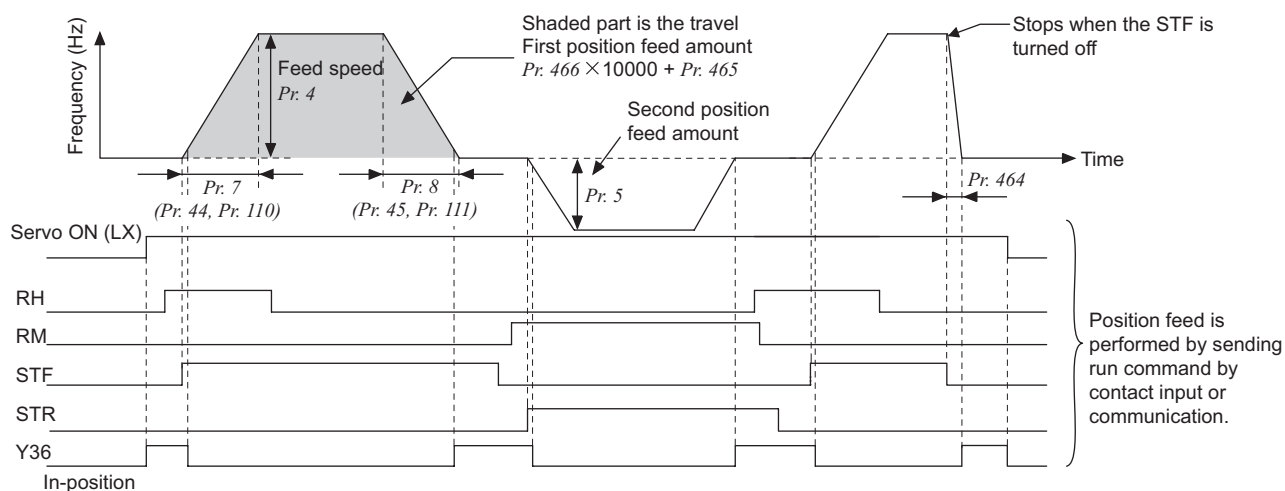

- For deceleration by turning the STF(STR) OFF, use *Pr. 464 Digital position control sudden stop deceleration time* to set deceleration time.

### REMARKS

- Acceleration/deceleration time is 0.1s minimum and 360s maximum.
- *Pr. 20 Acceleration/deceleration reference frequency* is clamped at a minimum of 16.66Hz (500r/min).
- The acceleration/deceleration patterns for position control are all linear acceleration and the setting of *Pr. 29 Acceleration/deceleration pattern selection* is invalid.

### CAUTION

Information on multi-speed command (position command by RL, RM, RH, and REX signals) is determined at rising of the forward (reverse) command to perform position control. Therefore, set forward (reverse) command after multi-speed command (position command). Position feed is invalid if the multi-speed command is given after forward (reverse) command.

#### ◆Parameters referred to◆

*Pr. 20 Acceleration/deceleration reference frequency* Refer to page 155

*Pr. 29 Acceleration/deceleration pattern selection* Refer to page 158



### 4.6.3 Position control (Pr. 419, Pr. 428 to Pr. 430) by inverter pulse train input Vector

Simple position pulse train command can be input by pulse train input and sign signal (NP) to the JOG terminal.

Parameter Number	Name	Initial Value	Setting Range	Description
419	Position command source selection	0	0	Conditional position control function by contact input. (position command by parameter settings)
			1 <b>Ver.UP</b>	Pulse train position command from the positioning module of the programmable controller system (when FR-A7AL is installed)
			2	Conditional pulse train position command by inverter pulse train input
428	Command pulse selection	0	0 to 2	Pulse train + rotation
			3 to 5	signal sign
429	Clear signal selection	1	0	Deviation counter is cleared at edge of turning on of the clear signal (CLR) from off.
			1	Deviation counter while the clear signal (CLR) is on
430	Pulse monitor selection	9999	0 to 5	The status of various pulses during running is displayed.
			9999	Frequency monitor is displayed.

The above parameters can be set when the FR-A7AP/FR-A7AL (option) is mounted.

**Ver.UP** ..... Specifications differ according to the date assembled. Refer to page 456 to check the SERIAL number.

#### (1) Operation

Turning ON the servo ON signal (LX) cancels the output shut-off and the operation ready signal (RDY) turns ON after 0.1s. Turning ON the STF (forward stroke end signal) or STR (reverse stroke end signal) runs the motor according to the commanded pulse. When the forward (reverse) stroke end signal turns OFF, the motor does not run in that direction.

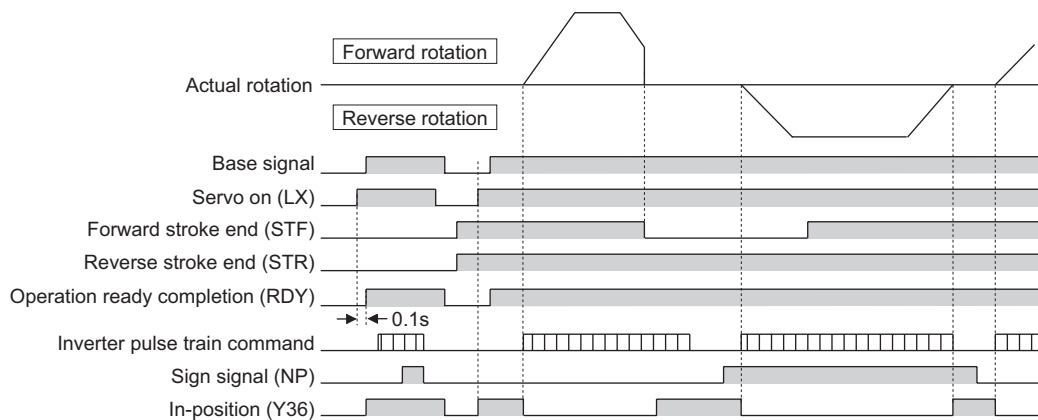

#### (2) Pulse train form type selection (Pr. 428, NP signal)

- 1) Set "2" (conditional pulse train position command) in Pr. 419.
- 2) Set "68" in Pr. 178 to Pr. 189 (input terminal function selection) to assign simple position pulse train sign (NP).
- 3) Select command pulse train using Pr. 428

Pr. 428 Setting	Command Pulse Train Type	At Forward Rotation	At Reverse Rotation
0 to 2	Negative logic Pulse train + rotation signal sign	JOG NP	JOG NP
3 to 5	Positive logic Pulse train + rotation signal sign	JOG NP	JOG NP

4) Select vector control, then select position control.

#### REMARKS

- When Pr. 419 Position command source selection = "2" (conditional pulse train position command), JOG terminal serves as simple position pulse train input terminal regardless of the Pr. 291 Pulse train I/O selection setting.

**(3) Selection of clear signal (Pr. 429, CLR signal)**

- Use this function to zero the droop pulse for home position operation, etc.
- When "0" is set in Pr. 429, the deviation counter is cleared at the edge of turning ON of the clear signal (CLR). In addition, the CLR signal turns on in synchronization with zero pulse signal of the encoder at home position operation, etc., deviation counter is cleared.
- For the terminal used for CLR signal, set "69" in any of Pr. 178 to Pr. 189 (input terminal function selection) to assign the function.

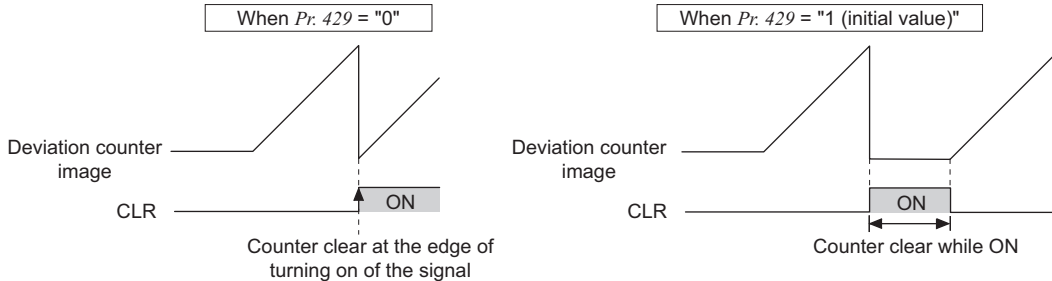

**(4) Pulse monitor selection (Pr. 430)**

The status of various pulses during running is displayed.  
Set "0" in Pr. 52 DU/PU main display data selection to display output frequency monitor.

Pr. 430 Setting	Description	Display Range (FR-DU07)	Display Range (FR-PU04/FR-PU07)
0	The cumulative command pulse value is displayed.	Lower 4 digits	Lower 5 digits
1		Upper 4 digits	Upper 5 digits
2	The cumulative feedback pulse value is displayed.	Lower 4 digits	Lower 5 digits
3		Upper 4 digits	Upper 5 digits
4	The droop pulses are monitored.	Lower 4 digits	Lower 5 digits
5		Upper 4 digits	Upper 5 digits
9999	Frequency monitor is displayed. (initial value)		

**REMARKS**

- Count the number of pulses when the servo is on.
- The cumulative pulse value is cleared when the base is shut off or the clear signal (CLR) is turned on.

**CAUTION**

- Changing the terminal assignment using Pr. 178 to Pr. 189 (input terminal function selection) may affect the other functions. Set parameters after confirming the function of each terminal.

**◆Parameters referred to◆**

Pr. 52 DU/PU main display data selection Refer to page 229  
Pr. 178 to Pr. 189 (input terminal function selection) Refer to page 207





**4.6.4 Setting of the electronic gear (Pr. 420, Pr. 421, Pr. 424)** Vector

Set the ratio of the machine side gear and the motor side gear.

Parameter Number	Name	Initial Value	Setting Range	Description
420	Command pulse scaling factor numerator	1	0 to 32767 *	Set the electric gear. Pr. 420 is a numerator and Pr. 421 is a denominator.
421	Command pulse scaling factor denominator	1	0 to 32767 *	
424	Position command acceleration/deceleration time constant	0s	0 to 50s	Used when rotation has become unsmooth at a large electronic gear ratio (about 10 times or more) and low speed.

The above parameters can be set when the FR-A7AP/FR-A7AL (option) is mounted.

\* When the operation panel (FR-DU07) is used, the maximum setting is 9999. When a parameter unit is used, up to the maximum value within the setting range can be set.

**(1) Calculation of the gear ratio (Pr. 420, Pr. 421)**

- The position resolution (travel per pulse  $\Delta \ell$  [mm]) is determined by the travel per motor revolution  $\Delta s$  [mm] and the feedback pulses Pf [pulse/rev] of the detector, and is represented by the following expression.

$$\Delta \ell = \frac{\Delta s}{Pf}$$

$\Delta \ell$ : travel per pulse [mm]  
 $\Delta s$ : travel per motor rotation [mm]  
 Pf: number of feedback pulses [pulse/rev] (number of pulses after multiplying the number of encoder pulses by four)

Using the parameters, the travel per command pulse can be set separately to set the travel per command pulse without a fraction.

$$\Delta \ell = \frac{\Delta s}{Pf} \times \frac{Pr. 420}{Pr. 421}$$

In addition, the relationship between the motor speed and internal command pulse frequency is as follows:

$$fo \times \frac{Pr. 420}{Pr. 421} = Pf \times \frac{No}{60}$$

$fo$  : Internal command pulse frequency [pps]  
 $No$  : Motor speed [r/min]

**CAUTION**

Set the electronic gear in the range of 1/50 to 20.

Note that too small a value will decrease the speed command and too large a value will increase the speed ripples.

[Setting example 1]

The electronic gear ratio is  $\Delta s = 10$  (mm) when the travel per pulse  $\Delta \ell = 0.01$  (mm) and the number of feedback pulses Pf = 4000 (pulse/rev) in a drive system where the ballscrew pitch PB = 10 (mm) and the reduction ratio  $1/n = 1$ . According to the following expression,

$$\begin{aligned} \Delta \ell &= \frac{\Delta s}{Pf} \times \frac{Pr. 420}{Pr. 421} \\ \frac{Pr. 420}{Pr. 421} &= \Delta \ell \times \frac{Pf}{\Delta s} \\ &= 0.01 \times \frac{4000}{10} = \frac{4}{1} \end{aligned}$$

Therefore, set "4" in Pr. 420 and "1" in Pr. 421 .

[Setting example 2]

Find the internal command pulse frequency of the dedicated motor rated speed.

Note that the command pulse scaling factor  $Pr. 420/Pr. 421 = 1$ .

Assuming that the number of encoder pulses is 2048 (pulses/rev) (feedback pulse Pf =  $2048 \times 4$ ),

$$\begin{aligned} fo &= 2048 \times \frac{4}{(\text{multiplication})} \times \frac{No}{60} \times \frac{Pr. 421}{Pr. 420} \\ &= 204800 \end{aligned}$$

Therefore, the internal command pulse frequency is 204800 (pps).



Relationship between position resolution  $\Delta \ell$  and overall accuracy

Since overall accuracy (positioning accuracy of machine) is the sum of electrical error and mechanical error, normally take measures to prevent the electrical system error from affecting the overall error. As a guideline, refer to the following relationship.

$$\Delta \ell < \left( \frac{1}{5} \text{ to } \frac{1}{10} \right) \times \Delta \varepsilon \quad \Delta \varepsilon: \text{positioning accuracy}$$

<Stopping characteristic of motor>

When parameters are used to run the motor, the internal command pulse frequency and motor speed have the relationship as shown in the chart on page 116, and as the motor speed decreases, pulses are accumulated in the deviation counter of the inverter. These pulses are called droop pulses ( $\varepsilon$ ) and the relationship between command frequency ( $f_0$ ) and position loop gain ( $K_p$ : Pr. 422) is as represented by the following expression.

$$\varepsilon = \frac{f_0}{K_p} \text{ [pulse]} \quad \varepsilon = \frac{204800}{25} \text{ [pulse] (rated motor speed)}$$

When the initial value of  $K_p$  is  $25s^{-1}$ , the droop pulses ( $\varepsilon$ ) are 8192 pulses.

Since the inverter has droop pulses during running, a stop settling time ( $t_s$ ) is needed from when the command has zeroed until the motor stops. Set the operation pattern in consideration of the stop settling time.

$$t_s = 3 \times \frac{1}{K_p} \text{ [s]}$$

When the initial value of  $K_p$  is  $25s^{-1}$ , the stop settling time ( $t_s$ ) is 0.12s.

The positioning accuracy  $\Delta \varepsilon$  is  $(5 \text{ to } 10) \times \Delta \ell = \Delta \varepsilon$  [mm]

## (2) Position command acceleration/deceleration time constant (Pr. 424)

- When the electronic gear ratio is large (about 10 or more times) and the speed is low, rotation will not be smooth, resulting in pulse-wise rotation. At such a time, set this parameter to smooth the rotation.
- When acceleration/deceleration time cannot be provided for the command pulses, a sudden change in command pulse frequency may cause an overshoot or error excess alarm. At such a time, set this parameter to provide acceleration/deceleration time.

Normally set 0.

### ◆ Parameters referred to ◆

Pr. 422 Position loop gain Refer to page 124

## 4.6.5 Setting of positioning adjustment parameter (Pr. 426, Pr. 427)

Parameter Number	Name	Initial Value	Setting Range	Description
426	In-position width	100 pulses	0 to 32767 pulses*	When the number of droop pulses has fallen below the setting value, the in-position signal (Y36) turns on.
427	Excessive level error	40K	0 to 400K	Excessive position error (E.OD) occurs when the number of droop pulses exceeds the setting.
			9999	Function invalid

The above parameters can be set when the FR-A7AP/FR-A7AL (option) is mounted.

\* When the operation panel (FR-DU07) is used, the maximum setting is 9999. When a parameter unit is used, up to the maximum value within the setting range can be set.

### (1) In-position width (Pr. 426)

The Y36 signal acts as an in-position signal.

When the number of droop pulses has fallen below the setting value, the in-position signal (Y36) turns on.

For the Y36 signal, assign the function by setting "36" (positive logic) or "136" (negative logic) in any of Pr. 190 to Pr. 196 (output terminal function selection).

### (2) Excessive level error (Pr. 427)

When droop pulses exceed the value set in Pr. 427, excessive position error occurs and displays a fault (E.OD) to trip the inverter. When you decreased the Pr. 422 Position loop gain setting, increase the error excessive level setting. Also decrease the setting when you want to detect an error slightly earlier under large load.

When "9999" is set in Pr. 427, excessive position error (E.OD) does not occur regardless of droop pulses.



#### 4.6.6 Gain adjustment of position control (Pr. 422, Pr. 423, Pr. 425) Vector

Easy gain tuning is available as an easy tuning method. Refer to *page 88* for easy gain tuning. If it does not produce any effect, make fine adjustment by using the following parameters. Set "0" in *Pr. 819 Easy gain tuning selection* before setting the parameters below.

Parameter Number	Name	Initial Value	Setting Range	Description
422	Position loop gain	25s <sup>-1</sup>	0 to 150s <sup>-1</sup>	Set the gain of the position loop.
423	Position feed forward gain	0%	0 to 100%	Function to cancel a delay caused by the droop pulses of the deviation counter.
425	Position feed forward command filter	0s	0 to 5s	Enters the primary delay filter in response to the feed forward command.

The above parameters can be set when the FR-A7AP/FR-A7AL (option) is mounted.

##### (1) Position loop gain (Pr. 422)

- Make adjustment when any of such phenomena as unusual vibration, noise and overcurrent of the motor/machine occurs.
- Increasing the setting improves trackability for the position command and also improves servo rigidity at a stop, but oppositely makes an overshoot and vibration more liable to occur.
- Normally set this parameter within the range about 5 to 50.

Phenomenon/Condition	Adjustment Method	
Slow response	Increase the <i>Pr. 422</i> value.	
	<i>Pr. 422</i>	Increase the value 3s <sup>-1</sup> by 3s <sup>-1</sup> until just before an overshoot, stop-time vibration or other instable phenomenon occurs, and set about 0.8 to 0.9 of that value.
Overshoot, stop-time vibration or other instable phenomenon occurs.	Decrease the <i>Pr. 422</i> value.	
	<i>Pr. 422</i>	Decrease the value 3s <sup>-1</sup> by 3s <sup>-1</sup> until just before an overshoot, stop-time vibration or other instable phenomenon does not occur, and set about 0.8 to 0.9 of that value.

##### (2) Position feed forward gain (Pr. 423)

- This function is designed to cancel a delay caused by the droop pulses of the deviation counter.
- When a tracking delay for command pulses poses a problem, increase the setting gradually and use this parameter within the range where an overshoot or vibration will not occur.
- This function has no effects on servo rigidity at a stop.
- Normally set this parameter to 0.

**(3) Troubleshooting (Position control)**

	Phenomenon	Cause	Countermeasures
1	Motor does not rotate.	(1) The phase sequence of the motor or encoder wiring is wrong. (2) The control mode selection <i>Pr. 800</i> setting is improper. (3) The servo on signal or stroke end signal (STF, STR) is not input. (4) Command pulse, position pulse sign (NP) are not correctly input.  (5) <i>Pr. 419 Position command source selection</i> setting is not correct. (6) When "0" is set in <i>Pr. 419 Position command source selection</i> , the settings of position feed amount in <i>Pr. 465 to Pr. 494</i> are not correct.	(1) Check the wiring. (Refer to page 33 )  (2) Check the <i>Pr. 800</i> setting. (Refer to page 75 )  (3) Check that the signals are input normally.  (4)-1 Check that the command pulses are input normally. (Check the cumulative command pulse value in <i>Pr. 430</i> ) (4)-2 Check the command pulse form and command pulse selection, <i>Pr. 428</i> , setting. (4)-3 Check that the position pulse sign (NP) is assigned to the input terminal. (inverter pulse input)  (5) Check the position command source selection in <i>Pr. 419</i> .  (6) Check the position feed amount in <i>Pr. 465 to Pr. 494</i> .
2	Position shift occurs.	(1) The command pulses are not input correctly.  (2) The command is affected by noise. Or the encoder feedback signal is compounded with noise.	(1)-1 Check the command pulse form and command pulse selection, <i>Pr. 428</i> setting. (1)-2 Check that the command pulses are input normally. (Check the cumulative command pulse value in <i>Pr. 430</i> ) (1)-3 Check that the position pulse sign (NP) is assigned to the input terminal. (inverter pulse input)  (2)-1 Decrease the <i>Pr. 72 PWM frequency selection</i> value. (2)-2 Change the earthing (grounding) point of shielded wire. Or leave the cable suspended.
3	Motor or machine hunts.	(1) The position loop gain is high. (2) The speed gain is high.	(1) Decrease the <i>Pr. 422</i> value. (2)-1 Perform easy gain tuning. (2)-2 Decrease <i>Pr. 820</i> and increase <i>Pr. 821</i> .
4	Machine operation is unstable.	(1) The acceleration/deceleration time setting has adverse effect.	(1) Decrease <i>Pr. 7</i> and <i>Pr. 8</i> .

## ◆ Parameters referred to ◆

*Pr. 7 Acceleration time* Refer to page 155  
*Pr. 8 Deceleration time* Refer to page 155  
*Pr. 72 PWM frequency selection* Refer to page 261  
*Pr. 800 Control method selection* Refer to page 75  
*Pr. 802 Pre-excitation selection* Refer to page 185  
*Pr. 819 Easy gain tuning selection* Refer to page 88  
*Pr. 820 Speed control P gain 1* Refer to page 88  
*Pr. 821 Speed control integral time 1* Refer to page 88

4.6.7 Trouble shooting for when position control is not exercised normally Vector

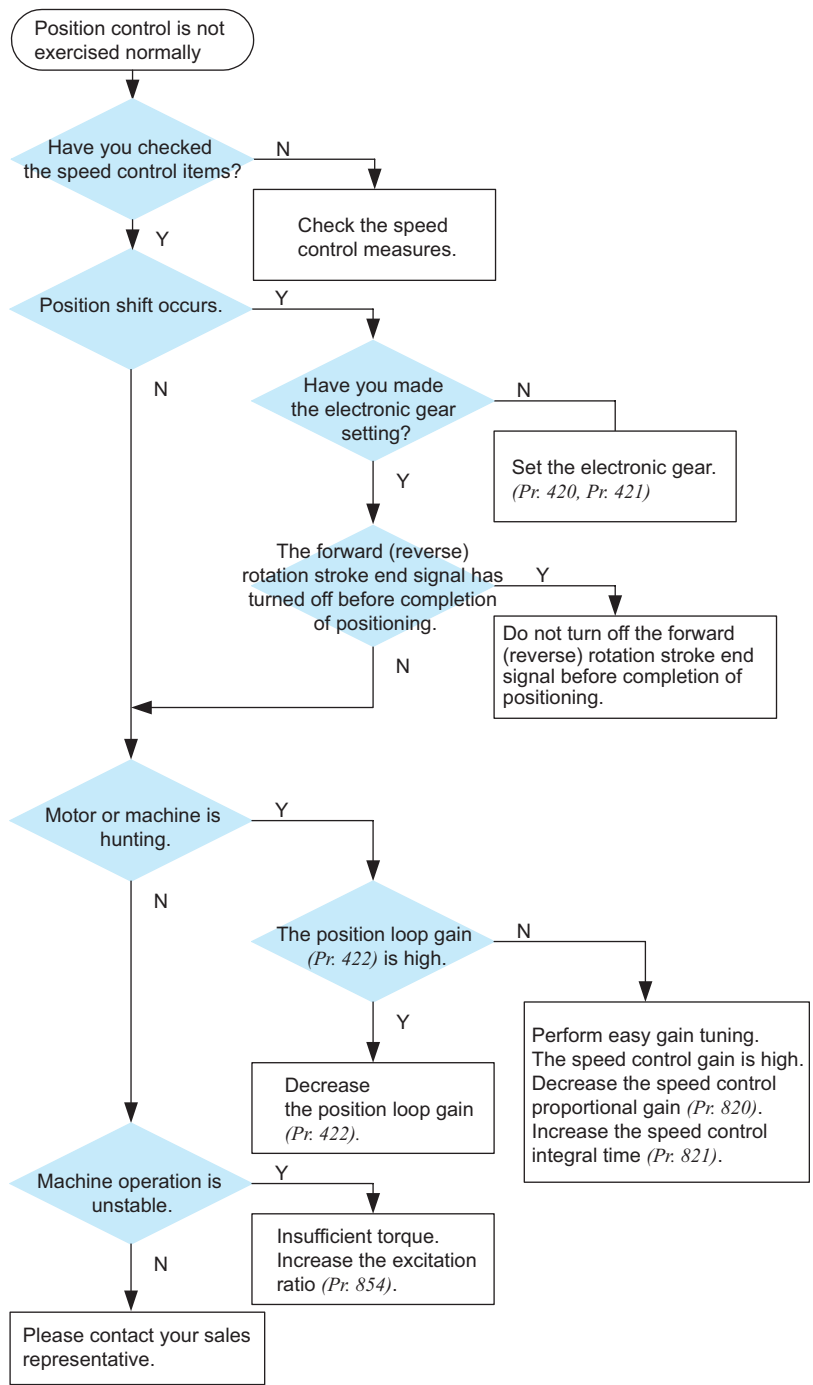

**REMARKS**

The speed command of position control relates to speed control. (Refer to page 81 )

## 4.7 Adjustment of Real sensorless vector control, vector control

Purpose	Parameter that should be Set		Refer to Page
Stabilize speed and feedback signal	Speed detection filter Torque detection filter	Pr. 823, Pr. 827, Pr. 833, Pr. 837	127
Change the excitation ratio	Excitation ratio	Pr. 854	128

### 4.7.1 Speed detection filter and torque detection filter (Pr. 823, Pr. 827, Pr. 833, Pr. 837) Sensorless Vector

Set the time constant of the primary delay filter relative to the speed feedback signal and torque feedback signal. Since this function reduces the speed loop response, use it with the initial value.

Parameter Number	Name	Initial Value	Setting Range	Description
823 *1	Speed detection filter 1	0.001s	0	Without filter
			0.001 to 0.1s	Set the time constant of the primary delay filter relative to the speed feedback signal.
827	Torque detection filter 1	0s	0	Without filter
			0.001 to 0.1s	Set the time constant of the primary delay filter relative to the torque feedback signal.
833 *1	Speed detection filter 2	9999	0 to 0.1s	Second function of Pr. 823 (valid when RT signal is on)
			9999	Same as the Pr. 823 setting
837	Torque detection filter 2	9999	0 to 0.1s	Second function of Pr. 827 (valid when RT signal is on)
			9999	Same as the Pr. 827 setting

\*1 This parameter can be set when the FR-A7AP/FR-A7AL (option) is mounted.

#### (1) Stabilize speed detection (Pr. 823, Pr. 833)

- Since the current loop response reduces, use it with the initial value. Increase the setting value gradually and adjust the value to stabilize the speed when speed ripples occur due to harmonic disturbance, etc. A too large value will run the motor unstably.
- Pr. 823 and Pr. 833 are valid only during vector control

#### (2) Stabilize speed detection (Pr. 827, Pr. 837)

- Since the current loop response reduces, use it with the initial value. Increase the setting value gradually and adjust the value to stabilize the speed when torque ripples occur due to harmonic disturbance, etc. A too large value will run the motor unstably.

#### (3) Use multiple primary delay filters.

- Use Pr. 833 and Pr. 837 to change the filter according to applications. Pr. 833 and Pr. 837 are valid when the RT signal is ON.

#### REMARKS

- The RT signal acts as the second function selection signal and makes the other second functions valid. (Refer to page 211.)
- The RT signal is assigned to the RT terminal in the initial setting. By setting "3" in any of Pr. 178 to Pr. 189 (input terminal function selection), you can assign the RT signal to the other terminal.



**4.7.2 Excitation ratio (Pr. 854)** Sensorless Vector

Decrease the excitation ratio when you want to improve efficiency under light load. (Motor magnetic noise decreases.)

Parameter Number	Name	Initial Value	Setting Range	Description
854	Excitation ratio	100%	0 to 100%	Set the excitation ratio under no load.

- Note that the rise of output torque becomes slow if excitation ratio is decreased.
- This function is appropriate for applications as machine tools which repeat rapid acceleration/deceleration up to high speed.

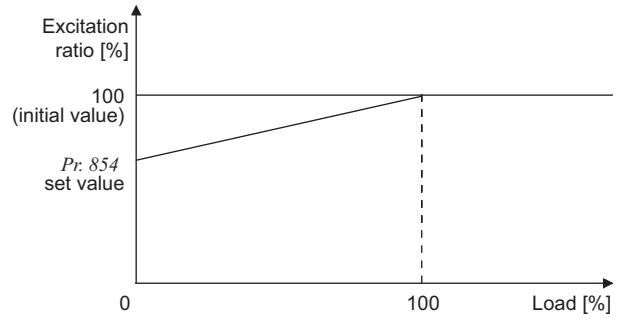

**REMARKS**

- When "1" (magnetic flux with terminal) is set in *Pr. 858 Terminal 4 function assignment* or *Pr. 868 Terminal 1 function assignment*, the *Pr. 854* setting is invalid.

## 4.8 Adjust the output torque (current) of the motor

Purpose	Parameter that must be Set		Refer to Page
Set starting torque manually	Manual torque boost	Pr. 0, Pr. 46, Pr. 112	129
Automatically control output current according to load	Advanced magnetic flux vector control	Pr. 71, Pr. 80, Pr. 81, Pr. 89, Pr. 450, Pr. 451, Pr. 453, Pr. 454, Pr. 569, Pr. 800	131
Compensate for motor slip to secure low-speed torque	Slip compensation	Pr. 245 to Pr. 247	134
Limit output current to prevent inverter trip	Stall prevention operation	Pr. 22, Pr. 23, Pr. 66, Pr. 154, Pr. 156, Pr. 157	135

### 4.8.1 Manual torque boost (Pr. 0, Pr. 46, Pr. 112)

You can compensate for a voltage drop in the low-frequency range to improve motor torque reduction in the low-speed range.

- Motor torque in the low-frequency range can be adjusted to the load to increase the starting motor torque.
- Three types of starting torque boost can be changed by switching terminals.

Parameter Number	Name	Initial Value		Setting Range	Description
0	Torque boost	7.5K or lower	3%	0 to 30%	Set the output voltage at 0Hz as %.
		11K or higher	2%		
46	Second torque boost	9999		0 to 30%	Set the torque boost value when the RT signal is ON.
				9999	Without second torque boost
112	Third torque boost	9999		0 to 30%	Set the torque boost value when the X9 signal is ON.
				9999	Without third torque boost

#### (1) Starting torque adjustment

- On the assumption that *Pr. 19 Base frequency voltage* is 100%, set the output voltage at 0Hz in % in *Pr. 0 (Pr. 46, Pr. 112)*.
- Adjust the parameter little by little (about 0.5%), and check the motor status each time. If the setting is too large, the motor will overheat. The guideline is about 10% at the greatest.

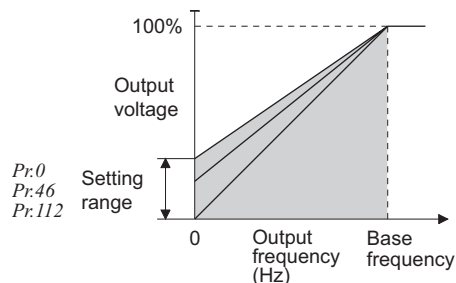



## (2) Set multiple torque boost (RT signal, X9 signal, Pr. 46, Pr. 112)

- Use the second (third) torque boost when changing the torque boost according to application or when using multiple motors by switching between them by one inverter.
- Pr. 46 Second torque boost is valid when the RT signal turns ON.
- Pr. 112 Third torque boost is valid when the X9 signal is ON. For the terminal used for X9 signal input, set "9" in any of Pr. 178 to Pr. 189 (input terminal function selection) to assign the X9 signal function.



### REMARKS

- The RT(X9) signal acts as the second (third) function selection signal and makes the other second (third) functions valid. (Refer to page 211)
- The RT signal is assigned to the RT terminal in the default setting. By setting "3" in any of Pr. 178 to Pr. 189 (input terminal function selection), you can assign the RT signal to the other terminal.

### CAUTION

- Increase the setting when the distance between the inverter and motor is long or when motor torque is insufficient in the low-speed range. If the setting is too large, an overcurrent trip may occur.
- The Pr. 0, Pr. 46, Pr. 112 settings are valid only when V/F control is selected.
- When using the inverter dedicated motor (constant torque motor) with the 5.5K or 7.5K, set the torque boost value to 2%. If the initial set Pr. 71 value is changed to the setting for use with a constant-torque motor, the Pr. 0 setting changes to the corresponding value in above.
- Changing the terminal assignment using Pr. 178 to Pr. 189 (input terminal function selection) may affect the other functions. Set parameters after confirming the function of each terminal.

### ◆ Parameters referred to ◆

Pr. 3 Base frequency, Pr. 19 Base frequency voltage  Refer to page 142  
Pr. 71 Applied motor  Refer to page 169  
Pr. 178 to Pr. 189 (Input terminal function selection)  Refer to page 207

### 4.8.2 Advanced magnetic flux vector control (Pr. 71, Pr. 80, Pr. 81, Pr. 89, Pr. 450, Pr. 451, Pr. 453, Pr. 454, Pr. 569, Pr. 800) Magnetic flux

Advanced magnetic flux vector control can be selected by setting the capacity, number and type of motor to be used in Pr. 80 and Pr. 81.

●What is Advanced magnetic flux vector control?

The low speed torque can be improved by providing voltage compensation to flow a motor current which meets the load torque. Output frequency compensation (slip compensation) is made so that the motor actual speed approximates a speed command value. Effective when load fluctuates drastically, etc.

Parameter Number	Name	Initial Value	Setting Range	Description
71	Applied motor	0	0 to 8, 13 to 18, 30, 33, 34, 40, 43, 44, 50, 53, 54	By selecting a standard motor or constant-torque motor, thermal characteristic and motor constants of each motor are set.
80	Motor capacity	9999	0.4 to 55kW	Set the applied motor capacity.
			9999	V/F control
81	Number of motor poles	9999	2, 4, 6, 8, 10	Set the number of motor poles.
			12, 14, 16, 18, 20	X18 signal-ON:V/F control · Set 10 + number of motor poles.
			9999	V/F control
89	Speed control gain (magnetic flux vector)	9999	0 to 200%	Motor speed fluctuation due to load fluctuation is adjusted during Advanced magnetic flux vector control. 100% is a referenced value.
			9999	Gain matching with the motor set in Pr. 71.
450	Second applied motor	9999	0 to 8, 13 to 18, 30, 33, 34, 40, 43, 44, 50, 53, 54	Set when using the second motor. (same specifications as Pr. 71 )
			9999	Function invalid (Pr. 71 is valid)
451	Second motor control method selection	9999	10, 11, 12	Real sensorless vector control
			20, 9999	V/F control (Advanced magnetic flux vector control)
453	Second motor capacity	9999	0.4 to 55kW	Set the capacity of the second motor.
			9999	V/F control
454	Number of second motor poles	9999	2, 4, 6, 8, 10	Set the number of poles of the second motor.
			9999	V/F control
569	Second motor speed control gain	9999	0 to 200%	Second motor speed fluctuation due to load fluctuation is adjusted during Advanced magnetic flux vector control. 100% is a referenced value.
			9999	Gain matching with the motor set in Pr. 450.
800	Control method selection	20	0 to 5	Vector control
			9	Vector control test operation
			10, 11, 12	Real sensorless vector control
			20	V/F control (Advanced magnetic flux vector control)

\* Use Pr. 178 to Pr. 189 to assign the terminals used for the X18 and MC signal. (Refer to page 207 )

**POINT**

If the following conditions are not satisfied, select V/F control since malfunction such as insufficient torque and uneven rotation may occur.

- The motor capacity should be equal to or one rank lower than the inverter capacity.
- Motor to be used is any of Mitsubishi standard motor (SF-JR 3.7kW or higher), high efficiency motor (SF-HR 3.7kW or higher) or Mitsubishi constant torque motor (SF-JRCA 4P, SF-HRCA 3.7kW or higher). When using a motor other than the above (other manufacturer's motor, etc.), perform offline auto tuning without fail.
- Single-motor operation (one motor run by one inverter) should be performed.
- The wiring length from inverter to motor should be within 30m. (Perform offline auto tuning in the state where wiring work is performed when the wiring length exceeds 30m.)

**(1) Selection method of Advanced magnetic flux vector control**

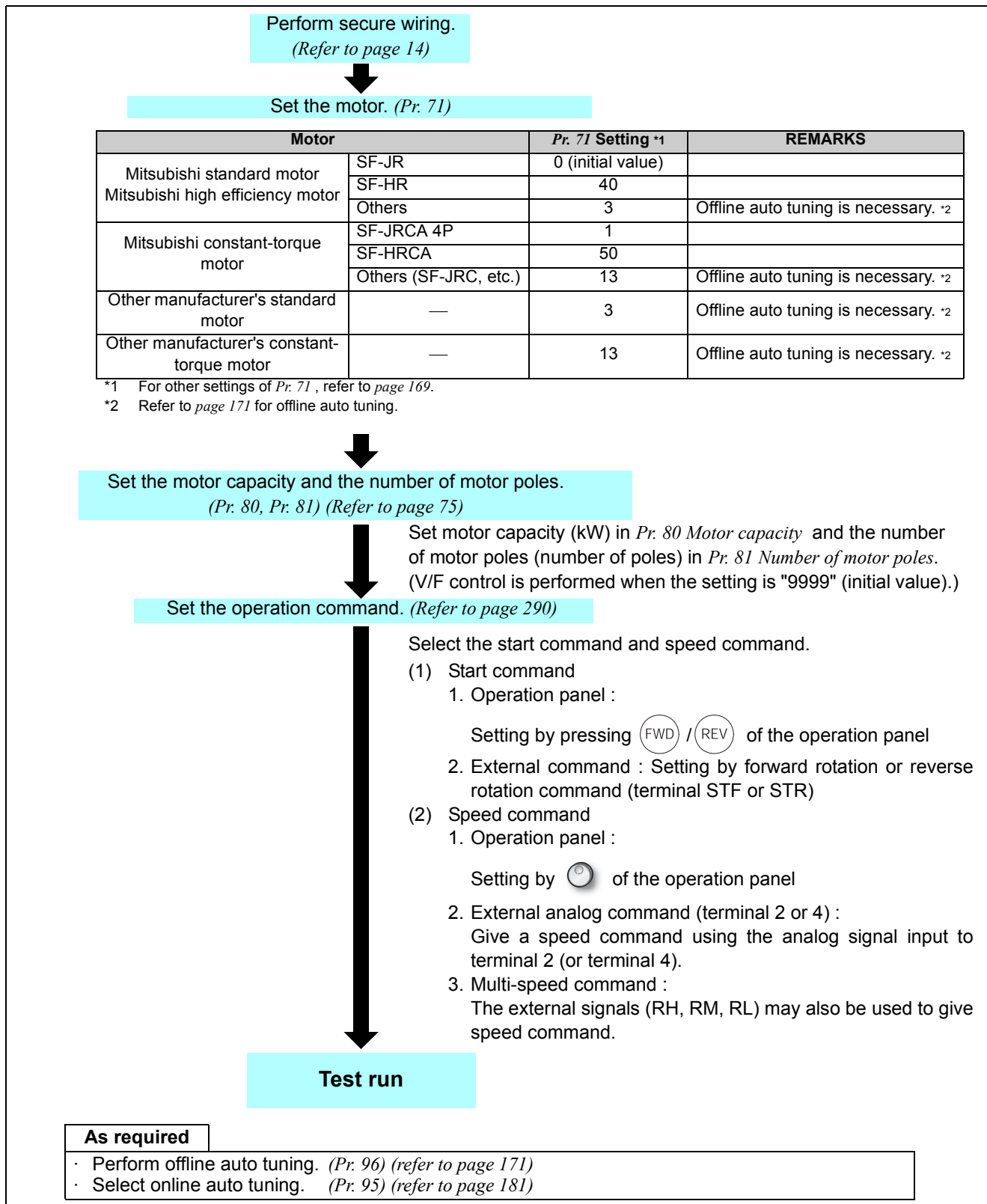

**REMARKS**

- When higher accuracy operation is necessary, set online auto tuning after performing offline auto tuning and select Real sensorless vector control.

**CAUTION**

- Uneven rotation slightly increases as compared to the V/F control. (It is not suitable for machines such as grinding machine and wrapping machine which requires less uneven rotation at low speed.)
- When a surge voltage suppression filter (FR-ASF-H) is connected between the inverter and motor, output torque may decrease.
- Changing the terminal assignment using Pr. 178 to Pr. 189 (input terminal function selection) may affect the other functions. Set parameters after confirming the function of each terminal.

**(2) Adjust the motor speed fluctuation at load fluctuation (speed control gain)**

The motor speed fluctuation at load fluctuation can be adjusted using *Pr. 89*. (It is useful when the speed command does not match the motor speed after the FR-A201 series inverter is replaced with the FR-A701 series inverter, etc.)

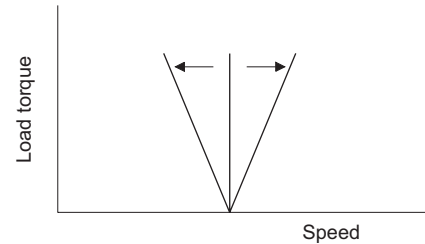

**(3) Advanced magnetic flux vector control is performed with two motors**

- Turning the RT signal ON allows the second motor to be controlled.
- Set the second motor in *Pr. 450 Second applied motor*. (Initial setting is "9999" (without second applied motor). Refer to page 169.)

Function	RT signal ON (second motor)	RT signal OFF (first motor)
Applied motor	Pr. 450	Pr. 71
Motor capacity	Pr. 453	Pr. 80
Number of motor poles	Pr. 454	Pr. 81
Speed control gain	Pr. 569	Pr. 89
Control method selection	Pr. 451	Pr. 800

**REMARKS**

- The RT signal acts as the second function selection signal and makes the other second functions valid. (Refer to page 211)  
The RT signal is assigned to the terminal RT in the initial setting. By setting "3" in any of *Pr. 178 to Pr. 189 (input terminal function selection)*, the RT signal can be assigned to the other terminal.

**CAUTION**

- Changing the terminal assignment using *Pr. 178 to Pr. 189 (input terminal function selection)* may affect the other functions. Set parameters after confirming the function of each terminal.

**◆Parameters referred to◆**

*Pr. 71, Pr. 450 Applied motor* Refer to page 169  
*Pr. 800, Pr. 451 Control method selection* Refer to page 75

**4.8.3 Slip compensation (Pr. 245 to Pr. 247)** 

The inverter output current may be used to assume motor slip to keep the motor speed constant.

Parameter Number	Name	Initial Value	Setting Range	Description
245	Rated slip	9999	0.01 to 50%	Used to set the rated motor slip.
			0, 9999	No slip compensation
246	Slip compensation time constant	0.5s	0.01 to 10s	Used to set the slip compensation response time. When the value is made smaller, response will be faster. However, as load inertia is greater, a regenerative overvoltage fault (E.OV□) is more liable to occur.
247	Constant-power range slip compensation selection	9999	0	Slip compensation is not made in the constant power range (frequency range above the frequency set in Pr. 3)
			9999	Slip compensation is made in the constant power range.

- Slip compensation is validated when the motor rated slip calculated by the following formula is set in Pr. 245. Slip compensation is not made when Pr. 245 = "0" or "9999".

$$\text{Rated slip} = \frac{\text{Synchronous speed at base frequency} - \text{rated speed}}{\text{Synchronous speed at base frequency}} \times 100[\%]$$

**REMARKS**

When performing slip compensation, the output frequency may become greater than the set frequency. Set the Pr. 1 Maximum frequency value a little higher than the set frequency.

## ◆ Parameters referred to ◆

Pr. 1 Maximum frequency  Refer to page 140

Pr. 3 Base frequency  Refer to page 142

#### 4.8.4 Stall prevention operation (Pr. 22, Pr. 23, Pr. 48, Pr. 49, Pr. 66, Pr. 114, Pr. 115, Pr. 148, Pr. 149, Pr. 154, Pr. 156, Pr. 157, Pr. 858, Pr. 868) V/F Magnetic flux

This function monitors the output current and automatically changes the output frequency to prevent the inverter from coming to trip due to overcurrent, overvoltage, etc. It can also limit stall prevention and fast response current limit operation during acceleration/deceleration, driving or regeneration. Invalid under Real sensorless vector control or vector control.

● Stall prevention

If the output current exceeds the stall prevention operation level, the output frequency of the inverter is automatically varied to reduce the output current.

Also the second stall prevention function can restrict the output frequency range in which the stall prevention function is valid. (Pr. 49)

● Fast response current limit

If the current exceeds the limit value, the output of the inverter is shut off to prevent an overcurrent.

Parameter Number	Name	Initial Value	Setting Range	Description	
22*	Stall prevention operation level	150%	0	Stall prevention operation selection becomes invalid.	
			0.1 to 400%	Set the current value at which stall prevention operation will be started.	
23	Stall prevention operation level compensation factor at double speed	9999	0 to 200%	The stall operation level can be reduced when operating at a high speed above the rated frequency.	
			9999	Constant according to Pr. 22	
48	Second stall prevention operation current	150%	0	Second stall prevention operation invalid	
			0.1 to 220%	The second stall prevention operation level can be set.	
49	Second stall prevention operation frequency	0Hz	0	Second stall prevention operation invalid	
			0.01 to 400Hz	Set the frequency at which stall prevention operation of Pr. 48 is started.	
			9999	Pr. 48 is valid when the RT signal is on.	
66	Stall prevention operation reduction starting frequency	60Hz	0 to 400Hz	Set the frequency at which the stall operation level is started to reduce.	
114	Third stall prevention operation current	150%	0	Third stall prevention operation invalid	
			0.1 to 220%	Stall prevention operation level can be changed with the X9 signal.	
115	Third stall prevention operation frequency	0Hz	0	Third stall prevention operation invalid	
			0.01 to 400Hz	Set the frequency at which stall prevention operation when the X9 signal is on starts.	
148	Stall prevention level at 0V input	150%	0 to 220%	Stall prevention operation level can be changed by the analog signal input to terminal 1 (terminal 4).	
149	Stall prevention level at 10V input	200%	0 to 220%		
154	Voltage reduction selection during stall prevention operation	1	0	With voltage reduction	You can select whether to use output voltage reduction during stall prevention operation or not.
			1	Without voltage reduction	
156	Stall prevention operation selection	0	0 to 31, 100, 101	You can select whether stall prevention operation and fast response current limit operation will be performed or not.	
157	OL signal output timer	0s	0 to 25s	Set the output start time of the OL signal output when stall prevention is activated.	
			9999	Without the OL signal output	
858	Terminal 4 function assignment	0	0, 1, 4, 9999	By setting "4", the stall prevention operation level can be changed with a signal to terminal 4.	
868	Terminal 1 function assignment	0	0 to 6, 9999	By setting "4", the stall prevention operation level can be changed with a signal to terminal 1.	

\* This parameter allows its setting to be changed during operation in any operation mode even if "0 (initial value) or 1" is set in Pr. 77 Parameter write selection.

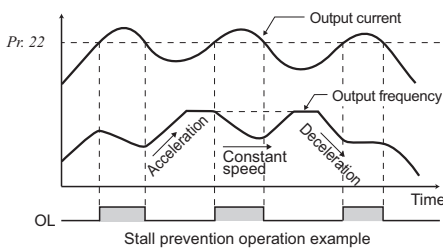

#### (1) Setting of stall prevention operation level (Pr. 22)

- Set in Pr. 22 the ratio of the output current to the rated inverter current at which stall prevention operation will be performed. Normally set 150% (initial value).
- Stall prevention operation stops acceleration (makes deceleration) during acceleration, makes deceleration during constant speed, and stops deceleration during deceleration.
- When stall prevention operation is performed, the OL signal is output.

#### CAUTION

- If an overload status lasts long, an inverter trip (e.g. electronic thermal relay function (E.THM)) may occur.
- When Pr. 156 has been set to activate the fast response current limit (initial setting), the Pr. 22 setting should not be higher than 170%. The torque will not be developed by doing so.
- When Real sensorless vector control or vector control is selected using Pr. 800 Control method selection, Pr.22 serves as torque limit level.

## (2) Stall prevention operation signal output and output timing adjustment (OL signal, Pr. 157)

- When the output power exceeds the stall prevention operation level and stall prevention is activated, the stall prevention operation signal (OL signal) turns on for longer than 100ms. When the output power falls to or below the stall prevention operation level, the output signal turns off.
- Use Pr. 157 OL signal output timer to set whether the OL signal is output immediately or after a preset period of time.
- This operation is also performed when the regeneration avoidance function  $\sigma L$  (overvoltage stall) is executed.

Pr. 157 Setting	Description
0 (initial value)	Output immediately
0.1 to 25	Output after the set time (s) has elapsed
9999	Not output

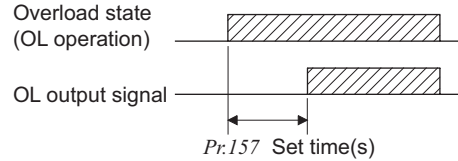

### REMARKS

- The OL signal is assigned to the terminal OL in the initial setting. The OL signal can also be assigned to the other terminal by setting "3 (positive logic) or 103 (negative logic)" to any of Pr. 190 to Pr. 196 (output terminal function selection).

### CAUTION

- If the frequency has fallen to 0.5Hz by stall prevention operation and remains for 3s, a fault (E.OLT) appears to trip the inverter output.
- Changing the terminal assignment using Pr. 190 to Pr. 196 (output terminal function selection) may affect the other functions. Set parameters after confirming the function of each terminal.

## (3) Setting of stall prevention operation in high frequency range (Pr. 22, Pr. 23, Pr. 66)

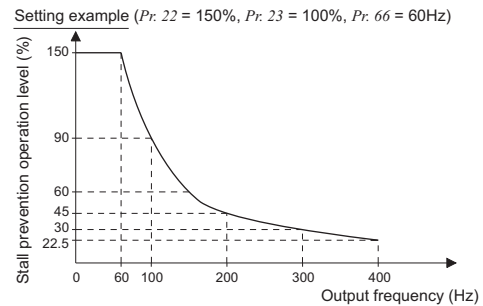
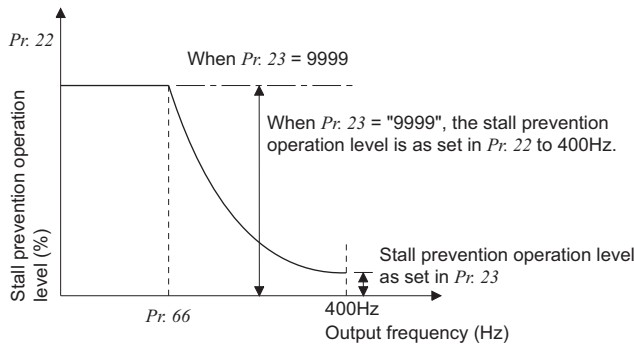

- During high-speed operation above the rated motor frequency, acceleration may not be made because the motor current does not increase. If operation is performed in a high frequency range, the current at motor lockup becomes smaller than the rated output current of the inverter, and the protective function (OL) is not executed if the motor is at a stop.

To improve the operating characteristics of the motor in this case, the stall prevention level can be reduced in the high frequency range. This function is effective for performing operation up to the high-speed range on a centrifugal separator, etc. Normally, set 60Hz in Pr. 66 and 100% in Pr. 23.

- Formula for stall prevention operation level

$$\text{Stall prevention operation level in high frequency range (\%)} = A + B \times \left[ \frac{\text{Pr. 22} - A}{\text{Pr. 22} - B} \right] \times \left[ \frac{\text{Pr. 23} - 100}{100} \right]$$

$$\text{However, } A = \frac{\text{Pr. 66(Hz)} \times \text{Pr. 22(\%)}}{\text{Output frequency (H)}}, \quad B = \frac{\text{Pr. 66(Hz)} \times \text{Pr. 22(\%)}}{400\text{Hz}}$$

- When Pr. 23 Stall prevention operation level compensation factor at double speed = "9999" (initial value), the stall prevention operation level is kept constant at the Pr. 22 setting up to 400Hz.

**(4) Set multiple stall prevention operation levels (Pr. 48, Pr. 49, Pr. 114, Pr. 115)**

- Setting "9999" in Pr. 49 Second stall prevention operation frequency and turning the RT signal on make Pr. 48 Second stall prevention operation current valid.
- In Pr. 48 (Pr. 114), you can set the stall prevention operation level at the output frequency from 0Hz to that set in Pr. 49 (Pr. 115).  
During acceleration, however, the operation level is as set in Pr. 22.
- This function can also be used for stop-on-contact or similar operation by decreasing the Pr. 48 (Pr. 114) setting to weaken the deceleration torque (stopping torque).
- Pr. 114 and Pr. 115 are valid when the X9 signal is ON. For the terminal used for X9 signal input, set "9" in any of Pr. 178 to Pr. 189 input terminal function selection to assign the X9 signal function.

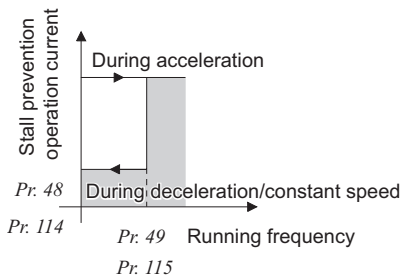

Pr. 49 Setting	Pr. 115 Setting	Operation
0 (initial value)		The second (third) stall prevention operation is not performed.
0.01Hz to 400Hz		The second (third) stall prevention operation is performed according to the frequency.*1
9999 *2	Setting can not be made.	The second (third) stall prevention function is performed according to the RT signal. RT signal ON ... Stall level Pr. 48 RT signal OFF ... Stall level Pr. 22

\*1 The smaller setting of the stall prevention operation levels set in Pr. 22 and Pr. 48 has a higher priority.  
\*2 When Pr. 868 = "4" (Stall prevention operation level analog input), the stall prevention operation level also switches from the analog input (terminal 1 input) to the stall prevention operation level of Pr. 48 when the RT signal turns ON. (The second stall prevention operation level cannot be input in an analog form.)

Set frequency exceeds Pr. 49 (Pr. 115)

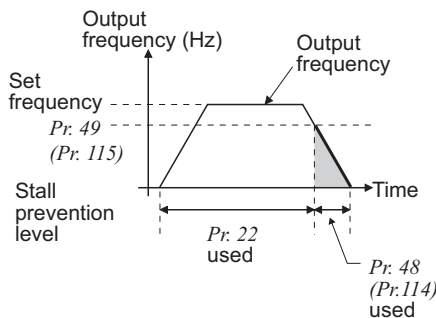

Set frequency is Pr. 49 (Pr. 115) or less

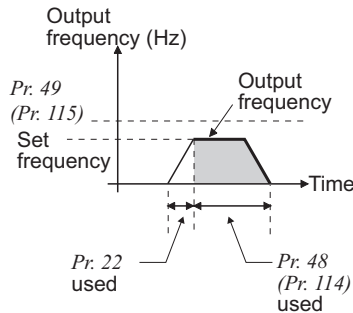

**REMARKS**

- When Pr. 49 ≠ "9999" (level changed according to frequency) and Pr. 48 = "0%", the stall prevention operation level is 0% at or higher than the frequency set in Pr. 49.
- In the initial setting, the RT signal is assigned to the RT terminal. By setting "3" in any of Pr. 178 to Pr. 189 (input terminal function selection), you can assign the RT signal to the other terminal.

**CAUTION**

- Changing the terminal assignment using Pr. 178 to Pr. 189 (input terminal function selection) may affect the other functions. Set parameters after confirming the function of each terminal.
- The RT(X9) signal acts as the second (third) function selection signal and makes the other second (third) functions valid. (Refer to page 211)



**(5) Stall prevention operation level setting by terminal 1 (terminal 4) (analog variable) (Pr. 148, Pr. 149, Pr. 858, Pr. 868)**

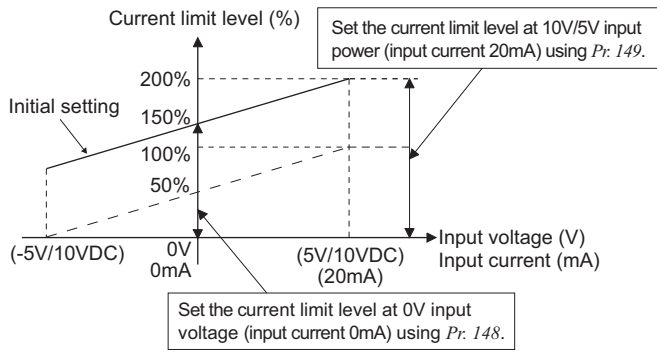

- To set the stall prevention operation level using terminal 1 (analog input), set Pr. 868 Terminal 1 function assignment to "4".
- Input 0 to 5V (or 0 to 10V) to terminal 1. Select 5V or 10V using Pr. 73 Analog input selection. When Pr. 73 = "1" (initial value), 0 to ±10V is input.
- To set stall prevention operation level using terminal 4 (analog current input), set "4" in Pr. 858 Terminal 4 function assignment. Input 0 to 20mA to terminal 4. The AU signal need not be turned on.
- Set the current limit level at the input voltage of 0V (0mA) in Pr. 148 Stall prevention level at 0V input
- Set the current limit level at the input voltage of 10V/ 5V (20mA) in Pr. 149 Stall prevention level at 10V input.

Pr. 858 Setting	Pr. 868 Setting	V/F, Advanced Magnetic Flux Vector Control	
		Terminal 4 function	Terminal 1 function
0 (initial value)	0 (initial value)	Frequency command (AU signal-ON)	Frequency auxiliary
	1		Magnetic flux command
	2		—
	3		—
	4 *1		Stall prevention
	5		—
	6		Torque bias
	9999		—
1	0 (initial value)	Magnetic flux command	—
	1	—	Magnetic flux command
	2	Magnetic flux command	—
	3		—
	4 *1		Stall prevention
	5		—
	6		Torque bias
	9999		—
4 *2	0 (initial value)	Stall prevention	Frequency auxiliary
	1		Magnetic flux command
	2		—
	3	—	—
	4 *1	—*3	Stall prevention
	5	Stall prevention	—
	6		Torque bias
	9999		—
9999	—	—	—

\*1 When Pr. 868 = "4" (analog stall prevention), other functions of terminal 1 (auxiliary input, override function, PID control) do not function.  
 \*2 When Pr. 858 = "4" (analog stall prevention), PID control and speed command from terminal 4 do not function even if the AU signal turns ON.  
 \*3 When "4" (stall prevention) is set in both Pr. 858 and Pr. 868, function of terminal 1 has higher priority and terminal 4 has no function.

**REMARKS**

- The fast response current limit level cannot be set.

**(6) To further prevent an alarm stop (Pr. 154)**

- When Pr. 154 is set to "0", the output voltage reduces during stall prevention operation. By making setting to reduce the output voltage, an overcurrent trip can further become difficult to occur.
- Use this function where a torque decrease will not pose a problem.

Pr. 154 Setting	Description
0	Output voltage reduced
1 (initial value)	Output voltage not reduced

**(7) Limit the stall prevention operation and fast response current limit operation according to the operating status (Pr. 156)**

· Refer to the following table and select whether stall prevention and fast-response current limit operation will be performed or not and the operation to be performed at OL signal output.

Pr. 156 Setting	Fast Response Current Limit ○: Activated ●: Not activated	Stall Prevention Operation Selection ○: Activated ●: Not activated			OL Signal Output ○: Operation continued ●: Operation not continued *1	Pr. 156 Setting	Fast Response Current Limit ○: Activated ●: Not activated	Stall Prevention Operation Selection ○: Activated ●: Not activated			OL Signal Output ○: Operation continued ●: Operation not continued *1
		Acceleration	Constant speed	Deceleration				Acceleration	Constant speed	Deceleration	
0 (initial value)	○	○	○	○	○	16	○	○	○	○	●
1	●	○	○	○	○	17	●	○	○	○	●
2	○	●	○	○	○	18	○	●	○	○	●
3	●	●	○	○	○	19	●	●	○	○	●
4	○	○	●	○	○	20	○	○	●	○	●
5	●	○	●	○	○	21	●	○	●	○	●
6	○	●	●	○	○	22	○	●	●	○	●
7	●	●	●	○	○	23	●	●	●	○	●
8	○	○	○	●	○	24	○	○	○	○	●
9	●	○	○	●	○	25	●	○	○	●	●
10	○	●	○	●	○	26	○	●	○	●	●
11	●	●	○	●	○	27	●	●	○	●	●
12	○	○	●	●	○	28	○	○	●	●	●
13	●	○	●	●	○	29	●	○	●	●	●
14	○	●	●	●	○	30	○	●	●	●	●
15	●	●	●	●	—*2	31	●	●	●	●	—*2

100 *3	Driving	○	○	○	○	○	101 *3	Driving	●	○	○	○	○
	Regeneration	●	●	●	●	—*2		Regeneration	●	●	●	●	—*2

\*1 When "Operation not continued for OL signal output" is selected, the "E.O.L.T" fault (stopped by stall prevention) is displayed and operation stopped.  
 \*2 Since both fast response current limit and stall prevention are not activated, OL signal and E.OLT are not output.  
 \*3 The settings "100" and "101" allow operations to be performed in the driving and regeneration modes, respectively. The setting "101" disables the fast response current limit in the driving mode.

**CAUTION**

- When the load is heavy, or when the acceleration/deceleration time is short, stall prevention is activated and acceleration/deceleration may not be made according to the preset acceleration/deceleration time. Set Pr. 156 and stall prevention operation level to the optimum values.
- In vertical lift applications, make setting so that the fast response current limit is not activated. Torque may not be produced, causing a drop due to gravity.

**⚠ CAUTION**

- ⚠ Do not set a small value as the stall prevention operation current. Otherwise, torque generated will reduce.
- ⚠ Always perform test operation.  
 Stall prevention operation during acceleration may increase the acceleration time.  
 Stall prevention operation performed during constant speed may cause sudden speed changes.  
 Stall prevention operation during deceleration may increase the deceleration time, increasing the deceleration distance.

◆ Parameters referred to ◆

- Pr. 22 Torque limit level Refer to page 83
- Pr. 73 Analog input selection Refer to page 263
- Pr. 178 to Pr. 189 (Input terminal function selection) Refer to page 207
- Pr. 190 to Pr. 196 (output terminal function selection) Refer to page 215
- Pr. 858 Terminal 4 function assignment, Pr. 868 Terminal 1 function assignment Refer to page 262



## 4.9 Limiting the output frequency

Purpose	Parameter that must be Set		Refer to Page
Set upper limit and lower limit of output frequency	Maximum/minimum frequency	Pr. 1, Pr. 2, Pr. 18	140
Perform operation by avoiding mechanical resonance points	Frequency jump	Pr. 31 to Pr. 36	141

### 4.9.1 Maximum/minimum frequency (Pr. 1, Pr. 2, Pr. 18)

You can limit the motor speed. Clamp the upper and lower limits of the output frequency.

Parameter Number	Name	Initial Value	Setting Range	Description
1	Maximum frequency	120Hz	0 to 120Hz	Set the upper limit of the output frequency.
2	Minimum frequency	0Hz	0 to 120Hz	Set the lower limit of the output frequency.
18	High speed maximum frequency	120Hz	120 to 400Hz	Set when performing the operation at 120Hz or more.

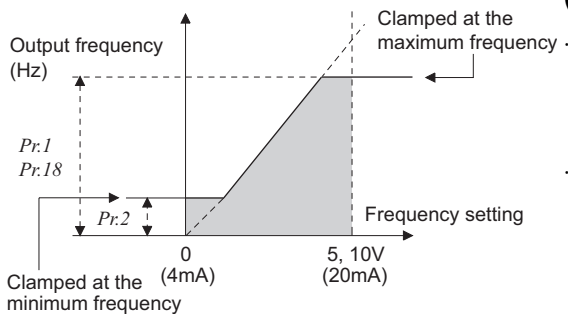

#### (1) Set maximum frequency

- Set the upper limit of the output frequency in *Pr. 1 Maximum frequency*. If the value of the frequency command entered is higher than the setting, the output frequency is clamped at the maximum frequency.
- When you want to perform operation above 120Hz, set the upper limit of the output frequency to *Pr. 18 High speed maximum frequency*. (When *Pr. 18* is set, *Pr. 1* automatically switches to the frequency of *Pr. 18*. When *Pr. 18* is set, *Pr. 18* automatically switches to the frequency of *Pr. 1*.)

#### REMARKS

- When performing operation above 60Hz using the frequency setting analog signal, change *Pr. 125 (Pr. 126) (frequency setting gain)*. If only *Pr. 1* or *Pr. 18* is changed, operation above 60Hz cannot be performed.

#### (2) Set minimum frequency

- Use *Pr. 2 Minimum frequency* to set the lower limit of the output frequency.
- The output frequency is clamped by the *Pr. 2* setting even if the set frequency is equal to or less than the *Pr. 2* setting (The frequency will not decrease to the *Pr. 2* setting.)

#### REMARKS

- When *Pr. 15 Jog frequency* is equal to or less than *Pr. 2*, the *Pr. 15* setting has precedence over the *Pr. 2* setting.
- When stall prevention is activated to decrease the output frequency, the output frequency may drop to *Pr. 2* or below.

## ⚠ CAUTION

⚠ Note that when *Pr. 2* is set to any value equal to or more than *Pr. 13 Starting frequency*, simply turning ON the start signal will run the motor at the preset frequency according to the set acceleration time even if the command frequency is not input.

#### ◆ Parameters referred to ◆

*Pr. 13 Starting frequency* Refer to page 157

*Pr. 15 Jog frequency* Refer to page 150

*Pr. 125 Terminal 2 frequency setting gain frequency, Pr. 126 Terminal 4 frequency setting gain frequency* Refer to page 271

## 4.9.2 Avoiding mechanical resonance points (Frequency jump) (Pr. 31 to Pr. 36)

When it is desired to avoid resonance attributable to the natural frequency of a mechanical system, these parameters allow resonant frequencies to be jumped.

Parameter Number	Name	Initial Value	Setting Range	Description
31	Frequency jump 1A	9999	0 to 400Hz, 9999	1A to 1B, 2A to 2B, 3A to 3B is frequency jumps 9999: Function invalid
32	Frequency jump 1B	9999	0 to 400Hz, 9999	
33	Frequency jump 2A	9999	0 to 400Hz, 9999	
34	Frequency jump 2B	9999	0 to 400Hz, 9999	
35	Frequency jump 3A	9999	0 to 400Hz, 9999	
36	Frequency jump 3B	9999	0 to 400Hz, 9999	

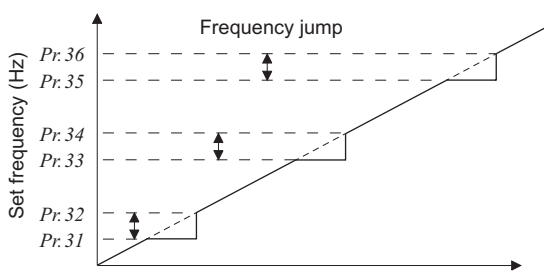

- Up to three areas may be set, with the jump frequencies set to either the top or bottom point of each area.
- The settings of frequency jumps 1A, 2A, 3A are jump points, and operation is performed at these frequencies in the jump areas.

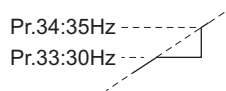

**Example 1**

To fix the frequency to 30Hz in the range 30Hz to 35Hz, set 35Hz in *Pr. 34* and 30Hz in *Pr. 33*.

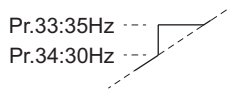

**Example 2**

To jump the frequency to 35Hz in the range 30Hz to 35Hz, set 35Hz in *Pr. 33* and 30Hz in *Pr. 34*.

### CAUTION

- During acceleration/deceleration, the running frequency within the set area is valid.



## 4.10 V/F pattern

Purpose	Parameter that must be Set		Refer to Page
Set motor ratings	Base frequency, base frequency voltage	Pr. 3, Pr. 19, Pr. 47, Pr. 113	142
Select a V/F pattern according to applications	Load pattern selection	Pr. 14	144
Automatically set a V/F pattern for elevators	Elevator mode (automatic acceleration/deceleration)	Pr. 61, Pr. 64, Pr. 292	146
Use special motor	Adjustable 5 points V/F	Pr. 71, Pr. 100 to Pr. 109	147

### 4.10.1 Base frequency, voltage (Pr. 3, Pr. 19, Pr. 47, Pr. 113) V/F

Used to adjust the inverter outputs (voltage, frequency) to the motor rating.

Parameter Number	Name	Initial Value	Setting Range	Description
3	Base frequency	60Hz	0 to 400Hz	Set the frequency when the motor rated torque is generated. (50Hz/60Hz)
19	Base frequency voltage	9999	0 to 1000V	Set the base voltage.
			8888	95% of power supply voltage
			9999	Same as power supply voltage
47	Second V/F (base frequency)	9999	0 to 400Hz	Set the base frequency when the RT signal is ON.
			9999	Second V/F invalid
113	Third V/F (base frequency)	9999	0 to 400Hz	Set the base frequency when the X9 signal is ON.
			9999	Third V/F is invalid

#### (1) Setting of base frequency (Pr. 3)

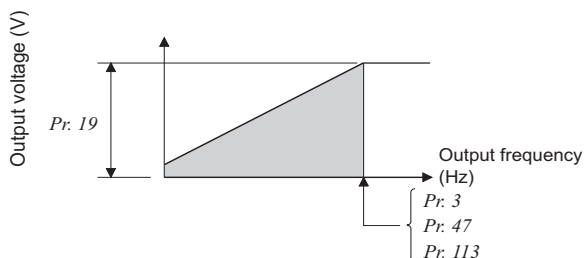

- When operating a standard motor, generally set the rated frequency of the motor to *Pr. 3 Base frequency*. When running the motor using bypass operation, set *Pr. 3* to the same value as the power supply frequency.
- If the frequency given on the motor rating plate is "50Hz" only, always set to "50Hz". Leaving the base frequency unchanged from "60Hz" may make the voltage too low and the torque insufficient. It may result in an inverter trip due to overload. Special care must be taken when "1" (reduced torque load) is set in *Pr. 14 Load pattern selection*.
- When using the Mitsubishi constant-torque motor, set *Pr. 3* to 60Hz.

#### (2) Set multiple base frequencies (Pr. 47, Pr. 113)

- When you want to change the base frequency when switching two motors with one inverter, use the *Pr. 47 Second V/F (base frequency)*.
- Pr. 47 Second V/F (base frequency)* is valid when the RT signal is ON, and *Pr. 113 Third V/F (base frequency)* is valid when the X9 signal is ON. Assign the terminal for X9 signal input using any of *Pr. 178 to Pr. 189 (input terminal function selection)*.

#### REMARKS

- The RT(X9) signal acts as the second (third) function selection signal and makes the other second (third) functions valid. (Refer to page 211)
- In the initial setting, the RT signal is assigned to the RT terminal. By setting "3" in any of *Pr. 178 to Pr. 189 (input terminal function selection)*, you can assign the RT signal to the other terminal.

### (3) Base frequency voltage setting (Pr. 19)

- Use Pr. 19 Base frequency voltage to set the base voltage (e.g. rated motor voltage).
- If the setting is less than the power supply voltage, the maximum output voltage of the inverter is as set in Pr. 19.
- Pr. 19 can be utilized in the following cases.
  - (a) When regeneration frequency is high (e.g. continuous regeneration)  
During regeneration, the output voltage becomes higher than the reference and may cause an overcurrent trip (E.OC□) due to an increased motor current.
  - (b) When power supply voltage variation is large  
When the power supply voltage exceeds the rated voltage of the motor, speed variation or motor overheat may be caused by excessive torque or increased motor current.
- Set parameters as below when running the vector control dedicated motor (SF-V5RU, SF-V5RU1, SF-V5RU3, SF-V5RU4, SF-VR) under V/F control.

Motor Type	Pr. 19 Setting	Pr. 3 Setting
SF-V5RU-3.7kW	170V	50Hz
SF-V5RU-5.5kW or more	160V	
SF-V5RUH-3.7kW	340V	
SF-V5RUH-5.5kW or more	320V	
SF-V5RU1-30kW or less	160V	33.33Hz
SF-V5RU1-37kW	170V	
SF-V5RU3-22kW or less	160V	
SF-V5RU3-30kW	170V	
SF-V5RU4-3.7kW, 7.5kW	150V	16.67Hz
SF-V5RU4-other than the above	160V	
SF-VR	160V	50Hz
SF-VRH	320V	

#### REMARKS

When operation is discontinued under vector control due to failure of an encoder, etc., setting "9999" in Pr. 80 Motor capacity or Pr. 81 Number of motor poles enables V/F control operation.

#### CAUTION

- When Advanced magnetic flux vector control mode, Real sensorless vector control or vector control is selected, Pr. 3, Pr. 47, Pr. 113 and Pr. 19 are invalid and Pr. 83 and Pr. 84 are valid.  
Note that Pr. 3 or Pr. 47 and Pr. 113 values are valid as inflection points of S-pattern when Pr. 29 Acceleration/deceleration pattern selection = "1" (S-pattern acceleration/deceleration A).
- When Pr. 71 Applied motor is set to "2" (adjustable 5 points V/F characteristic), the Pr. 47 and Pr. 113 settings become invalid. In addition, you cannot set "8888" or "9999" in Pr. 19.
- Changing the terminal assignment using Pr. 178 to Pr. 189 (input terminal function selection) may affect the other functions. Set parameters after confirming the function of each terminal.

#### ◆ Parameters referred to ◆

Pr. 14 Load pattern selection Refer to page 144  
 Pr. 29 Acceleration/deceleration pattern selection Refer to page 158  
 Pr. 71 Applied motor Refer to page 169  
 Pr. 80 Motor capacity Refer to page 75.  
 Pr. 83 Rated motor voltage, Pr. 84 Rated motor frequency Refer to page 171.  
 Pr. 178 to Pr. 189 (input terminal function selection) Refer to page 207.  
 Advanced magnetic flux vector control Refer to page 131.  
 Real sensorless vector control Refer to page 75.



### 4.10.2 Load pattern selection (Pr. 14) V/F

You can select the optimum output characteristic (V/F characteristic) for the application and load characteristics.

Parameter Number	Name	Initial Value	Setting Range	Description
14	Load pattern selection	0	0	For constant-torque load
			1	For variable-torque load
			2	For constant-torque elevators (at reverse rotation boost of 0%)
			3	For constant-torque elevators (at forward rotation boost of 0%)
			4	RT signal ON..... for constant torque load RT signal OFF... for constant torque elevators at reverse rotation boost of 0%
			5	RT signal ON..... for constant torque load RT signal OFF... for constant torque elevators at forward rotation boost of 0%

Pr.14=0

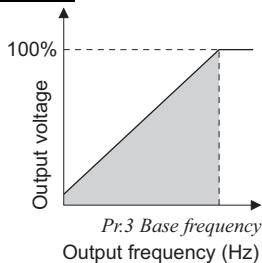

#### (1) For constant-torque load (setting "0", initial value)

- At or less than the base frequency, the output voltage varies linearly with the output frequency.
- Set this value when driving the load whose load torque is constant even if the speed varies, e.g. conveyor, cart or roll drive.

#### POINT

If the load is a fan or pump, select "for rated torque load (setting "0")" in any of the following cases.

- When a blower of large moment of inertia (J) is accelerated in a short time
- For constant-torque load such as rotary pump or gear pump
- When load torque increases at low speed, e.g. screw pump

Pr.14=1

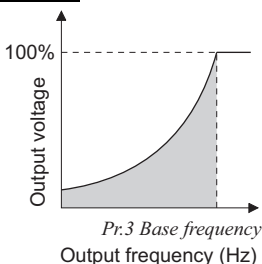

#### (2) For variable-torque load (setting "1")

- At or less than the base frequency, the output voltage varies with the output frequency in a square curve.
- Set this value when driving the load whose load torque varies in proportion to the square of the speed, e.g. fan or pump.

#### (3) Vertical lift load applications (setting values "2, 3")

Pr.14=2

For vertical lift loads  
At forward rotation boost...Pr:0 setting  
At reverse rotation boost...0%

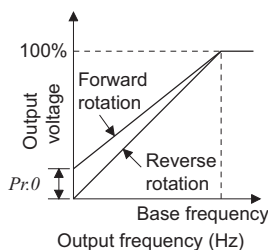

Pr.14=3

For vertical lift loads  
At forward rotation boost...0%  
At reverse rotation boost...Pr:0 setting

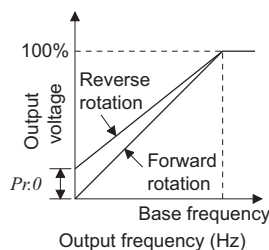

- Set "2" when a vertical lift load is fixed as power driving load at forward rotation and regenerative load at reverse rotation.
- Pr. 0 Torque boost is valid during forward rotation and torque boost is automatically changed to "0%" during reverse rotation.
- Set "3" for an elevated load that is in the driving mode during reverse rotation and in the regenerative load mode during forward rotation according to the load weight, e.g. counterweight system.

#### REMARKS

- When torque is continuously regenerated as vertical lift load, it is effective to set the rated voltage in Pr. 19 Base frequency voltage to prevent trip due to current at regeneration.

Pr. 14 Setting	RT(X17) Signal	Output Characteristics
4	ON	For constant torque load (same as when the setting is "0")
	OFF	For elevators at reverse rotation boost of 0% (same as when the setting is "2")
5	ON	For constant torque load (same as when the setting is "0")
	OFF	For elevators at forward rotation boost of 0% (same as when the setting is "3")

#### (4) Change load pattern selection using terminal (setting values are "4, 5")

- Output characteristic can be switched between for constant torque load and for elevator using the RT signal or X17 signal.
- For the terminal used for X17 signal input, set "17" in any of *Pr. 178 to Pr. 189 (input terminal function selection)* to assign the function. When X17 is assigned, switchover by the RT signal is invalid.





#### REMARKS

- The RT signal is assigned to the terminal RT in the initial setting. By setting "3" in any of *Pr. 178 to Pr. 189 (input terminal function selection)*, the RT signal can be assigned to the other terminal.

#### CAUTION

- When Advanced magnetic flux vector control, Real sensorless vector control or vector control is selected, this parameter setting is ignored.
- Changing the terminal assignment using *Pr. 178 to Pr. 189 (input terminal function selection)* may affect the other functions. Set parameters after confirming the function of each terminal. When the RT signal is ON, the other second functions are also valid.

#### ◆ Parameters referred to ◆

*Pr. 0 Torque boost*  Refer to page 129  
*Pr. 3 Base frequency*  Refer to page 142  
*Pr. 178 to Pr. 189 (input terminal function selection)*  Refer to page 207  
*Advanced magnetic flux vector control*  Refer to page 131.  
*Real sensorless vector control*  Refer to page 75.





### 4.10.3 Elevator mode (automatic acceleration/deceleration) (Pr. 61, Pr. 64, Pr. 292) V/F

Operation matching a load characteristic of elevator with counterweight can be performed.

Parameter Number	Name	Initial Value	Setting Range	Description
61	Reference current	9999	0 to 500A	Set the reference current for elevator mode.
			9999	Rated inverter current value reference
64	Starting frequency for elevator mode	9999	0 to 10%	Set the starting frequency for the elevator mode.
			9999	Starting frequency 2Hz
292	Automatic acceleration/ deceleration	0	0	Normal mode
			3	Optimum acceleration/deceleration mode (Refer to page 162.)
			5	Elevator mode 1 (stall prevention operation level 150%)
			6	Elevator mode 2 (stall prevention operation level 180%)
			7, 8	Brake sequence mode 1, 2 (Refer to page 193.)
			11	Minimum acceleration/deceleration mode (Refer to page 162.)

#### (1) Elevator mode

- When "5" or "6" is set in Pr. 292 Automatic acceleration/deceleration, elevator mode is selected and each setting is changed as in the table below.
- Enough torque is generated during power driving and the torque boost value is automatically changed during regeneration and operation without load so that overcurrent protection function does not activate due to over excitation.

	Normal Mode	Elevator Mode	
		Pr. 292 = 5	Pr. 292 = 6
Torque boost	Pr. 0 (3/2%)	Changes according to the output current (right chart)	
Starting frequency	Pr. 13 (0.5Hz)	Pr. 64 (2Hz) Accelerate after maintaining 100ms	
Base frequency voltage	Pr. 19 (9999)	220V (440V)	
Stall prevention operation level	Pr. 22 (150%) etc.	150%	180%

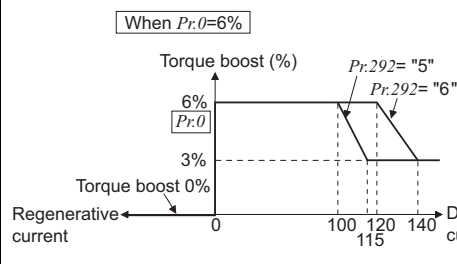

- When operating the elevator with load more than the rated inverter current, the maximum torque may become insufficient.
- For the elevator without counterweight, setting "2 or 3" (for elevator load) in Pr. 14 Load pattern selection and an appropriate value in Pr. 19 Base frequency voltage will generate larger maximum torque than when elevator mode is selected.

#### REMARKS

- Stall prevention operation level automatically decreases according to the electronic thermal relay function cumulative value, to prevent inverter overload trip (E.THT, E.THM).

#### (2) Adjustment of elevator mode (Pr. 61, Pr. 64)

- By setting the adjustment parameters Pr. 61 and Pr. 64, the application range can be made wider.

Parameter Number	Name	Setting Range	Description
61	Reference current	0 to 500A	For example, when the motor and inverter are different in capacity, set the rated motor current value. Set reference current (A) of the stall prevention operation level
		9999 (initial value)	The rated inverter output current is defined as reference.
64	Starting frequency for elevator mode	0 to 10Hz	Set the starting frequency for the elevator mode.
		9999 (initial value)	Starting frequency 2Hz

#### REMARKS

- Even if elevator mode has been selected, inputting the JOG signal (jog operation), RT signal (second function selection) or X9 signal (third function selection) during an inverter stop will switch to the normal operation and give priority to jog operation or second and third function selection. Note that JOG and RT signal input is invalid even if JOG signal and RT signal are input during operation with acceleration/deceleration selected.
- Elevator mode is invalid when Advanced magnetic flux vector, Real sensorless vector control or vector control is selected.
- Since the Pr. 61 and Pr. 64 settings automatically return to the initial value (9999) if the Pr. 292 setting is changed, set Pr. 292 first when you need to set Pr. 61 and Pr. 64.

#### 4.10.4 Adjustable 5 points V/F (Pr. 71, Pr. 100 to Pr. 109) V/F

A dedicated V/F pattern can be made by freely setting the V/F characteristic between a startup and the base frequency and base voltage under V/F control (frequency voltage/frequency). The torque pattern that is optimum for the machine's characteristic can be set.

Parameter Number	Name	Initial Value	Setting Range	Description
71	Applied motor	0	0 to 8, 13 to 18, 30, 33, 34, 40, 43, 44, 50, 53, 54	Set "2" for adjustable 5 points V/F control.
100	V/F1(first frequency)	9999	0 to 400Hz, 9999	Set each points (frequency, voltage) of V/F pattern. 9999: No V/F setting
101	V/F1(first frequency voltage)	0V	0 to 1000V	
102	V/F2(second frequency)	9999	0 to 400Hz, 9999	
103	V/F2(second frequency voltage)	0V	0 to 1000V	
104	V/F3(third frequency)	9999	0 to 400Hz, 9999	
105	V/F3(third frequency voltage)	0V	0 to 1000V	
106	V/F4(fourth frequency)	9999	0 to 400Hz, 9999	
107	V/F4(fourth frequency voltage)	0V	0 to 1000V	
108	V/F5(fifth frequency)	9999	0 to 400Hz, 9999	
109	V/F5(fifth frequency voltage)	0V	0 to 1000V	

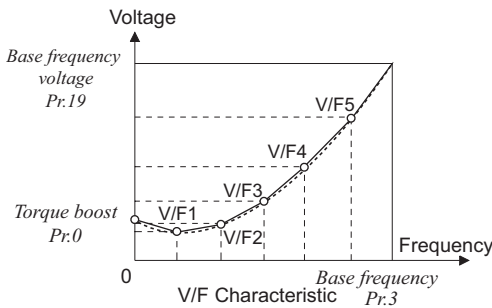

- Any V/F characteristic can be provided by presetting the parameters of V/F1 (first frequency voltage/first frequency) to V/F5.
- For a machine of large static friction coefficient, for example, set a V/F pattern that will increase the voltage only in a low-speed range since such a machine requires large torque at a start.

##### (Setting procedure)

- Set the rated motor voltage in Pr. 19 Base frequency voltage. (No function at the setting of "9999" (initial value) or "8888".)
- Set Pr. 71 Applied motor to "2" (Adjustable 5 points V/F characteristic).
- Set the frequency and voltage you want to set in Pr. 100 to Pr. 109.

## ⚠ CAUTION

- ⚠ Make sure to set this parameter correctly according to the motor used. Incorrect setting may cause the motor to overheat and burn.

### CAUTION

- Adjustable 5 points V/F characteristics function only under V/F control. They do not function under Advanced magnetic flux vector control, Real sensorless vector control or vector control.
- When Pr. 19 Base frequency voltage = "8888" or "9999", Pr. 71 cannot be set to "2". To set Pr. 71 to "2", set the rated voltage value in Pr. 19.
- When the frequency values at each point are the same, a write disable error ( $\epsilon_r 1$ ) appears.
- Set the points (frequencies, voltages) of Pr. 100 to Pr. 109 within the ranges of Pr. 3 Base frequency and Pr. 19 Base frequency voltage.
- When "2" is set in Pr. 71, Pr. 47 Second V/F (base frequency) and Pr. 113 Third V/F (base frequency) will not function.
- When Pr. 71 is set to "2", the electronic thermal relay function makes calculation as a standard motor.

### REMARKS

- A greater energy saving effect can be expected by combining Pr. 60 Energy saving control selection and adjustable 5 points V/F.
- For the 5.5K, 7.5K, the Pr. 0 Torque boost and Pr. 12 DC injection brake operation voltage settings are automatically changed according to the Pr. 71 setting as follows.

Pr. 71	Standard Motor Setting 0, 2, 3 to 8, 40, 43, 44	Constant Torque Motor Setting 1, 13 to 18, 50, 53, 54
Pr. 0	3%	2%
Pr. 12	4%	2%

#### ◆ Parameters referred to ◆

- Pr. 3 Base frequency, Pr. 19 Base frequency voltage Refer to page 142
- Pr. 12 DC injection brake operation voltage Refer to page 185
- Pr. 47 Second V/F (base frequency), Pr. 113 Third V/F (base frequency) Refer to page 142
- Pr. 60 Energy saving control selection Refer to page 255
- Pr. 71 Applied motor, Pr. 450 Second applied motor Refer to page 169
- Advanced magnetic flux vector control Refer to page 131
- Real sensorless vector control Refer to page 75
- Vector control Refer to page 75

## 4.11 Frequency setting by external terminals

Purpose	Parameter that must be Set		Refer to Page
Make frequency setting by combination of terminals	Multi-speed operation	Pr. 4 to Pr. 6, Pr. 24 to Pr. 27, Pr. 232 to Pr. 239	148
Perform jog operation	Jog operation	Pr. 15, Pr. 16	150
Added compensation for multi-speed setting and remote setting	Multi-speed input compensation selection	Pr. 28	152
Infinitely variable speed setting by terminals	Remote setting function	Pr. 59	152

### 4.11.1 Multi-speed setting operation (Pr. 4 to Pr. 6, Pr. 24 to Pr. 27, Pr. 232 to Pr. 239)

Can be used to change the preset speed in the parameter with the contact terminals.  
Any speed can be selected by merely turning on-off the contact signals (RH, RM, RL, REX signals).

Parameter Number	Name	Initial Value	Setting Range	Description
4	Multi-speed setting (high speed)	60Hz	0 to 400Hz	Set the frequency when RH turns on.
5	Multi-speed setting (middle speed)	30Hz	0 to 400Hz	Set the frequency when RM turns on.
6	Multi-speed setting (low speed)	10Hz	0 to 400Hz	Set the frequency when RL turns on.
24	Multi-speed setting (speed 4)	9999	0 to 400Hz, 9999	Frequency from speed 4 to speed 15 can be set according to the combination of the RH, RM, RL and REX signals. 9999: not selected
25	Multi-speed setting (speed 5)	9999	0 to 400Hz, 9999	
26	Multi-speed setting (speed 6)	9999	0 to 400Hz, 9999	
27	Multi-speed setting (speed 7)	9999	0 to 400Hz, 9999	
232	Multi-speed setting (speed 8)	9999	0 to 400Hz, 9999	
233	Multi-speed setting (speed 9)	9999	0 to 400Hz, 9999	
234	Multi-speed setting (speed 10)	9999	0 to 400Hz, 9999	
235	Multi-speed setting (speed 11)	9999	0 to 400Hz, 9999	
236	Multi-speed setting (speed 12)	9999	0 to 400Hz, 9999	
237	Multi-speed setting (speed 13)	9999	0 to 400Hz, 9999	
238	Multi-speed setting (speed 14)	9999	0 to 400Hz, 9999	
239	Multi-speed setting (speed 15)	9999	0 to 400Hz, 9999	

The above parameters allow its setting to be changed during operation in any operation mode even if "0" (initial value) is set in Pr. 77 Parameter write selection.

#### (1) Multi-speed setting (Pr. 4 to Pr. 6)

- Operation is performed at the frequency set in Pr. 4 when the RH signal turns on, Pr. 5 when the RM signal turns on, and Pr. 6 when the RL signal turns ON.

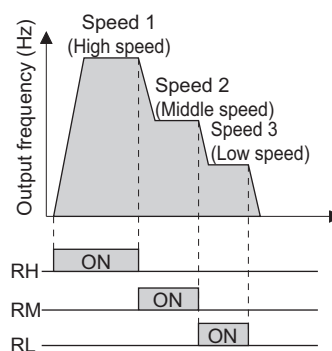

#### REMARKS

- In the initial setting, if two or three speeds are simultaneously selected, priority is given to the set frequency of the lower signal. For example, when the RH and RM signals turn on, the RM signal (Pr. 5) has a higher priority.
- The RH, RM, RL signals are assigned to the terminal RH, RM, RL in the initial setting. By setting "0 (RL)", "1 (RM)", "2 (RH)" in any of Pr.178 to Pr.189 (input terminal function assignment), the signals can be assigned to other terminals.

**(2) Multi-speed setting higher than speed 4 (Pr. 24 to Pr. 27, Pr. 232 to Pr. 239)**

- Frequency from speed 4 to speed 15 can be set according to the combination of the RH, RM, RL and REX signals. Set the running frequencies in Pr. 24 to Pr. 27, Pr. 232 to Pr. 239. (In the initial value setting, speed 4 to speed 15 are invalid.)
- For the terminal used for REX signal input, set "8" in any of Pr. 178 to Pr. 189 (input terminal function selection) to assign the function.

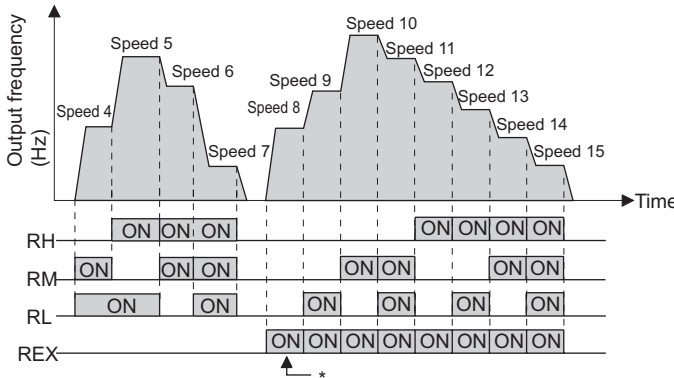

\* When "9999" is set in Pr. 232 Multi-speed setting (speed 8), operation is performed at frequency set in Pr. 6 when RH, RM and RL are turned OFF and REX is turned ON.

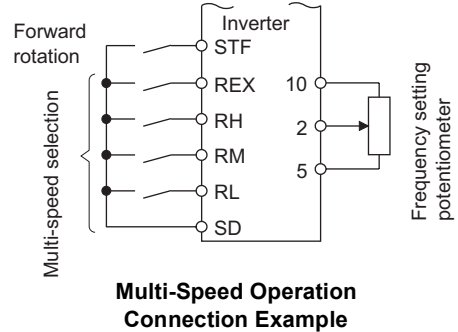

**REMARKS**

- The priorities of the frequency commands by the external signals are "jog operation > multi-speed operation > terminal 4 analog input > terminal 2 analog input". (Refer to page 271 for the frequency command by analog input)
- Valid in External operation mode or PU/External combined operation mode (Pr. 79 = "3" or "4").
- Multi-speed parameters can also be set in the PU or External operation mode.
- Pr. 24 to Pr. 27 and Pr. 232 to Pr. 239 settings have no priority between them.
- When a value other than "0" is set in Pr. 59 Remote function selection, the RH, RM and RL signals are used as the remote setting signals and the multi-speed setting becomes invalid.
- When making analog input compensation, set "1" in Pr. 28 Multi-speed input compensation selection.

**CAUTION**

- Changing the terminal assignment using Pr. 178 to Pr. 189 (input terminal function selection) may affect the other functions. Set parameters after confirming the function of each terminal.

**◆ Parameters referred to ◆**

- Pr. 15 Jog frequency Refer to page 150
- Pr. 28 Multi-speed input compensation selection Refer to page 152
- Pr. 59 Remote function selection Refer to page 152
- Pr. 79 Operation mode selection Refer to page 290
- Pr. 178 to Pr. 189 (input terminal function selection) Refer to page 207

### 4.11.2 Jog operation (Pr. 15, Pr. 16)

You can set the frequency and acceleration/deceleration time for jog operation. Jog operation can be performed either externally or from the PU. This function is useful for conveyor positioning, test operation, etc.

Parameter Number	Name	Initial Value	Setting Range	Description
15	Jog frequency	5Hz	0 to 400Hz	Set the frequency for jog operation.
16	Jog acceleration/deceleration time	0.5s	0 to 3600/360s*	Set the acceleration/deceleration time for jog operation. Set the time taken to reach the frequency (Initial value is 60Hz) set in Pr. 20 Acceleration/deceleration reference frequency for acceleration/deceleration time. The acceleration and deceleration time cannot be set separately.

The above parameters are displayed as simple mode parameters only when the parameter unit (FR-PU04/FR-PU07) is connected. When the operation panel (FR-DU07) is connected, the above parameters can be set only when Pr. 160 User group read selection = "0". (Refer to page 285)

\* When the setting of Pr. 21 Acceleration/deceleration time increments is "0" (initial value), the setting range is "0 to 3600s" and the setting increments are "0.1s", and when the setting is "1", the setting range is "0 to 360s" and the setting increments are "0.01s"

#### (1) Jog operation from outside

- When the JOG signal is ON, a start and stop can be made by the start signal (STF, STR). (The JOG signal is assigned to the terminal JOG in the initial setting)

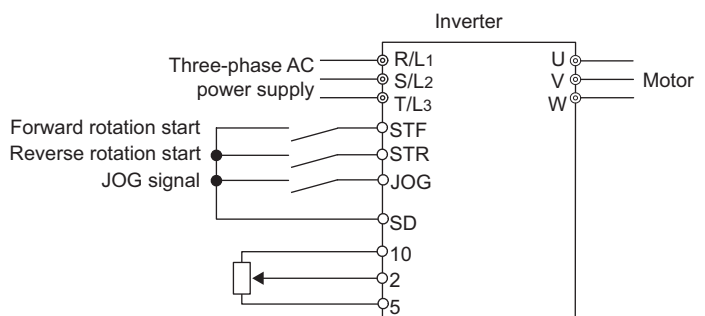
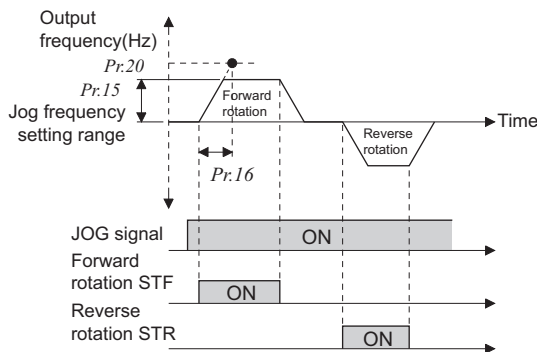

Connection diagram for external jog operation

#### Operation

- Screen at power-ON
  - Confirm that the External operation mode is selected. ([EXT] lit)
  - If not displayed, press (PU/EXT) to change to the External [EXT] operation mode.
  - If the operation mode still does not change, set Pr. 79 to change to the External operation mode.
- Turn the JOG switch ON.
- Turn the start switch (STF or STR) ON.
  - The motor rotates while start switch (STF or STR) is ON.
  - Rotates at 5Hz. (Initial value of Pr. 15)
- Turn the start switch (STF or STR) OFF.

#### Indication

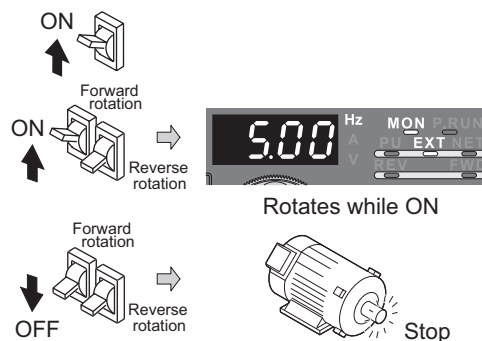

#### REMARKS

- When you want to change the running frequency, change Pr. 15 Jog frequency. (initial value "5Hz")
- When you want to change the acceleration/deceleration time, change Pr. 16 Jog acceleration/deceleration time. (initial value "0.5s")

## (2) Jog operation from PU

- Set the PU (FR-DU07/FR-PU07/FR-PU04) to the jog operation mode. Operation is performed only while the start button is pressed.

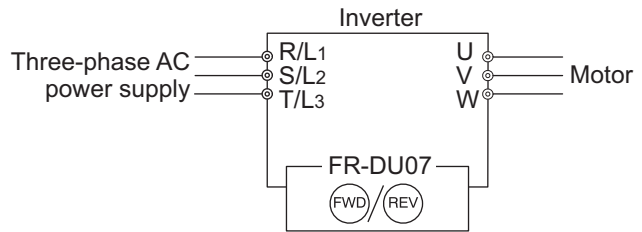

### Operation

- Confirmation of the RUN indicator and operation mode indicator
  - The monitor mode should have been selected.
  - The inverter should be at a stop.
- Press **PU/EXT** to choose the PU JOG operation mode.
- Press **FWD** (or **REV**).
  - While **FWD** (or **REV**) is pressed, the motor rotates.
  - Rotates at 5Hz. (initial value of Pr. 15)
- Release **FWD** (or **REV**).

### Indication

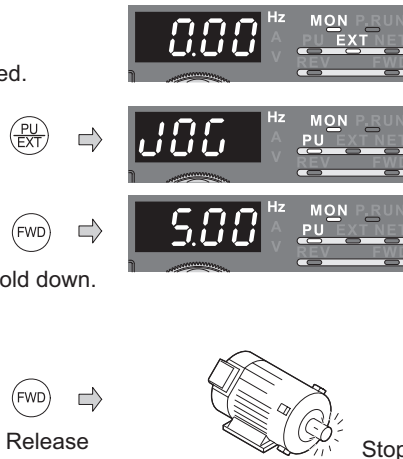

### [When changing the frequency of PU JOG operation]

- Press **MODE** to choose the parameter setting mode.
- Turn **▲** until Pr. 15 JOG frequency appears.
- Press **SET** to show the currently set value. (5Hz)
- Turn **▲** to set the value to "10.00". (10Hz)
- Press **SET** to set.
- Perform the operations in steps 1 to 4. The motor rotates at 10Hz.

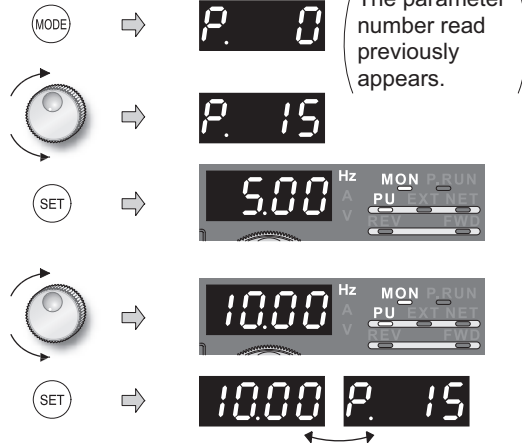

The parameter number read previously appears.

Flicker ··· Parameter setting complete!!

### CAUTION

- When Pr. 29 Acceleration/deceleration pattern selection = "1" (S-pattern acceleration/deceleration A), the acceleration/deceleration time is the period of time required to reach Pr. 3 Base frequency.
- The Pr. 15 setting should be equal to or higher than the Pr. 13 Starting frequency setting.
- The JOG signal can be assigned to the input terminal using any of Pr. 178 to Pr. 189 (input terminal function selection). When terminal assignment is changed, the other functions may be affected. Set parameters after confirming the function of each terminal.
- During jog operation, the second acceleration/deceleration via the RT signal cannot be selected. (The other second functions are valid. (Refer to page 211))
- When Pr. 79 Operation mode selection = "4", push **FWD** / **REV** of the PU (FR-DU07/FR-PU04/FR-PU07) to make a start or push **STOP/RESET** to make a stop.
- This function is invalid when Pr. 79 = "3".
- Jog operation is invalid under position control.

### ◆ Parameters referred to ◆

- Pr. 13 Starting frequency Refer to page 157
- Pr. 29 Acceleration/deceleration pattern selection Refer to page 158
- Pr. 20 Acceleration/deceleration reference frequency, Pr. 21 Acceleration/deceleration time increments Refer to page 155
- Pr. 79 Operation mode selection Refer to page 290
- Pr. 178 to Pr. 189 (input terminal function selection) Refer to page 207



### 4.11.3 Input compensation of multi-speed and remote setting (Pr. 28)

By inputting the frequency setting compensation signal (terminal 1, 2), the speed (frequency) can be compensated for relative to the multi-speed setting or the speed setting by remote setting function.

Parameter Number	Name	Initial Value	Setting Range	Description
28	Multi-speed input compensation selection	0	0	Without compensation
			1	With compensation

#### REMARKS

- Select the terminal (terminal 1, 2) used for compensation input voltage (0 to ±5V, 0 to ±10) using Pr. 73 Analog input selection.
- When using terminal 1 for compensation input, set "0" (initial value) in Pr. 868 Terminal 1 function assignment.

#### ◆ Parameters referred to ◆

Pr. 4 to Pr. 6, Pr. 24 to Pr. 27, Pr. 232 to Pr. 239 (multi-speed operation) Refer to page 148  
 Pr. 73 Analog input selection Refer to page 263  
 Pr. 59 Remote function selection Refer to page 152  
 Pr. 868 Terminal 1 function assignment Refer to page 262

### 4.11.4 Remote setting function (Pr. 59)

- Even if the operation panel is located away from the enclosure, you can use contact signals to perform continuous variable-speed operation, without using analog signals.
- By simply setting this parameter, you can use the acceleration, deceleration and setting clear functions of the motorized speed setter (FR-FK).

Parameter Number	Name	Initial Value	Setting Range	Description	
				RH, RM, RL signal function	Frequency setting storage function
59	Remote function selection	0	0	Multi-speed setting	—
			1	Remote setting	Yes
			2	Remote setting	No
			3	Remote setting	No (Turning STF/STR off clears remotely- set frequency.)

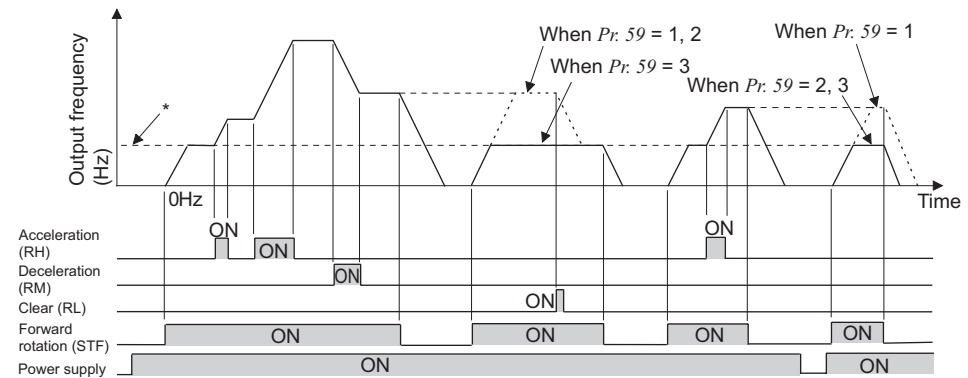
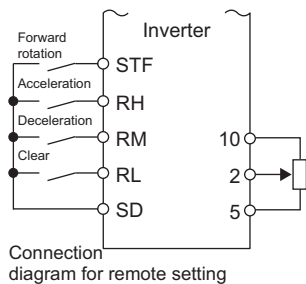

\* External operation frequency (other than multi-speed) or PU running frequency

#### (1) Remote setting function

- Use Pr. 59 to select whether the remote setting function is used or not and whether the frequency setting storage function in the remote setting mode is used or not.  
 When Pr. 59 is set to any of "1 to 3" (remote setting function valid), the functions of the RH, RM and RL signals are changed to acceleration (RH), deceleration (RM) and clear (RL).
- When the remote function is used, the output frequency of the inverter can be compensated for as follows:  
 External operation .. Frequency set with RH and RM operation + external operation frequency other than multi-speed (PU operation frequency when Pr. 79 = "3" (external, PU combined)) and terminal 4 input.  
 (When making analog input compensation, set "1" in Pr. 28 Multi-speed input compensation selection.  
 When Pr. 28 is set to "0" and acceleration/deceleration is made to reach the set frequency of the analog voltage input (terminal 2 or terminal 4) by RH/RM, the auxiliary input by terminal 1 becomes invalid.)  
 PU operation ..... Frequency set by RH/RM operation + PU running frequency

### (2) Frequency setting storage

- The frequency setting storage function stores the remotely-set frequency (frequency set by RH/RM operation) into the memory (EEPROM). When power is switched OFF once, then ON, operation is resumed with that output frequency value. (*Pr. 59 = 1*)

#### <Frequency setting storage conditions>

- Frequency at the point when the start signal (STF or STR) turns OFF
- Remotely-set frequency is stored every minute after turning OFF (ON) the RH (acceleration) and RM (deceleration) signals together. (The frequency is overwritten if the latest frequency is different from the previous frequency when comparing the two. The state of the RL signal does not affect writing.)

#### CAUTION

- The range of frequency changeable by RH (acceleration) and RM (deceleration) is 0 to maximum frequency (*Pr. 1 or Pr. 18* setting). Note that the maximum value of set frequency is (main speed + maximum frequency).

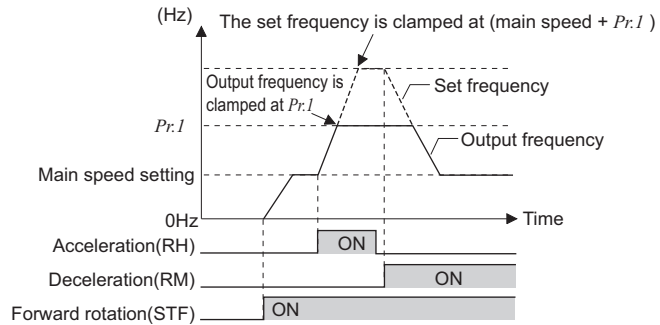

- When the acceleration or deceleration signal switches ON, acceleration/deceleration time is as set in *Pr. 44 Second acceleration/deceleration time* and *Pr. 45 Second deceleration time*. Note that when the time set in *Pr. 7 or Pr. 8* is longer than the time set in *Pr. 44 or Pr. 45*, the acceleration/deceleration time is as set in *Pr. 7 or Pr. 8*. (when RT signal is OFF)
- When the RT signal is ON, acceleration/deceleration is made in the time set to *Pr. 44* and *Pr. 45*, regardless of the *Pr. 7 or Pr. 8* setting.
- Even if the start signal (STF or STR) is OFF, turning ON the acceleration (RH) or deceleration (RM) signal varies the preset frequency.
- When switching the start signal from ON to OFF, or changing frequency by the RH or RM signal frequently, set the frequency setting value storage function (write to EEPROM) invalid (*Pr. 59 = "2, 3"*). If set valid (*Pr. 59 = "1"*), frequency is written to EEPROM frequently, this will shorten the life of the EEPROM.
- The RH, RM, RL signals can be assigned to the input terminal using any *Pr. 178 to Pr. 189 (input terminal function selection)*. When terminal assignment is changed, the other functions may be affected. Set parameters after confirming the function of each terminal.
- Also available for the Network operation mode.



**REMARKS**

During jog operation or PID control operation, the remote setting function is invalid.

**Setting frequency is "0"**

Even when the remotely-set frequency is cleared by turning on the RL (clear) signal after turn OFF (ON) of both the RH and RM signals, the inverter operates at the remotely-set frequency stored in the last operation if power is reapplied before one minute has elapsed since turn OFF (ON) of both the RH and RM signals

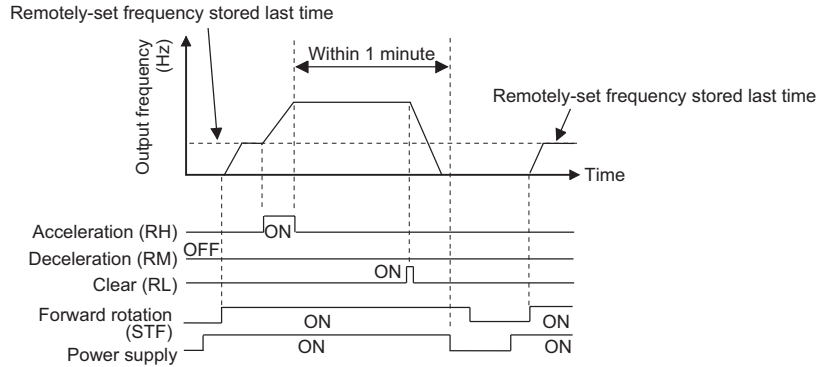

When the remotely-set frequency is cleared by turning on the RL (clear) signal after turn OFF (ON) of both the RH and RM signals, the inverter operates at the frequency in the remotely-set frequency cleared state if power is reapplied after one minute has elapsed since turn OFF (ON) of both the RH and RM signals.

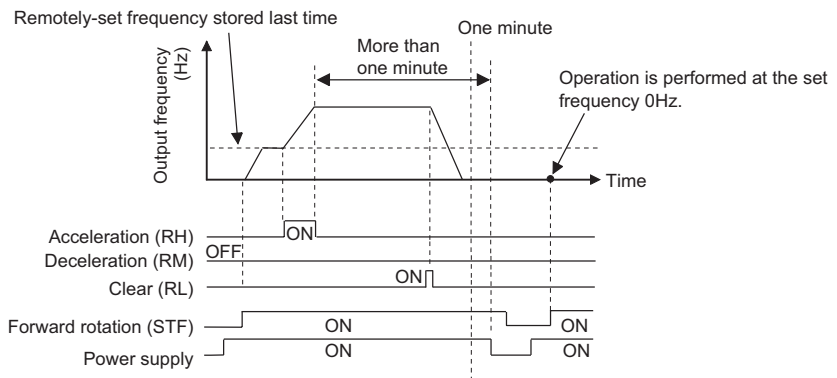

**CAUTION**

⚠ When selecting this function, re-set the maximum frequency according to the machine.

◆ Parameters referred to ◆

Pr. 1 Maximum frequency, Pr. 18 High speed maximum frequency Refer to page 140  
 Pr. 7 Acceleration time, Pr. 8 Deceleration time, Pr. 44 Second acceleration/deceleration time, Pr. 45 Second deceleration time Refer to page 155  
 Pr. 28 Multi-speed input compensation selection Refer to page 152  
 Pr. 178 to Pr. 189 (input terminal function selection) Refer to page 207

## 4.12 Setting of acceleration/deceleration time and acceleration/deceleration pattern

Purpose	Parameter that must be Set		Refer to Page
Motor acceleration/deceleration time setting	Acceleration/deceleration time	Pr. 7, Pr. 8, Pr. 20, Pr. 21, Pr. 44, Pr. 45, Pr. 110, Pr. 111	155
Starting frequency	Starting frequency and start-time hold	Pr. 13, Pr. 571	157
Set acceleration/deceleration pattern suitable for application	Acceleration/deceleration pattern and backlash measures	Pr. 29, Pr. 140 to Pr. 143, Pr. 380 to Pr. 383, Pr. 516 to Pr. 519	158
Automatically set appropriate acceleration/deceleration time	Automatic acceleration/deceleration	Pr. 61 to Pr. 63, Pr. 292	162

### 4.12.1 Setting of the acceleration and deceleration time (Pr. 7, Pr. 8, Pr. 20, Pr. 21, Pr. 44, Pr. 45, Pr. 110, Pr. 111)

Used to set motor acceleration/deceleration time.

Set a larger value for a slower speed increase/decrease or a smaller value for a faster speed increase/decrease. For the acceleration time at automatic restart after instantaneous power failure, refer to *Pr. 611 Acceleration time at a restart (page 243)*.

Parameter Number	Name	Initial Value		Setting Range	Description
7	Acceleration time	7.5K or lower	5s	0 to 3600/360s *1	Set the motor acceleration time.
		11K or higher	15s		
8	Deceleration time	7.5K or lower	5s	0 to 3600/360s *1	Set the motor deceleration time.
		11K or higher	15s		
20	Acceleration/deceleration reference frequency	60Hz		1 to 400Hz	Set the frequency that will be the basis of acceleration/deceleration time. As acceleration/deceleration time, set the frequency change time from stop to <i>Pr. 20</i> .
21	Acceleration/deceleration time increments	0		0	Increments and setting range of acceleration/deceleration time setting can be changed.
				1	
44	Second acceleration/deceleration time	5s		0 to 3600/360s *1	Set the acceleration/deceleration time when the RT signal is on.
45	Second deceleration time	9999		0 to 3600/360s *1	Set the deceleration time when the RT signal is on.
				9999	Acceleration time = deceleration time
110	Third acceleration/deceleration time	9999		0 to 3600/360s *1	Set the acceleration/deceleration time when the X9 signal is on.
				9999	Without the third acceleration/deceleration function.
111	Third deceleration time	9999		0 to 3600/360s *1	Set the deceleration time when the X9 signal is on.
				9999	Acceleration time = deceleration time

\*1 Depends on the *Pr. 21 Acceleration/deceleration time increments* setting. The initial value for the setting range is "0 to 3600s" and the setting increments is "0.1s".

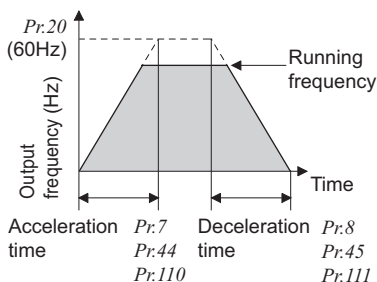

#### (1) Acceleration time setting (Pr. 7, Pr. 20)

- Use *Pr. 7 Acceleration time* to set the acceleration time required to reach *Pr. 20 Acceleration/deceleration reference frequency* from 0Hz.
- Set the acceleration time according to the following formula.

$$\text{Acceleration time setting} = \frac{\text{Pr. 20}}{\text{Maximum operating frequency} - \text{Pr. 13}} \times \text{Acceleration time from stop to maximum operating frequency}$$

Example) How to find the setting value for *Pr. 7* when increasing the output frequency to the maximum frequency of 50Hz in 10s with *Pr.20* = 60Hz (initial setting) and *Pr.13* = 0.5Hz.

$$\text{Pr. 7} = \frac{60\text{Hz}}{50\text{Hz} - 0.5\text{Hz}} \times 10\text{s} \doteq 12.1\text{s}$$

**(2) Deceleration time setting (Pr. 8, Pr. 20)**

- Use Pr. 8 Deceleration time to set the deceleration time required to reach 0Hz from Pr. 20 Acceleration/deceleration reference frequency.
- Set the deceleration time according to the following formula.

$$\text{Deceleration time setting} = \frac{\text{Pr. 20}}{\text{Maximum operating frequency} - \text{Pr. 10}} \times \text{Deceleration time from maximum operating frequency to stop.}$$

Example) How to find the setting value for Pr.8 when decreasing the output frequency from the maximum frequency of 50Hz in 10s with Pr. 20 = 120Hz and Pr. 10 = 3Hz.

$$\text{Pr. 8} = \frac{120\text{Hz}}{50\text{Hz} - 3\text{Hz}} \times 10\text{s} \doteq 25.5\text{s}$$

**(3) Change the setting range and increments of the acceleration/deceleration time (Pr. 21)**

- Use Pr. 21 to set the acceleration/deceleration time and minimum setting range.  
 Setting "0" (initial value).....0 to 3600s (minimum setting increments 0.1s)  
 Setting "1" .....0 to 360s (minimum setting increments 0.01s)

**CAUTION**

- Changing the Pr. 21 setting changes the acceleration/deceleration time setting (Pr. 7, Pr. 8, Pr. 16, Pr. 44, Pr. 45, Pr. 110, Pr. 111, Pr. 264, Pr. 265).  
 (The Pr. 611 Acceleration time at a restart setting is not affected.)  
 <Example>  
 When Pr. 21 = "0", setting "5.0" s in Pr. 7 and "1" in Pr. 21 automatically changes the Pr. 7 setting to "0.5" s.

**(4) Set multiple acceleration/deceleration time (RT signal, Pr. 44, Pr. 45, Pr. 110, Pr. 111)**

- Pr. 44 and Pr. 45 are valid when the RT signal is ON, and Pr. 110 and Pr. 111 are valid when the X9 signal is ON. When both the RT and X9 are ON, Pr. 110 and Pr. 111 are valid.
- For the terminal used for X9 signal input, set "9" in any of Pr. 178 to Pr. 189 (input terminal function selection) to assign the function.
- When "9999" is set in Pr. 45 or Pr. 111, the deceleration time becomes equal to the acceleration time (Pr. 44, Pr. 110).
- When Pr. 110 = "9999", third acceleration/deceleration time is invalid.

**CAUTION**

- In S-shaped acceleration/deceleration pattern A (refer to page 158), the set time is the period required to reach the base frequency set in Pr. 3 Base frequency.
- Acceleration/deceleration time formula when the set frequency is the base frequency or higher

$$t = \frac{4}{9} \times \frac{T}{(\text{Pr. 3})^2} \times f^2 + \frac{5}{9} T \quad \begin{matrix} T: \text{Acceleration/deceleration time setting value(s)} \\ f: \text{Set frequency(Hz)} \end{matrix}$$

- Guideline for acceleration/deceleration time when Pr. 3 Base frequency = 60Hz (0Hz to set frequency)

Frequency setting (Hz) \ Acceleration/ deceleration time (s)	Frequency setting (Hz)			
	60	120	200	400
5	5	12	27	102
15	15	35	82	305

- The RT and X9 signals can be assigned to the input terminal using any of Pr. 178 to Pr. 189 (input terminal function selection). When terminal assignment is changed, the other functions may be affected. Set parameters after confirming the function of each terminal.

**REMARKS**

- The RT (X9) signal acts as the second (third) function selection signal and makes the other second (third) function valid. (Refer to page 211)
- The RT signal is assigned to the RT terminal in the default setting. By setting "3" in any of Pr. 178 to Pr. 189 (input terminal function selection), you can assign the RT signal to the other terminal.
- If the Pr. 20 setting is changed, the Pr. 125 and Pr. 126 (frequency setting signal gain frequency) settings do not change. Set Pr. 125 and Pr. 126 to adjust the gains.
- When the Pr. 7, Pr. 8, Pr. 44, Pr. 45, Pr. 110 and Pr. 111 settings are 0.03s or less, the acceleration/deceleration time is 0.04s (under V/F control, Advanced magnetic flux vector control). At that time, set Pr. 20 to "120Hz" or less.
- If the acceleration/deceleration time is set, the actual motor acceleration/deceleration time cannot be made shorter than the shortest acceleration/deceleration time determined by the mechanical system J (moment of inertia) and motor torque.

◆ Parameters referred to ◆

- Pr. 3 Base frequency Refer to page 142
- Pr. 10 DC injection brake operation frequency Refer to page 185
- Pr. 29 Acceleration/deceleration pattern selection Refer to page 158
- Pr. 125, Pr. 126 (frequency setting gain frequency) Refer to page 271
- Pr. 178 to Pr. 189 (input terminal function selection) Refer to page 207

### 4.12.2 Starting frequency and start-time hold function (Pr. 13, Pr. 571)

You can set the starting frequency and hold the set starting frequency for a certain period of time. Set these functions when you need the starting torque or want to smooth motor drive at a start.

Parameter Number	Name	Initial Value	Setting Range	Description
13	Starting frequency	0.5Hz	0 to 60Hz	Frequency at start can be set in the range 0 to 60Hz. You can set the starting frequency at which the start signal is turned on.
571	Holding time at a start	9999	0.0 to 10.0s	Set the holding time of Pr. 13 Starting frequency.
			9999	Holding function at a start is invalid

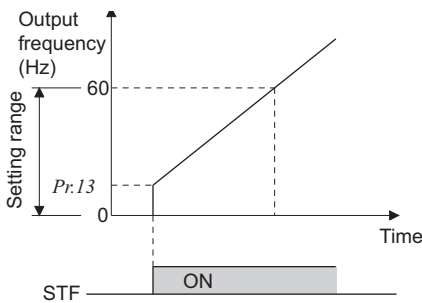

#### (1) Starting frequency setting (Pr. 13)

- Frequency at start can be set in the range 0 to 60Hz.
- You can set the starting frequency at which the start signal is turned on.

#### CAUTION

The inverter will not start if the frequency setting signal is less than the value set in Pr. 13. For example, when 5Hz is set in Pr. 13, the motor will not start running until the frequency setting signal reaches 5Hz.

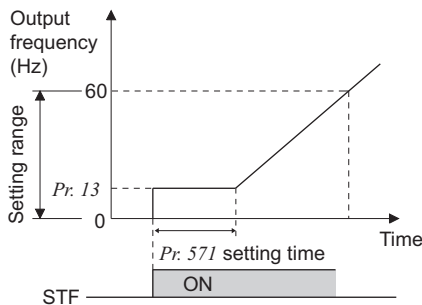

#### (2) Start-time hold function (Pr. 571)

- This function holds the time set in Pr. 571 and the output frequency set in Pr. 13 Starting frequency.
- This function performs initial excitation to smooth the motor drive at a start.

#### REMARKS

When Pr. 13 = "0Hz", the starting frequency is held at 0.01Hz.

#### CAUTION

- When the start signal was turned OFF during start-time hold, deceleration is started at that point.
- At switching between forward rotation and reverse rotation, the starting frequency is valid but the start-time hold function is invalid.

## ⚠ CAUTION

⚠ Note that when Pr. 13 is set to any value equal to or less than Pr. 2 Minimum frequency, simply turning ON the start signal will run the motor at the preset frequency even if the command frequency is not input.

#### ◆ Parameters referred to ◆

Pr. 2 Minimum frequency Refer to page 140

### 4.12.3 Acceleration/deceleration pattern (Pr. 29, Pr. 140 to Pr. 143, Pr. 380 to Pr. 383, Pr. 516 to Pr. 519)

You can set the acceleration/deceleration pattern suitable for application.

You can also set the backlash measures that stop acceleration/deceleration once at the parameter-set frequency and time during acceleration/deceleration.

Parameter Number	Name	Initial Value	Setting Range	Description
29	Acceleration/deceleration pattern selection	0	0	Linear acceleration/ deceleration
			1	S-pattern acceleration/deceleration A
			2	S-pattern acceleration/deceleration B
			3	Backlash measures
			4	S-pattern acceleration/deceleration C
			5	S-pattern acceleration/deceleration D
140	Backlash acceleration stopping frequency	1Hz	0 to 400Hz	Set the stopping frequency and time for backlash measures. Valid when Pr. 29 = 3
141	Backlash acceleration stopping time	0.5s	0 to 360s	
142	Backlash deceleration stopping frequency	1Hz	0 to 400Hz	
143	Backlash deceleration stopping time	0.5s	0 to 360s	
380	Acceleration S-pattern 1	0	0 to 50%	Valid when S-pattern acceleration/ deceleration C (Pr. 29 = 4) is set. Set the time taken for S-pattern from starting of acceleration/deceleration to linear acceleration as % to the acceleration/deceleration time (Pr. 7, Pr. 8 etc.). An acceleration/deceleration pattern can be changed with the X20 signal.
381	Deceleration S-pattern 1	0	0 to 50%	
382	Acceleration S-pattern 2	0	0 to 50%	
383	Deceleration S-pattern 2	0	0 to 50%	
516	S-pattern time at a start of acceleration	0.1s	0.1 to 2.5s	Valid when S-pattern acceleration/ deceleration D (Pr. 29 = 5) is set. Set the time taken for S-pattern acceleration/deceleration (S-pattern operation).
517	S-pattern time at a completion of acceleration	0.1s	0.1 to 2.5s	
518	S-pattern time at a start of deceleration	0.1s	0.1 to 2.5s	
519	S-pattern time at a completion of deceleration	0.1s	0.1 to 2.5s	

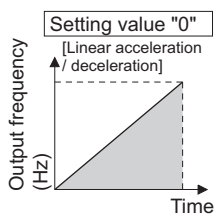

#### (1) Linear acceleration/ deceleration (Pr. 29 = "0", initial value)

- When the frequency is changed for acceleration, deceleration, etc. in inverter operation, the output frequency is changed linearly (linear acceleration/ deceleration) to reach the set frequency without straining the motor and inverter. Linear acceleration/deceleration has a uniform frequency/time slope.

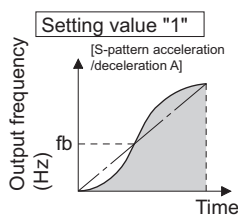

#### (2) S-pattern acceleration/deceleration A (Pr. 29 = "1")

- For machine tool spindle applications, etc.  
Used when acceleration/deceleration must be made in a short time to a high-speed range of not lower than the base frequency. In this acceleration/ deceleration pattern, Pr. 3 Base frequency (fb) is the inflection point of the S pattern and you can set the acceleration/deceleration time appropriate for motor torque reduction in a constant-power operation region of base frequency (fb) or higher.

#### CAUTION

- As the acceleration/deceleration time of S-pattern acceleration/deceleration A, set the time taken until Pr. 3 Base frequency is reached, not Pr. 20 Acceleration/deceleration reference frequency.

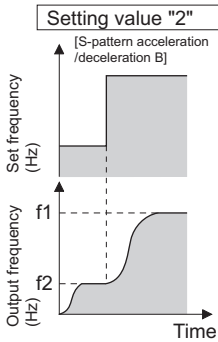

**(3) S-pattern acceleration/deceleration B (Pr. 29 = "2")**

- For prevention of load shifting in conveyor and other applications Since acceleration/deceleration is always made in an S shape from current frequency (f2) to target frequency (f1), this function eases shock produced at acceleration/deceleration and is effective for load collapse prevention, etc.

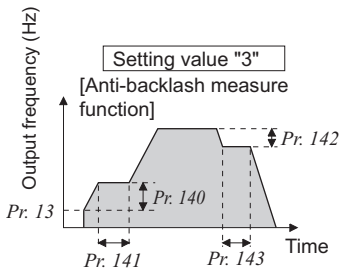

**(4) Backlash measures (Pr. 29 = "3", Pr. 140 to Pr. 143)**

- What is backlash? Reduction gears have an engagement gap and have a dead zone between forward rotation and reverse rotation. This dead zone is called backlash, and this gap disables a mechanical system from following motor rotation. More specifically, a motor shaft develops excessive torque when the direction of rotation changes or when constant-speed operation shifts to deceleration, resulting in a sudden motor current increase or regenerative status.
- To avoid backlash, acceleration/deceleration is temporarily stopped. Set the acceleration/deceleration stopping frequency and time in Pr. 140 to Pr. 143.

**CAUTION**

Setting the backlash measures increases the acceleration/deceleration time by the stopping time.

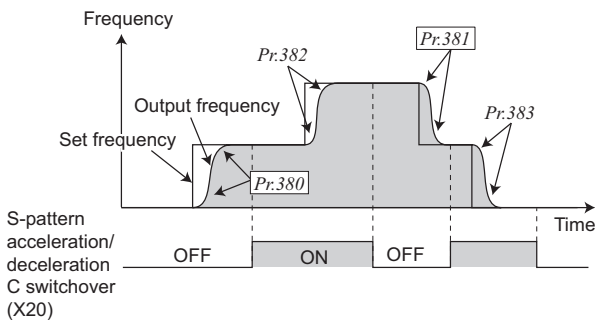

**(5) S-pattern acceleration/deceleration C (Pr. 29 = "4", Pr. 380 to Pr. 383)**

- With the S-pattern acceleration/deceleration C switch signal (X20), an acceleration/deceleration curve S-pattern 1 or S-pattern 2 can be selected.
- For the terminal used for X20 signal input, set "20" in any of Pr. 178 to Pr. 189 (input terminal function selection) to assign the function.

Operation X20 signal	During Acceleration	During Deceleration
OFF	Pr. 380 Acceleration S-pattern 1	Pr. 381 Deceleration S-pattern 1
ON	Pr. 382 Acceleration S-pattern 2	Pr. 383 Deceleration S-pattern 2

Parameter setting (%)  $T_s / T \times 100\%$

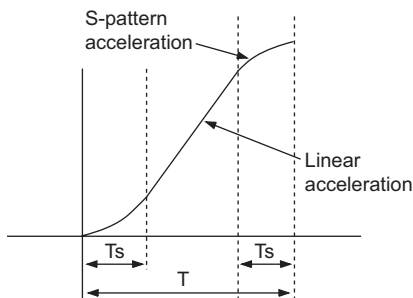

- Set % of time taken for forming an S-pattern in Pr. 380 to Pr. 383 as acceleration time is 100%.

**REMARKS**

- At a start, the motor starts at Pr. 13 Starting frequency when the start signal turns ON.
- If there is a difference between the speed command and speed at a start of deceleration due to torque limit operation etc., the speed command is matched with the speed to make deceleration.

**CAUTION**

- Change the S pattern acceleration/deceleration C switch (X20 signal) after the speed becomes constant.
- S pattern operation before switching continues even if the X20 signal is changed during acceleration or deceleration.
- The X20 signal can be assigned to the input terminal using any of Pr. 178 to Pr. 189 (input terminal function selection). Changing the terminal assignment may affect the other functions. Set parameters after confirming the function of each terminal.



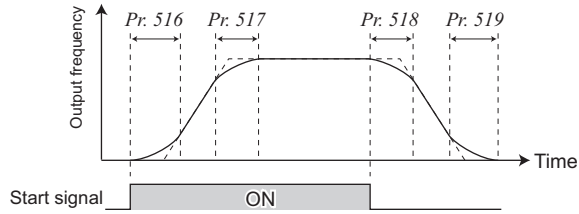

**(6) S-pattern acceleration/deceleration D (Pr. 29 = "5", Pr. 516 to Pr. 519)**

- Set the time taken for S-pattern operation of S-pattern acceleration/deceleration using Pr. 516 to Pr. 519. Set each S-pattern operation time for acceleration start (Pr. 516), acceleration completion (Pr. 517), deceleration start (Pr. 518) and deceleration completion (Pr. 519).
- When S-pattern acceleration/deceleration D is set, acceleration/deceleration time will become longer as follows:

Actual acceleration time T2 = set acceleration time T1 + (S-pattern time at a start of acceleration+S-pattern time at a completion of acceleration) /2  
 Actual deceleration time T2 = set deceleration time T1 + (S-pattern time at a start of deceleration+S-pattern time at a completion of deceleration) /2

Set acceleration/deceleration time T1 indicates the actual time taken for linear acceleration/deceleration calculated based on the Pr. 7, Pr. 8, Pr. 44, Pr. 45, Pr. 110 and Pr. 111 setting.

**CAUTION**

- Even if the start signal is turned off during acceleration, the inverter will not decelerate immediately to avoid sudden frequency change. (Likewise, the inverter will not immediately accelerate when deceleration is changed to reacceleration by turning the start signal on during deceleration, etc.)

- For example, the actual acceleration time when starting the inverter with an S-pattern acceleration/deceleration pattern D selected for a stop to 60Hz in the parameter initial setting is as shown left:

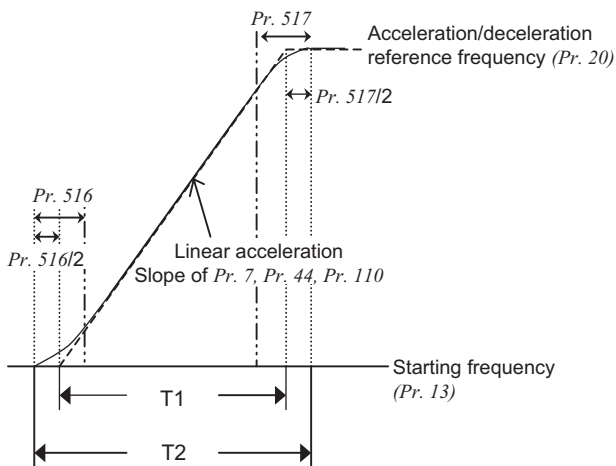

Set acceleration time T1 = (Set frequency - Pr. 13) × Pr. 7/Pr. 20  
 Actual acceleration time T2 = set acceleration time T1 + (Pr. 516 + Pr. 517) /2

Therefore,

Set acceleration time T1 = (60Hz - 0.5Hz) × 5s/60Hz  
 ≃ 4.96s (actual acceleration time at linear acceleration)  
 Actual acceleration time T2 = 4.96s + (0.1s + 0.1s)/2  
 = 5.06s (acceleration time at S-pattern acceleration)

- The actual deceleration time when stopping the inverter with an S-pattern acceleration/deceleration D selected from running frequency to 0 Hz in the parameter initial setting is as shown left:

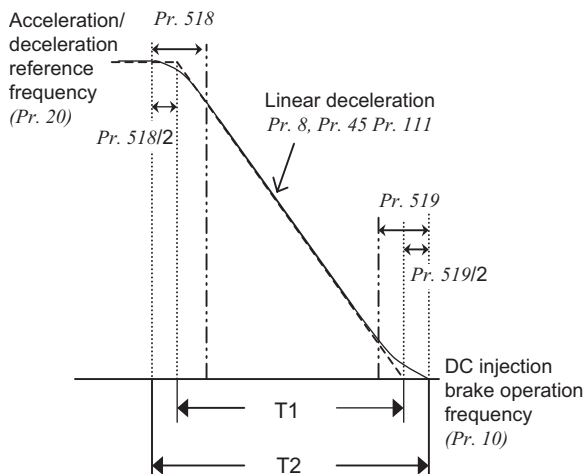

Set deceleration time T1 = (Set frequency - Pr. 10\*) × Pr. 8/Pr. 20  
 Actual deceleration time T2 = Set deceleration time T1 + (Pr. 518 + Pr. 519) /2

\* Pr.10 .... DC injection brake operation frequency

Therefore,

Set deceleration time T1 = (60Hz - 3Hz) × 5s/60Hz  
 ≃ 4.75s (actual deceleration time at linear deceleration)  
 Actual deceleration time T2 = 4.75s + (0.1s + 0.1s)/2  
 = 4.85s (deceleration time at S-pattern deceleration)

---

---





**CAUTION**

---

---

- When the acceleration/deceleration time (*Pr. 7, Pr. 8, etc.*) setting under Real sensorless vector control or vector control is 0s, the S-pattern acceleration/deceleration A to D (*Pr. 29 = "1, 2, 4, 5"*) is linear acceleration/deceleration.
  - Set linear acceleration/deceleration (*Pr. 29 = "0 (initial value)"*) when torque control is exercised under Real sensorless vector control or vector control. When acceleration/deceleration patterns other than the linear acceleration/deceleration are selected, the protective function of the inverter may function.
- 
- 

**◆ Parameters referred to ◆**

*Pr. 3 Base frequency*  Refer to page 142  
*Pr. 7 Acceleration time, Pr. 8 Deceleration time, Pr. 20 Acceleration/deceleration reference frequency*  Refer to page 155  
*Pr. 10 DC injection brake operation frequency*  Refer to page 185  
*Pr. 178 to Pr. 189 ( Input terminal function selection )*  Refer to page 207





#### 4.12.4 Shortest acceleration/deceleration and optimum acceleration/deceleration (automatic acceleration/deceleration) (Pr. 61 to Pr. 63, Pr. 292, Pr. 293)

The inverter operates in the same conditions as when appropriate values are set in each parameter even if acceleration/deceleration time and V/F pattern are not set. This function is useful when you just want to operate, etc. without fine parameter setting.

Parameter Number	Name	Initial Value	Setting Range	Description
61	Reference current	9999	0 to 500A	Set the reference current during shortest/ optimum acceleration/deceleration.
			9999	Rated inverter output current value is reference
62	Reference value at acceleration	9999	0 to 220%	Set the limit value/optimum value during shortest/optimum acceleration.
			9999	Shortest acceleration/deceleration: 150% is a limit value Optimum acceleration/deceleration: 100% is an optimum value
63	Reference value at deceleration	9999	0 to 220%	Set the limit value/optimum value during shortest/optimum deceleration.
			9999	Shortest acceleration/deceleration: 150% is a limit value Optimum acceleration/deceleration: 100% is an optimum value
292	Automatic acceleration/ deceleration	0	0	Normal mode
			3	Optimum acceleration/deceleration mode
			5, 6	Elevator mode1, 2 (refer to page 146)
			7, 8	Brake sequence mode 1, 2 (Refer to page 193.)
			11	Shortest acceleration/deceleration mode
293	Acceleration/ deceleration separate selection	0	0	Both acceleration and deceleration are made in the shortest/ optimum acceleration/deceleration mode
			1	Only acceleration is made in the shortest/optimum acceleration/deceleration mode
			2	Only deceleration is made in the shortest/optimum acceleration/deceleration mode

##### (1) Shortest acceleration/deceleration mode (Pr. 292 = "1, 11", Pr. 293)

- Set when you want to accelerate/decelerate the motor for the shortest time. It is desired to make acceleration/ deceleration in a shorter time for a machine tool etc. but the design values of machine constants are unknown.
- Acceleration/deceleration speed is automatically adjusted at a start of acceleration/deceleration so that acceleration/deceleration is made with the maximum torque the inverter can output according to the setting value of Pr. 7 Acceleration time and Pr. 8 Deceleration time. (The setting values of Pr. 7 and Pr. 8 are not changed)
- Either acceleration or deceleration can be made in the shortest time using Pr. 293 Acceleration/deceleration separate selection.

When the setting value is "0" (initial value), both acceleration and deceleration can be made in the shortest time.

- When the shortest acceleration/deceleration mode is selected under V/F control and Advanced magnetic flux vector control, the stall prevention operation level during acceleration/deceleration becomes 150% (adjustable using Pr. 61 to Pr. 63). The setting of Pr. 22 Stall prevention operation level and stall level by analog input are used only during a constant speed operation.

Adjustment using Pr. 61 to Pr. 63 can not be made under Real sensorless vector control or vector control since torque limit level (Pr. 22 etc.) is used during acceleration/deceleration.

- It is inappropriate to use for the following applications.
  - Machine with a large inertia such as a fan (more than 10 times). Since stall prevention operation will be activated for a long time, this type of machine may be brought to an alarm stop due to motor overloading, etc.
  - It is desired to always perform operation with a constant acceleration/deceleration time.

##### REMARKS

- Even if automatic acceleration/deceleration mode has been selected, inputting the JOG signal (jog operation), RT signal (second function selection) or X9 signal (third function selection) during an inverter stop will switch to the normal operation and give priority to jog operation, second function selection or third function selection. Note that JOG and RT signal input is invalid even if JOG signal and RT signal are input during operation in automatic acceleration/deceleration mode.
- Since acceleration/deceleration is made with the stall prevention operation being activated, the acceleration/deceleration speed always varies according to the load conditions.
- Note that when proper values are set in Pr. 7 and Pr. 8, acceleration/deceleration time may be shorter than selecting shortest acceleration/deceleration mode.

**(2) Optimum acceleration/deceleration mode (Pr. 292 = "3", Pr. 293)**

- The optimum operation within the rating range where the inverter can be continuously used regardless of the inverter capability is performed.  
Automatically set torque boost and acceleration/deceleration time so that the average current during acceleration/deceleration is the rated current by the self-learning of the inverter.  
It is appropriate for applications such as automatic transfer machine, etc. which is small in load change and is operated in a predetermined pattern.
- At the initial time when the optimum acceleration/deceleration mode has been selected, operation is performed at the values set in Pr. 0 Torque boost, Pr. 7 Acceleration time and Pr. 8 Deceleration time. After operation, the average current and peak current are calculated from the motor current during acceleration/deceleration. These values are compared with the reference current (initial value is rated inverter current) and calculated, then more appropriate values are set in Pr. 0, Pr. 7 and Pr. 8 .  
After that, operation is performed under the conditions of Pr. 0, Pr. 7 and Pr. 8 set, and more appropriate values are calculated.  
Note that the Pr. 0 value will not change under Advanced magnetic flux vector control, Real sensorless vector control or vector control.
- When overvoltage fault (E.OV3) occurs at deceleration, the Pr. 8 setting value becomes 1.4 times larger.

**Storage of parameters**  
The optimum values of Pr. 0, Pr. 7 and Pr. 8 are written to both the parameter RAM and EEPROM only three times of acceleration/deceleration after the optimum acceleration/deceleration mode has been selected or after the power is switched on or the inverter is reset. At of after the fourth attempt, they are not stored into EEPROM. Hence, after power-on or inverter reset, the values changed at the third time are valid. Note that the values changed at the fourth or later time are calculated to optimum and the values of Pr. 0, Pr. 7 and Pr. 8 are set to RAM, the values can be stored into EEPROM by reading and writing the values with the operation panel and parameter unit.

Number of Optimum Value Changes	Pr. 0, Pr. 7, Pr. 8		Optimum Conditions
	EEPROM value	RAM value	
1 to 3 times	Updated	Updated	Updated
4 or more times	Unchanged from third value	Updated	Updated

- Either acceleration or deceleration can be made in the optimum acceleration/deceleration mode using Pr. 293 Acceleration/deceleration separate selection.  
When the setting value is "0" (initial value), both acceleration and deceleration are made in the optimum acceleration/deceleration mode.
- It is inappropriate for machines which change in load and operation conditions.  
Optimum values are saved for the next operation. If the operating condition changes before the next operation, a fault such as overcurrent trip or a lack of acceleration/deceleration may occur.

**REMARKS**

- If shortest acceleration/deceleration mode has been selected, inputting the JOG signal (jog operation), RT signal (second function selection) or X9 signal (third function selection) during an inverter stop will switch to the normal operation and give priority to jog operation, second function selection or third function selection. Note that JOG and RT signal input is invalid even if JOG signal and RT signal are input during operation in shortest/optimum acceleration/deceleration mode.
- Because of the learning system, this mode is not valid at the first operation after the optimum acceleration/deceleration mode is set.
- The optimum value are operated on only when acceleration is made from a stop to 30Hz or more or when deceleration is made from 30Hz or more to stop.
- When the motor is not connected or output current is less than 5% of the rated inverter current, optimum acceleration/deceleration mode will not function.
- Even when the optimum acceleration/deceleration mode is selected and Pr. 293 = "1" (acceleration only for the optimum acceleration/deceleration mode), overvoltage fault (E.OV3) occurrence at deceleration makes the Pr. 8 setting value be set again longer.



### (3) Adjustment of shortest and optimum acceleration/deceleration mode (Pr. 61 to Pr. 63)

- By setting the adjustment parameters Pr. 61 to Pr. 63, the application range can be made wider.

Parameter Number	Name	Setting Range	Description
61	Reference current	0 to 500A	For example, when the motor and inverter are different in capacity, set the rated motor current value. Shortest acceleration/deceleration: Set reference current (A) of the stall prevention operation level during acceleration/deceleration Optimum acceleration/deceleration: Set reference current (A) of the optimum current during acceleration/deceleration
		9999 (initial value)	The rated inverter current is defined as reference.
62 63	Reference value at acceleration Reference value at deceleration	0 to 220%	Set when it is desired to change the reference level of acceleration and deceleration. Shortest acceleration/deceleration: Set the stall prevention operation level (ratio to the current value of Pr. 61 ) during acceleration/deceleration. Optimum acceleration/deceleration: Set the optimum current level (ratio to the current value of Pr. 61 ) during acceleration/deceleration.
		9999 (initial value)	Shortest acceleration/deceleration: The 150% value during shortest acceleration/deceleration is judged as the stall prevention operation level. Optimum acceleration/deceleration: 100% is the optimum value

#### REMARKS

- Pr. 61 to Pr. 63 are invalid when Real sensorless vector control or vector control is selected in the shortest acceleration/deceleration mode.
- Since the Pr. 61 to Pr. 63 settings automatically return to the initial value (9999) if the Pr. 292 setting is changed, set Pr. 292 first when you need to set Pr. 61 to Pr. 63.

#### ◆ Parameters referred to ◆

- Pr. 0 Torque boost Refer to page 129
- Pr. 7 Acceleration time, Pr. 8 Deceleration time Refer to page 155
- Pr. 22 Stall prevention operation level Refer to page 135
- Pr. 22 Torque limit level Refer to page 83

## 4.13 Selection and protection of a motor

Purpose	Parameter that must be Set		Refer to Page
Motor protection from overheat	Electronic thermal O/L relay	Pr. 9, Pr. 51	165
Use the constant torque motor	Applied motor	Pr. 71	169
The motor performance can be maximized for operation in magnetic flux vector control method	Offline auto tuning	Pr. 82 to Pr. 84, Pr. 90 to Pr. 94, Pr. 96	171
High accuracy operation unaffected by the motor temperature and stable operation with high torque down to ultra low speed are performed	Online auto tuning	Pr. 95, Pr. 574	181

### 4.13.1 Motor protection from overheat (Electronic thermal relay function) (Pr. 9, Pr. 51)

Set the current of the electronic thermal O/L relay to protect the motor from overheat. This feature provides the optimum protective characteristics, including reduced motor cooling capability, at low speed.

Parameter Number	Name	Initial Value	Setting Range	Description
9	Electronic thermal O/L relay	Rated inverter current	0 to 500A	Set the rated motor current.
51	Second electronic thermal O/L relay *	9999	0 to 500A	Made valid when the RT signal is ON. Set the rated motor current.
			9999	Second electronic thermal O/L relay invalid

\* When parameter is read using the FR-PU04, a parameter name different from an actual parameter is displayed.

#### (1) Electronic thermal relay function operation characteristic (THM)

[Electronic thermal relay function operation characteristic (E.THM)]

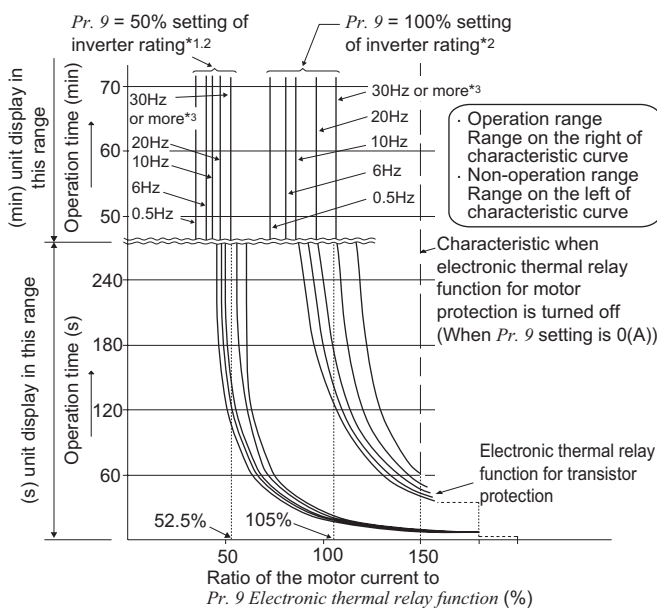

This function detects the overload (overheat) of the motor, stops the operation of the inverter's output transistor, and trips. (The operation characteristic is shown on the left)

- Set the rated current [A] of the motor in Pr. 9. (If the motor has both 50Hz and 60Hz rating and the Pr. 3 Base frequency is set to 60Hz, set the 1.1 times of the 60Hz rated motor current.)
- Set "0" in Pr. 9 when you do not want to activate the electronic thermal relay function, e.g. when using an external thermal relay with the motor. (Note that the output transistor protection of the inverter functions (E.THT).)
- When using the Mitsubishi constant-torque motor
  - Set "1" or any of "13" to "18", "50", "53", "54" in Pr. 71. (This provides a 100% continuous torque characteristic in the low-speed range.)
  - Set the rated current of the motor in Pr. 9.

- \*1 When 50% of the rated inverter current (current value) is set in Pr. 9
- \*2 The % value denotes the percentage to the rated inverter current. It is not the percentage to the rated motor current.
- \*3 When you set the electronic thermal relay function dedicated to the Mitsubishi constant-torque motor, this characteristic curve applies to operation at 6Hz or higher.

#### CAUTION

- Fault by electronic thermal relay function is reset by inverter power reset and reset signal input. Avoid unnecessary reset and power-OFF.
- When multiple motors are operated by a single inverter, protection cannot be provided by the electronic thermal relay function. Install an external thermal relay to each motor.
- When the difference between the inverter and motor capacities is large and the setting is small, the protective characteristics of the electronic thermal relay function will be deteriorated. In this case, use an external thermal relay.
- A special motor cannot be protected by the electronic thermal relay function. Use the external thermal relay.
- Since a thermal relay protector is built in a motor dedicated for vector control (SF-V5RU), set "0" in Pr. 9 to use the motor.

**(2) Electronic thermal relay function operation characteristic (THT)**

Electronic thermal relay function (transistor protection thermal) operation characteristics of the inverter when the ratio of the motor current to the inverter rated current is presented as transverse is shown. Transverse is calculated as follows: (motor current [A]/inverter rated current [A]) × 100 [%].

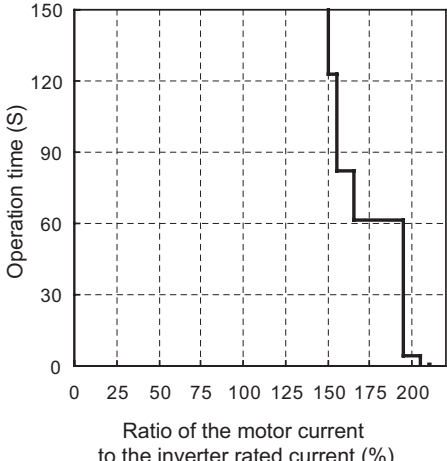
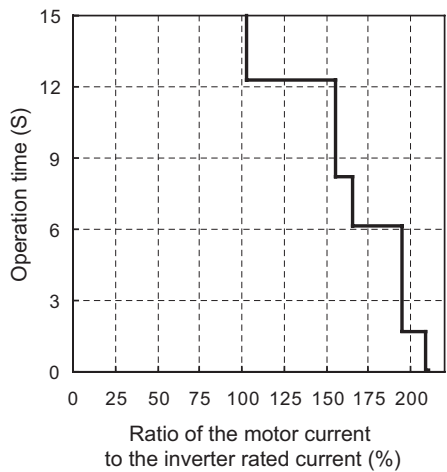
Optimum Conditions	Electronic thermal relay function operation characteristic (THT)
Running frequency : 1Hz or more Carrier frequency: 2kHz	
Running frequency : 1Hz or less Carrier frequency: 2kHz	

**CAUTION**

- Fault by electronic thermal relay function is reset by inverter power reset and reset signal input. Avoid unnecessary reset and power-off.
- The operation time of the transistor protection thermal relay shortens when the *Pr. 72 PWM frequency selection* setting increases.

### (3) Set multiple electronic thermal relay functions (Pr. 51)

Use this function when rotating two motors of different rated currents individually by a single inverter. (When rotating two motors together, use external thermal relays.)

- Set the rated current of the second motor in Pr. 51.
- When the RT signal is ON, thermal protection is provided based on the Pr. 51 setting.

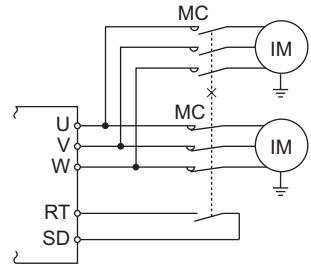

Pr. 450 Second applied motor	Pr. 9 Electronic thermal O/L relay	Pr. 51 Second electronic thermal O/L relay	RT = OFF		RT = ON	
			First motor	Second motor	First motor	Second motor
9999	0	9999	×	×	×	×
		0	×	×	×	×
		0.01 to 500 (0.1 to 3600)	×	★	×	○
9999	Other than 0	9999	○	×	○	×
		0	○	×	★	×
		0.01 to 500 (0.1 to 3600)	○	★	★	○
Other than 9999	0	9999	×	×	×	×
		0	×	×	×	×
		0.01 to 500 (0.1 to 3600)	×	★	×	○
Other than 9999	Other than 0	9999	○	★	★	○
		0	○	×	★	×
		0.01 to 500 (0.1 to 3600)	○	★	★	○

- .... Output current value is used to perform integration processing.
- ★ .... Output current is assumed as 0A to perform integration processing. (cooling processing)
- × ..... Electronic thermal relay function is not activated.

#### REMARKS

- The RT signal acts as the second function selection signal and makes the other second functions valid. (Refer to page 211)
- The RT signal is assigned to the terminal RT in the initial setting. By setting "3" in any of Pr. 178 to Pr. 189 (input terminal function selection), you can assign the RT signal to the other terminal.

### (4) Electronic thermal relay function prealarm (TH) and alarm signal (THP signal)

100%: Electronic thermal relay function alarm operation value

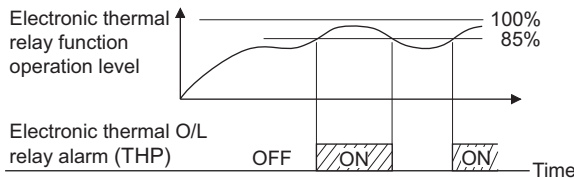

- The alarm signal (THP) is output and an electronic thermal prealarm (TH) is displayed when the electronic thermal relay function cumulative value reaches 85% of the level set in Pr. 9 or Pr. 51. If it reaches 100% of the Pr. 9 Electronic thermal O/L relay setting, electronic thermal relay function protection (E. THM/E.THT) occurs.
- The inverter does not trip even when the alarm signal (THP) is output.
- For the terminal used for the THP signal output, assign the function by setting "8" (positive logic) or "108" (negative logic) in any of Pr. 190 to Pr. 196 (output terminal function selection).

#### CAUTION

- Changing the terminal assignment using Pr. 190 to Pr. 196 (output terminal function selection) may affect the other functions. Set parameters after confirming the function of each terminal.

### (5) External thermal relay input (OH signal)

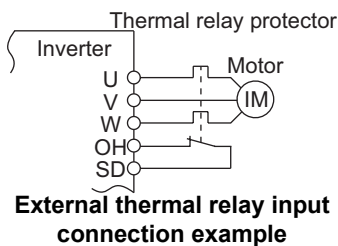

- To protect the motor against overheat, use the OH signal when using an external thermal relay or the built-in thermal protector of the motor.
- When the thermal relay operates, the inverter trips and outputs the fault signal (E.OHT).
- For the terminal used for OH signal input, assign the function by setting "7" in any of Pr. 178 to Pr. 189 (input terminal function selection)

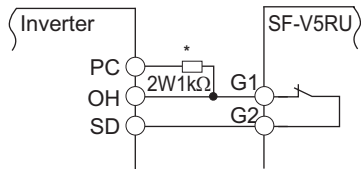

Connection of the thermal protector of the SF-V5RU

- A thermal protector is provided for a vector control dedicated motor (SF-V5RU).
- \* Assign OH (external thermal input) signal to the CS terminal.  
(Pr. 186 = "7")  
Connect a 2W1kΩ resistor between the terminal PC and CS(OH).  
Install the resistor pushing it against the bottom part of the terminal block so as to avoid a contact with other cables.  
Refer to page 207 for details of Pr. 186 CS terminal function selection.

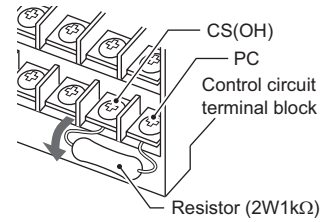

**CAUTION**

- Changing the terminal assignment using Pr. 178 to Pr. 189 (input terminal function selection) may affect the other functions. Set parameters after confirming the function of each terminal.

**(6) PTC thermistor input (PTC signal)**

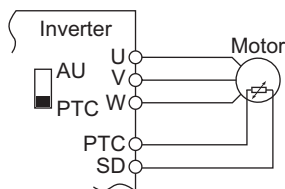

PTC thermistor input connection example

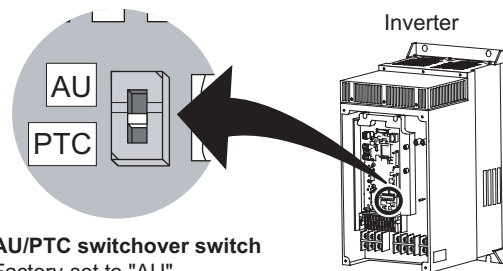

**AU/PTC switchover switch**  
Factory-set to "AU".  
Set to the "PTC" position to validate the PTC signal input.

Built-in PTC thermistor of the motor can be input to the PTC signal (AU terminal).

- For the terminal used for PTC signal input, assign the function by setting "63" in Pr. 184 AU terminal function selection and also set the AU/PTC switchover switch to the PTC terminal function. (The initial setting is the AU terminal function.)
- If a motor overheat state is detected for more than 10s according to the input from the PTC thermistor, the inverter trips and outputs the PTC thermal fault signal (E.PTC).
- The input specifications of the PTC thermistor are shown on the right.

Motor Temperature	PTC Thermistor Resistance Value (Ω)
Normal	0 to 500
Boundary	500 to 4k
Overheat	4k or higher

**CAUTION**

- When the PTC signal was not assigned to Pr. 184 and the AU/PTC switchover switch was set to the PTC terminal function, the function assigned to the AU terminal is always OFF. Reversely, when the PTC signal was assigned to Pr. 184 and the AU/PTC switchover switch was set to the AU terminal function, a PTC thermal fault (E.PTC) occurs since the function is always in a motor overheat state.
- When you want to input a current, assign the AU signal to the other signal.
- When terminal assignment is changed, the other functions may be affected. Set parameters after confirming the function of the AU terminal.

◆ Parameters referred to ◆

- Pr. 71 Applied motor Refer to page 169
- Pr. 72 PWM frequency selection Refer to page 261
- Pr. 178 to Pr. 189 (input terminal function selection) Refer to page 207
- Pr. 190 to Pr. 196 (output terminal function selection) Refer to page 215
- Specifications of the AU terminal Refer to page 22

### 4.13.2 Applied motor (Pr. 71, Pr. 450)

Setting of the used motor selects the thermal characteristic appropriate for the motor. Setting is necessary when using a constant-torque motor. Thermal characteristic of the electronic thermal relay function suitable for the motor is set. When Advanced magnetic flux vector, Real sensorless vector control or vector control is selected, the motor constants (SF-JR, SF-HR, SF-JRCA, SF-HRCA, SF-V5RU (1500r/min series)) necessary for control are selected as well.

Parameter Number	Name	Initial Value	Setting Range	Description
71	Applied motor	0	0 to 8, 13 to 18, 30, 33, 34, 40, 43, 44, 50, 53, 54	Selecting the standard motor or constant-torque motor sets the corresponding motor thermal characteristic.
450	Second applied motor	9999	0 to 8, 13 to 18, 30, 33, 34, 40, 43, 44, 50, 53, 54	Set when using the second motor. (same specifications as Pr. 71)
			9999	Not function

#### (1) Set the motor to be used

Refer to the following list and set this parameter according to the motor used.

Pr. 71 (Pr. 450) Setting		Thermal Characteristic of the Electronic Thermal Relay Function		Motor (O : used motor)		
Pr. 71	Pr. 450			Standard (SF-JR etc.)	Constant torque (SF-JRCA etc.)	Vector (SF-V5RU)
0 (Pr. 71 initial value)		Thermal characteristics of a standard motor		○		
1		Thermal characteristics of the Mitsubishi constant-torque motor			○	
2		Thermal characteristics of a standard motor Adjustable 5 points V/F (Refer to page 147)		○		
30		Vector control dedicated motor SF-V5RU (1500r/min series)				○
40		Thermal characteristic of Mitsubishi high efficiency motor SF-HR		○*1		
50		Thermal characteristic of Mitsubishi constant-torque motor SF-HRCA			○*2	
3		Standard motor	Select "offline auto tuning setting"	○		
13		Constant-torque motor Vector control dedicated motor SF-V5RU (except for 1500 r/min series).			○	○*3
33		Vector control dedicated motor SF-V5RU (1500r/min series), SF-THY				○
43		Mitsubishi High efficiency motor (SF-HR)		○*1		
53		Mitsubishi constant-torque motor (SF-HRCA)			○*2	
4		Standard motor	Auto tuning data can be read, changed, and set	○		
14		Constant-torque motor Vector control dedicated motor SF-V5RU (except for 1500 r/min series).			○	○*3
34		Vector control dedicated motor SF-V5RU (1500r/min series), SF-THY				○
44		Mitsubishi High efficiency motor (SF-HR)		○*1		
54		Mitsubishi constant-torque motor (SF-HRCA)			○*2	
5		Standard motor	Star connection	Direct input of motor constants is enabled	○	
15		Constant-torque motor	Delta connection		○	
6		Standard motor	Star connection	Motor constants direct input + offline auto tuning	○	
16		Constant-torque motor			○	
7		Standard motor	Delta connection		○	
17		Constant-torque motor			○	
8		Standard motor				
18		Constant-torque motor			○	
—	9999 (initial value)	Without second applied motor				

\*1 Motor constants of Mitsubishi high efficiency motor SF-HR.  
 \*2 Motor constants of Mitsubishi constant-torque motor SF-HRCA.  
 \*3 Select this setting for vector control dedicated motor (SF-V5RU (except for 1500 r/min series)).





**REMARKS**

- When performing offline auto tuning, set "3, 7, 8, 13, 17, 18, 33, 43, 53" in Pr. 71. (Refer to page 171 for offline auto tuning)
- For the 5.5K and 7.5K, the Pr. 0 Torque boost and Pr. 12 DC injection brake operation voltage settings are automatically changed according to the Pr. 71 setting as follows.

Pr. 71	Standard Motor Setting 0, 2, 3 to 8, 40, 43, 44	Constant Torque Motor Setting 1, 13 to 18, 50, 53, 54
Pr. 0	3%	2%
Pr. 12	4%	2%

**(2) Use two types of motors (Pr. 450)**

- Set Pr. 450 Second applied motor to use two types of motors with one inverter.
- When "9999" (initial value) is set, no function is selected.
- When Pr. 450 ≠ 9999, turning the RT signal on makes the following parameter valid.

Function	RT Signal ON (second motor)	RT Signal OFF (first motor)
Applied motor	Pr. 450	Pr. 71
Control method selection	Pr. 451	Pr. 800
Motor capacity	Pr. 453	Pr. 80
Number of motor poles	Pr. 454	Pr. 81
Motor excitation current	Pr. 455	Pr. 82
Rated motor voltage	Pr. 456	Pr. 83
Rated motor frequency	Pr. 457	Pr. 84
Motor constant (R1)	Pr. 458	Pr. 90

Function	RT Signal ON (second motor)	RT Signal OFF (first motor)
Motor constant (R2)	Pr. 459	Pr. 91
Motor constant (L1)	Pr. 460	Pr. 92
Motor constant (L2)	Pr. 461	Pr. 93
Motor constant (X)	Pr. 462	Pr. 94
Auto tuning setting/status	Pr. 463	Pr. 96
Online auto tuning selection	Pr. 574	Pr. 95
Torque current	Pr. 860	Pr. 859

**REMARKS**

- The RT signal acts as the second function selection signal and makes the other second functions valid. (Refer to page 211)
- The RT signal is assigned to the terminal RT in the initial setting. By setting "3" in any of Pr. 178 to Pr. 189 (input terminal function selection), you can assign the RT signal to the other terminal.

**CAUTION**

- Changing the terminal assignment using Pr. 178 to Pr. 189 (input terminal function selection) may affect the other functions. Set parameters after confirming the function of each terminal.

**⚠ CAUTION**

- ⚠ Set this parameter correctly according to the motor used. Incorrect setting may cause the motor to overheat and burn.

◆ Parameters referred to ◆

- Pr. 0 Torque boost Refer to page 129
- Pr. 12 DC injection brake operation voltage Refer to page 185
- Pr. 80 Motor capacity, Pr. 81 Number of motor poles, Pr. 453 Second motor capacity, Pr. 454 Number of second motor poles Refer to page 131
- Pr. 82 to Pr. 84, Pr. 90 to Pr. 94, Pr. 96, Pr. 455 to Pr. 463, Pr. 859, Pr. 860 (Motor constant) Refer to page 171
- Pr. 95 Online auto tuning selection, Pr. 574 Second motor online auto tuning Refer to page 181
- Pr. 451 Second motor control method selection, Pr. 800 Control method selection Refer to page 75
- Pr. 100 to Pr. 109 (Adjustable 5 points V/F) Refer to page 147

**4.13.3 Offline auto tuning (Pr. 71, Pr. 80 to Pr. 84, Pr. 90 to Pr. 94, Pr. 96, Pr. 450, Pr. 453 to Pr. 463, Pr. 684, Pr. 859, Pr. 860)**

Magnetic flux
Sensorless
Vector

The motor performance can be maximized with offline auto tuning.

- What is offline auto tuning?

When performing Advanced magnetic flux vector control, Real sensorless vector control or vector control, the motor can be run with the optimum operating characteristics by automatically measuring the motor constants (offline auto tuning) even when each motor constants differs, other manufacturer's motor is used, or the wiring length is long. (30m or longer as reference)

Parameter Number	Name	Initial Value	Setting Range	Description
71	Applied motor	0	0 to 8, 13 to 18, 30, 33, 34, 40, 43, 44, 50, 53, 54	By selecting a standard motor or constant-torque motor, thermal characteristic and motor constants of each motor are set.
80	Motor capacity	9999	0.4 to 55kW	Set the applied motor capacity.
			9999	V/F control
81	Number of motor poles	9999	2, 4, 6, 8, 10	Set the number of motor poles.
			12, 14, 16, 18, 20	X18 signal-ON:V/F control Set 10 + number of motor poles.
			9999	V/F control
82	Motor excitation current	9999	0 to 500A	Tuning data (The value measured by offline auto tuning is automatically set.)
			9999	Use the Mitsubishi motor (SF-JR, SF-HR, SF-JRCA, SF-HRCA, SF-V5RU (1500r/min series)) constants
83	Rated motor voltage	200/400V *	0 to 1000V	Set the rated motor voltage(V). * The initial value differs according to the voltage level. (200V/400V)
84	Rated motor frequency	60Hz	10 to 120Hz	Set the rated motor frequency (Hz).
90	Motor constant (R1)	9999	0 to 50Ω, 9999	Tuning data (The value measured by offline auto tuning is automatically set.) 9999: Use the Mitsubishi motor (SF-JR, SF-HR, SF-JRCA, SF-HRCA, SF-V5RU (1500r/min series)) constants
91	Motor constant (R1)	9999	0 to 50Ω, 9999	
92	Motor constant (L1)	9999	0 to 50Ω, (0 to 1000mH), 9999	
93	Motor constant (L2)	9999	0 to 50Ω (0 to 1000mH), 9999	
94	Motor constant (X)	9999	0 to 500Ω (0 to 100%), 9999	
96	Auto tuning setting/ status	0	0	Offline auto tuning is not performed
			1	Offline auto tuning is performed without motor running
			101	Offline auto tuning is performed with motor running
450	Second applied motor	9999	0 to 8, 13 to 18, 30, 33, 34, 40, 43, 44, 50, 53, 54	Set when using the second motor. (same specifications as Pr. 71)
			9999	Not function
453	Second motor capacity	9999	0.4 to 55kW	Set the capacity of the second motor.
			9999	V/F control
454	Number of second motor poles	9999	2, 4, 6, 8, 10	Set the number of poles of the second motor.
			9999	V/F control
455	Second motor excitation current	9999	0 to 500A	Tuning data of the second motor (The value measured by offline auto tuning is automatically set.)
			9999	Use the Mitsubishi motor (SF-JR, SF-HR, SF-JRCA, SF-HRCA, SF-V5RU (1500r/min series)) constants
456	Rated second motor voltage	200/400V *	0 to 1000V	Set the rated voltage (V) of the second motor. * The initial value differs according to the voltage level. (200V/400V)
457	Rated second motor frequency	60Hz	10 to 120Hz	Set the rated motor frequency (Hz) of the second motor.



Parameter Number	Name	Initial Value	Setting Range	Description
458	Second motor constant (R1)	9999	0 to 50Ω, 9999	Tuning data of the second motor (The value measured by offline auto tuning is automatically set.) 9999: Use the Mitsubishi motor (SF-JR, SF-HR, SF-JRCA, SF-HRCA, SF-V5RU (1500r/min series)) constants
459	Second motor constant (R2)	9999	0 to 50Ω, 9999	
460	Second motor constant (L1)	9999	0 to 50Ω (0 to 1000mH), 9999	
461	Second motor constant (L2)	9999	0 to 50Ω (0 to 1000mH), 9999	
462	Second motor constant (X)	9999	0 to 500Ω (0 to 100%), 9999	
463	Second motor auto tuning setting/status	0	0	Second motor auto tuning is not performed
			1	Offline auto tuning is performed without second motor running
			101	Offline auto tuning is performed with second motor running
684	Tuning data unit switchover	0	0	Internal data converted value
			1	Displayed in "A, Ω, mH, %"
859	Torque current	9999	0 to 500A	Tuning data (The value measured by offline auto tuning is automatically set.)
			9999	Use the Mitsubishi motor (SF-JR, SF-HR, SF-JRCA, SF-HRCA, SF-V5RU (1500r/min series)) constants
860	Second motor torque current	9999	0 to 500A	Tuning data of the second motor (The value measured by offline auto tuning is automatically set.)
			9999	Use the Mitsubishi motor (SF-JR, SF-HR, SF-JRCA, SF-HRCA, SF-V5RU (1500r/min series)) constants

**POINT**

- This function is valid only when a value other than "9999" is set in *Pr. 80* and *Pr. 81* and Advanced magnetic flux vector control, Real sensorless vector control or vector control is selected.
- You can copy the offline auto tuning data (motor constants) to another inverter with the PU (FR-DU07/FR-PU07).
- Even when motors (other manufacturer's motor, SF-JRC, etc.) other than Mitsubishi standard motor (SF-JR 3.7kW or higher), high efficiency motor (SF-HR 3.7kW or higher), Mitsubishi constant-torque motor (SF-JRCA 4P, SF-HRCA 3.7kW or higher) and vector control dedicated motor (SF-V5RU (1500r/min series)) are used or the wiring length is long (30m or longer as reference), using the offline auto tuning function runs the motor with the optimum operating characteristics.
- Tuning is enabled even when a load is connected to the motor. (As the load is lighter, tuning accuracy is higher. Tuning accuracy does not change even if the inertia is large.)
- For the offline auto tuning, you can select either the motor non-rotation mode (*Pr. 96* = "1") or rotation mode (*Pr. 96* = "101").
- The rotation mode has higher tuning accuracy than the non-rotation mode.
- Reading/writing/copy of motor constants tuned by offline auto tuning are enabled.
- The offline auto tuning status can be monitored with the PU (FR-DU07/FR-PU07/FR-PU04).
- Do not use an inverter with a surge voltage suppression filter (FR-ASF-H) connected between the inverter and motor.

## (1) Before performing offline auto tuning

Check the following before performing offline auto tuning.

- Make sure Advanced magnetic flux vector control (*Pr. 80, Pr. 81*), Real sensorless vector control or vector control (*Pr. 800*) is selected.
- A motor should be connected. Note that the motor should be at a stop at a tuning start.
- The motor capacity should be equal to or one rank lower than the inverter capacity.
- Motors such as high-slip motor, high-speed motor and special motor cannot be tuned. (The maximum frequency is 120Hz.)
- Even if tuning is performed without motor running (*Pr. 96 Auto tuning setting/status = "1"*), the motor may run slightly. Therefore, fix the motor securely with a mechanical brake, or before tuning, make sure that there will be no problem in safety if the motor runs. (Caution is required especially in vertical lift applications). Note that if the motor runs slightly, tuning performance is unaffected.
- Note the following when selecting offline auto tuning performed with motor running (*Pr. 96 Auto tuning setting/status = "101"*).
  - Torque is not enough during tuning.
  - The motor may be run at nearly its rated speed.
  - The mechanical brake is open.
  - No external force is applied to rotate the motor.
- Offline auto tuning will not be performed properly if it is performed with a surge voltage suppression filter (FR-ASF-H) connected between the inverter and motor. Remove it before starting tuning.
- When exercising vector control, use the encoder that is coupled directly to the motor shaft without looseness. Speed ratio should be 1:1.



**(2) Setting**

- 1) Select the Advanced magnetic flux vector control, Real sensorless vector control or vector control (refer to page 75).
- 2) Set "1" or "101" in Pr. 96 Auto tuning setting/status .
  - When the setting is "1" . . . . . Tuning is performed without motor running.  
It takes approximately 25 to 120s \* until tuning is completed.  
(Excitation noise is produced during tuning.)  
\*Tuning time differs according to the inverter capacity and motor type.
  - When the setting is "101" . . . . . Tuning is performed with motor running.  
It takes approximately 40s until tuning is completed.  
The motor runs at nearly its rated frequency.
- 3) Set the rated motor current (initial value is rated inverter current) in Pr. 9 Electronic thermal O/L relay (refer to page 165 ).
- 4) Set the rated voltage of motor (initial value is 200V/400V) in Pr. 83 Rated motor voltage and rated frequency of motor (initial value is 60Hz) in Pr. 84 Rated motor frequency .  
(For a Japanese standard motor, etc. which has both 50Hz and 60Hz rated values, set 200V/60Hz or 400V/60Hz.)  
For vector control dedicated motor SF-V5RU1 / V5RU3 / V5RU4, set as the following table.

	Pr. 83 Setting	Pr. 84 Setting
SF-V5RU1-30kW or less	160V	33.33Hz
SF-V5RU1-37kW	170V	
SF-V5RU3-22kW or less	160V	
SF-V5RU3-30kW	170V	
SF-V5RU4-3.7kW, 7.5kW	150V	16.67Hz
SF-V5RU4-other than the above	160V	

**REMARKS**

- When using the vector control dedicated motor SF-V5RU (1500r/min series) or SF-THY, setting 33 and 34 in Pr. 71 selects internal constants appropriate for dedicated motors. Therefore, Pr. 83 and Pr. 84 settings are unnecessary.
- Perform auto tuning for SF-V5RU (except for 1500 r/min series) with setting 13 or 14 in Pr. 71 ( For perform auto tuning, set Pr. 83 and Pr. 84)
- When Pr. 11 DC injection brake operation time = "0" or Pr.12 DC injection brake operation voltage = "0," offline auto tuning is performed at the initial setting of Pr. 11 or Pr. 12.
- When the positioning control is selected (Pr. 800 = "3" or "5" (when MC signal is OFF)), offline auto tuning is not performed.

- 5) Set Pr. 71 Applied motor according to the motor used.



Motor	Pr. 71 Setting *	
Mitsubishi standard motor Mitsubishi high efficiency motor	SF-JR	3
	SF-HR	43
	Others	3
Mitsubishi constant-torque motor	SF-JRCA 4P	13
	SF-HRCA	53
	Others (SF-JRC, etc.)	13
Vector control dedicated motor	SF-V5RU (1500r/min series)	33
	SF-THY	13
	SF-V5RU (except for 1500r/min series)	13
Other manufacturer's standard motor	—	3
Other manufacturer's constant-torque motor	—	13

\* For other settings of Pr. 71, refer to page 169.

### (3) Execution of tuning

**CAUTION**

- Before performing tuning, check the monitor display of the operation panel (FR-DU07) or parameter unit (FR-PU04/FR-PU07) if the inverter is in the state ready for tuning. (Refer to 2) below) When the start command is turned ON under V/F control, the motor starts.

1)When performing PU operation, press  /  of the operation panel.

For external operation, turn ON the start command (STF signal or STR signal). Tuning starts.

**REMARKS**

- The offline auto tuning starts when the inverter start conditions, including the ON status of the MRS signal, are met.
- To force tuning to end, use the MRS or RES signal or press  of the operation panel.  
(Turning the start signal (STF signal or STR signal) off also ends tuning.)
- During offline auto tuning, only the following I/O signals are valid: (initial value)
  - Input signals <valid signal> STOP, OH, MRS, RT, CS, RES, STF, STR
  - Output terminal RUN, OL, IPF, FM, AM, A1B1C1
 Note that the progress status of offline auto tuning is output in fifteen steps from AM and FM when speed and output frequency are selected.
- Do not perform ON/OFF switching of the second function selection signal (RT) during execution of offline auto tuning. Auto tuning is not executed properly.
- Setting offline auto tuning (Pr. 96 Auto tuning setting/status = "1 or 101") will make pre-excitation invalid.

**CAUTION**

- When selecting offline auto tuning performed with motor running (Pr. 96 Auto tuning setting/status = "101"), caution must be taken since the motor runs.
- Since the RUN signal turns ON when tuning is started, caution is required especially when a sequence which releases a mechanical brake by the RUN signal has been designed.
- When executing offline auto tuning, input the run command after switching on the main circuit power (R/L1, S/L2, T/L3) of the inverter.
- When Pr.79 = "7," turn ON the X12 signal and select the PU operation mode to perform tuning.

2)Monitor is displayed on the operation panel (FR-DU07) and parameter unit (FR-PU07/FR-PU04) during tuning as below.

	Parameter Unit (FR-PU07/FR-PU04) Display		Operation Panel (FR-DU07) Display	
Pr. 96 setting	1	101	1	101
(1) Setting				
(2) Tuning in progress				
(3) Normal end				
(4) Error end (when the inverter protective function is activated)				

Reference: Offline auto tuning time (when the initial value is set)

Offline Auto Tuning Setting	Time
Non-rotation mode (Pr. 96 = "1")	Approximately 25 to 120s (Tuning time differs according to the inverter capacity and motor type.)
Rotation mode (Pr. 96 = "101")	Approximately 40s (Offline auto tuning time varies with the acceleration and deceleration time settings as indicated below. Offline auto tuning time = acceleration time + deceleration time + approx. 30s)



- 3) When offline auto tuning ends, press  of the operation panel during PU operation. For external operation, turn OFF the start signal (STF signal or STR signal).  
 This operation resets the offline auto tuning and the PU's monitor display returns to the normal indication.  
 (Without this operation, next operation cannot be started.)

**REMARKS**

- Do not change the *Pr. 96* setting after completion of tuning (3 or 103).  
 If the *Pr. 96* setting is changed, tuning data is invalid.  
 If the *Pr. 96* setting is changed, tuning must be performed again.

- 4) If offline auto tuning ended in error (see the table below), motor constants are not set.  
 Perform an inverter reset and restart tuning.



Error Display	Error Cause	Remedy
8	Forced end	Set "1" or "101" in <i>Pr. 96</i> and perform tuning again.
9	Inverter protective function operation	Make setting again.
91	Current limit (stall prevention) function was activated.	Increase acceleration/deceleration time. Set "1" in <i>Pr. 156</i> .
92	Converter output voltage reached 75% of rated value.	Check for fluctuation of power supply voltage.
93	Calculation error A motor is not connected.	Check the motor wiring and make setting again. Set the rated current of the motor in <i>Pr. 9</i> .

- 5) When tuning is ended forcibly by pressing  or turning off the start signal (STF or STR) during tuning, offline auto tuning does not end properly. (The motor constants have not been set.)  
 Perform an inverter reset and restart tuning.
- 6) When using the motor corresponding to the following specifications and conditions, reset *Pr. 9 Electronic thermal O/L relay* as below after tuning is completed.
- a) When the rated power specifications of the motor is 200/220V (400/440V) 60Hz, set 1.1 times rated motor current value in *Pr. 9*.
  - b) When performing motor protection from overheat using a PTC thermistor or motor with temperature detector such as Klixon, set "0" (motor overheat protection by the inverter is invalid) in *Pr. 9*.

**CAUTION**

- The motor constants measured once in the offline auto tuning are stored as parameters and their data are held until the offline auto tuning is performed again.
- An instantaneous power failure occurring during tuning will result in a tuning error.  
 After power is restored, the inverter goes into the normal operation mode. Therefore, when STF (STR) signal is on, the motor runs in the forward (reverse) rotation.
- Any alarm occurs during tuning is handled as in the ordinary mode. Note that if a fault retry has been set, retry is ignored.
- The set frequency monitor displayed during the offline auto tuning is 0Hz.

 **CAUTION**

-  Note that the motor may start running suddenly.
-  When the offline auto tuning is used in vertical lift application, e.g. a lifter, it may drop due to insufficient torque.

#### (4) Utilizing or changing offline auto tuning data for use

The data measured in the offline auto tuning can be read and utilized or changed.

<Operating procedure>

1) Set *Pr. 71* according to the motor used.

	Motor	<i>Pr. 71</i> Setting*
Mitsubishi standard motor Mitsubishi high efficiency motor	SF-JR	4
	SF-HR	44
	Others	4
Mitsubishi constant-torque motor	SF-JRCA 4P	14
	SF-HRCA	54
	Others (SF-JRC, etc.)	14
Vector control dedicated motor	SF-V5RU (1500r/min series) SF-THY	34
	SF-V5RU (except for 1500r/min series)	14
	Other manufacturer's standard motor	–
Other manufacturer's constant torque motor	–	14

\*1 For other settings of *Pr. 71*, refer to page 169.

2) In the parameter setting mode, read the following parameters and set desired values.

Parameter Number	Name	Setting Range	Setting Increments	Initial Value
82	Motor excitation current	0 to ***, 9999	1	9999
90	Motor constant (R1)	0 to ***, 9999	1	9999
91	Motor constant (R2)	0 to ***, 9999	1	9999
92	Motor constant (L1)	0 to ***, 9999	1	9999
93	Motor constant (L2)	0 to ***, 9999	1	9999
94	Motor constant (X)	0 to ***, 9999	1	9999
859	Torque current	0 to ***, 9999	1	9999

#### REMARKS

- The display units of the motor constants read using *Pr. 684* Tuning data unit switchover can be changed. Note that parameter values can not be changed.

<i>Pr. 684</i> Setting	<i>Pr. 82, Pr. 455</i>	<i>Pr. 90, Pr. 458</i>	<i>Pr. 91, Pr. 459</i>	<i>Pr. 92, Pr. 460</i>	<i>Pr. 93, Pr. 461</i>	<i>Pr. 94, Pr. 462</i>	<i>Pr. 859, Pr. 860</i>
0	Internal data converted value						
1	0.01A	0.001Ω	0.001Ω	0.1mH	0.1mH	0.1%	0.01A

- When "9999" is set in *Pr. 82, Pr. 90 to Pr. 94, Pr. 455, Pr. 458 to Pr. 462, Pr. 859, Pr. 860*, Mitsubishi motor (SF-JR, SF-HR, SF-JRCA, SF-HRCA, SF-V5RU (1500r/min series)) constants are used.

- As the motor constants measured in the offline auto tuning have been converted into internal data (\*\*\*\*), refer to the following setting example when making setting:

Setting example To slightly increase *Pr. 90* value (5%)

When *Pr. 90* is displayed "2516",

set 2642, i.e.  $2516 \times 1.05 = 2641.8$ , in *Pr. 90*.

(The value displayed has been converted into a value for internal use. Hence, simple addition of a given value to the displayed value has no significance.)



**(5) Method to set the motor constants without using the offline auto tuning data**

The *Pr. 92* and *Pr. 93* motor constants may either be entered in [ $\Omega$ ] or in [mH]. Before starting operation, confirm which motor constant unit is used.

- To enter the *Pr. 92* and *Pr. 93* motor constants in [ $\Omega$ ]

<Operating procedure>

1) Set *Pr. 71* according to the motor used.

		Star Connection Motor	Delta Connection Motor
Setting	Standard motor	5	6
	Constant-torque motor	15	16

2) In the parameter setting mode, read the following parameters and set desired values.

$I_q$  = torque current,  $I_{100}$  = rated current,  $I_0$  = no load current

$$I_q = \sqrt{I_{100}^2 - I_0^2}$$

Parameters Number	Name	Setting Range	Setting Increments	Initial Value
82	Motor excitation current (no load current)	0 to 500A, 9999	0.01A	9999
90	Motor constant (r1)	0 to 50 $\Omega$ , 9999	0.001 $\Omega$	9999
91	Motor constant (r2)	0 to 50 $\Omega$ , 9999	0.001 $\Omega$	9999
92	Motor constant (x1)	0 to 50 $\Omega$ , 9999	0.001 $\Omega$	9999
93	Motor constant (x2)	0 to 50 $\Omega$ , 9999	0.001 $\Omega$	9999
94	Motor constant (xm)	0 to 500 $\Omega$ , 9999	0.01 $\Omega$	9999
859	Torque current	0 to 500A, 9999	0.01A	9999

3) Refer to the following table and set *Pr. 83* and *Pr. 84*.

Parameter Number	Name	Setting Range	Setting Increments	Initial Value
83	Rated motor voltage	0 to 1000V	0.1V	200V/400V*
84	Rated motor frequency	10 to 120Hz	0.01Hz	60Hz

\* The initial value differs according to the voltage level. (200V/400V)

**REMARKS**

- When "9999" is set in *Pr. 82*, *Pr. 90 to Pr. 94*, *Pr. 859*, Mitsubishi motor (SF-JR, SF-HR, SF-JRCA, SF-HRCA, SF-V5RU (1500r/min series)) constants are used.

**CAUTION**

- If "star connection" is mistaken for "delta connection" or vice versa during setting of *Pr. 71*, Advanced magnetic flux vector control, Real sensorless vector control and vector control cannot be exercised properly.

- To enter the Pr. 92 and Pr. 93 motor constants in [mH]  
<Operating procedure>

1) Set Pr. 71 according to the motor used.

Motor		Pr.71 Setting*
Mitsubishi standard motor Mitsubishi high efficiency motor	SF-JR	0
	SF-HR	40
Mitsubishi constant-torque motor	SF-JRCA 4P	1
	SF-HRCA	50
Vector control dedicated motor	SF-V5RU 1500r/min series	30

\*1 For other settings of Pr. 71, refer to page 169.

2) In the parameter setting mode, read the following parameters and set desired values.  
Calculate the Pr. 94 value from the following formula.

$$\text{Pr. 94 setting} = \left( 1 - \frac{M^2}{L1 \times L2} \right) \times 100 (\%)$$

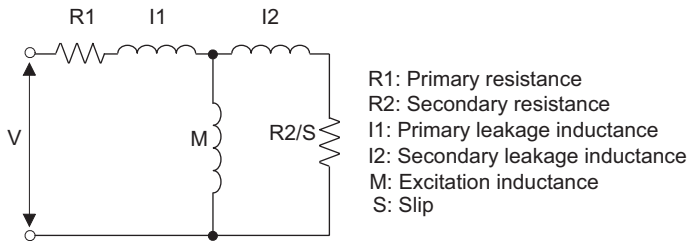

R1: Primary resistance  
R2: Secondary resistance  
I1: Primary leakage inductance  
I2: Secondary leakage inductance  
M: Excitation inductance  
S: Slip

L1= I1+ M: Primary inductance  
L2= I2+ M: Secondary inductance

**Motor equivalent circuit diagram**

Parameter Number	Name	Setting Range	Setting Increments	Initial Value
82	Motor excitation current (no load current)	0 to 500A, 9999	0.01A	9999
90	Motor constant (R1)	0 to 50Ω, 9999	0.001Ω	9999
91	Motor constant (R2)	0 to 50Ω, 9999	0.001Ω	9999
92	Motor constant (L1)	0 to 1000mH, 9999	0.1mH	9999
93	Motor constant (L2)	0 to 1000mH, 9999	0.1mH	9999
94	Motor constant (X)	0 to 100%, 9999	0.1%	9999
859	Torque current	0 to 500A, 9999	0.01A	9999

3) Refer to the following table and set Pr. 83 and Pr. 84 .

Parameter Number	Name	Setting Range	Setting Increments	Initial Value
83	Rated motor voltage	0 to 1000V	0.1V	200V/400V*
84	Rated motor frequency	10 to 120Hz	0.01Hz	60Hz

\* The initial value differs according to the voltage level. (200V/400V)

**REMARKS**

- When "9999" is set in Pr. 82, Pr. 90 to Pr. 94, Pr. 859, Mitsubishi motor (SF-JR, SF-HR, SF-JRCA, SF-HRCA, SF-V5RU (1500r/min series)) constants are used.



## (6) Tune second applied motor

- When you want to switch two motors with one inverter, set the second motor in *Pr. 450 Second applied motor* (refer to page 169). Initial setting is without second applied motor.
- Turning the RT signal on makes the following parameters for the second parameters valid.

Functions	RT Signal ON (second motor)	RT Signal OFF (first motor)
Motor capacity	Pr. 453	Pr. 80
Number of motor poles	Pr. 454	Pr. 81
Motor excitation current	Pr. 455	Pr. 82
Rated motor voltage	Pr. 456	Pr. 83
Rated motor frequency	Pr. 457	Pr. 84
Motor constant (R1)	Pr. 458	Pr. 90
Motor constant (R2)	Pr. 459	Pr. 91
Motor constant (L1)	Pr. 460	Pr. 92
Motor constant (L2)	Pr. 461	Pr. 93
Motor constant (X)	Pr. 462	Pr. 94
Auto tuning setting/status	Pr. 463	Pr. 96

### REMARKS

- The RT signal is assigned to the terminal RT in the initial setting. By setting "3" in any of *Pr. 178 to Pr. 189* (input terminal function selection), you can assign the RT signal to the other terminal.

### CAUTION

- Changing the terminal assignment using *Pr. 178 to Pr. 189* (input terminal function selection) may affect the other functions. Set parameters after confirming the function of each terminal.

#### ◆ Parameters referred to ◆

*Pr. 7 Acceleration time, Pr. 8 Deceleration time* Refer to page 155  
*Pr. 9 Electronic thermal O/L relay* Refer to page 165  
*Pr. 71 Applied motor* Refer to page 169  
*Pr. 80 Motor capacity, Pr. 81 Number of motor poles* Refer to page 75  
*Pr. 95 Online auto tuning selection* Refer to page 181  
*Pr. 156 Stall prevention operation selection* Refer to page 135  
*Pr. 178 to Pr. 189* (input terminal function selection) Refer to page 207  
*Pr. 190 to Pr. 196* (output terminal function selection) Refer to page 215  
*Pr. 800 Control method selection* Refer to page 75

**4.13.4 Online auto tuning (Pr. 95, Pr. 574)** Magnetic flux Sensorless Vector

When online auto tuning is selected under Advanced magnetic flux vector control, Real sensorless vector control or vector control, excellent torque accuracy is provided by temperature compensation even if the secondary resistance value of the motor varies with the rise of the motor temperature.

Parameter Number	Name	Initial Value	Setting Range	Description
95	Online auto tuning selection	0	0	Online auto tuning is not performed
			1	Start-time online auto tuning
			2	Magnetic flux observer (normal tuning)
574	Second motor online auto tuning	0	0, 1	Select the second motor online auto tuning. (same as Pr. 95)

**(1) Start-time online auto tuning (setting is "1")**

- By quickly tuning the motor constants at a start, high accuracy operation unaffected by the motor temperature and stable operation with high torque down to ultra low speed can be performed.
- Make sure Advanced magnetic flux vector control (Pr. 80, Pr. 81), Real sensorless vector control or vector control (Pr. 800) is selected.
- Before performing online auto tuning, perform offline auto tuning without fail.

**<Operation method>**

- 1) Refer to page 171 to perform offline auto tuning.
- 2) Check that "3" or "103" (offline auto tuning completion) is set in Pr. 96 Auto tuning setting/status.
- 3) Set "1" (start-time online auto tuning) in Pr. 95 Online auto tuning selection.  
Online auto tuning is performed from the next starting.
- 4) Before starting operation, check that the following parameters have been set.

Parameter Number	Description
9	Used as rated motor current and electronic thermal relay parameters.
71	Applied motor
80	Motor capacity (down to one rank lower than the inverter capacity, note that the capacity should be 0.4kW or more)
81	Number of motor poles

- 5) When performing PU operation, press FWD / REV of the operation panel.

For external operation, turn ON the run command (STF signal or STR signal).

**CAUTION**

- For using start-time online auto tuning in elevator, examine the utilization of a brake sequence for the brake opening timing at a start. Though the tuning ends in about a maximum of 500ms after a start, torque is not provided fully during that period. Therefore, note that there may be a possibility of drop due to gravity.  
It is recommended to perform tuning using a start time tuning signal (X28). (Refer to page 183.)



## (2) Magnetic flux observer (normal tuning) (setting value is "2")

- When exercising vector control using a motor with encoder, it is effective for torque accuracy improvement. The current flowing in the motor and the inverter output voltage are used to estimate/observe the magnetic flux in the motor. The magnetic flux of the motor is always (including during operation) detected with high accuracy so that an excellent characteristic is provided regardless of the change in the temperature of the secondary resistance.
- Vector control (*Pr. 80, Pr. 81, Pr. 800*) should be selected. (*Refer to page 75.*)

---



---

### CAUTION

---



---

- For the SF-V5RU, SF-JR (with encoder), SF-HR (with encoder), SF-JRCA (with encoder) or SF-HRCA (with encoder), it is not necessary to perform offline auto tuning to select adaptive magnetic flux observer. (Note that it is necessary to perform offline auto tuning for the wiring length resistance to be reflected on the control when the wiring length is long (30m or longer as reference).)
- 
- 

### REMARKS

- Online auto tuning does not operate if the MRS signal is input, if the preset speed is less than the *Pr. 13 Starting frequency* (V/F control or Advanced magnetic flux vector control), or if the starting conditions of the inverter are not satisfied, e.g. inverter error.
- Online auto tuning does not operate during deceleration or at a restart during DC brake operation.
- Invalid for jog operation.
- Automatic restart after instantaneous power failure overrides when automatic restart after instantaneous power failure is selected. (Start-time online auto tuning is not performed at frequency search.)  
Perform online auto tuning at a stop with the X28 signal when using automatic restart after instantaneous power failure together. (Refer to *the following* for details.)
- Zero current detection and output current detection are valid during online auto tuning.
- The RUN signal is not output during online auto tuning. The RUN signal turns on at a start.
- If the period from an inverter stop to a restart is within 4s, start-time tuning is performed but the tuning results are not reflected.

**(3) Start-time online auto tuning from external terminal (X28 signal, Y39 signal)**

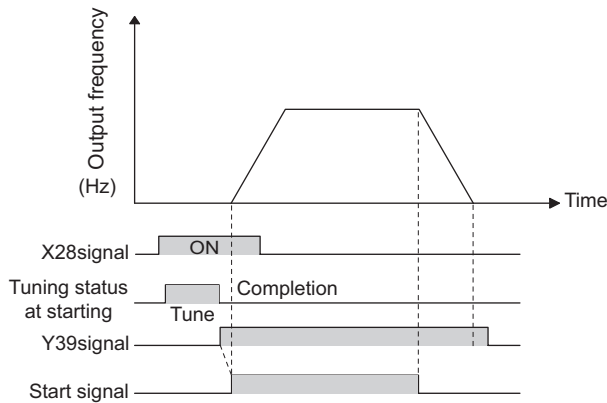

- By turning ON the start-time tuning signal (X28) before the start signal (STF or STR) turns ON (at a stop), online tuning is performed and a starting delay after start signal turns ON due to tuning can be avoided.
- Perform offline auto tuning and set "1" (start-time tuning) in Pr. 95.
- When the start-time tuning completion signal (Y39) is OFF, start-time tuning with the X28 signal is performed.
- Start-time tuning ends within 500ms maximum.
- When using the X28 signal, set "28" in Pr. 178 to Pr. 189 (input terminal function selection) and assign functions to the input terminal.
- When using the Y39 signal, set "39 (positive logic) or 139 (negative logic)" in Pr. 190 to Pr. 196 (output terminal function selection) and assign functions to the output terminal.

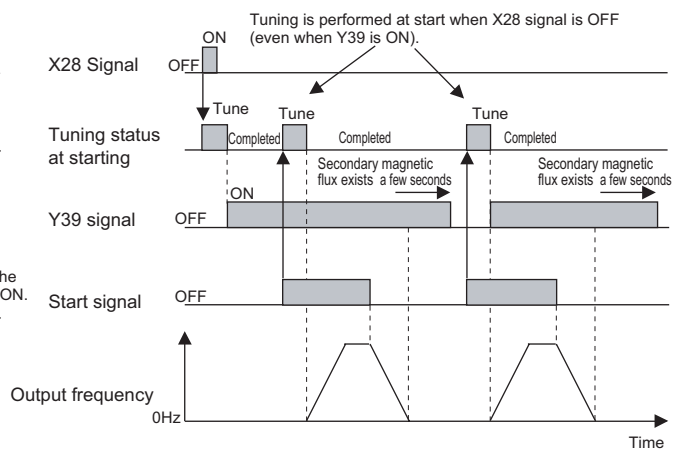
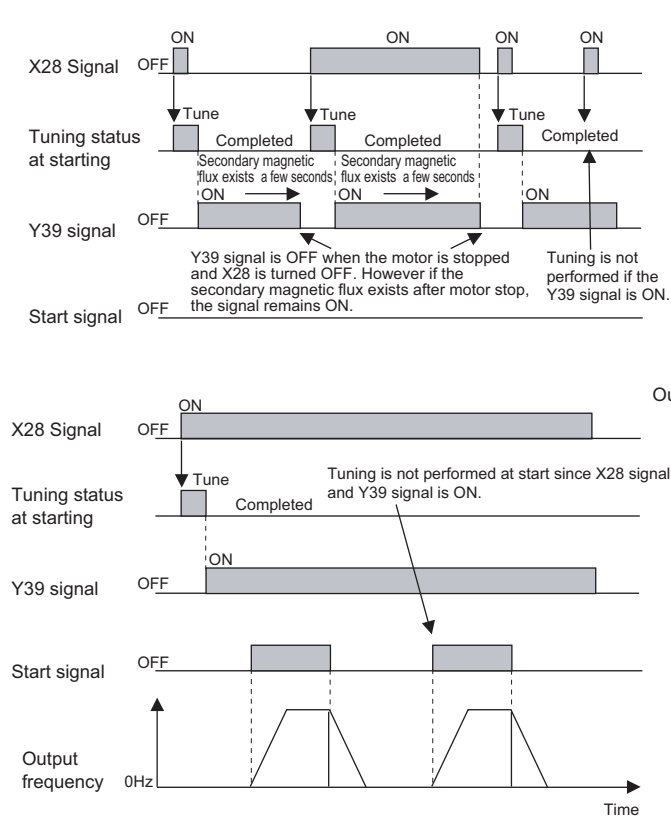

**REMARKS**

- Start-time tuning is performed when the start signal is turned ON during zero speed control also.
- The Y39 signal is in ON status while secondary magnetic flux exists after the motor stop.
- While the Y39 signal is ON, the X28 signal is not valid.
- The STF, STR signals are valid after completion of the start-time tuning.
- The following output terminals (initial setting) are valid during online auto tuning:  
IPF, A1B1C1
- Tuning is invalid during V/F control.

**CAUTION**

- Changing the terminal assignment using Pr. 178 to Pr. 189 (input terminal function selection) or Pr. 190 to Pr. 196 (output terminal function selection) may affect the other functions. Set parameters after confirming the function of each terminal.

#### (4) Tune second applied motor

- When you want to switch two motors with one inverter, set the second motor in *Pr. 450 Second applied motor*. (Initial setting is without second applied motor. (Refer to page 169))  
Perform tuning using *Pr. 574 Second motor online auto tuning*.  
*Pr. 574 Second motor online auto tuning* is valid when the RT signal turns on.

Parameter Number	Description
51	Used as rated motor current and electronic thermal relay parameters.
450	Applied motor
453	Motor capacity (down to one rank lower than the inverter capacity, note that the capacity should be 0.4kW or more)
454	Number of motor poles







#### REMARKS

- The RT signal acts as the second function selection signal and makes the other second functions valid. (Refer to page 211.)  
The RT signal is assigned to the terminal RT in the initial setting. By setting "3" in any of *Pr. 178 to Pr. 189 (input terminal function selection)*, you can assign the RT signal to the other terminal.

#### CAUTION

- Changing the terminal assignment using *Pr. 178 to Pr. 189 (input terminal function selection)* may affect the other functions. Set parameters after confirming the function of each terminal.

#### ◆ Parameters referred to ◆

*Pr. 9 Electronic thermal O/L relay*  Refer to page 165  
*Pr. 71 Applied motor*  Refer to page 169  
*Pr. 80 Motor capacity*  Refer to page 75  
*Pr. 81 Number of motor poles*  Refer to page 75  
*Pr. 96 Auto tuning setting/status*  Refer to page 171  
*Pr. 178 to Pr. 189 (input terminal function selection)*  Refer to page 207  
*Pr. 190 to Pr. 196 (output terminal function selection)*  Refer to page 215



## 4.14 Motor brake and stop operation

Purpose	Parameter that must be Set		Refer to Page
Motor braking torque adjustment	DC injection brake and zero speed control, servo lock Magnetic flux decay output shutoff	Pr. 10 to Pr. 12, Pr. 802, Pr. 850	185
Coast the motor to a stop	Selection of motor stopping method	Pr. 250	189
Used to stop the motor with a mechanical brake (vibration restraint at stop-on-contact)	Stop-on-contact control	Pr. 270, Pr. 275, Pr. 276	190
Used to stop the motor with a mechanical brake (operation timing of a mechanical brake)	Brake sequence function	Pr. 278 to Pr. 285, Pr. 292	193
Perform position stop (orientation) control of the rotation shaft	Orientation control	Pr. 350 to Pr. 366, Pr. 369, Pr. 393, Pr. 396 to Pr. 399	196

### 4.14.1 DC injection brake and zero speed control, servo lock (LX signal, X13 signal, Pr. 10 to Pr. 12, Pr. 802, Pr. 850)

- The DC injection brake can be operated at a motor stop to adjust the stop timing and braking torque. Zero speed control can be selected during Real sensorless vector control and either zero speed control or servo lock can be selected under vector control. In DC injection brake operation, DC voltage is directly applied to the motor to prevent the motor shaft from rotating when a motor decelerates to stop. While, in zero speed control, vector control is performed to maintain 0r/min. In either control, the motor will not return to the original position if the motor shaft rotates due to external force. The motor shaft position is maintained with servo lock. The motor will return to the original position if the motor shaft rotates due to external force.
- Select the magnetic flux decay output shutoff function to decay the magnetic flux before shutting off the output at a stop.

Parameter Number	Name	Initial Value		Setting Range	Description
10	DC injection brake operation frequency	3Hz		0 to 120Hz	Set the operation frequency of the DC injection brake (zero speed control, servo lock).
				9999	Operated at Pr. 13 or less.
11	DC injection brake operation time	0.5s		0	DC injection brake (zero speed control) disabled
				0.1 to 10s	Set the operation time of the DC injection brake (zero speed control, servo lock).
12	DC injection brake operation voltage	7.5K or lower	4%	0 to 30%	Set the DC injection brake voltage (torque). When "0" is set, DC injection brake is disabled.
		11K or higher	2%		
802 *	Pre-excitation selection	0		0	Zero speed control
				1	Servo lock
850	Brake operation selection	0		0	DC injection brake operation
				1	Zero speed control
				2	Magnetic flux decay output shutoff

\* This parameter can be set when the FR-A7AP/FR-A7AL (option) is mounted.

**Ver.UP** .....Specifications differ according to the date assembled. Refer to page 456 to check the SERIAL number.





When Pr: 11 = "0.1 to 10s"

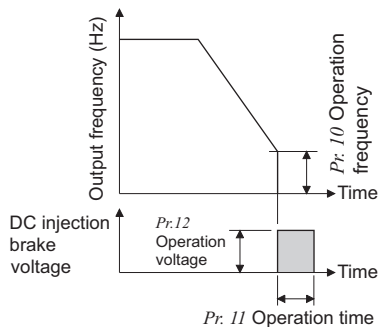

### (1) Operation frequency setting (Pr: 10)

- When the frequency at which the DC injection brake (zero speed control, servo lock) operates is set in Pr: 10, the DC voltage is applied to the motor upon reaching to the set frequency during deceleration.
- At the Pr: 10 setting of "9999", the DC injection brake (zero speed control, servo lock) is applied to the motor when deceleration is made to the frequency set in Pr: 13 Starting frequency.

#### REMARKS

- Performing pre-excitation (zero speed control) under Real sensorless vector may cause motor vibration, etc. at deceleration to stop. To prevent this, set Pr:10 DC injection brake operation frequency to 0.5Hz or less.
- The initial value of Pr: 10 automatically changes to 0.5Hz during vector control.

When Pr: 11 = "8888"

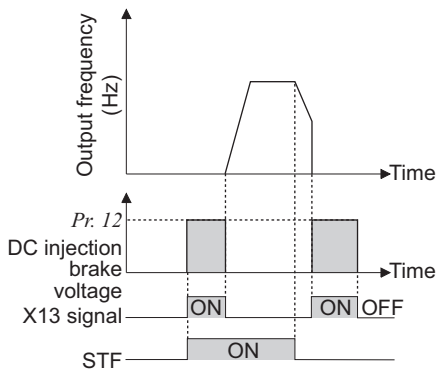

### (2) Operation time setting (X13 signal, Pr: 11)

- Use Pr: 11 to set the duration period the DC injection brake (zero speed control, servo lock) is applied.
- When the motor does not stop due to large load moment (J), increasing the setting produces an effect.
- When Pr: 11 = "0s", the DC injection brake (zero speed control, servo lock) is not operated. (At a stop, the motor coasts.)
- When Pr: 11 = "8888", the DC injection brake (zero speed control, servo lock) is applied when X13 signal is turned on.
- For the terminal used for X13 signal input, set "13" in any of Pr: 178 to Pr: 189 to assign the function. (Refer to page 207)

#### REMARKS

- When the X13 signal is turned on with Pr: 11 = "8888", zero speed control is activated regardless of setting of Pr: 850 Brake operation selection.
- Under vector control, zero speed control or servo lock is activated depending on the Pr: 802 setting.

### (3) Operation voltage (torque) setting (Pr: 12)

- Use Pr: 12 to set the percentage to the power supply voltage. (This parameter is not used during zero speed control or servo lock.)
- When Pr: 12 = "0%", the DC injection brake is not operated. (At a stop, the motor coasts.)
- When using the constant-torque motor (SF-JRCA) and energy saving motor (SF-HR, SF-HRCA), change the Pr: 12 setting as follows.  
SF-JRCA: 3.7K or lower ...4%, 5.5K or higher...2%  
SF-HR, SF-HRCA: 5.5K and 7.5K...3%, 11K or higher...2%

#### REMARKS

- For the 5.5K and 7.5K, when the Pr: 12 setting is as below, changing the Pr: 71 Applied motor setting changes the Pr: 12 setting automatically, it is not necessary to change the Pr: 12 setting.  
(a)When Pr: 12 is 4% (initial value)  
The Pr: 12 setting is automatically changed to 2% if the Pr: 71 value is changed from the value selecting the standard motor (0, 2 to 8, 40, 43, 44) to the value selecting the constant torque motor (1, 13 to 18, 50, 53, 54).  
(b)When Pr: 12 is 2%  
The Pr: 12 setting is automatically changed to 4% (initial value) if the Pr: 71 value is changed from the value selecting the constant torque motor (1, 13 to 18, 50, 53, 54) to the value selecting the standard motor (0, 2 to 8, 40, 43, 44).
- Even if the Pr: 12 setting is increased, braking torque is limited so that the output current is within the rated inverter current.

### (4) Brake operation selection during Real sensorless vector control (Pr: 850 = "0, 1")

- You can select DC injection brake (initial value) or zero speed control for brake operation during Real sensorless vector control.  
When Pr: 850 = "1", zero speed control is exercised when the frequency reaches or decreases below the frequency set in Pr: 10.

#### REMARKS

- When the X13 signal is on with Pr: 11 = "8888", zero speed control is activated regardless of setting of Pr: 850 Brake operation selection.
- When restarting from brake operation during Real sensorless vector control, set "1" (zero speed control) in Pr: 850. When the setting value is "0" (DC injection brake), it may take approx. 2s until frequency is actually output from when the start command is input.

### (5) Magnetic flux decay output shutoff

- Frequent starts/stops (inching) with the mechanical brake via the output shutoff signal (MRS) may cause an inverter failure and create a difference in operation with the motor at a restart under Real sensorless vector control. The reason is that some magnetic flux is left in the motor at shutoff of the inverter output. If this is the case, set *Pr. 850* = "2" to select the magnetic flux decay output shutoff, and decay the magnetic flux before shutting off the output at a stop.
- Set the magnetic flux decay output shutoff function (*Pr. 850* = "2") to shut off the output after decaying the motor residual magnetic flux during Real sensorless vector control.
- Turning OFF the start command decelerates the speed. Then, when an estimated speed is lower than *Pr. 10 DC injection brake operation frequency*, inverter starts the magnetic flux decay output shutoff function.
- When using brake sequence, the inverter starts the magnetic flux decay output shutoff function at 0.5Hz or *Pr. 13 Starting frequency* (whichever is lower) during deceleration.
- During magnetic flux decay output shutoff, the torque decreases. Set a mechanical brake to be activated during magnetic flux decay output shutoff.
- When the MC is provided on the inverter output side, open the MC after magnetic flux decay processing time (refer to the following) has passed.
- The magnetic flux decay output shutoff function is stopped at restart or when turning ON the Pre-excitation signal (LX)/External DC injection brake operation start signal (X13).

#### REMARKS

- Regardless of the *Pr. 850* setting, turning ON the X74 (magnetic flux decay output shutoff signal) starts the magnetic flux decay output shutoff.

#### Inverter output voltage shutoff timing

##### · Normal operation

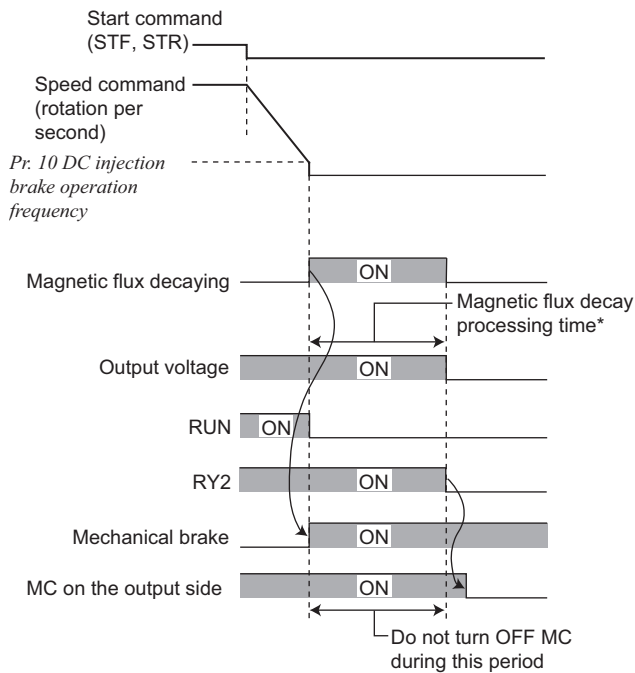

##### · During brake sequence

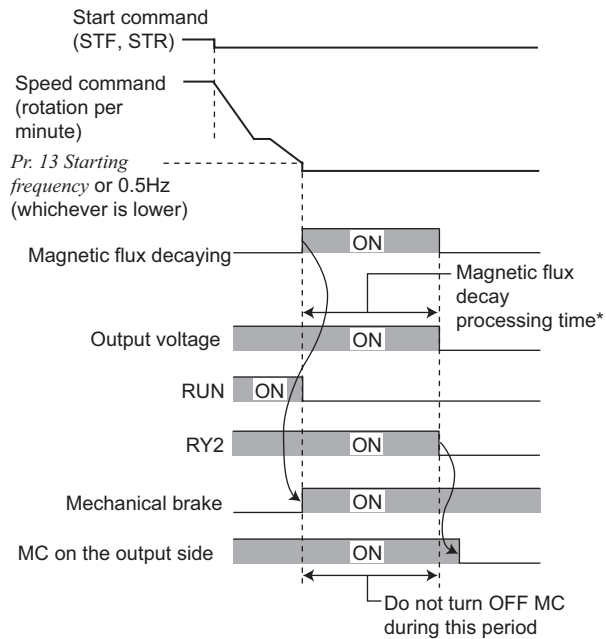

\* The maximum time for magnetic flux decaying

Motor capacity ( <i>Pr. 80</i> setting)	3.7kW to 11kW	15kW to 30kW	37kW to 55kW
Magnetic flux decay processing time	500ms	800ms	900ms

#### REMARKS

- When some other factor affecting output shutoff (such as inverter fault or MRS signal ON) occurs during the magnetic flux decay output shutoff function, the magnetic flux decay output shutoff function is immediately stopped and shuts off the output.
- To operate the magnetic flux decay output shutoff function by turning ON the X74 signal, set "74" in any of *Pr. 178 to Pr. 189 (input terminal function selection)* to assign the function.

#### CAUTION

- Voltage is output during magnetic flux decay processing. Take caution to avoid an electrical shock.
- If the timing of mechanical brake opening is early, motor shaft may be forced to turn by a gravity drop or external force. If the timing of mechanical brake opening is late, overcurrent, stall prevention operation or electronic thermal relay function may be activated. Use output frequency detection signal (FU) or output current detection signal (Y12) to perform the mechanical brake opening suitable for the machine.



**(6) Brake operation selection under vector control (Pr. 802)**

- When pre-excitation is performed, select zero speed control or servo lock using Pr. 802.

Pr. 802 Setting	Pre-excitation	Description
0 (initial value)	Zero speed control	Even under load, an attempt is made to maintain 0r/min to keep the motor shaft stopped. Note that if the shaft is overcome and turned by external force, it does not return to the original position. Position control is not exercised and only speed control is carried out to perform operation.
1	Servo lock	Even under load, an attempt is made to maintain the motor shaft position. Note that if the shaft is turned by external force, it returns to the original position after the external force has gone away. Since position control is exercised, you can adjust this position loop gain using Pr. 422 Position loop gain.

- The relationship between the DC injection brake operation and pre-excitation operation under each control

Control Method	Control Mode	Pr. 802	Pr. 850	Decelerates to Stop	LX-ON	X13-ON (Pr. 11 = "8888")
V/F control	—	—	—	DC Injection brake	—	DC Injection brake
Advanced magnetic flux vector control	—	—	—	DC Injection brake	—	DC Injection brake
Real sensorless vector control	Speed	—	0	DC Injection brake	Zero speed	Zero speed
		—	1	Zero speed		
	Torque	—	0	DC Injection brake	Zero speed	Zero speed
		—	1	Zero speed		
Vector control	Speed	0	—	Zero speed	Zero speed	Zero speed
		1	—	Servo lock	Servo lock	Servo lock
	Torque	—	—	Zero speed	Zero speed	Zero speed
	Position	—	—	—	Servo lock	—

**(7) Pre-excitation signal (LX signal)**

- When the LX signal is turned on under Real sensorless vector control or vector control, pre-excitation (zero speed control or servo lock) is exercised during a stop.
- For the terminal used for LX signal input, set "23" in any of Pr. 178 to Pr. 186 to assign the function.

When Pr. 850 = 1

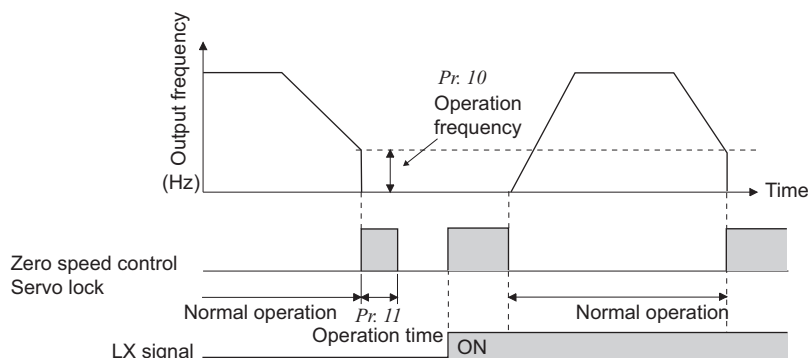

**CAUTION**

- Changing the terminal assignment using Pr. 178 to Pr. 189 (input terminal function selection) may affect the other functions. Set parameters after confirming the function of each terminal.
- Performing pre-excitation (LX signal and X13 signal) under torque control (Real sensorless vector control) may start the motor running at a low speed even when the start command (STF or STR) is not input. The motor may run also at a low speed when the speed limit value=0 with a start command input. Perform pre-excitation after making sure that there will be no problem in safety if the motor runs.
- Although FWD/REV of the operation panel is not lit during pre-excitation, note that voltage is applied to the motor.
- Note that when offline auto tuning (Pr. 96 Auto tuning setting/status = "1 or 101") is performed during pre-excitation, offline auto tuning is not executed but the motor starts.

**CAUTION**

- Do not set Pr. 11 to "0, 8888" and Pr. 12 to "0" under orientation operation. Otherwise, the motor will not stop properly.
- As stop holding torque is not produced, install a mechanical brake. After the machine stops fully and the mechanical brake is applied, switch the LX signal (pre-excitation) OFF.

◆ Parameters referred to ◆

- Pr. 13 Starting frequency Refer to page 157
- Pr. 71 Applied motor Refer to page 169
- Pr. 178 to Pr. 189 (Input terminal function selection) Refer to page 207
- Pr. 422 Position loop gain Refer to page 124

### 4.14.2 Stop selection (Pr. 250)

Used to select the stopping method (deceleration to a stop or coasting) when the start signal turns OFF. Used to stop the motor with a mechanical brake, etc. together with switching off of the start signal.

You can also select the operations of the start signals (STF/STR). (Refer to *page 212* for start signal selection)

Parameter Number	Name	Initial Value	Setting Range	Description	
				Start signal (STF/STR) (Refer to page 212)	Stop operation
250	Stop selection	9999	0 to 100s	STF signal: Forward rotation start STR signal: Reverse rotation start	The motor is coasted to a stop when the preset time elapses after the start signal is turned off. The motor is coasted to a stop (Pr. 250 - 1000)s after the start signal is turned OFF.
			1000s to 1100s	STF signal: Start signal STR signal: Forward/reverse signal	
			9999	STF signal: Forward rotation start STR signal: Reverse rotation start	When the start signal is turned OFF, the motor decelerates to stop.
			8888	STF signal: Start signal STR signal: Forward/reverse signal	

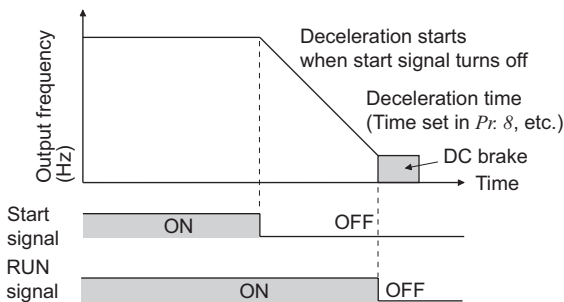

#### (1) Decelerate the motor to a stop

- Set Pr. 250 to "9999" (initial value) or "8888".
- The motor decelerates to a stop when the start signal (STF/STR) turns OFF.

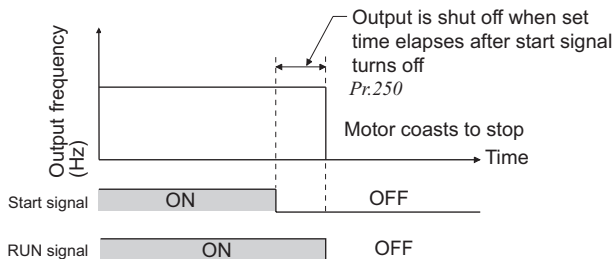

#### (2) Coast the motor to a stop

- Use Pr. 250 to set the time from when the start signal turns off until the output is shut off. When any of "1000" to "1100" is set, the output is shut off after (Pr. 250 - 1000)s.
- The output is shut off when the time set in Pr. 250 has elapsed after the start signal had turned off. The motor coasts to a stop.
- The RUN signal turns OFF when the output stops.

#### REMARKS

Stop selection is invalid when the following functions are activated.

- Position control (Pr. 419 = 0)
- Power failure stop function (Pr. 261)
- PU stop (Pr. 75)
- Deceleration stop because of fault definition (Pr. 875)
- Deceleration stop because of communication error (Pr. 502)
- Offline auto tuning (with motor running)
- Emergency stop by LONWORKS communication

When setting of Pr. 250 is not 9999 nor 8888, acceleration/deceleration is performed according to the frequency command, until start signal is OFF and output is shutoff.

#### CAUTION

- When the start signal is turned ON again during motor coasting, the motor starts at Pr. 13 Starting frequency.

#### ◆ Parameters referred to ◆

Pr. 7 Acceleration time, Pr. 8 Deceleration time Refer to page 155  
Pr. 13 Starting frequency Refer to page 157



### 4.14.3 Stop-on contact control function (Pr. 6, Pr. 48, Pr. 270, Pr. 275, Pr. 276)

Magnetic flux Sensorless

To ensure accurate positioning at the upper limit etc. of a lift, stop-on-contact control causes a mechanical brake to be closed while the motor is developing a holding torque to keep the load in contact with a mechanical stopper etc.

This function suppresses vibration which is liable to occur when the load is stopped upon contact in vertical motion applications, ensuring steady precise positioning.

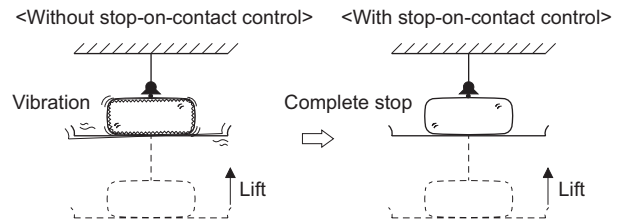

Parameter Number	Name	Initial Value	Setting Range	Description
6	Multi-speed setting (low speed)	10Hz	0 to 400Hz	Set the output frequency for stop-on-contact control.
22*1	Stall prevention operation level	150%	0 to 400%	Set the stall prevention operation level for stop-on-contact control. The smaller value set in either Pr. 22 or Pr. 48 has a priority.
48	Second stall prevention operation current	150%	0 to 220%	
270	Stop-on contact/load torque high-speed frequency control selection	0	0	Normal operation
			1	Stop-on-contact control
			2	Load torque high speed frequency control (Refer to page 351)
			3	Stop-on-contact+load torque high speed frequency control (Refer to page 351)
275*2	Stop-on contact excitation current low-speed multiplying factor	9999	0 to 1000%	Set the force (holding torque) for stop-on-contact control. Normally set 130% to 180%. Valid only during Advanced magnetic flux vector control
			9999	No compensation.
276	PWM carrier frequency at stop-on contact	9999	0 to 9	Set a PWM carrier frequency for stop-on-contact control. For Real sensorless vector control, carrier frequency is always 2Hz when a setting value is 0 to 5 and always 6Hz when a setting value is 6 to 9. (Valid at the frequency of 3Hz or less.)
			9999	As set in Pr. 72 PWM frequency selection.

\*1 This parameter allows its setting to be changed during operation in any operation mode even if "0 (initial value) or 1" is set in Pr. 77 Parameter write selection.

\*2 This parameter allows its setting to be changed during operation even if "0" (initial value) is set in Pr. 77 Parameter write selection.

#### <Connection and operation example>

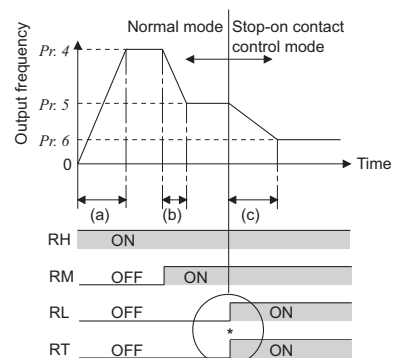
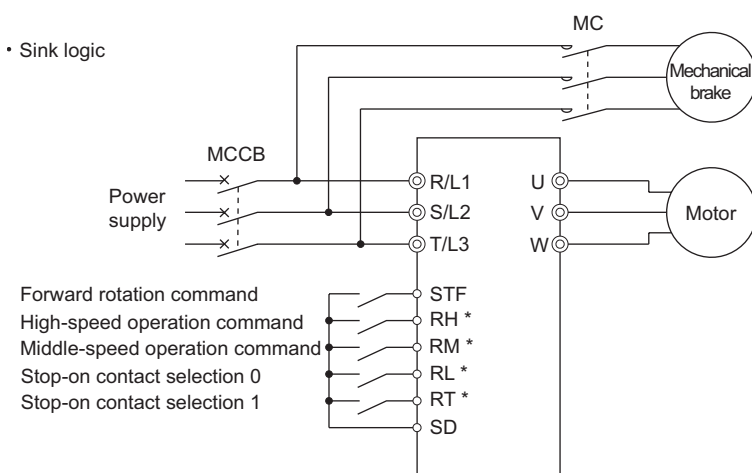

Goes into stop-on-contact control mode when both RL and RT switch on.  
 \*RL and RT may be switched on in any order with any time difference  
 (a): Acceleration time (Pr. 7)  
 (b): Deceleration time (Pr. 8)  
 (c): Second deceleration time (Pr. 44/Pr. 45)

\* The input terminal used differs according to the Pr. 180 to Pr. 189 settings.

**(1) Set stop-on-contact control**

- Make sure that the inverter is in External operation mode. (Refer to page 290 )
- Select either Real sensorless vector control or Advanced magnetic flux vector control.
- Set "1 or 3" in Pr. 270 Stop-on contact/load torque high-speed frequency control selection .
- Set output frequency during stop-on-contact control in Pr. 6 Multi-speed setting (low speed).  
The frequency should be as low as possible (about 2Hz). If it is set to more than 30Hz, the operating frequency will be 30Hz.
- When both the RT and RL signals are switched on, the inverter enters the stop-on-contact mode, in which operation is performed at the frequency set in Pr. 6 independently of the preceding speed.

**CAUTION**

- By increasing the Pr. 275 setting, the low-speed (stop-on-contact) torque increases, but overcurrent fault (E.OCT) may occur or the machine may oscillate in a stop-on-contact state.
- The stop-on-contact function is different from servo-lock function, and if used to stop or hold a load for an extended period, this function can cause the motor to overheat.  
After a stop, immediately change to a mechanical brake to hold the load.
- Under the following operating conditions, the stop-on-contact function is invalid:
  - PU operation (Pr. 79) · JOG operation (JOG signal) · PU+external operation (Pr. 79) · PID control function operation (Pr. 128)
  - Remote setting function operation (Pr. 59) · Start time tuning · Orientation control function operation
- When performing stop-on-contact control during encoder feedback control, encoder feedback control is invalid due to a mode shift to the stop-on-contact control mode.

**(2) Function switching of stop-on-contact control selection**

Useful Functions	Normal Operation (either RL or RT is off or both are off)		With Stop-on-Contact Control (both RL and RT are on)	
	Real sensorless vector control	Advanced magnetic flux vector control	Real sensorless vector control	Advanced magnetic flux vector control
Output frequency	Multi-speed 0 to 5V, 0 to 10V 4 to 20mA etc.		Pr. 6 setting	
Stall prevention operation level	—	Pr. 22 setting	—	The smaller value set in either Pr. 22 or Pr. 48. *
Torque limit level	Pr. 22 setting	—	Pr. 22 setting	—
Excitation current low speed scaling factor	—		—	The current is compensated for by Pr. 275 (0 to 1000%) settings from normal operation.
Carrier frequency	Pr. 72 setting		Pr. 276 setting when output frequency is 3Hz or less (Pr. 72 when Pr. 276 = "9999")	
Fast response current limit	—	Valid	—	Invalid

\* When RL and RT are on, Pr. 49 Second stall prevention operation frequency is invalid.



**(3) Set frequency when stop-on-contact control (Pr. 270 = 1, 3) is selected**

- The following table lists the frequencies set when the input terminals (RH, RM, RL, RT, JOG) are selected together. Bold frame indicates stop-on-contact control is valid.
- Stop-on-contact control is disabled when remote setting function is selected (Pr. 59 = 1 to 3).

Input Signal (○ = on)					Set Frequency
RH	RM	RL	RT	JOG	
○					Pr. 4 Multi-speed setting (high speed)
	○				Pr. 5 Multi-speed setting (middle speed)
		○			Pr. 6 Multi-speed setting (low speed)
			○		By 0 to 5V(0 to 10V), 4 to 20mA input
				○	Pr. 15 Jog frequency
○	○				Pr. 26 Multi-speed setting (speed 6)
○		○			Pr. 25 Multi-speed setting (speed 5)
○			○		Pr. 4 Multi-speed setting (high speed)
○				○	Pr. 15 Jog frequency
	○	○			Pr. 24 Multi-speed setting (speed 4)
	○		○		Pr. 5 Multi-speed setting (middle speed)
	○			○	Pr. 15 Jog frequency
		○	○		<b>Pr. 6 Multi-speed setting (low speed)</b>
		○		○	Pr. 15 Jog frequency
			○	○	Pr. 15 Jog frequency
		○	○	○	Pr. 15 Jog frequency

Input Signal (○ = on)					Set Frequency
RH	RM	RL	RT	JOG	
	○		○	○	Pr. 15 Jog frequency
	○	○		○	Pr. 15 Jog frequency
	○	○	○		<b>Pr. 6 Multi-speed setting (low speed)</b>
○			○	○	Pr. 15 Jog frequency
○		○		○	Pr. 15 Jog frequency
○		○	○		<b>Pr. 6 Multi-speed setting (low speed)</b>
○	○			○	Pr. 15 Jog frequency
○	○		○		Pr. 26 Multi-speed setting (speed 6)
○	○	○			Pr. 27 Multi-speed setting (speed 7)
	○	○	○	○	Pr. 15 Jog frequency
○		○	○	○	Pr. 15 Jog frequency
○	○		○	○	Pr. 15 Jog frequency
○	○	○		○	Pr. 15 Jog frequency
○	○	○	○		<b>Pr. 6 Multi-speed setting (low speed)</b>
○	○	○	○	○	Pr. 15 Jog frequency
					By 0 to 5V(0 to 10V), 4 to 20mA input

**CAUTION**

- Changing the terminal function using any of Pr. 178 to Pr. 189 may affect the other functions. Set parameters after confirming the function of each terminal.

◆ Parameters referred to ◆

- Pr. 4 to Pr. 6, Pr. 24 to Pr. 27 (multi-speed setting) Refer to page 148
- Pr. 15 Jog frequency Refer to page 150
- Pr. 22 Stall prevention operation level, Pr. 48 Second stall prevention operation current Refer to page 135
- Pr. 22 Torque limit level Refer to page 83
- Pr. 59 Remote function selection Refer to page 152
- Pr. 72 PWM frequency selection Refer to page 261
- Pr. 79 Operation mode selection Refer to page 290
- Pr. 95 Online auto tuning selection Refer to page 181
- Pr. 128 PID action selection Refer to page 338
- Pr. 178 to Pr. 189 (input terminal function selection) Refer to page 207
- Pr. 270 = 2, 3 (load torque high-speed frequency control) Refer to page 351





4.14.4 Brake sequence function (Pr. 278 to Pr. 285, Pr. 292) Magnetic flux Sensorless Vector

This function is used to output from the inverter the mechanical brake operation timing signal in vertical lift and other applications.

This function prevents the load from dropping with gravity at a start due to the operation timing error of the mechanical brake or an overcurrent alarm from occurring at a stop, ensuring secure operation.

Parameter Number	Name	Initial Value	Setting Range	Description
278	Brake opening frequency	3Hz	0 to 30Hz	Set to the rated slip frequency of the motor + about 1.0Hz. This parameter may be only set if $Pr. 278 \leq Pr. 282$ .
279	Brake opening current	130%	0 to 220%	Generally, set this parameter to about 50 to 90%. If the setting is too low, the load is liable to drop due to gravity at start. Suppose that the rated inverter current is 100%.
280	Brake opening current detection time	0.3s	0 to 2s	Generally, set this parameter to about 0.1 to 0.3s.
281	Brake operation time at start	0.3s	0 to 5s	Set the mechanical delay time until the brake is loosened. Set the mechanical delay time until the brake is loosened + about 0.1 to 0.2s when $Pr. 292 = "8"$ .
282	Brake operation frequency	6Hz	0 to 30Hz	Set the frequency to activate the mechanical brake by turning off the brake opening request signal (BOF). Generally, set this parameter to the $Pr. 278$ setting + 3 to 4Hz. Setting is enabled only when $Pr. 282 \geq Pr. 278$ .
283	Brake operation time at stop	0.3s	0 to 5s	Set the mechanical delay time until the brake is closed + 0.1s when $Pr. 292=7$ . Set the mechanical delay time until the brake is closed + 0.2 to 0.3s when $Pr. 292 = 8$ .
284	Deceleration detection function selection	0	0	Deceleration is not detected.
			1	If deceleration is not normal during deceleration operation, the inverter fault is provided.
285	Overspeed detection frequency *1	9999	0 to 30Hz	If (detected frequency) - (output frequency) $\geq Pr. 285$ during encoder feedback control, the inverter fault (E.MB1) is provided.
			9999	Overspeed is not detected.
292	Automatic acceleration/ deceleration	0	0	Normal operation mode
			3	Optimum acceleration/deceleration mode (Refer to page 163)
			5, 6	Elevator mode (Refer to page 146)
			7	Brake sequence mode 1
			8	Brake sequence mode 2
			11	Shortest acceleration/deceleration mode (Refer to page 162)

\*1 When exercising vector control with the FR-A7AP/FR-A7AL (option), this parameter changes to excessive speed deviation detection frequency (For details, refer to page 100)

<Connection diagram>

- Sink logic
- $Pr.184 = 15$
- $Pr.190 = 20$

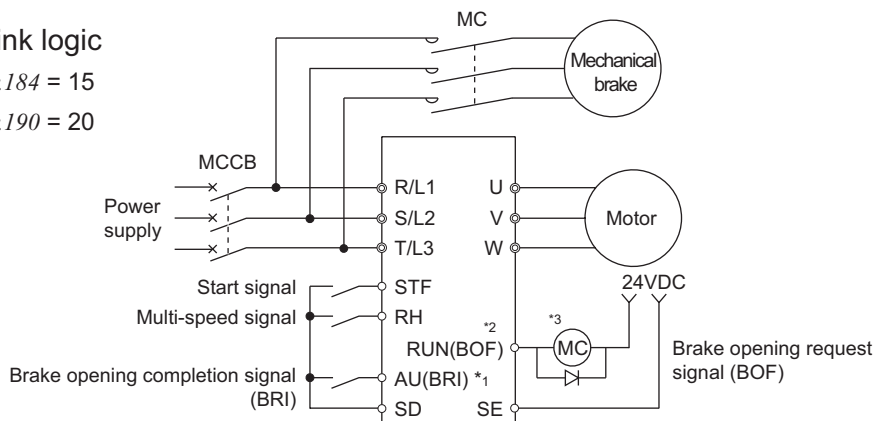

- \*1 The input signal terminal used differs according to the  $Pr. 178$  to  $Pr. 189$  settings.
- \*2 The output signal terminal used differs according to the  $Pr. 190$  to  $Pr. 196$  settings.
- \*3 The current should be within the permissible current of transistor in the inverter. (24V 0.1ADC)

**CAUTION**

- When brake sequence mode is selected, automatic restart after instantaneous power failure is invalid.
- When using this function, set the acceleration time to 1s or longer.
- Changing the terminal function using any of  $Pr. 178$  to  $Pr. 189$ ,  $Pr. 190$  to  $Pr. 196$  may affect the other functions. Set parameters after confirming the function of each terminal.





**(1) Set the brake sequence mode**

- Select either Real sensorless vector control, vector control (speed control) or Advanced magnetic flux vector control. The brake sequence function is valid only when the External operation mode, External/PU combined operation mode 1 or Network operation mode is selected.
- Set "7 or 8" (brake sequence mode) in *Pr. 292* .  
To ensure more complete sequence control, it is recommended to set "7" (brake opening completion signal input) in *Pr. 292* .
- Set "15" in any of *Pr. 178 to Pr. 189 (input terminal function selection)* and assign the brake opening completion signal (BRI) to the input terminal.
- Set "20 (positive logic)" or "120 (negative logic)" in any of *Pr. 190 to Pr. 196 (output terminal function selection)* and assign the brake opening request signal (BOF) to the output terminal.

**(2) With brake opening completion signal input (*Pr. 292 = "7"*)**

- When the start signal is input to the inverter, the inverter starts running. When the internal speed command reaches the value set in *Pr. 278* and the output current is not less than the value set in *Pr. 279* , the inverter outputs the brake opening request signal (BOF) after the time set in *Pr. 280* has elapsed.  
When the time set in *Pr. 281* elapses after the brake opening completion signal (BRI) was activated, the inverter increases the output frequency to the set speed.
- When the inverter decelerates to the frequency set in *Pr. 282* during deceleration, the inverter turns OFF the BOF signal and decelerates further to the frequency set in *Pr. 278*. After electromagnetic brake operation completes and inverter recognizes the turn OFF of BRI signal, the inverter holds the frequency set in *Pr. 278* for the time set in *Pr. 283*. And after the time set in *Pr. 283* passes, the inverter decelerates again. The inverter finally stops when its frequency reaches to *Pr. 13 Starting frequency* setting or 0.5Hz, whichever is lower.

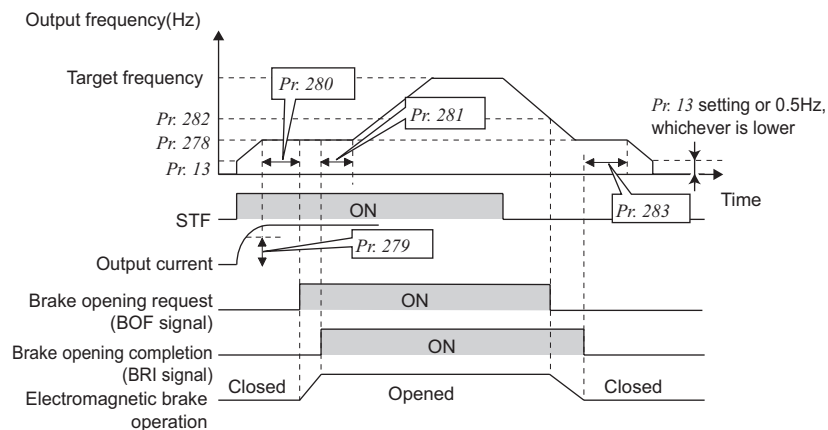

**(3) Without brake opening completion signal input (*Pr. 292 = "8"*)**

- When the start signal is input to the inverter, the inverter starts running. When the internal speed command reaches the value set in *Pr. 278* and the output current is not less than the value set in *Pr. 279* , the inverter outputs the brake opening request signal (BOF) after the time set in *Pr. 280* has elapsed.  
When the time set in *Pr. 281* elapses after the BOF signal is output, the inverter increases the output frequency to the set speed.
- When the inverter decelerates to the frequency set in *Pr.282* during deceleration, the inverter turns OFF the BOF signal and decelerates further to the frequency set in *Pr.278*. After the turn OFF of BOF signal, the inverter holds the frequency set in *Pr.278* for the time set in *Pr.283*. And after the time set in *Pr.283* passes, the inverter decelerates again. The inverter finally stops when its frequency reaches to *Pr. 13 Starting frequency* setting or 0.5Hz, whichever is lower.

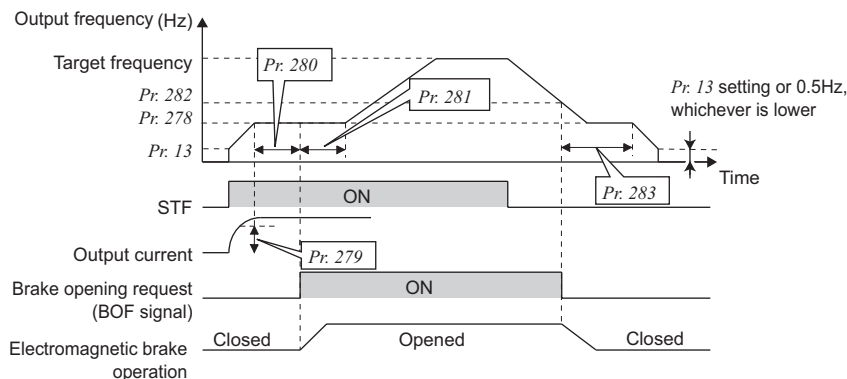

**REMARKS**

- Even if brake sequence mode has been selected, inputting the JOG signal (jog operation), RT signal (second function selection) or X9 signal (third function selection) during an inverter stop will switch to the normal operation and give priority to jog operation or second and third function selection. Note that JOG and RT signal input is invalid even if JOG signal and RT signal are input during automatic acceleration/deceleration operation.



**(4) Protective functions**

If any of the following errors occurs in the brake sequence mode, the inverter results in a fault, trips, and turns off the brake opening request signal (BOF).

Fault Display	Description
E.MB1	(Detection frequency) - (output frequency) > Pr. 285 during encoder feedback control When Pr. 285 <i>Overspeed detection frequency</i> = 9999, overspeed is not detected.
E.MB2	Deceleration is not normal during deceleration operation from the set frequency to the frequency set in Pr. 282. (when Pr. 284 =1) (except stall prevention operation)
E.MB3	Brake opening request signal (BOF) turned on though the motor is at a stop. (gravity drop prevention function)
E.MB4	Although more than 2s have elapsed after the start command (forward or reverse rotation) is input, the brake opening request signal (BOF) does not turn on.
E.MB5	Although more than 2s have elapsed after the brake opening request signal (BOF) turned on, the brake opening completion signal (BRI) does not turn on.
E.MB6	Though the inverter had turned on the brake opening request signal (BOF), the brake opening completion signal (BRI) turned off midway.
E.MB7	Although more than 2s have elapsed after the brake opening request signal (BOF) turned off at a stop, the brake opening completion signal (BRI) does not turn off.

**CAUTION**

- During deceleration, inverter output is shut OFF when the frequency reaches Pr. 13 *Starting frequency* or 0.5Hz, whichever is lower. For Pr. 278 *Brake opening frequency*, set a frequency equal to or higher than the Pr. 13 setting or 0.5Hz.
- Overspeed detection (Pr. 285) is valid under encoder feedback control (used with the FR-A7AP/FR-A7AL (option)) even if a value other than "7 or 8" is set in Pr. 292.
- Setting Pr. 278 *Brake opening frequency* too high activates stall prevention operation and may cause E.MB4.
- If the sum of the time between Pr. 13 *Starting frequency* and Pr. 278 *Brake opening frequency* + Pr. 280 *Brake opening current detection time* is more than 2s, E.MB4 occurs.

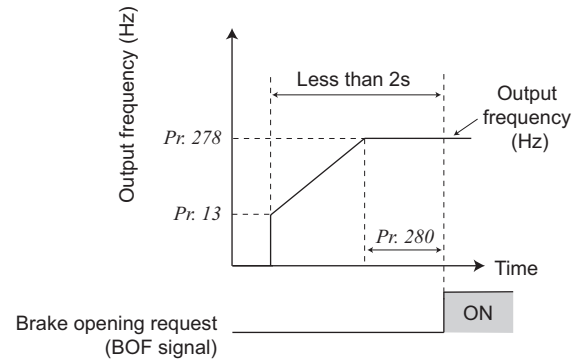

**◆ Parameters referred to ◆**

- Pr. 80 *Motor capacity*, Pr. 81 *Number of motor poles* Refer to page 75
- Pr. 180 to Pr. 186 (*input terminal function selection*) Refer to page 207
- Pr. 190 to Pr. 195 (*output terminal function selection*) Refer to page 215
- Pr. 800 *Control method selection* Refer to page 75
- Encoder feedback control Refer to page 359



### 4.14.5 Orientation control (Pr. 350 to Pr. 366, Pr. 369, Pr. 393, Pr. 396 to Pr. 399)

V/F    Magnetic flux    Vector

This function is used with a position detector (encoder) installed to the spindle of a machine tool, etc. to allow a rotation shaft to be stopped at the specified position (oriented).

Option FR-A7AP/FR-A7AL is necessary.

Pr. 350 Stop position command selection is initially set to "9999", orientation control function is invalid.

Parameter Number	Name	Initial Value	Setting Range	Description
350	Stop position command selection	9999	0	Internal stop position command (Pr. 356)
			1	External stop position command (FR-A7AX 16-bit data)
			9999	Orientation control invalid
351	Orientation speed	2Hz	0 to 30Hz	Decrease the motor speed to the set value when the orientation command (X22) is given.
352	Creep speed	0.5Hz	0 to 10Hz	After the speed reaches the orientation speed, the speed decreases to the creep speed set in Pr. 352 as soon as the current position pulse reaches the creep switchover position set in Pr. 353.
353	Creep switchover position	511	0 to 16383*	As soon as the current position pulse reaches the set position loop switchover position, control is changed to position loop.
354	Position loop switchover position	96	0 to 8191	After changed to position loop, DC injection brake is applied and the motor stops as soon as the current position pulse reaches the set DC injection brake start position.
355	DC injection brake start position	5	0 to 255	When "0" is set in Pr. 350, the internal position command is activated and the setting value of Pr. 356 becomes a stop position.
356	Internal stop position command	0	0 to 16383*	Set the in-position zone at a stop of the orientation.
357	Orientation in-position zone	5	0 to 255	Functions at orientation complete can be selected.
358	Servo torque selection	1	0 to 13	
359	Encoder rotation direction	1	0 1	
360	16 bit data selection	0	0	Speed command
			1	16 bit data is used as external position command as is.
			2 to 127	Set the stop position dividing up to 128 stop positions at regular intervals.
361	Position shift	0	0 to 16383*	When 1 is set in Pr. 350 and the FR-A7AX is mounted, set a stop position using 16-bit data. Stop position command is input as binary regardless of the Pr. 304 setting.
362	Orientation position loop gain	1	0.1 to 100	Shift the origin using a compensation value without changing the origin of the encoder. The stop position is a position obtained by adding the setting value of Pr. 361 to the position command.
363	Completion signal output delay time	0.5s	0 to 5.0s	When servo torque function is selected using Pr. 358, output frequency for generating servo torque increases to the creep speed of Pr. 352 gradually according to the slope set in Pr. 362. Although the operation becomes faster when the value is increased, a machine may hunt, etc.
363	Completion signal output delay time	0.5s	0 to 5.0s	The orientation complete signal is output delaying the set time after in-position zone is entered. Also, the signal turns off delaying the set time after in-position zone is out.



Parameter Number	Name	Initial Value	Setting Range	Description
364	Encoder stop check time	0.5s	0 to 5.0s	Orientation fault signal (ORM) is output when the encoder remains stopped for the set time without orientation complete in the state where no orientation complete signal (ORA) is output. ORM signal is output when orientation is not completed again in the set time in the state where ORA signal is output.
365	Orientation limit	9999	0 to 60.0s	Measure the time taken after passing the creep switchover position and output the orientation fault signal (ORM) if orientation is not completed within the set time.
			9999	Set to 120s.
366	Recheck time	9999	0 to 5.0s	Turning off the start signal with orientation command (X22) on after stopping the motor by orientation control, the present position is checked again after the set time elapses and the orientation complete signal (ORA) or orientation fault signal (ORM) is output.
			9999	Not checked.
369	Number of encoder pulses	1024	0 to 4096	Set the number of pulses of the encoder. Set the number of pulses before multiplied by four.
393	Orientation selection	0	0	Orientation is executed from the current rotation direction.
			1	Orientation is executed from the forward rotation direction.
			2	Orientation is executed from the reverse rotation direction.
396	Orientation speed gain (P term)	60	0 to 1000	Response level during position control loop (servo rigidity) at orientation stop can be adjusted.
397	Orientation speed integral time	0.333	0 to 20.0s	
398	Orientation speed gain (D term)	1	0 to 100.0	Lag/advance compensation gain can be adjusted.
399	Orientation deceleration ratio	20	0 to 1000	Make adjustment when the motor runs back at orientation stop or the orientation time is long.

The above parameters can be set when the FR-A7AP/FR-A7AL (option) is mounted.

\* When the operation panel (FR-DU07) is used, the maximum setting is 9999. When a parameter unit is used, up to the maximum value within the setting range can be set.



(1) Connection example

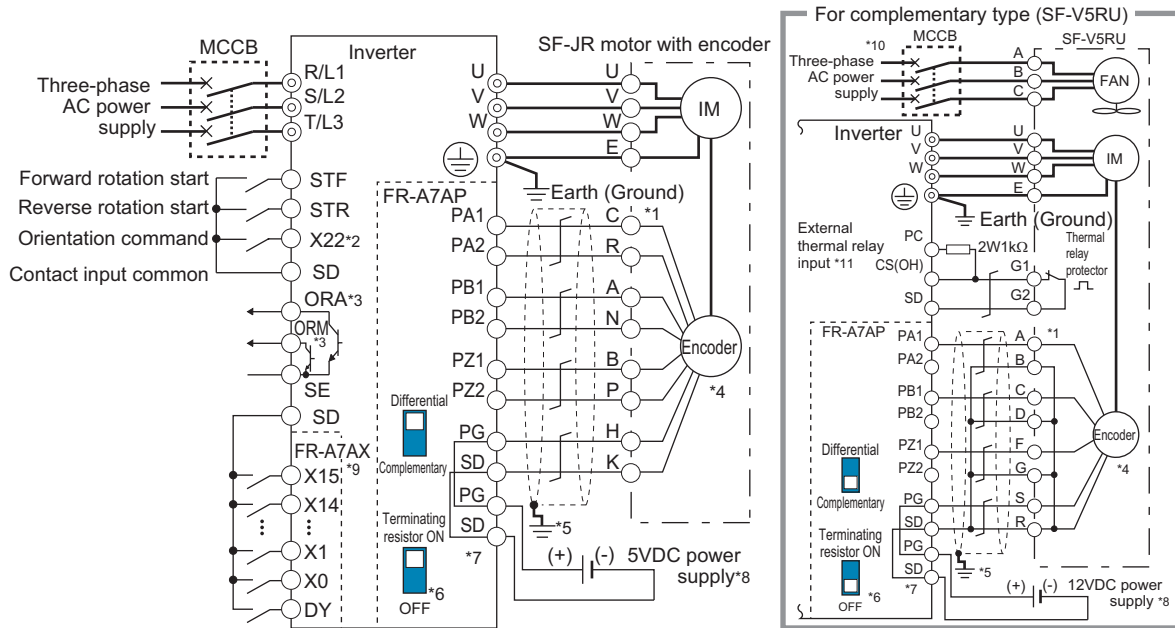

- \*1 The pin number differs according to the encoder used.
- \*2 Use Pr. 178 to Pr. 189 (input terminal function selection) to assign the function to any of terminal. (Refer to page 207.)
- \*3 Use Pr. 190 to Pr. 196 (output terminal function selection) to assign the function to any of terminal. (Refer to page 215.)
- \*4 Connect the encoder so that there is no looseness between the motor and motor shaft. Speed ratio should be 1:1.
- \*5 Earth (Ground) the shielded cable of the encoder cable to the enclosure with a P clip, etc. (Refer to page 35.)
- \*6 For the differential line driver, set the terminating resistor selection switch to on position (initial status) to use. (Refer to page 31.)  
Note that the terminating resistor switch should be set to off position when sharing the same encoder with other unit (NC, etc) or a terminating resistor is connected to other unit.  
For the complementary, set the switch to off position.
- \*7 For terminal compatibility of the FR-JCBL, FR-V7CBL and FR-A7AP, refer to page 33.
- \*8 A separate power supply of 5V/12V/15V/24V is necessary according to the encoder power specification.  
When performing encoder feedback control and vector control together, an encoder and power supply can be shared.
- \*9 When a stop position command is input from outside, a plug-in option FR-A7AX is necessary. Refer to page 199 for external stop position command.)
- \*10 For the fan of the 7.5kW or less dedicated motor, the power supply is single phase. (200V/50Hz, 200 to 230V/60Hz)
- \*11 Assign OH (external thermal input) signal to the terminal CS. (Set "7" in Pr. 186)  
Connect a 2W1kΩ resistor between the terminal PC and CS(OH).  
Install the resistor pushing it against the bottom part of the terminal block so as to avoid a contact with other cables.

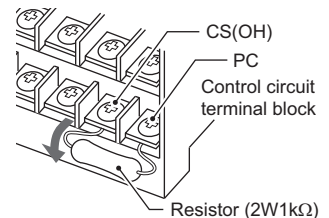

<Setting>

If the orientation command signal (X22) is turned on during operation after the various parameters have been set, the speed will decelerate to the "orientation switchover speed". After the "orientation stop distance" is calculated, the speed will further decelerate, and the "orientation state" (servo lock) will be entered. The "orientation complete signal" (ORA) will be output when the "orientation complete width" is entered.

(2) Setting I/O signals

Signal	Signal Name	Application Explanation
X22-1	Orientation command input	Used to enter an orientation signal for orientation. For the terminal used for X22 signal input, set "22" in any of Pr. 178 to Pr. 189 to assign the function.
SD	Contact input common	Common terminal for the orientation signal.
ORA-2	Orientation complete signal output	Switched low if the orientation has stopped within the in-position zone while the start and orientation signals are input. For the terminal used for the ORA signal output, assign the function by setting "27 (positive logic) or 127 (negative logic)" in any of Pr. 190 to Pr. 196.
ORM-2	Orientation fault signal output	Switched low if the orientation has not stopped within the in-position zone while the start and orientation signals are input. For the terminal used for the ORM signal output, assign the function by setting "28 (positive logic) or 128 (negative logic)" in any of Pr. 190 to Pr. 196.
SE	Open collector output common	Common terminal for the ORA and ORM open collector output terminals.

\*1 For X22 signals, assign functions to any of terminal using Pr. 178 to Pr. 189 (output terminal function selection). (Refer to page 207)  
\*2 For ORA and ORM signals, assign functions to any of terminal using Pr. 190 to Pr. 196 (output terminal function selection). (Refer to page 215)



**(3) Selecting stop position command (Pr. 350 Stop position command selection)**

- Select either the internal stop position command (Pr. 356) or the external stop position command (16-bit data using the FR-A7AX).

Pr. 350 Setting	Stop Position Command Source
0	Internal stop position command (Pr. 356: 0 to 16383)
1	External stop position command (FR-A7AX) 16-bit data
9999 (Initial value)	Orientation control invalid

1) Internal stop position command (Pr. 350 = "0")

The value set in Pr. 356 is the stop position.

When the number of encoder pulses is 1024p/r, one revolution of the encoder is divided into 4096 positions, i.e.  $360^\circ/4096$  pulses =  $0.0879^\circ$ /pulses per address, as shown on the right. The stop positions (addresses) are indicated in parentheses.

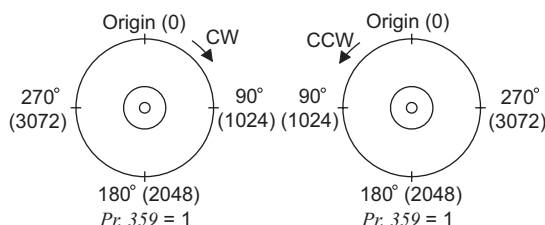

2) External stop position command (Pr. 350 = "1")

Mount the option FR-A7AX and set a stop position using 16-bit data (binary input).

- The value set in Pr. 360 16 bit data selection should be the number of stop positions less 1.

Pr. 360 Setting	Description
0	External position command is invalid (speed command or torque command with the FR-A7AX)
1	Position command direct input The 16-bit digital signal from the FR-A7AX is directly serves as stop position command. <Example> When the Pr. 369 Number of encoder pulses setting is 1024, stop position command from 0 to 4095 can be directly input using the FR-A7AX and input digital signal of 2048 (H800) to stop the motor at 180° position. The command more than 4096 is considered as 4095.
2 to 127	Set the stop position command dividing up to 128 stop positions at regular intervals. If the external stop command entered is greater than the setting, the stop positions are the same as those in the maximum external stop command value. <Example> When the number of stop positions is 90 (divided at intervals of 4°), 90 - 1 = 89. Hence, set "89".

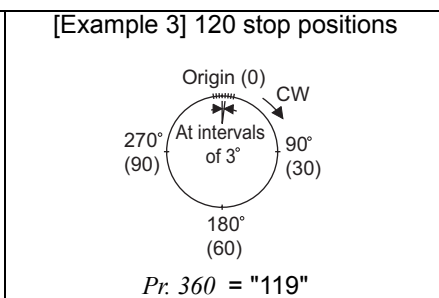
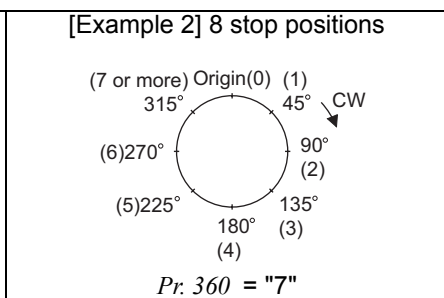
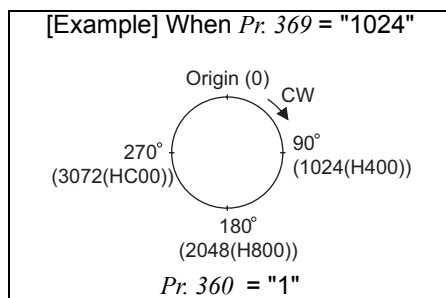

**CAUTION**

- Values in parentheses indicate binary data entered from the terminals. Even if the position pulse monitor (Pr. 52 DU/PU main display data selection = 19) is selected, the data monitored is not the number of stop positions but is 0 to 65535 pulses.
- FR-A7AX parameters (Pr. 300 to Pr. 305) are invalid. (Valid when Pr. 360 = "0")
- Terminal DY (data read timing input signal) is invalid during vector control. (The position data is downloaded at the start of orientation.)
- Internal stop position command is given even if "1" (external stop position command) is set in Pr. 350 when an option card (FR-A7AX) is not mounted or Pr. 360 = "0".



- Relationship between stop position command and 16-bit data

Pr. 350 Stop position command selection	Pr. 360 16 bit data selection	Operation		
		Stop position command	16 bit data (FR-A7AX)	Speed command
0: internal	0: speed command	Internal (Pr. 356)	Speed command	16 bit data
	1, 2 to 127: position command	Internal (Pr. 356)	Invalid	External command (or PU)
1: external	0: speed command	Internal (Pr. 356)	Speed command	16 bit data
	1, 2 to 127: position command	External (Internal when the FR-A7AX is not mounted (Pr. 356))	Position command	External command (or PU)

3) Pr. 361 Position shift (initial value "0")

The stop position is a position obtained by adding the setting value of Pr. 361 to the position command.

<Position shift function>

Shift the origin using a compensation value without changing the origin of the position detector (encoder).

**REMARKS**

- When orientation control is valid using Pr. 350 Stop position command selection with the FR-A7AP/FR-A7AL (option) mounted, the rotation direction of encoder is displayed on the rotation direction display of the PU (FR-DU07/FR-PU04/FR-PU07). Set the parameter so that turning on the STF signal displays FWD or turning on the STR signal displays REV.

**(4) Monitor display change**

Monitor	Remarks
Position pulse monitor	When "19" is set in Pr. 52, position pulse monitor is displayed instead of output voltage monitor of the PU. (Displayed only when the FR-A7AP/FR-A7AL (option) is mounted.)
Orientation status*	When "22" is set in Pr. 52, orientation status is displayed instead of output voltage monitor of the PU. (Displayed only when the FR-A7AP/FR-A7AL (option) is mounted.) 0: Other than orientation operation or orientation speed is not reached 1: Orientation speed is reached 2: Creep speed is reached 3: Position loop is reached 4: Orientation complete 5: Orientation fault (pulse stop) 6: Orientation fault (orientation limit) 7: Orientation fault (recheck) 8: Continuous multi-point orientation

\* Invalid during vector control. ("0" is always displayed)

**(5) Pr. 357 Orientation in-position zone (initial value "5")**

- The positioning width for orientation stop can be set. The initial setting of Pr. 357 is "5". To change the  $\Delta\theta$  value, finely adjust with  $\pm 10$  increments, and make fine adjustment.
- If the position detection value from the encoder enters  $\pm\Delta\theta$  during orientation stop, the orientation complete signal (ORA) will be output.

Example of operation

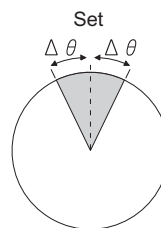

$$\Delta\theta = \frac{360^\circ}{\text{Pr.369} \times \text{four times}} \times \text{Pr. 357}$$

Number of encoder pulses





**(6) Orientation operation (under V/F control, Advanced magnetic flux vector control)**

**● Orientation during running**

- 1) When the orientation command (X22) is input, the motor speed decreases to the orientation speed set in *Pr. 351 Orientation speed* . (*Pr. 351* initial value: 2Hz)
- 2) After the speed reaches the orientation speed, the speed decreases to the creep speed set in *Pr. 352 Creep speed* as soon as the current position pulse reaches the creep switchover position set in *Pr. 353 Creep switchover position* (*Pr. 352* initial value:0.5Hz, *Pr. 353* initial value: 511)
- 3) Moreover, as soon as the current position pulse reaches the set position loop switchover position in *Pr. 354 Position loop switchover position* , control is changed to position loop. (*Pr. 354* initial value: 96)
- 4) After switching to position loop, the inverter decelerates and stops with DC injection brake as soon as the current position pulse has reached the DC injection brake start position set in *Pr. 355 DC injection brake start position*. (*Pr. 355* initial value: 5)
- 5) When the position pulse has stopped within the in-position zone set in *Pr. 357 Orientation in-position zone* , the orientation complete signal (ORA) is output after the completion signal output delay time set in *Pr. 363 Completion signal output delay time* has elapsed. If the motor does not stop within the in-position zone due to external force, etc., the orientation complete signal is turned off after the time set in *Pr. 363 Completion signal output delay time* has elapsed. (*Pr. 357* initial value: 5)
- 6) If the orientation is not completed continuously for the time set in *Pr. 365 Orientation limit* after passing the creep switchover position, the orientation fault signal (ORM) is output.
- 7) When the motor stops before the position pulse reaching the in-position zone due to external force after orientation start and orientation complete signal (ORA) is not output, orientation fault signal (ORM) is output after the time set in encoder stop check time set in *Pr. 364 Encoder stop check time* has elapsed. Moreover, the orientation complete signal (ORA) is turned off after the time set in *Pr. 363 Completion signal output delay time* has elapsed if the position pulse is outside the in-position zone due to external force, etc. after outputting the orientation complete signal (ORA), and the orientation fault signal (ORM) is output if the orientation has not completed within the time set in *Pr. 364 Encoder stop check time* .
- 8) When the start signal (STF or STR) is turned off with the orientation command on after outputting the orientation complete signal (ORA) and orientation fault signal (ORM), the orientation complete signal (ORM) or orientation fault signal (ORM) is output again after recheck time set in *Pr. 366 Recheck time* has elapsed.
- 9) The orientation complete signal (ORA) and orientation fault signal (ORM) are not output when the orientation command is off.

**REMARKS**

- When the orientation command is off with the start signal on, the speed accelerates to the command speed.

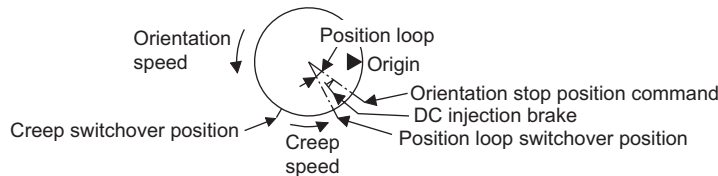

- If the hunting of the motor shaft occurs, set a larger value in *Pr. 354 Position loop switchover position* or a smaller value in *Pr. 352 Creep speed* to prevent it.
- Action time chart

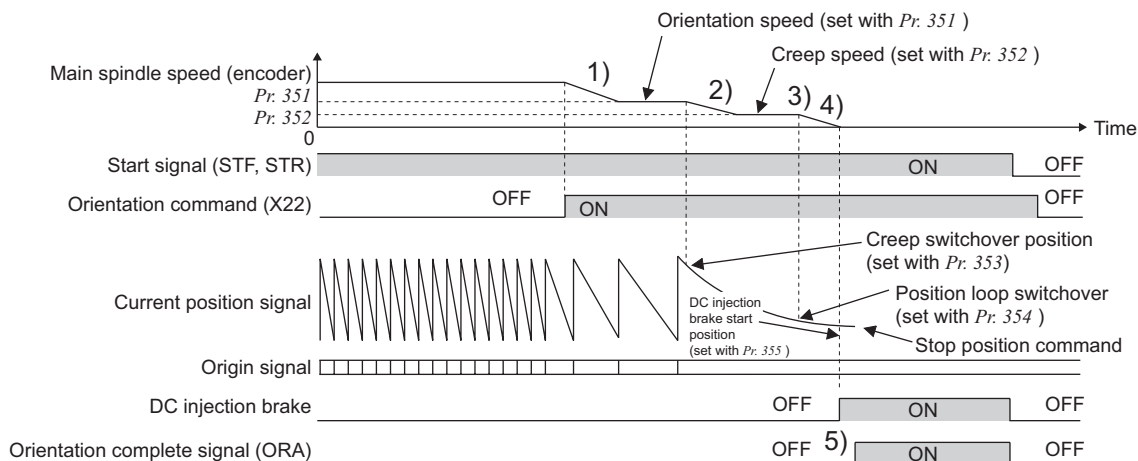





● Orientation from stop

After turning on the orientation command (X22), turning on the start signal will increase the motor speed to the orientation speed set in Pr. 351 Orientation speed, then orientation operation same as when "orientation during running" is performed.

Note that, DC injection brake is operated if the position signal is within the DC injection brake start position.

• Action time chart

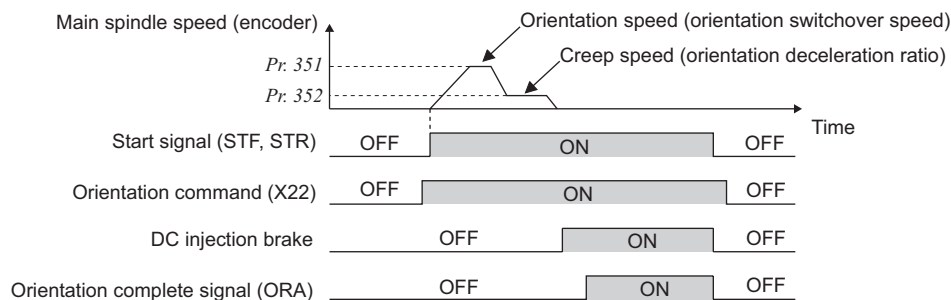

● Continuous multi-point orientation

Orientation command and orientation with STF/STR on  
(Orientation in servo in status)

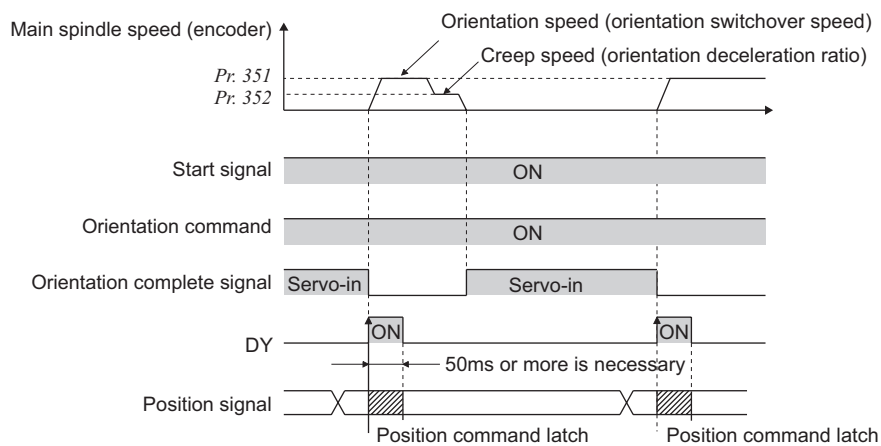

- Read the position data at starting up of DY (refer to the FR-A7AX instruction manual ).
- When the position signal is within the creep switchover position, the speed starts up to the creep speed not to the orientation speed.
- When the position signal is not within the creep switchover position, the speed starts up to the orientation speed.
- The DC injection brake is operated if the position signal is within the DC injection brake start position.
- 16-bit data with the FR-A7AX is valid only when the DY signal is on.

**CAUTION**

- The encoder should be coupled with the motor shaft or main spindle oriented with a speed ratio of 1 to 1 without any mechanical looseness.
- DC injection brake operates when orientation stop is made. Release the DC injection brake in a time as short as possible (within several seconds) since continuous operation of the DC injection brake will cause the motor to overheat, leading to burnout.
- Since no servo lock function is available after orientation stop, provide a holding mechanism such as mechanical brake or knock pin when secure holding of a main spindle is required.
- To ensure correct positioning, the encoder must be set in the proper rotation direction and the A and B phases connected correctly.
- When the pulse signal from the encoder stops due to the encoder signal loss, etc. during orientation, the orientation fault signal (ORM) may be output.
- When the DC injection brake is set to disabled using parameter for DC injection brake adjustment (voltage, frequency, speed, time) when performing orientation control, orientation operation can not be completed. Always set the DC injection brake enabled.
- To terminate orientation, the start signal (STF or STR) must be first switched off and the orientation signal (X22) must be switched off. As soon as this orientation signal is switched off, orientation control ends.(Depending on the Pr. 358 Servo torque selection setting, orientation status continues if the orientation signal remains on even if DC injection brake is released at turning off of the start signal. Therefore, the orientation status of the monitor function is not 0.)
- When retry function of Pr. 358 Servo torque selection is selected, the retry operation is performed three times including the first orientation.
- When performing orientation control, make proper setting of Pr. 350 Stop position command selection and Pr. 360 16 bit data selection (external position command selection). If the values set are incorrect, proper orientation control will not be performed.
- When Pr. 11 DC injection brake operation time = "8888" (DC injection brake external selection), DC injection brake does not operate if the X13 signal is not turned on. Note that the DC injection brake is applied under orientation control regardless of the X13 signal status.
- When orientation control is exercised, PID control is invalid.



● Servo torque selection (Pr. 358)

Valid only under V/F control and Advanced magnetic flux vector control.

Function	Pr. 358 Setting													Remarks	
	0	1	2	3	4	5	6	7	8	9	10	11	12		13
1) Servo torque function selection until output of the orientation complete signal (ORA)	×	○	○	○	○	×	○	×	○	×	○	×	×	○	○: With servo torque function ×: Without servo torque function
2) Retry function selection	×	×	×	×	×	×	○	×	×	×	○	×	×	○: With retry function ×: Without retry function	
3) Output frequency is compensated when the motor stops outside the in-position zone	×	×	○	○	×	○	○	×	×	×	×	×	○	○	○: With frequency compensation ×: Without frequency compensation
4) DC injection brake and servo torque selection when the position pulse comes off the in-position zone after output of the orientation complete signal (ORA)	○	×	×	×	×	○	○	○	○	○	○	○	○	○	○: With DC injection brake ×: With servo torque
5) End switch selection of the DC injection brake and orientation complete signal (ORA)	○	○	○	×	×	○	○	○	×	×	×	×	×	×	○: When the start signal (STF, STR) or orientation command is turned off ×: When the orientation command is turned off
6) Completion signal off selection when the position pulse comes off the in-position zone after output of the orientation complete signal (ORA)	○	○	○	○	○	×	×	×	×	×	×	×	×	×	○: Turns off the completion signal when the motor stops outside of the in-position zone ×: Completion signal remains on even if the position pulse comes off the completion zone (orientation fault signal (ORM) is not output)

**REMARKS**

- When the orientation command is off with the start signal on, the speed accelerates to the command speed.
- When the motor shaft stops outside of the set setting range of stop position, the motor shaft is returned to the stop position by servo torque function (if enough torque is generated).

1) Servo torque function selection until output of the orientation complete signal

Whether servo torque is available or not is selected using *Pr. 358 Servo torque selection*. Servo torque is not generated if the current position pulse is in between the orientation stop position and DC injection brake start position. Although, the shaft is retained by the DC injection brake, servo torque is generated to return the shaft within the width if the shaft moves out of the width by external force, etc. Once the orientation complete signal (ORA) is output, the motor runs according to the setting made in 4).

2) Retry function selection

Select retry function using *Pr. 358 Servo torque selection*. Note that servo torque function can not be used together. When the motor shaft is not stopped within the in-position zone when the motor stop is checked, orientation operation is performed again by retry function.

With this retry function, three orientations including the first one are performed. More than three times retry operations are not made. (The orientation fault signal (ORM) is not output during retry operation)

3) Frequency compensation function when the motor stops outside the orientation in-position zone

When the motor stops before entering the in-position zone due to external force, etc., output frequency is increased to move the shaft to the orientation stop position. The output frequency is gradually increased to the creep speed of *Pr. 352 Creep speed*.

Note that retry function can not be used together.

4) DC injection brake and servo torque selection when the position pulse comes off the in-position zone after output of the orientation complete signal (ORA)

If the position pulse comes off the orientation in-position width, you can select a setting either fixing a shaft with the DC injection brake or returning the motor to the orientation stop position with servo torque.

5) Orientation operation end switch operation selection between DC injection brake or servo torque

When ending the orientation operation, turn off the start signal (STF or STR), then turn off the orientation command (X22). At this time, you can select when to turn off the orientation complete signal (ORA) from between at turning off of the start signal or turning off of the orientation command signal.

6) Selection of completion signal off or on when the motor stops outside of the in-position zone after output of the orientation complete signal (ORA)

You can select the mode to turn off the completion signal or keep the completion signal on (orientation fault signal (ORM) is not output) when the motor stops outside of the in-position zone.



● **Position loop gain (Pr. 362)**

When servo torque function is selected using Pr. 358 Servo torque selection , output frequency for generating servo torque increases to the creep speed of Pr. 352 Creep speed gradually according to the slope set in Pr. 362 Orientation position loop gain .

Although the operation becomes faster when the value is increased, a machine may hunt, etc.

**(7) Orientation operation explanation (during vector control)**

● **Setting the rotation direction (Pr. 393 Orientation selection )**

Pr. 393 Setting	Rotation Direction	Remarks
0 (initial value)	Pre-orientation	Orientation is executed from the current rotation direction.
1	Forward rotation orientation	Orientation is executed from the forward rotation direction. (If the motor is running in reverse, orientation is executed from the forward rotation direction after deceleration.)
2	Reverse rotation orientation	Orientation is executed from the reverse rotation direction. (If the motor is running in forward, orientation is executed from the reverse rotation direction after deceleration.)

1) Orientation from the current rotation direction

- When the orientation command (X22) is input, the motor speed will decelerate from the running speed to Pr. 351 Orientation speed.  
At the same time, the orientation stop position command will be read in.  
(The stop position command is determined by the setting of Pr. 350 and Pr. 360. Refer to the right chart.)
- When the orientation switchover speed is reached, the encoder Z phase pulse will be confirmed, and the mode will change from speed control to position control (Pr. 362 Orientation position loop gain ).
- The distance to the orientation stop position is calculated at switching of the control, and the motor decelerates and stops with a set deceleration pattern (Pr. 399) and the orientation (servo lock) state will be entered.
- When entered in the Pr. 357 Orientation in-position zone, the orientation complete signal (ORA) will be output.
- The zero point position (origin) can be moved using Pr. 361 Position shift .

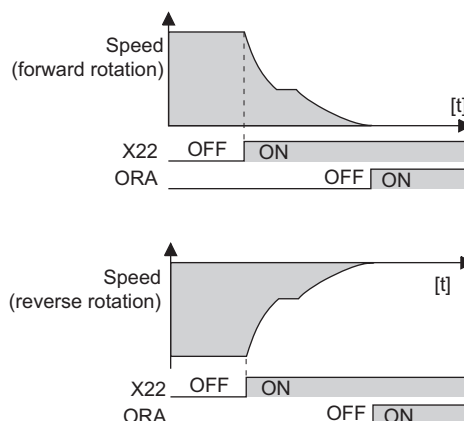

## ⚠ WARNING

⚠ If the orientation command (X22) is turned off while the start signal is input, the motor will accelerate toward the speed of the current speed command. Thus, to stop, turn the forward rotation (reverse rotation) signal off.

2) Orientation from the forward rotation direction

- This method is used to improve the stopping precision and maintain the mechanical precision when the backlash is large.
- If the motor is running in the forward rotation direction, it will make an orientation stop with the same method as "orientation from the current rotation direction".
- If the motor is running in reverse, it will decelerate, the rotation direction will be changed to forward run, and then orientation stop will be executed.

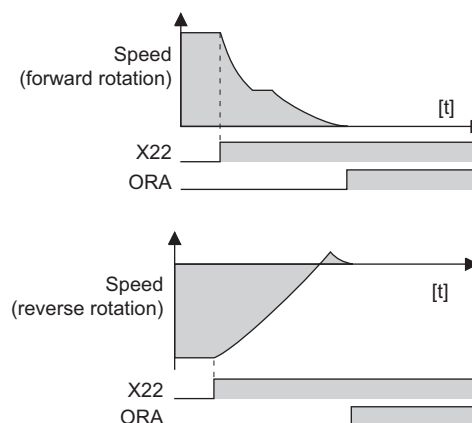



3) Orientation from the reverse rotation direction

- If the motor is running in the reverse rotation direction, it will make an orientation stop with the same method as "orientation from the current rotation direction".
- If the motor is running in forward, it will decelerate, the rotation direction will be changed to reverse run, and then orientation stop will be executed.

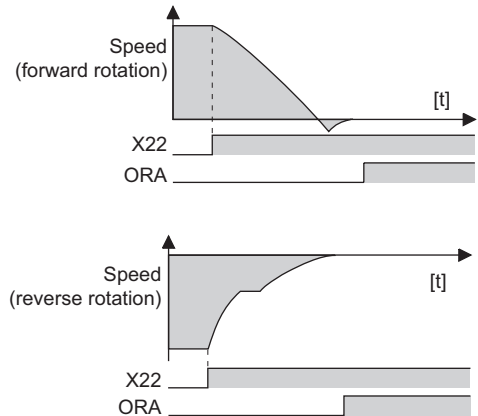

**CAUTION**

- The encoder should be coupled with the motor shaft oriented with a speed ratio of 1 to 1 without any mechanical looseness.
- To ensure correct positioning, the encoder must be set in the proper rotation direction and the A and B phases connected correctly.
- Orientation may not be completed if the pulse signals are not received from the encoder during orientation due to a break in the cable or the like.
- To terminate orientation, the start signal (STF or STR) must be first switched off and the orientation signal (X22) must be switched off. As soon as this orientation signal is switched off, orientation control ends.
- When performing orientation control, make proper setting of *Pr. 350 Stop position command selection* and *Pr. 360 16 bit data selection*. If the values set are incorrect, proper orientation control will not be performed.
- When orientation control is exercised, PID control is invalid.

**REMARKS**

If "E.ECT" (no encoder signal) is displayed causing the inverter to trip when the orient signal (X22) is ON, check for a single loss in the cable of the Z phase of the encoder.

● **Servo rigidity adjustment (Pr. 362, Pr. 396 to Pr. 398)**

- To increase the servo rigidity <sup>1</sup> during orientation stop using *Pr. 396 or Pr. 397*, adjust with the following procedures.
  - 1) Increase the *Pr. 362 Orientation position loop gain* value to the extent that rocking <sup>2</sup> does not occur during orientation stop.
  - 2) Increase *Pr. 396 and Pr. 397* at the same rate.  
Generally adjust *Pr. 396* in the range from 10 to 100, and *Pr. 397* from 0.1 to 1.0s.  
(Note that these do not need to be set to the same rate.)

<Example>

When the *Pr. 396* value is multiplied by 1.2, divide the *Pr. 397* value by 1.2.

If vibration occurs during orientation stop, the scale cannot be raised any higher.

- 3) *Pr. 398* is the lag/advance compensation gain.  
The limit cycle <sup>3</sup> can be prevented by increasing the value, and the running can be stopped stably. However, the torque in regard to the position deviation will drop, and the motor will stop with deviation.

**POINT**

Application of lag/advance control and PI control  
PI control can be applied by setting *Pr. 398* to 0. Normally, the lag/advance control is selected. Note that PI control should be used when using a machine with a high spindle stationary friction torque and requires a stopping position precision.

\*1 Servo rigidity: This is the response when a position control loop is configured. When the servo rigidity is raised, the holding force will increase, the running will stabilize, but vibration will occur easily. When the servo rigidity is lowered, the holding force will drop, and the setting time will increase.  
\*2 Rocking: Movement in which return occurs if the stopping position is exceeded.  
\*3 Limit cycle: This is a phenomenon that generates ± continuous vibration centering on the target position.



● **Pr. 399 Orientation deceleration ratio (initial value is 20)**

- Make adjustments as shown below according to the orientation status.  
(Refer to the Pr. 396 and Pr. 397 details also.)  
Generally adjust Pr. 362 in the range from 5 to 20, and Pr. 399 from 5 to 50.

Phenomenon	Adjustment Procedure			
	Pr. 396	Pr. 397	Pr. 362	Pr. 399
Rocking occurs during stopping	3) ↗	3) ↗	2) ↘	1) ↘
The orientation time is long	→	→	2) ↗	1) ↗
Hunting occurs when stopping	2) ↘	2) ↗	1) ↘	→
The servo rigidity during stopping is low	1) ↗	1) ↘	2) ↗	→

**REMARKS**

- ↗ :Increase the parameter setting value.  
→ :Do not change the parameter setting value.  
↘ :Decrease the parameter setting value.
- The numbers 1) , 2) and 3) in the table show the order of priority for changing the parameters setting value.

**CAUTION**

Or, if the motor does forward/reverse reciprocation operation (↻), the parameter setting value for the orientation detector installation direction may be incorrect. Review Pr. 393 Orientation selection (refer to page 197) and Pr. 359 Encoder rotation direction (refer to page 196).

● **Pr. 351 Orientation speed (initial value: 2Hz)**

- Set the speed when switching between the speed control mode and the position control mode is performed under orientation operation.  
Decreasing the set speed enables stable orientation stop. Note that the orientation time will increase.

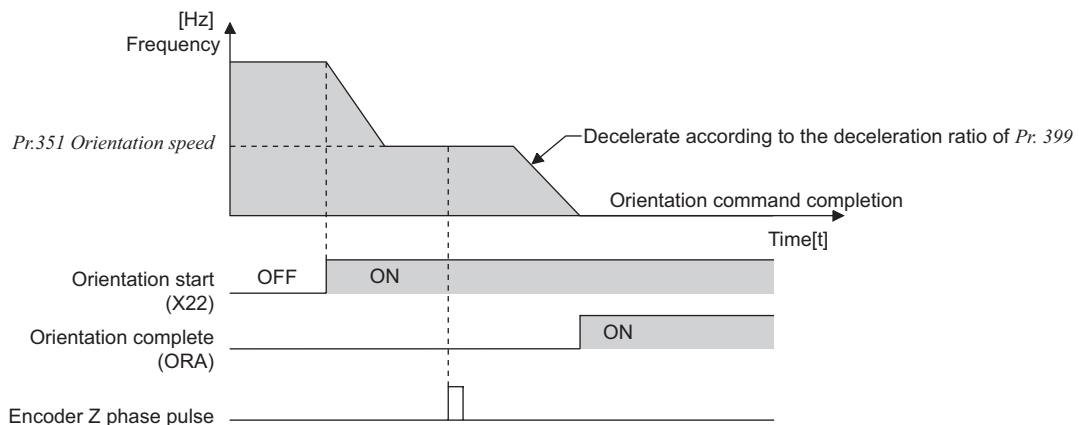

**REMARKS**

When "19" is set in Pr. 52 DU/PU main display data selection , position pulse monitor is displayed instead of PU output voltage monitor.

## 4.15 Function assignment of external terminal and control

Purpose	Parameter that must be Set		Refer to Page
Assign function to input terminal	Input terminal function selection	Pr. 178 to Pr. 189	207
Set MRS signal (output shutoff) to normally closed contact specification	MRS input selection	Pr. 17	210
Make the second (third) function valid only during constant speed operation	RT signal function validity condition selection	Pr. 155	211
Assign start signal and forward/reverse command to other signals	Start signal (STF/STR) operation selection	Pr. 250	212
Assign function to output terminal	Output terminal function assignment	Pr. 190 to Pr. 196	215
Detect output frequency	Up-to-frequency sensitivity Output frequency detection Low speed detection	Pr. 41 to Pr. 43, Pr. 50, Pr. 116, Pr. 865	222
Detect output current	Output current detection Zero current detection	Pr. 150 to Pr. 153, Pr. 166, Pr. 167	224
Remote output function	Remote output	Pr. 495 to Pr. 497	226
Detect output torque	Output torque detection	Pr. 864	225

### 4.15.1 Input terminal function selection (Pr. 178 to Pr. 189)

Use these parameters to select/change the input terminal functions.

Parameter Number	Name	Initial Value	Initial Signal	Setting Range
178	STF terminal function selection	60	STF (forward rotation command)	0 to 9, 12 to 20, 22 to 28, 42 to 44, 60, 62, 64 to 69, 74, 9999
179	STR terminal function selection	61	STR (reverse rotation command)	0 to 9, 12 to 20, 22 to 28, 42 to 44, 61, 62, 64 to 69, 74, 9999
180	RL terminal function selection	0	RL (low-speed operation command)	0 to 9, 12 to 20, 22 to 28, 42 to 44, 62, 64 to 69, 74, 9999
181	RM terminal function selection	1	RM (middle-speed operation command)	
182	RH terminal function selection	2	RH (high speed operation command)	
183	RT terminal function selection	3	RT (second function selection)	
184	AU terminal function selection	4	AU (terminal 4 input selection)	0 to 9, 12 to 20, 22 to 28, 42 to 44, 62 to 69, 74, 9999
185	JOG terminal function selection	5	JOG (Jog operation selection)	0 to 9, 12 to 20, 22 to 28, 42 to 44, 62, 64 to 69, 74, 9999
186	CS terminal function selection	6	CS (selection of automatic restart after instantaneous power failure)	
187	MRS terminal function selection	24	MRS (output stop)	
188	STOP terminal function selection	25	STOP (start self-holding selection)	
189	RES terminal function selection	62	RES (inverter reset)	

#### (1) Input terminal function assignment

- Use Pr. 178 to Pr. 189 to set the functions of the input terminals.
- Refer to the following table and set the parameters:

Setting	Signal Name	Function		Related Parameters	Refer to Page
0	RL	Pr. 59 = 0 (initial value)	Low-speed operation command	Pr. 4 to Pr. 6, Pr. 24 to Pr. 27, Pr. 232 to Pr. 239	148
		Pr. 59 = 1, 2 *1	Remote setting (setting clear)	Pr. 59	152
		Pr. 270 = 1, 3 *2	Stop-on-contact selection 0	Pr. 270, Pr. 275, Pr. 276	190
1	RM	Pr. 59 = 0 (initial value)	Middle-speed operation command	Pr. 4 to Pr. 6, Pr. 24 to Pr. 27, Pr. 232 to Pr. 239	148
		Pr. 59 = 1, 2 *1	Remote setting (deceleration)	Pr. 59	152
2	RH	Pr. 59 = 0 (initial value)	High-speed operation command	Pr. 4 to Pr. 6, Pr. 24 to Pr. 27, Pr. 232 to Pr. 239	148
		Pr. 59 = 1, 2 *1	Remote setting (acceleration)	Pr. 59	152

Setting	Signal Name	Function	Related Parameters	Refer to Page
3	RT	Second function selection	Pr. 44 to Pr. 51, Pr. 450 to Pr. 463, Pr. 569, Pr. 832, Pr. 836, etc.	211
		Pr. 270 = 1, 3 *2	Stop-on-contact selection 1	Pr. 270, Pr. 275, Pr. 276
4	AU	Terminal 4 input selection	Pr. 267	263
5	JOG	Jog operation selection	Pr. 15, Pr. 16	150
6	CS	Selection of automatic restart after instantaneous power failure, flying start	Pr. 57, Pr. 58, Pr.162 to Pr.165, Pr. 299, Pr. 611	243
		Electronic bypass function	Pr. 57, Pr. 58, Pr.135 to Pr.139, Pr. 159	346
7	OH	External thermal relay input *3	Pr. 9	165
8	REX	15-speed selection (combination with three speeds RL, RM, RH)	Pr. 4 to Pr. 6, Pr. 24 to Pr. 27, Pr.232 to Pr.239	148
9	X9	Third function selection	Pr. 110 to Pr. 116	211
12	X12	PU operation external interlock	Pr. 79	290
13	X13	External DC injection brake operation start	Pr. 10 to Pr. 12	185
14	X14	PID control valid terminal	Pr. 127 to Pr. 134, Pr. 575 to Pr. 577	338
15	BRI	Brake opening completion signal	Pr. 278 to Pr. 285	193
16	X16	PU-External operation switchover (turning on X16 selects external operation)	Pr. 79, Pr. 340	296
17	X17	Load pattern selection forward/reverse rotation boost (turning on X17 changes the output characteristics to constant torque load)	Pr. 14	144
18	X18	V/F switchover (V/F control is performed when X18 is ON.)	Pr. 80, Pr. 81, Pr. 800	75, 131
19	X19	Load torque high-speed frequency	Pr. 270 to Pr. 274	351
20	X20	S-pattern acceleration/deceleration C switching terminal	Pr. 380 to Pr. 383	158
22	X22	Orientation command *4, *6	Pr. 350 to Pr. 369	196
23	LX	Pre-excitation/servo on *5	Pr. 850	185
24	MRS	Output stop	Pr. 17	210
		Electronic bypass function	Pr. 57, Pr. 58, Pr.135 to Pr.139, Pr. 159	346
25	STOP	Start self-holding selection	—	212
26	MC	Control mode changing	Pr. 800	75
27	TL	Torque limit selection	Pr. 815	83
28	X28	Start-time tuning start external input	Pr. 95	181
42	X42	Torque bias selection 1 *6	Pr. 840 to Pr. 845	97
43	X43	Torque bias selection 2 *6	Pr. 840 to Pr. 845	97
44	X44	P/PI control switchover (turning on X44 selects P control)	Pr. 820, Pr. 821, Pr. 830, Pr. 831	88
60	STF	Forward rotation command (assigned to STF terminal (Pr. 178) only)	—	212
61	STR	Reverse rotation command (assigned to STR terminal (Pr. 179) only)	—	212
62	RES	Inverter reset	—	—
63	PTC	PTC thermistor input (assigned to AU terminal (Pr. 184) only)	Pr. 9	165
64	X64	PID forward/reverse action switchover	Pr. 127 to Pr. 134, Pr. 5	338
65	X65	PU/NET operation switchover (turning on X65 selects PU operation)	Pr. 79, Pr. 340	297
66	X66	External/NET operation switchover (turning on X66 selects NET operation)	Pr. 79, Pr. 340	297
67	X67	Command source switchover (turning on X67 makes Pr. 338 and Pr. 339 commands valid)	Pr. 338, Pr. 339	299
68	NP	Simple position pulse train sign *6	Pr. 291, Pr. 419 to Pr. 430, Pr. 464	120
69	CLR	Simple position droop pulse clear *6	Pr. 291, Pr. 419 to Pr. 430, Pr. 464	120
74	X74	Magnetic flux decay output shutoff signal	—	214
9999	—	No function	—	—

\*1 When Pr. 59 Remote function selection = "1 or 2", the functions of the RL, RM and RH signals change as listed above.  
 \*2 When Pr. 270 Stop-on contact/load torque high-speed frequency control selection = "1 or 3", the functions of the RL and RM signals change as listed above.  
 \*3 The OH signal turns on when the relay contact "opens".  
 \*4 The FR-A7AX (16-bit digital input) is needed to externally input a stop position under orientation control.  
 \*5 Servo ON is valid during position control under vector control operation.  
 \*6 Available only when used with the FR-A7AP/FR-A7AL (option).

#### REMARKS

- Same function can be assigned to two or more terminals. In this case, the logic of terminal input is OR.
- The priorities of the speed commands are in order of jog > multi-speed setting (RH, RM, RL, REX) > PID (X14).
- When the PU operation external interlock (X12) signal is not assigned at the *Pr. 79 Operation mode selection* setting of "7", the MRS signal shares this function.
- Same signal is used to assign multi-speeds (7 speeds) and remote setting. They cannot be set individually.  
(Same signal is used since multi-speed (7 speeds) setting and remote setting are not used to set speed at the same time.)
- When V/F switching (X18) signal and load pattern selection forward rotation reverse rotation boost (X17) signal are not assigned, the RT signal shares this function. (*Pr. 81 Number of motor poles* = "12, 14, 16, 18, 20")  
In this case, V/F control is controlled by the second function.

---

---

#### CAUTION

- Changing the terminal assignment using *Pr. 178 to Pr. 189 (input terminal function selection)* may affect the other functions. Also check that wiring is correct, since the terminal name and the signal function became different.  
Set parameters after confirming the function of each terminal.
- 
-



### 4.15.2 Inverter output shutoff signal (MRS signal, Pr. 17)

The inverter output can be shut off from the MRS signal. The logic of the MRS signal can also be selected.

Parameter Number	Name	Initial Value	Setting Range	Description
17	MRS input selection	0	0	Normally open input
			2	Normally closed input (NC contact input specifications)
			4	External terminal: Normally closed input (NC contact input specifications) Communication: Normally open input

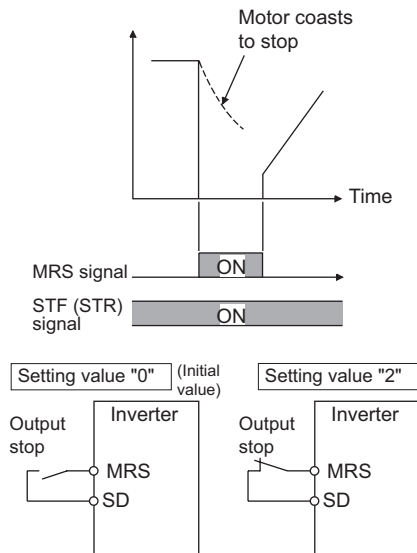

#### (1) Output shutoff signal (MRS signal)

- Turning on the output shutoff signal (MRS) during inverter running shuts off the output immediately.
- Terminal MRS may be used as described below.
  - When mechanical brake (e.g. electromagnetic brake) is used to stop motor  
The inverter output is shut off when the mechanical brake operates.
  - To provide interlock to disable operation by the inverter  
With the MRS signal on, the inverter cannot be operated if the start signal is entered into the inverter.
  - Coast the motor to a stop  
When the start signal is turned off, the inverter decelerates the motor to a stop in the preset deceleration time, but when the MRS signal is turned on, the motor coasts to a stop

#### (2) MRS signal logic inversion (Pr. 17 = "2")

- When Pr. 17 is set to "2", the MRS signal (output stop) can be changed to the normally closed (NC contact) input specification. When the MRS signal turns on (opens), the inverter shuts off the output.

#### (3) Assign a different action for each MRS signal input from communication and external terminal (Pr. 17 = "4")

- When Pr. 17 is set to "4", the MRS signal from external terminal (output stop) can be changed to the normally closed (NC contact) input, and the MRS signal from communication can be changed to the normally open (NO contact) input.  
This function is useful to perform operation by communication with MRS signal from external terminal remained on.

External MRS	Communication MRS	Pr. 17 Setting		
		0	2	4
OFF	OFF	Operation enabled	Output shutoff	Output shutoff
OFF	ON	Output shutoff	Output shutoff	Output shutoff
ON	OFF	Output shutoff	Output shutoff	Operation enabled
ON	ON	Output shutoff	Operation enabled	Output shutoff

#### REMARKS

- The MRS signal is assigned to the terminal MRS in the initial setting. By setting "24" in any of Pr. 178 to Pr. 189 (input terminal function selection), the MRS signal can be assigned to the other terminal.
- When using an external terminal to input the MRS signal, the MRS signal shuts off the output in any of the operation modes.

#### CAUTION

- Changing the terminal assignment using Pr. 178 to Pr. 189 (input terminal function selection) may affect the other functions. Set parameters after confirming the function of each terminal.

#### ◆ Parameters referred to ◆

Pr. 178 to Pr. 189 (Input terminal function selection) Refer to page 207

### 4.15.3 Condition selection of function validity by the second function selection signal (RT) and third function selection signal (X9) (RT signal, X9 signal, Pr. 155)

You can select the second (third) function using the RT(X9) signal.  
 You can also set the condition (reflection condition) where the second function and third function become valid.

Parameter Number	Name	Initial Value	Setting Range	Description
155	RT signal function validity condition selection	0	0	Second (third) function is immediately valid with on of the RT(X9) signal.
			10	Second (third) function is valid only during the RT (X9) signal is on and constant speed operation. (invalid during acceleration/deceleration)

- When the RT signal turns on, the second function becomes valid.
- When the X9 signal turns on, the third function becomes valid.
- For the X9 signal, set "9" in any of Pr. 178 to Pr. 189 (input terminal function selection) to assign the function.
- The second (third) function has the following applications.
  - Switching between normal use and emergency use
  - Switching between heavy load and light load
  - Changing of acceleration/deceleration time by broken line acceleration/deceleration
  - Switching of characteristic between main motor and sub motor

Second function connection diagram

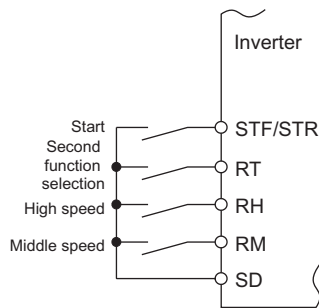

Second acceleration/deceleration time example

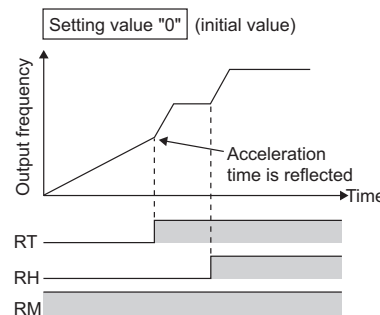

- When the RT signal or X9 signal is ON, the following functions are selected at the same time.

Function	First Function Parameter Number	Second Function Parameter Number	Third Function Parameter Number	Referto Page
Torque boost	Pr. 0	Pr. 46	Pr. 112	129
Base frequency	Pr. 3	Pr. 47	Pr. 113	142
Acceleration time	Pr. 7	Pr. 44	Pr. 110	155
Deceleration time	Pr. 8	Pr. 44, Pr. 45	Pr. 110, Pr. 111	155
Electronic thermal relay function*	Pr. 9	Pr. 51	—	165
Stall prevention	Pr. 22	Pr. 48, Pr. 49	Pr. 114, Pr. 115	135
Applied motor*	Pr. 71	Pr. 450	—	169
Motor constant*	Pr. 80 to Pr. 84, Pr. 89, Pr. 90 to Pr. 94, Pr. 96, Pr. 859	Pr. 453 to Pr. 457, Pr. 569, Pr. 458 to Pr. 462, Pr. 463, Pr. 860	—	171
Online auto tuning selection*	Pr. 95	Pr. 574	—	181
Motor control method*	Pr. 800	Pr. 451	—	75
Speed control gain	Pr. 820, Pr. 821	Pr. 830, Pr. 831	—	88
Analog input filter	Pr. 822, Pr. 826	Pr. 832, Pr. 836	—	269
Speed detection filter	Pr. 823	Pr. 833	—	127
Torque control gain	Pr. 824, Pr. 825	Pr. 834, Pr. 835	—	113
Torque detection filter	Pr. 827	Pr. 837	—	127

\* The function could be changed by switching the RT signal ON/OFF while the inverter is stopped.  
 If a signal is switched during the operation, the operation method changes after the inverter stops.

#### REMARKS

- The RT signal is assigned to the RT terminal in the initial setting. By setting "3" in any of Pr. 178 to Pr. 189 (input terminal function selection), the RT signal can be assigned to the other terminal.

#### CAUTION

- Changing the terminal assignment using Pr. 178 to Pr. 189 (input terminal function selection) may affect the other functions. Set parameters after confirming the function of each terminal.

#### ◆ Parameters referred to ◆

Pr. 178 to Pr. 189 (input terminal function selection) Refer to page 207

### 4.15.4 Start signal operation selection (STF, STR, STOP signal, Pr. 250)

You can select the operation of the start signal (STF/STR).  
 Select the stopping method (deceleration to stop or coasting) at turn-OFF of the start signal.  
 Use this function to stop a motor with a mechanical brake at turn-OFF of the start signal.  
 (Refer to page 189 for stop selection)

Parameter Number	Name	Initial Value	Setting Range	Description	
				Start signal (STF/STR)	Stop operation (Refer to page 189)
250	Stop selection	9999	0 to 100s	STF signal: Forward rotation start STR signal: Reverse rotation start	The motor is coasted to a stop when the preset time elapses after the start signal is turned OFF. When the setting is any of 1000s to 1100s, the inverter coasts to a stop in (Pr. 250 - 1000)s.
			1000s to 1100s	STF signal: Start signal STR signal: Forward/reverse rotation signal	
			9999	STF signal: Forward rotation start STR signal: Reverse rotation start	When the start signal is turned OFF, the motor decelerates to stop.
			8888	STF signal: Start signal STR signal: Forward/reverse rotation signal	

#### (1) 2-wire type (STF, STR signal)

- Two-wire type connections are shown below.
- In the initial setting, the forward/reverse rotation signals (STF/STR) are used as start and stop signals. Turn ON either of the forward and reverse rotation signals to start the motor in the corresponding direction. If both are turned OFF (or ON) during operation, the inverter decelerates to a stop.
- The speed setting signal may either be given by entering 0 to 10VDC across the speed setting input terminal 2 and 5, by setting the required values in Pr. 4 to Pr. 6 Multi-speed setting (high, middle, low speeds), etc. (For multi-speed operation, refer to page 148)
- When Pr. 250 is set to any of "1000 to 1100, 8888", the STF signal becomes a start command and the STR signal a forward/reverse command.

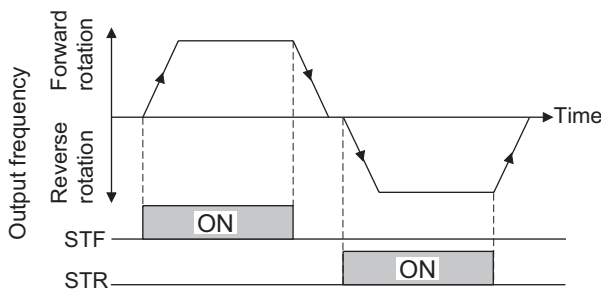
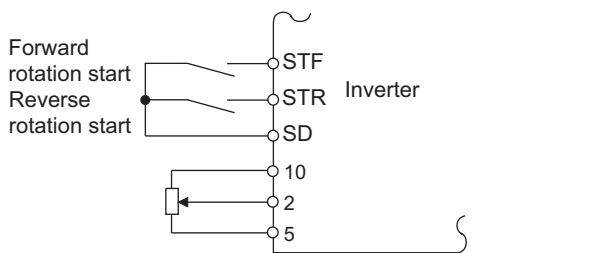

2-wire connection example (Pr. 250 = "9999")

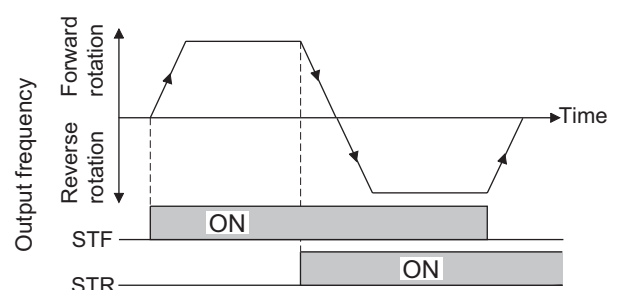
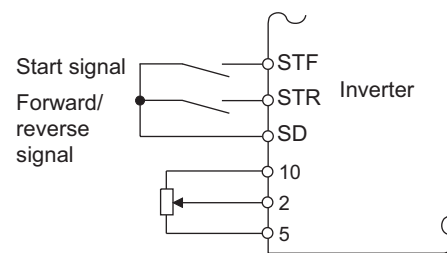

2-wire connection example (Pr. 250 = "8888")

#### REMARKS

- When Pr. 250 is set to any of "0 to 100, 1000 to 1100", the motor coasts to a stop if the start command is turned OFF. (Refer to page 189)
- The STF and STR signals are assigned to the STF and STR terminals in the initial setting. The STF signal can be assigned to Pr. 178 STF terminal function selection and the STR signal to Pr. 179 STR terminal function selection only.

## (2) 3-wire type (STF, STR, STOP signal)

- Three-wire type connections are shown below.
- The start self-holding selection becomes valid when the STOP signal is turned ON. In this case, the forward/reverse rotation signal functions only as a start signal.
- If the start signal (STF or STR) is turned ON and then OFF, the start signal is held and makes a start. When changing the direction of rotation, turn STR (STF) ON once and then OFF.
- To stop the inverter, turning OFF the STOP signal once decelerates it to a stop.

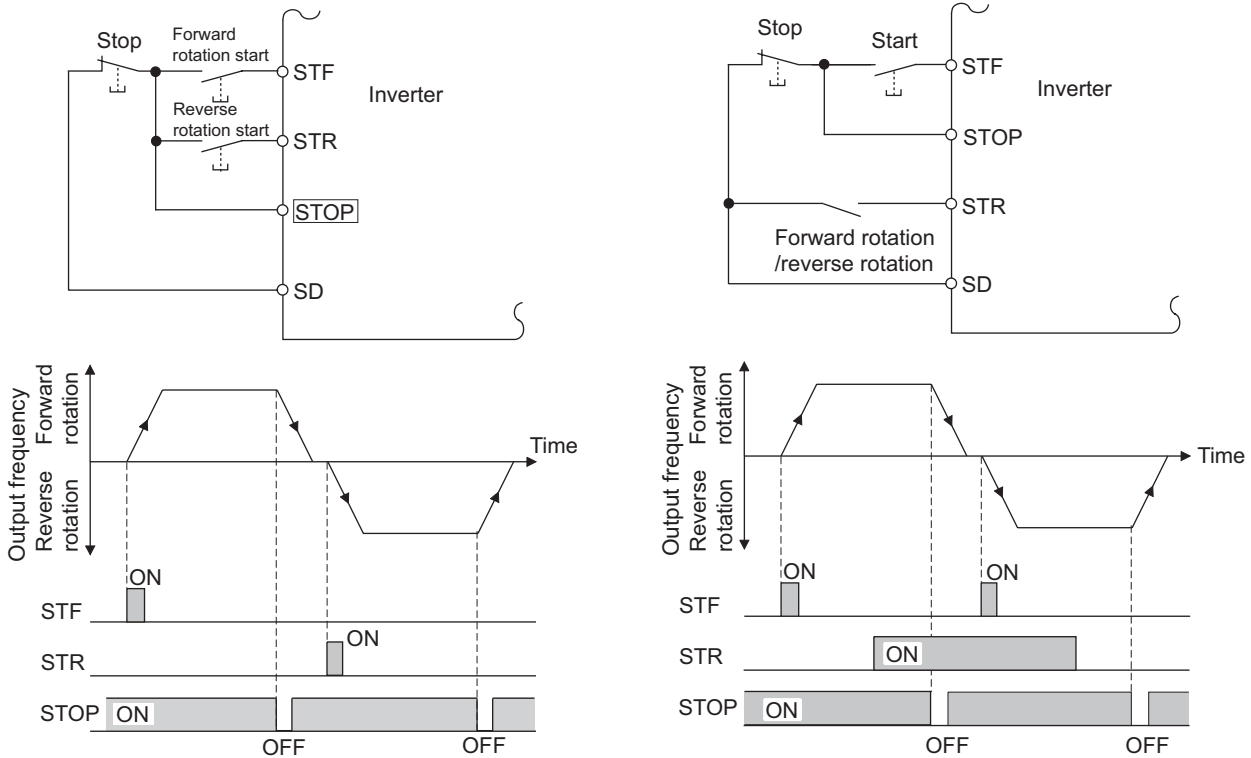

Three-Wire Type Connection Example (Pr. 250 = "9999")

Three-Wire Type Connection Example (Pr. 250 = "8888")

### REMARKS

- The STOP signal is assigned to the terminal STOP in the initial setting. By setting "25" in Pr. 178 to Pr. 189, the STOP signal can also be assigned to the other terminal.
- When the JOG signal is turned ON to enable jog operation, the STOP signal becomes invalid.
- If the MRS signal is turned ON to stop the output, the self-holding function is not canceled.

## (3) Start signal selection

STF	STR	Pr. 250 Setting	Inverter Status
		0 to 100s, 9999	1000s to 1100s, 8888
OFF	OFF	Stop	Stop
OFF	ON	Reverse rotation	
ON	OFF	Forward rotation	Forward rotation
ON	ON	Stop	Reverse rotation

### ◆ Parameters referred to ◆

Pr. 4 to Pr. 6 (Multi-speed setting) Refer to page 148  
 Pr. 178 to Pr. 189 (Input terminal function selection) Refer to page 207

### 4.15.5 Magnetic flux decay output shutoff signal (X74 signal)

Performing frequent start/stop (inching operation) with mechanical brake using output shutoff signal (MRS) during Real sensorless vector control may cause an inverter fault (electronic thermal relay function fault: E.THT, etc) due to residual magnetic flux and an error in monitor output (running speed, motor torque, load meter, torque command, torque current command, motor output).

In such a case, use magnetic flux decay output shutoff signal (X74) as output shutoff signal.

Turning X74 signal on shuts off output after decaying motor residual magnetic flux.

- For the X74 signal, set "74" in any of Pr. 178 to Pr. 189 (input terminal function selection) to assign the function.
- Operate a mechanical brake after turning X74 signal on.
- When the MC is provided on the inverter output side, turn X74 signal on and open the MC after magnetic flux decay operation time (refer to below) has elapsed.

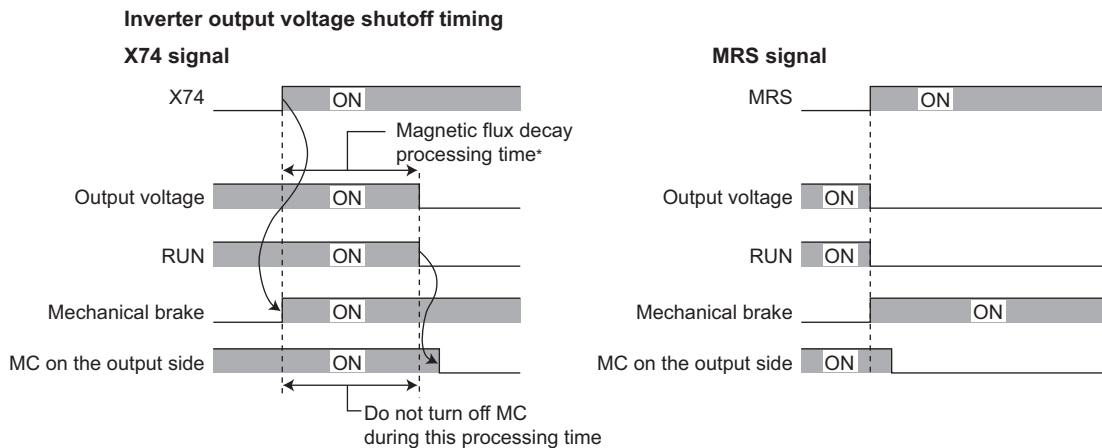

\* Maximum time of magnetic flux decay operation

Motor Capacity(Pr. 80 setting)	5.5kW to 11kW	15kW to 30kW	37kW to 55kW
Magnetic flux decay processing time	500ms	800ms	900ms

#### REMARKS

- When performing operation other than Real sensorless vector control, turning X74 signal on immediately shuts off inverter output.
- During an automatic restart after instantaneous power failure or start-time online auto tuning under Real sensorless vector control, turning X74 signal on immediately shuts off inverter output.
- When some other factor affecting output shutoff (inverter alarm, MRS signal on, etc.) occurs during magnetic flux decay operation, magnetic flux decay operation is stopped to immediately shut off output.
- Refer to page 185 to perform the magnetic flux decay output shutoff without the X74 signal.

#### CAUTION

- Changing the terminal assignment using Pr. 178 to Pr. 189 (input terminal function selection) may affect the other functions. Set parameters after confirming the function of each terminal.
- Different from MRS signal, voltage is output during magnetic flux decay processing even if X74 signal turns on.
- If the timing of mechanical brake opening is early, motor shaft may be forced to turn by a gravity drop or external force. If the timing of mechanical brake opening is late, overcurrent, stall prevention operation or electronic thermal relay function may be activated. Use output frequency detection signal (FU) or output current detection signal (Y12) to perform the mechanical brake opening suitable for the machine.

### 4.15.6 Output terminal function selection (Pr. 190 to Pr. 196)

You can change the functions of the open collector output terminal and relay output terminal.

Parameter Number	Name		Initial Value	Initial Signal	Setting Range
190	RUN terminal function selection	Open collector output terminal	0	RUN (inverter running)	0 to 6, 8, 10 to 20, 25 to 28, 30 to 36, 39, 41 to 47, 64, 70, 84, 90 to 99, 100 to 106, 108, 110 to 116, 120, 125 to 128, 130 to 136, 139, 141 to 147, 164, 170, 184, 190 to 199, 9999
191	SU terminal function selection		1	SU (up to frequency)	
192	IPF terminal function selection		2	IPF (instantaneous power failure, undervoltage)	
193	OL terminal function selection		3	OL (overload alarm)	
194	FU terminal function selection		4	FU (output frequency detection)	
195	ABC1 terminal function selection	Relay output terminal	99	ALM (fault output)	0 to 6, 8, 10 to 20, 25 to 28, 30 to 36, 39, 41 to 47, 64, 70, 84, 85, 90, 91, 94 to 99, 100 to 106, 108, 110 to 116, 120, 125 to 128, 130 to 136, 139, 141 to 147, 164, 170, 184, 190, 191, 194 to 199, 9999
196	ABC2 terminal function selection		9999	No function	

#### (1) Output signal list

- You can set the functions of the output terminals.
- Refer to the following table and set the parameters: (0 to 99: Positive logic, 100 to 199: Negative logic)

Setting		Signal Name	Function	Operation	Related Parameters	Refer to Page
Positive Logic	Negative Logic					
0	100	RUN	Inverter running	Output during operation when the inverter output frequency rises to or above <i>Pr. 13 Starting frequency</i> .	—	218
1	101	SU	Up to frequency *1	Output when the output frequency is reached to the set frequency.	Pr. 41	222
2	102	IPF	Instantaneous power failure/undervoltage	Output at occurrence of an instantaneous power failure or when undervoltage protection is activated.	Pr. 57	243
3	103	OL	Overload alarm	Output while stall prevention function is activated.	Pr. 22, Pr. 23, Pr. 66, Pr. 148, Pr. 149, Pr. 154	135
4	104	FU	Output frequency detection	Output when the output frequency reaches the frequency set in <i>Pr. 42 (Pr. 43 for reverse rotation)</i> . *3	Pr. 42, Pr. 43	222
5	105	FU2	Second output frequency detection	Output when the output frequency reaches the frequency set in <i>Pr. 50</i> .	Pr. 50	222
6	106	FU3	Third output frequency detection	Output when the output frequency reaches the frequency set in <i>Pr. 116</i> .	Pr. 116	222
8	108	THP	Electronic thermal O/L relay pre-alarm	Output when the electronic thermal relay function cumulative value reaches 85% of the trip level. (Electronic thermal relay function protection (E.THT/E.THM) activates, when the value reached 100%.)	Pr. 9	167
10	110	PU	PU operation mode	Output when the PU operation mode is selected.	Pr. 79	290
11	111	RY	Inverter operation ready	Output when the inverter power is turned on, then output after reset process is completed (when the inverter can be started by switching the start signal on or while it is running).	—	218
12	112	Y12	Output current detection	Output when the output current is higher than the <i>Pr. 150</i> setting for longer than the time set in <i>Pr. 151</i> .	Pr. 150, Pr. 151	224
13	113	Y13	Zero current detection	Output when the output power is lower than the <i>Pr. 152</i> setting for longer than the time set in <i>Pr. 153</i> .	Pr. 152, Pr. 153	224

Setting		Signal Name	Function	Operation	Related Parameters	Refer to Page
Positive Logic	Negative Logic					
14	114	FDN	PID lower limit	Output when the feedback value falls below the lower limit of PID control.	Pr. 127 to Pr. 134, Pr. 575 to Pr. 577	338
15	115	FUP	PID upper limit	Output when the feedback value rises above the upper limit of PID control.		
16	116	RL	PID forward/reverse rotation output	Output when forward rotation is performed in PID control.		
17	—	MC1	Electronic bypass MC1	Used when the commercial power supply-inverter switchover function is used.	Pr. 135 to Pr. 139, Pr. 159	346
18	—	MC2	Electronic bypass MC2			
19	—	MC3	Electronic bypass MC3			
20	120	BOF	Brake opening request	Output to open the brake when the brake sequence function is selected.	Pr. 278 to Pr. 285, Pr. 292	193
25	125	FAN	Fan fault output	Output at the time of a fan fault.	Pr. 244	363
26	126	FIN	Heatsink overheat pre-alarm	Output when the heatsink temperature reaches about 85% of the heatsink overheat protection providing temperature.	—	391
27	127	ORA	Orientation complete *3	When orientation is valid	Pr. 350 to Pr. 366, Pr. 369, Pr. 393, Pr. 396 to Pr. 399	196
28	128	ORM	Orientation fault *3			
30	130	Y30	Forward rotation output *3	Output when the motor is running in forward direction.	—	220
31	131	Y31	Reverse rotation output *3	Output when the motor is running in reverse direction.		220
32	132	Y32	Regenerative status output *3	Output in the regenerative status under vector control operation.		220
33	133	RY2	Operation ready 2	Output during pre-excitation or operation under Real sensorless vector control.	—	218
34	134	LS	Low speed output	Output when the output frequency drops below the <i>Pr. 865</i> setting.	Pr. 865	222
35	135	TU	Torque detection	Output when the motor torque rises above the <i>Pr. 864</i> value.	Pr. 864	225
36	136	Y36	In-position *3	Output when the number of droop pulses has fallen below the setting value.	Pr. 426	123
39	139	Y39	Start time tuning completion	Output on completion of start-time tuning.	Pr. 95, Pr. 574	181
41	141	FB	Speed detection	Output when the actual motor speed (estimated actual speed value) reaches the <i>Pr. 42 (Pr. 50, Pr.116)</i> setting.	Pr. 42, Pr. 50, Pr. 116	222
42	142	FB2	Second speed detection			
43	143	FB3	Third speed detection			
44	144	RUN2	Inverter running 2	<ul style="list-style-type: none"> <li>· Output during forward rotation or the reverse rotation signal is on.</li> <li>· Output at deceleration even during forward rotation or the reverse rotation signal is off. (Does not output during pre-excitation LX is on.)</li> <li>· Output during the orientation command signal (X22) is on.</li> <li>· Switched on when the servo is on (LX-ON) under position control. (Switched off when the servo is off (LX-OFF))</li> </ul>	—	218
45	145	RUN3	Inverter running and start command is on	Output when the inverter is running and start command is on.	—	218
46	146	Y46	During deceleration at occurrence of power failure	Output when the power failure-time deceleration function is executed. (retained until release)	Pr. 261 to Pr. 266	247
47	147	PID	During PID control activated	Output during PID control.	Pr. 127 to Pr. 134, Pr. 575 to Pr. 577	338
64	164	Y64	During retry	Output during retry processing.	Pr. 65 to Pr. 69	250
70	170	SLEEP	PID output interruption	Output when the PID output interruption function is executed.	Pr. 127 to Pr. 134, Pr. 575 to Pr. 577	338
84	184	RDY	Position control preparation ready *3	Output when the servo is on (LX-ON) and ready to operate.	Pr. 419, Pr. 428 to Pr. 430	120

Setting		Signal Name	Function	Operation	Related Parameters	Refer to Page
Positive Logic	Negative Logic					
90	190	Y90	Life alarm	Output when any of the control circuit capacitor, main circuit capacitor and inrush current limit circuit or the cooling fan approaches the end of its service life.	Pr. 255 to Pr. 259	364
91	191	Y91	Fault output 3 (power-off signal)	Output when a fault occurs due to the circuit failure of the inverter wiring mistake.	—	221
92	192	Y92	Energy saving average value updated timing	Turned on and off alternately every time the power saving average value is updated when the power saving monitor is used. Cannot be set to <i>Pr. 195</i> and <i>Pr. 196</i> (relay output terminal).	Pr. 52, Pr. 54, Pr. 158, Pr. 891 to Pr. 899	256
93	193	Y93	Current average value monitor signal	Average current value and maintenance timer value are output as pulses. Cannot be set to <i>Pr. 195</i> and <i>Pr. 196</i> (relay output terminal).	Pr. 555 to Pr. 557	368
94	194	ALM2	Fault output 2	Output when the fault occurs. Continue outputting the signal during inverter reset and stop outputting after reset status is finished. *2	—	221
95	195	Y95	Maintenance timer signal	Output when <i>Pr. 503</i> rises to or above the <i>Pr. 504</i> setting.	Pr. 503, Pr. 504	367
96	196	REM	Remote output	Output to the terminal when a value is set to the parameter.	Pr. 495 to Pr. 497	226
97	197	ER	Alarm output 2	When <i>Pr. 875</i> = "0" (initial value), the signal is output when the fault occurs. When <i>Pr. 875</i> = "1", the signal is output when the inverter protective function is activated at occurrence of OHT/THM/PTC fault and deceleration is started. Output when other protective functions are activated and the inverter trips.	Pr. 875	254
98	198	LF	Alarm output	Output when an alarm (fan failure or communication error warning) occurs.	Pr. 121, Pr. 244	310, 363
99	199	ALM	Fault output	Output when the fault occurs. The signal output is stopped when the fault is reset.	—	221
9999	—	—	No function	—	—	—

- \*1 Note that when the frequency setting is varied using an analog signal or of the operation panel (FR-DU07), the output of the SU (up to frequency) signal may alternate on and off depending on that varying speed and the timing of the varying speed due to acceleration/deceleration time setting. (The output will not alternate on and off when the acceleration/deceleration time setting is "0s".)
- \*2 When a power supply reset is performed, the fault output 2 signal (ALM2) turns off as soon as the power supply switches off.
- \*3 This function is valid when the FR-A7AP/FR-A7AL (option) is mounted.

**REMARKS**

- The same function may be set to more than one terminal.
- When the function is executed, the terminal conducts at the setting of any of "0" to "99", and does not conduct at the setting of any of "100" to "199".
- When *Pr. 76 Fault code output selection* = "1", the output signals of the terminals SU, IPF, OL and FU are switched as set in *Pr. 76*. (When an inverter fault occurs, the signal output is switched to the fault code output.)
- The output assignment of the terminal RUN and alarm output relay are as set above regardless of *Pr. 76*.

**CAUTION**

- Changing the terminal assignment using *Pr. 190 to Pr. 196 (output terminal function selection)* may affect the other functions. Set parameters after confirming the function of each terminal.
- Do not assign signals which repeat frequent ON/OFF to A1, B1, C1, A2, B2, C2. Otherwise, the life of the relay contact decreases.



**(2) Inverter operation ready signal (RY, RY2 signal) and inverter running signal (RUN, RUN2, RUN3 signal)**

**Under V/F control, Advanced magnetic flux vector control**

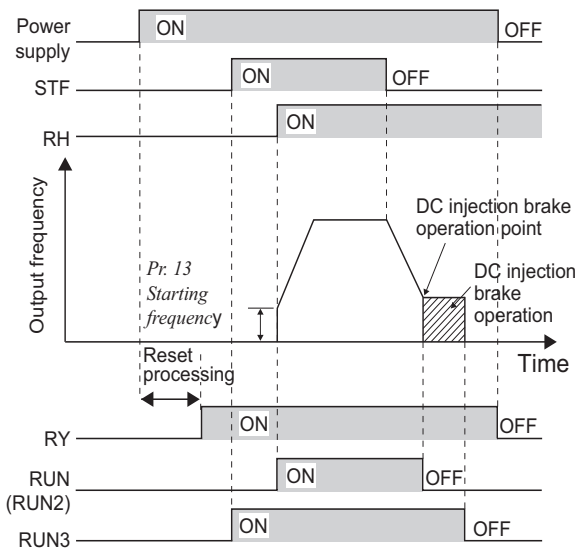

- When the inverter is ready to operate, the output of the operation ready signal (RY) is ON. (It is also on during inverter running.)
- When the output frequency of the inverter rises to or above *Pr. 13 Starting frequency*, the output of the inverter running signals (RUN, RUN2) is turned ON. During an inverter stop or DC injection brake operation, the output is OFF.
- For the RUN3 signal, output is ON while the inverter running and the start signal is ON. (For the RUN3 signal, output is ON if the starting command is on even when a fault occurs or the MRS signal is ON.) The output is ON during DC injection brake operation and OFF during an inverter stop.

Inverter Status / Output Signal	Start Signal is OFF (during stop)	Start Signal is ON (during stop)	Start Signal is ON (during running)	Under DC Injection Brake	Output Shutoff *2		Automatic Restart after Instantaneous Power Failure		
					Start signal is ON	Start signal is OFF	Coasting		Restarting
							Start signal is ON	Start signal is OFF	
RY	ON	ON	ON	ON	OFF	OFF	ON *1	ON	
RY2	OFF	OFF	OFF	OFF	OFF	OFF	OFF	OFF	
RUN	OFF	OFF	ON	OFF	OFF	OFF	OFF	ON	
RUN2	OFF	OFF	ON	OFF	OFF	OFF	OFF	ON	
RUN3	OFF	ON	ON	ON	ON	OFF	ON	OFF	ON

\*1 This signal turns OFF during power failure or undervoltage.

\*2 Output is shutoff in conditions like a fault and when the MRS signal is ON.

**Under Real sensor less vector control, vector control**

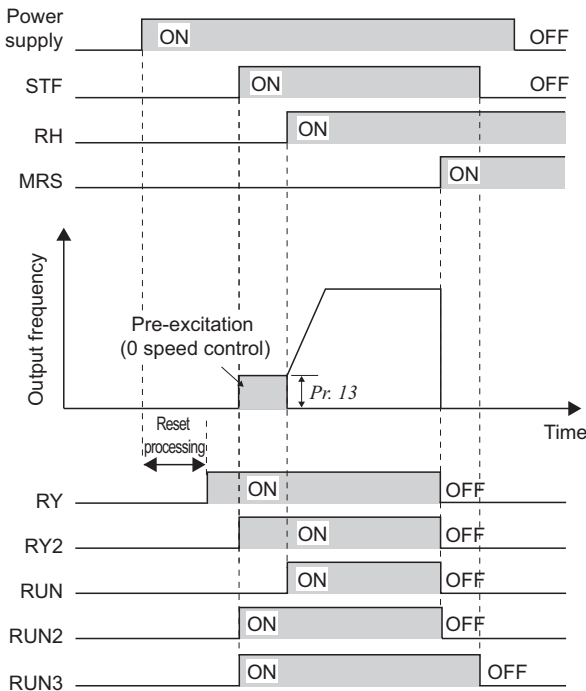

- When the inverter is ready to operate, the output of the operation ready signal (RY) is ON. (It is also on during inverter running.)
- When the inverter output frequency rises to or above the *Pr. 13 Starting frequency* setting, the output of the inverter running signal (RUN) is turned ON. During an inverter stop, DC injection brake operation, start time tuning or pre-excitation, the output is off.
- For the RUN2 signal, the output is ON while the inverter is running and the start signal is ON. (For the RUN2 signal, the output is off when the inverter protective function is activated and the MRS signal is ON.)
- For the RUN3 signal, the output is ON while the inverter is running and the start signal is ON.
- The RUN2 and RUN3 signals are ON when the start command is ON and even during pre-excitation with "0" set in speed command. (Note that the RUN2 signal turns OFF during pre-excitation by turning the LX signal on.)
- The RY2 signal turns ON at the start of pre-excitation. The signal is ON while pre-excitation is activated even during an inverter stop. The signal turns OFF while the output is shut off (MRS signal).

**REMARKS**

For pre-excitation by pre-excitation signal (LX), the RY2 signal turns ON when 100ms has elapsed after LX signal turn ON.

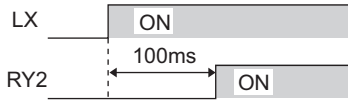

Inverter Status / Output Signal	Start Signal is OFF (during stop)	Start Signal is ON *1 (pre-excitation)	Start Signal is ON (during running)	LX Signal is ON (pre-excitation)	DC Injection Brake Operation (pre-excitation)	Output Shutoff *2		Automatic Restart after Instantaneous Power Failure		Restarting
						Start signal is ON	Start signal is OFF	Coasting		
								Start signal is ON	Start signal is OFF	
RY	ON	ON	ON	ON	ON	OFF	OFF	ON *3	ON	ON
RY2	OFF	ON	ON	ON *4	ON	OFF	OFF	OFF	OFF	OFF
RUN	OFF	OFF	ON	OFF	OFF	OFF	OFF	OFF	OFF	ON
RUN2	OFF	ON	ON	OFF *5	OFF	OFF	OFF	OFF	OFF	ON
RUN3	OFF	ON	ON	ON	ON	ON	OFF	ON	OFF	ON

- \*1 Pre-excitation is made when the start signal is ON and frequency command is 0Hz.
- \*2 Output is shutoff in conditions like a fault and when the MRS signal is ON.
- \*3 This signal turns OFF during power failure or undervoltage.
- \*4 There is a delay of 100ms when the signal is ON.
- \*5 This signal turns ON during servo ON (LX signal is ON) under position control.

Output Signal	Pr. 190 to Pr. 196 Setting	
	Positive logic	Negative logic
RY	11	111
RY2	33	133
RUN	0	100
RUN2	44	144
RUN3	45	145

**REMARKS**

- The RUN signal is assigned to the terminal RUN in the initial setting.

- When using the RY, RY2, RUN, RUN2 and RUN3 signals, assign functions to *Pr. 190 to Pr. 196 (output terminal selection function)* referring to the table on the left.

### (3) Forward rotation and reverse rotation signal (Y30, Y31 signal)

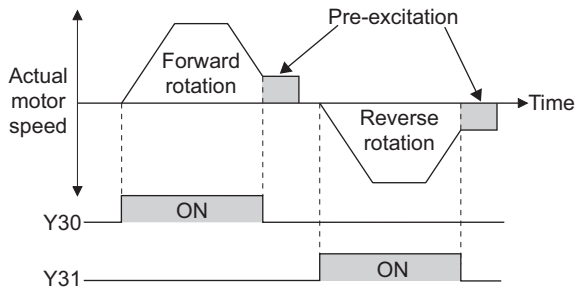

- The status during forward rotation (Y30) and reverse rotation (Y31) are output from the actual motor speed under vector control.
- Y30 and Y31 signals turn OFF during pre-excitation (zero speed, servo lock) under speed control or torque control operation. Note that signals are output according to the motor rotation during servo lock under position control as same as inverter running.
- When using the Y30 signal, set "30 (positive logic) or 130 (negative logic)" to any of Pr. 190 to Pr. 196 (output terminal function selection) to assign the function to the output terminal.
- When using the Y31 signal, set "31 (positive logic) or 131 (negative logic)" to any of Pr. 190 to Pr. 196 (output terminal function selection) to assign the function to the output terminal.

#### REMARKS

- This signal is always OFF during V/F control, Advanced magnetic flux vector control or Real sensorless vector control.
- If the motor is made to run by external force, etc. during an inverter stop, Y30 and Y31 remain OFF.
- The FR-A7AP/FR-A7AL (option) is necessary for vector control.

### (4) Regenerative mode output signal (Y32 signal)

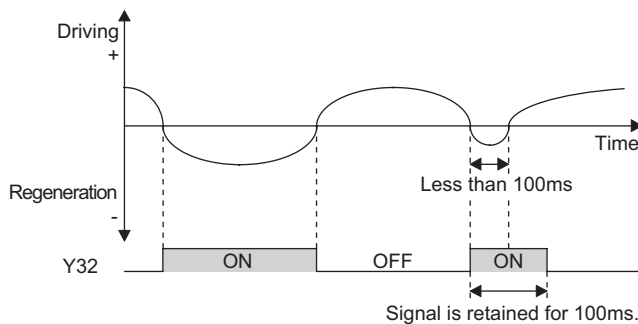

- While the motor is in regenerative status (motor is in power regenerative status), the regenerative status output signal (Y32) is turned ON. If the signal is turned ON once, it will be retained for at least 100ms.
- It turns OFF while the inverter is stopped and during pre-excitation.
- When using the Y32 signal, set "32 (positive logic) or 132 (negative logic)" to any of Pr. 190 to Pr. 196 (output terminal function selection) to assign the function to the output terminal.

#### REMARKS

- This signal is always OFF during V/F control, Advanced magnetic flux vector control or Real sensorless vector control.
- The FR-A7AP/FR-A7AL (option) is necessary for vector control.

**(5) Fault output signal (ALM, ALM2 signal)**

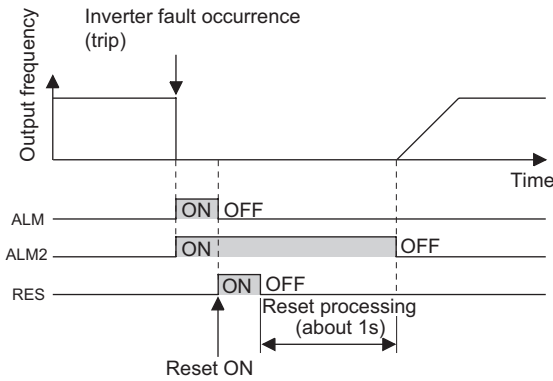

- If the inverter comes to trip, the ALM and ALM2 signals are output.
- The ALM2 signal remains ON during a reset period after fault occurrence.
- When using the ALM2 signal, set "94 (positive logic)" or "194 (negative logic)" to any of Pr. 190 to Pr. 196 (output terminal function selection) to assign the function to the output terminal.
- The ALM signal is assigned to the A1B1C1 contact in the initial setting.

**REMARKS**  
Refer to page 384 for the inverter fault description.

**(6) Input MC shutoff signal (Y91 signal)**

- The Y91 signal is output at occurrence of a fault attributable to the failure of the inverter circuit or a fault caused by a wiring mistake.
- When using the Y91 signal, set "91 (positive logic)" or "191 (negative logic)" to any of Pr. 190 to Pr. 196 (output terminal function selection) to assign the function to the output terminal.
- The following table indicates the faults that will output the Y91 signal. (Refer to page 384 for the fault description.)

Fault Description
Inrush current limit circuit fault (E.IOH)
CPU fault (E.CPU)
CPU fault (E.5)
CPU fault (E.6)
CPU fault (E.7)
Parameter storage device fault (E.PE)
Parameter storage device fault (E.PE2)
24VDC power output short circuit (E.P24)
Operation panel power supply short circuit, RS-485 terminal power supply short circuit(E.CTE)
Output side earth(ground) fault overcurrent protection(E.GF)
Output phase loss (E.LF)

◆ Parameters referred to ◆

Pr. 13 Starting frequency Refer to page 157 .  
Pr. 76 Fault code output selection Refer to page 252

### 4.15.7 Detection of output frequency (SU, FU, FU2, FU3, FB, FB2, FB3, LS signal, Pr. 41 to Pr. 43, Pr. 50, Pr. 116, Pr. 865)

The inverter output frequency is detected and output to the output signal.

Parameter Number	Name	Initial Value	Setting Range	Description
41	Up-to-frequency sensitivity	10%	0 to 100%	Set the level where the SU signal turns ON.
42	Output frequency detection	6Hz	0 to 400Hz	Set the frequency where the FU (FB) signal turns on.
43	Output frequency detection for reverse rotation	9999	0 to 400Hz	Set the frequency where the FU (FB) signal turns on in reverse rotation.
			9999	Same as Pr. 42 setting
50	Second output frequency detection	30Hz	0 to 400Hz	Set the frequency where the FU2 (FB2) signal turns on.
116	Third output frequency detection	60Hz	0 to 400Hz	Set the frequency where the FU3 (FB3) signal turns on.
865	Low speed detection	1.5Hz	0 to 400Hz	Set the frequency where the LS signal turns ON.

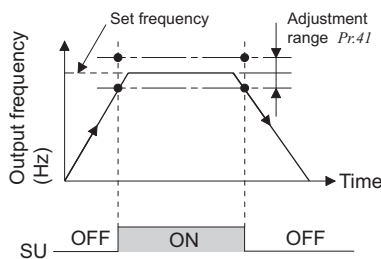

#### (1) Up-to-frequency sensitivity (SU signal, Pr. 41)

- When the output frequency reaches the set frequency, the up-to-frequency signal (SU) is output.
- The Pr. 41 value can be adjusted within the range  $\pm 1\%$  to  $\pm 100\%$  on the assumption that the set frequency is 100%.
- This parameter can be used to ensure that the set frequency has been reached to provide the operation start signal etc. for related equipment.

#### (2) Output frequency detection (FU (FB) signal, FU2 (FB2) signal, FU3 (FB3) signal, Pr. 42, Pr. 43, Pr. 50, Pr. 116)

- When the output frequency rises to or above the Pr. 42 setting, the output frequency detection signal (FU, FB) is output.
- This function can be used for electromagnetic brake operation, open signal, etc.
- The FU (FU2, FU3) signal is output when the output frequency (frequency command) reaches the set frequency. The FB (FB2, FB3) signal is output when the actual rotation detection speed (estimated speed in Real sensorless vector control, feedback value in vector control) of the motor reaches the set frequency. The FU signal and FB signal are output simultaneously during V/F control, Advanced magnetic flux vector control and encoder feedback control.
- Frequency detection that is dedicated to reverse operation can be set by setting detection frequency to Pr. 43. This function is effective for switching the timing of electromagnetic brake operation between forward rotation (rise) and reverse rotation (fall) during elevator operation, etc.
- When Pr. 43  $\neq$  "9999", the Pr. 42 setting applies to forward rotation and the Pr. 43 setting applies to reverse rotation.
- When outputting a frequency detection signal besides the FU signal, set the detection frequency in Pr. 50 or Pr. 116. The FU2 (FB2) signal (FU3 (FB3) signal if Pr. 116 or more) is output when the output frequency reaches or exceeds the Pr. 50 setting.
- For each signal, assign functions to Pr. 190 to Pr. 196 (output terminal function selection) referring to the table below.

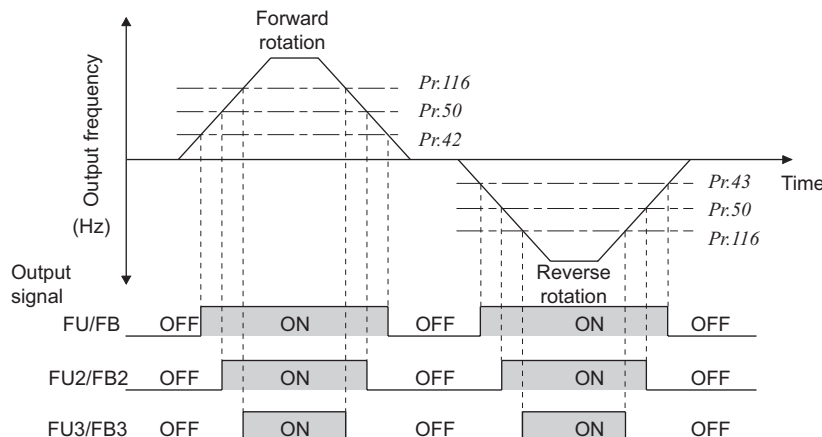

Parameter Number	Output Signal	Pr. 190 to Pr. 196 Setting	
		Positive logic	Negative logic
42, 43	FU	4	104
	FB	41	141
50	FU2	5	105
	FB2	42	142
116	FU3	6	106
	FB3	43	143

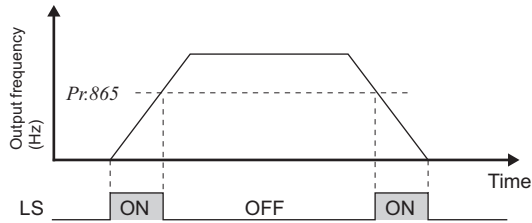

### (3) Low speed detection (LS signal, Pr. 865)

- The low speed detection signal (LS) is output when the output frequency drops below the Pr. 865 Low speed detection setting.
- When speed control is performed by Real sensorless vector control or vector control, a fault (E.OLT) is displayed and the inverter trips if frequency drops to the Pr. 865 setting by torque limit operation and the output torque exceeds Pr. 874 OLT level setting and remains for more than 3s.
- For the LS signal, set "34 (positive logic) or 134 (negative logic)" in Pr. 190 to Pr. 196 (output terminal function selection) and assign functions to the output terminal.

#### REMARKS

- The FU signal is assigned to the terminal FU and the SU signal is assigned to the terminal SU in the initial setting.
- All signals are OFF during DC injection brake, pre-excitation (zero speed control, servo lock), or start time tuning.
- The type of frequency (output as the following signals), which is compared with the set frequency, differs by the control method.

Control Method	Compared frequency	
	FU, FU2, FU3	FB, FB2, FB3, SU, LS
V/F control	Output frequency	Output frequency
Advanced magnetic flux vector control	Output frequency before the slip compensation.	Output frequency before the slip compensation.
Real sensorless vector control	Frequency command $\omega^*$ (Refer to page 73)	Estimated frequency (estimated from the actual motor speed)
Encoder feedback control	Actual motor speed converted as frequency	Actual motor speed converted as frequency
Vector control	Frequency command $\omega^*$ (Refer to page 73)	Actual motor speed converted as frequency

#### CAUTION

- Changing the terminal assignment using Pr. 190 to Pr. 196 (output terminal function selection) may affect the other functions. Set parameters after confirming the function of each terminal.

#### ◆ Parameters referred to ◆

Pr. 190 to Pr. 196 (output terminal function selection) Refer to page 215  
 Pr. 874 OLT level setting Refer to page 83

### 4.15.8 Output current detection function (Y12 signal, Y13 signal, Pr. 150 to Pr. 153, Pr. 166, Pr. 167)

The output power during inverter running can be detected and output to the output terminal.

Parameter Number	Name	Initial Value	Setting Range	Description
150	Output current detection level	150%	0 to 220%	Set the output current detection level. 100% is the rated inverter current.
151	Output current detection signal delay time	0s	0 to 10s	Set the output current detection period. Set the time from when the output current has risen above the setting until the output current detection signal (Y12) is output.
152	Zero current detection level	5%	0 to 220%	Set the zero current detection level. The rated inverter current is assumed to be 100%.
153	Zero current detection time	0.5s	0 to 1s	Set this parameter to define the period from when the output current drops below the Pr. 152 value until the zero current detection signal (Y13) is output.
166	Output current detection signal retention time	0.1s	0 to 10s	Set the retention time when the Y12 signal is on.
			9999	The Y12 signal on status is retained. The signal is turned off at the next start.
167	Output current detection operation selection	0	0	Operation continues when the Y12 signal is on
			1	The inverter trips when the Y12 signal is ON. (E.CDO)

Pr. 166 ≠ 9999, Pr. 167 = 0

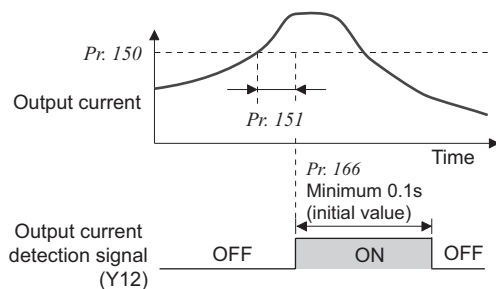

#### (1) Output current detection (Y12 signal, Pr. 150, Pr. 151, Pr. 166, Pr. 167)

- The output current detection function can be used for excessive torque detection, etc.
- If the output current remains higher than the Pr. 150 setting during inverter operation for longer than the time set in Pr. 151, the output current detection signal (Y12) is output from the inverter's open collector or relay output terminal.
- When the Y12 signal turns on, the ON state is held for the time set in Pr. 166.
- When Pr. 166 = "9999", the ON state is held until a next start.
- At the Pr. 167 setting of "1", the inverter trips and the output current detection fault (E.CDO) is displayed when the Y12 signal turns on. When fault occurs, the Y12 signal is on for the time set in Pr. 166 at the Pr. 166 setting of other than "9999", and remains on until a reset is made at the Pr. 166 setting of "9999". E.CDO does not occur even if "1" is set in Pr. 167 while Y12 is ON. The Pr. 167 setting is valid after Y12 turns OFF.
- Set "12 (positive logic)" or "112 (negative logic)" to any of Pr. 190 to Pr. 196 (output terminal function selection) to assign the function of the Y12 signal to the output terminal.

**(2) Zero current detection (Y13 signal, Pr. 152, Pr. 153)**

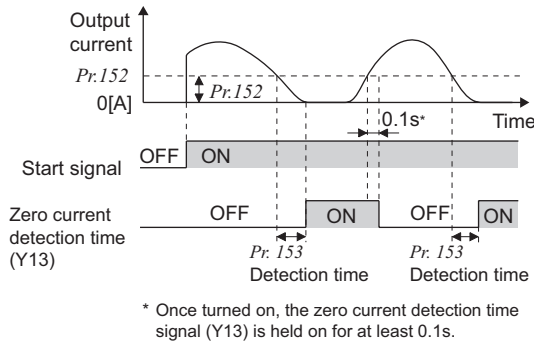

- If the output current remains lower than the Pr. 152 setting during inverter operation for longer than the time set in Pr. 153, the zero current detection (Y13) signal is output from the inverter's open collector or relay output terminal.
- When the inverter's output current falls to "0", torque will not be generated. This may cause a drop due to gravity when the inverter is used in vertical lift application. To prevent this, the Y13 signal can be output from the inverter to close the mechanical brake when the output current has fallen to "zero".
- Set "13 (positive logic)" or "113 (negative logic)" in any of Pr. 190 to Pr. 196 (output terminal function selection) to assign the function of the Y13 signal to the output terminal.

**CAUTION**

- This function is also valid during execution of the online or offline auto tuning.
- The response time of Y12 and Y13 signals is approximately 0.1s. Note that the response time changes according to the load condition. When Pr. 152 = "0", detection is disabled.
- Changing the terminal assignment using Pr. 190 to Pr. 196 (output terminal function selection) may affect the other functions. Set parameters after confirming the function of each terminal.

**CAUTION**

- ⚠ The zero current detection level setting should not be too low, and the zero current detection time setting not too long. Otherwise, the detection signal may not be output when torque is not generated at a low output current.
- ⚠ To prevent the machine and equipment from resulting in hazardous conditions by use of the zero current detection signal, install a safety backup such as an emergency brake.

◆ Parameters referred to ◆

Online auto tuning Refer to page 181  
 Offline auto tuning Refer to page 171  
 Pr. 190 to Pr. 196 (output terminal function selection) Refer to page 215

**4.15.9 Detection of output torque (TU signal, Pr. 864)** Sensorless Magnetic flux Vector

Output the signal when the motor torque rises above the setting value.  
 This function can be used for electromagnetic brake operation, open signal, etc.

Parameter Number	Name	Initial Value	Setting Range	Description
864	Torque detection	150%	0 to 400%	Set the torque value where the TU signal turns on.

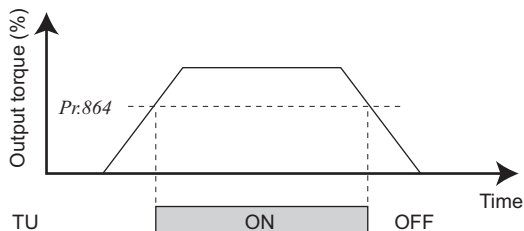

- When the output torque reaches or exceeds the detected torque value set in Pr. 864 under Real sensorless vector control, Advanced magnetic flux vector control or vector control, the torque detection signal (TU) turns on. It turns off when the torque falls below the detection torque value.
- For the TU signal, set "35 (positive logic) or 135 (negative logic)" in Pr. 190 to Pr. 196 (output terminal function selection) and assign functions to the output terminal.

**CAUTION**

- Changing the terminal assignment using Pr. 190 to Pr. 196 (output terminal function selection) may affect the other functions. Set parameters after confirming the function of each terminal.

◆ Parameters referred to ◆

Pr. 190 to Pr. 196 (output terminal function selection) Refer to page 215



### 4.15.10 Remote output function (REM signal, Pr. 495 to Pr. 497)

You can utilize the on/off of the inverter's output signals instead of the remote output terminal of the programmable logic controller.

Parameter Number	Name	Initial Value	Setting Range	Description	
495	Remote output selection	0	0	Remote output data clear at powering off	Remote output data is cleared during an inverter reset
			1	Remote output data retention even at powering off	
			10	Remote output data clear at powering off	Remote output data is retained during an inverter reset
			11	Remote output data retention even at powering off	
496 *	Remote output data 1	0	0 to 4095	Refer to the following diagram.	
497 *	Remote output data 2	0	0 to 4095		

\* The above parameters allow its setting to be changed during operation in any operation mode even if "0" (initial value) is set in Pr. 77 Parameter write selection.

<Remote output data>

Pr. 496



Pr. 497

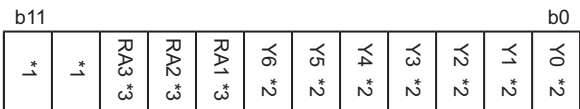

- \*1 As desired
- \*2 Y0 to Y6 are available only when the extension output option (FR-A7AY) is fitted
- \*3 RA1 to RA3 are available only when the relay output option (FR-A7AR) is fitted

- The output terminal can be turned on/off depending on the Pr. 496 or Pr. 497 setting. The remote output selection can be controlled on/off by computer link communication from the PU connector or RS-485 port or by communication from the communication option.
- Set "96" (positive logic) or "196" (negative logic) to any of Pr. 190 to Pr. 196 (output terminal function selection), and assign the remote output (REM) signal to the terminal used for remote output,
- When you refer to the diagram on the left and set 1 to the terminal bit (terminal where the REM signal has been assigned) of Pr. 496 or Pr. 497, the output terminal turns on (off for negative logic). By setting 0, the output terminal turns off (on for negative logic).

Example) When "96" (positive logic) is set in Pr. 190 RUN terminal function selection and "1" (H01) is set in Pr. 496, the terminal RUN turns on.

**ON/OFF example for positive logic**

Pr. 495 = 0, 10

Pr. 495 = 1, 11

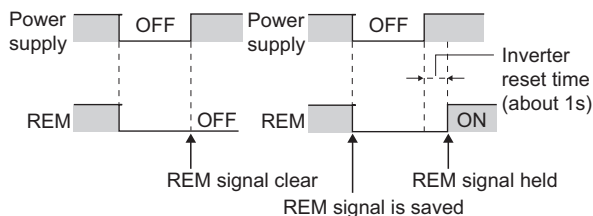

- When Pr. 495 = "0" (initial value), 10", performing a power supply reset (including a power failure) clears the REM signal output. (The ON/OFF status of the terminals are as set in Pr. 190 to Pr. 196.) The Pr. 496 and Pr. 497 settings are also "0". When Pr. 495 = "1, 11", the remote output data before power supply-off is stored into the EEPROM, so the signal output at power recovery is the same as before power supply-off. However, it is not stored when the inverter is reset (terminal reset, reset request through communication). (See the chart on the left)
- When Pr. 495 = "10 or 11," the signal before the reset is held even during an inverter reset.

**Signal condition during a reset**

Pr. 495 = 0, 1

Pr. 495 = 10, 11

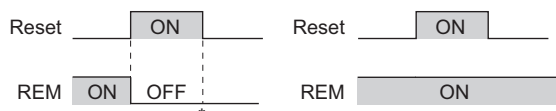

\* When Pr. 495 = "1," the signal condition saved in EEPROM (condition of the last power OFF) is applied.

**REMARKS**

- The output terminal where the REM signal is not assigned using any of Pr. 190 to Pr. 196 does not turn on/off if 0/1 is set to the terminal bit of Pr. 496 or Pr. 497. (It turns on/off with the assigned function.)
- When the inverter is reset (terminal reset, reset request through communication), Pr. 496 and Pr. 497 values turn to "0". When Pr. 495 = "1, 11", however, they are the settings at power supply-off. (The settings are stored at power supply-off.) When Pr. 495 = "10, 11", they are the same as before an inverter reset is made.

**CAUTION**

- When Pr. 495 = "1, 11"(remote output data retention at power OFF), connect R1/11 with P/+, and S1/L21 with N/- so that the control power is retained. If you do not take such a step, the output signals provided after power-on are not guaranteed.

◆ Parameters referred to ◆

- Pr. 190 to Pr. 196 (output terminal function selection) Refer to page 215

## 4.16 Monitor display and monitor output signal

Purpose	Parameter that must be Set		Refer to Page
Display motor speed Set speed	Speed display and speed setting	Pr. 37, Pr. 144, Pr. 505, Pr. 811	227
Change PU monitor display data	DU/PU main display data selection Cumulative power monitor (cumulative regenerative power monitor) clear	Pr. 52, Pr. 170, Pr. 171, Pr. 268, Pr. 891	229
Change of the monitor output from terminal FM and AM	Terminal FM, AM function selection	Pr. 54, Pr. 158, Pr. 291, Pr. 866, Pr. 867	229
Set the reference of the monitor output from terminal FM and AM	Setting of reference of terminal FM and AM	Pr. 55, Pr. 56, Pr. 291, Pr. 866, Pr. 867	236
Adjust terminal FM, AM outputs	Terminal FM, AM calibration	Pr. 900, Pr. 901	240

### 4.16.1 Speed display and speed setting (Pr. 37, Pr. 144, Pr. 505, Pr. 811)

You can change the PU (FR-DU07/FR-PU04/FR-PU07) monitor display or frequency setting to motor speed or machine speed.

Parameter Number	Name	Initial Value	Setting Range	Description	
37	Speed display	0	0	Frequency display, setting	
			1 to 9998*	Set the machine speed at Pr. 505.	
144	Speed setting switchover	4	0, 2, 4, 6, 8, 10, 102, 104, 106, 108, 110	Set the number of motor poles when displaying the motor speed.	
505	Speed setting reference	60Hz	1 to 120Hz	Set the reference speed for Pr. 37.	
811	Set resolution switchover	0		Speed setting and running speed monitor increments from the PU, RS-485 communication or communication option.	
			0	1r/min	Torque limit setting increments Pr. 22, Pr. 812 to Pr. 817
			1	0.1r/min	0.1%
			10	1r/min	0.01%
11	0.1r/min				

\* The maximum value of the setting range differs according to the Pr. 1 Maximum frequency and Pr. 505 Speed setting reference settings and it can be calculated from the following formula.

$$\text{Maximum setting value of Pr. 37} < \frac{65535 \times \text{Pr. 505}}{\text{Setting value of Pr. 1 (Hz)}}$$

Note that the maximum setting value of Pr. 37 is 9998 if the result of the above formula exceeds 9998.

- To display the machine speed, set in *Pr. 37* the machine speed for operation with frequency set in *Pr. 505*.  
For example, when *Pr. 505* = "60Hz" and *Pr. 37* = "1000", "1000" is displayed on the running speed monitor when the running frequency is 60Hz. When running frequency is 30Hz, "500" is displayed.
- When displaying the motor speed, set the number of motor poles (2, 4, 6, 8, 10) or number of motor poles + 100 (102, 104, 106, 108, 110) in *Pr. 144*.
- The *Pr. 144* setting is automatically changed if the number of motor poles is set in *Pr. 81* Number of motor poles. The *Pr. 81* setting is not automatically changed even if the setting of *Pr. 144* is changed.  
Example 1) When the initial setting of *Pr. 81* is changed to "2" or "12", the *Pr. 144* setting changes from "4" to "2".  
Example 2) When *Pr. 144* = "104", setting "2" in *Pr. 81* changes the *Pr. 144* setting from "104" to "102".
- When "1, or 11" is set in *Pr. 811*, the setting increments of speed setting from the PU, speed setting from RS-485 communication or communication options (other than FR-A7ND, FR-A7NL) and running speed monitor is 0.1r/min.
- When both *Pr. 37* and *Pr. 144* have been set, their priorities are as given below.  
*Pr. 144, 102 to 110* > *Pr. 37, 1 to 9998* > *Pr. 144, 2 to 10*
- When the running speed monitor is selected, each monitor and setting are determined by the combination of *Pr. 37* and *Pr. 144* as listed below. (The units within the thick frame are the initial values.)

<i>Pr. 37</i> Setting	<i>Pr. 144</i> Setting	Output Frequency Monitor	Set Frequency Monitor	Running Speed Monitor	Frequency Setting Parameter Setting
0 (initial value)	0	Hz	Hz	r/min *1	Hz
	2 to 10	Hz	Hz	r/min *1	Hz
	102 to 110	r/min *1	r/min *1	r/min *1	r/min *1
1 to 9998	0	Hz	Hz	Machine speed *1	Hz
	2 to 10	Machine speed *1	Machine speed *1	Machine speed *1	Machine speed *1
	102 to 110	Hz	Hz	r/min *1	Hz

\*1 Motor speed r/min conversion formula..... frequency × 120/number of motor poles (*Pr. 144*)

Machine speed conversion formula.....*Pr. 37* × frequency/*Pr. 505*

For *Pr. 144* in the above formula, the value is "*Pr. 144* - 100" when "102 to 110" is set in *Pr. 144* and the value is "4" when *Pr. 37* = 0 and *Pr. 144* = 0.

\*2 Hz is in 0.01Hz increments, machine speed is in 1 increments, and r/min is in 1r/min increments (depending on *Pr. 811*).

\*3 *Pr. 505* is always set as frequency (Hz).

### CAUTION

- Under V/F control, the output frequency of the inverter is displayed in terms of synchronous speed, and therefore, displayed value = actual speed + motor slip. This display changes to the actual speed (estimated value calculated based on the motor slip) when the Advanced magnetic flux vector control or Real sensorless vector control is selected, and actual speed from the encoder is displayed when encoder feed back control or vector control is performed.
- When the running speed display is selected at the setting of *Pr. 37* = "0" and *Pr. 144* = "0", the monitor display is provided on the assumption that the number of motor poles is 4. (1800r/min is displayed at 60Hz)
- Refer to *Pr. 52* when you want to change the PU main monitor (PU main display).
- Since the panel display of the operation panel (FR-DU07) is 4 digits in length, the monitor value of more than "9999" is displayed "----".
- After setting the running speed in 0.1r/min increments (*Pr. 811* = "1, 11"), changing the setting increments to 1r/min increments (*Pr. 811* = "0, 10") changes the speed resolution from 0.1r/min to 0.3r/min (four poles), which may round down 0.1r/min increments.
- When the machine speed is displayed on the FR-PU04/FR-PU07, do not change the speed by using an up/down key in the state where the set speed exceeding 65535 is displayed. The set speed may become arbitrary value.
- When an optional FR-A7ND or FR-A7NL card is mounted, frequency is displayed regardless of *Pr. 37* and *Pr. 144* setting.

## CAUTION

 Make sure that the settings of the running speed and number of motor poles are correct. Otherwise, the motor might run at extremely high speed, damaging the machine.

### ◆ Parameters referred to ◆

*Pr. 1* Maximum frequency  Refer to page 140

*Pr. 52* DU/PU main display data selection  Refer to page 229

*Pr. 80* Motor capacity, *Pr. 81* Number of motor poles  Refer to page 131

*Pr. 800* Control method selection  Refer to page 75

*Pr. 811* Set resolution switchover  Refer to page 83

**4.16.2 DU/PU, FM, AM terminal monitor display selection (Pr. 52, Pr. 54, Pr. 158, Pr. 170, Pr. 171, Pr. 268, Pr. 563, Pr. 564, Pr. 891)**

The monitor to be displayed on the main screen of the operation panel (FR-DU07)/parameter unit (FR-PU04/FR-PU07) can be selected.  
 In addition, signals to be output from the terminal FM (pulse train output) and AM (analog voltage output) can be selected.

Parameter Number	Name	Initial Value	Setting Range	Description
52*	DU/PU main display data selection	0 (output frequency)	0, 5 to 8, 10 to 14, 17 to 20, 22 to 25, 32 to 35, 50 to 57, 65, 66, 100 <b>Ver.UP</b>	Select the monitor to be displayed on the operation panel and parameter unit. Refer to the following table for monitor description.
54*	FM terminal function selection	1 (output frequency)	1 to 3, 5 to 8, 10 to 14, 17, 18, 21, 24, 32 to 34, 50, 52, 53	Select the monitor output to terminal FM.
158*	AM terminal function selection			Select the monitor output to terminal AM.
170	Watt-hour meter clear	9999	0	Set "0" to clear the watt-hour meter monitor.
			2 <b>Ver.UP</b>	Set "2" to clear the cumulative regenerative power monitor.
			10	Sets the maximum value for the monitoring from communication to 9999kWh.
			9999	Sets the maximum value for the monitoring from communication to 65535kWh.
171	Operation hour meter clear	9999	0, 9999	Set "0" to clear the operation time monitor. Setting "9999" has no effect.
268*	Monitor decimal digits selection	9999	0	Displayed as integral value
			1	Displayed in 0.1 increments
			9999	No function
563	Energization time carrying-over times	0	0 to 65535 (reading only)	Displays the numbers of cumulative energization time monitor exceeded 65535h. Reading only
564	Operating time carrying-over times	0	0 to 65535 (reading only)	Displays the numbers of operation time monitor exceeded 65535h. Reading only
891	Cumulative power monitor digit shifted times	9999	0 to 4	Set the number of times to shift the cumulative power monitor digit. Clamps the monitor value at maximum.
			9999	No shift Clears the monitor value when it exceeds the maximum value.

\* The above parameters allow its setting to be changed during operation in any operation mode even if "0" (initial value) is set in Pr. 77 Parameter write selection.

**Ver.UP** ..... Specifications differ according to the date assembled. Refer to page 456 to check the SERIAL number.

**(1) Monitor description list (Pr. 52)**

- Set the monitor to be displayed on the operation panel (FR-DU07) and parameter unit (FR-PU04/FR-PU07) in Pr. 52 DU/PU main display data selection.
- Set the monitor to be output to the terminal FM (pulse train output) in Pr. 54 FM terminal function selection.
- Set the monitor to be output to the terminal AM (analog voltage output (0 to 10VDC voltage output)) in Pr. 158 AM terminal function selection.
- Refer to the following table and set the monitor to be displayed. (The signals marked × cannot be selected for monitoring)

Types of Monitor	Increments	Pr. 52 Setting		Pr. 54 (FM) Pr. 158 (AM) Setting	Full-scale Value of the Terminal FM and AM	Description
		DU LED	PU main monitor			
Output frequency	0.01Hz	0/100		1	Pr. 55	Displays the inverter output frequency.
Output current	0.01A	0/100		2	Pr. 56	Displays the inverter output current effective value.
Output voltage	0.1V	0/100		3	200V class: 400V 400V class: 800V	Displays the inverter output voltage.

Types of Monitor	Increments	Pr. 52 Setting		Pr. 54 (FM) Pr. 158 (AM) Setting	Full-scale Value of the Terminal FM and AM	Description
		DU LED	PU main monitor			
Fault display	—	0/100		×	—	Displays 8 past alarms individually.
Frequency setting value	0.01Hz	5	*1	5	Pr. 55	Displays the set frequency.
Running speed	1(r/min)	6	*1	6	The value converted with the Pr. 37 value from Pr. 55	Displays the motor speed (The display differs depending on the Pr. 37 and Pr. 144 settings. The running speed is the actual speed by the encoder signal during encoder feedback control and vector control. For details, refer to page 227.)
Motor torque	0.1%	7	*1	7	Pr. 866	Displays the motor torque in percentage on the assumption that the rated motor torque is 100% (0% is displayed during V/F control)
Converter output voltage	0.1V	8	*1	8	200V class: 400V 400V class: 800V	Displays the DC bus voltage value.
Electronic thermal relay function load factor	0.1%	10	*1	10	100%	Displays the motor thermal cumulative value on the assumption that the thermal operation level is 100%.
Output current peak value	0.01A	11	*1	11	Pr. 56	Retains the peak value of the output current monitor and displays (clears at every start)
Converter output voltage peak value	0.1V	12	*1	12	200V class: 400V 400V class: 800V	Retains the peak value of the DC bus voltage value and displays (clears at every start)
Input power	0.01kW	13	*1	13	Rated inverter power × 2	Displays power on the inverter input side
Output power	0.01kW	14	*1	14	Rated inverter power × 2	Displays power on the inverter output side
Load meter	0.1%	17		17	Pr. 866	Displays the torque current in % on the assumption that the Pr. 56 setting is 100% (displayed on the assumption that rated motor torque is 100% during sensorless vector and vector control)
Motor excitation current	0.01A	18		18	Pr. 56	Displays the excitation current of the motor
Position pulse *2	—	19		×	—	Displays the number of pulses per rotation of the motor when orientation control is valid
Cumulative energization time *4	1h	20		×	—	Displays the cumulative energization time since the inverter shipment. You can check the numbers of the monitor value exceeded 65535h with Pr. 563.
Reference voltage output	—	—		21	—	Terminal FM: 1440 pulse/s is output when Pr. 291 = 0, 1. 50k pulse/s is output when Pr. 291 ≠ 0, 1. Terminal AM: 10V is output
Orientation status *2	1	22		×	—	Displays only when orientation control is valid (Refer to page 196)
Actual operation time *4, *5	1h	23		×	—	Displays the cumulative inverter running time. You can check the numbers of the monitor value exceeded 65535h with Pr. 564. Use Pr. 171 to clear the value. (Refer to page 235)
Motor load factor	0.1%	24		24	200%	Displays the output current value in % on the assumption that the rated inverter current value is 100%. Monitor value = output current monitor value/ rated inverter current × 100 [%]
Cumulative power *7	0.01kWh *6	25		×	—	Displays the cumulative power amount according to the output power monitor. Use Pr. 170 to clear the value. (Refer to page 234)
Torque command	0.1%	32		32	Pr. 866	Displays torque command value obtained from vector control
Torque current command	0.1%	33		33	Pr. 866	Displays torque current command value

Types of Monitor	Increments	Pr. 52 Setting		Pr. 54 (FM) Pr. 158 (AM) Setting	Full-scale Value of the Terminal FM and AM	Description
		DU LED	PU main monitor			
Motor output	0.01kW	34		34	Rated motor capacity	Multiplies the motor speed by the then output torque and displays the machine output of the motor shaft end
Feedback pulse <sup>*3, *7</sup>	—	35		×	—	Displays the number of pulses fed back from the encoder during one sampling (displays during a stop). The sampling time varies with the Pr. 369 Number of encoder pulses setting. 1050 or less: 1s 1051 to 2100: 0.5s 2101 to 4096: 0.25s
Power saving effect	Variable according to parameters	50		50	Inverter capacity	Displays energy saving effect monitor You can change the monitor to power saving, power saving average value, charge display and % display using parameters. (For details, refer to page 257)
Cumulative saving power <sup>*7</sup>		51		×	—	
PID set point	0.1%	52		52	100%	Displays the set point, measured value and deviation during PID control (For details, refer to page 343)
PID measured value	0.1%	53		53	100%	
PID deviation	0.1%	54		×	—	
Input terminal status	—	55	*1	×	—	Displays the input terminal ON/OFF status on the PU (refer to page 233 for DU display)
Output terminal status	—		*1	×	—	Displays the output terminal ON/OFF status on the PU (refer to page 233 for DU display)
Option input terminal status	—	56	×	×	—	Displays the input terminal ON/OFF status of the digital input option (FR-A7AX) on the DU (refer to page 233 for details)
Option output terminal status	—	57	×	×	—	Displays the output terminal ON/OFF states of the digital output option (FR-A7AY) or relay output option (FR-A7AR) on the DU (refer to page 233 for details)
Output power (with regenerative display)	0.1kW	65		×	Inverter rated power × 2	Displays the regenerative power at the inverter output side.
Cumulative regenerative power <sup>*7</sup>	0.01kWh (1kWh for communication)	66		×	—	Accumulated regenerative power is displayed based on the output power (with regenerative display). The value can be cleared by Pr.170.

- \*1 Frequency setting to output terminal status on the PU main monitor are selected by "other monitor selection" of the parameter unit (FR-PU04/FR-PU07).
- \*2 Position pulse and orientation status function when used with an FR-A7AP/FR-A7AL (option). When orientation control is invalid, "0" remains displayed and these functions are invalid.
- \*3 Feedback pulse functions when the FR-A7AP/FR-A7AL (option) is used and vector control is performed.
- \*4 The cumulative energization time and actual operation time are accumulated from 0 to 65535 hours, then cleared, and accumulated again from 0. When the operation panel (FR-DU07) is used, the time is displayed up to 65.53 (65530h) in the indication of 1h = 0.001, and thereafter, it is added up from 0.
- \*5 The actual operation time is not added up if the cumulative operation time before power supply-off is less than 1h.
- \*6 When using the parameter unit (FR-PU04/FR-PU07), "kW" is displayed.
- \*7 Since the panel display of the operation panel (FR-DU07) is 4 digits in length, the monitor value of more than "9999" is displayed as "----".

**REMARKS**

- By setting "0" in Pr. 52, the monitoring of output frequency to fault display can be selected in sequence by (SET).
- When the operation panel (FR-DU07) is used, the displayed units are Hz, V and A only and the others are not displayed.
- The monitor set in Pr. 52 is displayed in the third monitor position (The output voltage monitor is changed).  
Note that load meter, motor excitation current, and motor load factor are displayed in the second monitor (output current).

**Initial value**

\* The monitor displayed at powering on is the first monitor. Display the monitor you want to display on the first monitor and hold down

(SET) for 1s. (To return to the output frequency monitor, hold down (SET) for 1s after displaying the output frequency monitor.)

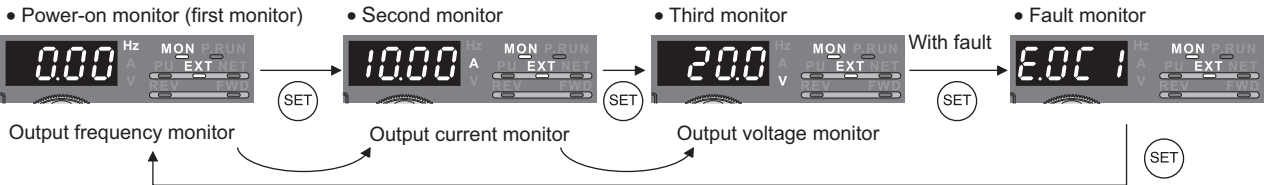

Example) When Pr. 52 is set to "20" (cumulative energization time), the monitor is displayed on the operation panel as described below.

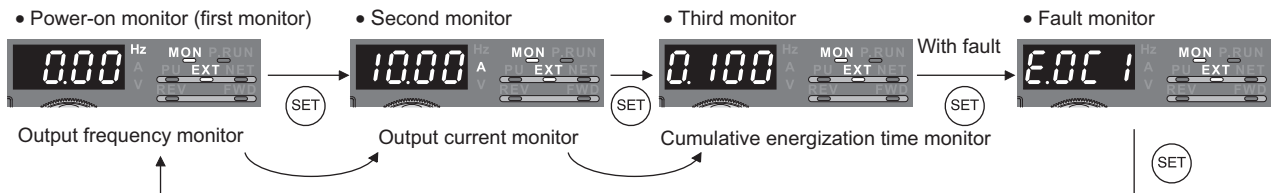

**(2) Display set frequency during stop (Pr. 52)**

- When Pr. 52 is set to "100", the set frequency monitor is displayed during a stop and the output frequency monitor is displayed during operation. (LED of Hz flickers during stop and is lit during running.)
- When Pr. 52 = "100", the set frequency displayed at a stop indicates frequency to be output when the start command is ON.  
Different from the frequency setting displayed when Pr. 52 = "5", the value based on maximum/minimum frequency and frequency jump is displayed.

Type of Monitor	Pr. 52		
	0	100	
	During running/stop	During stop	During running
Output frequency	Output frequency	Set frequency	Output frequency
Output current	Output current		
Output voltage	Output voltage		
Fault display	Fault display		

**REMARKS**

- During an error, the output frequency at error occurrence appears.
- During MRS, the values displayed are the same as during a stop.
- During offline auto tuning, the tuning status monitor has priority.

**(3) Operation panel (FR-DU07) I/O terminal monitor (Pr. 52)**

- When Pr. 52 is set to any of "55 to 57", the I/O terminal states can be monitored on the operation panel (FR-DU07).
- The I/O terminal monitor is displayed on the third monitor.
- The LED is ON when the terminal is ON, and the LED is OFF when the terminal is OFF. The center line of LED is always ON.

Pr. 52 Setting	Monitor Description
55	Displays the I/O and output terminal ON/OFF status of the inverter unit.
56 *	Displays the input terminal ON/OFF status of the digital input option (FR-A7AX).
57 *	Displays the output terminal ON/OFF status of the digital output option (FR-A7AY) or relay output option (FR-A7AR).

\* You can set "56" or "57" even if the option is not fitted. When the option is not fitted, the monitor displays are all OFF.

- On the unit I/O terminal monitor (Pr. 52 = "55"), the upper LEDs denote the input terminal status and the lower the output terminal status.

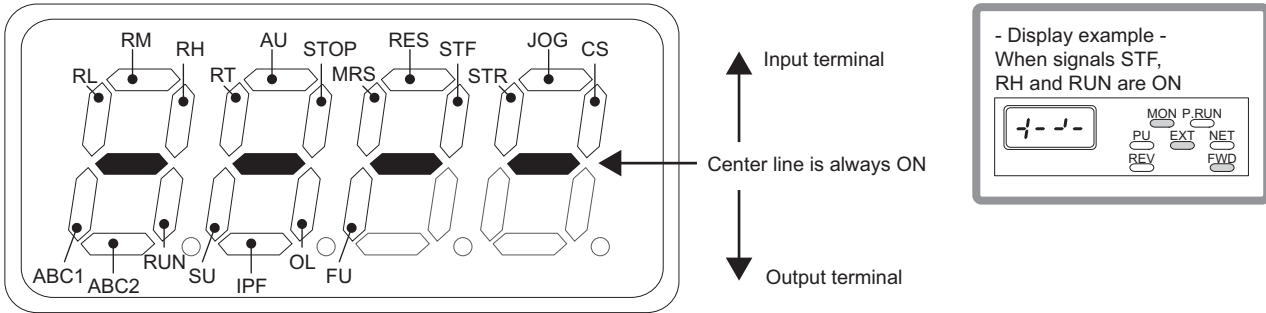

- On the input option terminal monitor (Pr. 52 = "56"), the decimal point LED of the first digit LED is on.

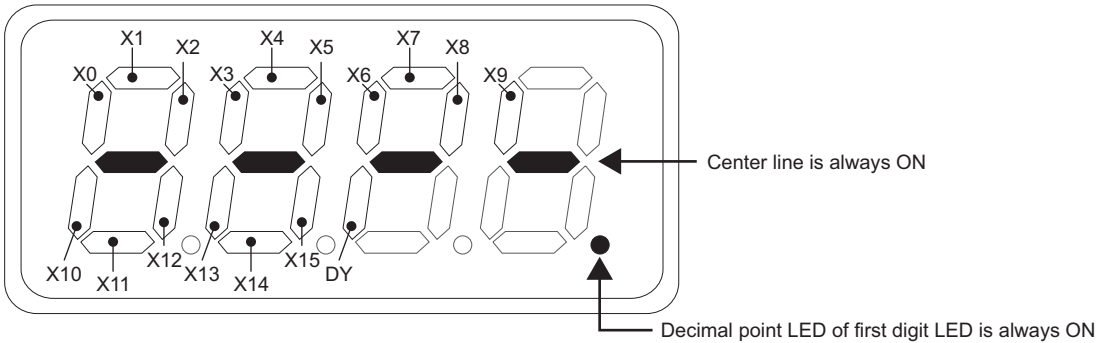

- On the input option terminal monitor (Pr. 52 = "57"), the decimal point LED of the second digit LED is ON.

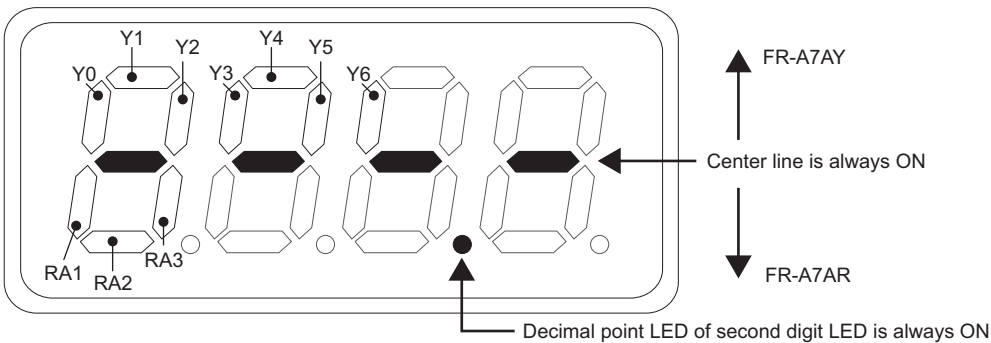



**(4) Cumulative regenerative power monitor, cumulative regenerative power monitor and clear (Pr. 170, Pr. 891)**

- On the cumulative power monitor (Pr. 52 = "25"), the output power monitor value is added up and is updated in 1h increments.
- On the cumulative regenerative power monitor (Pr. 52 = "66"), the output power (with regenerative display) is added up and updated in 1h increments.
- The operation panel (FR-DU07), parameter unit (FR-PU04, FR-PU07) and communication (RS-485 communication, communication option) display increments and display ranges are as indicated below.

Operation Panel *1		Parameter Unit *2		Communication		
Range	Increments	Range	Increments	Range		Increments
				Pr. 170 = 10	Pr. 170 = 9999	
0 to 99.99kWh	0.01kWh	0 to 999.99kWh	0.01kWh	0 to 9999kWh	0 to 65535kWh (initial value)	1kWh
100.0 to 999.9kWh	0.1kWh	1000.0 to 9999.9kWh	0.1kWh			
1000 to 9999kWh	1kWh	10000 to 99999kWh	1kWh			

\*1 Power is measured in the range 0 to 9999.99kWh, and displayed in 4 digits. When the monitor value exceeds "99.99", a carry occurs, e.g. "100.0", so the value is displayed in 0.1kWh increments.  
 \*2 Power is measured in the range 0 to 99999.99.99kWh, and displayed in 5 digits. When the monitor value exceeds "999.99", a carry occurs, e.g. "1000.0", so the value is displayed in 0.1kWh increments.

- The monitor data digit can be shifted to the right by the number of Pr. 891 settings. For example, if the cumulative power value is 1278.56kWh when Pr. 891 = "2", the PU/DU display is 12.78 (display in 100kWh increments) and the communication data is 12.
- If the maximum value is exceeded at Pr. 891 = "0 to 4", the monitor value is clamped at the maximum value, indicating that a digit shift is necessary. If the maximum value is exceeded at Pr. 891 = "9999", the monitor value returns to 0 and is recounted.
- Writing "0" in Pr. 170 clears the cumulative power monitor.
- Writing "2" to Pr.170 clears the cumulative regenerative driving power amount.

**REMARKS**

- If "0, 2" is written in Pr. 170 and Pr. 170 is read again, "9999" or "10" is displayed.
- Cumulative regenerative driving power (Pr. 52 = "66") cannot be assigned to the terminal FM/AM or the analog output terminal of FR-A7AY, or neither to Pr. 838 DA1 terminal function selection.

**(5) Output power (with regenerative display) (Pr. 52 = "65")**

- Regenerative driving power at the inverter output side is displayed in the output power monitor (with regenerative display) (Pr. 52 = "65").
- Positive value (no sign) is displayed in the output power display on the operation panel during power driving, and negative value is displayed during regenerative driving.

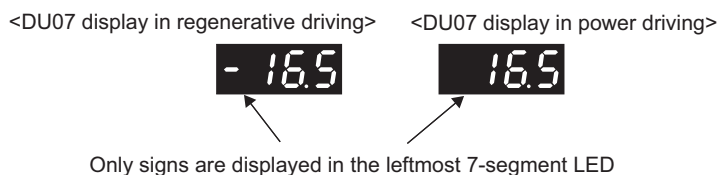

- When the monitored value is 100kW or more, the displayed unit is 1kW. When the power value is 1000kW or more, it is limited at 999kW. When the power value is -1000kW or less, it is limited at -999kW.
- Positive value (no sign) is displayed in the output power display on the communication option and FR-PU07 during power driving and regenerative driving.

**REMARKS**

- Output power (with regenerative display) (Pr. 52 = "65") cannot be assigned to the terminal FM/AM or to the analog output terminal of FR-A7AY.
- Analog output pattern when Pr. 838 DA1 terminal function selection = "65" is shown below. (Pr. 838 DA1 terminal function selection is a parameter dedicated to FR-A7AZ. Read and write to this parameter is available only when the option is installed.)
  - During power driving: positive value is output
  - During regenerative driving: negative value is output

**(6) Cumulative energization time and actual operation time monitor (Pr. 171, Pr. 563, Pr. 564)**

- On the cumulative energization time monitor (Pr. 52 = "20"), the inverter running time is added up every hour.
- On the actual operation time monitor (Pr. 52 = "23"), the inverter running time is added up every hour. (Time is not added up during a stop.)
- If the numbers of monitor value exceeds 65535, it is added up from 0. You can check the numbers of cumulative energization time monitor exceeded 65535h with Pr. 563 and the numbers of actual operation time monitor exceeded 65535h with Pr. 564.
- Writing "0" in Pr. 171 clears the actual operation time monitor. (Energization time monitor can not be cleared.)

**REMARKS**

- The cumulative energization time does not increase if the power is ON for less than an hour.
- The actual operation time does not increase if the cumulative running time during power-ON status is less than an hour.
- If "0" is written in Pr. 171 and Pr. 171 is read again, "9999" is always displayed. Setting "9999" does not clear the actual operation time meter.

**(7) You can select the decimal digits of the monitor (Pr. 268)**

- As the operation panel (FR-DU07) display is 4 digits long, the decimal places may vary at analog input, etc. The decimal places can be hidden by selecting the decimal digits. In such a case, the decimal digits can be selected by Pr. 268.

Pr. 268 Setting	Description
9999 (initial value)	No function
0	When 1 or 2 decimal places (0.1 increments or 0.01 increments) are monitored, the decimal places are dropped and the monitor displays an integer value (1 increments). The monitor value of 0.99 or less is displayed as 0.
1	When 2 decimal places (0.01 increments) are monitored, the 0.01 decimal place is dropped and the monitor displays the first decimal place (0.1 increments). When the monitor display digit is originally in 1 increments, it is displayed unchanged in 1 increments.

**REMARKS**

- The number of display digits on the cumulative energization time (Pr. 52 = "20"), actual operation time (Pr. 52 = "23"), cumulative power (Pr. 52 = "25") or cumulative saving power monitor (Pr. 52 = "51") does not change.

◆ **Parameters referred to** ◆

Pr. 37 Speed display, Pr. 144 Speed setting switchover  Refer to page 227

Pr. 55 Frequency monitoring reference, Pr. 56 Current monitoring reference, Pr. 866 Torque monitoring reference  Refer to page 236

Pr. 291 Pulse train I/O selection  Refer to page 236

### 4.16.3 Reference of the terminal FM (pulse train output) and AM (analog voltage output) (Pr. 55, Pr. 56, Pr. 291, Pr. 866, Pr. 867)

Two types of monitor output, pulse train output from the terminal FM and analog voltage output from the terminal AM, are available. In addition, pulse train output by voltage output and by open collector output can be selected for terminal FM.

Set the reference of the signal output from terminal FM and AM.

Parameter Number	Name	Initial Value	Setting Range	Description	
55 *	Frequency monitoring reference	60Hz	0 to 400Hz	Full-scale value when frequency monitor value is output to terminal FM and AM.	
56 *	Current monitoring reference	Rated inverter current	0 to 500A	Full-scale value when current monitor value is output to terminal FM and AM.	
291	Pulse train I/O selection	0	0	Pulse train input	Pulse train output
				Terminal JOG	FM output
			1	Pulse train input	FM output
				Terminal JOG	High speed pulse train output (50%Duty)
			10	Pulse train input	High speed pulse train output (50%Duty)
				Terminal JOG	High speed pulse train output (ON width is always same)
			20	Pulse train input	High speed pulse train output (ON width is always same)
Terminal JOG	High speed pulse train output (ON width is always same)				
21	Pulse train input	High speed pulse train output (ON width is always same)	High speed pulse train output (ON width is always same)		
	Terminal JOG	High speed pulse train output (ON width is always same)	The inverter outputs the signal input as pulse train as is		
100	Pulse train input	High speed pulse train output (ON width is always same)	High speed pulse train output (ON width is always same)		
866 *	Torque monitoring reference	150%	0 to 400%	Set the full-scale value to output the torque monitor value to terminal FM and AM.	
867	AM output filter	0.01s	0 to 5s	Set the output filter of terminal AM.	

\* The above parameters allow its setting to be changed during operation in any operation mode even if "0" (initial value) is set in Pr. 77 Parameter write selection.

#### (1) Pulse train output of the terminal FM (Pr. 291)

- Two types of pulse train can be output to the terminal FM.

##### FM output circuit

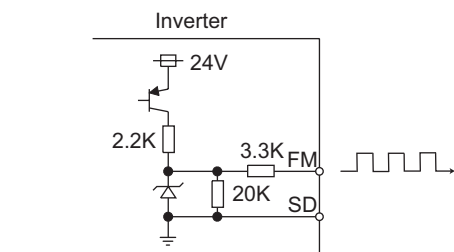

- When Pr. 291 Pulse train I/O selection = "0 (initial value) or 1", FM output is selected and pulse train with maximum of 8VDC 2400pulses/s is output. The pulse width can be adjusted by calibration parameter C0 (Pr. 900) FM terminal calibration using the operation panel and parameter unit.
- Output frequency, etc. of the inverter can be indicated by connecting a DC ammeter of full-scale 1mA, digital indicator, etc.

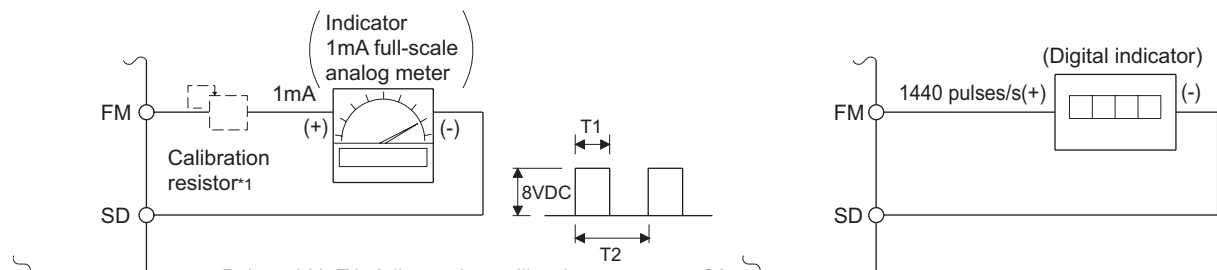

Pulse width T1: Adjust using calibration parameter C0  
 Pulse cycle T2: Set with Pr. 55 (frequency monitor)  
 Set with Pr.56 (current monitor)

\*1 Not needed when the operation panel (FR-DU07) or parameter unit (FR-PU04/FR-PU07) is used for calibration. This resistor is used when calibration must be made near the frequency meter for such a reason as a remote frequency meter. Note that the needle of the frequency meter may not deflect to full-scale when the calibration resistor is connected. In this case, use this resistor and operation panel or parameter unit together.  
 \*2 The initial setting is 1mA full-scale and 1440 pulse/s terminal FM frequency at 60Hz.

**High speed pulse train output circuit  
(connection example with a pulse counter)**

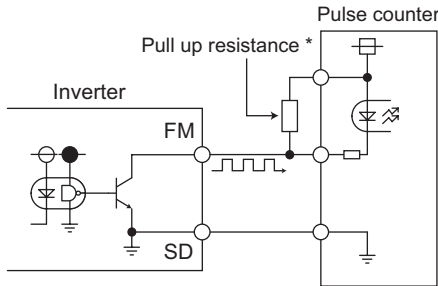

**Pulse when Pr. 291 = "10, 11"**

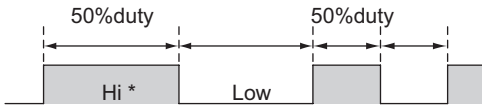

**Pulse when Pr. 291 = "20, 21, 100"**



- When Pr. 291 Pulse train I/O selection = "10, 11, 20, 21, 100", high speed pulse train is output by open collector output. Pulse train of maximum of 55k pulses/s is output. Two types of pulse width, 50% Duty and fixed ON width, are available. Adjustment by calibration parameter C0 (Pr. 900) FM terminal calibration can not be performed.

\* When the output wiring length is long, a pulse shape is deformed due to the stray capacitances of the wiring and output pulse can not be recognized. If the wiring length is long, connect the open collector output signal and the power supply using an external pull up resistance. Check specifications of a pulse counter for a resistance value to pull up. Select an appropriate resistance value so that the load current is 80mA or less.

- When Pr. 291 = "10, 11", the pulse cycle is 50% Duty (ON width and OFF width are the same).
- When Pr. 291 = "20, 21, 100", fixed ON width of pulse is output (approx. 10µs).
- When the setting value is "100", the pulse train from the pulse train input (terminal JOG) is output as is. Use this value for synchronous speed operation of multiple inverters. (Refer to page 356)

\* Hi indicates that the open collector output transistor is on.

● High speed pulse train output specifications

Item	Specifications
Output method	NPN open collector output
Voltage between a collector and emitter	30V (max)
Maximum permissible load current	80mA
Output pulse rate	0 to 55kpps *
Output resolution	3pps (excluding a jitter)

\* The output pulse rate is 50kpps when a monitor output value is 100%.

**CAUTION**

- Input specifications of terminal JOG (pulse train input or contact input) can be selected with Pr. 291. Change the setting value using care not to change input specifications of terminal JOG. (Refer to page 356 for pulse train input.)
- After changing a setting value of Pr. 291, connect a meter between terminal FM and SD. Take care that a voltage should not be applied to terminal FM when FM output (voltage output) pulse train is selected.
- The FM output of the inverter can not be connected to devices which have source logic type pulse input.
- When high speed pulse train output (Pr. 291 = "10, 11, 20, 21, 100") is selected, performing parameter all clear returns the Pr. 291 setting to the initial value of "0", changing the terminal FM output from high speed pulse train output to FM output (voltage output).

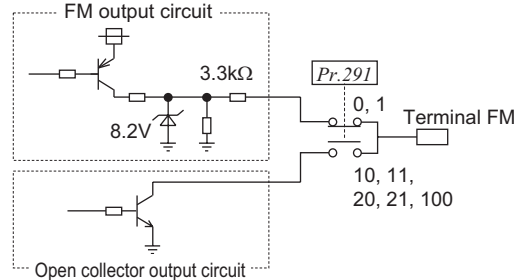

**(2) Frequency monitoring reference (Pr. 55)**

- Set the full scale value when outputting the frequency monitor from terminal FM or AM.
- For the calibration of terminal FM, set the full-scale value of the connected meter when the pulse speed of terminal FM is 1440 pulse/s (50k pulse/s).  
Set the frequency to be indicated as the full scale value on the frequency meter (1mA analog meter) connected between terminal FM and SD. (For example, 60Hz or 120Hz.)  
Pulse speed is proportional to the output frequency of the inverter. (Maximum pulse train output is 2400 pulse/s (55k pulse/s).)
- For the calibration of terminal AM, set the full-scale value of the connected meter when output voltage of terminal AM is 10VDC.  
Set the frequency to be indicated as the full scale value on the meter (10VDC voltmeter) connected between terminal AM and 5. (For example, 60Hz or 120Hz.)  
Output voltage is proportional to the frequency. (Maximum output voltage is 10VDC.)

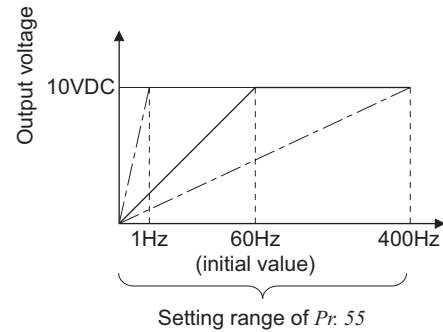
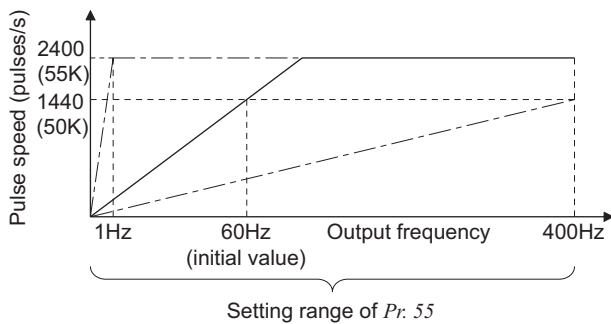

**(3) Current monitoring reference (Pr. 56)**

- Set the full scale value when outputting the current monitor from terminal FM or AM.
- For calibration of terminal FM, set the full-scale value of the connected current meter when the pulse speed of terminal FM is 1440 pulse/s (50k pulse/s).  
Set the current to be indicated as the full scale value on the meter (1mA analog meter) connected between terminal FM and SD.  
Pulse speed is proportional to the monitored value of output current. (Maximum pulse train output is 2400 pulse/s (55k pulse/s).)
- For the calibration of terminal AM, set the full-scale value of the connected current meter when the output voltage of terminal AM is 10VDC.  
Set the current to be indicated as the full scale value on the meter (10VDC voltmeter) connected between terminal AM and 5.  
Output voltage is proportional to the monitored value of output current. (Maximum output voltage is 10VDC.)

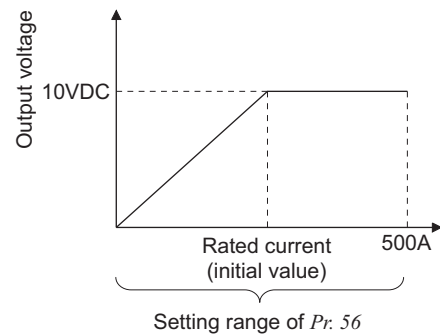
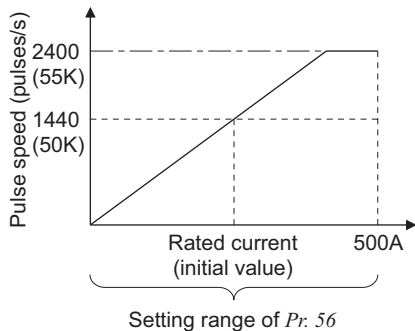

**(4) Reference of torque monitor (Pr. 866)**

- Set the full scale value when outputting the torque monitor from terminal FM or AM.
- For calibration of terminal FM, set the full-scale value of the connected torque meter when the pulse speed of terminal FM is 1440 pulse/s (50k pulse/s).  
Set the torque to be indicated as the full scale value on the meter (1mA analog meter) connected between terminal FM and SD.  
Pulse speed is proportional to the monitored value of torque. (Maximum pulse train output is 2400 pulse/s (55k pulse/s).)
- For the calibration of terminal AM, set the full-scale value of the connected current meter when the output voltage of terminal AM is 10VDC.  
Set the torque to be indicated as the full scale value on the meter (10VDC voltmeter) connected between terminal AM and 5.  
Output voltage is proportional to the monitored value of torque. (Maximum output voltage is 10VDC.)

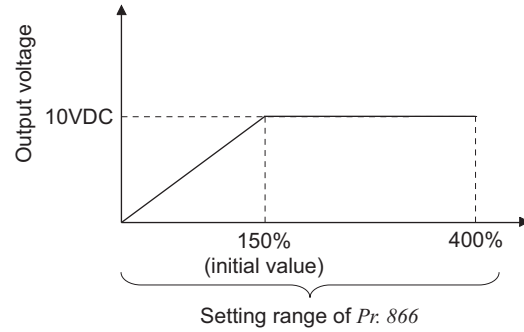
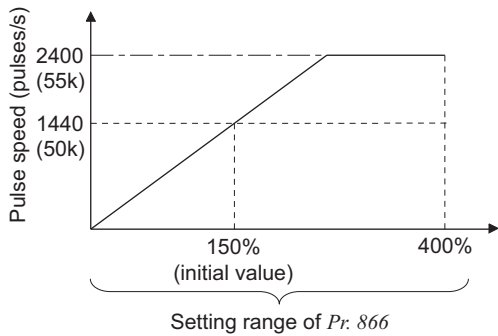

**(5) Terminal AM response adjustment (Pr. 867)**

- Using Pr. 867, the output voltage response of the terminal AM can be adjusted within the range 0 to 5s.
- Increasing the setting stabilizes the terminal AM output more but reduces the response level. (Setting "0" sets the response level to 7ms)

#### 4.16.4 Terminal FM, AM calibration (Calibration parameter C0 (Pr. 900), C1 (Pr. 901))

By using the operation panel or parameter unit, you can calibrate terminal FM and terminal AM to full scale deflection.

Parameter Number	Name	Initial Value	Setting Range	Description
C0(900)	FM terminal calibration	—	—	Calibrate the scale of the meter connected to terminal FM.
C1(901)	AM terminal calibration	—	—	Calibrate the scale of the analog meter connected to terminal AM.

\*1 The parameter number in parentheses is the one for use with the parameter unit (FR-PU04/FR-PU07).

\*2 The above parameters allow its setting to be changed during operation in any operation mode even if "0" (initial value) is set in Pr. 77 Parameter write selection.

##### (1) FM terminal calibration (C0(Pr. 900))

- The terminal FM is preset to output pulses. By setting the Calibration parameter C0 (Pr. 900), the meter connected to the inverter can be calibrated by parameter setting without use of a calibration resistor.
- Using the pulse train output of the terminal FM, a digital display can be provided by a digital counter. The monitor value is 1440 pulses/s output at the full-scale value of the table on the previous page (Pr. 54 FM terminal function selection).

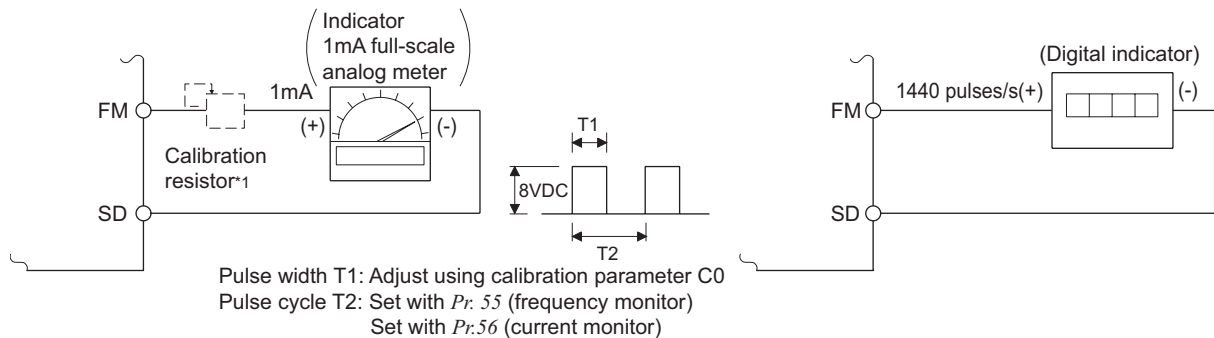

\*1 Not needed when the operation panel (FR-DU07) or parameter unit (FR-PU04/FR-PU07) is used for calibration.

This resistor is used when calibration must be made near the frequency meter for such a reason as a remote frequency meter. Note that the needle of the frequency meter may not deflect to full-scale when the calibration resistor is connected. In this case, use this resistor and perform calibration of operation panel or parameter unit.

\*2 The initial settings are 1mA full-scale and 1440 pulses/s terminal FM frequency at 60Hz.

- Calibrate the terminal FM in the following procedure.
  - 1) Connect an indicator (frequency meter) across the terminals FM-SD of the inverter. (Note the polarity. The terminal FM is positive.)
  - 2) When a calibration resistor has already been connected, adjust the resistance to "0" or remove the resistor.
  - 3) Refer to the output signal list (page 229) and set Pr. 54. When you selected the running frequency or inverter output current as the output signal, preset the running frequency or current value, at which the output signal will be 1440 pulses/s, to Pr. 55 Frequency monitoring reference or Pr. 56 Current monitoring reference. At 1440 pulses/s, the meter generally deflects to full-scale.

#### REMARKS

- When calibrating a monitor output signal, which cannot adjust to a 100% value without an actual load and a measurement equipment, set Pr. 54 to "21" (reference voltage output) and make calibration. 1440 pulses/s are output from the terminal FM.
- The wiring length of the terminal FM should be 200m maximum.

#### CAUTION

- The initial value of the calibration parameter C0 (Pr. 900) is set to 1mA full-scale and 1440 pulses/s FM output frequency at 60Hz. The maximum pulse train output of terminal FM is 2400 pulses/s.
- When a frequency meter is connected to across terminals FM-SD to monitor the running frequency, the FM terminal output is filled to capacity at the initial setting if the maximum output frequency reaches or exceeds 100Hz. In this case, the Pr. 55 setting must be changed to the maximum frequency.
- When Pr. 291 Pulse train I/O selection = "10, 11, 20, 21, 100" (high speed pulse train output), calibration using calibration parameter C0 (Pr. 900) can not be made.

**(2) AM terminal calibration (C1 (Pr. 901))**

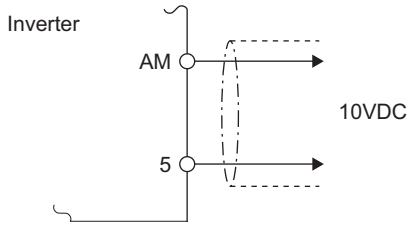

· Terminal AM is factory-set to provide a 10VDC output in the full-scale status of the corresponding monitor item. Calibration parameter C1 (Pr. 901) allows the output voltage ratios (gains) to be adjusted according to the meter scale. Note that the maximum output voltage is 10VDC.

- Calibrate the AM terminal in the following procedure.
  - 1) Connect a 0-10VDC meter (frequency meter) to across inverter terminals AM-5. (Note the polarity. The terminal AM is positive.)
  - 2) Refer to the monitor description list (page 229) and set Pr. 158. When you selected the running frequency, inverter output current, etc. as monitor, preset in Pr. 55 or Pr. 56 the running frequency or current value at which the output signal will be 10V.
  - 3) When outputting the item that cannot achieve a 100% value easily by operation, e.g. output current, set "21" (reference voltage output) in Pr. 158 and perform the following operation. After that, set "2" (output current, for example) in Pr. 158.

**REMARKS**

· When outputting an item, which cannot reach a 100% value easily without actual load or a meter, set Pr. 158 = "21(reference voltage output)" and perform the calibration. 10VDC is output from the terminal AM.



**(3) How to calibrate the terminal FM when using the operation panel (FR-DU07)**

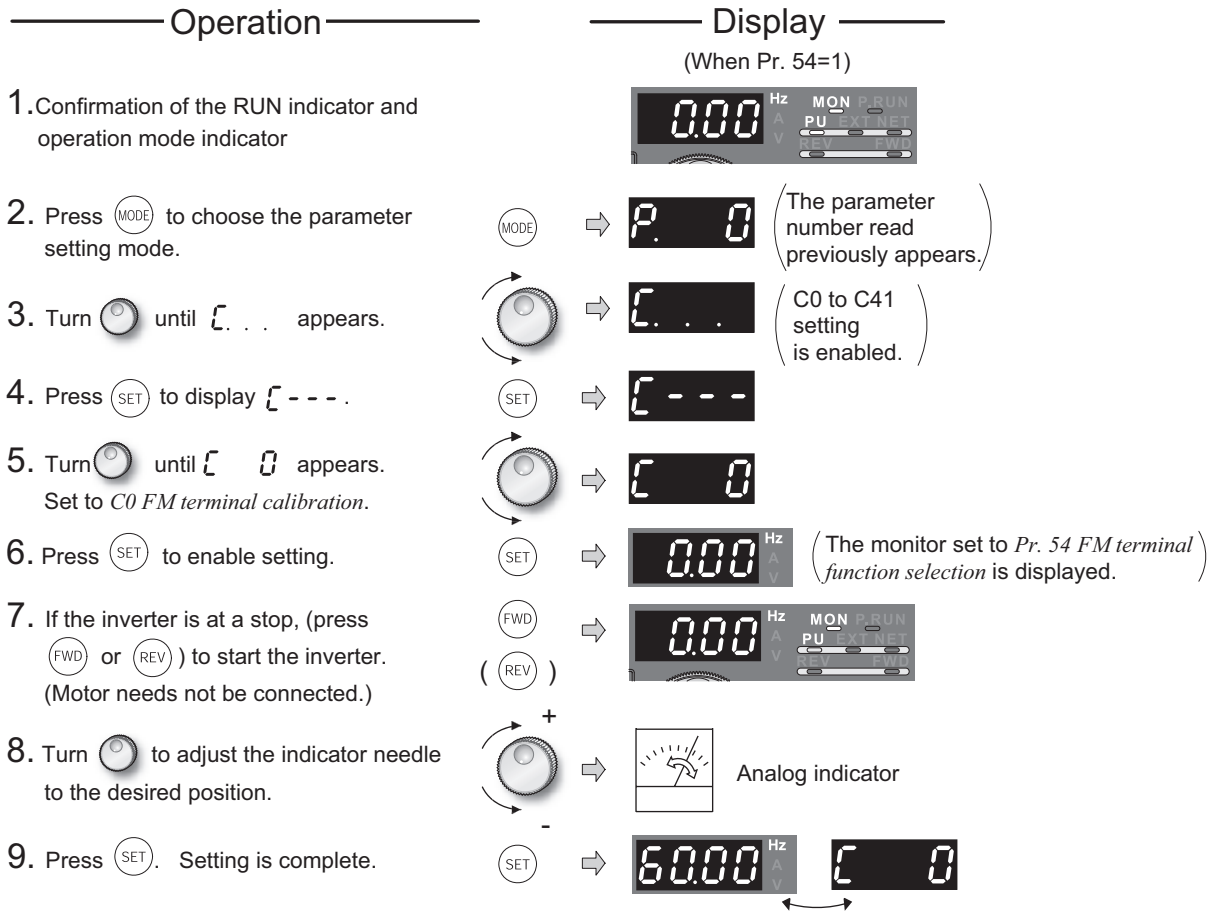

**Flicker...Parameter setting complete!!**

- Turn to read another parameter.
- Press **(SET)** to return to the **[ - - - ]** indication (step 4).
- Press **(SET)** twice to show the next parameter (**Pr.[ ]**).

**REMARKS**

- Calibration can also be made for external operation. Set the frequency in External operation mode, and make calibration in the above procedure.
- Calibration can be made even during operation.
- For the operating procedure using the parameter unit (FR-PU04/FR-PU07), refer to the parameter unit instruction manual.

**◆ Parameters referred to ◆**

- Pr. 54 FM terminal function selection Refer to page 229
- Pr. 55 Frequency monitoring reference Refer to page 236
- Pr. 56 Current monitoring reference Refer to page 236
- Pr. 158 AM terminal function selection Refer to page 229
- Pr. 291 Pulse train I/O selection Refer to page 356

## 4.17 Operation selection at power failure and instantaneous power failure

Purpose	Parameter that must be Set		Refer to Page
At instantaneous power failure occurrence, restart inverter without stopping motor	Automatic restart operation after instantaneous power failure/flying start	Pr. 57, Pr. 58, Pr. 162 to Pr. 165, Pr. 299, Pr. 611	243
When undervoltage or a power failure occurs, the inverter can be decelerated to a stop.	Power failure-time deceleration-to-stop function	Pr. 261 to Pr. 266, Pr. 294	247

### 4.17.1 Automatic restart after instantaneous power failure/flying start (Pr. 57, Pr. 58, Pr. 162 to Pr. 165, Pr. 299, Pr. 611)

You can restart the inverter without stopping the motor in the following cases.

- when commercial power supply operation is switched to inverter operation
- when power comes back on after an instantaneous power failure
- when motor is coasting at start

Parameter Number	Name	Initial Value	Setting Range	Description
57	Restart coasting time	9999	0	· 5.5K, 7.5K ..... 1s, · 11K or higher ..... 3.0s, The above times are coasting time.
			0.1 to 5s	Set the waiting time for inverter-triggered restart after an instantaneous power failure.
			9999	No restart
58	Restart cushion time	1s	0 to 60s	Set a voltage starting time at restart.
162	Automatic restart after instantaneous power failure selection	0	0	With frequency search
			1	Without frequency search (reduced voltage system)
			2	Encoder detection frequency search
			10	Frequency search at every start
			11	Reduced voltage system at every start
12	Encoder detection frequency search at every start			
163	First cushion time for restart	0s	0 to 20s	Set a voltage starting time at restart.
164	First cushion voltage for restart	0%	0 to 100%	Consider using these parameters according to the load (moment of inertia, torque) magnitude.
165	Stall prevention operation level for restart	150%	0 to 220%	Consider the rated inverter current as 100% and set the stall prevention operation level during restart operation.
299	Rotation direction detection selection at restarting	0	0	Without rotation direction detection
			1	With rotation direction detection
			9999	When Pr. 78 = "0", the rotation direction is detected. When Pr. 78 = "1","2", the rotation direction is not detected.
611	Acceleration time at a restart	5s	0 to 3600s, 9999	Set the acceleration time that takes to reach Pr. 20 Acceleration/deceleration reference frequency setting at a restart. Acceleration time for restart is the normal acceleration time (e.g. Pr. 7) when "9999" is set.



**(1) Automatic restart after instantaneous power failure operation**

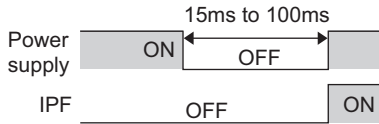

When instantaneous power failure protection (E.IPF) and undervoltage protection (E.UVT) are activated, the inverter trips. (Refer to page 391 for E.IPF and E.UVT.)

When automatic restart after instantaneous power failure operation is set, the motor can be restarted if power is restored after an instantaneous power failure or undervoltage is corrected. (E.IPF and E.UVT are not activated.)

- When E.IPF and E.UVT are activated, instantaneous power failure/under voltage signal (IPF) is output.
- The IPF signal is assigned to the terminal IPF in the initial setting. The IPF signal can also be assigned to the other terminal by setting "2 (positive logic) or 102 (negative logic)" to any of Pr. 190 to Pr. 196 (output terminal function selection).

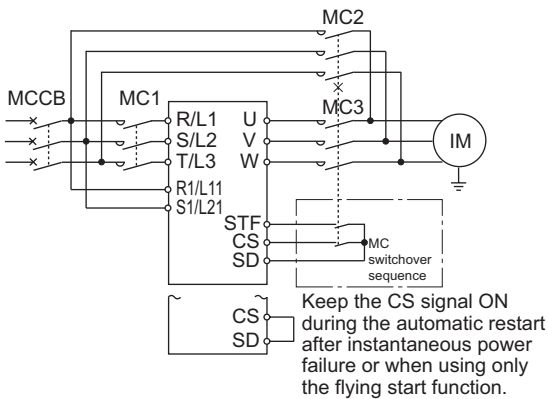

**(2) Connection (CS signal)**

- When the automatic restart after instantaneous power failure selection signal (CS) is turned on, automatic restart operation is enabled.
- When Pr. 57 is set to other than "9999" (automatic restart operation enabled), the inverter will not operate if used with the CS signal remained off.

**REMARKS**

- The CS signal is assigned to the terminal CS in the initial setting. By setting "6" in any of Pr. 178 to Pr. 189 (input terminal function selection), you can assign the CS signal to the other terminal.

**(3) Automatic restart operation selection (Pr. 162, Pr. 299)**

● When Pr. 162 = 0, 10 (with frequency search)

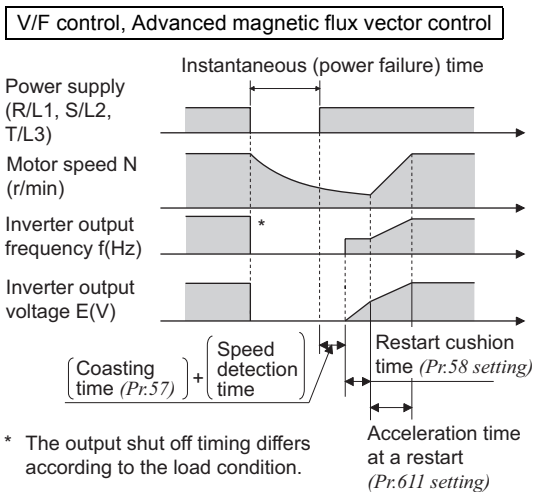

● With frequency search

- When "0 (initial value), 10" is set in Pr. 162, the inverter smoothly starts after detecting the motor speed upon power restoration.
- During reverse rotation, the inverter can be restarted smoothly as the direction of rotation is detected.
- You can select whether to make rotation direction detection or not with Pr. 299 Rotation direction detection selection at restarting. When capacities of the motor and inverter differ, set "0" (without rotation direction detection) in Pr. 299.

Pr. 299 Setting	Pr. 78 Setting		
	0	1	2
9999	○	×	×
0 (initial value)	×	×	×
1	○	○	○

○:with rotation direction detection  
×:without rotation direction detection

Real sensorless vector control

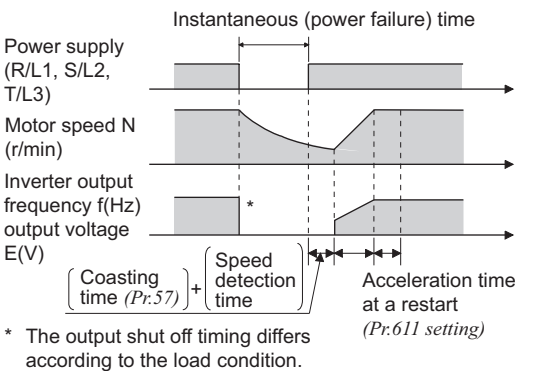

**REMARKS**

- Speed detection time (frequency search) changes according to the motor speed. (maximum 500ms)
- When the inverter capacity is two rank or more larger than the motor capacity, the inverter may not start due to overcurrent trip (E.O.C).
- If two or more motors are connected to one inverter, the inverter functions abnormally. (The inverter does not start smoothly.)
- Since the DC injection brake is operated instantaneously when the speed is detected at a restart, the speed may reduce if the moment of inertia of the load is small.
- When reverse rotation is detected when Pr. 78 = "1" (reverse rotation disabled), the rotation direction is changed to forward rotation after decelerates in reverse rotation when the start command is forward rotation. The inverter will not start when the start command is reverse rotation.

● When Pr. 162 = 1, 11 (without frequency search)

V/F control, Advanced magnetic flux vector control

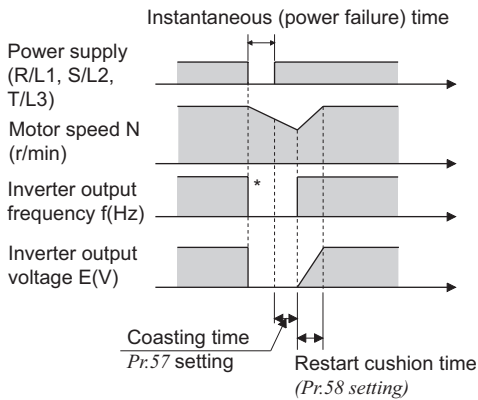

\* The output shut off timing differs according to the load condition.

Real sensorless vector control

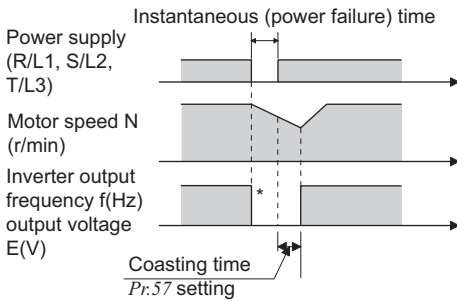

\* The output shut off timing differs according to the load condition.

● When Pr. 162 = 2, 12 (encoder detection frequency search)

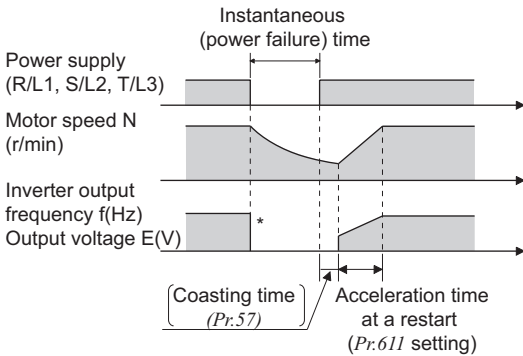

\* The output shut off timing differs according to the load condition.

● Without frequency search

When Pr. 162 = "1" or "11", automatic restart operation is performed in a reduced voltage system, where the voltage is gradually risen with the output frequency unchanged from prior to an instantaneous power failure independently of the coasting speed of the motor.

For Real sensorless vector control, output frequency and voltage before instantaneous power failure are output. (Pr. 58 is invalid.)

**REMARKS**

- This system stores the output frequency prior to an instantaneous power failure and increases the voltage. Therefore, if the instantaneous power failure time exceeds 0.2s, the inverter starts at Pr. 13 Starting frequency (initial value = 0.5Hz) since the stored output frequency cannot be retained.

● Encoder detection frequency search

- When "2 or 12" is set in Pr. 162 under encoder feedback control, the motor starts at the motor speed and in the rotation direction detected from the encoder at power restoration.
- Encoder detection frequency search is performed regardless of the Pr. 162 setting under vector control.
- The Pr. 58 and Pr. 299 settings are invalid for encoder detection frequency search.

**REMARKS**

- When encoder feedback control is invalid, setting "2 or 12" in Pr. 162 enables frequency search (Pr. 162 = "0, 10").

● Restart operation at every start

When Pr. 162 = "10, 11 or 12", automatic restart operation is also performed every start, in addition to the automatic restart after instantaneous power failure. When Pr. 162 = "0" or "2", automatic restart operation is performed at the first start after power supply-on, but the inverter starts at the starting frequency at the second time or later.



#### (4) Restart coasting time (Pr. 57)

- Coasting time is the time from when the motor speed is detected until automatic restart control is started.
- Set Pr. 57 to "0" to perform automatic restart operation. The coasting time is automatically set to the value below. Generally this setting will pose no problems.  
5.5K, 7.5K . . . . . 1s, 11K or higher . . . . . 3.0s
- Operation may not be performed well depending on the magnitude of the moment of inertia (J) of the load or running frequency. Adjust the coasting time between 0.1s and 5s according to the load specifications.

#### (5) Restart cushion time (Pr. 58)

- Cushion time is the length of time taken to raise the voltage appropriate to the detected motor speed (output frequency prior to instantaneous power failure when Pr. 162 = "1" or "11").
- Normally the initial value need not be changed for operation, but adjust it according to the magnitude of the moment of inertia (J) of the load or torque.
- Pr. 58 is invalid during encoder feedback control (Pr. 162 = "2, 12"), Real sensorless vector control or vector control.

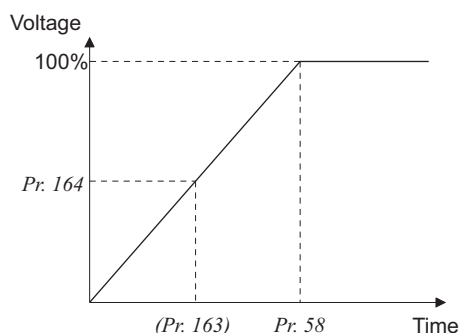

#### (6) Automatic restart operation adjustment (Pr. 163 to Pr. 165, Pr. 611)

- Using Pr. 163 and Pr. 164, you can adjust the voltage rise time at a restart as shown on the left.
- Using Pr. 165, you can set the stall prevention operation level at a restart.
- Using Pr. 611, you can set the acceleration time until Pr. 20 Acceleration/deceleration reference frequency is reached when automatic restart operation is performed besides the normal acceleration time.

#### REMARKS

- If the setting of Pr. 21 Acceleration/deceleration time increments is changed, the setting increments of Pr. 611 does not change.

#### CAUTION

- Changing the terminal assignment using Pr. 178 to Pr. 189 (input terminal function selection) may affect the other functions. Set parameters after confirming the function of each terminal.
- When automatic restart operation is selected, undervoltage protection (E.UVT) and instantaneous power failure protection (E.IPF) among the fault output signals will not be provided at occurrence of an instantaneous power failure.
- The SU and FU signals are not output during a restart. They are output after the restart cushion time has elapsed.
- Automatic restart operation will also be performed after a reset or when a retry is made by the retry function.
- Automatic restart after instantaneous power failure function is invalid when load torque high speed frequency control (Pr. 270 = "2, 3") is set.

## ⚠ CAUTION

- ⚠ Provide mechanical interlocks for MC1 and MC2. The inverter will be damaged if the power supply is input to the inverter output section.
- ⚠ When automatic restart after instantaneous power failure has been selected, the motor and machine will start suddenly (after the reset time has elapsed) after occurrence of an instantaneous power failure. Stay away from the motor and machine. When you have selected automatic restart after instantaneous power failure function, apply in easily visible places the CAUTION stickers supplied to the Instruction Manual (Basic).

#### ◆ Parameters referred to ◆

- Pr. 7 Acceleration time, Pr. 21 Acceleration/deceleration time increments Refer to page 155
- Pr. 13 Starting frequency Refer to page 157
- Pr. 65, Pr. 67 to Pr. 69 Retry function Refer to page 250
- Pr. 78 Reverse rotation prevention selection Refer to page 285
- Pr. 178 to Pr. 189 (input terminal function selection) Refer to page 207

### 4.17.2 Power failure-time deceleration-to-stop function (Pr. 261 to Pr. 266, Pr. 294)

When a power failure or undervoltage occurs, the inverter can be decelerated to a stop or can be decelerated and re-accelerated to the set frequency.

Parameter Number	Name	Initial Value	Setting Range	Description	
261	Power failure stop selection	0	0	Coasting to stop When undervoltage or power failure occurs, the inverter output is shut off.	
			1	Without under voltage avoidance	When undervoltage or a power failure occurs, the inverter can be decelerated to a stop.
			11	With under voltage avoidance	
			2	Without under voltage avoidance	When undervoltage or a power failure occurs, the inverter can be decelerated to a stop. If power is restored during a power failure, the inverter accelerates again.
			12	With under voltage avoidance	
262	Subtracted frequency at deceleration start	3Hz	0 to 20Hz	Normally operation can be performed with the initial value unchanged. But adjust the frequency according to the magnitude of the load specifications (moment of inertia, torque).	
263	Subtraction starting frequency	60Hz	0 to 120Hz	When output frequency $\geq$ Pr. 263 Decelerate from the speed obtained from output frequency minus Pr. 262. When output frequency $<$ Pr. 263 Decelerate from output frequency	
			9999	Decelerate from the speed obtained from output frequency minus Pr. 262.	
264	Power-failure deceleration time 1	5s	0 to 3600/ 360s *	Set a deceleration slope down to the frequency set in Pr. 266.	
265	Power-failure deceleration time 2	9999	0 to 3600/ 360s *	Set a deceleration slope below the frequency set in Pr. 266.	
			9999	Same slope as in Pr. 264	
266	Power failure deceleration time switchover frequency	60Hz	0 to 400Hz	Set the frequency at which the deceleration slope is switched from the Pr. 264 setting to the Pr. 265 setting.	
294	UV avoidance voltage gain	100%	0 to 200%	Adjust the response level during undervoltage avoidance operation. A larger setting will improve responsiveness to the bus voltage change.	

\* When the setting of Pr. 21 Acceleration/deceleration time increments is "0" (initial value), the setting range is "0 to 3600s" and the setting increments are "0.1s", and when the setting is "1", the setting range is "0 to 360s" and the setting increments are "0.01s"

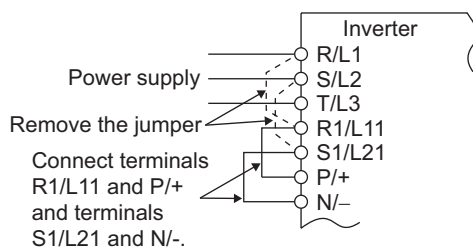

#### (1) Connection and parameter setting

- Remove the jumpers across terminals R/L1-R1/L11 and across terminals S/L2-S1/L21, and connect terminals R1/L11 and P/+ and terminals S1/L21 and N/-.
- When setting of Pr. 261 is not "0", the inverter decelerates to a stop if an undervoltage, power failure or input phase loss (when Pr. 872 ="1"(input phase loss enabled)) occurs.

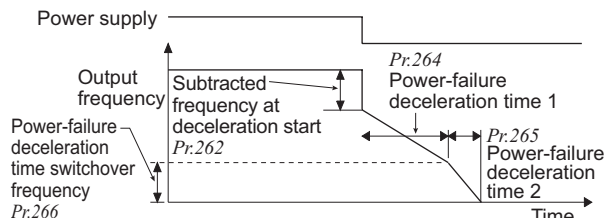

#### (2) Operation outline of deceleration to stop at power failure

- If an undervoltage or power failure occurs, the output frequency is dropped by the frequency set in Pr. 262.
- Deceleration is made in the deceleration time set in Pr. 264. (The deceleration time setting is the time required from Pr. 20 Acceleration/deceleration reference frequency to a stop.)
- When the frequency is low and enough regeneration energy is not provided, for example, the deceleration time (slope) from Pr. 265 to a stop can be changed.

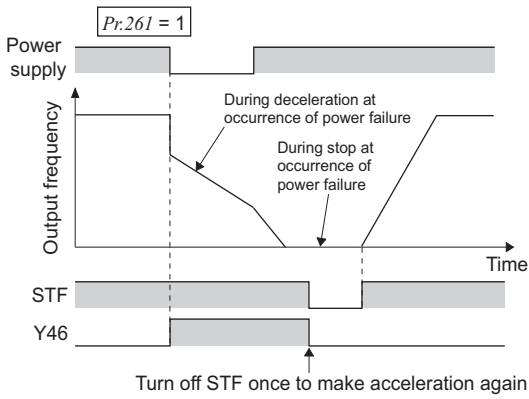

**(3) Power failure stop function (Pr. 261 = "1, 11")**

- If power is restored during power failure deceleration, deceleration to a stop is continued and the inverter remains stopped. To restart, turn off the start signal once, then turn it on again.

**REMARKS**

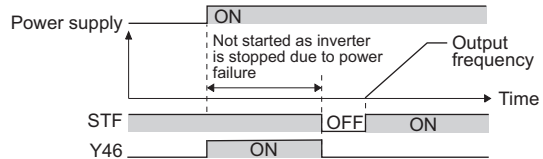

- When automatic restart after instantaneous power failure is selected (Pr. 57 ≠ "9999"), deceleration to stop function is invalid and the restart after instantaneous power failure operation is performed.
- When the power failure stop function is active (Pr. 261 = "1, 11"), the inverter will not start even if the power is turned ON with the start signal (STF/STR) ON. After switching ON the power supply, turn OFF the start signal once and then ON again to make a start.

**(4) Original operation continuation at instantaneous power failure function (Pr. 261 = "2, 12")**

- When power is restored during deceleration after an instantaneous power failure, acceleration is made again up to the set frequency.
- When this function is used in combination with the automatic restart after instantaneous power failure operation, deceleration can be made at a power failure and acceleration can be made again after power restoration. When power is restored after a stop by deceleration at an instantaneous power failure, automatic restart operation is performed if automatic restart after instantaneous power failure has been selected (Pr. 57 ≠ "9999")

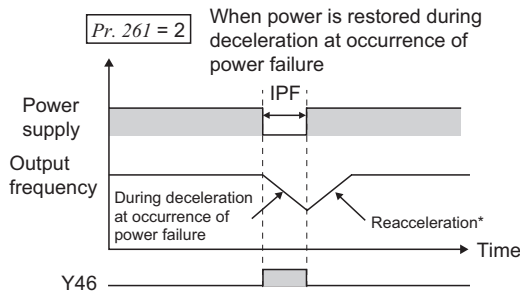

\* Acceleration time depends on Pr. 7 (Pr. 44).

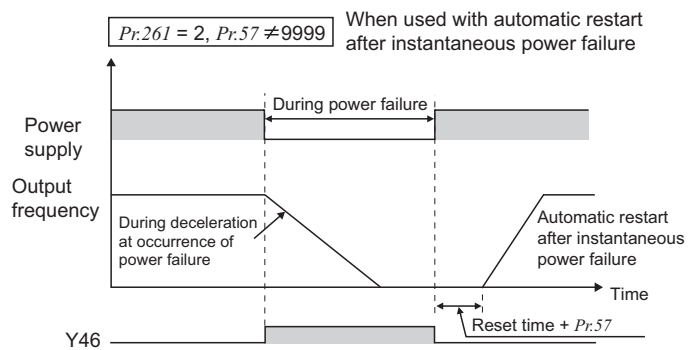

**(5) Undervoltage avoidance function (Pr. 261 = "11, 12", Pr. 294)**

- When Pr. 261 = "11, 12", the deceleration time is automatically adjusted (shortened) to prevent undervoltage from occurring during deceleration at an instantaneous power failure.
- Adjust the slope of frequency decrease and response level with Pr. 294. A larger setting will improve responsiveness to the bus voltage.

**REMARKS**

Undervoltage avoidance function is invalid during torque control by Real sensorless vector control. When Pr. 261 = "11 (12)", the inverter operates in the same manner as when "1 (2)" is set in Pr. 261.

**(6) Power failure deceleration signal (Y46 signal)**

- After deceleration at an instantaneous power failure, inverter can not start even if the start command is given. In this case, check the power failure deceleration signal (Y46 signal). (at occurrence of input phase failure protection (E.ILF), etc.)
- The Y46 signal is on during deceleration at an instantaneous power failure or during a stop after deceleration at an instantaneous power failure.
- For the Y46 signal, set "46 (positive logic)" or "146 (negative logic)" in any of *Pr. 190 to Pr. 196 (output terminal function selection)* to assign the function.





**CAUTION**

- When the (output frequency - *Pr. 262*) at undervoltage or power failure occurrence is negative, the calculation result is regarded as 0Hz. (DC injection brake operation is performed without deceleration).
- During a stop or trip, the power failure stop selection is not performed.
- Y46 signal turns on when undervoltage occurs even when the motor is not decelerating at an instantaneous power failure. For this reason, Y46 signal outputs instantly at powering off, which is not a fault.
- When power failure deceleration stop function is selected, undervoltage protection (E.UVT), instantaneous power failure protection (E.IPF), and input phase loss protection (E.ILF) do not function.
- Changing the terminal assignment using *Pr. 190 to Pr. 196 (output terminal function selection)* may affect the other functions. Set parameters after confirming the function of each terminal.

 **CAUTION**

 If power-failure stop function is set, some loads may cause the inverter to trip and the motor to coast. The motor will coast if enough regenerative energy is given from the motor.

**◆ Parameters referred to ◆**

- Pr. 12 DC injection brake operation voltage*  Refer to page 185
- Pr. 20 Acceleration/deceleration reference frequency, Pr. 21 Acceleration/deceleration time increments*  Refer to page 155
- Pr. 57 Restart coasting time*  Refer to page 243
- Pr. 190 to Pr. 196 (output terminal function selection)*  Refer to page 215
- Pr. 872 Input phase loss protection selection*  Refer to page 253



## 4.18 Operation setting at fault occurrence

Purpose	Parameter that must be Set		Refer to Page
Recover by retry operation at fault occurrence	Retry operation	Pr. 65, Pr. 67 to Pr. 69	250
Output fault code from terminal	Fault code output function	Pr. 76	252
Do not output input/output phase failure alarm	Input/output phase loss protection selection	Pr. 251, Pr. 872	253
The motor is decelerated to stop at motor thermal activation	Fault definition	Pr. 875	254

### 4.18.1 Retry function (Pr. 65, Pr. 67 to Pr. 69)

If a fault occurs, the inverter resets itself automatically to restart. You can also select the fault description for a retry.  
 When automatic restart after instantaneous power failure is selected (*Pr. 57 Restart coasting time* ≠ "9999"), restart operation is performed at retry operation as at an instantaneous power failure. (Refer to *page 243* for the restart function.)

Parameter Number	Name	Initial Value	Setting Range	Description
65	Retry selection	0	0 to 5	A fault for retry can be selected. (Refer to the next page)
67	Number of retries at fault occurrence	0	0	No retry function
			1 to 10	Set the number of retries at fault occurrence. A fault output is not provided during retry operation.
			101 to 110	Set the number of retries at fault occurrence. (The setting value of minus 100 is the number of retries.) A fault output is provided during retry operation.
68	Retry waiting time	1s	0 to 10s	Set the waiting time from when an inverter fault occurs until a retry is made.
69	Retry count display erase	0	0	Clear the number of restarts succeeded by retry.

Retry success example

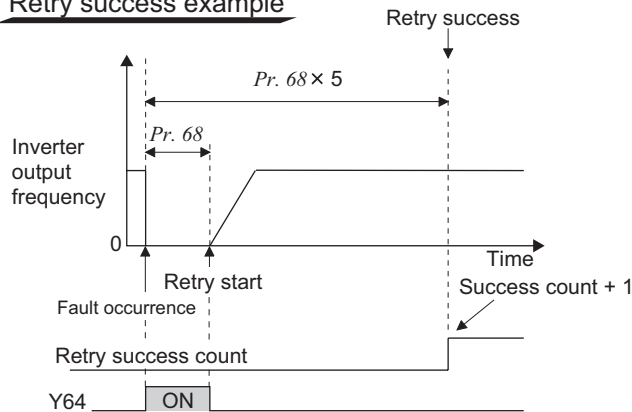

Retry failure example

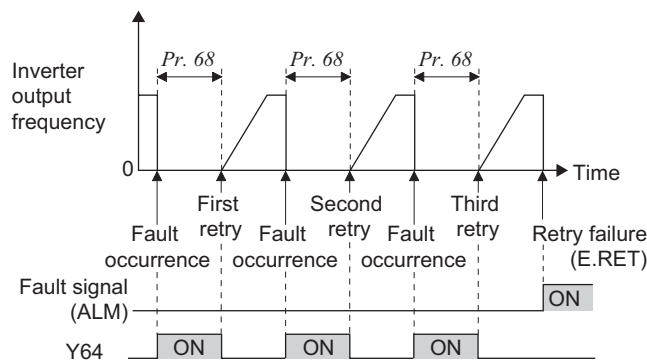

- Retry operation automatically resets a fault and restarts the inverter at the starting frequency when the time set in *Pr. 68* elapses after the inverter is tripped.
- Retry operation is performed by setting *Pr. 67* to any value other than "0". Set the number of retries at fault occurrence in *Pr. 67*.
- When retries fail consecutively more than the number of times set in *Pr. 67*, a retry count excess fault (E.RET) occurs, resulting in inverter trip. (Refer to retry failure example)
- Use *Pr. 68* to set the waiting time from when an inverter trips until a retry is made in the range 0 to 10s. (When the setting value is "0s", the actual time is 0.1s.)
- Reading the *Pr. 69* value provides the cumulative number of successful restart times made by retry. The cumulative count in *Pr. 69* is increased by 1 when a retry is regarded as successful after normal operation continues without faults occurring for more than four times longer than the time set in *Pr. 68* after a retry start. (When retry is successful, cumulative number of retry failure is cleared.)
- Writing "0" in *Pr. 69* clears the cumulative count.
- During a retry, the Y64 signal is on. For the Y64 signal, assign the function by setting "64 (positive logic)" or "164 (negative logic)" in any of *Pr. 190 to Pr. 196* (output terminal function selection).

#### CAUTION

Changing the terminal assignment using *Pr. 190 to Pr. 196* (output terminal function selection) may affect the other functions. Set parameters after confirming the function of each terminal.

- Using Pr. 65 you can select the fault that will cause a retry to be executed. No retry will be made for the fault not indicated. (Refer to page 384 for the fault description.)
- indicates the errors selected for retry.

Fault for Retry	Pr. 65 Setting						Fault for Retry	Pr. 65 Setting					
	0	1	2	3	4	5		0	1	2	3	4	5
E.OC1	●	●		●	●	●	E.MB2	●				●	
E.OC2	●	●		●	●		E.MB3	●				●	
E.OC3	●	●		●	●	●	E.MB4	●				●	
E.OV1	●		●	●	●		E.MB5	●				●	
E.OV2	●		●	●	●		E.MB6	●				●	
E.OV3	●		●	●	●		E.MB7	●				●	
E.THM	●						E.OS	●				●	
E.THT	●						E.OSD	●				●	
E.IPF	●				●		E.OD	●				●	
E.UVT	●				●		E.PTC	●					
E. GF	●				●		E.CDO	●				●	
E.OHT	●						E.SER	●				●	
E.OLT	●				●		E.USB	●				●	
E.OPT	●				●		E.ILF	●				●	
E.OP3	●				●		E.4	●				●	
E. PE	●				●		E.8	●				●	
E.MB1	●				●		E.10	●				●	

**CAUTION**

- For a retry error, only the description of the first fault is stored.
- When an inverter fault is reset by the retry function at the retry time, the accumulated data of the electronic thermal relay function etc. are not cleared. (Different from the power-on reset.)
- Retry is not performed if E.PE (Parameter storage device fault) occurred at power on.
- If a fault that is not selected for a retry occurs during retry operation (retry waiting time), the retry operation stops while the fault indication is still displayed.

 **CAUTION**

 When you have selected the retry function, stay away from the motor and machine when the inverter is tripped. They will start suddenly (after the reset time has elapsed) after the inverter trip.  
When you have selected the retry function, apply in easily visible places the CAUTION stickers supplied to the *Instruction Manual (Basic)*.

◆ Parameters referred to ◆

Pr. 57 Restart coasting time  Refer to page 243

### 4.18.2 Fault code output selection (Pr. 76)

At fault occurrence, its description can be output as a 4-bit digital signal from the open collector output terminals. The fault code can be read by a programmable controller, etc., and its corrective action can be shown on a display, etc.

Parameter Number	Name	Initial Value	Setting Range	Description
76	Fault code output selection	0	0	Without fault code output
			1	With fault code output (Refer to the following table)
			2	Fault code output at fault occurrence only (Refer to the following table)

- By setting Pr. 76 to "1" or "2", the fault code can be output to the output terminals.
- When the setting is "2", a fault code is output at only fault occurrence, and during normal operation, the terminals output the signals assigned to Pr. 191 to Pr. 194 (output terminal function selection).
- The following table indicates fault codes to be output. (0: output transistor off, 1: output transistor on)

Operation Panel Indication (FR-DU07)	Output of Output Terminals				Fault Code
	SU	IPF	OL	FU	
Normal *	0	0	0	0	0
E.OC1	0	0	0	1	1
E.OC2	0	0	1	0	2
E.OC3	0	0	1	1	3
E.OV1 to E.OV3	0	1	0	0	4
E.THM	0	1	0	1	5
E.THT	0	1	1	0	6
E.IPF	0	1	1	1	7
E.UVT	1	0	0	0	8
E.FIN	1	0	0	1	9
E. GF	1	0	1	1	B
E.OHT	1	1	0	0	C
E.OLT	1	1	0	1	D
E.OPT	1	1	1	0	E
E.OP3	1	1	1	0	E
Other than the above	1	1	1	1	F

\* When Pr. 76 = "2", the output terminals output the signals assigned to Pr. 190 to Pr. 196 .

#### CAUTION

- When a value other than "0" is set in Pr. 76  
When a fault occurs, the output terminals SU, IPF, OL, FU output the signal in the above table, independently of the Pr. 191 to Pr. 194 (output terminal function selection) settings. Please be careful when inverter control setting has been made with the output signals of Pr. 191 to Pr. 194.

#### ◆ Parameters referred to ◆

Pr. 191 to Pr. 194 (output terminal function selection)  Refer to page 215

### 4.18.3 Input/output phase loss protection selection (Pr. 251, Pr. 872)

You can disable the output phase loss protection function that trips the inverter if one phase of the inverter output side (load side) three phases (U, V, W) is lost.

The input phase loss protection function of the inverter input side (R/L1, S/L2, T/L3) can be invalid.

Parameter Number	Name	Initial Value	Setting Range	Description
251	Output phase loss protection selection	1	0	Without output phase loss protection
			1	With output phase loss protection
872	Input phase loss protection selection	1	0	Without input phase loss protection
			1	With input phase loss protection

#### (1) Output phase loss protection selection (Pr. 251)

- When Pr. 251 is set to "0", output phase loss protection (E.LF) becomes invalid.

#### (2) Input phase loss protection selection (Pr. 872)

- When Pr. 872 is set to "1"(initial value), input phase loss protection (E.ILF) is provided if a phase loss of one phase among the three phases is detected for 1s continuously.
- When Pr.872 is set to "0", input phase loss protection (E.ILF) becomes invalid.

#### REMARKS

If input phase is lost when Pr. 872 = "1" (with input phase loss) and Pr. 261 ≠ "0" (power failure stop function valid), input phase loss protection (E.ILF) is not provided but power-failure deceleration is made.

#### CAUTION

- When an input phase loss occurs in the R/L1 and S/L2 phases, input phase loss protection is not provided but the inverter output is shut off.
- If an input phase loss continues for a long time, the converter section and capacitor lives of the inverter will be shorter.

#### ◆ Parameters referred to ◆

Pr. 261 Power failure stop selection Refer to page 247

### 4.18.4 Overspeed detection (Pr. 374)

Parameter Number	Name	Initial Value	Setting Range	Description
374	Overspeed detection level	140Hz	0 to 400Hz	When the motor speed reaches or exceeds the speed set in Pr. 374 during encoder feedback control, Real sensorless vector control, or vector control, over speed (E.OS) occurs and trips the inverter.

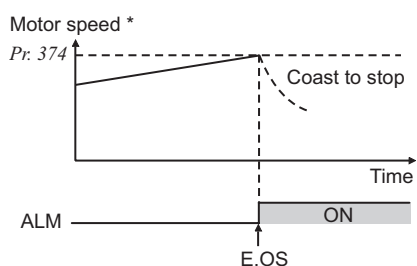

\* The output frequency and Pr. 374 are compared during Real sensorless vector control.

### 4.18.5 Encoder signal loss detection (Pr. 376) V/F Magnetic flux Vector

When the encoder signal is lost during encoder feedback control, orientation control, or vector control, signal loss detection (E.ECT) is activated to trip the inverter.

Parameter Number	Name	Initial Value	Setting Range	Description
376	Encoder signal loss detection enable/disable selection	0	0	Signal loss detection is invalid
			1	Signal loss detection is valid

\* Setting can be made only when the FR-A7AP/FR-A7AL (option) is mounted.



### 4.18.6 Fault definition (Pr. 875)

When motor thermal protection is activated, a fault can be output after the motor decelerates to a stop.

Parameter Number	Name	Initial Value	Setting Range	Description
875	Fault definition	0	0	Normal operation
			1	The motor decelerates to stop when motor thermal protection is activated.

**(1) The inverter trips immediately at occurrence of any fault (setting value is "0", initial value)**

- The inverter trips immediately and a fault signal output is provided at fault occurrence.

**(2) The motor decelerates to stop when motor thermal protection is activated (setting value is "1")**

When Pr. 875 = "1"

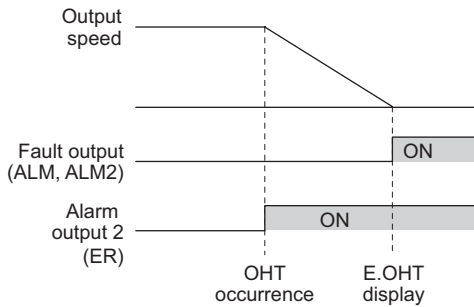

- When external thermal relay *E.OHT* (OHT), motor overload (electronic thermal relay function) *E.FTH* (THM) or PTC thermistor *E.PTC* (PTC) is activated, turning on the alarm output 2 signal (ER) starts the motor to decelerate and provides a fault after deceleration to a stop.
- When the ER signal turns on, decrease load, etc. to allow the inverter to decelerate.
- At occurrence of a fault other than OHT, THM and PTC, the inverter trips immediately and a fault signal is output.
- Set "97 (positive logic) or 197 (negative logic)" in Pr. 190 to Pr. 196 (output terminal function selection) and assign the ER signal to the output terminal.
- This function is invalid during position control.

**CAUTION**

- The value "0" is recommended for the system in which the motor continues running without deceleration due to a large torque on the load side.
- Changing the terminal assignment using Pr. 190 to Pr. 196 (output terminal function selection) may affect the other functions. Set parameters after confirming the function of each terminal.

◆ Parameters referred to ◆

Pr. 190 to Pr. 196 (output terminal function selection) Refer to page 215

## 4.19 Energy saving operation and energy saving monitor

Purpose	Parameter that must be Set		Refer to Page
Energy saving operation	Energy saving operation	Pr. 60	255
How much energy can be saved	Energy saving monitor	Pr. 52, Pr. 54, Pr. 158, Pr. 891 to Pr. 899	256

### 4.19.1 Energy saving control (Pr. 60)

Without a detailed parameter setting, the inverter automatically performs energy saving control. This function is optimal for fan and pump applications.

Parameter Number	Name	Initial Value	Setting Range	Description
60	Energy saving control selection*	0	0	Normal operation mode
			4	Energy saving operation mode

\* When parameter is read using the FR-PU04, a parameter name different from an actual parameter is displayed.

#### Energy saving operation mode (setting "4")

- When "4" is set in *Pr. 60*, the inverter operates in the energy saving operation mode.
- In the energy saving operation mode, the inverter automatically controls the output voltage to minimize the inverter output voltage during a constant operation.

#### REMARKS

- For applications a large load torque is applied to or machines repeat frequent acceleration/deceleration, an energy saving effect is not expected.

#### CAUTION

- When the energy saving mode is selected, deceleration time may be longer than the setting value. Since overvoltage alarm tends to occur as compared to the constant torque load characteristics, set a longer deceleration time.
- The energy saving operation mode functions only under V/F control. When the Advanced magnetic flux vector control, Real sensorless vector control and vector control are selected, the energy saving mode is invalid.
- Since output voltage is controlled in energy saving operation mode, output current may slightly increase.

### 4.19.2 Energy saving monitor (Pr. 891 to Pr. 899)

From the power consumption estimated value during commercial power supply operation, the energy saving effect by use of the inverter can be monitored/output.

Parameter Number	Name	Initial Value	Setting Range	Description
52	DU/PU main display data selection	0 (output frequency)	0, 5 to 8, 10 to 14, 17 to 20, 22 to 25, 32 to 35, 50 to 57, 100	50:Power saving monitor 51:Cumulative saving power monitor
54	FM terminal function selection	1 (output frequency)	1 to 3, 5 to 8, 10 to 14, 17, 18, 21, 24, 32 to 34, 50, 52, 53	50:Power saving monitor
158	AM terminal function selection			
891	Cumulative power monitor digit shifted times	9999	0 to 4	Set the number of times to shift the cumulative power monitor digit Clamps the monitor value at maximum.
			9999	No shift Clears the monitor value when it exceeds the maximum value.
892	Load factor	100%	30 to 150%	Set the load factor for commercial power supply operation. Multiplied by the power consumption rate (page 259) during commercial power supply operation.
893	Energy saving monitor reference (motor capacity)	Rated inverter capacity	0.1 to 55kW	Set the motor capacity (pump capacity). Set when calculating power saving rate, power saving rate average value, commercial operation power.
894	Control selection during commercial power supply operation	0	0	Discharge damper control (fan)
			1	Inlet damper control (fan)
			2	Valve control (pump)
			3	Commercial power supply drive (fixed value)
895	Power saving rate reference value	9999	0	Consider the value during commercial power supply operation as 100%
			1	Consider the Pr. 893 setting as 100%.
			9999	No function
896	Power unit cost	9999	0 to 500	Set the power unit cost. Displays the power saving amount charge on the energy saving monitor.
			9999	No function
897	Power saving monitor average time	9999	0	Average for 30 minutes
			1 to 1000h	Average for the set time
			9999	No function
898	Power saving cumulative monitor clear	9999	0	Cumulative monitor value clear
			1	Cumulative monitor value hold
			10	Totalization continued (communication data upper limit 9999)
			9999	Totalization continued (communication data upper limit 65535)
899	Operation time rate (estimated value)	9999	0 to 100%	Use for calculation of annual power saving amount. Set the annual operation ratio (consider 365 days × 24hr as 100%).
			9999	No function

The above parameters allow its setting to be changed during operation in any operation mode even if "0" (initial value) is set in Pr. 77 Parameter write selection.

### (1) Energy saving monitor list

- The following provides the items that can be monitored by the power saving monitor (*Pr. 52, Pr. 54, Pr. 158 = "50"*). (Only 1) power saving and 3) power saving average value can be output to *Pr. 54* (terminal FM) and *Pr. 158* (terminal AM))

	Energy Saving Monitor Item	Description and Formula	Increments	Parameter Setting			
				<i>Pr. 895</i>	<i>Pr. 896</i>	<i>Pr. 897</i>	<i>Pr. 899</i>
1)	<b>Power saving</b>	Difference between the estimated value of power necessary for commercial power supply operation and the input power calculated by the inverter <b>Power during commercial power supply operation – input power monitor</b>	0.01kW	9999			
2)	<b>Power saving rate</b>	Ratio of power saving on the assumption that power during commercial power supply operation is 100% $\frac{\text{1) Power saving}}{\text{Power during commercial power supply operation}} \times 100$	0.1%	0	—	9999	
		Ratio of power saving on the assumption that <i>Pr. 893</i> is 100% $\frac{\text{1) Power saving}}{\text{Pr. 893}} \times 100$		1			
3)	<b>Power saving average value</b>	Average value of power saving amount per hour during predetermined time ( <i>Pr. 897</i> ) $\frac{\Sigma (\text{1) Power saving} \times \Delta t)}{\text{Pr. 897}}$	0.01kWh	9999			—
4)	<b>Power saving rate average value</b>	Ratio of power saving average value on the assumption that the value during commercial power supply operation is 100% $\frac{\Sigma (\text{2) Power saving rate} \times \Delta t)}{\text{Pr. 897}} \times 100$	0.1%	0	9999	0 to 1000h	
		Ratio of power saving average value on the assumption that <i>Pr. 893</i> is 100% $\frac{\text{3) Power saving average value}}{\text{Pr. 893}} \times 100$		1			
5)	<b>Power saving amount average value</b>	Power saving average value represented in terms of charge <b>3) Power saving average value</b> × <i>Pr. 896</i>	0.01	—	0 to 500		

- The following shows the items which can be monitored by the cumulative saving power monitor (*Pr. 52 = "51"*). (The monitor value of the cumulative monitor can be shifted to the right with *Pr. 891 Cumulative power monitor digit shifted times*.)

	Energy Saving Monitor Item	Description and Formula	Increments	Parameter Setting			
				<i>Pr. 895</i>	<i>Pr. 896</i>	<i>Pr. 897</i>	<i>Pr. 899</i>
6)	<b>Power saving amount</b>	Power saving is added up per hour. $\Sigma (\text{1) Power saving} \times \Delta t)$	0.01kWh <sup>*1,2</sup>	—	9999		9999
7)	<b>Power saving amount charge</b>	Power saving amount represented in terms of charge <b>6) Power saving amount</b> × <i>Pr. 896</i>	0.01 <sup>*1</sup>	—	0 to 500		
8)	<b>Annual power saving amount</b>	Estimated value of annual power saving amount $\frac{\text{6) Power saving amount}}{\text{Operation time during accumulation of power saving amount}} \times 24 \times 365 \times \frac{\text{Pr. 899}}{100}$	0.01kWh <sup>*1,2</sup>	—	9999	—	0 to 100%
9)	<b>Annual power saving amount charge</b>	Annual power saving amount represented in terms of charge <b>8) Annual power saving amount</b> × <i>Pr. 896</i>	0.01 <sup>*1</sup>	—	0 to 500		

\*1 For communication (RS-485 communication, communication option), the display increments are 1. For example, the communication data is "10" for "10.00kWh".

\*2 When using the parameter unit (FR-PU04/FR-PU07), "kW" is displayed.

#### REMARKS

- As the operation panel (FR-DU07) is 4-digit display, it displays in 0.1 increments since a carry occurs, e.g. "100.0", when a monitor value in 0.01 increments exceeds "99.99". The maximum display is "9999".
- As the operation panel (FR-PU04/FR-PU07) is 5-digit display, it displays in 0.1 increments since a carry occurs, e.g. "1000.0", when a monitor value in 0.01 increments exceeds "999.99". The maximum display is "99999".
- The upper limit of communication (RS-485 communication, communication option) is "65535" when *Pr. 898 Power saving cumulative monitor clear* = "9999". The upper limit of 0.01 increments monitor is "655.35" and that of 0.1 increments monitor is "6553.5".



**(2) Power saving instantaneous monitor ( 1) power savings, 2) power saving rate )**

- On the power saving monitor ( 1)), an energy saving effect as compared to the power consumption during commercial power supply operation (estimated value) is calculated and displays on the main monitor.
- In the following case, the power saving monitor ( 1)) is "0".
  - (a) Calculated values of the power saving monitor are negative values.
  - (b) During the DC injection brake operation
  - (c) Motor is not connected (output current monitor is 0A)
- On the power saving rate monitor ( 2)), setting "0" in *Pr. 895 Power saving rate reference value* displays the power saving rate on the assumption that power (estimated value) during commercial power supply operation is 100%. When *Pr. 895 = "1"*, the power saving rate on the assumption that the *Pr. 893 Energy saving monitor reference (motor capacity)* value is 100% is displayed.

**(3) Power saving average value monitor ( 3) power saving average value, 4) average power saving rate average value, 5) power saving amount average value)**

- Power saving average value monitor can be displayed when a value other than "9999" is set in *Pr. 897 Power saving monitor average time*.
- The power saving average value monitor ( 3)) displays the average value per unit time of the power saving amount at averaging.
- The average value is updated every time an average time has elapsed after the *Pr. 897* setting is changed, power is turned on or the inverter is reset, assuming as a starting point. The power savings average value update timing signal (Y92) is inverted every time the average value is updated.

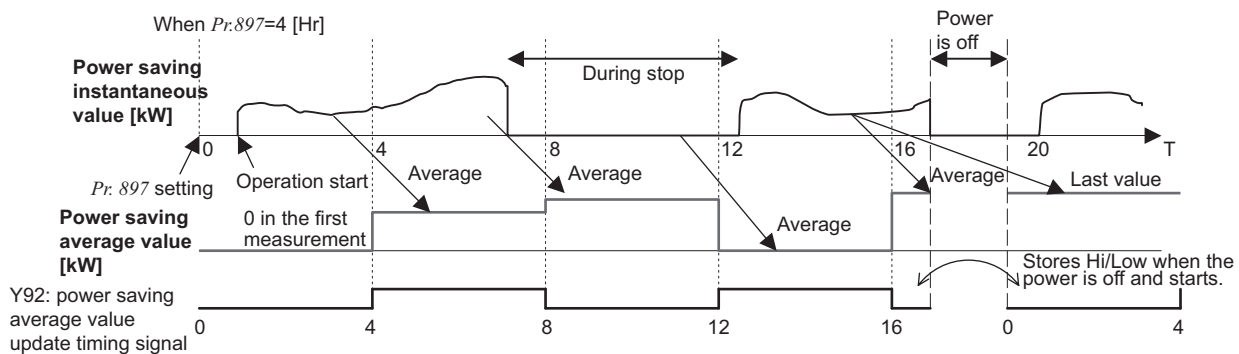

- The power saving average value monitor ( 4)) displays the average value per unit time of power saving rate ( 2)) at every average time by setting "0" or "1" in *Pr. 895 Power saving rate reference value*.
- By setting the charge (power unit) per 1kWh of power amount in *Pr. 896 Power unit cost*, the power saving amount average value monitor ( 5)) displays the charge relative to the power saving average value (power saving average value ( 3)) × *Pr. 896*.

**(4) Cumulative saving power monitor ( 6) power saving amount, 7) power saving amount charge, 8) annual power saving amount, 9) annual power saving amount charge)**

- On the cumulative saving power monitor, the monitor data digit can be shifted to the right by the number of *Pr. 891 Cumulative power monitor digit shifted times* settings. For example, if the cumulative power value is 1278.56kWh when *Pr. 891 = "2"*, the PU/DU display is 12.78 (display in 100kWh increments) and the communication data is 12. If the maximum value is exceeded at *Pr. 891 = "0 to 4"*, the power is clamped at the maximum value, indicating that a digit shift is necessary. If the maximum value is exceeded at *Pr. 891 = "9999"*, the power returns to 0 and is recounted. The other monitors are clamped at the display maximum value.
- The cumulative saving power monitor ( 6)) can measure the power amount during a predetermined period. Measure according to the following steps
  - Write "9999" or "10" in *Pr. 898 Power saving cumulative monitor clear*.
  - Write "0" in *Pr. 898* at measurement start timing to clear the cumulative saving power monitor value and start totalization of power saving.
  - Write "1" in *Pr. 898* at measurement end timing to hold the cumulative saving power monitor value.

**REMARKS**

- The cumulative saving power monitor value is stored every hour. Hence, when the power supply is switched on again within one hour after it was switched off, the previously stored monitor value is displayed and totalization starts. (The cumulative monitor value may decrease)

**(5) Power estimated value of commercial power supply operation (Pr. 892, Pr. 893, Pr. 894)**

- Select the commercial power supply operation pattern from among the four patterns of discharge damper control (fan), inlet damper control (fan), valve control (pump) and commercial power supply drive, and set it to Pr. 894 *Control selection during commercial power supply operation*.
- Set the motor capacity (pump capacity) in Pr. 893 *Energy saving monitor reference (motor capacity)*.
- The power consumption rate (%) during commercial power supply operation is estimated from the operation pattern and the ratio of speed to rating (current output frequency/Pr. 3 *Base frequency*) in the following chart.

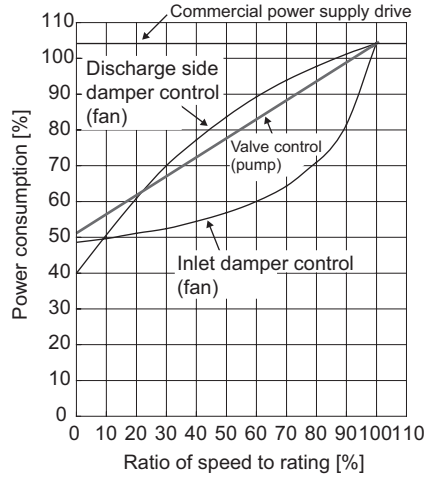

- From the motor capacity set in Pr. 893 and Pr. 892 *Load factor*, the power estimated value (kW) during commercial power supply operation is found by the following formula.

<p><b>Power estimated value (kW) during commercial power supply operation</b></p> $= Pr. 893 \text{ (kW)} \times \frac{\text{Power consumption (\%)}}{100} \times \frac{Pr. 892 \text{ (\%)}}{100}$
---

**REMARKS**

- Since the speed does not increase above the power supply frequency in commercial power supply operation, it becomes constant when the output frequency rises to or above Pr. 3 *Base frequency*.

**(6) Annual power saving amount, power charge (Pr. 899)**

- By setting the operation time rate [%] (ratio of time when the motor is actually driven by the inverter during a year) in Pr. 899, the annual energy saving effect can be predicted.
- When the operation pattern is predetermined to some degree, the estimated value of the annual power saving amount can be found by measurement of the power saving amount during a given measurement period.
- Refer to the following and set the operation time rate.
  - 1) Predict the average time [h/day] of operation in a day.
  - 2) Find the annual operation days [days/year]. (Monthly average operation days × 12 months)
  - 3) Calculate the annual operation time [h/year] from 1) and 2).

$$\text{Annual operation time (h/year)} = \text{Average time (h/day)} \times \text{Operation days (days/year)}$$

- 4) Calculate the operation time rate and set it to Pr. 899.

$$\text{Operation time rate (\%)} = \frac{\text{Annual operation time (h/year)}}{24 \text{ (h/day)} \times 365 \text{ (days/year)}} \times 100(\%)$$

**REMARKS**

- Operation time rate setting example: When operation is performed for about 21 hours per day and the monthly average operation days are 16 days  
 Annual operation time = 21 (h/day) × 16 (days/month) × 12 months = 4032 (h/year)  

$$\text{Operation time rate (\%)} = \frac{4032 \text{ (h/year)}}{24 \text{ (h/day)} \times 365 \text{ (days/year)}} \times 100(\%) = \underline{46.03\%}$$
  
 Set 46.03% to Pr. 899.

- Calculate the annual power saving amount from Pr. 899 Operation time rate (estimated value) and power saving average value monitor

$$\text{Annual power saving amount (kWh/year)} = \frac{\text{Power saving average value (kW) during totalization when Pr. 898 = 10 or 9999}}{\text{Pr. 899}} \times 24\text{h} \times 365 \text{ days} \times \frac{100}{100}$$





- The annual power saving amount charge can be monitored by setting the power charge per hour in Pr. 896 Power unit cost.  
 Calculate the annual power saving amount charge in the following method.

$$\text{Annual power saving amount charge} = \text{Annual power saving amount (kWh/year)} \times \text{Pr. 896}$$

**REMARKS**

In the regeneration mode, make calculation on the assumption that "power saving = power during commercial power supply operation (input power = 0)".

◆ Parameters referred to ◆

- Pr. 3 Base frequency  Refer to page 142
- Pr. 52 DU/PU main display data selection  Refer to page 229
- Pr. 54 FM terminal function selection  Refer to page 229
- Pr. 158 AM terminal function selection  Refer to page 229

## 4.20 Motor noise, EMI measures

### 4.20.1 PWM carrier frequency and Soft-PWM control (Pr. 72, Pr. 240)

You can change the motor sound.

Parameter Number	Name	Initial Value	Setting Range	Description
72 *1	PWM frequency selection	2	0 to 15	PWM carrier frequency can be changed. The setting displayed is in [kHz]. Note that 0 indicates 0.7kHz and 15 indicates 14.5kHz.
240 *1	Soft-PWM operation selection	1	0	Soft-PWM is invalid
			1	When Pr. 72 = "0 to 5", soft-PWM is valid.

\*1 The above parameters allow its setting to be changed during operation in any operation mode even if "0" (initial value) is set in Pr. 77 Parameter write selection.

#### (1) PWM carrier frequency changing (Pr. 72)

- You can change the PWM carrier frequency of the inverter.
- Changing the PWM carrier frequency produces an effect on avoiding the resonance frequency of a mechanical system or motor or on measures against noise (EMI) generated from the inverter or on leakage current reduction caused by the PWM switching.
- Carrier frequencies under Real sensorless vector control or vector control are as shown below.

Pr. 72 Setting	Carrier Frequencies (kHz)
0 to 5	2
6 to 9	6
10 to 13	10
14, 15	14

#### (2) Soft-PWM control (Pr. 240)

- Soft-PWM control is a control method that changes the motor noise from a metallic tone into an unoffending complex tone.

#### CAUTION

- Decreasing the PWM carrier frequency effect on measures against noises (EMI) generated from the inverter and on leakage current reduction, but increases motor noise.
- When PWM carrier frequency is set to 1kHz or less ( $Pr. 72 \leq 1$ ), fast response current limit may function prior to stall prevention operation due to increase in ripple currents, resulting in insufficient torque. In such case, set fast response current limit operation invalid using Pr. 156 Stall prevention operation selection.

#### ◆ Parameters referred to ◆

Pr. 156 Stall prevention operation selection  Refer to page 135



## 4.21 Frequency/torque setting by analog input (terminal 1, 2, 4)

Purpose	Parameter that must be Set		Refer to Page
Function assignment of analog input terminal	Terminal 1 and terminal 4 function assignment	Pr. 858, Pr. 868	262
Selection of voltage/current input (terminal 1, 2, 4) Perform forward/reverse rotation by analog input	Analog input selection	Pr. 73, Pr. 267	263
Adjust the main speed by analog auxiliary input	Analog auxiliary input and compensation (added compensation and override function)	Pr. 73, Pr. 242, Pr. 243, Pr. 252, Pr. 253	267
Noise elimination at the analog input	Input filter	Pr. 74, Pr. 822, Pr. 826, Pr. 832, Pr. 836, Pr. 849	269
Adjustment (calibration) of analog input frequency and voltage (current)	Bias and gain of frequency setting voltage (current)	Pr. 125, Pr. 126, Pr. 241, C2 to C7 (Pr. 902 to Pr. 905) C12 to C15 (Pr. 917 to Pr. 918)	271
Adjustment (calibration) of analog input torque and voltage (current)	Bias and gain of torque setting voltage (current)	Pr. 241, C16 to C19 (Pr. 919 to Pr. 920), C38 to C41 (Pr. 932 to Pr. 933)	277

### 4.21.1 Function assignment of analog input terminal (Pr. 858, Pr. 868)

Function assignment of terminal 1 and terminal 4 of analog input can be selected and changed by parameter.

Parameter Number	Name	Initial Value	Setting Range	Description
858	Terminal 4 function assignment	0	0, 1, 4, 9999	Select the terminal 4 function. (Refer to the following list)
868	Terminal 1 function assignment	0	0 to 6, 9999	Select the terminal 1 function. (Refer to the following list)

- For the terminal 1 and terminal 4 used for analog input, frequency (speed) command, magnetic flux command, torque command, etc. can be selected. Functions change according to the control mode as in the table below.

●Terminal 1 function according to control

Pr. 868 Setting	V/F Control, Advanced Magnetic Flux Vector Control	Real Sensorless Vector Control, Vector Control		Vector Control
		Speed control	Torque control	Position control
0 (Initial value)	Frequency setting auxiliary	Speed setting auxiliary	Speed limit auxiliary	—
1	—	Magnetic flux command *	Magnetic flux command *	Magnetic flux command
2	—	Regenerative torque limit (Pr. 810 = 1)	—	Regenerative torque limit (Pr. 810 = 1)
3	—	—	Torque command (Pr. 804 = 0)	—
4	Stall prevention operation level input (Pr. 810 = 1)	Torque limit (Pr. 810 = 1)	Torque command (Pr. 804 = 0)	Torque limit (Pr. 810 = 1)
5	—	—	Forward/reverse rotation speed limit (Pr. 807 = 2)	—
6	—	Torque bias input (Pr. 840 = 1, 2, 3) *	—	—
9999	—	—	—	—

●Terminal 4 function according to control

Pr. 858 Setting	V/F Control, Advanced Magnetic Flux Vector Control	Real Sensorless Vector Control, Vector Control		Vector Control
		Speed control	Torque control	Position control
0 (Initial value)	Frequency command (AU signal-ON)	Speed command (AU signal-ON)	Speed limit (AU signal-ON)	—
1	—	Magnetic flux command *	Magnetic flux command *	Magnetic flux command
4	Stall prevention operation level input (Pr. 810 = 1)	Torque limit (Pr. 810 = 1)	—	Torque limit (Pr. 810 = 1)
9999	—	—	—	—

— :No function

\* This function is valid under vector control.

**REMARKS**

- When "1 or 4" is set in both Pr. 868 and Pr. 858, terminal 1 is valid and terminal 4 has no function.
- When "1" (magnetic flux), "4" (stall prevention/torque limit) is set in Pr. 868, functions of terminal 4 become valid independently of whether the AU terminal is on or off.

◆ **Parameters referred to** ◆

Advanced magnetic flux vector control Refer to page 131  
 Real sensorless vector control Refer to page 75  
 Pr. 804 Torque command source selection Refer to page 108  
 Pr. 807 Speed limit selection Refer to page 110  
 Pr. 810 Torque limit input method selection Refer to page 83

**4.21.2 Analog input selection (Pr. 73, Pr. 267)**

You can select the function that switches between forward rotation and reverse rotation according to the analog input terminal selection specifications, the override function and the input signal polarity.

Parameter Number	Name	Initial Value	Setting Range	Description	
				Voltage/current input switch	
73	Analog input selection	1	0 to 5, 10 to 15	Switch 2 - OFF (initial status)	You can select the input specifications of terminal 2 (0 to 5V, 0 to 10V, 0 to 20mA) and input specifications of terminal 1 (0 to ±5V, 0 to ±10V). Override and reversible operation can be selected.
			6, 7, 16, 17	Switch 2 - ON	
267	Terminal 4 input selection	0	0	Switch 1 - ON (initial status)	Terminal 4 input 0 to 20mA
			1	Switch 1 - OFF	Terminal 4 input 0 to 5V
			2		Terminal 4 input 0 to 10V

**(1) Selection of analog input specifications**

- For the terminals 2, 4 used for analog input, voltage input (0 to 5V, 0 to 10V) or current input (0 to 20mA) can be selected.

Change parameters (Pr. 73, Pr. 267) and a voltage/current input switch (switch 1, 2) to change input specifications.

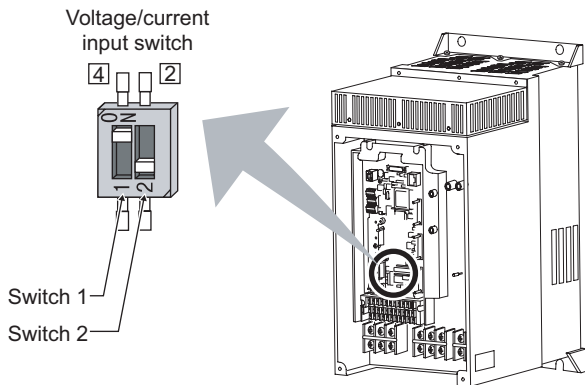

Switch 1: Terminal 4 input  
 ON: Current input (initial status)  
 OFF: Voltage input

Switch 2: Terminal 2 input  
 ON: Current input  
 OFF: Voltage input (initial status)

- Rated specifications of terminal 2 and 4 change according to the voltage/current input switch setting.

Voltage input: Input resistance  $10k\Omega \pm 1k\Omega$ , Maximum permissible voltage 20VDC

Current input: Input resistance  $245\Omega \pm 5\Omega$ , Maximum permissible current 30mA

**CAUTION**

- Set Pr. 73, Pr. 267, and a voltage/current input switch correctly, then input an analog signal in accordance with the setting. Incorrect setting as in the table below could cause component damage. Incorrect settings other than below can cause abnormal operation.

Setting Causing Component Damage		Operation
Switch setting	Terminal input	
ON (Current input)	Voltage input	This could cause component damage to the analog signal output circuit of signal output devices. (electrical load in the analog signal output circuit of signal output devices increases)
OFF (Voltage input)	Current input	This could cause component damage of the inverter signal input circuit. (output power in the analog signal output circuit of signal output devices increases)

## Frequency/torque setting by analog input (terminal 1, 2, 4)



- Refer to the following table and set Pr. 73 and Pr. 267. (□ indicates the main speed setting)

Pr. 73 Setting	Terminal 2 Input	Terminal 1 Input	Terminal 4 Input		Pr. 73 Setting	Compensation Input Terminal and Compensation Method	Polarity Reversible
			AU signal				
0	0 to 10V	0 to ±10V	Off	—	0	Terminal 1 Added compensation	No (Indicates that a frequency command signal of negative polarity is not accepted.)
1 (initial value)	0 to 5V	0 to ±10V					
2	0 to 10V	0 to ±5V					
3	0 to 5V	0 to ±5V					
4	0 to 10V	0 to ±10V					
5	0 to 5V	0 to ±5V					
6	0 to 20mA	0 to ±10V					
7	0 to 20mA	0 to ±5V					
10	0 to 10V	0 to ±10V					
11	0 to 5V	0 to ±10V					
12	0 to 10V	0 to ±5V					
13	0 to 5V	0 to ±5V					
14	0 to 10V	0 to ±10V					
15	0 to 5V	0 to ±5V					
16	0 to 20mA	0 to ±10V					
17	0 to 20mA	0 to ±5V					
0	—	0 to ±10V			On	According to Pr. 267 setting 0: 4 to 20mA (initial value) 1: 0 to 5V 2: 0 to 10V	0
1 (initial value)		0 to ±10V					
2		0 to ±5V					
3		0 to ±5V					
4		0 to 10V	—				
5		0 to 5V	—				
6		—	0 to ±10V				
7		—	0 to ±5V				
10		—	0 to ±10V				
11		—	0 to ±10V				
12		—	0 to ±5V				
13		—	0 to ±5V				
14		0 to 10V	—				
15		0 to 5V	—				
16		—	0 to ±10V				
17		—	0 to ±5V				

— : Invalid

- Set the voltage/current input switch referring to the table below.

Terminal 2 Input Specifications	Pr. 73 Setting	Switch 2	Terminal 4 Input Specifications	Pr. 267 Setting	Switch 1
Voltage input (0 to 10V)	0, 2, 4, 10, 12, 14	OFF	Voltage input (0 to 10V)	2	OFF
Voltage input (0 to 5V)	1 (initial value), 3, 5, 11, 13, 15	OFF	Voltage input (0 to 5V)	1	OFF
Current input (0 to 20mA)	6, 7, 16, 17	ON	Current input (4 to 20mA)	0 (initial value)	ON

□ indicates an initial value.

### CAUTION

- Turn the AU signal on to make terminal 4 valid.
- Match the setting of parameter and switch. A different setting may cause a fault, failure or malfunction.
- The terminal 1 (frequency setting auxiliary input) signal is added to the main speed setting signal of the terminal 2 or 4.
- When an override is selected, the terminal 1 or 4 is used for the main speed setting and the terminal 2 for the override signal (50% to 150% at 0 to 5V or 0 to 10V). (When the main speed of the terminal 1 or terminal 4 is not input, compensation by the terminal 2 is invalid.)
- Use Pr. 125 (Pr. 126) (frequency setting gain) to change the maximum output frequency at input of the maximum output frequency command voltage (current). At this time, the command voltage (current) need not be input. Also, the acceleration/deceleration time, which is a slope up/down to the acceleration/deceleration reference frequency, is not affected by the change in Pr. 73 setting.
- When Pr. 858 Terminal 4 function assignment, Pr. 868 Terminal 1 function assignment = "4", the value of the terminal 1 or terminal 4 is as set to the stall prevention operation level. When terminal 1 and terminal 4 are used for frequency setting, set "0" (initial value) in Pr. 858 and Pr. 868.

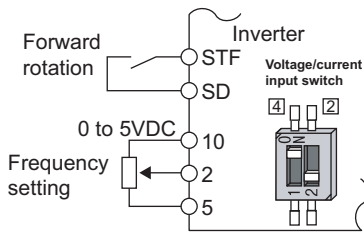

**Connection diagram using terminal 2 (0 to 5VDC)**

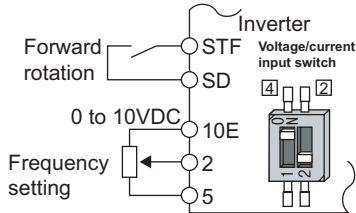

**Connection diagram using terminal 2 (0 to 10VDC)**

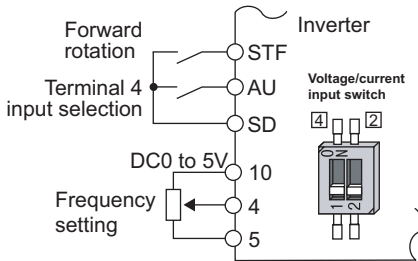

**Connection diagram using terminal 4 (0 to 5VDC)**

**(2) Perform operation by analog input voltage**

- The frequency setting signal inputs 0 to 5VDC (or 0 to 10VDC) to across the terminals 2 and 5. The 5V (10V) input is the maximum output frequency. The maximum output frequency is reached when 5V (10V) is input.
- The power supply 5V (10V) can be input by either using the internal power supply or preparing an external power supply. The internal power supply outputs 5VDC across terminals 10-5, or 10V across terminals 10E-5.

Terminal	Inverter Built-in Power Supply Voltage	Frequency Setting Resolution	Pr. 73 (terminal 2 input voltage)
10	5VDC	0.030Hz/60Hz	0 to 5VDC input
10E	10VDC	0.015Hz/60Hz	0 to 10VDC input

- When inputting 10VDC to the terminal 2, set any of "0, 2, 4, 10, 12, 14" in Pr: 73. (The initial value is 0 to 5V)
- Setting "1 (0 to 5VDC)" or "2 (0 to 10VDC)" in Pr: 267 and a voltage/current input switch in the OFF position changes the terminal 4 to the voltage input specification. When the AU signal turns on, the terminal 4 input becomes valid.

**REMARKS**

The wiring length of the terminal 10, 2, 5 should be 30m maximum.



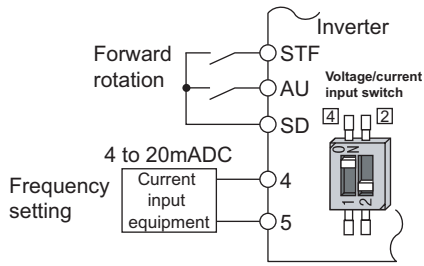

Connection diagram using terminal 4 (4 to 20mADC)

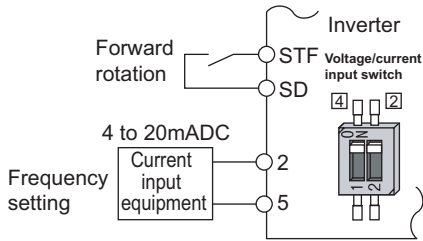

Connection diagram using terminal 2 (4 to 20mADC)

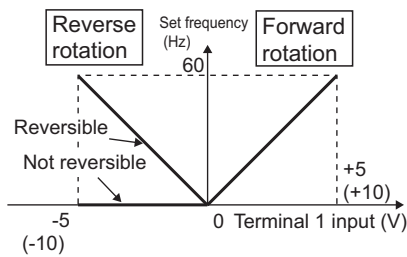

Compensation input characteristic when STF is on

◆ Parameters referred to ◆

- Pr. 22 Stall prevention operation level Refer to page 135
- Pr. 125 Terminal 2 frequency setting gain frequency, Pr. 126 Terminal 4 frequency setting gain frequency Refer to page 271
- Pr. 252, Pr. 253 Override bias/gain Refer to page 267
- Pr. 858 Terminal 4 function assignment, Pr. 868 Terminal 1 function assignment Refer to page 262

**(3) Perform operation by analog input current**

- When the pressure or temperature is controlled constant by a fan, pump, etc., automatic operation can be performed by inputting the output signal 0 to 20mADC of the adjuster to across the terminals 4-5.
- The AU signal must be turned on to use the terminal 4.

- Setting any of "6, 7, 16, 17" in Pr. 73 and a voltage/current input switch in the ON position changes the terminal 2 to the current input specification. At this time, the AU signal need not be turned on.

**(4) Perform forward/reverse rotation by analog input (polarity reversible operation)**

- Setting any of "10 to 17" in Pr. 73 enables polarity reversible operation.
- Providing  $\pm$  input (0 to  $\pm 5V$  or 0 to  $\pm 10V$ ) to the terminal 1 enables forward/reverse rotation operation according to the polarity.

### 4.21.3 Analog input compensation (Pr. 73, Pr. 242, Pr. 243, Pr. 252, Pr. 253)

A fixed ratio of analog compensation (override) can be made by the added compensation or terminal 2 as an auxiliary input for multi-speed operation or the speed setting signal (main speed) of the terminal 2 or terminal 4.

Parameter Number	Name	Initial Value	Setting Range	Description
73	Analog input selection	1	0 to 3, 6, 7, 10 to 13, 16, 17	Added compensation
			4, 5, 14, 15	Override compensation
242	Terminal 1 added compensation amount (terminal 2)	100%	0 to 100%	Set the ratio of added compensation amount when terminal 2 is the main speed.
243	Terminal 1 added compensation amount (terminal 4)	75%	0 to 100%	Set the ratio of added compensation amount when terminal 4 is the main speed.
252	Override bias	50%	0 to 200%	Set the bias side compensation value of override function.
253	Override gain	150%	0 to 200%	Set the gain side compensation value of override function.

#### (1) Added compensation (Pr. 242, Pr. 243)

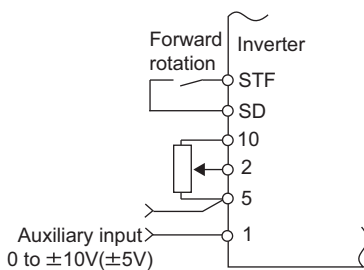

**Added compensation connection example**

- The compensation signal can be input for the main speed setting for synchronous/continuous speed control operation, etc.
- Setting any of "0 to 3, 6, 7, 10 to 13, 16, 17" in Pr. 73 adds the voltage across terminals 1 and 5 to the voltage signal across terminals 2 and 5.
- If the result of addition is negative, it is regarded as 0 at the Pr. 73 setting of any of "0 to 3, 6, 7", or reverse rotation operation (polarity reversible operation) is performed when the STF signal turns on at the Pr. 73 setting of any of "10 to 13, 16, 17".
- The compensation input of the terminal 1 can also be added to the multi-speed setting or terminal 4 (initial value 4 to 20mA).
- The added compensation for terminal 2 can be adjusted by Pr. 242, and the compensation for terminal 4 by Pr. 243.

Analog command value using terminal 2

$$= \text{Terminal 2 input} + \text{Terminal 1 input} \times \frac{\text{Pr. 242}}{100(\%)}$$

Analog command value using terminal 4

$$= \text{Terminal 4 input} + \text{Terminal 1 input} \times \frac{\text{Pr. 243}}{100(\%)}$$

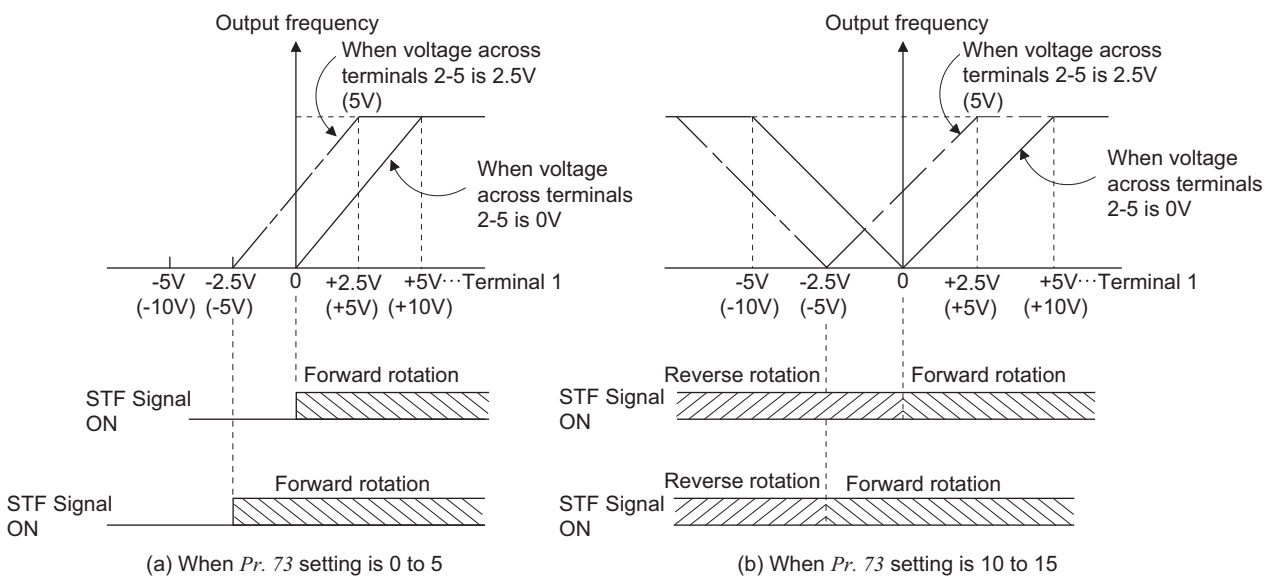

**Auxiliary input characteristics**

**CAUTION**

- When the Pr. 73 setting was changed, check the voltage/current input switch setting. Different setting may cause a fault, failure or malfunction. (Refer to page 263 for setting.)



**(2) Override function (Pr. 252, Pr. 253)**

- Use the override function to change the main speed at a fixed ratio.
- Set any of "4, 5, 14, 15" in Pr. 73 to select an override.
- When an override is selected, the terminal 1 or terminal 4 is used for the main speed setting and the terminal 2 for the override signal. (When the main speed of the terminal 1 or terminal 4 is not input, compensation made by the terminal 2 becomes invalid.)
- Using Pr. 252 and Pr. 253, set the override range.
- How to find the set frequency for override

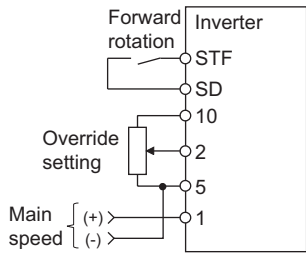

**Override connection diagram**

$$\text{Set frequency (Hz)} = \text{Main speed set frequency (Hz)} \times \frac{\text{Compensation amount (\%)}}{100(\%)}$$

Main speed set frequency (Hz): Terminal 1, 4 input, multi-speed setting

Compensation amount (%): Terminal 2 input

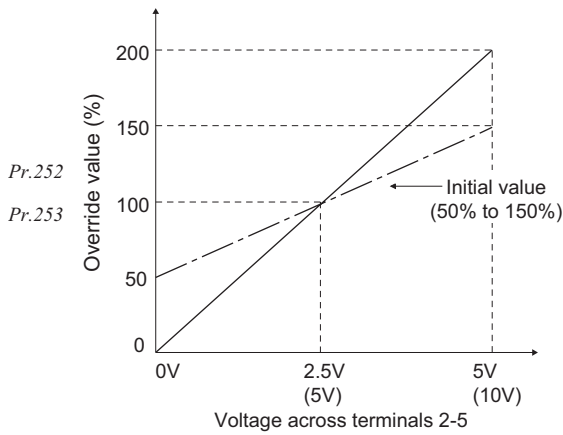

Example) When Pr. 73 = "5"

The set frequency changes as shown below according to the terminal 1 (main speed) and terminal 2 (auxiliary) inputs.

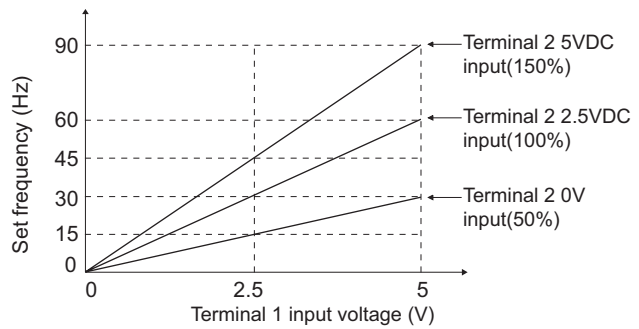

**CAUTION**

- When the Pr. 73 setting was changed, check the voltage/current input switch setting. Different setting may cause a fault, failure or malfunction. (Refer to page 263 for setting.)

**REMARKS**

- The AU signal must be turned on to use the terminal 4.
- When inputting compensation to multi-speed operation or remote setting, set "1" (compensation made) in Pr. 28 Multi-speed input compensation selection. (Initial value is "0")

◆ Parameters referred to ◆

Pr. 28 Multi-speed input compensation selection Refer to page 152  
 Pr. 73 Analog input selection Refer to page 263

**4.21.4 Response level of analog input and noise elimination**  
**(Pr. 74, Pr. 822, Pr. 826, Pr. 832, Pr. 836, Pr. 849)**

Response level and stability of frequency reference command and torque reference command by analog input (terminal 1, 2, 4) signal can be adjusted.

Parameter Number	Name	Initial Value	Setting Range	Description
74	Input filter time constant	1	0 to 8	The primary delay filter time constant for the analog input can be set. A larger setting results in slower response.
822	Speed setting filter 1	9999	0 to 5s	Set the time constant of the primary delay filter relative to the external speed command (analog input command).
			9999	Pr. 74 is used
826	Torque setting filter 1	9999	0 to 5s	Set the time constant of the primary delay filter relative to the external torque command (analog input command).
			9999	Pr. 74 is used
832	Speed setting filter 2	9999	0 to 5s, 9999	Second function of Pr. 822 (valid when RT terminal is on)
836	Torque setting filter 2	9999	0 to 5s, 9999	Second function of Pr. 826 (valid when RT terminal is on)
849	Analog input offset adjustment	100%	0 to 200%	This function provides speed command by analog input (terminal 2) with offset. Motor rotation due to noise, etc. by analog input can be avoided at zero speed command.

**(1) Block diagram**

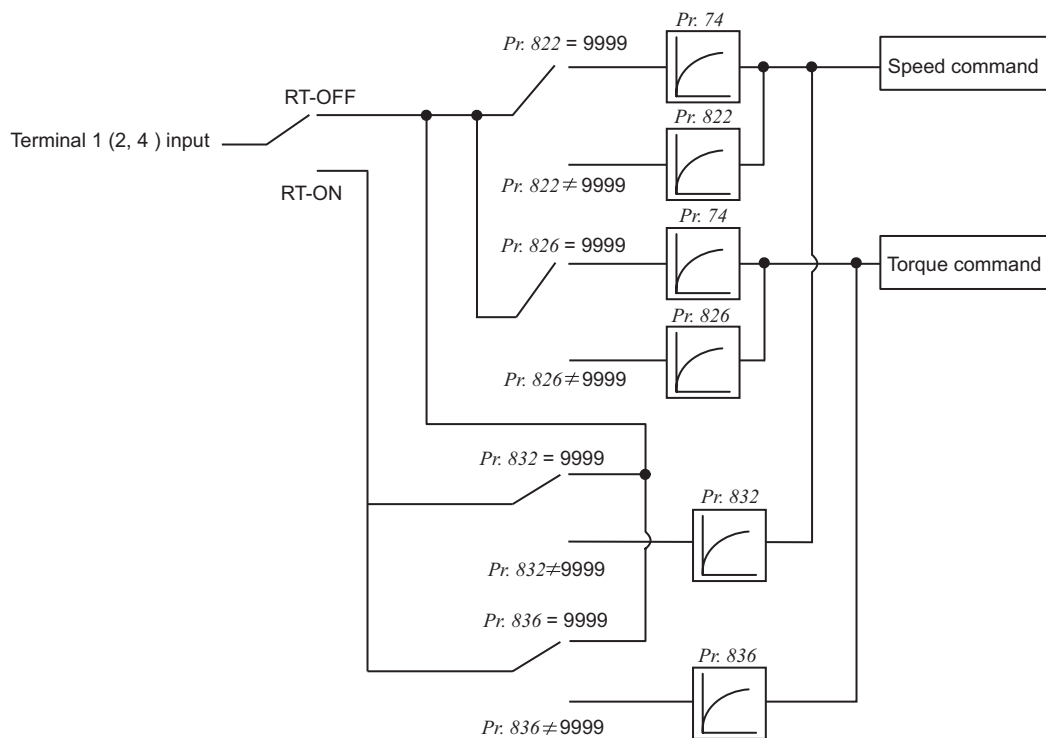



**(2) Time constant of analog input (Pr. 74)**

- Effective for eliminating noise in the frequency setting circuit.
- Increase the filter time constant if steady operation cannot be performed due to noise.  
A larger setting results in slower response (The time constant can be set between approximately 5ms to 1s with the setting of 0 to 8).

**(3) Time constant of analog speed command input (Pr. 822, Pr. 832)**

- Set the time constant of the primary delay filter relative to the external torque command (analog input command) using Pr. 822 Speed setting filter 1.  
Set a large time constant when you want to delay the tracking of the speed command, when the analog input voltage fluctuates, etc.
- When you want to change time constant when switching two motors with one inverter, use the Pr. 832 Speed setting filter 2.
- Pr. 832 Speed setting filter 2 is valid when the RT signal turns ON.

**(4) Time constant of analog torque command input (Pr. 826, Pr. 836)**

- Set the time constant of the primary delay filter relative to the external torque command (analog input command) using Pr. 826 Torque setting filter 1.  
Set a large time constant value when you want to delay the tracking of the torque command, when the analog input voltage fluctuates, etc.
- When you want to change time constant when switching two motors with one inverter, etc., use Pr. 836 Torque setting filter 2.
- Pr. 836 Torque setting filter 2 is valid when the RT signal turns ON.

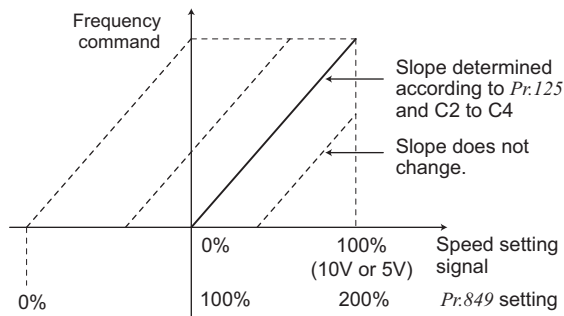

**(5) Offset adjustment of analog speed command input (Pr. 849)**

- When speed command by analog input is set, create the range where the motor remains stop to prevent malfunction at very low speed.
- On the assumption that the Pr. 849 setting 100% as 0, the offset voltage is offset as follows:  
100% < Pr. 849 ..... positive side  
100% > Pr. 849 ..... negative side  
The offset voltage is found by the following formula.

$$\text{Offset voltage} = \frac{\text{Voltage at 100\% (5V or 10V *)}}{100} \times \frac{\text{Pr. 849} - 100}{100} [\text{V}]$$

\* According to the Pr. 73 setting

◆ Parameters referred to ◆

Pr. 73 Analog input selection Refer to page 263

Pr. 125, C2 to C4 (Bias and gain of the terminal 2 frequency setting) Refer to page 271

**4.21.5 Bias and gain of frequency setting voltage (current)  
(Pr. 125, Pr. 126, Pr. 241, C2(Pr. 902) to C7(Pr. 905), C12(Pr. 917) to C15(Pr. 918))**

You can set the magnitude (slope) of the output frequency as desired in relation to the frequency setting signal (0 to 5V, 0 to 10V or 0 to 20mADC).  
Set Pr. 73, Pr. 267 and voltage/current input switch to switch between 0 to 5VDC, 0 to 10VDC and 4 to 20mADC.  
(Refer to page 263)

● Frequency setting bias/gain parameter

Parameter Number	Name	Initial Value	Setting Range	Description	
125	Terminal 2 frequency setting gain frequency	60Hz	0 to 400Hz	Set the frequency of terminal 2 input gain (maximum).	
126	Terminal 4 frequency setting gain frequency	60Hz	0 to 400Hz	Set the frequency of terminal 4 input gain (maximum).	
241 *2	Analog input display unit switchover	0	0	Displayed in %	Select the unit of analog input display.
			1	Displayed in V/mA	
C2(902) *1	Terminal 2 frequency setting bias frequency	0Hz	0 to 400Hz	Set the frequency on the bias side of terminal 2 input.	
C3(902) *1	Terminal 2 frequency setting bias	0%	0 to 300%	Set the converted % of the bias side voltage (current) of terminal 2 input.	
C4(903) *1	Terminal 2 frequency setting gain	100%	0 to 300%	Set the converted % of the gain side voltage (current) of terminal 2 input.	
C5(904) *1	Terminal 4 frequency setting bias frequency	0Hz	0 to 400Hz	Set the frequency on the bias side of terminal 4 input.	
C6(904) *1	Terminal 4 frequency setting bias	20%	0 to 300%	Set the converted % of the bias side current (voltage) of terminal 4 input.	
C7(905) *1	Terminal 4 frequency setting gain	100%	0 to 300%	Set the converted % of the gain side current (voltage) of terminal 4 input.	

● Speed limit bias/gain parameter

Parameter Number	Name	Initial Value	Setting Range	Description
C12(917) *1	Terminal 1 bias frequency (speed)	0Hz	0 to 400Hz	Set the frequency (speed) on the bias side of terminal 1 input.
C13(917) *1	Terminal 1 bias (speed)	0%	0 to 300%	Set the converted % of the bias side voltage of terminal 1 input.
C14(918) *1	Terminal 1 gain frequency (speed)	60Hz	0 to 400Hz	Set the frequency (speed) of terminal 1 input gain (maximum).
C15(918) *1	Terminal 1 gain (speed)	100%	0 to 300%	Set the converted % of the gain side voltage of terminal 1 input.

\*1 The parameter number in parentheses is the one for use with the parameter unit (FR-PU04/FR-PU07).

\*2 The above parameters allow its setting to be changed during operation in any operation mode even if "0" (initial value) is set in Pr. 77 Parameter write selection.



**(1) The relationship between analog input terminal and calibration parameter**

●Terminal 1 functional calibration parameter

Pr. 868 Setting	Terminal Function	Calibration Parameters	
		Bias setting	Gain setting
0 (initial value)	Frequency (speed) setting auxiliary	C2(Pr. 902) Terminal 2 frequency setting bias frequency C3(Pr. 902) Terminal 2 frequency setting bias C5(Pr. 904) Terminal 4 frequency setting bias frequency C6(Pr. 904) Terminal 4 frequency setting bias	Pr. 125 Terminal 2 frequency setting gain frequency C4(Pr. 903) Terminal 2 frequency setting gain Pr. 126 Terminal 4 frequency setting gain frequency C7(Pr. 905) Terminal 4 frequency setting gain
1	Magnetic flux command	C16(Pr.919) Terminal 1 bias command (torque/magnetic flux) C17(Pr.919) Terminal 1 bias (torque/magnetic flux)	C18(Pr. 920) Terminal 1 gain command (torque/magnetic flux) C19(Pr. 920) Terminal 1 gain (torque/magnetic flux)
2	Regenerative torque limit		
3	Torque command	C16(Pr. 919) Terminal 1 bias command (torque/magnetic flux) C17(Pr. 919) Terminal 1 bias (torque/magnetic flux)	C18(Pr. 920) Terminal 1 gain command (torque/magnetic flux) C19(Pr. 920) Terminal 1 gain (torque/magnetic flux)
4	Stall prevention operation level */ torque limit/torque command		
5	Forward/reverse rotation speed limit	C12(Pr.917) Terminal 1 bias frequency (speed) C13(Pr. 917) Terminal 1 bias (speed)	C14(Pr. 918) Terminal 1 gain frequency (speed) C15(Pr. 918) Terminal 1 gain (speed)
6	Torque bias input	C16(Pr. 919) Terminal 1 bias command (torque/magnetic flux) C17(Pr. 919) Terminal 1 bias (torque/magnetic flux)	C18(Pr. 920) Terminal 1 gain command (torque/magnetic flux) C19(Pr. 920) Terminal 1 gain (torque/magnetic flux)
9999	—	—	—

●Terminal 4 functional calibration parameter

Pr. 858 Setting	Terminal Function	Calibration Parameters	
		Bias setting	Gain setting
0 (initial value)	Frequency command/speed command	C5(Pr. 904) Terminal 4 frequency setting bias frequency C6(Pr. 904) Terminal 4 frequency setting bias	Pr. 126 Terminal 4 frequency setting gain frequency C7(Pr. 905) Terminal 4 frequency setting gain
1	Magnetic flux command	C38(Pr.932) Terminal 4 bias command (torque/magnetic flux) C39(Pr.932) Terminal 4 bias (torque/magnetic flux)	C40(Pr.933) Terminal 4 gain command (torque/magnetic flux) C41(Pr.933) Terminal 4 gain (torque/magnetic flux)
4	Stall prevention operation level */ torque limit	C38(Pr. 932) Terminal 4 bias command (torque/magnetic flux) C39(Pr. 932) Terminal 4 bias (torque/magnetic flux)	C40(Pr. 933) Terminal 4 gain command (torque/magnetic flux) C41(Pr. 933) Terminal 4 gain (torque/magnetic flux)
9999	—	—	—

— : No function

\* Use Pr. 148 Stall prevention level at 0V input and Pr. 149 Stall prevention level at 10V input to adjust bias/gain of stall prevention operation level

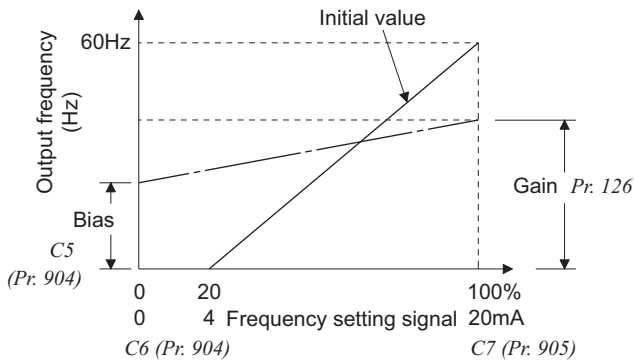
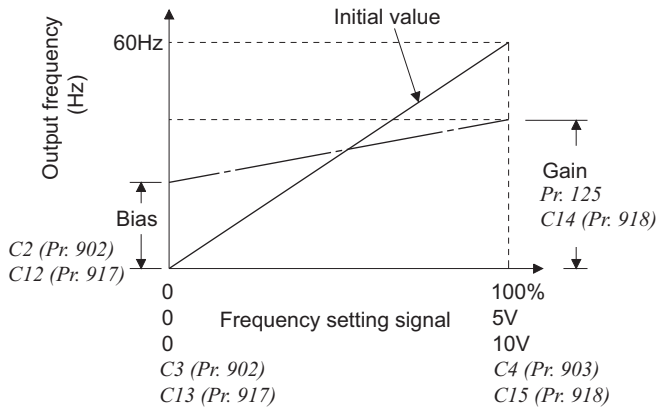

**(2) Change the frequency at maximum analog input. (Pr. 125, Pr. 126)**

- Set a value in Pr. 125 (Pr. 126) when changing only the frequency setting (gain) of the maximum analog input power (current). (C2 (Pr. 902) to C7 (Pr. 905) setting need not be changed)

**(3) Analog input bias/gain calibration (C2(Pr. 902) to C7(Pr. 905), C12(Pr. 917) to C15(Pr. 918))**

- The "bias" and "gain" functions are used to adjust the relationship between the input signal entered from outside the inverter to set the output frequency, e.g. 0 to 5V, 0 to 10V or 4 to 20mADC, and the output frequency.
- Set the bias frequency of the terminal 2 input using C2 (Pr. 902). (factory-set to the frequency at 0V)
- Using Pr. 125, set the output frequency relative to the frequency command voltage (current) set in Pr. 73 Analog input selection.
- Set the bias frequency of the terminal 1 input using C12 (Pr. 917). (factory-set to the frequency at 0V)
- Set the gain frequency of the terminal 1 input using C14 (Pr. 918). (factory-set to the frequency at 10V)
- Set the bias frequency of the terminal 4 input using C5 (Pr. 904). (factory-set to the frequency at 4mA)
- Using Pr. 126, set the output frequency relative to 20mA of the frequency command current (4 to 20mA).
- There are three methods to adjust the frequency setting voltage (current) bias/gain.
  - Method to adjust any point by application of voltage (current) to across the terminals 2 and 5 (4 and 5). [page 274](#)
  - Method to adjust any point without application of a voltage (current) to across terminals 2 and 5 (4 and 5). [page 275](#)
  - Adjusting only the frequency without adjusting the voltage (current). [page 276](#)

**CAUTION**

- When the terminal 2 is calibrated to change the inclination of the set frequency, the setting of the terminal 1 is also changed.
- When a voltage is input to the terminal 1 to make calibration, (terminal 2 (4) analog value + terminal 1 analog value) is the analog calibration value.
- When the voltage/current input signal was changed using Pr. 73, Pr. 267 and voltage/current input switch, be sure to make calibration.

**(4) Analog input display unit changing (Pr. 241)**

- You can change the analog input display unit (%V/mA) for analog input bias/gain calibration.
- Depending on the terminal input specification set to Pr. 73, Pr. 267 and voltage/current input switch, the display units of C3 (Pr. 902), C4 (Pr. 903), C6 (Pr. 904) C7 (Pr. 905) change as shown below.

Analog Command (terminal 2, 4) (according to Pr. 73, Pr. 267, voltage/current input switch)	Pr. 241 = 0 (initial value)	Pr. 241 = 1
0 to 5V input	0 to 5V → displayed in 0 to 100% (0.1%).	0 to 100% → displayed in 0 to 5V (0.01V).
0 to 10V input	0 to 10V → displayed in 0 to 100% (0.1%).	0 to 100% → displayed in 0 to 10V (0.01V).
0 to 20mA input	0 to 20mA → displayed in 0 to 100% (0.1%).	0 to 100% → displayed in 0 to 20mA (0.01mA).

**REMARKS**

- Analog input display is not displayed correctly if voltage is applied to terminal 1 when terminal 1 input specifications (0 to ±5V, 0 to ±10V) and main speed (terminal 2, terminal 4 input) specifications (0 to 5V, 0 to 10V, 0 to 20mA) differ. (For example, 5V (100%) is analog displayed when 0V and 10V are applied to terminal 2 and terminal 1 respectively in the initial status. In this case, set "0" (initial value is 0% display) in Pr. 241 to use.





### (5) Frequency setting voltage (current) bias/gain adjustment method

(a) Method to adjust any point by application of voltage (current) to across the terminals 2 and 5 (4 and 5).

#### Operation

1. Confirm the RUN indicator and operation mode indicator
  - The inverter must be at a stop.
  - The inverter must be in the PU operation mode. (Using )
2. Press to choose the parameter setting mode.
3. Turn until  $\text{C} \dots$  appears.
4. Press to display  $\text{C} \text{---}$ .
5. Turn until  $\text{C} \text{ 4}$  ( $\text{C} \text{ 7}$ ) appears. Set to C4 Terminal 2 frequency setting gain.

#### Display



(The parameter number read previously appears.)



(C0 to C41 setting is enabled.)



Terminal 2 input Terminal 4 input



Analog voltage (current) value (%) across terminals 2 and 5 (across terminals 4 and 5)

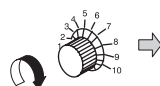

\* The value is nearly 100 (%) in the maximum position of the potentiometer.

**CAUTION**  
After performing the operation in step 6, do not touch until completion of calibration.

8. Press to set.



Flicker...Parameter setting complete!!  
(Adjustment completed)

\* The value is nearly 100 (%) in the maximum position of the potentiometer.

- Turn to read another parameter.
- Press to return to the  $\text{C} \text{---}$  indication (step 4).
- Press twice to show the next parameter ( $\text{Pr} \text{C} \text{L}$ ).

#### REMARKS

- If the frequency meter (indicator) connected to across terminals FM and SD does not indicate exactly 60Hz, set *calibration parameter C0 FM terminal calibration*. (Refer to page 240)
- If the gain and bias of frequency setting voltage (current) are too close, an error ( $\text{E} \text{r} \text{3}$ ) may be displayed at setting.

(b) Method to adjust any point without application of a voltage (current) to across terminals 2 and 5 (4 and 5).  
(To change from 4V (80%) to 5V (100%))

**Operation**

1. Confirm the RUN indicator and operation mode indicator  
 • The inverter must be at a stop.  
 • The inverter must be in the PU operation mode.  
 (Using )

2. Press  to choose the parameter setting mode.

3. Turn  until **[ . . . ]** appears.

4. Press  to display **[ - - - ]**.

5. Turn  until **[ 4 ]** (**[ 7 ]**) appears. Set to *C4 Terminal 2 frequency setting gain*.

6. Press  to display the analog voltage (current) value (%).

7. Turn  to set the gain voltage (%).  
 "0V (0mA) equals to 0%, 5V (10V, 20mA) to 100%"

**REMARKS**



The current setting at the instant of turning  is displayed.

8. Press  to set.

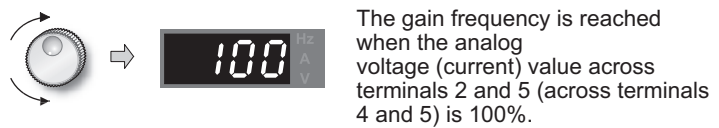
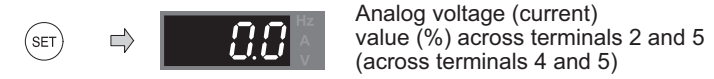
**Display**



Flicker...Parameter setting complete!!  
(Adjustment completed)

- Turn  to read another parameter.
- Press  to return to the **[ - - - ]** indication (step 4).
- Press  twice to show the next parameter (**P.r.[L]**).

**REMARKS**

By pressing  after step 6, you can confirm the current frequency setting bias/gain setting.  
 It cannot be confirmed after execution of step 7.



(c) Method to adjust only the frequency without adjustment of a gain voltage (current).  
(When changing the gain frequency from 60Hz to 50Hz)

Operation

1. Turn until *P. 125* (*Pr. 125*) or *P. 126* (*Pr. 126*) appears.
2. Press to show the present set value. (60.00Hz)
3. Turn to change the set value to "50.00". (50.00Hz)
4. Press to set.
5. Mode/monitor check  
Press twice to choose the monitor/frequency monitor.
6. Apply a voltage across the inverter terminals 2 and 5 (across 4 and 5) and turn ON the start command (STF, STR).  
Operation starts at 50Hz.

Display

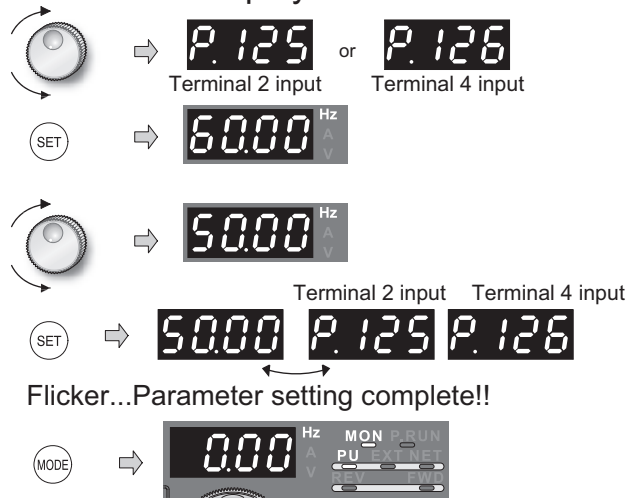

REMARKS

- Changing *C4* (*Pr. 903*) or *C7* (*Pr. 905*) (gain adjustment) setting will not change the *Pr. 20* setting. The input of terminal 1 (frequency setting auxiliary input) is added to the frequency setting signal.
- For the operating procedure using the parameter unit (FR-PU04/FR-PU07), refer to the FR-PU04/FR-PU07 instruction manual.
- When setting the value to 120Hz or higher, it is necessary to set *Pr. 18 High speed maximum frequency* to 120Hz or higher. (Refer to page 140)
- Make the bias frequency setting using *calibration parameter C2* (*Pr. 902*) or *C5* (*Pr. 904*). (Refer to page 273)

CAUTION

Be cautious when setting any value other than "0" as the bias frequency at 0V (0mA). Even if a speed command is not given, merely turning on the start signal will start the motor at the preset frequency.

◆ Parameters referred to ◆

- Pr. 20 Acceleration/deceleration reference frequency* Refer to page 155  
*Pr. 73 Analog input selection, Pr. 267 Terminal 4 input selection* Refer to page 263  
*Pr. 79 Operation mode selection* Refer to page 290

### 4.21.6 Bias and gain of torque (magnetic flux) setting voltage (current)

(Pr. 241, C16(Pr. 919) to C19(Pr. 920), C38 (Pr. 932) to C41 (Pr. 933)) Sensorless Vector

You can set the magnitude (slope) of the torque as desired in relation to the torque setting signal (0 to 5VDC, 0 to 10V or 4 to 20mA).

Use Pr. 73 and Pr. 267 to switch from among 0 to 5V, 0 to 10V, 4 to 20mADC. (Refer to page 263)

Parameter Number	Name	Initial Value	Setting Range	Description	
241 *2	Analog input display unit switchover	0	0	Displayed in %	Select the unit of analog input display.
			1	Displayed in V/mA	
C16(919) *1	Terminal 1 bias command (torque/magnetic flux)	0%	0 to 400%	Set the torque (magnetic flux) on the bias side of terminal 1 input.	
C17(919) *1	Terminal 1 bias (torque/magnetic flux)	0%	0 to 300%	Set the converted % of the bias side voltage (current) of terminal1 input.	
C18(920) *1	Terminal 1 gain command (torque/magnetic flux)	150%	0 to 400%	Set the torque (magnetic flux) of the terminal 1 input gain (maximum).	
C19(920) *1	Terminal 1 gain (torque/magnetic flux)	100%	0 to 300%	Set the converted % of the gain side voltage of terminal1 input.	
C38(932) *1	Terminal 4 bias command (torque/magnetic flux)	0%	0 to 400%	Set the torque (magnetic flux) on the bias side of terminal 4 input.	
C39(932) *1	Terminal 4 bias (torque/magnetic flux)	20%	0 to 300%	Set the converted % of the bias side current (voltage) of terminal 4 input.	
C40(933) *1	Terminal 4 gain command (torque/magnetic flux)	150%	0 to 400%	Set the torque (magnetic flux) of the terminal 4 input gain (maximum).	
C41(933) *1	Terminal 4 gain (torque/magnetic flux)	100%	0 to 300%	Set the converted % of the gain side current (voltage) of terminal 4 input.	

\*1 The parameter number in parentheses is the one for use with the parameter unit (FR-PU04/FR-PU07).

\*2 The above parameters allow its setting to be changed during operation in any operation mode even if "0" (initial value) is set in Pr. 77 Parameter write selection .

#### (1) Change functions of analog input terminal

In the initial setting status, terminal 1 and terminal 4 used for analog input are respectively set to speed setting auxiliary (speed limit auxiliary) and speed command (speed limit). To use an analog input terminal as torque command, torque limit input or magnetic flux command input, set Pr. 868 Terminal 1 function assignment and Pr. 858 Terminal 4 function assignment to change functions. (Refer to page 262)

#### (2) The relationship between analog input terminal and calibration parameter

- Terminal 1 functional calibration parameter

Pr. 868 Setting	Terminal Function	Calibration Parameters	
		Bias setting	Gain setting
0 (initial value)	Frequency (speed) setting auxiliary	C2(Pr. 902) Terminal 2 frequency setting bias frequency C3(Pr. 902) Terminal 2 frequency setting bias C5(Pr. 904) Terminal 4 frequency setting bias frequency C6(Pr. 904) Terminal 4 frequency setting bias	Pr. 125 Terminal 2 frequency setting gain frequency C4(Pr. 903) Terminal 2 frequency setting gain Pr. 126 Terminal 4 frequency setting gain frequency C7(Pr. 905) Terminal 4 frequency setting gain
1	Magnetic flux command	C16(Pr. 919) Terminal 1 bias command (torque/magnetic flux) C17(Pr. 919) Terminal 1 bias (torque/magnetic flux)	C18(Pr. 920) Terminal 1 gain command (torque/magnetic flux) C19(Pr. 920) Terminal 1 gain (torque/magnetic flux)
2	Regenerative torque limit		
3	Torque command		
4	Stall prevention operation level */ torque limit/torque command	C16(Pr. 919) Terminal 1 bias command (torque/magnetic flux) C17(Pr. 919) Terminal 1 bias (torque/magnetic flux)	C18(Pr. 920) Terminal 1 gain command (torque/magnetic flux) C19(Pr. 920) Terminal 1 gain (torque/magnetic flux)
5	Forward/reverse rotation speed limit	C12(Pr. 917) Terminal 1 bias frequency (speed) C13(Pr. 917) Terminal 1 bias (speed)	C14(Pr. 918) Terminal 1 gain frequency (speed) C15(Pr. 918) Terminal 1 gain (speed)
6	Torque bias input	C16(Pr. 919) Terminal 1 bias command (torque/magnetic flux) C17(Pr. 919) Terminal 1 bias (torque/magnetic flux)	C18(Pr. 920) Terminal 1 gain command (torque/magnetic flux) C19(Pr. 920) Terminal 1 gain (torque/magnetic flux)
9999	—	—	—

\* Use Pr. 148 Stall prevention level at 0V input and Pr. 149 Stall prevention level at 10V input to adjust bias/gain of stall prevention operation level.



● Terminal 4 functional calibration parameter

Pr. 858 Setting	Terminal Function	Calibration Parameters	
		Bias setting	Gain setting
0 (initial value)	Frequency (speed) command/speed limit	C5(Pr. 904) Terminal 4 frequency setting bias frequency C6(Pr. 904) Terminal 4 frequency setting bias	Pr. 126 Terminal 4 frequency setting gain frequency C7(Pr. 905) Terminal 4 frequency setting gain
1	Magnetic flux command	C38(Pr. 932) Terminal 4 bias command (torque/magnetic flux) C39(Pr. 932) Terminal 4 bias (torque/magnetic flux)	C40(Pr. 933) Terminal 4 gain command (torque/magnetic flux) C41(Pr. 933) Terminal 4 gain (torque/magnetic flux)
4	Stall prevention operation level */ torque limit	C38(Pr. 932) Terminal 4 bias command (torque/magnetic flux) C39(Pr. 932) Terminal 4 bias (torque/magnetic flux)	C40(Pr. 933) Terminal 4 gain command (torque/magnetic flux) C41(Pr. 933) Terminal 4 gain (torque/magnetic flux)
9999	—	—	—

— : No function

\* Use Pr. 148 Stall prevention level at 0V input and Pr. 149 Stall prevention level at 10V input to adjust bias/gain of stall prevention operation level.

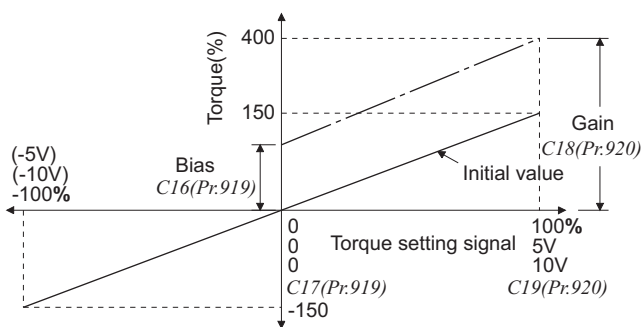

Calibration example of terminal 1

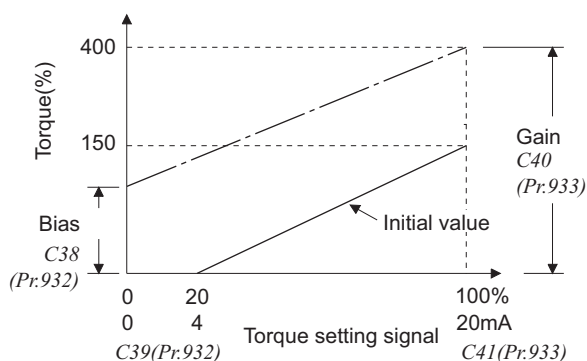

Calibration example of terminal 4

**(3) Change the torque at maximum analog input (C18(Pr. 920), C40(Pr. 933))**

- Set C18(Pr. 920), C40(Pr. 933) when changing only torque setting (gain) of the maximum analog input voltage (current).

**(4) Calibration of analog input bias and gain (C16(Pr. 919) to C19(Pr. 920), C38 (Pr. 932) to C41 (Pr. 933))**

- The "bias" and "gain" functions are used to adjust the relationship between the input signal entered from outside the inverter to set the torque command and torque limit, e.g. 0 to 5V, 0 to 10V or 4 to 20mADC, and the torque.
- Set the bias torque of terminal 1 input in C16 (Pr. 919) . (It is factory-set to the torque at 0V)
- Set the torque in C18 (Pr. 920) for the torque command voltage set with Pr. 73 Analog input selection. (initial value is 10V)
- Set the bias torque of terminal 4 input in C38 (Pr. 932) . (It is factory-set to the torque at 4mA)
- Set the torque in C40 (Pr. 933) for 20mA of the torque command current (4 to 20mA).
- There are the following three methods to adjust the torque setting voltage (current) bias and gain.
  - Method to adjust any point without application of voltage (current) to across terminals 1 and 5 (4 and 5)
    - ☞ page 279
  - Method to adjust any point without application of voltage (current) to across terminals 1 and 5 (4 and 5)
    - ☞ page 280
  - Method to adjust torque only without adjustment of voltage (current) ☞ page 281

**CAUTION**

- When voltage/current input specifications were switched using Pr. 73 and Pr. 267 , perform calibration without fail.

**(5) Analog input display unit changing (Pr. 241)**

- You can change the analog input display unit (%/V/mA) for analog input bias/gain calibration.
- Display unit of C17 (Pr. 919), C19 (Pr. 920), C39 (Pr. 932), C41 (Pr. 933) changes as follows according to the terminal input specifications set in Pr. 73 and Pr. 267 .

Analog Command (terminal 1,4) (according to Pr. 73, Pr. 267 )	Pr. 241 = 0 (initial value)	Pr. 241 = 1
0 to 5V input	0 to 5V → displayed in 0 to 100% (0.1%)	0 to 100% → displayed in 0 to 5V (0.01V)
0 to 10V input	0 to 10V → displayed in 0 to 100% (0.1%)	0 to 100% → displayed in 0 to 10V (0.01V)
0 to 20mA input	0 to 20mA → displayed in 0 to 100% (0.1%)	0 to 100% → displayed in 0 to 20mA (0.01mA)

## (6) Adjustment method of torque setting voltage (current) bias and gain

a) Method to adjust any point without application of a voltage (current) to across terminals 1 and 5 (4 and 5)

### Operation

1. Confirm the RUN indicator and operation mode indicator
  - The inverter must be at a stop.
  - The inverter must be in the PU operation mode. (Using  $\text{PU/EXT}$ )
2. Press  $\text{MODE}$  to choose the parameter setting mode.
3. Turn  $\text{POT}$  until  $\text{C} \dots$  appears.
4. Press  $\text{SET}$  to display  $\text{C} \text{---}$ .
5. Turn  $\text{POT}$  until  $\text{C} \text{ 19}$  ( $\text{C} \text{ 41}$ ) appears.  
Set to  $\text{C19}$  Terminal 1 gain (torque).
6. Press  $\text{SET}$  to display the analog voltage (current) value (%).
7. Apply a 10V (20mA) voltage (current).  
(Turn the external potentiometer connected across terminals 1 and 5 (across terminals 4 and 5) to maximum (any position).)

### Display

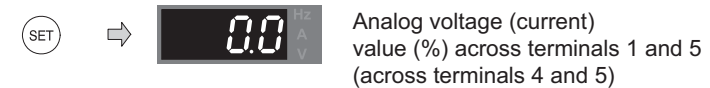

**CAUTION**  
After performing the operation in step 6, do not touch  $\text{POT}$  until completion of calibration.

8. Press  $\text{SET}$  to set.

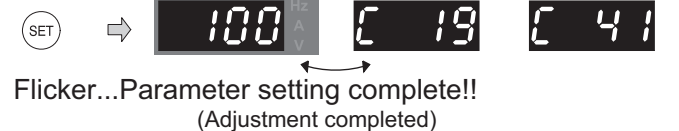

- Turn  $\text{POT}$  to read another parameter.
- Press  $\text{SET}$  to return to the  $\text{C} \text{---}$  indication (step 4).
- Press  $\text{SET}$  twice to show the next parameter ( $\text{Pr.CC}$ ).









### REMARKS

- An error at writing ( $\text{Er} \text{ 3}$ ) may appear if torque setting value of gain and bias are too close.

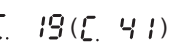

- b) Method to adjust any point without application of a voltage (current) to across terminals 1 and 5 (4 and 5)  
(To change from 8V (80%) to 10V (100%))

**Operation**

1. Confirm the RUN indicator and operation mode indicator
  - The inverter must be at a stop.
  - The inverter must be in the PU operation mode. (Using )
2. Press  to choose the parameter setting mode.
3. Turn  until  appears.
4. Press  to display .
5. Turn  until  appears. Set to *C19 Terminal 1 gain (torque)*.
6. Press  to display the analog voltage (current) value (%).
7. Turn  to set the gain voltage (%). "0V (0mA) equals to 0%, 10V (5V, 20mA) to 100%"





**REMARKS**

The current setting at the instant of turning  is displayed.

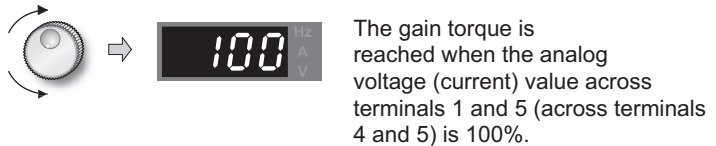
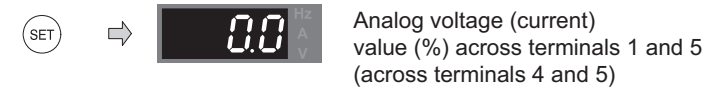
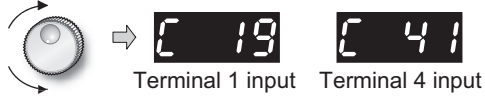
8. Press  to set.

**Display**



- Turn  to read another parameter.
- Press  to return to the  indication (step 4).
- Press  twice to show the next parameter ().





**REMARKS**

You can check the current torque setting bias/gain setting by pressing  after step 6.  
You can not check after performing operation in step 7.



- c) Method to adjust torque only without adjustment of gain voltage (current)  
(when changing gain torque from 150% to 130%)

**Operation**

1. Turn  until **C. 18** (Pr.920) or **C. 40** (Pr.933) appears.
2. Press  to show the currently set value. (150%)
3. Turn  to change the set value to "1300" (130.0%)
4. Press  to set.
5. Mode/monitor check  
Press  twice to choose the monitor/frequency monitor.
6. Apply a voltage across the inverter terminals 1 and 5 (across 4 and 5) and turn ON the start command (STF, STR).  
Operation starts with 130% torque.

**Display**

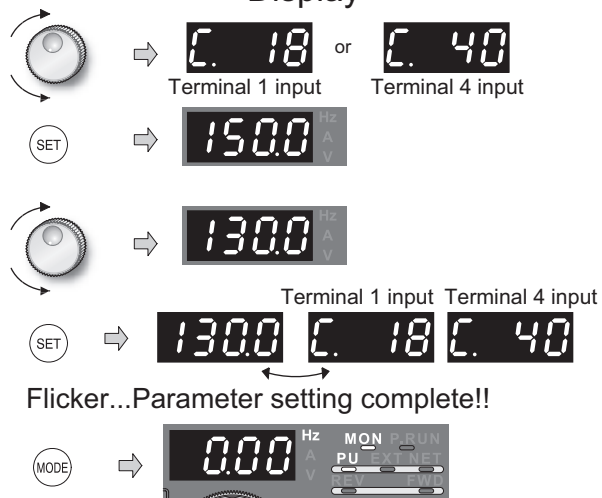





**REMARKS**

- For operation from the parameter unit (FR-PU04/FR-PU07), refer to the instruction manual of the FR-PU04/FR-PU07.
- Set bias torque setting using *calibration parameter C16 (Pr. 919) or C38 (Pr. 932)*. (Refer to page 278 )

**CAUTION**

 Take care when setting any value other than "0" as the bias torque at 0V (0mA). Torque is applied to the motor by simply tuning ON the start signal without torque command.

**◆ Parameters referred to ◆**

- Pr. 20 Acceleration/deceleration reference frequency  Refer to page 155
- Pr. 73 Analog input selection, Pr. 267 Terminal 4 input selection  Refer to page 263
- Pr. 79 Operation mode selection  Refer to page 290
- Pr. 858 Terminal 4 function assignment, Pr. 868 Terminal 1 function assignment  Refer to page 262





## 4.22 Misoperation prevention and parameter setting restriction



Purpose	Parameter that must be Set		Refer to Page
Limit reset function Trips when PU is disconnected Stop from PU	Reset selection/disconnected PU detection/PU stop selection	Pr. 75	282
Prevention of parameter rewrite	Parameter write disable selection	Pr. 77	284
Prevention of reverse rotation of the motor	Reverse rotation prevention selection	Pr. 78	285
Display necessary parameters	Display of applied parameters and user group function	Pr. 160, Pr. 172 to Pr. 174	285
Parameter restriction using password	Password function	Pr. 296, Pr. 297	287
Control of parameter write by communication	EEPROM write selection	Pr. 342	311

### 4.22.1 Reset selection/disconnected PU detection/PU stop selection (Pr. 75)

You can select the reset input acceptance, disconnected PU (FR-DU07/FR-PU04/FR-PU07) connector detection function and PU stop function.

Parameter Number	Name	Initial Value	Setting Range	Description
75	Reset selection/disconnected PU detection/PU stop selection	14	0 to 3, 14 to 17	For the initial value, reset always enabled, without disconnected PU detection, and with PU stop function are set.

This parameter allows its setting to be changed during operation in any operation mode even if "0 (initial value) or 1" is set in Pr. 77 Parameter write selection. Also, if parameter (all) clear is executed, this setting will not return to the initial value.

Pr. 75 Setting	Reset Selection	Disconnected PU Detection	PU Stop Selection
0	Reset input normally enabled.	If the PU is disconnected, operation will be continued.	Pressing  decelerates the motor to a stop only in the PU operation mode.
1	Reset input enabled only when the fault occurs		
2	Reset input normally enabled.	When the PU is disconnected, the inverter trips.	
3	Reset input enabled only when the fault occurs		
14 (initial value)	Reset input normally enabled.	If the PU is disconnected, operation will be continued.	Pressing  decelerates the motor to a stop in any of the PU, external and communication operation modes.
15	Reset input enabled only when the fault occurs		
16	Reset input normally enabled.	When the PU is disconnected, the inverter trips.	
17	Reset input enabled only when the fault occurs		

#### (1) Reset selection

- You can select the operation timing of reset function (RES signal, reset command through communication) input.
- When Pr. 75 is set to any of "1, 3, 15, 17", a reset can be input only when a fault occurs.

#### CAUTION

- When the reset signal (RES) is input during operation, the motor coasts since the inverter being reset shuts off the output. Also, the cumulative value of the electronic thermal relay function and regenerative brake duty is cleared.
- The reset key of the PU is valid only when a fault occurs, independently of the Pr. 75 setting.



## (2) Disconnected PU detection

- This function detects that the PU (FR-DU07/FR-PU04/FR-PU07) has been disconnected from the inverter for longer than 1s and causes the inverter to provide a fault output (E.PUE) and come to trip.
- When Pr. 75 is set to any of "0, 1, 14, 15", operation is continued if the PU is disconnected.

### CAUTION

- When the PU has been disconnected since before power-on, it is not judged as a fault.
- To make a restart, confirm that the PU is connected and then reset the inverter.
- The motor decelerates to a stop when the PU is disconnected during PU jog operation with Pr. 75 set to any of "0, 1, 14, 15" (operation is continued if the PU is disconnected).
- When RS-485 communication operation is performed through the PU connector, the reset selection/PU stop selection function is valid but the disconnected PU detection function is invalid.

## (3) PU stop selection

- In any of the PU operation, external operation and Network operation modes, the motor can be stopped by pressing  of the PU.
- When the inverter is stopped by the PU stop function, "PS" is displayed. A fault signal is not provided.
- When Pr. 75 is set to any of "0 to 3", deceleration to a stop by  is valid only in the PU operation mode.



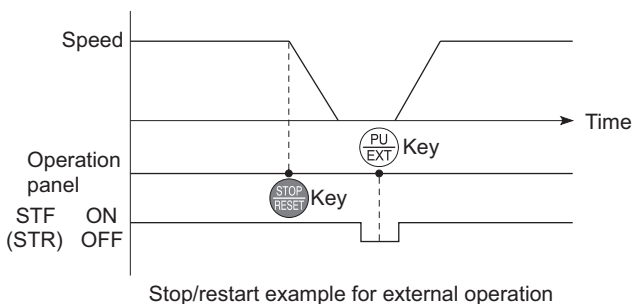

### REMARKS

The motor will also decelerate to a stop (PU stop) when  is input during operation in the PU mode through RS-485 communication with Pr. 551 PU mode operation command source selection set to "1" (PU mode RS-485 terminals).

## (4) Restarting method when stop was made by pressing from the PU during external operation (PU stop (PS) reset method)



### (a) When operation panel (FR-DU07) is used

- 1) After the motor has decelerated to a stop, turn OFF the STF or STR signal.
- 2) Press  to display .....(PS canceled)
- 3) Press  to return to .
- 4) Turn ON the STF or STR signal.

### (b) Connection of the parameter unit (FR-PU04/FR-PU07)

- 1) After the motor has decelerated to a stop, turn OFF the STF or STR signal.
- 2) Press .....(PS canceled)
- 3) Turn ON the STF or STR signal.

- The motor can be restarted by making a reset using a power supply reset or RES signal.

### CAUTION

- If Pr. 250 Stop selection is set to other than "9999" to select coasting to a stop, the motor will not be coasted to a stop but decelerated to a stop by the PU stop function during external operation

## CAUTION

 Do not reset the inverter with the start signal ON. Doing so will cause the inverter to start immediately after a reset, leading to hazardous conditions.

### ◆ Parameters referred to ◆

Pr. 250 Stop selection  Refer to page 189

### 4.22.2 Parameter write selection (Pr. 77)

You can select whether write to various parameters can be performed or not. Use this function to prevent parameter values from being rewritten by misoperation.

Parameter Number	Name	Initial Value	Setting Range	Description
77	Parameter write selection	0	0	Write is enabled only during a stop.
			1	Parameter write is not enabled.
			2	Parameter write is enabled in any operation mode regardless of operating status.

Pr. 77 can be always set independently of the operation mode and operating status.

#### (1) Write parameters only at a stop (setting "0", initial value)

- Parameters can be written only during a stop in the PU operation mode.
- The shaded parameters in the parameter list (page 55) can always be written, regardless of the operation mode and operating status. However, Pr. 72 PWM frequency selection, Pr. 240 Soft-PWM operation selection and Pr. 275 Stop-on contact excitation current low-speed multiplying factor can be written during operation in the PU operation mode, but cannot be written in External operation mode.

#### (2) Disable parameter write (setting "1")

- Parameter write is not enabled. (Reading is enabled.)
- Parameter clear and all parameter clear cannot be performed, either.
- The parameters given on the right can be written even if Pr. 77 = "1".

Parameter Number	Name
22	Stall prevention operation level
75	Reset selection/disconnected PU detection/PU stop selection
77	Parameter write selection
79	Operation mode selection
160	User group read selection

#### (3) Write parameters during operation (setting "2")

- Parameters can always be written.
- The following parameters cannot be written during operation if Pr. 77 = "2". Stop operation when changing their parameter settings.

Parameter Number	Name
23	Stall prevention operation level compensation factor at double speed
48	Second stall prevention operation current
49	Second stall prevention operation frequency
60	Energy saving control selection
61	Reference current
66	Stall prevention operation reduction starting frequency
71	Applied motor
79	Operation mode selection
80	Motor capacity
81	Number of motor poles
82	Motor excitation current
83	Rated motor voltage
84	Rated motor frequency
90 to 94	(Motor constants)
95	Online auto tuning selection
96	Auto tuning setting/status
100 to 109	(Adjustable 5 points V/F parameter)
135 to 139	(Parameter for electronic bypass sequence)
178 to 196	(I/O terminal function selection)
291	Pulse train I/O selection

Parameter Number	Name
292	Automatic acceleration/deceleration
293	Acceleration/deceleration separate selection
329	Digital input increments selection (Parameter for the plug-in option FR-A7AX)
450	Second applied motor
451	Second motor control method selection
453	Second motor capacity
454	Number of second motor poles
455	Second motor excitation current
456	Rated second motor voltage
457	Rated second motor frequency
458 to 462	(Second motor constant)
463	Second motor auto tuning setting/status
541	Frequency command sign selection (CC-Link) (Parameter for the plug-in option FR-A7NC)
574	Second motor online auto tuning
800	Control method selection
819	Easy gain tuning selection
858	Terminal 4 function assignment
859	Torque current
860	Second motor torque current
868	Terminal 1 function assignment

#### ◆ Parameters referred to ◆

Pr. 79 Operation mode selection  Refer to page 290

### 4.22.3 Reverse rotation prevention selection (Pr. 78)

This function can prevent reverse rotation fault resulting from the incorrect input of the start signal.

Parameter Number	Name	Initial Value	Setting Range	Description
78	Reverse rotation prevention selection	0	0	Both forward and reverse rotations allowed
			1	Reverse rotation disabled
			2	Forward rotation disallowed

- Set this parameter when you want to limit the motor rotation to only one direction.
- This parameter is valid for all of the reverse rotation and forward rotation keys of the operation panel (FR-DU07), parameter unit (FR-PU04/FR-PU07), start signals (STF, STR signals) via external terminals, and the forward and reverse rotation commands through communication.

### 4.22.4 Display of applied parameters and user group function (Pr. 160, Pr. 172 to Pr. 174)

Parameter which can be read from the operation panel and parameter unit can be restricted.

Parameter Number	Name	Initial Value	Setting Range	Description
160 *2	User group read selection	0	9999	Only the simple mode parameters can be displayed.
			0	The simple mode and extended parameters can be displayed
			1	Only parameters registered in the user group can be displayed.
172	User group registered display/ batch clear	0	(0 to 16)	Displays the number of cases registered as a user group. (Reading only)
			9999	Batch clear the user group registration
173 *1	User group registration	9999	0 to 999, 9999	Set the parameter numbers to be registered to the user group.
174 *1	User group clear	9999	0 to 999, 9999	Set the parameter numbers to be cleared from the user group.

\*1 The values read from Pr. 173 and Pr. 174 are always "9999".

\*2 This parameter allows its setting to be changed during operation in any operation mode even if "0 (initial value) or 1" is set in Pr. 77 Parameter write selection.

#### (1) Display of simple mode parameters and extended parameters (Pr. 160)

- When Pr. 160 = "9999", only the simple mode parameters can be displayed on the operation panel (FR-DU07) and parameter unit (FR-PU04/FR-PU07). (Refer to the parameter list, pages 55 to 67, for the simple mode parameters.)
- In the initial setting (Pr. 160 = "0") status, simple mode parameters and extended parameters can be displayed.

#### REMARKS

- When a plug-in option is fitted to the inverter, the option parameters can also be read.
- When reading the parameters using the communication option, all parameters can be read regardless of the Pr. 160 setting.
- When reading the parameters using the RS-485 terminals, all parameters can be read regardless of the Pr. 160 setting by setting Pr.550 NET mode operation command source selection and Pr. 551 PU mode operation command source selection.

Pr. 551	Pr. 550	Pr. 160 Valid/Invalid
1 (RS-485)	—	Valid
2 (PU) (initial value) 3 (USB)	0 (OP)	Valid
	1 (RS-485)	Invalid (all readable)
	9999 (auto-detect) (initial value)	With OP: valid Without OP: invalid (all readable)

\* OP indicates a communication option

- Pr. 15 Jog frequency, Pr. 16 Jog acceleration/deceleration time Pr. 991 PU contrast adjustment are displayed as simple mode parameters when the parameter unit (FR-PU04/FR-PU07) is mounted.

**(2) User group function (Pr. 160, Pr. 172 to Pr. 174)**

- The user group function is designed to display only the parameters necessary for setting.
- From among all parameters, a maximum of 16 parameters can be registered to a user group. When Pr. 160 is set to "1", only the parameters registered to the user group can be accessed. (Reading of parameters other than the user group registration is disabled.)
- To register a parameter to the user group, set its parameter number to Pr. 173.
- To delete a parameter from the user group, set its parameter number to Pr. 174. To batch-delete the registered parameters, set Pr. 172 to "9999".

**(3) Registration of parameter to user group (Pr. 173)**

When registering Pr. 3 to user group

Operation	Indication
<p>1. Confirm the operation display and operation mode display.</p> <ul style="list-style-type: none"> <li>• The inverter must be at a stop.</li> <li>• The inverter must be in the PU operation mode. (Press  in the External operation mode.)</li> </ul>	
<p>2. Press  to choose the parameter setting mode.</p>	⇒  Parameter setting mode
<p>3. Turn  until P. 173 appears.</p>	⇒  Pr. 173 User group registration is displayed.
<p>4. Press  to display. "9999"</p>	⇒  When Pr. 173 is read, "9999" is displayed.
<p>5. Turn  until Pr. 3 appears.</p>	⇒  Select the parameter number to be registered.
<p>6. Press  to set.</p> <p>"P. 173" and "3" are displayed alternately.</p> <p>To continue parameter registration, repeat steps 3 to 6.</p>	⇒ <p><b>Flicker ... Registration of Pr. 3 to user group completed!!</b></p>

**(4) Deletion of parameter from user group (Pr. 174)**

When deleting Pr. 3 from user group

Operation	Indication
<p>1. Confirm the operation display and operation mode display.</p> <ul style="list-style-type: none"> <li>• The inverter must be at a stop.</li> <li>• The inverter must be in the PU operation mode. (Press  in the External operation mode.)</li> </ul>	
<p>2. Press  to choose the parameter setting mode.</p>	⇒  Parameter setting mode
<p>3. Turn  until P. 174 appears.</p>	⇒  Pr. 174 User group clear is displayed.
<p>4. Press  to display. "9999"</p>	⇒  When Pr. 174 is read, "9999" is displayed.
<p>5. Turn  until Pr. 3 appears.</p>	⇒  Select the parameter number to be deleted.
<p>6. Press  to clear.</p> <p>"P. 174" and "3" are displayed alternately.</p> <p>To continue parameter registration, repeat steps 3 to 6.</p>	⇒ <p><b>Flicker ... Deletion of Pr. 3 from user group completed!!</b></p>

**REMARKS**

- Pr. 77, Pr. 160 and Pr. 991 can always be read, independently of the user group setting.
- Pr. 77, Pr. 160 and Pr. 172 to Pr. 174 cannot be registered to the user group.
- When Pr. 174 is read, "9999" is always displayed. Although "9999" can be written, no function is available.
- When any value other than "9999" is set to Pr. 172, no function is available.

◆ Parameters referred to ◆

Pr. 550 NET mode operation command source selection Refer to page 299  
 Pr. 551 PU mode operation command source selection Refer to page 299

### 4.22.5 Password function (Pr. 296, Pr. 297)

Registering a 4-digit password can restrict parameter reading/writing.

Parameter Number	Name	Initial Value	Setting Range	Description
296 *2 <b>Ver.UP</b>	Password lock level	9999	0 to 6, 99, 100 to 106, 199	Select restriction level of parameter reading/writing when a password is registered.
			9999	No password lock
297 *2 <b>Ver.UP</b>	Password lock/unlock	9999	1000 to 9998	Register a 4-digit password
			(0 to 5) *1	Displays password unlock error count. (Reading only) (Valid when Pr. 296 = "100" to "106", "199")
			9999 *1	No password lock

The above parameters can be set when Pr. 160 User group read selection = "0".

When Pr. 296 ≠ "9999" (with password lock), note that Pr. 297 is always available for setting regardless of Pr. 160 setting.

\*1 Only Pr.297 can be set anytime as Pr.297 = "0 or 9999." However, the setting is invalid (the displayed value does not change).

\*2 This parameter allows its setting to be changed during operation in any operation mode even if "0 (initial value) or 1" is set in Pr. 77 Parameter write selection.

**Ver.UP** .....Specifications differ according to the date assembled. Refer to page 456 to check the SERIAL number.

#### (1) Parameter reading/writing restriction level (Pr. 296)

- Level of reading/writing restriction by PU/NET operation mode operation command can be selected by Pr. 296.

Pr. 296 Setting	PU Operation Mode Operation Command *3		NET Operation Mode Operation Command *4			
	Read *1	Write *2	RS-485 Terminals		Communication Option	
			Read	Write *2	Read	Write *2
9999	○	○	○	○	○	○
0, 100 *6	×	×	×	×	×	×
1, 101	○	×	○	×	○	×
2, 102	○	×	○	○	○	○
3, 103	○	○	○	×	○	×
4, 104	×	×	×	×	○	×
5, 105	×	×	○	○	○	○
6, 106	○	○	×	×	○	×
99, 199	Only parameters registered in the user group can be read/written. *5 (For the parameters not registered in the user group, same restriction level as "4, 104" applies.)					

○: enabled, ×: restricted

\*1 If the parameter reading is restricted by the Pr. 160 setting, those parameters are unavailable for reading even when "○" is indicated.

\*2 If the parameter writing is restricted by the Pr. 77 setting, those parameters are unavailable for writing even when "○" is indicated.

\*3 This restricts parameter access from the command source that can write a parameter under the PU operation mode (initially the operation panel (FR-DU07) or the parameter unit). (For how to select the PU mode command source, refer to page 299.)

\*4 This restricts parameter access from the command source that can write a parameter under the Network operation mode (initially the RS-485 terminals or a communication option). (For how to select the NET mode command source, refer to page 299.)

\*5 Read/write is enabled only in the simple mode parameters registered in the user group when Pr.160 User group read selection = "9999". Pr.296 and Pr.297 are always read/write enabled whether registered to a user group or not.

\*6 If a communication option is installed, option fault (E.OPT) occurs, and inverter trips. (Refer to page 393.)



**(2) Password lock/unlock (Pr.296, Pr.297)**

<Lock>

1) Set parameter reading/writing restriction level. (Pr. 296 ≠ 9999)

Pr.296 Setting	Restriction of Password Unlock Error	Pr.297 Display
0 to 6, 99	No restriction	Always 0
100 to 106, 199	Restricted at fifth error	Displays error count (0 to 5)

\* If password unlock error has occurred 5 times when Pr. 296 = "100 to 106, 199", correct password will not unlock the restriction. All parameter clear can unlock the restriction.  
(In this case, parameter setting are cleared.)

2) Write a four-digit number (1000 to 9998) in Pr. 297 as a password.

(When Pr. 296 = "9999", Pr. 297 cannot be written.)

When password is registered, parameter reading/writing is restricted with the restriction set level in Pr. 296 until unlocking.

**REMARKS**

- After registering a password, a read value of Pr. 297 is always "0" to "5".
- When a password restricted parameter is read/written, **LOc d** is displayed.
- Even if a password is registered, parameters which the inverter itself writes, such as inverter parts life, are overwritten as needed.
- Even if a password is registered, Pr. 991 PU contrast adjustment can be read/written when a parameter unit (FR-PU04/FR-PU07) is connected.

<Unlock>

There are two ways of unlocking the password.

- Enter a password in Pr. 297.

Unlocked when a password is correct. If a password is incorrect, an error occurs and not unlocked.

If password unlock error has occurred 5 times when Pr. 296 = "100 to 106, 199", correct password will not unlock the restriction. (During password lock)

- Perform all parameter clear.

**CAUTION**

- If the password has been forgotten, perform all parameter clear to unlock the parameter restriction. In that case, other parameters are also cleared.
- All parameter clear can not be performed during the operation.
- Do not use FR Configurator under the conditions that parameter read is restricted (Pr. 296 = "0, 4, 5, 99, 100, 104, 105, 199"). FR Configurator may not function properly.

**REMARKS**

- The password unlock method is different for operation panel (FR-DU07)/FR-PU07, RS-485 communication, and communication option.

	FR-DU07/ FR-PU07	RS-485 Communication	Communication Option
All Parameter Clear (Instruction Code H9966, H55AA)	○	○	○
Parameter Clear (Instruction Code H9696, H5A5A)	×	×	○

○: Password can be unlocked, ×: Password cannot be unlocked

**(3) Parameter operation during password locked/unlocked**

Parameter Operation		Password Unlocked		Password Registered	Password Locked
		<i>Pr. 296 = 9999</i> <i>Pr. 297 = 9999</i>	<i>Pr. 296 ≠ 9999</i> <i>Pr. 297 = 9999</i>	<i>Pr. 296 ≠ 9999</i> <i>Pr. 297 = 0 to 4</i> (Read value)	<i>Pr. 296 = 100 to 106, 199</i> <i>Pr. 297 = 5</i> (Read value)
<i>Pr. 296</i>	Read	○ *1	○	○	○
	Write	○ *1	○ *1	×	×
<i>Pr. 297</i>	Read	○ *1	○	○	○
	Write	×	○	○	○ *3
Performing Parameter Clear		○	○	× *4	× *4
Performing All Parameter Clear		○	○	○ *2	○ *2
Performing Parameter Copy		○	○	×	×

○: enabled, ×: restricted

- \*1 Reading/writing is unavailable when there is restriction to reading by the *Pr. 160* setting. (Reading is available in NET operation mode regardless of *Pr. 160* setting.)
- \*2 Unavailable during the operation.
- \*3 Correct password will not unlock the restriction.
- \*4 Parameter clear is available only from the communication option.

**REMARKS**

- When *Pr.296 = "4, 5, 104, 105"* (password lock), the setting screen for PU JOG frequency is not displayed in the parameter unit (FR-PU04 or FR-PU07).
- Parameter copy is not available with operation panel (FR-DU07)/parameter unit (FR-PU07) when password is registered.

◆ **Parameters referred to** ◆

- Pr. 77 Parameter write selection* Refer to page 284
- Pr. 160 User group read selection* Refer to page 285
- Pr. 550 NET mode operation command source selection* Refer to page 299
- Pr. 551 PU mode operation command source selection* Refer to page 299

















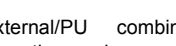
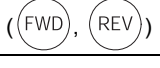

## 4.23 Selection of operation mode and operation location

Purpose	Parameter that must be Set		Refer to Page
Operation mode selection	Operation mode selection	Pr. 79	290
Started in network operation mode	Operation mode at power on	Pr. 79, Pr. 340	298
Selection of control location	Selection of control source, speed command source and control location during communication operation	Pr. 338, Pr. 339, Pr. 550, Pr. 551	299

### 4.23.1 Operation mode selection (Pr. 79)

Used to select the operation mode of the inverter.

Mode can be changed as desired between operation using external command signals (external operation), operation from the PU (FR-DU07/FR-PU07/FR-PU04), combined operation of PU operation and external operation (external/PU combined operation, and network operation (when RS-485 terminals or a communication option is used).

Parameter Number	Name	Initial Value	Setting Range	Description	LED Indicator  : OFF  : ON		
79 *1	Operation mode selection	0	0	Use external/PU switchover mode (  ) to switch between the PU and External operation mode. At power on, the inverter is in the External operation mode.	PU operation mode  External operation mode  NET operation mode 		
			1	Fixed to PU operation mode	PU operation mode 		
			2	Fixed to External operation mode Operation can be performed by switching between the external and NET operation mode.	External operation mode  NET operation mode 		
			3	External/PU combined operation mode 1		PU (FR-DU07/FR-PU04/FR-PU07) setting or external signal input (multi-speed setting, across terminals 4-5 (valid when AU signal turns on)). *2 External signal input (terminal STF, STR)	External/PU combined operation mode 
				Frequency command	Start command		
			4	External/PU combined operation mode 2		External signal input (Terminal 2, 4, 1, JOG, multi-speed selection, etc.) 	External/PU combined operation mode 
				Frequency command	Start command		
			6	Switch-over mode Switch among PU operation, external operation, and NET operation while keeping the same operating status.	PU operation mode  External operation mode  NET operation mode 		
			7	External operation mode (PU operation interlock) X12 signal ON Operation mode can be switched to the PU operation mode. (output stop during external operation) X12 signal OFF Operation mode can not be switched to the PU operation mode.	PU operation mode  External operation mode  NET operation mode 		

The above parameters can be changed during a stop in any operation mode.

\*1 This parameter allows its setting to be changed in any operation mode even if "0 (initial value) or 1" is set in Pr. 77 Parameter write selection.

\*2 The priorities of the frequency commands when Pr. 79 = "3" are "Multi-speed operation (RL/RM/RH/REX) > PID control (X14) > terminal 4 analog input (AU) > digital input from the operation panel".

## (1) Operation mode basics

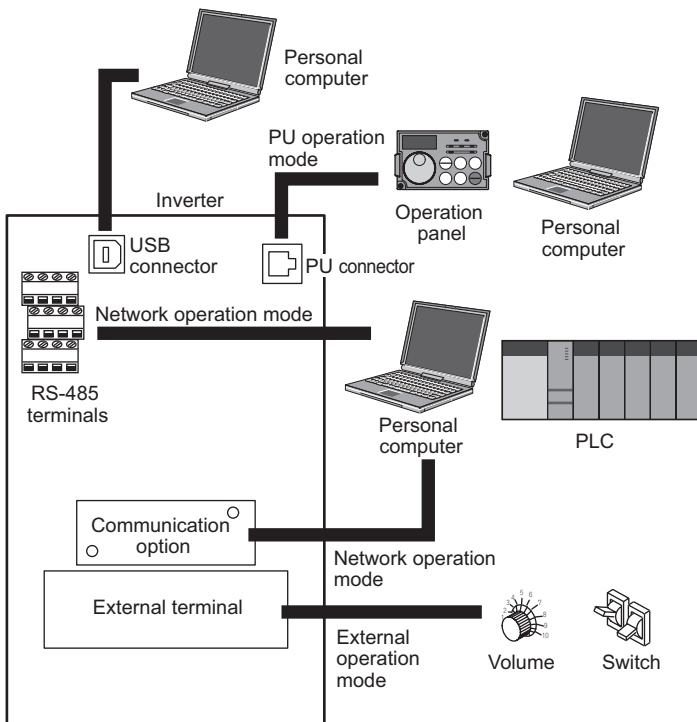

- The operation mode specifies the source of the start command and frequency command for the inverter.
- Basically, there are following operation modes.
  - **External operation mode:** For inputting start command and frequency command by an external potentiometer and switches which are connected to the control circuit terminal.
  - **PU operation mode:** For inputting start command and frequency command by operation panel (FR-DU07), parameter unit (FR-PU04-MGI) and RS-485 communication with PU connector.
  - **Network operation mode (NET operation mode):** For inputting start command and frequency command by RS-485 terminal and communication options.
- The operation mode can be selected from the operation panel or with the communication instruction code.

### REMARKS

- Either "3" or "4" may be set to select the PU/external combined operation, and these settings differ in starting method.
- In the initial setting, the stop function by of the PU (FR-DU07/FR-PU07) (PU stop selection) is valid also in other than the PU operation mode. (Pr. 75 Reset selection/disconnected PU detection/PU stop selection. Refer to page 282.)

## (2) Operation mode switching method

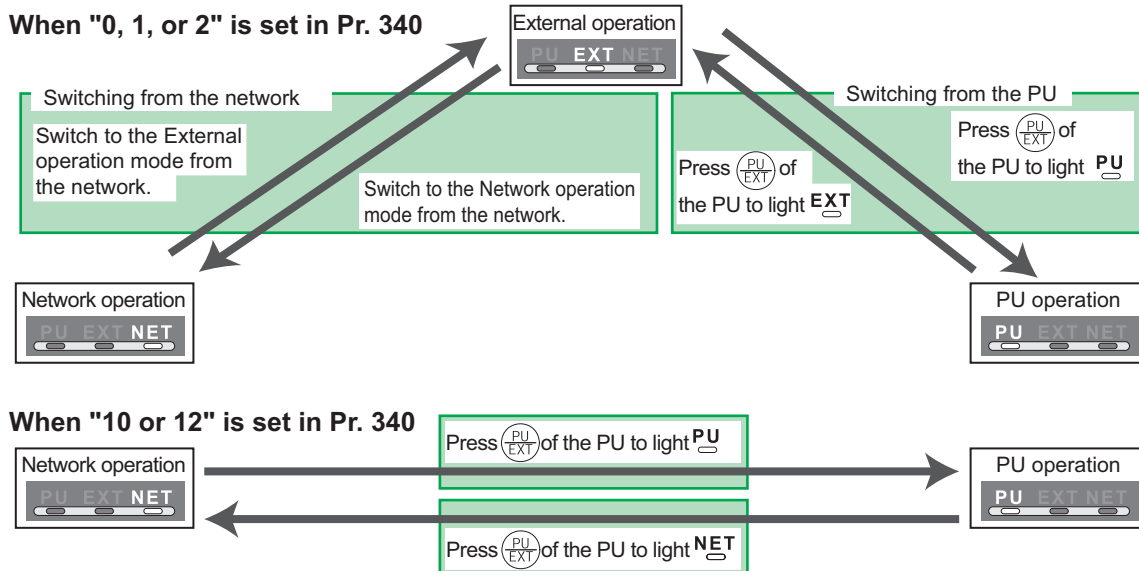

### REMARKS

- For switching of operation by external terminals, refer to the following:
  - PU operation external interlock signal (X12 signal) page 295
  - PU-external operation switch-over signal (X16) page 296
  - PU-NET operation switchover signal (X65), External-NET operation switchover signal (X66) page 297
  - Pr. 340 Communication startup mode selection page 298

### (3) Operation mode selection flow

In the following flowchart, select the basic parameter setting and terminal connection related to the operation mode.

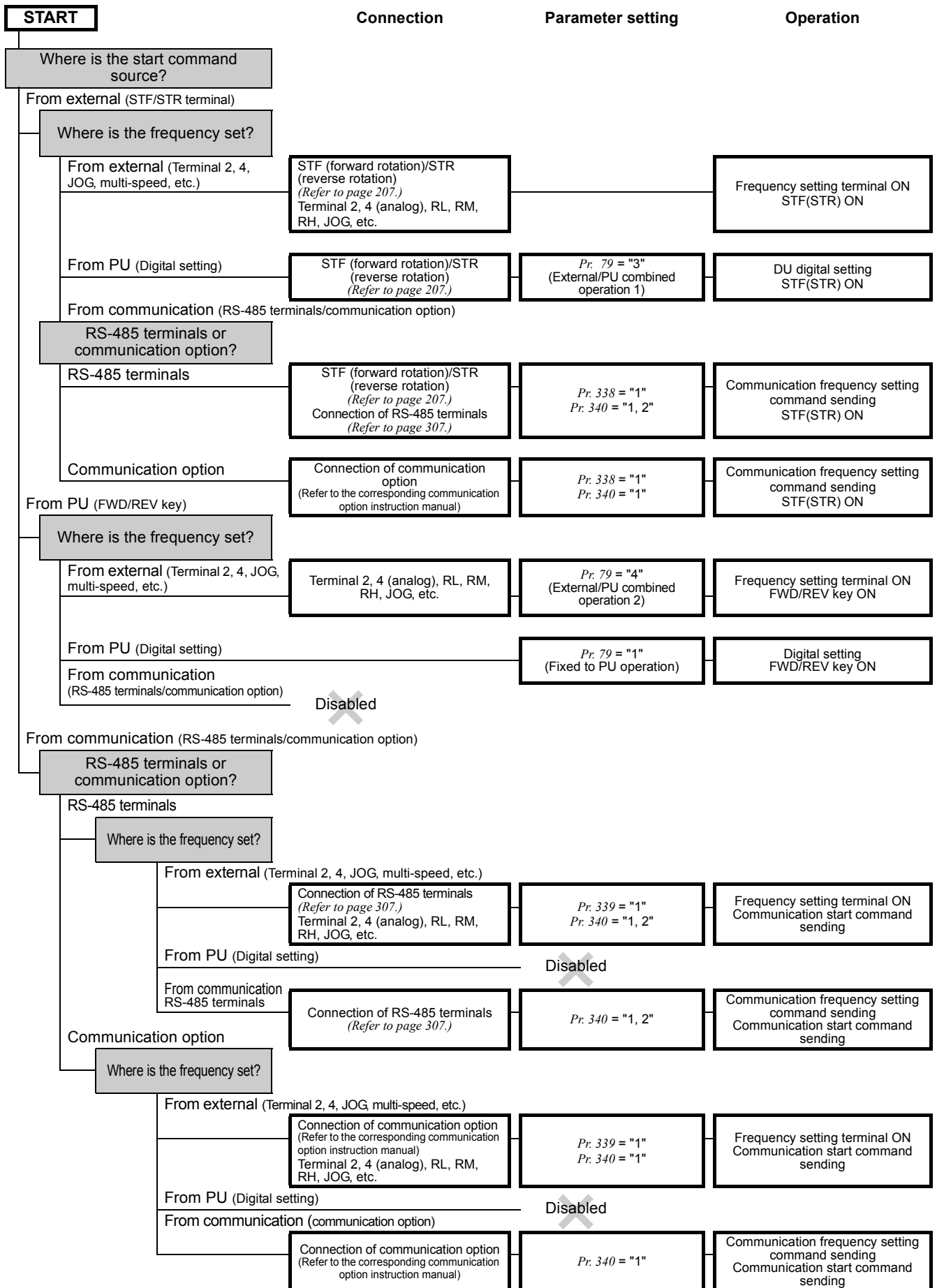

**(4) External operation mode (setting "0" (initial value), "2")**

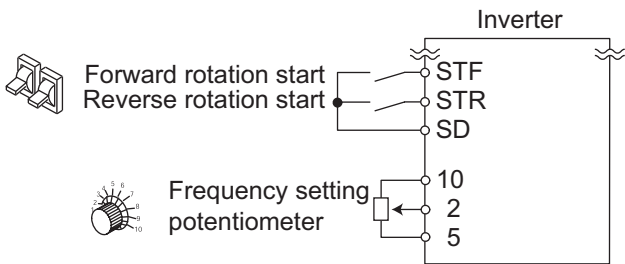
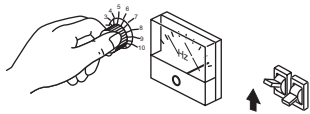

- Select the External operation mode when the start command and the frequency command are applied from a frequency setting potentiometer, start switch, etc. externally and connecting them to the control circuit terminals of the inverter.
- Generally, parameter change cannot be performed from the operation panel in the External operation mode. (Some parameters can be changed. Refer to the detailed description of each parameter.)
- When "0" or "2" is selected for *Pr. 79*, the inverter enters the External operation mode at power on. (When using the Network operation mode, refer to *page 298*)
- When parameter changing is seldom necessary, setting "2" fixes the operation mode to External operation mode. When frequent parameter changing is necessary, setting "0" (initial value) allows the operation mode to be changed easily to PU operation mode by pressing  of the operation panel. When you switched to PU operation mode, always return to External operation mode.
- The STF and STR signal are used as a start command, and the voltage or current signal to terminal 2, 4, multi-speed signal, JOG signal, etc. are used as frequency command.

**(5) PU operation mode (setting "1")**

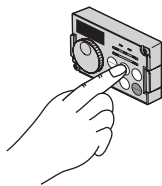

Operation panel (FR-DU07)

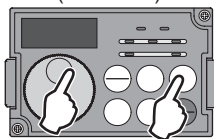

- Select the PU operation mode when applying start command and the frequency command by only the key operation of the operation panel (FR-DU07) or parameter unit (FR-PU04/FR-PU07). Also select the PU operation mode when making communication using the PU connector.
- When "1" is selected for *Pr. 79*, the inverter enters the PU operation mode at power on. You cannot change to the other operation mode.
- The setting dial of the operation panel can be used for setting like a potentiometer. (*Pr. 161 Frequency setting/key lock operation selection, refer to page 371.*)
- When PU operation mode is selected, the PU operation mode signal (PU) can be output. For the terminal used for the PU signal output, assign the function by setting "10 (positive logic) or 110 (negative logic)" in any of *Pr. 190 to Pr. 196 (output terminal function selection)*.

**(6) PU/External combined operation mode 1 (setting "3")**

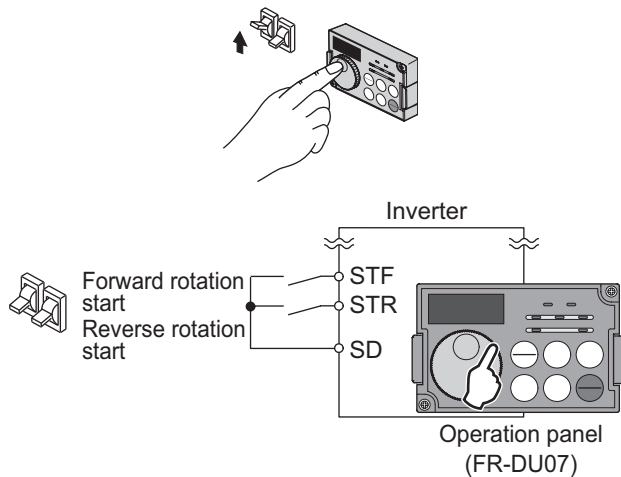

- Select the PU/External combined operation mode 1 when applying frequency command from the operation panel (FR-DU07) or parameter unit (FR-PU04/FR-PU07) and inputting the start command with the external start switch.
- Select "3" for Pr. 79. You cannot change to the other operation mode.
- When a frequency is input from the external signal by multi-speed setting, it has a higher priority than the frequency setting of the PU. When AU is on, the command signal to terminal 4 is used.

**(7) PU/External combined operation mode 2 (setting "4")**

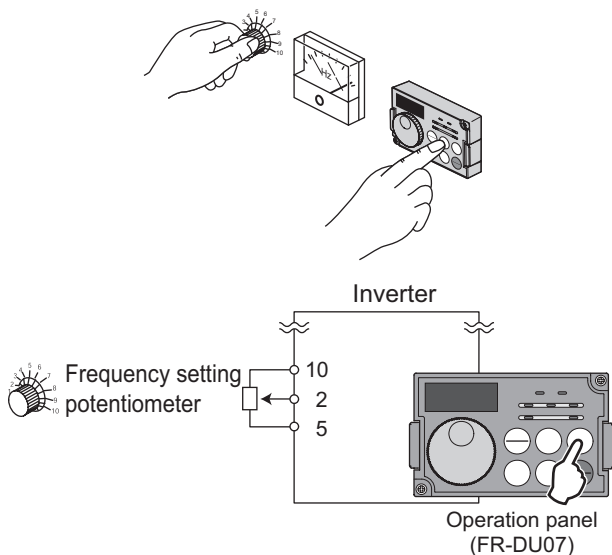

- Select the PU/External combined operation mode 2 when applying frequency command from the external potentiometer, multi-speed or JOG signal and inputting the start command by key operation of the operation panel (FR-DU07) or parameter unit (FR-PU04/FR-PU07).
- Select "4" for Pr. 79. You cannot change to the other operation mode.

### (8) Switch-over mode (setting "6")

- While continuing operation, you can switch among PU operation, External operation and Network operation (when RS-485 terminals or communication option is used).

Operation Mode Switching	Switching Operation/Operating Status
External operation → PU operation	Select the PU operation mode with the operation panel or parameter unit. <ul style="list-style-type: none"> <li>Rotation direction is the same as that of external operation.</li> <li>The frequency set with the potentiometer (frequency setting command), etc. is used unchanged. (Note that the setting will disappear when power is switched off or the inverter is reset.)</li> </ul>
External operation → NET operation	Send the mode change command to Network operation mode through communication. <ul style="list-style-type: none"> <li>Rotation direction is the same as that of external operation.</li> <li>The value set with the setting potentiometer (frequency setting command) or like is used unchanged. (Note that the setting will disappear when power is switched off or the inverter is reset.)</li> </ul>
PU operation → External operation	Press the external operation key of the operation panel, parameter unit. <ul style="list-style-type: none"> <li>The rotation direction is determined by the input signal of the external operation.</li> <li>The set frequency is determined by the external frequency command signal.</li> </ul>
PU operation → NET operation	Send the mode change command to Network operation mode through communication. <ul style="list-style-type: none"> <li>Rotation direction and set frequency are the same as those of PU operation.</li> </ul>
NET operation → External operation	Send the mode change command to External operation mode through communication. <ul style="list-style-type: none"> <li>The rotation direction is determined by the input signal of the external operation.</li> <li>The set frequency is determined by the external frequency command signal.</li> </ul>
NET operation → PU operation	Select the PU operation mode with the operation panel or parameter unit. <ul style="list-style-type: none"> <li>The rotation direction and frequency command in Network operation mode are used unchanged.</li> </ul>

### (9) PU operation interlock (setting "7")

- The PU operation interlock function is designed to forcibly change the operation mode to External operation mode when the PU operation interlock signal (X12) input turns off. This function prevents the inverter from being inoperative by the external command if the mode is accidentally left unswitched from PU operation mode.
- Set "7" (PU operation interlock) in Pr. 79.
- For the terminal used for X12 signal (PU operation interlock signal) input, set "12" in any of Pr. 178 to Pr. 189 (input terminal function selection) to assign the function. (Refer to page 207 for Pr. 178 to Pr. 189.)
- When the X12 signal has not been assigned, the function of the MRS signal switches from MRS (output stop) to the PU operation interlock signal.

X12 (MRS) Signal	Function/Operation	
	Operation mode	Parameter write
ON	Operation mode (External, PU, NET) switching enabled Output stop during external operation	Parameter write enabled (Pr. 77 Parameter write selection, depending on the corresponding parameter write condition (Refer to page 55 for the parameter list))
OFF	Forcibly switched to External operation mode External operation allowed Switching to PU or NET operation mode disabled	Parameter write disabled with exception of Pr. 79

#### <Function/operation changed by switching ON/OFF the X12 (MRS) signal>

Operating Condition		X12 (MRS) Signal	Operation Mode	Operating Status	Switching to PU, NET Operation Mode
Operation mode	Status				
PU/NET	During stop	ON→OFF *1	External *2	If external operation frequency setting and start signal are entered, operation is performed in that status.	Disallowed
	Running	ON→OFF *1			Disallowed
External	During stop	OFF→ON	External *2	During stop	Allowed
		ON→OFF			Disallowed
	Running	OFF→ON		During operation → output stop	Disallowed
		ON→OFF		Output stop → operation	Disallowed

\*1 The operation mode switches to External operation mode independently of whether the start signal (STF, STR) is on or off. Therefore, the motor is run in External operation mode when the X12 (MRS) signal is turned off with either of STF and STR on.

\*2 At alarm occurrence, pressing  of the operation panel resets the inverter.

#### CAUTION

- If the X12 (MRS) signal is on, the operation mode cannot be switched to PU operation mode when the start signal (STF, STR) is on.
- When the MRS signal is used as the PU interlock signal, the MRS signal serves as the normal MRS function (output stop) by turning on the MRS signal and then changing the Pr. 79 value to other than "7" in the PU operation mode. Also as soon as "7" is set in Pr. 79, the signal acts as the PU interlock signal.
- When the MRS signal is used as the PU operation interlock signal, the logic of the signal is as set in Pr. 17. When Pr. 17 = "2", read ON as OFF and OFF as ON in the above explanation.
- Changing the terminal assignment using Pr. 178 to Pr. 189 (input terminal function selection) may affect the other functions. Set parameters after confirming the function of each terminal.

### (10) Switching of operation mode by external signal (X16 signal)

- When external operation and operation from the operation panel are used together, use of the PU-external operation switching signal (X16) allows switching between the PU operation mode and External operation mode during a stop (during a motor stop, start command off).
- When Pr. 79 = any of "0, 6, 7", the operation mode can be switched between the PU operation mode and External operation mode. (Pr. 79 = "6" At switch-over mode, operating mode can be changed during operation)
- For the terminal used for X16 signal input, set "16" in any of Pr. 178 to Pr. 189 (input terminal function selection) to assign the function.

Pr. 79 Setting	X16 Signal State Operation Mode		Remarks
	ON (external)	OFF (PU)	
0 (initial value)	External operation mode	PU operation mode	Can be switched to external, PU or NET operation mode
1	PU operation mode		Fixed to PU operation mode
2	External operation mode		Fixed to External operation mode (Can be switched to NET operation mode)
3, 4	External/PU combined operation mode		External/PU combined mode fixed
6	External operation mode	PU operation mode	Can be switched to External, PU or NET operation mode with operation continued
7	X12 (MRS) ON	External operation mode	Can be switched to External, PU or NET operation mode (Output stop in External operation mode)
	X12 (MRS) OFF	External operation mode	

#### REMARKS

- The operation mode status changes depending on the setting of Pr. 340 Communication startup mode selection and the ON/OFF status of the X65 and X66 signals. (For details, refer to page 297.)
- The priorities of Pr. 79, Pr. 340 and signals are Pr. 79 > X12 > X66 > X65 > X16 > Pr. 340.

#### CAUTION

- Changing the terminal assignment using Pr. 178 to Pr. 189 (input terminal function selection) may affect the other functions. Set parameters after confirming the function of each terminal.

### (11) Switching of operation mode by external signal (X65, X66 signal)

- When Pr. 79 = any of "0, 2, 6" the operation mode switching signals (X65, X66) can be used to change the PU or External operation mode to Network operation mode during a stop (during a motor stop or start command off). (Pr. 79 = "6" switch-over mode can be changed during operation)
- When switching between the Network operation mode and PU operation mode
  - 1) Set Pr. 79 to "0" (initial value), "6".
  - 2) Set "10 or 12" in Pr. 340 Communication startup mode selection.
  - 3) Set "65" in any of Pr. 178 to Pr. 189 to assign the NET-PU operation switchover signal (X65) to the terminal.
  - 4) The operation mode changes to PU operation mode when the X65 signal turns on, or to Network operation mode when the X65 signal turns off.

Pr. 340 Setting	Pr. 79 Setting	X65 Signal State		Remarks	
		ON (PU)	OFF (NET)		
10, 12	0 (initial value)	PU operation mode *1	NET operation mode *2	—	
	1	PU operation mode		Fixed to PU operation mode	
	2	NET operation mode		Fixed to NET operation mode	
	3, 4	External/PU combined operation mode		External/PU combined mode fixed	
	6	PU operation mode *1	NET operation mode *2	Operation mode can be switched with operation continued	
	7	X12(MRS) ON	Switching among the external and PU operation mode is enabled		Output stop in External operation mode
		X12(MRS) OFF	External operation mode		Forcibly switched to External operation mode

\*1 NET operation mode when the X66 signal is on.

\*2 PU operation mode when the X16 signal is off. PU operation mode also when Pr. 550 NET mode operation command source selection = "0" (communication option control source) and the communication option is not fitted.  
External operation mode when the X16 signal is on.

- When switching between the Network operation mode and External operation mode
  - 1) Set Pr. 79 to "0" (initial value), "2", "6" or "7". (At the Pr. 79 setting of "7", the operation mode can be switched when the X12 (MRS) signal turns on.)
  - 2) Set "0 (initial value), 1 or 2" in Pr. 340 Communication startup mode selection.
  - 3) Set "66" in any of Pr. 178 to Pr. 189 to assign the NET-external operation switchover signal (X66) to the terminal.
  - 4) The operation mode changes to Network operation mode when the X66 signal turns on, or to External operation mode when the X66 signal turns off.

Pr. 340 Setting	Pr. 79 Setting	X66 Signal State		Remarks	
		ON (NET)	OFF(external)		
0 (initial value), 1, 2	0 (initial value)	NET operation mode *1	External operation mode *2	—	
	1	PU operation mode		Fixed to PU operation mode	
	2	NET operation mode *1	External operation mode	Cannot be switched to PU operation mode	
	3, 4	External/PU combined operation mode		External/PU combined mode fixed	
	6	NET operation mode *1	External operation mode *2	Operation mode can be switched with operation continued	
	7	X12(MRS) ON	NET operation mode *1	External operation mode *2	Output stop in External operation mode
		X12(MRS) OFF	External operation mode		Forcibly switched to External operation mode

\*1 PU operation mode is selected when Pr. 550 NET mode operation command source selection = "0" (communication option control source) and the communication option is not fitted.

\*2 PU operation is selected when the X16 signal is off. When the X65 signal has been assigned, the operation mode changes with the ON/OFF state of the X65 signal.

#### REMARKS

- The priorities of Pr. 79, Pr. 340 and signals are Pr. 79 > X12 > X66 > X65 > X16 > Pr. 340.

#### CAUTION

- Changing the terminal assignment using Pr. 178 to Pr. 189 (input terminal function selection) may affect the other functions. Set parameters after confirming the function of each terminal.

#### ◆ Parameters referred to ◆

- Pr. 15 Jog frequency Refer to page 150
- Pr. 4 to 6, Pr. 24 to 27, Pr. 232 to Pr. 239 Multi-speed operation Refer to page 148
- Pr. 75 Reset selection/disconnected PU detection/PU stop selection Refer to page 282
- Pr. 161 Frequency setting/key lock operation selection Refer to page 371
- Pr. 178 to Pr. 189 (input terminal function selection) Refer to page 207
- Pr. 190 to Pr. 196 (output terminal function selection) Refer to page 215
- Pr. 340 Communication startup mode selection Refer to page 298
- Pr. 550 NET mode operation command source selection Refer to page 299



### 4.23.2 Operation mode at power on (Pr. 79, Pr. 340)

When power is switched on or when power comes back on after instantaneous power failure, the inverter can be started up in Network operation mode.

After the inverter has started up in the Network operation mode, parameter write and operation can be performed from a program.

Set this mode for communication operation using the RS-485 terminals or communication option.

Parameter Number	Name	Initial Value	Setting Range	Description
79 *1	Operation mode selection	0	0 to 4, 6, 7	Select the operation mode. (Refer to page 292.)
340 *2, *3	Communication startup mode selection	0	0	As set in Pr. 79.
			1, 2	Started in Network operation mode. When the setting is "2", it will resume the pre-instantaneous power failure operation mode after an instantaneous power failure occurs.
			10, 12	Started in Network operation mode. Operation mode can be changed between the PU operation mode and Network operation mode from the operation panel. When the setting is "12", it will resume the pre-instantaneous power failure operation mode after an instantaneous power failure occurs.

The above parameters can be changed during a stop in any operation mode.

\*1 This parameter allows its setting to be changed in any operation mode even if "0 (initial value) or 1" is set in Pr. 77 Parameter write selection.

\*2 This parameter allows its setting to be changed in any operation mode even if "0 (initial value)" is set in Pr. 77 Parameter write selection.

\*3 \*The parameters can be set whenever the communication option is connected. (Refer to page 285.).

#### (1) Specify operation mode at power on (Pr. 340)

· Depending on the Pr. 79 and Pr. 340 settings, the operation mode at power on (reset) changes as described below.

Pr. 340 Setting	Pr. 79 Setting	Operation Mode at Power on, Power Restoration, Reset	Operation Mode Switching	
0 (initial value)	0 (initial value)	External operation mode	Switching among the external, PU, and NET operation mode is enabled *2	
	1	PU operation mode	Fixed to PU operation mode	
	2	External operation mode	Switching between the external and Net operation mode is enabled Switching to PU operation mode is disabled	
	3, 4	External/PU combined operation mode	Operation mode switching is disabled	
	6	External operation mode	Switching among the external, PU, and NET operation mode is enabled while running	
	7	External operation mode when X12 (MRS) signal ON	Switching among the external, PU, and NET operation mode is enabled *2	
		External operation mode when X12 (MRS) signal OFF	Fixed to External operation mode (forcibly switched to External operation mode.)	
1, 2 *1	0	NET operation mode	Same as when Pr. 340 = "0"	
	1	PU operation mode		
	2	NET operation mode		
	3, 4	External/PU combined operation mode		
	6	NET operation mode		
	7	NET operation mode when X12 (MRS) signal ON		
		External operation mode when X12 (MRS) signal OFF		
10, 12 *1	0	NET operation mode	Switching between the PU and NET operation mode is enabled *3	
	1	PU operation mode	Same as when Pr. 340 = "0"	
	2	NET operation mode	Fixed to NET operation mode	
	3, 4	External/PU combined operation mode	Same as when Pr. 340 = "0"	
	6	NET operation mode	Switching among the external, PU, and NET operation mode is enabled while running *3	
	7	External operation mode	Same as when Pr. 340 = "0"	

\*1 The Pr. 340 setting "2" or "12" is mainly used for communication operation using the inverter RS-485 terminals. When a value other than "9999" (selection of automatic restart after instantaneous power failure) is set in Pr. 57 Restart coasting time, the inverter will resume the same operation state which was in before after power has been restored from an instantaneous power failure.

When Pr. 340 = "1, 10", a start command turns off if power failure has occurred and then restored during a start command is on.

\*2 The operation mode cannot be switched directly between the PU operation mode and Network operation mode.

\*3 Operation mode can be changed between the PU operation mode and Network operation mode with  key of the operation panel (FR-DU07) and X65 signal.

#### ◆ Parameters referred to ◆

Pr. 57 Restart coasting time  Refer to page 243.

Pr. 79 Operation mode selection  Refer to page 290.

### 4.23.3 Start command source and frequency command source during communication operation (Pr. 338, Pr. 339, Pr. 550, Pr. 551)

When the RS-485 terminals or communication option is used, the external start command and frequency command can be valid. Command source in the PU operation mode can be selected.

Parameter Number	Name	Initial Value	Setting Range	Description
338	Communication operation command source	0	0	Start command source communication
			1	Start command source external
339	Communication speed command source	0	0	Frequency command source communication
			1	Frequency command source external
			2	Frequency command source external (Frequency command from communication is valid, frequency command from terminal 2 is invalid)
550 *	NET mode operation command source selection	9999	0	The communication option is the command source when NET operation mode.
			1	RS-485 terminals are the command source when NET operation mode.
			9999	Automatic communication option recognition Normally, RS-485 terminals are the command source. When a communication option is mounted, the communication option is the command source.
551 *	PU mode operation command source selection	2	1	RS-485 terminals are the command source when PU operation mode
			2	PU connector is the command source when PU operation mode.
			3	USB connector is the command source when PU operation mode.

The above parameters can be set whenever the communication option is connected. (Refer to page 285.)

\*1 This parameter can be changed during a stop in any operation mode.

\*2 This parameter allows its setting to be changed in any operation mode even if "0 (initial value)" is set in Pr. 77 Parameter write selection.

#### (1) Select the command source of the network operation mode (Pr. 550)

- Either the RS-485 terminals or communication option can be specified as the command source in network operation mode.
- For example, set Pr. 550 to "1" when executing parameter write, start command or frequency command from the inverter RS-485 terminals in the Network operation mode independently of whether the communication option is connected or not.

#### CAUTION

- Since Pr. 550 = "9999" (automatic recognition of the communication option) in the initial setting, parameter write, start command and frequency command cannot be executed by communication using the inverter RS-485 terminals when the communication option is fitted. (Monitor and parameter read can be performed.)

**(2) Select the control source of the PU operation mode (Pr. 551)**

- Any of the PU connector, RS-485 terminals, or USB connector can be specified as the source of control in the PU operation mode.
- Set Pr.551 = "1" to use the RS-485 terminals to write parameters or send start and frequency commands in the PU operation mode. Set Pr.551 = "3" to use the USB connector to do those in the PU operation mode.

**CAUTION**

- The PU operation mode has a higher priority when Pr. 550 = "1" (NET mode RS-485 terminals) and Pr. 551 = "1" (PU mode RS-485 terminals). When the communication option is not fitted, therefore, the operation mode cannot be switched to Network operation mode.
- Changed setting value is valid when powering on or resetting the inverter.

Pr. 550 Setting	Pr. 551 Setting	Operation Mode of Control Source				Remarks
		PU connector	USB connector	RS-485 terminals	Communication option	
0	1	×	×	PU operation mode <sup>*1</sup>	NET operation mode <sup>*2</sup>	
	2 (initial value)	PU operation mode	×	×	NET operation mode <sup>*2</sup>	
	3	×	PU operation mode	×	NET operation mode <sup>*2</sup>	
1	1	×	PU operation mode <sup>*1</sup>	PU operation mode <sup>*1</sup>	×	Switching to NET operation mode disabled
	2 (initial value)	PU operation mode	NET operation mode	NET operation mode	×	
	3	×	PU operation mode	NET operation mode	×	
9999 (initial value)	1	×	PU operation mode <sup>*1</sup>	PU operation mode <sup>*1</sup>	NET operation mode <sup>*2</sup>	
	2 (initial value)	PU operation mode	×	×	NET operation mode <sup>*2</sup>	Communication option fitted
			NET operation mode	NET operation mode	×	Communication option not fitted
3	×	PU operation mode	NET operation mode	×	Communication option not fitted	

\*1 The Modbus-RTU protocol cannot be used in the PU operation mode. When using the Modbus-RTU protocol, set Pr. 551 to "2".

\*2 When the communication option is not fitted, the operation mode cannot be switched to Network operation mode.

(3) Controllability through communication

Operation Location	Condition (Pr. 551 Setting)	Operation Mode	PU Operation	External Operation	External/PU Combined Operation Mode 1 (Pr. 79 = 3)	External/PU Combined Operation Mode 2 (Pr. 79 = 4)	NET Operation (when RS-485 terminals are used) *6			
		Item						NET Operation (when communication option is used) *7		
Control by RS-485 communication from PU connector	2 (PU connector)	Run command (start)	○	×	×	○	×			
		Run command (stop)	○	★ *3	★ *3	○	★ *3			
		Running frequency setting	○	×	○	×	×			
		Monitor	○	○	○	○	○			
		Parameter write	○ *4	×	○ *4	○ *4	×			
		Parameter read	○	○	○	○	○			
		Inverter reset	○	○	○	○	○			
	Except for 2	Run command (start)	×	×	×	×	×			
		Run command (stop)	★ *3	★ *3	★ *3	★ *3	★ *3			
		Running frequency setting	×	×	×	×	×			
		Monitor	○	○	○	○	○			
		Parameter write	×	×	×	×	×			
		Parameter read	○	○	○	○	○			
		Inverter reset	○	○	○	○	○			
Control by communication from RS-485 terminals	1 (RS-485 terminals)	Run command (start, stop)	○	×	×	○	×			
		Running frequency setting	○	×	○	×	×			
		Monitor	○	○	○	○	○			
		Parameter write	○ *4	×	○ *4	○ *4	×			
		Parameter read	○	○	○	○	○			
		Inverter reset	○	○	○	○	○			
	Except for 1	Run command (start, stop)	×	×	×	×	○ *1	×		
		Running frequency setting	×	×	×	×	○ *1	×		
		Monitor	○	○	○	○	○	○		
		Parameter write	×	×	×	×	○ *4	×		
		Parameter read	○	○	○	○	○	○		
		Inverter reset	×	×	×	×	○ *2	×		
		Operation from the USB connector	3 (USB connector)	Run command (start, stop)	○	×	×	○	×	
				Running frequency setting	○	×	○	×	×	
Monitor	○			○	○	○	○			
Parameter write	○ *4			×	×	×	×			
Parameter read	○			○	○	○	○			
Inverter reset	○			○	○	○	○			
Except for 3	Run command (start, stop)		×	×	×	×	×			
	Running frequency setting		×	×	×	×	×			
	Monitor		○	○	○	○	○			
	Parameter write		×	×	×	×	×			
	Parameter read		○	○	○	○	○			
	Inverter reset		○	○	○	○	○			
	Control by communication from communication option		—	Run command (start, stop)	×	×	×	×	×	○ *1
				Running frequency setting	×	×	×	×	×	×
Monitor		○		○	○	○	○	○	○	
Parameter write		×		×	×	×	×	×	○ *4	
Parameter read		○		○	○	○	○	○	○	
Inverter reset		×		×	×	×	×	×	○ *2	

○: Enabled, ×: Disabled, ★: Some are enabled

Operation Location	Condition (Pr. 551 Setting)	Operation Mode Item	PU Operation	External Operation	External/PU Combined Operation Mode 1 (Pr. 79 = 3)	External/PU Combined Operation Mode 2 (Pr. 79 = 4)	NET Operation (when RS-485 terminals are used) *6	NET Operation (when communication option is used) *7
Control circuit external terminals	—	Inverter reset	○	○	○	○		○
		Run command (start, stop)	×	○	○	×		× *1
		Frequency setting	×	○	×	○		× *1

○: Enabled, ×: Disabled, ★ : Some are enabled

- \*1 As set in Pr. 338 Communication operation command source and Pr. 339 Communication speed command source. (Refer to page 299)
- \*2 At occurrence of RS-485 communication error, the inverter cannot be reset from the computer.
- \*3 Enabled only when stopped by the PU. At a PU stop, PS is displayed on the operation panel. As set in Pr. 75 Reset selection/disconnected PU detection/PU stop selection. (Refer to page 282)
- \*4 Some parameters may be write-disabled according to the Pr. 77 Parameter write selection setting and operating status. (Refer to page 284)
- \*5 Some parameters are write-enabled independently of the operation mode and command source presence/absence. When Pr. 77 = 2, write is enabled. (Refer to page 55 for the parameter list)Parameter clear is disabled.
- \*6 When Pr. 550 NET mode operation command source selection = 1 (RS-485 terminals valid) or Pr. 550 NET mode operation command source selection = 9999 and the communication option is not fitted.
- \*7 When Pr. 550 NET mode operation command source selection = 0 (communication option valid) or Pr. 550 NET mode operation command source selection = 9999 and the communication option is fitted.

#### (4) Operation at alarm occurrence

Alarm Definition	Condition (Pr. 551 setting)	Operation Mode	PU Operation	External Operation	External/PU Combined Operation Mode 1 (Pr. 79 = 3)	External/PU Combined Operation Mode 2 (Pr. 79 = 4)	NET Operation (when RS-485 terminals are used) *5	NET Operation (when communication option is used) *6
Inverter fault	—		Stop					
PU disconnection of the PU connector	2 (PU connector)		Stop/continued *1, 4					
	Except for 2		Stop/continued *1					
Communication alarm of PU connector	2 (PU connector)	Stop/continued *2	Continued		Stop/continued *2		Continued	
	Except for 2		Continued					
Communication alarm of RS-485 terminals	1 (RS-485 terminals)	Stop/continued *2	Continued		Stop/continued *2		Continued	
	Except for 1		Continued				Stop/continued *2	Continued
Communication alarm of USB connector	3 (USB connector)	Stop/continued *2	Continued					
	Except for 3		Continued					
Communication alarm of communication option	—		Continued				Stop/continued *3	Continued

- \*1 Can be selected using Pr. 75 Reset selection/disconnected PU detection/PU stop selection
- \*2 Can be selected using Pr. 122 PU communication check time interval, Pr. 336 RS-485 communication check time interval or Pr. 548 USB communication check time interval.
- \*3 As controlled by the communication option.
- \*4 In the PU jog operation mode, operation is always stopped when the PU is disconnected. Whether fault (E.PUE) occurrence is allowed or not is as set in Pr. 75 Reset selection/disconnected PU detection/PU stop selection.
- \*5 When Pr. 550 NET mode operation command source selection = 1 (RS-485 terminals valid) or Pr. 550 NET mode operation command source selection = 9999 and the communication option is not fitted
- \*6 When Pr. 550 NET mode operation command source selection = 0 (communication option valid) or Pr. 550 NET mode operation command source selection = 9999 and the communication option is fitted

**(5) Selection of control source in network operation mode (Pr. 338, Pr. 339)**

- There are two control sources: operation command source, which controls the signals related to the inverter start command and function selection, and speed command source, which controls signals related to frequency setting.
- In Network operation mode, the commands from the external terminals and communication (RS-485 terminals or communication option) are as listed below.

Operation Location Selection	Pr. 338 Communication operation command source			0: NET			1: External			Remarks
	Pr. 339 Communication speed command source			0: NET	1:External	2:External	0: NET	1:External	2:External	
Fixed function (Terminal-equivalent function)	Running frequency from communication			NET	—	NET	NET	—	NET	
	Terminal 2			—	External	—	—	External	—	
	Terminal 4			—	External		—	External		
	Terminal 1			Compensation						
Selective function Pr. 178 to Pr. 189 setting	0	RL	Low speed operation command/remote setting clear stop-on-contact selection 0	NET	External		NET	External		Pr. 59 = "0" (multi-speeds) Pr. 59 = "1, 2" (remote) Pr. 270 = "1, 3" (stop-on-contact)
	1	RM	Middle-speed operation command/remote set deceleration	NET	External		NET	External		
	2	RH	High speed operation command/remote set acceleration	NET	External		NET	External		
	3	RT	Second function selection/ Stop-on contact selection 1	NET			External			Pr. 270 = "1, 3" (stop-on-contact)
	4	AU	Current input selection	—	Combined		—	Combined		
	5	JOG	Jog operation selection	—			External			
	6	CS	Selection of automatic restart after instantaneous power failure	External						
	7	OH	External thermal relay input	External						
	8	REX	Fifteen speed selection	NET	External		NET	External		Pr. 59 = "0" (multi-speeds)
	9	X9	Third function selection	NET			External			
	12	X12	PU operation external interlock	External						
	13	X13	External DC injection brake operation start	NET			External			
	14	X14	PID control valid terminal	NET	External		NET	External		
	15	BRI	Brake opening completion signal	NET			External			
	16	X16	PU-external operation switchover	External						
	17	X17	Load pattern selection forward rotation reverse rotation boost	NET			External			
	18	X18	V/F switching	NET			External			
	19	X19	Load torque high-speed frequency	NET			External			
	20	X20	S-pattern acceleration/deceleration C switchover	NET			External			
	22	X22	Orientation command	NET			External			
23	LX	Pre-excitation	NET			External				
24	MRS	Output stop	Combined			External			Pr. 79 ≠ "7"	
		PU operation interlock	External						Pr. 79 = "7" When X12 signal is not assigned	
25	STOP	Start self-holding selection	—			External				
26	MC	Control mode switchover	NET			External				
27	TL	Torque limit selection	NET			External				
28	X28	Start-time tuning start external input	NET			External				

Operation Location Selection	Pr. 338 Communication operation command source		0: NET			1: External			Remarks	
	Pr. 339 Communication speed command source		0: NET	1:External	2:External	0: NET	1:External	2:External		
Selective function Pr. 178 to Pr. 189 setting	42	X42	Torque bias selection 1		NET			External		
	43	X43	Torque bias selection 2		NET			External		
	44	X44	P/PI control switchover		NET			External		
	60	STF	Forward rotation command		NET			External		
	61	STR	Reverse rotation command		NET			External		
	62	RES	Reset		External					
	63	PTC	PID forward action switchover		External					
	64	X64	PID forward action switchover		NET	External	NET	External		
	65	X65	PU-NET operation switchover		External					
	66	X66	External-NET operation switchover		External					
	67	X67	Command source switchover		External					
	68	NP	Simple position pulse train sign		External					
	69	CLR	Simple position droop pulse clear		External					
	74	X74	Magnetic flux decay output shutoff		NET		External			

**[Explanation of table]**

- External : Control is valid only from external terminal signal.
- NET : Control only from communication is valid
- Combined : Control is valid from either of external terminal and communication.
- : Control is invalid from either of external terminal and communication.
- Compensation : Control by signal from external terminal is only valid when Pr. 28 Multi-speed input compensation selection = "1"

**REMARKS**

- The command source of communication is as set in Pr. 550 and Pr. 551.
- The Pr. 338 and Pr. 339 settings can be changed during operation when Pr. 77 = 2. Note that the setting change is reflected after the inverter has stopped. Until the inverter has stopped, communication operation command source and communication speed command source before the setting change are valid.

**(6) Switching of command source by external terminal (X67)**

- In Network operation mode, the command source switching signal (X67) can be used to switch the start command source and speed command source. This signal can be utilized to control the signal input from both the control terminal and communication.
- Set "67" in any of Pr. 178 to Pr. 189 (input terminal function selection) to assign the X67 signal to the control terminal.
- When the X67 signal is off, the start command source and speed command source are control terminal.

X67 Signal State	Start Command Source	Speed Command Source
No signal assignment	According to Pr. 338	According to Pr. 339
ON		
OFF	Command is valid only from control terminal signal.	

**REMARKS**

- The ON/OFF state of the X67 signal is reflected only during a stop. It is reflected after a stop when the terminal is switched during operation.
- When the X67 signal is off, a reset via communication is disabled.

**CAUTION**

- Changing the terminal assignment using Pr. 178 to Pr. 189 (input terminal function selection) may affect the other functions. Set parameters after confirming the function of each terminal.

◆ Parameters referred to ◆

- Pr. 28 Multi-speed input compensation selection Refer to page 152.
- Pr. 59 Remote function selection Refer to page 152.
- Pr. 79 Operation mode selection Refer to page 290.

## 4.24 Communication operation and setting

Purpose	Parameter that must be Set		Refer to Page
Communication operation from PU connector	Initial setting of computer link communication (PU connector)	Pr. 117 to Pr. 124	310
Communication operation from RS-485 terminals	Initial setting of computer link communication (RS-485 terminals)	Pr. 331 to Pr. 337, Pr. 341	
	Modbus-RTU communication specifications	Pr. 331, Pr. 332, Pr. 334, Pr. 343, Pr. 549	324
Restrictions on parameter write through communication	Communication EEPROM write selection	Pr. 342	311
Communication using USB (FR Configurator)	USB communication	Pr. 547, Pr. 548	337

### 4.24.1 Wiring and configuration of PU connector

Using the PU connector, you can perform communication operation from a personal computer etc. When the PU connector is connected with a personal, FA or other computer by a communication cable, a user program can run and monitor the inverter or read and write to parameters.

#### (1) PU connector pin-outs

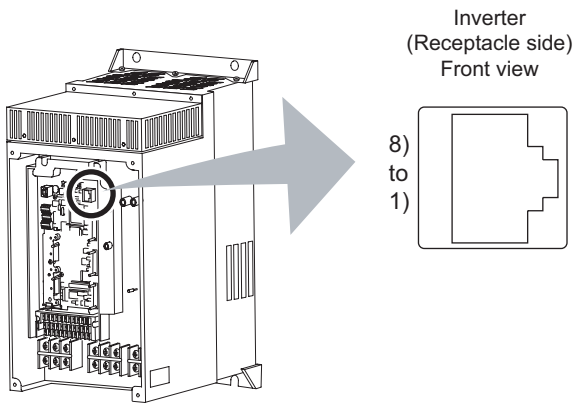

Pin Number	Name	Description
1)	SG	Earth (Ground) (connected to terminal 5)
2)	—	Operation panel power supply
3)	RDA	Inverter receive+
4)	SDB	Inverter send-
5)	SDA	Inverter send+
6)	RDB	Inverter receive-
7)	SG	Earth (Ground) (connected to terminal 5)
8)	—	Operation panel power supply

#### CAUTION

- Pins No. 2 and 8 provide power to the operation panel or parameter unit. Do not use these pins for RS-485 communication.
- Do not connect the PU connector to the computer's LAN board, FAX modem socket or telephone modular connector. The product could be damaged due to differences in electrical specifications.



(2) PU connector communication system configuration and wiring

● System configuration

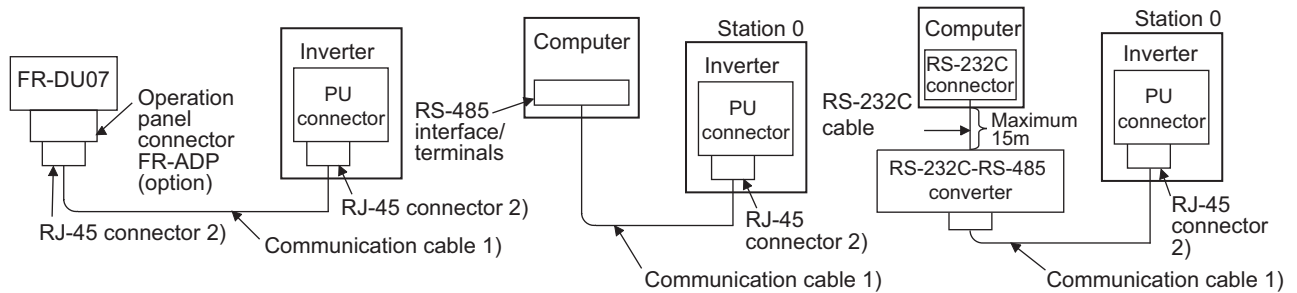

● Connection with RS-485 computer

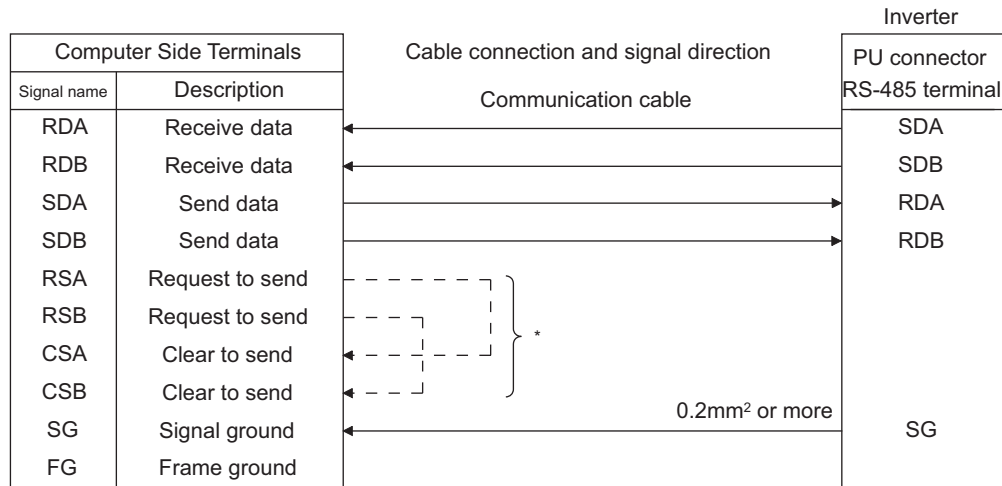

\* Make connections in accordance with the manual of the computer used. Fully check the terminal numbers of the computer since they change with the model.

**REMARKS**

- Refer to the following when fabricating the cable on the user side. Commercially available product examples (as of January 2010)

	Product	Type	Maker
1)	Communication cable	SGLPEV-T (Cat5e/300m) 24AWG × 4P *	Mitsubishi Cable Industries, Ltd.
2)	RJ-45 connector	5-554720-3	Tyco Electronics

\* Do not use pins No. 2, 8 of the 10-BASE-T cable.

**CAUTION**

When performing RS-485 communication with multiple inverters, use the RS-485 terminals. (Refer to page 308)

### 4.24.2 Wiring and arrangement of RS-485 terminals

#### (1) RS-485 terminal layout

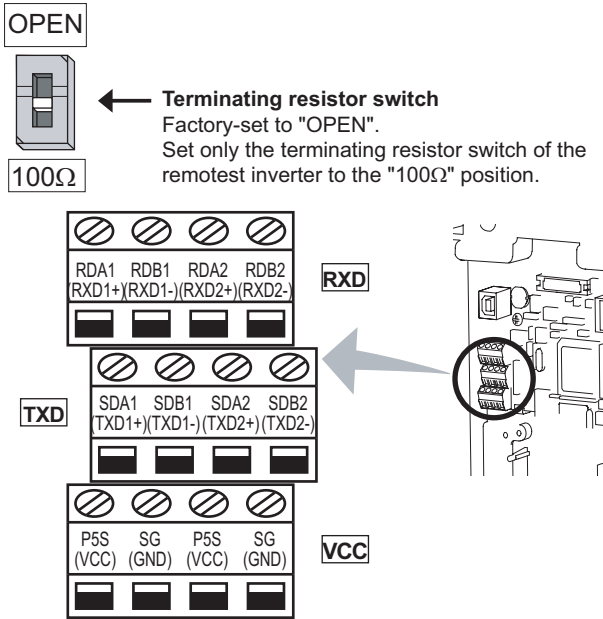

Name	Description
RDA1 (RXD1+)	Inverter receive+
RDB1 (RXD1-)	Inverter receive-
RDA2 (RXD2+)	Inverter receive+ (for branch)
RDB2 (RXD2-)	Inverter receive- (for branch)
SDA1 (TXD1+)	Inverter send+
SDB1 (TXD1-)	Inverter send-
SDA2 (TXD2+)	Inverter send+ (for branch)
SDB2 (TXD2-)	Inverter send- (for branch)
P5S (VCC)	5V Permissible load current 100mA
SG (GND)	Earth (Ground) (connected to terminal SD)

#### (2) Connection of RS-485 terminals and wires

Loosen the terminal screw and insert the cable into the terminal.

<b>Screw size</b>	M2
<b>Tightening torque</b>	0.22N•m to 0.25N•m
<b>Cable size</b>	0.3mm <sup>2</sup> to 0.75mm <sup>2</sup>
<b>Screwdriver</b>	Small ⊖ flat-blade screwdriver (Tip thickness: 0.4mm / tip width: 2.5mm)

Wire the stripped cable after twisting it to prevent it from becoming loose. In addition, do not solder it.



Use a blade terminal as necessary.

#### CAUTION

Undertightening can cause signal loss or malfunction. Overtightening can cause a short circuit or malfunction due to damage to the screw or unit.

#### REMARKS

##### Information on blade terminals

Commercially available products (as of January 2010)

●Phoenix Contact Co.,Ltd.

Terminal Screw Size	Wire Size (mm <sup>2</sup> )	Blade Terminal Model		Blade terminal crimping tool
		with insulation sleeve	without insulation sleeve	
M2	0.3, 0.5	AI 0,5-6WH	A 0,5-6	CRIMPFOX 6

●NICHIFU Co.,Ltd.

Terminal Screw Size	Wire Size (mm <sup>2</sup> )	Blade terminal product number	Insulation product number	Blade terminal crimping tool
M2	0.3 to 0.75	BT 0.75-7	VC 0.75	NH 67

Use shielded or twisted cables for connection to the control circuit terminals and run them away from the main and power circuits (including the 200V relay sequence circuit).

When using the bar terminal (without insulation sleeve), use care so that the twisted wires do not come out.

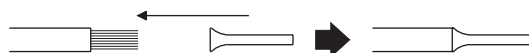

**(3) RS-485 terminal system configuration**

**● Connection of a computer to the inverter (1:1 connection)**

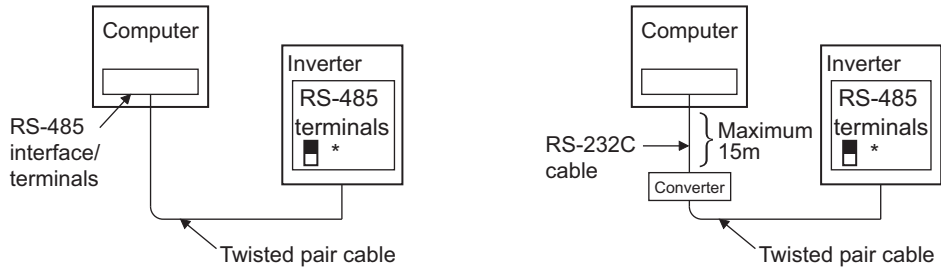

\*Set the terminating resistor switch to the "100Ω" position.

**● Combination of computer and multiple inverters (1:n connection)**

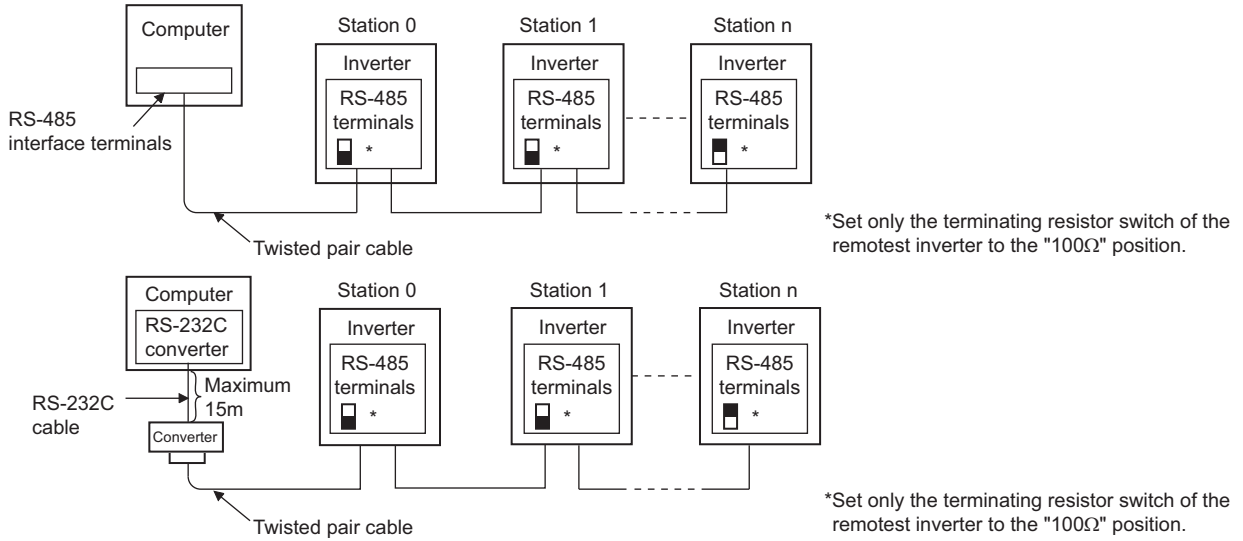

(4) RS-485 terminal wiring method

● Wiring of one RS-485 computer and one inverter

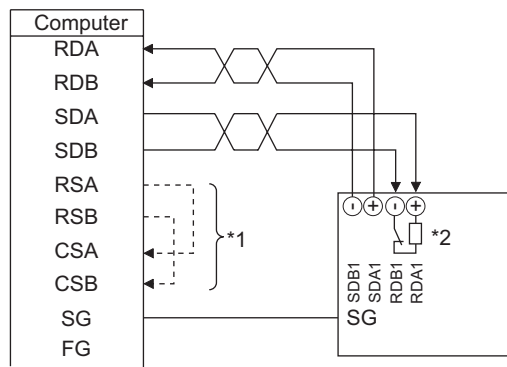

● Wiring of one RS-485 computer and "n" inverters (several inverters)

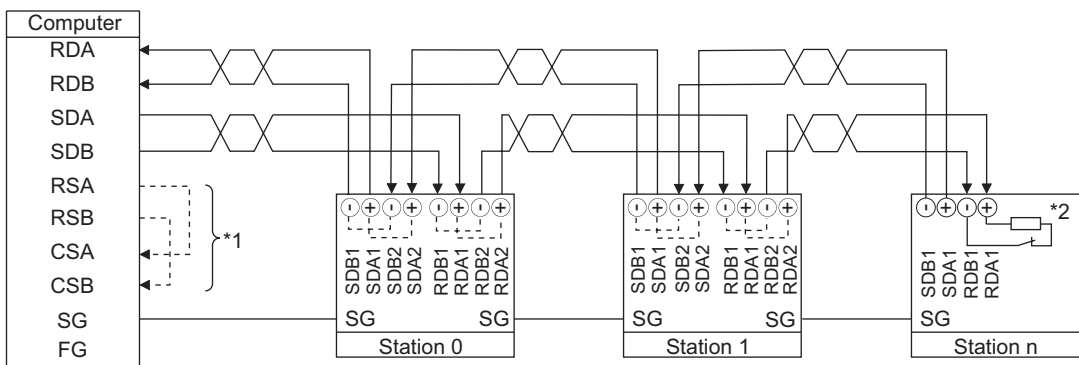

- \*1 Make connections in accordance with the manual of the computer used. Fully check the terminal numbers of the computer since they change with the model.
- \*2 For the inverter farthest from the computer, set the terminating resistor switch to ON (100Ω side).

REMARKS

For branching, connect the wires as shown below.

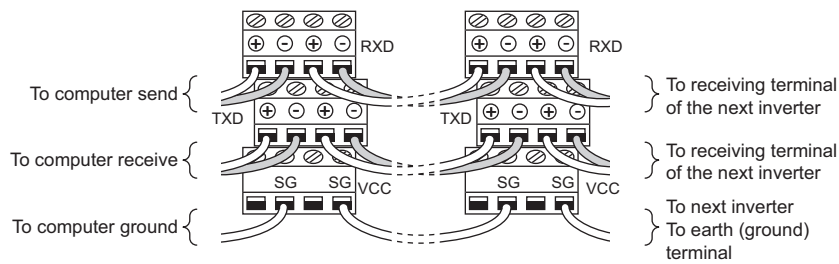

(5) 2-wire type connection

If the computer is 2-wire type, pass wires across receiving terminals and transmission terminals of the RS-485 terminals to enable 2-wire type connection with the inverter.

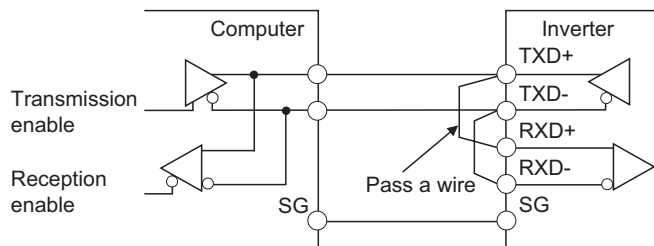

REMARKS

- A program should be created so that transmission is disabled (receiving state) when the computer is not sending and reception is disabled (sending state) during sending to prevent the computer from receiving its own data.

### 4.24.3 Initial settings and specifications of RS-485 communication (Pr. 117 to Pr. 124, Pr. 331 to Pr. 337, Pr. 341, Pr. 549)

Used to perform required settings for communication between the inverter and personal computer.

- There are two different communications: communication using the PU connector of the inverter and communication using the RS-485 terminals.
- You can perform parameter setting, monitor, etc. from the PU connector or RS-485 terminals of the inverter using the Mitsubishi inverter protocol (computer link communication).
- To make communication between the personal computer and inverter, initialization of the communication specifications must be made to the inverter.  
Data communication cannot be made if the initial settings are not made or there is any setting error.

#### [PU connector communication related parameter]

Parameter Number	Name	Initial Value	Setting Range	Description	
117	PU communication station number	0	0 to 31	Specify the inverter station number. Set the inverter station numbers when two or more inverters are connected to one personal computer.	
118	PU communication speed	192	48, 96, 192, 384	Set the communication speed. The setting value × 100 equals the communication speed. For example, the communication speed is 19200bps when the setting value is "192".	
119	PU communication stop bit length	1		Stop bit length	Data length
			0	1 bit	8 bits
			1	2 bits	
			10	1 bit	7 bits
11	2 bits				
120	PU communication parity check	2	0	Without parity check	
			1	With odd parity check	
			2	With even parity check	
121	Number of PU communication retries	1	0 to 10	Set the permissible number of retries at occurrence of a data receive error. If the number of consecutive errors exceeds the permissible value, the inverter trips.	
			9999	If a communication error occurs, the inverter will not trip.	
122	PU communication check time interval	9999	0	No PU connector communication	
			0.1 to 999.8s	Set the interval of communication check (signal loss detection) time. If a no-communication state persists for longer than the permissible time, the inverter trips.	
			9999	No communication check (signal loss detection)	
123	PU communication waiting time setting	9999	0 to 150ms	Set the waiting time between data transmission to the inverter and response.	
			9999	Set with communication data.	
124	PU communication CR/LF selection	1	0	Without CR/LF	
			1	With CR	
			2	With CR/LF	

[RS-485 terminal communication related parameter]

Parameter Number	Name	Initial Value	Setting Range	Description
331	RS-485 communication station number	0	0 to 31 (0 to 247) <sup>*1</sup>	Set the inverter station number. (same specifications as <i>Pr. 117</i> )
332	RS-485 communication speed	96	3, 6, 12, 24, 48, 96, 192, 384	Used to select the communication speed. (same specifications as <i>Pr. 118</i> )
333 <sup>*2</sup>	RS-485 communication stop bit length	1	0, 1, 10, 11	Select stop bit length and data length. (same specifications as <i>Pr. 119</i> )
334	RS-485 communication parity check selection	2	0, 1, 2	Select the parity check specifications. (same specifications as <i>Pr. 120</i> )
335 <sup>*3</sup>	RS-485 communication retry count	1	0 to 10, 9999	Set the permissible number of retries at occurrence of a data receive error. (same specifications as <i>Pr. 121</i> )
336 <sup>*3</sup>	RS-485 communication check time interval	0s	0	RS-485 communication can be made, but the inverter trips in the NET operation mode.
			0.1 to 999.8s	Set the interval of communication check (signal loss detection) time. (same specifications as <i>Pr. 122</i> )
			9999	No communication check (signal loss detection)
337 <sup>*3</sup>	RS-485 communication waiting time setting	9999	0 to 150ms, 9999	Set the waiting time between data transmission to the inverter and response. (same specifications as <i>Pr. 123</i> )
341 <sup>*3</sup>	RS-485 communication CR/LF selection	1	0, 1, 2	Select presence/absence of CR/LF. (same specifications as <i>Pr. 124</i> )
549	Protocol selection	0	0	Mitsubishi inverter (computer link) protocol
			1	Modbus-RTU protocol <sup>*4</sup>

\*1 When "1" (Modbus-RTU protocol) is set in *Pr. 549*, the setting range within parenthesis is applied.

\*2 For the Modbus-RTU protocol, the data length is fixed to 8 bits and the stop bit depends on the *Pr. 334* setting. (Refer to page 324)

\*3 Invalid during the Modbus-RTU protocol.

\*4 The Modbus-RTU protocol is valid for only communication from the RS-485 terminals.

**CAUTION**

- If communication is made without *Pr. 336 RS-485 communication check time interval* being changed from "0" (initial value), monitor, parameter read, etc. can be performed, but the inverter results in a fault as soon as it is switched to the NET operation mode. If the operation mode at power on is the Network operation mode, a communication fault (E.SER) occurs after first communication.

When performing operation or parameter write through communication, set "9999" or a greater value to *Pr. 336*. (The setting depends on the computer side program.) (Refer to page 316)

- Always reset the inverter after making the initial settings of the parameters. After you have changed the communication-related parameters, communication cannot be made until the inverter is reset.

**4.24.4 Communication EEPROM write selection (Pr. 342)**

When parameter write is performed from PU connector, RS-485 terminal, USB communication, and communication option connected to the inverter, parameter's storage device can be changed from EEPROM + RAM to only RAM. Set this parameter when frequent parameter changes are required.

Parameter Number	Name	Initial Value	Setting Range	Description
342	Communication EEPROM write selection	0	0	Parameter values written by communication are written to the EEPROM and RAM.
			1	Parameter values written by communication are written to the RAM.

The above parameters can be set any time when the communication option is connected. (Refer to page 285)

- When changing the parameter values frequently, set "1" in *Pr. 342* to write them to the RAM. The life of the EEPROM will be shorter if parameter write is performed frequently with the setting unchanged from "0 (initial value)" (EEPROM write).

**REMARKS**

- When *Pr. 342* is set to "1" (only RAM write), the new values of the parameters will be cleared at power supply-off of the inverter. Therefore, the parameter values available when power is switched on again are the values stored in EEPROM previously.

### 4.24.5 Mitsubishi inverter protocol (computer link communication)

You can perform parameter setting, monitor, etc. from the PU connector or RS-485 terminals of the inverter using the Mitsubishi inverter protocol (computer link communication).

#### (1) Communication specifications

The communication specifications are given below.

Item		Description	Related Parameters
Communication protocol		Mitsubishi protocol (computer link)	Pr. 551
Conforming standard		EIA-485 (RS-485)	—
Number of inverters connected		1:N (maximum 32 units), setting is 0 to 31 stations	Pr. 117 Pr. 331
Communication speed	PU connector	Selected among 4800/9600/19200/38400bps	Pr. 118
	RS-485 terminal	Selected among 300/600/1200/2400/4800/9600/19200/38400bps	Pr. 332
Control protocol		Asynchronous system	—
Communication method		Half-duplex system	—
Communication specifications	Character system	ASCII (7 bits or 8 bits can be selected)	Pr. 119 Pr. 333
	Start bit	1bit	—
	Stop bit length	1 bit or 2 bits can be selected	Pr. 119 Pr. 333
	Parity check	Check (with even or odd parity) or no check can be selected	Pr. 120 Pr. 334
	Error check	Sum code check	—
	Terminator	CR/LF (presence or absence can be selected)	Pr. 124 Pr. 341
Waiting time setting		Selectable between presence and absence	Pr. 123 Pr. 337

#### (2) Communication procedure

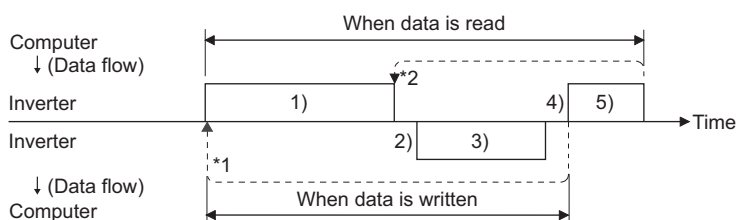

Data communication between the computer and inverter is made in the following procedure.

- 1) Request data is sent from the computer to the inverter. (The inverter will not send data unless requested.)
- 2) After waiting for the waiting time
- 3) The inverter sends reply data to the computer in response to the computer request.
- 4) After having waited for the time taken for inverter processing
- 5) Answer from computer in response to reply data 3) is sent. (Even if 5) is not sent, subsequent communication is made properly.)

\*1 If a data error is detected and a retry must be made, execute retry operation with the user program. The inverter comes to trip if the number of consecutive retries exceeds the parameter setting.

\*2 On receipt of a data error occurrence, the inverter returns "reply data 3)" to the computer again. The inverter comes to trip if the number of consecutive data errors reaches or exceeds the parameter setting.

**(3) Communication operation presence/absence and data format types**

- Data communication between the computer and inverter is made in ASCII code (hexadecimal code).
- Communication operation presence/absence and data format types are as follows:

Symbol	Operation	Run Command	Running Frequency	Parameter Write	Inverter Reset	Monitor	Parameter Read	
1)	Communication request is sent to the inverter in accordance with the user program in the computer.	A A'	A	A	A	B	B	
2)	Inverter data processing time	Present	Present	Present	Absent	Present	Present	
3)	Reply data from the inverter (Data 1) is checked for error)	No error *1 (Request accepted)	C	C	C	C *2	E E'	E
		With error. (Request rejected)	D	D	D	D *2	D	D
4)	Computer processing delay time	10ms or more						
5)	Answer from computer in response to reply data 3) (Data 3) is checked for error)	No error *1 (No inverter processing)	Absent	Absent	Absent	Absent	Absent (C)	Absent (C)
		With error (Inverter re-outputs 3))	Absent	Absent	Absent	Absent	F	F

\*1 In the communication request data from the computer to the inverter, 10ms or more is also required after "no data error (ACK)". (Refer to page 314)

\*2 The inverter response to the inverter reset request can be selected. (Refer to page 319)

1) Communication request data from the computer to the inverter

Format	Number of Characters												
	1	2	3	4	5	6	7	8	9	10	11	12	13
<b>A</b> (Data write)	ENQ *1	Inverter station number *2	Instruction code		Waiting time *3	Data					Sum check		*4
<b>A'</b> (Data write)	ENQ *1	Inverter station number *2	Instruction code		Waiting time *3	Data			Sum check		*4		
<b>B</b> (Data read)	ENQ *1	Inverter station number *2	Instruction code		Waiting time *3	Sum check		*4					

3) Reply data from the inverter to the computer

- When data is written

Format	Number of Characters				
	1	2	3	4	5
<b>C</b> (No data error detected)	ACK *1	Inverter station number *2	*4		
<b>D</b> (Data error detected)	NAK *1	Inverter station number *2	Error Code	*4	

- When data is read

Format	Number of Characters										
	1	2	3	4	5	6	7	8	9	10	11
<b>E</b> (No data error detected)	STX *1	Inverter station number *2	Read data					ETX *1	Sum check		*4
<b>E'</b> (No data error detected)	STX *1	Inverter station number *2	Read data			ETX *1	Sum check		*4		
<b>D</b> (Data error detected)	NAK *1	Inverter station number *2	Error Code	*4							

5) Send data from the computer to the inverter during data read

Format	Number of Characters			
	1	2	3	4
<b>C</b> (No data error detected)	ACK *1	Inverter station number *2	*4	
<b>F</b> (Data error detected)	NAK *1	Inverter station number *2	*4	

\*1 Indicate a control code

\*2 Specify the inverter station numbers between H00 and H1F (stations 0 to 31) in hexadecimal.

\*3 When Pr. 123, Pr. 337 (waiting time setting) ≠ "9999", create the communication request data without "waiting time" in the data format. (The number of characters decreases by 1.)

\*4 CR, LF code

When data is transmitted from the computer to the inverter, CR (carriage return) and LF (line feed) codes are automatically set at the end of a data group on some computers. In this case, setting must also be made on the inverter according to the computer. Whether the CR and LF codes will be present or absent can be selected using Pr. 124 or Pr. 341 (CR/LF selection).



**(4) Data definitions**

1) Control codes

Signal Name	ASCII Code	Description
STX	H02	Start Of Text (start of data)
ETX	H03	End Of Text (end of data)
ENQ	H05	Enquiry (communication request)
ACK	H06	Acknowledge (no data error detected)
LF	H0A	Line Feed
CR	H0D	Carriage Return
NAK	H15	Negative Acknowledge (data error detected)

2) Inverter station number

Specify the station number of the inverter which communicates with the computer.

3) Instruction code

Specify the processing request, e.g. operation or monitoring, given by the computer to the inverter. Hence, the inverter can be run and monitored in various ways by specifying the instruction code as appropriate. (Refer to page 439)

4) Data

Indicates the data such as frequency and parameters transferred to and from the inverter. The definitions and ranges of set data are determined in accordance with the instruction codes. (Refer to page 439)

5) Waiting time

Specify the waiting time between the receipt of data at the inverter from the computer and the transmission of reply data. Set the waiting time in accordance with the response time of the computer between 0 and 150ms in 10ms increments (e.g. 1 = 10ms, 2 = 20ms).

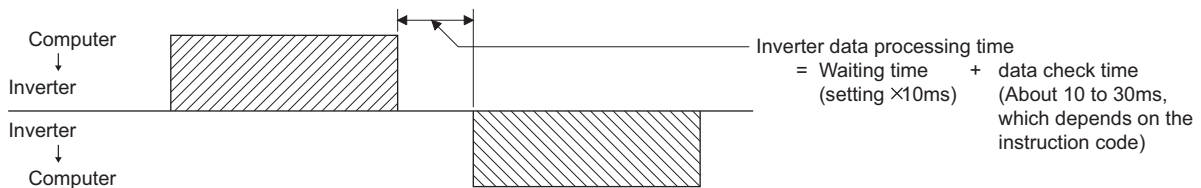

**REMARKS**

- When Pr. 123, Pr. 337 (waiting time setting) ≠ "9999", create the communication request data without "waiting time" in the data format. (The number of characters decreases by 1.)
- The data check time changes depending on the instruction code. (Refer to page 315)

6) Sum check code

The sum check code is 2-digit ASCII (hexadecimal) representing the lower 1 byte (8 bits) of the sum (binary) derived from the checked ASCII data

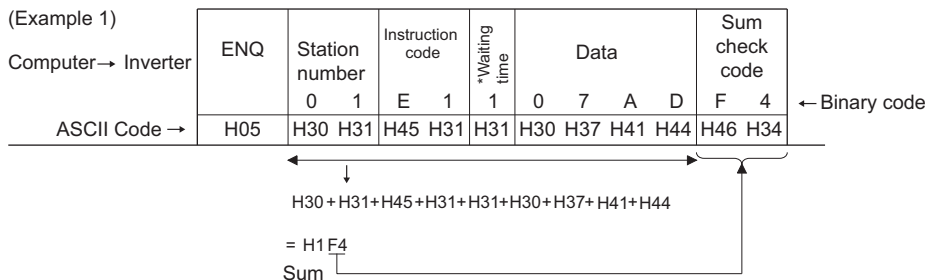

\* When the Pr. 123 Waiting time setting ≠ "9999", create the communication request data without "waiting time" in the data format. (The number of characters decreases by 1.)

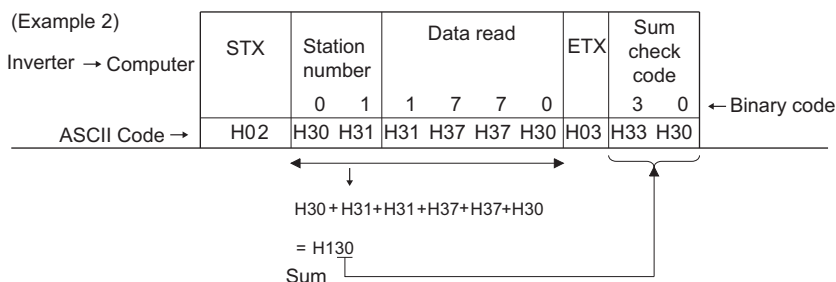

7) Error Code

If any error is found in the data received by the inverter, its definition is sent back to the computer together with the NAK code.

Error Code	Error Item	Error Description	Inverter Operation
H0	Computer NAK error	The number of errors consecutively detected in communication request data from the computer is greater than allowed number of retries.	Brought to trip if error occurs continuously more than the allowable number of retries. (E.PUE/E.SER)
H1	Parity error	The parity check result does not match the specified parity.	
H2	Sum check error	The sum check code in the computer does not match that of the data received by the inverter.	
H3	Protocol error	The data received by the inverter has a grammatical mistake. Alternatively, data receive is not completed within the predetermined time. CR or LF is not as set in the parameter.	
H4	Framing error	The stop bit length differs from the initial setting.	
H5	Overrun error	New data has been sent by the computer before the inverter completes receiving the preceding data.	
H6	—	—	—
H7	Character error	The character received is invalid (other than 0 to 9, A to F, control code).	Does not accept received data but is not brought to trip.
H8	—	—	—
H9	—	—	—
HA	Mode error	Parameter write was attempted in other than the computer link operation mode, when operation command source is not selected or during inverter operation.	Does not accept received data but is not brought to trip.
HB	Instruction code error	The specified command does not exist.	
HC	Data range error	Invalid data has been specified for parameter write, frequency setting, etc.	
HD	—	—	
HE	—	—	—
HF	—	—	—

(5) Response time

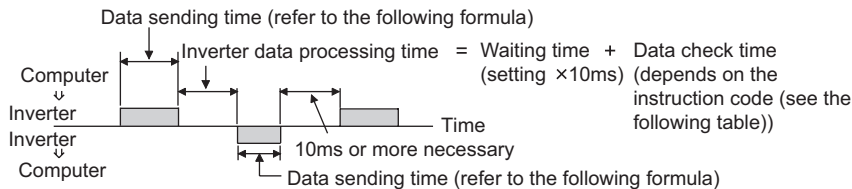

[Formula for data sending time]

$$\frac{1}{\text{Communication speed (bps)}} \times \text{Number of data characters (Refer to page 313)} \times \text{Communication specifications (total number of bits) (See below.)} = \text{Data send time (s)}$$

●Communication specifications

Name	Number of Bits	
Stop bit length	1 bit 2 bits	
Data length	7 bits 8 bits	
Parity check	Yes	1 bit
	No	0

In addition to the above, 1 start bit is necessary.  
 Minimum number of total bits..... 9 bits  
 Maximum number of total bits..... 12 bits

●Data check time

Item	Check Time
Various monitors, run command, frequency setting (RAM)	< 12ms
Parameter read/write, frequency setting (EEPROM)	< 30ms
Parameter clear/all clear	< 5s
Reset command	No answer

**(6) Retry count setting (Pr. 121, Pr. 335)**

- Set the permissible number of retries at occurrence of a data receive error. (Refer to page 315 for data receive error for retry)
- When data receive errors occur consecutively and exceed the permissible number of retries set, an inverter trips (E.PUE) and a motor stops.
- When "9999" is set, the inverter will not trip even if data receive error occurs but an alarm output signal (LF) is output. For the terminal used for the LF signal output, assign the function by setting "98 (positive logic) or 198 (negative logic)" in any of Pr. 190 to Pr. 196 (output terminal function selection).

Example: PU connector communication, Pr. 121 = "1" (initial value)

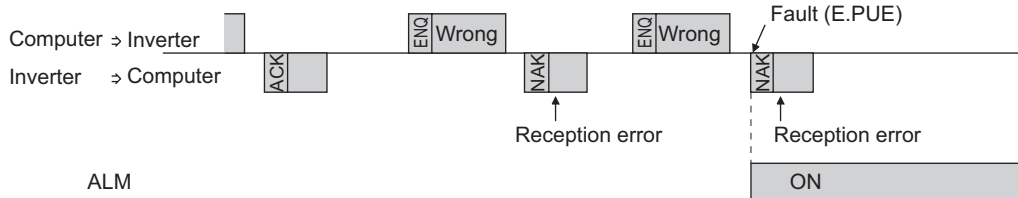

Example: PU connector communication, Pr. 121 = "9999"

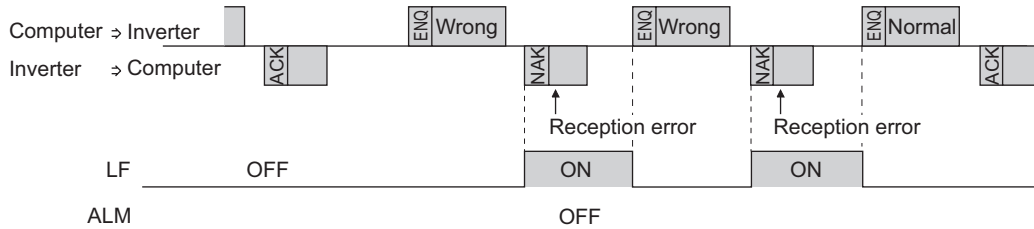

**(7) Signal loss detection (Pr. 122, Pr. 336 RS-485 communication check time interval)**

- If a signal loss (communication stop) is detected between the inverter and computer as a result of a signal loss detection, a communication fault (PU connector communication: E.PUE, RS-485 terminal communication: E.SER) occurs and the inverter trips.
- When the setting is "9999", communication check (signal loss detection) is not made.
- When the setting is "0", communication from the PU connector cannot be performed. For communication via the RS-485 terminals, monitor, parameter read, etc. can be performed, but a communication fault (E.SER) occurs as soon as the inverter is switched to Network operation mode.
- A signal loss detection is made when the setting is any of "0.1s" to "999.8s". To make a signal loss detection, it is necessary to send data (control code refer to page 314) from the computer within the communication check time interval. (The send data has nothing to do with the station number)
- Communication check is started at the first communication in the operation mode having the operation source (PU operation mode for PU connector communication in the initial setting or Network operation mode for RS-485 terminal communication).

Example: PU connector communication, Pr. 122 = "0.1 to 999.8s"

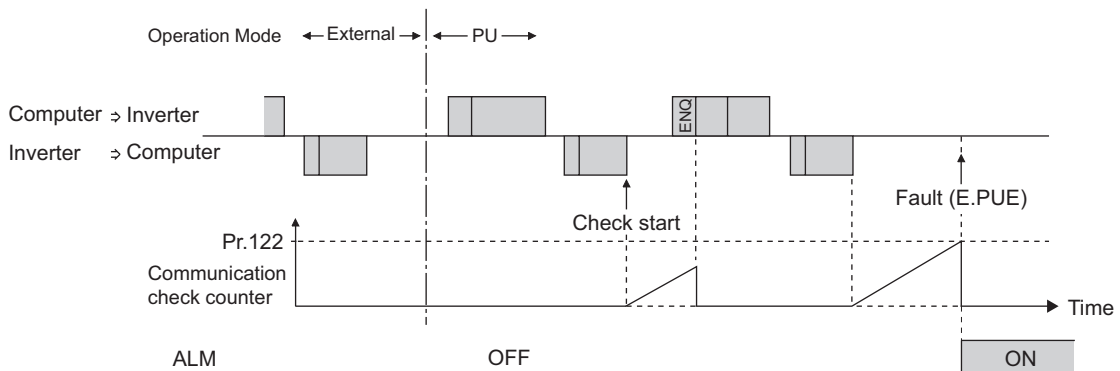

## (8) Instructions for the program

- 1) When data from the computer has any error, the inverter does not accept that data. Hence, in the user program, always insert a retry program for data error.
- 2) All data communication, e.g. run command or monitoring, are started when the computer gives a communication request. The inverter does not return any data without the computer's request. Hence, design the program so that the computer gives a data read request for monitoring, etc. as required.
- 3) Program example  
To change the operation mode to computer link operation

### Programming example of Microsoft® Visual C++® (Ver.6.0)

```
#include <stdio.h>
#include <windows.h>

void main(void){
    HANDLE          hCom;           //Communication handle
    DCB              hDcb;         //Structure for communication setting
    COMMTIMEOUTS    hTim;        // Structure for time out setting

    char            szTx[0x10];    // Send buffer
    char            szRx[0x10];    // Receive buffer
    char            szCommand[0x10]; // Command
    int             nTx,nRx;       // For buffer size storing
    int             nSum;          // For sum code calculation
    BOOL            bRet;
    int             nRet;
    int             i;

    //**** Opens COM1 port****
    hCom = CreateFile ("COM1", (GENERIC_READ | GENERIC_WRITE), 0, NULL, OPEN_EXISTING, FILE_ATTRIBUTE_NORMAL, NULL);
    if (hCom != NULL) {
        //**** Makes a communication setting of COM1 port****
        GetCommState(hCom,&hDcb); // Retrieves current communication information
        hDcb.DCBLength = sizeof(DCB); // Structure size setting
        hDcb.BaudRate = 19200; // Communication speed=19200bps
        hDcb.ByteSize = 8; // Data length=8bit
        hDcb.Parity = 2; // Even parity
        hDcb.StopBits = 2; // Stop bit=2bit
        bRet = SetCommState(hCom,&hDcb); // Sets the changed communication data
        if (bRet == TRUE) {
            //**** Makes a time out setting of COM1 port****
            GetCommTimeouts(hCom,&hTim); // Obtains the current time out value
            hTim.WriteTotalTimeoutConstant = 1000; // Write time out 1s
            hTim.ReadTotalTimeoutConstant = 1000; // Read time out 1s
            SetCommTimeouts(hCom,&hTim); // Changed time out value setting
            //**** Sets the command to switch the operation mode of the station 1 inverter to the Network operation mode ****
            sprintf(szCommand,"01FB10000"); // Send data (NET operation write)
            nTx = strlen(szCommand); //Send data size
            //**** Generates sum code****
            nSum = 0; // Initialization of sum data
            for (i = 0;i < nTx;i++) {
                nSum += szCommand[i]; // Calculates sum code
                nSum &= (0xff); // Masks data
            }



            //**** Generates send data****
            memset(szTx,0,sizeof(szTx)); // Initialization of send buffer
            memset(szRx,0,sizeof(szRx)); // Initialization of receive buffer
            sprintf(szTx,"%5s%02X",szCommand,nSum); // ENQ code+send data+sum code
            nTx = 1 + nTx + 2; // Number of ENQ code+number of send data+number of sum code

            nRet = WriteFile(hCom,szTx,nTx,&nTx,NULL);
            //**** Sending ****
            if(nRet != 0) {
                nRet = ReadFile(hCom,szRx,sizeof(szRx),&nRx,NULL);
            }
            //**** Receiving ****
            if(nRet != 0) {
                //**** Displays the receive data ****
                for(i = 0;i < nRx;i++) {
                    printf("%02X ",(BYTE)szRx[i]); // Consol output of receive data
                    // Displays ASCII coder in hexadecimal. Displays 30 when "0"
                }
                printf("\n\r");
            }
        }
        CloseHandle(hCom); // Close communication port
    }
}
```

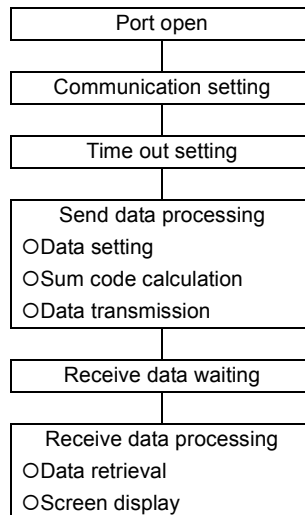
General flowchart



 **CAUTION**

-  Always set the communication check time interval before starting operation to prevent hazardous conditions.
-  Data communication is not started automatically but is made only once when the computer provides a communication request. If communication is disabled during operation due to signal loss etc., the inverter cannot be stopped. When the communication check time interval has elapsed, the inverter will come to a trip (E.PUE, E.SER). The inverter can be coasted to a stop by switching on its RES signal or by switching power off.
-  If communication is broken due to signal loss, computer fault etc., the inverter does not detect such a fault. This should be fully noted.

**(9) Setting items and set data**

After completion of parameter setting, set the instruction codes and data then start communication from the computer to allow various types of operation control and monitoring.

No.	Item	Read/Write	Instruction Code	Data Description	Number of Data Digits (format)														
1	Operation mode	Read	H7B	H0000: Network operation H0001: External operation H0002: PU operation (RS-485 communication operation via PU connector)	4 digits (B,E/D)														
		Write	HFB		4 digits (A,C/D)														
2	Monitor	Output frequency/speed	Read	H6F	H0000 to HFFFF: Output frequency in 0.01Hz increments Speed in 1r/min increments (when <i>Pr. 37</i> = 1 to 9998 or <i>Pr. 144</i> = 2 to 10, 102 to 110)	4 digits (B,E/D)													
		Output current	Read	H70	H0000 to HFFFF: Output current (hexadecimal) in 0.01A increments	4 digits (B,E/D)													
		Output voltage	Read	H71	H0000 to HFFFF: Output voltage (hexadecimal) in 0.1V increments	4 digits (B,E/D)													
		Special monitor	Read	H72	H0000 to HFFFF: Monitor data selected in instruction code HF3	4 digits (B,E/D)													
		Special monitor selection No.	Read	H73	H01 to H3C: Monitor selection data Refer to the special monitor No. table (page 321)	2digits (B,E/D)													
			Write	HF3		2digits (A',C/D)													
Fault record	Read	H74 to H77	H0000 to HFFFF: Two most recent fault records  <div style="text-align: center;"> <table border="1" style="margin: auto;"> <tr> <td style="text-align: center;">b15</td> <td style="text-align: center;">b8 b7</td> <td style="text-align: center;">b0</td> </tr> <tr> <td>H74</td> <td style="text-align: center;">Second fault in past</td> <td style="text-align: center;">Latest fault</td> </tr> <tr> <td>H75</td> <td style="text-align: center;">Fourth fault in past</td> <td style="text-align: center;">Third fault in past</td> </tr> <tr> <td>H76</td> <td style="text-align: center;">Sixth fault in past</td> <td style="text-align: center;">Fifth fault in past</td> </tr> <tr> <td>H77</td> <td style="text-align: center;">Eighth fault in past</td> <td style="text-align: center;">Seventh fault in past</td> </tr> </table> </div> Refer to the fault data table (page 322)	b15	b8 b7	b0	H74	Second fault in past	Latest fault	H75	Fourth fault in past	Third fault in past	H76	Sixth fault in past	Fifth fault in past	H77	Eighth fault in past	Seventh fault in past	4 digits (B,E/D)
b15	b8 b7	b0																	
H74	Second fault in past	Latest fault																	
H75	Fourth fault in past	Third fault in past																	
H76	Sixth fault in past	Fifth fault in past																	
H77	Eighth fault in past	Seventh fault in past																	
3	Run command (extended)	Write	HF9	You can set the control input commands such as the forward rotation signal (STF) and reverse rotation signal (STR). (Refer to page 322 for details)	4 digits (A,C/D)														
	Run command	Write	HFA		2digits (A',C/D)														
4	Inverter status monitor (extended)	Read	H79	You can monitor the status of the output signals such as forward rotation, reverse rotation and inverter running (RUN). (Refer to page 323 for details)	4 digits (B,E/D)														
	Inverter status monitor	Read	H7A		2digits (B,E/D)														
5	Set frequency (RAM)	Read	H6D	Read the set frequency/speed from the RAM or EEPROM. H0000 to HFFFF: Set frequency in 0.01Hz increments Speed in 1r/min increments (When <i>Pr. 37</i> = 1 to 9998 or <i>Pr. 144</i> = 2 to 10, 102 to 110)	4 digits (B,E/D)														
	Set frequency (EEPROM)		H6E																
	Set frequency (RAM)	Write	HED	Write the set frequency/speed into the RAM or EEPROM. H0000 to H9C40 (0 to 400.00Hz) : frequency in 0.01Hz increments H0000 to H270E (0 to 9998) : speed in r/min increments (when <i>Pr. 37</i> = 1 to 9998 or <i>Pr. 144</i> = 2 to 10, 102 to 110) · To change the running frequency consecutively, write data to the inverter RAM. (Instruction code: HED)	4 digits (A,C/D)														
	Set frequency (RAM, EEPROM)		HEE																
6	Inverter reset	Write	HFD	H9696: Resets the inverter. · As the inverter is reset at start of communication by the computer, the inverter cannot send reply data back to the computer.	4 digits (A,C/D)														
				H9966: Resets the inverter. · When data is sent normally, ACK is returned to the computer and then the inverter is reset.	4 digits (A,D)														
7	Faults history batch clear	Write	HF4	H9696: Clears the faults history as a batch	4 digits (A,C/D)														

Refer to page 313 for data formats (A, A', B, B', C, D)

No.	Item	Read/Write	Instruction Code	Data Description	Number of Data Digits (format)													
8	Parameter clear All parameter clear	Write	HFC	<p>All parameters return to the initial values. Whether to clear communication parameters or not can be selected according to data. (O: clear, x: not clear) Refer to <i>page 439</i> for parameter clear, all clear, and communication parameters.</p> <table border="1"> <thead> <tr> <th>Clear type</th> <th>Data</th> <th>Communication parameters</th> </tr> </thead> <tbody> <tr> <td rowspan="2">Parameter clear</td> <td>H9696</td> <td>○</td> </tr> <tr> <td>H5A5A</td> <td>×</td> </tr> <tr> <td rowspan="2">All parameter clear</td> <td>H9966</td> <td>○</td> </tr> <tr> <td>H55AA</td> <td>×</td> </tr> </tbody> </table> <p>When clear is executed for H9696 or H9966, communication-related parameter settings also return to the initial values. When resuming operation, set the parameters again. Executing clear will clear the instruction code HEC, HF3, and HFF settings. Only H9966 and H55AA (all parameter clear) are valid during the password lock.</p>	Clear type	Data	Communication parameters	Parameter clear	H9696	○	H5A5A	×	All parameter clear	H9966	○	H55AA	×	4 digits (A,C/D)
Clear type	Data	Communication parameters																
Parameter clear	H9696	○																
	H5A5A	×																
All parameter clear	H9966	○																
	H55AA	×																
9	Parameters	Read	H00 to H63	Refer to the instruction code ( <i>page 439</i> ) and write and/or read the values as required.	4 digits (B,E/D)													
10		Write	H80 to HE3	When setting <i>Pr. 100</i> and later, link parameter extended setting must be set.	4 digits (A,C/D)													
11	Link parameter extended setting	Read	H7F	Parameter description is changed according to the H00 to H09 setting.	2digits (B,E'/D)													
		Write	HFF	For details of the setting, refer to the instruction code ( <i>page 439</i> ).	2digits (A',C/D)													
12	Second parameter changing (instruction code HFF=1, 9)	Read	H6C	<p>When setting the calibration parameters *1 H00:Frequency *2 H01: Parameter-set analog value H02: Analog value input from terminal</p>	2digits (B,E'/D)													
		Write	HEC	<p>*1 Refer to the list of calibration parameters on the next page for calibration parameters. *2 The gain frequency can also be written using <i>Pr. 125</i> (instruction code H99) or <i>Pr. 126</i> (instruction code H9A).</p>	2digits (A',C/D)													

Refer to *page 313* for data formats (A, A', B, B', C, D)

**REMARKS**

- Set 65520 (HFFF0) as a parameter value "8888" and 65535 (HFFFF) as "9999".
- For the instruction codes HFF, HEC and HF3, their values are held once written but cleared to zero when an inverter reset or all clear is performed.

Example) When reading the *C3 (Pr. 902)* and *C6 (Pr. 904)* settings from the inverter of station 0

	Computer Send Data	Inverter Send Data	Description
1)	ENQ 00 FF 0 01 82	ACK 00	Set "H01" in the extended link parameter.
2)	ENQ 00 EC 0 01 7E	ACK 00	Set "H01" in second parameter changing.
3)	ENQ 00 5E 0 0F	STX 00 0000 ETX 25	<i>C3 (Pr. 902)</i> is read. 0% is read.
4)	ENQ 00 60 0 FB	STX 00 0000 ETX 25	<i>C6 (Pr. 904)</i> is read. 0% is read.

To read/write *C3 (Pr. 902)* and *C6 (Pr. 904)* after inverter reset or parameter clear, execute from 1) again.

●List of calibration parameters

Parameter	Name	Instruction code		
		Read	Write	Extended
C2 (902)	Terminal 2 frequency setting bias frequency	5E	DE	1
C3 (902)	Terminal 2 frequency setting bias	5E	DE	1
125 (903)	Terminal 2 frequency setting gain frequency	5F	DF	1
C4 (903)	Terminal 2 frequency setting gain	5F	DF	1
C5 (904)	Terminal 4 frequency setting bias frequency	60	E0	1
C6 (904)	Terminal 4 frequency setting bias	60	E0	1
126 (905)	Terminal 4 frequency setting gain frequency	61	E1	1
C7 (905)	Terminal 4 frequency setting gain	61	E1	1
C12 (917)	Terminal 1 bias frequency (speed)	11	91	9

Parameter	Name	Instruction code		
		Read	Write	Extended
C13 (917)	Terminal 1 bias frequency (speed)	11	91	9
C14 (918)	Terminal 1 gain frequency (speed)	12	92	9
C15 (918)	Terminal 1 gain (speed)	12	92	9
C16 (919)	Terminal 1 bias command (torque/magnetic flux)	13	93	9
C17 (919)	Terminal 1 bias (torque/magnetic flux)	13	93	9
C18 (920)	Terminal 1 gain command (torque/magnetic flux)	14	94	9
C19 (920)	Terminal 1 gain (torque/magnetic flux)	14	94	9

Parameter	Name	Instruction code		
		Read	Write	Extended
C38 (932)	Terminal 4 bias command (torque/magnetic flux)	20	A0	9
C39 (932)	Terminal 4 bias (torque/magnetic flux)	20	A0	9
C40 (933)	Terminal 4 gain command (torque/magnetic flux)	21	A1	9
C41 (933)	Terminal 4 gain (torque/magnetic flux)	21	A1	9

[Special monitor selection No.]

Refer to page 229 for details of the monitor description.

Data	Description	Increments
H01	Output frequency/speed *6	0.01Hz/1
H02	Output current	0.01A
H03	Output voltage	0.1V
H05	Frequency setting/speed setting *6	0.01Hz/1
H06	Running speed	1r/min
H07	Motor torque	0.1%
H08	Converter output voltage	0.1V
H0A	Electronic thermal relay function load factor	0.1%
H0B	Output current peak value	0.01A/ 0.1A *1
H0C	Converter output voltage peak value	0.1V
H0D	Input power	0.01kW
H0E	Output power	0.01kW
H0F	Input terminal status *1	—

Data	Description	Increments
H10	Output terminal status *2	—
H11	Load meter	0.1%
H12	Motor excitation current	0.01A
H13	Position pulse	—
H14	Cumulative energization time	1h
H16	Orientation status	—
H17	Actual operation time	1h
H18	Motor load factor	0.1%
H19	Cumulative power	1kWh
H20	Torque command	0.1%
H21	Torque current command	0.1%
H22	Motor output	0.01kW
H23	Feedback pulse	—
H32	Power saving effect	Variable
H33	Cumulative saving power	Variable
H34	PID set point	0.1%

Data	Description	Increments
H35	PID measured value	0.1%
H36	PID deviation value	0.1%
H3A	Option input terminal status1 *3	—
H3B	Option input terminal status2 *4	—
H3C	Option output terminal status *5	—
H41	Output power *7	0.1kW
H42	Cumulative regenerative power	1kWh

**Ver.UP** .....Specifications differ according to the date assembled. Refer to page 456 to check the SERIAL number.

\*1 Input terminal monitor details

b15

b0

—	—	—	—	CS	RES	STOP	MRS	JOG	RH	RM	RL	RT	AU	STR	STF
---	---	---	---	----	-----	------	-----	-----	----	----	----	----	----	-----	-----

\*2 Output terminal monitor details

b15

b0

—	—	—	—	—	—	—	—	—	—	ABC2	ABC1	FU	OL	IPF	SU	RUN
---	---	---	---	---	---	---	---	---	---	------	------	----	----	-----	----	-----

\*3 Details of option input terminal monitor 1 (input terminal status of FR-A7AX)-all terminals are off when an option is not fitted

b15

b0

X15	X14	X13	X12	X11	X10	X9	X8	X7	X6	X5	X4	X3	X2	X1	X0
-----	-----	-----	-----	-----	-----	----	----	----	----	----	----	----	----	----	----

\*4 Details of option input terminal monitor 2 (input terminal status of FR-A7AX)-all terminals are off when an option is not fitted

b15

b0

—	—	—	—	—	—	—	—	—	—	—	—	—	—	—	—	DY
---	---	---	---	---	---	---	---	---	---	---	---	---	---	---	---	----

\*5 Details of option output terminal monitor (output terminal status of FR-A7AY/A7AR)-all terminals are off when an option is not fitted

b15

b0

—	—	—	—	—	—	—	RA3	RA2	RA1	Y6	Y5	Y4	Y3	Y2	Y1	Y0
---	---	---	---	---	---	---	-----	-----	-----	----	----	----	----	----	----	----

\*6 When Pr: 37 = "1 to 9998" or Pr: 144 = "2 to 10, 102 to 110," the unit is an integral value (one increment). (Refer to page 227)

\*7 Regenerative display is not available. Regenerative display is only available on the operation panel (FR-DU07).



**[Fault data]**

Refer to *page 383* for details of fault description.

Data	Description	Data	Description	Data	Description
H00	No alarm	HA3	E.OP3	HD7	E.MB3
H10	E.OC1	HB0	E.PE	HD8	E.MB4
H11	E.OC2	HB1	E.PUE	HD9	E.MB5
H12	E.OC3	HB2	E.RET	HDA	E.MB6
H20	E.OV1	HB3	E.PE2	HDB	E.MB7
H21	E.OV2	HC0	E.CPU	HDC	E.EP
H22	E.OV3	HC1	E.CTE	HF1	E.1
H30	E.THT	HC2	E.P24	HF2	E.2
H31	E.THM	HC4	E.CDO	HF3	E.3
H40	E.FIN	HC5	E.IOH	HF4	E.4
H50	E.IPF	HC6	E.SER	HF6	E.6
H51	E.UVT	HC7	E.AIE	HF7	E.7
H52	E.ILF	HC8	E.USB	HF8	E.8
H60	E.OLT	HD0	E.OS	HFA	E.10
H80	E.GF	HD1	E.OSD	HFB	E.11
H81	E.LF	HD2	E.ECT	HFD	E.13
H90	E.OHT	HD3	E.OD	HFF	E.15
H91	E.PTC	HD5	E.MB1		
HA0	E.OPT	HD6	E.MB2		

**Fault record display example (instruction code H74)**

For read data H30A0  
(Previous fault ..... THT)  
(Latest fault ..... OPT)

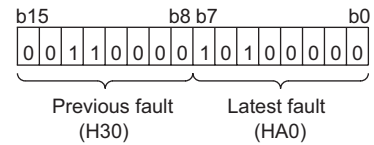

**[Run command]**

Item	Instruction Code	Bit Length	Description	Example
Run command	HFA	8 bits	b0: AU (current input selection) *1 *3 b1: Forward rotation command b2: Reverse rotation command b3: RL (low speed operation command) *1 *3 b4: RM (middle speed operation command) *1 *3 b5: RH (high speed operation command) *1 *3 b6: RT (second function selection) *1 *3 b7: MRS (output stop) *1 *3	[Example 1] H02 Forward rotation b7 b0 0 0 0 0 0 0 1 0  [Example 2] H00 Stop b7 b0 0 0 0 0 0 0 0 0
Run command (extended)	HF9	16 bits	b0:AU (current input selection) *1 *3 b1:Forward rotation command b2:Reverse rotation command b3:RL (low speed operation command) *1 *3 b4:RM (middle speed operation command) *1 *3 b5: RH (high speed operation command) *1 *3 b6:RT (second function selection) *1 *3 b7:MRS (output stop) *1 *3 b8:JOG (Jog operation) *2 *3 b9:CS (selection of automatic restart after instantaneous power failure) *2 *3 b10: STOP (start self-holding) *2 *3 b11:RES (reset) *2 *3 b12:— b13:— b14:— b15:—	[Example 1] H0002 Forward rotation b15 b0 0 0 0 0 0 0 0 0 0 0 0 0 0 0 0 1 0  [Example 2] H0800 low speed operation (When Pr. 189 RES terminal function selection is set to "0") b15 b0 0 0 0 0 1 0 0 0 0 0 0 0 0 0 0 0 0

\*1 The signal within parentheses is the initial setting. The description changes depending on the setting of Pr. 180 to Pr. 184, Pr. 187 (input terminal function selection) (page 207).  
 \*2 The signal within parentheses is the initial setting. Since jog operation/selection of automatic restart after instantaneous power failure/start self-holding/reset cannot be controlled by the network, bit 8 to bit 11 are invalid in the initial status. When using bit 8 to bit 11, change the signals with Pr. 185, Pr. 186, Pr. 188, Pr. 189 (input terminal function selection) (page 207). (Reset can be executed with the instruction code HFD.)  
 \*3 Only forward rotation command and reverse rotation command are available for RS-485 communication using PU connector.

**[Inverter status monitor]**

Item	Instruction Code	Bit Length	Description	Example
Inverter status monitor	H7A	8 bits	b0:RUN (inverter running) * b1:Forward rotation b2:Reverse rotation b3:SU (up to frequency) * b4:OL (overload) * b5:IPF (instantaneous power failure) * b6:FU (frequency detection) * b7:ABC1 (fault) *	[Example 1] H02... During forward rotation b7 b0 0 0 0 0 0 0 1 0 [Example 2] H80... Stop at fault occurrence b7 b0 1 0 0 0 0 0 0 0
Inverter status monitor (extended)	H79	16 bits	b0:RUN (inverter running) * b1:Forward rotation b2:Reverse rotation b3:SU (up to frequency) * b4:OL (overload) * b5:IPF (instantaneous power failure) * b6:FU (frequency detection) * b7:ABC1 (fault) * b8:ABC2 (—) * b9:— b10:— b11:— b12:— b13:— b14:— b15: Fault occurrence	[Example 1] H0002... During forward rotation b15 b0 0 0 0 0 0 0 0 0 0 0 0 0 0 0 0 1 0 [Example 2] H8080... Stop at fault occurrence b15 b0 1 0 0 0 0 0 0 0 1 0 0 0 0 0 0 0 0

\* The signal within parentheses is the initial setting. The description changes depending on the setting of Pr. 190 to Pr. 196 (output terminal function selection).

#### 4.24.6 Modbus-RTU communication specifications (Pr. 331, Pr. 332, Pr. 334, Pr. 343, Pr. 539, Pr. 549)

Using the Modbus-RTU communication protocol, communication operation or parameter setting can be performed from the RS-485 terminals of the inverter.

Parameter Number	Name	Initial Value	Setting Range	Description
331	RS-485 communication station number	0	0	Broadcast communication is selected.
			1 to 247	Specify the inverter station number. Set the inverter station numbers when two or more inverters are connected to one personal computer.
332	RS-485 communication speed	96	3, 6, 12, 24, 48, 96, 192, 384	Set the communication speed. The setting value × 100 equals the communication speed. For example, the communication speed is 9600bps when the setting value is "96".
334	RS-485 communication parity check selection	2	0	Without parity check Stop bit length 2bits
			1	With odd parity check Stop bit length 1bit
			2	With even parity check Stop bit length 1bit
343	Communication error count	0	—	Display the number of communication errors during Modbus-RTU communication. Reading only
539	Modbus-RTU communication check time interval	9999	0	Modbus-RTU communication can be made, but the inverter trips in the NET operation mode.
			0.1 to 999.8s	Set the interval of communication check time. (same specifications as Pr. 122)
			9999	No communication check (signal loss detection)
549	Protocol selection	0	0	Mitsubishi inverter (computer link) protocol
			1	Modbus-RTU protocol

#### CAUTION

When Modbus-RTU communication is performed from the master with address 0 (station 0) set, broadcast communication is selected and the inverter does not send a response message to the master.  
When response from the inverter is necessary, set a value other than "0" in Pr. 331 (initial value 0).  
Some functions are invalid for broadcast communication. (Refer to page 326)

#### REMARKS

- When using the Modbus-RTU protocol, set Pr. 549 Protocol selection to "1".
- When the communication option is fitted with Pr. 550 NET mode operation command source selection set to "9999" (initial value), the command source (e.g. run command) from the RS-485 terminals is invalid. (Refer to page 299)

#### (1) Communication specifications

- The communication specifications are given below.

Item	Description	Related Parameters	
Communication protocol	Modbus-RTU protocol	Pr. 549	
Conforming standard	EIA-485 (RS-485)	—	
Number of inverters connected	1: N (maximum 32 units), setting is 0 to 247 stations	Pr. 331	
Communication speed	Selected among 300/600/1200/2400/4800/9600/19200/38400bps	Pr. 332	
Control protocol	Asynchronous system	—	
Communication method	Half-duplex system	—	
Communication specifications	Character system	Binary(fixed to 8 bits)	
	Start bit	1bit	
	Stop bit length	Select from the following three types · No parity, stop bit length 2 bits · Odd parity, stop bit length 1 bit · Even parity, stop bit length 1 bit	Pr. 334
	Parity check		
	Error check	CRC code check	—
	Terminator	Not used	—
Waiting time setting	Not used	—	

**(2) Outline**

The Modbus protocol is the communication protocol developed by Modicon for programmable controller. The Modbus protocol performs serial communication between the master and slave using the dedicated message frame. The dedicated message frame has the functions that can perform data read and write. Using the functions, you can read and write the parameter values from the inverter, write the input command of the inverter, and check the operating status. In this product, the inverter data are classified in the holding register area (register addresses 40001 to 49999). By accessing the assigned holding register address, the master can communicate with the inverter which is a slave.

**REMARKS**

There are two different serial transmission modes: ASCII (American Standard Code for Information Interchange) mode and RTU (Remote Terminal Unit) mode. This product supports only the RTU mode in which 1-byte (8-bit) data is transmitted as-is. Only the communication protocol is defined by the Modbus protocol, and the physical layer is not stipulated.

**(3) Message format**

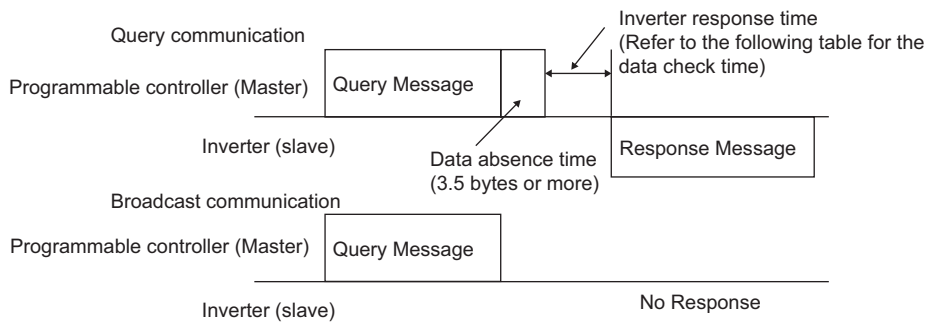

●Data check time

Item	Check Time
Various monitors, operation command, frequency setting (RAM)	< 12ms
Parameter read/write, frequency setting (EEPROM)	< 30ms
Parameter clear/all clear	< 5s
Reset command	No answer

1)Query

The master sends a message to the slave (= inverter) at the specified address.

2)Normal Response

After receiving the query from the master, the slave executes the requested function and returns the corresponding normal response to the master.

3)Error Response

If an invalid function code, address or data is received, the slave returns it to the master.

When a response description is returned, the error code indicating that the request from the master cannot be executed is added.

No response is returned for the hardware-detected error, frame error and CRC check error.

4)Broadcast

By specifying address 0, the master can send a message to all slaves. All slaves that received the message from the master execute the requested function. In this communication, the slaves do not return a response to the master.

**REMARKS**

The slave executes the function independently of the inverter station number setting (*P*: 331) during broadcast communication.

**(4) Message frame (protocol)**

● Communication method

Basically, the master sends a query message (question) and the slave returns a response message (response). When communication is normal, Device Address and Function Code are copied as they are, and when communication is abnormal (function code or data code is illegal), bit 7 (= 80h) of Function Code is turned on and the error code is set to Data Bytes.

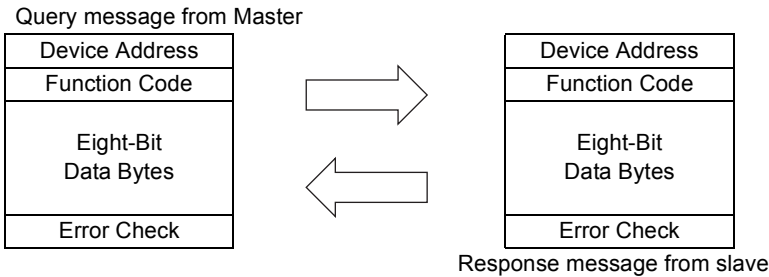

The message frame consists of the four message fields as shown above.

By adding the no-data time (T1: Start, End) of 3.5 characters to the beginning and end of the message data, the slave recognizes it as one message.

● Protocol details

The four message fields will be explained below.

Start	1) ADDRESS	2) FUNCTION	3) DATA	4) CRC CHECK		End
T1	8 bits	8 bits	n × 8 bits	L 8 bits	H 8 bits	T1

Message Field	Description																								
1) ADDRESS field	The address is 1 byte long (8 bits) and any of 0 to 247 can be set. Set 0 to send a broadcast message (all-address instruction) or any of 1 to 247 to send a message to each slave. When the slave responds, it returns the address set from the master. The value set to <i>Pr. 331 RS-485 communication station number</i> is the slave address.																								
2) FUNCTION field	<p>The function code is 1 byte long (8 bits) and any of 1 to 255 can be set. The master sets the function that it wants to request from the slave, and the slave performs the requested operation. The following table gives the supported function codes. An error response is returned if the set function code is other than those in the following table. When the slave returns a normal response, it returns the function code set by the master. When the slave returns an error response, it returns H80 + function code.</p> <table border="1" style="width: 100%; border-collapse: collapse;"> <thead> <tr> <th>Code</th> <th>Function Name</th> <th>Outline</th> <th>Broadcast Communication</th> </tr> </thead> <tbody> <tr> <td>H03</td> <td>Read Holding Register</td> <td>Reads the holding register data.</td> <td>Disallowed</td> </tr> <tr> <td>H06</td> <td>Preset Single Register</td> <td>Writes data to the holding register.</td> <td>Allowed</td> </tr> <tr> <td>H08</td> <td>Diagnostics</td> <td>Makes a function diagnosis. (communication check only)</td> <td>Disallowed</td> </tr> <tr> <td>H10</td> <td>Preset Multiple Registers</td> <td>Writes data to multiple consecutive holding registers.</td> <td>Allowed</td> </tr> <tr> <td>H46</td> <td>Read Holding Register Access Log</td> <td>Reads the number of registers that succeeded in communication last time.</td> <td>Disallowed</td> </tr> </tbody> </table> <p style="text-align: center;"><b>Table 1: Function code list</b></p>	Code	Function Name	Outline	Broadcast Communication	H03	Read Holding Register	Reads the holding register data.	Disallowed	H06	Preset Single Register	Writes data to the holding register.	Allowed	H08	Diagnostics	Makes a function diagnosis. (communication check only)	Disallowed	H10	Preset Multiple Registers	Writes data to multiple consecutive holding registers.	Allowed	H46	Read Holding Register Access Log	Reads the number of registers that succeeded in communication last time.	Disallowed
Code	Function Name	Outline	Broadcast Communication																						
H03	Read Holding Register	Reads the holding register data.	Disallowed																						
H06	Preset Single Register	Writes data to the holding register.	Allowed																						
H08	Diagnostics	Makes a function diagnosis. (communication check only)	Disallowed																						
H10	Preset Multiple Registers	Writes data to multiple consecutive holding registers.	Allowed																						
H46	Read Holding Register Access Log	Reads the number of registers that succeeded in communication last time.	Disallowed																						
3) DATA field	The format changes depending on the function code ( <i>refer to page 327</i> ). Data includes the byte count, number of bytes, description of access to the holding register, etc.																								
4) CRC CHECK field	The received message frame is checked for error. CRC check is performed, and 2 byte long data is added to the end of the message. When CRC is added to the message, the low-order byte is added first and is followed by the high-order byte. The CRC value is calculated by the sending side that adds CRC to the message. The receiving side recalculates CRC during message receiving, and compares the result of that calculation and the actual value received in the CRC CHECK field. If these two values do not match, the result is defined as error.																								

**(5) Message format types**

The message formats corresponding to the function codes in Table 1 on page 326 will be explained.

● **Read holding register data (H03 or 03)**

Can read the description of 1) system environment variables, 2) real-time monitor, 3) faults history, and 4) inverter parameters assigned to the holding register area (refer to the register list (page 332)).

Query Message

1) Slave Address	2) Function	3) Starting Address		4) No. of Points		CRC Check	
(8 bits)	H03 (8 bits)	H (8 bits)	L (8 bits)	H (8 bits)	L (8 bits)	L (8 bits)	H (8 bits)

Normal response (Response message)

1) Slave Address	2) Function	5) Byte Count	6) Data				CRC Check	
(8 bits)	H03 (8 bits)	(8 bits)	H (8 bits)	L (8 bits)	...	(n × 16 bits)	L (8 bits)	H (8 bits)

· **Query message setting**

Message	Setting Description
1)Slave Address	Set the address to which the message will be sent. Broadcast communication cannot be made (0 is invalid).
2)Function	Set H03.
3)Starting Address	Set the address at which holding register data read will be started. Starting address = starting register address (decimal) – 40001 For example, setting of the starting address 0001 reads the data of the holding register 40002.
4)No. of Points	Set the number of holding registers from which data will be read. The number of registers from which data can be read is a maximum of 125.

· **Description of normal response**

Message	Setting Description
5)Byte Count	The setting range is H02 to HFA (2 to 250). Twice greater than the No. of Points specified at 4) is set.
6)Data	The number of data specified at 4) is set. Data are read in order of Hi byte and Lo byte, and set in order of starting address data, starting address + 1 data, starting address + 2 data, ...

Example) To read the register values of 41004 (Pr. 4) to 41006 (Pr. 6) from the slave address 17 (H11)

Query message

Slave Address	Function	Starting Address		No. of Points		CRC Check	
H11 (8 bits)	H03 (8 bits)	H03 (8 bits)	HEB (8 bits)	H00 (8 bits)	H03 (8 bits)	H77 (8 bits)	H2B (8 bits)

Normal response (Response message)

Slave Address	Function	Byte Count	Data						CRC Check	
H11 (8 bits)	H03 (8 bits)	H06 (8 bits)	H17 (8 bits)	H70 (8 bits)	H0B (8 bits)	HB8 (8 bits)	H03 (8 bits)	HE8 (8 bits)	H2C (8 bits)	HE6 (8 bits)

Read value

- Register 41004 (Pr. 4): H1770 (60.00Hz)
- Register 41005 (Pr. 5): H0BB8 (30.00Hz)
- Register 41006 (Pr. 6): H03E8 (10.00Hz)

● **Write multiple holding register data (H06 or 06)**

You can write the description of 1) system environment variables and 4) inverter parameters assigned to the holding register area (refer to the register list (page 332)).

Query message

1) Slave Address	2) Function	3) Register Address		4) Preset Data		CRC Check	
(8 bits)	H06 (8 bits)	H (8 bits)	L (8 bits)	H (8 bits)	L (8 bits)	L (8 bits)	H (8 bits)

Normal response (Response message)

1) Slave Address	2) Function	3) Register Address		4) Preset Data		CRC Check	
(8 bits)	H06 (8 bits)	H (8 bits)	L (8 bits)	H (8 bits)	L (8 bits)	L (8 bits)	H (8 bits)

· **Query message setting**

Message	Setting Description
1) Slave Address	Set the address to which the message will be sent. Setting of address 0 enables broadcast communication
2) Function	Set H06.
3) RegisterAddress	Set the address of the holding register to which data will be written. Register address = holding register address (decimal) – 40001 For example, setting of register address 0001 writes data to the holding register address 40002.
4) Preset Data	Set the data that will be written to the holding register. The written data is fixed to 2 bytes.

· **Description of normal response**

1) to 4) (including CRC check) of the normal response are the same as those of the query message.  
No response is made for broadcast communication.

Example) To write 60Hz (H1770) to 40014 (running frequency RAM) at slave address 5 (H05).

Query message

Slave Address	Function	Register Address		Preset Data		CRC Check	
H05 (8 bits)	H06 (8 bits)	H00 (8 bits)	H0D (8 bits)	H17 (8 bits)	H70 (8 bits)	H17 (8 bits)	H99 (8 bits)

Normal Response (Response message)

Same data as the query message

**CAUTION**

For broadcast communication, no response is returned in reply to a query. Therefore, the next query must be made when the inverter processing time has elapsed after the previous query.

● **Function diagnosis (H08 or 08)**

A communication check can be made since the query message sent is returned unchanged as a response message (function of subfunction code H00).

Subfunction code H00 (Return Query Data)

Query Message

1) Slave Address	2) Function	3) Subfunction		4) Date		CRC Check	
(8 bits)	H08 (8 bits)	H00 (8 bits)	H00 (8 bits)	H (8 bits)	L (8 bits)	L (8 bits)	H (8 bits)

Normal Response (Response message)

1) Slave Address	2) Function	3) Subfunction		4) Date		CRC Check	
(8 bits)	H08 (8 bits)	H00 (8 bits)	H00 (8 bits)	H (8 bits)	L (8 bits)	L (8 bits)	H (8 bits)

· **Query message setting**

Message	Setting Description
1) Slave Address	Set the address to which the message will be sent. Broadcast communication cannot be made (0 is invalid).
2) Function	Set H08.
3) Subfunction	Set H0000.
4) Data	Any data can be set if it is 2 bytes long. The setting range is H0000 to HFFFF.

· **Description of normal response**

1) to 4) (including CRC check) of the normal response are the same as those of the query message.

**CAUTION**

For broadcast communication, no response is returned in reply to a query. Therefore, the next query must be made when the inverter processing time has elapsed after the previous query.

● **Write multiple holding register data (H10 or 16)**

You can write data to multiple holding registers.

Query message

1) Slave Address	2) Function	3) Starting Address		4) No. of Registers		5) ByteCount	6) Data			CRC Check		
(8 bits)	H10 (8 bits)	H (8 bits)	L (8 bits)	H (8 bits)	L (8 bits)	(8 bits)	H (8 bits)	L (8 bits)	...	(n × 2 × 8 bits)	L (8 bits)	H (8 bits)

Normal Response (Response message)

1) Slave Address	2) Function	3) Starting Address	4) No. of Registers		CRC Check	
(8 bits)	H10 (8 bits)	H (8 bits)	L (8 bits)	H (8 bits)	L (8 bits)	L (8 bits)    H (8 bits)

· **Query message setting**

Message	Setting Description
1) Slave Address	Set the address to which the message will be sent. Setting of address 0 enables broadcast communication.
2) Function	Set H10.
3) Starting Address	Set the address where holding register data write will be started. Starting address = starting register address (decimal) – 40001 For example, setting of the starting address 0001 reads the data of the holding register 40002.
4) No. of Points	Set the number of holding registers where data will be written. The number of registers where data can be written is a maximum of 125.
5) Byte Count	The setting range is H02 to HFA (2 to 250). Set a value twice greater than the value specified at 4).
6) Data	Set the data specified by the number specified at 4). The written data are set in order of Hi byte and Lo byte, and arranged in order of the starting address data, starting address + 1 data, starting address + 2 data ...



· **Description of normal response**

1) to 4) (including CRC check) of the normal response are the same as those of the query message.

Example) To write 0.5s (H05) to 41007 (Pr. 7) at the slave address 25 (H19) and 1s (H0A) to 41008 (Pr. 8).

Query Message

Slave Address	Function	Starting Address		No. of Points		Byte Count	Data				CRC Check	
H19 (8 bits)	H10 (8 bits)	H03 (8 bits)	HEE (8 bits)	H00 (8 bits)	H02 (8 bits)	H04 (8 bits)	H00 (8 bits)	H05 (8 bits)	H00 (8 bits)	H0A (8 bits)	H86 (8 bits)	H3D (8 bits)

Response message (Response message)

Slave Address	Function	Starting Address		No. of Points		CRC Check	
H19 (8 bits)	H10 (8 bits)	H03 (8 bits)	HEE (8 bits)	H00 (8 bits)	H02 (8 bits)	H22 (8 bits)	H61 (8 bits)

● **Read holding register access log (H46 or 70)**

A response can be made to a query made by the function code H03 or H10.

The starting address of the holding registers that succeeded in access during previous communication and the number of successful registers are returned.

In response to the query for other than the above function code, 0 is returned for the address and number of registers.

Query Message

1) Slave Address	2) Function	CRC Check	
(8 bits)	H46 (8 bits)	L (8 bits)	H (8 bits)

Normal Response (Response message)

1) Slave Address	2) Function	3) Starting Address		4) No. of Points		CRC Check	
(8 bits)	H46 (8 bits)	H (8 bits)	L (8 bits)	H (8 bits)	L (8 bits)	L (8 bits)	H (8 bits)

· **Query message setting**

Message	Setting Description
1) Slave Address	Set the address to which the message will be sent. Broadcast communication cannot be made (0 is invalid)
2) Function	Set H46.

· **Description of normal response**

Message	Setting Description
3) Starting Address	The starting address of the holding registers that succeeded in access is returned. Starting address = starting register address (decimal) – 40001 For example, when the starting address 0001 is returned, the address of the holding register that succeeded in access is 40002.
4) No. of Points	The number of holding registers that succeeded in access is returned.

Example) To read the successful register starting address and successful count from the slave address 25 (H19).

Query Message

Slave Address	Function	CRC Check	
H19 (8 bits)	H46 (8 bits)	H8B (8 bits)	HD2 (8 bits)

Normal Response (Response message)

Slave Address	Function	Starting Address		No. of Points		CRC Check	
H19 (8 bits)	H10 (8 bits)	H03 (8 bits)	HEE (8 bits)	H00 (8 bits)	H02 (8 bits)	H22 (8 bits)	H61 (8 bits)

Success of two registers at starting address 41007 (Pr. 7) is returned.

● **Error response**

An error response is returned if the query message received from the master has an illegal function, address or data. No response is returned for a parity, CRC, overrun, framing or busy error.

**CAUTION**

No response message is sent in the case of broadcast communication also.

Error response (Response message)

1) Slave Address	2) Function	3) Exception Code	CRC Check	
(8bit)	H80 + Function (8bit)	(8bit)	L (8bit)	H (8bit)

Message	Setting Description
1) Slave address	Set the address received from the master.
2) Function	The master-requested function code + H80 is set.
3) Exception code	The code in the following table is set.

**Error code list**

Code	Error Item	Error Definition
01	ILLEGAL FUNCTION	The set function code in the query message from the master cannot be handled by the slave.
02	ILLEGAL DATA ADDRESS *1	The set register address in the query message from the master cannot be handled by the inverter. (No parameter, parameter read disabled, parameter write disabled)
03	ILLEGAL DATA VALUE	The set data in the query message from the master cannot be handled by the inverter. (Out of parameter write range, mode specified, other error)

\*1 An error will not occur in the following cases.

1) Function code H03 (Read Holding Register Data )

When the No. of Points is 1 or more and there is one or more holding registers from which data can be read

2) Function code H10 (Write Multiple Holding Register Data)

When the No. of Points is 1 or more and there is 1 or more holding registers to which data can be written

Namely, when the function code H03 or H10 is used to access multiple holding registers, an error will not occur if a non-existing holding register or read disabled or write disabled holding register is accessed.

**REMARKS**

An error will occur if all accessed holding registers do not exist.

Data read from a non-existing holding register is 0, and data written there is invalid.

· **Message data mistake detection**

To detect the mistakes of message data from the master, they are checked for the following errors. If an error is detected, a trip will not occur.

**Error check item**

Error Item	Error Definition	Inverter Side Operation
Parity error	The data received by the inverter differs from the specified parity (Pr. 334 setting).	1) Pr. 343 is increased by 1 at error occurrence. 2) The terminal LF is output at error occurrence.
Framing error	The data received by the inverter differs from the specified stop bit length (Pr. 334).	
Overrun error	The following data was sent from the master before the inverter completes data receiving.	
Message frame error	The message frame data length is checked, and the received data length of less than 4 bytes is regarded as an error.	
CRC check error	A mismatch found by CRC check between the message frame data and calculation result is regarded as an error.	

## (6) Modbus registers

- System environment variable

Register	Definition	Read/Write	Remarks
40002	Inverter reset	Write	Any value can be written
40003	Parameter clear	Write	Set H965A as a written value.
40004	All parameter clear	Write	Set H99AA as a written value.
40006	Parameter clear *1	Write	Set H5A96 as a written value.
40007	All parameter clear *1	Write	Set HAA99 as a written value.
40009	Inverter status/control input instruction *2	Read/write	See below.
40010	Operation mode/inverter setting *3	Read/write	See below.
40014	Running frequency (RAM value)	Read/write	According to the Pr. 37 and Pr. 144 settings, the frequency and selectable speed are in 1r/min increments.
40015	Running frequency (EEPROM value)	Write	

\*1 The communication parameter values are not cleared.

\*2 For write, set the data as a control input instruction. For read, data is read as an inverter operating status.

\*3 For write, set data as the operation mode setting. For read, data is read as the operation mode status.

### <Inverter status/control input instruction>

Bit	Definition	
	Control input instruction	Inverter status
0	Stop command	RUN (inverter running) *2
1	Forward rotation command	Forward rotation
2	Reverse rotation command	Reverse rotation
3	RH (high speed operation command) *1	SU (up to frequency) *2
4	RM (middle speed operation command) *1	OL (overload) *2
5	RL (low speed operation command) *1	IPF (instantaneous power failure) *2
6	JOG (Jog operation) *1	FU (frequency detection) *2
7	RT (second function selection) *1	ABC1 (alarm) *2
8	AU (current input selection) *1	ABC2 (—) *2
9	CS (selection of automatic restart after instantaneous power failure) *1	0
10	MRS (output stop) *1	0
11	STOP (start self-holding) *1	0
12	RES (reset) *1	0
13	0	0
14	0	0
15	0	Fault occurrence

### <Operation mode/inverter setting>

Mode	Read Value	Written Value
EXT	H0000	H0010
PU	H0001	—
EXT JOG	H0002	—
PU JOG	H0003	—
NET	H0004	H0014
PU+ EXT	H0005	—

The restrictions depending on the operation mode changes according to the computer link specifications.

\*1 The signal within parentheses is the initial setting. The description changes depending on the setting of Pr. 180 to Pr. 189 (input terminal function selection) (page 207).

Each assigned signal is valid or invalid depending on NET. (Refer to page 299)

\*2 The signal within parentheses is the initial setting. The description changes depending on the setting of Pr. 190 to Pr. 196 (output terminal function selection) (page 215).

- Real-time monitor  
Refer to page 229 for details of the monitor description.

Register	Definition	Increments	Register	Definition	Increments	Register	Definition	Increments
40201	Output frequency/speed *6	0.01Hz/1	40215	Input terminal status *1	—	40235	Feedback pulse	—
40202	Output current	0.01A	40216	Output terminal status *2	—	40250	Power saving effect	Variable
40203	Output voltage	0.1V	40217	Load meter	0.1%	40251	Cumulative saving power	Variable
40205	Frequency setting/speed setting *6	0.01Hz/1	40218	Motor excitation current	0.01A	40252	PID set point	0.1%
40206	Running speed	1r/min	40219	Position pulse	—	40253	PID measured value	0.1%
40207	Motor torque	0.1%	40220	Cumulative energization time	1h	40254	PID deviation value	0.1%
40208	Converter output voltage	0.1V	40222	Orientation status	—	40258	Option input terminal status1 *3	—
40210	Electronic thermal relay function load factor	0.1%	40223	Actual operation time	1h	40259	Option input terminal status2 *4	—
40211	Output current peak value	0.01A	40224	Motor load factor	0.1%	40260	Option output terminal status *5	—
40212	Converter output voltage peak value	0.1V	40225	Cumulative power	1kWh	40263	Output power *7	0.1kW
40213	Input power	0.01kW	40232	Torque command	0.1%	<b>Ver. UP</b>		
40214	Output power	0.01kW	40233	Torque current command	0.1%	40266	Cumulative regenerative power	1kWh
			40234	Motor output	0.01	<b>Ver. UP</b>		

**Ver. UP** .....Specifications differ according to the date assembled. Refer to page 456 to check the SERIAL number.

\*1 Input terminal monitor details  
b15

—	—	—	—	CS	RES	STOP	MRS	JOG	RH	RM	RL	RT	AU	STR	STF
---	---	---	---	----	-----	------	-----	-----	----	----	----	----	----	-----	-----

\*2 Output terminal monitor details  
b15

—	—	—	—	—	—	—	—	—	—	ABC2	ABC1	FU	OL	IPF	SU	RUN
---	---	---	---	---	---	---	---	---	---	------	------	----	----	-----	----	-----

\*3 Details of option input terminal monitor 1 (input terminal status of FR-A7AX)-all terminals are off when an option is not fitted  
b15

X15	X14	X13	X12	X11	X10	X9	X8	X7	X6	X5	X4	X3	X2	X1	X0
-----	-----	-----	-----	-----	-----	----	----	----	----	----	----	----	----	----	----

\*4 Details of option input terminal monitor 2 (input terminal status of FR-A7AX)-all terminals are off when an option is not fitted  
b15

—	—	—	—	—	—	—	—	—	—	—	—	—	—	—	DY
---	---	---	---	---	---	---	---	---	---	---	---	---	---	---	----

\*5 Details of option input terminal monitor (output terminal status of FR-A7AY/A7AR)-all terminals are off when an option is not fitted  
b15

—	—	—	—	—	—	—	RA3	RA2	RA1	Y6	Y5	Y4	Y3	Y2	Y1	Y0
---	---	---	---	---	---	---	-----	-----	-----	----	----	----	----	----	----	----

\*6 When Pr: 37 = "1 to 9998" or Pr: 144 = "2 to 10, 102 to 110," the unit is an integral value (one increment). (Refer to page 227)

\*7 Regenerative display is not available. Regenerative display is only available on the operation panel (FR-DU07).

## ● Parameter

Parameters	Register	Parameter Name	Read/Write	Remarks
0 to 999	41000 to 41999	Refer to the parameter list (page 55) for the parameter names.	Read/write	The parameter number + 41000 is the register number.
C2(902)	41902	Terminal 2 frequency setting bias (frequency)	Read/write	
C3(902)	42092	Terminal 2 frequency setting bias (analog value)	Read/write	The analog value (%) set to C3 (902) is read.
	43902	Terminal 2 frequency setting bias (terminal analog value)	Read	The analog value (%) of the voltage (current) applied to the terminal 2 is read.
125(903)	41903	Terminal 2 frequency setting gain (frequency)	Read/write	
C4(903)	42093	Terminal 2 frequency setting gain (analog value)	Read/write	The analog value (%) set to C4 (903) is read.
	43903	Terminal 2 frequency setting gain (terminal analog value)	Read	The analog value (%) of the voltage (current) applied to the terminal 2 is read.
C5(904)	41904	Terminal 4 frequency setting bias (frequency)	Read/write	
C6(904)	42094	Terminal 4 frequency setting bias (analog value)	Read/write	The analog value (%) set to C6 (904) is read.
	43904	Terminal 4 frequency setting bias (terminal analog value)	Read	The analog value (%) of the current (voltage) applied to the terminal 4 is read.
126(905)	41905	Terminal 4 frequency setting gain (frequency)	Read/write	
C7(905)	42095	Terminal 4 frequency setting gain (analog value)	Read/write	The analog value (%) set to C7 (905) is read.
	43905	Terminal 4 frequency setting gain (terminal analog value)	Read	The analog value (%) of the current (voltage) applied to the terminal 4 is read.
C12(917)	41917	Terminal 1 bias frequency (speed)	Read/write	
C13(917)	42107	Terminal 1 bias (speed)	Read/write	Analog value (%) set in C13 (917) is read.
	43917	Terminal 1 bias (speed) (terminal analog value)	Read	Analog value (%) of the voltage applied to terminal 1 is read.
C14(918)	41918	Terminal 1 gain frequency (speed)	Read/write	
C15(918)	42108	Terminal 1 gain (speed)	Read/write	Analog value (%) set in C15 (918) is read.
	43918	Terminal 1 gain (speed) (terminal analog value)	Read	Analog value (%) of the voltage applied to terminal 1 is read.
C16(919)	41919	Terminal 1 bias command (torque/magnetic flux)	Read/write	
C17(919)	42109	Terminal 1 bias (torque/magnetic flux)	Read/write	Analog value (%) set in C17 (919) is read.
	43919	Terminal 1 bias (torque/magnetic flux) (terminal analog value)	Read	Analog value (%) of the voltage applied to terminal 1 is read.
C18(920)	41920	Terminal 1 gain command (torque/magnetic flux)	Read/write	
C19(920)	42110	Terminal 1 gain (torque/magnetic flux)	Read/write	Analog value (%) set in C19 (920) is read.
	43920	Terminal 1 gain (torque/magnetic flux) (terminal analog value)	Read	Analog value (%) of the voltage applied to terminal 1 is read.
C38(932)	41932	Terminal 4 bias command (torque/magnetic flux)	Read/write	
C39(932)	42122	Terminal 4 bias (torque/magnetic flux)	Read/write	Analog value (%) set in C39 (932) is read.
	43932	Terminal 4 bias (torque/magnetic flux) (terminal analog value)	Read	Analog value (%) of the current (voltage) applied to terminal 4 is read.
C40(933)	41933	Terminal 4 gain command (torque/magnetic flux)	Read/write	
C41(933)	42123	Terminal 4 gain (torque/magnetic flux)	Read/write	Analog value (%) set in C41 (933) is read.
	43933	Terminal 4 gain (torque/magnetic flux) (terminal analog value)	Read	Analog value (%) of the current (voltage) applied to terminal 4 is read.

● Alarm history

Register	Definition	Read/Write	Remarks
40501	Fault history 1	Read/write	Being 2 bytes in length, the data is stored as "H0000". Refer to the lowest 1 byte for the fault code. Performing write using the register 40501 batch-clears the faults history. Set any value as data.
40502	Fault history 2	Read	
40503	Fault history 3	Read	
40504	Fault history 4	Read	
40505	Fault history 5	Read	
40506	Fault history 6	Read	
40507	Fault history 7	Read	
40508	Fault history 8	Read	

Fault code list

Data	Description	Data	Description	Data	Description	Data	Description
H00	No alarm	H80	E.GF	HC5	E.IOH	HDB	E.MB7
H10	E.OC1	H81	E.LF	HC6	E.SER	HDC	E.EP
H11	E.OC2	H90	E.OHT	HC7	E.AIE	HF1	E.1
H12	E.OC3	H91	E.PTC	HC8	E.USB	HF2	E.2
H20	E.OV1	HA0	E.OPT	HD0	E.OS	HF3	E.3
H21	E.OV2	HA3	E.OP3	HD1	E.OSD	HF4	E.4
H22	E.OV3	HB0	E.PE	HD2	E.ECT	HF6	E.6
H30	E.THT	HB1	E.PUE	HD3	E.OD	HF7	E.7
H31	E.THM	HB2	E.RET	HD5	E.MB1	HF8	E.8
H40	E.FIN	HB3	E.PE2	HD6	E.MB2	HFA	E.10
H50	E.IPF	HC0	E.CPU	HD7	E.MB3	HFB	E.11
H51	E.UVT	HC1	E.CTE	HD8	E.MB4	HFD	E.13
H52	E.ILF	HC2	E.P24	HD9	E.MB5	HFF	E.15
H60	E.OLT	HC4	E.CDO	HDA	E.MB6		

\* Refer to page 383 for details of alarm definition.

(7) Pr. 343 Communication error count

You can check the cumulative number of communication errors.

Parameters	Setting Range	Minimum Setting Range	Initial Value
343	(Read only)	1	0

**CAUTION**

The number of communication errors is temporarily stored into the RAM. As it is not stored into the EEPROM, performing a power supply reset or inverter reset clears the value to 0.

(8) Output signal LF "alarm output (communication error warnings)"

During a communication error, the alarm signal (LF signal) is output by open collector output. Assign the used terminal using any of Pr. 190 to Pr. 196 (output terminal function selection).

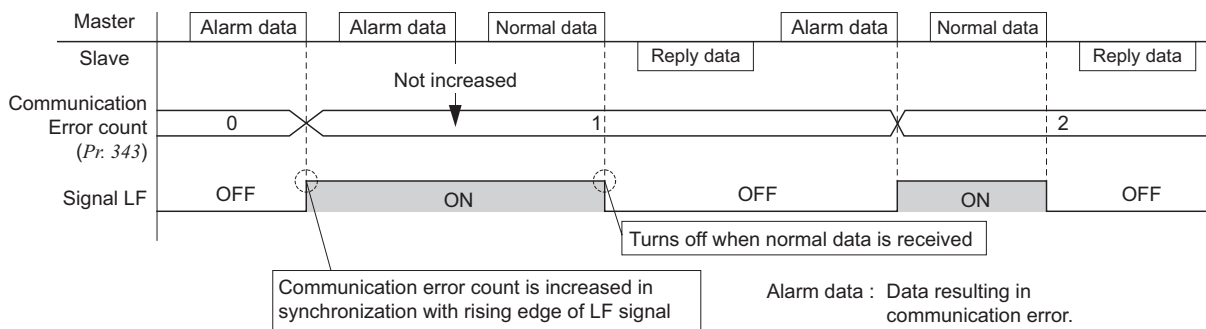

**CAUTION**

The LF signal can be assigned to the output terminal using any of Pr. 190 to Pr. 196. When terminal assignment is changed, the other functions may be affected. Set parameters after confirming the function of each terminal.

**(9) Signal loss detection (Pr. 539 Modbus-RTU communication check time interval)**

If a signal loss (communication stop) is detected between the inverter and master as a result of a signal loss detection, a communication fault (E.SER) occurs and the inverter trips.

- When the setting is "9999", communication check (signal loss detection) is not made.
  - When the setting value is "0", monitor, parameter read, etc. can be performed. However, a communication fault (E.SER) occurs as soon as the inverter is switched to the Network operation mode.
  - A signal loss detection is made when the setting is any of "0.1s to 999.8s". To make a signal loss detection, it is necessary to send data from the master within the communication check time interval. (The inverter makes communication check (clearing of communication check counter) regardless of the station number setting of the data sent from the master.)
  - Communication check is started from the first communication after switching to the Network operation mode (use Pr. 551 PU mode operation command source selection to change).
  - Communication check time of query communication includes data absence time (3.5 byte).
- Since this data absence time differs according to the communication speed, make setting considering this absence time.

**Example: RS-485 terminal communication, Pr. 539 = "0.1 to 999.8s"**

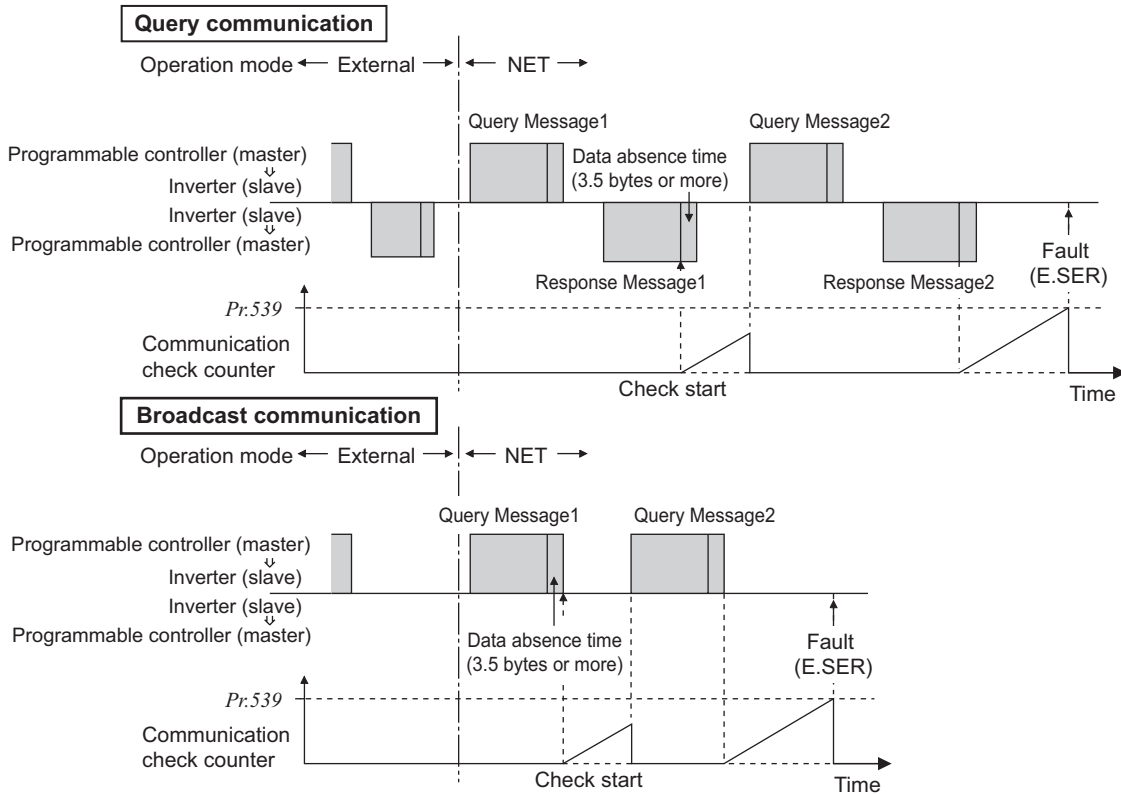

### 4.24.7 USB communication (Pr. 547, Pr. 548)

Inverter setup can be easily performed using FR Configurator by connecting the inverter and personal computer with a USB cable.

- A personal computer and inverter can be easily connected with one USB cable.

Parameter Number	Name	Initial Value	Setting Range	Description
547*	USB communication station number	0	0 to 31	Specify the inverter station number.
548*	USB communication check time interval	9999	0	USB communication is enabled. However, the inverter will trip (E. USB) if operation is changed to PU operation mode.
			0.1 to 999.8s	Set the interval of communication check time. If a no-communication state persists for longer than the permissible time, the inverter will trip (E.USB).
			9999	No communication check

\* Changed setting value is valid when powering ON or resetting the inverter.

#### ●USB communication specifications

<b>Interfase</b>	Conforms to USB1.1
<b>Transmission speed:</b>	12Mbps
<b>Connector</b>	USB B connector (B receptacle)
<b>Cable</b>	Twisted pair shield cable 5m maximum
<b>Power supply</b>	Self-power supply

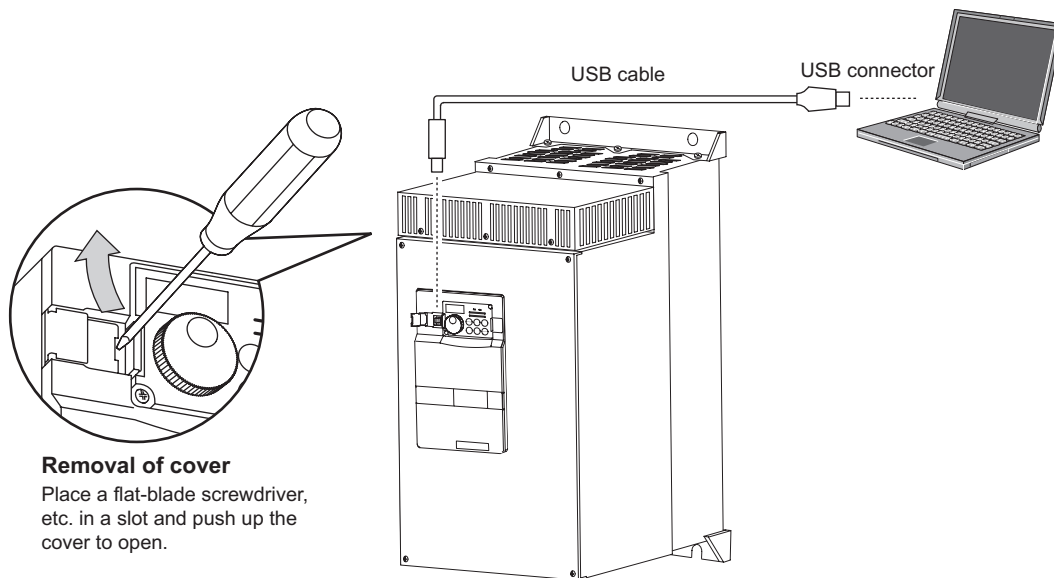

- When using USB communication, set "3" in Pr. 551 PU mode operation command source selection.
- You can perform parameter setting and monitoring with FR Configurator. Refer to the instruction manual of FR Configurator for details.

◆ Parameters referred to ◆

Pr. 551 PU mode operation command source selection Refer to page 299



## 4.25 Special operation and frequency control

Purpose	Parameter that must be Set		Refer to Page
Perform process control such as pump and air volume.	PID control	Pr. 127 to Pr. 134, Pr. 575 to Pr. 577	338
Switch between the inverter operation and bypass operation to operate.	Bypass-inverter switchover function	Pr. 135 to Pr. 139, Pr. 159	346
Increase speed when the load is light.	Load torque high speed frequency control	Pr. 4, Pr. 5, Pr. 270 to Pr. 274	351
Frequency control appropriate for the load torque	Droop control	Pr. 286 to Pr. 288	354
Frequency setting by pulse train input	Pulse train input	Pr. 291, Pr. 384 to Pr. 386	356
Make the motor speed constant by encoder	Encoder feedback control	Pr. 144, Pr. 285, Pr. 359, Pr. 367 to Pr. 369	359
Avoid overvoltage alarm due to regeneration by automatic adjustment of output frequency	Regeneration avoidance function	Pr. 882 to Pr. 886	361

### 4.25.1 PID control (Pr. 127 to Pr. 134, Pr. 575 to Pr. 577)

The inverter can be used to exercise process control, e.g. flow rate, air volume or pressure.

The terminal 2 input signal or parameter setting is used as a set point and the terminal 4 input signal used as a feedback value to constitute a feedback system for PID control.

Parameter Number	Name	Initial Value	Setting Range	Description	
127	PID control automatic switchover frequency	9999	0 to 400Hz	Set the frequency at which the control is automatically changed to PID control.	
			9999	Without PID automatic switchover function	
128	PID action selection	10	10	PID reverse action	Deviation value signal input (terminal 1 )
			11	PID forward action	
			20	PID reverse action	Measured value (terminal 4 ) Set point (terminal 2 or Pr. 133)
			21	PID forward action	
			50	PID reverse action	Deviation value signal input (LONWORKS , CC-Link communication)
			51	PID forward action	
			60	PID reverse action	Measured value, set point input (LONWORKS , CC-Link communication)
61	PID forward action				
129 *1	PID proportional band	100%	0.1 to 1000%	If the proportional band is narrow (parameter setting is small), the manipulated variable varies greatly with a slight change of the measured value. Hence, as the proportional band narrows, the response sensitivity (gain) improves but the stability deteriorates, e.g. hunting occurs. Gain $K_p = 1/\text{proportional band}$	
			9999	No proportional control	
130 *1	PID integral time	1s	0.1 to 3600s	When deviation step is input, time (Ti) is the time required for integral (I) action to provide the same manipulated variable as proportional (P) action. As the integral time decreases, the set point is reached earlier but hunting occurs more easily.	
			9999	No integral control	
131	PID upper limit	9999	0 to 100%	Set the upper limit value. If the feedback value exceeds the setting, the FUP signal is output. The maximum input (20mA/5V/10V) of the measured value (terminal 4) is equivalent to 100%.	
			9999	No function	
132	PID lower limit	9999	0 to 100%	Set the lower limit value. If the measured value falls below the setting range, the FDN signal is output. The maximum input (20mA/5V/10V) of the measured value (terminal 4) is equivalent to 100%.	
			9999	No function	
133 *1	PID action set point	9999	0 to 100%	Used to set the set point for PID control.	
			9999	Terminal 2 input is the set point.	

Parameter Number	Name	Initial Value	Setting Range	Description
134 *1	PID differential time	9999	0.01 to 10.00s	When deviation lamp is input, time (Td) is the time required to provide the manipulated variable of only the proportional (P) action. As the differential time increases, greater response is made to a deviation change.
			9999	No differential control
575	Output interruption detection time	1s	0 to 3600s	The inverter stops operation if the output frequency after PID operation remains at less than the Pr: 576 setting for longer than the time set in Pr: 575.
			9999	Without output interruption function
576	Output interruption detection level	0Hz	0 to 400Hz	Set the frequency at which the output interruption processing is performed.
577	Output interruption cancel level	1000%	900 to 1100%	Set the level (Pr: 577 minus 1000%) at which the PID output interruption function is canceled.

\*1 Pr: 129, Pr: 130, Pr: 133 and Pr: 134 can be set during operation. They can also be set independently of the operation mode.

### (1) PID control basic configuration

Pr: 128 = "10, 11" (Deviation value signal input)

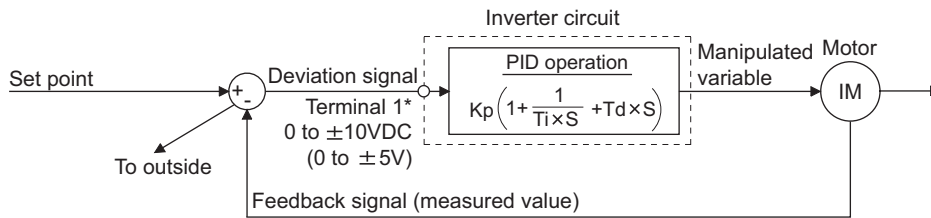

Kp: Proportionality constant Ti: Integral time S: Operator Td: Differential time

\* Set 0 in Pr: 868 Terminal 1 function assignment. PID control is invalid when Pr: 868 ≠ 0.

Pr: 128 = "20, 21" (Measured value input)

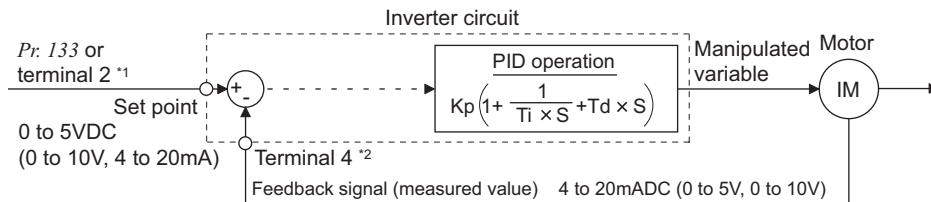

Kp: Proportionality constant Ti: Integral time S: Operator Td: Differential time

\*1 Note that terminal 1 input is added to the set point of terminal 2 input.

\*2 Set 0 in Pr: 858 Terminal 4 function assignment. PID control is invalid when Pr: 858 ≠ 0.

## (2) PID action overview

### 1) PI action

A combination of P action (P) and I action (I) for providing a manipulated variable in response to deviation and changes with time.

[Operation example for stepped changes of measured value]

(Note) PI action is the sum of P and I actions.

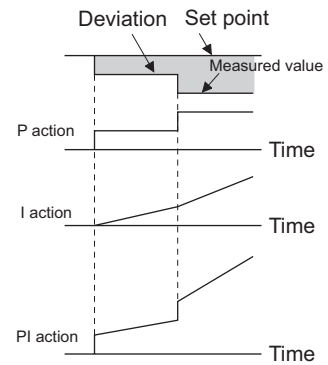

### 2) PD action

A combination of P action (P) and differential control action (D) for providing a manipulated variable in response to deviation speed to improve the transient characteristic.

[Operation example for proportional changes of measured value]

(Note) PD action is the sum of P and D actions.

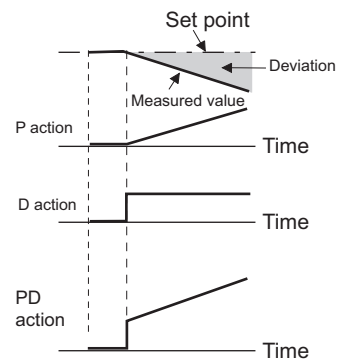

### 3) PID action

The PI action and PD action are combined to utilize the advantages of both actions for control.

(Note) PID action is the sum of P, I and D actions.

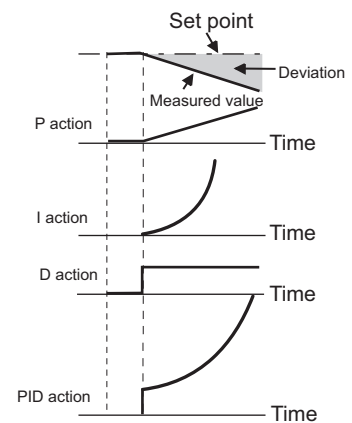

**4) Reverse action**

Increases the manipulated variable (output frequency) if deviation  $X = (\text{set point} - \text{measured value})$  is positive, and decreases the manipulated variable if deviation is negative.

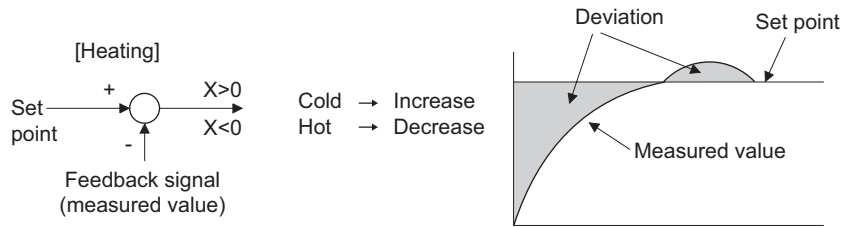

**5) Forward action**

Increases the manipulated variable (output frequency) if deviation  $X = (\text{set point} - \text{measured value})$  is negative, and decreases the manipulated variable if deviation is positive.

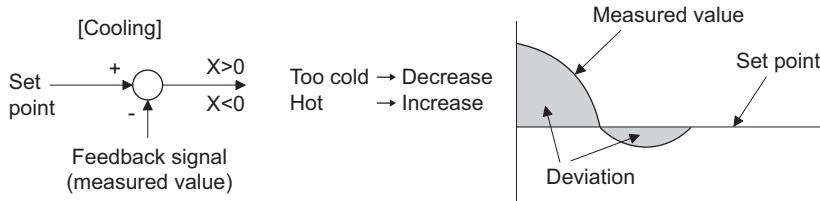

Relationships between deviation and manipulated variable (output frequency)

	Deviation	
	Positive	Negative
Reverse action	↗	↘
Forward action	↘	↗

**(3) Connection diagram**

- Sink logic
- Pr. 128 = 20
- Pr. 183 = 14
- Pr. 191 = 47
- Pr. 192 = 16
- Pr. 193 = 14
- Pr. 194 = 15

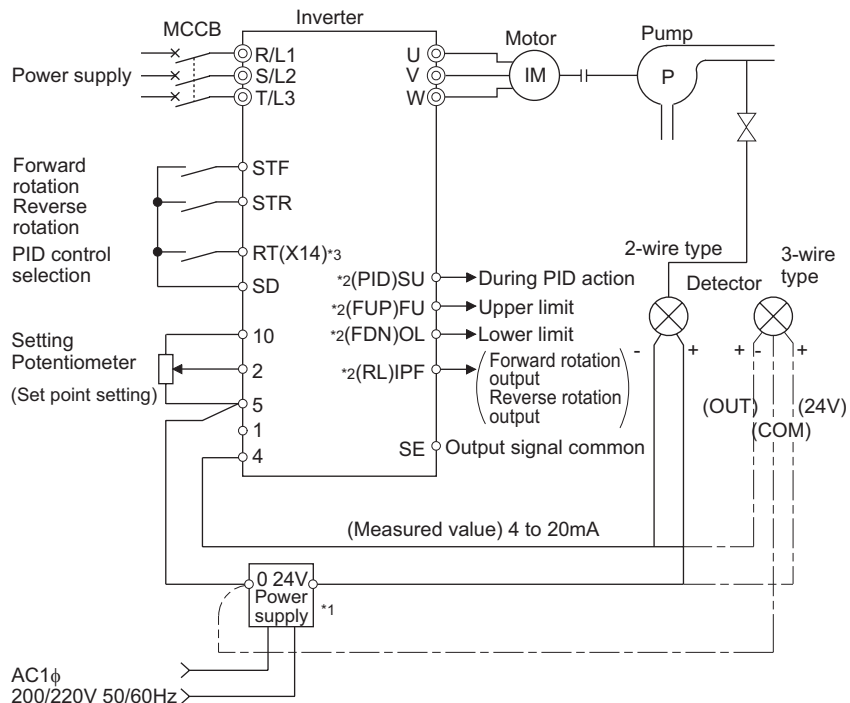

\*1 The power supply must be selected in accordance with the power specifications of the detector used.  
 \*2 The used output signal terminal changes depending on the Pr. 190 to Pr. 196 (output terminal selection) setting.  
 \*3 The used input signal terminal changes depending on the Pr. 178 to Pr. 189 (input terminal selection) setting.  
 \*4 The AU signal need not be input.

**(4) I/O signals and parameter setting**

- Turn ON the X14 signal to perform PID control. When this signal is OFF, PID action is not performed and normal inverter operation is performed. (Note that it is not necessary to turn ON X14 signal when performing PID control with using LONWORKS or CC-Link communication. )
- Enter the set point across inverter terminals 2 and 5 or into Pr. 133 and enter the measured value signal across inverter terminals 4 and 5. At this time, set "20" or "21" in Pr. 128.
- When entering the externally calculated deviation signal, enter it across terminals 1 and 5. At this time, set "10" or "11" in Pr. 128.

Signal	Terminal Used	Function	Description	Parameter Setting	
Input	X14	PID control selection	Turn on X14 to perform PID control.	Set 14 in any of Pr. 178 to Pr. 189.	
	X64	Depending on Pr. 178 to Pr. 189 PID forward/reverse action switchover	By turning on X64, forward action can be selected for PID reverse action (Pr. 128 = 10, 20), and reverse action for forward action (Pr. 128 = 11, 21).	Set 64 in any of Pr. 178 to Pr. 189.	
	2	2	Set point input	Enter the set point for PID control.	Pr. 128 = 20, 21, Pr. 133 = 9999
				0 to 5V.....0 to 100%	Pr. 73 = 1 *1, 3, 5, 11, 13, 15
				0 to 10V.....0 to 100%	Pr. 73 = 0, 2, 4, 10, 12, 14
				0 to 20mA.....0 to 100%	Pr. 73 = 6, 7, 16, 17
	PU	—	Set point input	Set the set value (Pr. 133) from the operation panel or parameter unit.	Pr. 128 = 20, 21, Pr. 133 = 0 to 100%
	1	1	Deviation signal input	Input the deviation signal calculated externally.	Pr. 128 = 10 *1, 11
				-5V to +5V .....-100% to +100%	Pr. 73 = 2, 3, 5, 7, 12, 13, 15, 17
				-10V to +10V .....-100% to +100%	Pr. 73 = 0, 1 *1, 4, 6, 10, 11, 14, 16
	4	4	Measured value input	Input the signal from the detector (measured value signal).	Pr. 128 = 20, 21
				4 to 20mA. 0 to 100%	Pr. 267 = 0 *1
0 to 5V..... 0 to 100%				Pr. 267 = 1	
0 to 10V.... 0 to 100%				Pr. 267 = 2	
Communication *2	—	Deviation value input	Input the deviation value from LONWORKS, CC-Link communication.	Pr. 128 = 50, 51	
		Set value, measured value input	Input the set value and measured value from LONWORKS, CC-Link communication.	Pr. 128 = 60, 61	
Output	FUP	Upper limit output	Output to indicate that the measured value signal exceeded the maximum value (Pr. 131).	Pr. 128 = 20, 21, 60, 61 Pr. 131 ≠ 9999 Set 15 or 115 in any of Pr. 190 to Pr. 196. *3	
	FDN	Lower limit output	Output when the measured value signal falls below the minimum value (Pr. 132).	Pr. 128 = 20, 21, 60, 61 Pr. 132 ≠ 9999 Set 14 or 114 in any of Pr. 190 to Pr. 196. *3	
	RL	Depending on Pr. 190 to Pr. 196 Forward (reverse) rotation direction output	"Hi" is output to indicate that the output indication of the parameter unit is forward rotation (FWD) or "Low" to indicate that it is reverse rotation (REV) or stop (STOP).	Set 16 or 116 in any of Pr. 190 to Pr. 196. *3	
	PID	During PID control activated	Turns ON during PID control.	Set 47 or 147 in any of Pr. 190 to Pr. 196. *3	
	SLEEP	PID output interruption	Turns ON when the PID output interruption function is performed.	Pr. 575 ≠ 9999 Set 70 or 170 in any of Pr. 190 to Pr. 196. *3	
	SE	SE	Output terminal common	Common terminal for terminals FUP, FDN, RL, PID and SLEEP	

\*1 The shaded area indicates the parameter initial value.

\*2 For the setting method via LONWORKS communication, refer to the LONWORKS communication option (FR-A7NL) instruction manual. For the setting method via CC-Link communication, refer to the CC-Link communication option (FR-A7NC) instruction manual.

\*3 When 100 or larger value is set in any of Pr. 190 to Pr. 196 (output terminal function selection), the terminal output has negative logic. (Refer to page 215 for details)

**CAUTION**

- Changing the terminal function using any of Pr. 178 to Pr. 189, Pr. 190 to Pr. 196 may affect the other functions. Set parameters after confirming the function of each terminal.
- When the Pr. 73 and Pr. 267 settings were changed, check the voltage/current input switch setting. Different setting may cause a fault, failure or malfunction. (Refer to page 263 for setting.)

**(5) PID control automatic switchover control (Pr. 127)**

- The inverter can be started up without PID control mode only at a start.
- When the frequency is set to Pr. 127 PID control automatic switchover frequency within the range 0 to 400Hz, the system starts up without PID operation from a start until Pr. 127 is reached, and then it shifts to PID control operation mode. Once the system has entered PID control operation, it continues PID control if the output frequency falls to or below Pr. 127.

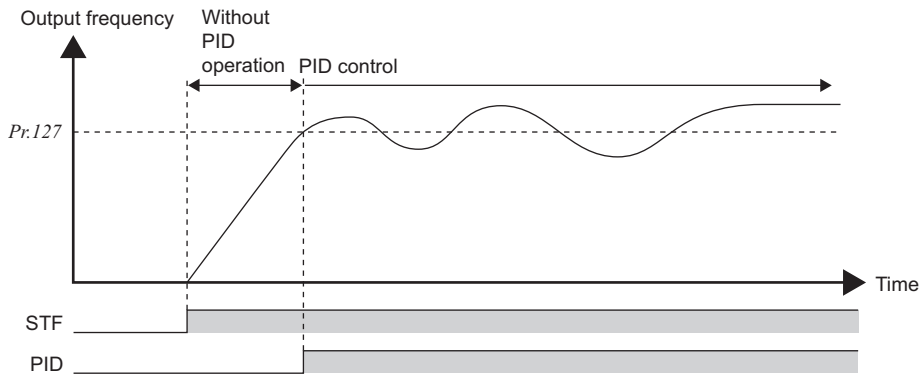

**(6) PID output suspension function (SLEEP function) (SLEEP signal, Pr. 575 to Pr. 577)**

- The inverter stops operation if the output frequency after PID operation remains at less than the Pr. 576 Output interruption detection level setting for longer than the time set in Pr. 575 Output interruption detection time. This function can reduce energy consumption in the low-efficiency, low-speed range.
- When the deviation (= set value - measured value) reaches the PID output shutoff cancel level (Pr. 577 setting - 1000%) while the PID output interruption function is ON, the PID output interruption function is canceled and PID control operation is resumed automatically.
- While the PID output interruption function is ON, the PID output interruption signal (SLEEP) is output. At this time, the inverter running signal (RUN) is OFF and the PID control operating signal (PID) is ON.

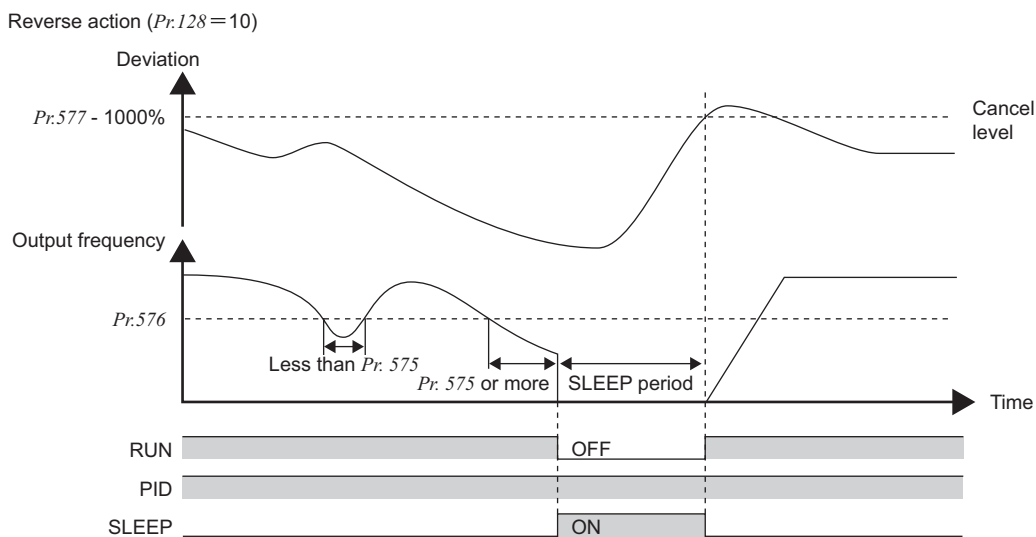

**(7) PID monitor function**

- The PID control set point, measured value and deviation value can be displayed on the operation panel and output from terminal FM, AM.
- Integral value indicating a negative % can be displayed on the deviation monitor. 0% is displayed as 1000. (The deviation monitor cannot be output from the terminal FM, AM.)
- For the monitors, set the following values in Pr. 52 DU/PU main display data selection, Pr. 54 FM terminal function selection, and Pr. 158 AM terminal function selection.

Setting	Monitor Description	Minimum Increments	Terminal FM, AM Full Scale	Remarks
52	PID set point	0.1%	100%	For deviation input (Pr. 128 = 10, 11), the monitor value is always displayed as 0.
53	PID measurement value	0.1%	100%	
54	PID deviation value	0.1%	—	Value cannot be set to Pr. 54 or Pr. 158. The PID deviation value of 0% is displayed as 1000.

**(8) Adjustment procedure**

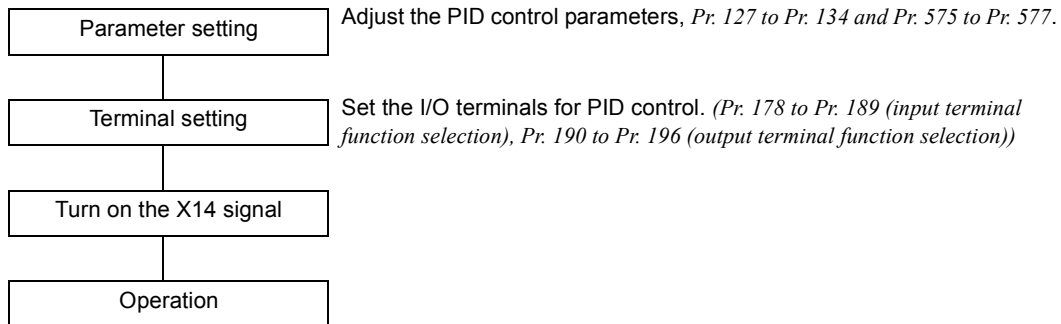

**(9) Calibration example**

(A detector of 4mA at 0°C and 20mA at 50°C is used to adjust the room temperature to 25°C under PID control. The set point is given to across inverter terminals 2 and 5 (0 to 5V).)

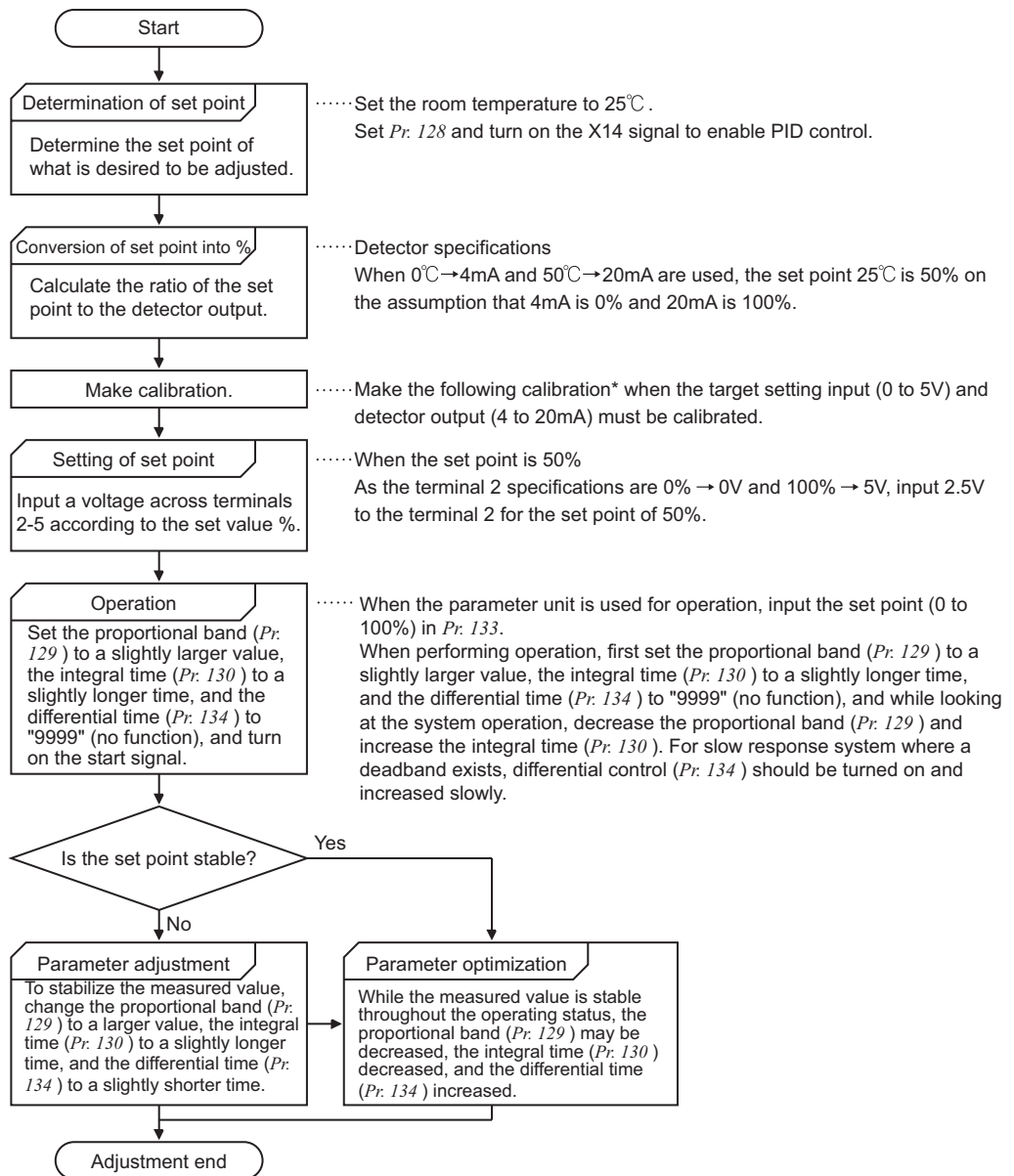

\*When calibration is required → Using calibration Pr. 902 and Pr. 903 (terminal 2) or Pr. 904 and Pr. 905 (terminal 4), calibrate the detector output and target setting input. Make calibration in the PU mode during an inverter stop.

**<Set point input calibration>**

1. Apply the input voltage of 0% set point setting (e.g. 0V) across terminals 2 and 5.
2. Enter in C2 (Pr. 902) the frequency which should be output by the inverter at the deviation of 0% (e.g. 0Hz).
3. In C3 (Pr. 902), set the voltage value at 0%.
4. Apply the voltage of 100% set point (e.g. 5V) to across terminals 2 and 5.
5. Enter in Pr. 125 the frequency which should be output by the inverter at the deviation of 100% (e.g. 60Hz).
6. In C4 (Pr. 903), set the voltage value at 100%.

**<Measured value calibration>**

1. Apply the input current of 0% measured value (e.g. 4mA) across terminals 4-5.
2. Make calibration using C6 (Pr. 904).
3. Apply the input current of 100% measured value (e.g. 20mA) across terminals 4-5.
4. Make calibration using C7 (Pr. 905).

**REMARKS**

- The frequency set in C5 (Pr. 904) and Pr. 126 should be the same as set in C2 (Pr. 902) and Pr. 125.

The results of the above calibration are as shown below:

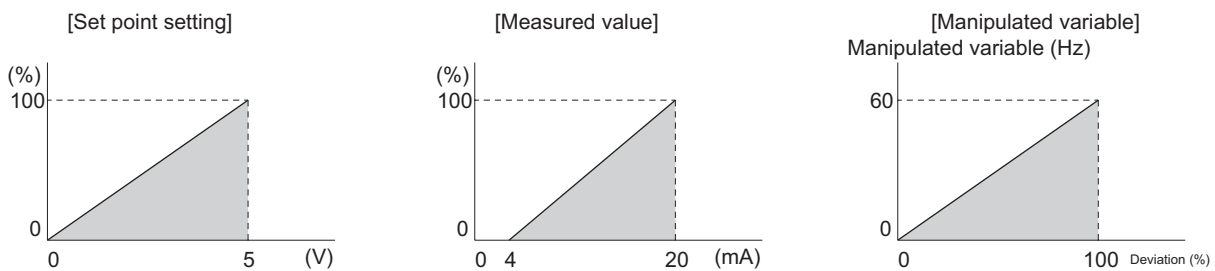

**CAUTION**

- If the RH, RM, RL, REX signal (multi-speed) or JOG signal (Jog operation) is entered with the X14 signal on, PID control is stopped and multi-speed or jog operation is started.
- If the setting is as follows, PID control becomes invalid.  
Pr. 79 Operation mode selection = "6" (switchover mode)
- When the Pr. 128 setting is "20" or "21", note that the input across inverter terminals 1-5 is added to the set value across terminals 2 and 5.
- When using terminal 4 (measured value input) and terminal 1 (deviation input) under PID control, set "0" (initial value) in Pr. 858 Terminal 4 function assignment and "0" (initial value) in Pr. 868 Terminal 1 function assignment. PID control can not be performed when a value other than 0 is set.
- Changing the terminal function using any of Pr. 178 to Pr. 189, Pr. 190 to Pr. 196 may affect the other functions. Set parameters after confirming the function of each terminal.
- When PID control is selected, the minimum frequency is the frequency set in Pr. 902 and the maximum frequency is the frequency set in Pr. 903. (Pr. 1 Maximum frequency and Pr. 2 Minimum frequency settings are also valid.)
- The remote operation function is invalid during PID operation.
- When the control is switched to PID control during normal operation, the frequency command value calculated by PID operation using 0Hz as standard is used without the frequency during the operation.

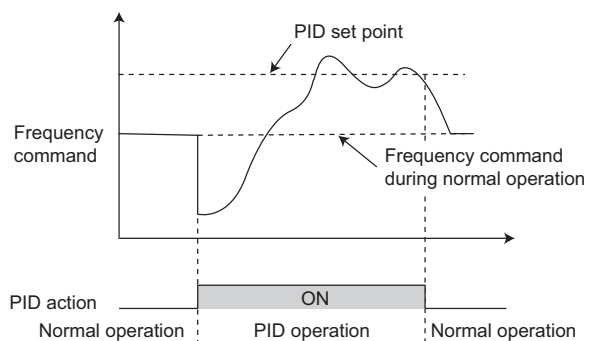

Operation when control is switched to PID control during normal operation

**◆ Parameters referred to ◆**

- Pr. 59 Remote function selection Refer to page 152
- Pr. 73 Analog input selection Refer to page 263
- Pr. 79 Operation mode selection Refer to page 290
- Pr. 178 to Pr. 189 (input terminal function selection) Refer to page 207
- Pr. 190 to Pr. 196 (output terminal function selection) Refer to page 215
- C2 (Pr. 902) to C7 (Pr. 905) Frequency setting voltage (current) bias/gain Refer to page 271



#### 4.25.2 Bypass-inverter switchover function (Pr. 57, Pr. 58, Pr. 135 to Pr. 139, Pr. 159)

The complicated sequence circuit for bypass operation is built in the inverter. Hence, simply inputting the start, stop or automatic switchover selection signal facilitates the interlock operation of the switchover magnetic contactor.

Parameter Number	Name	Initial Value	Setting Range	Description
57	Restart coasting time	9999	0	· 5.5K, 7.5K ..... 1s, · 11K or higher ..... 3.0s, The above times are coasting time.
			0.1 to 5s	Set the waiting time for inverter-triggered restart after an instantaneous power failure.
			9999	No restart
58	Restart cushion time	1s	0 to 60s	Set a voltage starting time at restart.
135	Electronic bypass sequence selection	0	0	Without electronic bypass sequence
			1	With electronic bypass sequence
136	MC switchover interlock time	1s	0 to 100s	Set the operation interlock time of MC2 and MC3.
137	Start waiting time	0.5s	0 to 100s	Set the time slightly longer (0.3 to 0.5s or so) than the time from when the ON signal enters MC3 until it actually turns on.
138	Bypass selection at a fault	0	0	Inverter output is stopped (motor coast) at inverter fault.
			1	Operation is automatically switched to bypass operation at inverter fault (Not switched when an external thermal relay operation (E.OHT) or CPU error (E.CPU) occurs).
139	Automatic switchover frequency from inverter to bypass operation	9999	0 to 60Hz	Set the frequency to switch inverter operation to bypass operation. Inverter operation is performed from a start until Pr. 139 is reached, and when the output frequency is at or above Pr. 139, inverter operation is automatically switched to bypass operation.
			9999	Without automatic switchover
159	Automatic switchover frequency range from bypass to inverter operation	9999	0 to 10Hz	Valid during automatic switchover operation (Pr. 139 ≠ 9999) When the frequency command decreases below (Pr. 139 - Pr. 159) after operation is switched from inverter operation to bypass operation, the inverter automatically switches operation to inverter operation and operates at the frequency of frequency command. When the inverter start command (STF/STR) is turned off, operation is switched to inverter operation also.
			9999	Valid during automatic switchover operation (Pr. 139 ≠ 9999) When the inverter start command (STF/STR) is turned off after operation is switched from inverter operation to bypass operation, operation is switched to inverter operation and the motor decelerates to stop.

- When the motor is operated at 60Hz (or 50Hz), more efficient operation can be performed by the commercial power supply than by the inverter. When the motor cannot be stopped for a long time for the maintenance/inspection of the inverter, it is recommended to provide the commercial power supply circuit.
- To switch between inverter operation and bypass operation, an interlock must be provided to stop the motor once and then start it by the inverter in order to prevent the inverter from resulting in an overcurrent alarm. Using the electronic bypass sequence function that outputs the timing signal for operation of the magnetic contactor, a complicated commercial power supply switchover interlock can be provided by the inverter.

#### CAUTION

Commercial operation can not be performed with the Mitsubishi vector motor (SF-V5RU).

(1) Connection diagram

- The following shows the connection diagram of a typical electronic bypass sequence. Sink logic, Pr. 185 = "7", Pr. 192 = "17", Pr. 193 = "18", Pr. 194 = "19"

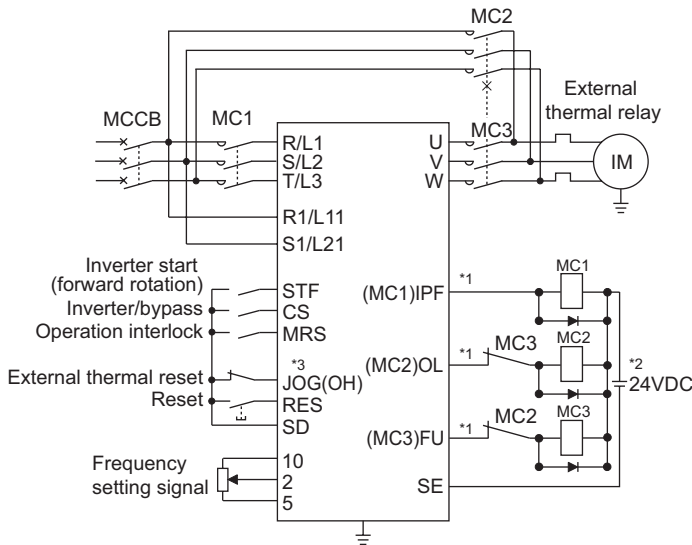

Electronic bypass sequence connection diagram

\*1 Take caution for the capacity of the sequence output terminal. The used terminal changes depending on the setting of Pr. 190 to Pr. 196 (output terminal function selection).

Output Terminal Capacity	Output Terminal Permissible Load
Inverter open collector output (RUN, SU, IPF, OL, FU)	24VDC 0.1A
Inverter relay output (A1-C1, B1-C1, A2-B2, B2-C2) Relay output option (FR-A7AR)	230VAC 0.3A 30VDC 0.3A

\*2 When connecting a DC power supply, insert a protective diode. When connecting an AC power supply, connect a relay output option (FR-A7AR) and use a contact output.

\*3 The used terminal changes depending on the setting of Pr. 180 to Pr. 189 (input terminal function selection).

**CAUTION**

- Use the bypass operation function in External operation mode. Be sure to connect the other power supply since the function is not performed normally unless the connection terminals R1/L11, S1/L21 are not connected to the other power supply (power supply that does not pass MC1).
- Be sure to provide mechanical interlocks for MC2 and MC3.

- Operations of magnetic contactors (MC1, MC2, MC3)

Magnetic Contactor	Installation Place	Operation (O: Shorted, ×: Open)		
		Bypass operation	During inverter operation	At an inverter fault occurrence
MC1	Between power supply and inverter input	O	O	× (Shorted by reset)
MC2	Between power supply and motor	O	×	× (Can be selected using Pr. 138, always open when external thermal relay is on)
MC3	Between inverter output and motor	×	O	×

· The input signals are as indicated below.

Signal	Terminal Used	Function	Operation	MC Operation *6		
				MC1 *5	MC2	MC3
MRS	MRS	Operation enable/disable selection *1	ON ..... Bypass-inverter operation enabled	○	—	—
			OFF ... Bypass-inverter operation disabled	○	×	No change
CS	CS	Inverter/bypass *2	ON..... Inverter operation	○	×	○
			OFF ... Bypass operation	○	○	×
STF (STR)	STF(STR)	Inverter operation command (Invalid for bypass) *3	ON..... Forward rotation (reverse rotation)	○	×	○
			OFF .... Stop	○	×	○
OH	Set "7" in any of Pr. 180 to Pr. 189.	External thermal relay input	ON ..... Motor normal	○	—	—
			OFF .... Motor abnormal	×	×	×
RES	RES	Operating status initialization *4	ON..... Initialization	No change	×	No change
			OFF .... Normal operation	○	—	—

- \*1 Unless the MRS signal is turned on, neither bypass operation nor inverter operation can be performed.
- \*2 The CS signal functions only when the MRS signal is on.
- \*3 STF (STR) functions only when both the MRS signal and CS signal are on.
- \*4 The RES signal enables reset input acceptance selection using Pr. 75 Reset selection/disconnected PU detection/PU stop selection.
- \*5 MC1 turns off when an inverter fault occurs.
- \*6 MC operation
  - : MC-ON
  - × : MC-OFF
  - : Inverter operation ..... MC2 is off and MC3 is on  
Bypass operation ..... MC2 is on and MC3 is off
  - No change : The status before the signal turns on or off is held.

· The output signals are as indicated below.

Signal	Terminal Used (Pr. 190 to Pr. 196 setting)	Description
MC1	17	Control signal output of inverter input side magnetic contactor MC1
MC2	18	Control signal output of bypass operation magnetic contactor MC2
MC3	19	Control signal output of inverter output side magnetic contactor MC3

## (2) Electronic bypass operation sequence

· Operation sequence example when there is no automatic switchover sequence (Pr. 139 = "9999")

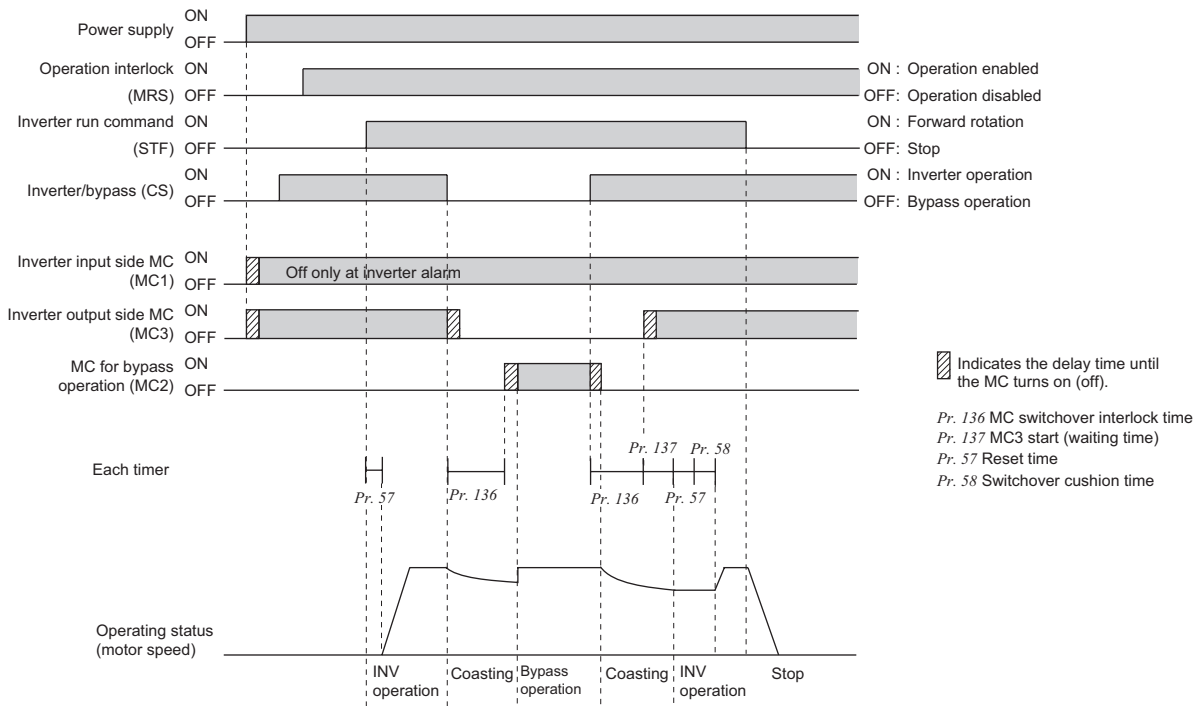

· Operation sequence example when there is automatic switchover sequence (Pr. 139 ≠ "9999", Pr. 159 = "9999")

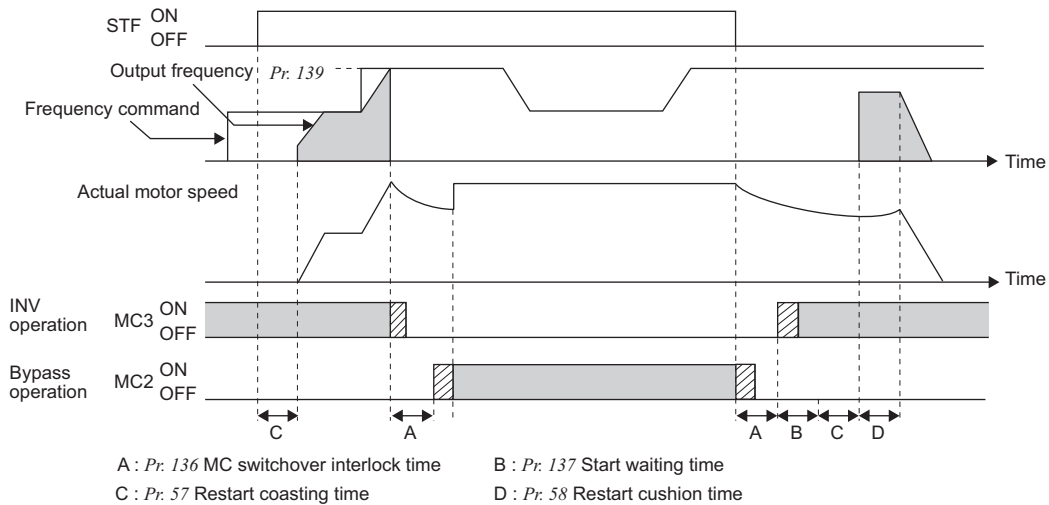

· Operation sequence example when there is automatic switchover sequence (Pr. 139 ≠ "9999", Pr. 159 ≠ "9999")

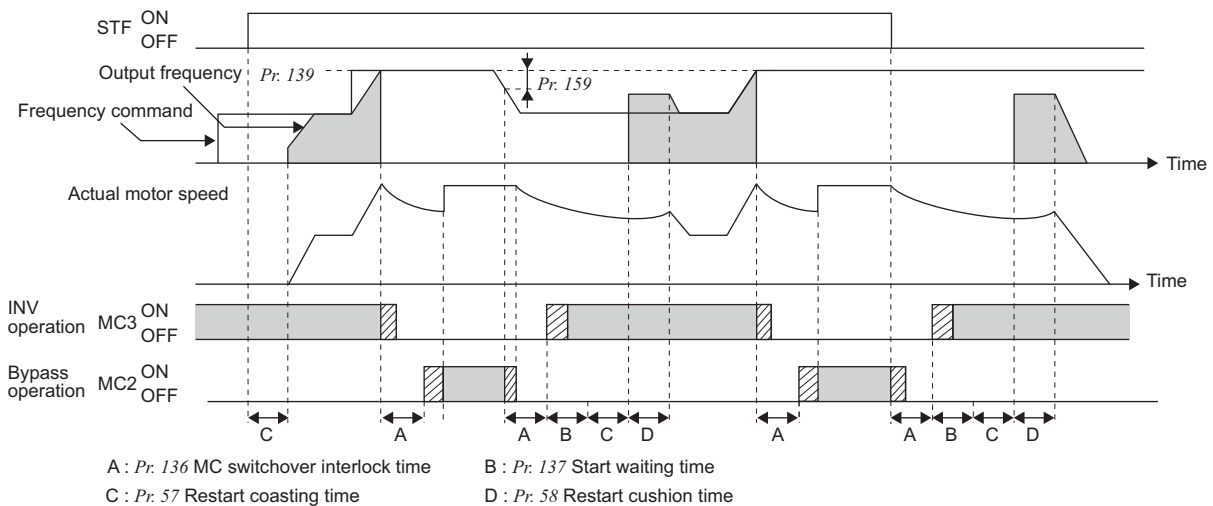

### (3) Operating procedure

#### 1) Procedure for operation

Operation pattern

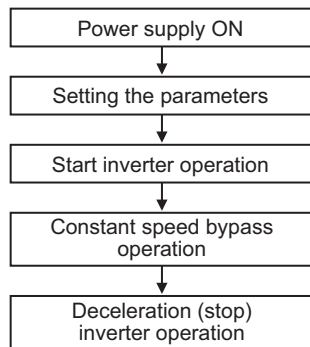

- Pr: 135 = "1" (open collector output terminal of inverter)
- Pr: 136 = "2.0s"
- Pr: 137 = "1.0s" (Set the time longer than the time from when MC3 actually turns on until the inverter and motor are connected. If the time is short, a restart may not function properly.)
- Pr: 57 = "0.5s"
- Pr: 58 = "0.5s" (Be sure to set this parameter when bypass operation is switched to inverter operation.)

#### 2) Signal ON/OFF after parameter setting

	MRS	CS	STF	MC1	MC2	MC3	Remarks
Power supply ON	OFF (OFF)	OFF (OFF)	OFF (OFF)	OFF → ON (OFF → ON)	OFF (OFF)	OFF → ON (OFF → ON)	External operation mode (PU operation mode)
At start (inverter)	OFF → ON	OFF → ON	OFF → ON	ON	OFF	ON	
At constant speed (commercial power supply)	ON	ON → OFF	ON	ON	OFF → ON	ON → OFF	MC2 turns on after MC3 turns off (coasting status during this period) Waiting time 2s
Switched to inverter for deceleration (inverter)	ON	OFF → ON	ON	ON	ON → OFF	OFF → ON	MC3 turns on after MC2 turns off (coasting status during this period) Waiting time 4s
Stop	ON	ON	ON → OFF	ON	OFF	ON	

#### CAUTION

- Connect the control power supply (R1/L11, S1/L21) in front of input side MC1. If the control power supply is connected behind input side MC1, the electronic bypass sequence function is not executed.
- The electronic bypass sequence function is valid only when Pr: 135 = "1" in the External operation or combined operation mode (PU speed command, external operation command Pr: 79 = "3"). When Pr: 135 = "1" in the operation mode other than the above, MC1 and MC3 turn on.
- When the MRS and CS signals are on and the STF (STR) signal is off, MC3 is on, but when the motor was coasted to a stop from bypass operation last time, a start is made after the time set in Pr: 137 has elapsed.
- Inverter operation can be performed when the MRS, STF (STR) and CS signals turn on. In any other case (MRS signal - ON), bypass operation is performed.
- When the CS signal is turned off, the motor switches to bypass operation. However, when the STF (STR) signal is turned off, the motor is decelerated to a stop in the inverter operation mode.
- When both MC2 and MC3 are off and either MC2 or MC3 is then turned on, there is a waiting time set in Pr: 136.
- If electronic bypass sequence is valid (Pr: 135 = "1"), the Pr: 136 and Pr: 137 settings are ignored in the PU operation mode. The input terminals (STF, CS, MRS, OH) of the inverter return to their normal functions.
- When the electronic bypass sequence function (Pr: 135 = "1") and PU operation interlock function (Pr: 79 = "7") are used simultaneously, the MRS signal is shared by the PU operation external interlock signal unless the X12 signal is assigned. (When the MRS and CS signals turn on, inverter operation is enabled)
- Changing the terminal function using any of Pr: 178 to Pr: 189, 190 to Pr: 196 may affect the other functions. Set parameters after confirming the function of each terminal.

#### ◆ Parameters referred to ◆

- Pr: 11 DC injection brake operation time Refer to page 185
- Pr: 57 Restart coasting time Refer to page 243
- Pr: 58 Restart cushion time Refer to page 243
- Pr: 79 Operation mode selection Refer to page 290
- Pr: 178 to Pr: 189 (Input terminal function selection) Refer to page 207
- Pr: 190 to Pr: 196 (Output terminal function selection) Refer to page 215

### 4.25.3 Load torque high speed frequency control (Pr. 4, Pr. 5, Pr. 270 to Pr. 274)

Load torque high speed frequency control is a function which automatically sets the operational maximum frequency according to the load.

The load size during power driving is estimated by detecting average currents at set timings after a start. When the load is light, the frequency is increased from the originally-set frequency. (During regenerative driving, the frequency is not increased.)

This function is designed to increase speed automatically under light load, for example to minimize the incoming/outgoing time in a multi-story parking lot.

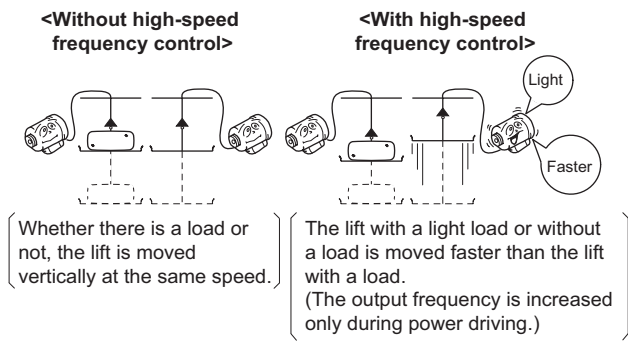

Parameter Number	Name	Initial Value	Setting Range	Description
4	Multi-speed setting (high speed)	60Hz	0 to 400Hz	Set the higher-speed frequency.
5	Multi-speed setting (middle speed)	30Hz	0 to 400Hz	Set the lower-speed frequency.
270	Stop-on contact/load torque high-speed frequency control selection	0	0	Normal operation
			1	Stop-on-control (refer to page 190)
			2	Load torque high speed frequency control
			3	Stop-on-contact (refer to page 190) + load torque high speed frequency control
271 *	High-speed setting maximum current	50%	0 to 220%	Set the upper and lower limits of the current at high and middle speeds.
272 *	Middle-speed setting minimum current	100%	0 to 220%	
273 *	Current averaging range	9999	0 to 400Hz	Average current during acceleration from (Pr. 273 × 1/2) Hz to (Pr. 273) Hz can be achieved.
			9999	Average current during acceleration from (Pr. 5 × 1/2) Hz to (Pr. 5) Hz is achieved.
274 *	Current averaging filter time constant	16	1 to 4000	Set the time constant of the primary delay filter relative to the output current. The time constant [ms] is 0.75 × Pr. 274 and the initial value is 12ms. A larger setting provides higher stability but poorer response.

\* This parameter allows its setting to be changed during operation in any operation mode even if "0" (initial value) is set in Pr. 77 Parameter write selection.

#### <Connection diagram>

- Sink logic
- Pr. 186 = 19

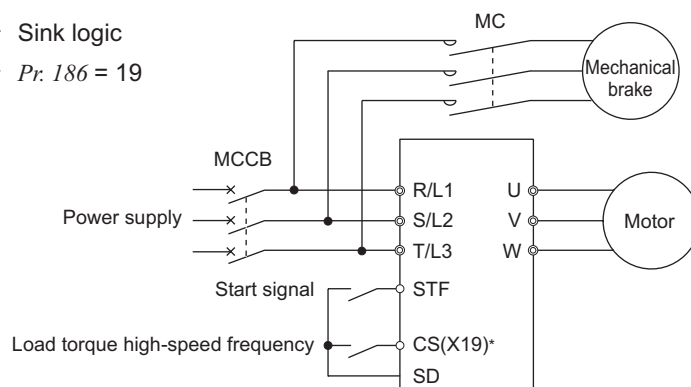

\* The used terminal changes according to the Pr. 180 to Pr. 189 (input terminal function selection) settings.

### (1) Load torque high speed frequency control setting

- Set "2 or 3" in Pr. 270 Stop-on contact/load torque high-speed frequency control selection.
- When operating with the load torque high speed frequency function selection signal (X19) on, the inverter automatically changes the maximum frequency within the setting range of Pr. 4 Multi-speed setting (high speed) and Pr. 5 according to the magnitude of the average current during the time to accelerate from 1/2 of the frequency set in Pr. 5 Multi-speed setting (middle speed) to the frequency set in Pr. 5.
- Set "19" in Pr. 178 to Pr. 189 (input terminal function selection) and assign the X19 signal function to the input terminal.
- Made valid only in the External operation mode.
- This control can be activated at every start.

### (2) Operation of load torque high speed frequency control setting

- When the average current of the current averaging range (A in the chart below) during operation with the X19 signal on is less than the "rated inverter current × Pr. 271 setting (%)", the maximum frequency automatically becomes the Pr. 4 Multi-speed setting (high speed) setting value.
- When the average current of the current averaging range (B in the chart below) during operation with the X19 signal on is more than the "rated inverter current × Pr. 272 setting (%)", the maximum frequency automatically becomes the Pr. 5 Multi-speed setting (middle speed) setting value.
- During regeneration load operation, setting of Pr. 5 is the maximum frequency regardless of the average current.

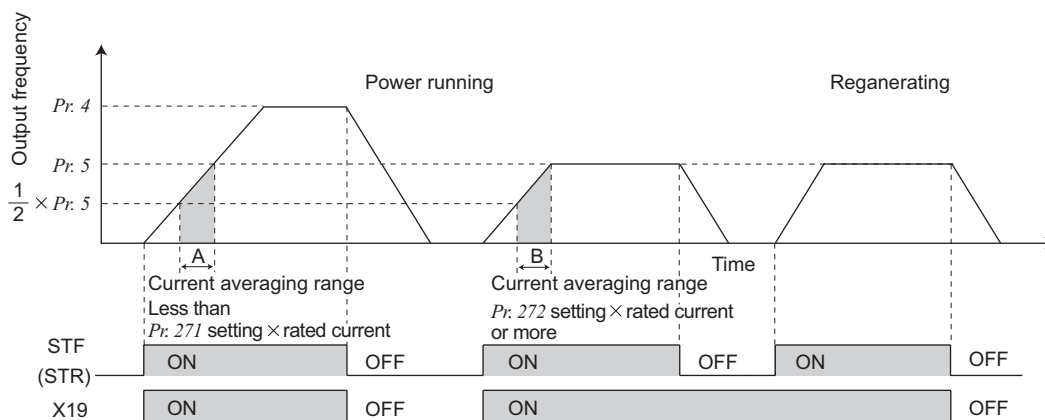

- The current averaging range can be set between 1/2 frequency of the Pr. 273 setting value and Pr. 273 set frequency.

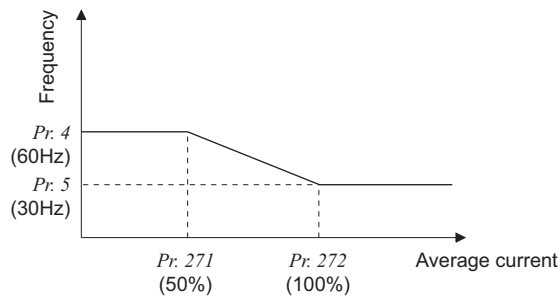

### CAUTION

- When the current averaging range includes the constant power range, the output current may become large in the constant power range.
- When the average current value in the current averaging range is small, deceleration time becomes longer as the running frequency increases.
- The maximum output frequency is 120Hz. The output frequency is 120Hz even when the setting is above 120Hz.
- The automatic restart after instantaneous power failure function and the fast-response current limit operation are invalid.
- Changing the terminal function using any of Pr. 178 to Pr. 189 may affect the other functions. Set parameters after confirming the function of each terminal.
- The load torque high speed frequency function is invalid in the following operation conditions.  
 PU operation (Pr. 79), PU+external operation (Pr. 79), JOG operation (JOG signal), PID control function operation (X14 signal), remote setting function operation (Pr. 59), orientation control function operation, multi-speed setting (RH, RM, RL signal), 16 bit digital input option (FR-A7AX)
- When the average current during acceleration is too small, it may be judged as regeneration and the maximum frequency becomes the setting of Pr. 5.

## CAUTION

 When the load is light, the motor may suddenly accelerate to 120Hz maximum, causing hazard.  
Securely provide mechanical interlock on the machine side to perform.

### ◆ Parameters referred to ◆

Pr. 4 to Pr. 6, Pr. 24 to Pr. 27 (multi-speed setting)  Refer to page 148

Pr. 59 Remote function selection  Refer to page 152

Pr. 79 Operation mode selection  Refer to page 290

Pr. 128 PID action selection  Refer to page 338

Pr. 178 to Pr. 189 (input terminal function selection)  Refer to page 207



4.25.4 Droop control (Pr. 286 to Pr. 288) Magnetic flux Sensorless Vector

This function is designed to balance the load in proportion to the load torque to provide the speed drooping characteristic under Advanced magnetic flux vector control, Real sensorless vector control and vector control. This function is effective for balancing the load when using multiple inverters

Parameter Number	Name	Initial Value	Setting Range	Description
286	Droop gain	0%	0	Normal operation
			0.1% to 100%	Droop control is valid Set the drooping amount at the rated torque as a percentage with respect to the rated motor frequency.
287	Droop filter time constant	0.3s	0 to 1s	Set the time constant of the filter applied on the torque current.
288	Droop function activation selection	0	0	Droop control is not exercised during acceleration/ deceleration.
			1	Droop control is always exercised during operation. (with 0 limit)
			2	Droop control is always exercised during operation. (without 0 limit)
			10	Droop control is not exercised during acceleration/ deceleration. (Motor speed is referenced)
			11	Droop control is always exercised during operation. (Motor speed is referenced)

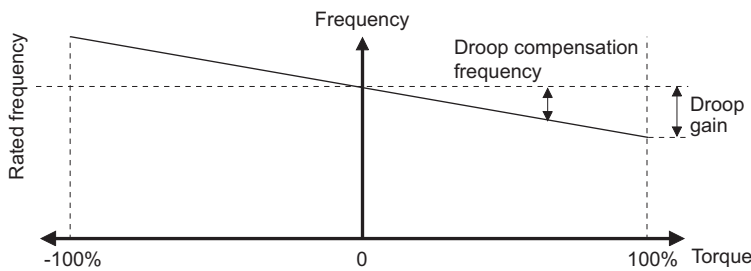

(1) Droop control

- The output frequency is changed according to the magnitude of torque current under Advanced magnetic flux vector control, Real sensorless vector control and vector control. The drooping amount at the rated torque is set by the droop gain as a percentage using the rated frequency (Motor speed when Pr. 288 = "10, 11") as a reference.
- The maximum droop compensation frequency is 120Hz.

When Pr. 288 = "0 to 2", or under Advanced magnetic flux vector control

$$\text{Droop compensation frequency} = \frac{\text{Torque current after filtering}}{\text{Rated value of torque current}} \times \frac{\text{Rated motor frequency} \times \text{Droop gain}}{100}$$

When Pr. 288 = "10, 11"

$$\text{Droop compensation frequency} = \frac{\text{Torque current after filtering}}{\text{Rated value of torque current}} \times \frac{\text{Motor speed} \times \text{Droop gain}}{100}$$

**REMARKS**

Set the droop gain to about the rated slip of the motor.

$$\text{Rated slip} = \frac{\text{Synchronous speed at base frequency} - \text{Rated speed}}{\text{Synchronous speed at base frequency}} \times 100[\%]$$

**(2) Limit the frequency after droop compensation (0 limit)**

- Setting *Pr. 288* under Real sensorless vector control or vector control can limit the frequency command when the frequency after droop compensation is negative.

<i>Pr. 288</i> Setting	Description	
	Under Advanced magnetic flux vector control	Under Real sensorless vector control or vector control
0 (initial value), 10	Droop control is not exercised during acceleration/ deceleration. Note that the frequency command after droop control is limited at 0.5Hz when the frequency command after droop control is negative. Droop compensation amount is determined using the rated motor frequency as reference.	Droop control is not exercised during acceleration/ deceleration. Note that the frequency command is limited at 0Hz when the frequency command after droop control is negative. When <i>Pr. 288</i> = "10", droop compensation amount is determined using the motor speed as reference.
1, 11		Droop control is always exercised during operation. Note that the frequency command is limited at 0Hz when the frequency command after droop control is negative. When <i>Pr. 288</i> = "11", droop compensation amount is determined using the motor speed as reference.
2		Droop control is always exercised during operation. Note that under vector control, the frequency command is not limited at 0Hz even when the frequency command after droop control is negative. (The frequency command is limited at 0Hz under Real sensorless vector control.)

**REMARKS**

The maximum value of frequency after droop compensation is either 120Hz or *Pr. 1 Maximum frequency*, whichever is smaller.

◆ **Parameters referred to** ◆

*Pr. 1 Maximum frequency*  Refer to page 140

### 4.25.5 Frequency setting by pulse train input (Pr. 291, Pr. 384 to Pr. 386)

The inverter speed can be set by inputting pulse train from terminal JOG.  
 In addition, synchronous speed operation of inverters can be performed by combining pulse train I/O.

Parameter Number	Name	Initial Value	Setting Range	Description
291	Pulse train I/O selection	0	0	Pulse train input Terminal JOG FM output
			1	Pulse train input FM output
			10	Terminal JOG High speed pulse train output (50%Duty)
			11	Pulse train input High speed pulse train output (50%Duty)
			20	Terminal JOG High speed pulse train output (ON width is always same)
			21	Pulse train input High speed pulse train output (ON width is always same)
			100	Pulse train input High speed pulse train output (ON width is always same) The inverter outputs the signal input as pulse train as it
384	Input pulse division scaling factor	0	0 1 to 250	0 Pulse train input invalid Indicates division scaling factor to the input pulse and the frequency resolution to the input pulse changes according to the value.
385	Frequency for zero input pulse	0Hz	0 to 400Hz	Set the frequency when the input pulse is 0 (bias).
386	Frequency for maximum input pulse	60Hz	0 to 400Hz	Set the frequency when the input pulse is maximum (gain).

#### (1) Pulse train input selection (Pr. 291)

- Setting any of "1, 11, 21, 100" in Pr. 291 Pulse train I/O selection and a value other than "0" in Pr. 384 Input pulse division scaling factor switches terminal JOG to pulse train input terminal and frequency setting of the inverter can be performed. (The initial value is JOG signal)  
 Pulse train input of maximum of 100k pulse/s is enabled.
- Output specifications (high speed pulse train output or FM output) of terminal FM can be selected using Pr. 291.

##### ● Connection with an open collector output system pulse generator

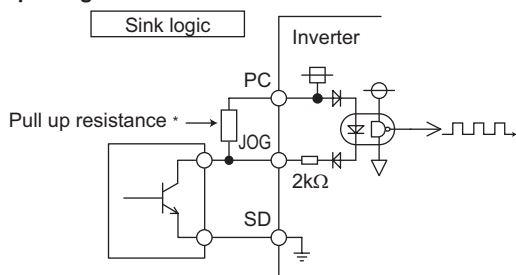

##### ● Connection with a complementary output system pulse generator

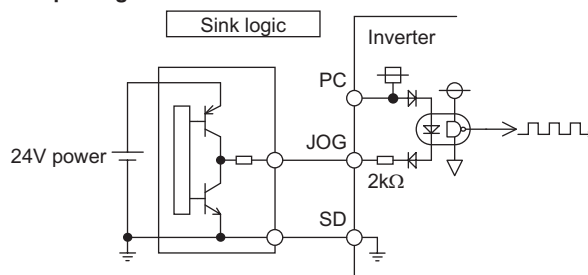

##### ● Connection with an open collector output system pulse generator

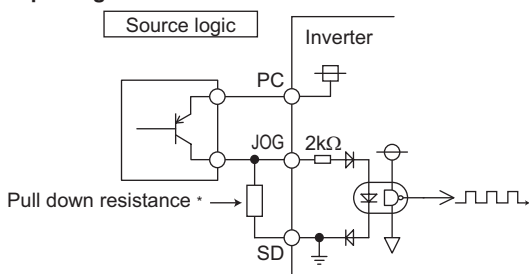

##### ● Connection with a complementary output system pulse generator

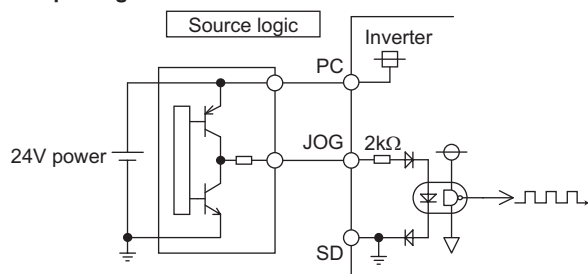

- \* When the wiring length of the open collector output connection is long, input pulse can not be recognized because of a pulse shape deformation due to the stray capacitances of the wiring.

When wiring length is long (10m or more of 0.75mm<sup>2</sup> twisted cable is recommended), connect an open collector output signal and power supply using a pull up resistance. The reference of resistance value to the wiring length is as in the table below,

Wiring Length	Less than 10m	10 to 50m	50 to 100m
Pull up/down resistance	Not necessary	1kΩ	470Ω
Load current (for reference)	10mA	35mA	65mA

Stray capacitances of the wiring greatly differ according to the cable type and cable laying, the above cable length is not a guaranteed value.

When using a pull up/down resistance, check the permissible power of the resistor and permissible load current of output transistor and use them within a permissible range.

**REMARKS**

- When pulse train input is selected, a function assigned to terminal JOG using *Pr. 185 JOG terminal function selection* is invalid.
- When *Pr. 419 Position command source selection* = "2" (simple position pulse train command by inverter pulse train input), JOG terminal serves as simple position pulse train terminal regardless of the *Pr. 291*.

**CAUTION**

- Since *Pr. 291* is a selection parameter for pulse train output/FM output, check the specifications of a device connected to terminal FM when changing the setting value. (Refer to *page 236* for pulse train output.)
- Output specifications (high speed pulse train output or FM output) of terminal FM can be selected using *Pr. 291*. Change the setting value using care not to change output specifications of terminal FM. (Refer to *page 236* for pulse train output.)

**●Pulse train input specifications**

Item	Specifications
Available pulse method	Open collector output Complementary output (power supply voltage 24V)
H input level	20V or more (voltage between JOG-SD)
L input level	5V or less (voltage between JOG-SD)
Maximum input pulse rate	100kpps
Minimum input pulse width	2.5us
Input resistance/load current	2kΩ (typ) / 10mA (typ)
Maximum wiring length (reference value)	Open collector output system
	Complementary output system
Detection resolution	1/3750

\* The wiring length of complementary output depends on the output wiring specifications of complementary output device. Stray capacitances of the wiring greatly differ according to the cable type and cable laying, the maximum cable length is not a guaranteed value.

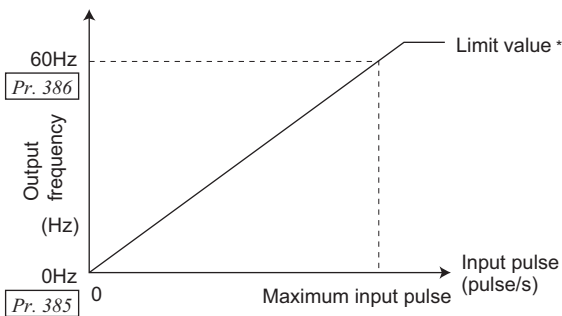

**(2) Adjustment of pulse train input and frequency (Pr. 385, Pr. 386)**

- Frequency for zero input pulse can be set using *Pr. 385 Frequency for zero input pulse* and frequency at maximum input pulse can be set using *Pr. 386 Frequency for maximum input pulse*.

\* Limit value can be calculated from the following formula.  
 $(Pr. 386 - Pr. 385) \times 1.1 + Pr. 385$

**(3) Calculation method of division scaling factor of input pulse (Pr. 384)**

- Maximum input pulse can be calculated from the following formula using *Pr. 384 Input pulse division scaling factor*.

Maximum of input pulse (pulse/s) =  $Pr. 384 \times 400$

(maximum of 100kpulse/s)

Detectable pulse = 11.45 pulse/s

- For example, when you want to operate at 0Hz when pulse train input is zero and operate at 30Hz when pulse train is 4000 pulse/s, set parameters as below.

$Pr. 384 = 10$

(maximum input pulse 4000 pulse/s)

$Pr. 385 = 0\text{Hz}, Pr. 386 = 30\text{Hz}$

(pulse train limit value is 33Hz)

**REMARKS**

The priorities of the frequency commands by the external signals are "jog operation > multi-speed operation > terminal 4 analog input > pulse train input".

When pulse train input is valid (when *Pr. 291* = "1, 11, 21, or 100" and *Pr. 384* ≠ "0"), terminal 2 analog input is invalid.

#### (4) Synchronous speed operation by pulse I/O

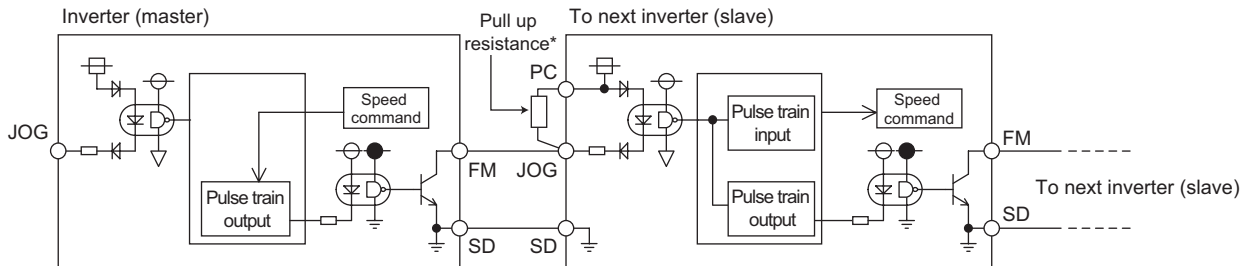

\* When the wiring length between FM and JOG is long, a pulse shape is deformed due to the stray capacitances of the wiring and input pulse can not be recognized.

When wiring length is long (10m or more of 0.75mm<sup>2</sup> twisted cable is recommended), connect terminal JOG and terminal PC using an external pull up resistance. The reference of resistance value to the wiring length is as in the table below.

Wiring Length	Less than 10m	10 to 50m	50 to 100m
Pull up resistance	Not necessary	1kΩ	470Ω
Load current (for reference)	10mA	35mA	65mA

Stray capacitances of the wiring greatly differ according to the cable type and cable laying, the above cable length is not a guaranteed value.

When using a pull up resistance, check the permissible power and permissible load current (terminal PC : 100mA, high speed pulse train output : 85mA) of the resistor and use them within a permissible range.

- By setting "100" in Pr. 291, pulse train input can be output at pulse train output (terminal FM) as it is. Synchronous speed operation of multiple inverters can be enabled by daisy chain connection.
- Since maximum pulse train output is maximum of 50k pulse/s, set "125" in Pr. 384 of the inverter receiving pulse train.
- When operating two or more inverters synchronously, perform wiring according to the following steps. (so that 24V contact input will not be applied to terminal FM)
  - 1) Set pulse train output (a value other than "0, 1") in Pr. 291 of the master side inverter.
  - 2) Turn off the inverter power
  - 3) Perform wiring of the master side terminal FM-SD and slave side terminal JOG-SD
  - 4) Turn on the inverter power

#### CAUTION

- After changing a setting value of Pr. 291, connect JOG terminal between terminal FM and SD. Take note that a voltage should not be applied to terminal FM specially when FM output (voltage output) pulse train is selected.
- For the slave side inverter, use sink logic (factory setting). The inverter will not function properly if source logic is selected.

#### ●Specifications of synchronous speed operation

Item	Specifications
Output pulse type	Pulse width is fixed (10μs)
Pulse rate	0 to 50kpps
Pulse transmission delay	1 to 2μs per inverter *

\* When a pulse transmission delay in a slave is approximately 1 to 2μs and wiring length is long, the delay further increases.

#### ◆ Parameters referred to ◆

Pr. 291 (pulse train output) Refer to page 236

### 4.25.6 Encoder feedback control (Pr. 144, Pr. 285, Pr. 359, Pr. 367 to Pr. 369)

**V/F** **Magnetic flux**

This controls the inverter output frequency so that the motor speed is constant to the load variation by detecting the motor speed with the speed detector (encoder) to feed it back to the inverter.  
Option FR-A7AP is necessary.

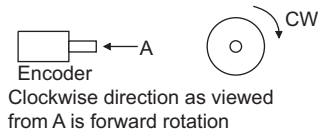
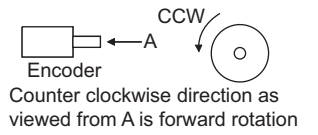
Parameter Numbers	Name	Initial Value	Setting Range	Description
144	Speed setting switchover	4	0, 2, 4, 6, 8, 10, 102, 104, 106, 108, 110	Set the number of motor poles when performing encoder feedback control under V/F control.
285	Overspeed detection frequency (Speed deviation excess detection frequency) *1	9999	0 to 30Hz	If (detected frequency) - (output frequency) > Pr. 285 during encoder feedback control, the inverter fault (E.MB1) is provided.
			9999	Overspeed is not detected.
359 *2	Encoder rotation direction	1	0	 <p>Encoder Clockwise direction as viewed from A is forward rotation</p>
			1	 <p>Encoder Counter clockwise direction as viewed from A is forward rotation</p>
367 *2	Speed feedback range	9999	0 to 400Hz	Set the range of speed feedback control.
			9999	Encoder feedback control is invalid
368 *2	Feedback gain	1	0 to 100	Set when the rotation is unstable or response is slow.
369 *2	Number of encoder pulses	1024	0 to 4096	Set the number of pulses of the encoder.
				Set the number of pulses before multiplied by four.

\*1 When exercising vector control with FR-A7AP/FR-A7AL (option), this parameter changes to excessive speed deviation detection frequency. (For details, refer to page 100)

\*2 The above parameters can be set when the FR-A7AP/FR-A7AL (option) is mounted.

#### (1) Setting before the operation (Pr. 144, Pr. 359, Pr. 369 )

- When performing encoder feedback control under V/F control, set the number of motor poles in Pr. 144 Speed setting switchover according to the motor used. Because the number of motor poles is set in Pr. 81 Number of motor poles under Advanced magnetic flux vector control, it is unnecessary to change Pr. 144.
- Set the rotation direction and the number of encoder pulses of the encoder using Pr. 359 Encoder rotation direction and Pr. 369 Number of encoder pulses.

#### REMARKS

- When "0, 10, 110" is set in Pr. 144 and run the inverter, fault E.1 to E.3 occurs.
- When "102, 104, 106, 108" is set in Pr. 144, the value subtracting 100 is set as the number of motor poles.
- Setting Pr. 81 Number of motor poles changes the Pr. 144 setting automatically. However, changing the Pr. 144 setting will not change the Pr. 81 setting automatically.

#### CAUTION

- If the number of motor poles is wrong, control at correct speed can not be performed. Always check before operation.
- Encoder feedback control can not be performed when the setting of encoder rotation direction is wrong. (Inverter operation is enabled.)  
Encoder rotation direction can be checked with the rotation direction display of the parameter unit.

**(2) Selection of encoder feedback control (Pr. 367)**

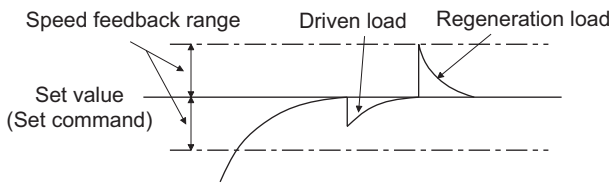

- When a value other than "9999" is set in Pr. 367 Speed feedback range, encoder feedback control is valid. Using the set point (frequency at which stable speed operation is performed) as reference, set the higher and lower setting range. Normally, set the frequency converted from the slip amount (r/min) of the rated motor speed (rated load). If the setting is too large, response becomes slow.

Example: Rated speed of a 4-pole motor is 1740r/min (60Hz)

$$\begin{aligned} \text{Slip Nsp} &= \text{Synchronous speed} - \text{Rated speed} \\ &= 1800 - 1740 = 60(\text{r/min}) \end{aligned}$$

Frequency equivalent to slip (fsp)

$$\text{fsp} = \frac{\text{Nsp} \times \text{Number of poles}}{120} = \frac{60 \times 4}{120} = 2 \text{ (Hz)}$$

**(3) Feedback gain (Pr. 368)**

- Set Pr. 368 Feedback gain when the rotation is unstable or response is slow.
- If the acceleration/deceleration time is long, feedback response becomes slower. In this case, increase the Pr. 368 setting.

Pr. 368 Setting	Description
Pr. 368 > 1	Although the response becomes faster, overcurrent or unstable rotation is liable to occur.
1 < Pr. 368	Although the response becomes slower, the motor rotation becomes stable.

**(4) Overspeed detection (Pr. 285)**

- If (detection frequency) - (output frequency) > Pr. 285 under encoder feedback control, E.MB1 occurs and the inverter output is stopped to prevent malfunction when the accurate pulse signal from the encoder can not be detected. Overspeed is not detected when Pr. 285 = "9999".

**CAUTION**

- The encoder should be coupled on the same axis with the motor shaft without any mechanical looseness with a speed ratio of 1 to 1.
- During acceleration/deceleration, encoder feedback control is not performed to prevent unstable phenomenon such as hunting.
- Encoder feedback control is performed once output frequency has reached within [set speed] ± [speed feedback range].
- If the following conditions occur during encoder feedback control, the inverter operates at the frequency within [set speed] ± [speed feedback range] without coming to trip nor tracking the motor speed.
  - The pulse signals are not received from the encoder due to a signal loss, etc.
  - The accurate pulse signal from the encoder can not be detected due to induction noise, etc.
  - The motor has been forcibly accelerated (regeneration) or decelerated (motor lock or the like) by large external force.
- For the motor with brake, use the RUN signal (inverter running) to open the brake. (The brake may not be opened if the FU (output frequency detection) signal is used.)
- Do not turn off the external power supply of the encoder during encoder feedback control. Encoder feedback control functions abnormally.

◆ Parameters referred to ◆

Pr. 81 Number of motor poles Refer to page 131

### 4.25.7 Regeneration avoidance function (Pr. 665, Pr. 882 to Pr. 886)

This function detects a regenerative status and increases the frequency to avoid the regenerative status.

- Possible to avoid regeneration by automatically increasing the frequency and continue operation if the fan happens to rotate faster than the set speed due to the effect of another fan in the same duct.

Parameter Number	Name	Initial Value	Setting Range	Description
882	Regeneration avoidance operation selection	0	0	Regeneration avoidance function invalid
			1	Regeneration avoidance function is always valid
			2	Regeneration avoidance function is valid only during a constant speed operation
883	Regeneration avoidance operation level	200V class 380V DC 400V class 760V DC	300 to 800V	Set the bus voltage level at which regeneration avoidance operates. When the bus voltage level is set to low, overvoltage error will be less apt to occur. However, the actual deceleration time increases. The set value must be higher than the power supply voltage $\times \sqrt{2}$ .
884	Regeneration avoidance at deceleration detection sensitivity	0	0	Regeneration avoidance by bus voltage change ratio is invalid
			1 to 5	Set sensitivity to detect the bus voltage change ratio Setting 1 $\rightarrow$ 5 Detection sensitivity low $\rightarrow$ high
885	Regeneration avoidance compensation frequency limit value	6Hz	0 to 10Hz	Set the limit value of frequency which rises at activation of regeneration avoidance function.
			9999	Frequency limit invalid
886	Regeneration avoidance voltage gain	100%	0 to 200%	Adjust responsiveness at activation of regeneration avoidance. A larger setting will improve responsiveness to the bus voltage change. However, the output frequency could become unstable. When vibration is not suppressed by decreasing the Pr. 886 setting, set a smaller value in Pr. 665.
665	Regeneration avoidance frequency gain	100%	0 to 200%	

#### (1) What is regeneration avoidance function? (Pr. 882, Pr. 883)

- When the regenerative status is serious, the DC bus voltage rises and an overvoltage fault (E. OV□) may occur. When this bus voltage rise is detected and the bus voltage level reaches or exceeds Pr. 883, increasing the frequency avoids the regenerative status.
- For regeneration avoidance operation, you can select whether it is always activated or activated only at a constant speed.

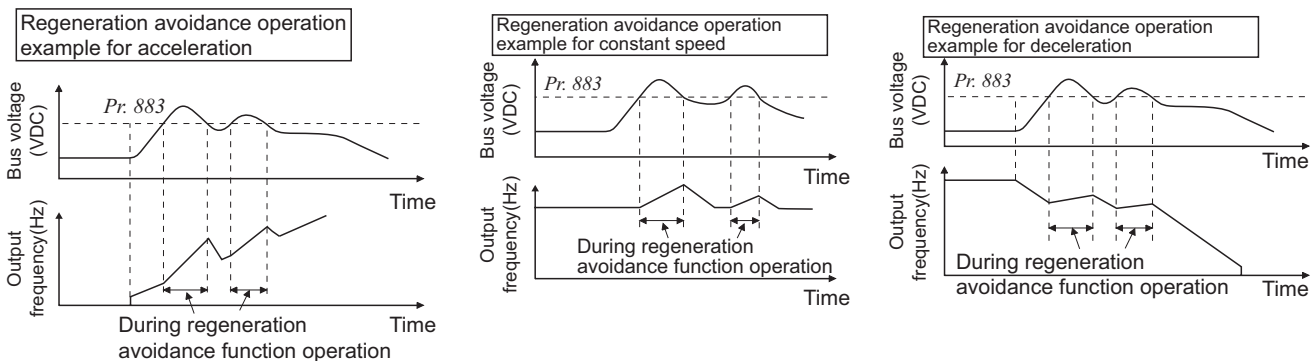

- Setting Pr. 882 to "1, 2" validates the regeneration avoidance function.

#### REMARKS

- The inclination of the frequency increased or decreased by the regeneration avoidance function changes depending on the regenerative status.
- The DC bus voltage of the inverter is normally about  $\sqrt{2}$  times greater than the input voltage. When the input voltage is 220VAC (440VAC), the bus voltage is about 311VDC (622VDC). However, it varies with the input power supply waveform.
- The Pr. 883 setting should be kept higher than the DC bus voltage level. Otherwise, the regeneration avoidance function is always on even if the non-regeneration status and the frequency increases.
- While overvoltage stall ( $\square$ ) is activated only during deceleration and stops the decrease in output frequency, the regeneration avoidance function is always on (Pr. 882 = 1) or activated only during a constant speed (Pr. 882 = 2) and increases the frequency according to the regeneration amount.



## (2) To detect the regenerative status during deceleration faster (Pr. 884)

- As the regeneration avoidance function cannot respond to an abrupt voltage change by detection of the bus voltage level, the ratio of bus voltage change is detected to stop deceleration if the bus voltage is less than Pr. 883 *Regeneration avoidance operation level*.  
Set that detectable bus voltage change ratio to Pr. 884 as detection sensitivity.  
Increasing the setting raises the detection sensitivity.

### CAUTION

Too small setting (low detection sensitivity) will disable detection, and too large setting will turn on the regeneration avoidance function if the bus voltage is varied by an input power change, etc.

## (3) Limit regeneration avoidance operation frequency (Pr. 885)

You can limit the output frequency compensated for (increased) by the regeneration avoidance function.

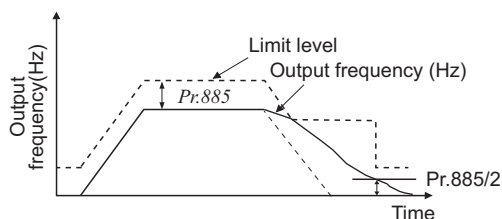

- The frequency is limited to the output frequency (frequency prior to regeneration avoidance operation) + Pr. 885 *Regeneration avoidance compensation frequency limit value* during acceleration or constant speed. If the frequency increased by regeneration avoidance function exceeds the limit value during deceleration, the limit value is held until the output frequency falls to 1/2 of Pr. 885.
- When the frequency increased by regeneration avoidance function has reached Pr. 1 *Maximum frequency*, it is limited to the maximum frequency.
- Pr. 885 is set to "9999", regeneration avoidance function operation frequency setting is invalid.



## (4) Regeneration avoidance function adjustment (Pr. 665, Pr. 886)

- If the frequency becomes unstable during regeneration avoidance operation, decrease the setting of Pr. 886 *Regeneration avoidance voltage gain*. Reversely, if sudden regeneration causes an overvoltage alarm, increase the setting.
- When vibration is not suppressed by decreasing the Pr. 886 *Regeneration avoidance voltage gain* setting, set a smaller value in Pr. 665 *Regeneration avoidance frequency gain*.

### CAUTION

- When regeneration avoidance operation is performed, OL (overvoltage stall) is displayed and the OL signal is output. Set the operation pattern at an OL signal output using Pr.156 *Stall prevention operation selection*. Set the output timing of the OL signal using Pr.157 *OL signal output timer*.
- When regeneration avoidance operation is performed, stall prevention is also activated.
- Under vector control, unusual noise may be generated from the motor during deceleration when using regeneration avoidance function. To prevent this, make gain adjustment, e.g. by performing easy gain tuning. (Refer to page 88)

### ◆ Parameters referred to ◆

Pr. 1 *Maximum frequency*  Refer to page 140  
Pr. 8 *Deceleration time*  Refer to page 155  
Pr. 22 *Stall prevention operation level*  Refer to page 135

## 4.26 Useful functions

Purpose	Parameter that must be Set		Refer to Page
Increase cooling fan life	Cooling fan operation selection	Pr. 244	363
To determine the maintenance time of parts.	Inverter part life display	Pr. 255 to Pr. 259	364
	Maintenance output function	Pr. 503, Pr. 504	367
	Current average value monitor signal	Pr. 555 to Pr. 557	368
Freely available parameter	Free parameter	Pr. 888, Pr. 889	370

### 4.26.1 Cooling fan operation selection (Pr. 244)

You can control the operation of the cooling fan built in the inverter.

Parameter Number	Name	Initial Value	Setting Range	Description
244	Cooling fan operation selection	1	0	A cooling fan operates at power on Cooling fan on/off control invalid (The cooling fan is always on at power on)
			1	Cooling fan on/off control valid The fan is always on while the inverter is running. During a stop, the inverter status is monitored and the fan switches on-off according to the temperature.

- In either of the following cases, fan operation is regarded as faulty, [FN] is shown on the operation panel, and the fan fault (FAN) and alarm signals are output.
  - Pr. 244 = "0"  
When the fan comes to a stop with power on
  - Pr. 244 = "1"  
When the fan stops during the fan ON command while the inverter is running
- For the terminal used for FAN signal output, set "25" (positive logic) or "125" (negative logic) in any of Pr. 190 to Pr. 196 (output terminal function selection), and for the LF signal, set "98" (positive logic) or "198" (negative logic).

#### CAUTION

- Changing the terminal assignment using Pr. 190 to Pr. 196 (output terminal function selection) may affect the other functions. Set parameters after confirming the function of each terminal.

#### ◆ Parameters referred to ◆

Pr. 190 to Pr. 196 (output terminal function selection)  Refer to page 215



#### 4.26.2 Display of the life of the inverter parts (Pr. 255 to Pr. 259)

Degrees of deterioration of main circuit capacitor, control circuit capacitor, cooling fan and inrush current limit circuit can be diagnosed by monitor.

When any part has approached the end of its life, an alarm can be output by self diagnosis to prevent a fault.

(Use the life check of this function as a guideline since the life except the main circuit capacitor is calculated theoretically.)

For the life check of the main circuit capacitor, the alarm signal (Y90) will not be output if a measuring method of (4) is not performed.

Parameter Number	Name	Initial Value	Setting Range	Description
255	Life alarm status display	0	(0 to 15)	Display whether the control circuit capacitor, main circuit capacitor, cooling fan, and each parts of the inrush current limit circuit has reached the life alarm output level or not. Reading only
256	Inrush current limit circuit life display	100%	(0 to 100%)	Display the deterioration degree of the inrush current limit circuit. Reading only
257	Control circuit capacitor life display	100%	(0 to 100%)	Display the deterioration degree of the control circuit capacitor. Reading only
258	Main circuit capacitor life display	100%	(0 to 100%)	Display the deterioration degree of the main circuit capacitor. Reading only The value measured by Pr. 259 is displayed.
259	Main circuit capacitor life measuring	0	0, 1 (2, 3, 8, 9)	Setting "1" and switching the power supply off starts the measurement of the main circuit capacitor life. When the Pr. 259 value is "3" after powering on again, the measuring is completed. Read the deterioration degree in Pr. 258.

#### REMARKS

- Since repeated inrush currents at power ON will shorten the life of the converter circuit, frequent starts and stops of the magnetic contactor must be avoided.

### (1) Life alarm display and signal output (Y90 signal, Pr. 255)

- Whether any of the control circuit capacitor, main circuit capacitor, cooling fan and inrush current limit circuit has reached the life alarm output level or not can be checked by Pr. 255 Life alarm status display and life alarm signal (Y90).

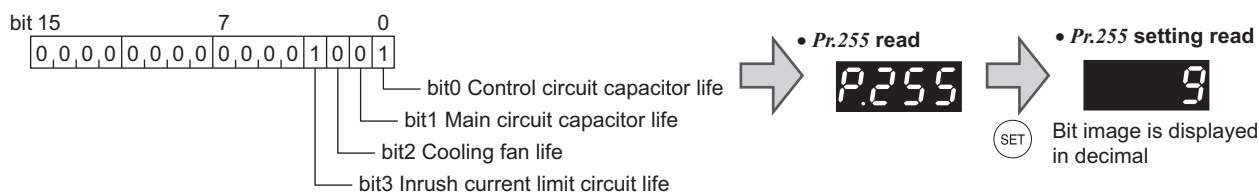

Pr. 255 (decimal)	Bit (binary)	Inrush Current Limit Circuit Life	Cooling Fan Life	Main Circuit Capacitor Life	Control Circuit Capacitor Life
15	1111	○	○	○	○
14	1110	○	○	○	×
13	1101	○	○	×	○
12	1100	○	○	×	×
11	1011	○	×	○	○
10	1010	○	×	○	×
9	1001	○	×	×	○
8	1000	○	×	×	×
7	0111	×	○	○	○
6	0110	×	○	○	×
5	0101	×	○	×	○
4	0100	×	○	×	×
3	0011	×	×	○	○
2	0010	×	×	○	×
1	0001	×	×	×	○
0	0000	×	×	×	×

○: With warnings, ×: Without warnings

- The life alarm signal (Y90) turns on when any of the control circuit capacitor, main circuit capacitor, cooling fan and inrush current limit circuit reaches the life alarm output level.
- For the terminal used for the Y90 signal, set "90" (positive logic) or "190" (negative logic) to any of Pr. 190 to Pr. 196 (output terminal function selection).

#### REMARKS

- The digital output option (FR-A7AY, FR-A7AR, FR-A7NC) allows the control circuit capacitor life signal (Y86), main circuit capacitor life signal (Y87), cooling fan life signal (Y88) and inrush current limit circuit life signal (Y89) to be output individually.

#### CAUTION

- Changing the terminal assignment using Pr. 190 to Pr. 196 (output terminal function selection) may affect the other functions. Set parameters after confirming the function of each terminal.

### (2) Life display of the inrush current limit circuit (Pr. 256)

- The life of the inrush current limit circuit (relay, contactor and inrush resistor) is displayed in Pr. 256.
- The number of contact (relay, contactor, thyristor) ON times is counted, and it is counted down from 100% (zero times) every 1%/10,000 times. As soon as 10% (900,000 times) is reached, Pr. 255 bit 3 is turned ON and also an alarm is output to the Y90 signal.

### (3) Control circuit capacitor life display (Pr. 257)

- The deterioration degree of the control circuit capacitor is displayed in Pr. 257 as a life.
- In the operating status, the control circuit capacitor life is calculated from the energization time and temperature, and is counted down from 100%. As soon as the control circuit capacitor life falls below 10%, Pr. 255 bit 0 is turned ON and also an alarm is output to the Y90 signal.



#### (4) Main circuit capacitor life display (Pr. 258, Pr. 259)

- The deterioration degree of the main circuit capacitor is displayed in Pr. 258 as a life.
- On the assumption that the main circuit capacitor capacitance at factory shipment is 100%, the capacitor life is displayed in Pr. 258 every time measurement is made. When the measured value falls to or below 85%, Pr. 255 bit 1 is turned on and also an alarm is output to the Y90 signal.
- Measure the capacitor capacity according to the following procedure and check the deterioration level of the capacitor capacity.
  - 1) Check that the motor is connected and at a stop.
  - 2) Set "1" (measuring start) in Pr. 259
  - 3) Switch power off. The inverter applies DC voltage to the motor to measure the capacitor capacity while the inverter is off.
  - 4) After making sure that the power lamp is off, switch on the power supply again.
  - 5) Check that "3" (measuring completion) is set in Pr. 259, read Pr. 258, and check the deterioration degree of the main circuit capacitor.

Pr. 259	Description	Remarks
0	No measurement	Initial value
1	Measurement start	Measurement starts when the power supply is switched off.
2	During measurement	Only displayed and cannot be set
3	Measurement complete	
8	Forced end	
9	Measurement error	

#### REMARKS

- When the main circuit capacitor life is measured under the following conditions, "forced end" (Pr. 259 = "8") or "measuring error" (Pr. 259 = "9") occurs or it remains in "measuring start" (Pr. 259 = "1").  
When measuring, avoid the following conditions beforehand. In addition, even when "measurement completion" (Pr. 259 = "3") is confirmed under the following conditions, proper measurement can not be taken.
  - (a) Terminals R1/L11, S1/L21 or DC power supply is connected to the terminal P/+ and N/-.
  - (b) Switch power on during measuring.
  - (c) The motor is not connected to the inverter.
  - (d) The motor is running. (The motor is coasting.)
  - (e) The motor capacity is two rank smaller as compared to the inverter capacity.
  - (f) The inverter is tripped or a fault occurred when power is off.
  - (g) The inverter output is shut off with the MRS signal.
  - (h) The start command is given while measuring.
- Operating environment: Surrounding air temperature (annual average 40°C (free from corrosive gas, flammable gas, oil mist, dust and dirt))  
Output current (80% of the inverter rated current)

#### POINT

For the accurate life measuring of the main circuit capacitor, perform after more than 3h passed since the turn off of the power as it is affected by the capacitor temperature.

## WARNING

-  When measuring the main circuit capacitor capacity (Pr. 259 Main circuit capacitor life measuring = "1"), the DC voltage is applied to the motor for 1s at powering off. Never touch the motor terminal, etc. right after powering off to prevent an electric shock.

#### (5) Cooling fan life display

- The cooling fan speed of 50% or less is detected and "FN" is displayed on the operation panel (FR-DU07) and parameter unit (FR-PU04/FR-PU07). As an alarm display, Pr. 255 bit 2 is turned on and also an alarm is output to the Y90 signal.

#### REMARKS

- When the inverter is mounted with two or more cooling fans, "FN" is displayed with one or more fans with speed of 50% or less.

#### CAUTION

- For replacement of each part, contact the nearest Mitsubishi FA center.

### 4.26.3 Maintenance timer alarm (Pr. 503, Pr. 504)

When the cumulative energization time of the inverter reaches the parameter set time, the maintenance timer output signal (Y95) is output.  $\overline{MT}$  (MT) is displayed on the operation panel (FR-DU07). This can be used as a guideline for the maintenance time of peripheral devices.

Parameter Number	Name	Initial Value	Setting Range	Description
503	Maintenance timer	0	0 (1 to 9998)	Display the cumulative energization time of the inverter in 100h increments. Reading only Writing the setting of "0" clears the cumulative energization time.
504	Maintenance timer alarm output set time	9999	0 to 9998	Set the time taken until when the maintenance timer alarm output signal (Y95) is output.
			9999	No function

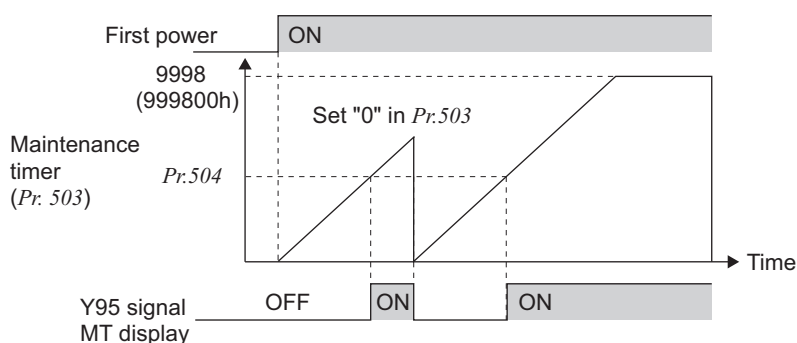

- The cumulative energization time of the inverter is stored into the EEPROM every hour and indicated in *Pr. 503 Maintenance timer* in 100h increments. *Pr. 503* is clamped at 9998 (999800h).
- When the *Pr. 503* value reaches the time set in *Pr. 504 Maintenance timer alarm output set time* (100h increments), the maintenance timer alarm output signal (Y95) is output.
- For the terminal used for the Y95 signal output, assign the function by setting "95" (positive logic) or "195" (negative logic) to any of *Pr. 190 to Pr. 196 (output terminal function selection)*.

#### CAUTION

- The cumulative energization time is counted every hour. The energization time of less than 1h is not counted.
- Changing the terminal assignment using *Pr. 190 to Pr. 196 (output terminal function selection)* may affect the other functions. Set parameters after confirming the function of each terminal.

#### ◆ Parameters referred to ◆

*Pr. 190 to Pr. 196 (output terminal function selection)* Refer to page 215



#### 4.26.4 Current average value monitor signal (Pr. 555 to Pr. 557)

The average value of the output current during constant speed operation and the maintenance timer value are output as a pulse to the current average value monitor signal (Y93).

The pulse width output to the I/O module of the programmable controller etc. can be used as a guideline due to abrasion of machines and elongation of belt and for aged deterioration of devices to know the maintenance time.

The current average value monitor signal (Y93) is output as pulse for 20s as 1 cycle and repeatedly output during constant speed operation.

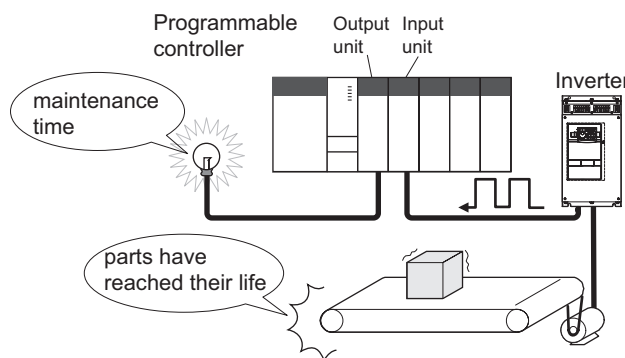

Parameter Number	Name	Initial Value	Setting Range	Description
555	Current average time	1s	0.1 to 1.0s	Set the time taken to average the current during start pulse output (1s).
556	Data output mask time	0s	0.0 to 20.0s	Set the time for not obtaining (mask) transient state data.
557	Current average value monitor signal output reference current	Rated inverter current	0 to 500A	Set the reference (100%) for outputting the signal of the current average value.

The above parameters allow its setting to be changed during operation in any operation mode even if "0" (initial value) is set in *Pr. 77 Parameter write selection*.

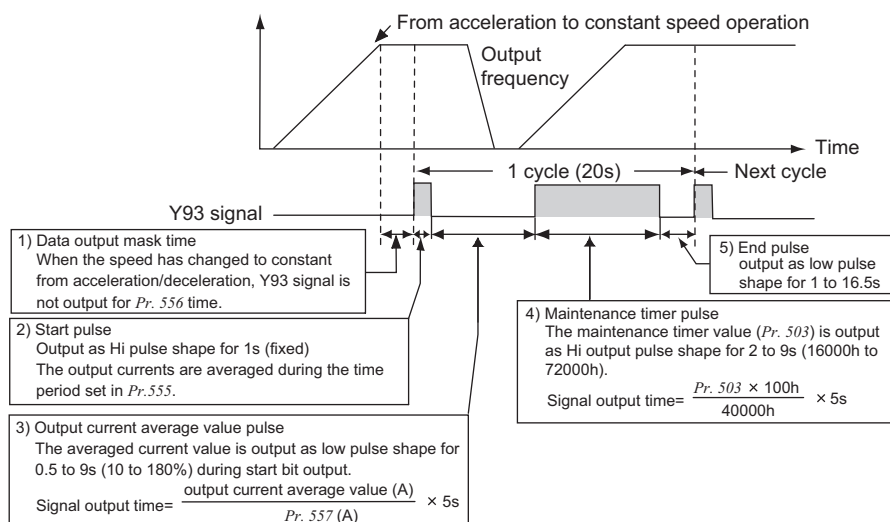

- The pulse output of the current average value monitor signal (Y93) is shown above.
- For the terminal used for the Y93 signal output, assign the function by setting "93" (positive logic) or "193" (negative logic) to any of *Pr. 190 to Pr. 194 (output terminal function selection)*. (The function can not be assigned to *Pr. 195 ABC1 terminal function selection* and *Pr. 196 ABC2 terminal function selection*.)

##### (1) Setting of *Pr. 556 Data output mask time*

The output current is unstable (transient state) right after the operation is changed from the acceleration/deceleration state to the constant speed operation. Set the time for not obtaining (mask) transient state data in *Pr. 556*.

##### (2) Setting of the *Pr. 555 Current average time*

The average output current is calculated during Hi output of start bit (1s). Set the time taken to average the current during start bit output in *Pr. 555*.

(3) Setting of Pr. 557 Current average value monitor signal output reference current

Set the reference (100%) for outputting the signal of the current average value. Obtain the time to output the signal from the following formula.

$$\frac{\text{Output current average value}}{\text{Pr. 557 setting}} \times 5\text{s (output current average value 100\%/5s)}$$

Note that the output time range is 0.5 to 9s, and it is 0.5s when the output current average value is less than 10% of the setting value of Pr. 557 and 9s when exceeds 180%.

Example) When Pr. 557 = 10A and the average value of output current is 15A  
 As  $15\text{A}/10\text{A} \times 5\text{s} = 7.5$ , the current average value monitor signal is output as low pulse shape for 7.5s.

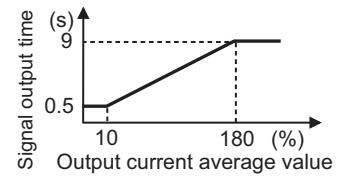

(4) Output of Pr. 503 Maintenance timer

After the output current average value is output as low pulse shape, the maintenance timer value is output as high pulse shape. The output time of the maintenance timer value is obtained from the following formula.

$$\frac{\text{Pr. 503} \times 100}{40000\text{h}} \times 5\text{s (maintenance timer value 100\%/5s)}$$

Note that the output time range is 2 to 9s, and it is 2s when Pr. 503 is less than 16000h and 9s when exceeds 72000h.

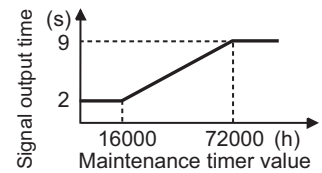

**REMARKS**

- Mask of data output and sampling of output current are not performed during acceleration/deceleration.
- When the speed is changed to acceleration/deceleration from constant speed during start pulse output, the data is judged as invalid, the start pulse is output as high pulse shape for 3.5s, and the end signal is output as low pulse shape for 16.5s. The signal is output for at least 1 cycle even when acceleration/deceleration state continues after the start pulse output is completed.

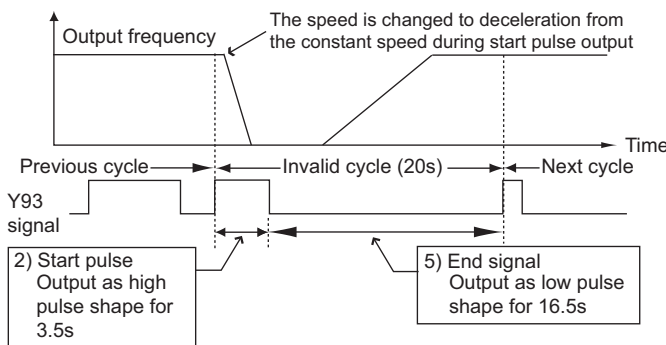

- When the output current value (inverter output current monitor) is 0A on completion of the 1 cycle signal output, the signal is not output until the speed becomes constant next time
- The current average value monitor signal (Y93) is output as low pulse shape for 20s (without data output) under the following condition.
  - When the motor is in the acceleration/deceleration state on completion of the 1 cycle signal output
  - When 1-cycle signal output was ended during restart operation with the setting of automatic restart after instantaneous power failure (Pr. 57 ≠ "9999")
  - When automatic restart operation was being performed with automatic restart after instantaneous power failure selected (Pr. 57 ≠ "9999") on completion of the data output mask

**CAUTION**

- Changing the terminal assignment using Pr. 190 to Pr. 196 (output terminal function selection) may affect the other functions. Set parameters after confirming the function of each terminal.

◆ Parameters referred to ◆

Pr. 190 to Pr. 196 (output terminal function selection) Refer to page 215  
 Pr. 503 Maintenance timer Refer to page 367  
 Pr. 57 Restart coasting time Refer to page 243





#### 4.26.5 Free parameter (Pr. 888, Pr. 889)

You can input any number within the setting range 0 to 9999.

For example, the number can be used:

- As a unit number when multiple units are used.
- As a pattern number for each operation application when multiple units are used.
- As the year and month of introduction or inspection.

Parameter Number	Name	Initial Value	Setting Range	Description
888	Free parameter 1	9999	0 to 9999	Desired values can be input. Data is held even if the inverter power is turned off.
889	Free parameter 2	9999	0 to 9999	

The above parameters allow its setting to be changed during operation in any operation mode even if "0" (initial value) is set in *Pr. 77 Parameter write selection*.

#### REMARKS

- *Pr. 888* and *Pr. 889* do not influence the inverter operation.



## 4.27 Setting of the parameter unit and operation panel

Purpose	Parameter that must be Set		Refer to Page
Switch the display language of the parameter unit	PU display language selection	Pr. 145	371
Use the setting dial of the operation panel like a potentiometer for frequency setting. Key lock of operation panel	Operation panel operation selection	Pr. 161	371
Control of the parameter unit, operation panel buzzer	PU buzzer control	Pr. 990	373
Adjust the LCD contrast of the parameter unit	PU contrast adjustment	Pr. 991	373

### 4.27.1 PU display language selection (Pr. 145)

You can switch the display language of the parameter unit (FR-PU04/FR-PU07) to another.

Parameter Number	Name	Initial Value	Setting Range	Description
145	PU display language selection	0	0	Japanese
			1	English
			2	Germany
			3	French
			4	Spanish
			5	Italian
			6	Swedish
			7	Finnish

### 4.27.2 Operation panel frequency setting/key lock selection (Pr. 161)

The setting dial of the operation panel (FR-DU07) can be used like a potentiometer to perform operation.  
The key operation of the operation panel can be disabled.

Parameter Number	Name	Initial Value	Setting Range	Description	
161	Frequency setting/key lock operation selection	0	0	Setting dial frequency setting mode	Key lock invalid
			1	Setting dial potentiometer mode	
			10	Setting dial frequency setting mode	Key lock valid
			11	Setting dial potentiometer mode	



## (1) Using the setting dial like a potentiometer to set the frequency

**Operation example** Changing the frequency from 0Hz to 60Hz during operation

Operation	Display
1. Screen at power-ON The monitor display appears.	
2. Press <b>PU/EXT</b> to choose the PU operation mode.	PU indicator is lit. 
3. Press <b>MODE</b> to choose the parameter setting mode.	
4. Turn  until <b>P. 16 1</b> ( <i>Pr. 161</i> ) appears.	
5. Press <b>SET</b> to read the currently set value. "0" (initial value) appears.	
6. Turn  to change it to the setting value "1".	
7. Press <b>SET</b> to set.	
<b>Flicker ... Parameter setting complete!!</b>	
8. Mode/monitor check Press <b>MODE</b> twice to choose monitor/frequency monitor.	
9. Press <b>FWD</b> (or <b>REV</b> ) to start the inverter.	
10. Turn  until " <b>60.00</b> " appears. The flickering frequency is the set frequency. You need not press <b>SET</b> .	
	The frequency flickers for about 5s.



### REMARKS

- If the display changes from flickering "60.00" to "0.00", the setting of *Pr. 161 Frequency setting/key lock operation selection* may not be "1".
- Independently of whether the inverter is running or at a stop, the frequency can be set by simply turning the dial.
- When the frequency is changed, it will be stored in EEPROM as the set frequency after 10s.

### CAUTION

- When setting frequency by turning setting dial, the frequency goes up to the set value of *Pr. 1 Maximum frequency* (initial value is 120Hz).  
Adjust *Pr. 1 Maximum frequency setting* according to the application.

## (2) Disable the setting dial and key operation of the operation panel (Press [MODE] long (2s))

- Operation using the setting dial and key of the operation panel can be invalid to prevent parameter change, and unexpected start or frequency setting.
- Set "10 or 11" in *Pr. 161*, then press  for 2s to make the setting dial and key operation invalid.
- When the setting dial and key operation are invalid, **HOLD** appears on the operation panel. If dial or key operation is attempted while dial and key operation are invalid, **HOLD** appears (When dial or key is not touched for 2s, monitor display appears. )
- To make the setting dial and key operation valid again, press  for 2s.

### REMARKS

- Even if the setting dial and key operation are disabled, the monitor display  is valid.

### CAUTION

- Release the operation lock to release the PU stop by key operation.

## 4.27.3 Buzzer control (Pr. 990)

You can make the buzzer "beep" when you press key of the operation panel (FR-DU07) and parameter unit (FR-PU04/FR-PU07).

Parameter Number	Name	Initial Value	Setting Range	Description
990	PU buzzer control	1	0	Without buzzer
			1	With buzzer

The above parameters allow its setting to be changed during operation in any operation mode even if "0" (initial value) is set in *Pr. 77 Parameter write selection*.

## 4.27.4 PU contrast adjustment (Pr. 991)

Contrast adjustment of the LCD of the parameter unit (FR-PU04/FR-PU07) can be performed.  
Decreasing the setting value makes contrast light.

Parameter Number	Name	Initial Value	Setting Range	Description
991	PU contrast adjustment	58	0 to 63	0 : Light ↓ 63: Dark

The above parameters are displayed as simple mode parameters only when the parameter unit (FR-PU04/FR-PU07) is connected.



## 4.28 Parameter clear

**POINT**

· Set "1" in *Pr. CL* parameter clear to initialize all parameters. (Parameters are not cleared when "1" is set in *Pr. 77* Parameter write selection. In addition, calibration parameters are not cleared.)

Operation	Display
1. Screen at power-ON The monitor display appears.	
2. Press  to choose the PU operation mode.	PU indicator is lit. 
3. Press  to choose the parameter setting mode.	(The parameter number read previously appears.)
4. Turn  until "Pr.CL" appears.	
5. Press  to read the currently set value. "0"(initial value) appears.	
6. Turn  to change it to the setting value "1".	
7. Press  to set.	

**Flicker ... Parameter setting complete!!**

- Turn to read another parameter.
- Press to show the setting again.
- Press twice to show the next parameter.

Setting	Description
0	Not executed.
1	Returns all parameters to the initial values except for <i>calibration parameters, terminal function selection parameters, etc.</i> Refer to the list of parameters on <i>page 439</i> for availability of parameter clear.

? 

The inverter is not in PU operation mode.

1. Press .

is lit and the monitor (4-digit LED) displays "0" (*Pr. 79* = "0" (initial value)).

2. Carry out operation from step 6 again.

## 4.29 All parameter clear

### POINT

- Set "1" in *ALLC parameter clear* to initialize all parameters. (Parameters are not cleared when "1" is set in *Pr. 77 Parameter write selection*.)

Operation	Display
1. Screen at power-ON The monitor display appears.	
2. Press  to choose the PU operation mode.	PU indicator is lit. 
3. Press  to choose the parameter setting mode.	 (The parameter number read previously appears.)
4. Turn  until <i>ALLC</i> (all parameter clear) appears.	
5. Press  to read the currently set value. "0" (initial value) appears.	
6. Turn  to change it to the setting value "1".	
7. Press  to set.	 Flicker ... Parameter setting complete!!

- Press to read another parameter.
- Press to show the setting again.
- Press twice to show the next parameter.

Setting	Description
0	Not executed.
1	All parameters return to the initial values. Refer to the list of parameters on <i>page 439</i> for availability of all parameter clear. Refer to the list of parameters on <i>page 439</i> for availability of parameter clear.

? and are displayed alternately ... Why?

The inverter is not in the PU operation mode.

- Press .

is lit and the monitor (4-digit LED) displays "0" (*Pr. 79* = "0" (initial value)).

- Carry out operation from step 6 again.

## 4.30 Parameter copy and parameter verification

PCPY Setting	Description
0	Cancel
1	Copy the source parameters to the operation panel.
2	Write the parameters copied to the operation panel into the destination inverter.
3	Verify parameters in the inverter and operation panel. (Refer to page 377.)

### REMARKS

- When the copy destination inverter is not the FR-A701 series or parameter copy write is performed after parameter copy read is stopped, "model error ( r E 4 )" is displayed.
- Refer to the parameter list on page 439 and later for availability of parameter copy.
- When the power is turned OFF or an operation panel is disconnected, etc. during parameter copy write, perform write again or check the values by parameter verification.
- Initial settings of certain parameters are different for different capacities, so some parameter settings may be automatically changed when parameter copy is performed from a different-capacity inverter. After performing a parameter copy from a different-capacity inverter, check the parameter settings. (Refer to the parameter list (page 103) for the parameters with different initial settings for different capacities.)

### 4.30.1 Parameter copy

Parameter settings can be copied to multiple inverters.

Operation	Display
1. Connect the operation panel to the copy source inverter. • <u>Connect it during a stop.</u>	
2. Press <b>MODE</b> to choose the parameter setting mode.	<b>MODE</b> → P. 0 (The parameter number previously read appears.)
3. Turn <b>▲</b> until <b>PCPY</b> (parameter copy) appears.	<b>▲</b> → PCPY
4. Press <b>SET</b> to read the currently set value. "0" (initial value) appears.	<b>SET</b> → 0
5. Turn <b>▲</b> to change it to the setting value "1".	<b>▲</b> → 1
6. Press <b>SET</b> to copy the source parameters to the operation panel.	<b>SET</b> → 1 (Flickers for about 30s)
	About 30s later → 1 PCPY
	<b>Flicker ... Parameter copy complete!!</b>
7. Connect the operation panel to the copy source inverter.	
8. After performing steps 2 to 5, turn <b>▲</b> to change it to "2".	<b>▲</b> → 2
9. Press <b>SET</b> to write the parameters copied to the operation panel to the destination inverter.	<b>SET</b> → 2 (The frequency flickers for about 30s)
10. When copy is completed, "2" and "PCPY" flicker.	→ 2 PCPY
11. After writing the parameter values to the copy destination inverter, always reset the inverter, e.g. switch power OFF once, before starting operation.	<b>Flicker ... Parameter copy complete!!</b>

- ? *rE1* appears...Why? Parameter read error. Perform operation from step 3 again.
- ? *rE2* appears...Why? Parameter write error. Perform operation from step 8 again.

**4.30.2 Parameter verification**

Whether same parameter values are set in other inverters or not can be checked.

Operation	Display
<p>1. Move the operation panel to the inverter to be verified.</p> <p>• <u>Move it during a stop.</u></p>	
<p>2. Screen at power-ON The monitor display appears.</p>	
<p>3. Press  to choose the parameter setting mode.</p>	→  (The parameter number read previously appears.)
<p>4. Turn  until <i>PCPY</i> (parameter copy) appears.</p>	→
<p>5. Press  to read the currently set value. "0" (initial value) appears.</p>	→
<p>6. Turn  to change it to the set value "3" (parameter copy verification mode).</p>	→
<p>7. Press  to read the parameter setting of the verified inverter to the operation panel.</p>	→  Flickers for about 30s
<p>• If different parameters exist, different parameter numbers and <i>rE3</i> flicker.</p>	
<p>• Hold down  to verify.</p>	→  Flickering
<p>8. If there is no difference, "<i>PCPY</i>" and "3" flicker to complete verification.</p>	

**Flicker ... Parameter verification complete!!**

- ? *rE3* flickers ... Why?  
 Set frequencies, etc. may be different. Check set frequencies.



## 4.31 Check and clear of the faults history

### (1) Check for the faults history

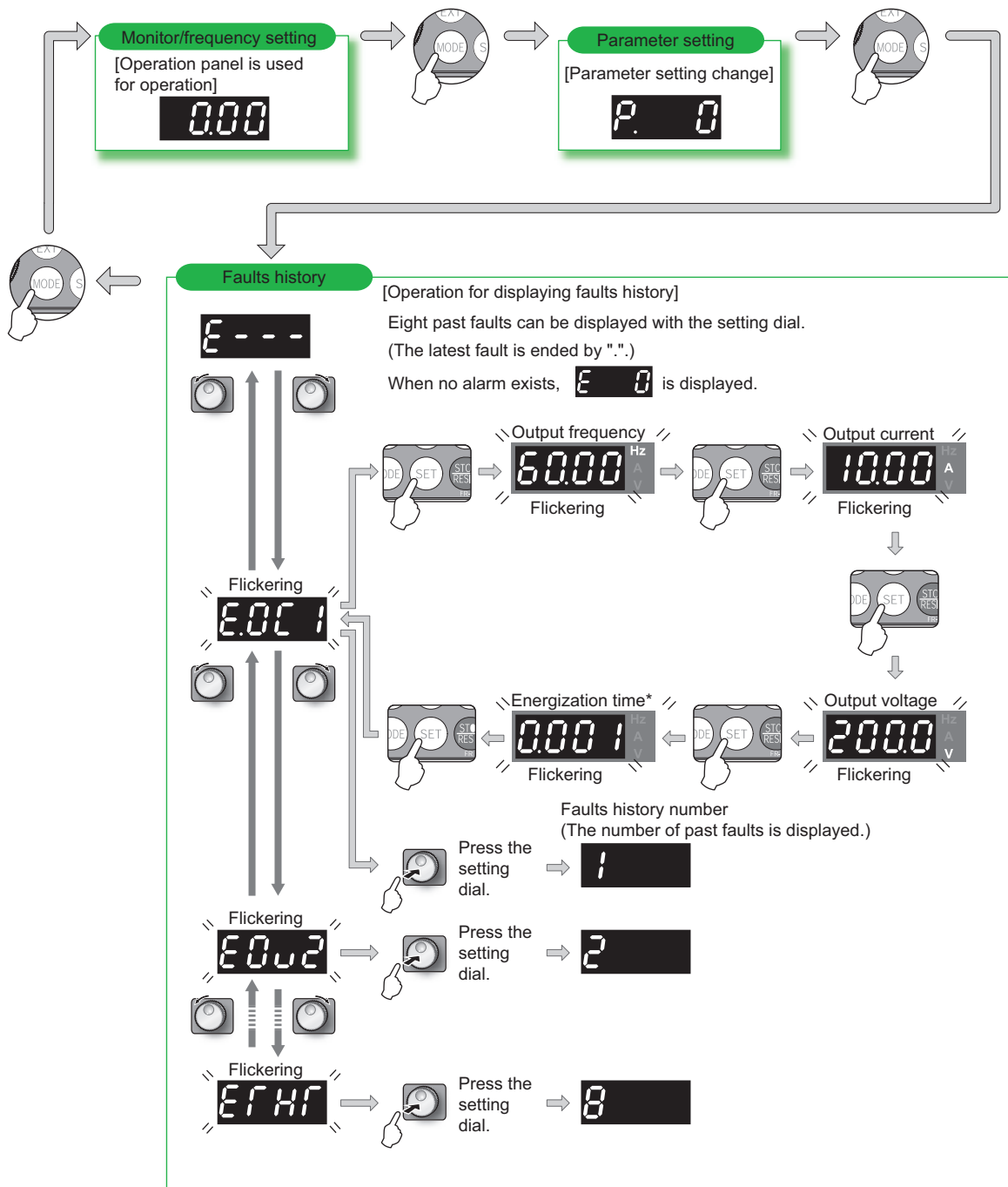

\* The cumulative energization time and actual operation time are accumulated from 0 to 65535 hours, then cleared, and accumulated again from 0.

When the operation panel (FR-DU07) is used, the time is displayed up to 65.53 (65530h) in the indication of 1h = 0.001, and thereafter, it is added up from 0.

**(2) Clearing procedure**

**POINT**

· The faults history can be cleared by setting "1" in *Er.CL Faults history clear*.

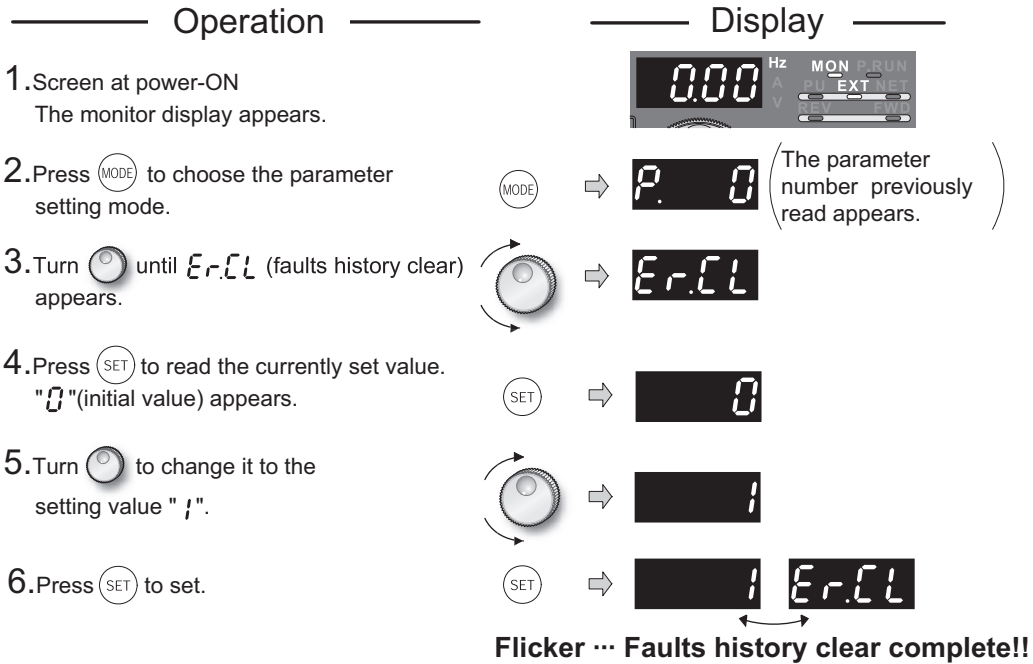

- Press (rotary knob) to read another parameter.
- Press (SET) to show the setting again.
- Press (SET) twice to show the next parameter.

# MEMO

# 5 PROTECTIVE FUNCTIONS

This chapter describes the basic "PROTECTIVE FUNCTION" for use of this product.

Always read the instructions before using the equipment.

5.1	Reset method of protective function.....	382
5.2	List of fault or alarm display .....	383
5.3	Causes and corrective actions .....	384
5.4	Correspondences between digital and actual characters .....	399
5.5	Check first when you have a trouble .....	396

1

2

3

4

5

6

7

When a fault occurs in the inverter, the inverter trips and the PU display automatically changes to one of the following fault or alarm indications.

If the fault does not correspond to any of the following faults or if you have any other problem, please contact your sales representative.

- Retention of fault output signal .. When the magnetic contactor (MC) provided on the input side of the inverter is opened when a fault occurs, the inverter's control power will be lost and the fault output will not be held.
- Fault or alarm indication.....When a fault or alarm occurs, the operation panel display automatically switches to the fault or alarm indication.
- Resetting method.....When a fault occurs, the inverter output is kept stopped. Unless reset, therefore, the inverter cannot restart. (Refer to page 382)
- When any fault occurs, take the appropriate corrective action, then reset the inverter, and resume operation.  
Not doing so may lead to the inverter fault and damage.

Inverter fault or alarm indications are roughly categorized as below.

- (1) Error message  
A message regarding operational fault and setting fault by the operation panel (FR-DU07) and parameter unit (FR-PU04 /FR-PU07) is displayed. The inverter does not trip.
- (2) Warning  
The inverter does not trip even when a warning is displayed. However, failure to take appropriate measures will lead to a fault.
- (3) Alarm  
The inverter does not trip. You can also output an alarm signal by making parameter setting.
- (4) Fault  
When a fault occurs, the inverter trips and a fault signal is output.

### REMARKS

- Past eight faults can be displayed using the setting dial. (Refer to page 378 for the operation.)

## 5.1 Reset method of protective function

### (1) Resetting the inverter

The inverter can be reset by performing any of the following operations. Note that the internal thermal integrated value of the electronic thermal relay function and the number of retries are cleared (erased) by resetting the inverter. Inverter recovers about 1s after the reset is released.

Operation 1: ..... Using the operation panel, press  to reset the inverter.

(This may only be performed when a fault occurs (Refer to page 388 for fault.))

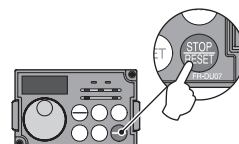

Operation 2:..... Switch power OFF once. After the indicator of the operation panel turns OFF, switch it ON again.

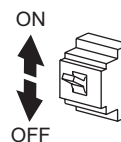

Operation 3: ..... Turn ON the reset signal (RES) for more than 0.1s. (If the RES signal is kept ON, "Err." appears (flickers) to indicate that the inverter is in a reset status.)

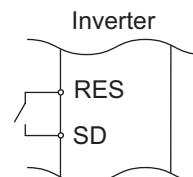

### CAUTION

- OFF status of the start signal must be confirmed before resetting the inverter fault. Resetting inverter fault with the start signal ON restarts the motor suddenly.



## 5.2 List of fault or alarm display

Operation Panel Indication		Name	Refer to	
Error message	E ---	E ---	Faults history	378
	HOLD	HOLD	Operation panel lock	384
	LOCd	LOCd <small>Ver.UP</small>	Password locked	384
	Er 1 to Er 4	Er1 to 4	Parameter write error	384
	rE 1 to rE 4	rE1 to 4	Copy operation error	385
	Err.	Err.	Error	386
Warning	OL	OL	Stall prevention (overcurrent)	386
	oL	oL	Stall prevention (overvoltage)	386
	TH	TH	Electronic thermal relay function prealarm	387
	PS	PS	PU stop	387
	MT	MT	Maintenance signal output	387
	CP	CP	Parameter copy	387
	SL	SL	Speed limit indication (Output during speed limit)	387
Alarm	F <sub>n</sub>	FN	Fan alarm	388
Fault	EDC 1	E.OC1	Overcurrent trip during acceleration	388
	EDC 2	E.OC2	Overcurrent trip during constant speed	389
	EDC 3	E.OC3	Overcurrent trip during deceleration or stop	389
	EDV 1	E.OV1	Regenerative overvoltage trip during acceleration	389
	EDV 2	E.OV2	Regenerative overvoltage trip during constant speed	390
	EDV 3	E.OV3	Regenerative overvoltage trip during deceleration or stop	390
	E <sub>T</sub> HT	E.THT	Inverter overload trip (electronic thermal relay function)	390
	E <sub>T</sub> HM	E.THM	Motor overload trip (electronic thermal relay function)	390
	E <sub>F</sub> IN	E.FIN	Heatsink overheat	391
	E <sub>I</sub> PF	E.IPF	Instantaneous power failure	391
	E <sub>U</sub> V	E.UVT	Undervoltage	391
	E <sub>I</sub> LF	E.ILF*	Input phase loss	391
	E <sub>O</sub> LT	E.OLT	Stall prevention stop	392
	E <sub>.</sub> GF	E.GF	Output side earth (ground) fault overcurrent	392
	E <sub>.</sub> LF	E.LF	Output phase loss	392
	E <sub>O</sub> HT	E.OHT	External thermal relay operation *2	392

Operation Panel Indication		Name	Refer to
E.PTC	E.PTC*	PTC thermistor operation	392
E.OPT <small>Ver.UP</small>	E.OPT	Option fault	393
E.OP3	E.OP3	Communication option fault	393
E. 1 to E. 3	E. 1 to E. 3	Option fault	393
E. PE	E.PE	Parameter storage device fault	393
E.PUE	E.PUE	PU disconnection	394
E.RET	E.RET	Retry count excess	394
E.PE2	E.PE2*	Parameter storage device fault	394
E. 5 E. 6 E. 7 E.CPU	E. 5 E. 6 E. 7 E.CPU	CPU fault	394
E.CTE	E.CTE	Operation panel power supply short circuit, RS-485 terminal power supply short circuit	394
E.P24	E.P24	24VDC power output short circuit	396
E.CDO	E.CDO*	Output current detection value exceeded	396
E.IOH	E.IOH*	Inrush current limit circuit fault	396
E.SER	E.SER*	Communication fault (inverter)	397
E.AIE	E.AIE*	Analog input fault	397
E.OS	E.OS	Overspeed occurrence	395
E.OSD	E.OSD	Speed deviation excess detection	395
E.ECT	E.ECT	Signal loss detection	395
E.OD	E.OD	Excessive position fault	396
E <sub>N</sub> b 1 to E <sub>N</sub> b 7	E.MB1 to E.MB7	Brake sequence fault	395
E.EP	E.EP	Encoder phase fault	396
E.USB	E.USB*	USB communication fault	397
E. 4	E.4	Converter overcurrent	397
E. 8	E.8	Power supply fault	397
E. 10	E.10	Converter transistor protection thermal operation (electronic thermal)	398
E. 11	E.11	Opposite rotation deceleration fault	398
E. 13	E.13	Internal circuit fault	398
E. 15	E.15	Converter circuit fault	398

\* If an error occurs when using the FR-PU04, "Fault 14" is displayed on the FR-PU04.



**Ver.UP** .....Specifications differ according to the date assembled. Refer to page 456 to check the SERIAL number.



## 5.3 Causes and corrective actions

### (1) Error message

A message regarding operational troubles is displayed. Output is not shut off.

<b>Operation Panel Indication</b>	<b>HOLD</b>	<b>HOLD</b>
<b>Name</b>	Operation panel lock	
<b>Description</b>	Operation lock mode is set. Operation other than  is invalid. (Refer to page 373.)	
<b>Check point</b>	—	
<b>Corrective action</b>	Press  for 2s to release lock.	

<b>Operation Panel Indication</b>	<b>LOCd</b> 	<b>LOCd</b>
<b>Name</b>	Password locked	
<b>Description</b>	Password function is active. Display and setting of parameter is restricted.	
<b>Check point</b>	—	
<b>Corrective action</b>	Enter the password in <i>Pr. 297 Password lock/unlock</i> to unlock the password function before operating. (Refer to page 287.)	

**Ver.UP** .... Specifications differ according to the date assembled. Refer to page 456 to check the SERIAL number.

<b>Operation Panel Indication</b>	<b>Er1</b>	<b>Er1</b>
<b>Name</b>	Write disable error	
<b>Description</b>	<ul style="list-style-type: none"> <li>You attempted to make parameter setting when <i>Pr. 77 Parameter write selection</i> has been set to disable parameter write.</li> <li>Frequency jump setting range overlapped.</li> <li>Adjustable 5 points V/F settings overlapped</li> <li>The PU and inverter cannot make normal communication</li> </ul>	
<b>Check point</b>	<ul style="list-style-type: none"> <li>Check the setting of <i>Pr. 77 Parameter write selection</i> (Refer to page 284.)</li> <li>Check the settings of <i>Pr. 31 to 36 (frequency jump)</i>. (Refer to page 141.)</li> <li>Check the settings of <i>Pr. 100 to Pr. 109 (adjustable 5 points V/F)</i>. (Refer to page 147.)</li> <li>Check the connection of the PU and inverter.</li> </ul>	

<b>Operation Panel Indication</b>	<b>Er2</b>	<b>Er2</b>
<b>Name</b>	Write error during operation	
<b>Description</b>	When parameter write was performed during operation with a value other than "2" (writing is enabled independently of operating status in any operation mode) is set in <i>Pr. 77</i> and the STF (STR) is on.	
<b>Check point</b>	<ul style="list-style-type: none"> <li>Check the <i>Pr. 77</i> setting. (Refer to page 284.)</li> <li>Check that the inverter is not operating.</li> </ul>	
<b>Corrective action</b>	<ul style="list-style-type: none"> <li>Set "2" in <i>Pr. 77</i>.</li> <li>After stopping operation, make parameter setting.</li> </ul>	

<b>Operation Panel Indication</b>	<b>Er3</b>	<b>Er3</b>
<b>Name</b>	Calibration error	
<b>Description</b>	Analog input bias and gain calibration values are too close.	
<b>Check point</b>	Check the settings of C3, C4, C6 and C7 (calibration functions). (Refer to page 271.)	



<b>Operation Panel Indication</b>	<b>Er4</b>	<b>Er4</b>
<b>Name</b>	Mode designation error	
<b>Description</b>	<ul style="list-style-type: none"> <li>• Appears if a parameter setting is attempted in the External or NET operation mode with Pr. 77 ≠ "2".</li> <li>• Appears if a parameter setting is attempted when the command source is not at the operation panel. (FR-DU07).</li> </ul>	
<b>Check point</b>	<ul style="list-style-type: none"> <li>• Check that operation mode is "PU operation mode".</li> <li>• Check the Pr. 77 setting. (Refer to page 284.)</li> <li>• Check the Pr. 551 setting.</li> </ul>	
<b>Corrective action</b>	<ul style="list-style-type: none"> <li>• After setting the operation mode to "PU operation mode", make parameter setting. (Refer to page 284.)</li> <li>• After setting Pr. 77 = "2", make parameter setting.</li> <li>• Set Pr. 551 = "2 (initial setting)". (Refer to page 299.)</li> </ul>	

<b>Operation Panel Indication</b>	<b>rE1</b>	<b>rE1</b>
<b>Name</b>	Parameter read error	
<b>Description</b>	An error occurred in the EEPROM on the operation panel side during parameter copy reading.	
<b>Check point</b>	—	
<b>Corrective action</b>	<ul style="list-style-type: none"> <li>• Make parameter copy again. (Refer to page 376.)</li> <li>• Check for an operation panel (FR-DU07) failure. Please contact your sales representative.</li> </ul>	

<b>Operation Panel Indication</b>	<b>rE2</b>	<b>rE2</b>
<b>Name</b>	Parameter write error	
<b>Description</b>	<ul style="list-style-type: none"> <li>• You attempted to perform parameter copy write during operation.</li> <li>• An error occurred in the EEPROM on the operation panel side during parameter copy writing.</li> </ul>	
<b>Check point</b>	Is the FWD or REV LED of the operation panel (FR-DU07) lit or flickering?	
<b>Corrective action</b>	<ul style="list-style-type: none"> <li>• After stopping operation, make parameter copy again. (Refer to page 376.)</li> <li>• Check for an operation panel (FR-DU07) failure. Please contact your sales representative.</li> </ul>	

<b>Operation Panel Indication</b>	<b>rE3</b>	<b>rE3</b>
<b>Name</b>	Parameter verification error	
<b>Description</b>	<ul style="list-style-type: none"> <li>• Data on the operation panel side and inverter side are different.</li> <li>• An error occurred in the EEPROM on the operation panel side during parameter verification.</li> </ul>	
<b>Check point</b>	Check for the parameter setting of the source inverter and inverter to be verified.	
<b>Corrective action</b>	<ul style="list-style-type: none"> <li>• Press  to continue verification.</li> <li>• Make parameter verification again. (Refer to page 377.)</li> <li>• Check for an operation panel (FR-DU07) failure. Please contact your sales representative.</li> </ul>	

<b>Operation Panel Indication</b>	<b>rE4</b>	<b>rE4</b>
<b>Name</b>	Model error	
<b>Description</b>	<ul style="list-style-type: none"> <li>• A different model was used for parameter write and verification during parameter copy.</li> <li>• When parameter copy write is stopped after parameter copy read is stopped</li> </ul>	
<b>Check point</b>	<ul style="list-style-type: none"> <li>• Check that the verified inverter is the same model.</li> <li>• Check that the power is not turned OFF or an operation panel is not disconnected, etc. during parameter copy read.</li> </ul>	
<b>Corrective action</b>	<ul style="list-style-type: none"> <li>• Use the same model (FR-A701 series) for parameter copy and verification.</li> <li>• Perform parameter copy read again.</li> </ul>	







<b>Operation Panel Indication</b>	<b>Err.</b>	<b>Err.</b>
<b>Description</b>	<ul style="list-style-type: none"> <li>The RES signal is ON</li> <li>The PU and inverter cannot make normal communication (contact fault of the connector)</li> <li>When the voltage drops in the inverter's input side.</li> <li>When the control circuit power (R1/L11, S1/L21) and the main circuit power (R/L1, S/L2, T/L3) are connected to a separate power, it may appear at turning ON of the main circuit. It is not a fault.</li> </ul>	
<b>Corrective action</b>	<ul style="list-style-type: none"> <li>Turn OFF the RES signal.</li> <li>Check the connection of the PU and inverter.</li> <li>Check the voltage on the inverter's input side.</li> </ul>	

(2) Warning

When the protective circuit is activated, the output is not shut off.

<b>Operation Panel Indication</b>	<b>OL</b>	<b>OL</b>	<b>FR-PU04 FR-PU07</b>	<b>OL</b>
<b>Name</b>	Stall prevention (overcurrent)			
<b>Description</b>	During acceleration	When the output current (output torque during Real sensorless vector control or vector control) of the inverter exceeds the stall prevention operation level ( <i>Pr. 22 Stall prevention operation level</i> , etc.), this function stops the increase in frequency until the overload current decreases to prevent the inverter from resulting in overcurrent trip. When the overload current has decreased below stall prevention operation level, this function increases the frequency again.		
	During constant speed operation	When the output current (output torque during Real sensorless vector control or vector control) of the inverter exceeds the stall prevention operation level ( <i>Pr. 22 Stall prevention operation level</i> , etc.), this function reduces frequency until the overload current decreases to prevent the inverter from resulting in overcurrent trip. When the overload current has decreased below stall prevention operation level, this function increases the frequency up to the set value.		
	During deceleration	When the output current (output torque during Real sensorless vector control or vector control) of the inverter exceeds the stall prevention operation level ( <i>Pr. 22 Stall prevention operation level</i> , etc.), this function stops the decrease in frequency until the overload current decreases to prevent the inverter from resulting in overcurrent trip. When the overload current has decreased below stall prevention operation level, this function decreases the frequency again.		
<b>Check point</b>	<ul style="list-style-type: none"> <li>Check that the <i>Pr. 0 Torque boost</i> setting is not too large.</li> <li>Check that the <i>Pr. 7 Acceleration time</i> and <i>Pr. 8 Deceleration time</i> settings are not too small.</li> <li>Check that the load is not too heavy.</li> <li>Are there any failure in peripheral devices?</li> <li>Check that the <i>Pr. 13 Starting frequency</i> is not too large.</li> <li>Check that the <i>Pr. 22 Stall prevention operation level</i> is appropriate.</li> </ul>			
<b>Corrective action</b>	<ul style="list-style-type: none"> <li>Increase or decrease the <i>Pr. 0 Torque boost</i> value 1% by 1% and check the motor status. (<i>Refer to page 129.</i>)</li> <li>Set a larger value in <i>Pr. 7 Acceleration time</i> and <i>Pr. 8 Deceleration time</i>. (<i>Refer to page 155.</i>)</li> <li>Reduce the load weight.</li> <li>Try Advanced magnetic flux vector control, Real sensorless vector control or vector control.</li> <li>Change the <i>Pr. 14 Load pattern selection</i> setting.</li> <li>Set stall prevention operation current in <i>Pr. 22 Stall prevention operation level</i>. (The initial value is 150%.) The acceleration/deceleration time may change. Increase the stall prevention operation level with <i>Pr. 22 Stall prevention operation level</i>, or disable stall prevention with <i>Pr. 156 Stall prevention operation selection</i>. (<i>Use Pr. 156 to set either operation continued or not at OL operation.</i>)</li> </ul>			

<b>Operation Panel Indication</b>	<b>oL</b>	<b>oL</b>	<b>FR-PU04 FR-PU07</b>	<b>oL</b>
<b>Name</b>	Stall prevention (overvoltage)			
<b>Description</b>	During deceleration	<ul style="list-style-type: none"> <li>If the regenerative energy of the motor becomes excessive and exceeds the regenerative energy consumption capability, this function stops the decrease in frequency to prevent overvoltage trip. As soon as the regenerative energy has decreased, deceleration resumes.</li> <li>If the regenerative energy of the motor becomes excessive when regeneration avoidance function is selected (<i>Pr. 882 = 1</i>), this function increases the speed to prevent overvoltage trip. (<i>Refer to page 361.</i>)</li> </ul>		
<b>Check point</b>	<ul style="list-style-type: none"> <li>Check for sudden speed reduction.</li> <li>Regeneration avoidance function (<i>Pr. 882 to Pr. 886</i>) is being used? (<i>Refer to page 361.</i>)</li> </ul>			
<b>Corrective action</b>	The deceleration time may change. Increase the deceleration time using <i>Pr. 8 Deceleration time</i> .			

Operation Panel Indication	PS	PS	FR-PU04 FR-PU07	PS
Name	PU stop			
Description	Stop with  of the PU is set in Pr. 75 Reset selection/disconnected PU detection/PU stop selection. (For Pr. 75, refer to page 282.)			
Check point	Check for a stop made by pressing  of the operation panel.			
Corrective action	Turn the start signal off and release with  .			

Operation Panel Indication	TH	TH	FR-PU04 FR-PU07	TH
Name	Electronic thermal relay function prealarm			
Description	Appears if the cumulative value of the Pr. 9 Electronic thermal O/L relay reaches or exceeds 85% of the preset level. If it reaches 100% of the Pr. 9 Electronic thermal O/L relay setting, a motor overload trip (E. THM) occurs. The THP signal can be simultaneously output with the [TH] display. For the terminal used for the THP signal output, assign the function by setting "8" (positive logic) or "108" (negative logic) in any of Pr. 190 to Pr. 196 (output terminal function selection). (Refer to page 215)			
Check point	<ul style="list-style-type: none"> <li>Check for large load or sudden acceleration.</li> <li>Is the Pr. 9 Electronic thermal O/L relay setting is appropriate? (Refer to page 165.)</li> </ul>			
Corrective action	<ul style="list-style-type: none"> <li>Reduce the load weight or the number of operation times.</li> <li>Set an appropriate value in Pr. 9 Electronic thermal O/L relay. (Refer to page 165.)</li> </ul>			

Operation Panel Indication	MT	MT	FR-PU04 FR-PU07	MT
Name	Maintenance signal output			
Description	Indicates that the cumulative energization time of the inverter has reached a given time. When the setting of Pr. 504 Maintenance timer alarm output set time is the initial value (Pr. 504 = "9999"), this protective function does not function.			
Check point	The Pr. 503 Maintenance timer setting is larger than the Pr. 504 Maintenance timer alarm output set time setting. (Refer to page 367.)			
Corrective action	Setting "0" in Pr. 503 Maintenance timer erases the signal.			

Operation Panel Indication	CP	CP	FR-PU04 FR-PU07	CP
Name	Parameter copy			
Description	Displayed when parameters are copied between the FR-A701 series and FR-A700 series 75K or higher.			
Check point	Check that parameters are not copied between the FR-A701 series and FR-A700 series 75K or higher.			
Corrective action	Copy between the same FR-A701 series.			

Operation Panel Indication	SL	SL	FR-PU04 FR-PU07	SL
Name	Speed limit indication (output during speed limit)			
Description	Output if the speed limit level is exceeded during torque control.			
Check point	<ul style="list-style-type: none"> <li>Check that the torque command is not larger than required.</li> <li>Check that the speed limit level is not low.</li> </ul>			
Corrective action	<ul style="list-style-type: none"> <li>Decrease the torque command.</li> <li>Increase the speed limit level.</li> </ul>			



(3) Alarm

When an alarm occurs, the output is not shut off. You can also output an alarm signal by making parameter setting. (Set "98" in any of Pr. 190 to Pr. 196 (output terminal function selection). (Refer to page 215.))

<b>Operation Panel Indication</b>	FN	$F_n$	FR-PU04 FR-PU07	FN
<b>Name</b>	Fan alarm			
<b>Description</b>	For the inverter that contains a cooling fan, $F_n$ appears on the operation panel when the cooling fan stops due to a fault or different operation from the setting of Pr. 244 Cooling fan operation selection.			
<b>Check point</b>	Check the cooling fan for a fault.			
<b>Corrective action</b>	Check for fan fault. Please contact your sales representative.			

(4) Fault

When a fault occurs, the inverter trips and a fault signal is output.

<b>Operation Panel Indication</b>	E.OC1	$E.OC1$	FR-PU04 FR-PU07	OC During Acc
<b>Name</b>	Overcurrent trip during acceleration			
<b>Description</b>	When the inverter output current reaches or exceeds approximately 220% of the rated current during acceleration, the protective circuit is activated to stop the inverter output.			
<b>Check point</b>	<ul style="list-style-type: none"> <li>• Check for sudden acceleration.</li> <li>• Check that the downward acceleration time is not long for lift.</li> <li>• Check for output short circuit.</li> <li>• Check that the Pr. 3 Base frequency setting is not 60Hz when the motor rated frequency is 50Hz.</li> <li>• Check if the stall prevention operation level is set too high.</li> <li>• Check if the fast-response current limit operation is disabled.</li> <li>• Check that the regeneration is not performed frequently. (Check that the output voltage becomes larger than the V/F reference voltage at regeneration and overcurrent due to increase in motor current occurs.)</li> <li>• Check that the power supply for RS-485 terminal is not shorted. (under vector control)</li> <li>• Check that the rotation direction is not switched from forward to reverse rotation (or from reverse to forward) during torque control under Real sensorless vector control.</li> <li>• Check if a start command is given to the inverter while the motor is coasting.</li> </ul>			
<b>Corrective action</b>	<ul style="list-style-type: none"> <li>• Increase the acceleration time. (Shorten the downward acceleration time for lift.)</li> <li>• When "E.OC1" is always lit at starting, disconnect the motor once and start the inverter. If "E.OC1" is still lit, contact your sales representative.</li> <li>• Check the wiring to make sure that output short circuit does not occur.</li> <li>• Set the Pr. 3 Base frequency to 50Hz. (Refer to page 142.)</li> <li>• Lower the setting of stall prevention operation level. (Refer to page 135.)</li> <li>• Activate the fast-response current limit operation.</li> <li>• Set base voltage (rated voltage of the motor, etc.) in Pr. 19 Base frequency voltage. (Refer to page 142.)</li> <li>• Check RS-485 terminal connection. (under vector control)</li> <li>• Prevent the motor from switching the rotation direction from forward to reverse (or from reverse to forward) during torque control under Real sensorless vector control.</li> <li>• Input a start command after the motor stops. Alternatively, set the automatic restart after instantaneous power failure/flying start function. (Refer to page 243.)</li> </ul>			



<b>Operation Panel Indication</b>	E.OC2	<b>E.OC2</b>	FR-PU04 FR-PU07	Stedy Spd OC
<b>Name</b>	Overcurrent trip during constant speed			
<b>Description</b>	When the inverter output current reaches or exceeds approximately 220% of the rated current during constant speed operation, the protective circuit is activated to stop the inverter output.			
<b>Check point</b>	<ul style="list-style-type: none"> <li>• Check for sudden load change.</li> <li>• Check for output short circuit.</li> <li>• Check if the stall prevention operation level is set too high.</li> <li>• Check if the fast-response current limit operation is disabled.</li> <li>• Check that the power supply for RS-485 terminal is not shorted. (under vector control)</li> <li>• Check that the rotation direction is not switched from forward to reverse rotation (or from reverse to forward) during torque control under Real sensorless vector control.</li> <li>• Check if a start command is given to the inverter while the motor is coasting.</li> </ul>			
<b>Corrective action</b>	<ul style="list-style-type: none"> <li>• Keep load stable.</li> <li>• Check the wiring to make sure that output short circuit does not occur.</li> <li>• Lower the setting of stall prevention operation level. (Refer to page 135.)</li> <li>• Activate the fast-response current limit operation.</li> <li>• Check RS-485 terminal connection. (under vector control)</li> <li>• Prevent the motor from switching the rotation direction from forward to reverse (or from reverse to forward) during torque control under Real sensorless vector control.</li> <li>• Input a start command after the motor stops. Alternatively, set the automatic restart after instantaneous power failure/flying start function. (Refer to page 243.)</li> </ul>			

<b>Operation Panel Indication</b>	E.OC3	<b>E.OC3</b>	FR-PU04 FR-PU07	OC During Dec
<b>Name</b>	Overcurrent trip during deceleration or stop			
<b>Description</b>	When the inverter output current reaches or exceeds approximately 220% of the rated inverter current during deceleration (other than acceleration or constant speed), the protective circuit is activated to stop the inverter output.			
<b>Check point</b>	<ul style="list-style-type: none"> <li>• Check for sudden speed reduction.</li> <li>• Check for output short circuit.</li> <li>• Check for too fast operation of the motor's mechanical brake.</li> <li>• Check if the stall prevention operation level is set too high.</li> <li>• Check if the fast-response current limit operation is disabled.</li> <li>• Check that the power supply for RS-485 terminal is not shorted. (under vector control)</li> <li>• Check that the rotation direction is not switched from forward to reverse rotation (or from reverse to forward) during torque control under Real sensorless vector control.</li> <li>• Check if a start command is given to the inverter while the motor is coasting.</li> </ul>			
<b>Corrective action</b>	<ul style="list-style-type: none"> <li>• Increase the deceleration time.</li> <li>• Check the wiring to make sure that output short circuit does not occur.</li> <li>• Check the mechanical brake operation.</li> <li>• Lower the setting of stall prevention operation level. (Refer to page 135.)</li> <li>• Activate the fast-response current limit operation.</li> <li>• Check RS-485 terminal connection. (under vector control)</li> <li>• Prevent the motor from switching the rotation direction from forward to reverse (or from reverse to forward) during torque control under Real sensorless vector control.</li> <li>• Input a start command after the motor stops. Alternatively, set the automatic restart after instantaneous power failure/flying start function. (Refer to page 243)</li> </ul>			

<b>Operation Panel Indication</b>	E.OV1	<b>E.OV1</b>	FR-PU04 FR-PU07	OV During Acc
<b>Name</b>	Regenerative overvoltage trip during acceleration			
<b>Description</b>	If regenerative energy causes the inverter's internal main circuit DC voltage to reach or exceed the specified value, the protective circuit is activated to stop the inverter output. The circuit may also be activated by a surge voltage produced in the power supply system. Protective circuit may activate even if the regeneration converter is not activated due to power supply failure (Input phase failure and instantaneous power failure).			
<b>Check point</b>	<ul style="list-style-type: none"> <li>• Check for power supply fault or wrong wiring.</li> <li>• Check for too slow acceleration. (e.g. during descending acceleration in vertical lift load)</li> <li>• Check that the Pr. 22 Stall prevention operation level is not lower than the no load current.</li> </ul>			
<b>Corrective action</b>	<ul style="list-style-type: none"> <li>• Perform wiring correctly.</li> <li>• Decrease the acceleration time.</li> <li>• Use regeneration avoidance function (Pr. 882 to Pr. 886). (Refer to page 361.)</li> <li>• Set a value larger than the no load current in Pr. 22 Stall prevention operation level.</li> </ul>			



<b>Operation Panel Indication</b>	E.OV2		FR-PU04 FR-PU07	<b>Stedy Spd OV</b>
<b>Name</b>	Regenerative overvoltage trip during constant speed			
<b>Description</b>	If regenerative energy causes the inverter's internal main circuit DC voltage to reach or exceed the specified value, the protective circuit is activated to stop the inverter output. The circuit may also be activated by a surge voltage produced in the power supply system. Protective circuit may activate even if the regeneration converter is not activated due to power supply failure (Input phase failure and instantaneous power failure).			
<b>Check point</b>	<ul style="list-style-type: none"> <li>• Check for power supply fault or wrong wiring.</li> <li>• Check for sudden load change.</li> <li>• Check that the <i>Pr. 22 Stall prevention operation level</i> is not lower than the no load current.</li> </ul>			
<b>Corrective action</b>	<ul style="list-style-type: none"> <li>• Perform wiring correctly.</li> <li>• Keep load stable.</li> <li>• Use regeneration avoidance function (<i>Pr. 882 to Pr. 886</i>). (Refer to page 361.)</li> <li>• Set a value larger than the no load current in <i>Pr. 22 Stall prevention operation level</i>.</li> </ul>			

<b>Operation Panel Indication</b>	E.OV3		FR-PU04 FR-PU07	<b>OV During Dec</b>
<b>Name</b>	Regenerative overvoltage trip during deceleration or stop			
<b>Description</b>	If regenerative energy causes the inverter's internal main circuit DC voltage to reach or exceed the specified value, the protective circuit is activated to stop the inverter output. The circuit may also be activated by a surge voltage produced in the power supply system. Protective circuit may activate even if the regeneration converter is not activated due to power supply failure (Input phase failure and instantaneous power failure).			
<b>Check point</b>	<ul style="list-style-type: none"> <li>• Check for power supply fault or wrong wiring.</li> <li>• Check for sudden speed reduction.</li> </ul>			
<b>Corrective action</b>	<ul style="list-style-type: none"> <li>• Perform wiring correctly.</li> <li>• Increase the deceleration time. (Set the deceleration time which matches the moment of inertia of the load)</li> <li>• Decrease the braking duty.</li> <li>• Use regeneration avoidance function (<i>Pr. 882 to Pr. 886</i>). (Refer to page 361.)</li> </ul>			

<b>Operation Panel Indication</b>	E.THT		FR-PU04 FR-PU07	<b>Inv. Overload</b>
<b>Name</b>	Inverter overload trip (electronic thermal relay function) *1			
<b>Description</b>	If a current not less than 150% of the rated output current flows and overcurrent trip does not occur (220% or less), the electronic thermal relay activate to stop the inverter output in order to protect the output transistors. (Overload capacity 150% 60s inverse-time characteristics)			
<b>Check point</b>	<ul style="list-style-type: none"> <li>• Check that acceleration/deceleration time is not too short.</li> <li>• Check that torque boost setting is not too large (small).</li> <li>• Check that load pattern selection setting is appropriate for the load pattern of the using machine.</li> <li>• Check the motor for use under overload.</li> </ul>			
<b>Corrective action</b>	<ul style="list-style-type: none"> <li>• Increase acceleration/deceleration time.</li> <li>• Adjust the torque boost setting.</li> <li>• Set the load pattern selection setting according to the load pattern of the using machine.</li> <li>• Reduce the load weight.</li> </ul>			

<b>Operation Panel Indication</b>	E.THM		FR-PU04 FR-PU07	<b>Motor Ovrload</b>
<b>Name</b>	Motor overload trip (electronic thermal relay function) *1			
<b>Description</b>	The electronic thermal relay function in the inverter detects motor overheat due to overload or reduced cooling capability during constant speed operation and pre-alarm (TH display) is output when the $I^2t$ value reaches 85% of the <i>Pr. 9 Electronic thermal O/L relay</i> setting and the protection circuit is activated to stop the inverter output when the $I^2t$ value reaches the specified value. When running a special motor such as a multi-pole motor or two motors, provide a thermal relay on the inverter output side since such motor(s) cannot be protected by the electronic thermal relay function.			
<b>Check point</b>	<ul style="list-style-type: none"> <li>• Check the motor for use under overload.</li> <li>• Check that the setting of <i>Pr. 71 Applied motor</i> for motor selection is correct. (Refer to page 169.)</li> <li>• Check that stall prevention operation setting is correct.</li> </ul>			
<b>Corrective action</b>	<ul style="list-style-type: none"> <li>• Reduce the load weight.</li> <li>• For a constant-torque motor, set the constant-torque motor in <i>Pr. 71 Applied motor</i>.</li> <li>• Check that stall prevention operation setting is correct. (Refer to page 135.)</li> </ul>			

\*1 Resetting the inverter initializes the internal thermal integrated data of the electronic thermal relay function.



Operation Panel Indication	E.FIN	<i>E.FIN</i>	FR-PU04 FR-PU07	H/Sink O/Temp
Name	Heatsink overheat			
Description	If the heatsink overheats, the temperature sensor is actuated to stop the inverter output. The FIN signal can be output when the temperature becomes approximately 85% of the heatsink overheat protection operation temperature. For the terminal used for the FIN signal output, assign the function by setting "26" (positive logic) or "126" (negative logic) in any of Pr. 190 to Pr. 196 (output terminal function selection). (Refer to page 215)			
Check point	<ul style="list-style-type: none"> <li>• Check for too high surrounding air temperature.</li> <li>• Check for heatsink clogging.</li> <li>• Check that the cooling fan is stopped. (Check that <i>F<sub>n</sub></i> is displayed on the operation panel.)</li> </ul>			
Corrective action	<ul style="list-style-type: none"> <li>• Set the surrounding air temperature to within the specifications.</li> <li>• Clean the heatsink.</li> <li>• Replace the cooling fan.</li> </ul>			

Operation Panel Indication	E.IPF	<i>E.IPF</i>	FR-PU04 FR-PU07	Inst. Pwr. Loss
Name	Instantaneous power failure			
Description	If a power failure occurs for longer than 15ms (this also applies to inverter input shut-off), the instantaneous power failure protective function is activated to trip the inverter in order to prevent the control circuit from malfunctioning. If a power failure persists for longer than 100ms, the fault output is not provided, and the inverter restarts if the start signal is on upon power restoration. (The inverter continues operating if an instantaneous power failure is within 15ms.) In some operating status (load magnitude, acceleration/deceleration time setting, etc.), overcurrent or other protection may be activated upon power restoration. When instantaneous power failure protection is activated, the IPF signal is output. (Refer to page 243)			
Check point	Find the cause of instantaneous power failure occurrence.			
Corrective action	<ul style="list-style-type: none"> <li>• Remedy the instantaneous power failure.</li> <li>• Prepare a backup power supply for instantaneous power failure.</li> <li>• Set the function of automatic restart after instantaneous power failure (Pr. 57). (Refer to page 243.)</li> </ul>			

Operation Panel Indication	E.UVT	<i>E.UVT</i>	FR-PU04 FR-PU07	Under Voltage
Name	Undervoltage			
Description	If the power supply voltage of the inverter decreases, the control circuit will not perform normal functions. In addition, the motor torque will be insufficient and/or heat generation will increase. To prevent this, if the power supply voltage decreases below about 150VAC (300VAC for the 400V class), this function stops the inverter output. When undervoltage protection is activated, the IPF signal is output. (Refer to page 243)			
Check point	Check for start of large-capacity motor.			
Corrective action	<ul style="list-style-type: none"> <li>• Check the power supply system equipment such as the power supply.</li> <li>• If the problem still persists after taking the above measure, please contact your sales representative.</li> </ul>			

Operation Panel Indication	E.ILF	<i>E.ILF</i>	FR-PU04 FR-PU07	Fault 14 Input phase loss
Name	Input phase loss			
Description	This fault is output when function valid setting (= 1) is set in Pr. 872 Input phase loss protection selection and one phase of the three phase power input is lost. (If the input power voltage is less than 100VAC, the inverter may detect an input phase loss (E.ILF).) (Refer to page 253.)			
Check point	Check for a break in the cable for the three-phase power supply input.			
Corrective action	<ul style="list-style-type: none"> <li>• Wire the cables properly.</li> <li>• Repair a break portion in the cable.</li> <li>• Check the Pr. 872 Input phase loss protection selection setting.</li> </ul>			





Operation Panel Indication	E.OLT	<i>E.OLT</i>	FR-PU04 FR-PU07	Still Prev STP ( OL shown during stall prevention operation)
Name	Stall prevention stop			
Description	If the frequency has fallen to 0.5Hz by stall prevention operation and remains for 3s, a fault (E.OLT) appears and trips the inverter. OL appears while stall prevention is being activated. When speed control is performed by Real sensorless vector control or vector control, a fault (E.OLT) is displayed and the inverter output is stopped if frequency drops to the <i>Pr. 865 Low speed detection</i> (initial value is 1.5Hz) setting by torque limit operation and the output torque exceeds <i>Pr. 874 OLT level setting</i> (initial value is 150%) setting and remains for more than 3s.			
Check point	<ul style="list-style-type: none"> <li>• Check the motor for use under overload. (Refer to page 135.)</li> <li>• Check that the <i>Pr. 865 Low speed detection</i> and <i>Pr. 874 OLT level setting</i> values are correct. (Check the <i>Pr. 22 Stall prevention operation level</i> setting if V/F control is exercised.)</li> </ul>			
Corrective action	<ul style="list-style-type: none"> <li>• Reduce the load weight.</li> <li>• Change the <i>Pr. 22 Stall prevention operation level</i>, <i>Pr. 865 Low speed detection</i> and <i>Pr. 874 OLT level setting</i> values. (Check the <i>Pr. 22 Stall prevention operation level</i> setting if V/F control is exercised.)</li> </ul>			

Operation Panel Indication	E.GF	<i>E. GF</i>	FR-PU04 FR-PU07	Ground Fault
Name	Output side earth (ground) fault overcurrent			
Description	This function stops the inverter output if an earth (ground) fault overcurrent flows due to an earth (ground) fault that occurred on the inverter's output (load) side.			
Check point	Check for an earth (ground) fault in the motor and connection cable.			
Corrective action	Remedy the earth (ground) fault portion.			

Operation Panel Indication	E.LF	<i>E. LF</i>	FR-PU04 FR-PU07	E. LF
Name	Output phase loss			
Description	This function stops the inverter output if one of the three phases (U, V, W) on the inverter's output side (load side) is lost.			
Check point	<ul style="list-style-type: none"> <li>• Check the wiring (Check that the motor is normal.)</li> <li>• Check that the capacity of the motor used is not smaller than that of the inverter.</li> <li>• Check if a start command is given to the inverter while the motor is coasting.</li> </ul>			
Corrective action	<ul style="list-style-type: none"> <li>• Wire the cables properly.</li> <li>• Input a start command after the motor stops. Alternatively, set the automatic restart after instantaneous power failure/flying start function. (Refer to page 243.)</li> </ul>			

Operation Panel Indication	E.OHT	<i>E.OHT</i>	FR-PU04 FR-PU07	OH Fault
Name	External thermal relay operation			
Description	If the external thermal relay provided for motor overheat protection, or the internally mounted temperature relay in the motor, etc. switches on (contacts open), the inverter output is stopped. This function is available when "7" (OH signal) is set in any of <i>Pr. 178 to Pr. 189 (input terminal function selection)</i> . When the initial value (without OH signal assigned) is set, this protective function is not available.			
Check point	<ul style="list-style-type: none"> <li>• Check for motor overheating.</li> <li>• Check that the value of 7 (OH signal) is set correctly in any of <i>Pr. 178 to Pr. 189 (input terminal function selection)</i>.</li> </ul>			
Corrective action	<ul style="list-style-type: none"> <li>• Reduce the load and operating duty.</li> <li>• Even if the relay contacts are reset automatically, the inverter will not restart unless it is reset.</li> </ul>			

Operation Panel Indication	E.PTC	<i>E.PTC</i>	FR-PU04 FR-PU07	Fault 14 PTC activated
Name	PTC thermistor operation			
Description	Stops the inverter output when the motor overheat status is detected for 10s or more by the external PTC thermistor input connected to the terminal AU. This fault is available when "63" is set in <i>Pr. 184 AU terminal function selection</i> and AU/PTC switchover switch is set in PTC side. When the initial value ( <i>Pr. 184 = "4"</i> ) is set, this protective function is not available.			
Check point	<ul style="list-style-type: none"> <li>• Check the connection between the PTC thermistor switch and thermal protector.</li> <li>• Check the motor for operation under overload.</li> <li>• Is valid setting (= 63) selected in <i>Pr. 184 AU terminal function selection</i> ? (Refer to page 168, 207.)</li> </ul>			
Corrective action	Reduce the load weight.			



Operation Panel Indication	E.OPT <b>Ver.UP</b>	<b>E.OPT</b>	FR-PU04 FR-PU07	Option Fault
Name	Option fault			
Description	<ul style="list-style-type: none"> <li>• Appears when torque command by the plug-in option is selected using <i>Pr.804 Torque command source selection</i> selection and no plug-in option is mounted.</li> <li>• Appears when the switch for the manufacturer setting of the plug-in option is changed.</li> <li>• Appears when a communication option is connected while <i>Pr. 296 = "0 or 100."</i></li> </ul>			
Check point	<ul style="list-style-type: none"> <li>• Check that the plug-in option for torque command setting is connected.</li> <li>• Check for the password lock with a setting of <i>Pr. 296 = "0, 100"</i></li> </ul>			
Corrective action	<ul style="list-style-type: none"> <li>• Check for connection of the plug-in option. Check the <i>Pr. 804 Torque command source selection setting</i>.</li> <li>• Return the switch for the manufacturer setting of the plug-in option to the initial status. (<i>Refer to instruction manual of each option</i>)</li> <li>• To apply the password lock when installing a communication option, set <i>Pr.296 ≠ "0,100"</i>. (<i>Refer to page 287.</i>)</li> <li>• If the problem still persists after taking the above measure, please contact your sales representative.</li> </ul>			

**Ver.UP** .....Specifications differ according to the date assembled. *Refer to page 456 to check the SERIAL number.*

Operation Panel Indication	E.OP3	<b>E.OP3</b>	FR-PU04 FR-PU07	Option 3 Fault
Name	Communication option fault			
Description	Stops the inverter output when a communication line error occurs in the communication option.			
Check point	<ul style="list-style-type: none"> <li>• Check for a wrong option function setting and operation.</li> <li>• Check that the plug-in option is plugged into the connector securely.</li> <li>• Check for a break in the communication cable.</li> <li>• Check that the terminating resistor is fitted properly.</li> </ul>			
Corrective action	<ul style="list-style-type: none"> <li>• Check the option function setting, etc.</li> <li>• Connect the plug-in option securely.</li> <li>• Check the connection of communication cable.</li> </ul>			

Operation Panel Indication	E. 1 to E. 3	<b>E. 1 to E. 3</b>	FR-PU04 FR-PU07	Fault 1 to Fault 3
Name	Option fault			
Description	Stops the inverter output if a contact fault, etc. of the connector between the inverter and plug-in option occurs or if a communication option is fitted to the connector 1 or 2. Appears when the switch for the manufacturer setting of the plug-in option is changed.			
Check point	<ul style="list-style-type: none"> <li>• Check that the plug-in option is plugged into the connector securely. (1 to 3 indicate the option connector numbers.)</li> <li>• Check for excess electrical noises around the inverter.</li> <li>• Check that the communication option is not fitted to the connector 1 or 2.</li> </ul>			
Corrective action	<ul style="list-style-type: none"> <li>• Connect the plug-in option securely.</li> <li>• Take measures against noises if there are devices producing excess electrical noises around the inverter. If the problem still persists after taking the above measure, please contact your sales representative or distributor.</li> <li>• Fit the communication option to the connector 3.</li> <li>• Return the switch for the manufacturer setting of the plug-in option to the initial status. (<i>Refer to Instruction Manual of each option</i>)</li> </ul>			

Operation Panel Indication	E.PE	<b>E. PE</b>	FR-PU04 FR-PU07	Corrupt Memry
Name	Parameter storage device fault (control circuit board)			
Description	Stops the inverter output if fault occurred in the parameter stored. (EEPROM failure)			
Check point	Check for too many number of parameter write times.			
Corrective action	Please contact your sales representative. When performing parameter write frequently for communication purposes, set "1" in <i>Pr. 342</i> to enable RAM write. Note that powering off returns the inverter to the status before RAM write.			





Operation Panel Indication	E.PE2	E.PE2	FR-PU04	Fault 14
			FR-PU07	PR storage alarm
Name	Parameter storage device fault (main circuit board)			
Description	Stops the inverter output if fault occurred in the parameter stored. (EEPROM failure)			
Check point	_____			
Corrective action	Please contact your sales representative.			

Operation Panel Indication	E.PUE	E.PUE	FR-PU04	PU Leave Out
			FR-PU07	
Name	PU disconnection			
Description	<ul style="list-style-type: none"> <li>This function stops the inverter output if communication between the inverter and PU is suspended, e.g. the operation panel and parameter unit is disconnected, when "2", "3", "16" or "17" was set in <i>Pr. 75 Reset selection/disconnected PU detection/PU stop selection</i>.</li> <li>This function stops the inverter output when communication errors occurred consecutively for more than permissible number of retries when a value other than "9999" is set in <i>Pr. 121 Number of PU communication retries</i> during the RS-485 communication with the PU connector.</li> <li>This function stops the inverter output if communication is broken within the period of time set in <i>Pr. 122 PU communication check time interval</i> during the RS-485 communication with the PU connector.</li> </ul>			
Check point	<ul style="list-style-type: none"> <li>Check that the FR-DU07 or parameter unit (FR-PU04/FR-PU07) is fitted tightly.</li> <li>Check the <i>Pr. 75</i> setting.</li> </ul>			
Corrective action	Fit the FR-DU07 or parameter unit (FR-PU04/FR-PU07) securely.			

Operation Panel Indication	E.RET	E.RET	FR-PU04	Retry No Over
			FR-PU07	
Name	Retry count excess			
Description	If operation cannot be resumed properly within the number of retries set, this function trips the inverter. This function is available only when <i>Pr. 67 Number of retries at fault occurrence</i> is set. When the initial value ( <i>Pr. 67</i> = "0") is set, this fault does not occur.			
Check point	Find the cause of alarm occurrence.			
Corrective action	Eliminate the cause of the error preceding this error indication.			

Operation Panel Indication	E. 5	E. 5	FR-PU04 FR-PU07	Fault 5
	E. 6	E. 6		Fault 6
	E. 7	E. 7		Fault 7
	E.CPU	E.CPU		CPU Fault
Name	CPU fault			
Description	Stops the inverter output if the communication error of the built-in CPU occurs.			
Check point	Check for devices producing excess electrical noises around the inverter.			
Corrective action	<ul style="list-style-type: none"> <li>Take measures against noises if there are devices producing excess electrical noises around the inverter.</li> <li>Please contact your sales representative.</li> </ul>			

Operation Panel Indication	E.CTE	E.CTE	FR-PU04	_____
			FR-PU07	E.CTE
Name	Operation panel power supply short circuit, RS-485 terminal power supply short circuit			
Description	When the operation panel power supply (PU connector) is shorted, this function shuts off power output and stops the inverter output. At this time, the operation panel (parameter unit) cannot be used and RS-485 communication from the PU connector cannot be made. When the internal power supply for the RS-485 terminals are shorted, this function shuts off the power output. At this time, communication from the RS-485 terminals cannot be made. To reset, enter the RES signal or switch power off, then on again.			
Check point	<ul style="list-style-type: none"> <li>Check for a short circuit in the PU connector cable.</li> <li>Check that the RS-485 terminals are connected correctly.</li> </ul>			
Corrective action	<ul style="list-style-type: none"> <li>Check the PU and cable.</li> <li>Check the connection of the RS-485 terminals</li> </ul>			



Operation Panel Indication	E.MB1 to 7		FR-PU04	—
			FR-PU07	E.MB1 Fault to E.MB7 Fault
Name	Brake sequence fault			
Description	The inverter output is stopped when a sequence error occurs during use of the brake sequence function (Pr. 278 to Pr. 285). This fault is not available in the initial status (brake sequence function is invalid). (Refer to page 193.)			
Check point	Find the cause of alarm occurrence.			
Corrective action	Check the set parameters and perform wiring properly.			

Operation Panel Indication	E.OS		FR-PU04	E. OS
			FR-PU07	
Name	Overspeed occurrence			
Description	Stops the inverter output when the motor speed exceeds the Pr. 374 Overspeed detection level during encoder feedback control Real sensorless vector control and vector control. This fault is not available in the initial status.			
Check point	<ul style="list-style-type: none"> <li>• Check that the Pr. 374 Overspeed detection level value is correct.</li> <li>• Check that the number of encoder pulses does not differ from the actual number of encoder pulses.</li> </ul>			
Corrective action	<ul style="list-style-type: none"> <li>• Set the Pr. 374 Overspeed detection level value correctly.</li> <li>• Set the correct number of encoder pulses in Pr. 369 Number of encoder pulses.</li> </ul>			

Operation Panel Indication	E.OSD		FR-PU04	E. OSd
			FR-PU07	
Name	Speed deviation excess detection			
Description	Stops the inverter output if the motor speed is increased or decreased under the influence of the load etc. during vector control with Pr. 285 Speed deviation excess detection frequency set and cannot be controlled in accordance with the speed command value. This fault is not available in the initial status.			
Check point	<ul style="list-style-type: none"> <li>• Check that the values of Pr. 285 Speed deviation excess detection frequency and Pr. 853 Speed deviation time are correct.</li> <li>• Check for sudden load change.</li> <li>• Check that the number of encoder pulses does not differ from the actual number of encoder pulses.</li> </ul>			
Corrective action	<ul style="list-style-type: none"> <li>• Set Pr. 285 Speed deviation excess detection frequency and Pr. 853 Speed deviation time correctly.</li> <li>• Keep load stable.</li> <li>• Set the correct number of encoder pulses in Pr. 369 Number of encoder pulses.</li> </ul>			

Operation Panel Indication	E.ECT		FR-PU04	E. ECT
			FR-PU07	
Name	Signal loss detection			
Description	Trips the inverter when the encoder signal is shut off under orientation control, encoder feedback control or vector control. This fault is not available in the initial status.			
Check point	<ul style="list-style-type: none"> <li>• Check for the encoder signal loss.</li> <li>• Check that the encoder specifications are correct.</li> <li>• Check for a loose connector.</li> <li>• Check that the switch setting of the FR-A7AP/FR-A7AL (option) is correct.</li> <li>• Check that the power is supplied to the encoder. Or, check that the power is not supplied to the encoder later than the inverter.</li> </ul>			
Corrective action	<ul style="list-style-type: none"> <li>• Remedy the signal loss.</li> <li>• Use an encoder that meets the specifications.</li> <li>• Make connection securely.</li> <li>• Make a switch setting of the FR-A7AP/FR-A7AL (option) correctly. (Refer to page 31)</li> <li>• Supply the power to the encoder. Or supply the power to the encoder at the same time when the power is supplied to the inverter.</li> </ul> <p>If the power is supplied to the encoder after the inverter, check that the encoder signal is securely sent and set "0" in Pr. 376.</p>			



Operation Panel Indication	E.OD	E. Od	FR-PU04	Fault 14
			FR-PU07	E. Od
Name	Excessive position fault			
Description	Stops the inverter output when the difference between the position command and position feedback exceeds <i>Pr. 427 Excessive level error</i> under position control. This fault is not available in the initial status.			
Check point	<ul style="list-style-type: none"> <li>• Check that the position detecting encoder mounting orientation matches the parameter.</li> <li>• Check that the load is not large.</li> <li>• Check that the <i>Pr. 427 Excessive level error</i> and <i>Pr. 369 Number of encoder pulses</i> are correct.</li> </ul>			
Corrective action	<ul style="list-style-type: none"> <li>• Check the parameters.</li> <li>• Reduce the load weight.</li> <li>• Set the <i>Pr. 427 Excessive level error</i> and <i>Pr. 369 Number of encoder pulses</i> correctly.</li> </ul>			

Operation Panel Indication	E.EP	E.EP	FR-PU04	Fault 14
			FR-PU07	E.EP
Name	Encoder phase fault			
Description	Stops the inverter output when the rotation command of the inverter differs from the actual motor rotation direction detected from the encoder. This fault is not available in the initial status.			
Check point	<ul style="list-style-type: none"> <li>• Check for mis-wiring of the encoder cable.</li> <li>• Check for wrong setting of <i>Pr. 359 Encoder rotation direction</i>.</li> </ul>			
Corrective action	<ul style="list-style-type: none"> <li>• Perform connection and wiring securely.</li> <li>• Change the <i>Pr. 359 Encoder rotation direction</i> value.</li> </ul>			

Operation Panel Indication	E.P24	E.P24	FR-PU04	E.P24
			FR-PU07	
Name	24VDC power output short circuit			
Description	When the 24VDC power output from the PC terminal is shorted, this function shuts off the power output. At this time, all external contact inputs switch off. The inverter cannot be reset by entering the RES signal. To reset it, use the operation panel or switch power off, then on again.			
Check point	<ul style="list-style-type: none"> <li>• Check for a short circuit in the PC terminal output.</li> </ul>			
Corrective action	<ul style="list-style-type: none"> <li>• Remedy the earth (ground) fault portion.</li> </ul>			

Operation Panel Indication	E.CDO	E.CDO	FR-PU04	Fault 14
			FR-PU07	OC detect level
Name	Output current detection value exceeded			
Description	Trips the inverter when the output current exceeds the setting of <i>Pr. 150 Output current detection level</i> . This function is available when <i>Pr. 167 Output current detection operation selection</i> is set to "1". When the initial value ( <i>Pr. 167</i> = "0") is set, this protective function is not available.			
Check point	Check the settings of <i>Pr. 150 Output current detection level</i> , <i>Pr. 151 Output current detection signal delay time</i> , <i>Pr. 166 Output current detection signal retention time</i> , <i>Pr. 167 Output current detection operation selection</i> . (Refer to page 224.)			

Operation Panel Indication	E.IOH	E.IOH	FR-PU04	Fault 14
			FR-PU07	Inrush overheat
Name	Inrush current limit circuit fault			
Description	Stops the inverter output when the resistor of inrush current limit circuit overheated. The inrush current limit circuit failure			
Check point	<ul style="list-style-type: none"> <li>• Check that frequent power ON/OFF is not repeated.</li> <li>• Check that the power supply circuit of inrush current limit circuit contactor is not damaged.</li> </ul>			
Corrective action	Configure a circuit where frequent power ON/OFF is not repeated. If the problem still persists after taking the above measure, please contact your sales representative.			



Operation Panel Indication	E.SER	E.SEr	FR-PU04	Fault 14
			FR-PU07	VFD Comm error
Name	Communication fault (inverter)			
Description	This function stops the inverter output when communication error occurs consecutively for more than permissible retry count when a value other than "9999" is set in <i>Pr. 335 RS-485 communication retry count</i> during RS-485 communication from the RS-485 terminals. This function also stops the inverter output if communication is broken for the period of time set in <i>Pr. 336 RS-485 communication check time interval</i> .			
Check point	Check the RS-485 terminal wiring.			
Corrective action	Perform wiring of the RS-485 terminals properly.			

Operation Panel Indication	E.AIE	E.AIE	FR-PU04	Fault 14
			FR-PU07	Analog in error
Name	Analog input fault			
Description	Stops the inverter output when a 30mA or higher current or a 7.5V or higher voltage is input to terminal 2 while the current input is selected by <i>Pr.73 Analog input selection</i> , or to terminal 4 while the current input is selected by <i>Pr.267 Terminal 4 input selection</i> .			
Check point	Check the setting of <i>Pr. 73 Analog input selection</i> , <i>Pr. 267 Terminal 4 input selection</i> and voltage/current input switch. ( <i>Refer to page 263.</i> )			
Corrective action	Either give a frequency command by current input or set <i>Pr. 73 Analog input selection</i> , <i>Pr. 267 Terminal 4 input selection</i> , and voltage/current input switch to voltage input.			

Operation Panel Indication	E.USB	E.USB	FR-PU04	Fault 14
			FR-PU07	USB comm error
Name	USB communication fault			
Description	When the time set in <i>Pr. 548 USB communication check time interval</i> has broken, this function stops the inverter output.			
Check point	Check the USB communication cable.			
Corrective action	<ul style="list-style-type: none"> <li>• Check the <i>Pr. 548 USB communication check time interval</i> setting.</li> <li>• Check the USB communication cable.</li> <li>• Increase the <i>Pr. 548 USB communication check time interval</i> setting. Or, change the setting to 9999. (<i>Refer to page 337</i>)</li> </ul>			

Operation Panel Indication	E.4	E. 4	FR-PU04	Fault 4
			FR-PU07	
Name	Converter overcurrent			
Description	The current flows in the regeneration converter module exceeds the specified value, protective circuit activates and stops the inverter output.			
Check point	<ul style="list-style-type: none"> <li>• Check that sudden acceleration/deceleration is not performed.</li> <li>• Check for sudden load change.</li> <li>• Check that wiring is correct.</li> <li>• Check that instantaneous power failure did not occur.</li> <li>• Check that the thyristor load does not exist in the same power supply system.</li> </ul>			
Corrective action	<ul style="list-style-type: none"> <li>• Increase acceleration/deceleration time.</li> <li>• Keep load stable.</li> <li>• Wire the cables properly.</li> <li>• When a thyristor load exist in the same power supply system, install an AC reactor (FR-HAL).</li> </ul>			

Operation Panel Indication	E.8	E. 8	FR-PU04	Fault 8
			FR-PU07	
Name	Power supply fault			
Description	<ul style="list-style-type: none"> <li>• When overvoltage occurs in the converter side during input phase failure detection</li> <li>• When overvoltage occurs in the converter side during instantaneous power failure detection</li> <li>• When fault of power supply frequency is detected</li> <li>• When phase shift is not detected</li> </ul> When any of the above conditions applied, it is judged as power supply and the inverter output is stopped.			
Check point	Check the power supply and wiring.			
Corrective action	Perform wiring correctly.			



<b>Operation Panel Indication</b>	E.10	E. 10	FR-PU04 FR-PU07	<b>Fault 10</b>
<b>Name</b>	Converter transistor protection thermal operation (electronic thermal)			
<b>Description</b>	Current flowing in the module of the regeneration converter is less than the overcurrent shutoff level and exceeds the specified value, electronic thermal relay activates for protection and the inverter output is stopped.			
<b>Check point</b>	<ul style="list-style-type: none"> <li>• Check the motor for use under overload. (excess regeneration amount)</li> <li>• Check that the thyristor load does not exist in the same power supply system.</li> </ul>			
<b>Corrective action</b>	<ul style="list-style-type: none"> <li>• Reduce the load weight.</li> <li>• When a thyristor load exists in the same power supply system, install an AC reactor (FR-HAL).</li> </ul>			

<b>Operation Panel Indication</b>	E.11	E. 11	FR-PU04 FR-PU07	<b>Fault 11</b>
<b>Name</b>	Opposite rotation deceleration fault			
<b>Description</b>	The speed may not decelerate during low speed operation if the rotation direction of the speed command and the estimated speed differ when the rotation is changing from forward to reverse or from reverse to forward during torque control under Real sensorless vector control. At this time, the inverter output is stopped if the rotation direction will not change, causing overload. This fault is not available in the initial status (V/F control). (It is available only during Real sensorless vector control.)			
<b>Check point</b>	Check that the rotation direction is not switched from forward to reverse rotation (or from reverse to forward) during torque control under Real sensorless vector control.			
<b>Corrective action</b>	<ul style="list-style-type: none"> <li>• Prevent the motor from switching the rotation direction from forward to reverse (or from reverse to forward) during torque control under Real sensorless vector control.</li> <li>• Please contact your sales representative.</li> </ul>			

<b>Operation Panel Indication</b>	E.13	E. 13	FR-PU04 FR-PU07	<b>Fault 13</b>
<b>Name</b>	Internal circuit fault			
<b>Description</b>	Stop the inverter output when an internal circuit fault occurred.			
<b>Corrective action</b>	Please contact your sales representative.			

<b>Operation Panel Indication</b>	E.15	E. 15	FR-PU04 FR-PU07	<b>Fault 15</b>
<b>Name</b>	Converter circuit fault			
<b>Description</b>	<ul style="list-style-type: none"> <li>• When a fault occurs in the peripheral circuit of the regeneration converter CPU</li> <li>• When a fault occurs in the control power supply circuit.</li> <li>• When a fault occurs in the inrush current limit circuit.</li> </ul> If any of the above conditions applied, it is judged as converter circuit fault and the inverter output is stopped.			
<b>Check point</b>	Check for devices producing excess electrical noises around the inverter.			
<b>Corrective action</b>	<ul style="list-style-type: none"> <li>• Take measures against noises if there are devices producing excess electrical noises around the inverter.</li> <li>• Please contact your sales representative.</li> </ul>			

**CAUTION**

- If protective functions of E.ILF, E.PTC, E.PE2, E.EP, E.OD, E.CDO, E.IOH, E.SER, E.AIE, E.USB are activated when using the FR-PU04, "Fault 14" appears.  
Also when the faults history is checked on the FR-PU04, the display is "E.14".
- If faults other than the above appear, contact your sales representative.

## 5.4 Correspondences between digital and actual characters

There are the following correspondences between the actual alphanumeric characters and the digital characters displayed on the operation panel.

Actual	Digital
0	0
1	1
2	2
3	3
4	4
5	5
6	6
7	7
8	8
9	9

Actual	Digital
A	A
B	b
C	C
D	d
E	E
F	F
G	G
H	H
I	I
J	J
L	L

Actual	Digital
M	m
N	n
O	O
o	o
P	P
S	S
T	T
U	U
V	V
r	r
-	-

## 5.5 Check first when you have a trouble

When performing real sensorless vector control or vector control, refer to trouble shooting on *page 93* (speed control), *page 114* (torque control) and *page 126* (position control) in addition to the following check points.



### POINT

- If the cause is still unknown after every check, it is recommended to initialize the parameters (initial value) then reset the required parameter values and check again.

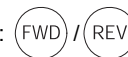
### 5.5.1 Motor does not start

Check points	Possible Cause	Countermeasures	Refer to page
Main Circuit	Appropriate power supply voltage is not applied. (Operation panel display is not provided.)	Power ON a moulded case circuit breaker (MCCB), an earth leakage circuit breaker (ELB), or a magnetic contactor (MC).	—
		Check for the decreased input voltage, input phase loss, and wiring.	
Main Circuit	Motor is not connected properly.	If only the control power is ON when using a separate power source for the control circuit, turn ON the main circuit power.	21
		Check the wiring between the inverter and the motor. If commercial power supply-inverter switchover function is active, check the wiring of the magnetic contactor connected between the inverter and the motor.	16
Input signal	Start signal is not input.	Check the start command source, and input a start signal.  PU operation mode:  External operation mode : STF/STR signal	292
	Both the forward and reverse rotation start signals (STF, STR) are input simultaneously.	Turn ON only one of the forward and reverse rotation start signals (STF or STR). If STF and STR signals are turned ON simultaneously in the initial setting, a stop command is given.	22
	Frequency command is zero. (FWD or REV LED on the operation panel is flickering.)	Check the frequency command source and enter a frequency command.	292
	AU signal is not ON when terminal 4 is used for frequency setting. (FWD or REV LED on the operation panel is flickering.)	Turn ON the AU signal. Turning ON the AU signal activates terminal 4 input.	263
	Output stop signal (MRS) or reset signal (RES) is ON. (FWD or REV LED on the operation panel is flickering.)	Turn MRS or RES signal OFF. Inverter starts the operation with a given start command and a frequency command after turning OFF MRS or RES signal. Before turning OFF, ensure the safety.	22
	CS signal is OFF when automatic restart after instantaneous power failure function is selected ( <i>Pr. 57</i> ≠ "9999"). (FWD or REV LED on the operation panel is flickering.)	Turn ON the CS signal. Restart operation is enabled when restart after instantaneous power signal (CS) is ON.	243
	Jumper connector of sink - source is wrongly selected. (FWD or REV LED on the operation panel is flickering.)	Check that the control logic switchover jumper connector is correctly installed. If it is not installed correctly, input signal is not recognized.	25
	Wiring of encoder is incorrect. (Under encoder feedback control or vector control)	Check the wiring of encoder.	33
	Voltage/current input switch is not correctly set for analog input signal (0 to 5V/0 to 10V, 4 to 20mA). (FWD or REV LED on the operation panel is flickering.)	Set <i>Pr. 73</i> , <i>Pr. 267</i> , and a voltage/current input switch correctly, then input an analog signal in accordance with the setting.	22



Check points	Possible Cause	Countermeasures	Refer to page
Parameter Setting	 was pressed. (Operation panel indication is <b>PS</b> (PS).)	During the External operation mode, check the method of restarting from a  input stop from PU.	387
	Two-wire or three-wire type connection is wrong.	Check the connection. Connect STOP signal when three-wire type is used.	212
	<i>Pr. 0 Torque boost</i> setting is improper when V/F control is used.	Increase <i>Pr. 0</i> setting by 0.5% increments while observing the rotation of a motor. If that makes no difference, decrease the setting.	129
	<i>Pr. 78 Reverse rotation prevention selection</i> is set.	Check the <i>Pr. 78</i> setting. Set <i>Pr. 78</i> when you want to limit the motor rotation to only one direction.	285
	<i>Pr. 79 Operation mode selection</i> setting is wrong.	Select the operation mode which corresponds with input methods of start command and frequency command.	290
	Bias and gain ( <i>calibration parameter C2 to C7</i> ) settings are improper.	Check the bias and gain ( <i>calibration parameter C2 to C7</i> ) settings.	271
	<i>Pr. 13 Starting frequency</i> setting is greater than the running frequency.	Set running frequency higher than <i>Pr. 13</i> . The inverter does not start if the frequency setting signal is less than the value set in <i>Pr. 13</i> .	157
	Frequency settings of various running frequency (such as multi-speed operation) are zero. Especially, <i>Pr. 1 Maximum frequency</i> is zero.	Set the frequency command according to the application. Set <i>Pr. 1</i> higher than the actual frequency used.	140
	<i>Pr. 15 Jog frequency</i> setting is lower than <i>Pr. 13 Starting frequency</i> .	Set <i>Pr. 15 Jog frequency</i> higher than <i>Pr. 13 Starting frequency</i> .	150
	The <i>Pr. 359 Encoder rotation direction</i> setting is incorrect under encoder feedback control or under vector control.	If the "REV" on the operation panel is lit even though the forward-rotation command is given, set <i>Pr. 359</i> = "1."	35
	Operation mode and a writing device do not match.	Check <i>Pr. 79</i> , <i>Pr. 338</i> , <i>Pr. 339</i> , <i>Pr. 550</i> , <i>Pr. 551</i> , and select an operation mode suitable for the purpose.	290, 299
	Start signal operation selection is set by the <i>Pr. 250 Stop selection</i>	Check <i>Pr. 250</i> setting and connection of STF and STR signals.	212
	Inverter decelerated to a stop when power failure deceleration stop function is selected.	When power is restored, ensure the safety, and turn OFF the start signal once, then turn ON again to restart. Inverter restarts when <i>Pr. 261</i> = "2, 12".	247
Auto tuning is being performed.	In the PU operation, press  on the operation panel after the offline auto tuning completes. In the External operation, turn OFF the start signal (STF, STR). By this operation, offline auto tuning is cancelled, and the monitor display on the PU goes back to normal. (If this operation is not performed, you cannot proceed to the next operation.)	171	
Automatic restart after instantaneous power failure function or power failure stop function is activated. (Performing overload operation during input phase loss may cause voltage insufficiency, and that may result in detection of power failure.)	<ul style="list-style-type: none"> <li>Set <i>Pr. 872 Input phase loss protection selection</i> = "1" (input phase failure protection active).</li> <li>Disable the automatic restart after instantaneous power failure function and power failure stop function.</li> <li>Reduce the load.</li> <li>Increase the acceleration time if the automatic restart after instantaneous power failure function or power failure stop function occurred during acceleration.</li> </ul>	243, 247, 253	
Load	Load is too heavy.	Reduce the load.	—
	Shaft is locked.	Inspect the machine (motor).	—



### 5.5.2 Motor or machine is making abnormal acoustic noise

Check points	Possible Cause	Countermeasures	Refer to page
<b>Input signal</b>	Disturbance due to EMI when frequency command is given from analog input (terminal 1, 2, 4).	Take countermeasures against EMI.	38
<b>Parameter Setting</b>		Increase the <i>Pr. 74 Input filter time constant</i> if steady operation cannot be performed due to EMI.	269
<b>Parameter Setting</b>	No carrier frequency noises (metallic noises) are generated.	In the initial setting, <i>Pr. 240 Soft-PWM operation selection</i> is enabled to change motor noise to an unoffending complex tone. Therefore, no carrier frequency noises (metallic noises) are generated. Set <i>Pr. 240 = "0"</i> to disable this function.	261
	Resonance occurs. (output frequency)	Set <i>Pr. 31 to Pr. 36 (Frequency jump)</i> . When it is desired to avoid resonance attributable to the natural frequency of a mechanical system, these parameters allow resonant frequencies to be jumped.	141
	Resonance occurs. (carrier frequency)	Change <i>Pr. 72 PWM frequency selection</i> setting. Changing the PWM carrier frequency produces an effect on avoiding the resonance frequency of a mechanical system or a motor.	261
		Set a notch filter.	101
	Auto tuning is not performed under Advanced magnetic flux vector control, Real sensorless vector control, or vector control.	Perform offline auto tuning.	171
	Gain adjustment during PID control is insufficient.	To stabilize the measured value, change the proportional band ( <i>Pr. 129</i> ) to a larger value, the integral time ( <i>Pr. 130</i> ) to a slightly longer time, and the differential time ( <i>Pr. 134</i> ) to a slightly shorter time. Check the calibration of set point and measured value.	338
	The gain is too high under Real sensorless vector control or vector control.	During speed control, check the setting of <i>Pr. 820 (Pr. 830) speed control P gain</i> .	88
During torque control, check the setting of <i>Pr. 824 (Pr. 834) torque control P gain</i> .		113	
<b>Others</b>	Mechanical looseness	Adjust machine/equipment so that there is no mechanical looseness.	—
	Contact the motor manufacturer.		
<b>Motor</b>	Operating with output phase loss	Check the motor wiring.	—

### 5.5.3 Inverter generates abnormal noise

Larger acoustic noise is generated during regenerative driving than during power driving because the inverter contains an AC reactor. This is not a fault.

Connecting a single-phase power supply device or having an unbalanced power supply may cause the reactor to generate acoustic noise even in non-operating status. This is not a fault.

Check points	Possible Cause	Countermeasures	Refer to page
<b>Fan</b>	Fan cover was not correctly installed when a cooling fan was replaced.	Install a fan cover correctly.	414

### 5.5.4 Motor generates heat abnormally

Check points	Possible Cause	Countermeasures	Refer to page
Motor	Motor fan is not working (Dust is accumulated.)	Clean the motor fan. Improve the environment.	—
	Phase to phase insulation of the motor is insufficient.	Check the insulation of the motor.	—
Main Circuit	The inverter output voltage (U, V, W) are unbalanced.	Check the output voltage of the inverter. Check the insulation of the motor.	411
Parameter Setting	The Pr. 71 Applied motor setting is wrong.	Check the Pr. 71 Applied motor setting.	169
—	Motor current is large.	Refer to "5.5.8 Motor current is too large"	404

### 5.5.5 Motor rotates in the opposite direction

Check points	Possible Cause	Countermeasures	Refer to page
Main Circuit	Phase sequence of output terminals U, V and W is incorrect.	Connect phase sequence of the output cables (terminal U, V, W) to the motor correctly.	15
Input signal	The start signals (forward rotation, reverse rotation) are connected improperly.	Check the wiring. (STF: forward rotation , STR: reverse rotation)	22
	The polarity of the frequency command is negative during the polarity reversible operation set by Pr. 73 Analog input selection.	Check the polarity of the frequency command.	263
Input signal Parameter setting	Torque command is negative during torque control under vector control.	Check the torque command value.	108

### 5.5.6 Speed greatly differs from the setting

Check points	Possible Cause	Countermeasures	Refer to page
Input signal	Frequency setting signal is incorrectly input.	Measure the input signal level.	—
	The input signal lines are affected by external EMI.	Take countermeasures against EMI such as using shielded wires for input signal lines.	40
Parameter Setting	Pr. 1, Pr. 2, Pr. 18, calibration parameter C2 to C7 settings are improper.	Check the settings of Pr. 1 Maximum frequency, Pr. 2 Minimum frequency, Pr. 18 High speed maximum frequency.	140
		Check the calibration parameter C2 to C7 settings.	271
	Pr. 31 to Pr. 36 (frequency jump) settings are improper.	Narrow down the range of frequency jump.	141
Load	Stall prevention (torque limit) function is activated due to a heavy load.	Reduce the load weight.	—
Parameter Setting		Set Pr. 22 Stall prevention operation level (Torque limit level) higher according to the load. (Setting Pr. 22 too large may result in frequent overcurrent trip (E.O.C□).)	135 (83)
Motor		Check the capacities of the inverter and the motor.	—

### 5.5.7 Acceleration/deceleration is not smooth

Check points	Possible Cause	Countermeasures	Refer to page
Parameter Setting	Acceleration/deceleration time is too short.	Increase acceleration/deceleration time.	155
	Torque boost ( <i>Pr. 0, Pr. 46, Pr. 112</i> ) setting is improper under V/F control, so the stall prevention function is activated.	Increase/decrease <i>Pr. 0 Torque boost</i> setting value by 0.5% increments to the setting.	129
	The base frequency setting and the motor characteristic does not match.	For V/F control, set <i>Pr. 3 Base frequency, Pr. 47 Second V/F (base frequency), and Pr.113 Third V/F (base frequency)</i> .	142
		For vector control, set <i>Pr.84 Rated motor frequency</i> .	171
	Regeneration avoidance operation is performed	If the frequency becomes unstable during regeneration avoidance operation, decrease the setting of <i>Pr. 886 Regeneration avoidance voltage gain</i> .	361
Load		Reduce the load weight.	—
Parameter Setting	Stall prevention (torque limit) function is activated due to a heavy load.	Set <i>Pr. 22 Stall prevention operation level (Torque limit level)</i> higher according to the load. (Setting <i>Pr. 22</i> too large may result in frequent overcurrent trip (E.OC□).)	135 (83)
Motor		Check the capacities of the inverter and the motor.	—

### 5.5.8 Motor current is too large

Check points	Possible Cause	Countermeasures	Refer to page
Parameter Setting	Torque boost ( <i>Pr. 0, Pr. 46, Pr. 112</i> ) setting is improper under V/F control, so the stall prevention function is activated.	Increase/decrease <i>Pr. 0 Torque boost</i> setting value by 0.5% increments to the setting.	129
	V/F pattern is improper when V/F control is performed. ( <i>Pr. 3, Pr. 14, Pr. 19</i> )	Set rated frequency of the motor to <i>Pr. 3 Base frequency</i> . Use <i>Pr. 19 Base frequency voltage</i> to set the base voltage (e.g. rated motor voltage).	142
		Change <i>Pr. 14 Load pattern selection</i> according to the load characteristic.	144
	Stall prevention (torque limit) function is activated due to a heavy load.	Reduce the load weight.	—
		Set <i>Pr. 22 Stall prevention operation level (Torque limit level)</i> higher according to the load. (Setting <i>Pr. 22</i> too large may result in frequent overcurrent trip (E.OC□).)	135 (83)
		Check the capacities of the inverter and the motor.	—
	Auto tuning is not performed under Advanced magnetic flux vector control, Real sensorless vector control, or vector control.	Perform offline auto tuning.	171

### 5.5.9 Speed does not accelerate

Check points	Possible Cause	Countermeasures	Refer to page
Input signal	Start command and frequency command are chattering.	Check if the start command and the frequency command are correct.	—
	The wiring length used for analog frequency command is too long, and it is causing a voltage (current) drop.	Perform analog input bias/gain calibration.	271
	Input signal lines are affected by external EMI.	Take countermeasures against EMI, such as using shielded wires for input signal lines.	40
Parameter Setting	<i>Pr. 1, Pr. 2, Pr. 18, calibration parameter C2 to C7 settings are improper.</i>	Check the settings of <i>Pr. 1 Maximum frequency and Pr. 2 Minimum frequency</i> . If you want to run the motor at 120Hz or higher, set <i>Pr. 18 High speed maximum frequency</i> . Check the <i>calibration parameter C2 to C7 settings</i> .	140 271
	Torque boost ( <i>Pr. 0, Pr. 46, Pr. 112</i> ) setting is improper under V/F control, so the stall prevention function is activated.	Increase/decrease <i>Pr. 0 Torque boost</i> setting value by 0.5% increments so that stall prevention does not occur.	129
	V/F pattern is improper when V/F control is performed. ( <i>Pr. 3, Pr. 14, Pr. 19</i> )	Set rated frequency of the motor to <i>Pr. 3 Base frequency</i> . Use <i>Pr. 19 Base frequency voltage</i> to set the base voltage (e.g. rated motor voltage). Change <i>Pr. 14 Load pattern selection</i> according to the load characteristic.	142 144
	Auto tuning is not performed under Advanced magnetic flux vector control, Real sensorless vector control, or vector control.	Perform offline auto tuning.	171
	The setting of pulse train input is improper.	Check the specification of the pulse generator (open collector output or complementary output) and check the adjustment of the pulse train and frequency ( <i>Pr. 385 and Pr. 386</i> ).	356
	During PID control, output frequency is automatically controlled to make measured value = set point.		338
	Load		Reduce the load weight.
Parameter Setting	Stall prevention (torque limit) function is activated due to a heavy load.	Set <i>Pr. 22 Stall prevention operation level (Torque limit level)</i> higher according to the load. (Setting <i>Pr. 22</i> too large may result in frequent overcurrent trip (E.O.C).)	135 (83)
Motor		Check the capacities of the inverter and the motor.	—

### 5.5.10 Motor and machine vibrate



Check points	Possible Cause	Countermeasures	Refer to page
Parameter Setting	<i>Pr.19 Base frequency voltage</i> is improper under V/F control.	Set the rated motor voltage to <i>Pr.19 Base frequency voltage</i> .	142
	Mechanical looseness	Adjust machine/equipment so that there is no mechanical looseness.	—

### 5.5.11 Speed varies during operation

When Advanced magnetic flux vector control, Real sensorless vector control, vector control or encoder feedback control is exercised, the output frequency varies with load fluctuation between 0 and 2Hz. This is a normal operation and is not a fault.

Check points	Possible Cause	Countermeasures	Refer to page
Load	Load varies during an operation.	Select Advanced magnetic flux vector control, Real sensorless vector control, vector control, or encoder feedback control.	75, 359
	Frequency setting signal is varying.	Check the frequency setting signal.	—
Input signal	The frequency setting signal is affected by EMI.	Set filter to the analog input terminal using <i>Pr. 74 Input filter time constant, Pr. 822 Speed setting filter 1.</i>	269
		Take countermeasures against EMI, such as using shielded wires for input signal lines.	40
	Malfunction is occurring due to the undesirable current generated when the transistor output unit is connected.	Use terminal PC (terminal SD when source logic) as a common terminal to prevent a malfunction caused by undesirable current.	26
	Multi-speed command signal is chattering.	Take countermeasures to suppress chattering.	—
	Feedback signal from the encoder is affected by EMI.	Place the encoder cable far from the EMI source such as main circuit and power supply voltage. Earth (ground) the shield of the encoder cable to the enclosure using a metal P-clip or U-clip.	33
Parameter Setting	<i>Pr.80 Motor capacity</i> and <i>Pr.81 Number of motor poles</i> are not appropriate for the motor capacity under Advanced magnetic flux vector control, Real sensorless vector control, or vector control.	Check the settings of <i>Pr.80 Motor capacity</i> and <i>Pr.81 Number of motor poles</i> .	75
	Fluctuation of power supply voltage is too large.	Change the <i>Pr. 19 Base frequency voltage</i> setting (about 3%) under V/F control.	142
	Wiring length exceeds 30m when Advanced magnetic flux vector control, Real sensorless vector control, or vector control is selected.	Perform offline auto tuning.	171
	Wiring length is too long for V/F control, and the a voltage drop occurs.	Adjust the <i>Pr. 0 Torque boost</i> setting by increasing with 0.5% increments for the low-speed operation.	129
		Change the control method to Advanced magnetic flux vector control or Real sensorless vector control.	75
	Hunting occurs by the generated vibration, for example, when structural rigidity at load side is insufficient.	Disable automatic control functions, such as the energy saving operation, the fast-response current limit function, the torque limit, the regeneration avoidance function, Advanced magnetic flux vector control, Real sensorless vector control, vector control, encoder feedback control, droop control, the stall prevention, online auto tuning, the notch filter, and orientation control. During the PID control, set smaller values to <i>Pr.129 PID proportional band</i> and <i>Pr.130 PID integral time</i> . Lower the control gain, and adjust to increase the stability.	—
		Change <i>Pr. 72 PWM frequency selection</i> setting.	261

### 5.5.12 Operation mode is not changed properly

Check points	Possible Cause	Countermeasures	Refer to page
Input signal	Start signal (STF or STR) is ON.	Check that the STF and STR signals are OFF. When either is ON, the operation mode cannot be changed.	290
Parameter Setting	Pr. 79 setting is improper.	When Pr. 79 Operation mode selection setting is "0" (initial value), the inverter is placed in the External operation mode at input power ON. To switch to the PU operation mode, press  on the operation panel (press  when the parameter unit (FR-PU04/FR-PU07) is used). At other settings (1 to 4, 6, 7), the operation mode is limited accordingly.	290
	Operation mode and a writing device do not correspond.	Check Pr. 79, Pr. 338, Pr. 339, Pr. 550, Pr. 551, and select an operation mode suitable for the purpose.	290, 299

### 5.5.13 Operation panel (FR-DU07) display is not operating

Check points	Possible Cause	Countermeasures	Refer to page
Main Circuit, Control Circuit	Power is not input.	Input the power.	14
Front cover	Operation panel is not properly connected to the inverter.	Check if the inverter front cover is installed securely. The inverter cover may not fit properly when using wires whose size are 1.25mm <sup>2</sup> or larger, or when using many wires, and this could cause a contact fault of the operation panel.	5

### 5.5.14 Power lamp is not lit

Check points	Possible Cause	Countermeasures	Refer to page
Main Circuit, Control Circuit	Wiring or installation is improper.	Check for the wiring and the installation. Power lamp is lit when power is input to the control circuit (R1/L11, S1/L21).	15

### 5.5.15 Unable to write parameter setting

Check points	Possible Cause	Countermeasures	Refer to page
Input signal	Operation is being performed (signal STF or STR is ON).	Stop the operation. When Pr. 77 = "0" (initial value), write is enabled only during a stop.	284
Parameter Setting	You are attempting to set the parameter in the External operation mode.	Choose the PU operation mode. Or, set Pr. 77 = "2" to enable parameter write regardless of the operation mode.	284
	Parameter is disabled by the Pr. 77 Parameter write selection setting.	Check Pr. 77 Parameter write selection setting.	284
	Key lock is activated by the Pr. 161 Frequency setting/key lock operation selection setting.	Check Pr. 161 Frequency setting/key lock operation selection setting.	371
	Operation mode and a writing device do not correspond.	Check Pr. 79, Pr. 338, Pr. 339, Pr. 550, Pr. 551, and select an operation mode suitable for the purpose.	290, 299

# MEMO

# 6 PRECAUTIONS FOR MAINTENANCE AND INSPECTION

This chapter provides the "PRECAUTIONS FOR MAINTENANCE AND INSPECTION" of this product.

Always read the instructions before using the equipment.

6.1	Inspection item .....	410
6.2	Measurement of main circuit voltages, currents and powers.....	416

1

2

3

4

5

6

7





The inverter is a static unit mainly consisting of semiconductor devices. Daily inspection must be performed to prevent any fault from occurring due to the adverse effects of the operating environment, such as temperature, humidity, dust, dirt and vibration, changes in the parts with time, service life, and other factors.

• **Precautions for maintenance and inspection**

For some short time after the power is switched off, a high voltage remains in the smoothing capacitor. When accessing the inverter for inspection, wait for at least 10 minutes after the power supply has been switched off, and then make sure that the voltage across the main circuit terminals P/+-N/- of the inverter is not more than 30VDC using a tester, etc.

---

## **6.1 Inspection item**

### **6.1.1 Daily inspection**

Basically, check for the following faults during operation.

- (1) Motor operation fault
- (2) Improper installation environment
- (3) Cooling system fault
- (4) Unusual vibration and noise
- (5) Unusual overheat and discoloration

### **6.1.2 Periodic inspection**

Check the areas inaccessible during operation and requiring periodic inspection.

Consult us for periodic inspection.

- 1) Check for cooling system fault..... Clean the air filter, etc.
- 2) Tightening check and retightening ..... The screws and bolts may become loose due to vibration, temperature changes, etc.  
Tighten them according to the specified tightening torque. *(Refer to page 18)*
- 3) Check the conductors and insulating materials for corrosion and damage.
- 4) Measure insulation resistance.
- 5) Check and change the cooling fan and relay.

### 6.1.3 Daily and periodic inspection

Area of Inspection	Inspection Item	Description	Interval		Corrective Action at Alarm Occurrence	Customer's Check	
			Daily	Periodic <sup>*2</sup>			
General	Surrounding environment	Check the surrounding air temperature, humidity, dirt, corrosive gas, oil mist, etc.	○		Improve environment		
	Overall unit	Check for unusual vibration and noise.	○		Check alarm location and retighten		
	Power supply voltage	Check that the main circuit voltages and control voltages are normal.*1	○		Inspect the power supply		
Main circuit	General	(1) Check with megger (across main circuit terminals and earth (ground) terminal). (2) Check for loose screws and bolts. (3) Check for overheat traces on the parts. (4) Check for stain.		○ ○ ○ ○	Contact the manufacturer Retighten Contact the manufacturer Clean		
	Conductors, cables	(1) Check conductors for distortion. (2) Check cable sheaths for breakage and deterioration (crack, discoloration, etc.).		○ ○	Contact the manufacturer Contact the manufacturer		
	Transformer/reactor	Check for unusual odor and abnormal increase in whining sound.	○		Stop the device and contact the manufacturer.		
	Terminal block	Check for damage.		○	Stop the device and contact the manufacturer.		
	Smoothing aluminum electrolytic capacitor	(1) Check for liquid leakage. (2) Check for safety valve projection and bulge. (3) Visual check and judge by the life check of the main circuit capacitor. (Refer to page 412)		○ ○ ○	Contact the manufacturer Contact the manufacturer		
	Relay/contacter	Check that the operation is normal and no chatter is heard.		○	Contact the manufacturer		
	Resistor	(1) Check for crack in resistor insulation. (2) Check for a break in the cable.		○ ○	Contact the manufacturer Contact the manufacturer		
Control circuit protective circuit	Operation check	(1) Check that the output voltages across phases with the inverter operated alone is balanced. (2) Check that no fault is found in protective and display circuits in a sequence protective operation test.		○ ○	Contact the manufacturer Contact the manufacturer		
	Parts check	Overall	(1) Check for unusual odor and discoloration. (2) Check for serious rust development.		○ ○	Stop the device and contact the manufacturer. Contact the manufacturer	
		Aluminum electrolytic capacitor	(1) Check for liquid leakage in a capacitor and deformation trace. (2) Visual check and judge by the life check of the control circuit capacitor. (Refer to page 364.)		○ ○	Contact the manufacturer	
Cooling system	Cooling fan	(1) Check for unusual vibration and noise. (2) Check for loose screws and bolts. (3) Check for stain.	○	○ ○ ○	Replace the fan Fix with the fan cover fixing screws Clean		
	Heatsink	(1) Check for clogging. (2) Check for stain.		○ ○	Clean Clean		
	Air filter, etc.	(1) Check for clogging. (2) Check for stain.		○ ○	Clean or replace Clean or replace		
Display	Indication	(1) Check that display is normal. (2) Check for stain.	○	○	Contact the manufacturer Clean		
	Meter	Check that reading is normal.	○		Stop the device and contact the manufacturer.		
Load motor	Operation check	Check for vibration and abnormal increase in operation noise.	○		Stop the device and contact the manufacturer.		

\*1 It is recommended to install a device to monitor voltage for checking the power supply voltage to the inverter.

\*2 One to two years of periodic inspection cycle is recommended. However, it differs according to the installation environment. Consult us for periodic inspection.



### 6.1.4 Display of the life of the inverter parts

The self-diagnostic alarm is output when the lifespan of the control circuit capacitor, cooling fan, each parts of the inrush current limit circuit is near its end. It gives an indication of replacement time .

The life alarm output can be used as a guideline for life judgement.

Parts	Judgement Level
Main circuit capacitor	85% of the initial capacity
Control circuit capacitor	Estimated 10% life remaining
Inrush current limit circuit	Estimated 10% life remaining (Power on: 100,000 times left)
Cooling fan	Less than 50% of the predetermined speed



Refer to page 364 to perform the life check of the inverter parts.

### 6.1.5 Checking the inverter and converter modules

#### <Preparation>

- (1) Disconnect the external power supply cables (R/L1, S/L2, T/L3) and motor cables (U, V, W).
- (2) Prepare a tester. (Use 100Ω range.)

#### <Checking method>

Change the polarity of the tester alternately at the inverter terminals R/L1, S/L2, T/L3, U, V, W, P/+ and N/–, and check for electric continuity.

#### <Module device numbers and terminals to be checked>

	Tester Polarity		Measured Value		Tester Polarity		Measured Value	
	⊕	⊖			⊕	⊖		
Converter module	TR11	R/L1	P/+	Discontinuity	TR14	R/L1	N/–	Continuity
		P/+	R/L1	Continuity		N/–	R/L1	Discontinuity
	TR13	S/L2	P/+	Discontinuity	TR16	S/L2	N/–	Continuity
		P/+	S/L2	Continuity		N/–	S/L2	Discontinuity
	TR15	T/L3	P/+	Discontinuity	TR12	T/L3	N/–	Continuity
		P/+	T/L3	Continuity		N/–	T/L3	Discontinuity
Inverter module	TR1	U	P/+	Discontinuity	TR4	U	N/–	Continuity
		P/+	U	Continuity		N/–	U	Discontinuity
	TR3	V	P/+	Discontinuity	TR6	V	N/–	Continuity
		P/+	V	Continuity		N/–	V	Discontinuity
	TR5	W	P/+	Discontinuity	TR2	W	N/–	Continuity
		P/+	W	Continuity		N/–	W	Discontinuity

(Assumes the use of an analog meter.)

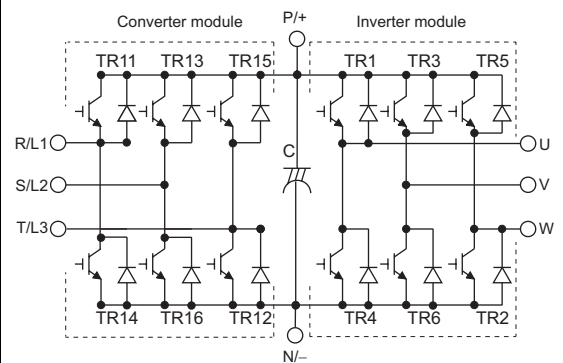

### 6.1.6 Cleaning

Always run the inverter in a clean status.

When cleaning the inverter, gently wipe dirty areas with a soft cloth immersed in neutral detergent or ethanol.

---

#### CAUTION

---

Do not use solvent, such as acetone, benzene, toluene and alcohol, as they will cause the inverter surface paint to peel off.

The display, etc. of the operation panel (FR-DU07) and parameter unit (FR-PU04/FR-PU07) are vulnerable to detergent and alcohol. Therefore, avoid using them for cleaning.

---

### 6.1.7 Replacement of parts

The inverter consists of many electronic parts such as semiconductor devices.

The following parts may deteriorate with age because of their structures or physical characteristics, leading to reduced performance or fault of the inverter. For preventive maintenance, the parts must be replaced periodically.

Use the life check function as a guidance of parts replacement.

Part Name	Estimated lifespan *1	Description
Cooling fan	10 years	Replace (as required)
Main circuit smoothing capacitor	10 years *2	Replace (as required)
On-board smoothing capacitor	10 years	Replace the board (as required)
Relays	–	as required

\*1 Estimated lifespan for when the yearly average surrounding air temperature is 40°C (without corrosive gas, flammable gas, oil mist, dust and dirt etc)

\*2 Output current : 80% of the inverter rated current

#### REMARKS

- Since repeated inrush currents at power ON will shorten the life of the converter circuit, frequent starts and stops of the magnetic contactor must be avoided.

---

#### CAUTION

---

For parts replacement, consult the nearest Mitsubishi FA Center.

---



### (1) Cooling fan

The replacement interval of the cooling fan used for cooling the parts generating heat such as the main circuit semiconductor is greatly affected by the surrounding air temperature. When unusual noise and/or vibration is noticed during inspection, the cooling fan must be replaced immediately.

• Removal

- 1) Remove a fan cover.
- 2) After removing a fan connector, remove a fan block.
- 3) Remove the fan.

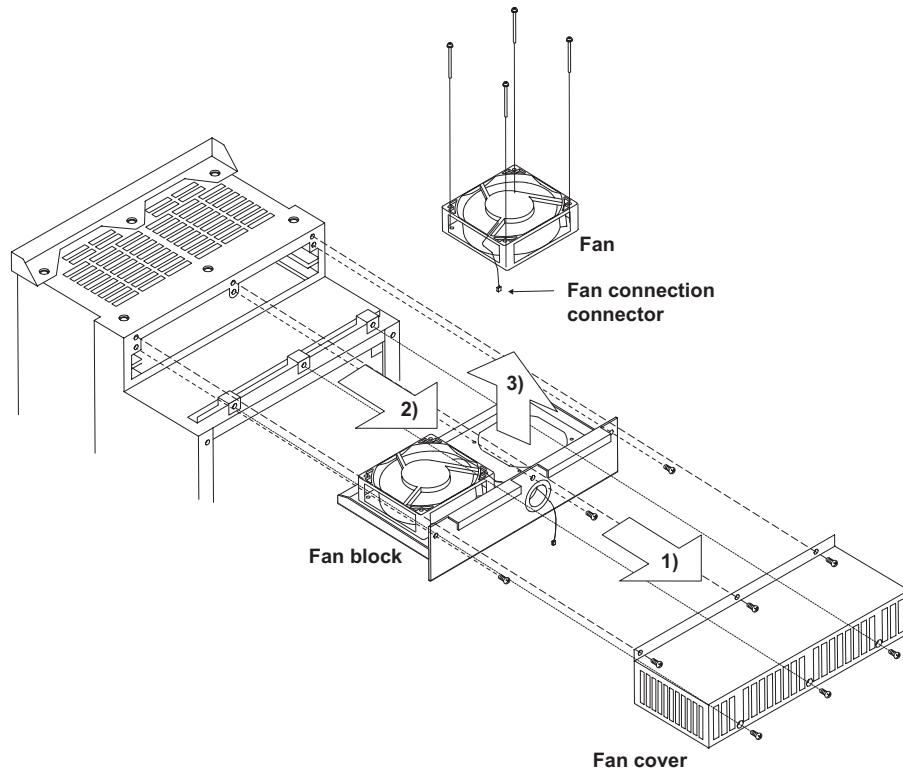

• Reinstallation

- 1) After confirming the orientation of the fan, reinstall the fan so that the arrow on the left of "AIR FLOW" faces up.

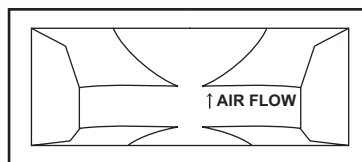

<Fan side face>

- 2) Install fans referring to the above figure.

**CAUTION**

- Installing the fan in the opposite of air flow direction can cause the inverter life to be shorter.
- Prevent the cable from being caught when installing a fan.
- Switch the power off before replacing fans. Since the inverter circuits are charged with voltage even after power off, replace fans only when the inverter cover is on the inverter to prevent an electric shock accident.

## (2) Smoothing capacitors

A large-capacity aluminum electrolytic capacitor is used for smoothing in the main circuit DC section, and an aluminum electrolytic capacitor is used for stabilizing the control power in the control circuit. Their characteristics are deteriorated by the adverse effects of ripple currents, etc.

The replacement intervals greatly vary with the surrounding air temperature and operating conditions. When the inverter is operated in air-conditioned, normal environment conditions, replace the capacitors about every 10 years.

The appearance criteria for inspection are as follows:

- 1) Case: Check the side and bottom faces for expansion
- 2) Sealing plate: Check for remarkable warp and extreme crack.
- 3) Check for external crack, discoloration, fluid leakage, etc. Judge that the capacitor has reached its life when the measured capacitance of the capacitor reduced below 80% of the rating.



Refer to page 364 to perform the life check of the main circuit capacitor.

## (3) Relays

To prevent a contact fault, etc., relays must be replaced according to the cumulative number of switching times (switching life).

## 6.2 Measurement of main circuit voltages, currents and powers

Since the voltages and currents on the inverter power supply and output sides include harmonics, measurement data depends on the instruments used and circuits measured.

When instruments for commercial frequency are used for measurement, measure the following circuits with the instruments given on the next page.

- When installing meters etc. on the inverter output side

When the inverter-to-motor wiring length is large, especially in the 400V class, small-capacity models, the meters and CTs may generate heat due to line-to-line leakage current. Therefore, choose the equipment which has enough allowance for the current rating.

When measuring and indicating the output voltage and output current of the inverter, it is recommended to utilize the terminals AM and FM output function of the inverter.

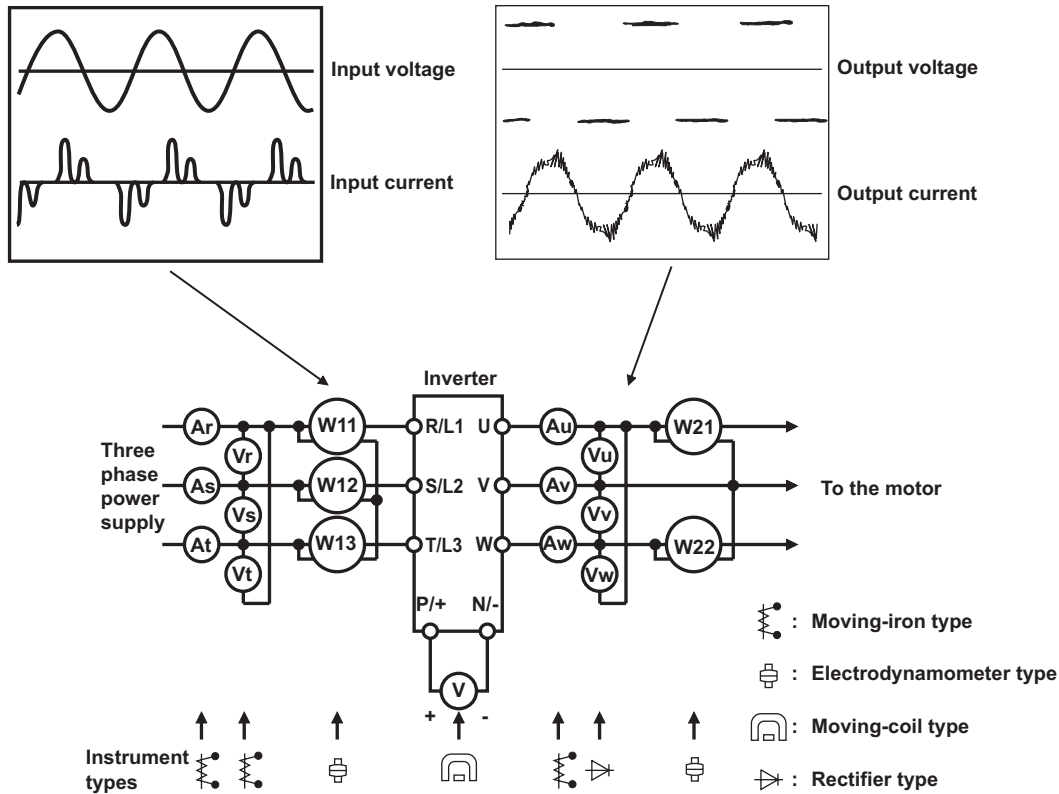

Examples of Measuring Points and Instruments

**Measuring points and instruments**

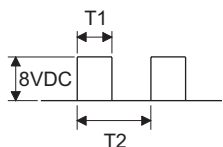
Item	Measuring Point	Measuring Instrument	Remarks (Reference Measured Value)	
Power supply voltage V1	Across R/L1 and S/L2, S/L2 and T/L3, T/L3 and R/L1	Moving-iron type AC voltmeter *4	Commercial power supply Within permissible AC voltage fluctuation (Refer to page 422)	
Power supply side current I1	R/L1, S/L2, and T/L3 line currents	Moving-iron type AC ammeter *4		
Power supply side power P1	R/L1, S/L2, T/L3 and R/L1 and S/L2, S/L2 and T/L3, T/L3 and R/L1	Digital power meter (designed for inverter) or electrodynamic type single-phase wattmeter	P1=W11+W12+W13 (3-wattmeter method)	
Power supply side power factor Pf1	Calculate after measuring power supply voltage, power supply side current and power supply side power. $Pf_1 = \frac{P_1}{\sqrt{3} V_1 \times I_1} \times 100\%$			
Output side voltage V2	Across U and V, V and W and U	Rectifier type AC voltage meter *1 *4 (Moving-iron type cannot measure)	Difference between the phases is within ±1% of the maximum output voltage.	
Output side current I2	U, V and W line currents	Moving-iron type AC ammeter *2 *4	Difference between the phases is 10% or lower of the rated inverter current.	
Output side power P2	U, V, W and U and V, V and W	Digital power meter (designed for inverter) or electrodynamic type single-phase wattmeter	P2 = W21 + W22 2-wattmeter method (or 3-wattmeter method)	
Output side power factor Pf2	Calculate in similar manner to power supply side power factor. $Pf_2 = \frac{P_2}{\sqrt{3} V_2 \times I_2} \times 100\%$			
Converter output	Across P/+ and N/-	Moving-coil type (such as tester)	Inverter LED display is lit. 1.35 × V1	
Frequency setting signal	Across 2 and 5 Across 4(+) and 5 Across 1(+) and 5	Moving-coil type (Tester and such may be used) (Internal resistance: 50kΩ or larger)	0 to 10VDC, 4 to 20mA	
Frequency setting power supply	Across 10 (+) and 5 Across 10E(+) and 5		0 to ±5VDC, 0 to ±10VDC	
Frequency meter signal	Across AM(+) and 5  Across FM(+) and SD		5.2VDC	"5" is common
			10VDC	"SD" is common
			Approximately 10VDC at maximum frequency (without frequency meter)	
			Approximately 5VDC at maximum frequency (without frequency meter)	
				
		Pulse width T1: Adjusted by C0 (Pr: 900)		
		Pulse cycle T2: Set by Pr: 55 (Valid for frequency monitoring only)		
Start signal Select signal	Across SD and the following: STF, STR, RH, RM, RL, JOG, RT, AU, STOP, CS (+)		When open 20 to 30VDC ON voltage: 1V or less	
Reset	Across RES (+) and SD			
Output stop	Across MRS (+) and SD			
Alarm signal	Across A1 and C1 Across B1 and C1	Moving-coil type (such as tester)	Electric continuity check*3 <Normal> <Abnormal> Across A1-C1 Discontinuity Continuity Across B1-C1 Continuity Discontinuity	

\*1 Use an FFT to measure the output voltage accurately. A tester or general measuring instrument cannot measure accurately.  
 \*2 When the carrier frequency exceeds 5kHz, do not use this instrument since using it may increase eddy-current losses produced in metal parts inside the instrument, leading to burnout. If the wiring length between the inverter and motor is long, the instrument and CT may generate heat due to line-to-line leakage current.  
 \*3 When the setting of Pr: 195 ABC1 terminal function selection is positive logic  
 \*4 A digital power meter (designed for inverter) can also be used to measure.





### 6.2.1 Measurement of powers

Use digital power meters (for inverter) for the both of inverter input and output side. Alternatively, measure using electrodynamic type single-phase wattmeters for the both of inverter input and output side in two-wattmeter or three-wattmeter method. As the current is liable to be imbalanced especially in the input side, it is recommended to use the three-wattmeter method.

Examples of measured value differences produced by different measuring meters are shown below.

An error will be produced by difference between measuring instruments, e.g. power calculation type and two- or three-wattmeter type three-phase wattmeter. When a CT is used in the current measuring side or when the meter contains a PT on the voltage measurement side, an error will also be produced due to the frequency characteristics of the CT and PT.

**[Measurement conditions]**

Constant-torque (100%) load, constant-power at 60Hz or more.

3.7kW, 4-pole motor, value indicated in 3-wattmeter method is 100%.

**[Measurement conditions]**

Constant-torque (100%) load, constant-power at 60Hz or more.

3.7kW, 4-pole motor, value indicated in 3-wattmeter method is 100%.

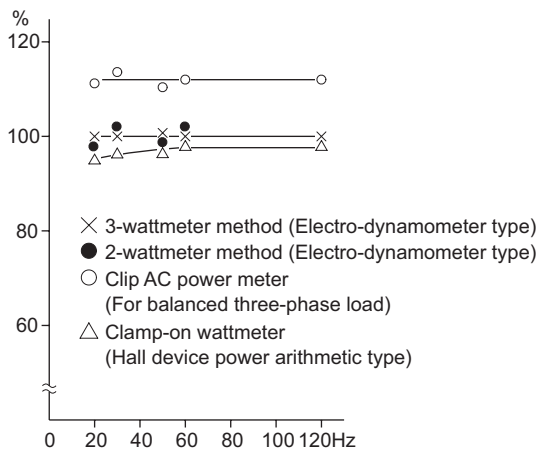

Example of measuring inverter input power

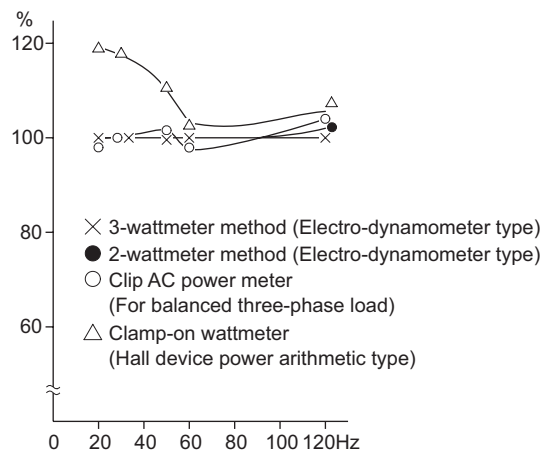

Example of measuring inverter output power

### 6.2.2 Measurement of voltages and use of PT

#### (1) Inverter input side

As the input side voltage has a sine wave and it is extremely small in distortion, accurate measurement can be made with an ordinary AC meter.

#### (2) Inverter output side

Since the output side voltage has a PWM-controlled rectangular wave, always use a rectifier type voltmeter. A needle type tester can not be used to measure the output side voltage as it indicates a value much greater than the actual value. A moving-iron type meter indicates an effective value which includes harmonics and therefore the value is larger than that of the fundamental wave. The value monitored on the operation panel is the inverter controlled voltage itself. Hence, that value is accurate and it is recommended to monitor values (provide analog output) using the operation panel.

#### (3) PT

No PT can be used in the output side of the inverter. Use a direct-reading meter. (A PT can be used in the input side of the inverter.)

### 6.2.3 Measurement of currents

Use a moving-iron type meter on both the input and output sides of the inverter. However, if the carrier frequency exceeds 5kHz, do not use that meter since an overcurrent losses produced in the internal metal parts of the meter will increase and the meter may burn out. In this case, use an approximate-effective value type.

As the inverter input side current is easily imbalanced, measurement of currents in all three phases is recommended. Correct values can not be measured in one or two phases. On the other hand, the phase imbalanced ratio of the output side current must be within 10%.

When using a clamp ammeter, always use an effective value detection type. A mean value detection type produces a large error and may indicate an extremely smaller value than the actual value. The value monitored on the operation panel is accurate if the output frequency varies, and it is recommended to monitor values (provide analog output) using the operation panel.

An example of the measured value difference produced by different measuring meters is shown below.

**[Measurement conditions]**

Value indicated by moving-iron type ammeter is 100%.

**[Measurement conditions]**

Value indicated by moving-iron type ammeter is 100%.

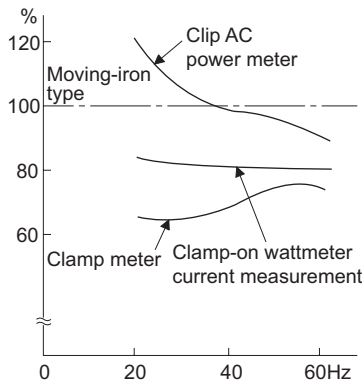

Example of measuring inverter input current

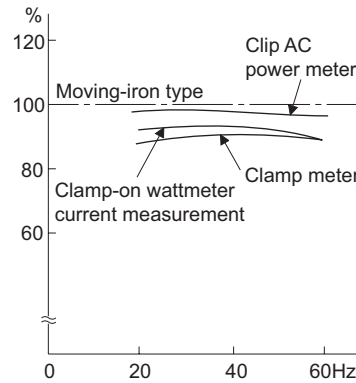

Example of measuring inverter output current

### 6.2.4 Use of CT and transducer

A CT may be used in both the input and output sides of the inverter, but the one used should have the largest possible VA ability because an error will increase if the frequency gets lower.

When using a transducer, use the effective value calculation type which is immune to harmonics.

### 6.2.5 Measurement of inverter input power factor

Use the effective power and apparent power to calculate the inverter input power factor. A power-factor meter can not indicate an exact value.

$$\begin{aligned} \text{Total power factor of the inverter} &= \frac{\text{Effective power}}{\text{Apparent power}} \\ &= \frac{\text{Three-phase input power found by 3-wattmeter method}}{\sqrt{3} \times V \text{ (power supply voltage)} \times I \text{ (input current effective value)}} \end{aligned}$$

### 6.2.6 Measurement of converter output voltage (across terminals P/+ and N/-)

The output voltage of the converter is developed across terminals P/+ - N/- and can be measured with a moving-coil type meter (tester). Although the voltage varies according to the power supply voltage, approximately 270V to 300V (approximately 540V to 600V for the 400V class) is output when no load is connected and voltage decreases when a load is connected.

When energy is regenerated from the motor during deceleration, for example, the converter output voltage rises to nearly 400VDC to 450VDC (800VDC to 900VDC for the 400V class) maximum.

### 6.2.7 Measurement of inverter output frequency

A pulse train proportional to the output frequency is output across the frequency meter signal output terminal FM-SD of the inverter. This pulse train output can be counted by a frequency counter, or a meter (moving-coil type voltmeter) can be used to read the mean value of the pulse train output voltage. When a meter is used to measure the output frequency, approximately 5VDC is indicated at the maximum frequency.

For detailed specifications of the frequency meter signal output terminal FM, refer to *page 240*.

### 6.2.8 Insulation resistance test using megger

For the inverter, conduct the insulation resistance test on the main circuit only as shown below and do not perform the test on the control circuit. (Use a 500VDC megger.)

---

**CAUTION**

---

- Before performing the insulation resistance test on the external circuit, disconnect the cables from all terminals of the inverter so that the test voltage is not applied to the inverter.
  - For the electric continuity test of the control circuit, use a tester (high resistance range) and do not use the megger or buzzer.
- 

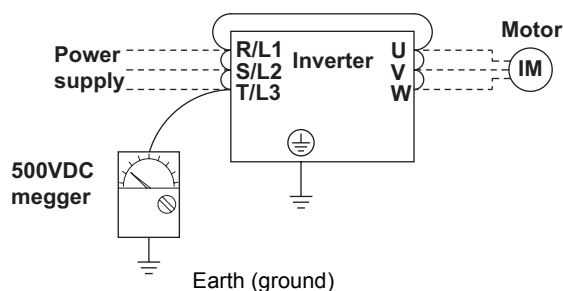

### 6.2.9 Pressure test

Do not conduct a pressure test. Deterioration may occur.

# 7 SPECIFICATIONS

---

This chapter provides the "SPECIFICATIONS" of this product. Always read the instructions before using the equipment.

---

7.1	Rating .....	422
7.2	Common specifications .....	424
7.3	Outline dimension drawings .....	425
7.4	Installation of the heatsink portion outside the enclosure for use .....	434

1

2

3

4

5

6

7



## 7.1 Rating

### 7.1.1 Inverter rating

#### ●200V class

Model FR-A721-□□K		5.5	7.5	11	15	18.5	22	30	37	45	55
Applicable motor capacity (kW) *1		5.5	7.5	11	15	18.5	22	30	37	45	55
Output	Rated capacity (kVA) *2	9.2	12.6	17.6	23.3	29	34	44	55	67	82
	Rated current (A)	24	33	46	61	76	90	115	145	175	215
	Overload current rating *3	150% 60s, 200% 3s (inverse-time characteristics) surrounding air temperature 50°C									
	Rated voltage *4	Three-phase 200 to 240V									
	Regenerative braking torque	100% continuous 150% 60s									
Power supply	Rated input AC voltage/frequency	Three-phase 200 to 220V 50Hz, 200 to 240V 60Hz									
	Permissible AC voltage fluctuation	170 to 242V 50Hz, 170 to 264V 60Hz									
	Permissible frequency fluctuation	±5%									
	Power supply capacity (kVA) *5	12	17	20	28	34	41	52	66	80	100
Protective structure (JEM 1030) *6		Open type (IP00)									
Cooling system		Forced air cooling									
Approx. mass (kg)		20	22	33	35	50	52	69	87	90	120

\*1 The applicable motor capacity indicated is the maximum capacity applicable for use of the Mitsubishi 4-pole standard motor.

\*2 The rated output capacity indicated assumes that the output voltage is 220V.

\*3 The % value of the overload current rating indicated is the ratio of the overload current to the inverter's rated output current. For repeated duty, allow time for the inverter and motor to return to or below the temperatures under 100% load.

\*4 The maximum output voltage does not exceed the power supply voltage. The maximum output voltage can be changed within the setting range. However, the pulse voltage value of the inverter output side voltage remains unchanged at about  $\sqrt{2}$  that of the power supply.

\*5 The power supply capacity varies with the value of the power supply side inverter impedance (including those of the input reactor and cables).

\*6 FR-DU07:IP40 (except for the PU connector)

#### ●400V class

Model FR-A741-□□K		5.5	7.5	11	15	18.5	22	30	37	45	55
Applicable motor capacity (kW) *1		5.5	7.5	11	15	18.5	22	30	37	45	55
Output	Rated capacity (kVA) *2	9.1	13	17.5	23.6	29	32.8	43.4	54	65	84
	Rated current (A)	12	17	23	31	38	44	57	71	86	110
	Overload current rating *3	150% 60s, 200% 3s (inverse-time characteristics) surrounding air temperature 50°C									
	Rated voltage *4	Three-phase 380 to 480V									
	Regenerative braking torque	100% continuous 150% 60s									
Power supply	Rated input AC voltage/frequency	Three-phase 380 to 480V 50Hz/60Hz									
	Permissible AC voltage fluctuation	323 to 528V 50Hz/60Hz									
	Permissible frequency fluctuation	±5%									
	Power supply capacity (kVA) *5	12	17	20	28	34	41	52	66	80	100
Protective structure *6		Open type (IP00)									
Cooling system		Forced air cooling									
Approx. mass (kg)		25	26	37	40	48	49	65	80	83	115

\*1 The applicable motor capacity indicated is the maximum capacity applicable for use of the Mitsubishi 4-pole standard motor.

\*2 The rated output capacity indicated assumes that the output voltage is 440V.

\*3 The % value of the overload current rating indicated is the ratio of the overload current to the inverter's rated output current. For repeated duty, allow time for the inverter and motor to return to or below the temperatures under 100% load.

\*4 The maximum output voltage does not exceed the power supply voltage. The maximum output voltage can be changed within the setting range. However, the pulse voltage value of the inverter output side voltage remains unchanged at about  $\sqrt{2}$  that of the power supply.

\*5 The power supply capacity varies with the value of the power supply side inverter impedance (including those of the input reactor and cables).

\*6 FR-DU07:IP40 (except for the PU connector)

## 7.1.2 Motor rating

### (1) SF-V5RU

#### ●200V class (Mitsubishi dedicated motor [SF-V5RU (1500r/min series)])

Motor model SF-V5RU□□K	3	5	7	11	15	18	22	30	37	45
Applicable inverter model FR-A721-□□K	5.5	7.5	11	15	18.5	22	30	37	45	55
Rated output (kW)	3.7	5.5	7.5	11	15	18.5	22	30 *1	37 *1	45 *1
Rated torque (N*m)	23.6	35.0	47.7	70.0	95.5	118	140	191	235	286
Maximum torque 150% 60s (N*m)	35.4	52.4	71.6	105	143	176	211	287	353	429
Rated speed (r/min)	1500									
Maximum speed (r/min)	3000									
Frame No.	112M	132S	132M	160M	160L	180M	180M	200L	200L	200L
Inertia moment J ( $\times 10^{-4} \text{kg} \cdot \text{m}^2$ )	175	275	400	750	875	1725	1875	3250	3625	3625
Noise *4	75dB or less							80dB or less		
Cooling fan (with thermal protector) *5	Voltage	Single-phase 200V/50Hz Single-phase 200V to 230V/60Hz				Three-phase 200V/50Hz Three-phase 200 to 230V/60Hz				
	Input *2	36/55W (0.26/ 0.32A)	22/28W (0.11/0.13A)			55/71W (0.37/0.39A)		100/156W (0.47/0.53A)		
Surrounding air temperature, humidity	-10 to +40°C (non-freezing), 90%RH or less (non-condensing)									
Structure (Protective structure)	Totally enclosed forced draft system (Motor: IP44, cooling fan: IP23S) *3									
Detector	Encoder 2048P/R, A phase, B phase, Z phase +12VDC power supply									
Equipment	Encoder, thermal protector, fan									
Heat resistance class	F									
Vibration rank	V10									
Approx. mass (kg)	41	52	62	99	113	138	160	238	255	255

#### ●400V class (Mitsubishi dedicated motor [SF-V5RUH (1500r/min series)])

Motor model SF-V5RUH□□K	5	7	11	15	18	22	30	37	45	
Applicable inverter model FR-A741-□□K	7.5	11	15	18.5	22	30	37	45	55	
Rated output (kW)	5.5	7.5	11	15	18.5	22	30 *1	37 *1	45 *1	
Rated torque (N*m)	35.0	47.7	70.0	95.5	118	140	191	235	286	
Maximum torque 150% 60s (N*m)	52.4	71.6	105	143	176	211	287	353	429	
Rated speed (r/min)	1500									
Maximum speed (r/min)	3000									
Frame No.	132S	132M	160M	160L	180M	180M	200L	200L	200L	
Inertia moment J ( $\times 10^{-4} \text{kg} \cdot \text{m}^2$ )	275	400	750	875	1725	1875	3250	3625	3625	
Noise *4	75dB or less							80dB or less		
Cooling fan (with thermal protector) *5	Voltage	Single-phase 200V/50Hz Single-phase 200V to 230V/ 60Hz			Three-phase 380 to 400V/50Hz Three-phase 400 to 460V/60Hz					
	Input *1	22/28W (0.11/0.13A)			55/71W (0.19/0.19A)		100/156W (0.27/0.30A)			
Surrounding air temperature, humidity	-10 to +40°C (non-freezing), 90%RH or less (non-condensing)									
Structure (Protective structure)	Totally enclosed forced draft system (Motor: IP44, cooling fan: IP23S) *3									
Detector	Encoder 2048P/R, A phase, B phase, Z phase +12VDC power supply									
Equipment	Encoder, thermal protector, fan									
Heat resistance class	F									
Vibration rank	V10									
Approx. mass (kg)	52	62	99	113	138	160	238	255	255	

\*1 80% output in the high-speed range. (The output is reduced when the speed is 2400r/min or more. Contact us separately for details.)

\*2 Power (current) at 50Hz/60Hz.

\*3 Since a motor with brake has a window for gap check, the protective structure of both the cooling fan section and brake section is IP20. S of IP23S is an additional code indicating the condition that protection from water intrusion is established only when a cooling fan is not operating.

\*4 The value when high carrier frequency is set (Pr.72 = 6, Pr.240 = 0).

\*5 The cooling fan is equipped with a thermal protector. The cooling fan stops when the coil temperature exceeds the specified value in order to protect the fan motor. The cooling fan re-starts when the coil temperature drops to normal.



## 7.2 Common specifications

Control specifications	Control method		Soft-PWM control/high carrier frequency PWM control (V/F control, Advanced magnetic flux vector control and Real sensorless vector control are available) / vector control *1	
	Output frequency range		0.2 to 400Hz (The maximum frequency is 120Hz under Real sensorless vector control and vector control.)	
	Frequency setting resolution	Analog input	0.015Hz/60Hz (terminal 2, 4: 0 to 10V/12bit) 0.03Hz/60Hz (terminal 2, 4: 0 to 5V/11bit, 0 to 20mA/about 11bit, terminal 1: 0 to ±10V/12bit) 0.06Hz/60Hz (terminal 1: 0 to ±5V/11bit)	
		Digital input	0.01Hz	
	Frequency accuracy	Analog input	Within ±0.2% of the max. output frequency (25°C±10°C)	
		Digital input	Within 0.01% of the set output frequency	
	Voltage/frequency characteristics		Base frequency can be set from 0 to 400Hz Constant torque/variable torque pattern or adjustable 5 points V/F can be selected	
	Starting torque		150% at 0.3Hz (under Real sensorless vector control or vector control *1)	
	Torque boost		Manual torque boost	
	Acceleration/deceleration time setting		0 to 3600s (acceleration and deceleration can be set individually), linear or S-pattern acceleration/deceleration mode, backlash measures acceleration/deceleration mode are available.	
	DC injection brake		Operation frequency (0 to 120Hz), operation time (0 to 10s), operation voltage (0 to 30%) can be changed	
	Stall prevention operation level		Operation current level can be set (0 to 220% adjustable), whether to use the function or not can be selected	
Torque limit level		Torque limit value can be set (0 to 400% variable)		
Operation specifications	Frequency setting signal	Analog input	* Terminal 2, 4: 0 to 10V, 0 to 5V, 4 to 20mA (0 to 20mA) can be selected* Terminal 1: -10 to +10V, -5 to +5V can be selected	
		Digital input	Input using the setting dial of the operation panel or parameter unit Four-digit BCD or 16 bit binary (when used with option FR-A7AX)	
	Start signal		Forward and reverse rotation or start signal automatic self-holding input (3-wire input) can be selected.	
	Input signals (twelve terminals)		The following signals can be assigned to Pr. 178 to Pr. 189 (input terminal function selection): multi speed selection, remote setting, stop-on-contact, second function selection, third function selection, terminal 4 input selection, JOG operation selection, selection of automatic restart after instantaneous power failure, flying start, external thermal relay input, PU operation/external inter lock signal, external DC injection brake operation start, PID control enable terminal, brake opening completion signal, PU operation/External operation switchover, load pattern selection forward rotation reverse rotation boost, V/F switching, load torque high-speed frequency, S-pattern acceleration/deceleration C switchover, pre-excitation, output stop, start self-holding selection, control mode changing, torque limit selection, start-time tuning start external input, torque bias selection 1, 2*1, P/PI control switchover, forward rotation command, reverse rotation command, inverter reset, PTC thermistor input, PID forward reverse operation switchover, PU-NET operation switchover, NET-External operation switchover, command source switchover, simple position pulse train sign*1, simple position droop pulse clear*1, magnetic flux decay output shutoff.	
	Pulse train input		100kpps	
	Operational functions		Maximum/minimum frequency setting, frequency jump operation, external thermal relay input selection, polarity reversible operation, automatic restart after instantaneous power failure operation, electronic bypass operation, forward/reverse rotation prevention, remote setting, brake sequence, second function, third function, multi-speed operation, original operation continuation at instantaneous power failure, stop-on-contact control, load torque high speed frequency control, droop control, regeneration avoidance, slip compensation, operation mode selection, offline auto tuning function, online auto tuning function, PID control, computer link operation (RS-485), motor end orientation *1, machine end orientation *2, pre-excitation, notch filter, machine analyzer *1, easy gain tuning, speed feed forward, and torque bias *1	
	Output signals Open collector output (5 terminals) relay output (1 terminal)		The following signals can be assigned to Pr. 190 to Pr. 196 (output terminal function selection): inverter running, inverter running/start command on, up-to-frequency, instantaneous power failure/undervoltage, overload warning, output frequency (speed) detection, second output frequency (speed) detection, third output frequency (speed) detection, electronic thermal relay function pre-alarm, PU operation mode, inverter operation ready, output current detection, zero current detection, PID lower limit, PID upper limit, PID forward rotation reverse rotation output, electronic bypass MC1, electronic bypass MC2, electronic bypass MC3, orientation fault *1, brake opening request, fan fault output, heatsink overheat pre-alarm, deceleration at an instantaneous power failure, PID control activated, during retry, PID output interruption, position control preparation ready *1, life alarm, fault output 1, 2, 3 (power-off signal), power savings average value update timing, current average monitor, maintenance timer alarm, remote output, forward rotation output *1, reverse rotation output *1, low speed output, torque detection, regenerative status output *1, start-time tuning completion, in-position completion *1, alarm output and fault output. Alarm code of the inverter can be output (4 bit) from the open collector.	
	When used with the FR-A7AY, FR-A7AR (option)		In addition to above, the following signal can be assigned to Pr.313 to Pr. 319 (extension output terminal function selection): control circuit capacitor life, main circuit capacitor life, cooling fan life, inrush current limit circuit life. (only positive logic can be set for extension terminals of the FR-A7AR)	
	Pulse train output		50kpps	
	For meter Pulse train output (Max. 2.4kHz: one terminal) Analog output (Max. 10VDC: one terminal)		The following signals can be assigned to Pr. 54 FM terminal function selection (pulse train output) and Pr. 158 AM terminal function selection (analog output): output frequency, motor current (steady or peak value), output voltage, frequency setting, operation speed, motor torque, converter output voltage (steady or peak value), electronic thermal relay function load factor, input power, output power, load meter, motor excitation current, reference voltage output, motor load factor, power saving effect, PID set point, PID measured value, motor output, torque command, torque current command, and torque monitor.	
	Indication	Operation panel (FR-DU07)	Operating status	The following operating status can be displayed: Output frequency, motor current (steady or peak value), output voltage, frequency setting, running speed, motor torque, overload, converter output voltage (steady or peak value), electronic thermal relay function load factor, input power, output power, load meter, motor excitation current, position pulse*1, cumulative energization time, orientation status *1, actual operation time, motor load factor, cumulative power, energy saving effect, cumulative saving power, regenerative brake duty, PID set point, PID measured value, PID deviation, inverter I/O terminal monitor, input terminal option monitor*3, output terminal option monitor*3, option fitting status*4, terminal assignment status*4, torque command, torque current command, feed back pulse*1, motor output
			Fault record	Fault record is displayed when a fault occurs, the output voltage/current/frequency/cumulative energization time right before the fault occurs and past 8 fault records are stored.
Parameter unit (FR-PU07)		Interactive guidance	Function (help) for operation guide*4	
Protective/warning function	Protective function		Overcurrent during acceleration, overcurrent during constant speed, overcurrent during deceleration, overvoltage during acceleration, overvoltage during constant speed, overvoltage during deceleration, inverter protection thermal operation, motor protection thermal operation, heatsink overheat, instantaneous power failure occurrence, undervoltage, input phase loss *6, motor overload, output side earth (ground) fault overcurrent, output short circuit, main circuit element overheat, output phase loss, external thermal relay operation*6, PTC thermistor operation*6, option fault, parameter error, PU disconnection, retry count excess*6, CPU fault, operation panel power supply short circuit, 24VDC power output short circuit, output current detection value excess*6, inrush current limit circuit fault, communication fault (inverter), USB fault, opposite rotation deceleration fault*6, analog input fault, speed deviation large *1*6, overspeed *1*6, excessive position fault *1*6, signal loss detection *1*6, brake sequence fault*6, encoder phase error *1*6, regeneration converter overcurrent, regeneration converter circuit fault, regeneration converter transistor protection thermal, internal circuit fault, power supply fault	
	Warning function		Fan fault, overcurrent stall prevention, overvoltage stall prevention, electronic thermal relay function prealarm, PU stop, maintenance timer alarm *6, parameter write error, copy operation error, operation panel lock, password locked, parameter copy alarm, speed limit indication	
Environment	Surrounding air temperature		-10°C to +50°C (non-freezing)	
	Ambient humidity		90%RH maximum (non-condensing)	
	Storage temperature*5		-20°C to +65°C	
	Atmosphere		Indoors (without corrosive gas, flammable gas, oil mist, dust and dirt etc.)	
Altitude/vibration		Maximum 1000m above sea level for standard operation. 5.9m/s <sup>2</sup> or less at 10 to 55Hz (directions of X, Y, Z axes)		

\*1 Available only when the option (FR-A7AP/FR-A7AL) is mounted.

\*2 Available only when the option (FR-A7AL) is mounted.

\*3 Can be displayed only on the operation panel (FR-DU07).

\*4 Can be displayed only on the parameter unit (FR-PU07).

\*5 Temperature applicable for a short period in transit, etc.

\*6 This protective function is not available in the initial status.

## 7.3 Outline dimension drawings

### 7.3.1 Inverter outline dimension drawings

- FR-A721-5.5K, 7.5K
- FR-A741-5.5K, 7.5K

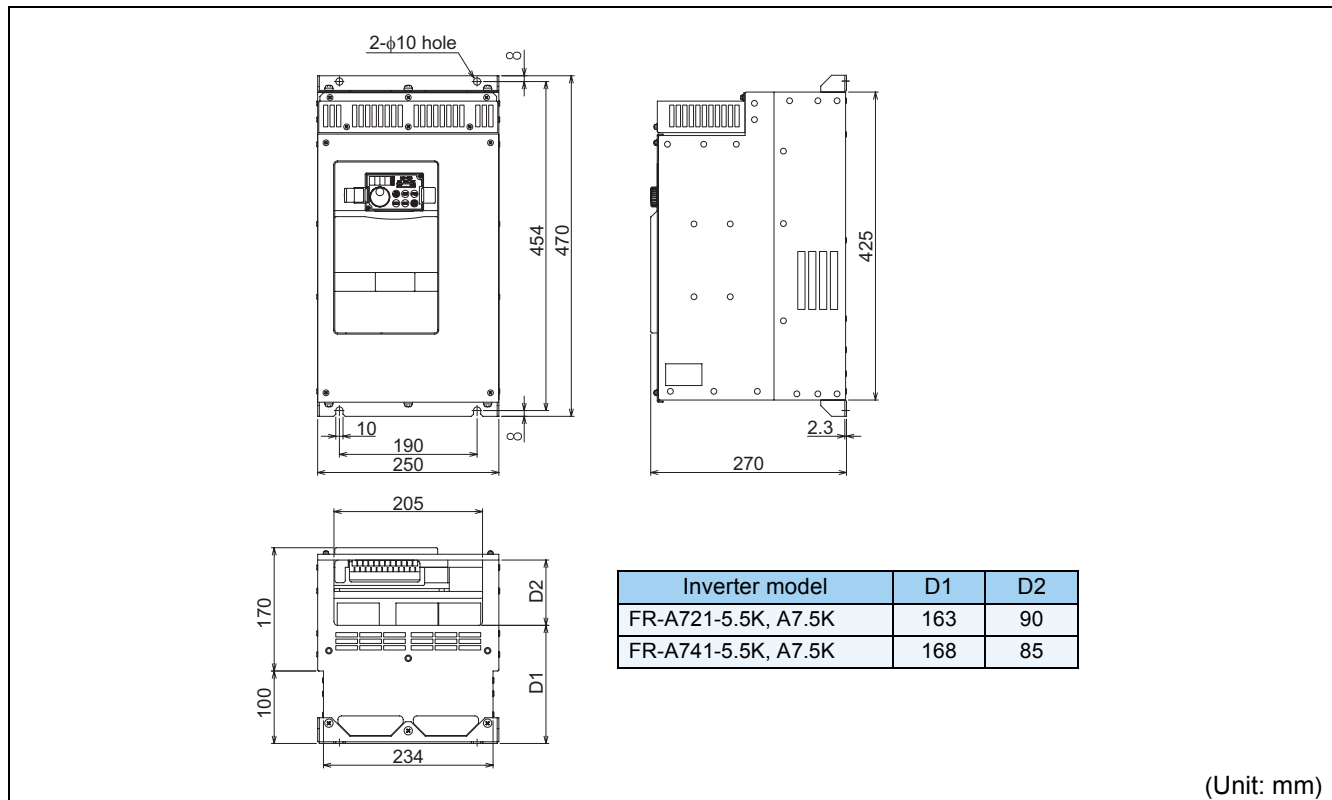

- FR-A721-11K, 15K
- FR-A741-11K, 15K

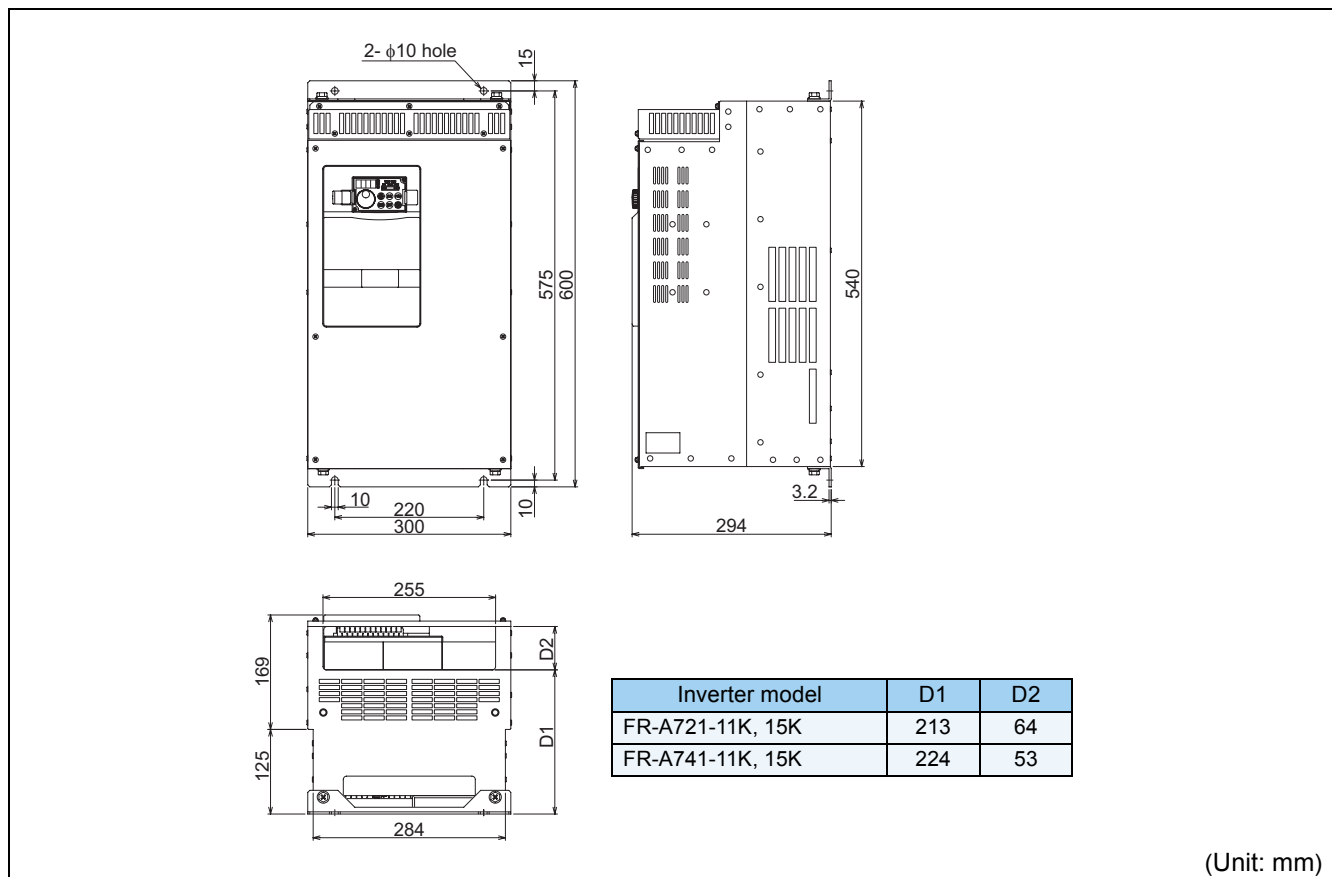





●FR-A721-18.5K, 22K

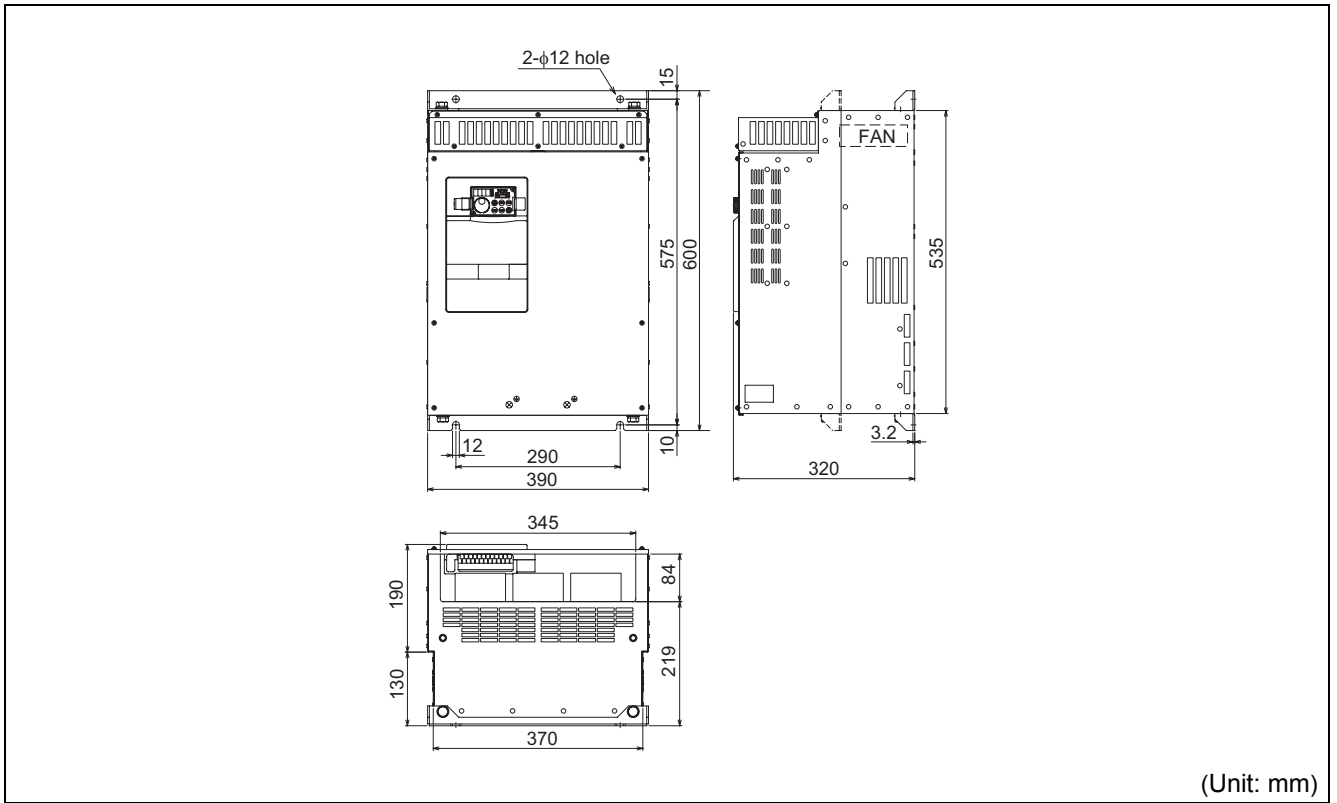

●FR-A741-18.5K, 22K

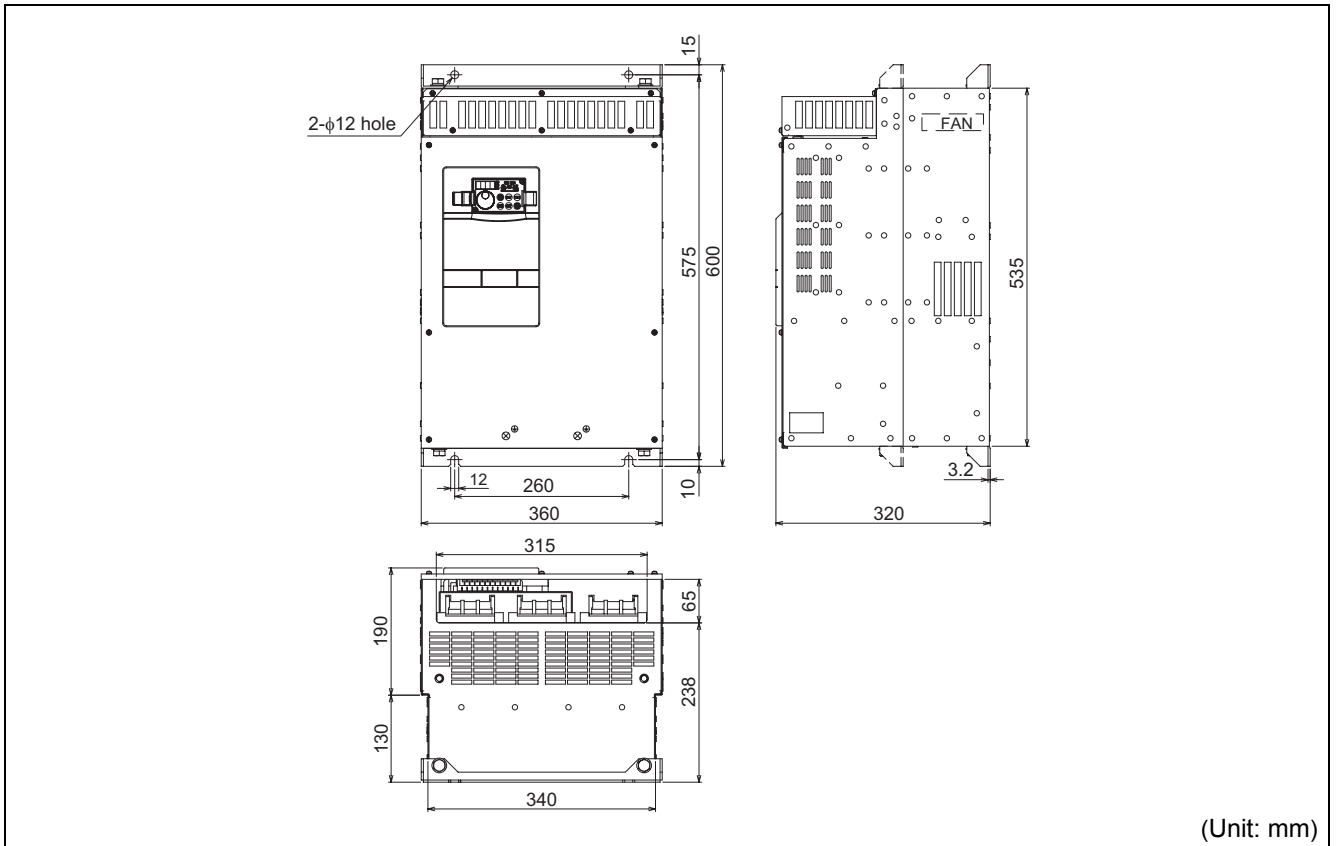

- FR-A721-30K
- FR-A741-30K

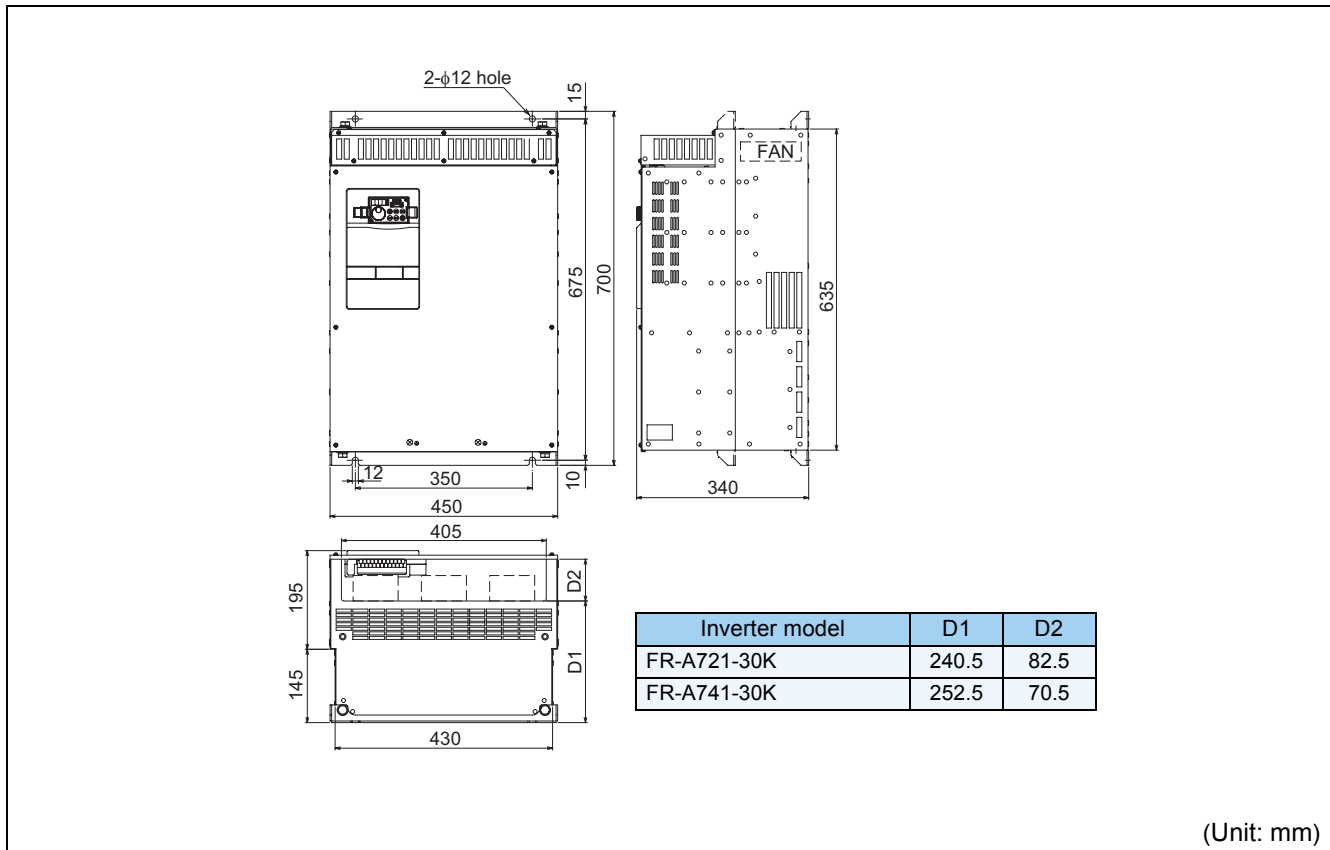

- FR-A721-37K, 45K
- FR-A741-37K, 45K

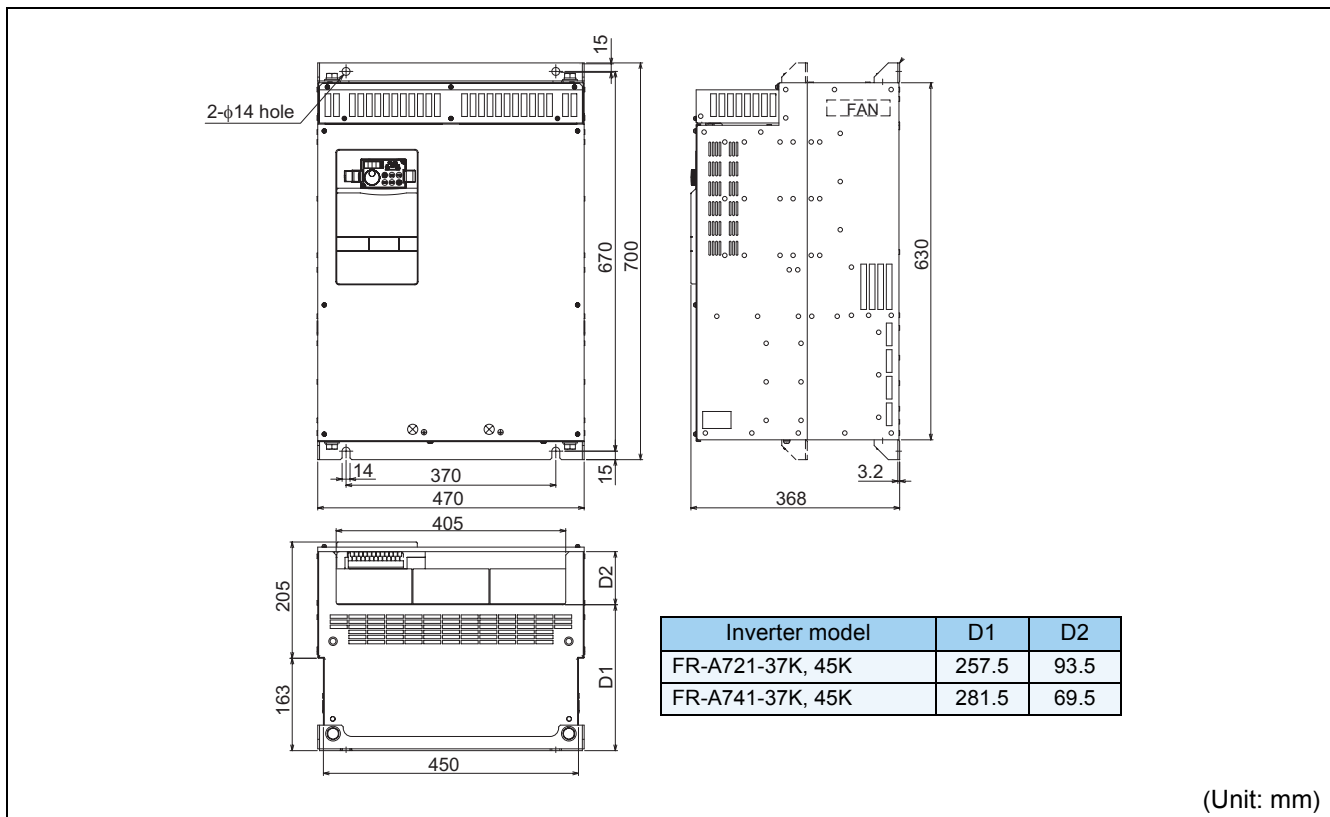

# Outline dimension drawings



- FR-A721-55K
- FR-A741-55K

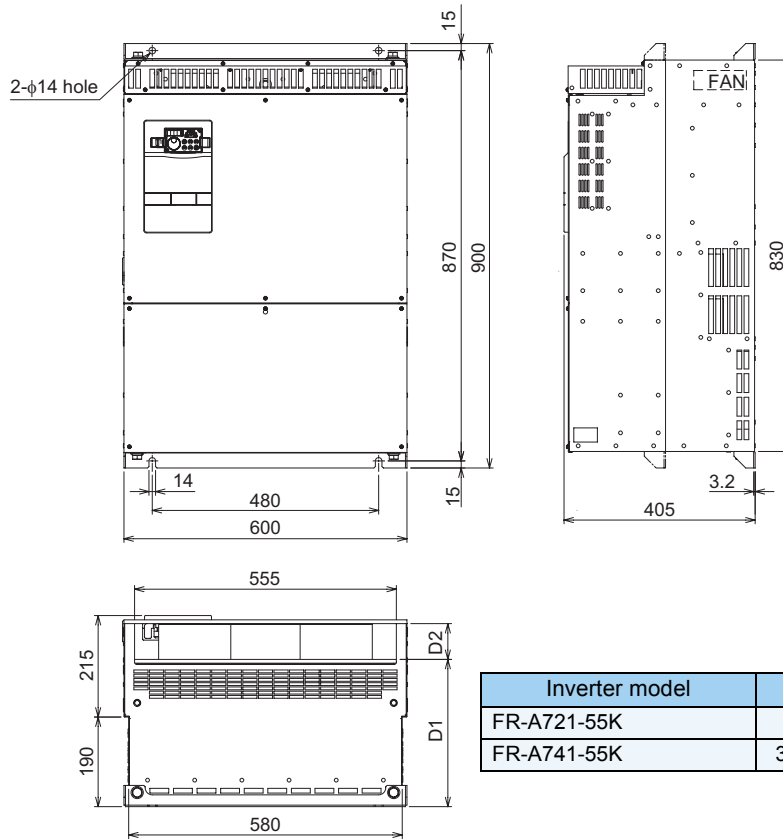

(Unit: mm)

● Operation panel (FR-DU07)

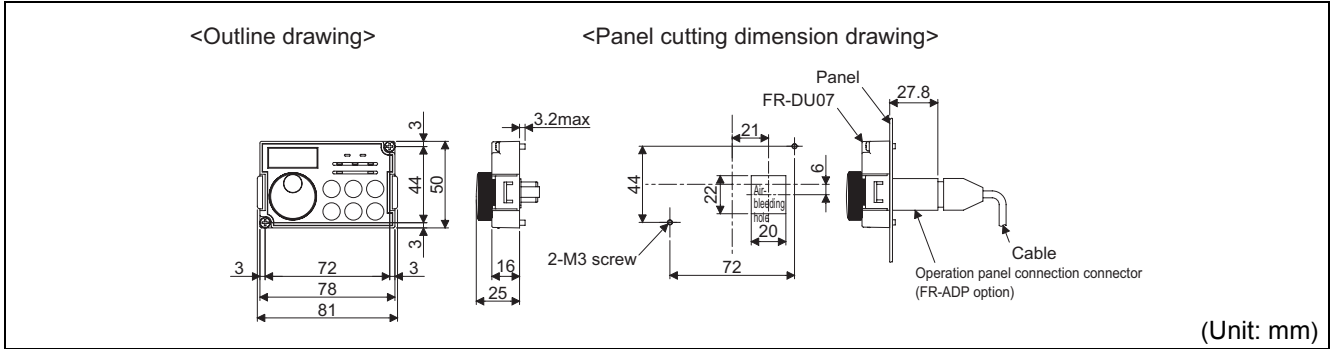

● Parameter unit (option) (FR-PU07)

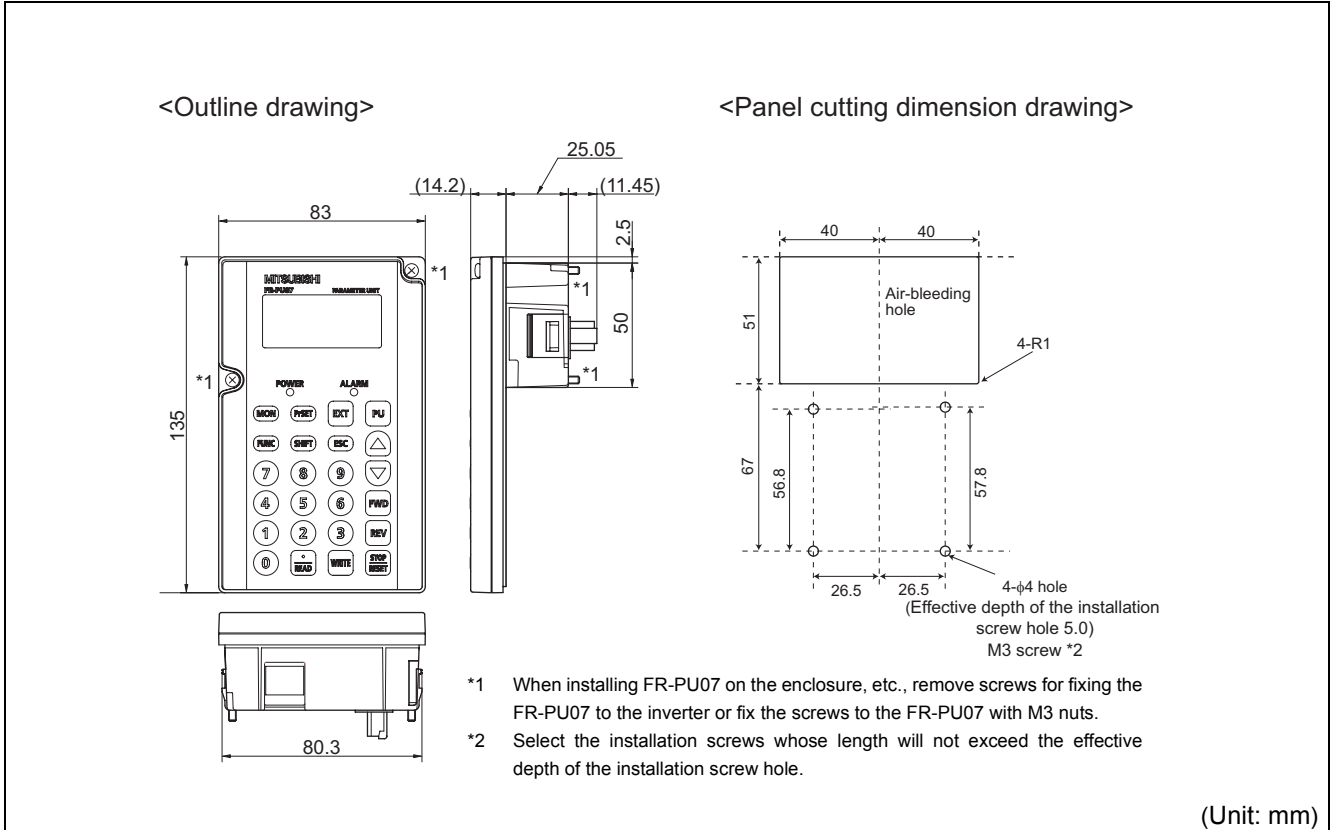



### 7.3.2 Dedicated motor outline dimension drawings

#### ● Dedicated motor (SF-V5RU(H)) outline dimension drawings (standard horizontal type)

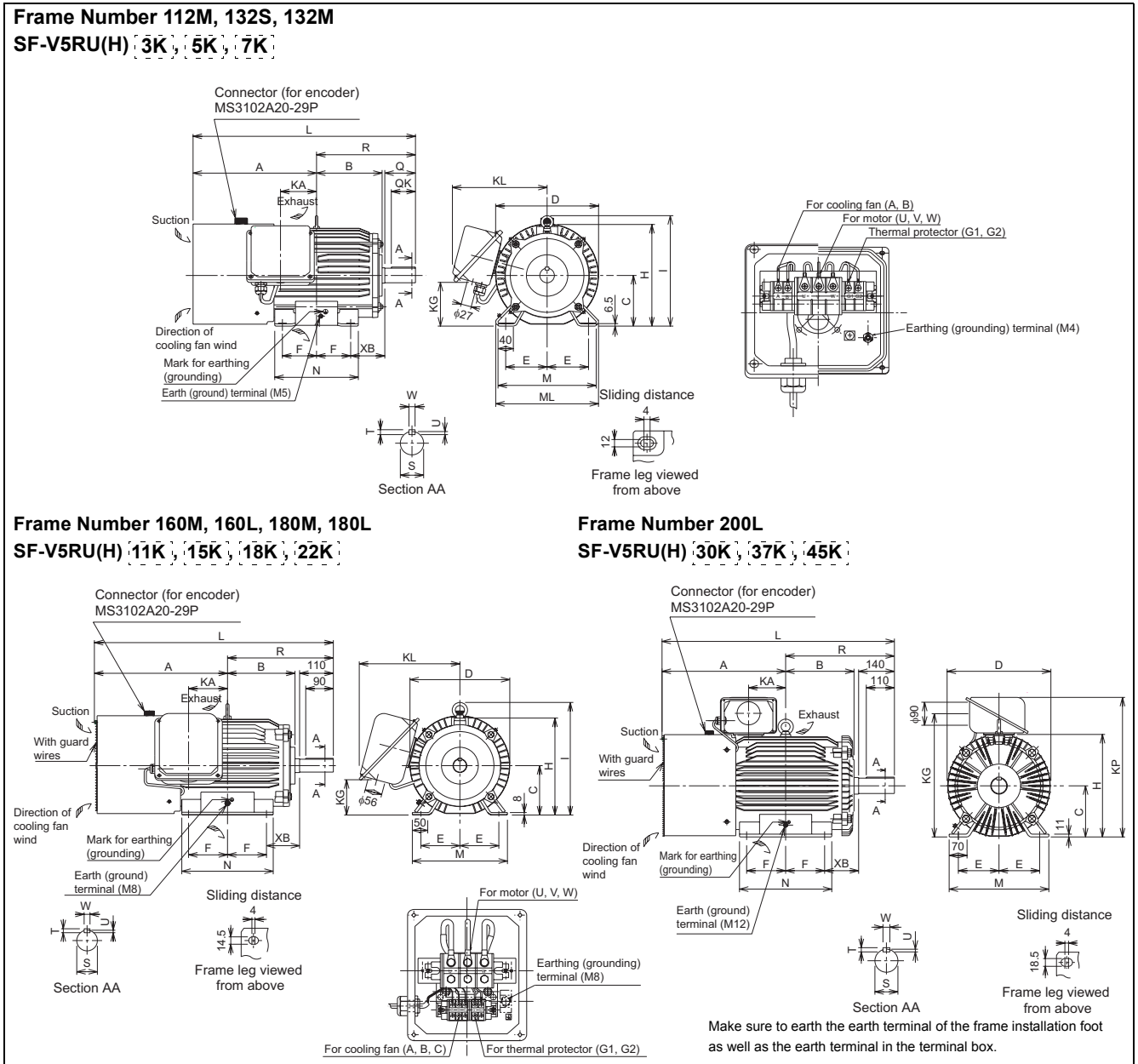

Dimensions table

(Unit: mm)

SF-V5RU □K	SF-V5RU □K1	SF-V5RU □K3	SF-V5RU □K4	Frame No.	Mass (kg)	Motor																	Terminal Screw Size								
						A	B	C	D	E	F	H	I	KA	KG	KL(KP)	L	M	ML	N	XB	Q	QK	R	S	T	U	W	U,V,W	A,B,C	G1,G2
3	—	—	—	112M	41	278	135	112	228	95	70	226	253	69	93	242	478	230	242	180	70	60	45	200	28j6	7	4	8	M6	M4	M4
5	3	—	—	132S	52	303	152	132	266	108	70	265	288	75	117	256	542	256	268	180	89	80	63	239	38k6	8	5	10	M6	M4	M4
7	5	3	—	132M	62	322	171	132	266	108	89	265	288	94	117	256	580	256	268	218	89	80	63	258	38k6	8	5	10	M6	M4	M4
11	7	5	—	160M	99	412	198	160	318	127	105	316	367	105	115	330	735	310	—	254	108	—	—	323	42k6	8	5	12	M8	M4	M4
15	11	7	3	160L	113	434	220	160	318	127	127	316	367	127	115	330	779	310	—	298	108	—	—	345	42k6	8	5	12	M8	M4	M4
18	—	—	—	180M	138	438.5	225.5	180	363	139.5	120.5	359	410	127	139	352	790	335	—	285	121	—	—	351.5	48k6	9	5.5	14	M8	M4	M4
22	15	11	—	180L	160	457.5	242.5	180	363	139.5	139.5	359	410	146	139	352	828	335	—	323	121	—	—	370.5	55m6	10	6	16	M8	M4	M4
30	—	—	7	200L	238	483.5	267.5	200	406	159	152.5	401	—	145	487	(546)	909	390	—	361	133	—	—	425.5	60m6	—	—	—	M10	M4	M4
37, 45	22, 30	18, 22	—	225S	255	500	277	225	446	178	143	446	—	145	533	(592)	932	428	—	342	149	—	—	432	65m6	—	—	—	M10	M4	M4

- Note) 1. Install the motor on the floor and use it with the shaft horizontal.  
 2. Leave an enough clearance between the fan suction port and wall to ensure adequate cooling.  
 Also, check that the ventilation direction of a fan is from the opposite load side to the load side.  
 3. The size difference of top and bottom of the shaft center height is  $\pm 0.5$   
 4. The 400V class motor has -H at the end of its type name.

● Dedicated motor (SF-V5RU(H)) outline dimension drawings (standard horizontal type with brake)

Frame Number 112M, 132S, 132M

SF-V5RU(H) 3KB, 5KB, 7KB

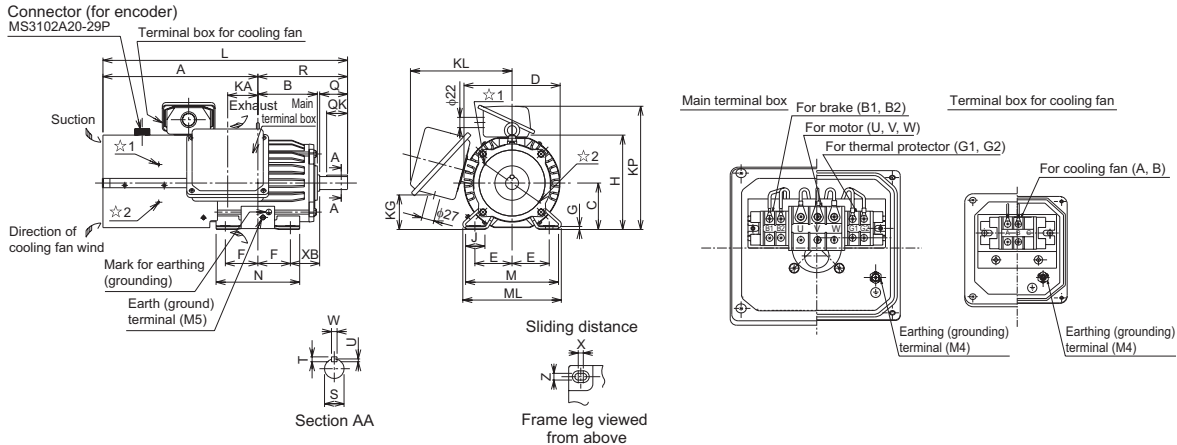

Frame Number 160M, 160L, 180M, 180L

SF-V5RU(H) 11KB, 15KB, 18KB, 22KB

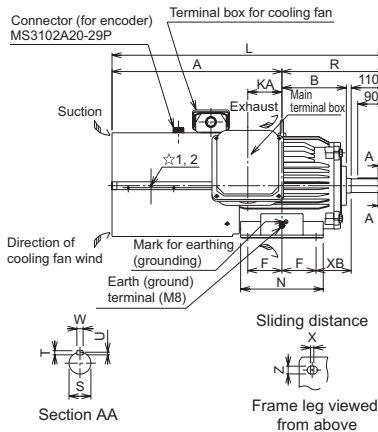

Frame Number 200L

SF-V5RU(H) 30KB, 37KB, 45KB

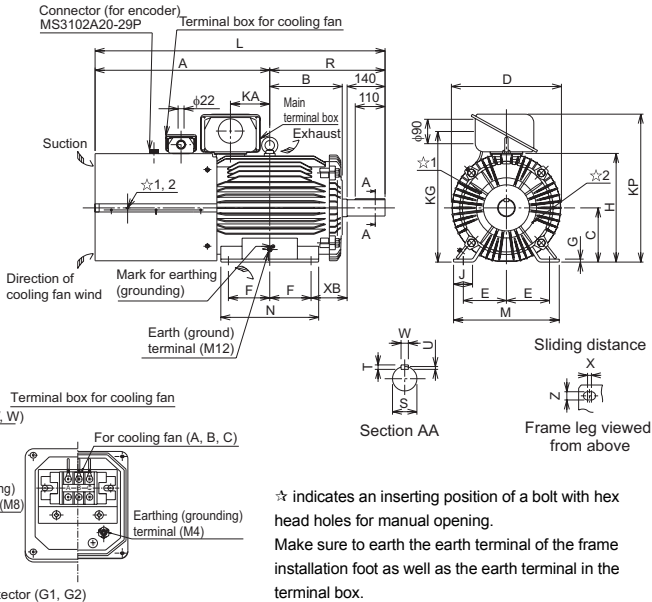

☆ indicates an inserting position of a bolt with hex head holes for manual opening.  
Make sure to earth the earth terminal of the frame installation foot as well as the earth terminal in the terminal box.

Dimensions table

(Unit: mm)

SF-V5RU □K	SF-V5RU □K1	SF-V5RU □K3	SF-V5RU □K4	Frame No.	Mass (kg)	Motor																			Shaft End										Terminal Screw Size			
						A	B	C	D	E	F	G	H	I	J	KA	KD	KG	KL	KP	L	M	ML	N	X	XB	Z	Q	QK	R	S	T	U	W	UVW	A,B,C	G1,G2	B1,B2
3	—	—	—	112M	53	355	135	112	228	95	70	6.5	—	40	69	27	93	242	290	555	230	242	180	4	70	12	60	45	200	28j6	7	4	8	M6	M4	M4	M4	
5	3	—	—	132S	70	416	152	132	266	108	70	6.5	—	40	75	27	117	256	329	655	256	268	180	4	89	12	80	63	239	38k6	8	5	10	M6	M4	M4	M4	
7	5	3	—	132M	80	435	171	132	266	108	89	6.5	—	40	94	27	117	256	329	693	256	268	218	4	89	12	80	63	258	38k6	8	5	10	M6	M4	M4	M4	
11	7	5	—	160M	140	522.5	198	160	318	127	105	8	—	50	105	56	115	330	391	845.5	310	—	254	4	108	14.5	110	90	323	42k6	8	5	12	M8	M4	M4	M4	
15	11	7	3	160L	155	544.5	220	160	318	127	127	8	—	50	127	56	115	330	391	889.5	310	—	298	4	108	14.5	110	90	345	42k6	8	5	12	M8	M4	M4	M4	
18	—	—	—	180M	185	588.5	225.5	180	363	139.5	120.5	8	—	50	127	56	139	352	428	920	335	—	285	4	121	14.5	110	90	351.5	48k6	9	5.5	14	M8	M4	M4	M4	
—	18	15	5	180L	255	587.5	242.5	180	363	139.5	139.5	8	—	50	146	56	139	352	428	958	335	—	323	4	121	14.5	110	90	370.5	55m6	10	6	16	M8	M4	M4	M4	
30	—	—	7	200L	305	644.5	267.5	200	406	159	152.5	11	—	70	145	90	487	—	546	1070	390	—	361	4	133	18.5	140	110	425.5	60m6	11	7	18	M10	M4	M4	M4	
37, 45	22, 30	18, 22	—	200L	330	644.5	267.5	200	406	159	152.5	11	—	70	145	90	487	—	546	1070	390	—	361	4	133	18.5	140	110	425.5	60m6	11	7	18	M10	M4	M4	M4	
—	37	30	11, 15	225S	395	659	277	225	446	178	143	11	—	70	145	90	533	—	592	1091	428	—	342	4	149	18.5	140	110	432	65m6	11	7	18	M10	M4	M4	M4	

- Note) 1. Install the motor on the floor and use it with the shaft horizontal.  
 2. Leave an enough clearance between the fan suction port and wall to ensure adequate cooling.  
 Also, check that the ventilation direction of a fan is from the opposite load side to the load side.  
 3. The size difference of top and bottom of the shaft center height is  $\frac{1}{5}$ .  
 4. The 400V class motor has -H at the end of its type name.  
 5. Since a brake power device is a stand-alone, install it inside the enclosure.  
 (This device should be arranged at the customer side.)



● Dedicated motor (SF-V5RU(H)) outline dimension drawings (flange type)

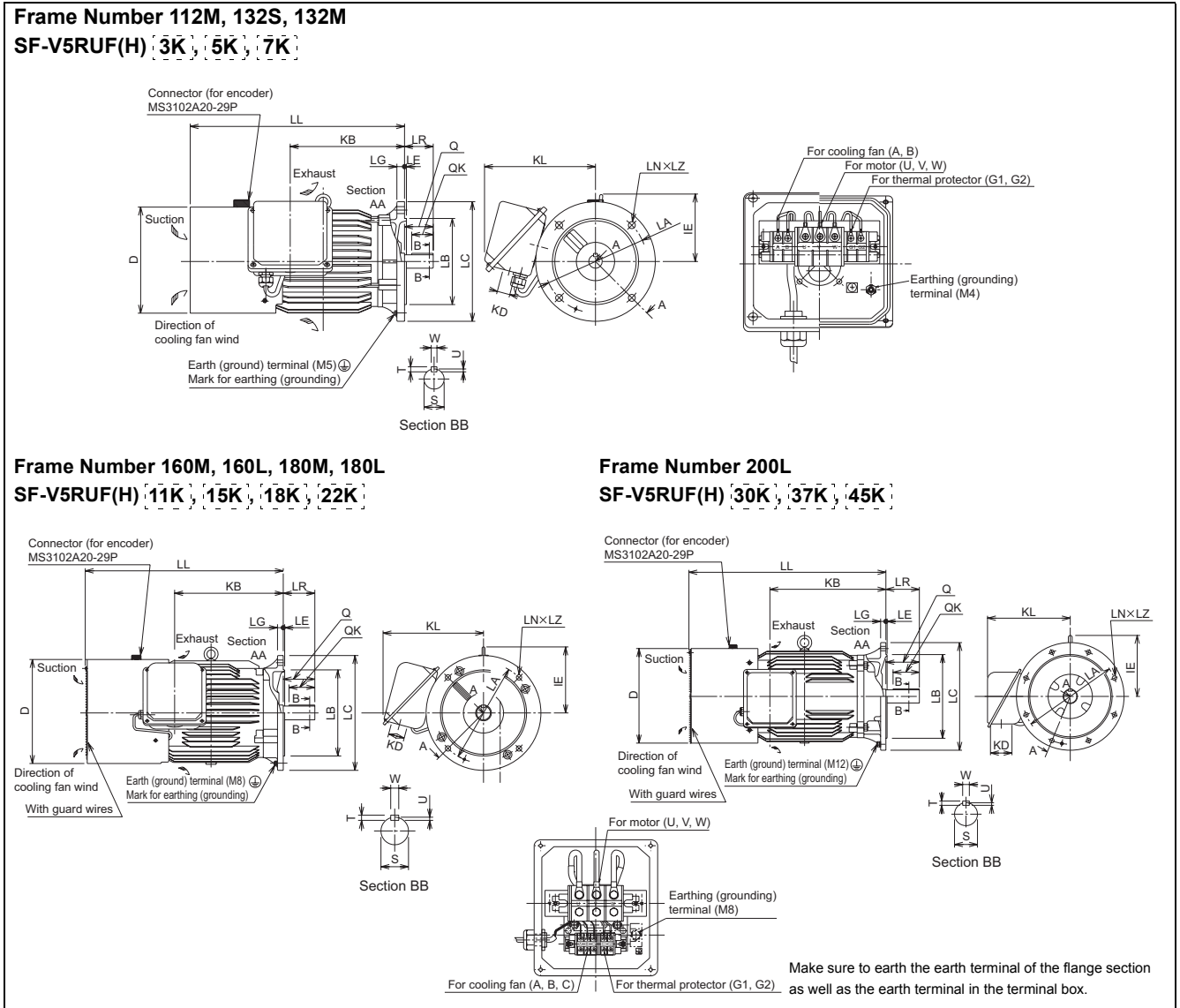

Dimensions table

(Unit: mm)

SF-V5RU □K	SF-V5RU □K1	SF-V5RU □K3	SF-V5RU □K4	Flange Number	Frame No.	Mass (kg)	Motor													Shaft End					Terminal Screw Size				
							D	IE	KB	KD	KL	LA	LB	LC	LE	LG	LL	LN	LZ	LR	Q	QK	S	T	U	W	U,V,W	A,B,C	G1,G2
3	—	—	—	FF215	112M	46	228	141	239	27	242	215	180j6	250	4	16	448	4	14.5	60	60	45	28j6	7	4	8	M6	M4	M4
5	3	—	—	FF265	132S	65	266	156	256	27	256	265	230j6	300	4	20	484	4	14.5	80	80	63	38k6	8	5	10	M6	M4	M4
7	5	3	—	FF265	132M	70	266	156	294	27	256	265	230j6	300	4	20	522	4	14.5	80	80	63	38k6	8	5	10	M6	M4	M4
11	7	5	—	FF300	160M	110	318	207	318	56	330	300	250j6	350	5	20	625	4	18.5	110	110	90	42k6	8	5	12	M8	M4	M4
15	11	7	3	FF300	160L	125	318	207	362	56	330	300	250j6	350	5	20	669	4	18.5	110	110	90	42k6	8	5	12	M8	M4	M4
18	—	—	—	—	160	—	—	—	—	—	—	—	—	—	—	—	—	—	—	—	—	—	—	—	—	—	—	—	—
22	15	11	—	FF350	180M	185	363	230	378.5	56	352	350	300j6	400	5	20	690	4	18.5	110	110	90	48k6	9	5.5	14	M8	M4	M4
—	18	15	5	FF350	180L	225	363	230	416.5	56	352	350	300j6	400	5	20	728	4	18.5	110	110	90	55m6	10	6	16	M8	M4	M4
30	—	—	7	—	—	—	—	—	—	—	—	—	—	—	—	—	—	—	—	—	—	—	—	—	—	—	—	—	—
—	—	—	—	FF400	200L	270	406	255	485	90	346	400	350j6	450	5	22	823.5	8	18.5	140	140	110	60m6	11	7	18	M10	M4	M4
37, 45	22, 30	18, 22	—	—	—	290	—	—	—	—	—	—	—	—	—	—	—	—	—	—	—	—	—	—	—	—	—	—	—

Note) 1. Install the motor on the floor and use it with the shaft horizontal.

For use under the shaft, the protection structure of the cooling fan is IP20.

2. Leave an enough clearance between the fan suction port and wall to ensure adequate cooling. Also, check that the ventilation direction of a fan is from the opposite load side to the load side.

3. The size difference of top and bottom of the shaft center height is  $\pm 0.5$ .

4. The 400V class motor has -H at the end of its type name.

● Dedicated motor (SF-V5RU(H)) outline dimension drawings (flange type with brake)

Frame Number 112M, 132S, 132M  
SF-V5RUF(H) {3KB}, {5KB}, {7KB}

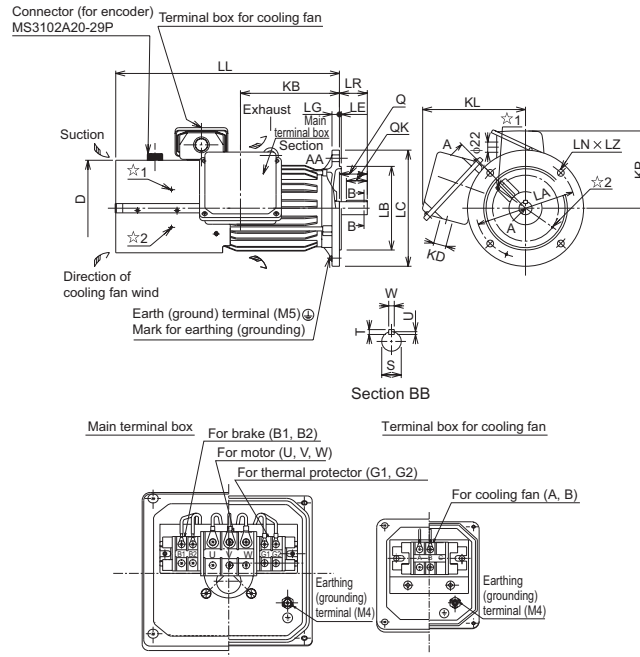

Frame Number 160M, 160L  
SF-V5RUF(H) {11KB}, {15KB}

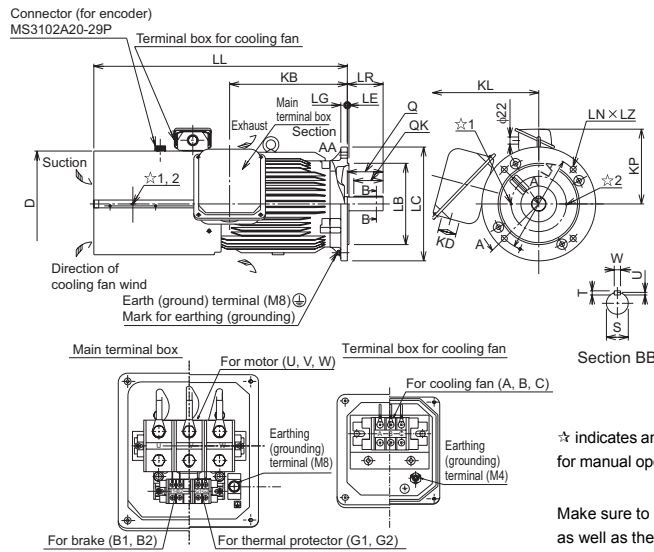

☆ indicates an inserting position of a bolt with hex head holes for manual opening.

Make sure to earth the earth terminal of the flange section as well as the earth terminal in the terminal box.

Dimensions table

(Unit: mm)

SF-V5RU □K	SF-V5RU □K1	SF-V5RU □K3	SF-V5RU □K4	Flange Number	Frame No.	Mass (kg)	Motor										Shaft End						Terminal Screw Size								
							D	KB	KD	KL	KP	LA	LB	LC	LE	LG	LL	LN	LZ	LR	Q	QK	S	T	U	W	U,V,W	A,B,C	B1,B2	G1,G2	
3	—	—	—	FF215	112M	58	228	239	27	242	178	215	180j6	250	4	16	525	4	14.5	60	60	60	45	28j6	7	4	8	M6	M4	M4	M4
5	3	—	—	FF265	132S	83	266	256	27	256	197	265	230j6	300	4	20	597	4	14.5	80	80	63	38k6	8	5	10	M6	M4	M4	M4	
7	5	3	—	FF265	132M	88	266	294	27	256	197	265	230j6	300	4	20	635	4	14.5	80	80	63	38k6	8	5	10	M6	M4	M4	M4	
11	7	5	—	FF300	160M	151	318	318	56	330	231	300	250j6	350	5	20	735.5	4	18.5	110	110	90	42k6	8	5	12	M8	M4	M4	M4	
15	11	7	3	FF300	160L	167	318	362	56	330	231	300	250j6	350	5	20	779.5	4	18.5	110	110	90	42k6	8	5	12	M8	M4	M4	M4	

- Note) 1. Install the motor on the floor and use it with the shaft horizontal.  
 2. Leave an enough clearance between the fan suction port and wall to ensure adequate cooling.  
 Also, check that the ventilation direction of a fan is from the opposite load side to the load side.  
 3. The size difference of top and bottom of the shaft center height is  $\frac{1}{5}$ .  
 4. The 400V class motor has -H at the end of its type name.  
 5. Since a brake power device is a stand-alone, install it inside the enclosure.  
 (This device should be arranged at the customer side.)





## 7.4 Installation of the heatsink portion outside the enclosure for use

When encasing the inverter in an enclosure, the generated heat amount in an enclosure can be greatly reduced by installing the heatsink portion of the inverter outside the enclosure. When installing the inverter in a compact enclosure, etc., this installation method is recommended.

### 7.4.1 Protrusion of heatsink

(1) Panel cutting

Cut the panel of the enclosure according to the inverter capacity.

• FR-A721-5.5K to 55K, FR-A741-5.5K to 55K

Inverter model	W	W1	H	H1	H2	H3	C
FR-A721-5.5K, 7.5K FR-A741-5.5K, 7.5K	240	190	454	434	12	8	M8
FR-A721-11K, 15K FR-A741-11K, 15K	290	220	575	548	17	10	M8
FR-A721-18.5K, 22K FR-A741-18.5K, 22K	376	290	575	546	17	12	M10
FR-A721-30K FR-A741-30K	436	350	675	646	17	12	M10
FR-A721-37K, 45K FR-A741-37K, 45K	456	370	670	641	17	12	M12
FR-A721-55K FR-A741-55K	586	480	870	841	17	12	M12

Unit: mm

(2) Shift and removal of a rear side installation frame

One installation frame is attached to each of the upper and lower parts of the inverter. Change the position of the rear side installation frame on the upper and lower sides of the inverter to the front side as shown on the right. When changing the installation frames, make sure that the installation orientation is correct.

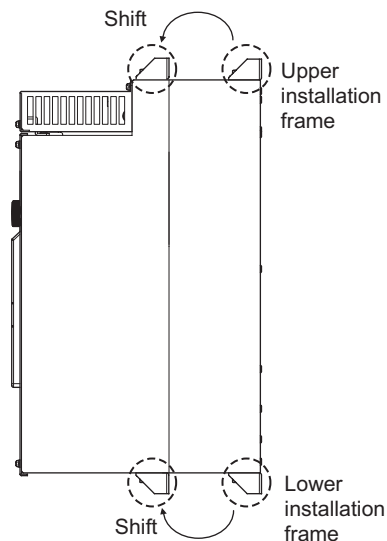

(3) Installation of the inverter

Push the inverter heatsink portion outside the enclosure and fix the enclosure and inverter with upper and lower installation frame.

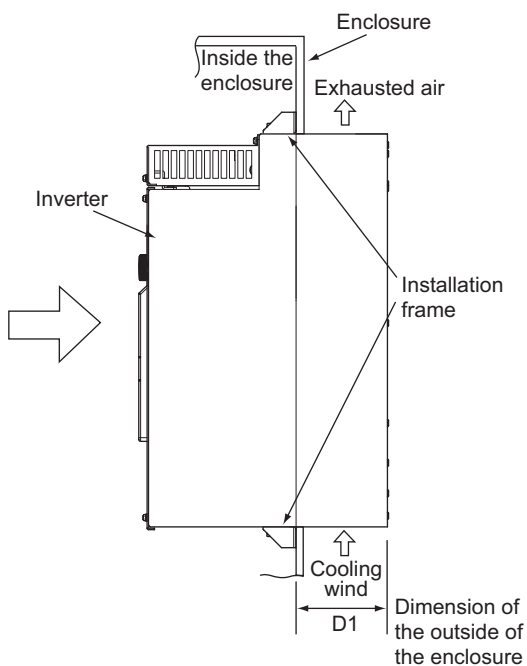

Inverter model	D1
FR-A721-5.5K, 7.5K FR-A741-5.5K, 7.5K	100
FR-A721-11K, 15K FR-A741-11K, 15K	125
FR-A721-18.5K, 22K FR-A741-18.5K, 22K	130
FR-A721-30K FR-A741-30K	145
FR-A721-37K, 45K FR-A741-37K, 45K	163
FR-A721-55K FR-A741-55K	190

(Unit: mm)

**CAUTION**

- Having a cooling fan, the cooling section which comes out of the enclosure can not be used in the environment of water drops, oil, mist, dust, etc.
- Be careful not to drop screws, dust etc. into the inverter and cooling fan section.

# MEMO



# APPENDICES

---

This chapter provides the "APPENDICES" of this product.  
Always read the instructions before using the equipment.

---

## Appendix 1 Main differences and compatibilities with the FR-A700 series

Item	FR-A700	FR-A701
Model configuration	200V class .....0.4K to 90K 400V class .....0.4K to 500K	200V class ..... 5.5K to 55K 400V class ..... 5.5K to 55K
Regenerative braking torque	5.5/7.5K .....100%torque 2%ED 11K to 55K .....20%torque continuous	100% torque/continuous 150% torque 60s
Built-in EMC filter	With	Without
Changed/cleared functions	<i>Pr. 30 Regenerative function selection, Pr. 70 Special regenerative brake duty</i>	Deleted
	<i>Pr. 872 Input phase loss protection selection</i> Initial value "0" (without input phase protection)	The initial value is changed to "1" (with input phase failure protection)
	Protective functions E.BE	Deleted E.4, E.10, E.8, E.15 added
Stand-alone option	<ul style="list-style-type: none"> <li>· AC reactor (FR-HAL)</li> <li>· DC reactor (FR-HEL)</li> <li>· High-duty brake resistor (FR-ABR)</li> <li>· Power regeneration common converter (FR-CV)</li> <li>· High power factor converter (FR-HC)</li> <li>· Power regeneration converter (FR-RC)</li> </ul>	Not available (AC reactor (FR-HAL) is built-in) * Note that an AC reactor (FR-HAL) should be used only when a thyristor load exists in the same power supply system and protective function E.4 and E.10 activate.
Outline dimension Installation size	Not compatible	

## Appendix 2 Control mode-based parameter (function) correspondence table and instruction code list

- \*1 These instruction codes are used for parameter read and write by using Mitsubishi inverter protocol with the RS-485 communication. (Refer to *page 310* for RS-485 communication)
- \*2 Validity and invalidity according to operation mode are as follows:  
 ○:Usable parameter  
 ×:Unusable parameter  
 Δ:Parameters available only during position control set by parameter
- \*3 "○" indicates valid and "×" indicates invalid of "parameter copy", "parameter clear", and "all parameter clear".
- \*4 Parameters can be used with conditions. Refer to *page 185* for details.
- \*5 When a communication option is installed, parameter clear (lock release) during password lock (*Pr. 297* ≠ 9999) can be performed only from the communication option.
- \*6 These parameters are communication parameters that are not cleared when parameter clear (all clear) is executed from RS-485 communication. (Refer to *page 305* for RS-485 communication)

Symbols in the table indicate parameters which function when an option is mounted.

**AX** ..... FR-A7AX, **AY** ..... FR-A7AY, **AR** ..... FR-A7AR, **AP** ..... FR-A7AP, **AL** ..... FR-A7AL **Ver.UP** , **AZ** FR-A7AZ,

**NC** ..... FR-A7NC, **ND** ..... FR-A7ND, **NL** ..... FR-A7NL, **NP** ..... FR-A7NP, **NS** ..... FR-A7NS

**Ver.UP** ..... Specifications differ according to the date assembled. Refer to *page 456* to check the SERIAL number.

Parameter	Name	Instruction Code *1			Control Mode-based Correspondence Table *2							Parameter Copy *3	Parameter Clear *3	All Parameter Clear *3
		Read	Write	Extended	V/F Control	Advanced magnetic flux vector control	Vector control			Real sensorless vector control				
							Speed control	Torque control	Position control	Speed control	Torque control			
0	Torque boost	00	80	0	○	×	×	×	×	×	×	○	○	○
1	Maximum frequency	01	81	0	○	○	○	○	○	○	○	○	○	○
2	Minimum frequency	02	82	0	○	○	○	○	×	○	○	○	○	○
3	Base frequency	03	83	0	○	×	×	×	×	×	×	○	○	○
4	Multi-speed setting (high speed)	04	84	0	○	○	○	○	Δ	○	○	○	○	○
5	Multi-speed setting (middle speed)	05	85	0	○	○	○	○	Δ	○	○	○	○	○
6	Multi-speed setting (low speed)	06	86	0	○	○	○	○	Δ	○	○	○	○	○
7	Acceleration time	07	87	0	○	○	○	○	Δ	○	○	○	○	○
8	Deceleration time	08	88	0	○	○	○	○	Δ	○	○	○	○	○
9	Electronic thermal O/L relay	09	89	0	○	○	○	○	○	○	○	○	○	○
10	DC injection brake operation frequency	0A	8A	0	○	○	○	○	×	○	○	○	○	○
11	DC injection brake operation time	0B	8B	0	○	○	○	○	×	○	○	○	○	○
12	DC injection brake operation voltage	0C	8C	0	○	○	×	×	×	○*4	○*4	○	○	○
13	Starting frequency	0D	8D	0	○	○	○	○	×	○	○	○	○	○
14	Load pattern selection	0E	8E	0	○	×	×	×	×	×	×	○	○	○
15	Jog frequency	0F	8F	0	○	○	○	○	×	○	○	○	○	○
16	Jog acceleration/ deceleration time	10	90	0	○	○	○	○	×	○	○	○	○	○
17	MRS input selection	11	91	0	○	○	○	○	○	○	○	○	○	○
18	High speed maximum frequency	12	92	0	○	○	×	×	×	×	×	○	○	○
19	Base frequency voltage	13	93	0	○	×	×	×	×	×	×	○	○	○
20	Acceleration/deceleration reference frequency	14	94	0	○	○	○	○	Δ	○	○	○	○	○
21	Acceleration/deceleration time increments	15	95	0	○	○	○	○	Δ	○	○	○	○	○
22	Stall prevention operation level (Torque limit level )	16	96	0	○	○	○	×	○	○	×	○	○	○
23	Stall prevention operation level compensation factor at double speed	17	97	0	○	○	×	×	×	×	×	○	○	○
24	Multi-speed setting (speed 4)	18	98	0	○	○	○	○	Δ	○	○	○	○	○
25	Multi-speed setting (speed 5)	19	99	0	○	○	○	○	Δ	○	○	○	○	○
26	Multi-speed setting (speed 6)	1A	9A	0	○	○	○	○	Δ	○	○	○	○	○

Parameter	Name	Instruction Code *1			Control Mode-based Correspondence Table *2							Parameter Copy *3	Parameter Clear *3	All Parameter Clear *3
		Read	Write	Extended	V/F Control	Advanced magnetic flux vector control	Vector control			Real sensorless vector control				
							Speed control	Torque control	Position control	Speed control	Torque control			
27	Multi-speed setting (speed 7)	1B	9B	0	○	○	○	○	△	○	○	○	○	○
28	Multi-speed input compensation selection	1C	9C	0	○	○	○	○	×	○	○	○	○	○
29	Acceleration/deceleration pattern selection	1D	9D	0	○	○	○	○	×	○	○	○	○	○
31	Frequency jump 1A	1F	9F	0	○	○	○	○	×	○	○	○	○	○
32	Frequency jump 1B	20	A0	0	○	○	○	○	×	○	○	○	○	○
33	Frequency jump 2A	21	A1	0	○	○	○	○	×	○	○	○	○	○
34	Frequency jump 2B	22	A2	0	○	○	○	○	×	○	○	○	○	○
35	Frequency jump 3A	23	A3	0	○	○	○	○	×	○	○	○	○	○
36	Frequency jump 3B	24	A4	0	○	○	○	○	×	○	○	○	○	○
37	Speed display	25	A5	0	○	○	○	○	○	○	○	○	○	○
41	Up-to-frequency sensitivity	29	A9	0	○	○	○	×	×	○	×	○	○	○
42	Output frequency detection	2A	AA	0	○	○	○	○	○	○	○	○	○	○
43	Output frequency detection for reverse rotation	2B	AB	0	○	○	○	○	○	○	○	○	○	○
44	Second acceleration/deceleration time	2C	AC	0	○	○	○	○	△	○	○	○	○	○
45	Second deceleration time	2D	AD	0	○	○	○	○	△	○	○	○	○	○
46	Second torque boost	2E	AE	0	○	×	×	×	×	×	×	○	○	○
47	Second V/F (base frequency)	2F	AF	0	○	×	×	×	×	×	×	○	○	○
48	Second stall prevention operation current	30	B0	0	○	○	×	×	×	×	×	○	○	○
49	Second stall prevention operation frequency	31	B1	0	○	○	×	×	×	×	×	○	○	○
50	Second output frequency detection	32	B2	0	○	○	○	○	○	○	○	○	○	○
51	Second electronic thermal O/L relay	33	B3	0	○	○	○	○	○	○	○	○	○	○
52	DU/PU main display data selection	34	B4	0	○	○	○	○	○	○	○	○	○	○
54	FM terminal function selection	36	B6	0	○	○	○	○	○	○	○	○	○	○
55	Frequency monitoring reference	37	B7	0	○	○	○	○	○	○	○	○	○	○
56	Current monitoring reference	38	B8	0	○	○	○	○	○	○	○	○	○	○
57	Restart coasting time	39	B9	0	○	○	○	○	×	○	○	○	○	○
58	Restart cushion time	3A	BA	0	○	○	×	×	×	×	×	○	○	○
59	Remote function selection	3B	BB	0	○	○	○	○	×	○	○	○	○	○
60	Energy saving control selection	3C	BC	0	○	×	×	×	×	×	×	○	○	○
61	Reference current	3D	BD	0	○	○	○	×	×	○	×	○	○	○
62	Reference value at acceleration	3E	BE	0	○	○	○	×	×	○	×	○	○	○
63	Reference value at ddceleration	3F	BF	0	○	○	○	×	×	○	×	○	○	○
64	Starting frequency for elevator mode	40	C0	0	○	×	×	×	×	×	×	○	○	○
65	Retry selection	41	C1	0	○	○	○	○	×	○	○	○	○	○
66	Stall prevention operation reduction starting frequency	42	C2	0	○	○	×	×	×	×	×	○	○	○
67	Number of retries at fault occurrence	43	C3	0	○	○	○	○	×	○	○	○	○	○
68	Retry waiting time	44	C4	0	○	○	○	○	×	○	○	○	○	○

Parameter	Name	Instruction Code *1			Control Mode-based Correspondence Table *2							Parameter Copy *3	Parameter Clear *3	All Parameter Clear *3
		Read	Write	Extended	V/F Control	Advanced magnetic flux vector control	Vector control			Real sensorless vector control				
							Speed control	Torque control	Position control	Speed control	Torque control			
69	Retry count display erase	45	C5	0	○	○	○	○	×	○	○	○	○	○
71	Applied motor	47	C7	0	○	○	○	○	○	○	○	○	○	○
72	PWM frequency selection	48	C8	0	○	○	○	○	○	○	○	○	○	○
73	Analog input selection	49	C9	0	○	○	○	○	×	○	○	○	○	○
74	Input filter time constant	4A	CA	0	○	○	○	○	×	○	○	○	○	○
75	Reset selection/ disconnected PU detection/ PU stop selection	4B	CB	0	○	○	○	○	○	○	○	○	×	×
76	Alarm code output selection	4C	CC	0	○	○	○	○	○	○	○	○	○	○
77 *	Parameter write selection	4D	CD	0	○	○	○	○	○	○	○	○	○	○
78	Reverse rotation prevention selection	4E	CE	0	○	○	○	○	○	○	○	○	○	○
79 *	Operation mode selection	4F	CF	0	○	○	○	○	○	○	○	○	○	○
80	Motor capacity	50	D0	0	×	○	○	○	○	○	○	○	○	○
81	Number of motor poles	51	D1	0	×	○	○	○	○	○	○	○	○	○
82	Motor excitation current	52	D2	0	×	○	○	○	○	○	○	○	×	○
83	Rated motor voltage	53	D3	0	×	○	○	○	○	○	○	○	○	○
84	Rated motor frequency	54	D4	0	×	○	○	○	○	○	○	○	○	○
89	Speed control gain (magnetic flux vector)	59	D9	0	×	○	×	×	×	×	×	○	×	○
90	Motor constant (R1)	5A	DA	0	×	○	○	○	○	○	○	○	×	○
91	Motor constant (R2)	5B	DB	0	×	○	○	○	○	○	○	○	×	○
92	Motor constant (L1)	5C	DC	0	×	○	○	○	○	○	○	○	×	○
93	Motor constant (L2)	5D	DD	0	×	○	○	○	○	○	○	○	×	○
94	Motor constant (X)	5E	DE	0	×	○	○	○	○	○	○	○	×	○
95	Online auto tuning selection	5F	DF	0	×	○	○	○	○	○	○	○	○	○
96	Auto tuning setting/status	60	E0	0	×	○	○	○	○	○	○	○	×	○
100	V/F1(first frequency)	00	80	1	○	×	×	×	×	×	×	○	○	○
101	V/F1(first frequency voltage)	01	81	1	○	×	×	×	×	×	×	○	○	○
102	V/F2(second frequency)	02	82	1	○	×	×	×	×	×	×	○	○	○
103	V/F2(second frequency voltage)	03	83	1	○	×	×	×	×	×	×	○	○	○
104	V/F3(third frequency)	04	84	1	○	×	×	×	×	×	×	○	○	○
105	V/F3(third frequency voltage)	05	85	1	○	×	×	×	×	×	×	○	○	○
106	V/F4(fourth frequency)	06	86	1	○	×	×	×	×	×	×	○	○	○
107	V/F4(fourth frequency voltage)	07	87	1	○	×	×	×	×	×	×	○	○	○
108	V/F5(fifth frequency)	08	88	1	○	×	×	×	×	×	×	○	○	○
109	V/F5(fifth frequency voltage)	09	89	1	○	×	×	×	×	×	×	○	○	○
110	Third acceleration/ deceleration time	0A	8A	1	○	○	○	○	△	○	○	○	○	○
111	Third deceleration time	0B	8B	1	○	○	○	○	△	○	○	○	○	○
112	Third torque boost	0C	8C	1	○	×	×	×	×	×	×	○	○	○
113	Third V/F (base frequency)	0D	8D	1	○	×	×	×	×	×	×	○	○	○
114	Third stall prevention operation current	0E	8E	1	○	○	×	×	×	×	×	○	○	○
115	Thrid stall prevention operation frequency	0F	8F	1	○	○	×	×	×	×	×	○	○	○

\* Read and write from communication with PU connector only is enabled.



Parameter	Name	Instruction Code *1			Control Mode-based Correspondence Table *2							Parameter Copy *3	Parameter Clear *3	All Parameter Clear *3
		Read	Write	Extended	V/F Control	Advanced magnetic flux vector control	Vector control			Real sensorless vector control				
							Speed control	Torque control	Position control	Speed control	Torque control			
116	Third output frequency detection	10	90	1	○	○	○	○	○	○	○	○	○	○
117	PU communication station number	11	91	1	○	○	○	○	○	○	○	○	○ <sup>*6</sup>	○ <sup>*6</sup>
118	PU communication speed	12	92	1	○	○	○	○	○	○	○	○	○ <sup>*6</sup>	○ <sup>*6</sup>
119	PU communication stop bit length	13	93	1	○	○	○	○	○	○	○	○	○ <sup>*6</sup>	○ <sup>*6</sup>
120	PU communication parity check	14	94	1	○	○	○	○	○	○	○	○	○ <sup>*6</sup>	○ <sup>*6</sup>
121	Number of PU communication retries	15	95	1	○	○	○	○	○	○	○	○	○ <sup>*6</sup>	○ <sup>*6</sup>
122	PU communication check time interval	16	96	1	○	○	○	○	○	○	○	○	○ <sup>*6</sup>	○ <sup>*6</sup>
123	PU communication waiting time setting	17	97	1	○	○	○	○	○	○	○	○	○ <sup>*6</sup>	○ <sup>*6</sup>
124	PU communication CR/LF presence/absence selection	18	98	1	○	○	○	○	○	○	○	○	○ <sup>*6</sup>	○ <sup>*6</sup>
125	Terminal 2 frequency setting gain frequency	19	99	1	○	○	○	○	×	○	○	○	×	○
126	Terminal 4 frequency setting gain frequency	1A	9A	1	○	○	○	○	×	○	○	○	×	○
127	PID control automatic switchover frequency	1B	9B	1	○	○	○	×	×	○	×	○	○	○
128	PID action selection	1C	9C	1	○	○	○	×	×	○	×	○	○	○
129	PID proportional band	1D	9D	1	○	○	○	×	×	○	×	○	○	○
130	PID integral time	1E	9E	1	○	○	○	×	×	○	×	○	○	○
131	PID upper limit	1F	9F	1	○	○	○	×	×	○	×	○	○	○
132	PID lower limit	20	A0	1	○	○	○	×	×	○	×	○	○	○
133	PID action set point	21	A1	1	○	○	○	×	×	○	×	○	○	○
134	PID differential time	22	A2	1	○	○	○	×	×	○	×	○	○	○
135	Electronic bypass sequence selection	23	A3	1	○	○	○	×	×	○	×	○	○	○
136	MC switchover interlock time	24	A4	1	○	○	○	×	×	○	×	○	○	○
137	Start waiting time	25	A5	1	○	○	○	×	×	○	×	○	○	○
138	Bypass selection at a fault	26	A6	1	○	○	○	×	×	○	×	○	○	○
139	Automatic switchover frequency from inverter to bypass operation	27	A7	1	○	○	○	×	×	○	×	○	○	○
140	Backlash acceleration stopping frequency	28	A8	1	○	○	○	○	×	○	○	○	○	○
141	Backlash acceleration stopping time	29	A9	1	○	○	○	○	×	○	○	○	○	○
142	Backlash deceleration stopping frequency	2A	AA	1	○	○	○	○	×	○	○	○	○	○
143	Backlash deceleration stopping time	2B	AB	1	○	○	○	○	×	○	○	○	○	○
144	Speed setting switchover	2C	AC	1	○	○	○	○	○	○	○	○	○	○
145	PU display language selection	2D	AD	1	○	○	○	○	○	○	○	○	×	×
148	Stall prevention level at 0V input	30	B0	1	○	○	×	×	×	×	×	○	○	○
149	Stall prevention level at 10V input	31	B1	1	○	○	×	×	×	×	×	○	○	○
150	Output current detection level	32	B2	1	○	○	○	○	○	○	○	○	○	○

Parameter	Name	Instruction Code *1			Control Mode-based Correspondence Table *2							Parameter Copy *3	Parameter Clear *3	All Parameter Clear *3	
		Read	Write	Extended	V/F Control	Advanced magnetic flux vector control	Vector control			Real sensorless vector control					
							Speed control	Torque control	Position control	Speed control	Torque control				
151	Output current detection signal delay time	33	B3	1	○	○	○	○	○	○	○	○	○	○	
152	Zero current detection level	34	B4	1	○	○	○	○	○	○	○	○	○	○	
153	Zero current detection time	35	B5	1	○	○	○	○	○	○	○	○	○	○	
154	Voltage reduction selection during stall prevention operation	36	B6	1	○	○	×	×	×	×	×	○	○	○	
155	RT signal function validity condition selection	37	B7	1	○	○	○	×	×	○	×	○	○	○	
156	Stall prevention operation selection	38	B8	1	○	○	×	×	×	×	×	○	○	○	
157	OL signal output timer	39	B9	1	○	○	○	○	○	○	○	○	○	○	
158	AM terminal function selection	3A	BA	1	○	○	○	○	○	○	○	○	○	○	
159	Automatic switchover frequency range from bypass to inverter operation	3B	BB	1	○	○	○	×	×	○	×	○	○	○	
160	User group read selection	00	80	2	○	○	○	○	○	○	○	○	○	○	
161	Frequency setting/key lock operation selection	01	81	2	○	○	○	○	○	○	○	○	×	○	
162	Automatic restart after instantaneous power failure selection	02	82	2	○	○	○	○	×	○	○	○	○	○	
163	First cushion time for restart	03	83	2	○	○	×	×	×	×	×	○	○	○	
164	First cushion voltage for restart	04	84	2	○	○	×	×	×	×	×	○	○	○	
165	Stall prevention operation level for restart	05	85	2	○	○	×	×	×	×	×	○	○	○	
166	Output current detection signal retention time	06	86	2	○	○	○	○	○	○	○	○	○	○	
167	Output current detection operation selection	07	87	2	○	○	○	○	○	○	○	○	○	○	
168	Parameter for manufacturer setting. Do not set.														
169															
170	Watt-hour meter clear	0A	8A	2	○	○	○	○	○	○	○	○	○	×	○
171	Operation hour meter clear	0B	8B	2	○	○	○	○	○	○	○	○	×	×	×
172	User group registered display/batch clear	0C	8C	2	○	○	○	○	○	○	○	○	×	×	
173	User group registration	0D	8D	2	○	○	○	○	○	○	○	×	×	×	
174	User group clear	0E	8E	2	○	○	○	○	○	○	○	×	×	×	
178	STF terminal function selection	12	92	2	○	○	○	○	○	○	○	○	×	○	
179	STR terminal function selection	13	93	2	○	○	○	○	○	○	○	○	×	○	
180	RL terminal function selection	14	94	2	○	○	○	○	○	○	○	○	×	○	
181	RM terminal function selection	15	95	2	○	○	○	○	○	○	○	○	×	○	
182	RH terminal function selection	16	96	2	○	○	○	○	○	○	○	○	×	○	
183	RT terminal function selection	17	97	2	○	○	○	○	○	○	○	○	×	○	
184	AU terminal function selection	18	98	2	○	○	○	○	○	○	○	○	×	○	
185	JOG terminal function selection	19	99	2	○	○	○	○	○	○	○	○	×	○	

Parameter	Name	Instruction Code *1			Control Mode-based Correspondence Table *2							Parameter Copy *3	Parameter Clear *3	All Parameter Clear *3
		Read	Write	Extended	V/F Control	Advanced magnetic flux vector control	Vector control			Real sensorless vector control				
							Speed control	Torque control	Position control	Speed control	Torque control			
186	CS terminal function selection	1A	9A	2	○	○	○	○	○	○	○	○	×	○
187	MRS terminal function selection	1B	9B	2	○	○	○	○	○	○	○	○	×	○
188	STOP terminal function selection	1C	9C	2	○	○	○	○	○	○	○	○	×	○
189	RES terminal function selection	1D	9D	2	○	○	○	○	○	○	○	○	×	○
190	RUN terminal function selection	1E	9E	2	○	○	○	○	○	○	○	○	×	○
191	SU terminal function selection	1F	9F	2	○	○	○	○	○	○	○	○	×	○
192	IPF terminal function selection	20	A0	2	○	○	○	○	○	○	○	○	×	○
193	OL terminal function selection	21	A1	2	○	○	○	○	○	○	○	○	×	○
194	FU terminal function selection	22	A2	2	○	○	○	○	○	○	○	○	×	○
195	ABC1 terminal function selection	23	A3	2	○	○	○	○	○	○	○	○	×	○
196	ABC2 terminal function selection	24	A4	2	○	○	○	○	○	○	○	○	×	○
232	Multi-speed setting (speed 8)	28	A8	2	○	○	○	○	△	○	○	○	○	○
233	Multi-speed setting (speed 9)	29	A9	2	○	○	○	○	△	○	○	○	○	○
234	Multi-speed setting (speed 10)	2A	AA	2	○	○	○	○	△	○	○	○	○	○
235	Multi-speed setting (speed 11)	2B	AB	2	○	○	○	○	△	○	○	○	○	○
236	Multi-speed setting (speed 12)	2C	AC	2	○	○	○	○	△	○	○	○	○	○
237	Multi-speed setting (speed 13)	2D	AD	2	○	○	○	○	△	○	○	○	○	○
238	Multi-speed setting (speed 14)	2E	AE	2	○	○	○	○	△	○	○	○	○	○
239	Multi-speed setting (speed 15)	2F	AF	2	○	○	○	○	△	○	○	○	○	○
240	Soft-PWM operation selection	30	B0	2	○	○	○	○	○	○	○	○	○	○
241	Analog input display unit switchover	31	B1	2	○	○	○	○	○	○	○	○	○	○
242	Terminal 1 added compensation amount (terminal 2)	32	B2	2	○	○	○	○	×	○	○	○	○	○
243	Terminal 1 added compensation amount (terminal 4)	33	B3	2	○	○	○	○	×	○	○	○	○	○
244	Cooling fan operation selection	34	B4	2	○	○	○	○	○	○	○	○	○	○
245	Rated slip	35	B5	2	○	×	×	×	×	×	×	○	○	○
246	Slip compensation time constant	36	B6	2	○	×	×	×	×	×	×	○	○	○
247	Constant-power region slip compensation selection	37	B7	2	○	×	×	×	×	×	×	○	○	○
250	Stop selection	3A	BA	2	○	○	○	○	×	○	○	○	○	○
251	Output phase loss protection selection	3B	BB	2	○	○	○	○	○	○	○	○	○	○
252	Override bias	3C	BC	2	○	○	○	○	×	○	○	○	○	○
253	Override gain	3D	BD	2	○	○	○	○	×	○	○	○	○	○
255	Life alarm status display	3F	BF	2	○	○	○	○	○	○	○	×	×	×
256	Inrush current limit circuit life display	40	C0	2	○	○	○	○	○	○	○	×	×	×

Parameter	Name	Instruction Code *1			Control Mode-based Correspondence Table *2							Parameter Copy *3	Parameter Clear *3	All Parameter Clear *3	
		Read	Write	Extended	V/F Control	Advanced magnetic flux vector control	Vector control			Real sensorless vector control					
							Speed control	Torque control	Position control	Speed control	Torque control				
257	Control circuit capacitor life display	41	C1	2	○	○	○	○	○	○	○	○	×	×	×
258	Main circuit capacitor life display	42	C2	2	○	○	○	○	○	○	○	○	×	×	×
259	Main circuit capacitor life measuring	43	C3	2	○	○	○	○	○	○	○	○	○	○	○
261	Power failure stop selection	45	C5	2	○	○	○	○	×	○	○	○	○	○	○
262	Subtracted frequency at deceleration start	46	C6	2	○	○	○	○	×	○	○	○	○	○	○
263	Subtraction starting frequency	47	C7	2	○	○	○	○	×	○	○	○	○	○	○
264	Power-failure deceleration time 1	48	C8	2	○	○	○	○	×	○	○	○	○	○	○
265	Power-failure deceleration time 2	49	C9	2	○	○	○	○	×	○	○	○	○	○	○
266	Power failure deceleration time switchover frequency	4A	CA	2	○	○	○	○	×	○	○	○	○	○	○
267	Terminal 4 input selection	4B	CB	2	○	○	○	○	○	○	○	○	×	○	○
268	Monitor decimal digits selection	4C	CC	2	○	○	○	○	○	○	○	○	○	○	○
269	Parameter for manufacturer setting. Do not set.														
270	Stop-on contact/load torque high-speed frequency control selection	4E	CE	2	○	○	○	×	×	○	×	○	○	○	○
271	High-speed setting maximum current	4F	CF	2	○	○	○	×	×	○	×	○	○	○	○
272	Middle-speed setting minimum current	50	D0	2	○	○	○	×	×	○	×	○	○	○	○
273	Current averaging range	51	D1	2	○	○	○	×	×	○	×	○	○	○	○
274	Current averaging filter time constant	52	D2	2	○	○	○	×	×	○	×	○	○	○	○
275	Stop-on contact excitation current low-speed multiplying factor	53	D3	2	×	○	×	×	×	×	×	○	○	○	○
276	PWM carrier frequency at stop-on contact	54	D4	2	×	○	×	×	×	×	×	○	○	○	○
278	Brake opening frequency	56	D6	2	×	○	○	×	×	○	×	○	○	○	○
279	Brake opening current	57	D7	2	×	○	○	×	×	○	×	○	○	○	○
280	Brake opening current detection time	58	D8	2	×	○	○	×	×	○	×	○	○	○	○
281	Brake operation time at start	59	D9	2	×	○	○	×	×	○	×	○	○	○	○
282	Brake operation frequency	5A	DA	2	×	○	○	×	×	○	×	○	○	○	○
283	Brake operation time at stop	5B	DB	2	×	○	○	×	×	○	×	○	○	○	○
284	Deceleration detection function selection	5C	DC	2	○	○	○	×	×	×	×	○	○	○	○
285	Overspeed detection frequency (Speed deviation excess detection frequency)	5D	DD	2	○	○	○	×	×	○	×	○	○	○	○
286	Drift gain	5E	DE	2	×	○	○	×	×	○	×	○	○	○	○
287	Drift filter time constant	5F	DF	2	×	○	○	×	×	○	×	○	○	○	○
288	Drift function activation selection	60	E0	2	×	×	○	×	×	○	×	○	○	○	○
291	Pulse train I/O selection	63	E3	2	○	○	○	○	×	○	○	○	×	○	○
292	Automatic acceleration/ deceleration	64	E4	2	○	○	○	×	×	○	×	○	○	○	○

Parameter	Name	Instruction Code *1			Control Mode-based Correspondence Table *2							Parameter Copy *3	Parameter Clear *3	All Parameter Clear *3
		Read	Write	Extended	V/F Control	Advanced magnetic flux vector control	Vector control			Real sensorless vector control				
							Speed control	Torque control	Position control	Speed control	Torque control			
293	Acceleration/deceleration time individual calculation selection	65	E5	2	○	○	○	×	×	○	×	○	○	○
294	UV avoidance voltage gain	66	E6	2	○	○	○	○	×	○	○	○	○	○
296	Password lock level	68	E8	2	○	○	○	○	○	○	○	○	×	○
297	Password lock/unlock	69	E9	2	○	○	○	○	○	○	○	○	○*	○
299	Rotation direction detection selection at restarting	6B	EB	2	○	○	×	×	×	○	×	○	○	○
300	BCD input bias [AX]	00	80	3	○	○	○	○	×	○	○	○	○	○
301	BCD input gain [AX]	01	81	3	○	○	○	○	×	○	○	○	○	○
302	BIN input bias [AX]	02	82	3	○	○	○	○	×	○	○	○	○	○
303	BIN input gain [AX]	03	83	3	○	○	○	○	×	○	○	○	○	○
304	Digital input and analog input compensation enable/disable selection [AX]	04	84	3	○	○	○	○	×	○	○	○	○	○
305	Read timing operation selection [AX]	05	85	3	○	○	○	○	×	○	○	○	○	○
306	Analog output signal selection [AY]	06	86	3	○	○	○	○	○	○	○	○	○	○
307	Setting for zero analog output [AY]	07	87	3	○	○	○	○	○	○	○	○	○	○
308	Setting for maximum analog output [AY]	08	88	3	○	○	○	○	○	○	○	○	○	○
309	Analog output signal voltage/current switchover [AY]	09	89	3	○	○	○	○	○	○	○	○	○	○
310	Analog meter voltage output selection [AY]	0A	8A	3	○	○	○	○	○	○	○	○	○	○
311	Setting for zero analog meter voltage output [AY]	0B	8B	3	○	○	○	○	○	○	○	○	○	○
312	Setting for maximum analog meter voltage output [AY]	0C	8C	3	○	○	○	○	○	○	○	○	○	○
313	DO0 output selection [AY] [NC]	0D	8D	3	○	○	○	○	○	○	○	○	○	○
314	DO1 output selection [AY] [NC]	0E	8E	3	○	○	○	○	○	○	○	○	○	○
315	DO2 output selection [AY] [NC]	0F	8F	3	○	○	○	○	○	○	○	○	○	○
316	DO3 output selection [AY]	10	90	3	○	○	○	○	○	○	○	○	○	○
317	DO4 output selection [AY]	11	91	3	○	○	○	○	○	○	○	○	○	○
318	DO5 output selection [AY]	12	92	3	○	○	○	○	○	○	○	○	○	○
319	DO6 output selection [AY]	13	93	3	○	○	○	○	○	○	○	○	○	○
320	RA1 output selection [AR]	14	94	3	○	○	○	○	○	○	○	○	○	○
321	RA2 output selection [AR]	15	95	3	○	○	○	○	○	○	○	○	○	○
322	RA3 output selection [AR]	16	96	3	○	○	○	○	○	○	○	○	○	○
323	AM0 0V adjustment [AY]	17	97	3	○	○	○	○	○	○	○	○	×	○
324	AM1 0mA adjustment [AY]	18	98	3	○	○	○	○	○	○	○	○	×	○
329	Digital input increments selection [AX]	1D	9D	3	○	○	○	○	×	○	○	○	×	○
331	RS-485 communication station	1F	9F	3	○	○	○	○	○	○	○	○	○*	○*

Parameter	Name	Instruction Code *1			Control Mode-based Correspondence Table *2								Parameter Copy *3	Parameter Clear *3	All Parameter Clear *3
		Read	Write	Extended	V/F Control	Advanced magnetic flux vector control	Vector control			Real sensorless vector control					
							Speed control	Torque control	Position control	Speed control	Torque control				
332	RS-485 communication speed	20	A0	3	○	○	○	○	○	○	○	○	○	○	○
333	RS-485 communication stop bit length	21	A1	3	○	○	○	○	○	○	○	○	○	○	○
334	RS-485 communication parity check selection	22	A2	3	○	○	○	○	○	○	○	○	○	○	○
335	RS-485 communication retry count	23	A3	3	○	○	○	○	○	○	○	○	○	○	○
336	RS-485 communication check time interval	24	A4	3	○	○	○	○	○	○	○	○	○	○	○
337	RS-485 communication waiting time setting	25	A5	3	○	○	○	○	○	○	○	○	○	○	○
338	Communication operation command source	26	A6	3	○	○	○	○	○	○	○	○	○	○	○
339	Communication speed command source	27	A7	3	○	○	○	○	○	○	○	○	○	○	○
340	Communication startup mode selection	28	A8	3	○	○	○	○	○	○	○	○	○	○	○
341	RS-485 communication CR/LF selection	29	A9	3	○	○	○	○	○	○	○	○	○	○	○
342	Communication EEPROM write selection	2A	AA	3	○	○	○	○	○	○	○	○	○	○	○
343	Communication error count	2B	AB	3	○	○	○	○	○	○	○	×	×	×	×
345	DeviceNet address [ND]	2D	AD	3	○	○	○	○	○	○	○	○	○	○	○
346	DeviceNet baud rate [ND]	2E	AE	3	○	○	○	○	○	○	○	○	○	○	○
349	Communication reset selection [NC] [ND] [NL] [NP]	31	B1	3	○	○	○	○	○	○	○	○	○	○	○
350	Stop position command selection [AP] [AL]	32	B2	3	○	○	○	×	×	×	×	○	○	○	○
351	Orientation speed [AP] [AL]	33	B3	3	○	○	○	×	×	×	×	○	○	○	○
352	Creep speed [AP] [AL]	34	B4	3	○	○	○	×	×	×	×	○	○	○	○
353	Creep switchover position [AP] [AL]	35	B5	3	○	○	○	×	×	×	×	○	○	○	○
354	Position loop switchover position [AP] [AL]	36	B6	3	○	○	○	×	×	×	×	○	○	○	○
355	DC injection brake start position [AP] [AL]	37	B7	3	○	○	○	×	×	×	×	○	○	○	○
356	Internal stop position command [AP] [AL]	38	B8	3	○	○	○	×	×	×	×	○	○	○	○
357	Orientation in-position zone [AP] [AL]	39	B9	3	○	○	○	×	×	×	×	○	○	○	○
358	Servo torque selection [AP] [AL]	3A	BA	3	○	○	○	×	×	×	×	○	○	○	○
359	Encoder rotation direction [AP] [AL]	3B	BB	3	○	○	○	○	○	○	×	×	○	○	○
360	16 bit data selection [AP] [AL]	3C	BC	3	○	○	○	×	×	×	×	○	○	○	○
361	Position shift [AP] [AL]	3D	BD	3	○	○	○	×	×	×	×	○	○	○	○
362	Orientation position loop gain [AP] [AL]	3E	BE	3	○	○	○	×	×	×	×	○	○	○	○
363	Completion signal output delay time [AP] [AL]	3F	BF	3	○	○	○	×	×	×	×	○	○	○	○
364	Encoder stop check time [AP] [AL]	40	C0	3	○	○	○	×	×	×	×	○	○	○	○
365	Orientation limit [AP] [AL]	41	C1	3	○	○	○	×	×	×	×	○	○	○	○

Parameter	Name	Instruction Code *1			Control Mode-based Correspondence Table *2								Parameter Copy *3	Parameter Clear *3	All Parameter Clear *3
		Read	Write	Extended	V/F Control	Advanced magnetic flux vector control	Vector control			Real sensorless vector control					
							Speed control	Torque control	Position control	Speed control	Torque control				
366	Recheck time [AP] [AL]	42	C2	3	○	○	○	×	×	×	×	○	○	○	
367	Speed feedback range [AP] [AL]	43	C3	3	○	○	○	×	×	×	×	○	○	○	
368	Feedback gain [AP] [AL]	44	C4	3	○	○	×	×	×	×	×	○	○	○	
369	Number of encoder pulses [AP] [AL]	45	C5	3	○	○	○	○	○	×	×	○	○	○	
374	Overspeed detection level	4A	CA	3	×	×	○	○	○	○	○	○	○	○	
376	Encoder signal loss detection enable/disable selection [AP] [AL]	4C	CC	3	○	○	○	○	○	×	×	○	○	○	
379	SSCNET III rotation direction selection [NS]	4F	CF	3	×	×	○	○	○	×	×	○	○	○	
380	Acceleration S-pattern 1	50	D0	3	○	○	○	○	×	○	○	○	○	○	
381	Deceleration S-pattern 1	51	D1	3	○	○	○	○	×	○	○	○	○	○	
382	Acceleration S-pattern 2	52	D2	3	○	○	○	○	×	○	○	○	○	○	
383	Deceleration S-pattern 2	53	D3	3	○	○	○	○	×	○	○	○	○	○	
384	Input pulse division scaling factor	54	D4	3	○	○	○	○	×	○	○	○	○	○	
385	Frequency for 0 input pulse	55	D5	3	○	○	○	○	×	○	○	○	○	○	
386	Frequency for maximum input pulse	56	D6	3	○	○	○	○	×	○	○	○	○	○	
387	Initial communication delay time [NL]	57	D7	3	○	○	○	○	○	○	○	○	○	○	
388	Send time interval at heart beat [NL]	58	D8	3	○	○	○	○	○	○	○	○	○	○	
389	Minimum sending time at heart beat [NL]	59	D9	3	○	○	○	○	○	○	○	○	○	○	
390	% setting reference frequency [NL]	5A	DA	3	○	○	○	○	○	○	○	○	○	○	
391	Receive time interval at heart beat [NL]	5B	DB	3	○	○	○	○	○	○	○	○	○	○	
392	Event driven detection width [NL]	5C	DC	3	○	○	○	○	○	○	○	○	○	○	
393	Orientation selection [AP] [AL]	5D	DD	3	×	×	○	×	×	×	×	○	○	○	
396	Orientation speed gain (P term) [AP] [AL]	60	E0	3	×	×	○	×	×	×	×	○	○	○	
397	Orientation speed integral time [AP] [AL]	61	E1	3	×	×	○	×	×	×	×	○	○	○	
398	Orientation speed gain (D term) [AP] [AL]	62	E2	3	×	×	○	×	×	×	×	○	○	○	
399	Orientation deceleration ratio [AP] [AL]	63	E3	3	×	×	○	×	×	×	×	○	○	○	
406	High resolution analog input selection [AZ]	06	86	4	○	○	○	○	○	○	○	○	×	○	
407	Motor temperature detection filter [AZ]	07	87	4	○	○	○	○	○	○	○	○	○	○	
408	Motor thermistor selection [AZ]	08	88	4	○	○	○	○	○	○	○	○	○	○	
413	Encoder pulse division ratio [AL]	0D	8D	4	○	○	○	○	○	○	○	○	○	○	
419	Position command source selection [AP] [AL]	13	93	4	×	×	×	×	○	×	×	○	○	○	

Parameter	Name	Instruction Code *1			Control Mode-based Correspondence Table *2								Parameter Copy *3	Parameter Clear *3	All Parameter Clear *3
		Read	Write	Extended	V/F Control	Advanced magnetic flux vector control	Vector control			Real sensorless vector control					
							Speed control	Torque control	Position control	Speed control	Torque control				
420	Command pulse scaling factor numerator <input type="checkbox"/> AP <input type="checkbox"/> AL	14	94	4	×	×	×	×	○	×	×	○	○	○	
421	Command pulse scaling factor denominator <input type="checkbox"/> AP <input type="checkbox"/> AL	15	95	4	×	×	×	×	○	×	×	○	○	○	
422	Position loop gain <input type="checkbox"/> AP <input type="checkbox"/> AL	16	96	4	×	×	×	×	○	×	×	○	○	○	
423	Position feed forward gain <input type="checkbox"/> AP <input type="checkbox"/> AL	17	97	4	×	×	×	×	○	×	×	○	○	○	
424	Position command acceleration/deceleration time constant <input type="checkbox"/> AP <input type="checkbox"/> AL	18	98	4	×	×	×	×	○	×	×	○	○	○	
425	Position feed forward command filter <input type="checkbox"/> AP <input type="checkbox"/> AL	19	99	4	×	×	×	×	○	×	×	○	○	○	
426	In-position width <input type="checkbox"/> AP <input type="checkbox"/> AL	1A	9A	4	×	×	×	×	○	×	×	○	○	○	
427	Excessive level error <input type="checkbox"/> AP <input type="checkbox"/> AL	1B	9B	4	×	×	×	×	○	×	×	○	○	○	
428	Command pulse selection <input type="checkbox"/> AP <input type="checkbox"/> AL	1C	9C	4	×	×	×	×	○	×	×	○	○	○	
429	Clear signal selection <input type="checkbox"/> AP <input type="checkbox"/> AL	1D	9D	4	×	×	×	×	○	×	×	○	○	○	
430	Pulse monitor selection <input type="checkbox"/> AP <input type="checkbox"/> AL	1E	9E	4	×	×	×	×	○	×	×	○	○	○	
432	Pulse train torque command bias <input type="checkbox"/> AL	20	A0	4	×	×	×	○	×	×	○	○	○	○	
433	Pulse train torque command gain <input type="checkbox"/> AL	21	A1	4	×	×	×	○	×	×	○	○	○	○	
447	Digital torque command bias <input type="checkbox"/> AX	2F	AF	4	×	×	×	○	×	×	○	○	○	○	
448	Digital torque command gain <input type="checkbox"/> AX	30	B0	4	×	×	×	○	×	×	○	○	○	○	
449	SSCNET III input filter setting <input type="checkbox"/> NS	31	B1	4	×	×	○	○	○	×	×	○	○	○	
450	Second applied motor	32	B2	4	○	○	×	×	×	○	○	○	○	○	
451	Second motor control method selection	33	B3	4	○	○	×	×	×	○	○	○	○	○	
453	Second motor capacity	35	B5	4	×	○	×	×	×	○	○	○	○	○	
454	Number of second motor poles	36	B6	4	×	○	×	×	×	○	○	○	○	○	
455	Second motor excitation current	37	B7	4	×	○	×	×	×	○	○	○	×	○	
456	Rated second motor voltage	38	B8	4	×	○	×	×	×	○	○	○	○	○	
457	Rated second motor frequency	39	B9	4	×	○	×	×	×	○	○	○	○	○	
458	Second motor constant (R1)	3A	BA	4	×	○	×	×	×	○	○	○	×	○	
459	Second motor constant (R2)	3B	BB	4	×	○	×	×	×	○	○	○	×	○	
460	Second motor constant (L1)	3C	BC	4	×	○	×	×	×	○	○	○	×	○	
461	Second motor constant (L2)	3D	BD	4	×	○	×	×	×	○	○	○	×	○	
462	Second motor constant (X)	3E	BE	4	×	○	×	×	×	○	○	○	×	○	
463	Second motor auto tuning setting/status	3F	BF	4	×	○	×	×	×	○	○	○	×	○	
464	Digital position control sudden stop deceleration time <input type="checkbox"/> AP <input type="checkbox"/> AL	40	C0	4	×	×	×	×	○	×	×	○	○	○	
465	First position feed amount lower 4 digits <input type="checkbox"/> AP <input type="checkbox"/> AL	41	C1	4	×	×	×	×	○	×	×	○	○	○	
466	First position feed amount upper 4 digits <input type="checkbox"/> AP <input type="checkbox"/> AL	42	C2	4	×	×	×	×	○	×	×	○	○	○	



Parameter	Name	Instruction Code *1			Control Mode-based Correspondence Table *2							Parameter Copy *3	Parameter Clear *3	All Parameter Clear *3
		Read	Write	Extended	V/F Control	Advanced magnetic flux vector control	Vector control			Real sensorless vector control				
							Speed control	Torque control	Position control	Speed control	Torque control			
467	Second position feed amount lower 4 digits <small>[AP] [AL]</small>	43	C3	4	×	×	×	×	○	×	×	○	○	○
468	Second position feed amount upper 4 digits <small>[AP] [AL]</small>	44	C4	4	×	×	×	×	○	×	×	○	○	○
469	Third position feed amount lower 4 digits <small>[AP] [AL]</small>	45	C5	4	×	×	×	×	○	×	×	○	○	○
470	Third position feed amount upper 4 digits <small>[AP] [AL]</small>	46	C6	4	×	×	×	×	○	×	×	○	○	○
471	Fourth position feed amount lower 4 digits <small>[AP] [AL]</small>	47	C7	4	×	×	×	×	○	×	×	○	○	○
472	Fourth position feed amount upper 4 digits <small>[AP] [AL]</small>	48	C8	4	×	×	×	×	○	×	×	○	○	○
473	Fifth position feed amount lower 4 digits <small>[AP] [AL]</small>	49	C9	4	×	×	×	×	○	×	×	○	○	○
474	Fifth position feed amount upper 4 digits <small>[AP] [AL]</small>	4A	CA	4	×	×	×	×	○	×	×	○	○	○
475	Sixth position feed amount lower 4 digits <small>[AP] [AL]</small>	4B	CB	4	×	×	×	×	○	×	×	○	○	○
476	Sixth position feed amount upper 4 digits <small>[AP] [AL]</small>	4C	CC	4	×	×	×	×	○	×	×	○	○	○
477	Seventh position feed amount lower 4 digits <small>[AP] [AL]</small>	4D	CD	4	×	×	×	×	○	×	×	○	○	○
478	Seventh position feed amount upper 4 digits <small>[AP] [AL]</small>	4E	CE	4	×	×	×	×	○	×	×	○	○	○
479	Eighth position feed amount lower 4 digits <small>[AP] [AL]</small>	4F	CF	4	×	×	×	×	○	×	×	○	○	○
480	Eighth position feed amount upper 4 digits <small>[AP] [AL]</small>	50	D0	4	×	×	×	×	○	×	×	○	○	○
481	Ninth position feed amount lower 4 digits <small>[AP] [AL]</small>	51	D1	4	×	×	×	×	○	×	×	○	○	○
482	Ninth position feed amount upper 4 digits <small>[AP] [AL]</small>	52	D2	4	×	×	×	×	○	×	×	○	○	○
483	Tenth position feed amount lower 4 digits <small>[AP] [AL]</small>	53	D3	4	×	×	×	×	○	×	×	○	○	○
484	Tenth position feed amount upper 4 digits <small>[AP] [AL]</small>	54	D4	4	×	×	×	×	○	×	×	○	○	○
485	Eleventh position feed amount lower 4 digits <small>[AP] [AL]</small>	55	D5	4	×	×	×	×	○	×	×	○	○	○
486	Eleventh position feed amount upper 4 digits <small>[AP] [AL]</small>	56	D6	4	×	×	×	×	○	×	×	○	○	○
487	Twelfth position feed amount lower 4 digits <small>[AP] [AL]</small>	57	D7	4	×	×	×	×	○	×	×	○	○	○
488	Twelfth position feed amount upper 4 digits <small>[AP] [AL]</small>	58	D8	4	×	×	×	×	○	×	×	○	○	○
489	Thirteenth position feed amount lower 4 digits <small>[AP] [AL]</small>	59	D9	4	×	×	×	×	○	×	×	○	○	○
490	Thirteenth position feed amount upper 4 digits <small>[AP] [AL]</small>	5A	DA	4	×	×	×	×	○	×	×	○	○	○
491	Fourteenth position feed amount lower 4 digits <small>[AP] [AL]</small>	5B	DB	4	×	×	×	×	○	×	×	○	○	○
492	Fourteenth position feed amount upper 4 digits <small>[AP] [AL]</small>	5C	DC	4	×	×	×	×	○	×	×	○	○	○

Parameter	Name	Instruction Code *1			Control Mode-based Correspondence Table *2								Parameter Copy *3	Parameter Clear *3	All Parameter Clear *3
		Read	Write	Extended	V/F Control	Advanced magnetic flux vector control	Vector control			Real sensorless vector control					
							Speed control	Torque control	Position control	Speed control	Torque control				
493	Fifteenth position feed amount lower 4 digits <input type="checkbox"/> AP <input type="checkbox"/> AL	5D	DD	4	×	×	×	×	○	×	×	○	○	○	
494	Fifteenth position feed amount upper 4 digits <input type="checkbox"/> AP <input type="checkbox"/> AL	5E	DE	4	×	×	×	×	○	×	×	○	○	○	
495	Remote output selection	5F	DF	4	○	○	○	○	○	○	○	○	○	○	
496	Remote output data 1	60	E0	4	○	○	○	○	○	○	○	×	×	×	
497	Remote output data 2	61	E1	4	○	○	○	○	○	○	○	×	×	×	
499	SSCNET III operation selection <input type="checkbox"/> NS	63	E3	4	×	×	○	○	○	×	×	○	○	○	
500	Communication error execution waiting time <input type="checkbox"/> NC <input type="checkbox"/> ND <input type="checkbox"/> NL <input type="checkbox"/> NP	00	80	5	○	○	○	○	○	○	○	○	○	○	
501	Communication error occurrence count display <input type="checkbox"/> NC <input type="checkbox"/> ND <input type="checkbox"/> NL <input type="checkbox"/> NP	01	81	5	○	○	○	○	○	○	○	×	○	○	
502	Stop mode selection at communication error <input type="checkbox"/> NC <input type="checkbox"/> ND <input type="checkbox"/> NL <input type="checkbox"/> NP	02	82	5	○	○	○	○	○	○	○	○	○	○	
503	Maintenance timer	03	83	5	○	○	○	○	○	○	○	×	×	×	
504	Maintenance timer alarm output set time	04	84	5	○	○	○	○	○	○	○	○	×	○	
505	Speed setting reference	05	85	5	○	○	○	○	○	○	○	○	○	○	
516	S-pattern time at a start of acceleration	10	90	5	○	○	○	○	×	○	○	○	○	○	
517	S-pattern time at a completion of acceleration	11	91	5	○	○	○	○	×	○	○	○	○	○	
518	S-pattern time at a start of deceleration	12	92	5	○	○	○	○	×	○	○	○	○	○	
519	S-pattern time at a completion of deceleration	13	93	5	○	○	○	○	×	○	○	○	○	○	
539	Modbus-RTU communication check time interval	27	A7	5	○	○	○	○	○	○	○	○	○*6	○*6	
541	Frequency command sign selection (CC-Link) <input type="checkbox"/> NC	29	A9	5	○	○	○	×	×	○	×	○	○*6	○*6	
542	Communication station number (CC-Link) <input type="checkbox"/> NC	2A	AA	5	○	○	○	○	○	○	○	○	○*6	○*6	
543	Baud rate (CC-Link) <input type="checkbox"/> NC	2B	AB	5	○	○	○	○	○	○	○	○	○*6	○*6	
544	CC-Link extended setting <input type="checkbox"/> NC	2C	AC	5	○	○	○	○	○	○	○	○	○*6	○*6	
547	USB communication station number	2F	AF	5	○	○	○	○	○	○	○	○	○*6	○*6	
548	USB communication check time interval	30	B0	5	○	○	○	○	○	○	○	○	○*6	○*6	
549	Protocol selection	31	B1	5	○	○	○	○	○	○	○	○	○*6	○*6	
550	NET mode operation command source selection	32	B2	5	○	○	○	○	○	○	○	○	○*6	○*6	
551	PU mode operation command source selection	33	B3	5	○	○	○	○	○	○	○	○	○*6	○*6	
555	Current average time	37	B7	5	○	○	○	○	○	○	○	○	○	○	
556	Data output mask time	38	B8	5	○	○	○	○	○	○	○	○	○	○	
557	Current average value monitor signal output reference current	39	B9	5	○	○	○	○	○	○	○	○	○	○	

Parameter	Name	Instruction Code *1			Control Mode-based Correspondence Table *2							Parameter Copy *3	Parameter Clear *3	All Parameter Clear *3
		Read	Write	Extended	V/F Control	Advanced magnetic flux vector control	Vector control			Real sensorless vector control				
							Speed control	Torque control	Position control	Speed control	Torque control			
563	Energization time carrying-over times	3F	BF	5	○	○	○	○	○	○	○	×	×	×
564	Operating time carrying-over times	40	C0	5	○	○	○	○	○	○	○	×	×	×
569	Second motor speed control gain	45	C5	5	×	○	×	×	×	×	×	○	×	○
571	Holding time at a start	47	C7	5	○	○	○	○	×	○	○	○	○	○
574	Second motor online auto tuning	4A	CA	5	×	○	×	×	×	○	○	○	○	○
575	Output interruption detection time	4B	CB	5	○	○	○	×	×	○	×	○	○	○
576	Output interruption detection level	4C	CC	5	○	○	○	×	×	○	×	○	○	○
577	Output interruption cancel level	4D	CD	5	○	○	○	×	×	○	×	○	○	○
611	Acceleration time at a restart	0B	8B	6	○	○	○	×	×	○	×	○	○	○
665	Regeneration avoidance frequency gain	41	C1	6	○	○	○	×	×	○	×	○	○	○
684	Tuning data increments switchover	54	D4	6	×	○	○	○	○	○	○	○	○	○
800	Control method selection	00	80	8	○	○	○	○	○	○	○	○	○	○
802	Pre-excitation selection [AP] [AL]	02	82	8	×	×	○	×	×	×	×	○	○	○
803	Constant power range torque characteristic selection	03	83	8	×	×	○	○	○	○	○	○	○	○
804	Torque command source selection	04	84	8	×	×	×	○	×	×	○	○	○	○
805	Torque command value (RAM)	05	85	8	×	×	×	○	×	×	○	×	○	○
806	Torque command value (RAM,EEPROM)	06	86	8	×	×	×	○	×	×	○	○	○	○
807	Speed limit selection	07	87	8	×	×	×	○	×	×	○	○	○	○
808	Forward rotation speed limit	08	88	8	×	×	×	○	×	×	○	○	○	○
809	Reverse rotation speed limit	09	89	8	×	×	×	○	×	×	○	○	○	○
810	Torque limit input method selection	0A	8A	8	×	×	○	×	○	○	×	○	○	○
811	Set resolution switchover	0B	8B	8	○	○	○	○	○	○	○	○	○	○
812	Torque limit level (regeneration)	0C	8C	8	×	×	○	×	○	○	×	○	○	○
813	Torque limit level (3rd quadrant)	0D	8D	8	×	×	○	×	○	○	×	○	○	○
814	Torque limit level (4th quadrant)	0E	8E	8	×	×	○	×	○	○	×	○	○	○
815	Torque limit level 2	0F	8F	8	×	×	○	×	○	○	×	○	○	○
816	Torque limit level during acceleration	10	90	8	×	×	○	×	○	○	×	○	○	○
817	Torque limit level during deceleration	11	91	8	×	×	○	×	○	○	×	○	○	○
818	Easy gain tuning response level setting	12	92	8	×	×	○	×	○	○	×	○	○	○
819	Easy gain tuning selection	13	93	8	×	×	○	×	○	○	×	○	×	○
820	Speed control P gain 1	14	94	8	×	×	○	×	○	○	×	○	○	○
821	Speed control integral time 1	15	95	8	×	×	○	×	○	○	×	○	○	○
822	Speed setting filter 1	16	96	8	×	×	○	○	×	○	○	○	○	○
823	Speed detection filter 1 [AP] [AL]	17	97	8	×	×	○	○	○	×	×	○	○	○
824	Torque control P gain 1	18	98	8	×	×	○	○	○	○	○	○	○	○

Parameter	Name	Instruction Code *1			Control Mode-based Correspondence Table *2							Parameter Copy *3	Parameter Clear *3	All Parameter Clear *3
		Read	Write	Extended	V/F Control	Advanced magnetic flux vector control	Vector control			Real sensorless vector control				
							Speed control	Torque control	Position control	Speed control	Torque control			
825	Torque control integral time 1	19	99	8	×	×	○	○	○	○	○	○	○	○
826	Torque setting filter 1	1A	9A	8	×	×	○	○	○	○	○	○	○	○
827	Torque detection filter 1	1B	9B	8	×	×	○	○	○	○	○	○	○	○
828	Model speed control gain	1C	9C	8	×	×	○	×	○	○	×	○	○	○
829	Number of machine end encoder pulses [AL]	1D	9D	8	○	○	○	×	×	×	×	○	○	○
830	Speed control P gain 2	1E	9E	8	×	×	○	×	○	○	×	○	○	○
831	Speed control integral time 2	1F	9F	8	×	×	○	×	○	○	×	○	○	○
832	Speed setting filter2	20	A0	8	×	×	○	○	×	○	○	○	○	○
833	Speed detection filter 2 [AP] [AL]	21	A1	8	×	×	○	×	○	×	×	○	○	○
834	Torque control P gain 2	22	A2	8	×	×	○	○	○	○	○	○	○	○
835	Torque control integral time 2	23	A3	8	×	×	○	○	○	○	○	○	○	○
836	Torque setting filter2	24	A4	8	×	×	○	○	○	○	○	○	○	○
837	Torque detection filter 2	25	A5	8	×	×	○	○	○	○	○	○	○	○
838	DA1 terminal function selection [AZ]	26	A6	8	○	○	○	○	○	○	○	○	○	○
839	DA1 output filter [AZ]	27	A7	8	○	○	○	○	○	○	○	○	○	○
840	Torque bias selection [AP] [AL]	28	A8	8	×	×	○	×	×	×	×	○	○	○
841	Torque bias 1 [AP] [AL]	29	A9	8	×	×	○	×	×	×	×	○	○	○
842	Torque bias 2 [AP] [AL]	2A	AA	8	×	×	○	×	×	×	×	○	○	○
843	Torque bias 3 [AP] [AL]	2B	AB	8	×	×	○	×	×	×	×	○	○	○
844	Torque bias filter [AP] [AL]	2C	AC	8	×	×	○	×	×	×	×	○	○	○
845	Torque bias operation time [AP] [AL]	2D	AD	8	×	×	○	×	×	×	×	○	○	○
846	Torque bias balance compensation [AP] [AL]	2E	AE	8	×	×	○	×	×	×	×	○	○	○
847	Fall-time torque bias terminal 1 bias [AP] [AL]	2F	AF	8	×	×	○	×	×	×	×	○	○	○
848	Fall-time torque bias terminal 1 gain [AP] [AL]	30	B0	8	×	×	○	×	×	×	×	○	○	○
849	Analog input off set adjustment	31	B1	8	○	○	○	○	○	○	○	○	○	○
850	Control operation selection	32	B2	8	×	×	×	×	×	○	○	○	○	○
853	Speed deviation time [AP] [AL]	35	B5	8	×	×	○	×	×	×	×	○	○	○
854	Excitation ratio	36	B6	8	×	×	○	○	○	○	○	○	○	○
857	DA1-0V adjustment [AZ]	39	B9	8	○	○	○	○	○	○	○	○	×	○
858	Terminal 4 function assignment	3A	BA	8	○	○	○	○	○	○	○	○	×	○
859	Torque current	3B	BB	8	×	○	○	○	○	○	○	○	×	○
860	Second motor torque current	3C	BC	8	×	○	×	×	×	○	○	○	×	○
862	Notch filter time constant	3E	BE	8	×	×	○	×	○	○	×	○	○	○
863	Notch filter depth	3F	BF	8	×	×	○	×	○	○	×	○	○	○
864	Torque detection	40	C0	8	×	×	○	○	○	○	○	○	○	○
865	Low speed detection	41	C1	8	×	×	○	○	○	○	○	○	○	○
866	Torque monitoring reference	42	C2	8	×	○	○	○	○	○	○	○	○	○
867	AM output filter	43	C3	8	○	○	○	○	○	○	○	○	○	○
868	Terminal 1 function assignment	44	C4	8	○	○	○	○	○	○	○	○	×	○
872	Input phase failure protection selection	48	C8	8	○	○	○	○	○	○	○	○	○	○
873	Speed limit [AP] [AL]	49	C9	8	×	×	○	×	×	×	×	○	○	○

Parameter	Name	Instruction Code *1			Control Mode-based Correspondence Table *2							Parameter Copy *3	Parameter Clear *3	All Parameter Clear *3
		Read	Write	Extended	V/F Control	Advanced magnetic flux vector control	Vector control			Real sensorless vector control				
							Speed control	Torque control	Position control	Speed control	Torque control			
874	OLT level setting	4A	CA	8	×	×	○	×	○	○	×	○	○	○
875	Fault definition	4B	CB	8	○	○	○	○	×	○	○	○	○	○
877	Speed feed forward control/ model adaptive speed control selection	4D	CD	8	×	×	○	×	○	○	×	○	○	○
878	Speed feed forward filter	4E	CE	8	×	×	○	×	○	○	×	○	○	○
879	Speed feed forward torque limit	4F	CF	8	×	×	○	×	○	○	×	○	○	○
880	Load inertia ratio	50	D0	8	×	×	○	×	○	○	×	○	×	○
881	Speed feed forward gain	51	D1	8	×	×	○	×	○	○	×	○	○	○
882	Regeneration avoidance operation selection	52	D2	8	○	○	○	×	×	○	×	○	○	○
883	Regeneration avoidance operation level	53	D3	8	○	○	○	×	×	○	×	○	○	○
884	Regeneration avoidance at deceleration detection sensitivity	54	D4	8	○	○	○	×	×	○	×	○	○	○
885	Regeneration avoidance compensation frequency limit value	55	D5	8	○	○	○	×	×	○	×	○	○	○
886	Regeneration avoidance voltage gain	56	D6	8	○	○	○	×	×	○	×	○	○	○
888	Free parameter 1	58	D8	8	○	○	○	○	○	○	○	○	×	×
889	Free parameter 2	59	D9	8	○	○	○	○	○	○	○	○	×	×
891	Cumulative power monitor digit shifted times	5B	DB	8	○	○	○	○	○	○	○	○	○	○
892	Load factor	5C	DC	8	○	○	○	○	○	○	○	○	○	○
893	Energy saving monitor reference (motor capacity)	5D	DD	8	○	○	○	○	○	○	○	○	○	○
894	Control selection during commercial power supply operation	5E	DE	8	○	○	○	○	○	○	○	○	○	○
895	Power saving rate reference value	5F	DF	8	○	○	○	○	○	○	○	○	○	○
896	Power unit cost	60	E0	8	○	○	○	○	○	○	○	○	○	○
897	Power saving monitor average time	61	E1	8	○	○	○	○	○	○	○	○	○	○
898	Power saving cumulative monitor clear	62	E2	8	○	○	○	○	○	○	○	○	×	○
899	Operation time rate (estimated value)	63	E3	8	○	○	○	○	○	○	○	○	○	○
C0 (900)	FM terminal calibration	5C	DC	1	○	○	○	○	○	○	○	○	×	○
C1 (901)	AM terminal calibration	5D	DD	1	○	○	○	○	○	○	○	○	×	○
C2 (902)	Terminal 2 frequency setting bias frequency	5E	DE	1	○	○	○	○	○	○	○	○	×	○
C3 (902)	Terminal 2 frequency setting bias	5E	DE	1	○	○	○	○	○	○	○	○	×	○
125 (903)	Terminal 2 frequency setting gain frequency	5F	DF	1	○	○	○	○	○	○	○	○	×	○
C4 (903)	Terminal 2 frequency setting gain	5F	DF	1	○	○	○	○	○	○	○	○	×	○
C5 (904)	Terminal 4 frequency setting bias frequency	60	E0	1	○	○	○	○	○	○	○	○	×	○

Parameter	Name	Instruction Code *1			Control Mode-based Correspondence Table *2								Parameter Copy *3	Parameter Clear *3	All Parameter Clear *3
		Read	Write	Extended	V/F Control	Advanced magnetic flux vector control	Vector control			Real sensorless vector control					
							Speed control	Torque control	Position control	Speed control	Torque control				
C6 (904)	Terminal 4 frequency setting bias	60	E0	1	○	○	○	○	○	○	○	○	○	×	○
126 (905)	Terminal 4 frequency setting gain frequency	61	E1	1	○	○	○	○	○	○	○	○	○	×	○
C7 (905)	Terminal 4 frequency setting gain	61	E1	1	○	○	○	○	○	○	○	○	○	×	○
C12 (917)	Terminal 1 bias frequency (speed)	11	91	9	×	×	○	○	○	○	○	○	○	×	○
C13 (917)	Terminal 1 bias frequency (speed)	11	91	9	×	×	○	○	○	○	○	○	○	×	○
C14 (918)	Terminal 1 gain frequency (speed)	12	92	9	×	×	○	○	○	○	○	○	○	×	○
C15 (918)	Terminal 1 gain (speed)	12	92	9	×	×	○	○	○	○	○	○	○	×	○
C16 (919)	Terminal 1 bias command (torque/magnetic flux)	13	93	9	×	×	○	○	○	○	○	○	○	×	○
C17 (919)	Terminal 1 bias (torque/magnetic flux)	13	93	9	×	×	○	○	○	○	○	○	○	×	○
C18 (920)	Terminal 1 gain command (torque/magnetic flux)	14	94	9	×	×	○	○	○	○	○	○	○	×	○
C19 (920)	Terminal 1 gain (torque/magnetic flux)	14	94	9	×	×	○	○	○	○	○	○	○	×	○
C29 (925)	Motor temperature detection calibration (analog input) [AZ]	19	99	9	○	○	○	○	○	○	○	○	○	×	○
C30 (926)	Terminal 6 bias frequency (speed) [AZ]	1A	9A	9	○	○	○	○	○	○	○	○	○	×	○
C31 (926)	Terminal 6 bias (speed) [AZ]	1A	9A	9	○	○	○	○	○	○	○	○	○	×	○
C32 (927)	Terminal 6 gain frequency (speed) [AZ]	1B	9B	9	○	○	○	○	○	○	○	○	○	×	○
C33 (927)	Terminal 6 gain (speed) [AZ]	1B	9B	9	○	○	○	○	○	○	○	○	○	×	○
C34 (928)	Terminal 6 bias command (torque) [AZ]	1C	9C	9	×	×	○	○	○	○	○	○	○	×	○
C35 (928)	Terminal 6 bias (torque) [AZ]	1C	9C	9	×	×	○	○	○	○	○	○	○	×	○
C36 (929)	Terminal 6 gain command (torque) [AZ]	1D	9D	9	×	×	○	○	○	○	○	○	○	×	○
C37 (929)	Terminal 6 gain (torque) [AZ]	1D	9D	9	×	×	○	○	○	○	○	○	○	×	○
C38 (932)	Terminal 4 bias command (torque/magnetic flux)	20	A0	9	×	×	○	○	○	○	○	○	○	×	○
C39 (932)	Terminal 4 bias (torque/magnetic flux)	20	A0	9	×	×	○	○	○	○	○	○	○	×	○
C40 (933)	Terminal 4 gain command (torque/magnetic flux)	21	A1	9	×	×	○	○	○	○	○	○	○	×	○
C41 (933)	Terminal 4 gain (torque/magnetic flux)	21	A1	9	×	×	○	○	○	○	○	○	○	×	○
989	Parameter for manufacturer setting. Do not set.														
990	PU buzzer control	5A	DA	9	○	○	○	○	○	○	○	○	○	○	○
991	PU contrast adjustment	5B	DB	9	○	○	○	○	○	○	○	○	○	×	○

## Appendix 3 Specification change

### Appendix 3-1 SERIAL number check

Check the SERIAL number indicated on the inverter rating plate or package. (Refer to page 2)

#### Rating plate example

□	○	○	○○○○○○
Symbol	Year	Month	Control number
SERIAL (Serial No.)			

The SERIAL consists of one symbol, two characters indicating production year and month, and six characters indicating control number.

The last digit of the production year is indicated as the Year, and the Month is indicated by 1 to 9, X (October), Y (November), or Z (December.)

### Appendix 3-2 Changed functions

- (1) · The setting values "65 and 66" are added to *Pr. 52 DU/PU main display data selection*.
- The setting value "2" is added to *Pr. 170 Watt-hour meter clear*.
- Writing/reading of *Pr. 296 Password lock level* and *Pr. 297 Password lock/unlock*, and output of Password locked (LOCd)
- Reading of the monitors dedicated to the Mitsubishi inverter protocol (computer link communication), "output voltage (with regenerative display)" and "cumulative regenerative power"
- Reading of the monitors dedicated to Modbus-RTU communication, "output voltage (with regenerative display)" and "cumulative regenerative power"
- Output of the option fault (E.OPT)

<b>Operation Panel Indication</b>	<b>E.OPT</b>	<i>E.OPT</i>	<b>FR-PU04 FR-PU07</b>	<b>Option Fault</b>
<b>Name</b>	Option fault			
<b>Description</b>	<ul style="list-style-type: none"> <li>• Appears when torque command by the plug-in option is selected using <i>Pr.804 Torque command source selection</i> selection and no plug-in option is mounted.</li> <li>• Appears when the switch for the manufacturer setting of the plug-in option is changed.</li> <li>• <b>Appears when a communication option is connected while <i>Pr. 296 = "0 or 100."</i></b></li> </ul>			
<b>Check point</b>	<ul style="list-style-type: none"> <li>• Check that the plug-in option for torque command setting is connected.</li> <li>• <b>Check for the password lock with a setting of <i>Pr. 296 = "0, 100"</i></b></li> </ul>			
<b>Corrective action</b>	<ul style="list-style-type: none"> <li>• Check for connection of the plug-in option. Check the <i>Pr. 804 Torque command source selection</i> setting.</li> <li>• Return the switch for the manufacturer setting of the plug-in option to the initial status. (Refer to instruction manual of each option)</li> <li>• <b>To apply the password lock when installing a communication option, set <i>Pr.296 ≠ "0,100"</i>.</b></li> <li>• If the problem still persists after taking the above measure, please contact your sales representative.</li> </ul>			

The changes apply to the August 2009 production or later.

- (2) · Compatibility with the plug-in option, FR-A7AL
- The setting value "1" is added to *Pr. 419 Position command source selection*. The setting value "2" is added to *Pr. 804 Torque command source selection*.
- The setting value "2 (magnetic flux decay output shutoff)" is added to *Pr. 850 Brake operation selection*.

The changes apply to the January 2010 production or later.

# MEMO



REVISIONS

\*The manual number is given on the bottom left of the back cover.

Print Date	*Manual Number	Revision
Jan. 2008	IB(NA)-0600337ENG-A	First edition
Mar. 2008	IB(NA)-0600337ENG-B	<p><b>Additions</b></p> <ul style="list-style-type: none"> <li>· FR-A721-18.5K to 55K</li> </ul>
Sep. 2008	IB(NA)-0600337ENG-C	<p><b>Additions</b></p> <ul style="list-style-type: none"> <li>· FR-A741-5.5K to 55K</li> </ul>
Mar. 2011	IB(NA)-0600337ENG-D	<p><b>Addition</b></p> <ul style="list-style-type: none"> <li>· Setting values "65, 66" for <i>Pr. 52 DU/PU main display data selection</i></li> <li>· Setting value "2" for <i>Pr. 170 Watt-hour meter clear</i></li> <li>· <i>Pr. 296 Password lock level</i></li> <li>· <i>Pr. 297 Password lock/unlock</i></li> <li>· Setting value "2" for <i>Pr. 850 Brake operation selection</i></li> <li>· Password locked (LOCD)</li> <li>· Compatibility with FR-A7AL</li> </ul> <p><b>Modification</b></p> <ul style="list-style-type: none"> <li>· Option fault (E.OPT)</li> </ul>

 **For Maximum Safety**

- Mitsubishi inverters are not designed or manufactured to be used in equipment or systems in situations that can affect or endanger human life.
- When considering this product for operation in special applications such as machinery or systems used in passenger transportation, medical, aerospace, atomic power, electric power, or submarine repeating applications, please contact your nearest Mitsubishi sales representative.
- Although this product was manufactured under conditions of strict quality control, you are strongly advised to install safety devices to prevent serious accidents when it is used in facilities where breakdowns of the product are likely to cause a serious accident.
- Please do not use this product for loads other than three-phase induction motors.

# FR-V500, A700, A701 Series

## Instruction Manual Supplement

When installing a thermal relay to the cooling fan of the vector-control dedicated motors (SF-V5RU), use the following recommended thermal relay settings.

- 200V class (Mitsubishi dedicated motor [SF-V5RU (1500r/min series)])

Motor type SF-V5RU□□K		1	2	3	5	7	11	15	18	22	30	37	45	55	
Cooling fan (with thermal protector)*2*3	Voltage	Single-phase 200V/50Hz Single-phase 200V to 230V/60Hz					Three-phase 200V/50Hz Three-phase 200 to 230V/60Hz								
	Input *1	36/55W (0.26/0.32A)		22/28W (0.11/0.13A)		55/71W (0.37/0.39A)			100/156W (0.47/0.53A)			85/130W (0.46/0.52A)			
	Thermal relay settings	0.36A		0.18A		0.51A			0.69A			0.68A			

- 400V class (Mitsubishi dedicated motor [SF-V5RUH (1500r/min series)])

Motor type SF-V5RUH□□K		1	2	3	5	7	11	15	18	22	30	37	45	55	
Cooling fan (with thermal protector)*2*3	Voltage	Single-phase 200V/50Hz Single-phase 200V to 230V/60Hz					Three-phase 380 to 400V/50Hz Three-phase 400 to 460V/60Hz								
	Input *1	36/55W (0.26/0.32A)		22/28W (0.11/0.13A)		55/71W (0.19/0.19A)			100/156W (0.27/0.30A)			85/130W (0.23/0.26A)			
	Thermal relay settings	0.36A		0.18A		0.25A			0.39A			0.34A			

\*1 Power (current) at 50Hz/60Hz.

- \*2 The cooling fan is equipped with a thermal protector. The cooling fan stops when the coil temperature exceeds the specified value in order to protect the fan motor. A restrained cooling fan or degraded fan motor insulation may cause the rise in coil temperature. The fan motor re-starts when the coil temperature drops to normal.
- \*3 The voltage and input values are the standard specifications of the cooling fan in free air. When the cooling fan is used with a motor, it requires more energy to perform its work, and thus the above input values become slightly larger. The cooling fan can, however, be used as it is without causing problems. When a thermal relay is to be prepared at the customer's side, use the recommended thermal relay settings.

# FR-A701 Series

## Instruction Manual Supplement

For the FR-A701 series manufactured in September 2013 or later, the following specifications are added. Check the serial number printed on the rating plate of the inverter. (For how to find the SERIAL number, refer to page 4.)

- Brake sequence function (Pr.278 to Pr.285, Pr.292)

When the brake sequence mode 1 or 2 (Pr.292 = "17 or 18") is selected, the brake sequence remains active even if the RT signal or X9 signal is turned ON to select the second or third function.

Parameter Number	Name	Initial Value	Setting Range	Description	
278	Brake opening frequency	3Hz	0 to 30Hz	Set to the rated slip frequency of the motor + about 1.0Hz. This parameter may be only set if $Pr.278 \leq Pr.282$ .	
279	Brake opening current	130%	0 to 220%	Generally, set this parameter to about 50 to 90%. If the setting is too low, the load is liable to drop due to gravity at start. Suppose that the rated inverter current is 100%.	
280	Brake opening current detection time	0.3s	0 to 2s	Generally, set this parameter to about 0.1 to 0.3s.	
281	Brake operation time at start	0.3s	0 to 5s	Set the mechanical delay time until the brake is loosened when $Pr.292 = "7 \text{ or } 17"$ . Set the mechanical delay time until the brake is loosened + about 0.1 to 0.2s when $Pr.292 = "8 \text{ or } 18"$ .	
282	Brake operation frequency	6Hz	0 to 30Hz	Set the frequency to activate the mechanical brake by turning off the brake opening request signal (BOF). Generally, set this parameter to the $Pr.278$ setting + 3 to 4Hz. Setting is enabled only when $Pr.282 \geq Pr.278$ .	
283	Brake operation time at stop	0.3s	0 to 5s	Set the mechanical delay time until the brake is closed + 0.1s when $Pr.292 = "7 \text{ or } 17"$ . Set the mechanical delay time until the brake is closed + 0.2 to 0.3s when $Pr.292 = "8 \text{ or } 18"$ .	
284	Deceleration detection function selection	0	0	Deceleration is not detected.	
			1	If deceleration is not normal during deceleration operation, the inverter fault is provided.	
285	Overspeed detection frequency*	9999	0 to 30Hz	If (detected frequency) - (output frequency) $\geq Pr.285$ during encoder feedback control, the inverter fault (E.MB1) is provided.	
			9999	Overspeed is not detected.	
292	Automatic acceleration/ deceleration	0	0	Normal operation mode	
			3	Optimum acceleration/deceleration mode (Refer to the Instruction Manual)	
			5, 6	Elevator mode (Refer to the Instruction Manual)	
			7	Brake sequence mode 1	Disabled when the second or third function is selected
			8	Brake sequence mode 2	
			11	Shortest acceleration/deceleration mode (Refer to the Instruction Manual)	
			17	Brake sequence mode 1	Enabled even if the second or third function is selected
18	Brake sequence mode 2				

\* When exercising vector control with the FR-A7AP/FR-A7AL (option), this parameter changes to excessive speed deviation detection frequency. (For details, refer to the Instruction Manual.)

## <Connection diagram>

- Sink logic
- Pr.184 = 15
- Pr.190 = 20

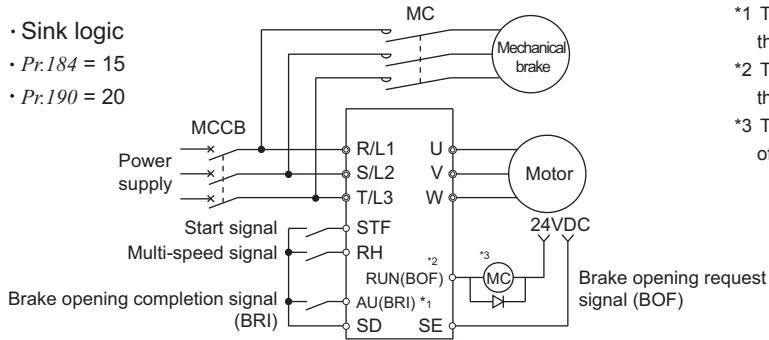

- \*1 The input signal terminal used differs according to the Pr.178 to Pr.189 settings.
- \*2 The output signal terminal used differs according to the Pr.190 to Pr.196 settings.
- \*3 The current should be within the permissible current of transistor in the inverter. (24V 0.1ADC)

### CAUTION

- When brake sequence mode is selected, automatic restart after instantaneous power failure is invalid.
- When using this function, set the acceleration time to 1s or longer.
- Changing the terminal function using any of Pr.178 to Pr.189, Pr.190 to Pr.196 may affect the other functions. Set parameters after confirming the function of each terminal.

### (1) Set the brake sequence mode

- Select either Real sensorless vector control, vector control (speed control) or Advanced magnetic flux vector control. The brake sequence function is valid only when the External operation mode, External/PU combined operation mode 1 or Network operation mode is selected.
- Set "7(17) or 8(18)" (brake sequence mode) in Pr.292.  
To ensure more complete sequence control, it is recommended to set "7(17)" (brake opening completion signal input) in Pr.292.
- Set "15" in any of Pr.178 to Pr.189 (input terminal function selection) and assign the brake opening completion signal (BRI) to the input terminal.
- Set "20 (positive logic)" or "120 (negative logic)" in any of Pr.190 to Pr.196 (output terminal function selection) and assign the brake opening request signal (BOF) to the output terminal.

### (2) With brake opening completion signal input (Pr.292 = "7 or 17")

- When the start signal is input to the inverter, the inverter starts running. When the internal speed command reaches the value set in Pr.278 and the output current is not less than the value set in Pr.279, the inverter outputs the brake opening request signal (BOF) after the time set in Pr.280 has elapsed.  
When the time set in Pr.281 elapses after the brake opening completion signal (BRI) was activated, the inverter increases the output frequency to the set speed.
- When the inverter decelerates to the frequency set in Pr.282 during deceleration, the inverter turns OFF the BOF signal and decelerates further to the frequency set in Pr.278. After electromagnetic brake operation completes and inverter recognizes the turn OFF of BRI signal, the inverter holds the frequency set in Pr.278 for the time set in Pr.283. And after the time set in Pr.283 passes, the inverter decelerates again. The inverter finally stops when its frequency reaches to Pr.13 Starting frequency setting or 0.5Hz, whichever is lower.

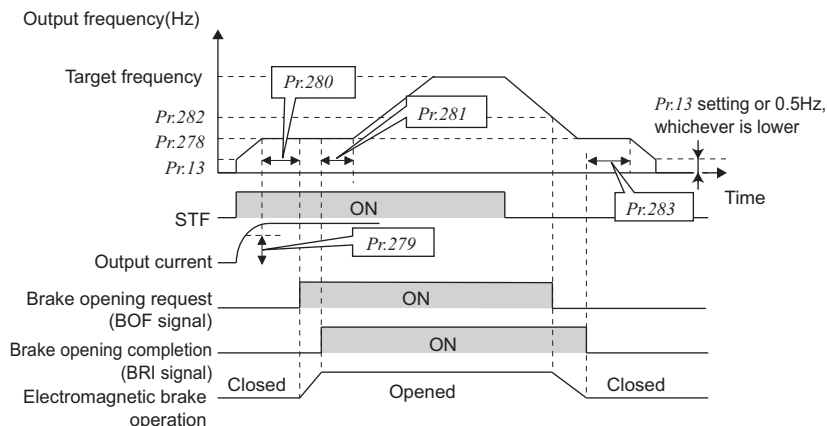

### (3) Without brake opening completion signal input (Pr.292 = "8 or 18")

- When the start signal is input to the inverter, the inverter starts running. When the internal speed command reaches the value set in Pr.278 and the output current is not less than the value set in Pr.279, the inverter outputs the brake opening request signal (BOF) after the time set in Pr.280 has elapsed. When the time set in Pr.281 elapses after the BOF signal is output, the inverter increases the output frequency to the set speed.
- When the inverter decelerates to the frequency set in Pr.282 during deceleration, the inverter turns OFF the BOF signal and decelerates further to the frequency set in Pr.278. After the turn OFF of BOF signal, the inverter holds the frequency set in Pr.278 for the time set in Pr.283. And after the time set in Pr.283 passes, the inverter decelerates again. The inverter finally stops when its frequency reaches to Pr.13 Starting frequency setting or 0.5Hz, whichever is lower.

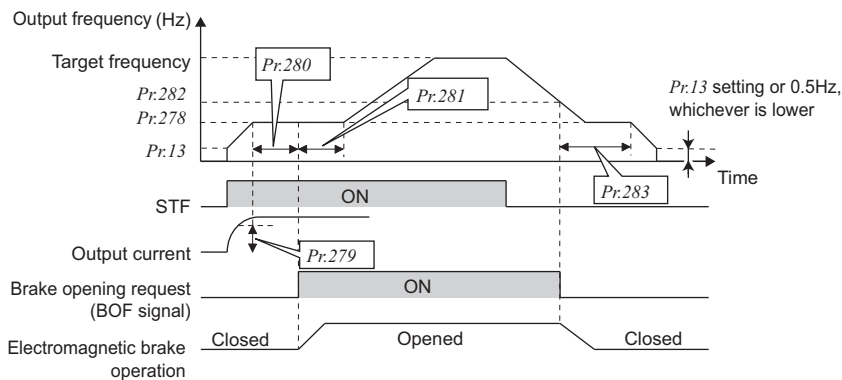

### (4) Relation between Pr.292 Automatic acceleration/deceleration and the RT, X9, or JOG signal

- The table below shows when the function of each input signal becomes available depending on the Pr.292 setting.

Pr.292 setting	RT signal / X9 signal	JOG signal
0	Depending on the Pr.155 setting	Always available
3, 5 to 8, 11	Only during an inverter stop	Only during an inverter stop
17, 18	Depending on the Pr.155 setting	Only during an inverter stop

- The table below shows the relation between each input signal and the operating status depending on the Pr.292 setting.

Pr.292 setting	Input signal status		Operating status (Automatic acceleration/deceleration / Normal operation)	
			During an inverter stop	During inverter operation
0	—		Normal operation	Normal operation
3, 5 to 8, 11	JOG signal	OFF	Automatic acceleration/deceleration (JOG invalid)	Maintains the operating status before switching of the signal
		ON	Normal operation (JOG valid)	
	RT/X9 signal	OFF	Automatic acceleration/deceleration (RT/X9 invalid)	Maintains the operating status before switching of the signal
		ON	Normal operation (RT/X9 valid)	
17, 18	JOG signal	OFF	Automatic acceleration/deceleration (JOG invalid)	Maintains the operating status before switching of the signal
		ON	Normal operation (JOG valid)	
	RT/X9 signal	OFF	Automatic acceleration/deceleration (RT/X9 invalid)	Automatic acceleration/deceleration (RT/X9 invalid)
		ON	Automatic acceleration/deceleration (RT/X9 valid)	Automatic acceleration/deceleration (RT/X9 valid)

## (5) Protective functions

If any of the following errors occurs in the brake sequence mode, the inverter results in a fault, trips, and turns off the brake opening request signal (BOF).

Fault Display	Description
E.MB1	(Detection frequency) - (output frequency) > Pr.285 during encoder feedback control When Pr.285 Overspeed detection frequency = 9999, overspeed is not detected.
E.MB2	Deceleration is not normal during deceleration operation from the set frequency to the frequency set in Pr.282. (when Pr.284 =1) (except stall prevention operation)
E.MB3	Brake opening request signal (BOF) turned on though the motor is at a stop. (gravity drop prevention function)
E.MB4	Although more than 2s have elapsed after the start command (forward or reverse rotation) is input, the brake opening request signal (BOF) does not turn on.
E.MB5	Although more than 2s have elapsed after the brake opening request signal (BOF) turned on, the brake opening completion signal (BRI) does not turn on.
E.MB6	Though the inverter had turned on the brake opening request signal (BOF), the brake opening completion signal (BRI) turned off midway.
E.MB7	Although more than 2s have elapsed after the brake opening request signal (BOF) turned off at a stop, the brake opening completion signal (BRI) does not turn off.

### CAUTION

- During deceleration, inverter output is shut OFF when the frequency reaches Pr.13 Starting frequency or 0.5Hz, whichever is lower. For Pr.278 Brake opening frequency, set a frequency equal to or higher than the Pr.13 setting or 0.5Hz.
- Overspeed detection (Pr.285) is valid under encoder feedback control (used with the FR-A7AP/FR-A7AL (option)) even if a value other than "7, 8, 17 or 18" is set in Pr. 292.
- Setting Pr.278 Brake opening frequency too high activates stall prevention operation and may cause E.MB4.
- If the sum of the time between Pr.13 Starting frequency and Pr.278 Brake opening frequency + Pr.280 Brake opening current detection time is more than 2s, E.MB4 occurs.

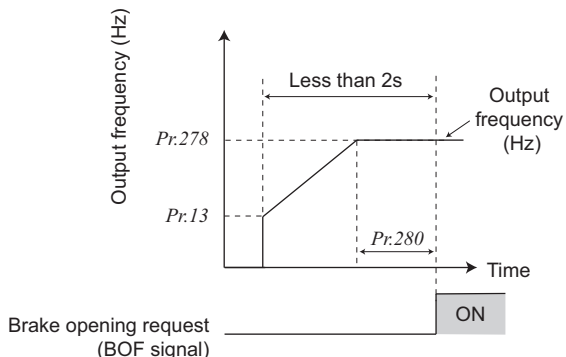

### Additional notes for Instructions for UL and cUL

#### Motor overload protection

When using the electronic thermal relay function as motor overload protection, set the rated motor current in Pr:9 Electronic thermal O/L relay.

### CAUTION

- Motor over temperature sensing is not provided by the drive.

#### General precaution

CAUTION - Risk of Electric Shock -

The bus capacitor discharge time is 10 minutes. Before starting wiring or inspection, switch power off, wait for more than 10 minutes.

ATTENTION - Risque de choc électrique -

La durée de décharge du condensateur de bus est de 10 minutes. Avant de commencer le câblage ou l'inspection, mettez l'appareil hors tension et attendez plus de 10 minutes.

### SERIAL number check

Check the SERIAL number indicated on the inverter rating plate or package.  
Refer to the inverter manual for the location of the rating plate.

#### Rating plate example

□	3	9	○○○○○○
Symbol	Year	Month	Control number
SERIAL (Serial No.)			

The SERIAL consists of one symbol, two characters indicating production year and month, and six characters indicating control number.  
The last digit of the production year is indicated as the Year, and the Month is indicated by 1 to 9, X (October), Y (November), or Z (December).

# FR-A701 Series

## Instruction Manual Supplement

For the FR-A701 series manufactured in January 2015 or later, the following specifications are added. Check the year and month of manufacture by the SERIAL number printed on the rating plate of the inverter.

### ● SERIAL number check

Refer to the inverter manual for the location of the rating plate.

#### Rating plate example

□	5	1	○○○○○○
Symbol	Year	Month	Control number
SERIAL			

The SERIAL consists of one symbol, two characters indicating production year and month, and six characters indicating control number. The last digit of the production year is indicated as the Year, and the Month is indicated by 1 to 9, X (October), Y (November), or Z (December).

In the following sections, P M indicates the functions that are driven by PM sensorless vector control.

## 1 PM sensorless vector control P M

Purpose	Parameters to be Set		Refer to Page
To perform IPM parameter initialization	IPM parameter initialization	Pr. 998	4
To select the torque characteristic in a low-speed range	Low-speed range torque characteristics	Pr. 788	14
To adjust the gain for PM sensorless vector control	Adjusting the speed control gain	Pr. 820, Pr. 821	<i>Chapter 4 of the Instruction Manual (Applied)</i>

Highly efficient motor control and highly accurate motor speed control can be performed by using the inverter with an IPM (internal permanent magnet) motor, which is more efficient than an induction motor.

The motor speed is calculated based on the output voltage and current from the inverter. It does not require a speed detector such as an encoder. The inverter drives the IPM motor with the least required current when a load is applied in order to achieve the highest motor efficiency.

### POINT

The following conditions must be met to perform PM sensorless vector control.

- For the motor model, IPM motor must be used.
- The motor capacity must be equal to or one rank lower than the inverter capacity.
- Single-motor operation (one motor run by one inverter) must be performed.
- The overall wiring length with the motor must be 100m or less. (When the wiring length exceeds 30m, offline auto tuning must be performed.)

### CAUTION

- The speed setting range for an MM-CF IPM motor is between 0 and 200Hz.
- The carrier frequency is limited during PM sensorless vector control. (Refer to *page 17*)
- Constant-speed operation cannot be performed in the low-speed range of 200r/min or less under current synchronization operation. (Refer to *page 14*)
- During PM sensorless vector control, the RUN signal is output about 100ms after turning ON the start command (STF, STR). The delay is due to the magnetic pole detection.
- During PM sensorless vector control, the automatic restart after instantaneous power failure function operates only when an MM-CF IPM motor is connected. However, the frequency search may not be available at 2200 r/min or above. The restart operation cannot be performed until the motor speed drops to a frequency where the frequency search is available.

## 1.1 Setting procedure of PM sensorless vector control P M

- This inverter is set for a general-purpose motor in the initial setting. Follow the following procedure to change the setting for the PM sensorless vector control.

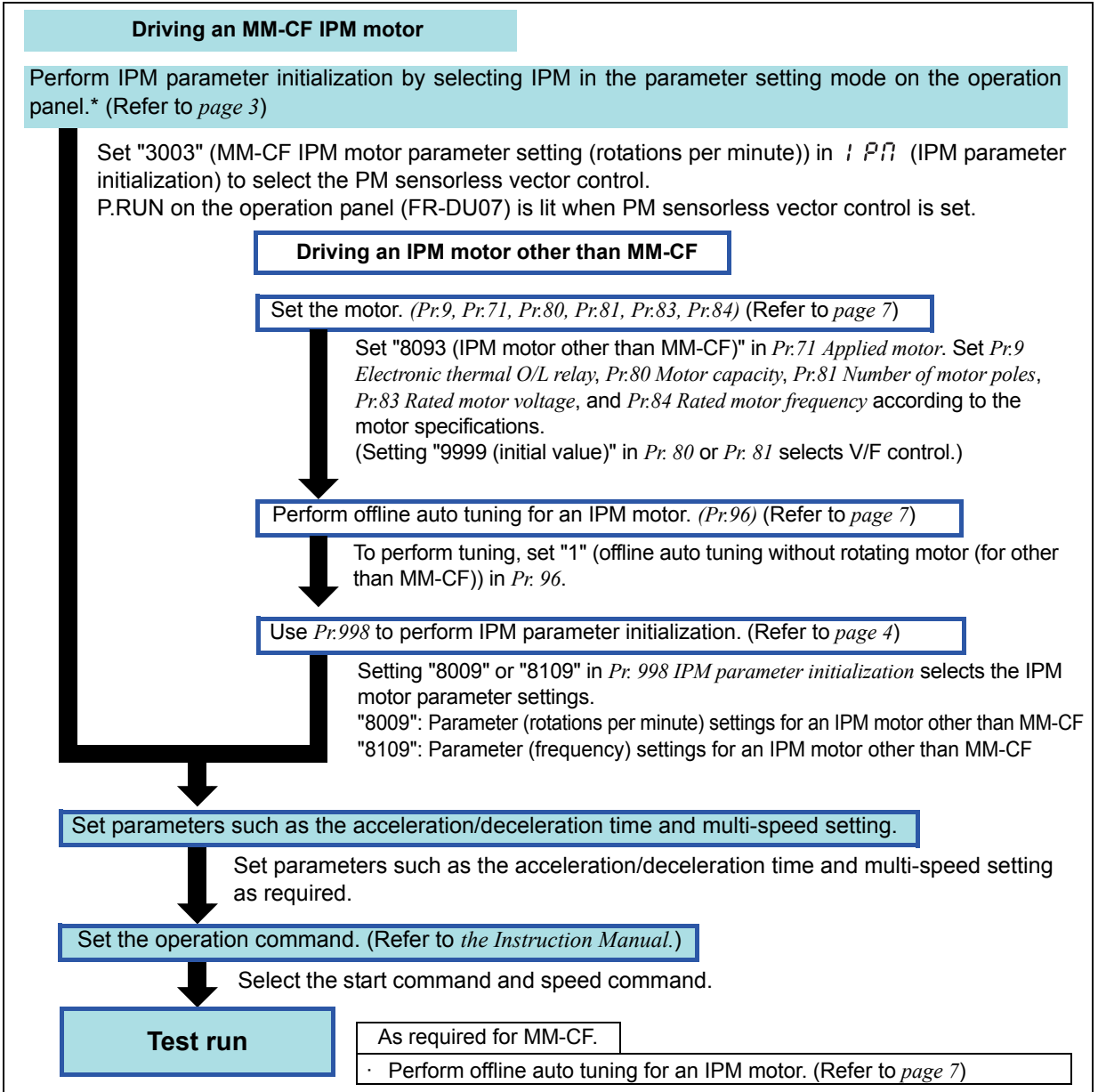

\* Two IPM parameter initialization methods are available for MM-CF IPM motors; setting *Pr.998 IPM parameter initialization*, and selecting  $\text{P}\Omega$  (IPM parameter initialization) mode on the operation panel. One of the two methods can be selected.

To change to the PM sensorless vector control, perform IPM parameter initialization at first. If parameter initialization is performed after setting other parameters, some of those parameters will be initialized too. (Refer to *page 6* for the parameters that are initialized.)

### REMARKS

- To use a motor capacity that is one rank lower than the inverter capacity, set *Pr. 80 Motor capacity* before performing IPM parameter initialization.



# (1) PM sensorless vector control setting by selecting IPM in the parameter setting mode on the operation panel (IPM)

## POINT

- The parameters required to drive an MM-CF IPM motor are automatically changed as a batch. (Refer to page 6)

## Operation example

Initialize the parameter setting for an MM-CF IPM motor by selecting IPM in the parameter setting mode on the operation panel.

Operation	Display
<p>1. Screen at power-ON The monitor display appears.</p>	
<p>2. Parameter setting mode Press <b>(MODE)</b> to choose the parameter setting mode.</p>	<p><b>(MODE)</b> →  (The parameter number read previously appears.)</p>
<p>3. Selecting the parameter Turn <b>(◀)</b> until <b>IPM</b> (IPM parameter initialization) appears.</p>	<p><b>(◀)</b> → </p>
<p>4. Displaying the setting Press <b>(SET)</b> to read the currently set value. "0" (initial value) appears.</p>	<p><b>(SET)</b> → </p>
<p>5. Selecting the setting Turn <b>(◀)</b> to change it to the set value "3003".</p>	<p><b>(◀)</b> → </p>
<p>6. Parameter setting Press <b>(SET)</b> to set.</p>	<p><b>(SET)</b> → </p> <p>Flicker ... Parameter setting complete!! P.RUN indicator is lit.</p>

- Turn **(◀)** to read another parameter.
- Press **(SET)** to show the setting again.
- Press **(SET)** twice to show the automatic parameter setting (AUTO).

Setting	Description
0	Parameter settings for a general-purpose motor
3003	Parameter settings for an IPM motor MM-CF (rotations per minute)

## REMARKS



- Performing IPM parameter initialization by selecting IPM in the parameter setting mode on the operation panel automatically changes the *Pr. 998 IPM parameter initialization* setting.
- In the initial parameter setting, the capacity same as the inverter capacity is set in *Pr. 80 Motor capacity*. (Refer to page 18.) To use a motor capacity that is one rank lower than the inverter capacity, set *Pr. 80 Motor capacity* before performing IPM parameter initialization by selecting the mode on the operation panel.
- To set a speed or to display monitored items in frequency, set *Pr. 998*. (Refer to page 4.)

## (2) PM sensorless vector control display and PM sensorless vector control signal

P.RUN on the operation panel (FR-DU07) is lit and the PM sensorless vector control signal (IPM) is output during PM sensorless vector control.

For the terminal to output the PM sensorless vector control signal, assign the function by setting "57 (positive logic)" or "157 (negative logic)" in any of *Pr.190 to Pr.196 (Output terminal function selection)*.

## (3) Loss of synchronism detection

<b>Operation Panel Indication</b>	<b>E.SOT</b> 		<b>FR-PU04</b>	<b>Fault 14</b>
			<b>FR-PU07</b>	<b>Motor step out</b>
<b>Name</b>	Loss of synchronism detection			
<b>Description</b>	Stops the output when the operation is not synchronized. (This function is only available under PM sensorless vector control.)			
<b>Description</b>	<ul style="list-style-type: none"> <li>· Check that the IPM motor is not driven overloaded.</li> <li>· Check if a start command is given to the inverter while the IPM motor is coasting.</li> <li>· Check if a motor other than the IPM motor (MM-CF series) is driven.</li> </ul>			
<b>Corrective action</b>	<ul style="list-style-type: none"> <li>· Set the acceleration time longer.</li> <li>· Reduce the load.</li> <li>· If the inverter restarts during coasting, set <i>Pr.57 Restart coasting time</i> ≠ "9999," and select the automatic restart after instantaneous power failure.</li> <li>· Drive an IPM motor (MM-CF series).</li> </ul>			

## 1.2 Initializing the parameters required for the PM sensorless vector control

### (Pr.998)

- By performing IPM parameter initialization, PM sensorless vector control is selected and the parameters, which are required to drive an IPM motor, are selected. Initial settings and setting ranges of the parameters are adjusted automatically to drive an IPM motor.
- Two IPM parameter initialization methods are available; setting *Pr.998 IPM parameter initialization*, and selecting *IPM* (IPM parameter initialization) mode on the operation panel. One of the two methods can be selected.

Parameter number	Name	Initial value	Setting range	Description	
998 *1	IPM parameter initialization	0	0	Parameter settings for a general-purpose motor (frequency)	Initial parameter settings required to drive a general-purpose motor are set.
			3003	Parameter settings for an MM-CF IPM motor (rotations per minute)	Initial parameter settings required to drive an IPM motor are set.
			3103	Parameter settings for an MM-CF IPM motor (frequency)	
			8009	Parameter (rotations per minute) settings for an IPM motor other than MM-CF (after tuning) *2	
			8109	Parameter (frequency) settings for an IPM motor other than MM-CF (after tuning) *2	

\*1 This parameter allows its setting to be changed in any operation mode even if "0 (initial value)" is set in *Pr. 77 Parameter write selection*.

\*2 To use an IPM motor other than MM-CF, offline auto tuning must be performed for the IPM motor.

## (1) IPM parameter initialization (Pr.998)

- To use a motor capacity that is one rank lower than the inverter capacity, set *Pr.80 Motor capacity* before performing IPM parameter initialization. By performing IPM parameter initialization, initial settings required to drive an IPM motor are set in parameters.
- When *Pr. 998* = "3003," the monitor is displayed and the frequency is set using the motor rotations per minute. To use frequency to display or set, set *Pr. 998* = "3103."
- Set *Pr. 998* = "0" to change the PM sensorless vector control parameter settings to the parameter settings required to drive a general-purpose motor.
- When using an IPM motor other than MM-CF, set *Pr. 998* = "8009 or 8109" to select the parameter settings required to perform PM sensorless vector control. The setting can be made after performing offline auto tuning for an IPM motor.

<i>Pr.998</i> Setting	Description	Operation IPM in the parameter setting mode
0 (initial value)	Parameter settings for a general-purpose motor (frequency)	<i>IPM</i> (IPM)⇒ Write "0"
3003	Parameter settings for an IPM motor MM-CF (rotations per minute)	<i>IPM</i> (IPM)⇒ Write "3003"
3103	Parameter settings for an IPM motor MM-CF (frequency)	—
8009	Parameter (rotations per minute) settings for an IPM motor other than MM-CF (after tuning)	—
8109	Parameter (frequency) settings for an IPM motor other than MM-CF (after tuning)	—

### REMARKS

- Make sure to set *Pr. 998* before setting other parameters. If the *Pr. 998* setting is changed after setting other parameters, some of those parameters will be initialized too. (Refer to "(2)" for the parameters that are initialized.)
  - To change back to the parameter settings required to drive a general-purpose motor, perform parameter clear or all parameter clear.
  - If the setting of *Pr. 998 IPM parameter initialization* is changed from "3003, 8009 (rotations per minute)" to "3103, 8109 (frequency)," or from "3103, 8109" to "3003, 8009," all the target parameters are initialized.
- The purpose of *Pr. 998* is not to change the display units. Use *Pr. 144 Speed setting switchover* to change the display units between rotations per minute and frequency. *Pr. 144* enables switching of display units between rotations per minute and frequency without initializing the parameter settings.
- Example) Changing the *Pr. 144* setting between "6" and "106" switches the display units between frequency and rotations per minute.

## (2) IPM parameter initialization list

The parameter settings in the following table are changed to the settings required to perform PM sensorless vector control by selecting PM sensorless vector control with the IPM parameter initialization mode on the operation panel or with *Pr. 998 IPM parameter initialization* setting. The changed settings differ according to the IPM motor specification (capacity).

Performing parameter clear or all parameter clear sets back the parameter settings to the settings required to drive a general-purpose motor.

Parameter	Name	Setting					Setting increments	
		General-purpose motor	IPM motor (rotations per minute)		IPM motor (frequency)			
		<i>Pr. 998</i> 0 (Initial setting)	3003 (MM-CF)	8009 (other than MM-CF)	3103 (MM-CF)	8109 (other than MM-CF)	3003, 8009	0, 3103, 8109
<b>1</b>	Maximum frequency	120Hz	3000r/min	—	200Hz	—	1r/min	0.01Hz
<b>4</b>	Multi-speed setting (high speed)	60Hz	2000r/min	<i>Pr. 84</i>	133.33Hz	<i>Pr. 84</i>	1r/min	0.01Hz
<b>9</b>	Electronic thermal O/L relay	Rated inverter current	Rated motor current (Refer to page 18)	—	Rated motor current (Refer to page 18)	—	0.01A	
<b>13</b>	Starting frequency	0.5Hz	8r/min *4	<i>Pr. 84</i> × 10%	0.5Hz *5	<i>Pr. 84</i> × 10%	1r/min	0.01Hz
<b>15</b>	Jog frequency	5Hz	200r/min	<i>Pr. 84</i> × 10%	13.33Hz	<i>Pr. 84</i> × 10%	1r/min	0.01Hz
<b>18</b>	High speed maximum frequency	120Hz	3000r/min	—	200Hz	—	1r/min	0.01Hz
<b>20</b>	Acceleration/deceleration reference frequency	60Hz	2000r/min	<i>Pr. 84</i>	133.33Hz	<i>Pr. 84</i>	1r/min	0.01Hz
<b>22</b>	Stall prevention operation level	150%	150%				0.1%	
<b>37</b>	Speed display	0	0				1	
<b>55</b>	Frequency monitoring reference	60Hz	2000r/min	<i>Pr. 84</i>	133.33Hz	<i>Pr. 84</i>	1r/min	0.01Hz
<b>56</b>	Current monitoring reference	Rated inverter current	Rated motor current (Refer to page 18)	<i>Pr. 859</i>	Rated motor current (Refer to page 18)	<i>Pr. 859</i>	0.01A	
<b>71</b>	Applied motor	0	330 *1	—	330 *1	—	1	
<b>80</b>	Motor capacity	9999	Motor capacity (MM-CF) *2	—	Motor capacity (MM-CF) *2	—	0.01kW	
<b>81</b>	Number of motor poles	9999	8	—	8	—	1	
<b>84</b>	Rated motor frequency	60Hz	2000r/min	—	133.33Hz	—	1r/min	0.01Hz
<b>125 (903)</b>	Terminal 2 frequency setting gain frequency	60Hz	2000r/min	<i>Pr. 84</i>	133.33Hz	<i>Pr. 84</i>	1r/min	0.01Hz
<b>126 (905)</b>	Terminal 4 frequency setting gain frequency	60Hz	2000r/min	<i>Pr. 84</i>	133.33Hz	<i>Pr. 84</i>	1r/min	0.01Hz
<b>144</b>	Speed setting switchover	4	108	<i>Pr. 81</i> +100	8	<i>Pr. 81</i>	1	
<b>240</b>	Soft-PWM operation selection	1	0				1	
<b>263</b>	Subtraction starting frequency	60Hz	2000r/min	<i>Pr. 84</i>	133.33Hz	<i>Pr. 84</i>	1r/min	0.01Hz
<b>266</b>	Power failure deceleration time switchover frequency	60Hz	2000r/min	<i>Pr. 84</i>	133.33Hz	<i>Pr. 84</i>	1r/min	0.01Hz
<b>374</b>	Overspeed detection level	140Hz	3150r/min	<i>Pr. 1 (Pr. 18)</i> × 105%	210Hz	<i>Pr. 1 (Pr. 18)</i> × 105%	1r/min	0.01Hz
<b>386</b>	Frequency for maximum input pulse	60Hz	2000r/min	<i>Pr. 84</i>	133.33Hz	<i>Pr. 84</i>	1r/min	0.01Hz
<b>390 *3</b>	% setting reference frequency	60Hz	133.33Hz	<i>Pr. 84</i>	133.33Hz	<i>Pr. 84</i>	0.01Hz	
<b>505</b>	Speed setting reference	60Hz	133.33Hz	<i>Pr. 84</i>	133.33Hz	<i>Pr. 84</i>	0.01Hz	
<b>557</b>	Current average value monitor signal output reference current	Rated inverter current	Rated motor current (Refer to page 18)	<i>Pr. 859</i>	Rated motor current (Refer to page 18)	<i>Pr. 859</i>	0.01A	
<b>820</b>	Speed control P gain 1	60%	30%				1%	
<b>821</b>	Speed control integral time 1	0.333s	0.333s				0.001s	
<b>824</b>	Torque control P gain 1	100%	100%				1%	
<b>825</b>	Torque control integral time 1	5ms	20ms				0.1ms	
<b>870</b>	Speed detection hysteresis	0Hz	8r/min		0.5Hz		1r/min	0.01Hz
<b>885</b>	Regeneration avoidance compensation frequency limit value	6Hz	200r/min	<i>Pr. 84</i> × 10%	13.33Hz	<i>Pr. 84</i> × 10%	1r/min	0.01Hz
<b>893</b>	Energy saving monitor reference (motor capacity)	Rated inverter capacity	Motor capacity ( <i>Pr. 80</i> )				0.01kW	
<b>C14 (918)</b>	Terminal 1 gain frequency (speed)	60Hz	2000r/min	<i>Pr. 84</i>	133.33Hz	<i>Pr. 84</i>	1r/min	0.01Hz

—: The setting does not change.

\*1 Setting *Pr. 71 Applied motor* = one of "333, 334, 8093, 8094" does not change the *Pr. 71 Applied motor* setting.

\*2 Setting *Pr. 80 Motor capacity* ≠ "9999" does not change the *Pr. 80 Motor capacity* setting.

\*3 This parameter can be set when FR-A7NL is mounted.

\*4 200r/min when *Pr. 788 Low-speed range torque characteristics* = "0".

\*5 13.33Hz when *Pr. 788 Low-speed range torque characteristics* = "0".

### REMARKS

If IPM parameter initialization is performed in rotations per minute (*Pr. 998* = "3003" or "8009"), the parameters not listed in the table above are also set and displayed in rotations per minute.

### 1.3 Offline auto tuning for an IPM motor (motor constant tuning)

(Pr.1, Pr.9, Pr.18, Pr.71, Pr.80, Pr.81, Pr.83, Pr.84, Pr.90, Pr.92, Pr.93, Pr.96, Pr.684, Pr.706, Pr.707, Pr.711, Pr.712, Pr.721, Pr.724, Pr.725, Pr.859) 

The offline auto tuning for an IPM motor enables the optimal operation of an IPM motor.

- What is offline auto tuning?

Under PM sensorless vector control, setting motor constants automatically (offline auto tuning) enables optimal operation of motors even when motor constants vary or when the wiring distance is long. The offline auto tuning also enables the operation with an IPM motor other than MM-CF.

Parameter Number	Name	Initial Value	Setting Range	Description	
1	Maximum frequency	120Hz	0 to 120Hz	Set the upper limit of the output frequency.	
9	Electronic thermal O/L relay	Rated inverter current	0 to 500A	Set the rated motor current.	
18	High speed maximum frequency	120Hz	120 to 400Hz	Set when performing the operation at 120Hz or more. (Limited at 300Hz under PM sensorless vector control)	
71	Applied motor	0	0 to 8, 13 to 18, 30, 33, 34, 40, 43, 44, 50, 53, 54, 330, 333, 334, 8093, 8094	Setting a motor type selects its thermal characteristic and the motor constant.	
80	Motor capacity	9999	0.4 to 55kW	Set the applied motor capacity.	
			9999	V/F control	
81	Number of motor poles	9999	2, 4, 6, 8, 10	Set the number of motor poles.	
			12, 14, 16, 18, 20	X18 signal-ON:V/F control	Set 10 + number of motor poles.
			9999	V/F control	
83	Rated motor voltage	200/400V*	0 to 1000V	Set the rated motor voltage (V).	
84	Rated motor frequency	60Hz	10 to 300Hz	Set the rated motor frequency (Hz). (Limited at 120Hz when Pr. 71 is set to a motor other than IPM)	
90	Motor constant (R1)	9999	0 to 50Ω, 9999	Tuning data	
92	Motor constant (L1)/d-axis inductance	9999	0 to 50Ω, (0 to 1000mH), 9999	(The value measured by offline auto tuning is automatically set.)	
93	Motor constant (L2)/q-axis inductance	9999	0 to 50Ω, (0 to 1000mH), 9999	9999: Motor constant of the MM-CF IPM motor. (Except 9999, the set value is the motor constant.)	
96	Auto tuning setting/status	0	0	Offline auto tuning is not performed	
			1	Offline auto tuning is performed without motor running (other than MM-CF)	
			11	Offline auto tuning is performed without motor running (MM-CF)	
			101	Offline auto tuning by rotating a general-purpose motor (no tuning during PM sensorless vector control)	
684	Tuning data unit switchover	0	0	Internal data converted value	
			1	Displayed in "A, Ω, mH, %"	
706	Induced voltage constant	9999	0 to 5000mV • s/rad	Adjust the constant if the current fluctuates during operation after tuning.	
			9999	Constant value calculated based on the tuning data	
707	Motor inertia (integer)	9999	10 to 999	Set the motor inertia.	
			9999	Uses the inertia of the MM-CF IPM motor	

Parameter Number	Name	Initial Value	Setting Range	Description
711	Motor d-axis inductance Ld decay ratio	9999	0 to 100%, 9999	Tuning data (The value measured by offline auto tuning is automatically set.) 9999: Motor constant of the MM-CF IPM motor. (Except 9999, the set value is the motor constant.)
712	Motor q-axis inductance Lq decay ratio	9999	0 to 100%, 9999	
721	Starting magnetic pole position detection pulse width	9999	0 to 6000 $\mu$ s, 9999	
724	Motor inertia (exponent)	9999	1 to 7	Set the motor inertia.
			9999	Uses the inertia of the MM-CF IPM motor
725	Motor protection current level	9999	0 to 500%	Set the maximum current (OCT) level of the motor (%).
			9999	Uses the maximum current of MM-CF
859	Torque current	9999	0 to 500A	Tuning data (The value measured by offline auto tuning is automatically set.)
			9999	Uses the constant of the MM-CF IPM motor

\* The initial value differs according to the voltage level. (200V/400V)

### POINT

- The settings are valid only under the PM sensorless vector control.
- When the wiring length between the inverter and the motor is long (30m or longer as a reference), use the offline auto tuning function to drive the motor in the optimum operation characteristic.
- The offline auto tuning enables the operation with an IPM motor other than MM-CF.
- Tuning is enabled even when a load is connected to the motor. (As the load is lighter, tuning accuracy is higher. Tuning accuracy does not change even if the inertia is large.)
- Reading/writing of motor constants tuned by offline auto tuning are enabled. You can copy the offline auto tuning data (motor constants) to another inverter with the PU (FR-DU07/FR-PU07).
- The offline auto tuning status can be monitored with the PU (FR-DU07/FR-PU07/FR-PU04).
- Do not use an inverter with a surge voltage suppression filter (FR-ASF-H/FR-BMF-H) connected between the inverter and the motor.

## (1) Before performing offline auto tuning

Check the following before performing offline auto tuning.

- The PM sensorless vector control should be selected.
- A motor should be connected. Note that the motor should be at a stop at a tuning start.
- The motor capacity should be equal to or one rank lower than the inverter capacity.
- The maximum frequency under PM sensorless vector control should be 300Hz.
- Even if tuning is performed without motor running (*Pr. 96 Auto tuning setting/status* = "11"), the motor may run slightly. Therefore, fix the motor securely with a mechanical brake, or before tuning, make sure that there will be no problem in safety if the motor runs. (Caution is required especially in vertical lift applications). Note that if the motor runs slightly, tuning performance is unaffected.
- Tuning is not available during position control under PM sensorless vector control.

## (2) Setting



To perform tuning, set the following parameters about the motor.

Parameter Number	Name	Setting for an IPM motor other than MM-CF	Setting for MM-CF
80	Motor capacity	Motor capacity (kW)	Set by the IPM parameter initialization (Refer to <i>page 4.</i> )
81	Number of motor poles	Number of motor poles	
1(18)	Maximum frequency (High speed maximum frequency)	The maximum motor frequency (Hz)	
9	Electronic thermal O/L relay	Rated motor current (A)	
84	Rated motor frequency	Rated motor frequency (Hz)	
83	Rated motor voltage	Rated motor voltage (V)	Rated motor voltage (V) printed on the motor's rating plate.
707	Motor inertia (integer)	Motor inertia $J_m = Pr.707 \times 10^{(-Pr.724)} \text{ (kg}\cdot\text{m}^2)$	9999 (Initial value)
724	Motor inertia (exponent)		
725	Motor protection current level	Maximum current (OCT) level of the motor (%)	9999 (Initial value)
71	Applied motor	8093	333
96	Auto tuning setting/status	1	11

## (3) Execution of tuning

### CAUTION

- Before performing tuning, check the monitor display of the operation panel (FR-DU07) or parameter unit (FR-PU04/FR-PU07) if the inverter is in the state ready for tuning. (Refer to 2) below) Turning ON the start command while tuning is unavailable starts the motor.

1)When performing PU operation, press  /  on the operation panel.

For External operation, turn ON the start command (STF signal or STR signal). Tuning starts.

### REMARKS

- Satisfy the required inverter start conditions to start offline auto tuning. For example, stop the input of MRS signal.
- To force tuning to end, use the MRS or RES signal or press  on the operation panel.  
(Turning the start signal (STF signal or STR signal) OFF also ends tuning.)
- During offline auto tuning, only the following I/O signals are valid (initial value):
  - Input signals <valid signal> STOP, OH, MRS, RT, RES, STF, STR
  - Output terminal RUN, OL, IPF, FM, AM, A1B1C1
 Note that the progress status of offline auto tuning is output in fifteen steps from AM and FM when speed and output frequency are selected.
- Do not perform ON/OFF switching of the second function selection signal (RT) during execution of offline auto tuning. Auto tuning is not executed properly.
- Setting offline auto tuning (*Pr. 96 Auto tuning setting/status* = "1 or 11") will make pre-excitation invalid.

### CAUTION

- Since the RUN signal turns ON when tuning is started, caution is required especially when a sequence which releases a mechanical brake by the RUN signal has been designed.
- When executing offline auto tuning, input the run command after switching ON the main circuit power (R/L1, S/L2, T/L3) of the inverter.
- While *Pr. 79* = "7," turn the X12 signal ON to tune in the PU operation mode.

2) Monitor is displayed on the operation panel (FR-DU07) and parameter unit (FR-PU07/FR-PU04) during tuning as below.

	Parameter Unit (FR-PU07/FR-PU04) Display		Operation Panel (FR-DU07) Display	
	1	11	1	11
Pr. 96 setting	1	11	1	11
(1) Setting				
(2) Tuning in progress				
(3) Normal end				
(4) Error end (when the inverter protective function is activated)				

3) When offline auto tuning ends, press of the operation panel during PU operation. For External operation, turn OFF the start signal (STF signal or STR signal). This operation resets the offline auto tuning and the PU's monitor display returns to the normal indication. (Without this operation, next operation cannot be started.)

#### REMARKS

- The motor constants measured once in the offline auto tuning are stored as parameters and their data are held until the offline auto tuning is performed again.
- Changing Pr. 96 setting from "3 or 13" after tuning completion will invalidate the tuning data. In this case, tune again.

4) If offline auto tuning ended in error (see the table below), motor constants are not set. Perform an inverter reset and restart tuning.

Error Display	Error Cause	Remedy
8	Forced end	Set "1" or "11" in Pr. 96 and perform tuning again.
9	Inverter protective function operation	Make setting again.
92	Converter output voltage has reached 75% of rated value.	Check for fluctuation of power supply voltage.
93	Calculation error A motor is not connected.	Check the motor wiring and make setting again.

5) When tuning is ended forcibly by pressing or turning OFF the start signal (STF or STR) during tuning, offline auto tuning does not end properly. (The motor constants have not been set.) Perform an inverter reset and restart tuning.

#### CAUTION

- An instantaneous power failure occurring during tuning will result in a tuning error. After power is restored, the inverter goes into the normal operation mode. Therefore, when STF (STR) signal is ON, the motor runs in the forward (reverse) rotation.
- Any alarm occurring during tuning is handled as in the ordinary mode. Note that even if a retry operation has been set, retry is not performed.
- The set frequency monitor displayed during the offline auto tuning is 0Hz.

## CAUTION

Note that the motor may start running suddenly.



#### (4) Utilizing or changing offline auto tuning data

The data measured in the offline auto tuning can be read and utilized or changed.

<Operating procedure>

1) Set *Pr. 71* according to the motor used.

Motor		<i>Pr. 71</i> Setting
IPM motor	MM-CF	334
	Other than MM-CF	8094

2) In the parameter setting mode, read the following parameters and set desired values.

The display units of the read motor constants can be changed with *Pr. 684 Tuning data unit switchover*.

Setting *Pr.684 = "1"* does not change the parameter settings.

Parameter Number	Name	Setting Increments		Read Value		Setting Range
		<i>Pr.684 = 0</i>	<i>Pr.684 = 1</i>	<i>Pr.71 = 334</i>	<i>Pr.71 = 8094</i>	
90	Motor constant (R1)	Internal data	0.001Ω	Tuned data *1	Tuned data *1	0 to ***, 9999
92	Motor constant (L1)/d-axis inductance	Internal data	0.1mH	9999 *2	Tuned data *1	0 to ***, 9999
93	Motor constant (L2)/q-axis inductance	Internal data	0.1mH	9999 *2	Tuned data *1	0 to ***, 9999
711	Motor d-axis inductance Ld decay ratio	Internal data	0.1%	9999 *2	Tuned data *1	0 to ***, 9999
712	Motor q-axis inductance Lq decay ratio	Internal data	0.1%	9999 *2	Tuned data *1	0 to ***, 9999
721	Starting magnetic pole position detection pulse width	Internal data	1(μs)	9999 *2	Tuned data *1	0 to ***, 9999
859	Torque current	Internal data	0.01A	Tuned data *1	Tuned data *1	0 to ***, 9999

\*1 As the motor constants measured in the offline auto tuning have been converted into internal data (\*\*\*)\*, refer to the following setting example when making setting:

Setting example To slightly increase *Pr. 90* value (5%)

When *Pr. 90* is displayed "2516",

set 2642, i.e.  $2516 \times 1.05 = 2641.8$ , in *Pr. 90*.

(The value displayed has been converted into a value for internal use. Hence, simple addition of a given value to the displayed value has no significance.)

\*2 Setting "9999" selects the IPM motor (MM-CF) constant.

If the current fluctuates after tuning, adjust the constant by referring to the induced voltage constant, which can be found in the data sheet.

Parameter Number	Name	Setting Range	Setting Increments	Initial Setting
706	Induced voltage constant	0 to 5000, 9999	0.1(mV/(rad/s))	9999 *

\* Setting "9999" sets a calculated value based on tuning.

## 1.4 Applied motor (Pr. 71)

Setting of the used motor selects the thermal characteristic appropriate for the motor.

Setting is necessary when using a constant-torque motor. Thermal characteristic of the electronic thermal relay function suitable for the motor is set.

When PM sensorless vector control is selected, the motor constants (MM-CF etc.) necessary for control are selected as well.

Parameter Number	Name	Initial Value	Setting Range	Description
71	Applied motor	0	0 to 8, 13 to 18, 30, 33, 34, 40, 43, 44, 50, 53, 54, <b>330, 333, 334, 8093, 8094</b>	Selecting the standard motor or constant-torque motor sets the corresponding motor thermal characteristic.

### (1) Set the motor to be used

Refer to the following list and set this parameter according to the motor used.

Pr. 71 Setting	Motor	Electronic thermal relay function operation characteristic	
		Constant torque	IPM
330*	IPM Motor MM-CF		<input type="radio"/>
333*	IPM Motor MM-CF		<input type="radio"/>
8093	IPM Motor (other than MM-CF)	Select "offline auto tuning setting"	
334*	IPM Motor MM-CF	<input type="radio"/>	<input type="radio"/>
8094	IPM Motor (other than MM-CF)	Auto tuning data can be read, changed, and set	
		<input type="radio"/>	

\* The setting is available for FR-A721-11K or lower.

### REMARKS

- When performing offline auto tuning, set "3, 7, 8, 13, 17, 18, 33, 43, 53, 333, 8093" in Pr. 71. (Refer to page 7 for offline auto tuning)
- For the 5.5K and 7.5K, the Pr. 0 Torque boost and Pr. 12 DC injection brake operation voltage settings are automatically changed according to the Pr. 71 setting as follows.

Pr. 71	Standard Motor Setting 0, 2, 3 to 8, 40, 43, 44, 330, 333, 334, 8093, 8094	Constant Torque Motor Setting 1, 13 to 18, 50, 53, 54
Pr. 0	3%	2%
Pr. 12	4%	2%

- In position control, speed commands, which are calculated to eliminate the difference between the command pulse (parameter setting) and the estimated feedback pulse, are output to rotate the motor.
- This inverter can perform simple position feed by contact input, position control by inverter simple pulse input, and position control by FR-A7AL pulse train input.

**(1) Setting procedure**

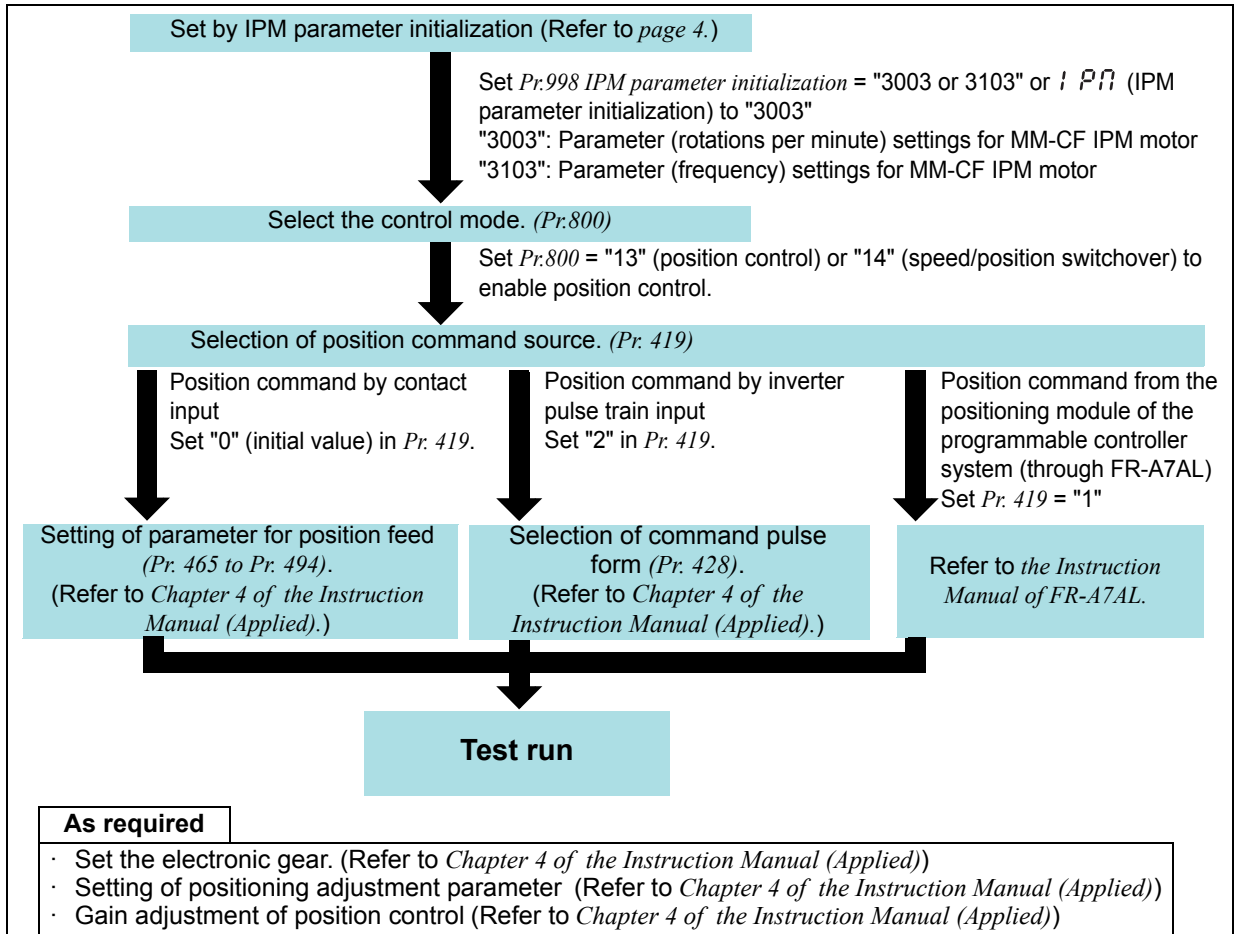

**CAUTION**

- The carrier frequency is limited during PM sensorless vector control. (Refer to page 17.)
- Position deviation may occur due to motor temperature changes. In such case, shut off the inverter outputs, and restart.
- The Z-phase outputs cannot be made under PM sensorless vector control. When Pr.419 = "1" is set to send positioning commands in pulses via a programmable controller positioning module and FR-A7AL, use the home position return operation that does not require Z-phase signals.

**(2) Select the control method**

Pr.998	Pr.998 Setting	Control Method	Control Type	Remarks
3003, 3103 (MM-CF)	20 (Initial Value)	PM sensorless vector control	Speed control	—
	9		Test operation	—
	13		Position control	—
	14		Speed control/position control switchover	MC signal ON: position control MC signal OFF: speed control

\* The operation for the setting of "20" is performed when a value other than "9, 13, or 14" is set.

**REMARKS**

- Perform position control under PM sensorless vector control only when using an MM-CF IPM motor with the low-speed range high-torque characteristic enabled ( Pr.788 = "9999 (initial value)")
- Position control is performed on the assumption of 4096 pulses/motor rotation.  
Positioning accuracy 100 pulses/rev (no load)

Refer to Chapter 4 of the Instruction Manual (Applied) for the detail of the position control.

## 1.6 Low-speed range torque characteristics (Pr.788) P M

Torque characteristics in a low-speed range can be changed.

Parameter Number	Name	Initial Setting	Setting Range	Operation
788 <span style="border: 1px solid black; border-radius: 10px; padding: 2px 5px;">P M</span>	Low-speed range torque characteristics	9999	0	Disables the low-speed range high-torque characteristic (current synchronization operation).
			9999*	Enables the low-speed range high-torque characteristic (high frequency superposition control)

\* Current synchronization operation is always performed for IPM motors other than MM-CF, even if "9999" is set.

### (1) When the low-speed range high-torque characteristic is enabled ("9999" (initial value))

- The high frequency superposition control provides enough torque in the low-speed range operation.
- Refer to *page 19* for the torque characteristics.

### (2) When the low-speed range high-torque characteristic is disabled ("0")

- The current synchronization operation reduces much motor noise compared with the high frequency superposition control.
- The torque in a low-speed range is low. Use this setting for an operation with light start-up load.
- Refer to *page 19* for the torque characteristics.

#### REMARKS

- Position control under PM sensorless vector control is not available when the current synchronization operation is selected.

## 1.7 Setting the acceleration/deceleration time in the low-speed range (Pr.791, Pr.792) P M

Parameter Number	Name	Initial Value	Setting Range	Description
791 <span style="border: 1px solid black; padding: 2px;">P M</span>	Acceleration time in low-speed range	9999	0 to 3600/360s*	Set the acceleration time in a low-speed range (less than 10% of the rated motor frequency).
			9999	The acceleration time set in Pr.7 is applied. (When the second functions are enabled, the settings are applied.)
792 <span style="border: 1px solid black; padding: 2px;">P M</span>	Deceleration time in low-speed range	9999	0 to 3600/360s*	Set the deceleration time in a low-speed range (less than 10% of the rated motor frequency).
			9999	The deceleration time set in Pr.8 is applied. (When the second functions are enabled, the settings are applied.)

\* Depends on the Pr. 21 Acceleration/deceleration time increments setting. The initial value for the setting range is "0 to 3600s" and the setting increments is "0.1s".

If torque is required in a low-speed range (less than 10% of the rated motor frequency), set Pr.791 Acceleration time in low-speed range and Pr.792 Deceleration time in low-speed range settings higher than the Pr.7 Acceleration time and Pr.8 Deceleration time settings so that the mild acceleration/deceleration is performed in the low-speed range. Such a setting is especially effective when the low-speed range high-torque characteristic is disabled (Pr.788 = "0"). (For an operation with second acceleration/deceleration times, set the acceleration/deceleration times longer than the second acceleration/deceleration times.)

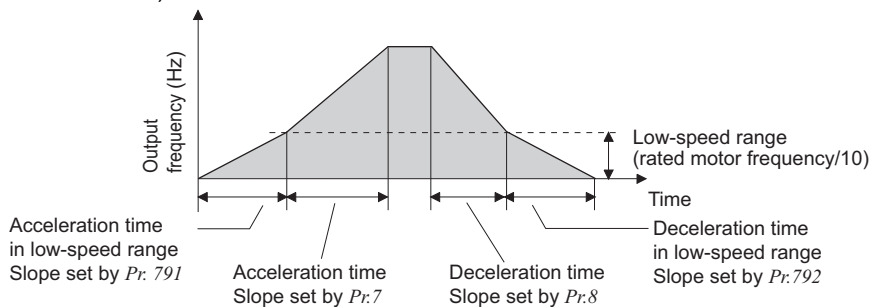

### REMARKS

- Set Pr.791 higher than Pr.7, and Pr.792 higher than Pr.8. If set as Pr.791 < Pr.7, the operation is performed as Pr.791 = Pr.7. If set as Pr.792 < Pr.8, the operation is performed as Pr.792 = Pr.8.
- Refer to page 6 for the rated motor frequency of MM-CF.

## 1.8 Braking operation selection for vector control, PM sensorless vector control (Pr.802)

Vector

P M

The pre-excitation operation selection is available under PM sensorless vector control.

- Select the braking operation when the pre-excitation is performed with *Pr.802 Pre-excitation selection* from either zero speed control or servo lock.

Pr.802 setting	Pre-excitation	Description
0 (initial value)	Zero speed control	It will try to maintain 0 r/min so the motor shaft will not rotate even when a load is applied. However, it will not return to its original position when the shaft moves due to external force. It will not perform position control, but operate only with the speed control.
1	Servo lock	It will try to maintain the position of the motor shaft even if a load is applied. When the shaft moves due to external force, it will return to its original position after the external force is removed. To perform the position control, this loop gain can be adjusted with <i>Pr.422 Position control gain</i> .

- The relation between the DC injection brake operation and pre-excitation operation is as follows.

Control method	Control mode	Pr.802	Pr.850	Deceleration stop	LX-ON	X13-ON (Pr.11 = "8888")
V/F control	—	—	—	DC injection brake	—	DC injection brake
Advanced magnetic flux vector control	—	—	—	DC injection brake	—	DC injection brake
Real sensorless vector control	Speed	—	0	DC injection brake	Zero speed	Zero speed
		—	1	Zero speed		
		—	2	Magnetic flux decay output shutoff		
	Torque	—	0	DC injection brake	Zero speed	Zero speed
		—	1	Zero speed		
		—	2	Magnetic flux decay output shutoff		
Vector control	Speed	0	—	Zero speed	Zero speed	Zero speed
		1	—	Servo lock	Servo lock	Servo lock
	Torque	—	—	Zero speed	Zero speed	Zero speed
	Position	—	—	—	Servo lock	—
PM sensorless vector control, low-speed range high-torque mode disabled	Speed	—	—	DC injection brake	—	—
PM sensorless vector control, low-speed range high-torque mode enabled	Speed	0	—	Zero speed	Zero speed	—
		1	—	Servo lock	Servo lock	—
	Position	—	—	—	Servo lock	—

## 1.9 DC injection brake of the PM sensorless vector control P M

DC injection brake operation frequency will be fixed to 0 Hz at the time of PM sensorless vector control (low-speed range high-torque mode disabled).

<When the low-speed range high-torque characteristic is disabled ( $Pr.788 = "0"$ )>

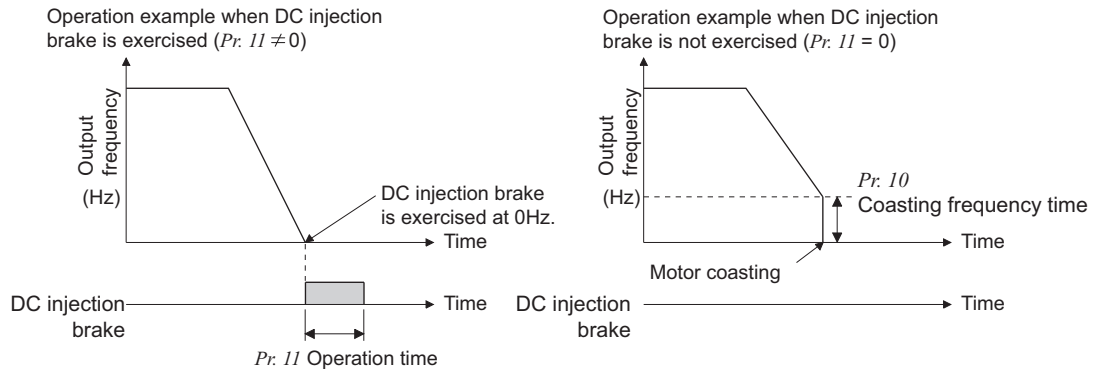

### REMARKS

- The X13 signal is disabled during PM sensorless vector control.
- $Pr.12$  DC injection brake operation voltage is invalid during PM sensorless vector control.

## 1.10 PM sensorless vector control specification

Item	Specification	
<b>Control method</b>	Sensorless vector control Low-speed range: Control method in a low-speed range can be selected by parameter (high frequency superposition control (initial setting) / current synchronization operation)	
<b>Starting torque</b>	High frequency superposition control	150% (Used in combination with MM-CF)
	Current synchronization operation	50%
<b>Speed control range</b>	High frequency superposition control	1:1000 (Use a one rank higher inverter for the ratio of 1:1000)
	Current synchronization operation	1:10
<b>Zero speed</b>	High frequency superposition control	Possible (Use a one rank higher inverter for zero-speed 200%)
	Current synchronization operation	Not available
<b>Carrier frequency</b>	High frequency superposition control	6kHz ( $Pr.72 = "0$ to $9"$ ), 10kHz ( $Pr.72 = "10$ to $13"$ ), 14kHz ( $Pr.72 = "14, 15"$ ) (6kHz in a low-speed range of 10kHz or higher. 2kHz is not selectable.)
	Current synchronization operation	2kHz ( $Pr.72 = "0$ to $5"$ ), 6kHz ( $Pr.72 = "6$ to $9"$ ), 10kHz ( $Pr.72 = "10$ to $13"$ ), 14kHz ( $Pr.72 = "14, 15"$ ) (6kHz in a low-speed range of 10kHz or higher.)
<b>Position control</b>	High frequency superposition control	Possible
	Current synchronization operation	Not available
<b>Offline auto tuning for an IPM motor</b>	Possible	
<b>Applicable motor</b>	Mitsubishi MM-CF series IPM motors (3.5 to 7.0kW) IPM motors other than MM-CF (tuning required) (no capacity limit)	

## 1.11 Motor specification

### (1) Specifications

Item		Motor	2000r/min Series		
			MM-CF352(C)(B)	MM-CF502(C)	MM-CF702(C)
Compatible inverter	FR-A721-□	-	5.5K	7.5K	
		5.5K * <sub>6</sub>	7.5K * <sub>6</sub>	11K * <sub>6</sub>	
Continuous characteristics * <sub>1</sub>	Rated output [kW]	3.5	5.0	7.0	
	Rated torque [N·m]	16.70	23.86	33.41	
Rated speed * <sub>1</sub> [r/min]		2000			
Max. speed [r/min]		3000			
Instantaneous permissible speed [r/min]		3450			
Max. torque [N·m]		33.41	47.73	66.82	
Inertia moment J * <sub>5</sub> [ $\times 10^{-4}$ kg·m <sup>2</sup> ]		85.6 (89.0)	120.0	160.0	
Recommended ratio of load inertia moment to motor shaft inertia moment * <sub>2</sub>		50 times max.			
Rated current [A]		12.5	20.5	27.0	
Insulation rank		Class F			
Structure		Totally-enclosed, self-cooling (protective system:IP44 * <sub>3</sub> , IP65 * <sub>3</sub> , * <sub>4</sub> )			
Environmental conditions	Surrounding air temperature and humidity	-10C° to +40C° (non-freezing) • 90%RH or less (non-condensing)			
	Storage temperature and humidity	-20C° to +70C° (non-freezing) • 90%RH or less (non-condensing)			
	Ambience	Indoors (no direct sunlight), free from corrosive gas, flammable gas, oil mist, dust and dirt			
	Altitude	Max. 1000m above sea level			
	Vibration	X: 9.8m/s <sup>2</sup> , Y: 24.5m/s <sup>2</sup>			
Mass * <sub>5</sub> [kg]		19 (28)	27	36	

\*1 When the power supply voltage drops, we cannot guarantee the above output and rated speed.

\*2 When the load torque is 20% of the motor rating. The permissible load inertia moment ratio is smaller when the load torque is larger. Consult us if the load inertia moment ratio exceeds the above value.

\*3 This does not apply to the shaft through portion.

\*4 Value for MM-CF□2C.

\*5 The value for MM-CF□2B is indicated in parentheses.

\*6 Applicable one-rank higher inverters for the lifted low-speed range torque operation.



## (2) Torque characteristics

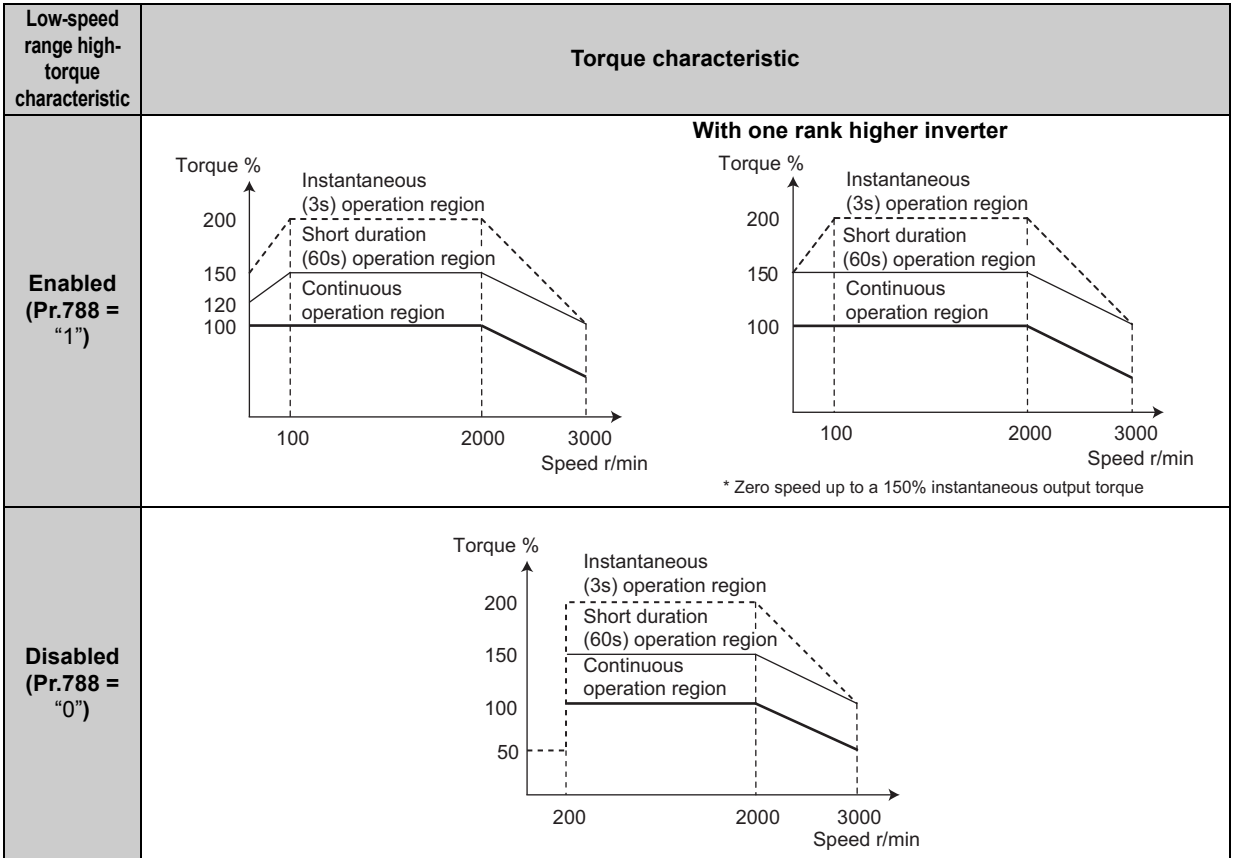

## 2 Speed detection hysteresis (Pr.870)

This function prevents chattering of the speed detection signals.

Parameter Number	Name	Initial Value	Setting Range	Description
870	Speed detection hysteresis	0Hz*	0 to 5Hz	Set the hysteresis width for the detected frequency.

\* Performing IPM parameter initialization changes the settings. (Refer to page 6)

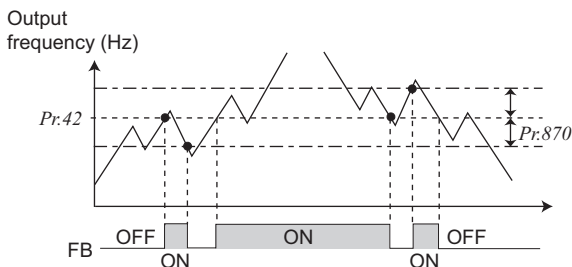

Example of the speed detection signal (FB)

- When an output frequency fluctuates, the following signals may repeat ON/OFF (chatters).
    - Up to frequency (SU)
    - Speed detection (FB, FB2, FB3)
    - Low speed output (LS)
- Setting hysteresis to the detected frequency prevents chattering of these signals.

### REMARKS

- Setting a higher value to this parameter slows the response of frequency detection signals (SU, FB, FB2, FB3, and LS).
- The ON/OFF logic for the LS signal is opposite for the FB signal.

### 3 Extended parameter setting ranges (Pr. 263, Pr. 505, Pr. 885)

The setting ranges of the following parameters have been extended.

#### (1) Power failure-time deceleration-to-stop function

Parameter Number	Name	Initial Value	Setting Range	Description
263	Subtraction starting frequency	60 Hz	0 to 400 Hz	When output frequency $\geq Pr. 263$ Decelerate from the speed obtained from output frequency minus <i>Pr. 262</i> . When output frequency $< Pr. 263$ Decelerate from output frequency
			9999	Decelerate from the speed obtained from output frequency minus <i>Pr. 262</i> .

#### (2) Speed display and speed setting

Parameter Number	Name	Initial Value	Setting Range	Description
505	Speed setting reference	60 Hz	1 to 400 Hz	Set the reference speed for <i>Pr. 37</i> .

#### (3) Regeneration avoidance function

Parameter Number	Name	Initial Value	Setting Range	Description
885	Regeneration avoidance compensation frequency limit value	6 Hz	0 to 30 Hz	Set the limit value of frequency which rises at activation of regeneration avoidance function.
			9999	Frequency limit invalid

## 4 Break point setting for droop control (Pr.994, Pr.995)

Magnetic flux Sensorless Vector P M

Set *Pr.994* and *Pr.995* to have a break point on a droop compensation frequency line. Setting a break point allows the inverter to raise the droop compensation frequency for light-load (no load) operation without raising it for heavy-load operation.

Parameter Number	Name	Initial Value	Setting Range	Description
994	Droop break point gain	9999	0.1 to 100%	Set the changing droop amount as a percentage value of the rated motor frequency.
			9999	No function
995	Droop break point torque	100%	0.1 to 100%	Set the torque where the droop amount is changed.

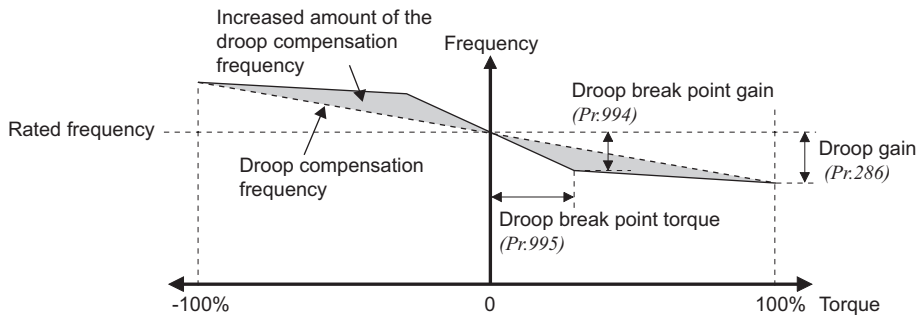

### CAUTION

The droop break point function is disabled when any of the following conditions is met. (Linear compensation by *Pr.286* is performed.)

- *Pr.995* = "100% (initial value)"
- *Pr.286* < *Pr.994*
- $Pr.994 \leq Pr.995 \times Pr.286 / 100\%$

## 5 Setting multiple parameters as a batch (Pr.999)

- Parameter settings are changed as a batch. Those include communication parameter settings for the Mitsubishi human machine interface (GOT) connection, rated frequency settings of 50Hz/60Hz, and acceleration/deceleration time increment settings.
- Multiple parameters are changed automatically. Users do not have to consider each parameter number. (Automatic parameter setting mode)

Parameter Number	Name	Initial Value	Setting Range	Description
999 *1	Automatic parameter setting	9999 *2	10	GOT initial setting (PU connector)
			11	GOT initial setting (RS-485 terminals)
			20	50Hz rated frequency
			21	60Hz rated frequency
			30	Acceleration/deceleration time (0.1s increment)
			31	Acceleration/deceleration time (0.01s increment)
			9999	No action

\*1 This parameter allows its setting to be changed in any operation mode even if "0 (initial value)" is set in *Pr. 77 Parameter write selection*.

\*2 The read value is always "9999."

### (1) Automatic parameter setting (Pr.999)

- Select which parameters to be automatically set, and set that to *Pr. 999*. Multiple parameter settings are changed automatically. Refer to *page 23* for the list of parameters that are changed automatically.

Pr.999 setting	Description	Operation in the automatic parameter setting mode
10	Automatically sets the communication parameters for the GOT connected with a PU connector	<i>AUTO</i> (AUTO) → <i>GOT</i> (GOT) → Write "1"
11	Automatically sets the communication parameters for the GOT connected with RS-485 terminals	—
20	50Hz rated frequency	<i>AUTO</i> (AUTO) → <i>F50</i> (F50) → Write "1"
21	60Hz rated frequency	
30	0.1s increment	—
31	0.01s increment	<i>AUTO</i> (AUTO) → <i>T0.01</i> (T0.01) → Write "1"

### REMARKS

If the automatic setting is performed, the selected settings including the changed parameter settings will be changed.

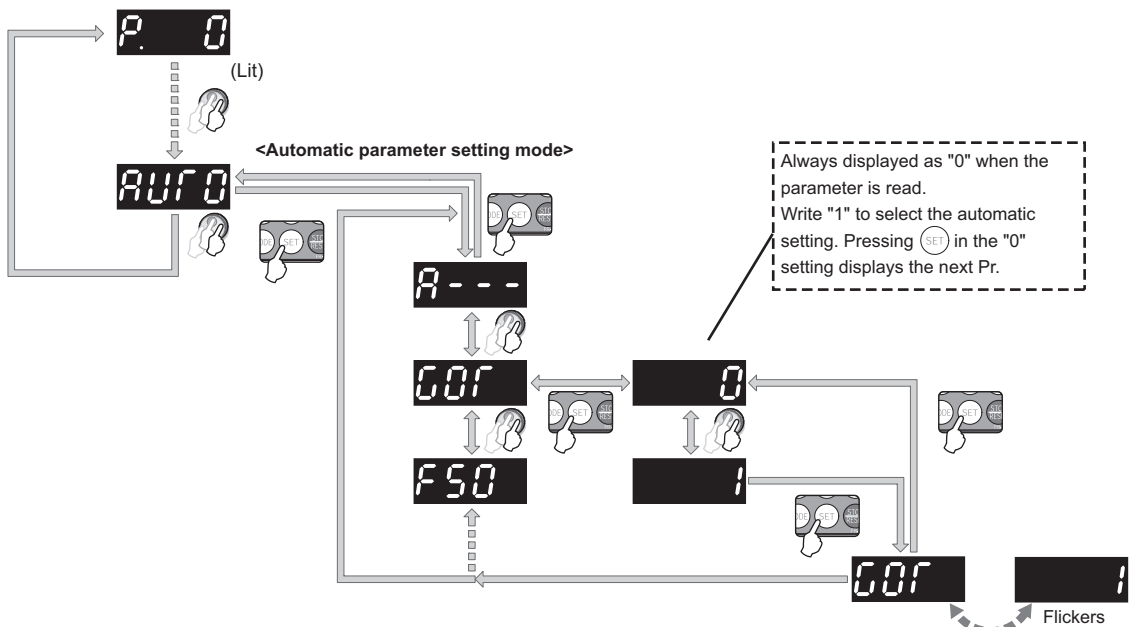

## (2) List of automatically-set parameters

The following tables show which parameters are changed in each of the automatic parameter settings.

### CAUTION

- If the automatic setting is performed with *Pr.999* or the automatic parameter setting mode, the listed settings including the changed parameter settings (changed from the initial setting) will be automatically changed. Before performing the automatic setting, confirm that changing the listed parameters will not cause any problem.

- GOT initial setting (PU connector) (*Pr.999* = "10")

Parameter	Name	Initial value	Automatically set to	Refer to
79	Operation mode selection	0	1	<i>Chapter 4 of the Instruction Manual (Applied)</i>
118	PU communication speed	192	192	
119	PU communication stop bit length	1	10	
120	PU communication parity check	2	1	
121	Number of PU communication retries	1	9999	
122	PU communication check time interval	9999	9999	
123	PU communication waiting time setting	9999	0ms	
124	PU communication CR/LF selection	1	1	
340	Communication startup mode selection	0	0	

### REMARKS

Always perform an inverter reset after the initial setting.

- GOT initial setting (RS-485 terminals) (*Pr.999* = "11")

Parameter	Name	Initial value	Automatically set to	Refer to
79	Operation mode selection	0	0	<i>Chapter 4 of the Instruction Manual (Applied)</i>
332	RS-485 communication speed	96	192	
333	RS-485 communication stop bit length	1	10	
334	RS-485 communication parity check selection	2	1	
335	RS-485 communication retry count	1	9999	
336	RS-485 communication check time interval	0s	9999	
337	RS-485 communication waiting time setting	9999	0ms	
340	Communication startup mode selection	0	1	
341	RS-485 communication CR/LF selection	1	1	
549	Protocol selection	0	0	

### REMARKS

Always perform an inverter reset after the initial setting.

· Rated frequency (Pr. 999 = "20(50Hz), 21(60Hz)")

Parameter	Name	Initial value	Pr.999 = "21"	Pr.999 = "20" Automatic parameter setting	Refer to
3	Base frequency	60Hz	60Hz	50Hz	<i>Chapter 4 of the Instruction Manual (Applied)</i>
4	Multi-speed setting (high speed)	60Hz	60Hz	50Hz	
20	Acceleration/deceleration reference frequency	60Hz	60Hz	50Hz	
37	Speed display	0	0		
55	Frequency monitoring reference	60Hz	60Hz	50Hz	
66	Stall prevention operation reduction starting frequency	60Hz	60Hz	50Hz	
116	Third output frequency detection	60Hz	60Hz	50Hz	
125 (903)	Terminal 2 frequency setting gain frequency	60Hz	60Hz	50Hz	
126 (905)	Terminal 4 frequency setting gain frequency	60Hz	60Hz	50Hz	
263	Subtraction starting frequency	60Hz	60Hz	50Hz	
266	Power failure deceleration time switchover frequency	60Hz	60Hz	50Hz	
386	Frequency for maximum input pulse	60Hz	60Hz	50Hz	
390*	% setting reference frequency	60Hz	60Hz	50Hz	<i>FR-A7NL manual</i>
505	Speed setting reference	60Hz	60Hz	50Hz	<i>Chapter 4 of the Instruction Manual (Applied)</i>
808	Forward rotation speed limit	60Hz	60Hz	50Hz	
C14 (918)	Terminal 1 gain frequency (speed)	60Hz	60Hz	50Hz	

\* This parameter can be set when the option FR-A7NL is mounted.

· Acceleration/deceleration time increment (Pr.999 = "30(0.1s) or 31(0.01s)")

Parameter	Name	Initial set increment	Pr.999 = "30"	Pr.999 = "31" Automatic parameter setting	Refer to
7	Acceleration time	0.1s	0.1s	0.01s	<i>Chapter 4 of the Instruction Manual (Applied)</i>
8	Deceleration time	0.1s	0.1s	0.01s	
16	Jog acceleration/deceleration time	0.1s	0.1s	0.01s	
21	Acceleration/deceleration time increments	1	0 *	1 *	
44	Second acceleration/ deceleration time	0.1s	0.1s	0.01s	
45	Second deceleration time	0.1s	0.1s	0.01s	
110	Third acceleration/ deceleration time	0.1s	0.1s	0.01s	
111	Third deceleration time	0.1s	0.1s	0.01s	
264	Power-failure deceleration time 1	0.1s	0.1s	0.01s	
265	Power-failure deceleration time 2	0.1s	0.1s	0.01s	
791	Acceleration time in low-speed range	0.1s	0.1s	0.01s	
792	Deceleration time in low-speed range	0.1s	0.1s	0.01s	

\* The set value is changed for Pr. 21.

#### REMARKS

- When a parameter is set as the acceleration/deceleration time (0.1s), the 0.01s increment is dropped.
- When a parameter is set as the acceleration/deceleration time (0.01s), the parameters are limited at the maximum value of the parameter setting range. For example, Pr.7 = "361.0s" when 0.1s increment is selected, and Pr.7 = "360.00s" when 0.01s increment is selected.

## 6 Setting to disable E.OLT during stop-on-contact control

You can set the following parameter so that E.OLT (stall prevention stop) will not be activated during stop-on-contact control.

Parameter Number	Name	Initial Value	Setting Range	Description	
270	Stop-on contact/load torque high-speed frequency control selection	0	0	Normal operation	
			1	Stop-on-contact control	
			2	Load torque high speed frequency control	
			3	Stop-on-contact+load torque high speed frequency control	
			11	Stop-on-contact control	
			13	Stop-on-contact+load torque high speed frequency control	E.OLT invalid under stop-on-contact control

## 7 Acceleration/deceleration time switching frequency (Pr. 147)

When output frequency reaches *Pr. 147 Acceleration/deceleration time switching frequency* or higher, the acceleration/deceleration time automatically switches to *Pr. 44 Second acceleration/deceleration time* and *Pr. 45 Second deceleration time* settings.

The RT signal is not necessary for switching the acceleration/deceleration time.

Parameter Number	Name	Initial Value	Setting Range	Description
147	Acceleration/deceleration time switching frequency	9999	0 to 400Hz	Frequency when automatically switching to the acceleration/deceleration time of <i>Pr. 44</i> and <i>Pr. 45</i> .
			9999	No function

- When the RT signal (X9 signal) turns ON, the acceleration/deceleration time switches to the second (third) acceleration/deceleration time even when the output frequency has not reached the *Pr. 147* setting. Priority of switching is X9 signal > RT signal > *Pr. 147* setting.
- If the *Pr. 147* setting is lower than *Pr. 10 DC injection brake operation frequency* or *Pr. 13 Starting frequency* setting, the acceleration/deceleration time switches to the *Pr. 44 (Pr. 45)* setting when the output frequency exceeds the *Pr. 10* or *Pr. 13* setting.

<i>Pr. 147</i> Setting	Acceleration/Deceleration Time	Description
9999 (initial value)	<i>Pr. 7, Pr. 8</i>	No automatic switching of the acceleration/deceleration time
0.00Hz	<i>Pr. 44, Pr. 45</i>	Second acceleration/deceleration time from a start
$0.01\text{Hz} \leq \text{Pr. 147} \leq \text{Set frequency}$	Output frequency < <i>Pr. 147</i> : <i>Pr. 7, Pr. 8</i>  <i>Pr. 147</i> ≤ Output frequency : <i>Pr. 44, Pr. 45</i>	Acceleration/deceleration time automatic switching
Set frequency < <i>Pr. 147</i>	<i>Pr. 7, Pr. 8</i>	No automatic switching, since output frequency will not reach the switching frequency

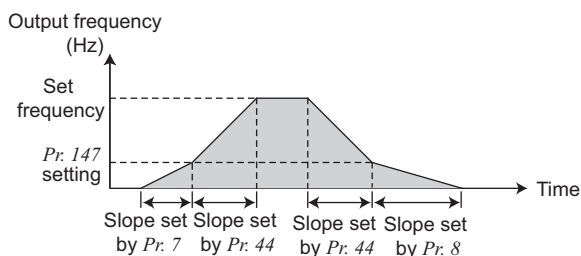

- Switching frequency for each control method

Control Method	Switching frequency
V/F control	Output frequency
Advanced magnetic flux vector control	Output frequency before the slip compensation
Real sensorless vector control	Estimated speed converted as frequency
Vector control, encoder feedback control	Actual motor speed converted as frequency

## 8 USB automatic recognition (Pr. 551 PU mode operation command source selection = "9999")

FR-A701 can automatically recognize the USB connection and switch the command source during PU operation mode.

Parameter Number	Name	Initial Value	Setting Range	Description
551 *	PU mode operation command source selection	9999	1	RS-485 terminals are the command source when PU operation mode.
			2	PU connector is the command source when PU operation mode.
			3	USB connector is the command source when PU operation mode.
			9999	USB automatic recognition Normally, the PU connector is the command source. When USB is connected, the USB connector is the command source.

\* This parameter allows its setting to be changed in any operation mode even if "0 (initial value)" is set in Pr. 77 Parameter write selection. When a communication option is installed, parameter setting is always enabled.

## 9 Modbus-RTU communication stop bit length selection (Pr. 333, Pr. 334)

The stop bit length can be selected for the Modbus-RTU communication.

- When parity checking is not performed (Pr. 334 RS-485 communication parity check selection = "0"), the stop bit length can be selected with Pr. 333 RS-485 communication stop bit length.

Parameter number	Name	Initial value	Setting range	Description
333	RS-485 communication stop bit length	1	0	Stop bit length 1 bit
			1	Stop bit length 2 bits
			10	Stop bit length 1 bit
			11	Stop bit length 2 bits
334	RS-485 communication parity check selection	2	0	Without parity check Stop bit length according to Pr. 333
			1	With odd parity Stop bit length 1 bit
			2	With even parity Stop bit length 1 bit

## 10 Plug-in option compatibility

### (1) FR-A7AZ

The motor temperature detection signal (Y55) and the motor temperature monitor output of the plug-in option FR-A7AZ is supported. For the details of FR-A7AZ, refer to *the Instruction Manual of FR-A7AZ*.

### (2) FR-A7AD

The plug-in option FR-A7AD is supported. The 0V voltage calibration request signal (X83) and the during 0V calibration signal (Y83) can be used for 0V calibration of the high speed analog output. For the details of FR-A7AD, refer to *the Instruction Manual of FR-A7AD*.

### (3) FR-A7NCE

For the details of FR-A7NCE, refer to *the Instruction Manual of FR-A7NCE*.

The communication option FR-A7NCE is supported. The following monitor items are assigned to the remote registers RWrn+71 and RWrn+72. (Refer to page 40 of the Instruction Manual of FR-A7NCE.)

Address	Description	
	Upper 8 bits	Lower 8 bits
RWrn+71	Output power (with regenerative display)	
RWrn+72	Cumulative regenerative power	

For the details of FR-A7NCE, refer to *the Instruction Manual of FR-A7NCE*



#### (4) FR-A7NF

The communication option FR-A7NF is supported. When the FR-A7NF is used for the FR-A701 series, the inverter is operated in the PU operation interlock (X12 signal) specification. For the details of FR-A7NF, refer to *the Instruction Manual of FR-A7NF*.

#### (5) FR-A701 dedicated monitor code / fault code for communication options

The FR-A701 dedicated monitor codes and the fault codes when the communication options are used are as shown below.

• Monitor code

Code Number		Monitor Description	Increments
FR-A7NCE	FR-A7NF		
H41	H10000210	Output power (with regenerative display)	0.1kW
H42	H10000212	Cumulative regenerative power	1kWh

• Fault code (fault data)

Fault code (data)	Fault indication (description)	Fault name
HF4	E.4	Fault 4 (Converter overcurrent)
HF8	E.8	Fault 8 (Power supply fault)
HFA	E.10	Fault 10 (Converter transistor protection thermal operation (electronic thermal))
HFF	E.15	Fault 15 (Convertor circuit fault)

### 11 Regenerative operation stop signal (X75 signal)

The converter operation can be stopped by turning ON the X75 signal.

Parameter Number	Name	Initial Value	Initial signal	Setting Range
178	STF terminal function selection	60	STF (Forward rotation command)	0 to 9, 12 to 20, 22 to 28, 42 to 44, 60, 62, 64 to 69, 74, <b>75</b> , 9999
179	STR terminal function selection	61	STR (Reverse rotation command)	0 to 9, 12 to 20, 23 to 28, 42 to 44, 61, 62, 64 to 69, 74, <b>75</b> , 9999
180	RL terminal function selection	0	RL (Low-speed operation command)	0 to 9, 12 to 20, 22 to 28, 42 to 44, 62, 64 to 69, 74, <b>75</b> , 9999
181	RM terminal function selection	1	RM (Middle-speed operation command)	
182	RH terminal function selection	2	RH (High-speed operation command)	
183	RT terminal function selection	3	RT (Second function selection)	
184	AU terminal function selection	4	AU (Terminal 4 input selection)	0 to 9, 12 to 20, 22 to 28, 42 to 44, 62 to 69, 74, <b>75</b> , 9999
185	JOG terminal function selection	5	JOG (Jog operation selection)	0 to 9, 12 to 20, 22 to 28, 42 to 44, 62, 64 to 69, 74, <b>75</b> , 9999
186	CS terminal function selection	6	CS (Electronic bypass function)	
187	MRS terminal function selection	24	MRS (Output stop)	
188	STOP terminal function selection	25	STOP (Start self-holding selection)	
189	RES terminal function selection	62	RES (Inverter reset)	

- The converter operation stops when the X75 signal is turned ON during an inverter stop.
- When the regenerative status is entered during a converter stop, the protective function (E.OV□) is activated due to overvoltage, and the inverter trips.
- To apply the X75 signal status to the converter operation, it is necessary to stop the inverter.

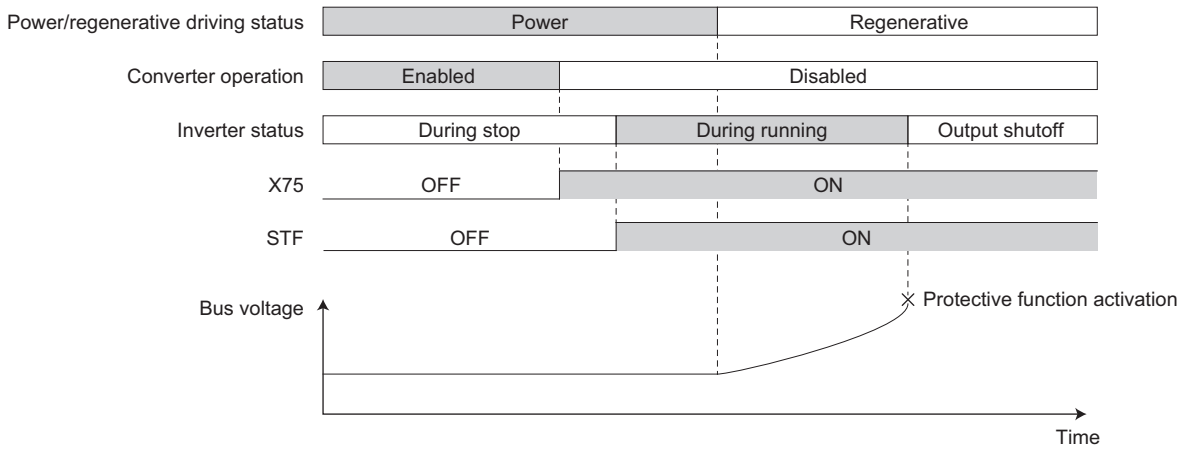

#### REMARKS

- If the X75 signal is turned ON while the inverter is running and remains ON, the X75 signal will be valid after the inverter stops.
- If the inverter is reset by turning ON the RES signal while the converter operation is stopped by the X75 signal, the converter stopped status is retained even while the reset is being processed.

## 12 Support for the PU operation mode of the brake sequence function

The brake sequence function is enabled when either the PU operation mode or the External/PU combined operation mode 2 is selected.

## 13 Parameter for manufacturer setting

- Pr. 414 to Pr. 417, Pr. 498, Pr. 506 to Pr. 515 are parameters for manufacturer setting. Do not set.
- The setting value "50" of Pr. 178 to Pr. 189 (*input terminal function selection*) is for manufacturer setting. Do not set.

