



# INVERTER FR-E700

## INSTRUCTION MANUAL (BASIC)

### *CC-Link communication function*

**FR-E720-0.1KNC to 15KNC**  
**FR-E740-0.4KNC to 15KNC**  
**FR-E720S-0.1KNC to 2.2KNC**

Thank you for choosing this Mitsubishi Electric Inverter.  
This Instruction Manual (Basic) provides handling information and precautions for use of the equipment.  
Please forward this Instruction Manual (Basic) to the end user.

<b>[1]</b>	<b>PRODUCT CHECKING AND PARTS IDENTIFICATION.....</b>	<b>1</b>
<b>[2]</b>	<b>INSTALLATION AND WIRING .....</b>	<b>2</b>
<b>[3]</b>	<b>PRECAUTIONS FOR USE OF THE INVERTER.....</b>	<b>22</b>
<b>[4]</b>	<b>FAILSAFE OF THE SYSTEM WHICH USES THE INVERTER ....</b>	<b>24</b>
<b>[5]</b>	<b>PARAMETER LIST.....</b>	<b>25</b>
<b>[6]</b>	<b>TROUBLESHOOTING .....</b>	<b>29</b>
<b>[7]</b>	<b>PRECAUTIONS FOR MAINTENANCE AND INSPECTION .....</b>	<b>34</b>
<b>[8]</b>	<b>SPECIFICATIONS.....</b>	<b>36</b>



### **To obtain the Instruction Manual (Applied) and the Safety stop function instruction manual**

Contact where you purchased the inverter, your Mitsubishi Electric sales representative, or the nearest Mitsubishi Electric FA Center for the following manuals:

- *Instruction Manual (Applied) [IB(NA)-0600402ENG]*
- *Safety stop function instruction manual [BCN-A211508-004]*

These manuals are required if you are going to utilize functions and performance.

The PDF version of this manual is also available for download at "MELFANS Web," the Mitsubishi Electric FA network service on the world wide web (URL: <http://www.MitsubishiElectric.co.jp/melfansweb>)

This Instruction Manual (Basic) provides handling information and precautions for use of the equipment. Please forward this Instruction Manual (Basic) to the end user.

**This section is specifically about safety matters**

Do not attempt to install, operate, maintain or inspect the inverter until you have read through the Instruction Manual (Basic) and appended documents carefully and can use the equipment correctly. Do not use this product until you have a full knowledge of the equipment, safety information and instructions.

In this Instruction Manual (Basic), the safety instruction levels are classified into "WARNING" and "CAUTION".

**WARNING** Incorrect handling may cause hazardous conditions, resulting in death or severe injury.

**CAUTION** Incorrect handling may cause hazardous conditions, resulting in medium or slight injury, or may cause only material damage.

The **CAUTION** level may even lead to a serious consequence according to conditions. Both instruction levels must be followed because these are important to personal safety.

1. Electric Shock Prevention

**WARNING**

- While power is ON or when the inverter is running, do not open the front cover. Otherwise you may get an electric shock.
- Do not run the inverter with the front cover or wiring cover removed. Otherwise you may access the exposed high-voltage terminals or the charging part of the circuitry and get an electric shock.
- Even if power is OFF, do not remove the front cover except for wiring or periodic inspection. You may accidentally touch the charged inverter circuits and get an electric shock.
- Before wiring or inspection, power must be switched OFF. To confirm that, LED indication of the operation panel must be checked. (It must be OFF.) Any person who is involved in wiring or inspection shall wait for at least 10 minutes after the power supply has been switched OFF and check that there are no residual voltage using a tester or the like. The capacitor is charged with high voltage for some time after power OFF, and it is dangerous.
- This inverter must be earthed (grounded). Earthing (grounding) must conform to the requirements of national and local safety regulations and electrical code (NEC section 250, IEC 536 class 1 and other applicable standards). A neutral-point earthed (grounded) power supply for 400V class inverter in compliance with EN standard must be used.
- Any person who is involved in wiring or inspection of this equipment shall be fully competent to do the work.
- The inverter must be installed before wiring. Otherwise you may get an electric shock or be injured.
- Setting dial and key operations must be performed with dry hands to prevent an electric shock.
- Do not subject the cables to scratches, excessive stress, heavy loads or pinching. Otherwise you may get an electric shock.
- Do not change the cooling fan while power is ON. It is dangerous to change the cooling fan while power is ON.
- Do not touch the printed circuit board or handle the cables with wet hands. Otherwise you may get an electric shock.
- When measuring the main circuit capacitor capacity, the DC voltage is applied to the motor for 1s at powering OFF. Never touch the motor terminal, etc. right after powering OFF to prevent an electric shock.

2. Fire Prevention

**CAUTION**

- Inverter must be installed on a nonflammable wall without holes (so that nobody touches the inverter heatsink on the rear side, etc.). Mounting it to or near flammable material can cause a fire.
- If the inverter has become faulty, the inverter power must be switched OFF. A continuous flow of large current could cause a fire.
- When using a brake resistor, a sequence that will turn OFF power when a fault signal is output must be configured. Otherwise the brake resistor may overheat due to damage of the brake transistor and possibly cause a fire.
- Do not connect a resistor directly to the DC terminals P/+ and N/-. Doing so could cause a fire.

3. Injury Prevention

**CAUTION**

- The voltage applied to each terminal must be the ones specified in the Instruction Manual. Otherwise burst, damage, etc. may occur.
- The cables must be connected to the correct terminals. Otherwise burst, damage, etc. may occur.
- Polarity must be correct. Otherwise burst, damage, etc. may occur.
- While power is ON or for some time after power-OFF, do not touch the inverter as they will be extremely hot. Doing so can cause burns.

4. Additional Instructions

Also the following points must be noted to prevent an accidental failure, injury, electric shock, etc.

(1) Transportation and Mounting

**CAUTION**

- The product must be transported in correct method that corresponds to the weight. Failure to do so may lead to injuries.
- Do not stack the boxes containing inverters higher than the number recommended.
- The product must be installed to the position where withstands the weight of the product according to the information in the Instruction Manual.
- Do not install or operate the inverter if it is damaged or has parts missing.
- When carrying the inverter, do not hold it by the front cover or setting dial; it may fall off or fail.
- Do not stand or rest heavy objects on the product.
- The inverter mounting orientation must be correct.
- Foreign conductive objects must be prevented from entering the inverter. That includes screws and metal fragments or other flammable substance such as oil.
- As the inverter is a precision instrument, do not drop or subject it to impact.
- The inverter must be used under the following environment. Otherwise the inverter may be damaged.

Environment	Surrounding air temperature	-10°C to +50°C (non-freezing)
	Ambient humidity	90%RH or less (non-condensing)
	Storage temperature	-20°C to +65°C *1
	Atmosphere	Indoors (free from corrosive gas, flammable gas, oil mist, dust and dirt)
	Altitude/vibration	Maximum 1,000m above sea level. 5.9m/s <sup>2</sup> or less at 10 to 55Hz (directions of X, Y, Z axes)

\*1 Temperature applicable for a short time, e.g. in transit.

## (2) Wiring

### CAUTION

- Do not install a power factor correction capacitor or surge suppressor/capacitor type filter on the inverter output side. These devices on the inverter output side may be overheated or burn out.
- The connection orientation of the output cables U, V, W to the motor affects the rotation direction of the motor.

## (3) Trial run

### CAUTION

- Before starting operation, each parameter must be confirmed and adjusted. A failure to do so may cause some machines to make unexpected motions.

## (4) Usage

### WARNING

- Any person must stay away from the equipment when the retry function is set as it will restart suddenly after trip.
- Since pressing  key may not stop output depending on the function setting status, separate circuit and switch that make an emergency stop (power OFF, mechanical brake operation for emergency stop, etc.) must be provided.
- OFF status of the start signal must be confirmed before resetting the inverter fault. Resetting inverter alarm with the start signal ON restarts the motor suddenly.
- The inverter must be used for three-phase induction motors. Connection of any other electrical equipment to the inverter output may damage the equipment.
- Do not modify the equipment.
- Do not perform parts removal which is not instructed in this manual. Doing so may lead to fault or damage of the product.

### CAUTION

- The electronic thermal relay function does not guarantee protection of the motor from overheating. It is recommended to install both an external thermal and PTC thermistor for overheat protection.
- Do not use a magnetic contactor on the inverter input for frequent starting/stopping of the inverter. Otherwise the life of the inverter decreases.
- The effect of electromagnetic interference must be reduced by using a noise filter or by other means. Otherwise nearby electronic equipment may be affected.
- Appropriate measures must be taken to suppress harmonics. Otherwise power supply harmonics from the inverter may heat/damage the power factor correction capacitor and generator.
- When driving a 400V class motor by the inverter, the motor must be an insulation-enhanced motor or measures must be taken to suppress surge voltage. Surge voltage attributable to the wiring constants may occur at the motor terminals, deteriorating the insulation of the motor.
- When parameter clear or all parameter clear is performed, the required parameters must be set again before starting operations because all parameters return to the initial value.
- The inverter can be easily set for high-speed operation. Before changing its setting, the performances of the motor and machine must be fully examined.
- Stop status cannot be hold by the inverter's brake function. In addition to the inverter's brake function, a holding device must be installed to ensure safety.
- Before running an inverter which had been stored for a long period, inspection and test operation must be performed.
- For prevention of damage due to static electricity, nearby metal must be touched before touching this product to eliminate static electricity from your body.

## (5) Emergency stop

### CAUTION

- A safety backup such as an emergency brake must be provided to prevent hazardous condition to the machine and equipment in case of inverter failure.
- When the breaker on the inverter input side trips, the wiring must be checked for fault (short circuit), and internal parts of the inverter for a damage, etc. The cause of the trip must be identified and removed before turning ON the power of the breaker.
- When any protective function is activated, appropriate corrective action must be taken, and the inverter must be reset before resuming operation.

## (6) Maintenance, inspection and parts replacement

### CAUTION

- Do not carry out a megger (insulation resistance) test on the control circuit of the inverter. It will cause a failure.

## (7) Disposal

### CAUTION

- The inverter must be treated as industrial waste.

#### General instruction

Many of the diagrams and drawings in this Instruction Manual (Basic) show the inverter without a cover or partially open for explanation. Never operate the inverter in this manner. The cover must be always reinstalled and the instruction in this Instruction Manual (Basic) must be followed when operating the inverter.

#### Harmonic suppression guideline (when inverters are used in Japan)

All models of general-purpose inverters used by specific consumers are covered by "Harmonic suppression guideline for consumers who receive high voltage or special high voltage". (For further details, refer to the *Instruction Manual (Applied)*.)

# 1 PRODUCT CHECKING AND PARTS IDENTIFICATION

Unpack the inverter and check the capacity plate on the front cover and the rating plate on the inverter side face to ensure that the product agrees with your order and the inverter is intact.

## ● Inverter model

FR - E720 - 2.2 KNC

No.	Voltage class
E720	Three-phase 200V class
E740	Three-phase 400V class
E720S	Single-phase 200V class

Represents the inverter capacity [kW]

### Operation panel

Refer to the Instruction Manual (Applied)

Terminating resistor switch (SW1) (Refer to page 17)

CC-Link communication connector (2-port type) (Refer to page 19)

### Front cover

Refer to the Instruction Manual (Applied)

### Cooling fan

Refer to the Instruction Manual (Applied)

LED (operation status indicator)

Refer to the Instruction Manual (Applied)  
Switch for manufacturer setting (SW2)

Do not change the initial setting (OFF).  
Standard control circuit terminal block (Refer to page 6)

Main circuit terminal block (Refer to page 6)

Combed shaped wiring cover  
 Refer to the Instruction Manual (Applied)

### Capacity plate \*

FR-E720-2.2KNC ← Inverter model  
SERIAL: XXXXXX ← Serial number

\* Location of the capacity plate and the rating plate differs according to the inverter capacity.

Refer to the outline dimension drawing. Refer to the Instruction Manual (Applied)

### Rating plate \*

MITSUBISHI INVERTER  
MODEL FR-E720-2.2KNC  
INPUT : XXXXX  
OUTPUT : XXXXX  
SERIAL : \_\_\_\_\_

MITSUBISHI ELECTRIC CORPORATION  
MADE IN JAPAN

PASSED

## ● Accessory

- P-clip (for M4 screw)  
Use this to ground (earth) the CC-Link dedicated cable. (Refer to page 19)



- Fan cover fixing screws (M3 × 35mm)  
These screws are necessary for compliance with the EU Directive (Refer to page 41)

Capacity	Quantity
FR-E720-1.5KNC to 3.7KNC, FR-E740-1.5KNC to 3.7KNC, FR-E720S-0.75KNC to 2.2KNC	1
FR-E720-5.5KNC to 15KNC, FR-E740-5.5KNC to 15KNC	2

# 2 INSTALLATION AND WIRING



### AC power supply

Use within the permissible power supply specifications of the inverter. To ensure safety, use a moulded case circuit breaker, earth leakage circuit breaker or magnetic contactor to switch power ON/OFF. (Refer to page 36)

### Moulded case circuit breaker (MCCB) or earth leakage circuit breaker (ELB), fuse

The breaker must be selected carefully since an in-rush current flows in the inverter at power ON. (Refer to page 3)

### Magnetic contactor (MC)

Install the magnetic contactor to ensure safety. Do not use this magnetic contactor to start and stop the inverter. Doing so will cause the inverter life to be shorter. (Refer to page 3)

### Reactor (FR-HAL, FR-HEL option)

Reactors (option) must be used when power harmonics measures are taken, the power factor is to be improved or the inverter is installed near a large power supply system (500kVA or more). The inverter may be damaged if you do not use reactors. Select the reactor according to the model. Remove the jumpers across the terminals P/+ and P1 to connect the DC reactor.

### AC reactor (FR-HAL)



### DC reactor (FR-HEL) \*



### EMC filter (ferrite core) \* (FR-BSF01, FR-BLF)

Install an EMC filter (ferrite core) to reduce the electromagnetic noise generated from the inverter. Effective in the range from about 1MHz to 10MHz. When more wires are passed through, a more effective result can be obtained. A wire should be wound four turns or more.



### Programmable controller

Load the "QJ61BT11N", "QJ61BT11", "AJ61OBT11", "A1SJ61OBT11", "AJ61BT11" or "A1SJ61BT11" CC-Link system master/local module on the main or extension base unit having the programmable controller CPU used as the master station.

Master station (for example, QJ61BT11N)



Terminating resistor

CC-Link dedicated cable

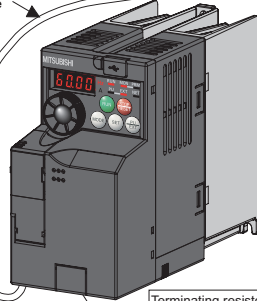

Terminating resistor



**Approved safety relay module**  
Required for compliance with safety standard.

S1  
S2  
PC

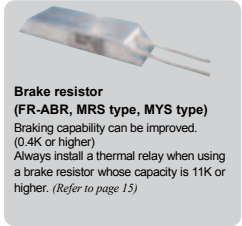

### Brake resistor (FR-ABR, MRS type, MYS type)

Braking capability can be improved. (0.4K or higher)  
Always install a thermal relay when using a brake resistor whose capacity is 11K or higher. (Refer to page 15)

Inverter (FR-E700-NC)

P/+

PR

P/+P1

P1

R/L1

S/L2

T/L3

Earth (Ground)

EMC filter (capacitor) \* (FR-BIF)

Reduces the radio noise.

P/+ N/-

U V W

Earth (Ground)

### EMC filter (ferrite core) (FR-BSF01, FR-BLF)

Install an EMC filter (ferrite core) to reduce the electromagnetic noise generated from the inverter. Effective in the range from about 1MHz to 10MHz. A wire should be wound four turns at a maximum.



Motor

Earth (Ground)

Earth (Ground)

Earth (Ground)

Earth (Ground)

Earth (Ground)

Earth (Ground)

Earth (Ground)

Earth (Ground)

Earth (Ground)

Earth (Ground)

Earth (Ground)

Earth (Ground)

Earth (Ground)

Earth (Ground)

Earth (Ground)

Earth (Ground)

Earth (Ground)

Earth (Ground)

Earth (Ground)

Earth (Ground)

Earth (Ground)

Earth (Ground)

Earth (Ground)

Earth (Ground)

Earth (Ground)

Earth (Ground)

Earth (Ground)

Earth (Ground)

Earth (Ground)

Earth (Ground)

Earth (Ground)

Earth (Ground)

\* Filterpack (FR-BFP2), which contains DC reactor and EMC filter in one package, is also available.

### Brake unit (FR-BU2)



The regenerative braking capability of the inverter can be exhibited fully. Install this as required.

### Resistor unit (FR-BR)

### Discharging resistor (GZG, GRZG)

### Devices connected to the output

Do not install a power factor correction capacitor, surge suppressor or capacitor type filter on the output side of the inverter. When installing a moulded case circuit breaker on the output side of the inverter, contact each manufacturer for selection of the moulded case circuit breaker.

### Earth (Ground)

To prevent an electric shock, always earth (ground) the motor and inverter. For reduction of induction noise from the power line of the inverter, it is recommended to wire the earth (ground) cable by returning it to the earth (ground) terminal of the inverter.

## NOTE

- Up to 42 inverters can be connected when using CC-Link communication.
- The life of the inverter is influenced by surrounding air temperature. The surrounding air temperature should be as low as possible within the permissible range. This must be noted especially when the inverter is installed in an enclosure. (Refer to page 4)
- Wrong wiring might lead to damage of the inverter. The control signal lines must be kept fully away from the main circuit to protect them from noise. (Refer to page 5)
- Do not install a power factor correction capacitor, surge suppressor or capacitor type filter on the inverter output side. This will cause the inverter to trip or the capacitor and surge suppressor to be damaged. If any of the above devices are connected, immediately remove them.
- Electromagnetic wave interference
- The input/output (main circuit) of the inverter includes high frequency components, which may interfere with the communication devices (such as AM radios) used near the inverter. In this case, install options among the capacitor type EMC filter FR-BIF (for use in the input side only), the ferrite core type EMC filter FR-BSF01/FR-BLF, Filterpack, and EMC filter to minimize the interference. (Refer to the Instruction Manual (Applied)).
- Refer to the instruction manual of each option and peripheral devices for details of peripheral devices.

## 2.1 Peripheral devices

Check the inverter model of the inverter you purchased. Appropriate peripheral devices must be selected according to the capacity. Refer to the following list and prepare appropriate peripheral devices:

Inverter Model	Motor Output (kW)	Moulded Case Circuit Breaker (MCCB) *1 or Earth Leakage Circuit Breaker (ELB) *2 (NF, NV type)		Magnetic Contactor (MC) *3		Reactor		
		Reactor connection		Reactor connection		FR-HAL	FR-HEL	
		without	with	without	with			
Three-Phase 200V	FR-E720-0.1KNC	0.1	5A	5A	S-N10	S-N10	0.4K *4	0.4K *4
	FR-E720-0.2KNC	0.2	5A	5A	S-N10	S-N10	0.4K *4	0.4K *4
	FR-E720-0.4KNC	0.4	5A	5A	S-N10	S-N10	0.4K	0.4K
	FR-E720-0.75KNC	0.75	10A	10A	S-N10	S-N10	0.75K	0.75K
	FR-E720-1.5KNC	1.5	15A	15A	S-N10	S-N10	1.5K	1.5K
	FR-E720-2.2KNC	2.2	20A	15A	S-N10	S-N10	2.2K	2.2K
	FR-E720-3.7KNC	3.7	30A	30A	S-N20, S-N21	S-N10	3.7K	3.7K
	FR-E720-5.5KNC	5.5	50A	40A	S-N25	S-N20, S-N21	5.5K	5.5K
	FR-E720-7.5KNC	7.5	60A	50A	S-N25	S-N25	7.5K	7.5K
Three-Phase 400V	FR-E740-0.4KNC	0.4	5A	5A	S-N10	S-N10	H0.4K	H0.4K
	FR-E740-0.75KNC	0.75	5A	5A	S-N10	S-N10	H0.75K	H0.75K
	FR-E740-1.5KNC	1.5	10A	10A	S-N10	S-N10	H1.5K	H1.5K
	FR-E740-2.2KNC	2.2	15A	10A	S-N10	S-N10	H2.2K	H2.2K
	FR-E740-3.7KNC	3.7	20A	15A	S-N10	S-N10	H3.7K	H3.7K
	FR-E740-5.5KNC	5.5	30A	20A	S-N20, S-N21	S-N11, S-N12	H5.5K	H5.5K
	FR-E740-7.5KNC	7.5	30A	30A	S-N20, S-N21	S-N20, S-N21	H7.5K	H7.5K
	FR-E740-11KNC	11	50A	40A	S-N20, S-N21	S-N20, S-N21	H11K	H11K
	FR-E740-15KNC	15	60A	50A	S-N25	S-N20, S-N21	H15K	H15K
Single-Phase 200V	FR-E720S-0.1KNC	0.1	5A	5A	S-N10	S-N10	0.4K *4	0.4K *4
	FR-E720S-0.2KNC	0.2	5A	5A	S-N10	S-N10	0.4K *4	0.4K *4
	FR-E720S-0.4KNC	0.4	10A	10A	S-N10	S-N10	0.75K *4	0.75K *4
	FR-E720S-0.75KNC	0.75	15A	10A	S-N10	S-N10	1.5K *4	1.5K *4
	FR-E720S-1.5KNC	1.5	20A	20A	S-N10	S-N10	2.2K *4	2.2K *4
	FR-E720S-2.2KNC	2.2	40A	30A	S-N20, S-N21	S-N10	3.7K *4	3.7K *4

- \*1 • Select an MCCB according to the power supply capacity.  
• Install one MCCB per inverter.

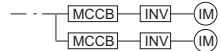

- \*2 For the use in the United States or Canada, select a UL and cUL certified fuse with Class T fuse equivalent cut-off speed or faster with the appropriate rating for branch circuit protection. Alternatively, select a UL489 molded case circuit breaker (MCCB).
- \*3 Magnetic contactor is selected based on the AC-1 class. The electrical durability of magnetic contactor is 500,000 times. When the magnetic contactor is used for emergency stop during motor driving, the electrical durability is 25 times.  
When using the MC for emergency stop during motor driving or using on the motor side during commercial-power supply operation, select the MC with class AC-3 rated current for the motor rated current.
- \*4 The power factor may be slightly lower.



### NOTE

- When the inverter capacity is larger than the motor capacity, select an MCCB and a magnetic contactor according to the inverter model and cable and reactor according to the motor output.
- When the breaker on the inverter input side trips, check for the wiring fault (short circuit), damage to internal parts of the inverter, etc. Identify the cause of the trip, then remove the cause and power on the breaker.

## 2.2 Installation of the inverter and instructions

### (1) Installation of the inverter

Enclosure surface mounting

Remove the front cover and wiring cover to fix the inverter to the surface. (Remove the covers in the directions of the arrows.)

- FR-E720-0.1KNC to 0.75KNC
- FR-E720S-0.1KNC to 0.4KNC

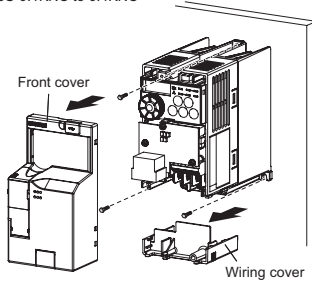

- FR-E720-1.5KNC or higher
- FR-E740-0.4KNC or higher
- FR-E720S-0.75KNC or higher

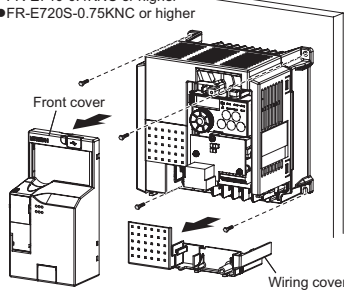

**Note**

- When encasing multiple inverters, install them in parallel as a cooling measure.
- Install the inverter vertically.
- For heat dissipation and maintenance, take at least the clearances shown in the table below from the inverter to the other devices and to the enclosure surface.

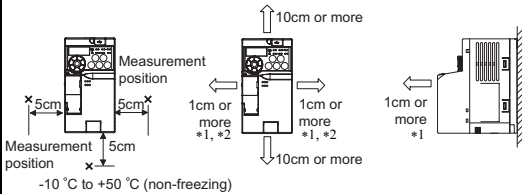

\*1 Take 5cm or more clearances for 5.5K or higher.

\*2 When using the inverters at the surrounding air temperature of 40°C or less, the inverters can be installed without any clearance between them (0cm clearance).

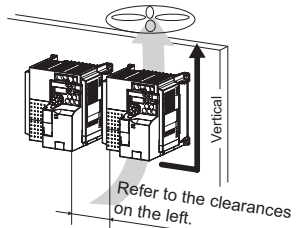

### (2) Environment

Before installation, check that the environment meets the specifications on page 38.



**Note**

- Install the inverter on a strong surface securely and vertically with bolts.
- Leave enough clearances and take cooling measures.
- Avoid places where the inverter is subjected to direct sunlight, high temperature and high humidity.
- Install the inverter on a non-flammable wall surface.





### 2.3.2 Terminal specifications

Type	Terminal Symbol	Terminal Name	Description																
Main circuit	R/L1, S/L2, T/L3 *	AC power input	Connect to the commercial power supply. * When using single-phase power input, terminals are R/L1 and S/L2.																
	U, V, W	Inverter output	Connect a three-phase squirrel-cage motor.																
	P/+, PR	Brake resistor connection	Connect a brake resistor (FR-ABR, MRS type, MYS type) across terminals P/+ and PR. (The brake resistor cannot be connected to the 0.1K or 0.2K.)																
	P/+, N/-	Brake unit connection	Connect the brake unit (FR-BU2).																
	P/+, P1	DC reactor connection	Remove the jumper across terminals P/+ and P1 and connect a DC reactor.																
		Earth (Ground)	For earthing (grounding) the inverter chassis. Must be earthed (grounded).																
Control circuit	24V external power supply	+24	24V external power supply	Even when the main circuit power supply is OFF, CC-Link communication continues with the input from the 24V external power supply.	Input voltage 23.5 to 26.5VDC Input current 0.7A or less														
		SD	24V external power supply common terminal	Common terminal for the terminal +24															
	Safety stop function	S1	Safety stop input (Channel 1)	Terminal S1/S2 are safety stop signals for use with in conjunction with an approved external safety unit. Both terminal S1/S2 must be used in dual channel form. Inverter output is shutoff depending on shorting/opening between S1 and PC, S2 and PC.	Input resistance 4.7kΩ Voltage when contacts are open 21 to 26VDC When contacts are short-circuited 4 to 6mADC														
		S2	Safety stop input (Channel 2)	In the initial status, terminal S1 and S2 are shorted with terminal PC by shorting wire. Remove the shorting wire and connect the safety relay module when using the safety stop function.															
		PC	Safety stop input terminal common	Common terminal for safety stop input terminals S1 and S2.															
	Open collector	Y0	Open collector output Y0 (Inverter running)	Switched low when the inverter output frequency is equal to or higher than the starting frequency (initial value 0.5Hz). Switched high during stop or DC injection brake operation. (Low indicates that the open collector output transistor is ON (conducts). High indicates that the transistor is OFF (does not conduct).) Use Pr.190 RX2 (terminal Y0) function selection to change the function assigned to the terminal.	Permissible load 24VDC (maximum 27VDC) 0.1A (a voltage drop is 3.4V maximum when the signal is ON)														
		SE	Open collector output common	Common terminal of terminal Y0.															
	CC-Link	CONA	CC-Link communication connector	Pin arrangement															
CONB		<table border="1"> <thead> <tr> <th>Pin number</th> <td>5</td> <td>4</td> <td>3</td> <td>2</td> <td>1</td> </tr> </thead> <tbody> <tr> <th>Signal name</th> <td>SLD</td> <td>NC</td> <td>DG</td> <td>DB</td> <td>DA</td> </tr> </tbody> </table> <p>One-touch connector for CC-Link communication</p> <table border="1"> <thead> <tr> <th>Model name</th> <th>Manufacturer</th> </tr> </thead> <tbody> <tr> <td>A6CON-L5P</td> <td>Mitsubishi Electric Corporation</td> </tr> <tr> <td>35505-6000-B0M GF</td> <td>Sumitomo 3M Limited</td> </tr> </tbody> </table>		Pin number	5	4	3	2	1	Signal name	SLD	NC	DG	DB	DA	Model name	Manufacturer	A6CON-L5P	Mitsubishi Electric Corporation
Pin number	5	4	3	2	1														
Signal name	SLD	NC	DG	DB	DA														
Model name	Manufacturer																		
A6CON-L5P	Mitsubishi Electric Corporation																		
35505-6000-B0M GF	Sumitomo 3M Limited																		

### 2.3.3 Terminal arrangement of the main circuit terminal, power supply and the motor wiring

#### Three-phase 200V class

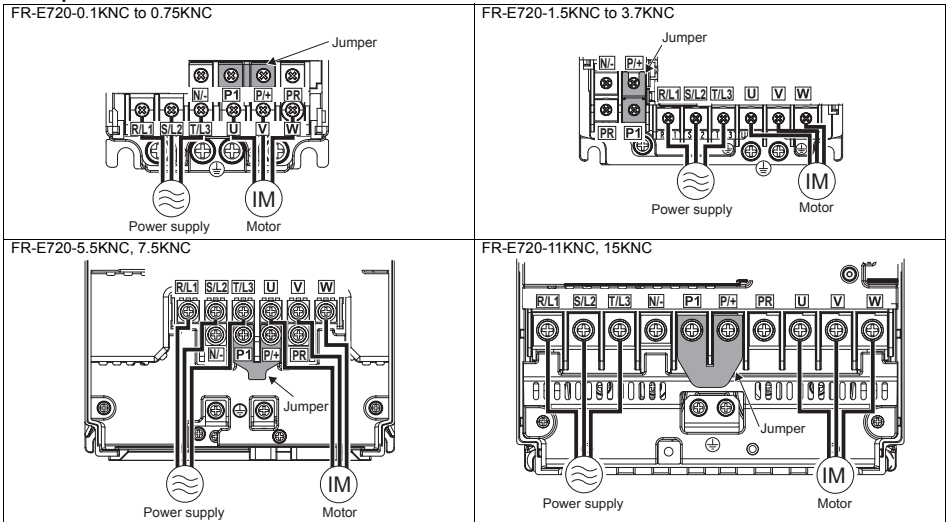

#### Three-phase 400V class

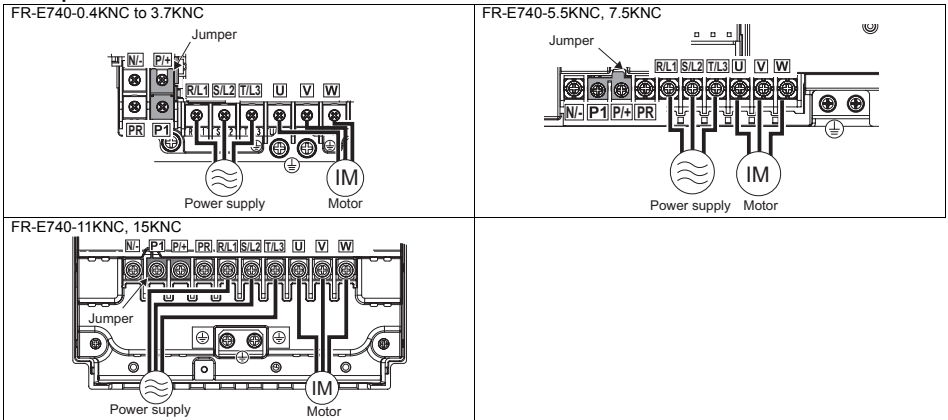

#### Single-phase 200V class

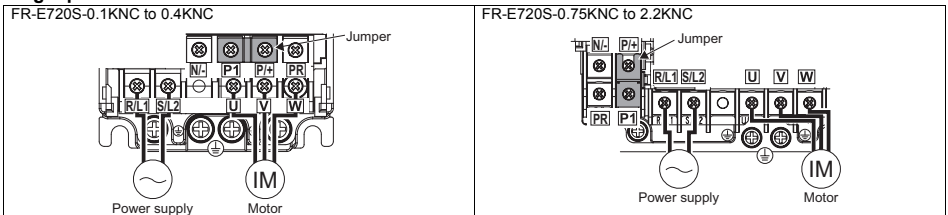

#### NOTE

- Make sure the power cables are connected to the R/L1, S/L2, and T/L3. (Phase need not be matched.) Never connect the power cable to the U, V, W of the inverter. Doing so will damage the inverter.
- Connect the motor to U, V, and W. Turning ON the forward rotation switch (signal) at this time rotates the motor counterclockwise when viewed from the load shaft.

### 2.3.4 Cables and wiring length

#### (1) Cable size and other specifications of the main circuit terminals and the earthing terminal

Select the recommended cable size to ensure that a voltage drop will be 2% or less.

If the wiring distance is long between the inverter and motor, a main circuit cable voltage drop will cause the motor torque to decrease especially at the output of a low frequency.

The following table indicates a selection example for the wiring length of 20m.

#### Three-phase 200V class (when input power supply is 220V)

Applicable Inverter Model	Terminal Screw Size <sup>+4</sup>	Tightening Torque N·m	Crimping Terminal		Cable Size								
					HIV Cables, etc. (mm <sup>2</sup> ) <sup>+1</sup>			AWG <sup>+2</sup>			PVC Cables, etc. (mm <sup>2</sup> ) <sup>+3</sup>		
					R/L1 S/L2 T/L3	U, V, W	R/L1 S/L2 T/L3	U, V, W	Earth (ground) cable	R/L1 S/L2 T/L3	U, V, W	R/L1 S/L2 T/L3	U, V, W
FR-E720-0.1KNC to 0.75KNC	M3.5	1.2	2-3.5	2-3.5	2	2	2	14	14	2.5	2.5	2.5	
FR-E720-1.5KNC, 2.2KNC	M4	1.5	2-4	2-4	2	2	2	14	14	2.5	2.5	2.5	
FR-E720-3.7KNC	M4	1.5	5.5-4	5.5-4	3.5	3.5	3.5	12	12	4	4	4	
FR-E720-5.5KNC	M5	2.5	5.5-5	5.5-5	5.5	5.5	5.5	10	10	6	6	6	
FR-E720-7.5KNC	M5	2.5	14-5	8-5	14	8	8	6	8	16	10	6	
FR-E720-11KNC	M5	2.5	14-5	14-5	14	14	14	6	6	16	16	16	
FR-E720-15KNC	M6(M5)	4.4	22-6	22-6	22	22	14	4	4	25	25	16	

#### Three-phase 400V class (when input power supply is 440V)

Applicable Inverter Model	Terminal Screw Size <sup>+4</sup>	Tightening Torque N·m	Crimping Terminal		Cable Size								
					HIV Cables, etc. (mm <sup>2</sup> ) <sup>+1</sup>			AWG <sup>+2</sup>			PVC Cables, etc. (mm <sup>2</sup> ) <sup>+3</sup>		
					R/L1 S/L2 T/L3	U, V, W	R/L1 S/L2 T/L3	U, V, W	Earth (ground) cable	R/L1 S/L2 T/L3	U, V, W	R/L1 S/L2 T/L3	U, V, W
FR-E740-0.4KNC to 3.7KNC	M4	1.5	2-4	2-4	2	2	2	14	14	2.5	2.5	2.5	
FR-E740-5.5KNC	M4	1.5	5.5-4	2-4	3.5	2	3.5	12	14	4	2.5	4	
FR-E740-7.5KNC	M4	1.5	5.5-4	5.5-4	3.5	3.5	3.5	12	12	4	4	4	
FR-E740-11KNC	M4	1.5	5.5-4	5.5-4	5.5	5.5	8	10	10	6	6	10	
FR-E740-15KNC	M5	2.5	8-5	8-5	8	8	8	8	8	10	10	10	

#### Single-phase 200V class (when input power supply is 220V)

Applicable Inverter Model	Terminal Screw Size <sup>+4</sup>	Tightening Torque N·m	Crimping Terminal		Cable Size								
					HIV Cables, etc. (mm <sup>2</sup> ) <sup>+1</sup>			AWG <sup>+2</sup>			PVC Cables, etc. (mm <sup>2</sup> ) <sup>+3</sup>		
					R/L1 S/L2 T/L3	U, V, W	R/L1 S/L2 T/L3	U, V, W	Earth (ground) cable	R/L1 S/L2 T/L3	U, V, W	R/L1 S/L2 T/L3	U, V, W
FR-E720S-0.1KNC to 0.4KNC	M3.5	1.2	2-3.5	2-3.5	2	2	2	14	14	2.5	2.5	2.5	
FR-E720S-0.75KNC	M4	1.5	2-4	2-4	2	2	2	14	14	2.5	2.5	2.5	
FR-E720S-1.5KNC	M4	1.5	2-4	2-4	2	2	2	14	14	2.5	2.5	2.5	
FR-E720S-2.2KNC	M4	1.5	5.5-4	2-4	3.5	2	2	12	14	4	2.5	2.5	

<sup>+1</sup> The cable size is that of the cable (HIV cable (600V class 2 vinyl-insulated cable) etc.) with continuous maximum permissible temperature of 75°C. Assumes that the surrounding air temperature is 50°C or less and the wiring distance is 20m or less.

<sup>+2</sup> The recommended cable size is that of the cable (THHW cable) with continuous maximum permissible temperature of 75°C. Assumes that the surrounding air temperature is 40°C or less and the wiring distance is 20m or less. (Selection example for use mainly in the United States.)

<sup>+3</sup> The recommended cable size is that of the cable (PVC cable) with continuous maximum permissible temperature of 70°C. Assumes that the surrounding air temperature is 40°C or less and the wiring distance is 20m or less. (Selection example for use mainly in Europe.)

<sup>+4</sup> The terminal screw size indicates the terminal size for R/L1, S/L2, T/L3, U, V, W, PR, P/+, N/-, P1 and a screw for earthing (grounding).

A screw for earthing (grounding) of the FR-E720-15KNC is indicated in ( ).

For single-phase power input, the terminal screw size indicates the size of terminal screw for R/L1, S/L2, U, V, W, PR, P/+, N/-, P1 and a screw for earthing (grounding).



#### NOTE

- Tighten the terminal screw to the specified torque. A screw that has been tighten too loosely can cause a short circuit or malfunction. A screw that has been tighten too tightly can cause a short circuit or malfunction due to the unit breakage.
- Use crimping terminals with insulation sleeve to wire the power supply and motor.

The line voltage drop can be calculated by the following formula:

$$\text{Line voltage drop [V]} = \frac{\sqrt{3} \times \text{wire resistance [m}\Omega/\text{m]} \times \text{wiring distance [m]} \times \text{current [A]}}{1000}$$

Use a larger diameter cable when the wiring distance is long or when it is desired to decrease the voltage drop (torque reduction) in the low speed range.

## (2) Total wiring length

The overall wiring length for connection of a single motor or multiple motors should be within the value in the table below.

Pr. 72 PWM frequency selection Setting (carrier frequency)		0.1K	0.2K	0.4K	0.75K	1.5K	2.2K	3.7K or Higher
1 (1kHz) or less	200V class	200m	200m	300m	500m	500m	500m	500m
	400V class	—	—	200m	200m	300m	500m	500m
2 to 15 (2kHz to 14.5kHz)	200V class	30m	100m	200m	300m	500m	500m	500m
	400V class	—	—	30m	100m	200m	300m	500m

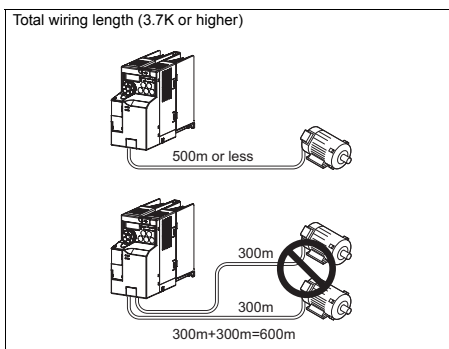

When driving a 400V class motor by the inverter, surge voltages attributable to the wiring constants may occur at the motor terminals, deteriorating the insulation of the motor. Take the following measures (1) or (2) in this case.



- Use a "400V class inverter-driven insulation-enhanced motor" and set frequency in *Pr. 72 PWM frequency selection* according to wiring length.

Carrier frequency	Wiring Length		
	50m or less	50m to 100m	Exceeding 100m
	14.5kHz or less	8kHz or less	2kHz or less

- Connect the surge voltage suppression filter (FR-ASF-H/FR-BMF-H) on the inverter output side.



### NOTE

- Especially for long-distance wiring, the inverter may be affected by a charging current caused by the stray capacitances of the wiring, leading to a malfunction of the overcurrent protective function, fast response current limit function, or stall prevention function or a malfunction or fault of the equipment connected on the inverter output side. If malfunction of fast-response current limit function occurs, disable this function. If malfunction of stall prevention function occurs, increase the stall level. (  Refer to *Pr. 22 Stall prevention operation level* and *Pr. 156 Stall prevention operation selection in Chapter 5 of the Instruction Manual (Applied)* )
-  Refer to *Chapter 5 of the Instruction Manual (Applied)* for details of *Pr. 72 PWM frequency selection*. Refer to the manual of the option for details of surge voltage suppression filter (FR-ASF-H/FR-BMF-H).
- When using the automatic restart after instantaneous power failure function with wiring length exceeding than 100m, select without frequency search (*Pr. 162* = "1 (initial setting) or 11"). (  Refer to *Chapter 5 of the Instruction Manual (Applied)* )

### 2.3.5 Wiring of control circuit

#### (1) Terminal layout of control circuit terminal

Recommended wire size:  
0.3mm<sup>2</sup> to 0.75mm<sup>2</sup>

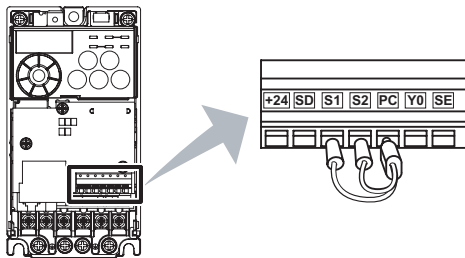

#### (2) Wiring method

##### ●Wiring

For the control circuit wiring, strip off the sheath of wires, and use them with a blade terminal. For a single wire, strip off the sheath of the wire and apply directly.

Insert the blade terminal or the single wire into a socket of the terminal.

- Strip off the sheath about the length below. If the length of the sheath peeled is too long, a short circuit may occur among neighboring wires. If the length is too short, wires might come off.

Wire the stripped wire after twisting it to prevent it from becoming loose. In addition, do not solder it.

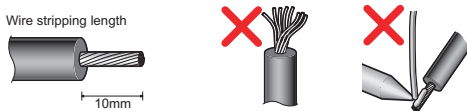

- Crimp the blade terminal.

Insert wires to a blade terminal, and check that the wires come out for about 0 to 0.5 mm from a sleeve.

Check the condition of the blade terminal after crimping. Do not use a blade terminal of which the crimping is inappropriate, or the face is damaged.

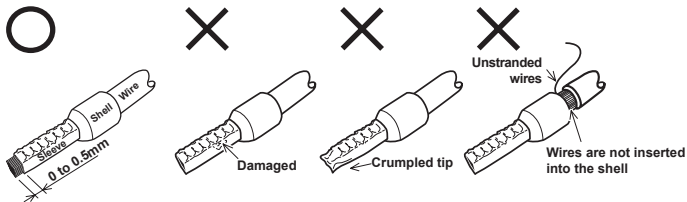

Commercially available blade terminals (as of January 2010)

##### ●Phoenix Contact Co.,Ltd.

Wire Size (mm <sup>2</sup> )	Blade Terminal Model			Blade terminal crimping tool
	with insulation sleeve	without insulation sleeve	for UL wire*	
0.3	AI 0,5-10WH	—	—	CRIMPFOX 6
0.5	AI 0,5-10WH	—	AI 0,5-10WH-GB	
0.75	AI 0,75-10GY	A 0,75-10	AI 0,75-10GY-GB	
1	AI 1-10RD	A1-10	AI 1-10RD/1000GB	
1.25, 1.5	AI 1,5-10BK	A1,5-10	—	
0.75 (for two wires)	AI-TWIN 2 x 0,75-10GY	—	—	

\* A blade terminal with an insulation sleeve compatible with MTW wire which has a thick wire insulation

##### ●NICHIFU Co.,Ltd.

Wire Size (mm <sup>2</sup> )	Blade terminal product number	Insulation product number	Blade terminal crimping tool
0.3 to 0.75	BT 0.75-11	VC 0.75	NH 67

3) Insert the wire into a socket.

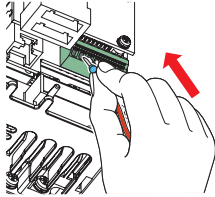

When using a single wire or a stranded wire without a blade terminal, push an open/close button all the way down with a flathead screwdriver, and insert the wire.

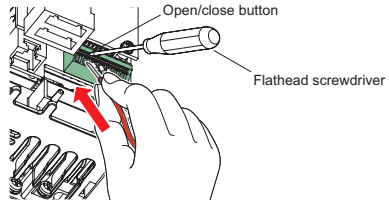

**NOTE**

- When using a stranded wire without a blade terminal, twist enough to avoid short circuit with a nearby terminals or wires.
- Place the flathead screwdriver vertical to the open/close button. In case the blade tip slips, it may cause to damage of inverter or injury.

●Wire removal

Pull the wire with pushing the open/close button all the way down firmly with a flathead screwdriver.

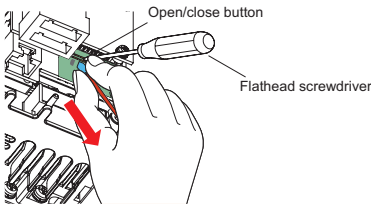

**NOTE**

- Pulling out the terminal block forcefully without pushing the open/close button all the way down may damage the terminal block.
  - Use a small flathead screwdriver (Tip thickness: 0.4mm/tip width: 2.5mm). If a flathead screwdriver with a narrow tip is used, terminal block may be damaged.
- Commercially available product (as of October 2008)

Product	Model	Manufacturer
Flathead screwdriver	SZF 0- 0,4 x 2,5	Phoenix Contact Co.,Ltd.

- Place the flathead screwdriver vertical to the open/close button. In case the blade tip slips, it may cause to damage of inverter or injury.

**(3) Control circuit common terminals (SD, SE)**

Terminals SD and SE are common terminals for I/O signals. (Both common terminals are isolated from each other.) Do not earth them.

Terminal SD is a common terminal for the 24V external power supply terminal (+24). The open collector circuit is isolated from the internal control circuit by photocoupler.

Terminal SE is a common terminal for the open collector output terminal (Y0). The contact input circuit is isolated from the internal control circuit by photocoupler.

**(4) Wiring instructions**



- 1) It is recommended to use the cables of 0.3mm<sup>2</sup> to 0.75mm<sup>2</sup> gauge for connection to the control circuit terminals.
- 2) The maximum wiring length should be 30m.
- 3) Do not short across terminals +24 and SD. It may cause a failure to the external power supply.
- 4) Use shielded or twisted cables for connection to the control circuit terminals and run them away from the main and power circuits (including the 200V relay sequence circuit).

### 2.3.6 Connecting the 24V external power supply

CC-Link communication between the master module and the inverter can be continued while the main power circuit is OFF if the 24V external power supply is connected across terminals +24 and SD. When the main circuit power supply is turned ON, the power supply changes from the 24V external power supply to the main circuit power supply.

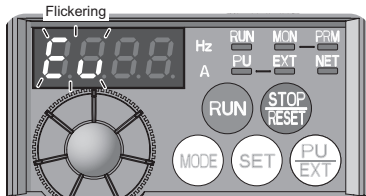
- (1) Specification of the applied 24V external power supply
  - Input voltage 23.5 to 26.5VDC
  - Input current 0.7A or less
- (2) Confirming the 24V external power supply
  - "EV" flickers in the monitor display on the operation panel while the 24V external power is being supplied. The 24V external power supply operation signal (EV) is also output. For the EV signal, assign the function to the terminal Y0 or a virtual terminal of CC-Link communication by setting "68 (positive logic) or 168 (negative logic)" in Pr. 190 to Pr. 192 or Pr. 313 to Pr. 315 (Output terminal function selection).



- (3) Function of the 24V external power supply operation
  - When the main power supply is turned ON during the 24V external power supply operation, a reset is performed in the inverter, then the power supply changes to the main circuit power supply. During the reset operation in the inverter, the inverter cannot be controlled through the CC-Link communication.
  - The operation stops when the power supply changes to the 24V external power supply from the main circuit power supply regardless of the operating status (in a stop, in running, in automatic restart after instantaneous power failure, in offline tuning, in main circuit capacitor life measurement).
  - All start signals (STF signal, STR signal, and  on the operation panel) are invalid during the 24V external power supply operation.
  - Faults history and parameters can be read and parameters can be written (when the parameter write from the operation panel is enabled) using the operation panel keys.
  - The safety stop function is also valid during the 24V external power supply operation. When the safety stop function is active, however, "SA" is not displayed because "EV" is displayed. The "EV" display has priority over the "SA" display.
  - The following items can be monitored during the 24V external power supply operation:
    - Frequency setting, output current peak value\*, converter output voltage peak value\*, cumulative energization time, actual operation time\*, cumulative power\*, PID set point, PID measured value, PID deviation, and cumulative power 2\* (dedicated to CC-Link communication)
    - \* The monitored data is not updated after the power supply is changed from the main circuit power supply.
 (Refer to  Chapter 5 of the Instruction Manual (Applied) for the details of each monitor.)
  - The valid signals when the 24V external power supply is ON are EV, SAFE, SAFE2, Y90, Y91, Y95, REM, LF, and ALM. (Other signals are OFF.)
    - (Refer to  Chapter 5 of the Instruction Manual (Applied) for the detail of each signal.)
  - The alarms, which have occurred when the main circuit power supply is ON, continue to be output after the power supply is changed to the 24V external power supply. Perform the inverter reset to reset the alarms.
  - The retry function is invalid for all alarms when the 24V external power supply is ON.
  - If the power supply changes from the main circuit power supply to the 24V external power supply while measuring the main circuit capacitor's life, the measurement completes after the power supply changes back to the main circuit power supply (Pr.259 = "3").



**NOTE**

- When the 24V external power supply is input while the main circuit power supply is OFF, the CC-Link communication is enabled, but the inverter operation is disabled.
- Inrush current higher than the value described in (1) may flow at a power-ON. Confirm that the power supply and other devices are not affected by the inrush current and the voltage drop caused by it.
- When the wiring length between the external power supply and the inverter is long, the voltage often drops. Select the appropriate wiring size and length to keep the voltage in the rated input voltage range.
- In a serial connection of several inverters, the current increases when it flows through the inverter wiring near the power supply. The increase of the current causes voltage to drop further. When connecting different inverters to different power supplies, use the inverters after confirming that the input voltage of each inverter is within the rated input voltage range.
- "E.SAF" may appear when the start-up time of the 24V power supply is too long in the 24V external power supply operation.

### 2.3.7 Safety stop function

#### (1) Description of the function

The terminals related to the safety stop function are shown below.

Terminal Symbol	Description		
S1 +1	For input of safety stop channel 1.	Between S1 and PC / S2 and PC Open: In safety stop state. Short: Other than safety stop state.	
S2 +1	For input of safety stop channel 2.		
PC +1	Common terminal for terminal S1 and S2.		
Y0 or virtual terminal of CC-Link communication*2	SAFE signal +3	Outputs the safety stop status. The signal is output when inverter output is shut off due to the safety stop function.	OFF: Drive enabled or drive stop (at an internal safety circuit failure*5) ON: Drive stop (no internal safety circuit failure*5)
	SAFE2 signal +4	Outputs when an alarm or failure is detected. The signal is output when no internal safety circuit failure*5 exists.	
SE	Common terminal for open collector outputs (terminal Y0)		

- \*1 In the initial status, terminals S1 and S2 are shorted with terminal PC by shortening wire. Remove the shortening wire and connect the safety relay module when using the safety stop function.
- \*2 Inverter running (RUN signal) is assigned to the terminal Y0 in the initial status.
- \*3 To use the SAFE signal, set "80 (positive logic) or 180 (negative logic)" in any of Pr.190 to Pr.192 or Pr.313 to Pr.315 (Output terminal function selection) to assign the function. (Refer to Chapter 5 of the Instruction Manual (Applied))
- \*4 To use the SAFE 2 signal, set "81 (positive logic) or 181 (negative logic)" in any of Pr.190 to Pr.192 or Pr.313 to Pr.315 (Output terminal function selection) to assign the function. (Refer to Chapter 5 of the Instruction Manual (Applied))
- \*5 At an internal safety circuit failure, one of E.SAF, E.6, E.7, and E.CPU is displayed on the operation panel.



#### NOTE

- Hold the ON or OFF status for 2ms or longer to input signal to terminal S1 or S2. Signal input shorter than 2ms is not recognized.
- Use SAFE signal to monitor safety stop status. SAFE signal cannot be used as safety stop input signal to other devices (other than the safety relay module).
- SAFE 2 signal can only be used to output an alarm or to prevent restart of an inverter. The signal cannot be used as safety stop input signal to other devices.

#### (2) Wiring connection diagram

To prevent restart at fault occurrence, connect terminals Y0 (SAFE 2 signal) and SE to terminals XS0 and XS1, which are the feedback input terminals of the safety relay module.

By setting Pr. 190 RX2 (terminal Y0) function selection = "81 (SAFE2 signal)", terminal RUN is turned OFF at fault occurrence.

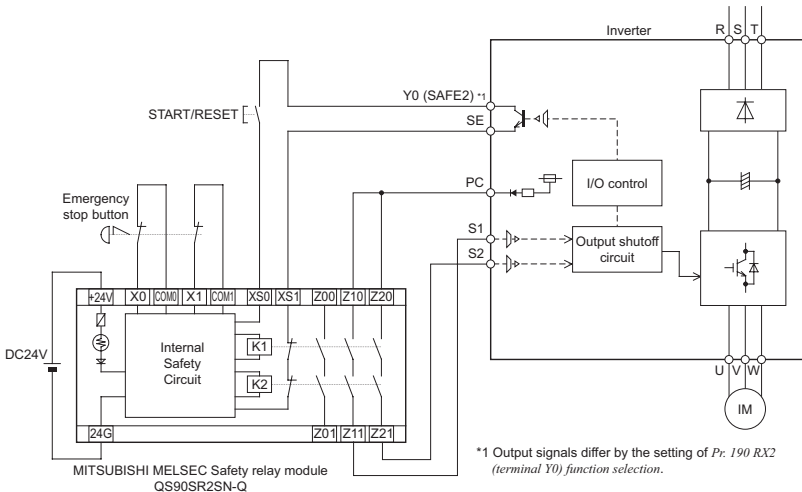

\*1 Output signals differ by the setting of Pr. 190 RX2 (terminal Y0) function selection.



#### NOTE

- Changing the terminal assignment of SAFE or SAFE2 signal using Pr. 190 RX2 (terminal Y0) function selection may affect the other functions. Set parameters after confirming the function of terminal Y0.



### (3) Safety stop function operation

Input power	Input signal		Internal safety circuit <sup>*1</sup>	Output signal		Inverter operation enable signal
	S1-PC	S2-PC		SAFE <sup>*3</sup>	SAFE2 <sup>*3</sup>	
OFF	—	—	—	OFF	OFF	Output shutoff (Safe state)
ON	Short	Short	No failure	OFF	ON	Drive enabled
			Failure	OFF	OFF	Output shutoff (Safe state)
	Open	Open	No failure <sup>*2</sup>	ON	ON	Output shutoff (Safe state)
			Failure	OFF	OFF	Output shutoff (Safe state)
	Short	Open	Failure	OFF	OFF	Output shutoff (Safe state)
Open	Short	Failure	OFF	OFF	Output shutoff (Safe state)	

\*1 At an internal safety circuit failure, one of E.SAF, E.6, E.7, and E.CPU is displayed on the operation panel.

\*2 SA is displayed when both of the S1 and S2 signals are in open status and no internal safety circuit failure exists.

\*3 ON: Transistor used for an open collector output is conducted.

OFF: Transistor used for an open collector output is not conducted.

For more details, refer to the Safety stop function instruction manual (BCN-A211508-004). (Refer to the front cover for how to obtain the manual.)



## 2.5 Wiring for CC-Link communication

### 2.5.1 System configuration example

#### (1) Programmable controller side

Mount the "QJ61BT11N", "LJ61BT11", "AJ61QBT11", "A1SJ61QBT11", "AJ61BT11" or "A1SJ61BT11" "CC-Link system master/local module" on the main or extension base unit having the programmable controller CPU used as the master station.

#### (2) Connect the master station of the CC-Link programmable controller unit to the CC-Link communication connector of FR-E700-NC with the CC-Link dedicated cable.

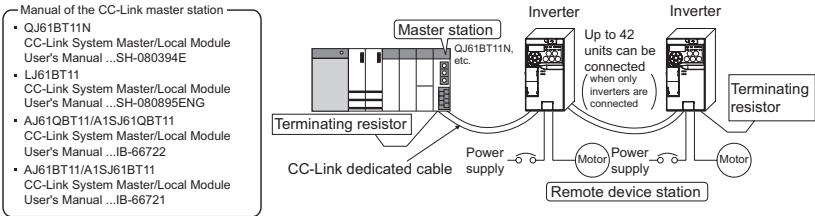

#### REMARKS

- When the CPU has the automatic refresh function (example: QnA series CPU)  
Through communication with the corresponding devices using sequence ladder logic, data is automatically transferred to the refresh buffer of the master station at the execution of the END instruction to perform communication with the remote devices.
- When the CPU does not have the automatic refresh function (example: AnA series CPU)  
Data is transferred to the refresh buffer of the master station directly by sequence ladder logic to perform communication with the remote devices.

### 2.5.2 Connection of several inverters

An inverter can join the link system as a CC-Link remote device station, and such device stations can be controlled and monitored with a user program of a programmable controller. These devices can be useful components of an automated factory. Connect shielding wires of the CC-Link dedicated cable to "SLD" of each unit.

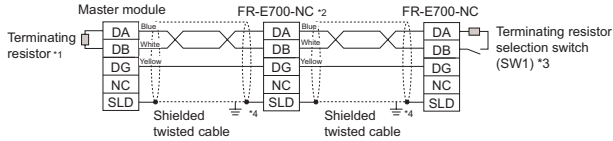

- \*1 Use the terminating resistors supplied with the programmable controller.
- \*2 Set "1" and "2" of the terminating resistor selection switch (SW1) to OFF (without terminating resistor) in the middle units.

	1	2	Description
	OFF	OFF	Without terminating resistor (initial setting)
	ON	OFF	Do not use.
	OFF	ON	130Ω
	ON	ON	110Ω

130Ω is a resistance value for the CC-Link Ver.1.00 dedicated high performance cable.

- \*3 Set the terminating resistor selection switch (SW1). (Refer to Chapter 1 of the Instruction Manual (Applied) for switch positions.) Do not use the built-in terminating resistor selection switch (SW1) when using a one-touch connector plug with terminating resistor. (SW1-OFF, 2-OFF) (Refer to page 20 for the details of the one-touch connector plug with terminating resistor.)
- \*4 Use a conduction area of a P-clip (enclosed item) to ground (earth) shielding wires of the CC-Link dedicated cable to a position (as close as possible to the inverter) on the enclosure. Take caution not to subject the CC-Link communication connector to stress. (Refer to page 19)

#### (1) Maximum number of units connected to one master station (CC-Link Ver.1.10) 42 units (when only inverters are connected)

If any other units are included, the number of stations occupied depends on the unit and therefore the following conditions must be satisfied:

$$\{(1 \times a) + (2 \times b) + (3 \times c) + (4 \times d)\} \leq 64$$

a: Number of units occupying 1 station    c: Number of units occupying 3 stations  
 b: Number of units occupying 2 stations    d: Number of units occupying 4 stations

$$\{(16 \times A) + (54 \times B) + (88 \times C)\} \leq 2304$$

A: Number of remote I/O ≤ 64  
 B: Number of remote device stations ≤ 42  
 C: Number of local, standby master and intelligent device stations ≤ 26

#### (2) Maximum number of units connected to one master station (CC-Link Ver.2.00) 42 units (when only inverters are connected)

If any other units are included, the number of stations occupied depends on the unit and therefore the following conditions must be satisfied:

$$\{(a + a2 + a4 + a8) + (b + b2 + b4 + b8) \times 2 + (c + c2 + c4 + c8) \times 3 + (d + d2 + d4 + d8) \times 4\} \leq 64$$

$$\{(a \times 32 + a2 \times 32 + a4 \times 64 + a8 \times 128) + (b \times 64 + b2 \times 96 + b4 \times 192 + b8 \times 384) + (c \times 96 + c2 \times 160 + c4 \times 320 + c8 \times 640) + (d \times 128 + d2 \times 224 + d4 \times 448 + d8 \times 896)\} \leq 8192$$

$$\{(a \times 4 + a2 \times 8 + a4 \times 16 + a8 \times 32) + (b \times 8 + b2 \times 16 + b4 \times 32 + b8 \times 64) + (c \times 12 + c2 \times 24 + c4 \times 48 + c8 \times 96) + (d \times 16 + d2 \times 32 + d4 \times 64 + d8 \times 128)\} \leq 2048$$

a: Number of single setting devices occupying one station  
 b: Number of single setting devices occupying two stations  
 c: Number of single setting devices occupying three stations  
 d: Number of single setting devices occupying four stations  
 a2: Number of double setting devices occupying one station  
 b2: Number of double setting devices occupying two stations  
 c2: Number of double setting devices occupying three stations  
 d2: Number of double setting devices occupying four stations  
 a4: Number of quadruple setting devices occupying one station  
 b4: Number of quadruple setting devices occupying two stations  
 c4: Number of quadruple setting devices occupying three stations  
 d4: Number of quadruple setting devices occupying four stations  
 a8: Number of octuple setting devices occupying one station  
 b8: Number of octuple setting devices occupying two stations  
 c8: Number of octuple setting devices occupying three stations  
 d8: Number of octuple setting devices occupying four stations

$$16 \times A + 54 \times B + 88 \times C \leq 2304$$

A: Numbers of remote I/O ≤ 64  
 B: Number of remote device stations ≤ 42  
 C: Number of local and intelligent device stations ≤ 26

## 2.5.3 Connection cable and plug

In the CC-Link system, use CC-Link dedicated cables.

If the cable used is other than the CC-Link dedicated cable, the performance of the CC-Link system is not guaranteed.

For the specifications of the CC-Link dedicated cable, refer to the website of the CC-Link Partner Association.

Website of the CC-Link Partner Association <http://www.cc-link.org/>



- One-touch communication connector plug (as of December 2009)

Refer to the following table for the plug required to fabricate a cable on your own.

Model	Manufacturer
A6CON-L5P	Mitsubishi Electric Corporation
35505-6000-B0M GF	3M

### (1) Cable-end treatment

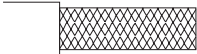
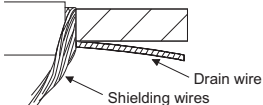
Apply the following treatment to the CC-Link dedicated cable that is inserted to a one-touch communication connector plug.

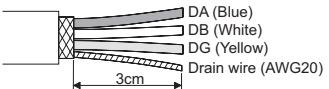
<p>1. Cut the sheath.</p> 	<p>2. Separate shielding wires from the drain wire. Cut the shielding wires.</p> 
<p>3. Cut the aluminum tape and braid.</p> 	<p>4. Straighten the drain wire and twist it from the root. (Twist seven times or more per 3cm.)</p> 

### REMARKS

- Where possible, round the cable tip that is cut off with a tool such as nippers. If the cable is not rounded, it may get caught in the middle of a plug, without fully entering into the plug.
- If required, apply an insulation treatment to the shielding wire area where it is not covered by the one-touch communication connector plug.

### (2) Plug cover check

Check that a plug cover is snapped into a plug.

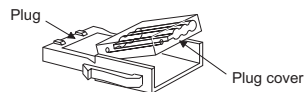

### Note

- Do not push the plug cover onto the plug before inserting a cable. Once crimped, the plug cover cannot be reused.

### (3) Cable insertion

Lift up the tail of the plug cover, and fully insert a cable. Insert different signal wires to the one-touch communication connector plug as shown in the right figure.

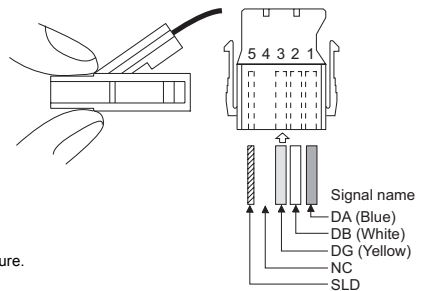

### REMARKS

- Insert the cable fully. Failure to do so may cause a crimping failure.
- A cable sometimes comes out of the head of the cover.  
In that case, pull the cable a little so that the cable stays under the plug cover.

#### (4) Crimping the plug cover

Push the plug cover onto the plug with a tool such as pliers. After crimping, check that the plug cover is securely snapped into the plug as shown in the right figure.



#### REMARKS

- Misaligned latches between the plug cover and the plug may keep the cover lifted. The plug cover is not sufficiently crimped in this condition. Push the plug cover until it snaps into the plug.

### 2.5.4 Connection of CC-Link dedicated cable

#### (1) Connection to the connector

Connect the CC-Link dedicated cable to the CC-link communication connector.

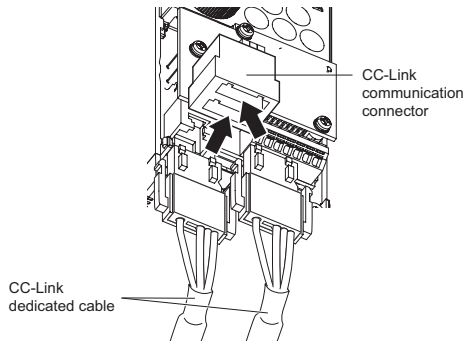



#### (2) Grounding (earthing) the CC-Link dedicated cable

Use an M4 screw and a conduction area of a P-clip (enclosed item) to ground (earth) shielding wires of the CC-Link dedicated cable to a position (as close as possible to the inverter) on the enclosure.

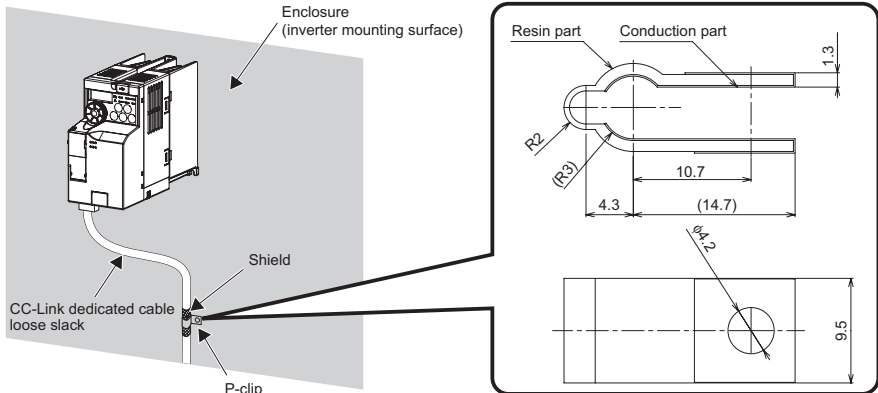
Take caution not to subject the CC-Link communication connector to stress.



## CAUTION

-  Take caution not to subject the cables to stress.
-  After wiring, wire offcuts must not be left in the inverter. Wire offcuts can cause an alarm, failure or malfunction.

**2.5.5 Unit replacement while online**

Connect an online communication connector to the CC-Link communication connector. The online communication connector enables a unit replacement without interrupting the communication. Always connect the online communication connector to CONA (front side) of the CC-Link communication connector. (Do not connect it to CONB (back side) of the CC-Link communication connector. Doing so will cause a failure or breakage of the inverter and the connectors.)

Also connect a one-touch connector plug with terminating resistor to the CC-Link communication connector of FR-E700-NC at the end.

(A replacement while online is not available for the units, which are using the built-in terminating resistor selection switches (SW1).)

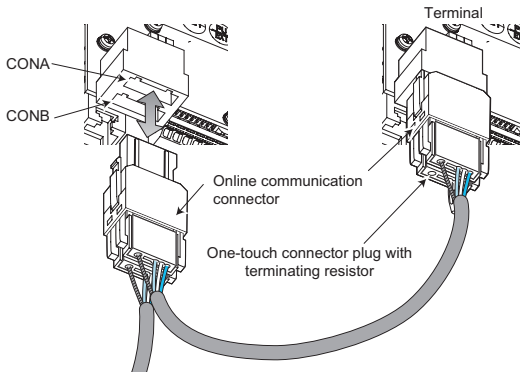

Use the following online communication connector and one-touch connector plug with terminating resistor.

- Online communication connector (as of December 2009)

Model	Manufacturer
35715-L010-B00 AK	3M

- One-touch connector plug with terminating resistor (as of December 2009)

Model	Manufacturer
A6CON-TR11	Mitsubishi Electric Corporation



**Note**

- Do not use the online communication connector A6CON-LJ5P (Mitsubishi Electric Corporation) and 35720-L200-B00 AK (3M) for this product. Doing so will cause a failure or breakage of the inverter and the connectors.

## 2.6 CC-Link function setting

### 2.6.1 Station number setting (Pr. 542)

- Use Pr. 542 Communication station number (CC-Link) to set station number of the inverter. Set this parameter within the range of 1 to 64. (Pr. 542 is initially set to "1.")



#### Note

- Use different station numbers for different devices. (If different devices have the same station number, the communication cannot be performed properly.)

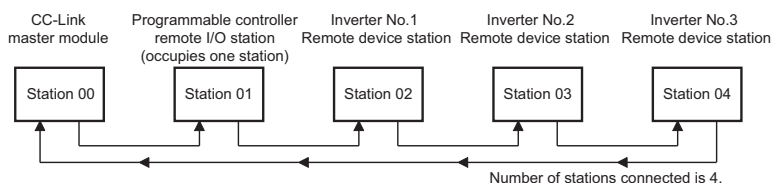

#### REMARKS

- Set consecutive numbers for the station numbers. (Do not skip a number in sequence like "station number 1 - station number 2 - station number 4".)  
The station number does not have to match with the physical connection sequence. (There is no problem with having the physical connection sequence like "station number 1 - station number 3 - station number 4 - station number 2".)
- One inverter occupies one station. (One remote device station)
- "L.ERR" LED flickers if the setting is changed. When power is switched ON again (inverter is reset), the setting value is applied and the LED turns OFF.

### 2.6.2 Baud rate setting (Pr. 543)

- Set the transmission speed. (Refer to the manual for the CC-Link master module for details of transmission speed.)

Pr. 543 Setting	Transmission Speed
0 (initial setting)	156kbps
1	625kbps
2	2.5Mbps
3	5Mbps
4	10Mbps



#### REMARKS

- "L.ERR" LED flickers if the setting is changed. When power is switched ON again (inverter is reset), the setting value is applied and the LED turns OFF.



---

---

## 3 PRECAUTIONS FOR USE OF THE INVERTER

---

---

The FR-E700 series is a highly reliable product, but incorrect peripheral circuit making or operation/handling method may shorten the product life or damage the product.

Before starting operation, always recheck the following items.

- (1) **Use crimping terminals with insulation sleeve to wire the power supply and motor.**
- (2) **Application of power to the output terminals (U, V, W) of the inverter will damage the inverter. Never perform such wiring.**
- (3) **After wiring, wire offcuts must not be left in the inverter.**

Wire offcuts can cause an alarm, failure or malfunction. Always keep the inverter clean.

When drilling mounting holes in an enclosure etc., take care not to allow chips and other foreign matter to enter the inverter.
- (4) **Use cables of the size to make a voltage drop 2% or less.**

If the wiring distance is long between the inverter and motor, a main circuit cable voltage drop will cause the motor torque to decrease especially at the output of a low frequency.

Refer to *page 8* for the recommended wire sizes.
- (5) **The overall wiring length should be 500m or less.**

Especially for long distance wiring, the fast-response current limit function may decrease or the equipment connected to the secondary side may malfunction or become faulty under the influence of a charging current due to the stray capacity of the wiring. Therefore, note the overall wiring length. (*Refer to page 9*)
- (6) **Electromagnetic wave interference**

The input/output (main circuit) of the inverter includes high frequency components, which may interfere with the communication devices (such as AM radios) used near the inverter. In this case, install the FR-BIF optional capacitor type filter (for use in the input side only) or FR-BSF01 common mode filter to minimize interference.
- (7) **Do not install a power factor correction capacitor, surge suppressor or capacitor type filter on the inverter output side.**

This will cause the inverter to trip or the capacitor and surge suppressor to be damaged. If any of the above devices are connected, immediately remove them. (When using capacitor type filter (FR-BIF) for single-phase power supply specification, make sure of secure insulation of T-phase, and connect to the input side of the inverter.)
- (8) **For some short time after the power is switched OFF, a high voltage remains in the smoothing capacitor.**

Before wiring or inspecting inside the inverter, wait 10 minutes or longer after turning OFF the power supply, then confirm that the voltage across the main circuit terminals P/+ and N/- of the inverter is 30VDC or less using a tester, etc. The capacitor is charged with high voltage for some time after power OFF, and it is dangerous.
- (9) **If "EV" is displayed on the operation panel, turn off the 24V external power supply before wiring and inspection.**
- (10) **A short circuit or earth (ground) fault on the inverter output side may damage the inverter modules.**
  - Fully check the insulation resistance of the circuit prior to inverter operation since repeated short circuits caused by peripheral circuit inadequacy or an earth (ground) fault caused by wiring inadequacy or reduced motor insulation resistance may damage the inverter modules.
  - Fully check the to-earth (ground) insulation and phase to phase insulation of the inverter output side before power-on. Especially for an old motor or use in hostile atmosphere, securely check the motor insulation resistance etc.

**(11) Do not use the inverter input side magnetic contactor to start/stop the inverter.**

Since repeated inrush currents at power ON will shorten the life of the converter circuit (switching life is about 1,000,000 times.), frequent starts and stops of the MC must be avoided. Turn ON/OFF the inverter start controlling terminals (STF, STR) to run/stop the inverter. ( Refer to the Instruction Manual (Applied))

**(12) Across P/+ and PR terminals, connect only an external regenerative brake discharging resistor.**

Do not connect a mechanical brake.

The brake resistor cannot be connected to the 0.1K or 0.2K. Leave terminals P/+ and PR open.

Also, never short between these terminals.

**(13) Do not apply a voltage higher than the permissible voltage to the inverter I/O signal circuits.**

Application of a voltage higher than the permissible voltage to the inverter I/O signal circuits or opposite polarity may damage the I/O devices.

**(14) Provide electrical and mechanical interlocks for MC1 and MC2 which are used for bypass operation.**

When the wiring is incorrect and if there is a bypass operation circuit as shown right, the inverter will be damaged when the power supply is connected to the inverter U, V, W terminals, due to arcs generated at the time of switch-over or chattering caused by a sequence error.

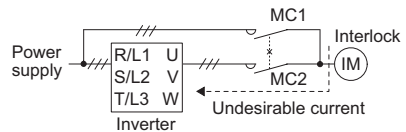

**(15) If the machine must not be restarted when power is restored after a power failure, provide a magnetic contactor in the inverter's input side and also make up a sequence which will not switch ON the start signal.**

If the start signal (start switch) remains ON after a power failure, the inverter will automatically restart as soon as the power is restored.

**(16) Inverter input side magnetic contactor (MC)**

On the inverter input side, connect a MC for the following purposes. (Refer to *page 3* for selection.)

- 1) To release the inverter from the power supply when a fault occurs or when the drive is not functioning (e.g. emergency stop operation). For example, MC avoids overheat or burnout of the brake resistor when heat capacity of the resistor is insufficient or brake regenerative transistor is damaged with short while connecting an optional brake resistor.
- 2) To prevent any accident due to an automatic restart at restoration of power after an inverter stop made by a power failure
- 3) To separate the inverter from the power supply to ensure safe maintenance and inspection work.

The inverter's input side MC is used for the above purpose, select class JEM1038-AC3 MC for the inverter input side current when making an emergency stop during normal operation.

**(17) Handling of inverter output side magnetic contactor**

Switch the magnetic contactor between the inverter and motor only when both the inverter and motor are at a stop. When the magnetic contactor is turned ON while the inverter is operating, overcurrent protection of the inverter and such will activate. When MC is provided for switching to the commercial power supply, for example, switch it ON/OFF after the inverter and motor have stopped.

**(18) Instructions for overload operation**

When performing operation of frequent start/stop of the inverter, rise/fall in the temperature of the transistor element of the inverter will repeat due to a repeated flow of large current, shortening the life from thermal fatigue. Since thermal fatigue is related to the amount of current, the life can be increased by reducing current at locked condition, starting current, etc. Decreasing current may increase the life. However, decreasing current will result in insufficient torque and the inverter may not start. Therefore, choose the inverter which has enough allowance for current (up to 2 rank larger in capacity).

**(19) Make sure that the specifications and rating match the system requirements.**

## 4 FAILSAFE OF THE SYSTEM WHICH USES THE INVERTER

When a fault occurs, the inverter trips to output a fault signal. However, a fault output signal may not be output at an inverter fault occurrence when the detection circuit or output circuit fails, etc. Although Mitsubishi assures best quality products, provide an interlock which uses inverter status output signals to prevent accidents such as damage to machine when the inverter fails for some reason and at the same time consider the system configuration where failsafe from outside the inverter, without using the inverter, is enabled even if the inverter fails.

(1) Interlock method which uses the inverter status output signals

By providing interlocks, inverter fault can be detected. For the interlocks, use different status output signals of the inverter (virtual terminals of the CC-Link communication) in combinations shown below.

No.	Interlock Method	Check Method	Used Signals	Refer to Page
1)	Inverter protective function operation	Operation check of an alarm contact Circuit error detection by negative logic	Fault output signal (ALM signal)	<i>Refer to Chapter 4 of the Instruction Manual (Applied).</i>
2)	Inverter running status	Check of the reset release signal	Reset release signal (RY signal)	<i>Refer to Chapter 4 of the Instruction Manual (Applied).</i>
3)	Inverter running status	Logic check of the start signal and running signal	Start signal (STF signal, STR signal) Running signal (RUN signal)	<i>Refer to Chapter 4 of the Instruction Manual (Applied).</i>
4)	Inverter running status	Logic check of the start signal and output current	Start signal (STF signal, STR signal) Output current detection signal (Y12 signal)	<i>Refer to Chapter 4 of the Instruction Manual (Applied).</i>

(2) Backup method outside the inverter

Even if the interlock is provided by the inverter status signal, enough failsafe is not ensured depending on the failure status of the inverter itself. For example, even if the interlock is provided using the inverter fault output signal, start signal and RUN signal output, there is a case where a fault output signal is not output and RUN signal is kept output even if an inverter fault occurs.

Provide a speed detector to detect the motor speed and current detector to detect the motor current and consider the backup system such as checking up as below according to the level of importance of the system.

1) Start signal and actual operation check

Check the motor running and motor current while the start signal is input to the inverter by comparing the start signal to the inverter and detected speed of the speed detector or detected current of the current detector. Note that the motor current runs as the motor is running for the period until the motor stops since the inverter starts decelerating even if the start signal turns off. For the logic check, configure a sequence considering the inverter deceleration time. In addition, it is recommended to check the three-phase current when using the current detector.

2) Command speed and actual operation check

Check if there is no gap between the actual speed and commanded speed by comparing the inverter speed command and detected speed of the speed detector.

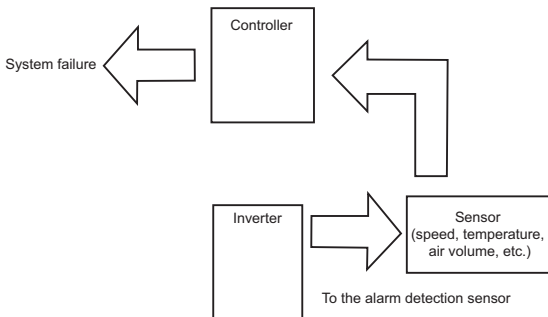

# 5 PARAMETER LIST

For simple variable-speed operation of the inverter, the initial setting of the parameters may be used. Set the necessary parameters to meet the load and operational specifications. Parameter setting, change and check can be made from the operation panel.



## REMARKS

- indicates simple mode parameters. (Initially set to extended mode)
- The parameters surrounded by a black border in the table allow its setting to be changed during operation even if "0" (initial value) is set in *Pr. 77 Parameter write selection*. (Note that the *Pr.77* setting cannot be changed through the CC-Link communication.)

Parameter	Name	Setting Range	Initial Value
● 0	Torque boost	0 to 30%	6/4/3/2% +1
● 1	Maximum frequency	0 to 120Hz	120Hz
● 2	Minimum frequency	0 to 120Hz	0Hz
● 3	Base frequency	0 to 400Hz	60Hz
● 4	Multi-speed setting (high speed)	0 to 400Hz	60Hz
● 5	Multi-speed setting (middle speed)	0 to 400Hz	30Hz
● 6	Multi-speed setting (low speed)	0 to 400Hz	10Hz
● 7	Acceleration time	0 to 3600/ 360s	5/10/15s +2
● 8	Deceleration time	0 to 3600/ 360s	5/10/15s +2
● 9	Electronic thermal O/L relay	0 to 500A	Rated inverter current
10	DC injection brake operation frequency	0 to 120Hz	3Hz
11	DC injection brake operation time	0 to 10s	0.5s
12	DC injection brake operation voltage	0 to 30%	6/4/2% +3
13	Starting frequency	0 to 60Hz	0.5Hz
14	Load pattern selection	0 to 3	0
15	Jog frequency	0 to 400Hz	5Hz
16	Jog acceleration/deceleration time	0 to 3600/ 360s	0.5s
17	MRS input selection	0, 2, 4	0
18	High speed maximum frequency	120 to 400Hz	120Hz
19	Base frequency voltage	0 to 1000V, 8888, 9999	9999
20	Acceleration/deceleration reference frequency	1 to 400Hz	60Hz
21	Acceleration/deceleration time increments	0, 1	0
22	Stall prevention operation level	0 to 200%	150%
23	Stall prevention operation level compensation factor at double speed	0 to 200%, 9999	9999
24	Multi-speed setting (speed 4)	0 to 400Hz, 9999	9999
25	Multi-speed setting (speed 5)	0 to 400Hz, 9999	9999

Parameter	Name	Setting Range	Initial Value
26	Multi-speed setting (speed 6)	0 to 400Hz, 9999	9999
27	Multi-speed setting (speed 7)	0 to 400Hz, 9999	9999
29	Acceleration/deceleration pattern selection	0, 1, 2	0
30	Regenerative function selection	0, 1, 2	0
31	Frequency jump 1A	0 to 400Hz, 9999	9999
32	Frequency jump 1B	0 to 400Hz, 9999	9999
33	Frequency jump 2A	0 to 400Hz, 9999	9999
34	Frequency jump 2B	0 to 400Hz, 9999	9999
35	Frequency jump 3A	0 to 400Hz, 9999	9999
36	Frequency jump 3B	0 to 400Hz, 9999	9999
37	Speed display	0, 0.01 to 9998	0
40	RUN key rotation direction selection	0, 1	0
41	Up-to-frequency sensitivity	0 to 100%	10%
42	Output frequency detection	0 to 400Hz	6Hz
43	Output frequency detection for reverse rotation	0 to 400Hz, 9999	9999
44	Second acceleration/ deceleration time	0 to 3600/ 360s	5/10/15s +2
45	Second deceleration time	0 to 3600/ 360s, 9999	9999
46	Second torque boost	0 to 30%, 9999	9999
47	Second V/F (base frequency)	0 to 400Hz, 9999	9999
48	Second stall prevention operation current	0 to 200%, 9999	9999
51	Second electronic thermal O/L relay	0 to 500A, 9999	9999
52	DU/PU main display data selection	0, 5, 7 to 12, 14, 20, 23 to 25, 52 to 57, 61, 62, 100	0
54 to 56	Parameter for manufacturer setting. Do not set.		
57	Restart coasting time	0, 0.1 to 5s, 9999	9999

Parameter	Name	Setting Range	Initial Value
58	Restart cushion time	0 to 60s	1s
59	Remote function selection	0, 1, 2, 3	0
60	Energy saving control selection	0, 9	0
61	Reference current	0 to 500A, 9999	9999
62	Reference value at acceleration	0 to 200%, 9999	9999
63	Reference value at deceleration	0 to 200%, 9999	9999
65	Retry selection	0 to 5	0
66	Stall prevention operation reduction starting frequency	0 to 400Hz	60Hz
67	Number of retries at fault occurrence	0 to 10, 101 to 110	0
68	Retry waiting time	0.1 to 360s	1s
69	Retry count display erase	0	0
70	Special regenerative brake duty	0 to 30%	0%
71	Applied motor	0, 1, 3 to 6, 13 to 16, 23, 24, 40, 43, 44, 50, 53, 54	0
72	PWM frequency selection	0 to 15	1
73, 74	Parameter for manufacturer setting. Do not set.		
75	Reset selection/PU stop selection	0 to 3, 14 to 17	14
77 *6	Parameter write selection	0, 1, 2	0
78	Reverse rotation prevention selection	0, 1, 2	0
◎ 79 *9	Operation mode selection	0, 1, 2, 3, 4, 6, 7	0
80	Motor capacity	0.1 to 15kW, 9999	9999
81	Number of motor poles	2, 4, 6, 8, 10, 9999	9999
82	Motor excitation current	0 to 500A (0 to ****), 9999 *5	9999
83	Rated motor voltage	0 to 1000V	200V/400V *4
84	Rated motor frequency	10 to 120Hz	60Hz
89	Speed control gain (Advanced magnetic flux vector)	0 to 200%, 9999	9999
90	Motor constant (R1)	0 to 50Ω (0 to ****), 9999 *5	9999
91	Motor constant (R2)	0 to 50Ω (0 to ****), 9999 *5	9999
92	Motor constant (L1)	0 to 1000mH (0 to 50Ω, 0 to ****), 9999 *5	9999
93	Motor constant (L2)	0 to 1000mH (0 to 50Ω, 0 to ****), 9999 *5	9999
94	Motor constant (X)	0 to 100% (0 to 500Ω, 0 to ****), 9999 *5	9999
96	Auto tuning setting/status	0, 1, 11, 21	0

Parameter	Name	Setting Range	Initial Value
117 to 124	Parameter for manufacturer setting. Do not set.		
◎ 125	Frequency setting gain frequency	0 to 400Hz	60Hz
126	Parameter for manufacturer setting. Do not set.		
127	PID control automatic switchover frequency	0 to 400Hz, 9999	9999
128	PID action selection	0, 20, 21, 40 to 43, 50, 51, 60, 61	0
129	PID proportional band	0.1 to 1000%, 9999	100%
130	PID integral time	0.1 to 3600s, 9999	1s
131	PID upper limit	0 to 100%, 9999	9999
132	PID lower limit	0 to 100%, 9999	9999
133	Parameter for manufacturer setting. Do not set.		
134	PID differential time	0.01 to 10.00s, 9999	9999
145, 146	Parameter for manufacturer setting. Do not set.		
147	Acceleration/deceleration time switching frequency	0 to 400Hz, 9999	9999
150	Output current detection level	0 to 200%	150%
151	Output current detection signal delay time	0 to 10s	0s
152	Zero current detection level	0 to 200%	5%
153	Zero current detection time	0 to 1s	0.5s
156	Stall prevention operation selection	0 to 31, 100, 101	0
157	OL signal output timer	0 to 25s, 9999	0s
◎ 160	User group read selection	0, 1, 9999	0
161	Frequency setting/key lock operation selection	0, 1, 10, 11	0
162	Automatic restart after instantaneous power failure selection	0, 1, 10, 11	1
165	Stall prevention operation level for restart	0 to 200%	150%
168, 169	Parameter for manufacturer setting. Do not set.		
170	Watt-hour meter clear	0, 10, 9999	9999
171	Operation hour meter clear	0, 9999	9999
172	User group registered display/batch clear	9999, (0 to 16)	0
173	User group registration	0 to 999, 9999	9999
174	User group clear	0 to 999, 9999	9999
178, 179	Parameter for manufacturer setting. Do not set.		
180	RY4 function selection	0 to 5, 7, 8,	0
181	RY3 function selection	10, 12,	1
182	RY2 function selection	14 to 16, 18,	2
183	RY9 function selection	24, 25, 62,	24
184	RYB function selection	65 to 67, 9999	62

Parameter	Name	Setting Range	Initial Value
190	RX2 (terminal Y0) function selection	0, 1, 3, 4, 7, 8, 11 to 16, 20, 25, 26, 46, 47, 64, 68, 80, 81, 90, 91, 93, 95, 96, 98, 99, 100, 101, 103, 104, 107, 108, 111 to 116, 120, 125, 126, 146, 147, 164, 168, 180, 181,	0
191	RX6 function selection	0, 1, 3, 4, 7, 8, 11 to 16, 20, 25, 26, 46, 47, 64, 68, 80, 81, 90, 91, 95, 96, 98, 99, 100, 101, 103, 104, 107, 108, 111 to 116, 120, 125, 126, 146, 147, 164, 168, 180, 181,	4
192	RX7 function selection	0, 1, 3, 4, 7, 8, 11 to 16, 20, 25, 26, 46, 47, 64, 68, 80, 81, 90, 91, 95, 96, 98, 99, 100, 101, 103, 104, 107, 108, 111 to 116, 120, 125, 126, 146, 147, 164, 168, 180,	99
232	Multi-speed setting (speed 8)	0 to 400Hz, 9999	9999
233	Multi-speed setting (speed 9)	0 to 400Hz, 9999	9999
234	Multi-speed setting (speed 10)	0 to 400Hz, 9999	9999
235	Multi-speed setting (speed 11)	0 to 400Hz, 9999	9999
236	Multi-speed setting (speed 12)	0 to 400Hz, 9999	9999
237	Multi-speed setting (speed 13)	0 to 400Hz, 9999	9999
238	Multi-speed setting (speed 14)	0 to 400Hz, 9999	9999
239	Multi-speed setting (speed 15)	0 to 400Hz, 9999	9999
240	Soft-PWM operation selection	0, 1	1
241	Parameter for manufacturer setting. Do not set.		
244	Cooling fan operation selection	0, 1	1
245	Rated slip	0 to 50%, 9999	9999
246	Slip compensation time constant	0.01 to 10s	0.5s
247	Constant-power range slip compensation selection	0, 9999	9999
249	Earth (ground) fault detection at start	0, 1	0

Parameter	Name	Setting Range	Initial Value
250	Stop selection	0 to 100s, 1000 to 1100s, 8888, 9999	9999
251	Output phase loss protection selection	0, 1	1
255	Life alarm status display	(0 to 15)	0
256	Inrush current limit circuit life display	(0 to 100%)	100%
257	Control circuit capacitor life display	(0 to 100%)	100%
258	Main circuit capacitor life display	(0 to 100%)	100%
259	Main circuit capacitor life measuring	0, 1 (2, 3, 8, 9)	0
261	Power failure stop selection	0, 1, 2	0
267	Parameter for manufacturer setting. Do not set.		
268	Monitor decimal digits selection	0, 1, 9999	9999
269	Parameter for manufacturer setting. Do not set.		
270	Stop-on contact control selection	0, 1	0
275	Stop-on contact excitation current low-speed multiplying factor	0 to 300%, 9999	9999
276	PWM carrier frequency at stop-on contact	0 to 9, 9999	9999
277	Stall prevention operation current switchover	0, 1	0
278	Brake opening frequency	0 to 30Hz	3Hz
279	Brake opening current	0 to 200%	130%
280	Brake opening current detection time	0 to 2s	0.3s
281	Brake operation time at start	0 to 5s	0.3s
282	Brake operation frequency	0 to 30Hz	6Hz
283	Brake operation time at stop	0 to 5s	0.3s
286	Droop gain	0 to 100%	0%
287	Droop filter time constant	0 to 1s	0.3s
292	Automatic acceleration/ deceleration	0, 1, 7, 8, 11	0
293	Acceleration/deceleration separate selection	0 to 2	0
295	Magnitude of frequency change setting	0, 0.01, 0.1, 1, 10	0
296	Password lock level	0 to 6, 99, 100 to 106, 199, 9999	9999
297	Password lock/unlock	1000 to 9999 (0 to 5)	9999
298	Frequency search gain	0 to 32767, 9999	9999
299	Rotation direction detection selection at restarting	0, 1, 9999	0

Parameter	Name	Setting Range	Initial Value
⊙ 313	RX9 function selection	0, 1, 3, 4, 7, 8, 11 to 16, 20, 25, 26, 46, 47, 64, 68, 80, 81, 90, 91, 93, 95, 96, 98, 99, 100, 101, 103, 104, 107, 108, 111 to 116, 120, 125, 126, 146, 147, 164, 168, 180, 181, 190, 191, 193, 195, 196, 198, 199, 9999	9999
⊙ 314	RXA function selection	146, 147, 164, 168, 180, 181, 190, 191, 193, 195, 196, 198, 199, 9999	9999
⊙ 315	RXB function selection	146, 147, 164, 168, 180, 181, 190, 191, 193, 195, 196, 198, 199, 9999	9999
338 to 340	Parameter for manufacturer setting. Do not set.		
342	Communication EEPROM write selection	0, 1	0
343	Parameter for manufacturer setting. Do not set.		
⊙ 349	Communication reset selection	0, 1	0
450	Second applied motor	0, 1, 9999	9999
495	Remote output selection	0, 1, 10, 11	0
496	Remote output data 1	0 to 4095	0
497	Parameter for manufacturer setting. Do not set.		
⊙ 500	Communication error execution waiting time	0 to 999.8s	0
⊙ 501	Communication error occurrence count display	0	0
502	Stop mode selection at communication error	0, 1, 2, 3	0
503	Maintenance timer	0 (1 to 9998)	0
504	Maintenance timer alarm output set time	0 to 9998, 9999	9999
⊙ 541	Frequency command sign selection (CC-Link)	0, 1	0
⊙ 542 <sup>*7</sup>	Communication station number (CC-Link)	1 to 64	1
⊙ 543 <sup>*7</sup>	Baud rate selection (CC-Link)	0 to 4	0
⊙ 544 <sup>*6</sup>	CC-Link extended setting	0, 1, 12, 14, 18	0
547 to 551	Parameter for manufacturer setting. Do not set.		
550	NET mode operation command source selection	0, 2, 9999	9999
551	PU mode operation command source selection	2 to 4, 9999	9999
555	Current average time	0.1 to 1.0s	1s
556	Data output mask time	0 to 20s	0s
557	Current average value monitor signal output reference current	0 to 500A	Rated inverter current
563	Energization time carrying-over times	(0 to 65535)	0
564	Operating time carrying-over times	(0 to 65535)	0
571	Holding time at a start	0 to 10s, 9999	9999
611	Acceleration time at a restart	0 to 3600s, 9999	9999
653	Speed smoothing control	0 to 200%	0
665	Regeneration avoidance frequency gain	0 to 200%	100

Parameter	Name	Setting Range	Initial Value
800	Control method selection	20, 30	20
859	Torque current	0 to 500A (0 to ****) , 9999 <sup>*5</sup>	9999
872 <sup>*8</sup>	Input phase loss protection selection	0, 1	1
882	Regeneration avoidance operation selection	0, 1, 2	0
883	Regeneration avoidance operation level	300 to 800V	400VDC/ 780VDC <sup>*4</sup>
885	Regeneration avoidance compensation frequency limit value	0 to 10Hz, 9999	6Hz
886	Regeneration avoidance voltage gain	0 to 200%	100%
888	Free parameter 1	0 to 9999	9999
889	Free parameter 2	0 to 9999	9999
C0	Parameter for manufacturer setting. Do not set.		
C2	Frequency setting bias frequency	0 to 400Hz	0Hz
C3 to C7, C22 to C25, 990, 991	Parameter for manufacturer setting. Do not set.		
Pr.CL	Parameter clear	0, 1	0
ALLC	All parameter clear	0, 1	0
Er.CL	Faults history clear	0, 1	0
Pr.CH	Initial value change list	—	—

\*1 Differ according to capacities.

6%: 0.75K or lower

4%: 1.5K to 3.7K

3%: 5.5K, 7.5K

2%: 11K, 15K

\*2 Differ according to capacities.

5s: 3.7K or lower

10s: 5.5K, 7.5K

15s: 11K, 15K

\*3 Differ according to capacities.

6%: 0.1K, 0.2K

4%: 0.4K to 7.5K

2%: 11K, 15K

\*4 The initial value differs according to the voltage class. (200V class/400V class)

\*5 The range differs according to the Pr. 71 setting.

\*6 The setting cannot be changed through the FL remote communication.

\*7 Changing the setting value causes the "L.ERR" LED to flicker. Turn OFF the power once, then turn ON again (inverter reset) to apply the setting and to turn OFF the LED.

\*8 Available only for the three-phase power input model.

\*9 Settings cannot be written during CC-Link communication (under Network operation mode).

---

---

## 6 TROUBLESHOOTING

---

---

When a fault occurs in the inverter, the inverter trips and the display on the operation panel automatically changes to one of the fault or alarm indications on *page 30*.

If the fault does not correspond to any of the following faults or if you have any other problem, please contact your sales representative.

- Retention of fault output signal .. When the magnetic contactor (MC) provided on the input side of the inverter is opened when a fault occurs, the inverter's control power will be lost and the fault output will not be held.
- Fault or alarm indication.....When a fault or alarm occurs, the operation panel display automatically switches to the fault or alarm indication.
- Resetting method.....When a fault occurs, the inverter output is kept stopped. Unless reset, therefore, the inverter cannot restart.
- When any fault occurs, take the appropriate corrective action, then reset the inverter, and resume operation.  
Not doing so may lead to the inverter fault and damage.

Inverter fault or alarm indications are roughly categorized as below.

- (1) Error message  
A message regarding operational fault and setting fault by the operation panel is displayed. The inverter does not trip.
- (2) Warning  
The inverter does not trip even when a warning is displayed. However, failure to take appropriate measures will lead to a fault.
- (3) Alarm  
The inverter does not trip. An alarm can also be output with a parameter setting.
- (4) Fault  
When a fault occurs, the inverter trips and a fault signal is output. The ALM signal is also output.



### REMARKS

- For the details of fault displays and other malfunctions, also refer to the *Instruction Manual (Applied)*.
- Past eight faults can be displayed using the setting dial.

---

### 6.1 Reset method of protective function

---

The inverter can be reset by performing any of the following operations. Note that the internal thermal integrated value of the electronic thermal relay function and the number of retries are cleared (erased) by resetting the inverter.

Inverter recovers about 1s after reset is released.

Operation 1: ..... Using the operation panel, press to reset the inverter.

(This may only be performed when a fault occurs.)



Operation 2: ..... Write HFD (inverter reset) to an instruction code of CC-Link communication.

(Inverter reset though CC-Link communication is invalid during communication error.)

Operation 3: ..... Switch OFF the power once, then switch it ON again after the indicator of the operation panel turns OFF.

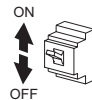

### REMARKS

- Use the operation 1 or 2 to reset when using the 24V external power supply.





### NOTE

- OFF status of the start signal must be confirmed before resetting the inverter fault. Resetting inverter fault with the start signal ON restarts the motor suddenly.



## 6.2 List of fault or alarm indications

When a fault occurs, the inverter trips and the PU display automatically changes to one of the following fault or alarm indications.

Function Name	Description	Corrective action	Display	
<b>Error message</b> *2	<b>Operation panel lock</b>	Appears when operation was tried during operation panel lock.	Press  for 2s to release lock.	HOL d
	<b>Password locked</b>	Appears when a password restricted parameter is read/written.	Enter the password in Pr. 297 Password lock/unlock to unlock the password function before operating.	L O C d
	<b>Parameter write error</b>	Appears when an error occurred during parameter writing.	<ul style="list-style-type: none"> <li>• Check the setting of Pr. 77 Parameter write selection.</li> <li>• Check the settings of Pr. 31 to Pr. 36 (frequency jump).</li> <li>• After stopping operation, make parameter setting.</li> <li>• After setting the operation mode to the "PU operation mode", make parameter setting.</li> </ul>	Er 1 Er 2 Er 4
	<b>Inverter reset</b>	Appears when the RES signal is ON.	<ul style="list-style-type: none"> <li>• Turn OFF the reset command</li> </ul>	Err.
<b>Warning</b> *3	<b>Stall prevention (overcurrent)</b>	Appears during overcurrent stall prevention.	<ul style="list-style-type: none"> <li>• Increase or decrease the Pr. 0 Torque boost setting by 1% and check the motor status.</li> <li>• Set a larger value in Pr. 7 Acceleration time and Pr. 8 Deceleration time.</li> <li>• Reduce the load weight.</li> <li>• Try Advanced magnetic flux vector control and General-purpose magnetic flux vector control.</li> <li>• Change the Pr. 14 Load pattern selection setting.</li> <li>• Set stall prevention operation current in Pr. 22 Stall prevention operation level. (The initial value is 150%.) The acceleration/ deceleration time may change. Increase the stall prevention operation level with Pr. 22 Stall prevention operation level, or disable stall prevention with Pr. 156 Stall prevention operation selection. (Operation at OL occurrence can be selected using Pr. 156.)</li> </ul>	OL
	<b>Stall prevention (overvoltage)</b>	Appears during overvoltage stall prevention. Appears while the regeneration avoidance function is activated.	The deceleration time may change. Increase the deceleration time using Pr. 8 Deceleration time.	oL
	<b>Regenerative brake prealarm *6</b>	Appears if the regenerative brake duty reaches or exceeds 85% of the Pr. 70 Special regenerative brake duty value. If the regenerative brake duty reaches 100%, a regenerative overvoltage (E.OV_) occurs.	<ul style="list-style-type: none"> <li>• Increase the deceleration time.</li> <li>• Check that the Pr. 30 Regenerative function selection and Pr. 70 Special regenerative brake duty settings.</li> </ul>	r b
	<b>Electronic thermal relay function prealarm</b>	Appears when the electronic thermal O/L relay has reached 85% of the specified value.	<ul style="list-style-type: none"> <li>• Reduce the load and frequency of operation.</li> <li>• Set an appropriate value in Pr. 9 Electronic thermal O/L relay.</li> </ul>	fH
	<b>PU stop</b>	Appears when  on the operation panel was pressed during External operation.	Turn the start signal OFF and release with  .	P S
	<b>Maintenance signal output *6</b>	Appears when the cumulative energization time has exceeded the maintenance output timer set value.	Setting "0" in Pr. 503 Maintenance timer erases the signal.	Mf
	<b>Undervoltage</b>	Appears when the main circuit power became low voltage.	Check the power supply system equipment such as power supply.	Uu
	<b>Safety stop</b>	Appears when the safety stop function is activated (during output shutoff).	<ul style="list-style-type: none"> <li>• When not using the safety stop function, short across terminals S1 and PC and across S2 and PC with shorting wire for the inverter to run.</li> <li>• If S<sub>R</sub> is indicated when across S1 and PC and across S2 and PC are both shorted while using the safety stop function (drive enabled), internal failure might be the cause. Check the wiring of terminals S1, S2 and PC and contact your sales representative if the wiring has no fault.</li> </ul>	S <sub>R</sub>
<b>24V external power supply operation</b>	Flickers when the main circuit power supply is not supplied and the 24V external power is supplied.	<ul style="list-style-type: none"> <li>• Turn ON the power supply for the inverter (main circuit).</li> <li>• If E<sub>U</sub> appears by turning ON the power supply of the inverter (main circuit) while the external 24V power is supplied, check the power supply (for the main circuit).</li> <li>• Check if the jumper is installed securely between terminal P/+ and P1.</li> </ul>	E <sub>U</sub>	
<b>Alarm</b> *4	<b>Fan alarm</b>	Appears when the cooling fan remains stopped when operation is required or when the speed has decreased.	Check for fan alarm. Please contact your sales representative.	F <sub>n</sub>
<b>Fault</b> *5	<b>Overcurrent trip during acceleration</b>	Appears when an overcurrent occurred during acceleration.	<ul style="list-style-type: none"> <li>• Increase the acceleration time. (Shorten the downward acceleration time for the lift.)</li> <li>• When "E.OC1" is always lit at start, disconnect the motor once and start the inverter.</li> <li>• If "E.OC1" is still lit, contact your sales representative.</li> <li>• Check the wiring to make sure that output short circuit/ ground fault does not occur.</li> <li>• Set 50Hz in Pr. 3 Base frequency.</li> <li>• Lower the setting of stall prevention operation level.</li> <li>• Activate the fast-response current limit operation.</li> <li>• Set base voltage (rated voltage of the motor, etc.) in Pr. 19 Base frequency voltage.</li> </ul>	EOC 1

Function Name	Description	Corrective action	Display	
Fault <sub>*5</sub>	Overcurrent trip during constant speed	Appears when an overcurrent occurred during constant speed operation.	<ul style="list-style-type: none"> <li>Keep load stable.</li> <li>Check the wiring to make sure that output short circuit/ ground fault does not occur.</li> <li>Lower the setting of stall prevention operation level.</li> <li>Activate the fast-response current limit operation.</li> </ul>	E0C2
	Overcurrent trip during deceleration or stop	Appears when an overcurrent occurred during deceleration and at a stop.	<ul style="list-style-type: none"> <li>Increase the deceleration time.</li> <li>Check the wiring to make sure that output short circuit/ ground fault does not occur.</li> <li>Check the mechanical brake operation.</li> <li>Lower the setting of stall prevention operation level.</li> <li>Activate the fast-response current limit operation.</li> </ul>	E0C3
	Regenerative overvoltage trip during acceleration	Appears when an overvoltage occurred during acceleration.	<ul style="list-style-type: none"> <li>Decrease the acceleration time.</li> <li>Use regeneration avoidance function (Pr. 882, Pr. 883, Pr. 885, Pr. 886).</li> <li>Set the Pr.22 Stall prevention operation level correctly.</li> </ul>	E0U1
	Regenerative overvoltage trip during constant speed	Appears when an overvoltage occurred during constant speed operation.	<ul style="list-style-type: none"> <li>Keep load stable.</li> <li>Use regeneration avoidance function (Pr. 882, Pr. 883, Pr. 885, Pr. 886).</li> <li>Use the brake resistor, brake unit or power regeneration common converter (FR-CV) as required.</li> <li>Set the Pr.22 Stall prevention operation level correctly.</li> </ul>	E0U2
	Regenerative overvoltage trip during deceleration or stop	Appears when an overvoltage occurred during deceleration and at a stop.	<ul style="list-style-type: none"> <li>Increase the deceleration time. (Set the deceleration time which matches the moment of inertia of the load)</li> <li>Make the brake cycle longer.</li> <li>Use regeneration avoidance function (Pr. 882, Pr. 883, Pr. 885, Pr. 886).</li> <li>Use the brake resistor, brake unit or power regeneration common converter (FR-CV) as required.</li> </ul>	E0U3
	Inverter overload trip (electronic thermal relay function)	Appears when the electronic thermal relay function for inverter element protection was activated.	<ul style="list-style-type: none"> <li>Increase acceleration/deceleration time.</li> <li>Adjust the torque boost setting.</li> <li>Set the load pattern selection setting according to the load pattern of the using machine.</li> <li>Reduce the load weight.</li> <li>Set the surrounding air temperature to within the specifications.</li> </ul>	E1HF
	Motor overload trip (electronic thermal relay function) *1	Appears when the electronic thermal relay function for motor protection was activated.	<ul style="list-style-type: none"> <li>Reduce the load weight.</li> <li>For a constant-torque motor, set the constant-torque motor in Pr. 71 Applied motor.</li> <li>Check that stall prevention operation setting is correct.</li> </ul>	E1HN
	Heatsink overheat	Appears when the heatsink was overheated.	<ul style="list-style-type: none"> <li>Set the surrounding air temperature to within the specifications.</li> <li>Clean the heatsink.</li> <li>Replace the cooling fan.</li> </ul>	E1n
	Input phase loss *6 *7 *8	Appears if one of the three phases on the inverter input side is lost. It may also appear if phase-to-phase voltage of the three-phase power input becomes largely unbalanced.	<ul style="list-style-type: none"> <li>Wire the cables properly.</li> <li>Repair a break portion in the cable.</li> <li>Check the Pr. 872 Input phase loss protection selection setting.</li> <li>Set Pr. 872 = "0" (without input phase loss protection) when three-phase input voltage is largely unbalanced.</li> </ul>	E1LF
	Stall prevention stop	Appears when the output frequency drops to 1Hz as a result of deceleration due to the excess motor load.	Reduce the load weight. (Check the Pr. 22 Stall prevention operation level setting.)	E0LF
	Brake transistor alarm detection	This function stops the inverter output if an alarm occurs in the brake circuit, e.g. damaged brake transistors. In this case, the inverter must be powered off immediately.	Replace the inverter.	E. bE
	Output side earth (ground) fault overcurrent at start *6	Appears when an earth (ground) fault occurred on the inverter's output side. (detects only at a start)	Remedy the ground fault portion.	E. GF
Output phase loss	If one of the three phases (U, V, W) on the inverter's output side (load side) is lost during inverter operation (except during DC injection brake operation and when output frequency is under 1Hz), inverter stops the output.	<ul style="list-style-type: none"> <li>Wire the cables properly.</li> <li>Check the Pr. 251 Output phase loss protection selection setting.</li> </ul>	E. LF	

## List of fault or alarm indications

Function Name	Description	Corrective action	Display	
Fault *5	<b>Communication option fault</b>	Stops inverter outputs at a communication line error of CC-Link communication.	<ul style="list-style-type: none"> <li>Refer to "Error check with LEDs" in the <i>Instruction Manual (Applied)</i>, and take a corrective action for the error.</li> <li>Check the connection of the CC-Link dedicated cable.</li> <li>Check that each CC-Link dedicated cable length between nodes is within the specified value. (Refer to the User's Manual of the CC-Link master module for the cable length between the nodes compatible with the CC-Link Ver. 1.00.)</li> <li>Set the built-in terminating resistor switch to ON at the end stations. Alternatively, correctly connect the one-touch connector plug with terminating resistor.</li> </ul>	EOP1
	<b>Option fault</b>	<ul style="list-style-type: none"> <li>Appears when Pr.296 = "0 or 100."</li> </ul>	<ul style="list-style-type: none"> <li>Set Pr.296 ≠ "0 or 100" for the password lock.</li> <li>If the problem still persists after taking the above measure, contact your sales representative.</li> </ul>	EOPF
	<b>Option fault</b>	<ul style="list-style-type: none"> <li>Stops the inverter output if there is excess electrical noise around the inverter.</li> <li>Also appears when a switch for manufacturer setting is changed.</li> </ul>	<ul style="list-style-type: none"> <li>Take measures against noises if there are devices producing excess electrical noises around the inverter.</li> <li>Set back the switch for manufacturer setting in the initial setting.</li> <li>If the problem still persists after taking the above measure, contact your sales representative.</li> </ul>	E. 1
	<b>Parameter storage device fault</b>	Appears when operation of the element where parameters stored became abnormal. (control board)	<p>Please contact your sales representative.</p> <p>When performing parameter write frequently for communication purposes, set "1" in Pr. 342 to enable RAM write. Note that powering OFF returns the inverter to the status before RAM write.</p>	E. PE
	<b>Internal board fault</b>	Inverter output is stopped when the control circuit board and the main circuit board do not match with each other.	<p>Please contact your sales representative.</p> <p>(For parts replacement, consult the nearest Mitsubishi FA Center.)</p>	EPE2
	<b>Retry count excess *6</b>	Operation restart within the set number of retries has failed.	Eliminate the cause of the error preceding this error indication.	E.r.EF
	<b>CPU fault</b>	Appears during the CPU and peripheral circuit errors.	<ul style="list-style-type: none"> <li>Take measures against noises if there are devices producing excess electrical noises around the inverter.</li> <li>Check the connection between terminals PC and SD. (E6/ E7)</li> <li>Please contact your sales representative.</li> </ul>	E. S1 E. 61 E. 71 E.CPU
	<b>Brake sequence fault *6</b>	Stops inverter outputs when a sequence fault occurs while using the brake sequence function (Pr. 278 to Pr. 283).	Check the parameters and correct the wiring.	Erb4 to Erbr7
	<b>Inrush current limit circuit fault</b>	Appears when the resistor of the inrush current limit circuit overheated.	<p>Configure a circuit where frequent power ON/OFF is not repeated.</p> <p>If the problem still persists after taking the above measure, please contact your sales representative.</p>	E10H
	<b>Internal circuit fault</b>	Appears when an internal circuit fault has occurred.	Please contact your sales representative.	E. 13
<b>Safety circuit fault</b>	Appears when safety circuit is malfunctioning.	<ul style="list-style-type: none"> <li>When not using the safety stop function, short across terminals S1 and PC and across S2 and PC with shorting wire.</li> <li>When using the safety stop function, check that wiring of terminal S1, S2 and PC is correct and the safety stop input signal source such as safety relay module is operating properly. Refer to the <i>Safety stop function instruction manual (BCN-211508-004)</i> for causes and countermeasures. (Please contact your sales representative for the manual.)</li> </ul>	E.SRF	

\*1 Resetting the inverter initializes the internal cumulative heat value of the electronic thermal relay function.

\*2 The error message shows an operational error. The inverter output is not shut off.

\*3 Warnings are messages given before fault occur. The inverter output is not shut off.

\*4 Alarms warn the operator of failures with output signals. The inverter output is not shut off.

\*5 When faults occur, the protective functions are activated to trip the inverter and output the fault signals.

\*6 This protective function does not function in the initial status.

\*7 This protective function activates when Pr.872 *Input phase loss protection selection* = "1".

\*8 This function is only available for three-phase power input models.

### 6.3 Check first when you have a trouble

---

If the following malfunctions occur, refer to the troubleshooting in  the *Instruction Manual (Applied)*.

- Motor does not start
- Motor or machine is making abnormal acoustic noise
- Inverter generates abnormal noise
- Motor generates heat abnormally
- Motor rotates in the opposite direction
- Speed greatly differs from the setting
- Acceleration/deceleration is not smooth
- Speed varies during operation
- Operation mode is not changed properly
- Operation panel display is not operating
- Motor current is too large
- Speed does not accelerate
- Unable to write parameter setting

# 7 PRECAUTIONS FOR MAINTENANCE AND INSPECTION

The inverter is a static unit mainly consisting of semiconductor devices. Daily inspection must be performed to prevent any fault from occurring due to the adverse effects of the operating environment, such as temperature, humidity, dust, dirt and vibration, changes in the parts with time, service life, and other factors.



## REMARKS

- For the details of fault displays and other malfunctions, also refer to the *Instruction Manual (Applied)*.

### ●Precautions for maintenance and inspection

Before wiring or inspecting inside the inverter, wait 10 minutes or longer after turning OFF the power supply, then confirm that the voltage across the main circuit terminals P/+ and N/- of the inverter is 30VDC or less using a tester, etc. The capacitor is charged with high voltage for some time after power OFF, and it is dangerous.

If "EV" is displayed on the operation panel, turn OFF the 24V external power supply before inspection.

## 7.1 Inspection items

Area of Inspection	Inspection Item	Description	Interval		Corrective Action at Alarm Occurrence	Customer's Check	
			Daily	Periodic *2			
General	Surrounding environment	Check the surrounding air temperature, humidity, dirt, corrosive gas, oil mist, etc.	○		Improve environment		
	Overall unit	Check for unusual vibration and noise.	○		Check alarm location and retighten		
	Power supply voltage	Check that the main circuit voltages are normal.*1	○		Inspect the power supply		
Main circuit	General	(1) Check with megger (across main circuit terminals and earth (ground) terminal).		○	Contact the manufacturer		
		(2) Check for loose screws and bolts.		○	Retighten		
		(3) Check for overheat traces on the parts.		○	Contact the manufacturer		
		(4) Check for stain.		○	Clean		
	Conductors, cables	(1) Check conductors for distortion. (2) Check cable sheaths for breakage and deterioration (crack, discoloration, etc.).		○	Contact the manufacturer		
	Terminal block	Check for damage.		○	Stop the device and contact the manufacturer.		
Smoothing aluminum electrolytic capacitor	(1) Check for liquid leakage. (2) Check for safety valve projection and bulge. (3) Visual check and judge by the life check of the main circuit capacitor ( Refer to Chapter 7 of the <i>Instruction Manual (Applied)</i> )		○	Contact the manufacturer			
			○	Contact the manufacturer			
Relay	Check that the operation is normal and no chatter is heard.		○	Contact the manufacturer			
Control circuit, Protective circuit	Operation check	(1) Check that the output voltages across phases with the inverter operated alone is balanced. (2) Check that no fault is found in protective and display circuits in a sequence protective operation test.		○	Contact the manufacturer		
				○	Contact the manufacturer		
	Parts check	Overall	(1) Check for unusual odor and discoloration. (2) Check for serious rust development.		○	Stop the device and contact the manufacturer.	
		Aluminum electrolytic capacitor	(1) Check for liquid leakage in a capacitor and deformation trace. (2) Visual check and judge by the life check of the main circuit capacitor ( Refer to Chapter 7 of the <i>Instruction Manual (Applied)</i> )		○	Contact the manufacturer	
Cooling system	Cooling fan	(1) Check for unusual vibration and noise. (2) Check for loose screws and bolts. (3) Check for stain.	○	○	Replace the fan Fix with the fan cover fixing screws Clean		
	Heatsink	(1) Check for clogging. (2) Check for stain.		○	Clean Clean		
Display	Indication	(1) Check that display is normal. (2) Check for stain.	○	○	Contact the manufacturer Clean		
	Meter	Check that reading is normal.	○		Stop the device and contact the manufacturer.		
Load motor	Operation check	Check for vibration and abnormal increase in operation noise.	○		Stop the device and contact the manufacturer.		

\*1 It is recommended to install a device to monitor voltage for checking the power supply voltage to the inverter.

\*2 One to two years of periodic inspection cycle is recommended. However, it differs according to the installation environment. Consult us for periodic inspection.

When using the safety stop function, periodic inspection is required to confirm that safety function of the safety system operates correctly.

For more details, refer to the *Safety stop function instruction manual (BCN-A211508-004)*. (Refer to the front cover for how to obtain the manual.)

## 7.2 Replacement of parts

The inverter consists of many electronic parts such as semiconductor devices.

The following parts may deteriorate with age because of their structures or physical characteristics, leading to reduced performance or fault of the inverter. For preventive maintenance, the parts must be replaced periodically.

Use the life check function as a guidance of parts replacement.

Part Name	Estimated Lifespan *1	Description
Cooling fan	10 years	Replace (as required)
Main circuit smoothing capacitor	10 years *2	Replace (as required)
On-board smoothing capacitor	10 years *2	Replace the board (as required)
Relays	—	as required

\*1 Estimated lifespan for when the yearly average surrounding air temperature is 40°C (without corrosive gas, flammable gas, oil mist, dust and dirt etc.)

\*2 Output current: 80% of the inverter rated current



### NOTE

For parts replacement, consult the nearest Mitsubishi FA Center.

# 8 SPECIFICATIONS

## 8.1 Rating

### ● Three-phase 200V power supply

Model FR-E720-□KNC		0.1	0.2	0.4	0.75	1.5	2.2	3.7	5.5	7.5	11	15
Applicable motor capacity (kW) *1		0.1	0.2	0.4	0.75	1.5	2.2	3.7	5.5	7.5	11	15
Output	Rated capacity (kVA) *2	0.3	0.6	1.2	2.0	3.2	4.4	7.0	9.5	13.1	18.7	23.9
	Rated current (A) *7	0.8 (0.8)	1.5 (1.4)	3 (2.5)	5 (4.1)	8 (7)	11 (10)	17.5 (16.5)	24 (23)	33 (31)	47 (44)	60 (57)
	Overload current rating *3	150% 60s, 200% 3s (inverse-time characteristics)										
	Rated voltage *4	Three-phase 200 to 240V										
Power supply	Regenerative braking torque *5	150%			100%		50%		20%			
	Rated input AC (DC) voltage/frequency	Three-phase 200 to 240V 50Hz/60Hz (283 to 339VDC *8)										
	Permissible AC (DC) voltage fluctuation	170 to 264V 50Hz/60Hz (240 to 373VDC *8)										
	Permissible frequency fluctuation	±5%										
	Power supply capacity (kVA) *6	0.4	0.8	1.5	2.5	4.5	5.5	9	12	17	20	28
	Protective structure (JEM1030)	Open type (IP00)										
Cooling system	Self-cooling					Forced air cooling						
Approximate mass (kg)	0.5	0.5	0.7	1.0	1.4	1.4	1.7	4.3	4.3	6.5	6.5	

### ● Three-phase 400V power supply

Model FR-E740-□KNC		0.4	0.75	1.5	2.2	3.7	5.5	7.5	11	15
Applicable motor capacity (kW)*1		0.4	0.75	1.5	2.2	3.7	5.5	7.5	11	15
Output	Rated capacity (kVA)*2	1.2	2.0	3.0	4.6	7.2	9.1	13.0	17.5	23.0
	Rated current (A)*7	1.6 (1.4)	2.6 (2.2)	4.0 (3.8)	6.0 (5.4)	9.5 (8.7)	12	17	23	30
	Overload current rating*3	150% 60s, 200% 3s (inverse-time characteristics)								
	Rated voltage*4	Three-phase 380 to 480V								
Power supply	Regenerative braking torque *5	100%			50%		20%			
	Rated input voltage/frequency	Three-phase 380 to 480V 50Hz/60Hz								
	Permissible AC voltage fluctuation	325 to 528V 50Hz/60Hz								
	Permissible frequency fluctuation	±5%								
	Power supply capacity (kVA)*6	1.5	2.5	4.5	5.5	9.5	12	17	20	28
	Protective structure (JEM1030)	Open type (IP00)								
Cooling system	Self-cooling				Forced air cooling					
Approximate mass (kg)	1.4	1.4	1.9	1.9	1.9	3.2	3.2	6.0	6.0	

\*1 The applicable motor capacity indicated is the maximum capacity applicable for use of the Mitsubishi 4-pole standard motor.

\*2 The rated output capacity indicated assumes that the output voltage is 230V for three-phase 200V class and 440V for three-phase 400V class.

\*3 The % value of the overload current rating indicated is the ratio of the overload current to the inverter's rated output current. For repeated duty, allow time for the inverter and motor to return to or below the temperatures under 100% load.

\*4 The maximum output voltage does not exceed the power supply voltage. The maximum output voltage can be changed within the setting range. However, the pulse voltage value of the inverter output side voltage remains unchanged at about  $\sqrt{2}$  that of the power supply.

\*5 The braking torque indicated is a short-duration average torque (which varies with motor loss) when the motor alone is decelerated from 60Hz in the shortest time and is not a continuous regenerative torque. When the motor is decelerated from the frequency higher than the base frequency, the average deceleration torque will reduce. Since the inverter does not contain a brake resistor, use the optional brake resistor when regenerative energy is large. A brake unit (FR-BU2) may also be used. (Option brake resistor cannot be used for 0.1K and 0.2K.)

\*6 The power supply capacity varies with the value of the power supply side inverter impedance (including those of the input reactor and cables).

\*7 Setting 2kHz or more in Pr. 72 PWM frequency selection to perform low acoustic noise operation in the surrounding air temperature exceeding 40°C, the rated output current is the value in parenthesis.

\*8 • Connect DC power supply to terminal P/+ and N/-. Connect the plus side of the power supply to terminal P/+ and minus side to terminal N/-.

• Since the voltage between P/+ and N/- may increase due to the regeneration energy from the motor and exceeds 415V temporarily, select the DC power supply which can withstand the voltage/energy during regeneration. If using the power supply which can not withstand voltage/energy during regeneration, insert diodes in series for reverse current prevention.

• Although the FR-E700 series has the built-in inrush current limit circuit, select the DC power supply considering the inrush current at powering ON as the inrush current four times of the rated inverter flows at powering ON.

• Since the power supply capacity depends on the output impedance of the power, select the power supply capacity which has enough allowance according to the AC power supply system capacity.

**● Single-phase 200V power supply**

Model FR-E720S-□KNC		0.1	0.2	0.4	0.75	1.5	2.2
Applicable motor capacity (kW) <sup>*1</sup>		0.1	0.2	0.4	0.75	1.5	2.2
Output	Rated capacity (kVA) <sup>*2</sup>	0.3	0.6	1.2	2.0	3.2	4.4
	Rated current (A) <sup>*7</sup>	0.8 (0.8)	1.5 (1.4)	3.0 (2.5)	5.0 (4.1)	8.0 (7.0)	11.0 (10.0)
	Overload current rating <sup>*3</sup>	150% 60s, 200% 3s (inverse-time characteristics)					
	Rated output voltage <sup>*4</sup>	Three-phase 200 to 240V					
	Regenerative braking torque <sup>*5</sup>	150%		100%		50%	20%
Power supply	Rated input AC voltage/frequency	Single-phase 200 to 240V 50Hz/60Hz					
	Permissible AC voltage fluctuation	170 to 264V 50Hz/60Hz					
	Permissible frequency fluctuation	Within ±5%					
	Power supply capacity (kVA) <sup>*6</sup>	0.5	0.9	1.5	2.5	4.0	5.2
Protective structure (JEM1030)	Open type (IP00)						
Cooling system	Self-cooling			Forced air cooling			
Approximate mass (kg)	0.6	0.6	0.9	1.4	1.5	2.0	

\*1 The applicable motor capacity indicated is the maximum capacity applicable for use of the Mitsubishi 4-pole standard motor.

\*2 The rated output capacity indicated assumes that the output voltage is 230V.

\*3 The % value of the overload current rating indicated is the ratio of the overload current to the inverter's rated output current. For repeated duty, allow time for the inverter and motor to return to or below the temperatures under 100% load. If the automatic restart after instantaneous power failure function (*Pr. 57*) or power failure stop function (*Pr. 261*) is set and power supply voltage is low while load becomes bigger, the bus voltage decreases to power failure detection level and load of 100% or more may not be available.

\*4 The maximum output voltage does not exceed the power supply voltage. The maximum output voltage can be changed within the setting range. However, the pulse voltage value of the inverter output side voltage remains unchanged at about  $\sqrt{2}$  that of the power supply.

\*5 The braking torque indicated is a short-duration average torque (which varies with motor loss) when the motor alone is decelerated from 60Hz in the shortest time and is not a continuous regenerative torque. When the motor is decelerated from the frequency higher than the base frequency, the average deceleration torque will reduce. Since the inverter does not contain a brake resistor, use the optional brake resistor when regenerative energy is large. A brake unit (FR-BU2) may also be used. (Option brake resistor cannot be used for 0.1K and 0.2K.)

\*6 The power supply capacity varies with the value of the power supply side inverter impedance (including those of the input reactor and cables).

\*7 Setting 2kHz or more in *Pr. 72 PWM frequency selection* to perform low acoustic noise operation with the surrounding air temperature exceeding 40°C, the rated output current is the value in parenthesis.



## 8.2 Common specifications

Control specifications	<b>Control method</b>	Soft-PWM control/high carrier frequency PWM control (V/F control, Advanced magnetic flux vector control, General-purpose magnetic flux vector control, Optimum excitation control are available)
	<b>Output frequency range</b>	0.2 to 400Hz
	<b>Frequency setting resolution (digital input)</b>	0.01Hz
	<b>Frequency accuracy (digital input)</b>	Within 0.01% of the set output frequency
	<b>Voltage/frequency characteristics</b>	Base frequency can be set from 0 to 400Hz, Constant-torque/variable torque pattern can be selected
	<b>Starting torque</b>	200% or more (at 0.5Hz)...when Advanced magnetic flux vector control is set (3.7K or lower)
	<b>Torque boost</b>	Manual torque boost
	<b>Acceleration/deceleration time setting</b>	0.01 to 360s, 0.1 to 3600s (acceleration and deceleration can be set individually), linear or S-pattern acceleration/ deceleration modes are available.
	<b>DC injection brake</b>	Operation frequency (0 to 120Hz), operation time (0 to 10s), operation voltage (0 to 30%) can be changed.
Environment	<b>Stall prevention operation level</b>	Operation current level can be set (0 to 200% adjustable), whether to use the function or not can be selected
	<b>Surrounding air temperature</b>	-10°C to +50°C (non-freezing) *2
	<b>Ambient humidity</b>	90%RH or less (non-condensing)
	<b>Storage temperature *1</b>	-20°C to +65°C
	<b>Atmosphere</b>	Indoors (without corrosive gas, flammable gas, oil mist, dust and dirt etc.)
	<b>Altitude/vibration</b>	Maximum 1000m above sea level, 5.9m/s <sup>2</sup> or less at 10 to 55Hz (directions of X, Y, Z axes)

\*1 Temperatures applicable for a short time, e.g. in transit.

\*2 When using the inverters at the surrounding air temperature of 40°C or less, the inverters can be installed closely attached (0cm clearance).

## 8.3 Outline dimension drawings

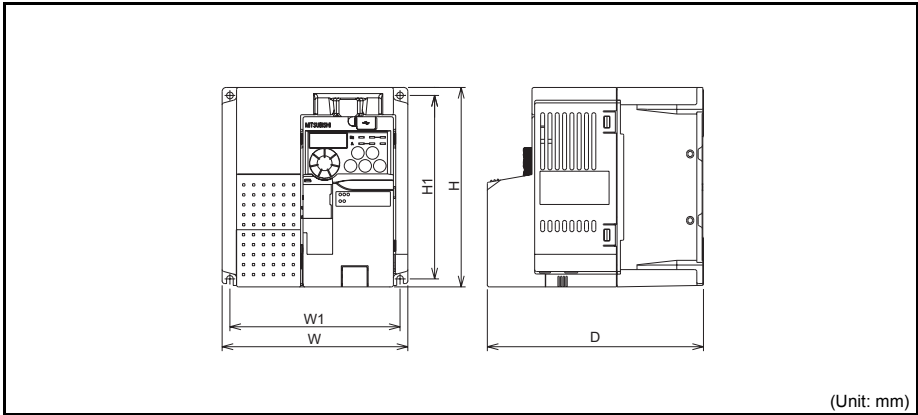

- Three-phase 200V class

Inverter model	W	W1	H	H1	D
FR-E720-0.1KNC	68	56	128	118	108
FR-E720-0.2KNC					140
FR-E720-0.4KNC					160
FR-E720-0.75KNC					163
FR-E720-1.5KNC	108	96	260	244	170
FR-E720-2.2KNC	170	158			192.5
FR-E720-3.7KNC	180	164			217.5
FR-E720-5.5KNC	220	195	260	244	192.5
FR-E720-7.5KNC					217.5
FR-E720-11KNC					
FR-E720-15KNC					

- Three-phase 400V class

Inverter model	W	W1	H	H1	D
FR-E740-0.4KNC	140	128	150	138	141.5
FR-E740-0.75KNC					162.5
FR-E740-1.5KNC					174.5
FR-E740-2.2KNC					192.5
FR-E740-3.7KNC	220	208	260	244	174.5
FR-E740-5.5KNC					217.5
FR-E740-7.5KNC					
FR-E740-11KNC					
FR-E740-15KNC					

- Single-phase 200V class

Inverter model	W	W1	H	H1	D
FR-E720S-0.1KNC	68	56	128	118	108
FR-E720S-0.2KNC					170
FR-E720S-0.4KNC					163
FR-E720S-0.75KNC	108	96	260	244	188.5
FR-E720S-1.5KNC					183
FR-E720S-2.2KNC	140	128	150	138	183

## Appendix 1 Instructions for Compliance with the EU Directives

The EU Directives are issued to standardize different national regulations of the EU Member States and to facilitate free movement of the equipment, whose safety is ensured, in the EU territory.

Since 1996, compliance with the EMC Directive that is one of the EU Directives has been legally required. Since 1997, compliance with the Low Voltage Directive, another EU Directive, has been also legally required. When a manufacturer confirms its equipment to be compliant with the EMC Directive and the Low Voltage Directive, the manufacturer must declare the conformity and affix the CE marking.

### ● The authorized representative in the EU

The authorized representative in the EU is shown below.

Name: Mitsubishi Electric Europe B.V.

Address: Gothaer Strasse 8, 40880 Ratingen, Germany

### ● Note

We declare that this inverter, when equipped with the dedicated EMC filter, conforms with the EMC Directive in industrial environments and affix the CE marking on the inverter. When using the inverter in a residential area, take appropriate measures and ensure the conformity of the inverter used in the residential area.

### (1) EMC Directive

We declare that this inverter, when equipped with the EMC Directive compliant EMC filter, conforms with the EMC Directive and affix the CE marking on the inverter.

- EMC Directive: 2004/108/EC
- Standard(s): EN61800-3:2004 (Second environment / PDS Category "C3")

#### Note: First environment

Environment including residential buildings. Includes building directly connected without a transformer to the low voltage power supply network which supplies power to residential buildings.

#### Second environment

Environment including all buildings except buildings directly connected without a transformer to the lower voltage power supply network which supplies power to residential buildings.

### ● Note

- \* Set the EMC Directive compliant EMC filter to the inverter. Insert line noise filters and ferrite cores to the power and control cables as required.
- \* Connect the inverter to an earthed power supply.
- \* Install a motor, the EMC Directive compliant EMC filter, and a control cable according to the instructions written in the EMC Installation Guidelines (BCN-A21041-204) (Please contact your sales representative for the EMC Installation Guidelines.)
- \* The cable length between the inverter and the motor is 5m maximum.
- \* Confirm that the final integrated system with the inverter conforms with the EMC Directive.

## (2) Low Voltage Directive

We have self-confirmed our inverters as products compliant to the Low Voltage Directive (Conforming standard EN 61800-5-1) and place the CE mark on the inverters.

Outline of instructions

- \* Do not use an earth leakage circuit breaker as an electric shock protector without connecting the equipment to the earth. Connect the equipment to the earth securely.
- \* Wire the earth (ground) terminal independently. (Do not connect two or more cables to one terminal.)
- \* Use the cable sizes on *page 8* under the following conditions.
  - Surrounding air temperature: 40°C maximum

If conditions are different from above, select appropriate wire according to EN60204 ANNEX C TABLE 5.

- \* Use a tinned (plating should not include zinc) crimping terminal to connect the earth cable. When tightening the screw, be careful not to damage the threads.
  - For use as a product compliant with the Low Voltage Directive, use PVC cable on *page 8*.
- \* Use the moulded case circuit breaker and magnetic contactor which conform to the EN or IEC Standard.
- \* When using an earth leakage circuit breaker, use a residual current operated protective device (RCD) of type B (breaker which can detect both AC and DC). If not, provide double or reinforced insulation between the inverter and other equipment, or put a transformer between the main power supply and inverter.
- \* Use the inverter under the conditions of overvoltage category II (usable regardless of the earth (ground) condition of the power supply), overvoltage category III (usable with the earthed-neutral system power supply, 400V class only) specified in IEC664.
- To use the inverter under the conditions of pollution degree 3, install it in the enclosure of IP54 or higher.
- To use the inverter outside of an enclosure in the environment of pollution degree 2, fix a fan cover with fan cover fixing screws enclosed.

3.7K or lower

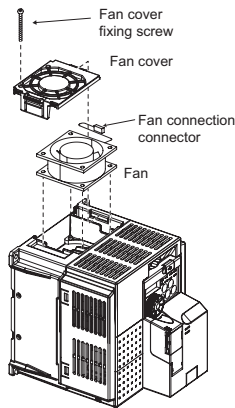

Example for FR-E740-3.7KNC

5.5K or higher

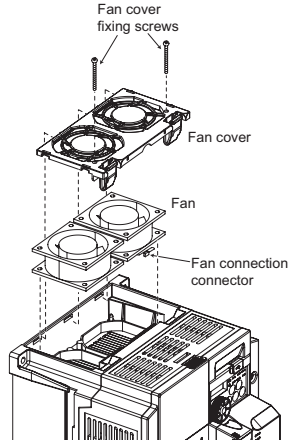

Example for FR-E720-5.5KNC

Note, the protection structure of the inverter units is considered to be an IP00.

- \* On the input and output of the inverter, use cables of the type and size set forth in EN60204 Appendix C.
- \* Control circuit terminals on *page 5* are safely isolated from the main circuit.
- \* Environment

	Running	In Storage	During Transportation
Surrounding Air Temperature	-10°C to +50°C	-20°C to +65°C	-20°C to +65°C
Humidity	90% RH or less	90% RH or less	90% RH or less
Maximum Altitude	1000m	1000m	10000m

Details are given in the technical information "Low Voltage Directive Conformance Guide" (BCN-A21041-203). (Please contact your sales representative for the technical information.)

\* Select a UL and cUL certified fuse with Class T fuse equivalent cut-off speed or faster with the appropriate rating for branch circuit protection, or a UL489 molded case circuit breaker (MCCB) in accordance with the table below.

FR-E720-□□KNC		0.1	0.2	0.4	0.75	1.5	2.2	3.7	5.5	7.5	11	15
Rated fuse voltage(V)		240V or more										
Fuse Maximum allowable rating (A)*	Without power factor improving reactor	15	15	15	20	30	40	60	70	80	150	175
	With power factor improving reactor	15	15	15	20	20	30	50	60	70	125	150
Molded case circuit breaker (MCCB) Maximum allowable rating (A)*		15	15	15	15	20	25	40	60	80	110	150

FR-E740-□□KNC		0.4	0.75	1.5	2.2	3.7	5.5	7.5	11	15	
Rated fuse voltage(V)		480V or more									
Fuse Maximum allowable rating (A)*	Without power factor improving reactor	6	10	15	20	30	40	70	80	90	
	With power factor improving reactor	6	10	10	15	25	35	60	70	90	
Molded case circuit breaker (MCCB) Maximum allowable rating (A)*		15	15	15	15	20	30	40	50	70	

FR-E720S-□□KNC		0.1	0.2	0.4	0.75	1.5	2.2
Rated fuse voltage(V)		240V or more					
Fuse Maximum allowable rating (A)*	Without power factor improving reactor	15	20	20	30	40	60
	With power factor improving reactor	15	20	20	20	30	50
Molded case circuit breaker (MCCB) Maximum allowable rating (A)*		15	15	15	20	25	40

\* Maximum allowable rating by US National Electrical Code. Exact size must be chosen for each installation.

\* When using the electronic thermal relay function as motor overload protection, set the rated motor current to Pr. 9 Electronic thermal O/L relay.

### Electronic thermal relay function operation characteristic

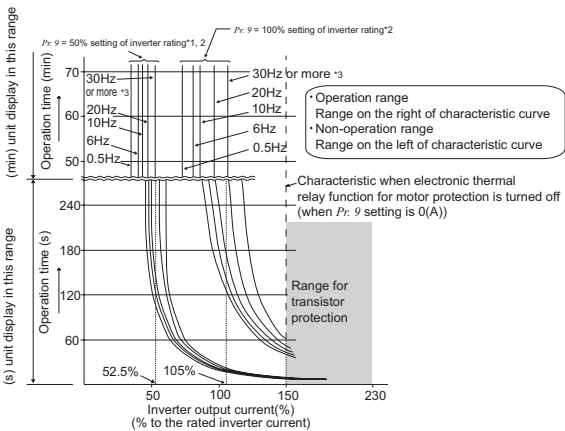

This function detects the overload (overheat) of the motor, stops the operation of the inverter's output transistor, and stops the output. (The operation characteristic is shown on the left)

When using the Mitsubishi constant-torque motor

- 1) Set "1" or any of "13" to "16", "50", "53", "54" in Pr. 71. (This provides a 100% continuous torque characteristic in the low-speed range.)
- 2) Set the rated current of the motor in Pr. 9.

- \*1 When 50% of the inverter rated output current (current value) is set in Pr. 9
- \*2 The % value denotes the percentage to the inverter rated output current. It is not the percentage to the motor rated current.
- \*3 When you set the electronic thermal relay function dedicated to the Mitsubishi constant-torque motor, this characteristic curve applies to operation at 6Hz or higher.



### Note

- Protective function by electronic thermal relay function is reset by inverter power reset and reset signal input. Avoid unnecessary reset and power-OFF.
- When multiple motors are operated by a single inverter, protection cannot be provided by the electronic thermal relay function. Install an external thermal relay to each motor.
- When the difference between the inverter and motor capacities is large and the setting is small, the protective characteristics of the electronic thermal relay function will be deteriorated. In this case, use an external thermal relay.
- A special motor cannot be protected by the electronic thermal relay function. Use the external thermal relay.
- Electronic thermal relay may not function when 5% or less of inverter rated current is set to electronic thermal relay setting.

- \* Short circuit current ratings
  - 200V class  
Suitable For Use in A Circuit Capable of Delivering Not More Than 5 kA rms Symmetrical Amperes, 264 V Maximum.
  - 400V class  
Suitable For Use in A Circuit Capable of Delivering Not More Than 5 kA rms Symmetrical Amperes, 528 V Maximum.

## Appendix 2 Instructions for UL and cUL

(Standard to comply with: UL 508C, CSA C22.2 No. 14)

### 1. General Precaution

The bus capacitor discharge time is 10 minutes. Before starting wiring or inspection, switch power off, wait for more than 10 minutes, and check for residual voltage between terminal P/+ and N/- with a meter etc. to avoid a hazard of electrical shock.

### 2. Installation

The below types of inverter have been approved as products for use in enclosure and approval tests were conducted under the following conditions. Design the enclosure so that the surrounding air temperature, humidity and ambience of the inverter will satisfy the specifications (*Refer to page 4*).

#### Wiring protection

Integral solid state short circuit protection does not provide branch circuit protection. Branch circuit protection must be provided in accordance with the National Electrical Code for the U.S. or the Canadian Electrical Code for Canada and any additional codes. As specified on *page 42*, UL Class T fuses or any faster acting fuse with the appropriate rating or Listed UL 489 Molded Case Circuit Breaker (MCCB) must be employed.

### 3. Short circuit ratings

- **200V class**  
Suitable For Use in A Circuit Capable of Delivering Not More Than 100 kA rms Symmetrical Amperes, 264 V Maximum.
- **400V class**  
Suitable For Use in A Circuit Capable of Delivering Not More Than 100 kA rms Symmetrical Amperes, 528 V Maximum.

### 4. Wiring

For wiring the input (R/L1, S/L2, T/L3) and output (U, V, W) terminals of the inverter, use the UL Listed copper, stranded wires (rated at 75°C) and round crimping terminals. Crimp the crimping terminals with the crimping tool recommended by the terminal maker.

### 5. Motor overload protection

When using the electronic thermal relay function as motor overload protection, set the rated motor current to Pr. 9 "Electronic thermal O/L relay". (*Refer to page 42*)



#### Note

- Protective function by electronic thermal relay function is reset by inverter power reset and reset signal input. Avoid unnecessary reset and power-OFF.
- When multiple motors are operated by a single inverter, protection cannot be provided by the electronic thermal relay function. Install an external thermal relay to each motor.
- When the difference between the inverter and motor capacities is large and the setting is small, the protective characteristics of the electronic thermal relay function will be deteriorated. In this case, use an external thermal relay.
- A special motor cannot be protected by the electronic thermal relay function. Use the external thermal relay.
- Electronic thermal relay may not function when 5% or less of inverter rated current is set to electronic thermal relay setting.



#### REMARKS

- Safety stop function is not certified by the UL.

# MEMO

# MEMO



REVISIONS

\*The manual number is given on the bottom left of the back cover.

Print Date	*Manual Number	Revision
May 2011	IB-0600401ENG-A	First edition

 **For Maximum Safety**

- Mitsubishi inverters are not designed or manufactured to be used in equipment or systems in situations that can affect or endanger human life.
- When considering this product for operation in special applications such as machinery or systems used in passenger transportation, medical, aerospace, atomic power, electric power, or submarine repeating applications, please contact your nearest Mitsubishi sales representative.
- Although this product was manufactured under conditions of strict quality control, you are strongly advised to install safety devices to prevent serious accidents when it is used in facilities where breakdowns of the product are likely to cause a serious accident.
- Please do not use this product for loads other than three-phase induction motors.

# FR-E700-NC Series

## Instruction Manual Supplement

---

### 1 For the terminating resistor selection switch





Please make corrections to the following error in this manual.

#### Connection of several inverters

- Instruction Manual (Basic) : page 17
- Instruction Manual (Applied): page 50

#### (Incorrect)





- \*2 Set "1" and "2" of the terminating resistor selection switch (SW1) to OFF (without terminating resistor) in the middle units.

	1	2	Description
	OFF	OFF	Without terminating resistor (initial setting)
	ON	OFF	Do not use.
	OFF	ON	130Ω
	ON	ON	110Ω

130Ω is a resistance value for the CC-Link Ver. 1.00 dedicated high performance cable

#### (Correct)

- \*2 Set "1" and "2" of the terminating resistor selection switch (SW1) to OFF (without terminating resistor) in the middle units.

	1	2	Description
	OFF	OFF	Without terminating resistor (initial setting)
	ON	OFF	130Ω
	OFF	ON	Do not use.
	ON	ON	110Ω

130Ω is a resistance value for the CC-Link Ver. 1.00 dedicated high performance cable

## 2 Additional notes for instructions for UL and cUL

- Instruction Manual (Basic) : page 43

### General precaution

CAUTION - Risk of Electric Shock -

The bus capacitor discharge time is 10 minutes. Before starting wiring or inspection, switch power off, wait for more than 10 minutes.

ATTENTION - Risque de choc électrique -

La durée de décharge du condensateur de bus est de 10 minutes.

Avant de commencer le câblage ou l'inspection, mettez l'appareil hors tension et attendez plus de 10 minutes.

### Motor overload protection

When using the electronic thermal relay function as motor overload protection, set the rated motor current to *Pr. 9 "Electronic thermal O/L relay"*.



#### NOTE

- Motor over temperature sensing is not provided by the drive.

# Mitsubishi Inverter Instruction Manual Supplement



The product certified in compliance with the Eurasian Conformity has the EAC marking.

Note: EAC marking

In 2010, three countries (Russia, Belarus, and Kazakhstan) established a Customs Union for the purposes of revitalizing the economy by forming a large economic bloc by abolishing or reducing tariffs and unifying regulatory procedures for the handling of articles.

Products to be distributed over these three countries of the Customs Union must comply with the Customs Union Technical Regulations (CU-TR), and the EAC marking must be affixed to the products.

For information on the country of origin, manufacture year and month, and authorized sales representative (importer) in the CU area of this product, refer to the following:

## •Country of origin indication

Check the rating plate of the product.

Example: MADE IN JAPAN

Rating plate (Example: FR-E700 series)

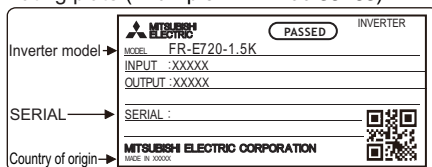

## •Manufactured year and month

Check the SERIAL number indicated on the rating plate of the product.

Rating plate example

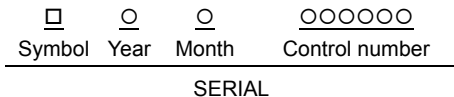

The SERIAL consists of one symbol, two characters indicating the production year and month, and six characters indicating the control number. The last digit of the production year is indicated as the Year, and the Month is indicated by 1 to 9, X (October), Y (November), or Z (December).

## •Authorized sales representative (importer) in the CU area

The authorized sales representative (importer) in the CU area is shown below.

Name: Mitsubishi Electric (Russia) LLC

Address: 52, bld 1 Kosmodamianskaya Nab 115054, Moscow, Russia

Phone: +7 (495) 721-2070

Fax: +7 (495) 721-2071

# 電器電子製品有害物質使用制限について

中華人民共和國の『電器電子製品有害物質使用制限管理弁法』に基づき、「電器電子製品有害物質使用制限の標識」の内容を以下に記載いたします。

## Restricted Use of Hazardous Substances in Electronic and Electrical Products

The mark of restricted use of hazardous substances in electronic and electrical products is applied to the product as follows based on the “Management Methods for the Restriction of the Use of Hazardous Substances in Electrical and Electronic Products” of the People’s Republic of China.

## 关于电器电子产品有害物质限制使用

根据中华人民共和国的《电器电子产品有害物质限制使用管理办法》，对适用于产品的“电器电子产品有害物质限制使用标识”的内容记载如下。

电器电子产品有害物质限制使用标识要求



本产品中所含有的有害物质的名称、含量、含有部件如下表所示。

- 产品中所含有害物质的名称及含量

部件名称*2	有害物质*1					
	铅 (Pb)	汞 (Hg)	镉 (Cd)	六价铬 (Cr (VI))	多溴联苯 (PBB)	多溴二苯醚 (PBDE)
电路板组件 (包括印刷电路板及其构成的零部件, 如电阻、电容、集成电路、连接器等)、电子部件	×	○	×	○	○	○
金属壳体、金属部件	×	○	○	○	○	○
树脂壳体、树脂部件	○	○	○	○	○	○
螺丝、电线	○	○	○	○	○	○

上表依据SJ/T11364的规定编制。

○：表示该有害物质在该部件所有均质材料中的含量均在GB/T26572规定的限量要求以下。

×：表示该有害物质在该部件的至少一种均质材料中的含量超出GB/T26572规定的限量要求。

\*1 即使表中记载为×，根据产品型号，也可能会有有害物质的含量为限制值以下的情况。

\*2 根据产品型号，一部分部件可能不包含在产品中。

# FREQROL-E700 シリーズ 取扱説明書 追加説明書

UL、cUL についての注意事項を変更しました。

---

## UL、cUL についての注意事項

(準拠規格 UL 508C, CSA C22.2 No.14)

### (1) 据付け

盤内使用の製品として認定を取得しています。

インバータの周囲温度、湿度、雰囲気仕様を満足するように盤を設計してください。 (4ページ参照)

#### 分岐回路保護

アメリカ合衆国内に設置する場合は分岐回路の保護はNational Electrical Code および現地の規格に従って実施してください。

カナダ国内に設置する場合は分岐回路の保護はCanadian Electrical Code および現地の規格に従って実施してください。

インバータが装備している短絡保護は、分岐回路を保護するものではありません。

また、分岐回路保護用のクラスT、クラスJ、クラスCCタイプのヒューズ以上の遮断速度を持つ適切な定格のUL、cUL認定ヒューズ、もしくはUL489配線用遮断器 (MCCB) を40ページに従い選定し、使用してください。

## FR-E700 Series Instruction Manual Supplement

Instructions for UL and cUL have been revised.

---

## Instructions for UL and cUL

(Standard to comply with: UL 508C, CSA C22.2 No. 14)

### Installation

The below types of inverter have been approved as products for use in enclosure and approval tests were conducted under the following conditions. Design the enclosure so that the surrounding air temperature, humidity and ambience of the inverter will satisfy the above specifications.

### Branch Circuit Protection

Integral solid state short circuit protection does not provide branch circuit protection. Branch circuit protection must be provided in accordance with the National Electrical Code for the U.S. or the Canadian Electrical Code for Canada and any additional codes. As specified, UL Class T, Class J, Class CC fuses or any faster acting fuse with the appropriate rating or Listed UL 489 Molded Case Circuit Breaker (MCCB), or Type E combination motor controller must be employed.

FR-E720-□□KNC		0.1	0.2	0.4	0.75	1.5	2.2	3.7	5.5	7.5	11	15
Rated fuse voltage(V)		240V or more										
Fuse allowable rating (A)	Without power factor improving reactor	15	15	15	20	30	40	60	70	80	150	175
	With power factor improving reactor	15	15	15	20	20	30	50	60	70	125	150
Molded case circuit breaker (MCCB) Maximum allowable rating (A)*1*2		15	15	15	15	20	25	40	60	80	110	150
Type E combination motor controller*3	Maximum current rating (A)	1.6	4	6.3	10	13	18	25				
	Maximum SCCR (kA)*4	50	50	50	50	50	50	25				

FR-E740-□□KNC		0.4	0.75	1.5	2.2	3.7	5.5	7.5	11	15	
Rated fuse voltage(V)		480V or more									
Fuse allowable rating (A)	Without power factor improving reactor	6	10	15	20	30	40	70	80	90	
	With power factor improving reactor	6	10	10	15	25	35	60	70	90	
Molded case circuit breaker (MCCB) Maximum allowable rating (A)*1*2		15	15	15	15	20	30	40	50	70	
Type E combination motor controller*3	Maximum current rating (A)	4	6.3	8	10	18	25	32			
	Maximum SCCR (kA)*4	50	50	50	50	50	25	25			

FR-E720S-□□KNC		0.1	0.2	0.4	0.75	1.5	2.2
Rated fuse voltage(V)		240V or more					
Fuse allowable rating (A)	Without power factor improving reactor	15	20	20	30	40	60
	With power factor improving reactor	15	20	20	20	30	50
Molded case circuit breaker (MCCB) Maximum allowable rating (A)*1*2		15	15	15	20	25	40

\*1 Maximum allowable rating by US National Electrical Code.Exact size must be chosen for each installation.

\*2 Select an appropriate molded case circuit breaker with a rating that is suitable for the size of the cable.

\*3 For UL/cUL certification, use the following product.

Model	Manufacturer	Rated Voltage, Vac
MMP-T32	Mitsubishi Electric Corp.	480Y/277

\*4 Suitable for Use in a Circuit Capable of Delivering Not More Than 50 or 25 kA rms Symmetrical Amperes, 480Y/277 Volts Maximum when protected by the Type E Combination motor Controllers indicated in the above table.

## International FA Center



### ●North American FA Center

MITSUBISHI ELECTRIC AUTOMATION, INC.  
500 Corporate Woods Parkway, Vernon Hills, IL60061 U.S.A  
TEL. +1-847-478-2100 FAX. +1-847-478-0327

### ●Korean FA Center

MITSUBISHI ELECTRIC AUTOMATION KOREA CO., LTD.  
B1F,2F, 1480-6, Gayang-Dong, Gangseo-Gu, Seoul, 157-200, Korea  
TEL. +82-2-3660-9607 FAX. +82-2-3664-0475

### ●Taiwan FA Center

SETSUYO ENTERPRISE CO., LTD.  
6F No.105, Wu Kung 3rd RD, Wu-Ku Hsiang Taipei Hsien, 248, Taiwan  
TEL. +886-2-2299-2499 FAX. +886-2-2299-2509

### ●Beijing FA Center

MITSUBISHI ELECTRIC AUTOMATION (CHINA) LTD. BEIJING OFFICE  
9F Office Tower 1, Henderson Center, 18 Jianguomennei Avenue, Dongcheng District, Beijing, China 100005  
TEL. +86-10-6518-8830 FAX. +86-10-6518-8030

### ●Russian FA Center

MITSUBISHI ELECTRIC EUROPE B.V.  
-Representative Office in St. Petersburg  
Sverdlovskaya Emb.,44, Bld Sch, BC "Benua";195027, St.Petersburg, Russia  
TEL. +7-812-633-3496 FAX. +7-812-633-3499

### ●Tianjin FA Center

MITSUBISHI ELECTRIC AUTOMATION (CHINA) LTD. TIANJIN OFFICE  
B-2 801/802, Youyi Building, No.50 Youyi Road, Hexi District, Tianjin, China 300061  
TEL. +86-22-2813-1015 FAX. +86-22-2813-1017

### ●Shanghai FA Center

MITSUBISHI ELECTRIC AUTOMATION (CHINA) LTD.  
4/F Zhi Fu Plazz, No.80 Xin Chang Road, Shanghai, China 200003  
TEL. +86-21-6121-2460 FAX. +86-21-6121-2424

### ●Guangzhou FA Center

MITSUBISHI ELECTRIC AUTOMATION (CHINA) LTD. GUANGZHOU OFFICE  
Rm.1609, North Tower, The Hub Center, No.1068, Xing Gang East Road, Haizhu District, Guangzhou, China 510335  
TEL. +86-20-8923-6713 FAX. +86-20-8923-6715

### ●India FA Center

Mitsubishi Electric Asia Pvt. Ltd. Gurgaon Branch  
2nd Floor, DLF Building No.9B, DLF Cyber City Phase III, Gurgaon 122002, Haryana, India  
TEL. +91-124-4630300 FAX. +91-124-4630399

### ●Thailand FA Center

MITSUBISHI ELECTRIC AUTOMATION (THAILAND) CO., LTD.  
Bang-Chan Industrial Estate No.111, Soi Serithai 54, T.Kannayao, A.Kannayao, Bangkok 10230  
TEL. +66-2-906-3238 FAX. +66-2-906-3239

### ●ASEAN FA Center

MITSUBISHI ELECTRIC ASIA PTE. LTD.  
307 Alexandra Road #05-01/02, Mitsubishi Electric Building, Singapore 159943  
TEL. +65-6470-2480 FAX. +65-6476-7439

### ●European FA Center

MITSUBISHI ELECTRIC EUROPE B. V. GERMAN BRANCH  
Gothaer Strasse 8, D-40880 Ratingen, Germany  
TEL. +49-2102-486-0 FAX. +49-2102-486-1120

### ●UK FA Center

MITSUBISHI ELECTRIC EUROPE B. V. UK BRANCH  
Travellers Lane, Hatfield, Hertfordshire, AL10 8XB, UK.  
TEL. +44-1707-276100 FAX. +44-1707-278695

### ●Central and Eastern Europe FA Center

MITSUBISHI ELECTRIC EUROPE B.V. CZECH BRANCH  
Avenir Business Park, Radlicka 714/113a,158 00 Praha 5, Czech Republic  
TEL. +420-251-551-470 FAX. +420-251-551-471

### ●Brazil FA Center

MELCO-TEC Representacao Comercial e Assessoria Tecnica Ltda.  
Av. Paulista 1439, conj.74, Bela Vista CEP: 01311-200 Sao Paulo-SP-Brazil  
TEL. +55-11-3146-2202 FAX. +55-11-3146-2217



# **mitsubishi electric corporation**

HEAD OFFICE: TOKYO BUILDING 2-7-3, MARUNOUCHI, CHIYODA-KU, TOKYO 100-8310, JAPAN