

VECTOR INVERTER

FR-V500L

INSTRUCTION MANUAL (Basic)

FR-V520L-75K (-NA)

FR-V540L-75K to 250K (-NA)

Thank you for choosing this Mitsubishi Vector Inverter.
 If this is the first time for you to use the FR-V500L series, please read through this Instruction Manual (basic) carefully to use the inverter safely.
 When you are going to use the inverter for higher-leveled applications, please refer to the FR-V500L Instruction Manual (detailed) [IB-T7312].

Contents

1	OUTLINE	1
	1.1 Basic configuration and connection of peripheral devices	2
	1.2 Motor	4
	1.3 Structure	12
2	INSTALLATION AND WIRING	14
	2.1 Installations for installation	14
	2.2 Connection diagram, PU connector	15
	2.3 Precautions for use of the vector inverter	24
<p>This inverter is factory-set to connect the PLG for 12V and Complimentary (Japanese version) / 5V and differential line driver (NA Version). Please check the motor and PLG specifications before operating the inverter.</p>		
3	RUN AND OPERATION	25
	3.1 Checks prior to test run	25
	3.2 Basic operation (Speed setting, run, speed meter adjustment)	25
	3.3 Names and functions of the operation panel	29
4	CONTROL	35
	4.1 Speed control operation	35
	4.2 Torque control operation	39
	4.3 Position control operation	44
	4.4 Control mode switchover timing	45
	4.5 Easy gain tuning	47
	4.6 Online auto tuning	50
	4.7 Biases and gains of speed setting terminals (Pr. 902 to Pr. 905, Pr. 917 to Pr. 920)	51
5	PARAMETERS	54
	5.1 Function list (Simple mode parameters)	54
	5.2 Function list (Extended function parameters)	59
6	ERRORS AND PROTECTIVE FUNCTIONS	74
	6.1 Errors (Alarms)	74
	6.2 Correspondences between digital and actual characters	86
	6.3 Resetting the inverter	86
	6.4 Troubleshooting	87
	6.5 Precautions for maintenance and inspection	98
7	SPECIFICATIONS	104
	7.1 Model specifications	104
	7.2 Common specifications	106
	7.3 Outline dimension drawings	107

1

2

3

4

5

6

7

This Instruction Manual (basic) provides handling information and precautions for use of the equipment. Please forward this Instruction Manual (basic) to the end user.

This instruction manual uses the International System of Units (SI). The measuring units in the yard and pound system are indicated in parentheses as reference values.

This section is specifically about safety matters

Do not attempt to install, operate, maintain or inspect the inverter until you have read through the Instruction Manual and appended documents carefully and can use the equipment correctly. Do not use the inverter until you have a full knowledge of the equipment, safety information and instructions. In this Instruction Manual, the safety instruction levels are classified into "WARNING" and "CAUTION".



WARNING

Assumes that incorrect handling may cause hazardous conditions, resulting in death or severe injury.



CAUTION

Assumes that incorrect handling may cause hazardous conditions, resulting in medium or slight injury, or may cause physical damage only.

Note that even the CAUTION level may lead to a serious consequence according to conditions. Please follow the instructions of both levels because they are important to personnel safety.

1. Electric Shock Prevention



WARNING

- While power is on or when the inverter is running, do not open the front cover. You may get an electric shock.
- Do not run the inverter with the front cover removed. Otherwise, you may access the exposed high-voltage terminals or the charging part of the circuitry and get an electric shock.
- Even If power is off, do not remove the front cover except for wiring or periodic inspection. You may access the charged inverter circuits and get an electric shock.
- Before starting wiring or inspection, check that power lamp display is turned off and check for residual voltages with a meter etc. more than 10 minutes after power-off.
- Earth (Ground) the inverter.
- Any person who is involved in wiring or inspection of this equipment should be fully competent to do the work.
- Always install the inverter before wiring. Otherwise, you may get an electric shock or be injured.
- Perform setting dial and key operations with dry hands to prevent an electric shock.
- Do not subject the cables to scratches, excessive stress, heavy loads or pinching. Otherwise, you may get an electric shock.
- Do not change the cooling fan while power is on. It is dangerous to change the cooling fan while power is on.

2. Fire Prevention



CAUTION

- Mount the inverter to incombustible material. Mounting it to or near combustible material can cause a fire.
- If the inverter has become faulty, switch off the inverter power. A continuous flow of large current could cause a fire.
- Do not connect a resistor directly to the DC terminals P, N. This could cause a fire.

3. Injury Prevention



CAUTION

- Apply only the voltage specified in the instruction manual to each terminal to prevent damage etc.
- Ensure that the cables are connected to the correct terminals. Otherwise damage etc. may occur.
- Always make sure that polarity is correct to prevent damage etc.
- While power is on and for some time after power-off, do not touch the inverter or brake resistor as they are hot and you may get burnt.

4. Additional Instructions

Also note the following points to prevent an accidental failure, injury, electric shock, etc.

1) Transportation and installation



CAUTION

- When carrying products, use correct lifting gear to prevent injury.
- Do not stack the inverter boxes higher than the number recommended.
- Ensure that installation position and material can withstand the weight of the inverter.
- Do not operate if the inverter is damaged or has parts missing.
- When carrying the inverter, do not hold it by the front cover or setting dial; it may fall off or fail.
- Do not stand or rest heavy objects on the inverter.
- Check the inverter mounting orientation is correct.
- Prevent screws, wire fragments, other conductive bodies, oil or other flammable substances from entering the inverter.
- Do not drop the inverter, or subject it to impact
- Use the inverter under the following environmental conditions:

Environment	Ambient temperature	-10°C to +50°C (14°F to 122°F) (non-freezing)
	Ambient humidity	90%RH or less (non-condensing)
	Storage temperature	-20°C to +65°C* (-4°F to 149°F)
	Ambience	Indoors (free from corrosive gas, flammable gas, oil mist, dust and dirt)
	Altitude, vibration	Maximum 1000m (3280.80feet) above sea level for standard operation. After that derate by 3% for every extra 500m (1640.40feet) up to 2500m (8202.00feet) (91%). 5.9m/s 2 or less (conforming to JIS C 0040)

*Temperature applicable for a short time, e.g. in transit.

2) Wiring

CAUTION

- Do not fit capacitive equipment such as power factor correction capacitor, surge suppressor or radio noise filter (option FR-BIF) to the inverter output side.
- The connection orientation of the output cables (terminals U, V, W) to the motor will affect the direction of rotation of the motor.

3) Trial run

CAUTION

- Check all parameters, and ensure that the machine will not be damaged by a sudden start-up.

4) Operation

WARNING

- When you have chosen the retry function, stay away from the equipment as it will restart suddenly after an alarm stop.
- The [STOP] key is valid only when the appropriate function setting has been made. Prepare an emergency stop switch separately.
- Make sure that the start signal is off before resetting the inverter alarm. A failure to do so may restart the motor suddenly.
- The load used should be a three-phase induction motor only. Connection of any other electrical equipment to the inverter output may damage the equipment.
- Do not modify the equipment.

CAUTION

- The electronic thermal relay does not guarantee protection of the motor from overheating.
- Do not use a magnetic contactor on the inverter input for frequent starting/stopping of the inverter.
- Use a noise filter to reduce the effect of electromagnetic interference. Otherwise nearby electronic equipment may be affected.
- Take measures to suppress harmonics. Otherwise power from the inverter may heat/damage the power capacitor and generator.
- When a 400V class motor is inverter-driven, it should be insulation-enhanced or surge voltages suppressed. Surge voltages attributable to the wiring constants may occur at the motor terminals, deteriorating the insulation of the motor.
- When parameter clear or all clear is performed, each parameter returns to the factory setting. Re-set the required parameters before starting operation.
- The inverter can be easily set for high-speed operation. Before changing its setting, fully examine the performances of the motor and machine.
- In addition to the inverter's holding function, install a holding device to ensure safety.
- Before running an inverter which had been stored for a long period, always perform inspection and test operation. In addition to the inverter's holding function, install a holding device to ensure safety.

5) Emergency stop

CAUTION

- Provide a safety backup such as an emergency brake which will prevent the machine and equipment from hazardous conditions if the inverter fails.

6) Maintenance, inspection and parts replacement

CAUTION

- Do not carry out a megger (insulation resistance) test on the control circuit of the inverter.

7) Disposing of the inverter

CAUTION

- Treat as industrial waste

8) General instructions

Many of the diagrams and drawings in this Instruction Manual (basic) show the inverter without a cover, or partially open. Never operate the inverter in this manner. Always replace the cover and follow this Instruction Manual (basic) when operating the inverter.

Basic configuration and connection of peripheral devices

1.1 Basic configuration and connection of peripheral devices

1.1.1 Basic configuration

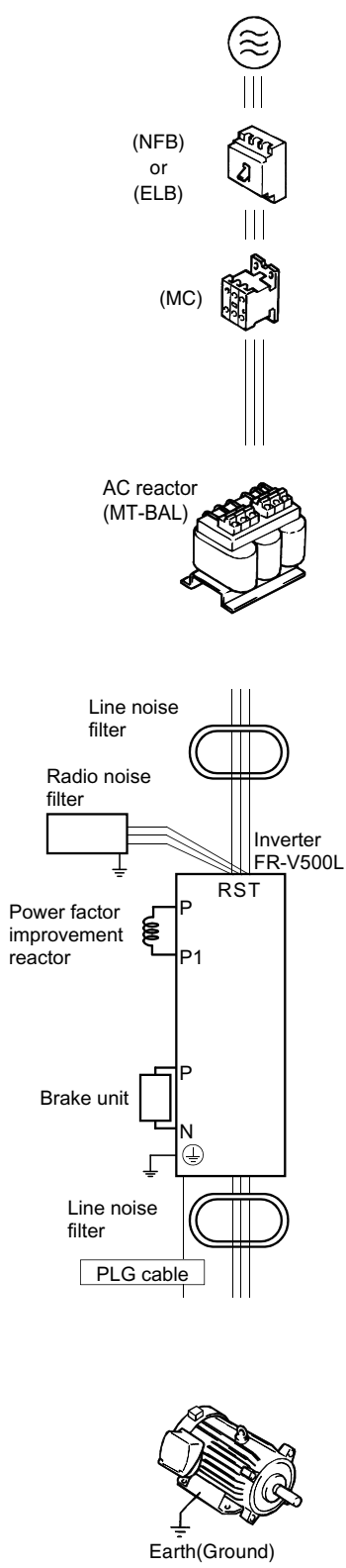

Power supply

Use within the permissible power supply specifications of the inverter. (Refer to page 104.)

No-fuse breaker (NFB) or earth leakage circuit breaker (ELB)

The breaker must be selected carefully since an in-rush current flows in the inverter at power-on. (Refer to page 3.)

Magnetic contactor

Install the magnetic contactor to ensure safety.

Do not use this magnetic contactor to start and stop the inverter. Doing so will cause the inverter life to be shortened. (Refer to page 3.)

Power factor improvement reactor

- AC reactor (MT-BAL)

Reactors must be used when the power factor is to be improved or when the inverter is installed near a large power supply system. The inverter may be damaged if you do not use reactors.

Make selection carefully. (Refer to page 3.)

- DC reactor (Standard)

Always connect the DC reactor.

Noise filter

Install a noise filter to reduce the magnetic noise generated from the inverter.

- Line noise filter (FR-BLF)

Effective in the range from about 1MHz to 10MHz. When more wires are passed through, a more effective result can be obtained. (Note that the number of wires run through is limited when fitting to the output side.)

- Radio noise filter (FR-BIF)

Effective in reducing the noises in the AM radio frequency band. Dedicated filter for the input side.

Inverter

The life of the inverter is influenced by ambient temperature. The ambient temperature should be as low as possible within the permissible range. This must be noted especially when the inverter is installed in an enclosure. (Refer to page 14.)

Wrong wiring might lead to damage of the inverter. The control signal lines must be kept fully away from the main circuit to protect them from noise. (Refer to page 15.)

Brake unit, Brake resistor

(Caution) • Connect to terminal P-N.

- Set "1" in Pr. 30 "regenerative function selection".
- Set "10%" in Pr. 70 "special regenerative brake duty".

Motor with PLG

Having the auto tuning function as standard, this inverter can also be used with motors other than Mitsubishi motors. (Refer to page 6.)

Devices connected to the output

Do not install a power factor correction capacitor, surge suppressor or radio noise filter in the output side of the inverter.

Earth (Ground)

To prevent an electric shock, always earth (ground) the motor and inverter. For reduction of induction noise from the power line of the inverter, it is recommended to wire the earth (ground) cable by returning it to the earth (ground) terminal of the inverter.

(📖) For details of noise reduction techniques, refer to the Instruction Manual (detailed).

Caution

- **Do not fit capacitive equipment such as power factor correction capacitor, radio noise filter (FR-BIF option) or surge suppressor to the output side of the inverter. This will cause the inverter to trip or power factor correction capacitor and surge suppressor to be damaged. If any of the above devices are connected, immediately remove them. (If the FR-BIF radio noise filter is connected, switching power off during motor operation may result in "E.UVT". In this case, connect the radio noise filter on the primary side of the magnetic contactor.)**
- **Electromagnetic wave interference**
The input/output (main circuit) of the inverter includes harmonic components, which may interfere with the communication devices (such as AM radios) used near the inverter. In this case, install the FR-BIF optional radio noise filter (for use in the input side only) or FR-BLF line noise filter to minimize interference.
- **For details of peripheral devices, refer to each option manual.**

1.1.2 Selection of peripheral devices

Check the motor applicable to the inverter you purchased. Appropriate peripheral devices need to be selected according to the motor capacity. Refer to the list below and prepare appropriate peripheral devices.

200V class

Motor Output (kW (HP))	Applicable Inverter Type	No-fuse Breaker (NFB ^{*1}) or Earth Leakage Circuit Breaker (ELB ^{*2})	Magnetic Contactor (MC)	Cooling fan
75 (100)	FR-V520L-75K (-NA)	Type NF400 300A	S-N300	EF-30BSB 1φ 100/110V 50/60Hz 20mm ³ /min 4mmAq 500mm 500mm more

400V class

Motor Output (kW (HP))	Applicable Inverter Type	No-fuse Breaker (NFB ^{*1}) or Earth Leakage Circuit Breaker (ELB ^{*2})	Magnetic Contactor (MC)	Cooling fan
75 (100)	FR-V540L-75K (-NA)	Type NF225 225A	S-N80	EF-25ASB 1φ 100/110V 50/60Hz 12mm ³ /min 4mmAq 500mm 500mm more
90 (125)	FR-V540L-90K (-NA)	Type NF225 225A	S-N150	
110 (150)	FR-V540L-110K (-NA)	Type NF225 225A	S-N150	
132 (200)	FR-V540L-132K (-NA)	Type NF400 300A	S-N180	
160 (250)	FR-V540L-160K (-NA)	Type NF400 300A	S-N300	EF-30BSB 1φ 100/110V 50/60Hz 20mm ³ /min 4mmAq 500mm 500mm more
200 (300)	FR-V540L-200K (-NA)	Type NF600 400A	S-N400	
250 (350)	FR-V540L-250K (-NA)	Type NF600 500A	S-N400	

*1. Select the NFB type according to the power supply capacity.

*2. For installation in the United States and Canada, select circuit breakers authorized by UL and cUL.

1.2 Motor

POINT

When using other manufacturers' motors, offline auto tuning (rotation mode) is necessary. Perform offline auto tuning with the motor alone before connecting a load. If higher torque accuracy is required, perform online auto tuning next.

? Offline auto tuning

☞ The inverter measures necessary motor circuit constant and stores it to improve low speed torque. (Refer to page 6)

? Online auto tuning

☞ High torque accuracy corresponding to the motor temperature variation is available. (Refer to page 50)

• Japanese version

This inverter is factory-set to connect the PLG 12V and complimentary connector. Please check PLG specifications before operating the inverter.

• NA version

This inverter is factory-set to connect the PLG for 5V and differential line driver connector. Please check PLG specifications before operating the inverter.

(1) At-a-glance guide to motor setting

Item	Parameter, Jumper Connector, Terminal	Refer to
Motor setting	Pr. 71 "applied motor"	6
Offline tuning	Pr. 96 "auto tuning setting/status"	7
Capacity setting	Pr. 80 "motor capacity"	7
Number of PLG pulses	Pr. 851 "number of PLG pulses"	6
PLG rotation direction	Pr. 852 "PLG rotation direction"	6
PLG power supply specification	PLG power supply jumper connector on the back of the control terminal	5
PLG output type		
Electronic thermal relay	Pr. 9 "electronic thermal O/L relay"	56
Thermal protector input	Across OH-SD	72
	Pr. 876 "thermal relay protector input"	

1.2.1 PLG cable and PLG setting

(1) Specification of encoder

Item	Specification	Setting	Refer to
Resolution	1000 to 4096 Pulse/Rev	Setting by Pr. 851 "number of PLG pulses"	6
Power supply voltage	5V, 12V, 24VDC	Switching the position of the jumper connector on the back surface of the control circuit terminal block	5
Output signal form	A, B phases (90° phase) Z phase (1 Pulse/Rev)	—	19
Output circuit	Differential line driver, Complimentary	Switching the position of the jumper connector on the back surface of the control circuit terminal block	5

(2) Wiring example

1) Differential line driver

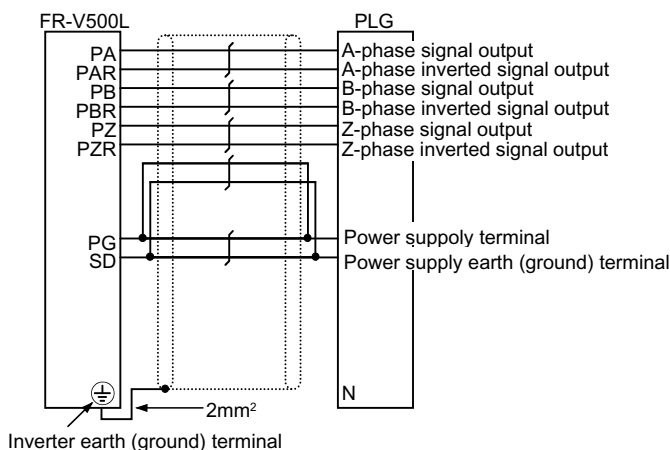

2) Complimentary

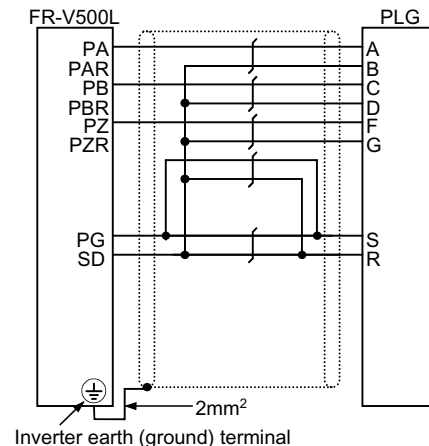

(3) PLG cable gauge (Cable specification)

Wiring Distance	Wiring 0.2mm ² Cables	Using larger gauge cable	
		mm ²	AWG
0 to 10m (0 to 32.81feet)	2 parallels or more	0.4mm ²	26 or more
10 to 20m (32.81 to 65.62feet)	4 parallels or more	0.75mm ²	21 or more
20 to 100m (65.62 to 328.08feet)	6 parallels or more	1.25mm ²	16 or more

(4) Cable stresses

- (1) The way of clamping the cable must be fully considered so that flexing stress and cable's own weight stress are not applied to the cable connection.
- (2) In any application where the motor moves, do not subject the cable to excessive stress.
- (3) Avoid any probability that the cable sheath might be cut by sharp chips, rubbed by a machine corner or trampled over by workers or vehicles.
- (4) When mounting the PLG on a machine where the motor will move, the flexing radius should be as large as possible.

CAUTION

Please contact the cable manufacturer for the number of cable flexes and cable stress due to the flexing radius.

(5) Setting the power supply specification of the PLG and pulse output type

CAUTION

Make setting correctly.

Fitting the jumper connector to the position exceeding the power specification results in a PLG failure.

Fitting the jumper connector to the position below the power specification results in a PLG malfunction.

Switch the position of the jumper connector on the back surface of the control circuit terminal block according to the PLG specification. (Refer to page 21 for removal and installation of the control circuit terminal block.)

CAUTION

- **Jumper connector for the PLG power supply**
The jumper connector is fitted to 12V (Japanese Version) /5V (NA Version) when shipped from the factory. Switch its position according to power supply specification.

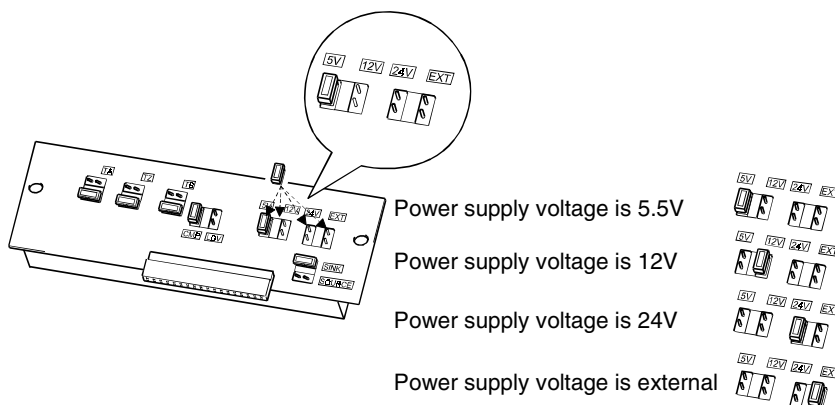

- **Jumper connector PLG output circuit**

- Japanese Version
The jumper connector is fitted to Complimentary (CMP) when shipped from the factory.
- NA Version
The jumper connector is fitted to differential line driver (LDV) when shipped from the factory.

Switch its position according to output circuit.

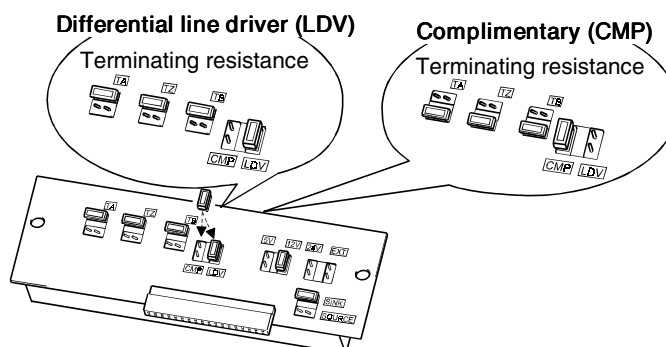

Motor

(6) Setting the number of PLG pulses and PLG rotation direction

Set the following parameters according to the PLG specification.

Parameter	Name	Factory Setting	Setting Range	Remarks
851	Number of PLG pulses	Japanese Version 2048	0 to 4096	These are extended mode parameters. Set "1" in Pr. 160 "extended function selection"
		NA Version 1024		
852	PLG rotation direction	1	0, 1	

- The rotation direction monitor of the parameter unit displays the rotation direction of the encoder.

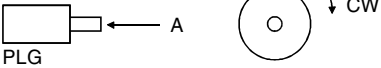
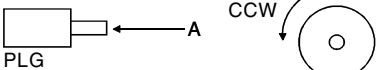
Pr. 852 Setting	Relationship between the motor and PLG
0	 <p>Forward rotation is clockwise rotation when viewed from A.</p>
1 (factory setting)	 <p>Forward rotation is counterclockwise rotation when viewed from A.</p>

REMARKS

- The number of PLG pulses should be between 1000 and 4096.

1.2.2 Setting the motor

(1) Setting the Pr. 71 "applied motor"

Setting	Motor	Control Constants
0	SF-LHA	Inverter internal constants
3	Other manufacturer's motor	Offline auto tuning
4		Offline auto tuning data utilization
5		Star connection direct input
6		Delta connection direct input
7		Star connection direct input + offline auto tuning
8		Delta connection direct input + offline auto tuning
10		Japanese Version : SF-LHCA NA Version (400V) : Blue Max [®] 2000
13	Other manufacturer's motor	Offline auto tuning
14		Offline auto tuning data utilization
15		Star connection direct input
16		Delta connection direct input
17		Star connection direct input + offline auto tuning
18		Delta connection direct input + offline auto tuning
20	SF-VH	Inverter internal constants
23		Offline auto tuning
24		Offline auto tuning data utilization
30	SF-THY	Inverter internal constants
33		Offline auto tuning
34		Offline auto tuning data utilization

(2) Setting the motor specification

Set the following parameters to perform offline auto tuning.

Parameter	Name	Factory Setting	Setting Range	Description
9	Electronic thermal O/L relay	Rated inverter output current	0 to 3600A	Set the rated motor current. Set "0" after offline auto tuning when using an external thermal relay. Electronic thermal function is made invalid. Set "0" in Pr. 876 when an external thermal relay is not used.
80	Motor capacity	Inverter capacity	0 to 3600kW	Set the motor capacity. Set the capacity equal to the inverter or one rank lower.
81	Number of motor poles	4	2, 4, 6	Set the number of motor poles.
83	Rated motor voltage	200V/400V	0 to 1000V	Set the rated motor voltage (V).
84	Rated motor frequency	60Hz	20 to 200Hz	Set the rated motor frequency (Hz).
96	Auto tuning setting/status	0	0, 1, 101	Refer to (3) on the next page.

CAUTION

For the setting value, set the motor rating plate value. When using a motor having several rated values, e.g. a standard motor, set a value for 200V/60Hz or 400V/60Hz.

(3)-1 Offline auto tuning

When using other manufacturer's motors, using the offline auto tuning function runs the motor with the optimum operating characteristics.

- By performing offline auto tuning, the inverter measures the necessary motor constants.
- Offline auto tuning can be performed with an inertia load, e.g. coupling, connected. (As the load is smaller, tuning accuracy is higher. Tuning accuracy does not change if the inertia is large.)
- For the offline auto tuning, you can select either the motor non-rotation mode or rotation mode. Operation in the rotation mode provides higher tuning accuracy than the non-rotation mode. The rotation mode should be selected with the motor alone for the online auto tuning. (inertia load can be connected)
- Note that it is necessary to perform offline auto tuning (non-rotation mode (Pr. 96="1")) in order for the wiring length resistance to be reflected on the control when the wiring length of the SF-THY, SF-VH, SF-LHA, SF-LHCA is long (30m (98.42 feet) or longer as a reference).
(For online auto tuning, refer to page 50.)

CAUTION



- 1. Set the capacity equal to the inverter or one rank lower.**
- 2. Special motors such as high-slip motor and high-speed motor cannot be tuned.**
- 3. Motor runs at up to about the rated speed of the motor.**
- 4. Make sure that the motor is connected. (At a tuning start, the motor should be at a stop.)**
- 5. Tune the motor alone without connecting a load (e.g. frictional stationary load) to the motor. (An inertia load such as a coupling may remain connected.)**
- 6. Use the PLG that is coupled directly to the motor shaft without looseness.**
- 7. Offline auto tuning will not be performed properly if it is performed when a reactor or surge voltage suppress filter (FR-ASF-H) is connected between the inverter and motor. Remove it before starting tuning.**

- 1) Set any one of the following values in Pr. 71:
 - Standard motor Pr. 71 = "3"
 - Constant-torque motor Pr. 71 = "13"
 - SF-VH Pr. 71 = "23"
 - SF-THY Pr. 71 = "33"
- 2) Set "1" or "101" in Pr. 96
 - When the setting is "1", tuning is performed without motor running
 - When the setting is "101", tuning is performed with motor running

CAUTION

- **Note the following when "101" (offline auto tuning performed with motor running) is set in Pr. 96.**
 - **Ensure safety when the motor starts running.**
 - **Torque is not enough during tuning.**
 - **The motor may be run at nearly its rated frequency (Pr. 84 setting) without any problem.**
 - **The brake is open.**
 - **When over current alarm (E.OC1, OC2, OC3) occurs, set acceleration time longer using Pr. 7.**
 - **No external force is applied to rotate the motor.**
 - Even if "1" (tuning performed without motor running) is set in Pr. 96, the motor may run slightly (However, torque is not enough). Therefore, fix the motor securely with a mechanical brake, or before tuning, make sure that there will be no problem in safety if the motor runs.**
 - *This instruction must be followed especially in vertical lift applications.**
 - Note that if the motor runs slightly, tuning performance is unaffected.**
 - **During offline auto tuning, only the following I/O signals are valid:**
 - Input signals (STOP, OH, MRS, RT, RES, STF, STR)**
 - Output signals (RUN, OL, IPF, DA1, DA2, A, B, C)**
- Take extra precaution when designing a sequence where a mechanical brake is opened by the RUN signal.**

3) Tuning command



After setting the above parameters, press  or .

(For external operation, turn on the run command (STF, STR).)

● Monitoring during execution

When the parameter unit (FR-PU04V) is used, the value of Pr. 96 is displayed during tuning on the main monitor as shown below. When the operation panel (FR-DU04-1) is used, only the same value as on the PU is displayed. When Pr.96=1

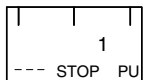
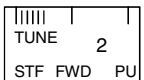
- Parameter unit (FR-PU04V) main monitor

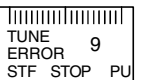
	1. Setting	2. Tuning in progress	3. Completion	4. Error-activated end (for inverter trip)
Display				

- Operation panel (FR-DU04-1) display

	1. Setting	2. Tuning in progress	3. Completion	4. Error-activated end (for inverter trip)
Displayed value				

REMARKS

- Offline auto tuning time (factory setting)
 - 1: Non-rotation mode: Approx. 25s
 - 2: Rotation mode: Approx. 40s

(Offline auto tuning time varies with the acceleration and deceleration time settings as indicated below.
Offline auto tuning time = acceleration time + deceleration time + approx. 30s)
- To force tuning to end, use the MRS or RES signal or press . (The start signal may also be turned off to end.)
- Excitation noise is produced during tuning.
- When executing offline auto tuning, input the run command after switching on the main circuit power (R, S, T) of the inverter.

4) Ending offline auto tuning

4)-1 Confirm the value of Pr. 96.

- Normal end: "3" or "103" is displayed.
- Abnormal end: "9", "91", "92" or "93" is displayed.
- Forced end: "8" is displayed.

4)-2 When tuning ended normally

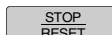
For PU operation, press . For external operation, turn off the start signal (STF or STR) once. This operation resets the offline auto tuning and the PU's monitor display returns to the normal indication. (Without this operation, next operation cannot be started.)
For inverter reset, refer to page 86.

4)-3 When tuning was ended due to an error

Offline auto tuning did not end normally. (The motor constants have not been set.) Reset the inverter and start tuning over again.

4)-4 Error display definitions

Error Display	Error Cause	Remedy
9	Inverter trip	Make setting again.
91	Current limit (stall prevention) function was activated.	Increase acceleration/deceleration time. Set "1" in Pr. 156.
92	Converter output voltage reached 75% of the rated value.	Check for fluctuation of power supply voltage.
93	Calculation error	Check the motor wiring and make setting again.

No connection with motor will also result in "93" error.



4)-5 When tuning was ended forcibly

Tuning is ended forcibly by pressing  or turning off the start signal (STF or STR) during tuning. In this case, offline auto tuning has not ended properly. (The motor constants have not been set.) Perform an inverter reset and restart tuning.

REMARKS

- Set "3 (standard motor), "13" (constant-torque motor), "23" (SF-VH) or "33" (SF-THY) in Pr. 71 to use the constants measured in the offline auto tuning.
- The motor constants measured once in the offline auto tuning are stored as parameters and the data are held until the offline auto tuning is performed again.
- An instantaneous power failure occurring during tuning will result in a tuning error. After power is restored, the inverter goes into the ordinary operation mode. Therefore, when STF (STR) is on, the motor runs in forward (reverse) rotation.
- Any alarm occurring during tuning is handled as in the ordinary mode. Note that if an error retry has been set, retry is ignored.
- The preset speed monitor displayed during the offline auto tuning is 0r/min.

CAUTION

-  **Note that the motor may start running suddenly.**
-  **When the offline auto tuning is used in vertical lift application, e.g. a lifter, it may drop due to insufficient torque.**

<Setting the motor constants as desired>

The motor constants (Pr. 90 to Pr. 94) may be set as desired in either of two ways; the data measured in the offline auto tuning are read and utilized or changed, or the motor constants are set without the offline auto tuning data being used.

(3)-2 Utilizing or changing offline auto tuning data for use

POINT

It is necessary to read and write extended function parameters. The extended function parameters are made valid by setting "1" in Pr. 160 "extended function selection".

<Operating procedure>

- Set any one of the following values in Pr. 71:
 - Standard motor Pr. 71 = "4"
 - Constant-torque motor Pr. 71 = "14"
 - SF-VH Pr. 71 = "24"
 - SF-THY Pr. 71 = "34"
- Set "801" in Pr. 77.
(The parameter values of Pr. 82 "motor excitation current" and Pr. 90 to Pr. 94 (motor constants) can be displayed. Though the parameter values of other than Pr. 82 and Pr. 90 to Pr. 94 can also be displayed, they are parameters for manufacturer setting and their values should not be changed.)
- In the parameter setting mode, read the following parameters and set desired values.

Parameter Number	Name	Setting Range	Setting Increments	Factory Setting
82	Motor excitation current (no load current)	0 to ****, 9999	1	9999
90	Motor constant R1	0 to ****, 9999	1	9999
91	Motor constant R2	0 to ****, 9999	1	9999
92	Motor constant L1	0 to ****, 9999	1	9999
93	Motor constant L2	0 to ****, 9999	1	9999
94	Motor constant x	0 to ****, 9999	1	9999
859	Torque current	0 to ****, 9999	1	9999

REMARKS

When "0" (factory setting) is set in Pr. 684 "tuning data increment switchover", the motor constants are set in "internal variable increment". When "1" is set in Pr. 684, the motor constants are set in "mH, mΩ, A". (can be set when Pr.77 = "801")

Motor

4) Return the Pr. 77 setting to the original value.

REMARKS

1. Set "9999" in Pr. 90 to Pr. 94 to use the standard motor constants (including those for the constant-torque motor).
2. Setting "4, 14, 24 or 34" in Pr. 71 to change the motor constants changes the motor constants to the values measured in the offline auto tuning.
3. As the motor constants measured in the offline auto tuning have been converted into internal data (****), refer to the following setting example when making setting:
Setting example: To slightly increase Pr. 90 value (5%)
When Pr. 90 is displayed "2516", set 2642, i.e. $2516 \times 1.05 = 2641.8$, in Pr. 90. (The value displayed has been converted into a value for internal use. Hence, simple addition of a given value to the displayed value has no significance.)

(3)-3 Setting the motor constants directly

Offline auto tuning is not used.

The Pr. 92 and Pr. 93 motor constants may either be entered in [mΩ] or in [mH]. Before starting operation, confirm which motor constant unit is used.

- To enter the Pr. 92 and Pr. 93 motor constants in [mΩ]

<Operating procedure>

- 1) After checking that the input motor constants are those for star connection or delta connection, set the Pr. 71 value as indicated below (When direct input is selected and offline auto tuning is performed, set "7, 8, 17 or 18") in Pr. 71. (Refer to page 11.).

		Star Connection Motor	Delta Connection Motor
Pr. 71	Standard motor	5	6
Setting	Constant-torque motor	15	16

- 2) Set "801" in Pr. 77.

(The parameter values of the motor constants (Pr. 90 to Pr. 94) can be displayed. Though the parameter values of other than Pr. 90 to Pr. 94 can also be displayed, they are parameters for manufacturer setting and their values should not be changed.)

- 3) If "0" is set in Pr. 684 "tuning data increments switchover", the motor constants are set in "internal variable increments". When "1" is set in Pr. 684, the motor constants are set in "mH, mΩ, A". (can be set when Pr. 77 = "801")
- 4) In the parameter setting mode, read the following parameters and set desired values.

I_q =Torque, I_{100} =Constant current, I_0 =No load current

$$I_q = \sqrt{I_{100}^2 - I_0^2}$$

Parameter Number	Name	Setting Range	Setting Increments	Factory Setting
82	Motor excitation current (no load current)	0 to 3600A	0.1A	9999
90	Motor constant r1	0 to 400mΩ, 9999	0.01mΩ	9999
91	Motor constant r2	0 to 400mΩ, 9999	0.01mΩ	9999
92	Motor constant x1	0 to 3600mΩ, 9999	0.1mΩ	9999
93	Motor constant x2	0 to 3600mΩ, 9999	0.1mΩ	9999
94	Motor constant xm	0 to 100Ω, 9999	0.01Ω	9999
859	Torque current	0 to 3600A	0.1A	9999

- 5) Return the Pr. 77 setting to the original value.

- 6) Set Pr. 83 and Pr. 84.

Parameter Number	Name	Setting Range	Setting Increments	Factory Setting
83	Rated motor voltage	0 to 1000V	0.1V	200V/400V
84	Rated motor frequency	20 to 200Hz	0.01Hz	60Hz

CAUTION

1. Set "9999" in Pr. 90 to Pr. 94 to use the standard motor constants (including those for the constant-torque motor).
2. If "star connection" is mistaken for "delta connection" or vice versa during setting of Pr. 71, control cannot be exercised properly.

- To enter the Pr. 92 and Pr. 93 motor constants in [mH]

<Operating procedure>

- 1) After checking that the input motor constants are those for star connection or delta connection, set the Pr. 71 value as indicated below.

Pr. 71 Setting	Standard motor	0 (factory setting)
	Constant-torque motor	10
	SF-THY	30

- 2) Set "801" in Pr. 77.

(The parameter values of the motor constants (Pr. 90 to Pr. 94) can be displayed. Though the parameter values of other than Pr. 90 to Pr. 94 can also be displayed, they are parameters for manufacturer setting and their values should not be changed.)

- 3) If "0" (factory setting) is set in Pr. 684 "tuning data increments switchover", the motor constants are set in "internal variable increments". When "1" is set in Pr. 684, the motor constants are set in "mH, mΩ, A". (can be set when Pr. 77 = "801")

- 4) In the parameter setting mode, read the following parameters and set desired values.

Parameter Number	Name	Setting Range	Setting Increments	Factory Setting
82	Motor excitation current (no load current)	0 to 3600A	0.1A	9999
90	Motor constant R1	0 to 400mΩ, 9999	0.01mΩ	9999
91	Motor constant R2	0 to 400mΩ, 9999	0.01mΩ	9999
92	Motor constant L1	0 to 400mH, 9999	0.01mH	9999
93	Motor constant L2	0 to 400mH, 9999	0.01mH	9999
94	Motor constant x	0 to 100%, 9999	0.1%	9999
859	Torque current	0 to 3600A	0.1A	9999

- 5) Return the Pr. 77 setting to the original value.

- 6) Refer to the following table and set Pr. 84.

Parameter Number	Name	Setting Range	Setting Increments	Factory Setting
83	Rated motor voltage	0 to 1000V	0.1V	200V/400V
84	Rated motor frequency	20 to 200Hz	0.01Hz	60Hz

CAUTION

Set "9999" in Pr. 90 to Pr. 94 to use the standard motor constants (including those for the constant-torque motor).

(3)-4 Direct input + offline auto tuning

Perform offline auto tuning after directly inputting the motor constants.

- 1) Set Pr. 71.

Pr. 71 Setting	Description	
7	Star connection direct input + offline auto tuning	General-purpose motor
8	Delta connection direct input + offline auto tuning	
17	Star connection direct input + offline auto tuning	Constant-torque motor
18	Delta connection direct input + offline auto tuning	

- 2) Set the motor constants (Refer to page 11).

- 3) Set Pr. 96 to perform offline auto tuning (Refer to page 7).

1.3 Structure

1.3.1 Appearance and structure

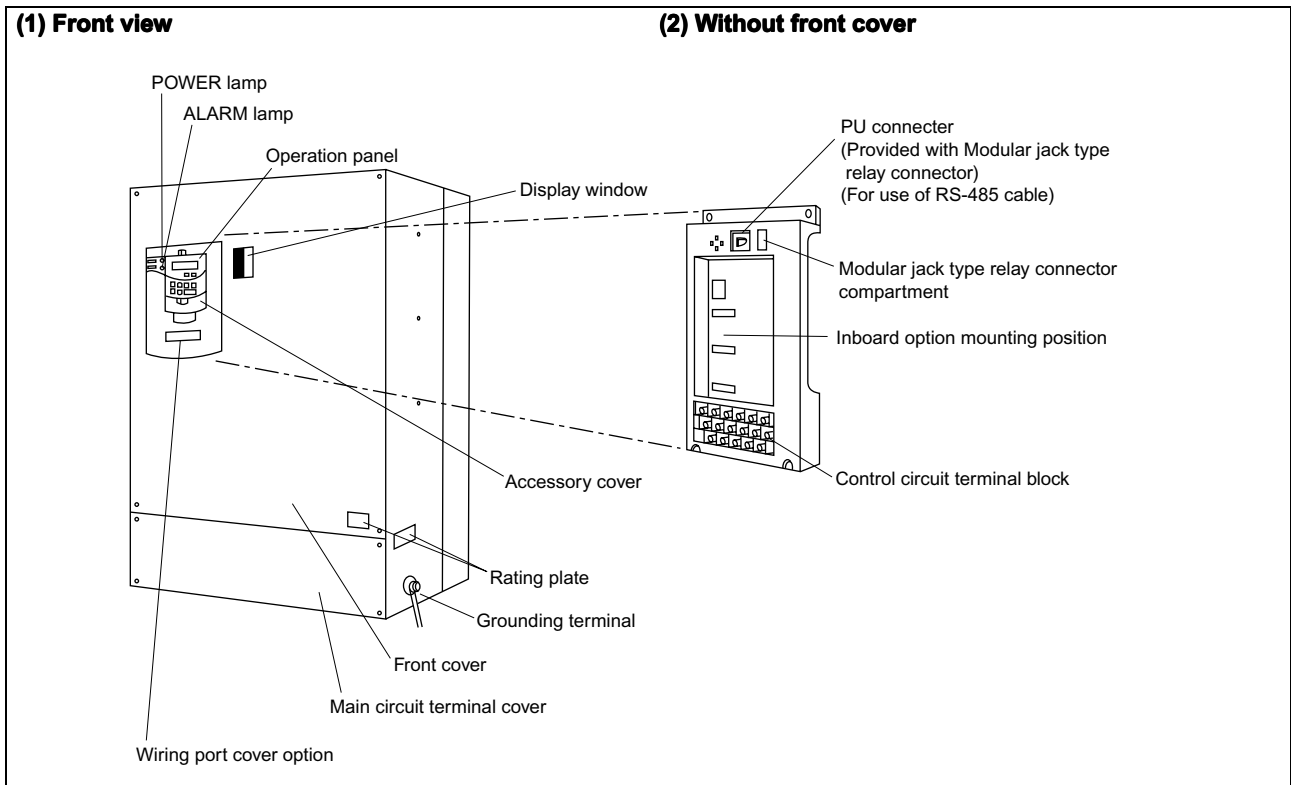

1.3.2 Removal and reinstallation of the front cover

• **Removal**

- 1) Remove the installation screw for the main circuit terminal cover.
- 2) Remove the front cover mounting screws.

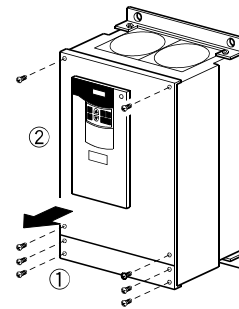

• **Reinstallation**

- 1) Fix the front cover with the mounting screws.
- 2) Fix the main circuit terminal cover with the installation screw.

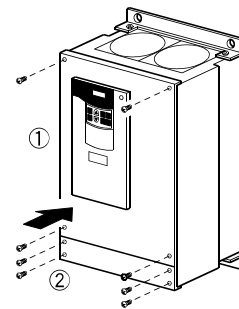

CAUTION

1. Fully make sure that the front cover has been reinstalled securely.
2. The same serial number is printed on the capacity plate of the front cover and the rating plate of the inverter. Before reinstalling the front cover, check the serial numbers to ensure that the cover removed is reinstalled to the inverter from where it was removed.

1.3.3 Removal and reinstallation of the operation panel

To ensure safety, remove and reinstall the operation panel after powering off.

● Removal

Hold down the top button of the operation panel and pull the operation panel toward you to remove.

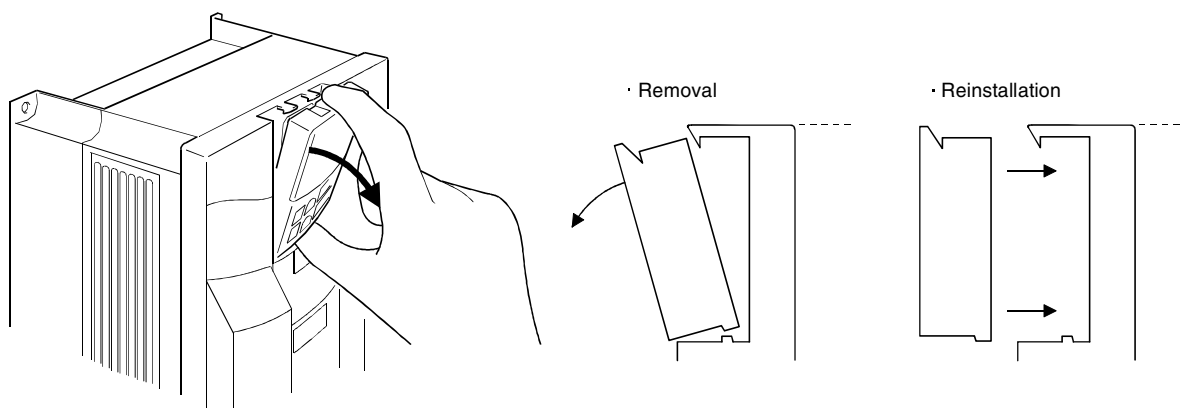

When reinstalling the operation panel, insert it straight and reinstall it securely.

● Reinstallation using the connection cable

- 1) Remove the operation panel.
- 2) Disconnect the modular jack type relay connector. (Place the disconnected modular jack type relay connector in the modular jack type relay connector compartment.)

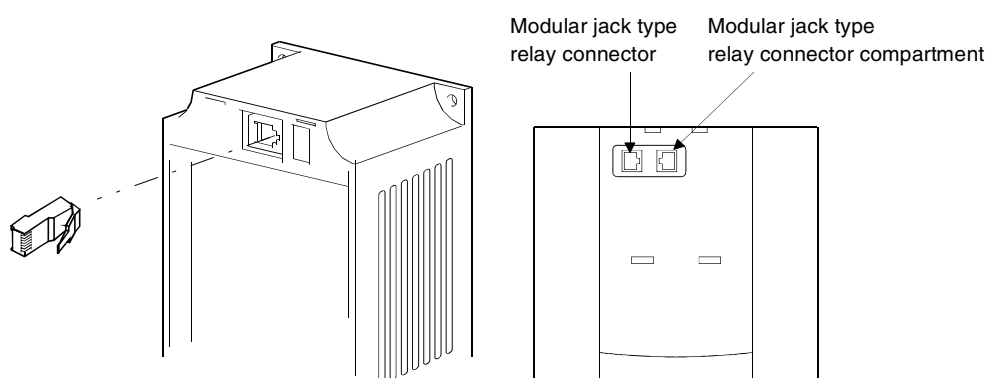

- 3) Securely plug one end of the connection cable into the PU connector of the inverter and the other end into the operation panel. (Refer to page 23 for the connection cable.)

CAUTION

Install the operation panel only when the front cover is on the inverter.

2 INSTALLATION AND WIRING

2.1 Instructions for installation

- 1) Handle the unit carefully.
The inverter uses plastic parts. Handle it gently to protect it from damage. Also, hold the unit with even strength and do not apply too much pressure to the front cover alone.
- 2) Install the inverter where it is not subjected to vibration.
Note the vibration of a cart, press, etc.
- 3) Note on ambient temperature
The inverter life is under great influence of ambient temperature. In the place of installation, ambient temperature must be within the permissible range (-10°C to 50°C (14°F to 122°F)). Check that the ambient temperature is within that range in the positions shown in figure 3).
- 4) Install the inverter on a non-combustible surface.
The inverter will be very hot (maximum about 150°C (302°F)). Install it on a non-combustible surface (e.g. metal). Also leave sufficient clearances around the inverter.
- 5) Avoid high temperature and high humidity.
Avoid places where the inverter is subjected to direct sunlight, high temperature and high humidity.
- 6) The amount of heat generated in an enclosure can be reduced considerably by placing the heat sink outside the enclosure.

Note : The cooling section outside the enclosure has the cooling fan. Do not use the inverter in any environment where it is exposed to waterdrops, oil mist, dust, etc.

- 7) Avoid places where the inverter is exposed to oil mist, flammable gases, fluff, dust, dirt, etc.
Install the inverter in a clean place or inside a "totally enclosed" panel which does not accept any suspended matter.
- 8) Note the cooling method when the inverter is installed in an enclosure.
When an inverter is mounted in an enclosure, the ventilation fans of the inverter and enclosure must be carefully positioned to keep the ambient temperature of the inverter below the permissible value. If they are installed in improper positions, the rise in ambient temperature will result in reduced performance of the inverter.
- 9) Secure the inverter vertically, with bolts.
Install the inverter on an installation surface securely and vertically with screws or bolts.

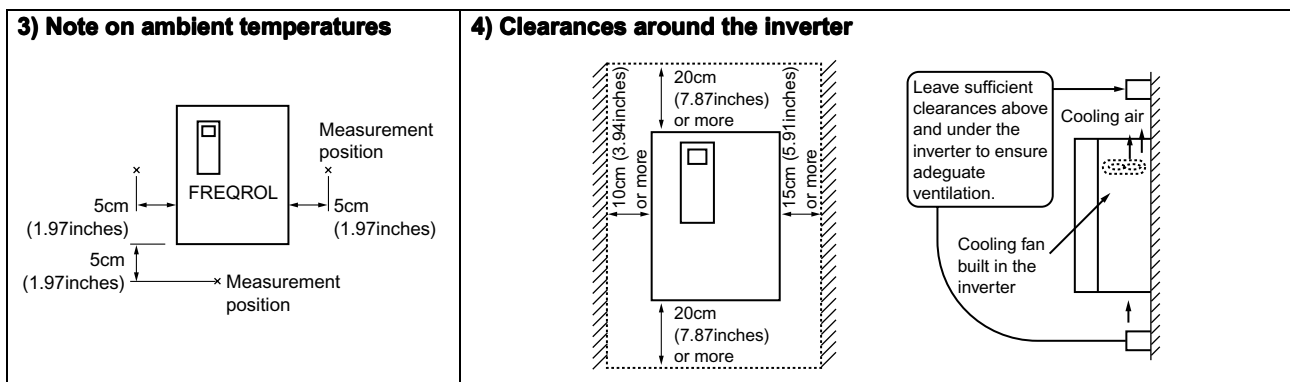

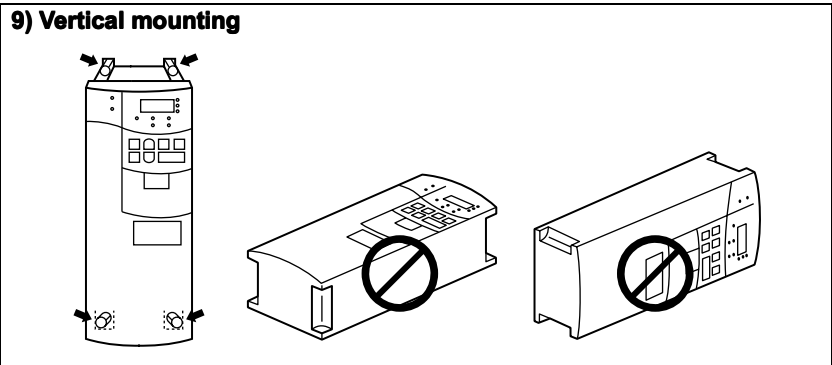
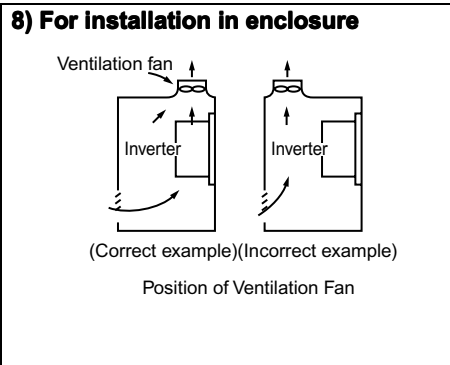

2.2 Connection diagram, PU connector

2.2.1 Connection diagram

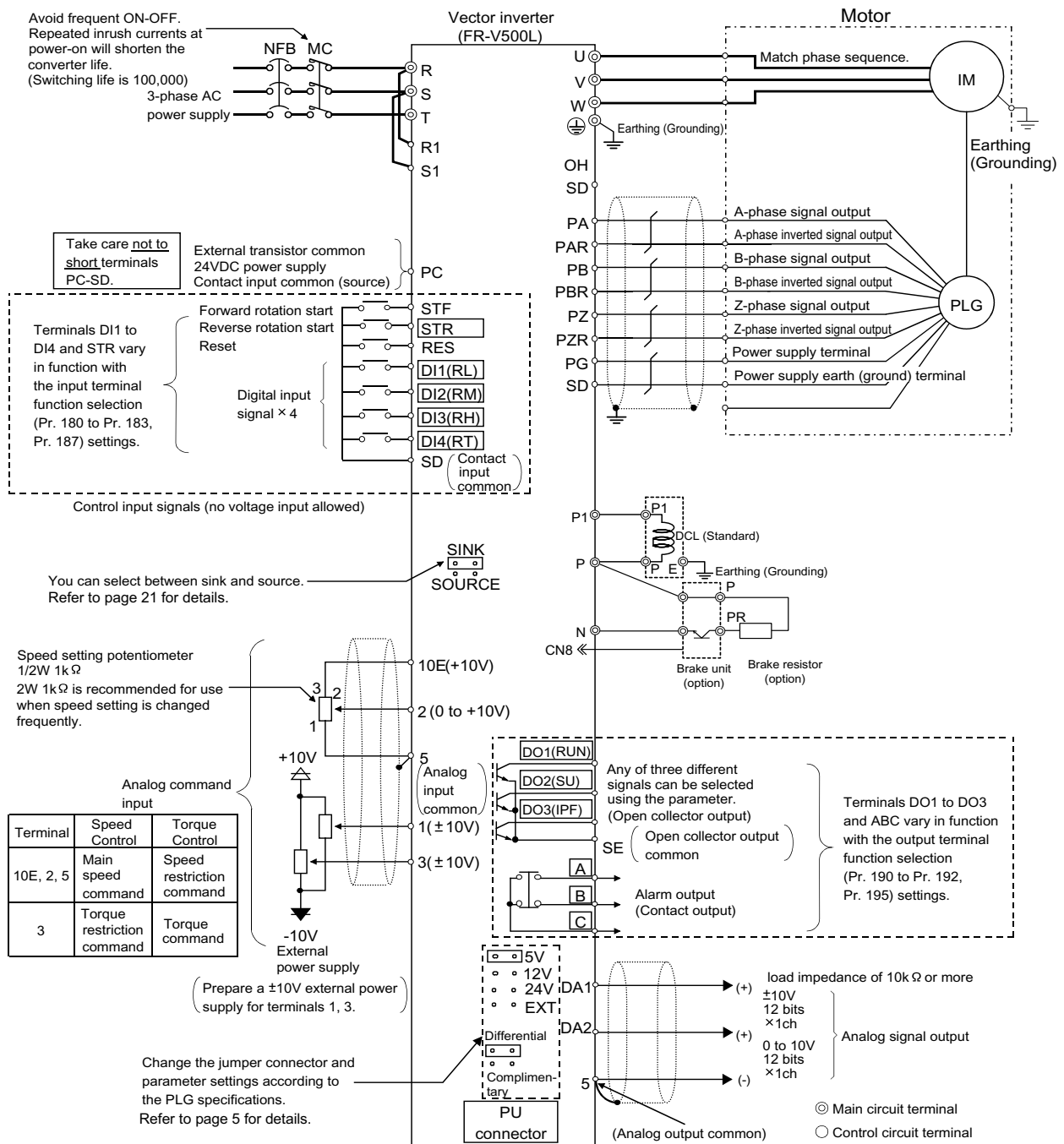

CAUTION

- To prevent a malfunction caused by noise, separate the signal cables more than 10cm (3.94 inches) from the power cables.
- During wiring, do not leave wire off-cuts in the inverter. Wire off-cuts will cause an alarm, failure or malfunction. Always keep the inverter clean. When drilling mounting holes in a control box etc., take care not to allow chips and other foreign matter to enter the inverter.
- Always connect the enclosed DC reactor.

Connection diagram, PU connector

2.2.2 Main circuit

(1) Specification of main circuit terminal

Terminal Symbol	Terminal Name	Description
R, S, T	AC power input	Connect to the commercial power supply. Keep these terminals open when using the high power factor converter (MT-HC).
U, V, W	Inverter output	Connect a motor.
R1, S1	Power supply for control circuit	Connected to the AC power supply terminals R and S. To retain the alarm display and alarm output or when using the high power factor converter (MT-HC), remove the jumpers from terminals R-R1 and S-S1 and apply external power to these terminals. Do not turn off the power supply for control circuit (R1, S1) with the main circuit power (R, S, T) on. Doing so may damage the inverter. The circuit should be configured so that the main circuit power (R, S, T) is also turned off when the power supply for control circuit (R1, S1) is off. 80VA
P, N	Brake unit connection	Connect the optional MT-BU5 brake unit, high power factor converter (MT-HC).
P, P1	Power factor improving DC reactor connection	Connect the power factor improving DC reactor (Standard).
	Earth (Ground)	For earthing (grounding) the inverter chassis. Must be earthed (grounded).

CAUTION

- **The inverter will be damaged if power is applied to the inverter output terminals (U, V, W). Never perform such wiring.**

(2) Terminal arrangement of the main circuit terminal

In the main circuit of the inverter, the terminals are arranged as shown below:

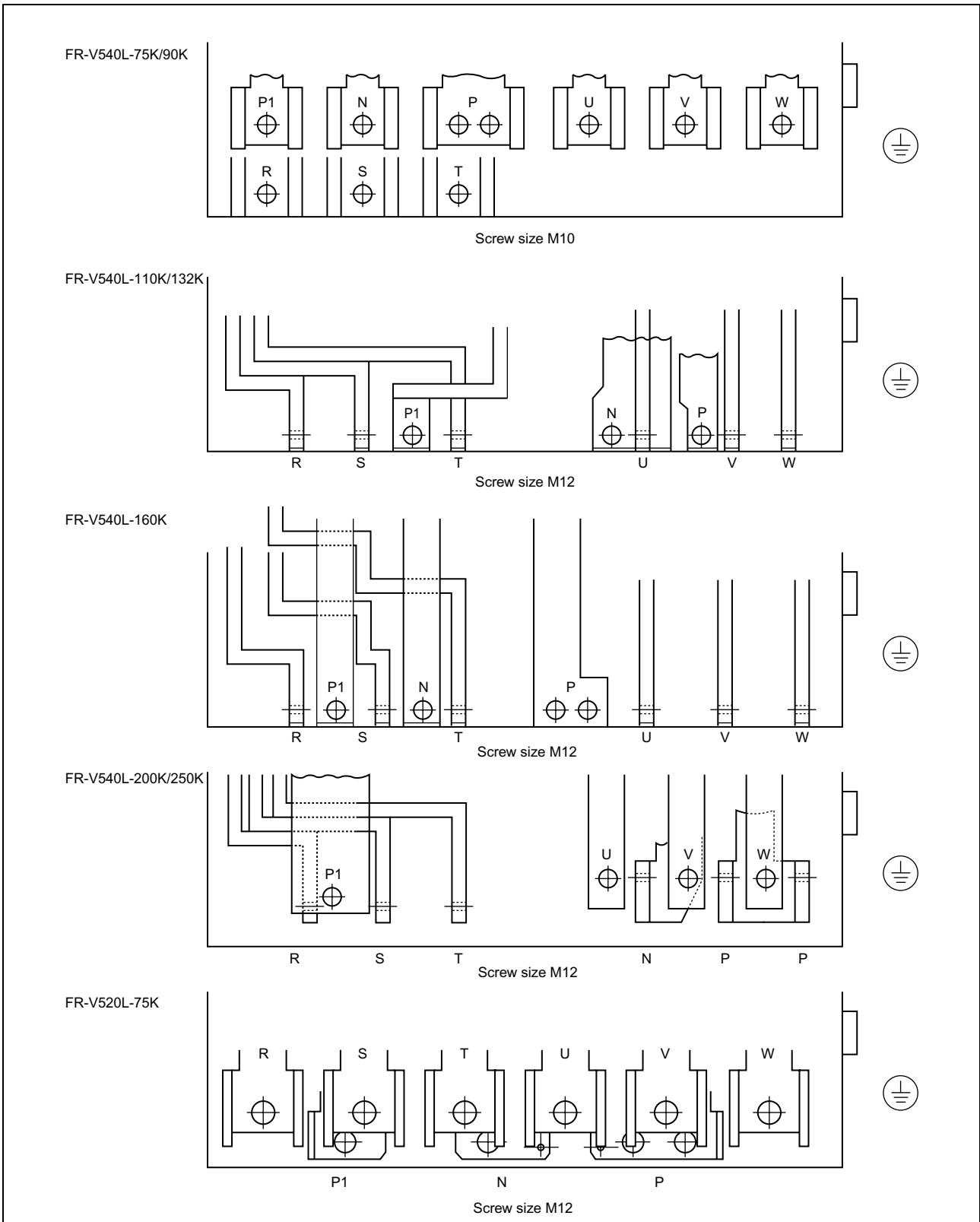

CAUTION

- Always connect the power supply cables to R, S, T. If they are connected to U, V, W, the inverter will be damaged. (Phase sequence needs not to be matched.)
- Connect the motor to U, V, W. At this time, turning on the forward rotation switch (signal) rotates the motor in the counterclockwise direction when viewed from the motor shaft.

Connection diagram, PU connector

(3) Cables and wiring length

Select the recommended cable size to ensure that a voltage drop will be 2% max.

If the wiring distance between the inverter and motor is long, the motor torque will decrease due to the voltage drop of the main circuit cable especially at high-frequency output. The PLG signal will also be affected by the voltage drop.

200V class (When input power supply is 220V)

Applicable Inverter Type	Terminal Screw Size	Tightening Torque Kgf-cm	Cable					
			mm ²			AWG		
			R, S, T	U, V, W	P, P1	R, S, T	U, V, W	P, P1
FR-V540L-75K	M10	270	60	60	60	1/0	1/0	1/0
FR-V540L-90K	M10	270	60	80	80	1/0	3/0	3/0
FR-V540L-110K	M12	470	80	100	100	3/0	4/0	4/0
FR-V540L-132K	M12	470	100	125	125	4/0	MCM250	MCM250
FR-V540L-160K	M12	470	125	150	150	MCM250	MCM300	MCM300
FR-V540L-200K	M12	470	150	2X100	2X100	MCM300	2X4/0	2X4/0
FR-V540L-250K	M12	470	2X100	2X100	2X100	2X4/0	2X4/0	2X4/0
FR-V520L-75K	M12	470	100	150	150	4/0	MCM300	MCM300

The line voltage drop can be calculated by the following expression:

$$\text{Line voltage drop [V]} = \frac{\sqrt{3} \times \text{cable resistance [m}\Omega/\text{m}] \times \text{wiring distance [m]} \times \text{current [A]}}{1000}$$

Use a larger diameter cable when the wiring distance is long or when it is desired to decrease the voltage drop (torque reduction) in the low speed range.

CAUTION

- **Tighten the terminal screw to the specified torque.**
A screw that has been tighten too loosely can cause a short circuit or malfunction.
A screw that has been tighten too tightly can cause a short circuit or malfunction due to the unit breakage.
- **The crimping terminals recommended for use to wire the power supply and motor are those provided with insulation sleeves.**

(4) Wiring length

- **The wiring length should be 100m (328.08 feet) maximum. (during vector control)**

CAUTION

- **Especially for long-distance wiring, the inverter may be affected by a charging current caused by the stray capacitances of the wiring, leading to a malfunction of the overcurrent protective function or a malfunction or fault of the equipment connected on the secondary side. If fast-response current restriction malfunctions when fast-response current restriction function is made valid, disable fast-response current restriction. (Refer to Pr.156 "stall prevention operation selection".)**

(5) Cable size for the control circuit power

- Cable size: 0.75mm² to 2mm²
- Tightening torque: 1.5N·m

2.2.3 Control circuit

(1) Specifications of control circuit terminals

Type	Terminal Symbol	Terminal Name	Description
Contact input	STF	Forward rotation start	Turn on the STF signal to start forward rotation and turn it off to stop.
	STR	Reverse rotation start	Turn on the STR signal to start reverse rotation and turn it off to stop. The terminal function varies with the input terminal function selection (Pr. 187) setting. Refer to page 65 for details.
	DI1 to DI4	Digital input terminals 1 to 4	The terminal functions vary with the input terminal function selection (Pr. 180 to Pr. 183) settings. Refer to page 65 for details.
	OH	Thermal protector input	Temperature sensor terminal input for motor overheat protection. OHT error occurs when terminals OH and SD are open.
	RES	Reset	Used to reset instantly. By setting Pr. 75 "reset selection", reset input possible or reset input possible only during protective circuit operation can be selected. Turn on the RES signal for more than 0.1s, then turn it off.
	SD	Contact input common (sink)	Common to the contact input. Common output terminal for 24VDC 0.1A power supply (PC terminal). Isolated from terminals 5 and SE.
	PC	24VDC power supply and external transistor common, contact input common (source)	When connecting a transistor output (open collector output), such as a programmable controller, connect the external power supply common for transistor output to this terminal to prevent a malfunction caused by a sneak current. PC-SD can be used as a 24VDC, 0.1A power supply. Note that this connection does not prevent a sneak current. When source logic has been selected, this terminal serves as a contact input common.
Input signals Speed setting	10E	Speed setting power supply	10VDC, permissible load current 10mA
	2	Speed setting (voltage)	By entering 0 to 10VDC, the maximum output speed is reached at 10V and I/O are proportional. Acts as a speed command terminal for speed control or as a speed restriction for torque control. Input resistance 10kΩ, maximum permissible voltage 20V.
	3	Torque setting terminal	Acts as a torque setting signal for torque control or a torque restriction signal for speed control and position control. Acts as an input terminal when torque bias function by external analog is selected. 0 to ±10VDC input, input resistance 10kΩ, maximum permissible voltage ±20VDC
	1	Multi-function setting terminal	Since this is a multi-function selection terminal, its function varies with the Pr. 868 "No. 1 terminal function assignment" setting. The function of this terminal is factory-set to adding auxiliary of speed setting terminal of terminal 2. Refer to Pr. 868 "No. 1 terminal function assignment" in the Instruction Manual (detailed). 0 to ±10VDC input, input resistance 10kΩ, maximum permissible voltage ±20V
	5	Speed setting common	Speed setting signal (terminal 2, 1 or 3) common terminal. Isolated from terminals SD and SE. Do not earth(ground).
PLG signal	PA	A-phase signal input terminal	A-, B- and Z-phase signals are input from the PLG.
	PAR	A-phase inverted signal input terminal	
	PB	B-phase signal input terminal	
	PBR	B-phase inverted signal input terminal	
	PZ	Z-phase signal input terminal	
	PZR	Z-phase inverted signal input terminal	
	PG	PLG power supply terminal (Positive side)	Power supply for PLG. You can switch the power supply between 5, 12 and 24VDC. You can also switch to external power supply. The jumper connector is factory-set to 5VDC. (Refer to page 5.)
	SD	Power supply earth (ground) terminal	Common terminal for the PLG power supply. Isolated from terminals 5 and SE. Do not earth (ground).

Connection diagram, PU connector

Type	Terminal Symbol	Terminal Name	Description	
Output signals	Contact	A, B, C	Alarm output 1 contact output indicating that the output has been stopped by the inverter protective function 230VAC 0.3A, 30VDC 0.3A. Alarm: discontinuity across B-C (continuity across A-C), Normal: continuity across B-C (discontinuity across A-C). The terminal function varies with the output terminal function selection (Pr. 195) setting. Refer to page 65 for details.	
	Open collector	DO1 to DO3	Digital output terminals 1 to 3 Permissible load 24VDC 0.1A The terminal functions vary with the output terminal function selection (Pr. 190 to Pr. 192) settings. Refer to page 65 for details.	
		SE	Open collector output common Common terminal for terminals DO1, DO2 and DO3. Isolated from terminals SD and 5.	
	Analog	DA1	Analog signal output One selected from the monitoring items, such as the speed, is output.* The output signal is proportional to the magnitude of the corresponding monitoring item.	Factory setting of output item: Speed monitoring, output signal 0 to ± 10 VDC, permissible load current 1mA
		DA2	Analog signal output	Factory setting of output item: Torque monitoring, output signal 0 to 10VDC, permissible load current 1mA
		5	Analog signal output common Common terminal for DA1 and DA2. Isolated from terminals SD and SE. Do not earth(ground).	
Communication	RS-485	–	PU connector With the PU connector, communication can be made through RS-485. • Conforming standard : EIA Standard RS-485 • Transmission format : Multidrop link system • Communication speed : Maximum 19200bps • Overall length : 500m (1640.42 feet)	

* Not output during inverter reset.

REMARKS

For the input terminal function switchover timing, refer to page 45.

(2) Control circuit terminal layout

Terminal screw size : M3.5
Tightening torque : 1.2N·m

A	B	C	DO1	DO2	DI4	DI3	DI2	DI1	STR	STF
10E	2	DA1	DO3	SE	PZ	PZR	PG	RES	PC	
5	3	1	DA2	PA	PAR	PB	PBR	SD	OH	SD

(3) Wiring instructions

- Terminals 5, SD and SE are common to the I/O signals and isolated from each other. These common terminals must not be connected to each other nor earthed (grounded).
- Use shielded or twisted cables for connection to the control circuit terminals and run them away from the main and power circuits (including the 200V relay sequence circuit).
- Since the control circuit input signals are micro currents, use two parallel micro signal contacts or a twin contact to prevent a contact fault.
- It is recommended to use the cables of 0.75mm² gauge for connection to the control circuit terminals. If the cable gauge used is 1.25mm² or more, the front cover may be lifted when there are many cables running or the cables are run improperly, resulting in an operation panel or parameter unit contact fault.
- The maximum wiring length should be 30m (98.43 feet).

(4) Changing the control logic

The input signals are factory set to sink logic (SINK).

To change the control logic, the jumper connector on the back of the control circuit terminal block must be moved to the other position.

(The output signals may be used in either the sink or source logic independently of the jumper connector position.)

- 1) Loosen the two mounting screws in both ends of the control circuit terminal block. (The screws cannot be removed.) With both hands, pull down the terminal block from the back of the control circuit terminals.

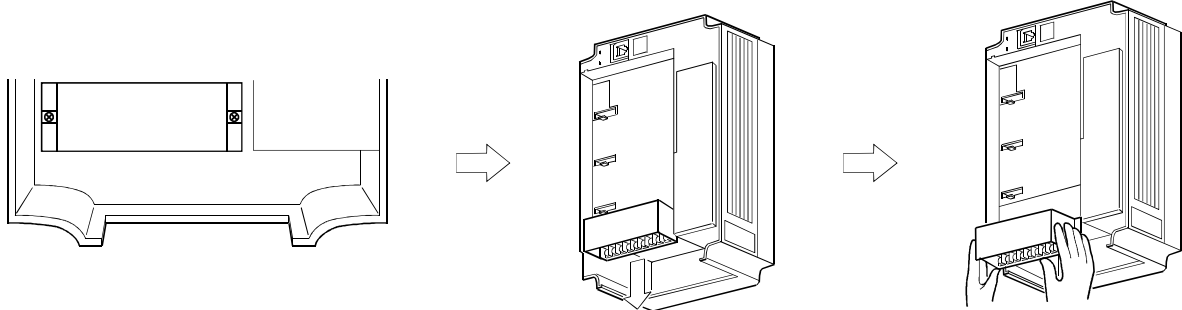

- 2) Fit the jumper connector from the sink logic (SINK) position on the back surface of the control circuit terminal block to the source logic (SOURCE) position to change to the source logic.

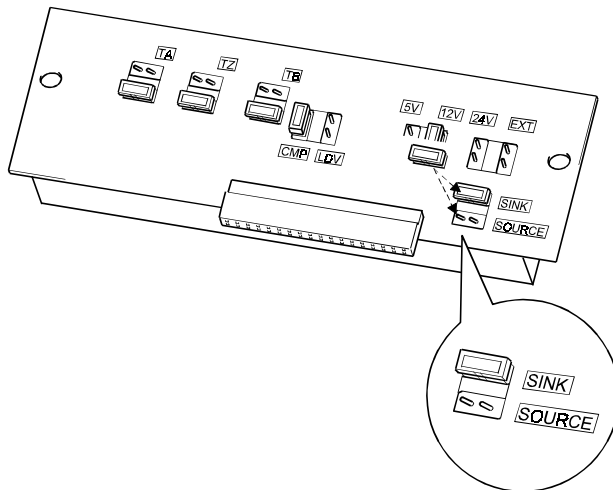

- 3) Using care not to bend the pins of the inverter's control circuit connector, reinstall the control circuit terminal block and fix it with the mounting screws.

CAUTION

1. **Make sure that the control circuit connector is fitted correctly.**
2. **While power is on, never disconnect the control circuit terminal block.**
3. **The sink-source logic change-over jumper connector must be fitted in only one of those positions. If it is fitted in both positions at the same time, the inverter may be damaged.**

Connection diagram, PU connector

4) Sink logic type and source logic type

- The sink logic type is a logic where a signal turns on when a current flows out of the corresponding signal input terminal.

Terminal SD is common to the contact input signals. Terminal SE is common to the open collector output signals.

- The source logic type is a logic where a signal turns on when a current flows into the corresponding signal input terminal. Terminal PC is common to the contact input signals. Terminal SE is common to the open collector output signals.

● Current flow concerning the RUN signal when sink logic is selected

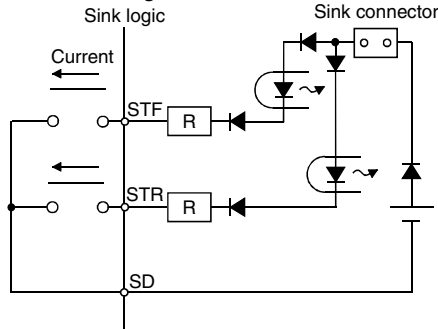

● Current flow concerning the RUN signal when source logic is selected

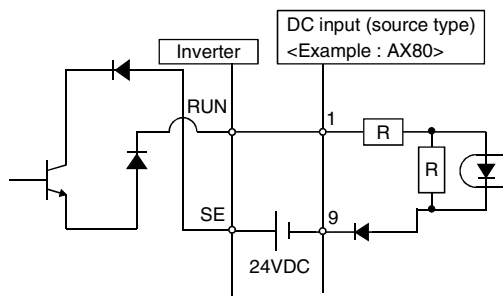
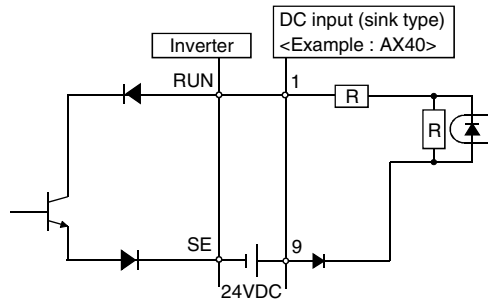
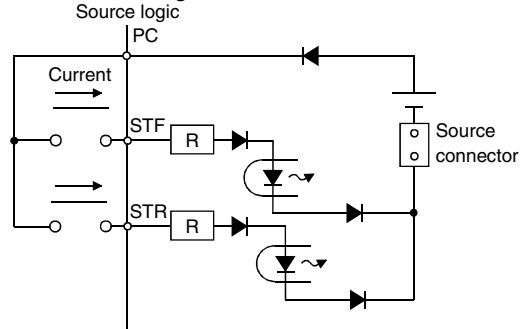

● When using an external power supply for transistor output

- Sink logic type**
Using terminal PC as a common terminal prevents a malfunction caused by undesirable current. (Do not connect terminal SD of the inverter with terminal 0V of the external power supply. When using terminals PC-SD as a 24VDC power supply, do not install a power supply in parallel in the outside of the inverter. Doing so may cause a malfunction due to undesirable current.)

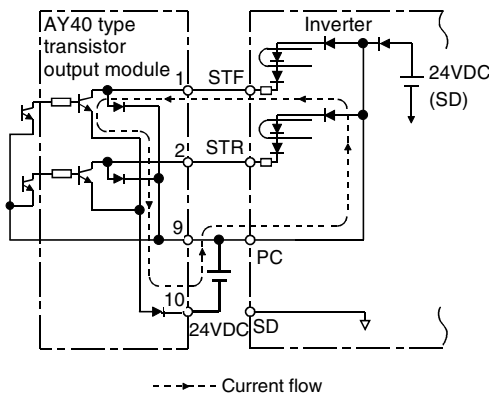

- Source logic type**
Use terminal SD as a common to prevent a malfunction caused by undesirable current.

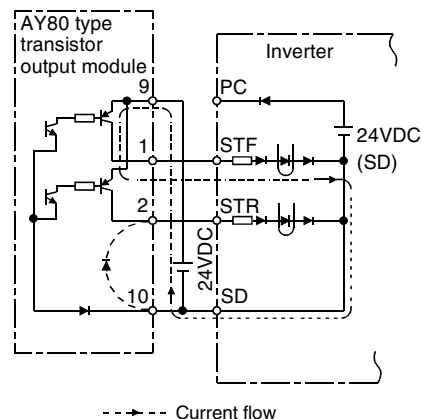

2.2.4 Connection to the PU connector

(1) When connecting the operation panel or parameter unit using a connection cable

<Recommended connection cable>

- Parameter unit connection cable (FR-CB2) (option) or the following connector and cable available on the market
- Connector : RJ45 connector
Example: 5-554720-3 of Tyco Electronics Corporation
- Cable : Cable conforming to EIA568 (e.g. 10BASE-T cable)
Example: SGLPEV 0.5mm x 4P(twisted pair cable, 4 pairs) of Mitsubishi Cable Industries, LTD.
- Maximum wiring length : 20m (65.62feet)

(2) For computer link communication

Using the PU connector, you can perform communication operation from a personal computer etc. By connecting the PU connector to computers such as a personal computer and FA unit with a communication cable, you can run/monitor the inverter and read/write parameter values using a user program.

 Refer to the Instruction Manual (detailed) for details.

- Conforming Standard : EIA Standard RS-485
- Transmission form : Multidrop link system
- Communication speed : Maximum 19200bps
- Overall length : 500m (1640.42feet)

CAUTION

Do not connect the PU connector to the computer's LAN board, FAX modem socket or telephone connector. Doing so may damage the inverter due to electrical specification differences.

2.2.5 Notes on earthing (grounding)

- Leakage currents flow in the inverter. To prevent an electric shock, the inverter and motor must be earthed (grounded).
- Use the dedicated earth (ground) terminal to earth (ground) the inverter. (Do not use the screw in the case, chassis, etc.)
Connect the earth (ground) cable using a tin-plated* crimping terminal. Tighten the screw, taking care not to break its threads.
*Plating should not include zinc.
- Use the largest possible gauge for the earth (ground) cable. The gauge should be equal to or larger than 38mm². The earthing (grounding) point should be as near as possible to the inverter to minimize the earth (ground) cable length.

2.3 Precautions for use of the vector inverter

The FR-V500L series is a highly reliable product, but incorrect peripheral circuit making or operation/handling method may shorten the product life or damage the product.

Before starting operation, always recheck the following items.

- (1) Use insulation-sleeved crimping terminals for the power supply and motor cables.
- (2) Power must not be applied to the output terminals (U, V, W) of the inverter. Otherwise the inverter will be damaged.
- (3) After wiring, wire off-cuts must not be left in the inverter.
Wire off-cuts can cause an alarm, fault or malfunction. Always keep the inverter clean.
When drilling mounting holes in a control box or the like, use care not to allow chips etc. to enter the inverter.
- (4) Wire the cables of the recommended size to make a voltage drop 2% or less.
If the wiring distance is long between the inverter and motor, a main circuit cable voltage drop will cause the motor torque to decrease especially at the output of a high frequency.
Refer to page 18 for the recommended wire sizes.
- (5) The overall wiring length should be 100m (328.08 feet) maximum.
Especially for long distance wiring, the fast-response current restriction function may be reduced or the equipment connected to the secondary side may malfunction or become faulty under the influence of a charging current due to the stray capacity of the wiring. Therefore, note the overall wiring length.
- (6) Electromagnetic wave interference
The input/output (main circuit) of the inverter includes harmonic components, which may interfere with the communication devices (such as AM radios) used near the inverter. In this case, install the optional FR-BIF radio noise filter (for use in the input side only) or FR-BLF line noise filter to minimize interference.
- (7) Do not install a power factor correction capacitor, surge suppressor or radio noise filter (FR-BIF option) in the output side of the inverter.
This will cause the inverter to trip or the capacitor and surge suppressor to be damaged. If any of the above devices is installed, immediately remove it. (When the FR-BIF radio noise filter is connected, switching power off during motor operation may result in E. UVT. In this case, connect the radio noise filter in the primary side of the magnetic contactor.)
- (8) When rewiring after operation, switch power off, wait for more than 10 minutes, and then make sure that the voltage is zero using a tester, etc. For some time after power-off, there is a dangerous voltage in the capacitor.
- (9) A short circuit or earth (ground) fault in the inverter output side may damage the inverter modules.
 - Fully check the insulation resistance of the circuit prior to inverter operation since repeated short circuits caused by peripheral circuit inadequacy or an earth (ground) fault caused by wiring inadequacy or reduced motor insulation resistance may damage the inverter modules.
 - Fully check the to-earth (ground) insulation and inter-phase insulation of the inverter secondary side before power-on. Especially for an old motor or use in hostile atmosphere, securely check the motor insulation resistance etc.
- (10) Do not use the inverter power supply side magnetic contactor to start/stop the inverter.
Always use the start signal (turn on/off terminals STF, STR-SD) to start/stop the inverter. (Refer to page 15.)
- (11) Do not apply a voltage higher than the permissible voltage to the inverter I/O signal circuits.
Application (contact) of a voltage higher than the permissible voltage to the inverter I/O signal circuits or opposite polarity may damage the I/O devices. Especially check the wiring to prevent the speed setting potentiometer from being connected incorrectly to short terminals 10E-5.
- (12) Use of single-phase power supply
Do not use single-phase power input.
- (13) Precautions for use of any motor other than the SF-THY and SF-VH
 - a) Vector control cannot be exercised without PLG.
 - b) Connect the PLG directly to the backlash-free motor shaft.
- (14) Since the rated voltage differs from the commercial power supply voltage, the SF-THY cannot perform commercial power supply-inverter switchover operation.

3 RUN AND OPERATION

3.1 Checks prior to test run

Installation check

Check that the inverter is installed correctly in a correct place. (Refer to page 14.)

Wiring check

Check that wiring is correct. (Refer to page 15.)

3.2 Basic operation (Speed setting, run, speed meter adjustment)

3.2.1 Setting the speed and running the motor

(1) Choosing PU operation mode (operation from the operation panel (FR-DU04-1)) and running at 150r/min

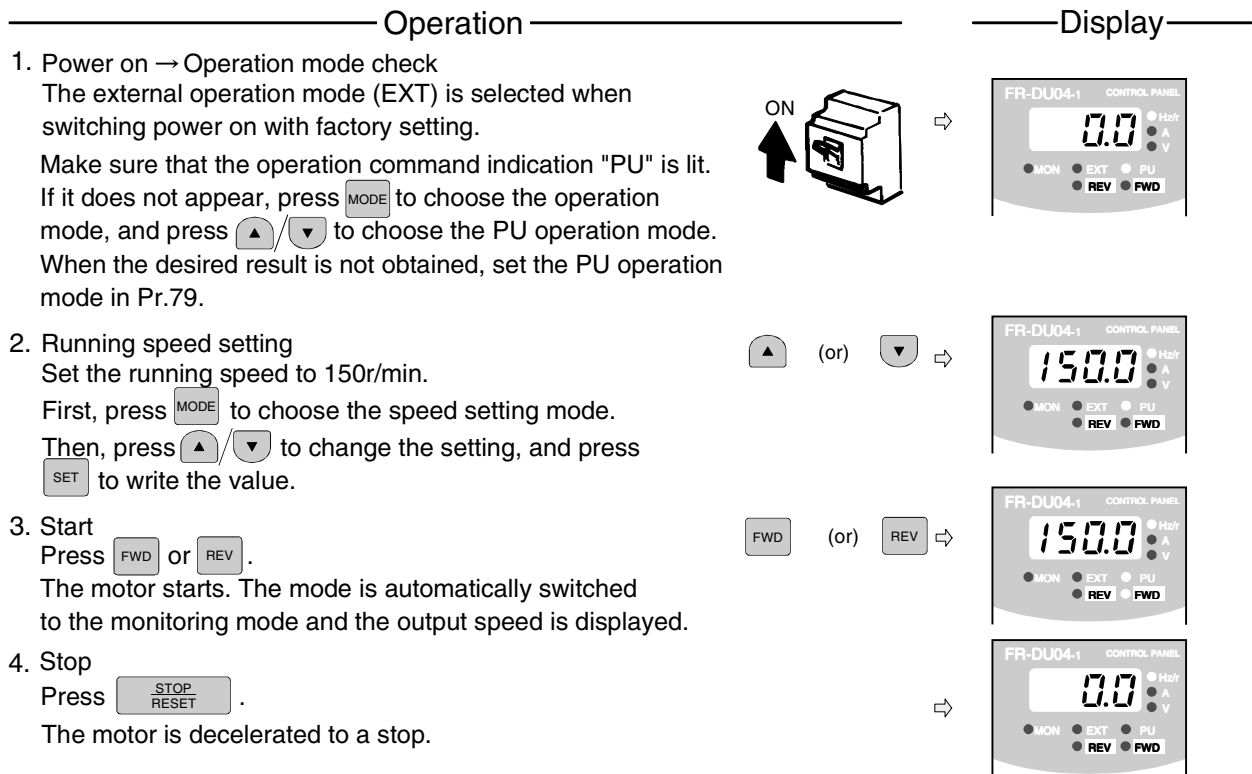

REMARKS

- The operation speed can be changed by changing the preset speed during operation following the steps 2 and 3 above.
- For monitor display changes by **MODE**, refer to page 30.
- To select the PU operation mode in Pr.79 "operation mode selection", set "1" in the parameter. Refer to page 58 for details.

Basic operation (Speed setting, run, speed meter adjustment)

● PU jog operation

Hold down **FWD** or **REV** to perform operation, and release it to stop.

1) Set Pr. 15 "jog speed setting" and Pr. 16 "jog acceleration/deceleration time".

2) Set PU jog operation. (Press **MODE** to select the operation mode and press **▲**/**▼** to switch to PU jog operation.)

3) Hold down the **FWD** or **REV** key to perform operation.

(If the motor remains stopped, check Pr. 13 "starting speed". The motor will not start if its setting is lower than the starting speed.)

REMARKS

- If the motor does not rotate ⇒
 - Checking the PLG jumper connector (Refer to page 5.)
 - Checking the phase sequence of the PLG cable (Refer to page 4.)
 - For other cases, refer to Troubleshooting on page 87.
- When you want to set the speed to higher than 1500r/min, set Pr. 1 "maximum speed". (Refer to page 56.)

(2) Choosing external operation mode (operation using external speed setting potentiometer and external start signals)

● Running at 1500 r/min

- Operation command : start signals connected outside
- Speed setting : speed setting potentiometer connected outside

Operation

1. Power on → Operation mode check

The external operation (EXT) is selected when switching power on with factory setting. Make sure that the operation command indication "EXT" is lit.

If it does not appear, press **MODE** to choose the operation mode, and press **▲**/**▼** to choose the external (EXT) operation mode.

When the desired result is not obtained, set the external operation mode in Pr. 79.

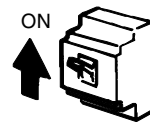

Display

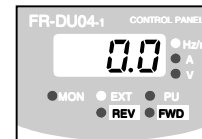

2. Start

Turn on the start switch (STF or STR).

The operation status indication FWD or REV flickers.

CAUTION

The motor does not start if both the forward and reverse rotation switches are turned on. If both switches are turned on during operation, the motor decelerates to a stop.

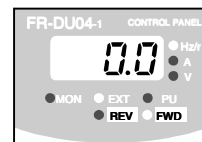
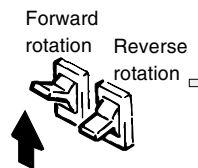

3. Acceleration → Constant speed

Slowly turn the potentiometer (speed setting potentiometer) connected to across terminals 2-5 full clockwise.

The speed shown on the display increases gradually to 1500r/min.

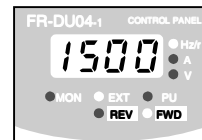

4. Deceleration

Slowly turn the potentiometer (speed setting potentiometer) connected to across terminals 2-5 full counterclockwise.

The speed shown on the display decreases gradually to 0r/min.

The motor stops running.

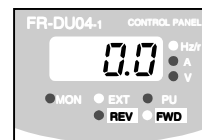

5. Stop

Turn off the start switch (STF or STR).

CAUTION

When Pr. 75 "PU stop selection" = "14 to 17",

STOP RESET is valid.

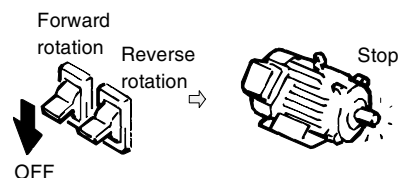

REMARKS

- The operation speed of the external potentiometer can be adjusted in Pr. 902 and Pr. 903 (bias and gain of the speed setting terminal). (Refer to page 51.)
- For monitor display changes by **MODE**, refer to page 30.
- To select the external operation mode in Pr. 79 "operation mode selection", set "2" in the parameter. Refer to page 58 for details.

● **External jog operation**





Keep the start switch (STF or STR) on to perform operation, and turn it off to stop.

- 1) Set Pr. 15 "jog speed setting" and Pr. 16 "jog acceleration/deceleration time".
- 2) Select the external operation mode.
- 3) Switch on the jog signal. Keep the start switch (STF or STR) on to perform operation.
Assign the terminal used for the jog signal in any of Pr. 180 to Pr. 183 and Pr. 187 (input terminal function selection). (Refer to page 65.)

(3) Choosing external/PU combined operation mode 1 (operation using the external start signal and operation panel)

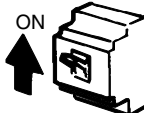
● **When setting the start signals from outside inverter (e.g. switches or relays) and the running speed from the operation panel (Pr. 79=3)**

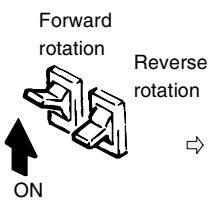
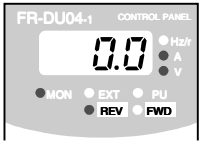
- Operation command : start signal connected outside
- Speed setting : ▲/▼ of PU or multi-speed command (multi-speed command has priority)
For multi-speed command, refer to Pr.4 to Pr.6 on page 54.

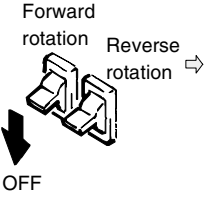
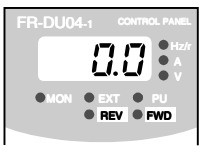
Operation	Display
<p>1. Power on Switch power on.</p>	
<p>2. Operation mode selection Set "3" in Pr. 79 "operation mode selection". (Refer to page 58 for details of Pr.79.) The combined operation mode is selected and the operation status indication "EXT" and "PU" are lit.</p>	
<p>3. Start Turn on the start switch (STF or STR). The operation status indication "FWD" or "REV" is lit.</p> <div style="border: 1px solid black; padding: 5px; margin-top: 10px;"> <p>REMARKS</p> <ul style="list-style-type: none"> The motor does not start if both the forward and reverse rotation switches are turned on. If both switches are turned on during operation, the motor decelerates to a stop. Set the speed in the speed setting mode (Refer to page 30.). </div>	 
<p>4. Running speed setting Using ▲/▼ of PU, set the running speed to 150r/min and press SET. The operation command indication FWD or REV is lit.</p>	 
<p>5. Stop Turn off the start switch (STF or STR). The motor decelerates to stop. The operation status indication "FWD" or "REV" is lit.</p>	 

CAUTION

When Pr. 75 "PU stop selection" = "14 to 17",
 is valid.

REMARKS
 When setting the start signal from the PU and speed setting signal from outside inverter, set "4" (combined operation mode 2) in Pr.79 "operation mode selection".

Basic operation (Speed setting, run, speed meter adjustment)

3.2.2 Adjustment (calibration) of speed meter (meter)

Changing example At the preset speed of 1500r/min, make adjustment so that the meter (analog meter) deflects to full-scale. Calibrate the DA1 terminal ($\pm 10V$). (in PU operation mode)

POINT

- Pr. 900 "DA1 terminal calibration" can be read by setting "1" (extended function parameter enable) in Pr. 160 "extended function selection".
- Set Pr. 900 "DA1 terminal calibration".
- Set any of "1 to 3, 5 to 12, 17, 18, 21, 32 to 34 and 36" in Pr. 54 "DA1 terminal function selection" to output a signal to the terminal DA1. (Refer to page 61)

Operation

1. Press **FWD** to operate the inverter. (It is not necessary to connect a motor.)

2. Press **MODE** to select the parameter setting mode.

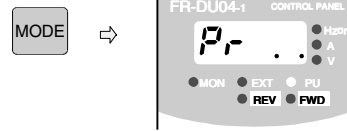

3. Display the present operation speed by pressing **SET** to read Pr. 900.



4. Press **▲** or **▼** to adjust the meter pointer to a predetermined position. (Depending on the setting, it may take some time until the pointer moves.)

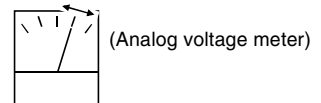

REMARKS

1. Pressing **REV** to start reverse rotation operation will move the meter pointer reversely (in the negative direction).
2. The terminal DA1 output will also keep displaying the monitor when the inverter stops due to an alarm.

5. Press **SET** for about 1.5s.
This completes the setting.



Flicker ...
Parameter setting complete!!

6. Press **STOP RESET** to stop the inverter.

CAUTION

1. When the speed meter is connected across terminals DA1-5 to monitor the speed, the output of terminal DA1 is saturated if the maximum output speed reaches or exceeds 1500r/min, with the factory setting unchanged. Hence, the setting of Pr. 55 "speed monitoring reference" must be changed to the maximum output speed. (Refer to page 61.)
2. Terminal DA2 can be adjusted in Pr. 901
3. For operation from the parameter unit (FR-PU04V), refer to the instruction manual of the FR-PU04V.

REMARKS

- For monitor display changes by **MODE**, refer to page 30.
- Calibration can be made also during external operation.

3.3 Names and functions of the operation panel

With the operation panel (FR-DU04-1), you can perform operation, set the speed, monitor the operation command display, set parameters, display an error, and copy parameters.

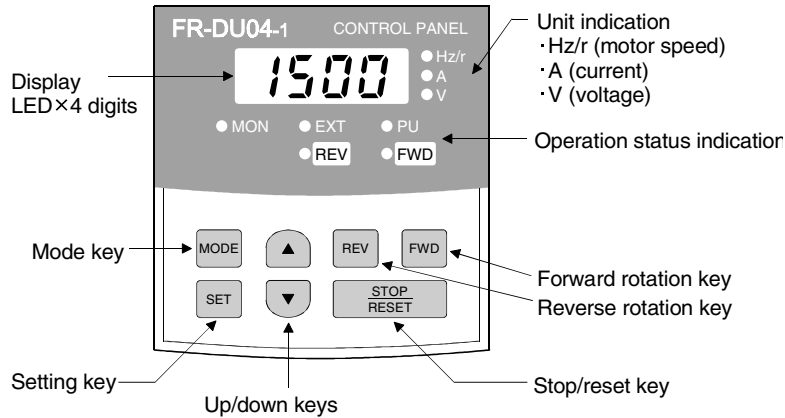

REMARKS

The ON of the LED is indicated by ○, and OFF by ●.

● Key indication

Key	Description
	Select the operation mode or setting mode.
	Determine the speed or parameter setting.
	<ul style="list-style-type: none"> Used to increase or decrease the running speed consecutively. Hold down this key to change the speed. Press this key in the setting mode to change the parameter setting consecutively.
	Forward rotation command key.
	Reverse rotation command key.
	<ul style="list-style-type: none"> Used to stop operation. Used to reset the inverter when the protective function (major fault) is activated to stop the output.

● Unit indication, operation status indication

Indication	Description
Hz/r	Lit to indicate the output speed.
A	Lit to indicate the current.
V	Lit to indicate the voltage.
MON	Lit in the monitor display mode.
PU	Lit in the PU operation mode.
EXT	Lit in the external operation mode.
FWD	Flickers during forward rotation.
REV	Flickers during reverse rotation.

Names and functions of the operation panel

3.3.1 Monitor display changed by pressing MODE

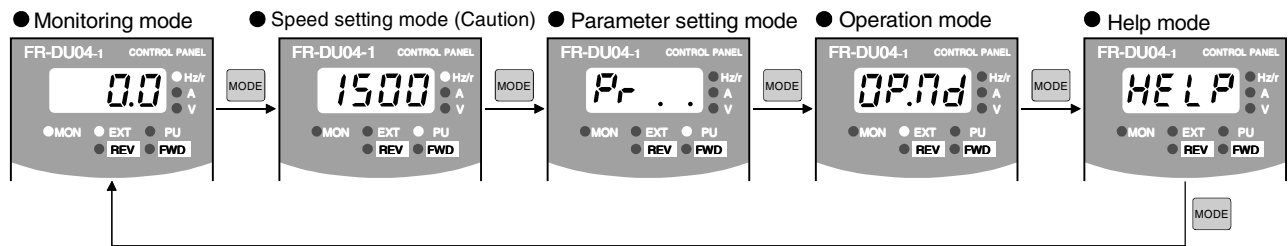

CAUTION

The speed setting mode appears only when the operation mode is the PU operation mode.

3.3.2 Monitoring

- Operation command indications in the monitoring mode
EXT is lit to indicate external operation.
PU is lit to indicate PU operation.
Both EXT and PU are lit to indicate PU/external combined operation.
- The monitor display can also be changed during operation.

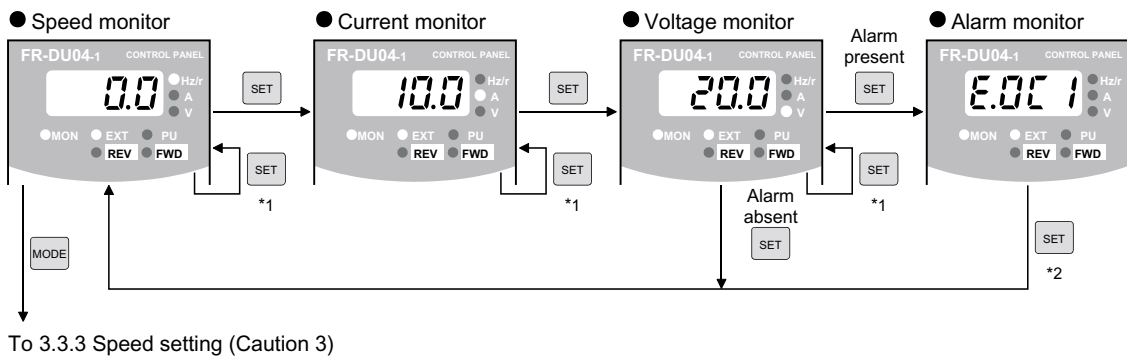

CAUTION



1. Hold down SET marked *1 for more than 1.5s to change the current monitor to the power-on monitor.
2. Hold down SET marked *2 for more than 1.5s to display four errors including the latest one.
3. In the external operation mode, it shifts to the parameter setting mode.

3.3.3 Speed setting

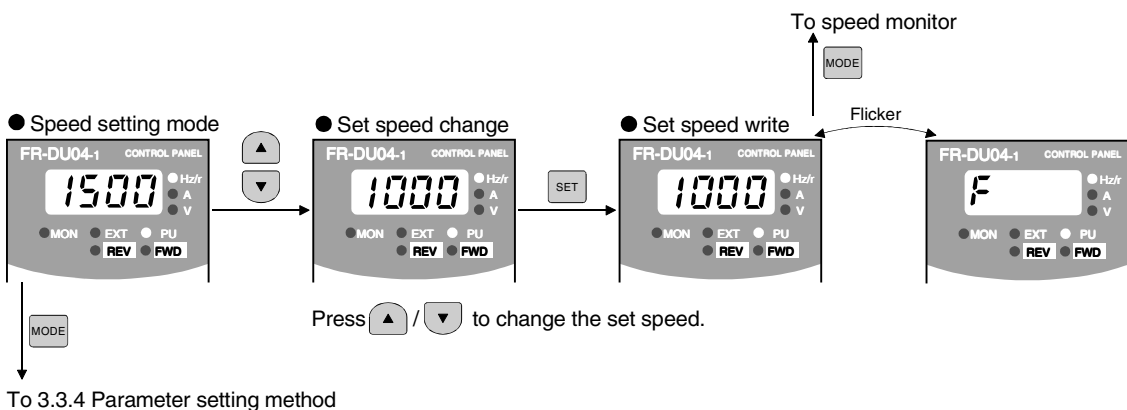
- Used to set the running speed in the PU operation mode.



3.3.4 Parameter setting method (Example: Method to enable extended function parameters)

- A parameter value may either be set by updating its parameter number or setting the value digit-by-digit using  .

- To write the setting, change it and press  for 1.5s.

Example: To change the Pr. 160 "extended function selection" setting from "0" (extended function parameter invalid) to "1" (extended function parameter valid) (Refer to page 58 for details of Pr. 160.)

Press  to choose the "parameter setting mode".

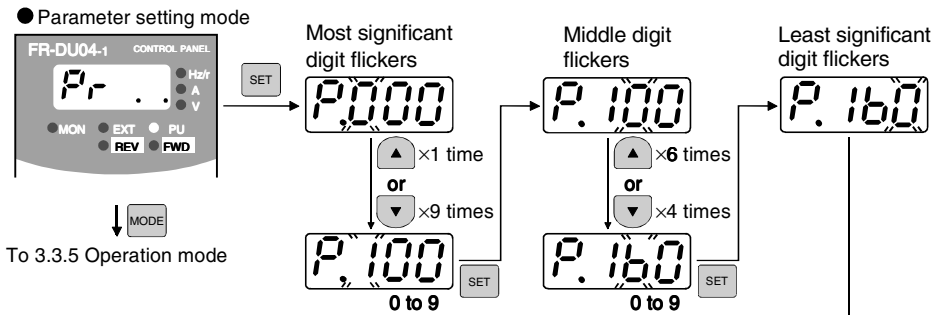

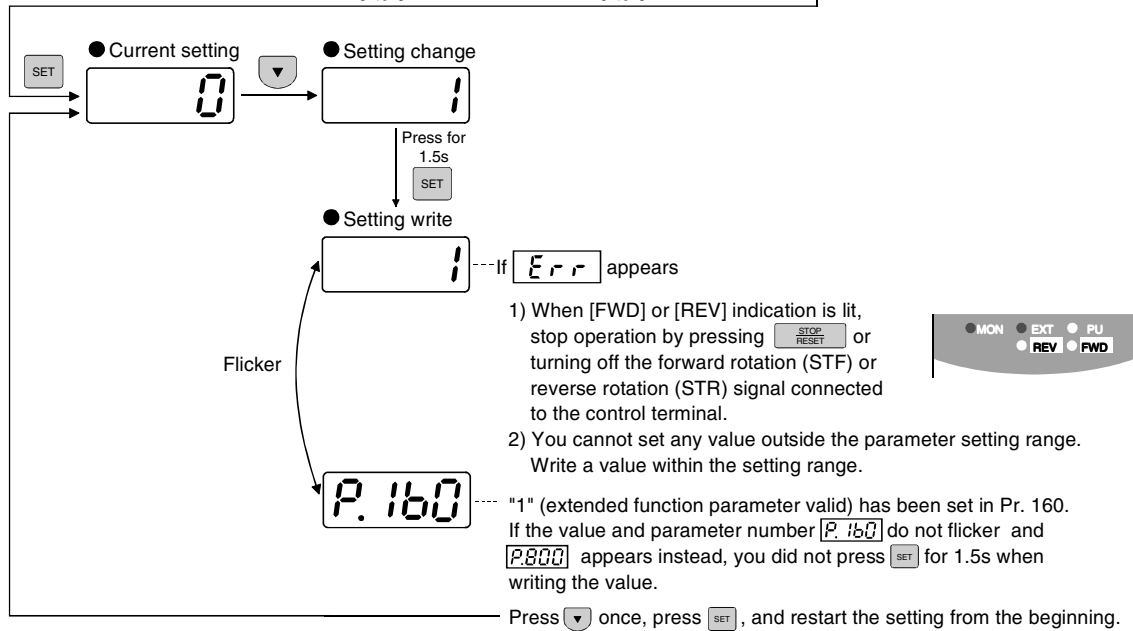

To 3.3.5 Operation mode

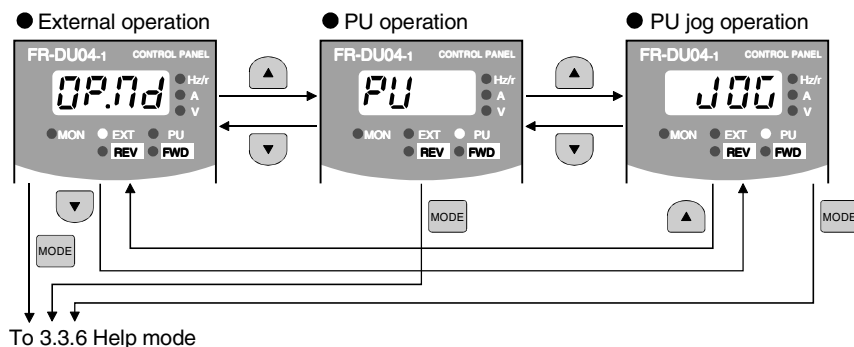

3.3.5 Operation mode



REMARKS

- If one operation mode cannot be switched to another, check the following items.
- External input signals Make sure that the STF and STR signals are off.
 - Parameter setting Check the Pr. 79 setting. When the Pr. 79 "operation mode selection" setting is "0" (factory setting), the inverter is placed in the external operation mode at input power-on. At this time, press  on the operation panel twice and press  (press  when the parameter unit (FR-PU04V) is used) to switch to the PU operation mode. For the other values (1 to 8), the operation mode is limited accordingly.

Names and functions of the operation panel

3.3.6 Help mode

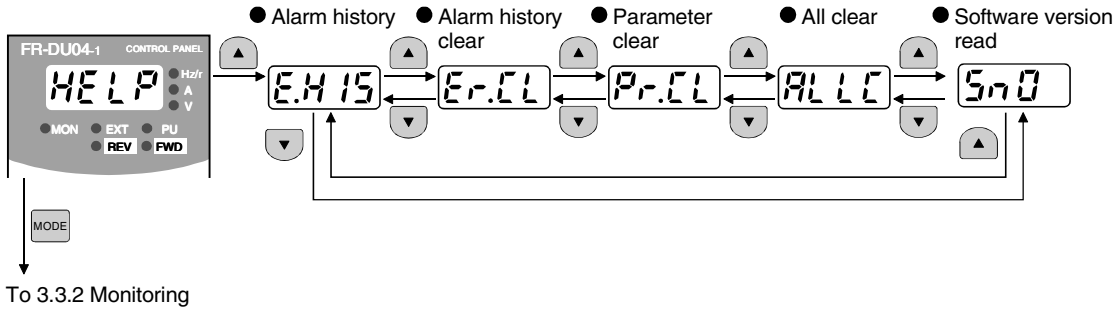

(1) Alarm history

Four past alarms can be displayed with / . ("." is appended to the latest alarm.)

When no alarm exists, E. 0 is displayed.

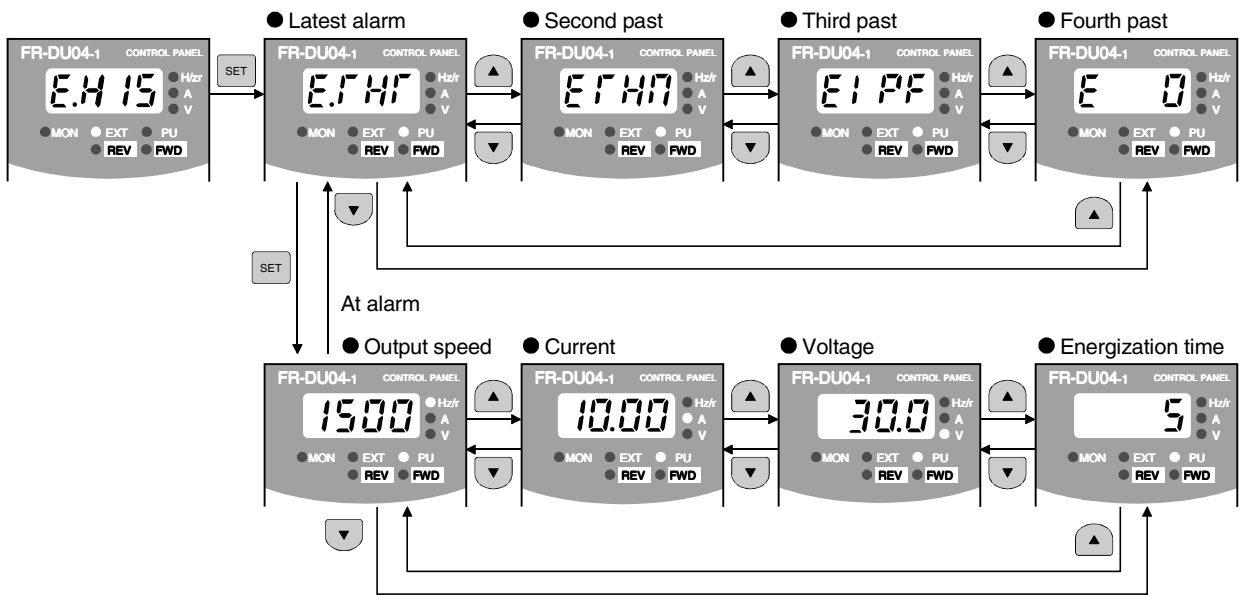

(2) Alarm history clear

Clears all alarm history.

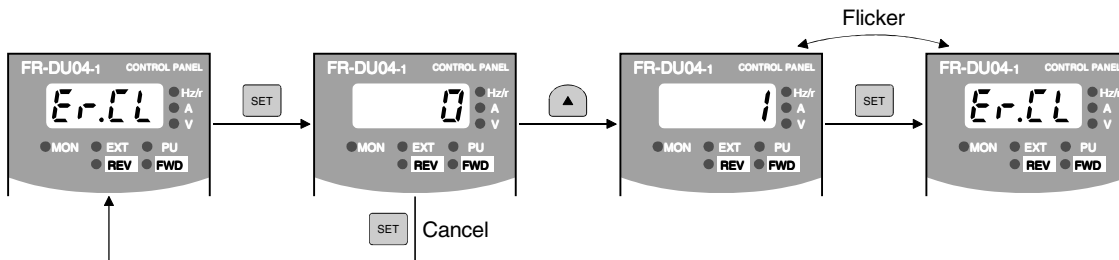

(3) Parameter clear

Initializes the parameter values to the factory settings. The calibration values are not initialized.
 (Parameter values are not cleared by setting "1" in Pr. 77 "parameter write disable selection".)

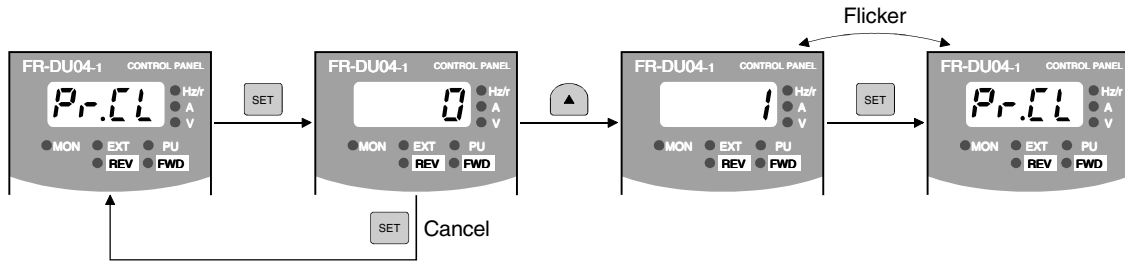

REMARKS

Pr. 75, Pr. 82, Pr. 90 to Pr. 94, Pr. 96, Pr. 145, Pr. 171, Pr. 180 to Pr. 183, Pr. 187, Pr. 190 to Pr. 192, Pr. 195, Pr. 496, Pr. 497, Pr. 819, Pr. 849, Pr. 868, Pr. 880, Pr. 890 to Pr. 892, Pr. 900 to Pr. 905, Pr. 917 to Pr. 920, and Pr. 991 are not initialized.

(4) All clear

Initializes the parameter values and calibration values to the factory settings.
 (Parameter values are not cleared by setting "1" in Pr. 77 "parameter write disable selection".)

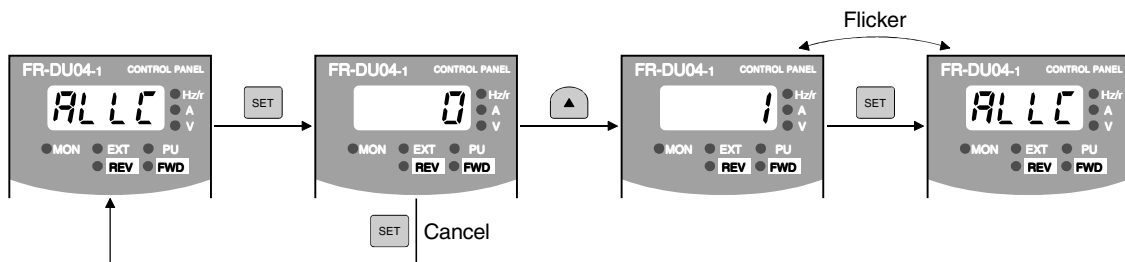

REMARKS

Pr. 75, Pr. 145, Pr. 171, Pr. 496, Pr. 497 and Pr. 891 are not initialized.

Names and functions of the operation panel

3.3.7 Copy mode

By using the operation panel (FR-DU04-1), the parameter values can be copied to another inverter (only the FR-V500 series).

1) Operation procedure

After reading the parameter values from the copy source inverter, connect the operation panel to the copy destination inverter, and write the parameter values.

After writing the parameter values to the copy destination inverter, always reset the inverter, e.g. switch power off once, before starting operation.

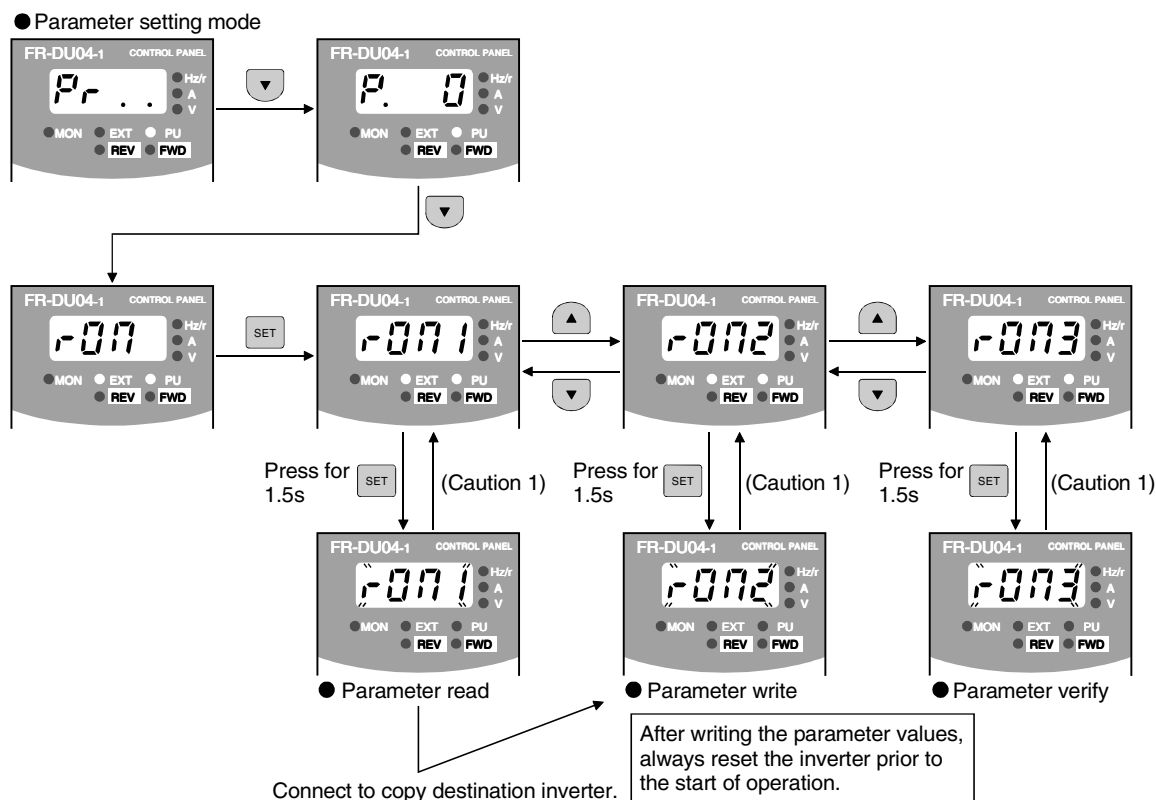

CAUTION

1. While the copy function is being activated, the monitor display flickers. The display returns to the lit-up state on completion of the copy function.
2. If a read error occurs during parameter read, "read error (E.rE1)" is displayed.
3. If a write error occurs during parameter write, "write error (E.rE2)" is displayed.
4. If a data discrepancy occurs during parameter verify, the corresponding parameter number and "verify error (E.rE3)" are displayed alternately. If the directly preset speed or jog speed setting differs, "verify error (E.rE3)" flickers. Press to ignore this display and continue verify.
5. When the copy destination inverter is not the FR-V500, "model error (E.rE4)" is displayed.

Reference: It is recommended to perform parameter read after completion of parameter setting. (When performing auto tuning, it is recommended to perform read after completion of auto tuning.) When the inverter has been changed, performing parameter write from the operation panel fitted to a new inverter completes parameter setup.

4 CONTROL

This inverter can control a motor under speed, torque or position control. (As required, set "1" (extended function parameters valid) in Pr. 160 "extended function selection".)

Refer to page 31 for the setting method of Pr. 160 "extended function selection" and to page 54 for details. (Since the factory setting of Pr. 77 is "0", perform parameter write in the PU mode or during a stop.)

4.1 Speed control operation

4.1.1 Speed control

Speed control is exercised to match the speed command and actual motor speed.

Speed response..... Maximum 300 rad/s by internal processing is available.

The response including analog input signal will become worse.

4.1.2 Operation transition

- Turning on the start signal increases the speed up to the preset speed according to the acceleration time.
- Turning off the start signal decreases the speed according to the deceleration time. When the speed has decreased down to the DC brake operation speed, operation changes to 0 speed control or servo lock. (Refer to Pr. 802 "pre-excitation selection" on page 70.)

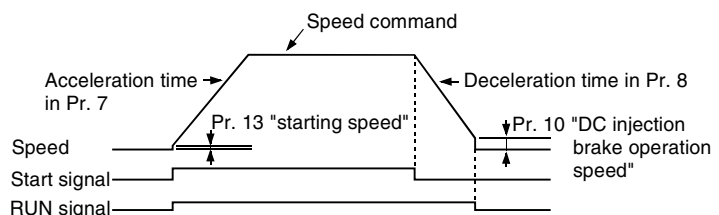

REMARKS

- When the RT signal is off, Pr. 7 and Pr. 8 are acceleration time and deceleration time.
- When the RT signal is on, Pr. 44 and Pr. 45 (second acceleration/deceleration time) are acceleration/deceleration time.
- Pr. 44 and Pr. 45 are valid when the RT signal is on, and Pr. 110 and Pr. 111 (third acceleration/deceleration time) are valid when the X9 signal is on. When both the RT and X9 are on, Pr. 110 and Pr. 111 are valid.

4.1.3 Setting procedure

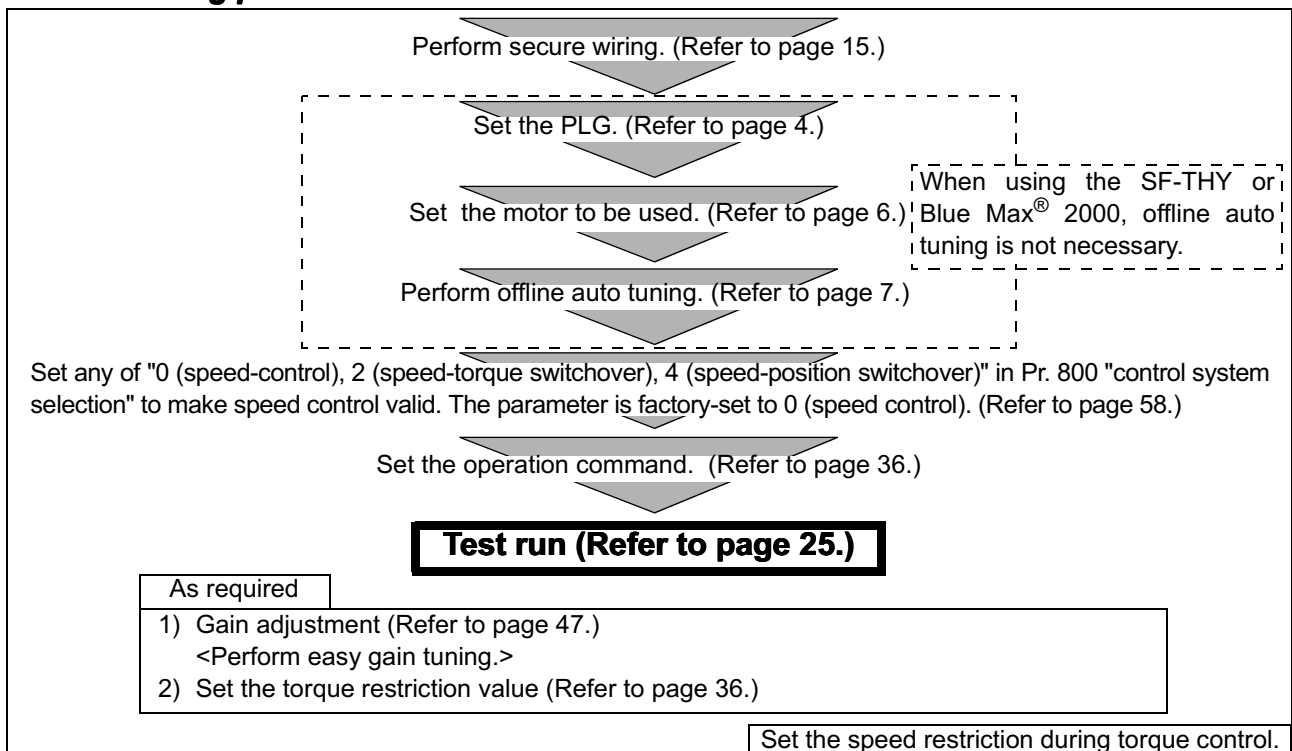

Speed control operation

4.1.4 Operation command setting

(1) Forward and reverse rotation commands (terminals STF, STR)

- 1) Command from the operation panel (FR-DU04-1): Turn on or (Refer to page 25.).
- 2) External command: Turn the forward/reverse rotation command (terminal STF, STR) on. (Refer to page 26.)
(Turning both terminals STF and STR on or off will give a stop command.)

REMARKS

Use Pr. 79 "operation mode" to change the operation mode between operation panel (PU) and external command (EXT). (Refer to page 58.)

(2) Speed command

- 1) Operation panel (FR-DU04-1) speed setting (Refer to page 25.)

REMARKS

Use Pr. 79 "operation mode selection" to change the operation mode between operation panel (PU) and external command (EXT). (Refer to page 58.)

- 2) External analog command (terminal 2 (or terminal 1))

Give a speed command using the analog signal input to terminal 2 (or terminal 1).

REMARKS

- Set Pr. 73 "speed setting signal" to change between the main speed and override of terminal 2.
( Refer to the Instruction Manual (detailed)).
- For the adjustment of bias/gain of analog signal, set terminal 2 in Pr. 902 "speed setting No. 2 bias" or Pr. 903 "speed setting No. 2 gain". (Refer to page 51.)
- The function of terminal 1 changes according to the setting of Pr. 868 "terminal 1 function selection". For the factory set function of terminal 1, refer to the Instruction Manual (detailed). The function of this terminal is factory-set to adding auxiliary of the speed setting signal of terminal 2.
- Set the adjustment of bias/gain of terminal 1 in Pr. 902 "speed setting No. 2 bias" or Pr. 903 "speed setting No. 2 gain".

- 3) Multi-speed commands

The external signals (RH, RM, RL) may also be used to give speed command.

(The terminals are factory-set as follows. DI1 = RH, DI2 = RM, DI3 = RL)

REMARKS

- The RH, RM and RL signals are assigned to terminals DI1 to DI4 and STR using Pr. 180 to Pr. 183 and Pr. 187 (input terminal function selection).
- Speed control has the following priority:
maximum setting > Jog > speed jump > minimum setting > 12 bit digital (FR-A5AX) / 16 bit digital (FR-V5AH) > multi-speed > option high-resolution output (FR-V5AX) > PID control > analog input

CAUTION

When the speed command is to be given using the analog command (terminal 2), turn off the external signals (RH, RM, RL). If any of external signals (RH, RM, RL) is on, the multi-speed commands are made valid.

4.1.5 Torque restriction

Select the setting method of output torque restriction during speed control from among the external analog input terminal "3" or "1" (Pr. 868 "No.1 terminal function selection" = "2") or parameter settings using Pr. 810 "torque restriction mode".

Torque restriction is factory-set to exercise by parameter settings, and the restriction level is 150%.

Parameter	Name	Factory Setting	Description
803	Constant output region torque characteristic selection	0	0: Motor output is made constant (torque is reduced) 1: Torque is made constant You can select whether the torque restriction in the constant output region to be constant torque restriction or constant output restriction. (Refer to page 41.)
810	Torque restriction input method selection	0	0: Internal torque restriction (torque restriction by parameter settings) (Refer to page 37) 1: External torque restriction (torque restriction using No. 3 and No. 1 (option (FR-V5AX) No. 6 terminal)) With the upper limit of torque restriction as set in Pr. 22, Pr. 812, Pr. 813 and Pr. 814, the analog input from the No. 3 terminal input is used as the torque restriction value on the driving side within the Pr. 22 setting range. When regenerative torque restriction is assigned to the No. 1 terminal or option's No. 6 terminal on the regenerative side, the analog input from the No. 1 terminal or No. 6 terminal is used as the torque restriction.

Parameter	Name	Factory Setting	Description
22	Torque restriction level	150	Set the torque restriction level in % for speed control or position control so that the output torque does not exceed the predetermined value. (0 to 400%) When Pr. 810 = 0, 1st quadrant Pr. 22 2nd quadrant Pr. 812 3rd quadrant Pr. 813 4th quadrant Pr. 814
812	Torque restriction level (regeneration)	9999	Set the torque restriction level in % for regeneration. (0 to 400%) Valid for regeneration when Pr. 810 = 0. 9999: Restricted to the Pr. 22 value.
813	Torque restriction level (3rd quadrant)	9999	Set the torque restriction level in % for 3rd quadrant. (0 to 400%) Valid for reverse rotation driving when Pr. 810 = 0. 9999: Restricted to the Pr. 22 value.
814	Torque restriction level (4th quadrant)	9999	Set the torque restriction level in % for 4th quadrant. (0 to 400%) Valid for reverse rotation regeneration when Pr. 810 = 0. 9999: Restricted to the Pr. 22 value.
815	Torque restriction level 2	9999	When the TL signal is on, the Pr. 815 value is a torque restriction value regardless of Pr. 810. Set the torque restriction level in % for all operations. (0 to 400%) Valid when the TL terminal (torque restriction selection) input is provided. 9999: According to the Pr. 22 value.
816	Acceleration torque restriction	9999	Set the torque restriction value for acceleration. 9999: Same torque restriction as at constant speed
817	Deceleration torque restriction	9999	Set the torque restriction value for deceleration. 9999: Same torque restriction as at constant speed

(1) Torque restriction level

1) When Pr. 810 = 0

In the factory setting, restriction is made on all quadrants on the Pr. 22 torque restriction level. When you want to set the level on a quadrant basis, change the corresponding parameter value.

2) When Pr. 810 = 1

With the upper limit of torque restriction as set in Pr. 22, the analog input from the No. 3 terminal input is used as the torque restriction value within the Pr. 22 setting range. When the torque restriction function is selected in the regenerative mode with the No. 1 terminal selected, the input from the No. 1 is used as the torque restriction on the regenerative side. (Pr. 868=2)

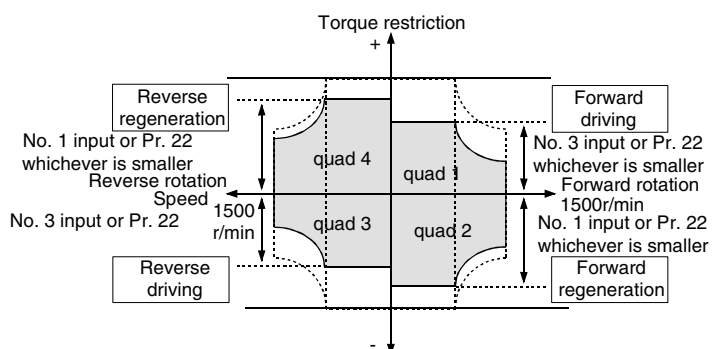
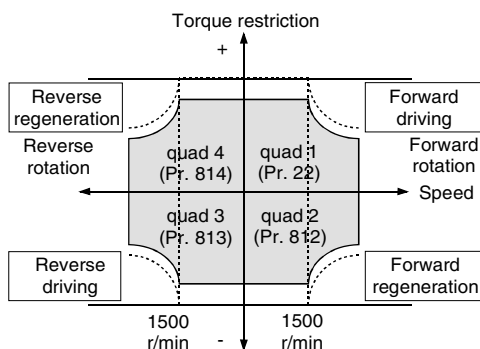

(2) Second torque restriction level

- When the TL signal is on, the Pr. 815 value is a torque restriction value regardless of the mode in Pr. 810.

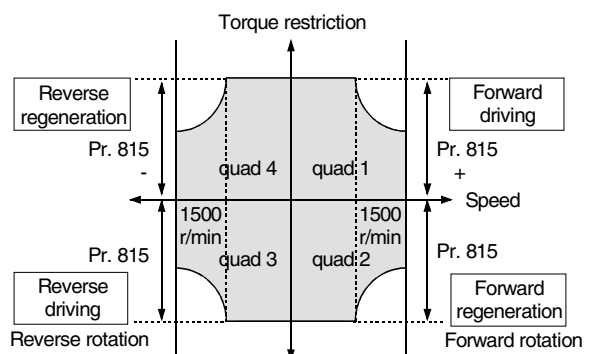

Speed control operation

Related parameters

TL signal terminal assignment ⇒ Set "26" in any of Pr. 180 to Pr. 183 and Pr. 187 (input terminal function selection). (Refer to page 65)

REMARKS

- When an analog signal is used to make external torque restriction, refer to page 51 for calibration of the No. 3 terminal (Pr. 904 "torque command No.3 bias" and Pr. 905 "torque command No.3 gain").
- When an analog signal is used to make regenerative torque restriction from the No. 1 terminal, perform calibration of the No. 1 terminal. (Pr. 919 "No. 1 terminal bias (torque/magnetic flux)", Pr. 920 "No. 1 terminal gain (torque/magnetic flux)") Refer to page 51.

(3) Torque restrictions during acceleration and deceleration

You can set torque restrictions during acceleration and deceleration individually.

The following chart shows torque restrictions according to the settings of Pr. 816 "acceleration torque restriction" and Pr. 817 "deceleration torque restriction".

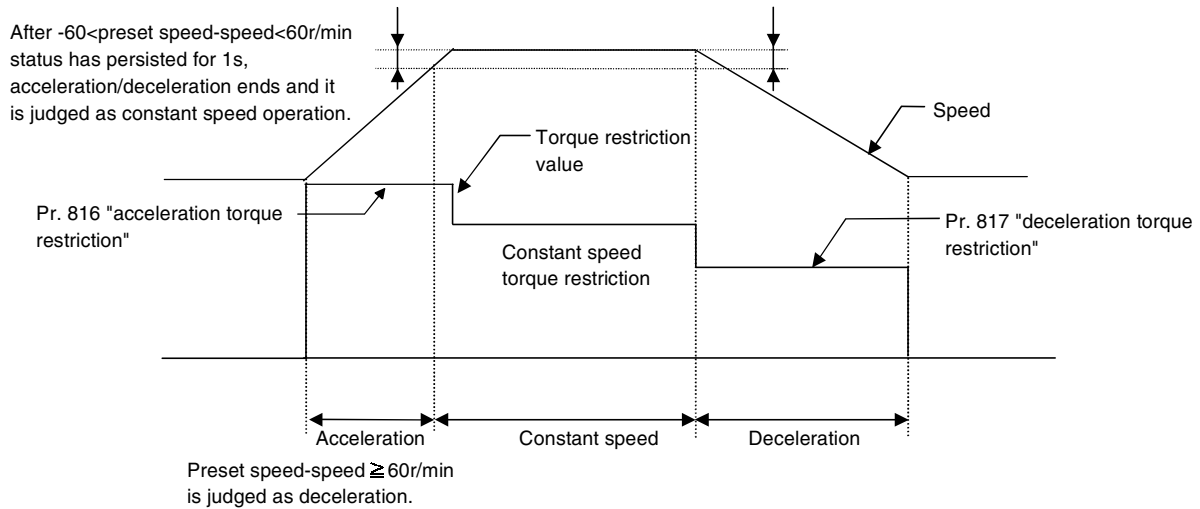

4.1.6 Gain adjustment

As a simple tuning method, the Pr. 819 "easy gain tuning" function is available. (Refer to page 47.)

REMARKS



For fine adjustment of gain, refer to the Instruction Manual (detailed))

- Manual gain adjustment (Pr. 820, Pr. 821, Pr. 830, Pr. 831)
- Speed feed forward control and model adaptive speed control are also available.

4.2 Torque control operation

4.2.1 Torque control

Torque control is exercised to develop torque as set in the torque command. The motor speed becomes constant when the motor output torque and load torque are balanced. For torque control, therefore, the speed is determined by the load.

For torque control, the motor gains speed as the motor output torque becomes greater than the motor load. Here, set the speed restriction value so that the motor speed does not increase too high. The speed restriction value is set in the following method. When speed restriction is not set, the speed restriction value setting is regarded as 0r/min to disable torque control.

(Torque control is disabled under speed restriction. (Speed control is performed.))

4.2.2 Operation transition

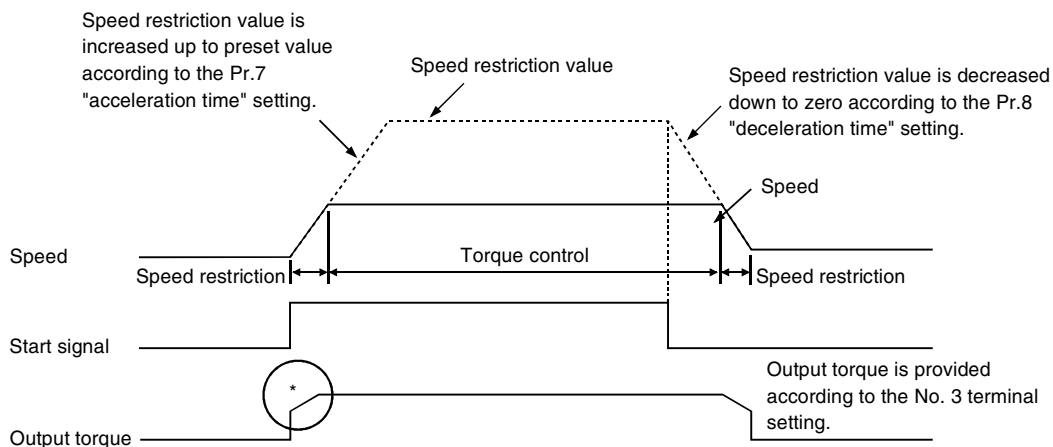

* Speed control is performed during speed restriction. (thus, torque according to the command is not developed)

REMARKS

When the load is smaller than torque command, the speed increases up to the speed restriction value.

● When "0" is set in Pr. 7 or Pr. 8 "acceleration/deceleration time"

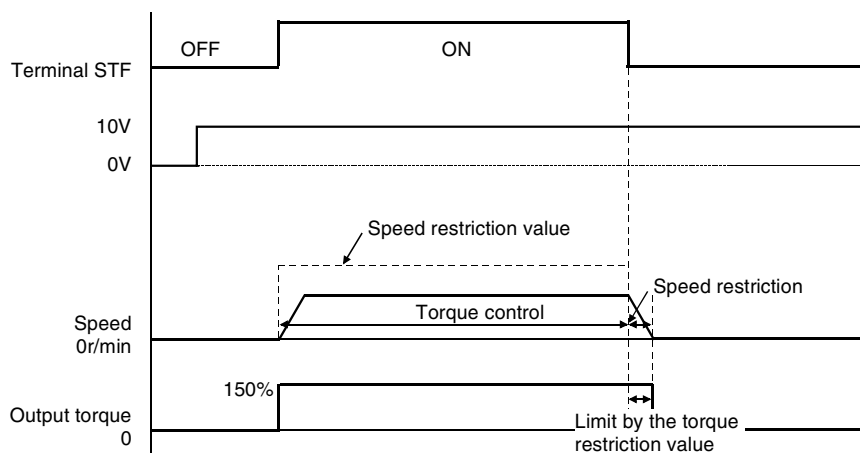

Torque control operation

(1) I/O signals

The following table indicates the operations of the signals.

Signal	Terminal Name		Remarks
Start signal	External operation	STF, STR signal	Start and stop are the same as under speed control. A stop is made when the STF and STR signals are both on.
	PU operation	Forward or reverse rotation from PU04V or DU04-1	
Torque command	As set in the torque command right selection parameter.		Input torque command.
Speed restriction	As set in the speed restriction selection parameter.		Display SL and output OL signal during speed restriction.

(2) Operation example (Pr. 804=0)

Torque control is enabled if the actual speed is less than the speed restriction value.

When the actual speed reaches or exceeds the speed restriction value, speed restriction operation starts, torque control is stopped, and speed control (proportional control) starts.

The following shows the operations in response to the analog input command from the No. 3 terminal.

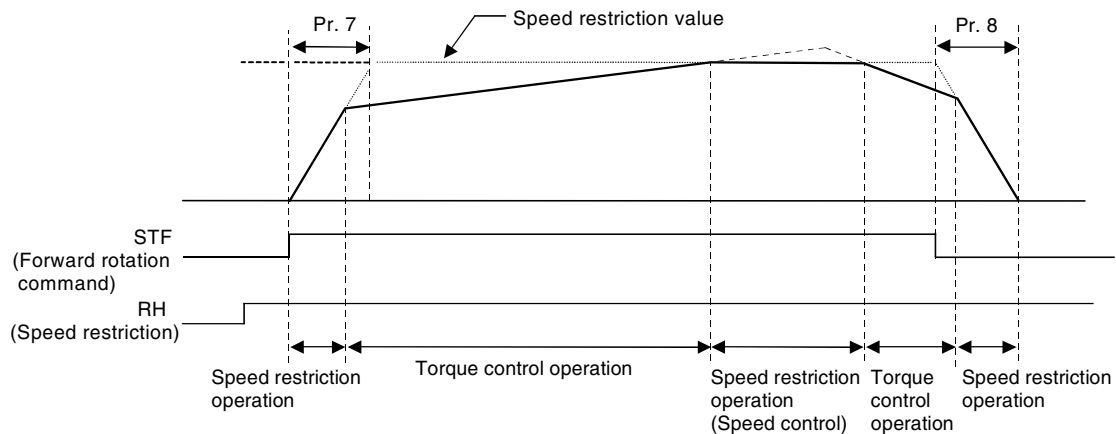

- 1) When STF is turned on, the speed restriction value is increased according to the time set in Pr. 7.
- 2) Torque control operation is performed when the actual speed is less than the speed restriction value.
- 3) When the STF start signal is turned off, the speed restriction value is decreased according to the time set in Pr. 8.
- 4) For torque control, the actual speed becomes constant when the torque command and load torque are balanced.
- 5) The motor torque developing direction is determined by the combination of the torque command input polarity and start signal as indicated in the following table.

Torque Command Polarity	Torque Developing Direction (Mode)	
	STF signal ON	STR signal ON
Positive torque command	Forward rotation direction (forward rotation driving/reverse rotation regeneration)	Reverse rotation direction (forward rotation regeneration/reverse rotation driving)
Negative torque command	Reverse rotation direction (forward rotation regeneration/reverse rotation driving)	Forward rotation direction (forward rotation driving/reverse rotation regeneration)

REMARKS

When speed restriction operation starts, speed control is exercised to enable internal torque restriction (Pr. 22 "torque restriction level") (factory setting). Speed control may not be returned to torque control in this case. Torque restriction be set to external torque restriction (terminals No. 3, No. 1 and No. 6 (option FR-V5AX).

(Refer to Pr. 803 "constant output region torque characteristic selection" (page 36).)

4.2.3 Setting procedure

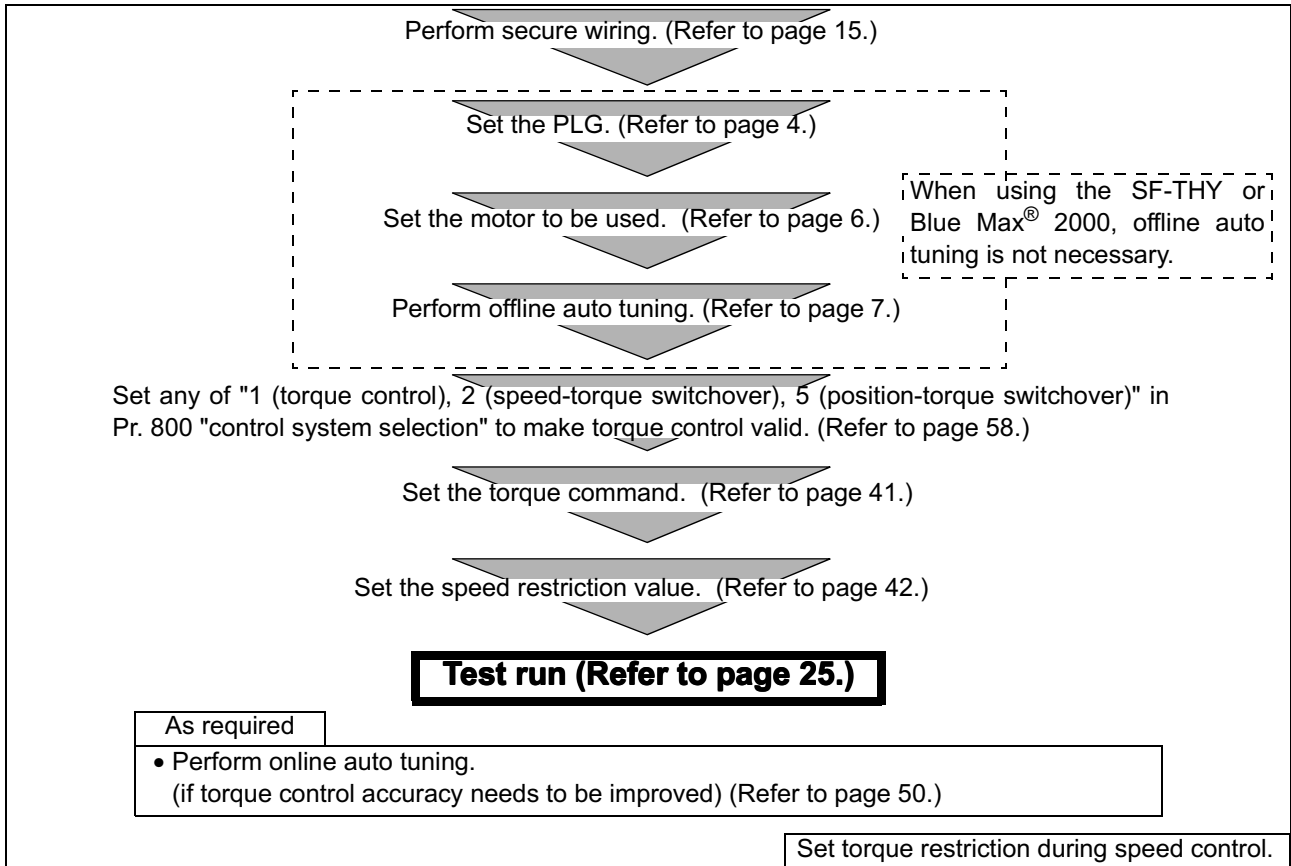

4.2.4 Torque command right selection

Using Pr. 804 "torque command right selection", set the method by which the torque command will be given. The torque command is factory set to the torque command connected across terminals 3-5. (This parameter is an extended function parameter. Set "1" in Pr.160 "extended function selection".)

Pr. 804 Setting	Description	
0 (factory setting)	Torque command connected across terminals 3-5 (analog)	
1	Torque command by setting Pr. 805 or Pr. 806 (digital)	Refer to the Instruction Manual (detailed).
2 (FR-V5AP)	Torque command by pulse train command	Fit an option to set these values. Refer to the instruction manual of options (detailed) for details.
3 (FR-A5NC)	Torque command by using CC-Link.	
4 (FR-V5AH, FR-A5AX)	Torque command from the option (digital)	

4.2.5 "Torque command setting"

● Torque command selection

The figure on the right shows how to give the torque command in the constant output region (extended function parameter).

Parameter	Name	Factory Setting	Setting Range
803	Constant output region torque characteristic selection	0	0, 1

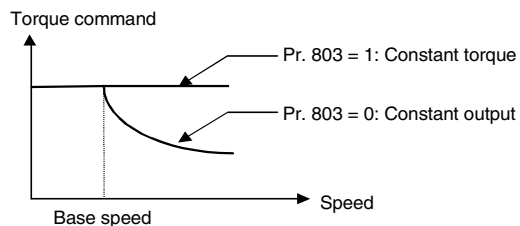

Torque control operation

- (1) Calibration of torque command No. 3 terminal
Refer to the chart on the right for the relationship between torque setting input voltage and output torque. The torque setting input signal is in proportion to the output torque. Note that the motor-developed torque varies with the motor temperature.

Use Pr. 904 and Pr. 905 to adjust bias/gain of the No. 3 terminal. (Refer to page 51.)

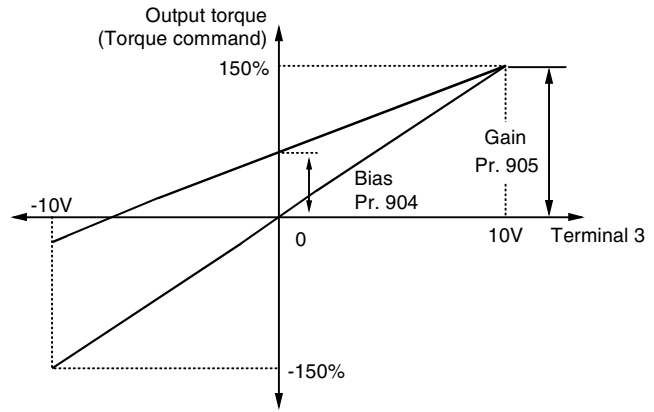

4.2.6 Speed restriction

Set the speed restriction value to prevent the motor from over speeding due to a smaller load torque than the torque command value.

Parameter	Name	Factory Setting	Setting Range
807	Speed restriction selection	0	0, 1, 2
808	Forward rotation speed control	1800r/min	0 to 3600r/min
809	Reverse rotation speed control	9999	0 to 3600r/min, 9999

Select the speed restriction input method using Pr. 807.

Pr. 807 Setting	Speed Restriction Input Method	Operation
0 (factory setting)	Same method as speed setting for speed control	<ul style="list-style-type: none"> Speed setting from the operation panel External analog command (terminal 1, 2) Multi-speed command Option (FR-V5AX etc.) For both PU and external operations, the speed restriction changes according to the acceleration/deceleration time. (Refer to 43 page)
1	Pr. 808 Forward rotation speed control Pr. 809 Reverse rotation speed control	According to the rotation direction, set the speed restriction in forward and reverse rotation directions individually. When the reverse rotation speed restriction is 9999, the setting is the same as that of the torque restriction in forward rotation direction. (Refer to the Instruction Manual (detailed).)
2	Forward/reverse rotation speed restriction (analog polarity switchover speed restriction) (No. 1 terminal analog input)	The analog voltage of the No. 1 terminal input is used to make speed restriction. For 0 to 10V input, set the forward rotation speed restriction. (The reverse rotation speed restriction is Pr. 1 "maximum speed".) For -10 to 0V input, set the reverse rotation speed restriction. (The forward rotation speed restriction is Pr. 1 "maximum speed".) The maximum speed of both the forward and reverse rotations is Pr. 1 "maximum speed". When No. 1 terminal input is selected, set "5" in Pr. 868 "No. 1 terminal function assignment". Use Pr. 917 or Pr. 918 to calibrate the No. 1 terminal. (Refer to the Instruction Manual (detailed).)

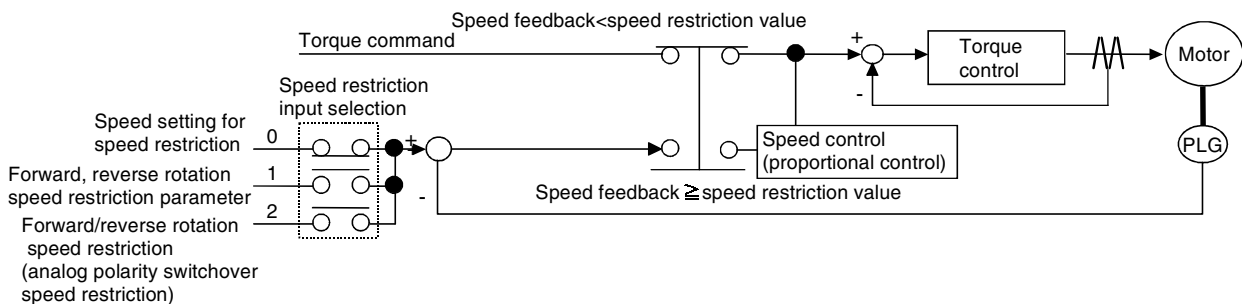

(1) When Pr. 807 = 0

The speed command value during speed restriction acts as a speed restriction level. At this time, according to the acceleration/deceleration time set in Pr. 7 "acceleration time" and Pr. 8 "deceleration time", the restriction level is increased from 0r/min upon start, and when the start signal turns off, the speed restriction level is decreased from the then speed restriction level to the DC injection brake operation speed in Pr. 10 to a stop. The speed restriction level at this time is shown on the right.

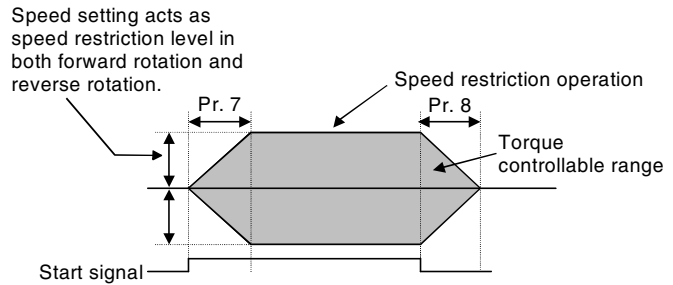

1) External analog speed restriction (terminal 1, 2)

The analog signal (0 to +10V (±10V)) input to terminal 2 (or terminal 1) is used to give a speed restriction command.

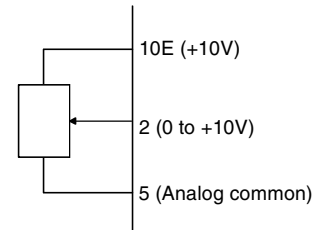

REMARKS

- Set Pr. 73 "speed setting signal" to change between the main speed and override of terminal 2.
(Refer to the Instruction Manual (detailed).)
- If the above speed restriction command is greater than Pr. 1 "maximum speed", the speed restriction value is regarded as the Pr. 1 "maximum speed" value. If the speed restriction command is smaller than Pr. 2 "minimum speed", the speed restriction value is regarded as the Pr. 2 "minimum speed". Similarly when the speed restriction command is smaller than Pr. 13 "starting speed", the speed restriction value is 0r/min.
- Set the speed restriction of terminal 1 using Pr. 868 "No. 1 terminal function selection".
(Refer to the Instruction Manual (detailed).)

2) Speed restriction on multi-speeds

The speed restriction command can also be set for the external signals (RH, RM, RL).
(The terminals are factory-set as follows. DI1 = RH, DI2 = RM, DI3 = RL)

REMARKS

The RH, RM and RL signals are assigned to terminals DI1 to DI4 using Pr. 180 to Pr. 183 and Pr. 187 (input terminal function selection).

CAUTION

When speed restriction is to be made using the analog command (terminal 2), turn off the external signals (RH, RM, RL). If any of external signals (RH, RM, RL) is on, multi-speed restrictions are made valid.

REMARKS

- Changing the terminal assignment in Pr. 180 to Pr. 183 and Pr. 187 may affect the other functions. Make setting after checking the functions of the corresponding terminals.
- If the value set in Pr. 187 is other than "9999", the external command cannot be used to perform reverse rotation operation. To start reverse rotation, set "9999" (factory setting) in Pr. 187 to make the STR signal of terminal STR valid.
- When the above speed restriction command is greater than the Pr. 1 "maximum speed" value, the speed restriction value is the Pr. 1 "maximum speed" value, and when the speed restriction command is less than the Pr. 2 "minimum speed" value, the speed restriction value is the Pr. 2 "minimum speed" value. When the speed restriction command is less than the Pr. 13 "starting speed" value, the speed restriction value is 0r/min.
- When external speed restriction is to be made using analog, calibrate the No. 2 (No.1) terminal. Refer to Pr. 902 "speed setting No. 2 bias" and Pr. 903 "speed setting No. 2 gain". Refer to Pr. 902 "speed setting No. 2 bias" and Pr. 903 "speed setting No. 2 gain" for the No.1 terminal. (Refer to page 51.)

(2) For Pr. 807="1 or 2", refer to the Instruction Manual (detailed).

4.2.7 Optimum speed estimation and torque control accuracy improvement

To eliminate the temperature drift of torque under torque control, change the Pr. 95 "online auto tuning" setting to "2". (Refer to page 50.)

For torque control, easy gain tuning has no effect.

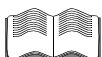

When an unfavorable phenomenon such as torque pulsation occurs or when you want to exhibit the best performance according to the machine, refer to the Instruction Manual (detailed) to perform a manual gain adjustment (Pr.824 to Pr.827).

4.3 Position control operation

On this inverter, you can use parameter and pulse inputs to exercise position control.

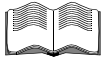

Refer to the Instruction Manual (detailed) for details.

4.3.1 Position command from parameter setting

Position control is exercised using the position feed amounts set in Pr. 465 to Pr. 494.

4.3.2 Position command from PLC

Position control is exercised by connecting the PLC, such as the MELSEC-Q series PLC positioning module (QD75), and the positioning control option (FR-V5AP) to the inverter.

4.4 Control mode switchover timing

Depending on a parameter setting change or whether the MC terminal turns on/off, the control mode switches at the following timing.

Switchover Pattern	Switchover Operation
Speed ↔ Torque	The mode can be changed any time independently of whether the motor is at a stop or running or the DC brake (servo lock) is operating.
Speed ↔ Position	The mode can be changed when the speed is equal to or lower than the low speed detection level.
Position ↔ Torque	When the speed is higher than the low speed detection level, changing the MC signal during rotation will not switch the control mode to the other, and as soon as the speed falls to or below Pr. 865 "low speed detection level", the control mode is changed according to the terminal status.

⟨Example: Speed ↔ Position, when Pr. 800 = 4⟩

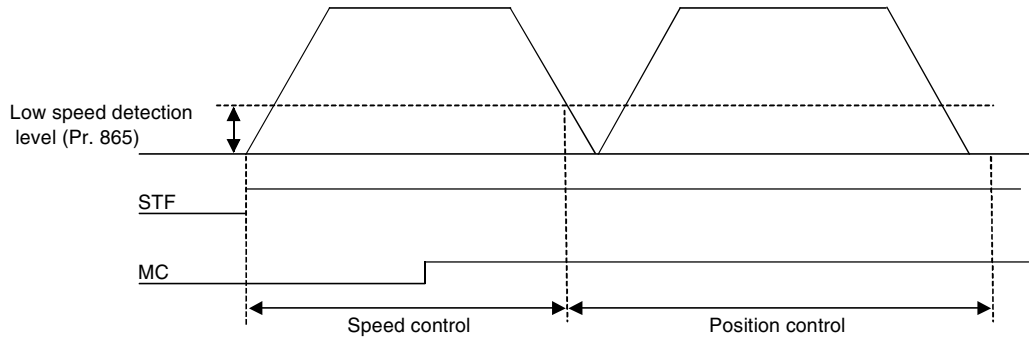

- Terminals and terminal functions changed by control mode switchover
The terminal functions vary with the control mode as indicated in the following table.

Classification	Terminal Name	Description					
		Pr. 800="0"	Pr. 800="1"	Pr. 800="2"	Pr. 800="3"	Pr. 800="4"	Pr. 800="5"
		Speed Control	Torque Control	Speed Control/Torque Control Switchover (MC:ON/OFF)	Position Control	Speed Control/Position Control Switchover (MC signal:ON/OFF)	Position Control/Torque Control Switchover (MC signal: ON/OFF)
Contact input signal	STF	Forward rotation command	←	←	←	←	←
	STR	Reverse rotation command	←	←	←	←	←
	DI1	Multi-function input 1	←	←	←	←	←
	DI2	Multi-function input 2	←	←	←	←	←
	DI3	Multi-function input 3	←	←	←	←	←
	DI4	Multi-function input 4	←	←	←	←	←
Contact output	ABC	Alarm contact	←	←	←	←	←
Open collector output	DO1	Multi-function output 1	←	←	←	←	←
	DO2	Multi-function output 2	←	←	←	←	←
	DO3	Multi-function output 3	←	←	←	←	←

Control mode switchover timing

Classi- fica- tion	Terminal Name	Description					
		Pr. 800="0"	Pr. 800="1"	Pr. 800="2"	Pr. 800="3"	Pr. 800="4"	Pr. 800="5"
		Speed Control	Torque Control	Speed Con- trol/Torque Control Switchover (MC:ON/OFF)	Position Control	Speed Control/ Position Con- trol Switcho- ver(MC signal:ON/OFF)	Position Con- trol/Torque Control Switchover (MC signal: ON /OFF)
Analog input	2	Speed command input	Speed restriction input	Speed command/ speed restriction	Invalid	Speed Command / invalid	Invalid/speed restriction
	1*	Speed command auxiliary input	Speed restriction auxiliary input	Speed command/ speed restriction	Invalid	Speed Command / invalid	Invalid/speed restriction
	3	Torque restriction input	Torque command input	Torque restriction/ torque command	Torque restriction input	←	Torque restriction/torque command
Analog output	DA1	Multi- function monitor output 1	←	←	←	←	←
	DA2	Multi- function monitor output 2	←	←	←	←	←

*: Assumes that the Pr. 868 value is the factory setting.

Related parameters

- DI1 to DI4, STR terminal function selection ⇒ Pr. 180 to Pr. 183, Pr. 187 (input terminal function selection). (Refer to page 65.)
- DO1 to DO3, ABC terminal function selection ⇒ Pr. 190 to Pr. 192, Pr. 195 (output terminal function selection). (Refer to page 65.)
- No. 1 terminal function selection ⇒ Pr. 868 "No. 1 terminal function assignment" (Refer to the Instruction Manual (detailed).)
- No. 1, 2, 3 terminal bias/gain adjustment ⇒ Pr. 902 to Pr. 905, Pr. 917, Pr. 918 (bias/gain adjustment) (Refer to page 51.)
- DA1, DA2 terminal function selection ⇒ Pr. 54, Pr. 158 (DA1, DA2 function selection) (Refer to page 61 (DA1) and page 64 (DA2).)
- DA1, DA2 terminal calibration ⇒ Pr. 900, Pr. 901 (DA1, DA2 terminal calibration) (Refer to page 28.)
- MC signal terminal assignment ⇒ Set "26" to any of DI1 to DI4 and STR using any of Pr. 180 to Pr. 183 and Pr. 187 (input terminal function selection). (Refer to page 65.)
- Control system selection ⇒ Pr. 800 (Refer to page 58.)

4.5 Easy gain tuning

The ratio of the load inertia to the motor inertia (load inertia moment ratio) is estimated in real time from the torque command and speed during motor operation to automatically set the optimum gains for speed control/ position control from that ratio and response level setting.

4.5.1 Parameter

Parameter	Name	Factory Setting	Setting Range	Remarks
818	Easy gain tuning response level setting	2	1 to 15	Set the response level. 1: Slow response to 15: Fast response
819	Easy gain tuning selection	0	0, 1, 2	0: No tuning 1: With load estimation, with gain calculation 2: Manual load input (Pr. 880), with gain calculation

4.5.2 Easy gain tuning execution procedure

(1) Setting the response level in Pr. 818 "easy gain tuning response level setting"

Refer to the diagram on the right and set the response level.

Increasing the value will improve trackability to the command, but too high value will generate vibration. The relationship between the setting and response level are shown on the right.

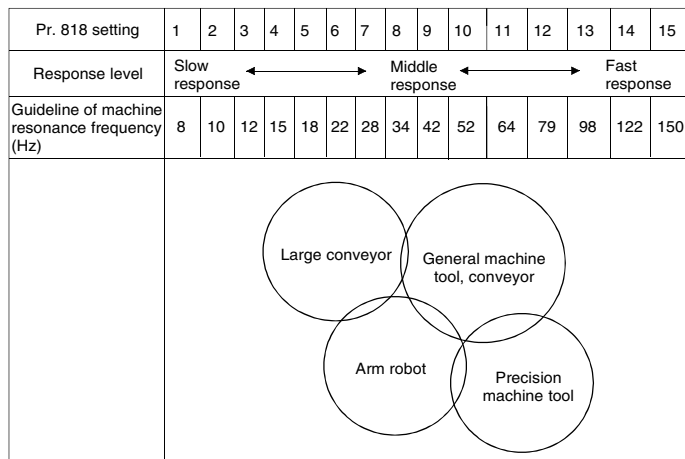

(2) Setting easy gain tuning enable in Pr. 819 "easy gain tuning selection"

Pr. 819 Setting	Description
0 (factory setting)	<ul style="list-style-type: none"> Easy gain tuning is invalid. None of the load inertia ratio, position control gain and speed control gain values are updated.
1	<ul style="list-style-type: none"> Easy gain tuning is valid. Each control gain is automatically set from the load inertia ratio estimated during acceleration/ deceleration operation and the Pr. 818 "easy gain tuning response level setting" value. Pr. 880 "load inertia ratio" is used as the initial value of the load inertia ratio for tuning. Estimated value is set in Pr. 880 during tuning.
2	<ul style="list-style-type: none"> Used when the load inertia ratio cannot be estimated well due to load disturbance and such or when the load inertia ratio is known in advance, for example. At this time, the load inertia ratio is not estimated and each control gain is automatically set from the Pr. 880 "load inertia ratio" setting (factory setting: 7) and Pr. 818 "easy gain tuning response level setting" value.

(3) Start signal

Press **FWD** or **REV** to estimate the load inertia ratio or calculate gain any time.
(The operation command for external operation is the STF or STR signal.)

REMARKS

When "1 or 2" is set in Pr. 819 "easy gain tuning selection" and then returned to "0", tuning results which are automatically set in each parameter remain unchanged.

4.5.3 Precautions for easy gain tuning

(1) Checking the Pr. 800 "control system selection" value

Easy gain tuning is valid **only for the speed control/position control mode under PLG vector control.**
It is invalid for torque control and V/F control.

Pr. 800 Setting	Drive System	Control Mode	Easy Gain Tuning
0	PLG vector control	Speed control	Valid
1		Torque control	Invalid
2		Speed-torque switchover	When speed is selected: Valid When torque is selected: Invalid
3		Position control	Valid
4		Speed-position switchover	Valid
5		Position-torque switchover	When position is selected: Valid When torque is selected: Invalid
20	V/F control	Speed control	Invalid

(2) Load inertia ratio estimation restriction conditions

When "1" is set in Pr. 819 "easy gain tuning selection", the load inertia ratio may not be estimated well, e.g. it takes a long time for estimation, if the following conditions are not satisfied.

- Time taken for acceleration/deceleration to reach 1500r/min is 5s or less.
- Speed is 150r/min or more.
- Acceleration/deceleration torque is 10% or more of the rated torque.
- Abrupt disturbance is not applied during acceleration/deceleration.
- Load inertia ratio is about 30 times or less.

4.5.4 Automatically set parameters by easy gain tuning

Parameter	Name	Factory Setting	Setting Range	Remarks
422	Position loop gain	1	0 to 150	Valid during position control (1/s)
820	Speed control P gain 1	60%	0 to 1000%	100%:200rad/s
821	Speed control integration time	0.333s	0 to 10s	
828	Model speed control gain	60%	0 to 1000%	Valid during model adaptive control
880	Load inertia ratio	7	0, 1 to 200 times	Setting value when easy gain tuning load estimation is performed Inertia ratio with load only (Refer to the table below for the inertia reference.)

REMARKS 1

Operation when the first or second function is selected

Load inertia estimation and gain calculation are performed only when the RT terminal is off. The gain calculated is also reflected only on these parameters. When the RT terminal is on, both the inertia estimation value and gain remain unchanged from the previous values.

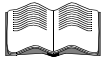

When some adjustments are required after executing easy gain tuning due to disturbance and such, perform fine adjustment (adjustment of Pr. 820, Pr. 821) by manual input. (Set "0" (without gain tuning) in Pr. 819 "easy gain tuning".)

If the fast responsiveness to the speed command is desired, consider exercising speed feed forward control or model adaptive speed control. Refer to the Instruction Manual (detailed) for details.

4.5.5 Easy gain tuning-related parameter operation

Refer to the following table for the parameter/gain read/write operation using Pr. 819 "easy gain tuning selection".

		Pr. 819=0 Without tuning	Pr. 819=1 With inertia estimation, with gain calculation	Pr. 819=2 Inertia as set in Pr. 880, with gain calculation
Pr. 880 "load inertia"	Read	Setting is displayed.	Inertia estimation result is displayed from the RAM.	Setting is displayed.
	Write	Setting can be changed.	Load inertia estimation result is written. (Write is enabled only during a stop.)	Setting can be changed.
Timing of writing load inertia ratio and control gains into E ² PROM	—	Not written	<ul style="list-style-type: none"> •Every hour after power-on •When the Pr. 819 setting is changed to other than "1". •When the vector control mode is changed to other drive systems due to the Pr. 800 "control system selection" setting change. 	When the Pr. 819 setting is changed to "2" When Pr. 880 "load inertia ratio" or Pr. 818 "easy gain tuning response level setting" is changed
Control gains (Pr. 820, Pr. 821, Pr. 828, Pr. 422)	Read	Settings are displayed.	Gain calculation results (RAM) are displayed.	Settings are displayed.
	Write	Settings can be changed.	Write disabled (operation error)	Write disabled (operation error)

CAUTION

RAM data is erased when the power is not supplied or the inverter is reset.

4.6 Online auto tuning

Excellent torque accuracy is provided by temperature compensation even if the secondary resistance value of the motor varies with the rise in the motor temperature.

4.6.1 Parameters

- For the motor with PLG, set "2" in Pr. 95 "online auto tuning selection".

Parameter	Name	Factory Setting	Setting Range	Remarks
95	Online auto tuning selection	0	0, 1, 2	0: No online auto tuning 1: Start-time tuning (at start-up) 2: Adaptive magnetic flux observer (normal)

4.6.2 Pr. 95="1" (start-time tuning)

The current at a start is detected to compensate for the secondary resistance of the motor so that excellent characteristics are provided regardless of the change in value of the secondary resistance of the motor with the rise of the motor temperature.

CAUTION

- Perform offline auto tuning in the mode with rotation before performing start-time tuning of the online auto tuning.**
For offline auto tuning, refer to page 7.
- For using start-time tuning in vertical lift applications, examine the utilization of a brake sequence for the brake opening timing at a start. Though the tuning ends in about a maximum of 500ms after a start, torque is not provided fully during that period. Therefore, note that there may be a possibility of gravity drop.**

4.6.3 Pr. 95 = "2" (normal tuning)/adaptive magnetic flux observer

This function is effective for torque accuracy improvement when using the motor with PLG.

The current flowing in the motor and the inverter output voltage are used to estimate/observe the magnetic flux in the motor.

The magnetic flux of the motor is always detected with high accuracy so that excellent characteristics are provided regardless of the change in the temperature of the secondary resistance.

Set "2" when exercising PLG vector control.

CAUTION

- If any other manufacturer's motor is used, perform offline auto tuning (Pr. 96="101") with motor alone to run the motor before performing online auto tuning. (The motor with inertia load can be connected.)**
- For the SF-THY, SF-VH, SF-LHA (with PLG) or SF-LHCA (with PLG) Blue Max® 2000 (NA version), it is not necessary to perform offline auto tuning to select adaptive magnetic flux observer. (Note that it is necessary to perform offline auto tuning (non-rotation mode) for the wiring length resistance to be reflected on the control when the wiring length is long (30m (98.43feet) or longer as reference).)**
For offline auto tuning, refer to page 7.

REMARKS

- Online auto tuning of the start-time tuning does not operate if the MRS is input, if the preset speed is less than the starting speed (Pr. 13), or if the starting conditions of the inverter are not satisfied, e.g. inverter error.
- Online auto tuning of the start-time tuning does not operate during deceleration or at a restart during DC brake operation.
- Invalid for jog operation.
- The RUN signal is not output during online auto tuning of the start-time tuning. The RUN signal turns on at a start.
- If the period from an inverter stop to a restart is within 4s, online auto tuning of the start-time tuning is performed but the tuning results are not reflected.
- Automatic restart after instantaneous power failure overrides when automatic restart after instantaneous power failure is selected.
- Zero current detection and output current detection are valid during online auto tuning.

4.7 Biases and gains of speed setting terminals (Pr. 902 to Pr. 905, Pr. 917 to Pr. 920)

Adjust the biases and gains of the speed setting No. 2, torque command No. 3 and multi-function No. 1 terminals.

The "bias" and "gain" functions are designed to adjust the relationship between the 0 to 10V input signal, which is externally input for the setting of output speed, torque or magnetic flux.

Parameter	Name	Factory Setting		Setting Range		Remarks
902	Speed setting No. 2 bias	0V	0r/min	0 to 10V	0 to 3600r/min	Extended mode
903	Speed setting No. 2 gain	10V	Japanese version 1500r/min	0 to 10V	0 to 3600r/min	
			NA version 1800r/min			
904	Torque command No. 3 bias	0V	0%	0 to 10V	0 to 400%	
905	Torque command No. 3 gain	10V	150%	0 to 10V	0 to 400%	
917	No. 1 terminal bias (speed)	0V	0r/min	0 to 10V	0 to 3600r/min	
918	No. 1 terminal gain (speed)	10V	Japanese version 1500r/min	0 to 10V	0 to 3600r/min	
			NA version 1800r/min			
919	No. 1 terminal bias (torque/magnetic flux)	0V	0%	0 to 10V	0 to 400%	
920	No. 1 terminal gain (torque/magnetic flux)	10V	150%	0 to 10V	0 to 400%	

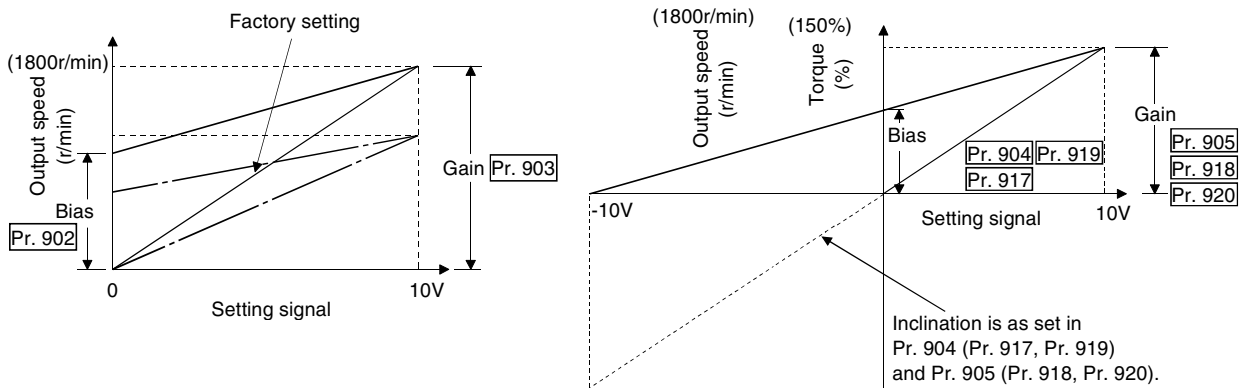

CAUTION

Torque command bias and gain can not be set by applying an external negative setting signal to the torque command No. 3 or No. 1 terminal.

Biases and gains of speed setting terminals (Pr. 902 to Pr. 905, Pr. 917 to Pr. 920)

<Setting>

There are the following three methods to adjust the speed setting voltage bias and gain.

- 1) Method to adjust any point by application of a voltage to across terminals 2(1)(3) - 5
- 2) Method to adjust any point without application of a voltage to across terminals 2(1)(3) - 5
- 3) Method that does not adjust the bias voltage

(Example) Pr. 903 "speed setting No. 2 gain"
(Pr. 902 to Pr. 920 can be adjusted in the similar manner.)

<Adjustment procedure> Using the speed setting signal from the operation panel (FR-DU04-1) to make speed setting

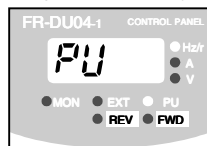
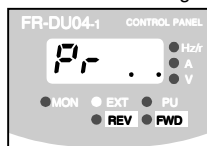
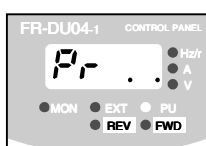
<p>(1) Power on (monitoring mode)</p>  <p>REMARKS ON of the LED is indicated by ○, and OFF by ●.</p>	<p>(2) Choose the PU operation mode.</p> <p>1) Make sure that the inverter is in the PU operation mode. (LED of PU is lit.) (Refer to page 31 for monitor transition.)</p> <p>● Operation mode (PU operation mode)</p> 
<p>2) Set 1 (PU operation mode) in Pr. 79 "operation mode selection". (Refer to page 58.) Example: To change the external operation mode (Pr. 79 = 2) to the PU operation mode (Pr. 79 = 1)</p> <p>Press MODE one time.</p> <p>● Parameter setting mode</p>  <p>Most significant digit flickering: P.0000 → Middle digit flickering: P.0000 → Least significant digit flickering: P.0000</p> <p>▲ ×7 times → P.0070 (0 to 9) → ▲ ×9 times → P.0079 (0 to 9)</p> <p>Press for:</p> <ul style="list-style-type: none"> ● Current setting: SET → 2 ● Setting change: ▼ → 1 ● Setting write: 1.5 s SET → 1 <p>If Err appears: Check that the forward rotation (STF) or reverse rotation (STR) signal connected to the control terminal is not on. If on, turn it off.</p> <p>If P. 80 appears, you did not press SET for 1.5s when writing the value.</p> <p>Press ▼ once, press SET, and make setting one more time.</p> <p>Result: P. 79</p>	
<p>(3) Read Pr. 903 to display the currently set gain speed.</p> <p>● Parameter setting mode</p> <p>As in the procedure in (2)-2), press MODE to choose the "parameter setting mode".</p>  <p>Most significant digit flickering: P.0000 → Middle digit flickering: P.9000 → Least significant digit flickering: P.9000</p> <p>▲ ×9 times → P.9000 (0 to 9) → ▲ ×3 times → P.9003 (0 to 9)</p> <p>Currently set gain speed: FR-DU04-1 control panel showing 1500 Hz/r</p>	

(4) Set the gain speed in Pr. 903 and display the analog voltage A/D value across terminals 2-5 in %.
(To change to 1000r/min)

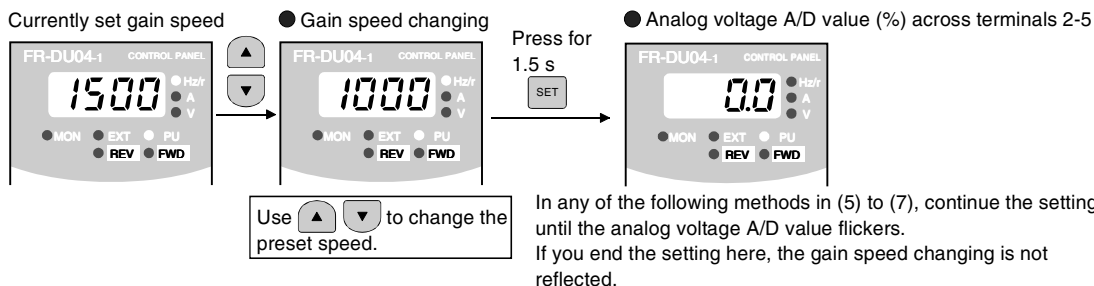

- When not adjusting the gain voltage → To (5)-1
- When adjusting any point by application of voltage → To (5)-2
- When adjusting any point without application of voltage → To (5)-3

(5)-1 Method to adjust only the gain speed and not to adjust the voltage

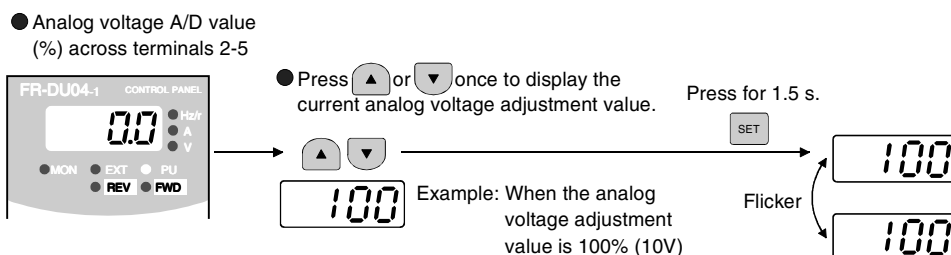

(5)-2 Method to adjust any point by application of voltage to across terminals 2-5 (e.g. applied from external potentiometer)

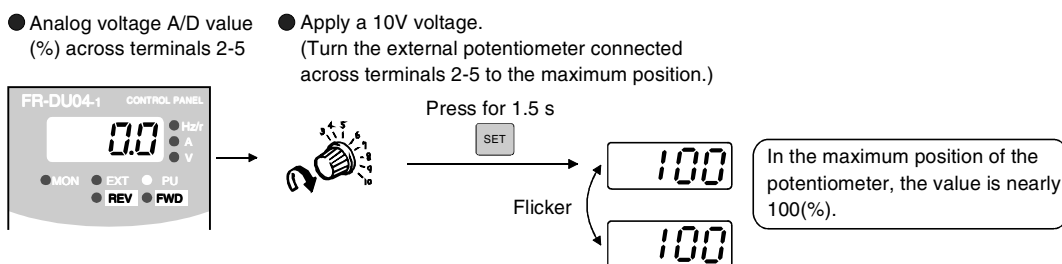

(5)-3 Method to adjust any point without application of voltage to across terminals 2-5 (To change from 80% to 100%)

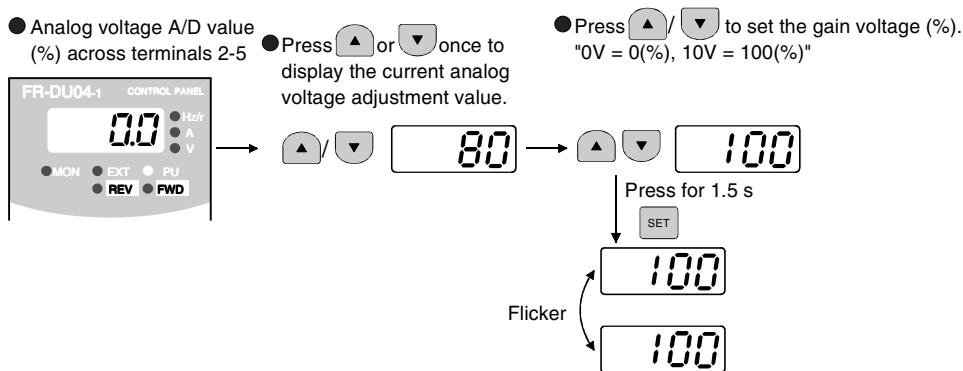

(6) Pressing SET shifts to the next parameter.

(7) Re-set the Pr. 79 "operation mode selection" value according to the operation mode being used.

CAUTION

1. Changing the Pr. 903 or Pr. 905 (gain adjustment) value will not change the Pr. 20 "acceleration/deceleration reference speed" value. (Refer to page 59 for Pr. 20.) The input of terminal 1 (speed setting auxiliary input) is added to the speed setting signal.
2. For the operation procedure using the parameter unit (FR-PU04V), refer to the FR-PU04V instruction manual.
3. When applying voltage for calibration, the difference of the set input voltage of bias and gain should be 5% or more. If the difference is 5% or less, a setting error will occur.

⚠ CAUTION

⚠ Take care when setting any value other than "0" as the bias speed at 0V. Even if a speed command is not given, merely turning on the start signal will start the motor at the preset speed.

5 PARAMETERS

5.1 Function list (Simple mode parameters)

5.1.1 Simple mode parameter list (Japanese version)

Function	Parameter	Name	Setting Range	Minimum Setting Increments	Factory Setting	Reference Page	Customer Setting	At-a-glance Guide to Functions		
								<ul style="list-style-type: none"> ○: Usable function ×: Unusable function *: Functions that can be used for parameter-set position feed forward function 		
								Vector Control		
			Speed control	Torque control	Position control					
Basic functions	1	Maximum speed	0 to 3600r/min	1r/min	1500r/min	56		○	○	○
	2	Minimum speed	0 to 3600r/min	1r/min	0r/min	56		○	○	
	4	Multi-speed setting (high speed)	0 to 3600r/min	1r/min	1500r/min	56		○	○	*
	5	Multi-speed setting (middle speed)	0 to 3600r/min	1r/min	750r/min	56		○	○	*
	6	Multi-speed setting (low speed)	0 to 3600r/min	1r/min	150r/min	56		○	○	*
	7	Acceleration time	0 to 3600s/ 0 to 360s	0.1s/0.01s	15s	56		○	○	*
	8	Deceleration time	0 to 3600s/ 0 to 360s	0.1s/0.01s	15s	56		○	○	*
	Operation selection functions	77	Parameter write disable selection	0,1,2	1	0	57		○	○
79		Operation mode selection	0 to 4,6 to 8	1	0	58		○	○	○
Auto tuning	95	Online auto tuning selection	0,1,2	1	0	50		○	○	○
Additional function	160	Extended function selection	0,1	1	0	58		○	○	○
Operation selection function	800	Control system selection	0 to 5, 20	1	0	58		○	○	○
Control system functions	818	Easy gain tuning response level setting	1 to 15	1	2	47		○		○
	819	Easy gain tuning selection	0,1,2	1	0	47		○		○

REMARKS

By setting "1" in Pr. 160 "extended function selection", the extended function parameters are made valid. (Refer to page 58).

5.1.2 Simple mode parameter list (NA version)

Function	Parameter	Name	Setting Range	Minimum Setting Increments	Factory Setting	Reference Page	Customer Setting	At-a-glance Guide to Functions		
								○: Usable function	×: Unusable function	*: Functions that can be used for parameter-set position feed forward function
								Vector Control		
								Speed control	Torque control	Position control
Basic functions	1	Maximum speed	0 to 3600r/min	1r/min	1800r/min	56		○	○	○
	2	Minimum speed	0 to 3600r/min	1r/min	0r/min	56		○	○	
	4	Multi-speed setting (high speed)	0 to 3600r/min	1r/min	1800r/min	56		○	○	*
	5	Multi-speed setting (middle speed)	0 to 3600r/min	1r/min	750r/min	56		○	○	*
	6	Multi-speed setting (low speed)	0 to 3600r/min	1r/min	150r/min	56		○	○	*
	7	Acceleration time	0 to 3600s/ 0 to 360s	0.1s/0.01s	15s	56		○	○	*
	8	Deceleration time	0 to 3600s/ 0 to 360s	0.1s/0.01s	15s	56		○	○	*
	9	Electronic thermal O/L relay	0 to 3600A	0.1A	Rated inverter output current	56		○	○	○
	Operation selection functions	71	Applied motor	0,3 to 8,10, 13 to 18, 20, 23, 24, 30, 33, 34	1	0	57		○	○
77		Parameter write disable selection	0,1,2	1	0	57		○	○	○
79		Operation mode selection	0 to 4,6 to 8	1	0	58		○	○	○
Motor constants	80	Motor capacity	0 to 3600kW	0.1kW	Inverter capacity	7		○	○	○
	81	Number of motor poles	2,4,6	1	4	7		○	○	○
	83	Rated motor voltage	0 to 1000V	0.1V	200V/400V	7		○	○	○
	84	Rated motor frequency	20 to 200Hz	0.01Hz	60Hz	7		○	○	○
Auto tuning	95	Online auto tuning selection	0,1,2	1	0	51		○	○	○
	96	Auto tuning setting/status	0,1,101	1	0	7		○	○	○
Additional function	160	Extended function selection	0,1	1	0	58		○	○	○
Operation selection function	800	Control system selection	0 to 5, 20	1	0	58		○	○	○
Control system functions	818	Easy gain tuning response level setting	1 to 15	1	2	48		○		○
	819	Easy gain tuning selection	0,1,2	1	0	48		○		○

REMARKS

By setting "1" in Pr. 160 "extended function selection", the extended function parameters are made valid. (Refer to page 58).

Function list (Simple mode parameters)

5.1.3 Explanation of simple mode parameters

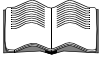

Refer to the separately available Instruction Manual (detailed) for details.

Pr. 1 "maximum speed", Pr. 2 "minimum speed"

- You can clamp the upper and lower limits of the output speed.

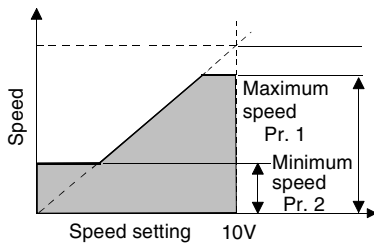

⚠ CAUTION

- Note that when you have set the minimum speed, merely turning on the start signal will start the motor at the preset speed, without the input of the speed command, according to the acceleration time setting.**

Pr. 7 "acceleration time", Pr. 8 "deceleration time"

- The time taken to reach the Pr. 20 acceleration/ deceleration reference speed (factory-set to 1500r/min <1800r/min : NA>) from 0r/min is set as the acceleration time, and the time taken to reach 0r/min from the Pr. 20 (factory-set to 1500r/min <1800r/min : NA>) speed is set as the deceleration time.

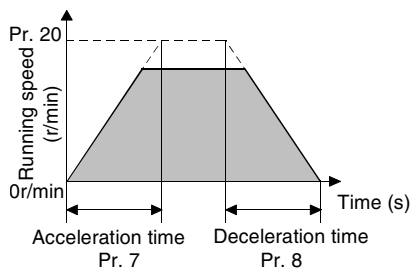

Pr. 4 "multi-speed setting (high speed)" Pr. 5 "multi-speed setting (middle speed)" Pr. 6 "multi-speed setting (low speed)"

- You can select any speed (RH, RM, RL) by simply switching the external contact signal.

	RH	RM	RL
High speed	ON	OFF	OFF
Middle speed	OFF	ON	OFF
Low speed	OFF	OFF	ON

- You can also set each speed to any value within the range of 0 to 3600r/min during inverter operation.
- Using the extended function, you can set up to 15 speeds.



Refer to the Instruction Manual (detailed) for the setting method.

Pr. 9 "electronic thermal O/L relay" (Japanese version : Extended function parameter)

- You can set a current value for protection of the motor from overheat.
- Normally set the rated motor current to 50Hz. If the rated current of 50Hz is not printed on the plate, set the value obtained from multiplying the rated current of 60Hz by 1.1.
- Setting "0" in Pr. 9 disables electronic thermal O/L relay (motor protective function). (Protective function of the inverter output transistor is activated.)

**Pr. 71 "applied motor"
(Japanese version : Extended function parameter)**

● Refer to the following table and set this parameter according to the motor used.

Setting	Motor	Control Constants
0	Mitsubishi standard motor (SF-LHA)	Inverter internal constants
3	Other manufacturer's motor	Offline auto tuning
4		Offline auto tuning data utilization
5		Star connection direct input
6		Delta connection direct input
7		Star connection direct input + offline auto tuning
8		Delta connection direct input + offline auto tuning
10	Japanese version Mitsubishi constant-torque motor (SF-LHCA) NA version Marathon constant-torque motor (Blue Max® 2000)	Inverter internal constants
13	Other manufacturer's motor	Offline auto tuning
14		Offline auto tuning data utilization
15		Star connection direct input
16		Delta connection direct input
17		Star connection direct input + offline auto tuning
18		Delta connection direct input + offline auto tuning
20	SF-VH	Inverter internal constants
23		Offline auto tuning
24		Offline auto tuning data utilization
30	SF-THY	Inverter internal constants
33		Offline auto tuning
34		Offline auto tuning data utilization

Pr. 77 "parameter write disable selection"

● You can select whether write to various parameters can be performed or not. Use this function to prevent parameter values from being rewritten by misoperation.

Setting	Description
0	Parameter write can be performed. (Write is enabled only during a stop in the PU operation mode.)
1	Parameter write cannot be performed. (Write to Pr. 22, Pr. 75, Pr. 77 and Pr. 79 "operation mode selection" is enabled.)
2	Write during operation is enabled.





REMARKS

- Parameters below are write-enabled during operation even when Pr. 77="0".
Pr. 4 to Pr. 6, Pr. 22, Pr. 24 to Pr. 27, Pr. 52 to Pr. 56, Pr. 75, Pr. 77, Pr. 129, Pr. 130, Pr. 133, Pr. 134, Pr. 158, Pr. 160, Pr. 232 to Pr. 240, Pr. 496, Pr. 497, Pr. 805, Pr. 806, Pr. 866, Pr. 900, Pr. 901 and Pr. 990.
- Parameters below are write-enabled even when Pr. 77="1".
Pr. 22, Pr. 75, Pr. 77 and Pr. 79
- Parameters below are write-disabled during operation even when Pr. 77="2".
Pr. 60, Pr. 71, Pr. 72, Pr. 79, Pr. 80 to Pr. 84, Pr. 90 to Pr. 96, Pr. 180 to Pr. 183, Pr. 187, Pr. 190 to Pr. 192, Pr. 195, Pr. 450, Pr. 451, Pr. 453, Pr. 454, Pr. 800, Pr. 819, Pr. 849, Pr. 851, Pr. 852 Pr. 859 and Pr. 868

Function list (Simple mode parameters)

Pr. 79 "operation mode selection"

- The inverter operation mode can be changed as desired between operation using external signals (external operation), operation from the PU (FR-DU04-1/FR-PU04V), combined operation of PU operation and external operation (external/PU combined operation), and computer link operation (when the FR-A5NR option is used).

Pr. 79 Setting	Function		
0	At power-on, the inverter is in the external operation mode. Operation can be performed by switching between PU and external operation.		
1	PU operation mode		
2	External operation mode		
3	External/PU combined operation mode 1	Speed command	Start command
		Set from the PU (FR-DU04-1/FR-PU04V) (direct setting,  / ) or external signal input (multi-speed setting only)	External signal input (terminal STF, STR)
4	External/PU combined operation mode 2	Speed command	Start command
		External signal input (terminal 2, 1, jog, multi-speed selection)	Input from the PU (FR-DU04-1/FR-PU04V) (start command using  , )
6	Switch-over mode Switch-over between PU operation, external operation, and computer link operation (when the FR-A5NR or any other communication option is used) can be done while running.		
7	External operation mode (PU operation interlock) X12 signal ON May be switched to PU operation mode (output stop during external operation) X12 signal OFF..... Switching to PU operation mode inhibited		
8	Operation mode switching by the external signal (disallowed during operation) X16 signal ON Switched to external operation mode X16 signal OFF..... Switched to PU operation mode		

- Refer to the Instruction Manual (detailed) for details.

Pr. 80 "motor capacity", Pr. 81 "number of motor poles", Pr. 83 "rated motor voltage", Pr. 84 "rated motor frequency", Pr. 96 "auto tuning setting/status" (Japanese version : Extended function parameter)

- Refer to page 7 for details.

Pr. 95 "online auto tuning selection"

- Refer to page 50 for details.

Pr. 160 "extended function display selection"

- Set this parameter to display/set the extended function parameters.

Setting	Description
0	Only the simple mode parameters are displayed.
1	All parameters are displayed.

REMARKS

Refer to page 59 for the parameters (extended function parameters) available when "1" is set in Pr. 160 "extended function display selection".

Pr. 800 "control system selection"

- Select the inverter control system such as speed control, torque control or position control.

Setting	Drive System	Control Method	Remarks
0 (factory setting)	PLG vector control	Speed control	Factory setting
1		Torque control	—
2		Speed control-torque control switchover	MC ON: Torque control MC OFF: Speed control
3		Position control	—
4		Speed control-position control switchover	MC ON: Position control MC OFF: Speed control
5		Position control-torque control switchover	MC ON: Torque control MC OFF: Position control
20	V/F control	Speed control	—

Related parameters

MC signal terminal assignment → Set "26" in any of Pr. 180 to Pr. 183 and Pr. 187 (input terminal function selection). (Refer to page 65.)

REMARKS

Set the control system selection of the second motor in Pr. 451 "second motor control method selection". Refer to the Instruction Manual (detailed) for details.

Pr. 818 "easy gain tuning response level setting", Pr. 819 "easy gain tuning"

- Refer to page 47 for details.

5.2 Function list (Extended function parameters)

54 for the function list of simple mode parameters.

The extended function parameters are made valid by setting "1" in Pr. 160 "extended function selection".

(Refer to page 31 for the setting method and to the Instruction Manual (detailed) for details.)

Function	Parameter	Name	Outline	Factory Setting (NA version)	Customer Setting	At-a-glance Guide to Functions		
						O: Usable function : Unusable function *: Functions that can be used for parameter-set position control		
						Vector Control		
						Speed control	Torque control	Position control
Basic functions	0	Torque boost (manual)	Made valid for V/F control. 0 to 30%	1%				
	1	Maximum speed	0 to 3600r/min	1500r/min (1800r/min)		○	○	○
	2	Minimum speed	0 to 3600r/min	0r/min		○	○	
	3	Base frequency	Made valid for V/F control. 20 to 200Hz	60Hz				
	4	Multi-speed setting (high speed)	0 to 3600r/min	1500r/min (1800r/min)		○	○	*
	5	Multi-speed setting (middle speed)	0 to 3600r/min	750r/min		○	○	*
	6	Multi-speed setting (low speed)	0 to 3600r/min	150r/min		○	○	*
	7	Acceleration time	0 to 3600s/ 0 to 360s	15s		○	○	*
	8	Deceleration time	0 to 3600s/ 0 to 360s	15s		○	○	*
9	Electronic thermal O/L relay	0 to 3600A	0A (Rated inverter output current)		○	○	○	
Standard operation functions	10	DC injection brake operation speed	Set the stopping accuracy of positioning operation or the like according to the load by adjusting the speed (0 to 1500r/min, 9999), time (0 to 0.5s) and voltage (0 to 30%) that are used to operate the braking torque at a motor stop for V/F control. (For vector control, these functions follow pre-excitation selection at not more than the speed in Pr. 10.)	15r/min		○	○	
	11	DC injection brake operation time		0.5s		○	○	
	12	DC injection brake voltage		1%				
	13	Starting speed	Set the speed at a start. 0 to 1500r/min	15r/min		○	○	
	15	Jog speed setting	Speed command (0 to 1500r/min) and acceleration/deceleration inclination (0 to 3600s/ 0 to 360s) for jog operation.	150r/min		○	○	
	16	Jog acceleration/ deceleration time		0.5s		○	○	
Operation selection functions	17	MRS input selection	0: Turning MRS on stops output, 2: Turning MRS off stops output	0		○	○	○
	19	Base frequency voltage	Made valid for V/F control. Represents the magnitude of the output voltage at the base frequency (Pr. 3). 8888: 95% of power supply voltage 9999: Same as power supply voltage 0 to 1000V, 8888, 9999	9999				
	20	Acceleration/ deceleration reference speed	Represents the speed to be referenced to increase or decrease the speed from or to 0r/min in the time preset as the acceleration (Pr. 7) or deceleration time (Pr. 8). 1 to 3600r/min	1500r/min (1800r/min)		○	○	*
	21	Acceleration/ deceleration time increments	0: 0.1s increments, 1: 0.01s increments	0		○	○	*
	22	Torque restriction level	You can set the level of torque restriction. 0 to 400%	150%		○		○
	24	Multi-speed setting (speed 4)	By setting a value other than "9999", set speeds 4 to 7. ON/OFF of the contact signals (RH, RM, RL signals) are combined to change the running speed in stages.	9999		○	○	*
	25	Multi-speed setting (speed 5)		9999		○	○	*
	26	Multi-speed setting (speed 6)		9999		○	○	*
27	Multi-speed setting (speed 7)	9999			○	○	*	
28	Multi-speed input compensation	The multiple speeds can be increased or overridden for compensation. 0: Without compensation 1: With compensation		0		○	○	



Function list (Extended function parameters)

Function	Parameter	Name	Outline	Factory Setting (NA version)	Customer Setting	At-a-glance Guide to Functions		
						: Usable function		
						* : Functions that can be used for parameter-set position control		
						Vector Control		
						Speed control	Torque control	Position control
Operation selection functions	29	Acceleration/deceleration pattern	Determines the frequency changing pattern for acceleration/deceleration. 0: Linear acceleration/deceleration 1: S-pattern acceleration/deceleration A 2: S-pattern acceleration/deceleration B 3: Backlash compensation acceleration/deceleration 4: S-pattern acceleration/deceleration C	0		○	○	
	30	Regenerative function selection	Set when using the MT-BU5, MT-HC or MT-RC option for frequent start/stop operation. 0: Internal brake resistor, brake unit 1: Brake resistor (MT-BU5), power return converter (MT-RC) 2: High power factor converter (MT-HC)	0		○	○	○
	31	Speed jump 1A	Set the speed ranges you want to avoid during constant-speed operation to avoid resonance with the machine. 0 to 3600r/min, 9999	9999		○	○	
	32	Speed jump 1B		9999		○	○	
	33	Speed jump 2A		9999		○	○	
	34	Speed jump 2B		9999		○	○	
	35	Speed jump 3A		9999		○	○	
	36	Speed jump 3B		9999		○	○	
37	Speed display	You can set the speed as a machine speed. 0, 1 to 9998		0		○	○	○
Output terminal functions	41	Up-to-speed sensitivity	You can adjust the output signal on/off range when the output speed reaches the running speed. 0 to 100%	10%		○		
	42	Speed detection	You can adjust the speed detected. 0 to 3600r/min	300r/min		○	○	○
	43	Speed detection for reverse rotation	You can change the speed detection level for forward or reverse rotation in vertical lift, transfer and other applications. 0 to 3600r/min, 9999	9999		○	○	○
Second functions	44	Second acceleration/deceleration time	Second function of the acceleration/deceleration time set in Pr. 7, Pr. 8. 0 to 3600s/0 to 360s	5s		○	○	*
	45	Second deceleration time	Second function of the deceleration time set in Pr. 8. 0 to 3600s/0 to 360s, 9999	9999		○	○	*
Output terminal functions	50	Second speed detection	Set the speed at which the FB2 signal is output. 0 to 3600r/min	750r/min		○	○	○
Display functions	52	DU/PU main display data selection	You can select the DU/PU main display data. 0, 100: Speed, output current, output voltage, alarm display 5: Preset speed 6: Output frequency 7: Motor torque 8: Converter output voltage 9: Regenerative brake duty 10: Electronic thermal relay load factor 11: Output current peak value 12: Converter output voltage peak value 17: Load meter 18: Motor exciting current 19: Position pulse 20: Cumulative energization time 23: Actual operation time 24: Motor load factor 32: Torque command 33: Torque current command 34: Motor output 35: Feedback pulse 38: Trace status	0		○	○	○
	53	PU level display data selection	You can select the PU level display data. 0: No monitor 1: Speed 2: Output current 3: Output voltage 5: Preset speed 6: Output frequency 7: Motor torque 8: Converter output voltage 9: Regenerative brake duty 10: Electronic thermal relay load factor 11: Output current peak value 12: Converter output voltage peak value 17: Load meter 18: Motor exciting current	1		○	○	○

Function list (Extended function parameters)

Function	Parameter	Name	Outline	Factory Setting (NA version)	Customer Setting	At-a-glance Guide to Functions		
						: Usable function		
						* : Functions that can be used for parameter-set position control		
						Vector Control		
						Speed control	Torque control	Position control
Display functions	54	DA1 terminal function selection	You can select the monitor output DA1 data. 1: Speed 2: Output current 3: Output voltage 5: Preset speed 6: Output frequency 7: Motor torque 8: Converter output voltage 9: Regenerative brake duty 10: Electronic thermal relay load factor 11: Output current peak value 12: Converter output voltage peak value 17: Load meter 18: Motor exciting current 21: Reference output 32: Torque command 33: Torque current command 34: Motor output 36: Torque monitor (driving/regenerative polarity switching)	1		○	○	○
	55	Speed monitoring reference	You can set the reference value of speed monitoring. 0 to 3600r/min	1800r/min		○	○	○
	56	Current monitoring reference	You can set the reference value of current monitoring. 0 to 3600A	Rated inverter output current		○	○	○
Automatic restart	57	Restart coasting time	When power is restored after an instantaneous power failure, you can start the inverter without stopping the motor (in a coasting status). When this time (Pr. 57) elapses after power was restored, the inverter begins to restart.	9999		○	○	
	58	Restart cushion time	When you set "9999", the inverter will not restart. Generally, you may set "0", but you can adjust the time (0, 0.1 to 30s, 9999) according to the load magnitude. When the restart coasting time (Pr. 57) elapses, the output voltage is risen gradually. Set this cushion time (Pr. 58) (0 to 60s). Normally, you can perform operation with the factory settings, but you can adjust them according to the load magnitude. Pr. 58 is valid only during V/F control.	1.0s				
Additional function	59	Remote setting function selection	You can make remote setting of the speed when the operation panel is located away from the control box. 0: None 1: With remote setting function, with frequency setting storage function 2: With remote setting function, without frequency setting storage function 3: With remote setting function, without frequency setting storage function (Turning STF/STR off clears remote setting)	0		○	○	
Operation selection functions	60	Intelligent mode selection	Set when using the brake sequence control. 0: Normal operation mode 7: Brake sequence mode (With mechanical brake opening completion signal input) 8: Brake sequence mode (Without mechanical brake opening completion signal input)	0		○		
	65	Retry selection	You can select alarms for a retry to be made when the protective function is activated. 0:E.OC1 to 3, E.OV1 to 3, E.THM, E.THT, E.IPF, E.UVT, E.BF, E.GF, E.OHT, E.OLT, E.OPT, E.OP1 to 3, E.PE, E.OS, E.OSD, E.OD, E.MB1 to 7 1:E.OC1 to 3 2:E.OV1 to 3 3:E.OC1 to 3, E.OV1 to 3 4:E.OC1 to 3, E.OV1 to 3, E.IPF, E.UVT, E.BF, E.GF, E.OLT, E.OPT, E.OP1 to 3, E.PE, E.OS, E.OSD, E.OD, E. MB1 to 7 5:E.OC1, E.OC3	0		○	○	
	67	Number of retries at alarm occurrence	You can set the number of retries to be made when the protective function is activated. 0: Retry not made. 1 to 10: Without alarm output during retry operation 101 to 110: With alarm output during retry operation	0		○	○	
	68	Retry waiting time	You can set the waiting time from activation of the protective function to a retry. 0 to 10s	1s		○	○	
	69	Retry count display erasure	You can display the cumulative number of successful restarts made by retries when the protective function was activated. 0	0		○	○	
	70	Special regenerative brake duty	Set to increase the regenerative brake duty when the MT-BU5, MT-RC option is used. 0 to 10%	0%		○	○	○

Function list (Extended function parameters)

Function	Parameter	Name	Outline	Factory Setting (NA version)	Customer Setting	At-a-glance Guide to Functions							
						Vector Control							
						Speed control	Torque control	Position control					
Operation selection functions	71	Applied motor	0,3 to 8,10, 13 to 18, 20, 23, 24, 30, 33, 34	0		○	○	○					
	72	PWM frequency selection	You can change the motor sound 1	1		○	○	○					
	73	Speed setting signal	You can set the input specifications of terminals 1 and 2 and whether to use the override function or not.		0		○	○					
			Pr. 73 Setting	Control Mode						Function		Terminal 1 (0 to ±10V)	Terminal 2 (0 to 10V)*3
			0	Speed control						×	×	Addition auxiliary Speed command *1	Main speed setting
			4							○*2	×	Main speed setting	Override signal
			10							×	○	Addition auxiliary Speed command *1	Main speed setting
			14							○*2	○	Main speed setting	Override signal
			0	Torque control						×	×	Addition auxiliary Speed restriction	Speed restriction
			4							○*4	×	Speed restriction	Override signal
10			×							×	Addition auxiliary Speed restriction	Speed restriction	
14	○*4	×	Speed restriction		Override signal								
0, 4, 10, 14	Position control	No function		No function	No function								
		*1 The value of terminal 1 (speed setting auxiliary input) is added to the main speed setting signal of terminal 2. *2 When override has been selected, terminal 1 acts as the main speed setting and terminal 2 acts as the override signal (50 to 150% at 0 to 10V). *3 When "30" or "31" is set in Pr. 128, terminal 2 acts as the PID set point function. *4 When override has been selected, terminal 1 acts as speed restriction and terminal 2 acts as the override signal.											
75	Reset selection/disconnected PU detection/PU stop selection	You can select the reset input acceptance, disconnected PU detection function and PU stop function.		14		○	○	○					
		Pr. 75 Setting	Reset Selection						Disconnected PU Detection	PU Stop Selection			
		0	Reset input is always enabled.						If the PU is disconnected, operation will be continued.	Pressing  decelerates the motor to a stop only in the PU operation mode.			
		1	Reset input is enabled only when the protective function is activated.										
		2	Reset input is always enabled.						When the PU is disconnected, the inverter output is shut off.	Pressing  decelerates the motor to a stop in any of the PU, external and communication operation modes.			
		3	Reset input is enabled only when the protective function is activated.										
		14	Reset input is always enabled.						If the PU is disconnected, operation will be continued.				
		15	Reset input is enabled only when the protective function is activated.										
16	Reset input is always enabled.	When the PU is disconnected, the inverter output is shut off.											
17	Reset input is enabled only when the protective function is activated.												
77	Parameter write disable selection	0,1,2	0		○	○	○						
78	Reverse rotation prevention selection	You can prevent any reverse rotation fault resulting from the mis-input of the start signal. 0: Both forward rotation and reverse rotation enabled, 1: Reverse rotation disabled, 2: Forward rotation disabled	0		○	○	○						
79	Operation mode selection	0 to 4,6 to 8	0		○	○	○						
Motor constants	80	Motor capacity	0 to 3600kW	Inverter capacity		○	○	○					
	81	Number of motor poles	2,4,6	4		○	○	○					
	82	Motor excitation current (no load current)	Used for tuning data utilization or direct input.	9999		○	○	○					
	83	Rated motor voltage	0 to 1000V	200V/400V		○	○	○					
	84	Rated motor frequency	20 to 200Hz	60Hz		○	○	○					
	90	Motor constant R1	Used for tuning data utilization or direct input.	9999		○	○	○					
	91	Motor constant R2		9999		○	○	○					
	92	Motor constant L1		9999		○	○	○					
	93	Motor constant L2		9999		○	○	○					
	94	Motor constant X		9999		○	○	○					
95	Online auto tuning selection	0,1,2		0		○	○	○					
96	Auto tuning setting/status	0,1,101	0		○	○	○						

Function list (Extended function parameters)

Function	Parameter	Name	Outline	Factory Setting (NA version)	Customer Setting	At-a-glance Guide to Functions		
						Vector Control		
						Speed control	Torque control	Position control
Third functions	110	Third acceleration/deceleration time	Third function of acceleration/deceleration time set in Pr. 7, Pr. 8 0 to 3600/0 to 360s	5s		○	○	*
	111	Third deceleration time	Third function of deceleration time set in Pr. 8 0 to 3600/0 to 360s, 9999	9999		○	○	*
Output terminal functions	116	Third speed detection	Set the speed at which the FB3 signal is output. 0 to 3600r/min	1500r/min (1800r/min)		○	○	○
Communication functions	117	Station number	Station number setting for performing communication operation from the PU connector using a computer link. 0 to 31: Specify the station number of the inverter.	0		○	○	○
	118	Communication speed	48:4800bps 96:9600bps 192:19200bps	192		○	○	○
	119	Stop bit length/data length	0: Stop bit length 1 bit/data length 8 1: Stop bit length 2 bits/data length 8 10: Stop bit length 1 bit/data length 7 11: Stop bit length 2 bits/data length 7	1		○	○	○
	120	Parity check presence/absence	0: None 1: With odd parity check 2: With even parity check	2		○	○	○
	121	Number of communication retries	Set the permissible number of retries at data receive error occurrence. When you set "9999", the inverter will not make an alarm stop if a communication error occurs. 0 to 10, 9999	1		○	○	○
	122	Communication check time interval	Set the communication check time interval. If communication continues for longer than the set time, the inverter will come to an alarm stop. 0: No communication 0.1 to 999.8s: Communication check time interval 9999: Check stop When making communication, set any value other than 0 as the communication check time interval.	0 (9999)		○	○	○
	123	Waiting time setting	Set the waiting time between data transmission to the inverter and response. 0 to 150ms 9999: Make setting using communication data.	9999		○	○	○
	124	CR, LF presence/absence selection	0: Without CR/LF, 1: With CR/without LF, 2: With CR/LF CAUTION After setting the parameter, make a reset. The setting is reflected after the reset is made. (Pr. 117 to Pr. 120, Pr. 123, Pr. 124)	1		○	○	○
PID control	128	PID action selection	Select the action of PID control. 10, 11, 30, 31	10		○		
	129	PID proportional band	Set the proportional band for PID control. 0.1 to 1000%, 9999	100%		○		
	130	PID integral time	Set the integral time for PID control. 0.1 to 3600s, 9999	1s		○		
	131	Upper limit	Set the upper limit value for PID control. 0 to 100%, 9999	9999		○		
	132	Lower limit	Set the lower limit value for PID control. 0 to 100%, 9999	9999		○		
	133	PID action set point for PU operation	Set the PID action set point value for PU operation. 0 to 100%	0%		○		
	134	PID differential time	Set the PID differential time for PID control. 0.01 to 10s, 9999	9999		○		
Backlash	140	Backlash acceleration stopping speed		30r/min		○	○	
	141	Backlash acceleration stopping time	Used for measures against the backlash of reduction gear, etc. Acceleration stopping speed (0 to 3600r/min) Acceleration stopping time (0 to 360s)	0.5s		○	○	
	142	Backlash deceleration stopping speed	Deceleration stopping speed (0 to 3600r/min) Deceleration stopping time (0 to 360s)	30r/min		○	○	
	143	Backlash deceleration stopping time		0.5s		○	○	
Display functions	144	Speed setting switchover	Set the number of motor poles when displaying the motor speed. When Pr. 37 = 0 0, 2, 4, 6, 8, 10	0		○	○	○
	145	Parameter for the option (FR-PU04V)						

Function list (Extended function parameters)

Function	Parameter	Name	Outline	Factory Setting (NA version)	Customer Setting	At-a-glance Guide to Functions																																																																																																			
						O: Usable function : Unusable function * : Functions that can be used for parameter-set position control																																																																																																			
						Vector Control																																																																																																			
						Speed control	Torque control	Position control																																																																																																	
Current detection	150	Output current detection level	Set when outputting the output current detection signal. 0 to 200% (Pr.150)	150%		<input type="radio"/>	<input type="radio"/>	<input type="radio"/>																																																																																																	
	151	Output current detection time	0 to 10s (Pr. 151)	0		<input type="radio"/>	<input type="radio"/>	<input type="radio"/>																																																																																																	
	152	Zero current detection level	Set when outputting the zero current detection signal. 0 to 200.0% (Pr.152)	5.0%		<input type="radio"/>	<input type="radio"/>	<input type="radio"/>																																																																																																	
	153	Zero current detection time	0 to 1s (Pr. 153)	0.5s		<input type="radio"/>	<input type="radio"/>	<input type="radio"/>																																																																																																	
Sub functions	156	Stall prevention operation selection	You can make setting to prevent the inverter from an overcurrent trip (prevent the fast-response current restriction from being activated) and/or set the OL signal output delay if stall prevention is activated by an overcurrent or an excessive current flows due to sudden fluctuation of load, ON-OFF of the running inverter output side or the like.	1		<input type="radio"/>	<input type="radio"/>	<input type="radio"/>																																																																																																	
									<table border="1"> <thead> <tr> <th>Setting</th> <th>Fast-Response Current Restriction O: Activated ●: Not activated</th> <th>OL Signal Output O: Operation continued ●: Operation not continued</th> </tr> </thead> <tbody> <tr><td>0</td><td><input type="radio"/></td><td><input type="radio"/></td></tr> <tr><td>1</td><td><input checked="" type="radio"/></td><td><input type="radio"/></td></tr> <tr><td>2</td><td><input type="radio"/></td><td><input type="radio"/></td></tr> <tr><td>3</td><td><input checked="" type="radio"/></td><td><input type="radio"/></td></tr> <tr><td>4</td><td><input type="radio"/></td><td><input type="radio"/></td></tr> <tr><td>5</td><td><input checked="" type="radio"/></td><td><input type="radio"/></td></tr> <tr><td>6</td><td><input type="radio"/></td><td><input type="radio"/></td></tr> <tr><td>7</td><td><input checked="" type="radio"/></td><td><input type="radio"/></td></tr> <tr><td>8</td><td><input type="radio"/></td><td><input type="radio"/></td></tr> <tr><td>9</td><td><input checked="" type="radio"/></td><td><input type="radio"/></td></tr> <tr><td>10</td><td><input type="radio"/></td><td><input type="radio"/></td></tr> <tr><td>11</td><td><input checked="" type="radio"/></td><td><input type="radio"/></td></tr> <tr><td>12</td><td><input type="radio"/></td><td><input type="radio"/></td></tr> <tr><td>13</td><td><input checked="" type="radio"/></td><td><input type="radio"/></td></tr> <tr><td>14</td><td><input type="radio"/></td><td><input type="radio"/></td></tr> <tr><td>15</td><td><input checked="" type="radio"/></td><td><input type="radio"/></td></tr> <tr><td>16</td><td><input type="radio"/></td><td><input checked="" type="radio"/></td></tr> <tr><td>17</td><td><input checked="" type="radio"/></td><td><input checked="" type="radio"/></td></tr> <tr><td>18</td><td><input type="radio"/></td><td><input checked="" type="radio"/></td></tr> <tr><td>19</td><td><input checked="" type="radio"/></td><td><input checked="" type="radio"/></td></tr> <tr><td>20</td><td><input type="radio"/></td><td><input checked="" type="radio"/></td></tr> <tr><td>21</td><td><input checked="" type="radio"/></td><td><input checked="" type="radio"/></td></tr> <tr><td>22</td><td><input type="radio"/></td><td><input checked="" type="radio"/></td></tr> <tr><td>23</td><td><input checked="" type="radio"/></td><td><input checked="" type="radio"/></td></tr> <tr><td>24</td><td><input type="radio"/></td><td><input checked="" type="radio"/></td></tr> <tr><td>25</td><td><input checked="" type="radio"/></td><td><input checked="" type="radio"/></td></tr> <tr><td>26</td><td><input type="radio"/></td><td><input checked="" type="radio"/></td></tr> <tr><td>27</td><td><input checked="" type="radio"/></td><td><input checked="" type="radio"/></td></tr> <tr><td>28</td><td><input type="radio"/></td><td><input checked="" type="radio"/></td></tr> <tr><td>29</td><td><input checked="" type="radio"/></td><td><input checked="" type="radio"/></td></tr> <tr><td>30</td><td><input type="radio"/></td><td><input checked="" type="radio"/></td></tr> <tr><td>31</td><td><input checked="" type="radio"/></td><td><input checked="" type="radio"/></td></tr> <tr><td>100</td><td>Driving Regeneration</td><td><input type="radio"/> <input type="radio"/></td></tr> <tr><td>101</td><td>Driving Regeneration</td><td><input checked="" type="radio"/> <input type="radio"/></td></tr> </tbody> </table>	Setting	Fast-Response Current Restriction O: Activated ●: Not activated	OL Signal Output O: Operation continued ●: Operation not continued	0	<input type="radio"/>	<input type="radio"/>	1	<input checked="" type="radio"/>	<input type="radio"/>	2	<input type="radio"/>	<input type="radio"/>	3	<input checked="" type="radio"/>	<input type="radio"/>	4	<input type="radio"/>	<input type="radio"/>	5	<input checked="" type="radio"/>	<input type="radio"/>	6	<input type="radio"/>	<input type="radio"/>	7	<input checked="" type="radio"/>	<input type="radio"/>	8	<input type="radio"/>	<input type="radio"/>	9	<input checked="" type="radio"/>	<input type="radio"/>	10	<input type="radio"/>	<input type="radio"/>	11	<input checked="" type="radio"/>	<input type="radio"/>	12	<input type="radio"/>	<input type="radio"/>	13	<input checked="" type="radio"/>	<input type="radio"/>	14	<input type="radio"/>	<input type="radio"/>	15	<input checked="" type="radio"/>	<input type="radio"/>	16	<input type="radio"/>	<input checked="" type="radio"/>	17	<input checked="" type="radio"/>	<input checked="" type="radio"/>	18	<input type="radio"/>	<input checked="" type="radio"/>	19	<input checked="" type="radio"/>	<input checked="" type="radio"/>	20	<input type="radio"/>	<input checked="" type="radio"/>	21	<input checked="" type="radio"/>	<input checked="" type="radio"/>	22	<input type="radio"/>	<input checked="" type="radio"/>	23	<input checked="" type="radio"/>	<input checked="" type="radio"/>	24	<input type="radio"/>	<input checked="" type="radio"/>	25	<input checked="" type="radio"/>	<input checked="" type="radio"/>	26	<input type="radio"/>	<input checked="" type="radio"/>	27	<input checked="" type="radio"/>	<input checked="" type="radio"/>	28	<input type="radio"/>	<input checked="" type="radio"/>	29	<input checked="" type="radio"/>	<input checked="" type="radio"/>	30	<input type="radio"/>	<input checked="" type="radio"/>
Setting	Fast-Response Current Restriction O: Activated ●: Not activated	OL Signal Output O: Operation continued ●: Operation not continued																																																																																																							
0	<input type="radio"/>	<input type="radio"/>																																																																																																							
1	<input checked="" type="radio"/>	<input type="radio"/>																																																																																																							
2	<input type="radio"/>	<input type="radio"/>																																																																																																							
3	<input checked="" type="radio"/>	<input type="radio"/>																																																																																																							
4	<input type="radio"/>	<input type="radio"/>																																																																																																							
5	<input checked="" type="radio"/>	<input type="radio"/>																																																																																																							
6	<input type="radio"/>	<input type="radio"/>																																																																																																							
7	<input checked="" type="radio"/>	<input type="radio"/>																																																																																																							
8	<input type="radio"/>	<input type="radio"/>																																																																																																							
9	<input checked="" type="radio"/>	<input type="radio"/>																																																																																																							
10	<input type="radio"/>	<input type="radio"/>																																																																																																							
11	<input checked="" type="radio"/>	<input type="radio"/>																																																																																																							
12	<input type="radio"/>	<input type="radio"/>																																																																																																							
13	<input checked="" type="radio"/>	<input type="radio"/>																																																																																																							
14	<input type="radio"/>	<input type="radio"/>																																																																																																							
15	<input checked="" type="radio"/>	<input type="radio"/>																																																																																																							
16	<input type="radio"/>	<input checked="" type="radio"/>																																																																																																							
17	<input checked="" type="radio"/>	<input checked="" type="radio"/>																																																																																																							
18	<input type="radio"/>	<input checked="" type="radio"/>																																																																																																							
19	<input checked="" type="radio"/>	<input checked="" type="radio"/>																																																																																																							
20	<input type="radio"/>	<input checked="" type="radio"/>																																																																																																							
21	<input checked="" type="radio"/>	<input checked="" type="radio"/>																																																																																																							
22	<input type="radio"/>	<input checked="" type="radio"/>																																																																																																							
23	<input checked="" type="radio"/>	<input checked="" type="radio"/>																																																																																																							
24	<input type="radio"/>	<input checked="" type="radio"/>																																																																																																							
25	<input checked="" type="radio"/>	<input checked="" type="radio"/>																																																																																																							
26	<input type="radio"/>	<input checked="" type="radio"/>																																																																																																							
27	<input checked="" type="radio"/>	<input checked="" type="radio"/>																																																																																																							
28	<input type="radio"/>	<input checked="" type="radio"/>																																																																																																							
29	<input checked="" type="radio"/>	<input checked="" type="radio"/>																																																																																																							
30	<input type="radio"/>	<input checked="" type="radio"/>																																																																																																							
31	<input checked="" type="radio"/>	<input checked="" type="radio"/>																																																																																																							
100	Driving Regeneration	<input type="radio"/> <input type="radio"/>																																																																																																							
101	Driving Regeneration	<input checked="" type="radio"/> <input type="radio"/>																																																																																																							
	157	OL signal output timer	Set whether to output the overload alarm signal (OL signal) immediately or after a preset period of time when an overload status has occurred. 0 to 25s, 9999	0		<input type="radio"/>	<input type="radio"/>	<input type="radio"/>																																																																																																	
Display functions	158	DA2 terminal function selection	Select the monitor output DA2 data. 1: Speed 2: Output current 3: Output voltage 5: Preset speed 6: Output frequency 7: Motor torque 8: Converter output voltage 9: Regenerative brake duty 10: Electronic thermal relay load factor 11: Output current peak value 12: Converter output voltage peak value 17: Load meter 18: Motor excitation current 21: Reference output 32: Torque command 33: Torque current command 34: Motor output 36: Torque monitor (driving/regenerative polarity switching)	1		<input type="radio"/>	<input type="radio"/>	<input type="radio"/>																																																																																																	
		160	Extended function selection	0,1	0		<input type="radio"/>	<input type="radio"/>	<input type="radio"/>																																																																																																

Function list (Extended function parameters)

Function	Parameter	Name	Outline	Factory Setting (NA version)	Customer Setting	At-a-glance Guide to Functions		
						Vector Control		
						Speed control	Torque control	Position control
Automatic restart after instantaneous power failure	162	Automatic restart after instantaneous power failure selection	Valid during V/F control You can select the method for automatic restart after instantaneous power failure. 0: With speed search 1: Without speed search 10: Speed search initiated per start	0				
	163	First cushion time for restart	Set the first cushion time for restart (0 to 20s), first cushion voltage for restart (0 to 100%) and restart current restriction level (0 to 200%) when a slight overload status has occurred at an automatic restart after instantaneous power failure.	0s				
	164	First cushion voltage for restart		0%				
	165	Restart current restriction level		150%				
Maintenance functions	168	Maker setting parameters. Do not make setting.						
	169							
Initial monitor	171	Actual operation hour meter clear	You can clear the actual operation hour meter.	0		○	○	○
Terminal assignment functions	180	DI1 terminal function selection	You can select the following input signals. 0: RL (multi-speed low-speed operation command) → Pr. 180 factory setting 1: RM (multi-speed middle-speed operation command) → Pr. 181 factory setting 2: RH (multi-speed high-speed operation command) → Pr. 182 factory setting 3: RT (second function selection) → Pr. 183 factory setting 5: JOG (jog operation selection) 8: REX (multi-speed 15 speeds selection) 9: X9 (third function selection) 10: X10 (MT-HC connection (inverter run enable signal)) 11: X11 (MT-HC connection (instantaneous power failure detection)) 12: X12 (PU operation external interlock) 14: X14 (PID control valid) 15: BRI (brake release completion signal) 16: X16 (PU operation-external operation switching) 20: X20 (S-pattern acceleration/deceleration C switching terminal) 22: X22 (orientation command) 23: LX (pre-excitation/servo on) 24: MRS (output stop) 25: STOP (start self-holding selection) 26: MC (control mode switching) 27: TL (torque restriction selection) 42: X42 (torque bias selection 1) 43: X43 (torque bias selection 2) 44: X44 (P control selection (P/PI control switching)) 9999: No function (STR when set in Pr. 187)	0		○	○	○
	181	DI2 terminal function selection		1		○	○	○
	182	DI3 terminal function selection		2		○	○	○
	183	DI4 terminal function selection		3		○	○	○
	187	STR terminal function selection		9999		○	○	○
Terminal assignment functions	190	DO1 terminal function selection	You can select the following output signals. 0 (positive logic) → Pr. 190 factory setting, 100 (negative logic): RUN (inverter running) 1 (positive logic) → Pr. 191 factory setting, 101 (negative logic): SU (up to speed) 2 (positive logic) → Pr. 192 factory setting, 102 (negative logic): IPF (instantaneous power failure or undervoltage) 3 (positive logic), 103 (negative logic) : OL (overload alarm) 4 (positive logic), 104 (negative logic) : FU (output speed detection) 5 (positive logic), 105 (negative logic) : FU2 (second output speed detection) 6 (positive logic), 106 (negative logic) : FU3 (third output speed detection) 7 (positive logic), 107 (negative logic) : RBP (regenerative brake prealarm) 8 (positive logic), 108 (negative logic) : THP (electronic thermal alarm prealarm) 10 (positive logic), 110 (negative logic) : PU (PU operation mode) 11 (positive logic), 111 (negative logic) : RY (inverter operation ready) 12 (positive logic), 112 (negative logic) : Y12 (output current detection) 13 (positive logic), 113 (negative logic) : Y13 (zero current detection) 14 (positive logic), 114 (negative logic) : FDN (PID lower limit) 15 (positive logic), 115 (negative logic) : FUP (PID upper limit) 16 (positive logic), 116 (negative logic) : RL (PID forward/reverse rotation output) 20 (positive logic), 120 (negative logic) : BOF (brake opening request) 26 (positive logic), 126 (negative logic) : FIN (fin overheat prealarm) 27 (positive logic), 127 (negative logic) : ORA (orientation completion) 30 (positive logic), 130 (negative logic) : Y30 (forward rotation output) 31 (positive logic), 131 (negative logic) : Y31 (reverse rotation output) 32 (positive logic), 132 (negative logic) : Y32 (regenerative status output) 33 (positive logic), 133 (negative logic) : RY2 (operation ready 2) 34 (positive logic), 134 (negative logic) : LS (low speed output) 35 (positive logic), 135 (negative logic) : TU (torque detection) 36 (positive logic), 136 (negative logic) : Y36 (in-position) 37 (positive logic), 137 (negative logic) : MT (maintenance timer output) 40 (positive logic), 140 (negative logic) : Y40 (trace status) 41 (positive logic), 141 (negative logic) : FB (speed detection) 42 (positive logic), 142 (negative logic) : FB2 (second speed detection) 43 (positive logic), 143 (negative logic) : FB3 (third speed detection) 44 (positive logic), 144 (negative logic) : RUN2 (second inverter operating) 96 (positive logic), 196 (negative logic): REM (remote output) 97 (positive logic), 197 (negative logic) : ER (minor fault output 2) 98 (positive logic), 198 (negative logic) : LF (minor fault output) 99 (positive logic) → Pr. 195 factory setting, 199 (negative logic): ABC (alarm output) 9999: No function	0		○	○	○
	191	DO2 terminal function selection		1		○	○	○
	192	DO3 terminal function selection		2		○	○	○
	195	A,B,C terminal function selection		99		○	○	○

Function list (Extended function parameters)

Function	Parameter	Name	Outline	Factory Setting (NA version)	Customer Setting	At-a-glance Guide to Functions																																															
						O: Usable function *: Functions that can be used for parameter-set position control																																															
						Vector Control																																															
						Speed control	Torque control	Position control																																													
Multi-speed operation	232	Multi-speed setting (speed 8)	By setting any value other than "9999", set speeds 8 to 15. This function is designed to change the running speed in stages by changing the ON/OFF combination of the contact signals (RH, RM, RL, REX signals). <table border="1" style="margin: 10px auto;"> <thead> <tr> <th></th> <th>RH</th> <th>RM</th> <th>RL</th> <th>REX</th> </tr> </thead> <tbody> <tr> <td>Speed 8</td> <td>OFF</td> <td>OFF</td> <td>OFF</td> <td>ON</td> </tr> <tr> <td>Speed 9</td> <td>OFF</td> <td>OFF</td> <td>ON</td> <td>ON</td> </tr> <tr> <td>Speed 10</td> <td>OFF</td> <td>ON</td> <td>OFF</td> <td>ON</td> </tr> <tr> <td>Speed 11</td> <td>OFF</td> <td>ON</td> <td>ON</td> <td>ON</td> </tr> <tr> <td>Speed 12</td> <td>ON</td> <td>OFF</td> <td>OFF</td> <td>ON</td> </tr> <tr> <td>Speed 13</td> <td>ON</td> <td>OFF</td> <td>ON</td> <td>ON</td> </tr> <tr> <td>Speed 14</td> <td>ON</td> <td>ON</td> <td>OFF</td> <td>ON</td> </tr> <tr> <td>Speed 15</td> <td>ON</td> <td>ON</td> <td>ON</td> <td>ON</td> </tr> </tbody> </table>		RH	RM	RL	REX	Speed 8	OFF	OFF	OFF	ON	Speed 9	OFF	OFF	ON	ON	Speed 10	OFF	ON	OFF	ON	Speed 11	OFF	ON	ON	ON	Speed 12	ON	OFF	OFF	ON	Speed 13	ON	OFF	ON	ON	Speed 14	ON	ON	OFF	ON	Speed 15	ON	ON	ON	ON	9999		O	O	*
		RH		RM	RL	REX																																															
	Speed 8	OFF		OFF	OFF	ON																																															
	Speed 9	OFF		OFF	ON	ON																																															
	Speed 10	OFF		ON	OFF	ON																																															
	Speed 11	OFF		ON	ON	ON																																															
	Speed 12	ON		OFF	OFF	ON																																															
	Speed 13	ON		OFF	ON	ON																																															
Speed 14	ON	ON	OFF	ON																																																	
Speed 15	ON	ON	ON	ON																																																	
233	Multi-speed setting (speed 9)	9999		O	O	*																																															
234	Multi-speed setting (speed 10)	9999		O	O	*																																															
235	Multi-speed setting (speed 11)	9999		O	O	*																																															
236	Multi-speed setting (speed 12)	9999		O	O	*																																															
237	Multi-speed setting (speed 13)	9999		O	O	*																																															
238	Multi-speed setting (speed 14)	9999		O	O	*																																															
239	Multi-speed setting (speed 15)	0 to 3600r/min, 9999	9999		O	O	*																																														
Sub functions	240	Soft-PWM setting	You can select to exercise Soft-PWM control and long wiring mode. When Soft-PWM control is made valid, you can change the metallic tone of motor sound into an unoffending complex tone. Surge voltage is suppressed in the long wiring mode regardless of the wiring length between the inverter and motor. (When operating a 400V motor with wiring length of 40m or more, select long wiring mode.) 0: Soft-PWM control invalid, long wiring mode invalid 1: Soft-PWM control valid, long wiring mode invalid 10: Soft-PWM control invalid, long wiring mode valid (carrier frequency is 2.25Hz *) 11: Soft-PWM control valid, long wiring mode valid (carrier frequency is 2.25Hz *) *The Pr.72 "PWM frequency selection" setting is made invalid.	10		O	O	O																																													
	244	Cooling fan operation selection	You can control the operation of the cooling fan built in the inverter. 0: The fan is always operated at power-on of the inverter. 1: The fan is always on while the inverter is running. During a stop, the inverter status is monitored and the fan switches on-off according to the temperature.	0		O	O	O																																													
Stop selection function	250	Stop selection	Set to allow the motor to be coasted to a stop by turning off the start command during V/F or speed control. 0 to 100s: Coasting to stop 9999: Deceleration to stop	9999		O	O																																														
Operation selection function	251	Output phase failure protection selection	You can disable the output phase failure function that stops the inverter output if one of the inverter output side (load side) three phases (U, V, W) opens. 0: Without output phase failure protection 1: With output phase failure protection	1		O	O	O																																													
Additional functions	252	Override bias	When you selected the override in Pr. 73, you can adjust the override bias (0 to 200%) and override gain (0 to 200%).	50%		O	O																																														
	253	Override gain		150%		O	O																																														
Power failure stop functions	261	Power failure stop selection	You can select the stopping method at a power failure. 0: Coasting to stop, inverter output shutoff 1: Inverter is decelerated to a stop.	0		O	O																																														
	262	Subtracted speed at deceleration start	0 to 600r/min	90r/min		O	O																																														
	263	Subtraction starting speed	0 to 3600r/min, 9999	1500r/min (1800r/min)		O	O																																														
	264	Power-failure deceleration time 1	0 to 3600/0 to 360s	5s		O	O																																														
	265	Power-failure deceleration time 2	0 to 3600/0 to 360s, 9999	9999		O	O																																														
	266	Power-failure deceleration time switchover speed	0 to 3600r/min	1500r/min (1800r/min)		O	O																																														
Brake sequence	278	Brake opening speed	Set when outputting the operation timing signal of the mechanical brake in vertical lift applications. (When speed control (invalid for V/F control) is selected) 0 to 900r/min (Pr. 278) 0 to 200% (Pr. 279) 0 to 2s (Pr. 280) 0 to 5s (Pr. 281) 0 to 900r/min (Pr. 282) 0 to 5s (Pr. 283) 0, 1 (Pr. 284) 0 to 900r/min, 9999 (Pr. 285)	20r/min		O																																															
	279	Brake opening current		130%		O																																															
	280	Brake opening current detection time		0.3s		O																																															
	281	Brake operation time at start		0.3s		O																																															
	282	Brake operation speed		25r/min		O																																															
	283	Brake operation time at stop		0.3s		O																																															
	284	Deceleration detection function selection		0		O																																															
	285	Overspeed detection speed		9999		O																																															

Function list (Extended function parameters)

Function	Parameter	Name	Outline	Factory Setting (NA version)	Customer Setting	At-a-glance Guide to Functions			
						O: Usable function : Unusable function *: Functions that can be used for parameter-set position control			
						Vector Control			
			Speed control	Torque control	Position control				
Droop	286	Droop gain	Set when providing a drooping characteristic for the speed in proportion to the load torque.	0%			O		
	287	Droop filter constant	0 to 100% (Pr. 286) 0.00 to 1.00s (Pr. 287) (Pr. 288)	0.3s			O		
	288	Droop function activation selection	0: Without droop operation during acceleration/deceleration 1: Without droop operation during acceleration/deceleration (Speed command after droop is zero limited) 2: With droop operation during acceleration/deceleration (Speed command after droop is not zero limited)	0			O		
Additional function	342	E ² PROM write presence/absence	0:E ² PROM 1:RAM	0			O	O	O
Orientation	350	Stop position command selection	For the stop position command, either the internal stop position command or the external stop position command using external signals may be selected. 0:Internal stop position command 1:External stop position command (6 bit data when the FR-V5AX is fitted) 2:External stop position command (12 bit data when the FR-A5AX is fitted) 3:External stop position command (16 bit data when the FR-V5AH is fitted) 9999:Orientation control invalid	9999			O		
	351	Orientation switchover speed	Decrease the motor speed to the set value during the orientation command is valid. 0 to 1000r/min	200r/min			O		
	356	Internal stop position command	When "0" is set in Pr. 350 "stop position command selection", the internal position command is activated and the setting value of Pr. 356 becomes a stop position. 0 to 16383	0			O		
	357	In-position zone	Set the in-position zone at a stop of the orientation. 0 to 8192	11			O		
	360	External position command selection	When "1" is set in Pr. 350 "stop position command selection", the external position command is activated and the setting value of Pr. 360 becomes a stop position. 0: External position command invalid 1: 4096 per rotation with the FR-A5AX, 64 per rotation with the FR-V5AX 2 to 127: The external stop position command may be used to set up to 128 stop positions at regular intervals.	0			O		
	361	Position shift	The stop position is a position obtained by adding the setting value of Pr. 361 to the position command. You can make fine adjustments to a stop position. 0 to 16383	0			O		
	362	Orientation position loop gain	Adjust at a stop of the orientation 0.1 to 100	10			O		
Control system function	374	Overspeed detection level	Overspeed occurs if the motor speed exceeds the preset speed. 0 to 4200r/min	4200 r/min			O	O	O
S-pattern C	380	Acceleration S-pattern 1	You can set X20 in any of Pr. 180 to 183 and Pr. 187, and set an S pattern by turning it on/off. Set an S pattern in Pr. 380 to Pr. 383. 0 to 50%	0%			O	O	
	381	Deceleration S-pattern 1		0%			O	O	
	382	Acceleration S-pattern 2		0%			O	O	
	383	Deceleration S-pattern 2		0%			O	O	
Orientation	393	Orientation selection	0,1,2,10,11,12	0			O		
	396	Orientation speed gain (P term)	0 to 1000	60			O		
	397	Orientation speed integral time	0 to 20.0s	0.333			O		
	398	Orientation speed gain (D term)	0 to 100.0%	1			O		
	399	Orientation deceleration ratio	0 to 1000	20			O		

Function list (Extended function parameters)

Function	Parameter	Name	Outline	Factory Setting (NA version)	Customer Setting	At-a-glance Guide to Functions			
						O : Usable function * : Functions that can be used for parameter-set position control			
						Vector Control			
						Speed control	Torque control	Position control	
Torque control	419	Position command right selection	Select the position command right for position control. 0, 1 0: Conditional position feed function by contact input 1: Position command by pulse train input (when the FR-V5AP is fitted).	0					○
	420	Command pulse scaling factor numerator	Set the electronic gear. Pr. 420 is a numerator and Pr. 421 is a denominator. 0 to 32767	1					○
	421	Command pulse scaling factor denominator		1					○
	422	Position loop gain	Set the gain of the position loop. 0 to 150s ⁻¹	25s ⁻¹					○
	423	Position feed forward gain	Function to cancel a delay caused by the droop pulses of the deviation counter. 0 to 100%	0%					○
	424	Position command acceleration/ deceleration time constant	Used when rotation has become unsmooth at a large electronic gear ratio (about 10 times or more) and low speed. 0 to 50s	0s					○
	425	Position feed forward command filter	Enters the primary delay filter in response to the feed forward command. 0 to 5s	0s					○
	426	In-position width	The in-position signal turns on when the droop pulses become less than the setting. 0 to 32767 pulses	100 pulses					○
	427	Excessive level error	An error becomes excessive when the droop pulses exceed the setting. 0 to 400K pulses, 9999	40K pulses					○
	430	Pulse monitor selection	0 to 5, 9999	9999					○
Second motor	450	Second applied motor	0, 10, 30, 9999	9999		○	○	○	
	451	Second motor control method selection	Select the method of controlling the second motor. 20, 9999	9999		○	○	○	
	452	Second electronic thermal O/L relay	Set the electronic thermal relay value of the second motor. 0 to 3600A, 9999	9999		○	○	○	
	453	Second motor capacity	Set the capacity of the second motor. 0 to 3600kW	Inverter capacity		○	○	○	
	454	Number of second motor poles	Set the number of poles of the second motor. 2, 4, 6	4		○	○	○	

Function	Parameter	Name	Outline	Factory Setting (NA version)	Customer Setting	At-a-glance Guide to Functions		
						Vector Control		
						Speed control	Torque control	Position control
Position control	464	Digital position control sudden stop deceleration time	Set the time until the inverter stops when the forward rotation (reverse rotation) command is turned off with the position feed forward function. 0 to 360.0s	0				○
	465	First position feed amount lower 4 digits	Parameters for setting position feed data for parameter-based position control.	0				○
	466	First position feed amount upper 4 digits		0				○
	467	Second position feed amount lower 4 digits		0				○
	468	Second position feed amount upper 4 digits		0				○
	469	Third position feed amount lower 4 digits		0				○
	470	Third position feed amount upper 4 digits		0				○
	471	Fourth position feed amount lower 4 digits		0				○
	472	Fourth position feed amount upper 4 digits		0				○
	473	Fifth position feed amount lower 4 digits		0				○
	474	Fifth position feed amount upper 4 digits		0				○
	475	Sixth position feed amount lower 4 digits		0				○
	476	Sixth position feed amount upper 4 digits		0				○
	477	Seventh position feed amount lower 4 digits		0				○
	478	Seventh position feed amount upper 4 digits		0				○
	479	Eighth position feed amount lower 4 digits		0				○
	480	Eighth position feed amount upper 4 digits		0				○
	481	Ninth position feed amount lower 4 digits		0				○
	482	Ninth position feed amount upper 4 digits		0				○
	483	Tenth position feed amount lower 4 digits		0				○
	484	Tenth position feed amount upper 4 digits		0				○
	485	Eleventh position feed amount lower 4 digits		0				○
	486	Eleventh position feed amount upper 4 digits		0				○
	487	Twelfth position feed amount lower 4 digits		0				○
	488	Twelfth position feed amount upper 4 digits		0				○
	489	Thirteenth position feed amount lower 4 digits		0				○
	490	Thirteenth position feed amount upper 4 digits		0				○
	491	Fourteenth position feed amount lower 4 digits		0				○
	492	Fourteenth position feed amount upper 4 digits		0				○
	493	Fifteenth position feed amount lower 4 digits		0				○
494	Fifteenth position feed amount upper 4 digits	0					○	

No.	Setting Range	Selection Method				Position Feed Speed
		REX	RH	RM	RL	
465	0 to 9999	OFF	ON	OFF	OFF	High speed, Pr. 4
466	0 to 9999	OFF	OFF	ON	OFF	Middle speed, Pr. 5
467	0 to 9999	OFF	OFF	OFF	ON	Low speed, Pr. 6
468	0 to 9999	OFF	OFF	ON	ON	Speed 4, Pr. 24
469	0 to 9999	OFF	ON	OFF	ON	Speed 5, Pr. 25
470	0 to 9999	OFF	ON	ON	OFF	Speed 6, Pr. 26
471	0 to 9999	OFF	ON	ON	ON	Speed 7, Pr. 27
472	0 to 9999	ON	OFF	OFF	OFF	Speed 8, Pr. 232
473	0 to 9999	ON	OFF	OFF	ON	Speed 9, Pr. 233
474	0 to 9999	ON	OFF	ON	OFF	Speed 10, Pr. 234
475	0 to 9999	ON	OFF	ON	ON	Speed 11, Pr. 235
476	0 to 9999	ON	ON	OFF	OFF	Speed 12, Pr. 236
477	0 to 9999	ON	ON	OFF	ON	Speed 13, Pr. 237
478	0 to 9999	ON	ON	ON	OFF	Speed 14, Pr. 238
479	0 to 9999	ON	ON	ON	ON	Speed 15, Pr. 239

Function list (Extended function parameters)

Function	Parameter	Name	Outline	Factory Setting (NA version)	Customer Setting	At-a-glance Guide to Functions		
						: Usable function		
						* : Functions that can be used for parameter-set position control		
Vector Control						Speed control	Torque control	Position control
Remote output	495	Remote output selection	You can turn on/off the inverter output. 0: Non-latch 1: Latch	0		○	○	○
	496	Remote output data 1	You can set the output signal data of the inverter. 0 to 4095	0		○	○	○
	497	Remote output data 2		0		○	○	○
Sub function	591	Start holding time	You can set the output speed hold at the start speed (at V/F control) 0 to 10s, 9999	9999		○		
Operation selection functions	800	Control system selection	0 to 5, 20	0		○	○	○
	801	Torque characteristic selection	You can select the torque characteristic when choosing the motor provided with PLG. 0: Cycle 1: Continuous	1		○	○	○
	802	Pre-excitation selection	You can select zero speed control or servo lock when the LX signal turns on at a stop. 0: Zero speed control 1: Servo lock	0		○		○
	803	Constant output region torque characteristic selection	You can select how to provide a torque command in the constant output region. 0: Constant output reference 1: Constant torque reference	0		○	○	○
	804	Torque command right selection	Select the torque command right. 0: No. 3 terminal analog input 1: Digital input from parameter (Pr. 805, Pr. 806) 2: Pulse train command input (when the FR-V5AP is fitted) 3: Input from CC-Link (when the FR-A5NC is fitted) 4: Digital input from option (when the FR-V5AH or FR-A5AX is fitted)	0			○	
	805	Torque command value (RAM)	You can set the torque command value in the parameter. (RAM) 600 to 1400%	1000%			○	
	806	Torque command value (RAM, E ² PROM)	You can set the torque command value in the parameter. (RAM, E ² PROM) 600 to 1400%	1000%			○	
	807	Speed restriction selection	You can select the speed restriction command input for torque control. 0: Same as speed setting for speed control 1: Control restrictions for individual rotation directions 2: No. 1 terminal analog input	0			○	
	808	Forward rotation speed restriction	Set the speed restriction in forward rotation direction individually according to the rotation direction. 0 to 3600r/min	1500r/min (1800r/min)			○	
	809	Reverse rotation speed restriction	Set the speed restriction in reverse rotation direction individually according to the rotation direction. 0 to 3600r/min, 9999	9999			○	
Control system functions	810	Torque restriction input method selection	Set whether to make torque restriction using internal parameter values or analog voltage. (0: Internal, 1: External)	0		○		○
	812	Torque restriction level (regeneration)	0 to 400%, 9999	9999		○		○
	813	Torque restriction level (3rd quadrant)	0 to 400%, 9999	9999		○		○
	814	Torque restriction level (4th quadrant)	0 to 400%, 9999	9999		○		○
	815	Torque restriction level 2	Second function of the torque restriction level. Made valid when the RT terminal is on. 0 to 400%, 9999	9999		○		○
	816	Acceleration torque restriction	Set the torque restriction value during acceleration. 0 to 400%, 9999	9999		○		○
	817	Deceleration torque restriction	Set the torque restriction value during deceleration. 0 to 400%, 9999	9999		○		○
	818	Easy gain tuning response level setting	1 to 15	2		○		○
	819	Easy gain tuning selection	0,1,2	0		○		○
	820	Speed control P gain 1	Set the proportional gain for speed control. (Increasing the value improves track ability in response to a speed command change and reduces speed variation with disturbance.) 0 to 1000%	60%		○		○
	821	Speed control integral time 1	Set the integral time during speed control. (Decrease the value to shorten the time taken for returning to the original speed if speed variation with disturbance occurs.) 0 to 20s	0.333s		○		○
	822	Speed setting filter 1	Set the primary delay filter for the analog voltage-based speed setting. 0 to 5s	0s		○	○	
	823	Speed detection filter 1	Set the primary delay filter for the speed feedback. 0 to 0.1s	0.001s		○	○	○
	824	Torque control P gain 1	Set the proportional gain for the current control of the q and d axes. (Increasing the value improves track ability in response to a current command change and reduces current variation with disturbance.) 0 to 200%	100%		○	○	○
	825	Torque control integral time 1	Set the integral time for the current control of the q and d axes. (Decreasing the value shortens the time taken to return to the original torque if current variation with disturbance occurs.) 0 to 500ms	5ms		○	○	○

Function list (Extended function parameters)

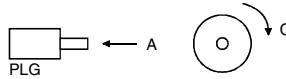
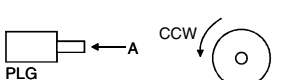
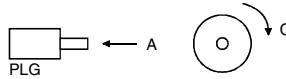
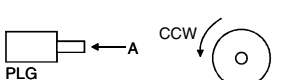
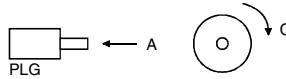
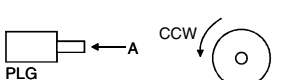
Function	Parameter	Name	Outline	Factory Setting (NA version)	Customer Setting	At-a-glance Guide to Functions								
						: Usable function								
						* : Functions that can be used for parameter-set position control								
						Vector Control								
						Speed control	Torque control	Position control						
Control system functions	826	Torque setting filter 1	Set the primary delay filter for the analog voltage (No. 3 terminal)-based torque command value. (Also valid for the torque restriction from the No. 3 terminal during speed control.) 0 to 5s	0s		<input type="radio"/>	<input type="radio"/>	<input type="radio"/>						
	827	Torque detection filter 1	Set the primary delay filter for the current feedback. 0 to 0.1s	0s		<input type="radio"/>	<input type="radio"/>	<input type="radio"/>						
	828	Model speed control gain	0 to 1000%	60%		<input type="radio"/>		<input type="radio"/>						
	830	Speed control P gain 2	Second function of Pr. 820 (valid when RT terminal is on) 0 to 1000%, 9999	9999		<input type="radio"/>		<input type="radio"/>						
	831	Speed control integral time 2	Second function of Pr. 821 (valid when RT terminal is on) 0 to 20s, 9999	9999		<input type="radio"/>		<input type="radio"/>						
	832	Speed setting filter 2	Second function of Pr. 822 (valid when RT terminal is on) 0 to 5s, 9999	9999		<input type="radio"/>	<input type="radio"/>							
	833	Speed detection filter 2	Second function of Pr. 823 (valid when RT terminal is on) 0 to 0.1s, 9999	9999		<input type="radio"/>	<input type="radio"/>	<input type="radio"/>						
	834	Torque control P gain 2	Second function of Pr. 824 (valid when RT terminal is on) 0 to 200%, 9999	9999		<input type="radio"/>	<input type="radio"/>	<input type="radio"/>						
	835	Torque control integral time 2	Second function of Pr. 825 (valid when RT terminal is on) 0 to 500ms, 9999	9999		<input type="radio"/>	<input type="radio"/>	<input type="radio"/>						
	836	Torque setting filter 2	Second function of Pr. 826 (valid when RT terminal is on) 0 to 5s, 9999	9999		<input type="radio"/>	<input type="radio"/>	<input type="radio"/>						
837	Torque detection filter 2	Second function of Pr. 827 (valid when RT terminal is on) 0 to 0.1s, 9999	9999		<input type="radio"/>	<input type="radio"/>	<input type="radio"/>							
Torque biases	840	Torque bias selection	The torque bias function is designed to quicken the rise of torque at a motor start. You can set the then output torque using the parameters or analog signals. 0: 3 internal parameters, 1 to 3: External analog input, 9999	9999		<input type="radio"/>								
	841	Torque bias 1	Set the torque bias values when you chose internal parameter-based torque bias selection. Assign X42 (torque bias selection 1) and X43 (torque bias selection 2) to the input terminals.	9999		<input type="radio"/>								
	842	Torque bias 2	600 to 1400%	9999		<input type="radio"/>								
	843	Torque bias 3	1) Pr. 841 when X42 is on and X43 is off, 2) Pr. 842 when X42 is off and X43 is on, 3) Pr. 843 when X42 is on and X43 is on	9999		<input type="radio"/>								
	844	Torque bias filter	You can slow the rise of torque for the torque command. A primary delay filter time constant. 0 to 5s, 9999	9999		<input type="radio"/>								
	845	Torque bias operation time	Set the time until the set torque of the torque bias amount is generated. 0 to 5s, 9999	9999		<input type="radio"/>								
	846	Torque bias balance compensation	Set the torque balance with the balance weight. 0 to 10V, 9999	9999		<input type="radio"/>								
	847	Fall-time torque bias No. 3 bias	When you set 1 or 2 in Pr. 840, set the bias value of the torque bias at the time of fall from the load input from the No. 3 terminal. 0 to 400%, 9999	9999		<input type="radio"/>								
848	Fall-time torque bias No. 3 gain	When you set 1 or 2 in Pr. 840, set the gain value of the torque bias at the time of fall from the load input from the No. 3 terminal. 0 to 400%, 9999	9999		<input type="radio"/>									
Additional functions	849	Analog input off set adjustment	When speed command by analog input is set, create the range where the motor remains stop to prevent malfunction at very low speed. 0 to 200%	100%										
	851	Number of PLG pulses	Set the number of pulses of the PLG. 0 to 4096	2048 (1024)		<input type="radio"/>	<input type="radio"/>	<input type="radio"/>						
	852	PLG rotation direction	Set the rotation direction of the PLG. <table border="1" style="width: 100%; border-collapse: collapse;"> <thead> <tr> <th style="width: 20%;">Pr. 852 Setting</th> <th style="width: 80%;">Relationship between the motor and PLG</th> </tr> </thead> <tbody> <tr> <td style="text-align: center;">0</td> <td>  <p>Forward rotation is clockwise rotation when viewed from A.</p> </td> </tr> <tr> <td style="text-align: center;">1 (Factory setting)</td> <td>  <p>Forward rotation is counterclockwise rotation when viewed from A.</p> </td> </tr> </tbody> </table>	Pr. 852 Setting	Relationship between the motor and PLG	0	 <p>Forward rotation is clockwise rotation when viewed from A.</p>	1 (Factory setting)	 <p>Forward rotation is counterclockwise rotation when viewed from A.</p>	1		<input type="radio"/>	<input type="radio"/>	<input type="radio"/>
	Pr. 852 Setting	Relationship between the motor and PLG												
	0	 <p>Forward rotation is clockwise rotation when viewed from A.</p>												
1 (Factory setting)	 <p>Forward rotation is counterclockwise rotation when viewed from A.</p>													
854	Excitation ratio	Set the excitation ratio under no load. 0 to 100%	100%		<input type="radio"/>	<input type="radio"/>	<input type="radio"/>							
859	Torque current	Use for utilization of the tuning data or direct input.	9999		<input type="radio"/>	<input type="radio"/>	<input type="radio"/>							
862	Notch filter frequency	You can use the machine resonance speed to make this setting to reduce the response level of the machine resonance frequency band, avoiding machine resonance. 0 to 60	0		<input type="radio"/>		<input type="radio"/>							

Function list (Extended function parameters)

Function	Parameter	Name	Outline	Factory Setting (NA version)	Customer Setting	At-a-glance Guide to Functions				
						O: Usable function *: Functions that can be used for parameter-set position control				
						Vector Control				
						Speed control	Torque control	Position control		
Additional functions	863	Notch filter depth	Set the depth at which the gain of the machine resonance frequency set in Pr. 862 is lowered. 0 to 3	0		O		O		
	864	Torque detection	You can make setting to output a signal if the motor torque exceeds the predetermined value. 0 to 400%	150%		O	O	O		
	865	Low speed detection	You can make setting to output a signal if the speed has fallen to or below the preset low speed. 0 to 3600r/min	45r/min		O	O	O		
Display functions	866	Torque monitoring reference	Set the reference for the motor torque or load meter torque monitoring output (DA1 or other analog output). 0 to 400%	150%		O	O	O		
	867	DA1 output filter	Set the primary delay filter for the DA1 analog output. 0 to 5s	0.05s		O	O	O		
Terminal assignment functions	868	No. 1 terminal function selection	You can change the setting of the multi-function analog terminal (No. 1 terminal).				0	O	O	O
			Setting	Speed Control	Torque Control	Position Control				
			0	Speed setting auxiliary	Speed restriction auxiliary	No function				
			1	Magnetic flux command	Magnetic flux command	Magnetic flux command				
			2	Regenerative torque restriction	No function	Regenerative torque restriction				
			5	No function	Forward/reverse rotation speed restriction (analog polarity switchover speed restriction)	No function				
9999	No function	No function	No function							
Protective functions	870	Speed deviation level	If the difference between speed command value and speed exceeds the setting of the speed deviation level (Pr. 870) for longer than the setting of the speed deviation time (Pr. 871), speed deviation excessive "E.OSD" is displayed and the motor stops. 0 to 1500r/min, 9999	9999		O				
	871	Speed deviation time	CAUTION Use this function when a difference in speed will constitute a hindrance. It is independent of torque control. 0 to 100s	12s		O				
	873	Speed restriction	0 to 3600r/min	600r/min			O			
	874	OLT level setting	Set the load level of the motor at which OLT alarm. 0 to 200%	150%		O		O		
Operation selection functions	875	Fault definition	You can classify faults into a minor fault and major faults according to the alarms, and make setting to select between immediate output shutoff and output shutoff after deceleration to stop. 0: Immediate output shutoff 1: Output shutoff after deceleration to stop (Immediate output shutoff other than OHT and THM)	0		O	O			
	876	Thermal relay protector input	When using the motor provided with PLG, you can input the contact signal of a thermal relay etc. to terminal OH to provide motor protection against overheat. 0: None 1: Thermal relay input available	1 (0)		O	O	O		
Control system functions	877	Speed feed forward control/model adaptive speed control selection	Select speed feed forward control (which improves the motor track ability in response to a speed command change (during acceleration/deceleration)) or model adaptive speed control (that can adjust speed track ability and motor disturbance torque response level individually). (0: No selection, 1: Speed feed forward control, 2: model adaptive speed control)	0		O		O		
	878	Speed feed forward filter	Set the primary delay filter for the speed feed forward result calculated using the speed command and load inertia ratio. 0 to 1s	0s		O		O		
	879	Speed feed forward torque restriction	Restricts the maximum value of the speed feed forward torque. 0 to 400%	150%		O		O		
	880	Load inertia ratio	Set the load inertia ratio. Inertia ratio found by easy gain turning. 0, 1 to 200 times	7		O		O		
	881	Speed feed forward gain	Set the feed forward calculation result as a gain. 0 to 1000%	0%		O		O		
Maintenance functions	890	Maintenance output setting time	When cumulative operation time of the inverter Pr. 891 "Maintenance output timer" has elapsed the time set in Pr. 890 "Maintenance output setting time", maintenance output [MT] is displayed. Set "0" in Pr. 892 to turn the MT display off. (Used for warning that the capacitor life is reached, for example.) Pr.890:0 to 9998, 9999: No setting	9999		O	O	O		
	891	Maintenance output timer	Pr.890:0 to 9998, 9999: No setting	0		O	O	O		
	892	Maintenance output signal clear	Pr.891:0 to 9998 Pr.892:0	0		O	O	O		

Function list (Extended function parameters)

Function	Parameter	Name	Outline	Factory Setting (NA version)	Customer Setting	At-a-glance Guide to Functions			
						O: Usable function : Unusable function *: Functions that can be used for parameter-set position control			
						Vector Control			
						Speed control	Torque control	Position control	
Calibration functions	900	DA1 terminal calibration	For calibration of external meter				○	○	○
	901	DA2 terminal calibration	For calibration of external meter				○	○	○
	902	Speed setting No.2 bias	You can set the magnitude of the output in response to the speed setting signal (0-10VDC) as desired. 0 to 10V, 0 to 3600r/min	0V, 0r/min			○	○	○
	903	Speed setting No.2 gain	You can set the magnitude of the output in response to the speed setting signal (0-10VDC) as desired. 0 to 10V, 0 to 3600r/min	10V, 1500r/min (1800r/min)			○	○	○
	904	Torque command No.3 bias	You can set the magnitude of the output in response to the torque setting signal (0±10VDC) as desired. 0 to 10V, 0 to 400%	0V, 0%			○	○	○
	905	Torque command No.3 gain	You can set the magnitude of the output in response to the torque setting signal (0±10VDC) as desired. 0 to 10V, 0 to 400%	10V, 150%			○	○	○
	917	No. 1 terminal bias (Speed)	You can set the magnitude of the output in response to the No. 1 terminal analog setting signal (0±10VDC) as desired. 0 to 10V, 0 to 3600r/min	0V, 0r/min			○	○	○
	918	No. 1 terminal gain (Speed)		10V, 1500r/min (1800r/min)			○	○	○
	919	No. 1 terminal bias (torque/magnetic flux)	You can set the magnitude of output (torque/magnetic flux) in response to the No.1 terminal analog set signal (DC0 ±10V) as desired. 0 to 10V, 0 to 400%	0V, 0%			○	○	○
	920	No. 1 terminal gain (torque/magnetic flux)	You can set the magnitude of output (torque/magnetic flux) in response to the No.1 terminal analog set signal (DC0 ±10V) as desired. 0 to 10V, 0 to 400%	10V, 150%			○	○	○
Additional functions	990	Buzzer control	You can control the "beep" sound produced when any key of the parameter unit is pressed. 0: Without sound 1: With sound	1			○	○	○
	991	Parameter for the option (FR-PU04V)							

6 ERRORS AND PROTECTIVE FUNCTIONS

6.1 Errors (Alarms)

If any fault has occurred in the inverter, the corresponding protective function is activated to bring the inverter to an alarm stop and automatically give the corresponding error (alarm) indication on the PU display.

If the fault does not correspond to any of the following errors or if you have any other problem, please contact your sales representative or distributor.

- When the alarm output signal holding protective function is activated, opening the magnetic contactor (MC) provided on the inverter's power supply side will cause the control power of the inverter to be lost and the alarm output not to be held.
- When the alarm display protective function is activated, the operation panel display section is changed automatically.
- When the resetting method protective function is activated, the inverter output stop status is held, and the inverter cannot restart unless it is reset. To reset, switch power off once, then on again, or turn on the RES signal for more than 0.1s.

If the RES signal is kept on, "Err." appears (flickers) to indicate that the inverter is in a reset status.

When any protective function is activated, take the corresponding corrective action, then reset the inverter, and resume operation.

6.1.1 Major faults

When the protective function is activated, the inverter output is shut off and an alarm is output.

Operation Panel Indication	E.OC1	E.OC 1	FR-PU04V	OC During Acc
Name	Overcurrent shut-off during acceleration (*1)			
Description	When the inverter output current reaches or exceeds approximately 200% of the rated inverter current during acceleration, the protective circuit is activated to stop the inverter output.			
Check point	<ul style="list-style-type: none"> • Check for sudden acceleration. • Check for long descending acceleration time of lift applications • Check for output short circuit. 			
Corrective action	<ul style="list-style-type: none"> • Decrease the acceleration time. 			

Operation Panel Indication	E.OC2	E.OC 2	FR-PU04V	Stedy Spd OV
Name	Overcurrent shut-off during constant speed (*1)			
Description	When the inverter output current reaches or exceeds approximately 200% of the rated inverter current during constant speed operation, the protective circuit is activated to stop the inverter output.			
Check point	<ul style="list-style-type: none"> • Check for sudden load change. • Check for output short circuit. 			
Corrective action	Keep load stable.			

*1: E. OC3 appears if the overcurrent shutoff occurs during positioning.

Operation Panel Indication	E.OC3	E.OC 3	FR-PU04V	OC During Dec
Name	Overcurrent shut-off during deceleration			
Description	When the inverter output current reaches or exceeds approximately 200% of the rated inverter current during deceleration (other than acceleration or constant speed), the protective circuit is activated to stop the inverter output.			
Check point	<ul style="list-style-type: none"> • Check for sudden speed reduction. • Check for output short circuit. • Check for too fast operation of the motor's mechanical brake. 			
Corrective action	<ul style="list-style-type: none"> • Increase the deceleration time. • Check the mechanical brake operation. 			

Operation Panel Indication	E.OV1	EOV1	FR-PU04V	OV During Acc
Name	Regenerative overvoltage shut-off during acceleration (*2)			
Description	If regenerative energy causes the inverter's internal main circuit DC voltage to reach or exceed the specified value, the protective circuit is activated to stop the inverter output. It may also be activated by a surge voltage generated in the power supply system.			
Check point	Check for too slow acceleration.(i.e. during descending acceleration with lifting load)			
Corrective action	<ul style="list-style-type: none"> • Decrease the acceleration time. • Use the brake unit or power regeneration converter (MT-RC) as required. 			

Operation Panel Indication	E.OV2	EOV2	FR-PU04V	Stedy Spd OV
Name	Regenerative overvoltage shut-off during constant speed (*2)			
Description	If regenerative energy causes the inverter's internal main circuit DC voltage to reach or exceed the specified value, the protective circuit is activated to stop the inverter output. It may also be activated by a surge voltage generated in the power supply system.			
Check point	Check for sudden load change.			
Corrective action	<ul style="list-style-type: none"> • Keep load stable. • Use the brake unit or power regeneration converter (MT-RC) as required. 			

*2: E. OV3 appears if the over voltage shutoff occurs during positioning.

Operation Panel Indication	E.OV3	EOV3	FR-PU04V	OV During Dec
Name	Regenerative overvoltage shut-off during deceleration or stop			
Description	If regenerative energy causes the inverter's internal main circuit DC voltage to reach or exceed the specified value, the protective circuit is activated to stop the inverter output. It may also be activated by a surge voltage generated in the power supply system.			
Check point	Check for sudden speed reduction.			
Corrective action	<ul style="list-style-type: none"> • Increase the deceleration time. (Set the deceleration time that meets the inertia moment of the load) • Decrease the braking duty. • Use the brake unit or power regeneration converter (MT-RC) as required. 			

Operation Panel Indication	E.THM	ETHM	FR-PU04V	Motor Overload
Name	Motor overload shut-off (electronic thermal relay) (*3)			
Description	The electronic thermal relay built in the inverter detects motor overheat due to overload or reduced cooling capability during low-speed operation to stop the inverter output. When running a multi-pole motor or two or more motors during V/F control, provide a thermal relay in the inverter output side since such motor(s) cannot be protected. Protection against burnout due to motor temperature rise			
Check point	Check the motor for use under overload.			
Corrective action	<ul style="list-style-type: none"> • Reduce the load weight. • For a constant-torque motor, set the constant-torque motor in Pr. 71 "applied motor". 			

Operation Panel Indication	E.THT	ETHI	FR-PU04V	Inv. Overload
Name	Inverter overload shut-off (electronic thermal relay) (*3)			
Description	If a current not less than 150% of the rated output current flows and overcurrent shut-off does not occur (200% or less), inverse-time characteristics cause the electronic thermal relay to be activated to stop the inverter output in order to protect the output transistors. Protection of output transistors against overheat.			
Check point	Check the motor for use under overload.			
Corrective action	Reduce the load weight.			

*3. Resetting the inverter initializes the internal heat integrating data of the electronic thermal relay.

Errors (Alarms)

Operation Panel Indication	E.IPF	<i>E.IPF</i>	FR-PU04V	Inst. Pwr. Loss
Name	Instantaneous power failure protection (*4)			
Description	If a power failure occurs for longer than 15ms (this also applies to inverter input shut-off), the instantaneous power failure protective function is activated to stop the inverter output in order to prevent the control circuit from malfunctioning. At this time, the alarm warning output contacts open (across terminals B-C) and close (across terminals A-C). If a power failure persists for longer than 100ms, the alarm warning output is not provided, and the inverter restarts if the start signal is on upon power restoration. (The inverter continues operating if an instantaneous power failure is within 15ms.)			
Check point	Find the cause of instantaneous power failure occurrence.			
Corrective action	<ul style="list-style-type: none"> • Remedy the instantaneous power failure. • Prepare a backup power supply for instantaneous power failure. • Set the function of automatic restart after instantaneous power failure (Pr. 57). (Refer to page 61.) 			

*4: When an instantaneous power failure occurs, the alarm display and alarm output are not provided, but the inverter performs protective operation to prevent a fault from occurring in itself. In some operating status (load magnitude, acceleration/deceleration time setting, etc.), overcurrent or other protection may be activated upon power restoration.

Operation Panel Indication	E.UVT	<i>E.UVT</i>	FR-PU04V	Under Voltage
Name	Undervoltage protection			
Description	If the power supply voltage of the inverter reduces, the control circuit will not perform normal functions. In addition, the motor torque will be insufficient and/or heat generation will increase. To prevent this, if the power supply voltage reduces below about 150V (300V for the 400V class), this function stops the inverter output. When a jumper is not connected across P-P1, the undervoltage protective function is activated.			
Check point	<ul style="list-style-type: none"> • Check for start of large-capacity motor. • Check that a jumper or DC reactor is connected across terminals P-P1. 			
Corrective action	<ul style="list-style-type: none"> • Check the power supply system equipment such as power supply. • Connect a jumper or DC reactor across terminals P-P1. 			

Operation Panel Indication	E.FIN	<i>E.FIN</i>	FR-PU04V	H/Sink O/Temp
Name	Fin overheat			
Description	If the heatsink overheats, the temperature sensor is actuated to stop the inverter output.			
Check point	<ul style="list-style-type: none"> • Check for too high ambient temperature. • Check for heatsink clogging. • Check that the cooling fan is stopped. 			
Corrective action	<ul style="list-style-type: none"> • Set the ambient temperature to within the specifications. • Replace the cooling fan. 			

Operation Panel Indication	E.GF	<i>E.GF</i>	FR-PU04V	Ground Fault
Name	Output side earth (ground) fault overcurrent protection			
Description	This function stops the inverter output if an earth (ground) fault overcurrent flows due to an earth (ground) fault that occurred in the inverter's output (load) side.			
Check point	Check for an earth (ground) fault in the motor and connection cable.			
Corrective action	Remedy the earth (ground) fault portion.			

Operation Panel Indication	E.OHT	<i>E.OHT</i>	FR-PU04V	OH Fault
Name	External thermal relay operation			
Description	If the external thermal relay provided for motor overheat protection, or the internally mounted temperature relay in the motor, etc. switches on (contacts open), the inverter output is stopped. If the relay contacts are reset automatically, the inverter will not restart unless it is reset.			
Check point	Check for motor overheating.			
Corrective action	Reduce the load and operating duty.			

Operation Panel Indication	E.OLT	<i>E.OLT</i>	FR-PU04V	Still Prev STP (OL shown during stall prevention operation)
Name	Motor overload			
Description	For V/F control, the stall prevention function is activated if the current flow in the motor exceeds 150% (factory setting) of the inverter rated current, an alarm stop is made if the status that the output frequency is lowered at 0Hz persists for 3s. For speed/position control, if the torque restriction is activated under high load, the motor stalls to the speed less than the low speed detection (Pr. 865) value, and an alarm stop is made if the status that the output torque is more than the OLT level setting (Pr. 874) value persists for 3s. This function is not activated for torque control.			
Check point	<ul style="list-style-type: none"> • Check the motor for use under overload. • Check that the low speed detection (Pr. 865) and OLT level setting (Pr. 874) values are correct. (Check the stall prevention operation level (Pr. 22) setting if V/F control is exercised.) 			
Corrective action	<ul style="list-style-type: none"> • Reduce the load weight. • Change the stall prevention operation level (Pr. 22), low speed detection (Pr. 865) and OLT level setting (Pr. 874) values. (Check the stall prevention operation level (Pr. 22) setting if V/F control is exercised.) 			

Operation Panel Indication	E.OPT	<i>E.OPT</i>	FR-PU04V	Option Fault
Name	Option alarm			
Description	Stops the inverter output when two or more communication options are mounted. (*5) When the high power factor converter (MT-HC) or power regeneration converter (MT-RC) is connected, this alarm appears if an AC power supply is connected to the R, S, T terminals accidentally.			
Check point	<ul style="list-style-type: none"> • Check that the number of communication options mounted is one. • When the high power factor converter (MT-HC) or power regeneration converter (MT-RC) is connected, check that an AC power supply is not connected to the R, S, T terminals. • When the parameter set is for the option use, the option is not fitted nor connected securely. 			
Corrective action	<ul style="list-style-type: none"> • Mount only one communication option. • Check the Pr. 30 setting and wiring. • Check the Pr. 419 and Pr. 804 settings. • When the high power factor converter (MT-HC) or power regeneration converter (MT-RC) is connected, connecting an AC power supply to the R, S, T terminals may damage the inverter. Please contact your sales representative. 			

*5: The FR-A5NR (relay output/computer link) allows one more communication option to be fitted. In this case, only relay output is usable and computer link is unusable.

Operation Panel Indication	E.OP1 to OP3	<i>E.OP1 to OP3</i>	FR-PU04V	Option slot alarm 1 to 3
Name	Option slot alarm (1 to 3 indicate the option slot numbers.)			
Description	Stops the inverter output if a functional alarm (e.g. communication line error of the communication option or contact fault of the plug-in option other than the communication option) occurs in the plug-in option fitted to the corresponding slot.			
Check point	<ul style="list-style-type: none"> • Check for a wrong option function setting and operation. • Check that the plug-in option is plugged into the connector securely. • Check for an open communication cable. • Check that the termination resistor is fitted properly. • Check that the option card is normal. 			
Corrective action	<ul style="list-style-type: none"> • Check the option function setting, etc. • Connect the plug-in option securely. 			

Operation Panel Indication	E. 1 to E. 3	<i>E. 1 to E. 3</i>	FR-PU04V	Fault 1 to Fault 3
Name	Option alarm			
Description	Stops the inverter output if a contact fault or the like of the connector between the inverter and communication option occurs.			
Check point	Check that the communication option is plugged into the connector securely. (1 to 3 indicate the option slot numbers.)			
Corrective action	<ul style="list-style-type: none"> • Connect the plug-in option securely. • Please contact your sales representative. 			

Errors (Alarms)

Operation Panel Indication	E.PE	<i>E. PE</i>	FR-PU04V	Corrupt Memry
Name	Parameter storage device alarm			
Description	Appears when an error occurred in the stored parameters. (E ² PROM fault)			
Check point	Check for too many number of parameter write times.			
Corrective action	<ul style="list-style-type: none"> • Please contact your sales representative. • When performing parameter write frequently for communication purposes, set "1" in Pr. 342 to enable RAM write. Note that powering off returns the inverter to the status before RAM write. 			

Operation Panel Indication	E.PUE	<i>EPUE</i>	FR-PU04V	PU Leave Out
Name	PU disconnection			
Description	This function stops the inverter output if communication between the inverter and PU is suspended, e.g. the operation panel or parameter unit is disconnected, when "2", "3", "16" or "17" was set in Pr. 75 "reset selection/disconnected PU detection/PU stop selection". This function stops the inverter output if the number of successive communication errors is greater than the permissible number of retries when the Pr. 121 value is other than "9999" for RS-485 communication from the PU connector. This function also stops the inverter output if communication is broken for the period of time set in Pr. 122.			
Check point	<ul style="list-style-type: none"> • Check for loose fitting of the FR-DU04-1 or FR-PU04V. • Check the Pr. 75 setting. 			
Corrective action	Fit the FR-DU04-1 or FR-PU04V securely.			

Operation Panel Indication	E.RET	<i>E. r ET</i>	FR-PU04V	Retry No Over
Name	Retry count excess			
Description	If operation cannot be resumed properly within the number of retries set, this function stops the inverter output.			
Check point	Find the cause of alarm occurrence.			
Corrective action	Eliminate the cause of the error preceding this error indication.			

Operation Panel Indication	E.LF	<i>ELF</i>	FR-PU04V	ELF
Name	Output phase failure protection			
Description	This function stops the inverter output if one of the three phases (U, V, W) on the inverter's output side (load side) opens.			
Check point	<ul style="list-style-type: none"> • Check the wiring (Check the motor for a fault.) • Check that the capacity of the motor used is not smaller than that of the inverter. 			
Corrective action	<ul style="list-style-type: none"> • Wire the cables properly. • Check the Pr. 251 "output phase failure protection selection" setting. 			

Operation Panel Indication	E.CPU	<i>ECPU</i>	FR-PU04V	CPU Fault
Name	CPU error			
Description	Stops the inverter output if the communication error of the built-in CPU occurs.			
Check point	—			
Corrective action	Please contact your sales representative.			

Operation Panel Indication	E. 6	<i>E. 6</i>	FR-PU04V	Fault 6
	E. 7	<i>E. 7</i>		Fault 7
Name	CPU error			
Description	If the arithmetic operation of the peripheral circuit of the built-in CPU does not end within the predetermined period or if an error exists in the receive data of the built-in CPU, the inverter self-determines it as an alarm and stops the output.			
Check point	—			
Corrective action	Please contact your sales representative.			

Operation Panel Indication	E.P24	<i>EP24</i>	FR-PU04V	E.P24
Name	24VDC power output short circuit			
Description	When the 24VDC power output from the PC terminal is shorted, this function shuts off the power output. At this time, all external contact inputs switch off. The inverter cannot be reset by entering the RES signal. To reset it, use the operation panel or switch power off, then on again. When the 24VDC power for encoder is shorted, this function shuts off the power output.			
Check point	<ul style="list-style-type: none"> • Check for a short circuit in the PC terminal output. • Check for wrong wiring. • Check for a loose connector. Check that the cables are short-circuited. 			
Corrective action	<ul style="list-style-type: none"> • Remedy the short circuit portion. • Connect the cables securely. Change the cables. 			

Operation Panel Indication	E.P12	<i>EP12</i>	FR-PU04V	E.P12
Name	12VDC power output short circuit			
Description	When the 12VDC power for encoder is shorted, this function shuts off the power output.			
Check point	<ul style="list-style-type: none"> • Check for wrong wiring. • Check for a loose connector. Check for an open cable. 			
Corrective action	Connect the cables securely. Change the cables.			

Operation Panel Indication	E.CTE	<i>ECTE</i>	FR-PU04V	—
Name	Operation panel power supply short circuit			
Description	When the operation panel power supply (P5S of the PU connector) is shorted, this function shuts off the power output. At this time, the operation panel (parameter unit) cannot be used and RS-485 communication from the PU connector cannot be made. To reset, enter the RES signal or switch power off, then on again. When the 5VDC power for encoder is shorted, this function shuts off the power output.			
Check point	<ul style="list-style-type: none"> • Check for a short circuit in the PU connector cable. Check for a loose connector. • Check that cables are short-circuited. • Check for wrong wiring. 			
Corrective action	<ul style="list-style-type: none"> • Check the PU and cable. • Connect the cable securely. Change the cable. 			

Operation Panel Indication	E.MB1 to 7	<i>EMB1 to 7</i>	FR-PU04V	—
Name	Brake sequence error			
Description	<ul style="list-style-type: none"> • The inverter output is stopped when a sequence error occurs during use of the brake sequence function (Pr. 278 to Pr. 285). • If (detection frequency) - (output frequency) > Pr. 285 under vector control, E.MB1 occurs and the inverter output is stopped. 			
Check point	Find the cause of alarm occurrence.			
Corrective action	Check the set parameters and perform wiring properly.			

Errors (Alarms)

Operation Panel Indication	E.OS	E. OS	FR-PU04V	Overspeed occurrence
Name	Overspeed occurrence			
Description	Indicates that the motor speed has exceeded the overspeed setting level.			
Check point	<ul style="list-style-type: none"> • Check that the Pr. 374 "overspeed detection level" value is correct. • Check that the number of PLG pulses differ from the actual number of PLG pulses. 			
Corrective action	<ul style="list-style-type: none"> • Set the Pr. 374 "overspeed detection level" value correctly. • Set the correct number of PLG pulses in Pr. 851. 			

Operation Panel Indication	E.OSD	E.OSd	FR-PU04V	Excessive speed deflection
Name	Speed deviation excess detection			
Description	Stops the inverter output if the motor speed is increased or decreased under the influence of the load etc. during vector control and cannot be controlled in accordance with the speed command value.			
Check point	<ul style="list-style-type: none"> • Check that the Pr. 870 "speed deviation level" and Pr. 871 "speed deviation time" values are correct. • Check for sudden load change. • Check that the number of PLG pulses differ from the actual number of PLG pulses. 			
Corrective action	<ul style="list-style-type: none"> • Set the Pr. 870 "speed deviation level" and Pr. 871 "speed deviation time" values correctly. • Keep load stable. • Set the correct number of PLG pulses in Pr. 851. 			

Operation Panel Indication	E.ECT	E.ECT	FR-PU04V	No encoder signal
Name	Open cable detection			
Description	Stops the inverter output if the PLG signal is shut off.			
Check point	<ul style="list-style-type: none"> • Check for an open cable of the PLG signal. • Check that the PLG specifications are correct. • Check for a loose connector. • Check that the jumper connector of the rear of the control terminal is correctly set. 			
Corrective action	<ul style="list-style-type: none"> • Remedy the open cable. • Use the PLG that meets the specifications. • Make connection securely. • Set the jumper connector of the rear of the control terminal correctly. (Refer to page 5.) 			

Operation Panel Indication	E.OD	E. Od	FR-PU04V	Excessive position error
Name	Position error large			
Description	Indicates that the difference between the position command and position feedback exceeded the reference.			
Check point	<ul style="list-style-type: none"> • Check that the position detecting encoder mounting orientation matches the parameter. • Check that the load is not large. • Check that the Pr. 427 "error excess level" and Pr. 851 "number of PLG pulses" values are correct. 			
Corrective action	<ul style="list-style-type: none"> • Check the parameters. • Reduce the load weight. • Set the Pr. 427 "error excess level" and Pr. 851 "number of PLG pulses" values correctly. 			

Operation Panel Indication	E.ECA	E.ECA	FR-PU04V	No encoder A signal
Name	Orientation encoder no-signal			
Description	The encoder pulse for the FR-V5AM or FR-A5AP is not input.			
Check point	<ul style="list-style-type: none"> • Check that the FR-V5AM or FR-A5AP is connected correctly. • Check for a loose connector. • Check for an open cable. • Check for a detector fault. 			
Corrective action	<ul style="list-style-type: none"> • Make connection securely. • Change the cable. • Replace the detector. 			

Operation Panel Indication	E.EP	E.EP	FR-PU04V	E.EP
Name	Encoder mis-wiring detection			
Description	The rotation command of the inverter differs from the actual motor rotation direction detected from the PLG during offline auto tuning.			
Check point	<ul style="list-style-type: none"> • Check for mis-wiring of the PLG cable. • Check for wrong setting of Pr. 852 "PLG rotation direction". 			
Corrective action	<ul style="list-style-type: none"> • Perform connection and wiring securely. • Change the Pr. 852 "PLG rotation direction" value. 			

Operation Panel Indication	E.15	E.15	FR-PU04	Fault 15
Name	Main circuit error			
Description	Brake unit cooling fin overheat, DC fuse blown, control board ambient temperature error, output overcurrent, cooling fan power supply error, capacitor overcurrent, cooling fin overheat, gate power supply error. Refer to the next page for details.			
Check point	Refer next table.			
Corrective action	Please contact your sales representative.			

Operation Panel Display	Check Point		Remedy
E.15	Brake unit cooling fin overheating	Is the usage frequency of the brake unit appropriate? Are the cooling fins clogged? Is there any error in the inverter unit cooling fan?	Reduce the load GD ² . Reduce the braking frequency. Clean the cooling fins. Replace the cooling fan.
	DC fuse blown	Is the DC circuit short circuited?	Repair the short-circuited section, and replace the DC fuse.
	Control board ambient temperature error	Is there an error in the cooling fan? Is the ambient temperature too high?	Replace the cooling fan. Keep the ambient temperature within the specifications
	Output over current	Is there an output short circuit or ground fault? (Check the motor winding and insulation resistance.) Was rapid acceleration attempted? Did the load fluctuate suddenly? Was rapid deceleration attempted? Were the motor's mechanical brakes applied too quickly?	Repair the output short circuit and ground fault. (Repair or replace the motor.) Lengthen the deceleration time. Eliminate the sudden fluctuate in the load. Lengthen the deceleration time. Investigate the braking operation.
	Cooling fan power supply error	Is the cooling fan's power supply output short circuited? Is the cooling fan's power supply abnormal? Is the fuse blown?	Repair the short-circuited section. Replace the cooling fan power supply. Replace the fuse.
	Capacitor overcurrent	Is the DC circuit short circuited? Is there an output short circuit or ground fault? (Check the motor winding and insulation resistance.)	Repair the short-circuited section, and replace the DC fuse. Repair the output short circuit and ground fault. (Repair or replace the motor.)
	Cooling fin overheat	Is there an error in the cooling fan? Are the cooling fins clogged? Is the ambient temperature too high?	Replace the cooling fan. Clean the cooling fins. Keep the ambient temperature within the specifications.
	Gate power supply error	Is the gate output short circuited? Is there an error in the control power supply board?	Repair the short-circuited section. Replace the control power supply board.

- When the protective function is activated, take proper corrective action, reset the inverter, then resume operation.

Main circuit error [E, 15] details

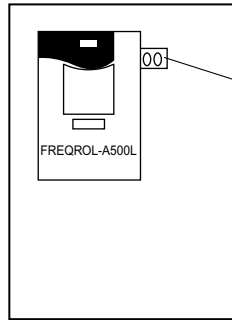

There are two 7-segment LEDs on the right of the operation panel as shown on the right. The following fault details are indicated by the LED display.

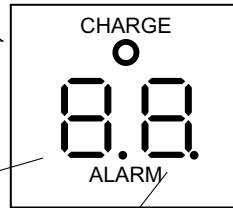

Left LED	Brake unit cooling fin overheating	DC fuse blown	Control board ambient temperature error	Output overcurrent	Right LED	Cooling fan power supply error	— overcurrent	Cooling fin overheat	Gate power supply error
0					0				
1				○	1				○
2			○		2			○	
3			○	○	3			○	○
4		○			4		○		
5		○		○	5		○		○
6		○	○		6		○	○	
7		○	○	○	7		○	○	○
8	○				8	○			
9	○			○	9	○			○
.0	○		○		.0	○		○	
.1	○		○	○	.1	○		○	○
.2	○	○			.2	○	○		
.3	○	○		○	.3	○	○		○
.4	○	○	○		.4	○	○		○
.5	○	○	○	○	.5	○	○	○	
.6	○	○	○		.6	○	○	○	
.7	○	○	○	○	.7	○	○	○	○
.8	○	○	○		.8	○	○	○	
.9	○	○	○	○	.9	○	○	○	○
.	○	○	○	○	.	○	○	○	○

* For example, if the display is 4 5 , the DC fuse blown, — overcurrent and gate power supply errors have occurred.

Name	Details
Brake unit cooling fin overheating	The inverter output will stop if the brake unit's cooling fin temperature rises above the specified value.
DC fuse blown	The inverter output will stop if the DC fuse blows.
Control board ambient temperature error	The inverter output will stop if the ambient temperature of the control board rises above the specified value.
Output overcurrent	The inverter output will stop if the inverter's output current flows above the specified value.
Cooling fan power supply error	The inverter output will stop if the cooling fan's power drops below the specified value.
Capacitor overcurrent	The inverter will stop if a current exceeding the specified value flows to the main circuit smoothing capacitor.
Cooling fin overheat	The inverter output will stop if the cooling fin's temperature rises above the specified value.
Gate power supply error	The inverter output will stop if the gate power supply voltage drops below the specified value.



6.1.2 Warnings

When the protective function is activated, the output is not shut off.

Operation Panel Indication	OL	<i>OL</i>	FR-PU04V	OL
Name	Stall prevention (overcurrent)			
Description	V/F control	Output if the inverter output current exceeds torque restriction level. (Refer to page 36.).		
	Speed control	• Output if torque restriction level is exceeded.		
	Position control	• Output if the PLG setting is wrong.		
Check point	<ul style="list-style-type: none"> • Check the motor for use under overload. • The acceleration/deceleration time may vary during V/F control. Check that the Pr. 0 "torque boost" setting is not higher than required. • Check that the Pr. 851 "number of PLG pulses" and Pr. 852 "PLG rotation direction" values are correct. 			
Corrective action	<ul style="list-style-type: none"> • Increase the operation level using torque restriction level (analog input or parameter input). • Check for the Pr. 851 "number of PLG pulses" and Pr. 852 "PLG rotation direction" values. 			

*5: Torque restriction level can be set using Pr. 22 "torque restriction level" as desired. (150% with the factory setting)

Operation Panel Indication	oL	<i>oL</i>	FR-PU04V	oL
Name	Stall prevention (overvoltage)			
Description	During deceleration	If the regenerative energy of the motor becomes excessive to exceed the brake capability, this function stops the decrease in frequency to prevent overvoltage shut-off. As soon as the regenerative energy has reduced, deceleration resumes.		
Check point	Check for sudden speed reduction.			
Corrective action	The deceleration time may change. Increase the deceleration time using Pr. 8 "deceleration time".			

Operation Panel Indication	PS	<i>PS</i>	FR-PU04V	PS
Name	PU stop			
Description	Appears when a stop was made by pressing of the operation panel  or parameter unit (FR-PU04V) during operation in the external operation mode with the Pr. 75 "reset selection/PU stop selection" setting.			
Check point	Check for a stop made by pressing  of the operation panel during external operation.			
Corrective action	Refer to page 85.			

Errors (Alarms)

Operation Panel Indication	RB	rb	FR-PU04V	RB
Name	Regenerative brake prealarm			
Description	Appears if the regenerative brake duty reaches or exceeds 85% of the Pr. 70 "special regenerative brake duty" value. If the regenerative brake duty reaches 100%, a regenerative overvoltage (E. OV_) occurs.			
Check point	<ul style="list-style-type: none"> • Check that the brake resistor duty is not high. • Check that the Pr. 30 "regenerative function selection" and Pr. 70 "special regenerative brake duty" values are correct. 			
Corrective action	<ul style="list-style-type: none"> • Increase the deceleration time. • Check the Pr. 30 "regenerative function selection" and Pr. 70 "special regenerative brake duty" values. 			
Operation Panel Indication	TH	TH	FR-PU04V	TH
Name	Electronic thermal relay prealarm			
Description	Appears if the integrating value of the electronic thermal relay reaches or exceeds 85% of the preset level. If it reaches 100% of the preset level, a motor overload shutoff (E. THM) occurs.			
Check point	Check for large load or sudden acceleration.			
Corrective action	Reduce the load weight or the number of operation times.			
Operation Panel Indication	MT	MT	FR-PU04V	MT
Name	Maintenance signal output			
Description	Indicates that the cumulative operation time of the inverter has reached a given time.			
Check point	Check that Pr. 890 "maintenance output setting time" has been set. (A short time has been set.)			
Corrective action	After checking the energization time, write "0" to Pr. 892 "maintenance output signal clear".			
Operation Panel Indication	SL	SL	FR-PU04V	SL
Name	Speed limit indication (speed restriction)			
Description	Output if the speed restriction level is exceeded during torque control.			
Check point	<ul style="list-style-type: none"> • Check that the torque command is not larger than required. • Check that the speed restriction level is not low. 			
Corrective action	Decrease the torque restriction. Increase the speed restriction level.			
Operation Panel Indication	Err.	Err		
Description	This alarm appears if: <ul style="list-style-type: none"> • The RES signal is on; • You attempted to make parameter setting in the external operation mode; • You attempted to change the operation mode during operation; • You attempted to set any parameter value outside its setting range; • The PU and inverter cannot make normal communication; • You attempted to make parameter setting during operation (when signal STF or STR is on); or • You attempted to make parameter setting when Pr. 77 "parameter write disable selection" has been set to disable parameter write. 			
Corrective action	Perform run and operation securely.			

6.1.3 How to recover from PU stop error (PS)

(1) Restarting method when stop was made by pressing from operation panel (Method of restarting from indication)

- 1) After the motor has decelerated to a stop, turn off the STF or STR signal.
- 2) Press  twice* to display *OPnd*.

CAUTION

When Pr. 79 = 3, press  three times to display *PU*. Then press  to proceed to 3).



(*For monitor screen) ... Refer to page 30 for details of the monitor display provided by pressing .

- 3) Press .
- 4) Turn on the STF or STR signal.

REMARKS

- When you provide a reset input (RES) during operation, the inverter that is being reset shuts off the output and resets the internal heat integrating value of the electronic thermal relay and the number of retries, and the motor coasts.
- The Pr. 75 value can be set any time. This value does not return to the initial value if parameter (all) clear is executed.
- When the motor is stopped from the PU, *PS* and *00* are displayed alternately. An alarm output is not provided.

(2) Restarting method when stop was made by pressing from PU

- 1) After the motor has decelerated to a stop, turn off the STF or STR signal.
- 2) Press  .
.....(Recovery from )
- 3) Turn on the STF or STR signal.

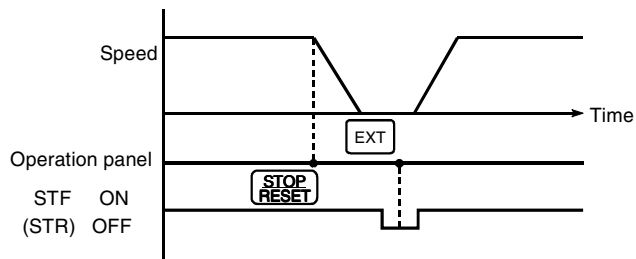

Example of stop and restart during external operation

Alternatively, you can make a restart by making a power-on reset or resetting the inverter using the reset terminal of the inverter.

REMARKS

- When you provide a reset input (RES) during operation, the inverter that is being reset shuts off the output and resets the data of the electronic thermal relay, and the motor coasts.
- To make a restart, confirm that the PU is connected and then reset the inverter.
- The Pr. 75 value can be set any time. This value does not return to the initial value if parameter (all) clear is executed.
- When the motor is stopped from the PU, PS is displayed. An alarm output is not provided.
- Since PS is not an inverter error, the inverter can not be reset with .

⚠ CAUTION

**⚠ Do not reset the inverter with the start signal input.
Doing so will start the inverter immediately after it has recovered from the error, causing hazard.**

6.2 Correspondences between digital and actual characters

There are the following correspondences between the actual alphanumeric characters and the digital characters displayed on the operation panel.

Actual	Digital
0	0
1	1
2	2
3	3
4	4
5	5
6	6
7	7
8	8
9	9

Actual	Digital
A	A
B	b
C	C
D	d
E	E
F	F
G	G
H	H
I	I
J	J
L	L

Actual	Digital
M	m
N	n
O	O
o	o
P	P
S	S
T	T
U	U
V	V
r	r
-	-

6.3 Resetting the inverter

The inverter can be reset by performing any of the following operations. Note that the electronic thermal relay's internal heat integrating value and the number of retries are cleared (erased) by resetting the inverter. It takes about 1s for reset.

Operation 1: Using the operation panel, press  to reset the inverter.

(Enabled only when the inverter protective function (major fault) is activated. (Refer to page 74 for major faults.))

Operation 2: Switch power off once, then switch it on again.

Operation 3: Turn on the reset signal (RES) for more than 0.1s.

6.4 Troubleshooting

POINT

If you have made various checks and still cannot find the cause of an error, we recommend you to initialize the parameter values (to the factory settings) once, then set necessary parameter values again, and check them. (Refer to page 33 for parameter all clear.)

6.4.1	Motor generates abnormal noise	87
6.4.2	Motor does not rotate	88
(1)	Vector control	88
(2)	V/F control	90
6.4.3	Motor generates heat abnormally	91
6.4.4	Motor hunts	92
(1)	Speed control	92
6.4.5	Machine operates unstably	93
(1)	Speed control	93
6.4.6	Speed command does not match motor speed	94
(1)	Speed control	94
6.4.7	Motor rotates but speed does not change	95
(1)	Speed control	95
6.4.8	Torque control is not exercised normally	96
(1)	Torque control	96

6.4.1 Motor generates abnormal noise

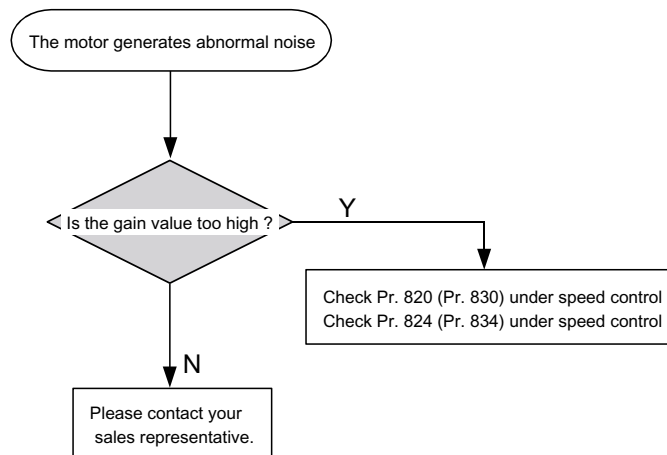

6.4.2 Motor does not rotate

(1) Vector control

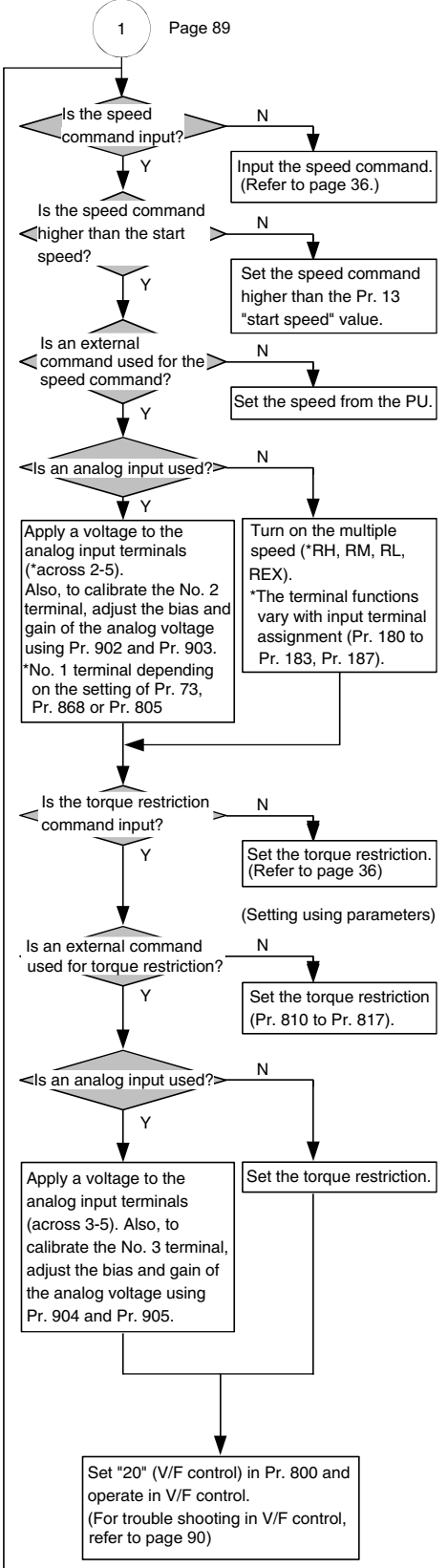
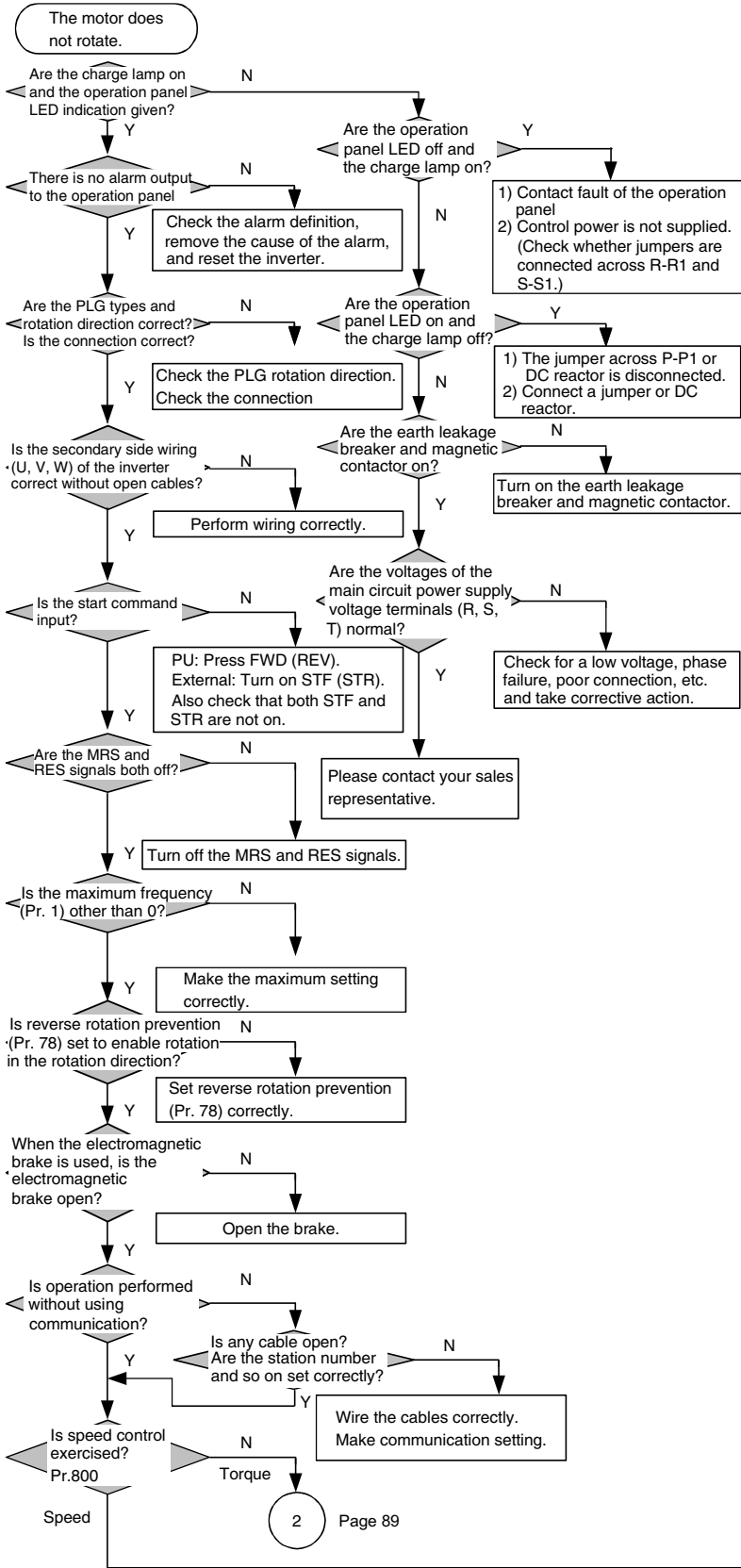

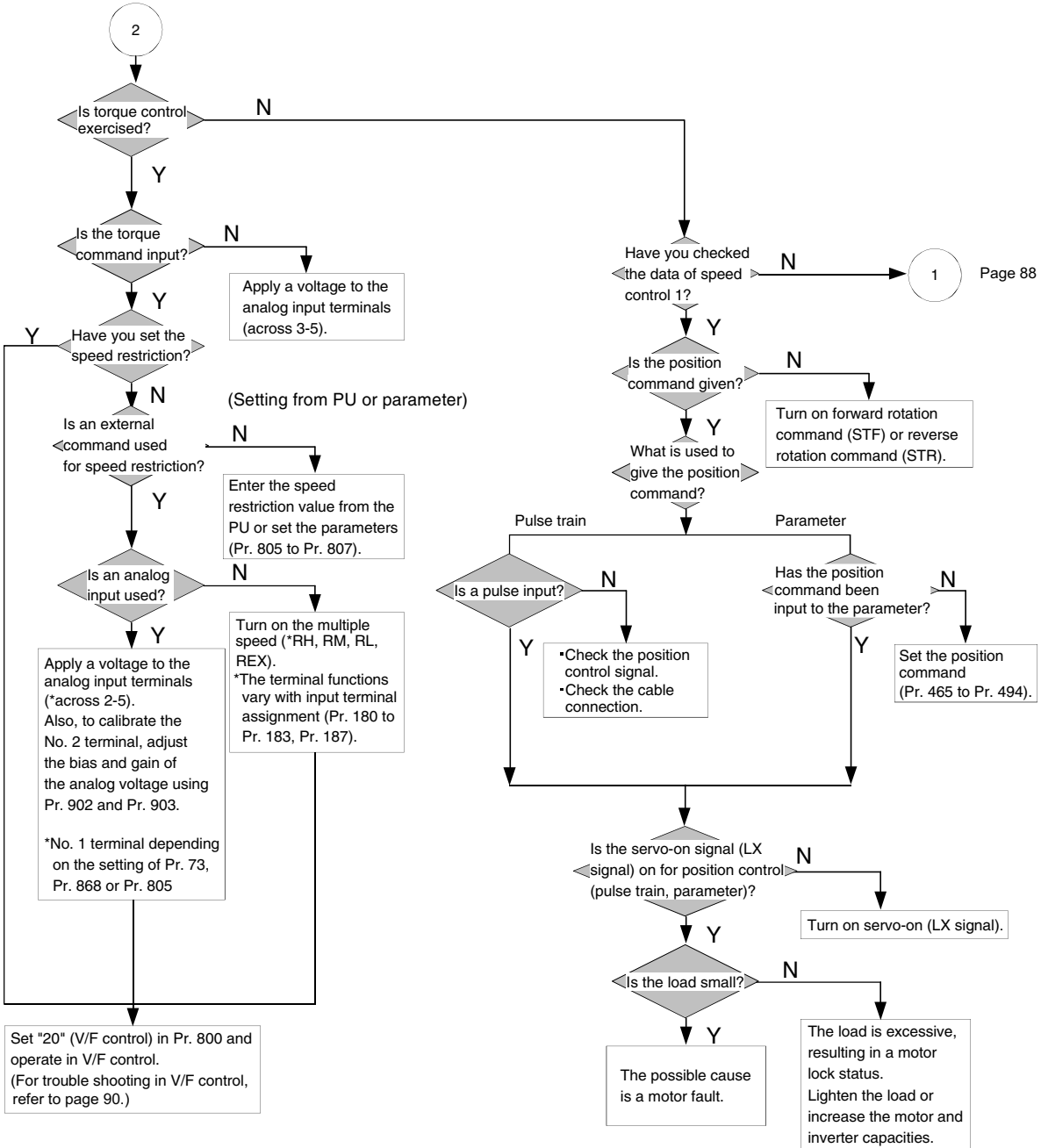

(2) V/F control

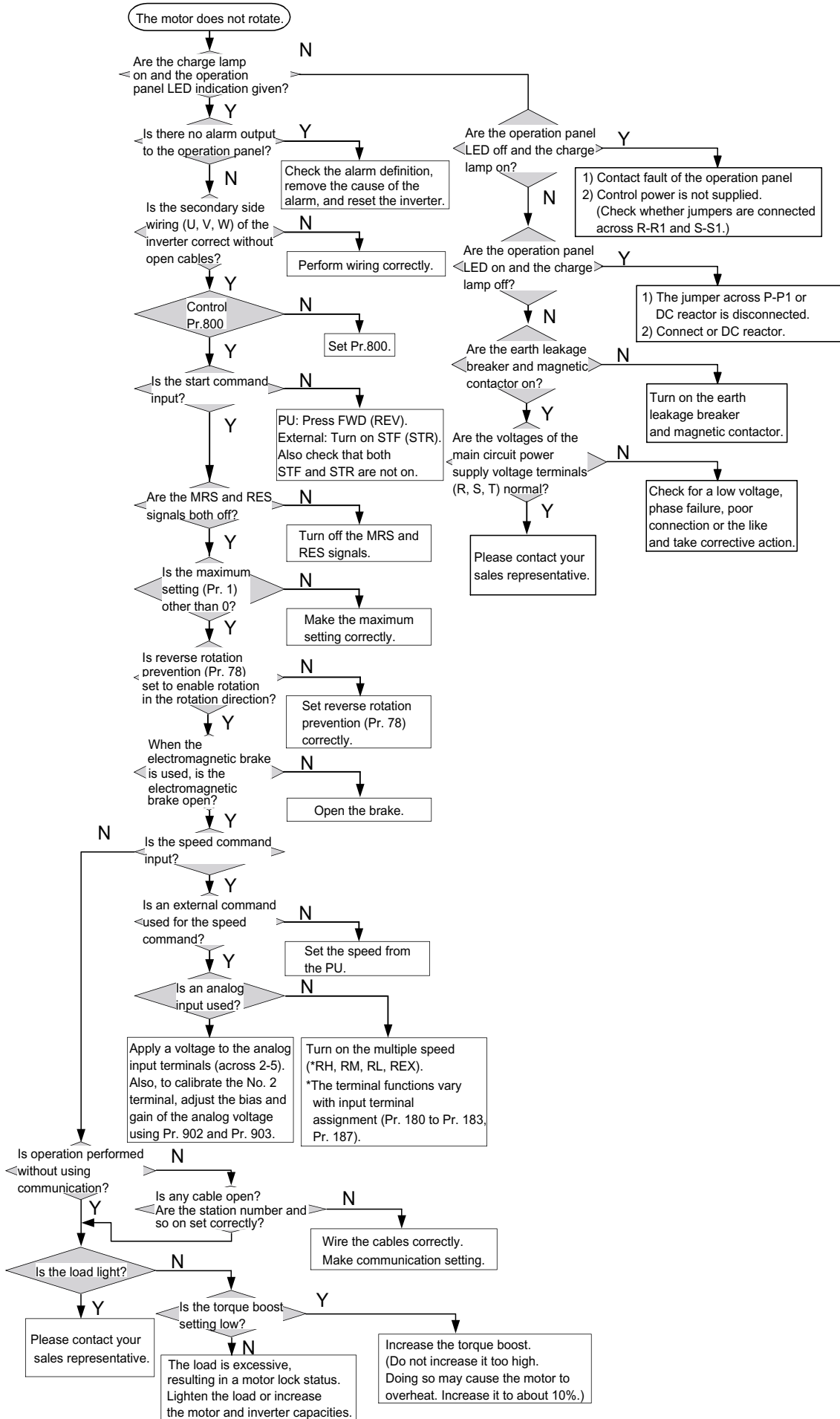

6.4.3 Motor generates heat abnormally

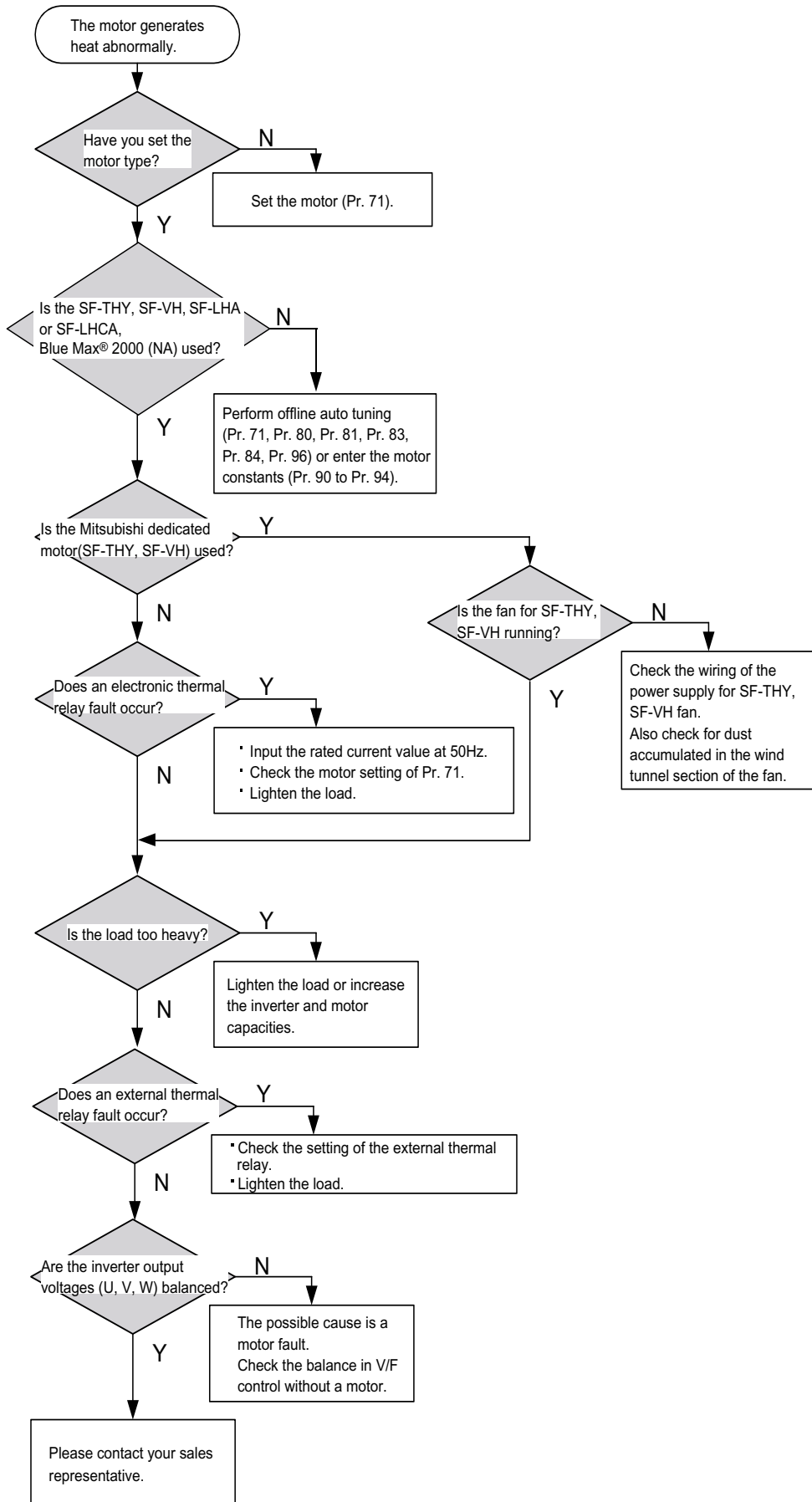

6.4.4 Motor hunts

(1) Speed control

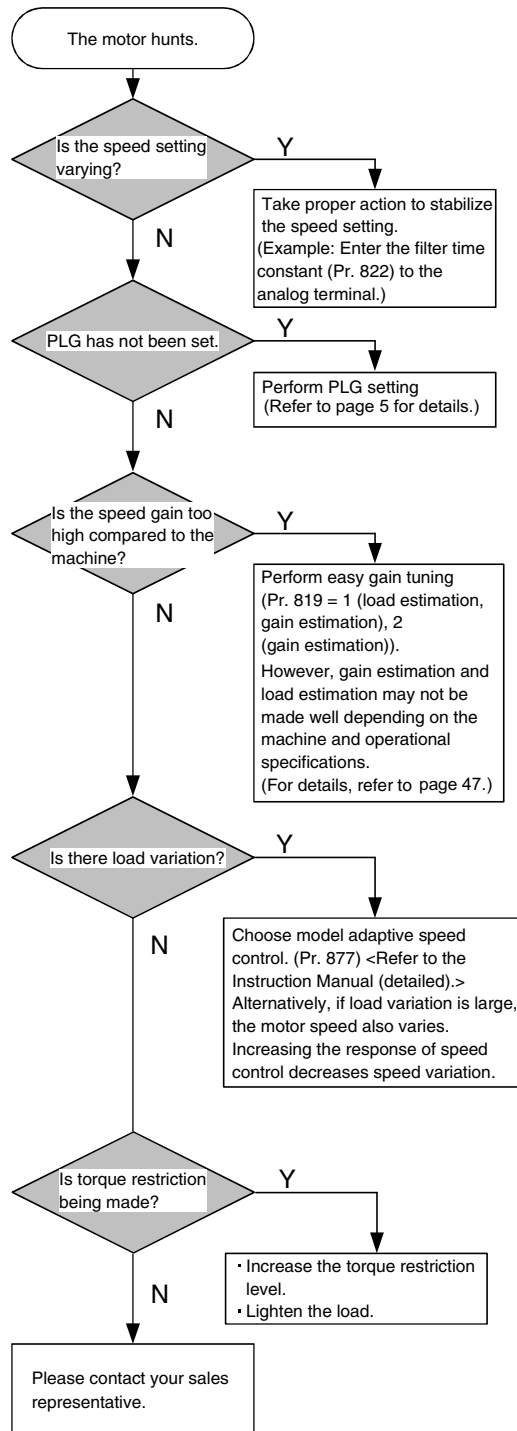

6.4.5 Machine operates unstably

(1) Speed control

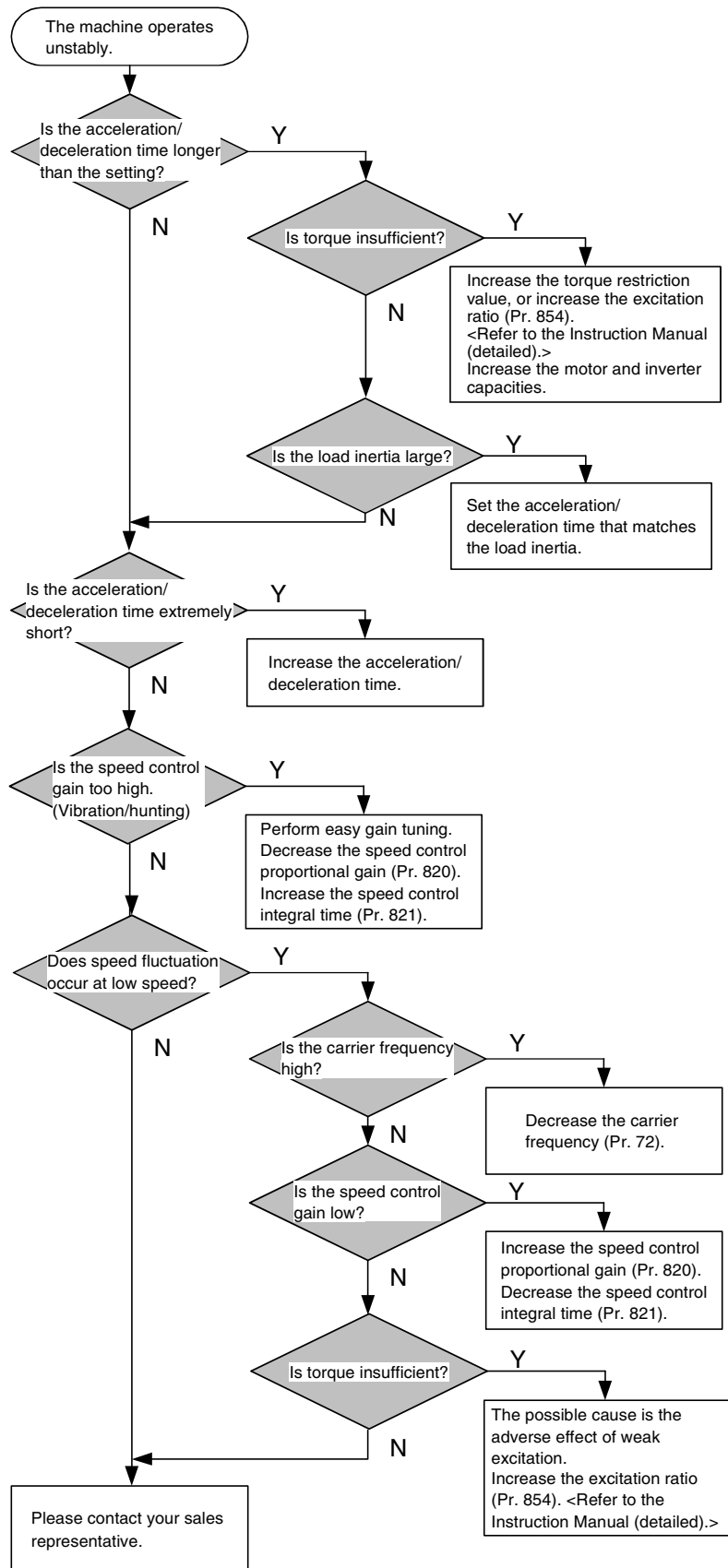

6.4.6 Speed command does not match motor speed

(1) Speed control

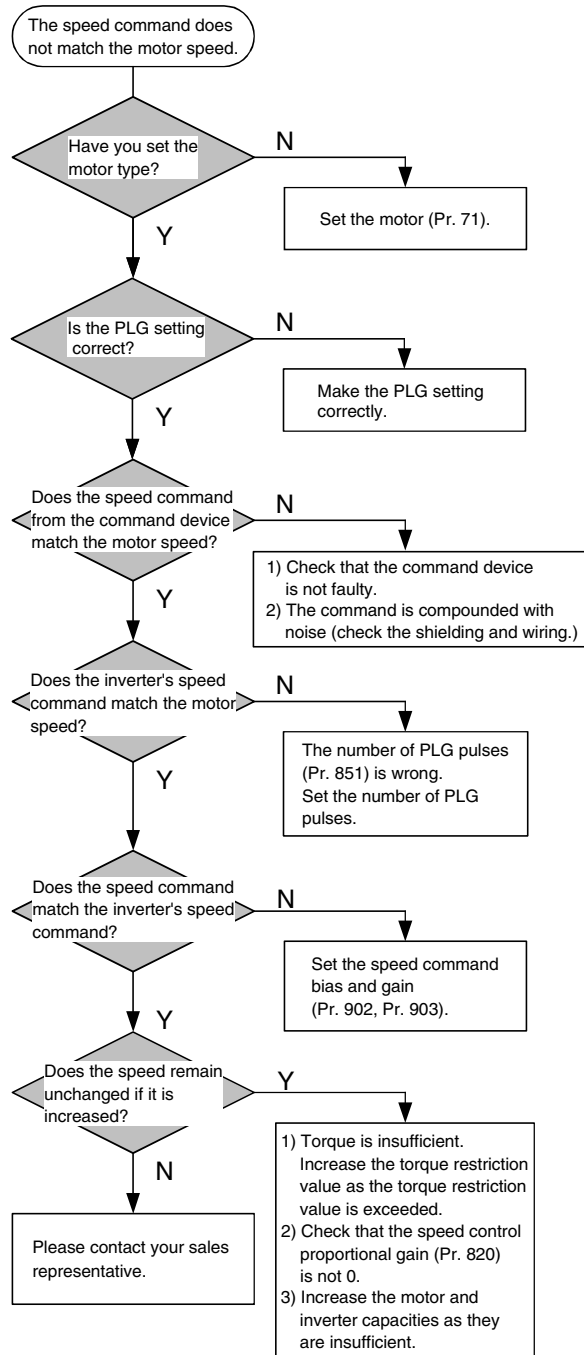

6.4.7 Motor rotates but speed does not change

(1) Speed control

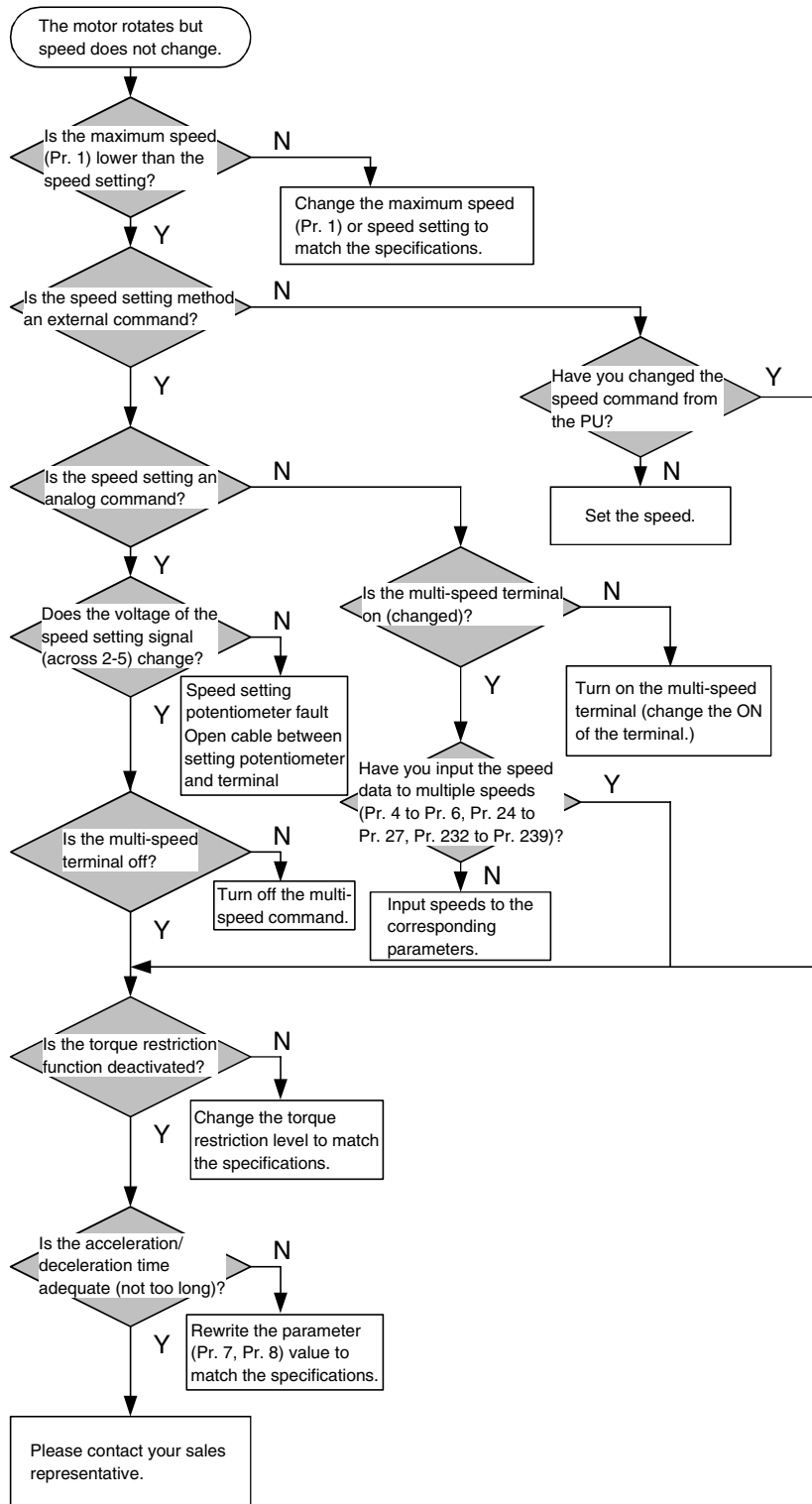

6.4.8 Torque control is not exercised normally

(1) Torque control

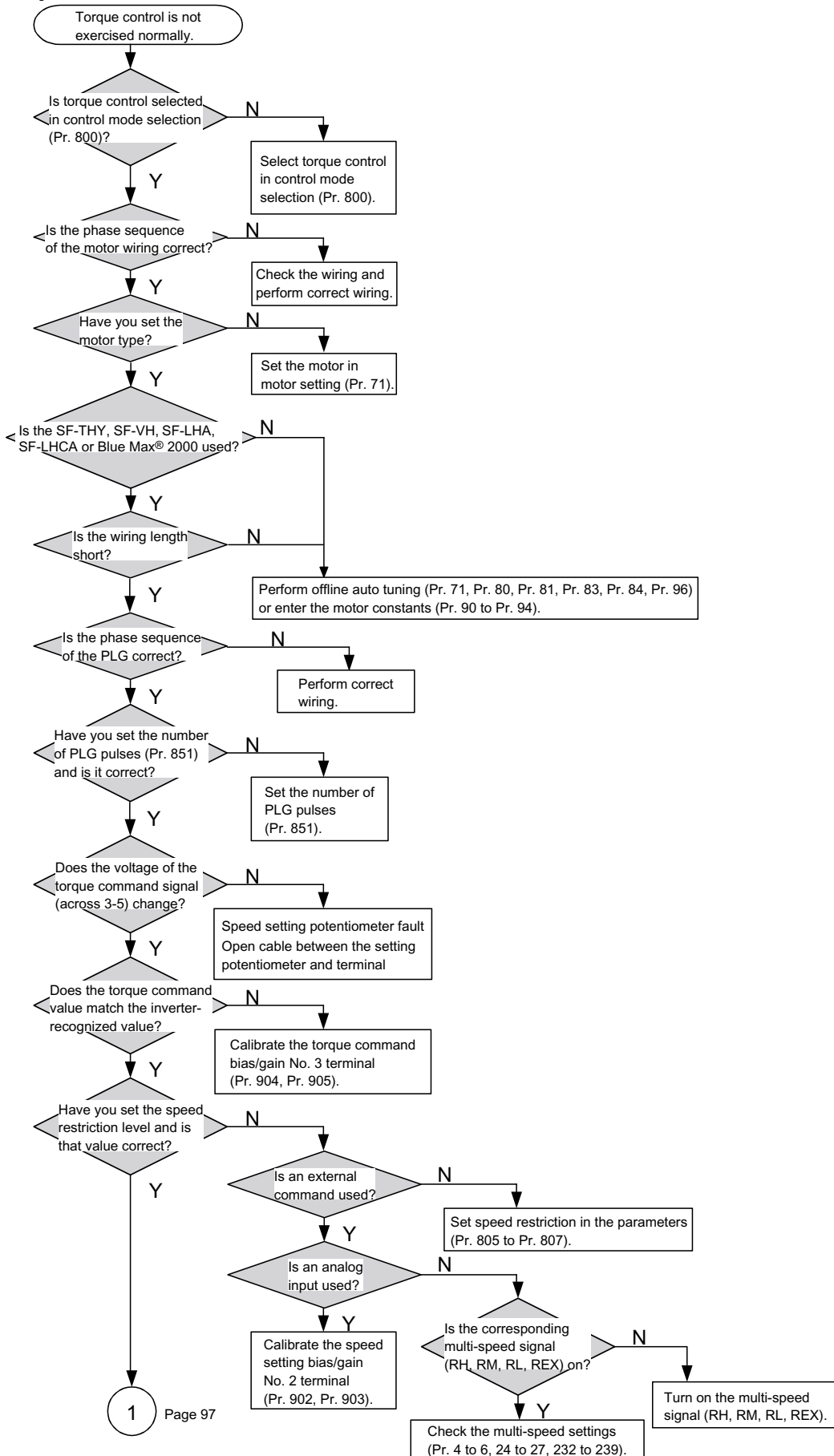

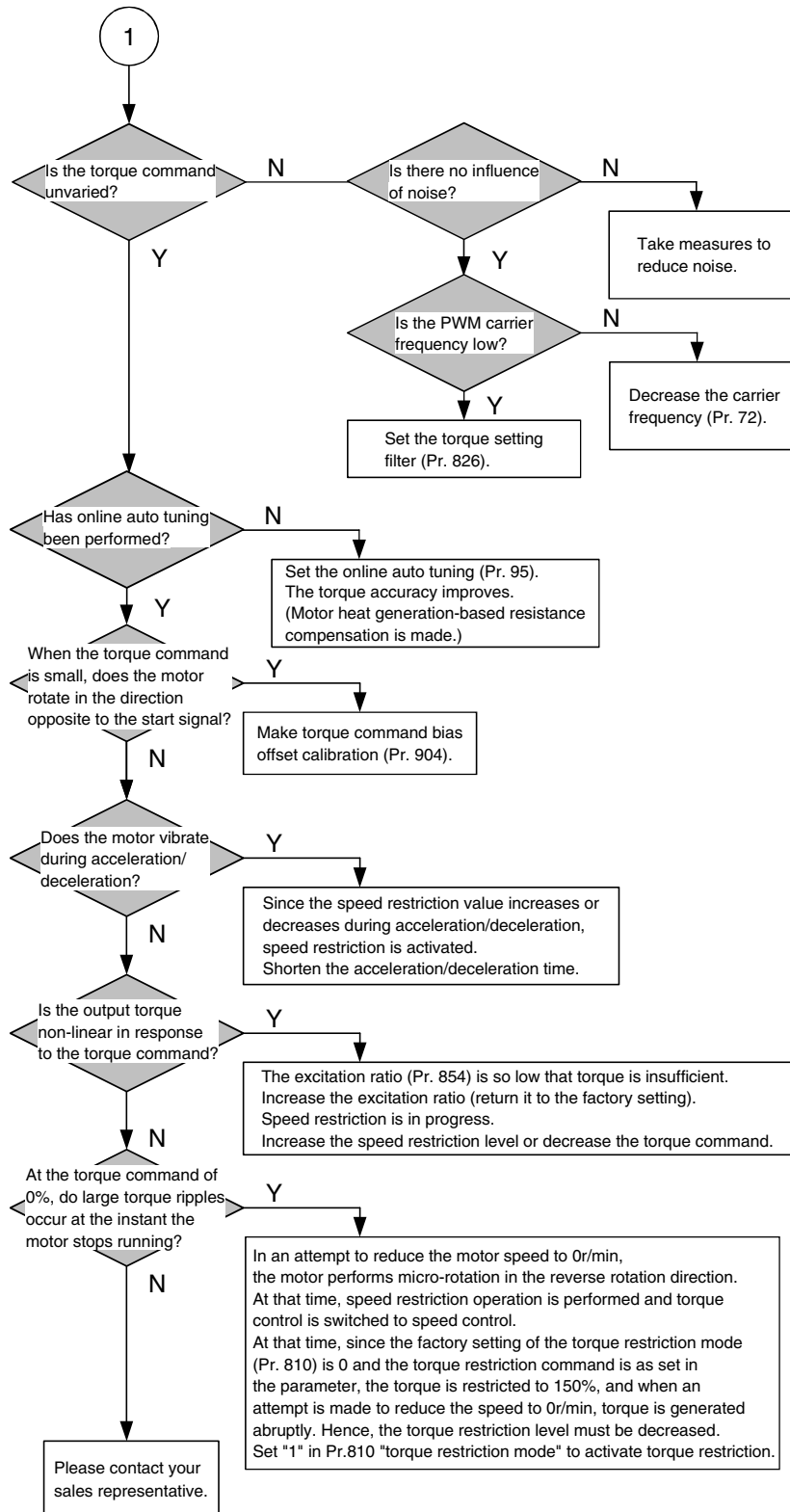

Precautions for maintenance and inspection

6.5 Precautions for maintenance and inspection

6.5.1 Precautions for maintenance and inspection

The inverter is a static unit mainly consisting of semiconductor devices. Daily inspection must be performed to prevent any fault from occurring due to the adverse effects of the operating environment, such as temperature, humidity, dust, dirt and vibration, changes in the parts with time, service life, and other factors.

● Precautions for maintenance and inspection

For some short time after the power is switched off, a high voltage remains in the smoothing capacitor. When accessing the inverter for inspection, switch power off, wait for more than 10 minutes, and then make sure that the voltage across the main circuit terminals P-N of the inverter is not more than 30VDC using a tester, etc.

6.5.2 Check items

(1) Daily inspection

Basically, check for the following faults during operation.

- 1) Motor operation fault
- 2) Improper installation environment
- 3) Cooling system fault
- 4) Unusual vibration and noise
- 5) Unusual overheat and discoloration

During operation, check the inverter input voltages using a tester.

(2) Cleaning

Always run the inverter in a clean status.

When cleaning the inverter, gently wipe dirty areas with a soft cloth immersed in neutral detergent or ethanol.

CAUTION

Do not use solvent, such as acetone, benzene, toluene and alcohol, as they will cause the inverter surface paint to peel off.

6.5.3 Periodic inspection

Check the areas inaccessible during operation and requiring periodic inspection. For periodic inspection, consult us.

- 1) Cooling system fault : Clean the air filter, etc.
- 2) Tightening check and retightening : The screws and bolts may become loose due to vibration, temperature changes, etc. Check and tighten them.
Tighten them according to the specified tightening torque. (Refer to page 18.)
- 3) Check the conductors and insulating materials for corrosion and damage.
- 4) Measure insulation resistance.
- 5) Check and change the cooling fan and relay.

6.5.4 Insulation resistance test using megger

- 1) Before performing the insulation resistance test on the external circuit, disconnect the cables from all terminals of the inverter so that the test voltage is not applied to the inverter.
- 2) For the continuity test of the control circuit, use a tester (high resistance range) and do not use the megger or buzzer.
- 3) For the inverter, conduct the insulation resistance test on the main circuit only as shown below and do not perform the test on the control circuit. (Use a 500VDC megger.)

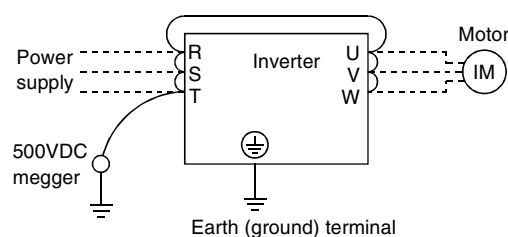

6.5.5 Pressure test

Do not conduct a pressure test. Deterioration may occur.

6.5.6 Daily and periodic inspection

Area of Inspection	Inspection Item	Description	Interval			Method	Criterion	Instrument	Customer's check
			Daily	Periodic*					
				1 year	2 years				
General	Surrounding environment	Check ambient temperature, humidity, dust, dirt, etc.	○			Measure 5cm (1.97 inches) away from the inverter. (Refer to page 14.)	Ambient temperature: -10°C to +50°C (14°F to 122°F), non-freezing. Ambient humidity: 90% or less, non-condensing.	Thermometer, hygrometer, recorder	
	Overall unit	Check for unusual vibration and noise.	○			Visual and auditory checks.	No fault.		
	Power supply voltage	Check that the main circuit voltages are normal.	○			Measure voltages across the inverter terminal block R, S and T phases.	Within permissible AC (DC) voltage fluctuation (refer to page 104)	Tester, digital multi meter	
Main circuit	General	(1) Check with megger (across main circuit terminals and earth (ground) terminal). (2) Check for loose screws and bolts. (3) Check for overheat traces on the parts. (4) Clean.		○		(1) Disconnect all cables from the inverter and measure across terminals R, S, T, U, V, W and earth terminal with megger. (2) Retighten. (3) Visual check.	(1) 5MΩ or more. (2), (3) No fault.	500VDC class megger	
	Conductors, cables	(1) Check conductors for distortion. (2) Check cable sheaths for breakage.		○		(1), (2) Visual check.	(1), (2) No fault.		
	Terminal block	Check for damage.		○		Visual check	No fault		
	Relay	(1) Check for chatter during operation. (2) Check for rough surface on contacts.		○		(1) Auditory check. (2) Visual check.	(1), (2) No fault.		
	Resistor	(1) Check for crack in resistor insulation. (2) Check for open cable.		○		(1) Visual check. Cement resistance, wire-wound resistor. (2) Disconnect one end and measure with tester.	(1) No fault. (2) Indication		
	Control circuit Protective circuit	Operation check	(1) Check balance of output voltages across phases with the inverter operated alone. (2) Perform sequence protective operation test to ensure no fault in protective and display circuits.		○		(1) Measure voltages across the inverter output terminals U-V-W. (2) Simulatively short or open the protective circuit output terminals of the inverter.	(1) Phase-to-phase voltage balance within 4V (8V) for 200V (400V). (2) Fault must occur because of sequence.	Digital multi meter, rectifier type voltmeter
Cooling system	Cooling fan	(1) Check for unusual vibration and noise. (2) Check for loose connection.	○		○	(1) Turn by hand with power off. (2) Visual check.	No unusual vibration and noise.		

Precautions for maintenance and inspection

Area of Inspection	Inspection Item	Description	Interval			Method	Criterion	Instrument	Customer's check
			Daily	Periodic*					
				1 year	2 years				
Display	Display	(1) Check for LED lamp blown. (2) Clean.	○	○		(1) Lamps indicate indicator lamps on panel. (2) Clean with rag.	(1) Check that lamps are lit.		
	Meter	Check that reading is normal.	○			Check the readings of the meters on the panel.	Must satisfy specified and management values.	Voltmeter, ammeter, etc.	
Motor	General	(1) Check for unusual vibration and noise. (2) Check for unusual odor.	○ ○			(1) Auditory, sensory, visual checks. (2) Check for unusual odor due to overheat, damage, etc.	(1), (2) No fault.		
	Insulation resistance	Check with megger (across terminals and earth (ground) terminal).			○	Disconnect cables from U, V, W (including motor cables).	5MΩ or more.	500V megger	

* Values in parentheses indicate those for 400V class.

*Consult us for periodic inspection.

6.5.7 Replacement of parts

The inverter consists of many electronic parts such as semiconductor devices.

The following parts may deteriorate with age because of their structures or physical characteristics, leading to reduced performance or fault of the inverter. For preventive maintenance, the parts must be replaced periodically.

Replacement Parts of the Inverter

Part Name	Standard Replacement Interval	Description
Cooling fan	5 years	Change (as required)
Smoothing capacitor in main circuit	5 years	Change (as required)
Smoothing capacitor on control board	5 years	Change the board (as required)
Smoothing capacitor on cooling fan power supply	5 years	Change the power supply (as required)
Relays	—	Change as required

CAUTION

For parts replacement, consult the nearest Mitsubishi FA Center.

(1) Cooling fan

The cooling fan is used to cool heat-generating parts such as the main circuit semiconductors. The life of the cooling fan bearing is usually 40,000 to 50,000 hours. Hence, the cooling fan must be replaced every 5 years if the inverter is run continuously. When unusual noise and/or vibration is noticed during inspection, the cooling fan must be replaced immediately.

• Removal

- 1) Turn the four knurled knobs fixing the cooling fan installation plate counterclockwise.
(The knobs can be turned easily using a coin, etc.)
- 2) Lift the installation plate and cooling fan slightly, and disconnect the fan connectors.
- 3) Remove the fan with the installation plate.
- 4) Remove the four screws fixing the cooling fan to the installation plate.

• Reinstallation

- 1) After confirming the orientation of the fan, reinstall the fan so that the arrow on the left of "AIR FLOW" faces up.



<Fan side face>

- 2) Connect the fan connectors
When wiring, use care to avoid catching the wires in the fan and sandwiching in the metal sections of the cooling fan and inverter unit.
- 3) Insert the cooling fan installation plate into the inverter unit, and securely fix with screws.

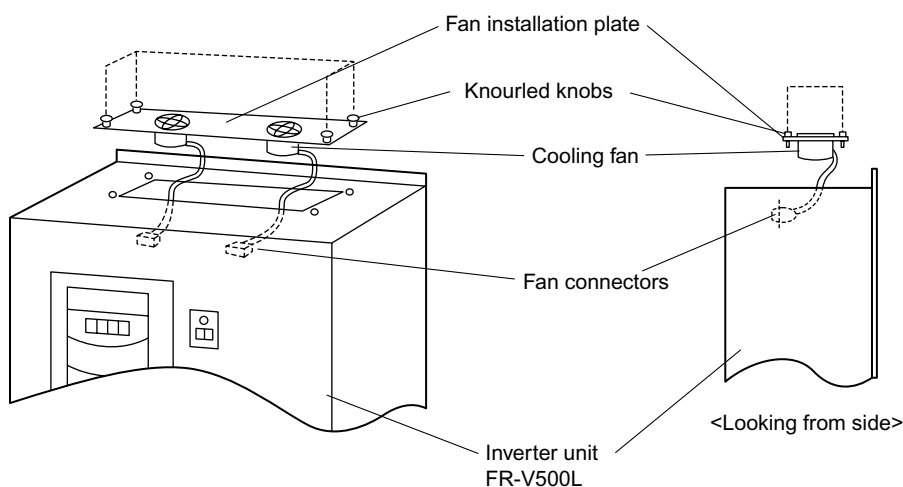

Caution : The number of cooling fans used differs according to the inverter capacity. Depending on the number of cooling fans used, they may be installed on two installation plates.

Precautions for maintenance and inspection

(2) Smoothing capacitors

A large-capacity aluminum electrolytic capacitor is used for smoothing the DC in the main circuit, and an aluminum electrolytic capacitor is also used for stabilizing the control power in the control circuit. Their characteristics are adversely affected by ripple current, etc. When the inverter is operated in an ordinary, air-conditioned environment, change the capacitors about every 5 years. When 5 years have elapsed, the capacitors will deteriorate more rapidly.

Check the capacitors at least every year (less than six months if their life will be expired soon).

Check the following :

- 1) Case (side faces and bottom face for expansion)
- 2) Sealing plate (for remarkable warping and extreme cracks)
- 3) Explosion-proof valve (for excessive valve expansion and operation)
- 4) Appearance, external cracks, discoloration, leakage. When the measured capacitance of the capacitor has reduced below 90% of the rating, change the capacitor.

(3) Relays

To prevent a contact fault, etc., relays must be changed according to the number of accumulative switching times (switching life).

See the following table for the inverter parts replacement guide. lamps and other short-life parts must also be changed during periodic inspection.

6.5.8 Measurement of main circuit voltages, currents and powers

● Measurement of voltages and currents

Since the voltages and currents on the inverter power supply and output sides include harmonics, measurement data depends on the instruments used and circuits measured.

When instruments for commercial frequency are used for measurement, measure the following circuits with the instruments given on the next page.

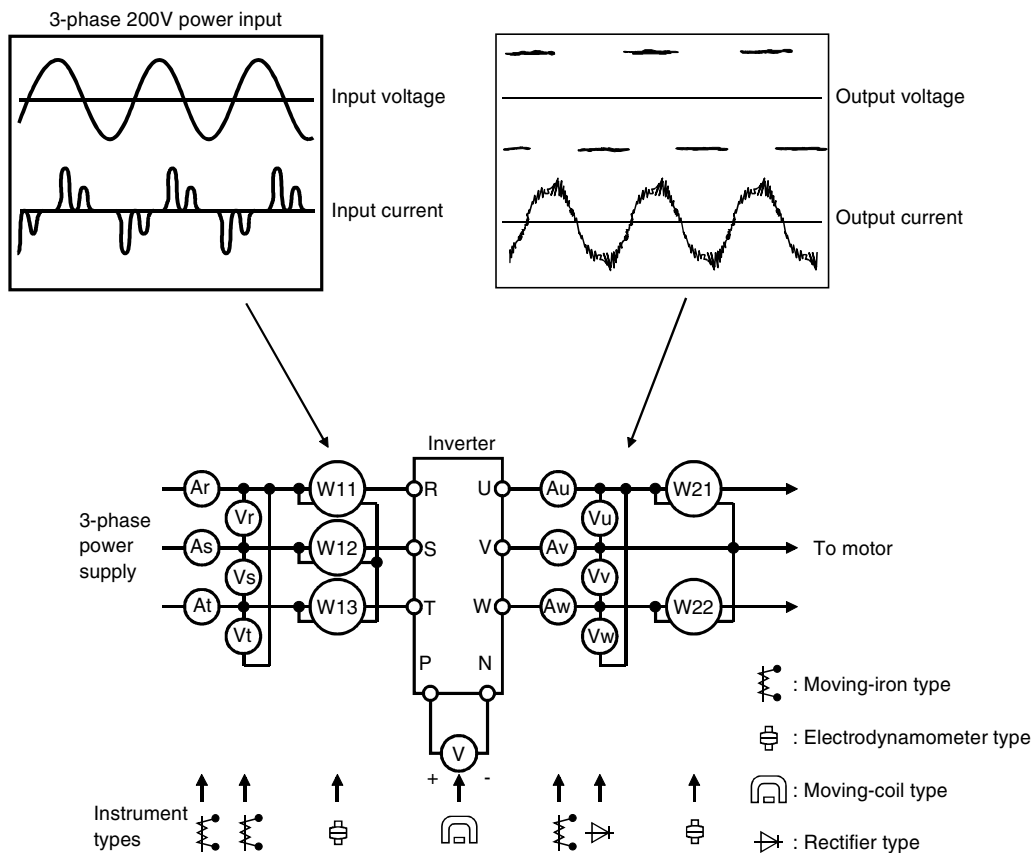

Examples of Measuring Points and Instruments

CAUTION

Use an FFT to measure the output voltage accurately.

A tester or general measuring instrument cannot measure accurately.

Measuring Points and Instruments

Item	Measuring Point	Measuring Instrument	Remarks (Reference Measurement Value)	
Power supply voltage V1	Across R-S, S-T and T-R	Moving-iron type AC voltmeter	Within permissible commercial power supply AC voltage fluctuation (Refer to page 104)	
Power supply side current I1	R, S and T line currents	Moving-iron type AC ammeter		
Power supply side power P1	At R, S and T, and across R-S, S-T and T-R	Electrodynamic type single-phase wattmeter	P1=W11+W12+W13 (3-wattmeter method)	
Power supply side power factor Pf1	Calculate after measuring power supply voltage, power supply side current and power supply side power. $Pf1 = \frac{P1}{\sqrt{3}V1 \times I1} \times 100\%$			
Output side voltage V2	Across U-V, V-W and W-U	Rectifier type AC voltmeter (Caution 1) (Moving-iron type cannot measure)	Difference between the phases is within $\pm 1\%$ of the maximum output voltage.	
Output side current I2	U, V and W line currents	Moving-iron type AC ammeter (Caution 2)	Difference between the phases is 10% or lower of the rated inverter current.	
Output side power P2	At U, V and W, and across U-V and V-W	Electrodynamic type single-phase wattmeter	P2=W21+W22 2-wattmeter method (or 3-wattmeter method)	
Output side power factor Pf2	Calculate in similar manner to power supply side power factor. $Pf2 = \frac{P2}{\sqrt{3}V2 \times I2} \times 100\%$			
Converter output	Across P-N	Moving-coil type (such as tester)	Inverter LED display is lit. 1.35 V1	
Speed setting signal (Torque setting signal)	Across 2(+)-5	Moving-coil type (Tester and such may be used) (Internal resistance: 50k Ω or larger)	0 to 10VDC	"5" is common.
	Across 1(+)-5		0 to ± 10 VDC	
Across 3(+)-5	0 to ± 10 VDC			
Frequency setting power supply	Across 10E(+)-5		10VDC	
Speed meter signal	Across DA1(+)-5		± 10 VDC at maximum speed (without speed meter)	Approx. 10VDC at maximum speed (without speed meter)
	Across DA2(+)-5			
Start signal Select signal	Across STF, STR, DI1, DI2, DI3, DI4(+)-SD		When open 20 to 30VDC ON voltage: 1V or less	"SD" is common.
Alarm signal	Across A-C Across B-C	Moving-coil type (such as tester)	Continuity check <Normal> <Abnormal> Across A-C: Discontinuity Continuity Across B-C: Continuity Discontinuity	

CAUTION

1. Use an FFT to measure the output voltage accurately. A tester or general measuring instrument cannot measure accurately.

7 SPECIFICATIONS

7.1 Model specifications

● 200V class (for use with the Mitsubishi dedicated motor [SF-THY (1500r/min series)])

Inverter	Type FR-V520L-□□K-NA		75K
	Applicable motor capacity (kW (HP))		75 (100)
	Output	Rated capacity (kVA) (Caution 1)	114
		Rated current (A)	330
		Overload current rating (Caution 2)	150%60s, 200%0.5s (inverse-time characteristics.)
		Voltage	Three-phase 200 to 230V 50/60Hz
	Power supply	Rated input AC voltage, frequency	Three-phase 200 to 230V 50/60Hz
		Permissible AC voltage fluctuation	170 to 253V 50/60Hz
		Permissible frequency fluctuation	±5%
		Power supply capacity (kVA) (Caution 4)	330
	Protective structure (JEM 1030)		Open type (IP00)
Cooling system		Forced air cooling	
Approx. mass (kg(lb))		77	
Mitsubishi dedicated motor	Motor type		SF-THY
	Rated output (kW (HP))		75
	Rated torque (N·m)		477
	Maximum torque 150% 60s (N·m)		715
	Rated speed (r/min)		1500
	Maximum speed (r/min)		2400
	Frame No.		250MD
	Inertia moment J (X10 ⁻⁴ kg·m ²)		1.1
			90dB
	Cooling fan	Voltage	Three-phase 200V/50Hz, 200V/60Hz, 220V/60Hz
	Input (W)	750	

CAUTION

1. The rated output capacity indicated assumes that the output voltage is 200V.
2. The overload current rating indicated in % is the ratio of the overload current to the rated output current of the inverter. For repeated duty, allow time for the inverter and motor to return to or below the temperatures under 100% load.
3. The short-time rating is 5s.
4. The power supply capacity varies with the value of the power supply side inverter impedance (including those of the input reactor and cables).
5. If the motor is one rank lower in capacity than the inverter, it can be used by setting Pr. 80 "motor capacity" and Pr. 81 "number of motor poles". Other manufacturers' motors and special motors can be used by performing online auto tuning.
6. The power supply fluctuation range is 200V ±10%.

● 400V class (for use with the Mitsubishi dedicated motor [SF-THV (1500r/min series)])

		75K	90K	110K	132K	160K	200K	250K		
Inverter	Type FR-V540L-□□K-NA		75K	90K	110K	132K	160K	200K	250K	
	Applicable motor capacity (kW (HP))		75 (100)	90 (125)	110 (150)	132 (200)	160 (250)	220 (300)	250 (350)	
	Output	Rated capacity (kVA) (Caution 1)		114	135	166	187	229	288	350
		Rated current (A)		165	195	240	270	330	415	505
		Overload current rating (Caution 2)		150%60s, 200%0.5s (inverse-time characteristics.)						
	Power supply	Voltage		Three-phase 380 to 480V 50/60Hz						
		Rated input AC voltage, frequency		Three-phase 380 to 480V 50/60Hz						
		Permissible AC voltage fluctuation		323 to 528V 50/60Hz						
		Permissible frequency fluctuation		±5%						
		Power supply capacity (kVA) (Caution 4)		114	135	166	187	229	288	350
Protective structure (JEM 1030)		Open type (IP00)								
Cooling system		Forced air cooling								
Approx. mass (kg (lbs))		75 (165)		120 (265)		220 (485)		235 (518)		
Mitsubishi dedicated motor	Motor type		SF-THV							
	Rated output (kW (HP))		75	90	110	132	160	200	250	
	Rated torque (N(m))		477	572	700	840	1018	1273	1591	
	Maximum torque 150% 60s (N·m)		715	858	1050	1260	1527	1909	2386	
	Rated speed (r/min)		1500							
	Maximum speed (r/min)		2400	1800						
	Frame No.		250MD	250MD	280MD	280MD	280MD	280L	315H	
	Inertia moment J (X10⁻⁴kg·m²)		1.1	1.7	2.3	2.3	4.0	3.8	5.0	
			90dB			95dB				
	Cooling fan	Voltage		Three-phase 200V/50Hz, 200V/60Hz, 220V/60Hz						
Input (W)		50Hz	400	400	400	400	400	750	750	
		60Hz	750	750	750	750	750	1500	1500	

CAUTION

1. The rated output capacity indicated assumes that the output voltage is 400V.
2. The overload current rating indicated in % is the ratio of the overload current to the rated output current of the inverter. For repeated duty, allow time for the inverter and motor to return to or below the temperatures under 100% load.
3. The short-time rating is 5s.
4. The power supply capacity varies with the value of the power supply side inverter impedance (including those of the input reactor and cables).
5. If the motor is one rank lower in capacity than the inverter, it can be used by setting Pr. 80 "motor capacity" and Pr. 81 "number of motor poles". Other manufacturers' motors and special motors can be used by performing online auto tuning.

7.2 Common specifications

Inverter	Control system		Soft-PWM control or high carrier frequency sine-wave PWM control can be selected.			
	Control mode		Vector control, or V/F control can be selected.			
	Speed setting resolution	Analog input	0.03% of the maximum set speed			
	Acceleration/deceleration time	Digital input	0.003% to the maximum setting (minimum setting 0.1r/min)			
	Acceleration/deceleration pattern		0 to 3600 s (0.1 s increments)			
	Torque restriction level		Linear, S pattern (3 types) or backlash compensation acceleration/deceleration can be selected.			
	Torque restriction level		Torque restriction value can be set (0 to 400% variable)			
	Input signals	Analog setting signal	Terminal No.	Setting Range	Speed Control	Torque Control
			2	0 to 10V (resolution 0.03%)	Main speed setting	Speed restriction
			1	0 to ±10V (resolution 0.05%)	Auxiliary speed setting/magnetic flux command/regenerative torque restriction	Speed restriction compensation/magnetic flux command/forward/reverse rotation speed restriction (analog polarity switchover speed restriction)
		Option (FR-V5AX)	6	0 to ±10V (resolution 0.003%)	Main speed setting (at this time, terminal 2 is invalid)/torque restriction	Speed restriction (at this time, terminal 2 is invalid)/Torque command (at this time, terminal 3 is invalid)
		Contact signal	3 fixed function terminals		Forward rotation command, alarm reset, external thermal relay	
			5 function terminals		Selection can be made from reverse rotation command, multi-speed setting (max. 15 speeds), remote setting, jog operation (Caution 1), second function selection, third function selection, output stop, start signal self-holding, pre-excitation, control mode switchover, torque restriction selection, S pattern switchover, PID control terminal, orientation command, break opening completion signal, PU operation/external operation switchover, torque bias selection 1, torque bias selection 2, P control selection, servo on, HC connection, and PU/external interlock.	
	Option (FR-V5AX)	6 multi-function terminals		Selection can be made from inverter running, inverter running 2, up to speed, instantaneous power failure (undervoltage), speed detection, second speed detection, third speed detection, PU operation mode, overload alarm, regenerative brake prealarm, electronic thermal relay prealarm, output current detection, zero current detection, PID lower limit, PID upper limit, PID forward/reverse rotation output, operation ready, operation ready 2, brake opening request, heatsink overheat prealarm, orientation in-position, forward rotation output, reverse rotation output, low speed output, torque detection, regenerative status output, minor fault output, minor fault output 2, alarm output, maintenance timer output, remote output, output speed detection, second (third) output speed detection, in-position and trace status.		
	Output signals	Contact signal	1 changeover contact (230VAC 0.3A, 30VDC 0.3A)		Selection can be made from speed, output current, output voltage, preset speed, output frequency, motor torque, converter output voltage, regenerative brake duty, electronic overcurrent protection load factor, output current peak value, converter output voltage peak value, input terminal status (Caution 3), output terminal status (Caution 4), load meter, motor exciting current, position pulse, cumulative operation time, actual operation time, motor load factor, torque command, torque current command, feedback pulse, motor output, trace status.	
		Open collector signal	3 multi-function terminals			
		Option (FR-V5AY)	3 multi-function terminals			
		Option (FR-V5AM)	1 multi-function terminal			
	Option (FR-A5AY)	7 multi-function terminals				
	Analog output	0 to ±10V 12 bits 1CH 0 to 10V 12 bits 1CH				
Option (FR-A5AY)	0 to 10V 10 bits 1CH 0 to 20mA 10 bits 1CH					
PLG pulse output option (FR-V5AY)	A phase, B phase, Z phase (A and B phases can be divided) Open collector/differential line driver.					
Operational functions		Maximum/minimum speed setting, speed jump, external thermal relay input selection, polarity reversible operation, override function, automatic restart operation after instantaneous power failure, forward/reverse rotation prevention, operation mode selection, offline auto tuning function, online auto tuning function, easy gain tuning, computer link operation, remote setting, second function, third function, multi-speed operation, coasting to stop, power failure stop, PID control, speed feed forward, model adaptive speed control, master/slave, torque bias, 12-bit digital command (FR-A5AX option), 16-bit digital command (FR-A5AH option), pulse train input (FR-A5AP option), motor thermistor interface (FR-V5AX option)				
Display	Parameter unit (FR-DU04-1/FR-PU04V)	Selection can be made from speed, output current, output voltage, preset speed, output frequency, motor torque, converter output voltage, regenerative brake duty, electronic overcurrent protection load factor, output current peak value, converter output voltage peak value, input terminal status (Caution 3), output terminal status (Caution 4), load meter, motor exciting current, position pulse, cumulative operation time, actual operation time, motor load factor, torque command, torque current command, feedback pulse, motor output, trace status.				
	Alarm definition	Alarm definition is displayed when protective function is activated. 8 past alarm definitions are stored. (Only 4 alarm definitions are displayed on the operation panel.)				
Protective functions		Overcurrent shut-off (acceleration, deceleration, constant speed), regenerative overvoltage shut-off (acceleration, deceleration, constant speed), undervoltage, instantaneous power failure, overload shut-off (electronic thermal relay), earth (ground) fault current, power output short circuit (12/24VDC/operation panel), stall prevention, external thermal relay, heatsink overheat, option alarm, parameter error, PU disconnection, encoder no-signal, speed deviation large, overspeed, position error large, CPU error, encoder phase error, output phase failure, retry count excess, brake sequence error, main circuit error				
Environment	Ambient temperature	-10C to +50°C (14°F to 122°F) (non-freezing)				
	Ambient humidity	90%RH or less (non-condensing)				
	Storage temperature (Caution 2)	-20 to +65°C (-4°F to 149°F)				
	Atmosphere	Indoor use. (No corrosive gas, flammable gas, oil mist, dust and dirt)				
	Altitude, vibration	Maximum 1,000m (3280.80feet) above sea level, 5.9m/s ² or less (compliant with JIS C 0040)				

CAUTION

1. Jog operation may also be performed from the operation panel (FR-DU04-1) or the parameter unit (FR-PU04V).
2. Temperature applicable for a short period in transit, etc.
3. Not provided for the operation panel (FR-DU04-1).

7.3 Outline dimension drawings

7.3.1 Inverter outline dimension drawings

● FR-V540L-75K, 90K/ FR-V520L-75K

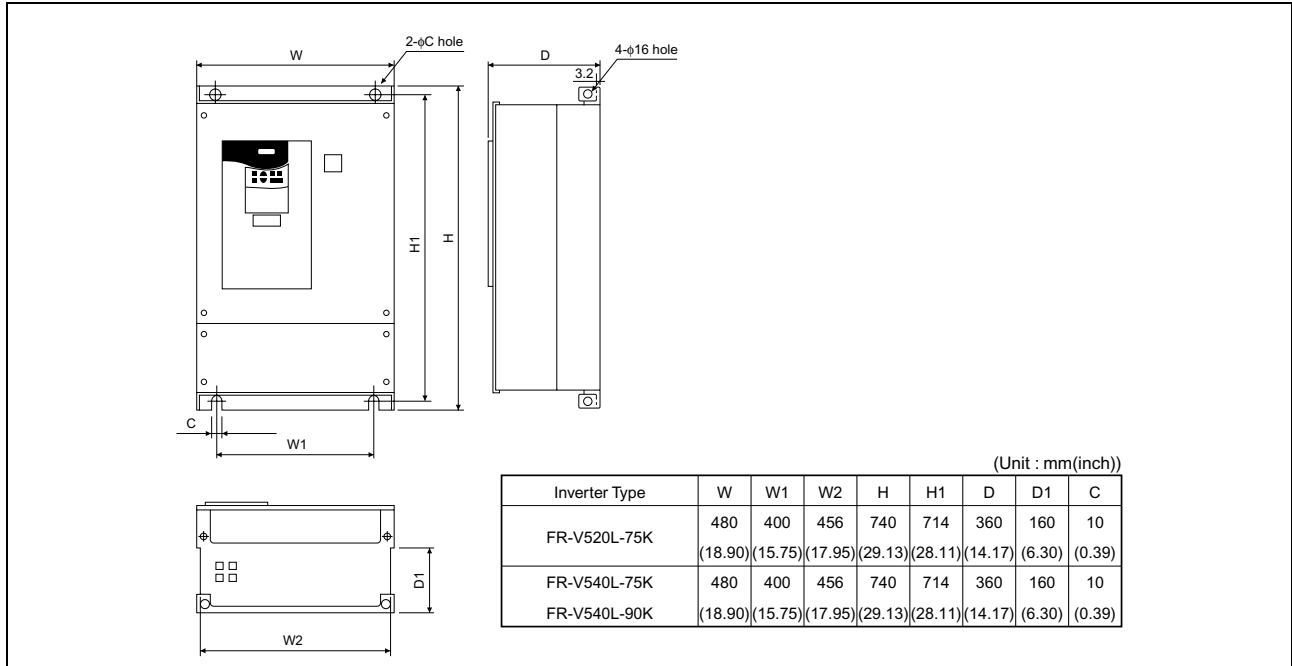

● DC reactor

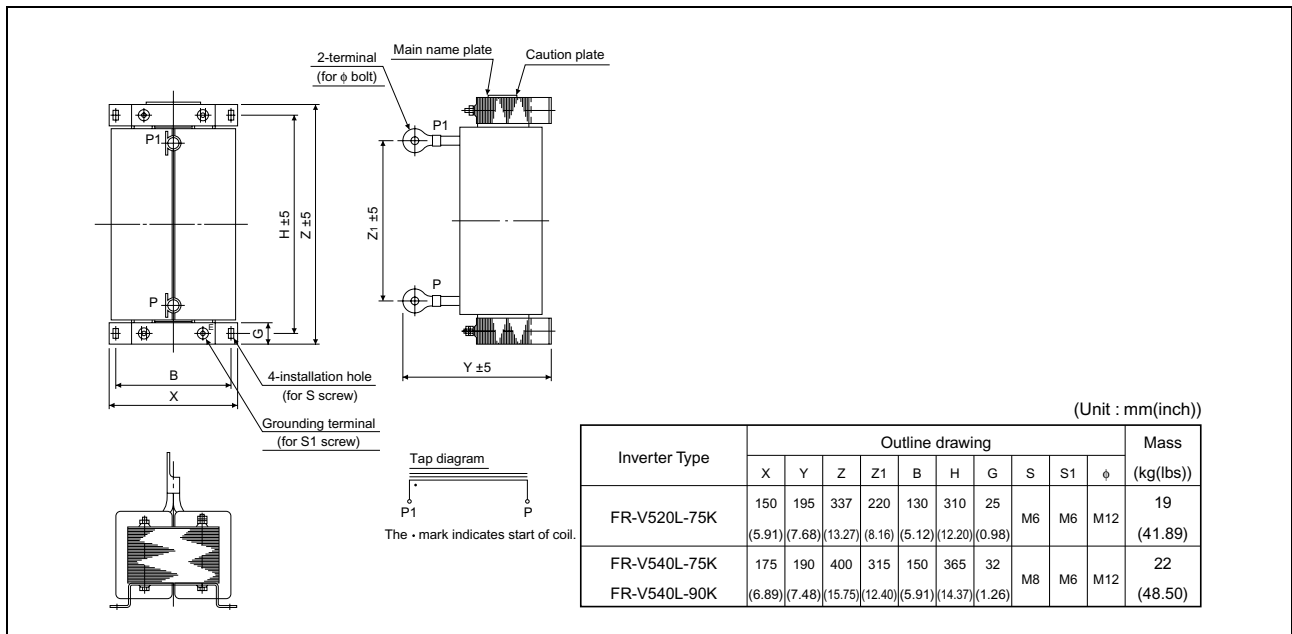

Outline dimension drawings

●FR-V540L-110K, 132K, 160K, 200K, 250K

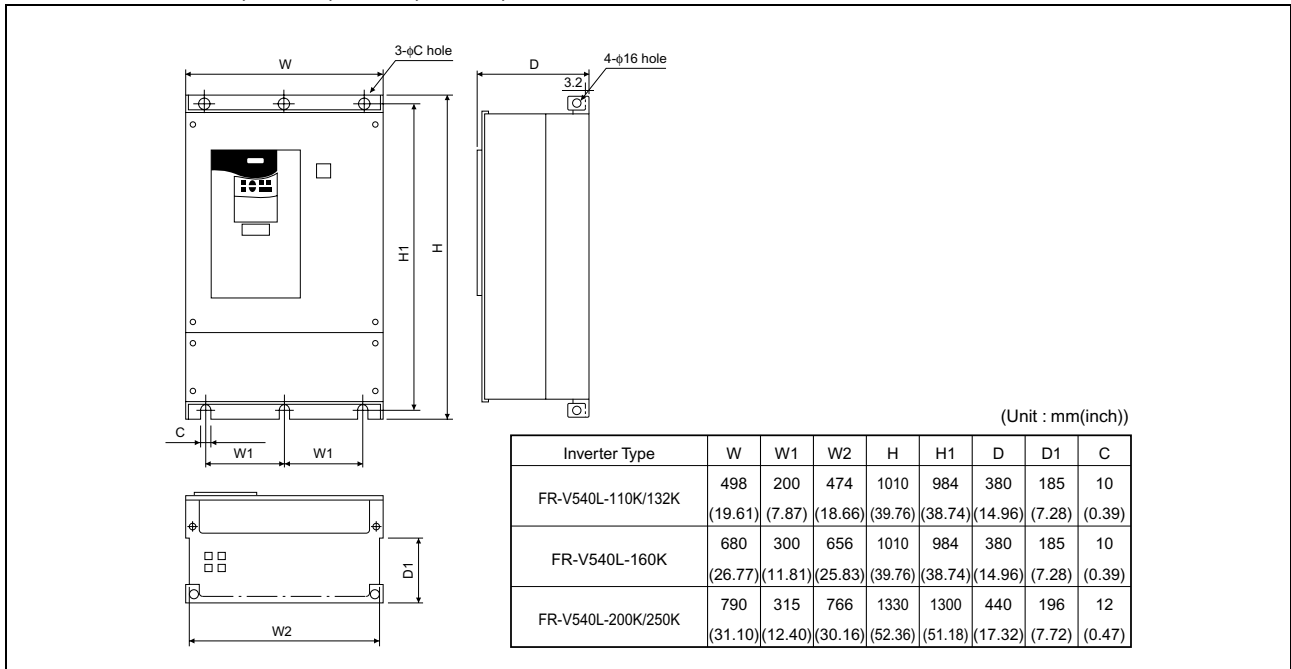

●DC reactor

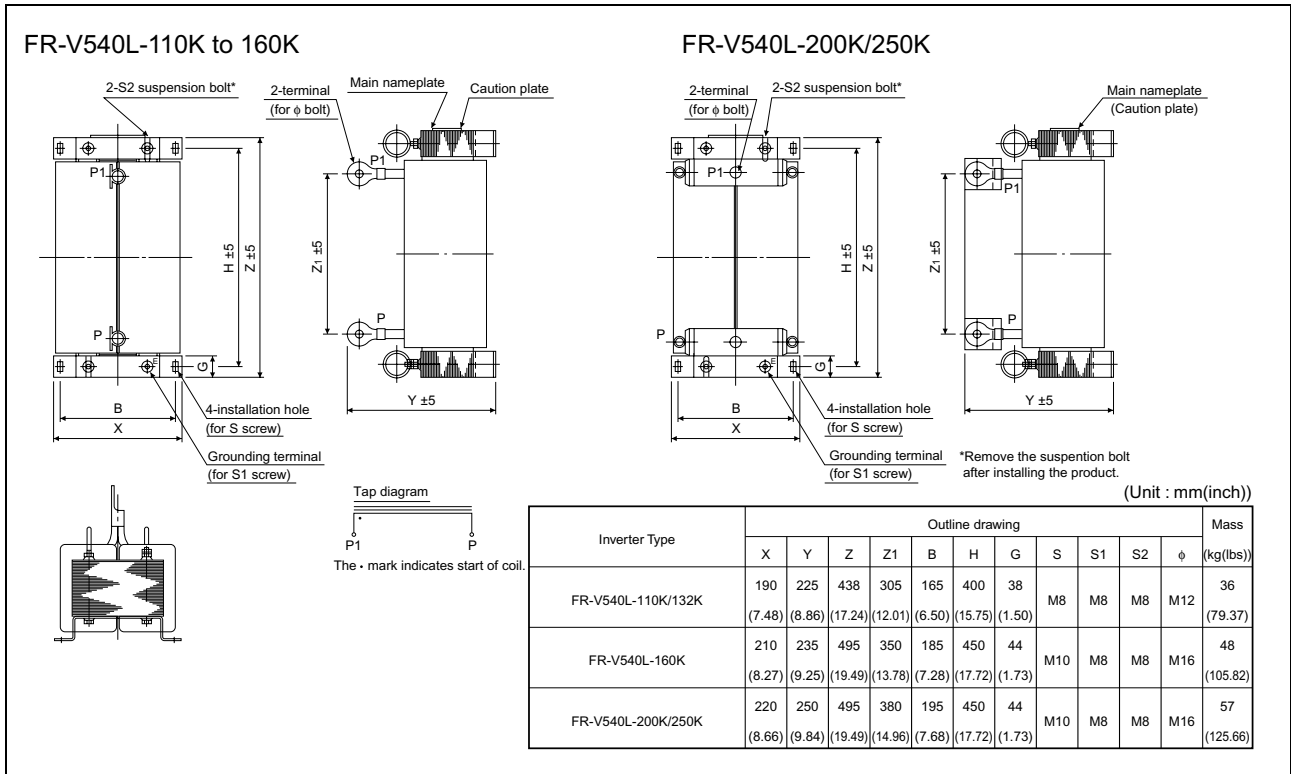

Appendix 1 Instructions for Compliance with UL and cUL

(Conformance Standard UL 508C)

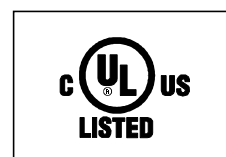

(1) Installation

The below types of inverter have been approved as products for use in enclosure and approval tests were conducted under the following conditions. For enclosure design, refer to these conditions so that the ambient temperature of the inverter 50°C or less.

Inverter Type	Cabinet (enclosure) (Unit : mm (inches))	Vent Hole Area	Cooling Fan
FR-V540L-75K/FR-V520L-75K	W H D 800 2100 550 (31.50 82.68 21.65)	625cm ²	Install a cooling fan at top of the enclosure to suck internal air to the outside. (Fan air flow : 19m ³ /min or more)
FR-V540L-90K			
FR-V540L-110K	W H D 800 2100 550 (31.50 82.68 21.65)	625cm ²	Install a cooling fan at top of the enclosure to suck internal air to the outside. (Fan air flow : 30m ³ /min or more)
FR-V540L-132K			
FR-V540L-160K			
FR-V540L-200K	W H D 1300 2300 800 (51.18 82.68 21.65)	3726cm ²	Install a cooling fan at top of the enclosure to suck internal air to the outside. (Fan air flow : 120m ³ /min or more)
FR-V540L-250K			

(2) Wiring of the power supply and motor

Use the UL-approved power supply and round crimping terminals to wire the input (R, S, T) <L₁, L₂, L₃> and output (U, V, W) terminals of the inverter. Crimp the terminals with the crimping tool recommended by the terminal manufacturer.

(3) Fuse

The fuse used on the input side should be any of the UL Class K5 fuses having the ratings as listed below :

Applicable Inverter Type	Rating (A)	Applicable Inverter Type	Rating (A)
FR-V520L-75K	600	FR-V540L-132K	600
FR-V540L-75K	350	FR-V540L-160K	800
FR-V540L-90K	400	FR-V540L-200K	1000
FR-V540L-110K	500	FR-V540L-250K	1000

(4) Short-circuit rating

This following inverter has been put to the short-circuit test of the UL in the AC circuit whose peak current and voltage are limited to * and 500V maximum., respectively, and conforms to this circuit.

Inverter Type	*
75K to 110K	10kA
132K to 220K	18kA
250K	30kA

