

MDU BREAKER: MDU

TYPE

MDU-BN, MDU-BP, MDU-BC, MDU-BM

MODEL

NF250-SEV with MDU, NF250-HEV with MDU



NF400-SEW with MDU, NF400-HEW with MDU

NF800-SEW with MDU, NF800-HEW with MDU

INSTRUCTION MANUAL

- Read this Instruction Manual carefully prior to use, so that the product is used properly.
- After reading this manual, store it in a safe place so that it can be easily referenced when needed.
- Make sure that the end user receives this Instruction Manual.

Indications and what they mean are listed below.

	Danger	Wrong handling may cause dangerous situation in which possibility of fatal accidents or serious injuries assumed.
	Caution	Wrong handling may cause dangerous situation in which possibility of significant or minor injuries, or material damages assumed.
		Using this under certain conditions may cause electrical shock.

Caution

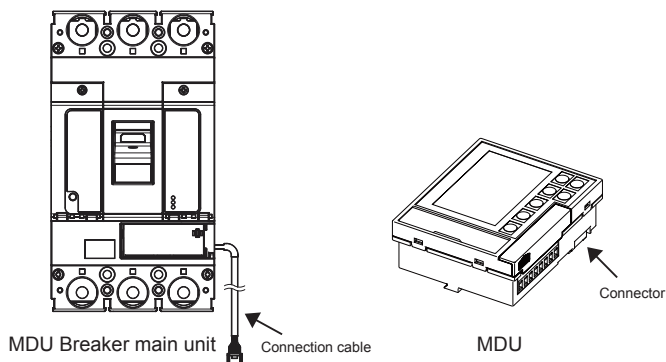

Securely insert the connection cable into the MDU connector (until the lock clicks into place). The product will be unable to measure properly if the connection is poor.

Some models/specifications do not measure or display some items. These items and functions will be skipped.

For models with CC-Link communication, refer to the PLC User's Manual before reading this Instruction Manual.

• CC-Link System Master/Local Module User's Manual

* The CC-Link version is "CC-Link Ver. 1.10."

■ Table of Contents

1. Safety Precautions	3
2. Precautions for Use	3
2.1 Standard operating conditions	3
2.2 Withstand voltage test	4
2.3 Connection and installation	5
2.4 Requests	6
2.5 Notes on usage	6
3. MDU Breaker Installation Instructions	7
3.1 MDU mounting (external mounting for 250 A frame)	7
3.1.1 Check the wiring of the connection cable	7
3.1.2 Mounting of MDU mounting plate (Figure 2 and 3)	7
3.1.3 Mounting of MDU to MDU Breaker main unit	8
3.2 MDU mounting (external mounting for 400/800 A frame)	9
3.2.1 Mounting of MDU mounting plate	9
3.2.2 Mounting of MDU to MDU Breaker main unit	10
3.3 MDU mounting (panel mounting)	11
3.3.1 No transmission, electric energy pulse output	11
3.3.2 With CC-Link communication/MODBUS communication	13
3.4 Wiring of MDU terminal block	14
3.4.1 External mounting type	14
3.4.2 Panel mounting type	14
4. MDU Features and Functions	16
4.1 Features of MDU	16
4.2 Functions of MDU	16
4.3 Measurement functions	17
4.3.1 Measurement function list	17
4.3.2 Measurement rated values/measurement range and accuracy	18
4.4 Monitoring functions	22
4.4.1 Monitoring function list	22
4.5 How to use monitoring functions	23
4.5.1 MDU Breaker alarms	23
4.5.2 MDU Breaker status	25
4.5.3 Fault causes	25
4.5.4 Electric current demand upper/lower limit alarms	25
4.5.5 Neutral line open phase alarm (NLA)	25
4.6 Network Specifications for MDU	26
4.6.1 Electric energy pulse output	26
4.6.2 CC-Link communication	26
4.6.3 MODBUS communication	26

5. Names and Functions of MDU Parts	27
5.1 Display/operation panel	27
5.2 MDU terminal block section	28
5.3 CC-Link setting area (with CC-Link communication option).....	29
5.4 Number of CC-Link communication connectable units and precautions	30
5.5 Installation and wiring for products with CC-Link communication	31
5.5.1 Terminator installation	31
5.5.2 Shielded wire grounding	31
5.6 MODBUS setting area (with MODBUS communication option)	32
5.7 Installation and wiring for products with MODBUS communication	33
6. MDU Detailed Specifications	34
6.1 Precautions for measurement	34
7. MDU Operation Procedure	36
7.1 Operating method for main menu screen	37
7.1.1 Display method for protection characteristic setting values	38
7.1.1-1 Protection characteristic setting and setting method for 250 A frame	38
7.1.1-2 Protection characteristic setting and setting method for 400/800 A frame	39
7.1.2 Method for various settings	40
7.1.2-1 Setting method for measurement-related items	40
7.1.2-2 Setting method for alarms	42
7.1.2-3 Setting method for LCD	44
7.1.2-4 Setting method for date and time	46
7.1.2-5 Setting method for electric energy	47
7.1.2-6 Setting method for measurement items	48
7.1.2-7 Setting method for free display	49
7.1.3 Method for resetting alarms	50
7.1.4 Method for resetting fault cause/current, maximum value, electric energy, and reactive energy	50
7.1.5 Method for displaying information screen	51
7.2 Operating method for measurement display screen	52
7.2.1 Switching method for display screen	52
7.2.2 Measurement display list	53
7.2.3 Fault/alarm display details	57
8. Appendix	58
8.1 Precautions for setting operation	58
8.2 Precautions when setting via CC-Link communication/MODBUS communication	58
8.3 Communication error codes and solutions	59
8.4 Troubleshooting	59

1. Safety Precautions

This Instruction Manual is meant mainly for those with specialized electrical knowledge who will use this product to manufacture assembled products, perform electrical work, or conduct maintenance and inspections. This also includes those who will operate this product (the end user).

Caution

- When installing or removing MDU Breaker main unit and a Measuring Display Unit (MDU), first turn the host circuit breaker OFF and confirm that no electricity is flowing.
- This product must be handled by someone with specialized knowledge.

2. Precautions for Use

Unless otherwise noted, the following terms in this Instruction Manual indicate the models shown below.

	250 A frame	400 A frame	800 A frame
Molded Case Circuit Breaker (MCCB)	NF250-SEV with MDU, NF250-HEV with MDU	NF400-SEW with MDU, NF400-HEW with MDU	NF800-SEW with MDU, NF800-HEW with MDU

2.1 Standard operating conditions

Caution

- The standard operating conditions are described below. Be sure to use MDU Breaker within these conditions.
 - [1] Operating ambient temperature: -10°C to +40°C (must not exceed an average of +35°C within a 24 hour period)
 - [2] Ambient storage temperature: -25°C to +55°C (no condensation/freezing)
 - [3] Relative operating/storage humidity: 85% RH or less (no condensation)
 - [4] Altitude: 2,000 m or lower
 - [5] Operating/storage atmosphere: Must contain hardly any dust, smoke, corrosive gas, combustible gas, moisture, salt, etc.
- If the ambient temperature of MDU Breaker exceeds +40°C, use with a decreasing continuous load current. Ambient temperature of +50°C: 0.9 times, ambient temperature of +60°C: 0.7 times
- Do not install in abnormal environments subject to high temperature, high humidity, dust, corrosive gas, vibration, impact, etc. Doing so may cause electrical shock, fire, or may cause the product to stop working.
- Do not wipe the MDU Breaker main unit or MDU with thinner, detergent, or chemical cloth. Doing so may fade printing, reduce insulation performance, or cause mold to form. Clean with air or by brushing.
- The case of the MDU may become discolored depending on the environment. However, this will not have any effect on performance.
- The LCD may have bright (always on) or dark (always off) pixels due to the characteristics of LCDs. Because LCDs contain many display elements, there is no way to ensure that bright or dark pixels will never occur. Bright or dark pixels are not defects in the product itself.
- The screen on the LCD may flicker due to the internal processing for refreshing, but this is not a trouble of the main body.

2.2 Withstand voltage test

Caution

- When conducting a MDU terminal test, always connect the MDU Breaker main unit and MDU.
- A voltage measurement transformer is connected between poles on the load side of the MDU Breaker main unit.
In the table below, × indicates that, because it causes a failure, withstand voltage test between poles on the load side must not be performed.
In the table below, △ indicates that, although nothing broke during a 500 VDC insulation resistance test, there was a low insulation resistance value.
No problems found during withstand voltage test and insulation resistance test conducted on entire main circuit and between ground on MDU Breaker main unit.
- When checking DA, DB, DG, 485+, 485-, Ter, SLD, and FG terminal conductivity for models with CC-Link communication/MODBUS communication, do not allow the voltage between each terminal to reach 5 VDC or higher.
Doing so may cause failure.

Measurement point/test		Insulation resistance measurement		Withstand voltage test		Test conditions	
		ON	OFF	ON	OFF		
Status of handle							
Between live part and ground		○	○	○	○		
Between different poles	Line side	Between left and middle poles	△	○	×	○	2500 VAC 1 min.
		Between middle and right poles	△	○	×	○	
		Between left and right poles	△	○	×	○	
		Between left and neutral poles, Between middle and neutral poles, Between right and neutral poles (for a four-poles circuit breaker)	△	○	×	○	
	Load side	Between left and middle poles	△	△	×	×	
		Between middle and right poles	△	△	×	×	
		Between left and right poles	△	△	×	×	
		Between left and neutral poles, Between middle and neutral poles, Between right and neutral poles (for a four-poles circuit breaker)	△	△	×	×	
Between power supply and load terminal		–	○	–	○		
Between main circuit and MDU terminals (L1, L2, FG)		○	○	○	○		
Between main circuit and MDU terminals (114, 113, FG) (with electric energy pulse output)		○	○	○	○		
Between main circuit and MDU terminals (DA, DB, DG, SLD, FG) (with CC-Link communication) (*4)		○	○	○	○	2500 VAC 1 min. (*1)	
Between main circuit and MDU terminals (485+, 485-, Ter, SLD, FG) (with MODBUS communication) (*6)		○	○	○	○		
Between MDU terminals (L1, L2) and MDU terminal (FG)		○	○	○	○		
Between MDU terminals (L1, L2) and MDU terminals (114, 113, FG) (with electric energy pulse output)		○	○	○	○		
Between MDU terminals (L1, L2) and MDU terminals (DA, DB, DG, SLD, FG) (with CC-Link communication) (*3) (*4)		○	○	○	○	1500 VAC 1 min. (*2)	
Between MDU terminals (L1, L2) and MDU terminals (485+, 485-, Ter, SLD, FG) (with MODBUS communication) (*5) (*6)		○	○	○	○		

*1. Test with MDU terminals (L1, L2, 114, 113, DA, DB, DG, 485+, 485-, Ter, SLD, FG) as ground side.

*2. Test with MDU terminals (114, 113, DA, DB, DG, 485+, 485-, Ter, SLD, FG) as ground side.

*3. Do not perform a withstand voltage test between MDU terminals (DA, DB, DG, SLD) and MDU terminal (FG).

*4. MDU terminals (DA, DB, DG, SLD, FG) must always be tested together.

*5. Do not perform a withstand voltage test between MDU terminals (485+, 485-, Ter, SLD) and MDU terminal (FG).

*6. MDU terminals (485+, 485-, Ter, SLD, FG) must always be tested together.

2.3 Connection and installation

Caution

- MDU Breaker cannot be used with the power side and load side reversed.
- Do not forcefully pull the connection cable between the MDU and MDU Breaker main unit (15 N or less). Doing so may loosen or disconnect the cable.
- When installed to the MDU, if the MDU Breaker main unit cuts off a fault current and must be replaced with a new unit, also replace the MDU. It cannot be reused.
- The connection cable between the MDU and MDU Breaker main unit forms a small-signal circuit. Install it at least 10 cm away from strong circuits. Use with the area around the connector fixed in place, so that no external forces are applied to the connector connection area when opening/closing the front door. When bending the cable, maintain a radius of at least 20 mm.
- The connector area used to connect to the MDU is insulated from the inside of the MDU Breaker main unit. The product will operate normally and will not break even if the MDU Breaker main unit is powered with the connector area disconnected (open).
- If a MDU will be installed later, do so within 1.5 years from installing the MDU Breaker main unit.
- Do not insert and pull out cables from the connector area more than 20 times each on the MDU Breaker main unit and MDU.
- Pulling out the connection cable connector when MDU control power is applied may cause a MDU alarm or the like to be erroneously displayed. If this happens, reset the alarm and clear the memory when pulling out the connector and starting use.
- Control power is required for the MDU. Apply the control power supply voltage shown on the MDU between the L1 and L2 terminals. Measurement, display, electric energy pulse output, CC-Link communication, and MODBUS communication cannot be used without power. Install a short-circuit protector (using a circuit breaker or fuse) to the control circuit.
- If using MDU Breaker with a single-phase two-wire circuit, connect it as shown in Figure 1. The left pole (1-phase) load side is a live part, so be sure to insulate it.
Use the middle pole (2-phase) and the right pole (3-phase) current, and two voltage between the middle pole (2-phase) and the right pole (3-phase) as measurement data.
Ignore the left pole (1-phase) current, as well as the voltage between the left pole (1-phase) and the middle pole (2-phase) and between the right pole (3-phase) and the left pole (1-phase).
- If using MDU Breaker with a single-phase three-wire circuit, connect it as shown in Figure 2 below with the neutral line connected to the middle pole (2-phase).
If the neutral line is connected to either the left pole (1-phase) or the right pole (3-phase), it will be impossible to measure with MDU.

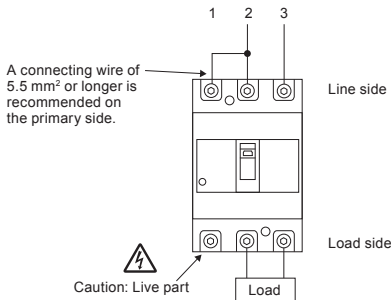

Figure 1. Connection method in a single-phase two-wire circuit

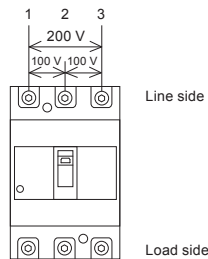

Figure 2. Connection method in a single-phase three-wire circuit

- Note that a three-pole MDU Breaker product cannot be used with a three-phase four-wire system.

The following table shows the items that can be measured when a three-pole product is used with a three-phase four-wire system.

Measurement item	Status	Reason
Load current	○ Voltage phase, × N phase	No CT on N phase, so measurement not possible
Line voltage	○ Between voltage phases, × Between voltage phase and N phase	No VT between N phases, so measurement not possible
Harmonic current	○ Voltage phase, × N phase	No CT on N phase, so measurement not possible
Electric power/ reactive power	×	No CT on N phase and no VT between N phases, so N phase not added
Electric energy/ reactive energy	×	No CT on N phase and no VT between N phases, so N phase not added
Power factor	×	No CT on N phase and no VT between N phases, so N phase not included

- MDU breaker can not be attached closely.
Secure a 30 mm wiring space on the right side of the circuit breaker and mount the main unit for wiring of the connection cable and installation of the connector for the connection cable.
- When installing the MDU in a box such as a switchboard or control panel, be careful of the ambient temperature.
Operating ambient temperature: Use within the range of -10°C to +40°C (however, the average value for 24 hours should not exceed +35°C).
If this condition is violated, it may lead to malfunction or loss of lifespan.

2.4 Requests

- The free warranty period and warranty scope for this product are as follows.
 - Free warranty period
 - The free warranty period lasts for one year from the time of purchase.
 - Warranty scope
 - (1) Any failures that occur during the warranty period will be repaired free of charge, assuming that the usage status, usage method, usage environment, etc. are as described in the product's catalog, Instruction Manual, warning labels, etc., and that the product was used under standard conditions as described in the precautions, etc.
However, the free warranty period shall last a maximum of 18 months after manufacture, with a maximum of six months for the distribution period after the product is shipped from Mitsubishi Electric.
 - (2) A fee will be charged for repairs under the following circumstances, even if the product is still within the free warranty period.
 - Failures resulting from inappropriate storage/handling, carelessness, error, etc. on the customer's part.
 - Failures resulting from installation mistakes.
 - Failures resulting from misuse or unreasonable modification.
 - Failures resulting from fires, abnormal voltage, or other external events beyond human control, or from earthquakes, wind disasters, or other natural disasters.
 - Failures resulting from phenomena that could not be foreseen using the scientific technology standards at the time the product was shipped by Mitsubishi Electric.
- The free warranty described here applies only to the delivered product, and does not apply to any damage or the like caused by failures in the delivered product.
- This free warranty does not apply to any damage or the like caused due to reprinting or reproducing the information included in this document in whole or in part in any form without the consent of Mitsubishi Electric.
 - All efforts have been made to keep the information in this document current as software and hardware is revised. However, there may be cases where inconsistencies arise.

2.5 Notes on usage

- (1) The products described in this User's Manual were designed and manufactured as general-purpose items meant for general industrial use, etc. Please contact Mitsubishi Electric sales to discuss use for special purposes including atomic energy, electric power, aerospace, medical, or passenger transport devices or systems.
- (2) Mitsubishi Electric shall not be held responsible for damage caused for reasons not attributable to Mitsubishi Electric; opportunities or profit lost by customers caused by Mitsubishi Electric product failure; damage caused from extraordinary circumstances, secondary damage, accident compensation, damage to anything other than Mitsubishi Electric products, or compensation for any other work, whether foreseen or not by Mitsubishi Electric.

3. MDU Breaker Installation Instructions

Caution

- When mounting or removing the MDU, first turn the host circuit breaker OFF and confirm that no electricity is flowing.
- First set the MDU Breaker main unit to OFF or TRIP, and then mount the MDU and connection cable.

3.1 MDU Mounting (external mounting for 250 A frame)

3.1.1 Check the wiring of the connection cable

- (1) Check that the connection cable is drawn out through the cable outlet port of the MDU Breaker without catching. (Figure 1)

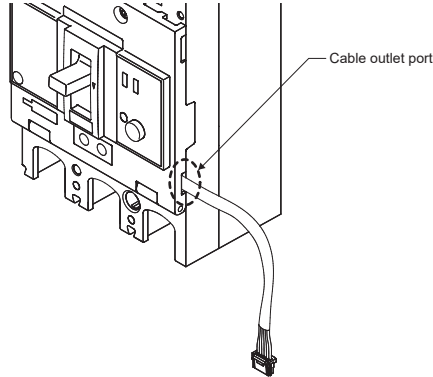

(Figure 1)

3.1.2 Mounting of MDU mounting plate (Figure 2 and 3)

- (1) Before mounting of MDU mounting plate, connect the terminals on the load side of the breaker.
- (2) While pressing the MDU mounting plate to the pressing area of the MDU Breaker main unit, screw the MDU mounting plate into the MDU Breaker main unit.
Use the included "3×10" screws.
- (3) Ground (class D) the FG terminal.

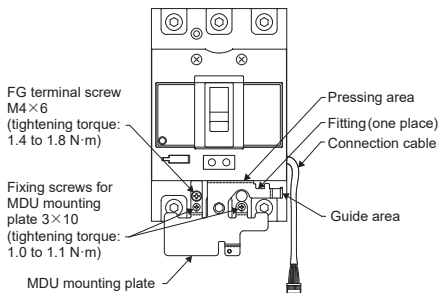

(Figure 2)

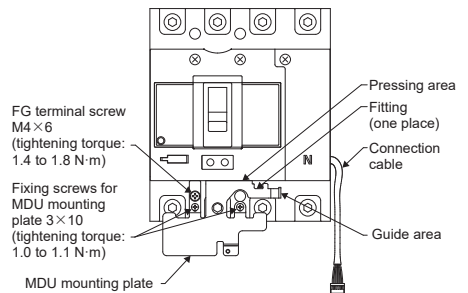

(Figure 3)

3.1.3 Mounting of MDU to MDU Breaker main unit

- (1) Ground (class D) the FG terminal on the MDU mounting plate.
- (2) Securely insert the connection cable coming out from the MDU Breaker main unit into the MDU connector (until the lock clicks into place). (Figure 4)

<Connecting the connector> (Figure 4)

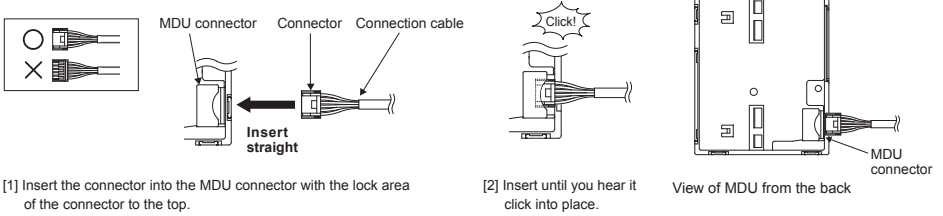

⚠ Caution

- Take note of the connector's orientation and insert it straight.
- Insert until you feel the lock click into place.

- (3) Hook the small tab on the back of the MDU onto the fitting on the MDU mounting plate. (Figure 5)

⚠ Caution

Make sure that the MDU connection cable is not caught by the plate.

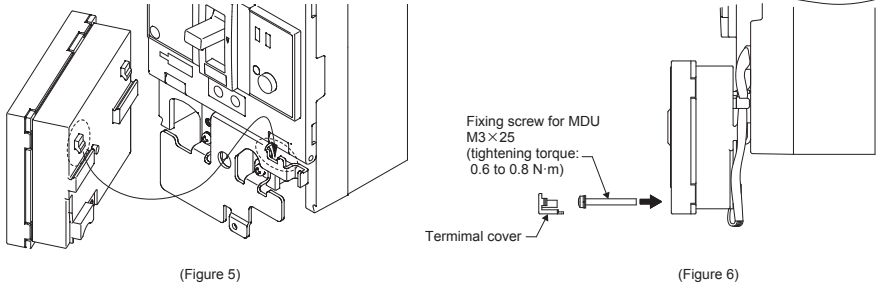

- (4) Remove the MDU terminal cover, and then screw it to the MDU mounting plate. (Figure 6)
Use the included "M3 x 25" fixing screw for MDU.
Arrange the connection cable through the guide area. (Figure 7)

<Mounting/removing the terminal cover>

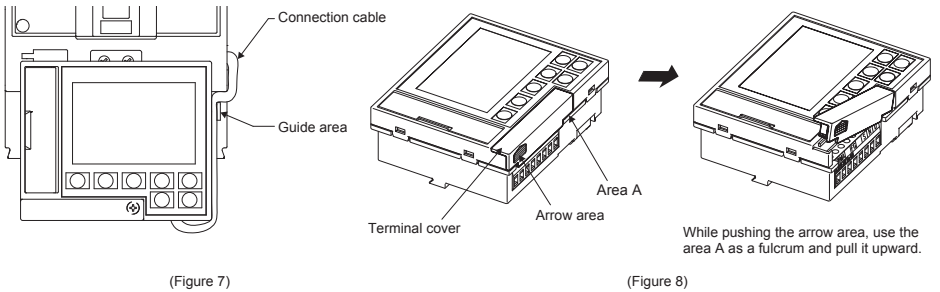

The terminal cover is removable, so use caution when handling it. (Figure 8)

⚠ Caution

Do not forcefully pull the connection cable. Doing so may result in a disconnection of the cable.

* When removing the MDU from the MDU Breaker main unit, do it in a reverse procedure to the mounting procedure.

3.2 MDU mounting (external mounting for 400/800 A frame)

3.2.1 Mounting of MDU mounting plate

- (1) Screw the MDU mounting plate into the MDU Breaker main unit. (Figures 9, 10)
Use the included "M4×8" screws.

⚠ Caution Make sure that the connection cable is not caught and damaged between the MDU mounting plate and MDU.

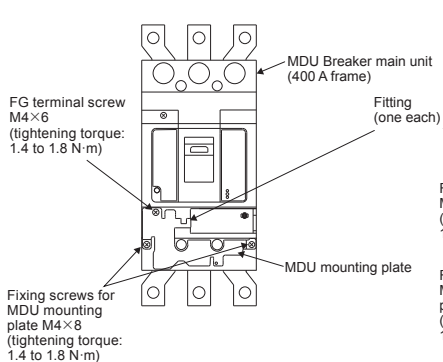

(Figure 9)

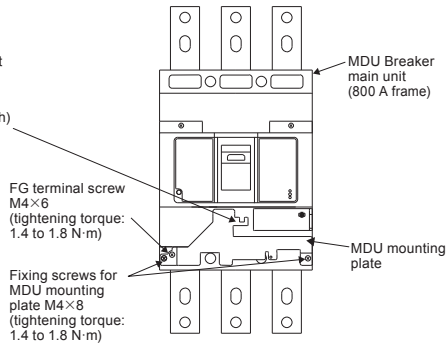

(Figure 10)

3.2.2 Mounting of MDU to MDU Breaker main unit

- (1) Ground (class D) the FG terminal on the MDU mounting plate.
- (2) Securely insert the connection cable coming out from the MDU Breaker main unit into the MDU connector (until the lock clicks into place). (Figure 11)

Caution Do not forcefully pull the connection cable. Doing so may result in a disconnection of the cable.

<Connecting the connector> (Figure 11)

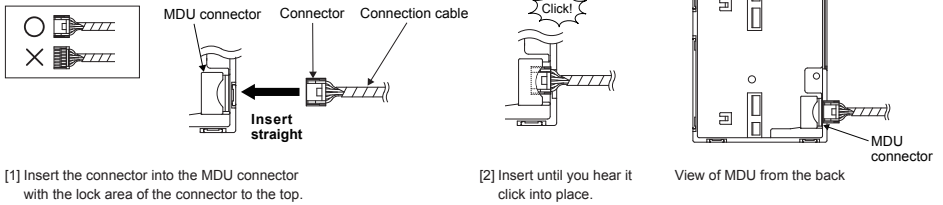

Caution

- Take note of the connector's orientation and insert it straight.
- Insert until you feel the lock click into place.

- (3) Hook the small tab on the back of the MDU on the fitting (1) on the MDU mounting plate. (Figure 12)

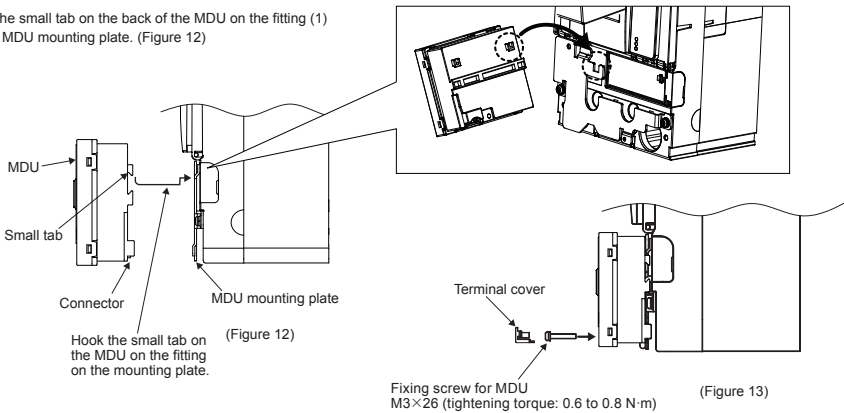

- (4) Remove the MDU terminal cover, and then screw the MDU mounting plate. (Figure 13 & Figure 14)
Use the included "M3x25" Fixing screw for MDU. The terminal cover is removable, so use caution when handling it. (Figure 15)

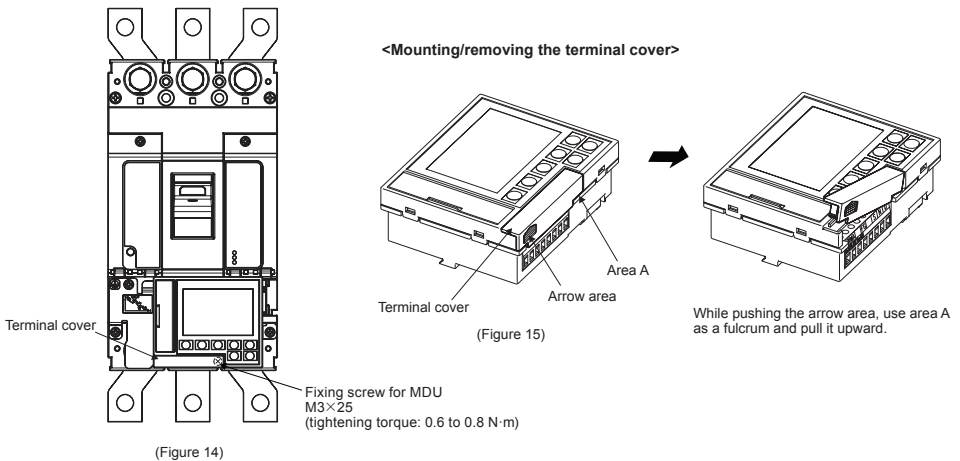

3.3 MDU mounting (panel mounting)

3.3.1 No transmission, electric energy pulse output

1 Precautions for mounting

Install with an amount of space left equal to the measurement on the right or higher. (Figure 17)

MDU panel cutting dimensions

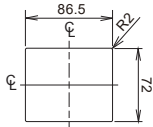

(Figure 16)

Use a panel with a board thickness from 1 mm to 3.2 mm.

(No transmission, with pulse output)

	Model	A	B
250 A frame	NF250-SEV with MDU	158	198
	NF250-HEV with MDU		208
400 A frame	NF400-SEW with MDU	205	244
	NF400-HEW with MDU		374
800 A frame	NF800-SEW with MDU	221	263
	NF800-HEW with MDU		383

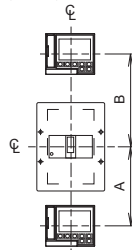

(Figure 17)

⚠ Caution

Rear type and plug-in type are shown. For rear type, leave some space with the connection wiring, insulation barrier, etc.

2 MDU panel mounting

- (1) Insert the terminal block and mounting bracket connected to the MDU into the holes cut into the panel, from the front of the panel. (Figure 18)
- (2) Insert the MDU so that it is pushing against the panel. (Figure 19)
Push it against the panel so that the two mounting bracket holes enter into the screw points, from the back of the panel.
- (3) Insert the included nuts (M3) into the screw points from the back of the panel, and then tighten them into place. (Figure 20)

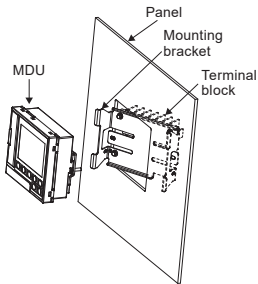

(Figure 18)

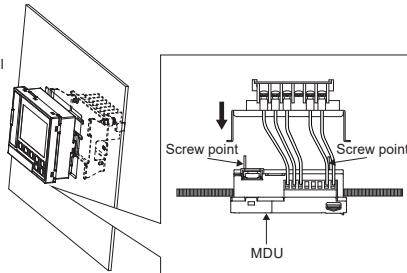

(Figure 19)

View from bottom of MDU

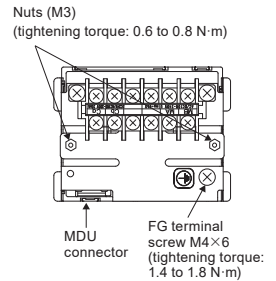

(Figure 20)

View from behind panel

⚠ Caution When mounting the MDU to the panel, be careful not to damage the terminal block or cables.

3 Connecting cable connection

Securely insert the connection cable coming out from the MDU Breaker main unit into the MDU connector (until the lock clicks into place). (Figure 21)

Caution Do not forcefully pull the connection cable. Doing so may result in a disconnection of the cable.

<Connecting the connector> (Figure 21)

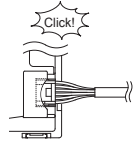
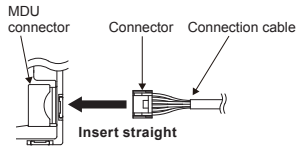
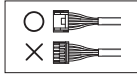
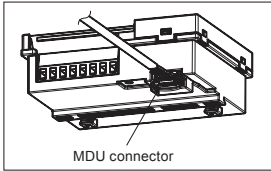

[1] Insert the connector into the MDU connector with the lock area of the connector to the top.

[2] Insert until you hear it click into place.

<Binding the cable>

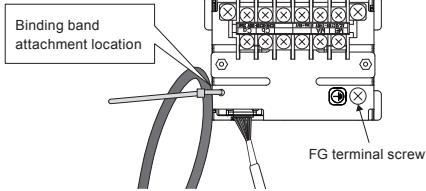

Caution
Secure with the binding band in such a way that direct force is not applied to the MDU connector. (No binding band is included.)

(1) Connect the connector of the connection cable to the connector of the MDU Breaker main unit's right side.

(2) Insert until you hear it click into place.

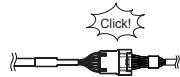
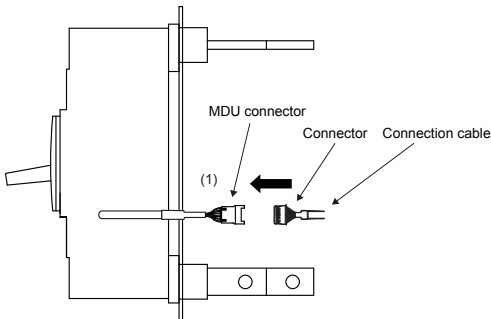

Caution
● Fasten the connection cable with clamps to avoid undue force.

3.3.2 With CC-Link communication/MODBUS communication

1 Precautions for mounting

Install with an amount of space left equal to the measurement on the right or higher. (Figure 23)

MDU panel cutting dimensions

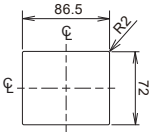

(Figure 22)

Use a panel with a board thickness from 1 mm to 3.2 mm.

(CC-Link/MODBUS)

Model		A	B
250 A frame	NF250-SEV with MDU	158	218
	NF250-HEV with MDU		228
400 A frame	NF400-SEV with MDU	205	263
	NF400-HEV with MDU		393
800 A frame	NF800-SEV with MDU	221	282
	NF800-HEV with MDU		402

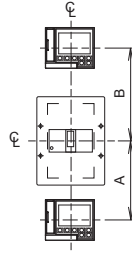

(Figure 23)

Caution
Rear type and plug-in type are shown. For rear type, leave some space with the connection wiring, insulation barrier, etc.

2 MDU panel mounting

- (1) Screw the FG wire (green) pulled from the MDU to the FG terminal on the fixing bracket.
(Use the included "M4×6" screw.)
- (2) Insert the terminal block and fixing bracket connected to the MDU into the holes cut into the panel, from the front of the panel.

Caution
When mounting the MDU to the panel, be careful not to damage the terminal block or cables.

3 Mounting of terminal block to fixing bracket

- (1) Connect the terminal block to the fixing bracket. (Figure 24)
(Use the two included "M3×12" screws.)

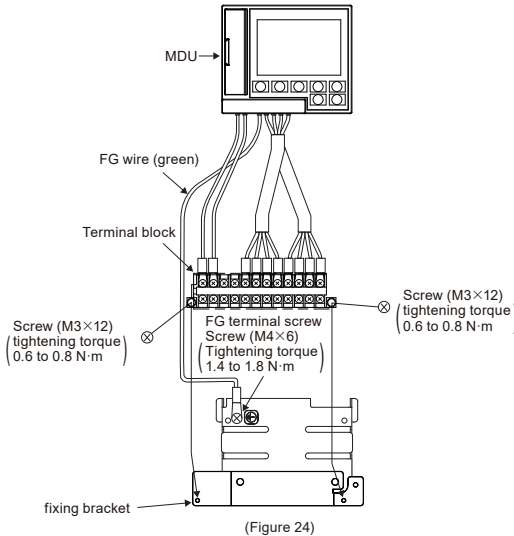

(Figure 24)

- (2) Insert the MDU so that it is pushing against the panel.
Push it against the panel so that the two fixing bracket holes are inserted into the screw points, from the back of the panel.
(Refer to 3.3.1 Figure 19 on page 11.)

- (3) Insert the included nuts (M3) into the screw points from the back of the panel, and then tighten them into place. (Figure 25)

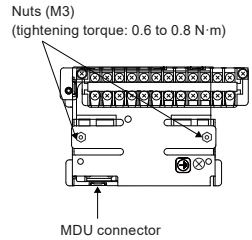

(Figure 25)

View from behind panel

4 Connecting cable connection

Securely insert the connection cable coming out from the MDU Breaker main unit into the MDU connector (until the lock clicks into place). (3.3.1 Figure 21 on page 12.)

Caution

Do not forcefully pull the connection cable. Doing so may result in a disconnection of the cable.

<Binding the cable>

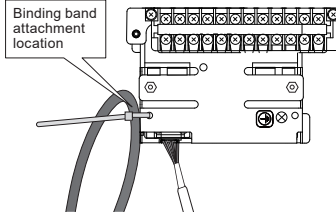

Caution

Secure with the binding band in such a way that direct force is not applied to the MDU connector. (No binding band is included.)

3.4 Wiring of MDU terminal block

3.4.1 External mounting type

Caution

- See below for compatible electric current sizes for the MDU terminal block.

	Solid wire	Twisted wire
One connected	ϕ 0.45 to ϕ 1.2 mm	0.14 to 1.5 mm ²
Two connected	ϕ 0.45 to ϕ 0.8 mm ⁽¹⁾	0.14 to 0.75 mm ²

- After inserting the electric wire into the terminal, tighten it using the applicable tightening torque. When tightening screws again, start slowly and do so in the vertical direction.

Applicable tightening torque : 0.5 to 0.6 N·m
 Flathead screwdriver as a tool : Tip thickness of 0.6 mm, total width of 3.5 mm
 [Recommended screwdriver: PHOENIX CONTACT screwdriver model SZS 0.6 × 3.5]
 Electric wire covering stripped length : 7 mm

- Electric wire terminal treatment: For a solid wire, the electric wire can be connected with the covering stripped.

For a twisted wire, strip the covering, twist the core, and then insert it into the junction area. Make sure that the core filler does not short neighboring poles. Do not solder the core.

The following pin terminals (crimped terminals) are also available for purchase.

PHOENIX CONTACT

Electric wire cross-section area of 0.25 mm² : AI 0.25-8 YE (product number 3200852)

Electric wire cross-section area of 0.5 mm² : AI 0.5-8 WH (product number 3200014)

Electric wire cross-section area (for two wires) of 0.5 mm² × 2 : AI-TWIN 2 × 0.5-8 WH (serial number 320933)

The products listed above may not be compatible with some electric wires. For details, contact the pin terminal (crimped terminal) manufacturer directly. However, if using a pin terminal (crimp terminal) with a metallic portion longer than 7 mm, cut the metallic portion to 7 mm as shown in the figure below.

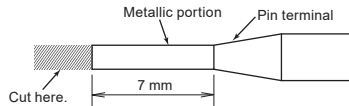
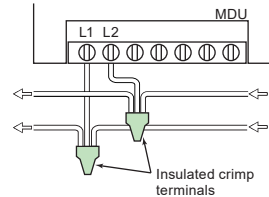

3.4.2 Panel mounting type

- Use a suitable size of electric wire for crimped terminal.
- Ground (class D) the earth terminal. Connect earth terminal to mounting plate with the cable FG (green) from MDU unit.

Caution

- Do not connect three or more electric wires to avoid heating or fire due to loose connection.
- Do not connect anything to unused terminals. Erroneous connection will cause failure.
- Do not put too much tension on electric wire to avoid pulling terminal block out.

[Wiring for products with electric energy pulse output]

Caution

- The 114 and 113 pulse output terminals are included with MDUs with electric energy pulse output.
- The pulse output line forms a small-signal circuit. Install it at least 10 cm away from strong circuits. The wiring length is determined by various conditions such as the anti-noise performance of the pulse receiver. However, the wiring should not exceed 100 m.
- If using A/C for the pulse output power supply, make sure that the pulse receiver does not erroneously operate due to leak current caused by conduit capacitance.

[Wiring for products with CC-Link communication]

Danger

- CC-Link communication terminals DA, DB, DG, and SLD are included with CC-Link communication MDUs. Connect these to the CC-Link transmission line. Never connect non-transmission line terminals (such as the L1 and L2 control power supply terminals).
- The CC-Link transmission line forms a small-signal circuit. Connecting it improperly is extremely dangerous.

Caution

- The CC-Link transmission line forms a small-signal circuit. Install it at least 10 cm away from strong circuits. However, install it at least 30 cm away if parallel for a long distance.
- If installing a MDU main unit with CC-Link communication, a hole cannot be made in the face board. Making a hole in the face board will leave a gap in the CC-Link communication cable wiring.

[Wiring for products with MODBUS communication]

Danger

- MODBUS communication terminals FG, SLD, 485+, 485-, Ter are included with MODBUS communication MDUs. Connect these to the MODBUS transmission line. Never connect non-transmission line terminals (such as the L1 and L2 control power supply terminals).
- The MODBUS transmission line forms a small-signal circuit. Connecting it improperly is extremely dangerous.

Caution

- The MODBUS transmission line forms a small-signal circuit. Install it at least 10 cm away from strong circuits. However, install it at least 30 cm away if parallel for a long distance.
- If installing a MDU main unit with MODBUS communication, a hole cannot be made in the face board. Making a hole in the face board will leave a gap in the MODBUS communication cable wiring.

4. MDU Features and Functions

4.1 Features of MDU

- The load current, line voltage, harmonic current (fundamental frequency; 3rd, 5th, 7th, 9th, 11th, 13th, 15th, 17th, and 19th order; and total), electric power, reactive power, electric energy, reactive energy, power factor, and frequency flowing to MDU Breaker can be measured and displayed.
- When MDU Breaker is tripped, the fault cause and fault current are stored in non-volatile memory. This information can be used to identify fault causes and recover.
- The maximum value of measurement items such as demand current and time electric energy is stored in non-volatile memory, along with when the maximum value occurred. This information can be used to identify peak energy usage times.
- The LCD backlight color changes from white to red when an alarm (PAL, OVER) or fault occurs, allowing users to notice abnormalities even from far away.
- Data such as measurement values, maximum values (and maximum value occurrence times), fault causes, fault current, and the alarm status can be sent over a field network (CC-Link, MODBUS).
- Some models do not measure or display (transmit) some items. These items and functions will be skipped.

4.2 Functions of MDU

Measurement functions (*1)	Load current I	○
	Line voltage V	○
	Harmonic current IH	○
	Electric power P	○
	Reactive power Q	○
	Electric energy EP	○
	Reactive energy EQ	○
	Power factor PF	○
	Frequency Hz	○
	Fault cause, Fault current (*2)	Long time delay
Short time delay		○
Instantaneous		○
Line system	1φ2W, 3φ3W, 1φ3W (applied to three-pole products), 3φ4W (applied to four-pole products)	
Output specifications (*3)	No transmission (standard product)	○
	Electric energy pulse output (option)	○
	CC-Link communication (option) (*4) (*5)	○
	MODBUS communication (option) (*5)	○
MDU control power supply (permissible voltage range 85% to 110%)	100 to 240 VAC/DC common 12 VA (*6)	
Alarm contact (MDU Breaker main unit option) (Refer to "4.4 Monitoring functions") (*7)	PAL, TI	

Caution

- *1. Refer to "4.3 Measurement functions" for details of measurement functions.
- *2. Either the latest fault cause or the latest fault current is shown. They are not displayed simultaneously.
- *3. Electric energy pulse output, CC-Link communication, and MODBUS communication can not be installed at the same time.
- *4. The CC-Link version is "CC-Link Ver. 1.10."
- *5. During MDU panel mounting, a CC-Link/MODBUS cable (part no. FANC-110SBH manufactured by Kuramo Electric Co., LTD.) is used from the front surface of the MDU to the terminal block on the rear surface.
- *6. When the MDU control power supply is turning on, a transitional inrush current will be generated. (Inrush current maximum value 2 A, energization time 1 ms [240 VAC].)
- *7. Refer to "6.1 Contact capacity and combinations for alarm contact output" in "MDU Breaker Instruction Manual for Main Unit" for alarm contact output combinations.

4.3 Measurement functions

4.3.1 Measurement function list

The following table lists measurement elements and elements that can be communicated/displayed.

Measurement elements that can be communicated and displayed.

Measurement elements			Communication	Display	Display range*	
I Load current (± 1.0%)	Present value	Each-phase	●	●	0.0, 1.2 to 999.9, 1000 to 1600 A	
		Total harmonic (average value)	●	–	–	
		Maximum phase	●	–	–	
	Present demand value	Each-phase	●	●	0.0, 1.2 to 999.9, 1000 to 1600 A	
		Maximum value	●	●		
		All-phase demand maximum value	●	●		
V Line voltage (± 1.0%)	Present value	Between each line	●	●	0.0, 22.0 to 99.9, 100 to 759 V	
		Total harmonic (average value)	●	●		
	Maximum value between all wires	●	●			
	Maximum value occurrence time between all wires	●	●	00/01/01 00:00 to 99/12/31 23:59		
P Electric power (± 1.5%)	Present value		●	●	-2103 to -1000, -999.9 to 999.9, 1000 to 2013 kW	
	Demand value	Present value	●	●	00/01/01 00:00 to 99/12/31 23:59	
		Maximum value	●	●		
		Maximum value occurrence time	●	●		
Q Reactive power (± 2.5%)	Present value		●	●	-2103 to -1000, -999.9 to 999.9, 1000 to 2013 kver	
	Demand value	Present value	●	●	00/01/01 00:00 to 99/12/31 23:59	
		Maximum value	●	●		
		Maximum value occurrence time	●	●		
EP Electric energy (± 2.0%)	Integrated value		●	●	0.0 to 99999.9 kWh (250 A frame)	
	Latest one hour amount		●	●	0 to 999999 kWh (400/800 A frame)	
	One hour amount maximum value		●	●		
	Occurrence time of one hour amount maximum value		●	●	00/01/01 00:00 to 99/12/31 23:00	
EQ Reactive energy (± 3.0%)	Integrated value		●	●	0.0 to 99999.9 kverh (250 A frame)	
	Latest one hour amount		●	●	0 to 999999 kverh (400/800 A frame)	
	One hour amount maximum value		●	●		
	Occurrence time of one hour amount maximum value		●	●	00/01/01 00:00 to 99/12/31 23:00	
PF Power factor (± 5.0%)	Present value		●	●	LAG 50.0 to LAG 99.9, 100.0, LEAD 99.9 to LEAD 50.0%	
	Maximum value		●	●		
	Maximum value occurrence time		–	●	00/01/01 00:00 to 99/12/31 23:59	
Hz Frequency (± 2.5%)	Present value		●	●	0.0, 45.0 to 65.0 Hz	
IH Harmonic current (± 2.5%)	Present value	Each-phase fundamental frequency	●	●	0.0, 2.5 to 99.9, 100 to 800 A	
		Each phase, each order (3rd, 5th, 7th, 9th, 11th, 13th, 15th, 17th, 19th order)	●	●		
		Total harmonic for each phase	●	●		
	Fundamental frequency maximum value for all phase		●	●		
	Occurrence time of fundamental frequency maximum value for all phase		–	●	00/01/01 00:00 to 99/12/31 23:59	
	Each-order maximum value for all phase		●	●	0.0, 2.5 to 99.9, 100 to 800 A	
	Occurrence time of each-order maximum value for all phase		●	●	00/01/01 00:00 to 99/12/31 23:59	
	Demand value	Total harmonic for each phase		●	●	0.0, 2.5 to 99.9, 100 to 800 A
		Total harmonic maximum value for all phase		●	●	
		Occurrence time of total harmony maximum value for all phase		●	●	00/01/01 00:00 to 99/12/31 23:59
All-phase total distortion ratio		–	●	0.0 to 99.9, 100%		
All-phase each-order content ratio		–	●			
Fault current (± 15%)			●	●	0 to 12800 A	

* The minimum value and the maximum value of the display range differ depending on the rated current of the MDU breaker. For details, refer to "4.3.2 Measurement rated values/measurement range and accuracy".

4.3.2 Measurement rated values/measurement range and accuracy

(1) Electric current

[1] The present value is the effective value during a single cycle.

[2] "Each-phase" means the 1-, 2-, 3-, and N-phase.

[3] Totals (average value) are calculated as follows when setting the phase and wire (factory setting is three-phase three-wire for three-pole products, and three-phase four-wire for four-pole products).

The present value of the maximum phase electric current and present value of the maximum phase electric current demand indicate the maximum value of the following phases via setting the phase and wire.

Line system	Electric current total present value	Maximum phase applicable phase
Single-phase 2-wire	I3	I3
Single-phase 3-wire	$(I1 + I3) / 2$	I1, I3
Three-phase 3-wire	$(I1 + I2 + I3) / 3$	I1, I2, I3
Three-phase 4-wire		I1, I2, I3, IN

[4] The electric current demand time limit can be set as follows. The demand time limit is a bulk setting value that includes other measurement elements. (Factory setting is two min.)

Item	Setting value
Demand time limit	0 to 15 min. (per 1 min.)

[5] The all-phase demand maximum value indicates the maximum value of the demand value for all phases, from when usage began (after previous reset) to now.

[6] The electric current measurement rated value, measurement range, and measurement accuracy are shown below.

Rated current I_n (A)	250	400	630	800
Current setting I_r (A)	125-250 adjustable (in 12.5 A steps)	200-400 adjustable	300-630 adjustable	400-800 adjustable
Accuracy ($\pm 1.0\%$ of I_n) (*)	± 2.5 A	± 4.0 A	± 6.3 A	± 8.0 A
Measurement lower limit current (1% of I_n)	2.5 A	4.0 A	6.3 A	8.0 A
Measurement upper limit current ($I_n \times 2$)	500 A	800 A	1260 A	1600 A

* The measurement accuracy is the ratio versus I_n , regardless of the rated voltage.

[7] Display/communication values will be as follows in the following conditions.

	Display	Communication
Less than 1% of I_n	0 A	
Measurement upper limit current exceeded	Blinks at measurement upper limit current	Fixed at measurement upper limit current

(2) Voltage

[1] The present value is the effective value during a single cycle.

[2] "Between each line" means the between phases, such as between 1-phase and 2-phase, 2-phase and 3-phase, 3-phase and 1-phase, 1-phase and N-phase, 2-phase and N-phase, and 3-phase and N-phase.

[3] Totals (average value) are calculated as follows when setting the phase wire type. (Factory setting is three-phase three-wire for three-pole products, and three-phase four-wire for four-pole products.)

The maximum value between all wires indicates the maximum value of the following interphases via setting the phase and wire.

Line system	Voltage total present value	Maximum phase applicable phase
Single-phase 2-wire	V23	V23
Single-phase 3-wire	$(V12 + V23) / 2$	V12, V23
Three-phase 3-wire	$(V12 + V23 + V31) / 3$	V12, V23, V31
Three-phase 4-wire		

[4] The maximum value between all wires indicates the maximum value of all line voltages, from when usage began (after previous reset) to now.

[5] The voltage measurement rated value, measurement range, and measurement accuracy are shown below.

Measurement rated voltage	440 V
Accuracy	$\pm 4.4 \text{ V}$ ($\pm 1.0\%$ of measurement rated voltage)
Measurement lower limit voltage	80 V (displays up to 22 V, but anything less than 80 V is a reference value)
Measurement upper limit voltage	759 V

[6] Display/communication values will be as follows in the following conditions.

	Display	Communication
Less than 22 V	0 V	
Measurement upper limit voltage exceeded	Blinks at 759 V	Fixed at 759 V

(3) Electric power/Reactive power

[1] The present value is the effective value during a single cycle. (The electric power during reverse power flow is also measured.)

[2] The demand time limit is a bulk setting value that includes other measurement elements. (Factory setting is two min.)

Item	Setting value
Demand time limit	0 to 15 min. (per 1 min.)

[3] The measurement rated electric power/reactive power, measurement range, and measurement accuracy are shown below.

Measurement rated electric power	$\sqrt{3} \times I_n \times 440 \text{ V}$				
Measurement rated reactive power					
Electric power accuracy	Measurement rated electric power $\pm 1.5\%$				
Reactive power accuracy	Measurement rated reactive power $\pm 2.5\%$				
Measurement upper limit Measurement lower limit	Rated current I_n (A)	250	400	630	800
	Measurement upper limit electric power	657.3 kW	1,052 kW	1,656 kW	2,103 kW
	Measurement lower limit electric power	-657.3 kW	-1,052 kW	-1,656 kW	-2,103 kW
	Measurement upper limit reactive power	657.3 kvar	1,052 kvar	1,656 kvar	2,103 kvar
	Measurement lower limit reactive power	-657.3 kvar	-1,052 kvar	-1,656 kvar	-2,103 kvar
<p>● If either the load current or line voltage exceeds the measurement upper limit, this will be the upper limit (lower limit) even if at or below the electric power/reactive power listed above.</p>					

[4] Display/communication values will be as follows in the following conditions.

	Display	Communication
All I are less than 0.4% of I_n	0 kW / 0 kvar	
All V are 0 V (less than 22 V)		
Less than measurement lower limit electric power/reactive power	Blinks at measurement lower limit electric power/reactive power	Fixed at Measurement lower limit electric power/reactive power
Measurement upper limit electric power/reactive power exceeded	Blinks at measurement upper limit electric power/reactive power	Fixed at measurement upper limit electric power/reactive power

Note: The display value will also blink if either the load current or line voltage reaches the measurement upper limit value.

(7) Harmonic current

[1] The present value is the effective value during a single cycle.

[2] The present harmonic current value measures the fundamental frequency and order (3rd, 5th, 7th, 9th, 11th, 13th, 15th, 17th, 19th) of each phase (1-phase, 2-phase, 3-phase, N-phase).

[3] "Each-phase total present harmonic current value" is the total value of the harmonic components for the 3rd, 5th, 7th...17th, and 19th orders (excluding fundamental frequency components). The calculation formula is shown below.

$$I_{IH} = \sqrt{IH_3^2 + IH_5^2 + IH_7^2 + \dots + IH_{17}^2 + IH_{19}^2}$$

[4] The all-phase each-order maximum value indicates the maximum value of the present harmonic current values for all phases, from when usage began (after previous reset) to now.

[5] The demand time limit is a bulk setting value that includes other measurement elements. (Factory setting is 2 min.)

Item	Setting value
Demand time limit	0 to 15 min. (per 1 min.)

[6] Each-phase total distortion ratio and each-phase order (3rd, 5th, 7th, 9th, 11th, 13th, 15th, 17th, 19th) content ratio are values calculated as follows.

Each-phase total distortion ratio (%)	(Each-phase IH (ALL) / each-phase IH (1st)) × 100
Each-phase 3rd, 5th...19th order content ratio (%)	(Each-phase IH (3rd), IH (5th),...IH (19th) / each-phase IH (1st)) × 100

[7] The harmonic current measurement rated value, measurement range, and measurement accuracy are shown below.

Rated current In (A)	250	400	630	800
Accuracy (± 2.5% of In) (*)	± 6.2	± 10.0	± 15.8	± 20.0
Measurement lower limit current (2% of In) (A)	5.0	8.0	12.6	16.0
Measurement upper limit current (In × 1) (A)	250	400	630	800

* The measurement accuracy is the ratio versus In, regardless of the rated voltage.

[8] Display/communication values will be as follows in the following conditions.

	Display	Communication
Less than 2% of In	0 A	
Measurement upper limit current exceeded	Blinks at measurement upper limit electric current value	Measurement upper limit electric current value fixed

(8) Fault current

[1] The fault current measures the overload/short circuit current.

[2] The measurement accuracy and measurement range for the overload/short circuit current are shown below.

Rated current In (A)	250	400	630	800
Accuracy	± 15% of actual value			
Measurement upper limit fault current (A) (In × 16)	4000	6400	10080	12800

[3] When a fault occurs, the measurement value blinks even if the fault current do not exceed the measurement upper limit value. (Fault cause/fault current display mode)

When the fault current exceeds the measurement upper limit value, the measurement value blinks even if the fault display mode is released.

4.4 Monitoring functions

4.4.1 Monitoring function list

- The following table shows monitoring elements, along with elements that can be displayed on the display or communicated. "Display" indicates that the item is displayed on the display. "Communication" indicates that the item can be communicated through CC-Link, MODBUS communication.

Monitoring element		Communication	Display
MDU Breaker alarm	Load current pre-alarm PAL (*3)	●	●
	Overcurrent alarm OVER	●	●
	Electric current demand alarm IDM_AL	●	●
	Electric current open phase alarm ILA_AL	●	●
	Electric current unbalance alarm IUB_AL	●	●
MDU Breaker status (*1)	Trip frequency	●	–
	Open/close frequency	●	–
Fault cause	Long time delay	●	●
	Short time delay	●	●
	Instantaneous (*4)	●	●
Electric current demand upper/lower limit alarm		●	–
Neutral line open phase alarm NLA (*2)		–	●

*1. Trip frequency and open/close frequency are enabled when "MDU transmission alarm switch (option)" and "MDU transmission auxiliary switch (option)" are installed, respectively.

*2. This function is turned ON when the line system is set to single-phase three-wire system. (The function is turned OFF when set to any other line system.)

*3. For 250 A frame, the Load current pre-alarm is enabled when the PAL module (option) is installed.

*4. For 250 A frame, the Fault cause on Instantaneous is enabled when the MDU transmission alarm switch (option) is installed.

4.5 How to use monitoring functions

4.5.1 MDU Breaker alarms

(1) PAL (load current pre-alarm)

Alarm details	The alarm is output to display/over communication when the load current \geq the pre-alarm current, and the duration \geq the pre-alarm operation time (1/2 the long limit time operation time TL).		
Setting method	Do not set it via communication or on the display. For 250 A frame, set it on the PAL module. For 400/800 A frame, set it on the MDU Breaker.		
Reset method	Set to either self-hold or automatic reset via communication or on the display.		
	Reset method	Self-hold	Reset the alarm via communication or on the display.
		Automatic reset	Automatically resets when the cause of the alarm is removed.

(2) OVER (overcurrent alarm)

Alarm details	The alarm is output to display/over communication when the load current exceeds 105 to 125% of the current setting of the circuit breaker.
Setting method	No settings.
Reset method	Automatic reset. (No settings.) Automatically resets when the cause of the alarm is removed.

(3) IDM_AL (electric current demand alarm)

Alarm details	The alarm is output to display/over communication when the electric current demand value (*) exceeds the pick up current.		
Setting method	Set via communication or on the display Function: ON/OFF Pick up current: 50 to 100% (per 1%) Demand time limit: 1 to 10 min. (per 1 min), 15, 20, 25, 30 min. (*) (Factory setting is OFF.)		
Reset method	Set to either self-hold or automatic reset via communication or on the display.		
	Reset method	Self-hold	Reset the alarm via communication or on the display.
		Automatic reset	Automatically resets when the cause of the alarm is removed.

* This differs from the demand time limit for each measurement value.

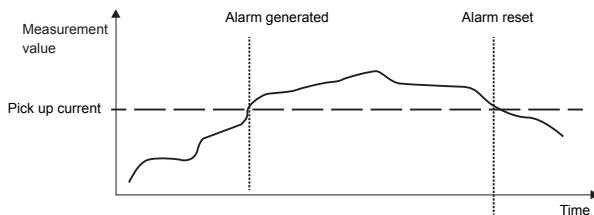

For automatic reset, the alarm will be reset if the value falls below the pick up current. For self-hold, the alarm will be maintained and will need to be reset manually.

(4) ILA_AL (electric current open phase alarm)

Alarm details	Monitoring starts when the load current for any phase reaches or exceeds 10% of the measurement rated current. The alarm is output to display/over communication when an energization phase equal to or less than the maximum phase current \times 10% is generated when monitoring starts and after 30 seconds have passed.	
Setting method	Set via communication or on the display Function: ON/OFF (Factory setting is OFF.) Pick up current: 10% fixed (no settings) Operating time: 30 s fixed (no settings)	
Reset method	Set to either self-hold or automatic reset via communication or on the display.	
	Reset method	Reset the alarm via communication or on the display. Automatically resets when the cause of the alarm is removed.

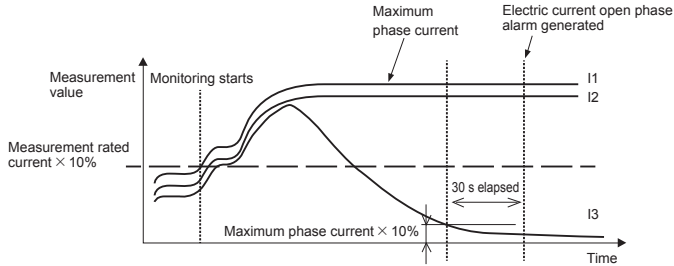

(5) IUB_AL (electric current unbalance alarm)

Alarm details	Monitoring starts when the load current for any phase reaches or exceeds 10% of the measurement rated current. The alarm is output to display/over communication when an energization phase equal to or less than the maximum phase current \times 30% is generated when monitoring starts and after 30 seconds have passed.	
Setting method	Set via communication or on the display Function: ON/OFF (Factory setting is OFF.) Pick up current: 30% fixed (no settings) Operating time: 30 s fixed (no settings)	
Reset method	Set to either self-hold or automatic reset via communication or on the display.	
	Reset method	Reset the alarm via communication or on the display. Automatically resets when the cause of the alarm is removed.

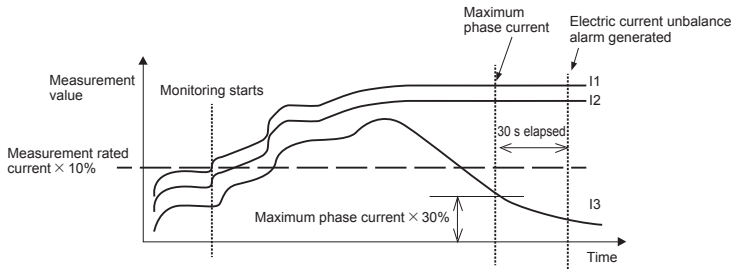

4.5.2 MDU Breaker status

MDU Breaker status details	Trip frequency	Communicates the total number of times the MDU Breaker has tripped from when usage began to now.
	Open/close frequency	Communicates the total number of times the MDU Breaker has opened/closed from when usage began to now.
Remarks	<ul style="list-style-type: none"> The following internal accessory devices are required to measure the trip frequency and open/close frequency. <ul style="list-style-type: none"> Measure trip frequency: "MDU transmission alarm switch" Measure open/close frequency: "MDU transmission auxiliary switch" Measure both trip frequency and open/close frequency: "MDU transmission alarm switch/auxiliary switch" 	

4.5.3 Fault causes

Fault cause details	Outputs to display/over communication the fault cause when MDU Breaker is tripped.
	Communicates/displays either long time delay (LTD), short time delay (STD), or instantaneous (INST).

4.5.4 Electric current demand upper/lower limit alarms

Upper/lower limit alarm	An alarm generation status is communicated if the electric current demand (current value of maximum phase electric current demand) exceeds the set upper limit value or falls below the set lower limit value. (It is not output to the display.)					
	Alarm generation status	Shows whether an alarm has been generated.				
Setting method	Sets the upper limit setting value and lower limit setting value via communication. (Cannot be set on display.)					
	Upper limit setting value	Sets the upper limit for the measurement value.				
	Lower limit setting value	Sets the lower limit for the measurement value.				
Alarm generation condition	Monitoring	Type	Alarm generation condition			
		Upper limit monitoring	<table border="1"> <tr> <td>Generation</td> <td>Measurement value > upper limit setting value</td> </tr> <tr> <td>Recovery</td> <td>Measurement value ≤ upper limit setting value</td> </tr> </table>	Generation	Measurement value > upper limit setting value	Recovery
	Generation	Measurement value > upper limit setting value				
	Recovery	Measurement value ≤ upper limit setting value				
Lower limit monitoring	Generation	Measurement value < lower limit setting value				
	Recovery	Measurement value ≥ lower limit setting value				
Reset method	Automatic reset. (No settings.) Automatically resets when the cause of the alarm is removed.					

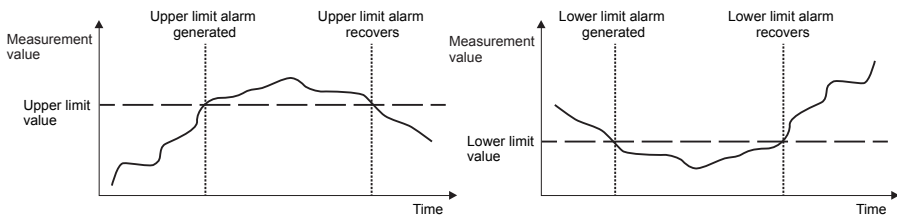

4.5.5 Neutral line open phase alarm (NLA)

Alarm details	The alarm generation status is displayed when the line voltage ≥ rated operation overvoltage, and the duration ≥ operating time. (It is not communicated.)		
Setting method	Set via communication or on the display		
	This function is turned ON when the line system is set to single-phase three-wire system. (The function is turned OFF when set to any other line system.)		
	Rated operation overvoltage:	135 VAC fixed (no settings)	
	Operating time:	1 s fixed (no settings)	
	Rated inoperative overvoltage:	120 VAC	
	Overvoltage inertia inoperative time:	0.1 s or more	
Reset method	Set to either self-hold or automatic reset via communication or on the display.		
	Reset method	Self-hold	Reset the alarm via communication or on the display.
		Automatic reset	Automatically resets when the cause of the alarm is removed.

4.6 Network Specifications for MDU

4.6.1 Electric energy pulse output

Item	Specification
Output elements	Solid state relay (SSR), No voltage a contact (113 and 114 terminals: no polarity)
Contact capacity	Compatible with 24 VDC and 100 to 200 VAC, 20 mA
Output pulse unit	1, 10, 100, 1000 and 10000 kWh/pulse (settable)
Output pulse width	0.35 to 0.45 s
Max. wiring length	100 m

4.6.2 CC-Link communication

Item	Specification
Communication method	Broadcast polling method
Communication speed	156 k/625 k/2.5 M/5 M/10 Mbps
Synchronization method	Frame synchronization method
Encoding method	NRZI
Transmission format	Conforming to HDLC
Number of occupied stations	Remote device occupying 1 station
CC-Link version	CC-Link Ver. 1.10
Max. total extension cable length	1200 m (156 kbps), 900 m (625 kbps), 400 m (2.5 Mbps), 160 m (5 Mbps), 100 m (10 Mbps)
Number of connected units	Max. 42
Connecting cable	Cables applicable to CC-Link Ver. 1.10 (shielded 3-core twisted pair cables)

Note: Refer to the CC-Link Partner Association website (<http://www.cc-link.org/>) for details.

4.6.3 MODBUS communication

Item	Specification
Communication method	RS-485, 2-wire system, half duplex communication
Communication protocol	MODBUS-RTU communication (Binary data transfer)
Synchronization method	Start-stop synchronization method
Connection method	Multidrop network
Communication speed	2400, 4800, 9600, 19200, and 38400 bps
Bit length	8 bits
Stop bit	1 bit or 2 bits (Default: 1 bit)
Parity bit	ODD, EVEN, and NONE (Default: EVEN)
Slave device address	1 to 127 (Default: 1)
Response time	From reception of a query to transmission of a response, it is 1 second or less.
Terminal resistance	120 Ω, 1/2 W
Maximum transmission distance	1,200 m
No. of connectable units	Up to 31 units per system
Connection cable	An equivalent cable to SPEV (SB)-MPC-0.2×1P (manufactured by MITSUBISHI CABLE INDUSTRIES, LTD.)

5. Names and Functions of MDU Parts

Some models do not measure or display (transmit) some items or functions. These items and functions will be skipped. * Refer to "7. MDU Operation Procedure" for details.

5.1 Display/operation panel

The display direction on the display can be changed. Refer to "7.1.2-3 Setting method for LCD."

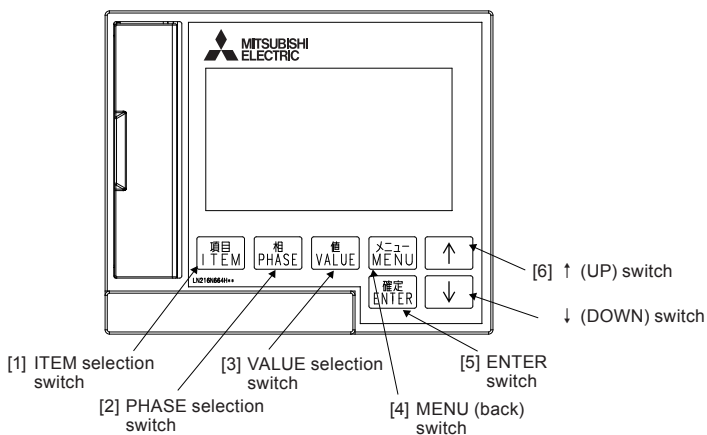

[1] ITEM selection switch

Used to select items to display on the measurement display screen.

[2] PHASE selection switch

Used to select phases to display on the measurement display screen.

[3] VALUE selection switch

Used to select measurement values to display on the measurement display screen.

[4] MENU (back) switch

Used to switch between the measurement display screen and main menu screen, and to return to the previous screen.

[5] ENTER switch

Used to confirm items/details set in the function selection mode.

[6] ↑ (UP) and ↓ (DOWN) switches

Used to set values and select items.

* Refer to "7 MDU Operation Procedure" for details on how to operate the device.

5.2 MDU terminal block section

- (1) Control power supply terminals: L1 and L2
Connect to the MDU control power supply. They have no polarity.
- (2) Ground terminal: FG (on mounting plate)
MDU external mounting: FG terminal on mounting plate of MDU Breaker main unit
MDU panel mounting: FG terminal on MDU mounting bracket
Connect above terminals to class D ground.
- (3) Ground terminal: FG (on terminal block)
Connect the FG terminal on the terminal block with the FG terminal in (2) above, and then ground (class D).
- (4) Pulse output terminals: 114 and 113 (with electric energy pulse output option)
These are electric energy pulse output terminals. They have no polarity.
- (5) CC-Link communication terminals: DA, DB, DG, and SLD (with CC-Link communication option)
Connect to CC-Link communication signals DA, DB, DG, and SLD.
- (6) MODBUS communication terminals: FG, SLD, 485+, 485-, and Ter (with MODBUS communication option)
Connect to MODBUS communication signals FG, SLD, 485+, and 485-.
If the 485- and Ter terminal are short-circuited, the end MDU of the MODBUS communication can be terminated using the 120 Ω terminal resistor.

Terminal layout figure: External mounting specification

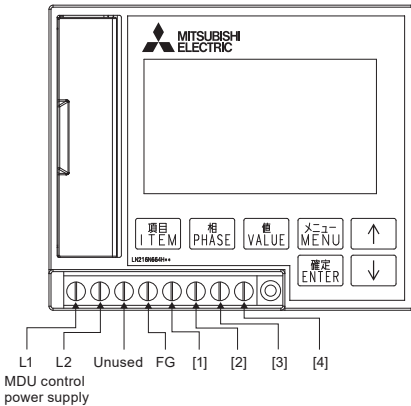

	[1]	[2]	[3]	[4]
No transmission	Unused	Unused	Unused	Unused
Pulse output	Unused	Unused	113	114
CC-Link	SLD	DG	DB	DA
MODBUS	SLD	485+	485-	Ter

⚠ Caution

- Do not connect anything to unused terminals.
- Do not use with connecting wiring.
Erroneous connection will cause failure.

Terminal layout figure: Panel mounting specification

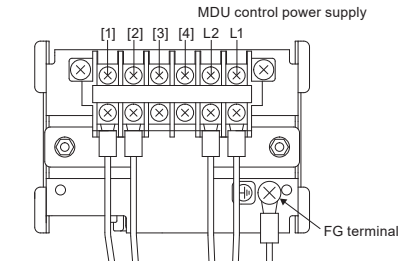

	[1]	[2]	[3]	[4]
No transmission	Unused	Unused	Unused	Unused
Pulse output	114	113	Unused	Unused

Screw size on terminal block is M3.5. Tightening torque is 0.94 to 1.51 N·m.
Use crimped terminal size 7.5 mm or less for M3.5 screw.

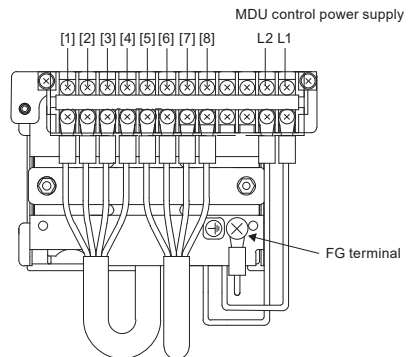

	[1]	[2]	[3]	[4]	[5]	[6]	[7]	[8]
CC-Link	DA	DB	DG	SLD	DA	DB	DG	SLD
MODBUS	Ter	485-	485+	SLD	Ter	485-	485+	SLD

Screw size on terminal block is M3. Tightening torque is 0.49 to 0.76 N·m.
Use crimped terminal size 6.3 mm or less for M3 screw.

5.3 CC-Link setting area (with CC-Link communication option)

The MDU is a remote device station that occupies a single station.

MDU input data is retained if a sequencer CPU error or data ring error occurs.

(1) Station number (STATION No.) setting switches

Open the cover for the setting area on the front of the MDU, and use the station number setting switches to set the CC-Link communication station number via BCD code.

(Setting range: 1 to 64) (factory setting: 1)

Setting example: Value of switches when turned ON:

10s place..... $2 \times 10 = 20$,

1s place..... $8 \times 1 + 1 \times 1 = 9$,

$20 + 9 = 29$, and then

station number is 29.

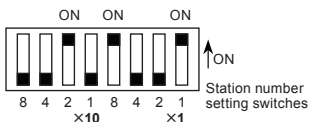

Set station numbers so that there are no duplicate ones set on the same transmission route.

Refer to "5.4 Number of CC-Link communication connectable units and precautions" for information on the number of connectable units and combinations with other devices.

(2) Communication speed (baud rate) setting switch

Use the communication speed setting switch to set the communication speed.

Switch setting	Communication speed
0	156 kbps (factory setting)
1	625 kbps
2	2.5 Mbps
3	5 Mbps
4	10 Mbps

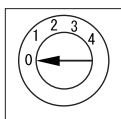

Communication speed setting switch

(3) Reset switch

The reset switch restarts the MDU status. If the station number (STATION No.) setting switches or communication speed (baud rate) setting switch are operated after the control power supply is turned on, be sure to press the reset switch.

(4) CC-Link communication LEDs

The CC-Link communication LEDs indicate the status of the transmission signal line and the error status of the MDU.

LED name	Details
L RUN LED	ON : Communication normal OFF : Communication stopped
L ERR. LED	ON : Communication data error Blinking : Communication data error OFF : Communication normal
SD LED	Turns ON when sending data
RD LED	Turns ON when receiving data

Station number setting switches

Communication speed setting switch

CC-Link communication LEDs

Reset switch

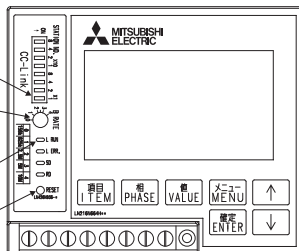

Caution

CC-Link operation precautions

- Prior to powering the transmission line for CC-Link communication, set the station number for each device, while keeping the number of occupied stations in mind.
CC-Link devices use these station numbers to communicate, so setting them is very important.
- Use a thin stick to operate the station number setting switches, and make sure that they have been switched all the way to the number to set.
Operate the station number setting switches at 10 N or less.
- If the station number setting switches are operated after turning the control power supply on, the set station number will not be recognized unless the reset switch is pressed.
- Use a thin stick to firmly press the reset switch.
- Do not use a mechanical pencil to operate the switch. The lead could enter the gap in the switch, resulting in erroneous operation and even causing failure.
- The terminal block is not formed from two pieces, so the unit cannot be replaced during communication.

5.4 Number of CC-Link communication connectable units and precautions

The MDU is a remote device station that occupies a single station. The number of connectable units and combinations with other devices must satisfy both "number of connectable units in condition 1" and "number of connectable units in condition 2" below.

Number of connectable units in condition 1

$$\{(1 \times a) + (2 \times b) + (3 \times c) + (4 \times d)\} \leq 64$$

a : Number of units occupying one station (this applies to the MDU)

b : Number of units occupying two stations

c : Number of units occupying three stations

d : Number of units occupying four stations

Number of connectable units in condition 2

$$\{(16 \times A) + (54 \times B) + (88 \times C)\} \leq 2304$$

A : Number of remote I/O single stations ≤ 64

B : Number of remote device stations ≤ 42 (this applies to the MDU)

C : Number of local stations ≤ 26

If only MDUs are connected, up to 42 devices can be connected.

$$\text{Number of connectable units in condition 1..... } \{(1 \times 42) + (2 \times 0) + (3 \times 0) + (4 \times 0)\} = 42 \leq 64$$

$$\text{Number of connectable units in condition 2..... } \{(16 \times 0) + (54 \times 42) + (88 \times 0)\} = 2268 \leq 2304$$

For the MDU panel mounting specification, the terminal block on the panel mounting bracket and the terminal block on the MDU are connected with a special CC-Link cable (15 cm one-way, 30 cm two-way), so keep the following three points in mind.

- (1) The one-way 15 cm length of the special CC-Link cable mentioned above is included in the distance between each station.
- (2) The two-way 30 cm length of the special CC-Link cable mentioned above is included in the maximum transmission distance (total length distance).
- (3) The CC-Link version is "CC-Link Ver. 1.10." The special CC-Link cable mentioned above is the cable of part no. FANC-110SBH manufactured by Kuramo Electric Co., LTD.

5.5 Installation and wiring for products with CC-Link communication

5.5.1 Terminator installation

Terminators (included with the master unit) must be installed on the units at both ends of the CC-Link transmission line.

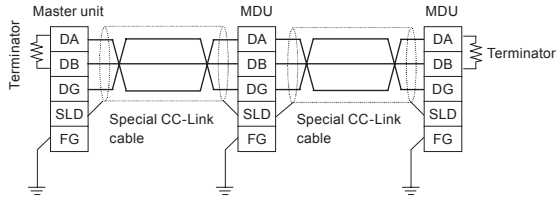

If the MDU is at the end of the CC-Link transmission line, connect a terminator between DA and DB in the MDU terminal block.
 MDU external mounting specification: Prepare the terminator included with the master unit as shown in the figure below.
 MDU panel mounting specification: Preparation not required.

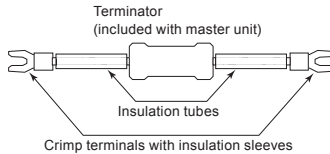

[Preparation method]

(1) Cut the resistor legs on both sides of terminator (leave 15 mm on each side).

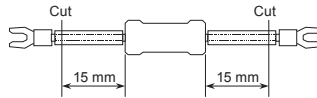

(2) Cut the insulation tubes 5 mm from their ends.

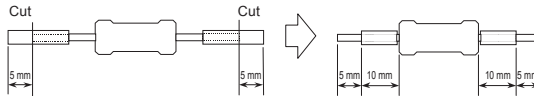

⚠ Caution

- Terminators are not included with this product. Use the terminator included with the master unit.
- Refer to the terminator manual included with the master unit for details on terminators.

5.5.2 Shielded wire grounding

Connect both ends of the shielded wires from the special CC-Link cable to "SLD" on each unit.
 Use "FG" on each unit as the dedicated ground.
 Use class D grounding.

If a dedicated ground cannot be used, use a common ground as shown in the figure below.

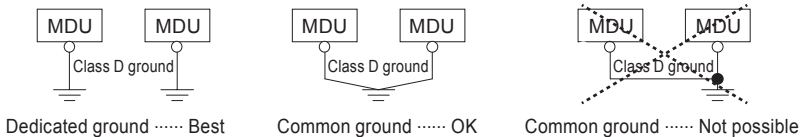

5.6 MODBUS setting area (with MODBUS communication option)

(1) MODBUS address setting switches

These switches are used to set the addresses for MODBUS communication. (Factory setting: ON, EVEN)
Set the addresses so that there are no duplicate ones set on the same transmission route.

Setting example: Values of the switch when turned ON are 16 and 1.
 $16 + 1 = 17$
 Address is 17.



(2) MODBUS parity bit setting switches

These switches are used to set the MODBUS communication parity bit. (Factory setting: ON, EVEN)

Switch setting	Parity bit
ODD, OFF	NONE
EVEN, OFF	NONE
ODD, ON	EVEN
EVEN, ON	ODD



(3) MODBUS stop bit setting switch

Open the cover for the setting area on the front of the MDU, and set the MODBUS communication stop bit using this switch. (Factory setting: 1 bit)

Switch setting	Stop bit
1-bit	1 bit
2-bit	2 bits

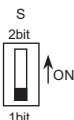

(4) MODBUS communication speed (baud rate) setting switch

This switch is used to set the MODBUS communication speed. (Factory setting: 19200 bps)

Switch setting	Communication speed [bps]
2.4	2400
4.8	4800
9.6	9600
19.2	19200
38.4	38400

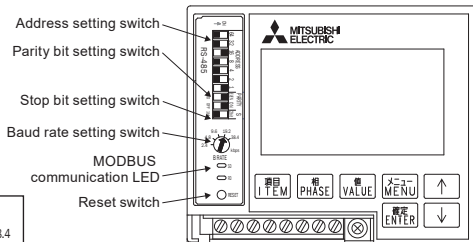
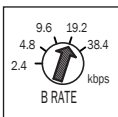

(5) Reset switch

The reset switch restarts the MDU status. If the stop bit setting switch, the parity bit setting switches, the address setting switches, or the communication speed (baud rate) setting switch are operated after the control power supply is turned on, be sure to press the reset switch.

(6) Transmission signal LED

The transmission signal LED shows the state of the transmission signal.

Blinking: Transmitting

OFF : Transmission stopped

Caution

MODBUS operation precautions

[1] Prior to powering the transmission line for MODBUS communication, set the address for each device.

MODBUS devices use these addresses to communicate, so setting them is very important.

[2] Use a thin stick to operate the address setting switches, and make sure that they have been switched all the way to the one to set.

Operate the address setting switches at 10 N or less.

[3] If the address setting switches are operated after turning the control power supply on, the set address will not be recognized unless the reset switch is pressed.

[4] Use a thin stick to firmly press the reset switch.

[5] Do not use a mechanical pencil to operate the switch. The lead could enter the gap in the switch, resulting in erroneous operation and even causing failure.

5.7 Installation and wiring for products with MODBUS communication

(1) Connection of termination resistor

A termination resistor must be connected to the unit at both ends of the MODBUS communication line.

Since the MDU has built-in terminating resistors, it is possible to connect a terminating resistor by short-circuiting 485- and Ter terminal.

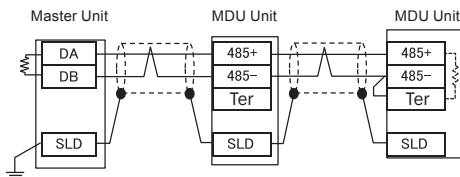

(2) Grounding the shielded wire

Connect the shielded wire of the MODBUS communication cable to the "SLD" terminal of each unit at both ends.

Connect the shielded wire to "FG" at one point on the master unit side.

6. MDU Detailed Specifications

6.1 Precautions for measurement

(1) Electric current measurement accuracy

The MDU electric current measurement accuracy is $\pm 1.0\%$ of the maximum current setting (measurement rated current) of the circuit breaker. For example, the permissible difference of NF400-SEW with MDU is 4.0 A ($400 \text{ A} \times 1.0\%$), so the permissible difference from a current of 0 A to 400 A would be $\pm 4.0 \text{ A}$.

If the measurement value is less than 1.0%, the display value is cut off to 0 A. However, if the current is 0.4% or more of the rated value, the electric power and electric energy are measured.

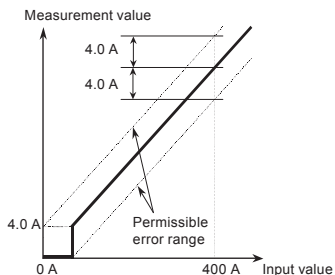

(2) Demand value

The demand value is generally the average value over the demand time limit.

The demand time limit (t_0) is the time until the measurement display value (I_0) when a fixed input (I) is continuously powered displays 95% of the input (I). It will take an amount of time roughly equal to three times the time limit (t_0) to display 100% of the input (I).

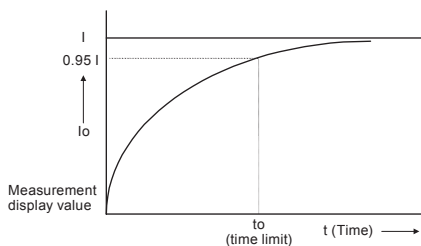

(3) Power factor measurement accuracy

The MDU power factor measurement accuracy is 5% versus the 90° electric angle.

This is phase angle 4.5° . With regard to power factor this means that a display value up to around 0.3% (LEAD (forward) 99.7 to LAG (delay) 99.7) at 100% and around 6% (64.9 to 76.0) at 70.7% of LEAD or LAG will be allowed.

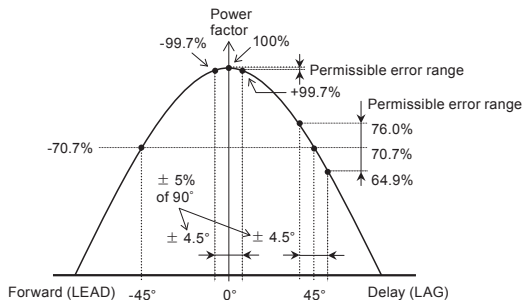

(4) Intermittent load (such as welder) measurement

Items such as current, voltage, and electric power are measured (sampled) once every 250 ms. Any values, such as current value, are calculated and the measurement value is updated at this timing.

However, the minimum update cycle for measurement results displayed on the display or output over communication data is 500 ms.

This will result in a larger errors if there is a continuous load (such as due to a resistance welder), and is therefore not suited for measurement in such cases.

If a subordinate circuit breaker operates during a short or earth leakage, the operating current might be measured at a low value.

Fault current is continuously monitored. However, the operating current of the MDU Breaker itself is measured, so the operating current of a subordinate circuit breaker cannot be measured.

(5) Operation during power outage/restoration

- The electric energy (integrated value) and reactive energy (integrated value) are stored in non-volatile memory when measurement values are updated or there is a power outage. When power is restored, it will continue measuring from the data that was stored prior to the power outage.
- Setting values are stored in non-volatile memory when set, so they do not need to be set again when power is restored.
- The device stores the last measurement display screen status prior to a power outage, and will return to this screen when the power is restored.
- The time setting might not be retained during a power outage. It should be reconfigured when power is restored. This setting is required to measure the "maximum value occurrence time" and "latest one hour amount" (the one hour amount from one hour to the next hour as measured by the internal clock).
- Maximum values and occurrence times are stored every 30 minutes. If there is a power outage, the data from 30 minutes prior to the power outage until the power outage may not be stored (in the worst case scenario).

7. MDU Operation Procedure

Display items and functions are set using the selection switches [1] through [4] shown in the figure below. Settings are switched each time a switch is pressed. (For example, when setting the phase it will cycle from 1 → 2 → 3 → N → 1 and repeat.) The UP and DOWN switches ([6]) can be used to set a numerical value for the selected item or when there are further items to select. Some models do not measure or display (transmit) some items or functions. These functions and items will be skipped.

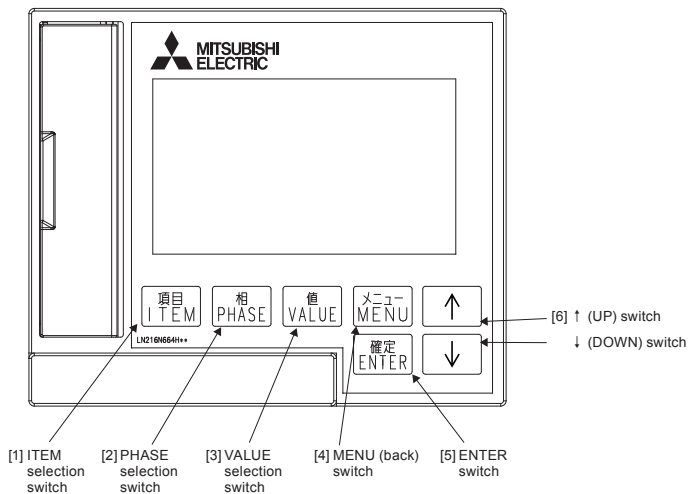

7.1 Operating method for main menu screen

The main menu screen provides access to each display screen. Use the UP/DOWN switches to select a screen to display/set, and then press ENTER to switch to the selected screen.

* Text will be inverted (black background and white text) when selected.

[Main menu screen]

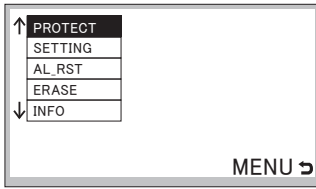

ENTER →
← MENU

Select this to display and configure protection characteristics. Refer to 7.1.1.

[Protection characteristics selection screen]
This is used to check overload, short-circuit protection characteristics, current setting, long time delay operating time, short time delay tripping current, short time delay operating time, and instantaneous tripping current.

DOWN ↓ ↑ UP

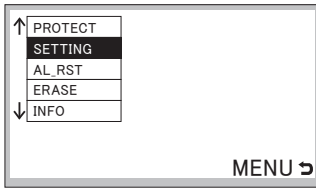

ENTER →
← MENU

Select this for settings. Refer to 7.1.2.

[Settings menu screen]
This is used to set phase switching, demand time limit, line system settings, pulse unit settings, alarms settings, LCD settings, time settings, and electric energy/reactive energy.

DOWN ↓ ↑ UP

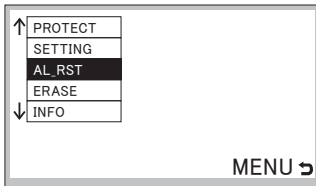

ENTER →
← MENU

Select this to reset alarms. Refer to 7.1.3.

DOWN ↓ ↑ UP

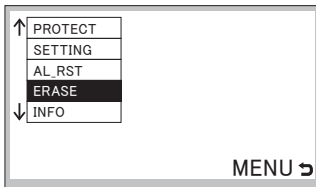

ENTER →
← MENU

Select this to reset fault causes/current, maximum values, electric energy, and reactive energy. Refer to 7.1.4.

DOWN ↓ ↑ UP

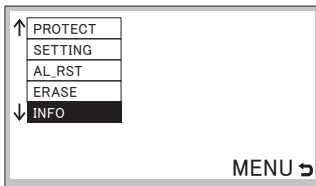

ENTER →
← MENU

Select this to check item settings. Refer to 7.1.5.

[Information screen]
This is used to check item settings for models, the protection characteristics list, the alarm list, and the measurement settings list.

7.1.1 Display method for protection characteristic setting values

- Select PROTECT from the main menu screen and press ENTER to switch to the protection characteristics selection screen.
- Switches through LTD ⇄ STD/INST ⇄ ER ⇄ LTD....
- * Protection characteristics cannot be set (changed). Use the setting dials on the MDU Breaker main unit to change them.

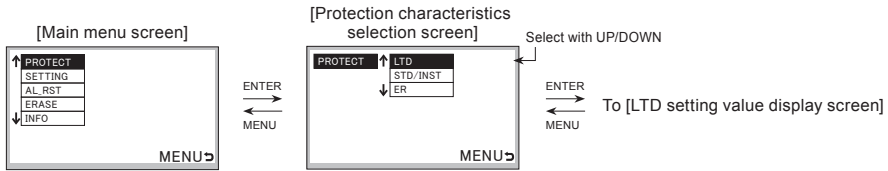

7.1.1-1 Protection characteristic setting and setting method for 250 A frame

- The setting current from the measurement display unit can not be changed for current setting (I_r) and instantaneous tripping current (I_i). Please change with the setting knob on the breaker.

(1) Current setting (I_r) check and long time delay operating time (TL), long time delay lamp characteristics (I^{lt}), N pole protection characteristic (NP) setting

- You can check the setting value of current setting (I_r).
- The long time delay operating time (TL) switches between 12 ⇄ 60 ⇄ 80 ⇄ 100 ⇄ 12 Enter to set the setting value.
- The long time delay lamp characteristics (I^{lt}) switches between ON ⇄ OFF ⇄ ON Please enter with Enter.
- N pole protection characteristic (NP) setting switches between ON ⇄ OFF ⇄ ON Please enter with Enter. (4 poles only)
- On the change permission screen, select "YES" and change the setting with Enter.
- After pressing the Enter button, it returns to the protection characteristics selection screen.

[LTD setting value display screen]

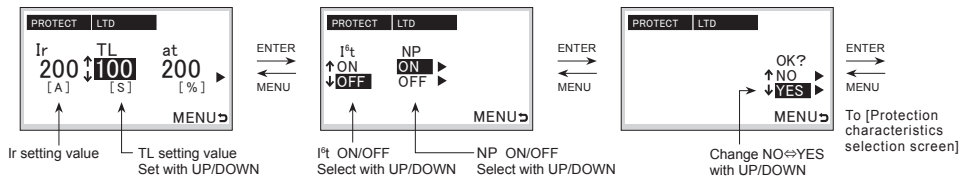

(2) Set short time delay current (I_s), short time delay operating time (T_s) and instantaneous tripping current (I_i) confirm

- The short time delay current (I_s) changes to 2.0 ⇄ 2.5 ⇄ 3.0 ⇄ 3.5 ⇄ 4.0 ⇄ 5.0 ⇄ 6.0 ⇄ 7.0 ⇄ 8.0 ⇄ 9.0 ⇄ 10 ⇄ 2.0 Enter to set the setting value.
- The short time delay operating time (T_s) switches between 0.1 ⇄ 0.2 ⇄ 0.3 ⇄ 0.1 Enter to set the setting value.
- The long time delay lamp characteristics (I^{lt}) switches between ON ⇄ OFF ⇄ ON Please enter with Enter.
- You can check the setting value of instantaneous tripping current (I_i).
- On the change permission screen, select "YES" and change the setting with Enter.
- After pressing the Enter button, it returns to the protection characteristics selection screen.

[STD/INST setting value display screen]

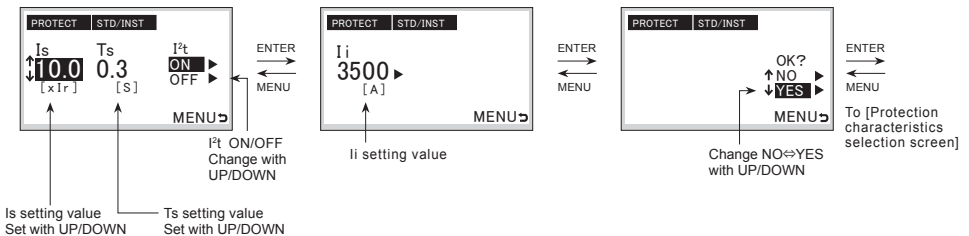

- (3) Rated Sensitivity Current $I \Delta n$, Maximum Operating Time T_e Check
 * No fuse breaker will be displayed as "-".

[Earth leakage characteristics
 ER setting value display screen]

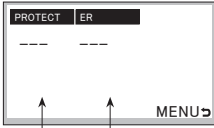

$I \Delta n$ and T_e setting values

- I_r : Current setting
- I_i : Instantaneous tripping current
- T_L : Long time delay operating time (at 200%)
- I_s : Short time delay tripping current
- T_s : Short time delay operating time (at $I_s \times 1.5$)
- I^{st} : Long time delay lamp characteristics (*)
- I^{st} : Short time delay lamp characteristics (*)
- $I \Delta n$: Rated sensitivity current
- T_e : Maximum operating time

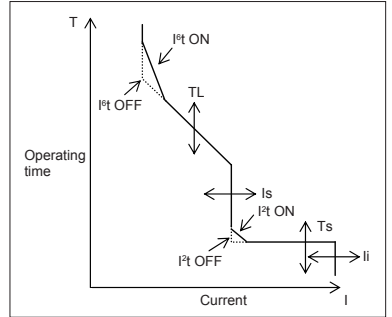

7.1-2 Protection characteristic setting and setting method for 400/800 A frame

- The setting current from the measurement display unit can not be changed for current setting (I_r) and instantaneous tripping current (I_i). Please change with the setting knob on the breaker.

- (1) Confirm current setting 2 (I_r) and long time delay operating time (T_L)

- MDU Breaker main unit current setting 2 (I_r) and long time delay operating time (T_L) setting values can be confirmed on the LTD setting value display screen.

[LTD setting value
 display screen]

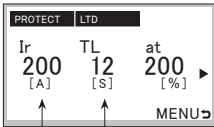

I_r and T_L setting values

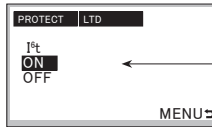

I^{st} ON/OFF

- (2) Confirm short time delay tripping current (I_s) and short time delay operating time (T_s), and then confirm instantaneous tripping current (I_i).

- Short time delay tripping current (I_s), short time delay operating time (T_s), and instantaneous tripping current (I_i) setting values can be confirmed on the STD/INST setting value display screen.

[STD/INST setting value
 display screen]

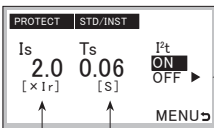

I_s and T_s setting values

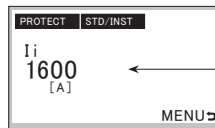

I_i setting value

- (3) Rated Sensitivity Current $I_{\Delta n}$, Maximum Operating Time T_e Check
 * No fuse breaker will be displayed as "-".

[Earth leakage characteristics
ER setting value display screen]

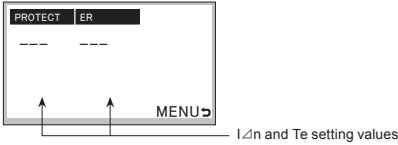

- I_r : Current setting
- I_i : Instantaneous tripping current
- T_L : Long time delay operating time (at 200%)
- I_s : Short time delay tripping current
- T_s : Short time delay operating time (at $I_s \times 1.5$)
- I_{t1} : Long time delay lamp characteristics (*)
- I_{t2} : Short time delay lamp characteristics (*)
- $I_{\Delta n}$: Rated sensitivity current
- T_e : Maximum operating time

* For 400/800 A model,
ON is set always.

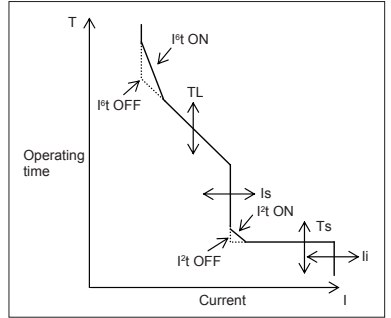

7.1.2 Method for various settings

- Select SETTING from the main menu screen and press ENTER to switch to the setting item selection screen.
- Switches through MEASURE \leftrightarrow ALARM \leftrightarrow LCD \leftrightarrow DATE \leftrightarrow EP/EQ \leftrightarrow ITEM_S \leftrightarrow FREE_S \leftrightarrow MEASURE...

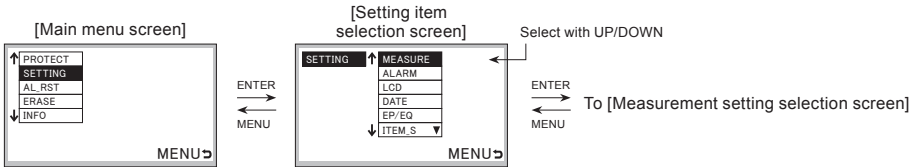

- Select MEASURE from the setting item selection screen and press ENTER to switch to the measurement setting selection screen.

7.1.2-1 Setting method for measurement-related items

- Select MEASURE from the setting item selection screen and press ENTER to switch to the measurement setting selection screen.
- Switches through PHASE \leftrightarrow LINE_S \leftrightarrow DEMAND \leftrightarrow PULSE \leftrightarrow PHASE.... (PULSE is only for models with electric energy pulse output.)

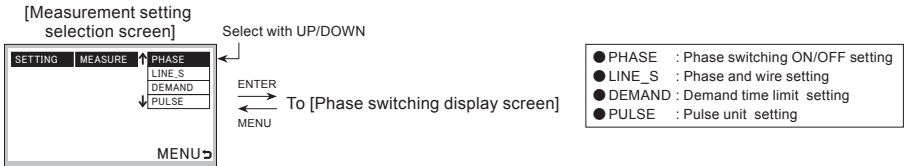

(1) Phase switching setting

[Default value: NORMAL (no phase switching)]

- Select PHASE on the measurement setting selection screen and press ENTER to switch to the phase switching display screen. (Screen [1])

This allows the phase switching setting value to be changed. Select INVERS (phase switching) and press ENTER to decide.

- Select YES on the allow changes screen and press ENTER to change the setting. (Screen [2])

* "NOW SETTING..." is displayed until the setting is completed.

- Once setting is complete, the screen will return to the measurement setting selection screen.

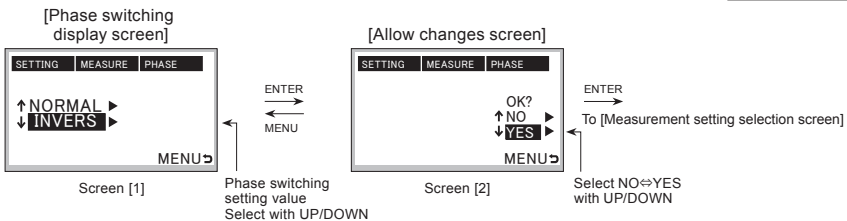
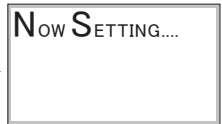

(2) Line system setting

[Default value: 3P3W] (3P4W for four-pole products)

- Select LINE_S on the measurement setting selection screen. (Screen [1])
- Press ENTER to switch to the line system display screen. This allows the line system setting value to be changed. (Screen [2])
- 1P2W (single-phase two-wire)
- 1P3W (single-phase three-wire)
- 3P3W (three-phase three-wire)
- 3P4W (three-phase four-wire) *Only for four-pole products
- Select an option and then press ENTER to decide the setting value.
- Select YES on the allow changes screen and press ENTER to decide the setting. (Screen [3])

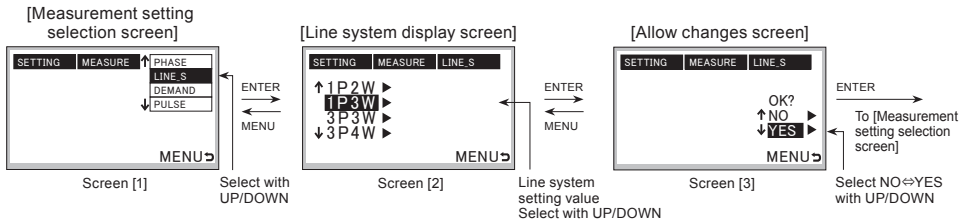

(3) Demand time limit setting

[Default value: 2 min.]

- Select DEMAND on the measurement setting selection screen. (Screen [1])
- Press ENTER to switch to the demand time limit display screen. (Screen [2])
- Setting value switches through 0 ⇔ 1 ⇔ 2 ⇔ ... ⇔ 14 ⇔ 15 ⇔ 0... (in 1 min. steps). Press ENTER to decide the setting.
- Select YES on the allow changes screen and press ENTER to decide the setting. (Screen [3])

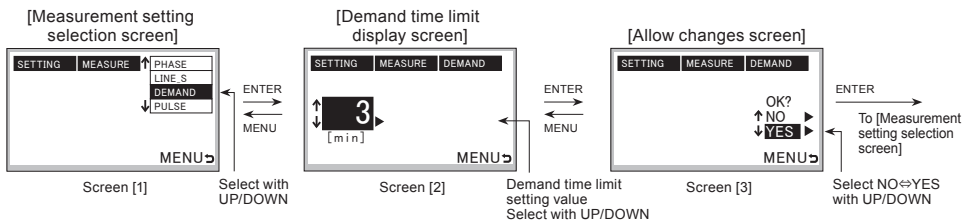

(4) Pulse unit setting

[Default value: 1 kWh]

- Select PULSE on the measurement setting selection screen. (Screen [1])
- Press ENTER to switch to the pulse unit display screen. (Screen [2])
- Setting value switches through 1 ⇔ 10 ⇔ 100 ⇔ 1000 ⇔ 10000 ⇔ 1... Press ENTER to decide the setting.
- Select YES on the allow changes screen and press ENTER to decide the setting. (Screen [3])

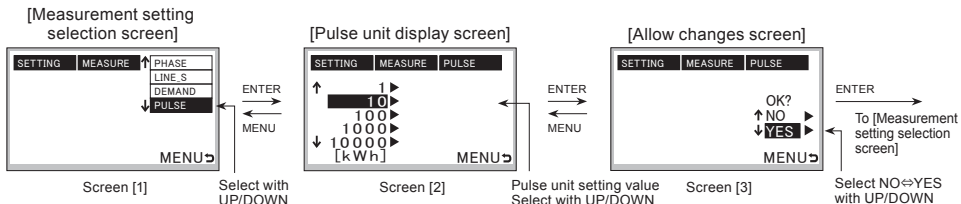

7.1.2-2 Setting method for alarms

- Select ALARM from the setting item selection screen and press ENTER to switch to the alarm setting selection screen.
- Switches through PAL ⇨ IDM_AL ⇨ ILA_AL ⇨ IUB_AL ⇨ AL_HOLD ⇨ PAL....

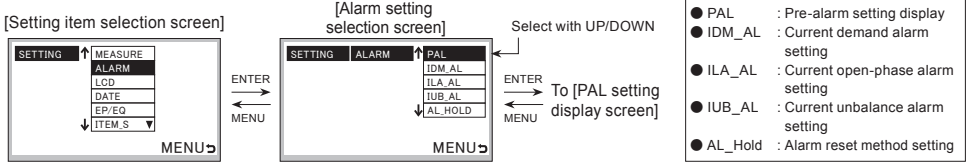

(1) Pre-alarm (PAL) setting

- Select PAL on the alarm setting selection screen and press ENTER to switch to the PAL setting display screen. (Screen [1])
- Press ENTER to confirm MDU Breaker main unit pre-alarm current (Ip) and pre-alarm operating time (Tp) setting values. (Screen [2])
- * The setting value cannot be set (changed). For 250 A frame, use the setting dials on the PAL module (option). For 400/800 A frame, use the setting dials on the MDU Breaker main unit.
- * There is no setting dial for the pre-alarm operating time. It will be set to 1/2 of long time delay operating time (TL).

[PAL setting display screen]

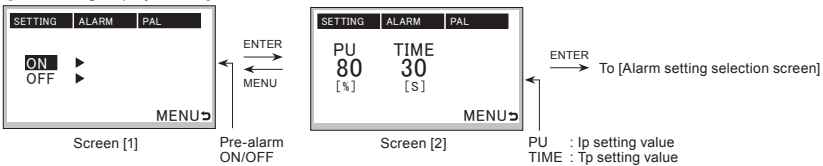

(2) Electric current demand alarm (IDM_AL) setting

[PU default value: 100%, TIME default value: 2 min.]

- Select IDM_AL on the alarm setting selection screen. (Screen [1])
- Press ENTER to switch to the electric current demand alarm setting display screen. (Screen [2])
- Select either ON (function enabled) or OFF (function disabled) and press ENTER to decide the setting.

[1] ON (function enabled) setting method

- The pick up electric current setting value can be changed to a setting value from 50 to 100 (per 1 %). (Screen [3])
- Press ENTER to switch to the demand time limit setting value.
- The demand time limit setting value can be changed to a setting value from 1 to 10 (per 1 min.) ⇨ 15 ⇨ 20 ⇨ 25 ⇨ 30 (per 5 min.). (Screen [4])
- Press ENTER to switch to the allow changes screen.
- Select YES on the allow changes screen and press ENTER to decide the setting. (Screen [5])

[2] OFF (function disabled) setting method

- After selecting OFF, press ENTER to switch to the allow changes screen. Select YES and press ENTER to decide the setting. (Screen [5])

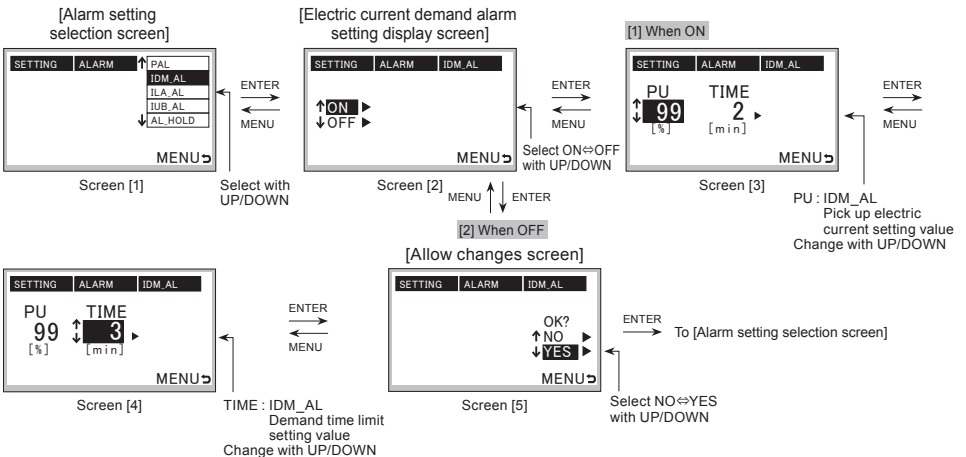

(3) Electric current open phase alarm (ILA_AL) setting

- Select ILA_AL on the alarm setting selection screen. (Screen [1])
- Press ENTER to switch to the electric current open phase alarm setting display screen. (Screen [2])
- Select ON (function enabled) or OFF (function disabled) and press ENTER to decide the setting.
- Select YES on the allow changes screen and press ENTER to decide the setting. (Screen [3])

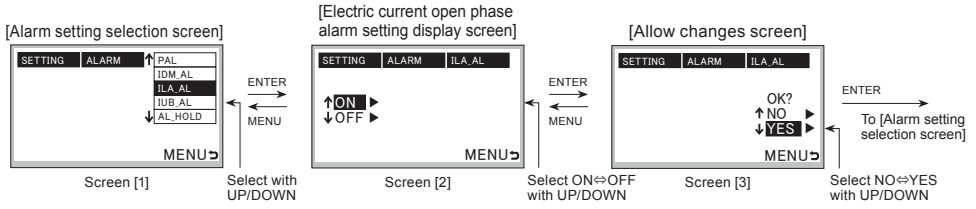

(4) Electric current unbalance alarm (IUB_AL) setting

- Select IUB_AL on the alarm setting selection screen. (Screen [1])
- Press ENTER to switch to the electric current unbalance alarm setting display screen. (Screen [2])
- Select ON (function enabled) or OFF (function disabled) and press ENTER to decide the setting.
- Select YES on the allow changes screen and press ENTER to decide the setting. (Screen [3])

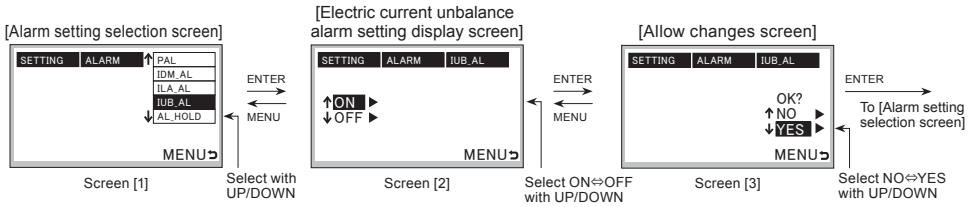

(5) Alarm reset method setting

- [Default value: AUTO (automatic reset)]
- Select AL_HOLD on the alarm setting selection screen. (Screen [1])
 - Press ENTER to switch to the alarm reset method setting display screen. (Screen [2])
 - Select HOLD (self-hold) and press ENTER to decide the setting.
 - Select YES on the allow changes screen and press ENTER to decide the setting. (Screen [3])

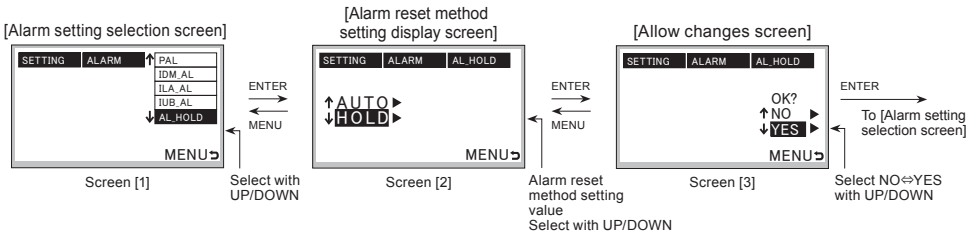

* Set alarm function collectively. Refer to "4.5 How to use monitoring functions" for related alarm.

7.1.2-3 Setting method for LCD

- Select LCD from the setting item selection screen and press ENTER to switch to the LCD setting selection screen.
- Switches through BACK_L ⇄ CTRST ⇄ BRT_W ⇄ BRT_R ⇄ VIEW ⇄ REV_B/W ⇄ AL_BL ⇄ BACK_L.....

[Setting item selection screen]

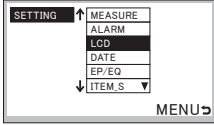

[LCD setting selection screen]

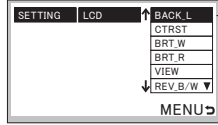

Select with UP/DOWN

ENTER → To [LCD backlight setting display screen]
← MENU

- BACK_L : LCD backlight setting
- CTRST : LCD contrast setting
- BRT_W : White brightness setting
- BRT_R : Red brightness setting
- VIEW : View setting (vertical or horizontal)
- REV_B/W : Color inversion setting (black & white)
- AL_BL : Backlight display during alarm setting

(1) LCD backlight setting

[Default value: AUTO (automatic OFF)]

- Select BACK_L on the LCD setting selection screen and press ENTER to switch to the LCD backlight setting display screen. (Screen [1])
- Select AUTO (automatic OFF: automatically turns OFF if there is no activity for around 5 min.; it will turn back ON when a switch is operated), ON (always ON), or OFF (always OFF) and press ENTER to decide the setting.
- Select YES on the allow changes screen and press ENTER to decide the setting. (Screen [2])

[LCD backlight setting display screen]

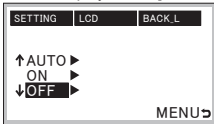

Screen [1]

ENTER →
← MENU
LCD backlight setting value
Select with UP/DOWN

[Allow changes screen]

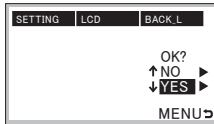

Screen [2]

ENTER → To [LCD setting selection screen]
← MENU

Select NO⇄YES with UP/DOWN

(2) LCD contrast setting

[Default value: 2 (center value of 0 to 4)]

- Select CTRST on the LCD setting selection screen. (Screen [1])
- Press ENTER to switch to the LCD contrast setting display screen. (Screen [2])
- Use UP/DOWN to switch the contrast of the screen. Press ENTER to decide the setting.
- Select YES on the allow changes screen and press ENTER to decide the setting. (Screen [3])

[LCD setting selection screen]

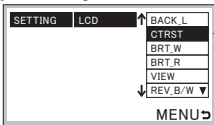

Screen [1]

Select with UP/DOWN
ENTER →
← MENU

[LCD contrast setting display screen]

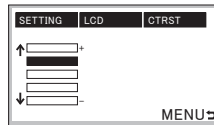

Screen [2]

ENTER →
← MENU
LCD contrast setting value
Change with UP/DOWN

[Allow changes screen]

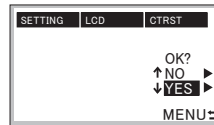

Screen [3]

ENTER → To [LCD setting selection screen]
← MENU

Select NO⇄YES with UP/DOWN

(3) White brightness setting

[Default value: 4 (center value of 1 to 7)]

- Select BRT_W on the LCD setting selection screen. (Screen [1])
- Press ENTER to switch to the white brightness setting display screen. (Screen [2])
- Use UP/DOWN to switch the white brightness of the screen. Press ENTER to decide the setting.
- Select YES on the allow changes screen and press ENTER to decide the setting. (Screen [3])

[LCD setting selection screen]

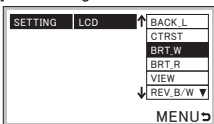

Screen [1]

Select with UP/DOWN
ENTER →
← MENU

[White brightness setting display screen]

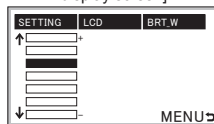

Screen [2]

ENTER →
← MENU
White brightness setting value
Change with UP/DOWN

[Allow changes screen]

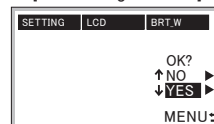

Screen [3]

ENTER → To [LCD setting selection screen]
← MENU

Select NO⇄YES with UP/DOWN

(4) Red brightness setting

[Default value: 4 (center value of 1 to 7)]

- Select BRT_R on the LCD setting selection screen. (Screen [1])
- Press ENTER to switch to the red brightness setting display screen. (Screen [2])
- Use UP/DOWN to switch the red brightness of the screen. Press ENTER to decide the setting.
- Select YES on the allow changes screen and press ENTER to decide the setting. (Screen [3])

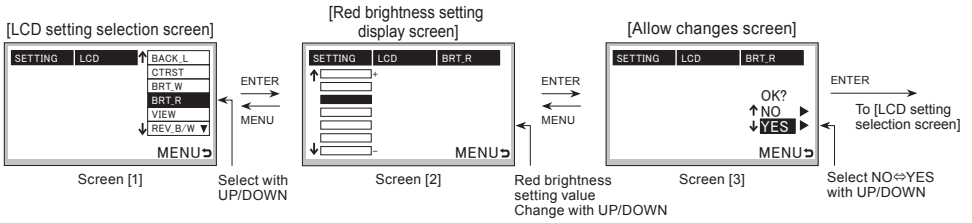

(5) View setting (vertical or horizontal)

[Default value: V-VIEW (horizontal display)]

- Select VIEW on the LCD setting selection screen. (Screen [1])
- Press ENTER to switch to the view setting display screen. (Screen [2])
- Setting value switches through V-VIEW ⇔ H-VIEW1 ⇔ H-VIEW2 ⇔ V-VIEW.... Press ENTER to decide the setting.
- Select YES on the allow changes screen and press ENTER to decide the setting. (Screen [3])

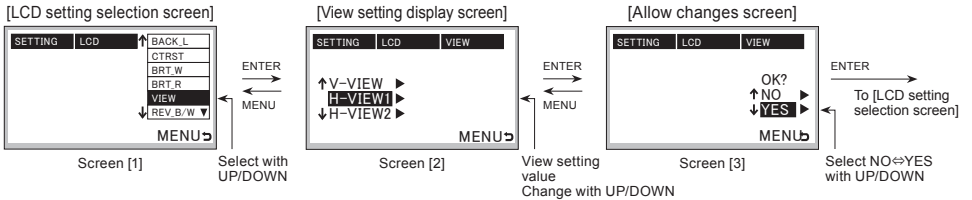
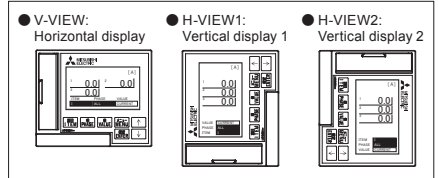

(6) Color inversion (black & white) setting

[Default value: NORMAL]

- Select REV_B/W on the LCD setting selection screen. (Screen [1])
- Press ENTER to switch to the color inversion (black & white) setting display screen. (Screen [2])
- Setting value switches through NORMAL ⇔ INVERS ⇔ NORMAL.... Press ENTER to decide the setting.
- Select YES on the allow changes screen and press ENTER to decide the setting. (Screen [3])

- NORMAL : White background and black text
- INVERS : Black background and white text

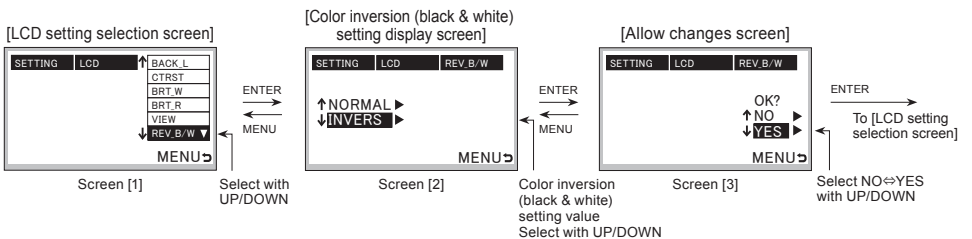

(7) Backlight display during alarm setting

[Default value: LIGHT (ON)]

- Select AL_BL on the LCD setting selection screen. (Screen [1])
- Press ENTER to switch to the backlight display during alarm screen. (Screen [2])
Setting value switches through LIGHT ⇄ BLINK ⇄ LIGHT... Press ENTER to decide the setting.
- Select YES on the allow changes screen and press ENTER to decide the setting. (Screen [3])

● LIGHT : ON
● BLINK : Blink

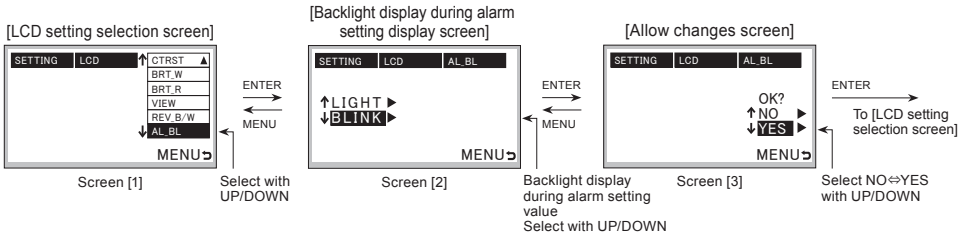

7.1.2-4 Setting method for date and time

[Default value: 17/01/01 00:00]

- Select DATE on the setting item selection screen. (Screen [1])
- Press ENTER to switch to the time setting display screen. (Screen [2] to Screen [6])
Press ENTER to scroll through year → month → day → hour → minute → allow changes screen, and MENU to scroll back through allow changes screen → minute → hour → day → month → year.
Select an item to change, and then change the value with UP/DOWN.
- After setting the minute, press ENTER to switch to the allow changes screen. Select YES and press ENTER to decide the setting. (Screen [7])
*The year setting takes a two digit number, where 00 to 99 corresponds to 2000 to 2099.

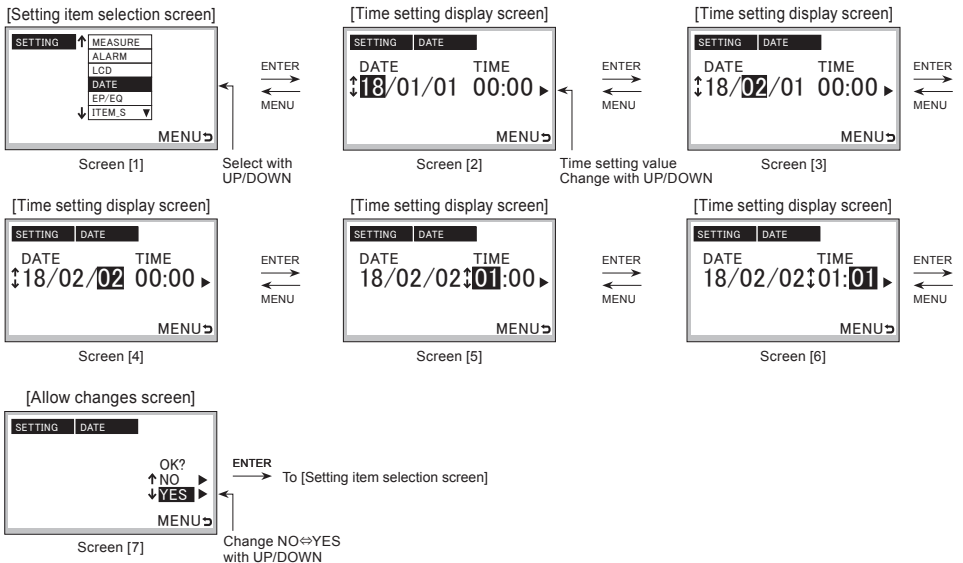

7.1.2-5 Setting method for electric energy

- Select EP/EQ from the setting item selection screen and press ENTER to switch to the electric energy setting selection screen.
- Switches from EP ⇔ EQ ⇔ EP...

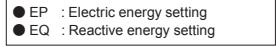

[Setting item selection screen]

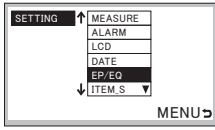

[Electric energy setting selection screen]

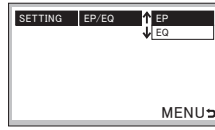

Select with UP/DOWN

ENTER
← MENU

To [Electric energy setting display screen]

(1) Electric energy setting

- Select EP on the electric energy setting selection screen and press ENTER to switch to the electric energy setting display screen. (Screen [1])
- Press ENTER to scroll through first digit → → → last digit → allow changes screen, and MENU to scroll back through allow changes screen → last digit → → → first digit.
- Select a digit to change the value.
- After setting the last digit, press ENTER to display the allow changes screen. Select YES and press ENTER to decide the setting. (Screen [2])

[Electric energy setting display screen]



Screen [1]

Electric energy setting value
Change with UP/DOWN

ENTER → Next digit
← MENU

ENTER → Last digit
← MENU

ENTER →
← MENU

[Allow changes screen]

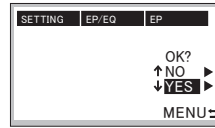

Screen [2]

ENTER →
To [Electric energy setting selection screen]

Select NO ⇔ YES
with UP/DOWN

(2) Reactive energy setting

- Select EQ on the electric energy setting selection screen and press ENTER to switch to the reactive energy setting display screen. (Screen [1])
- Press ENTER to scroll through first digit → → → last digit → allow changes screen, and MENU to scroll back through allow changes screen → last digit → → → first digit.
- Select a digit to change the value.
- After setting the last digit, press ENTER to display the allow changes screen. Select YES and press ENTER to decide the setting. (Screen [2])

[Reactive energy setting display screen]

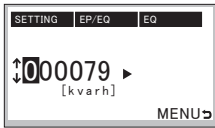

Screen [1]

Reactive energy setting value
Change with UP/DOWN

ENTER → Next digit
← MENU

ENTER → Last digit
← MENU

ENTER →
← MENU

[Allow changes screen]



Screen [2]

ENTER →
To [Electric energy setting selection screen]

Select NO ⇔ YES
with UP/DOWN

7.1.2-6 Setting method for measurement items

- Select ITEM_S from the setting item selection screen and press ENTER to switch to the measurement item selection screen.
- Switches through I ⇨ V ⇨ P ⇨ Q ⇨ EP ⇨ EQ ⇨ PF ⇨ Hz ⇨ HI (A) ⇨ HI (%) ⇨ FREE ⇨ SEQ_CHK ⇨ I

[Setting item selection screen]

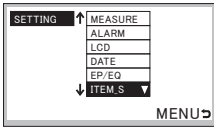

[Measurement item selection screen]

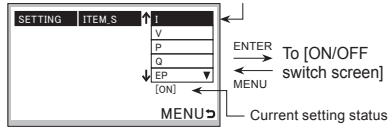

● I	: Load current
● V	: Line voltage
● P	: Electric power
● Q	: Reactive power
● EP	: Electric energy
● EQ	: Reactive energy
● PF	: Power factor
● Hz	: Frequency
● HI (A)	: Harmonic current
● HI (%)	: Harmonic current content ratio
● FREE	: Free display
● SEQ_CHK	: Phase sequence display (*)

* Only for 400/800 A frame

[Default value: All items ON]

- Select I on the measurement item selection screen and press ENTER to switch to the ON/OFF switch screen. (Screen [1])
- Select ON⇨OFF to change the setting.
- Press ENTER to display the allow changes screen. Select YES and press ENTER to decide the setting. (Screen [2])
- Other items can be changed the same way.

[ON/OFF switch screen]



Screen [1]

ON⇨OFF
Select with UP/DOWN

[Allow changes screen]



Screen [2]

Select NO⇨YES
with UP/DOWN

ENTER → To [Measurement item selection screen]

7.1.2-7 Setting method for free display

- Select FREE_S from the setting item selection screen and press ENTER to switch to the free display setting selection screen.
- Switches through 1/4P_L ⇔ 1/4P_R ⇔ 2/4P_L ⇔ 2/4P_R ⇔ 3/4P_L ⇔ 3/4P_R ⇔ 4/4P_L ⇔ 4/4P_R ⇔ 1/4P_L....
The display pattern can be freely changed to suit the application.

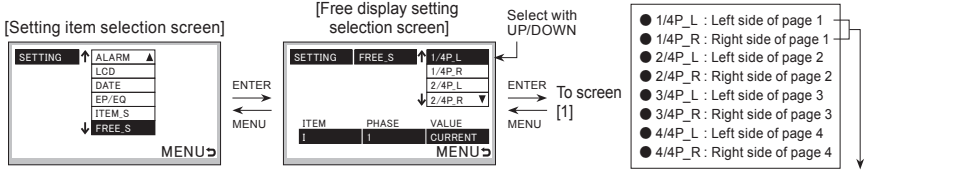

[Default value: Unregistered]

- Select 1/4P_L on the free display setting selection screen and press ENTER to confirm measurement items. (Screen [1])
 - Select an item from ITEM and press ENTER to decide the setting. (Screen [2])
 - Select an item from PHASE and press ENTER to decide the setting. (Screen [3])
 - * Items without a PHASE element are displayed as "-".
 - Select an item from VALUE and press ENTER to decide the setting. (Screen [4])
 - Press ENTER to display the allow changes screen. Select YES and press ENTER to decide the setting. (Screen [5])
- Other items can be changed the same way.

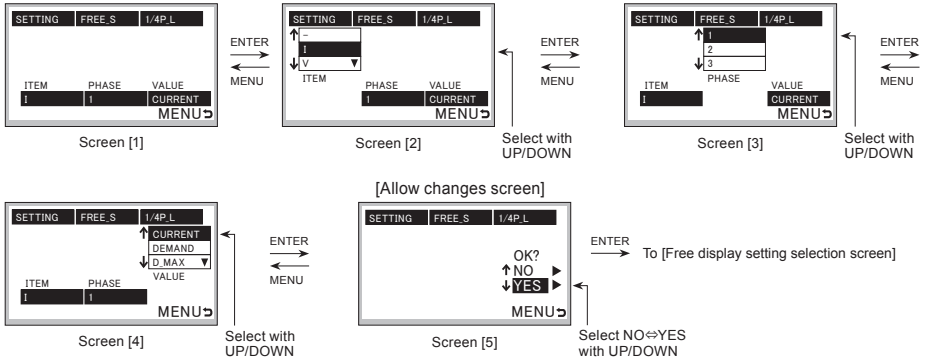
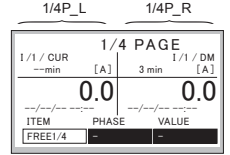

7.1.3 Method for resetting alarms

- Select AL_RST from the main menu screen and press ENTER to display the allow changes screen.
- Select YES and press ENTER to reset alarms.

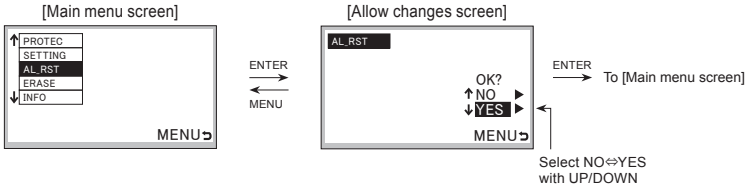

- * Reset all alarms at once. Refer to "4.5 How to use monitoring functions" for related alarm.
- * Resets PAL with alarm contact output (option).

7.1.4 Method for resetting fault cause/current, maximum value, electric energy, and reactive energy

- Select ERASE from the main menu screen and press ENTER to switch to the setting item selection screen.
 - Switches through TRIP ⇔ EP ⇔ EQ ⇔ ALL ⇔ TRIP...
 - Select an item, and then select YES on the allow changes screen and press ENTER to decide the setting.
- Other items can be set similarly.

- TRIP : Reset fault cause/current
- EP : Reset electric energy(to 0 kWh)
- EQ : Reset reactive energy(to 0 kvarh)
- ALL : Reset load current, line voltage, electric power, reactive power, power factor, harmonic current, occurrence time of maximum/minimum harmonic current content values
Electric energy, reactive energy, fault cause/current, and alarms are not reset

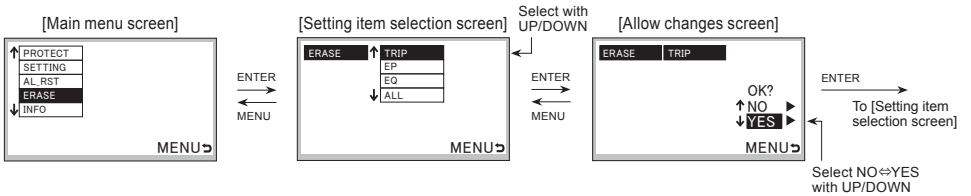

- * TRIP: Resets the fault cause and the fault current, and resets LTD, STD, INST.
- * Resets PAL with alarm contact output (option).

7.1.5 Method for displaying information screen

- Select INFO from the main menu screen and press ENTER to switch to the setting item display screen.
- Switches through MODEL ⇄ PROTECT ⇄ ALARM ⇄ MEASURE ⇄ MODEL....
- Select an item and press ENTER to confirm the setting for each item.

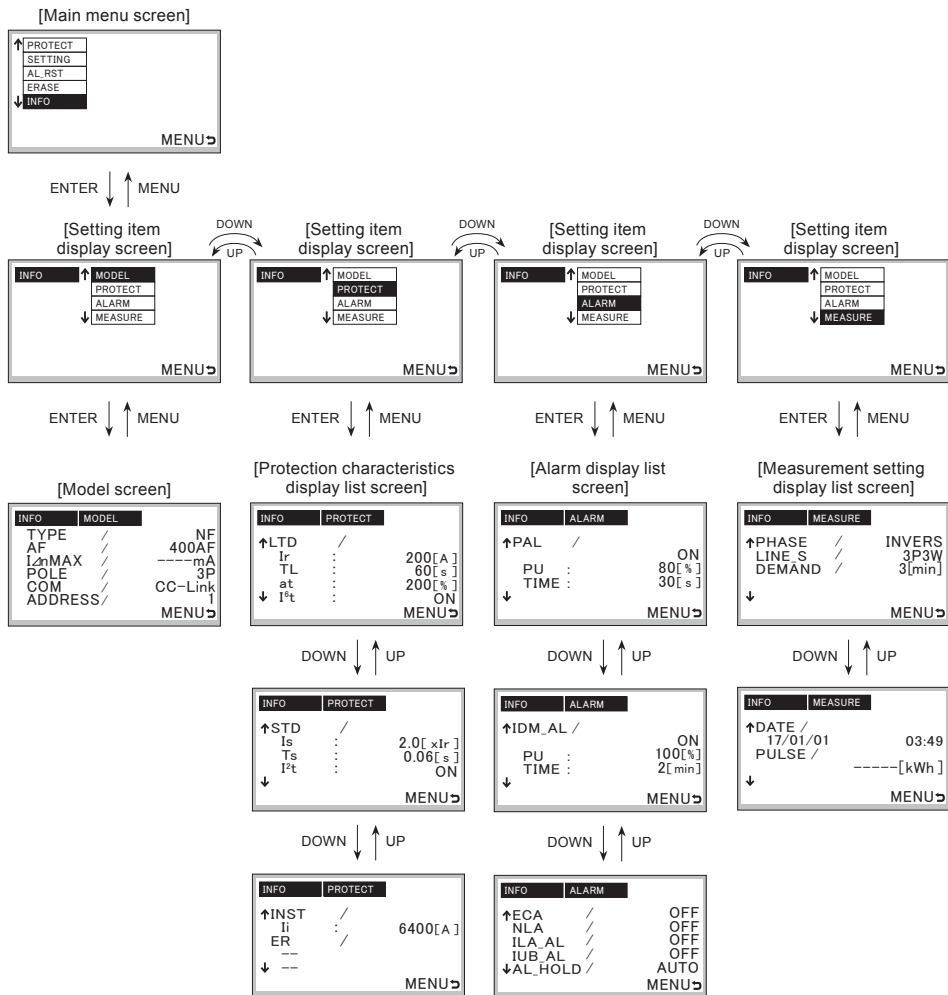

7.2 Operating method for measurement display screen

7.2.1 Switching method for display screen

- Press MENU to switch between the main menu screen and measurement display screen. The measurement display screen can be displayed from any screen by holding MENU for two seconds.

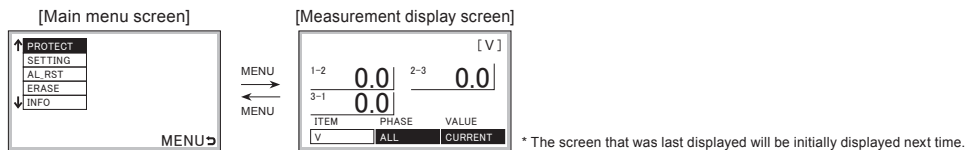

- ITEM items switch through I ⇔ V ⇔ P ⇔ Q ⇔ EP ⇔ EQ ⇔ PF ⇔ Hz ⇔ HI (A) ⇔ HI (%) ⇔ FREE1/4 ⇔ FREE2/4 ⇔ FREE3/4 ⇔ FREE4/4 ⇔ TRIP ⇔ ALARM ⇔ SEQ-CHK ⇔ I....

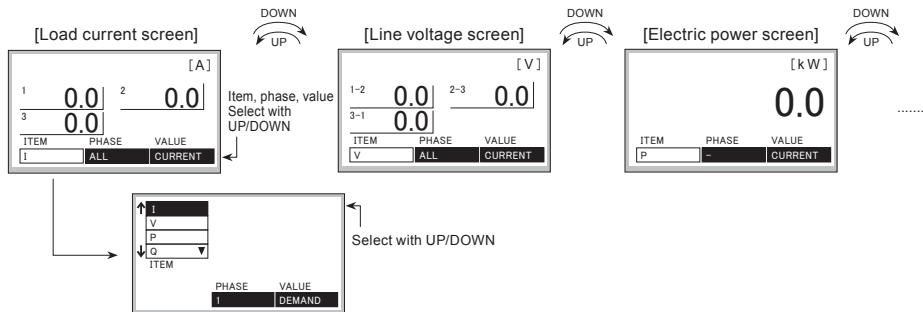

- * Can be changed by pressing ITEM twice, selecting with UP/DOWN, and pressing ENTER.

- PHASE items switch through ALL ⇔ 1 ⇔ 2 ⇔ 3 ⇔ N (only for four-pole product specification) ⇔ ALL....

- * Items without a PHASE element are displayed as "-".

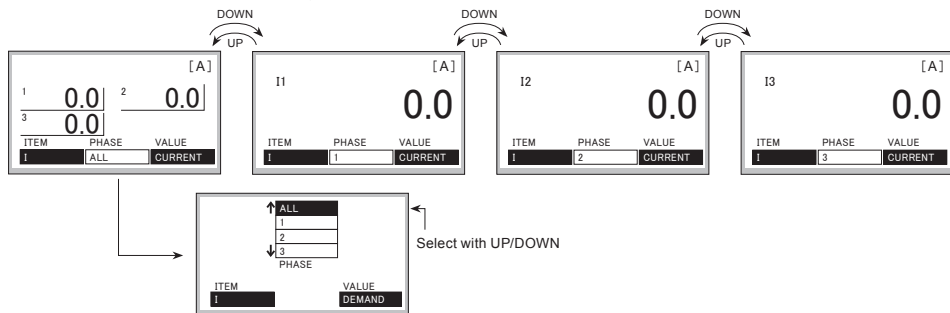

- * Can be changed by pressing PHASE twice, selecting with UP/DOWN, and pressing ENTER.

- VALUE items switch through CURRENT ⇔ DEMAND ⇔ D_MAX ⇔ D_MAX_P ⇔ CURRENT....

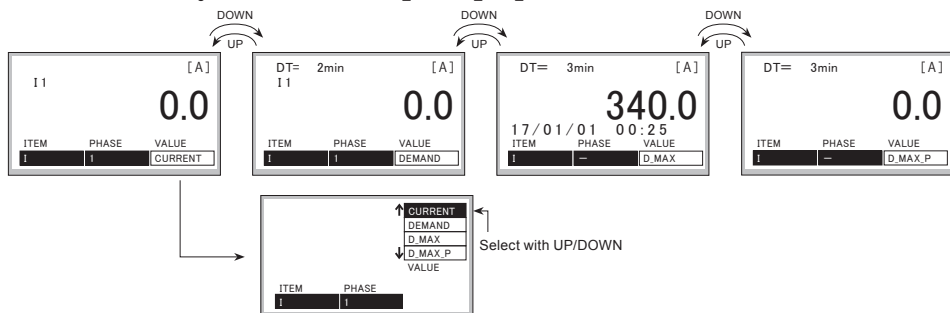

- * Can be changed by pressing VALUE twice, selecting with UP/DOWN, and pressing ENTER.

7.2.2 Measurement display list

(1) Horizontal display

[1] Load current	<p>[Present value] [A]</p> <p>1 0.0 2 0.0 3 0.0</p> <p>ITEM PHASE VALUE I ALL CURRENT</p>	<p>[Demand value/present value] [A]</p> <p>DT= 3min</p> <p>1 0.0 2 0.0 3 0.0</p> <p>ITEM PHASE VALUE I ALL DEMAND</p>	<p>[Demand value/maximum value] [A]</p> <p>DT= 3min</p> <p>17/01/01 00:25 340.0</p> <p>ITEM PHASE VALUE I -- D.MAX</p>	<p>[Demand value/ all-phase maximum value] [A]</p> <p>DT= 3min</p> <p>0.0</p> <p>ITEM PHASE VALUE I -- D.MAX.P</p>
[2] Line voltage	<p>[Present value] [V]</p> <p>1-2 0.0 2-3 0.0 3-1 0.0</p> <p>ITEM PHASE VALUE V ALL CURRENT</p>	<p>[Average value] [V]</p> <p>0.0</p> <p>ITEM PHASE VALUE V AVE CURRENT</p>	<p>[Maximum value between all wires] [V]</p> <p>17/01/01 00:25 420</p> <p>ITEM PHASE VALUE V -- MAX</p>	
[3] Electric power	<p>[Present value] [kW]</p> <p>0.0</p> <p>ITEM PHASE VALUE P -- CURRENT</p>	<p>[Demand value/present value] [kW]</p> <p>DT= 3min</p> <p>0.0</p> <p>ITEM PHASE VALUE P -- DEMAND</p>	<p>[Demand value/maximum value] [kW]</p> <p>DT= 3min</p> <p>17/01/01 00:25 175.2</p> <p>ITEM PHASE VALUE P -- D.MAX</p>	
[4] Reactive power	<p>[Present value] [kvar]</p> <p>0.0</p> <p>ITEM PHASE VALUE Q -- CURRENT</p>	<p>[Demand value/present value] [kvar]</p> <p>DT= 3min</p> <p>0.0</p> <p>ITEM PHASE VALUE Q -- DEMAND</p>	<p>[Demand value/maximum value] [kvar]</p> <p>DT= 3min</p> <p>17/01/01 00:25 120.9</p> <p>ITEM PHASE VALUE Q -- D.MAX</p>	
[5] Electric energy	<p>[Integrated value] [kWh]</p> <p>2000</p> <p>ITEM PHASE VALUE EP -- CURRENT</p>	<p>[Latest one hour amount] [kWh]</p> <p>0</p> <p>ITEM PHASE VALUE EP -- DEMAND</p>	<p>[One hour amount maximum value] [kWh]</p> <p>17/01/01 00:00 0</p> <p>ITEM PHASE VALUE EP -- D.MAX</p>	
[6] Reactive energy	<p>[Integrated value] [kvarh]</p> <p>79</p> <p>ITEM PHASE VALUE EQ -- CURRENT</p>	<p>[Latest one hour amount] [kvarh]</p> <p>0</p> <p>ITEM PHASE VALUE EQ -- DEMAND</p>	<p>[One hour amount maximum value] [kvarh]</p> <p>17/01/01 00:00 0</p> <p>ITEM PHASE VALUE EQ -- D.MAX</p>	
[7] Power factor	<p>[Present value] [%]</p> <p>100.0</p> <p>ITEM PHASE VALUE PF -- CURRENT</p>	<p>[Maximum value] [%]</p> <p>LAG</p> <p>17/01/01 00:25 82.3</p> <p>ITEM PHASE VALUE PF -- MAX</p>		
[8] Frequency	<p>[Present value] [Hz]</p> <p>0.0</p> <p>ITEM PHASE VALUE Hz -- CURRENT</p>			

[9] Harmonic current	<div style="display: flex; justify-content: space-between;"> <div style="width: 22%;"> <p>[Present value/total value]</p> <table border="1" style="width: 100%; text-align: center;"> <tr><td colspan="3">Total [A]</td></tr> <tr><td>1</td><td>0.0</td><td>2 0.0</td></tr> <tr><td>3</td><td>0.0</td><td></td></tr> <tr><td>ITEM</td><td>PHASE</td><td>VALUE</td></tr> <tr><td>HI(A)</td><td>ALL</td><td>Total</td></tr> </table> </div> <div style="width: 22%;"> <p>[Present value/1st order] [Present value/19th order]</p> <table border="1" style="width: 100%; text-align: center;"> <tr><td colspan="3">1st [A]</td></tr> <tr><td>1</td><td>0.0</td><td>2 0.0</td></tr> <tr><td>3</td><td>0.0</td><td></td></tr> <tr><td>ITEM</td><td>PHASE</td><td>VALUE</td></tr> <tr><td>HI(A)</td><td>ALL</td><td>1St</td></tr> </table> </div> <div style="width: 22%;"> <table border="1" style="width: 100%; text-align: center;"> <tr><td colspan="3">19th [A]</td></tr> <tr><td>1</td><td>0.0</td><td>2 0.0</td></tr> <tr><td>3</td><td>0.0</td><td></td></tr> <tr><td>ITEM</td><td>PHASE</td><td>VALUE</td></tr> <tr><td>HI(A)</td><td>ALL</td><td>19th</td></tr> </table> </div> <div style="width: 22%;"> <p>[Demand value]</p> <table border="1" style="width: 100%; text-align: center;"> <tr><td colspan="3">DT= 3min [A]</td></tr> <tr><td>1</td><td>0.0</td><td>2 0.0</td></tr> <tr><td>3</td><td>0.0</td><td></td></tr> <tr><td>ITEM</td><td>PHASE</td><td>VALUE</td></tr> <tr><td>HI(A)</td><td>ALL</td><td>DEMAND</td></tr> </table> </div> </div> <div style="display: flex; justify-content: space-between; margin-top: 10px;"> <div style="width: 22%;"> <p>[Demand value/maximum value]</p> <table border="1" style="width: 100%; text-align: center;"> <tr><td colspan="3">DT= 3min [A]</td></tr> <tr><td colspan="3" style="font-size: 2em;">134</td></tr> <tr><td>17/01/01</td><td>00:25</td><td></td></tr> <tr><td>ITEM</td><td>PHASE</td><td>VALUE</td></tr> <tr><td>HI(A)</td><td>--</td><td>D.MAX</td></tr> </table> </div> <div style="width: 22%;"> <p>[Maximum value/total value]</p> <table border="1" style="width: 100%; text-align: center;"> <tr><td colspan="3">M1st [A]</td></tr> <tr><td colspan="3" style="font-size: 2em;">313</td></tr> <tr><td>17/01/01</td><td>00:25</td><td></td></tr> <tr><td>ITEM</td><td>PHASE</td><td>VALUE</td></tr> <tr><td>HI(A)</td><td>--</td><td>M1St</td></tr> </table> </div> <div style="width: 22%;"> <p>[Maximum value/3rd order] [Maximum value/19th order]</p> <table border="1" style="width: 100%; text-align: center;"> <tr><td colspan="3">M3rd [A]</td></tr> <tr><td colspan="3" style="font-size: 2em;">102</td></tr> <tr><td>17/01/01</td><td>00:25</td><td></td></tr> <tr><td>ITEM</td><td>PHASE</td><td>VALUE</td></tr> <tr><td>HI(A)</td><td>--</td><td>M3rd</td></tr> </table> </div> <div style="width: 22%;"> <table border="1" style="width: 100%; text-align: center;"> <tr><td colspan="3">M19th [A]</td></tr> <tr><td colspan="3" style="font-size: 2em;">17.6</td></tr> <tr><td>17/01/01</td><td>00:25</td><td></td></tr> <tr><td>ITEM</td><td>PHASE</td><td>VALUE</td></tr> <tr><td>HI(A)</td><td>--</td><td>IM19th</td></tr> </table> </div> </div>	Total [A]			1	0.0	2 0.0	3	0.0		ITEM	PHASE	VALUE	HI(A)	ALL	Total	1st [A]			1	0.0	2 0.0	3	0.0		ITEM	PHASE	VALUE	HI(A)	ALL	1St	19th [A]			1	0.0	2 0.0	3	0.0		ITEM	PHASE	VALUE	HI(A)	ALL	19th	DT= 3min [A]			1	0.0	2 0.0	3	0.0		ITEM	PHASE	VALUE	HI(A)	ALL	DEMAND	DT= 3min [A]			134			17/01/01	00:25		ITEM	PHASE	VALUE	HI(A)	--	D.MAX	M1st [A]			313			17/01/01	00:25		ITEM	PHASE	VALUE	HI(A)	--	M1St	M3rd [A]			102			17/01/01	00:25		ITEM	PHASE	VALUE	HI(A)	--	M3rd	M19th [A]			17.6			17/01/01	00:25		ITEM	PHASE	VALUE	HI(A)	--	IM19th
Total [A]																																																																																																																									
1	0.0	2 0.0																																																																																																																							
3	0.0																																																																																																																								
ITEM	PHASE	VALUE																																																																																																																							
HI(A)	ALL	Total																																																																																																																							
1st [A]																																																																																																																									
1	0.0	2 0.0																																																																																																																							
3	0.0																																																																																																																								
ITEM	PHASE	VALUE																																																																																																																							
HI(A)	ALL	1St																																																																																																																							
19th [A]																																																																																																																									
1	0.0	2 0.0																																																																																																																							
3	0.0																																																																																																																								
ITEM	PHASE	VALUE																																																																																																																							
HI(A)	ALL	19th																																																																																																																							
DT= 3min [A]																																																																																																																									
1	0.0	2 0.0																																																																																																																							
3	0.0																																																																																																																								
ITEM	PHASE	VALUE																																																																																																																							
HI(A)	ALL	DEMAND																																																																																																																							
DT= 3min [A]																																																																																																																									
134																																																																																																																									
17/01/01	00:25																																																																																																																								
ITEM	PHASE	VALUE																																																																																																																							
HI(A)	--	D.MAX																																																																																																																							
M1st [A]																																																																																																																									
313																																																																																																																									
17/01/01	00:25																																																																																																																								
ITEM	PHASE	VALUE																																																																																																																							
HI(A)	--	M1St																																																																																																																							
M3rd [A]																																																																																																																									
102																																																																																																																									
17/01/01	00:25																																																																																																																								
ITEM	PHASE	VALUE																																																																																																																							
HI(A)	--	M3rd																																																																																																																							
M19th [A]																																																																																																																									
17.6																																																																																																																									
17/01/01	00:25																																																																																																																								
ITEM	PHASE	VALUE																																																																																																																							
HI(A)	--	IM19th																																																																																																																							
[10] Harmonic current content ratio	<div style="display: flex; justify-content: space-between;"> <div style="width: 22%;"> <p>[Content ratio/total value]</p> <table border="1" style="width: 100%; text-align: center;"> <tr><td colspan="3">THD [%]</td></tr> <tr><td>1</td><td>0.0</td><td>2 0.0</td></tr> <tr><td>3</td><td>0.0</td><td></td></tr> <tr><td>ITEM</td><td>PHASE</td><td>VALUE</td></tr> <tr><td>HI(%)</td><td>ALL</td><td>THD</td></tr> </table> </div> <div style="width: 22%;"> <p>[Content ratio/3rd order] [Content ratio/19th order]</p> <table border="1" style="width: 100%; text-align: center;"> <tr><td colspan="3">3rd [%]</td></tr> <tr><td>1</td><td>0.0</td><td>2 0.0</td></tr> <tr><td>3</td><td>0.0</td><td></td></tr> <tr><td>ITEM</td><td>PHASE</td><td>VALUE</td></tr> <tr><td>HI(%)</td><td>ALL</td><td>3rd</td></tr> </table> </div> <div style="width: 22%;"> <table border="1" style="width: 100%; text-align: center;"> <tr><td colspan="3">19th [%]</td></tr> <tr><td>1</td><td>0.0</td><td>2 0.0</td></tr> <tr><td>3</td><td>0.0</td><td></td></tr> <tr><td>ITEM</td><td>PHASE</td><td>VALUE</td></tr> <tr><td>HI(%)</td><td>ALL</td><td>19th</td></tr> </table> </div> </div>	THD [%]			1	0.0	2 0.0	3	0.0		ITEM	PHASE	VALUE	HI(%)	ALL	THD	3rd [%]			1	0.0	2 0.0	3	0.0		ITEM	PHASE	VALUE	HI(%)	ALL	3rd	19th [%]			1	0.0	2 0.0	3	0.0		ITEM	PHASE	VALUE	HI(%)	ALL	19th																																																																											
THD [%]																																																																																																																									
1	0.0	2 0.0																																																																																																																							
3	0.0																																																																																																																								
ITEM	PHASE	VALUE																																																																																																																							
HI(%)	ALL	THD																																																																																																																							
3rd [%]																																																																																																																									
1	0.0	2 0.0																																																																																																																							
3	0.0																																																																																																																								
ITEM	PHASE	VALUE																																																																																																																							
HI(%)	ALL	3rd																																																																																																																							
19th [%]																																																																																																																									
1	0.0	2 0.0																																																																																																																							
3	0.0																																																																																																																								
ITEM	PHASE	VALUE																																																																																																																							
HI(%)	ALL	19th																																																																																																																							
[11] Measurement item (free display)	<div style="display: flex; justify-content: space-around;"> <div style="width: 45%;"> <p>[Measurement item/ 1/4] [Measurement item/ 4/4]</p> <table border="1" style="width: 100%; text-align: center;"> <tr><td colspan="4">1/4 PAGE</td></tr> <tr><td>I</td><td>/</td><td>/</td><td>DM</td></tr> <tr><td>--min</td><td>[A]</td><td>3min</td><td>[A]</td></tr> <tr><td>0.0</td><td></td><td>0.0</td><td></td></tr> <tr><td>ITEM</td><td>PHASE</td><td>VALUE</td><td></td></tr> <tr><td>FREE1/4</td><td>--</td><td>--</td><td></td></tr> </table> </div> <div style="width: 45%;"> <table border="1" style="width: 100%; text-align: center;"> <tr><td colspan="4">4/4 PAGE</td></tr> <tr><td>--min</td><td>[----</td><td>--min</td><td>[----</td></tr> <tr><td>ITEM</td><td>PHASE</td><td>VALUE</td><td></td></tr> <tr><td>FREE4/4</td><td>--</td><td>--</td><td></td></tr> </table> </div> </div>	1/4 PAGE				I	/	/	DM	--min	[A]	3min	[A]	0.0		0.0		ITEM	PHASE	VALUE		FREE1/4	--	--		4/4 PAGE				--min	[----	--min	[----	ITEM	PHASE	VALUE		FREE4/4	--	--																																																																																	
1/4 PAGE																																																																																																																									
I	/	/	DM																																																																																																																						
--min	[A]	3min	[A]																																																																																																																						
0.0		0.0																																																																																																																							
ITEM	PHASE	VALUE																																																																																																																							
FREE1/4	--	--																																																																																																																							
4/4 PAGE																																																																																																																									
--min	[----	--min	[----																																																																																																																						
ITEM	PHASE	VALUE																																																																																																																							
FREE4/4	--	--																																																																																																																							
[12] Fault cause/current display screen	<p>[Fault cause/ current display screen] Without fault record</p> <table border="1" style="width: 100%; text-align: center;"> <tr><td colspan="3">TRIP [-]</td></tr> <tr><td>ITEM</td><td>PHASE</td><td>VALUE</td></tr> <tr><td>TRIP</td><td>--</td><td>--</td></tr> </table> <p>*Refer to 7.2.3 for details on what is displayed.</p>	TRIP [-]			ITEM	PHASE	VALUE	TRIP	--	--																																																																																																															
TRIP [-]																																																																																																																									
ITEM	PHASE	VALUE																																																																																																																							
TRIP	--	--																																																																																																																							
[13] Alarm display screen	<div style="display: flex; justify-content: space-between;"> <div style="width: 45%;"> <p>[Alarm display screen]</p> <table border="1" style="width: 100%; text-align: center;"> <tr><td>ALARM</td><td>---</td><td></td></tr> <tr><td>PAI</td><td>---</td><td></td></tr> <tr><td>OVER</td><td>---</td><td></td></tr> <tr><td>---</td><td>IDM_AL</td><td></td></tr> <tr><td>---</td><td>ILA_AL</td><td></td></tr> <tr><td>---</td><td>IUB_AL</td><td></td></tr> <tr><td>ITEM</td><td>PHASE</td><td>VALUE</td></tr> <tr><td>ALARM</td><td>--</td><td>--</td></tr> </table> <p>● Errors are displayed in inverse.</p> </div> <div style="width: 45%;"> <p>[Phase sequence display screen]</p> <table border="1" style="width: 100%; text-align: center;"> <tr><td>SEQ</td><td>---</td><td></td></tr> <tr><td>POSI</td><td>---</td><td></td></tr> <tr><td>NEGA</td><td>---</td><td></td></tr> <tr><td>ITEM</td><td>PHASE</td><td>VALUE</td></tr> <tr><td>SEQ_CHK</td><td>--</td><td>--</td></tr> </table> <p>● Phase detection results displayed in inverse (enabled for three-phase three-wire, displayed as "--" when disabled)</p> <p>● POSI : Normal phase ● NEGA : Reverse phase</p> <p>* Only for 400/800 A frame</p> </div> </div>	ALARM	---		PAI	---		OVER	---		---	IDM_AL		---	ILA_AL		---	IUB_AL		ITEM	PHASE	VALUE	ALARM	--	--	SEQ	---		POSI	---		NEGA	---		ITEM	PHASE	VALUE	SEQ_CHK	--	--																																																																																	
ALARM	---																																																																																																																								
PAI	---																																																																																																																								
OVER	---																																																																																																																								
---	IDM_AL																																																																																																																								
---	ILA_AL																																																																																																																								
---	IUB_AL																																																																																																																								
ITEM	PHASE	VALUE																																																																																																																							
ALARM	--	--																																																																																																																							
SEQ	---																																																																																																																								
POSI	---																																																																																																																								
NEGA	---																																																																																																																								
ITEM	PHASE	VALUE																																																																																																																							
SEQ_CHK	--	--																																																																																																																							

(2) Vertical display (view setting H-VIEW1)

[1] Load current	<p>[Present value]</p> <p>[A]</p> <table border="1"> <tr><td>1</td><td>0.0</td></tr> <tr><td>2</td><td>0.0</td></tr> <tr><td>3</td><td>0.0</td></tr> </table> <p>VALUE CURRENT PHASE ALL ITEM 1</p>	1	0.0	2	0.0	3	0.0	[5] Electric energy	<p>[Integrated value]</p> <p>[kWh]</p> <p>2000</p> <p>VALUE CURRENT PHASE - ITEM EP</p>	<p>[Latest one hour amount]</p> <p>[kWh]</p> <p>0</p> <p>VALUE DEMAND PHASE - ITEM EP</p>	<p>[One hour amount maximum value]</p> <p>[kWh]</p> <p>0</p> <p>17/01/01 00:00</p> <p>VALUE D MAX PHASE - ITEM EP</p>	
	1	0.0										
2	0.0											
3	0.0											
<p>[Demand value/current value]</p> <p>[A]</p> <p>DT= 3min</p> <table border="1"> <tr><td>1</td><td>0.0</td></tr> <tr><td>2</td><td>0.0</td></tr> <tr><td>3</td><td>0.0</td></tr> </table> <p>VALUE DEMAND PHASE ALL ITEM 1</p>	1	0.0	2	0.0	3	0.0	<p>[Demand value/maximum value]</p> <p>[A]</p> <p>DT= 3min</p> <p>340.0</p> <p>17/01/01 00:25</p> <p>VALUE D MAX PHASE - ITEM 1</p>	<p>[Demand value/all-phase maximum value]</p> <p>[A]</p> <p>DT= 3min</p> <p>0.0</p> <p>VALUE D MAX P PHASE - ITEM 1</p>	[6] Reactive energy	<p>[Integrated value]</p> <p>[kvarh]</p> <p>79</p> <p>VALUE CURRENT PHASE - ITEM EQ</p>	<p>[Latest one hour amount]</p> <p>[kvarh]</p> <p>0</p> <p>VALUE DEMAND PHASE - ITEM EQ</p>	<p>[One hour amount maximum value]</p> <p>[kvarh]</p> <p>0</p> <p>17/01/01 00:00</p> <p>VALUE D MAX PHASE - ITEM EQ</p>
1	0.0											
2	0.0											
3	0.0											
[2] Line voltage	<p>[Present value]</p> <p>[V]</p> <table border="1"> <tr><td>1-2</td><td>0.0</td></tr> <tr><td>2-3</td><td>0.0</td></tr> <tr><td>3-1</td><td>0.0</td></tr> </table> <p>VALUE CURRENT PHASE ALL ITEM V</p>	1-2	0.0	2-3	0.0	3-1	0.0	<p>[Average value]</p> <p>[V]</p> <p>0.0</p> <p>VALUE CURRENT PHASE AVE ITEM V</p>	<p>[Maximum value between all wires]</p> <p>[V]</p> <p>420</p> <p>17/01/01 00:25</p> <p>VALUE MAX PHASE - ITEM V</p>	[7] Power factor	<p>[Present value]</p> <p>[%]</p> <p>100.0</p> <p>VALUE CURRENT PHASE - ITEM PF</p>	<p>[Maximum value]</p> <p>[%]</p> <p>LAG</p> <p>82.3</p> <p>17/01/01 00:25</p> <p>VALUE MAX PHASE - ITEM PF</p>
	1-2	0.0										
2-3	0.0											
3-1	0.0											
[3] Electric power	<p>[Present value]</p> <p>[kW]</p> <p>0.0</p> <p>VALUE CURRENT PHASE - ITEM P</p>	<p>[Demand value/present value]</p> <p>[kW]</p> <p>DT= 3min</p> <p>0.0</p> <p>VALUE DEMAND PHASE - ITEM P</p>	<p>[Demand value/maximum value]</p> <p>[kW]</p> <p>DT= 3min</p> <p>175.2</p> <p>17/01/01 00:25</p> <p>VALUE D MAX PHASE - ITEM P</p>	[8] Frequency	<p>[Present value]</p> <p>[Hz]</p> <p>0.0</p> <p>VALUE CURRENT PHASE - ITEM Hz</p>							
	[4] Reactive power	<p>[Present value]</p> <p>[kvar]</p> <p>0.0</p> <p>VALUE CURRENT PHASE - ITEM Q</p>	<p>[Demand value/present value]</p> <p>[kvar]</p> <p>DT= 3min</p> <p>0.0</p> <p>VALUE DEMAND PHASE - ITEM Q</p>		<p>[Demand value/maximum value]</p> <p>[kvar]</p> <p>DT= 3min</p> <p>120.9</p> <p>17/01/01 00:25</p> <p>VALUE D MAX PHASE - ITEM Q</p>							

[9] Harmonic current	<p>[Present value/ total value] [A]</p> <table border="1"> <tr><td>Total</td><td>[A]</td></tr> <tr><td>1</td><td>0.0</td></tr> <tr><td>2</td><td>0.0</td></tr> <tr><td>3</td><td>0.0</td></tr> <tr><td>VALUE</td><td>Total</td></tr> <tr><td>PHASE</td><td>ALL</td></tr> <tr><td>ITEM</td><td>HI(A)</td></tr> </table>	Total	[A]	1	0.0	2	0.0	3	0.0	VALUE	Total	PHASE	ALL	ITEM	HI(A)	<p>[Present value/ 1st order] [A]</p> <table border="1"> <tr><td>1st</td><td>[A]</td></tr> <tr><td>1</td><td>0.0</td></tr> <tr><td>2</td><td>0.0</td></tr> <tr><td>3</td><td>0.0</td></tr> <tr><td>VALUE</td><td>1St</td></tr> <tr><td>PHASE</td><td>ALL</td></tr> <tr><td>ITEM</td><td>HI(A)</td></tr> </table>	1st	[A]	1	0.0	2	0.0	3	0.0	VALUE	1St	PHASE	ALL	ITEM	HI(A)	<p>[Present value/ 19th order] [A]</p> <table border="1"> <tr><td>19th</td><td>[A]</td></tr> <tr><td>1</td><td>0.0</td></tr> <tr><td>2</td><td>0.0</td></tr> <tr><td>3</td><td>0.0</td></tr> <tr><td>VALUE</td><td>19th</td></tr> <tr><td>PHASE</td><td>ALL</td></tr> <tr><td>ITEM</td><td>HI(A)</td></tr> </table>	19th	[A]	1	0.0	2	0.0	3	0.0	VALUE	19th	PHASE	ALL	ITEM	HI(A)	[12] Fault cause/current display screen	<p>[Fault cause/ current display screen] Without fault record</p> <table border="1"> <tr><td>[-]</td></tr> <tr><td>TRIP</td></tr> <tr><td>VALUE</td><td>--</td></tr> <tr><td>PHASE</td><td>--</td></tr> <tr><td>ITEM</td><td>TRIP</td></tr> </table> <p>* Refer to 7.2.3 for details on what is displayed.</p>	[-]	TRIP	VALUE	--	PHASE	--	ITEM	TRIP	
	Total	[A]																																																						
	1	0.0																																																						
2	0.0																																																							
3	0.0																																																							
VALUE	Total																																																							
PHASE	ALL																																																							
ITEM	HI(A)																																																							
1st	[A]																																																							
1	0.0																																																							
2	0.0																																																							
3	0.0																																																							
VALUE	1St																																																							
PHASE	ALL																																																							
ITEM	HI(A)																																																							
19th	[A]																																																							
1	0.0																																																							
2	0.0																																																							
3	0.0																																																							
VALUE	19th																																																							
PHASE	ALL																																																							
ITEM	HI(A)																																																							
[-]																																																								
TRIP																																																								
VALUE	--																																																							
PHASE	--																																																							
ITEM	TRIP																																																							
[10] Harmonic current content ratio	<p>[Demand value] [A]</p> <table border="1"> <tr><td>DT=</td><td>[A]</td></tr> <tr><td></td><td>3min</td></tr> <tr><td>1</td><td>0.0</td></tr> <tr><td>2</td><td>0.0</td></tr> <tr><td>3</td><td>0.0</td></tr> <tr><td>VALUE</td><td>DEMAND</td></tr> <tr><td>PHASE</td><td>ALL</td></tr> <tr><td>ITEM</td><td>HI(A)</td></tr> </table>	DT=	[A]		3min	1	0.0	2	0.0	3	0.0	VALUE	DEMAND	PHASE	ALL	ITEM	HI(A)	<p>[Demand value/ maximum value] [A]</p> <table border="1"> <tr><td>DT=</td><td>[A]</td></tr> <tr><td></td><td>3min</td></tr> <tr><td></td><td>134</td></tr> <tr><td></td><td>17/01/01</td></tr> <tr><td></td><td>00:25</td></tr> <tr><td>VALUE</td><td>D MAX</td></tr> <tr><td>PHASE</td><td>--</td></tr> <tr><td>ITEM</td><td>HI(A)</td></tr> </table>	DT=	[A]		3min		134		17/01/01		00:25	VALUE	D MAX	PHASE	--	ITEM	HI(A)		[13] Alarm display screen	<p>[Alarm display screen]</p> <table border="1"> <tr><td>ALARM</td></tr> <tr><td>PAI</td></tr> <tr><td>OVER</td></tr> <tr><td>---</td></tr> <tr><td>---</td></tr> <tr><td>---</td></tr> <tr><td>IDM_AL</td></tr> <tr><td>ILA_AL</td></tr> <tr><td>IUB_AL</td></tr> <tr><td>VALUE</td><td>--</td></tr> <tr><td>PHASE</td><td>--</td></tr> <tr><td>ITEM</td><td>ALARM</td></tr> </table> <p>● Errors are displayed in inverse</p>	ALARM	PAI	OVER	---	---	---	IDM_AL	ILA_AL	IUB_AL	VALUE	--	PHASE	--	ITEM	ALARM				
	DT=	[A]																																																						
		3min																																																						
1	0.0																																																							
2	0.0																																																							
3	0.0																																																							
VALUE	DEMAND																																																							
PHASE	ALL																																																							
ITEM	HI(A)																																																							
DT=	[A]																																																							
	3min																																																							
	134																																																							
	17/01/01																																																							
	00:25																																																							
VALUE	D MAX																																																							
PHASE	--																																																							
ITEM	HI(A)																																																							
ALARM																																																								
PAI																																																								
OVER																																																								

IDM_AL																																																								
ILA_AL																																																								
IUB_AL																																																								
VALUE	--																																																							
PHASE	--																																																							
ITEM	ALARM																																																							
[11] Measurement item (free display)	<p>[Maximum value/ total value] [A]</p> <table border="1"> <tr><td>M1st</td><td>[A]</td></tr> <tr><td></td><td>313</td></tr> <tr><td></td><td>17/01/01</td></tr> <tr><td></td><td>00:25</td></tr> <tr><td>VALUE</td><td>M1St</td></tr> <tr><td>PHASE</td><td>--</td></tr> <tr><td>ITEM</td><td>HI(A)</td></tr> </table>	M1st	[A]		313		17/01/01		00:25	VALUE	M1St	PHASE	--	ITEM	HI(A)	<p>[Maximum value/ 3rd order] [A]</p> <table border="1"> <tr><td>M3rd</td><td>[A]</td></tr> <tr><td></td><td>17.6</td></tr> <tr><td></td><td>17/01/01</td></tr> <tr><td></td><td>00:25</td></tr> <tr><td>VALUE</td><td>M3rd</td></tr> <tr><td>PHASE</td><td>--</td></tr> <tr><td>ITEM</td><td>HI(A)</td></tr> </table>	M3rd	[A]		17.6		17/01/01		00:25	VALUE	M3rd	PHASE	--	ITEM	HI(A)	<p>[Maximum value/ 19th order] [A]</p> <table border="1"> <tr><td>M19th</td><td>[A]</td></tr> <tr><td></td><td>17.6</td></tr> <tr><td></td><td>17/01/01</td></tr> <tr><td></td><td>00:25</td></tr> <tr><td>VALUE</td><td>M19th</td></tr> <tr><td>PHASE</td><td>--</td></tr> <tr><td>ITEM</td><td>HI(A)</td></tr> </table>	M19th	[A]		17.6		17/01/01		00:25	VALUE	M19th	PHASE	--	ITEM	HI(A)	[14] Phase sequence display screen	<p>[Phase sequence display screen]</p> <table border="1"> <tr><td>SEQ</td></tr> <tr><td>POSI</td></tr> <tr><td>NEGA</td></tr> <tr><td>VALUE</td><td>--</td></tr> <tr><td>PHASE</td><td>--</td></tr> <tr><td>ITEM</td><td>SEQ_CHK</td></tr> </table> <p>● Phase detection results displayed in inverse (enabled for three-phase three-wire, displayed as "--" when disabled)</p> <p>● POSI : Positive phase ● NEGA : Negative phase</p> <p>* Only for 400/800 A frame</p>	SEQ	POSI	NEGA	VALUE	--	PHASE	--	ITEM	SEQ_CHK
	M1st	[A]																																																						
		313																																																						
	17/01/01																																																							
	00:25																																																							
VALUE	M1St																																																							
PHASE	--																																																							
ITEM	HI(A)																																																							
M3rd	[A]																																																							
	17.6																																																							
	17/01/01																																																							
	00:25																																																							
VALUE	M3rd																																																							
PHASE	--																																																							
ITEM	HI(A)																																																							
M19th	[A]																																																							
	17.6																																																							
	17/01/01																																																							
	00:25																																																							
VALUE	M19th																																																							
PHASE	--																																																							
ITEM	HI(A)																																																							
SEQ																																																								
POSI																																																								
NEGA																																																								
VALUE	--																																																							
PHASE	--																																																							
ITEM	SEQ_CHK																																																							
[12] Measurement item (free display)	<p>[Content ratio/ total value] [%]</p> <table border="1"> <tr><td>THD</td><td>[%]</td></tr> <tr><td>1</td><td>0.0</td></tr> <tr><td>2</td><td>0.0</td></tr> <tr><td>3</td><td>0.0</td></tr> <tr><td>VALUE</td><td>THD</td></tr> <tr><td>PHASE</td><td>ALL</td></tr> <tr><td>ITEM</td><td>HI(%)</td></tr> </table>	THD	[%]	1	0.0	2	0.0	3	0.0	VALUE	THD	PHASE	ALL	ITEM	HI(%)	<p>[Content ratio/ 3rd order] [%]</p> <table border="1"> <tr><td>3rd</td><td>[%]</td></tr> <tr><td>1</td><td>0.0</td></tr> <tr><td>2</td><td>0.0</td></tr> <tr><td>3</td><td>0.0</td></tr> <tr><td>VALUE</td><td>3rd</td></tr> <tr><td>PHASE</td><td>ALL</td></tr> <tr><td>ITEM</td><td>HI(%)</td></tr> </table>	3rd	[%]	1	0.0	2	0.0	3	0.0	VALUE	3rd	PHASE	ALL	ITEM	HI(%)	<p>[Content ratio/ 19rd order] [%]</p> <table border="1"> <tr><td>19rd</td><td>[%]</td></tr> <tr><td>1</td><td>0.0</td></tr> <tr><td>2</td><td>0.0</td></tr> <tr><td>3</td><td>0.0</td></tr> <tr><td>VALUE</td><td>19th</td></tr> <tr><td>PHASE</td><td>ALL</td></tr> <tr><td>ITEM</td><td>HI(%)</td></tr> </table>	19rd	[%]	1	0.0	2	0.0	3	0.0	VALUE	19th	PHASE	ALL	ITEM	HI(%)											
	THD	[%]																																																						
	1	0.0																																																						
2	0.0																																																							
3	0.0																																																							
VALUE	THD																																																							
PHASE	ALL																																																							
ITEM	HI(%)																																																							
3rd	[%]																																																							
1	0.0																																																							
2	0.0																																																							
3	0.0																																																							
VALUE	3rd																																																							
PHASE	ALL																																																							
ITEM	HI(%)																																																							
19rd	[%]																																																							
1	0.0																																																							
2	0.0																																																							
3	0.0																																																							
VALUE	19th																																																							
PHASE	ALL																																																							
ITEM	HI(%)																																																							
[13] Measurement item (free display)	<p>[Measurement item/ 1/4]</p> <table border="1"> <tr><td>1/4 PAGE</td></tr> <tr><td>1 /1 / CUR</td></tr> <tr><td>--min [A]</td></tr> <tr><td>0.0</td></tr> <tr><td>--/--- --:--</td></tr> <tr><td>1 /1 / DM</td></tr> <tr><td>--min [A]</td></tr> <tr><td>0.0</td></tr> <tr><td>--/--- --:--</td></tr> <tr><td>VALUE</td><td>--</td></tr> <tr><td>PHASE</td><td>--</td></tr> <tr><td>ITEM</td><td>FREE1/4</td></tr> </table>	1/4 PAGE	1 /1 / CUR	--min [A]	0.0	--/--- --:--	1 /1 / DM	--min [A]	0.0	--/--- --:--	VALUE	--	PHASE	--	ITEM	FREE1/4	<p>[Measurement item/ 4/4]</p> <table border="1"> <tr><td>4/4 PAGE</td></tr> <tr><td>-----/-----/-----</td></tr> <tr><td>--min [-----]</td></tr> <tr><td>-----/-----/-----</td></tr> <tr><td>--:--</td></tr> <tr><td>-----/-----/-----</td></tr> <tr><td>--min [-----]</td></tr> <tr><td>-----/-----/-----</td></tr> <tr><td>--:--</td></tr> <tr><td>VALUE</td><td>--</td></tr> <tr><td>PHASE</td><td>--</td></tr> <tr><td>ITEM</td><td>FREE4/4</td></tr> </table>	4/4 PAGE	-----/-----/-----	--min [-----]	-----/-----/-----	--:--	-----/-----/-----	--min [-----]	-----/-----/-----	--:--	VALUE	--	PHASE	--	ITEM	FREE4/4																								
	1/4 PAGE																																																							
	1 /1 / CUR																																																							
--min [A]																																																								
0.0																																																								
--/--- --:--																																																								
1 /1 / DM																																																								
--min [A]																																																								
0.0																																																								
--/--- --:--																																																								
VALUE	--																																																							
PHASE	--																																																							
ITEM	FREE1/4																																																							
4/4 PAGE																																																								
-----/-----/-----																																																								
--min [-----]																																																								
-----/-----/-----																																																								
--:--																																																								
-----/-----/-----																																																								
--min [-----]																																																								
-----/-----/-----																																																								
--:--																																																								
VALUE	--																																																							
PHASE	--																																																							
ITEM	FREE4/4																																																							

8. Appendix

8.1 Precautions for setting operation

The display can be used to set and clear the items described in "7.1.2 Method for various settings," "7.1.3 Method for resetting alarms," and "7.1.4 Method for resetting fault cause/current, maximum value, electric energy, and reactive energy."

When items are set or cleared, the non-volatile memory storage will be overwritten for all of these except for the items described in "7.1.2-4 Setting method for day and time."

It takes some time to overwrite the non-volatile memory storage, and items may not be properly overwritten in the non-volatile memory if they are set or cleared in quick succession. Therefore, as shown in the examples below, wait around three seconds after setting or clearing an item, before setting or clearing another item (regardless of whether the items are similar or different).

<Consecutive setting example 1> Consecutive setting of different settings (demand time limit, alarm reset method, storage clear)

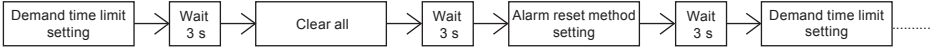

<Consecutive setting example 2> Consecutive setting of different settings (demand time limit, storage clear)



8.2 Precautions when setting via CC-Link communication/MODBUS communication

If using a product with CC-Link communication/MODBUS communication, CC-Link communication can also be used to send certain commands and setting values to a MDU, allowing items to be set and cleared just as when operating the display (as described above).

(Refer to "MDU Breaker Programming Manual" for details on what can be configured and cleared.)

The non-volatile memory storage is overwritten (depending on what is set or cleared) when setting and clearing over CC-Link communication /MODBUS communication, and items may not be properly overwritten in the non-volatile memory if set/clear commands are transmitted in quick succession. Therefore, as shown in the examples below, wait around three seconds after transmitting a set or clear command, before transmitting another command (regardless of whether the commands are similar or different).

<Consecutive transmission example 1> Consecutive transmission of different commands (demand time limit, alarm reset method, storage clear)

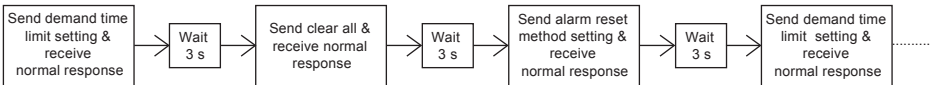

<Consecutive transmission example 2> Consecutive transmission of different commands (demand time limit, storage clear)

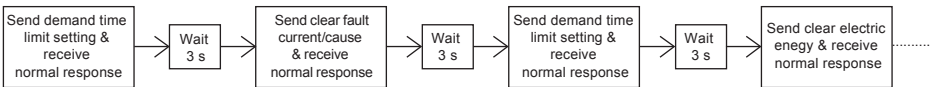

8.3 Communication error codes and solutions

(1) With CC-Link transmission option

Error code Note: The numbers in parentheses are in hexadecimal notation.		Error details	Solution
Standard command between devices	Digital command, analog command, or pulse command		
1 (01h)		Undefined command.	Set the correct command.
16 (10h)	192 (C0h)	Hardware error.	Turn the MDU control power supply OFF and then ON again, or press the reset switch.
65 (41h)	–	Group number out of range.	Set the group number to the correct value.
66 (42h)	193 (C1h)	Channel number out of range.	Set the channel number to the correct value.
81 (51h)	194 (C2h)	Setting value out of configuration range.	Set the setting value to the correct value.
83 (53h)	209 (D1h)	Upper limit value and lower limit value cross.	Set the upper limit value and lower limit value so that they do not cross.

Note: Errors other than those listed above are detected by the detector on the command transmission side. Refer to the Instruction Manual for that device for details.

Note: If the error status flag (RX(n+1) A) is set once to "1" (ON), the error status flag will not be set to "0" (OFF) even if the CPU of PLC is reset.

To set the error status flag to "0" (OFF), set the error reset status flag (RY(n+1) A) to "1" (ON).

However, even if the error status is released when the error reset status flag is set to "1" (ON), if there is an error in the retransmitted data, the error status flag will once again be set to "1" (ON). Therefore, refer to the error code and eliminate the cause of the error prior to retransmitting.

(2) With MODBUS transmission option

Error code	Error details	Solution
01h	Illegal function	Please correct it to the correct function.
02h	Register address error	Please use the register described in MDU breaker programming manual MODBUS communication.
03h	Data value error	Please correct it to the correct data.
04h	Slave abnormality	Please correct the setting value to the correct value.
06h	Slave Busy	Please review the timing of the query.

Note: Errors other than those listed above are detected by the detector on the command transmission side. Refer to the Instruction Manual for that device for details.

8.4 Troubleshooting

Check the following if your device appears to be failing.

- (1) Is the MDU applied control power?
 - (2) Nothing is displayed on the display.
Is the connection cable connector fully plugged in? Is it disconnected?
 - (3) The device is powered but the current is 0 A.
If the electric current measurement value is less than the measurement lower limit current (less than $\pm 1.0\%$ of the measurement rated current), it is cutoff so that the display value is 0 A.
 - (4) Unable to monitor when transmitting/communicating even though a value is displayed on the display.
 - [1] With CC-Link communication
 - Confirm that there are no errors in the communication line connection, and that no wires are disconnected.
 - Are there any stations with the same station number on the same transmission route? If there are, configure the correct station number and then press the reset switch.
 - Is the communication speed set to the same value as the master device? If it is different, configure the correct communication speed and then press the reset switch.
 - [2] With MODBUS communication
 - Confirm that there are no errors in the communication line connection, and that no wires are disconnected.
 - Are there any stations with the same station number on the same transmission route? If there are, configure the correct address and then press the reset switch.
 - Is the communication speed set to the same value as the master device? If it is different, configure the correct communication speed and then press the reset switch.
 - Is the setting of the master unit and parity bit the same? If it is different, set the correct parity bit, then press the reset switch.
 - Is the setting of the master unit and the stop bit the same? If it is different, set the correct stop bit, then press the reset switch.
 - (5) The electric current value measured by the device differs from other measurement values. (Permissible error value or greater.)
 - Confirm that the measurement instrument used for comparison measures the effective value correctly. The device indicates the effective value.
 - If the measurement instrument used for comparison measures the average value instead of the effective value, distortion in the current flowing through the measurement circuit will create a significant difference.

Sales Network

Country/Region	Corporation Name	Address	Telephone
Australia	Mitsubishi Electric Australia Pty. Ltd.	348 Victoria Road, Rydalmere, N.S.W. 2116 Australia	+61-2-9684-7777
Bangladesh	PROGRESSIVE TRADING CORPORATION	Haque Tower, 2nd floor, 610/11, Jubilee Road, Chittagong, Bangladesh	+880-31-624-307
	ELECTRO MECH AUTOMATION & ENGINEERING LTD.	Purana Pallan Lane, (VIP Road), Rokaya Mansion(6th floor), Room702,Dhaka-1000, Bangladesh	+880-28-3211-791
Belarus	Tehnikon	Oktyabrskaya 19, Off. 705. BY-220030 Minsk, Belarus	+375(0)177210 46 26
Belgium	Koning & Hartman B.V.	Wolvleaan 31, BE-1800 Vilvoorde, Belgium	+32(0)25720740
Cambodia	DHINIMEX CO.,LTD	#245, St. Tpp Phan, Phnom Penh, Cambodia	+855-23-9971-725
China	Rhona S.A.	Via. Agua Santa 4211 Castilla 30-0 (P.O. Box) Vina del Mar, Chile	+56-32-3-320-600
	Mitsubishi Electric Automation (China) Ltd.	Mitsubishi Electric Automation Building, No.1368 Hongqiao Road, Shanghai, 200336	+86-21-3232-3030
	Mitsubishi Electric Automation (China) Ltd. Beijing Branch	5/F, ONE INDIGO, 20 Juxianqiao Road Chaoyang District, Beijing, China	+86-10-6518-8830
	Mitsubishi Electric Automation (China) Ltd. She-Zhen Branch	Room 2512-2516, Great China International Exchange Square, Jintian Rd., Futian District, Shenzhen, 518034	+86-755-2399-8272
	Mitsubishi Electric Automation (China) Ltd. GuangZhou Branch	Room 1609, North Tower, The Hub Center, No.1068, King Gang East Road, Haizhu District, Guang Zhou, China 519335	+86-20-8923-6730
	Mitsubishi Electric Automation (China) Ltd. ChengDu Branch	Block B, Room 407-408, Shangri-La Center Office Building, No.9 BinJiang East Road, Chengdu, China 61021	+86-28-8446-8030
	Mitsubishi Electric Automation (Hong Kong) Ltd.	20/F, Cityplaza One, 111 King's Road, Taikoo shing, Hong Kong	+852-2510-9555
Colombia	Productico Representaciones S.A	Camera 42 # 75-367 Box 109 Itagu Colombia	+57-44-441284
Czech Republic	AUTOCOINT CONTROL SYSTEMS S,R,O	Technologicka 374/6, CZ-708 00 Ostrava - Ruskovec	+420 595 691 150
Denmark	BEJER ELECTRONICS A/S	LYKKEGAARDSVEJ 17, DK-4000 ROSKILDE	+45(0)4675 76 66
Egypt	Cairo Electrical Group	9, Rostoum St, Garden City P.O, Box 165-11516 Maglis El-Shaab, Cairo - Egypt	+20-2-27961337
France	Mitsubishi Electric Europe B.V.	25, Boulevard des Bouvets, F-92741 Nanterre Cedex	+33(0)155 58 85 68
Germany	Mitsubishi Electric Europe B.V.	SAPHANMO VillAGE, SAYSETHA DISTRICT, VIENTIANE CAPITAL, LAOS	+49(0)2102 486-0
	KALAMARKIS - SAPHOUNAS S.A.	IONIAS & NEROMILIOU STR., CHAMOMILIOS ACHARNES, ATHENS, 13678 Greece	+30-210-6200000
Greece	UTECCO	5, MAVROGENOUS STR., 18542 PIRAEUS, Greece	+30-211-1206-900
Hungary	Meltrade Ltd.	Fertő utca 14, HU-1107 Budapest, Hungary	+36(0)1-4631-9726
India	Mitsubishi Electric India Private Limited	2nd Floor, Tower A&B, Cyber Greens, DLF Cyber City, DLF Phase-III, Gurgaon - 122 022 Haryana, India	+91-124-4303000
Indonesia	P. T. Sahabat Indonesia	P.O.Box 5045 Kawasan Industri Pergudangan, Jakarta, Indonesia	+62-(0)21-6610651-9
Indonesia	Mitsubishi Electric Europe B.V.	Westgate Business Park, Ballymore, Dublin 24, Ireland	+353-1-4411330
Israel	Gino Industries Ltd.	26, Ophir Street IL-32235 Haifa, Israel	+972(0)4-8674-6656
Italy	Mitsubishi Electric Europe B.V.	Viale Colleoni 7, I-20041 Agrate Brianza (MI), Italy	+39 039-60531
Kazakhstan	Kazpromavtomatika	Uie. Zhambyla 28, KAZ - 100017 Karaganda	+7-7212-501000
Korea	Mitsubishi Electric Automation Korea Co., Ltd	9F Gangseo Hangang x-tower, 401 Yangcheon-ro, Gangseo-gu, Seoul 07528 Korea	+82-2-3660-9572
Laos	AROUNNIT CORPORATION IMPORT-EXPORT SOLE CO., LTD	SAPHANMO VILLAGE, SAYSETHA DISTRICT, VIENTIANE CAPITAL, LAOS	+855-20-415899
Lebanon	Comptoir d'Electricite Generale-Leban	Cebaco Center - Block A Autostrade Dora P.O. Box 11-2987 Beirut - Lebanon	+961-1-240445
Lithuania	Rifas UAB	Tirmu 29A, LT-5300 Panevezys, Lithuania	+370(0)45-582-728
Malaysia	Mitric Sdn Bhd	No. 5, Jalan Pemberita U1/49, Temasy Industrial Park, Glenmarie 40150 Shah Alam, Selangor, Malaysia	+603-5569-3748
Malta	ALFATRADE LTD	99 PAOLA HILL, PAOLA PLA 1702, Malta	+356(0)21-697-816
Morocco	SCHIELE MAROC	KM 7,2 NOUVELLE ROUTE DE RABAT AIN SEBAA, 20600 Casablanca, Morocco	+212 661 45 15 86
Myanmar	Peace Myanmar Electric Co.,Ltd.	NO137/139 Botahtung Pagoda Road, Botahtung Town Ship 11611, Yangon, Myanmar	+95-(0)1-202589
Nepal	Watt&Voh House	KHA 2-65, Voh House Dillibazar Post Box: 2108, Kathmandu, Nepal	+977-1-4411330
Netherlands	Intech Marine & Offshore B.V.	Sluisjesdijk 155, NL-3087 AG Rotterdam, Netherlands	+31(0)10-487-1911
North America	Mitsubishi Electric Automation, Inc.	500 Corporate Woods Parkway, Vernon Hills, IL 60061 USA	+847-478-2100
Norway	Scanelec AS	Leirvikasen 43B, NO-5179 Godvik, Norway	+47(0)55-500600
Middle East	Comptoir d'Electricite Generale-International-S.A.,L.	Cebaco Center - Block A Autostrade Dora P.O. Box 11-1314 Beirut - Lebanon	+961-1-240430
Arab Countries & Cyprus			
Pakistan	Prince Electric Co.	2-P, GULBERG II, LAHORE - 54660 PAKISTAN	+92-(0)42-35752323
	AL-KAMAL GROUP	Office No. 7 & 8, 1st Floor, Barkat Ali Khan Center, 101 Circular Road, Lahore, Pakistan	+92-(0)42-3753373
Philippines	Edison Electric Integrated, Inc.	24th Fl. Galleria Corporate Center, Edsa Cr, Ortigas Ave., Quezon City Metro Manila, Philippines	+63-(0)2-634-8691
Poland	Mitsubishi Electric Europe B.V. Polish Branch	Krakowska 50, 32-083 Balice, Poland	+49(0)12-630 47 00
Republic of Moldova	Intishea SRL	16i, Traian 231, MD-2000 Kishinev, Moldova	+373(0)23456-2424
Romania	Sirius Trading & Services SRL	RO-060841 Bucuresti, Sector 6 Aleea Lacul Morii Nr. 3	+40-(0)21-3430-4006
Russia	Mitsubishi Electric Europe B.V. Moscow Branch	52, bld. 3 Kosmodamianskaya Nab, 115054, Moscow, Russia	+7 495 121-72070
Saudi Arabia	Center of Electrical Goods	Al-Shuwayer St, Side way of Salahuddin Al-Ayubi St, P.O. Box 15955 Riyadh 11454 - Saudi Arabia	+966-1-4770149
Singapore	Mitsubishi Electric Asia Pte., Ltd.	3037 Alexandra Road, Mitsubishi Electric Building, Singapore 159943	+65-6473-2008
Slovakia	PROCOINT, Presov	Kupselna 17, SK-08031 Presov, Slovakia	+421(0)5-1560 611
	SIMPAP	Janka Derku 1671, SK - 91101 Trenčín, Slovakia	+42(0)32 743 04 72
Slovenia	Inea RBT d.o.o.	Stegne 11, SI-1000 Ljubljana, Slovenia	+386(0)1-513-8116
South Africa	CBI-electric: low voltage	Private Bag 2016, ZA-1600 Isando Gauteng, South Africa	+27(0)11-9282000
Spain	Mitsubishi Electric Europe B.V. Spanish Branch	Carretera de Rubi 76-80, E-08190 Sant Cugat del Valles (Barcelona), Spain	+34(0)93-565-3131
Sweden	Euro Energy Components AB	Järnvägsgatan 36, S-434 24 Kungälv, Sweden	+46(0)300-890040
Switzerland	TiElec AG	Munshofstrasse 136, CH-8201 Schaffhausen	+41(0)524528425
Taiwan	Setsuyo Enterprise Co., Ltd	5th Fl., No.105, Wu Kung 3rd, Wu-Ku Hsiang, Taipei, Taiwan, R.O.C.	+886-(0)2-2288-8889
Thailand	United Trading & Import Co., Ltd.	77/12 Bamrungmuang Road, Klomg Mahanak Pomprab Bangkok Thailand	+66-223-4220-3
Tunisia	MOTRA Electric	3, Residence Imen, Avenue des Martyrs Mourouj III, 2074 - El Mourouj III Ben Arous, Tunisia	+216-71 474 599
Turkey	GTS	Bayraktar Bulvarı Nutuk Sok, No:5, Posta Kutusu34384, TR-34775 Yukarı Dudulu-İcmranyay, Istanbul, Turkey	+90(0)216 526 3990
United Kingdom	Mitsubishi Electric Europe B.V.	Travellers Lane, Lich-Hatfield, Herts, AL10 8XS, United Kingdom	+44(0)1707-276100
Uruguay	Pierrro Vignoli S.A.	Avda. Uruguay 1274 Montevideo Uruguay	+598-2-902-0908
Venezuela	Adesco S.A.	Calle 7 La Urbina Edificio Los Robles Locales C y D Planta Baja, Caracas - Venezuela	+58-212-241-9945
Vietnam	Mitsubishi Electric Vietnam Co., Ltd, Head Office	Unit01-04, 10th Floor, Vincom Center, 72 Le Thanh Ton Street, District 1, Ho Chi Minh City, Vietnam	+84-28-3910-5945
	Mitsubishi Electric Vietnam Co., Ltd, Hanoi Branch	24th Floor, Hancock Tower, Pham Hung Road khu 5 thi moi Me Tri Ha, Nam Tu Liem District, Hanoi City, Vietnam	+84-24-3937-8075

MEMO

MDU Breakers

For Safety : Wiring and connection must be done by the person who has specialized knowledge of electric construction and wirings.

●Trademarks

- Of this product, export (or service trade) permission under this law is required for exports that fall under the safety and trade control related cargo (or service) specified in the Foreign Exchange and Foreign Trade Control Law.
- MODBUS is registered trademark of Schneider USA Inc.
- About the QR code described in the product
The QR code described in this product is for use in manufacturing management and is not intended to be used by the customer. We can not guarantee the operation when reading with a commercially available code reader. (QR code is a registered trademark of DENSO WAVE INCORPORATED.)
- Other company names and product names in this document are trademarks or registered trademarks of their respective owners.

MITSUBISHI ELECTRIC CORPORATION

HEAD OFFICE: TOKYO BUILDING, 2-7-3, MARUNOUCHI, CHIYODA-KU, TOKYO 100-8310, JAPAN

