

mitsubishi

Type SW3D5F-OLEX-E Excel Communication Support Tool
Operating Manual



Mitsubishi Programmable Logic Controller

● SAFETY PRECAUTIONS ●

(Always read these instructions before using this equipment.)

Before using this product, please read this manual and the relevant manuals introduced in this manual carefully and pay full attention to safety to handle the product correctly.

The instructions given in this manual are concerned with this product. For the safety instructions of the programmable controller system, please read the CPU module user's manual.

In this manual, the safety instructions are ranked as "DANGER" and "CAUTION".



DANGER

Indicates that incorrect handling may cause hazardous conditions, resulting in death or severe injury.



CAUTION

Indicates that incorrect handling may cause hazardous conditions, resulting in medium or slight personal injury or physical damage.

Note that the  CAUTION level may lead to a serious consequence according to the circumstances. Always follow the instructions of both levels because they are important to personal safety.

Please save this manual to make it accessible when required and always forward it to the end user.

[Design Instructions]



DANGER

- When data change is to be made from a peripheral device to the running PLC, configure up an interlock circuit in the outside of the PLC system to ensure that the whole system will always operate safely.
Also, determine corrective actions to be taken for the system when a communication error occurs due to a cable connection fault or the like in online operation performed from the peripheral device to the PLC CPU.

[Design Instructions]



CAUTION

- Online operation performed with a peripheral device connected to the running CPU module (especially forced output) should be started after carefully reading the manual and fully ensuring safety.
Not doing so can cause machine damage or accident due to an operation mistake.

REVISIONS

* The manual number is given on the bottom left of the back cover.

Print Date	* Manual Number	Revision
Sep., 1999	IB (NA)-0800016-A	First edition
Sep., 1999	IB (NA)-0800016-B	<p>Correction</p> <p>Subsection 10.2.4, subsection 10.2.5</p> <p>Addition</p> <p>Operating Instructions (15), subsection 10.2.5, subsection 11.1.1, subsection 11.1.2, subsection 11.1.3, subsection 11.1.4, section 12.2, Appendix 3</p>
Dec., 1999	IB (NA)-0800016-C	<p>Addition</p> <p>Operating Instructions (1), About the Generic Terms and Abbreviations, Product Makeup, section 2.2, section 3.1, chapter 4, subsection 11.7.1, section 12.1</p>
May, 2000	IB (NA)-0800016-D	<p>Correction</p> <p>About Manuals, subsection 10.2.5, subsection 11.1.2, section 12.3, section 12.4</p> <p>Addition</p> <p>Operating Instructions, About the Generic Terms and Abbreviations, section 12.2</p>
Jun., 2000	IB (NA)-0800016-E	<p>Correction</p> <p>Chapter 8, subsection 11.1.2</p> <p>Addition</p> <p>Operating Instructions, section 9.3, subsection 10.2.2, subsection 10.2.7, subsection 11.1.1, subsection 11.1.2, subsection 11.1.3, subsection 11.1.4, subsection 11.2.5, subsection 11.3.2, Appendix 1</p>
Feb., 2002	IB (NA)-0800016-F	<p>Correction</p> <p>Section 7.2, subsection 10.2.4, subsection 10.2.5, subsection 11.1.2, subsection 11.1.4, subsection 11.7.1</p> <p>Addition</p> <p>Operating Instructions</p>
Dec., 2003	IB (NA)-0800016-G	<p>Correction</p> <p>Operating Instructions, About Manuals</p>

Japanese Manual Version IB-0800012-G

This manual confers no industrial property rights or any rights of any other kind, nor does it confer any patent licenses. Mitsubishi Electric Corporation cannot be held responsible for any problems involving industrial property rights which may occur as a result of using the contents noted in this manual.

Operating Instructions

- (1) Starting the Tag management process
 - (a) OLEX will not operate if the Tag management process has not started.
The Tag management process must start from the menu of OLEX.
In the Tag management process of XMOP, OLEX does not operate.
 - (b) If any communication problem has occurred between the Tag management process and OLEX, an error message as indicated below may appear.
If such an error message or the like has appeared, restart the Tag management process.

<Error message example>
 - RPC server cannot be used.
 - Remote procedure call failed, resulting in no execution.Restart the Tag management process in the following procedure.
"OLEX stop" → "Logoff/Restart" → "Logon/Restart complete" → "Tag management process start"
- (2) About Ethernet communication
 - (a) When TCP/IP is used for Ethernet communication, there are the following restrictions.
 - 1) During automatic execution, the write function (OLEXWrite) cannot be used in relation to the PLC CPUs of the same logical station number.
 - 2) OLEX (Tag management process) and the other process (e.g. device monitor utility, user application) cannot have simultaneous access to the PLC CPUs of the same logical station number.
 - (b) If the CPU goes down or the Ethernet module is reset during Ethernet communication, the communication loop will be cut off.
In that case, restart the personal computer.
- (3) About errors that occur on OLEX
Errors, which occur on OLEX, are registered to the error viewer.
For details, refer to the error viewer.
- (4) About changing the sheet name
After cell setting, do not change the sheet name.
If you do so, we cannot guarantee the data.
- (5) About write during automatic execution
 - During automatic execution, you cannot change cell values.
When writing values, you should write sheet values in advance.
 - An error will occur if a cell value is NULL (00H).
You should write values to cells in advance.
- (6) When using Windows NT 4.0
When using Windows NT 4.0, OLEX may be installed and used only on the administrator's authority.
- (7) About computer link communication and CPU COM communication on Windows 95
On Windows 95, communication using the COM port, e.g. computer link communication or CPU COM communication, will cause a memory leak. Therefore, do not perform continuous operation.

- (8) About simultaneous use of OLEX and GPPW
When using GPPW and OLEX together on the same E71 module to make Ethernet communication, make the following settings.
- Set the protocol of the "Target" screen on the Ethernet utility of CSKP to "UDP/IP".
 - Set SW2 of the communication status setting switches of the E71 module to "OFF (binary)".
- (9) About installation
- (a) When using SW3D5F-OLEX-E
Install SW3D5F-OLEX-E after uninstalling SW2D5F-OLEX-E.
- (b) When using SW3D5F-OLEX-EV
Install SW3D5F-OLEX-EV with SW2D5F-OLEX-E installed.
Unless SW2D5F-OLEX-E has been installed, you cannot install SW3D5F-OLEX-EV.
- (10) About overwrite installation
When performing overwrite installation, install the software in the folder where it had already been installed.
- (11) About the start menu
When you have uninstalled OLEX, the item may remain in the start menu.
In such a case, restart the personal computer.
- (12) About reinstallation after uninstalling CSKP
If you uninstalled CSKP with OLEX installed and then you reinstalled CSKP, the communication setting information (information set with various utilities such as the computer link utility) will be lost.
At this time, you must make communication settings again.
- (13) Restrictions on OLEX
OLEX utilizes OLE automation to perform communication processing.
That means restrictions on OLE automation are restrictions on OLEX.
It has been reported that there are the following restrictions on Excel or an Excel macro during use of OLEX or user-created OLE automation.
- VBA: DoEvents must not be put in a For-Next loop.
 - VBA: Incorporating [Analyzing tool-VBA] will result in an error.
 - VBA: Closing the book opened by automation will result in an error.
 - VBA: Incorporating a virus detection add-in and executing the Quit method will result in an error.
 - VBA: fileFilter is ignored in the GetSaveAsFileName method
 - VBA: When Excel97 is used, the methods and properties of the Application object and its derivative objects are ignored if they are set/used in the Workbook_Open event.
Use the Auto_Open event when using the methods and properties of the Application object at the start of the Excel book.
- (14) About the number of licenses
The number of licenses are set to OLEX.
Installation decreases the number of licenses by 1.
Conversely, uninstallation increases the number of licenses by 1.
Therefore, when deleting OLEX, always uninstall it.
Note that the number of licenses will not increase if the folder and files are deleted on Explorer or the like.

- (15) Restriction of preservation function
When the book file in which the ActiveX control and the form are inserted is continuously operated using both the following functions, this may result in memory storage.
Make sure to shut down the personal computer regularly.
1. When using the preservation function of OLEX.
 2. When using the book file by which the Save function is called on VBA.
- (16) When using the Tag management process in Ethernet TCP/IP communication
If a communication error (error code: 102, 103) that a TCP connection is broken (e.g. CPU reset, open cable) occurs during execution of the Tag management process, communication is disabled because the Tag management process will not make a TCP connection again.
If a communication error occurs during execution of the Tag management process, reload using the Tag setup utility or restart the Tag management process after communication has been restored.
- (17) About resume and other functions of the personal computer
A communications error may occur if communications are made with the PLC CPU after setting the resume function, suspend setting, power-saving function or standby mode of the personal computer.
Hence, any of the above functions should not be set for making communications with the PLC CPU.
- (18) Precautions for USB communication
Connecting/disconnecting the USB cable, resetting the PLC CPU, or switching power OFF/ON frequently during communications with the PLC CPU can cause a communications error, from which recovery may not be made.
If recovery cannot be made from the communications error, completely disconnect the USB cable once and reconnect it in more than five seconds.
(Even after this operation, an error may occur at the initial communication, but communications will be made properly at the second time and later.)
- (19) Cell status during OLEX execution
When a cell is in an input status (e.g. the cell has been double-clicked or the cursor is on the mathematical bar) during OLEX execution, OLEX cannot perform operation for Excel and you cannot draw in the cell or save or print a book, for example.
Except when necessary, do not provide direct input to Excel during OLEX execution.
- (20) About changing the Excel type
- (a) The Excel type (Excel 97/2000) to be selected for OLEX installation should be the same as the one used to run OLEX.
If Excel chosen is different from the one used to run OLEX, OLEX will not operate properly.
 - (b) If you have changed the Excel type used to run OLEX, always uninstall OLEX and change the choice of Excel at the time of reinstallation.
If you perform overwrite installation without uninstallation, OLEX will not operate properly.
- (21) Excel Preview
To run OLEX, do not perform the preview setting.
If OLEX is run while Excel is in Preview mode, i.e., "Page Break Preview", a memory leak will occur.

INTRODUCTION

Thank you for choosing Type SW3D5F-OLEX-E Excel Communication Support Tool.

Before using Type SW3D5F-OLEX-E Excel Communication Support Tool, please read this manual carefully to use the product to its optimum.

A copy of this manual should be forwarded to the end user.

CONTENTS

Safety Precautions	A- 1
Revisions	A- 2
Operating Instructions	A- 3
About Manuals	A- 10
How to Use This Manual	A- 11
About the Generic Terms and Abbreviations	A- 12
Meanings and Definitions of the Terms.....	A- 13
Product Makeup	A- 13
1. OVERVIEW	1- 1 to 1- 8
1.1 Features	1- 2
1.2 Menu List	1- 6
1.3 Utility List	1- 6
1.4 About Compatibility with the Existing Software.....	1- 7
2. SYSTEM CONFIGURATION	2- 1 to 2- 2
2.1 System Configuration.....	2- 1
2.2 Operating Environment.....	2- 1
2.3 Usable PLC CPU	2- 1
3. INSTALLATION AND UNINSTALLATION	3- 1 to 3- 8
3.1 Installation	3- 1
3.2 Icons Registered	3- 6
3.3 Uninstallation	3- 7
4. ADD-IN REGISTRATION	4- 1 to 4- 2
5. FUNCTIONS OF OLEX	5- 1 to 5- 6
5.1 Monitor Function	5- 1
5.2 Logging Function.....	5- 2
5.3 Alarm Function	5- 3
5.4 Comment Function.....	5- 5
5.5 OLEX Functions	5- 6

6. OPERATING PROCEDURES	6- 1 to 6- 6
--------------------------------	---------------------

6.1 Common Operating Procedure	6- 1
6.2 Using the Monitor Function.....	6- 2
6.3 Using the Logging Function.....	6- 3
6.4 Using the Alarm Function	6- 4
6.5 Using the Comment Function	6- 5
6.6 Using the OLEX Functions	6- 6

7. CREATING A TAG FILE	7- 1 to 7- 6
-------------------------------	---------------------

7.1 Getting Information on "Tag"	7- 1
7.2 What Should Be Done First.....	7- 2
7.3 Creating a Tag File.....	7- 3

8. USING OLEX	8- 1 to 8- 12
----------------------	----------------------

8.1 Monitoring the Device States.....	8- 1
8.2 Logging the Device Values.....	8- 4
8.3 Displaying the Alarm Summary Comments	8- 7
8.4 Displaying the Comment.....	8- 10

9. OPERATIONS COMMON TO THE UTILITIES	9- 1 to 9- 4
--	---------------------

9.1 Starting the Utility	9- 1
9.2 Closing the Utility.....	9- 1
9.3 Saving the Settings	9- 2
9.4 Displaying the Help Screen	9- 3
9.5 Confirming the Version	9- 3

10. UTILITY OPERATIONS	10- 1 to 10- 38
-------------------------------	------------------------

10.1 Environment Setup Utility	10- 1
10.1.1 Operating Procedure.....	10- 1
10.1.2 Operations on the File Screen.....	10- 2
10.1.3 Operations on the Communicattion Screen	10- 3
10.1.4 Operations on the Comm. Interval Screen.....	10- 4
10.1.5 Operations on the Logging Time Screen	10- 5
10.1.6 About Saving Data as a Text.....	10- 6
10.2 Tag Setup Utility.....	10- 8
10.2.1 Operating Procedure.....	10- 8
10.2.2 About the Tag Management Process.....	10- 9
10.2.3 Operations on the File Screen	10- 11
10.2.4 Operations on the Communication Screen	10- 13
10.2.5 About the Network Setting	10- 19
10.2.6 Operations on the Extended Screen	10- 21

10.2.7 Operations on the Device Monitor Screen	10- 27
10.2.8 Operations on the List Screen	10- 28
10.3 Comment Setup Utility	10- 29
10.3.1 Operation Procedure.....	10- 29
10.3.2 Operations on the File Screen	10- 30
10.3.3 Operations on the Comment Screen.....	10- 31
10.3.4 Operations on the Comment List Screen	10- 32
10.3.5 Comment File Format	10- 33
10.4 Alarm Summary Setup Utility.....	10- 34
10.4.1 Operation Procedure.....	10- 34
10.4.2 Operations on the File Screen	10- 35
10.4.3 Operations on the Alarm Screen	10- 36
10.4.4 Operations on the Alarm List Screen	10- 37
10.4.5 Alarm Summary File Format.....	10- 38

11. HOW TO USE OLEX	11- 1 to 11- 40
----------------------------	------------------------

11.1 About Cell Setting	11- 1
11.1.1 Making Monitor Setting	11- 1
11.1.2 Making Logging Setting	11- 6
11.1.3 Making Alarm Setting.....	11- 11
11.1.4 Making Comment Setting	11- 15
11.2 Editing.....	11- 18
11.2.1 Cutting the Cell Area Set with OLEX.....	11- 18
11.2.2 Copying the Cell Area Set with OLEX	11- 18
11.2.3 Pasting the Cell Area Set with OLEX	11- 19
11.2.4 Deleting the Cell Area Set with OLEX	11- 21
11.2.5 Searching for the Cell Area Set with OLEX.....	11- 22
11.3 Making Communication Tests	11- 24
11.3.1 Making a Read Test.....	11- 24
11.3.2 Making a Write Test	11- 25
11.4 Setting Whether the Cell Area Is Made Valid or Invalid.....	11- 26
11.5 Setting/Releasing Automatic Start-Up.....	11- 28
11.5.1 Setting Automatic Start-Up	11- 28
11.5.2 Releasing Automatic Start-Up	11- 30
11.6 About Automatic Execution	11- 31
11.6.1 About the Status During Automatic Execution	11- 31
11.6.2 Stopping Automatic Execution.....	11- 32
11.7 Other Operations.....	11- 33
11.7.1 Making Setting to Save Collected Data Automatically.....	11- 33
11.7.2 Setting Automatic Printing.....	11- 36
11.7.3 Starting the Tag Setup Utility	11- 39
11.7.4 Displaying the Version Information.....	11- 40

12. OLEX FUNCTIONS	12- 1 to 12- 10
--------------------	-----------------

12.1 Setting References to Macro File	12- 1
12.2 Instructions for Use of the OLEX Functions	12- 3
12.3 OLEXRead	12- 4
12.4 OLEXWrite	12- 7

APPENDICES	APP- 1 to APP- 3
------------	------------------

APPENDIX 1 Specifications	APP- 1
APPENDIX 2 About the Automatic Save/Print Timing.....	APP- 1
APPENDIX 3 Tag Error Codes.....	APP- 3

About Manuals

The following manuals are also related to this product.
In necessary, order them by quoting the details in the tables below.

Related Manuals

Manual Name	Manual Number (Model Code)
Type SW3D5F-CSKP-E Basic Communication Support Tool Operating Manual This manual describes how to set up and use each utility for communication. (Packed with the product)	IB-0800014 (1LMS50)
Type SW3D5F-CSKP-E Basic Communication Support Tool Programming Manual Provides the programming procedure, detailed explanations, and error codes of the MELSEC data link library. (Packed with the product)	IB-0800015 (1LMS51)
Type A70BDE-J71QLP23/A70BDE-J71QLP23GE/A70BDE-J71QBR13/A70BDE-J71QLR23 MELSECNET/10 Interface Board User's Manual (For SW3DNF-MNET10) Describes the features, specifications, part names and setting of the MELSECNET/10 board, and the installation, uninstallation and others of the driver. (Packed with the product)	IB-0800035 (13JL93)
Type A80BDE-J61BT11 CC-Link System Master/Local Interface Board User's Manual (For SW4DNF-CCLINK) Describes the features, specifications, part names and setting of the CC-Link master board, and the installation, uninstallation and others of the driver. (Packed with the product)	IB-0800175 (13JR28)
Type A80BDE-J61BT13 CC-Link Interface Board User's Manual (For SW4DNF-CCLINK) Describes the features, specifications, part names and setting of the CC-Link local board, and the installation, uninstallation and others of the driver. (Packed with the product)	IB-0800176 (13JR29)
Type A80BDE-A2USH-S1 PLC CPU Board User's Manual (For SW1DNF-ANU-B) Describes the features, specifications, part names and setting of the CPU board, and the installation, uninstallation and others of the driver. (Packed with the product)	IB-0800174 (13JR27)

How to Use This Manual

"How to Use This Manual" is described by purposes of using OLEX. Refer to the following and use this manual.

- (1) To know the features (Section 1.1)
Features are given in Section 1.1.
- (2) Menu and utility lists (Sections 1.2 and 1.3)
The OLEX menu list is provided in Section 1.2 and the utility list in Section 1.3.
- (3) To know compatibility with the existing software (Section 1.4)
Section 1.4 provides compatibility with the existing software.
- (4) To know the system configuration (Section 2.1)
This section provides system configurations available by use of OLEX.
- (5) To know OLEX's operating environment and usable PLC CPUs (Sections 2.2 and 2.3)
OLEX's operating environment is given in Section 2.2.
Since usable PLC CPUs are the same as those of CSKP, refer to the CSKP Operating Manual.
- (6) To install or uninstall OLEX (Chapter 3)
Read Chapter 3 which describes how to install and uninstall OLEX.
- (7) To make add-in registration to Excel (Chapter 4)
Chapter 4 provides how to add OLEX into Excel.
- (8) To know the functions of OLEX (Chapter 5)
Chapter 5 describes the functions of OLEX briefly.
- (9) To know the operation procedures of OLEX (Chapters 6 to 8)
Chapter 6 provides the operation procedures of OLEX, Chapter 7 deals with the way of creating a tag file necessary to use OLEX, and Chapter 8 gives simple operation procedures for communication by actually using OLEX.
- (10) To know the operation methods of the utilities (Chapters 9 and 10)
Chapter 9 provides operations common to the utilities, and Chapter 10 describes how to perform operation on a utility basis.
Read these chapters when using the utilities.
- (11) To use OLEX (Chapters 11 and 12)
Chapter 11 gives detailed explanations for use of OLEX, and Chapter 12 describes the OLEX functions.
Read these chapters when using OLEX.
- (12) To know the accessible devices and ranges
The CSKP Operating Manual provides the accessible devices and ranges.
Refer to the CSKP Operating Manual.

About the Generic Terms and Abbreviations

Unless otherwise specified, this manual uses the following generic terms and abbreviations to describe Type SW3D5F-OLEX-E Excel Communication Support Tool.

Generic Term/Abbreviation	Description
OLEX	Abbreviation of Type SW3D5F-OLEX-E Excel Communication Support Tool
CSKP	Abbreviation of Type SW2D5F-CSKP-E / SW3D5F-CSKP-E Basic Communication Support Tool
Windows NT 4.0	Abbreviation of Microsoft Windows NT Workstation 4.0
Windows 95	Abbreviation of Microsoft Windows 95
Windows 98	Abbreviation of Microsoft Windows 98
Windows	Generic Term of Microsoft Windows 95, Microsoft Windows 98 and Microsoft Windows NT Workstation 4.0
Excel	Abbreviation of Microsoft Excel 97 and Excel 2000
Personal computer	DOS/V-compatible personal computer of IBM PC/AT and its compatibles
GPPW	Abbreviation of GPP Function Software for Windows SW <input type="checkbox"/> D5C-GPPW-E/SW <input type="checkbox"/> D5F-GPPW-E
MELSECNET/10 board	Abbreviation of Type A70BDE-J71QLP23/A70BDE-J71QLP23GE/A70BDE-J71QBR13/A70BDE-J71QLR23 MELSECNET/10 interface board
CC-Link board	Abbreviation of Type A80BDE-J61BT11 CC-Link system master/local interface board and Type A80BDE-J61BT13 CC-Link interface board
CPU board	Abbreviation of Type A80BDE-A2USH-S1 PLU CPU board

Meanings and Definitions of the Terms

The terms used in this manual have the following meanings and definitions.

(1) Tag management process

Process which must have been started when using OLEX.
Normally, this process is started simultaneously with Windows.
For full information, refer to Section 10.2.2.

(2) Tag

Data table which contains a set of information necessary for communication with the PLC, e.g. communication settings, devices and data types.
For full information, refer to Section 7.1.

(3) Field

Device information created in a tag.
For full information, refer to Section 7.1.

(4) Cell area

Area on Excel which displays the data alarm messages or comment of device information set on a tag.

(5) Cell area name

Name specified by the user to identify a cell area uniquely.

(6) Refresh timing

Timing at which the screen is updated.
Note that this timing is different from the communication interval of a tag.

Product Makeup

OLEX consists of the following products.

(1) Type SW3D5F-OLEX-E Excel Communication Support Tool

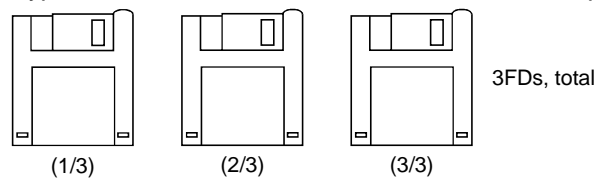

(2) Manual

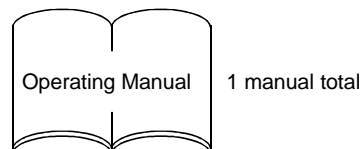

(3) Others

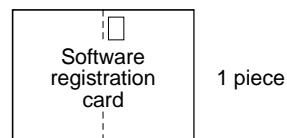

1. OVERVIEW

Type SW3D5F-OLEX-E Excel Communication Support Tool is add-in software for use in Microsoft Corporation's spreadsheet software "Excel".

OLEX utilizes OLE automation to perform communication processing.

You can have direct access to data by simple operation without caring about the communication program of the PLC.

To handle the data developed in worksheets, you can use the printing, graphing and other functions of Excel as they are.

Simplicity communication establishment!

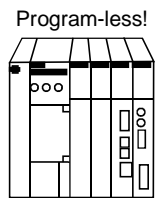
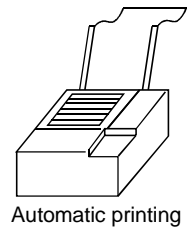
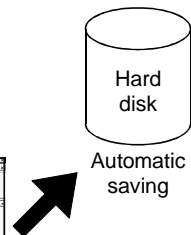
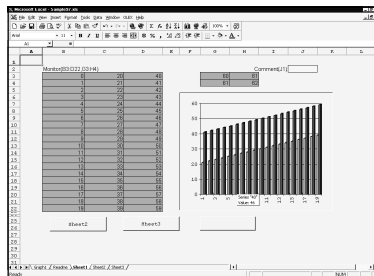
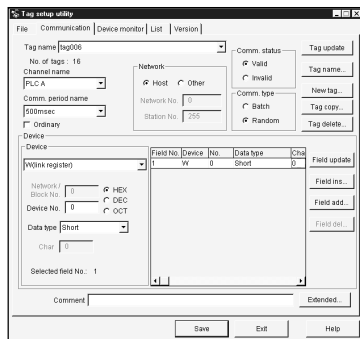

IMPORTANT

CSKP is required to create applications with OLEX.
 When using the created execution file for monitoring, set the communication means with the CSKP utility.
 For details, refer to the CSKP Operating Manual.

1.1 Features

OLEX has the following features.

(1) High functions

By simply connecting a personal computer with the PLC via a communication path supported by CSKP, you can transfer PLC data directly to/from an Excel worksheet.

Namely, you can perform "program-less" operation.

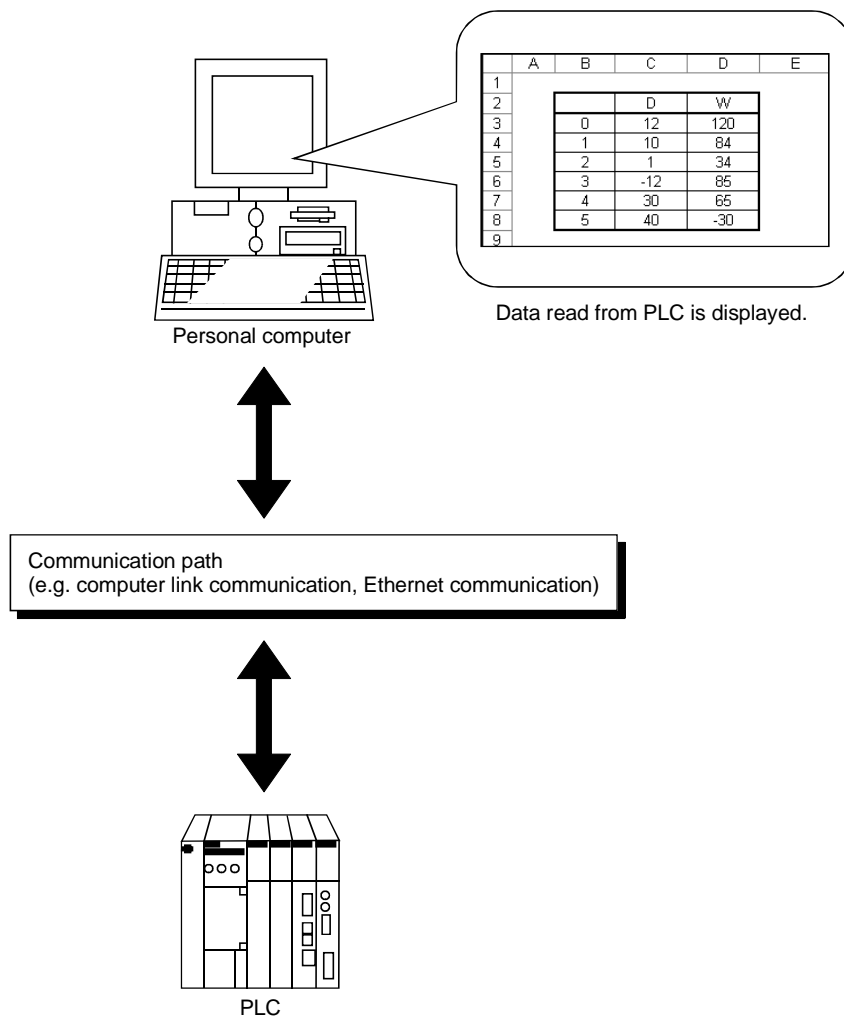

(2) Excellent operability

- Used as an add-in program in the menu, this software can be used easily by those who understand Excel.
- The production command data under control of Excel can be written unchanged from the Excel screen onto the specified devices of the PLC, without using a program.
- The operation results and quality data set to devices can be read onto an Excel worksheet, without using a program.
- The read data can be printed with the Excel function as imagined.
- For data communication timing, you can set automatic communication such as periodic communication or conditional communication.

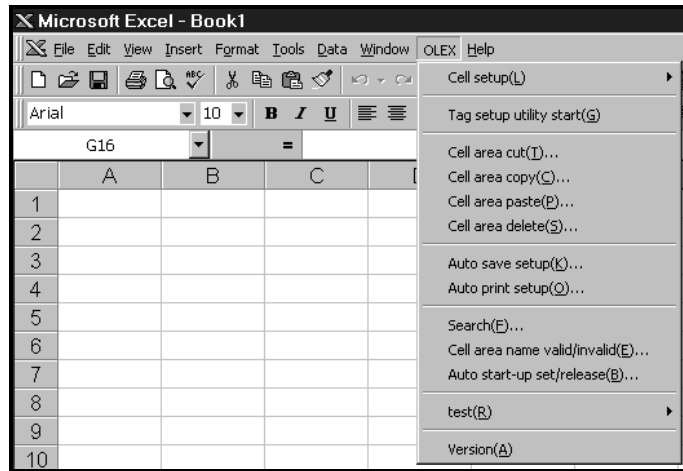

(3) Alarm summary and comment indications

An alarm message preset for error occurrence can be displayed with the date/time and a comment can be shown with the change of the corresponding device value.

<Alarm summary>

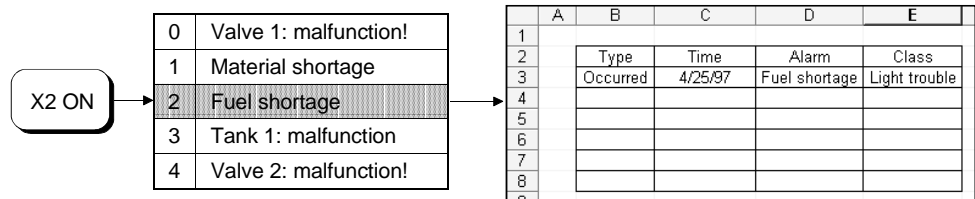

<Comment>

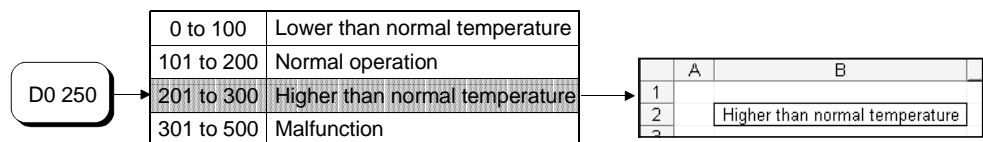

(4) Logging, automatic saving, printing

You can make a daily/monthly report easily by using the logging function which accumulates data in more than one cell per collection timing and the function of saving/printing an Excel worksheet automatically at the set time.

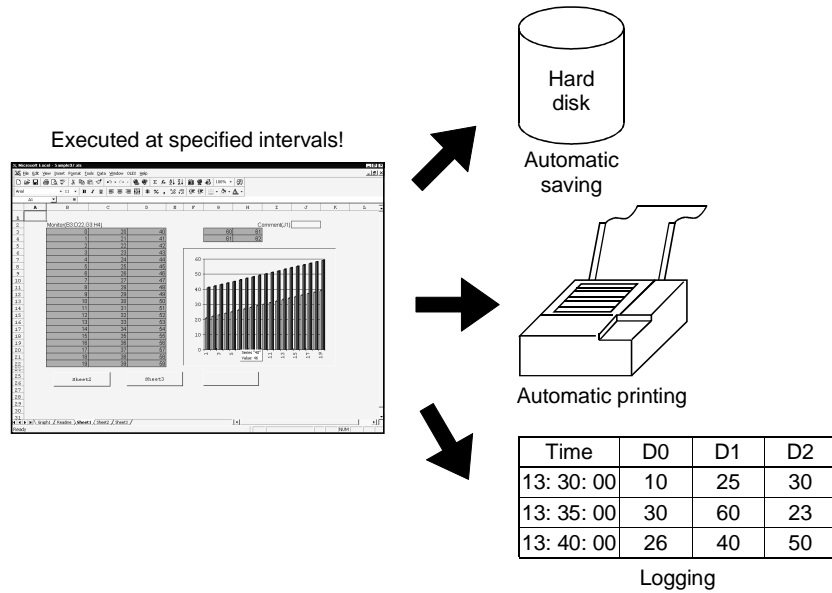

(5) Data can be transferred at any timing using the OLEX functions

By using the OLEX functions as Excel macros, you can transfer the data of the specified cell area at any timing.

<When OLEX function is set to button (Read)>

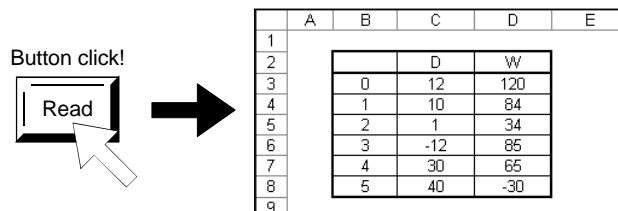

Device values are read to the cell area specified with the OLEX function.

(6) Simple communication using tags

When OLEX merely uses a tag having such information as the device types and device numbers in the environment where the Tag management process is running, you can easily access the devices set to the tag.

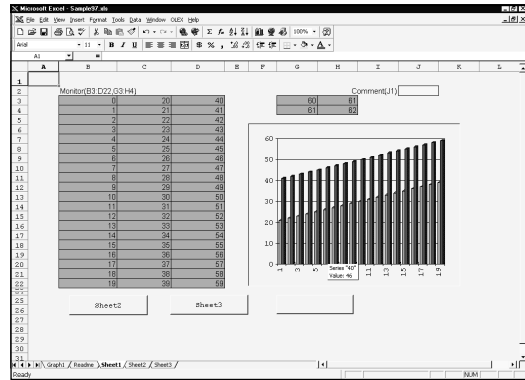

Set tags used on OLEX.

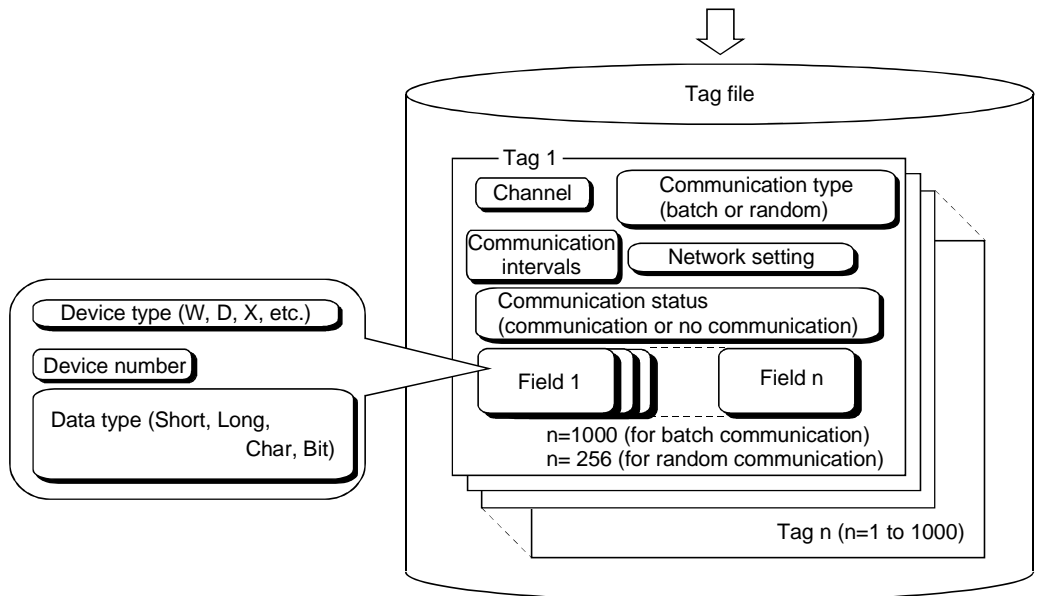

Communication path
 (e.g. computer link communication, Ethernet communication)

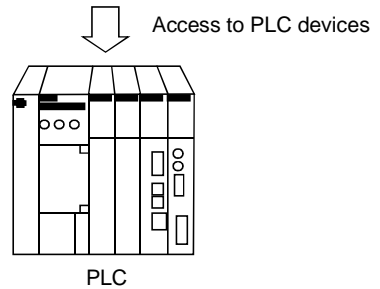

1.2 Menu List

The following is the menu list of OLEX.

Menu		Description
Cell setup	Monitor setup/revision	Used to set/correct the cell area for read/write.
	Logging setup/revision	Used to set/correct the cell area for logging.
	Alarm setup/revision	Used to set the cell area for using the alarm function.
	Comment setup/revision	Used to set the cell area for using the comment function.
Tag setup utility start		Used to start the Tag setup utility.
Cell area cut		Used to cut the cell area set with OLEX.
Cell area copy		Used to copy the cell area set with OLEX.
Cell area paste		Used to paste the cell area set with OLEX.
Cell area delete		Used to delete the cell area set with OLEX.
Auto save setup		Used to set the automatic saving of a worksheet.
Auto print setup		Used to set the automatic printing of a worksheet.
Search		Used to search a cell area.
Cell area name valid/invalid		Used to set the cell area made valid for automatic execution.
Auto start-up set/release		Used to set or release the automatic start-up of an edit file.
Test	Read test	Used to make a communication test on the set read area.
	Write test	Used to make a communication test on the set write area.
Version		Used to display the version information of OLEX.

POINT
The numbers of cell area names that can be set with OLEX are as follows. (1) Monitor setting : 1000 (2) Logging setting : 100 (3) Alarm setting : 100 (4) Comment setting : 500

1.3 Utility List

The OLEX utilities are listed below.

Utility Name	Description	Refer to
Environment setup utility	Used to set the environment when the Tag management process starts.	Section 10.1
Tag setup utility	Used to set the tag file used by the Tag management process.	Section 10.2
Comment setup utility	Used to set the comment file used for the comment function.	Section 10.3
Alarm summary setup utility	Used to set the alarm summary file used for the alarm function.	Section 10.4

1.4 About Compatibility with the Existing Software

The user programs and the Excel files for OLEX created using SW2D5F-OLEX-E can be used with SW3D5F-OLEX-E as they are.

In addition, combinations with CSKP are as follows.

	SW2D5F-OLEX-E		SW3D5F-OLEX-E
	A *1	B or later *1	
SW2D5F-CSKP-E	○	○	○
SW3D5F-CSKP-E	×	○	○

○ : Usable, × : Unusable

*1 Indicates the software version.

2. SYSTEM CONFIGURATION

This chapter deals with the system configuration, operating environment and usable CPU.

2.1 System Configuration

The system configuration for OLEX is similar to that for CSKP. Refer to the CSKP Operating Manual.

2.2 Operating Environment

The operating environment of OLEX is indicated below.

Item	Description
Operating System	Windows 95, Windows 98, Windows NT Workstation 4.0 *1
CPU	Pentium 100MHz or more (multiprocessor incompatible)
Display	Resolution 800 × 600 dots or more (recommended 1024 × 768 dots)
Required memory capacity	32MB or more
Hard disk free space	40MB or more
Disk drive	3.5 inch (1.44MB) floppy disk drive
Corresponding application	Excel 97, Excel 2000

*1 Service Pack 3 or higher is required for use of Windows NT Workstation 4.0.

2.3 Usable PLC CPU

The PLC CPU usable with OLEX is the same as those with CSKP. Refer to the CSKP Operating Manual.

3. INSTALLATION AND UNINSTALLATION

This chapter describes how to install and uninstall OLEX.

3.1 Installation

This section describes how to install OLEX.

POINTS
(1) When using SW3D5F-OLEX-E Install SW3D5F-OLEX-E after uninstalling SW2D5F-OLEX-E.
(2) When using SW3D5F-OLEX-EV Install SW3D5F-OLEX-EV with SW2D5F-OLEX-E installed. Unless SW2D5F-OLEX-E has been installed, you cannot install SW3D5F-OLEX-EV.
(3) Installation decreases the number of licenses by one.
(4) When the OS is Windows NT 4.0, log on as a user who has an administrator attribute.
(5) Start installation after removing all applications included in Startup and restarting Windows.
(6) CSKP must have been installed.
(7) Make the first floppy disk write-enabled.

1. After powering on the personal computer, start Windows.
2. Choose [Start]-[Settings]-[Control Panel].
When the control panel has opened, choose "Add/Remove Programs".

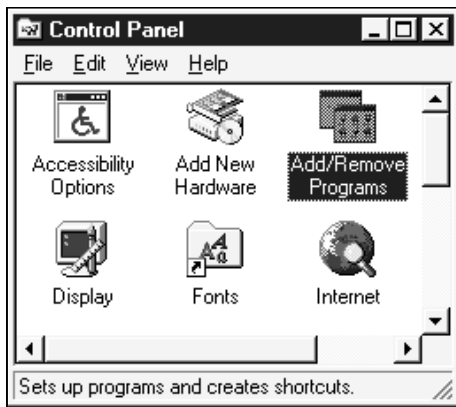

↓
(To the next page)

(From the preceding page)

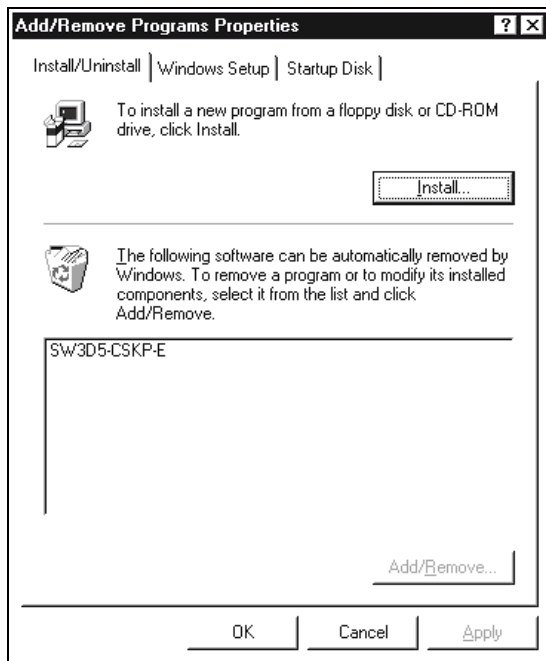

3. Click the "Install..." button.

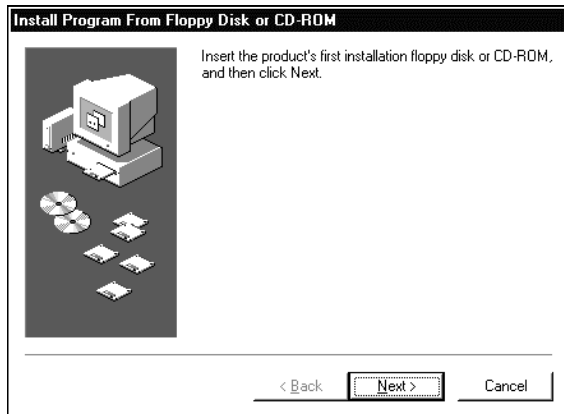

4. When the left screen has appeared, insert the first floppy disk into the FDD and click the "Next>" button.

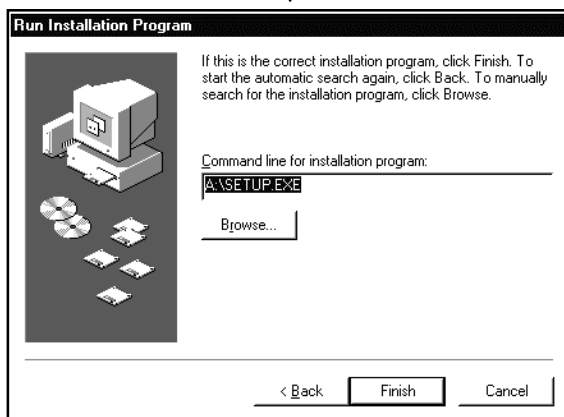

5. When the left screen has appeared, click the "Finish" button.

If "SETUP.EXE" could not be found, click the "Browse..." button to find "SETUP.EXE" in the FDD.

(To the next page)

(From the preceding page)

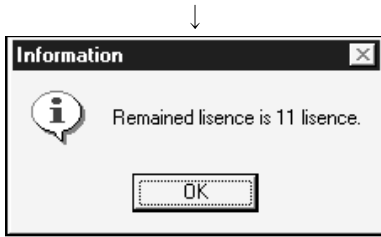

6. After a while, the screen as shown on the left will appear.
 Confirm the number of remaining licenses and click the "OK" button.
 When there is no licenses left, installation cannot be performed.
 *The actual number of licenses is the number of licenses plus a spare license.

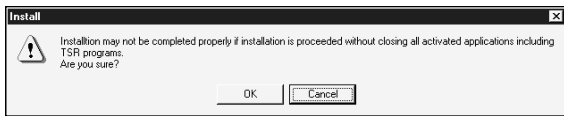

7. After making sure that all your running programs are closed, click the "OK" button.
 If your programs are running, close all running programs.

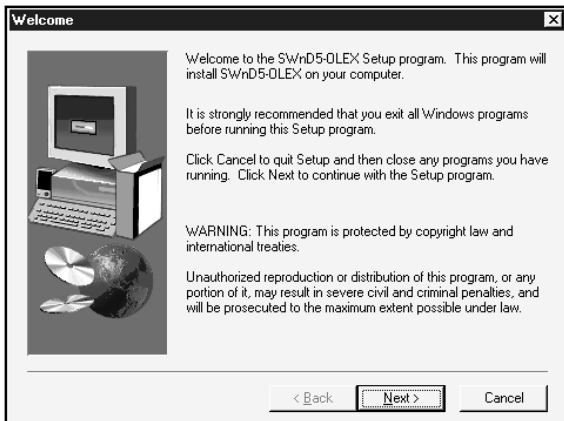

8. Confirm the instructions and click the "Next>" button.

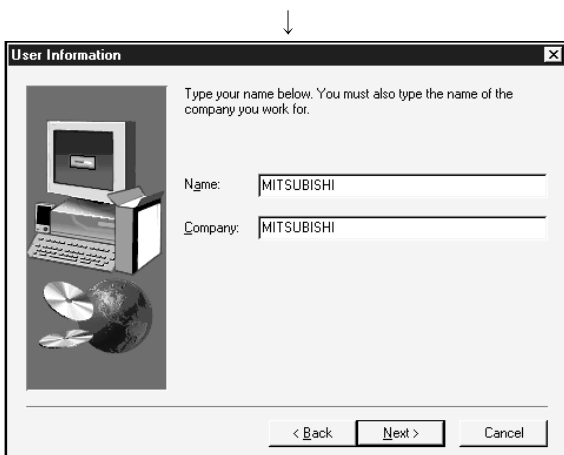

9. Type your name and company name, and click the "Next>" button.

(To the next page)

(From the preceding page)

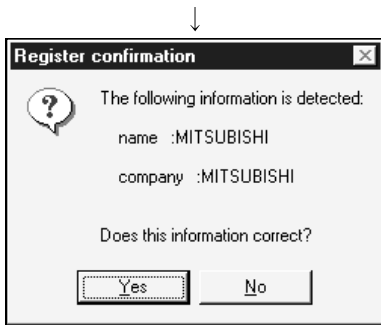

- 10. Confirm your name and company name registered. If they are correct, click the "Yes" button. To change any name, click the "No" button. This returns to the preceding screen.

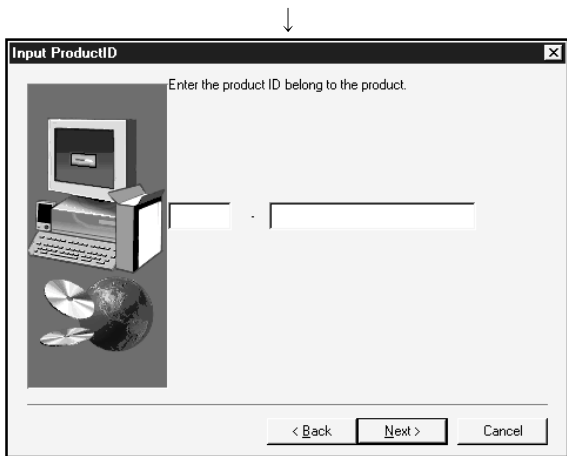

- 11. Enter the product ID and click the "Next>" button. The product ID is given in the "Software Registration Card" packed with the product.

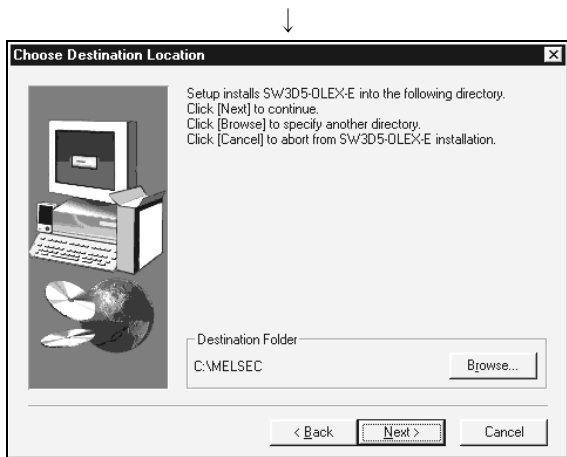

- 12. Specify the installation destination folder. The destination folder of OLEX defaults to "C:\MELSEC". To choose the default folder, click the "Next>" button. To change the destination folder, click the "Browse..." button and change the folder.

(To the next page)

(From the preceding page)

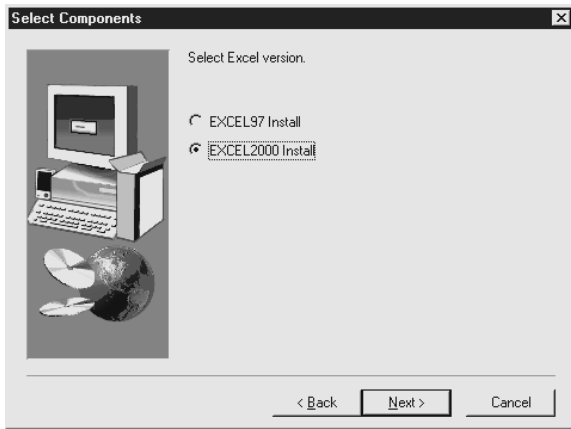

13. Excel used with OLEX is selected and the button is clicked.

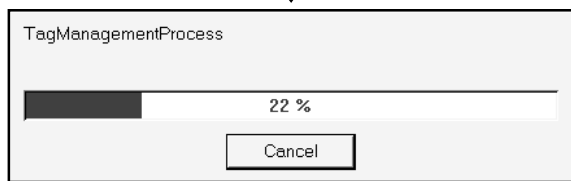

14. As installation starts, exchange the floppy disks in order according to the prompt.

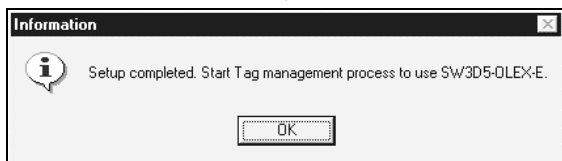

15. As the left screen appears, confirm the message, and then click the "OK" button.

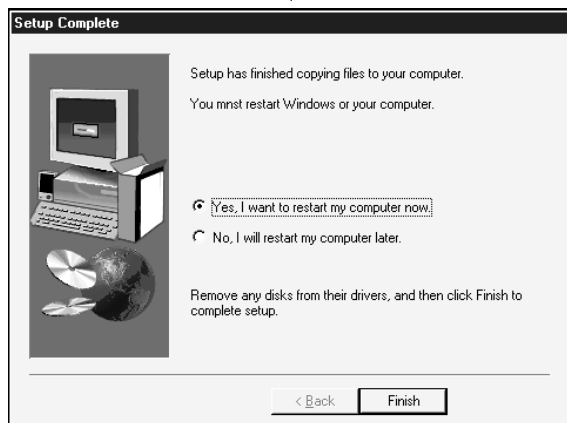

16. When the left dialog box appears, installation is complete.
 To restart, make sure that "Yes, I want to restart my computer now." is checked, and then click the "Finish" button.
 To restart later, check "No, I will restart my computer later." and then click the "Finish" button.
 * The number of licenses decreases by 1 on completion of installation.





POINT

If installation failed at any point in the above procedure and uninstallation can be performed, uninstall the program.
 The number of licenses will decrease by 1 if you do not perform uninstallation.

3.2 Icons Registered

Installing OLEX registers the following icons in [Start]-[Programs]-[MELSEC APPLICATION]-[EXCEL COMMUNICATION SUPPORT (OLEX-E)].

(1) Tag management

- (a)  Alarm summary setup utility
Used to start the Alarm summary setup utility.
- (b)  Comment setup utility
Used to start the Comment setup utility.
- (c)  Tag management process
Used to start the Tag management process.
- (d)  Tag setup utility
Used to start the Tag setup utility.
- (e)  Environment setup utility
Used to start the Environment setup utility.

(2) OLEX Help

Used to show the Help screen of OLEX.

3.3 Uninstallation

This section provides how to uninstall OLEX.

POINTS
(1) Always uninstall the program from the control panel. Do not start installed "Uninstaller.exe" directly.
(2) Uninstallation increases the number of licenses by 1. Therefore, always uninstall the program when deleting OLEX. The number of licenses will not return to the previous value if a folder or file is deleted by the user on Explorer or the like.
(3) Make the first floppy disk write-enabled.

1. Choose the [Start]-[Settings]-[Control Panel] menu.
2. As the control panel appears, double-click "Add/Remove Programs".

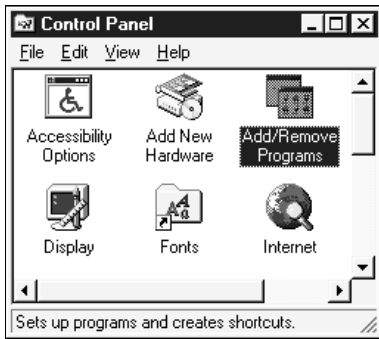

3. Choose "SW3D5-OLEX-E" and click the "Add/Remove..." button.

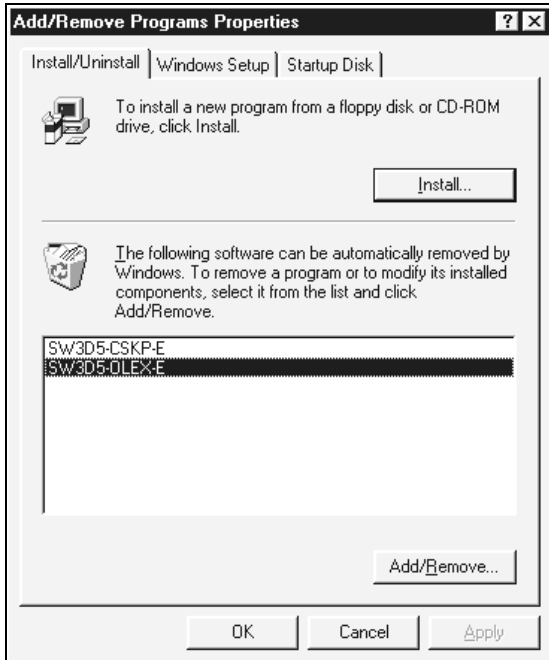

(To the next page)

(From the preceding page)



4. As the left screen appears, insert the first floppy disk into the floppy disk drive and click the "GO UNINSTALL" button.



5. Clicking the "OK" button starts uninstallation.

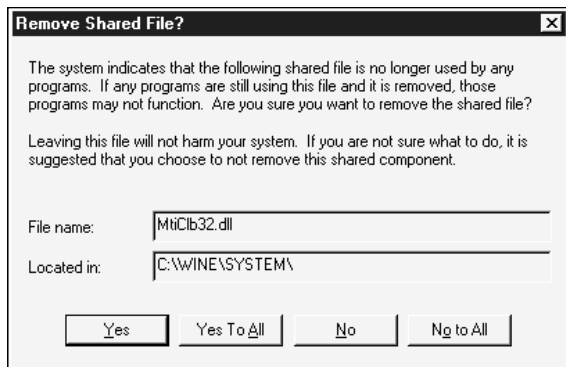

6. If the left screen has appeared, click the "No to All" button.

If you click the "Yes" or "Yes to All" button, the shared file of the MELSEC software packages is removed and the other software packages may not start properly.



7. When uninstallation is completed, click the "OK" button.

* The number of licenses increases by 1 on completion of uninstallation.

4. ADD-IN REGISTRATION

This chapter explains how to register add-ins of OLEX.
 Note that the Operating System and Excel have already been installed.

The following procedure performs add-in registration using Excel.

1. Start the Tag management process. For full information, refer to Section 10.2.2.
2. Start Excel.
3. Choose [Tools]-[Add-Ins...] on the menu bar.

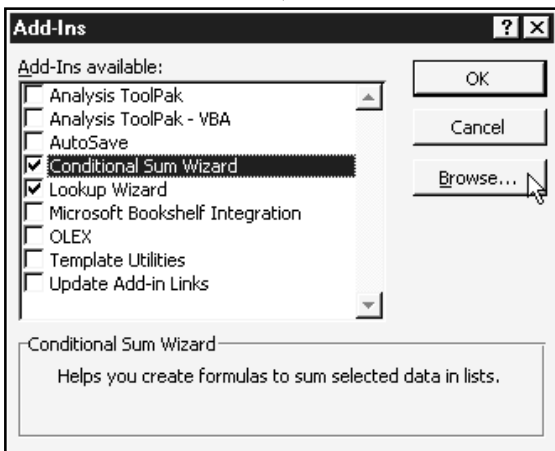
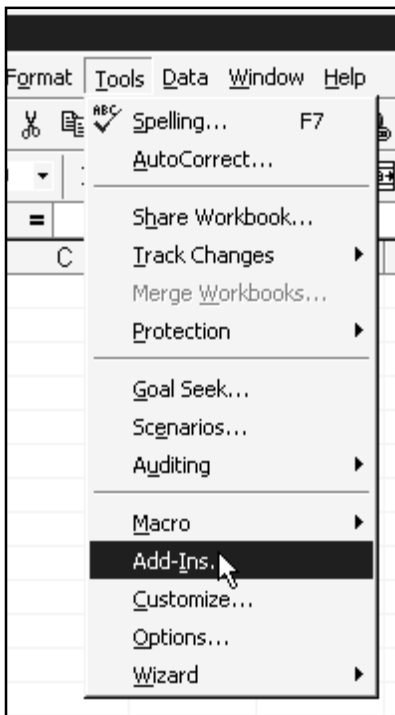

(To the next page)

(From the preceding page)

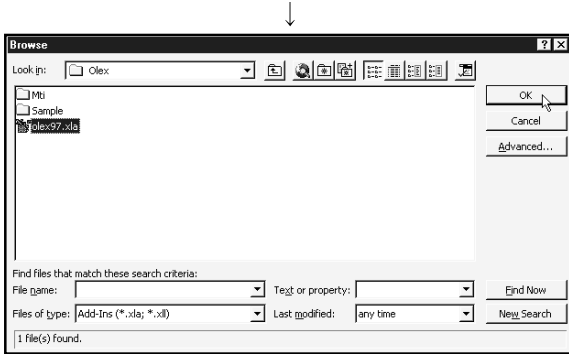

5. When using Excel 97, Choose "OLEX97.XLA" in C:\MELSEC\OLEX\ (default) and click the "OK" button. When using Excel 2000, Choose "OLEX2000.XLA" in C:\MELSEC\OLEX\ (default) and click the "OK" button.

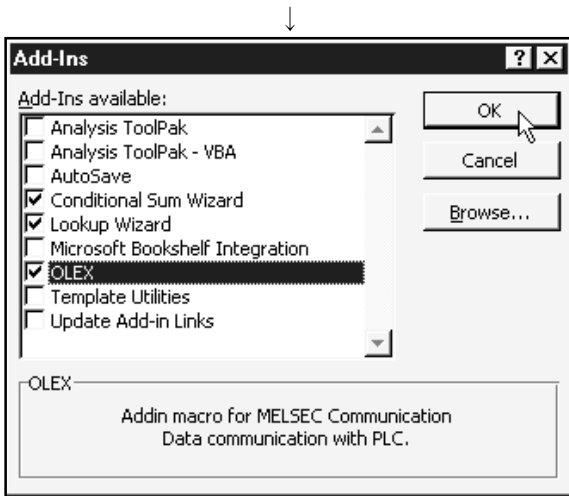

6. As the left dialog box opens, make sure that "OLEX" has been added to Add-Ins available and checked, and click the "OK" button.



7. "OLEX" is added to the menu bar.

5. FUNCTIONS OF OLEX

This chapter describes the functions of OLEX.

5.1 Monitor Function

With this function, the device data values set to a tag are displayed on an Excel sheet. Also, the Excel sheet data are written to devices according to the tag setting. When using the monitor function, making settings as in (1) and (2) displays data as in (3).

(1) Tag setup utility setting

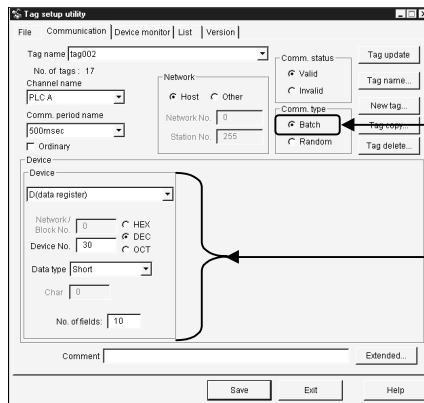

Batch is specified.
(Random may also be specified)

10 points are reserved in short (16 bits), beginning with device D30 (D30 to D39).



(2) OLEX setting

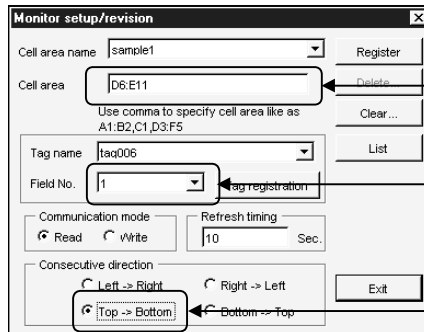

Cell area (D6 to E11)

Fields are displayed, starting with field No. 3 (D32).

Data is displayed from top to bottom.

(3) Display format

When the settings made are as shown in (1) and (2), the data of D32 to D39 on tag "tag002" are stored.

	C	D	E
5			
6		D32 value	D38 value
7		D33 value	D39 value
8		D34 value	No indication
9		D35 value	No indication
10		D36 value	No indication
11		D37 value	No indication
12			

5.2 Logging Function

With this function, the data gathered by the tag set for logging are displayed on an Excel sheet and accumulated in an Excel book.

When using the logging function, making setting as in (1) and (2) displays data as in (3).

(1) Tag setup utility setting

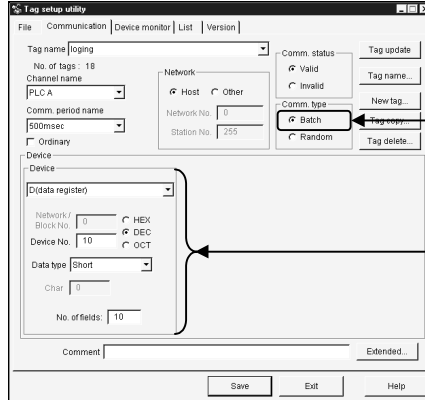

Batch is specified.
(Random may also be specified)

D10 to D19 (10 points) specified.

(2) OLEX setting

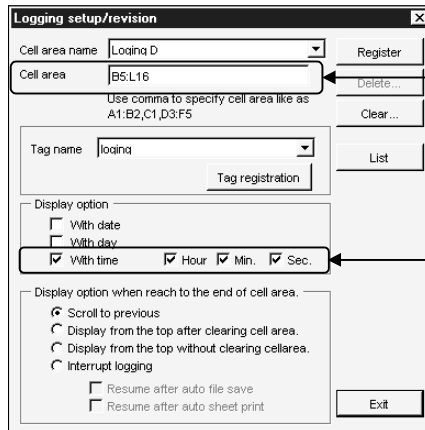

Cell area (B5 to I16)

Displayed in the left-end cell of the specified area.

(3) Display format

	A	B	C	D	E	F	G	H	I
4									
5		Time(1)	D10 value(1)	D11 value(1)	D11 value(1)	D11 value(1)	D11 value(1)	D11 value(1)	D11 value(1)
6	
7	
8	
9	
10	
11	
12	
13	
14	
15	
16		Time(12)	D10 value(12)	D11 value(12)	D11 value(12)	D11 value(12)	D11 value(12)	D11 value(12)	D11 value(12)

Older

Newer

Time appears.

As the cell area is smaller than the number of fields, up to the fields acceptable on the screen (D10 to D16) appear. D17 to D19 are not displayed.

POINT
This function logs the data of all fields specified in the tag. However, there are the following restrictions.
(1) If the number of cells is less than the number of fields, only the fields corresponding to the cells are displayed.
(2) If the number of fields is less than the number of cells, only the specified fields are displayed and no fields appear in the extra cells.

5.3 Alarm Function

With this function, the alarm messages registered beforehand in the alarm summary file are displayed on an Excel sheet to create a failure history or the like when the bit devices set to the tag turn on.

When using the alarm function, making setting as in (1) to (3) displays data as in (4). The alarm function shows alarm comments when the corresponding bit devices turn on.

(1) Tag setup utility setting

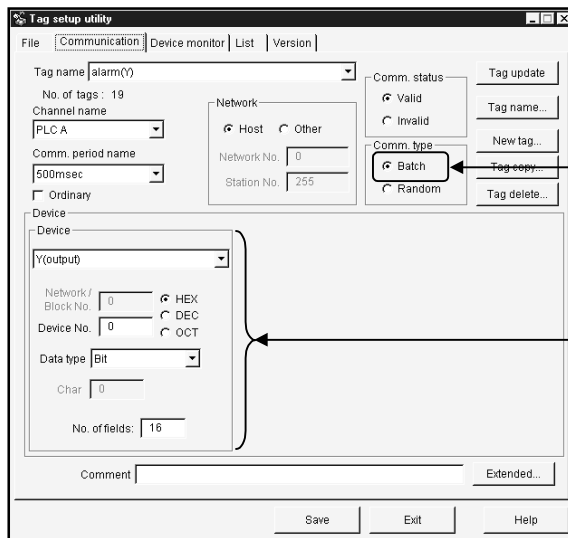

Batch is specified.
(Random may also be specified)

Y0 to Y15 specified.

POINTS

- (1) The devices specified must be bit devices.
- (2) Make setting so that the number of alarm comments is equal to or greater than the number of devices.

(2) Alarm summary setup utility setting

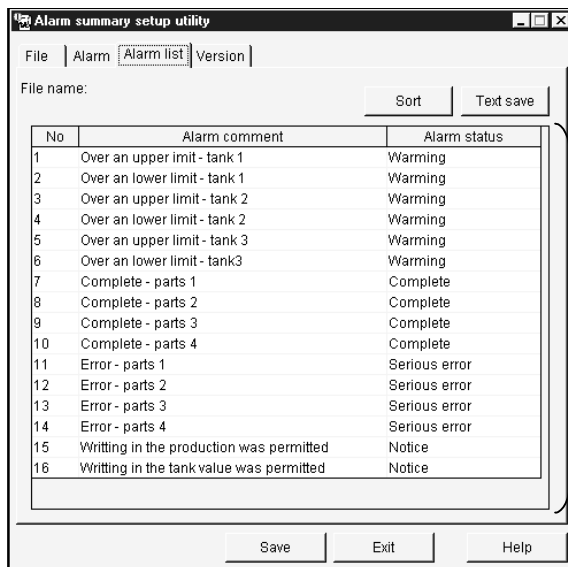

Corresponding to Y0 to Y15

When the corresponding bit turns on, the alarm comment appears.

Example: When Y0 turns on, "Over an upper limit - tank 1" appears.

POINT

The color setting made in the Alarm summary setup utility is invalid for OLEX.

(3) OLEX setting

(4) Display format

When the corresponding bit turns on, the alarm comment appears in the cell. The type shown is "Occurred" when the bit turns on, or "Restored" when the bit turns off.

	A	B	C	D	E
2					
3		Type(1)	Time(1)	Alarm message(1)	Class(1)
4	
5	
6	
7	
8	
9	
10	
11	
12	
13		Type(11)	Time(11)	Alarm message(11)	Class(11)

Newer

↑

↓

Older

5.4 Comment Function

With this function, a comment registered in advance to a comment file is displayed on an Excel sheet according to the device data value set to a tag.

When using the comment function, making setting as in (1) to (3) displays data as in (4).

The comment function checks the data value of a single field to show the comment.

(1) Tag setup utility setting

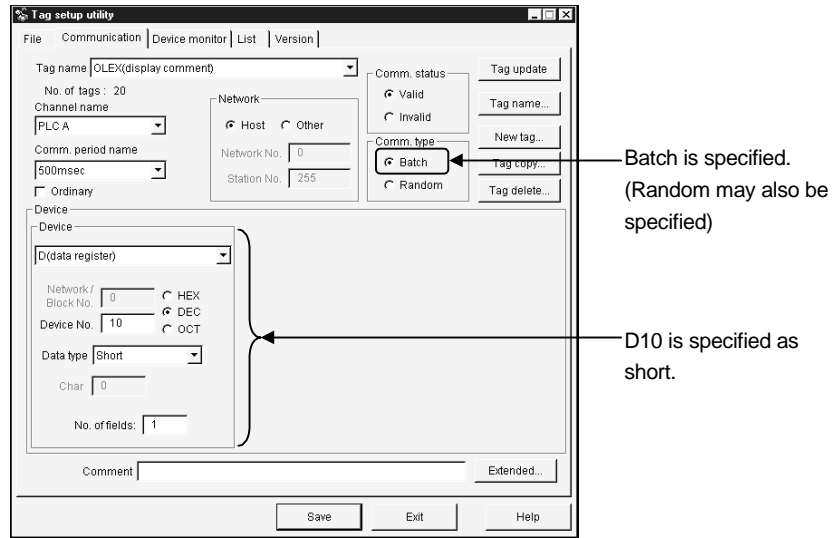

POINT
 Three device types are usable: Short, Long and Bit.

(2) Comment setup utility setting

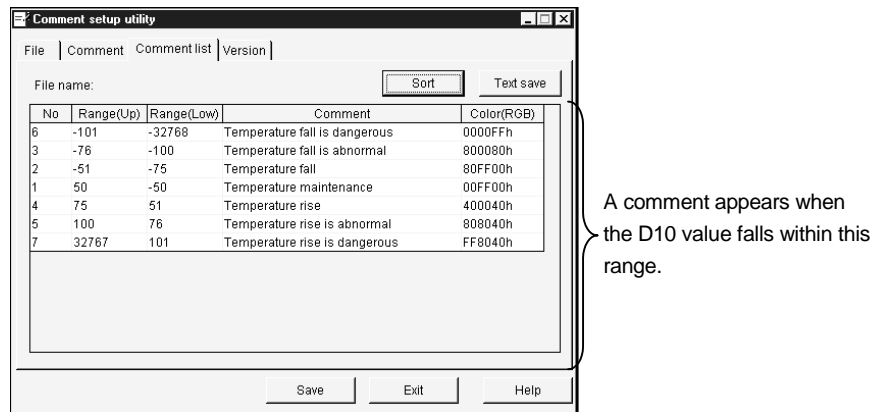

When the specified device falls within the range set to the Comment setup utility, the corresponding comment is displayed.

Example: When D10 has changed to 50, "Temperature maintenance" appears.

POINT
 The color setting made in the Comment setup utility is invalid for OLEX.

(3) OLEX setting

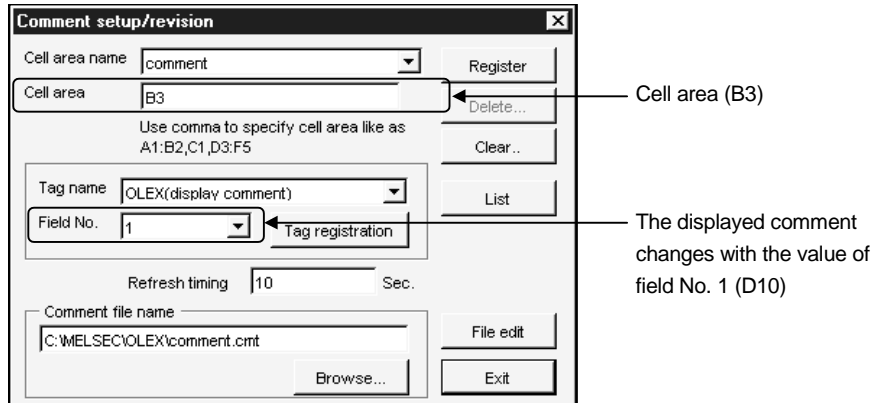

(4) Display format

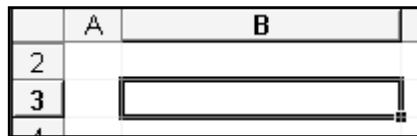

The comment is displayed according to the change of the specified device value.

5.5 OLEX Functions

By providing a function with the preset cell area name (cell area name of monitor setting or logging setting) as an argument using the setting function of OLEX, data can be read to the corresponding cell area or the data in the corresponding cell area can be written.

Refer to Chapter 12 for full information.

POINTS
<p>(1) The cell areas where data can be transferred with the OLEX functions are only the cell areas specified in the monitor setting and logging setting. Data cannot be transferred to/from the cell areas specified in the comment setting and alarm setting.</p> <p>(2) When OLEX is automatically executed in Ethernet communication, the read/write function cannot be executed.</p>

6. OPERATING PROCEDURES

This chapter deals with the operating procedures of OLEX.

6.1 Common Operating Procedure

The following flowchart provides a common operation procedure performed before using any function of OLEX.

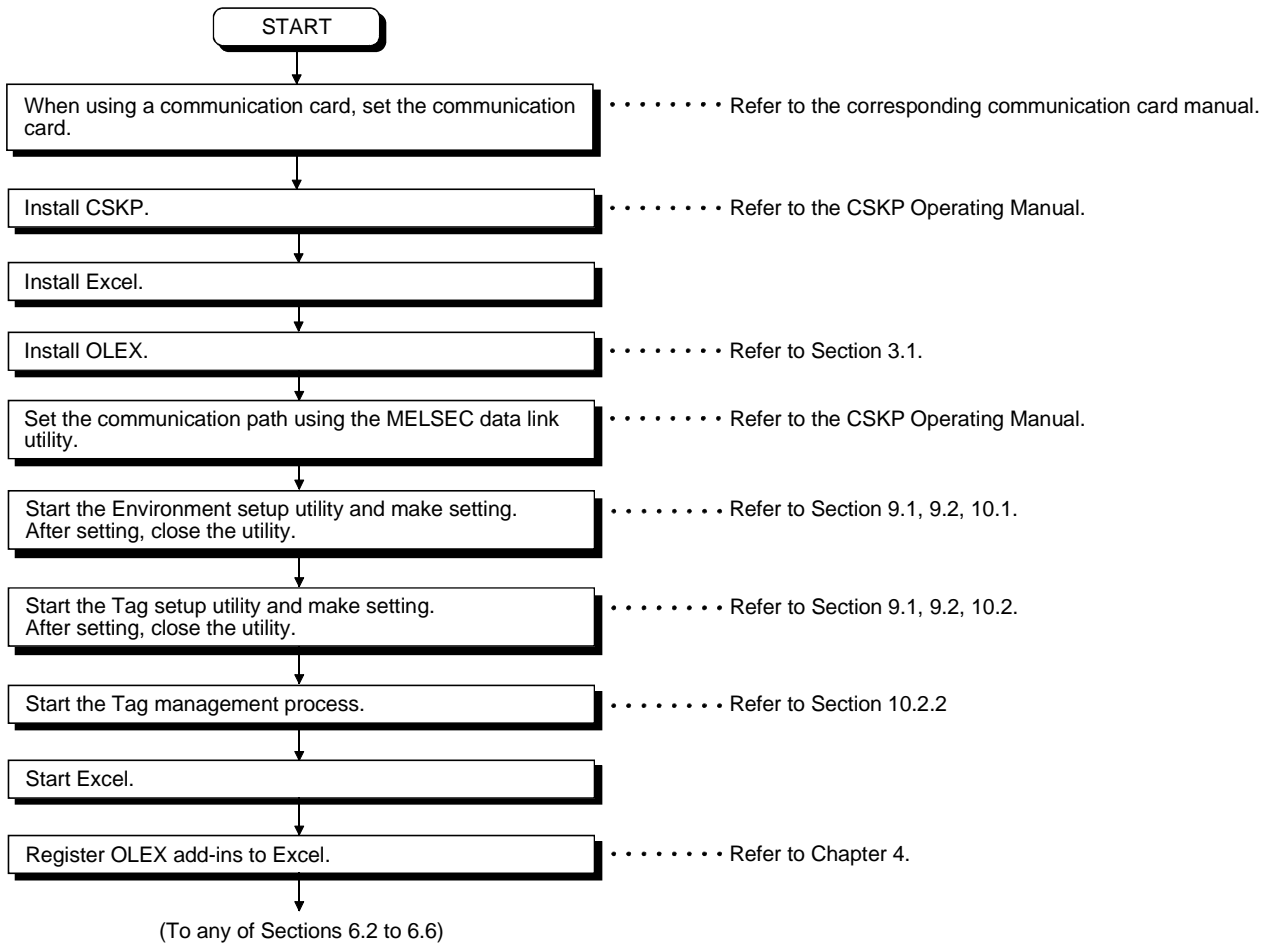

6.2 Using the Monitor Function

The following flowchart gives an operating procedure performed when using the monitor function.

Please read Section 6.1 before reading this section.

(From Section 6.1)

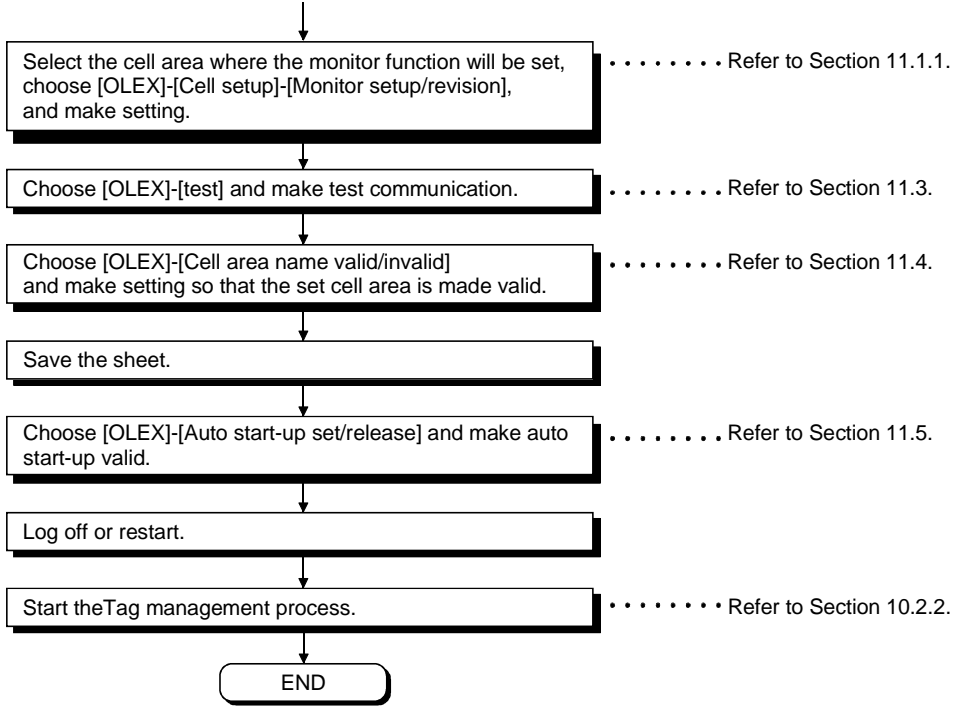

6.3 Using the Logging Function

The following flowchart gives an operating procedure performed when using the logging function.

Please read Section 6.1 before reading this section.

(From Section 6.1)

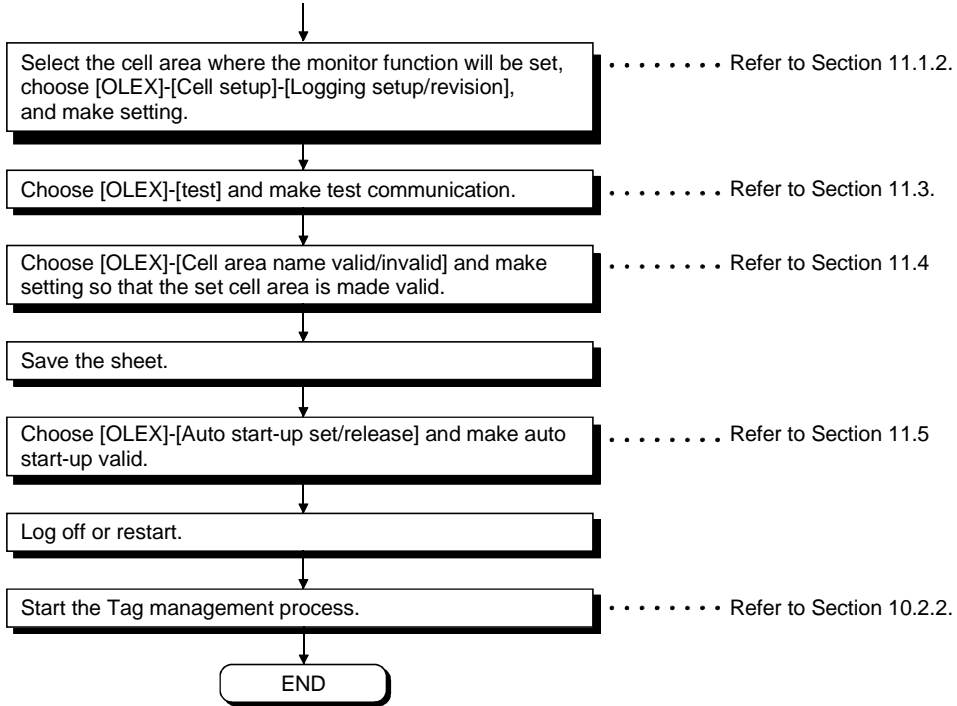

POINTS
(1) When performing the logging function, create a tag as a log-specified tag dedicated to logging.
(2) Set the tag collection intervals to 1 second or longer.

6.4 Using the Alarm Function

The following flowchart gives an operating procedure performed when using the alarm function.

Please read Section 6.1 before reading this section.

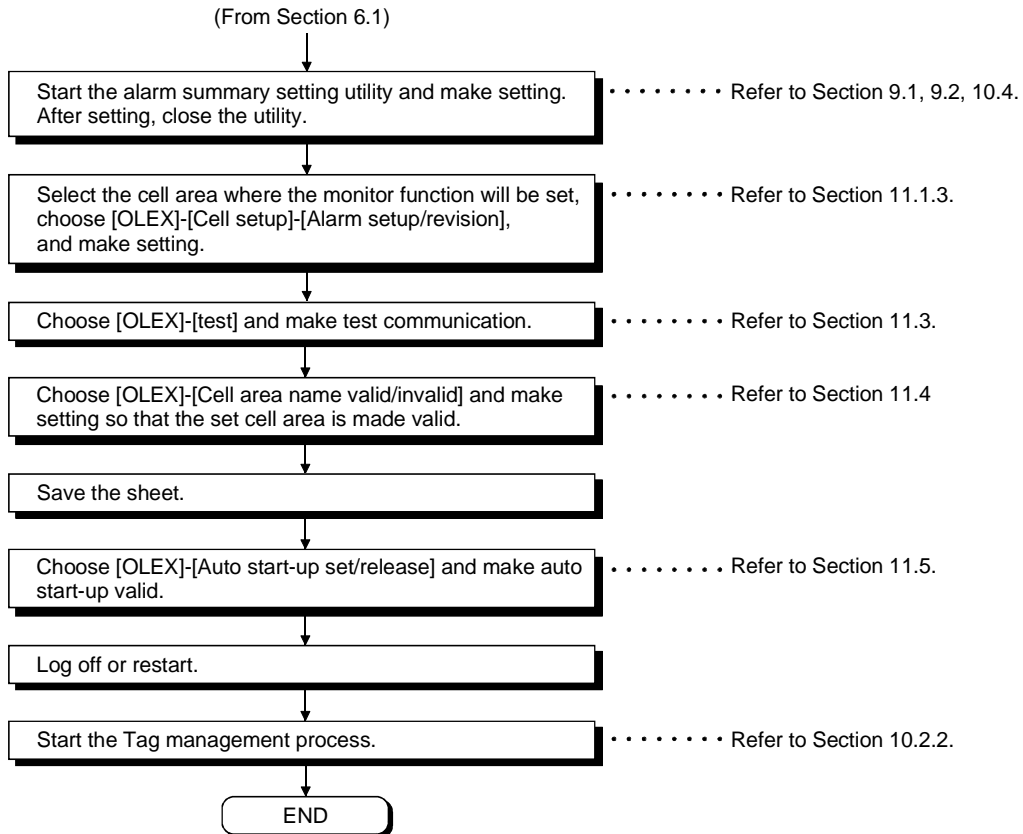

POINT	<p>Setting of the cell area requires cells in four or more columns. Similarly, setting of two or more consecutive areas requires cells in four or more columns.</p>
--------------	---

6.5 Using the Comment Function

The following flowchart gives an operating procedure performed when using the comment function.

Please read Section 6.1 before reading this section.

(From Section 6.1)

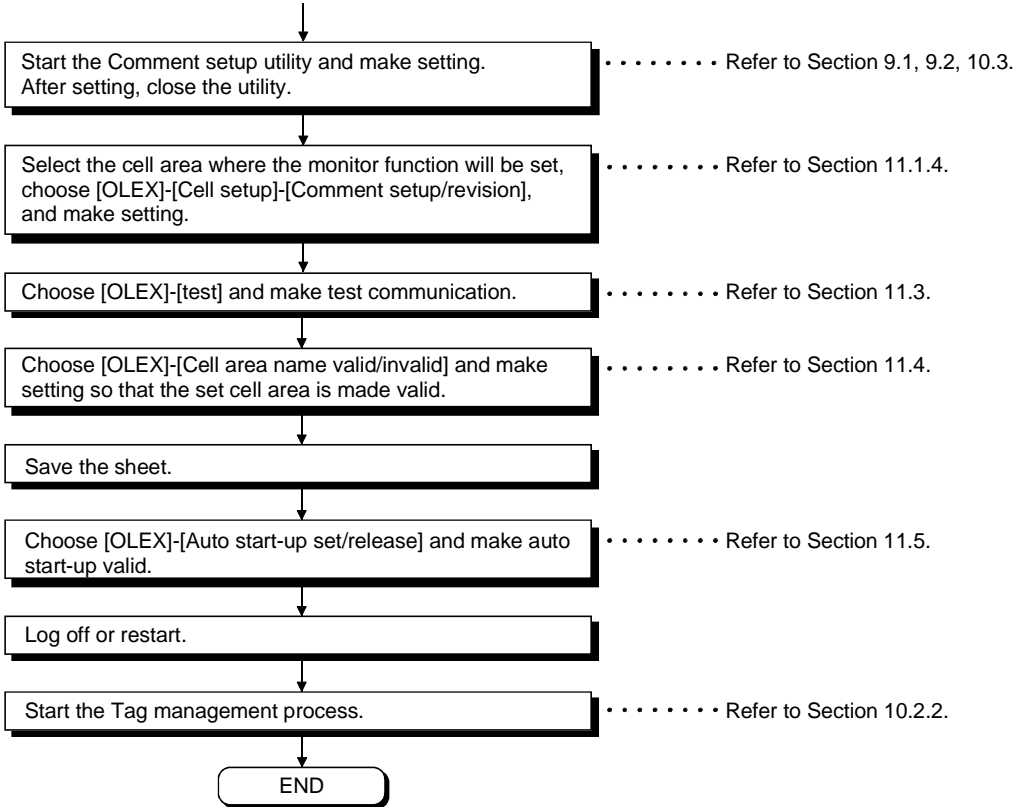

POINT
Set only one cell.

6.6 Using the OLEX Functions

The following flowchart gives an operating procedure performed when using the OLEX functions.

Please read Section 6.1 before reading this section.

(From Section 6.1)

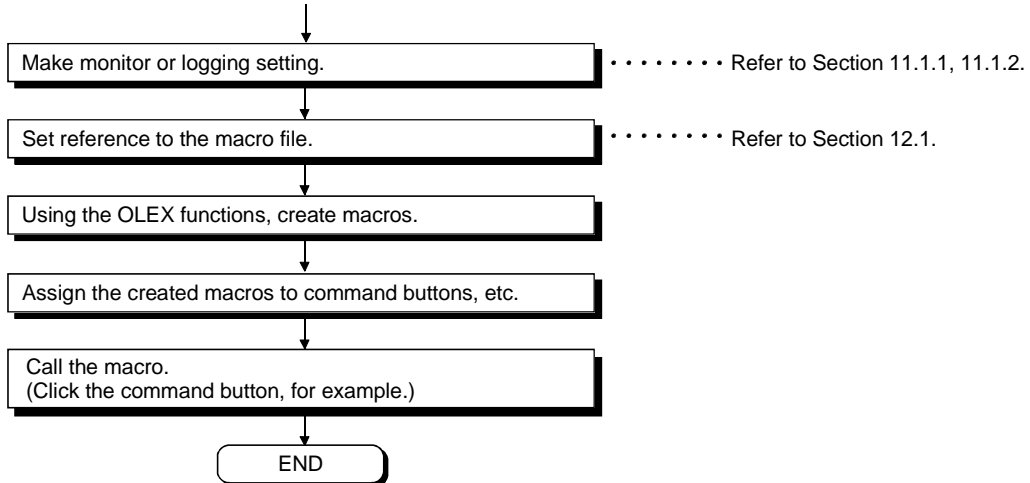

7. CREATING A TAG FILE

This chapter explains how to create a tag file which is utilized when using OLEX.

7.1 Getting Information on "Tag"

A tag is a data table which contains a set of information necessary for communication with the PLC CPU, e.g. communication setting, devices and data types.

By specifying a tag, OLEX can access devices defined in the tag.

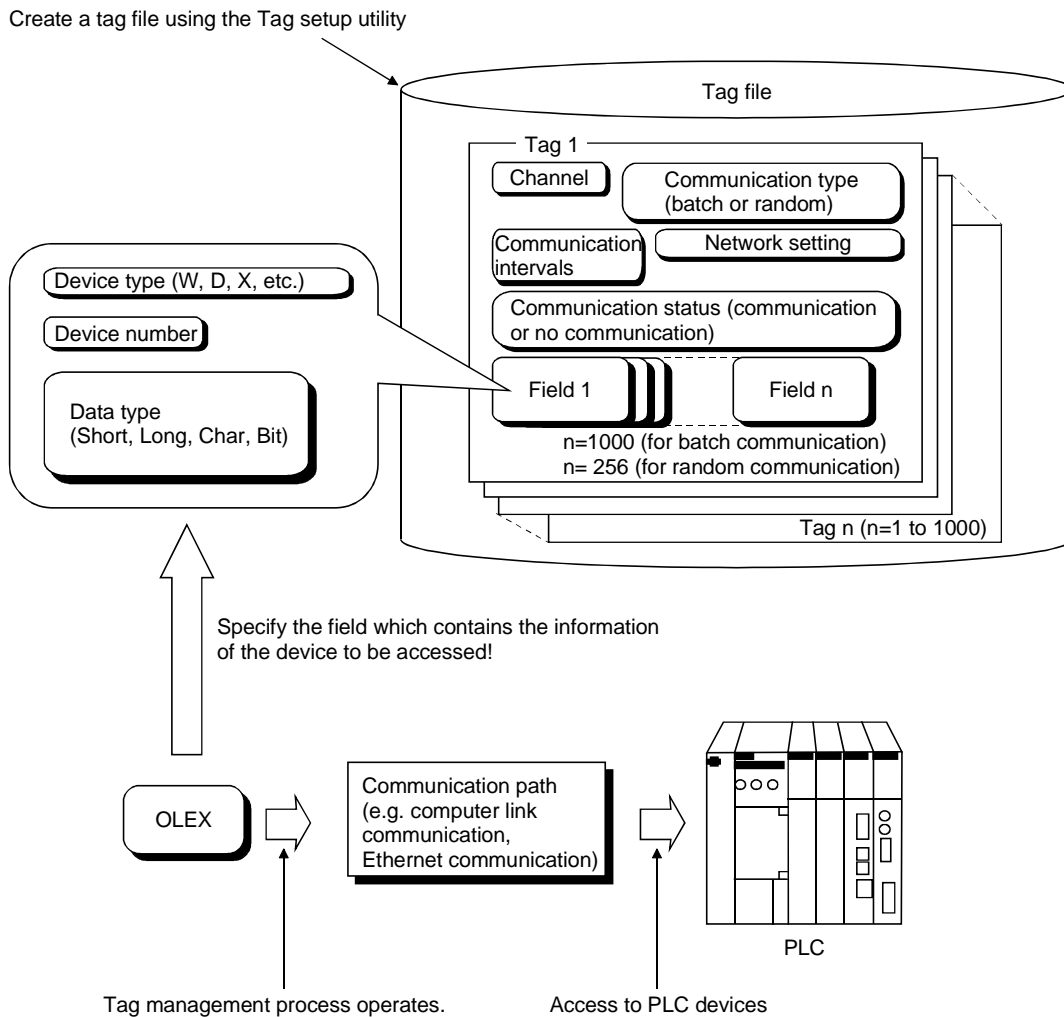

POINT	When using a tag, the Tag management process must be running. For full information, refer to Section 10.2.2.
--------------	--

7.2 What Should Be Done First

This section describes the operation to be performed first when creating a tag file. Please read this section before creating the tag of any communication path.

1. Set the corresponding utility according to the communication form used (e.g. computer link, Ethernet).
2. Start the Environment setup utility.
(Refer to Section 9.1.)
3. Open the "File" screen and set the tag file name used. When creating a new tag file, create a new tag within the "Tag setup utility" in advance. (Refer to Section 7.3)
4. Open the "Communication" screen and set channel names (aliases) to the communication channels used. The channel names set here are reflected on the Tag setup utility.
5. Open the "Comm. interval" screen and set communication interval names (aliases) to the communication intervals. The communication interval names set here are reflected on the Tag setup utility.
6. Save the data and close the Environment setup utility.
(Refer to Section 9.2 and 9.3.)

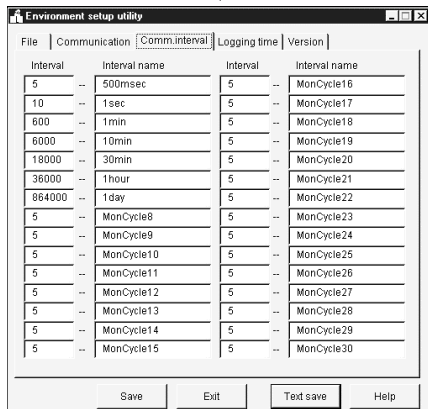
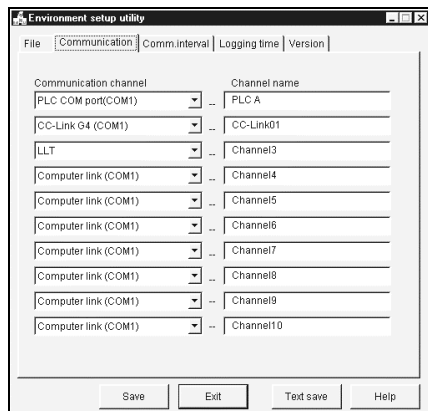
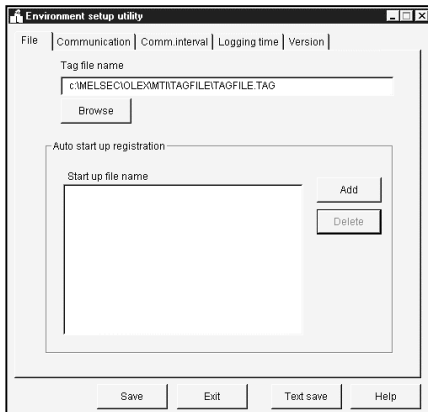

(To Section 7.3)

7.3 Creating a Tag File

This section gives how to create a tag file when collecting the device information of the PLC CPU connected via a computer link module.

Please read Section 7.2 before making setting in this section.

Tag file name : C:\MELSEC\USER\SAMPLE2.TAG
 Specified devices : tag001 ... D0 to D15 (Short) (for 16 points)
 tag002 ... M100 (Bit), D200 (Long)
 Logical station number : 0 (set on the computer link utility)

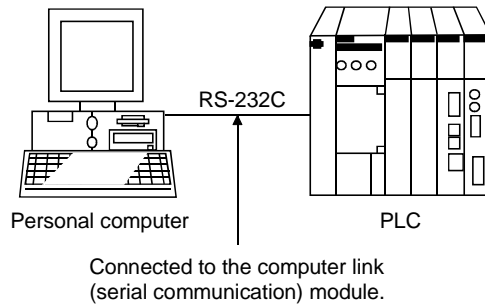

- (1) Start the Tag setup utility.
(Refer to Section 9.1.)
- (2) Open the "File" screen and specify the tag file name to be set.
If you had created no tag files, click the "New" button and create a tag file.

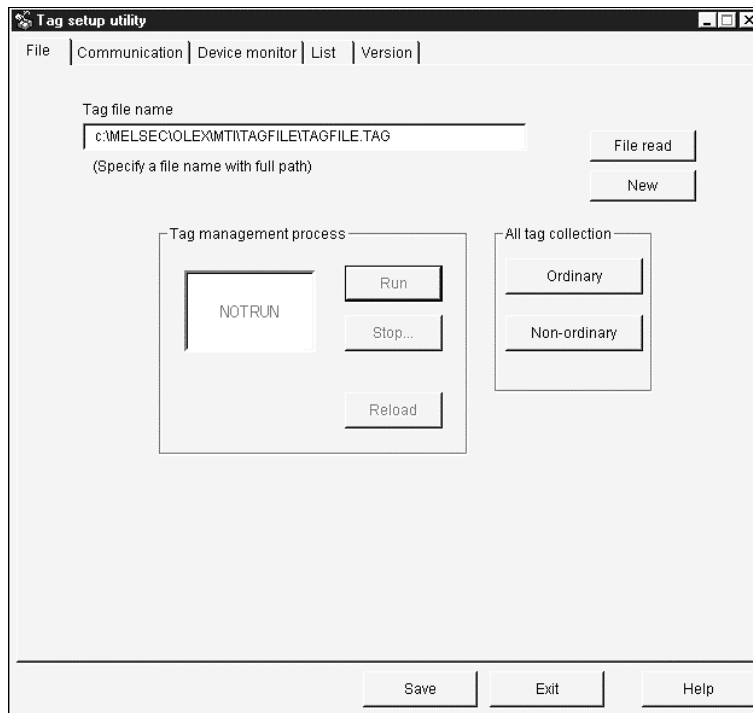

- (3) Open the "Communication" screen, make setting as shown on the screen below, and click the "Tag update" button.
(Set D0 to D15.)

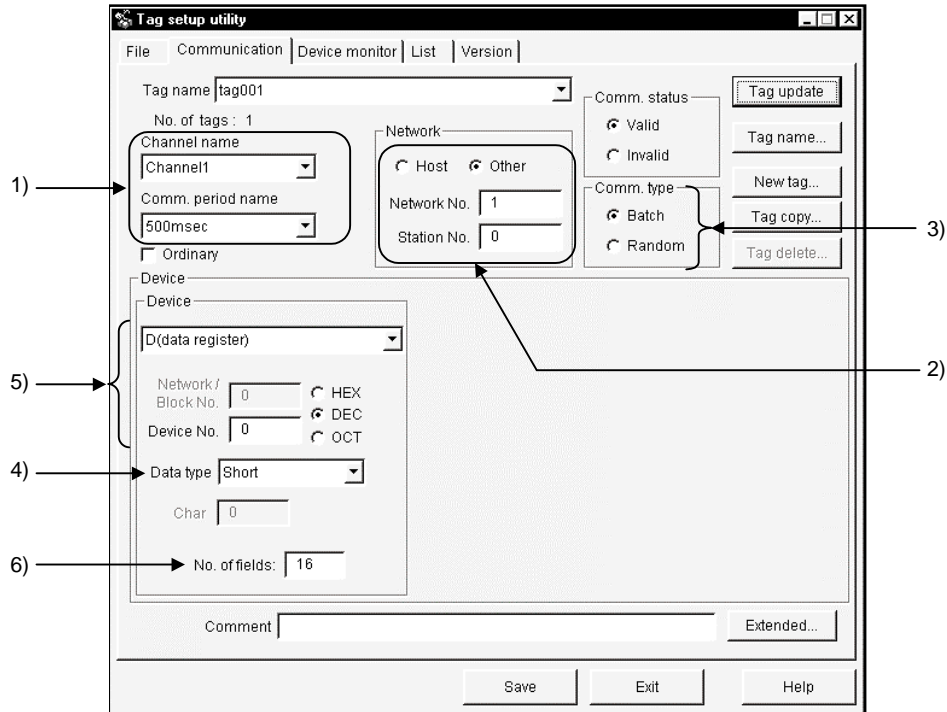

- 1) The data set on the Environment setup utility are reflected here.
Set the channel of the communication form used.
Here, set the channel name of the computer link communication.
- 2) Set the Network No. and Station No..
Here, set the logical station number in the Sta. No. box.
- 3) Since only D devices are set, specify Batch here.
When setting two or more devices, specify Random.
- 4) Set Short.
- 5) Set D0 in decimal.
When specifying bit devices, set a multiple of 8 (a multiple of 16 for Ethernet communication).
- 6) Set 16 points.
When specifying bit devices, set a multiple of 16.

- (4) Click the "New tag..." button and create a new tag.
Here, tag002 is created.



- (5) Make setting as shown on the screen below and click the "Field update" button.
(Set M100.)

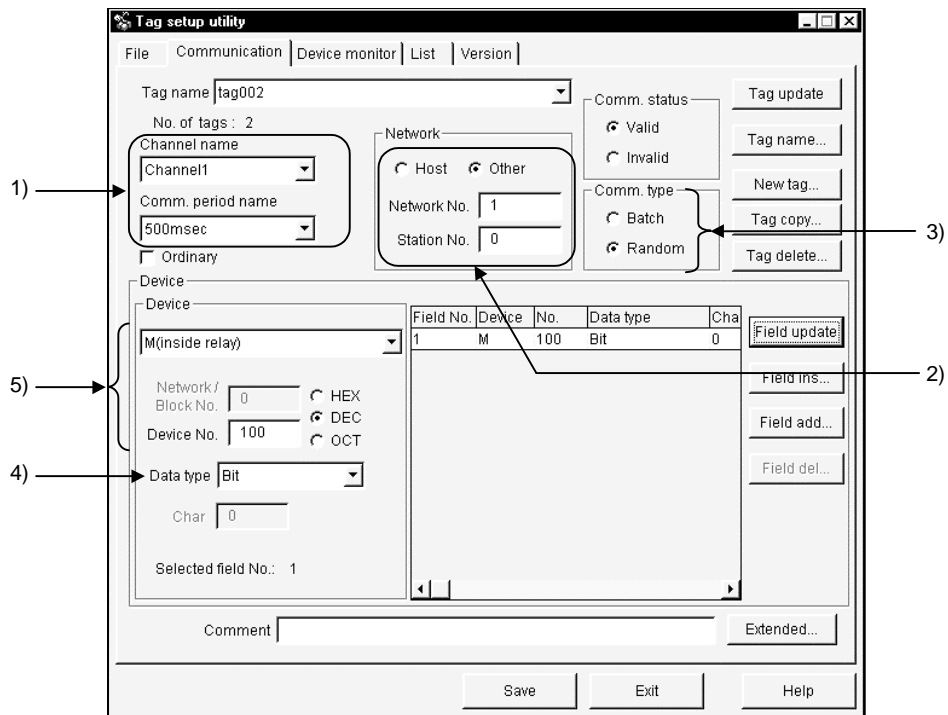

- 1) The data set on the Environment setup utility is reflected here.
Here, set the channel name of the computer link communication.
- 2) Set the logical station number in the Station No. box.
Ignore the network number as it is not used.
- 3) Since two devices, M100 and D200, are specified, set Random.
- 4) Set Bit.
- 5) Set M100 in decimal.

(6) Click the "Field add..." button.

(7) Make setting as shown on the screen below and click the "Field update" button.
(Set D200.)

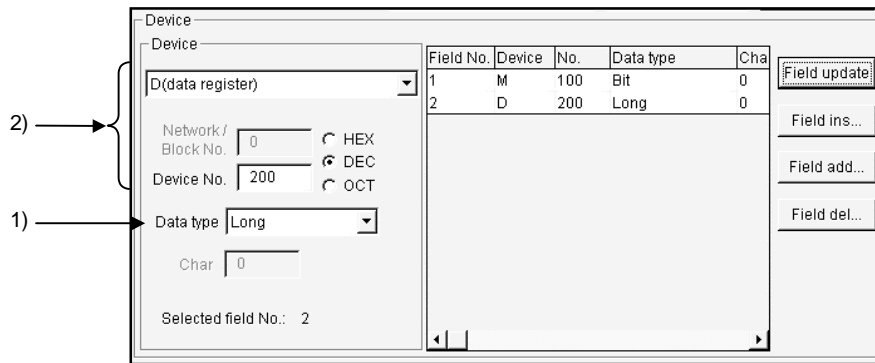

1) Set Long.

2) Set D200 in decimal.

(8) Click the "Tag update" button.

(9) After clicking the "Save" button, click the "Exit" button to close the Tag setup utility.

8. USING OLEX

This chapter provides the procedure of actually accessing the PLC CPU using OLEX.

POINT	
After cell setting, do not delete the sheet or change the sheet name. If you change it, we cannot guarantee the data.	

8.1 Monitoring the Device States

Perform the following procedure to actually monitor device states using OLEX.

(Example)

- Devices to be monitored : D100 to D109 (Short)
- Fields used : 1 to 10 (D100 to D109)
- Cell settings : Device states will be displayed as shown below.

	A	B	C
4			
5		D100 value	D105 value
6		D101 value	D106 value
7		D102 value	D107 value
8		D103 value	D108 value
9		D104 value	D109 value
10			

- (1) Create a tag.
Refer to Chapter 7 and Section 10.2 and create a tag.
Specifying "Ordinary" in the tag setting on the Tag setup utility enables fast data collection.
- (2) Start the Tag management process.
Refer to Section 10.2.2 and start the Tag management process.
- (3) Start Excel.
- (4) Set the cell area to be monitored.
Set the cell area (B5 to C9) you will monitor.

	A	B	C
4			
5			
6			
7			
8			
9			
10			

(5) Set the cell area name and set the communication mode, consecutive direction, etc.

(a) Choose [OLEX]-[Cell setup]-[Monitor setup/revision] in the menu and enter the cell area name.

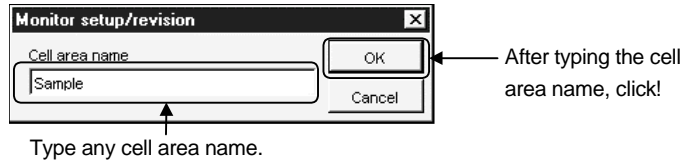

(b) Set the tag name, field No., communication mode and consecutive direction, and click the "Register" button.

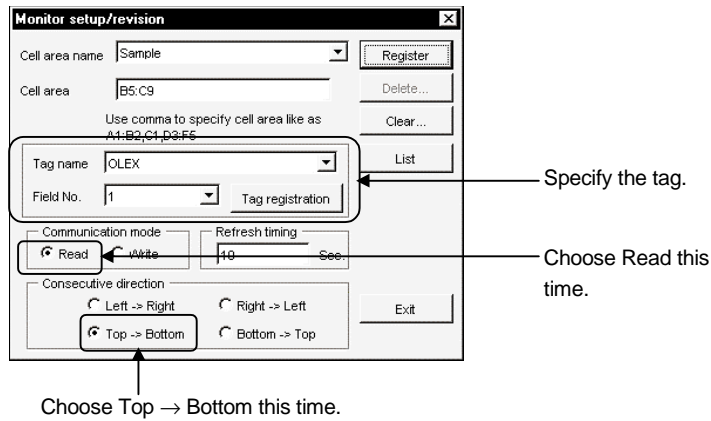

(6) Conduct a test.

Choose [OLEX]-[test]-[Read test] in the menu, set the cell area name to be tested, and click the "Execute" button.

At this time, make sure that the values of D100 to D109 are monitored correctly in the set area.

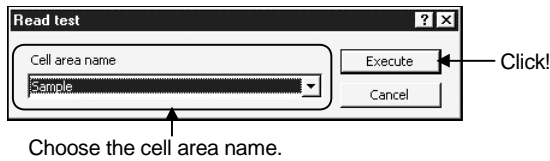

(7) Make setting to monitor device states in the set cell area.

Choose [OLEX]-[Cell area name valid/invalid] in the menu and make setting to make the set cell area valid.

(Defaults to a checked (valid) status.)

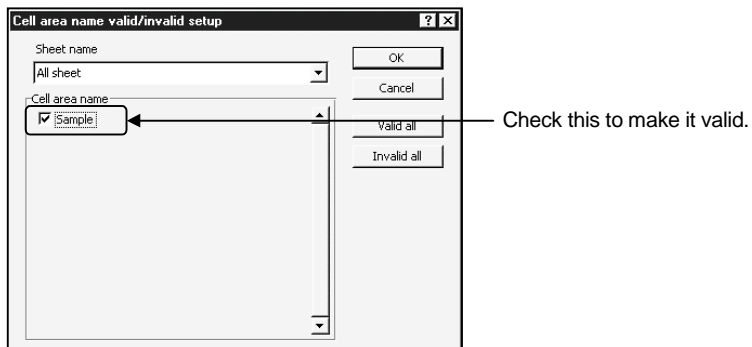

(8) Save the sheet.

Save the set sheet.

(9) Make setting to start monitoring.

(a) Choose [OLEX]-[Auto start-up set/release] in the menu.

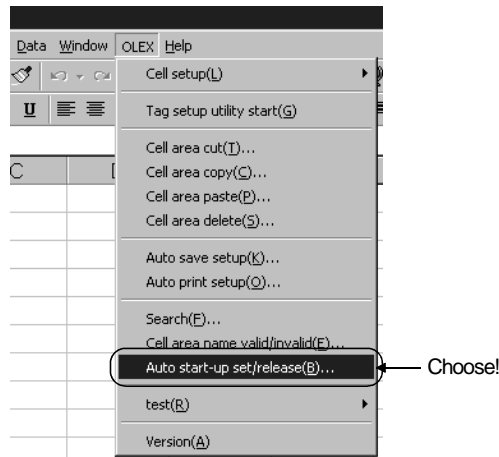

(b) As the following dialog box appears, click the "OK" button.

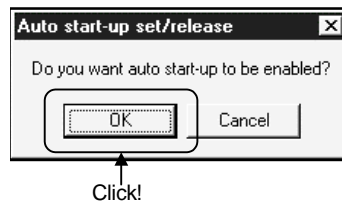

(c) As the following dialog box appears, select the file for which monitor setting has been made, and click the "Open" button.

(Here, select the file saved last.)



(d) As the following dialog box appears, click the "OK" button and then log off or restart.

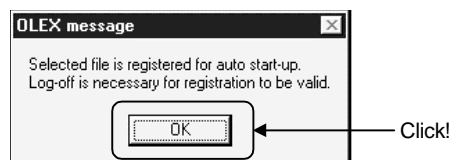

(e) After completion of logon or restart, starting the Tag management process starts Excel automatically, opens the file for which automatic start-up setting has been made, and starts execution.

8.2 Logging the Device Values

Perform the following procedure to actually log device values using OLEX.

(Example)

Devices to be logged : D100 to D104 (Short)

Cell settings : Device states will be displayed as shown below.

	A	B	C	D	E	F	G
4							
5		Date	D100 value	D101 value	D102 value	D103 value	D104 value
6							
7							
8							
9							
10							
11							
12							
13							
14							
15							

(1) Create a tag.

Refer to Chapter 7 and Section 10.2 and create a tag.

Specifying "Ordinary" in the tag setting on the Tag setup utility enables fast data collection.

POINT
The tag used must be the one for which the communication intervals have been set to 1 second or longer and Logging (Extended) has been made.

(2) Start the Tag management process.

Refer to Section 10.2.2 and start the Tag management process.

(3) Start Excel.

(4) Set the cell area to be logged.

Set the cell area (B5 to G14) you will log.

	A	B	C	D	E	F	G
4							
5							
6							
7							
8							
9							
10							
11							
12							
13							
14							
15							

(5) Set the cell area name and set the communication mode, consecutive direction, etc.

(a) Choose [OLEX]-[Cell setup]-[Logging setup/revision] in the menu and enter the cell area name.

Logging setup/revision [X]

Cell area name

Sample2

OK
Cancel

→ Type any cell area name.

→ After typing the cell area name, click!

(b) Set the tag name, the display option, and the display method used when the last part of the cell area is reached, and click the "Register" button.

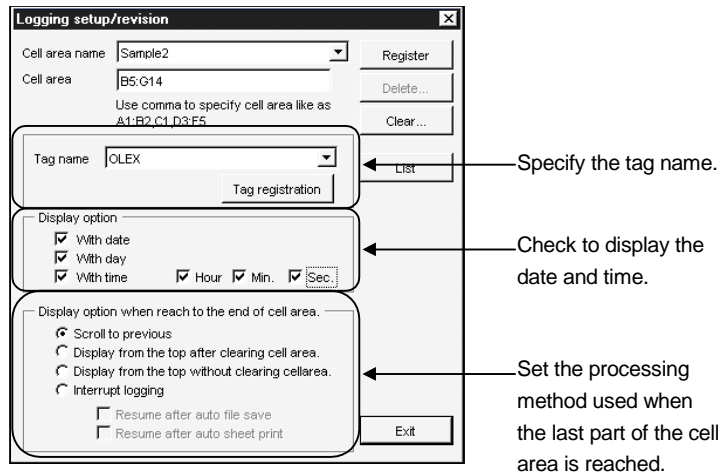

(6) Conduct a test.

Choose [OLEX]-[test]-[Read test] in the menu, set the cell area name to be tested, and click the "Execute" button.

At this time, make sure that the date/time when the logging test was made and the values of D100 to D104 are logged correctly on the top line of the set area.

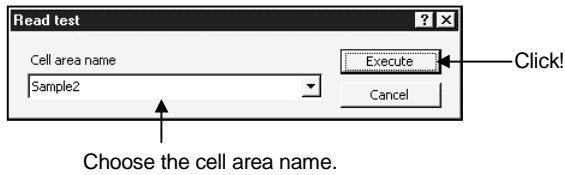

(7) Make setting to monitor device states in the set cell area.

Choose [OLEX]-[Cell area name valid/invalid] in the menu and make setting to make the set cell area valid.

(Defaults to a checked (valid) status.)

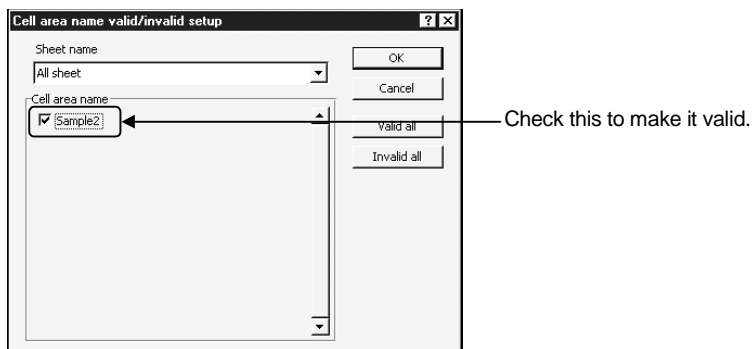

(8) Save the sheet.

Save the set sheet.

(9) Make setting to start logging.

(a) Choose [OLEX]-[Auto start-up set/release] in the menu.

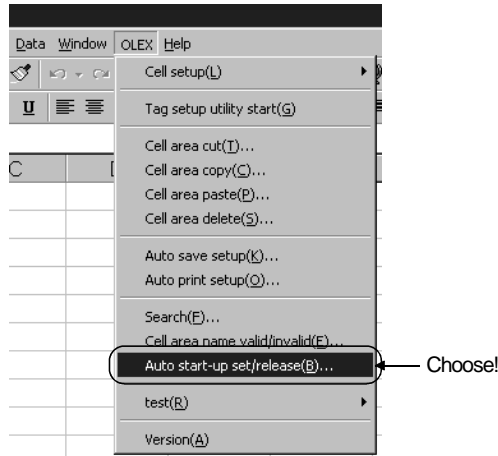

(b) As the following dialog box appears, click the "OK" button.

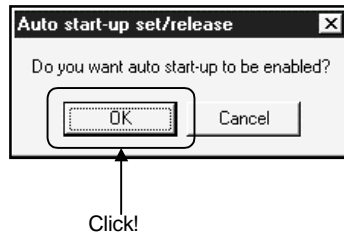

(c) As the following dialog box appears, select the file for which logging setting has been made, and click the "Open" button.

(Here, select the file saved last.)



(d) As the following dialog box appears, click the "OK" button and then log off or restart.

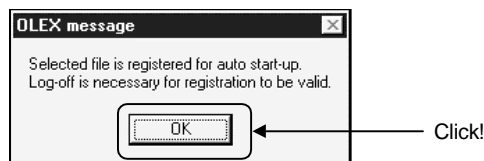

(e) After completion of logon or restart, starting the Tag management process starts Excel automatically, opens the file for which automatic start-up setting has been made, and starts execution.

8.3 Displaying the Alarm Summary Comments

Perform the following procedure to actually use the alarm summary function on OLEX.

(Example)

Bit devices to be used : Y0 to Y8

Cell settings : Alarm comments will be displayed in the following area.

	B	C	D	E	F
3					
4		Type (12)	Time (12)	Alarm message (12)	Class (12)
5	
6	
7	
8	
9	
10	
11	
12	
13	
14		Type (2)	Time (2)	Alarm message (2)	Class (2)
15		Type (1)	Time (1)	Alarm message (1)	Class (1)

- (1) Create a tag.
 Refer to Chapter 7 and Section 10.2 and create a tag.
 Always create a tag where bit devices are set.
 Specifying "Ordinary" in the tag setting on the Tag setup utility enables fast data collection.
- (2) Create an Alarm summary file.
 Create an Alarm summary file using the Alarm summary setup utility.
 Always set a larger number of alarm comments than the number of bit devices specified in the tag.
 Refer to Section 10.4 for the utility operations.
- (3) Start the Tag management process.
 Refer to Section 10.2.2 and start the Tag management process.
- (4) Start Excel.
- (5) Set the cell area where alarm comments will be displayed.
 Set the cell area (C4 to F15) you will display alarm comments.

	B	C	D	E	F
3					
4					
5					
6					
7					
8					
9					
10					
11					
12					
13					
14					
15					
16					

(6) Set the cell area name and set the communication mode, consecutive direction, etc.

(a) Choose [OLEX]-[Cell setup]-[Alarm setup/revision] in the menu and enter the cell area name.

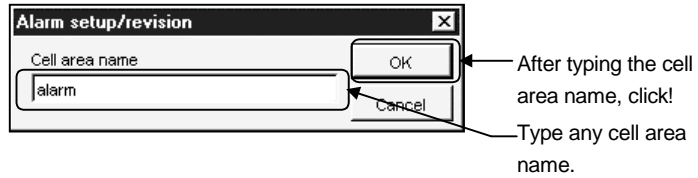

(b) Set the Tag name, Field No. and Alarm summary file, and click the "Register" button.

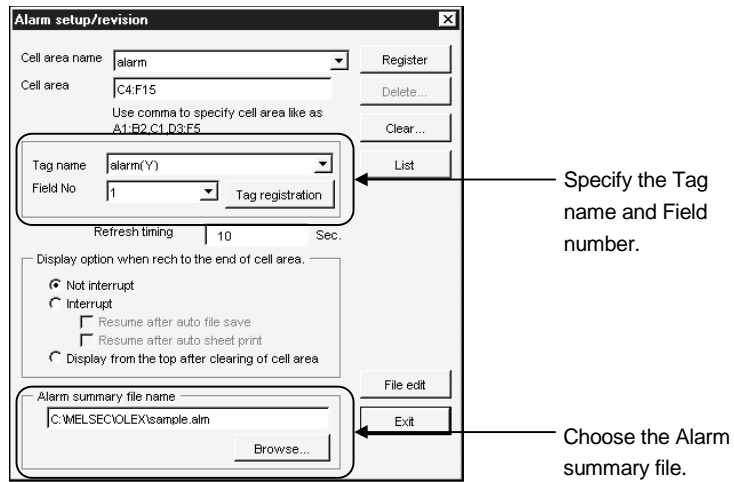

(7) Make setting to display alarm comments in the set cell area.

Choose [OLEX]-[Cell area name valid/invalid] in the menu and make setting to make the set cell area valid.

(Defaults to a checked (valid) status.)



(8) Save the sheet.

Save the set sheet.

(9) Make setting to start alarm comment display.

(a) Choose [OLEX]-[Auto start-up set/release] in the menu.

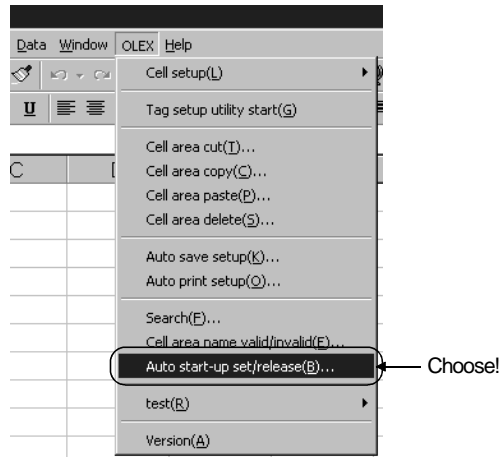

(b) As the following dialog box appears, click the "OK" button.

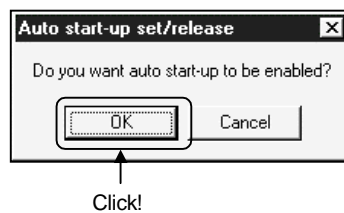

(c) As the following dialog box appears, select the file for which alarm setting has been made, and click the "Open" button.

(Here, select the file saved last.)

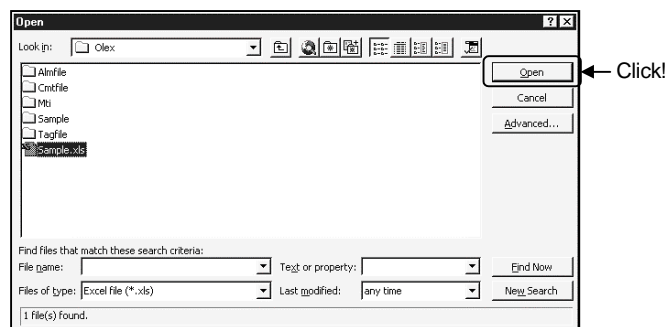

(d) As the following dialog box appears, click the "OK" button and then log off or restart.

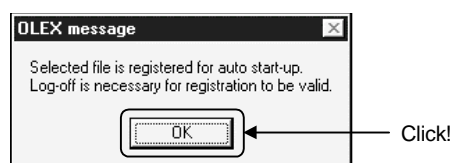

(e) After completion of logon or restart, starting the Tag management process starts Excel automatically, opens the file for which automatic start-up setting has been made, and starts execution.

8.4 Displaying the Comment

Perform the following procedure to actually use the comment function on OLEX.

(Example)

Device to be used : D10
 Cell settings : A comment will be displayed in the following area.
 Set only one cell.

	A	B
1		
2		
3		
4		

- (1) Create a tag.
 Refer to Chapter 7 and Section 10.2 and create a tag.
 Specifying "Ordinary" in the tag setting on the Tag setup utility enables fast data collection.
- (2) Create a comment file.
 Refer to Section 10.3 and create a comment file.
- (3) Start the Tag management process.
 Refer to Section 10.2.2 and start the Tag management process.
- (4) Start Excel.
- (5) Set the cell area where a comment will be displayed.
 Set the cell area (B2) you will display a comment.

	A	B
1		
2		
3		
4		

- (6) Set the cell area name and set the communication mode, consecutive direction, etc.
 - (a) Choose [OLEX]-[Cell setup]-[Comment setup/revision] in the menu and enter the cell area name.

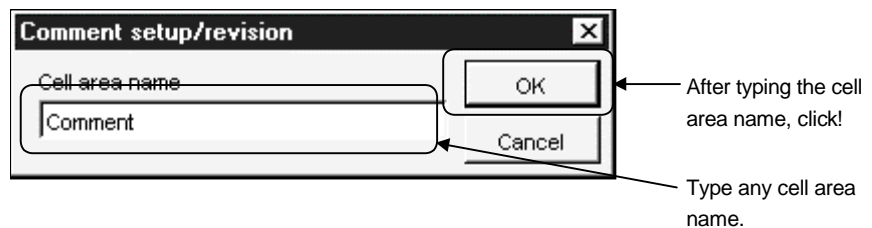

(b) Set the Tag name, Field No. and Comment file, and click the "Register" button.

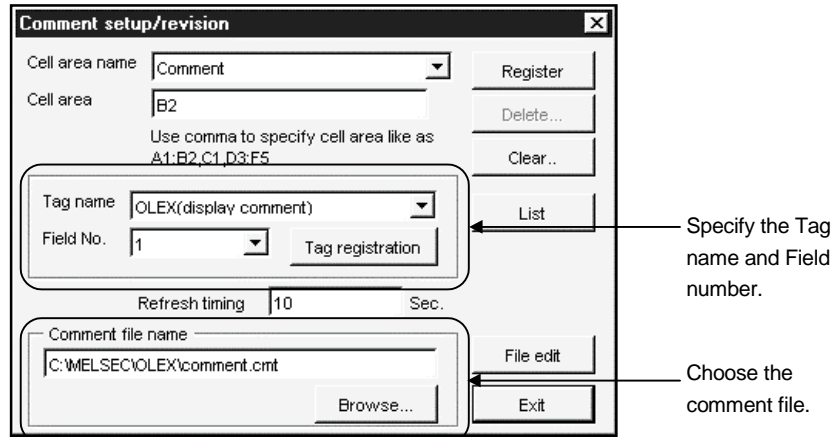

(7) Make setting to display a comment in the set cell area.
 Choose [OLEX]-[Cell area name valid/invalid] in the menu and make setting to make the set cell area valid.
 (Defaults to a checked (valid) status.)

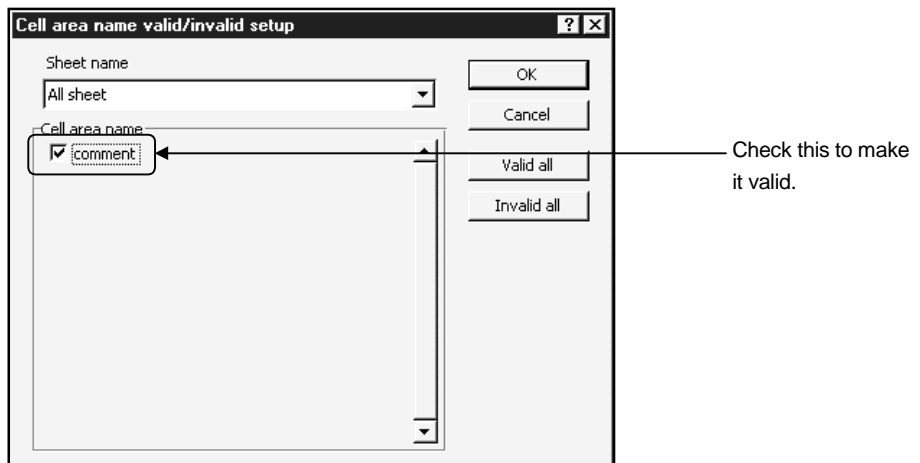

(8) Save the sheet.
 Save the set sheet.

(9) Make setting to display a comment.
 (a) Choose [OLEX]-[Auto start-up set/release] in the menu.

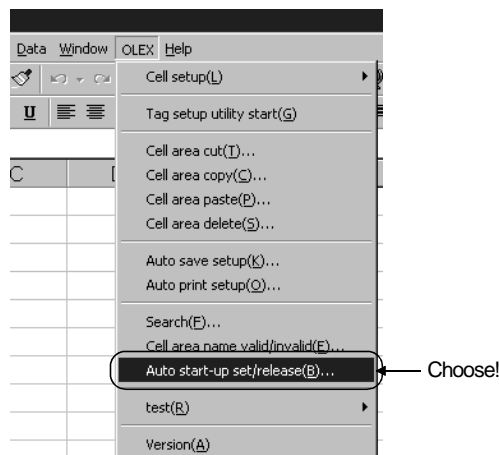

(b) As the following dialog box appears, click the "OK" button.

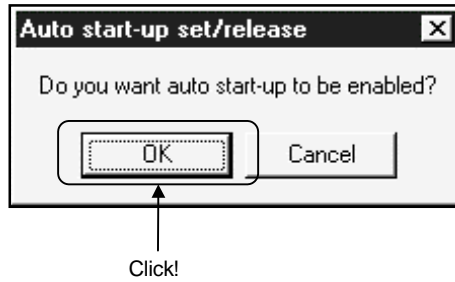

(c) As the following dialog box appears, select the file for which comment setting has been made, and click the "Open" button. (Here, select the file saved last.)

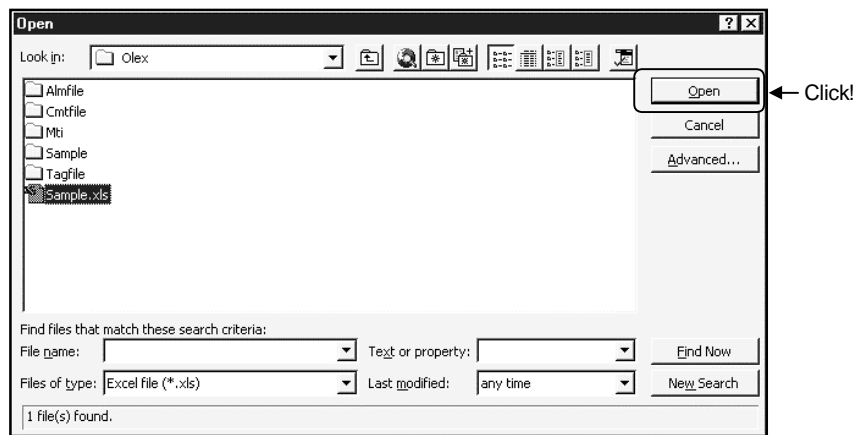

(d) As the following dialog box appears, click the "OK" button and then log off or restart.

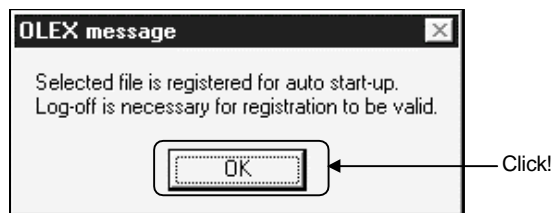

(e) After completion of logon or restart, starting the Tag management process starts Excel automatically, opens the file for which automatic start-up setting has been made, and starts execution.

9. OPERATIONS COMMON TO THE UTILITIES

This chapter describes the operations common to the utilities.

9.1 Starting the Utility

Any utility can be started by clicking the corresponding menu item among 1) to 5) shown below in the [Start]-[Programs]-[MELSEC APPLICATION]-[EXCEL COMMUNICATION SUPPORT (OLEX-E)]-[Tag Management] menu.

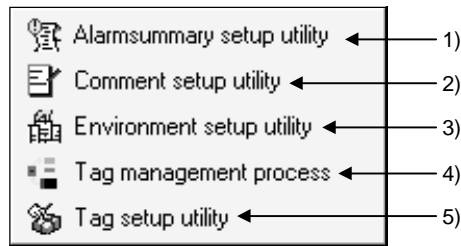

- 1) Start the Alarm summary setup utility.
- 2) Start the Comment setup utility.
- 3) Start the Environment setup utility.
- 4) Start the Tag management process.
(For details, refer to Section 10.2.2.)
- 5) Start the Tag setup utility.

9.2 Closing the Utility

Any utility can be closed by clicking the "Exit" button at the bottom of the Utility screen.

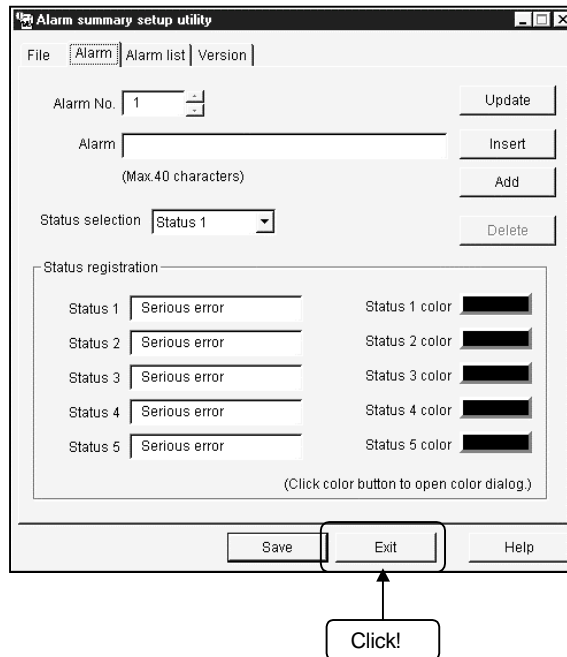

9.3 Saving the Settings

The settings made on the Utility can be saved by clicking the "Save" button at the bottom of the Utility screen.

The settings will not be saved if you close the Utility without clicking the "Save" button.

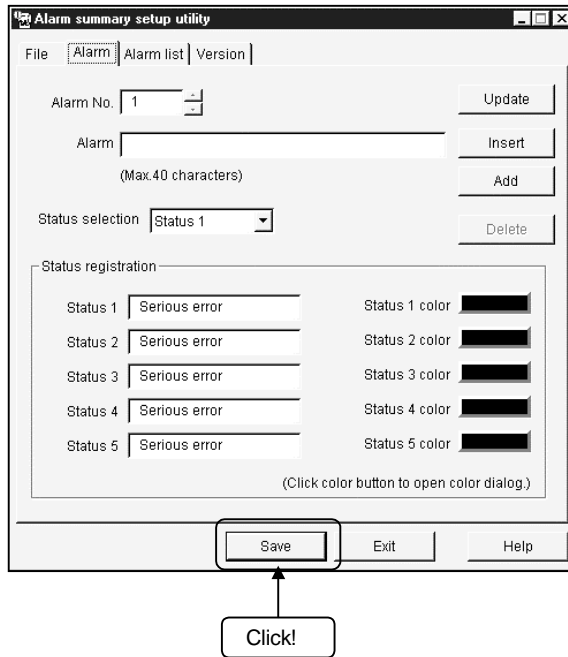

POINT
To reflect the utility settings on Excel during OLEX running, exit from OLEX and Tag management process once, then start the Tag management process and resume automatic execution.

9.4 Displaying the Help Screen

The Utility help screen can be displayed by clicking the "Help" button at the bottom of the Utility screen.

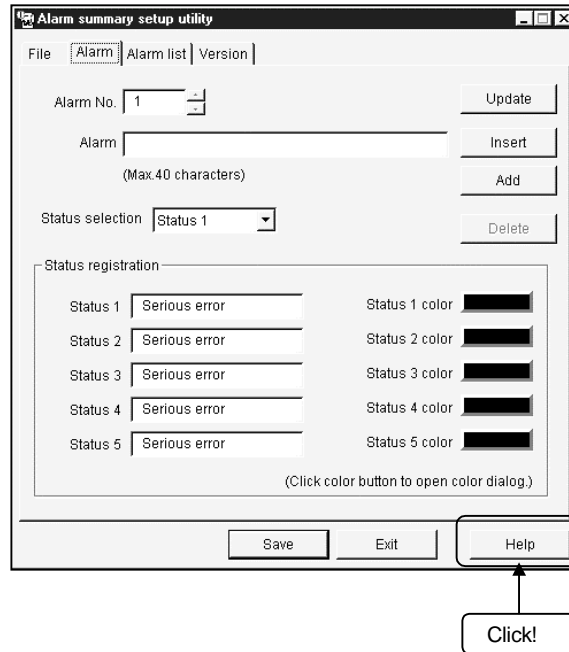

9.5 Confirming the Version

The version of the Utility can be confirmed by clicking the "Version" tab.

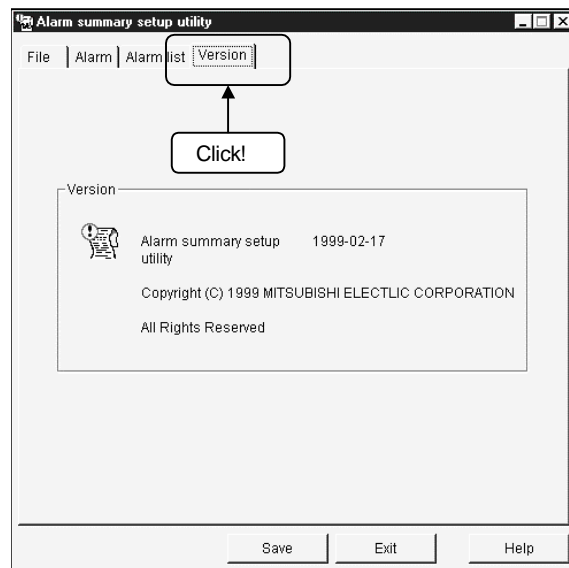

10. UTILITY OPERATIONS

This chapter describes how to operate and set the utilities.

10.1 Environment Setup Utility

This section explains how to operate and set the Environment setup utility.

10.1.1 Operating Procedure

This section provides the procedure of operating the Environment setup utility.

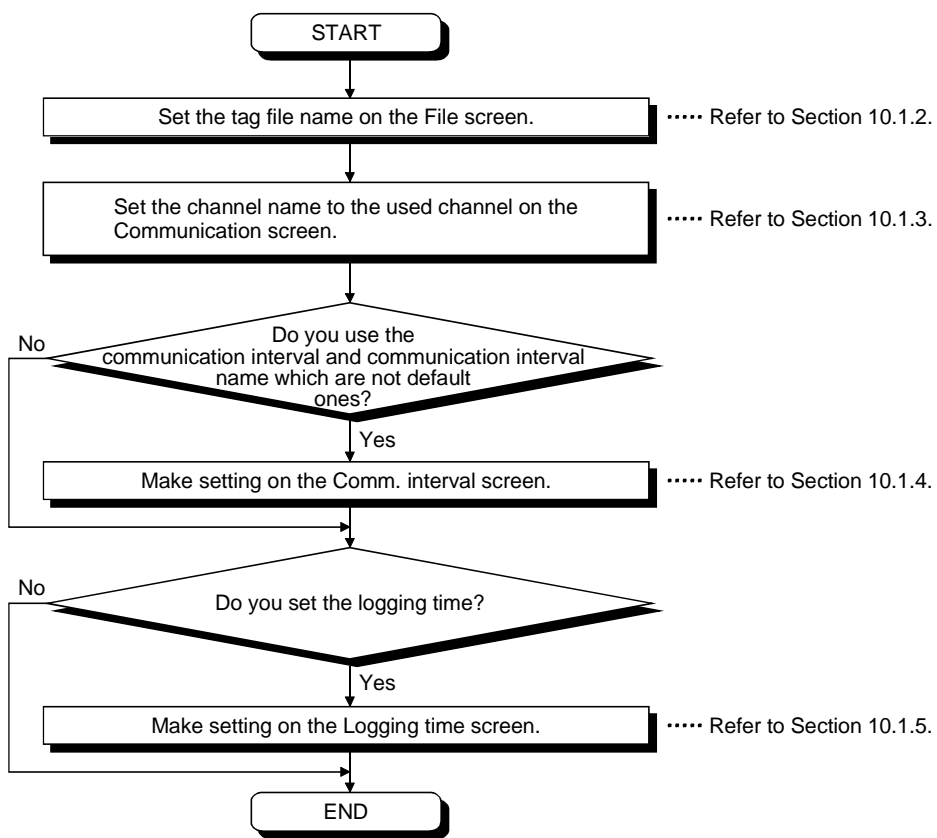

10.1.2 Operations on the File Screen

These operations include the setting of the tag file name to be read for execution of the Tag management process.

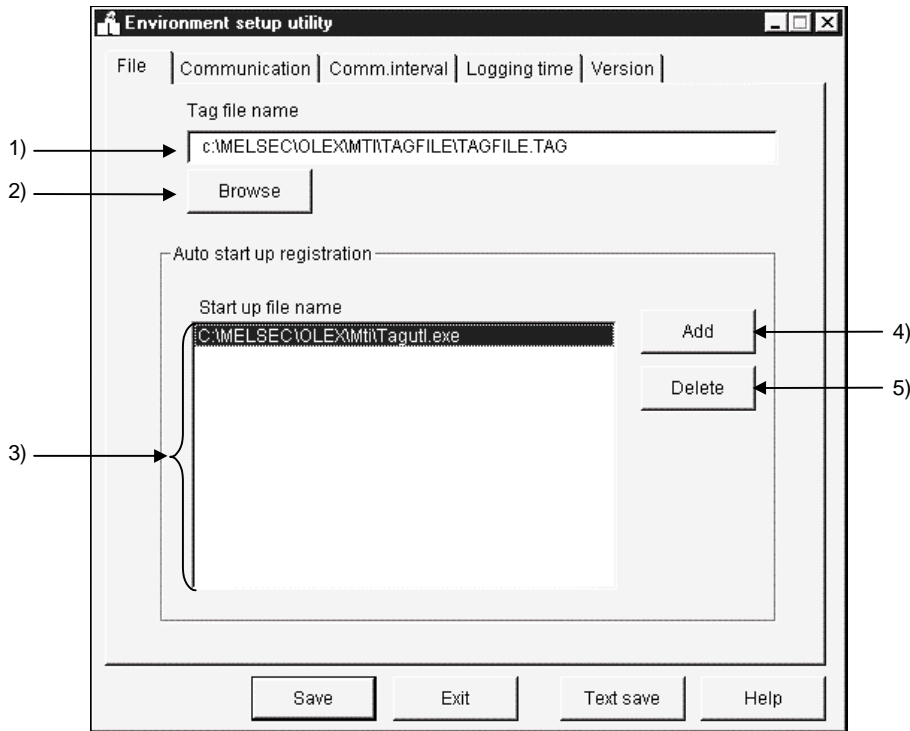

- 1) Tag file name
Set the tag file which the Tag management process will read.
- 2) "Browse" button
Used to find the tag file to be set in 1).
As the file setting dialog box opens, choose the tag file.
- 3) Start up file name
Shows the application started simultaneously with the starting of the Tag management process.

POINTS

The book file for which OLEX will be automatically executed is only the one which has been set to automatic execution on OLEX.
With this utility, you cannot register or delete files for OLEX.

- 4) "Add" button
Used to set the application started simultaneously.
You can set up to a total of 16 files.
However, the files that may be set are only those having EXE, XLS and MDB extensions. Any other files cannot be started if set.
- 5) "Delete" button
Choose the file name registered in 3) by clicking it, and click this button to delete the file selected in 3) and release automatic start-up.

10.1.3 Operations on the Communication Screen

Set channel names relative to the Communication channels. (Up to 10 names)

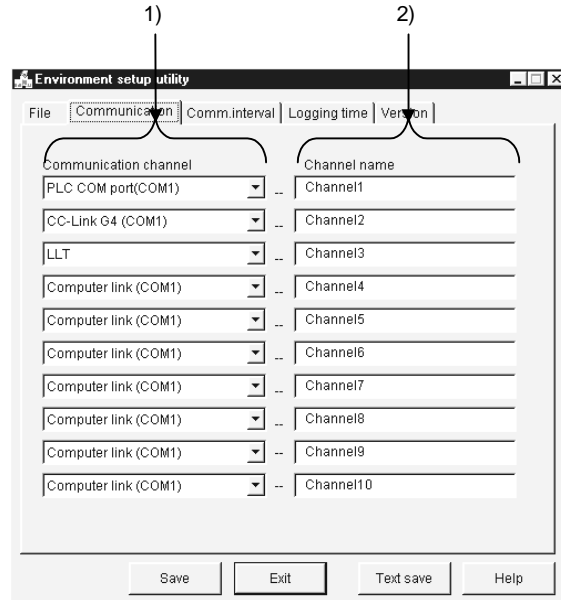

1) Communication Channel

Choose the communication channels relative to the channel names.

2) Channel Name

Set only the channel names with which the user's desired names will be used.

The user makes communication setting with the Tag setup utility on the basis of the channel names set.

Setting example

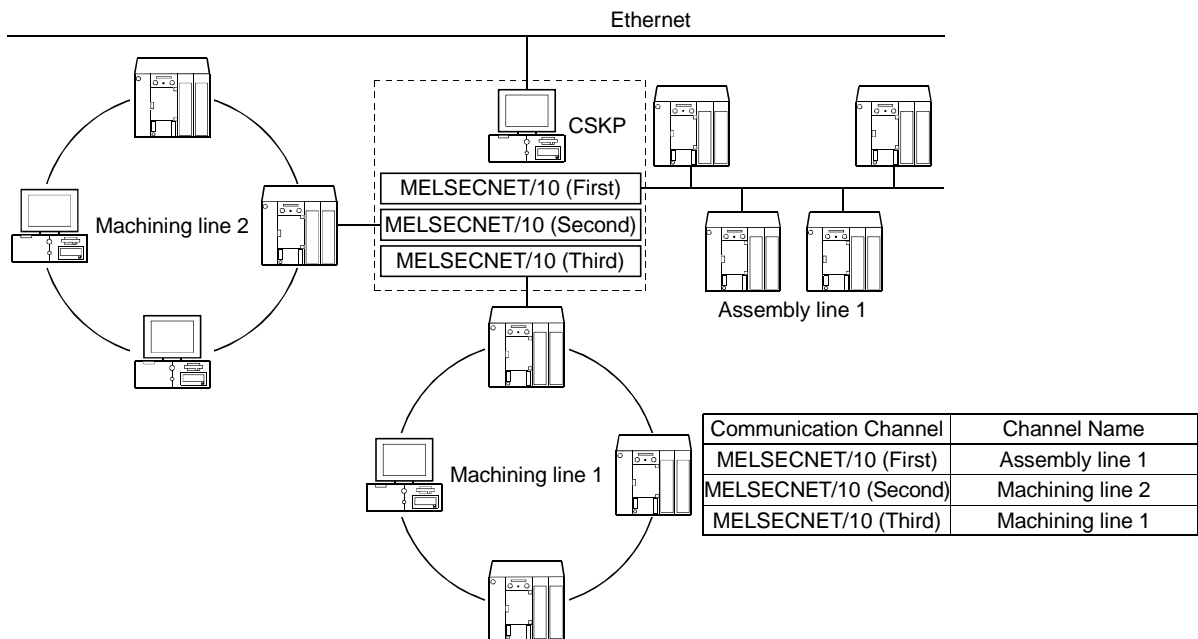

10.1.4 Operations on the Comm. Interval Screen

You can attach any names to the Communication intervals and define them as the communication names. (Up to 30 names)

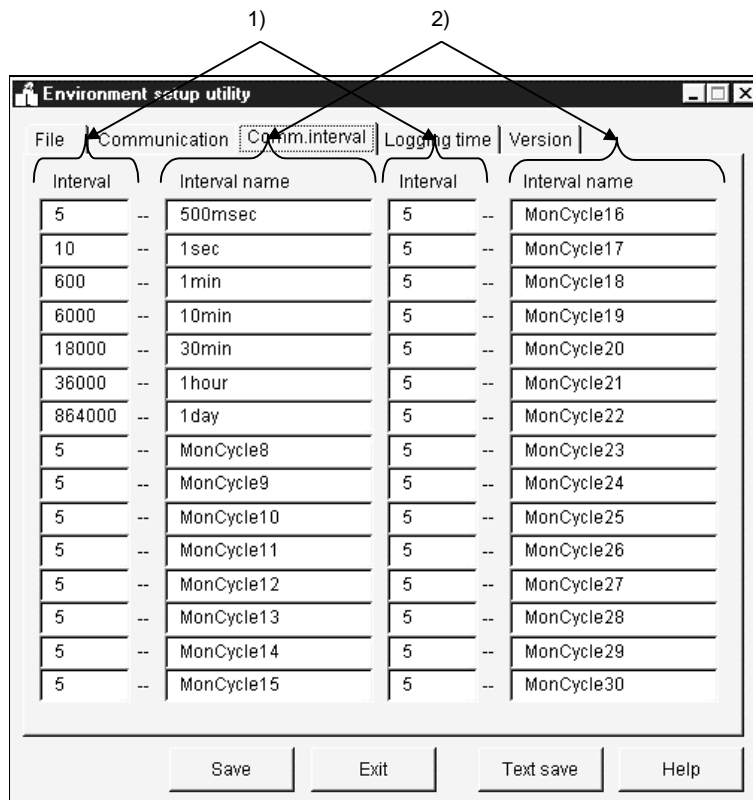

1) Comm. Interval

Intervals can be set in 100ms increments.
Hence, "5" sets the communication interval to 500ms.
(The setting range is 1 to 864000.)

2) Comm. Interval Name

Set the user's desired names.
The user makes communication setting with the Tag setup utility on the basis of the communication interval names set.

10.1.5 Operations on the Logging Time Screen

Set the time zones when the logging operation of the Tag management process will be performed.

You can set up to four zones.

(On OLEX, set them when using the automatic printing or automatic saving function.)

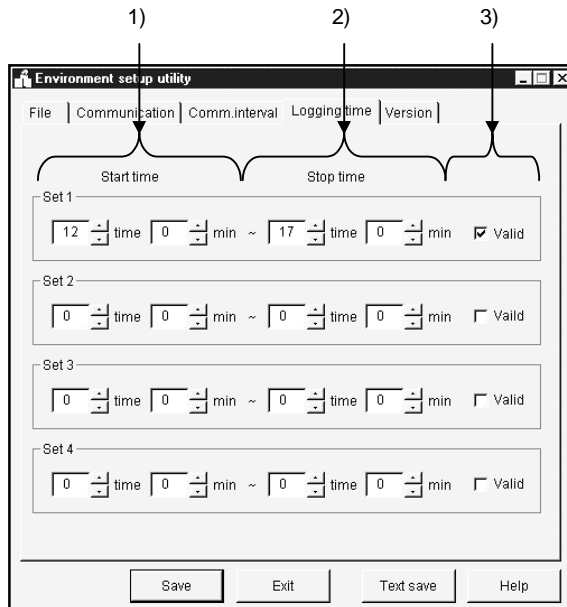

1) Start time

Set the data logging operation-starting time of the Tag management process.

Type the set time on a 24-hour basis. (Setting range: 0:00 to 23:59)

2) Stop time

Set the data logging operation-ending time of the Tag management process.

Type the set time on a 24-hour basis. (Setting range: 0:00 to 23:59)

3) Valid/invalid check box

Set whether the set operation times are made valid or not.

Check the box to make the set times valid.

When the box is unchecked, the set times are invalid.

POINTS
<p>(1) If the period between the Start time and the Stop time is longer than 24 hours, their settings cannot be made.</p> <p>(2) The settings on this screen are valid only when you have checked "Log within the operation time period" in Logging Setting within "Extended" on the Tag setup utility. For details, refer to Section 10.2.6 (3).</p> <p>(3) If you have made the logging setting, the following folder is created but never delete it. Deleting it will disable proper logging. Alternatively, if you want to delete all log information or change the personal computer time, delete all files in the folder.</p> <p style="text-align: center;"><HD drive>-<User-defined folder>-<CSKP>-<MTI>-<LOGFILE></p>

10.1.6 About Saving Data as a Text

By clicking the "Text save" button at the bottom of the Environment setup utility, the settings made with the Environment setup utility can be saved as a text file.

(1) Operation procedure

Perform the following procedure to save the data of the setting in a text file.

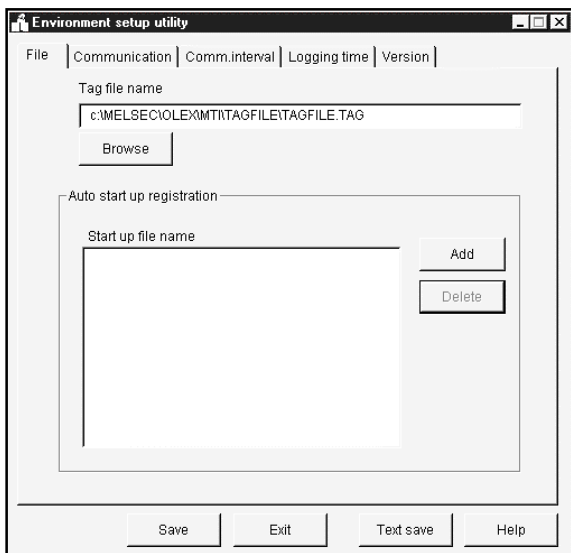

1. Click the "Text save" button on the Environment setup utility.

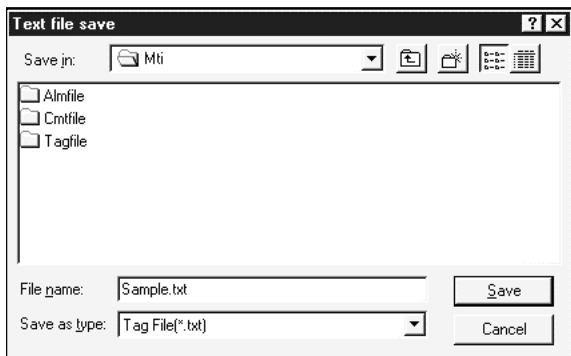

2. As the left dialog box appears, set the saving place and file name and click the "Save" button.

(2) File data

The data of the created text file will be described.

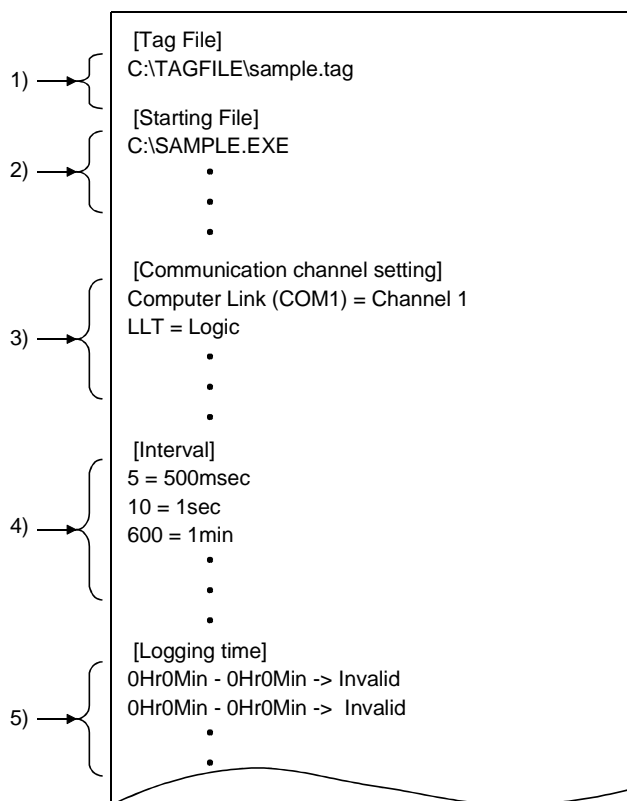

- 1) Indicates the data set to the tag file name on the "File" screen.
- 2) Indicates the data set to automatic start-up registration on the "File" screen.
- 3) Indicates the data set to the "Communication" screen.
- 4) Indicates the data set to the "Comm. interval" screen.
- 5) Indicates the data set to the "Logging time" screen.

10.2 Tag Setup Utility

This section provides how to operate and set the Tag setup utility.

10.2.1 Operating Procedure

The following flowchart provides the operation procedure of the Tag setup utility.

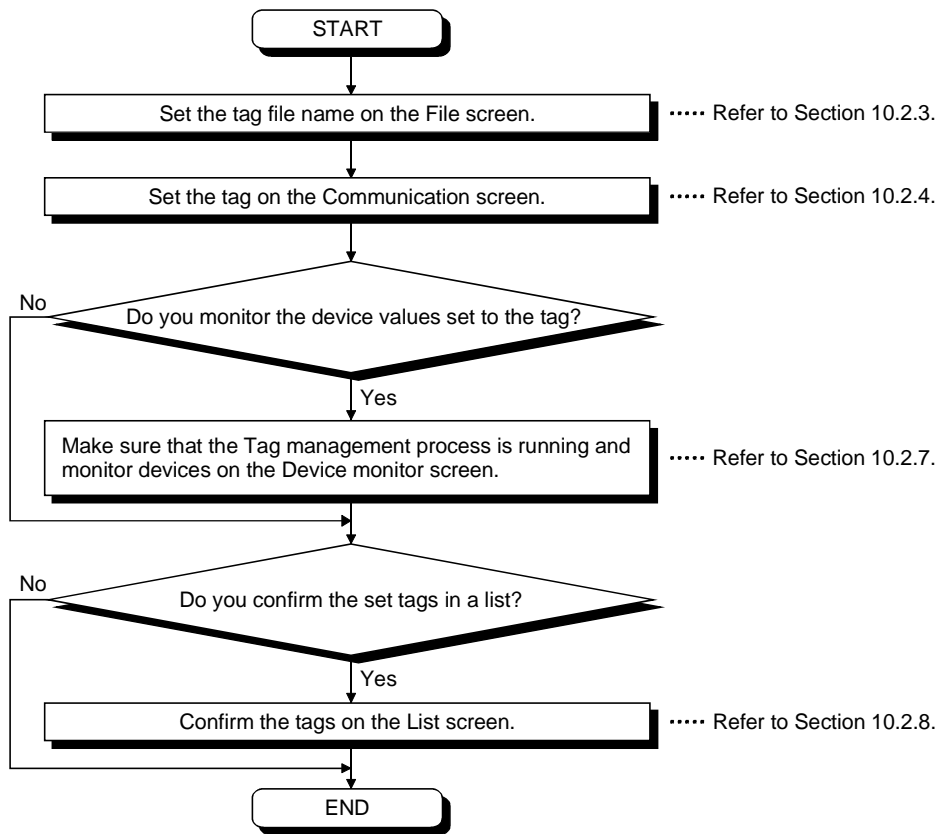

10.2.2 About the Tag Management Process

The Tag management process is a process which provides a communication method using a tag on the basis of the information set with the Environment setup utility and the information of the tag file.

When using a tag, the Tag management process must be running.

(1) Starting method

Click [Start]-[Programs]-[MELSEC APPLICATION]-[EXCEL COMMUNICATION SUPPORT (OLEX-E)]-[Tag management]-[Tag management process].

POINT	
(1)	Before starting the Tag management process, you need to create a tag file with the Tag setup utility and specify the tag file with the Environment setup utility.
(2)	When the Tag management process is running, the Tag setup utility communicates with the Tag management process. If the Tag setup utility is disabled from making normal communication due to forced exit from the Tag management process, for example, the following or similar error message may appear. If the error message has appeared, restart the Tag management process. <Error message example> <ul style="list-style-type: none"> • RPC server cannot be used. • Remote procedure call failed, resulting in no execution.

(2) Ending method

To close the Tag management process, force it to end.

Alternatively, choose "Tag management process" on the task bar and press the "Alt" + "F4" keys.

(3) Reloading procedure

The Tag management process must be reloaded to reflect the modified/added tag file for use during execution of the Tag management process.

1) Stop the Tag management process.

Open the "File" screen and click the "Stop..." button.

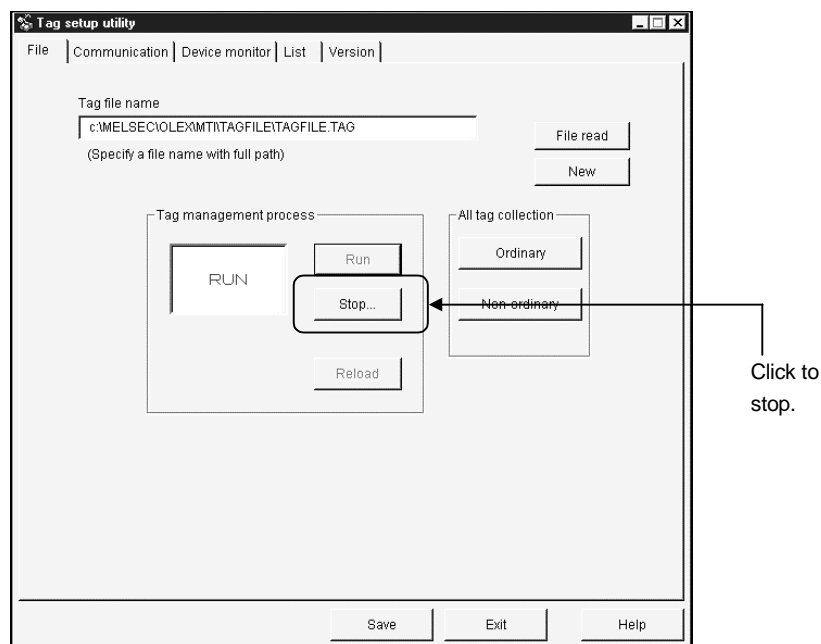

2) Edit the tag file.

- 3) Update the modified/added tag information.
Open the "Communication" screen, modify/add tags and click the "Tag Update" button.
- 4) Click the "Save" button to save the information.
- 5) Reload the Tag management process.
Click the "Reload" button to reload the Tag management process.

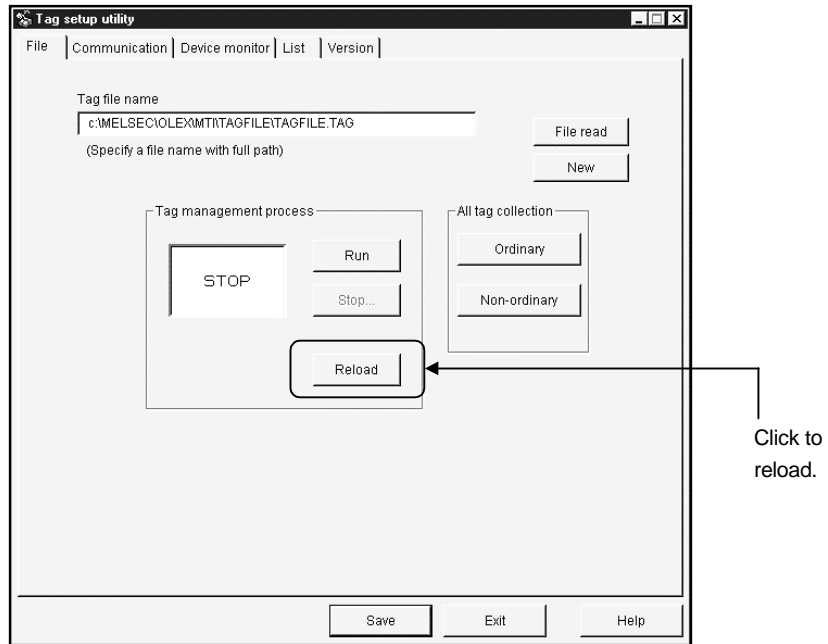

- 6) Execute the Tag management process.
Click the "Execute" button to run the Tag management process.

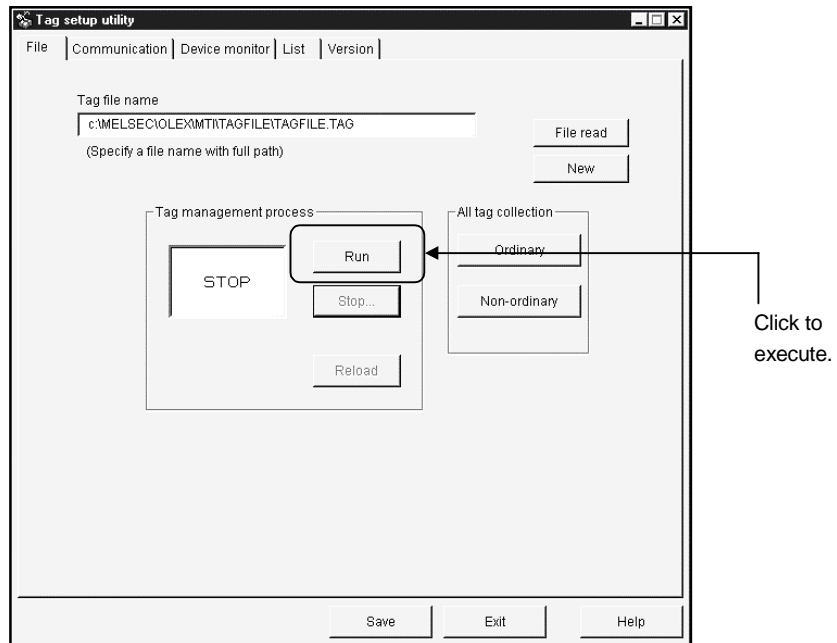

10.2.3 Operations on the File Screen

Set the tag file to be saved, collection timing, and whether the Tag management process is run or stopped.

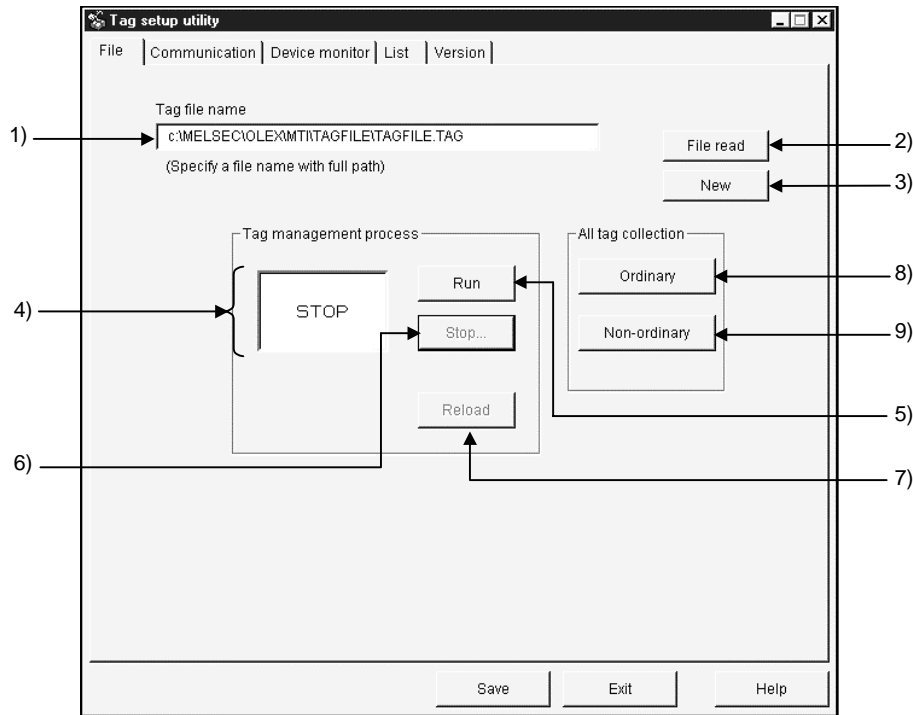

- 1) Tag file name
Specify the tag file name to be set.
- 2) "File read" button
Used to find the tag file to be set in 1).
As the file setting dialog box opens, choose the tag file.
- 3) "New" button
Used to create a new tag file.
As the file setting dialog box opens, set the name of a new tag file to be created.
- 4) Tag management process operating status
Indicates the current status of the Tag management process.

 RUN Indicates that the Tag management process is "running".
 STOP Indicates that the Tag management process is "at a stop".
 NOT RUN Indicates that the Tag management process is not started.
- 5) "Run" button
Used to run the Tag management process.
You cannot use this button to start the Tag management process.
(This button cannot be selected when the Tag management process has not yet been started.)

- 6) "Stop..." button
 Used to stop the Tag management process.
 You cannot use this button to end the Tag management process.
 (This button cannot be selected when the Tag management process has not yet been started.)

- 7) "Reload" button
 Used to reload the Tag management process.
 Note that this button may be selected only during the stop of the Tag management process.

- 8) "Ordinary" button
 Used to set all collection timings of the set tags to "Ordinary" in batch.
 OrdinaryData is always collected independently of whether the application using the tags is active or inactive.

- 9) "Non-ordinary" button
 Used to set all collection timings of the set tags to "Non-ordinary" in batch.
 Non-ordinaryData is collected only when the application using the tags is active.

POINT	
<p>The Tag management process has great influence on the processing speed of the personal computer. When using other application, it is recommended to stop the Tag management process.</p>	

10.2.4 Operations on the Communication Screen

Set the network, devices, etc. to the tag.

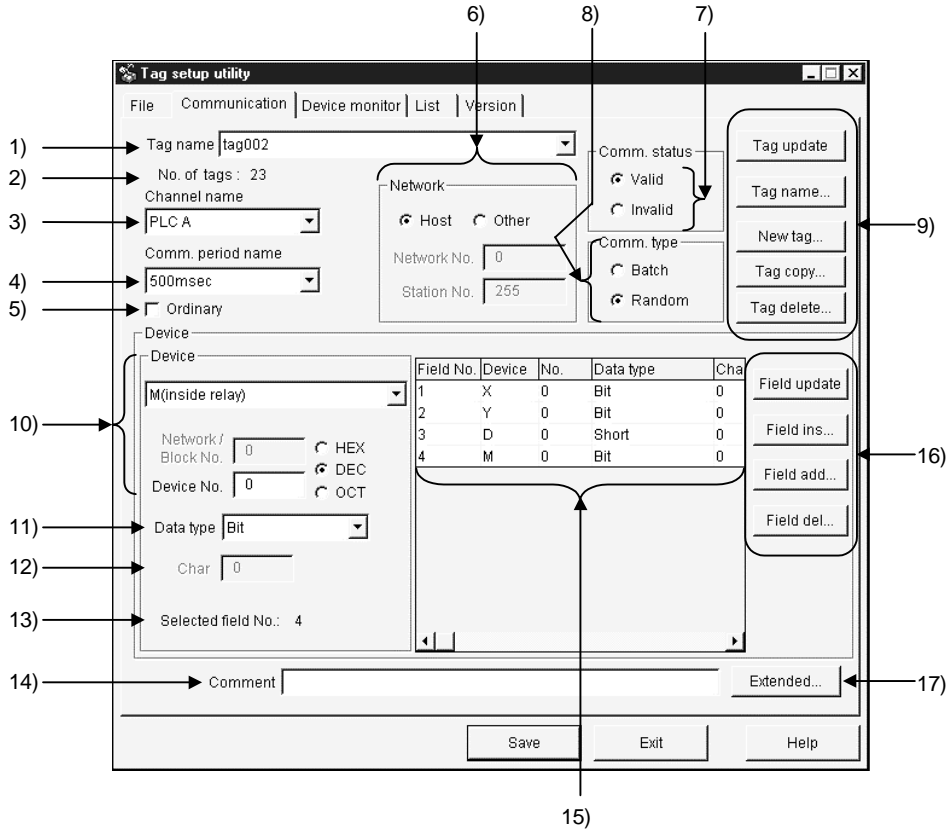

1) Tag Name

Choose the tag name to which the setting will be registered.

2) No. of tags

Shows the number of tags registered currently.

3) Channel name

Choose the channel name set with the Environment setup utility. (Refer to Section 10.1.3.)

4) Comm. period name

Choose the communication interval name set with the Environment setup utility. (Refer to Section 10.1.4.)

5) Ordinary

When this box is checked, data is always collected independently of whether the application using the tags is active or inactive.

When this box is unchecked, data is collected only when the application using the tags is active.

6) Network

To perform a communication, enter the logical station number and network settings.
Refer to Section 10.2.5.

Logical Station

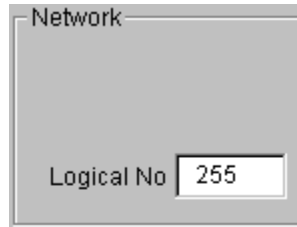

The screenshot shows a dialog box titled "Network". It contains a single input field labeled "Logical No" with the value "255" entered.

Direct Station

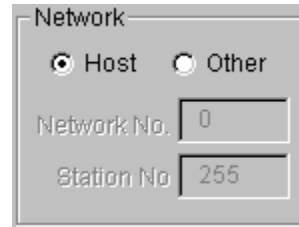

The screenshot shows a dialog box titled "Network". It contains two radio buttons: "Host" (selected) and "Other". Below the radio buttons are two input fields: "Network No." with the value "0" and "Station No." with the value "255".

7) Comm. status

Set whether the communication of the set tag is valid or invalid.
If you set Invalid, communication is not made.

8) Comm. type

Specify "Batch" or "Random" as the way of access to the PLC.

BatchChoose this when accessing the specified points of a single device name.

Random.....Choose this when accessing one point of each of many device names.

9) Tag-related buttons

"Tag Update" Used to update the tag data set to the tag file.
To save the data, click the "Save" button.

"Tag name..." Used to create the tag name automatically or change it.
The tag name created automatically is set as follows.
(The default tag name is the automatically created tag name.)

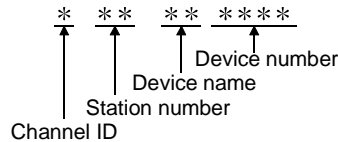

Example: When channel ID 1 is selected and W device No. 0 of the own station is specified

Tag name: 1FFWD0000

"New tag..." Used to create a new tag. (Up to 32 characters)
When entering a tag name, you cannot use the following characters.

"\", \"/\", \":\", \"*\", \"?\", \"'\", \"<\", \">\", \"|\"

"Tag copy" Used to copy the tag currently being edited.

"Tag delete" Used to delete the tag currently being edited.

10)Device

DeviceChoose the type of the device used for communication.

Network/Block No.You can enter data when you specify any of the following devices.

Device Name	Description
L* (Except L)	Set the network No. of the specified device.
ER	Set the block No. of the specified device.
EM	
ED	

Device No.....Set the device No. of the specified device type.

HEX, DEC, OCTSpecify the hexadecimal, decimal or octal when setting the extension No. or device No.

HEX.....Hexadecimal

DEC.....Decimal

OCT.....Octal

POINTS
<p>(1) If you selected Batch in Communication Type and "Bit" in Data Type, specify the device number as a multiple of 8 (0, 8, 16, ...) and the field count as a multiple of 16 (0, 16, 32, ...).</p> <p>However, when using any of the following communications, specify the device number as a multiple of 16 (0, 16, 32, ...).</p> <ul style="list-style-type: none"> • Computer Link (when using C24, UC24) • Ethernet (when using E71 (TCP/IP)) • CC-Link (access to own station RX, RY, SB) <p>(2) Note that the following devices cannot be accessed if they are set to the "random communication tag" and "write tag" in CC-Link communication.</p> <ul style="list-style-type: none"> • CC-Link board-dedicated devices (RX, RY, RW, RBM, RAB) • SB, SW (when CC-Link board is used)

11)Data type

Determine the data type relative to the set device.

12)Char

Specify the number of characters to reserve the number of device points.

The number of characters is up to 40 characters.

(Valid only when Char is selected in Data Type.)

13) Selected (Field No.)

Selected field No..... This number appears when the communication type is Random.

The field No. of the item currently selected in the field preview appears.

Field count..... This number appears when the communication type is Batch.

Set the field count which reserves the devices in the unit specified in Data Type.

Example: If Device = D, Device No. = 0, Data Type = Long, and field count = 3, devices of 32 bits are reserved as a single field since the data type is Long.

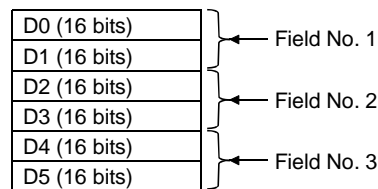

14) Comment

Comment the tag.

15) Field preview

Shows the field data set until now.

Alternatively, clicking selects the field.

(Appears only when "Random communication" is chosen in Communication Type.)

16) Field button (valid only when Random is selected in Communication Type)

"Field update"..... Used to register the current setting in the selected field.

"Field ins..." Used to insert a new field in a place preceding the currently selected field.

"Field add..." Used to create a new field in the last field.

"Field del..." Used to delete the currently selected field.

17)Extended...

Used to show the dialog screen where logging setting and Hand shake are set.

(Refer to Section 10.2.6.)

(Setting example for random communication)

For random communication with W100 (Short), D0 (Long) and ER0 (block No. 1) (Short)

- W100 setting {
 - 1) Choose communication type "Random".
 - 2) Choose device type "W" and type device number "100".
 - 3) Click the "Field update" button. (Use the data type of default single precision.)
- D0 setting {
 - 4) Click the "Field add" button.
 - 5) Choose device type "D" and type "0" in Device No.
 - 6) Choose data type "Long".
- ER0 setting {
 - 7) Click the "Field update" button.
 - 8) Click the "Field add" button.
 - 9) Choose device type "ER" and type "0" in Device No.
 - 10) Type block No. "1".
 - 11) Click the "Field update" button. (Use the data type of default single precision.)
 - 12) Click the "Tag Update" button.
 - 13) Click the "Save" button.

(Setting example for batch communication)

For batch communication with 10 points starting from W100 (Short)

- W100 setting {
 - 1) Choose communication type "Batch".
 - 2) Choose device type "W" and type device number "100".
 - 3) Type "10" in Field.
 - 4) Click the "Tag Update" button.
 - 5) Click the "Save" button.

10.2.5 About the Network Setting

The settings of "Network" on the "Communication" screen change with the communication path used as indicated below.

POINTS
To perform the Computer link, Ethernet, CPU COM, CPU USB or CC-Link G4 communication, set the network settings the same as those made on the "Target" screen within the CSKP.

(1) Displayed network settings

The settings displayed on the "Network setting" screen vary with each communication made within the CSKP and so forth.

Logical Station

Direct Station

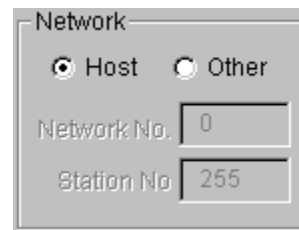
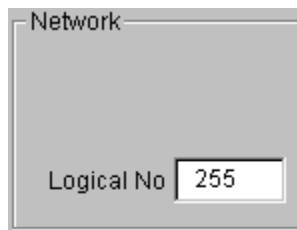

The following shows the station number specification methods applicable to each communication.

Communication	Station number specification method	
	Logical Station	Direct Station
Computer link	○	×
Ethernet	○	×
CPU COM	○	○
CPU USB	○	○
MELSECNET/10	×	○
CC-Link	×	○
CC-Link G4	○	×
CPU board	×	○
Shared device	×	○
LLT	×	○

○: Applicable, ×: N/A

(2) Host setting

When you choose Host in the network setting, the settings are as follows.

Communication	Description
Computer link	Not used.
Ethernet	
CPU COM	
CPU USB	
MELSECNET/10	Access is made to the own personal computer.
CC-Link	
CC-Link G4	Not used.
CPU board	Access is made to the own personal computer (equivalent to A2USHCPU-S1).
Shared device	Access is made to the EM and ED devices of the own personal computer.
LLT	Access is made to LLT on the own personal computer.

(3) Other setting

When you select Other in "Network Setting", the settings are as follows.

Communication		Description	
		Network number	Station number
Computer link		Not used.	Set the logical station number specified on the utility.
Ethernet			
CPU COM			
CPU USB			
CC-Link G4			
MELSECNET/10		Set the network number.	Set the station number.
CC-Link		Not used.	Set the station number.
CPU board	Via MELSECNET/10	Set the network number.	Set the station number.
Shared device	Via MELSECNET/10	Set the network number.	Set the station number.
LLT		Not used.	Not used.

POINTS
<p>(1) The shared devices (EM, ED) may be set only on Windows NT4.0 using the shared device utility. They cannot be set on Windows 95 or Windows 98. However, the shared devices (EM, ED) on Windows NT4.0 can be accessed from Windows 95 or Windows 98.</p> <p>(2) To access the shared devices (EM, ED) of the other personal computer (other station), specify the channel of MELSECNET/10 which is used as a communication path.</p> <p>(3) Please set local station in LLT.</p>

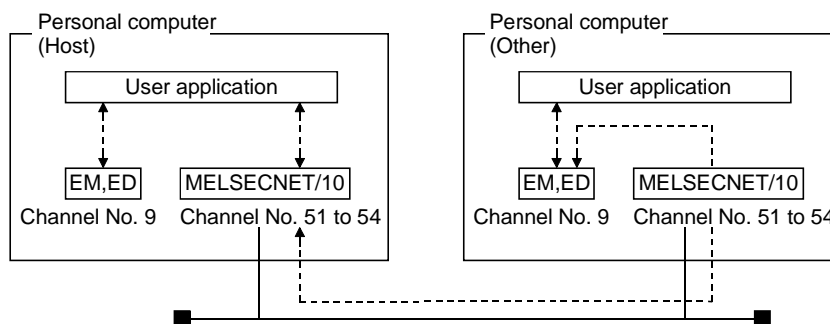

10.2.6 Operations on the Extended Screen

Set the Condition, Logging and Hand shake.

POINT
<p>Note that the following devices cannot be accessed if they are set on the "Logging" screen and "Handshake" screen in CC-Link communication.</p> <ul style="list-style-type: none"> • CC-Link board-dedicated devices (RX, RY, RW, RBM, RAB) • SB, SW (when CC-Link board is used)

(1) Explanation of buttons

The buttons function as follows.

"OK"Used to make the setting valid and return to the Communication Setting screen.

"Cancel" ...Used to make the setting invalid and return to the Communication Setting screen.

"Help"Used to display Help.

(2) Condition

Set the condition of signaling data collection.

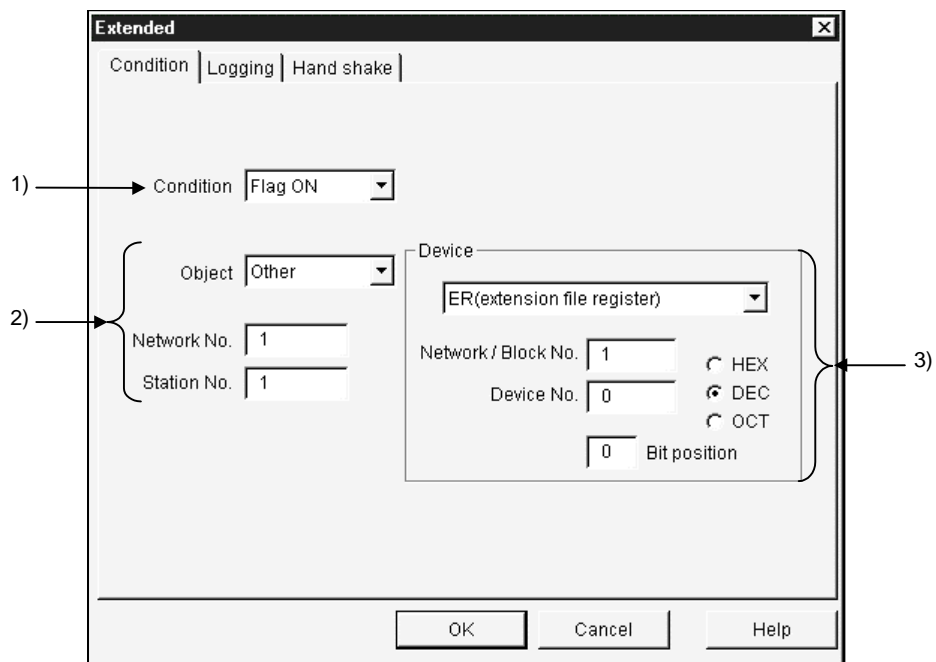

1) Condition

Set the condition of collecting data.

No Setting.....The collection condition on this screen is not reflected.

Flag ONData can be collected only when the specified bit device is ON.

Flag OFFData can be collected only when the specified bit device is OFF.

2) Network setting

Set the network No. and station No. of the device used as the collection condition.

Object Choose any of the following items in the combo box.

Host The device of the own station is set as the collection condition.

Other The device of the other station is set as the collection condition.

Also, you can enter the network No..

According to Tag The device of the station number whose setting was Updated on the communication setting screen is set as The collection condition. (Refer to Section 10.2.4.)

Network No. Specify the network No.
(Valid only when Other Station is selected in Station Setting.)

Station No. Set the station number.
(Valid only when Other Station is selected in Station Setting.)

POINTS	
	(1) Note that if you have specified "According to Tag" in Station Setting and then changed the station number in "Communication", that change is not reflected on the station setting of "Extended".
	(2) When setting "Other" in Station Setting (making transient communication), it is assumed that the communication speed will be affected greatly. Therefore, when specifying the station, we recommend you to specify "Host".

3) Device

Device typeChoose the type of the device used for communication.

Network/Block No. ...You can enter data when you specify any of the following devices.

Device Name	Description
L*	Set the network No. of the specified device. Set the block No. of the specified device.
ER	
EM	
ED	

Device No.Set the device No. of the specified device type.

HEX, DEC, OCT Specify the hexadecimal, decimal or octal when setting the extension No. or device No.

HEX.....Hexadecimal

DEC.....Decimal

OCT.....Octal

Bit PositionSet the bit used as the collection condition when you specified the word device.

(3) Logging

Set whether logging is specified or not.

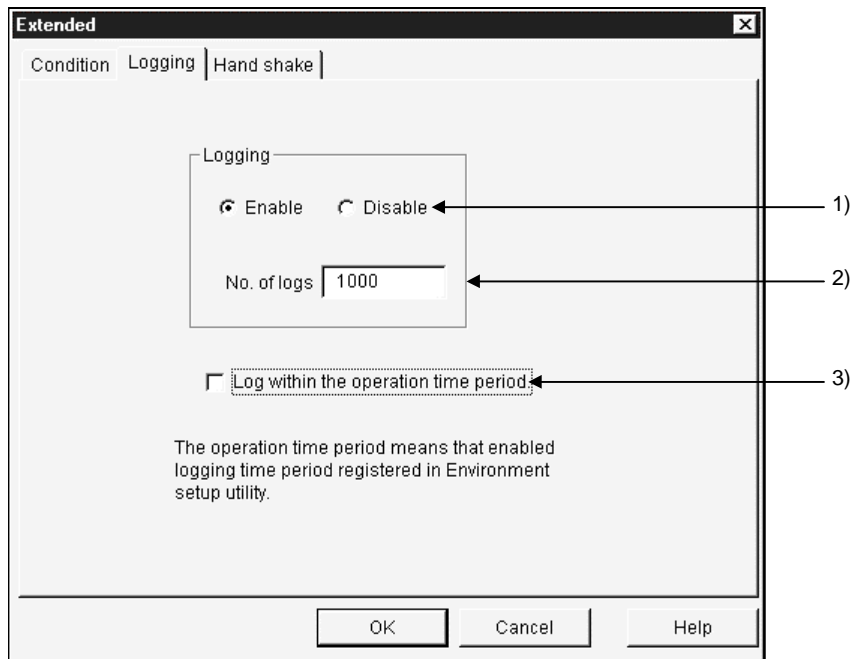

1) Logging

Set whether logging is made or not.

Enable As soon as the Tag management process has started, data collection starts and log data is saved.

Disable..... Logging is not made.

2) No. of logs

Set the number of log data to be collected. (1 to 10000)

3) Logging within the operation time period

Data is collected according to the operation time set on the Environment setup utility.

(Refer to Section 10.1.5.)

POINTS
(1) Set the communication interval to 1 second or longer in the tag to which logging setting is made.
(2) When you have chosen Logging within the operation time period, the Tag management process will not operate if none of the logging settings of the Environment setting utility is valid. Always set the logging time.
(3) When you exit from the Tag management process, the log file remains as <User-defined folder>-<CSKP>-<MTI>-<LOGFILE>\tagname.log. When you have changed the personal computer time, delete the above file.
(4) OLEX does not have the function to refer to a log file.

(4) Hand shake
Set the Hand shake data.

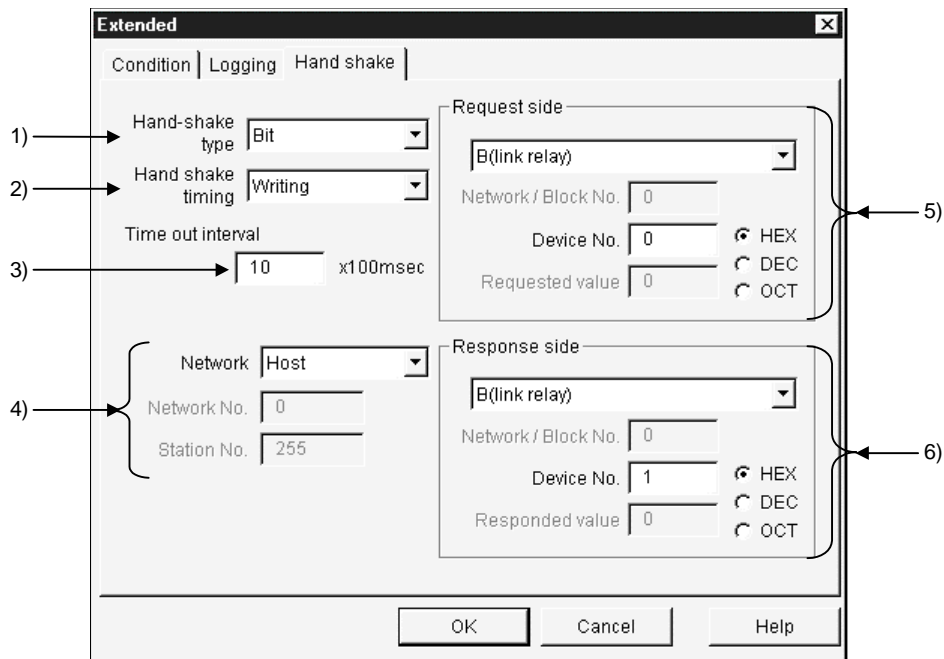

1) Hand-shake type

Choose the way of handshaking.

Bit.....Hand shake is made in accordance with ON and OFF of bit devices.

• Operation sequence

Request bit ON → Data transfer → Response bit ON → Request bit OFF → Response bit OFF → Completion

WordHand shake is performed according to the values stored into word devices.

• Operation sequence

Request value stored into request word device → Data transfer → Response value stored into response word device → 0 stored into request word device → 0 stored into response word device → Completion

Unconditional Data transfer is made without Hand shake.

2) Hand shake timing

Set the timing of handshaking.

3) Time out interval

Set the time-out period. (1 to 36000)

Time-out is a period from "request device set" to "request device reset" for write, and a period from "response device set" to "response device reset" for read.

4) Network

Set the network No. and station No. of the devices used for Hand shake.

Choose any of the items in the Network Setting combo box.

Host The devices of the own station are set to Hand shake.
 Other The devices of the other station are set to Hand shake.

Also, you can enter the network No.

According to tag The devices of the station number set on the
 Communication setting screen are set to Hand shake.
 (Refer to Section 10.2.4.)

Network No. Specify the network No.
 (Valid only when Other Station is selected in Station
 Setting.)

Station. No. Set the station number.
 (Valid only when Other Station is selected in Station
 Setting.)

5) Request side

Specify the device used as a request side flag.

Set the device type, network/block No., device number, and HEX, DEC or OCT
 as in this section, (2), 3).

Request value Set the value written to the word device as a request
 value.

(Valid only when the word device is selected in Hand-
 shake type.)

6) Response side

Specify the device used as a response side flag.

Set the device type, network/block No., device number, and HEX, DEC or OCT
 as in this section, (2), 3).

Response value Set the value written to the word device as a response
 value.

(Valid only when the word device is selected in Hand-
 shake type.)

POINTS
<p>(1) Note that if you have specified "According to tag" in Network Setting and then changed the station number in "Communication", that change is not reflected on the station setting of "Extended".</p> <p>(2) When setting "Other" in Network Setting (making transient communication), it is assumed that the communication speed will be affected greatly. Therefore, when specifying the station, we recommend you to specify "Host".</p> <p>(3) When the tag specified for handshake is specified to Logging for reading, the data collection of the other tag communicating at the same time will be affected extremely. (It will take longer time.)</p> <p>(4) Set the Hand shake time out interval so that the communication interval value is greater than the Hand shake time out value.</p>

(a) Hand shake timing

Hand shake is made as shown in the following timing charts.

1) When data is written to Tag management process device memory

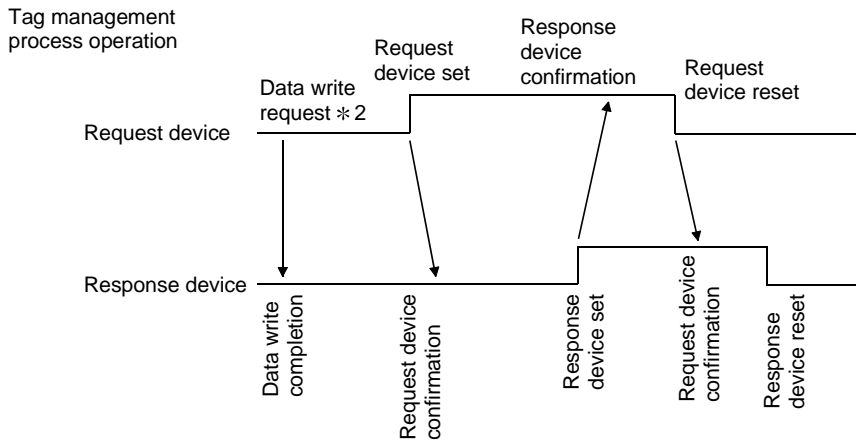

PLC operation *1

* 1 For PLC operation, a program must be written using the sequence ladder or MELSEC data link library.

* 2 Request of OLEX to write data to device memory.

Since the Tag management process makes this request actually, the Tag management process is on the request side.

2) When data is read from Tag management process device memory

When time-out occurs, read data is discarded.

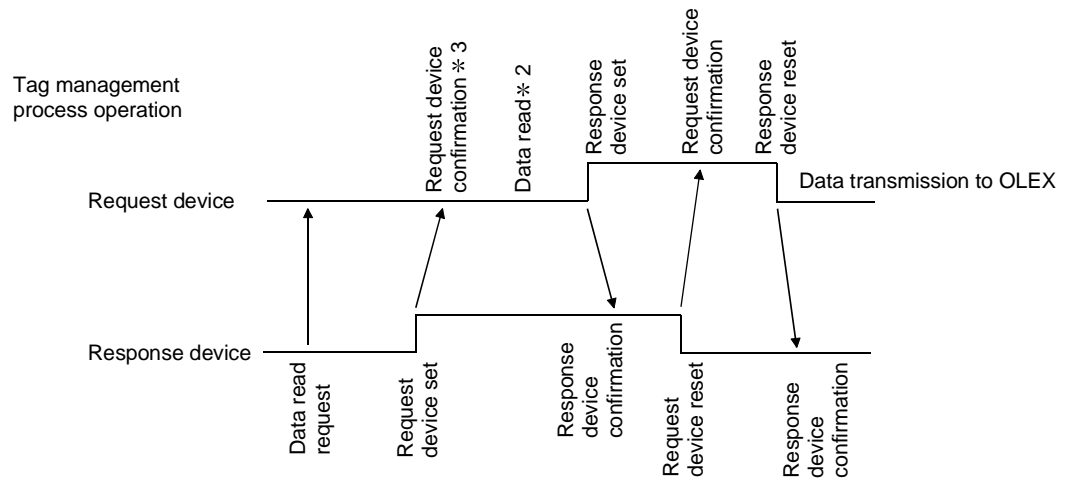

PLC operation *1

* 1 For PLC operation, a program must be written using the sequence ladder or MELSEC data link library.

* 2 The Tag management process reads the device memory data.

It is not read unless the request device is set on OLEX.

After reading data, the Tag management process sets the response data.

* 3 An error (-30) occurs if the request device has not been set for request device confirmation.

10.2.7 Operations on the Device Monitor Screen

Monitor devices based on the data of the tag file currently under control of the Tag management process.

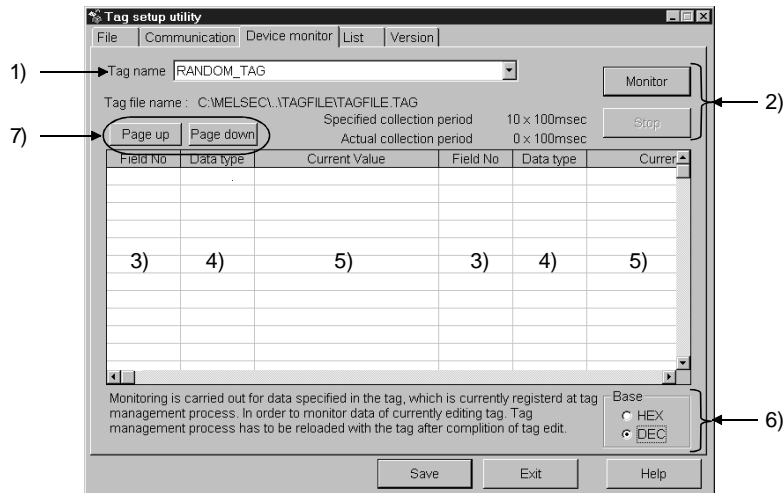

- 1) Tag name
Devices are monitored based on the data of the tag specified here.
- 2) Monitor and Stop buttons
"Monitor": Used to start monitor. "Stop": Used to stop monitor.
- 3) Field No.
Shows the field numbers being monitored.
- 4) Data type
Shows the data types of the devices set to the fields.
- 5) Current value
Shows the current device values. (When bit device is ON: "*")
- 6) Base
Set the format of the data to be displayed.

HEX ... Hexadecimal display
DEC ... Decimal display
- 7) PageUp, PageDown buttons
Used to scroll screen by screen if the fields take up more than one screen.
If all the fields can be displayed on one screen, the PageUp and PageDown buttons do not appear.

POINTS
(1) Monitor stops when you change the screen (to the file setting, communication setting or other screen) by tab operation.
(2) When monitoring the tag being edited, save the edited tag and restart the Tag management process.

10.2.8 Operations on the List Screen

List the data set to the tag file.

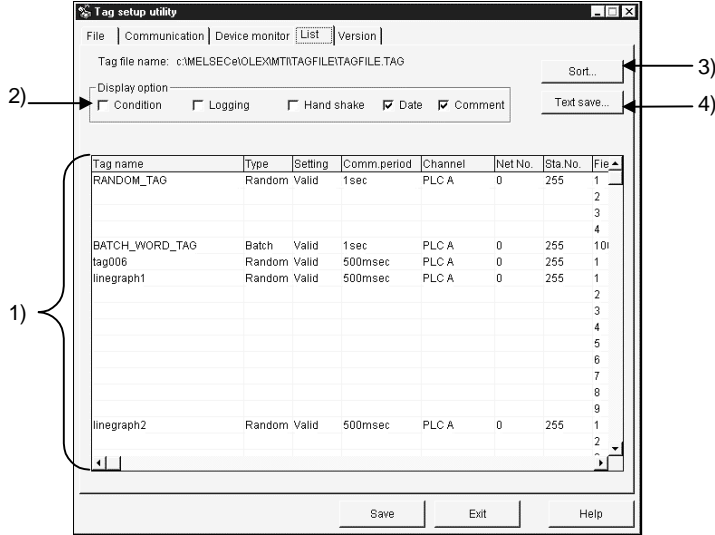

- 1) Setting display
Tags registered to the tag file are listed.
- 2) Display option
Check and display the items you want to display in addition to the data currently being shown.
- 3) "Sort..." button
As the following dialog box opens, set the sort conditions (Two or more conditions may be set.)
Note that priority is from top to bottom.
Items not checked return to the initial states.

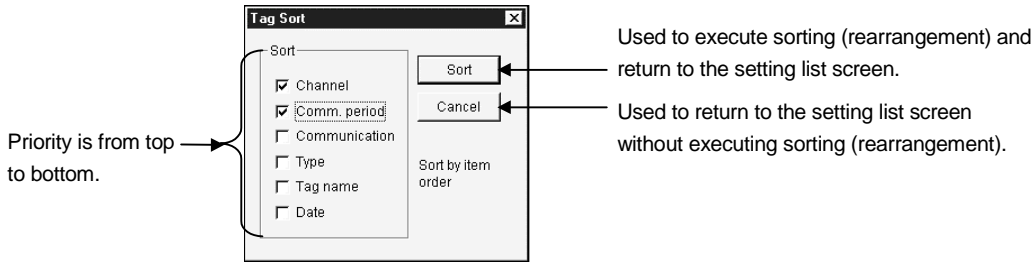

POINTS
(1) Sorting of character strings, such as comments, are made in ASCII code order. (Not in alphabetical order.)
(2) Data in the sorted status cannot be saved in the tag file.

- 4) "Text save" button
Used to save the currently displayed data in the specified text file.

POINT
Data is saved as a text in the sorted status.

10.3 Comment Setup Utility

This section describes the operation and setting procedures of the Comment setup utility.

10.3.1 Operation Procedure

The following flowchart provides the operation procedure of the Comment setup utility.

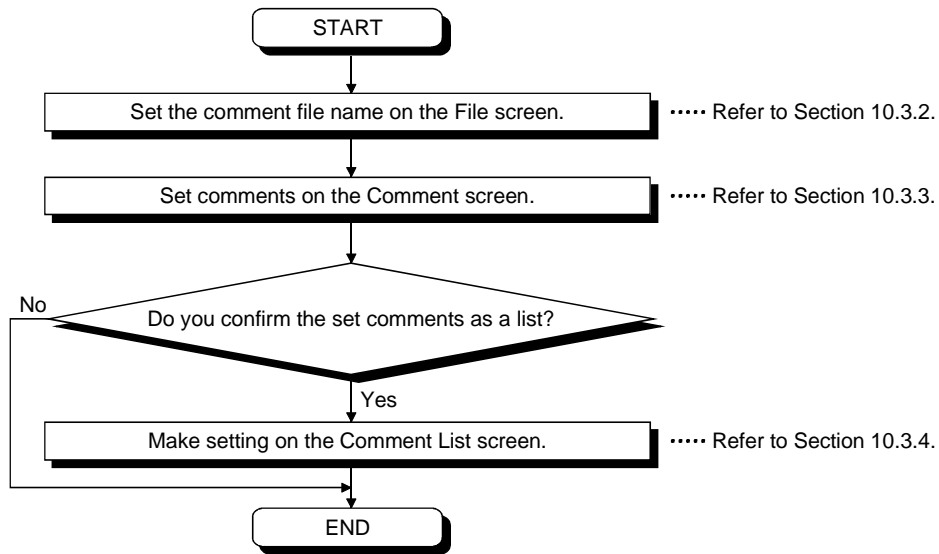

10.3.2 Operations on the File Screen

Set the file where comments will be saved.

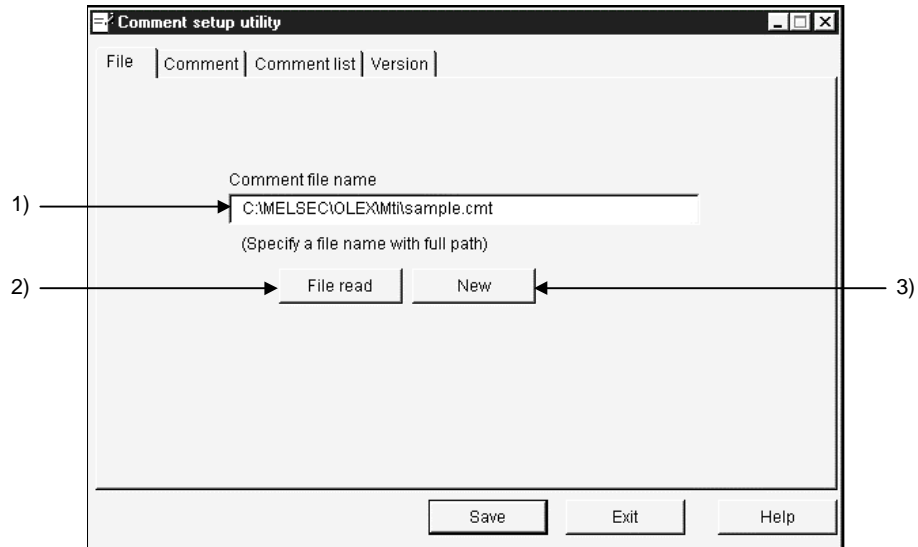

- 1) Comment file name
Specify the comment file name to be set.
- 2) "File read" button
Used to find the comment file to be set in 1).
As the file setting dialog box opens, set the comment file.
- 3) "New" button
Used to create a new comment file.
As the file setting dialog box opens, set a new comment file.

10.3.3 Operations on the Comment Screen

Set the definition, display range and character color of a comment.

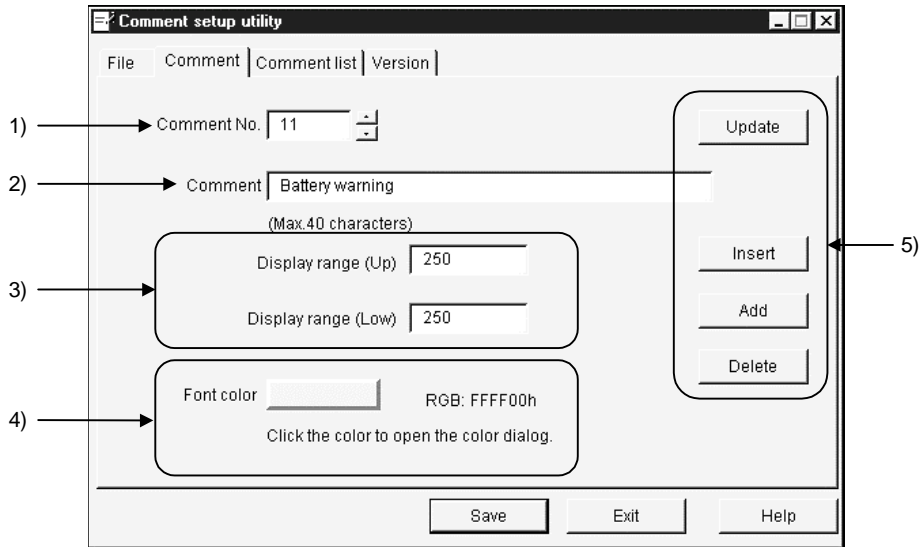

1) Comment No.

Set the comment number where the comment definition, display range, character color and so on are saved. (Up to No. 1000)

2) Comment

Describe the comment definition relative to the comment number. (Up to 40 characters)

3) Comment range

Set the upper and lower limits of the device value for displaying the comment. The comment is displayed when the device value is within the setting range. When specifying one point, set the same value to the upper and lower limits.

4) Font color

Since this setting does not concern the character color, you need not set the color.

5) Buttons

"Update"Used to update the definition of the comment currently being selected.

"Insert"Used to add a new comment in a place preceding the comment currently being selected.

"Add"Used to add a new comment in a place next to the last comment number.

"Delete"Used to delete the comment currently being selected.

10.3.4 Operations on the Comment List Screen

Show the set comments as a list.

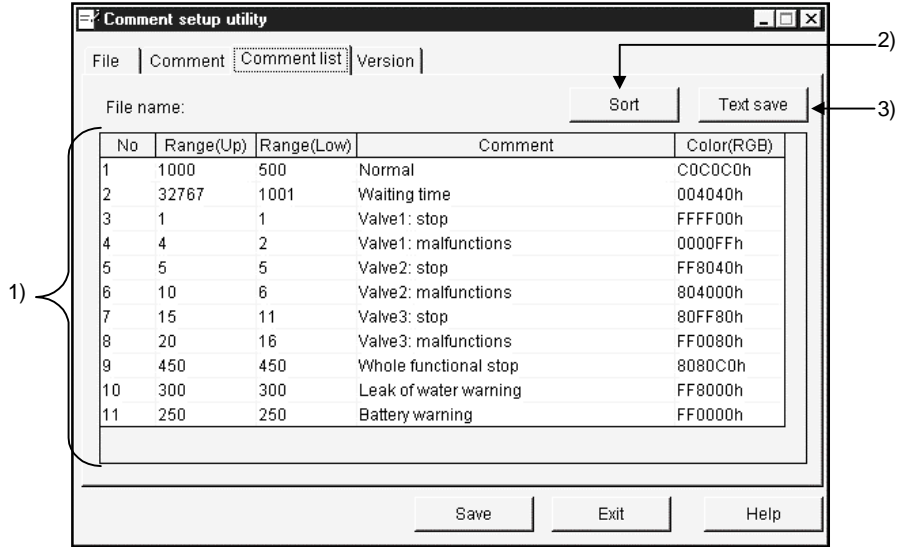

1) Setting display screen

Shows the comments registered to the comment file as a list.

2) "Sort" button

As the following dialog box opens, set the sort conditions

(Two or more conditions may be set.)

Note that priority is from top to bottom.

Items not checked return to the initial states.

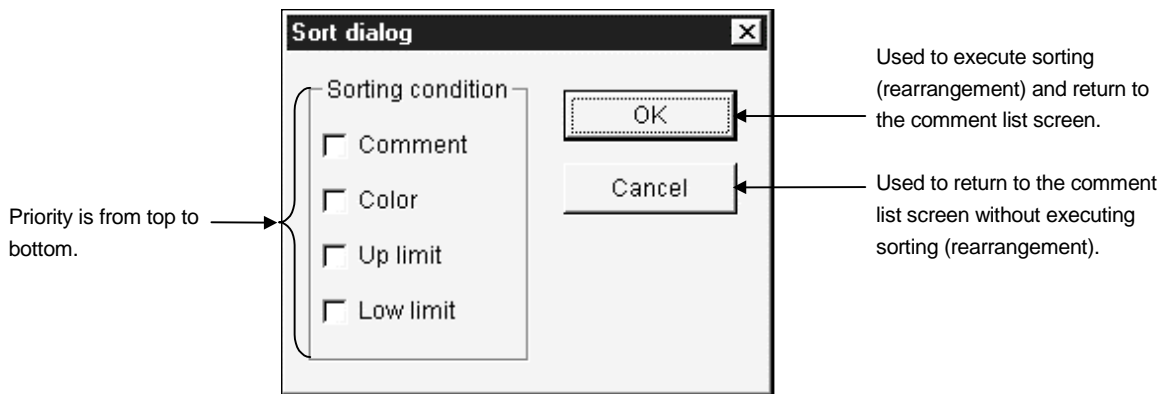

POINTS
(1) Sorting of character strings, such as comments, are made in character code order. (Not in alphabetical order.)
(2) Data in the sorted status cannot be saved in the comment file.

3) "Text save" button

Used to save the currently displayed data in the specified text file.

When sorting has been executed, data is saved as a text in the sorted status.

10.3.5 Comment File Format

The comment file is saved in a text file in the following format.

(Example) *.CMT

```

CMT 00A
1, 1, 2, Waiting time, 0[Enter]
2, -32000, -30000, Battery warning, FFFFFFFF[Enter]
3, 100000, 200000, Line 1: stop, FF00[Enter]
4, 201, 201, Line 1: start, FF0000[Enter]

```

- 1) Comment number
- 2) Lower limit
- 3) Upper limit
- 4) Comment character string
- 5) Color code (RGB code)

POINTS
(1) Settings should be separated by a comma (,).
(2) The line starting with "/" is handled as a comment.

10.4 Alarm Summary Setup Utility

This section describes the operation and setting procedures of the Alarm summary setup utility.

10.4.1 Operation Procedure

The following flowchart provides the operation procedure of the Alarm summary setup utility.

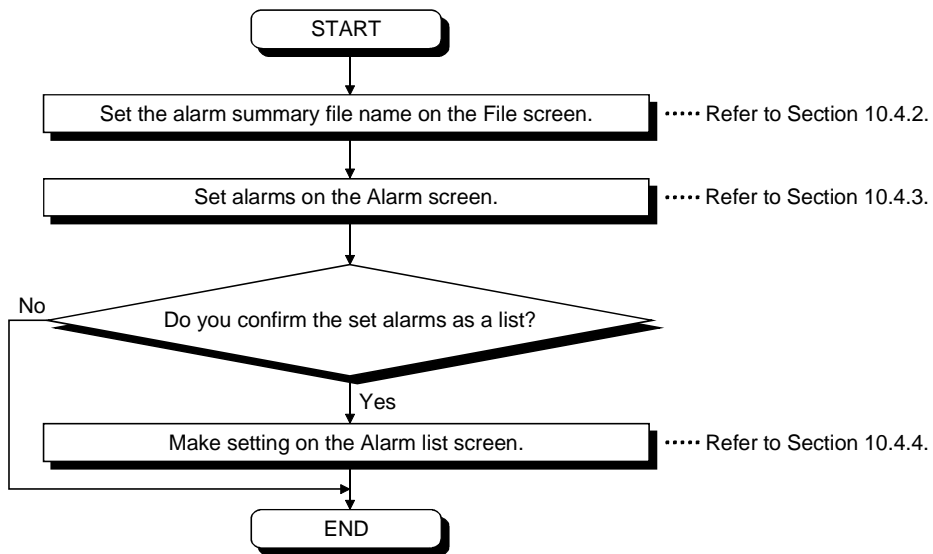

10.4.2 Operations on the File Screen

Set the file where alarm summary information will be saved.

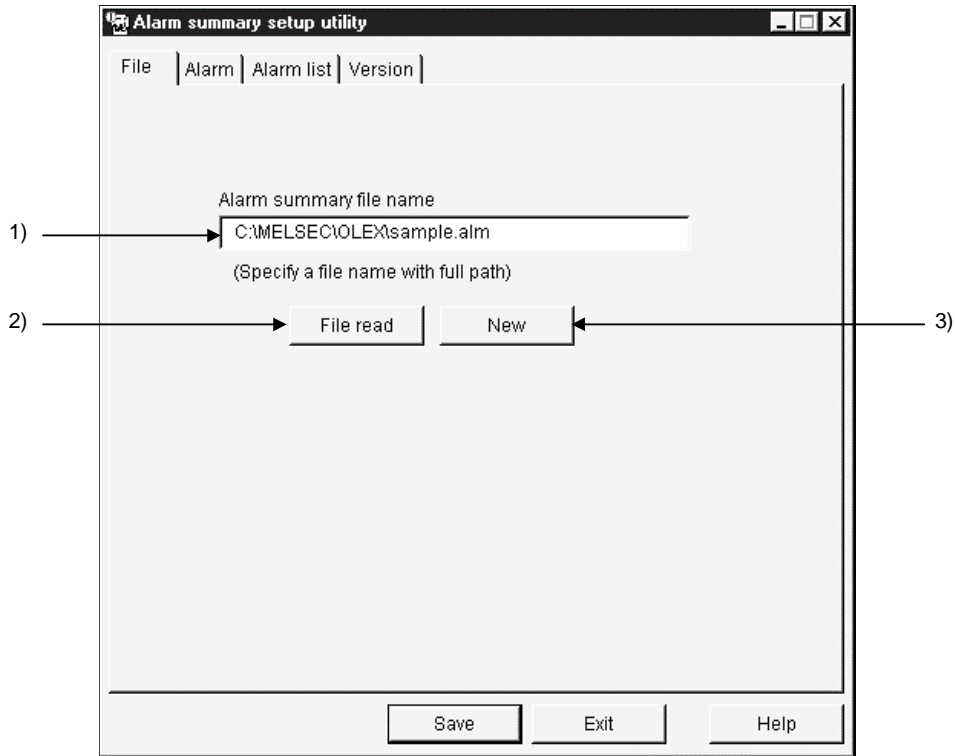

- 1) Alarm summary file name
Specify the file name where the data set with this utility will be saved.
- 2) "File read" button
Used to find the alarm summary file to be set in 1).
As the file setting dialog box opens, set the alarm summary file.
- 3) "New" button
Used to create a new alarm summary file.
As the file setting dialog box opens, set a new alarm summary file name.

10.4.3 Operations on the Alarm Screen

Set the definition, classification character strings and character colors of an alarm.

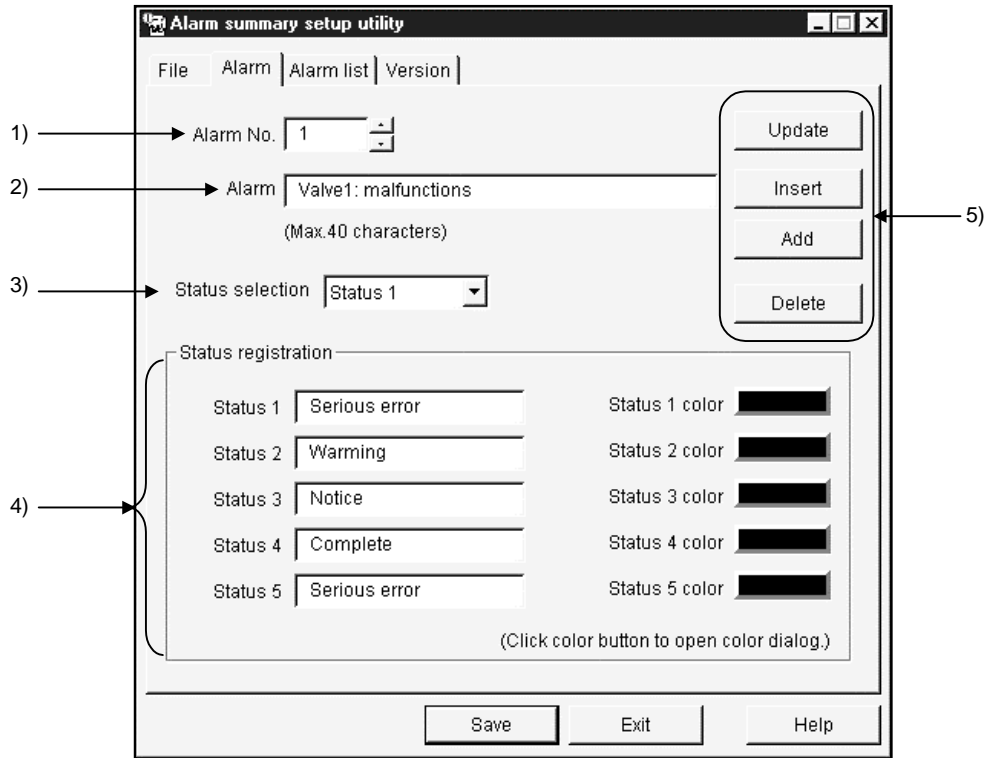

1) Alarm No.

Set the file name where the data set with this utility will be saved. (Up to No. 300)

2) Alarm

Describe the definition of the alarm message relative to the alarm number. (Up to 40 characters)

3) Status selection

Select the status which will be displayed simultaneously with the alarm definition.
Set the data to be selected in Set Status.

4) Status registration

Set the character strings and colors of the classifications to be displayed.
Status Set the character string of the classification to be displayed. (Up to 16 characters)
Status (1 to 5) Color You need not set this item.

5) Buttons

"Update"Used to update the data currently being selected.
"Insert"Used to insert a new alarm in a place preceding the alarm currently being selected.
"Add"Used to add a new alarm in a place next to the last alarm number.
"Delete"Used to delete the alarm summary currently being set.

10.4.4 Operations on the Alarm List Screen

Show the set alarms as a list.

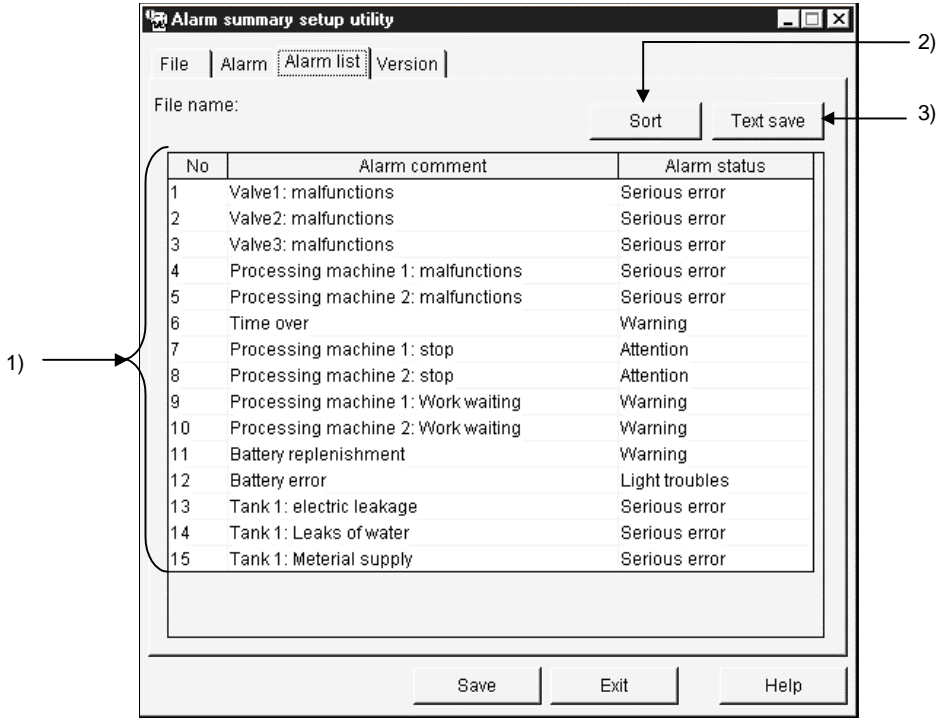

1) Setting display screen

Shows the set alarm comments and alarm states as a list.

2) "Sort" button

As the following dialog box opens, set the sort conditions (Two or more conditions may be set.)

Note that priority is from top to bottom.

Items not checked return to the initial states.

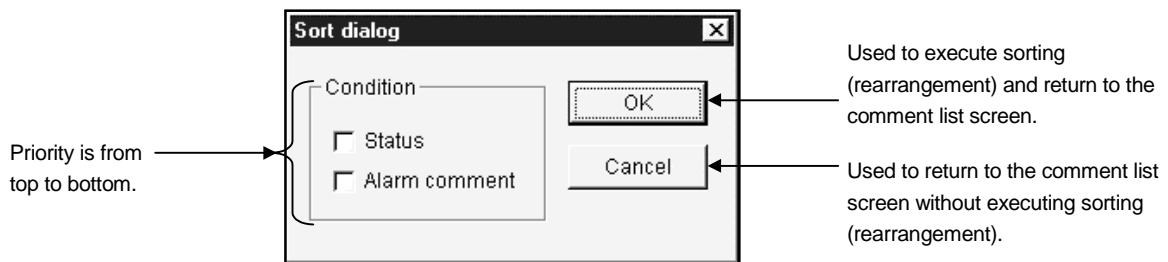

POINTS
(1) Sorting of character strings, such as comments, are made in ASCII code order. (Not in alphabetical order.)
(2) Data in the sorted status cannot be saved in the alarm summary file.

3) "Text save" button

Used to save the currently displayed data in the specified text file.

10.4.5 Alarm Summary File Format

The alarm summary file is saved in a text file in the following format.

(Example)

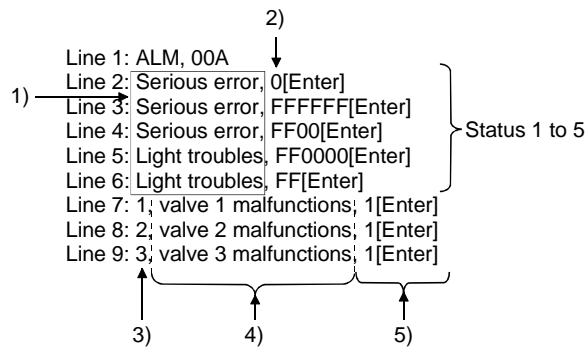

- 1) Status
- 2) Color code for status (RGB code)
- 3) Alarm number
- 4) Alarm comment character string
- 5) Status number

POINT	
Settings should be separated by a comma (,).	

11. HOW TO USE OLEX

This chapter explains how to use OLEX.

11.1 About Cell Setting

This section provides cell-setting methods.

Cell setting includes four different methods: monitor setting, logging setting, alarm setting and comment setting.

POINT

Before starting the correction of cell area setting information, always stop automatic start-up.
 This correction cannot be made during automatic execution.

11.1.1 Making Monitor Setting

This section describes the setting/editing of information (cell areas, tag name, etc.) required for the monitor function.

POINT

This function is designed to make setting or correction for monitoring.
 To make it valid actually, make setting in the Cell area name valid/invalid setup dialog. (Refer to Section 11.4.)

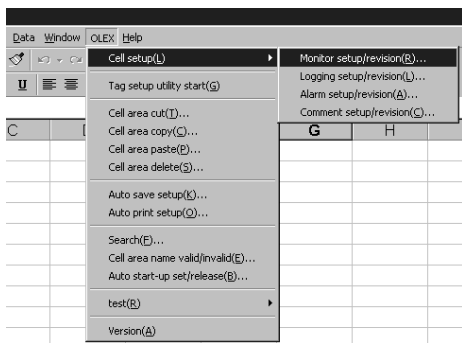

1. Select the area to be monitored and choose [OLEX]-[Cell setup]-[Monitor setup/revision] on the menu bar.

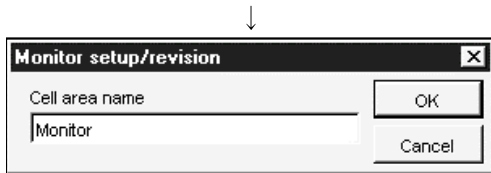

2. As the left screen appears, type any cell area name and click the "OK" button. (You can set the name in up to 32 characters.) Clicking the "Cancel" button suspends the setting and closes the dialog.

- To make correction
 Do not enter the cell area name but click the "OK" button and choose the cell area name on the Monitor setup/revision screen

(To the next page)

POINT

Maximums of the number of ranges of the cell of the monitor are 1,000 pieces.

(From the preceding page)



3. Set the tag name, field number and so on and click the "Register" button.

For more information, refer to the next page.

POINT
<p>The cell area name should not be headed by ' (single quotation). If so, proper operation may not be performed.</p> <p>Example: 'ABCDE: Not allowed '01234: Not allowed ABCDE: Allowed 01234: Allowed</p>

(1) Monitor setup/revision

Set the cell areas and items relative to the cell area name.

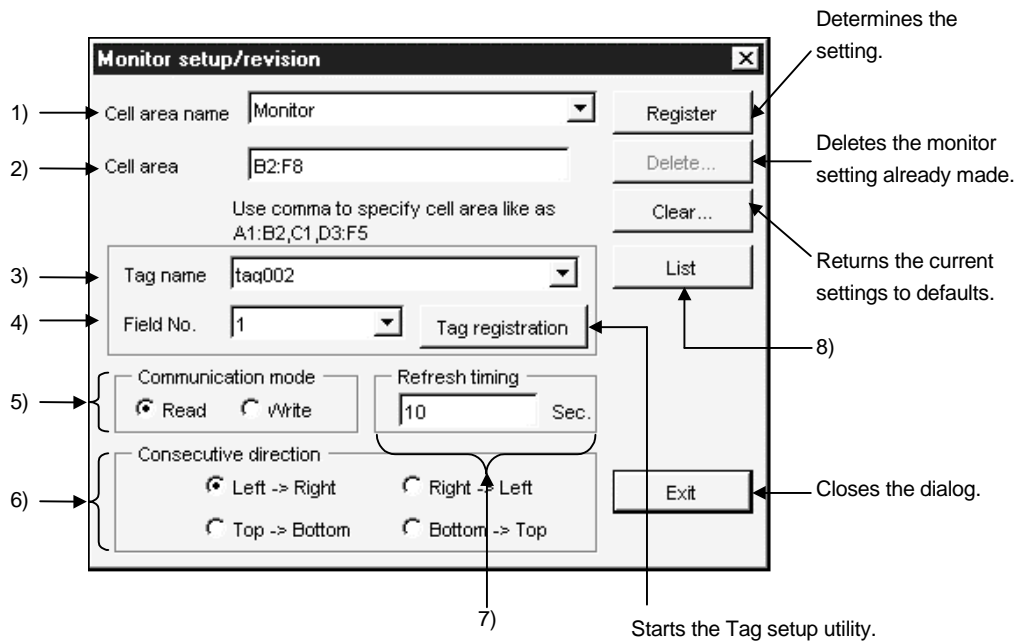

1) Cell area name

Shows the set cell area name.

To correct the cell area information already set, choose the corresponding cell area name.

(Note that the current settings are lost.)

POINT

The set data will be lost if you change the cell area name before clicking the Register button.

2) Cell area

Set the cell areas, e.g. "A1: C3, C4: E5". (You can set up to 16 areas.)
Set the cell areas as shown below.

Example: To set A1:E2, G1:H5, A4:E5

	A	B	C	D	E	F	G	H
1								
2			1)					
3							2)	
4								
5			3)					

1) A1:E2
↓
2) G1:H5
↓
3) A4:E5

Specify in the order of 1), 2) and 3).

POINTS

- (1) If you started "Monitor setup/revision" after choosing the cell areas, the cell areas have been entered in advance.
- (2) The maximum number of cell areas that may be set is 1000 points.
- (3) Choose cells within the area of row number 32767 and column number 256 (IV). If the cell selected exceeds the area of row number 32767 and column number 256 (IV) or is outside that area, the monitor function will not operate properly.

3) Tag name

Choose the tag name set with the Tag setup utility.

POINT
<p>If you change the tag name and the like on the Tag setup utility during Monitor setup/revision, they will not be reflected on the tag name list. To reflect the tag name changed on the Tag setup utility, close the Monitor setup/revision dialog once, and make Monitor setup/revision again.</p>

4) Field No.

Choose the field number of the tag set in 3).

5) Communication mode

Select the operation for communication from Read and Write.

6) Consecutive direction

Set the sequence in which data area stored.

- Top→Bottom (cell areas: A1:E2, G1:H5, A4:E5)

Cell area moving sequence

	A	B	C	D	E	F	G	H
1	1	3	5	7	9		11	16
2	2	4	6	8	10		12	17
3							13	18
4	21	23	25	27	29		14	19
5	22	24	26	28	30		15	20

- 1) A1:E2
- ↓
- 2) G1:H5
- ↓
- 3) A4:E5

- Left→Right (cell areas: G1:H5, A1:E2, A4:E5)

	A	B	C	D	E	F	G	H
1	11	12	13	14	15		1	2
2	16	17	18	19	20		3	4
3							5	6
4	21	22	23	24	25		7	8
5	26	27	28	29	30		9	10

- 1) G1:H5
- ↓
- 2) A1:E2
- ↓
- 3) A4:E5

- Bottom→Top (cell areas: A1:E2, A4:E5, G1:H5)

	A	B	C	D	E	F	G	H
1	2	4	6	8	10		25	30
2	1	3	5	7	9		24	29
3							23	28
4	12	14	16	18	20		22	27
5	11	13	15	17	19		21	26

- 1) A1:E2
- ↓
- 2) A4:E5
- ↓
- 3) G1:H5

- Right→Left (cell areas: A4:E5, G1:H5, A1:E2)

	A	B	C	D	E	F	G	H
1	25	24	23	22	21		12	11
2	30	29	28	27	26		14	13
3							16	15
4	5	4	3	2	1		18	17
5	10	9	8	7	6		20	19

- 1) A4:E5
- ↓
- 2) G1:H5
- ↓
- 3) A1:E2

7) Refresh timing

Set the intervals of transferring data. (1 to 86400 seconds)

For read: Set the intervals of rereading.

For write: Set the intervals of writing.

8) "List" button

A "list" sheet is created to display the already set data.

Microsoft Excel - Book1						
File Edit View Insert Format Tools Data Window OLEX OLEX button(M) Help						
A1 = Cell area name						
	A	B	C	D	E	F
1	Cell area name	Cell area	Sheet name	Tag name	Field No	Communication mode
2	Monitor	B2:F8	Sheet1	tag002	1	Read
3	sample	B10:F19	Sheet1	RANDOM_TAG	2	Read
4						

- [OLEX button] menu

Listing shows the [OLEX button] on the menu bar.

Choose [OLEX button]-[Exit] to end the listing.

- OLEX button toolbar

Listing shows the "OLEX button" toolbar.

Each button has the following function.



Ends listing.

Prints a list.

Deletes the setting of the selected line.

Returns to the Monitor setup/revision dialog box.

11.1.2 Making Logging Setting

This section describes the setting/editing of information (cell areas, tag name, etc.) required for the logging function.

POINT
<p>(1) This function is designed to make setting or correction for logging. To make it valid actually, make setting in the Cell area name valid/invalid setup dialog. (Refer to Section 11.4.)</p> <p>(2) If a load occurs on Excel due to the number of logging point or logging interval, an error such as "log data fall" or "log data no display" may be registered in the error viewer. If so, make the following adjustments to prevent the error from occurring.</p> <ul style="list-style-type: none"> • Lengthen the logging interval. • Reduce the number of logging point. • Reduce the cell range in size (column, row).

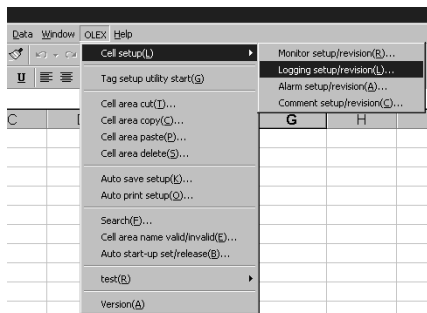

1. Select the area to be logged and choose [OLEX]-[Cell setup]-[Logging setup/revision] on the menu bar.

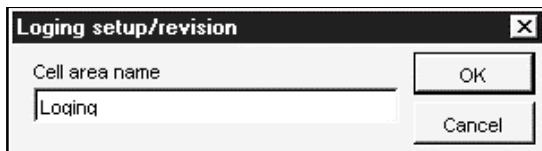

2. As the left screen appears, type any cell area name and click the "OK" button. (You can set the name in up to 32 characters.) Clicking the "Cancel" button suspends the setting and closes the dialog.

- To make correction
 Do not enter the cell area name but click the "OK" button and choose the cell area name on the Logging setup/revision screen.

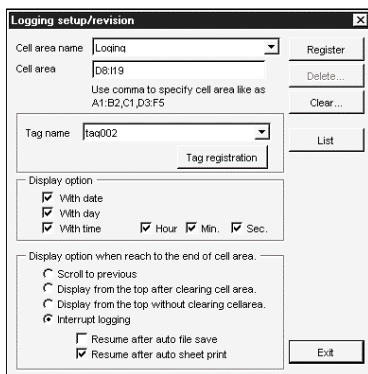

3. Set the tag name, display option and so on and click the "Register" button.

For more information, refer to the next page.

POINT
<p>Maximums of the number of ranges of the cell of logging are 100 pieces.</p>

POINT	
The cell area name should not be headed by ' (single quotation). If so, proper operation may not be performed.	
Example: 'ABCDE: Not allowed	'01234: Not allowed
ABCDE: Allowed	01234: Allowed

(1) Logging setup/revision

Set the cell areas and items relative to the cell area name.

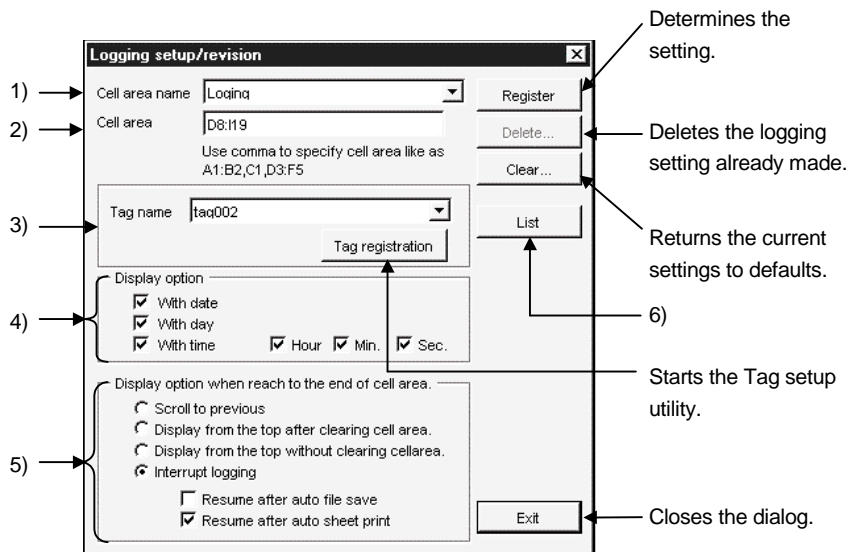

1) Cell area name

Shows the set cell area name.

To correct the cell area information already set, choose the corresponding cell area name.

(Note that the current settings are lost.)

POINT	
(1)	The set data will be lost if you change the cell area name before clicking the Register button.
(2)	After making the simple logging setting, do not change the date or time setting of the personal computer. If you have changed the date or time setting of the personal computer, the logging function will not operate properly. If you have changed it, restart the personal computer, delete the following file, and then restart OLEX. (Installation destination folder of CSKP)\CSKP\Mti\Logfile\ (tag name).log

2) Cell area

Set the cell areas, e.g. "A1: C3, C4: E5". (You can set up to 16 areas.) Set the cell areas as shown below.

Example: To set A1:E2, G1:H5, A4:E5

	A	B	C	D	E	F	G	H
1			1)					
2								
3							2)	
4			3)					
5								

1) A1:E2
↓
2) G1:H5
↓
3) A4:E5

Specify in the order of 1), 2) and 3).

POINT
(1) The maximum number of cell area lines that may be set is 2000 lines.
(2) Choose cells within the area of row number 32767 and column number 256 (IV). If the cell selected exceeds the area of row number 32767 and column number 256 (IV) or is outside that area, the monitor function will not operate properly.

3) Tag name

Choose the tag name set for logging with the Tag setup utility.

POINTS
(1) If you change the tag name and the like on the Tag setup utility during Logging setup/revision, they will not be reflected on the tag name list. To reflect the tag name changed on the Tag setup utility, close the Logging setup/revision dialog once, and make the Logging setup/revision again.
(2) The tag set in Logging setup/revision should be the log-specified tag dedicated to logging.
(3) Set the tag collection interval to 1 seconds or longer.
(4) Setting values greater than the required to the numbers of fields and logs of the tag will put a load on the Tag management process. Set values required for display to the numbers of fields and logs.

4) Display option

In the leftmost column of the logging data, set the date and time to be displayed when data is acquired.

Only "Min." cannot be set at "Display option" section when "With time" is checked.

Checking "Min." automatically checks "Hour".

If only "Hour" is unchecked keeping "Min." checked, this automatically unchecks "Min.".

The date and time display format is indicated below.

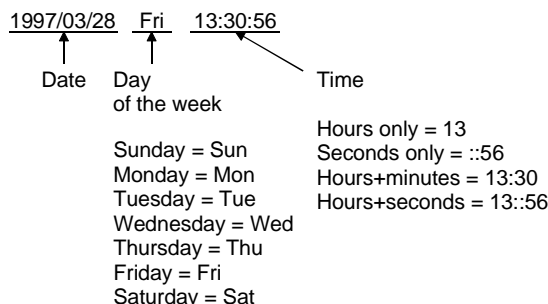

5) Display option when reach to the end of cell area

Set the action taken when the logging data has reached the last part of the cell area.

Any of the following operations may be selected when the logging data exceeds the cell area.

• Scroll to previous

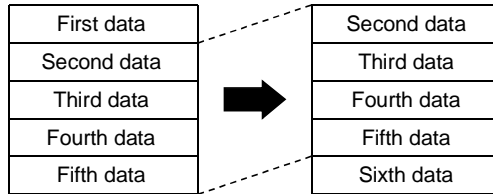

POINT	<p>When scrolling is specified, set the numbers of columns in the cell areas equal. If multiple cell areas are specified and the numbers of columns in the cell areas satisfy the following conditions:</p> <p style="margin-left: 20px;">Number of columns in cell area X in setting order n-1 > number of columns in cell area Y in setting order n</p> <p>the cell area X is overwritten by the data of the number of columns in the cell area Y smaller in number of columns as a result of scrolling. Hence, the right end columns of the cell area X are blanked.</p>
--------------	--

• Display from the top after clearing cell area

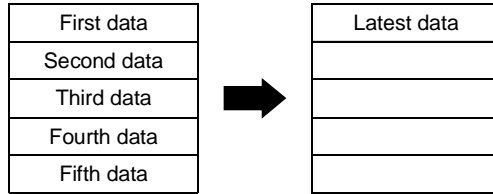

• Display from the top without clearing cell area

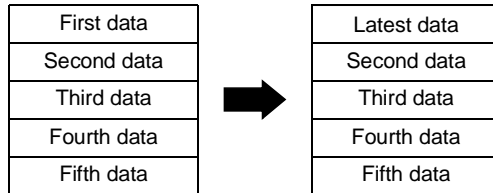

• Interrupt logging

Note that if automatic saving or automatic printing is not done, logging is aborted and the latest data cannot be displayed.

• Resume after auto file save

Logging starts after the file is saved automatically.

When logging is resumed, the cell area is cleared and data is displayed from the beginning.

Automatic saving is done at the timing set in Auto save setup.

POINT	<p>Automatic saving is not executed if you did not click the "Auto save" check box on the Auto save setup screen. (Refer to Section 11.7.1.)</p>
--------------	--

- Resume after auto sheet print
Logging is resumed after the sheet of the current setting is printed.
When logging is resumed, the cell area is cleared and data is displayed from the beginning.
Automatic printing is done at the timing set in Auto print setup.

POINT

Automatic printing is not executed if you did not click the "Auto print" check box on the Auto print setup screen. (Refer to Section 11.7.2.)

6) "List" button

A "list" sheet is created to display the already set data.

	A	B	C	D	E	F	G	H	I	J	K
1	Cell area name	Cell area	Sheet name	Tag name	Display option(Day)	(Week)	(Time)	(Hour)	(Min)	(Sec)	Resume direction
2	Logging	D8:I19	Sheet1	tag002	TRUE	TRUE	TRUE	TRUE	FALSE	FALSE	Logging abort
3	sample	D4:I6	Sheet1	BATCH_WORD_TAG	TRUE	FALSE	TRUE	TRUE	FALSE	FALSE	Scroll to previous
4											

- [OLEX button] menu
Listing shows the [OLEX button] on the menu bar.
Choose [OLEX button]-[Exit] to end the listing.
- OLEX button toolbar
Listing shows the "OLEX button" toolbar.
Each button has the following function.

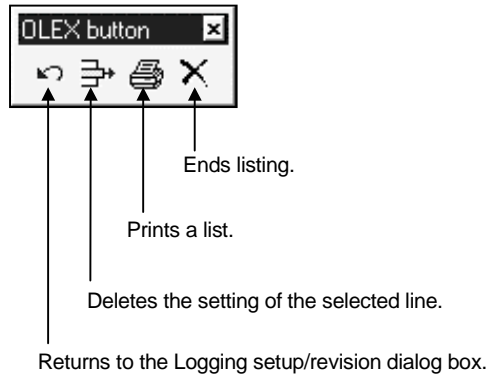

POINTS

(1) When there are two or more cell areas, logging is executed in the cell area setting order.

Example: When the cell areas were set as "A4:E5, G1:H5, A1:E2"

	A	B	C	D	E	F	G	H
1								
2			3)					
3							2)	
4								
5			1)					

1) A4:E5→2) G1:H5→3) A1:E2

(2) The refresh timing of logging is the same as the communication interval refresh timing of a tag.
Refer to the communication interval set for each tag on the Tag setup utility.

11.1.3 Making Alarm Setting

This section describes the setting/editing of information (cell area, tag name, etc.) required for the alarm summary.

POINTS
<p>(1) This function is designed to set or correct the alarm summary. To make it valid actually, make setting in the Cell area name valid/invalid setup dialog. (Refer to Section 11.4.)</p> <p>(2) When setting the cell area, four or more columns are always required. When setting two or more consecutive areas, four or more columns are also required similarly.</p>

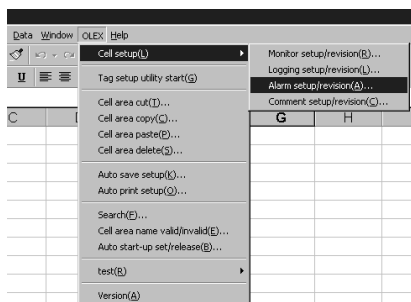

1. Select the area where the alarm summary will be displayed and choose [OLEX]-[Cell setup]-[Alarm setup/revision] on the menu bar.

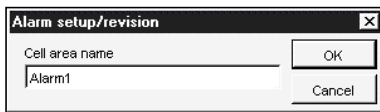

2. As the left screen appears, type any cell area name and click the "OK" button.
(You can set the name in up to 32 characters.)
Clicking the "Cancel" button suspends the setting and closes the dialog.

- To make correction
Do not enter the cell area name but click the "OK" button and choose the cell area name on the Monitor setup/revision screen.

3. Set the tag name, field number and so on and click the "Register" button.

For more information, refer to the next page.

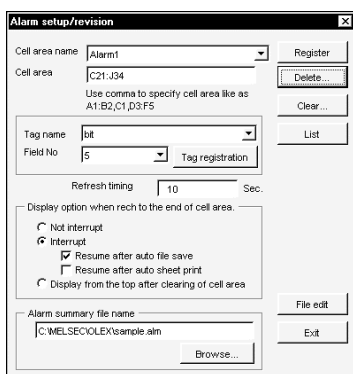

POINT
<p>1) The cell area name should not be headed by ' (single quotation). If so, proper operation may not be performed.</p> <p style="padding-left: 40px;">Example: 'ABCDE: Not allowed '01234: Not allowed ABCDE: Allowed 01234: Allowed</p> <p>2) Maximums of the number of ranges of the cell of the alarm are 100 pieces.</p>

(1) Alarm setup/revision

Set the cell areas and items relative to the cell area name.

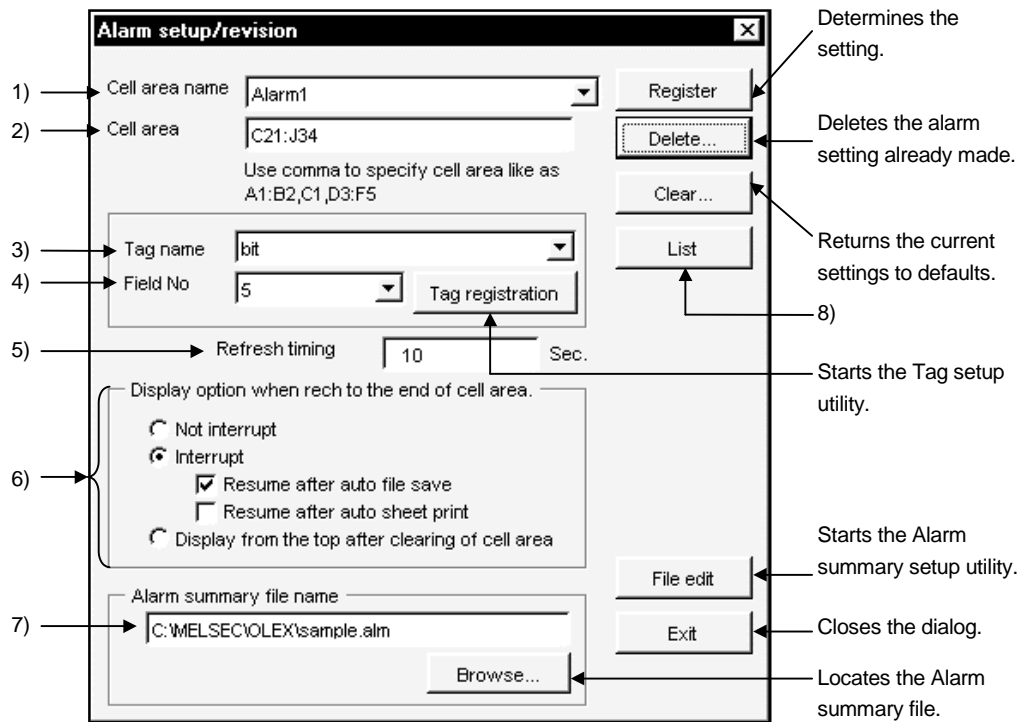

1) Cell area name

Shows the set cell area name.

To correct the cell area information already set, choose the corresponding cell area name.

(Note that the current settings are lost.)

POINT
The set data will be lost if you change the cell area name before clicking the Register button.

2) Cell area

Set the cell area, e.g. "A1: C3". (You can set only one area.)

Set the cell area as shown below.

Example: To set A1:D4

	A	B	C	D	E	F	G	H
1								
2								
3								
4								
5								

POINT
(1) The maximum number of cell area lines that may be set is 300 lines.
(2) Four or more columns are required for the cell area.
(3) Choose cells within the area of row number 32767 and column number 256 (IV). If the cell selected exceeds the area of row number 32767 and column number 256 (IV) or is outside that area, the monitor function will not operate properly.

3) Tag name

Choose the tag name set with the Tag setup utility.

POINT
<p>If you change the tag name and the like on the Tag setup utility during Alarm setup/revision, they will not be reflected on the tag name list. To reflect the tag name changed on the Tag setup utility, close the Alarm setup/revision dialog once, and make Alarm setup/revision again.</p>

4) Field No.

Choose the field number of the tag set in 3).

5) Refresh timing

Set the intervals of updating data. (1 to 86400 seconds)

6) Display option when reach to the end of cell area

Set the action taken when the alarm summary has reached the last part of the cell area.

Any of the following operations may be chosen when the alarm summary exceeds the cell area.

- Not interrupt (Default)

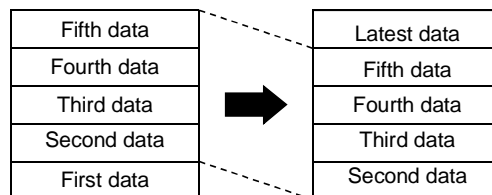

- Interrupt

Note that if automatic saving or automatic printing is not done, the alarm summary function is interrupted and the latest data cannot be displayed.

- Resume after auto file save

The file is saved automatically and the alarm summary is resumed.

POINT
<p>Automatic saving is not executed if you did not click the "Auto save" check box on the Auto save setup screen. (Refer to Section 11.7.1.)</p>

- Resume after auto sheet print ... The alarm summary is resumed after the sheet of the current setting is printed.

POINT
<p>Automatic printing is not executed if you did not click the "Auto print" check box on the Auto print setup screen. (Refer to Section 11.7.2.)</p>

When the alarm summary is resumed, the cell area is cleared and data is displayed from the beginning.

- Display from the top after clearing of cell area

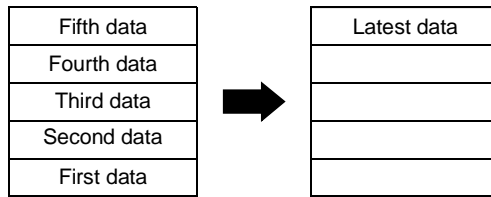

7) Alarm summary file name

Specify the alarm file set on the Alarm summary setup utility.

8) "List" button

A "list" sheet is created to display the already set data.

Microsoft Excel - Book1								
File Edit View Insert Format Tools Data Window OLEX OLEX button(M) Help								
Cell area name								
A	B	C	D	E	F	G	H	
1	Cell area name	Cell area	Sheet name	Tag name	Field No	Alarm summary file name	Refresh timing	Resume direction
2	Alarm	D12:H16	Sheet1	bit	6	C:\MELSEC\OLEX\sample.alm	10	Not interrupt
3	Alarm1	C21:J34	Sheet1	bit	5	C:\MELSEC\OLEX\sample.alm	10	Interrupt
4								
5								

- [OLEX button] menu

Listing shows the [OLEX button] on the menu bar.

Choose [OLEX button]-[Exit] to end the listing.

- OLEX button toolbar

Listing shows the "OLEX button" toolbar. Each button has the following function.



- Ends listing.
- Prints a list.
- Deletes the setting of the selected line.
- Returns to the Alarm setup/revision dialog box.

(2) Alarm display example

The display image of the alarm summary is as follows.

	A	B	C	D
1	Type	Time	Alarm Message	Class
2	Restored	1997/03/28 Fri 11:55:00	Valve 3: malfunction	Light trouble
3	Occurred	1997/03/28 Fri 11:49:50	Valve 3: malfunction	Light trouble
4	Occurred	1997/03/28 Fri 11:49:10	Valve 2: malfunction	Light trouble
5	Restored	1997/03/28 Fri 11:20:15	Valve 1: malfunction	Serious error
6	Occurred	1997/03/28 Fri 11:05:01	Machine 5: malfunction	Light trouble
7	Occurred	1997/03/28 Fri 10:25:21	Valve 1: malfunction	Serious error
8				
9				
10				
11				

Note: More recent alarms are displayed from top to bottom. [] ...Specified cell area

11.1.4 Making Comment Setting

This section describes the setting/editing of information (cell areas, tag name, etc.) required for the comment display function.

POINT

This function is designed to set or correct comments.
 To make it valid actually, make setting in the Cell area name valid/invalid setup dialog.
 (Refer to Section 11.4.)

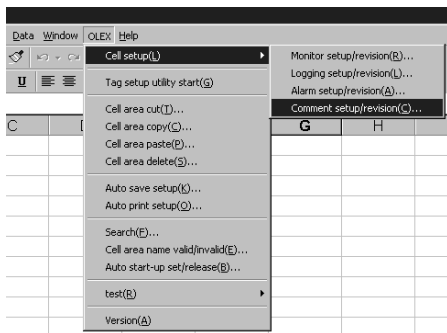

1. Select the area where a comment will be displayed and choose [OLEX]-[Cell setup]-[Comment setup/revision] on the menu bar.

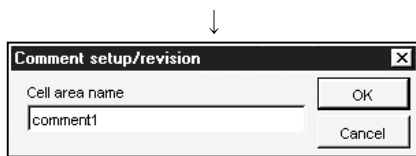

2. As the left screen appears, type any cell area name and click the "OK" button.
 (You can set the name in up to 32 characters.)
 Clicking the "Cancel" button suspends the setting and closes the dialog.

- To make correction
 Do not enter the cell area name but click the "OK" button and choose the cell area name on the Comment setup/revision screen.

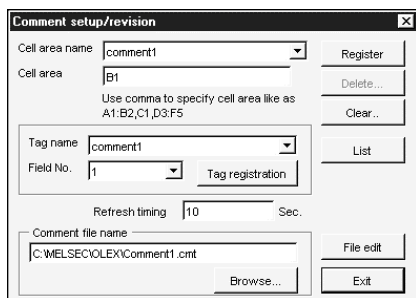

3. Set the tag name, field number and so on and click the "Register" button.
 For more information, refer to the next page.

POINT

- 1) The cell area name should not be headed by ' (single quotation). If so, proper operation may not be performed.
 Example: 'ABCDE: Not allowed '01234: Not allowed
 ABCDE: Allowed 01234: Allowed
- 2) Maximums of the number of ranges of the cell of the comment are 500 pieces.

(1) Comment setup/revision

Set the cell area and items relative to the cell area name.

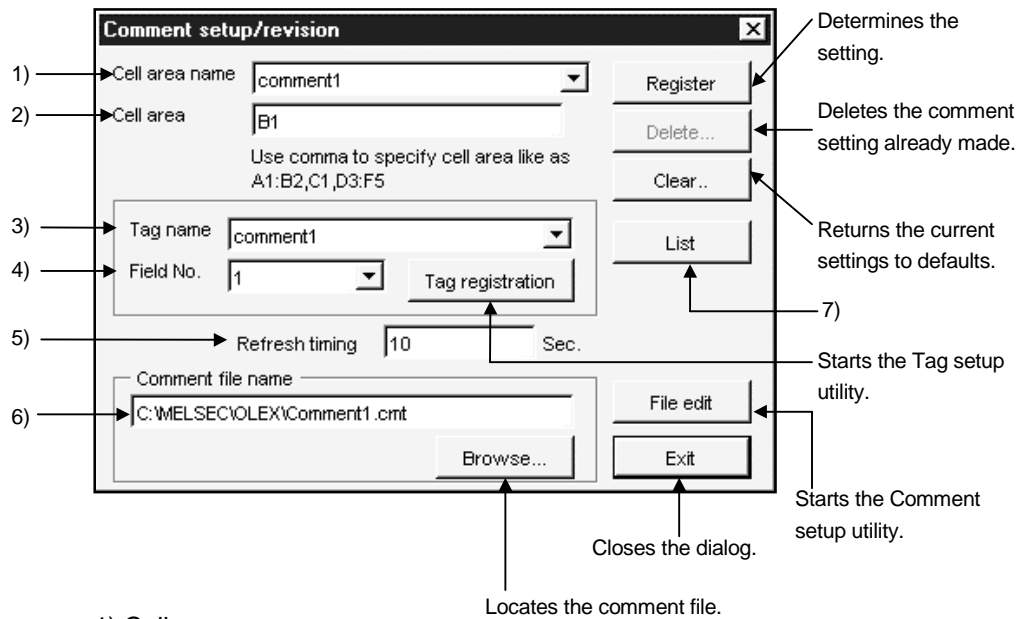

1) Cell area name

Shows the set cell area name.

To correct the cell area information already set, choose the corresponding cell area name.

(Note that the current settings are lost.)

POINT	The set data will be lost if you change the cell area name before clicking the Register button.
--------------	---

2) Cell area

Set the cell area for comment display.

The cell area has only one cell.

POINT	Choose cells within the area of row number 32767 and column number 256 (IV). If the cell selected exceeds the area of row number 32767 and column number 256 (IV) or is outside that area, the monitor function will not operate properly.
--------------	--

3) Tag name

Choose the tag name set with the Tag setup utility.

POINT	If you change the tag name and the like on the Tag setup utility during Comment setup/revision, they will not be reflected on the tag name list. To reflect the tag name changed on the Tag setup utility, close the Comment setup/revision dialog once, and make Comment setup/revision again.
--------------	---

- 4) Field No.
Choose the field number of the tag set in 3).
- 5) Refresh timing
Set the intervals of updating data. (1 to 86400 seconds)
- 6) Comment file name
Specify the comment file set with the Comment setup utility.
- 7) "List" button
A "list" sheet is created to display the already set data.

	A	B	C	D	E	F	G	H
1	Cell area name	Cell area	Sheet name	Tag name	Field No	Comment file name	Refresh timing	Cell area name valid/inva
2	comment	C1	Sheet1	bit	5	C:\MELSEC\OLEX\Comment1.cmt	10	Valid
3	comment1	B1	Sheet1	comment1	1	C:\MELSEC\OLEX\Comment1.cmt	10	Valid
4								
5								
6								

- [OLEX button] menu
Listing shows the [OLEX button] on the menu bar.
Choose [OLEX button]-[Exit] to end the listing.
- OLEX button toolbar
Listing shows the "OLEX button" toolbar.
Each button has the following function.

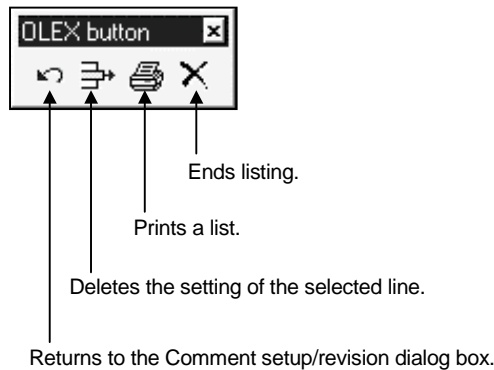

(2) Operation sequence

A comment is displayed in the following sequence.

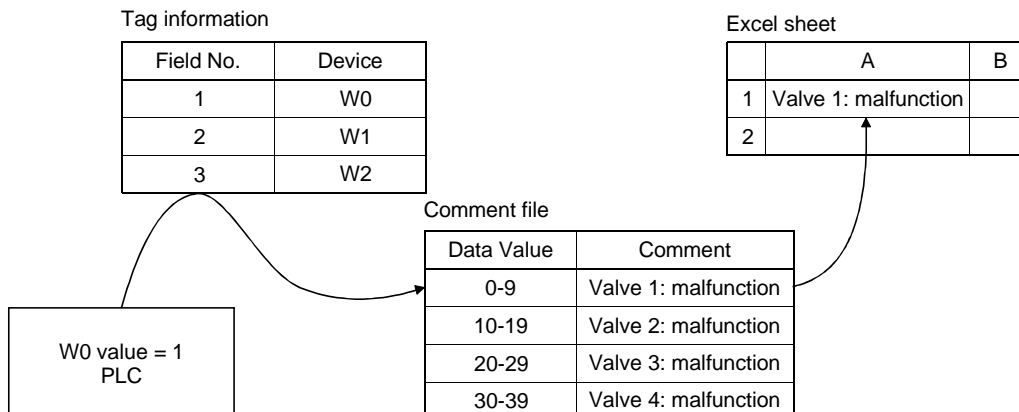

11.2 Editing

POINT
When editing the cell area, always stop automatic start-up. Editing cannot be done during automatic execution.

11.2.1 Cutting the Cell Area Set with OLEX

Cut the cell area set with OLEX.

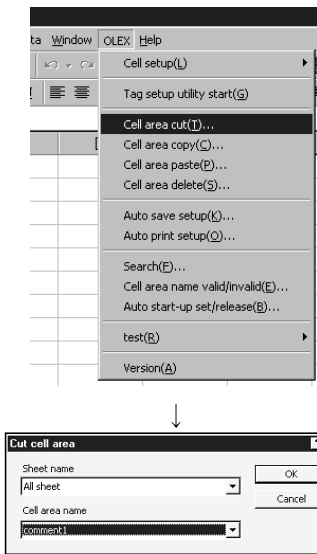

1. Choose [OLEX]-[Cell area cut] on the menu bar.

2. As the dialog box shown on the left appears, choose the sheet name and cell area name and click the "OK" button.

Cell area cutting complete

11.2.2 Copying the Cell Area Set with OLEX

Copy the cell area set with OLEX.

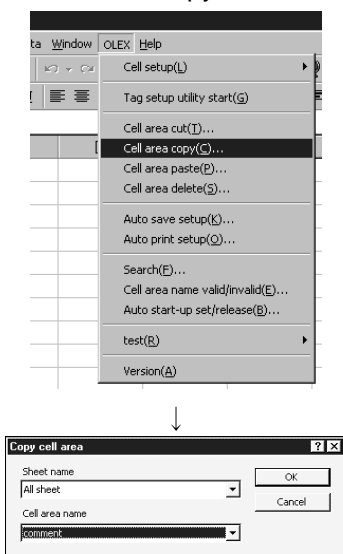

1. Choose [OLEX]-[Cell area copy] on the menu bar.

2. As the dialog box shown on the left appears, choose the sheet name and cell area name and click the "OK" button.

Cell area copying complete

11.2.3 Pasting the Cell Area Set with OLEX

Paste the cut/copied cell area to any sheet.

Refer to Section 11.2.1 for cutting the cell area, and to Section 11.2.2 for copying.

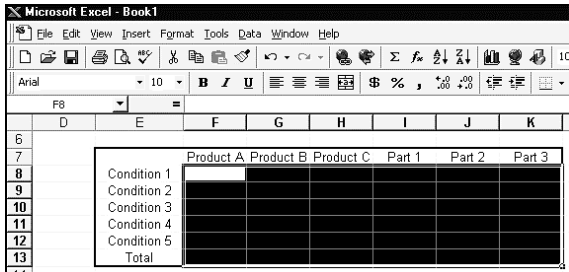

1. Specify the cell area to be pasted. (May be omitted.)

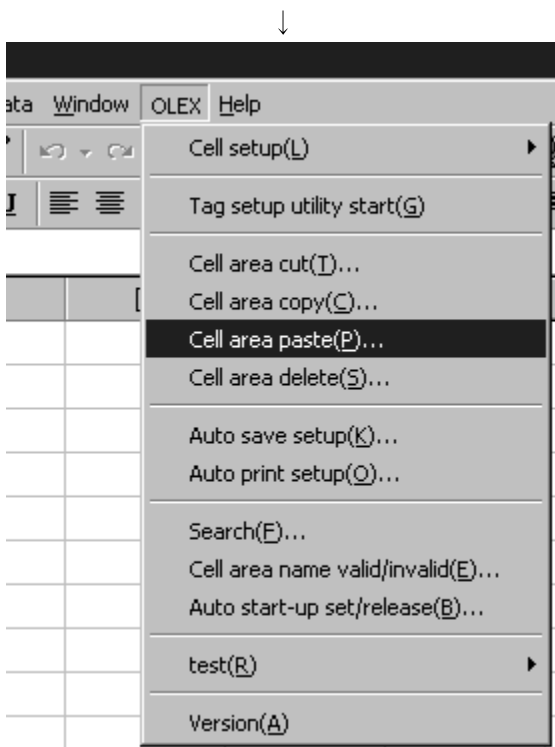

2. Choose [OLEX]-[Cell area paste] on the menu bar.

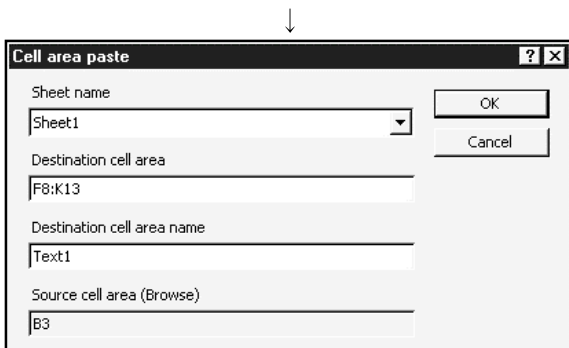

3. As the dialog box shown on the left appears, set the sheet name, cell area name, etc. and click the "OK" button.

For details, refer to the next page.

Cell area pasting complete

POINT
<p>The cell area of pasting destination to be set should be the same as the cell area cut or copied.</p> <p>Example: When copying and pasting 3 vertical × 4 horizontal cells, specify "3 vertical × 4 horizontal" cells similarly. (4 vertical × 3 horizontal is not allowed.)</p>

(1) Cell area paste
Set the cell area of paste destination.

The screenshot shows a dialog box titled "Cell area paste" with the following fields and buttons:

- 1)** Sheet name: A dropdown menu showing "Sheet1".
- 2)** Destination cell area: A text field containing "F8:K13".
- 3)** Destination cell area name: A text field containing "Text1".
- 4)** Source cell area (Browse): A text field containing "B3".
- OK** button: Located at the top right.
- Cancel** button: Located below the OK button.

Annotations on the right side of the dialog box:

- An arrow points to the **OK** button with the text: "Determines the setting and closes the dialog."
- An arrow points to the **Cancel** button with the text: "Discards the setting and closes the dialog."

- 1) Sheet name
Choose the sheet name of paste destination.
- 2) Destination cell area
Set the cell area of paste destination.
(This cell area has been set if you have already selected the cell area.)
- 3) Destination cell area name
Set any name to the cell area of paste destination.
(You can set a name of up to 32 characters.)
- 4) Source cell area (Browse)
Represents the cell area of paste source. (You cannot edit this.)

11.2.4 Deleting the Cell Area Set with OLEX

Delete the cell area set with OLEX.

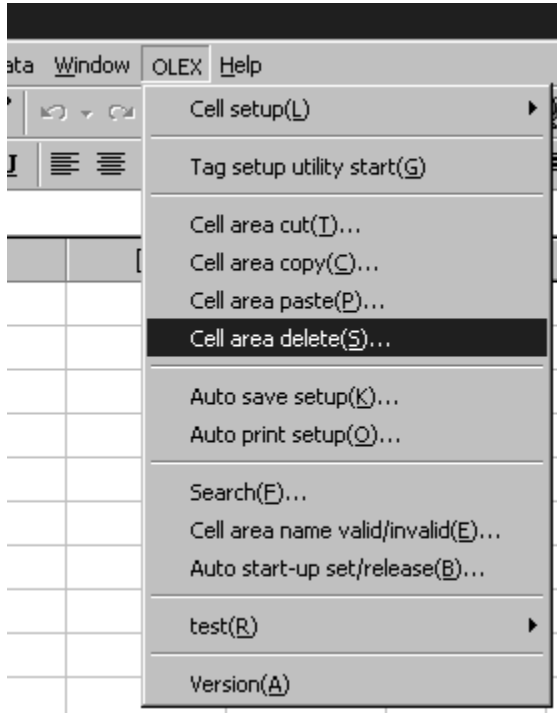

1. Choose [OLEX]-[Cell area delete] on the menu bar.

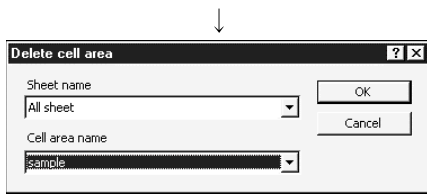

2. As the dialog box shown on the left appears, set the sheet name and cell area name and click the "OK" button.

Cell area deletion complete

POINT
The deleted cell area name information is lost.

11.2.5 Searching for the Cell Area Set with OLEX

This function searches for the cell area name or tag name to which monitor, logging, alarm or comment setting has been made, and makes the corresponding cell area active.

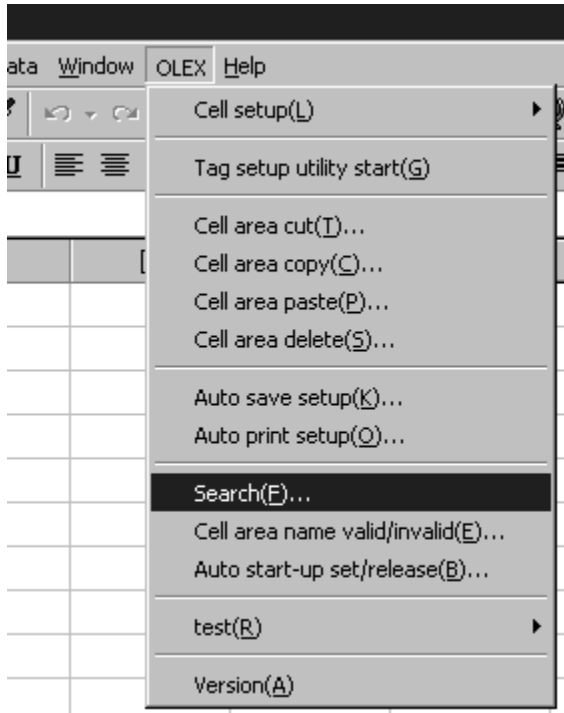

1. Choose [OLEX]-[Search] on the menu bar.

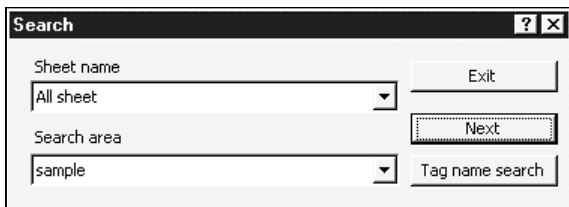

2. As the dialog box shown on the left appears, set the sheet name, the name to be searched for, etc. and click the "Next" button.
For details, refer to the next page.

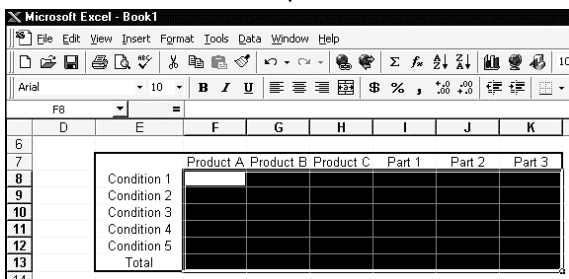

3. When the name to be searched for is found, the corresponding area is highlighted.

(1) Search

Set the name to be searched for.

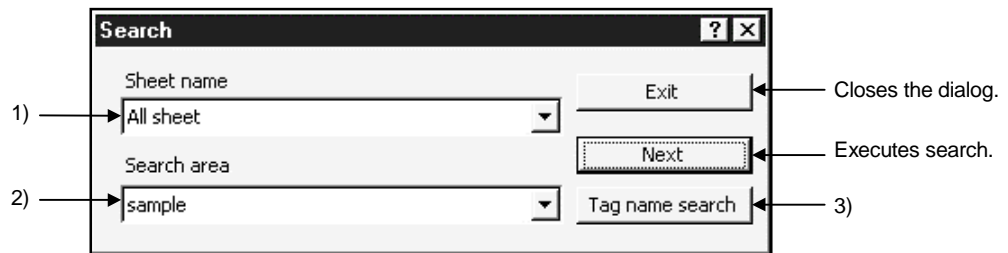

1) Sheet name

Set the sheet name to be searched for.

2) Search area

Set the cell area name or tag name to be searched for.

Use either of the "searched name changing" buttons to set the name to be searched for.

3) Searched name-changing buttons

By clicking either button, set whether the cell area name or tag name is used to make search.

"Cell name search" button The cell area name is searched for.

"Tag name search" button The tag name is searched for.

POINT
(1) If the lines/columns of Excel are deleted or added, the cell area set with OLEX does not change.
(2) When you chose [Format]-[Sheet]-[No display] in the Excel menu, the cell areas of the sheet hidden are not the target of search.

11.3 Making Communication Tests

POINTS
<p>(1) When conducting a cell area communication test, always stop automatic start-up. Communication tests cannot be done during automatic execution.</p> <p>(2) If the Tag management process error (-13) occurs during test execution, do the test again.</p>

11.3.1 Making a Read Test

Specify the cell area name to which monitor or logging setting has been made, and conduct a read test.

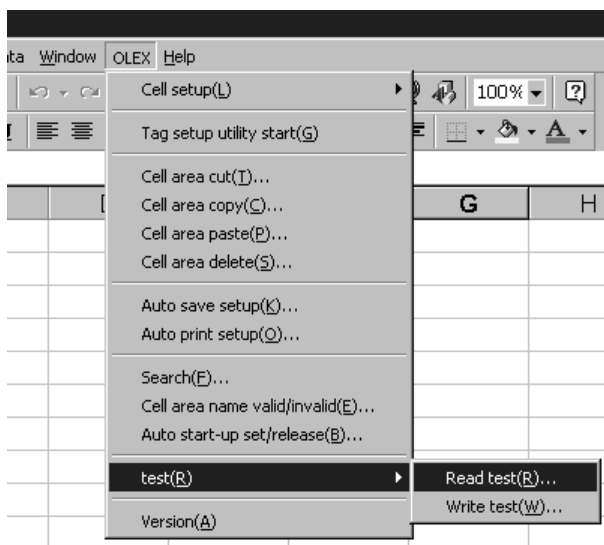

1. Choose [OLEX]-[test]-[Read test] on the menu bar.

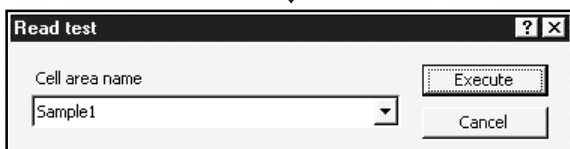

2. As the dialog box shown on the left appears, choose the cell area name and click the "Execute" button.

Read test execution

POINTS
<p>(1) When the read test is done on the cell area to which monitor setting has been made, read data appears in the set cell area.</p> <p>(2) When the read test is made on the cell area to which logging setting has been made, logged data appears in the top line of the set cell area.</p> <p>(3) Data is displayed according to the data type set with the Tag setup utility.</p> <p>(4) Bit data is displayed as follows. When the bit is ON ... TRUE When the bit is OFF ... FALSE</p>

11.3.2 Making a Write Test

Specify the cell area name to which monitor setting has been made, and conduct a write test.

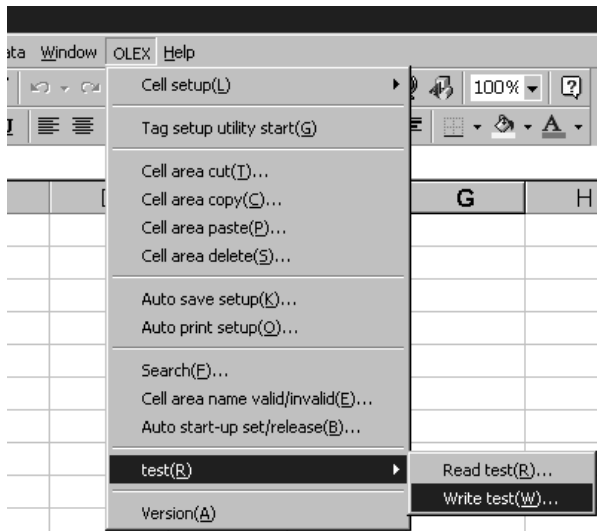

1. Choose [OLEX]-[test]-[Write test] on the menu bar.

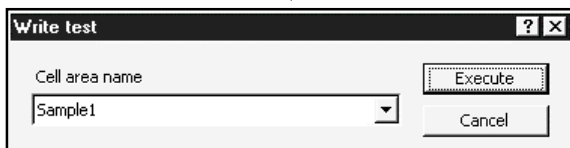

2. As the dialog box shown on the left appears, choose the cell area name and click the "Execute" button.

Write test execution

POINTS
(1) Numerals or characters must have been entered in the cell area where data will be written. If there is any blank cell that has no entry, the write test cannot be executed.
(2) Data is displayed according to the data type set with the Tag setup utility.
(3) Enter bit data as follows. When the bit is ON ... TRUE When the bit is OFF ... FALSE
(4) Character string data written should be headed by ' (single quotation) as indicated below. Example: 'ABCDEF'
(5) Set values as decimal integers. When handling decimal points, it is recommended to create a program which multiplies values by 10 ⁿ on Excel and divides them by 10 ⁿ within the PLC. When values set have decimal points, OLEX discards all digits to the right of the decimal point before writing them.

11.4 Setting Whether the Cell Area Is Made Valid or Invalid

The cell area to which monitor, logging, alarm or comment setting has been made is set to an executable status.

POINT

When setting whether the cell area is made valid or invalid, always stop automatic start-up.
 This setting cannot be made during automatic execution.

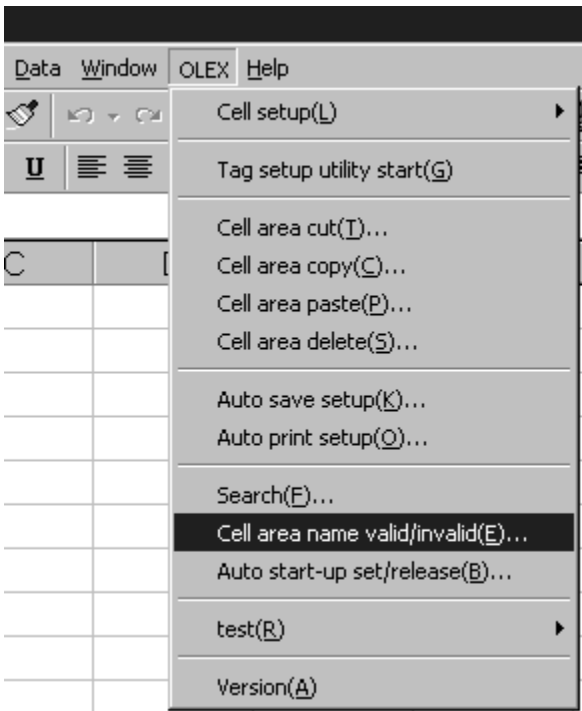

1. Choose [OLEX]-[Cell area name valid/invalid] on the menu bar.

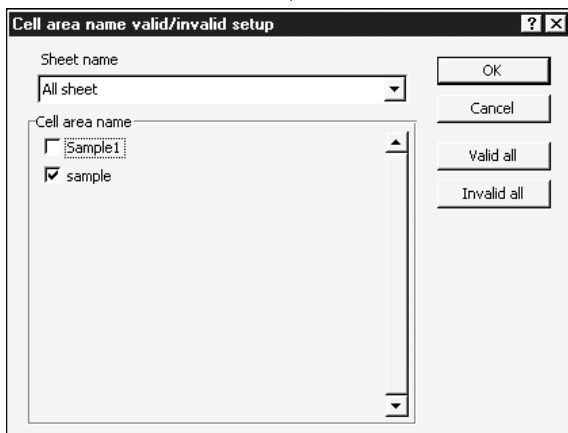

2. As the dialog box shown on the left appears, check the cell area name you will make valid, and click the "OK" button.

For more information, refer to the next page.
 (Defaults to the checked (valid) status.)

(1) Cell area name valid/invalid

Set whether the set cell area is made valid or invalid.

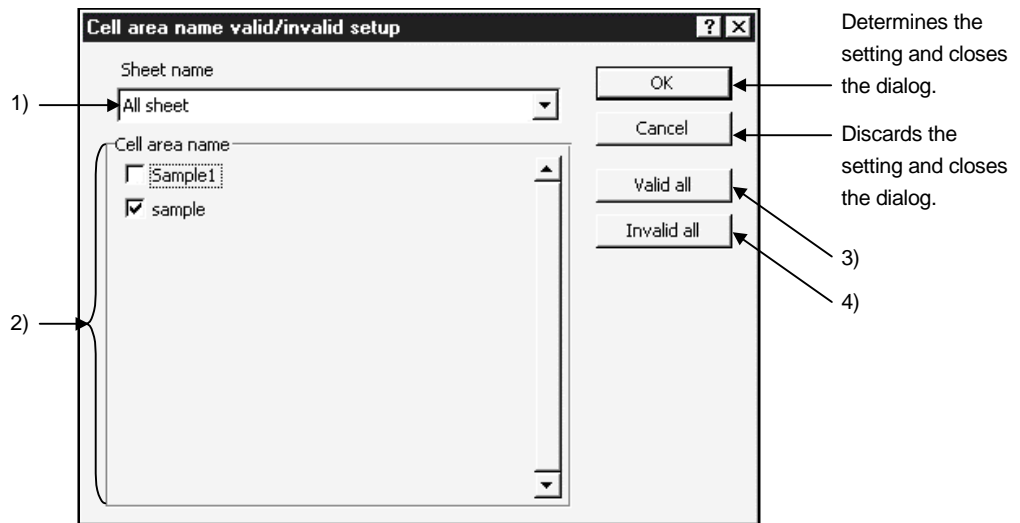

1) Sheet name

Set the sheet name where the cell area for valid/invalid setting exists.

2) Cell area name

Shows all cell area names set to the specified sheet.

Also, turning on the check box sets the corresponding cell area "valid".
(Defaults to the checked (valid) status.)

3) "Valid all" button

Sets all cell areas of the specified sheet "valid".

4) "Invalid all" button

Sets all cell areas of the specified sheet "invalid".

11.5 Setting/Releasing Automatic Start-Up

This section explains how to set/release automatic start-up of OLEX.

11.5.1 Setting Automatic Start-Up

Set the automatic start-up of the OLEX function.

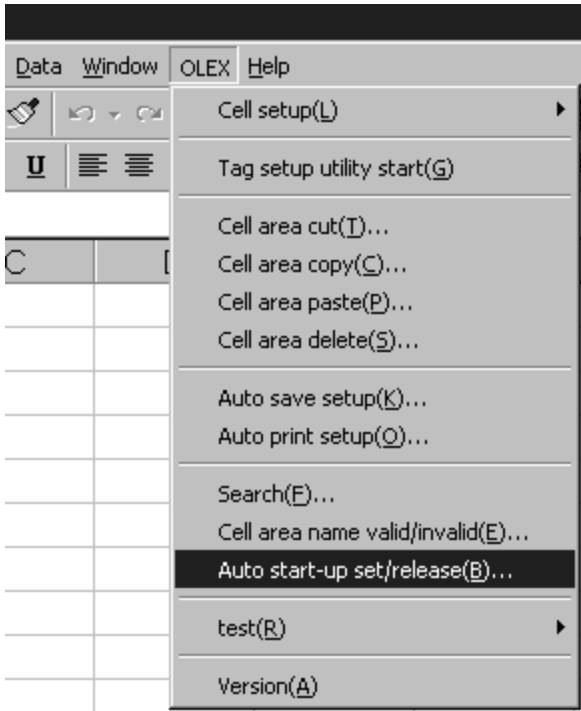

1. Choose [OLEX]-[Auto start-up set/release] on the menu bar.



2. As the dialog box shown on the left appears, click the "OK" button.

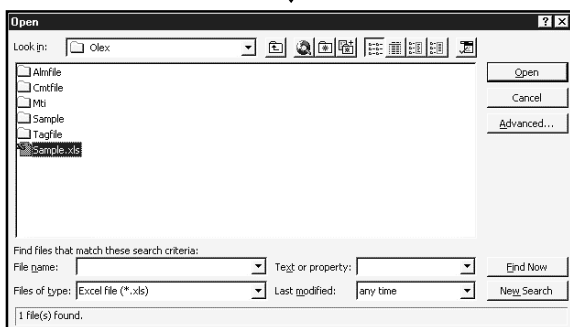

3. Choose the file name to which automatic start-up setting will be made.

(To the next page)

(From the preceding page)

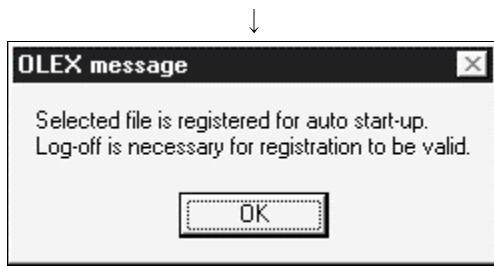

4. After confirming the message, click the "OK" button to execute logoff or restart.

After completion of logoff or restart, starting the Tag management process starts Excel automatically and starts access to the PLC CPU.

↓
Logoff/restart execution

↓
Tag management process start

↓
OLEX automatic execution start

POINTS

- (1) Only the existing files may be registered for automatic start-up.
To register the currently edited file for automatic start-up, you need to save it in advance.
- (2) Only one file may be set for automatic start-up.
To make an automatic start-up with the other file, stop the started file once, set the corresponding file for automatic start-up again, and execute logoff or restart.

11.5.2 Releasing Automatic Start-Up

Release the automatic start-up of started OLEX.

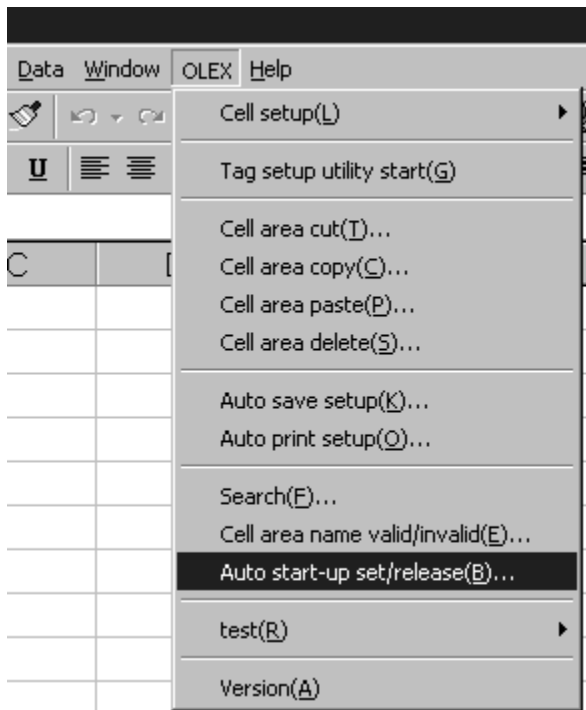

1. Choose [OLEX]-[Auto start-up set/release] on the menu bar.



2. As the dialog box shown on the left appears, click the "OK" button.

OLEX automatic start-up release complete

POINT
If you have released automatic start-up by clicking the "OK" button, starting the Tag management process after logoff or restart will not start automatic execution.

11.6 About Automatic Execution

11.6.1 About the Status During Automatic Execution

When you perform operations in the sequence of "Auto start-up setting", "Logoff/restart", "Logon/restart completion" and "Tag management process start", Excel will start in several seconds with OLEX in the automatic execution status as shown below.

Example: When there is monitor setting registration in the cell area "B1: F8" of the "Sample.xls" file

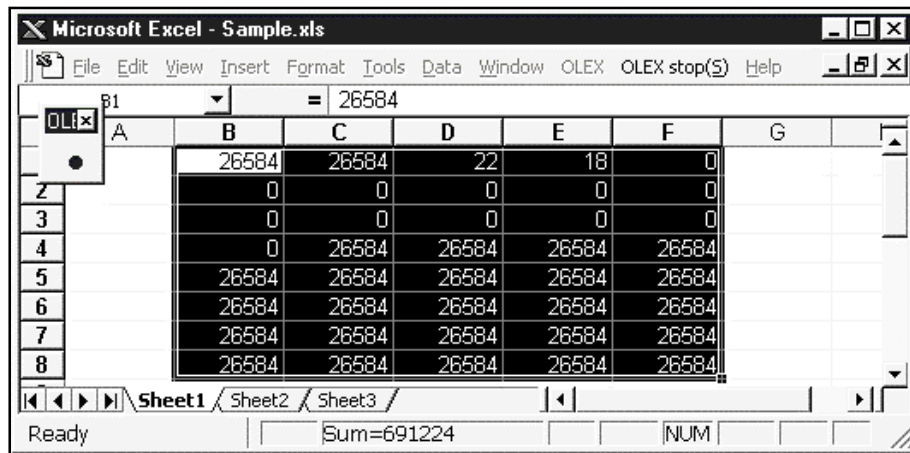

A monitor, logging, alarm summary or comment display is provided in automatically executed Excel according to the information set to one or more cell areas. If this display is not provided, an error definition and corrective action are registered to the error viewer. Remove the error according to the instructions. If you set automatic saving/printing, automatic saving/printing is performed at the specified timing.

POINTS
(1) During automatic execution, any menu other than "OLEX stop" cannot be selected and normal Excel operation cannot be performed. If you attempt to enter a value in any cell during automatic execution, an error takes place and is registered to the error viewer. To perform these operations, stop automatic execution.
(2) During automatic execution, cell values cannot be changed. When writing values, enter them in the sheet in advance.

11.6.2 Stopping Automatic Execution

Automatic execution may either be stopped by clicking the "OLEX stop" menu or by clicking the "OLEX stop" button.

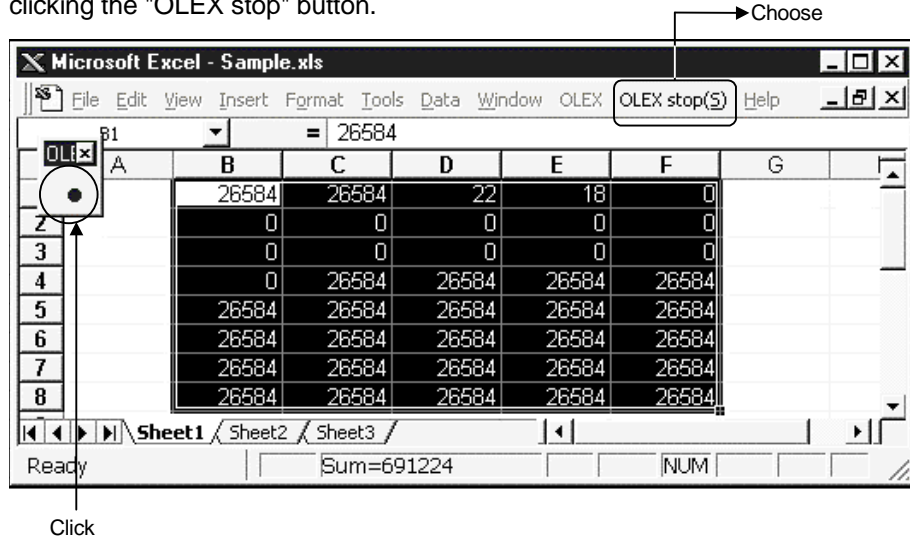

POINTS
<p>(1) If you click the stop button, the automatic start-up setting is not released. When releasing the automatic start-up setting, refer to Section 11.5.2.</p> <p>(2) To resume automatic execution after setting it once, perform operation in the following procedure.</p> <p style="padding-left: 40px;">"Logoff/restart" → "Logon/restart completion" → "Tag management process start"</p> <p>(3) Before making logoff, always stop OLEX.</p> <p>(4) When "Show window contents while dragging" has not been checked in Visual settings within the "Plus!" tab on the Display Properties screen, moving the window of Excel during OLEX automatic execution may leave the after-image of the Excel window frame on the screen. (Only when Windows NT 4.0 is used) In this case, display the full screen to avoid moving Excel or check "Show window contents while dragging" in Visual settings within the "Plus!" tab on the Display Properties screen.</p>

11.7 Other Operations

POINT

Before making any settings described in this chapter, always stop automatic start-up.
Correction cannot be made during automatic execution.

11.7.1 Making Setting to Save Collected Data Automatically

Make setting when saving a file automatically.
When automatic saving is set during logging or alarm setting, a file is also saved according to this setting.

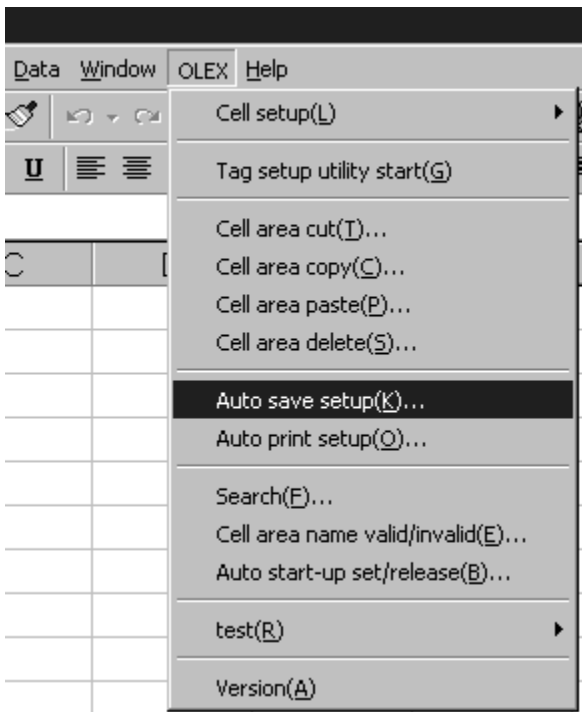

1. Choose [OLEX]-[Auto save setup] on the menu bar.

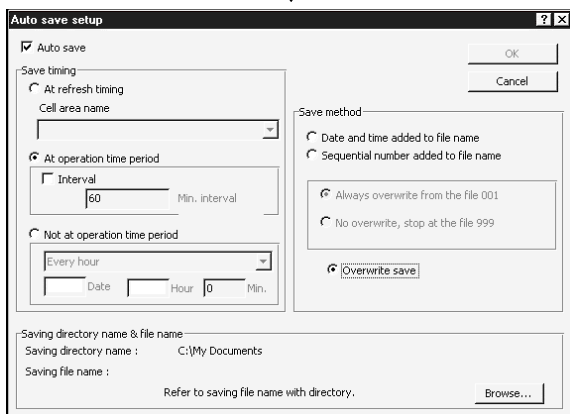

2. As the dialog box shown on the left appears, set each item and click the "OK" button.
For details, refer to the next page.

(1) Auto save setup
Set the timing of automatic saving.

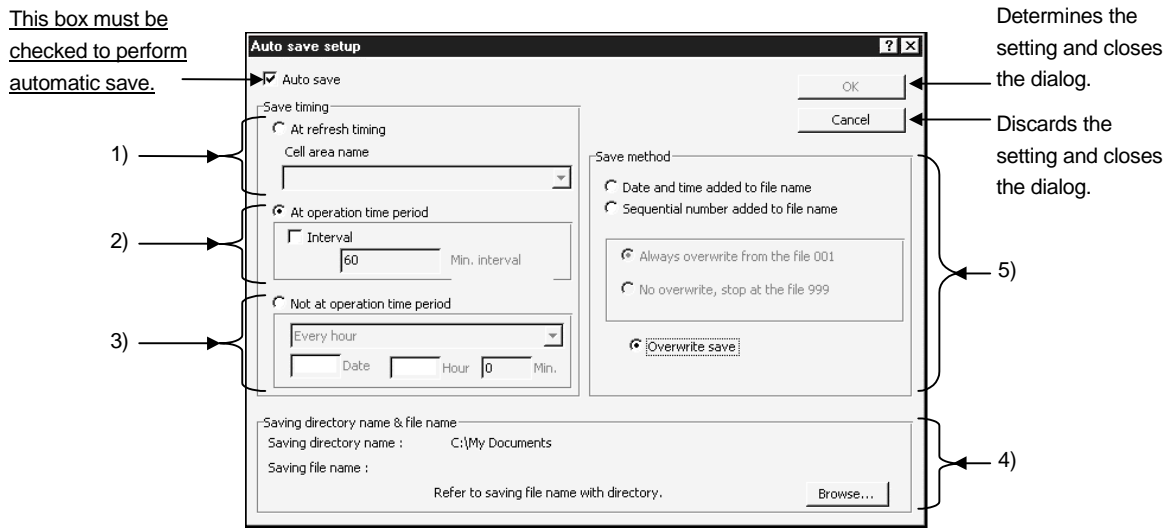

- 1) At refresh timing (Save timing)
Executes automatic saving according to the refresh timing set to the cell area.
Always set the selected cell area name valid.

POINT	Note that the refresh timing of the cell area to which logging setting has been made is the same as the communication interval of the tag.
-------	--

- 2) At operation time period (Save timing)
Executes automatic saving according to the starting and end times in "Logging time" set with the Environment setup utility.

POINT	If the starting and end times in "Logging time" have not been set, this error is registered to the error viewer.
-------	--

- Interval
By turning on the check box, the user can set the automatic saving interval to any time.
(1 minute to 24 hours)

Refer to Section 10.1 for the way of setting the Environment setup utility.

- 3) Not at operation time period (Save timing)
Set the date and time when automatic save is to be executed.

- 4) Saving directory name & file name
Set the file name for automatic saving.
(Extension XLS is added automatically.)
Click the "Browse" button to locate the folder and file.

POINT
When the entire folder name and file name are not displayed, click the folder name and file name. The entire folder and file names are displayed.

- 5) Save method
Set the way of saving.
- Date and time added to file name
Adds the date and time to a place after the save destination file name.

Example: When the save destination file name is "Book1.XLS"

Book1970408 121635.XLS
 ↑ ↑
 April 8, '97 12 hours 16 minutes 35 seconds

- * Name of an era of retention file name
The name of an era added to the retention file name becomes two last Christian era digits. Therefore, 1999 year become 99 , and 2000 year become 00.
- Sequential number added to file name
Inserts a three-digit serial number in a place after the save destination file name.
Example: When the save destination file name is "Sample.XLS"
Sample001.XLS
 ↑
 3-digit serial number
- * Always overwrite from the file 001
OLEX begins regardless of the presence of the same file name, automatic file saving begins from 001. The file will be overwritten from 001 when the file save exceeds 999.
- * No overwrite, stop at the file 999
If the same file name exists, without overwriting, the next free number will be searched and saved. The same file name exists from 001 to 999 the automatic saving will be stopped.
To resume automatic saving,
 1. Change the file name and re-save data.
 2. Delete the file.
- Overwrite save
Overwrites the file set to the save destination file name.

POINT
If "OLEX stop" is made during automatic execution, data is saved independently of the save timing.

11.7.2 Setting Automatic Printing

Make setting when printing the specified sheet automatically.

When automatic printing is specified during logging or alarm setting, printing is also done according to this setting.

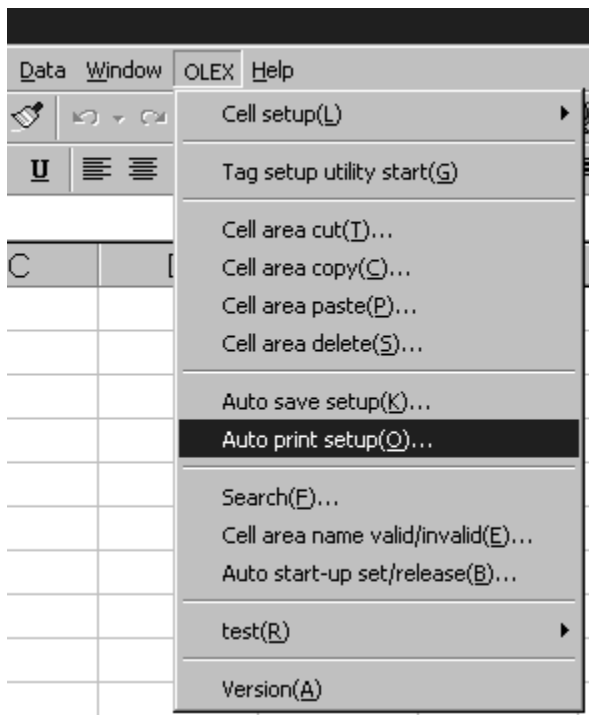

1. Choose [OLEX]-[Auto print setup] on the menu bar.

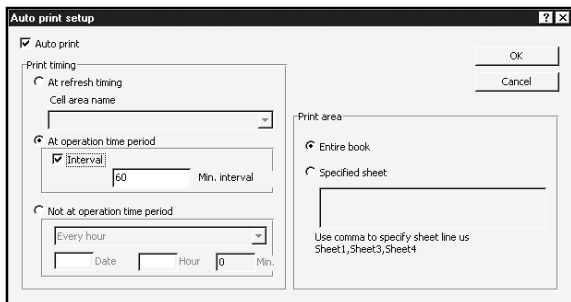

2. As the dialog box shown on the left appears, set each item and click the "OK" button. For details, refer to the next page.

(1) Auto print setup

Set the timing of automatic printing.

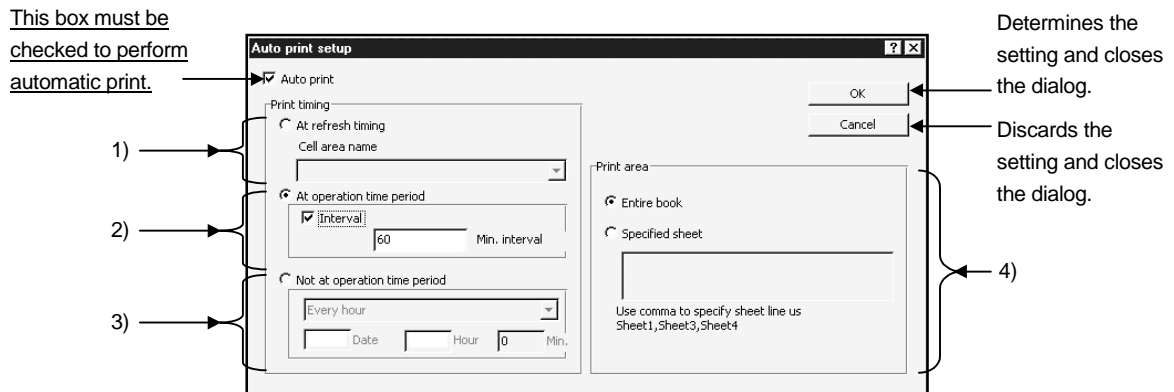

1) At refresh timing (Print timing)

Executes automatic printing according to the refresh timing set to the cell area. Always set the selected cell area name valid.

POINT

Note that the refresh timing of the cell area to which logging setting has been made is the same as the communication interval of the tag.

2) At operation time period (Print timing)

Executes automatic printing according to the starting and end times in "Logging time" set with the Environment setup utility.

POINT

If the starting and end times in "Logging time" have not been set, this error is registered to the error viewer.

• Interval

By turning on the check box, the user can set the automatic printing interval to any time.

(1 minute to 24 hours)

Refer to Section 10.1 for the way of setting the Environment setup utility.

3) Not at operation time period (Print timing)

Set the date and time when automatic print is to be executed.

4) Print area

Set the area of printing.

- Entire book

Prints the entire book.

The sheets shown are all printed.

- Specified sheet

Specify the sheets for printing.

The specified sheets are printed independently of whether they are being displayed or not.

POINTS
(1) If "OLEX stop" is made during automatic execution, data is printed independently of the print timing.
(2) When the print area is "Entire book", delete unnecessary sheets in advance.

11.7.3 Starting the Tag Setup Utility

Start the Tag setup utility.

Refer to Section 10.2 for the way of operating the Tag setup utility.

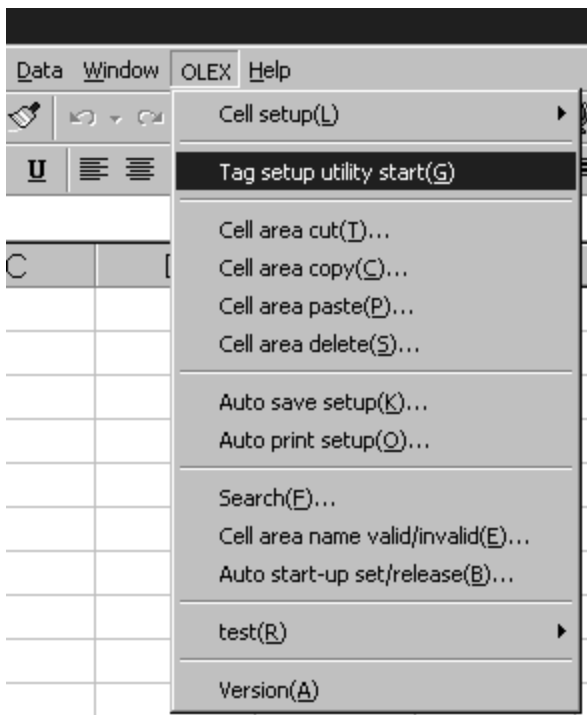

1. Choose [OLEX]-[Tag setup utility start] on the menu bar.

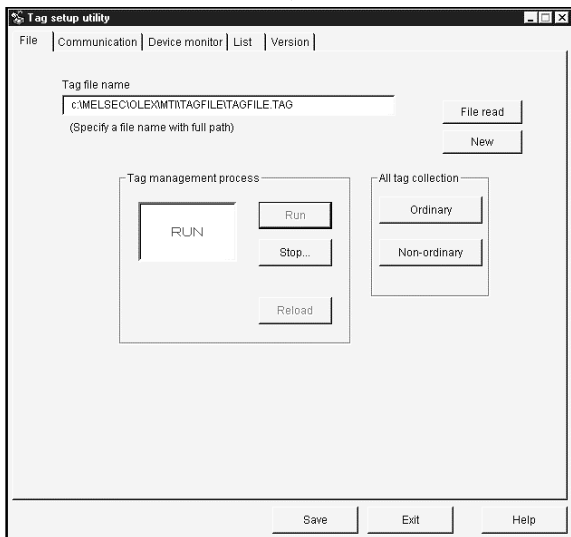

2. The Tag setup utility starts.

11.7.4 Displaying the Version Information

Display the version information of OLEX.

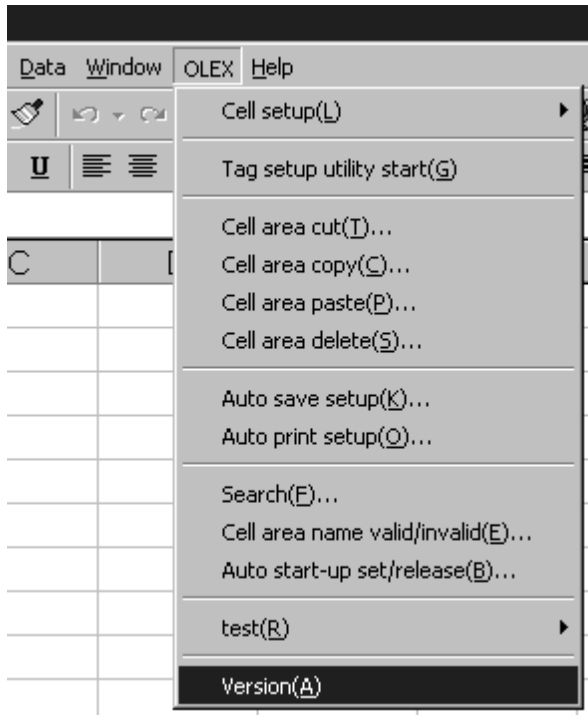

1. Choose [OLEX]-[Version] on the menu bar.



2. The version information appears.

12. OLEX FUNCTIONS

OLEX provides functions available for Visual Basic for Application. By providing functions with the preset cell area names as arguments using the setting functions of OLEX, data can be read to the corresponding cell areas and the data in the corresponding cell areas can be written.

POINT

If OLEX is executed automatically in Ethernet communication, the read/write function cannot be executed.

12.1 Setting References to Macro File

To use the OLEX functions in Excel, it is necessary to set references to the macro file to connect a calling file and the file, which includes functions to be called.

The following procedure sets references to the macro file using Excel.

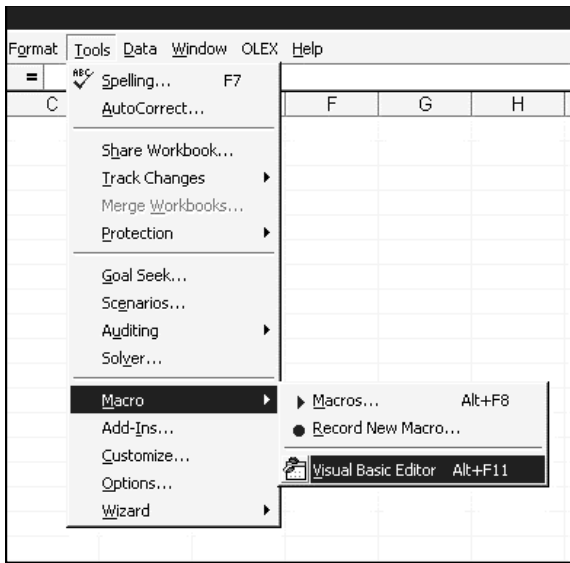

1. Choose [Tools]-[Macro]-[Visual Basic Editor] on the menu bar.

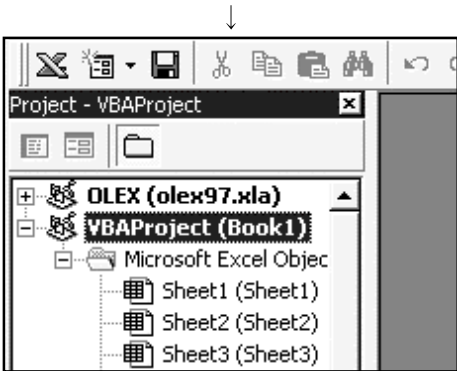

2. Choose the object being edited.

(To the next page)

(From the preceding page)

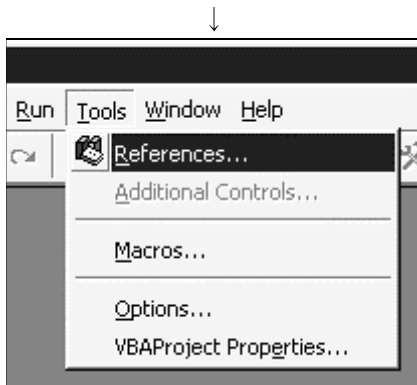

3. Choose [Tools]-[References...] on the menu bar.

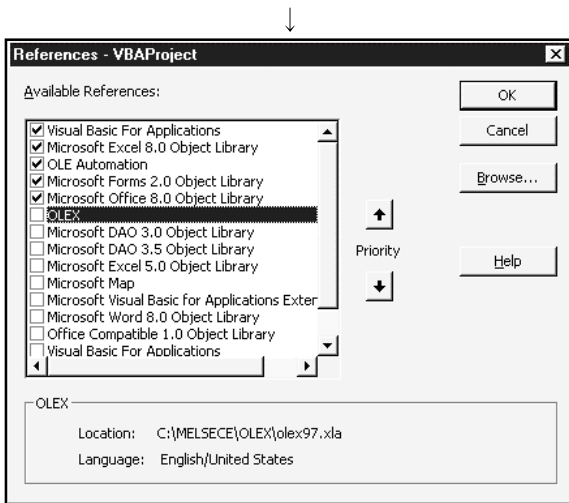

4. Choose "OLEX" in the Available References library file list in the "References" dialog box.
 If "OLEX" is not displayed in the list, click the "Browse..." button and add "OLEX97.XLA" or "OLEX2000.XLA".
 By default, "OLEX97.XLA" and "OLEX2000.XLA" is stored in C:\MELSECE\OLEX.

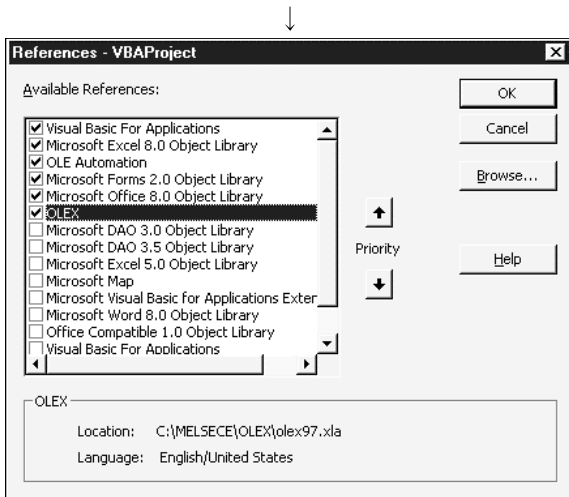

5. Click the "OLEX" check box.
 6. Click the "OK" button.

12.2 Instructions for Use of the OLEX Functions

- (1) OLEX saves five hidden sheets such as cell setting information.
When editing sheets, for example, do not delete these sheets or change their names.
In addition, do not change their settings.
There are the following OLEX information setting sheets.

- (a) #OLEX#AUTO#SAVE#PRINT##
- (b) #OLEX#COMMENTDAT##
- (c) #OLEX#ALARMDAT##
- (d) #OLEX#LOGINGDAT##
- (e) #OLEX#MONITDAT##

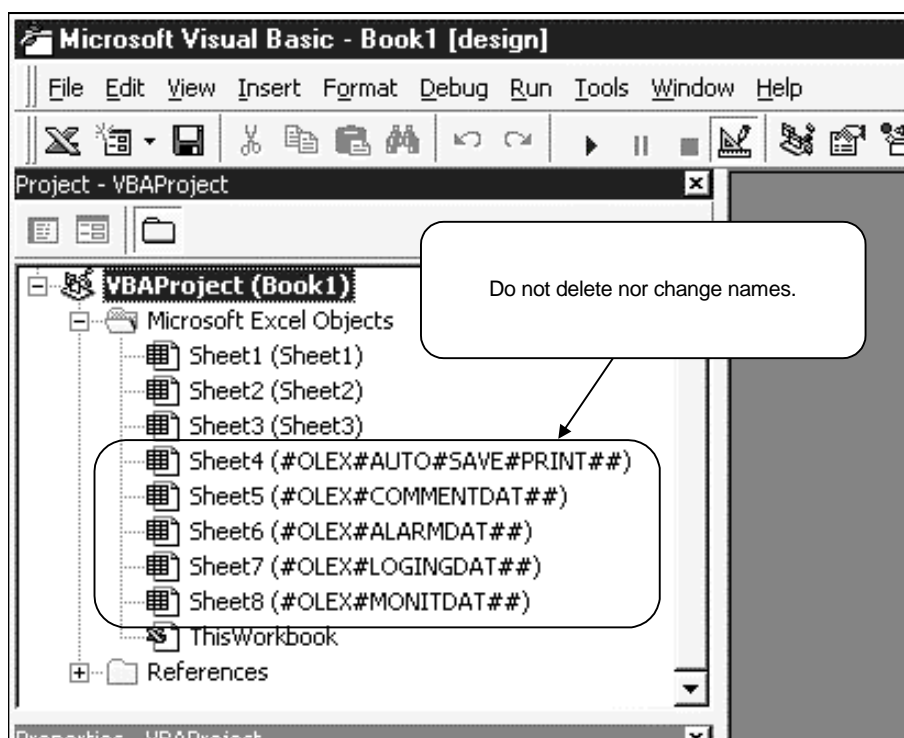

- (2) Please reactivate Excel to open the object maintained in OLEX when the OLEX function makes an error and Excel became debug mode.

12.3 OLEXRead

The OLEXRead function is a cell area reading function included in the OLEX macro file.

When you give an argument the cell area name to which monitor or logging setting has been made and call the function, values are displayed in the corresponding cell area. If errors occur, error codes appear in the cells.

In that case, refer to the error list and remove the errors or make a read test to check the error definitions.

(1) Syntax

String [OLEX]. OLEXRead (cellname)

(2) Argument

String cellname Cell area name to be read

(3) Makeup

[OLEX] : File name (book name) where the function is registered

OLEXRead : Function name

Cellname : Specify the cell area name passed to the function.

Specify a character string type variable.

When specifying two or more cell names, separate them by a comma (.). You can specify up to 16 names.

The cell area names you can specify are limited to the cell area names to which monitor setting has been made and the cell area names to which logging setting has been made.

(4) Return value

On normal termination, the function returns NULL ("").

If an error occurs, the cell area name in error is enclosed by parentheses and returned.

The return value is a string type character string.

If two or more areas result in error, the cell area names resulting in error are returned consecutively, e.g. (Cell area name 1)(Cell area name 2).

(5) Example of use

- (a) The following example assumes that the cell area name "Monitor read 1" is passed to the OLEXRead function as an argument.

```
result = [OLEX]. OLEXRead ("Monitor read 1")
```

- (b) Enter the following program into a subprocedure to execute the macro.

```
Sub Test1 ()  
    result = [OLEX]. OLEXRead ("Monitor read 1")  
End Sub
```

- (c) The return value appears if an error occurs in the above example.

MsgBox result "(Monitor read 1)" appears in the message box.

- (d) Two or more cell area names can be passed simultaneously as arguments.

In this case, separate the cell area names by a comma (,).

The following example assumes that the cell area names "Monitor read 1" and "Monitor read 2" are passed to the OLEXRead function as two arguments.

```
Sub Test2 ()  
    result = [OLEX]. OLEXRead ("Monitor read 1","Monitor read 2")  
End Sub
```

POINT

Reading the logging cell area displays only one line of the latest data at the point when it was called.
--

(6) Explanation

The cell area names in error are registered to the return value of the OLEXRead function, but the error codes and error definitions are not registered.

The error codes and error definitions are displayed in the reading cell areas.

Since the preset cell values and format may be cleared, execute the OLEXRead function after making sure that the cell format and values may be changed.

Example 1: "B2: B4" area was given as an argument and resulted in error

	A	B	C
1			
2		Communication error: Error code 102(66H)	
3		Communication error: Error code 102(66H)	
4		Communication error: Error code 102(66H)	
5			

Example 2: "B2: B3, B5: B6" and "D2: D3, D5: 6" areas were given as arguments and "D2: D3, D5: 6" resulted in error

	A	B	C	D	E
1					
2		100	Communication error: Error code 102(66H)		
3		200	Communication error: Error code 102(66H)		
4					
5		300	Communication error: Error code 102(66H)		
6		400	Communication error: Error code 102(66H)		
7					

(7) Instructions

(a) An error may occur in the VBA of Excel 97 if you call the OLEX function from the event procedure of the ActiveX object, which is a newly added function to the VBA, e.g. a command button of the "control/tool box".

In this case, first register the macro to the standard module sheet, and then assign the macro to the command button or the like of "Forms".

Example: Assigning the macro, which calls the OLEX function to a command button

1) Register the macro to the standard module. Specify any procedure name.

```
Sub OLEX_READ ()
    result = [OLEX]. OLEXRead ("Monitor read 1")
End Sub
```

2) Display the "Forms" toolbar (choose "Forms" from [View]-[Toolbars]), choose "Buttons", and paste it to the worksheet. As the "Assign Macro" dialog box appears at this time, assign the macro created.

(b) If an error occurred in the VBA

When an error occurs in the VBA, OLEX will not operate. After correcting the area in error, restart Excel.

12.4 OLEXWrite

The OLEXWrite function is a cell area writing function included in the OLEX macro file. When you give an argument the cell area name to which monitor setting has been made and call the function, values are written to the corresponding cell area. If errors occur, error codes appear in the cells. In that case, refer to the error list and remove the errors or make a write test to check the error definitions.

(1) Syntax

String [OLEX]. OLEXWrite (cellname)

(2) Argument

String cellname Cell area name where data will be written

(3) Makeup

[OLEX] : File name (book name) where the function is registered

OLEXWrite : Function name

cellname : Specify the cell area name passed to the function.

Specify a character string type variable.

When specifying two or more cell names, separate them by a comma (.). You can specify up to 16 names.

The cell area names you can specify are limited to the cell area names to which monitor setting has been made.

(4) Return value

On normal termination, the function returns NULL (").

If an error occurs, the cell area name in error is enclosed by parentheses and returned.

The return value is a string type character string.

If two or more areas result in error, the cell area names resulting in error are returned consecutively, e.g. (Cell area name 1)(Cell area name 2).

(5) Example of use

- (a) The following example assumes that the cell area name "Monitor write 1" is passed to the OLEXWrite function as an argument.

```
result = [OLEX]. OLEXWrite ("Monitor write 1")
```

- (b) Enter the following program into a subprocedure to execute the macro.

```
Sub Test1 ()  
    result = [OLEX]. OLEXWrite ("Monitor write 1")  
End Sub
```

- (c) The return value appears if an error occurs in the above example.
MsgBox result "(Monitor write 1)" appears in the message box.

- (d) Two or more cell area names can be passed simultaneously as arguments.

In this case, separate the cell area names by a comma (,).

The following example assumes that the cell area names "Monitor write 1" and "Monitor write 2" are passed to the OLEXWrite function as two arguments.

```
Sub Test2 ()  
    result = [OLEX]. OLEXWrite ("Monitor write 1","Monitor write 2")  
End Sub
```

(6) Explanation

The cell area names in error are registered to the return value of the OLEXWrite function, but the error codes and error definitions are not registered.

The error codes and error definitions are displayed in the writing cell areas.

Since the preset cell values and format may be cleared, execute the OLEXWrite function after making sure that the cell format and values may be changed.

Example 1: "B2: B4" area was given as an argument and resulted in error

	A	B	C
1			
2		Communication error: Error code 102(66H)	
3		Communication error: Error code 102(66H)	
4		Communication error: Error code 102(66H)	
5			

Example 2: "B2: B3, B5: B6" and "D2: D3, D5: 6" areas were given as arguments and "D2: D3, D5: 6" resulted in error

	A	B	C	D	E
1					
2		100		Communication error: Error code 102(66H)	
3		200		Communication error: Error code 102(66H)	
4					
5		300		Communication error: Error code 102(66H)	
6		400		Communication error: Error code 102(66H)	
7					

(7) Instructions

(a) An error may occur in the VBA of Excel 97 if you call the OLEX function from the event procedure of the ActiveX object, which is a newly added function to the VBA, e.g. a command button of the "control/tool box".

In this case, first register the macro to the standard module sheet, and then assign the macro to the command button or the like of "Forms".

Example: Assigning the macro, which calls the OLEX function, to a command button

1) Register the macro to the standard module. Specify any procedure name.

```
Sub OLEX_WRITE ()
    result = [OLEX]. OLEXWrite ("Monitor write 1")
End Sub
```

2) Display the "Forms" toolbar (choose "Forms" from [View]-[Toolbars]), choose "Buttons", and paste it to the worksheet. As the "Assign Macro" dialog box appears at this time, assign the macro created.

(b) If an error occurred in the VBA

When an error occurs in the VBA, OLEX will not operate. After correcting the area in error, restart Excel.

APPENDICES

APPENDIX 1 Specifications

The following is the OLEX specifications.

Item	Description
Number of Excel sheets	You can set up to 250 sheets.
Target area of cell	You can set within the area of 32767 rows and 256 columns.
Number of monitor cell areas	You can set up to 1000 areas.
Size of single monitor cell area	You can set up to 1000 points.
Number of logging cell areas	You can set up to 100 areas.
Number of logging times	You can set up to 2000 lines and 256 columns.
Number of comment cell areas	You can set up to 500 areas.
Size of comment cell area	You can set only 1 point.
Number of alarm cell areas	You can set up to 100 areas.
Size of alarm cell area	You can set four or more columns and up to 300 lines.

App.

APPENDIX 2 About the Automatic Save/Print Timing

When you have selected "At operation time period" as the automatic save/print timing, you have to specify the Start time and Stop time in "Logging time" set on the Environment setup utility.

An error occurs if there are no settings of the Start time and Stop time in "Logging time".

When you have turned on the interval designation check box, automatic save/print is performed automatically at the specified intervals between the Start time and Stop time.

If OLEX is stopped before the Stop time in "Logging time", saving/printing is done at a stop.

(1) The Start time is set to 9:00 and the Stop time to 12:00

(a) When OLEX is started at 8:30

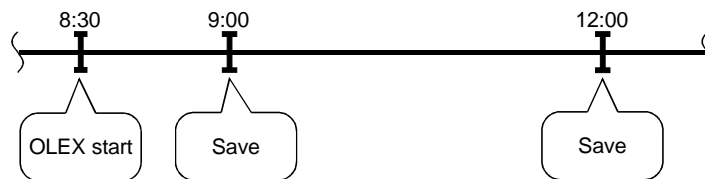

(b) When OLEX is started at 9:05

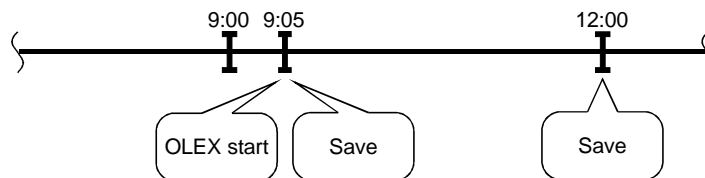

(c) When OLEX is stopped at 11:50

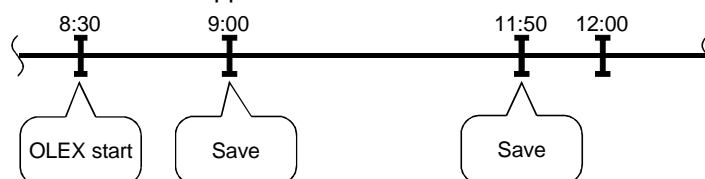

(2) The starting time is set to 9:00, the end time to 12:00, and the specified interval to 30 minutes

(a) When OLEX is started at 8:30

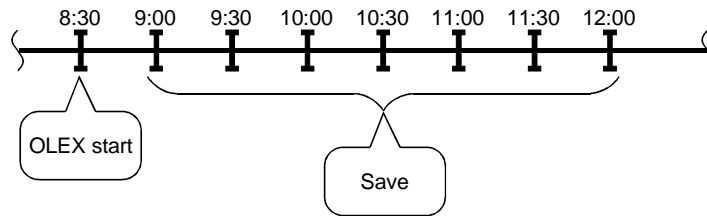

(b) When OLEX is started at 9:05

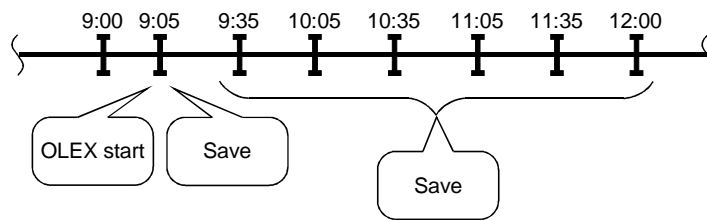

(c) When OLEX is stopped at 11:50

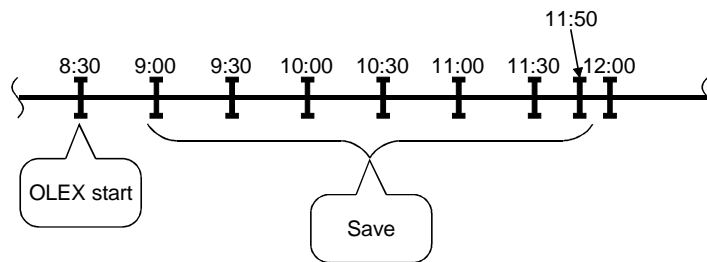

APPENDIX 3 Tag Error Codes

The following table lists the error codes displayed when tags are used.

Error Code		Error Definition	Corrective Action
Identifier	Number		
1	-1	Specified tag file is abnormal.	Choose the tag file created using the Tag setup utility.
1	-2	Failure to acquire shared memory. Memory for operation cannot be acquired due to memory shortage.	Execute after closing other running applications.
1	-3	Failure to acquire local memory. Memory for operation cannot be acquired due to memory shortage.	
1	-4	Failure to acquire resources. Acquirement of resources failed.	Since memory may be short, execute after closing other running applications.
1	-5	Tag name is wrong.	Specify the tag name registered as a valid tag in the specified tag file.
1	-6	Thread creation failed.	Since memory may be short, execute after closing other running applications.
1	-7	Registry contents are wrong. Registry information is corrupted.	Reinstall software.
1	-8	Timing of registration to user event is wrong.	As the set user timing is 0, set a proper value.
1	-9	Specified log timing is abnormal.	In a log-specified tag, log collection cannot be done at the timing of less than 1 second. Correct the collection timing.
1	-10	Collection condition is wrong.	Set a correct collection condition.
1	-11	Hand shake time out error	Make setting to make Hand shake established.
1	-12	Tag management process status is wrong.	Make tag information correct.
1	-13	Reload occurred in Tag management process.	Perform reload-related processing since reload occurred in Tag management process.
1	-14	Specified buffer size is wrong.	Specify proper buffer size.
1	-15	Tag not specified for logging was handled as a logged tag.	Choose a log-specified tag.
1	-16	Specified field number exceeds the number of tag fields.	Specify a proper field number.
1	-17	Number of fields is wrong.	Specify a proper field number and number of read/write fields.
1	-18	Number of read/write fields is wrong.	Specify a proper number of read/write fields.
1	-19	Event of a tag, which is not normally read, was awaited.	Specify the tag normally read.
1	-20	Specified tag is not normally collected.	Specify the tag normally collected.
1	-21	Error event occurred.	
1	-23	Data specified to wait for event is wrong.	
1	-24	Clock reading was attempted by specifying the CPU, which does not have the clock reading function.	Specify the CPU having the clock function.
1	-25	Log data saving failed.	Free space of hard disk may be small. Increase the free space of hard disk.
1	-27	Time-out occurred during clock data write.	Check that the special devices used to write clock data are in write-ready status.
1	-28	The effective time is not set.	There is no effective time though logging is set according to the operating time belt. Please set the effective time in one.
1	-30	Request device is not set.	For Hand shake read, set the request device.

Microsoft, Windows, Windows NT, Visual Basic and Visual C++ are registered trademarks of Microsoft Corporation in the United States and other countries.

Pentium is a registered trademark of Intel Corporation in the United States and other countries.

Other company and product names herein are either trademarks of registered trademarks of their respective owners.

Type SW3D5F-OLEX-E Excel Communication Support Tool Operating Manual

MODEL	SW3D5F-OLEX-E-O-E
MODEL CODE	1LMS52
IB(NA)-0800016-G(0312)MEE	

 **MITSUBISHI ELECTRIC CORPORATION**

HEAD OFFICE : 1-8-12, OFFICE TOWER Z 14F HARUMI CHUO-KU 104-6212, JAPAN
NAGOYA WORKS : 1-14 , YADA-MINAMI 5-CHOME , HIGASHI-KU, NAGOYA , JAPAN

When exported from Japan, this manual does not require application to the
Ministry of Economy, Trade and Industry for service transaction permission.

Specifications subject to change without notice.