



CC-Link System Space Optical Repeater Module

User's Manual
(Hardware)

AJ65BT-RPI-10A/

AJ65BT-RPI-10B

Thank you for purchasing the programmable controller MELSEC series.

Prior to use, please read this and relevant manuals thoroughly to fully understand the product.



MODEL	AJ65BT-RPI-10AB-U
MODEL CODE	13JQ86
IB(NA)-0800090-K(1806)MEE	

● SAFETY PRECAUTIONS ●

(Read these precautions before using this product.)

Before using this product, please read this manual and the relevant manuals carefully and pay full attention to safety to handle the product correctly.

The precautions given in this manual are concerned with this product only. For the safety precautions of the programmable controller system, refer to the user's manual for the CPU module used.

In this manual, the safety precautions are classified into two levels:

"⚠ WARNING" and "⚠ CAUTION".



Indicates that incorrect handling may cause hazardous conditions, resulting in death or severe injury.



Indicates that incorrect handling may cause hazardous conditions, resulting in minor or moderate injury or property damage.

Under some circumstances, failure to observe the precautions given under "⚠ CAUTION" may lead to serious consequences.

Observe the precautions of both levels because they are important for personal and system safety.

Make sure that the end users read this manual and then keep the manual in a safe place for future reference.

[Design precautions]

WARNING

- Input/output could be switched on or off when a problem occurs in the repeater module.
So build an external monitoring circuit that will monitor any input/output signals that could cause a serious accident.

CAUTION

- Use each module in an environment as specified in the "general specification" in the CPU module User's Manual.
Usage of the module outside the general specification range may cause electric shock, fire, malfunction, product damage or deterioration.
- Do not have control cables and communication cables bundled with or placed near by the main circuit and/or power cables.
Wire those cables at least 100mm(3.94 inch) away from the main circuit and/or power cables.
It may cause malfunction due to noise interference.

[Installation precautions]

CAUTION

- Do not directly touch the module's conductive parts.
Doing so could cause malfunction or trouble in the module.
- Tighten the module securely using DIN rail or installation screws within the specified torque range.
Loose terminal screws may cause falling, short circuit or erroneous operation.
If the terminal screws are too tight, it may cause falling or short circuit due to damage of the screws.
- When using multiple sets of the AJ65BT-RPI-10A/10B in line, provide shields between the sets.
Not doing so can cause a malfunction due to interference.
- When using multiple sets of the AJ65BT-RPI-10A/10B in parallel, place the A and B modules alternatively and keep a distance of at least 1m (3.28ft.).
Not placing them alternately can cause a malfunction due to interference.

[Wiring Precautions]

WARNING

- Be sure to shut off all phases of the external power supply used by the system before installation or wiring.
Not doing so can cause the product to be damaged or malfunction.

CAUTION

- Always ground the FG terminal to the protective ground conductor. Otherwise there will be an electric shock or misoperation.
- Terminal screws which are not to be used must be tightened always. Otherwise there will be a danger of short circuit against the bare solderless terminals.
- Use applicable solderless terminals and tighten them with the specified torque. If any solderless spade terminal is used, it may be disconnected when the terminal screw comes loose, resulting in failure.
- Perform correct wiring for the module according to the product's rated voltage and terminal arrangement. Connecting to a power supply different from the rating or mis-wiring may cause fire and/or trouble.
- Fix terminal screws securely with the specified torque. Loose terminal screws may cause short circuit or malfunction. If the terminal screws are too tight, it may cause falling, short circuit or erroneous operation due to damage of the screws or module.
- Make sure foreign objects do not get inside the module, such as dirt and wire chips. It may cause fire, trouble or malfunction.
- Be sure to fix wires or cables that are connected to the module in place, either by running them through a duct or by using clamps. If the cables are not fixed in one of these ways, dispersion, movement, or careless pulling of the cables may cause damage to the module or cables, or malfunction due to cable contact faults.
- Do not install the control lines together with the communication cables, or bring them close to each other. Failure to do so may cause malfunctions due to noise.
- When disconnecting a communication or power supply cable from the module, do not pull on the cable itself. Before disconnecting the cable from the terminal block, loosen off the screws of the terminal block. If you pull the cable connected to the module, the module or cable can be damaged or misoperation can occur due to cable connection fault.

[Startup and Maintenance Precautions]



WARNING

- Do not touch terminals when the power is on.
It may cause an electric shock or malfunction.



CAUTION

- For use in any environment where optical axis misalignment or the like is expected due to lens surface contamination, vibration, impact or the like, carry out periodic maintenance/inspection and improve the environment.
Not doing so can cause a malfunction.
- Never try to disassemble or modify module.
It may cause trouble, malfunction, injury or fire.
- The module case is made of resin; do not drop it or subject it to strong shock.
Module damage may result.
- Be sure to shut off all phases of the external power supply used by the system before cleaning or retightening the terminal screws.
Not doing so can cause the module to fail or malfunction.
- Be sure to shut off all phases of the external power supply used by the system before mounting or dismounting the module to or from the panel.
Not doing so can cause the module to fail or malfunction.
- Do not install/remove the terminal block more than 50 times after the first use of the product. (IEC 61131-2 compliant)
- Always make sure to touch the grounded metal to discharge the electricity charged in the body, etc., before touching the module.
Failure to do so may cause a failure or malfunctions of the module.

[Disposal Precautions]



CAUTION

- When disposing of this product, treat it as industrial waste.

● PRÉCAUTIONS DE SÉCURITÉ ●

(Lire ces précautions avant toute utilisation du produit.)

Avant d'utiliser ce produit, lire attentivement ce manuel ainsi que les manuels auxquels il renvoie, et toujours considérer la sécurité comme de la plus haute importance en manipulant le produit correctement.

Les précautions à observer figurant dans ce manuel ne concernent que ce produit. Quant aux précautions de sécurité à observer pour le système du contrôleur programmable, se reporter au manuel d'utilisation du module CPU utilisé.

Dans ce manuel, les précautions de sécurité sont classées en deux niveaux, à savoir : "  AVERTISSEMENT " et "  ATTENTION "

AVERTISSEMENT

Attire l'attention sur le fait qu'une négligence peut créer une situation de danger avec risque de mort ou de blessures graves.

ATTENTION

Attire l'attention sur le fait qu'une négligence peut créer une situation de danger avec risque de blessures légères ou de gravité moyennes ou risque de dégâts matériels.

Dans certaines circonstances, le non-respect d'une précaution de sécurité introduite sous le titre "  ATTENTION " peut avoir des conséquences graves.

Les précautions de ces deux niveaux doivent être observées dans leur intégralité car elles ont trait à la sécurité des personnes et aussi du système.

Veiller à ce que les utilisateurs finaux lisent ce manuel qui doit être conservé soigneusement à portée de main pour s'y référer autant que de besoin.

[Précautions lors de la conception]

AVERTISSEMENT

- *Les entrées/sorties peuvent se trouver activées ou désactivées par l'apparition d'un problème dans le module répéteur.
On doit donc constituer un circuit de surveillance externe pour le suivi des signaux d'entrée/sortie qui pourraient être à l'origine d'accidents ou d'incidents graves.*

ATTENTION

- *Utiliser chacun des modules dans un environnement conforme aux "Spécifications générales" du manuel de l'utilisateur du module CPU.
L'utilisation du module dans un environnement ne respectant pas les conditions prévues dans les spécifications générales peut entraîner une électrocution, un départ de feu, des dysfonctionnements et une détérioration du produit.*
- *Ne pas grouper ni placer à proximité les câbles de commande ou câbles de communication avec les câbles des circuits principaux et/ou d'alimentation.
Installer ces câbles à une distance d'au moins 100mm (3,94 pouces) des câbles des circuits principaux et/ou d'alimentation.
Cela pourrait produire des interférences à l'origine de dysfonctionnements.*

[Précautions d'installation]

ATTENTION

- *Éviter tout contact direct avec les parties conductrices du module. Cela pourrait être à l'origine de dysfonctionnements ou autres problèmes avec le module.*
- *Serrer le module fermement avec un rail DIN ou avec des vis de fixation serrées dans les limites du couple de serrage prescrit. Des vis de bornes desserrées peuvent tomber et être à l'origine de courts-circuits ou d'un fonctionnement erratique. Un serrage excessif des vis de borne risque de les endommager ces vis dont la chute risque de provoquer un court-circuit.*
- *Lors de l'utilisation de plusieurs ensembles AJ65BT-RPI-10A/10B en ligne, fournissez des blindages entre les ensembles. Faute de quoi, des interférences peuvent produire des dysfonctionnements.*
- *Quand on utilise plusieurs ensembles AJ65BT-RPI-10A/10B en ligne, disposer en alternance un module A et un module B en maintenant une distance minimum de 1m (3,28ft.). Le non-respect de cette disposition en alternance peut produire des interférences à l'origine de dysfonctionnement.*

[Précautions de câblage]

AVERTISSEMENT

- *Avant installation ou câblage, toujours vérifier que les alimentations externes utilisées par le système ont été coupées sur toutes les phases. Faute de quoi, il y a risque d'endommagement ou de dysfonctionnement du produit.*

ATTENTION

- *Toujours mettre à la masse la borne FG sur le conducteur de protection de terre. Autrement, il y aurait risque d'électrocution ou de dysfonctionnement.*
- *Toutes les vis des bornes inutilisées doivent être serrées. Autrement, il y aurait risque de court-circuit par contact sur les bornes sans soudure nues.*
- *Utiliser des bornes sans soudure de type approprié en les serrant dans les limites du couple de serrage prescrit. Une borne sans soudure dont la vis se desserre peut être une source de mauvais contact avec risque de panne.*
- *Effectuer le câblage du module correctement, en respectant la tension nominale et l'affectation des bornes du produit. Le raccordement à une source d'alimentation électrique différente de celle prescrite ou une erreur de câblage peut être à l'origine d'un départ de feu et/ou d'un dysfonctionnement.*
- *Bien serrer les vis de borne au couple de serrage prescrit. Des vis de bornes desserrées peuvent être à l'origine de court-circuits ou de dysfonctionnements. Un serrage excessif peut endommager le module ou les vis qui risquent de tomber et de provoquer un court-circuit ou un fonctionnement erratique.*
- *Veiller à ce qu'aucun objet ou impureté, débris de fil ou autres, ne pénètre dans le module. Cela peut être à l'origine d'un départ de feu, d'une panne ou d'un dysfonctionnement.*
- *Veillez à installer correctement les câbles ou fils connectés au module, soit en les faisant passer dans un conduit soit en utilisant des colliers de fixation. Si les câbles ne sont pas fixés d'une façon ou d'une autre, la dispersion ou le déplacement des câbles ou une traction exercée par inadvertance sur un câble pourrait endommager le module ou les câbles et créer un mauvais contact à l'origine de dysfonctionnements.*
- *Ne pas installer les lignes de commande et les câbles de communication avec les lignes des circuits principaux ou de l'alimentation, et ne pas les placer à proximité les uns des autres. Faute de quoi, les bruits parasites produiront des dysfonctionnements.*
- *Pour enlever un câble d'alimentation ou de communication du module, ne pas tirer sur le câble proprement dit. Avant de débrancher le câble de la plaque à bornes, desserrer les vis de la plaque à bornes. Tirer sur un câble raccordé au module peut endommager le module ou le câble et entraîner des dysfonctionnements par mauvais contact.*

[PRÉCAUTIONS DE MISE EN SERVICE ET DE MAINTENANCE]

AVERTISSEMENT

- *Ne pas toucher aux bornes quand l'appareil est sous tension.
Cela pourrait être à l'origine d'une électrocution ou d'un dysfonctionnement.*

ATTENTION

- *Pour l'utilisation dans un environnement où la contamination des lentilles, les vibrations, les chocs, etc. risquent d'entraîner un dérèglement des axes optiques, effectuer régulièrement les opérations de maintenance/inspection périodique et apporter des améliorations à l'environnement.
Faute de quoi, il y a risque de dysfonctionnement.*
- *Ne jamais tenter de démonter ou modifier le module.
Il y aurait risque de panne, dysfonctionnement, blessure ou départ de feu.*
- *Le boîtier du module est en matière plastique; ne pas faire tomber le module ou le soumettre à des chocs violents.
Il pourrait en résulter une détérioration du module.*
- *Ne pas oublier de couper toutes les phases de l'alimentation externe utilisée par le système avant le nettoyage ou le resserrage des vis de bornes.
Faute de quoi, il y a risque de panne ou de dysfonctionnement du module.*
- *Ne pas oublier de couper toutes les phases de l'alimentation externe utilisée par le système avant de mettre le module en place dans le tableau ou de l'en retirer.
Faute de quoi, il y a risque de panne ou de dysfonctionnement du module.*
- *Après la première utilisation du produit, le nombre maximum admissible d'opérations de pose/retrait du bornier est de 50. (selon IEC 61131-2)*
- *Avant de toucher le module, toujours se décharger de la charge électrostatique dont le corps est porteur en touchant un objet métallique mis à la terre.
Faute de quoi, il y a risque de panne ou de dysfonctionnements du module.*

[PRÉCAUTIONS DE MISE AU REBUT]

ATTENTION

- *Lors de sa mise au rebut, ce produit doit être traité comme un déchet industriel.*

● CONDITIONS OF USE FOR THE PRODUCT ●

- (1) Mitsubishi programmable controller ("the PRODUCT") shall be used in conditions;
- i) where any problem, fault or failure occurring in the PRODUCT, if any, shall not lead to any major or serious accident; and
 - ii) where the backup and fail-safe function are systematically or automatically provided outside of the PRODUCT for the case of any problem, fault or failure occurring in the PRODUCT.
- (2) The PRODUCT has been designed and manufactured for the purpose of being used in general industries.

MITSUBISHI SHALL HAVE NO RESPONSIBILITY OR LIABILITY (INCLUDING, BUT NOT LIMITED TO ANY AND ALL RESPONSIBILITY OR LIABILITY BASED ON CONTRACT, WARRANTY, TORT, PRODUCT LIABILITY) FOR ANY INJURY OR DEATH TO PERSONS OR LOSS OR DAMAGE TO PROPERTY CAUSED BY the PRODUCT THAT ARE OPERATED OR USED IN APPLICATION NOT INTENDED OR EXCLUDED BY INSTRUCTIONS, PRECAUTIONS, OR WARNING CONTAINED IN MITSUBISHI'S USER, INSTRUCTION AND/OR SAFETY MANUALS, TECHNICAL BULLETINS AND GUIDELINES FOR the PRODUCT.

("Prohibited Application")

Prohibited Applications include, but not limited to, the use of the PRODUCT in;

- Nuclear Power Plants and any other power plants operated by Power companies, and/or any other cases in which the public could be affected if any problem or fault occurs in the PRODUCT.
- Railway companies or Public service purposes, and/or any other cases in which establishment of a special quality assurance system is required by the Purchaser or End User.
- Aircraft or Aerospace, Medical applications, Train equipment, transport equipment such as Elevator and Escalator, Incineration and Fuel devices, Vehicles, Manned transportation, Equipment for Recreation and Amusement, and Safety devices, handling of Nuclear or Hazardous Materials or Chemicals, Mining and Drilling, and/or other applications where there is a significant risk of injury to the public or property.

Notwithstanding the above, restrictions Mitsubishi may in its sole discretion, authorize use of the PRODUCT in one or more of the Prohibited Applications, provided that the usage of the PRODUCT is limited only for the specific applications agreed to by Mitsubishi and provided further that no special quality assurance or fail-safe, redundant or other safety features which exceed the general specifications of the PRODUCTS are required. For details, please contact the Mitsubishi representative in your region.

REVISIONS

*The manual number is given on the bottom right of the cover.

Print date	*Manual number	Revision
Nov.,1999	IB (NA)-0800090-A	First edition
Feb.,2001	IB (NA)-0800090-B	<p>Partial correction</p> <p>Change specified torque range of Display window mounting screw from 32 to 5.8N/cm on Section 4.2.1(1)</p>
Jun.,2003	IB (NA)-0800090-C	<p>Partial correction</p> <p>SAFETY PRECAUTIONS, About the Manuals, Chapter 1, Section 1.3, 2.2, 3.1, 3.2, 4.2.1, 4.6</p>
Jul.,2005	IB (NA)-0800090-D	<p>Addition</p> <p>Conformation to the EMC Directive and Low Voltage Instruction</p> <p>Partial correction</p> <p>SAFETY PRECAUTIONS</p>
Dec.,2006	IB (NA)-0800090-E	<p>Partial correction</p> <p>SAFETY PRECAUTIONS, About the Manuals, Section 1.3, 2.2, 3.1, 3.2, 3.4, 4.2.1</p>
Jun.,2007	IB (NA)-0800090-F	<p>Partial correction</p> <p>Section 4.3, Contact address (Back cover)</p>
Aug.,2007	IB (NA)-0800090-G	<p>Partial correction</p> <p>Section 4.3</p>
Dec.,2011	IB (NA)-0800090-H	<p>Addition</p> <p>CONDITIONS OF USE FOR THE PRODUCT</p> <p>Partial correction</p> <p>SAFETY PRECAUTIONS, About the Manuals, COMPLIANCE WITH EMC AND LOW VOLTAGE DIRECTIVES, Section 3.1, 4.2.1, 4.5</p>
Jul.,2014	IB (NA)-0800090-I	<p>Partial correction</p> <p>About the Manuals, Section 1.3, 2.2, 4.3</p>
Dec., 2016	IB (NA)-0800090-J	<p>Addition</p> <p>SAFETY PRECAUTIONS (French)</p> <p>Partial correction</p> <p>Section 3.1, 4.2.1, 4.5</p>
Jun.,2018	IB (NA)-0800090-K	Descriptions are revised due to compliance with the Chinese standardized law.

This manual confers no industrial property rights or any rights of any other kind, nor does it confer any patent licenses. Mitsubishi Electric Corporation cannot be held responsible for any problems involving industrial property rights which may occur as a result of using the contents noted in this manual.

CONTENTS

1. OVERVIEW	1
1.1 Features	1
1.2 Packaged parts	3
1.3 Abbreviated names, generic names and terms	4
2. SYSTEM CONFIGURATION	5
2.1 Total configuration	5
2.2 Cautions on system configuration	7
3. SPECIFICATIONS	13
3.1 General specifications	13
3.2 Performance specifications	15
3.3 Specifications of connection cables	16
3.4 Max. transmission distance	16
3.5 List of I/O Signals from/to the Master Module	17
4. PROCEDURE UP TO START OF DATA LINK	18
4.1 Procedure up to start of data link	18
4.2 Mounting and installation	19
4.2.1 Cautions on handling	19
4.2.2 Installation environment	21
4.3 Names and settings of parts	21
4.4 Setting of switches	24
4.5 Connection of module through CC-Link dedicated cable	26
4.6 Optical axis adjustment	28
4.6.1 Precautions for optical axis adjustment	28
4.6.2 Optical axis adjustment method	29
4.6.3 Adjustment procedures for interference light	30
4.7 Check for state of connection (line test)	32
5. ABOUT THE MONITOR FUNCTION	34
6. TROUBLESHOOTING	35
7. EXTERNAL DIMENSIONS DIAGRAM	36

ABOUT MANUALS

The following manuals are related to this product.
Referring to this list, please request the necessary manuals.

Related Manual

Manual name	Manual Number (Model code)
CC-Link System Master/Local Module Type AJ61BT11/A1SJ61BT11 User's Manual	IB-66721 (13J872)
CC-Link System Master/Local Module Type AJ61QBT11/A1SJ61QBT11 User's Manual	IB-66722 (13J873)
MELSEC-Q CC-Link System Master/Local Module User's Manual	SH-080394E (13JR64)
MELSEC-L CC-Link System Master/Local Module User's Manual	SH-080895ENG (13JZ41)
CC-Link System Repeater (T-junction) Module User's Manual AJ65SBT-RPT	IB-0800078 (13JQ81)
CC-Link System Optical Repeater Module User's Manual	IB-0800089 (13JQ85)
CC-Link System Low Profile Waterproof Type Repeater Hub Module User's Manual AJ65FBTA-RPH	IB-0800288 (13JP55)
CC-Link System Spring Clamp Terminal Block Type Repeater Hub Module User's Manual AJ65BTS-RPH	IB-0800346 (13JP97)

COMPLIANCE WITH EMC AND LOW VOLTAGE

(1) Method of ensuring compliance

To ensure that Mitsubishi programmable controllers maintain EMC and Low Voltage Directives when incorporated into other machinery or equipment, certain measures may be necessary. Please refer to one of the following manuals.

- User's manual for the CPU module or head module used
- Safety Guidelines (this manual is included with the CPU module, base unit, or head module)

The CE mark on the side of the programmable controller indicates compliance with EMC and Low Voltage Directives.

(2) Additional measures

To ensure that this product maintains EMC and Low Voltage Directives, please refer to one of the manuals listed under (1).

1. OVERVIEW

This User's Manual describes the specifications, part names, settings and others of the AJ65BT-RPI-10A/10B type CC-Link system space optical repeater module (hereafter abbreviated to the AJ65BT-RPI-10A/10B) used in a CC-Link system.

1.1 Features

The AJ65BT-RPI-10A/10B is a module used to expand the CC-Link system.

By using the AJ65BT-RPI-10A and AJ65BT-RPI-10B in combination, infrared space transmission, increased transmission distance and T-junction wiring can be achieved in a CC-Link system (at the transmission speed of 2.5Mbps, 625kbps or 156kbps only).

Also, the optical axis adjustment can be made easily because the light receiving status of the module can be transmitted to the master station.

(1) Infrared space transmission

Using these modules enables infrared space transmission of 0 to 100m (0 to 327.87ft.).

This makes a CC-Link system usable in places where cabling is difficult.

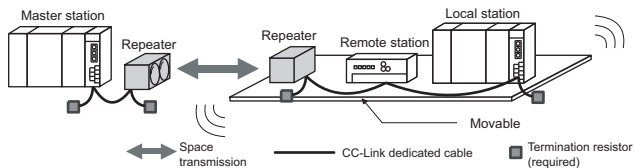

[Places where cabling is difficult]

- Place where a movable range is wide
- Place where the number of movable times is large and cables may be broken due to fatigue
- Place where you want to minimize the number of movable parts, e.g. cable bearers, for dust proof purpose (such as a clean room)

(2) Increased transmission distance

Using these modules increases the transmission distance of a CC-Link system.

Also, using multiple sets of these modules allows the transmission distance to be increased by up to two stages.

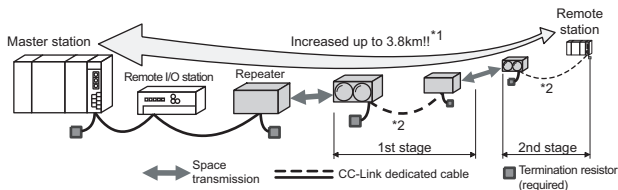

*1 Max. transmission distance at the transmission speed setting of 156kbps.

*2 Though omitted here, another remote station may be connected between repeaters.

(3) T-junction wiring enabled in CC-Link system

T-junction wiring can be performed by arrangement of these modules between the modules of a CC-Link system.

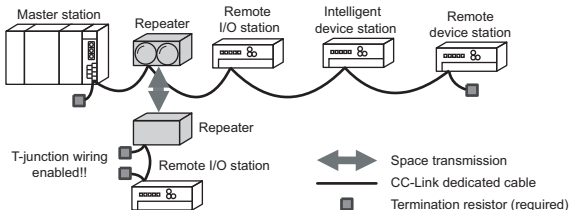

(4) Communication status of the module can be monitored

The light receiving status of the module can be monitored (imported to the master station) by setting the station numbers to these modules and also making the remote I/O station-equivalent parameter setting in the master station.

Also, the imported receiving status of the mating module can be indicated by the LEDs of the own module using the sequence program of the master station, ensuring ease of fine adjustment of the optical axes.

POINT

Station number and parameter settings are not needed when these modules are used as repeaters only, i.e. the light receiving status is not monitored (monitor function is not used).

1.2 Packaged parts

After unpacking, make sure that those parts listed below are packaged.

(1) AJ65BT-RPI-10A

Part name	Quantity
AJ65BT-RPI-10A module	1
Terminating resistances 110Ω 1/2W (Brown, Brown, Brown)	1
Terminating resistances 130Ω 1/2W (Brown, Orange, Brown)	1

(2) AJ65BT-RPI-10B

Part name	Quantity
AJ65BT-RPI-10B module	1
Terminating resistances 110Ω 1/2W (Brown, Brown, Brown)	1
Terminating resistances 130Ω 1/2W (Brown, Orange, Brown)	1

1.3 Abbreviated names, generic names and terms

Abbreviated names, generic names and terms Description

Abbreviated names, generic names and terms	Description
AJ65BT-RPI-10A/10B	Abbreviation of AJ65BT-RPI-10A/AJ65BT-RPI-10B type CC-Link system space optical repeater module
AJ65SBT-RPT	Abbreviation of AJ65SBT-RPT type CC-Link system repeater (T-junction) module.
AJ65SBT-RPS/RPG	Abbreviation of AJ65SBTRPS/AJ65SBT-RPG type CC-Link system optical repeater module.
AJ65FBTA-RPH	Abbreviation of AJ65FBTA-RPH type CC-Link system low profile waterproof type repeater hub module.
AJ65BTS-RPH	Abbreviation of AJ65BTS-RPH type CC-Link system spring clamp terminal block type repeater hub module.
A module	Abbreviation of AJ65BT-RPI-10A type CC-Link system space optical repeater module
B module	Abbreviation of AJ65BT-RPI-10B type CC-Link system space optical repeater module
Segment	System between terminating resistances connected to each other through cross-over cables. The conventional CC-Link system can be said to be configured with one segment (Refer to Section 2.1.).
Master station	Station to control the data link system. One station is required for each system.
Local station	Station which has a sequencer CPU and can communicate with the master station and the other local stations.
Remote I/O station	Remote station processing only information in unit of bit. (AJ65BTB1-16D, AJ65SBTB1-16D, AJ65SBTB1-8□, etc.)
Remote device station	Remote station processing only information in unit of bit and in unit of word. (AJ65BT-64AD, AJ65BT-64DAV, AJ65BT-64DAI, etc.)
Remote station	Generic name of remote I/O station and remote device station. Controlled by the master station.
Intelligent device station	Station allowing transient transmission such as AJ65BT-R2. (Including local stations)
Repeater	Module for expanding the CC-Link system by connecting the segments to each other.
Ready master station	Backup station which inherits data link control when the master station comes off parallel due to error.
Built-in CC-Link function	Abbreviation of built-in CC-Link system master/local functions of the L26CPU-BT and L26CPU-PBT
Master local module	Generic name of RJ61BT11, QJ61BT11N, QJ61BT11, built-in CC-Link function, AJ61BT11, A1SJ61BT11, AJ61QBT11, and A1SJ61QBT11
Master module	Generic name of the master local module that is used as a master station
Local module	Generic name of the master local module that is used as a local station
Remote module	Generic name of AJ65BTB1-16D, AJ65SBTB1-16D, AJ65BT-64AD, AJ65BT-64DAV, AJ65BT-64DAI and A852GOT.
Intelligent device module	Module allowing transient transmission such as AJ65BT-R2.

2. SYSTEM CONFIGURATION

2.1 Total configuration

The total configuration employed when the AJ65BT-RPI-10A/10B module is used is as shown below.

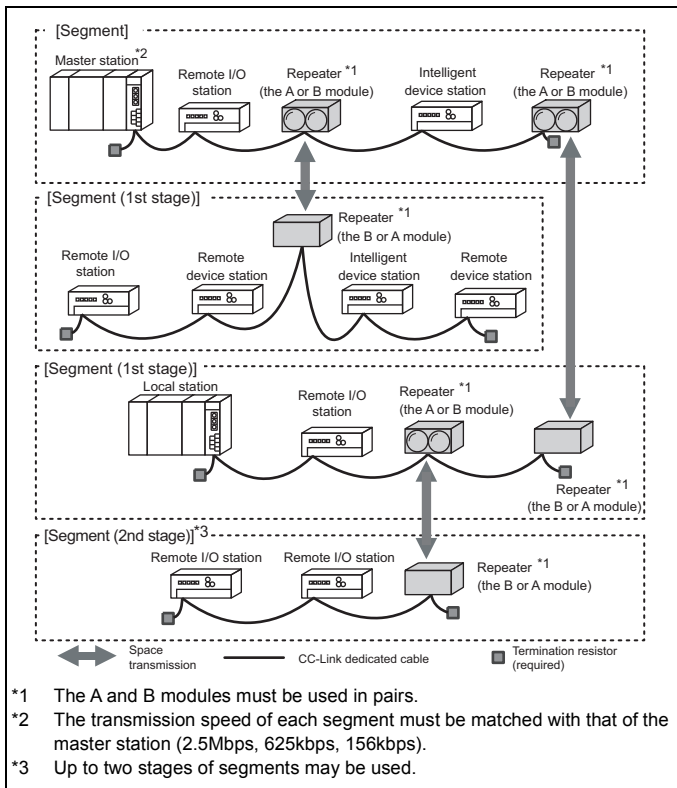

- (1) What is a repeater?
This is the module for expanding the CC-Link system by connecting the segments to each other.
- (2) What is a segment?
In the CC-Link system where repeaters are used, the equipment included between terminating resistances connected to each other through cross-over cables is generally called the segment.

- (4) Max. number of stages connected to configure segment
 These modules may be used to communicate with a remote station up to two segments away from the segment of the master station.

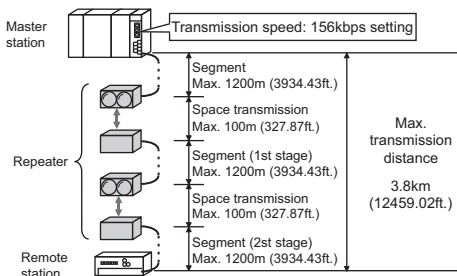

- (5) Instructions for using different models of repeaters in combination
 Note that when combining the repeaters of different models, there are the following restrictions on the number of connectable repeaters and the number of connected stages.

Combination pattern	Max. number of repeaters						Max. number of stages
	AJ65BTS-RPH	AJ65FBT A-RPH	AJ65SBT-RPH	AJ65SBT-RPS	AJ65SBT-RPG	AJ65BT-RPI -10A/10B	
1)	1	—	2	—	—	—	3
	—	1	2	—	—	—	
2)	1	—	—	2(1set)	—	—	2
	1	—	—	—	2(1 set)	—	
	—	1	—	—	2(1 set)	—	
3)	1	—	—	—	—	2(1 set)	2
	—	1	—	—	—	2(1 set)	
4)	—	—	2	4(2 set)	—	—	4
5)	—	—	2	—	2(1 set)	—	3
6)	—	—	2	—	—	2(1 set)	
7)	—	—	—	2(1 set)	2(1 set)	—	2
8)	—	—	—	2(1 set)	—	2(1 set)	
	—	—	—	—	2(1 set)	2(1 set)	
9)	1	1	—	—	—	—	

POINT

- For the CC-Link system, up to 2 repeater types can be used in combination. Using 3 models or more is not allowed.
- When repeaters are connected in the same segment by link wiring, up to 64 modules can be connected.

For details, refer to the user's manual of the master module used.

Ex.) A CC-Link system with combination pattern 7) is built

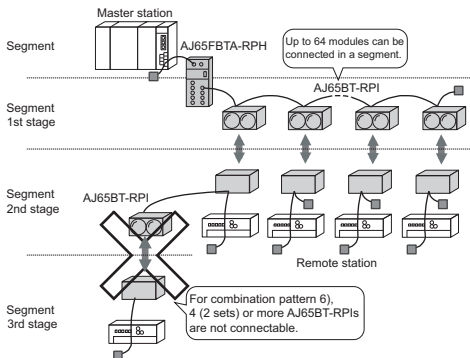

(a) Combination pattern 1)

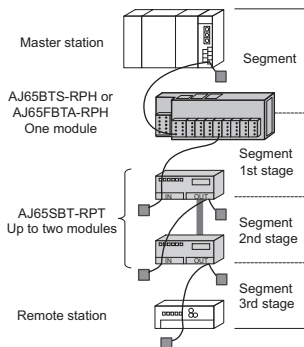

(c) Combination pattern 3)

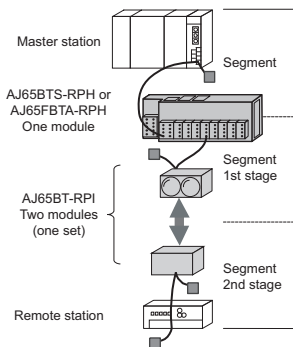

(b) Combination pattern 2)

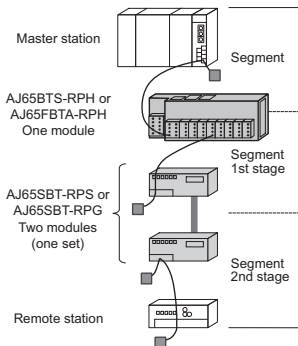

(d) Combination pattern 4)

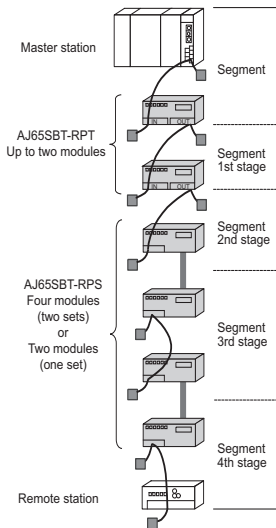

(e) Combination pattern 1)

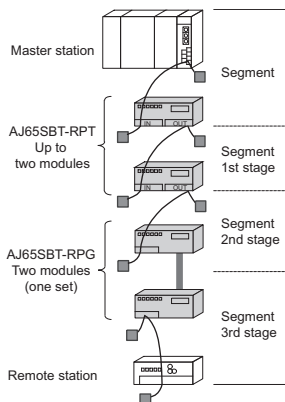

(g) Combination pattern 3)

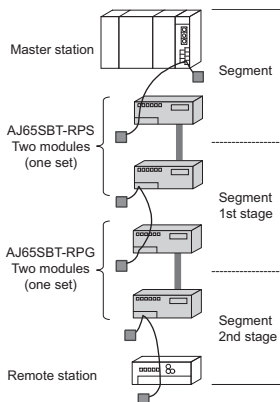

(f) Combination pattern 2)

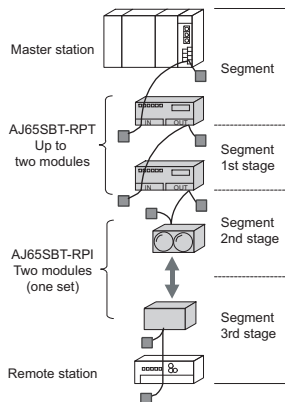

(h) Combination pattern 4)

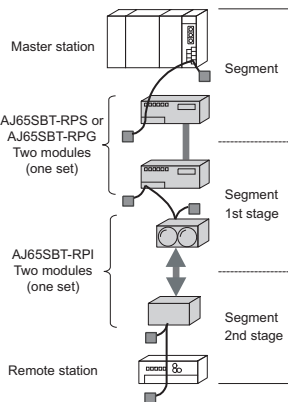

(h) Combination pattern 1)

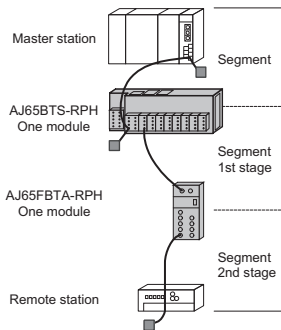

3. SPECIFICATIONS

3.1 General specifications

This section provides specifications of the AJ65BT-RPI-10A/10B module used.

Item	Specifications					
Operating ambient temperature <i>Température ambiante de fonctionnement</i>	0 to 50°C 0 à 50 °C					
Storage ambient temperature	-25 to 75°C					
Operating ambient humidity	10 to 90%RH, non-condensing					
Storage ambient humidity						
Vibration resistance	Compliant with JIS B 3502 and IEC 61131-2	Under intermittent vibration	Frequency	Constant acceleration	Half amplitude	Sweep count
			5 to 8.4Hz	——	3.5mm	10 times each in X, Y, Z directions
		Under continuous vibration	8.4 to 150Hz	9.8m/s ²	——	
			5 to 8.4Hz	——	1.75mm	——
8.4 to 150Hz	4.9m/s ²	——				
Shock resistance	Compliant with JIS B 3502, IEC 61131-2 (490 m/s ² , 10 times each in 3 directions X, Y, Z)					
Operating atmosphere	No corrosive gases					
Ambient illumination ^{*3}	10000 lx max. (no exposure to direct sunlight)					
Cooling method	Self-cooling method					
Operating altitude ^{*4}	0 to 2000m					
Installation location	Indoor					
Overvoltage category ^{*1}	II or less					
Pollution degree ^{*2}	2 or less					

- *1 This indicates the section of the power supply to which the equipment is assumed to be connected between the public electrical power distribution network and the machinery within premises. Category II applies to equipment for which electrical power is supplied from fixed facilities. The surge voltage withstand level for up to the rated voltage of 300 V is 2500 V.
- *2 This index indicates the degree to which conductive material is generated in terms of the environment in which the equipment is used. Pollution level 2 is when only non-conductive pollution occurs. A temporary conductivity caused by condensing must be expected occasionally.
- *3 The reference values of ambient illumination (in JIS Z 9110) are indicated below.
 - Illumination needed for fine visual work in factories : 3000 to 1500 lx
 - Illumination needed for work in offices : 2000 to 750 lx
- *4 Do not use or store the programmable controller under pressure higher than the atmospheric pressure of altitude 0m. Doing so may cause malfunction. When using the programmable controller under pressure, please consult your local Mitsubishi Electric representative.

3.2 Performance specifications

The following table lists the performance specifications of the AJ65BT-RPI-10A/10B.

Item		Specifications		
Common specifications	Power supply	Voltage	20.4 to 26.4VDC	
		Current	137mA (at TYP. 24VDC)	
	Noise immunity		Simulator noise of 500Vp-p, obtained by a noise simulator of 1 μ s noise width and 25 to 60Hz noise frequency	
	Dielectric withstand voltage		500VAC for 1 minute between all DC external terminals and ground	
	Insulation resistance		10M Ω or higher, measured with a 500VDC insulation resistance tester	
	Weight		0.5kg	
CC-Link communication specifications	Transmission speed		Can be selected from among 156kbps, 625kbps and 2.5Mbps.	
	Max. number of segments connected	AJ65BT-RPI only (Refer to Section 2.2 (4))		2stages
		Combination of AJ65BT-RPI and AJ65SBT-RPT (Refer to Section 2.2 (5))		3stages
		Combination of AJ65BT-RPI and one of AJ65SBT-RPS, AJ65SBT-RPG, AJ65FBTARPH, or AJ65BTS-RPH. (Refer to Section 2.2 (5))		2stages
	Max. transmission distance of each segment		Depending on the transmission speed. (Refer to the user's manual of the master module used.)	
	Max. number of connected modules		64 (Refer to Section 2.2 (3) for the conditions of the number of modules connected.)	
Number of stations occupied		When using monitor function : 1station When not using monitor function : 0station (Refer to Chapter 5 for details of the monitor function.)		
Optical communication specifications	Optical transmission distance		0 to 100m (0 to 327.87ft.)	
	Orientation angle		Optical transmission distance of 0 to 50m (0 to 163.94ft.) : Full angle 2° Optical transmission distance of 50 to 100m (163.94 to 327.87ft.) : Full angle 1°	
	Modulation frequency		A module to B module: 36 \pm 3MHz B module to A module: 44 \pm 2.5MHz	
	Modulation system		FSK	

3.3 Specifications of connection cables

Use the CC-Link dedicated cable for the CC-Link system. If a cable other than the CC-Link dedicated cable is used, the performance of the CC-Link system cannot be guaranteed.

For the specifications of the CC-Link dedicated cables or any other inquiries, visit the following site:

CC-Link Partner Association website: <http://www.cc-link.org/>

Remarks

For details, refer to the CC-Link cable wiring manual issued by the CC-Link Partner Association.

3.4 Max. transmission distance

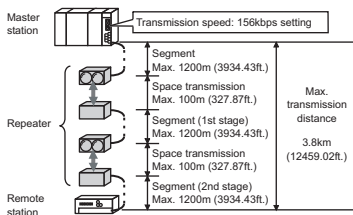

Conditions	Description
Transmission speed	The maximum transmission distance in each segment is the same as that in normal CC-Link system (system configured with one segment only). The maximum transmission distance in each segment varies according to the transmission speed. For details, refer to the User's Manual of the applicable master module. (The length of the cables between repeater stations is treated in the same manner as in the remote I/O station.)
Max. number of stages connected to configure segment	When one connection stage is added, the maximum transmission distance is added by an amount equivalent to one segment.

3.5 List of I/O Signals from/to the Master Module

The following tables provide the I/O signals transferred from/to the master module when the monitor function is used in the AJ65BT-RPI-10A/10B.

Refer to Chapter 5 for details of the monitor function.

Refer to Section 4.3 for the definitions of the operation indicator LEDs used to explain the signals.

(1) Input signals (AJ65BT-RPI-10A/10B to master module)

Input Signal	Signal Name	Description
RXn0	RC status	ON indicates that the module is ready to receive data.
RXn1	R1 status	ON indicates that the allowance of the light receiving level is 1.5 times or higher *.
RXn2	R2 status	ON indicates that the allowance of the light receiving level is 2.0 times or higher *.
RXn3	R3 status	ON indicates that the allowance of the light receiving level is 2.5 times or higher *.
RXn4 to RX(n+1)F	—	Must not be used.

* Value based on the RC status signal (1 time).

(2) Output signals (Master module to AJ65BT-RPI-10A/10B)

Output Signal	Signal Name	Description
Ryn0 to RYnF	—	Must not be used.
RY(n+1)0	SC ON	Lights up the "SC" operation indicator LED.*
RY(n+1)1	S1 ON	Lights up the "S1" operation indicator LED.*
RY(n+1)2	S2 ON	Lights up the "S2" operation indicator LED.*
RY(n+1)3	S2 ON	Lights up the "S3" operation indicator LED.*
RY(n+1)4 to RX(n+1)F	—	Must not be used.

* The RC, R1, R2 and R3 status signals of the mating module can be indicated by the operation indicator LEDs of the own module using the sequence program of the master station, ensuring ease of optical axis adjustment.

4. PROCEDURE UP TO START OF DATA LINK

4.1 Procedure up to start of data link

The procedure ranging from the installation of the AJ65BT-RPI-10A/10B module to the start of data link is described below.

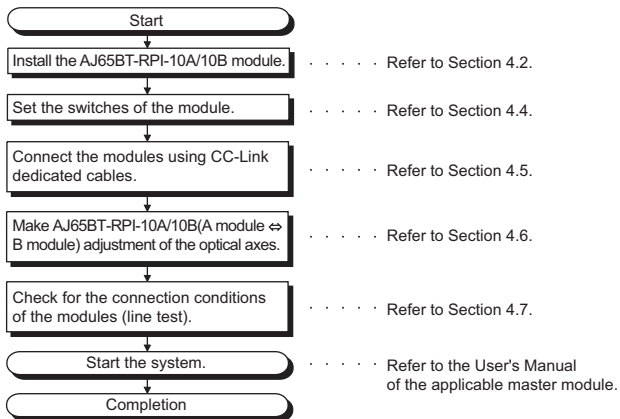

POINT

<p>The procedure described here is for the AJ65BT-RPI-10A/10B module only. In order for you to understand the procedure of the entire CC-Link system, refer to the User's Manual of the applicable master module.</p>

4.2 Mounting and installation

4.2.1 Cautions on handling

Cautions on handling the AJ65BT-RPI-10A/10B module are described below.

- (1) Tighten screws (such as a module fixing screw) within the tightening torque range specified in the table below. Do not over-tighten these screws. The screws and module case may be damaged.

Screw location	Specified torque range
Module mounting screw (M6 thread with finished circular flat washer)	1.2N•m
Display window mounting screw (M2.6 thread)	0.058N•m
Terminal block screw (M3 thread) <i>Vis de plaque à bornes (filetage M3)</i>	0.59 to 0.88N•m <i>0,59 à 0,88 N•m</i>
Terminal block mounting screw (M3.5 thread)	0.68 to 0.98N•m

- (2) When mounting the AJ65BT-RPI-10A/10B, it has no specific mounting orientation as a module alone. However, it should be mounted with its top face placed in the same orientation as that of the mating module with which optical communication is made. When these modules are mounted in opposite orientations, they must be mounted more than 1m(3.28ft.) away from each other.

[Top faces set in the same orientation]

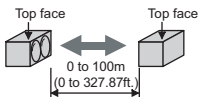

[Top faces set in the opposite orientations]



- (3) When using multiple sets of the AJ65BT-RPI-10A/10B in line, provide shields between the sets. Not doing so can cause a malfunction due to interference.

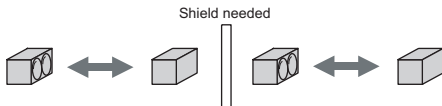

- (4) When using multiple sets of the AJ65BT-RPI-10A/10B in parallel, place the A and B modules alternately and keep a distance of at least 1m (3.28ft.). Not placing them alternately can cause a malfunction due to interference.

Referring to the figure showing the relation between the optical communication distance and the distance from the other system, adjust the optical axis to remove the influence of interference light. (Refer to Section 4.6.3.)

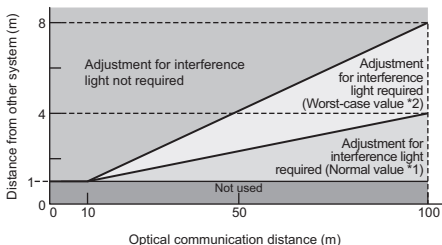
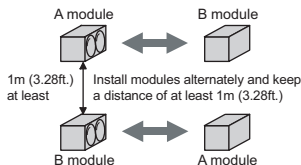

- *1 A value obtained when the optical axis of each system is adjusted to nearly the center of the area in which the operation indicator LED, R3 turns on.
- *2 A value obtained when the optical axis of the system is slanted toward the other system.

4.2.2 Installation environment

For installation environment, refer to Section 3.1 (General Specifications).

4.3 Names and settings of parts

This section explains the part names, LED indication definitions, and switch and control setting methods of the AJ65BT-RPI-10A/10B.

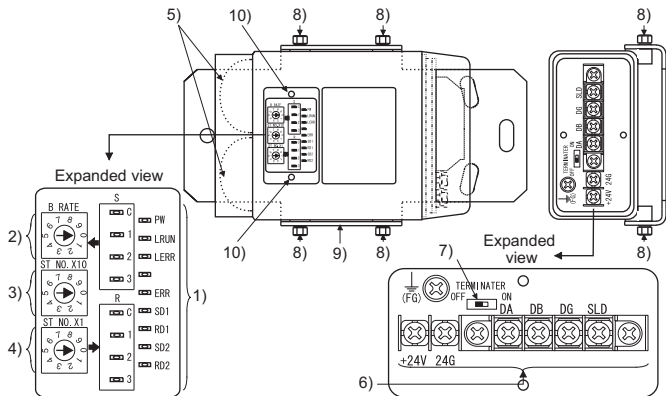

No.	Name	Application	
1)	Operation indicator LEDs	Check for the module condition by observing the state of lighting of the LED.	
		LED Name	Application
		PW	ON : Indicates that power is ON. OFF : Indicates that power is OFF.
		LRUN	ON : Indicates normal communication when the monitor function is used. OFF : Indicates that a communication error occurred when the monitor function is used or that the monitor function is not used.
		LERR	ON : Indicates that a communication error occurred when the monitor function is used or that the monitor function is not used. OFF : Indicates normal communication when the monitor function is used.
	ERR	ON : Indicates a communication error. OFF : Indicates a normal status.	

No.	Name	Application		
1)	Operation indicator LEDs	Check for the module condition by observing the state of lighting of the LED.		
		LED Name	Application	
		SD1	ON	: Indicates that data is being sent to the connection cable side.
			OFF	: Indicates that data is not sent to the connection cable side.
		SD2	ON	: Indicates that data is being sent to the light output side.
			OFF	: Indicates that data is not sent to the light output side.
		RD1	ON	: Indicates that data is being received from the connection cable side.
			OFF	: Indicates that data is not received from the connection cable side.
		RD2	ON	: Indicates that data is being received from the light input side.
			OFF	: Indicates that data is not received from the light input side.
		SC	ON	: Indicates that RY(n+1)0 is ON.
			OFF	: Indicates that RY(n+1)0 is OFF.
		S1	ON	: Indicates that RY(n+1)1 is ON.
			OFF	: Indicates that RY(n+1)1 is OFF.
S2	ON	: Indicates that RY(n+1)2 is ON.		
	OFF	: Indicates that RY(n+1)2 is OFF.		
S3	ON	: Indicates that RY(n+1)3 is ON.		
	OFF	: Indicates that RY(n+1)3 is OFF.		
RC	ON	: Indicates that the own module is enabled for light receiving.		
	OFF	: Indicates that the own module is disabled for light receiving.		
R1	ON	: Indicates that the light receiving level allowance of the own module is 1.5 times or more.		
	OFF	: Indicates that the light receiving level allowance of the own module is less than 1.5 times (based on RC).		
R2	ON	: Indicates that the light receiving level allowance of the own module is 2.0 times or more.		
	OFF	: Indicates that the light receiving level allowance of the own module is less than 2.0 times (based on RC).		
R3	ON	: Indicates that the light receiving level allowance of the own module is 2.5 times or more.		
	OFF	: Indicates that the light receiving level allowance of the own module is less than 2.5 times (based on RC).		
2)	Transmission speed setting switch	Used to set the transmission speed of the module. (Factory setting: 0)		
		0	: 156kbps	
		1	: 625kbps	
		2	: 2.5Mbps	
		3to 9	: Must not be set.	

No.	Name	Application
3)	Station number setting switch (Tens)	Used to set the station number of the module. Also used to set whether the monitor function is used or not. (Factory setting: 0)
4)	Station number setting switch (Units)	00 : Monitor function is not used 01 to 64 : Station number when monitor function is used 65 to 99 : Must not be set.
5)	Lens surfaces	Used to make optical communication.
6)	Terminal block	Used to connect the power supply cable and CC-Link dedicated cables.
7)	Termination resistor switch	Used to set whether the built-in termination resistor (110Ω) of the module is used or not. (Factory setting: OFF) ON : Used OFF: Not used
8)	Module mounting screws	Used to fix the module to the mounting bracket. Mounting bracket
9)	Mounting bracket	Used to mount the module.
10)	Display window mounting screws	Used to fix the display window to the module. The display window is removed when switch setting is to be made.

POINT

The settings of the transmission speed setting switch and station number setting switches are made valid when the module power is switched from OFF to ON. If any switch setting has been changed with the module power ON, perform the above operation again.

4.4 Setting of switches

The setting of the switches on the AJ65BT-RPI-10A/10B module is described below.

(1) Transmission speed setting switch

This switch is used to set the transmission speed of the AJ65BT-RPI-10A/10B module.

For detail of the setting, refer to Section 4.3.

POINT

- Set to the same state of setting as set in the master station.
- The states of setting of the transmission speed setting switch obtained when the module power supply is set from OFF to ON or the reset switch is set to OFF become effective. When the states of setting are changed with the module power supply turned ON, perform the above operations again.

(2) Station number setting switches

The station number setting switches are used to set the station number of the AJ65BT-RPI-10A/10B. It is also used to set whether the monitor function is used or not. For full information on the setting, refer to Section 4.3. For full information on the monitor function, refer to Chapter 5.

POINT

The setting of the station number setting switches is made valid when the module power is switched from OFF to ON. If the setting has been changed with the module power ON, perform the above operation again.

(3) Termination resistor switch

The termination resistor switch is used to set whether the built-in termination resistor (110Ω) of the AJ65BT-RPI-10A/10B is used (ON) or not (OFF). Set this switch to the ON (used) position when the AJ65BT-RPI-10A/10B is located on either side of the segment and the accessory termination resistor is not used.

POINT
<ul style="list-style-type: none">• In either of the following cases, do not use the built-in termination resistor (110Ω) of the AJ65BT-RPI-10A/10B but use the accessory termination resistor.<ol style="list-style-type: none">1) When the 130Ω termination resistor is needed.2) There is a possibility of removing the AJ65BT-RPI-10A/10B without affecting the other stations for maintenance or other purpose. When the built-in termination resistor is used, removing the terminal block from the module makes the termination resistor disconnected, disabling the other stations from making normal communication.• Do not use the built-in termination resistor and accessory termination resistor of the AJ65BT-RPI-10A/10B at the same time. Doing so makes the module doubly provided with the termination resistors, disabling normal communication.

4.5 Connection of module through CC-Link dedicated cable

Raccordement du câble dédié CC-Link de traversée de module

The method of connecting the AJ65BT-RPI-10A/10B module to the CC-Link system through the CC-Link dedicated cable is shown below.

La méthode de connexion d'un module AJ65BT-RPI-10A/10B à un système CC-Link par câble dédié CC-Link est représentée schématiquement ci-après.

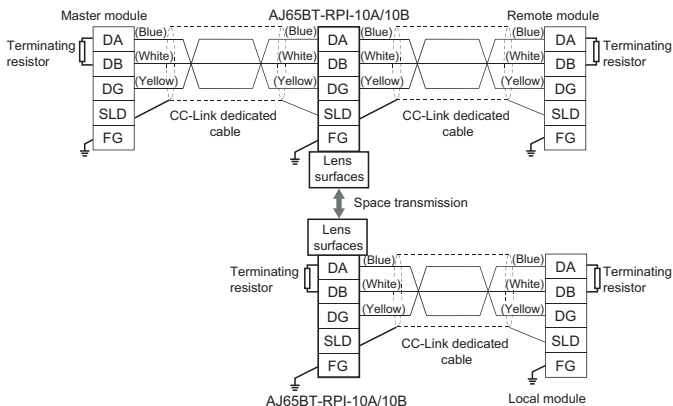

English	French	English	French
Master module	<i>Module maître</i>	Space transmission	<i>Transmission spatiale</i>
Remote module	<i>Module distant</i>	Local module	<i>Module local</i>
Terminating resistor	<i>Résistance d'extrémité</i>	Blue	<i>Bleu</i>
CC-Link dedicated cable	<i>Câble dédié pour CC-Link</i>	White	<i>Blanc</i>
Lens surfaces	<i>Surfaces des lentilles</i>	Yellow	<i>jaune</i>

Important
Important

In each segment, ensure to use the same type of CC-Link dedicated cables. If different types of cables are used, normal data transmission will not be assured.

Sur chaque segment, s'assurer qu'on utilise des câbles dédiés CC-Link du même type.

Si les câbles utilisés sont de types différents, la transmission normale des données ne peut être garantie.

POINT
POINT

- Ensure to connect the terminating resistances to both end modules of each segment. In addition, connect them between DA and DB (DA1-DB1 and DA2-DB2 for AJ65BT-RPI-10A/10B).
(The terminating resistances are furnished with the module.)
- The terminating resistances vary according to the type of cables in use. For detail, refer to the User's Manual of the applicable master module.
- Connect the shield cable of the CC-Link dedicated cable to "SLD" of each module, and ground both ends of the cable through "FG" to a class-D (class 3) ground.
SLD and FG are wired to each other inside the module.
- *Ne pas oublier de raccorder la résistance terminale aux deux modules d'extrémité sur chaque tronçon. De plus, établir la connexion entre DA et DB (DA1-DB1 et DA2-DB2 pour AJ65BT-RPI-10A/10B).
(Les résistances terminales sont fournies avec le module.)*
- *Les résistances terminales diffèrent en fonction du type des câbles utilisés. Pour le détail, voir le Manuel de l'utilisateur du module maître concerné.*
- *Raccorder le câble de blindage du câble dédié CC-Link sur "SLD" de chaque module, et mettre à la terre les deux extrémités du câble via "FG" sur une terre prise de terre de classe D (classe 3).
SLD et FG sont câblés entre eux à l'intérieur du module.*

4.6 Optical axis adjustment

4.6.1 Precautions for optical axis adjustment

For the optical axis adjustment, pay attention to the following.

- (1) Adjust the optical axis of each system to the center of the light receiving level area as much as possible. (Refer to Section 4.6.2.)
When multiple sets of the AJ65BT-RPI-10A/10B are used in parallel, turn off the other system(s) before starting the optical axis adjustment.
- (2) When the AJ65BT-RPI-10A/10B is installed to a movable body, check that the adjusted position in the light receiving level is not lowered during movement.
- (3) When multiple sets of the AJ65BT-RPI-10A/10B are used in parallel, check that the individual system is not affected by interference light from the other system. (Refer to Section 4.6.3.)

4.6.2 Optical axis adjustment method

The optical axis is adjusted in the following steps.

- (1) Place the modules face-to-face and align the module axes approximately.
- (2) While observing the operation indicator LEDs of the module (A module), change the angle of the other module (B module) in vertical or horizontal directions to obtain a proper angular range in which the operation indicator LED, R3 turns on.
Note that, if A module is moved at this time, the reference axis cannot be fixed and proper adjustment will be difficult.
- (3) Check the operation indicator LEDs on both modules.
Confirming the LEDs on one module only may not adjust the other optical axis.

(a) Vertical angle adjustment

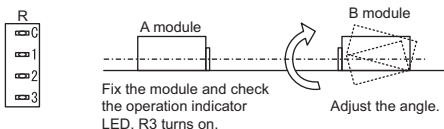

(b) Horizontal angle adjustment

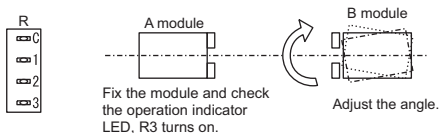

4.6.3 Adjustment procedures for interference light

The following is the adjustment procedures for interference light emitted from the other system.

- (1) Influence of interference light between module A1 and A2
 - (a) Turn on the module A1 and A2 only and turn off the module B1 and B2.
 - (b) Check for influence of interference light emitted from A1 to A2
 - 1) When the operation indicator LED, R1 of A2 is off:
No influence of interference light is identified.
 - 2) When the operation indicator LED, R1 of A2 is on:
The influence of interference light is identified.
Readjust the optical axis of module A1 by making it away from the system (2).
 - (c) Check for influence of interference light emitted from A2 to A1
 - 1) When the operation indicator LED, R1 of A1 is off:
No influence of interference light is identified.
 - 2) When the operation indicator LED, R1 of A1 is on:
Influence of interference light is identified.
Readjust the optical axis of module A2 by making it away from the system (1).

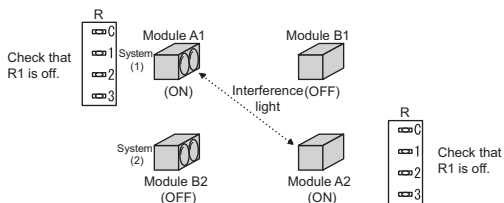

- (2) Influence of interference light between module B1 and B2
- (a) Turn on the module B1 and B2 only and turn off the module A1 and A2.
 - (b) Check for influence of interference light emitted from B1 to B2
 - 1) When the operation indicator LED, R1 of B2 is off:
No influence of interference light is identified.
 - 2) When the operation indicator LED, R1 of B2 is on:
The influence of interference light is identified.
Readjust the optical axis of module B1 by making it away from the system (2).
 - (c) Check for influence of interference light emitted from B2 to B1
 - 1) When the operation indicator LED, R1 of B1 is off:
No influence of interference light is identified.
 - 2) When the operation indicator LED, R1 of B1 is on:
The influence of interference light is identified.
Readjust the optical axis of module B2 by making it away from the system (1).

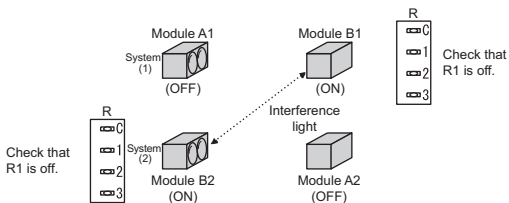

4.7 Check for state of connection (line test)

After connecting all modules including the AJ65BT-RPI-10A/10B, check whether the CC-Link system can establish proper data links or not. To perform the line test of the AJ65BT-RPI-10A/10B module, use the line test 2 of the master module. For the line test 2 of the master module, refer to the User's Manual of the applicable master module. Perform the test following the steps shown below.

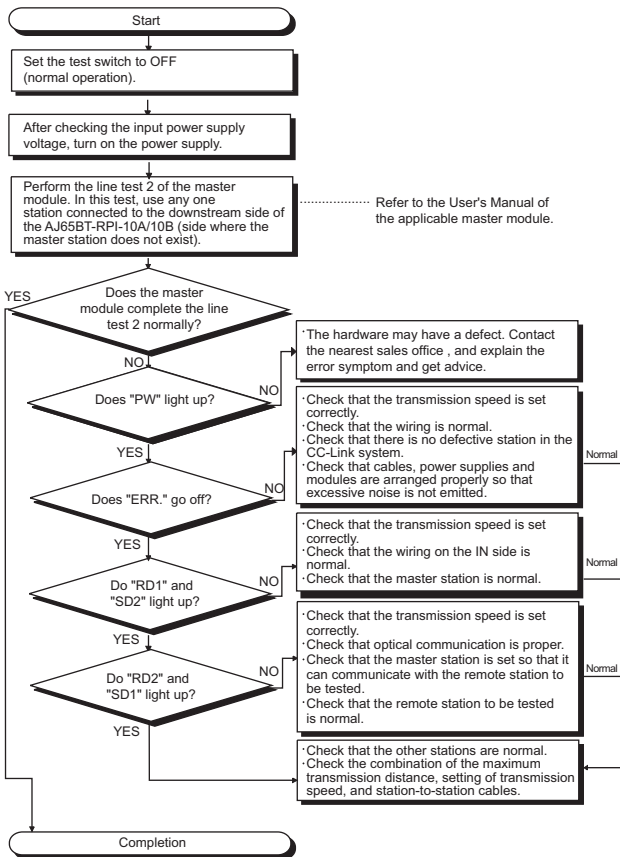

5. ABOUT THE MONITOR FUNCTION

The monitor function allows the receiving status (RC, R1, R2, R3) indicated by the operation indicator LEDs of the AJ65BT-RPI-10A/10B to be monitored (imported to the master station). To use the monitor function, the station numbers must be set and parameter setting to the master station must also be made as remote I/O stations. For the way to make parameter setting, refer to the user's manual of the master module used.

Also, the imported receiving status of the mating module can be indicated by the "SC, S1, S2, S3" operation indicator LEDs of the own module using the sequence program of the master station, ensuring ease of optical axis adjustment. Refer to Section 3.5 for the I/O signals transferred to/from the master module.

POINT
<ul style="list-style-type: none">• Make fine adjustment of the optical axes by adjusting the orientation of the own module until the receiving status of the mating module is maximized. Using the monitor function allows the receiving status of the mating module to be checked on the own module, ensuring ease of fine adjustment of the optical axes.• Since the monitor function transmits the receiving status through CC-Link data link, the modules must at least be ready to receive lights (the "RC" operation indicator LEDs are lit) each other.

6. TROUBLESHOOTING

Any error during data link can be checked by the ERR. LED of the master station.

If the ERR. LED of the master station is lit or flickers due to a data link error, first refer to the user's manual of the master module used and check the data link states of the other stations in the CC-Link system.

If there are many stations in data link error on the downstream side of the AJ65BT-RPI-10A/10B (the side on which the master station does not exist), the AJ65BT-RPI-10A/10B may be faulty. Therefore, make a line test again (refer to Section 4.7).

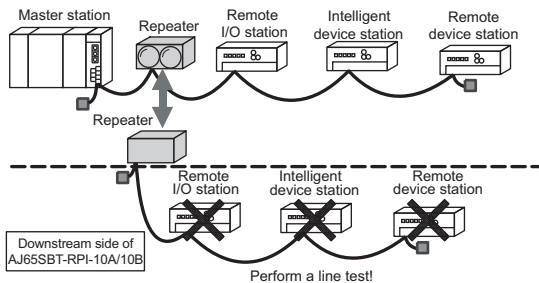

7. EXTERNAL DIMENSIONS DIAGRAM

The external dimensions diagram of the AJ65BT-RPI-10A/10B module is shown below.

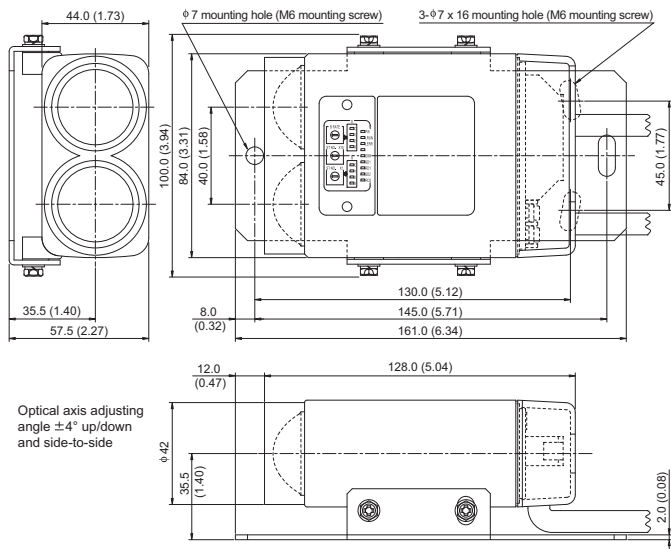

Unit : mm (inch)

WARRANTY

Mitsubishi will not be held liable for damage caused by factors found not to be the cause of Mitsubishi; machine damage or lost profits caused by faults in the Mitsubishi products; damage, secondary damage, accident compensation caused by special factors unpredictable by Mitsubishi; damages to products other than Mitsubishi products; and to other duties.

Country/ Region	Sales office/ Tel	Country/ Region	Sales office/ Tel
USA	MITSUBISHI ELECTRIC AUTOMATION, INC. 500 Corporate Woods Parkway, Vernon Hills, IL 60061, U.S.A. Tel : +1-847-478-2100	Turkey	MITSUBISHI ELECTRIC TURKEY A.Ş Ümraniye Branch Serifali Mahallesi Nutuk Sokak No:5, TR-34775 Umranli/Istanbul, Turkey Tel : +90-216-526-3990
Mexico	MITSUBISHI ELECTRIC AUTOMATION, INC. Mexico Branch Mariano Escobedo #69, Col. Zona Industrial, Tlalnepanitla Edo. Mexico, C.P.54030 Tel : +52-55-3067-7500	UAE	MITSUBISHI ELECTRIC EUROPE B.V. Dubai Branch Dubai Silicon Oasis, P.O.BOX 341241, Dubai, U.A.E. Tel : +971-4-3724716
Brazil	MITSUBISHI ELECTRIC DO BRASIL COMÉRCIO E SERVIÇOS LTDA. Avenida Adelino Cardana, 293, 21 andar, Bethaville, Barueri SP, Brazil Tel : +55-11-4689-3000	South Africa	ADROIT TECHNOLOGIES 20 Waterford Office Park, 189 Witkoppen Road, Fourways, South Africa Tel : +27-11-658-8100
Germany	MITSUBISHI ELECTRIC EUROPE B.V. German Branch Mitsubishi-Electric-Platz 1, 40882 Ratingen, Germany Tel : +49-2102-486-0	China	MITSUBISHI ELECTRIC AUTOMATION (CHINA) LTD. No.1386 Hongqiao Road, Mitsubishi Electric Automation Center, Shanghai, China Tel : +86-21-2322-3030
UK	MITSUBISHI ELECTRIC EUROPE B.V. UK Branch Travellers Lane, Hatfield, Hertfordshire, AL10 8XB, U.K. Tel : +44-1707-28-8780	Taiwan	SETSUYO ENTERPRISE CO., LTD. 6F, No.105, Wugong 3rd Road, Wugu District, New Taipei City 24889, Taiwan Tel : +886-2-2299-2499
Ireland	MITSUBISHI ELECTRIC EUROPE B.V. Irish Branch Westgate Business Park, Ballymount, Dublin 24, Ireland Tel : +353-1-4198800	Korea	MITSUBISHI ELECTRIC AUTOMATION KOREA CO., LTD. 7F-9F, Gangseo Hangang Xi-tower A, 401, Yangcheon-ro, Gangseo-Gu, Seoul 07528, Korea Tel : +82-2-3660-9530
Italy	MITSUBISHI ELECTRIC EUROPE B.V. Italian Branch Centro Direzionale Colleoni-Palazzo Sirio Viale Colleoni 7, 20864 Agrate Brianza(Milano) Italy Tel : +39-039-60531	Singapore	MITSUBISHI ELECTRIC ASIA PTE. LTD. 307, Alexandra Road, Mitsubishi Electric Building, Singapore 159943 Tel : +65-6473-2308
Spain	MITSUBISHI ELECTRIC EUROPE, B.V. Spanish Branch Carretera de Rubi, 76-80-Appdo. 420, 08190 Sant Cugat del Vallés (Barcelona), Spain Tel : +34-935-65-3131	Thailand	MITSUBISHI ELECTRIC FACTORY AUTOMATION (THAILAND) CO., LTD. 12th Floor, SV City Building, Office Tower 1, No. 896/19 and 20 Rama 3 Road, Kwaeng Bangpompang, Khet Yannawa, Bangkok 10120, Thailand Tel : +66-2682-6522
France	MITSUBISHI ELECTRIC EUROPE B.V. French Branch 25, Boulevard des Bouvets, 92741 Nanterre Cedex, France Tel : +33-1-55-68-55-68	Vietnam	MITSUBISHI ELECTRIC VIETNAM COMPANY LIMITED Hanoi Branch 6th Floor, Detech Tower, 8 Ton That Thuyet Street, My Dinh 2 Ward, Nam Tu Liem District, Hanoi, Vietnam Tel : +84-4-3937-8075
Czech Republic	MITSUBISHI ELECTRIC EUROPE B.V. Czech Branch Avenit Business Park, Radlicka 751/113e, 158 00 Praha5, Czech Republic Tel : +420-251-551-470	Indonesia	PT. MITSUBISHI ELECTRIC INDONESIA Gedung Jaya 11th Floor, JL. MH. Thamrin No.12, Jakarta Pusat 10340, Indonesia Tel : +62-21-3192-6461
Poland	MITSUBISHI ELECTRIC EUROPE B.V. Polish Branch ul. Krakowska 50, 32-083 Balice, Poland Tel : +48-12-347-65-00	India	MITSUBISHI ELECTRIC INDIA PVT. LTD. Pune Branch Emerald House, EL-3, J Block, M.I.D.C., Bhosari, Pune-411026, Maharashtra, India Tel : +91-20-2710-2000
Sweden	MITSUBISHI ELECTRIC EUROPE B.V. (Scandinavia) Fjellvägen 8, SE-22736 Lund, Sweden Tel : +46-8-625-10-00	Australia	MITSUBISHI ELECTRIC AUSTRALIA PTY. LTD. 348 Victoria Road, P.O. Box 11, Rydalmere, N.S.W 2116, Australia Tel : +61-2-9684-7777
Russia	MITSUBISHI ELECTRIC (RUSSIA) LLC St. Petersburg Branch Piskarevsky pr. 2, bld 2, lit "Sch", BC "Benua", office 720, 195027 St. Petersburg, Russia Tel : +7-812-633-3497		

MITSUBISHI ELECTRIC CORPORATION

HEAD OFFICE : TOKYO BUILDING, 2-7-3 MARUNOUCHI, CHIYODA-KU, TOKYO 100-8310, JAPAN
NAGOYA WORKS : 1-14, YADA-MINAMI 5-CHOME, HIGASHI-KU, NAGOYA, JAPAN

When exported from Japan, this manual does not require application to the Ministry of Economy,
Trade and Industry for service transaction permission.

Specifications subject to change without notice.