



**MITSUBISHI
ELECTRIC**

Safety Programmable Controller

MELSEC **QS** series

Safety Guidelines

Thank you for purchasing the Mitsubishi Electric safety programmable controller MELSEC-QS series.

The MELSEC-QS series programmable controller is suitable for establishing safety functions for general industrial machinery.

Prior to use, please read both this manual and detailed manual thoroughly and familiarize yourself with the product.

MODEL	QS03NB-U-HW
MODEL CODE	13JY84
IB(NA)-0800424-N(2311)MEE	

● SAFETY PRECAUTIONS ●

(Read these precautions before using this product.)

Before using this product, please read this manual and the relevant manuals carefully and pay full attention to safety to handle the product correctly.

In this manual, the safety precautions are classified into two levels:
"⚠ WARNING" and "⚠ CAUTION".



Indicates that incorrect handling may cause hazardous conditions, resulting in death or severe injury.



Indicates that incorrect handling may cause hazardous conditions, resulting in minor or moderate injury or property damage.

Under some circumstances, failure to observe the precautions given under "⚠ CAUTION" may lead to serious consequences.

Make sure that the end users read this manual and then keep the manual in a safe place for future reference.

WARNING

- When a safety programmable controller detects an error in an external power supply or a failure in programmable controller main module, it turns off all the outputs. Create an external circuit to securely stop the power of hazard by turning off the outputs. Incorrect configuration may result in an accident.
- Create short current protection for a safety relay, and a protection circuit such as a fuse, and breaker, outside a safety programmable controller.
- When data/program change, or status control is performed from a PC to a running safety programmable controller, create an interlock circuit outside the sequence program and safety programmable controller to ensure that the whole system always operates safely.

For the operations to a safety programmable controller, pay full attention to safety by reading the relevant manuals carefully, and establishing the operating procedure.

Furthermore, for the online operations performed from a PC to a safety CPU module, the corrective actions against a communication error due to a cable connection fault, etc. should be predetermined as a system.

- All output signals from a safety CPU module to the CC-Link Safety master module are prohibited to use. These signals can be found in the CC-Link Safety System Master Module User's Manual.
Do not turn ON or OFF these signals by sequence program, since turning ON/OFF these output signals of the programmable controller system may cause malfunctions and safety operation cannot be guaranteed.
- All output signals from a safety CPU module to the CC-Link IE Field Network master/local module (with safety functions) are prohibited to use. These signals can be found in the MELSEC-QS CC-Link IE Field Network Master/Local User's Manual.
Do not turn ON or OFF these signals by sequence program, since turning ON/OFF these output signals of the programmable controller system may cause malfunctions and safety operation cannot be guaranteed.

[Design Precautions]

WARNING

- When a safety remote I/O module has detected CC-Link Safety error, it turns off all the outputs. Note that the outputs in a sequence program are not automatically turned off. If CC-Link Safety or CC-Link IE Field Network error has been detected, create a sequence program that turns off the outputs in the program. If the CC-Link Safety or CC-Link IE Field Network is restored with the outputs on, it may suddenly operate and result in an accident.
- To inhibit restart without manual operation after safety function was performed and outputs were turned OFF, create an interlock program which uses a reset button for restart.
- To prevent an illegal operation and malfunction, do not connect a safety programmable controller to the Internet or to a wireless LAN.

[Design Precautions]

CAUTION

- Do not bunch the wires of external devices or communication cables together with the main circuit or power lines, or install them close to each other. They should be installed 100 mm (3.94 inch) or more from each other. Not doing so could result in noise that would cause malfunctions.

[Security Precautions]

WARNING

- To maintain the security (confidentiality, integrity, and availability) of the programmable controller and the system against unauthorized access, denial-of-service (DoS) attacks, computer viruses, and other cyberattacks from external devices via the network, take appropriate measures such as firewalls, virtual private networks (VPNs), and antivirus solutions.

[Installation Precautions]

CAUTION

- Use a safety programmable controller in the environment that meets the general specifications described in this manual.
Using this programmable controller in an environment outside the range of the general specifications could result in electric shock, fire, erroneous operation, and damage to or deterioration of the product.
- While pressing the installation lever located at the bottom of module, insert the module fixing tab into the fixing hole in the base unit until it stops. Then, securely mount the module with the fixing hole as a supporting point.
Incorrect loading of the module can cause a failure or drop.
Secure the module to the base unit with screws.
Tighten the screw in the specified torque range.
If the screws are too loose, it may cause a drop of the screw or module.
Overtightening may cause a drop due to the damage of the screw or module.
- Completely turn off the external supply power used in the system before mounting or removing the module.
Not doing so could result in damage to the product.
- Do not directly touch the module's conductive parts or electronic components.
Doing so may cause malfunctions or a failure.

[Wiring Precautions]

WARNING

- Be sure to shut off all phases of the external supply power used by the system before wiring.
Not completely turning off all power could result in electric shock or damage to the product.
- When energizing or operating the module after installation or wiring, be sure to close the attached terminal cover.
Not doing so may result in electric shock.

[Wiring Precautions]

CAUTION

- Ground the FG and LG terminals correctly.
Not doing so could result in electric shock or malfunctions.
- Use a solderless terminal with insulation sleeve for wiring of a terminal block.
Use up to two solderless terminals for a single terminal.
- Use applicable solderless terminals and tighten them with the specified torque.
If any solderless spade terminal is used, it may be disconnected when the terminal screw comes loose, resulting in a failure.
- Wire the module correctly after confirming the rated voltage and terminal layout.
Connecting a power supply of a different rated voltage or incorrect wiring may cause a fire or failure.
- Tighten a terminal block mounting screw, terminal screw, and module fixing screw within the specified torque range.
If the terminal block mounting screw or terminal screw is too loose, it may cause a short circuit, fire, or malfunctions.
If too tight, it may damage the screw and/or the module, resulting in a drop of the screw or module, a short circuit or malfunctions.
If the module fixing screw is too loose, it may cause a drop of the screw or module.
Overtightening the screw may cause a drop due to the damage of the screw or module.
- Be sure there are no foreign substances such as sawdust or wiring debris inside the module. Such debris could cause a fire, failure, or malfunctions.
- The module has an ingress prevention label on its top to prevent foreign matter, such as wire cutouts, from entering the module during wiring.
Do not peel this label during wiring. Before starting system operation, be sure to peel this label because of heat dissipation.
- Install our programmable controller in a control panel for use.
Wire the main power supply to the power supply module installed in a control panel through a distribution terminal block.
Furthermore, the wiring and replacement of a power supply module have to be performed by a maintenance worker who acquainted with shock protection.
(For the wiring methods, refer to the QSCPU User's Manual (Hardware Design, Maintenance and Inspection).)

[Wiring Precautions]

CAUTION

- Be sure to fix the communication cables or power cables by ducts or clamps when connecting them to the module. Failure to do so may cause damage of the module or cables due to a wobble, unintentional shifting, or accidental pull of the cables, or malfunctions due to poor contact of the cable.
- When removing the connected communication cables or power cables, do not pull the cable with grasping the cable part. Pulling the cable connected to a module may result in malfunctions or damage of the module or cable.
- For the cables to be used in the CC-Link Safety system, use the ones specified by the manufacturer.
Otherwise, the performance of the CC-Link Safety system is not guaranteed. As to the maximum overall cable length and station - to station cable length, follow the specifications described in the CC-Link Safety System Master Module User's Manual.
If not following the specification, the normal data transmission is not guaranteed.
- For the cables to be used in CC-Link IE Field Network, use the ones specified by the manufacturer. Otherwise, the performance of CC-Link IE Field Network is not guaranteed. As to the maximum overall cable length and station - to station cable length, follow the specifications described in the MELSEC-QS CC-Link IE Field Network Master/Local Module User's Manual.
If not following the specification, the normal data transmission is not guaranteed.

[Startup and Maintenance precautions]

WARNING

- Do not touch the terminals while power is on.
Doing so could result in electric shock.
- Correctly connect the battery. Also, do not charge, disassemble, heat, place in fire, short circuit, or solder the battery.
Mishandling of battery can cause overheating, cracks, or ignition which could result in injury and fires.
- Turn off all phases of the external supply power used in the system when cleaning the module or retightening the terminal block mounting screws, terminal screws, or module fixing screws.
Not doing so could result in electric shock. Tighten a terminal block mounting screw, terminal screw, and module fixing screw within the specified torque range.
If the terminal block mounting screw or terminal screw is too loose, it may cause a short circuit, fire, or malfunctions.
If too tight, it may damage the screw and/or the module, resulting in a drop of the screw or module, a short circuit or malfunctions.
If the module fixing screw is too loose, it may cause a drop of the screw or module.
Overtightening the screw may cause a drop due to the damage of the screw or module.

[Startup and Maintenance precautions]

CAUTION

- The online operations performed from a PC to a running safety programmable controller (Program change when a safety CPU module is RUN, device test, and operating status change such as RUN-STOP switching) have to be executed after the manual has been carefully read and the safety has been ensured.
Following the operating procedure predetermined at designing, the operation has to be performed by an instructed person.
When changing a program while a safety CPU module is RUN (Write during RUN), it may cause a program breakdown in some operating conditions. Fully understand the precautions described in the GX Developer's manual before use.
- Do not disassemble or modify the modules.
Doing so could cause a failure, malfunctions, injury, or fire.
If the product is repaired or remodeled by other than the specified FA centers or us, the warranty is not covered.
- Use any radio communication device such as a cellular phone or a PHS phone more than 25cm (9.85 inch) away in all directions of safety programmable controller.
Not doing so can cause malfunctions.
- Completely turn off the external supply power used in the system before mounting or removing the module.
Not doing so may result in a failure or malfunctions of the module.
- After the first use of the product, do not perform each of the following operations more than 50 times (IEC 61131-2/JIS B 3502 compliant):
 - Mounting/removing the module to/from the base unit
 - Mounting/removing the terminal block to/from the moduleExceeding the limit may cause malfunction.
- Do not drop or give an impact to the battery mounted to the module.
Doing so may damage the battery, causing the battery fluid to leak inside the battery.
If the battery is dropped or given an impact, dispose of it without using
- Before touching the module, always touch grounded metal, etc. to discharge static electricity from human body, etc.
Not doing so may result in a failure or malfunctions of the module.

[Disposal Precautions]

CAUTION

- When disposing of this product, treat it as industrial waste. When disposing of batteries, separate them from other wastes according to the local regulations. (For details of the battery directive in EU member states, refer to QSCPU User's Manual (Hardware Design, Maintenance and Inspection).

[Transportation Precautions]

CAUTION

- When transporting lithium batteries, make sure to treat them based on the transport regulations. (For details of the controlled models, refer to the QSCPU User's Manual (Hardware Design, Maintenance and Inspection).)

● **PRÉCAUTIONS DE SÉCURITÉ** ●

(Lire ces précautions avant toute utilisation du produit.)

Avant d'utiliser ce produit, lire attentivement ce manuel ainsi que les manuels auxquels il renvoie, et toujours considérer la sécurité comme de la plus haute importance en manipulant le produit correctement.

Dans ce manuel, les précautions de sécurité sont classées en deux niveaux, à savoir : "AVERTISSEMENT" et "ATTENTION"

AVERTISSEMENT

Attire l'attention sur le fait qu'une négligence peut créer une situation de danger avec risque de mort ou de blessures graves.

ATTENTION

Attire l'attention sur le fait qu'une négligence peut créer une situation de danger avec risque de blessures légères ou de gravité moyennes ou risque de dégâts matériels.

Dans certaines circonstances, le non-respect d'une précaution de sécurité introduite sous le titre "ATTENTION" peut avoir des conséquences graves. Veiller à ce que les utilisateurs finaux lisent ce manuel qui doit être conservé soigneusement à portée de main pour s'y référer autant que de besoin.

⚠ AVERTISSEMENT

- *Quand l'automate programmable de sécurité détecte une erreur dans une alimentation externe ou une panne de module principal d'automate programmable, il désactive toutes les sorties. Constituer un circuit externe coupant infailliblement l'alimentation en cas de danger pour désactiver les sorties. Une configuration incorrecte peut être à l'origine d'un accident.*
- *Prévoir, à l'extérieur de l'automate programmable de sécurité, une protection contre les courants de court-circuit pour les relais de sécurité et un circuit de protection avec fusible ou disjoncteur.*
- *Pour pouvoir exécuter un changement de données ou de programme ou une commande d'état sur un automate programmable de sécurité en marche à partir d'un ordinateur individuel, prévoir à l'extérieur du programme séquentiel et de l'automate programmable de sécurité un circuit de verrouillage qui garantisse en tous temps la sécurité de fonctionnement de l'ensemble du système.*

Pour toute intervention sur un automate programmable de sécurité, prêter une attention toute particulière à ce qui a trait à la sécurité dans les manuels correspondant et établir au préalable un mode opératoire.

En outre, pour effectuer des interventions en ligne à partir d'un PC sur un module CPU de sécurité, les mesures correctives en cas d'erreur de communication suite à une connexion de câble imparfaite doivent être prévues au préalable pour l'ensemble du système.

- *Tous les signaux de sortie du module CPU de sécurité vers le module maître/distant du réseau de terrain IE CC-Link sont interdits d'utilisation. Ces signaux sont présentés dans le manuel de l'utilisateur du module maître du système de sécurité CC-Link.*

Ne pas activer/désactiver ces signaux par instructions dans le programme séquentiel, car tout passage ON/OFF de ces signaux de sortie du système de l'automate programmable peut entraîner des dysfonctionnements ne permettant plus de garantir la sécurité de fonctionnement.

- *Tous les signaux de sortie du module CPU de sécurité vers le module maître/distant du réseau de terrain IE CC-Link (avec fonctions de sécurité) sont interdits d'utilisation.*

Ces signaux sont présentés dans le manuel de l'utilisateur du module maître/local du réseau de terrain IE CC-Link.

Ne pas activer/désactiver ces signaux par instructions dans le programme séquentiel, car tout passage ON/OFF de ces signaux de sortie du système de l'automate programmable peut entraîner des dysfonctionnements ne permettant plus de garantir la sécurité de fonctionnement.

[Précautions lors de la conception]

AVERTISSEMENT

- *Quand le module E/S distant de sécurité détecte une erreur de sécurité CC-Link, il désactive toutes les sorties. On remarquera que, dans un programme séquentiel, les sorties ne sont pas toujours automatiquement désactivées. Prévoir dans le programme séquentiel la désactivation des sorties dans l'éventualité où une erreur de sécurité CC-Link ou de réseau de terrain IE CC-Link serait détectée. Le rétablissement de la sécurité CC-Link ou du réseau de terrain IE CC-Link alors que les sorties sont actives pourrait causer un brusque mouvement à l'origine d'un accident.*
- *Pour interdire tout redémarrage sans intervention manuelle après déclenchement de la fonction de sécurité du module et mise hors tension des sorties, prévoir un circuit de mise en sécurité avec poussoir de réarmement.*
- *Pour se prémunir contre le risque de manipulations non autorisées ou mal intentionnées, un automate programmable de sécurité ne doit pas être connecté à Internet ou à un réseau local sans fil.*

[Précautions lors de la conception]

ATTENTION

- *Ne pas grouper les fils des dispositifs externes ou câbles de communication avec les fils des circuits principaux ou de l'alimentation, et ne pas les installer à proximité les uns des autres.
Ils doivent être installés à une distance de 100mm (3,94 pouces) les uns des autres.
Faute de quoi, il y a risque de bruit entraînant des dysfonctionnements.*

[Précautions de sécurité]

AVERTISSEMENT

- *Pour maintenir la sécurité (confidentialité, intégrité et disponibilité) de l'automate programmable et du système contre les accès non autorisés, les attaques par déni de service (DoS), les virus informatiques et autres cyberattaques d'appareils externes via le réseau, prendre les mesures appropriées telles que la configuration d'un pare-feu ou d'un réseau privé virtuel (VPN), ou l'installation d'un logiciel antivirus sur l'ordinateur.*

[Précautions d'installation]

ATTENTION

- *Un automate programmable de sécurité doit être utilisé dans un environnement conforme aux spécifications générales exposées dans ce manuel.
L'utilisation de cet automate programmable dans un environnement autre que celui prévu dans les spécifications générales peut être à l'origine d'un choc électrique, d'un départ de feu ou d'un fonctionnement erratique, ou peut endommager ou détériorer le produit.*
- *En appuyant sur le loquet du fond du module, introduire l'ergot de fixation du module dans le trou de fixation sur l'unité de base jusqu'en butée. Ensuite, installer fermement le module en utilisant le trou de fixation comme point d'appui.
UN chargement incorrect du module peut entraîner sa chute ou son dysfonctionnement.
Fixer le module sur l'unité de base avec des vis.
Serre la vis dans les limites du couple de serrage prescrit.
Si le serrage est insuffisant, les vis ou le module risquent de tomber.
Un serrage excessif peut endommager la vis ou le module et entraîner leur chute.*
- *Couper complètement l'alimentation externe utilisé par le système avant de mettre en place ou de retirer le module.
Faute de quoi, il y a risque d'endommagement du produit.*
- *Éviter tout contact direct avec les parties conductrices ou les composants électroniques du module.
Cela pourrait être à l'origine de d'un dysfonctionnement ou d'une panne.*

[Précautions de câblage]

AVERTISSEMENT

- *Ne pas oublier de couper toutes les phases de l'alimentation externe utilisée par le système avant le câblage.
Ne pas couper complètement toutes les alimentations expose au risque de chocs électriques et d'endommagement du produit.*
- *Avant de mettre sous tension et de mettre en marche le module à la fin des travaux d'installation et de câblage, ne oublier de refermer le couvre-bornes fourni.
Faute de quoi, il y a risque de choc électrique.*

[Précautions de câblage]

ATTENTION

- *Mettre les bornes FG et LG à la masse correctement.
Faute de quoi, il y a risque de choc électrique ou de dysfonctionnements.*
- *Pour le câblage sur le bornier, utiliser des bornes sans soudure avec manchon isolant.
On peut utiliser au plus deux cosses sans soudure à chaque emplacement de borne.*
- *Utiliser des bornes sans soudure du type prescrit en les serrant au couple prescrit.
Si on utilise des bornes sans soudure de type embrochable, il y a risque de déconnexion et de panne au cas où une vis de borne se desserrerait.*
- *Câbler le module correctement après vérification de la tension nominale et de l'affectation des bornes.
Le raccordement d'une alimentation d'une tension autre que la tension nominale ou une erreur de câblage peut être à l'origine d'un départ de feu ou d'une panne.*
- *Serrer les vis de fixation du bornier, les vis de borne et les vis de fixation du module dans les limites du couple de serrage prescrit.
Une vis de fixation de bornier ou un vis de borne mal serrée peut être à l'origine d'un court-circuit, d'un départ de feu ou de dysfonctionnements.
Un serrage excessif peut endommager la vis et/ou le module, et une chute de vis ou de module risque d'entraîner un court-circuit ou des dysfonctionnements.
Un serrage insuffisant des vis de fixation de module peut être à l'origine d'une chute des vis ou du module.
Un serrage excessif peut endommager la vis ou le module et entraîner leur chute.*
- *Veiller à ce qu'il n'y ait pas de sciure ou autre débris de câblage dans le module. Tout débris pourrait être à l'origine d'un départ de feu, d'une panne ou d'un dysfonctionnement.*
- *L'étiquette autocollante collée sur le haut du module est destinée à éviter toute pénétration de débris de fil ou autres corps étrangers dans le module pendant le câblage.
Ne pas enlever cette étiquette pendant le câblage. Avant la mise en marche du système, ne pas oublier de retirer l'étiquette pour une meilleure dissipation de la chaleur.*

ATTENTION

- *Notre automate programmable est destiné à être utilisé installé dans un tableau de commande.
Pour le câblage de l'alimentation principale vers le module d'alimentation installé en tableau de commande, utiliser un bloc de distribution.
En outre, le câblage et le remplacement d'un module d'alimentation doivent être effectués par un personnel d'entretien qualifié et formé à la protection contre les risques d'électrocution.
(Pour les méthodes de câblage, voir QSCPU User's Manual (Hardware Design, Maintenance and Inspection) (le Manuel de l'utilisateur QSCPU (conception du matériel, maintenance et inspection)).*

[Précautions de câblage]

ATTENTION

- *Les câbles de communication ou câbles d'alimentation raccordés au module doivent être placés dans des conduits de câbles ou doivent être attachés.
Faute de quoi, il y a risque d'endommagement du module ou du câble par ballonnement ou effort de traction exercé accidentellement sur le câble, tout mauvais contact d'un câble pouvant être à l'origine de dysfonctionnement.*
- *Pour débrancher les câbles de communication ou d'alimentation, ne pas tirer sur le câble proprement dit. Tirer sur un câble raccordé au module peut endommager le câble ou le module et être à l'origine de dysfonctionnements.*
- *Comme câbles de système de sécurité CC-Link, utiliser les câbles préconisés par le fabricant.
Faute de quoi, les performances du système de sécurité CC-Link ne peuvent être garanties.
Quant à la longueur de câble totale maximale et à la longueur de câble de station à station, suivre les spécifications présentées dans le manuel de l'utilisateur du module maître pour système de sécurité CC-Link.
Si les spécifications ne sont pas respectées, la transmission normale des données ne peut être garantie.*
- *Comme câbles de réseau de terrain IE CC-Link, utiliser les câbles préconisés par le fabricant. Faute de quoi, les performances du réseau de terrain IE CC-Link ne peuvent être garanties. Quant à la longueur de câble totale maximale et à la longueur de câble de station à station, suivre les spécifications présentées dans le manuel de l'utilisateur du module maître/local pour réseau de terrain IE CC-Link du MELSEC-QS.
Si les spécifications ne sont pas respectées, la transmission normale des données ne peut être garantie.*

 AVERTISSEMENT

- *Ne pas toucher aux bornes quand l'appareil est sous tension. Cela pourrait être à l'origine d'un choc électrique.*
- *Raccorder correctement la pile. En outre, noter que la pile ne doit pas être rechargée, démontée, réchauffée, exposée au feu, court-circuitée ou soudée. Une pile ayant subi de mauvais traitements tend à surchauffer, à se fendre ou s'enflammer, ce qui pourrait être à l'origine de blessures ou d'un départ de feu.*
- *Couper l'alimentation externe utilisée par le système sur toutes phases avant de nettoyer le module ou de resserrer les vis de fixation du bornier, les vis de bornes ou les vis de fixation du module.*

Faute de quoi, il y a risque de choc électrique. Serrer les vis de fixation du bornier, les vis de borne et les vis de fixation du module dans les limites du couple de serrage prescrit.

Une vis de fixation de bornier ou un vis de borne mal serrée peut être à l'origine d'un court-circuit, d'un départ de feu ou de dysfonctionnements.

Un serrage excessif peut endommager la vis et/ou le module, et une chute de vis ou de module risque d'entraîner un court-circuit ou des dysfonctionnements.

Un serrage insuffisant des vis de fixation de module peut être à l'origine d'une chute des vis ou du module.

Un serrage excessif peut endommager la vis ou le module et entraîner leur chute.

⚠ ATTENTION

- *Avant toute intervention en ligne à partir d'un PC sur un automate programmable en marche (comme un changement de programme avec le module de sécurité à l'état RUN ou un changement d'état fonctionnel RUN-STOP), lire attentivement le manuel pour faire en sorte de pouvoir assurer la sécurité.*
L'opération doit être effectuée par une personne qualifiée, selon le mode opératoire prévu lors de la conception.
Modifier un programme avec le module CPU de sécurité à l'état RUN (Write during RUN) peut, dans certaines conditions de marche, entraîner un plantage de programme.
Avant utilisation, s'assurer qu'on a une bonne compréhension des précautions exposées dans le manuel de GX Developer.
- *Ne pas démonter ni modifier les modules.*
Cela pourrait être à l'origine de pannes, de dysfonctionnements, de blessures ou d'un départ de feu. dysfonctionnements
Si le produit est réparé ou modifié par quiconque autre que nous-mêmes ou un de nos centre d'automatisation industrielles agréés, il n'est plus couvert par la garantie.
- *Tout type d'appareil de communication radio, y compris les téléphones portables et les appareils PHS, doit être tenu éloigné de plus de 25 cm (9,85 pouces) de l'automate programmable de sécurité, dans tous les sens.*
Faute de quoi, il y a risque de dysfonctionnements.
- *Couper complètement l'alimentation externe utilisé par le système avant de mettre en place ou de retirer le module.*
Faute de quoi, il y a risque de panne ou de dysfonctionnement du module.
- *Après la première mise en service du produit, n'effectuez pas chacune des opérations suivantes plus de 50 fois (selon CEI 61131-2/JIS B 3502) :*
 - *Monter/démonter le module sur l'unité de base*
 - *Monter/démonter le bornier sur le module**Le dépassement de cette limite peut causer un défaut de fonctionnement.*
- *Ne pas faire tomber ou soumettre à de forts chocs la pile installée dans le module.*
Cela pourrait endommager les piles, avec risque de fuite du liquide à l'intérieur des piles.
Une pile qui est tombée ou a reçu un choc ne doit pas être utilisée mais mise au rebut.

ATTENTION

- *Avant de toucher au module, se débarrasser de la charge électrostatique qu'accumule le corps humain en touchant un objet métallique raccordé à la terre.
Faute de quoi, il y a risque de panne ou de dysfonctionnement du module.*

[Précaution de mise au rebut]

ATTENTION

- *Lors de sa mise au rebut, ce produit doit être traité comme un déchet industriel.
Les piles ou batteries doivent être mises au rebut séparément des autres déchets et conformément à la réglementation locale. (Pour le détail de la directive sur les piles et batteries dans les pays membres de l'UE, voir QSCPU User's Manual (Hardware Design, Maintenance and Inspection) (le Manuel de l'utilisateur QSCPU (conception du matériel, maintenance et inspection)).*

[Précautions de transport]

ATTENTION

- *Pour le transport des piles au lithium, respecter les règles afférentes au transport de telles marchandises.
(Pour le détail des modèles couverts, voir QSCPU User's Manual (Hardware Design, Maintenance and Inspection) (le Manuel de l'utilisateur QSCPU (conception du matériel, maintenance et inspection)).*

● CONDITIONS OF USE FOR THE PRODUCT ●

- (1) Although MELCO has declared Product's compliance with the international safety standards IEC61508, ISO13849-1, this fact does not guarantee that Product will be free from any malfunction or failure. The user of this Product shall comply with any and all applicable safety standard, regulation or law and take appropriate safety measures for the system in which the Product is installed or used and shall take the second or third safety measures other than the Product. MELCO is not liable for damages that could have been prevented by compliance with any applicable safety standard, regulation or law.
- (2) MELCO prohibits the use of Products with or in any application involving, and MELCO shall not be liable for a default, a liability for defect warranty, a quality assurance, negligence or other tort and a product liability in these applications.
 - (a) power plants,
 - (b) trains, railway systems, airplanes, airline operations, other transportation systems,
 - (c) hospitals, medical care, dialysis and life support facilities or equipment,
 - (d) amusement equipments,
 - (e) incineration and fuel devices,
 - (f) handling of nuclear or hazardous materials or chemicals,
 - (g) mining and drilling,
 - (h) and other applications where the level of risk to human life, health or property are elevated.
- (3) Mitsubishi shall have no responsibility or liability for any problems involving programmable controller trouble and system trouble caused by DoS attacks, unauthorized access, computer viruses, and other cyberattacks.

REVISIONS

* The manual number is given on the bottom right of the cover.

Print Date	*Manual Number	Revision
Apr., 2008	IB(NA)-0800424-A	First edition
Sep., 2008	IB(NA)-0800424-B	Additions SAFETY PRECAUTIONS
Jun., 2009	IB(NA)-0800424-C	Additions Chapter 3
Jul., 2010	IB(NA)-0800424-D	Partial correction Chapter 3 Additions Section 1.2, 2.2, 2.3, 3.3, Chapter 4, Chapter 5, Chapter 6, Chapter 7
Apr., 2011	IB(NA)-0800424-E	Additions SAFETY PRECAUTIONS, About Manuals, Section 1.2, 2.2, 2.3, Chapter 3, Section 3.1.1, 3.1.3, 3.2.2, Chapter 6, 7
Aug., 2011	IB(NA)-0800424-F	Partial correction SAFETY PRECAUTIONS, Section 2.1, 3.1.1 Additions SAFETY PRECAUTIONS(Chinese)
Nov., 2013	IB(NA)-0800424-G	Partial correction Section 2.1, 3.2.1 Additions Section 3.1.5, 4.1, 4.2, 4.3 Deletion Section 3.2.5
Jun., 2014	IB(NA)-0800424-H	Partial correction Section 2.1, 2.2, 4.3, Chapter 7 Additions SAFETY PRECAUTIONS (French)
Dec., 2016	IB(NA)-0800424-I	Partial correction Section 2.2, Chapter 3, 7
Jul., 2018	IB(NA)-0800424-J	Partial correction Chapter 7

Print Date	*Manual Number	Revision
Nov., 2018	IB(NA)-0800424-K	Partial correction Chapter 6
Jan., 2019	IB(NA)-0800424-L	Partial correction Section 3.1.5
Oct., 2021	IB(NA)-0800424-M	Partial correction Chapter 3, 7
Nov., 2023	IB(NA)-0800424-N	Partial correction CONDITIONS OF USE FOR THE PRODUCT, Chapter 7, WARRANTY

This manual confers no industrial property rights or any rights of any other kind, nor does it confer any patent licenses. Mitsubishi Electric Corporation cannot be held responsible for any problems involving industrial property rights which may occur as a result of using the contents noted in this manual.

CONTENTS

1. OVERVIEW	1
1.1 Included Parts	1
1.2 Safety Programmable Controller Product List	2
2. GENERAL SPECIFICATIONS.....	3
2.1 General Specifications	3
2.2 Safety Standards	4
2.3 Module/Unit Replacement	5
3. EMC, LOW VOLTAGE, AND MACHINERY DIRECTIVES.....	6
3.1 Requirements for Conformance to EMC Directive	7
3.1.1 Standards relevant to the EMC Directive	7
3.1.2 Installation inside a control panel	9
3.1.3 Cables	10
3.1.4 Power supply module.....	14
3.1.5 Others	14
3.2 Requirement to Conform to the Low Voltage Directive	16
3.2.1 Standard applied for MELSEC-QS series programmable controller.....	16
3.2.2 MELSEC-QS series programmable controller selection	17
3.2.3 Power supply	17
3.2.4 Control panel.....	18
3.2.5 External wiring	19
3.3 Requirements for Compliance with the Machinery Directive	20
4. INSTALLATION	21
4.1 Instructions for mounting the base unit	21
4.2 Connecting to the power supply module	24
4.3 Wiring to a terminal block	25
5. MODULE STATUS AFTER POWER-ON AND LED INDICATION.....	26
6. PRECAUTIONS FOR USE.....	27
7. DECLARATION OF CONFORMITY FOR MACHINERY DIRECTIVE.....	30
7.1 Precautions for the Revision of the Declaration of Conformity to Machinery Directive	30
7.2 Declaration of Conformity (EU DECLARATION OF CONFORMITY)	31
7.3 Declaration of Conformity (UK DECLARATION OF CONFORMITY)	33

ABOUT MANUALS

Introduction Manual

Read the following manual before designing and constructing a safety system.

Manual name	Manual Number (Model code)
Safety Application Guide Explains the overview and construction method of the safety-related system, laying and wiring examples, application programs, etc. (Sold separately)	SH-080613ENG (13JR90)

Before using this product, always read the following detailed manuals.

Detailed Manual

Manual name	Manual Number (Model code)
QSCPU User's Manual (Hardware Design, Maintenance and Inspection) Explains the specifications of the QSCPU, safety power supply module, safety base unit, etc. (Sold separately)	SH-080626ENG (13JR92)
QSCPU User's Manual (Function Explanation, Program Fundamentals) Explains the functions, programming methods, devices and others that are necessary to create programs with the QSCPU. (Sold separately)	SH-080627ENG (13JR93)
CC-Link Safety System Master Module User's Manual Explains the specifications, procedures and settings before operation, parameter settings, and troubleshooting of the QS0J61BT12 CC-Link Safety system master module. (Sold separately)	SH-080600ENG (13JR88)
CC-Link Safety System Remote I/O Module User's Manual Explains the specifications, procedures and settings before operation, parameter settings, and troubleshooting of the CC-Link Safety system remote I/O modules. (Sold separately)	SH-080612ENG (13JR89)
MELSEC-QS CC-Link IE Field Network Master/Local Module User's Manual Explains the specifications, procedures and settings before operation, parameter settings, and troubleshooting of the CC-Link IE Field Network master/local module (with safety functions). (Sold separately)	SH-080969ENG (13JZ53)

Relevant Manual

Manual name	Manual Number (Model code)
QSCPU Programming Manual (Common Instructions) Explains how to use the sequence instructions, basic instructions, application instructions, and QSCPU dedicated instructions. (Sold separately)	SH-080628ENG (13JW01)
QSCPU Programming Manual (Safety FB) How to use sequence instructions, basic instructions, application instructions, and safety function blocks (Sold separately)	SH-080744ENG (13JW05)

1. OVERVIEW

This manual describes the precautions for using the QS series module in safety.

1.1 Included Parts

The following tables list the parts included with the corresponding modules.

(1) Safety CPU module

Product Name	Quantity
Module	1
Battery (Q6BAT)	1

(2) Safety main base unit for QS series

Product Name	Quantity
Unit	1
Base unit mounting screw (M4× 14 screw)	4
This manual	1

(3) Safety power supply module

Product Name	Quantity
Module	1

1.2 Safety Programmable Controller Product List

Product Name	Model	Description
Safety main base unit	QS034B	A unit where a safety CPU module, safety power supply module, and CC-Link Safety master module are mounted
	QS034B-K	An S-mark* ¹ certified safety main base unit
Safety power supply module	QS061P-A1	A module which is mounted on a safety main base unit and supplies 100VAC to the system
	QS061P-A2	A module which is mounted on a safety main base unit and supplies 200VAC to the system
	QS061P-A1-K	An S-mark* ¹ certified safety power supply module (100VAC)
	QS061P-A2-K	An S-mark* ¹ certified safety power supply module (200VAC)
Safety CPU module	QS001CPU	A module which is mounted on a safety main base unit and performs logic operations for safety control
	QS001CPU-K	An S-mark* ¹ certified safety CPU module
CC-Link Safety master module	QS0J61BT12	A module which is mounted on a safety main base unit and establishes connection to CC-Link Safety
	QS0J61BT12-K	An S-mark* ¹ certified CC-Link Safety master module
CC-Link Safety remote I/O module	QS0J65BTS2-8D	A safety input module connected to external devices. The module has eight safety input points and sends/receives safety data to/from the safety programmable controller over CC-Link Safety.
	QS0J65BTS2-4T	A safety output module connected to external devices. The module has four safety output points and sends/receives safety data to/from the safety programmable controller over CC-Link Safety.
	QS0J65BTB2-12DT	A safety I/O module connected to external devices. The module has eight safety input points and four safety output points, and sends/receives safety data to/from the safety programmable controller over CC-Link Safety.
	QS0J65BTB2-12DT-K	An S-mark* ¹ certified CC-Link Safety remote I/O module
CC-Link IE Field Network master/local module (with safety functions)	QS0J71GF11-T2	A module which is mounted on a safety main base unit and connects a safety programmable controller to CC-Link IE Field Network

*1: S-mark is a safety certification issued by Korea Occupational Safety and Health Agency (KOSHA).

2. GENERAL SPECIFICATIONS

2.1 General Specifications

The performance specifications of QS series programmable controller are shown in.

Item	Specifications					
Operating ambient temperature <i>Température ambiante de fonctionnement</i>	0 to 55 °C 0 à 55 °C					
Storage ambient temperature	-40 to 75 °C					
Operating ambient humidity	5 to 95%RH, non-condensing					
Storage ambient humidity						
Vibration resistance	Compliant with JIS B 3502 and IEC 61131-2	Under intermittent vibration	Frequency	Constant acceleration	Half amplitude	Sweep count
			5 to 8.4Hz	----	3.5mm	10 times each in X, Y, Z directions
		8.4 to 150Hz	9.8m/s ²	----		
		Under continuous vibration	5 to 8.4Hz	----	1.75mm	----
8.4 to 150Hz	4.9m/s ²	----				
Shock resistance	Compliant with JIS B 3502 and IEC 61131-2 (147 m/s ² , duration of action 11ms, 3 times each in 3 directions X, Y, Z by sine half-wave pulse)					
Operating atmosphere	No corrosive gases					
Operating altitude ^{*3}	0 to 2000m					
Installation location	Inside a control panel					
Overvoltage category ^{*1}	II or less					
Pollution degree ^{*2}	2 or less					
Equipment class	Class I					

- *1 This indicates the section of the power supply to which the equipment is assumed to be connected between the public electrical power distribution network and the machinery within premises.
Category II applies to equipment for which electrical power is supplied from fixed facilities.
The surge voltage withstand level for up to the rated voltage of 300V is 2500V.
- *2 This index indicates the degree to which conductive material is generated in terms of the environment in which the equipment is used.
Pollution degree 2 is when only non-conductive pollution occurs. A temporary conductivity caused by condensing must be expected occasionally.
- *3 Do not use or store the programmable controller under pressure higher than the atmospheric pressure of altitude 0m. Doing so may cause malfunction.
When using the programmable controller under pressure, please consult your local Mitsubishi representative.

2.2 Safety Standards

Normes de sécurité

Use the product according to the following safety standards.

Region	Safety Standards
International	IEC61508 Parts 1-7: 1998-2000, ISO13849-1: 2015, IEC61131-2: 2007, IEC61000-6-2: 2005, IEC61000-6-4: 2006, IEC61784-3: 2010, IEC60204-1: 2009
Europe	EN ISO13849-1: 2015, EN61131-2: 2007, EN61000-6-2: 2005, EN61000-6-4: 2007
North America	UL508, NFPA79: 2015

Utiliser le produit dans le respect des normes de sécurité suivantes.

Région	Normes de sécurité
International	IEC61508 Parts 1-7: 1998-2000, ISO13849-1: 2015, IEC61131-2: 2007, IEC61000-6-2: 2005, IEC61000-6-4: 2006, IEC61784-3: 2010, IEC60204-1: 2009
Europe	EN ISO13849-1: 2015, EN61131-2: 2007, EN61000-6-2: 2005, EN61000-6-4: 2007
Amérique du Nord	UL508, NFPA79: 2015

2.3 Module/Unit Replacement

Replace the module or unit according to the following replacement cycle.

Module/Unit	Replacement Cycle
Safety power supply module	5 years
Safety CPU module	10 years
Safety main base unit	10 years
CC-Link Safety master module	10 years
CC-Link IE Field Network master/local module (with safety functions)	10 years

3. EMC, LOW VOLTAGE, AND MACHINERY DIRECTIVES

In each country, laws and regulations concerning electromagnetic compatibility (EMC) and electrical safety are enacted.

For the products sold in the European countries, compliance with the EU's EMC Directive has been a legal obligation as EMC regulation since 1996, as well as the EU's Low Voltage Directive as electrical safety regulation since 1997.

Also, compliance with the EU's Machinery Directive has been a legal obligation since 1995.

Manufacturers who recognize their products are compliant to the EMC and Low Voltage Directives are required to attach a "CE marking" on their products in European countries.

In some other countries and regions, manufacturers are required to make their products compliant with applicable laws or regulations and attach a certification mark on the products as well (such as UK Conformity Assessed (UKCA) marking in the UK, and Korea Certification (KC) marking in South Korea).

Each country works to make their regulatory requirements consistent across countries based on international standards. When the requirements are consistent, measures to comply with the EMC and electrical safety regulations become common across countries.

The UK and South Korea have enacted EMC regulations whose requirements are consistent with those of the EMC Directive.

The UK has also enacted electrical safety regulations whose requirements are consistent with those of the Low Voltage Directive. In this section, the requirements of the EMC and Low Voltage Directives are described as examples of those of the EMC and electrical safety regulations.

3.1 Requirements for Conformance to EMC Directive

The EMC Directive specifies that products placed on the market must "be so constructed that they do not cause excessive electromagnetic interference (emissions) and are not unduly affected by electromagnetic interference (immunity)".

The applicable products are requested to meet these requirements. The Section 3.1.1 through Section 3.1.5 summarize the precautions on conformance to the EMC Directive of the machinery constructed using the MELSEC-QS series programmable controllers.

The details of these precautions has been prepared based on the control requirements and the applicable standards control. However, we will not assure that the overall machinery manufactured according to these details conforms to the above-mentioned directives. The method of conformance to the EMC Directive and the judgment on whether or not the machinery conforms to the EMC Directive must be determined finally by the manufacturer of the machinery.

3.1.1 Standards relevant to the EMC Directive

(1) Regulations regarding emission

Specification	Test item	Test details	Standard value
EN61131-2: 2007	CISPR16-2-3 Radiated emission*2	Radio waves from the product are measured.	<ul style="list-style-type: none">• 30M-230MHz QP: 40dBμV/m (10m in measurement range)*1• 230M-1000MHz QP: 47dBμV/m (10m in measurement range)
	CISPR16-2-1, CISPR16-1-2 Conducted emission*2	Noise from the product to the power line is measured.	<ul style="list-style-type: none">• 150k-500kHz QP: 79dB, Mean: 66dB*1• 500k-30MHz QP: 73dB, Mean: 60dB

*1 QP: Quasi-peak value, Mean: Average value

*2 Programmable controllers are open-type devices (devices designed to be housed inside other equipment) and must be installed inside a conductive control panel. The corresponding tests were conducted with the programmable controller installed inside a control panel.

(2) Regulations regarding immunity

Specification	Test item	Test details	Standard value
EN61131-2: 2007	EN61000-4-2 Electrostatic discharge immunity ^{*1}	Immunity test in which electrostatic is applied to the cabinet of the equipment.	<ul style="list-style-type: none"> • 8kV Air discharge • 4kV Contact discharge
	EN61000-4-3 Radiated, radio-frequency, electromagnetic field immunity ^{*1}	Immunity test in which electric fields are irradiated to the product.	80% AM modulation@1kHz <ul style="list-style-type: none"> • 80M-1000MHz: 10V/m • 1.4G-2.0GHz: 3V/m • 2.0G-2.7GHz: 1V/m
	EN61000-4-4 Electrical fast transient/burst immunity ^{*1}	Immunity test in which burst noise is applied to the power line and signal line.	<ul style="list-style-type: none"> • AC/DC main power, I/O power, AC I/O (unshielded): 2kV • DC I/O, analog, communication : 1kV
	EN61000-4-5 Surge immunity ^{*1}	Immunity test in which lightning surge is applied to the power line and signal line.	<ul style="list-style-type: none"> • AC power line, AC I/O power, AC I/O (unshielded) : 2kV CM, 1kV DM • DC power line, DC I/O power : 0.5kV CM, DM • DC I/O, AC I/O (shielded), analog^{*2}, communication: 1kV CM
	EN61000-4-6 Immunity to conducted disturbances, induced by radio-frequency fields ^{*1}	Immunity test in which high frequency noise is applied to the power line and signal line	0.15M-80MHz, 80% AM modulation @1kHz, 10Vrms
	EN61000-4-8 Power-frequency magnetic field immunity ^{*1}	Immunity test in which the product is installed in inductive magnetic field	50Hz/60Hz, 30A/m
	EN61000-4-11 Voltage dips and interruption immunity ^{*1}	Immunity test in which power supply voltage is momentarily interrupted	<ul style="list-style-type: none"> • Apply at 0%, 0.5 cycles and zero-cross point • 0%, 250/300 cycles (50/60Hz) • 40%, 10/12 cycles (50/60Hz) • 70%, 25/30 cycles (50/60Hz)

*1 Programmable controllers are open-type devices (devices designed to be housed inside other equipment) and must be installed inside a conductive control panel. The corresponding tests were conducted with the programmable controller installed inside a control panel.

*2 The accuracy of an analog-digital converter module may temporary vary within $\pm 10\%$.

3.1.2 Installation inside a control panel

The programmable controller is open equipment and must be installed within a control panel for use.*

This not only ensures safety but also ensures effective shielding of programmable controller-generated electromagnetic noise.

*: CC-Link Safety remote station should be used having the control panel installed.

(1) Control panel

- Use a conductive control panel.
- When attaching the control panel's top plate or base plate, mask painting and weld so that good surface contact can be made between the panel and plate.
- To ensure good electrical contact with the control panel, mask the paint on the installation bolts of the inner plate in the control panel so that contact between surfaces can be ensured over the widest possible area.
- Earth the control panel with a thick wire so that a low impedance connection to ground can be ensured even at high frequencies.
- Holes made in the control panel must be 10 cm (3.94 inch) diameter or less. If the holes are 10 cm (3.94 inch) or larger, radio frequency noise may be emitted.

In addition, because radio waves leak through a clearance between the control panel door and the main unit, reduce the clearance as much as practicable.

The leakage of radio waves can be suppressed by the direct application of an EMI gasket on the paint surface.

Our tests have been carried out on a panel having the damping characteristics of 37 dB max. and 30 dB mean (measured by 3 m method with 30 to 300 MHz).

(2) Connection of power and earth wires

Earthing and power supply wires for the programmable controller system must be connected as described below.

- Provide an earthing point near the power supply module. Earth the power supply's LG and FG terminals (LG : Line Ground, FG : Frame Ground) with the thickest and shortest wire possible. (The wire length must be 30 cm (11.81 inch) or shorter.) The LG and FG terminals function is to pass the noise generated in the programmable controller system to the ground, so an impedance that is as low as possible must be ensured. As the wires are used to relieve the noise, the wire itself carries a large noise content and thus short wiring means that the wire is prevented from acting as an antenna.
- The earth wire led from the earthing point must be twisted with the power supply wires. By twisting with the earthing wire, noise flowing from the power supply wires can be relieved to the earthing. However, if a filter is installed on the power supply wires, the wires and the earthing wire may not need to be twisted.

3.1.3 Cables

The cables pulled out from the control panel contain a high frequency noise component. On the outside of the control panel, therefore, they serve as antennas to emit noise.

To prevent noise emission, use shielded cables when pulling out the cables which are connected to CC-Link Safety master module, CC-Link IE Field Network master/local module (with safety functions), MELSECNET/H module, Ethernet module, and CC-Link Safety remote I/O module and using them outside of the control panel.

The use of shielded cables also increases noise immunity.

For signal lines (including common line) of CC-Link Safety master module, CC-Link IE Field Network master/local module (with safety functions), MELSECNET/H module, Ethernet module, and CC-Link Safety remote I/O module, the noise immunity satisfies the standard value on the condition that the shielded cables are used for grounding. If shielded cables are not used or not grounded correctly, the noise immunity does not meet the specified requirements.

(1) Shield grounding processing of shielded cables

- Provide a grounding point on the shielded cable as near the module as possible so that the wiring between the module and grounding point is not induced electromagnetically by the other parts of wiring on the cable.
- Take appropriate measures so that the exposed shield part of the shielded cable, where the cable jacket was partly removed, is grounded to the control panel on the widest contact surface. A clamp may also be used as shown.

In this case, however, a mask painting is required for the inner wall of the control panel which comes into contact with the clamp.

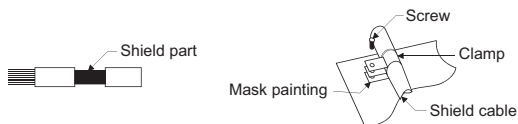

Note) If a wire is soldered onto the shield part of the shielded cable for grounding as shown below, the high-frequency impedance rises, resulting in a loss of shield effect.

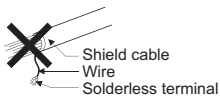

(2) MELSECNET/H module

Be sure to use double-shielded coaxial cables (MITSUBISHI CABLE INDUSTRIES, LTD.: 5C-2V-CCY) for the coaxial cables of MELSECNET/H module. Radiated noise in the range of 30MHz or higher can be suppressed by using double-shielded coaxial cables. Ground the double-shielded coaxial cable by connecting its outer shield to the ground.

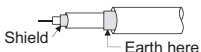

Refer to (1) for the shield grounding processing.

(3) Ethernet module

Precautions for using AUI cables, twisted pair cables, and coaxial cables are described below.

- Be sure to ground the AUI cables*¹ connected to the 10BASE5 connectors. Since the AUI cable is of the shielded type, ground the exposed shield section of the cable, where the cable jacket was partly removed as shown below, on the widest contact surface.

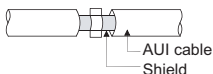

Refer to (1) for the shield grounding processing.

*1 : Make sure to install a ferrite core for the cable.

The ZCAT2032 ferrite core manufactured by TDK is recommended.

- Use shielded twisted pair cables for the twisted pair cables connected to the 10BASE-T/100BASE-TX connectors. Ground the exposed shield section of the shielded twisted pair cable, where the cable jacket was partly removed as shown below, on the widest contact surface.



Refer to (1) for the shield grounding processing.

- Be sure to use double-shielded coaxial cables for the coaxial cables*² connected to the 10BASE2 connectors. Ground the double-shielded coaxial cable by connecting its outer shield to the ground.

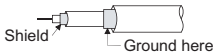

Refer to (1) for the shield grounding processing.

*2 : Make sure to install a ferrite core for the cable.

The ZCAT3035 ferrite core manufactured by TDK is recommended.

(4) CC-Link IE Field Network master/local module (with safety functions)

The following describes precautions for using CC-Link IE Field Network cables.

- Use the CC-Link IE Field Network cable (SCE5EW-S□M).
- Since the CC-Link IE Field Network cable is of the shielded type, ground the exposed shield section of the cable, where the cable jacket was partly removed as shown below, on the widest contact surface.



- Use shielded cables for the external wiring, and ground the shields of the external wiring cables to the control box with the AD75CK cable clamp (Mitsubishi).

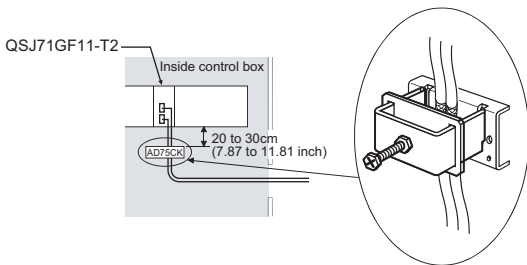

(5) I/O signal lines and other communication cables

If the I/O signal lines (including common line) and other communication cables (such as CC-Link Safety and CC-Link IE Field Network) are pulled out from the control panel, be sure to ground the shield sections of the cables as described in (1).

3.1.4 Power supply module

Always ground the LG and FG terminals after short-circuiting them.

3.1.5 Others

(1) Ferrite core

A ferrite core has the effect of reducing conduction noise in around 10MHz band and radiated noise in the 30MHz to 100MHz band. It is recommended to fit ferrite cores if shielded cables pulled out of the panel do not provide sufficient shielding effects or if the emission of conduction noise from the power supply line has to be suppressed.

It is also recommended to fit a ferrite core to the USB cable which connects the CPU and the personal computer as measures against noise.

Regarding the number of winding to the ferrite core, the more the better. The two turns or more is recommended as the number of winding.

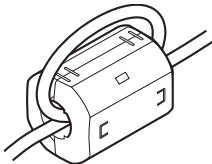

Note that the ferrite cores should be fitted to the cables in the position immediately before they are pulled out of the panel. If the fitting position is improper, the ferrite will not produce any effect.

(2) Noise filter (power supply line filter)

A noise filter is a component which has an effect on conducted noise.

It is not required to fit the noise filter to the power supply line, but fitting it can further suppress noise.

(The noise filter has the effect of reducing conducted noise of 10 MHz or less.)

The precautions required when installing a noise filter are described below.

- Do not bundle the wires on the input side and output side of the noise filter. When bundled, the output side noise will be induced into the input side wires from which the noise was filtered.

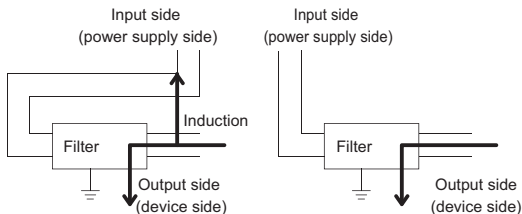

The noise will be induced when the input and output wires are bundled.

Separate and lay the input and output wires.

- Earth the noise filter earthing terminal to the control cabinet with the shortest wire possible (approx. 10 cm (3.94 inch)).

Remarks			
Noise Filter Model Name	FN343-3/01	FN660-6/06	ZHC2203-11
Manufacturer	SCHAFFNER	SCHAFFNER	TDK
Rated current	3A	6A	3A
Rated voltage	250V		

(3) AC surge protective devices

AC surge protective device (SPD) is a device designed to protect electrical devices from lightning surges on the AC power line. An AC SPD is necessary if common mode surges exceeding the tolerance limit ($\pm 2\text{kV}$) can occur in the installation environment.

Remarks

Before using an AC SPD, check the specifications and precautions in the manual.

3.2 Requirement to Conform to the Low Voltage Directive

The Low Voltage Directive requires each device that operates with the power supply ranging from 50 to 1000VAC and 75 to 1500VDC to satisfy the safety requirements.

In Section 3.2.1 to Section 3.2.5, cautions on installation and wiring of the MELSEC-QS series programmable controller to conform to the Low Voltage Directive are described.

These descriptions are based on the requirements and standards of the regulation, however, it does not guarantee that the entire machinery manufactured based on the descriptions conforms to the above-mentioned directive. The method and judgment for the conformity to the low voltage directive must be left to the manufacturer's own discretion.

3.2.1 Standard applied for MELSEC-QS series programmable controller

The standard applied for MELSEC-QS series programmable controller is EN61131-2 Programmable controllers-Part 2: Equipment requirements and tests. The MELSEC-QS series programmable controller modules which operate at the rated voltage of 50VAC/75VDC or above are also developed to conform to the above standard. The modules which operate at the rated voltage of less than 50VAC/75VDC are out of the Low Voltage Directive application range. For CE-marked products, please consult your local Mitsubishi representative.

3.2.2 MELSEC-QS series programmable controller selection

(1) Power supply module

There are dangerous voltages (voltages higher than 42.4V peak) inside the power supply modules of the 100/200VAC rated input voltages. Therefore, the CE marked models are enhanced in insulation internally between the primary and secondary.

(2) CPU module, base unit

Using 5VDC circuits inside, CPU modules and base units are out of the Low Voltage Directive application range.

(3) CC-Link Safety master module, CC-Link IE Field Network master/local module (with safety functions), CC-Link IE Controller Network module, MELSECNET/H module, Ethernet module

These modules are out of the scope of the Low Voltage Directive because the rated voltage is 24VDC or less.

3.2.3 Power supply

The insulation specification of the power supply module was designed assuming installation category II. Be sure to use the installation category II power supply to the programmable controller.

The installation category indicates the durability level against surge voltage generated by a thunderbolt. Category I has the lowest durability; category IV has the highest durability.

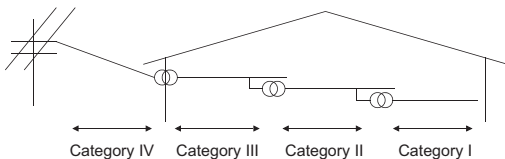

Category II indicates a power supply whose voltage has been reduced by two or more levels of isolating transformers from the public power distribution.

3.2.4 Control panel

Because the programmable controller is an open device (a device designed to be stored within another module), be sure to use it after storing in the control panel.*

*: Also, each network remote station needs to be installed inside the control panel.

(1) Electrical shock prevention

The control panel must be handled as shown below to protect a person who does not have adequate knowledge of electricity from an electric shock.

- Lock the control panel so that only those who are trained and have acquired enough knowledge of electric facilities can open the control panel.
- The control panel must have a structure which automatically stops the power supply when the box is opened.
- For electric shock protection, use IP20 or greater control panel.

(2) Dustproof and waterproof features

The control panel also has the dustproof and waterproof functions. Insufficient dustproof and waterproof features lower the insulation withstand voltage, resulting in insulation destruction.

The insulation in our programmable controller is designed to cope with the pollution level 2, so use in an environment with pollution level 2 or below.

Pollution level 1 : An environment where the air is dry and conductive dust does not exist.

Pollution level 2 : An environment where conductive dust does not usually exist, but occasional temporary conductivity occurs due to the accumulated dust. Generally, this is the level for inside the control box equivalent to IP54 in a control room or on the floor of a typical factory.

Pollution level 3 : An environment where conductive dust exists and conductivity may be generated due to the accumulated dust.
An environment for a typical factory floor.

Pollution level 4 : Continuous conductivity may occur due to rain, snow, etc. An outdoor environment.

As shown above, the programmable controller can realize the pollution level 2 when stored in a control panel equivalent to IP54.

3.2.5 External wiring

(1) 24VDC external power supply

To connect to the CC-Link Safety remote I/O module, use the power supply that meets the following conditions:

- SELV (Safety Extra Low Voltage): Product with reinforced insulation from the hazardous potential part (48V or more)
- LVD applicable product
- Output voltage specifications: 24VDC (ripple ratio: 5% or less) (allowable voltage range: 19.2 to 28.8VDC)

(2) External devices

When a device with a hazardous voltage circuit is externally connected to the programmable controller, use the device whose interface circuit section to the programmable controller has the reinforced insulation against the hazardous voltage circuit.

(3) Reinforced insulation

The reinforced insulation covers the withstand voltages shown in Table 3.1.

Table 3.1 Reinforced Insulation Withstand Voltage
(Installation Category II, source : IEC664)

Rated voltage of hazardous voltage area	Surge withstand voltage (1.2/50 μ s)
150VAC or below	2500V
300VAC or below	4000V

3.3 Requirements for Compliance with the Machinery Directive

The Machinery Directive requires that machinery satisfy the three pillars of safety: mechanical safety, electrical safety, and worker safety. This product complies with the Machinery Directive (2006/42/EC). Before using this product, please read this manual, the relevant manuals, the manuals for standard programmable controller, and the safety standards carefully and pay full attention to safety to handle the product correctly.

The descriptions are based on the requirements of the Machinery Directive and the harmonized standards. However, they do not guarantee that the entire machinery constructed according to the descriptions complies with the Machinery Directive. The manufacture of the machinery must determine the testing method for compliance and declare conformity to the Machinery Directive.

4. INSTALLATION

4.1 Instructions for mounting the base unit

When installing a programmable controller to a control panel or similar, fully consider its operability, maintainability, and environmental resistance. For details, refer to the QSCPU User's Manual (Hardware Design, Maintenance and Inspection).

(1) Installation position

Keep the clearances shown below between the top/bottom faces of the modules and the control panel or other parts so that good ventilation is ensured and the modules can be easily replaced.

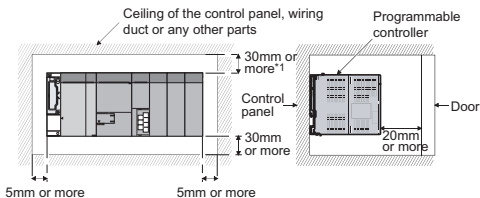

*1 : A clearance required when the wiring duct is 50mm or less in height.
A 40mm or more clearance is required when the wiring duct is longer.

(2) Module mounting orientation

- (a) Mount modules in the following orientation to ensure good ventilation for heat release.

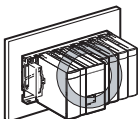

- (b) Do not mount modules in the following orientations.

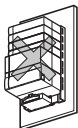

Vertical mounting

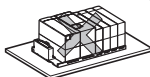
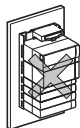

Upward/downward mounting



Upside-down mounting

(3) Installation precautions

- (a) Install a base unit on a flat surface.

If the surface is not flat, the printed circuit board is distorted, resulting in malfunction of the modules mounted.

- (b) If there is a vibration source, such as an electromagnetic contactor or no fuse breaker, separate the control panel or keep enough clearance from the vibration source to install the programmable controller.

In addition, keep the clearances shown below between the programmable controller and devices (such as contactors and relays) to avoid being affected by radiated noise or heat.

- In front of the programmable controller: 100mm or more
- On the right or left of the programmable controller: 50mm or more

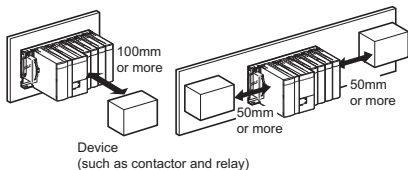

- (c) When installing a base unit to a control panel, do not mount any module in the rightmost slot of the base unit. Before uninstalling, remove the module mounted in the rightmost slot of the base unit.

(4) CC-Link Safety remote I/O module

For the installation of CC-Link Safety remote I/O modules, refer to the user's manual (hardware) provided with each module.

4.2 Connecting to the power supply module

The following figure shows the wiring example of power cable and ground wire to the base unit.

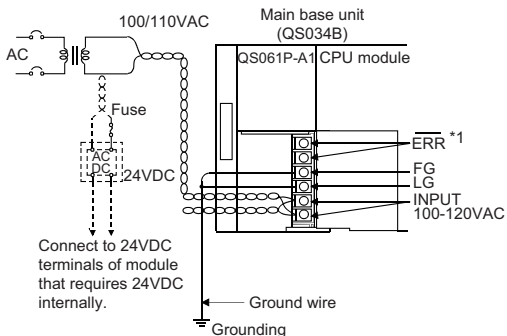

- *1: The ERR terminal turns ON/OFF as described below.
The terminal turns OFF (opens) when the AC power is not input, a CPU module stop error (including a reset) occurs, or the fuse of the safety power supply module is blown.

4.3 Wiring to a terminal block

Câblage à une plaque à bornes

The table below shows applicable solderless terminals connected to the terminal block. When wiring, use applicable wires and an appropriate tightening torque. Use UL listed solderless terminals and, for processing, use a tool recommended by their manufacturer.

Solderless terminal		Wire			
Model	Tightening torque	Diameter	Type	Material	Temperature rating
RAV1.25-3.5	0.66 to 0.89N•m	18 to 16 AWG	Stranded	Copper	75°C or more
RAV2-3.5		16 to 14 AWG			

Le tableau ci-dessous indique quelles bornes sans soudure on doit utiliser pour les raccordements sur la plaque à bornes. Pour le câblage, utiliser les fils et couples de serrage prescrits. Utiliser les bornes sans soudure répertoriées par UL et, pour le montage, utiliser l'outil recommandé par le fabricant de ces bornes.

Borne sans soudure		Fil			
Modèle	Couple de serrage	Diamètre	Type	Matériau	Gamme de température
RAV1.25-3.5	0,66 à 0,89 N•m	18 à 16 AWG	Torsadé	Cuivre	75°C ou plus
RAV2-3.5		16 à 14 AWG			

5. MODULE STATUS AFTER POWER-ON AND LED INDICATION

A safety programmable controller performs initial processing (such as self-diagnostics) after power-on or reset. The LEDs of each module indicate the module operating status after initial processing.

(1) Safety power supply module

No.	Name	Application
1)	POWER LED	On (green): The module is operating normally. (5VDC output or momentary power failure within 20ms) Off: • AC power is supplied, but the module has been failed. (5VDC output failure, overload, internal circuit failure or fuse blown) • AC power is not supplied. • Power has been failed (including momentary power failure 20ms or longer).

(2) Safety CPU module

No.	Name	Application
1)	ALIVE LED (green)	On: The module is operating normally.* ¹ Off: The module has detected a hardware WDT error. (The ERR. LED turns on.)
2)	TEST LED (yellow)	Indicates the operating mode of the CPU module. On: The module is in TEST MODE.* ¹ Flashing: The mode is switched from TEST MODE to SAFETY MODE. The LED turns off after the module is reset. (Flashing interval: on 200ms/off 200ms) Off: The module is in SAFETY MODE.
3)	RUN LED (green)	Indicates the operating status of the CPU module. On: The module is in the RUN status (the module is in operation).* ¹ Off: The module is in the STOP status (the module is not operating) or a stop error has been detected. Flashing: A program and parameters are written to the module which is in the STOP status and then the RUN/STOP/RESET switch is changed from STOP to RUN. (Flashing interval: on 200ms/off 200ms)
4)	ERR. LED (red)	On: A self-diagnostics error that will not stop module operation, except for a battery error, has been detected.* ¹ Off: The module is operating normally. Flashing: A self-diagnostics error that will stop module operation has been detected. (Flashing interval: on 200ms/off 200ms) Or, the module has been reset. (Flashing interval: on 60ms/off 60ms)
5)	USER LED (red)	On: The annunciator (F) turns on.* ¹ Off: The module is operating normally.
6)	BAT. LED (yellow)	On: A battery error has occurred due to the CPU battery voltage drop.* ¹ Off: The module is operating normally.

*1: The LED also turns on during the initial processing (such as self-diagnostics) immediately after power-on or reset.

6. PRECAUTIONS FOR USE

Users must prove that their entire safety system complies with the safety standards and the Machinery Directive. The third-party certification organization will validate the safety of product for the entire safety system, including a safety programmable controller and safety components.

To establish a safety system, calculate the target failure measure (PFD/PFH) for each safety application (safety function) based on the PFD/PFH values of the safety programmable controller and connected safety components. The target failure measure (PFD/PFH) is the reliability target value for each Safety Integrity Level (SIL) defined in IEC61508 and can be calculated by the following formula.

$PFD/PFH = A + B + C + D \dots$ Calculation formula of PFD/PFH

Variable	Definition
A	Total PFD/PFH of the safety CPU module, safety power supply module, safety main base unit, CC-Link Safety master module and CC-Link IE Field Network master/local module (with safety functions)
B	PFD/PFH of the CC-Link Safety remote I/O module (1) When safety input device(s) and safety output device(s) are connected to the same CC-Link Safety remote I/O module: $B=B1$ (2) When safety input device(s) and safety output device(s) are connected to different CC-Link Safety remote I/O modules: $B=B1+B2$
B1	PFD/PFH of the CC-Link Safety remote I/O module to which safety input device(s) is connected
B2	PFD/PFH of the CC-Link Safety remote I/O module to which safety output device(s) is connected
C^{*1}	PFD/PFH of safety input device(s)
D^{*1}	PFD/PFH of safety output device(s)

*1: For the values, refer to the manual for the safety component used.

The following tables show the PFD/PFH values for the safety programmable controller.

Module/Unit		PFD	PFH
PFD/PFH of the safety CPU module		4.10×10^{-53}	9.20×10^{-103}
PFD/PFH of the safety power supply module	QS061P-A1	8.75×10^{-54}	3.85×10^{-974}
	QS061P-A2	8.75×10^{-55}	3.85×10^{-975}
PFD/PFH of the safety main base unit ^{*2}		-	-
PFD/PFH of the CC-Link Safety master module ^{*2}		-	-
PFD/PFH of the CC-Link Safety remote I/O module	QS0J65BTB2-12DT	2.57×10^{-5}	1.15×10^{-9}
	QS0J65BTS2-8D	1.68×10^{-5}	7.46×10^{-10}
	QS0J65BTS2-4T	1.68×10^{-5}	7.46×10^{-10}
PFD/PFH of the CC-Link IE Field Network master/local module (with safety functions) ^{*2}		-	-

Module/Unit		PFD	PFH
PFD/PFH of the S-mark certified safety CPU module		4.10×10^{-5}	9.20×10^{-10}
PFD/PFH of the S-mark certified safety power supply module	QS061P-A1-K	8.75×10^{-56}	3.85×10^{-976}
	QS061P-A2-K	8.75×10^{-57}	3.85×10^{-977}
PFD/PFH of the S-mark certified safety main base unit ^{*2}		-	-
PFD/PFH of the S-mark certified CC-Link Safety master module ^{*2}		-	-
PFD/PFH of the S-mark certified CC-Link Safety remote I/O module	QS0J65BTB2-12DT-K	2.70×10^{-5}	1.21×10^{-9}

*2: The following modules are not subject to the calculation of PFD and PFH values.

- Safety main base unit
- CC-Link Safety master module
- CC-Link IE Field Network master/local module (with safety functions)

*3: For the safety CPU module with the serial number "12□□□3" or earlier (first six digits), the PFD and PFH values are as follows: PFD= 5.22×10^{-5} and PFH= 1.15×10^{-9} . (□□□ contains any figure.)

*4: For the QS061P-A1 with the serial number "12□□□5" or earlier (first six digits), the PFD and PFH values are as follows: PFD= 8.67×10^{-5} and PFH= 3.80×10^{-9} . (□□□ contains any figure.)

*5: For the QS061P-A2 with the serial number "12□□□9" or earlier (first six digits), the PFD and PFH values are as follows: PFD= 8.67×10^{-5} and PFH= 3.80×10^{-9} . (□□□ contains any figure.)

- *6: For the QS061P-A1-K with the serial number "20□□□4" or earlier (first six digits), the PFD and PFH values are as follows: $PFD=8.67 \times 10^{-5}$ and $PFH=3.80 \times 10^{-9}$. (□□□ contains any figure.)
- *7: For the QS061P-A2-K with the serial number "20□□□5" or earlier (first six digits), the PFD and PFH values are as follows: $PFD=8.67 \times 10^{-5}$ and $PFH=3.80 \times 10^{-9}$. (□□□ contains any figure.)

For details on the target failure measure (PFD/PFH), refer to the Safety Application Guide.

7. DECLARATION OF CONFORMITY FOR MACHINERY DIRECTIVE

7.1 Precautions for the Revision of the Declaration of Conformity to Machinery Directive

Mitsubishi Electric revised the declaration of conformity to Machinery Directive from the one certified by TUV Rheinland, an independent third-party inspection body, to the one self-certified as the TUV Rheinland Certificate will expire on December 2nd, 2021.

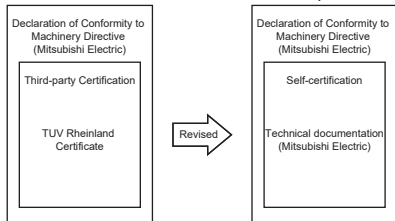

For this reason, note the following when reading the manuals for the product.

- Regard "the declaration is certified by TUV Rheinland/the third-party inspection body" as "the declaration is self-certified by Mitsubishi Electric".
- Regard "the approval/certification for the declaration is issued by TUV Rheinland/the third-party inspection body" as "the declaration is issued by Mitsubishi Electric".

For details, refer to the following technical bulletin:
Production Discontinuation of MELSEC-QS Series Safety Programmable Controllers (FA-A-0300)

7.2 Declaration of Conformity (EU DECLARATION OF CONFORMITY)



EU DECLARATION OF CONFORMITY

We,

Manufacturer : MITSUBISHI ELECTRIC CORPORATION

Address : TOKYO 100-8310, JAPAN
(Place of Declare)

Brand Name :  MITSUBISHI ELECTRIC  MITSUBISHI

declare under our sole responsibility that the product

Description : Safety Programmable Controller

Type of Model : MELSEC-QS series

Notice : Refer to next page about each type name

to which this declaration relates is in conformity with the following standard and directive.

Directive	Harmonized Standard	Notified Body	
EMC Directive	2014/30/EU	EN61131-2:2007	---
Machinery Directive	2006/42/EC	EN ISO 13849-1:2015	---
RoHS Directive	2011/65/EU,(EU)2015/863*1	EN IEC 63000:2018	---

*1 : Category 9 "Industrial monitoring and control instruments" is applicable.

Authorized representative in Europe (The person authorized to compile the Technical file or relevant Technical documentation)
Hartmut Pütz FA Product Marketing, Director, MITSUBISHI ELECTRIC EUROPE B.V., German Branch Mitsubishi-Electric-Platz 1, 40882 Ratingen, Germany Issue Date (Date of Declaration): 21 Sep. 2021

Signed for and on behalf of

(Signature) T. Yamaneha

[Takahiko Yamaneha]
Senior Manager, FA Standard Module Development Section
FA Systems Dept.2
MITSUBISHI ELECTRIC CORPORATION NAGOYA WORKS

Appendix List of type name to declare

QS001CPU
QS001CPU-K
QS034B
QS034B-K
QS0J61BT12
QS0J61BT12-K
QS0J65BTB2-12DT
QS0J65BTB2-12DT-K
QS0J65BTS2-4T
QS0J65BTS2-8D
QS0J71GF11-T2
QS061P-A1
QS061P-A1-K
QS061P-A2
QS061P-A2-K

7.3 Declaration of Conformity (UK DECLARATION OF CONFORMITY)



UK DECLARATION OF CONFORMITY

We,

Manufacturer : MITSUBISHI ELECTRIC CORPORATION

Address : TOKYO 100-8310, JAPAN
(Place of Declare)

Brand Name :  MITSUBISHI ELECTRIC

declare under our sole responsibility that the product

Description : Safety Programmable Controller

Type of Model : MELSEC-QS series

Notice : Refer to next page about each type name

to which this declaration relates is in conformity with the following standard and legislation.

Legislation	Designated Standard	Approved Body
Electromagnetic Compatibility Regulations 2016	EN 61131-2:2007	---
Supply of Machinery (Safety) Regulations 2008	EN ISO 13849-1:2015	---
The Restriction of the Use of Certain Hazardous Substances in Electrical and Electronic Equipment Regulations 2012	EN IEC 63000:2018	---

Issue Date (Date of Declaration): 21 Sep. 2021

Signed for and on behalf of

(Signature) T. Yamanaka

[Takahiko Yamanaka]
Senior Manager, FA Standard Module Development Section
FA Systems Dept. 2
MITSUBISHI ELECTRIC CORPORATION NAGOYA WORKS

Appendix List of type name to declare

QS001CPU
QS001CPU-K
QS034B
QS034B-K
QS0J61BT12
QS0J61BT12-K
QS0J65BTB2-12DT
QS0J65BTB2-12DT-K
QS0J65BTS2-4T
QS0J65BTS2-8D
QS0J71GF11-T2
QS061P-A1
QS061P-A1-K
QS061P-A2
QS061P-A2-K

WARRANTY

Please confirm the following product warranty details before using this product.

1. Limited Warranty and Product Support.

- a. Mitsubishi Electric Company ("MELCO") warrants that for a period of forty two(42) months after date of delivery from the point of manufacture or three(3) years from date of Customer's purchase, whichever is less, Mitsubishi MELSEC Safety programmable controllers (the "Products") will be free from defects in material and workmanship.
- b. At MELCO's option, for those Products MELCO determines are not as warranted, MELCO shall either repair or replace them or issue a credit or return the purchase price paid for them.
- c. For this warranty to apply:
 - (1) Customer shall give MELCO (i) notice of a warranty claim to MELCO and the authorized dealer or distributor from whom the Products were purchased, (ii) the notice shall describe in reasonable details the warranty problem, (iii) the notice shall be provided promptly and in no event later than thirty (30) days after the Customer knows or has reason to believe that Products are not as warranted, and (iv) in any event, the notice must be given within the warranty period;
 - (2) Customer shall cooperate with MELCO and MELCO's representatives in MELCO's investigation of the warranty claim, including preserving evidence of the claim and its causes, meaningfully responding to MELCO's questions and investigation of the problem, grant MELCO access to witnesses, personnel, documents, physical evidence and records concerning the warranty problem, and allow MELCO to examine and test the Products in question offsite or at the premises where they are installed or used; and
 - (3) If MELCO requests, Customer shall remove Products it claims are defective and ship them to MELCO or MELCO's authorized representative for examination and, if found defective, for repair or replacement. The costs of removal, shipment to and from MELCO's designated examination point, and reinstallation of repaired or replaced Products shall be at Customer's expense.
 - (4) If Customer requests and MELCO agrees to effect repairs onsite at any domestic or overseas location, the Customer will pay for the costs of sending repair personnel and shipping parts. MELCO is not responsible for any re-commissioning, maintenance, or testing on-site that involves repairs or replacing of the Products.
- d. Repairs of Products located outside of Japan are accepted by MELCO's local authorized service facility centers ("FA Centers"). Terms and conditions on which each FA Center offers repair services for Products that are out of warranty or not covered by MELCO's limited warranty may vary.
- e. Subject to availability of spare parts, MELCO will offer Product repair services for (7) years after each Product model or line is discontinued, at MELCO's or its FA Centers' rates and charges and standard terms in effect at the time of repair. MELCO usually produces and retains sufficient spare parts for repairs of its Products for a period of seven (7) years after production is discontinued.
- f. MELCO generally announces discontinuation of Products through MELCO's Technical Bulletins. Products discontinued and repair parts for them may not be available after their production is discontinued.

2. Limits of Warranties.

- a. MELCO does not warrant or guarantee the design, specify, manufacture, construction or installation of the materials, construction criteria, functionality, use, properties or other characteristics of the equipment, systems, or production lines into which the Products may be incorporated, including any safety, fail-safe and shut down systems using the Products.
- b. MELCO is not responsible for determining the suitability of the Products for their intended purpose and use, including determining if the Products provide appropriate safety margins and redundancies for the applications, equipment or systems into which they are incorporated.
- c. Customer acknowledges that qualified and experienced personnel are required to determine the suitability, application, design, construction and proper installation and integration of the Products. MELCO does not supply such personnel.
- d. MELCO is not responsible for designing and conducting tests to determine that the Product functions appropriately and meets application standards and requirements as installed or incorporated into the end-user's equipment, production lines or systems.
- e. MELCO does not warrant any Product:
 - (1) repaired or altered by persons other than MELCO or its authorized engineers or FA Centers;
 - (2) subjected to negligence, carelessness, accident, misuse, or damage;
 - (3) improperly stored, handled, installed or maintained;
 - (4) integrated or used in connection with improperly designed, incompatible or defective hardware or software;
 - (5) that fails because consumable parts were not tested, serviced or replaced;
 - (6) exchange of a consumable part such as batteries, backlights, or fuses;
 - (7) operated or used with equipment, production lines or systems that do not meet applicable and commensurate legal, safety and industry-accepted standards;
 - (8) operated or used in abnormal applications;
 - (9) installed, operated or used in contravention of instructions, precautions or warnings contained in MELCO's user, instruction and/or safety manuals, technical bulletins and guidelines for the Products;
 - (10) used with obsolete technologies or technologies not fully tested and widely accepted and in use at the time of the Product's manufacture;
 - (11) subjected to excessive heat or moisture, abnormal voltages, shock, excessive vibration, physical damage or other improper environment; or
 - (12) damaged or malfunctioning due to Acts of God, fires, acts of vandals, criminals or terrorists, communication or power failures, or any other cause or failure that results from circumstances beyond MELCO's control.
- f. All Product information and specifications contained on MELCO's website and in catalogs, manuals, or technical information materials provided by MELCO are subject to change without prior notice.
- g. The Product information and statements contained on MELCO's website and in catalogs, manuals, technical bulletins or other materials provided by MELCO are provided as a guide for Customer's use. They do not constitute warranties and are not incorporated in the contract of sale for the Products.
- h. These terms and conditions constitute the entire agreement between Customer and MELCO with respect to warranties, remedies and damages and supersede any other understandings, whether written or oral, between the parties. Customer expressly acknowledges that any representations or statements made by MELCO or others concerning the Products outside these terms are not part of the basis of the bargain between the parties and are not factored into the pricing of the Products.
- i. THE WARRANTIES AND REMEDIES SET FORTH IN THESE TERMS ARE THE EXCLUSIVE AND ONLY WARRANTIES AND REMEDIES THAT APPLY TO THE PRODUCTS.
- j. MELCO DISCLAIMS THE IMPLIED WARRANTIES OF MERCHANTABILITY AND FITNESS FOR A PARTICULAR PURPOSE.

3. Limits on Damages.

- a. MELCO'S MAXIMUM CUMULATIVE LIABILITY BASED ON ANY CLAIMS FOR BREACH OF WARRANTY OR CONTRACT, NEGLIGENCE, STRICT TORT LIABILITY OR OTHER THEORIES OF RECOVERY REGARDING THE SALE, REPAIR, REPLACEMENT, DELIVERY, PERFORMANCE, CONDITION, SUITABILITY, COMPLIANCE, OR OTHER ASPECTS OF THE PRODUCTS OR THEIR SALE, INSTALLATION OR USE SHALL BE LIMITED TO THE PRICE PAID FOR PRODUCTS NOT AS WARRANTED.
- b. Although MELCO has declared Product's compliance with the international safety standards IEC61508, ISO13849-1, this fact does not guarantee that Product will be free from any malfunction or failure. The user of this Product shall comply with any and all applicable safety standard, regulation or law and take appropriate safety measures for the system in which the Product is installed or used and shall take the second or third safety measures other than the Product. MELCO is not liable for damages that could have been prevented by compliance with any applicable safety standard, regulation or law.
- c. MELCO prohibits the use of Products with or in any application involving power plants, trains, railway systems, airplanes, airline operations, other transportation systems, amusement equipments, hospitals, medical care, dialysis and life support facilities or equipment, incineration and fuel devices, handling of nuclear or hazardous materials or chemicals, mining and drilling, and other applications where the level of risk to human life, health or property are elevated.
- d. MELCO SHALL NOT BE LIABLE FOR SPECIAL, INCIDENTAL, CONSEQUENTIAL, INDIRECT OR PUNITIVE DAMAGES, FOR LOSS OF PROFITS, SALES, OR REVENUE, FOR INCREASED LABOR OR OVERHEAD COSTS, FOR DOWNTIME OR LOSS OF PRODUCTION, FOR COST OVERRUNS, OR FOR ENVIRONMENTAL OR POLLUTION DAMAGES OR CLEAN-UP COSTS, WHETHER THE LOSS IS BASED ON CLAIMS FOR BREACH OF CONTRACT OR WARRANTY, VIOLATION OF STATUTE, NEGLIGENCE OR OTHER TORT, STRICT LIABILITY OR OTHERWISE.
- e. In the event that any damages which are asserted against MELCO arising out of or relating to the Products or defects in them, consist of personal injury, wrongful death and/or physical property damages as well as damages of a pecuniary nature, the disclaimers and limitations contained in these terms shall apply to all three types of damages to the fullest extent permitted by law. If, however, the personal injury, wrongful death and/or physical property damages cannot be disclaimed or limited by law or public policy to the extent provided by these terms, then in any such event the disclaimer of and limitations on pecuniary or economic consequential and incidental damages shall nevertheless be enforceable to the fullest extent allowed by law.
- f. In no event shall any cause of action arising out of breach of warranty or otherwise concerning the Products be brought by Customer more than one year after the cause of action accrues.
- g. Each of the limitations on remedies and damages set forth in these terms is separate and independently enforceable, notwithstanding the unenforceability or failure of essential purpose of any warranty, undertaking, damage limitation, other provision of these terms or other terms comprising the contract of sale between Customer and MELCO.

4. Delivery/Force Majeure.

- a. Any delivery date for the Products acknowledged by MELCO is an estimated and not a promised date. MELCO will make all reasonable efforts to meet the delivery schedule set forth in Customer's order or the purchase contract but shall not be liable for failure to do so.
- b. Products stored at the request of Customer or because Customer refuses or delays shipment shall be at the risk and expense of Customer.
- c. MELCO shall not be liable for any damage to or loss of the Products or any delay in or failure to deliver, service, repair or replace the Products arising from shortage of raw materials, failure of suppliers to make timely delivery, labor difficulties of any kind, earthquake, fire, windstorm, flood, theft, criminal or terrorist acts, war, embargoes, governmental acts or rulings, loss or damage or delays in carriage, acts of God, vandals or any other circumstances reasonably beyond MELCO's control.

5. Choice of Law/Jurisdiction.

These terms and any agreement or contract between Customer and MELCO shall be governed by the laws of the State of New York without regard to conflicts of laws. To the extent any action or dispute is not arbitrated, the parties consent to the exclusive jurisdiction and venue of the federal and state courts located in the Southern District of the State of New York. Any judgment there obtained may be enforced in any court of competent jurisdiction.

6. Arbitration.

Any controversy or claim arising out of, or relating to or in connection with the Products, their sale or use or these terms, shall be settled by arbitration conducted in accordance with the Center for Public Resources (CPR) Rules for Non-Administered Arbitration of International Disputes, by a sole arbitrator chosen from the CPR's panels of distinguished neutrals. Judgment upon the award rendered by the Arbitrator shall be final and binding and may be entered by any court having jurisdiction thereof. The place of the arbitration shall be New York City, New York. The language of the arbitration shall be English. The neutral organization designated to perform the functions specified in Rule 6 and Rules 7.7(b), 7.8 and 7.9 shall be the CPR.

Country/ Region	Sales office/ Tel	Country/ Region	Sales office/ Tel
USA	MITSUBISHI ELECTRIC AUTOMATION, INC. 500 Corporate Woods Parkway, Vernon Hills, IL 60061, U.S.A. Tel : +1-847-478-2100	Turkey	MITSUBISHI ELECTRIC TURKEY A.Ş Ümraniye Branch Serifali Mah. Kale Sok. No:41 34775 Ümraniye - Istanbul, Turkey Tel : +90-216-969-2500
Mexico	MITSUBISHI ELECTRIC AUTOMATION, INC. Mexico Branch Mariano Escobedo #69, Col. Zona Industrial, Tlalnepantla Edo. Mexico, C.P.54030 Tel : +52-55-3067-7500	UAE	MITSUBISHI ELECTRIC EUROPE B.V. Dubai Branch Dubai Silicon Oasis, P.O.BOX 341241, Dubai, U.A.E. Tel : +971-4-3724716
Brazil	MITSUBISHI ELECTRIC DO BRASIL COMÉRCIO E SERVIÇOS LTDA. Avenida Adélio Cardana, 293, 21 andar, Belthaville, Barueri SP, Brazil Tel : +55-11-4689-3000	South Africa	ADROIT TECHNOLOGIES 20 Waterford Office Park, 189 Witkoppen Road, Fourways, South Africa Tel : +27-11-658-8100
Germany	MITSUBISHI ELECTRIC EUROPE B.V. German Branch Mitsubishi-Electric-Platz 1, 40882 Ratingen, Germany Tel : +49-2102-486-0	China	MITSUBISHI ELECTRIC AUTOMATION (CHINA) LTD. No.1386 Hongqiao Road, Mitsubishi Electric Automation Center, Shanghai, China Tel : +86-21-2322-3030
UK	MITSUBISHI ELECTRIC EUROPE B.V. UK Branch Travellers Lane, Hatfield, Hertfordshire, AL10 8XB, U.K. Tel : +44-1707-28-8780	Korea	MITSUBISHI ELECTRIC AUTOMATION KOREA CO., LTD. 7F-9F, Gangseo Hangang Xi-tower A, 401, Yangcheon-ro, Gangseo-Gu, Seoul 07528, Korea Tel : +82-2-3660-9530
Ireland	MITSUBISHI ELECTRIC EUROPE B.V. Irish Branch Westgate Business Park, Ballymount, Dublin 24, Ireland Tel : +353-1-4198800	Singapore	MITSUBISHI ELECTRIC ASIA PTE. LTD. 307, Alexandra Road, Mitsubishi Electric Building, Singapore 159943 Tel : +65-6473-2308
Italy	MITSUBISHI ELECTRIC EUROPE B.V. Italian Branch Centro Direzionale Colleoni-Palazzo Sirio Viale Colleoni 7, 20864 Agrate Brianza(Milano) Italy Tel : +39-039-60531	Thailand	MITSUBISHI ELECTRIC FACTORY AUTOMATION (THAILAND) CO., LTD. 12th Floor, SV.City Building, Office Tower 1, No. 896/19 and 20 Rama 3 Road, Kwaeng Bangpongpan, Khet Yannawa, Bangkok 10120, Thailand Tel : +66-2682-6522
Spain	MITSUBISHI ELECTRIC EUROPE, B.V. Spanish Branch Carretera de Rubi, 76-80-Apdo. 420, 08190 Sant Cugat del Vallés (Barcelona), Spain Tel : +34-935-65-3131	Vietnam	MITSUBISHI ELECTRIC VIETNAM COMPANY LIMITED Hanoi Branch 6th Floor, Detech Tower, 8 Ton That Thuyet Street, My Dinh 2 Ward, Nam Tu Liem District, Hanoi, Vietnam Tel : +84-4-3937-8075
France	MITSUBISHI ELECTRIC EUROPE B.V. French Branch 25, Boulevard des Bouvets, 92741 Nanterre Cedex, France Tel : +33-1-55-68-55-68	Malaysia	MITSUBISHI ELECTRIC SALES MALAYSIA SDN. BHD. Lot 11, Jalan 219, 46100 Petaling Jaya, Selangor Darul Ehsan, Malaysia Tel : +60-3-7626-5000
Czech Republic	MITSUBISHI ELECTRIC EUROPE B.V. Czech Branch Avenir Business Park, Radlicka 751/113e, 158 00 Praha5, Czech Republic Tel : +420-251-551-470	Indonesia	PT. MITSUBISHI ELECTRIC INDONESIA Gedung Jaya 11th Floor, JL. MH. Thamrin No.12, Jakarta Pusat 10340, Indonesia Tel : +62-21-3192-6461
Poland	MITSUBISHI ELECTRIC EUROPE B.V. Polish Branch ul. Krakowska 50, 32-083 Balice, Poland Tel : +48-12-347-65-00	India	MITSUBISHI ELECTRIC INDIA PVT. LTD. Pune Branch Emerald House, EL-3, J Block, M.I.D.C., Bhosari, Pune-411026, Maharashtra, India Tel : +91-20-2710-2000
Sweden	MITSUBISHI ELECTRIC EUROPE B.V. (Scandinavia) Fjellvägen 8, SE-22736 Lund, Sweden Tel : +46-8-625-10-00	Australia	MITSUBISHI ELECTRIC AUSTRALIA PTY. LTD. 348 Victoria Road, P.O. Box 11, Rydalmere, N.S.W 2116, Australia Tel : +61-2-9684-7777
Russia	MITSUBISHI ELECTRIC (RUSSIA) LLC St. Petersburg Branch Piskarevsky pr. 2, bld 2, lit "Sch", BC "Benua", office 720, 195027 St. Petersburg, Russia Tel : +7-812-633-3497		

MITSUBISHI ELECTRIC CORPORATION

HEAD OFFICE: TOKYO BLDG., 2-7-3, MARUNOUCHI, CHIYODA-KU, TOKYO 100-8310, JAPAN
NAGOYA WORKS: 1-14, YADA-MINAMI 5-CHOME, HIGASHI-KU, NAGOYA 461-8670, JAPAN

When exported from Japan, this manual does not require application to the Ministry of Economy,
Trade and Industry for service transaction permission.

Specifications subject to change without notice.