

GX Developer Version 7

Operating Manual

mitsubishi

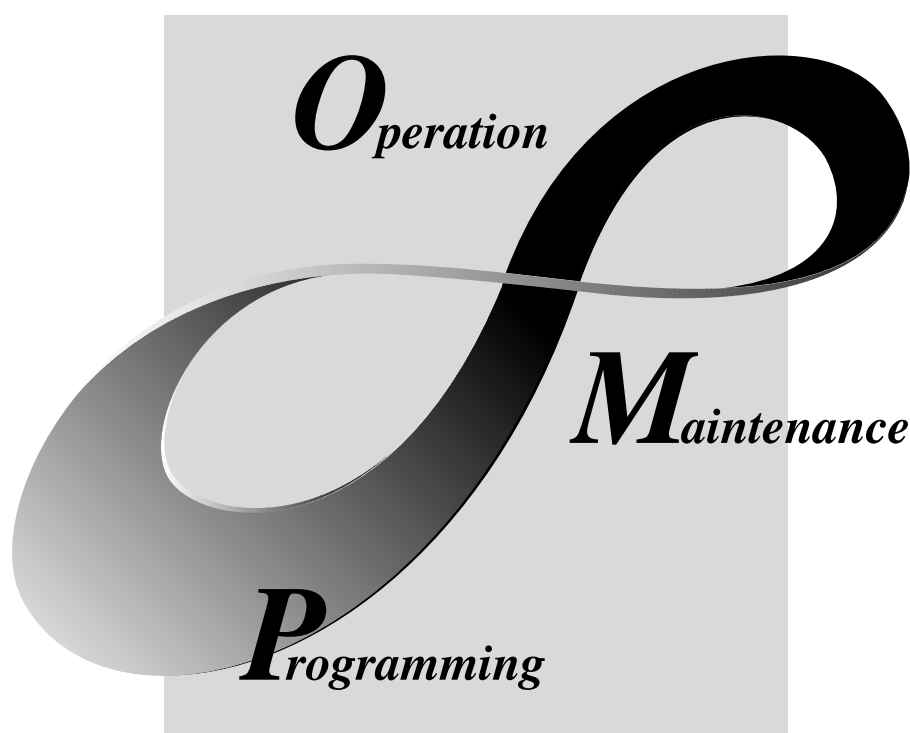

MELSOFT
Integrated FA Software

SW7D5C-GPPW-E

• SAFETY PRECAUTIONS •

(Always read these instructions before using this equipment.)

Before using this product, please read this manual and the relevant manuals introduced in this manual carefully and pay full attention to safety to handle the product correctly.

The instructions given in this manual are concerned with this product. For the safety instructions of the programmable controller system, please read the CPU module user's manual.

In this manual, the safety instructions are ranked as "DANGER" and "CAUTION".



Indicates that incorrect handling may cause hazardous conditions, resulting in death or severe injury.



Indicates that incorrect handling may cause hazardous conditions, resulting in medium or slight personal injury or physical damage.

Note that the  CAUTION level may lead to a serious consequence according to the circumstances. Always follow the instructions of both levels because they are important to personal safety.

Please save this manual to make it accessible when required and always forward it to the end user.

[Design Instructions]

DANGER

- For data change, program change, and status control made to the PLC which is running from a Personal computer, configure the interlock circuit externally so that the system safety is ensured. The action to be taken for the system at the occurrence of communication errors caused by such as loose cable connection must be determined for online operation of PLC from Personal computers.

CAUTION

- Be sure to read the manual carefully and exercise an appropriate amount of caution connecting to PLC CPU and performing online operations (PLC CPU program change during RUN, forced input/output operation, RUN-STOP or other operation condition changes, remote control operation) while the personal computer is operating.
Regarding the PLC CPU program change during RUN (Write during RUN), the program may be corrupted or have other problems depending on operation conditions. Exercise the appropriate amount of caution with regard to the Caution points in section 16.9.
- Please refer to the manual of each module for online module change and swap module during run, since there is restriction on the exchangeable module.

Revisions

*The manual number is given on the bottom left of the back cover.

| Print Date | *Manual Number | Revision |
|------------|-----------------|---|
| Jun.,2001 | SH(NA)-080166-A | First edition |
| Dec.,2001 | SH(NA)-080166-B | <p>Addition</p> <p>SAFETY PRECAUTIONS, Section1.1, Section2.2, Section2.3, Section2.5.4, Section4.14, Section9.1, Section13.1, Section13.1.1, Section13.1.2, Section13.2.2, Section16.1, Section16.2.4, Section16.3.1, Section16.3.2, Section21.5, Section21.6, Appendix 4</p> <p>Correction</p> <p>Abbreviations and Terms in This Manual, Section3.2.1, Section11.2, Section Chapter 12, Section13.2, Section16.9, Section17.8, Section21.1.2, Section21.3.1, Section21.3.2, Section21.3.3, Section21.4.1</p> |
| Jun.,2002 | SH(NA)-080166-C | <p>Addition</p> <p>Section1.1, Section3.13.2, Section5.1.4, Section14.5.6, Section16.2.4, Section16.3.1, Section16.3.2, Section21.1.2, Section21.3, Section21.3.1, Section21.3.2, Section21.3.3, Section21.4.9, Section22.2.3, Section22.3.5, Appendix 8, Appendix 9, Appendix 10</p> <p>Correction</p> <p>Section 2.3,Section3.13.2, Section4.18, Section5.1.4, Section9.1, Section13.1.1, Section13.1.2, Section15.14, Section16.2.2, Section16.2.3(2), Section16.2.4, Section 21.2.8, Section21.4.1, Section22.3.1, Section22.4.2, Appendix 4, Appendix 10</p> |
| Oct.,2002 | SH(NA)-080166-D | <p>Addition</p> <p>Section2.5.4, Section16.3</p> <p>Correction</p> <p>Appendix 9</p> |
| Nov.,2002 | SH(NA)-080166-E | <p>Addition</p> <p>Section4.7, Section16.4</p> <p>Correction</p> <p>Section16.1.2</p> |
| | | |

Japanese Manual Version SH-080160-F

This manual confers no industrial property rights or any rights of any other kind, nor does it confer any patent licenses. Mitsubishi Electric Corporation cannot be held responsible for any problems involving industrial property rights which may occur as a result of using the contents noted in this manual.

INTRODUCTION

Thank you for choosing the Mitsubishi MELSOFT series Integrated FA software.
Read this manual and make sure you understand the functions and performance of MELSEC series sequencer thoroughly in advance to ensure correct use.
Please make this manual available to the end user.

CONTENTS

| | |
|---|--------|
| SAFETY PRECAUTIONS | A - 1 |
| REVISIONS | A - 2 |
| CONTENTS..... | A - 3 |
| About Manuals..... | A - 13 |
| How the manual describes the explanation is shown below | A - 14 |
| Abbreviations and Terms in This Manual | A - 16 |

| | |
|--------------------------------------|----------------------|
| Chapter 1 GENERAL DESCRIPTION | 1- 1 to 1- 13 |
|--------------------------------------|----------------------|

| | |
|-----------------------------------|-------|
| 1.1 Functions Lists | 1- 3 |
| 1.2 FX Series Programming..... | 1- 11 |
| 1.3 Basic Key Specifications..... | 1- 13 |

| | |
|---------------------------------------|----------------------|
| Chapter 2 SYSTEM CONFIGURATION | 2- 1 to 2- 15 |
|---------------------------------------|----------------------|

| | |
|--|-------|
| 2.1 Connection from the Serial Port..... | 2- 1 |
| 2.2 Connection from the Interface Boards..... | 2- 4 |
| 2.3 Connection from GX Developer Installed in PC CPU Module..... | 2- 6 |
| 2.4 System Equipment Lists | 2- 7 |
| 2.5 Precautions for Handling Projects on the Earlier Versions..... | 2- 10 |
| 2.5.1 Using GX Developer Version 4 (SW4D5C-GPPW-E) or earlier to handle project | 2- 10 |
| 2.5.2 Using GX Developer Version 5 (SW5D5C -GPPW-E) or earlier to handle project | 2- 11 |
| 2.5.3 Using GX Developer Version 6 (SW6D5C-GPPW-E) or earlier to handle project | 2- 12 |
| 2.5.4 Using GX Developer Version 7.09K (SW7D5C-GPPW-E) or earlier to handle project..... | 2- 13 |

| | |
|------------------------------------|----------------------|
| Chapter 3 COMMON OPERATIONS | 3- 1 to 3- 24 |
|------------------------------------|----------------------|

| | |
|---|-------|
| 3.1 List of Shortcut Keys and Access Keys..... | 3- 1 |
| 3.2 Project Designation | 3- 5 |
| 3.2.1 Saving a project..... | 3- 6 |
| 3.2.2 Opening a project..... | 3- 9 |
| 3.3 Cut, Copy, and Paste | 3- 10 |
| 3.3.1 Cut and paste | 3- 10 |
| 3.3.2 Copy and paste | 3- 12 |
| 3.3.3 Notes on cutting, copying and pasting network parameters..... | 3- 14 |
| 3.4 Toolbar..... | 3- 16 |
| 3.5 Status Bar..... | 3- 17 |
| 3.6 Zooming in on or out of the Edit Screen..... | 3- 18 |
| 3.7 Project Data List..... | 3- 19 |
| 3.8 Comment Display..... | 3- 21 |
| 3.9 Statement Display | 3- 21 |
| 3.10 Note Display | 3- 21 |

| | |
|--|-------|
| 3.11 Alias Display | 3- 22 |
| 3.12 Comment Format | 3- 22 |
| 3.13 Alias format display | 3- 23 |
| 3.13.1 Replace device name and display | 3- 23 |
| 3.13.2 Arrange with device and display | 3- 23 |
| 3.14 Setting the Number of Contacts | 3- 24 |
| 3.14.1 Displaying 9 contacts | 3- 24 |
| 3.14.2 Displaying 11 contacts | 3- 24 |

| | |
|---------------------------------|----------------------|
| Chapter 4 INITIALIZATION | 4- 1 to 4- 32 |
|---------------------------------|----------------------|

| | |
|--|-------|
| 4.1 Creating a Project..... | 4- 1 |
| 4.2 Opening the Existing Project File | 4- 3 |
| 4.3 Closing a Project File | 4- 5 |
| 4.4 Saving a Project | 4- 5 |
| 4.5 Saving a Project with a New Name | 4- 6 |
| 4.6 Deleting a Project..... | 4- 6 |
| 4.7 Verifying Data in Projects..... | 4- 7 |
| 4.8 Copying a Project..... | 4- 10 |
| 4.9 Adding Data to a Project | 4- 12 |
| 4.10 Copying Data within a Project..... | 4- 14 |
| 4.11 Deleting Data in a Project | 4- 15 |
| 4.12 Renaming Data in a Project..... | 4- 16 |
| 4.13 Changing the Ladder and SFC with each other..... | 4- 17 |
| 4.14 Changing the PLC Type of a Project..... | 4- 18 |
| 4.15 Reading Other Format Files | 4- 20 |
| 4.15.1 Reading GPPQ, GPPA, FXGP(DOS) or FXGP(WIN) files..... | 4- 20 |
| 4.15.2 Reading a MELSEC MEDOC format file (Printout)..... | 4- 24 |
| 4.15.3 Reading a MELSEC MEDOC format file..... | 4- 25 |
| 4.16 Exporting GPPQ, GPPA, FXGP(DOS) or FXGP(WIN) Files..... | 4- 27 |
| 4.17 Starting Multiple Projects | 4- 31 |
| 4.18 Existing GX Developer..... | 4- 31 |

| | |
|---|----------------------|
| Chapter 5 STANDARDIZING THE PROGRAMS | 5- 1 to 5- 30 |
|---|----------------------|

| | |
|--|-------|
| 5.1 Label Programming..... | 5- 1 |
| 5.1.1 Label programming sequence | 5- 6 |
| 5.1.2 Label program input method..... | 5- 7 |
| 5.1.3 Making global variable/local variable setting | 5- 9 |
| 5.1.4 Making automatic device setting..... | 5- 13 |
| 5.1.5 Deleting External | 5- 14 |
| 5.1.6 All deletion | 5- 14 |
| 5.1.7 Importing device comments..... | 5- 15 |
| 5.1.8 Exporting to device comments..... | 5- 16 |
| 5.1.9 Converting label programs into actual programs (Compile) | 5- 18 |
| 5.1.10 Displaying the Device Program | 5- 20 |
| 5.2 About Macros | 5- 21 |
| 5.2.1 Registering a macro | 5- 23 |
| 5.2.2 Utilizing a macro..... | 5- 25 |
| 5.2.3 Deleting a macro | 5- 27 |

| | |
|---|-------|
| 5.2.4 Displaying macro references | 5- 28 |
|---|-------|

| | |
|-----------------------------------|----------------------|
| Chapter 6 CREATING CIRCUIT | 6- 1 to 6- 50 |
|-----------------------------------|----------------------|

| | |
|--|-------|
| 6.1 Restrictions on Circuit Creation | 6- 7 |
| 6.1.1 Restrictions in circuit display window..... | 6- 7 |
| 6.1.2 Restrictions in circuit edit window | 6- 8 |
| 6.2 Creating and Editing Circuits | 6- 12 |
| 6.2.1 Inputting contacts and application instructions..... | 6- 12 |
| 6.2.2 Inputting lines (vertical and horizontal) | 6- 14 |
| 6.2.3 Deleting contacts and application instructions | 6- 16 |
| 6.2.4 Deleting connecting lines | 6- 17 |
| 6.2.5 Inserting and deleting in circuit blocks | 6- 18 |
| 6.2.6 Inserting NOPs | 6- 20 |
| 6.2.7 Deleting NOPs..... | 6- 20 |
| 6.2.8 Cutting, copying and pasting circuits | 6- 21 |
| 6.2.9 Undo the last operation | 6- 23 |
| 6.2.10 Returning to the status after ladder conversion | 6- 24 |
| 6.3 Changing T/C Setting Values | 6- 25 |
| 6.4 Find and Replace | 6- 27 |
| 6.4.1 Finding a device | 6- 29 |
| 6.4.2 Finding an instruction | 6- 31 |
| 6.4.3 Finding a step No. | 6- 32 |
| 6.4.4 Finding a character string..... | 6- 33 |
| 6.4.5 Finding a contact/coil..... | 6- 35 |
| 6.4.6 Finding data..... | 6- 36 |
| 6.4.7 Replacing a device | 6- 37 |
| 6.4.8 Replacing an instruction..... | 6- 39 |
| 6.4.9 Changing A and B contacts | 6- 41 |
| 6.4.10 Replacing a character string | 6- 42 |
| 6.4.11 Replacing the module's first I/O number | 6- 44 |
| 6.4.12 Changing the statement or note type | 6- 45 |
| 6.4.13 Replacing data..... | 6- 46 |
| 6.4.14 Searching for a contact coil..... | 6- 47 |
| 6.4.15 Searching for a device-use instruction | 6- 49 |

| | |
|--|----------------------|
| Chapter 7 CREATING INSTRUCTION LIST | 7- 1 to 7- 11 |
|--|----------------------|

| | |
|--|------|
| 7.1 Common Notes on Instruction List Creation | 7- 1 |
| 7.2 Creating a Program Instruction list | 7- 3 |
| 7.2.1 Inputting a contact or application instruction | 7- 3 |
| 7.2.2 Changing the existing program in overwrite mode..... | 7- 4 |
| 7.2.3 Inserting or adding the existing program | 7- 5 |
| 7.2.4 Deleting the existing program list..... | 7- 6 |
| 7.2.5 Inserting NOPs | 7- 7 |
| 7.2.6 Deleting NOPs | 7- 7 |
| 7.3 Find and Replace | 7- 8 |
| 7.3.1 Finding a device | 7- 8 |
| 7.3.2 Finding an instruction | 7- 8 |
| 7.3.3 Finding a step No. | 7- 8 |

| | |
|---|-------|
| 7.3.4 Finding a character string..... | 7- 8 |
| 7.3.5 Finding a contact/coil..... | 7- 8 |
| 7.3.6 Replacing a device | 7- 8 |
| 7.3.7 Replacing an instruction..... | 7- 8 |
| 7.3.8 Changing an A or B contact..... | 7- 9 |
| 7.3.9 Replacing a character string | 7- 9 |
| 7.3.10 Change module start address..... | 7- 9 |
| 7.3.11 Changing the statement or note type | 7- 9 |
| 7.3.12 Searching for a contact coil..... | 7- 9 |
| 7.3.13 Searching for an instruction using a device..... | 7- 9 |
| 7.4 Display | 7- 10 |
| 7.4.1 Displaying an Alias | 7- 10 |
| 7.5 Switching Read and Write Modes | 7- 11 |
| 7.5.1 Switching to read mode..... | 7- 11 |
| 7.5.2 Switching to write mode | 7- 11 |
| 7.5.3 Switching to circuit mode | 7- 11 |
| 7.6 Changing T/C Setting Values | 7- 11 |

| | |
|-----------------------------|---------------------|
| Chapter 8 CONVERSION | 8- 1 to 8- 2 |
|-----------------------------|---------------------|

| | |
|--|------|
| 8.1 Converting an Edit Program | 8- 1 |
| 8.2 Converting Multiple Edit Programs..... | 8- 1 |

| | |
|--|----------------------|
| Chapter 9 SETTING DEVICE COMMENTS | 9- 1 to 9- 28 |
|--|----------------------|

| | |
|--|-------|
| 9.1 Points to be Noted before Comment Creation with GX Developer | 9- 1 |
| 9.1.1 Editing comments only on GX Developer..... | 9- 4 |
| 9.1.2 Writing to ACPU/GPPA file | 9- 6 |
| 9.1.3 Reading from ACPU/GPPA file..... | 9- 7 |
| 9.1.4 Writing to QCPU(Qmode) QnACPU/GPPQ file | 9- 9 |
| 9.1.5 Reading from QCPU(Qmode) QnACPU | 9- 9 |
| 9.1.6 Writing to FXCPU/FXGP(DOS), FXGP(WIN) file..... | 9- 10 |
| 9.1.7 Reading from FXCPU/FXGP(DOS), FXGP(WIN) file | 9- 11 |
| 9.2 List of Device Comments | 9- 12 |
| 9.3 Common Comments and Comments by Program..... | 9- 13 |
| 9.4 Creating Device Comments..... | 9- 16 |
| 9.4.1 Creating device comments on the device comment edit window..... | 9- 16 |
| 9.4.2 Creating device comments for the created circuit..... | 9- 18 |
| 9.4.3 Creating device comments after creating a circuit | 9- 19 |
| 9.4.4 Editing comments on the ladder editing screen | 9- 20 |
| 9.5 Deleting Device Comments | 9- 21 |
| 9.5.1 Deleting all device comments and Alias | 9- 21 |
| 9.5.2 Deleting display device comments and Alias | 9- 21 |
| 9.6 Setting Comment Types | 9- 22 |
| 9.7 Setting Comment Ranges..... | 9- 24 |

| | |
|--|------------------------|
| Chapter 10 SETTING THE STATEMENTS AND NOTES | 10- 1 to 10- 20 |
|--|------------------------|

| | |
|---|-------|
| 10.1 About the Statements/Notes..... | 10- 1 |
| 10.2 About Merging Operation Procedure..... | 10- 6 |

| | | |
|------------|--|--------|
| 10.3 | Creating and Deleting Statements | 10- 7 |
| 10.3.1 | When editing the circuit window | 10- 7 |
| 10.3.1(1) | Creating statements in the circuit edit window..... | 10- 7 |
| 10.3.1(2) | Deleting statements in the circuit edit window | 10- 8 |
| 10.3.2 | When editing the list window..... | 10- 9 |
| 10.3.2(1) | Editing statements on the list edit window | 10- 9 |
| 10.3.2(2) | Deleting statements on the list edit window..... | 10- 10 |
| 10.3.3 | Creating statements in the statement edit mode | 10- 11 |
| 10.4 | Creating and Deleting Notes..... | 10- 12 |
| 10.4.1 | Creating notes on the circuit edit window..... | 10- 12 |
| 10.4.1 (1) | Creating notes on the circuit edit window | 10- 12 |
| 10.4.1 (2) | Deleting notes in the circuit edit window | 10- 13 |
| 10.4.2 | Creating notes in the list edit window | 10- 14 |
| 10.4.2 (1) | Creating notes in the list edit window..... | 10- 14 |
| 10.4.2 (2) | Deleting notes in the list edit window | 10- 15 |
| 10.4.3 | Creating notes in the note edit mode..... | 10- 16 |
| 10.5 | Batch-Editing the Statements/Notes | 10- 17 |

| | |
|---|-----------------------|
| Chapter 11 SETTING DEVICE MEMORY (DWR SETTING) | 11- 1 to 11- 6 |
|---|-----------------------|

| | | |
|--------|-----------------------------------|-------|
| 11.1 | Device Memory | 11- 1 |
| 11.2 | Device Value Input..... | 11- 2 |
| 11.3 | All Clear | 11- 5 |
| 11.3.1 | Clearing all devices | 11- 5 |
| 11.3.2 | Clearing all display devices..... | 11- 5 |
| 11.4 | Making Fill Settings..... | 11- 6 |

| | |
|--|-----------------------|
| Chapter 12 SETTING DEVICE INITIALIZATION VALUES | 12- 1 to 12- 2 |
|--|-----------------------|

| | |
|--|------------------------|
| Chapter 13 SETTING THE PARAMETERS | 13- 1 to 13- 26 |
|--|------------------------|

| | | |
|--------|---|--------|
| 13.1 | Setting the PLC Parameters..... | 13- 3 |
| 13.1.1 | Common Notes on Parameters | 13- 4 |
| 13.1.2 | PLC Parameter Item Lists..... | 13- 7 |
| 13.1.3 | Explanations for PLC Parameter Setting Screen..... | 13- 16 |
| 13.2 | Setting the Network Parameters..... | 13- 17 |
| 13.2.1 | About Items Common to the Network Parameters | 13- 18 |
| 13.2.2 | Network Parameter Item Lists | 13- 20 |
| 13.2.3 | Explanations for Network Parameter Setting Screen | 13- 25 |
| 13.3 | Setting the Remote Password | 13- 26 |

| | |
|-------------------------|------------------------|
| Chapter 14 PRINT | 14- 1 to 14- 37 |
|-------------------------|------------------------|

| | | |
|--------|--|--------|
| 14.1 | Setting Up a Printer..... | 14- 2 |
| 14.2 | Setting a Page Layout..... | 14- 4 |
| 14.3 | Previewing a Print Image..... | 14- 7 |
| 14.4 | Printing..... | 14- 9 |
| 14.5 | Setting the Details for Printing | 14- 12 |
| 14.5.1 | Creating a title | 14- 12 |

| | | |
|---------|---|--------|
| 14.5.2 | Setting a ladder print range..... | 14- 13 |
| 14.5.3 | Setting a Instruction list print range | 14- 16 |
| 14.5.4 | Setting a TC setting value print range | 14- 18 |
| 14.5.5 | Setting a device comment print range..... | 14- 19 |
| 14.5.6 | Setting a device use list print range..... | 14- 21 |
| 14.5.7 | Setting a device memory print range..... | 14- 23 |
| 14.5.8 | Setting a device initial value print range..... | 14- 24 |
| 14.5.9 | Setting a PLC parameter print item | 14- 26 |
| 14.5.10 | Setting a network parameter print item | 14- 27 |
| 14.5.11 | Setting a list of contact coil used | 14- 28 |
| 14.5.12 | Displaying a project contents list | 14- 29 |
| 14.5.13 | Setting the TEL data print area..... | 14- 30 |
| 14.5.14 | Product information list..... | 14- 31 |
| 14.5.15 | Printing labels..... | 14- 32 |
| 14.6 | Print Examples | 14- 33 |

| | |
|----------------------------|-----------------|
| Chapter 15 OTHER FUNCTIONS | 15- 1 to 15- 39 |
|----------------------------|-----------------|

| | | |
|--------|--|--------|
| 15.1 | Checking Programs | 15- 1 |
| 15.2 | Merging Programs | 15- 3 |
| 15.3 | Checking Parameters | 15- 7 |
| 15.4 | All-clearing the Parameters | 15- 8 |
| 15.5 | IC Memory Card (GX Developer ↔ IC Memory Card) | 15- 9 |
| 15.5.1 | Reading the data of the IC memory card | 15- 11 |
| 15.5.2 | Writing data to the IC memory card..... | 15- 12 |
| 15.6 | Intelligent Function Utility..... | 15- 13 |
| 15.7 | Transferring ROM Data..... | 15- 15 |
| 15.7.1 | ROM reading, writing, and verification..... | 15- 21 |
| 15.7.2 | Writing to files in ROM format..... | 15- 23 |
| 15.8 | Batch-Deleting the Unused Device Comments | 15- 25 |
| 15.9 | Customizing Keys | 15- 26 |
| 15.10 | Changing the Display Color | 15- 27 |
| 15.11 | Setting Options..... | 15- 28 |
| 15.12 | Displaying Multiple Windows | 15- 36 |
| 15.13 | Opening a Specific Project Using a Shortcut | 15- 37 |
| 15.14 | Starting the Ladder Logic Test Tool | 15- 38 |
| 15.15 | Outline of Help Function | 15- 38 |
| 15.16 | Starting CC-Link Configurator | 15- 39 |

| | |
|-----------------------------|-----------------|
| Chapter 16 CONNECTING A PLC | 16- 1 to 16- 88 |
|-----------------------------|-----------------|

| | | |
|------------|--|--------|
| 16.1 | Specifying the Connection Target | 16- 1 |
| 16.1.1 | When accessing the own station | 16- 1 |
| 16.1.2 | When accessing the other station | 16- 4 |
| 16.1.3 | Accessing multiple CPUs..... | 16- 11 |
| 16.1.3 (1) | About access to other multiple CPU modules | 16- 11 |
| 16.1.3 (2) | About network access via multiple CPUs | 16- 13 |
| 16.2 | Making access via Ethernet, CC-Link, G4 module, C24 or telephone line..... | 16- 17 |
| 16.2.1 | Setting method for communication via the ethernet board..... | 16- 17 |

| | |
|--|--------|
| 16.2.1 (1) For A series..... | 16- 17 |
| 16.2.1 (2) For QnA series..... | 16- 22 |
| 16.2.1 (3) For Q series | 16- 25 |
| 16.2.2 Setting Method for Communication Via CC-Link (AJ65BT-G4) | 16- 28 |
| 16.2.2 (1) For A series..... | 16- 28 |
| 16.2.2 (2) For QnA series..... | 16- 31 |
| 16.2.2 (3) For Q series | 16- 35 |
| 16.2.3 Setting Method for Communication Via C24..... | 16- 38 |
| 16.2.3 (1) Connection in the form of one-for-one | 16- 38 |
| 16.2.3 (2) 1:n connection..... | 16- 40 |
| 16.2.4 Setting method for communication via a modem interface module | 16- 45 |
| 16.3 Using PLC Read/Write..... | 16- 53 |
| 16.3.1 Executing PLC read/PLC write | 16- 53 |
| 16.3.2 Setting the read/write range for device data..... | 16- 61 |
| 16.3.3 Setting the program reading/writing range | 16- 63 |
| 16.3.4 Setting the comment read/write range | 16- 64 |
| 16.4 Verifying the Peripheral Side and PLC Side Data | 16- 67 |
| 16.5 Write to PLC (Flash ROM)..... | 16- 71 |
| 16.5.1 Write the program memory to ROM | 16- 71 |
| 16.5.2 Write to PLC (Flash ROM)..... | 16- 72 |
| 16.6 Deleting Data in the PLC | 16- 73 |
| 16.7 Changing PLC Data Attributes | 16- 75 |
| 16.8 Reading/Writing PLC User Data..... | 16- 78 |
| 16.8.1 Reading | 16- 78 |
| 16.8.2 Writing PLC user data | 16- 79 |
| 16.9 Executing Online Change | 16- 80 |
| 16.10 Concept of the Routing Parameters..... | 16- 86 |

| | |
|------------------------------|------------------------|
| Chapter 17 MONITORING | 17- 1 to 17- 34 |
|------------------------------|------------------------|

| | |
|---|--------|
| 17.1 Monitoring, and Stopping/Resuming Monitoring..... | 17- 3 |
| 17.2 Monitoring/Stopping Monitoring in All Windows..... | 17- 6 |
| 17.3 Editing Programs During Ladder Monitoring..... | 17- 7 |
| 17.4 Switching Present Values Between Decimal and Hexadecimal | 17- 9 |
| 17.5 Batch Monitoring Devices/Buffer Memories..... | 17- 10 |
| 17.5.1 Batch monitoring devices/buffer memories | 17- 10 |
| 17.5.2 Batch-monitoring the multi-CPU buffer memory | 17- 14 |
| 17.6 Monitoring after Registering Devices | 17- 15 |
| 17.7 Setting Monitor Conditions/Stop Conditions | 17- 18 |
| 17.8 Program List Monitor..... | 17- 20 |
| 17.9 Monitoring the Interrupt Program List..... | 17- 23 |
| 17.10 Measuring Scan Time..... | 17- 24 |
| 17.11 Executing Sampling Trace..... | 17- 25 |
| 17.11.1 Setting execution & status display..... | 17- 26 |
| 17.11.2 Setting trace data | 17- 29 |
| 17.11.3 Setting trace conditions..... | 17- 31 |
| 17.12 Monitoring the Ladders Registered | 17- 33 |
| 17.13 Deleting All Ladders Registered..... | 17- 34 |

| | |
|-------------------------------|-----------------|
| Chapter 18 DEBUGGING PROGRAMS | 18- 1 to 18- 18 |
|-------------------------------|-----------------|

| | |
|--|--------|
| 18.1 Carrying Out a Device Test | 18- 2 |
| 18.2 Registering/Canceling the Forced I/O | 18- 5 |
| 18.2.1 Registration to PLC CPU | 18- 5 |
| 18.2.2 Registration/cancellation to remote I/O station | 18- 6 |
| 18.3 Carrying Out Partial Operation | 18- 7 |
| 18.4 Executing Step Run | 18- 11 |
| 18.5 Setting the Scan Range | 18- 14 |
| 18.6 Operating the PLC Remotely | 18- 16 |

| | |
|--|-----------------|
| Chapter 19 REGISTERING KEYWORD/PASSWORDS | 19- 1 to 19- 10 |
|--|-----------------|

| | |
|--|--------|
| 19.1 Registering Keyword | 19- 1 |
| 19.1.1 Registering new keyword/changing keyword | 19- 1 |
| 19.1.2 Canceling a keyword | 19- 4 |
| 19.1.3 Releasing a keyword | 19- 5 |
| 19.2 Registering Passwords | 19- 6 |
| 19.2.1 Register new passwords/changing passwords | 19- 7 |
| 19.2.2 Delete the passwords | 19- 9 |
| 19.2.3 Disable the passwords | 19- 10 |

| | |
|-----------------------|-----------------|
| Chapter 20 PLC MEMORY | 20- 1 to 20- 10 |
|-----------------------|-----------------|

| | |
|--|-------|
| 20.1 Clearing the PLC Memory | 20- 1 |
| 20.1.1 All-clearing on ACPUs memory | 20- 1 |
| 20.1.2 All-clearing the QCPU, QnACPU device memory | 20- 3 |
| 20.1.3 All-clearing an FXCPU memory | 20- 4 |
| 20.2 Formatting a QCPU (Qmode), QnACPU Memory | 20- 6 |
| 20.3 Sorting the QCPU (Qmode), QnACPU Memory | 20- 8 |
| 20.4 Setting for the PLC's Clock | 20- 9 |

| | |
|----------------------|-----------------|
| Chapter 21 DIAGNOSIS | 21- 1 to 21- 58 |
|----------------------|-----------------|

| | |
|---|--------|
| 21.1 Diagnosing the PLC | 21- 1 |
| 21.1.1 Diagnosing an ACPUs | 21- 1 |
| 21.1.2 Diagnosing a QCPU (Qmode), QnACPU | 21- 3 |
| 21.1.3 Diagnosing the QCPU (Qmode) | 21- 5 |
| 21.1.4 Diagnosing an FXCPU | 21- 8 |
| 21.2 Diagnosing a Network | 21- 9 |
| 21.2.1 Testing a network | 21- 11 |
| 21.2.2 Performing a loop test | 21- 12 |
| 21.2.3 Performing a setting confirmation test | 21- 13 |
| 21.2.4 Performing a station order confirmation test | 21- 15 |
| 21.2.5 Performing a transmission test | 21- 17 |
| 21.2.6 Monitoring the error history | 21- 18 |
| 21.2.7 Network monitor details | 21- 20 |
| 21.2.8 Monitoring other station information | 21- 21 |
| 21.3 Running CC-Link, CC-Link/LT Diagnostics | 21- 24 |

| | |
|---|--------|
| 21.3.1 Monitoring the line (own station)..... | 21- 24 |
| 21.3.2 Conducting a line test..... | 21- 26 |
| 21.3.3 Monitoring the lines (other stations)..... | 21- 27 |
| 21.4 Making Ethernet Diagnostics..... | 21- 29 |
| 21.4.1 Ethernet diagnostics..... | 21- 29 |
| 21.4.2 Parameter status..... | 21- 31 |
| 21.4.3 Error history..... | 21- 33 |
| 21.4.4 Status of each connection..... | 21- 35 |
| 21.4.5 Status of each protocol..... | 21- 36 |
| 21.4.6 LED status..... | 21- 38 |
| 21.4.7 Received e-mail information..... | 21- 39 |
| 21.4.8 Send e-mail information..... | 21- 41 |
| 21.4.9 PING test..... | 21- 43 |
| 21.4.10 Loopback test..... | 21- 46 |
| 21.5 System Monitor..... | 21- 49 |
| 21.6 Online Module Change..... | 21- 54 |

| | |
|--|-----------------|
| Chapter 22 SETTING A6TEL/Q6TEL/FX DATA | 22- 1 to 22- 41 |
|--|-----------------|

| | |
|---|--------|
| 22.1 Function Setting Item List..... | 22- 2 |
| 22.2 Preparations for Connecting the Telephone Line..... | 22- 3 |
| 22.2.1 Making remote access/pager notice (for ACPU)..... | 22- 3 |
| 22.2.2 Making remote access/pager notice (for QnACPU)..... | 22- 5 |
| 22.2.3 Making remote access to FXCPU..... | 22- 7 |
| 22.2.4 Making Q6TEL-Q6TEL communication..... | 22- 9 |
| 22.3 Making Initial Setting of Data..... | 22- 12 |
| 22.3.1 Creating a phone number book..... | 22- 12 |
| 22.3.2 Registering the AT command..... | 22- 16 |
| 22.3.3 Registering A6TEL data..... | 22- 19 |
| 22.3.4 Registering Q6TEL data..... | 22- 23 |
| 22.3.5 Setting the FX PLC..... | 22- 28 |
| 22.4 Connecting/Disconnecting the Line..... | 22- 32 |
| 22.4.1 Connecting the line automatically..... | 22- 32 |
| 22.4.2 Using callback function to make line connection..... | 22- 37 |
| 22.4.3 Connecting the line via a switchboard (manual connection)..... | 22- 39 |
| 22.4.4 Disconnecting the line..... | 22- 41 |

| | |
|------------|------------------------------|
| APPENDICES | Appendix- 1 to Appendix- 108 |
|------------|------------------------------|

| | |
|--|--------------|
| Appendix 1 GPP Function Access Ranges in MELSECNET(II/10) Systems..... | Appendix- 1 |
| 1.1 Access Range with MELSECNET (II)..... | Appendix- 1 |
| 1.2 Access Range for an A Series Start..... | Appendix- 3 |
| 1.3 Access Range for a QnA Series Start..... | Appendix- 5 |
| 1.4 Access Range at a Q Series Start..... | Appendix- 8 |
| Appendix 2 MELSECNET/10 MELSECNET/H Board Access Ranges..... | Appendix- 10 |
| 2.1 MELSECNET/10 Board, MELSECNET/H Board..... | Appendix- 10 |
| 2.1.1 A series start..... | Appendix- 11 |
| 2.1.2 QnA series start..... | Appendix- 13 |
| 2.1.3 Q series start..... | Appendix- 15 |
| 2.2 Access Range via an Ethernet Board..... | Appendix- 16 |

| | |
|---|--------------|
| 2.3 Access Range via CC-Link (AJ65BT-G4) | Appendix- 19 |
| 2.4 Access Range via Computer Link..... | Appendix- 21 |
| 2.5 Access Range via Serial Communication | Appendix- 23 |
| 2.6 Access Range for Mixed System..... | Appendix- 24 |
| Appendix 3 Using Data of Other Applications | Appendix- 26 |
| 3.1 Using Excel Files as Device Comments..... | Appendix- 26 |
| 3.2 Using a Word File as a Device Comment | Appendix- 28 |
| Appendix 4 Restrictions on PLC Type Change..... | Appendix- 30 |
| Appendix 5 Examples of Wiring RS-232 Cable for Connection of C24 and Personal computer | Appendix- 40 |
| 5.1 A Series | Appendix- 40 |
| 5.2 QnA Series | Appendix- 42 |
| 5.3 Q Series | Appendix- 44 |
| Appendix 6 ROM Writer Wiring Examples | Appendix- 45 |
| Appendix 7 PLC CPU Version Correspondence Chart | Appendix- 46 |
| 7.1 About QnA series function versions..... | Appendix- 46 |
| 7.2 About Q4ARCPU function version..... | Appendix- 47 |
| 7.3 About the Q series function version..... | Appendix- 48 |
| Appendix 8 Restrictions and Cautions..... | Appendix- 49 |
| Appendix 9 About SW <input type="checkbox"/> D5-GPPW Compatibility | Appendix- 58 |
| Appendix 10 GX Developer and GX Simulator Operations..... | Appendix- 60 |
| Appendix 11 Notes on FX Series Programming | Appendix- 61 |
| 11.1 Ladder Monitor Display | Appendix- 61 |
| 11.2 Handling of Comments..... | Appendix- 64 |
| Appendix 12 Instruction Conversion Lists | Appendix- 65 |
| 12.1 Instruction Conversion List for A ↔ Q/QnA Conversions | Appendix- 65 |
| 12.2 A Instruction Conversion List for FX Series Conversions | Appendix- 85 |
| 12.3 List of Instruction Conversions for Change between Q Series and A/QnA Series | Appendix- 98 |
| Appendix 13 About the A6TEL/Q6TEL..... | Appendix-102 |
| 13.1 A6TEL/Q6TEL Switch Settings..... | Appendix-102 |
| 13.2 How to Change the Proximate Mode of the Q6TEL | Appendix-105 |
| Appendix 14 Functions Added to Update from Previous Version | Appendix-106 |
| Appendix 15 The strings which can not be used in label programming..... | Appendix-107 |

| | |
|-------|----------------------|
| INDEX | Index- 1 to Index- 6 |
|-------|----------------------|

About Manuals

The following lists the manuals for this software package.
Refer to the following table when ordering manuals.

Related Manuals

| Manual Name | Manual No. (Model Code) |
|---|----------------------------|
| GX Developer Version7 Operating Manual (Startup). Describes the system configuration, installation method, and start-up procedure of GX Developer. | SH-080165 (13JU13) |
| GPP Function software for Windows SW4D5C-GPPW SW4D5F-GPPW SW4D5C-LLT SW4D5F-LLT Starting GX Developer. Describes the following using illustrations for persons who use SW4D5C -GPPW and SW4D5C -LLT for the first time: installation procedure, start-up procedure, basic information, ladder creating and editing procedure, printing out procedure, monitoring procedure, and debugging procedure. | IB-0800057 (13J966) |
| GX Simulator Version6 Operating Manual. Describes the setting and operating methods for monitoring the device memory and simulating the machine side operations using GX Simulator. (Sold separately.) | SH-080169 (13JU17) |
| GX Developer Version7 Operating Manual (SFC). Describes the editing and monitoring operations of the SFC functions using GX Developer. (Sold separately.) | SH-080167 (13JU15) |
| GX Developer Version7 Operating Manual (MELSAP-L). Describes the editing and monitoring operations of the MELSAP-L format SFC functions using GX Developer. (Sold separately.) | SH-080168 (13JU16) |
| GX Developer Version7 Operating Manual (Function Block). Describes the editing and monitoring operations of the function blocks using GX Developer. (Sold separately.) | SH-080174 (13JU20) |
| Data Conversion Software Package for Windows SW0D5C-CNVW-E Operating Manual. Explains the data conversion method and other functions using SW0D5C-CNVW-E. | IB-0800004 (13J949) |

How the manual describes the explanation is shown below.

5.11 Renaming Data in a Project

| | | |
|---|-----|----|
| A | QnA | FX |
| ○ | ○ | ○ |

[Purpose]
 Renames the existing data in a project.

[Operating Procedure]
 Select [Project] → [Edit data] → [Rename].

[Dialog Box]

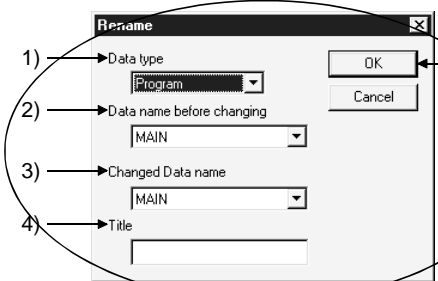

[Description]

- 1) Data type**
 Designates the data type (program, common comment, comments by program, device memory).
- 2) Data name before renaming**
 Designates the data name before renaming.
- 3) Renamed data name**
 Designates the new data name after renaming.
 The data name must be designated in up to 8 characters.
- 4) Title**
 Displays the set title of the data.
 If necessary, the title can be edited and stored.
 It must be designated in up to 32 characters.
- 5) OK button**
 Click this button after making necessary settings.

POINT

This operation cannot change the data name of comments by program to "COMMENT".
 For changing the comments by program to the common comment (COMMENT), refer to "Setting Comment Types" (Section 9.6).

5 - 11

This table indicates the applicable items for A series, QnA series and FX series.

Items which are set in the section are explained.

The desired window opens by selecting the items in the specified order.

The dialog boxes set in the section are explained.

The contents of the items and buttons are explained. The numbers correspond to those specified in the window shown under the title of [Dialog box].

This gives the information related to the topic discussed and also the helpful information.

Symbols used in this manual, and the contents and examples of them are shown below.

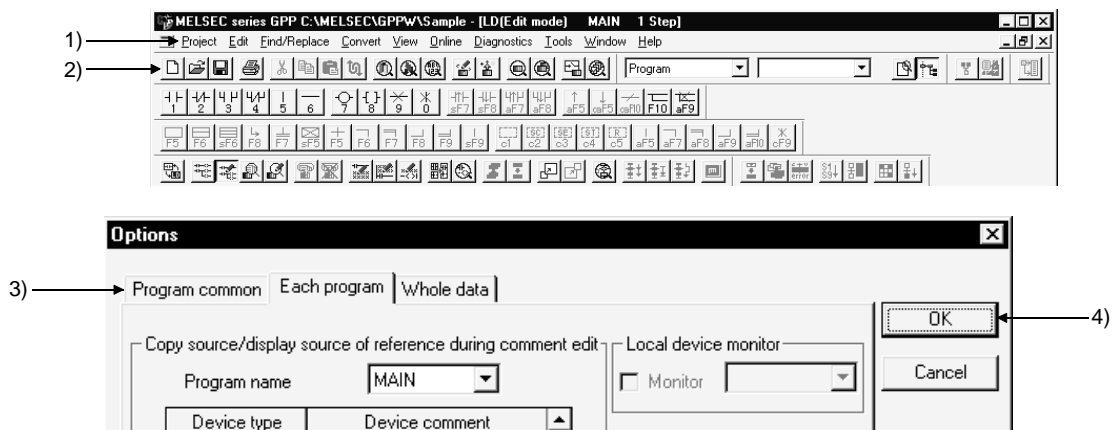

| No. | Symbol | Contents | Example |
|-----|--------|------------------------------|--------------------|
| 1) | [] | Menu name of menu bar | [Project] |
| 2) | | Icon in toolbar | |
| 3) | << >> | Tab name of dialog box | <<Program common>> |
| 4) | | Command button in dialog box | button |

The functions that cannot be operated on GX Developer are grayed (masked) and cannot be selected. There are the following reasons why they are not selectable.

- (1) The PLC CPU used does not have the functions
 - For example, when the A1SCPU is chosen as the PLC type, it does not have the STEP-RUN function and therefore [Online] → [Debug] → [Debug] cannot be selected.
 - To see if your PLC CPU has the operable functions, check the specifications in the PLC CPU user's manual or the like.
- (2) The functions cannot be selected because they cannot be used with the currently operated function
 - For example, when the monitor screen is open, PLC type change, connection setup, PLC data attribute change, data coupling, parameter check and all parameter clear cannot be performed.

Abbreviations and Terms in This Manual

This manual uses the abbreviations and terms listed in the following table to discuss the GX Developer Software Package and PLC module. In addition, the following table lists the names of modules whose names must be indicated explicitly.

| Abbreviation/Generic Term | | Description/Target Module |
|---|----------------|--|
| GX Developer | | Generic product name of the product types SWnD5C-GPPW-E, SWnD5C-GPPW-EA, SWnD5C-GPPW-EV and SWnD5C-GPPW-EVA. (n denotes any of versions 0 to 7) |
| GX Developer Version n (SWnD5C-GPPW-E) | | When limited to the major version (n denotes the version number) |
| GX Developer Version n (SWnD5C-GPPW-E) or earlier | | When limited to earlier than the major version (n denotes the version number) |
| GX Developer Version n (SWnD5C-GPPW-E) or later | | When limited to later than the major version (n denotes the version number) |
| GX Simulator | | Generic product name of the product types SWnD5C-LLT-E, SWnD5C-LLT-EA, SWnD5C-LLT-EV and SWnD5C-LLT-EVA. (n denotes any of versions 0 to 6) |
| ACPU | | Generic term for PLC available with MELSEC-A Including MOTION (SCPU) (However, GX Developer does not support A1, A2, A3, A3H, A3M, A52G, A73, A0J2 and A3V.) |
| QCPU (A mode) | | Generic term for Q02(H)-A and Q06H-A |
| QnACPU | | Generic term for PLC available with MELSEC-QnA |
| QCPU (Q mode) | | Generic term for Q00J, Q00, Q01, Q02(H), Q06H, Q12H, Q12PH, Q25H and Q25PHCPU |
| FXCPU | | Generic term for PLC available with MELSEC-F (The target PLCs are FX0, FX0S, FX0N, FX1, FX, FX2, FX2C, FX1S, FX1N, FX2N and FX2NC.) |
| AnNCPU | | A1NCPU, A2NCPU(S1), A3NCPU |
| AnACPU | | A2ACPU(S1), A3A |
| AnUCPU | | A2UCPU(S1), A2USCPU(S1), A2ASCPU(S1), A2ASCPU-S30, A2ASCPU-S60, A2USHCPU-S1, A3U, A4U |
| A series | | For GX Developer PLC type selection by ACPU |
| QnA series | | For GX Developer PLC type selection by QnACPU |
| Q series | | For GX Developer PLC type selection by QCPU (Q mode) |
| FX series | | For GX Developer PLC type selection by FXCPU |
| GPPA | | SW <input type="checkbox"/> SRXV-GPPA SW <input type="checkbox"/> IVD-GPPA |
| GPPQ | | SW <input type="checkbox"/> IVD-GPPQ |
| MEDOC | | MELSEC-MEDOC |
| FXGP(DOS) | | SW1PC-FXGP/AT |
| FXGP(WIN) | | SW0PC-FXGP/WIN-E |
| SFC | | Generic term for MELSAP2/MELSAP3/MELSAP-L |
| Computer link Module | For A series | A1SJ71C24-R2, A1SJ71C24-R4, A1SJ71C24-PRF A2CCPUC24(-PRF), A1SCPUC24-R2 |
| | For AnU | AJ71UC24, A1SJ71UC24-R2, A1SJ71UC24-R4, A1SJ71UC24-PRF |
| Serial communication Module | For QnA series | Generic term for AJ71QC24, AJ71QC24-R2, AJ71QC24-R4, AJ71QC24N, A1SJ71QC24, A1SJ71QC24-R2, AJ71QC24N-R2, AJ71QC24N-R4, A1SJ71QC24N and A1SJ71QC24N-R2 |
| | For Q series | Generic term for QJ71C24 and QJ71C24-R2 |
| C24 | | Computer link Module, Serial Communication Module |
| QE71 | | AJ71QE71(B5), A1SJ71QE71-B2, A1SJ71QE71-B5 |
| E71 | | AJ71AJ71E71-S3, A1SJ71E71-B2-S3, A1SJ71E71-B5-S3 A1SJ71E71-B2, A1SJ71E71-B5 |
| Q series-compatible E71 | | Generic term for QJ71E71, QJ71E71-B2 and QJ71E71-100 |
| Ethernet board | | Ethernet PC card, Ethernet I/F board |
| CC-Link | | Control & Communication Link |
| PLC | | PROGRAMMABLE LOGIC CONTROLLER |

| Abbreviation/Generic Term | Description/Target Module |
|---------------------------|--|
| Personal computer | Personal computer compatible with Windows [®] 95/98/Me/2000 and Windows NT [®] Workstation 4.0 |
| Actual program | A program created in the label program and compiled. A program executable via the PLC CPU. |
| Actual device | The term "actual device" is used in this manual to differentiate a program created under a label name and one that has been compiled. (A compiled program to which device has been assigned.) |
| GSV | Q173CPU/Q172CPU Programming Software SW6RN-GSV13 Q173CPU/Q172CPU Programming Software SW6RN-GSV22P |
| PC CPU module | MELSEC-Q series compatible PC CPU module (CONTEC CO. LTD. make) |

1. GENERAL DESCRIPTION

1

Product Outline and Features

Outline

This section explains GX Developer (unless otherwise specified, the product name represented GX Developer will hereafter be its English version 7).

GX Developer is a software package having the following functions.

1. Program creation

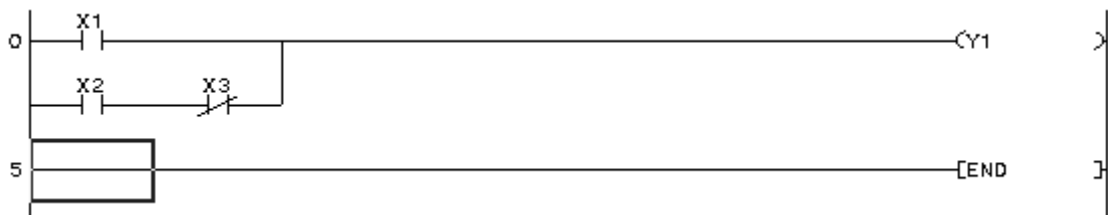

2. Writing and reading to/from PLC

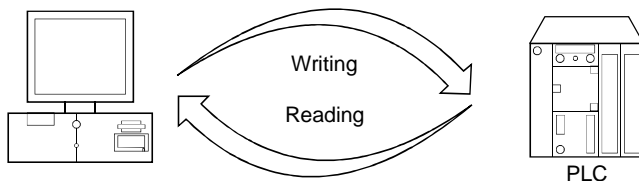

3. Monitoring (example: device batch monitoring)

The circuit monitor, device monitor, and device registration monitor can be used for monitoring.

| Device | +F | E | D | C | +B | A | 9 | 8 | +7 | 6 | 5 | 4 | +3 | 2 | 1 | 0 | | |
|--------|----|---|---|---|----|---|---|---|----|---|---|---|----|---|---|---|---|-----|
| D01 | 0 | 0 | 0 | 0 | 0 | 0 | 0 | 0 | 0 | 0 | 0 | 0 | 0 | 0 | 0 | 0 | 0 | 0 |
| D02 | 0 | 0 | 0 | 0 | 0 | 0 | 0 | 0 | 0 | 0 | 1 | 0 | 0 | 1 | 0 | 1 | | 37 |
| D03 | 0 | 0 | 0 | 0 | 0 | 0 | 0 | 0 | 1 | 0 | 0 | 1 | 0 | 0 | 0 | 0 | | 144 |

4. Debugging

The created sequence program is written into PLC to test that the written sequence program operates normally.

In addition, newly developed GX Simulator*1 (unless otherwise specified, the product name represented GX Simulator will hereafter be its English version 6) can be used to debug the program on a single personal computer.

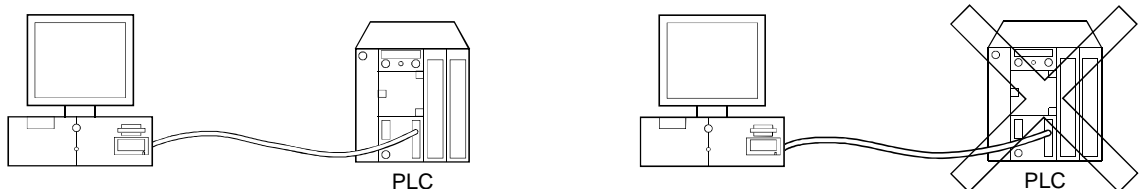

5. Diagnostics PLC

The current error status, error status or error log can be displayed to shorten the time required for error recovery.

Also, system monitoring (QCPU (Q mode) only) provides in-depth information on the special functions. Therefore, if an error occurs, recovery work can be done in much shorter time.

*: The GX Simulator is an independent function and may be purchased separately.

Features

GX Developer has the following features.

1. Common software

GX Developer can create the data of the Q series, QnA series, A series (including the motion controller (SCPU)) and FX series, with their setting operations common, and is abbreviated to GPPA. Note that this does not apply to the A6GPP/A6PHP-compatible software package. Data can be converted into an SW -GPPQ GPP function software package (hereafter abbreviated to GPPQ) format file and edited on GPPA or GPPW.

When the FX series is selected, data can be converted into a DOS version programming software (hereafter abbreviated to FXGP(DOS)) or SW0PC-FXGP/WIN programming software (hereafter abbreviated to FXGP(WIN)) format file and you can edit data on FXGP(DOS) or FXGP(WIN).

2. Advantages of Windows are utilized for dramatic improvements in operability

Comment data created on Excel, Word or the like can be copied or pasted for data diversion.

3. Standardized programs

(1) Label programming

By using label programming to create sequence programs, you can create standard programs with labels without being conscious of device numbers.

The programs created by label programming can be compiled for use as an actual program.

(2) Function block (hereafter abbreviated to the FB)

The FB is a function developed to improve the efficiency of developing sequence programs. The ladder blocks of a sequence program that are used repeatedly for sequence program development are converted into components to facilitate sequence program development. Also, the conversion of ladder blocks into components prevents sequence program inputting mistakes when they are utilized for other sequence programs.

(3) Macros

By naming any ladder patterns (macro names) and registering them to a file (macro registration), merely entering simple instructions allows the registered ladder patterns to be read and the devices to be changed for data diversion.

4. Ease of setting access to another station

As the connection target can be specified graphically, you can set access to another station easily if a complicated system has been configured.

5. Connection with PLC CPU in any of various methods

(1) Via serial port

(2) Via USB

(3) Via MELSECNET/10(H) board

(4) Via CC-Link board

(5) Via Ethernet board

(6) Via CPU board

(7) Via AF board

6. Fully useful debugging functions

(1) Use of the GX Simulator ensures much easier debugging.

(a) There is no need to make connection with the PLC CPU.

(b) There is no need to create a pseudo sequence program (debugging program).

(2) Containing the explanations of CPU errors and special relays/special registers, Help is useful when an error has occurred online or when you want to know the contents of the special relays/special registers during programming.

(3) If an error occurs during data creation, the corresponding message is displayed to indicate the cause of that error, substantially reducing data creation time.

1.1 Functions Lists

The GX Developer functions are listed below.

The functions are divided into normally common functions (project, online, diagnosis, tool, window, help) and functions for objects to be edited and set (edit, search/replacement, conversion, display).

In addition, there are executable and inexecutable functions depending on the CPU series.

"○" in the table indicates the function that is usable when GX Developer is installed as monitoring-only GX Developer.

(1) List of common functions

Fixed functions independent of the type of the object being edited or set

| Project (Common functions) | | Only for monitoring | Refer To |
|--|--|---------------------|----------|
| New project | Creates a new project. | | 4.1 |
| Open project | Opens an existing project. | ○ | 4.2 |
| Close project | Closes an open project. | ○ | 4.3 |
| Save | Saves the project. | ○ | 4.4 |
| Save as | Names and saves the project. | ○ | 4.5 |
| Delete project | Deletes an existing project. | | 4.6 |
| Verify | Verifys data between projects. | ○ | 4.7 |
| Copy | Copies data between projects. | | 4.8 |
| Edit data | | | |
| New | Adds data to a project. | | 4.9 |
| Copy | Copies data in a project. | | 4.10 |
| Delete | Deletes data in a project. | | 4.11 |
| Rename | Renames data in a project. | | 4.12 |
| Change program type | Change the program type in the project | | 4.13 |
| Change PLC type | Changes the PLC type. | | 4.14 |
| Import file | | | |
| Import from GPPQ format file | Read a GPPQ file | | 4.15.1 |
| Import from GPPA format file | Read a GPPA file | | 4.15.1 |
| Import from FXGP(WIN) format file | Read a FXGP(WIN) file | | 4.15.1 |
| Import from FXGP(DOS) format file | Read a FXGP(DOS) file | | 4.15.1 |
| Import from Melsec Medoc format file (Print out) | Import from Melsec Medoc format file | | 4.15.2 |
| Import from Melsec Medoc format file | Import from Melsec Medoc format file | | 4.15.3 |
| Export file | | | |
| Export to GPPQ format file | Write a GPPQ files | | 4.16 |
| Export to GPPA format file | Write a GPPA files | | 4.16 |
| Export to FXGP(WIN) format file | Write a FXGP(WIN) files | | 4.16 |
| Export to FXGP(DOS) format file | Write a FXGP(DOS) files | | 4.16 |
| Macro | | | |
| Registration macros | Registration macros | | 5.2.1 |
| Macro utilize | Macro utilize | | 5.2.2 |
| Delete macros | Delete macro instruction from the file | | 5.2.3 |
| Macro reference path | Set the macro instruction reference path | | 5.2.4 |
| Function Block | | | |
| Diversion | Diversion FB on ladder program. | | |
| Rename | Rename the FB | | |
| Printer setup | Changes the printer settings. | ○ | 14.1 |
| Print | Prints data. | ○ | 14 |
| Start new GX Developer session | Restarts GX Developer. | ○ | 4.17 |
| Exit GX Developer | Exits GX Developer. | ○ | 4.18 |

(To the next page)

(Continued from the previous page)

| Online (Common functions) | | Only for monitoring | Refer To |
|---|---|---------------------|----------|
| Transfer setup | Designates a PLC destination from GX Developer. | ○ | 16.1 |
| Read from PLC | Reads data from PLC. | ○ | 16.3 |
| Write to PLC | Writes data to PLC. | | 16.3 |
| Verify with PLC | Verifys data with PLC data. | ○ | 16.4 |
| Write to PLC (Flash ROM) | | | |
| Write the program memory to ROM | Writes program memory data to the standard ROM/IC memory card (ROM). | | 16.5.1 |
| Write to PLC (Flash ROM) | Writes data to the standard ROM/IC memory card (ROM). | | 16.5.2 |
| Delete PLC data | Deletes PLC data. | | 16.6 |
| Change PLC data attributes | Changes PLC data attributes. | | 16.7 |
| PLC user data | | | |
| Read PLC user data | Reads user data from the PLC. | ○ | 16.8.1 |
| Write PLC user data | Writes user data to the PLC. | | 16.8.2 |
| Delete PLC user data | Deletes user data of the PLC. | | 16.8.1 |
| Monitor | | | |
| Monitor mode | Places the circle edit screen in monitor mode. | ○ | 17.1 |
| Monitor (Write mode) | Sets the circuit (monitor write) mode. | | 17.3 |
| Start monitor (All windows) | Starts monitoring all open windows. | ○ | 17.2 |
| Stop monitor (All windows) | Stops monitoring all open windows. | ○ | 17.2 |
| Start monitor | Restarts the stopped monitor. | ○ | 17.1 |
| Stop monitor | Stops the monitor. | ○ | 17.1 |
| Change current value monitor (Decimal) | Displays the current device value of the circuit monitor in decimal form. | ○ | 17.4 |
| Change current value monitor (Hexadecimal) | Displays the current device value of the circuit monitor in hexadecimal form. | ○ | 17.4 |
| Device batch | Monitors devices in batch mode. | ○ | 17.5 |
| Entry data monitor | Entry data mode | ○ | 17.6 |
| Buffer memory batch | Monitors the buffer memory in batch mode. | ○ | 17.5 |
| Monitor condition setup | Sets the monitor execution conditions. | ○ | 17.7 |
| Monitor stop condition setup | Sets the monitor stop conditions. | ○ | 17.7 |
| Program monitor list | Monitors a program list. | | 17.8 |
| Interrupt program monitor list | Lists the interrupt programs. | | 17.9 |
| Scan time measurement | Measures the scan time. | ○ | 17.10 |
| Entry ladder monitor | Entry the ladder block | ○ | 17.12 |
| Delete all entry ladder | Delete all entry ladder | | 17.13 |
| Debug (ladder) | | | |
| Device test | Turns on or off the device or changes the value. | | 18.1 |
| Forced input output registration/cancellation | This will register the forced input output of device X/Y | | 18.2 |
| Debug | Executes/disables the debugging function. | | 18 |
| Skip execution | Makes settings for skip. | | 18.5 |
| Partial execution | Makes settings for partial operation. | | 18.3 |
| Step execution | Makes settings for step execution. | | 18.4 |
| Trace | | | |
| Sampling trace | Execute sampling trace. | ○ | 18.11 |
| Remote operation | Operates the PLC remotely. | | 18.6 |

(To the next page)

















(Continued from the previous page)

| Online (Common functions) | | Only for monitoring | Refer To |
|----------------------------------|--|---------------------|----------|
| Keyword/Password (Q series) | | | |
| Register keyword | Registers or changes the keyword. | | 19 |
| Delete keyword | Cancels the keyword. | | 19 |
| Disable keyword | Unlocks access by keywords | ○ | 19 |
| Clear PLC memory | Clears the PLC memory cassette or device memory. | | 20.1 |
| Format PLC memory | Formats the PLC memory. | | 20.2 |
| Arrange PLC memory | Arranges the data area within the PLC memory. | | 20.3 |
| Set clock | Sets the internal timer of the PLC. | ○ | 20.4 |
| Diagnosis (Common functions) | | | Refer To |
| PLC Diagnostics | Diagnoses the PLC. | ○ | 21.1 |
| Network diagnostics | Diagnoses the network | ○ | 21.2 |
| Ethernet diagnostics | Diagnoses Ethernet. | ○ | 21.4 |
| CC-Link / CC-Link/LT diagnostics | Diagnoses the CC-Link or CC-Link/LT | ○ | 21.3 |
| System monitor | Monitors the system status of the PLC. | ○ | 21.5 |
| Online module change | Changes module during online. | | 21.6 |
| Tool (Common functions) | | | Refer To |
| Check program | Checks the program. | ○ | 15.1 |
| Merge data | Links data. | | 15.2 |
| Check parameter | Checks the parameter. | ○ | 15.3 |
| Transfer ROM | | | |
| Read | Reads data from ROM. | ○ | 15.8.1 |
| Write | Writes data to ROM. | | 15.8.1 |
| Compare | Compares data with ROM data. | ○ | 15.8.1 |
| Write to file | Writes ROM data to files. | | 15.8.2 |
| Delete unused comments | Delete the comments which isn't used at program | | 15.9 |
| Clear all parameters | Deletes parameters. | | 15.4 |
| IC memory card | | | |
| Read IC memory card | Reads data from the IC memory card. | ○*1 | 15.5.1 |
| Write IC memory card | Writes data to the IC memory card. | | 15.5.2 |
| Start ladder logic test | Starts the ladder logic test. | | 15.14 |
| Set TEL data | | | |
| Connection | Connect the line for A6TEL/Q6TEL | ○ | 22.4 |
| Disconnect | Disconnect the line | ○ | 22.4.3 |
| TEL data | Set the report data of A6TEL or Q6TEL | ○ | 22.3.3 |
| AT command | Entry the modem | ○ | 22.3.2 |
| Call book | Set the call book | ○ | 22.3.1 |
| Intelligent function utility | | | |
| Utility list | Shows the utility names required to edit the intelligent function unit parameters. | ○ | 15.7 |
| Session | Starts the intelligent function utility. | ○ | 15.7 |
| Customize keys | Changes key assignments for circuit symbol input. | ○ | 15.9 |
| Change display color | The display color is changed | ○ | 15.10 |
| Options | Sets the options. | ○ | 15.11 |
| Create start-up settings file | Creates a file to save initial settings of the project. | ○ | 15.13 |
| Starting CC-Link Configurator | | | 15.16 |
| Window (Common functions) | | | Refer To |
| Cascade | Cascades windows. | ○ | 15.12 |
| Tile vertically | Tiles the windows vertically. | ○ | 15.12 |
| Tile horizontally | Tiles the windows horizontally. | ○ | 15.12 |
| Arrange icons | Arranges the icons in the lower part of the window. | ○ | 15.12 |
| Close all Windows | Close all open windows. | ○ | 15.12 |
| Help (Common functions) | | | Refer To |
| CPU error | Displays the description of each CPU error code. | ○ | 15.15 |
| Special relay/register | Displays the description of special relays or registers. | ○ | 15.15 |
| Key operation list | Displays the description of each key operation. | ○ | 15.15 |
| Product information | Displays product information (such as version number). | ○ | 15.15 |
| Connect to MELFANSweb | Connect to MELFANSweb | ○ | 15.15 |

*1: Disabled for Use Label + FB.

(2) Ladder editing function list

The following functions can be performed to edit the ladders and operation outputs/transition conditions.

| Edit (Ladder editing functions) | | Only for monitoring | Refer To |
|--|---|---------------------|-----------|
| Undo | Reverses the last operation. | ○*2 | 6.2.9 |
| Cut | Moves the selected data to the Clipboard. | ○*2 | 3.3.1 |
| Copy | Copies the selected data to the Clipboard. | ○ | 3.3.2 |
| Paste | Pastes the contents of the Clipboard at the cursor position. | ○*2 | 3.3.1 |
| Insert line | Inserts a row at the cursor position. | | 6.2.5 |
| Delete line | Deletes a row at the cursor position. | | 6.2.5 |
| Insert row | Inserts a column at the cursor position. | | 6.2.5 |
| Delete row | Deletes a column at the cursor position. | | 6.2.5 |
| Insert NOP batch | Inserts NOP before a circuit block at the cursor position. | | 6.2.6 |
| Delete NOP batch | Deletes all NOPs in the program at a time. | | 6.2.7 |
| Draw line | Inserts a line. | | 6.2.2 |
| Delete line | Deletes a line. | | 6.2.4 |
| Change TC setting | Changes the setting value of the timer or counter. | | 6.3 |
| Read mode | Places the circuit screen in the read mode. | ○ | 6 |
| Write mode | Places the circuit screen in write mode. | | 6 |
| Ladder symbol | | | |
| Open contact | Inserts  at the cursor position. | ○*3 | 6.2 |
| Close project contact | Inserts  at the cursor position. | ○*3 | 6.2 |
| Open branch | Inserts  at the cursor position. | ○*3 | 6.2 |
| Close project branch | Inserts  at the cursor position. | ○*3 | 6.2 |
| Coil | Inserts  at the cursor position. | ○*3 | 6.2 |
| Application instruction | Inserts  at the cursor position. | ○*3 | 6.2 |
| Vertical line | Inserts  at the cursor position. | | 6.2 |
| Horizontal line | Inserts  at the cursor position. | | 6.2 |
| Delete vertical line | Inserts  at the cursor position. | | 6.2 |
| Delete Horizontal line | Inserts  at the cursor position. | | 6.2 |
| Rising pulse | Inserts  at the cursor position. | ○*3 | 6.2 |
| Falling pulse | Inserts  at the cursor position. | ○*3 | 6.2 |
| Rising pulse Open branch | Inserts  at the cursor position. | ○*3 | 6.2 |
| Falling pulse Close branch | Inserts  at the cursor position. | ○*3 | 6.2 |
| Invert operation results | Inserts  at the cursor position. | ○*3 | 6.2 |
| Convert operation results to rising pulse | Inserts  at the cursor position. | ○*3 | 6.2 |
| Convert operation results to falling pulse | Inserts  at the cursor position. | ○*3 | 6.2 |
| Documentation | | | |
| Comment | Edits the comment at the cursor position. | | 9.4.4 |
| Statement | Edits the statement in the ladder at the cursor position. | | 10.3.1(1) |
| Note | Edits the note in the ladder at the cursor position. | | 10.4.1(1) |
| Statement/Note block edit | The statement and note under the program is edited by the batch. | | 10.5 |

*2: Enabled for ladder registration monitoring.

*3: Enabled as a search function.

| Search/Replacement (Ladder editing functions) | | Only for monitoring | Refer To |
|---|--|---------------------|----------|
| Find device | Searches for a device. | ○ | 6.4.1 |
| Find instruction | Searches for an instruction. | ○ | 6.4.2 |
| Find step No. | Searches for a step number. | ○ | 6.4.3 |
| Find character string | Searches for a character string in comment, note, or statement. | ○ | 6.4.4 |
| Find contact or coil | Find contact or coil | ○ | 6.4.5 |
| Finding data | Finding data | | 6.4.6 |
| Replace device | Searches for and replaces a device. | | 6.4.7 |
| Replace instruction | Searches for and replaces an instruction. | | 6.4.8 |
| Change open/close contact | Searches for and replaces a contact a with a contact b. | | 6.4.9 |
| Replace character string | Searches for and replaces a character string in comment, note, or statement. | | 6.4.10 |
| Change module start address | This will exchange the starting address of the buffer memory access instruction | | 6.4.11 |
| Replace statement/note type | Searches for and replaces the type of a character string between statement and note. | | 6.4.12 |
| Replacing data | Replacing data | | 6.4.13 |
| Cross referense list | Finds whether the device is being used by a contact or coil. | ○ | 6.4.14 |
| List of used devices | Finds where the device is used. | ○ | 6.4.15 |
| Conversion (Ladder editing functions) | | | Refer To |
| Convert | Converts the program. | | 8.1 |
| Convert (All programs being edited) | Converts the programs (not converted yet) in all windows. | | 8.2 |
| Convert block (Online change) | Converts the program and writes it during run. | | 16.9 |
| Display (Ladder editing functions) | | | Refer To |
| Comment | Displays or hides comments. | ○ | 3.8 |
| Statement | Displays or hides statements. | ○ | 3.9 |
| Note | Displays or hides notes. | ○ | 3.10 |
| Device Label | Displays or hides device names. | ○ | 3.11 |
| Macro instruction format display | Provides display in the user macro instruction format. | ○ | 5.16 |
| Comment format | | | |
| 4 × 8 characters | Shows comments in 4 × 8 or 2 × 8 characters. | ○ | 3.12 |
| 3 × 5 characters | Shows comments in 3 × 5 characters. | ○ | 3.12 |
| Alias display format | | | |
| Displayed instead of device | Displays the machine name at the device name display position. | ○ | 3.13.1 |
| Displayed with device | Arrange and displays the machine name above the device name. | ○ | 3.13.2 |
| Toolbar | Displays or hides the toolbar. | ○ | 3.4 |
| Status bar | Displays or hides the status bar. | ○ | 3.5 |
| Zoom | | | |
| 50% | Displays a circuit reduced to 50%. | ○ | 3.6 |
| 75% | Displays a circuit reduced to 75%. | ○ | 3.6 |
| 100% | Displays a full-size circuit. | ○ | 3.6 |
| 150% | Displays a circuit magnified to 150%. | ○ | 3.6 |
| Auto | Displays a circuit according to the screen size. | ○ | 3.6 |
| Project data list | Displays or hides the project data list. | ○ | 3.7 |
| Instruction list | Switches program circuit display and list display. | ○ | 6 |
| Elapsed time | Displays the elapsed time. | ○ | 22.4.1 |

(3) Device comment editing function list

The following functions can be performed to edit device comments.

| Edit | | Only for monitoring | Refer To |
|-------------------------------|--|---------------------|----------|
| Clear all (all devices) | Deletes the comments or device names of all devices. | ○ | 9.5.1 |
| Clear all (displayed devices) | Deletes the displayed comments or device names. | ○ | 9.5.2 |
| Setup comment | Sets the common comments or comments by program. | ○ | 9.6 |
| Setup comment range | Sets a comment range. | ○ | 9.7 |

(4) Device memory setting function list

The following functions can be performed to set the device memory.

| Edit | | Only for monitoring | Refer To |
|-------------------------------|--|---------------------|----------|
| Clear all (all devices) | Deletes data of all devices. | ○ | 11.3.1 |
| Clear all (displayed devices) | Deletes the data of displayed devices. | ○ | 11.3.2 |
| FULL | Sets all data to the specified value. | ○ | 11.4 |

(5) Label programming function list













The following functions are available for label program editing.

| Editing (Functions for label program editing) | | Only for monitoring | Refer To |
|--|---|---------------------|----------|
| Auto device setting | Setting auto device | | 5.1.4 |
| Global variable setting | Setting global variable | | 5.1.3 |
| Local variable setting | Setting local variable | | 5.1.3 |
| Editing (Functions for local label variable/global label variable editing) | | | Refer To |
| Insert line | Inserts a line at the cursor position | | 5.1.3 |
| Add line | Adds a line under the cursor position | | 5.1.3 |
| Delete line | Delete a line from the cursor position | | 5.1.3 |
| Delete auto External | Delete all Auto External | | 5.1.5 |
| Delete all | Delete all variables | | 5.1.6 |
| Auto device setting | Setting auto device | | 5.1.4 |
| Global variable setting | Setting global variable | | 5.1.3 |
| Import the device comment | Import the device comment (local label variables only) | | 5.1.7 |
| Export the device comment | Export the device comment | | 5.1.8 |
| Display (Functions for label program editing) | | | Refer To |
| Display device program | Switches the display/non-display of the device display screen. | | 5.1.10 |
| Device program display mode | | | |
| Below | Display the zoom or the device screen at below | | 5.1.10 |
| Right | Display the zoom or the device screen at right | | 5.1.10 |
| Display step synchronization | Display step synchronization between label program and device program | | 5.1.10 |
| Conversion (Functions for label program editing) | | | Refer To |
| Compile | Compile the label program | | 5.1.9 |
| Compile (All programs being edited) | Compile the all the not compiled label programs | | 5.1.9 |
| Compile (All programs) | Compile the all label programs | | 5.1.9 |
| Compile option | Set compile option | | |
| Tool | | | Refer To |
| Sort | | | 5.1.3 |
| Label order | Sort by label | | 5.1.3 |
| Device/Constant order | Sort by Device/Constant | | 5.1.3 |
| Device type order | Sort by Device type | | 5.1.3 |

(6) SFC editing function list

The following functions can be performed to edit SFC.

For details, refer to the GX Developer Version6 operating manual (SFC manual).

| Edit (SFC editing functions) | | Only for monitoring |
|---|---|---------------------|
| Insert line | Inserts a row at the cursor position. | |
| Delete line | Deletes a row at the cursor position. | |
| Insert row | Inserts a column at the cursor position. | |
| Delete row | Deletes a column at the cursor position. | |
| Edit the line | | |
| Vertical line | Writes a vertical line. | |
| Selection divergence | Writes selective branch. | |
| Simultaneous divergence | Write a parallel branch. | |
| Selection convergence | Writes a selective coupling. | |
| Simultaneous convergence | Writes a parallel coupling. | |
| Delete the line | Deletes the selective/parallel branch or selective/parallel coupling. | |
| Change TC setting | Changes the setting value of the timer or counter. | |
| Read mode | Places the circuit screen in the read mode. | ○ |
| Write mode | Places the circuit screen in write mode. | |
| Step attribute | | |
| Normal | Set the normal | |
| Stored coil | Set the stored coil (SC) type | |
| Stored operation (without transition check) | Stored operation (without transition check) [SE] type | |
| Stored operation (with transition check) | Set the stored operation (with transition check) [ST] type | |
| Reset | Set the reset [R] type | |
| Edit (SFC editing functions) | | |
| SFC symbol | | |
| Step | Inserts  at the cursor position. | |
| Block START step (with END check) | Inserts  at the cursor position. | |
| Block START step (without END check) | Inserts  at the cursor position. | |
| Jump | Inserts  at the cursor position. | |
| End step | Inserts  at the cursor position. | |
| Dummy step | Inserts  at the cursor position. | |
| Transition | Inserts  at the cursor position. | |
| Selection divergence | Inserts  at the cursor position. | |
| Simultaneous divergence | Inserts  at the cursor position. | |
| Selection convergence | Inserts  at the cursor position. | |
| Simultaneous convergence | Inserts  at the cursor position. | |
| Vertical line | Inserts  at the cursor position. | |
| Documentation | | |
| Comment | Edit comment | |
| Block information | Set the block information | |
| Search/Replacement (SFC editing functions) | | |
| Find device | Finds device. | ○ |
| Find instruction | Finds instruction. | ○ |
| Find step No./block No. | Finds the step number. | ○ |
| Find character string | Finds character string. | ○ |
| Replace device | Replaces a device. | |
| Replace instruction | Replaces an instruction. | |
| Change open/close contact | Replaces open/close contact. | |
| Replace step No. | Replace the step number | |
| Replace character string | Replaces a character string. | |
| Cross reference list | Finds whether the device is being used by a contact or coil. | ○ |
| List of used devices | Finds where the device is used. | ○ |

(To the next page)

(Continued from the previous page)

| Conversion (SFC editing functions) | | Only for monitoring |
|-------------------------------------|---|-----------------------|
| Convert (All programs being edited) | Converts the programs (not converted yet) in all windows. | |
| Convert (block) | Convert the block data | |
| Convert block (all block) | Convert the all block | |
| Display convert error | Display the convert error | |
| Display (SFC editing functions) | | |
| Display comment of step and TR | Displays the step and transition comment. | <input type="radio"/> |
| Display label of step and TR | Displays the step and transition label. | <input type="radio"/> |
| Row of SFC | Set the row number of SFC diagram. | <input type="radio"/> |
| Zoom setting | | |
| Below | Display the zoom ladder of list at below | <input type="radio"/> |
| Right | Display the zoom ladder of list at right | <input type="radio"/> |
| Split | Display the zoom ladder of list | <input type="radio"/> |
| Set the contact at right | | |
| 5 contacts, 11 contacts | You can select "5 contacts" or "9 contacts" when "Right" is specified for Zoom partition. | <input type="radio"/> |
| 9 contacts, 11 contacts | You can select "9 contacts" or "11 contacts" when "Bellow" is specified for Zoom partition. | <input type="radio"/> |
| Review SFC | Review SFC | <input type="radio"/> |
| Display block list | Display block list | <input type="radio"/> |
| MELSAP-L format | Change the SFC view format | <input type="radio"/> |
| Display the reference window | Display the reference window | <input type="radio"/> |
| Online (Common functions) | | |
| Debug (SFC) | | |
| Device test | Sets the device value. | |
| Block brake | Block brake | |
| Step brake | Step brake | |
| Block run | Block run | |
| Step run | Step run | |
| 1 step run | 1 step run | |
| Block forced stopping | Block forced stopping | |
| Step forced stopping | Step forced stopping | |
| Reset stored step | Reset stored step | |
| Run all block | Run All Block | |

1.2 FX Series Programming

This section describes the main differences between the GX Developer operating environment and FX-dedicated programming software (DOS[®] version, Windows[®] version) operating environment and the points to be noted.

Target PLC:

FX0, FX0S, FX0N, FX1, FX2, FX2C, FX1S, FX1N, FX2N, and FX2NC series

In the selection of PLC type, select FXU/FX2C for FX,FX2 and FX2C

See Section 2 for details on the system configuration and connection method.

Operating Environment

- Differences of main terms

- Program file handling

GX Developer programming data is created in units of folders (directories) called the projects.

FXGP(DOS) and FXGP(WIN) do not have the concept of project, and program files are created in any folders (directories) for management.

For this reason, the program file names in FXGP(DOS) and FXGP(WIN) are project names in GX Developer.

For details on project specification, see Section 3.2.

- Comments

(1) The number of characters that can be input may be different (see Appendix 11).

(2) The circuit comment is called the statement.

(3) The coil comment is called the note.

- Parameter settings

Some setup screens have different names (see Section 13).

- Differences in operations

- Step ladder instructions (STL, RET) are displayed in different ways (see Section 6.1.2).

- Monitor display may be partially different (see Appendix 11).

- Application instructions using the FNC. No. are not available.

- Although FX PLC operates in the sequence program with no End instructions, END instructions are forceful input in GX Developer.

- Common items and others
 - Items that are available for only A series or QnA series are disabled and displayed in gray in the GX Developer operation screens.
 - Partial execution, step run, and step run debug functions cannot be used when FXCPU is connected. However, these debug functions can be used for debugging with a single personal computer when the GX Simulator is connected (see Chapter 18 for details).
 - The program conversion function is provided for conversion from A to FX series and vice versa (see Section 4.13 and Appendix 4 for details).
 - The GX Developer FX series allows users to create only one program file. Because A series or QnA series allows users to create multiple program files, this manual may use screen examples including multiple program files when describing the function. However, when FX series is selected, only the main program is displayed on the screen.
 - The connection cable and RS-232/RS-422 converter for FX PLC may be different from those for A or QnA series PLC (see Subsection 2 for details).
 - GX Developer is capable of reading from or writing to FXGP(DOS) and FXGP(WIN) files basically. However, note that there are some exceptions (see Sections 4.14 and 4.15 and Chapter 9 for details).
 - SFC program of FX series is displayed as STL and RET instructions on the circuit edit screen of the GX Developer since the program is described as the step ladder instructions.
It is possible to edit on the circuit.

1.3 Basic Key Specifications

The following table summarizes the purposes of the keys used with the GX Developer.

| Key Name | Purpose |
|-------------------------------------|---|
| Esc | Closes the window, interrupts execution, and selects instructions. |
| Tab | Enters a tab code and switches the target to which the cursor must be moved quickly. |
| Ctrl + Tab | Used in a combination with a alphanumeric key or a function key. |
| Ctrl | |
| Shift | Selects a character at the Shift position. |
| Caps Lock | Switches upper-case and lower-case letters. |
| Alt | Selects the menu. |
| Back space | Deletes a character to the left of the cursor position. |
| Enter | Enters a carriage return. |
| Page Up | Scrolls down the circuit or list by page. (Scrolls a screen in minus direction.) |
| Page Down | Scrolls up the circuit or list by page. (Scrolls a screen in plus direction.) |
| Insert | Enters a space character at the cursor position. |
| Delete | Deletes a character at the cursor position. (Clears all settings.) |
| Home | Moves the cursor to the home position. |
| ↑ ↓ ← → | Moves the cursor or scrolls the circuit or list in unit of lines. (↑ ↓) |
| Ctrl + Home | Moves circuit the cursor to step 0 in the mode. |
| Ctrl + End | Moves the cursor to the End instruction in the circuit mode. |
| Scroll Lock | Inhibits scroll-up and scroll-down. |
| Num Lock | Uses the Ten-key pad for numeric key input only. |

2. SYSTEM CONFIGURATION

2.1 Connection from the Serial Port

The following system configuration is made up by connection from the serial port.

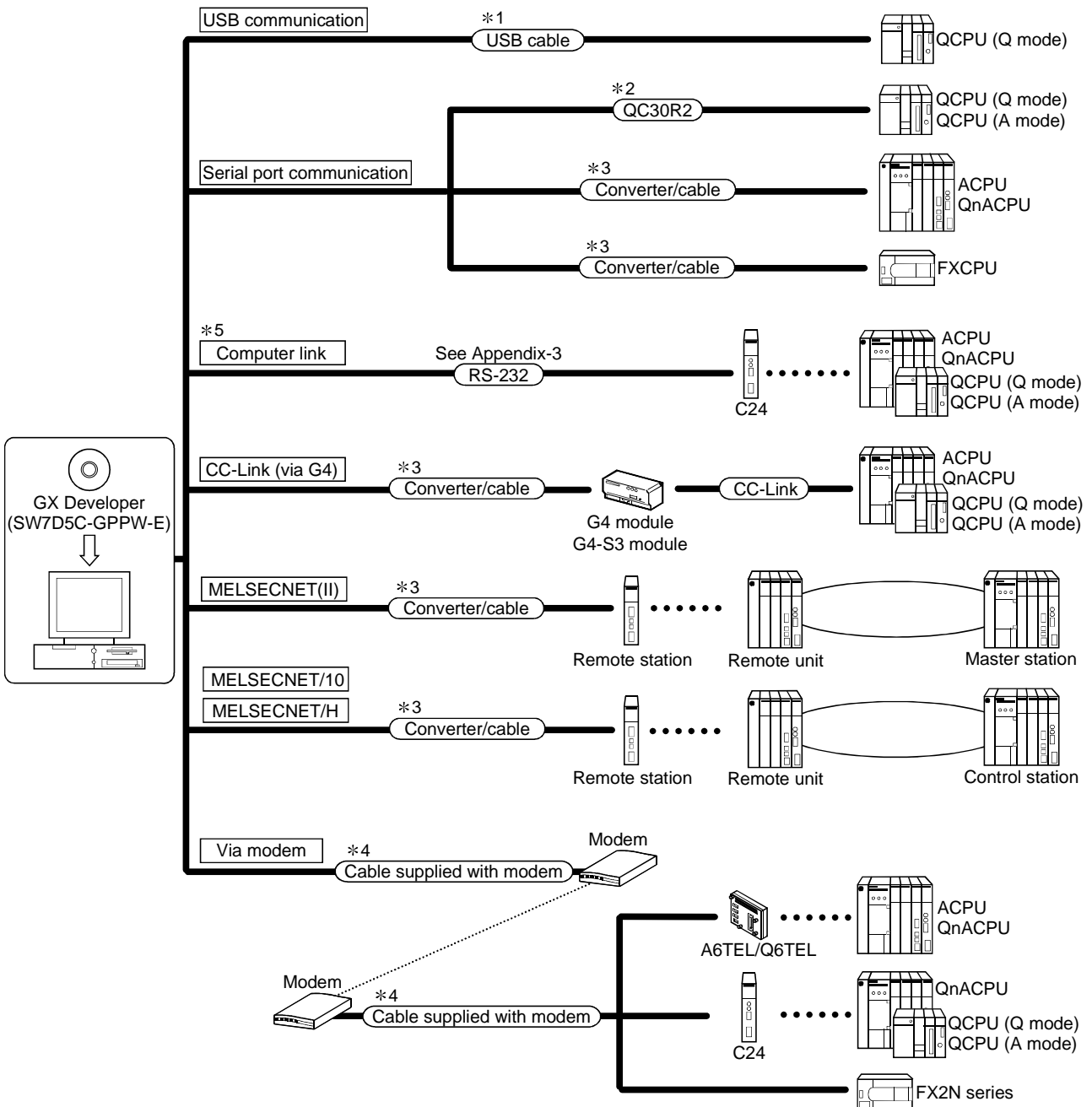

*1: About the USB cable (QCPU (Q mode) compatible)

- (1) Usable with Windows® 98/Me/2000 when the USB driver has been installed.
- (2) Unusable for Windows® 95, Windows NT® Workstation 4.0.
- (3) Use of the USB cable allows only one PLC CPU to be connected.
- (4) Use the USB cable which conforms to the USB Standard Rev. 1.1.
- (5) Refer to POINT in Section 16.1 for precautions for and restrictions on using the USB cable to make communications.

*2: About the cable (QCPU (Q mode), QCPU (A mode) compatible)

For communication in 115.2/57.6kbps
 Fast communication cannot be made if the Personal computer used is not compatible with the communication speed of 115.2/57.6kbps.
 If a communication error occurs, reduce the baud rate setting and restart communication.



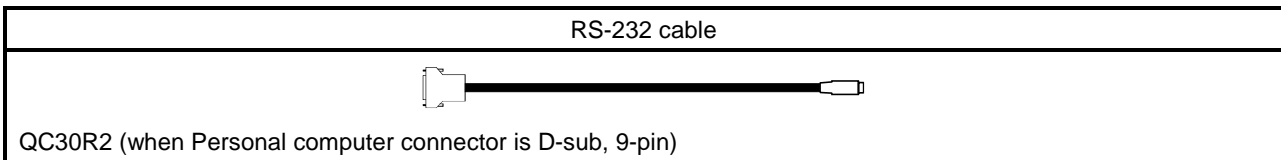

The following cable has been confirmed by Mitsubishi Electric that it will work properly.

Using the cable of Mitsubishi Electric make



*3: About the converter/cable (ACPU, QnACPU, FXCPU compatible)

(1) Using the products of Mitsubishi Electric make

| Personal computer Side (RS-232 cable) | RS-232/RS-422 Converter | PLC CPU Side (RS-422 cable) |
|--|--|---|
|  F2-232CAB-1 (when Personal computer connector is D-sub, 9-pin) |  FX-232AW(C) | For ACPUs, QnACPU, FX1/FX2CPU/FX2cCPU  FX-422CAB (0.3m) FX-422CAB-150 (1.5m) |
| | | For FX0/FX0s/FX0N/FX1S/FX1N/FX2N/FX2NC CPU  FX-422CABO (1.5m) |

- How to identify compatibility of the F2-232CAB and F2-232CAB-1 cables with the ACPU and QnACPU

Check the indication of the model label attached to the cable.

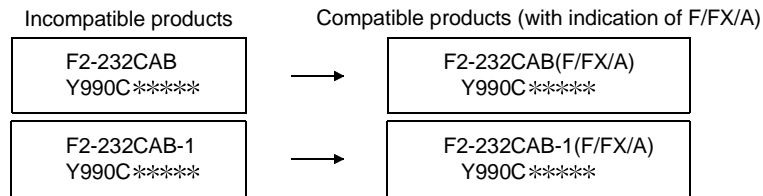

- *4: About the modems relayed

Use the straight cables supplied with the modems.

- *5: About computer link

When the A series is used for communication via the C24/UC24, the program which uses V, Z (index qualification) cannot be monitored.

2.2 Connection from the Interface Boards

The following system configuration is made up by connection from the interface boards.

Refer to the corresponding board manuals for the way to connect the boards and install the drivers.

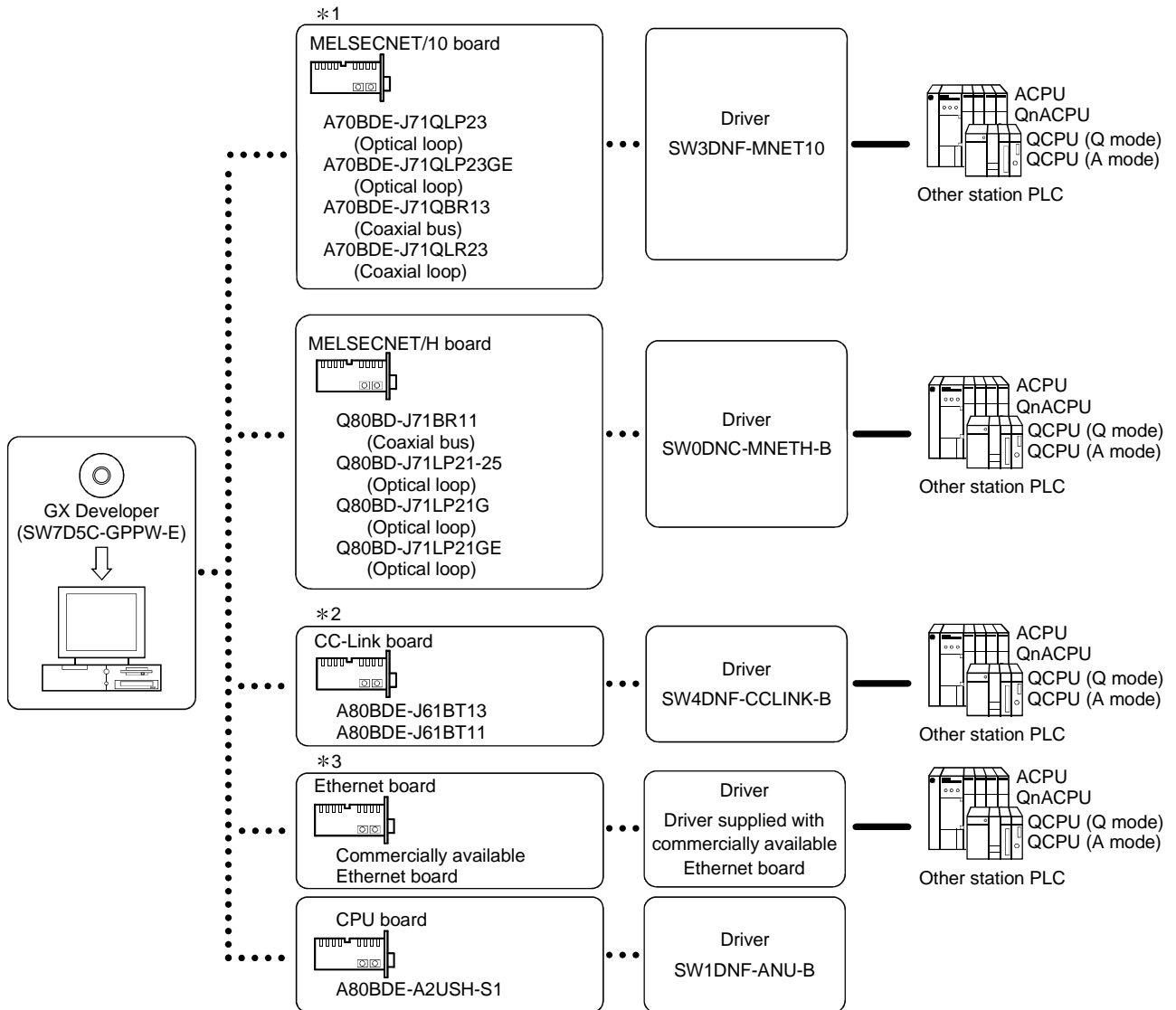

*1: MELSECNET/10 board
The following table indicates the drivers that cannot be used with the specific Operating Systems.

| Driver Name | Operating Systems |
|---------------|---------------------------------------|
| SW3DNF-MNET10 | Cannot be used with Windows® Me/2000. |

If a communications error takes place, an error code is indicated in the least significant 4 digits.

Refer to the error code list of the MELSECNET/10 board manual.

*2: MELSECNET/H board

The following table indicates the drivers that cannot be used with the specific Operating Systems.

| Driver Name | Operating Systems |
|----------------|--|
| SW0DNC-MNETH-B | Cannot be used with Windows [®] Me. |

If the project has been started after selection of the Q12PH or Q25PHCPU, connection via the MELSECNET/H board cannot be made.

*3: CC-Link board

- (1) The A80BDE-J61BT11 allows the master/local station to be set.
- (2) Accessible only when the CC-Link board is set as the local station.
- (3) If the project has been started after selection of the Q12PH or Q25PHCPU, connection via the CC-Link board cannot be made.

*4: Ethernet board

- (1) The following Ethernet boards/cards have been confirmed by Mitsubishi Electric to operate properly.

| | Maker Name | Model |
|---------------------|---------------------|--|
| Ethernet board/card | 3COM make | Ethernet Link III LAN PC Card |
| | Allied Telesis make | Center COM LA-PCM Ethernet PC Card LAN Adapter |
| | TDK make | 10BASE-T LAN card (Model: LAN-CD021BX) |
| Ethernet board | Allied Telesis make | RE2000 (ISA) |

2.3 Connection from GX Developer Installed in PC CPU Module

(1) The following is the system configuration that can be connected from GX Developer installed in the PC CPU module.

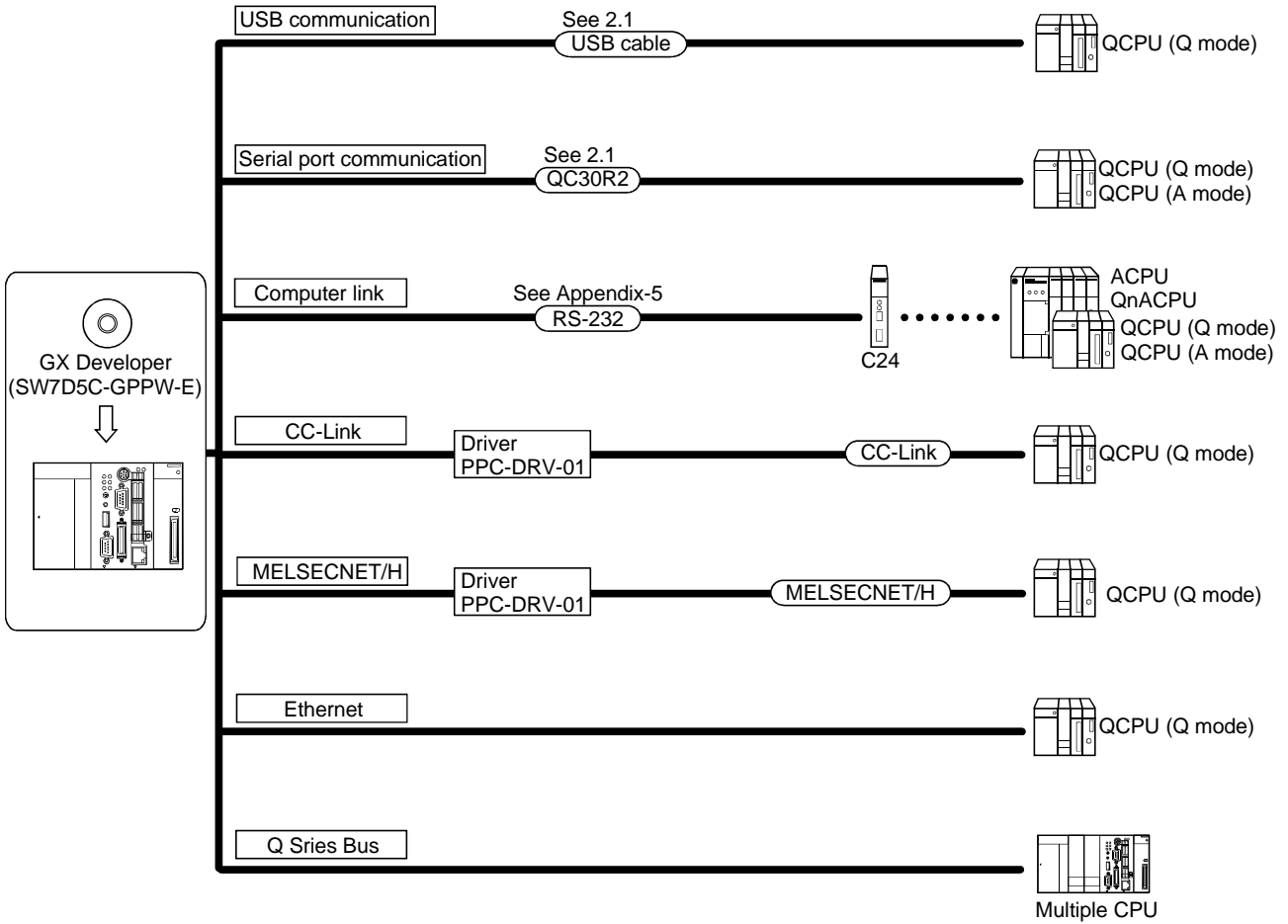

2.4 System Equipment Lists

(1) The following list indicates module connectable from the serial port.

| PLC Series | Module Name | Module Model |
|---------------|---|---|
| Q series | PLC CPU module | Q02(H), Q06H, Q12H, Q12PH, Q25H, Q25PH Q02(H)-A, Q06H-A |
| | Serial communication module*1 | QJ71C24, QJ71C24-R2 |
| | MELSECNET/H network remote I/O module | QJ72LP25, QJ72BR15 |
| | G4-S3 module | AJ65BT-G4-S3 |
| QnA series | PLC CPU module | Q2A, Q2AS(H), Q2AS1, Q2AS(H)S1, Q3A, Q4A, Q4AR |
| | Serial communication module*2 | AJ71QC24, AJ71QC24-R2, AJ71QC24-R4, AJ71QC24N, A1SJ71QC24, A1SJ71QC24-R2, AJ71QC24N-R2, AJ71QC24N-R4, A1SJ71QC24N, A1SJ71QC24N-R2 |
| | MELSECNET/10 network remote I/O module | AJ72QLP25, AJ72QBR15, A1SJ72QLP25, A1SJ72QBR15, QJ72LP25, QJ72BR15 |
| | G4 module | AJ65BT-G4, AJ65BT-G4-S3 |
| A series | PLC CPU module | A0J2H, A1S(S1), A1FX, A1SJ, A1SH, A1SJH, A1N, A2C, A2CJ, A2N(S1), A2S(S1), A2SH(S1), A3N, A2A(S1), A3A, A2U(S1), A2US(S1), A2AS(S1), A2AS- S30, A2AS-S60, A2USH-S1, A3U, A4U |
| | Computer link module*3 | AJ71UC24, A1SJ71UC24-R2, A1SJ71UC24-PRF, A1SJ71C24-R2, A1SJ71C24-PRF, A1SCPUC24-R2, A2CCPUC24, A2CCPUC24-PRF |
| | MELSECNET(II) data link remote I/O module | AJ72P25, AJ72R25 |
| | MELSECNET/B data link remote I/O module | AJ72T25B, A1SJ72T25B |
| | MELSECNET/10 network remote I/O module | AJ72LP25, AJ72LP25, AJ72BR15 |
| FX series | PLC CPU module | AJ65BT-G4, AJ65BT-G4-S3 |
| MOTION (SCPU) | PLC CPU module | FX0(S), FX0N, FX1, FX2(C), FX1S, FX1N, FX2N(C) A171SH, A172SH, A173UH(S1), A273UH(S3) |

(2) The following table indicates the modules which can be connected from the MELSECNET/10 or MELSECNET/H (MELSECNET/10 mode) board.

| PLC Series | Module Name |
|------------|--|
| Q series | QJ71LP21, QJ71BR11 |
| | QJ71LP21, QJ71BR11, QJ71LP21-25 |
| QnA series | AJ71QLP21, AJ71QBR11, A1SJ71QLP21, A1SJ71QBR11 |
| A series | AJ71LP21, AJ71BR11, A1SJ71LP21, A1SJ71BR11 |

(3) The following table indicates the modules which can be connected from the MELSECNET/H board.

| PLC Series | Module Name |
|------------|---------------------------------|
| Q series | QJ71LP21, QJ71BR11, QJ71LP21-25 |

(4) The following list indicates modules connectable from the CC-Link board.

| | Module Name |
|------------|------------------------|
| Q series | QJ61BT11 |
| QnA series | AJ61QBT11, A1SJ61QBT11 |
| A series | AJ61BT11, A1SJ61BT11 |

(5) The following list indicates modules connectable from the Ethernet board.

| | Module Name |
|------------|--|
| Q series | QJ71E71, QJ71E71-B2, QJ71E71-100 |
| QnA series | AJ71QE71, AJ71QE71-B5, A1SJ71QE71-B2, A1SJ71QE71-B5 |
| A series | AJ71E71-S3, A1SJ71E71-B2-S3, A1SJ71E71-B5-S3, A1SJ71E71-B2, A1SJ71E71-B5 |

*1: The following table indicates whether the interfaces may be connected to the personal computer when the PLC CPU is accessed from the personal computer via the serial communication module (Q series).
If the module cannot be connected directly with the personal computer, it may be usable as the "n"th module of multidropping.

| Type | Interface | 1:1 Connection | Multidropping | |
|------------|------------|----------------|---------------|--------------|
| | | | First module | "n"th module |
| QJ71C24 | RS-232 | ○ | ○ | × |
| | RS-422/485 | × | × | ○ |
| QJ71C24-R2 | RS-232 | ○ | × | × |
| | RS-232 | × | × | × |

*2: The following table indicates whether the interfaces may be connected to the personal computer when the PLC CPU is accessed from the personal computer via the serial communication module (QC24).
If the module cannot be connected directly with the personal computer, it may be usable as the "n"th module of multidropping.

| Type | Interface | 1:1 Connection | Multidropping | |
|----------------|------------|----------------|---------------|--------------|
| | | | First module | "n"th module |
| AJ71QC24 | RS-232 | ○ | ○ | × |
| | RS-422/485 | × | × | ○ |
| AJ71QC24N | RS-232 | ○ | ○ | × |
| | RS-422/485 | × | × | ○ |
| AJ71QC24-R2 | RS-232 | ○ | × | × |
| | RS-232 | × | × | × |
| AJ71QC24N-R2 | RS-232 | ○ | × | × |
| | RS-232 | × | × | × |
| AJ71QC24-R4 | RS-422 | × | × | × |
| | RS-422/485 | × | × | ○ |
| AJ71QC24N-R4 | RS-422 | × | × | × |
| | RS-422/485 | × | × | ○ |
| A1SJ71QC24 | RS-232 | ○ | ○ | × |
| | RS-422/485 | × | × | ○ |
| A1SJ71QC24N | RS-232 | ○ | ○ | × |
| | RS-422/485 | × | × | ○ |
| A1SJ71QC24-R2 | RS-232 | ○ | × | × |
| | RS-232 | × | × | × |
| A1SJ71QC24N-R2 | RS-232 | ○ | × | × |
| | RS-232 | × | × | × |

*3: About the computer link module

Note that when the PLC CPU is accessed from the personal computer via the computer link module, the modules that may be connected directly with the personal computer are limited.

If the module cannot be connected directly with the personal computer, it may be usable as the "n"th module of 1:n connection.

| Type | Interface | 1:1 Connection | 1:n Connection | |
|----------------|------------|----------------|----------------|--------------|
| | | | First module | "n"th module |
| AJ71UC24 | RS-232 | ○ | ○ | × |
| | RS-422/485 | × | × | ○ |
| AJ71C24-S6 | RS-232 | ○ | ○ | × |
| | RS-422 | × | × | ○ |
| AJ71C24-S8 | RS-232 | ○ | ○ | × |
| | RS-422 | × | × | ○ |
| A1SJ71UC24-R2 | RS-232 | ○ | × | × |
| A1SJ71C24-R2 | RS-232 | ○ | × | × |
| A1SJ71UC24-PRF | RS-232 | ○ | × | × |
| A1SJ71C24-PRF | RS-232 | ○ | × | × |
| A1SJ71UC24-R4 | RS-422/485 | × | × | ○ |
| A1SJ71C24-R4 | RS-422/485 | × | × | ○ |
| A1SCPUC24-R2 | RS-232 | ○ | × | × |
| A2CCPUC24 | RS-232 | ○ | ○ | × |
| | RS-422 | × | × | × |
| | RS-422/485 | × | × | ○ |
| A2CCPUUC24-PRF | RS-232 | ○ | ○ | × |
| | RS-422 | × | × | × |
| | RS-422/485 | × | × | ○ |

2.5 Precautions for Handling Projects on the Earlier Versions

2.5.1 Using GX Developer Version 4 (SW4D5C-GPPW-E) or earlier to handle project

The following are the precautions for using GX Developer Version4 (SW4D5C-GPPW) or earlier to handle the project that has been created with GX Developer Version7 (SW7D5C-GPPW-E).

Handle the project after reading the following precautions.

About device memory:

1. When editing on GX Developer (SW7D5C-GPPW-E) and the version of GX Developer (SW4D5C-GPPW-E or earlier), do not create multiple device memories.
(Refer to Chapter 11 for device memories.)

Do not read the GX Developer (SW7D5C-GPPW-E) created multiple device memories on the version of GX Developer (SW4D5C-GPPW-E or earlier). The data cannot be read correctly.

2. Do not read the GX Developer (SW7D5C-GPPW-E) created device memory of 32 MB or more on the version of GX Developer (SW4D5C-GPPW-E or earlier).

2.5.2 Using GX Developer Version 5 (SW5D5C-GPPW-E) or earlier to handle project

The following are the precautions for using GX Developer Version5 (SW5D5C-GPPW-E) or earlier to handle the project that has been created with GX Developer Version7 (SW7D5C-GPPW-E).

Handle the project after reading the following precautions.

1. About the parameters (for the Q02(H), Q06H, Q12H, Q25HCPU)
GX Developer Version5 (SW5D5C-GPPW-E) or earlier cannot handle the data where the parameters of the following items have been set.
The following dialog box appears if the project saved in the personal computer is read or read from PLC is performed from the PLC CPU.

[Items which cannot be read if set on GX Developer (SW7D5C-GPPW-E)]

- Multi PLC setting
 - I/O assignment (when multi PLC setting has been made)
 - Memory card of boot file setting→Standard ROM all data automatic write setting
 - Attached file format "CSV" of Ethernet ([E-mail settings] → [New setting])
 - "Local station 2, 3 setting" of CC-Link ([Operational setting] → Number of exclusive stations)
 - Scan mode setting "sync" of CC-Link (mode setting (in remote I/O network mode)
 - When the following network parameter is set
 - (a) MNET/H (remote master)
 - When multi-CPU automatic refresh setting is made
2. About the remote password (for the Q02(H), Q06H, Q12H, Q25HCPU)
 - (1) When the project having the remote password is read, the remote password setting does not appear in the project list of the screen. (Edit/change disabled)
 - (2) If the project is saved after execution of parameter editing or the like, the remote password setting is not deleted.
 - (3) When the PLC type is changed (including the case where the type is changed to other than the QCPU (Q mode)), the remote password file is not deleted.
 - (4) When the [Online] PLC user data list is being displayed, the remote password file is not displayed.
 3. About the remote I/O station project
 - The remote I/O station project cannot be read on GX Developer (SW5D5C-GPPW-E or earlier).

4. About the device comments (for QCPU (Q mode))
 - (1) The range where comments may be handled is U0(\G0) to U1FF(\G65535).
 - (2) Comment data created in U200 to U3FF and U3E\G0 to U3FF\G65335 cannot be edited, searched for, and replaced.
Comment data are not deleted if a project is saved without comment data editing or similar operation being performed.
However, when [Save as] or [Change PLC type] is performed, the comment data created in U200 to U3FF and U3E\G0 to U3FF\G65335 are deleted.

5. About the display scale factor specified
GX Developer (SW7D5C-GPPW-E) has the function to specify any scale factor in addition to 50, 75, 100 and 150%. Hence, when the project used on the version of GX Developer (SW5D5C-GPPW-E or earlier) is to be saved on GX Developer (SW7D5C-GPPW-E), do not specify the display scale factor of other than 50, 75, 100 and 150%.
If the project saved at the display scale factor of other than 50, 75, 100 and 150% is read on the GX Developer (SW5D5C-GPPW-E or earlier), that project opens at the preset scale factor, but is displayed blank when the scale factor is changed with the zoom tool button.
In that case, perform the following operation to change the display scale factor setting to any of 50, 75, 100 and 150%.

[Operating Procedure]

Select [View] → [Zoom], then select a magnification factor.

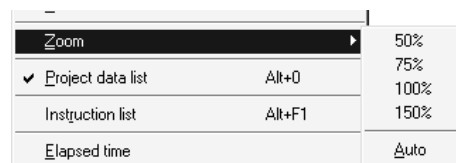

2.5.3 Using GX Developer Version 6 (SW6D5C-GPPW-E) or earlier to handle project

The following are the precautions for using GX Developer Version6 (SW6D5C-GPPW-E) or earlier to handle the project that has been created with GX Developer Version7 (SW7D5C-GPPW-E).

Handle the project after reading the following precautions.

1. About parameter (Applicable to the QCPU (Q mode))
GX Developer Version6 (SW6D5C-GPPW-E) or earlier cannot handle the data where the parameters of the following items have been set.
The following dialog box appears if the project saved in the personal computer is read or read from PLC is performed from the PLC CPU.

[Item that makes the project unreadable if set in GX Developer (SW7D5C-GPPW-E)*1]

- (1) Network parameters → **Ethernet** → **Open settings** → "Open system" → "MELSOFT connection" (Unreadable when handled on Version 6.04E or earlier)

*1: Readable on Version 6.05F or later.

2. About project
If either of the following parameters is set for the data, the project cannot be read from the personal computer/PLC CPU using GX Developer (SW6D5C-GPPW-E or earlier).
 - (1) The project has been created on the Q00J/Q00/Q01CPU.
 - (2) The project has been created by selecting "Label + FB".

2.5.4 Using GX Developer Version 7.09K (SW7D5C-GPPW-E) or earlier to handle project

Handle the project created with GX Developer Version 7.10L (SW7D5C-GPPW-E) or later using GX Developer Version 7.09K (SW7D5C-GPPW-E) or earlier, while paying the followings.

- (1) Unreadable parameters (Relevant for QCPU (Q mode))
The Project set with any of the parameters (a) to (C) described in this section cannot be handled with GX Developer Version 7.09K (SW7D5C-GPPW-E) or earlier.
The following dialog box appears when this project is read from a personal computer or PLC CPU.



Clicking on **OK** button changes the parameters to default. Be sure to reset the necessary parameters after the project is read.

- (a) PLC parameter → PLC system → "High speed interrupt setting"
- (b) Network param → Network type → NET/H (Multiplexed remote master) / "NET/H (Multiplexed remote sub)"
- (c) PLC parameter → Multiple PLC settings

GX Developer Version 7.10L or later includes "Online module change" parameter within "Multiple PLC settings".

When reading a project including "Multiple PLC settings", GX Developer operates differently depending on the version as follows:

- 1) When reading the project created using GX Developer Version 7.19V or later
 - a) GX Developer Version 7.09K (SW7D5C-GPPW-E) or earlier can read the project including "Multiple PLC settings" within which "Online module change" is disabled.
 - b) GX Developer Version 7.09K (SW7D5C-GPPW-E) or earlier cannot correctly read the project including "Multiple PLC settings" within which "Online module change" is enabled, automatically setting the parameters to default.
Therefore, be sure to reset the necessary parameters to the project after reading them.
- 2) When reading the project created using GX Developer Version 7.10L to 7.18U
GX Developer Version 7.09K (SW7D5C-GPPW-E) or earlier cannot correctly read the project including "Multiple PLC settings" within whichever "Online module change" is enabled/disabled, automatically setting the parameters to default.
Therefore, be sure to reset the necessary parameters to the project after reading them.

POINTS

- PLC parameter "High speed interrupt setting"
Note that write to PLC can be performed to the PLC that is incompatible with high speed interrupt setting, but the high speed interrupt setting is ignored.
- GX Developer Version7.19V(SW7D5C-GPPW-E) or later has been improved; the project created with this version and including "Multiple PLC setting" within which "Online module change" is disabled can be read using GX Developer Version7.09K(SW7D5C-GPPW-E) or earlier without changing the parameters.
The latest version of GX Developer is downloadable from the following URL
Mitsubishi Electric FA Network Service, MELFANSweb
http://www.nagoya.melco.co.jp/english/index_e.htm
- How to read the project created with GX Developer Version7.10L to 7.18U using GX Developer Version7.09K(SW7D5C-GPPW-E) or earlier.

It is required to perform the following operations using GX Developer Version7.19V(SW7D5C-GPPW-E) or later.

- (1) Project in which "Online module change" is enabled
Disable the "Online module change" setting and then save the project.
The saved project can be read using GX Developer Version7.09K(SW7D5C-GPPW-E) or earlier.
- (2) Project in which "Online module change" is disabled
The following dialog box appears when reading the project from Q02(H)CPU, Q06HCPU, Q12HCPU or Q25HCPU.

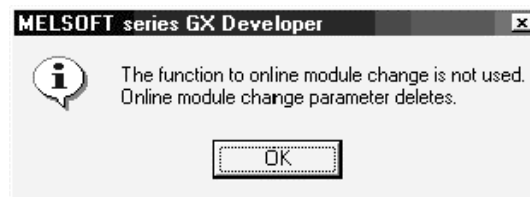

Clicking on button deletes the unnecessary parameters. Therefore, save the project.
The saved project can be read using GX Developer Version7.09K(SW7D5C-GPPW-E) or earlier.

- (2) About project created on Q12PH or Q25PHCPU
If GX Developer Version 7.09K (SW7D5C-GPPW-E) or earlier is used to read the Q12PH/Q25PHCPU project saved in the personal computer, the following dialog box appears and the project cannot be read.
Be careful when executing [Open project] or [Copy].



The data written to the PLC CPU can be read by performing read from PLC, but are read as the Q12H or Q25HCPU data.

3. COMMON OPERATIONS

This chapter describes the common key operations and screen operations in GX Developer and the common function operations in some modes.











3.1 List of Shortcut Keys and Access Keys

(1) List of shortcut keys

The following table lists the shortcut keys available with GX Developer.

| Shortcut Key | Tool Button | Function | Description | | |
|-----------------|----------------|--------------|----------------------------|--|---|
| [Alt] + [F4] | — | Close | Closes the active window. | | |
| [Ctrl] + [F6] | — | Next window | Activates the next window. | | |
| [Ctrl] + [N] | | Project | Create project | Creates a new project. | |
| [Ctrl] + [O] | | | Open project | Opens an existing project. | |
| [Ctrl] + [S] | | | Save project | Saves the project. | |
| [Ctrl] + [P] | | | Print | Prints the project. | |
| [Ctrl] + [Z] | | Edit | Undo | Reverts the previous operation. | |
| [Ctrl] + [X] | | | Cut | Moves the selected data to the Clipboard. | |
| [Ctrl] + [C] | | | Copy | Copies the selected data to the Clipboard. | |
| [Ctrl] + [V] | | | Paste | Copies the contents of the Clipboard to the cursor position. | |
| [Ctrl] + [A] | — | | Select all | Selects all the edit objects. | |
| [Shift] + [Ins] | — | | Insert row | Inserts a row at the cursor position. | |
| [Shift] + [Del] | — | | Delete row | Deletes a row at the cursor position. | |
| [Ctrl] + [Ins] | — | | Insert column | Inserts a column at the cursor position. | |
| [Ctrl] + [Del] | — | | Delete column | Deletes a column at the cursor position. | |
| [Shift] + [F2] | | | Read mode | Sets the read mode. | |
| [F2] | | | Write mode | Sets the write mode. | |
| GPPA GPPQ | [F5] | | Circuit symbol | Open contact | Inserts the contact a at the cursor position. |
| MEDOC | 1 | | | | |
| GPPA GPPQ | [Shift] + [F5] | | | Close contact | Inserts the contact b at the cursor position. |
| MEDOC | 2 | | | | |
| GPPA GPPQ | [F6] | | | Open branch | Inserts the contact a (open branch) at the cursor position. |
| MEDOC | 3 | | | | |
| GPPA GPPQ | [Shift] + [F6] | Close branch | | Inserts the contact b (close branch) at the cursor position. | |
| MEDOC | 4 | | | | |

| Shortcut Key | | Tool Button | Function | Description | |
|-------------------------|--------------------------------|-------------|----------------------------|---|---|
| GPPA GPPQ | F7 | | Edit Circuit symbol | Coil Inserts the coil (OUT) at the cursor position. | |
| MEDOC | 7 | | | | |
| GPPA GPPQ | F8 | | | Application instruction Inserts an application instruction at the cursor position. | |
| MEDOC | 8 | | | | |
| GPPA | F10 | | | Vertical line Inserts a vertical line at the cursor position. | |
| GPPQ | Shift + F9 | | | | |
| MEDOC | 5 | | | | |
| GPPA GPPQ | F9 | | | Horizontal line Inserts a horizontal line at the cursor position. | |
| MEDOC | 6 | | | | |
| GPPA GPPQ | Ctrl + F10 | | | Delete vertical line Deletes a vertical line at the cursor position. | |
| MEDOC | 0 | | | | |
| GPPA GPPQ | Ctrl + F9 | | | Delete horizontal line Deletes a horizontal line at the cursor position. | |
| MEDOC | 9 | | | | |
| Shift + F7 | | | Leading pulse | Inserts a leading pulse at the cursor position. | |
| Shift + F8 | | | Trailing pulse | Inserts the trailing pulse at the cursor position. | |
| Alt + F7 | | | Leading pulse open branch | Inserts the leading pulse (open branch) at the cursor pulse. | |
| Alt + F8 | | | Trailing pulse open branch | Inserts the trailing pulse (open branch) at the cursor position. | |
| Ctrl + Alt + F10 | | | Op result invert | Inserts the inverted Op result at the cursor position. | |
| Alt + F5 | | | Op result leading pulse | Inserts the inverted Op result at the cursor position. | |
| Ctrl + Alt + F5 | | | Op result trailing pulse | Inserts the Op result trailing pulse at the cursor position. | |
| GPPA GPPQ MEDOC | Alt + F10 F10 | | Insert line | Inserts a line. | |
| Alt + F9 | | | | | Delete line |
| F4 | | | Convert | Convert | Converts the program. |
| Ctrl + Alt + F4 | | | | Convert (all edit programs) | Converts all programs being edit at a time. |
| Shift + F4 | | — | | Convert (online change) | Converts the program and writes it to the CPU during running. |

| Shortcut Key | Tool Button | Function | | Description | |
|--------------------------------------|---|------------------|-------------------|--|--|
| Ctrl + F5 | — | View | Comment | Displays or hides comments. | |
| Ctrl + F7 | — | | Statement | Displays or hides statements. | |
| Ctrl + F8 | — | | Note | Displays or hides notes. | |
| Ctrl + Alt + F6 | — | | Alias | Displays or hides Alias. | |
| Alt + O |  | | Project data list | Displays or hides the project data list. | |
| Alt + F1 |  | | Instruction list | Switches circuit screen and list screen. | |
| F3 |  | Online | Monitor | Monitor | Monitors the screen. |
| Ctrl + F3 | — | | | Monitor (all windows) | Monitors all circuits of the programs currently open. |
| Shift + F3 |  | | | Monitor (write mode) | Sets the write mode during circuit monitoring. |
| F3 |  | | | Start monitor | Starts (restarts) circuit monitoring. |
| Alt + F3 |  | | | Stop monitor | Stops circuit monitoring. |
| Ctrl + Alt + F3 | — | | | Stop monitor (all windows) | Stops monitoring of all circuits of the program currently open. |
| Alt + 1 |  | | Debug | Device test | Forcibly turns on or off the device and changes the current value. |
| Alt + 2 |  | | | Skip | Performs a skip operation for a sequence program for which a range has been specified. |
| Alt + 3 |  | | | Partial operation | Partially executes the sequence program. |
| Alt + 4 |  | | | Run step | Performs step operation for the PLC. |
| Alt + 6 | — | Remote operation | Remote operation | Performs remote operation. | |

(2) Access key

An access key is indicated by an alphabetic character shown at the end of each menu title to enable the user to select the menu with the keyboard.

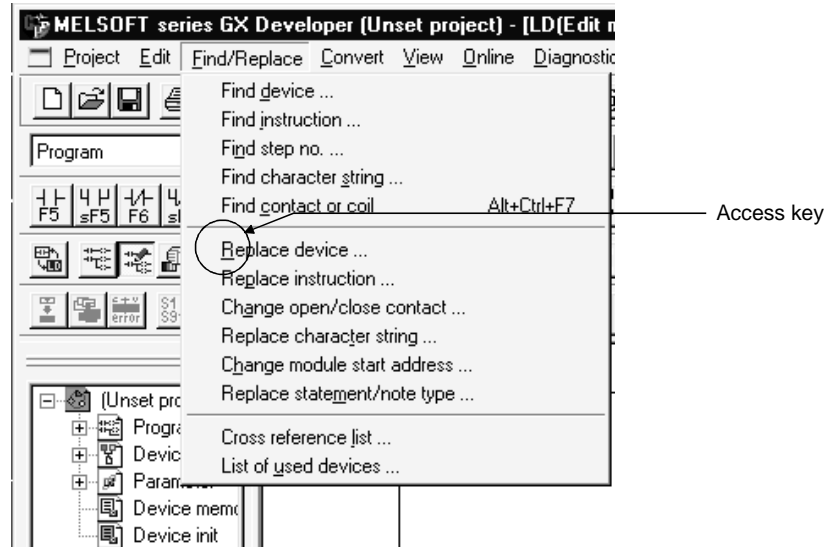

Press **[Alt]** and **[P]** key in order to highlight the [Project] menu.
 Press **[↓]** key, then the drop-down menu will be displayed.

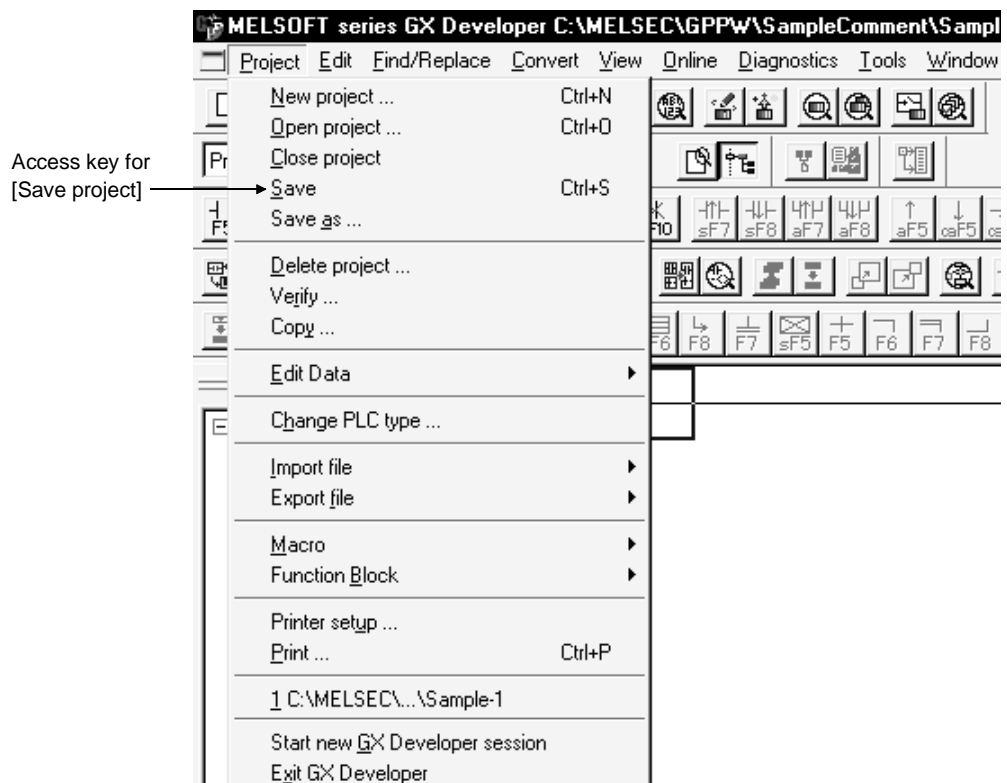

Press **[S]** key to save the project.

3.2 Project Designation

GX Developer sets a drive/path and a project name, but does not set the system name set like GPPA and GPPQ.

This section compares and describes the differences between GX Developer and GPPA/GPPQ.

- Designation in GPPA

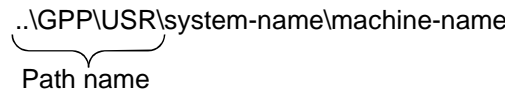
..\GPP\USR\system-name\machine-name

 Path name

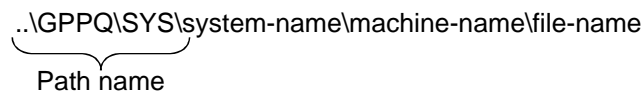
- Designation in GPPQ

..\GPPQ\SYS\system-name\machine-name\file-name

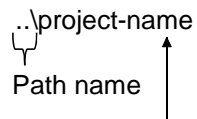
 Path name

- Designation in GX Developer

..\project-name

 Path name

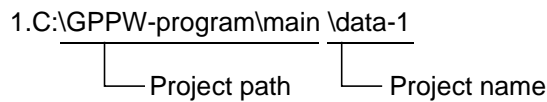
Corresponds to the machine name in GPPA or GPPQ.

- The GX Developer project path and project names can be designated as follows:
 Example

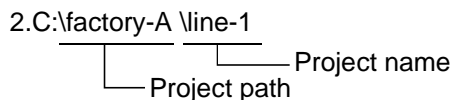
1.C:\GPPW-program\main\data-1

 Project path Project name

2.C:\factory-A\line-1

 Project path Project name

As shown above, the project can be saved in a desired folder.

3.2.1 Saving a project



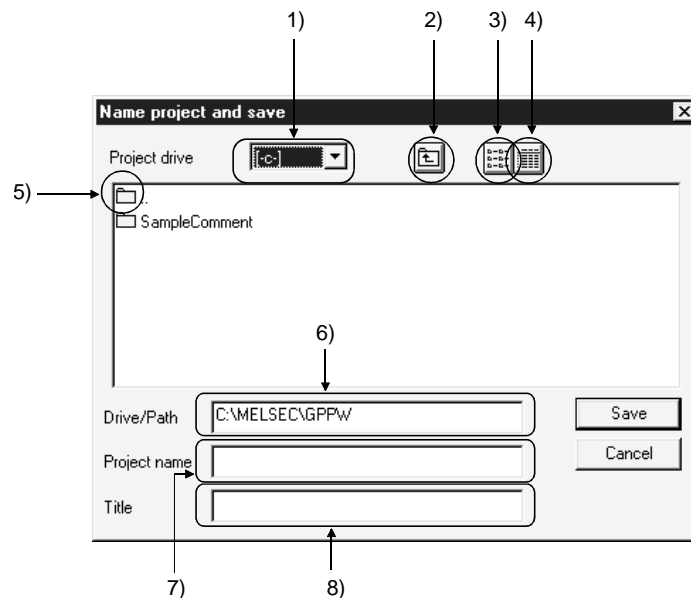

[Purpose]

Designate a project name to read, save or delete a project, or to create a new project.

[Dialog Box]



[Description]

- 1) Project drive
Designates a drive in which the project has been saved or is to be saved.
- 2)  button
Click this button to move to the folder one level upper than the current folder.
- 3)  button
Click this button to list the names of folders and projects contained in the current folder.
- 4)  button
Click this button to display the details of the folders and projects contained in the current folder such as the PLC types, creation dates, and title.
- 5)  ..
Double-click the icon to move to the folder one level upper than the current folder.
- 6) Drive/path
Designates the path of the folder where the project has been saved or is to be saved.
If you do not specify the drive/path (blank) but specify only the project name, the default drive/path is automatically created and the project is saved.

7) Project name

Designates a project name.

The following shows the characters and the number of characters that can be used to designate a drive path, project name, or data name.

- Number of characters

The total number of characters used for designating both the project path and the project name (8 or more characters may be set) is 154.

<Example>

C:\SW3D5GPPW\ABCDEFGHIJKLMNQPQRSTUVWXYZ

- Characters not available in A, QnA and FX series

/, \, >, <, *, ?, " ", |, :, ; (: and \ can be set for drive designation only)

(: and \ are available only when the drive is specified.)

Any project name cannot be ended by a period (.).

(If a space is inserted after the project name, it is automatically deleted.)

8) Title

Sets the title for the project in up to 32 characters.

POINT

- If 8 or more characters have been entered for the project name in GX Developer SW3D5C-GPPW-E or later, those after the 8th character won't be displayed when the project is read in an older version of GX Developer (SW2D5-GPPW-E or older).
- The following dialog box appears if the T/C coils of the same number exist in the ACPU program.

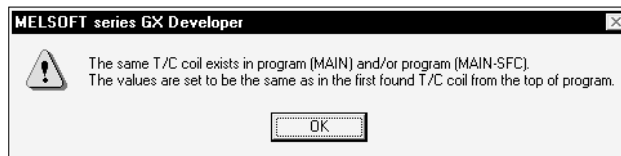

- When write to PLC, write to GPPA format file or write to ROM is to be performed, the above dialog box also appear if the T/C coils of the same number exist in the program. (This does not apply to the extended T/C.)

Note: If a program (MAIN-SFC) has not been created, it is displayed as a message.

[Example]

Project name to be saved : TEST1
 Title : Test program
 Project location : A:\GPPW\
 GX Developer installation location : C:\MELSEC\GPPW

[Operating Procedure]

1. Select [Project] → [Save as].
2. Change the project drive from [-c-] to [-a-].

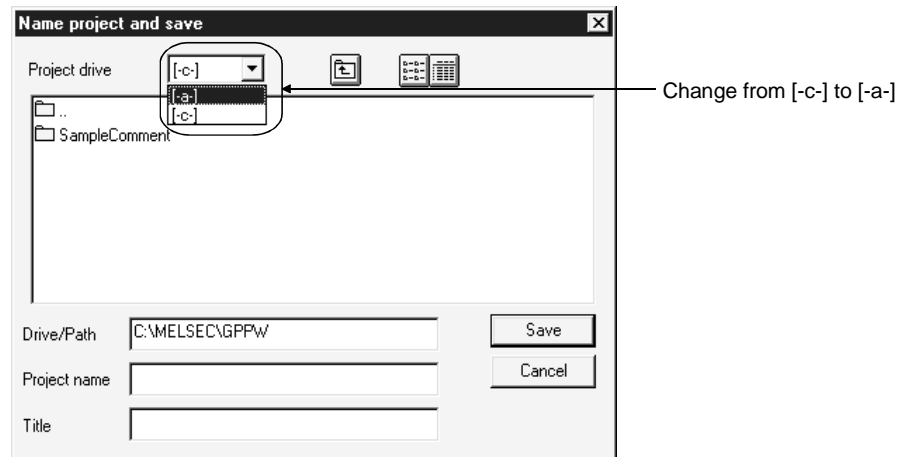

3. Type "GPPW" as the project path.

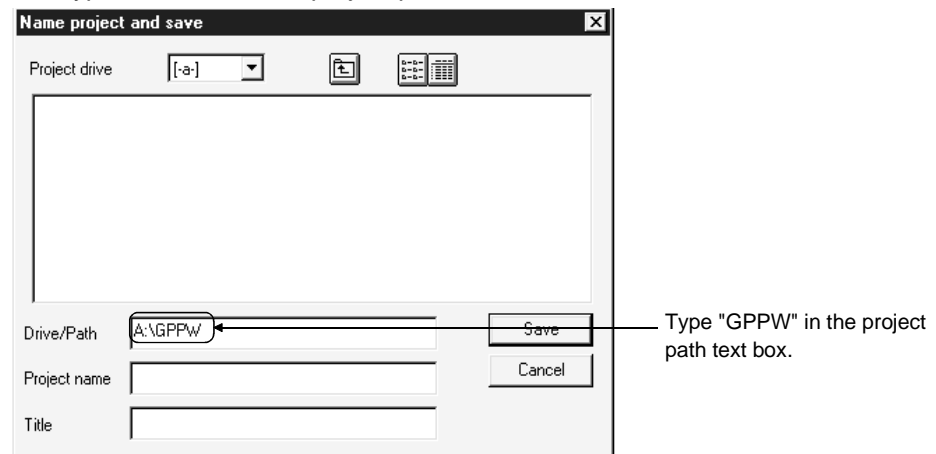

4. Type "TEST1" as a project name. Then, type "Test program" as the project title. Click the [Save] button, and the project will be saved in the designated folder.

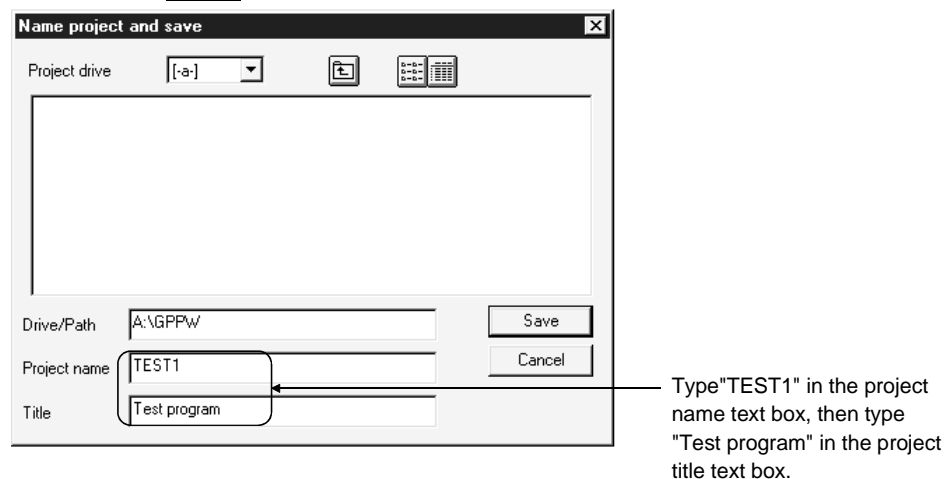

3.2.2 Opening a project

[Example]

Name of project to be read : TEST1
 Project save location : A:\GPPW\
 GX Developer installation location : C:\MELSEC\GPPW

[Operating Procedure]

1. Select [Project] → [Open project].
2. Change the project drive from [-c-] to [-a-].

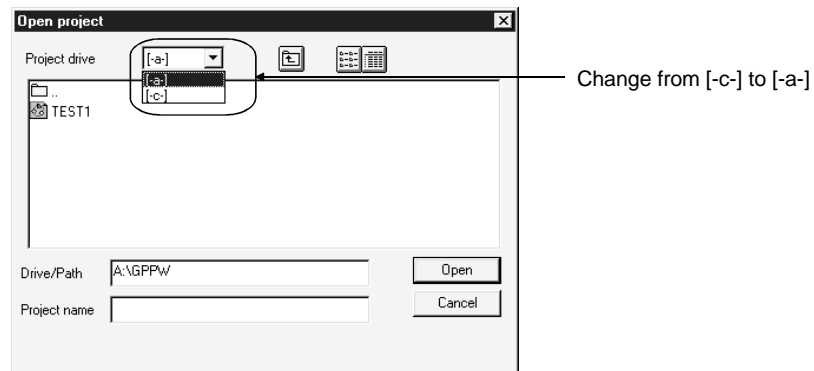

3. Double-click the "GPPW" folder icon in the list box to designate a project path.

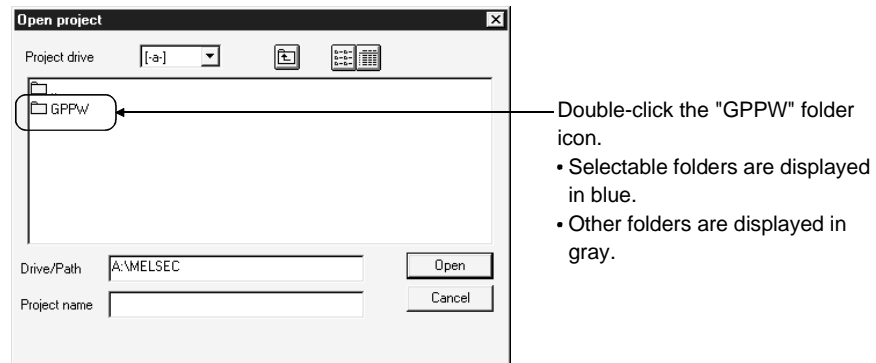

4. Click the "TEST1" project icon in the list box to designate the name of a project to be read.

Click the **Open** button, and the designated project will be opened.

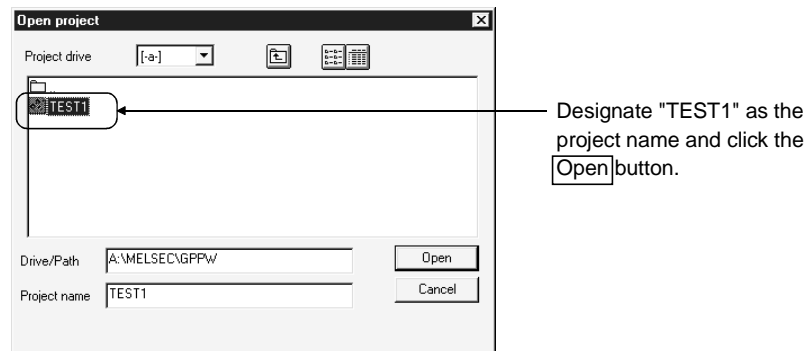

3.3 Cut, Copy, and Paste

This section describes the common operations such as cutting, copying and pasting table data such as comments, parameters, etc.

For details on how to cut, copy and paste the circuits, see Section 6.2.8.

3.3.1 Cut and paste

- Cutting and pasting the data

The following example shows how to cut and paste the comments.

Comments, parameters, and device memory can be cut and pasted through the same procedure.

[Operating Procedure]

1. Click the first cell of the comments to be cut, and the cursor will be positioned there.

| Device | Comment | Label |
|--------|-----------------------------|-------|
| X0 | Unit abnormal | |
| X1 | Host data link condition | |
| X2 | Parameter setting condition | |
| X3 | Other station condition | |
| X4 | Unit reset receive complete | |
| X5 | Start data link | |
| X6 | | |
| X7 | | |
| X8 | | |

2. Confirm that the cursor () is displayed, then drag the mouse over the range of the comments to be cut.

The dragged comment cells are highlighted (the first cell in the range is not highlighted).

To change the designated range, click any cell in the comment column.

| Device | Comment | Label |
|--------|-----------------------------|-------|
| X0 | Unit abnormal | |
| X1 | Host data link condition | |
| X2 | Parameter setting condition | |
| X3 | Other station condition | |
| X4 | Unit reset receive complete | |
| X5 | Start data link | |
| X6 | | |
| X7 | | |
| X8 | | |

3. Select [Edit] → [Cut] or click  (**[Ctrl] + [X]**), and the designated range of comments will be cut.

| Device | Comment | Label |
|--------|-----------------------------|-------|
| X0 | Unit abnormal | |
| X1 | Host data link condition | |
| X2 | Parameter setting condition | |
| X3 | | |
| X4 | | |
| X5 | Start data link | |
| X6 | | |
| X7 | | |
| X8 | | |

- Click the first cell in the comment column where the comments are to be pasted, and the cursor will be positioned there.

| Device | Comment | Label |
|--------|--------------------------|-------|
| X0 | Unit abnormal | |
| X1 | Host data link condition | |
| X2 | | |
| X3 | | |
| X4 | | |
| X5 | Start data link | |
| X6 | | |
| X7 | | |
| X8 | | |
| X9 | | |
| X0A | | |

- Confirm that the cursor () is displayed, then select [Edit] → [Paste] or click  ([Ctrl] + [V]).
The cut comments are pasted into the cells in the comment column starting from the designated cell.

| Device | Comment | Label |
|--------|-----------------------------|-------|
| X0 | Unit abnormal | |
| X1 | Host data link condition | |
| X2 | | |
| X3 | | |
| X4 | | |
| X5 | Start data link | |
| X6 | | |
| X7 | Parameter setting condition | |
| X8 | Other station condition | |
| X9 | Unit reset receive complete | |
| X0A | | |

| |
|---|
| POINT |
| The cut, copy, and paste menus can also be selected from the popup menu displayed by clicking the right mouse button. |

3.3.2 Copy and paste

- Copying and pasting the data
 The following example shows how to copy and paste comments.
 Comments, parameters, and device memory can be copied and pasted through the same procedure.

[Operating Procedure]

1. Click the first cell of the comments to be copied, and the cursor will be positioned there.

| Device | Comment | Label |
|--------|-----------------------------|-------|
| X0 | Unit abnormal | |
| X1 | Host data link condition | |
| X2 | Parameter setting condition | |
| X3 | Other station condition | |
| X4 | Unit reset receive complete | |
| X5 | Start data link | |
| X6 | | |
| X7 | | |
| X8 | | |

2. Confirm that the cursor () is displayed, then drag the mouse over the range of the comments to be copied.
 The dragged comment cells are highlighted (the first cell in the range is not highlighted).
 To change the designated range, click any cell in the comment column.

| Device | Comment | Label |
|--------|-----------------------------|-------|
| X0 | Unit abnormal | |
| X1 | Host data link condition | |
| X2 | Parameter setting condition | |
| X3 | Other station condition | |
| X4 | Unit reset receive complete | |
| X5 | Start data link | |
| X6 | | |
| X7 | | |
| X8 | | |

3. Click the first cell in the comment column where the comments are to be pasted, and the cursor will be positioned there.

| Device | Comment | Label |
|--------|--------------------------|-------|
| X0 | Unit abnormal | |
| X1 | Host data link condition | |
| X2 | | |
| X3 | | |
| X4 | | |
| X5 | Start data link | |
| X6 | | |
| X7 | | |
| X8 | | |
| X9 | | |
| X0A | | |

4. Confirm that the cursor () is displayed, then select [Edit] → [Paste] or click  ([Ctrl] + [V]).

The copy comments are pasted into the cells in the comment column starting from the designated cell.

| Device | Comment | Label | ▲ |
|--------|-----------------------------|-------|---|
| X0 | Unit abnormal | | |
| X1 | Host data link condition | | |
| X2 | | | |
| X3 | | | |
| X4 | | | |
| X5 | Start data link | | |
| X6 | | | |
| X7 | Parameter setting condition | | |
| X8 | Other station condition | | |
| X9 | Unit reset receive complete | | |
| X0A | | | |

| POINTS |
|--|
| <ul style="list-style-type: none"> • The cut, copy, and paste menus can also be selected from the popup menu displayed by clicking the right mouse button. • Notes on cut, copy and paste operations of parameters <ol style="list-style-type: none"> 1. Only numeric characters can be pasted. (Alphabetic characters cannot be pasted.) 2. The format conversion of the numeric value does not take place at a destination for pasting. <p><Example> Even when the network number (decimal) "10" is copied and pasted at the first I/O number (hexadecimal), it is not converted to "A."</p> |

3.3.3 Notes on cutting, copying and pasting network parameters

The following shows the areas in which you can cut, copy and paste network parameters and also the areas that prevent these operations.

Valid units during other station access: 1

Network parameter capacity: 2 KB

| | Unit No.1 | Unit No.2 | Unit No. |
|---------------|---------------------------|---------------------------|----------|
| Network Type | MNET/10(Controlling stati | MNET/10(Controlling stati | None |
| Start I/O No. | 0000 | 0020 | |
| Network No. | 1 | 2 | |
| Total No. | 6 | 9 | |
| Group No. | | | |
| Station No. | | | |
| | Network range assignment | Network range assignment | |
| | Refresh parameters | Refresh parameters | |

Prevent cut, copy and paste. (points to dropdown menu)

Allows cut, copy and paste. (points to table cells)

Setting common parameters and station inherent parameters.

Assignment method: No. of points/Start Start/End

Supplemental settings: Monitoring time: 200 X 10ms, No. of link slave stations: 6

Parameter name: []

Switch screens: LB/LW setting

| StationNo. | Send range for each st | | | Send range for each station. | | | | | | | | |
|------------|------------------------|-------|-----|------------------------------|-------|-----|-------|-------|-----|-------|-------|-----|
| | Point | Start | End | Point | Start | End | Point | Start | End | Point | Start | End |
| 1 | | | | | | | | | | | | |
| 2 | | | | | | | | | | | | |
| 3 | | | | | | | | | | | | |
| 4 | | | | | | | | | | | | |
| 5 | | | | | | | | | | | | |
| 6 | | | | | | | | | | | | |

Allows cut, copy and paste. (points to table cells)

Allows cut, copy and paste. (points to supplemental settings)

Prevents cut, copy and paste. (points to parameter name)

| | Link side | | | | PLC side | | | |
|--------------------|-----------|-------|------|---|----------|-------|-------|-------|
| | Point | Start | End | | BlockNo. | Point | Start | End |
| LB<->B transfer(1) | 4096 | 0000 | 00FF | ↔ | | 4096 | 0000 | 00FF |
| LW<->W transfer(1) | 4096 | 0000 | 00FF | ↔ | | 4096 | 0000 | 00FF |
| LX<->X transfer(1) | | | | ↔ | | | | |
| LY<->Y transfer(1) | | | | ↔ | | | | |
| SB transfer | 256 | 0000 | 00FF | ↔ | | 256 | Y1C00 | Y1CFF |
| SW transfer | 256 | 0000 | 00FF | ↔ | | 256 | D7168 | D7423 |

Allows cut, copy and paste. (points to table cells)

| |
|--------|
| POINTS |
|--------|

- When used together with MELSECNET(II), the L/R type is not changed even if lines in a local station are copied and pasted to a remote station (or vice versa).
- When some destination items allow paste but some prevent paste, parameter paste takes place only in the items allowing paste.
- When the data types of copy source and destination are not the same, an abnormal paste operation may result.
For example, this problem occurs when data in the Point column is pasted in the Start column of the destination.
- Only numeric characters can be copied and pasted.
- Even when decimal data is cut, copied, and pasted in a hexadecimal column, it is not converted into hexadecimal data.
However, when a decimal number "16" is copied into a hexadecimal column, it is handled as a decimal number "22."

3.4 Toolbar

The toolbar contains the menu items or the attributes of data types. To execute a menu item, move the cursor onto the icon, then click there.

To display or hide the tool bar, select [View] → [Toolbar].

[Dialog Box]

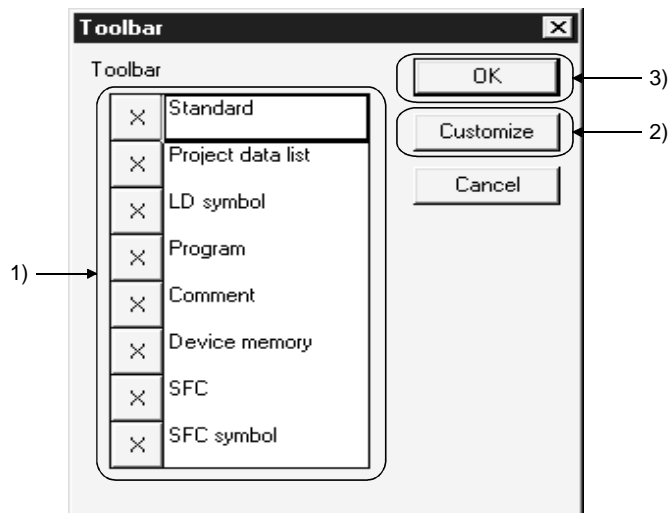

- 1) **Toolbar**
Click here to display or hide the toolbar.
Click to display the toolbar and click  to hide the tool bar.
- 2) **Customize**
Click this button to add/delete a tool button to/from the toolbar.
By default, all the tool buttons are displayed on the toolbar.

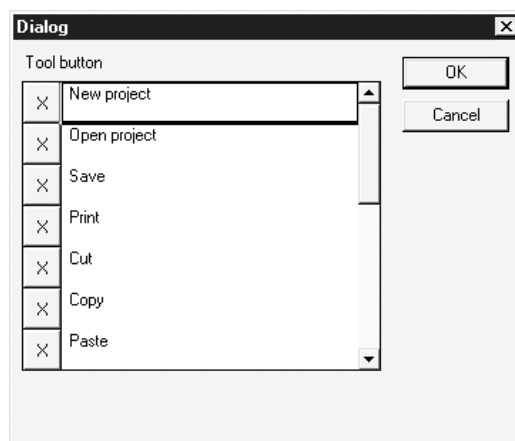

- 3) **OK** button
Click this button after making necessary settings.

3.5 Status Bar

The status bar is displayed at the bottom of the application window to indicate GX Developer status information.

To display or hide the status bar, select [View] → [Status bar].



[Description]



- 1) Indicates the status of the mouse cursor position.
- 2) Indicates the CPU type.
- 3) Indicates the destination CPU.
- 4) Indicates the current mode.
- 5) Indicates the status of the Caps Lock key.
- 6) Indicates the status of the Num Lock key.
- 7) Indicates the status of the Scroll Lock key.

3.6 Zooming in on or out of the Edit Screen

This section describes how to magnify (zoom in) or reduce (zoom out) the edit screen. The edit screen can be resized as necessary.

[Operating Procedure]

Select [View] → [Zoom], then select a magnification factor.

Or click  or  to get the same result.

When  on the tool bar is selected, the edit screen is magnified.

In contrast, when  is selected, the edit screen is reduced.

[Dialog Box]

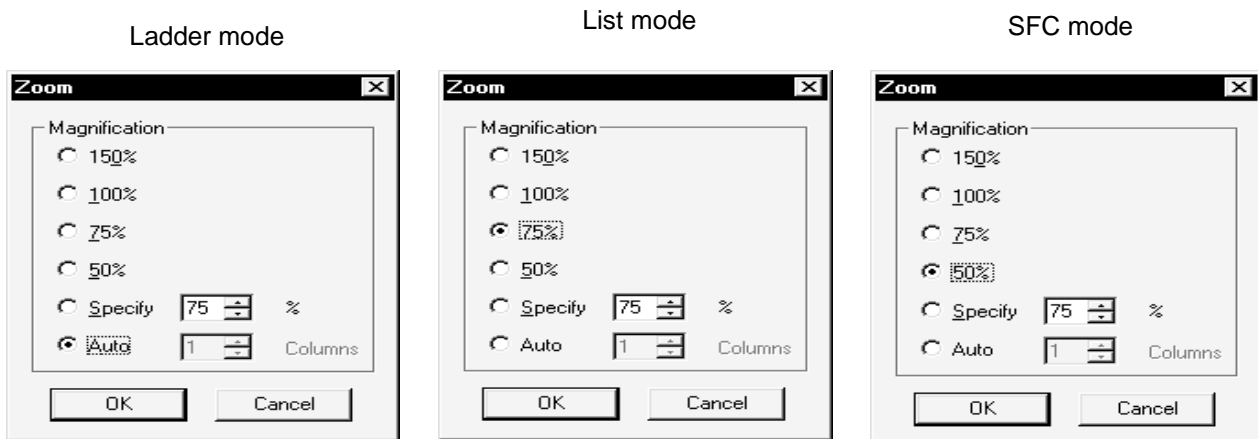

[Description]

- 1) Specify
Specify the scale factor within the range 50 to 150.
- 2) Auto
The width of a ladder is automatically adjusted to display the whole ladder.
In the ladder mode, the Columns setting is masked.
In the list mode, Auto is masked.
In the SFC mode, you can set the Columns within the range 1 to the maximum.

POINT

- Refer to Section 2.4.2 for the precautions for and restrictions on using the GX Developer (SW5D5-GPPW-E) or earlier version to read the project where this function has been set.
- Some characters used for comments or like may overlap or lie offscreen if the screen size is reduced.
If characters overlap, expand the screen or specify a proper scaling factor.

3.7 Project Data List

A project data list contains project data according to the data types.
 To directly display the edit screen, double-click on project data.
 To display or hide the project data list, select [View] → [Project data list] or click  ([Alt] + [O]).

To add, copy, delete or rename project data, click the target project data with the right mouse button.
 See Sections 4.9 to 4.12 for details on each operation.
 Data names except the parameters can also be deleted with the **Delete** key.

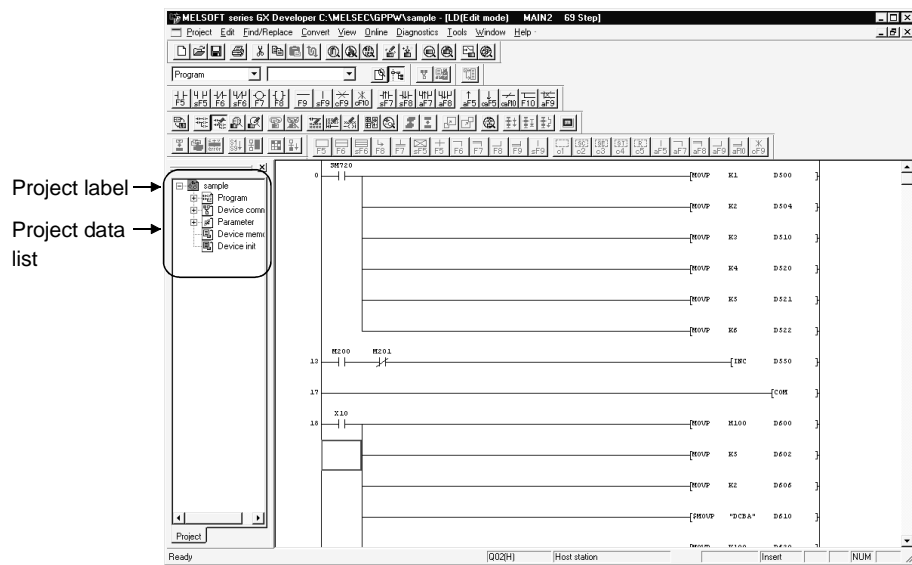

The project data list can be changed in size by floating it or can be hidden by clicking .

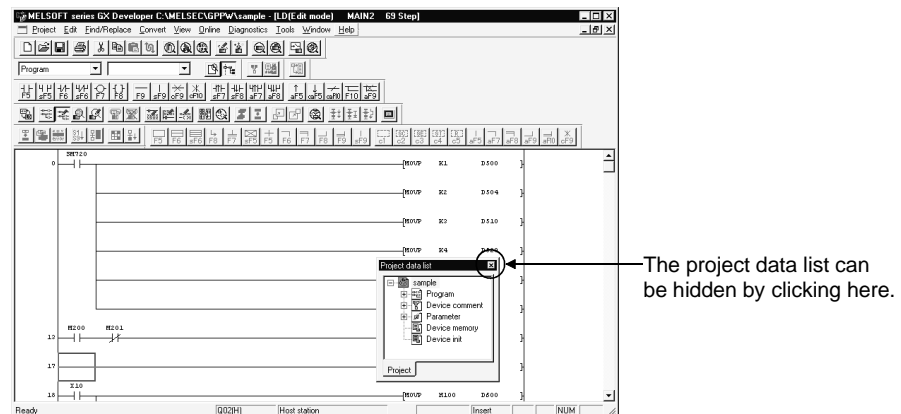

- You can change the edit screen from the toolbar.

1. Choose the data type.

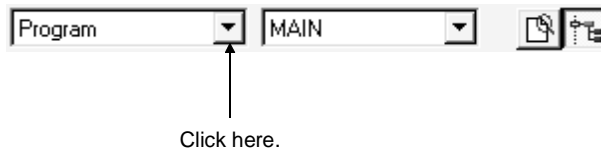

2. Choose the data type you want to change.

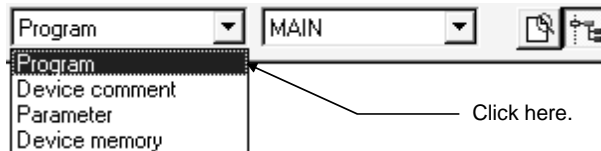

3. Choose the data name.



4. Choose the data you want to show.

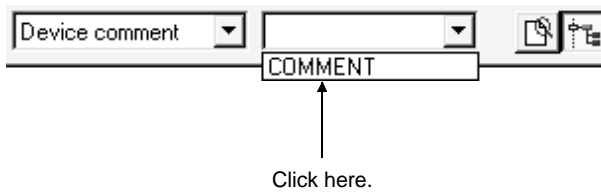

| |
|---|
| POINT |
| <p>If you opened multiple programs, comments, etc. or if you started multiple GX Developers, the screen may be changed in color or shape (displayed improperly).</p> <p>In such a case, close the other applications or program and comment screens.</p> <ul style="list-style-type: none"> If you use Windows[®] 2000 to open a project where multiple programs/ device comments/device memory data have been created, they are sorted and displayed in alphabetical order (A to Z). |

3.8 Comment Display

[Purpose]

Displays the created device comments on the circuit creation screen.

[Operating Procedure]

Select [View] → [Comment]

| POINT |
|---|
| <p>When a common comment and a comment by program have been set for the same device, click <<Each program>> tab on the dialog box displayed by selecting [Tool] → [Option] tab to set a comment to be displayed. Refer to Section 15.11.</p> <p>The comment from the GX Developer (SW3D5-GPPW-E) is displayed just beneath the circuit symbol. (It will be printed out just beneath the circuit symbol, if printed out.) Only when monitored, is it displayed with one line spaced.</p> |

3.9 Statement Display

[Purpose]

Displays the created statement on the circuit creation screen.

[Operating Procedure]

Select [View] → [Statement]

| POINT |
|---|
| <p>In the FXGP (DOS) and FXGP (WIN), "statement" is called the "circuit comment".</p> |

3.10 Note Display

[Purpose]

Displays the created notes on the circuit creation screen.

[Operating Procedure]

Select [View] → [Note]

| POINT |
|--|
| <p>In the FXGP (WIN), "note" is called the "coil comment".</p> |

3.11 Alias Display

[Purpose]

Displays the Alias in circuit mode on the circuit creation screen.

[Operating Procedure]

Select [View] → [Alias]

| POINT |
|--|
| <ul style="list-style-type: none">• Create the Alias on the device comment edit screen. Device names created in A Series format will not be saved when written in a different file format. |

3.12 Comment Format

[Purpose]

To display comments in the ladder mode in 4 × 8 characters or 3 × 5 characters.

[Operating Procedure]

[View] → [Comment format]

3.13 Alias format display

3.13.1 Replace device name and display

[Purpose]

Displays aliases in device display positions.

[Operating Procedure]

[View] → [Alias format display] → [Replace device name and display]

[Dialog Box]

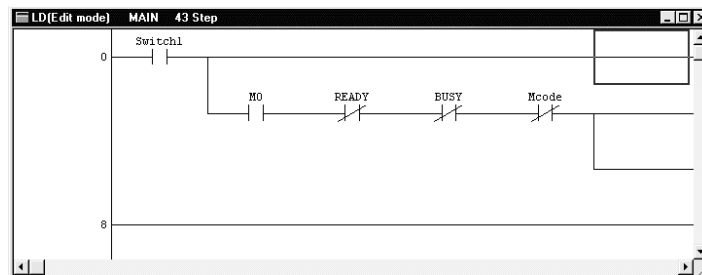

3.13.2 Arrange with device and display

[Purpose]

Displays aliases above devices shown. (Displays devices and aliases together)

[Operating Procedure]

[View] → [Alias format display] → [Arrange with device and display]

[Dialog Box]

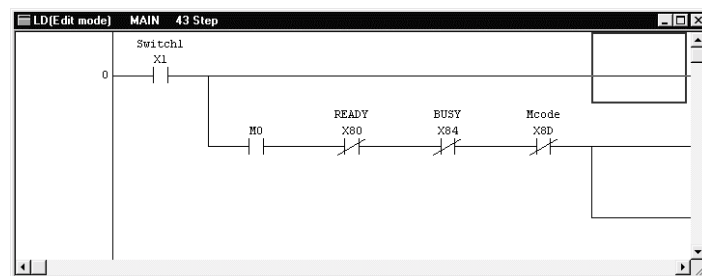

POINT

For timers/counters, if you set aliases to T0 and D0, respectively, in such an instruction as OUT T0 D0, the alias added to D0 (set value) does not appear. The device name will not be displayed either if word device bit specification (example: D0.1), bit device word specification (example: K4M0), indirect specification device (example: @D100) or index qualification specification (example: D12285Z1) has been set.

3.14 Setting the Number of Contacts

3.14.1 Displaying 9 contacts

[Purpose]

A ladder is displayed in a 9-contact format.

[Operating Procedure]

[View] → [Set the contact] → [9 contacts]

[Dialog Box]

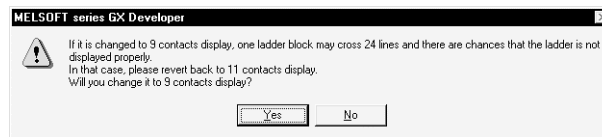

Click to change to a 9-contact display.

3.14.2 Displaying 11 contacts

[Purpose]

A ladder is displayed in an 11-contact format.

[Operating Procedure]

[View] → [Set the contact] → [11 contacts]

4. INITIALIZATION

4.1 Creating a Project

| | | |
|-----------------------|-----------------------|-----------------------|
| A | Q/QnA | FX |
| <input type="radio"/> | <input type="radio"/> | <input type="radio"/> |

[Purpose]

Designates the information required to create a project such as PLC series, PLC type and project name.

[Operating Procedure]

Select [Project] → [New project] or click  (**Ctrl** + **N**).

[Dialog Box]

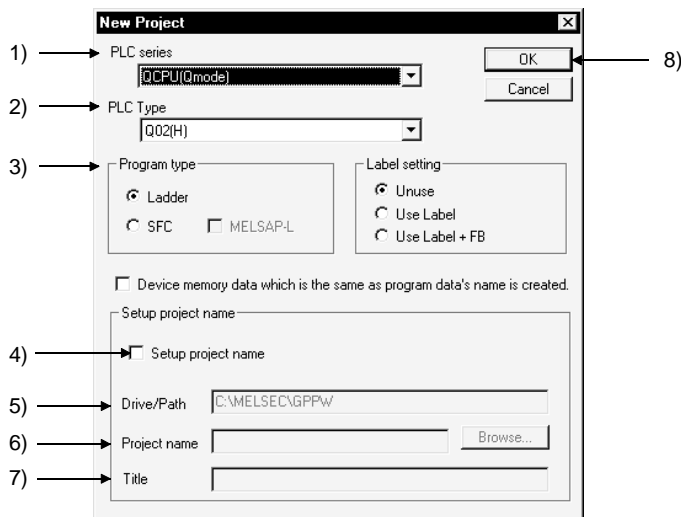

[Description]

- 1) **PLC series**
Designates the PLC series of the project by selecting from QCPU(Qmode), QnA series, QCPU(Amode), A series, MOTION(SCPU) and FX series.
- 2) **PLC type**
Designates the CPU type to be used by selecting from the list.
For FX and FX2, select FXU.
When creating remote I/O parameters on the Q series, choose the QCPU (Q mode) as the PLC series and then select "Remote I/O" as the PLC type.
- 3) **Program type**
Choose either of ladder program or SFC program. When creating an SFC on the A series, make the following settings.
 1. Set the microcomputer value in the memory capacity setting of PLC parameters.
 2. Choose SFC in the project type on the [Project][Edit data][New] screen. SFC is not compatible with label programming. Refer to Chapter 5 for the creating procedure.

4

- 4) Label setting
 - Unuse : To be specified when a label program is not created.
 - Use Label : To be specified when a label program is created.
 - Use Label+FB : To be specified when the FB is created.
 - Label program: Refer to Chapter 5 of this manual.
 - FB program : Refer to the GX Developer Operating Manual (Function Block).

- 5) Device memory data which is the same as program data's name is created.
 Make setting when creating the device memory having the same name as the program name for creation of a new project.

- 6) Set project name
 Designate a project name to save the created data.
 When designating a project name before creating a program, check the checkbox.
 The project name can be designated before and after program creation.
 When designating the project name after data creation, use the [Save As] menu.

See Section 5.4 "Naming and Saving a Project."

- 7) Drive/path
 - 8) Project name
 - 9) Title
- 
- See Section 3.2 for setting these fields.
- 10) button
 Click this button after making necessary settings.

| POINTS |
|--|
| <ul style="list-style-type: none"> The following lists the data and data names in new project creation. <p style="margin-left: 20px;"> Program : MAIN Comment : COMMENT (common comment) Parameter : PLC parameter : Network parameter (A series and QnA series only) </p> <p style="margin-left: 20px;">In addition, see Sections 4.9 and 11.2 for device memory, and Section 4.9 and Chapter 12 for device initial values (QnA series only).</p> <ul style="list-style-type: none"> If multiple programs are being created or multiple GX Developers are running, the screen may not be displayed properly due to the shortage of the personal computer resources. In this case, close GX Developers once or close other applications, if any. If you do not specify the drive/path (blank) but specify only the project name, the default drive/path is automatically created and the project is saved. |

4.2 Opening the Existing Project File

| | | |
|---|-------|----|
| A | Q/QnA | FX |
| ○ | ○ | ○ |

[Purpose]

Reads the saved project file.

[Operating Procedure]

Select [Project] → [Open project] or click  ([Ctrl] + [O]).

[Dialog Box]

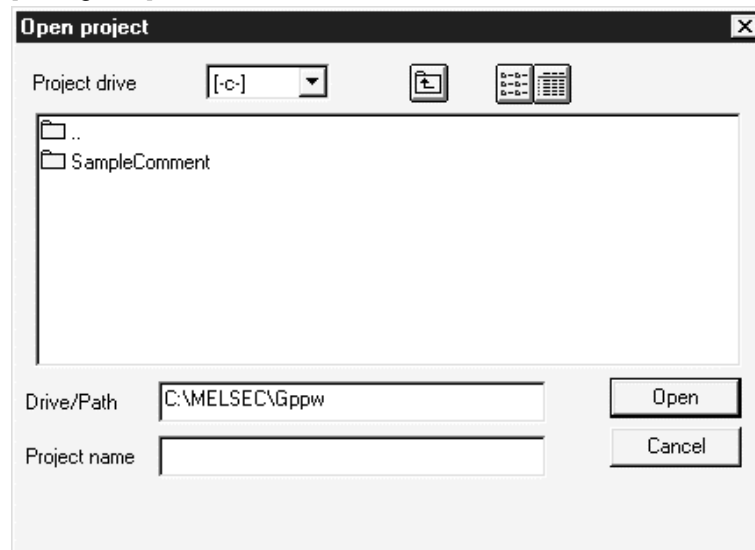

For details on how to designate the drive/path, project name, and project title, see Section 3.2.2.

| | |
|-------|---|
| POINT | <ul style="list-style-type: none"> • When the existing project is opened, GX Developer starts in the screen status that the project was saved. <ul style="list-style-type: none"> • GX Developer screen position and size. • Ladder monitor, registration monitor, batch monitor status (when connected with CPU) However, the screen is not restored properly if the resolution is different. • In GX Developer (SW3D5-GPPW-E Ver. 00A to SW5D5-GPPW-E Ver. 10B), 32-bit constants cannot be used for the third device in the DTO instruction of the ACPU. (Third device constants can have a maximum of 16 bits.) When the same data is also used in a version of GX Developer (other than SW3D5-GPPW-E Ver. 00A to SW5D5-GPPW-E Ver. 10B), the values displayed on the screen will become different. (Although data is saved in 32 bits internally, it becomes 16-bit data when the DTO instruction is edited in GPPA or a version of GX Developer between SW3D5-GPPW-E Ver. 00A and SW5D5-GPPW-E Ver. 10B. Caution is necessary.) GX Developer (SW3D5-GPPW-E Ver. 00A to SW5D5-GPPW-E Ver. 10B) and GPPA can only handle 16-bit data. Therefore, when a program created in 32 bits is displayed in these applications, the screen will show only the lower 16 bits. To align the values displayed in GX Developer and GPPA (regardless of versions), it is recommended that the 32-bit data be replaced using the DMOV instruction immediately before the DTO instruction. <Example of program> <div style="margin-top: 10px;"> </div> |
|-------|---|

4.3 Closing a Project File

| | | |
|-----------------------|-----------------------|-----------------------|
| A | Q/QnA | FX |
| <input type="radio"/> | <input type="radio"/> | <input type="radio"/> |

[Purpose]

Closes the active project file.

[Operating Procedure]

Select [Project] → [Close project].

[Description]

When no project name has been designated or data has been edited, you will be prompted to save change to the project when you select [Close project].

To save the change to the project, click the **[Yes]** button.

To close the project without saving it, click the **[No]** button.

For label programming

A dialog box appears if there are data being edited in global variable setting/local variable setting.

If you do not discard the edited data, click the **[No]** button, click the **[Register]** button on the global variable setting/local variable setting screen, and then close the project.

POINT

When saving the existing project with a name, an old project must exist.

(For example, if a project on an FD is opened and the FD is then removed, that project cannot be saved into another drive with a name.)

4.4 Saving a Project

| | | |
|-----------------------|-----------------------|-----------------------|
| A | Q/QnA | FX |
| <input type="radio"/> | <input type="radio"/> | <input type="radio"/> |

[Purpose]

Saves the active project file with the designated name.

[Operating Procedure]

Select [Project] → [Save project] or click  (**[Ctrl]** + **[S]**).

[Description]

Selecting [Save project] causes data to be written onto the existing project file.

For label programming

A dialog box appears if there are data being edited in global variable setting/local variable setting.

If you do not discard the edited data, click the **[No]** button, click the **[Register]** button on the global variable setting/local variable setting screen, and then save the project.

4.5 Saving a Project with a New Name

| | | |
|-----------------------|-----------------------|-----------------------|
| A | Q/QnA | FX |
| <input type="radio"/> | <input type="radio"/> | <input type="radio"/> |

[Purpose]

Saves the active project with a new name.

[Operating Procedure]

Select [Project] → [Save as].

[Description]

Designate the project path, project name, and project title before saving the project.

For details, see Section 3.2.1.

A dialog box appears if there are data being edited in global variable setting/local variable setting.

If you do not discard the edited data, click the **No** button, click the **Register** button on the global variable setting/local variable setting screen, and then save the project.

| | |
|---|--|
| POINT | |
| <p>When saving the existing project with a name, an old project must exist. (For example, if a project on an FD is opened and the FD is then removed, that project cannot be saved into another drive with a name.)</p> | |

4.6 Deleting a Project

| | | |
|-----------------------|-----------------------|-----------------------|
| A | Q/QnA | FX |
| <input type="radio"/> | <input type="radio"/> | <input type="radio"/> |

[Purpose]

Deletes the unnecessary project files.

[Operating Procedure]

Select [Project] → [Delete project].

[Description]

Select the project to be deleted, then click the **Delete project** button.

4.7 Verifying Data in Projects

| | | |
|-----------------------|-----------------------|-----------------------|
| A | Q/QnA | FX |
| <input type="radio"/> | <input type="radio"/> | <input type="radio"/> |

[Purpose]

Verifies data between the PLC projects of the same PLC type.

[Operating Procedure]

Select [Project] → [Verify].

[Dialog Box]

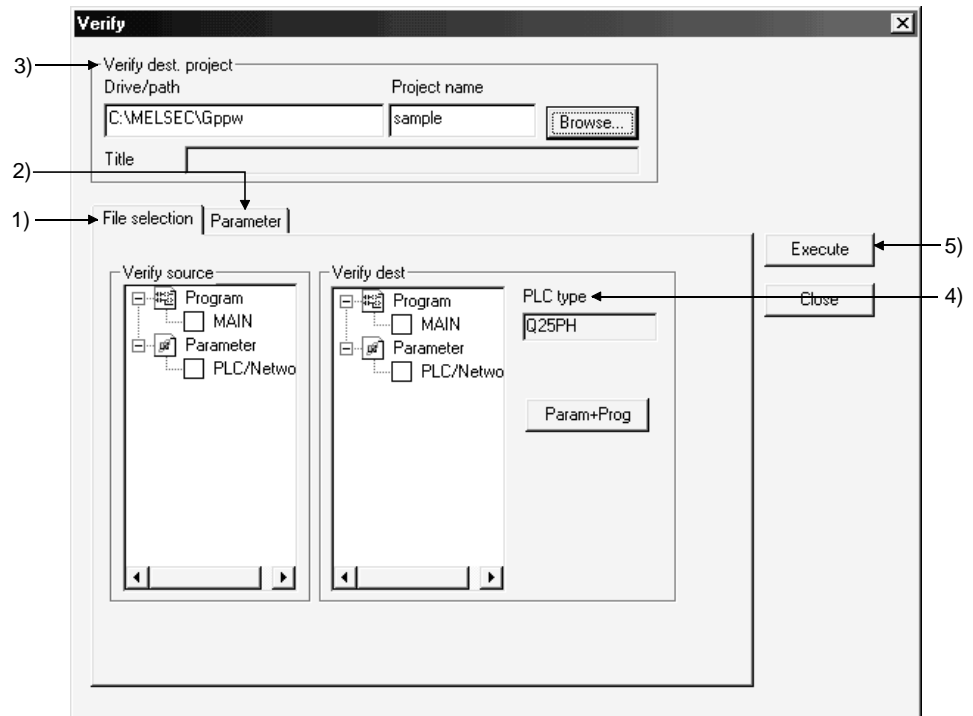

[Description]

1) <<File selection>>tab

- Verify source
Lists the current project data.
Check the checkbox of a data name to select it.
- Verify dest
Lists the project data of a destination.
Check the checkbox of a data name to select it.

- 2) <<Parameter>>tab (Q/QnA series only)
 Select the parameter verify level.
 The default is "Level 1".

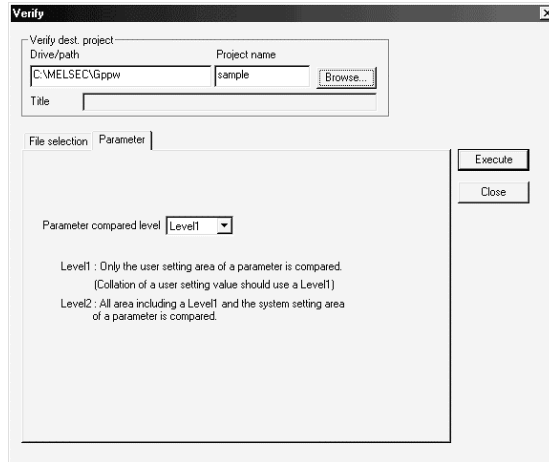

When verify is performed on "Level 2"

On "Level 2", the parameter area other than the user setting area is also verified.

The following message appears if any mismatch is detected as a result of verifying the parameter area other than the user setting area.

Take corrective action according to the message of the verify result.

| Message | Corrective Action |
|--|--|
| The header information of the parameter block is inconsistent. | A mismatch exists in other than the user setting area. Write the parameters to the PLC CPU again. |
| This parameter block can't analyze. | The GX Developer version used to create the project differs between the verify source and verify destination. This does not affect the operation of the PLC CPU. |

- 3) Drive/path, Project name
 Sets a drive path for the project data to be verified.
 See Section 3.2 for details on how to set the path.
- 4) PLC type
 Displays the PLC type of the project.
- 5) **Execute** button
 Click this button after making necessary settings.
- 6) **Param+prog** button
 Selects only the parameter data and program data of a source.

[Operating Procedure]

1. Select a project name in the dialog box displayed by clicking the **Browse** button to designate a destination drive/path name and a project name.
2. Check a checkbox for source data name and a checkbox for destination data name to be verified.
3. Click the **Execute** button after making necessary settings.

POINT

- Multiple data can be selected in source and destination data for verification as shown below.

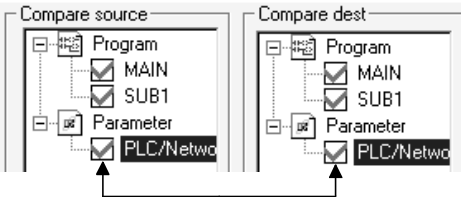

Check the checkbox of a data name to select it.

- For label programming
Verify can be performed when the verify source and verify destination projects are label-programmed. Verify cannot be performed if the project of other than the label-programmed is specified as the verify destination.
- For remote I/O projects
Verify can be performed when the verify source and verify destination projects are remote projects. You cannot select the project of other than the remote I/O project as the verify destination.

4.8 Copying a Project

| | | |
|-----------------------|-----------------------|-----------------------|
| A | Q/QnA | FX |
| <input type="radio"/> | <input type="radio"/> | <input type="radio"/> |

[Purpose]

Copies data between projects.

When the selected source data is already in the destination, the existing data in the destination is overwritten with the source data.

[Operating Procedure]

Select [Project] → [Copy].

[Dialog Box]

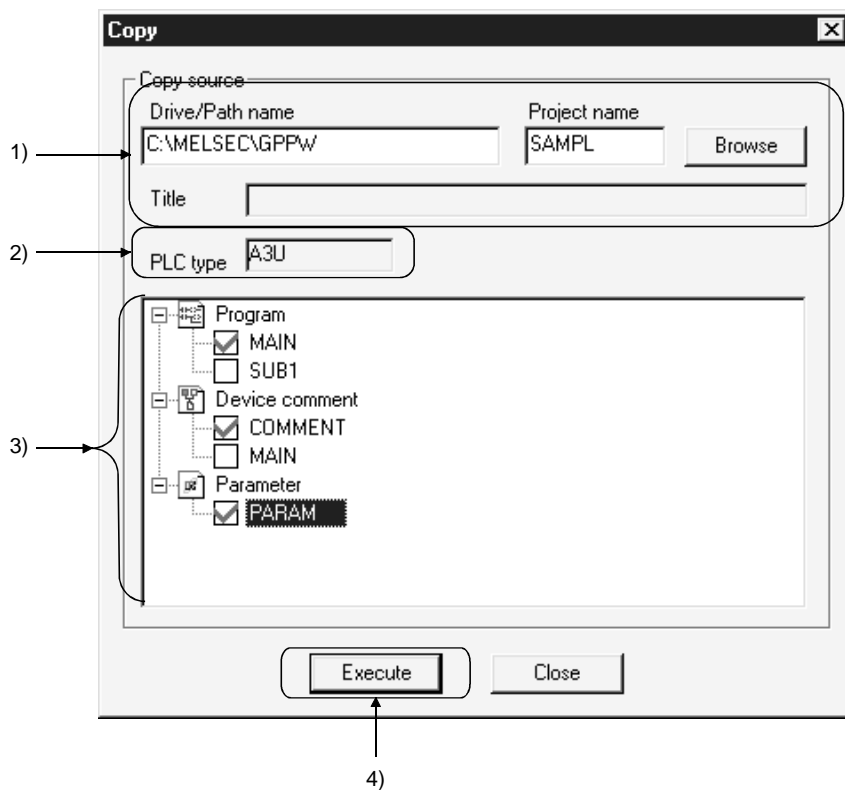

[Description]

- 1) Drive/path name, Project name
Designates a drive path for project data to be copied.
- 2) PLC type
Displays the PLC type of the source project.
- 3) Source data list
Lists source data.
- 4) **Execute** button
Click this button after setting necessary settings.

[Operating Procedure]

1. Select a project in the dialog box displayed by clicking the **[Browse]** button to designate a source data drive/path name and a project name.
2. Check a checkbox for source data name.
3. Click the **[Execute]** button after making necessary settings.

POINT

- All the selected data will be copied.
Source

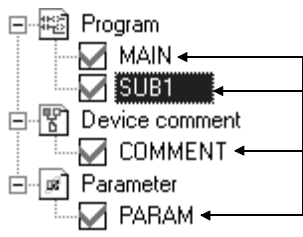

Check the checkbox of a data name to select it.

- For label programming (Q/QnA series only)
The following table indicates the items which can be copied when label programming is specified at the copy source and/or copy destination.

| Copy Destination (Open project) | Copy Source (Copy source project) | Copy Selectable Items |
|--|--|--|
| Label program | Label programming | <ul style="list-style-type: none"> • Label program • Local variable definition • Global variable definition |
| Label program | Other than label programming (Actual program) | <ul style="list-style-type: none"> • Program converted into label program is read • Local variables are initialized. |
| Other than label programming (Actual program) | Label program | <ul style="list-style-type: none"> • Only actual program is read. |

- For remote I/O station program (Q series only)
The following table indicates the after-copy status when remote I/O station projects are specified at the copy source and/or copy destination.

| Copy Destination (Open project) | Copy Source (Copy source project) | Copy |
|------------------------------------|--------------------------------------|--|
| Remote I/O | QCPU (Q mode) | The parameters of the copy source are copied to the project being edited. However, when the data selected is other than the parameters, the parameters of the copy source become defaults. |
| | Other than QCPU (Q mode) | Copy cannot be performed. |
| QCPU (Q mode) | Remote I/O | Only parameters can be copied. |
| Other than QCPU (Q mode) | Remote I/O | Copy cannot be performed. |

4.9 Adding Data to a Project

| A | Q/QnA | FX |
|---|-------|----|
| ○ | ○ | ○ |

[Purpose]

Adds a program, common comment, comments by program, or device memory data to the project.

[Operating Procedure]

Select [Project] → [Edit data] → [New]

[Dialog Box]

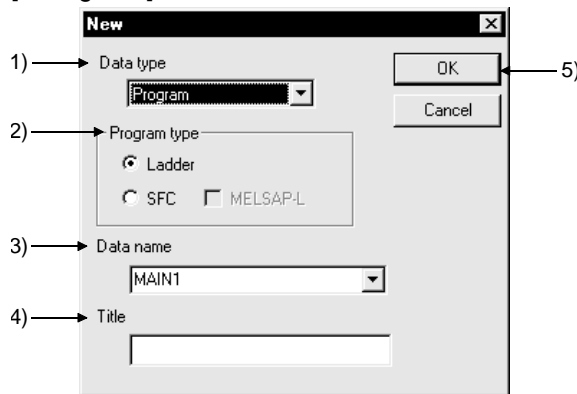

[Description]

1) Data type

Designates the type of the data to be added (program, common comment, comments by program, or device memory).

When you selected the Q00J/Q00/Q01CPU, you can add only the comments by program.

When the FXCPU is selected, only the comments by program or device memory may be added.

2) Program type

Choose either of ladder program or SFC program. When creating an SFC on the A series, make the following settings.

1. Set the microcomputer value in the memory capacity setting of PLC parameters.
2. Choose SFC in the project type on the [Project] → [Edit data] → [New] screen.

3) Data name of the data to be added

Designates the name of the data to be added.

If one of A series PLCs is set as the PLC type of the active project, the name is fixed as SUB1, SUB2, or SUB3. (If the PLC type is A4UCPU, comments by program, named SUB4, can also be added.)

Name of subprograms can be designated after completing memory capacity setting for parameters.

For Q/QnA series, the name should be designated within 8 characters.

For FX series, MAIN is designated as the name.

Characters that may be used to set a data name

For A series

The data name of the A series accepts only alphanumeric characters, - (hyphen) and _ (underline).

In the A series, an error will occur if the data name is headed by a numeral.

For Q/QnA/FX series

Alphanumeric characters, kana, kanji, _, ^, \$, -, (tilde), !, #, %, &, (), -, { }, @, * (apostrophe), ' (single quotation)

Unusable characters

An error will occur if any of " = | : ; , ¥ [] + * ? < > . / exists.

- 4) Title
Designates the title of the data in up to 32 characters.
- 5) button
Click this button after setting necessary settings.

| |
|---|
| POINT |
| Multiple device memories/device comments can be created in a project. |

4.10 Copying Data within a Project

| | | |
|---|-------|----|
| A | Q/QnA | FX |
| ○ | ○ | ○ |

[Purpose]

Copies the existing data within a project.

[Operating Procedure]

Select [Project] → [Edit data] → [Copy].

[Dialog Box]

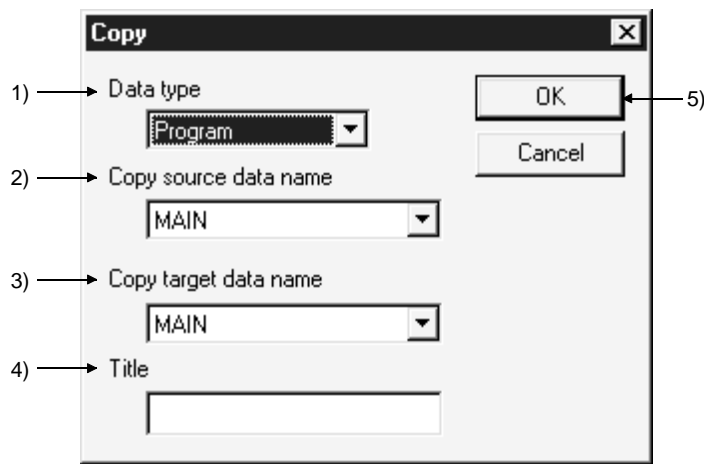

[Description]

- 1) Data type
Designates the data type (program, common comment, comments by program, device memory).
When you selected the Q00J/Q00/Q01CPU, you can choose only the device memory or device comment.
- 2) Source data name
Designates the name of source data.
- 3) Destination data name
Designates the new data name.
If necessary, source data can also be overwritten onto an existing data.
The data name must be designated in up to 8 characters.
- 4) Title
Displays the set title of the data.
If necessary, the title can be edited and stored.
It must be designated in up to 32 characters.
- 5) **OK** button
Click this button after making necessary settings.

4.11 Deleting Data in a Project

| | | |
|---|-------|----|
| A | Q/QnA | FX |
| ○ | ○ | ○ |

[Purpose]

Deletes an existing data in a project.

[Operating Procedure]

Select [Project] → [Edit data] → [Delete].

[Dialog Box]

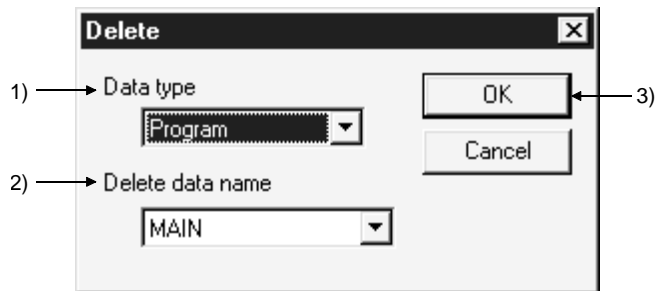

[Description]

- 1) Data type
Designates the data type (program, common comment, comments by program, device memory).
- 2) Data to be deleted
Designates the name of the data to be deleted.
- 3) **OK** button
Click this button after making necessary settings.

4.12 Renaming Data in a Project

| | | |
|---|-------|----|
| A | Q/QnA | FX |
| ○ | ○ | ○ |

[Purpose]

Renames the existing data in a project.

[Operating Procedure]

Select [Project] → [Edit data] → [Rename].

[Dialog Box]

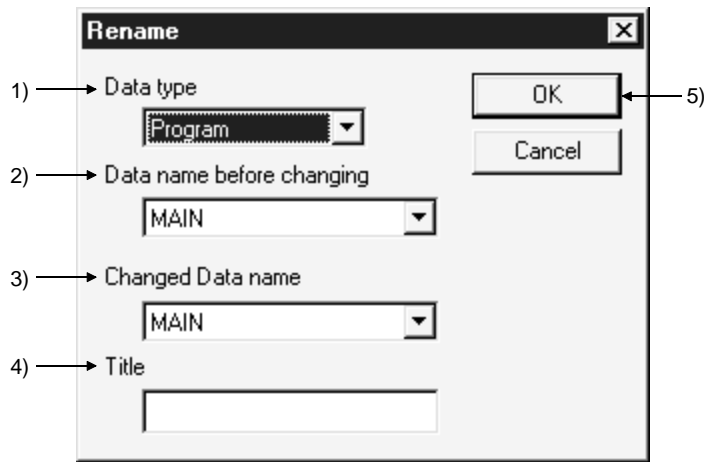

[Description]

- 1) Data type
Designates the data type (program, common comment, comments by program, device memory).
- 2) Data name before renaming
Designates the data name before renaming.
- 3) Renamed data name
Designates the new data name after renaming.
The data name must be designated in up to 8 characters.
- 4) Title
Displays the set title of the data.
If necessary, the title can be edited and stored.
It must be designated in up to 32 characters.
- 5) **OK** button
Click this button after making necessary settings.

| |
|--|
| POINT |
| <p>This operation cannot change the data name of comments by program to "COMMENT". For changing the comments by program to the common comment (COMMENT), refer to "Setting Comment Types" (Section 9.6).</p> |

4.13 Changing the Ladder and SFC with each other

| A | Q/QnA | FX |
|---|-------|----|
| × | × | ○ |

[Purpose]

Sets when the existing ladder program is changed to the SFC program, and vice versa.

[Operating Procedure]

Select [Project] → [Edit Data] → [Change program type].

[Dialog Box]

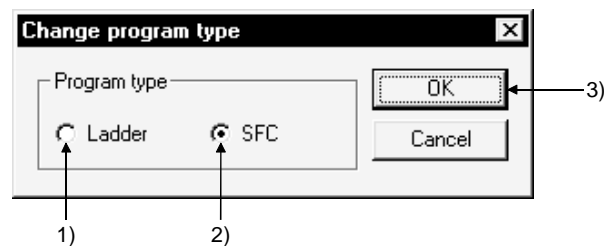

[Description]

1) Ladder

Changes the SFC program being displayed to the ladder program.
After the changing operation has been completed, editing of the ladder program is enabled.

2) SFC

Changes the ladder program being displayed to the SFC program.
After the changing operation has been completed, editing of the SFC program is enabled.

3) **OK** button

Click this button after making necessary settings.

POINTS

For cautions on interchanging, refer to the GX Developer Operating Manual (SFC Version).

4.14 Changing the PLC Type of a Project

| | | |
|---|-------|----|
| A | Q/QnA | FX |
| ○ | ○ | ○ |

[Purpose]

Changes the type of the existing data or the data being edited so that it can be used with another type or PLC series.

[Operating Procedure]

Select [Project] → [Change PLC type].

[Dialog Box]

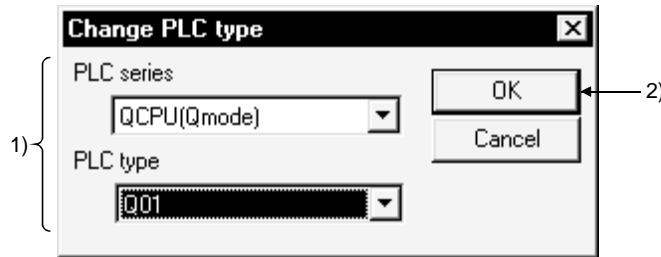

[Description]

1) PLC series/PLC type
Designates the PLC series or PLC type to be changed.

2) **OK** button
Click this button after making necessary settings.
After the **OK** button is clicked, the following dialog box appears.

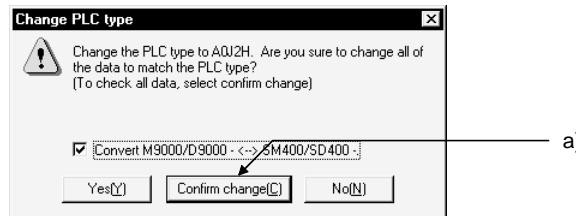

a) Turn on this check box when making conversion between the M9000/D9000 range and the SM400/SD400 range.
The above message appears for changing the following PLC types.

- Conversion between QCPU (Q mode) and ACPU
- Conversion between QnACPU and ACPU

Conversion can be made if you do not make the A series CPU compatibility setting after choosing [PLC parameter] - <PLC system>.

b) By clicking the **Confirm change** button, you can change the parameter and other settings while simultaneously confirming them.
When changing the PLC type between FX and FX, you can make corrections to the PLC parameter capacity within the specification range of the PLC type after change.

| POINTS | | | | |
|---|------------------|---------|------|------------|
| <ul style="list-style-type: none"> • For restrictions on changing each PLC series/PLC type, refer to the restrictions on PLC Change in Appendix 4. • When reading a project from an FD or the like, you cannot make a PLC type change if there is no source project. When changing the PLC type, do not remove the FD or the like nor delete the project. • Note that if SB and/or SW is used in CC-Link refresh setting, special module interrupt setting or the like, a Q → QnA change will cause the SB and/or SW in that part not to be refreshed or interrupt-processed. • PLC type cannot be changed during the monitoring of the circuit or device data in batch. • If you select Remote I/O of the QCPU (Q mode) in PLC type changing, the data of the conversion source are changed to defaults. • Refer to Appendix 4 for label programming. • When changing the PLC type of the project that includes the intelligent function module parameters to Q00J/Q00/Q01CPU or Remote I/O, reexamine the device ranges of the automatic refresh setting in the function module parameters, and make correction if there are devices outside the ranges. The devices other than the following need not be corrected. | | | | |
| | QCPU (Q Mode) | Q00/Q01 | Q00J | Remote I/O |
| X | 0-1FFF | 0-7FF | | — |
| Y | 0-1FFF | 0-7FF | | — |
| M | 0-32767 | | | 0-8191 |
| B | 0-7FFF | | | 0-3FFF |
| D | 0-32767 | | | 0-12287 |
| W | 0-7FFF | | | 0-3FFF |
| <ul style="list-style-type: none"> • If the PLC type is changed while the line is connected, the line is cut off. | | | | |

4.15 Reading Other Format Files

4.15.1 Reading GPPQ, GPPA, FXGP(DOS) or FXGP(WIN) files

| | | |
|---|-------|----|
| A | Q/QnA | FX |
| ○ | ○ | ○ |

[Purpose]

Reads the existing GPPQ, GPPA, FXGP(DOS), and FXGP(WIN) data into GX Developer. These data can be read according to the following procedure immediately after GX Developer is started.

[Operating Procedure]

- Select [Project] → [Import file] →
- [Import from GPPQ format file]
 - [Import from GPPA format file]
 - [Import from FXGP(WIN) format file]
 - [Import from FXGP(DOS) format file]

[Dialog Box]

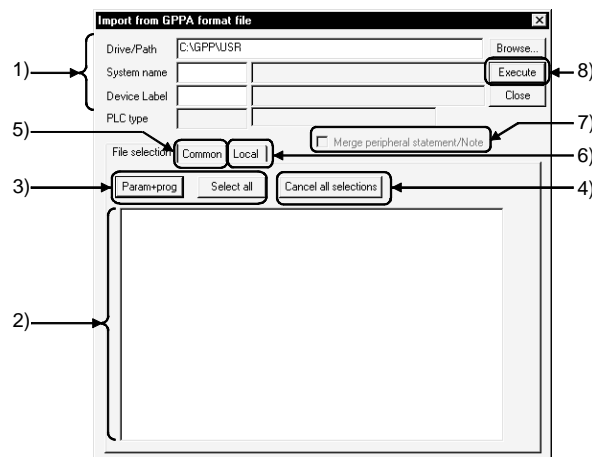

[Description]

- 1) Drive/path, System name, Machine name
Designates the location of data created by GPPQ, GPPA, FXGP(DOS) or FXGP(WIN).
Enter a system name and a machine name for the data specified in the drive path. Clicking the **[Browse]** button shows the dialog box for choosing the system name and machine name. Double-click the file to be read to specify.
When FXGP(DOS) or FXGP(WIN) data is read, a folder name is specified as the system name and a file name as a machine name.
Also, specifying a file name from a root directory, the system name is left blank. For details, see Subsection 3.2.2.
- 2) Source data list
Displays data created by GPPQ, GPPA, FXGP(DOS), and FXGP(WIN).
Check the checkbox of data names to be selected.
The selected comments can be edited in the program common tab or the program tab.

- 3) **Param+prog** button/ **Select all** button
- **Param+prog** button
Selects only the parameter data and program data of a source.
 - **Select all** button
Selects all data in a source data list.
comment2 is selected as comments in A series, and the device memories of the same quantity as the number of data are displayed.
The first data name is selected for comments and file registers in QnA series.
- 4) **Cancel all selections** button
Cancels all the selected data.
- 5) <<Common for programs>> sheet (A series)
Click <<Common for programs>> tab to set a range for common comments and read data.

Import from GPPA format file

Drive/Path: C:\GPP\USRA [Browse...]

System name: [] [Execute]

Machine: [] [Close]

PLC type: []

File selection: **Common** | Local Merge peripheral statement/note

[Read/write the comments of the set range.]

Comment type specification (Excluding Extended Comments):
 Comment1 Comment2

If closed, the changed range specifications will be deleted.

Range specification

PLC/GPPA Format | GX Developer Format

| Device | Start | End | Start | End |
|-----------|-------|-----|-------|-----|
| X/Y | | | | |
| Special M | | | | |
| Special D | | | | |

Comment1/2 memory capacity: [] K Bytes

| Device | Start | End | Start | End |
|--------|-------|-----|-------|-----|
| | | | | |
| | | | | |
| | | | | |

Extended comment memory capacity: [] K Bytes

For the setting method for each PLC series, refer to Chapter 9 "SETTING DEVICE COMMENTS".

- 6) <<For each program>> sheet (A series)
Click <<For each program>> tab to set a range for comments by program and read data.
(Except the FX series)

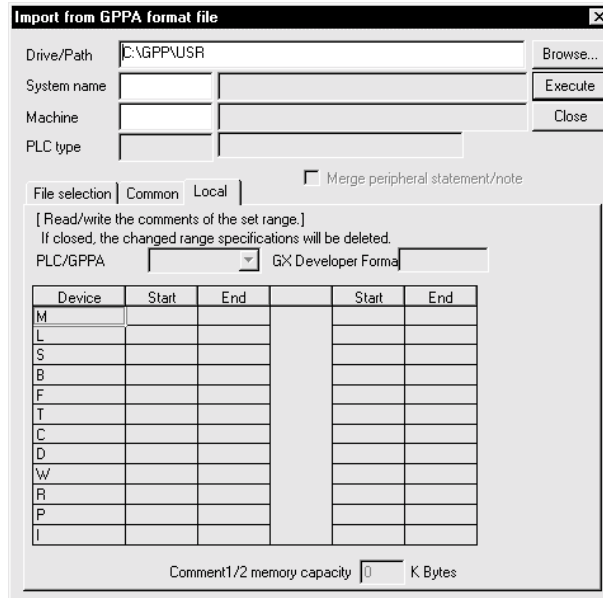

For the setting method for each PLC series, refer to Chapter 9 "SETTING DEVICE COMMENTS".

- 7) Merge peripheral Statement/Note
Refer to Section 10.2.
- 8) **Execute** button
Click this button after the setting is over.

[Setting Procedure]

- Data selection
 1. Set a drive/path for reading by GPPQ, GPPA, FX(DOS), or FX(WIN).
 2. Select a project name in the dialog box displayed by clicking the **Browse** button to designate a system name and machine name for the project to be read.
 3. Check the checkbox of data to be selected by using **Param+prog** button, **Select all** button, or the mouse.
 4. Click the **Execute** button after making necessary settings.
- Canceling data selection
 - (1) When canceling the selected data arbitrarily:
 - Clear the checkmark (✓) in the checkbox with the mouse or space key.
 - (2) When canceling all the selected data:
 - Click the **Cancel all selection** button.

Precautions for reading the other format files

| For A series | | |
|---------------------------------|--|---|
| A6GPP, SW0S-GPPA format data | Read data with GX Developer after performing the corresponding format conversion with GPPA. For the operating methods, refer to Type SW□SRXV/IVD-GPPA GPP Function Operating Manual (Details). | |
| For data selection | For device comment selection, you may only choose either comment 2 or comment 1. | |
| For GX Developer format reading | Abandon the project data on GX Developer and read the other format file. The area in excess of the program capacity is deleted when read. For the PLC type which cannot use subprograms, subprograms are deleted when read. | |
| For QnA series | | |
| Ladder return positions | Returning places are different between GPPQ and GX Developer. Because of this, if the total of return sources and return destinations exceeds 24 lines in a single ladder block, the program is not displayed properly. Corrective action: Add SM400 (normally ON contact) to adjust the return positions. | |
| For data selection | For the device memory and file register, you may select only one data name for each item. | |
| For FX series | | |
| For data selection | Any item that does not exist in the source data is not displayed. | |
| Read range | For the A6GPP format, read the data after making conversion once with the FXGP(DOS) software. For the conversion method, refer to the SW1PC-FXGP/EE/AT Software Operating Manual. The data will disappear if it includes microcomputer programs other than SFC programs. | |
| For FXGP(DOS) format | Files to be read | <ul style="list-style-type: none"> Program file (.PMC) Parameter, program, comment, file register Comment file (.COK) Comment Device memory file Data register, file register, RAM file register, special register (.DMD, .DME, .DMF, .DMG) |
| | Files not read | Circuit comment file (.COL), sampling trace file (.STA) Print title file (.PTL), comment file (.COH) Shared circuit file (.DAT) |
| For FXGP(WIN) format | Files to be read | <ul style="list-style-type: none"> Program file (.PMW) Parameter, program, comment, file register Comment file (.COW) Device comment, circuit comment, coil comment, Alias Device memory file (.DMW) Data register, special register, RAM file register |
| | Files not read | Sampling trace file (.STW), print title file (.PTW) Registration monitor file (.RMW) |
| | Restrictions | <ul style="list-style-type: none"> Device comment Up to 50 characters can be input for FXGP(WIN) device comments, but only the first 32 characters are read because the maximum number of character is 32 in GX Developer. Statement Any number of characters can be input for FXGP(WIN) circuit comments, but only the first 64 characters are read because the maximum number of characters is 64 in GX Developer. Note Any number of characters can be input for FXGP(WIN) coil comments, but only the first 32 characters are read because the maximum number of characters is 32 in GX Developer. |

4.15.2 Reading a MELSEC MEDOC format file (Printout)

| | | |
|---|-------|----|
| A | Q/QnA | FX |
| ○ | × | ○ |

[Purpose]

Reads the data output to a file with MELSEC MEDOC as print-out data.

[Operating Procedure]

[Project] → [Import file] → [Import from Melsec Medoc format file]

[Dialog Box]

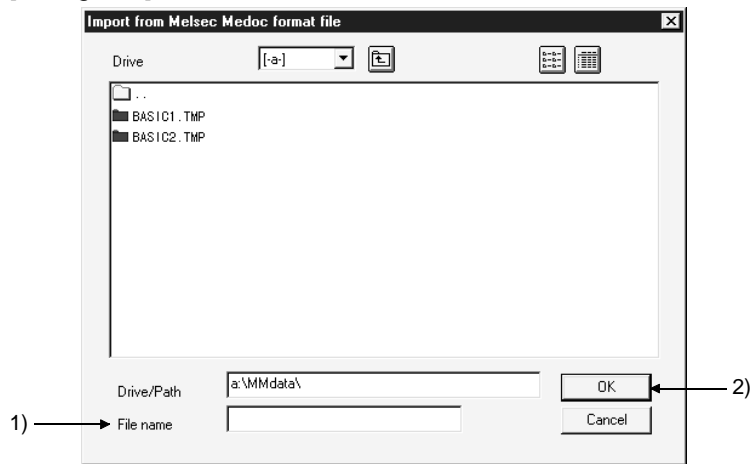

[Description]

1) File name

The data output to a file with MELSEC MEDOC as print-out data will be read. The MELSEC MEDOC data created with version Ver 2.3 or later will be read.

2) button

Click this button after the setting is over.

POINTS

- If print data created with the OS (MS-DOS) in other than English includes characters which cannot be handled by English Windows, reading the data to GX Developer may not show them correctly.
- The headers, parameters, programs and comments in the print-out data are read.
- The parameters read are only the memory capacity, latch range and timer/counter range (except the FX series).
- The instructions that cannot be converted are converted as abnormal instruction codes.
- When reading the MELSEC MEDOC data with GX Developer, always save it after adding the Printer Head (incompatible with the Small Header) on the MELSEC MEDOC side.

For the parameters, programs, etc., use the following table as reference.

| | MELSEC MEDOC Print-out DataType | Condition |
|-----------|--|-----------|
| Program | Instr | Any |
| Comment | Name (Name is to be printed out, Comment is not to be printed out) | Any *1 |
| Comment | parameter | Any *1 |
| Parameter | parameter | Any *1 |

Any *1: Only the print-out data for MAIN is valid.

Data existing in the print-out data for SUB is not read.

- Refer to Section 4.15.3.

4.15.3 Reading a MELSEC MEDOC format file

| | | |
|---|-------|----|
| A | Q/QnA | FX |
| ○ | × | ○ |

[Purpose]

Reads the data created with MELSEC MEDOC.

[Operating Procedure]

[Project] → [Import file] → [Import from Melsec Medoc format file]

[Dialog Box]

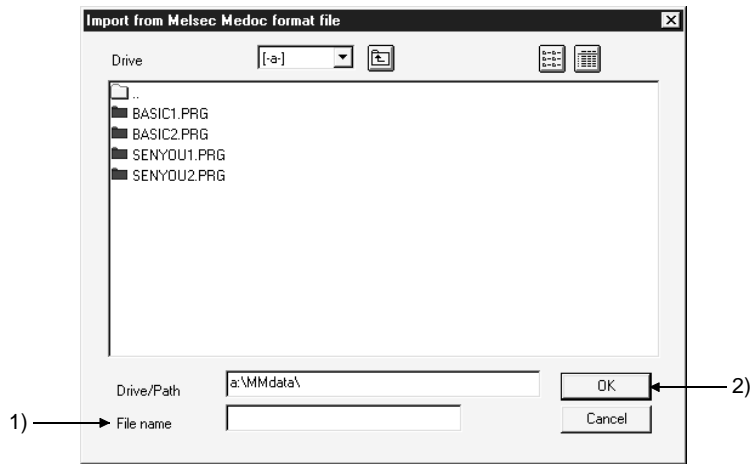

[Description]

- 1) File name
Choose the data created with MELSEC MEDOC.
- 2) **OK** button
Click this button after the setting is over.

| POINTS |
|---|
| <ul style="list-style-type: none"> • If you want to read subprogram data but the subprogram memory capacity has not been set on the project side, an error occurs and the data is not read. Preset the memory capacity in the PLC parameter. • Unconvertible instructions are converted as instruction code faults. • The definition of a conversion error is displayed in the dialog box and can be saved in the file. The place where it will be saved is the drive/path where the data to be read is saved. • Data having many statements cannot be displayed properly. Refer to Section 10.1. |

POINTS

- The MEMORY CAPACITY (Total memory-Sequence Program) parameter whose setting is step 0 in the sequence program created with MEDOC (PLC type: FX2N) will not be read properly.
- If you read the parameter where the set value devices are specified for the normal counters/timers other than the extended counters/extended timers in the sequence program created with MEDOC (PLC type: ACPU), the set value device numbers are deleted on GX Developer.
- A line-to-line statement headed by ";" results in a conversion error. Change ";" to another character to enable read.
- The following ladder created with MEDOC will not be displayed.

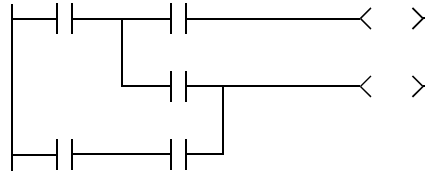

- When the MELSECNETII parameters have been set with MELSEC MEDOC, they will be written as MELSECNETII mixed parameters if they are written to the PLC CPU with the latter half setting screen merely opened and no settings made.
If a MEDOC format file is read with GX Developer, it is read as a MELSECNETII parameter file since the later half has not been set. Verifying the PLC and GX Developer data in this status will result in a verify mismatch.
- When starting GX Developer with Windows[®] 98, do not start the following application at the same time.
BarClock
- An error will occur if Swedish special characters are included in the ASC instruction of the MEDOC data.
- If lines of only line feed have been created in the program created with MEDOC, conversion to GX Developer data will erase those lines.
- A line-to-line statement headed by "@Export:" results in a conversion error.

4.16 Exporting GPPQ, GPPA, FXGP(DOS) or FXGP(WIN) Files

| | | |
|-----------------------|-----------------------|-----------------------|
| A | Q/QnA | FX |
| <input type="radio"/> | <input type="radio"/> | <input type="radio"/> |

[Purpose]

Saves GX Developer data in a GPPQ, GPPA, FXGP(DOS) or FXGP(WIN) file so that it can be read and edited as a GPPQ, GPPA, FXGP(DOS), or FXGP(WIN) file.

[Operating Procedure]

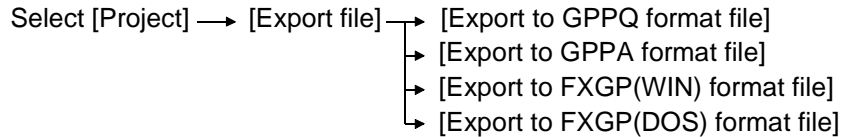

[Dialog Box]

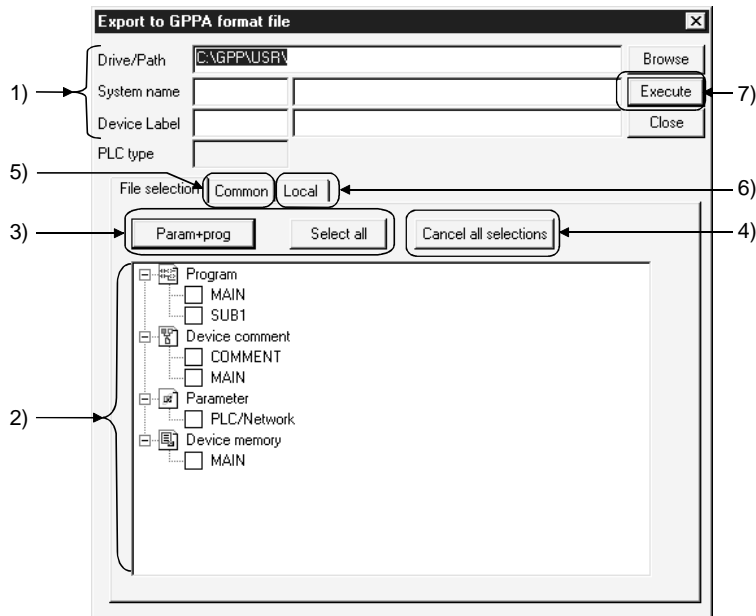

[Description]

- 1) Drive/path, System name, Machine name
Designates a drive/path for writing a GPPQ, GPPA, FXGP(DOS), or FXGP(WIN) file.
Enter a system name and a machine name for data specified in the project path.
When data is written to an FXGP(DOS) or FXGP(WIN) file, a folder name must be designated as a system name and a program file name as a machine name. See Section 3.2 for details on operating methods.

Characters that can be set for data name setting

For A series

You must not use any characters other than alphanumeric characters and - (hyphen).

The first character should be "alphabetic" (a numeral will result in an error).

For QnA/FX series

Alphanumeric characters, _, ^, \$, -, (tilde), !, #, %, &, (), -, { }, @, *
 (apostrophe), ' (single quotation)
 Unusable characters

An error will occur in presence of any of:

" = | : ; , ¥ [] + * ? < > . / (space)

- 2) Source data list
 Selects data to be written to a GPPQ, GPPA, FXGP(DOS) or FXGP(WIN) file.
 Check a checkbox of the data name to be selected.
- 3) **Param+Prog** button/ **Select all** button
 - **Param+Prog** button
 Selects only the source parameter data and program data.
 - **Select all selection** button
 Selects all the listed source data.
- 4) **Cancel all selection** button
 Cancels all the selected data.
- 5) <<Common>> sheet (A series)
 Click <<Common>> tab to set a range for common comments and write data.

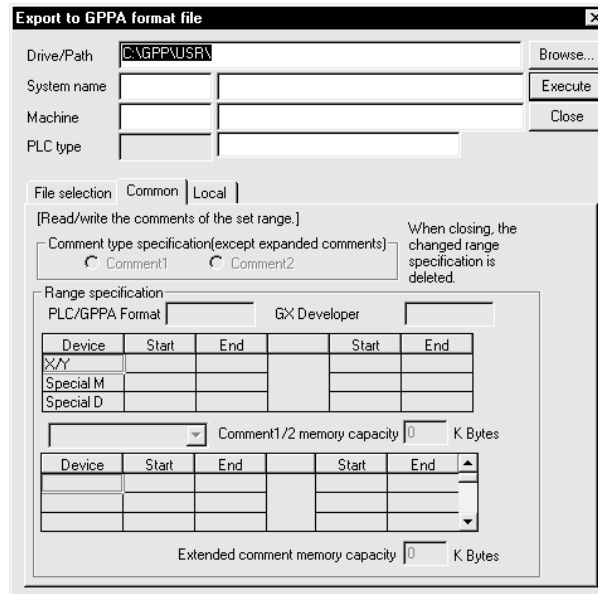

For the setting method for each PLC series, refer to Chapter 9 "SETTING DEVICE COMMENTS".

- 6) <<Local>> sheet (A series)
Click <<Local>> tab to set a range for comments by program and write data.
(Except the FX series)

Export to GPPA format file

Drive/Path: C:\GPP\USR [Browse...]

System name: [] [Execute]

Machine: [] [Close]

PLC type: []

File selection: Common Local

[Read/write the comments of the set range.]
If closed, the changed range specifications will be deleted.

PLC/GPPA Format: GX Developer

| Device | Start | End | | Start | End |
|--------|-------|-----|--|-------|-----|
| M | | | | | |
| L | | | | | |
| S | | | | | |
| B | | | | | |
| F | | | | | |
| T | | | | | |
| C | | | | | |
| D | | | | | |
| W | | | | | |
| R | | | | | |
| P | | | | | |
| I | | | | | |

Comment 1/2 memory capacity: 0 K Bytes

For the setting method for each PLC series, refer to Chapter 9 "SETTING DEVICE COMMENTS".

- 7) **Execute** button
Click this button after making necessary settings.

[Operating Procedure]

- Data selection
 1. Designate a drive/path for the project to be written.
 2. Select a project name in the dialog box displayed by clicking the **Browse** button to designate a system name and machine name for the project to be written.
 3. Check the checkbox of data to be selected by using **Param+Prog** button, **Select all selection** button, or the mouse.
 4. When setting a range for comments to be written, set the details of the comment range. (See Chapter 9 for details on setting methods.)
 5. Click the **Execute** button after making necessary settings.
- Canceling data selection
 - (1) Canceling the selected data arbitrarily
 - Clear the checkmark in the checkbox with the mouse or space key.
 - (2) Canceling all the selected data
 - Click the **Clear all selection** button.

Precautions for writing the other format files

| For A series, QnA series | | |
|--------------------------|---|---|
| Program name | When writing programs in the GPPA format in A series, the program names other than MAIN, SUB1, SUB2 and SUB3 cannot be used. | |
| Statement, note | When statements/notes are created, they are written at the same time by selecting programs. | |
| Writing method | The QCPU-A data is written to the A4UCPU file. | |
| For FX series | | |
| For data selection | For FXGP(DOS) and FXGP(WIN), the following items to be written are displayed, respectively. Note that any item that does not exist in the source data is not displayed. | |
| Write range | For reading the A6GPP format data, read the data with GX Developer after making conversion once with the FXGP(DOS) software. For the conversion method, refer to the SW1PC-FXGP/AT Software Operating Manual. For reading the other format file, the file will disappear if it includes microcomputer programs other than SFC programs. | |
| For FXGP(DOS) format | Files to be written | <ul style="list-style-type: none"> • Program file (.PMC) Parameter, program, comment, file register • Comment file (.COK) Comment • Device memory file Data register, file register, RAM file register, special register (.DMD, DME, .DMF, .DMG) |
| | Files not written | Circuit comment file (.COL), sampling trace file (.STA) Print title file (.PTL), comment file (.COH) Shared circuit file (.DAT) |
| | Restrictions | <ul style="list-style-type: none"> • Device comment Up to 32 characters can be input for GX Developer device comments, but only the first 16 characters are written because the maximum number of character is 16 in FXGP(DOS). • Comment The maximum number of comments is 3400. • P, I statement P, I statement is not written. |
| For FXGP(WIN) format | Files to be written | <ul style="list-style-type: none"> • Program file (.PMW) Parameter, program, comment, file register • Comment file (.COW) Device comment, circuit comment, coil comment, Alias • Device memory file (.DMW) Data register, special register, RAM file register |
| | Files not written | Sampling trace file (.STW), print title file (.PTW) Registration monitor file (.RMW) |
| | Restrictions | <ul style="list-style-type: none"> • Alias A GX Developer Alias can be input in up to 8 characters, but only the alphanumeric characters and symbols (/ + - * / = . ? # \$ % & ; : ; _) can be used in FXGP(WIN) (see Section 9.4.1). The Alias containing characters not written is deleted when writing the data. • P, I statement P, I statement is not written. |

4.17 Starting Multiple Projects

| | | |
|---|-------|----|
| A | Q/QnA | FX |
| ○ | ○ | ○ |

[Purpose]

Starts and reads multiple projects so that data can be edited (cut, copied and pasted) among the projects.

[Operating Procedure]

Select [Project] → [Start new GX Developer session].

[Description]

Once the window is displayed, open the projects and edit data.

4.18 Existing GX Developer

| | | |
|---|-------|----|
| A | Q/QnA | FX |
| ○ | ○ | ○ |

[Purpose]

Exits GX Developer.

[Operating Procedure]

Select [Project] → [End GX Developer] or click .



[Description]

When no project name has been designated, clicking [End GX Developer] causes a dialog box to be displayed for project name confirmation.

Click the **Yes** button to save the changes to the project.

For details on designating the project path and project name, see Section 3.2.

Click the **No** button not to save the changes to the project.

| |
|--|
| POINTS |
| <ul style="list-style-type: none"> When exiting GX Developer by clicking , click the button shown below. <div style="text-align: right; margin-right: 50px;">Click here. ↓</div>  When closing only the open data without exiting GX Developer, click  on the menu bar. When using WindowsNT[®] 4.0, exit from GX Developer to restart or shut down the personal computer. If GX Developer is exited with GX Simulator having been started, the following message may appear. Since no special problems will occur in operation, click the OK button to close the message. "Some operation ended incorrectly. If this application cannot start normally at the next operation. follow the messages." |

5. STANDARDIZING THE PROGRAMS

Programs can be standardized by using label programming or macros to create sequence programs.

The creation and monitoring operations of ladders are identical to those of actual programs.

5.1 Label Programming

| | | |
|---|-------|----|
| A | Q/QnA | FX |
| × | ○* | × |

*: The Q00J, Q00 and Q01CPUs are incompatible.

Label programming increases design efficiency.

- As creating a general program by label programming permits device assignment changes according to equipment makeup, it can be easily diverted to other programs.
- If you do not know equipment makeup, labels can be used for programming.
- When the equipment makeup has been determined, relating the labels and actual devices enables generation of an actual program easily.
- By merely specifying the label assignment method, you can make device assignment automatically by performing only compile operation, without being conscious of the device names/device numbers.
- The program can be monitored/debugged, without the label names being changed, ensuring efficient debugging.

Note that there are some restrictions on batch device monitoring and online program correction. For details, refer to the "instructions/restrictions on label programs" in this section.

5

Label program

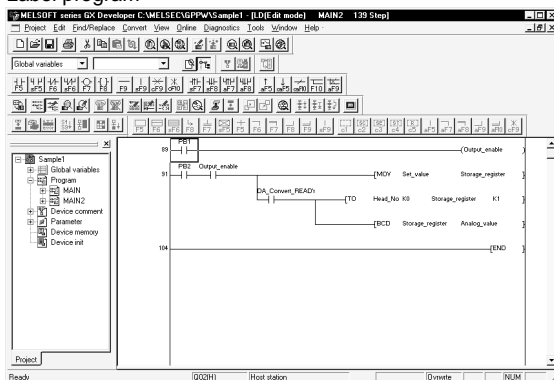

Global variable setting screen
Local variable setting screen

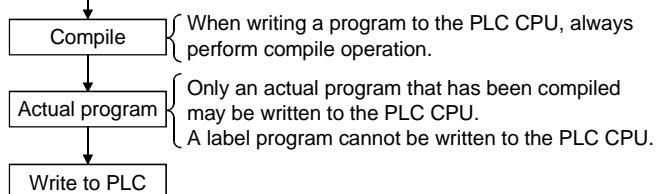
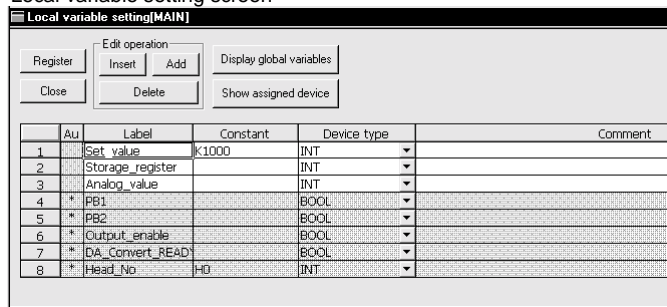

Label creating procedure

The sample label programs (SAMPLE1, SAMPLE2) used in the following explanation are contained on the CD-ROM of this product.

After installation of GX Developer, choose [Project] → [Open Project] to open the corresponding sample program.

New label creating procedure (The program used is SAMPLE1.)

1. List up the I/O equipment.
Temporarily determine the label names of the I/O equipment.
2. Set local variables.
Make setting to automatically assign constants or internal relays, data registers, etc. to the labels used in only the program created in above step 2.
To make automatic assignment, leave the constant fields blank.

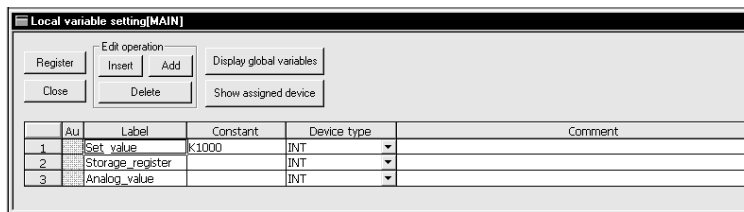

3. Set global variables.
 - (a) Set devices or constants to the labels of the I/O equipment or the labels used in multiple programs.

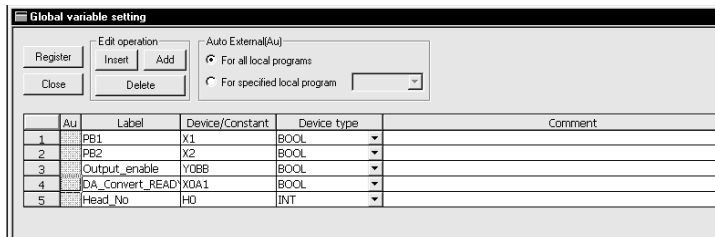

- (b) Register the programs where the labels will be used. (Auto External)
Also, to reflect the global variables on the local variables, click "○" under Au.

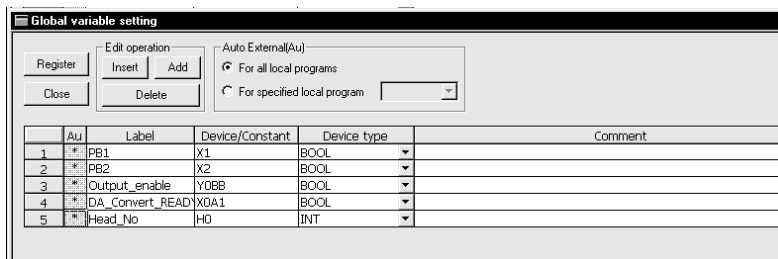

(c) The following screen gives an example of global variable setting reflected on the local variable setting screen.

| No. | AU | Label | Device/Constant | Device type | Comment |
|-----|----|------------------|-----------------|-------------|---------|
| 1 | | Set_value | K1000 | INT | |
| 2 | | Storage_register | D12287 | INT | |
| 3 | | Analog_value | D12286 | INT | |
| 4 | * | PB1 | | BOOL | |
| 5 | * | PB2 | | BOOL | |
| 6 | * | Output_enable | | BOOL | |
| 7 | * | DA_Convert_READ | | BOOL | |
| 8 | * | Head_No | H0 | INT | |

4. Start programming.
 Start programming using the label names (such as I/O equipment and internal relays).

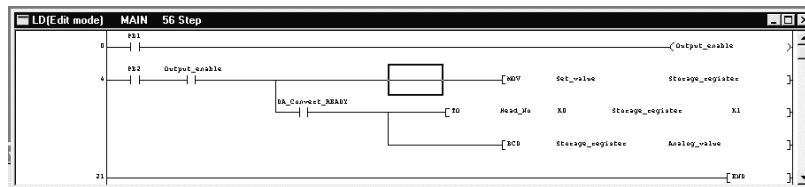

5 Compile.
 The actual program is generated.
 The number of steps in the actual program can be checked by selecting [View] → [Device program display mode].
 The screen below gives an example of circuit display. (See 5.1.10.)

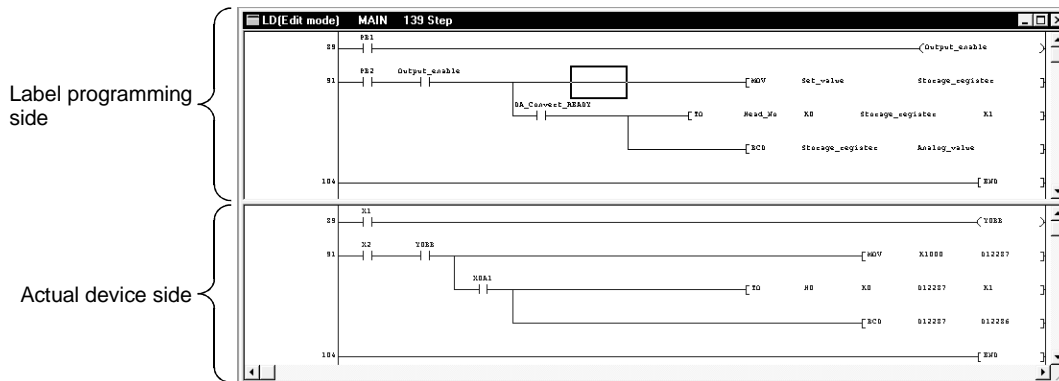

You can write the generated actual program to the PLC to run the program.
 The program can be debugged in the label programming description format (device names are displayed as labels).

Existing label program diverting procedure (The program used is SAMPLE2.)
 SAMPLE 2 is the program created by making the following modifications to SAMPLE1.

1. The device number of the I/O equipment was changed.
 PB1 was changed from X1 to X10.
2. The label of the I/O equipment was added.
 Operation ready
3. The constant was changed.
 The set value was changed from K1000 to K3000.

1. Open the existing label program project.
2. Add the label name in label programming.

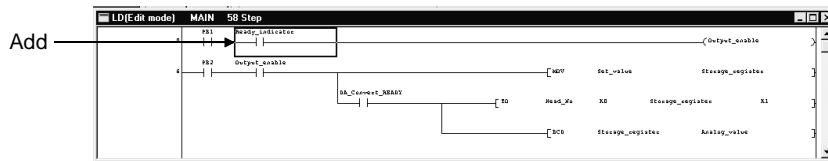

3. Change the global variable setting.
 - (a) After changing the device number assigned to the label of the I/O equipment, make registration again. Set the device and device type of the added label.

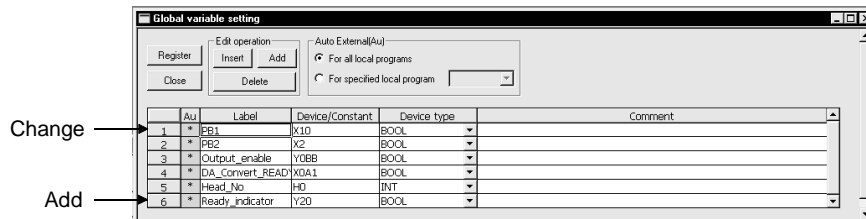

4. Change the local variable setting.
 Change K1000 of the set value to K3000.

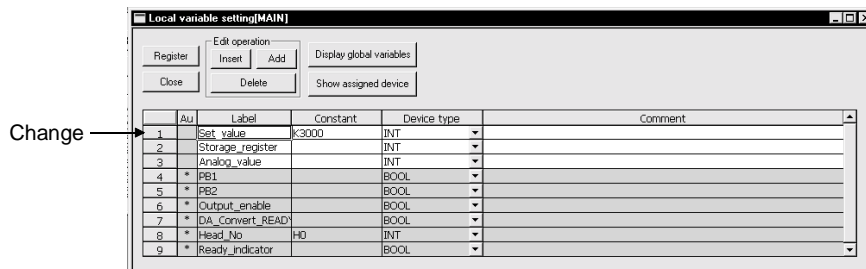

5. Compile.
 After compilation, you can check the actual step counts of the program by clicking [View] → [Device program display mode] (See Section 5.1.10)

The following terms will be used in label programming.

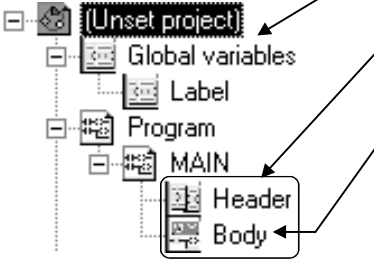
| Project List | Term | Description |
|---|--------------------------|---|
|  | Actual program | Program that can be executed by the PLC CPU. Compiled program when it is created by label programming. |
| | Actual device | The term "actual device" is used in this manual to differentiate a program created under a label name and one that has been compiled. (A compiled program to which device has been assigned.) |
| | Global variable | Label variable which is made valid for all label programs when multiple label programs were created in a project. |
| | Local variable | Label variable which is made valid for only within individual programs. Set this variable one for one to each label program. |
| | Label program | Sequence program where devices are described as labels. |
| | Global label | Generic term for labels assigned in global variable setting. |
| | Local label | Generic term for labels assigned in local variable setting. |
| | Automatic device setting | Sets the D, W, ZR, M, B, T, ST, C and P device setting ranges. Set the automatically assigned device ranges on the auto device setting screen. |
| | Compile | Operation which converts a label program into an actual program. |
| | External variable | Variable where the label variable set on the global variable setting screen has been reflected on (registered to) the local label variable. |

Instructions/restrictions on label programs

1. Label programming is compatible with ladders and lists but not with SFC and MELSAP-L.
2. Device comments displayed are those set on the global/local variable setting screen.
Comments created on the device comment batch-edit screen are not displayed. You can set a comment of up to 64 characters but the number of characters that may be displayed is up to 32.
3. If the same label has been set to global and local variables, local variables have higher priority than global variables when they are displayed on the edit screen.
4. To modify a program that has been written to the PLC CPU, first modify its label program stored in the personal computer and then write it to the PLC. ([Read from PLC] cannot be used for label programming projects.)
5. Devices specified by label can be monitored via registration monitor. Devices cannot be monitored in batch.
6. Restrictions when performing a write during RUN
 - (1) Edit within a range where global/local variables are set.
 - (2) Write during RUN cannot be performed if the program/parameters in the personal computer do not match those in the PLC CPU. When compiling was executed, be sure to write the compiled result to the PLC.

5.1.1 Label programming sequence

| | | |
|---|-------|----|
| A | Q/QnA | FX |
| × | ○* | × |

※: The Q00J, Q00 and Q01CPUs are incompatible.

The following flowchart shows a label programming procedure.

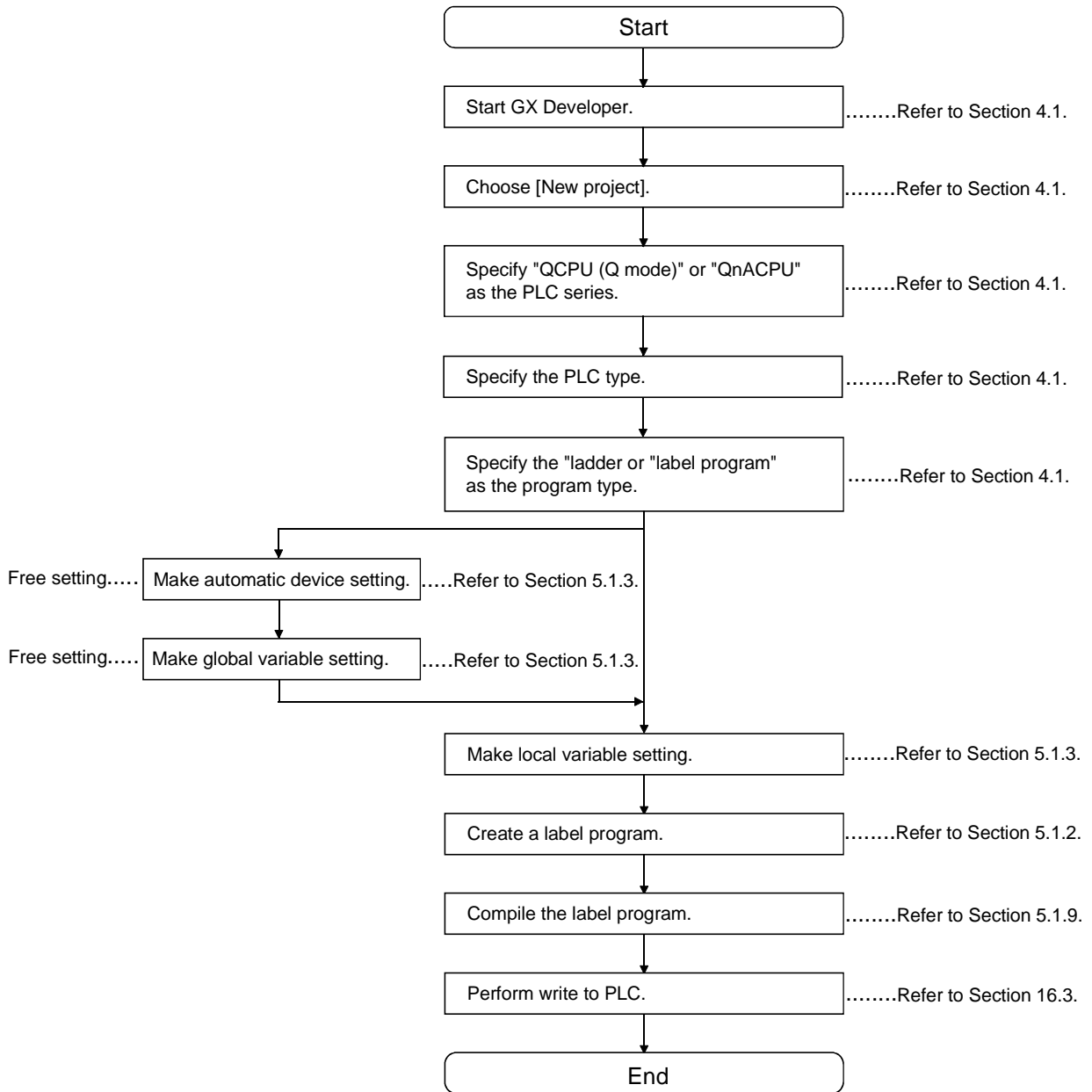

5.1.2 Label program input method

| | | |
|---|-------|----|
| A | Q/QnA | FX |
| × | ○* | × |

※: The Q00J, Q00 and Q01CPUs are incompatible.

Label programs can be created in the ladder/list mode. (Not in SFC mode)

The programming operation is identical to that in the ladder/list mode.

For details of the operation, refer to Section 6.2.

This section explains how to perform operation specific to label programming.

[Label input method example]

1. When entering a contact



2. When entering application instructions

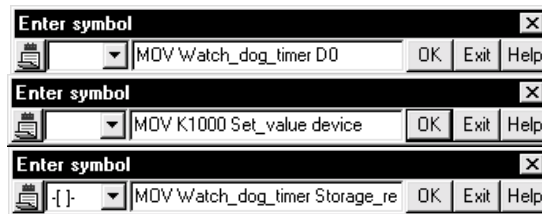

[Operating Procedure]

There are terms (reserved words) which cannot be used as labels. Refer to Appendix 15.

When entering a device name, do not include an apostrophe (').

[Number of steps in label program]

- The number of steps in the label program is indicated in parentheses (). When the label program is compiled, the number of steps in the actual program is displayed. (The screens below show that the number of steps has changed from 0 before compiling to 78 after compiling.)

Basically, the number of steps increases after compiling. When writing a program to the PLC CPU, perform compiling and check the number of steps.

Label program (before compiling)

Number of steps before compiling

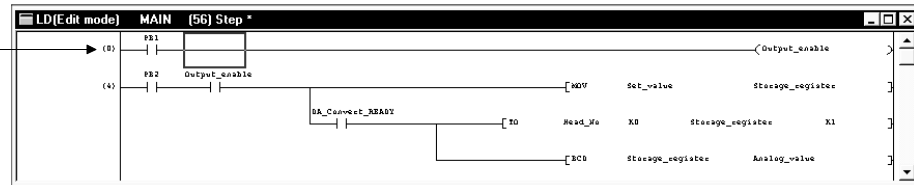

Label program (after compiling)

Number of steps after compiling

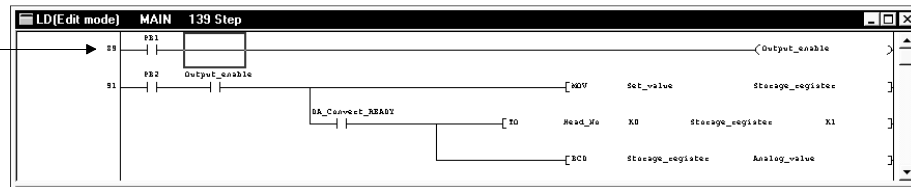

MOV aaa aaa }
 MOV aaa D0 } Any of these is in 3 steps.
 MOV D0 aaa }

When the device which increases in the number of steps, e.g. U0≠G0, (MOV U0≠G0 aaa) is used, the number of steps is 4.

- When the instruction is headed by S., e.g. S.FWRRITE, the number of steps is as given in the programming manual. The pointer, EGP and EGF instructions are in 1 step.

| POINT |
|--|
| <p>When a label program is created using label names and actual devices together, making automatic device assignment may generate double coils. In this case, make a program check after compiling. Also, the device use list and contact/coil use list can be used to check the devices used. These lists are useful for device checking.</p> |

5.1.3 Making global variable/local variable setting

| | | |
|---|-------|----|
| A | Q/QnA | FX |
| × | ○* | × |

*: The Q00J, Q00 and Q01CPUs are incompatible.

[Purpose]

Sets labels, device types, comments and others in a label program.

[Operating Procedure]

Local variable setting: Select [Edit] → [Local variable setting].

Global variable setting: Select [Edit] → [Global variable setting].

[Dialog Box]

Local variable setting screen

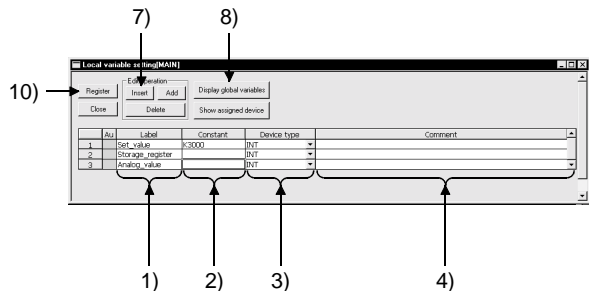

Global variable setting screen

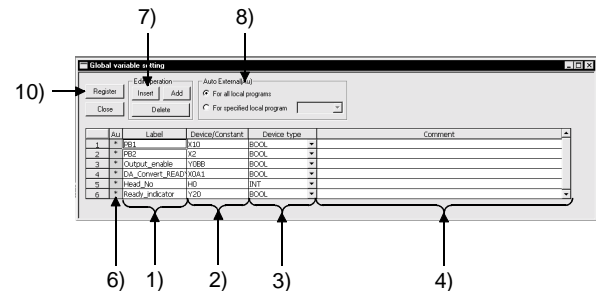

Local/global variable setting item list

| | Local Variable Setting | Global Variable Setting |
|-------------------------|---------------------------------|-------------------------|
| Auto External | — | Required |
| Au | Setting disabled (display only) | Required |
| Label | Required | Required |
| Device/constant value | As desired | Required |
| Device type | Required | Required |
| Comment | As desired | As desired |
| Global variable setting | As desired | — |

[Description]

1) Label

Create a label within 16 characters.

Reserved words and actual device names are characters unusable as labels. reserved word or actual device name displays a "An unusable device has been designated" or "The reserved word is used for label" dialog box. Set another label name.

The number of label creation lines for local/global variable setting is 5120.

Refer to Appendix 15 for reserved words.

2) Device/constant value

Local variable setting: Set a numerical value when setting a constant.
Leave the field blank when making automatic device assignment.

Refer to Section 5.1.3 for automatic device setting.

Global variable setting: Set an actual device/initial value.

- Enter a constant value headed by K, H, E or "" to ensure that it can be identified as a decimal, hexadecimal, actual number or character string constant.
- Device registerable qualifications are "bit designation" and "digit designation". "Indirect designation" and "index qualification" are unusable.

3) Device type

Set any of bit, word device, double word, actual number, character string, array, timer, counter, retentive timer and pointer.

Choosing a character string or array displays the following dialog box.

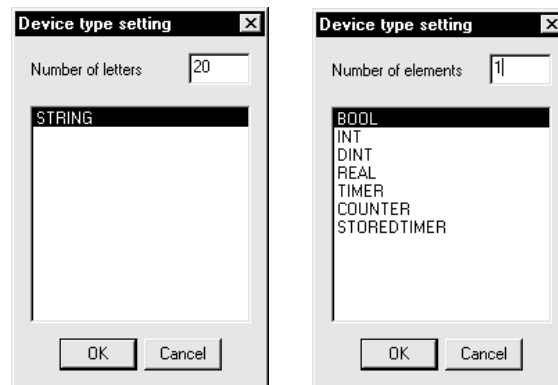

Max. number of characters: The input range is 1 to 50 characters.

Number of elements: The input range is 1 to 255.

4) Comment

Set a comment within 64 characters.

When comment addition/correction is made to any of the multiple labels which are the same (including all local/global variables), the latest comment is reflected on the data registered to the local/global variable setting and on the data on the label program edit screen.

5) Auto External

The data of the labels, set values, device types and comments set in global variable setting are reflected on all the local variables or the specified local variables.

- 6) Au
For registration
Choosing "○" of the variable you want to register on the global variable setting screen and clicking the Register button reflects the label, set value, device type and comment settings on the local variable setting screen.
For cancellation
Choosing "●" of the variable you want to cancel on the global variable setting screen displays the following dialog box to delete the settings from the local variable setting screen.
<Screen example>

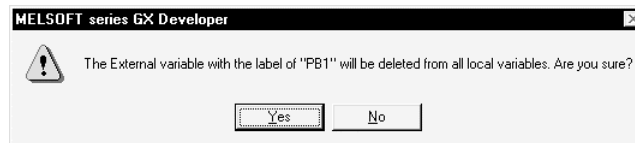

- 7) Edit operation
Insert line button
Used to insert a blank row in the current cell position.
When you want to batch-insert multiple rows, choose cells equal to the number of rows you want to insert.
Blank rows are inserted into the cell-selected range.
Add line button
Used to add a blank row under the current cell position.
When you want to batch-add multiple rows, choose cells equal to the number of rows you want to add.
Blank rows are added to under the top cell of the range-selected cells.
Delete line button
Used to delete the cell-selected range.
- 8) Global variable label setting
Used to display the global variable setting screen.
- 9) Automatically assigned device display/hide
Used to check how actual devices have been assigned to labels which are displayed on the local variable setting screen.
Perform compile when displaying automatically assigned devices.

10) [Register] button

Click the Register button after you have terminated setting the labels, constant values, device types and others.

If any of the labels, constant values and device types is not set correctly, the following dialog box will appear and they cannot be registered.

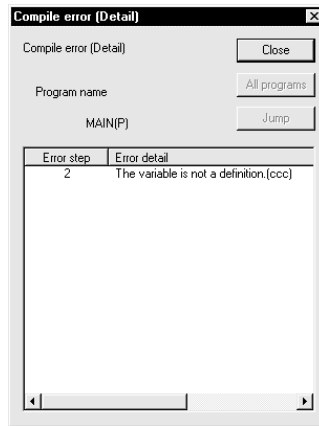

Choosing the Error detail and clicking the Jump button shows the error location.

POINT

On the global/local variable setting screen, the settings can be sorted in the label order, device/constant order, or device type order.

The sequence of sorting is as indicated below.

1. Symbols
2. Alphabets (upper-case letter)
3. Alphabets (lower-case letter)

5.1.4 Making automatic device setting

| | | |
|---|-------|----|
| A | Q/QnA | FX |
| × | ○* | × |

*: The Q00J, Q00 and Q01CPUs are incompatible.

[Purpose]

Sets the automatically assigned device ranges when you want to assign devices automatically to local labels.

[Operating Procedure]

Select [Edit] → [Auto device setting].

[Dialog Box]

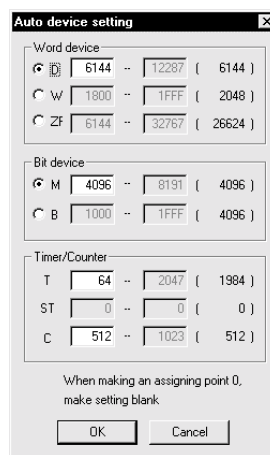

[Description]

1. For bit and word devices, use the radio buttons to choose the devices to be assigned automatically.
2. The maximum value of each device displayed is the value set for <<Device>> which is shown by choosing [PLC parameter] → <<Device>> tab.
When 0 points have been set to <<Device>>, it is masked to disable setting on the automatic device setting screen.
When you want to set ST (retentive timer) or the like, make setting in <<Device>>.
3. The maximum number of ZR (file register) points is 32K and that of P (pointer) points is 4K.
4. The word devices, bit devices or timers/counters are assigned in order of larger device numbers in the device range set in the automatic assignment device setting.
5. The Ps (pointers) used in each program are searched for, and the unused numbers are assigned in order of smaller numbers.
The largest device number that can be assigned is the (number set in the common pointer setting of the parameter dialog box) - 1.
The common pointer can be set from the [PLC parameters] → <<PLC system setting>> tab.

5.1.5 Deleting External

| A | Q/QnA | FX |
|---|-------|----|
| × | ○* | × |

*: The Q00J, Q00 and Q01CPUs are incompatible.

[Purpose]

Deletes all External variables on the active local variable setting screen..

[Operating Procedure]

Select [Edit] → [Delete Auto External]

[Dialog Box]

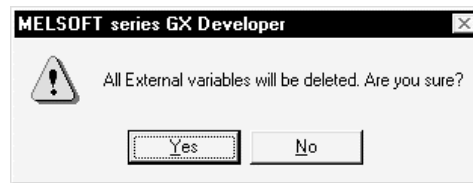

5.1.6 All deletion

| A | Q/QnA | FX |
|---|-------|----|
| × | ○* | × |

*: The Q00J, Q00 and Q01CPUs are incompatible.

[Purpose]

Deletes all variables on the active local/global variable setting screen.

[Operating Procedure]

Select [Edit] → [Delete all]

[Dialog Box]



5.1.7 Importing device comments

| | | |
|---|-------|----|
| A | Q/QnA | FX |
| × | ○* | × |

※: The Q00J, Q00 and Q01CPUs are incompatible.

[Purpose]

Imports the comments created on the device comment batch-edit screen to the label comments of the currently edited global variable setting.

[Operating Procedure]

Select [Edit] → [Import the device comment]

[Dialog Box]

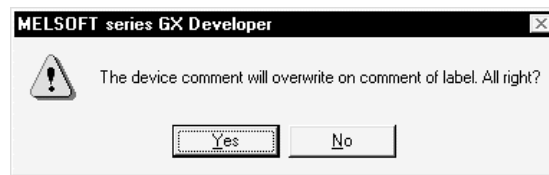

[Purpose]

- Device comments may be imported to the global variable setting only. They cannot be imported to the label comments of the local variable setting.
- The label comments are not rewritten if there are no device comments for the devices assigned in the global variable setting.
- When common comments (COMMENT) and program-based comments exist in the device comments, the common comments have higher priority in importing.

Common comments (COMMENT)

| Device name | Comment | Alias |
|-------------|-----------------|-------|
| X0 | | |
| X1 | Current status1 | |
| X2 | Current status2 | |
| X3 | Current status3 | |

Program-based comments (MAIN)

| Device name | Comment | Alias |
|-------------|------------|-------|
| X0 | | |
| X1 | Operation1 | |
| X2 | Operation2 | |
| X3 | Operation3 | |

Local device setting screen

| | Au | Label | Cons. | Device type |
|---|----|-------|-------|-------------|
| 1 | | LBL11 | | |
| 2 | | LBL22 | | |
| 3 | | LBL33 | | |
| 4 | | LBL44 | | |
| 5 | | LBL55 | | |

Global device setting screen

| | Au | Label | Device/Constant | Device type |
|---|----|-------|-----------------|-------------|
| 1 | | LBL1 | X1 | BOOL |
| 2 | | LBL2 | X2 | BOOL |
| 3 | | LBL3 | X3 | BOOL |
| 4 | | LBL4 | X4 | BOOL |
| 5 | | LBL5 | X5 | BOOL |

5.1.8 Exporting to device comments

| | | |
|---|-------|----|
| A | Q/QnA | FX |
| × | ○* | × |

*: The Q00J, Q00 and Q01 CPUs are incompatible.

[Purpose]

Exports the label comments of the currently edited local/global variable setting to the device comment batch-edit screen.

[Operating Procedure]

Select [Edit] → [Export the device comment]

[Dialog Box]

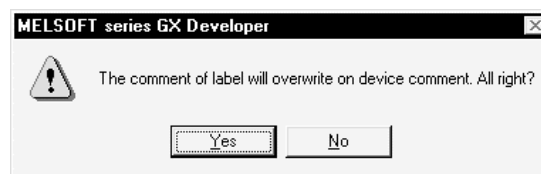

[Purpose]

- If 33 or more characters are set to a label comment, the 33rd and latter characters are deleted when it is exported to the device comment batch-edit screen.
- The device comments are not rewritten if there are no label comments.
- When the label comments of the local variables are exported, the reflection destinations of the label comments set in the local variable setting are the "copy source/display source of reference during comment edit" which are displayed by selecting [Tools] → [options] → <<Each program>> tab.
The global variables are reflected on the common comments (COMMENT).

Global device setting

| Au | Label | Device/constant | Device type | Comment |
|----|-------|-----------------|-------------|--|
| 1 | LBL1 | X1 | BOOL | Number of transmission errors detected |
| 2 | LBL2 | X2 | BOOL | Current status1 |
| 3 | LBL3 | X3 | BOOL | Current status2 |
| 4 | LBL4 | X4 | BOOL | Current status3 |
| 5 | LBL5 | X5 | BOOL | Current status4 |

Local device setting

| Au | Label | Constant | Device type | Comment |
|----|-------|----------|-------------|--|
| 1 | LBL11 | | BOOL | Number of transmission errors detected |
| 2 | LBL22 | | BOOL | Current status1 |
| 3 | LBL33 | | BOOL | Current status2 |
| 4 | LBL44 | | BOOL | Current status3 |
| 5 | LBL55 | | BOOL | Current status4 |

Common comments (COMMENT)

| Device name | Comment | Alias |
|-------------|-----------------------------------|-------|
| X0 | | |
| X1 | Number of transmission errors det | |
| X2 | Current status1 | |
| X3 | Current status2 | |
| X4 | Current status3 | |
| X5 | Current status4 | |

Program common [Each program] | Whole data | TEL

Copy source/display source of reference during comment edit

Program name: MAIN

| Device type | Device comment |
|-------------|-------------------------|
| M | Comment for all program |
| SM | Comment for all program |
| L | Comment for all program |
| F | Comment for all program |
| V | Comment for all program |
| X | Comment for all program |
| Y | Comment for all program |
| B | Comment for all program |
| SB | Comment for all program |

Reflection destinations of comments are governed by these settings.

Program-based comments (MAIN)

| Device name | Comment | Alias |
|-------------|-----------------------------------|-------|
| X0 | | |
| X1 | Number of transmission errors det | |
| X2 | Current status1 | |
| X3 | Current status2 | |
| X4 | Current status3 | |
| X5 | Current status4 | |

Common comments (COMMENT)

| Device name | Comment | Alias |
|-------------|-----------------------------------|-------|
| X0 | | |
| X1 | Number of transmission errors det | |
| X2 | Current status1 | |
| X3 | Current status2 | |
| X4 | Current status3 | |
| X5 | Current status4 | |

5.1.9 Converting label programs into actual programs (Compile)

| | | |
|---|-------|----|
| A | Q/QnA | FX |
| × | ○* | × |

*: The Q00J, Q00 and Q01 CPUs are incompatible.

[Purpose]

Converts programs created as ladders or lists into actual programs.

[Operating Procedure]

- Select [Convert] → [Compile]
- Select [Convert] → [Compile (All programs being edited)]
- Select [Convert] → [Compile (All programs)]
- Select [Convert] → [Compile option]

[Description]

- Compile can be executed when the global variable setting screen/local variable setting screen/ladder edit screen/list edit screen is active.

| | Global Variable Setting Screen | Local Variable Setting Screen | Ladder | List | Other Screen |
|---------------------------|--------------------------------|-------------------------------|--------|------|--------------|
| Compile | × | ○ | ○ | ○ | × |
| All programs being edited | ○ | ○ | ○ | ○ | × |
| All programs | ○ | ○ | ○ | ○ | × |

- How to identify whether a program has been compiled or not
The program not yet compiled is indicated by "**".

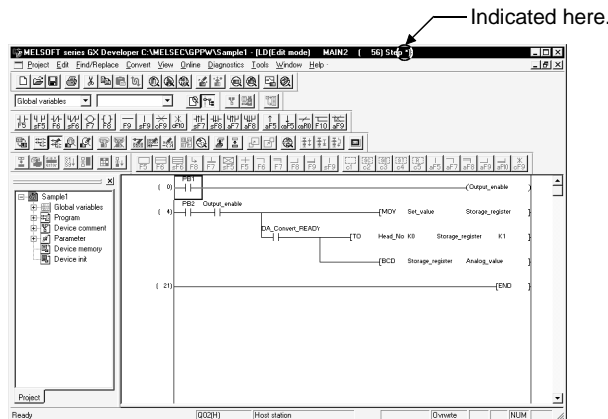

- Compiling option

When the compiling option is enabled, compiling is performed simultaneously upon conversion.

Do not check this option if a label program (circuit/list) is created before setting global/local variables.

If this option is enabled, an undefined label error will occur.

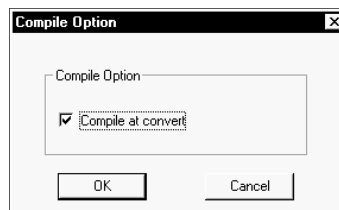

- If an error occurs after compile, the following dialog box appears.

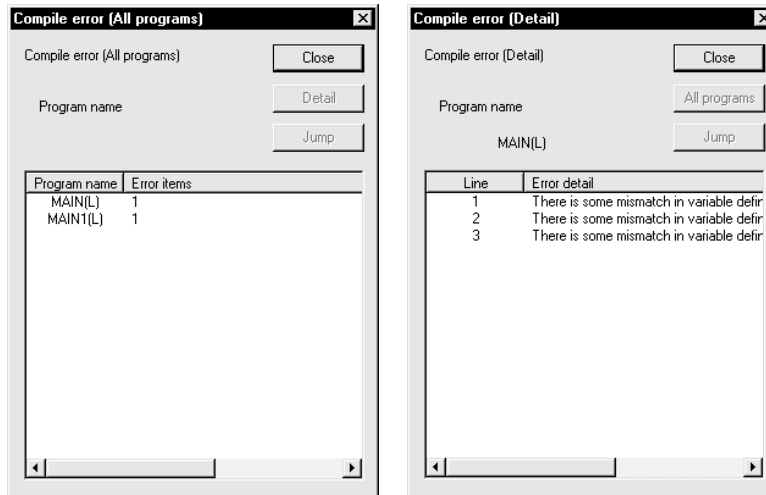

If errors have occurred over multiple programs, "Compile error (All program)" appears.

When there is only one error program, " Compile error (Detail)" appears.

| POINT |
|--|
| <p>Compile processing time Compile is completed in about 5 seconds when 1000 lines of labels are compiled on a personal computer (Digital CELEBRIS GL 5133ST Pentium® 133MHz, memory 80M). When 5000 lines are compiled, compile is completed in about 2 minutes 13 seconds.</p> |

5.1.10 Displaying the Device Program

| | | |
|---|-------|----|
| A | Q/QnA | FX |
| × | ○* | × |

*: The Q00J, Q00 and Q01CPUs are incompatible.

[Purpose]

This setting is used when, after compiling, you wish to check the actual device assigned to the label.

[Operating Procedure]

1. After compiling, select [View] → [Display device program].
2. Select [View] → [Device program display mode] → [Below] ([Right]).

[Setting Screen]

When splitting the circuit display to horizontally

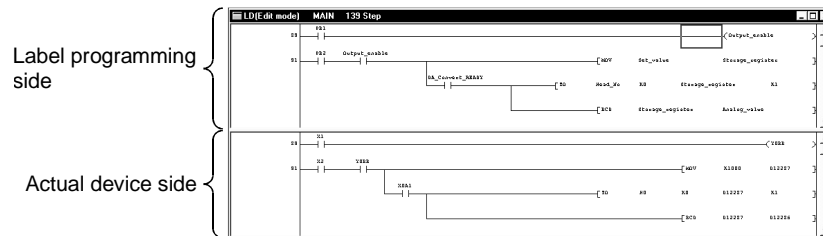

When splitting the list display vertically

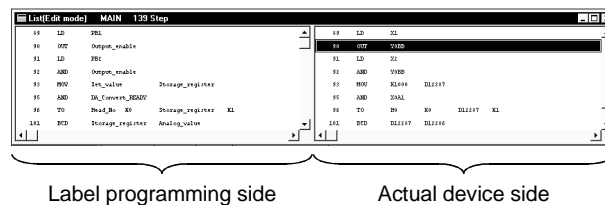

[Explanation of Items]

- When editing a program, do so on the label program side. Data cannot be edited on the actual device side.
- The label program panel and the actual device panel scroll separately.
- To synchronize the steps in the displayed program, select [View] → [Display step synchronization]. The panel without cursor scrolls in tandem with the panel with the cursor.
- When Display statement/note/comment is selected, the setting will be reflected in the label program side and the actual device side.
- The display positions of the label program panel and the actual device panel cannot be changed.
- Label program/actual device split display is available in the circuit/list mode and device registration monitor.

Note

If the number of characters in the label name differs from that in the device name, the loopback point will vary and the two sides of the circuit display may not become identical. Caution is necessary.

5.2 About Macros

| | | |
|---|-------|----|
| A | Q/QnA | FX |
| ○ | ○ | ○ |

By naming any ladder pattern (macro name) and registering it in a file (macro registration), you can read the registered ladder pattern, and change and utilize the devices (macro utilization) in actual programming.

Macro registration

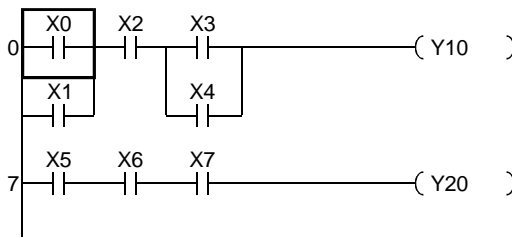

1. Choose the program area to be registered as a macro.
2. Set the devices and so on to be registered.
3. Set the file name of the macro to be registered.

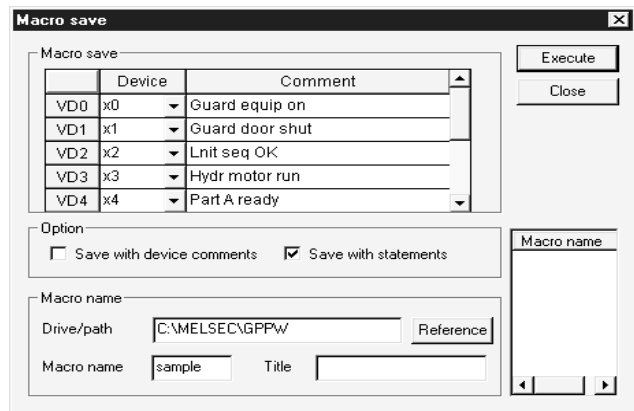

Macro utilization

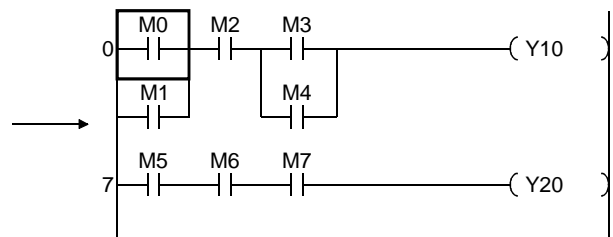
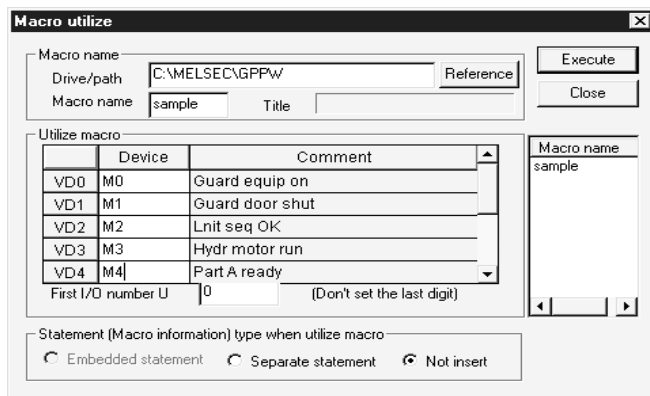

1. Specify the file name registered as a macro.
2. Set the devices to be changed.

Macro reference destination setting (Except the FX series)

If you have set a macro-registered file in macro reference destination setting, you can utilize the macro by entering a simple macro instruction.

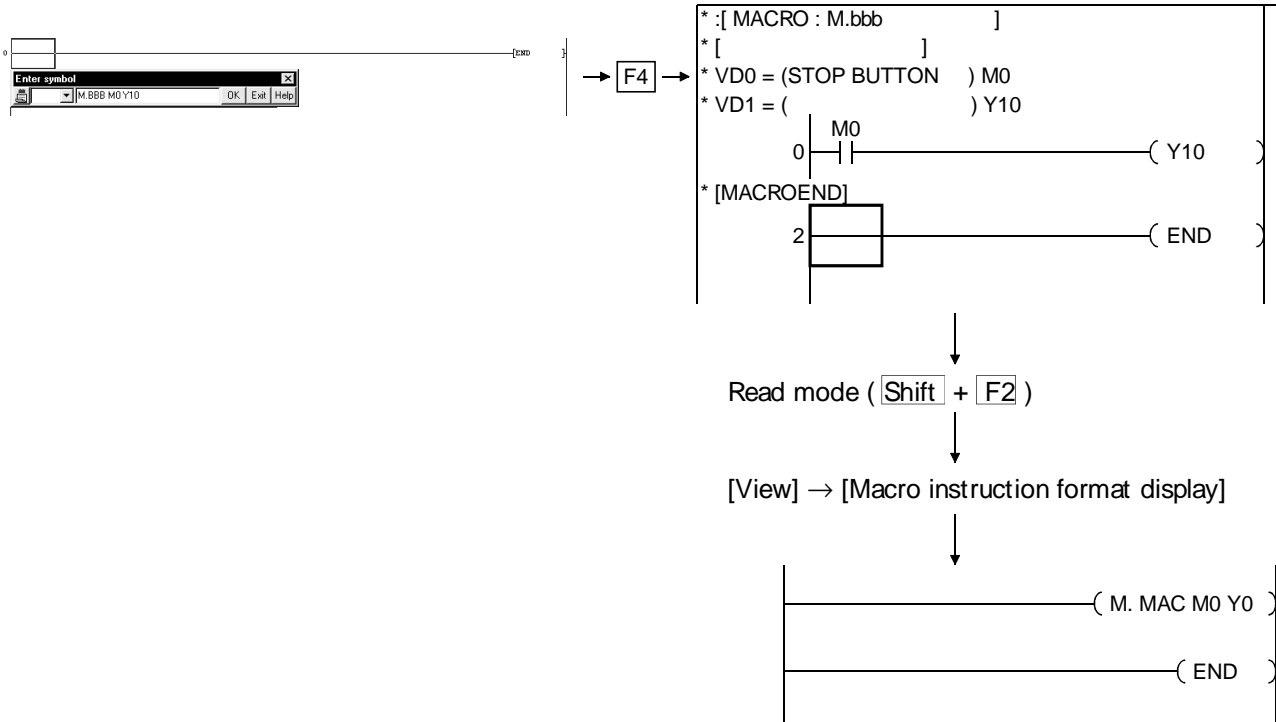

| POINTS |
|---|
| <p>Choosing [View] → [Macro instruction format display] in the read mode allows the developed macro instruction to be represented in the <u>M.Macro</u> VD0 VD1 VD2... instruction format.</p> <p>Any macro name may be set. </p> <p>(The macro instruction format display is compatible with the macros created with GX Developer (SW3D5-GPPW-E) or later.)</p> <p>Note the following to provide the macro instruction format display properly.</p> <ol style="list-style-type: none"> 1. Do not make corrections, deletions or the like to macro programs which utilize macros. 2. When a macro-utilized ladder is displayed with statements, do not utilize macros within MACROEND. 3. Do not change the utilized devices which have been specified as VDs. (The device numbers remain as utilized at first.) |

5.2.1 Registering a macro

| | | |
|---|-------|----|
| A | Q/QnA | FX |
| ○ | ○ | ○ |

[Purpose]

Registers part of a program to a file as a macro instruction.

The registered macro instruction can be used as an application instruction in a program.

[Operating Procedure]

[Project] → [Macro] → [Registration macros]

[Dialog Box]

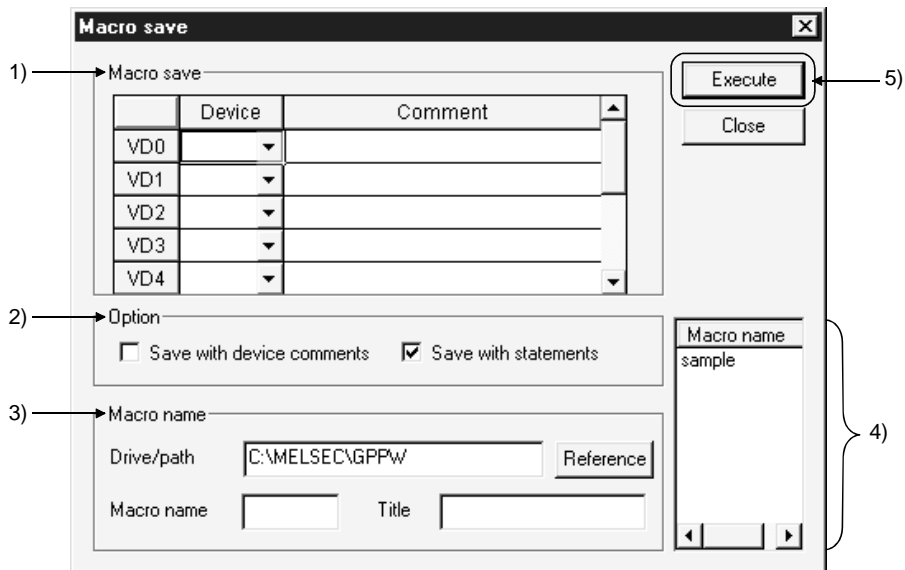

[Description]

1) Macro save

Among the devices in the area-specified ladder block, specify the devices you want to change for macro utilization as variable devices VD0 to VD9. The following example shows the devices registered.

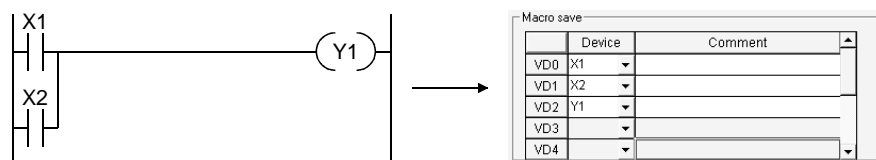

If the devices have been commented, the comments are automatically set. Also, comments may be edited. (Setting can be made independently of the number of comment characters in the option.)

2) Option

Set whether or not comments and statements will be registered together with the ladder for macro registration.

- 3) Macro name
Set the drive/path and where the macro will be registered and the macro file name.
The number of characters set to the title is within 32.
- 4) Macro name displays area
The existing macro name appears.
- 5) button
Click this button after the setting is over.

The following devices may be registered to macros.

| Device Type | | Example | Device Registerability |
|------------------------------------|----------------------|-----------------|--|
| Bit device | — | M0 | ○ |
| | Digit designation | K4M0 | ○ |
| Word device | — | D0Z0 | ○ |
| | Indirect designation | @D0Z0 | ○ |
| | Bit designation | D0.1 | ○ |
| Extended designation (J, U, BL) | Bit | J1\B1Z0 | ○ (J1B1 also possible) (J1) not possible for unit No. only. (B1Z0, B1) not possible for device only. |
| | Digit designation | J1\K1B1Z0 | ○ (J1K1B1 also possible) (J1) not possible for unit No. only. (K1B1Z0, K1B1) not possible for device only. |
| | Word | J1\W0Z0 | ○ (J1W0 also possible) (J1) not possible for unit No. only. (W0Z0, W0) not possible for device only. |
| | Indirect designation | @J1Z1W0Z0 | ○ (J1, J1Z1) not possible for unit No. only. (W0Z0, W0) not possible for device only. |
| | Bit designation | J1\W1.1 | ○ (J1) not possible for unit No. only. (W1.1) not possible for device only. |
| Designation with digit | | K4M0, J1\K1B1Z0 | (K4) not possible for designation with digit only. |
| Index qualification | | D0Z0, J1\K1B1Z0 | (Z0) not possible for index qualification only. |
| Constant | Integer/real number | K10, H10, E0.1 | ○ |
| | Character string | "Abcd" | × |
| Index | | Z0 | ○ |
| Pointer | | P, I | ○ |
| Alias | | | ○ Also possible for other than display/ Alias display. |

| |
|--|
| POINT |
| The macro registered as a ladder cannot be utilized in an SFC. Also, the macro registered as an SFC cannot be utilized in a ladder. |

5.2.2 Utilizing a macro

| | | |
|---|-------|----|
| A | Q/QnA | FX |
| ○ | ○ | ○ |

Macros that may be utilized are only those of the same series as the PLC series at the utilization destination. (Macros cannot be set if the PLC series is the same but the PLC type is different.)

However, macros can be utilized between the A series and MOTION(SCPU).

[Purpose]

Reads the macro-registered ladder block from the file, changes the devices registered, and utilizes the macro in any position of a ladder.

[Operating Procedure]

[Project] → [Macro] → [Macro utilize]

[Dialog Box]

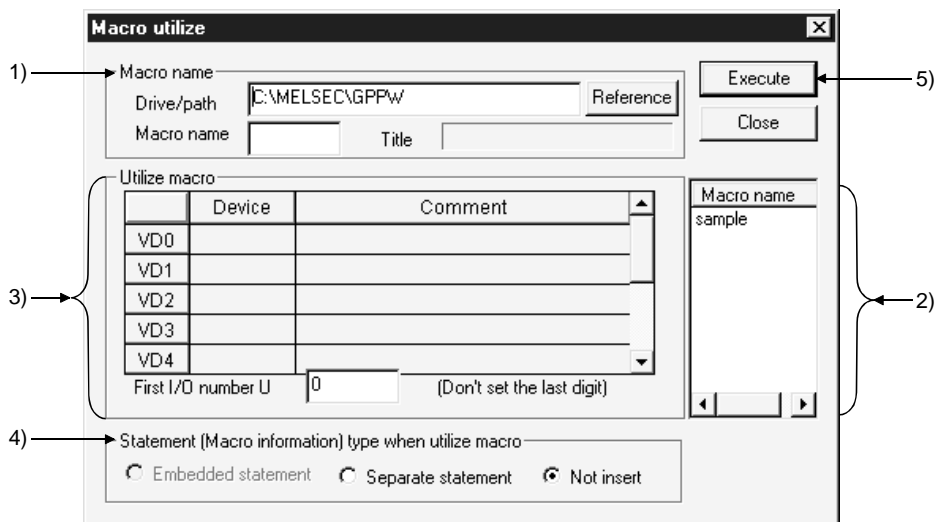

[Description]

- 1) Macro name
Specify the drive/path where the macro is registered.
The macro name can be specified from the Macro name displays area.
- 2) Macro name displays area
The macro file names registered appears.
Specify the macro name you want to utilize.

3) Utilize macro setting

The devices specified as VD0 to VD9 for macro registration are changed to the devices specified here. (Only the variable devices specified for macro registration may be set.)

The devices specified as VD0 to VD9 should be those equivalent to the devices specified for macro registration.

You cannot specify a bit device as a word device and vice versa.

Specifying the first I/O number biases the X, Y and U device numbers by the specified number.

<Example>

When the first I/O number specified is U[1F], the X and Y devices are biased by +1F0 and the U devices by +1F.

4) Statement(Macro information)type when utilize macro

Select whether macro development will be made with Embedded/Separate Line statement or without statements.

If you have also registered statements during macro registration, development will be made under the registered conditions independently of this setting.

5) button

Click this button after the setting is over.

The macro-utilized ladder is inserted in a place before the ladder block at the cursor position.

POINTS

- A macro is utilized unchanged if it includes the instructions/devices that cannot be used in the utilization destination project or the devices that are outside the range.
In that case, make a program check and correct the program.
- Macros created with GX Developer can be utilized. (QnA series only)
- The device names assigned to VD during macro utilization are added after the statements. (For Embedded statement, the number of statement steps increases.)
- If you have set "Save with device comments" during macro registration, the comment attached to the VD are utilized as comments.
If the device comments used with the VD already exist in the existing program, they are overwritten by the comment of the VD.
- When utilizing macros after MACROEND, utilize them in the list mode.

5.2.3 Deleting a macro

| | | |
|---|-------|----|
| A | Q/QnA | FX |
| ○ | ○ | ○ |

[Purpose]
Deletes the user-created macro file.

[Operating Procedure]
[Project] → [Macro] → [Delete macros]

[Dialog Box]

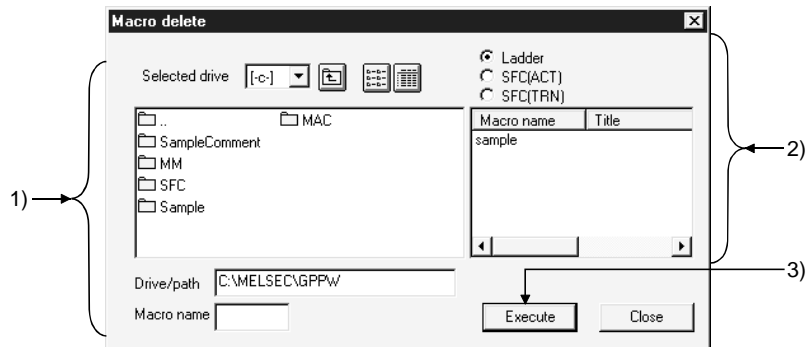

[Description]

- 1) Directory name displays
Specify the directory of the macro file to be deleted.
- 2) Macro file delete selection
Choose the object of deletion from the sequence program, SFC (ACT) and SFC (TRN), and specify the macro file name to be deleted.

| | Deletion Destination Folder | Description |
|-----------|-----------------------------|--------------------------------|
| Sequence | MAC | For sequence program |
| SFC (ACT) | MAC. ACT | For SFC (operation output) |
| SFC (TRN) | MAC. TRN | For SFC (transition condition) |

- 3) **Execute** button
Click this button after the setting is over.

5.2.4 Displaying macro references

| | | |
|---|-------|----|
| A | Q/QnA | FX |
| ○ | ○ | × |

[Purpose]

Enables GX Developer to use the macro data created by GPPQ.
 For A series or FX series, this function cannot be used.

[Operating Procedure]

Select [Project] → [Macro] → [Macro reference path].

[Dialog Box]

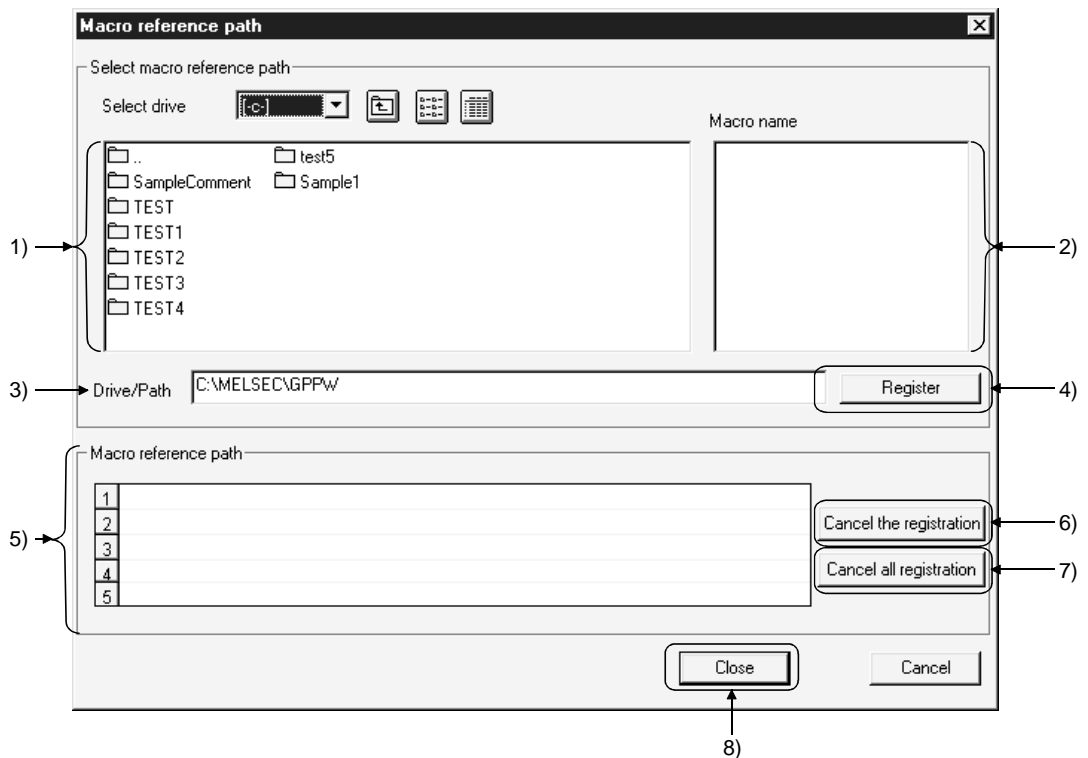

[Description]

- 1) Folder name list
 Displays the macro names of a project designated in the Drive/path.
- 2) Macro file name list
 Displays the macro files that can be referenced when the current drive/path is set for macro reference.
- 3) Drive/Path
 Designates a drive/path for the macro to be referenced. (The machine name folder created by GPPQ must be designated here.)
 Even though the folder name list contains the entries MAC, MAC.ACT and MAC.TRN, they cannot be designated because there is no macro file in them.

- 4) button
Click this button to register macros in Macro reference path.
The macros cannot be used unless they are registered in this field.
- 5) Macro reference path
Up to five macro names with different drives/paths can be registered in this field.
A maximum of 242 characters can be used to designate a drive/path. The number of characters of a drive/path listed in this reference field is 94 characters in large fonts and 103 characters in small fonts. Even when a macro name consists of more characters, it can be used though it cannot be displayed in this field.
- 6) button
Cancels the drive/paths displayed in Macro reference one by one.
- 7) button
Cancels all the drives/paths displayed in Macro reference at a time.
- 8) button
Click this button after making necessary settings.

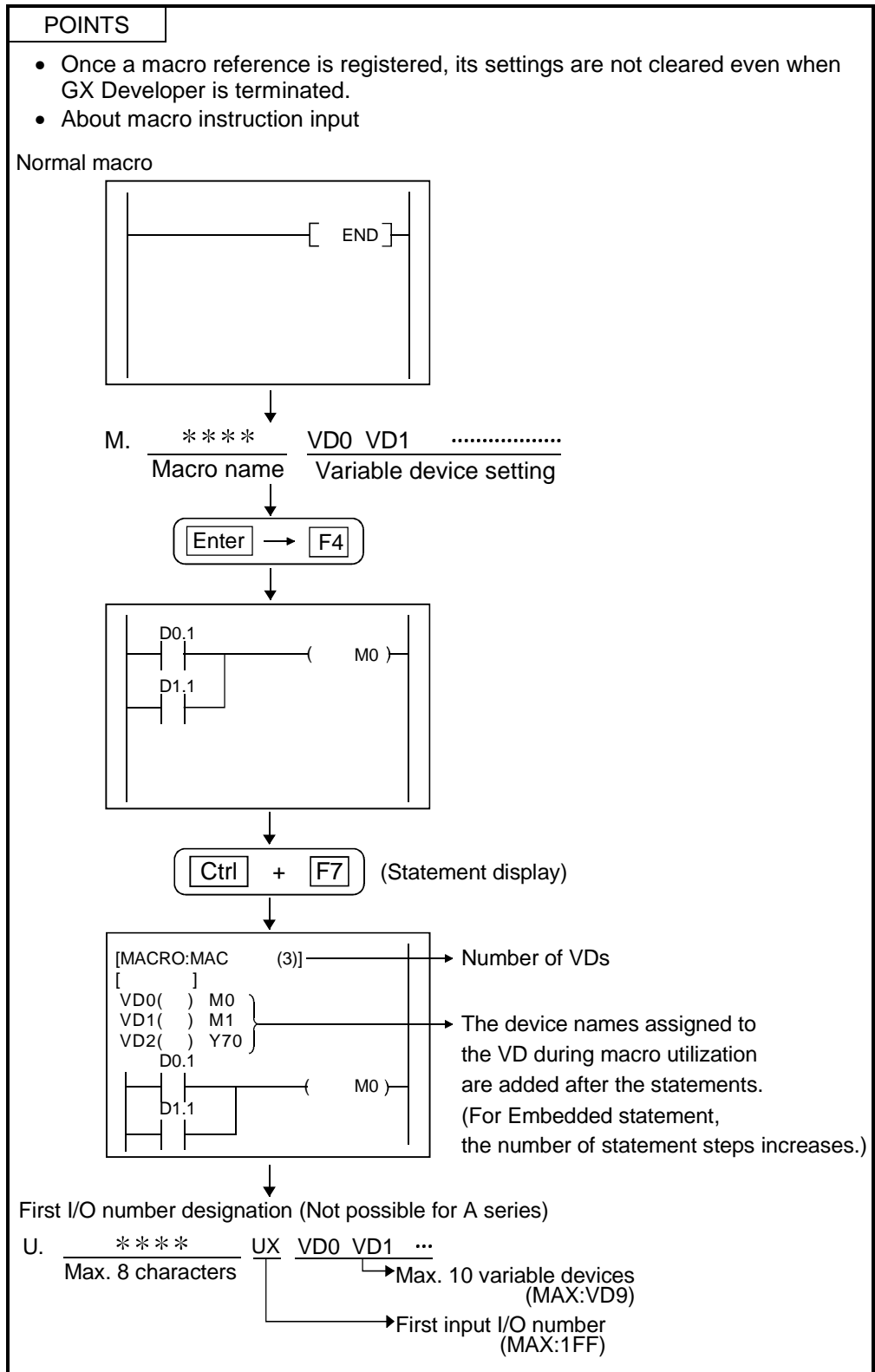



6. CREATING CIRCUIT

| POINTS | | |
|--|---------------------------------|---------------------------|
| <ul style="list-style-type: none"> • When creating comments, statements, notes, and Alias for creating circuits, refer to the following table. • Refer to Section 6.4 for finding and replacement. | | |
| | To edit | To display on edit window |
| Comment | Refer to Section 9.4. | Refer to Section 3.8. |
| Statement | Refer to Subsection 10.3.1 (1). | Refer to Section 3.9. |
| Note | Refer to Section 10.4.1. | Refer to Section 3.10. |
| Alias | Refer to Section 9.4. | Refer to Section 3.11. |

- (1) Circuit creation method
- Input instruction list representations (mnemonic language) with the keyboard.
 - Use tool buttons on the tool bar.
 - Use function keys.
 - Use the tool bar menu.

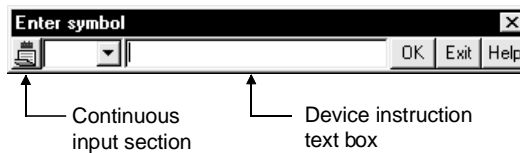
Once the above operation is started, the following circuit input dialog box is displayed.



Click  in the continuous input section so that the circuits or contacts can be input continuously without closing the circuit input dialog box. (This function will not apply to MEDOC style.)

- (2) Switching circuit and list modes (This operation also covers the SFC operation outputs and transition conditions.)

Used to switch the display modes of the edit window.

- (a) When switching from circuit edit window to list edit window:

Select [View] → [Instruction list] or click  (Alt + F1) to set the list mode.

- (b) When switching from list edit window to circuit edit window:

Select [View] → [Ladder], or click  (Alt + F1) to set the circuit mode.

- (3) Switching read and write modes

- (a) Read mode (to read a circuit)

Select [Edit] → [Read mode] or click  (Shift + F2).

If a device to be read, step No., or instruction is designated directly with the keyboard in read mode, a desired part of the circuit can be read.



Click here, and the search dialog box will be displayed for device designation

- (b) Write mode (to edit a circuit)

Select [Edit] → [Write mode] or click  (F2).

In write mode, sequence circuits can be edited (i.e., circuit creation or search and replacement can be performed.)

(4) Switching insert and write modes (Use **Insert** key to switch the mode.)

(a) Insert mode (Cursor: purple)

Used to insert contacts and application instructions into the existing circuits

1. Move the cursor to the following position.

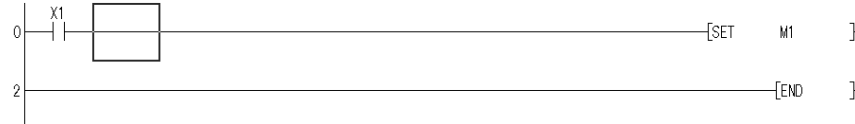

2. Enter "MOV K1 DO" with the keyboard, and the circuit input dialog box will be displayed. The entered data is written to the device instruction text box.



3. Press **Enter** key and click **OK** button to make input in the edit window.

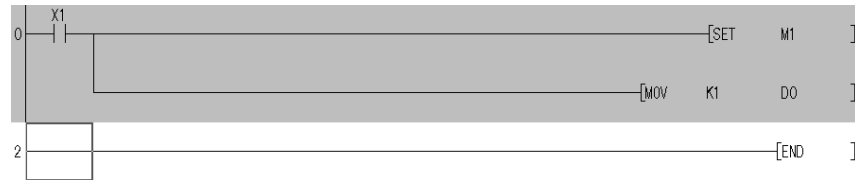

4. Press **F4** key and click  button for inputting.

(b) Overwrite mode (Cursor: blue)

Used to overwrite contacts and application instructions to the existing circuits

1. Move the cursor to the following position.

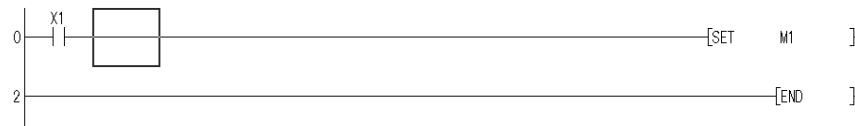

2. Enter "MOV K1 DO" with the keyboard, and the circuit input dialog box will be displayed. The entered data is written to the device instruction text box.



3. Press **Enter** key and click **OK** button to make input in the edit window.

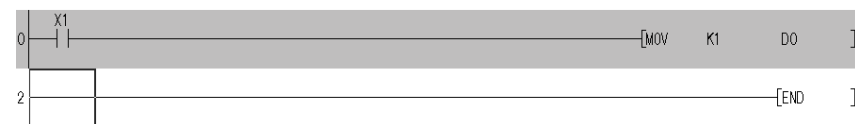

(5) Instruction help

(1) If you do not know instructions and others at the time of ladder creation, you can enter instructions without looking at the programming manual. Instruction help of GX Developer has the following features.

1. You can choose and enter the intended instructions if you do not know them.
2. You can enter instructions if you do not know instruction names/descriptive expressions.
3. You can enter instructions if you do not know devices usable with the corresponding instructions.

(2) The following is the operating procedure for Instruction help.

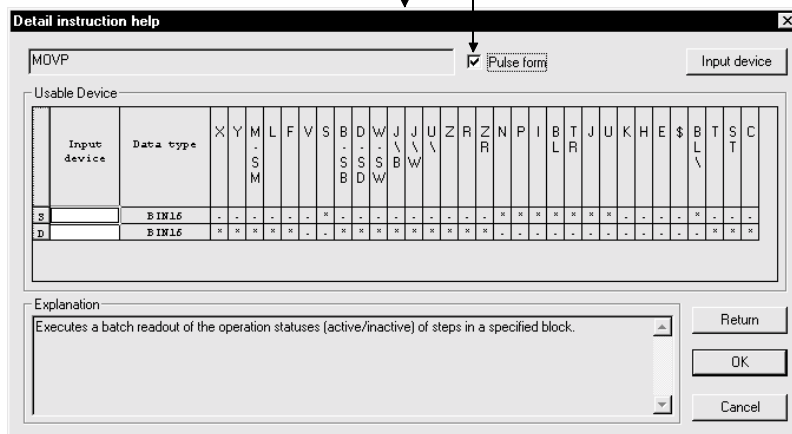
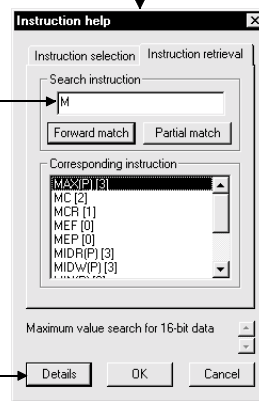
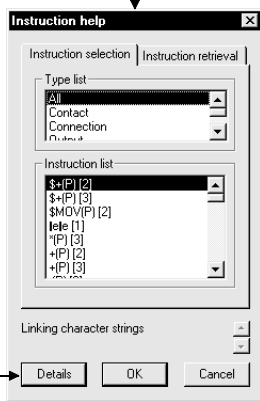
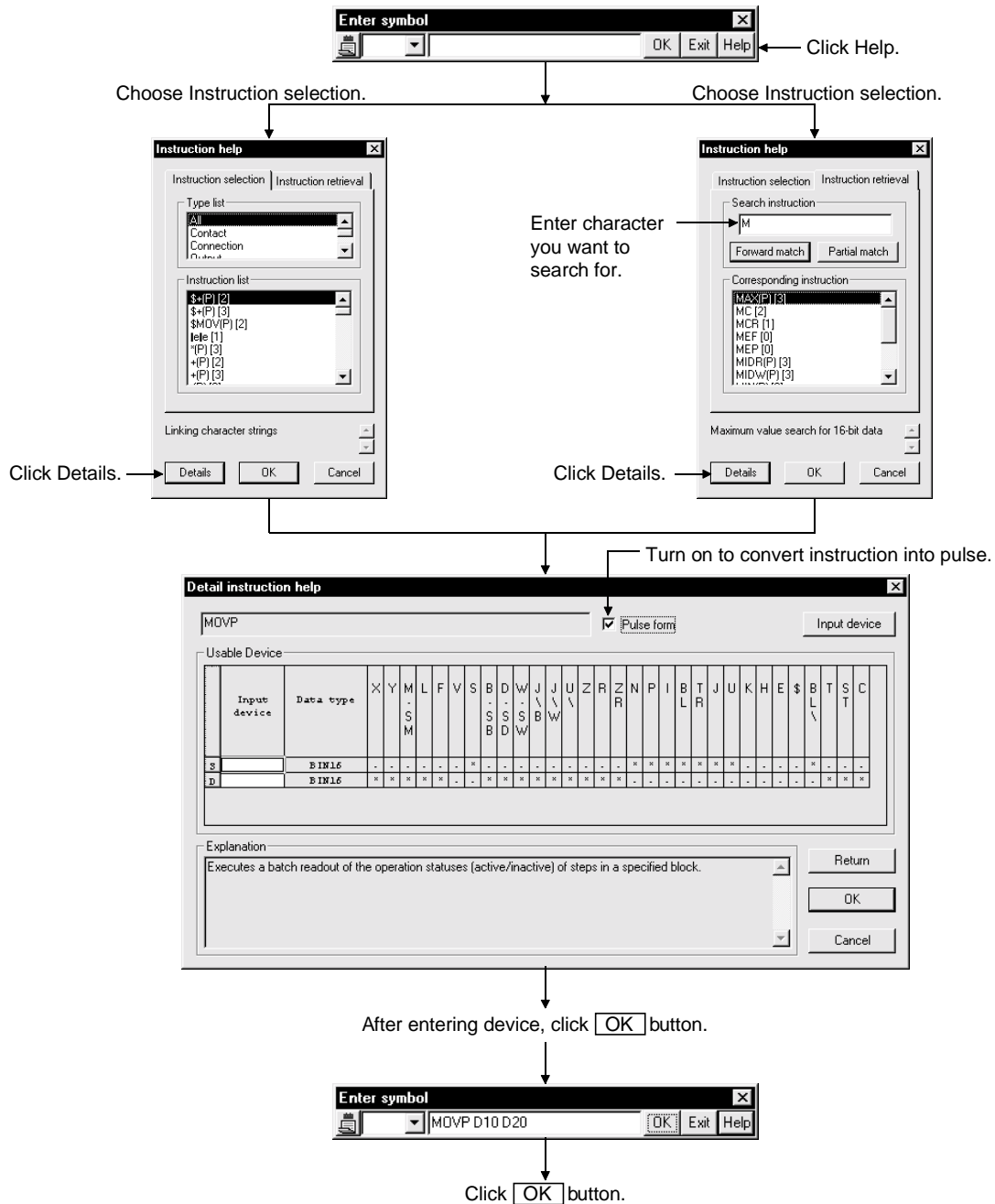

(3) Restrictions on use of Instruction help

The A series dedicated instructions will be explained using the entry of the PRN instruction as an example.

1. Entering method

When entering a dedicated instruction, repeat the procedure in "(2) The following is the operating procedure for Instruction help." instruction by instruction.

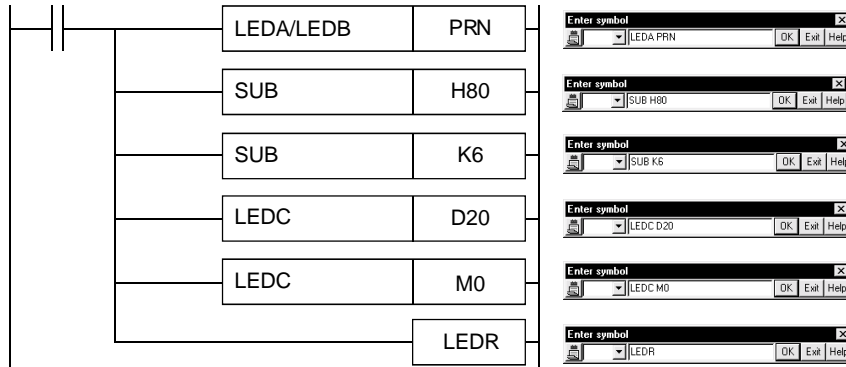

2. About the Detail instruction help screen

The Explanation field shows the explanation of LEDC instruction + device entry.

Detail instruction help

LEDA PRN Pulse form













Usable Device

| Input device | Data type | X | Y | M | L | S | B | D | W | R | A | Z | V | N | P | I | K | H | T | C | |
|--------------|-----------|---|---|---|---|---|---|---|---|---|---|---|---|---|---|---|---|---|---|---|---|
| n | BIN16 | - | - | - | - | - | - | - | - | - | - | - | - | - | - | - | * | * | - | - | |
| n | BIN16 | - | - | - | - | - | * | * | * | * | - | - | - | - | - | - | * | * | * | * | |
| S | BIN16 | - | - | - | - | - | * | * | * | * | - | - | - | - | - | - | - | - | - | * | * |
| D | Bit | - | * | * | * | * | * | * | - | - | - | - | - | - | - | - | - | - | - | - | |

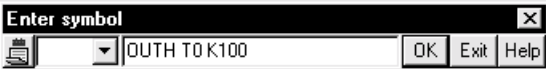
Explanation

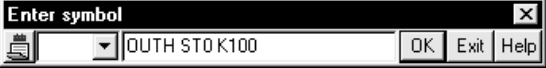
Please input the device used with LEDC/SUB instruction. Sends n2 byte or word data stored in the devices beginning with the device designated by S to the external device connected to the AJ71C24(S3,S6,S8)/AJ71UC24 designated by n1.

Return
OK
Cancel

| POINTS | |
|---|--|
| <p>Tool buttons:</p> <ul style="list-style-type: none"> • Tool buttons vary from model to model in the CPU series. • The key assignment can be changed by customizing the keys. Refer to Section 15.9 for details. | |
| <p>Function keys:</p> <ul style="list-style-type: none"> • How to read function key symbols shown on the tool buttons is shown below. | |
|  |  |
| ↑ | ↑ |
| [Shift] + [F5] | [Ctrl] + [F9] |
|  |  |
| ↑ | ↑ |
| [Alt] + [F7] | [Ctrl] + [Alt] + [F5] |
| <p>Inputting for low speed timers, high speed timers, integrating timers, and edge relays</p> <ul style="list-style-type: none"> • For Q /QnA series, input as follows. | |
| Low speed timer |   |
| High speed timer |   |
| High-speed integrating timer |   |
| Edge relay |   |
| <p>Read/write modes</p> <ul style="list-style-type: none"> • In the read mode, the sequence circuit cannot be edited. • In the write mode, searching by direct inputting cannot be performed. • The circuit input dialog box can also be displayed by double-clicking the cursor. • The contact or application instruction can be changed by pressing function keys ([F5] ⇄ [F6] ⇄ [F7] ⇄ [F8]). (If the key assignment is customized to MEDOC style, it is not possible to change the contact or application instruction by these function keys.) • In the write mode, with the [Ctrl] key + arrow keys, the cursor position can be moved with the input dialog box opened. | |
| <p>Ladder/list modes:</p> <ul style="list-style-type: none"> • For switching from circuit edit window to list edit window Position the cursor at any contact on the circuit edit window and switch the screen. The circuit block where the cursor is positioned will be displayed at the top of the list edit window. • For switching from list edit window to circuit edit window Position the cursor at any list on the list edit window and switch the screen. The circuit block where the cursor is positioned will be displayed at the top of the circuit edit window. | |

6.1 Restrictions on Circuit Creation

This section describes the restrictions of the circuit display window and circuit edit window.

6.1.1 Restrictions in circuit display window

| | | |
|---|-------|----|
| A | Q/QnA | FX |
| ○ | ○ | ○ |

1. The maximum number of lines on one screen is 12. (at 800 x 600 pixels, 50% reduced screen)
2. A created circuit block must be less than 24 lines. Excess lines cause an error.
3. A circuit line can consist of 11 contacts plus 1 coil.
4. The following table lists the number of comment characters.

| | No. of Input Characters | No. of Characters Displayed in Circuit Window |
|-------------------|-------------------------|--|
| Device comment *1 | 32 characters | All characters (8 characters x 4 lines) are displayed. |
| Statement | 64 characters | All specified characters are displayed. |
| Note | 32 characters | |
| Alias | 8 characters | |

*1: The number of device comment edit characters can be set to 16 characters or 32 characters. (see Section 15.11 for details.)

Note that only 16 characters can be used for writing data to PLC/GPPA files.

Note that only 16 characters can be used for writing data to FXGP(DOS) files.

6.1.2 Restrictions in circuit edit window

| A | Q/QnA | FX |
|---|-------|----|
| ○ | ○ | ○ |

1. The maximum number of edit lines per circuit block is 24.
2. The maximum number of edit lines (24 lines/circuit block) is 48.
3. Data up to 48 lines can be cut.
The maximum block size is 124k steps.
4. Data up to 48 lines can be copied.
The maximum block unit is 124k steps.
5. Data cannot be cut, copied and pasted in read mode.
6. Master control (MC) can not be edited and displayed.
The MC symbol appears in the read or monitor mode.
(It does not appear in the write mode.)
7. When a series circuit with 12 contacts or more is created on one line, excess contacts are automatically wrapped and continued to the next line.
Symbols K0 to K99 are used for wrapping and the same number is used for OUT(→) and IN(>-).
8. No circuits can be inserted between the lines OUT(→) and IN(>-).
9. When the circuit write function is used, wrapping symbols are assigned sequence numbers even when they are not within the same circuit block.
However, the circuit blocks read by the read function are assigned sequence wrapping numbers beginning with 0 during display.

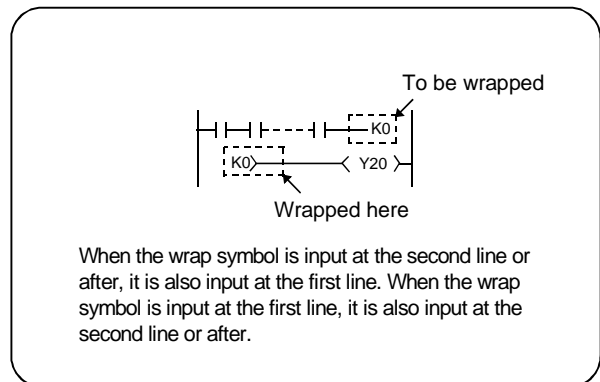
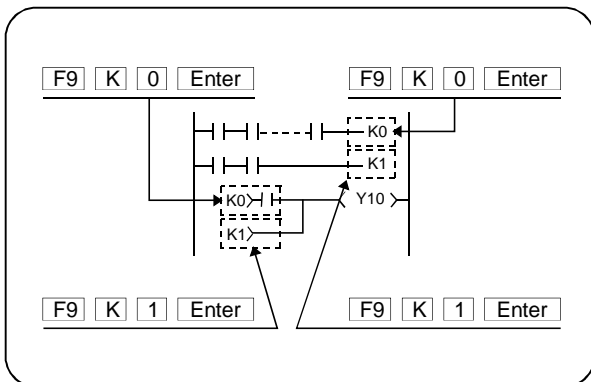

When the wrap symbol is input at the second line or after, it is also input at the first line. When the wrap symbol is input at the first line, it is also input at the second line or after.

10. When an overwrite contact or coil extends over multiple contacts, the circuit cannot be edited in write (overwrite) mode.

<Example>

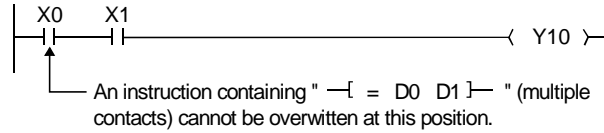

When the above change is made, "[= D0 D1]" must be input in write mode (insert mode), then "LD X0" must be deleted with the **Delete** key.

11. When wrapping occurs for contact insertion to the first line of the circuit, the contact cannot be inserted.

<Example>

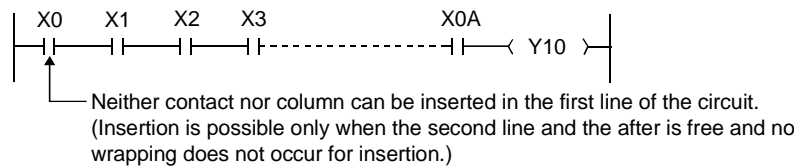

12. Line insertion processing is not possible if the insertion position is within an instruction.

<Example>

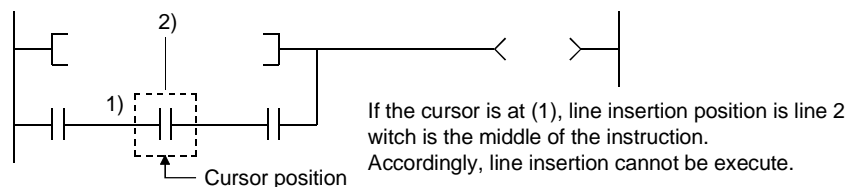

13. Since circuit symbol insertion is processed by the combination of rite flush and line insertion processing, insertion may be impossible depending on the circuit configuration.

<Example>

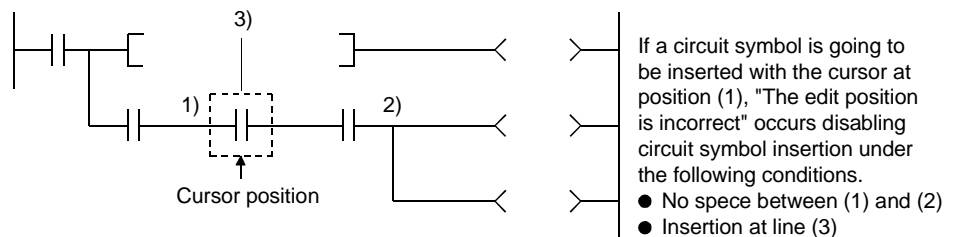

Note : Position (2) is the closest position to the cursor position among the branch symbols and the coil-equivalent instruction.

14. When inserting vertical lines in write (overwrite) mode according to specified number of lines/connecting lines, input the column in the second line and after with **Ctrl** + **Insert** keys, then insert the contact or column to the left of X0.
15. When a vertical line extends over a circuit symbol in writing the line in write (overwrite mode) according to the specified number of lines/connecting lines, writing takes place skipping the circuit symbol.

<Example>

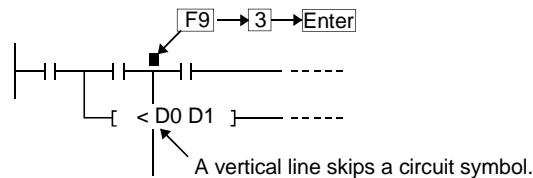

In the circuit edit stage, a vertical line is written skipping the circuit symbol, but such a circuit cannot be converted. Make changes to prevent the vertical line from intersecting the circuit symbol, then perform circuit conversion.

16. When a circuit block consists of 2 lines or more and an instruction cannot be input in one line, the instruction must be wrapped as shown below for instruction input.

(Example) Input of ECALL abcdefg hP0 ZR12345Z1 ZR12345Z1 ZR12345Z1 ZR12345Z1 ZR12345Z1
Input can be made from the position 2).

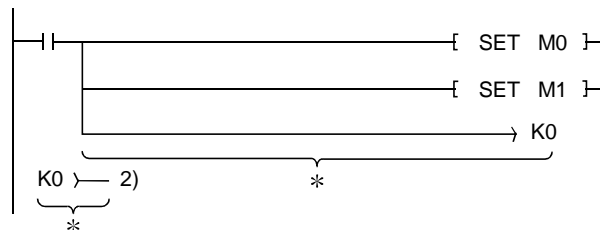

<When no circuit can be created>

The instruction shown in the above example cannot be created in 1).

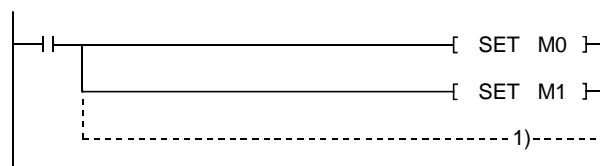

17. The instruction and device that can be input in the first line are shown below (for QnA series selection).

<Example>

U0\G12.1 → Use lines for one contact.
U0\G123.1 → Use lines for two contacts.

18. Create the steps of a single ladder block within approx. 4K steps. NOP instructions in the ladder block are also included in the number of steps. This does not apply to the NOP instruction existing between ladder blocks.

19. The representations of FX series step ladder instructions and cautions on programming

- Conventional representations in FXGP(DOS) and FXGP(WIN)

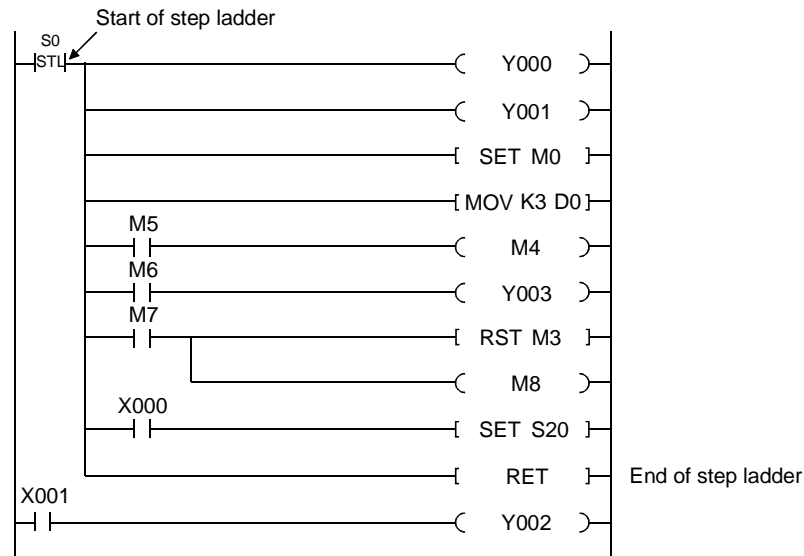

- Representations in GX Developer and cautions on programming

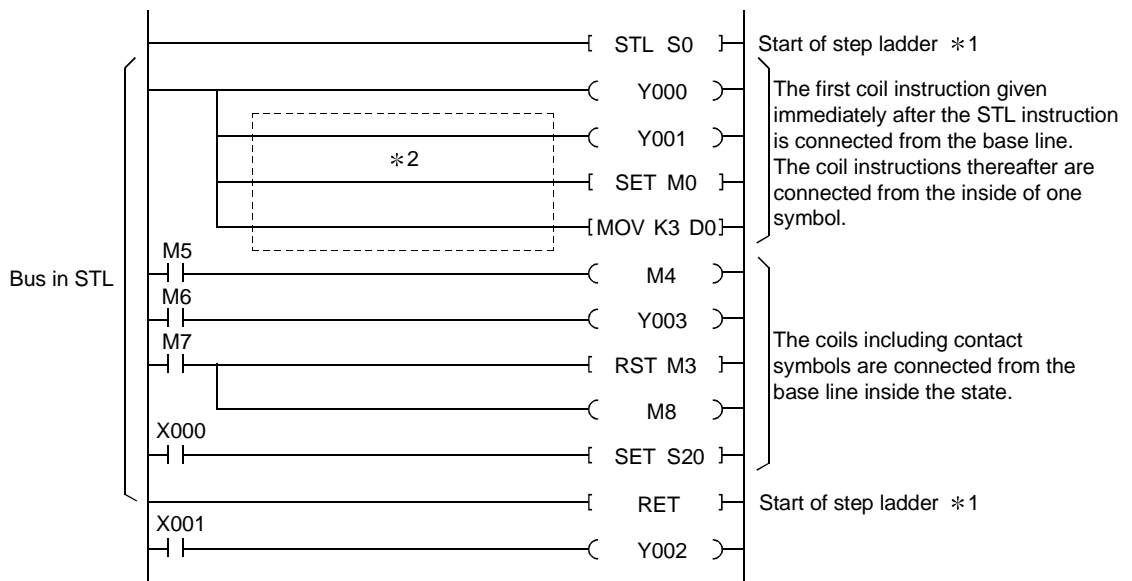

Though the FX series programming material gives descriptions using the above conventional representations, they must be given in a GPPW-specific style when the step ladder instructions are input by GX Developer.



- *1: When the programming is made to create the zoom circuit for SFC program, STL/RET instruction need not to be input.
- *2: Do not enter the contact to the coil instruction subsequently from the first coil instruction given immediately after STL instruction. (The circuit into which contact is input cannot be displayed in FXGP (DOS) and FXGP (WIN).
When entering contacts, enter from the base line.

6.2 Creating and Editing Circuits

| | | |
|---|-------|----|
| A | Q/QnA | FX |
| ○ | ○ | ○ |

POINTS

Replacing

- Replace (F4 / )
Replaces the program under editing.
- Replace (All programs under editing) (Ctrl + Alt + F4 / )
Replaces all programs at a time under editing.
- Replace (Write during RUN) (Shift + F4)
Refer to Section 15.11.

Replacing SFC figures.

- Refer to the GX Developer Version6 Operating Manual for Windows (SFC Version)

6.2.1 Inputting contacts and application instructions

[Contact input procedure]

1. Move the cursor to an input position.
2. Enter the contact.
 - For input with list representation
Enter "LD X1" with the keyboard.



- For input with tool buttons
Click , and enter "LD X1" with the keyboard.



- For input with function keys
Press [F5] key with the keyboard to enter "X1".



- For input with menu
Select [Edit] → [Ladder symbol] → [Open contact], and enter "X1" with the keyboard.



3. Press [Enter] key and click [OK] button to make input in the edit window.

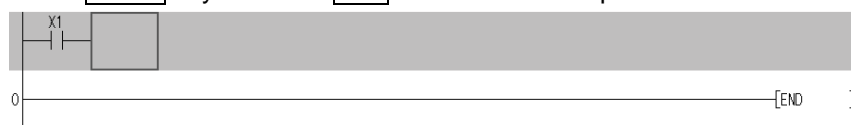

4. Press [F4] key and click  button for inputting.

| POINT | |
|---|---|
| The following shows the contacts that can be input with the tool buttons. | |
| Type | Contact tool button |
| GPPA contact | |
| GPPQ contact | |
| When FX series is selected | <p>sF7, sF8, aF7, and aF8 are effective only when the selected PLC type is FX2N(C).</p> |

[Application instruction input procedure]

1. Move the cursor to input position.
The application instruction and device can be input to the following cursor position.

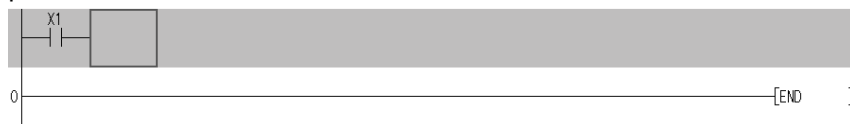

2. Enter the application instruction.
 - For input with list representation
Enter "MOV X1 DO" with the keyboard.



- For input with tool buttons Click , and enter "MOV K1 DO" with the keyboard.



- For input with function keys
Press the **[F8]** key with the keyboard to enter "MOV K1 DO".



- For input with menu
Select [Edit] → [Ladder symbol] → [Application instruction], and enter "MOV K1 DO" with the keyboard.



3. Press **[Enter]** key and click **[OK]** button to make input in the edit window.

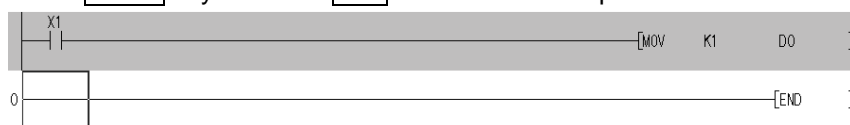

4. Press **[F4]** key and click button for inputting.

6.2.2 Inputting lines (vertical and horizontal)



| |
|--|
| POINT |
| Start drawing a connecting line from the upper left position of the connecting line. |

[Drawing lines]

1. Move the cursor to a connecting line input position.







2. Draw a line.
 - For input with tool buttons

- Click  and , and drag the cursor to draw a line.



- For input with function keys

- Press  key +  key () , and draw a connecting line using  key + arrow keys.





3. Press  key and click  button for inputting.

[Drawing vertical line]



1. Move the cursor to a vertical line input position.

2. Draw a vertical line.
 - For input with tool buttons



- Click  and , and enter the number of vertical lines to be input in the vertical line input window.

When the number of input lines is not designated, one vertical line is input.

- For input with function keys







- Press  ( + ) key to enter the number of vertical lines to be input in the vertical line input window.

When the number of input lines is not designated, one vertical line is input.

3. Press  key and click  button to make input in the edit window.



4. Press  key and click  button for inputting.

[Drawing horizontal line]

1. Move the cursor to a horizontal line input position.
2. Draw a horizontal line.
 - For input with tool buttons
Click , and enter the number of horizontal lines to be input in the horizontal line input window.
When the number of input lines is not designated, one horizontal line is input.
 - For input with function keys
Press  key to enter the number of horizontal lines to be input in the horizontal line input window.
When the number of input lines is not designated, one contact horizontal line is input.
3. Press  key and click  button to make input in the edit window.
4. Press  key and click  button for inputting.

POINT

Connecting lines cannot be input when the END line immediately follows the cursor-positioned line.

In this case, press  +  keys simultaneously to make free space in advance.

6.2.3 Deleting contacts and application instructions

[Deleting procedure]

1. Move the cursor to a contact or an application instruction to be deleted.
2. Press **Delete** key.
For deletion in insert mode, forward justification takes place for circuits.
However, forward justification does not take place on the wrapped line.

[Deleting all programs created]

1. Move the cursor to the outside of the left base line at the top of the program.

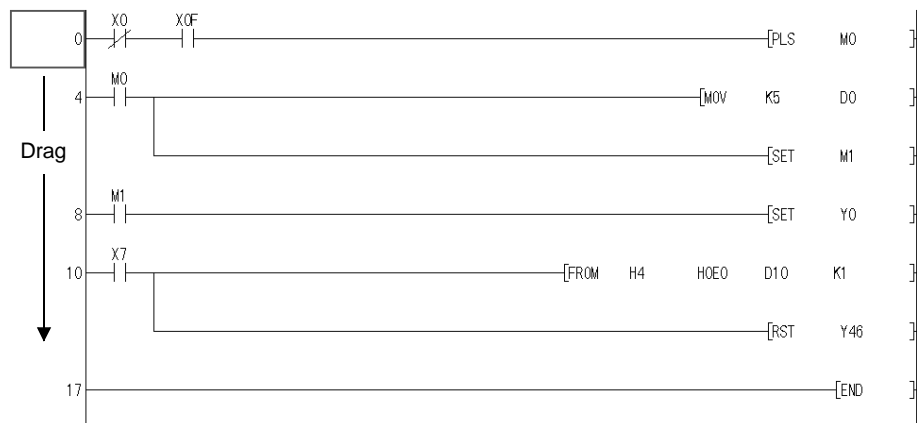

2. Drag the cursor just before the END instruction.

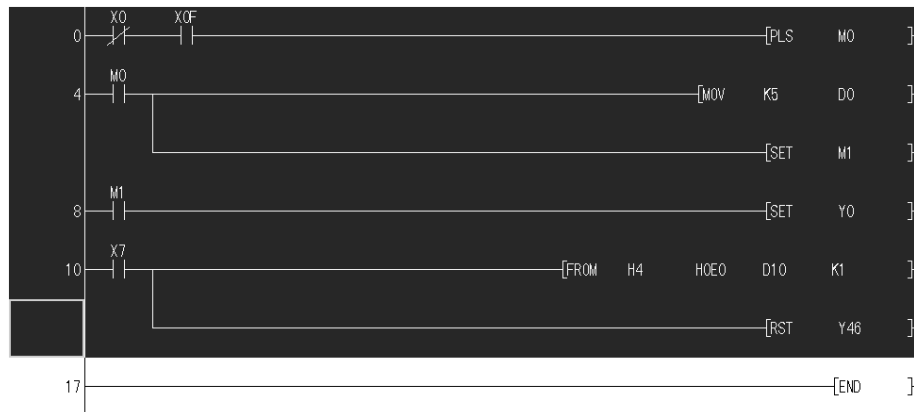

3. Press **Delete** key.

6.2.4 Deleting connecting lines

[Deleting procedure]

1. Move the cursor to a connecting line to be deleted.

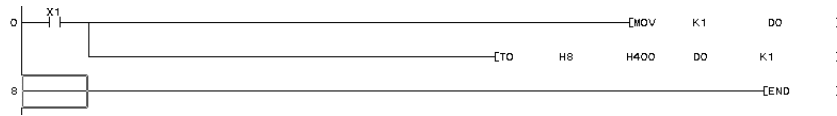

2. Delete the connecting line.

- For deletion with tool buttons

Click , and drag the cursor through a line to be deleted.

- For deletion with function keys

Press **[Alt]** key + **[F9]** key → **[Shift]** key + arrow keys to move the cursor through a line to be deleted.



6.2.5 Inserting and deleting in circuit blocks

(1) For line insertion (in one-circuit block)

[Operating procedure]

1. Move the cursor to a line to be inserted.



2. Insert the line.

- For insertion with function keys
Press **[Shift]** key + **[Insert]** key to insert a line.
- For insertion with menu
Select **[Edit]** → **[Insert Column]** to insert a line.



(2) For line deletion (in one-circuit block)

[Operating procedure]

1. Move the cursor to a line to be deleted.

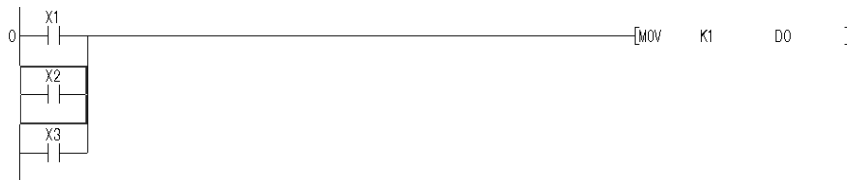

2. Delete the line.

- For deletion with function keys
Press **[Shift]** key + **[Delete]** key to delete a line.
- For deletion with menu
Select **[Edit]** → **[Delete Column]** to delete a line.



(3) For column insertion (in one-circuit block)

[Operating procedure]

1. Move the cursor to a column to be inserted.



2. Insert the column.

- For insertion with function keys
Press **[Ctrl]** key + **[Insert]** key to insert a column.
- For insertion with menu
Select **[Edit]** → **[Insert]** to insert a column.

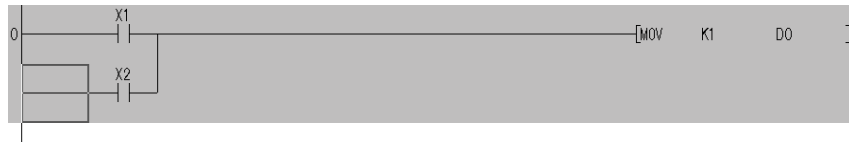

(4) For column deletion (in one-circuit block)

[Operating procedure]

1. Move the cursor to a column to be deleted.

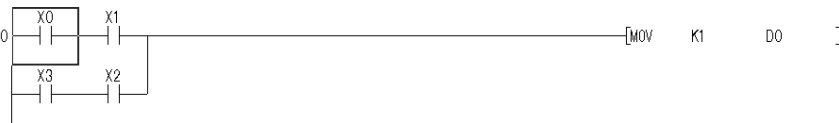

2. Delete the column.

- For deletion with function keys
Press **[Ctrl]** key + **[Delete]** key to delete a column.
- For deletion with menu
Select **[Edit]** → **[Delete]** to delete a column.



6.2.6 Inserting NOPs

| A | Q/QnA | FX |
|---|-------|----|
| ○ | ○ | ○ |

[Purpose]

Inserts all NOPs (no operation instructions) to reserve space in a program for debugging.

[Operating Procedure]

Move the cursor to an insert line (at any location), then select [Edit] → [Insert NOP batch].

[Dialog Box]

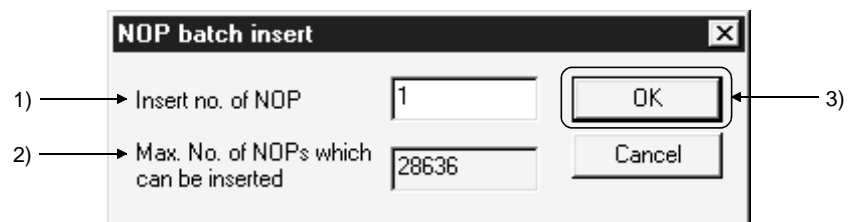

[Description]

- 1) Insert no. of NOP
Designates the number of NOPs to be inserted.
- 2) Max. No. of NOPs which can be inserted
Displays the maximum number of NOPs that can be inserted.
- 3) **OK** button
Click this button after making necessary settings.

6.2.7 Deleting NOPs

| A | Q/QnA | FX |
|---|-------|----|
| ○ | ○ | ○ |

[Purpose]

Deletes NOPs (no operation instructions).

[Operating Procedure]

Select [Edit] → [Delete NOP batch].

[Description]



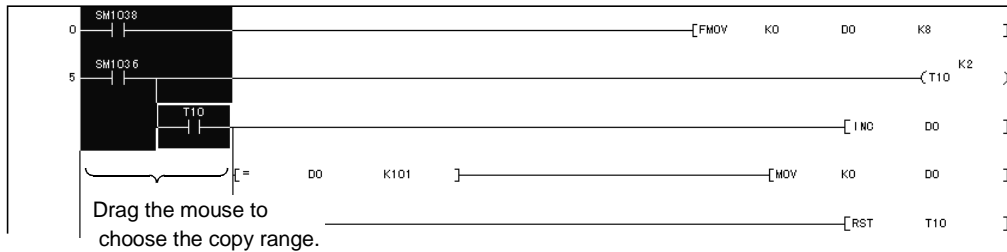

If the **OK** button is clicked on the confirmation dialog box, all NOP instructions from step 0 to the END instruction are deleted.

6.2.8 Cutting, copying and pasting circuits

(1) Pasting the circuits cut or copied by a specified range



[Operating procedure]

1. Set to the Write mode.
Select [Edit] → [Write mode] or click  ([F2]).
2. Specify the range of the cut/copied ladder.
 - (1) When specifying the range
Drag the mouse to specify the cut/copy range.
The specified range is highlighted.
 - (2) When not specifying the range (When cutting/copying only one contact)
The contact, coil or the like at the cursor is the target of cutting/copying.
At ladder mode editing, the line statement/P, I statement and END instruction cannot be cut/copied.
3. Cut or copy the specified range of circuit.
 - For cutting
Select [Edit] → [Cut] or click  ([Ctrl] + [X]).
 - For copying
Select [Edit] → [Copy] or click  ([Ctrl] + [C]).
4. Click the location in which the cut or copied circuit is to be pasted to set the cursor there.
5. Paste the circuit.
Select [Edit] → [Paste] or click  ([Ctrl] + [V]).
On completion of circuit paste, the pasted part is grayed.
6. Press [F4] key and click  button for inputting.

(2) Pasting the circuits cut or copied in circuit block



Move the cursor here and drag the mouse vertically to specify the range.

[Operating procedure]

1. Set to the Write mode.

Select [Edit] → [Write mode] or click  (**F2**).

2. Specify the range of the cut/copied ladder block.

- (1) When moving the cursor to specify the range

Click the position where the step number of the ladder block to be cut/copied is indicated, and drag the mouse vertically to specify the cut/copy range.

- (2) When making a search to set the range

Highlight one or more ladder blocks to select the range, and specify the device, character string or the like you want to search.

3. Cut or copy the specified range of circuit block.

- For cutting

Select [Edit] → [Cut] or click  (**Ctrl** + **X**).

- For copying

Select [Edit] → [Copy] or click  (**Ctrl** + **C**).

4. Click any location within a circuit block at the lower stage of the location to be pasted to set the cursor there.

5. Paste the circuit.

Select [Edit] → [Paste] or click  (**Ctrl** + **V**).

The designated circuit is pasted at the designated location.

6. Press **F4** key and click  button for inputting.

| POINTS |
|---|
| <ul style="list-style-type: none"> • The cut, copy or paste menu can also be selected from the popup menu displayed by clicking the right mouse button. • When a range designation is given as follows, the vertical bar at the rightmost end is not selected. <div style="text-align: center;"> </div> <ul style="list-style-type: none"> • Circuit paste takes place in overwrite or insert mode. • Performing cut/copy on a ladder block basis inserts and pastes the data to the existing ladder. When overwriting the data, delete the row to be overwritten in advance, and then paste the data. • You cannot paste the data cut or copied from a label program to an actual program. You can paste the data cut or copied from an actual program to a label program. Hold down Shift and press ↑ / ↓ to correct the specified range after selection of the cut/copy range. |

6.2.9 Undo the last operation

[Purpose]

Cancels the last operation (cut, copy, or paste) and restores the previous state.

[Operating Procedure]

1. Select [Edit] → [Undo] or click  immediately after cutting, copying or pasting the circuit.

(1) The following states can be restored.

- Line insertion, line deletion
- Column insertion, column deletion
- Connecting line input, connecting line deletion
- Instruction input
- Cut and paste within a specified range
- Circuit deletion by **Delete** or **Back space** keys

(2) The following states cannot be restored.

- After circuit conversion
- Abandoning the circuit not converted yet
- Program change due to PLC reading, other format file reading, copying from another project
- Replacement, inserting or deleting NOPs at a time, or TC setting value change
- Search after cut or paste in units of circuit blocks
- Errors due to cut, etc.

6.2.10 Returning to the status after ladder conversion

[Purpose]

Perform this operation at the time of ladder editing when you want to return to the status right after ladder conversion and perform reediting.

This operation is enabled only in the ladder or SFC (ZOOM) mode. (Disabled in the list mode)

[Operating Procedure]

Select [Edit] → [Return to status after ladder conversion].

6.3 Changing T/C Setting Values

| A | Q/QnA | FX |
|---|-------|----|
| ○ | ○ | ○ |

[Purpose]

Lists the setting values of timers and counters used in the program so that they can be changed at a time.

For SFC, the set values of the timers and counters within the block being displayed are changed.

[Operating Procedure]

Select [Edit] → [Change TC setting]

[Dialog Box]

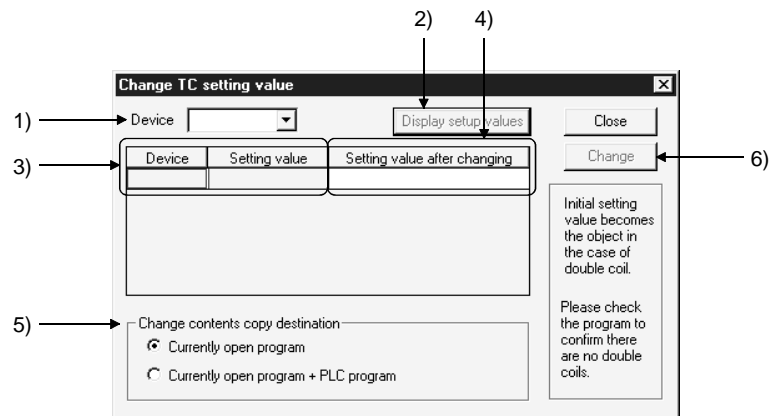

[Description]

1) Device

Designates the timer(s) or counter(s) for which the current setting values must be changed.

2) Display setup values button

Click this button to display the current setting values of the timers or counters designated by device input.

3) Device, Setting value

Displays the current setting values of the designated timer(s) or counter(s).

4) Setting value after changing

Designates the setting value of the timer or counter for which the current setting value is to be changed.

5) Change contents copy destination

Currently open program

Changes the setting values of the timers and counters in the open program at present.

Currently open program PLC program

Changes the setting values of the timers and counters in the open program at present and writes them to the PLC.

However, these setting values can be changed only between the constants.

- 6) **Change** button
Click this button for setting value change.

| POINTS |
|---|
| <ul style="list-style-type: none">• Setting values can be changed from constant (K) to indirect designation (D) and vice versa.• For a high-speed counter of the FX series, setting value change between constant(K) and indirect designation(D) is not allowed in the online state. (same as write Online change)• Devices with index modification cannot be designated.• When the changed setting value is to be written to the PLC CPU, the setting value cannot be changed using ZR. K10 → K1234 Can be set K10 → ZR100 Cannot be set ZR100 → D100 Cannot be set• The following dialog box appears if the T/C coils of the same number exist in the T/C set value changing program. (This does not apply to the extended T/C.)  |
| <p>Note: If a program (MAIN-SFC) has not been created, it is displayed as a message.</p> |

6.4 Find and Replace

| |
|-------|
| POINT |
|-------|

| |
|--|
| Refer to the GX Developer Operating Manual for Windows (SFC Version) for step No. and block No. finding and step No. replacement of SFC figures. |
|--|

- (1) Common operations for finding
 - (a) Find direction
 - From top to bottom
Searching takes place from step 0 to the END instruction.
 - From cursor to bottom
Searching takes place from cursor position to the END instruction.
 - From cursor to top
Searching takes place from cursor position to step 0.
 - (b) **Find Next** button
Click this button to search for the next device.
- (2) Common operations for replacement
 - (a) Find direction
 - From top to bottom
Searching takes place from step 0 to the END instruction.
 - From cursor to bottom
Searching takes place from cursor position to the END instruction.
 - Range designation
When a range to be replaced is designated, the step No. is set automatically.
Click the radio button, and a step range to be found can be designated.
A range to be replaced ranges from the head of a circuit block including a designated step No. to the end of the circuit block including the designated step No.
 - (b) **Find Next** button
Click this button to search for the next target device without replacing a cursor-positioned device.
 - (c) **Replace** button
Click this button to search for the next target device after replacing a cursor-positioned device.
 - (d) **Replace all** button
Click this button to replace all the target devices in the designated search range.
 - (e) About replacement during label program editing
Making replacement to an already compiled program puts the program in an uncompiled status.
Select [Convert] → [Compile] to recompile the program.

- (3) Find/replace of the other programs
Click **Find Next** button in each find and replace to find and replace the other programs.

[Operating procedure]

1. Find and replace the current open programs.
2. Click **Find Next** button to find and replace the other programs.
A prompt to ask for find and replace of the other programs is displayed one time only.
In searching for and replacing the other programs, searching takes place in the following order.

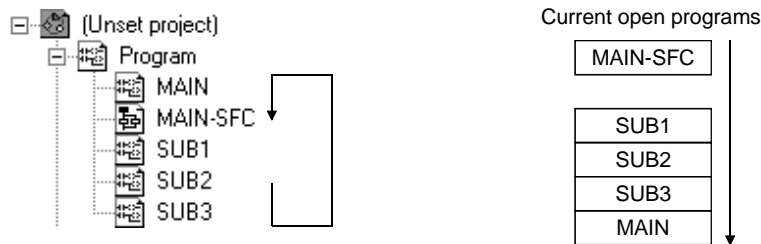

(4) About replacement in label programming

| | Local Variable Setting | Global Variable Setting |
|------------------------------|--|--|
| Device replacement | Search/replacement is made on only the active local variable setting screen. Auto External variables are only searched for. (Auto External variable replacement is made on the global variable setting screen.) | Search/replacement is made on only the global variable setting screen. |
| Character string replacement | Search/replacement is made on only the active local variable setting screen. Note that Auto External variables are only searched for. (Auto External variable replacement is made on the global variable setting screen.) | Search/replacement is made on only the global variable setting screen. |

- SFC programs will also be search and replacement targets.
- When there is no search program, search and replace terminates without displaying a message for searching for the other programs.
- When there remains a search program, searching for the program takes place automatically.
- When a range is designated for program replacement, this range specification is effective only for open programs. Searching in the other programs takes place from the beginning.

| | |
|--------------|--|
| POINT | Devices and character strings found and replaced are saved as a log. However, it is cleared when exiting GX Developer. |
|--------------|--|

6.4.1 Finding a device

| | | |
|-----------------------|-----------------------|-----------------------|
| A | Q/QnA | FX |
| <input type="radio"/> | <input type="radio"/> | <input type="radio"/> |

[Purpose]

Searches for a device in the program.

In A series and QnA series, it is possible to search in other programs in the project.

[Operating Procedure]

Select [Find/Replace] → [Find device] or click  .

[Dialog Box]

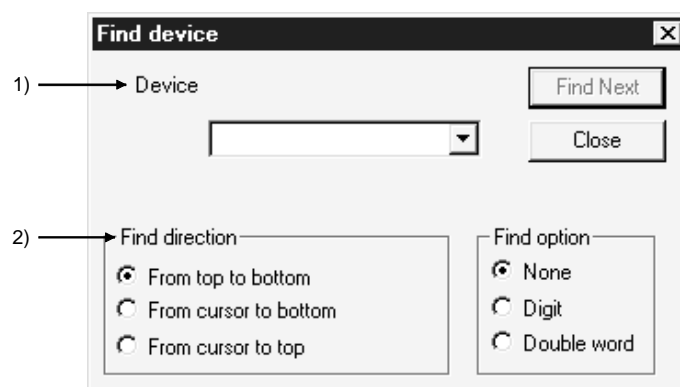

[Description]

1) Device

Designates a device to be searched.

For label programming

When a label or device search is made in the ladder/list mode, only the completely matching character string of the label or device is searched for.

2) Find direction

Sets a search direction.

Find from top to bottom

Searching takes place from step 0 to the END instruction.

Find from cursor bottom

Searching takes place from the cursor position to the END instruction.

Find from cursor to top

Searching takes place from the cursor position to step 0.

| POINTS | | |
|---|---------------------------|---|
| <ul style="list-style-type: none"> The following table shows device search examples. | | |
| Device Specification | Search Device | Search Example |
| B0 | (k***)B0(Z***) | B0, K4B0, B0Z1, K4B0Z1 |
| K4B0 | K4B0(Z***) | K4B0, K4B0Z1 |
| J12\B0 | J12(Z***)\ (K***)B0(Z***) | J12/B0, J12B0Z1, J12Z2\K4B0, J12Z1\K4B0Z1 |
| <ul style="list-style-type: none"> In the presence of the [BMOV K1X0 D100 K4] instruction in the program, choosing "Digit" with the search option makes a search when any of the following device numbers is specified. <ul style="list-style-type: none"> X0 to XF (devices included in the K1X0 specification range) Choosing "Double word" makes a search when any of the following device numbers is specified. D100 to D103 (devices included in the D100 specification range) | | |

6.4.2 Finding an instruction

| | | |
|---|-------|----|
| A | Q/QnA | FX |
| ○ | ○ | ○ |

[Purpose]

Searches for an instruction in the program.

[Operating Procedure]

Select [Find/Replace] → [Find instruction] or click  .

[Dialog Box]

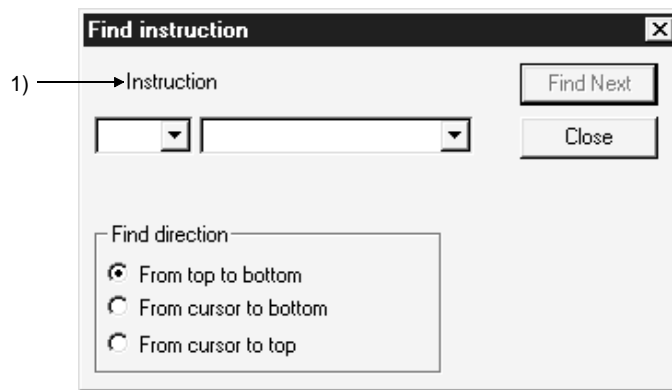

[Description]

1) Instruction

Designates an instruction symbol and an instruction name for search. The following lists the symbols that can be designated.

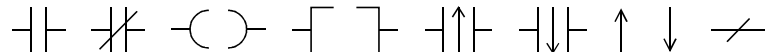

| POINTS | | |
|---|----------------------------------|--|
| <ul style="list-style-type: none"> The following table shows instruction search examples. | | |
| Instruction specification | Search instruction | Search example |
| MOV | MOV(P) | MOV, MOV P |
| MOV P | MOV P | MOV P |
| MOV D0 K4Y0 | MOV(P)D0(Z**) K4Y0(Z**) | MOV D0 K4Y0, MOV P D0Z1 K4Y0, MOV D0 K4Y0Z1, MOV P D0Z1 K4Y0Z1 |
| MOV P D0 J1W0 | MOV P D0(Z**) J1(Z**)\W0(Z**) | MOV P D0 J1W0, MOV P D0Z1 J1W0, MOV P D0 J1Z1W0Z1, MOV P D0Z1 J1Z1W0Z1 |
| <ul style="list-style-type: none"> When searching for the other programs, see Section 6.4.1. | | |

6.4.3 Finding a step No.

| | | |
|-----------------------|-----------------------|-----------------------|
| A | Q/QnA | FX |
| <input type="radio"/> | <input type="radio"/> | <input type="radio"/> |

[Purpose]

Searches for and displays a step No. during inter-line statement or note editing.

[Operating Procedure]

Select [Find/Replace] → [Find step No.].

[Dialog Box]

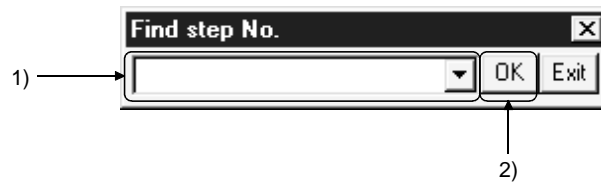

[Description]

- 1) Step No. text box
Designates a step No. to be used for search.
- 2) button
Click this button to display a circuit with a designated step No.

6.4.4 Finding a character string

| | | |
|-----------------------|-----------------------|-----------------------|
| A | Q/QnA | FX |
| <input type="radio"/> | <input type="radio"/> | <input type="radio"/> |

[Purpose]

Searches for a character string in the edit window for programs, device comments, or device memories

[Operating Procedure]

On each edit window, select [Find/Replace] → [Find character string] or click  .

[Dialog Box]

Ladder/list edit window

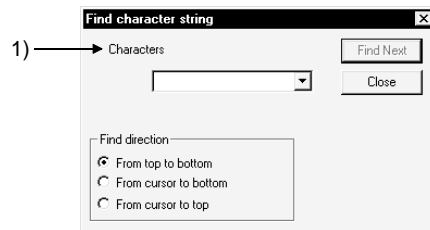

Device comment edit window

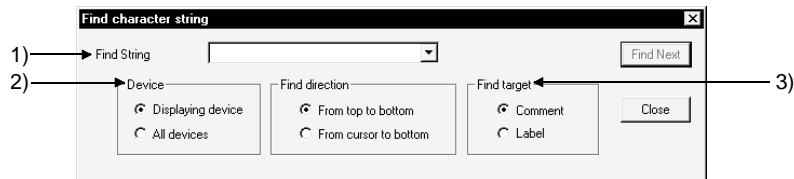

Device memory edit window

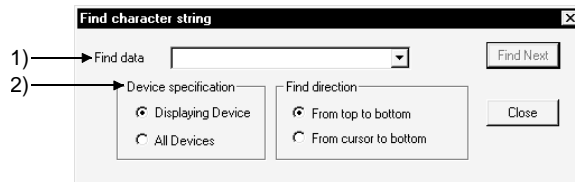

Device memory edit window

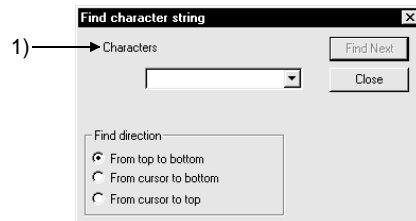

[Description]

- 1) Find character
Enter a character string to be searched for in up to 64 characters.
- 2) Device
 - Displaying devices
Select this to search for only the devices being displayed in the window.
 - All devices
Select this to search also those devices not displayed in the window.
- 3) Find target
Select a button to designate a comment or Alias.

| |
|--|
| POINT |
| Device memory find direction Find from top to bottom Searching takes place from D0, W0, or R0 to the bottom. |

6.4.5 Finding a contact/coil

| | | |
|-----------------------|-----------------------|-----------------------|
| A | Q/QnA | FX |
| <input type="radio"/> | <input type="radio"/> | <input type="radio"/> |

[Purpose]

Searches for a contact or coil corresponding to the device at the cursor position.

[Operating Procedure]

Select [Find/Replace] → [Find contact or coil]

[Dialog Box]

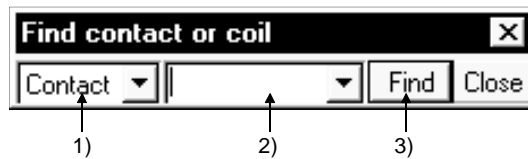

[Description]

- 1) **Contact or coil select**
Choose the contact or coil.
- 2) **Device text box**
Set the device you want to search for.
- 3) **[Find] button**
Click this button to search for the specified device.
A search starts from the beginning of the program.
If there are two or more programs, the other programs will be searched.

6.4.6 Finding data

| | | |
|-----------------------|-----------------------|-----------------------|
| A | Q/QnA | FX |
| <input type="radio"/> | <input type="radio"/> | <input type="radio"/> |

[Purpose]
Searches the set numerical data.

[Operating Procedure]
On the device memory edit window, select [Find/Replace] → [Find data].

[Dialog Box]

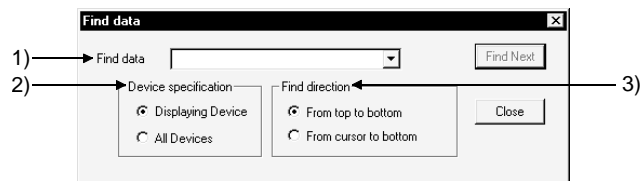

[Description]

- 1) Find data
Enter the data to be searched for.
- 2) Device
 - Displaying devices
Select this to search for only the devices being displayed in the window.
 - All devices
Select this to search for also those devices not displayed in the window.
- 3) Find direction
Select a button to designate whether to search for devices from the beginning or at the cursor position.
 - From top to bottom
Searching takes place from D0, W0, or R0 to the bottom.
 - From cursor to bottom
Searching takes place from the cursor position to bottom.

POINT

Since the find and replace of a floating point and a fixed point are processed as actual data, a target of search may not be found due to a conversion error between the floating point/fixed point and the actual data.

Do not find and replace the floating point or fixed point after a 32-bit integer has been converted to a floating point. Find and replace in the input conditions.

6.4.7 Replacing a device

| | | |
|---|-------|----|
| A | Q/QnA | FX |
| ○ | ○ | ○ |

[Purpose]

Replaces a device or character string constant in the program currently being edited.

[Operating Procedure]

Select [Find/Replace] → [Replace device].

[Dialog Box]

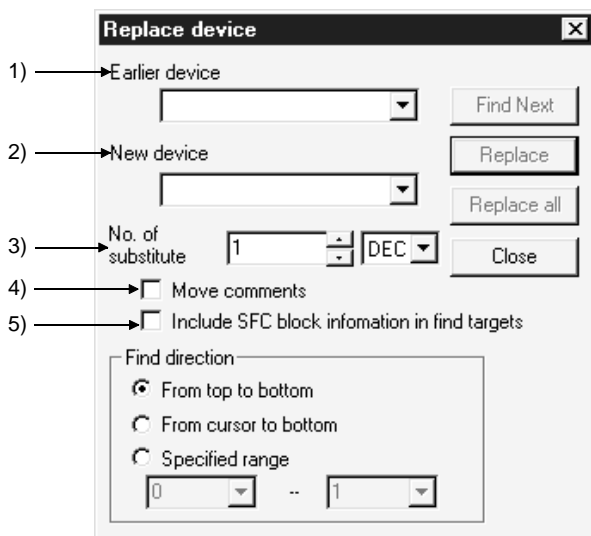

For label programming

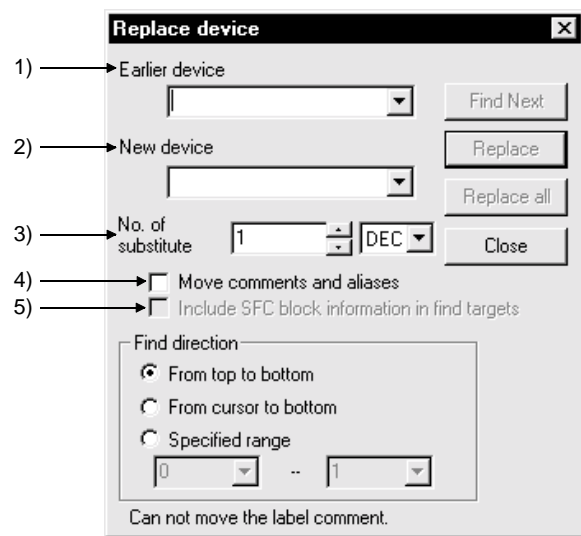

[Description]

- 1) Previous device
Designates a device or character string constant (before change) to be replaced.
- 2) New device
Designates a device or character string constant (after change) for replacement.
- 3) No. of substitute
Designates the number of devices to be replaced among the devices designated by old device setting.
Alternatively, you can specify the substitute count in decimal or hexadecimal.
For label programming
When specifying by label, limit the number of replacement points to 1.

| |
|--|
| POINT |
| During label program editing, label comments do not move independently of the "Move comments and aliases" setting. |

- 4) Move comments
Designates whether to move the comments and Alias attached to a device together.
- 5) Include SFC block information in find targets
Set whether the device set in the block information of each block will be replaced or not.

| POINTS | | | | | | | | | |
|---|---|------------------------------|-------------------------------|-------------------------------|---------------------------------|-----------------------------|---------------------------------|-------------------------------|--|
| <ul style="list-style-type: none"> • Device specification The following lists the devices that can be replaced. <ul style="list-style-type: none"> • Word device → Word device • Bit device → Bit device • Though an extended specification can be given, digit, index, and indirect modifications cannot be made. The table below lists the extended specification and word/bit device replacement examples | <table style="width: 100%; border-collapse: collapse;"> <tbody> <tr> <td style="padding: 2px;">X0 → J1\B0 Replaceable</td> <td style="padding: 2px;">X0 → D0 Not Replaceable</td> </tr> <tr> <td style="padding: 2px;">D0 → U10\G0 Replaceable</td> <td style="padding: 2px;">X0 → K4X0 Not Replaceable</td> </tr> <tr> <td style="padding: 2px;">X0 → D0.5 Replaceable</td> <td style="padding: 2px;">D0 → D0.5 Not Replaceable</td> </tr> <tr> <td style="padding: 2px;">D0.1 → D1.1 Replaceable</td> <td></td> </tr> </tbody> </table> | X0 → J1\B0 Replaceable | X0 → D0 Not Replaceable | D0 → U10\G0 Replaceable | X0 → K4X0 Not Replaceable | X0 → D0.5 Replaceable | D0 → D0.5 Not Replaceable | D0.1 → D1.1 Replaceable | |
| X0 → J1\B0 Replaceable | X0 → D0 Not Replaceable | | | | | | | | |
| D0 → U10\G0 Replaceable | X0 → K4X0 Not Replaceable | | | | | | | | |
| X0 → D0.5 Replaceable | D0 → D0.5 Not Replaceable | | | | | | | | |
| D0.1 → D1.1 Replaceable | | | | | | | | | |
| <ul style="list-style-type: none"> • When replacing a device in other programs, see Subsection 6.4.1. • When a replacement range is given, it is effective only for open programs at present and searching for the other programs takes place from the beginning. • Restrictions on FX series Device replacement cannot take place between the 16-bit counters and 32-bit counters. • The replacement of the device used in the SFC block information is suspended with an error indication if the new device will be unusable. | | | | | | | | | |

6.4.8 Replacing an instruction

| A | Q/QnA | FX |
|-----------------------|-----------------------|-----------------------|
| <input type="radio"/> | <input type="radio"/> | <input type="radio"/> |

[Purpose]

Replaces an instruction in the program currently being edited.

[Operating Procedure]

Select [Find/replace] → [Replace instruction].

[Dialog Box]

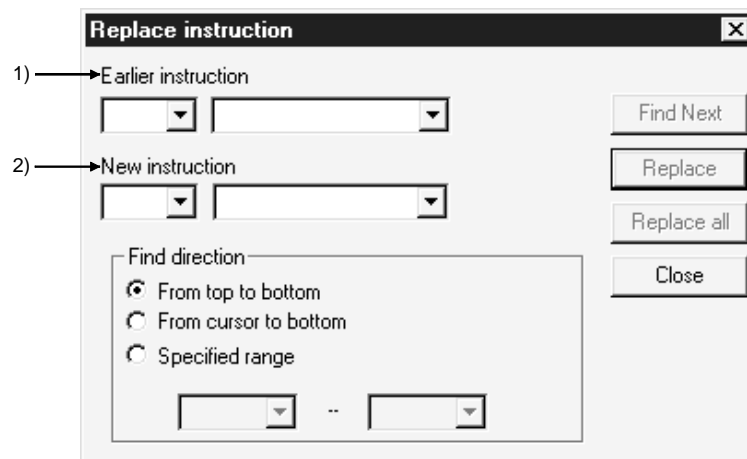

[Description]

- 1) Earlier instruction
Designates an instruction (before change) to be replaced.
- 2) New instruction
Designates an instruction (after change) for replacement.

| POINTS | | |
|--|-------------------|--|
| 1. An instruction plus device can be designated for instruction input. Only the circuit symbol can also be designated. | | |
| 2. The replaced instruction is not executed unless it is logical. | | |
| 3. The number of steps changes for instruction replacement. | | |
| 4. The following shows the instruction replacement examples. | | |
| | → | |
| Y90 | | MOV D0 D1..... Replaceable |
| | → | |
| M100 | | D1.1..... Replaceable |
| | → | |
| J12\B5 | | U3\G123.5..... Replaceable |
| | → | |
| B100 | | B100..... Not replaceable |
| | → | |
| MOV D0 D1 | | X0..... Not replaceable |
| <ul style="list-style-type: none"> • When replacing an instruction in other programs, see Section 6.4.1. • The step numbers specified for the SFC operation outputs/transition conditions are those used when the SFC diagram is represented as an equivalent to a ladder. • For the replacement of a 16 bit (word) handling instruction by a 32 bit (double word) handling instruction in instruction replacement, if a constant has been specified for the device, it will be changed as follows. | | |
| Negative constant of K (example: K-1) → Sign extension is made (K-1) | | |
| For H, constant whose bit corresponding to the sign is ON (example: HFFFF) → sign extension is not made and the constant is converted as it is (H0000FFFF) | | |
| Example: | MOV K-1 D0 | (MOV replaced by DMOV) DMOV K-1 D0 |
| | MOV K-200 D0 | (MOV replaced by DMOV) DMOV K-200 D0 |
| | MOV HFFFF D0 | (MOV replaced by DMOV) DMOV H0000FFFF D0 |
| For the replacement of a 32 bit handling instruction by a 16 bit handling instruction, the upper 16 bits are discarded. | | |
| Example: | DMOV K-1 D0 | (DMOV replaced by MOV) MOV K-1 D0 |
| | DMOV K150000 D0 | (DMOV replaced by MOV) MOV K18928 D0 |
| | DMOV HFFFFFFFF D0 | (DMOV replaced by MOV) MOV HFFFF D0 |

6.4.9 Changing A and B contacts

| | | |
|---|-------|----|
| A | Q/QnA | FX |
| ○ | ○ | ○ |

[Purpose]

Changing the contacts (open contact/close contact) of the program currently being edited.

[Operating Procedure]

Select [Find/Replace] → [Change open /close contact].

[Dialog Box]

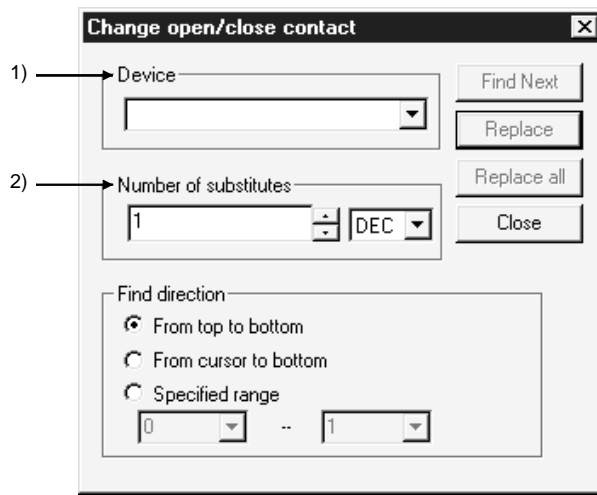

[Description]

- 1) Device
Designates a device for which contacts A and B are to be switched.
- 2) Number of substitutes
Designates the number of consecutive devices (including a designated device) for which contacts A and B are to be switched.
For label programming
For label programming, always set 1 point in the number of replacement points since replacement cannot be made if it is other than 1.
If you set 2 or more points, only 1 point is changed.

| POINTS |
|---|
| <ul style="list-style-type: none"> • Device specification Extended specifications and bit No. modifications are valid for device specification, but index modifications are not valid. • Device specification example <div style="margin-left: 20px;"> X0, J1\B6, D0.5, U10\G0.3 → Can be specified X0Z3 → Cannot be specified (index modification is not possible.) </div> • The open contact and close contact of the following instructions can be switched. Open contact : LD, AND, OR, LDR, ANDP, ORP, EGP Close contact : LDI, ANI, ORI, LDF, ANDF, ORF, EGF • When switching the open contact and close contact of other programs, see Section 6.4.1. • The step numbers specified for the SFC operation outputs/transition conditions are those used when the SFC diagram is represented as an equivalent to a ladder. |

6.4.10 Replacing a character string

| | | |
|-----------------------|-----------------------|-----------------------|
| A | Q/QnA | FX |
| <input type="radio"/> | <input type="radio"/> | <input type="radio"/> |

| |
|---|
| POINTS |
| <ul style="list-style-type: none"> • The step numbers specified for the SFC operation outputs/transition conditions are those used when the SFC diagram is represented as an equivalent to a ladder. • For a ladder, a statement or note is the target of search. • For an SFC, a note or SFC comment is the target of search. |

[Purpose]

Replaces the character string on each edit window for programs, device comments, or device memories.

[Operating Procedure]

On each edit window, select [Find/Replace] → [Replace character string].

[Dialog Box]

Ladder/list edit window

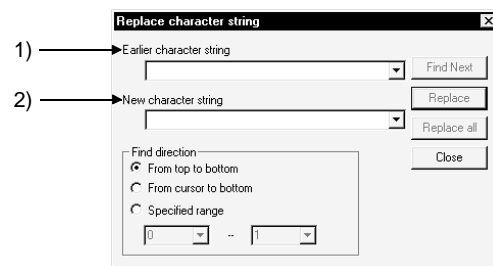

Device comment edit window

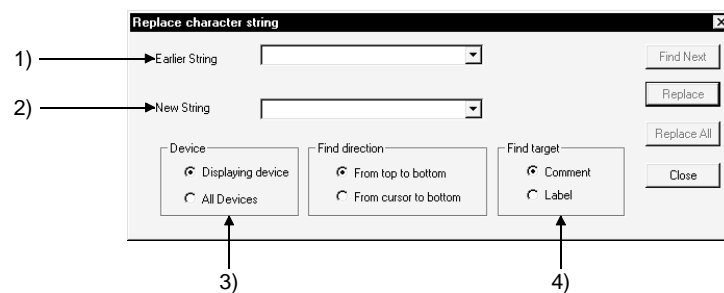

Device memory edit window

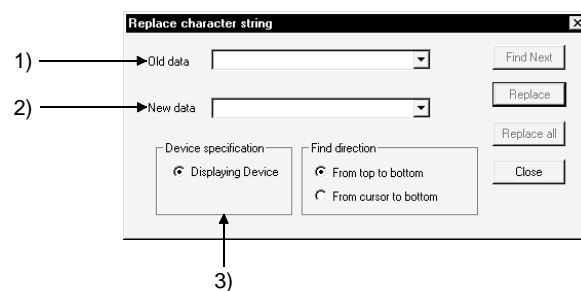

[Description]

- 1) Earlier character string
Enter a character string to be replaced (statement before change) in up to 64 characters.
- 2) New character string
Enter a character string for replacement (statement after change).
- 3) Device
 - Device under display
Select this to replace only the devices being displayed in the window.
 - All devices (device comment only)
Select this to replace also those devices not displayed in the window.
- 4) Find target
Select a button to designate a comment or a Alias.

| POINTS |
|---|
| <ul style="list-style-type: none">• Search with Find Next button Searches a device designated by earlier character string.• Search with Replace button Replaces for each device. |

6.4.11 Replacing the module's first I/O number

| A | Q/QnA | FX |
|----|-------|----|
| ○* | ○ | × |

*: Unusable for the A2C.

[Purpose]

Changes the first I/O number of the FROM(P), TO(P), DFRO(P), DTO(P), RFRP or RTOP instruction.

[Operating Procedure]

Select [Find/Replace] → [Replace the module's first I/O number].

[Dialog Box]

The following screen shows a setting example for replacing the old module I/O number range of 0 to FF with the new module's first I/O No. of 30.

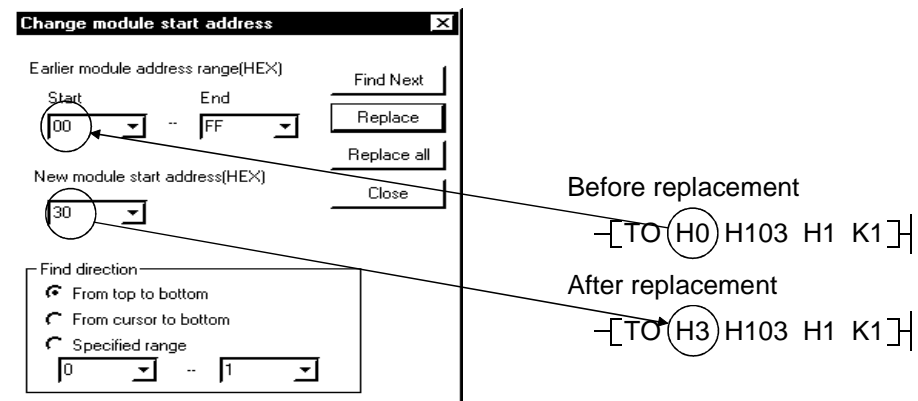

[Description]

- 1) Start
The input range is 0 to FFF0.
- 2) End
The input range is 0 to FFFF.
(Set a value greater than the value input in start.)
- 3) New module start address(HEX)
The input range is 0 to FFF0.
- 4) Find direction-Specified range
Set the replacement starting position and range.
The input range is 0 to 99999999.
If the starting step is greater than the end step, the [Replace], [Replace all] and [Close] buttons are masked.

POINT

- Specify the I/O addresses in the same method as in entering the instruction.
- When replacing the module I/O No. of the G. device, choose [Find/Replace] → [Device replace].

6.4.12 Changing the statement or note type

| | | |
|---|-------|----|
| A | Q/QnA | FX |
| ○ | ○ | ○ |

| |
|---|
| POINT |
| Refer to Section 10.1 for the data of integrated/peripheral statements. |

[Purpose]

Changes the type of the statement or note currently being edited to the integrated or peripheral statement or note.

For details on the integrated/peripheral statement or note, see Sections 10.1.

[Operating Procedure]

Select [Search/Replace] → [Replace statement/note type].

[Dialog Box]

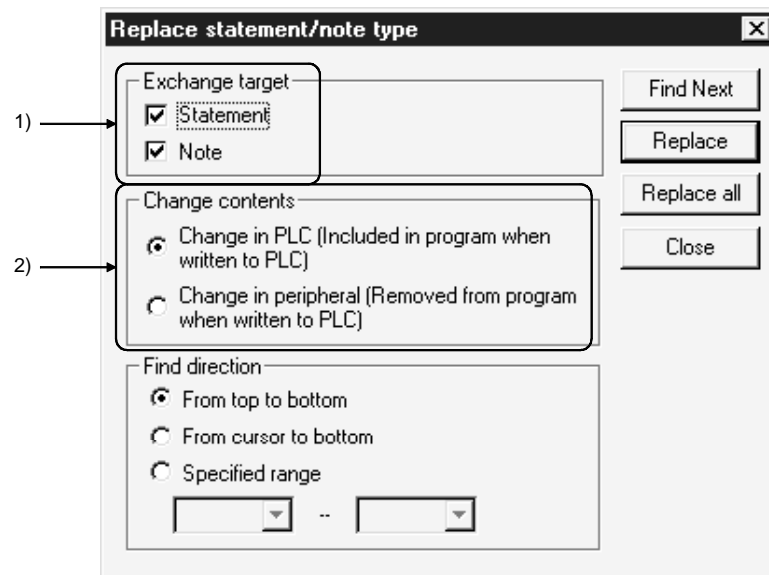

[Description]

- 1) Exchange target
Designates a target to be replaced (statement or note).
- 2) Change contents
 - ⊙ Change in PLC [Included in program when written to PLC]
Replaces a character string with an integrated statement or note.
PLC write/read processing takes place automatically for the character string.
 - ⊙ Change in peripheral [Removed from program when written to PLC]
Replaces a character string with a peripheral statement or note.
PLC write/read processing does not take place for the character string.

| |
|---|
| POINTS |
| <ul style="list-style-type: none"> • Because only the peripheral statements and notes are set in A series, the statement and note types cannot be changed. • The step numbers specified for the SFC operation outputs/transition conditions are those used when the SFC diagram is represented as an equivalent to a ladder. • For an SFC, only the note will be changed. (There are no statements.) |

6.4.13 Replacing data

| A | Q/QnA | FX |
|-----------------------|-----------------------|-----------------------|
| <input type="radio"/> | <input type="radio"/> | <input type="radio"/> |

[Purpose]

Replaces the set numerical data.

[Operating Procedure]

On the device memory edit window, select [Find/Replace] → [Replace data].

[Dialog Box]

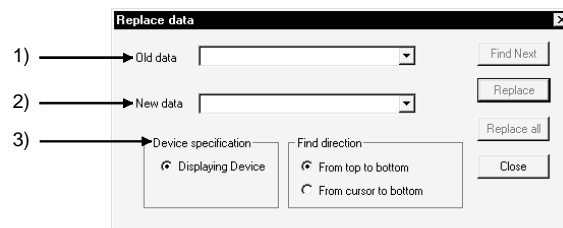

[Description]

- 1) Old data
Enter a numerical value to be replaced (statement before change).
- 2) New data
Enter a numerical data for replacement (statement after change).
- 3) Device
 Displaying device
 Select this to designate only the devices being displayed in the window (fixed).

POINTS

- Since the find and replace of a floating point and a fixed point are processed as actual data, a target of search may not be found due to a conversion error between the floating point/fixed point and the actual data. Do not find and replace the floating point or fixed point after a 32-bit integer has been converted to a floating point. Find and replace in the input conditions.
- A change mode cannot be replaced online.

6.4.14 Searching for a contact coil

| | | |
|-----------------------|-----------------------|-----------------------|
| A | Q/QnA | FX |
| <input type="radio"/> | <input type="radio"/> | <input type="radio"/> |

[Purpose]

Lists the step(s), instructions, and locations in which the designated instruction has been used.

[Operating Procedure]

Select [Find/Replace] → [Cross reference list].

[Dialog Box]

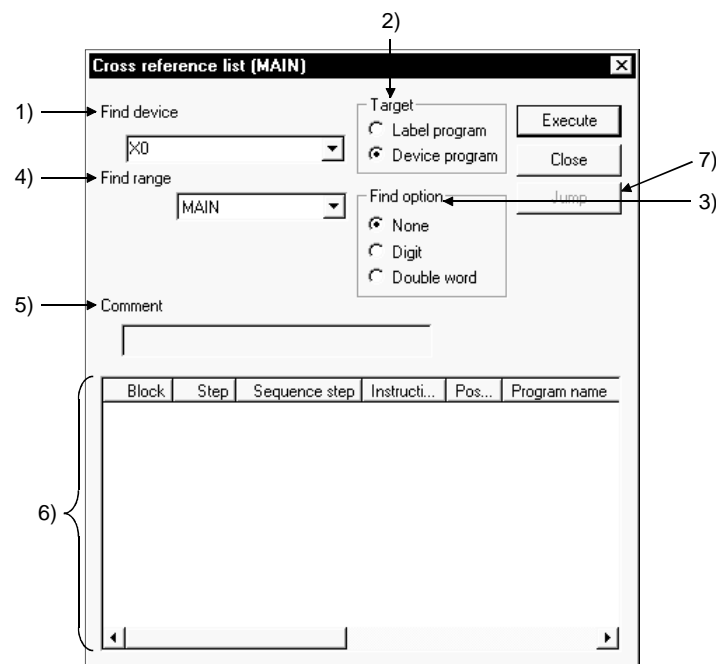

[Description]

- 1) Find device
Designates a device to be searched.
- 2) Target (only during label programming)
Select label program or actual device.
- 3) Find options
Sets the state of a search target.
The search options (with digit, double word, etc.) make it possible to search for a device which has not been coded in the program but is actually used.
 - None
Searches for a designated device only.
 - Digit
Searches for bit devices (including a designated device) with digits.
 - Double word
Searches for word devices including a designated device and double word devices (including real numbers and indirect specifications).

- 4) Target the whole program
 For ladder
 Choose the program to be searched (by program, all programs).
 For SFC
 All programs: All programs in the project are searched.
 All blocks: All blocks of the SFC diagram being edited are searched.
 Inside block (SFC diagram): Only the block being displayed is searched.
 Inside block (Zoom diagram): Only the operation outputs/transition conditions being displayed are searched.
- 5) Comment
 Displays a comment assigned to a designated device.
- 6) Contact coil use list
 Block.....Lists the numbers with which the block No. designated in the SFC is used.
 StepLists the numbers with which the step No. designated in the SFC is used.
 Sequence step. Lists the step numbers in which the designated device has been used.
 InstructionLists the instructions in which the designated device has been used.
 LocationIndicates by * the byte positions in which the designated device has been used.
 (Example)In the case of "MOV K4Y0 D0", the DO position is indicated by "-*."
 Program name. Lists the program names with which the specified device is used.
 Up to 500 items can be retrieved and displayed in this list.
- 7) button
 Click any data in the contact coil use list, then click the [Jump] button to locate the cursor at the position where the corresponding contact coil is used within the sequence circuit.

| | |
|---|--|
| POINT | |
| The cross reference list function can be used even when unconverted circuits exist. | |

6.4.15 Searching for a device-use instruction

| | | |
|-----------------------|-----------------------|-----------------------|
| A | Q/QnA | FX |
| <input type="radio"/> | <input type="radio"/> | <input type="radio"/> |

[Purpose]

Lists the device use conditions in a program on a specified device basis. Specifying the device displays the ladder symbol used, the frequency of use, and whether an error has occurred or not

[Operating Procedure]

Select [Find/Replace] → [List of used device].

[Dialog Box]

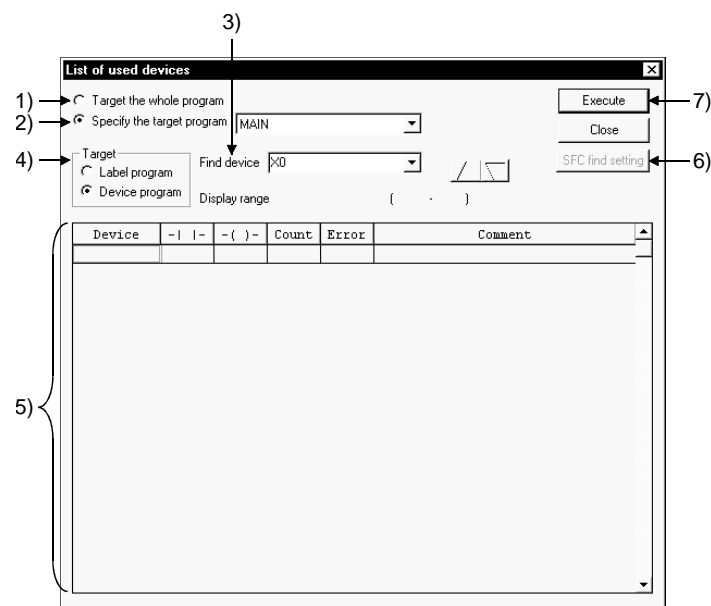

[Description]

- 1) Target the whole program
Click the radio button to display a device-use list for all programs in the project.
- 2) Specify the target program
Designates a program to be searched.
- 3) Find device
Designates the first device to be searched for.
Clicking the / button moves the screen up or down by 512 points.
(Clicking the scroll bar moves the screen by 512 points.)
In a single search, 512 points shown in the display area are searched.
When the cursor is on the device list, you can scroll the screen using **Ctrl** + **PageUp** / **PageDown**.
- 4) Target (only during label programming)
Select label program or actual device.

- 4) Device-use Instruction list
 Device..... Instruction lists devices in such a way that the device designated in the search device is listed first.
- ┆┆..... Displays * when the device has been used in the source of the instruction.
- ()..... Displays * when the device has been used in the destination of the instruction.
- Count..... Indicates the frequency of coil usage.
- Error..... Displays "ERR" when the device has been used only in the source or the destination.
- Comment..... Displays a comment attached to the device.
 Clicking the scroll bar moves the screen by 512 points.
- 5) Specify whether all blocks or only the specified block will be searched.

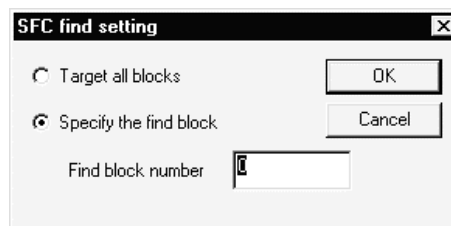

- 6) **Execute** button
 Click this button after designating a search program or a search device.
 A device-use list contains the instructions used and their frequency in such a way that the device designated in the search device comes first.

| POINTS |
|--|
| <ul style="list-style-type: none"> • When ZR is designated, 8,192 devices (including the designated device as the first one) are searched. To display out-of-range devices, the devices must be designated again. Page scroll takes place within 8,192 devices listed. • When two or more windows are open, the result of comment editing on the device use list screen is reflected on other windows as soon as the window is switched to another. • If there is an unconverted ladder, the device use list function can be used. • For label program creation, this function does not support label devices. Make an "N/O"/"N/C" contact change after searching for a label device in the contact/coil use list. |

7. CREATING INSTRUCTION LIST

This chapter describes how to create, modify and read the sequence programs.

7.1 Common Notes on Instruction List Creation

This section describes the common items and restrictions on Instruction list creation, Instruction list display window, and Instruction list edit window.

1. Instruction list input dialog box
Input alphanumeric characters.



2. Program display area
 - Display does not depend on the number of END instructions.
In addition, programs may be input after the END instructions.
When a new Instruction list is created, the END instruction appears at the first line.
No display takes place for NOP only.
3. Modification of existing Instruction list
For creating a new instruction list, move the cursor to an incorrect instruction location in the input (overwrite) mode, then input a correct instruction there.
For adding Instruction list, move the cursor to a line insert step in the input (insert) mode, then input an instruction.
To switch input modes (overwrite and insert modes), press **Insert** key.
4. Deletion in units of instructions
Move the line to be deleted, then press **Delete** key or **Shift** + **Delete** key.
5. The preceding or subsequent page of the current page can be displayed during a read/write operation.
Click **Page Up** key to display the preceding page.
Click **Page Down** key to display the subsequent page.
6. The following table lists the modes that can be used in Instruction list mode.

| Mode | Availability |
|--------------------|--------------|
| Read mode | ○ |
| Write mode | ○ |
| Monitor mode | × |
| Monitor write mode | × |

7. Circuit symbol buttons on the toolbar, monitor/write monitor, monitor start/stop, step run, partial run, skip are disabled.
8. Device comment display
No device comments are displayed.

9. Display with statements or notes

When statements or notes have been created, they are always displayed (fixed processing).

In A series and FX series, no step numbers are displayed.

In QnA series, step numbers are displayed.

Statements and notes can be created in the same way as for operations on the circuit edit window

(see Section 10.3.1 and 10.4.1 for details.)

10. SFC programs (only for QnA series)

These programs cannot be edited but displayed.

SFC programs in FX series are represented as an instruction words Instruction list by step ladder instructions.

7.2 Creating a Program Instruction list

Sequence programs are input by the Instruction list instructions.

In addition, it is convenient to edit in the Instruction list mode the instructions that cannot be edited in the circuit mode.

For details on how to switch the Instruction list mode, see Chapter 6.

7.2.1 Inputting a contact or application instruction

| | | |
|---|-------|----|
| A | Q/QnA | FX |
| ○ | ○ | ○ |

- For contact input (insert mode)
 1. Press **Insert** key to set the insert mode.

```

0 END
1
    
```

2. Enter "LD X1", then the Instruction list input dialog box is displayed and entered data is displayed in the device instruction text box. Press **Enter** key to make input in the edit window.



```

0 LD X1
1 END
2
    
```

- For application instruction input
 1. Enter "MOV K1 D0", then the Instruction list input dialog box is displayed with the entered data being displayed in the device instruction text box. Press **Enter** to make input in the edit window.



```

0 LD X1
1 MOV K1 D0
2 END
3
    
```

POINTS

Refer to Section 9.4.3 when creating a device comment right after writing the instruction.

7.2.2 Changing the existing program in overwrite mode

| | | |
|---|-------|----|
| A | Q/QnA | FX |
| ○ | ○ | ○ |

1. Confirm that the overwrite mode is indicated on the status bar. Press **Insert** key to switch the insert and overwrite modes.
2. Move the cursor onto the program to be corrected in overwrite mode. List input dialog box

```

0 LD X2
1 OUT Y70
2 OUT T0 K600
6 SET M0
7 LD T0
8 OUT C0 K3
12 RST T0
16 LD X3
17 OUT Y71
18 OUT T1 K100
22 SET M1
23 OUT Y40
24 LD T1
25 OUT C1 K6
29 RST T1
33 LD X4
34 OUT Y72
35 OUT T2 K1200
39 SET M2
    
```

3. Enter an instruction or device (LD M10) for correction, then the list input dialog box is displayed with the entered data being displayed in the device instruction text box. Press **Enter** key to make input in the edit window.

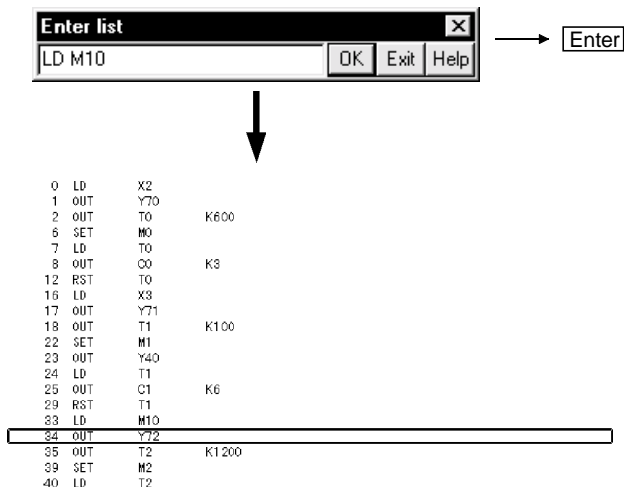

Input alphanumeric characters.

7.2.3 Inserting or adding the existing program

| | | |
|---|-------|----|
| A | Q/QnA | FX |
| ○ | ○ | ○ |

1. Confirm that the insert mode is indicated on the status bar.
Press **Insert** key to switch the insert and overwrite modes.
2. Move the cursor to the position to insert or add a program.

```

0 LD X2
1 OUT Y70
2 OUT T0 K600
6 SET M0
7 LD T0
8 OUT C0 K3
12 RST T0
16 LD X3
17 OUT Y71
18 OUT T1 K100
22 SET M1
23 OUT Y40
24 LD T1
25 OUT C1 K6
29 RST T1
33 LD X4
34 OUT Y72
35 OUT T2 K1200
39 SET M2
    
```

3. Enter an instruction to be inserted or added or device (LD M10), then the list input dialog box is displayed with the entered data being displayed in the device instruction text box.
Press **Enter** key to make input in the edit window.

```

0 LD X2
1 OUT Y70
2 OUT T0 K600
6 SET M0
7 LD T0
8 OUT C0 K3
12 RST T0
16 LD X3
17 OUT Y71
18 OUT T1 K100
22 SET M1
23 OUT Y40
24 LD T1
25 OUT C1 K6
29 RST T1
33 LD M10
34 OUT Y72
35 OUT T2 K1200
39 SET M2
40 LD T2
    
```

7.2.4 Deleting the existing program list

| A | Q/QnA | FX |
|---|-------|----|
| ○ | ○ | ○ |

1. Move the cursor to a program to be deleted.
2. Press **Delete** key or **Shift** + **Delete** key to delete the program.

```

0 LD      X2
1 OUT    Y70
2 OUT    T0      K600
6 SET    M0
7 LD     T0
8 OUT    C0      K3
12 RST   T0
16 LD    X3
17 OUT   Y71
18 OUT   T1      K100
22 SET   M1
23 OUT   Y40
24 LD    T1
25 OUT   C1      K6
29 RST   T1
33 LD    X4
34 OUT   Y72
35 OUT   T2      K1200
39 SET   M2

```

7.2.5 Inserting NOPs

| | | |
|-----------------------|-----------------------|-----------------------|
| A | Q/QnA | FX |
| <input type="radio"/> | <input type="radio"/> | <input type="radio"/> |

- Inserting NOPs in units of lines
 Move the cursor to a location for inserting a NOP, then press **[Shift] + [Insert]** key (The NOP is inserted in the line above the cursor.)
- Insert NOPs at a time
 Move the cursor to a location for inserting NOPs, then select **[Edit] → [insert NOP batch]**. The following dialog box is displayed for confirmation.

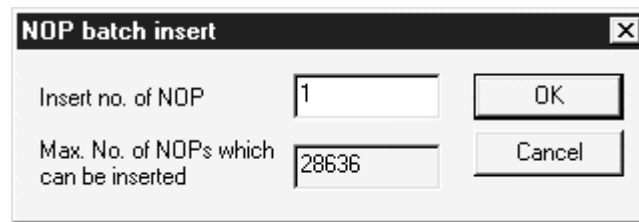

Input the number of NOPs to be inserted in insert no. of NOP text box, then click the **[OK]** button.

A ladder may not be displayed if NOPs are inserted at any points in a ladder block and the number of ladder block steps exceeds about 4k steps.

NOP insertion can take place even when the cursor has been positioned after the END line.

7.2.6 Deleting NOPs

| | | |
|-----------------------|-----------------------|-----------------------|
| A | Q/QnA | FX |
| <input type="radio"/> | <input type="radio"/> | <input type="radio"/> |

- Deleting NOPs in units of lines
 Move the cursor to a location for deleting a NOP, then press **[Delete]** key or **[Shift] + [Delete]** key to delete it. (The NOP in the line above the cursor is deleted.)
- Deleting NOPs
 Press **[Enter]** key, and the program will be displayed in the list input dialog box. Select **[Edit] → [Delete NOP batch]**, and the following dialog box will be displayed.

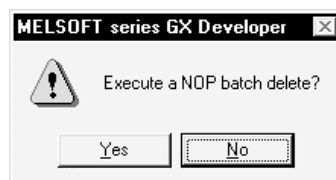

Click the **[Yes]** button, and NOPs will be deleted at a time. When there are NOPs after the END instruction, they are also deleted.

7.3 Find and Replace

7.3.1 Finding a device

See Section 6.4.1 for details.

| A | Q/QnA | FX |
|-----------------------|-----------------------|-----------------------|
| <input type="radio"/> | <input type="radio"/> | <input type="radio"/> |

7.3.2 Finding an instruction

See Section 6.4.2 for details.

| A | Q/QnA | FX |
|-----------------------|-----------------------|-----------------------|
| <input type="radio"/> | <input type="radio"/> | <input type="radio"/> |

7.3.3 Finding a step No.

See Section 6.4.3 for details.

| A | Q/QnA | FX |
|-----------------------|-----------------------|-----------------------|
| <input type="radio"/> | <input type="radio"/> | <input type="radio"/> |

7.3.4 Finding a character string

Searching for a statement or note takes place.
See Section 6.4.4. for details.

| A | Q/QnA | FX |
|-----------------------|-----------------------|-----------------------|
| <input type="radio"/> | <input type="radio"/> | <input type="radio"/> |

7.3.5 Finding a contact/coil

See Section 6.4.5 for details.

| A | Q/QnA | FX |
|-----------------------|-----------------------|-----------------------|
| <input type="radio"/> | <input type="radio"/> | <input type="radio"/> |

7.3.6 Replacing a device

See Section 6.4.7 for details.

| A | Q/QnA | FX |
|-----------------------|-----------------------|-----------------------|
| <input type="radio"/> | <input type="radio"/> | <input type="radio"/> |

7.3.7 Replacing an instruction

See Section 6.4.8 for details.

| A | Q/QnA | FX |
|-----------------------|-----------------------|-----------------------|
| <input type="radio"/> | <input type="radio"/> | <input type="radio"/> |

7.3.8 Changing an A or B contact

See Section 6.4.9 for details.

| A | Q/QnA | FX |
|---|-------|----|
| ○ | ○ | ○ |

7.3.9 Replacing a character string

See Section 6.4.10 for details.

| A | Q/QnA | FX |
|---|-------|----|
| ○ | ○ | ○ |

7.3.10 Change module start address

See Section 6.4.11 for details.

| A | Q/QnA | FX |
|---|-------|----|
| ○ | ○ | ○ |

7.3.11 Changing the statement or note type

See Section 6.4.12 for details.

| A | Q/QnA | FX |
|---|-------|----|
| × | ○ | × |

7.3.12 Searching for a contact coil

See Section 6.4.14 for details.

| A | Q/QnA | FX |
|---|-------|----|
| ○ | ○ | ○ |

7.3.13 Searching for an instruction using a device

See Section 6.4.15 for details.

| A | Q/QnA | FX |
|---|-------|----|
| ○ | ○ | ○ |

7.4 Display

7.4.1 Displaying a Alias

| | | |
|---|-------|----|
| A | Q/QnA | FX |
| ○ | ○ | ○ |

[Purpose]

Displays the created Alias on the circuit edit window.

[Operating procedure]

1. Select [View] → [Alias] ([Alt] + [Ctrl] + [F6]).

| 0 | LD | X2 | |
|----|-----|-----|-------|
| 1 | OUT | Y70 | |
| 2 | OUT | T0 | K600 |
| 6 | SET | M0 | |
| 7 | LD | T0 | |
| 8 | OUT | C0 | K3 |
| 12 | RST | T0 | |
| 16 | LD | X3 | |
| 17 | OUT | Y71 | |
| 18 | OUT | T1 | K100 |
| 22 | SET | M1 | |
| 23 | OUT | Y40 | |
| 24 | LD | T1 | |
| 25 | OUT | C1 | K6 |
| 29 | RST | T1 | |
| 33 | LD | M10 | |
| 34 | OUT | Y72 | |
| 35 | OUT | T2 | K1200 |
| 39 | SET | M2 | |

2. The Alias is displayed in the window instead of the device.

| 0 | LD | COVER | |
|----|-----|--------|-------|
| 1 | OUT | Y70 | |
| 2 | OUT | T0 | K100 |
| 3 | SET | M0 | |
| 4 | LD | SAFTY | |
| 5 | OUT | C0 | K3 |
| 6 | RST | T0 | |
| 9 | LD | READY | |
| 10 | OUT | Y71 | |
| 11 | OUT | T1 | K100 |
| 12 | SET | M1 | |
| 13 | OUT | Y40 | |
| 14 | LD | PARTSB | |
| 15 | OUT | C1 | K6 |
| 16 | RST | T1 | |
| 19 | LD | PARTSA | |
| 20 | OUT | Y72 | |
| 21 | OUT | T2 | K1200 |
| 22 | SET | M2 | |

7.5 Switching Read and Write Modes

7.5.1 Switching to read mode

See Chapter 6 for details.

| A | Q/QnA | FX |
|-----------------------|-----------------------|-----------------------|
| <input type="radio"/> | <input type="radio"/> | <input type="radio"/> |

7.5.2 Switching to write mode

See Chapter 6 for details.

| A | Q/QnA | FX |
|-----------------------|-----------------------|-----------------------|
| <input type="radio"/> | <input type="radio"/> | <input type="radio"/> |

7.5.3 Switching to circuit mode

See Chapter 6 for details.

| A | Q/QnA | FX |
|-----------------------|-----------------------|-----------------------|
| <input type="radio"/> | <input type="radio"/> | <input type="radio"/> |

7.6 Changing T/C Setting Values

See Section 6.3 for details.

| A | Q/QnA | FX |
|-----------------------|-----------------------|-----------------------|
| <input type="radio"/> | <input type="radio"/> | <input type="radio"/> |

8. CONVERSION

There are three kinds of menu provided for conversion, [Convert], [Convert (All programs being edited)], and [Convert (Online change)].

This chapter describes normal conversion and batch program conversion.

For conversion from the [Convert (Online change)] menu, see Section 16.9.

8.1 Converting an Edit Program

| A | Q/QnA | FX |
|---|-------|----|
| ○ | ○ | ○ |

[Purpose]

Converts the program currently being edited (in the active window).

[Operating Procedure]

Select [Convert] → [Convert].

8.2 Converting Multiple Edit Programs

| A | Q/QnA | FX |
|---|-------|----|
| ○ | ○ | × |

[Purpose]

Converts multiple edit programs at a time.

[Operating Procedure]

Select [Convert] → [Convert (All programs being edited)].

[Description]

Edit programs are converted in the order that the sequence programs have been opened.

| POINTS |
|--|
| For the conversion operation for SFC diagram editing, refer to the following manual. GX Developer Operating Manual(SFC) |

MEMO

9. SETTING DEVICE COMMENTS

This chapter describes the points to be noted on comment creation with GX Developer.

In addition, it describes how to input the device comments created with GX Developer to ACPU, QnACPU or FXCPU and how to input the data created with GPPA, GPPQ, FXGP(DOS) or FXGP(WIN) to GX Developer.

| POINT |
|---|
| <ul style="list-style-type: none"> Any FX project that was created with GX Developer (SW2D5-GPPW-E) or later appears in the project list display when GX Developer (SW0D5-GPPW-E) or GX Developer (SW1D5-GPPW-E) is started, but it cannot be read. For comment creation for label devices during label programming, refer to Section 5.1.3 or Section 9.4.2. |

9.1 Points to be Noted before Comment Creation with GX Developer

| A | Q/QnA | FX |
|---|-------|----|
| ○ | ○ | × |

This section describes the points to be noted and settings that vary depending on whether to handle comments only on peripheral devices or to input them to PLC.

(1) Comments on special resistors and special relays

Since the comments on special resistors and special relays are created in the installed directory (MELSEC\GX Developer\Sample Comment), it is useful to copy them to projects for which sequence programs will be created.

Sample-1 ACPU COMMENT SP.M SP.D

Sample-2 A1FX COMMENT SP.M SP.D

Sample-3 QnA COMMENT SM, SD, J1\SB, J1\SW

Sample-4 FX CPU COMMENT SP.M SP.D

Sample-5 Q COMMENT SM, SD, J1\SB, J1\SW

Sample-6 Q (A Mode) (SP.M, SP.D)

For multi-CPU-compatible SMs, comments are stored in SM240 to 247 and SM390.

For multi-CPU-compatible SDs, comments are stored in SD4 to SD15 and SD395.

Sample-7 Q00J/Q00/Q01CPU COMMENT SM, SD, J1\SB, J1\SW

(2) Extended comments

When AnNCPU is selected, the extended comments can be created with GX Developer, but cannot write them to the PLC CPU.

The extended comments 2 to 4 cannot be written to the ACPU/GPPA file.

The extended comments read from the ACPU/GPPA file to the GX Developer are stored in the common comment.

(3) Device comments when GX Developer and GPPA are used

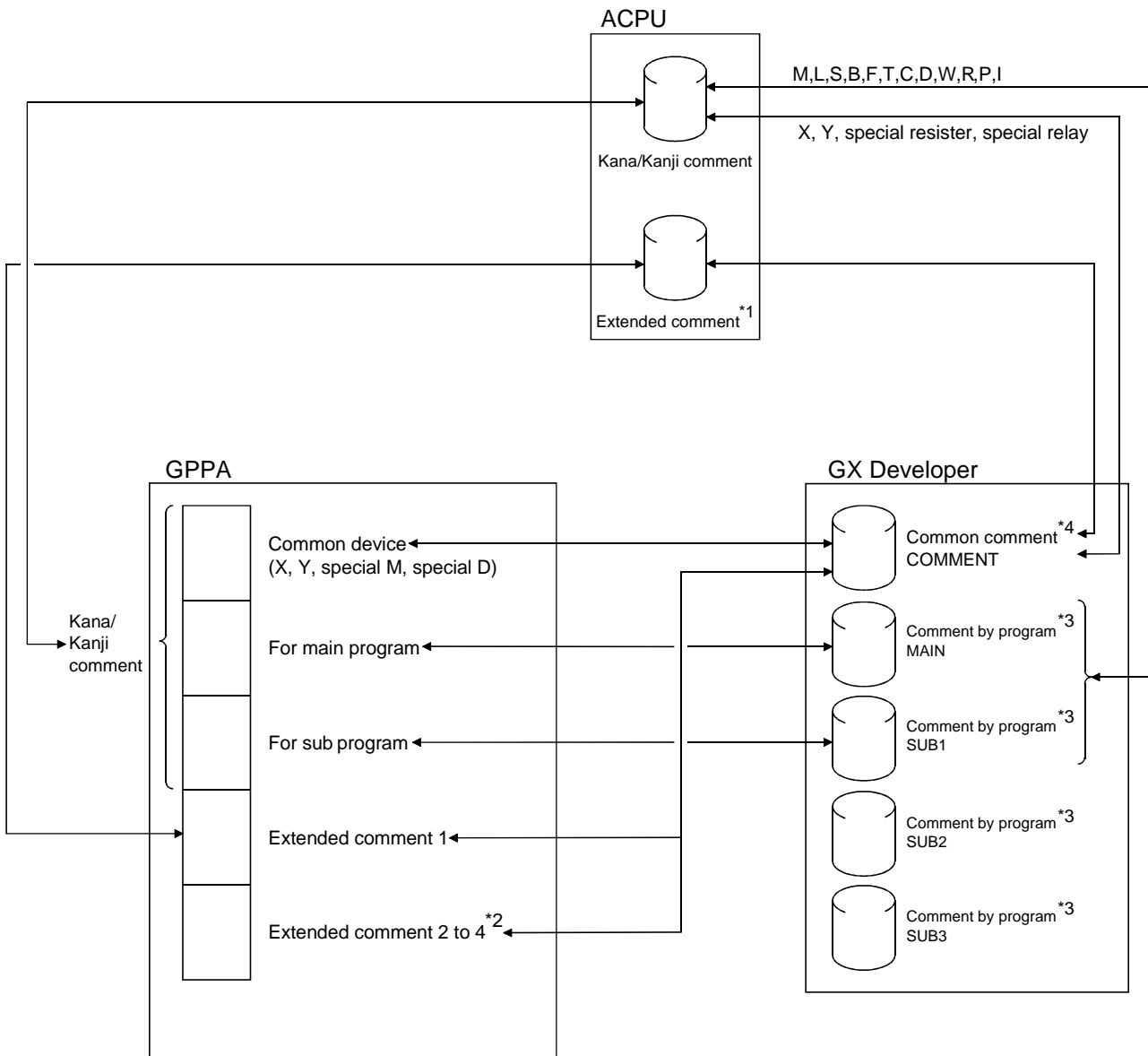

Precautions:

- *1: Only AnA and AnUCPU can be written to the PLC CPU.
- *2: The extended comments 2 to 4 cannot be written to the PLC CPU.
- *3: The comments created in X, Y, special resistors, special relays, SUB2, and SUB3 among those created by program cannot be written to the ACPU/GPPA file.
- *4: Those devices other than the X, Y, special resistors, and special relays created in COMMENT (common comment) can be written to the ACPU/GPPA file by setting them in the extended comment (Refer to Section 9.7).
When a comment on the same device (X, Y, etc.) is created for a common device and an extended comment, the device comment set in the extended comment is read (Refer to Section 9.1.3 for details).

- (4) About the device comment creation ranges for multi-CPU configuration
 Device comments can be created in the following ranges for the buffer memory (3E00 to 3E3F) of the PLC CPU in a multi-CPU configuration.

| System Configuration | Creation Enabled Range | Creation Disabled Range |
|----------------------------|----------------------------|----------------------------|
| No multi-CPU configuration | U0(¥G0) to U1FF(¥G65535) | — |
| Multi-CPU configuration | U0(¥G0) to U1FF(¥G65535) | U200(¥G0) to U3DF(¥G65535) |
| | U3E0(¥G0) to U3FF(¥G65535) | |

The created device comments are enabled for PLC read/write/verify and file read/write/verify.

9.1.1 Editing comments only on GX Developer

| A | Q/QnA | FX |
|-----------------------|-----------------------|-----------------------|
| <input type="radio"/> | <input type="radio"/> | <input type="radio"/> |

- (1) In A series, Q/QnA/A/FX series, the created comments can be saved. Neither parameter settings nor comment range settings are required.
- (2) Both common comments and comments by program can be created. Common comments can be created independent of comments for the main program and subprograms. (see Section 9.3 for details.)
- (3) The common comment data name is fixed to "COMMENT."
- (4) There are two methods for creating comments by program. The first method sets a comment data name according to the data name of a sequence program. The second method sets a data name different from the sequence program name. (see Sections 5.8 and 9.3 for details.)
- (5) The devices subject to comment creation are all displayed (for monitoring) or printed out.
- (6) When creating a Alias in A series, note that it cannot be input to ACPU or GPPA files.

POINT

- When a common comment and a comment by program have been set for the same device, click <<Each program>> tab on the dialog box displayed by selecting [Tools] → [Option] to set a comment to be displayed in units of devices (see Section 15.11 for details.).

| Common comments | | |
|-----------------|---------|-------|
| Device | Comment | Label |
| X0 | | |
| X1 | START | |
| X2 | | |

| Comments by program | | |
|---------------------|----------|-------|
| Device | Comment | Label |
| X0 | | |
| X1 | SECURITY | |
| X2 | | |

<<Each program>> sheet

Option

Program common | Each program | Whole data

Copy source/display source of reference during comment edit: Local device monitor

Program name: MAIN

| Device type | Device comment |
|-------------|----------------------|
| M | Comment for each p |
| Special M | Comment for all proc |
| L | Comment for each p |
| S | Comment for each p |
| F | Comment for each p |
| X | Comment for all proc |
| Y | Comment for all proc |
| B | Comment for each p |
| D | Comment for each p |

Common comment selection

MAIN

SUB1

When either a common comment or a comment by program has been set for a device, the set comment is displayed automatically.

- The number of letters used in editing comment devices or used for display in the circuit mode can be changed from 16 to 32 and from 32 to 16. Click <<Whole data>> tab on the dialog box displayed by selecting [Tool] → [Option] (See Section 15.10).

9.1.2 Writing to ACPU/GPPA file

| | | |
|---|-------|----|
| A | Q/QnA | FX |
| ○ | × | × |

- (1) Writing to ACPU takes place according to the memory size setting (comment, extended comment) and write comment range setting (see Section 9.7) in the PLC parameter.
Only comment1/2 and extended comment 1 can be input to the PLC (Extended comments 2 to 4 cannot be input.)
- (2) Comment1 (4032 comments x 15 character) can be input to ACPU while Comment2 (4032 comments x 16 character) can be input to ACPU.
- (3) Devices other than X, Y, SP.M (special relay), and SP.D (special register) must be saved in the extended comment 1 area.
(See Sections 9.3 and 9.7 for details.)
- (4) When a comment has been created in more than 17 characters with GX Developer, the comment part in the 18th character and after is not input to the PLC .
- (5) When X and Y areas are overlapping in a common comment, Y comment is not input because X takes precedence over Y.

9.1.3 Reading from ACPU/GPPA file

| | | |
|---|-------|----|
| A | Q/QnA | FX |
| ○ | × | × |

- (1) When the comments X and Y created by the PLC or GPPA are read into GX Developer, they are pasted onto the edit windows X and Y respectively.
- (2) When comment1/2 and extended comments have been set for the existing data, both comments are read into GX Developer common comments. In addition, when comment1/2 and extended comments are overlapping, the latter extended comments are read with precedence.

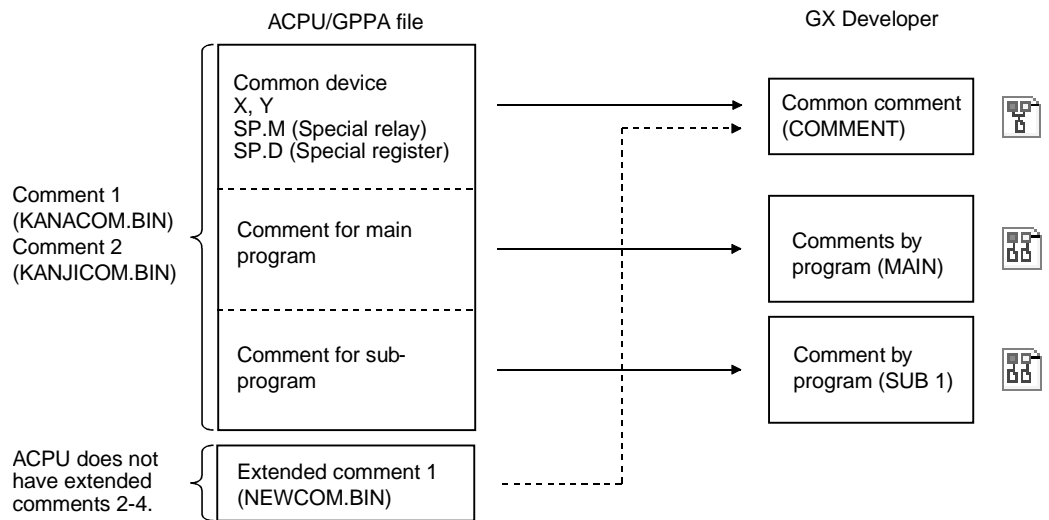

The comments for the main program and subprograms include the device comments, M, L, S, B, F, T, C, D, W, R, P, and I.

[Notes on reading and writing common comments]

When the common devices X0 to XF and extended comments Y0 to YF are overlapping (in files created on the preceding page) , if they are read into GX Developer, then input to ACPU, care should be taken because the comments Y0 to YF read from the extended comments are input to the common devices and the original common device comments are overwritten.

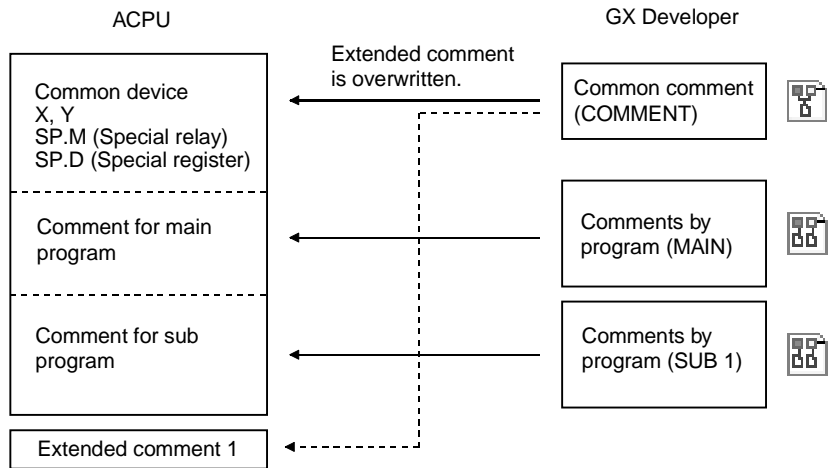

9.1.4 Writing to QCPU(Qmode) QnACPU/GPPQ file

| | | |
|---|-------|----|
| A | Q/QnA | FX |
| × | ○ | × |

- (1) Common comments or comments by program can be input to the PLC or GPPQ files according to the steps of editing.

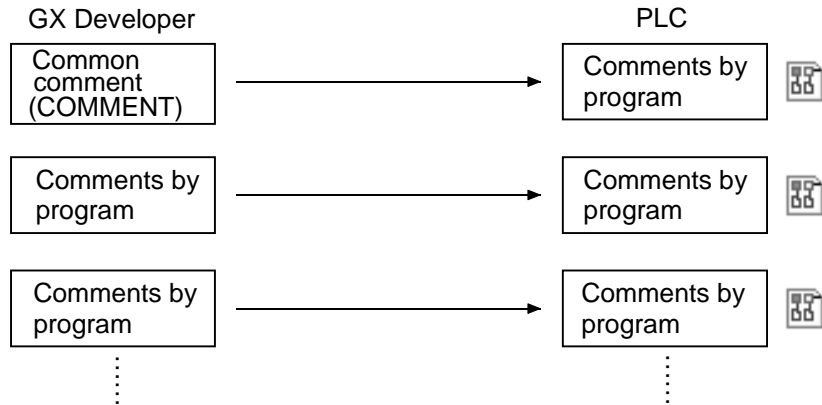

9.1.5 Reading from QCPU(Qmode) QnACPU

| | | |
|---|-------|----|
| A | Q/QnA | FX |
| × | ○ | × |

1. The comments created by GPPQ are read as they are. The GX Developer common comments are not read.

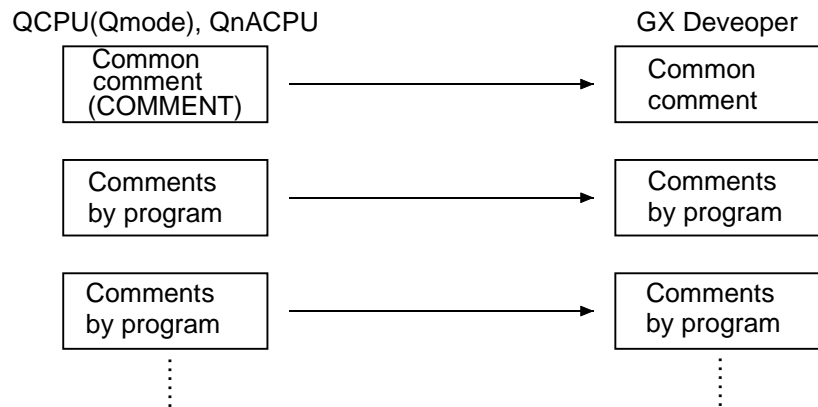

When the file "COMMENT" has been created as a QnACPU or GPPQ file, it is read into GX Developer as a common comment.

9.1.6 Writing to FXCPU/FXGP(DOS), FXGP(WIN) file

| | | |
|---|-------|----|
| A | Q/QnA | FX |
| × | × | ○ |

- (1) Writing to FXCPU can take place according to the memory size setting (comment size) and write comment range setting (see Section 9.7.) in the PLC parameter.
- (2) Only common comments can be input to FXCPU as device comments. Comments by program cannot be input to the PLC (see Section 9.3.)

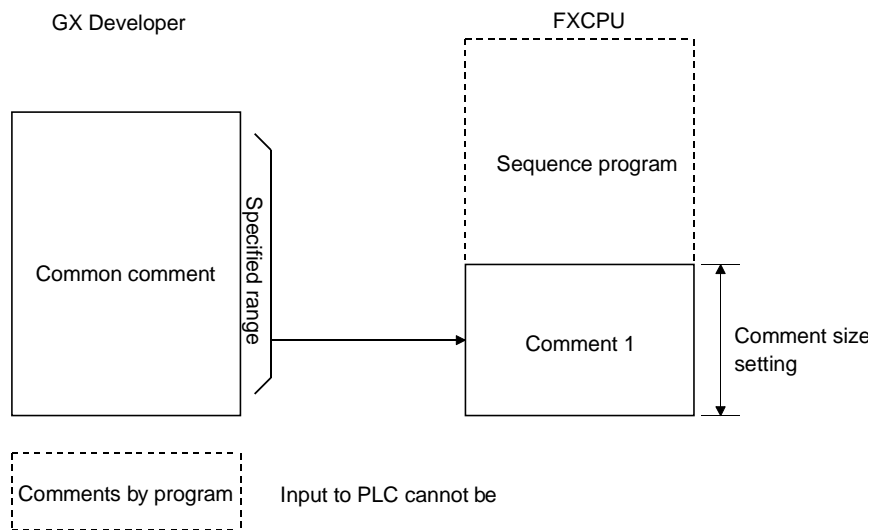

- (3) The number of comment1 characters that can be input to FXCPU from GX Developer is 16 characters. Though GX Developer allows comments of up to 32 characters, only 16 characters are input to the PLC . In addition, FXGP(DOS) allows only characters to be used for Comment1 and the maximum number of characters is 15. To display all comments normally by FXGP(DOS), device comments must be created in up to 15 characters.
- (4) The number of comment1 that can be input to FXCPU varies depending on the memory size setting in the PLC parameter.
- (5) All details of the common comment are written. For the Alias, however, only the alphanumeric characters and symbols (*, + - * / = . ? # \$ % & ; ; _) of half size are made valid (See Section 9.4.1). Those Alias containing full size characters or unspecified characters will be deleted at the time of writing.

9.1.7 Reading from FXCPU/FXGP(DOS), FXGP(WIN) file

| | | |
|---|-------|----|
| A | Q/QnA | FX |
| × | × | ○ |

1. Comments in FXCPU are read as common comments as they are.

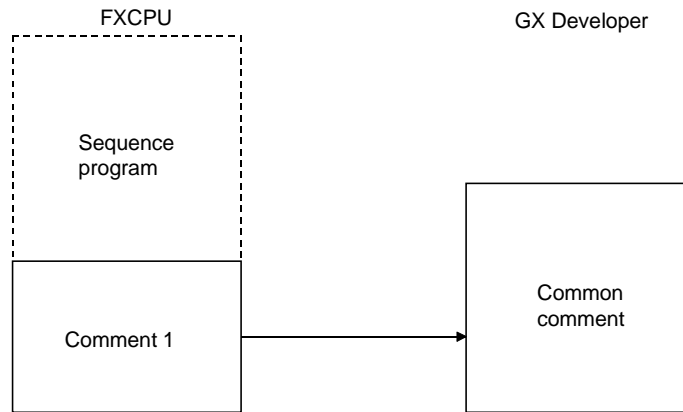

- (1) Reading an FXGP(DOS) file
All comments are read.
- (2) Reading an FXGP(WIN) file
Though FXGP(WIN) allows up to 50 characters to be input, only the first 32 characters are read for GX Developer input.
The number of comments is not limited and all comments are read.

9.2 List of Device Comments

| | | |
|---|-------|----|
| A | Q/QnA | FX |
| ○ | × | × |

The types of devices and the possibility of comment setting are listed below.

| Device name | Symbol | Bit device | A | Q/QnA | FX |
|------------------------|---|------------|---|-------|----|
| Bit device | Input/Output | XY | ○ | ○ | ○ |
| | Input/Output | DX/DY | - | ○ | - |
| | Internal relay | M | ○ | ○ | ○ |
| | Step relay | S | ○ | ○ | - |
| | Latch relay | L | ○ | ○ | - |
| | Annunciator | F | ○ | ○ | - |
| | Special relay | SP.M | ○ | - | - |
| | | SM | - | ○ | - |
| | | M | - | - | ○ |
| | FB Input/FB Output | FX | - | × | - |
| | Edge relay | V | - | ○ | - |
| | Link relay | B | ○ | ○ | - |
| | Link special relay | SB | - | ○ | - |
| | State | S | - | - | ○ |
| Timer/Counter | Timer | T | ○ | ○ | ○ |
| | Counter | C | ○ | ○ | ○ |
| | Count timer | ST | - | ○ | - |
| Word device | Data register | D | ○ | ○ | ○ |
| | Special register | SP.D | ○ | - | - |
| | | SD | - | ○ | - |
| | | D | - | - | ○ |
| | Link register | W | ○ | ○ | - |
| | File register | R | ○ | ○ | - |
| | (RAM) File register | D | - | - | ○ |
| | Sequence file R | ZR | - | ○ | - |
| Link special register | SW | - | ○ | - | |
| FB data | FD | - | × | - | |
| Others | Pointer | P | ○ | ○ | ○ |
| | Accumulator | A | ○ | - | - |
| | Interrupt pointer | I | ○ | ○ | ○ |
| | Nesting | N | × | × | - |
| Extended specification | Index | Z | × | × | × |
| | I/O No. | U | - | ○ | - |
| | Buffer register | G | - | - | - |
| | SFC block device | BL | - | ○ | - |
| | Step relay (Step relay with a block specification) | BL/S | - | ○ | - |

※: When the A1FXCPU is selected, S comment or extended comment cannot be created.
When the Q00J is selected, R and ZR comments cannot be created.

9.3 Common Comments and Comments by Program

| A | Q/QnA | FX |
|---|-------|----|
| ○ | ○ | ○ |

[Device comment system]

Device comments include common comments and comments by program.

[Common comment]

A series

Settings are required when a common comment is assigned for all sequence programs in CPU types with subprograms.

Q/QnA series

Settings are required when single comment data is used in common for creation of multiple programs.

These settings can also be made even when multiple programs are not present.

FX series

Settings are required when a comment is assigned for the main program (MAIN).

In FX series connection, these settings are not related to subprograms (SUB) because only one program file is created.



The common comment name is fixed to COMMENT. The common comment can be changed to comments by program later.

[Comments by program]

A series

Settings are required when a comment is assigned for each program during main sequence program creation or sub-sequence program creation.

Q/QnA series

Settings are required when a comment is assigned for each program.

FX series

Settings are required when comments other than common comments are assigned for the main program (MAIN).

In FX series, only common comments are automatically created in new project creation.

When comments by program are required, they must be added newly. (see Section 4.9 for details.)

Comments by program cannot be input to FXCPU and FXGP(DOS) or FXGP(WIN) files. When input to FXCPU or FXGP(DOS) or FXGP(WIN) files is required, comments must be created as common comments or the comments by program must be changed to common comments for operation. (see Section 9.6 for details.)

[Setting of comment data by program]
 See Section 4.9 for details on operation methods.

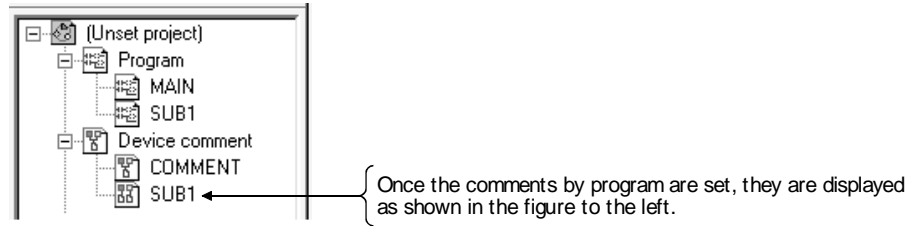

[Creation of only common comments]

Schematic diagram

A series (A4UCPU selection):

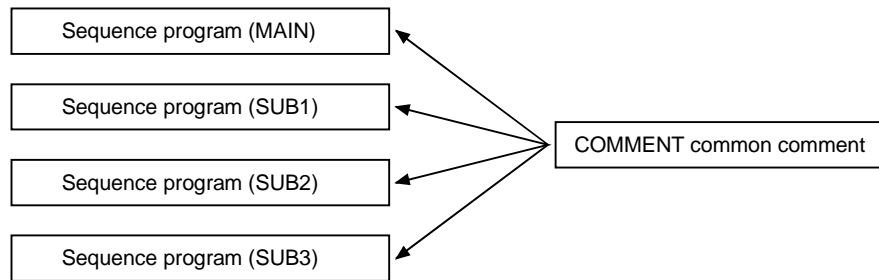

Q/QnA series:

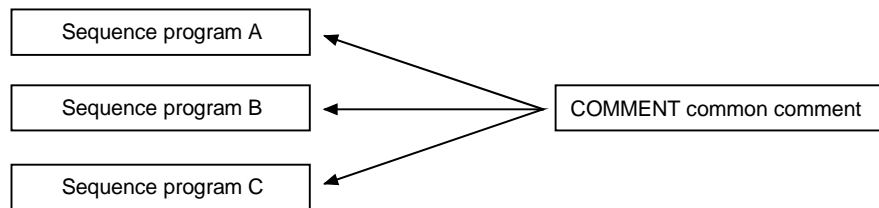

FX series:

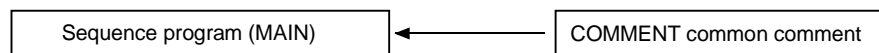

[Creation of only comments by program]

A series (A4UCPU selection):

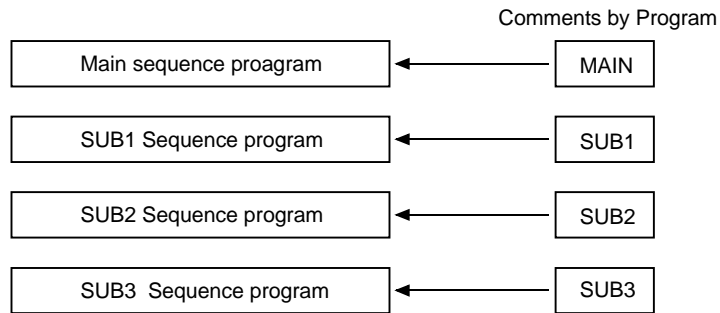

Q/QnA series:

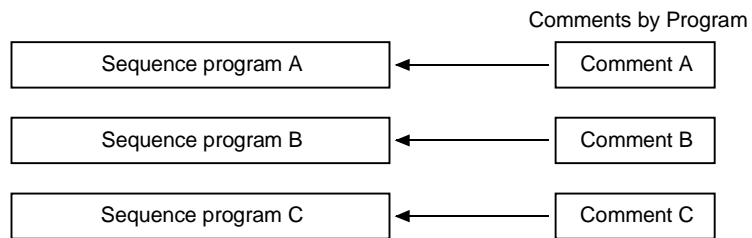

FX series:

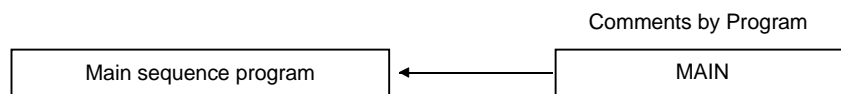

9.4 Creating Device Comments

9.4.1 Creating device comments on the device comment edit window

| | | |
|---|-------|----|
| A | Q/QnA | FX |
| ○ | ○ | ○ |

[Purpose]

Assigns the meaning for a device for easy-to-view programs. This function is helpful in creating the devices.

[Operating Procedure]

- For creation of common comments
Device comment in the project data list → COMMENT
- For creation of comments by program
Set the data type (comments by program), name of new data to be added, and title in the dialog box displayed by selecting [Project] → [Edit data] → [New].

[Dialog Box]

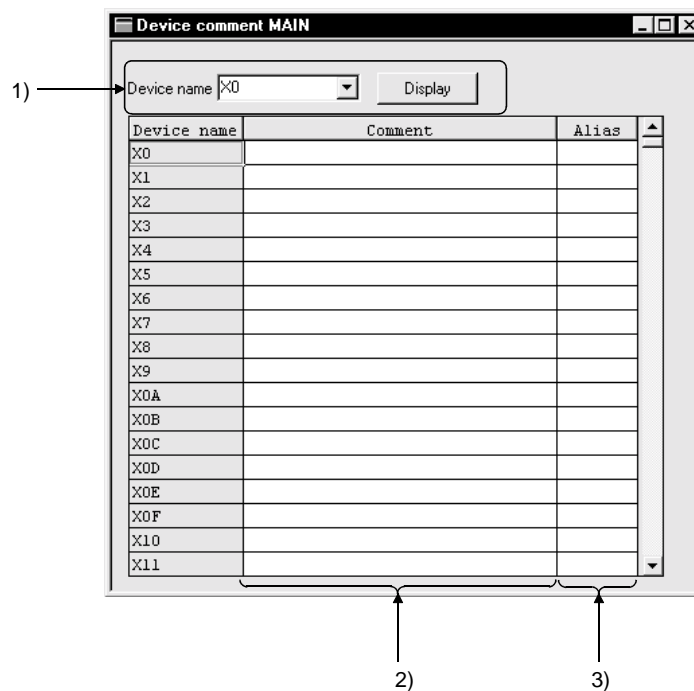

[Description]

1) Device

Designates a device for comment creation.
 After device designation, click the **Display** button.
 Once the device name is set, it is registered.
 When creating SFC comments, specify the device names as follows.
 Block title : BLM
 Step comment : BLM\Sn
 Transition comment : BLM\TRn
 (m: block number, n: step, transition number)

- 2) Comment
Sets a comment for each device.
 Comment1..... To be created in 15 characters.
 (see APP.11.2 for comment setting in the FX PLC .)
 Comment2..... To be created in 16 characters.

- 3) Alias
To be used when a device is set as an actual switch name.
A device name must be set in up to 8 characters.

<Example> Difference in displaying the Alias and device comment



Device names created in A Series format will not be written when [Write to GPPA file] or [Write to PLC] is executed. Caution is necessary.

| POINTS |
|--|
| <ul style="list-style-type: none"> • When either common comments or comments by program have already been created, the created device comments are displayed unconditionally. • When a Alias is input to an FXGP(WIN) file, it must be set only in alphanumeric characters and symbols (. + - * / = . ? # \$ % & ; ; _). Device names including the characters not permitted are deleted in writing them. • The number of comment characters can be changed to 32 characters in the <<Data>> sheet on the dialog box displayed by selecting [Tools] → [Options]. However, the number of comment characters is restricted as follows for input to ACPU or FXCPU (Comment1 only). Comment1 Up to 15 characters(For FX series, see Section Appendix 11.2) Comment2 Up to 16 characters |

9.4.2 Creating device comments for the created circuit

| A | Q/QnA | FX |
|---|-------|----|
| ○ | ○ | ○ |

[Purpose]

Assigns the meaning for a device for easy-to-view programs.
 This function is helpful in modifying or adding device comments.

[Operating Procedure]

1. Move the cursor to a device comment creation location.

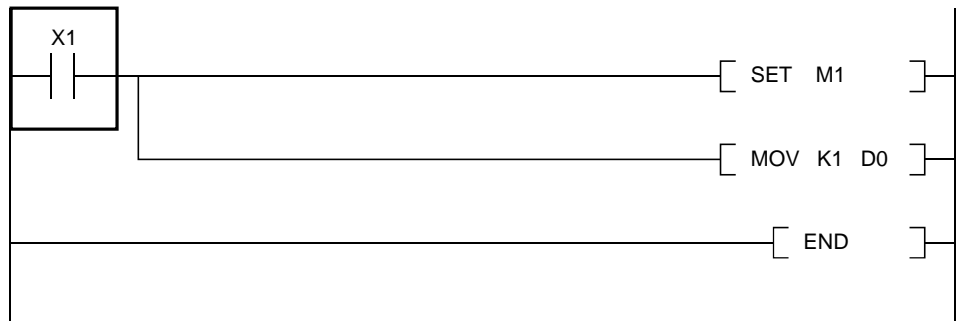

2. Press **Enter** key.



3. Make settings as follows for the circuit input dialog box. (Input two semicolons.)

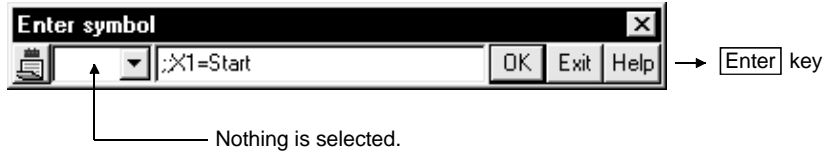

4. Comment display takes place as follows.

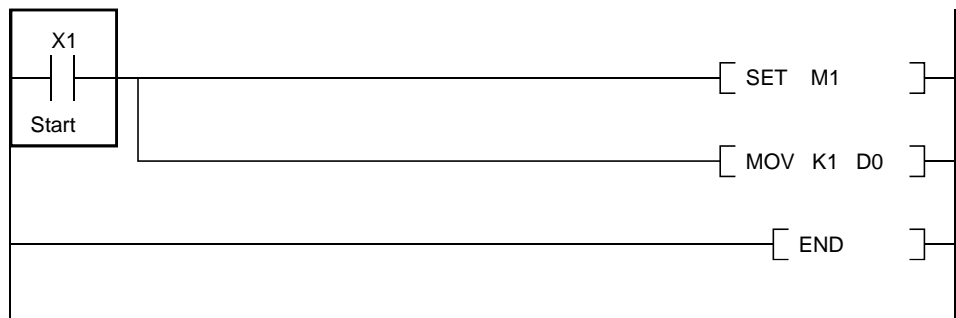

9.4.3 Creating device comments after creating a circuit

| | | |
|---|-------|----|
| A | Q/QnA | FX |
| ○ | ○ | ○ |

[Purpose]

Assigns the meaning for a device for easy-to-view programs.
 This function is helpful to create device comments and the circuit at the same time.

[Operating Procedure]

1. Check the Device comment check box on the dialog box displayed by selecting [Tools] → [Options].
2. Move the cursor to a device comment creation location.



3. Enter a contact and/or a device and click the **OK** button.



4. Enter a device comment and click the **OK** button.



5. Comment display takes place as follows.



9.4.4 Editing comments on the ladder editing screen

| | | |
|-----------------------|-----------------------|-----------------------|
| A | Q/QnA | FX |
| <input type="radio"/> | <input type="radio"/> | <input type="radio"/> |

[Purpose]

Comments the devices for ease of program viewing. This function is useful for device comment corrections/additions.

[Setting Procedure]

1. [Edit] → [Documentation] → [Comment] ()
2. Move the cursor to the position where a device comment will be created.
3. Pressing **Enter** shows the following dialog box.



4. Enter a device comment and click the **OK** button.



5. Providing a comment display shows the following ladder.

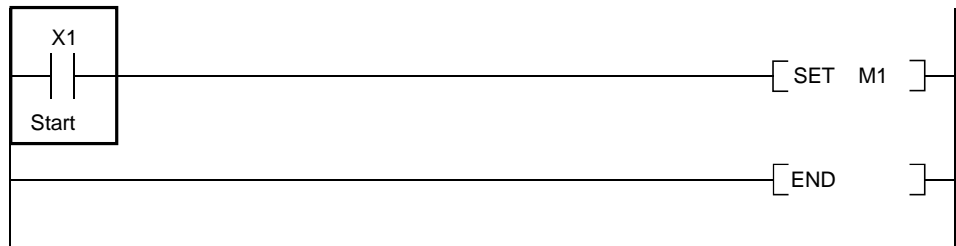

POINTS

- To cancel the comment edit mode, choose this menu again and uncheck the checked menu item.
- Note that comments of M, L and S can be created on the A series.
- For the FROM/TO and other instructions which can handle multiple devices, the number of devices used can be commented.

9.5 Deleting Device Comments

9.5.1 Deleting all device comments and Alias

| A | Q/QnA | FX |
|-----------------------|-----------------------|-----------------------|
| <input type="radio"/> | <input type="radio"/> | <input type="radio"/> |

[Purpose]

Deletes all device comments and Alias set so far.

[Operating Procedure]

Display the device comment edit window, then select [Edit] → [Clear all (all devices)].

9.5.2 Deleting display device comments and Alias

| A | Q/QnA | FX |
|-----------------------|-----------------------|-----------------------|
| <input type="radio"/> | <input type="radio"/> | <input type="radio"/> |

[Purpose]

Deletes the device comments and Alias being displayed.

[Operating Procedure]

Display the device comment edit window, then select [Edit] → [Clear all (displayed devices)].

9.6 Setting Comment Types

| | | |
|-----------------------|-----------------------|-----------------------|
| A | Q/QnA | FX |
| <input type="radio"/> | <input type="radio"/> | <input type="radio"/> |

[Purpose]

Switches the comment type from common comments to comments by program and vice versa.

<Example>

Settings are required when common comments are changed to SUB1 (comments by program) or comments by program are changed to common comments (COMMENT).

| | |
|----------------------------|------------------------------|
| Before change | After change |
| COMMENT (common comment) | → SUB1 (comments by program) |
| MAIN (comments by program) | → MAIN (comments by program) |

[Operating Procedure]

Display the device comment edit window, then select [Edit] → [Setup comment].

[Dialog Box]

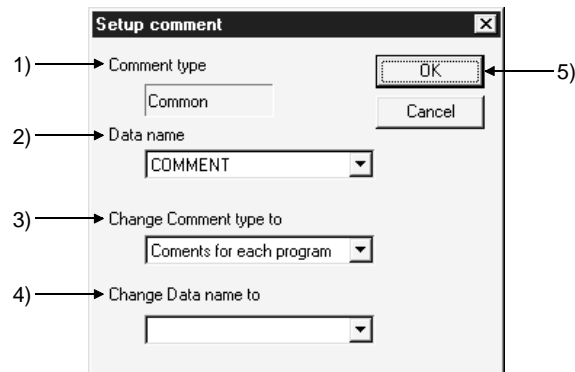

[Description]

- 1) **Comment type**
Indicates the type of the data selected for Data name.
- 2) **Data name**
Designates a data name for comment type change.
- 3) **Change comment type to**
Classifies data set in the data name field into two categories: common comments and comments by program.
- 4) **Change Data name to**
Changes the existing data name.
This data name must be designated in up to 8 characters.
- 5) **OK button**
Click this button after making necessary settings.

POINTS



- Common comments and comments by program can be classified from the device comment icons in the project data list.

The screenshot shows a 'Project data list' window with a tree view. The tree structure is as follows:

- (Unset project)
 - Program
 - MAIN
 - SUB1
 - Device comment
 - COMMENT (with a common comment icon)
 - MAIN (with a program comment icon)
 - SUB1 (with a program comment icon)
 - SAMPLE (with a program comment icon)

 Three arrows point to specific icons:

- One arrow points to the 'COMMENT' item under 'Device comment', labeled 'Icon for common comments'.
- Another arrow points to the 'COMMENT' item, labeled 'Icon for comments by program'.
- A third arrow points to the 'MAIN' item under 'Device comment', labeled 'Icon for comments by program'.

 This icon is displayed for comments corresponding to the sequence programs.
 This icon is displayed for comments not corresponding to the sequence programs.

- One common comment is allowed within one program.
In addition, the common comment data name is fixed to "COMMENT."
- Up to 124 comments by program can be set.

9.7 Setting Comment Ranges

| | | |
|-----------------------|-----------------------|-----------------------|
| A | Q/QnA | FX |
| <input type="radio"/> | <input type="radio"/> | <input type="radio"/> |

[Purpose]

Sets a data range when data created with GX Developer is written to a PLC or when a GPPA, GPPQ, FXGP(DOS) or FXGP(WIN) file is written to the FD or HD.

[Operating Procedure]

Display the device comment edit window, then select [Edit] → [Setup comment range].

- When A series is started

[Dialog Box]

<<Common programs>> sheet

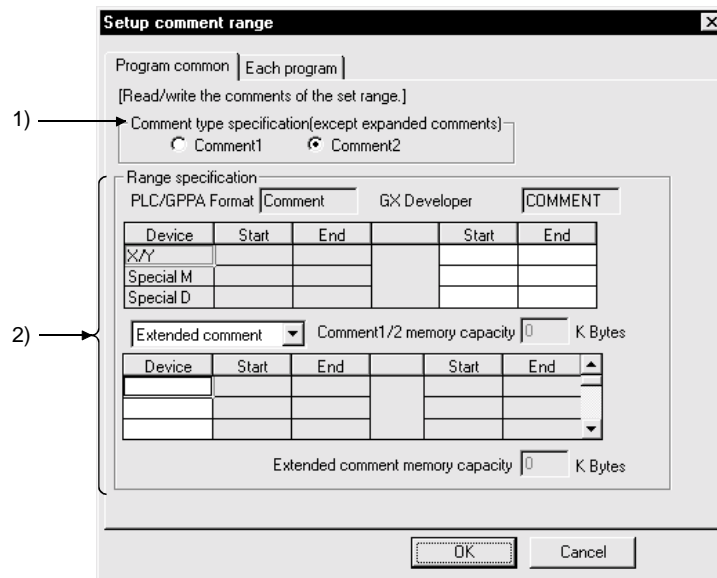

[Description]

- 1) Comment type specification
 - Ⓐ Comment1
To be selected when a device comment has been created as a Comment1.
 - Ⓑ Comment2
To be set when a device comment has been created as a Comment2.

2) Range specification

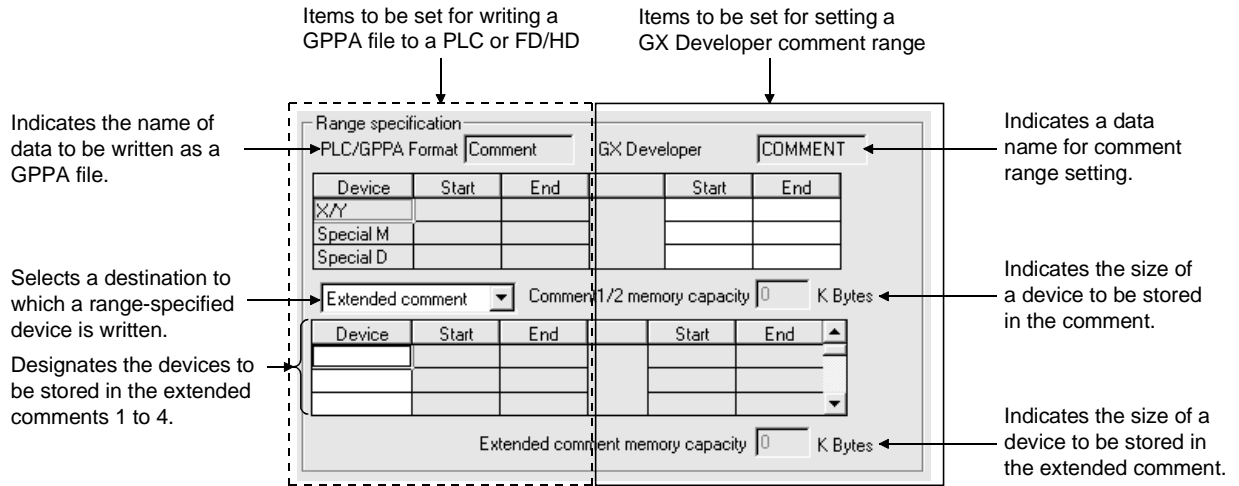

If the starting and end positions of a range are designated in GX Developer files, they are reflected in the PLC /GPPA table.

[Dialog Box]

<<Each program>> sheet (for main program and subprograms)

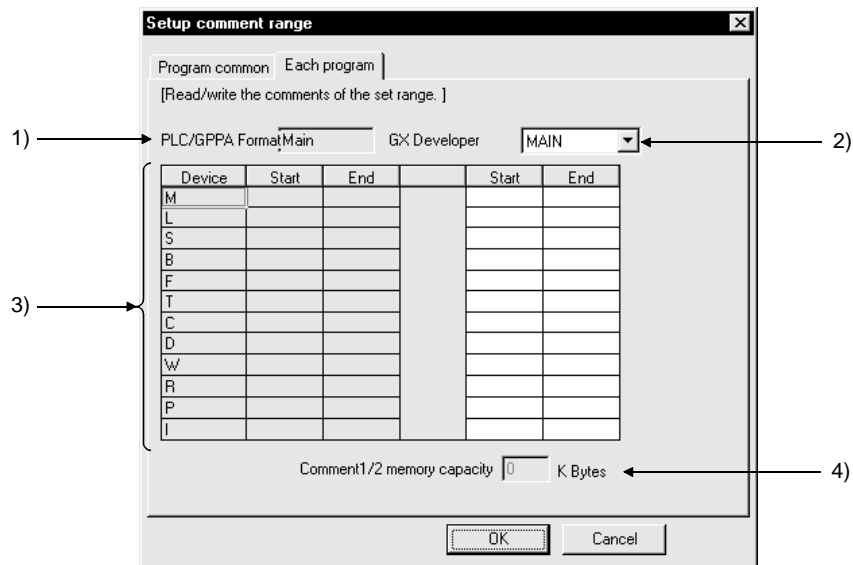

[Description]

- 1) PLC/GPPA Format
Indicates the name of data to be written as a GPPA file.
- 2) GX Developer Format
Designates MAIN or SUB1.
Even if SUB2, SUB3 or SUB4 is created with GX Developer, it cannot be designated in this setting item.

- 3) Device range setting
Designates a range of devices to be written to a PLC or a Personal computer.
- 4) Comment1/2 memory capacity
Indicates the size of a device to be saved in the comment or extended comment.

[Operating Procedure]

- When QnA series is started

[Dialog Box]

<<Program common>> sheet

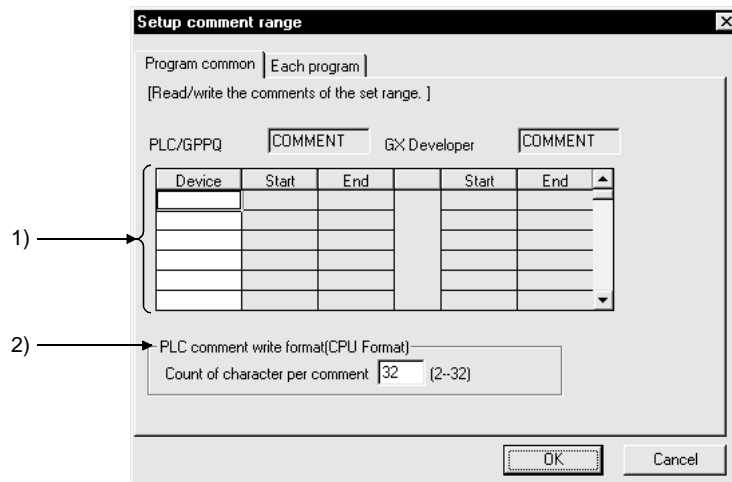

[Description]

1) Range setting

Designates the name of data to be written as a GPPQ file.

Designates the devices to be written to a PLC or FD/HD.

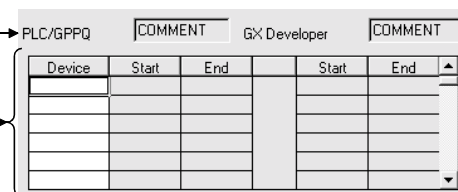

Indicates a data name for comment range setting.

If the starting and end positions of a range are designated in GX Developer files, they are reflected in the PLC /GPPA table.

- 2) PLC comment write format (PLC Format)
Designates how many characters are to be written to a PLC.

[Dialog Box]
 <<Each program>> sheet

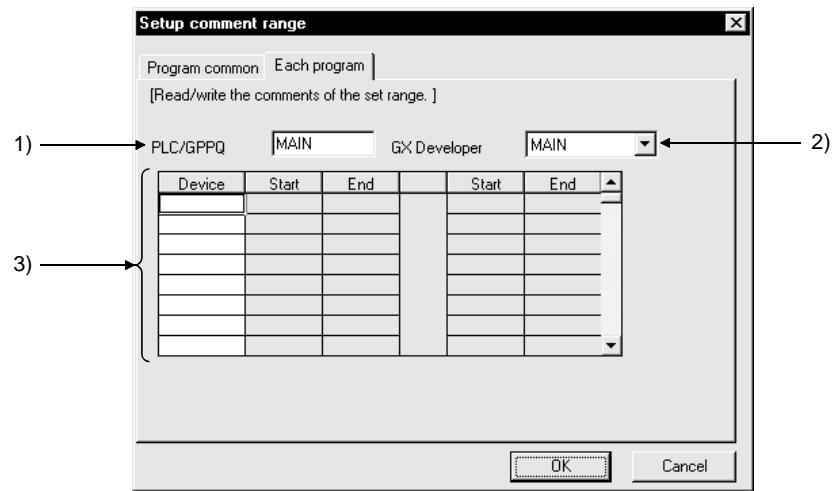

[Description]

- 1) PLC /GPPQ Format
 Designates the name of data to be written as a GPPQ file.
- 2) GX Developer Format
 Indicates a data name for comment range setting.
- 3) Device range setting
 Designates the devices to be written to a PLC or Personal computer.

| | |
|--------------|--|
| POINT | <p>To make input to ACPU, the comment1/2 memory size must be designated in the memory size parameter. (The memory size displayed here is not reflected to the parameter memory size.) If no size is designated, an error occurs. No settings are required when the other files are used for input.</p> |
|--------------|--|

[Operating Procedure]

- When FX series is started

[Dialog Box]

<<Program common>> sheet

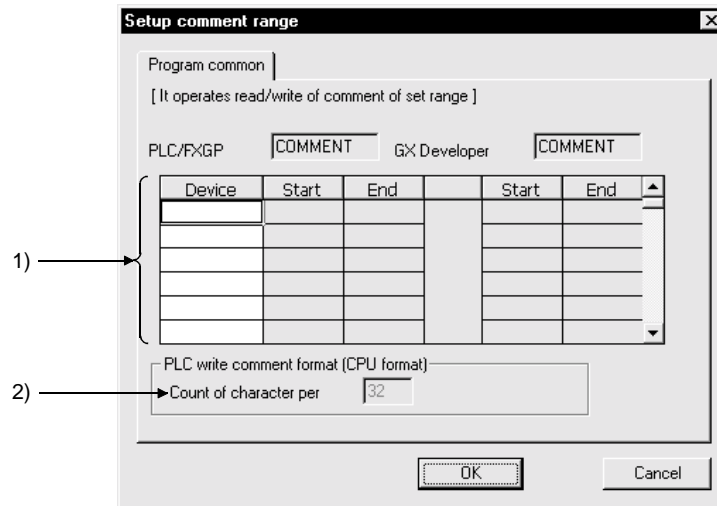

[Description]

1) Range setting

Designates the devices to be written to a PLC or Set

Set the comment range created by the GX Developer.

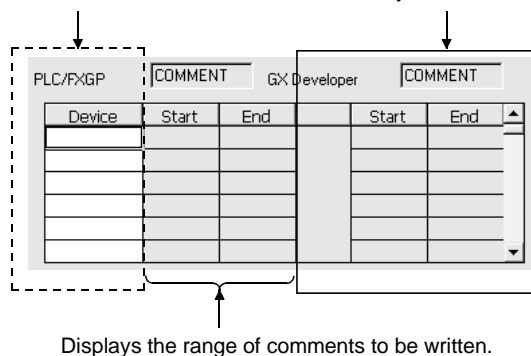

2) PLC write comment form (PLC form).

Setting is not possible for the FX series.

POINT
 Comments by program cannot be written to PLC and FD/HD (see Section 9.3).

10. SETTING THE STATEMENTS AND NOTES

Sequence programs are annotated with comments for ease of understanding.
Note that the A/FX series does not have the integrated statement/integrated note function.

10.1 About the Statements/Notes

| A | Q/QnA | FX |
|---|-------|----|
| ○ | ○ | ○ |

This section describes the statements created on the Q/QnA/A/FX series.
 On the FXGP(DOS) and FXGP(WIN), statements are called "ladder comments".

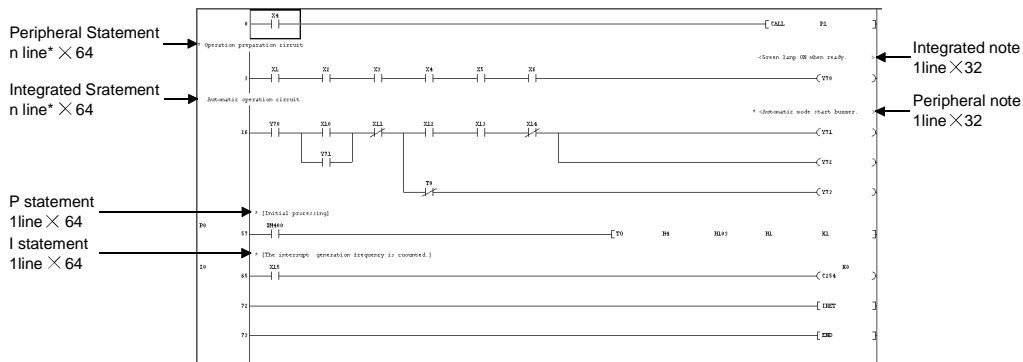

※:About the number of lines on which a peripheral statement/integrated statement can be created

A single line accepts 64 characters. No sentence can be written over two or more lines.

For the Q/QnA series

Number of statements that may be created in a single ladder block = 15 × number of lines in a single ladder block

The following ladder block can be annotated with statements on up to 30 lines.

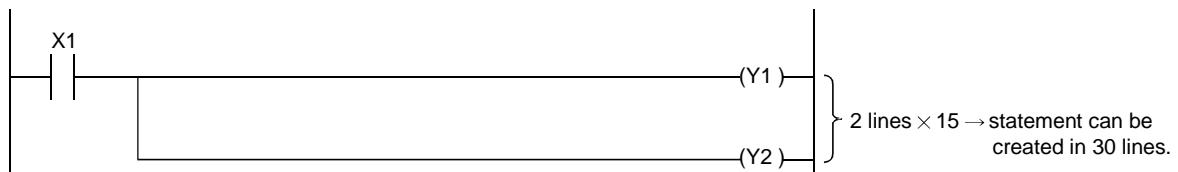

What are statements?

Statements include line, P and I statements.

Statements can annotate each ladder block with comments to ensure ease of understanding a sequence of the whole program.

The A/FX series has statements, and the Q/QnA series has integrated and peripheral statements.

What are notes?

Notes include integrated and peripheral notes.

Notes can be created for coils and application instructions.

The A/FX series has peripheral notes and the Q/QnA series has integrated and peripheral notes.

However, when notes are written to the Personal computer in an ACPU or GPPA format file, only the first notes of single ladder blocks are written.

On the FXGP(WIN), notes are called "coil comments".

About the integrated statements/notes

Since integrated statements/notes can be displayed or edited on GX Developer or statements be handled as part of a program, they can be written/read to/from the PLC CPU.

When performing maintenance in a factory or the like, for example, statements/notes are useful because they can be read from the PLC CPU.

However, writing integrated statements/notes to the PLC CPU requires much program memory. So, if the PLC CPU has a small free memory area, write peripheral statements instead of integrated statements.

<Number of steps exhausted>

$$\begin{array}{c} \uparrow \\ \text{Fixed} \end{array} 2 + \frac{\text{Number of characters}}{2} \text{ steps (Round off decimals.)}$$

A space entered in a character string is also handled as one character.

About the peripheral statements/notes

They may be displayed or edited only on GX Developer.

Peripheral statements/notes are preceded by "*".

Since they are not written to the PLC CPU, the program memory area of the PLC CPU can be reduced.

However, if program correction or similar operation is performed in the field or the like, the program on GX Developer will be different from the one in the PLC CPU. Therefore, if read from PLC is performed without merging*, the statements on GX Developer will be discarded. (Refer to Section 10.2.)

*: Merging indicates that a program in the PLC CPU and statements on GX Developer are combined.

[A/FX series]

The statement steps are not exhausted.

Note that statements are not written to the PLC CPU.

The P, I statements of the FX series are not written in the FXGP(DOS) or FXGP(WIN) format.

[Q/QnA series]

The number of steps exhausted is 1 independently of the number of characters.

Note that statements are not written to the PLC CPU.

[Caution when reading statements from the PLC]

When overwriting a program without statements read from the PLC to the hard disk, the program stored in the hard disk will be overwritten by the program without statements. Before reading such a program, store the program (originally retained in the hard disk) in a floppy disk.

If any program is edited on a Personal computer and written during running, program mismatching may occur.

(1) When programs are not merged

For the Q/QnA series

Peripheral statements on GX Developer are deleted.

For the A/FX series

Statements existing in the beginning of ladder blocks are merged.

If the program read to GX Developer is different from the program in the PLC CPU, statements are not added to the correct positions, resulting in a ladder creation fault. Therefore, the statements are deleted.

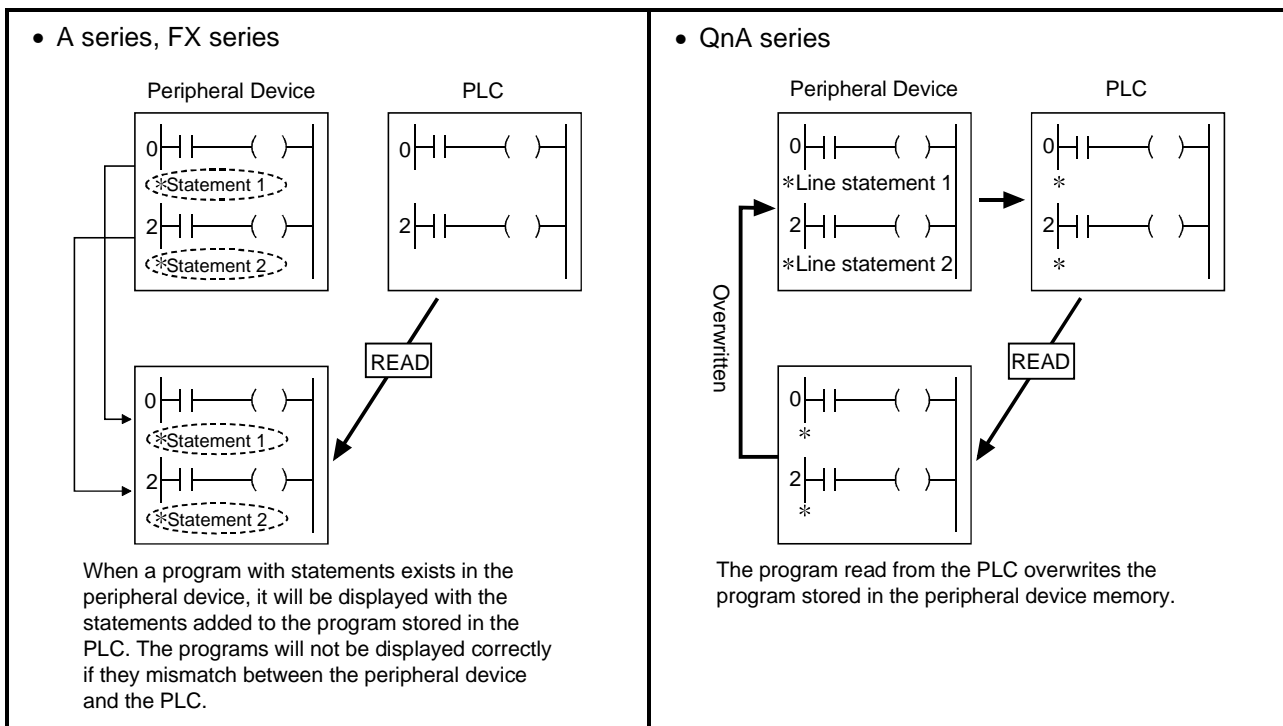

(2) When programs are merged

For the Q/QnA series

1) If the program on GX Developer and the program in the PLC CPU differ in step No., they are merged from the beginning.

However, if the program on GX Developer has become larger due to editing, e.g. addition/correction to the program on GX Developer or deletion to the program in the PLC CPU, the peripheral statements in the area greater than the program in the PLC CPU are deleted.

2) If integrated statements/notes exist in the program on GX Developer, they are deleted from the program on GX Developer after merging.

3) If integrated statements/notes exist in the program within the PLC CPU, they are read unchanged onto GX Developer.

For the A/FX series

- 1) Programs are merged independently of the positions of the statements which are added to the programs on GX Developer and in the PLC CPU. (Merging may insert statements between ladders. As it will result in an unauthorized ladder on the ladder display screen, a warning message appears. In that case, make correction in the statement block edit or list mode.)
- 2) If the step where a statement exists in the program on GX Developer is not found in the data within the PLC CPU, that statement is discarded.
- 3) When choosing [Import from GPPA format file] to merge programs, statements in the data saved in the GPPA format file are the target of merging, independently of the statements added to the program opened on GX Developer.

[Caution when reading notes from the PLC]

When overwriting a program without notes read from the PLC to the hard disk, the program stored in the hard disk will be overwritten by the program without notes. Before reading such a program, store the program, (originally retained on the hard disk) in a floppy disk.

If any program is edited on a Personal computer and written during running, program mismatching may occur.

(1) When programs are not merged

For the Q/QnA series

Peripheral notes on GX Developer are deleted.

For the A/FX series

Only the coil instructions whose step numbers of the program on GX

Developer and those of the program in the PLC CPU are identical are merged.

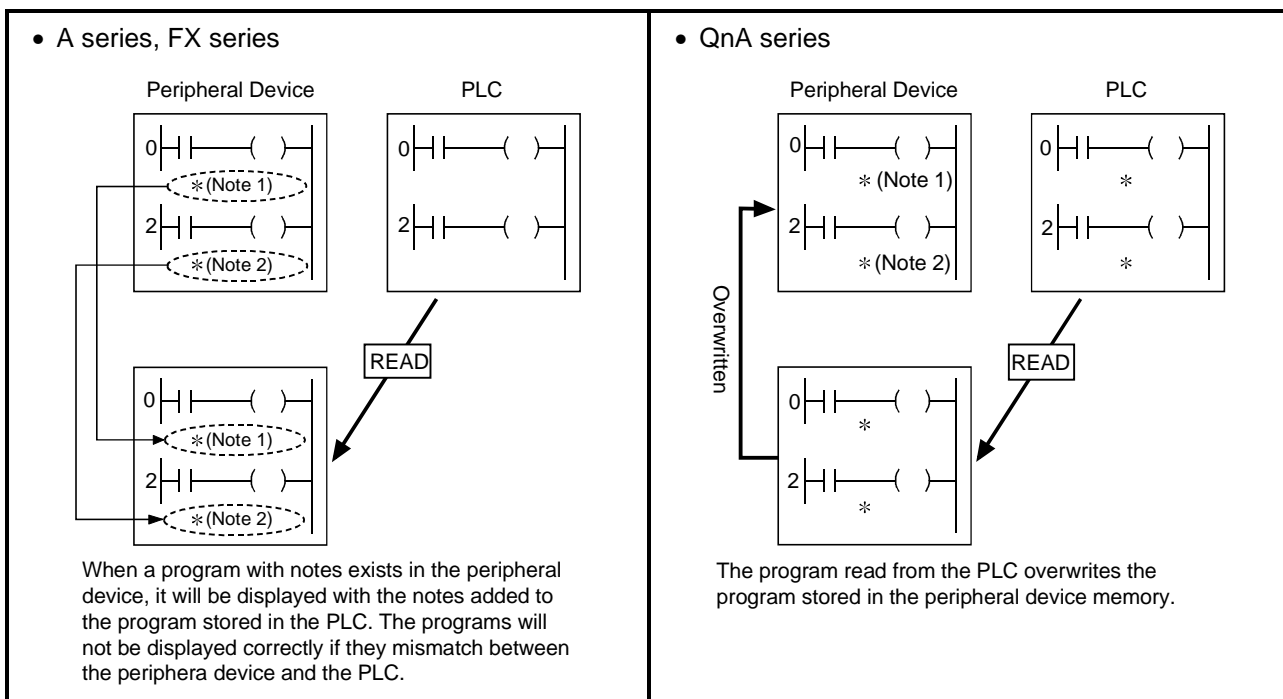

(2) When programs are merged

For the Q/QnA series

Refer to the caution given for reading statements from the PLC.

For the A/FX series

Programs are merged independently of the positions where the notes on GX Developer and the notes in the PLC CPU exist.

If the program on GX Developer has become larger due to editing, e.g. addition/correction to the program on GX Developer or deletion to the program in the PLC CPU, the peripheral statements in the area greater than the program in the PLC CPU are deleted.

10.2 About Merging Operation Procedure

The following operation procedure is used to merge the program on GX Developer and the program in the PLC CPU.

Refer to Section 15.2 when merging a file saved on an FD or the like and a program on GX Developer.

[Operating Procedure]

- 1) Read onto GX Developer the program which is equivalent to the program written to the PLC CPU.
(For the Q/QnA series, merging cannot be done if the programs on the PLC and GX Developer sides have the same data name.)
- 2) Read setting
 - (1) For read from PLC
Choose [Online] → [Read from PLC] → <<Program>> → "Peripheral statement/merging note". (Refer to Section 16.3.3)
 - (2) For IC memory card
Choose [Tools] → [IC memory card] → [Read IC memory card] → "Peripheral statement/merging note". (Refer to Section 15.5.1)
 - (3) For reading other format files
Choose [Project] → [Import file] → [Import from GPPA format file] → "Peripheral statement/merging note". (Refer to Section 5.14)
After setting, click the button.
- 3) Statement/note block edit
After completion of reading, perform the following operation.
Choose [Edit] → [Documentation] → [Statement/Note block edit].
Opening the statement/note block edit screen and clicking the button moves all statements/notes to the ladder.
- 4) Check whether the statements/notes of the program read to GX Developer are in the correct positions.
- 5) If they are not, reselect statement/note block edit and move them to the correct position. (Refer to Section 10.5)
- 6) Choose [Project] → [Name project and save] to save the program.

| POINT |
|---|
| <p>Merging instructions</p> <ol style="list-style-type: none"> 1. Programs are merged only when the statements added to the programs on GX Developer and in the PLC CPU are both peripheral statements. 2. Programs cannot be merged if their types are different. (Ladder and SFC programs cannot be merged.) 3. Programs cannot be merged if the program on GX Developer and the program written to the PLC CPU do not match in PLC type. 4. SFC programs cannot be merged. |

10.3 Creating and Deleting Statements

10.3.1 When editing the circuit window

10.3.1(1) Creating statements in the circuit edit window

| | | |
|---|-------|----|
| A | Q/QnA | FX |
| ○ | ○ | ○ |

[Operating Procedure]

1. Enter **[Insert]** key to set the insert mode.
2. Move the cursor to the position shown in the following figure.

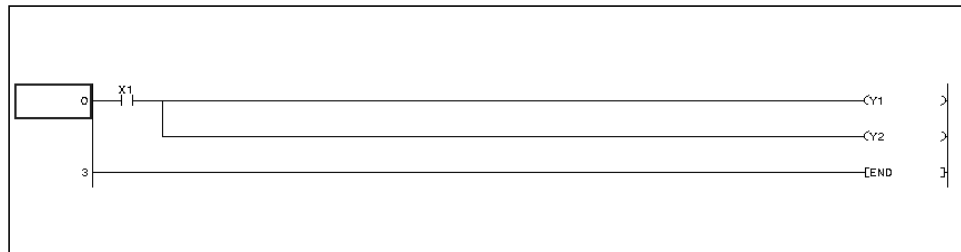

3. By entering a semicolon ";" the circuit input dialog box is displayed to enable the user to enter a statement.



To enter a P or I statement, enter a semicolon (;) after entering a P or I pointer.
(Example)

PI: P, I statement → **[ENTER]** key or **[OK]** key

↑
Enter a desired statement.

4. After entering the statement, press **[Enter]** key or click the **[OK]** button.

| |
|---|
| POINTS |
| <ul style="list-style-type: none"> • For switching integrated statements/peripheral statements on the Q/QnA series, see Section 6.4.12. • For displaying statements created, see Section 3.9. |

10.3.1(2) Deleting statements in the circuit edit window

| | | |
|---|-------|----|
| A | Q/QnA | FX |
| ○ | ○ | ○ |

[Operating procedure]

1. Move the cursor to the statement to be deleted, and press **Delete** key.

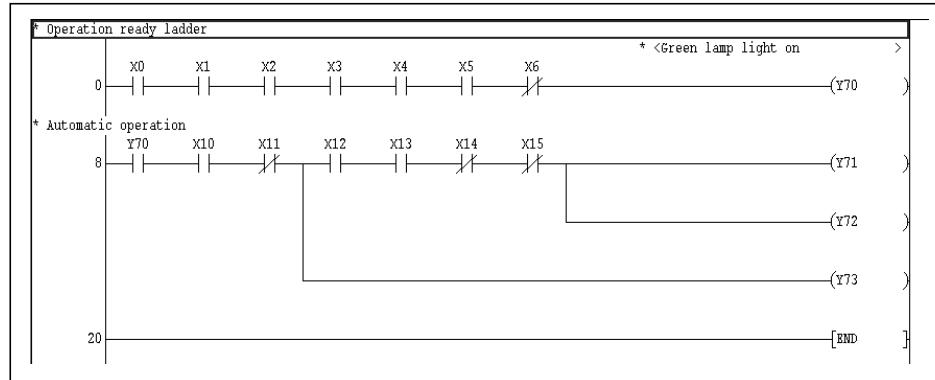

2. After the statement has been deleted, convert the program.

10.3.2 When editing the list window

10.3.2(1) Editing statements on the list edit window

| | | |
|---|-------|----|
| A | Q/QnA | FX |
| ○ | ○ | ○ |

1. Move the cursor to the head of the position to which a statement will be added.
(Move the cursor to the head of the circuit block of a circuit.)
2. By entering a semicolon ";", the list input dialog box is displayed.



PI: P, I statement → key or key

↑
Enter a desired statement.

3. Create a statement within up to 64 characters.
Up to 255 characters can be entered in the text box.

POINTS

- Statements will be displayed in the list mode at all times (it is impossible to not display statements).
- For integrated statements and peripheral statements, see Section 10.1.

10.3.2(2) Deleting statements on the list edit window

| A | Q/QnA | FX |
|---|-------|----|
| ○ | ○ | ○ |

1. Move the cursor to the statement to be deleted.

```

;* Operation ready ladder
0 LD X1
1 MOV R0 K1M1
6 MOV R0 K4Y60
11 RST C1
14 LD X0
15 AND X4
16 AND X5
17 OR Y70
18 ANI X1
19 NC N0 Y70
24 LD X2
25 MPS
26 ANI M1
27 ANI Y72
28 SET Y71
29 MPP
30 SET M1
31 LD Y71
32 ANI X2
33 OUT Y73
34 END
35

```

2. Press **Delete** key or **Shift** + **Delete** key.

```

0 LD X1
1 MOV R0 K1M1
6 MOV R0 K4Y60
11 RST C1
14 LD X0
15 AND X4
16 AND X5
17 OR Y70
18 ANI X1
19 NC N0 Y70
24 LD X2
25 MPS
26 ANI M1
27 ANI Y72
28 SET Y71
29 MPP
30 SET M1
31 LD Y71
32 ANI X2
33 OUT Y73
34 END
35

```

10.3.3 Creating statements in the statement edit mode

| | | |
|---|-------|----|
| A | Q/QnA | FX |
| ○ | ○ | ○ |

[Purpose]

Statements can be created easily

[Operating Procedure]

1. [Edit] → [Documentation] → [Statement] ()
2. Move the cursor to the ladder block where you want to attach a statement.
3. Pressing **Enter** shows the following dialog box.

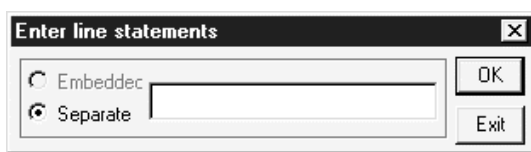

4. Enter a statement and click the **OK** button.

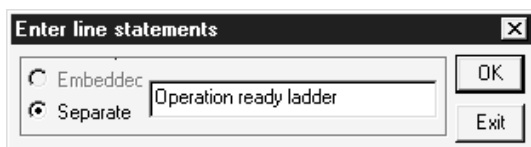

5. Providing a statement display shows the following ladder.

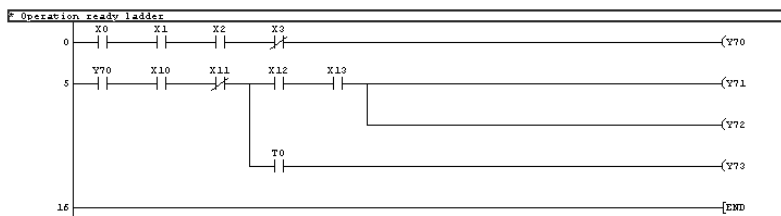

POINT

To cancel the statement edit mode, choose this menu again and uncheck the checked menu item.

10.4 Creating and Deleting Notes

10.4.1 Creating notes on the circuit edit window

10.4.1 (1) Creating notes on the circuit edit window

| | | |
|---|-------|----|
| A | Q/QnA | FX |
| ○ | ○ | ○ |

[Operating procedure]

1. Press **[Insert]** key to set the overwrite mode.
Note that a circuit will be added by creating a note in the insert mode.
2. Move the cursor to the position shown in the following figure.



3. By pressing **[Enter]** key, the following dialog box is displayed.



4. Add a semicolon ";" after Y1, and enter a note.

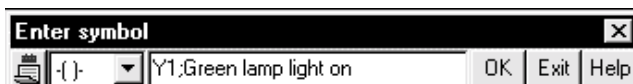

5. After the note has been entered, press **[Enter]** key or click the **[OK]** button.

| |
|---|
| POINTS |
| <ul style="list-style-type: none"> • For switching integrated notes and peripheral notes on the Q/QnA series, see Section 6.4.12. • For displaying notes created, see Section 3.10. |

10.4.1 (2) Deleting notes in the circuit edit window

| | | |
|---|-------|----|
| A | Q/QnA | FX |
| ○ | ○ | ○ |

[Operating procedure]

1. Press **[Insert]** key to set the overwrite mode.
2. Move the cursor to the note to be deleted, and press **[Enter]** key or double-click the **[mouse]** button.

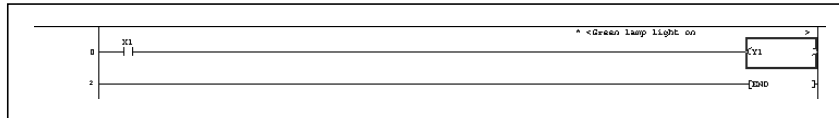

3. Delete the statement Green lamp lights when operation preparations are completed. after the semicolon ";".

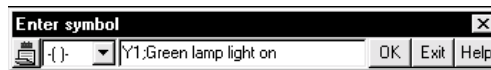

4. After the statement has been deleted, press the **[Enter]** key or click the **[OK]** button.

10.4.2 Creating notes in the list edit window

10.4.2 (1) Creating notes in the list edit window

| | | |
|---|-------|----|
| A | Q/QnA | FX |
| ○ | ○ | ○ |

[Operating procedure]

1. Move the cursor to the head of the position to which a note will be added.
(Move the cursor to the head of the circuit block of a circuit.)
2. By entering a semicolon ";", the list input dialog box appears.



3. Create a note within up to 64 characters.
Up to 255 characters can be entered in the text box.

POINTS

- Notes will be displayed in the list mode at all times (it is impossible to not display statements).
- For integrated notes and peripheral notes, see Section 10.1.

10.4.2 (2) Deleting notes in the list edit window

| | | |
|---|-------|----|
| A | Q/QnA | FX |
| ○ | ○ | ○ |

[Operating Procedure]

1. Move the cursor to the note to be deleted.

```

:* Operation ready ladder
0 LD X1
1 MOV K0 R1N1
6 MOV K0 R4Y60
11 RST C1
14 LD X0
15 AND X4
16 AND X5
17 OR Y70
18 ANI X1
19 NC NO Y70
24 LD X2
25 MPS
26 ANI M1
27 ANI Y72
28 SET Y71
29 MPP
30 SET M1
31 LD Y71
32 ANI X2
33 OUT Y73
34 END
35

```

2. Press **Delete** key or **Shift** + **Delete** key.

```

0 LD X1
1 MOV K0 K1M1
6 MOV K0 K4Y60
11 RST C1
14 LD X0
15 AND X4
16 AND X5
17 OR Y70
18 ANI X1
19 NC NO Y70
24 LD X2
25 MPS
26 ANI M1
27 ANI Y72
28 SET Y71
29 MPP
30 SET M1
31 LD Y71
32 ANI X2
33 RST M1
34 SET M2

```

10.4.3 Creating notes in the note edit mode

| | | |
|---|-------|----|
| A | Q/QnA | FX |
| ○ | ○ | ○ |

[Purpose]
Notes can be created easily

[Operating procedure]

1. [Edit] → [Documentation] → [Note] ()
2. Move the cursor to the coil/application instruction where you want to attach a note.
3. Pressing **[Enter]** shows the following dialog box.

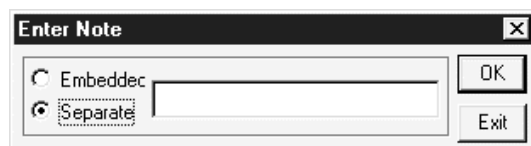

4. Enter a note and click the **[OK]** button.



5. Providing a note display shows the following ladder.

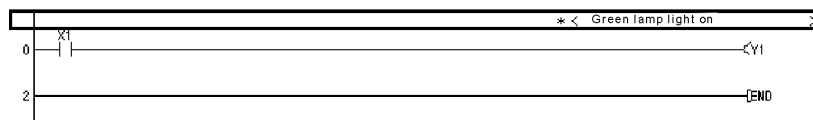

POINT

To cancel the note edit mode, choose this menu again and uncheck the checked menu item.

10.5 Batch-Editing the Statements/Notes

| | | |
|---|-------|----|
| A | Q/QnA | FX |
| ○ | ○ | ○ |

[Purpose]

You can batch-create multiple statements/notes.
The position of statement/note can be changed easily.

[Operating Procedure]

Select [Edit] → [Documentation] → [Statement/Note block edit].

[Dialog Box]

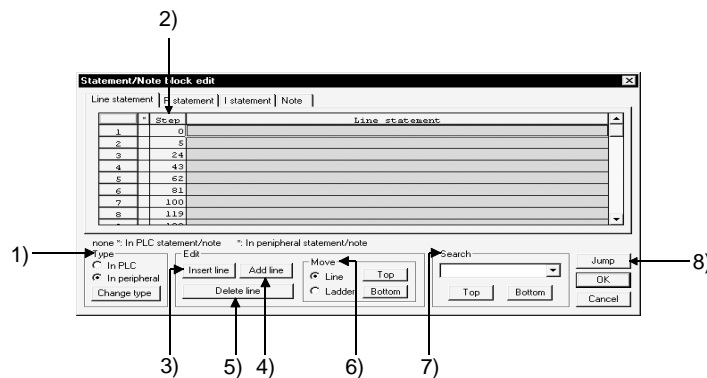

[Description]

1) Type

- * :No Integrated statement/note
- * :Yes Peripheral statement/note

When changing the Type, move the cursor to the line where you want to make a change, choose the Type (integrated/peripheral), and click the **Change type** button.

2) Step

Shows the steps or device numbers where the corresponding statements/notes exist.

Statement :The number of first steps in all ladder blocks in the program are displayed.

Note :The number of steps equivalent to all coils in the program are displayed.

P statement :The pointer number existing in the program is displayed.

I statement :The pointer number existing in the program is displayed.

3) Insert line

Inserts one line or selected lines of blank statements above the line at the cursor.

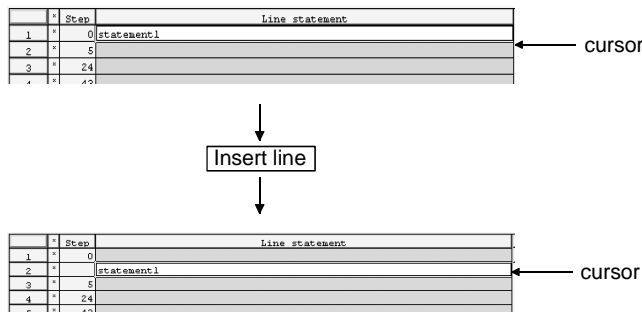

4) Add line

Inserts one line or selected lines of blank statements under the line at the cursor.

The inserted statement or statements are added to the ladder block at the cursor.

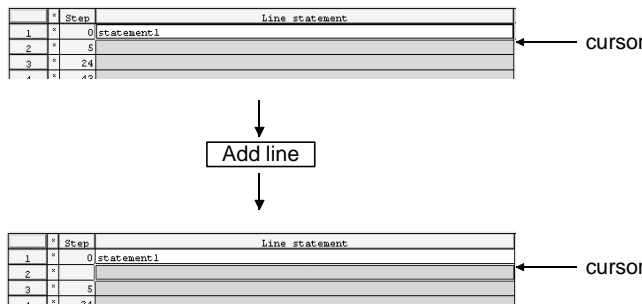

5) Delete line

Deletes the line of statement at the cursor or the selected lines of statements.

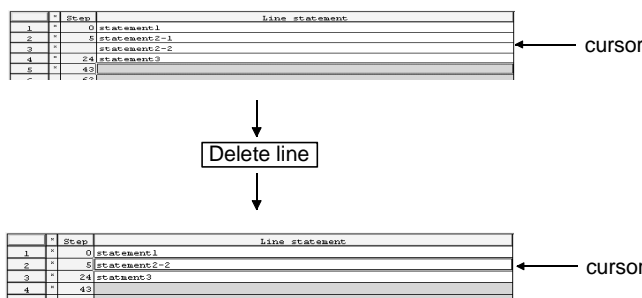

6) Move

If the statements/notes are not added to the correct positions after merge processing, they are moved to the positions which meet the purpose of the sequence program.

(1) Moving in line unit

For the **Top** button

Moves the statements/notes between the cursor line and bottom line up one line.

For the **Bottom** button

Moves the statements/notes between the cursor line and top line down one line.

In the following example, the statements are moved up.

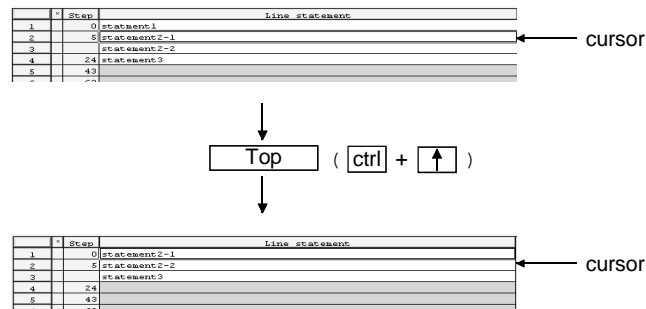

(2) Moving in ladder unit

For the **Top** button

Moves the statements/notes between the ladder block at the cursor and the bottom line up one ladder block.

For the **Bottom** button

Moves the statements/notes between the ladder block at the cursor and top line down one ladder block.

In the following example, the statements are moved down.

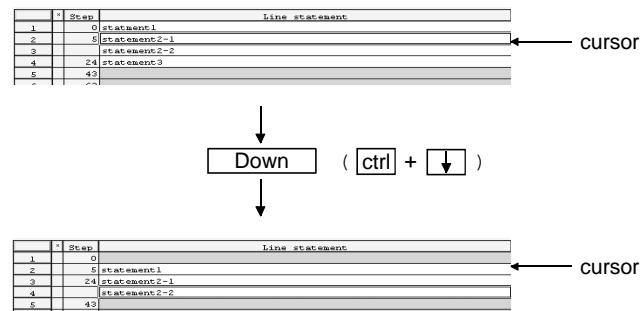

- 7) Search
Makes a search up or down line by line relative to the cursor.
- 8) Jump
Searches for the ladder having the statement specified by the cursor.

| POINTS |
|--|
| <ul style="list-style-type: none">• If a statement is created in other than the beginning of a ladder block, its step number is changed for the first step number of the ladder block and displayed when the dialog box is opened. Clicking the <input type="button" value="OK"/> button moves the statement to the beginning of the ladder block.• You cannot create a statement/note in the ladder block which does not exist in the program.• An SFC allows only notes to be created.• Do not edit the statements which are added for macro diversion. |

11. SETTING DEVICE MEMORY (DWR SETTING)

11.1 Device Memory

| | | |
|---|-------|----|
| A | Q/QnA | FX |
| ○ | ○ | ○ |

Using device memory, data (for example, data registers, link registers, and file registers) can be set online or read from the PLC and edited.

Although setting data using device memory makes it unnecessary to create a program for initial setting using the sequence program, the original data will be overwritten with the operating values which will be written when the PLC is running. It is necessary to re-write data when the PLC mode is switched from reset to run.

- When data is not set using device memory

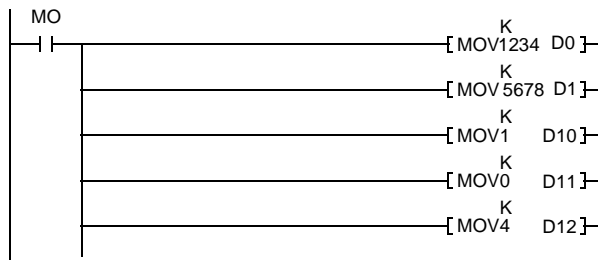

The above program is required.

- When device memory is set

| | | | | | | | | | |
|--------------|----|---------|----------------|-----|-----------|---|---|---|------------------|
| Device Label | D0 | Display | 16-bit integer | DEC | D0-D25983 | | | | |
| Device name | 0 | 1 | 2 | 3 | 4 | 5 | 6 | 7 | Character string |
| D0 | 0 | 0 | 0 | 0 | 0 | 0 | 0 | 0 | |
| D8 | 0 | 0 | 0 | 0 | 0 | 0 | 0 | 0 | |
| D16 | 0 | 0 | 0 | 0 | 0 | 0 | 0 | 0 | |
| n*24 | n | n | n | n | n | n | n | n | |

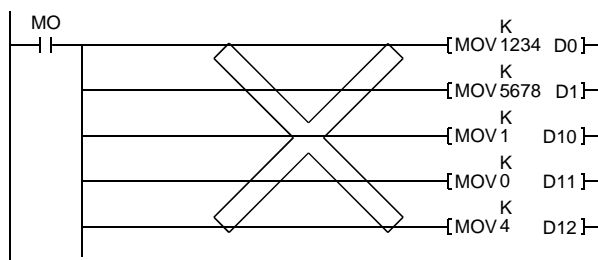

The above program is not required.

| |
|--|
| POINT |
| <p>On the Q/QnA series, initial device values can be set using device memory. Refer to the following manuals for the device init.</p> <p>QnA series: QnA Programming Manual (Fundamentals) Q series : QCPU User's Manual (Function Explanations, Program Fundamentals)</p> |

11.2 Device Value Input

| | | |
|---|-------|----|
| A | Q/QnA | FX |
| ○ | ○ | ○ |

[Purpose]
Changes word device data in batch.

[Operating Procedure]
Select [Project] → [Edit data] → [New], and set the data type (device memory), the name of the data to be added, and the comment.

[Dialog Box]

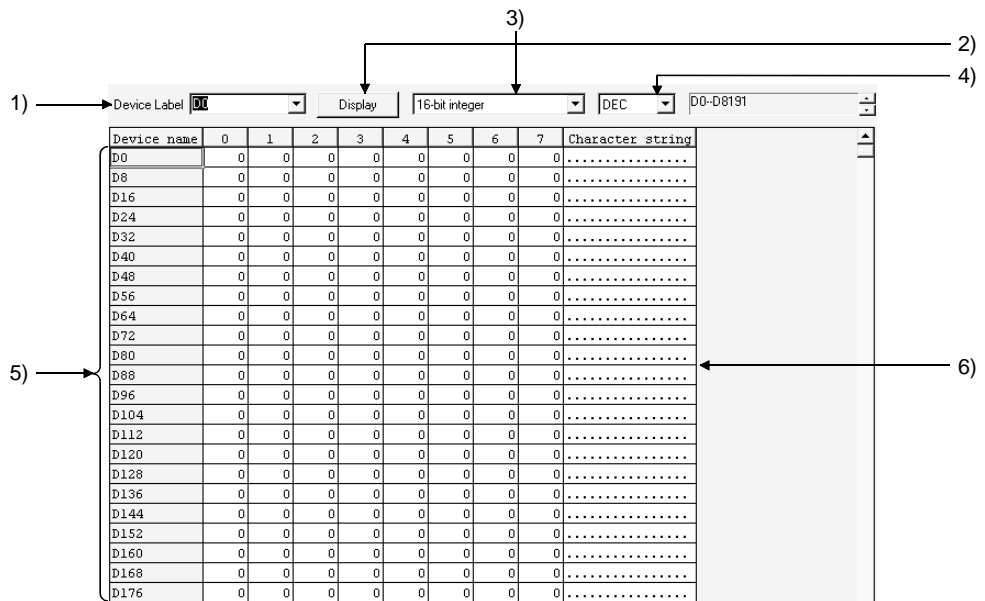

[Description]

1) Device name

The types of devices that can be edited are listed below:

A series

| Device Name | Symbol |
|-------------------------|--------|
| Timer (Current value) | T |
| Counter (Current value) | C |
| Retentive timer | ST |
| Data register | D |
| Special register | SD |
| Link register | W |
| File register | R |

Q/QnA series

| Device Name | Symbol |
|---------------------------------|-----------|
| Timer (Current value) | T |
| Counter (Current value) | C |
| Retentive timer (Current value) | ST |
| Data register | D |
| Special register | SD |
| Link register | W |
| Link special register | SW |
| File register | R |
| Through file register | ZR*1 |
| I/O No. setting | U**/G*** |
| Link No. setting | J**/W*** |
| | J**/SW*** |

*: The Q00JCPU cannot use R and ZR.

FX series

| Device Name | Symbol | FX ₀ FX _{0S} | FX _{0N} | FX ₁ | FX, FX ₂ FX _{2C} | FX _{1S} | FX _{1N} | FX _{2N} FX _{2NC} |
|-----------------------|--------|-------------------------------------|------------------|-----------------|---|------------------|------------------|---------------------------------------|
| Data register | D | ○ | ○ | ○ | ○ | ○ | ○ | ○ |
| Special data register | D | ○ | ○ | ○ | ○ | ○ | ○ | ○ |
| File register | D | — | ○ | — | ○ | ○ | ○ | ○ |
| RAM file register | D | ○ | — | — | ○ | — | — | — |

○ Can be edited — : No corresponding device.

- 2) **Display** button
Click this button after a device has been set.
- 3) Display switching
You can change the screen values to the 16-bit integer, 32 bit integer, fixed decimal point or floating decimal point.
- 4) Display switching
Switches the display form on the edit screen between decimal and hexadecimal.
- 5) Device Value Input
The device value input ranges are as follows.

| Display Format Changing | Numeric Input Range | |
|-------------------------|---|---------------------------|
| 16-bit integer | Decimal | -32768 to 32767 |
| | Hexadecimal | 0000 to FFFF |
| 32-bit integer | Decimal | -2147483648 to 2147483647 |
| | Hexadecimal | 00000000 to FFFFFFFF |
| Fixed decimal point | According to the number of integer part digits <Example> If the number of integer part digits is 9 0, 0.01 to 999999999 -999999999 to -0.01 | |
| Floating decimal point | -3.402823e+38 to 3.402823e+38 | |

To enter a character string (ASCII) in the device value input field, move the cursor to the desired device number and set the data.
The number of characters accepted is 64.

- 6) Character string input field
Move the cursor to the position where you want to set data, and enter the characters or press the space key. The following dialog box then appears.



The maximum number of characters that may be entered is 64.

If there is the existing data, the 16 characters of the character string in the selected position appear as a default.

Enter the character string (ASCII) data as follows.

<Example> To set "Device memory input"

Entering "Device memory input" in the D0 to D7 position of the character string input column sets the data, starting from D0.

The first setting position of data is always the device number of a multiple of 8, e.g. D0, D8, D16 ...



When copying/pasting the character string field that has no data, the following dialog box appears.

Note that clicking the **OK** button will set ".." (2E2EH) as data.

- 7) Device number change (ZR only)
When setting ZR, click the ▲ or ▼ button to change the device number in steps of 32K points.

POINTS

- When setting the device memory on a Personal computer
You can edit or save without following the parameter setting range.
- When performing PC write
Write the range set in the parameter.
- Refer to Section 6.4 for retrieval and substitution of device memory.
- A2N(S1), A2A(S1), A2U(S1), and A2US(S1) are set so that the default value of the device memory is 1024 points at the read/write to them. Change the range setting to within 512 points when data is read or written to A2N, A2A, A2U, or A2US.
- Device memory data can be cut (copied)/pasted only between GX Developers. Data cannot be guaranteed if cut (copy)/paste is performed between GX Developer and another application.
Use GX Converter to divert data between other applications.

11.3 All Clear

11.3.1 Clearing all devices

| | | |
|-----------------------|-----------------------|-----------------------|
| A | Q/QnA | FX |
| <input type="radio"/> | <input type="radio"/> | <input type="radio"/> |

[Purpose]

Clears all device values for which device memory is set.

[Operating Procedure]

Display the device memory edit window, and select [Edit] → [Clear all (all clear)].

11.3.2 Clearing all display devices

| | | |
|-----------------------|-----------------------|-----------------------|
| A | Q/QnA | FX |
| <input type="radio"/> | <input type="radio"/> | <input type="radio"/> |

[Purpose]

Clears device values displayed in the window, for which device memory is set.

[Operating Procedure]

Display the device memory edit window, and select [Edit] → [Clear all (displayed devices)].

11.4 Making Fill Settings

| | | |
|-----------------------|-----------------------|-----------------------|
| A | Q/QnA | FX |
| <input type="radio"/> | <input type="radio"/> | <input type="radio"/> |

[Purpose]

Writes the same data to consecutive devices in batch.

[Operating Procedure]

Display the device memory edit window, and select [Edit] → [FILL] or press  .

[Dialog Box]

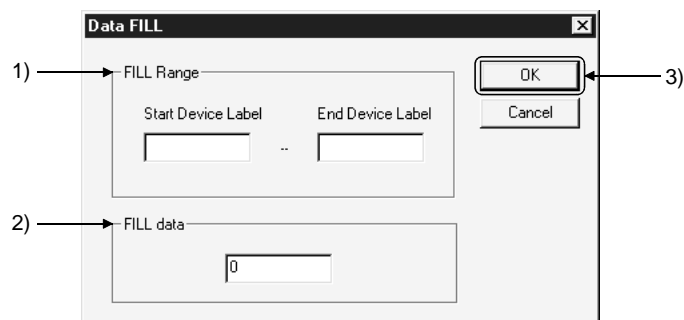

[Description]

- 1) FILL Range
Designates the devices to which the same data will be batch-written.
<Example of device designation>
D10-D20, T0-T30
- 2) FILL data
Designates the data to be batch-written.
Designate the data in the numeric form on the device memory edit window.
- 3)  button
Click this button after the setting has been completed.

12. SETTING DEVICE INITIALIZATION VALUES

| | | |
|---|-------|----|
| A | Q/QnA | FX |
| × | ○ | × |

[Purpose]

Utilizes the device values set in the device memory edit dialog box as device initial values.

[Operating Procedure]

Set the type and name of the data to be added in the dialog box displayed by selecting [Project] → [Edit data] → [New].

[Dialog Box]

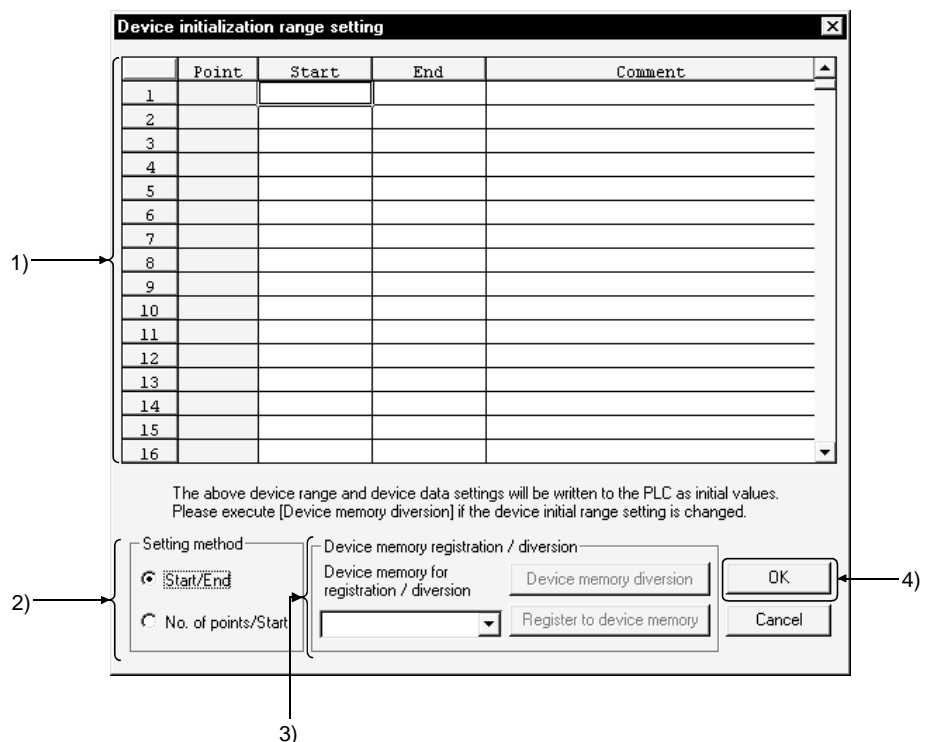

[Description]

1) Range to be set

Up to 8,000 points (8k words) can be set within a range.
Each comment can be set within 32 characters.

The devices, which can be treated as initial values, are listed below:

| Device Name | Device |
|-----------------------|--------------------------|
| Timer | The present value of T. |
| Retentive Timer | The present value of ST. |
| Counter | The present value of C. |
| Data register | D |
| Special register | SD |
| Link register | W |
| Link special register | SW |
| File register | R, ZR |
| Special direct device | U*IG* |
| Link direct device | J*W*, J*SW* |

- 2) Setting method
Set the range of the devices to be set for device initial values by specifying [Start/End] or [No. of point/start] Device
- 3) Device memory registration diversion
 Device memory diversion button
 All devices
 All devices set in the device initial value range setting dialog box are entered as device initial values.
- <Example>
D0-D10, W0-W30
- Register to device memory button
 The data set to the device initial values are reflected on the device memory.
 The data not set to the device initial values are not reflected.
- 4) button
 Click this button after the setting has been completed.

[Operating procedure] (Device data diversion)

1. Create new device memory.
2. Create device initial values in the device memory edit dialog box.
3. Create new device initial values.
4. Set the device initial values in the device initial value range setting dialog box.
5. Click the Device memory diversion button.
6. Choose All devices or Range to be set and click the Execute button.
7. Click the OK button in the device initial value range setting dialog box.
If you click Cancel, the data are not reflected.

| | |
|---|--|
| POINT | |
| To treat each device value, to which the range is set, as an initial value when starting the PLC, use the PLC file setting function for PLC parameters. | |

13. SETTING THE PARAMETERS

This manual explains only operations for the parameters. For any information or particular explanation required for parameter setting, refer to the corresponding CPU user's manual and programming manual to pre-design them. The setting items are assigned to the tab screen purpose-by-purpose.

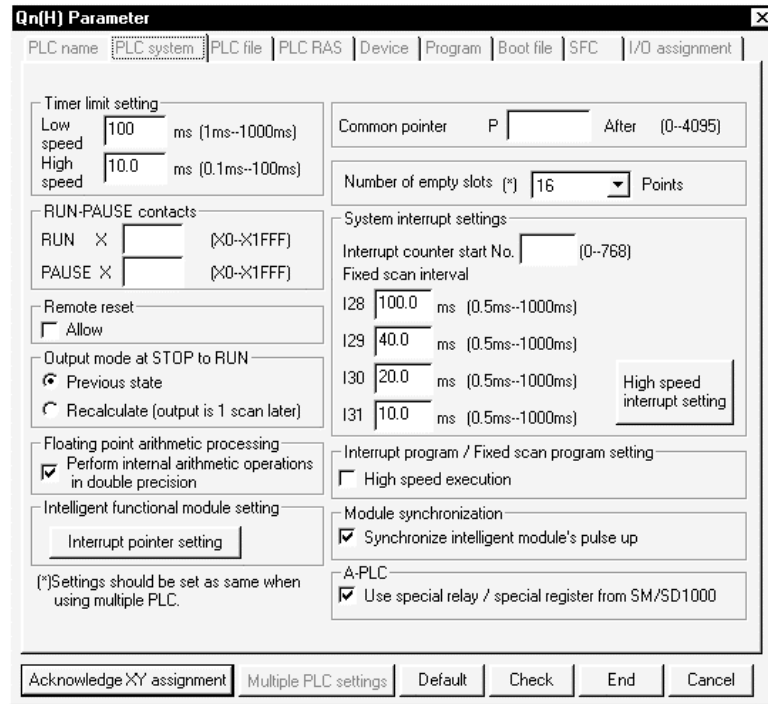

REMARKS

The following comparison table indicates the parameter item setting locations of GPPA and GX Developer because of the differences between them.

| GPPA | | GX Developer/GPPQ |
|--|--|-------------------|
| LATCH RANGE | | Device |
| Supplementary settings | | |
| STEP RELAY, TIMER, COUNTER | | Device |
| RUN-PAUSE contacts, Output mode at STOP to RUN, Interrupt counter | | PLC system |
| WDT setup, Operating mode when there is an error, Annunciator display mode | | PC RAS |
| Data communications request batch processing | | PLC system |
| MINI automatic refresh setting | | Network parameter |
| Network/link setting | | Network parameter |

The following comparison table indicates the parameter item setting locations of FXGP(DOS), FXGP(WIN) and GX Developer because of the differences between them.

| FXGP (DOS) | FXGP (WIN) | GX Developer |
|------------------------------|------------------------------|------------------------|
| Latch range | Latch range | Device setting |
| Program title setting | Print title setting | PLC name setting |
| PLC mode setting | PLC mode setting | PLC system setting (1) |
| Serial communication setting | Serial communication setting | PLC system setting (2) |
| — | Device assignment | I/O assignment setting |

<Network parameter screen examples>

[MELSECNET/Ethernet setting screen] (for Q series)

| | Module 1 | Module 2 | Module 3 | Module 4 |
|------------------|-------------------------------|------------------------------|-------------------------------|------------------------------|
| Network type | MNET/H mode (Control station) | MNET/H mode (Normal station) | MNET/H mode (Control station) | Ethernet |
| Starting I/O No. | 0000 | 0020 | 0040 | 0060 |
| Network No. | 1 | 2 | 3 | 4 |
| Total stations | 10 | 10 | 10 | 10 |
| Group No. | 1 | 2 | 3 | 4 |
| Station No. | 1 | 2 | 3 | 4 |
| Mode | On line | On line | On line | On line |
| | Network range assignment | Station inherent parameters | Network range assignment | Operational settings |
| | Refresh parameters | Refresh parameters | Refresh parameters | Initial settings |
| | Interrupt settings | Interrupt settings | Interrupt settings | Open settings |
| | Return as control station | Return as control station | Return as control station | Routing information |
| | | | | MNET/I/O routing information |
| | | | | FTP Parameters |
| | | | | E-mail settings |
| | | | | Interrupt settings |

[MELSECNET/MINI setting screen] (for QnA series)

No. of boards in Boards 0: MELSECNET MINI unit is not recognized.
Blank: Operation is by the default values.

| | 1 | 2 | 3 | 4 | 5 | 6 | 7 | 8 |
|-------------------------------------|----------|---|---|---|---|---|---|---|
| Start I/O No. | | | | | | | | |
| Model name | MINI-S3 | | | | | | | |
| Station count | | | | | | | | |
| Batch refresh receive data | X1000 | | | | | | | |
| Batch refresh send data | Y1000 | | | | | | | |
| Retry | 5 | | | | | | | |
| Response | PLC | | | | | | | |
| Error data clear | Clear | | | | | | | |
| Abnormal station detection bit data | | | | | | | | |
| Abnormal communication remote | | | | | | | | |
| Circuit error check | Maintain | | | | | | | |
| STOP time operation | Stop | | | | | | | |

Setting item

[CC-Link setting screen] (for Q series)

No. of boards in Boards Blank: no setting 0 boards: Set by the sequence program.

| | 1 | 2 | 3 | 4 |
|--------------------------------------|--------------------------|---|---|---|
| Start I/O No. | | | | |
| Operational settings | Operational settings | | | |
| Type | Master station | | | |
| Master station data link type | PLC parameter auto start | | | |
| Mode | Online (Remote net mode) | | | |
| All connectcount | 64 | | | |
| Remote input(RX) | | | | |
| Remote output(RY) | | | | |
| Remote register(RWrl) | | | | |
| Remote register(RWwl) | | | | |
| Special relay(SB) | | | | |
| Special register(SW) | | | | |
| Retry count | 3 | | | |
| Automatic reconnection station count | 1 | | | |
| Wait master station No. | | | | |
| PLC down select | Stop | | | |
| Scan mode setting | Asynchronous | | | |
| Delay information settings | 0 | | | |
| Station information settings | Station information | | | |
| Remote device station initial | Initial settings | | | |
| Interrupt settings | Interrupt settings | | | |

Indispensable settings[No setting / Already set] Set if it is needed[No setting / Already set]

Setup item details:

13.1 Setting the PLC Parameters

| | | |
|---|-------|----|
| A | Q/QnA | FX |
| ○ | ○ | ○ |

The following table lists the PLC parameter setting items on a series basis.
Set the parameters as required.

| | A | QnA | Q | | | FX |
|----------------------|---|-----|---|--------------|------------|----|
| | | | Q02(H)/Q06H/ Q12H/Q12PH/ Q25H/Q25PH | Q00J/Q00/Q01 | Remote I/O | |
| PLC name | × | ○ | ○ | ○ | × | ○ |
| PLC system | ○ | ○ | ○ | ○ | ○ | ○ |
| PLC file | × | ○ | ○ | ○*1 | × | × |
| PLC RAS | ○ | ○ | ○ | ○ | ○ | × |
| Device | ○ | ○ | ○ | ○ | × | ○ |
| Program | × | ○ | ○ | × | × | × |
| Boot file | × | ○ | ○ | ○ | × | × |
| SFC | × | ○ | ○ | × | × | × |
| I/O assignment | ○ | ○ | ○ | ○ | ○ | ○ |
| Memory capacity | ○ | × | × | × | × | ○ |
| Operational settings | × | × | × | × | ○ | × |
| Serial | × | × | × | ○ | × | × |

*1: The Q00CPU is not compatible with PLC file

13.1.1 Common Notes on Parameters

| | | |
|---|-------|----|
| A | Q/QnA | FX |
| ○ | ○ | ○ |

[Parameter display]

This part describes the setting item tabs and network parameter setting items.

<Example>

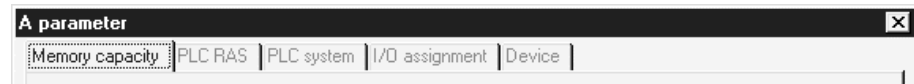

The meanings of the symbols are the same also when displayed with network parameters.

Red : The PLC does not operate until data is set. (Data is not set.)

Blue : Data is set.

Magenta : The PLC operates without setting data or with the default. (Data is set.)

Dark blue : Data is set. (Data is set.)

[Common notes on parameters]

This part describes the settings common to PLC and network parameters.

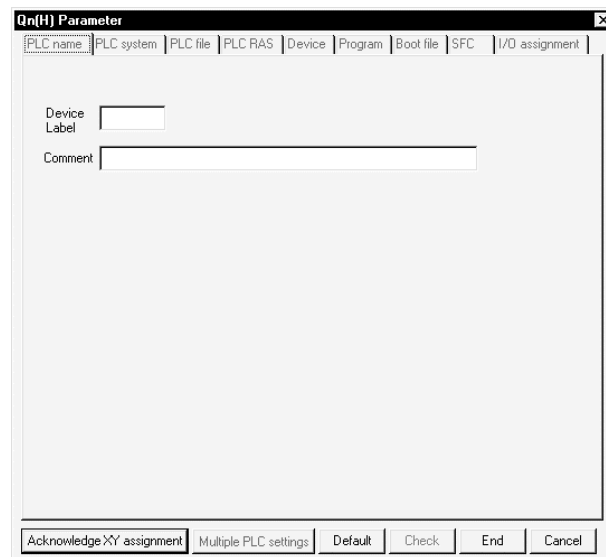

Default button

Returns all of the set items or values to the previous settings.
This button is available only for the currently open tab.

Check button

Used to check the set items or values to see if they are correct.
This button is available only for the currently open tab.

End setup

Defines the set items or values and terminates the setting.

Cancel button

Cancels the set items and terminates editing.

Acknowledge X/Y Assignment button

This button is available for the models A2ACPU(S1), A3ACPU, A2AS(S1), A2AS-S30, A2AS-S60, A2UCPU(S1), A2USCPU(S1), A2USHCPU(S1), A3UCPU, A4UCPU, and QnACPU, QCPU(Q mode).

It is used to confirm the X/Y assignment numbers of the data set in the I/O assignment setting.

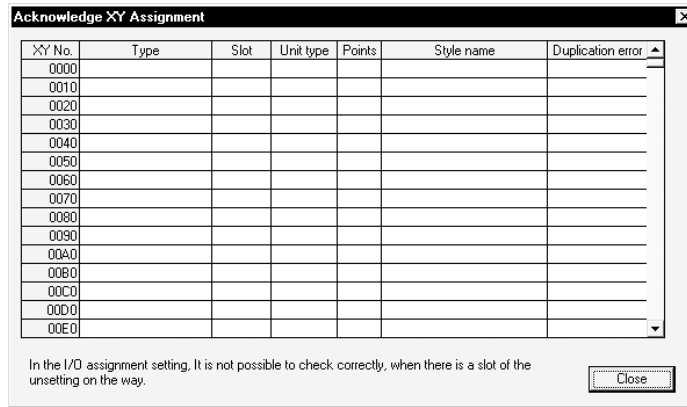

Display by type

| Display | Description |
|----------------|---|
| I/O assignment | Displays I/O assignment information. |
| MINI | Displays I/O assignment information and MINI automatic refresh setting information. |
| CC-Link | Displays I/O assignment information and CC-Link automatic refresh setting information. |
| NET (II) | Master station : Displays I/O assignment information and refresh parameter information. |
| | Local station : Displays I/O assignment information and refresh parameter information. |
| NET/10 | PLC-to-PLC network, remote I/O network : Displays network parameter information. |

The priority of display is shown below:

1. I/O assignment (AnACPU, AnUCPU, Q/QnA series)
2. Fourth MELSECNET network refresh parameter (AnUCPU, Q/QnA series)
3. Third MELSECNET network refresh parameter (AnUCPU, Q/QnA series)
4. Second MELSECNET network refresh parameter (AnUCPU, Q/QnA series)
5. First MELSECNET network refresh parameter (AnUCPU, Q/QnA series)
6. MELSECNET/MINI refresh (AnACPU, AnUCPU, QCPU (A mode)/QnA series)
7. CC-Link remote I/O (Q/QnA series)

The Duplicate Error area displays the first duplicate item detected in checking the items according to the priority.

| Duplicate Error | Description |
|-----------------|------------------------------------|
| First NET | First MELSECNET network parameter |
| Second NET | Second MELSECNET network parameter |
| Third NET | Third MELSECNET network parameter |
| Fourth NET | Fourth MELSECNET network parameter |
| MINI | MELSECNET/MINI refresh |
| CC-Link | CC-Link remote I/O |

Multiple PLC setting button

Setting cannot be made for Q00J/Q00/Q01CPU and remote I/O projects.

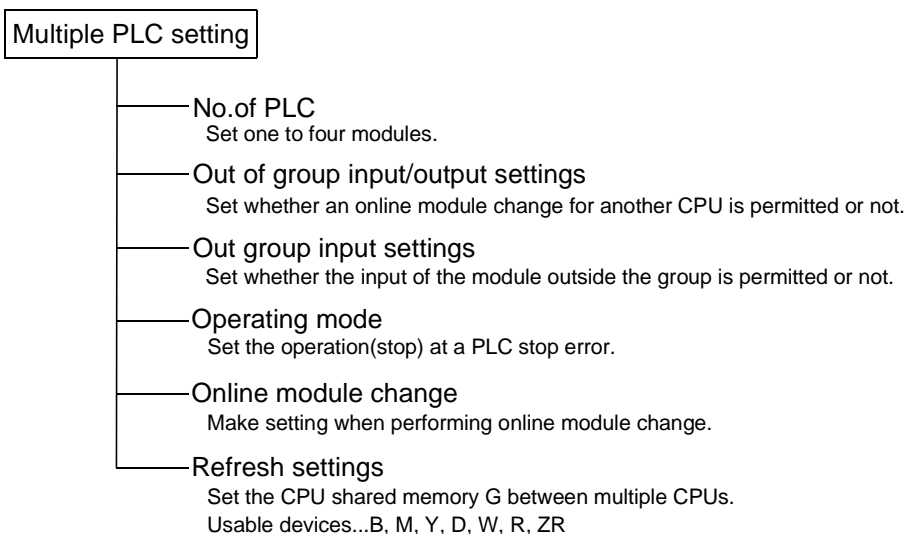

[Description]

No. of PLC

Clicking the **Default** button in I/O assignment keeps the multiple PLC setting unchanged.

When the set number of PLCs is one, a multiple CPU system configuration is not set.

Out group input settings

When the modules are not grouped, they are all put under the control PLC of the PLC No. 1.

OPERATION ERROR appears if access is made to any module outside the groups.

Refresh settings

The maximum input range of each module is 0 to 2048 points.

Set the total number of all modules to within 4096 points.

Diversion of multiple PLC parameter button

Specify the project to be diverted from the "Open Project" screen. Setting the source project shows the multiple PLC parameter diversion dialog box. Confirm the message and execute.

13.1.2 PLC Parameter Item Lists

| A | Q/QnA | FX |
|---|-------|----|
| ○ | ○ | ○ |

The PLC parameter items of each series are listed below.

(1) PLC parameter item list of the Q02(H)/Q06H/Q12H/Q25HCPU

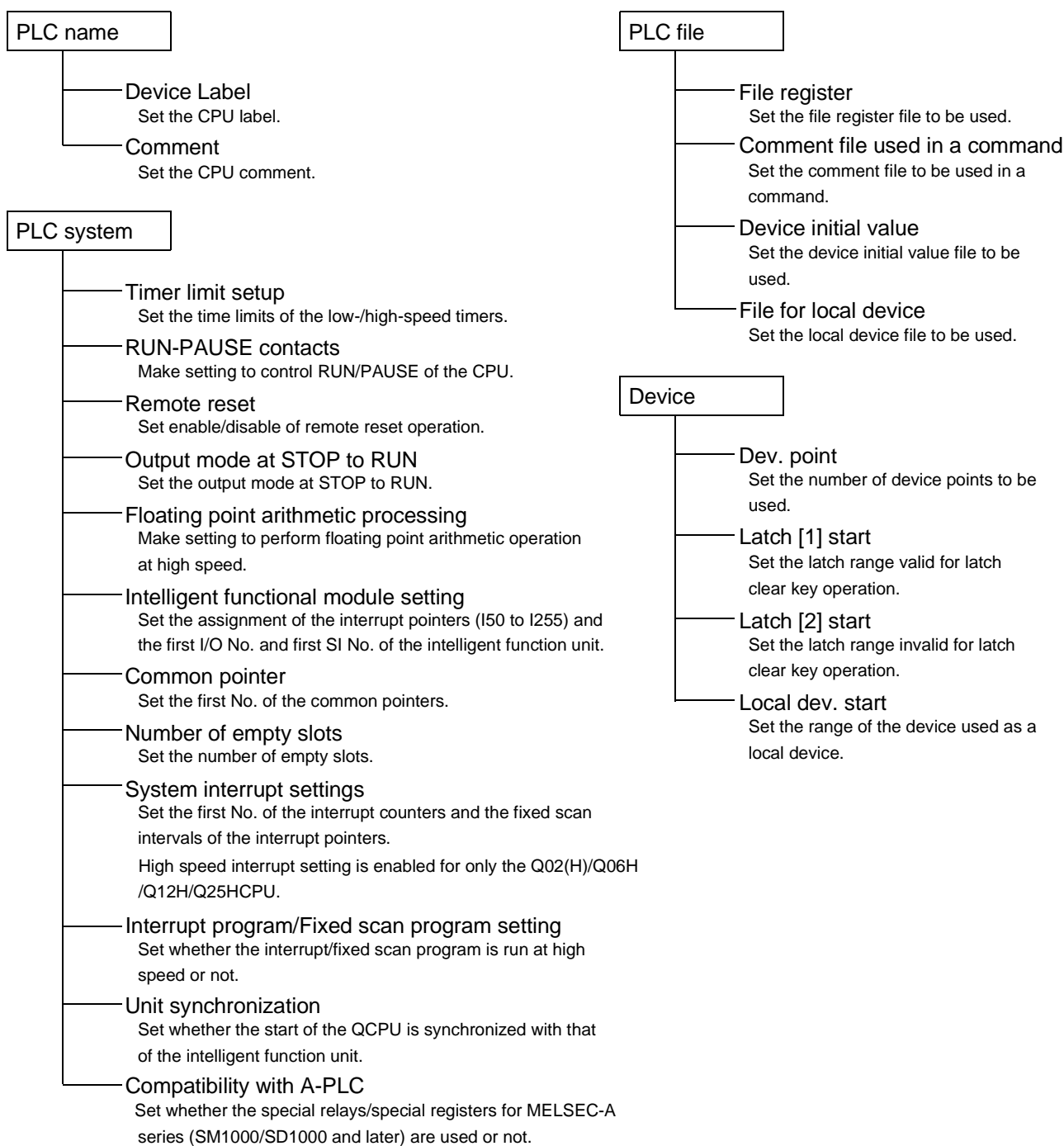

PLC RAS

- **WDT [Watchdog timer] setup**
Set WDT setting, Initial execution and Low speed execution of the PLC CPU.
- **Error check**
Set whether the specified error is to be detected or not.
- **Operating mode when there is an error**
Set the display mode of the CPU on detection of an error.
- **Constant scanning**
Set the constant scan time.
- **Low speed program execution time**
Set the time for execution of a low-speed program.
- **Breakdown history**
Set the storage target of the CPU's breakdown history.

Program

- **Program**
Set the execution type for use of multiple programs.

Boot file

- **Boot file setup**
Set the boot-run file, etc.

SFC

- **SFC**
Make various settings needed for an SFC program.

I/O assignment

- **I/O assignment**
 - Set each unit loading status of the system.
 - Make switch settings of the intelligent function module.
- Reserve the multiple CPUs.
(Refer to the items common to the PLC parameters for the multiple PLC setting.)
- **Standard setting**
Set the base model, power supply module model, etc.

(2) PLC parameter item list of the Q00J/Q00/Q01CPU

PLC name

- Device Label
Set the CPU label.
- Comment
Set the CPU comment.

PLC file

(Setting is disabled for Q00J)

- File register
Set the file register file to be used.
(Setting is fixed)

PLC system

- Timer limit setup
Set the time limits of the low-/high-speed timers.
- RUN-PAUSE contacts
Make setting to control RUN/PAUSE of the CPU.
- Remote reset
Set enable/disable of remote reset operation.
- Output mode at STOP to RUN
Set the output mode at STOP to RUN.
- Number of empty slots
Set the number of empty slots.
- System interrupt settings
Set the first No. of the interrupt counters and the fixed scan intervals of the interrupt pointers.
- Interrupt program/Fixed scan program setting
Set whether the interrupt/fixed scan program is run at high speed or not.
- Unit synchronization
Set whether the start of the QCPU is synchronized with that of the intelligent function unit.

Device

- Dev. point
Set the number of device points to be used.
- Latch [1] start
Set the latch range valid for latch clear key operation.
- Latch [2] start

PLC RAS

- WDT [Watchdog timer] setup
 - └ WDT setting
Make WDT settings of the CPU.
- Error check
Set whether the specified error is to be detected or not.
- Operating mode when there is an error
Set the display mode of the CPU on detection of an error.
- Constant scanning
Set the constant scan time.

Boot file

- Boot file setup
Set the boot-run file, etc.

I/O assignment

- I/O assignment
 - Set each unit loading status of the system.
 - Make switch settings of the intelligent function module.
Reserve the multiple CPUs.
- Standard setting
Set the base model, power supply module model, etc.

Serial

- Baud rate
Set the baud rate.
- Sum check
Set the sum check.
- Transmission weight time
Set the transmission wait time.
- RUN write setting
Set whether online program change can be made or not.

(3) PLC parameter item list for Q series remote I/O station

PLC system settings

- Number of vacant slot points
Set the number of vacant slot points.
- Module synchronization setting
Set whether a QCPU startup is synchronized with an intelligent function module startup or not.

I/O assignment settings

- I/O assignment settings
 - Set the module loading states of the system.
 - Make the switch settings of the intelligent function module.
- Basic settings
 - Set the base type, power supply module type, etc.

PLC RAS settings

- Error check
Set whether the specified error will be detected or not.
- Operating mode when there is an error
Set whether operation will be stopped or not at occurrence of a fuse blown or I/O module comparison error.

Operation settings

- Remote I/O station switch settings
Set cyclic communication error-time output hold and output hold designation enable.
- Inter-device transfer parameters
Set the link device range, etc. for communication with the I/O and special function modules of each remote I/O station.

(4) PLC parameter item list of the QnA series

PLC name

- Device label
Set the CPU label.
- Comment
Set the CPU comment.

PLC system

- Timer limit setup
Set the time limits of the low-/high-speed timers.
- RUN-PAUSE contacts
Make setting to control RUN/PAUSE of the CPU.
- Remote reset
Set enable/disable of remote reset operation.
- Output mode at STOP to RUN
Set the output mode at STOP to RUN.
- General data processing
Set the number of units to be handled by single general data processing.
- Common pointer
Set the first No. of the common pointers.
- Number of empty slots
Set the number of empty slots.
- System interrupt settings
Set the first No. of the interrupt counters and the fixed scan intervals of the interrupt pointers.

PLC file

- File register
Set the file register file to be used.
- Comment file used in a command
Set the comment file to be used in a command.
- Device initial value
Set the device initial value file to be used.
- File for local device
Set the local device file to be used.

Device

- Dev. point
Set the number of device points to be used.
- Latch [1] start
Set the latch range valid for latch clear key operation.
- Latch [2] start
Set the latch range invalid for latch clear key operation.
- Local dev. start
Set the range of the device used as a local device.

PLC RAS

- WDT [Watchdog timer] setup
 - WDT setting
 - Initial execution
 - Low speed execution
Set the WDT timers of the CPU.
- Error check
Set whether the specified error is to be detected or not.
- Operating mode when there is an error
Set the display mode of the CPU on detection of an error.
- Constant scanning
Set the constant scan time.
- Low speed program execution time
Set the time for execution of a low-speed program.
- Annunciator display mode
 - Display F No.
 - Display comment
 - Display occurrence time
 Set the display mode established when the annunciator has turned on.
- Breakdown history
Set the storage target of the CPU's breakdown history.

SFC

- SFC
Make various settings needed for an SFC program.

I/O assignment

- I/O assignment
Set each unit loading status of the system.
- Standard setting
Set the base model, power supply unit model, etc.

Program

- Program
Set the execution type for use of multiple programs.

Boot file

- Boot file setup
Set the boot-run file, etc.

(5) PLC parameter item list of the A series

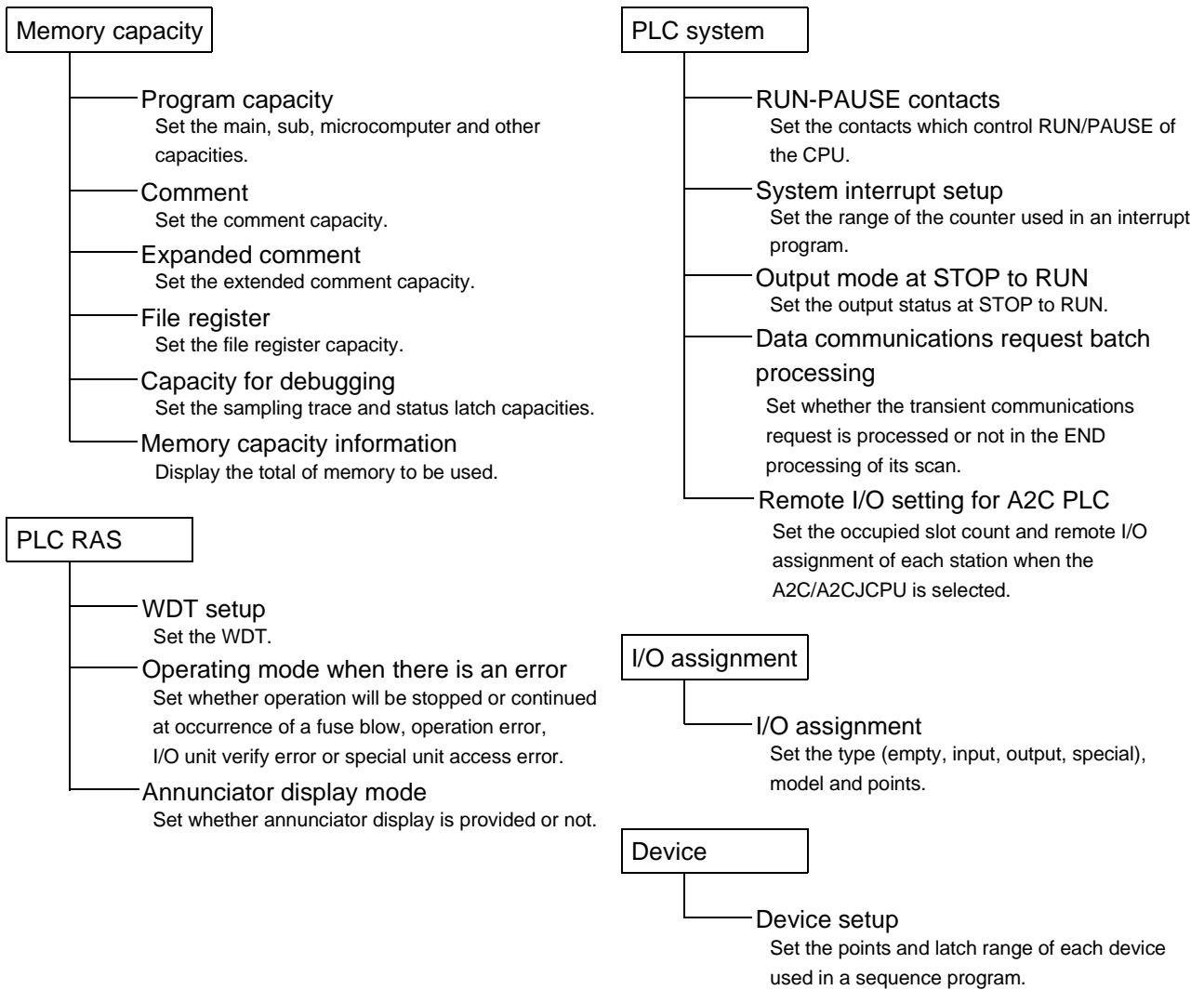

(6) PLC parameter item list of the FX series

Memory capacity

- Memory capacity
Set the memory capacity that the PLC has.
- Comment capacity
Set the comment capacity.
- File register capacity
Set the file register capacity.
- Program capacity
Set the sequence program capacity.

Device

- Device setup
Set the latch range.

PLC name

- PLC name
Comment the PLC program.

I/O assignment

- I/O assignment
Set the first/last values of the I/O relays.

PLC system (1)

- Battery less mode
Make this setting when performing operation without the memory backup battery of the FX_{2N} or FX_{2NC} PLC.
- MODEM initialized
Set the modem initialization command when making remote access to the FX_{1S}, FX_{1N}, FX_{1NC}, FX_{2N} and FX_{2NC} PLC.
- RUN terminal input
When using the input (X) of the FX_{1S}, FX_{1N}, FX_{1NC}, FX_{2N} and FX_{2NC} PLC as the external RUN/STOP terminal, set its input number.

PLC system (2)

- Protocol
Set the communication protocol.
- Data length
Set the data length.
- Parity
Set the parity.
- Stop bit
Set the stop bit.
- Baud rate
Set the baud rate.
- Header
Set the header.
- Terminator
Set when making the terminator valid.
- Control line
Set when making the control line valid.
- H/W type
Normally choose RS-232 or RS-485.
- Control mode
Display the control mode data.
- Sum check
Set when adding sum check.
- Transmission control procedure
Choose format 1/format 4.
- Station number setting
Make station number setting.
- Time out judge time
Set the time-out period.

13.1.3 Explanations for PLC Parameter Setting Screen

| | | |
|---|-------|----|
| A | Q/QnA | FX |
| × | ○ | × |

The following items are related to network parameter setting.

1. **Read PLC data** button
Location of Read PLC data button
[PLC parameter] → (I/O assignment) tab

For Q series

The implementation status is read if the parameter file exists in the PLC.

If the unit model, first X/Y, base model, power supply unit model, extension cable model and slot count have been set on the Personal computer, the data will be deleted.

If the parameters have been set on GX Developer, the following dialog box appears to ask you if the parameter data may be overwritten.

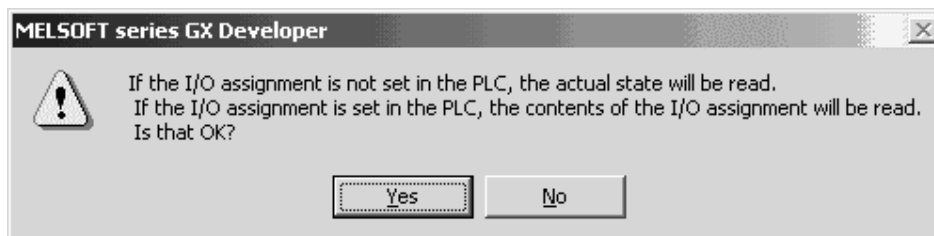

For QnA series

When the parameter file exists in the PLC

- The parameter file is read.

When the parameter file does not exist in the PLC (implementation read)

- After deleting the parameter file in the PLC, set the PLC from RESET to RUN and read the PLC data.

If the unit model, first X/Y, base, power supply unit and extension cable have been set on the Personal computer, the data will be deleted.

13.2 Setting the Network Parameters

| | | |
|---|-------|----|
| A | Q/QnA | FX |
| ○ | ○ | × |

The following table lists the network parameter setting items on a series basis.
Set the parameters as required.

| | A | | | QnA | Q | |
|----------------|--------|--------|----------------------------|-----|-----|---------------|
| | AnNCPU | AnACPU | AnUCPU QCPU (A mode) | | CPU | Remote I/O |
| MELSECNET | ○ | ○ | ○ | ○ | × | × |
| MELSECNET II | × | ○ | ○ | ○ | × | × |
| MELSECNET/10 | × | × | ○ | ○ | ○ | × |
| MELSECNET/H | × | × | × | × | ○ | × |
| MELSECNET/MINI | × | ○ | ○ | ○ | × | × |
| CC-Link | × | × | × | ○ | ○ | ○ |
| Ethernet | × | × | × | ○ | ○ | ○ |

13.2.1 About Items Common to the Network Parameters

[Purpose]

This section describes operations common to the setting of data link system and network system parameters.

The setting examples use MELSECNET II comp (Master station) and MELSECNET/10 network range assignment parameters.

The following operations cannot be performed as those common to the parameters.

- Cut, copy, paste
- [Home] and [End] keys are invalid.

[Dialog Box]

<Example> MELSECNET II combined (master station) network range assignment parameter setting window

| L/R station No. | Send range for each station | | | Send range for each station | | | M station -> R station | | | M station <- R station | | |
|-----------------|-----------------------------|-------|-----|-----------------------------|-------|-----|------------------------|-------|-----|------------------------|-------|-----|
| | First half LB | | | First half LW | | | LW | | | LW | | |
| | Points | Start | End | Points | Start | End | Points | Start | End | Points | Start | End |
| M 0 | | | | | | | | | | | | |
| L 1 | | | | | | | | | | | | |
| L 2 | | | | | | | | | | | | |
| L 3 | | | | | | | | | | | | |
| L 4 | | | | | | | | | | | | |
| L 5 | | | | | | | | | | | | |
| L 6 | | | | | | | | | | | | |
| L 7 | | | | | | | | | | | | |
| L 8 | | | | | | | | | | | | |
| L 9 | | | | | | | | | | | | |

[Description]

[Specify local] / [Specify remote] / [Specify MNET II local] button

Move the cursor to the L/R station No. to be specified, and click the corresponding button.

[Assign the same point to each station] button

Used to assign the same point to each local station.

[Clear] button

Used to default the preset parameters.

[Check] button

Used to check the preset parameter data.

[End setup] button

Clicking this button at the end of data setting returns to the network setting screen.

[Dialog Box]

<Example> MELSECNET/10 network range assignment

[Description]

I/O Master station specification button

Using Switch screens to choose LX/LY settings enables the I/O master station to be specified. To set the I/O master station, specify the station number with the cursor and click the **I/O Master station specification** button.

Reserved station specification button

Specify the reserved station No. and click this button.

Equal assignment button

Used to assign the link device points of all stations equally.

The first and last stations can be set within the number of stations between the first and last equally assigned station numbers (total number of link stations - (first station number - 1)).

Identical point assignment button

Used to make simple assignment with the same points according to the preset total number of stations.

Supplementary settings button

Used to set the constant scan, max. number of reconnected stations during 1 scan, multiple transmission, communications error setting and transient setting.

Station inherent parameters button

Used to change the network unit storage locations of the link devices assigned to each station in the common parameters.

Clear button

Used to default the parameter settings.

Check button

Used to check the preset parameter data.

End setup button

Clicking this button at the end of data setting returns to the network setting screen.

13.2.2 Network Parameter Item Lists

The network parameter items of each series are listed below.

(1) Network parameter items of the Q series

For the remote I/O project, only Ethernet or CC-Link may be set.

MELSECNET/H (Multiplexed remote master) and MELSECNET/H (Multiplexed remote sub) can be selected for only the Q12PH and Q25PHCPU.

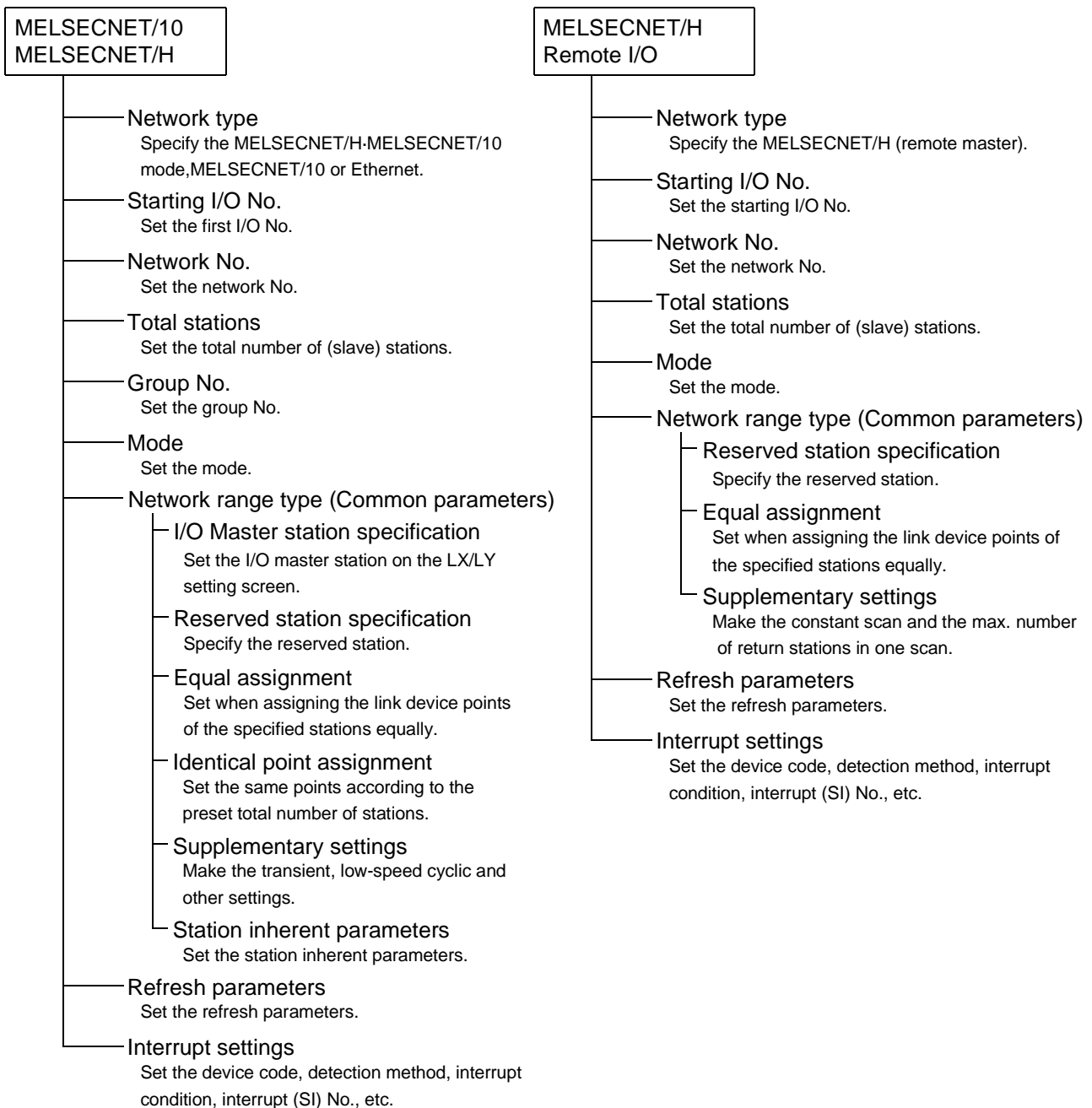

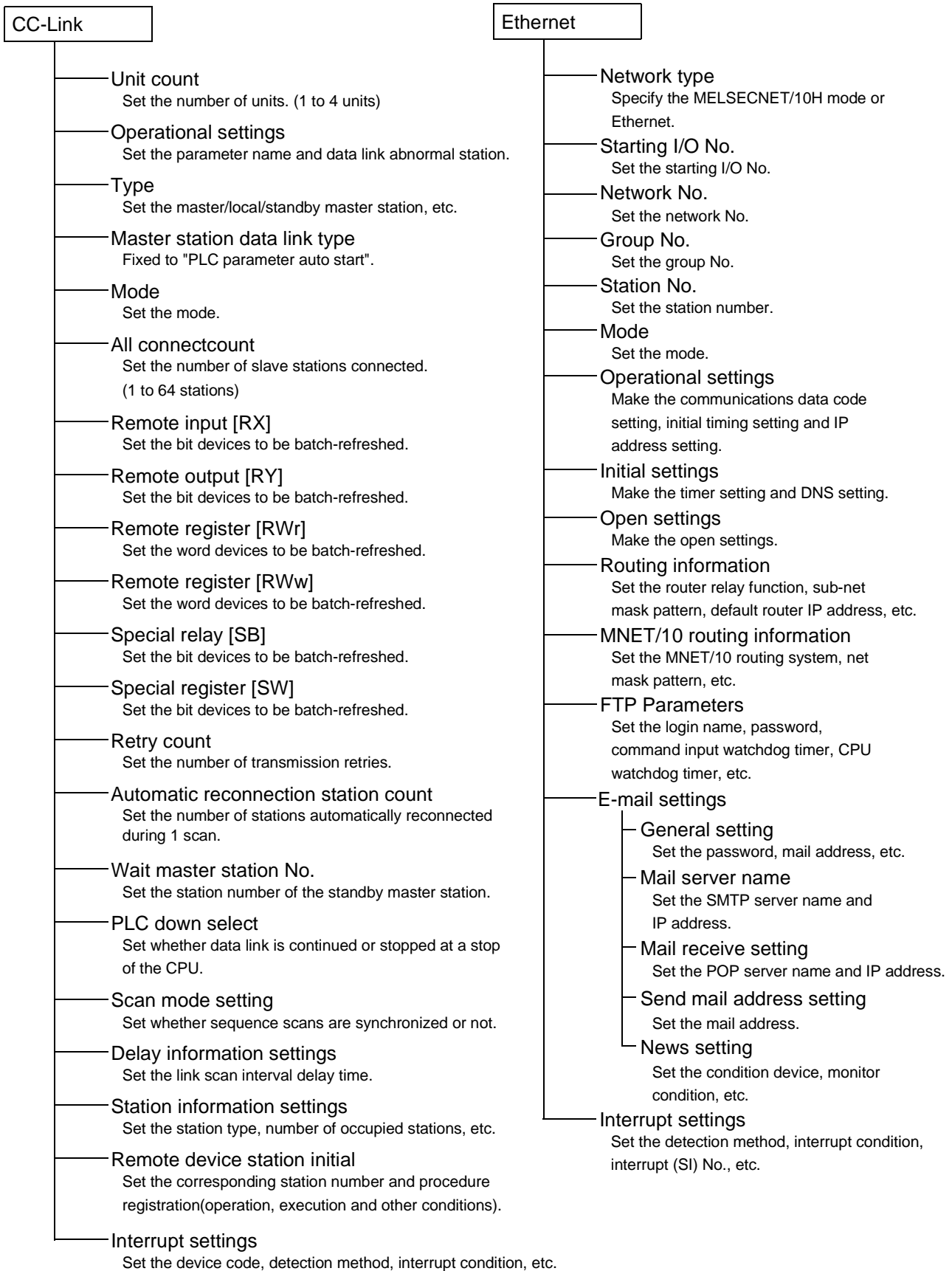

(2) Network parameter items of the QnA series

MELSECNET/10

- Network type
Specify the MELSECNET (II, /10) .
- Starting I/O No.
Set the first I/O No.
- Network No.
Set the network No.
- Total stations
Set the total number of (slave) stations.
- Network range type (Common parameters)
 - I/O Master station specification
Set the I/O master station on the LX/LY setting screen.
 - Reserved station specification
Specify the reserved station.
 - Equal assignment
Set when assigning the link device points of the specified stations equally.
 - Identical point assignment
Set the same points according to the preset total number of stations.
 - Supplementary settings
Make the transient, low-speed cyclic and other settings.
 - Station inherent parameters
Set the station inherent parameters.
- Refresh parameters
Set the refresh parameters.

Ethernet

- Network type
Specify Ethernet.
- Starting I/O No.
Set the first I/O No.
- Network No.
Set the network No.
- Group No.
Set the group No.
- Station No.
Set the station number.
- IP Address Settings
Set the IP address of the Ethernet unit.
- MNET/10 routing information
Set the MNET/10 routing system, net mask pattern, etc.
- FTP Parameters
Set the login name, password, command input watchdog timer, CPU watchdog timer, etc.
- Routing information
Set the router relay function, sub-net mask pattern, default router IP address, etc.

MELSECCNET/MINI

- Unit count
Set the number of units. (1 to 8 units)
- Model name
Set the model name of the MELSECCNET/MINI(S3) loaded.
- Station count
Set the total number of remote I/O stations.
- Batch refresh receive data
Set the receive data for batch refresh.
- Batch refresh send data
Set the send data for batch refresh.
- Retry
Set the number of retries made to the remote I/O station where a communications fault occurred.
- Response
Set whether access to the master unit buffer memory is assigned to "link" priority or "CPU" priority.
- Error data clear
Set whether the data of the station in communications error is cleared or held.
- Abnormal station detection bit data
Set the device where the abnormal station detection data will be stored.
- Abnormal communication remote
Set the device where the error code at error occurrence will be stored.
- Circuit error check
Set the transmission status at occurrence of a circuit error.
- STOP time operation
Set whether link is stopped or continued at STOP of the CPU.

CC-Link

- Unit count
Set the number of units. (1 to 4 units)
- Operational settings
Set the parameter name and data link abnormal station.
- Type
Set the master/local/standby master station, etc.
- Master station data link type
Fixed to "PLC parameter auto start".
- Mode
Set the mode.
- All connectcount
Set the number of slave stations connected. (1 to 64 stations)
- Remote input [RX]
Set the bit devices to be batch-refreshed.
- Remote output [RY]
Set the bit devices to be batch-refreshed.
- Remote register [RWr]
Set the word devices to be batch-refreshed.
- Remote register [RWw]
Set the word devices to be batch-refreshed.
- Special relay [SB]
Set the bit devices to be batch-refreshed.
- Special register [SW]
Set the bit devices to be batch-refreshed.
- Retry count
Set the number of transmission retries.
- Automatic reconnection station count
Set the number of stations automatically reconnected during 1 scan.
- Wait master station No.
Set the station number of the standby master station.
- PLC down select
Set whether data link is continued or stopped at a stop of the CPU.
- Scan mode setting
Set whether sequence scans are synchronized or not.
- Delay information settings
Set the link scan interval delay time.
- Station information settings
Set the station type, number of occupied stations, etc.

POINT

CC-Link parameters cannot be set to the Q4ARCPU.

(3) Network parameter items of the A series

MELSECNET (II, /10)

- Network type
Specify the MELSECNET (II, /10) .
- Starting I/O No.
Set the first I/O No.
- Network No.
Set the network No.
- Total stations
Set the total number of (slave) stations.
- Network range type (Common parameters)
 - I/O Master station specification
Set the I/O master station on the LX/LY setting screen.
 - Reserved station specification
Specify the reserved station.
 - Equal assignment
Set when assigning the link device points of the specified stations equally.
 - Identical point assignment
Set the same points according to the preset total number of stations.
 - Supplementary settings
Make the transient, link start indication and other settings.
 - Station inherent parameters
Set the station inherent parameters.
- Refresh parameters
Set the refresh parameters.

MELSECNET/MINI

- Unit count
Set the number of units. (1 to 8 units)
- Model name
Set the model name of the MELSECNET/MINI(S3) loaded.
- Station count
Set the total number of remote I/O stations.
- Batch refresh receive data
Set the receive data for batch refresh.
- Batch refresh send data
Set the send data for batch refresh.
- Retry
Set the number of retries made to the remote I/O station where a communications fault occurred.
- Response
Set whether access to the master unit buffer memory is assigned to "link" priority or "CPU" priority.
- Error data clear
Set whether the data of the station in communications error is cleared or held.
- Abnormal station detection bit data
Set the device where the abnormal station detection data will be stored.
- Abnormal communication remote
Set the device where the error code at error occurrence will be stored.
- Circuit error check
Set the transmission status at occurrence of a circuit error.
- STOP time operation
Cannot be set for the A series.

13.2.3 Explanations for Network Parameter Setting Screen

The following items are related to network parameter setting.

1. Unit valid for other station access
This setting is made valid when there are multiple units which are used without specifying the network No. or when the network No. has not been set for access to the other station.
2. **Read PLC data** button
Reads the implementation status.

For QnA series

Always delete the parameter file of the PLC before reading the implementation status.

The parameter file is read if the parameter file exists in the PLC.

3. Remote I/O project
You can set up to four Ethernet modules and CC-Link modules, respectively.
4. "MELSOFT connection" in Ethernet connection (Q Series only)
This setting is used when connecting multiple MELSOFT products such as GX Developer (a maximum of 17 units) using the TCP/IP communication system.

Setting procedure

Ethernet → Open settings → Protocol (TCP) → Open system (MELSOFT connection)

The screen below gives a setting example when user connections 14 to 16 are used to connect MELSOFT products, while connections 1 to 5 are used to communicate with non-MELSOFT products via a MC protocol communication, fixed-buffer communication, etc.

| | Protocol | Open system | Fixed buffer | Fixed buffer communication | Pairing open | Existence confirmation | Local station Port No. | Destination IP address | Dest. Port No. |
|----|----------|--------------------|--------------|----------------------------|--------------|------------------------|------------------------|------------------------|----------------|
| 1 | TCP | Active | Receive | Procedure exist | No pairs | No confirm | 0621 | No Settings | |
| 2 | TCP | Active | Send | Procedure exist | No pairs | No confirm | 0612 | 192.0.1.200 | 0821 |
| 3 | TCP | Active | Receive | Procedure exist | No pairs | No confirm | 0623 | No Settings | |
| 4 | TCP | Active | Send | Procedure exist | No pairs | No confirm | 0614 | No Settings | |
| 5 | UDP | | Send | Procedure exist | No pairs | No confirm | 0735 | 192.0.1.201 | 1000 |
| 6 | | | | | | | | | |
| 7 | | | | | | | | | |
| 8 | | | | | | | | | |
| 9 | | | | | | | | | |
| 10 | | | | | | | | | |
| 11 | | | | | | | | | |
| 12 | | | | | | | | | |
| 13 | | | | | | | | | |
| 14 | TCP | MELSOFT connection | | | | | | | |
| 15 | TCP | MELSOFT connection | | | | | | | |
| 16 | TCP | MELSOFT connection | | | | | | | |

Used for various communications. (Rows 1-5)

Used to connect MELSOFT products. (Rows 14-16)

REMARKS

For the Q series, Read PLC data is not available for the network parameters.

13.3 Setting the Remote Password

| | | |
|---|-------|----|
| A | Q/QnA | FX |
| ○ | ○* | × |

※: The Q00J, Q00 and Q01CPUs are incompatible.

[Purpose]

Set the password to prevent access by other than the intended user since remote access can be made via the Q-compatible E71 and serial communication module (Q series).

Refer to Appendix 7 to confirm the version of the PLC CPU with which this function is compatible.

[Operating Procedure]

Select Project list - [Parameter] - [Remote Pass].

Select Toolbar project change - [Parameter] - [Remote Pass].

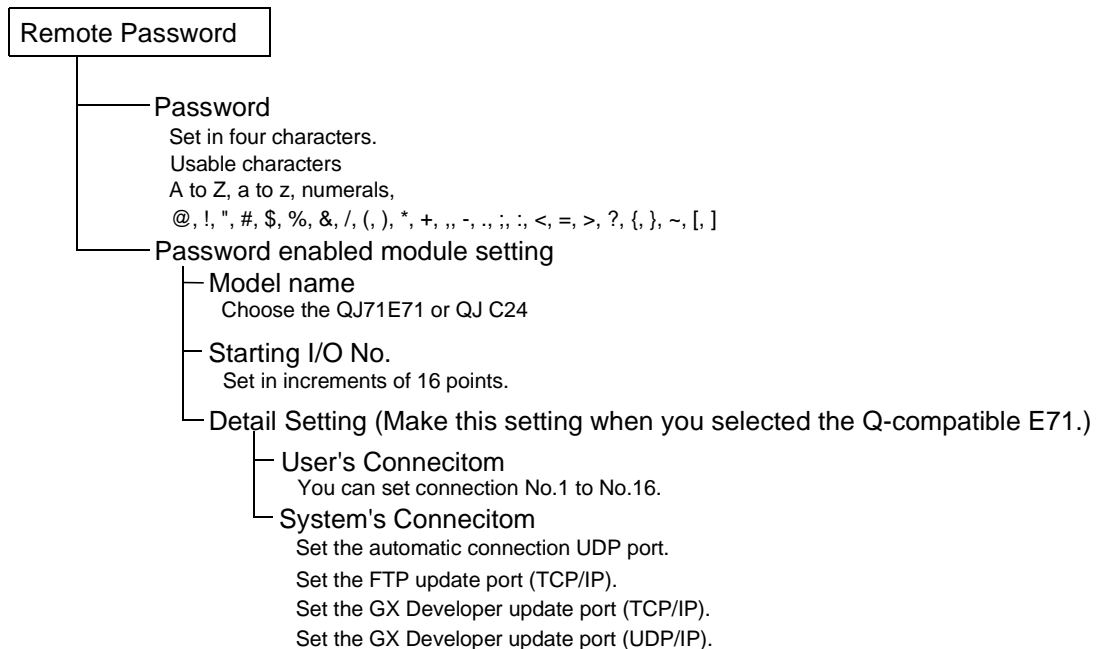

| POINT |
|---|
| <ul style="list-style-type: none"> Refer to Section 16.3 for the operating procedure used to access the PLC CPU where the remote password has been registered. The remote password is made invalid under any of the following conditions. <ol style="list-style-type: none"> The project ends. The connection setup is changed. The PLC type is changed (only when the PLC series changes). |

14. PRINT

This chapter describes how to print data, including sequence programs created by a GX Developer, device comments, and set parameters, on a printer from a personal computer.

[Outline of operations to printing]

Shown below is the basic flow of steps to printing.

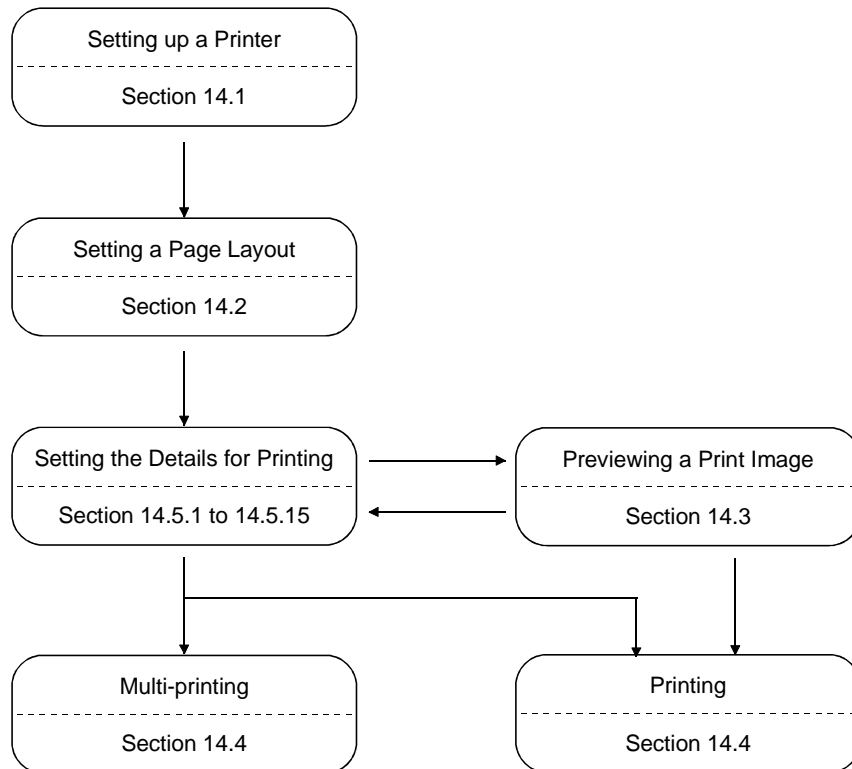

14.1 Setting Up a Printer

| | | |
|-----------------------|-----------------------|-----------------------|
| A | Q/QnA | FX |
| <input type="radio"/> | <input type="radio"/> | <input type="radio"/> |

[Purpose]

Selects a printer for printing and sets the paper size, the printing orientation, and other printing format-related items.

[Operating procedure]

Select [Project] → [Printer setup] or click  ([Ctrl] + [P]) and the **Printer setup** button.

[Dialog box]

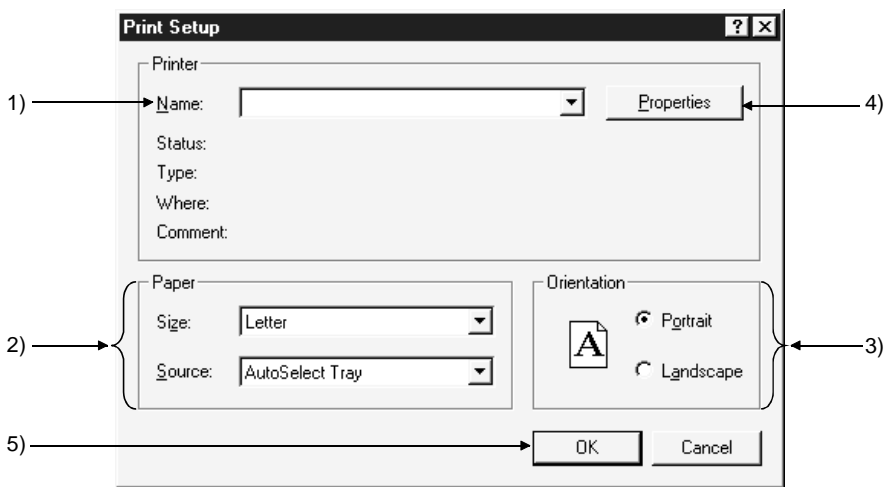

[Description]

- 1) **Printer**
Selects a printer for printing.
- 2) **Paper**
Sets the size of the paper for printing and the paper feed method of the printer. The setting range depends on the printer.
- 3) **Orientation**
 - Portrait**
Characters will be printed along the paper feed direction.
 - Landscape**
Characters will be printed across the paper feed direction.
- 4) **Properties** button
Clicking this button displays the properties dialog box. The printer property option is used to make the basic settings of the printer.
- 5) **OK** button
Click this button after the printer setting is completed.

| |
|--------|
| POINTS |
|--------|

- A printer model operable, whose performance was verified by Mitsubishi, is available.
HP Laser Jet 4000N
- Consult the operation manual for the selected printer for the printer properties that depend on the printer manufacturer and the printer model.
- To print large quantities of data, open the printer property window from the control panel of Windows[®] 95, and select "Print directly to the printer" for the spool setting.

14.2 Setting a Page Layout

| | | |
|---|-------|----|
| A | Q/QnA | FX |
| ○ | ○ | ○ |

[Purpose]

Makes settings related paper, page number, header, and so on.

[Operating procedure]

Select [Project] → [Printing] and click the **Page setup** button, or click  (**Ctrl** + **P**) then the **Page setup** button.

[Dialog box]

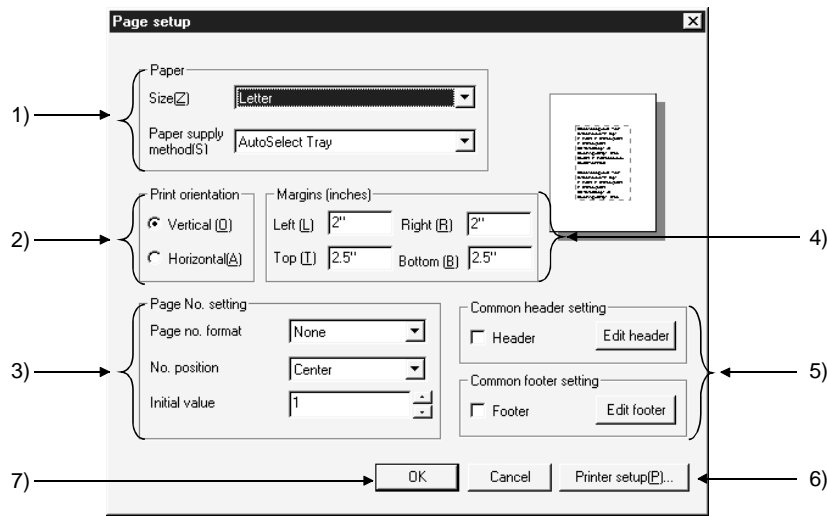

[Description]

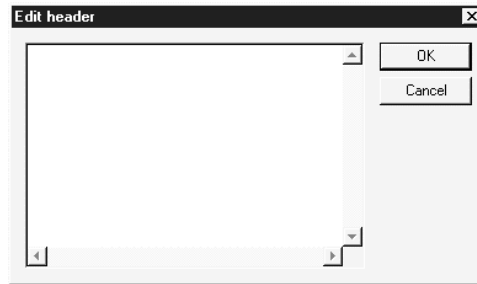

- 1) Paper
Sets paper size and paper feed method.
- 2) Print orientation
Sets the orientation of printing on paper.
- 3) Page No. setting
 Page no. form..... When page numbers are not required, set "None"
 The symbol "-* *- " indicates that page numbers starting from the initial value will be printed by item. However, serial number will be printed when the data to be printed is more than one page long.
 The symbol "* *- * *- " indicates that page numbers starting from the initial number will be printed according to the printing order set in the Multi-Printing dialog box.
 No. position..... Sets the position of page numbers.
 Initial value..... Sets the page number to be printed on the first page.

- 4) Margins
Sets the margins of the page.
- 5) Common header setting
By checking off the check box, a header will be printed on each page.
Click the **Edit header** button, and the Header Edit dialog box as shown below will be displayed.



Alternatively, clicking the **Edit footer** button displays the Footer Edit dialog box like the Header Edit dialog box.
The header (or footer) can be edited within the range of 64 characters x seven lines.
Lines and images cannot be edited, and characters cannot be decorated.

- 6) **Printer setup** button
By clicking this button, the printer dialog box will be displayed (see Section 14.1.).
- 7) **OK** button
Click this button after the page setting is completed.

| POINT |
|---|
| <ul style="list-style-type: none"> • If the print characters are small, reduce the value of margin setting. • When the mouse button is clicked while the shape of the mouse pointer is , the window zooms in. When the mouse button is clicked while the shape of the mouse pointer is , the data is displayed in the standard scale. |

POINTS

- The printing date will be printed automatically in the header (footer) by setting "#YY-MM-DD#" in the Header (Footer) Edit dialog box.
The PC type will also be printed automatically in the header (footer) by setting "#CPU#."

<Example>

#YY-MM-DD#
#CPU#

<Printing example>

98-03-01
A3U

- Entered character patterns and printed characters

| Character Pattern | Function | Remarks |
|-------------------|------------------------------------|--|
| #YY-MM-DD# | Date (year-month-day) | / |
| #YYYY-MM-DD# | Date (year-month-day) | |
| #YY/MM/DD# | Date (year/month/day) | |
| #YYYY/MM/DD# | Date (year/month/day) | |
| #YY# | Year (last two digits) | |
| #YYYY# | Year (four digits) | |
| #MM# | Month | |
| #DD# | Day | |
| #CPU# | CPU model | When setting characters after the CPU model, the total length of characters including the CPU model must not exceed 64 characters. Otherwise the CPU model may not be printed. |
| #PROJECT# | Project name | / |
| #PROJ_COMMENT# | Quick reference title of project | |
| #DATA# | Data name (MAIN, SUB1, etc.) | |
| #DATA_COMMENT# | Quick reference title of data name | |

To add a fixed character after the character pattern, insert a space after #CPU#.

<Example> Printed characters when A2USHCPU-S1 is selected

When no space is inserted after CPU

#CPU#_ABCD → Print → A2USH-S1ABCD

↑
Insert a space.

14.3 Previewing a Print Image

| | | |
|---|-------|----|
| A | Q/QnA | FX |
| ○ | ○ | ○ |

[Purpose]

The image of the entire page when it is printed will be displayed.

[Operating procedure]

Select [Project] → [Print] and click the **Print preview** button, or click  (**Ctrl** + **P**), then the **Print preview** button.

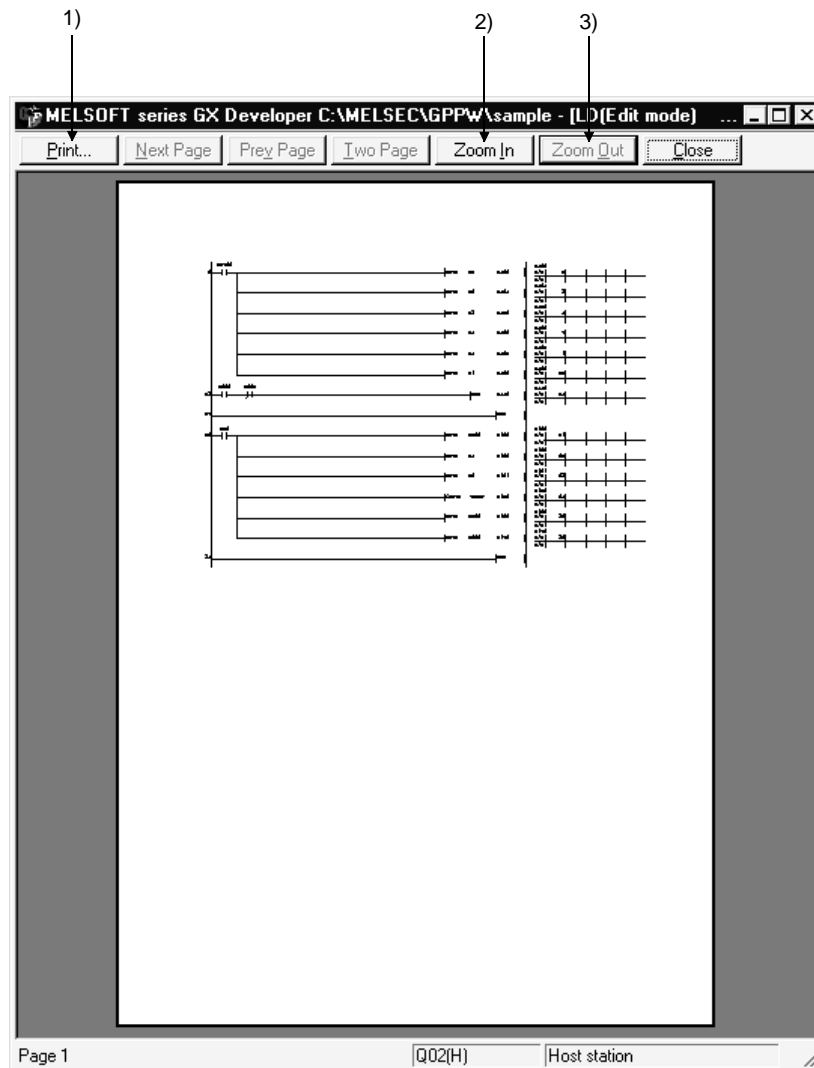

[Preview Window]



[Description]

- 1) **Print** button
The data displayed on the print preview window will be printed.
- 2) **Zoom In** button
The displayed image will be enlarged by clicking this button.
Data will be displayed in three different scales.
- 3) **Zoom Out** button
The displayed image will be reduced by clicking this button.

| |
|-------|
| POINT |
|-------|

- The print preview may be displayed only on page 1.
(It cannot be displayed on page 2 or later.)
However, only the parameters can be previewed on all pages. (Except X/Y assignment confirmation)
- When the mouse button is clicked while the shape of the mouse pointer is , the window zooms in.
When the mouse button is clicked while the shape of the mouse pointer is , the data is displayed in the standard scale.

14.4 Printing

| | | |
|-----------------------|-----------------------|-----------------------|
| A | Q/QnA | FX |
| <input type="radio"/> | <input type="radio"/> | <input type="radio"/> |

[Purpose]

Prints data, such as sequence programs and device comments.

Data can be printed in two ways: each volume of data will be printed or two or more volumes of data will be printed at a time.

[Operating procedure]

Select [Project] → [Print], or click  (**Ctrl** + **P**), then the **Print preview** button.

[Dialog box]

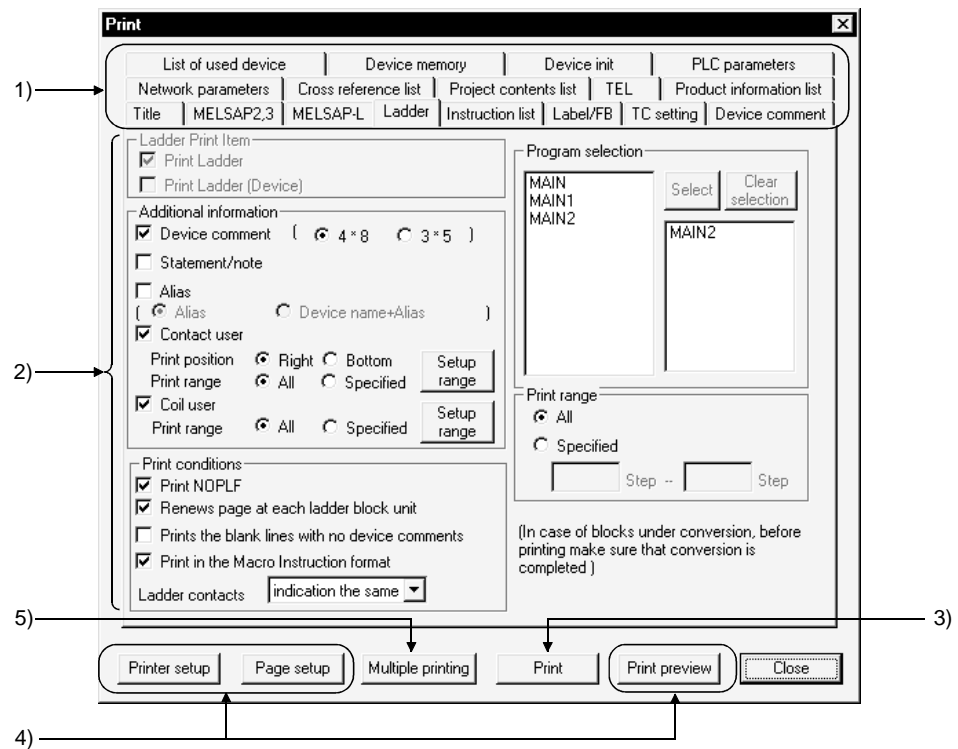

[Description]

- 1) Data print tabs
Clicking the required tab switches to the detail setting screen.
- 2) Sheet
Each sheet provides the items to be set to designate items and range of the data to be printed and other details.
Select each item by checking the check box to the left.
For details on each sheet, see Subsections 14.5.1 to 14.5.13.
- 3) **Print** button
Click this button after details have been set on each sheet.
The data of the displayed sheet will be printed.

- 4) **Related function**
By clicking on each button, the corresponding dialog box related to printing will be displayed. (See Sections 14.1, 14.2, and 14.3.)
- 5) **Multiple printing** button
By clicking this button, the Multiple Data Printing dialog box shown below will be displayed.
Two or more volumes of data will be printed at a time.

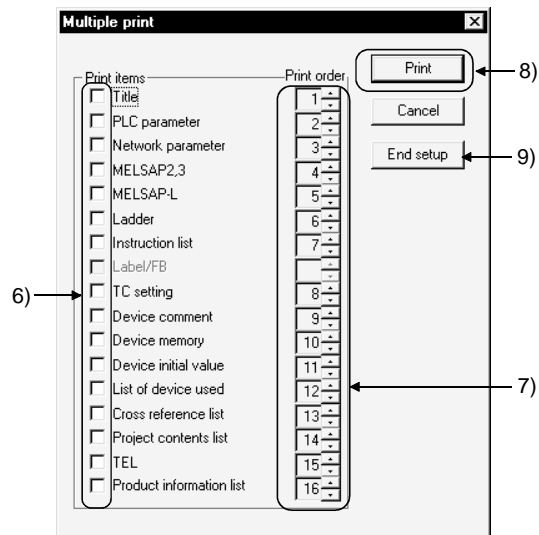

- 6) **Print items**
Select the data items to batch-print by checking the check box.
- 7) **Print order**
Sets the order in which each data will be printed.
Set the order number of each item using 
The order number of any data, which is not set to be printed, will be ignored.
- 8) **Print** button
By clicking this button, the data items with a checkmark ✓ will be batch-printed.
Select data items to batch-print by checking their check boxes.
- 9) **End setup** button
The data items to print will be set, and the initial setting dialog box will be displayed.

[Setting procedure]

1. After the printer setting is completed, display the print dialog box.
2. Open the page setting dialog box, and set the page format.
3. Open each sheet, and set details.
4. To confirm the image of the data when it is printed, click [Print preview].
5. Click the button 3) when printing data one by one.
The data displayed on the current sheet will be printed.
To batch-print two or more volumes of data, click the button 5).
The multiple data printing dialog box will be displayed.
6. Set the items to print 6) and the printing orders 7).
7. By clicking the button 8), the selected volumes of data will be batch-printed.

| |
|--------|
| POINTS |
|--------|

- | |
|--|
| <ul style="list-style-type: none">• In data-by-data printing, a ladder will be printed by clicking the <input type="button" value="Print"/> button when the <<Ladder>> sheet is displayed, or a device comment will be printed by clicking on the <input type="button" value="Print"/> button when the <<Device comment>> is displayed.• When the page number form "-* *- " is set in page setting for multiple data printing, the data will be printed in the set printing order, and serial page numbers will be printed.• Depending on the printer type, printer driver type/version, or set data, a part of the data may not be printed. If this problem occurs, change the setting of the printer driver. |
|--|

14.5 Setting the Details for Printing

Set details for printing, such as the range and contents of each data.
For a printing example of each data, see Section 14.6.

14.5.1 Creating a title

| | | |
|---|-------|----|
| A | Q/QnA | FX |
| ○ | ○ | ○ |

[Purpose]

Creates a title for the project to be printed.

[Operating procedure]

Select [Project] → [Print] and click the <<Title>> tab, or click  ([Ctrl] + [P]), then the <<Title>> tab.

[Dialog box]

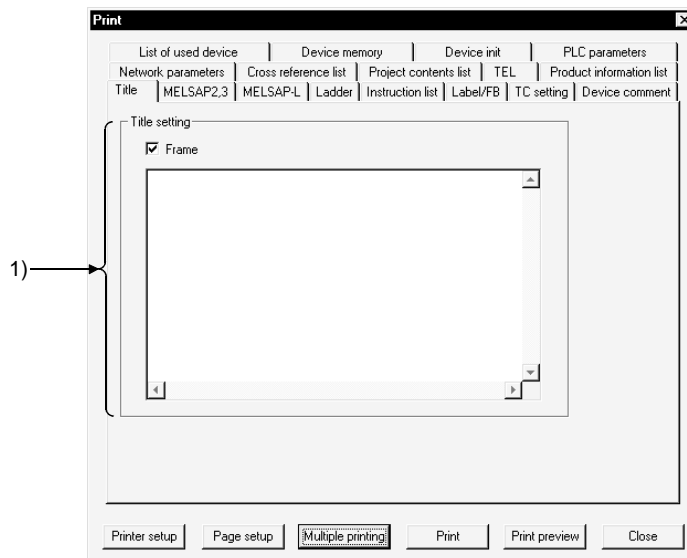

[Description of item]

1) Title setting

Edit the title within 64 characters x nine lines.

Lines and images cannot be edited, and characters cannot be decorated.

By checking the check box, the title edited will be framed.

The date will be printed automatically when a character pattern, such as "#YY-MM-DD#", is set.

On this dialog box, the date (#YY-MM-DD#) and the CPU model (#CPU#) can be set.

For input characters patterns, see Section 14.2.

14.5.2 Setting a ladder print range

| | | |
|---|-------|----|
| A | Q/QnA | FX |
| ○ | ○ | ○ |

[Purpose]

Sets details about ladder printing, such as the ladder print range and additional information.

[Operating procedure]

Select [Project] → [Print] and click the <<Ladder>> tab, or click  ([Ctrl] + [P]), then the <<Ladder>> tab.

[Dialog box]

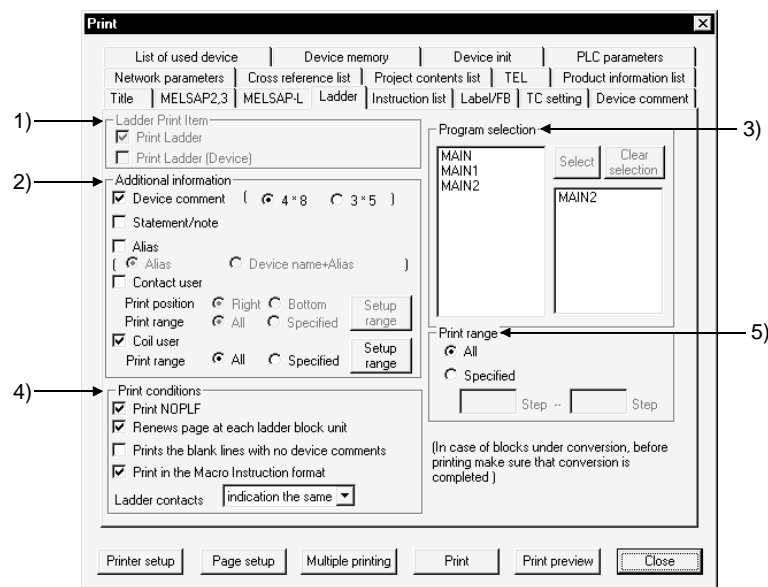

[Description]

- 1) Ladder print item (Label programming only)
 Print Ladder..... Printed as label name.
 Print Ladder (Device) Printed as actual device.
- 2) Additional information
 Any item with a checkmark ✓ will be added to the ladder to be printed.
 By clicking the **Setup range** button for contact using data or for coil using data, the following Device Range Setting dialog box appears.
 Set the head and final devices or the number of points and the head device of each range to be specified.

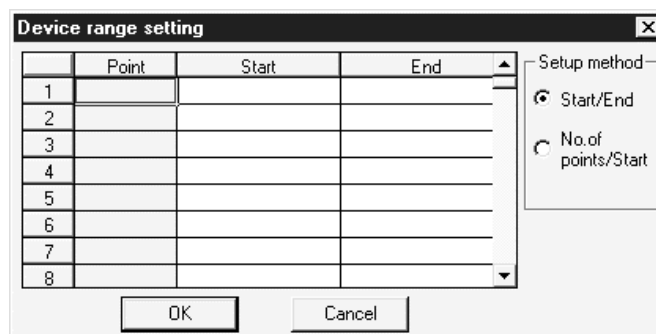

Destinations where contacts and coils are used

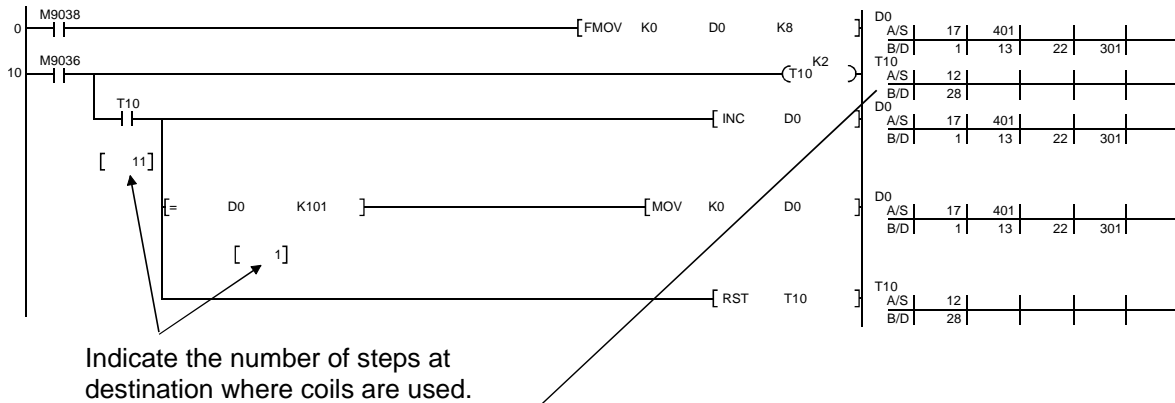

Indicate the number of steps at destination where coils are used.

• Destination where contacts are used

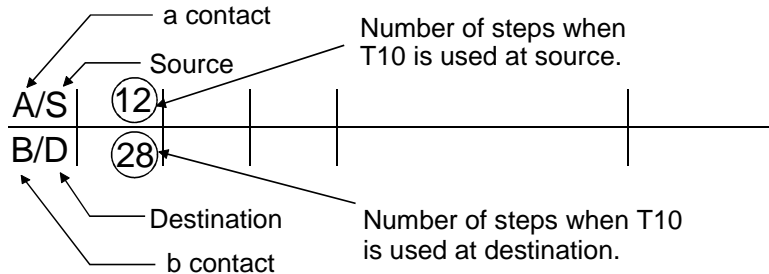

2) Program selection

If the program to be printed is not yet set, the data name of the program which is active in the ladder mode is automatically selected.

If the program to be printed is already set, the set program name appears. Using the mouse, select on the list a program to print, and click the **Select** button to set the selection.

Also, you can select and batch-print multiple sequence programs.

3) Print conditions

Sets the condition for printing the ladder.

- Print NOPLF (Except the FX series)
NOPLF will be printed by checking the check box.
- Renews page at each ladder block unit
Pages will be renewed by ladder block by checking the check box.
When the check box is not checked, pages will be renewed by ladder line.
- Prints the blank lines with no device comments
Any line without a device comment will also be printed by checking the check box.
- Printing in the macro instruction format (Except the FX series)
Prints the macro-input instructions in the macro format.
- Ladder contacts
Choose "indication the same", "9 contacts" or "11 contacts".

4) Print range

Sets the print range of the ladder.

- Ⓐ All
The entire range from step 0 to the END instruction of the program will be printed.
- Ⓑ Specified
The range between the specified steps will be printed.

POINT

Precautions

Printing condition

Pages will be fed at the position following an NOPLF instruction even if the NOPLF check box is not checked. (Except the FX series)

If the program is read from the GPPA by selecting [Project] → [Import file], the number of contacts to be displayed on a line is different between the GX Developer and the GPPA and the number of lines printed by the GPPA may therefore vary.

When feeding pages

Selected

Not selected

If there are two or more lines of contact using data under the above settings, pages will be fed in the middle of the lines. Pages will not be fed in the middle of the ladder and the coil using data.

14.5.3 Setting a Instruction list print range

| | | |
|-----------------------|-----------------------|-----------------------|
| A | Q/QnA | FX |
| <input type="radio"/> | <input type="radio"/> | <input type="radio"/> |

[Purpose]

Sets details about Instruction list printing, such as the list print range and additional information.

[Operating procedure]

Select [Project] → [Print] and click the <<Instruction list>> tab, or click  (**Ctrl** + **P**), then the <<Instruction list>> tab.

[Dialog box]

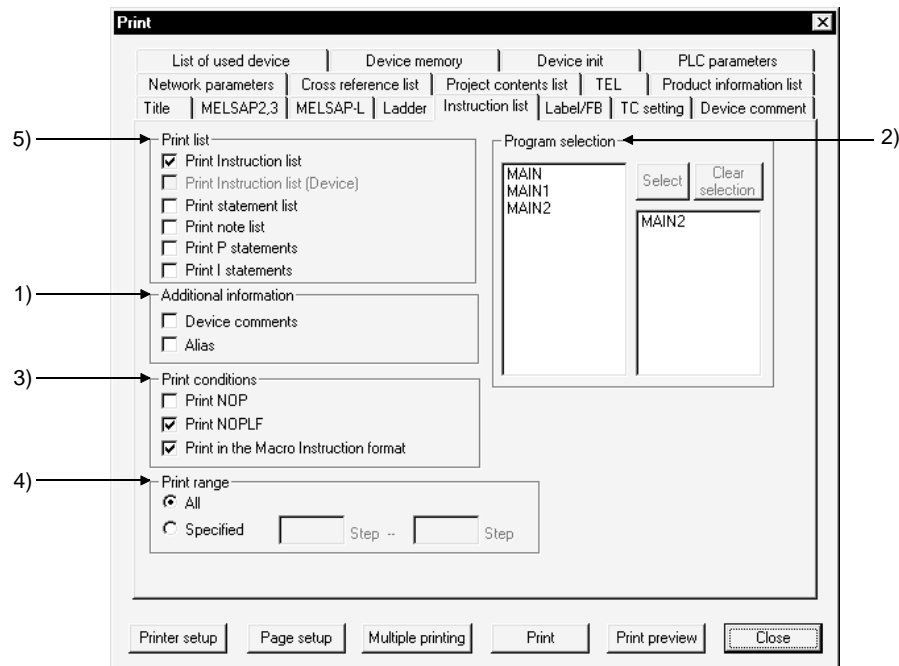

[Description]

- 1) **Additional information**
A device name will be added to the Instruction list.
Select this item by checking the check box.
- 2) **Program selection**
If the program to be printed is not yet set, the data name of the program which is active in the ladder mode is automatically selected.
If the program to be printed is already set, the set program name appears.
Using the mouse, select on the list a program to print, and click the **Select** button to set the selection.
Press the **Clear selection** button to clear the program selected.
- 3) **Print conditions**
Prints NOP
NOP will be printed by checking the check box.
Print NOPLF (Except the FX series)
NOPLF will be printed by checking the check box.
Printing in the macro instruction format (Except the FX series)
Prints the macro-input instructions in the macro format.

- 4) Print range
 - Set the print range of the list.
 - ⊙ All
 - The entire range from step 0 to the END instruction of the program will be printed.
 - ⊙ Specified
 - The range between the specified steps will be printed.

- 5) Print list
 - Print Instruction list (Device) prints the actual program in label programming.
 - Choose [Edit] → [Documentation] → [Statement/Note block edit] to print the created statements/notes.

| POINT | | | | | | | | | | | | | | | | | | | | | | | | | | | | | | | | | | | | | | | | | |
|--|------------|------------|------------|-------------|-------------|-------------|-------------|-------------|---|---|---|---|---|---|---|------------|------------|------------|------------|------------|------------|------------|------------|-----|--------|-----------|----|----------|----------|----------|----------|----------|-----|--------|-----------|----|-------------|-------------|-------------|-------------|-------------|
| <p>Precautions</p> <p>Printing condition Pages will be fed at the position following an NOPLF instruction even if the Printing NOPLF check box is not checked. (Except the FX series)</p> <p>Print range In setting the print range, enter both the start step and the end step, and the former must be larger than the latter. When two or more steps are specified as the start or end step for an instruction, or when the instruction includes the steps specified, the instruction will also be printed.</p> <p>When printing data on A4 portrait paper If the number of device characters of an instruction exceeds 80 on A4 portrait paper or 130 on A4 landscape paper, the excessive characters may not be printed. Any entire instruction or device within eight characters will be printed. If a device is more than eight characters long, the third device will not be printed completely. (All device characters will be printed on A3 landscape paper even if the number of characters is maximum.)</p> <p><Example> Printing on A4 portrait paper</p> <table border="1" style="width: 100%; border-collapse: collapse; text-align: center;"> <thead> <tr> <th style="width: 12.5%;">1</th> <th style="width: 12.5%;">2</th> <th style="width: 12.5%;">3</th> <th style="width: 12.5%;">4</th> <th style="width: 12.5%;">5</th> <th style="width: 12.5%;">6</th> <th style="width: 12.5%;">7</th> <th style="width: 12.5%;">8</th> </tr> </thead> <tbody> <tr> <td>1234567890</td> <td>1234567890</td> <td>1234567890</td> <td>1234567890</td> <td>1234567890</td> <td>1234567890</td> <td>1234567890</td> <td>1234567890</td> </tr> <tr> <td>123</td> <td>ERCALL</td> <td>"File001"</td> <td>P0</td> <td>ZR1000Z0</td> <td>ZR1100Z0</td> <td>ZR1200Z1</td> <td>ZR1300Z0</td> <td>ZR1400Z0</td> </tr> <tr> <td>123</td> <td>ERCALL</td> <td>"File001"</td> <td>P0</td> <td>J123W100Z12</td> <td>J123W100Z12</td> <td>J123W100Z12</td> <td>J123W100Z12</td> <td>J123W100Z12</td> </tr> </tbody> </table> <p style="text-align: center; margin-top: 10px;"> 80 characters Will not be printed. </p> | | | | | | | | 1 | 2 | 3 | 4 | 5 | 6 | 7 | 8 | 1234567890 | 1234567890 | 1234567890 | 1234567890 | 1234567890 | 1234567890 | 1234567890 | 1234567890 | 123 | ERCALL | "File001" | P0 | ZR1000Z0 | ZR1100Z0 | ZR1200Z1 | ZR1300Z0 | ZR1400Z0 | 123 | ERCALL | "File001" | P0 | J123W100Z12 | J123W100Z12 | J123W100Z12 | J123W100Z12 | J123W100Z12 |
| 1 | 2 | 3 | 4 | 5 | 6 | 7 | 8 | | | | | | | | | | | | | | | | | | | | | | | | | | | | | | | | | | |
| 1234567890 | 1234567890 | 1234567890 | 1234567890 | 1234567890 | 1234567890 | 1234567890 | 1234567890 | | | | | | | | | | | | | | | | | | | | | | | | | | | | | | | | | | |
| 123 | ERCALL | "File001" | P0 | ZR1000Z0 | ZR1100Z0 | ZR1200Z1 | ZR1300Z0 | ZR1400Z0 | | | | | | | | | | | | | | | | | | | | | | | | | | | | | | | | | |
| 123 | ERCALL | "File001" | P0 | J123W100Z12 | J123W100Z12 | J123W100Z12 | J123W100Z12 | J123W100Z12 | | | | | | | | | | | | | | | | | | | | | | | | | | | | | | | | | |

14.5.4 Setting a TC setting value print range

| | | |
|-----------------------|-----------------------|-----------------------|
| A | Q/QnA | FX |
| <input type="radio"/> | <input type="radio"/> | <input type="radio"/> |

[Purpose]

Sets details about timer or counter settings, such as the items to be printed and additional information.

[Operating procedure]

Select [Project] → [Print] and click the <<TC setting>> tab, or click  ([Ctrl] + [P]), then the <<TC setting>> tab.

[Dialog box]

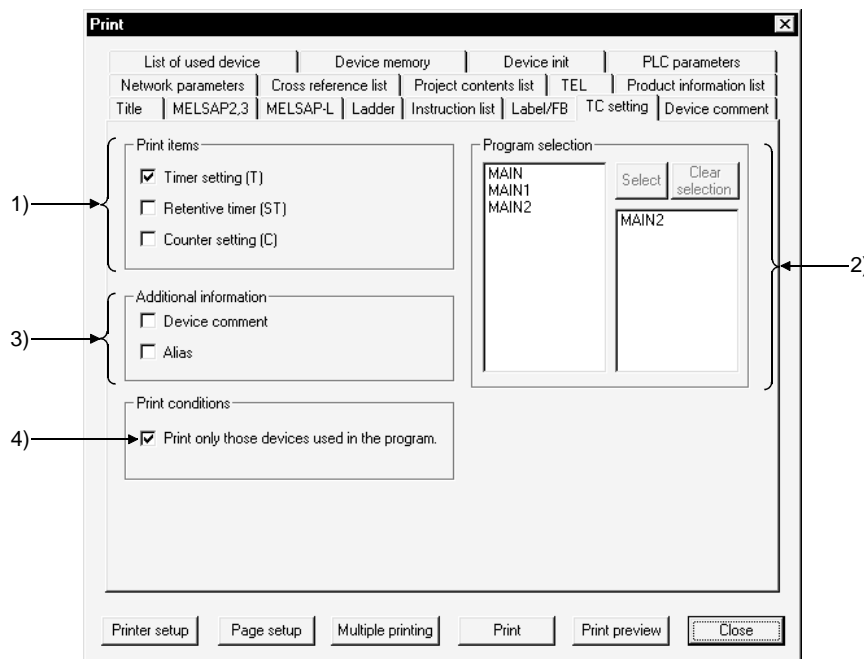

[Description]

- 1) **Print items**
The item with a checkmark ✓ will be printed.
- 2) **Program selection**
If the program to be printed is not yet set, the data name of the program which is active in the ladder mode is automatically selected.
If the program to be printed is already set, the set program name appears.
Select on the list a program for which timer or counter settings will be made, and click the **Select** button to set the selection.
- 3) **Additional information**
The item with a checkmark ✓ will be added.
- 4) **Print conditions**
Only the timer or counter used in the program will be printed by checking this check box.

14.5.5 Setting a device comment print range

| | | |
|-----------------------|-----------------------|-----------------------|
| A | Q/QnA | FX |
| <input type="radio"/> | <input type="radio"/> | <input type="radio"/> |

[Purpose]

Sets the print range of device comments and so on.

[Operating procedure]

Select [Project] → [Print] and click the <<Device comment>> tab, or click  ([Ctrl] + [P]), then the <<Device comment>> tab.

[Dialog box]

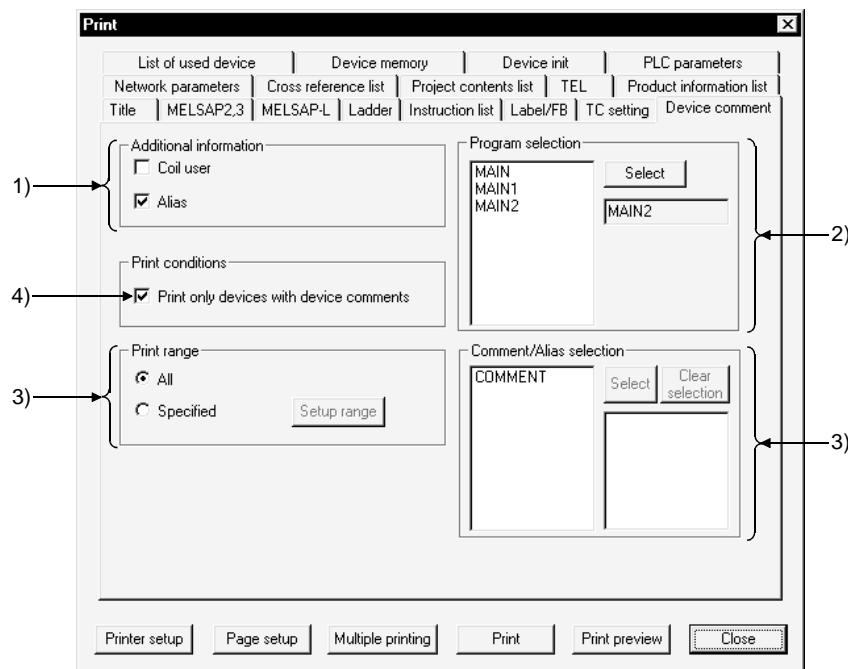

[Description]

- 1) Additional information
Device comments will be printed with additional information. Check the desired check box.
- 2) Program selection
Select on the list a program as the coil using data specified for Additional information, and click the **Select** button to set the selection.
- 3) Comment/Device Label selection
Select on the list the device comment data to be printed, and click the **Select** button to set the selection.
- 4) Print conditions
Only devices with a comment will be printed. Select this item by checking the check box.

5) Print range

Set the range of the device comments to be printed.

All

All device comments of the data selected will be printed.

Specified

The device comments within the specified range will be printed.

By clicking the **setup range** button, the Device Range Setting dialog box shown below will be displayed.

Set the head and final devices or the number of points and the head device of the range to be designated.

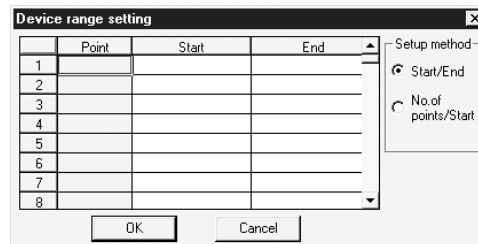

| |
|-------|
| POINT |
|-------|

Whenever device comments are read from the GPPA, GPPQ, FXGP(DOS) or FXGP(WIN) from the [Import file] menu, confirm before printing whether the data is read properly.

If the data is not read properly, check whether the comment range is set according to Chapter 9 "Setting Device Comments."

14.5.6 Setting a device use list print range

| | | |
|-----------------------|-----------------------|-----------------------|
| A | Q/QnA | FX |
| <input type="radio"/> | <input type="radio"/> | <input type="radio"/> |

[Purpose]

Sets the print range of device using data and so on.

[Operating procedure]

Select [Project] → [Print] and click the <<List of used device>> tab, or click  ([Ctrl] + [P]), then the <<List of used device>> tab.

[Dialog box]

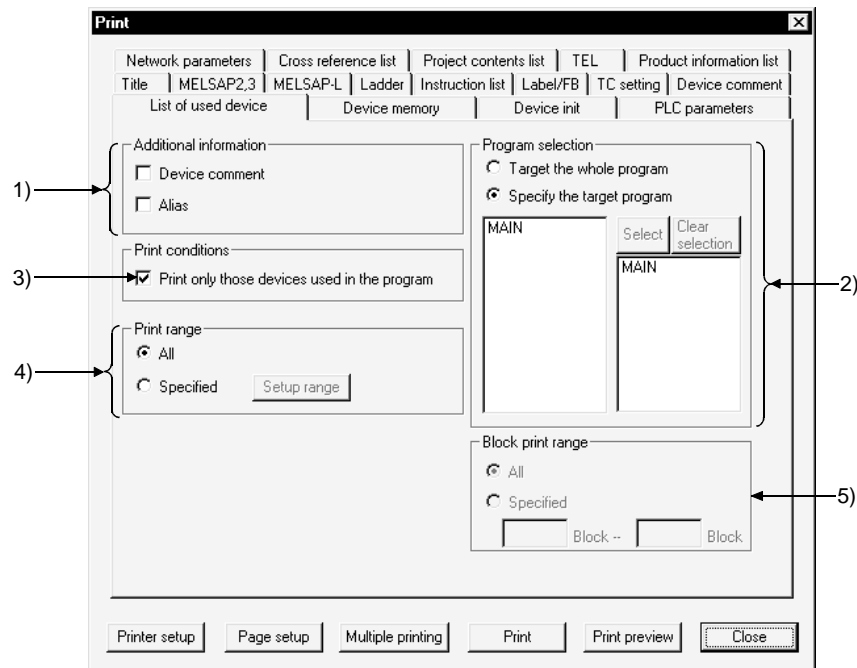

[Description]

1) Additional information

A device use list will be printed with additional information. Check the desired check box.

2) Program selection

When changing or adding the program to be printed, specify the data name from program selection and click the **Select** button to set it.

Target the whole program

Prints the device use lists of all programs in the project.

When the comment/device name of "Additional information" has been selected, only the data name displayed at the beginning of the project data list is printed.

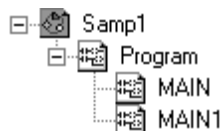

| Program Name | Device | Comment | Device Name |
|--------------|--------|---------|-------------|
| MAIN | X0 | ABCDE | 12345 |
| MAIN1 | X0 | FGHIJ | 67890 |

In this case, the comment or device name of MAIN is printed.

Specify the target program

Prints only the device use lift of the specified program.

By default, the data name of the active program is automatically selected.

If the program to be printed has already been set, the set program name is displayed.

- 3) Print conditions
Prints only devices being used during the program.
Select this item by checking the check box.
- 4) Print range
Sets the range of the device use list to be printed.
 - Ⓐ All
All device use lists of the data selected will be printed.
 - Ⓑ Specified
The device use lists within the specified range will be printed.
At the Device Range Setting dialog box displayed by clicking the setup range button, set the head and final devices or the number of points and the head device of the range to be designated.
- 5) Block print range (only for SFC selection)
Set when block printing SFC programs.

14.5.7 Setting a device memory print range

| | | |
|-----------------------|-----------------------|-----------------------|
| A | Q/QnA | FX |
| <input type="radio"/> | <input type="radio"/> | <input type="radio"/> |

[Purpose]

Sets the print range of the device memory using data and so on.

[Operating procedure]

Select [Project] → [Print] and click the <<Device memory>> tab, or click  ([Ctrl] + [P]), then the <<Device memory>> tab.

[Dialog box]

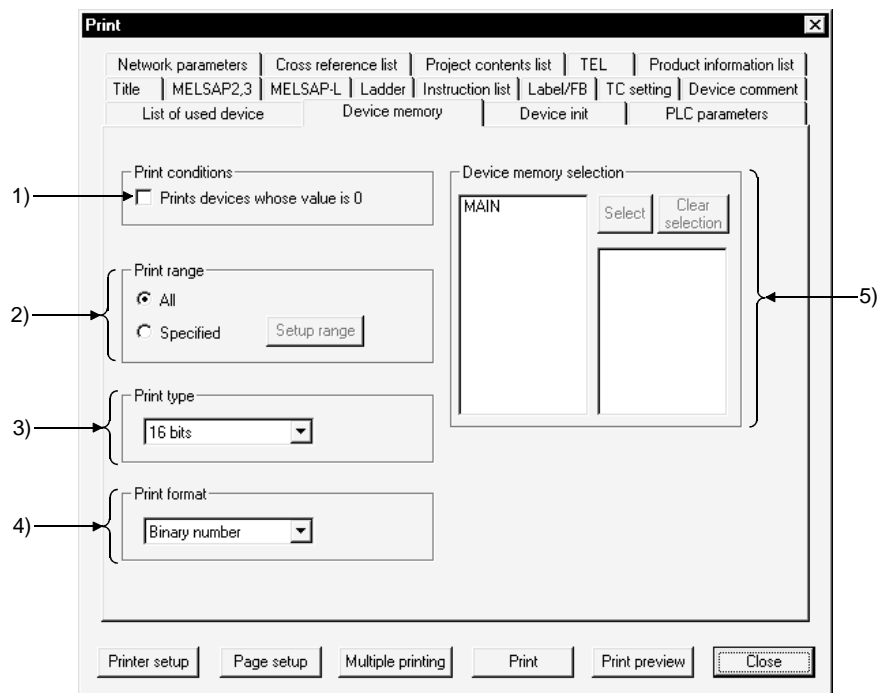

[Description]

1) Print conditions

Any device whose value is "0" will also be printed.
Select this item by checking the check box.

2) Print range

Sets the print range of the device memory.

Ⓐ All

The entire device memory will be printed.

Ⓑ Specified

The specified range of the device memory will be printed.

By clicking the **Specified range** button, the Device Range Setting dialog box will be displayed. Set the head and final devices or the number of points and the head device of the range to be designated.

- 3) Print type
Set device memory values in 16-bit integers, 32-bit integers or real numbers.
- 4) Printing format
Sets device memory values in binary, decimal or hexadecimal.
- 5) Device memory selection
Allows multiple device memories to be selected.

14.5.8 Setting a device initial value print range

| | | |
|---|-------|----|
| A | Q/QnA | FX |
| × | ○ | × |

[Purpose]

Sets the print range of the QnA series device initial values and so on.

[Operating procedure]

Select [Project] → [Print] and click the <<Device init>> tab, or click  ([Ctrl] + [P]), then the <<Device init>> tab.

[Dialog box]

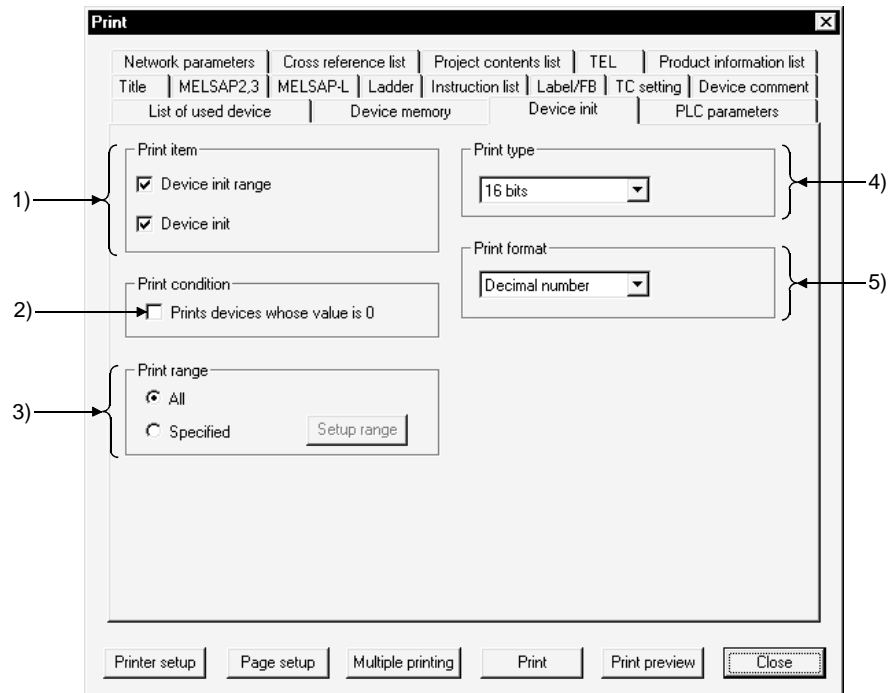

[Description]

- 1) Print item
The items selected will be printed.
Select the desired item by checking the check box.
- 2) Print condition
Any device whose value is "0" will also be printed.
Select this item by checking the check box.

- 3) Print range
Sets the print range of the device initial values.
 - Ⓐ All
All device initial values will be printed.
 - Ⓑ Specified
The device initial values within the specified range will be printed.
By clicking the Setup range button, the Device Range Setting dialog box will be displayed. Set the head and final devices or the number of points and the head device of the range to be designated.
- 4) Print type
Sets device initial values in 16-bit integers, 32-bit integers or real numbers.
- 5) Print format
Sets device initial values in binary, decimal or hexadecimal.

14.5.9 Setting a PLC parameter print item

| | | |
|---|-------|----|
| A | Q/QnA | FX |
| ○ | ○ | ○ |

[Purpose]

Sets the PLC parameter items to be printed.

[Operating procedure]

Select [Project] → [Print] and click the <<PLC parameters>> tab, or click  ([Ctrl] + [P]), then the <<PLC parameters>> tab.

[Dialog box]

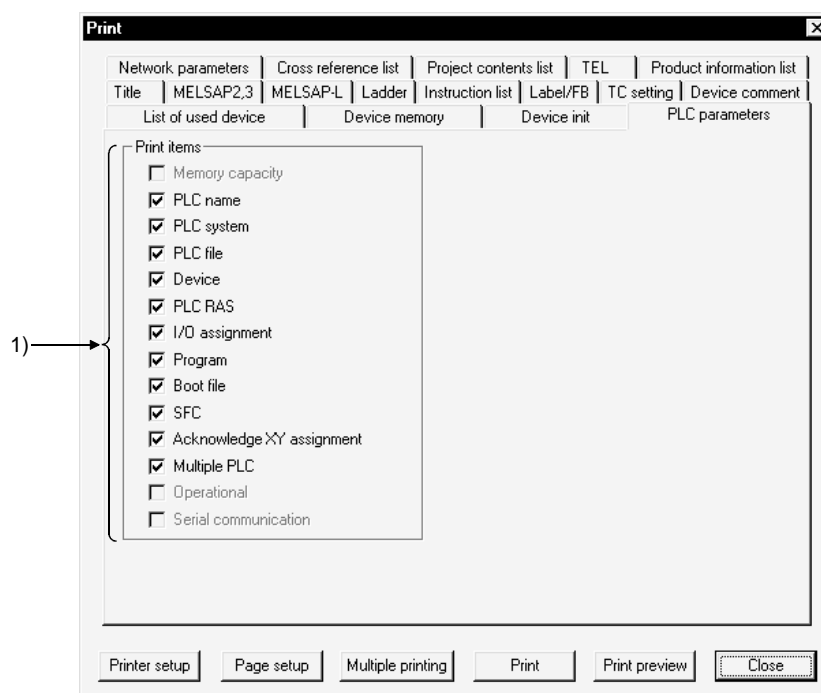

[Description]

1) Print items

The items selected will be printed.

Select each desired item by checking the check box.

PLC name setting, PLC file setting, Program setting/Boot file setting, and SFC setting are not required and cannot therefore be selected for the A series.

Memory capacity setting is not required and cannot therefore be selected for the Q/QnA series.

PLC file setting, PLC RAS setting, Program setting, Boot file setting, and SFC setting are not required and cannot therefore be selected for the FX series.

X/Y assignment check can be selected only for the AnA, AnU, Q, and QnA series.

14.5.10 Setting a network parameter print item

| | | |
|---|-------|----|
| A | Q/QnA | FX |
| ○ | ○ | × |

[Purpose]

Sets the network parameter items to be printed.

[Operating procedure]

Select [Project] → [Print] and click the <<Network parameters>> tab, or click  ([Ctrl] + [P]), then the <<Network parameters>> tab.

[Dialog box]

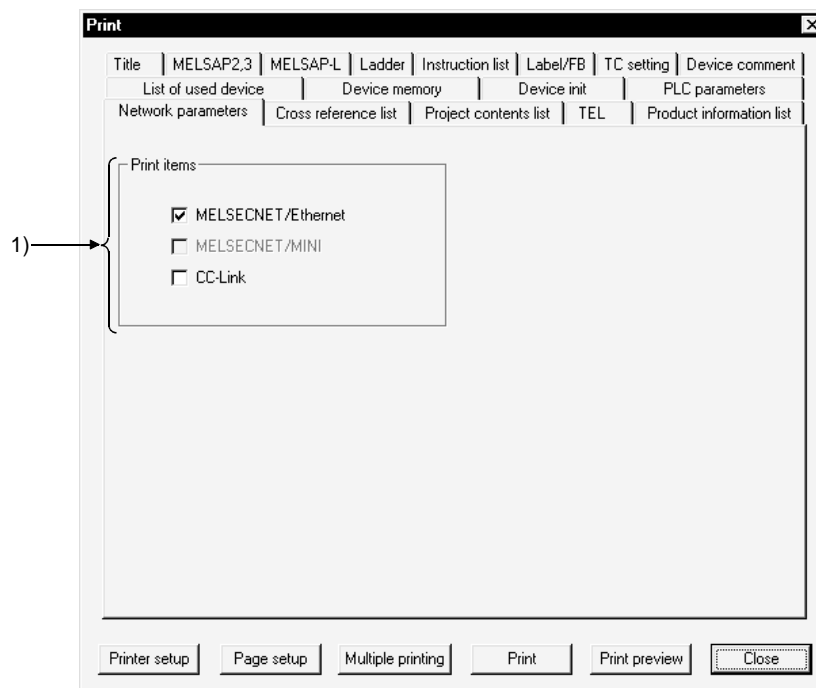

[Description]

1) Print items

The items selected will be printed.

Select each desired item by checking the check box.

CC-link setting is not available and cannot therefore be selected for the A series.

14.5.11 Setting a list of contact coil used

| | | |
|-----------------------|-----------------------|-----------------------|
| A | Q/QnA | FX |
| <input type="radio"/> | <input type="radio"/> | <input type="radio"/> |

[Purpose]

Sets the print range of the devices used for contacts or coils and so on.

[Operating procedure]

Select [Project] → [Print] and click the <<List of contact coil used>> tab, or click  ([Ctrl] + [P]), then the <<List of contact coil used>> tab.

[Dialog box]

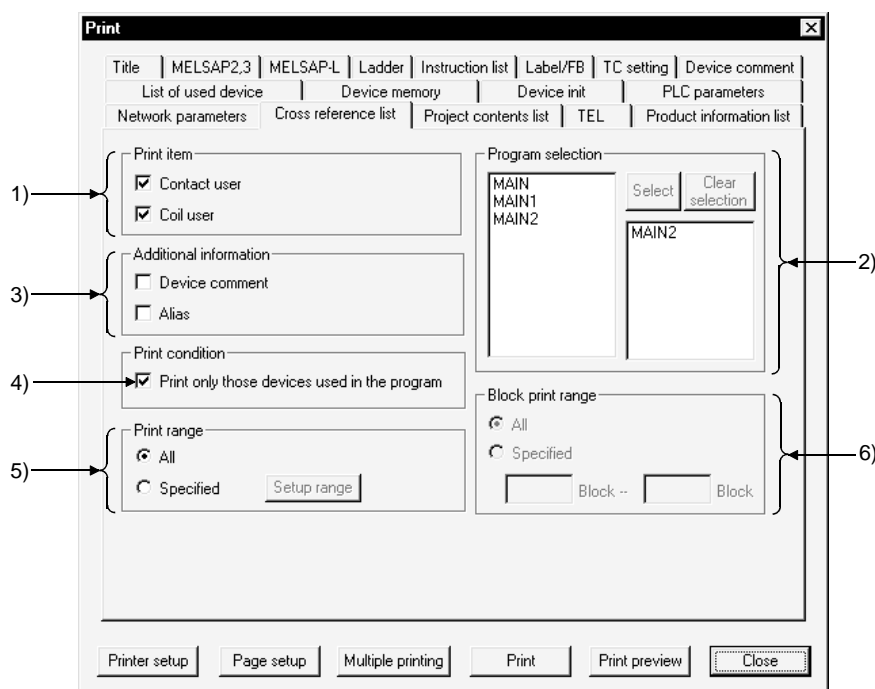

[Description]

- 1) **Print item**
A list will be printed with the selected items added.
Check the desired check box.
- 2) **Program selection**
If the program to be printed is not yet set, the data name of the program which is active in the ladder mode is automatically selected.
If the program to be printed is already set, the set program name appears.
Select on the list a program as the contact or coil using data, and click the **Select** button to set the selection.
- 3) **Additional information**
The list will be printed with additional information.
Select this item by checking the check box.
- 4) **Print condition**
Only devices used in the program selected will be printed.

- 5) Print range
 - Set the range of the contact/coil use list to be printed.
 - All
 - The entire range from step 0 to the END instruction of the program will be printed.
 - Specified
 - The range specified by the step numbers will be printed.
 - To specify the range, set the head and final devices or the number of points and the head device in the Device Range Setting dialog box.

- 6) Block print range (only for SFC selection)
 - Set when block printing SFC programs.

14.5.12 Displaying a project contents list

| | | |
|---|-------|----|
| A | Q/QnA | FX |
| ○ | ○ | ○ |

[Purpose]
 Displays a list of project data.

[Operating procedure]
 Select [Project] → [Print] and click the <<Project contents list>> tab, or click  (**Ctrl** + **P**), then the <<Project contents list>> tab.

[Dialog box]

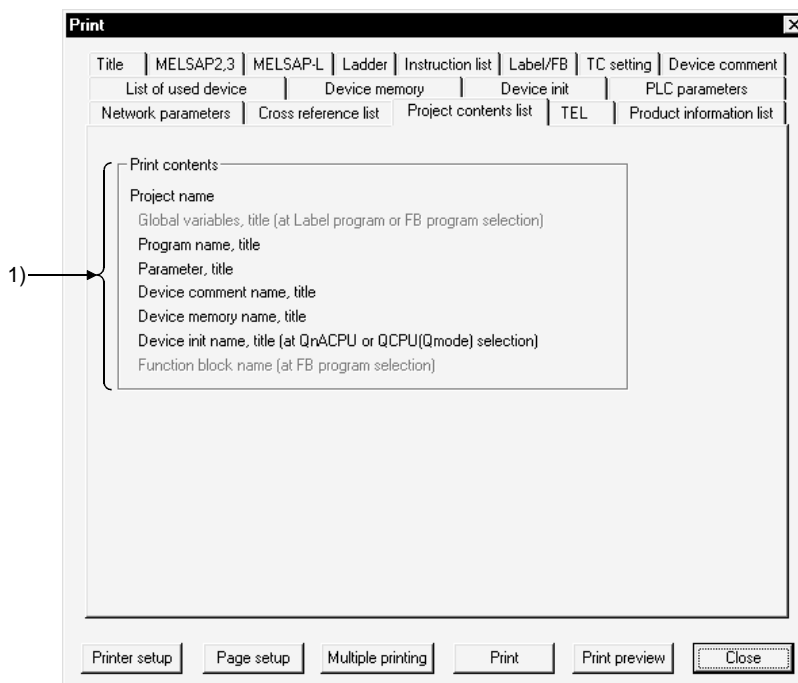

[Description]
 1) Print contents
 The items to be printed on a list of project data are displayed.

14.5.13 Setting the TEL data print area

| | | |
|---|-------|----|
| A | Q/QnA | FX |
| ○ | ○ | × |

[Purpose]

Prints the data set on the TEL data creation screen.

[Operating Procedure]

[Project] → [Print] → <<TEL>> tab or  (**Ctrl** + **P**) → <<TEL>> tab

[Dialog Box]

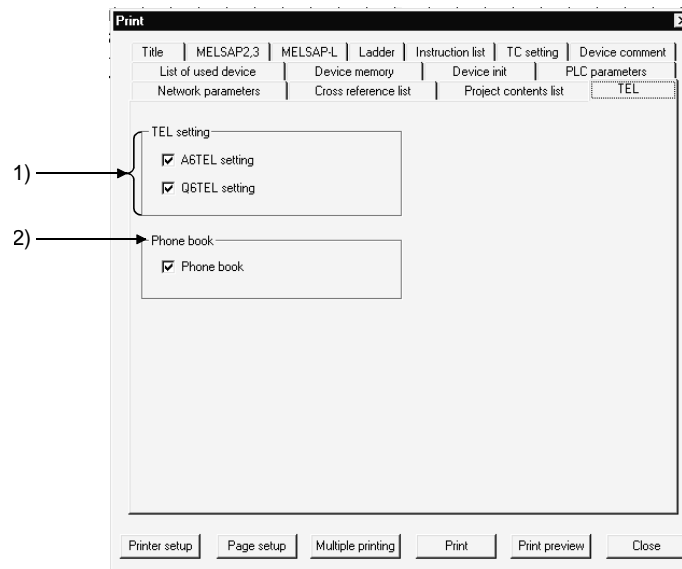

[Description]

1) TEL setting

Prints the data set on the TEL data creation screen.

2) Phone book

Prints the data registered on the phone number book setting screen.

14.5.14 Product information list

| | | |
|---|-------|----|
| A | Q/QnA | FX |
| × | ○* | × |

*: Compatible with only the QCPU (Q mode)

[Purpose]

Prints the production information list of System monitor.

[Operating Procedure]

Select [Project] → [Print] → << Product information list >> tab or  ([Ctrl] + [P]) → << Product information list >> tab

[Dialog Box]

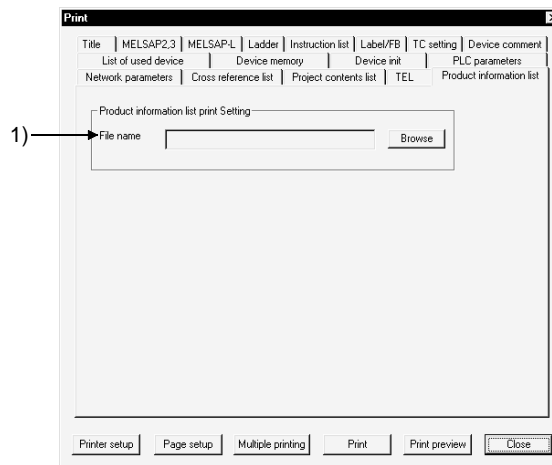

[Description]

- 1) File name
Set the product information list file (CSV format).
Make setting from only the **Browse** button.

POINT

Before starting printing, always save the file when you have selected [Diagnostics] → [System monitor] → <<Product information list>> tab. (Refer to Section 21.4)
An error will occur if you set the file other than the product information list file.

14.5.15 Printing labels

| | | |
|---|-------|----|
| A | Q/QnA | FX |
| × | ○ | × |

[Purpose]

Prints global and local variable data created by label programming.

[Operating Procedure]

Choose [Project] → [Print] → <<Label>> tab or  (**Ctrl** + **P**) → <<Label>> tab.

[Dialog Box]

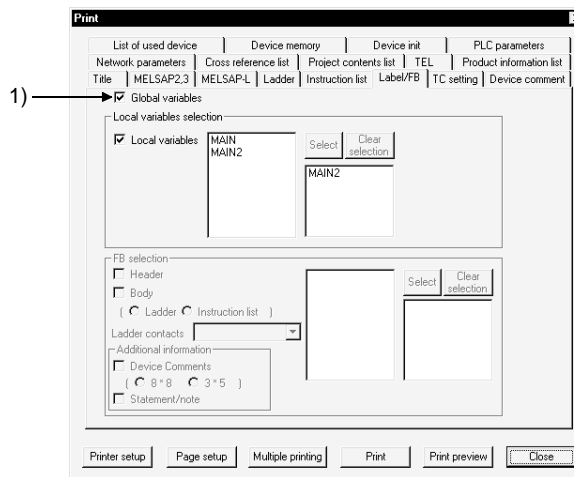

[Description]

1) Program selection

When the program to be printed is not yet specified, the data name of the active program is automatically selected.

When the program to be printed is already set, the preset program name appears.

When changing or adding the label program to be printed, specify the data name from program selection and click the **Select** button to make setting.

14.6 Print Examples

| | | |
|---|-------|----|
| A | Q/QnA | FX |
| ○ | ○ | ○ |

Print examples are shown below.

<<Title>>

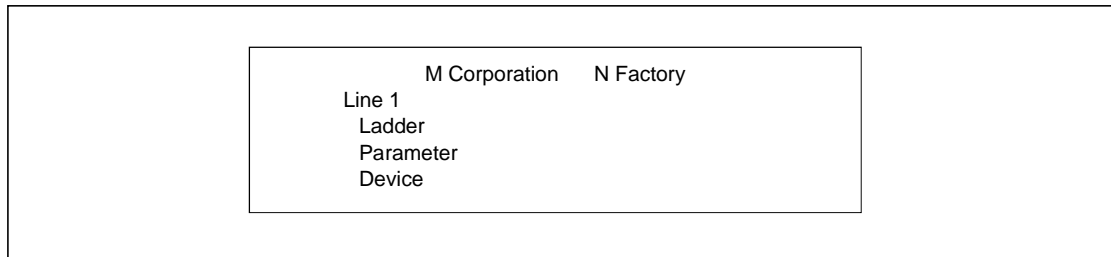

<<Ladder>>



<<TC setting>>

| Time set val list | | | | | |
|-------------------|---------|--------|---------|--------|---------|
| Device | Setting | Device | Setting | Device | Setting |
| T0 | K1000 | | | | |
| T1 | K120 | | | | |
| T2 | K6000 | | | | |
| T3 | K50 | | | | |
| T4 | K850 | | | | |

<<Device comment>>

| Device comment list | | |
|---------------------|------------------|---------|
| Device | Device comment | Dev Lbl |
| M10 | Operation ready | |
| X0 | Safety equipment | SAFETY |
| X1 | Safety cover | COVER |
| X2 | Operation ready | READY |
| X3 | Oil pressure | OIL-M |

<<List of used device>>

| Device use list | | | | | |
|-----------------|-------------|-----|-------|------------------|---------|
| Device | Use/Not use | No. | Error | Device comment | Dev Lbl |
| X0 | ┆┆ | 0 | | Safety equipment | SAFETY |
| X2 | ┆┆ | 0 | | Cycle stop | READY |
| X3 | ┆┆ | 0 | | Sensor1 | OIL-M |
| X7 | ┆┆ | 0 | | Safety cover | |
| Y70 | ┆┆ | 1 | ERROR | | |
| M10 | ┆┆┆┆ | 1 | | Operation ready | |

<<Device memory>>

| Device memory list | | | | | | | | | |
|--------------------|---------|---------|------|------|------|------|------|------|------------------|
| Device | 16 bits | | | | | | | | Character string |
| | Type | decimal | | | | | | | |
| | +0 | +1 | +2 | +3 | +4 | +5 | +6 | +7 | |
| D0 | 7086 | 37 | 3786 | 898 | 3 | 8798 | 4641 | 1697 | |
| D6 | 9678 | 8860 | 7697 | 35 | 4400 | 736 | 16 | 4 | |
| D16 | 67 | 3 | 7376 | 767 | 2000 | 373 | 43 | 774 | |
| D24 | 100 | 738 | 737 | 6767 | 7463 | 234 | 55 | 7799 | |
| D32 | 1156 | 878 | 763 | 4343 | 800 | 7438 | 4 | 777 | |
| D40 | 343 | 7895 | 64 | 867 | 364 | 343 | 360 | 3 | |
| D48 | 8381 | 137 | 434 | 789 | 43 | 1587 | 7888 | 796 | |
| D56 | 100 | 0 | 0 | 0 | 0 | 0 | 0 | 0 | |

<<Device init >>
Q/QnA series only

| Dev init set range | | | | |
|--------------------|----------|--------------|------------|---------|
| No. | Items | Start device | End device | Comment |
| 1 | 50 D0 | | D49 | |
| 2 | 100 D100 | | D199 | |

| Device memory list | | | | | | | | | | |
|--------------------|--------|------|---------|------|------|------|-----|------|------------------|--|
| | 16 bit | Type | decimal | | | | | | | |
| Device | +0 | +1 | +2 | +3 | +4 | +5 | +6 | +7 | Character string | |
| D0 | 374 | 4687 | 6 | 746 | 76 | 37 | 3 | 387 | | |
| D6 | 354 | 37 | 3 | 76 | 64 | 35 | 76 | 37 | | |
| D16 | 697 | 879 | 6 | 78 | 3 | 3789 | 379 | 3794 | | |
| D24 | 3998 | 3687 | 489 | 1579 | 3794 | 874 | 679 | 7897 | | |
| D32 | 57 | 4 | 486 | 7 | 867 | 687 | 68 | 76 | | |
| D40 | 87 | 8676 | 87 | 7767 | 6 | 76 | 7 | 687 | | |
| D48 | 687 | 78 | | | | | | | | |

<<PC parameters>>

| Mem capcty set | |
|----------------|-------------------------------------|
| 1 | Sequence program capacity |
| | Main [6] K step |
| | Sub 1 [0] K step |
| | Sub 1 [] K step |
| 2 | Microcomputer program capacity |
| | Main [0] K step |
| | Sub [] K step |
| 3 | Comment capacity |
| | Comment [0] K bytes |
| | Extension comment [0] K bytes |
| 4 | File register capacity [0] K bytes |
| | [0] points |
| 5 | Capacity for debug |
| | Sampling trace [0] K bytes |
| | Stat latch (data mem) [] K bytes |
| | Stat latch (file reg) [] K bytes |
| 6 | Total capacity [16] K bytes |

<<Network parameters>>
Except the FX series

Set unit count

| | | |
|---|--------------------------------|----------------------------|
| 1 | MELSECNET (II/10) No. of units | [2] Unit(s) |
| | Unit 1 | <MELSECNET/10 (Ctrl sta) > |
| | Unit 2 | <MELSECNET/10 (Ctrl sta) > |
| | Unit 3 | < > |
| | Unit 4 | < > |
| 2 | Valid unit accessing other st | [1] (Older of unit) |

Network setting

| | Unit 1 NET/10 Ctrl Sta | Unit 2 NET/10 Ctrl Sta | Unit 3 | Unit 4 |
|---------------|------------------------------|------------------------------|--------|--------|
| Start I/O No. | [0] | [30] | [] | [] |
| Network No. | [1] | [2] | [] | [] |

<<List contact coil used>>

List of Contact-Coil

| Device | Step | Ld sym | Ins | Pos |
|--------|------|--------|-----|-----|
| X0 | 0 | ┆┆ | LD | * |
| X2 | 4 | ┆┆ | LDI | * |
| X3 | 5 | ┆┆ | OR | * |
| X7 | 2 | ┆┆ | ANI | * |
| Y70 | 7 | ┆) | OUT | * |
| M10 | 1 | ┆┆ | OR | * |
| M10 | 3 | ┆) | OUT | * |
| M10 | 6 | ┆┆ | AND | * |

<<Project contents list>>

Drive/Path A:\

Project name TESTA

Title

| Data name | Size | Creation data | Title |
|---------------------|------|---------------------|-------|
| • Program | | | |
| ┆ MAIN | 13KB | 1998/ 9/19 16:22:50 | |
| • Device comment | | | |
| ┆ COMMENT | 1KB | 1998/ 9/19 16:22:54 | |
| ┆ MAIN | 1KB | 1998/ 9/19 16:40:56 | |
| • Device memory | | | |
| ┆ MAIN | 1KB | 1998/ 9/19 16:45:00 | |
| • Parameter | | | |
| ┆ PC parameter | | 1998/ 9/19 16:44:56 | |
| ┆ Network parameter | | 1998/ 9/19 16:44:56 | |

<<A6TEL/Q6TEL data list>>

A6TEL data list

| | |
|-------------------------|----------------|
| Title | Modem |
| AT command | ATQ0E1V1X1S0=1 |
| Line type | Tone |
| Main/Sub switching time | 11min |

| NO. | Register item and condition | | | | | |
|---------------|-----------------------------|----------------|----------------|-------------|------------------------|-------|
| 1 | Title | TEST DATA | | | | |
| | Reporting | Report 1 time. | | | | |
| | Report Information | Main | Call number | 0123456789 | An outside line number | |
| | | | Setting | Select time | Time | 30sec |
| | | Sub | Call number | -- | An outside line number | -- |
| | | | Setting | -- | Time | -- |
| | Trigger condition | Device | Word device C0 | | | |
| Condition | | = | Value | Dec. 10 | | |
| Pager message | | History | D100 | | | |

<<Product information list>>

| Slot | Type | Series | Type name | Items | StartI/O | ControlPLC | Serial No. | Ver |
|------|----------|--------|------------|-------|----------|------------|------------------|-----|
| PLC | PLC | Q | Q25HCPU | - | - | - | SYS001000000000 | B |
| 0-0 | Input | Q | QX41 | 32pt | 0000 | - | - | - |
| 0-1 | Output | Q | QY41P | 32pt | 0020 | - | - | - |
| 0-2 | Intelli. | Q | QJ71C24-R2 | 32pt | 0040 | - | 0205100000000000 | B |
| 0-3 | Intelli. | Q | QJ71LP21 | 32pt | 0060 | - | 0108100000000000 | A |
| 0-4 | - | - | None | - | - | - | - | - |
| 0-5 | - | - | None | - | - | - | - | - |
| 0-6 | - | - | None | - | - | - | - | - |
| 0-7 | - | - | None | - | - | - | - | - |
| 0-8 | - | - | None | - | - | - | - | - |
| 0-9 | - | - | None | - | - | - | - | - |
| 0-10 | - | - | None | - | - | - | - | - |
| 0-11 | - | - | None | - | - | - | - | - |

<<Label>>

Label

Local variables Program name : MAIN Title :

```

Set_value          K1000          INT
Storage_register  D12287          INT
Analog_value      D12286          INT
PB1                X1             BOOL
PB2                X2             BOOL
Output_ineiburu   Y0BB          BOOL
DA_convert_READY  X0A1          BOOL
Head_No           H0             INT
    
```

15. OTHER FUNCTIONS

15.1 Checking Programs

| | | |
|---|-------|----|
| A | Q/QnA | FX |
| ○ | ○ | ○ |

[Purpose]

Checks for logical errors and input errors in programs.

[Operating Procedure]

Select [Tools] → [Check program], or click .

[Dialog Box]

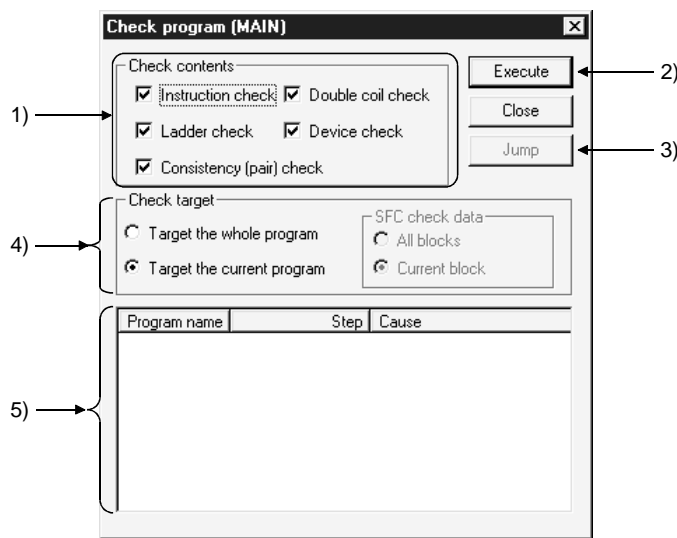

[Description]

1) Check contents

Selects the item to be checked.

The range for the check is from step 0 to the END instruction (or the end of the program if there is no END instruction).

- Instruction check
Check the checkbox to check if instructions can be used, depending on the PC type.
- Ladder check
Check the checkbox to check whether the program is a valid ladder.
- Consistency (pair) check
Check the checkbox to check for consistency in the program, for example whether there are pointers at jump destinations and if there are RET instructions for subroutines.
- Double coil check
Check the checkbox to check for duplicate coils.

- Device check
Check the checkbox to check if device numbers are within the parameter range.
For the A series, an error will not occur if the T/C outside the parameter range setting is used besides contacts and coils.
- 2) button
Click this button after making the necessary settings.
- 3) button
If there is a step with an error, designating the error in the check result and clicking this button moves the cursor to the relevant step of the ladder.
- 4) Check target
 - Target the whole program
Checks all programs in the project.
 - Target the current program
Checks only the currently open program.
- 5) Check result
Displays the result of the project check.

15.2 Merging Programs

| | | |
|-----------------------|-----------------------|-----------------------|
| A | Q/QnA | FX |
| <input type="radio"/> | <input type="radio"/> | <input type="radio"/> |

[Purpose]

Merges multiple programs/comment data.
Merges label programs/local variables for label programming.

[Operating Procedure]

[Tools] → [Merge data]

[Dialog Box]

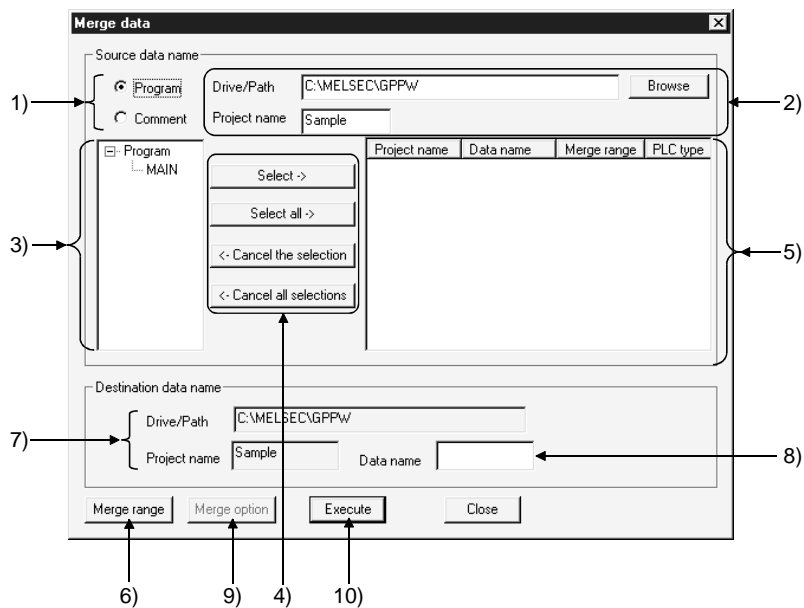

[Description]

- 1) Merged data type setting
Specify the data (programs/comments) to be merged.
- 2) Merge source drive/path, project name
Set the drive/path and project name of the data to be merged.
You can also set the drive/path and project name from the **Browse** button.
- 3) Merge source program list
Lists the programs of the merge source project.
Lists only label programs for label programming.
- 4) Merged program selection buttons
Press the **Select** button to choose the data specified in the merge source data list.
Press the **Select all** button to choose all data in the merge source data list.
Press the **Cancel the selection** button to clear the selected data.
Press the **Cancel all selections** button to clear all selected data.
- 5) Merged data setting
Shows up to 128 pieces of data to be merged.
Data are merged in displayed order.
When concatenating the data you are currently editing, first save the data and then add the name of the edited data to the selection.

- 6) **Merge range** button (Program only)
 Specifies the step numbers of the program specified as a merge source.
 The default is All range.
 For label programming, the program names and local variables specified as the merge range are merged unconditionally.

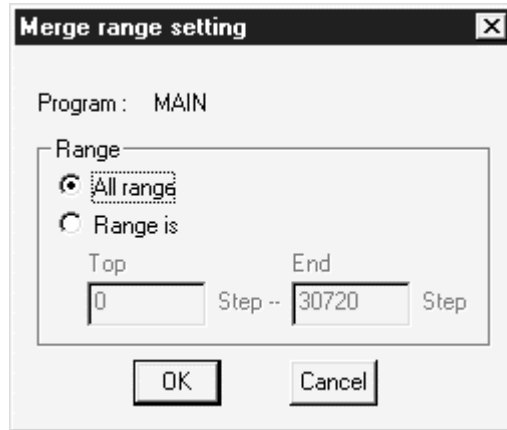

- 7) Merge destination drive/path, project list
 Specifies the currently open project name and drive/path.
- 8) Merge destination data name
 Set the data name used after merging.
 If you specified the existing data name, the data overwrite confirmation dialog box appears.
 When the Q00J/Q00/Q01CPU is selected, the data name is fixed at "MAIN".
- 9) **Merge option** button (Comment only)
 Data are merged in the order of selected data names.
 (Equipment names are not the object of an overlap check.)

For label programming (programs only)

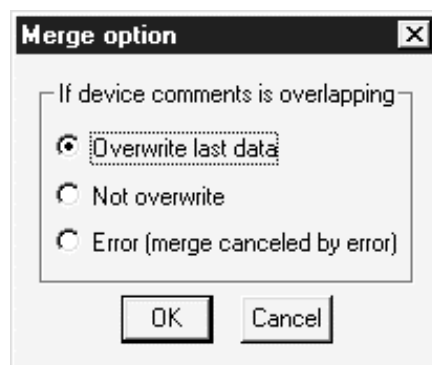

If the data to be merged include the data which exceeds the device range of the merge destination CPU, the comment data in the excess area is deleted.

For A series

The capacity set in the parameter/comment capacity setting of the merge destination is not checked. Data are merged after they are checked within the device range of the CPU.

For Q/QnA series

The device range of the merge destination is the maximum points of the CPU type of the merge destination project, and the range check by the device setting of the parameter is not performed.

Also, the number of ZR devices merged is up to 32k points.

For label programming

- If label names overlap at the time of local variable merging, they are merged according to the merge option setting.
- If the number of labels exceeds 5120 at the time of local variable merging, the 5121th and latter labels are not merged.

If the program/local variable capacity for label programming is exceeded by merging, the area in excess of the capacity is not merged.

10) button

Click this button when the setting is finished.

When data are merged, the END instruction at any point in the program is deleted automatically and an END instruction is inserted at the end of the program.

[Setting Procedure]

- 1) When programs are merged in the entire range
 1. Choose the data type to be merged.
 2. Set the drive/path and project name of the merge source data from the button.
 3. Choose the data to be merged at 5) from the data displayed at 3).
 4. Repeat steps 1 and 2. When the data to be merged are all selected, set 8).
 5. When the setting is over, click 10).
- 2) When programs are merged in the specified range
 1. Choose the data type to be merged.
 2. Set the drive/path and project name of the merge source data from the button
 3. Choose the data to be merged at 5) from the data displayed at 3).
 4. Repeat steps 1 and 2. When the data to be merged are all selected, set 8).
 5. After selecting the program data to be range-specified from 5), click 6).
 6. Click 6) to set the merge range.
(Range setting may also be made by double-clicking the data name at 5).)
 7. Repeat steps 5 and 6 until the merge range is set to all files that need the merge range setting.
 8. When the setting is over, click 10).

| POINTS | | | |
|--|----------------------|-------------|----------------------|
| <ul style="list-style-type: none"> • Any programs not saved in the peripheral device cannot be merged. • After programs are merged, make a program check. • Programs cannot be merged between different PLC series, e.g. A series and QnA series. However, they can be merged between ACPU and QCPU(Amode). • When merging programs of the A or FX series, the program capacity is as set in the parameter of the merge destination project. • When merging the programs of the Q/QnA series, the maximum number of steps corresponds to the PLC type of the merge destination project. | | | |
| QnACPU | | QCPU(Qmode) | |
| PLC Type | Max. Number of Steps | PLC Type | Max. Number of Steps |
| Q2A, Q2AS(H) | 28K | Q02(H) | 28K |
| Q2AS1, Q2AS(H)S1 | 60K | Q06H | 60K |
| Q3A | 92K | Q12H | 124K |
| Q4A, 4AR | 124K | Q25H | 252K |
| <ul style="list-style-type: none"> • If the capacity is exceeded after merging, data are merged on a program basis up to the capacity. (Data that may only be merged to a midway point are not merged.) • SFC programs cannot be merged. | | | |

15.3 Checking Parameters

| A | Q/QnA | FX |
|---|-------|----|
| ○ | ○* | ○ |

*: Compatible with the Q series remote I/O.

[Purpose]

Checks for errors in the parameter settings.

[Operating Procedure]

Select [Tools] → [Check parameter], or click .

[Dialog Box]

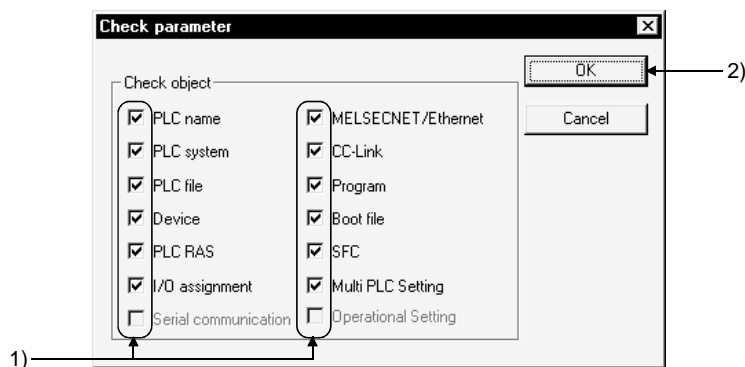

[Description]

1) Check object

Select the items you want to check by clicking the unchecked checkboxes of the items.

Operational setting can be selected for a remote I/O project.

When you selected the Q00J/Q00/Q01CPU, you can choose the Serial item.

15.4 All-clearing the Parameters

| A | Q/QnA | FX |
|-----------------------|-------------------------|-----------------------|
| <input type="radio"/> | <input type="radio"/> * | <input type="radio"/> |

*: Compatible with the Q series remote I/O.

[Purpose]

Clears all parameter settings and sets their default values.

[Operating Procedure]

Select [Tools] → [Clear all Parameters].

[Dialog Box]

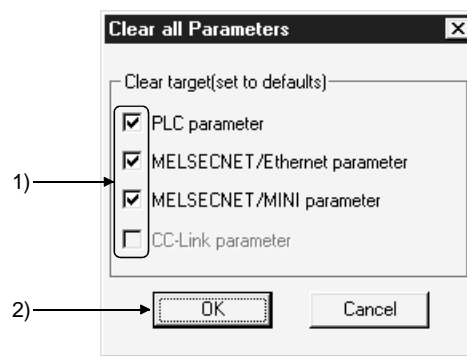

[Description]

1) Clear target

Select the items you want to clear by clicking the unchecked checkboxes of the items.

15.5 IC Memory Card (GX Developer ↔ IC Memory Card)

| | | |
|---|-------|----|
| A | Q/QnA | FX |
| × | ○* | × |

*: Compatible with the Q02(H)/Q06H/Q12H/Q25H CPU.

Read/write the data of the IC memory card.

(1) IC memory card overview

(a) About driver

| PLC | IC Memory Card | Function | | Driver | |
|----------|----------------|----------|-------|------------------------------|-----------------------------|
| | | Read | Write | Windows [®] 95/98*3 | Windows NT [®] 4.0 |
| Q series | SRAM card | ○*1 | ○*1 | Using Windows driver | — |
| | ATA card | ○*2 | ○*2 | Using Windows driver | — |
| | Flash card | × | × | — | — |

*1: Depending on your personal computer or OS, the operations may not be performed.

Windows[®] Me/2000 cannot use SRAM card.

*2: If it takes a long time to read/write the ATA data from GX Developer when Windows[®] 95 is used, change the driver from Hardware Controller ([Start] → [Control Panel] → [Hardware]) to "SunDisk (SunDisk ATA FlashDisk)".

*3: When using SRAM, set the driver to CONFIG.SYS.

(For details, refer to Windows help.)

When ATA is used, Windows recognizes it automatically.

If it is not recognized, set it after choosing [Control Panel] → [System].

Remove the driver for SRAM if it has been set to CONFIG.SYS.

(b) About loading of IC memory card into PLC card slot

An adaptor is required to load the IC memory card into the PLC card slot.

| | |
|------------------|----------------------------------|
| | Mitsubishi Electric Make (Model) |
| PLC card adaptor | Q2MEM-ADP |

(c) About formatting of IC memory card

To format the IC memory card, choose [Online] → [Format PLC memory] on GX Developer. (For more information, refer to Section 20.2.)

| IC Memory Card | Memory Card Name on Setting Screen |
|----------------|------------------------------------|
| SRAM card | Memory card (RAM) |
| ATA card | Memory card (ROM) |

(2) About PLC user data

For read/write of PC user data from/to the IC memory card, GX Developer cannot directly access the IC memory card.

Use Explorer of Windows or the like.

Refer to Section 16.8 for the operation to read/write PLC user data when the IC memory card is loaded in the PLC.

15.5.1 Reading the data of the IC memory card

| | | |
|---|-------|----|
| A | Q/QnA | FX |
| × | ○* | × |

*: Compatible with the Q02(H)/Q06H/Q12H/Q25H CPU.

This section explains the operation to read the data of the IC memory card with the personal computer which has a PLC card slot.
Refer to Section 16.3 for reading data when the IC memory card is loaded in the PLC.

[Purpose]

Reads the data of the IC memory card.

[Operating Procedure]

Select [Tools] → [IC memory card] → [Read IC memory card].

[Dialog Box]

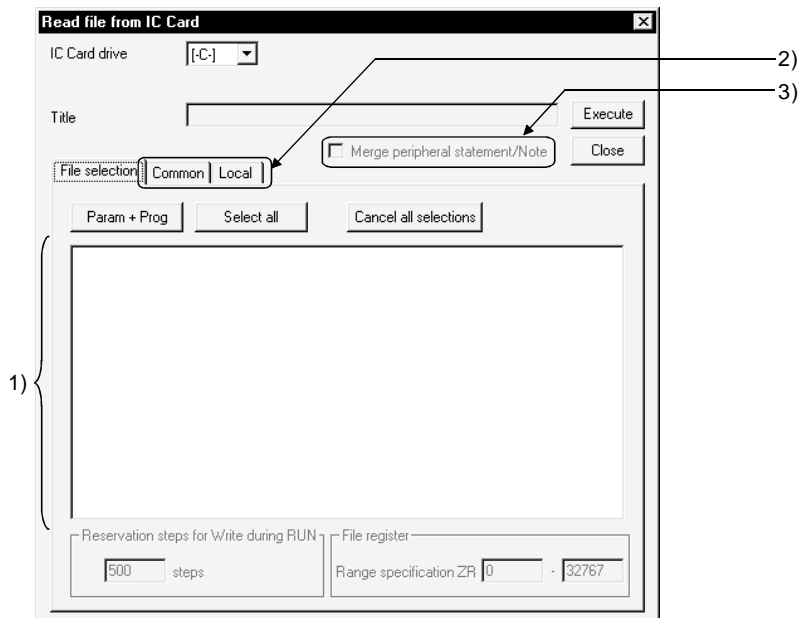

[Description]

- 1) Read data list
Choose the data to be read.
- 2) <<Common>> tab, <<Local>> tab
Choose either tab when setting a range to comments to read.
For details, refer to Section 9.7.
- 3) Merge peripheral Statement/Note
Refer to Section 10.2.

POINT

When there is a password already set, the confirmation dialog box appears at the time of read execution.
For details of the passwords, refer to Section 19.2.

15.5.2 Writing data to the IC memory card

| | | |
|---|-------|----|
| A | Q/QnA | FX |
| × | ○* | × |

*: Compatible with the Q02(H)/Q06H/Q12H/Q25H CPU.

This section explains the operation to write data to the IC memory card with the personal computer which has a PLC card slot. (Q series only)
 Refer to Section 16.3 for writing data when the IC memory card is loaded in the PLC.

[Purpose]

Writes data to the IC memory card.

[Operating Procedure]

Select [Tools] → [IC memory card] → [Write IC memory card].

[Dialog Box]

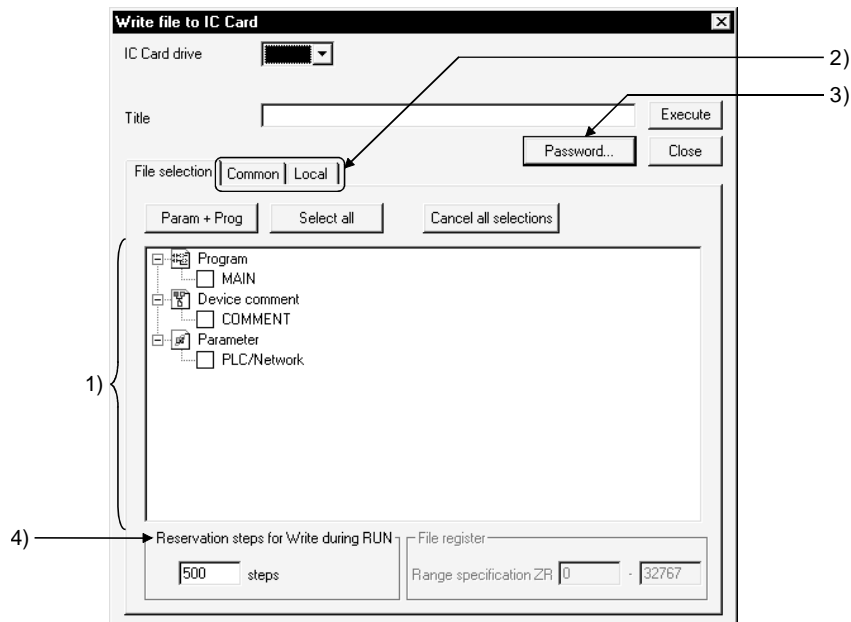

[Description]

- 1) Written data list
Choose the data to be written.
- 2) <<Common>> tab, <<Local>> tab
Choose either tab when setting a range to comments to read.
For details, refer to Section 9.7.
- 3) **Password** button
Sets the password from the password setting dialog box.
For details, refer to Section 19.2.
- 4) Reservation steps for Write during RUN
Reserves the area for the steps increased by Write during RUN.
For Write during RUN, refer to Section 16.9.

CAUTION

If the same file name already exists, the overwrite confirmation dialog box appears. Click the **Yes** button to abandon and overwrite the existing data.

15.6 Intelligent Function Utility

| | | |
|---|-------|----|
| A | Q/QnA | FX |
| × | ○* | × |

*: Compatible with the QCPU (Q mode).

The corresponding intelligent function utilities must be installed.

(1) Utility list (Q series only)

Show the utility list by selecting [Tools] → [Intelligent function utility] → [Utility list].

This displays the list of the intelligent function utilities required to edit the intelligent function utility parameters in the currently edited project.

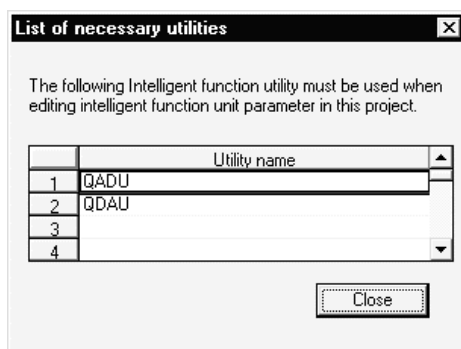

The list does not appear if the intelligent function utility parameters do not exist in the currently edited project or if the project name has not yet been set.

(2) Starting the intelligent function utilities (Q series only)

Start the intelligent function utilities by selecting [Tools] → [Intelligent function utility] → [Start].

(3) Intelligent function utility parameters on GX Developer (Q series only)

The intelligent function utility parameters are not displayed in the project list. However, they are displayed in the Read from/Write to/Delete PLC, Copy project and Read/Write IC memory card dialog boxes.

In this case, if the **Param+Prog** button in the corresponding dialog box is used to make selection, the intelligent function utility parameters are also selected. (Except for copying the project)

- (4) Intelligent function utility parameters for operations (Q series only)
 When the following operations are performed, the intelligent function utility parameters will be as described below.
 If the intelligent function utilities have already used the intelligent function utility parameters, any of the following operations and others cannot be performed.
 Start any operation after closing the intelligent function utilities.

| Operation | Description |
|--|--|
| Read from PLC/Read IC memory card | The intelligent function utility parameters in the PLC/IC memory card are read to the GX Developer project. If the project name has not yet been set, the intelligent function utility parameters cannot be read. |
| Write to PLC/Write IC memory card | The intelligent function utility parameters in the GX Developer project are written to the PLC/IC memory card. If the project name has not yet been set, the intelligent function utility parameters cannot be written. |
| Newly read from PLC | Operation cannot be performed. |
| Password | Setting cannot be made. |
| Delete PLC data | The intelligent function utility parameters are deleted. |
| Verify PLC | Operation cannot be performed. |
| Save project | |
| Save | The intelligent function utility parameters are not changed. |
| Save as | The intelligent function utility parameters are added to the project to be saved. |
| Verify project | Operation cannot be performed. |
| Copy project | Copy cannot be performed if the copy source/destination is used in the intelligent function utilities. |
| Change PLC type | |
| Q series →Q series | The intelligent function utility parameters are retained intact. |
| Q series → other than Q series | The intelligent function utility parameters are deleted. |
| Delete intelligent function utility parameters saved in GX Developer project | The intelligent function utility parameters cannot be deleted using GX Developer. Use the intelligent function utilities to delete. |

POINTS

- Data in the PLC/IC memory card cannot be read/written directly from/to the intelligent function utilities.
Use the corresponding read/write function of GX Developer to read/write them to the intelligent function utilities.
- For more information on the intelligent function utility parameters, refer to the corresponding module user's manual.

15.7 Transferring ROM Data

| | | |
|---|-------|----|
| A | Q/QnA | FX |
| ○ | × | ○ |

Reads, writes, and verifies data from the GX Developer, either with respect to the EP-ROM or E²P-ROM installed in an A series memory cassette, or an FX series memory cassette.

- (1) System configuration for ROM writer transfer
 The system configuration for reading/writing/verification with a ROM writer is indicated below.

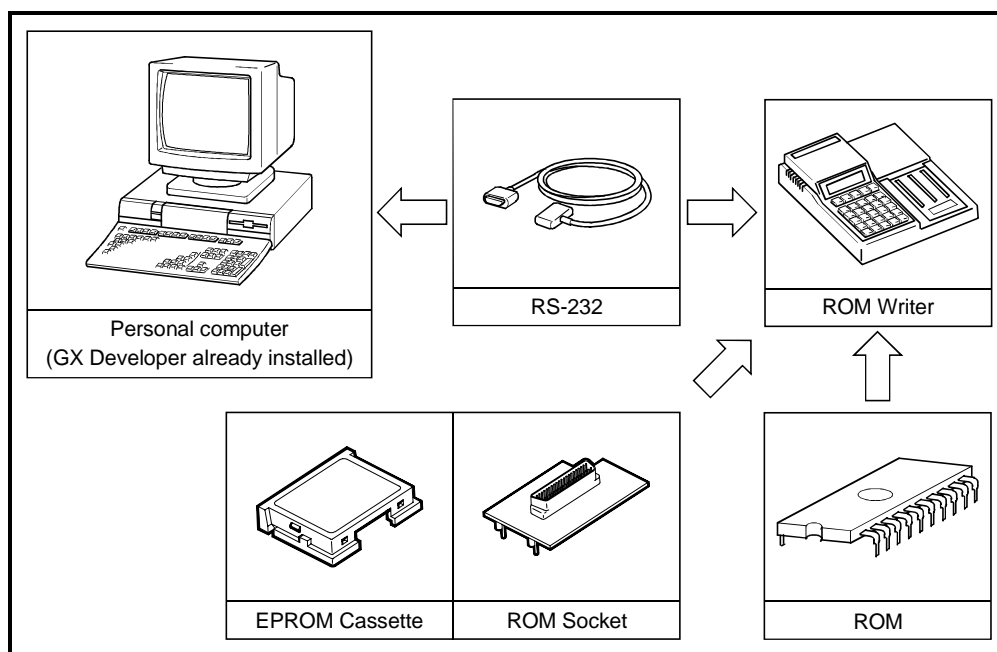

*1: See Appendix 6 for an example of connecting cable wiring.

The correctness of the operation was confirmed for the ROM writers shown below.

- PECKER-10(PKW-1000)
- PECKER-11(PKW-1100)
- PECKER-30(PKW-3100)

- (2) Making settings at the ROM writer
 Before reading/writing/verification with the ROM writer, make the following settings at it.

| Item | | Details |
|-------------|-------------|----------|
| Data format | Data length | 8-bit |
| | Stop bit | 1 bit |
| | Parity | Odd |
| | Baud rate | 9600 bps |
| X ON/OFF | | Provided |

"A" series program memory configuration

(1) Memory capacity setting

The data written to the ROM is classified into two types: main program and main + subprogram.

A memory capacity setting must be made for each data type.

(a) Setting main program capacity

When a main program is set, the main program capacity set in the PLC parameters and automatically added parameters (fixed at 4K bytes) are written to the ROM.

Set the main program capacity in the PLC parameters so as to satisfy the following condition:

$$\boxed{\text{Main program capacity}} \leq \boxed{\text{Total memory capacity of ROM - parameters (4K bytes)}}$$

In the case of an AnUCPU, QCPU(Amode) for which network parameters are set, up to 16K bytes (a maximum of 4K bytes for each network unit) is added.

Check the memory capacity in the network parameters on the PLC parameter memory capacity setting dialog box, then set the main program capacity.

$$\boxed{\text{Main program capacity}} \leq \boxed{\text{Total memory capacity of ROM - parameters (4K bytes) - network parameters}}$$

If the writing capacity exceeds the capacity of the ROM, either make the setting for the main program memory capacity in the PLC parameters smaller, or replace the existing ROM with one with a larger capacity.

<Example> : Memory capacity setting for AnUCPU, QCPU(Amode) with network parameters set)

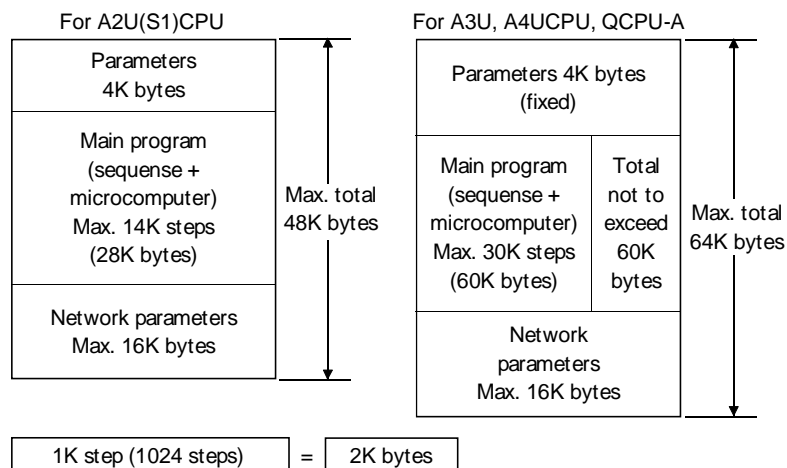

- (b) Setting main program + subprogram capacity
 Write A3U/A4UCPU, QCPU(Amode) subprograms together with the main program. It is not possible to write a subprogram by itself.
 When writing a main program + subprogram, the main program capacity set in the PLC parameters, the automatically added parameters (fixed at 4K bytes), and the subprogram capacity, are written to the ROM.
 The subprogram capacity is automatically set at 64K bytes per subprogram.

Example: Memory capacity setting for A3U/A4UCPU, QCPU(Amode)

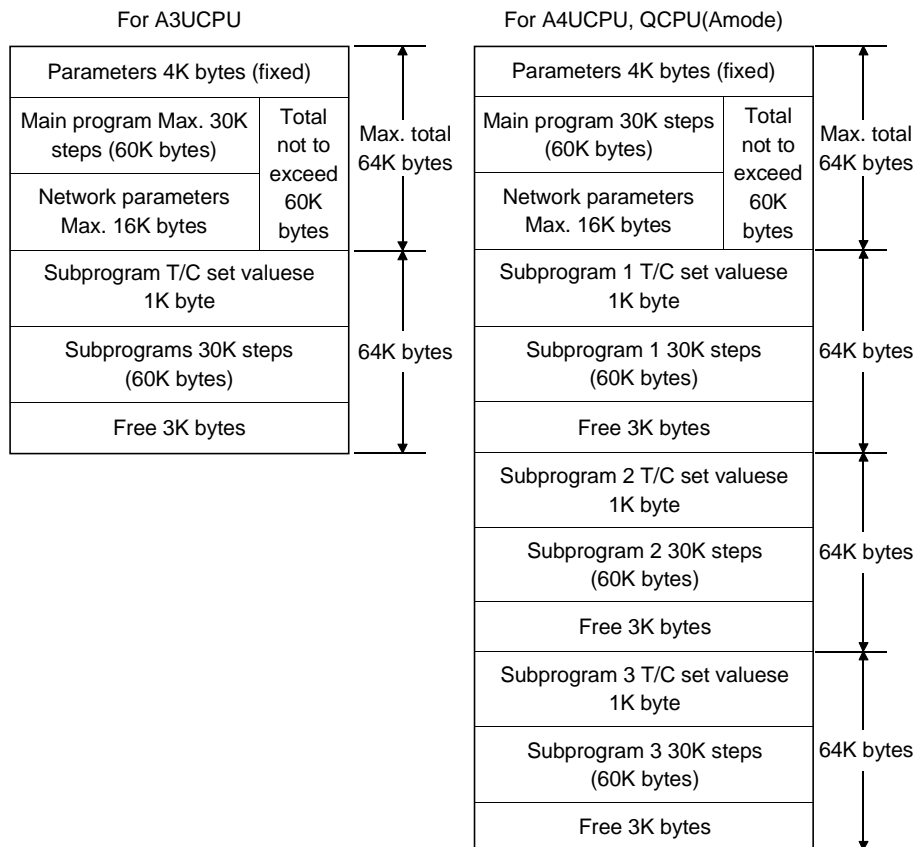

| | |
|--------------|--|
| POINT | <p>The ROMs to which A3U/A4UCPU, QCPU(Amode) subprograms can be written are the 32KROM and the 64KROM. The 32KROM and 64KROM are capable of ROM operation with a subprogram written to them. The 32KROM and 64KROM can only be used with the A4UMCA-128 memory cassette.</p> |
|--------------|--|

The total memory capacity, including main program and subprograms, for each ROM, is indicated below.

| Model Name | ROM Type | Program Memory Capacity | | | | | | |
|----------------|----------|-------------------------|----------------------|---------------------------------|------------------------|---|------------------------|---|
| | | A0J2H, A2C, A2CJ | A1N *1 | A2N(S1), *1 A2A(S1), A2U(S1) | A3A, A3N *1 | A3U, A4U *1 QCPU(Amode) | A1S, A1SJ, A1SH, A1SJH | A2S(S1), A2USH-S1, A2AS(S1), A2AS-S30, A2AS-S60 |
| 4KROM | 2764 | 2K steps (0 to 2046) | 6K steps (0 to 6142) | 6K steps (0 to 6142) | 6K steps (0 to 6142) | 6K steps (0 to 6142) | — | — |
| 4KEROM | X2864A | — | 6K steps (0 to 6142) | — | — | — | — | — |
| 8KROM | 27128 | 6K steps (0 to 6142) | — | 14K steps (0 to 14334) | 14K steps (0 to 14334) | 14K steps (0 to 14334) | — | — |
| 16KROM | 27256 | 14K steps (0 to 14334) | — | 14K steps (0 to 14334) | 30K steps (0 to 30178) | 30K steps (0 to 30718) | — | — |
| 32KROM *2 | 27512 | — | — | — | — | 30K steps (0 to 30718) + 30K bytes | — | — |
| 64KROM *3 | 27010 | — | — | — | — | 30K steps (0 to 30718) 30K + bytes x 3 | — | — |
| A1SNMCA-8KP *4 | | — | — | — | — | — | 8K steps (0 to 8190) | — |
| A2SMCA-14KP *5 | | — | — | — | — | — | — | 14K steps (0 to 14334) |

*1: Two ROMs of the same model are used (for odd addresses and even addresses).

*2: Only the A4UMCA-128 memory cassette can be installed.
A main program and subprogram 1 can be written, and ROM operation with a subprogram is possible.

*3: Only the A4UMCA-128 memory cassette can be installed.
With A4UCPU, QCPU(Amode), a main program and subprograms 1, 2, 3 can be written, and ROM operation with a subprogram is possible.
With A3UCPU, a main program and subprogram 1 can be written, and ROM operation with a subprogram is possible.

*4: An A6WA-28P memory rewrite adapter is required.
Only modls PECKER-11 and 30 can perform write function.
Other ROM writers (including PECKER-10) cannot perform write function.
For occasions such as reading and writing, set the ROM type as "27256."

*5: An A2SWA-28P memory rewrite adapter is required.
Only modls PECKER-11 and 30 can perform write function.
Other ROM writers (including PECKER-10) cannot perform write function.
For occasions such as reading and writing, set the ROM type as "27256."
Switch between odd and even addresses with the ODD/EVEN setting pins of the A2SWA-28P rewrite adapter.

POINTS

- The A1SMCA-8KP conventional mode EP-ROM is not compatible with A1SHCPU.
Note also that there is no EP-ROM cassette compatible with A2SHCPU.
- Since data writing with a ROM writer is not possible when using A1SNMCA-2KE/8KE or A2SNMCA-30KE E²P-ROM cassettes, write data using the PLC write function.

(4) Address type

Depending on the CPU type, the ROM may have either of two address types (writing methods). The correspondence between CPU types and address types is indicated below.

| Address Type | Writing Method | CPU Type |
|-------------------|--|--|
| Odd *1 Even *1 | Addresses are divided into odd and even, and the data written to two ROM's. *2 | A1N, A2N(S1), A3N, A2A(S1), A3A, A2U(S1), A3U, A4U, A2S(S1), A2AS(S1), A2AS-S30, A2AS-S60, A2SH, A2US-S1, A2USH-S1 |
| Contiguous | Data is written to one ROM without division into odd and even addresses. | A0J2H, A1S, A1SJ, A1SH, A1SJH, A2C, A2CJ |

*1: Two EP-ROMs of the same model are used (one for odd, one for even)

However, note that the EP-ROM cassettes that can be used with A2S, A2SH, A2US(S1), and A2USH-S1 have two ROMs built in.

*2: When there is one ROM writer socket, divide the data into odd and even addresses before writing to the ROM.

Note also that because the memory write adapter has to be switched over with A2S, A2SH, A2US(S1), and A2USH-S1, odd and even address data cannot be written at the same time.

<Example 1> : Writing the main program of an A1NCP (4K steps) to a 4KROM

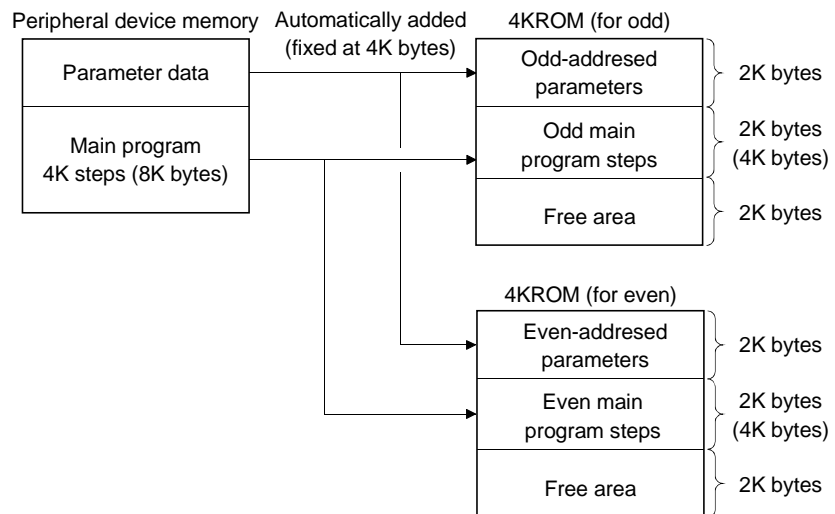

<Example 2> : Writing the main program of an A1SCPU to an A1S8MCA-8KP

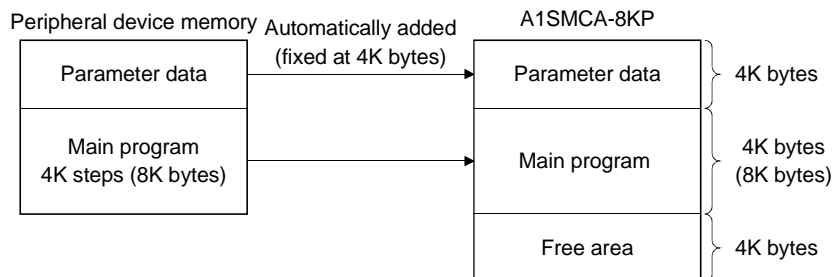

Program memory configuration of the FX series

(1) Memory capacity setting

The program memory of the PLC allows writing of sequence program (including parameters), file registers, and device comments.

The capacity setting ranges for each type of data are indicated below.

| Type | Setting Details | Capacity Setting Range |
|-------------------|-------------------|--|
| FX0 FX0s | Sequence programs | 800 |
| | File registers | — |
| | Comments | — |
| | Total | 800 |
| FX0N | Sequence programs | 500 to 2000 |
| | File registers | 0 to 1500 |
| | Comments | 0 to 1500 |
| | Total | 2000 |
| FX1 | Sequence programs | 500 to 2000 |
| | File registers | — |
| | Comments | 0 to 4000 *1 |
| | Total | 2000 |
| FX FX2 FX2c | Sequence programs | 500 to 8000 |
| | File registers | 0 to 2000 |
| | Comments | 0 to 4000 |
| | Total | Max. 8000, 200/4000 modes also possible |
| FX1s | Sequence programs | 500 to 2000 |
| | File registers | 0 to 1500 |
| | Comments | 0 to 1500 |
| | Total | 2000 |
| FX1N | Sequence programs | 500 to 8000 |
| | File registers | 0 to 7000 |
| | Comments | 0 to 7500 |
| | Total | Max. 8000, 2000/4000 modes also possible |
| FX2N FX2NC | Sequence programs | 500 to 16000 |
| | File registers | 0 to 7000 |
| | Comments | 0 to 15500 |
| | Total | Max. 16000 2000, 4000, 8000 modes also possible |

(Units: steps)

*1: The maximum program capacity is 2000 steps. However, when using a memory cassette it is possible to write comments up to 2000 steps outside the program area too.

15.7.1 ROM reading, writing, and verification

| | | |
|---|-------|----|
| A | Q/QnA | FX |
| ○ | × | ○ |

[Purpose]

Using a ROM writer connected to the personal computer, reads from the ROM, writes to the ROM, or verifies the data in the personal computer against the data in the ROM.

[Operating Procedure]

Select [Tools] → [Transfer ROM] → [Read] ([Write] / [Compare].)

[Dialog Box]

The dialog box for ROM reading is shown here; similar dialog boxes are displayed for writing and verification.

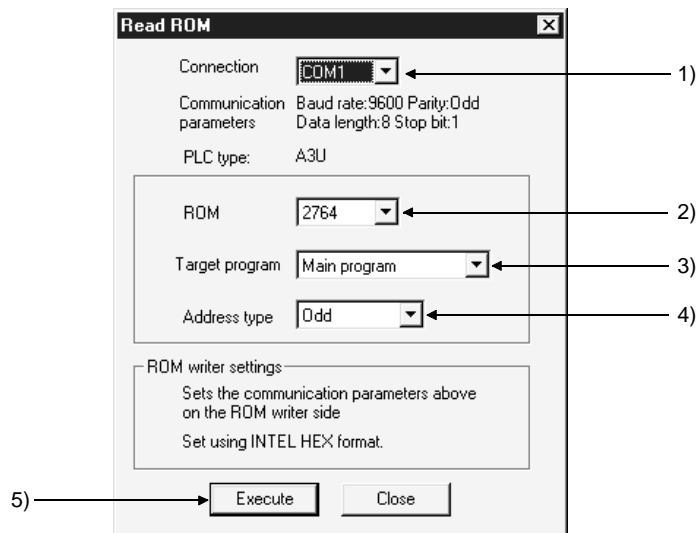

[Description]

- 1) Connection
Selects the interface at the personal computer connected to the ROM writer.
- 2) ROM (A series only)
Selects the type of ROM used.
"Automatic" cannot be selected for writing.
- 3) Target program (A series only)
Selects the type of data to be read, written, or verified.
- 4) Address type (A series only)
Sets the address type of the ROM.
The address type is sequential for the following CPU types: A0J2H, A1S, A1S(S1) A1SJ, A1SH, A2C, A2CJ, and either odd or even for other CPU types.
Note that when there are two ROM writer sockets it is possible to write simultaneously to odd and even addresses.
However, when writing to an A2SMCA-14KP, ODD and EVEN settings are made at the memory write adapter, making simultaneous writing impossible.

- 5) **Execute** button
Click this button after setting the necessary settings.

[Operating Procedure]

- For ROM reading/verification
 1. Install the ROM at the ROM writer, connect to the personal computer and make the necessary settings.
 2. Set the memory capacity in the PLC parameters at the reading (verification) destination.
 3. Operate the ROM writer to read the ROM data into the buffer memory. *1
 4. Set (1) through (4) in the ROM reading (verification) dialog box.
 5. Click (5) after setting the necessary settings.
- For ROM writing
 1. Install the ROM at the ROM writer, connect to the personal computer and make the necessary settings.
 2. Set the memory capacity in the PLC parameters.
 3. Set (1) through (4) in the ROM writing dialog box.
 4. Click (5) after setting the necessary settings.
 5. Operate the ROM writer to write the buffer memory data to the ROM. *1

*1: For details on how to operate the ROM writer, refer to the instruction manual for the model used.

| POINTS |
|---|
| <ul style="list-style-type: none">• When data is written to the ROM, the ROM writer checks in advance whether the data in the ROM has been deleted.• If the address type setting is incorrect, reading, writing and verification with the ROM writer will not be possible. Affix labels to ROMs or use some other method to distinguish among them.• When the ROM type is set to automatic for reading or verification, an error will occur if there is a discrepancy between the memory capacity settings at the ROM side and personal computer side. Alter the setting at the personal computer side. |

15.7.2 Writing to files in ROM format

| A | Q/QnA | FX |
|---|-------|----|
| ○ | × | ○ |

[Purpose]

Writes data to the HD, FD, etc., of a personal computer in a file format like the address type for writing to a ROM.

[Operating Procedure]

Select [Tools] → [Transfer ROM] → [Write to file].

[Dialog Box]

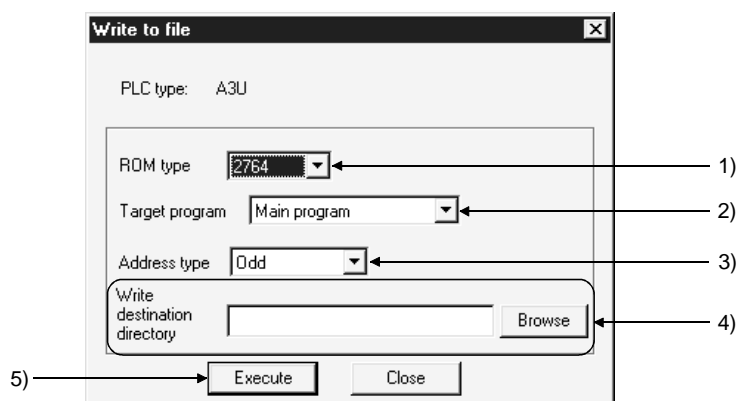

[Description]

- 1) ROM type (A series only)
Set the same type as the ROM used.
- 2) Target program (A series only)
Selects the type of data for file writing.
- 3) Address type (A series only)
Set the same address type as the ROM used
If the CPU type is A0J2H, A1S, A1S(S1), A1SJ, A1SH, A2C, or A2CJ, the address type is "sequential."
In other cases it is odd, even, or odd/even.
- 4) Write destination directory
Sets the folder of file writing destinations.
- 5) **Execute** button
Click this button after setting the necessary settings.

| POINT |
|--|
| <p>Some examples of how files are saved, and the address type-dependent extensions used, when file writing operations are executed are given below.</p> <p>Saving example</p> <p>W[s512].hex</p> <p>Identifier (common) File name (depends on ROM type, applicable program) Extension (depends on address type)</p> <p>Extension</p> <p>W..... Odd/even addresses O..... Odd addresses E..... Even addresses S..... Sequential addresses</p> |

15.8 Batch-Deleting the Unused Device Comments

| | | |
|-----------------------|-----------------------|-----------------------|
| A | Q/QnA | FX |
| <input type="radio"/> | <input type="radio"/> | <input type="radio"/> |

[Purpose]

Batch-deletes comments not used in the program.

[Operating Procedure]

[Tools] → [Delete unused comments]

[Description]

Comments to be deleted should satisfy the following conditions.

1. Comments attached to the devices not used in the program are batch-deleted.
Device comments not searched for in the device use list, if any, by a device search are deleted.
2. Common comments of the devices not used in all programs are deleted.
3. Comments by program which are not used in the corresponding program are deleted.
4. Comments by program whose program does not exist are deleted together with data.
5. Common comments and comments by program which are set to the same device used are not deleted.
6. Click the button to perform batch delete.

| POINTS |
|--|
| <p>Device comments are batch-deleted under the following conditions.</p> <ul style="list-style-type: none"> • Any device using index qualification is handled as not being qualified. <p><Example></p> <p>(1) MOV D0 D100Z0 D0 and D100 will be the target of deletion and the device specified indirectly by Z0 will not be the target of deletion.</p> <p>(2) Two words of any indirectly specified device will be the target of deletion. MOV D0 @D10 D0, D10 and D11 will be the target of deletion, and the device number stored in D10 will not be the target of deletion.</p> <ul style="list-style-type: none"> • Comments not deleted are indicated below. SP.M (A series), SP.D (A series), SM (QnA series), SD (QnA series), Jn\SB, Jn\SW |

15.9 Customizing Keys

| | | |
|-----------------------|-----------------------|-----------------------|
| A | Q/QnA | FX |
| <input type="radio"/> | <input type="radio"/> | <input type="radio"/> |

[Purpose]

Sets the key allocations for ladder creation as GPPA format, GPPQ format, or MEDOC format.

[Operating Procedure]

Select [Tools] → [Customize keys].

[Dialog Box]

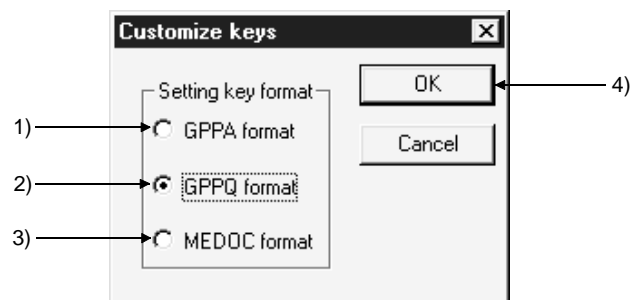

[Description]

- 1) GPPA format
Sets the key allocations corresponding to GPPA.
- 2) GPPQ format
Sets the key allocations corresponding to GPPQ.
- 3) MEDOC format
Sets the key allocations corresponding to MELSEC MEDOC. *1
- 4) **OK** button
Click this button after setting the necessary settings.

*1: "MELSEC MEDOC" is a programming and document creation system retailed by Mitsubishi Electric Europe GMBH.

15.10 Changing the Display Color

| | | |
|---|-------|----|
| A | Q/QnA | FX |
| ○ | ○ | ○ |

[Purpose]
Changes the GX Developer screen to any color.

[Operating Procedure]
Select [Tool] → [Change display color].

[Dialog Box]

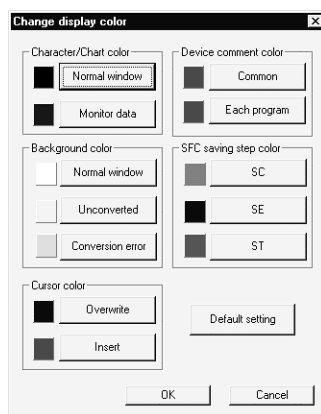

For label programming

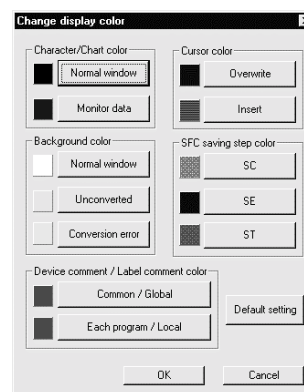

[Description]
Ladder, list, SFC and MELSAP-L screens can be changed in color.
Parameter, device memory, device comment edit and similar screens are not compatible with this function.

Clicking the **Default setting** button returns to the initial status.

| |
|---|
| POINT |
| Unless the personal computer of 256 or more colors is used, the screen may not be displayed properly. |

15.11 Setting Options

| | | |
|-----------------------|-----------------------|-----------------------|
| A | Q/QnA | FX |
| <input type="radio"/> | <input type="radio"/> | <input type="radio"/> |

[Purpose]
Sets the options for data creation.

[Operating Procedure]
Select [Tools] → [Options].

[Dialog Box]
<<Program common>> sheet

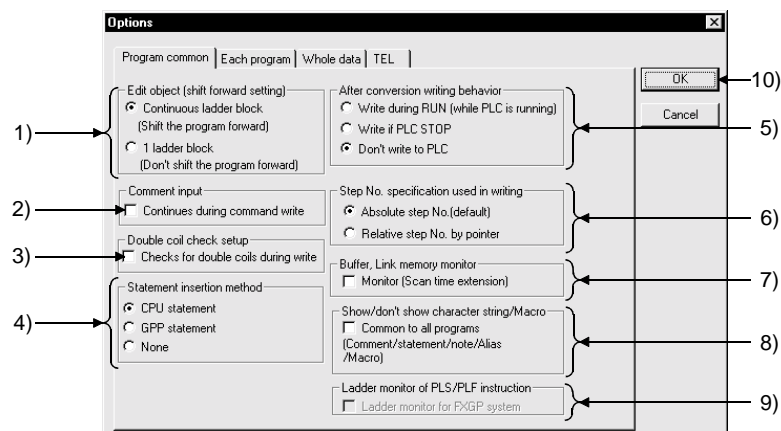

[Description]

- 1) Edit object (shift forward setting)
 - ⊙ Continuous ladder block (Shift the program forward)
If the edited ladder is shorter than it was before conversion, it is shifted forward on conversion.
 - ⊙ 1 ladder block (Don't shift the program forward)
If the edited ladder is shorter than it was before conversion, NOP instructions are written at the missing steps on conversion.
- 2) Device comment input
Check the checkbox to select.
After ladder input the comment input window opens, allowing device comments to be set.

3) Double coil check setup

Sets whether a duplicate coil check is to be performed at program creation.

The devices and instructions to which the duplicate coil check applies are indicated below.

A series

| | OUT | SET | SFT | PLS | PLF | MC |
|--------------|-----|-----|-----|-----|-----|----|
| Y, M, L, B.F | ○ | ○ | ○ | ○ | ○ | ○ |
| T, C | ○ | — | — | — | — | — |

○: Applicable —: Not applicable

Q/QnA series

| | OUT | SET | SFT | PLS | PLF | EGP, EGF | MC | FF | DELTA |
|----------------------------|-----|-----|-----|-----|-----|-------------|----|----|-------|
| Y, M, L, B.F.SM, DY, SB | ○ | ○ | ○ | ○ | ○ | — | ○ | ○ | ○ |
| D, SD, W, SW, R, ZR | ○ | — | ○ | ○ | ○ | — | ○ | ○ | ○ |
| T, C | ○ | — | — | — | — | — | — | — | — |
| Z | — | — | — | — | — | ○ | — | — | — |

○: Applicable —: Not applicable

FX series

| | OUT | SET | PLS | PLF | MC |
|------|-----|-----|-----|-----|----|
| Y, M | ○ | ○ | ○ | ○ | ○ |
| S | ○ | ○ | ○ | ○ | — |
| T, C | ○ | — | — | — | — |

○: Applicable —: Not applicable

It is possible to use the same coil, but attention must be paid to program operation.

In program editing by copying and pasting, no duplicate coil check is performed; for this reason you should perform a program check after editing.

See Section 15.1 for details of program checks.

4) Statement insertion method (Q/QnA series only)

At macro registration, regardless of the option, the statements registered together with ladder are expanded. If no statements have been registered, before expanding the macro select "CPU statement", "GPP statement", or "None".

Ⓒ CPU statement

When writing to the PLC, the statements are written as part of the program. However, the number of steps taken up increases.

Ⓒ GPP statement

The statements of the macro are displayed only at the personal computer. The number of steps taken up does not increase, but the statements cannot be written to the PLC.

Ⓒ None

Statements of the macro are not displayed.

- 5) After conversion writing behavior
Sets writing of the program to the PLC after conversion.
- Ⓒ Write during RUN (while PLC is running)
The program is unconditionally written to the PLC during the RUN status.
"LD[R Edit mode]" is displayed to the Title bar.
 - Ⓒ Write if PLC is STOP
The program is written to the PLC if its status is STOP (PAUSE).
"LD[R Edit mode]" is displayed to the Title bar.
 - Ⓒ Don't write to PLC
The program is not written to the PLC.

- 6) Step No. specification used in writing (Q/QnA series only)
Sets the method for online program change (write during RUN).
 - ⊙ Absolute step No.(default)
Online program change (write during RUN) is executed based on absolute step numbers.
 - ⊙ Relative step No. by pointer (Setting is disabled for Q00J/Q00/Q01CPU)
Online program change (write during RUN) is executed based on relative step numbers, using pointers.

Only the pointer identified areas of a program created by several operators on a pointer-by-pointer basis can be written during RUN.

This method is useful when a program is to be debugged by several people. When performing the relative step number type online program change, do not annotate the program with a line statement. (Refer to the following program.)

Making online program change to the program annotated with a line statement may result in a program mismatch.

In that case, perform read from PLC and make the absolute step number type online program change.

Do not create line statement.

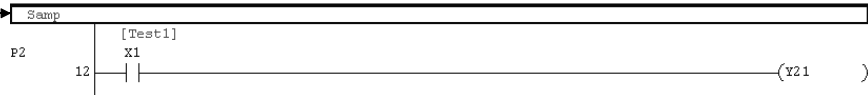

Example:

Online program change (write during RUN) of the program at the personal computer and the program in the PLC in different states, for example when a single program is being written and debugged by several people.

| Write During Normal RUN | Relative Write by Pointer During RUN |
|---|--|
| <p>When another programmer has made an addition to the program in the PLC, normal write during RUN overwrites the steps before the addition, and the program discrepancy makes the writing impossible.</p> <p>GX Developer side</p> <p>Online change not possible</p> <p>CPU side</p> | <p>Even in a case where another programmer has made an addition to the program in the PLC from P1, since the writing is to relative steps, with respect to P2, no program discrepancy occurs.</p> <p>GX Developer side</p> <p>Online change possible</p> <p>CPU side</p> |

- 7) Buffer, Link memory monitor (Except FX series)
Checking the checkbox causes monitoring of the buffer memory and link memory during ladder monitoring.
When the buffer memory and link memory are monitored, the scan time of the PLC is further increased.
See 17.5 for monitor operation.
- 8) Show/don't show character string (Except FX series)
Checking the checkbox causes display of comments/statements/notes/device names for all programs.
- 9) Ladder monitor of PLS/PLF instruction (FX series only)
Checking the checkbox causes the monitor display of PLS/PLF instructions to be actuated in FXGP(DOS) and FXGP(WIN) formats. When the checkbox is cleared, monitor display is actuated in the GX Developer format. The default is the GX Developer format.
(See Appendix 11.)
- 10) button
Click this button after setting all the necessary settings in each dialog box.

[Dialog Box]
 <<Each program>> sheet

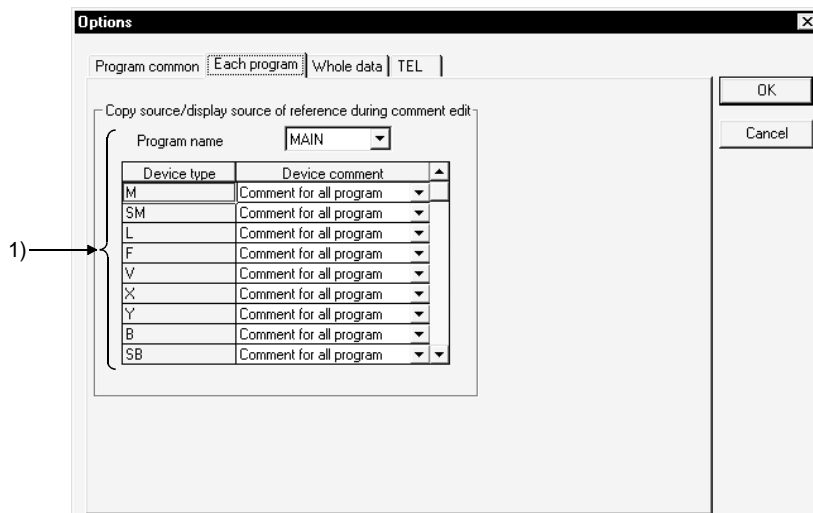

[Description]

- 1) Copy source/display source of reference during comment edit
 When both a comment common to all programs and a comment specific to the individual program have been assigned to the same device, specifies which of these is to be displayed in the ladder window.
 However, where only a comment common to all programs or only a program-specific comment is set for a device, the set comment is automatically displayed and therefore this setting is invalidated.
 You cannot not make setting when you selected the Q00J/Q00/Q01CPU.

[Dialog Box]
 <<Whole data>> sheet

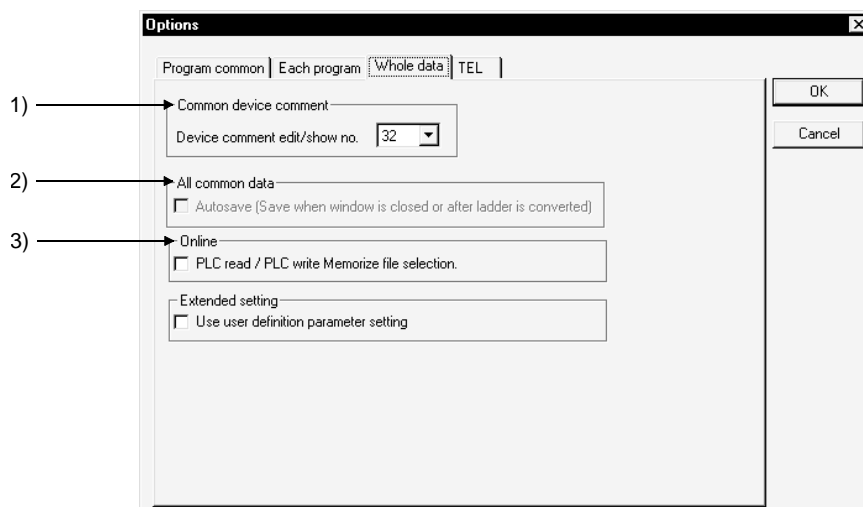

[Description]

- 1) Common device comment
 Sets the largest number of characters that can be set for a device comment as 16 characters or 32 characters.
- 2) All common data
 Checking this checkbox causes the data to be saved automatically when the window is closed.
 The data is also automatically saved when ladder changes are made.
 However, if no project name has been set when creating a new project this setting is not possible because there is no saving destination.
- 3) Online
 Saves the file selection status set on the Read/Write from/to PLC screen.
 The setting is canceled if the PLC type change, connection setup change, project end or target memory change is performed.
 Also, the A series comment selection status is not saved.
- 4) Extended setting (Q series only)
 Do not make this setting.

[Dialog Box]

When the GX Developer is connected via modem, set each item in correspondence with the error condition.

<<TEL function>> tab screen

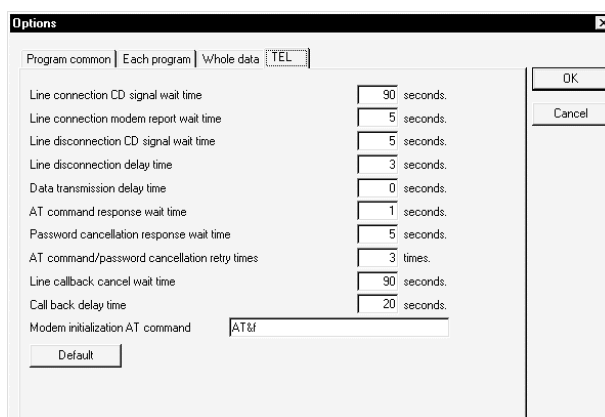

| Setting Items | Contents/measures |
|--|--|
| Line connection CD signal wait time | Depending on the region (e.g., overseas) where line connection is made, extend the set time if the CD signal does not turn ON within the time. |
| Line connection modem report wait time | Extend the set time when the model response speed is slow. |
| Line disconnection CD signal wait time | Depending on the region (e.g., overseas) where line is being disconnected, extend the set time if the CD signal does not turn OFF within the time. |
| Line disconnection delay time | Extend the set time when the model response speed is slow. |
| Data transmission delay time | Extend the set time when the model response speed is slow. |
| AT command response wait time | Extend the set time when the model response speed is slow. |
| Password cancellation response wait time | Extend the set time when the quality of line connection with the opposite party is poor. |
| AT command/password cancellation retry times | Increase the set number of retries. |
| Line callback cancel wait time | Depending on the region (e.g. overseas) where line connection is made, extend the set time if the line of the other end (Q series C24 side) is not disconnected within the set time. |
| Call back delay time | Extend the set time when the equipment for relaying connection to the line (e.g. modem) must have a given time for reconnection of the line after disconnection. |
| Modem initialization AT command | The number of input characters is up to 70. |

15.12 Displaying Multiple Windows

| | | |
|---|-------|----|
| A | Q/QnA | FX |
| ○ | ○ | ○ |

[Purpose]

Adjusts the size and position of windows when multiple windows are opened. However, when four or more windows are arranged horizontally or vertically, the number of lines and columns changes.

[Operating Procedure]

Select [Window] → [Cascade] ([Tile vertically], [Tile horizontally], [Arrange icons])

[Dialog Box]

This is an example where windows are displayed cascaded.

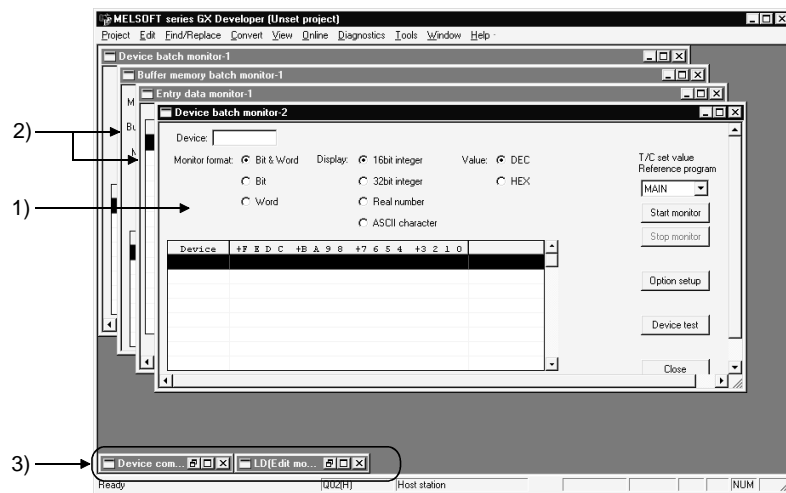

[Description]

- 1) Active window
If [Cascade] is selected, the sheet currently being edited is brought to the top. When [Arrange horizontally] or [Arrange vertically] is selected, the window being edited is brought to the top left of the screen.
- 2) Non-active window
When [Cascade] is selected, windows that are not being edited are moved to the back.
- 3) Icon
When [Arrange icons] is executed, icons (minimized windows) are arranged on the bottom line of the screen.

| |
|---|
| POINT |
| To close multiple windows at once, select [Window] → [Close all windows]. |

15.13 Opening a Specific Project Using a Shortcut

| | | |
|---|-------|----|
| A | Q/QnA | FX |
| ○ | ○ | ○ |

[Purpose]

Creates the start setting file that is to act as the shortcut to a particular project. Just by opening the start setting file, or double-clicking an icon, GX Developer can be started up and a project opened.

[Operating Procedure]

Select [Tools] → [Create Start-up setting file].

[Dialog Box]

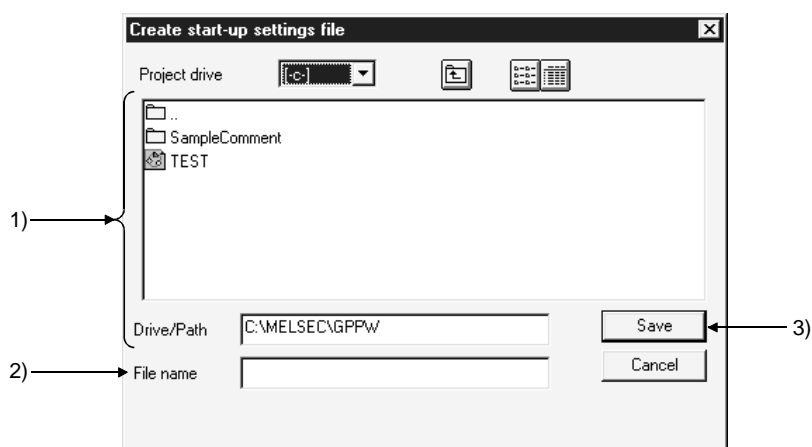

[Description]

- 1) Project drive, Drive/path
Sets where the start setting file is saved.
- 2) File name
Sets the start setting file name.
- 3) **Save** button
Click this button after setting all the necessary settings.

| |
|--|
| POINTS |
| <ul style="list-style-type: none"> • It is convenient to set the start setting files of frequently opened projects in the desktop. • Initialization files have the extension ".GPS." The icon at initial setting is as follows. <div style="text-align: center;">  <p>Test.gps</p> </div> |

15.14 Starting the Ladder Logic Test Tool

| | | |
|---|-------|----|
| A | Q/QnA | FX |
| ○ | ○ | ○ |

[Purpose]

Starts the GX Simulator from GX Developer and carries out debugging offline.

[Operating Procedure]

Select [Tools] → [Start ladder logic test], or click .

[Description]

Starting GX Simulator causes the ladder displayed on GX Developer to be automatically put in the monitor mode.

For label programming

For label programs, only actual programs compiled may be executed.

For programs not yet compiled, perform [Convert] → [Compile].

For details of various functions of GX Simulator, refer to the GX Simulator Operating Manual.

| |
|---|
| POINT |
| The GX Simulator is available as an option. It must be purchased separately to debug programs offline. |

15.15 Outline of Help Function

| | | |
|---|-------|----|
| A | Q/QnA | FX |
| ○ | ○ | ○ |

The help function reproduces some of the information in this manual and the PLC manual.

Information can be checked on the screen of the personal computer during GX Developer operations.

The help menu is explained below.

| Help menu | Details |
|--------------------------|--|
| CPU error | Displays details of the error codes listed in the User's Manuals for each CPU and elsewhere. Error codes read during PLC diagnosis can be checked at the personal computer. |
| Special relays/registers | Displays explanations of special relays and special registers, classified by function and device number. Allows you to check special relays and special registers during program creation and monitoring. |
| Shortcut key list | Displays shortcut keys for shortcuts to the menu in GX Developer, and lists the key allocations for key customization for ladder creation. |
| Product information | Displays information about the product, such as the GX Developer version. |
| Connect to MELFANSweb | Connect to MELFANSweb. |

15.16 Starting CC-Link Configurator

| | | |
|---|-------|----|
| A | Q/QnA | FX |
| × | ○* | ○ |

*: Compatible with QCPU (Q mode).

Installing GX Configurator-CC (SW0D5C-J61P Version 1.10L) enables [Tools] → [Start CC-Link Configurator] to be selected.

This menu does not appear if GX Configurator-CC (SW0D5C-J61P Version 1.10L) is installed in GX Developer (SW6D5C-GPPW or earlier).

16. CONNECTING A PLC

16.1 Specifying the Connection Target

16.1.1 When accessing the own station

| | | |
|-----------------------|-----------------------|-----------------------|
| A | Q/QnA | FX |
| <input type="radio"/> | <input type="radio"/> | <input type="radio"/> |

[Purpose]

Specify when making access to the own station.

[Operating Procedure]

Select [Online] → [Transfer setup].

[Dialog Box]

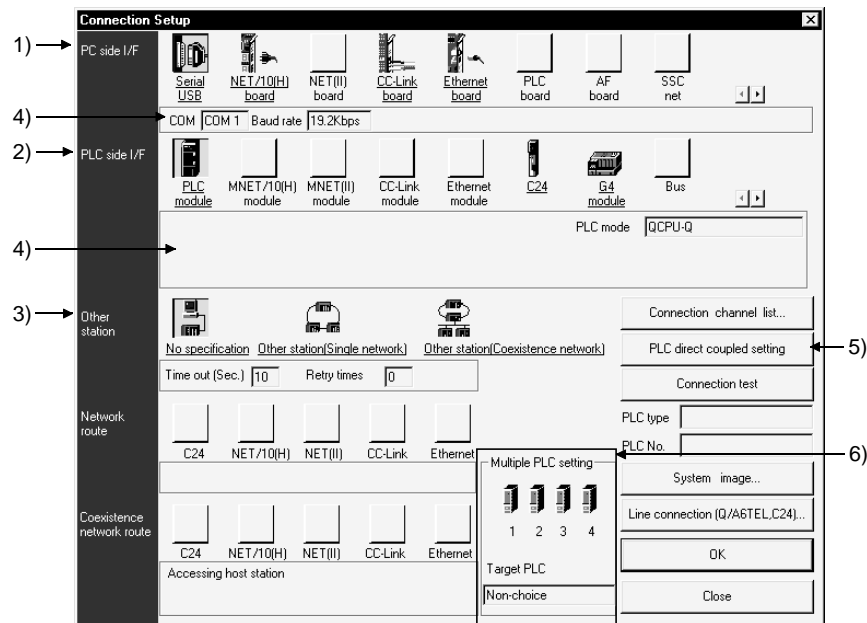

POINT

An underline on the setting screen indicates that detailed setting can be made by double-clicking it.
 The icons displayed can be selected.
 The icon shown yellow means that it has already been selected.

[Description]

- 1) PC side I/F
For Q series

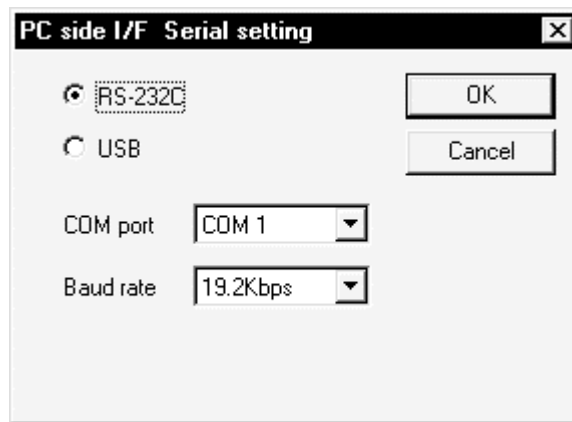

- USB may be set only when the QCPU (Q mode) has been selected.
- Precautions for communication at 115.2/57.6kbps
Fast communication cannot be made if the personal computer used is not compatible with the communication speed of 115.2/57.6kbps.
If communications delay due to communications tries or a communication error occurs, reduce the baud rate setting and restart communication.
- Refer to (4), (5), (6) in POINT of Section 16.1 for precautions for making USB communication.

QnA/A/FX series

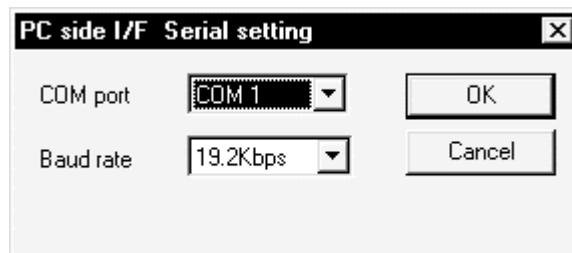

- The baud rate value that may be chosen differs between the PLC series and PLC types.
- For the QnA series, the CPU that can communicate at the communication speed of 38.4kbps is the QnACPU whose function version is B or later. Refer to Appendix 7 for the way to identify the unit version.
Refer to Section 22.3.3 when using the A6TEL as a converter.

- 2) PLC side I/F
Choose the PLC series of the PLC to be connected with GX Developer.
For A series

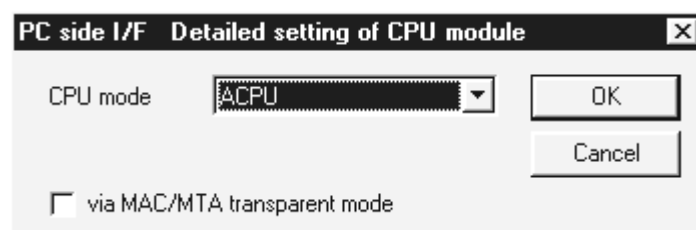

- Via MAC/MTA transparent mode (A/FX only)
Please make settings only when using MAC/MTA.

- 3) Other station
Choose No specification when specifying the own station.
When power-off, hardware reset or the like of the PLC CPU is performed during ladder monitor, it will take time until a communications error appears.
Until the error appears, during execution is displayed in Monitor status.
The longest time until the error appears can be found by the following expression.
(Time specified for communications time check) × 3 × (Count specified for the number of retries + 1)
For example, when the communications time check is specified as 30 seconds and the number of retries as 0 times, the resultant time is (30 seconds) × 3 × (0 + 1) = 90 seconds, and the error appears after a maximum of 90 seconds have elapsed.
- 4) Detailed settings display column
Shows the setting status.
- 5) PLC direct coupled setting button
This button is useful to change from Other station to the own station.
- 6) Multiple PLC Setting
Refer to Section 16.1.3 (1).

16.1.2 When accessing the other station

| | | |
|---|-------|----|
| A | Q/QnA | FX |
| ○ | ○ | × |

[Purpose]

Specify when making access to the other station.

[Operating Procedure]

Select [Online] → [Transfer Setup].

[Dialog Box]

When specifying the other station, it will be convenient to specify the connection target while looking at the connection channel diagram from Connection channel list.

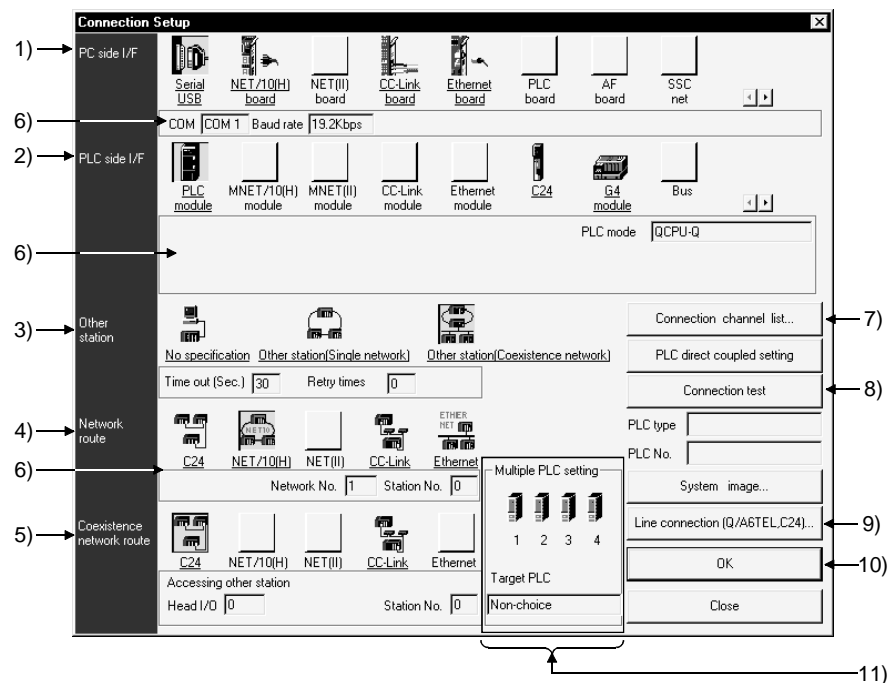

POINT

An underline on the setting screen indicates that detailed setting can be made by double-clicking it.
 The icons displayed can be selected.
 The icon shown yellow means that it has already been selected.

[Description]

1) PC side I/F

Refer to Section 16.1.1

When using GX Developer on the PC CPU module

The following six access paths are supported.

| Path | Remarks |
|-----------------------------|--|
| Serial | — |
| USB | — |
| Q series bus | Choose  to access the other CPU. |
| MELSECNET/H MELSECNET/10 | <ul style="list-style-type: none"> • Choose the MELSECNET/10(H) board. • Access to the other station requires the PPC-DRV-01 bus interface driver. |
| CC-Link | <ul style="list-style-type: none"> • Choose the CC-Link board. • Access to the other station requires the PPC-DRV-01 bus interface driver. |
| Ethernet | Access to the other station can be made by the Ethernet module communication port equipped for the personal computer CPU module as standard. |

2) PLC side I/F

Choose the unit to be connected with the personal computer.

Refer to Section 16.1.1

3) Other station

What is Single network?

It indicates a system which is configured by a single network and a multilevel system, e.g., only MELSECNET/10 or only Ethernet. (Since Ethernet is regarded as the MELSECNET/10, specify Single network for an MELSECNET/10 and Ethernet mixed system.)

What is Coexistence network?

Set this network when making access to the other station PLC via two different networks.

This network indicates a system which is made up of different networks, e.g. from MELSECNET/10 to CC-Link unit or from Q-compatible C24/QC24 to MELSECNET/10.

This network cannot be chosen for the A series.

4) Network route

When Single network is selected

Choose the network type, network No., station number and first I/O No. to be accessed.

The setting items depend on the network type that has been set.

When Coexistence network is selected

Choose this when making access to the network different from the one where the personal computer is connected.

5) Coexistence network route

Choose the network type, network No., station number and first I/O No. to be accessed.

The setting items depend on the network type that has been set.

6) Detailed settings display column

Shows the setting status.

7) Connection channel list

You can set the connection target while looking at the Connection channel list. As clicking **OK** automatically sets the connection channel on the Connection Setup screen, settings can be made easily if a complicated system is configured. Set the network number, station number and others as desired according to the access target.

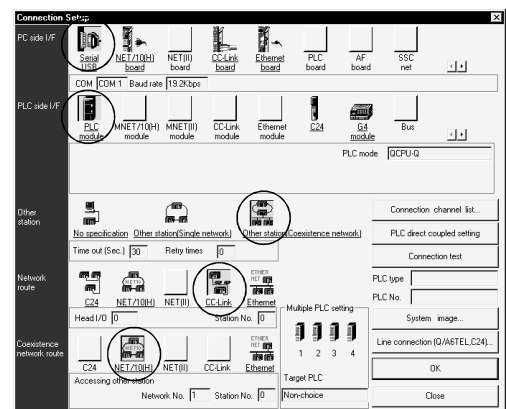
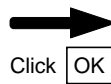
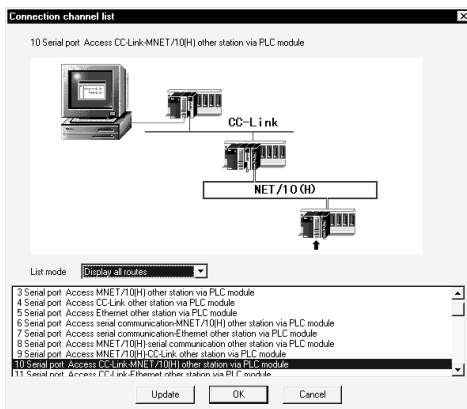

Clicking the **OK** button automatically sets the connection channel (areas enclosed by circles) on the Connection Setup screen.

Changing from one display to another

Convenient usage of Display selected routes

When Display selected routes are selected by specifying the PC side I/F and PLC side I/F on the Connection Setup screen, only the routes in the accessible range are displayed from among the other station, network route and coexistence network route.

A list of system configurations different in series can also be displayed.

| Request Source | PC-Connected PLC | Relay Station | Access Target |
|-------------------|------------------|---------------|---------------|
| Personal computer | QCPU (Q mode) | QCPU (Q mode) | Q series |
| | | | QnA series |
| | | | A series |

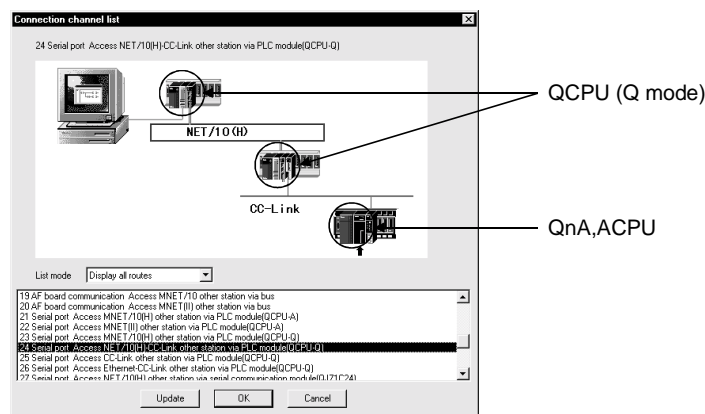

8) Connection test

Tests whether proper access can be made to the PLC set as the access target on the Connection Setup screen.

If proper access can be made, the model name of the PLC as the access target appears in the CPU type field.

9) System image

Illustrates the preset connection channel.

10) Line connection (Q/A6TEL, C24) button

Set when using a telephone line to make communication.

Refer to Section 23.4 for the way to set the Line connection setting screen.

11) Multiple PLC setting

Specify when the access target is multiple CPUs.

For details, refer to Section 16.1.3 (2).

Screen setting for MELSECNET/10 and Ethernet combined system (Single network)
In an MELSECNET/10 and Ethernet mixed system configuration, specify Single network to access the other station. (Since Ethernet is equivalent to the MELSECNET/10)

An example of the Connection Setup setting screen is provided for the following system configuration (Q/QnA only).

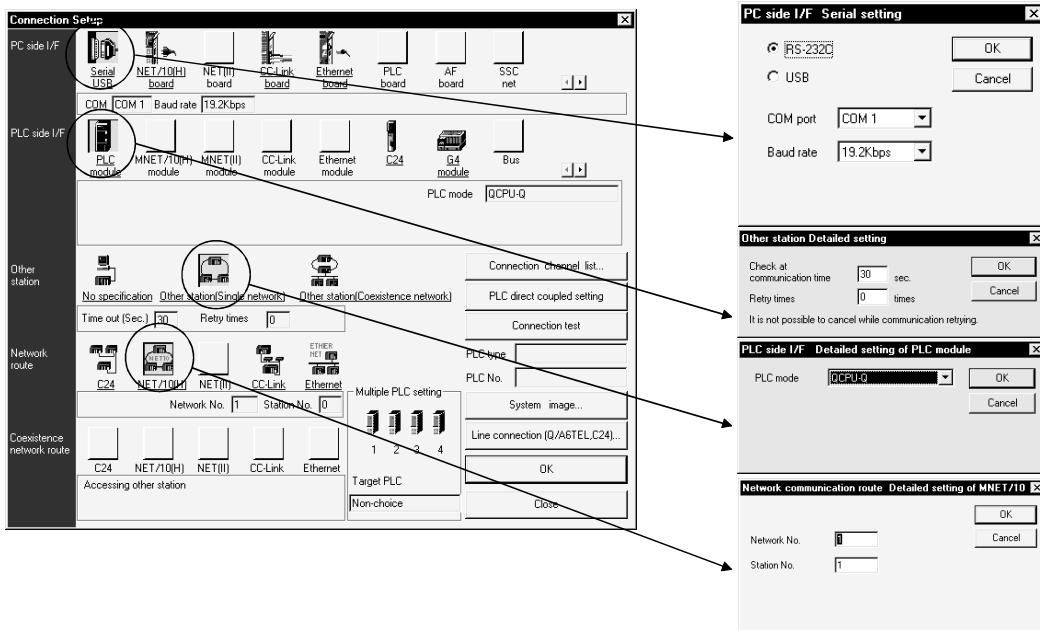
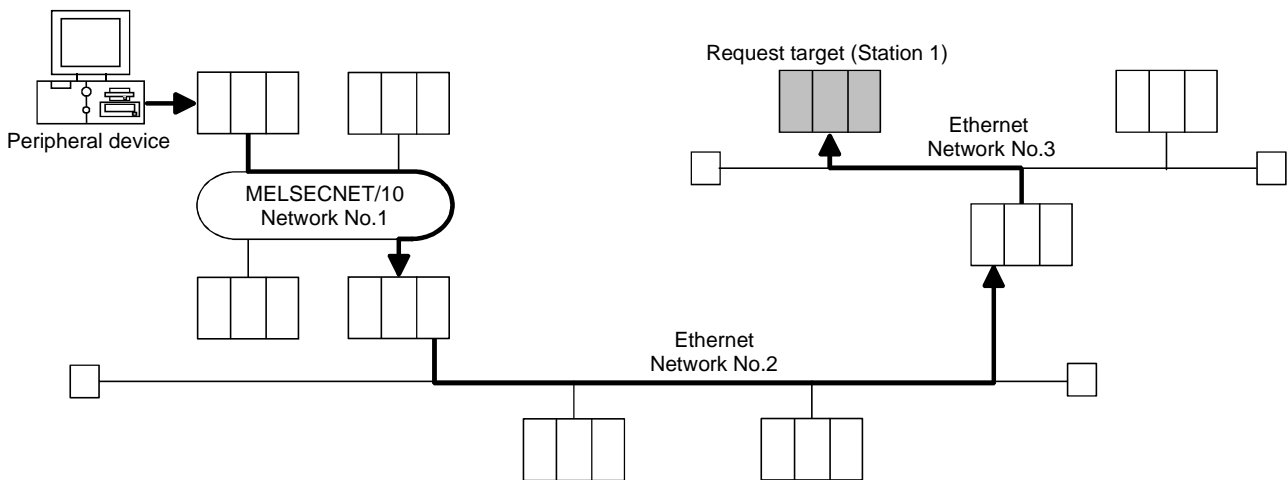

For access to the other station or multilevel system, not only the Connection Setup but also the routing parameters should be set to enable communications.

Screen setting for MELSECNET/H, MELSECNET/10 and C24 mixed system (Coexistence network)

Specify Coexistence network when accessing the other station via different networks, e.g. from MELSECNET/H, MELSECNET/10 to Q-compatible C24/QC24. An example of the Connection Setup setting screen is provided for the following system configuration (Q/QnA only).

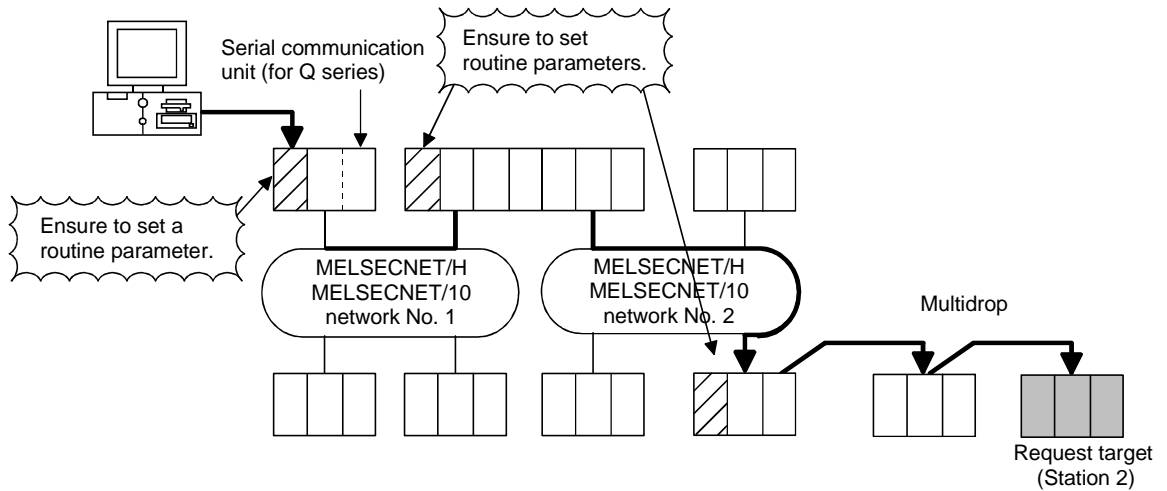

The screenshot shows the 'Connection Setup' dialog box. Callouts from the diagram above point to the following settings:

- PC side I/F:** The 'Serial setting' dialog is shown, with 'RS-232C' selected, 'COM 1' as the port, and '19.2Kbps' as the baud rate.
- Other station:** The 'Detailed setting of C24' dialog is shown, with 'QJ71C24' as the CPU type, '0' as the station number, 'Odd' as parity, and 'Existence' as the sum check.
- Network route:** The 'Detailed setting of MNET/10' dialog is shown, with '0' as the network number and '1' as the station number.
- Coexistence network route:** The 'Detailed setting of Computer I...' dialog is shown, with '0' as the head I/O and '0' as the station number.

Additional settings visible in the main 'Connection Setup' window include: Station No. 0, Parity Odd, Sum check Existence, Data bit 8, Stop bit 1, Computer type QJ71C24, Network No. 0, and Station No. 0.

REMARKS

Precautions are indicated for when accessing to other station like the following system example.

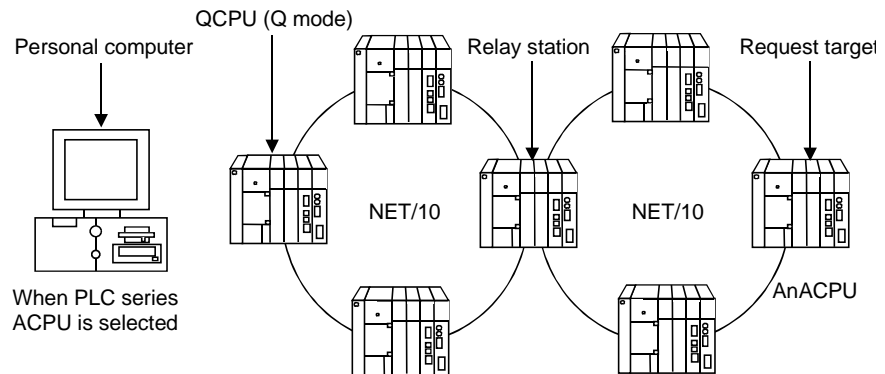

1. Change the personal computer to the PLC type of the request target. Communication cannot be made if the PLC type differs.
2. The relay station used should be the QCPU (Q mode), AnUCPU.

16.1.3 Accessing multiple CPUs

16.1.3 (1) About access to other multiple CPU modules

| | | |
|---|-------|----|
| A | Q/QnA | FX |
| × | ○* | × |

*: Compatible with the Q02(H)/Q06H/Q12H/Q25H CPU.

[Purpose]

Specify when accessing multiple CPUs.

[Operating Procedure]

Select [Online] → [Connection setup].

[Dialog Box]

The following setting example assumes that the personal computer is connected to the No. 1 module by a cable to access the No. 4 module.

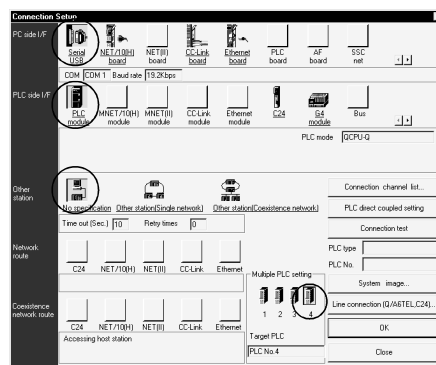

[Description]

When accessing other than the connected PLC CPU, always specify the module No. to be accessed in Multiple PLC setting. Note that if it is not specified in Multiple PLC setting, access will be made to the PLC CPU with which the cable is connected.

How to set "No module No. specified" in Multiple PLC setting

No module No. specified is indicated by the icons of the PLC No. 1 to PLC No. 4 modules in Multiple PLC setting which are not selected (when selected, the icons are shown yellow).

When the icons of the PLC No. 1 to PLC No. 4 modules have been selected, clicking the selected icon sets it to "No module No. specified".

When "No module No. specified" has been set, access is made to the PLC CPU connected by the RS232/USB cable.

An example on the above setting screen is shown by the following image sketch.

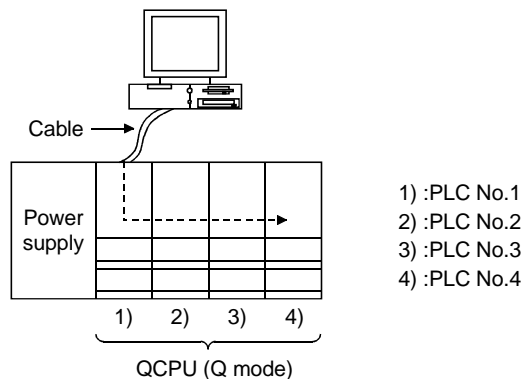

Restrictions on access to the PLC CPU and Q motion CPU

You cannot start GX Developer and GSV to access the PLC CPU and Q motion controller at the same time.

<Connection example>

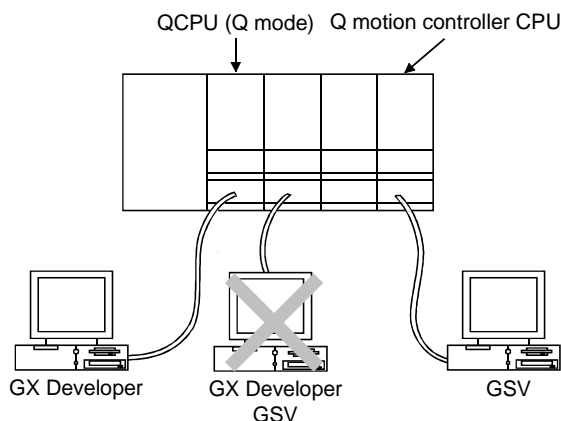

| POINT |
|--|
| <ul style="list-style-type: none"> • The Q motion CPU is incompatible with GX Developer. Accordingly, do not connect GX Developer to the Q motion CPU. Accidental connection will cause a communication error. In that case, reconnect it to the PLC CPU. • In the multiple PLC system, access can be made to only the "No. 1 CPU" when access is to be made to the other PLC CPU from the personal computer CPU module via the Q bus. |

16.1.3 (2) About network access via multiple CPUs

| | | |
|---|-------|----|
| A | Q/QnA | FX |
| ○ | ○* | ○ |

*: Compatible with the Q02(H)/Q06H/Q12H/Q25HCPU.

[Purpose]

Access is made to any network station under control of the own module.

[Operating Procedure]

Select [Online] → [Connection setup].

[Dialog Box]

The following setting assumes that access will be made to the accessed station (PLC No. 1 to PLC No. 4 modules) in [Description].

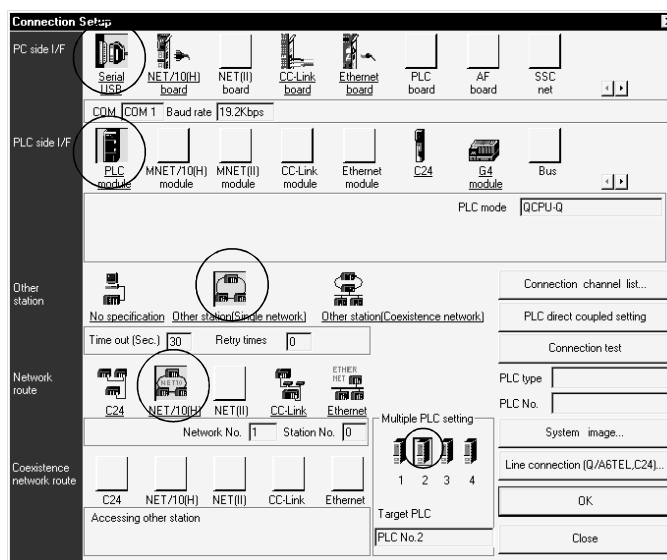

[Description]

The concept of an access path in the following system configuration will be described.

When access is made to non-control PLC as module used for routing of the accessed other station in a Multiple CPU system, the relay modules and QCPUs of the own station, all relay stations and accessed station should be the modules of function version B.

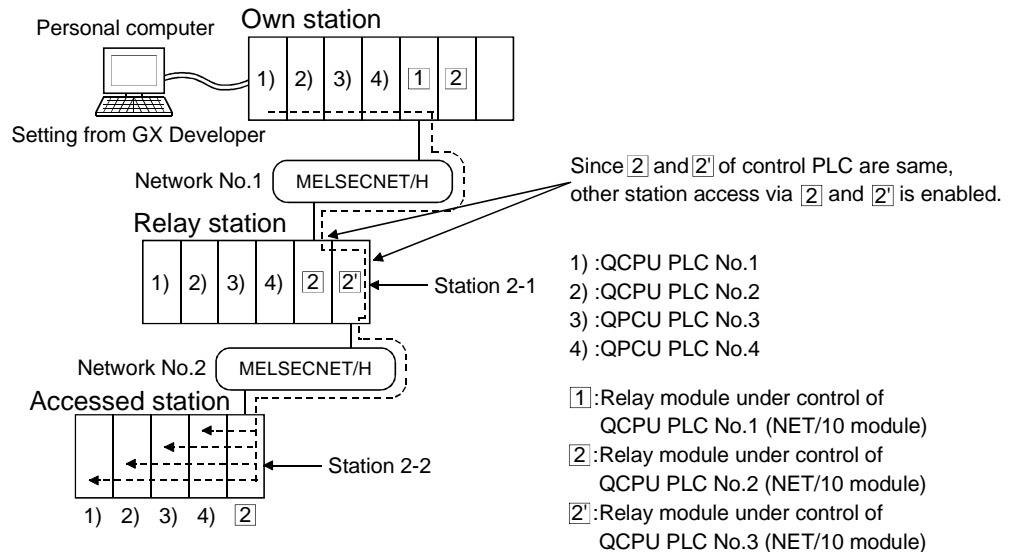

Precautions for and restrictions on access to other station

- (1) When accessing the CPU controlled or not controlled by the accessed station, change the accessed module in "Multiple PLC setting" on the Connection setup screen.
- (2) Assign the two network modules on the relay station to the same control CPU.
- (3) When the network module of the accessed station is that of function version B, access can be made to PLC No. 1 to PLC No. 4 modules.
When the the network module of the accessed station is that of function version A, access may be made to only the control PLC by the network module (PLC No. 1).

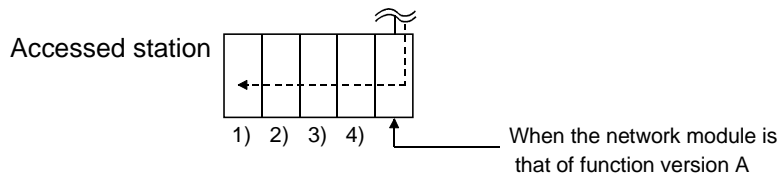

POINT

Setting the routing parameters of the MELSECNET/H, MELSECNET/10 (including Ethernet) allows access to the other station PLC within the range of the network system specifications.

| POINTS |
|--|
| <p>(1) Precautions for access to the other stations of the MELSECNET (II, /10) via the computer link unit (for A series) or E71 GX Developer recognizes the MELSECNET/10 as the MELSECNET (II) when the other stations are to be accessed via the computer link unit (for A series) or E71. When the same station exists on the MELSECNET (II) and MELSECNET/10, the other stations beyond the MELSECNET/10 may not be accessed if Via MELSECNET/10 has been selected in Connection Setup. (Because communications from the station of the unit set in the "Unit valid for other station access" network parameter are executed.) When you want to access all other stations via the computer link unit (for A series) or E71, do not set the same station number on the networks.</p> |
| <p>(2) When the MELSECNET/10 /CC-Link card is used, the time check is fixed to 30 seconds.</p> |
| <p>(3) Precautions for access to the motion controller (SCPU) via the MELSECNET (II, /10)</p> <ul style="list-style-type: none"> • Set the A171SH/A172SH as the A2SH. • Set the A273UH(S3) as the A3U. <p>In this case, the instructions dedicated to the motion controller (SCPU) cannot be used.</p> |
| <p>(4) A communications error may occur if communications are made with the PLC after setting the resume function, suspend setting, power-saving function or standby mode of the personal computer. Hence, any of the above functions should not be set for making communications with the PLC.</p> |
| <p>(5) Connecting/disconnecting the USB cable, resetting the PLC, or switching power OFF/ON frequently during communications with the PLC can cause a communications error, from which recovery may not be made. Hence, place GX Developer in an offline status* where possible before connecting/disconnecting the USB cable, resetting the PLC, or switching power OFF/ON. If recovery cannot be made from the communications error, completely disconnect the USB cable once and reconnect it in more than five seconds. (Even after this operation, an error may occur at the initial communication, but communications will be made properly at the second time and later.) *Offline status: Indicates the status other than PLC write/read, monitor, test and PLC diagnostic</p> |
| <p>(6) Communication errors may occur depending on the type of personal computer used or USB cable assembly In this case. Please execute communication again according to the error message contents.</p> |
| <p>(7) When fast communication is made after the baud rate has been changed on the personal computer's serial port (personal computer side interface), communications may not be made or communications retries may take place to delay communications, depending on the performance of the personal computer. If communications cannot be made in fast communication, reduce the baud rate and make communication.</p> |
| <p>(8) Other station access cannot be made for the 171SHCPU and A172SHCPU of the motion controller (SCPU). Access may be made to only the own station.</p> |

POINTS

(9) Do not reset the PLC CPU when starting GX Developer on Windows® 2000 and making communications with the PLC CPU using the USB cable.

If you reset the PLC CPU during communications using the USB cable, the following dialog box will appear and the USB driver will be removed.

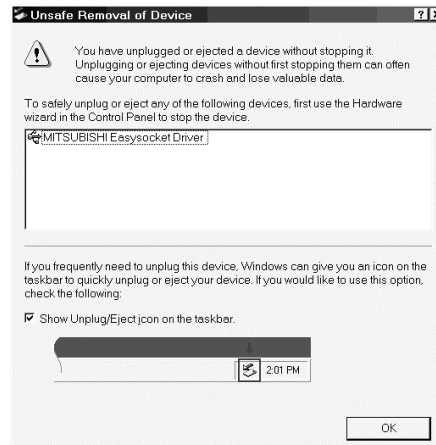

Take the following action when the above dialog box has appeared.

- Click the **OK** button and remove the USB driver once.

(10) When the serial communication function is used to make communication between the Q00J/Q00/Q01 CPU and external device, perform the following operation to change the other end device for GX Developer.

- When making connection from GX Developer, match the baud rate to that set in Serial communication setting.

Refer to Section 16.1.1 for operation.

16.2 Making access via Ethernet, CC-Link, G4 module, C24 or telephone line

16.2.1 Setting method for communication via the ethernet board

16.2.1 (1) For A series

| | | |
|---|-------|----|
| A | Q/QnA | FX |
| ○ | × | × |

For communication from GX Developer via the E71, there are the following setting items and precautions. The explanations in this section will be made for the following system configuration.

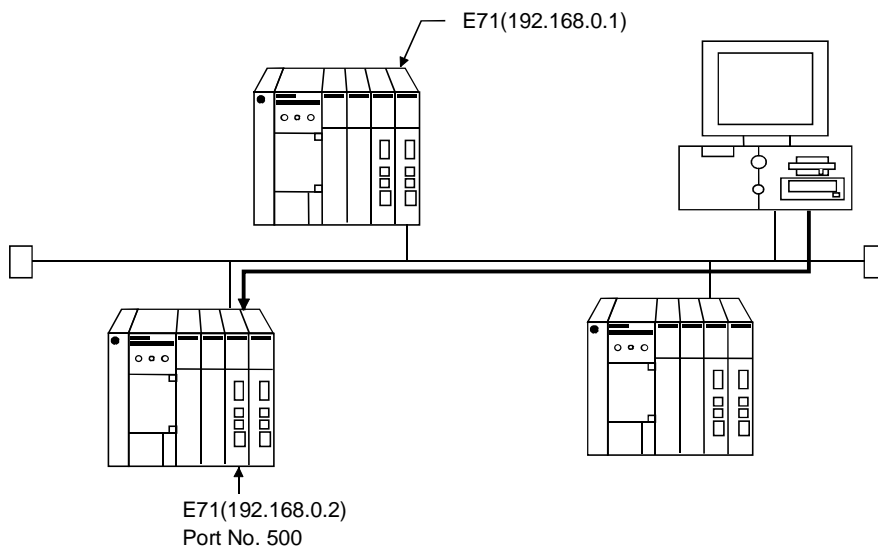

Procedure for communications via E71

Restrictions

- (a) When the AnUCPU type has been started on the personal computer, change the PLC type to the AnACPU.
- (b) Communications can be made only within the same segment. Communication cannot be made via the router or gateway.

(1) Compatible models

AJ71E71-S3, A1SJ71E71-B2-S3, A1SJ71E71-B5-S3

(2) E71 switch settings

| | AJ71E71-S3 | A1SJ71E71-B2-S3, A1SJ71E71-B5-S3 |
|--|--|--|
| Operation mode setting switch | 0 (online mode) | 0 (online mode) |
| Communications condition setting switch | SW2 OFF (BIN code) | SW2 OFF (BIN code) |
| CPU communications timing setting switch | SW7 ON (online program correction enabled) | SW3 ON (online program correction enabled) |

(3) Sequence program

An initial processing and communication line open processing sequence program is required.

Required communications parameters and a sequence program example are given below.

(a) Communications parameters

The following is an example of setting the communications parameters.

| Item | Setting |
|-------------------------|-------------|
| Application settings *1 | 100H |
| E71's IP address | 192.168.0.2 |
| E71 port number | 500H |
| Other node IP address | FFFFFFFF |
| Other node port number | FFFF(*2) |

*1: Values specified for application settings

The details of application settings are indicated below.

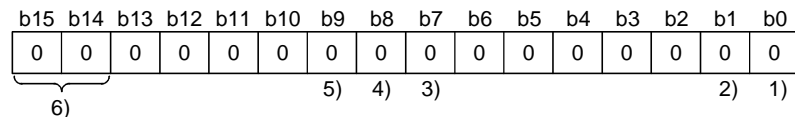

The settings of 1), 2), 3) can be changed by the user.

The settings of 4), 5), 6) are fixed.

- 1) Fixed buffer application
 - 0: For send/no communications
 - 1: For receive
- 2) Existence check
 - 0: No
 - 1: Yes
- 3) Pairing open
 - 0: No
 - 1: Yes
- 4) Communication system (Set to 1: UDP/IP.)
 - 0: TCP/IP
 - 1: UDP/IP
- 5) Fixed buffer communications (Set to 0: With protocol.)
 - 0: With protocol
 - 1: Without protocol
- 6) Open system (Set to 00: Active, UDP/IP.)
 - 00: Active, UDP/IP
 - 10: Unpassive
 - 11: Fullpassive

*2: The other node port number is fixed.

The other settings can be changed by the user.

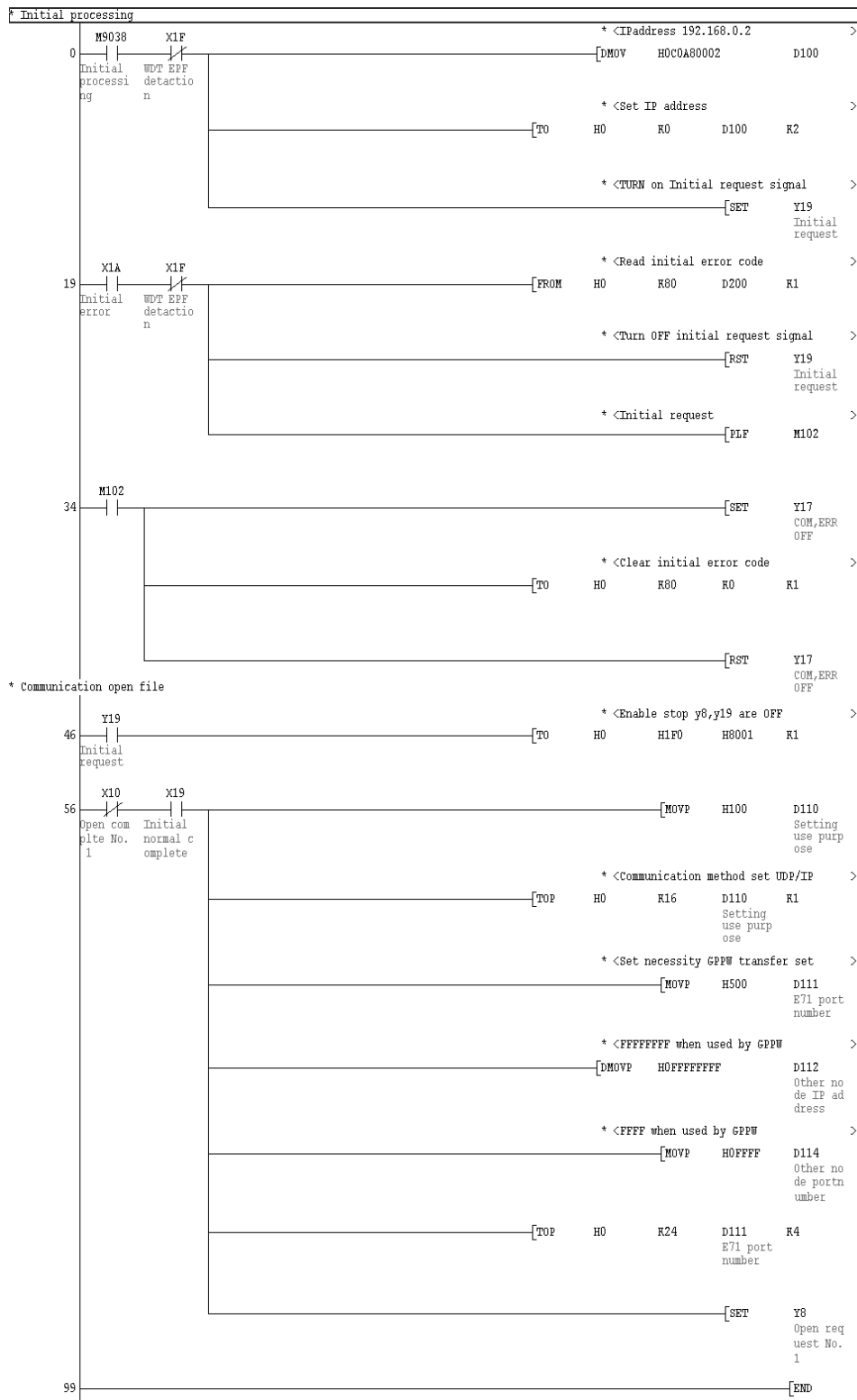

In a communications-ready status, the E71's RUN LED comes on and RDY LED flickers.

- (4) Setting on the personal computer
Set the IP address.
- (5) Communications check
When the preparations for communications via the E71 are complete, execute a Ping test. Refer to Section 21.4.9 for the operation method.

When connections are OK

C:\>ping 192. 168. 0. 2

Reply from 192. 168. 0. 2:bytes=32 time<10ms TTL=32

When connections are not good

C:\>ping 192. 168. 0. 2

Request timed out.

If ping does not pass through, check the cable and unit connections and Windows® side IP address and other settings.

- (6) Connection Setup screen
Setting screen for communication via Ethernet unit

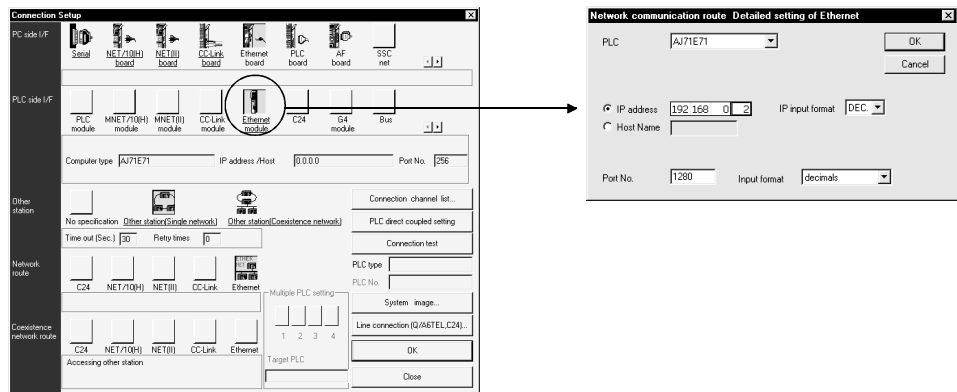

- (a) Double-click the Ethernet icon on PLC side I/F to choose the unit model to be connected.
- (b) The detail setting screen for the Ethernet unit to be connected opens.
 - 1) Set the IP address assigned to the E71 to be connected.
(When the host name has been selected, specify the name preset in the hosts file within 64 characters.)
 - 2) As the port No., set the port No. of the connected E71 set in the sequence program.

POINT

- To make connection to the QCPU (A mode) or AnUCPU via Ethernet, set the AnACPU as the PLC type using New project. Access can be made within the range that can be handled by the AnACPU, e.g. sequence program or device memory. Therefore, access cannot be made to the devices and network parameters that have been extended by subprogram 2/3, QCPU (A mode) or AnUCPU.
- When making access to the AnUCPU in the following system configuration via the QJ71E71, the project need not be changed for the AnACPU. The devices can be accessed within the range that can be handled by the AnACPU.

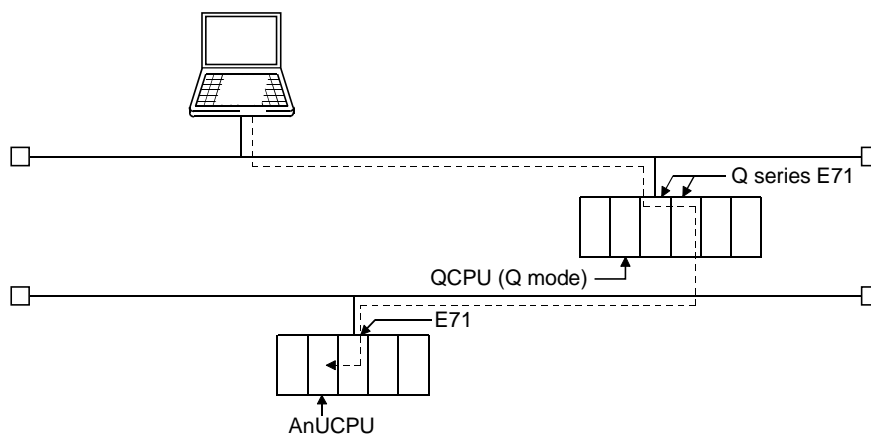

- When accessing the A173SHCPU/A273UHCPU of the motion controller (SCPU), specify the A3ACPU to start the project. When accessing the A171SHCPU/A172SHCPU, specify the PLC type of the access target to start the project.

16.2.1 (2) For QnA series

| A | Q/QnA | FX |
|---|-------|----|
| × | ○* | × |

*: Excluded from the Q series.

For communication from GX Developer via the QE71, there are the following setting items and precautions. The explanations in this section will be made for the following system configuration.

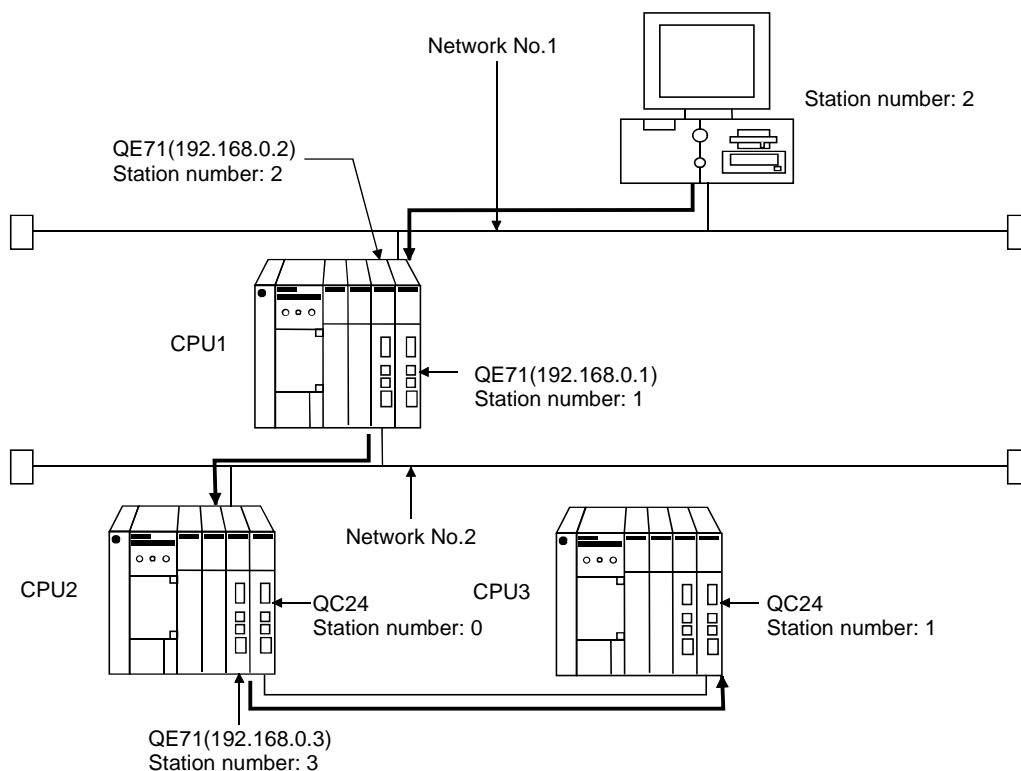

Procedure for communications via QE71

Restrictions

- (a) Communications cannot be made via the MELSECNET(II).
 - (b) Communications can be made only within the same segment.
Communication cannot be made via the router or gateway.
- (1) Compatible models
Use the QE71 and PLC whose function version is B or later.

- (2) QE71 switch settings
 Operation mode setting switch..... 0 (online)
 Automatic start mode..... SW3 ON
 When SW3 is ON, initial processing is performed independently of Y19 (initial processing request). Communications are also enabled if the CPU module is STOPped.
 For the way to perform initial processing using Y19 (initial processing request), refer to the AJ71QE71 User's Manual and create an initial processing program.
- (3) Parameter setting
 On the MELSECNET/Ethernet network parameter setting screen, set the network type, starting I/O No., network No., group No., station number and IP address.

| Setting Screen Examples | | | | | | | | | | | | | | | | | | | | | | | | | | | | | | | | | | |
|--------------------------|--|-----------------------------|-----------|-----------|--------------|----------|----------|---------------|------|------|-------------|---|---|--------------------------|--|--|-----------|---|---|-------------|---|---|---------------|---------------|---------------|--|-----------------------------|-----------------------------|--|----------------|----------------|--|---------------------|---------------------|
| CPU1 | <div style="text-align: center;">Ethernet parameters</div> <table border="1" style="width: 100%; border-collapse: collapse;"> <thead> <tr> <th></th> <th style="text-align: center;">Unit No.1</th> <th style="text-align: center;">Unit No.2</th> </tr> </thead> <tbody> <tr> <td>Network type</td> <td style="text-align: center;">Ethernet</td> <td style="text-align: center;">Ethernet</td> </tr> <tr> <td>Start I/O No.</td> <td style="text-align: center;">0040</td> <td style="text-align: center;">0060</td> </tr> <tr> <td>Network No.</td> <td style="text-align: center;">2</td> <td style="text-align: center;">1</td> </tr> <tr> <td>Total number of stations</td> <td></td> <td></td> </tr> <tr> <td>Group No.</td> <td style="text-align: center;">0</td> <td style="text-align: center;">0</td> </tr> <tr> <td>Station No.</td> <td style="text-align: center;">2</td> <td style="text-align: center;">1</td> </tr> <tr> <td>IP addressDEC</td> <td style="text-align: center;">192.168. 0. 2</td> <td style="text-align: center;">192.168. 0. 1</td> </tr> <tr> <td></td> <td style="text-align: center;">MNET/10 routing information</td> <td style="text-align: center;">MNET/10 routing information</td> </tr> <tr> <td></td> <td style="text-align: center;">FTP Parameters</td> <td style="text-align: center;">FTP Parameters</td> </tr> <tr> <td></td> <td style="text-align: center;">Routing information</td> <td style="text-align: center;">Routing information</td> </tr> </tbody> </table> <div style="text-align: center;">IP address setting</div> <div style="border: 1px solid black; padding: 5px; width: fit-content; margin: auto;"> <p>IP Address ✕</p> <p>Input format: DEC.</p> <p>IP address: 192 168 0 2</p> <p style="text-align: center;"> OK Cancel </p> </div> | | Unit No.1 | Unit No.2 | Network type | Ethernet | Ethernet | Start I/O No. | 0040 | 0060 | Network No. | 2 | 1 | Total number of stations | | | Group No. | 0 | 0 | Station No. | 2 | 1 | IP addressDEC | 192.168. 0. 2 | 192.168. 0. 1 | | MNET/10 routing information | MNET/10 routing information | | FTP Parameters | FTP Parameters | | Routing information | Routing information |
| | Unit No.1 | Unit No.2 | | | | | | | | | | | | | | | | | | | | | | | | | | | | | | | | |
| Network type | Ethernet | Ethernet | | | | | | | | | | | | | | | | | | | | | | | | | | | | | | | | |
| Start I/O No. | 0040 | 0060 | | | | | | | | | | | | | | | | | | | | | | | | | | | | | | | | |
| Network No. | 2 | 1 | | | | | | | | | | | | | | | | | | | | | | | | | | | | | | | | |
| Total number of stations | | | | | | | | | | | | | | | | | | | | | | | | | | | | | | | | | | |
| Group No. | 0 | 0 | | | | | | | | | | | | | | | | | | | | | | | | | | | | | | | | |
| Station No. | 2 | 1 | | | | | | | | | | | | | | | | | | | | | | | | | | | | | | | | |
| IP addressDEC | 192.168. 0. 2 | 192.168. 0. 1 | | | | | | | | | | | | | | | | | | | | | | | | | | | | | | | | |
| | MNET/10 routing information | MNET/10 routing information | | | | | | | | | | | | | | | | | | | | | | | | | | | | | | | | |
| | FTP Parameters | FTP Parameters | | | | | | | | | | | | | | | | | | | | | | | | | | | | | | | | |
| | Routing information | Routing information | | | | | | | | | | | | | | | | | | | | | | | | | | | | | | | | |
| CPU2 | <div style="text-align: center;">Ethernet parameters</div> <table border="1" style="width: 100%; border-collapse: collapse;"> <thead> <tr> <th></th> <th style="text-align: center;">Unit No.1</th> <th style="text-align: center;">Unit No.2</th> </tr> </thead> <tbody> <tr> <td>Network type</td> <td style="text-align: center;">Ethernet</td> <td style="text-align: center;">None</td> </tr> <tr> <td>Start I/O No.</td> <td style="text-align: center;">0040</td> <td></td> </tr> <tr> <td>Network No.</td> <td style="text-align: center;">2</td> <td></td> </tr> <tr> <td>Total number of stations</td> <td></td> <td></td> </tr> <tr> <td>Group No.</td> <td style="text-align: center;">0</td> <td></td> </tr> <tr> <td>Station No.</td> <td style="text-align: center;">3</td> <td></td> </tr> <tr> <td>IP addressDEC</td> <td style="text-align: center;">192.168. 0. 3</td> <td></td> </tr> <tr> <td></td> <td style="text-align: center;">MNET/10 routing information</td> <td></td> </tr> <tr> <td></td> <td style="text-align: center;">FTP Parameters</td> <td></td> </tr> <tr> <td></td> <td style="text-align: center;">Routing information</td> <td></td> </tr> </tbody> </table> <div style="text-align: center;">IP address setting</div> <div style="border: 1px solid black; padding: 5px; width: fit-content; margin: auto;"> <p>IP Address ✕</p> <p>Input format: DEC.</p> <p>IP address: 192 168 0 3</p> <p style="text-align: center;"> OK Cancel </p> </div> | | Unit No.1 | Unit No.2 | Network type | Ethernet | None | Start I/O No. | 0040 | | Network No. | 2 | | Total number of stations | | | Group No. | 0 | | Station No. | 3 | | IP addressDEC | 192.168. 0. 3 | | | MNET/10 routing information | | | FTP Parameters | | | Routing information | |
| | Unit No.1 | Unit No.2 | | | | | | | | | | | | | | | | | | | | | | | | | | | | | | | | |
| Network type | Ethernet | None | | | | | | | | | | | | | | | | | | | | | | | | | | | | | | | | |
| Start I/O No. | 0040 | | | | | | | | | | | | | | | | | | | | | | | | | | | | | | | | | |
| Network No. | 2 | | | | | | | | | | | | | | | | | | | | | | | | | | | | | | | | | |
| Total number of stations | | | | | | | | | | | | | | | | | | | | | | | | | | | | | | | | | | |
| Group No. | 0 | | | | | | | | | | | | | | | | | | | | | | | | | | | | | | | | | |
| Station No. | 3 | | | | | | | | | | | | | | | | | | | | | | | | | | | | | | | | | |
| IP addressDEC | 192.168. 0. 3 | | | | | | | | | | | | | | | | | | | | | | | | | | | | | | | | | |
| | MNET/10 routing information | | | | | | | | | | | | | | | | | | | | | | | | | | | | | | | | | |
| | FTP Parameters | | | | | | | | | | | | | | | | | | | | | | | | | | | | | | | | | |
| | Routing information | | | | | | | | | | | | | | | | | | | | | | | | | | | | | | | | | |
| CPU3 | Set the station number with the rotary switches of the module. | | | | | | | | | | | | | | | | | | | | | | | | | | | | | | | | | |

- (4) Routing parameter setting
 Set the routing parameters on the Ethernet parameter setting screen. Refer to Section 16.10 for the concept of the routing parameters.

| | | Setting Screen Examples | | | |
|------|---|-------------------------|------------------|------------------|----------------|
| CPU1 | | Target networkNo. | Relay networkNo. | Relay StationNo. | Via StationNo. |
| | 1 | 1 | 2 | 2 | |
| | 2 | 2 | 1 | 1 | |
| | 3 | | | | |
| CPU2 | | Target networkNo. | Relay networkNo. | Relay StationNo. | Via StationNo. |
| | 1 | 1 | 2 | 2 | |
| | 2 | | | | |
| | 3 | | | | |

After parameter setting is over, write the parameters to the PLC using Write to PLC. In a communications-ready status, the QE71's RUN LED comes on and RDY LED flickers.

- (5) Communications check
 Refer to Section 16.2.1 (1) for communications check.
- (6) Connection Setup screen

The main screenshot shows the 'Connection Setup' dialog box with several sections: PC side I/F, PLC side I/F, Other station, Network route, and Coexistence network route. Four callout boxes provide detailed settings for each section:

- PC side I/F Ethernet board setting:** Network No. [0], Station No. [1].
- Network communication route Detailed setting of Ethernet:** PLC [AJ71QE71], Network No. [1], Station No. [1], IP address [192.168.0.1], IP input format [DEC].
- Network communication route Detailed setting of Ethernet:** Access to Ethernet unit set on PC side I/F [checked].
- Coexistence network route Detailed setting of Computer I/O:** Head I/O [0], Station No. [0].

| Item | Description |
|---------------------------|---|
| PC side I/F | Set the network No. and station number. |
| PLC side I/F | Set the model name, station number, IP address, etc. of the unit connected to the personal computer. |
| Network route | As access is made to the other station via the Ethernet unit, choose "Other station in the same loop or access to multilevel system". |
| Coexistence network route | Set the first I/O address and station number of the station to be accessed. |

16.2.1 (3) For Q series

| | | |
|---|-------|----|
| A | Q/QnA | FX |
| × | ○* | × |

*: Except the QnA series.

For communication from GX Developer via the Q-compatible E71, there are the following setting items and precautions. The explanations in this section will be made for the following system configuration.

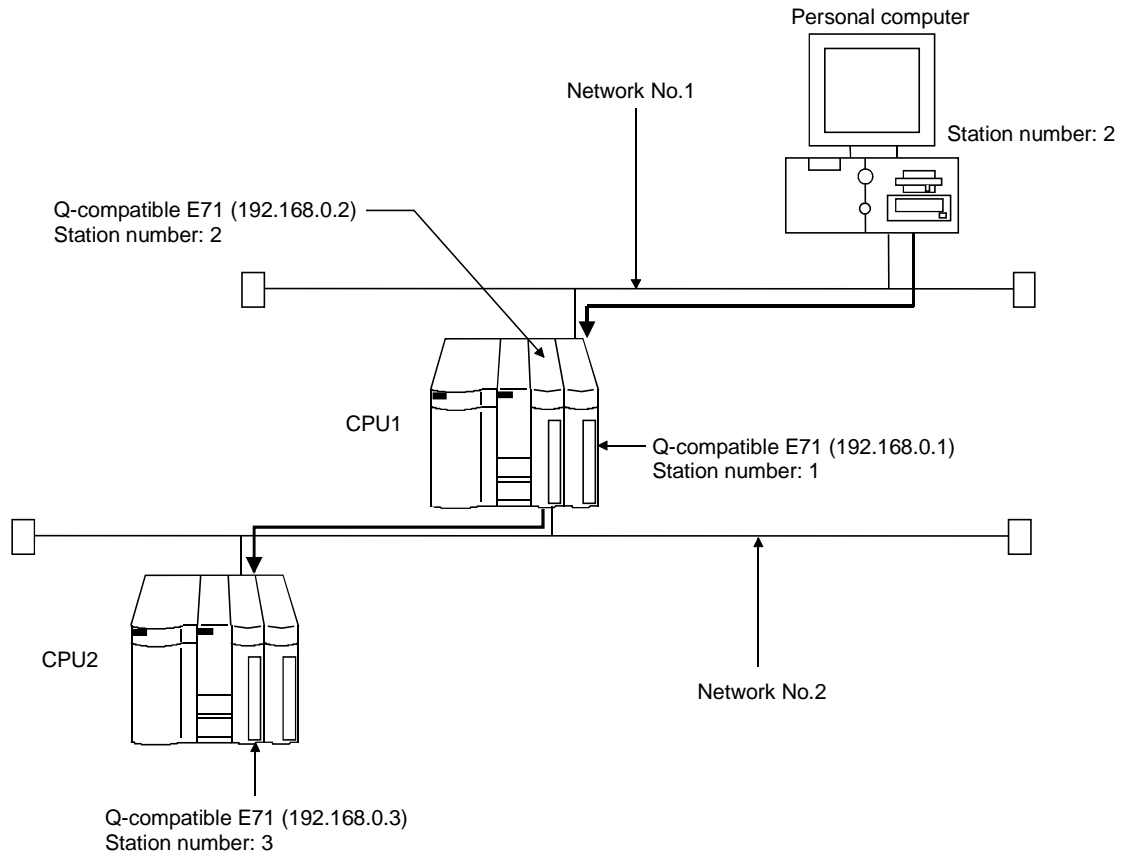

Procedure for and restrictions on communications via Q-compatible E71

- (1) Compatible models
QJ71E71, QJ71E71-B2, QJ71E-100

- (2) Network parameter setting
 Parameter setting can be made from the MELSECNET/ETHERNET network parameter setting screen.
 Set the network type, first I/O No., network No., group No., station number, mode and operation setting.

| Setting Screen Examples | | | | | | | | | | | | | | | | | | | | | | | | | | | | | | | | | | | | | | | | | | | | | | | | | | | | | |
|-------------------------|--|-----------------------------|--|--|--|--------|--------|--------------|----------|----------|------------------|------|------|-------------|---|---|----------------|--|--|-----------|---|---|-------------|---|---|------|---------|---------|--|----------------------|----------------------|--|------------------|------------------|--|---------------|---------------|--|---------------------|---------------------|--|-----------------------------|-----------------------------|--|----------------|----------------|--|-----------------|-----------------|--|--------------------|--------------------|--|
| CPU1 | <table border="1" style="width: 100%; border-collapse: collapse;"> <thead> <tr> <th colspan="3" style="text-align: center;">Ethernet parameters</th> </tr> <tr> <th></th> <th style="text-align: center;">Unit 1</th> <th style="text-align: center;">Unit 2</th> </tr> </thead> <tbody> <tr> <td>Network type</td> <td style="text-align: center;">Ethernet</td> <td style="text-align: center;">Ethernet</td> </tr> <tr> <td>Starting I/O No.</td> <td style="text-align: center;">0000</td> <td style="text-align: center;">0020</td> </tr> <tr> <td>Network No.</td> <td style="text-align: center;">2</td> <td style="text-align: center;">1</td> </tr> <tr> <td>Total stations</td> <td></td> <td></td> </tr> <tr> <td>Group No.</td> <td style="text-align: center;">0</td> <td style="text-align: center;">0</td> </tr> <tr> <td>Station No.</td> <td style="text-align: center;">2</td> <td style="text-align: center;">1</td> </tr> <tr> <td>Mode</td> <td style="text-align: center;">On line</td> <td style="text-align: center;">On line</td> </tr> <tr> <td></td> <td style="text-align: center;">Operational settings</td> <td style="text-align: center;">Operational settings</td> </tr> <tr> <td></td> <td style="text-align: center;">Initial settings</td> <td style="text-align: center;">Initial settings</td> </tr> <tr> <td></td> <td style="text-align: center;">Open settings</td> <td style="text-align: center;">Open settings</td> </tr> <tr> <td></td> <td style="text-align: center;">Routing information</td> <td style="text-align: center;">Routing information</td> </tr> <tr> <td></td> <td style="text-align: center;">MNET/10 routing information</td> <td style="text-align: center;">MNET/10 routing information</td> </tr> <tr> <td></td> <td style="text-align: center;">FTP Parameters</td> <td style="text-align: center;">FTP Parameters</td> </tr> <tr> <td></td> <td style="text-align: center;">E-mail settings</td> <td style="text-align: center;">E-mail settings</td> </tr> <tr> <td></td> <td style="text-align: center;">Interrupt settings</td> <td style="text-align: center;">Interrupt settings</td> </tr> </tbody> </table> | Ethernet parameters | | | | Unit 1 | Unit 2 | Network type | Ethernet | Ethernet | Starting I/O No. | 0000 | 0020 | Network No. | 2 | 1 | Total stations | | | Group No. | 0 | 0 | Station No. | 2 | 1 | Mode | On line | On line | | Operational settings | Operational settings | | Initial settings | Initial settings | | Open settings | Open settings | | Routing information | Routing information | | MNET/10 routing information | MNET/10 routing information | | FTP Parameters | FTP Parameters | | E-mail settings | E-mail settings | | Interrupt settings | Interrupt settings | |
| Ethernet parameters | | | | | | | | | | | | | | | | | | | | | | | | | | | | | | | | | | | | | | | | | | | | | | | | | | | | | |
| | Unit 1 | Unit 2 | | | | | | | | | | | | | | | | | | | | | | | | | | | | | | | | | | | | | | | | | | | | | | | | | | | |
| Network type | Ethernet | Ethernet | | | | | | | | | | | | | | | | | | | | | | | | | | | | | | | | | | | | | | | | | | | | | | | | | | | |
| Starting I/O No. | 0000 | 0020 | | | | | | | | | | | | | | | | | | | | | | | | | | | | | | | | | | | | | | | | | | | | | | | | | | | |
| Network No. | 2 | 1 | | | | | | | | | | | | | | | | | | | | | | | | | | | | | | | | | | | | | | | | | | | | | | | | | | | |
| Total stations | | | | | | | | | | | | | | | | | | | | | | | | | | | | | | | | | | | | | | | | | | | | | | | | | | | | | |
| Group No. | 0 | 0 | | | | | | | | | | | | | | | | | | | | | | | | | | | | | | | | | | | | | | | | | | | | | | | | | | | |
| Station No. | 2 | 1 | | | | | | | | | | | | | | | | | | | | | | | | | | | | | | | | | | | | | | | | | | | | | | | | | | | |
| Mode | On line | On line | | | | | | | | | | | | | | | | | | | | | | | | | | | | | | | | | | | | | | | | | | | | | | | | | | | |
| | Operational settings | Operational settings | | | | | | | | | | | | | | | | | | | | | | | | | | | | | | | | | | | | | | | | | | | | | | | | | | | |
| | Initial settings | Initial settings | | | | | | | | | | | | | | | | | | | | | | | | | | | | | | | | | | | | | | | | | | | | | | | | | | | |
| | Open settings | Open settings | | | | | | | | | | | | | | | | | | | | | | | | | | | | | | | | | | | | | | | | | | | | | | | | | | | |
| | Routing information | Routing information | | | | | | | | | | | | | | | | | | | | | | | | | | | | | | | | | | | | | | | | | | | | | | | | | | | |
| | MNET/10 routing information | MNET/10 routing information | | | | | | | | | | | | | | | | | | | | | | | | | | | | | | | | | | | | | | | | | | | | | | | | | | | |
| | FTP Parameters | FTP Parameters | | | | | | | | | | | | | | | | | | | | | | | | | | | | | | | | | | | | | | | | | | | | | | | | | | | |
| | E-mail settings | E-mail settings | | | | | | | | | | | | | | | | | | | | | | | | | | | | | | | | | | | | | | | | | | | | | | | | | | | |
| | Interrupt settings | Interrupt settings | | | | | | | | | | | | | | | | | | | | | | | | | | | | | | | | | | | | | | | | | | | | | | | | | | | |
| CPU2 | <table border="1" style="width: 100%; border-collapse: collapse;"> <thead> <tr> <th colspan="3" style="text-align: center;">Ethernet parameters</th> </tr> <tr> <th></th> <th style="text-align: center;">Unit 1</th> <th style="text-align: center;">Unit 2</th> </tr> </thead> <tbody> <tr> <td>Network type</td> <td style="text-align: center;">Ethernet</td> <td style="text-align: center;">None</td> </tr> <tr> <td>Starting I/O No.</td> <td style="text-align: center;">0000</td> <td></td> </tr> <tr> <td>Network No.</td> <td style="text-align: center;">2</td> <td></td> </tr> <tr> <td>Total stations</td> <td></td> <td></td> </tr> <tr> <td>Group No.</td> <td style="text-align: center;">0</td> <td></td> </tr> <tr> <td>Station No.</td> <td style="text-align: center;">3</td> <td></td> </tr> <tr> <td>Mode</td> <td style="text-align: center;">On line</td> <td></td> </tr> <tr> <td></td> <td style="text-align: center;">Operational settings</td> <td></td> </tr> <tr> <td></td> <td style="text-align: center;">Initial settings</td> <td></td> </tr> <tr> <td></td> <td style="text-align: center;">Open settings</td> <td></td> </tr> <tr> <td></td> <td style="text-align: center;">Routing information</td> <td></td> </tr> <tr> <td></td> <td style="text-align: center;">MNET/10 routing information</td> <td></td> </tr> <tr> <td></td> <td style="text-align: center;">FTP Parameters</td> <td></td> </tr> <tr> <td></td> <td style="text-align: center;">E-mail settings</td> <td></td> </tr> <tr> <td></td> <td style="text-align: center;">Interrupt settings</td> <td></td> </tr> </tbody> </table> | Ethernet parameters | | | | Unit 1 | Unit 2 | Network type | Ethernet | None | Starting I/O No. | 0000 | | Network No. | 2 | | Total stations | | | Group No. | 0 | | Station No. | 3 | | Mode | On line | | | Operational settings | | | Initial settings | | | Open settings | | | Routing information | | | MNET/10 routing information | | | FTP Parameters | | | E-mail settings | | | Interrupt settings | | |
| Ethernet parameters | | | | | | | | | | | | | | | | | | | | | | | | | | | | | | | | | | | | | | | | | | | | | | | | | | | | | |
| | Unit 1 | Unit 2 | | | | | | | | | | | | | | | | | | | | | | | | | | | | | | | | | | | | | | | | | | | | | | | | | | | |
| Network type | Ethernet | None | | | | | | | | | | | | | | | | | | | | | | | | | | | | | | | | | | | | | | | | | | | | | | | | | | | |
| Starting I/O No. | 0000 | | | | | | | | | | | | | | | | | | | | | | | | | | | | | | | | | | | | | | | | | | | | | | | | | | | | |
| Network No. | 2 | | | | | | | | | | | | | | | | | | | | | | | | | | | | | | | | | | | | | | | | | | | | | | | | | | | | |
| Total stations | | | | | | | | | | | | | | | | | | | | | | | | | | | | | | | | | | | | | | | | | | | | | | | | | | | | | |
| Group No. | 0 | | | | | | | | | | | | | | | | | | | | | | | | | | | | | | | | | | | | | | | | | | | | | | | | | | | | |
| Station No. | 3 | | | | | | | | | | | | | | | | | | | | | | | | | | | | | | | | | | | | | | | | | | | | | | | | | | | | |
| Mode | On line | | | | | | | | | | | | | | | | | | | | | | | | | | | | | | | | | | | | | | | | | | | | | | | | | | | | |
| | Operational settings | | | | | | | | | | | | | | | | | | | | | | | | | | | | | | | | | | | | | | | | | | | | | | | | | | | | |
| | Initial settings | | | | | | | | | | | | | | | | | | | | | | | | | | | | | | | | | | | | | | | | | | | | | | | | | | | | |
| | Open settings | | | | | | | | | | | | | | | | | | | | | | | | | | | | | | | | | | | | | | | | | | | | | | | | | | | | |
| | Routing information | | | | | | | | | | | | | | | | | | | | | | | | | | | | | | | | | | | | | | | | | | | | | | | | | | | | |
| | MNET/10 routing information | | | | | | | | | | | | | | | | | | | | | | | | | | | | | | | | | | | | | | | | | | | | | | | | | | | | |
| | FTP Parameters | | | | | | | | | | | | | | | | | | | | | | | | | | | | | | | | | | | | | | | | | | | | | | | | | | | | |
| | E-mail settings | | | | | | | | | | | | | | | | | | | | | | | | | | | | | | | | | | | | | | | | | | | | | | | | | | | | |
| | Interrupt settings | | | | | | | | | | | | | | | | | | | | | | | | | | | | | | | | | | | | | | | | | | | | | | | | | | | | |

*: Operation settings

To make communications with GX Developer, ask the person in charge of the network about the IP address setting to confirm, and set the IP address. Since "any" values may be set to the other items, set them according to the specifications of the other node and application connected to the Q series-compatible E71.

The following are the operation setting items that may be set to "any" values on GX Developer.

- (1) Communication data code
 Either "Binary code" or "ASCII code" may be specified.
- (2) Initial Timing
 Independently of this setting, communications can be made from GX Developer if the PLC CPU is at a STOP.
- (3) Enable Write at RUN time
 Independently of this setting, online program correction or device test can be performed from GX Developer.

- (3) Routing parameter setting
Set the routing parameters on the Ethernet parameter setting screen. Refer to Section 16.10 for the concept of the routing parameters.

| Setting Screen Examples | | | | |
|-------------------------|---|-------------------------|--------------------------|--------------------------|
| CPU1 | | Transfer to network No. | Intermediate network No. | Intermediate station No. |
| | 1 | 1 | 2 | 2 |
| | 2 | 2 | 1 | 1 |
| | 3 | | | |
| CPU2 | | Transfer to network No. | Intermediate network No. | Intermediate station No. |
| | 1 | 1 | 2 | 2 |
| | 2 | | | |
| | 3 | | | |

After parameter setting is over, write the parameters to the PLC using Write to PLC. In a communications-ready status, the RUN LED and INIT. LED of the Q-compatible E71 are lit.

- (4) Communications check
Refer to Section 16.2.1 (1) for communications check.
- (5) Connection Setup screen

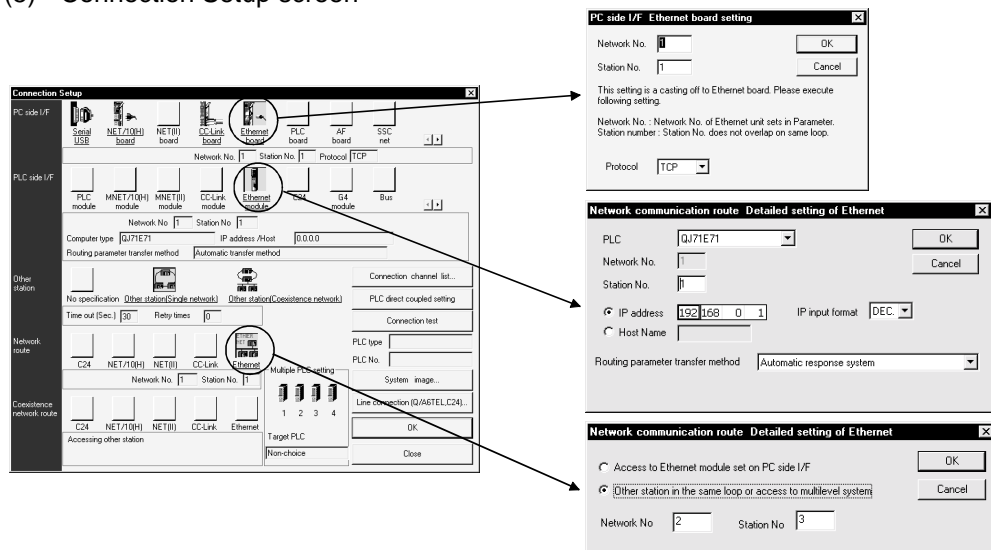

| Item | Description |
|---------------|--|
| PC side I/F | Set the network No. and station number. |
| PLC side I/F | Set the model name, station number, IP address, etc. of the unit connected to the personal computer. |
| Network route | Set the network number and station number of the station to be accessed. |

POINT

TCP/IP or UDP/IP can be used to make communications when multiple GX Developers are connected. (TCP/IP communications can be made by combining GX Developer (SW6D5C-GPPW 6.05F or later) and Q series-compatible E71 (whose function version is B and whose serial number's five upper digits are 02122 or later).) Refer to Section 13.2.3 for parameter setting to be made for communications using TCP/IP.

16.2.2 Setting Method for Communication Via CC-Link (AJ65BT-G4)

16.2.2 (1) For A series

| | | |
|---|-------|----|
| A | Q/QnA | FX |
| ○ | × | × |

This section indicates the setting examples of the switches, parameters, program and others of the unit based on the following system configuration.

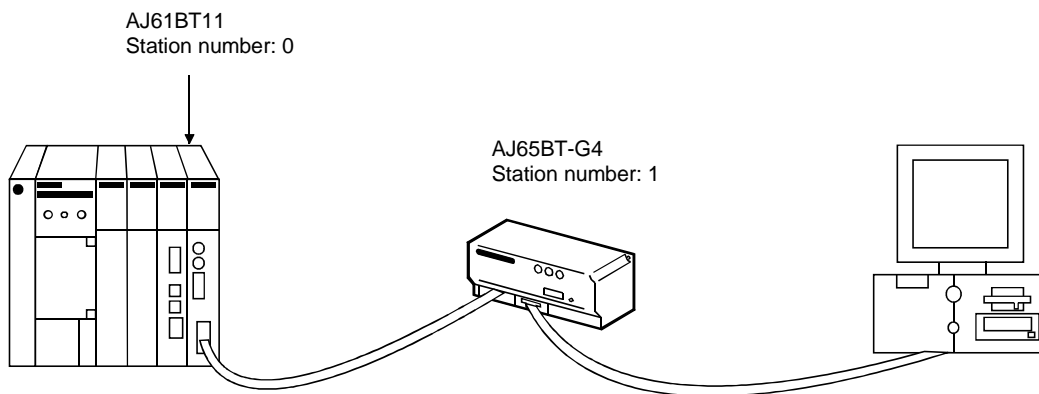

(1) Module switch settings

For G4 Module

| Unit Name | Name | | Setting | Description | |
|-------------------|--|--|-------------|----------------------------|------------------|
| AJ61BT11 | STATION No. (station number setting switches) | | 0 | Station 0 (master station) | |
| | MODE (mode setting switch) | | 0 | Online | |
| | B RATE (transmission speed setting switch) | | 4 | 10Mbps | |
| | Condition setting switches | | All OFF | All OFF | |
| AJ65BT-G4 | STATION No. (station number setting switches) | | 1 | Station 1 (local station) | |
| | B RATE (data link transmission speed setting switch) | | 4 | 10Mbps | |
| | Operation setting DIP switches | Operation mode setting | SW1 | OFF | A mode |
| | | To-personal computer transmission speed setting | SW2 | OFF | Fixed to 9600bps |
| | | | SW3 | OFF | |
| | | Parity bit yes/no setting | SW4 | OFF | Fixed |
| | | | SW5 | OFF | |
| | | Not used | SW6 | OFF | -- |
| Not used | SW7 | OFF | -- | | |
| Test mode setting | SW8 | OFF | Online mode | | |

G4 unit or G4-S3 unit

| Unit Name | Switch Name | | Setting | Description | |
|-------------------|--|---|-------------|----------------------------|--|
| AJ61BT11 | STATION No. (station number setting switches) | | 0 | Station 0 (master station) | |
| | MODE (mode setting switch) | | 0 | Online | |
| | B RATE (transmission speed setting switch) | | 4 | 10Mbps | |
| | Condition setting switches | | All OFF | All OFF | |
| AJ65BT-G4-S3 | STATION No. (station number setting switches) | | 1 | Station 1 (local station) | |
| | B RATE (data link transmission speed setting switch) | | 4 | 10Mbps | |
| | Operation setting DIP switches | Operation mode setting | SW1 | OFF | A mode set by combination of SW1 and SW6 |
| | | To-personal computer transmission speed setting | SW2 | No need to set | Invalid in A mode (Automatic setting) |
| | | | SW3 | | |
| | | Parity bit yes/no setting | SW4 | OFF | Fixed |
| | | | SW5 | OFF | |
| | | Operation mode | SW6 | OFF | A mode set by combination of SW1 and SW6 |
| Not used | SW7 | OFF | — | | |
| Test mode setting | SW8 | OFF | Online mode | | |

(2) Cable connection

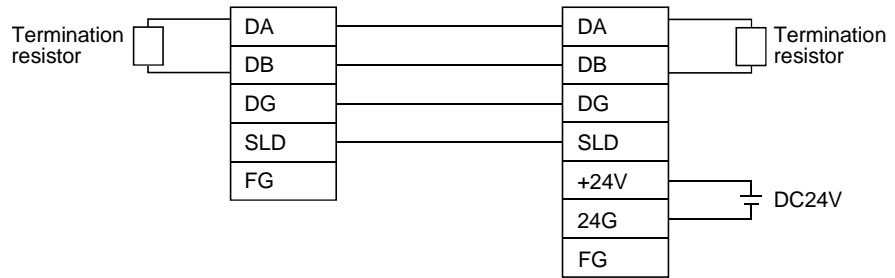

(3) Parameter setting

The parameter setting items and sequence program example for data link are given below.

Parameter setting items

| Address | Item | Description | Setting |
|---------|-----------------------------|---|---------|
| 1H | Number of connected modules | Set the number of remote station/local station modules connected. | 1H |
| 20H | Station information | G4 module or G4-S3 module | 2101H |

Sequence program

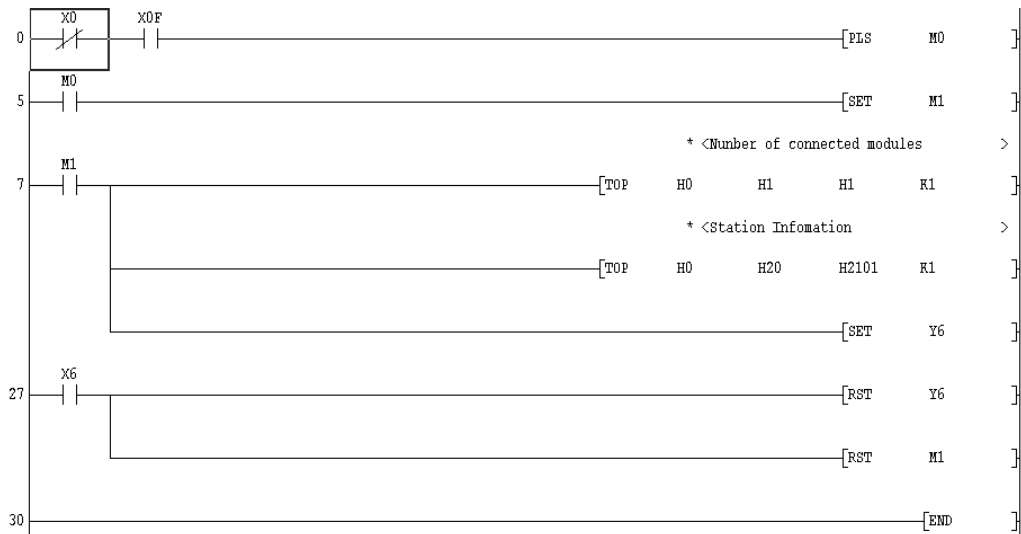

POINT

When the G4 module or G4-S3 module is connected, accessible stations are stations 0 to 64 in other station access via CC-Link.

16.2.2 (2) For QnA series

| | | |
|---|-------|----|
| A | Q/QnA | FX |
| × | ○* | × |

*: This function is compatible with the QnACPU.

For the Q series, omit this section.

This section indicates the setting examples of the switches, parameters, program and others of the unit based on the following system configuration.

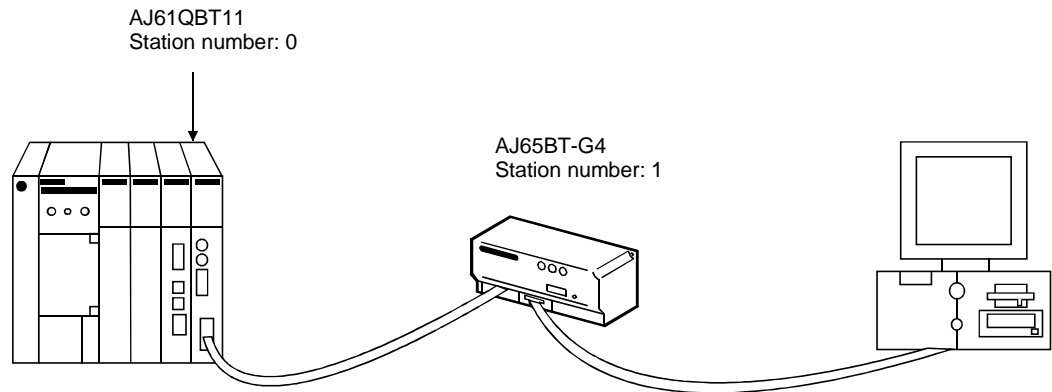

(1) Module switch settings

G4 module

| Unit Name | Name | | Setting | Description | | |
|-------------------|--|--|---------|-------------------------------|---|-------|
| AJ61QBT11 | STATION No. (station number setting switches) | | 0 | Station 0 (master station) | | |
| | MODE (mode setting switch) | | 0 | Online | | |
| | B RATE (transmission speed setting switch) | | 4 | 10Mbps | | |
| | Condition setting switches | | All OFF | All OFF | | |
| AJ65BT-G4 | STATION No. (station number setting switches) | | 1 | Station 1 (local station) | | |
| | B RATE (data link transmission speed setting switch) | | 4 | 10Mbps | | |
| | Operation setting DIP switches | Operation mode setting | SW1 | OFF | QnA mode | |
| | | To-personal computer transmission speed setting (Kbps) | SW2 | 9.6 | Set to the same transmission speed as that of GX Developer. | |
| | | | | 19.2 | | |
| | | | | 38.4 | | |
| | | Parity bit yes/no setting | SW3 | OFF | OFF | ON |
| | | | SW4 | OFF | | Fixed |
| Not used | | SW5 | OFF | | | |
| Not used | SW6 | OFF | | — | | |
| Not used | SW7 | OFF | | — | | |
| Test mode setting | SW8 | OFF | | Online mode | | |

For G4-S3 module

| Unit Name | Switch Name | | Setting | | | Description | |
|------------------------|---|--|---------|-----|-------------|--|--|
| AJ61QBT11 | STATION No. (station number setting switches) | | 0 | | | Station 0 (master station) | |
| | MODE (mode setting switch) | | 0 | | | Online | |
| | B RATE (transmission speed setting switch) | | 4 | | | 10Mbps | |
| | Condition setting switches | | All OFF | | | All OFF | |
| AJ65BT-G4-S3 | STATION No. (station number setting switches) | | 1 | | | Station 1 (local station) | |
| | B RATE (data link transmission speed setting switch) | | 4 | | | 10Mbps | |
| | Operation setting DIP switches | Operation mode setting | SW1 | ON | | | QnA mode set by combination of SW1 and SW6 |
| | | To-personal computer transmission speed setting (Kbps) | SW2 | 9.6 | 19.2 | 38.4 | Matched to transmission of GX Developer |
| | | | | OFF | ON | OFF | |
| | | | | OFF | OFF | ON | |
| | | Parity bit yes/no setting | SW4 | OFF | | | Fixed |
| | | | SW5 | OFF | | | |
| Operation mode setting | | SW6 | OFF | | | QnA mode set by combination of SW1 and SW6 | |
| Not used | SW7 | OFF | | | — | | |
| Test mode setting | SW8 | OFF | | | Online mode | | |

(2) Cable connection

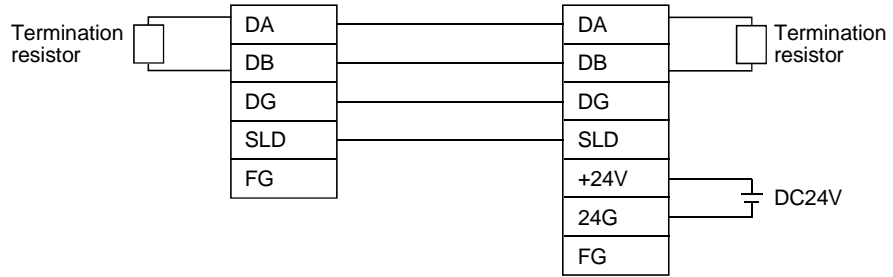

(3) Parameter setting

Parameter setting can be made from either the CC-Link network parameter setting screen or the sequence program.

(a) Setting the parameters on the CC-Link setting screen

Set the first I/O No., type, total number of connected units, and station information.

Set the other items as required.

CC-Link parameter setting screen

No. of boards in Boards Blank: no setting 0 boards: Set by the sequence program.

| | 1 | 2 | 3 | 4 |
|--------------------------------------|---------------------|---|---|---|
| Start I/O No. | 0000 | | | |
| Type | Master station | | | |
| All connect count | 1 | | | |
| Remote input(RX) | | | | |
| Remote output(RY) | | | | |
| Remote register(RW/r) | | | | |
| Remote register(RW/w) | | | | |
| Special relay(SB) | | | | |
| Special register(SW) | | | | |
| Retry count | 3 | | | |
| Automatic reconnection station count | 1 | | | |
| Wait master station No. | 0 | | | |
| PLC down select | Stop | | | |
| Scan mode setting | Asynchronously | | | |
| Delay information setting | 0 | | | |
| Station information setting | Station information | | | |

Station information setting screen

CC-Link station information unit 1 [X]

| StationNo. | Station type | Exclusive station count | Reserve/invalid station select | Intelligent buffer select(word) | | |
|------------|--------------------|-------------------------|--------------------------------|---------------------------------|---------|--------------|
| | | | | Send | Receive | Automatic ic |
| 1/1 | Remote/I/O station | Exclusive station 1 | No setting | | | |

Default Check End setup Cancel

After setting the CC-Link parameters, write them to the PLC.

- (b) Setting the parameters in the sequence program
 The parameter setting items and sequence program example for parameter setting in the sequence program are given below.

Parameter setting items

| Address | Item | Description | Setting |
|---------|-----------------------------|---|---------|
| 1H | Number of connected modules | Set the number of remote station/local station modules connected. | 1H |
| 20H | Station information | G4 module or G4-S3 module | 2101H |

When creating the network parameters in the sequence program, set the number of units to 0 on the CC-Link setting screen.

Sequence program

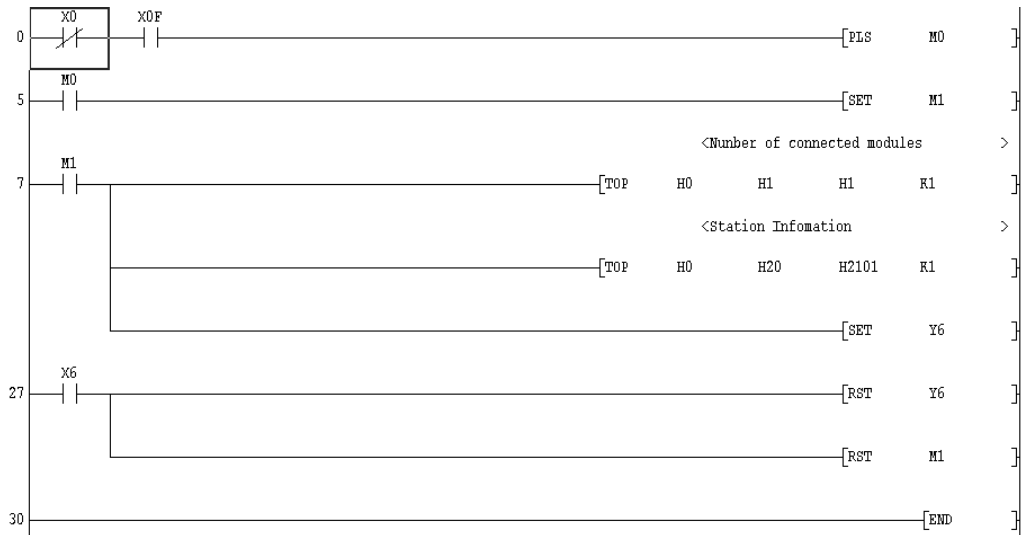

| POINTS |
|--|
| <ul style="list-style-type: none"> • When connection is made to the CPU directly or via computer link, accessible stations are stations 0 (master) to 63 in other station access via CC-Link. • When the G4 module or G4-S3 module is connected, accessible stations are stations 0 to 64 in other station access via CC-Link. |

16.2.2 (3) For Q series

| | | |
|---|-------|----|
| A | Q/QnA | FX |
| × | ○* | × |

*: Compatible with the QCPU (Q mode).

This section gives a setting example of the switches, parameters, program and others of the units based on the following system configuration.

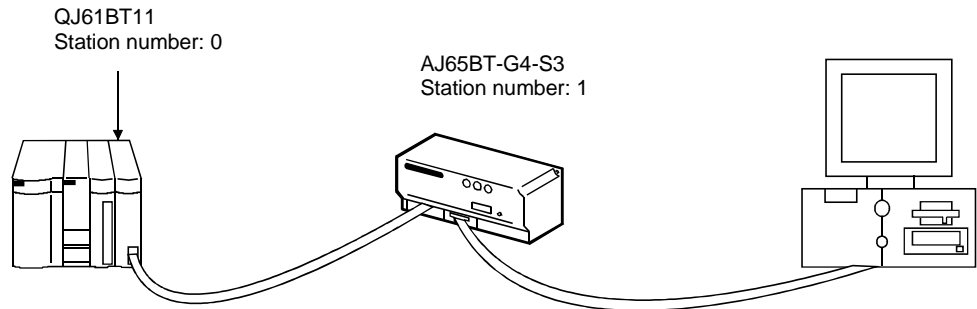

(1) Module switch settings

For G4-S3 module

| Unit Name | Switch Name | | Setting | Description | |
|-------------------|--|--|-------------|----------------------------|--|
| QJ61BT11 | STATION No. (station number setting switches) | | 0 | Station 0 (master station) | |
| | MODE (mode setting switch) | | 0 | Online | |
| | B RATE (transmission speed setting switch) | | 4 | 10Mbps | |
| | Condition setting switches | | All OFF | All OFF | |
| AJ65BT-G4-S3 | STATION No. (station number setting switches) | | 1 | Station 1 (local station) | |
| | B RATE (data link transmission speed setting switch) | | 4 | 10Mbps | |
| | Operation setting DIP switches | Operation mode setting | SW1 | OFF | Q mode set by combination of SW1 and SW6 |
| | | To-personal computer transmission speed setting (Kbps) | SW2 | No need to set | Invalid in Q mode (Automatic setting) |
| | | | SW3 | | |
| | | Parity bit yes/no setting | SW4 | OFF | Fixed |
| | | | SW5 | OFF | |
| | | Operation mode setting | SW6 | ON | Q mode set by combination of SW1 and SW6 |
| Not used | SW7 | OFF | — | | |
| Test mode setting | SW8 | OFF | Online mode | | |

(2) Cable connection

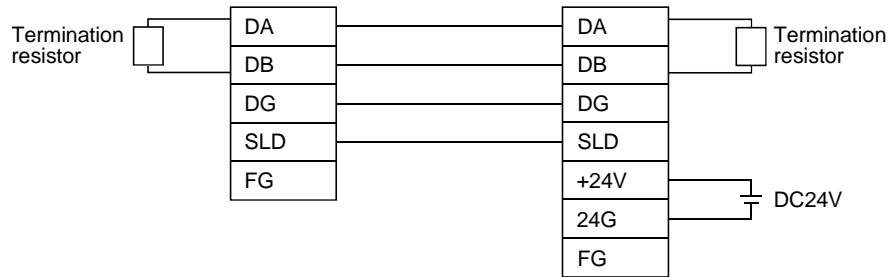

(3) Parameter setting

Parameter setting may either be made from the CC-Link network parameter setting screen or the sequence program.

(a) Setting the parameters on the CC-Link setting screen

Set the starting I/O No., type, total number of connected units, and station information.

Set the other items as required.

CC-Link parameter setting screen

No. of boards in Boards Blank: no setting 0 boards: Set by the sequence program.

| | 1 | 2 | 3 | 4 |
|--------------------------------------|---------------------|---|---|---|
| Start I/O No. | 0000 | | | |
| Type | Master station | | | |
| All connect count | 1 | | | |
| Remote input(RX) | | | | |
| Remote output(RY) | | | | |
| Remote register(RWr) | | | | |
| Remote register(RWw) | | | | |
| Special relay(SB) | | | | |
| Special register(SW) | | | | |
| Retry count | 3 | | | |
| Automatic reconnection station count | 1 | | | |
| Wait master station No. | 0 | | | |
| PLC down select | Stop | | | |
| Scan mode setting | Asynchronously | | | |
| Delay information setting | 0 | | | |
| Station information setting | Station information | | | |

Station information setting screen

CC-Link station information unit 1

| StationNo. | Station type | Exclusive station count | Reserve/invalid station select | Intelligent buffer select[word] | | |
|------------|--------------------|-------------------------|--------------------------------|---------------------------------|---------|-----------|
| | | | | Send | Receive | Automatic |
| 1/1 | Remote/I/O station | Exclusive station 1 | No setting | | | |

Default Check End setup Cancel

After setting the CC-Link parameters, write them to the PLC CPU.

(b) Setting the parameters with the sequence program

The following parameter setting items and sequence program example are used when the parameter values are set with the sequence program.

Parameter setting items

| Address | Item | Description | Setting |
|---------|---------------------------|---|---------|
| 1H | Number of units connected | Set the number of remote/local station units connected. | 1H |
| 20H | Station information | G4-S3 module | 2101H |

When creating network parameters using the sequence program, set the number of units to 0 on the CC-Link setting screen.

Sequence program

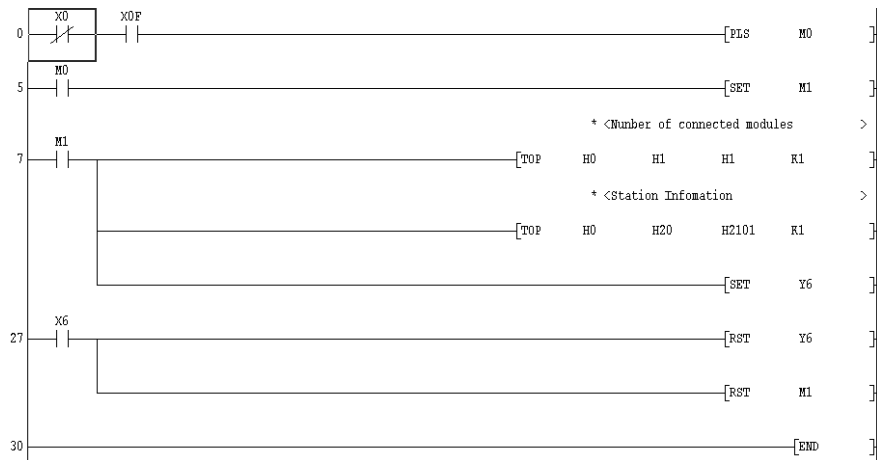

- | POINTS |
|--|
| <ul style="list-style-type: none"> • When connection is made to the CPU directly or via computer link, accessible station numbers are stations 0 (master) to 63 in other station access via CC-Link. • When the G4-S3 module is connected, accessible stations are stations 0 to 64 in other station access via CC-Link. |

16.2.3 Setting Method for Communication Via C24

16.2.3 (1) Connection in the form of one-for-one

| | | |
|---|-------|----|
| A | Q/QnA | FX |
| ○ | ○ | × |

This section indicates the setting examples of the switches and others of the unit based on the following system configuration.



(1) UC24 switch settings

The A1SJ71UC24-R24 or A1SJ71C24-R4 cannot be connected.

| Item | Setting |
|--------------------------------------|---|
| Mode setting switch | 1 |
| STATION No. | 0 |
| Main channel setting | RS-232 |
| Data bit setting | 8 |
| Transmission speed setting | 9600bps/19200bps |
| Parity bit yes/no setting | Odd |
| Stop bit setting | 1 |
| Sum check yes/no setting | Yes |
| Online change enable/disable setting | Enable |
| Computer link/multidrop link setting | Computer link (set computer link also for multidrop) |

A cable of AC30N2A can be diverted for this connection.

Refer to Appendix 5.1 for the pin assignment of the cable.

When GX Developer is connected to the 2) loaded UC24 and the 9-25 pin conversion connector + AC30N2A equivalent are used, write 1 (CD terminal not checked) to 10B of the buffer memory.

(2) Serial communication unit (QnA series) switch settings

| Item | Setting | Item | Setting |
|---------------------------|---------------------|---------------------------------------|---------------------------|
| Mode setting switch | 5 | Sum check yes/no setting | Yes |
| STATION No. | 0 | Online change enable/disable setting | Enable |
| Operation setting | Independent setting | Setting change enable/disable setting | Enable |
| Data bit setting | 8 | Transmission speed setting | 9600bps/19200bps |
| Parity bit yes/no setting | Odd | — | SW13 to SW15 are all OFF. |
| Stop bit setting | 1 | — | — |

A cable of AC30N2A can be diverted for this connection.
Refer to Appendix 5.2 for the pin assignment of the cable.
When an AC30N2A cable is connected, use the 9-25 pin conversion connector.

(3) Serial communication unit (for Q series) switch settings

Make switch settings of the units on the GX Developer I/O assignment setting screen.

For details of switch settings, refer to the Q-compatible C24 serial communication unit user's manual (basic manual).

| Item | Description | | Setting |
|----------|-------------------------|-----------------------------|---|
| Switch 1 | CH1 communication speed | CH1 transmission setting | 0000H |
| Switch 2 | — | CH1 communications protocol | 0000H |
| Switch 3 | CH2 communication speed | CH2 transmission setting | Set according to the application on CH2 side. |
| Switch 4 | — | CH2 communications protocol | Set according to the application on CH2 side. |
| Switch 5 | Module station number | | 0000H |

For the connection cable, refer to Appendix 5.3.

As switch 5 is used to set the station number, set the value (0 to 31 (decimal)) as required. (Note that if the value is other than 0, match it with the value which was set by choosing Connection Setup → PC side I/F → Station number.)

Detailed description of settings

| Item | Setting |
|---------------------------------------|---------------------|
| Operation setting | Independent setting |
| Data bit setting | 8 |
| Parity bit yes/no setting | Yes |
| Odd/even parity bit | Odd |
| Stop bit setting | 1 |
| Sum check yes/no setting | Yes |
| Online change enable/disable setting | Enable |
| Setting change enable/disable setting | Disable |
| Transmission speed setting | 19200bps |
| Communications protocol | GX Developer link |

- (4) Connection target setting
The screen setting example for access from GX Developer to C24 is given below.

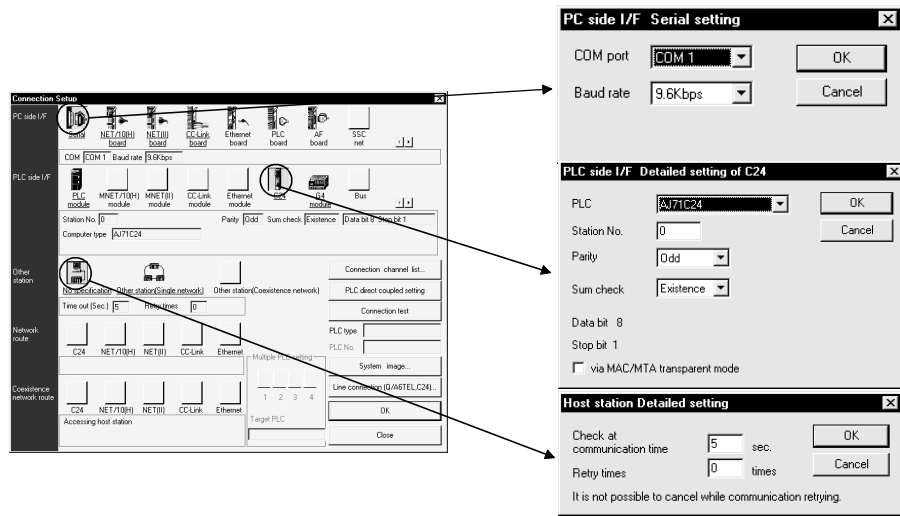

| Item | Description |
|---------------|--|
| PC side I/F | Set the COM port and baud rate. |
| PLC side I/F | Set the model name, station number, etc. of the C24 connected. |
| Network route | Set the station number of the connection target C24. |

16.2.3 (2) 1:n connection

| | | |
|---|-------|----|
| A | Q/QnA | FX |
| ○ | ○ | × |

This section gives the setting examples of the switches and others of the modules based on the following system configurations.

[Via serial communication/computer link module]

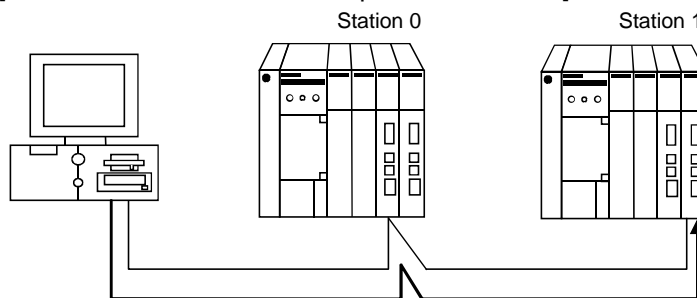

[Direct connection with PLC CPU]

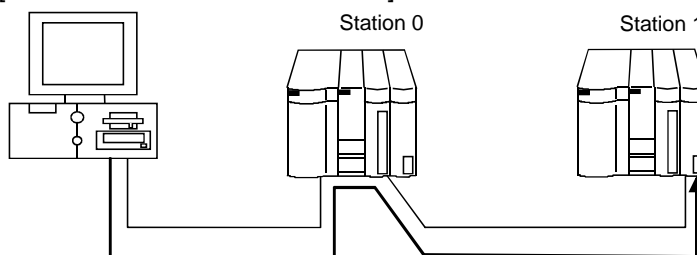

- (1) Computer link module switch settings
Station 0 (Connect GX Developer to the RS-232 connector of the computer link module.)

| Item | Setting |
|--------------------------------------|---|
| Mode setting switch | A |
| STATION No. | 0 |
| Main channel setting | RS-232 |
| Data bit setting | 8 |
| Transmission speed setting | 9600bps |
| Parity bit yes/no setting | Odd |
| Stop bit setting | 1 |
| Sum check yes/no setting | Yes |
| Online change enable/disable setting | Enable |
| Computer link/multidrop link setting | Computer link (set computer link also for multidrop) |

A cable of AC30N2A can be diverted for this connection.
Refer to Appendix 5.1 for the pin assignment of the cable.
When GX Developer is connected to the UC24 and the 9-25 pin conversion connector + AC30N2A are used, write 1 (CD terminal not checked) to 10B of the buffer memory.

Station 1

| Item | Setting |
|--------------------------------------|---|
| Mode setting switch | 5 |
| STATION No. | 1 |
| Main channel setting | RS-422 |
| Data bit setting | 8 |
| Transmission speed setting | 9600bps |
| Parity bit yes/no setting | Odd |
| Stop bit setting | 1 |
| Sum check yes/no setting | Yes |
| Online change enable/disable setting | Enable |
| Computer link/multidrop link setting | Computer link (set computer link also for multidrop) |

- (2) Serial communication module (for QnA series) switch settings
 The AJ71QC24-R4 or A1SJ71QC24-R4 cannot be connected.
 Station 0 (Connect GX Developer to the RS-232 connector of the serial communication module.)

| Item | | Setting |
|---------------------------------------|------|-------------------|
| Mode setting switch | CH 1 | 0 |
| | CH 2 | 5 |
| STATION No. | | 0 |
| Operation setting | | Interlock setting |
| Data bit setting | | 8 |
| Parity bit yes/no setting | | Odd |
| Stop bit setting | | 1 |
| Sum check yes/no setting | | Yes |
| Online change enable/disable setting | | Enable |
| Setting change enable/disable setting | | Enable |
| Transmission speed setting | | 9600bps |

A cable of AC30N2A can be diverted for this connection.
 Refer to Appendix 5.2 for the pin assignment of the cable.
 When an AC30N2A cable is used, use a 9-25 pin conversion connector.

Station 1

| Item | | Setting |
|---------------------------------------|------|-------------------------------------|
| Mode setting switch | CH 1 | Set to meet the application of CH1. |
| | CH 2 | 5 |
| STATION No. | | 1 |
| Operation setting | | Independent setting |
| Data bit setting | | 8 |
| Parity bit yes/no setting | | Odd |
| Stop bit setting | | 1 |
| Sum check yes/no setting | | Yes |
| Online change enable/disable setting | | Enable |
| Setting change enable/disable setting | | Enable |
| Transmission speed setting | | 9600bps |

- (3) Serial communication module (for Q series) switch settings
 Make switch settings of the units on the GX Developer I/O assignment setting window.
 For details of the switch settings, refer to the Q-compatible C24 serial communication unit user's manual (basic manual).

Station 0

| Item | Description | | Setting |
|----------|-------------------------|-----------------------------|---------|
| Switch 1 | CH1 communication speed | CH1 transmission setting | 0726H |
| Switch 2 | — | CH1 communications protocol | 0008H |
| Switch 3 | CH2 communication speed | CH2 transmission setting | 0727H |
| Switch 4 | — | CH2 communications protocol | 0000H |
| Switch 5 | Module station number | | 0000H |

For the connection cable, refer to Appendix 5.3.

Station 1

| Item | Description | | Setting |
|----------|-------------------------|-----------------------------|---------|
| Switch 1 | CH1 communication speed | CH1 transmission setting | 0726H |
| Switch 2 | — | CH1 communications protocol | 0000H |
| Switch 3 | CH2 communication speed | CH2 transmission setting | 0727H |
| Switch 4 | — | CH2 communications protocol | 0000H |
| Switch 5 | Module station number | | 0001H |

Detailed description of settings

| Item | Setting |
|---------------------------------------|---------------------|
| Operation setting | Independent setting |
| Data bit setting | 8 |
| Parity bit yes/no setting | Yes |
| Odd/even parity bit | Odd |
| Stop bit setting | 1 |
| Sum check yes/no setting | Yes |
| Online change enable/disable setting | Enable |
| Setting change enable/disable setting | Disable |
| Transmission speed setting | 19200bps |
| Communications protocol | GX Developer link |

- (4) Connection target setting
 The screen setting example for access from GX Developer to C24 is given below.

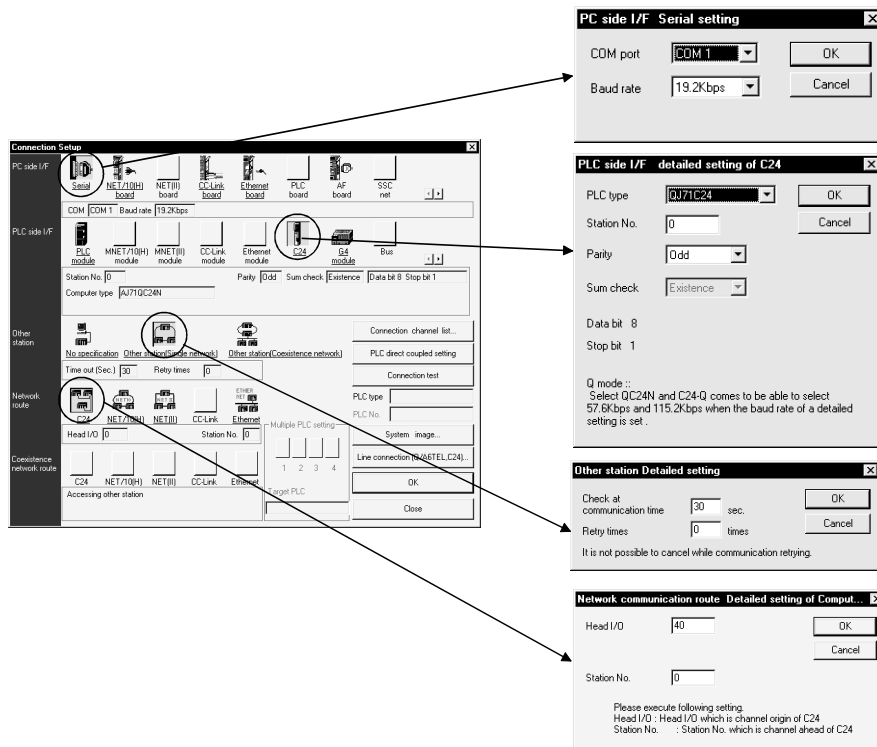

| Item | Description |
|---------------------------|---|
| PC side I/F | Set the COM port and baud rate. |
| PLC side I/F*1 | Set the model name, station number, etc. of the C24 connected. |
| Other station designation | Set the no specification of other station when not making access to the other station. |
| Network route | Set the top I/O number of a station connected to GX Developer and a station number of the station to be accessed. |

*1: When making access to the other station with the computer link module, designate a station number setting item of the PLC side I/F. The icons of the Network route cannot be selected.

16.2.4 Setting method for communication via a modem interface module

| | | |
|---|-------|----|
| A | Q/QnA | FX |
| ○ | ○ | ○ |

This section provides how to set the functions and information on line connection to line disconnection for use of the A6TEL modem interface module (hereafter called the A6TEL) and the Q6TEL modem interface module (hereafter called the Q6TEL). The A6TEL is a modem interface module designed to connect the A series PLC CPU and modem.

The Q6TEL is a modem interface module designed to connect the A/QnA series PLC CPU and modem. (The Q6TEL can connect to either the ACPU or QnACPU using the A mode/QnA mode select switch.)

The modems shown in the following system configuration include the external type, modem built in personal computer, PC card modem (PIMCIA) and TA (terminal adapter).

(1) Between PLC and A6TEL/Q6TEL (A/QnA series only)

Functions such as monitoring, test and program write/read can be performed via remote access over the telephone line.

For the operation procedures, see Sections 22.2.1 and 22.2.2.

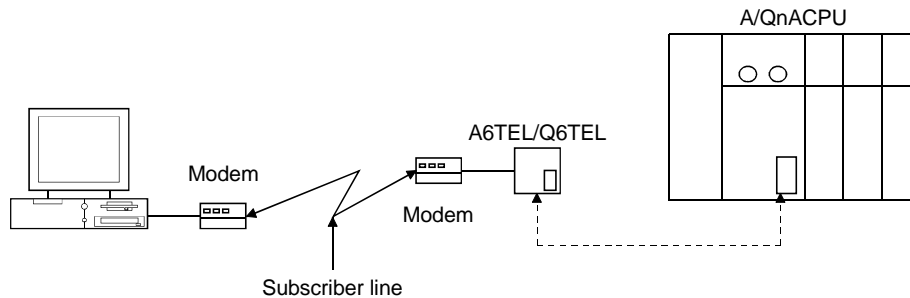

(2) For access to FXCPU (FX series only)

Functions such as monitoring, test and program write/read can be performed via remote access over the telephone line by connecting the FX1S/FX1N/FX1NC/FX2N/FX2NC PLC using a modem.

For the operation procedures, see Section 22.2.3.

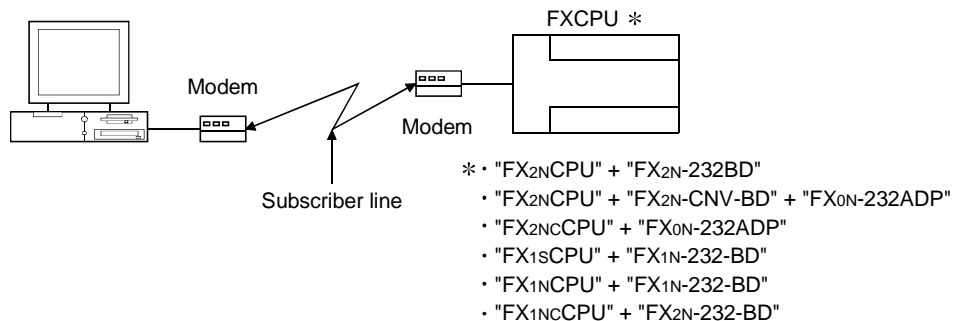

(3) When making access from personal computer to serial communication module Q/QnA series only)

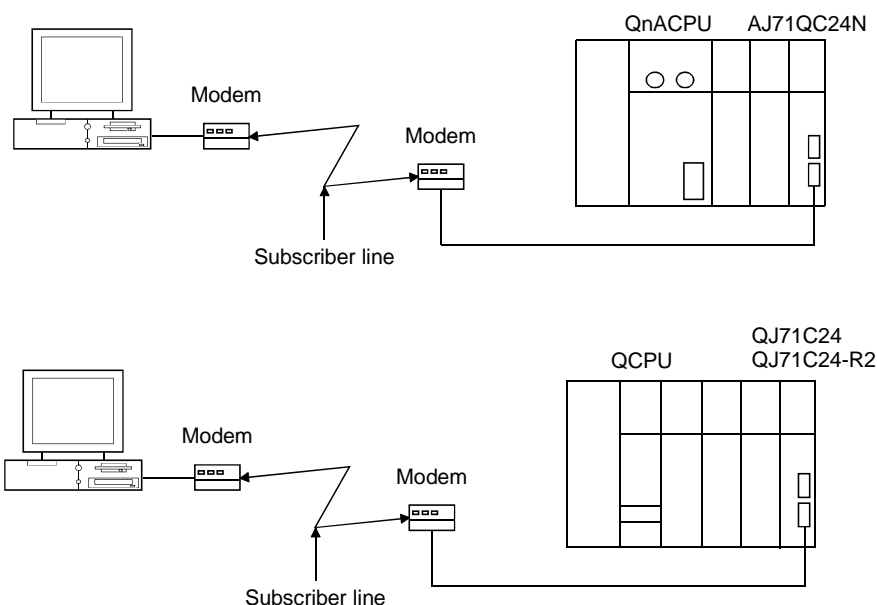

For access from the personal computer to the serial communication module, choose [Tools] → [Set TEL data/Connect via modem] → [Connect]. Refer to Section 22.4 for the setting of items on the line connection screen. For the switch settings of the corresponding modules, refer to the following manuals.

- QnA series : Serial Communication Module User's Manual (Details Manual) (Additional modem function version)
- Q series : Q-compatible Serial Communication Module User's Manual (Application)

(a) Switch settings of QJ71C24, QJ71C24-R2, AJ71QC24N

| Item | | Setting | |
|----------|-------------------------|-------------------------------|-------------------------------|
| Switch 1 | Transmission setting | Operation setting | Independent |
| | | Data length | 8 |
| | | Parity bit | No |
| | | Even/odd parity | Match to modem specifications |
| | | Stop bit | 1 |
| | | Sum check | Yes |
| | | Online change | Enable |
| | | Setting change | Disable |
| | Communication speed | Match to modem specifications | |
| Switch 2 | Communications protocol | 5 | |

When using the QC24N, use the above settings as reference.

(b) Connection of QJ71C24/QJ71C24-R2/AJ71QC24N and modem

A program is needed to make the following buffer memory settings.

For QJ71C24, QJ71C24-R2

| Buffer Memory Address | Name and Setting |
|-----------------------|--|
| 2EH | Modem connection CH designation 0: None 1: CH1 2: CH2 |
| 34H *1 | Initialization data No. designation 0H: Sending of initialization data specified in sending user registration frame designation area 7D0H to 7D4H: Initialization data No. |
| 36H | GX Developer link designation 0: No 1: Yes |

*1: The following initialization data have been registered to the QJ71C24.
If the modem used is included in any of 7D0 (2000) to 7DA (2010) of the initialization data, specify that registration No.
If the modem used is other than the registered, you can use it after registering the AT command to the buffer memory address 1B00 of the serial communication module.

For AJ71QC24N

| Buffer Memory Address | Name and Setting |
|-----------------------|--|
| 2EH | Modem connection CH designation 0: None 1: CH1 2: CH2 |
| 34H *2 | Initialization data No. designation 0H: Sending of initialization data specified in sending user registration frame designation area 7D0H to 7D4H: Initialization data No. |
| 36H | Q6TEL link designation 0: No 1: Yes |

*2: The AJ71QC24N has the following registered initialization data.
If the modem to be used is in 7D0 (2000) to 7D4 (2004) of the initialization data, specify that registration number.
The modem other than the registered ones can be used by registering the AT command to the buffer memory address 1B00 of the serial communication module buffer memory.

Sample program (for QJ71C24, QJ71C24-R2, AJ71QC24N)

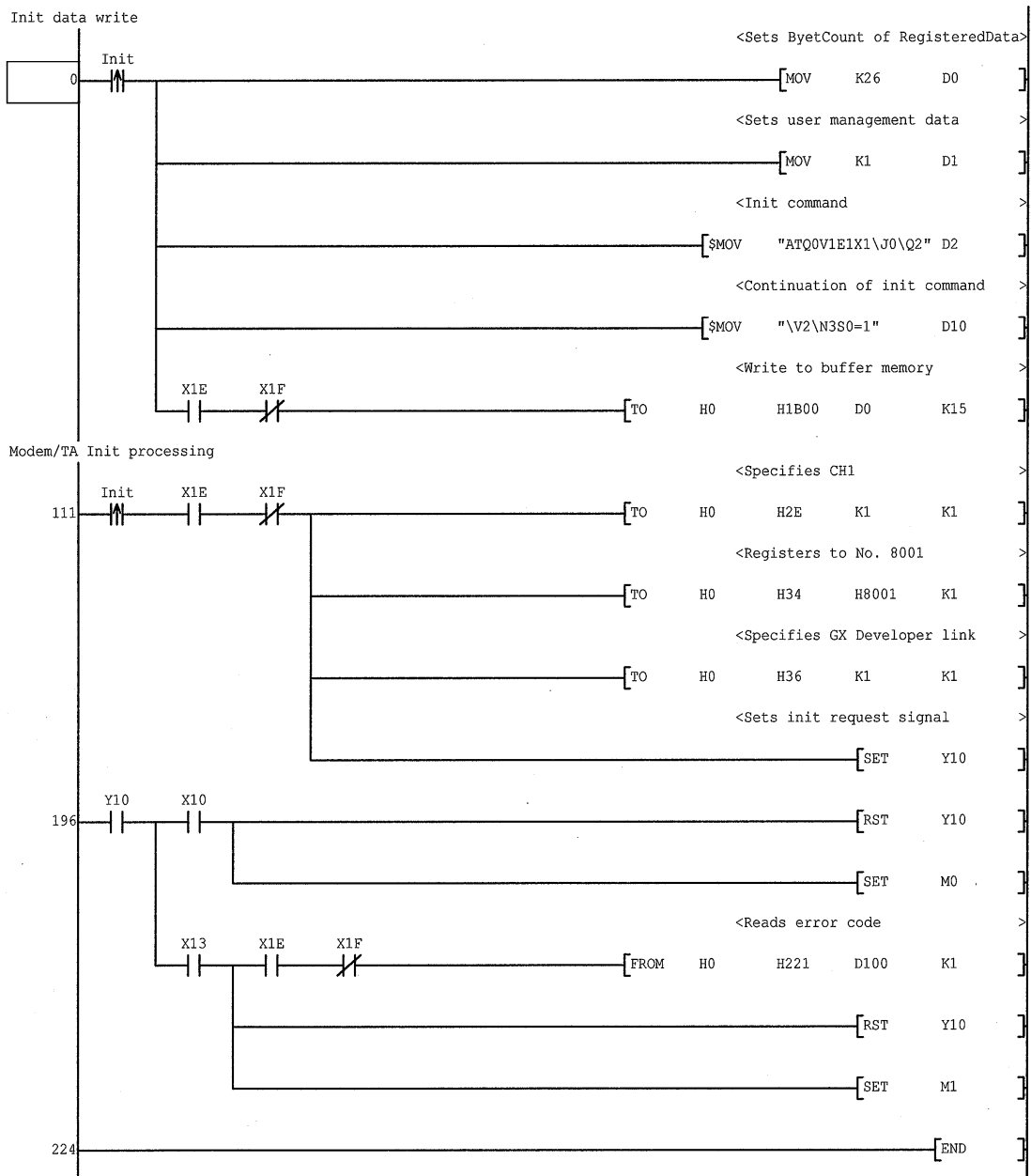

(4) Pager notice (A/QnA series only)

An on-the-spot trouble occurrence can be notified with a message.
 For the A6TEL or the A mode of the Q6TEL, you can set up to 10 characters.
 For the QnA mode of the Q6TEL, you can set up to 10 characters or notice data of up to 480 points of a word device. (Note that the number of characters displayed on the pager depends on the pager used.)
 For the operating procedure, refer to Sections 22.2.1 and 22.2.2.)

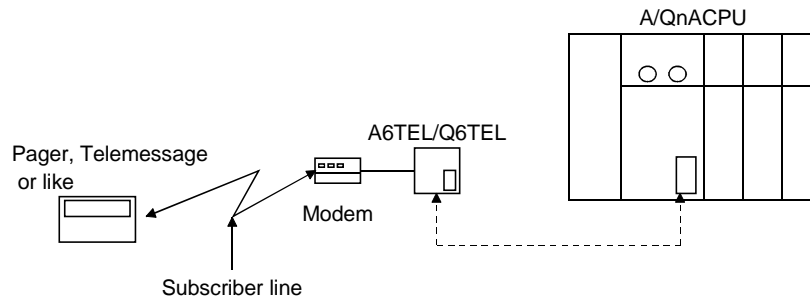

(5) Q6TEL-Q6TEL communication (only QnA mode of Q6TEL)

When the device condition set to the send side Q6TEL holds, the word device data of up to 480 words can be transferred to the device specified in the receive side PLC.
 Local devices cannot be used as a transfer or trigger condition.
 For the operating procedure, refer to Section 22.2.4.

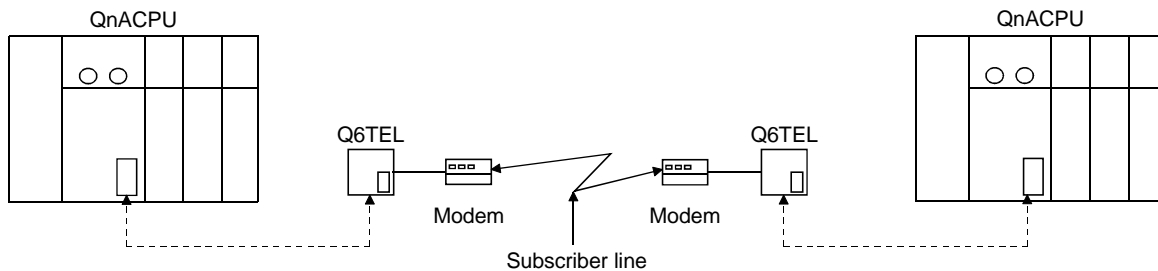

(6) Modem specifications

When using modems, choose the ones which satisfy the following specifications.
 In addition, you can make communication from a personal computer with a built-in modem or a PC card modem (PCMCIA) for use in connection with a notebook personal computer.

(a) When using subscriber telephone line/private branch telephone

- AT command compatible (initialization command)
- Only the DR terminal can be turned ON (High) independently
- (Example: You cannot use the modem whose CD terminal turns on at the same time when only the DR terminal is turned on.)
- Communication standards: ITU-T V.90/V.34/V.32bis/V.32/V.22bis/V.22/V.21/V.FC
 Bell 212A/103

(b) Manual line connection (for connection via an operator)

- Specifications as in above (a)
- Switching can be made between the "ANS mode" and "ORG mode". (AIWA's some modems have the above mode switch.)

Communication may not be made depending on the line status.

| | |
|--------------|--|
| POINT | <ul style="list-style-type: none"> When a modem built in personal computer or the PC card (PCMCIA) is used to make communication, COM port setting is required on the connection destination specifying screen. Also, the COM port of the modem built in personal computer or the PC card (PCMCIA) is determined internally. For the setting method, refer to the personal computer manual. The standard AT command cannot be used in some modems. If the standard command is selected but the modem cannot connect with the line, the user should designate the AT command. For the standard and AT command designation setting, refer to Section 22.4.1. |
|--------------|--|

(7) Connection cable

For connection of the personal computer and modem, use the RS-232 cable supplied with the modem or the specified cable.

Since the personal computer may have a different connector, check the specifications of the connector when purchasing the modem.

(8) Modem setting

Make modem setting.

The following screen can be browsed using Line connection or AT command help for AT command registration.

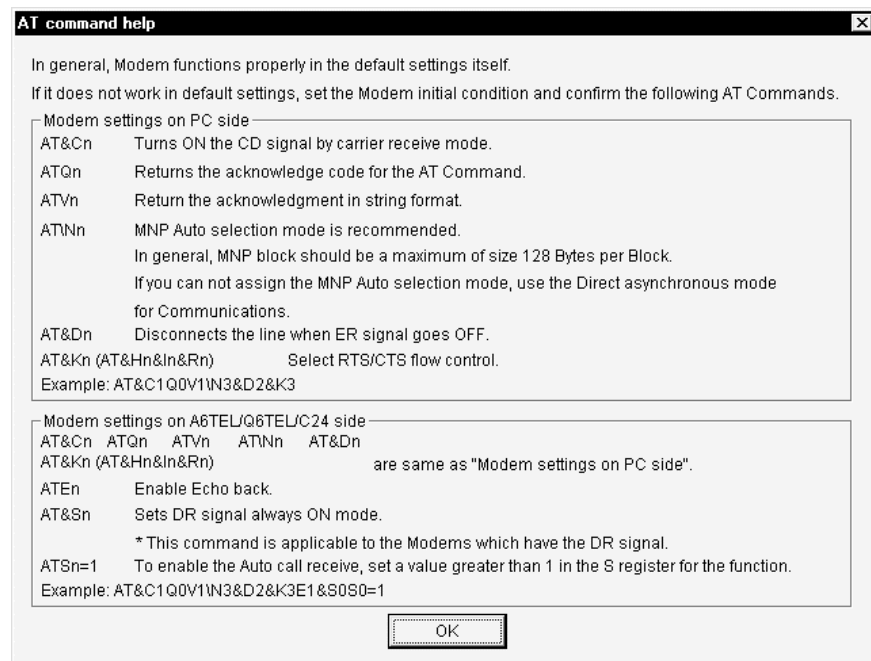

| | |
|--------------|---|
| POINT | <p>When you used the modem for the other purpose previously, return the modem to the factory-set status using the following command.</p> <p style="text-align: center;">AT&F&W</p> |
|--------------|---|

(9) About RS-232 interface

When the TEL data set on GX Developer is transferred from the personal computer to the A6TEL/Q6TEL, the RS-232 interface specifications on the A6TEL/Q6TEL side are as follows.

| Pin Number | Signal Abbreviation | Signal Name | Signal Direction | Modem Side |
|------------|---------------------|--|------------------|----------------------|
| 2 | SD(TXD) | Send data | → | Equivalent to RD |
| 3 | RD(RXD) | Receive data | ← | Equivalent to SD |
| 4 | ER(DTR) | Terminal ready notification | → | Equivalent to ER |
| 5 | SG | Signal ground | — | SG |
| 6 | DR(DSR) | Data equipment ready | ← | Equivalent to DR |
| 7 | RS(RTS) | Request to send | → | Equivalent to RS |
| 8 | CS(CTS) | Clear to send | ← | Equivalent to CS |
| 9 | RI(CI) | Receive indication (Call detection) | ← | Equivalent to RI(CI) |

The following wiring example is for proximate connection.

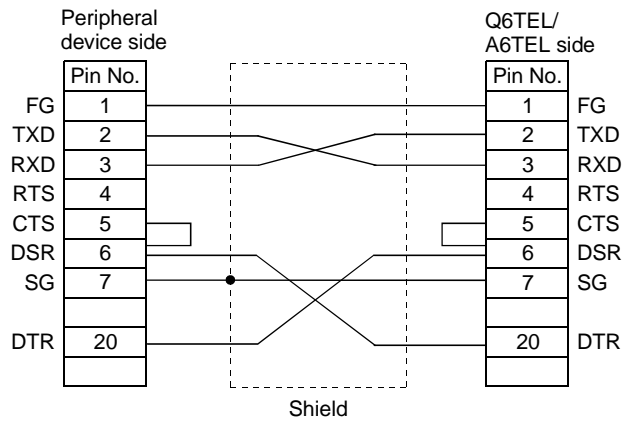

For 9 pins-25 pins

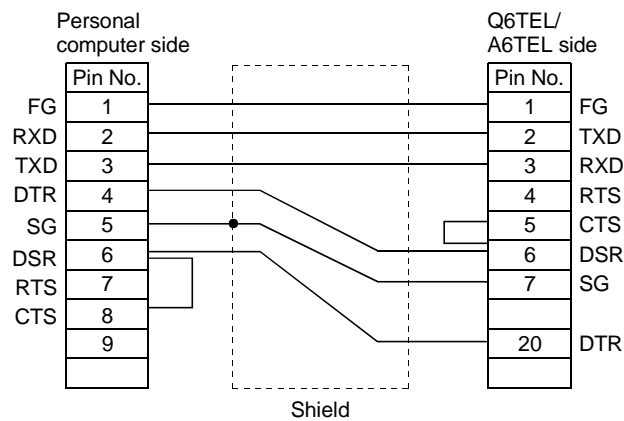

- (10) Restrictions on telephone line
- (a) Do not use the call-waiting phone line.
On the call-waiting phone line, interruption ringers may corrupt the data or disconnect the telephone line.
 - (b) Avoid using a party line.
If you pick up the receiver during telephone line connection, the telephone line may be disconnected.
 - (c) An analog two-wire type telephone line can be used.
Note that a digital line can be connected by using a terminal adopter.

| POINT |
|--|
| The telephone line of four wire type may not be connected depending on the modular jack wiring type. For the four wire type, conduct a connection test in advance to check whether connection can be made or not. |

- (d) Instructions for cellular phones
 - 1) About the modem for radio communication using a cellular phone
Though different makers call modems differently, this manual call them a cellular phone communication unit as a generic name.
Choose the model according to the cellular phone used.
For details, contact the company of the cellular phone you use.
 - 2) Although the cellular phone model which can automatically get an incoming call has no problems when it connects to the line, the model which cannot automatically get an incoming call cannot connect to the line if the modem is not provided with the ANS/ORG/TEL select switch.
As the line connection procedure depends on the phone company or model, consult the maker of the phone you use.
- (11) Coexistence with other applications for modem communication
For modem communication, GX Developer and any other application, such as MX Component, cannot make communication simultaneously.
When making modem communication using GX Developer, do not make modem communication using any other application.
If GX Developer and any other application are used to make modem communication simultaneously, a communication error, telephone line disconnection or similar phenomenon will occur.

16.3 Using PLC Read/Write

PLC read and PLC write access the PLC and read/write data.

Since the same kind of dialog box is used for PLC read and PLC write operations, a common explanation is given for both here.

Refer to Section 19.2 for the PLC read/write password for the Q series.

About the remote password

When the remote password has been set to the serial communication module (for Q series) or Q series-compatible E71, making access to the PLC shows the remote password clearing dialog box. Access to the PLC CPU cannot be made unless the remote password is cleared.

Refer to Section 13.3 for the setting of the remote password.

When the permissible number of remote password mismatches or permissible cumulative number of remote password mismatches has been set on SW0D5C-QSCU, the following status will occur if password mismatch operation is performed more than the preset number of times. In that case, refer to the Q-compatible serial communication module user's manual (applications).

Permissible number of remote password mismatches..... Line is cut off automatically.
 Permissible cumulative number of remote password mismatches Module's error LED is lit.

16.3.1 Executing PLC read/PLC write

| | | |
|-----------------------|-----------------------|-----------------------|
| A | Q/QnA | FX |
| <input type="radio"/> | <input type="radio"/> | <input type="radio"/> |

[Purpose]

Selects data and subjects it to a PLC read or PLC write operation.

[Operating Procedure]

Select [Online] → [Read from PLC] ([Write to PLC]), or click ().

[Dialog Box]

The Write from PLC screen is shown below. The **Password** button does not appear on the Read from PLC screen.

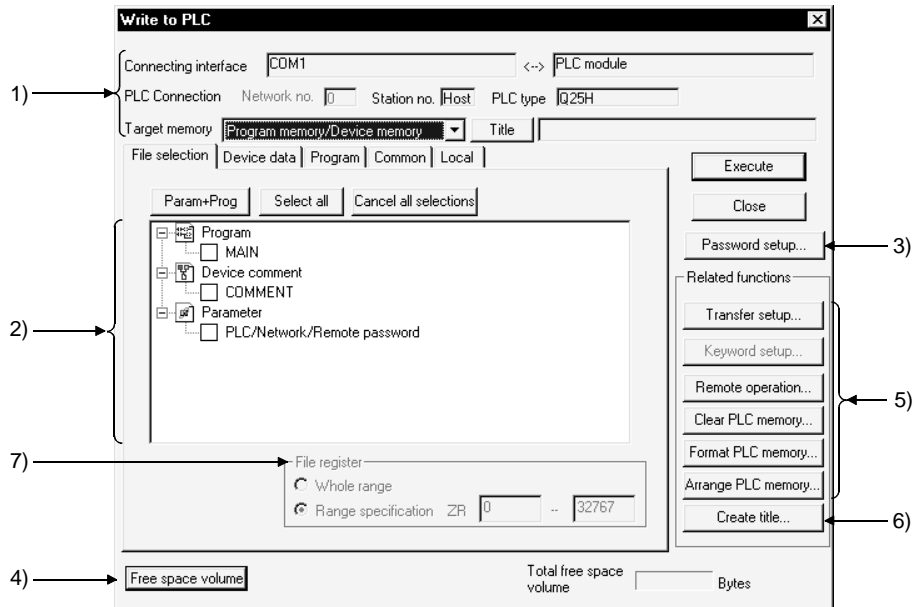

[Description]

Items in parentheses relate to "PLC write."

1) Connecting interface

Shows the connected interface and access target station.

For the Q/QnA series, set the target memory.

| Series | | Selectable Memory |
|------------|------------|--|
| QnA series | | Built-in RAM, memory card (RAM), memory card (ROM) |
| Q series | CPU | Program memory, standard RAM, standard ROM, memory card (RAM), memory card (ROM) |
| | Remote I/O | Standard ROM |

When performing write to the remote I/O station, the write destination is fixed to the standard ROM. For the applications of the memory cards, refer to the following manuals.

QnA series

QnACPU Programming Manual (Fundamentals)

Q series

QCPU (Q Mode) User's Manual (Function Explanation/Program Fundamentals)

Clicking the button displays the title attached to the Q/QnA series memory.

2) PLC data (active data)

- For "PLC read", the list of data in the applicable memory is displayed.
For "PLC read", if there is no data for either comment 1/comment 2 or extension comment, nothing is displayed. Note that it is not possible to select more than one data item each for file register and device initial value (when using Q/QnA series).
- For label programming, you cannot perform [PLC read].
[PLC read] is enabled for only compiled programs.
- For "PLC write", a data list of the opened project is displayed.
- Select the parameters and all programs of the project with the buttons.
- Clear all data with the button.
For the Q series, the intelligent function module parameters are displayed on the screen if their values have been written or set.
- Device data name (read only)
Clicking this button sets a data name to be read when multiple device memories are present.
- button (read only)
Clicking this button updates the PLC data in the PLC read window.
This button is not featured with "PLC write."
When several personal computers are connected to the PLC, click the button to check the latest PLC data before reading the PLC file.

3) Password

Refer to Section 19.2.

4) button (Q/QnA series only)

Clicking this button shows the maximum contiguous area (QnA series only) and total free area of the applicable memory.

This button is not effective for the A series.

5) Related function

Clicking the buttons displays functions related to PLC read/PLC write.

See Section 16.1 Specifying the Connection Target

See Section 18.6 Operating the PLC Remotely

See Section 19.1.1 Registering New Entry Codes/Changing Entry Codes

See Section 20.1 Clearing the PLC Memory

See Section 20.2 Formatting a QCPU (Q mode), QnACPU

See Section 20.3 Sorting the QCPU (Q mode), QnACPU Memory

6) Create title

Creates a label for the applicable memory when using Q/QnA series.

Clicking this button displays the dialog box shown below.

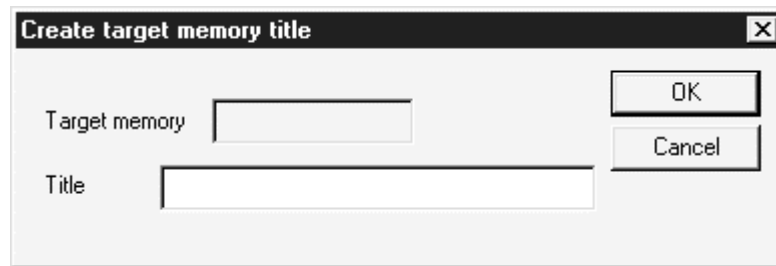

Set a label of up to 32 characters, then click the **OK** button.

7) Extension file register

For A series:

A block No. can be designated only if extension file register was selected at 2).



For Q/QnA series:

- You cannot choose Whole range.
- When there are multiple file registers, the value of each file register is read (written) according to the range specified.
- Setting cannot be made when the Q00JCPU is selected.

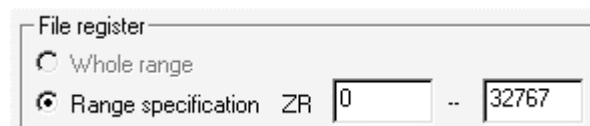

For FX series:
This setting is not possible with the FX series.

File register registration procedure

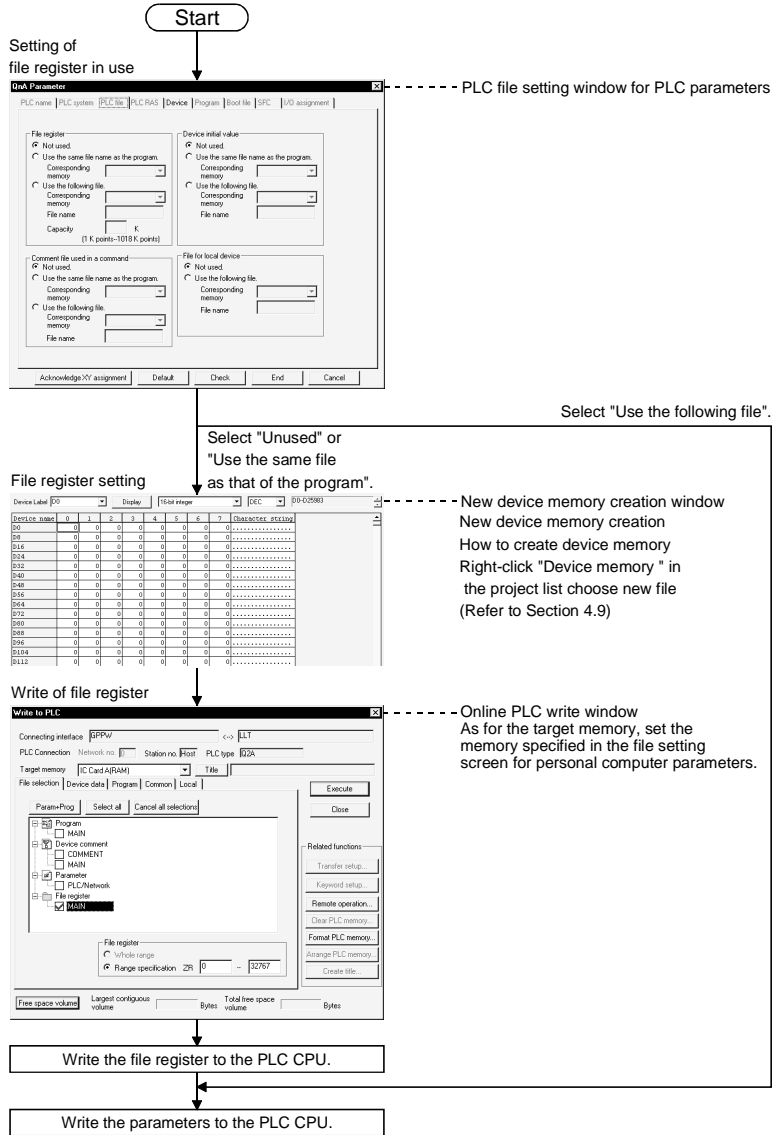

POINT

When creating and writing a new file register name that is the same as the file register name written to the PLC CPU, delete the existing file register from the PLC CPU.

The following is the procedure from file register deletion to write.

1. Using [Delete PLC data], delete the existing file register.
2. From the [Write to PLC] → <<File selection>> tab, select the file to be written.
3. After making setting in "File register" → "Range specification", perform write to the PLC.

[Operating Procedure]

1. Set the access destination as described in "Specifying the Connection Destination."
2. Display the PLC read (write) dialog box.
3. At 2), check the checkbox of the data name for which PLC read (write) is to be carried out.
4. When the file selection is a program, device comment, or device memory, set the range setting and other settings on the relevant tabbed sheet.
5. Click the button.

When the PLC is in the RUN mode, the After STOP remotely is the PLC writing executed? dialog box appears. Choose .

At this time, check the peripheral and PLC side parameters.

If the parameter check results in mismatch, read (write) is suspended.

Also, if data of the same name exists at the read destination (write destination) on the Q/QnA series, the overwrite confirmation dialog box appears.

When you click , the confirmation dialog box does not appear and you can perform batch read from (write to) PLC.

When write to PLC is finished, the PLC state is STOP. Is remote-RUN executed? dialog box appears. Choose .

- Choosing Online on the [Tool] - [Options] - "Whole data" tab saves the file selection status set on the PLC read/write screen.
The file selection status is canceled if a PLC type change, specified connection setup change, project end or target memory change is made.
In addition, the comment selection status of the A series is not saved.
- When performing write to PLC during RUN of the PLC CPU (Q series only)
Since write to PLC can be performed on a program basis if the QCPU (Q mode) is in a RUN status, it is useful when there are many corrections and additions to be made to the program being debugged.
However, if write to PLC during RUN has made the memory capacity of the PLC CPU insufficient, STOP the PLC CPU and then perform write to PLC again. Note that the parameter, device memory and device memory initial values cannot be written while the PLC CPU is during RUN.

Precautions when reading project from PLC

The following dialog box appears to disable the parameter from being read, when reading the project from ACPUR using GX Developer.



The following two methods are available for parameter modification

(1) When the file created using GPPA is provided

Read the parameters from the file created using GPPA and then write it to the PLC CPU according to the following procedures.

1. Read data from GX Developer menu [Project] → [Import file] → [Import from GPPA format file]
2. Click on **OK** button if following message appears when reading data. This deletes the incorrect parts and GX Developer reads them. (The parameters related with PLC CPU operation will never be changed.)



3. Write the read parameter data into the PLC using GX Developer. This enables GX Developer to read the parameters from ACPUR.
4. Save the project within the file.

(2) When the file created using GPPA is not provided

Read [PARAM. +NET PRAM. (AnU) + Main] from ACPUR using GPPA and then save it within a file.

Operate as instructed in (1) using the saved file.

Precautions for PLC write

- (1) When PLC write is performed from multiple personal computers
Do not perform write from multiple personal computers to one PLC CPU simultaneously.
 1. When connected to the network
 2. When multiple projects were started on one personal computer
- (2) When the free space of the PLC CPU drive is insufficient (Q/QnA series only)
Performing PLC write displays the following dialog box to delete all files being written.
For example, if the free file space is insufficient for parameter write, the parameters in the PLC CPU are deleted.



If the above dialog box has appeared, delete unnecessary data and re-execute [Write to PLC].

| POINTS | | | | | | |
|--|------------------------------|----------------|-----------|------------|---------------|-------------|
| <ul style="list-style-type: none"> • If online change is necessary, set this function by selecting [Tools] → [Options], and setting to the online change mode from the write mode or monitor mode. Alternatively, select [Convert] → [Convert (Online change)]. For details on online change, see Section 16.9. For details on online change settings, see Section 15.11. • With the A series, as long as the program capacity settings match, program reading (writing) is possible, even if there is a mismatch with, for example, the device comment capacity. However, if parameter reading (writing) is executed at the same time, no capacity mismatch will occur. • When writing to the E²PROM of a memory cassette with built-in RAM/E²PROM for AnUCPU (A4UMCA-8E, 32E, 128E), set the memory switch to "ROM." • The number of subprograms that can be written with an A4UCPU differs according to the installed memory cassette. The subprograms that can be written are indicated below. | | | | | | |
| | Memory Cassette | A3NMCA-0 to 56 | A3AMCA-96 | A4UMCA-128 | A4UMCA-8E,32E | A4UMCA-128E |
| <ul style="list-style-type: none"> • With the Q/QnA series, if a program with peripheral statements/notes appended is written, the statements/notes are not written to the PLC. Therefore, when reading out a program from the PLC, be careful not to save (by overwriting) the program with no statements or notes. Since the CPU/GPP setting is made when the statements/notes are created, see Section 10.1. • When using the Q/QnA series, it is not possible to write a device memory to an IC memory card. Similarly, it is not possible to write file registers to the built-in RAM. • When using the Q/QnA series, when multiple sequence programs are written to the memory using "PLC write", carry out program setting in the PLC parameters. • When batch writing data to an FX series model, set the PLC to the STOP status. If the PLC is in the RUN status, batch writing is not possible; in this case use the online change function described above. • If the program memory of an FX series model is an EPROM cassette, write programs with a ROM writer. If it is an EEPROM cassette, set the protect switch OFF before writing. • When the A171SH project of MOTION (SCPU) is open, performing PLC read/write to A172SH executes it as A171SH. When the A172SH project of MOTION (SCPU) is open, performing PLC read/write to A171SH executes it as A171SH. • PLC write cannot be performed if an instruction code error program exists after the END instruction. Delete it in the list mode. | Writing possible Subprograms | Sub 1 only | Sub 1,2,3 | Sub 1,2,3 | Sub 1 only | Sub 1,2,3 |

16.3.2 Setting the read/write range for device data

| | | |
|---|-------|----|
| A | Q/QnA | FX |
| ○ | ○ | ○ |

[Purpose]

Sets the type, range, etc., of the devices to be read (written) when device memory has been selected on the <<File selection>> sheet. The device memory contents are not written to the program memory of the PLC. They are written to the device memory area.

[Operating Procedure]

Select [Online] → [Read from PLC] ([write to PLC]) → <<Device data>> tab, or click () → then click the <<Device data>> tab

[Dialog Box]

The screen for "PLC read" is shown here; the screen for "PLC write" is of the same type.

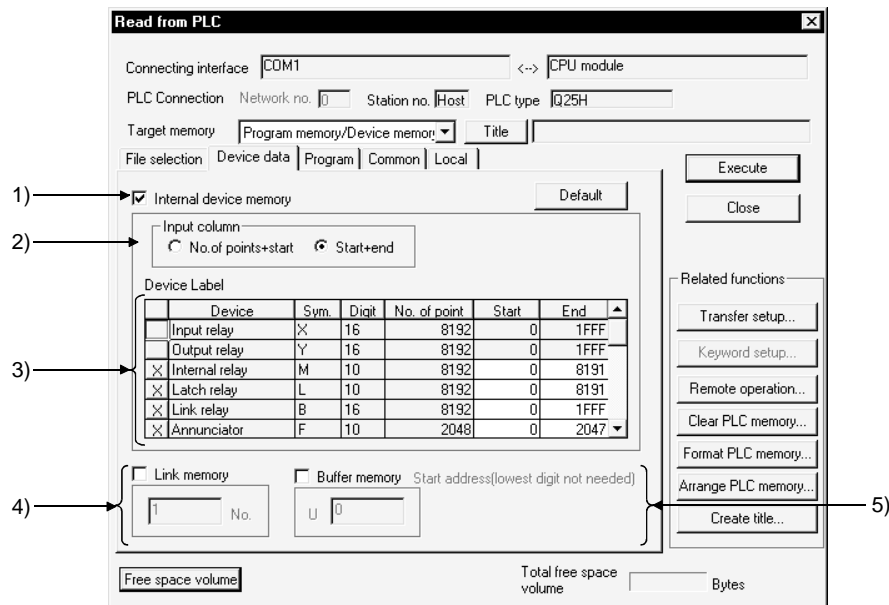

[Description]

- 1) Internal device memory
 Reads (writes) the designated built-in device data.
 Check the checkbox to select it.
 If device memory has been selected in the <<File selection>> sheet, an error will be displayed if the Internal device data checkbox is cleared.
- 2) Input column (Q/QnA/A series only)
 Sets the range designation method for the devices to be read (written).
 - No. of points + start
 Set the number of device points and the first device number.
 - Start + end
 Set the first device number and the final device number.

3) Device Laval

The default settings are for all device types, and the entire range of each. The devices that can be read (written) with the A series and Q/QnA series are indicated below.

A series

| | |
|----------------------------|---|
| Readable/writ able devices | M/L/S *1, B, F, T *2, C *2, D, W, A, Z, V |
| Readable devices | X, Y, special D, special M |

Q/QnA series

| | |
|----------------------------|---|
| Readable/writ able devices | M, L, B, F, SB, V, S *3, T *2, ST *2, C *2, D, W, SW, FX, FY, FD, Z |
| Readable devices | X, Y, SM, SD |

*1 : With the A series, a single range setting is made for the three device types M, L, and S.

*2 : Three types - contact, coil, and present value - are read (written).

*3 : For the S device of GX Developer Version 7.17T (SW7D5C-GPPW-E) or later, the read (write) default setting status is OFF.

FX series

With the FX series, all the readable/writ able devices are designated.

4) Link memory Start address (Q/QnA series only)

Checking this checkbox with the Q/QnA series causes batch reading of the link memory of the designated data link module or network module.

The range of modules that can be designated is 1 to 4.

Since "PLC write" is not possible with a link memory, only reading can be designated.

The data can be read to J*\W** of the device memory.

For details on the device designation method, see the Q/QnACPU Programming Manual (Common Instructions).

This setting is not possible with the A series.

5) Buffer memory start address (Q/QnA series only)

Checking this checkbox with the Q/QnA series causes batch reading of the buffer memory of the designated special function module.

To designate the special function module, set the first output number (however, the lowest digit is unnecessary).

The setting range is 0 to 1FF.

Since "PLC write" is not possible with respect to a buffer memory, only reading can be set.

The data can be read to U*\G** of the device memory.

For details on the device designation method, see the Q/QnACPU Programming Manual (Common Instructions).

This setting is not possible with the A series.

<Setting Example>

Case where the first I/O number is 40

| | |
|---|---|
| U | 4 |
|---|---|

6)

| |
|---------|
| Default |
|---------|

 button

Always click this button when performing write to PLC after changing the device range from [PLC parameter] - <Device> tab.

16.3.3 Setting the program reading/writing range

| | | |
|---|-------|----|
| A | Q/QnA | FX |
| ○ | ○ | ○ |

[Purpose]

Sets the program range for reading/writing.

[Operating Procedure]

Select [Online] → [Read from PLC] ([Write to PLC]) → <<Program>> tab, or click () → then click the <<Program>> tab.

[Dialog Box]

The dialog box for "PLC read" is shown here; the dialog box for "PLC write" is of the same type.

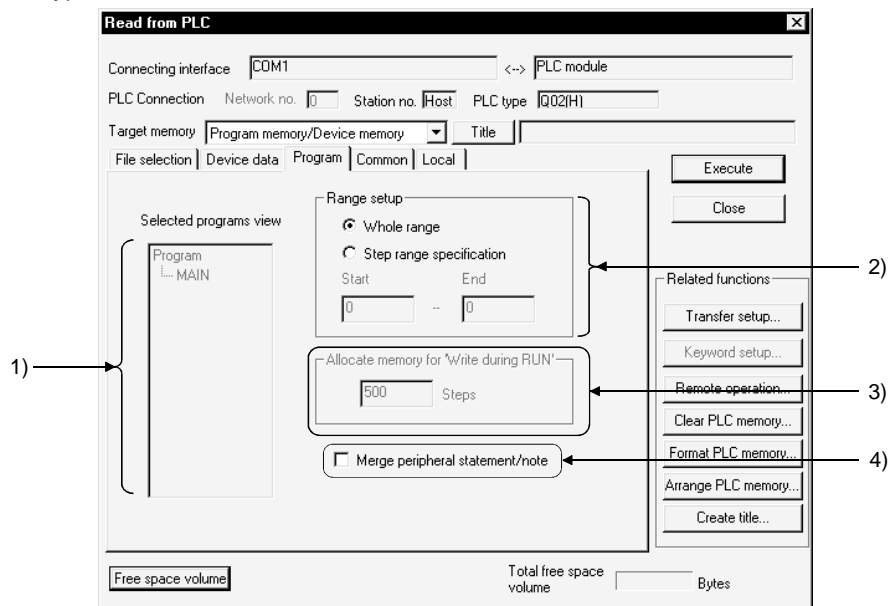

[Description]

- 1) Selected programs view
Displays a list of programs selected for read (write) data using file selection.
- 2) Range setup
Sets the range for programs selected for read (write) data.
When multiple programs have been selected, the All range setting is automatically made.
 - Whole range
The whole range is read (written).
 - Step range specification
The range designated by first and final step numbers is read (written).
- 3) Allocate memory for "Write during RUN" (Q/QnA series only)
 - With the Q/QnA series, to accommodate the increase in steps during online change, an area equivalent to the number of steps secured for online change is secured when a program is written to the PLC.
For details on online change, see Section 16.9.
When you selected the Q00J/Q00/Q01CPU, you need not make setting since the steps are automatically secured.
 - This setting is not possible with the A series and FX series.
- 4) Merge peripheral statement/note
Refer to Section 10.2.

16.3.4 Setting the comment read/write range

| | | |
|-----------------------|-----------------------|-----------------------|
| A | Q/QnA | FX |
| <input type="radio"/> | <input type="radio"/> | <input type="radio"/> |

[Operating Procedure]

- Reading (writing) comments common to all programs
 Select [Online] → [Read from PLC] ([Write to PLC]) → <<Common>> tab, or click (), then click the <<Common>> tab.
- Reading (writing) program-specific comments
 Select [Online] → [Read from PLC] ([Write to PLC]) → <<Local>> tab, or click , then click the <<Local>> tab.

[Dialog Box]

A series PLC read the <<Common>> sheet and Q/QnA series PLC write. The <<Common>> sheet is shown here; the <<Local>> sheet is of the same type. (However, the A series <<Local>> sheet has no range setting for extension comments.)

- A series PLC read <<Common>> sheet:

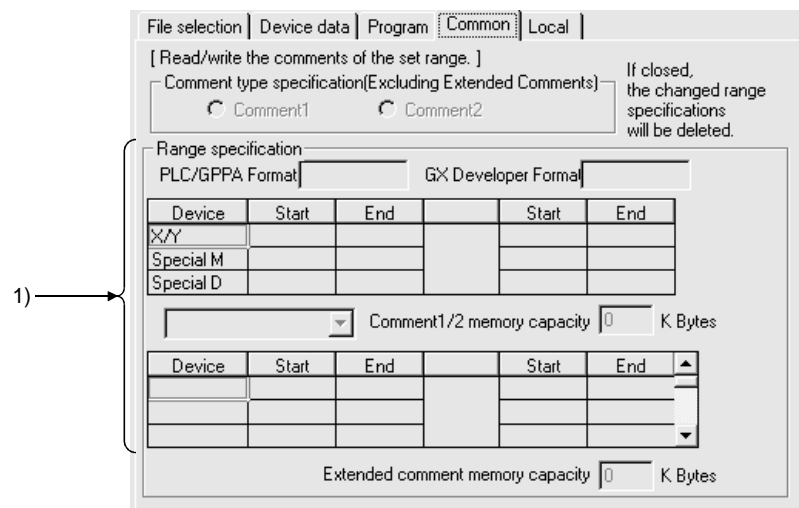

- Q/QnA series PLC write <<Common>> sheet:

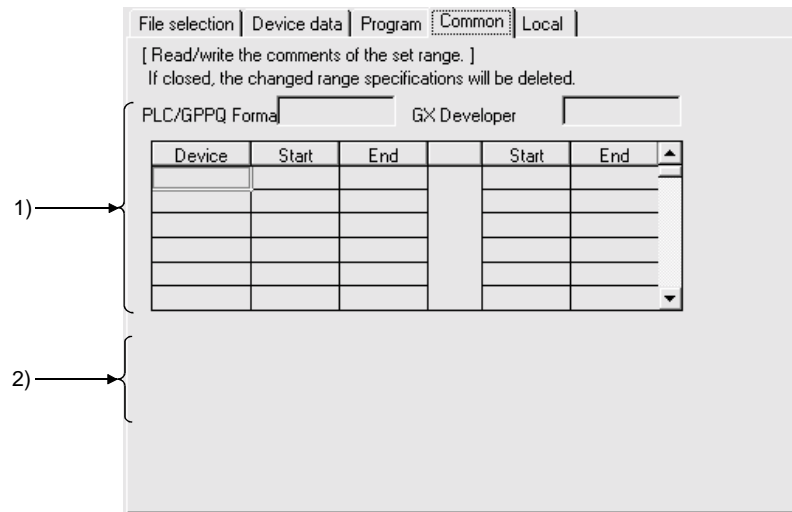

[Dialog Box]

The FX series PLC read <<Common>> sheet and PLC write <<Common>> sheet are shown here. With the FX series, there is no <<Local>> tab.

- FX series PLC read <<Common>> sheet:

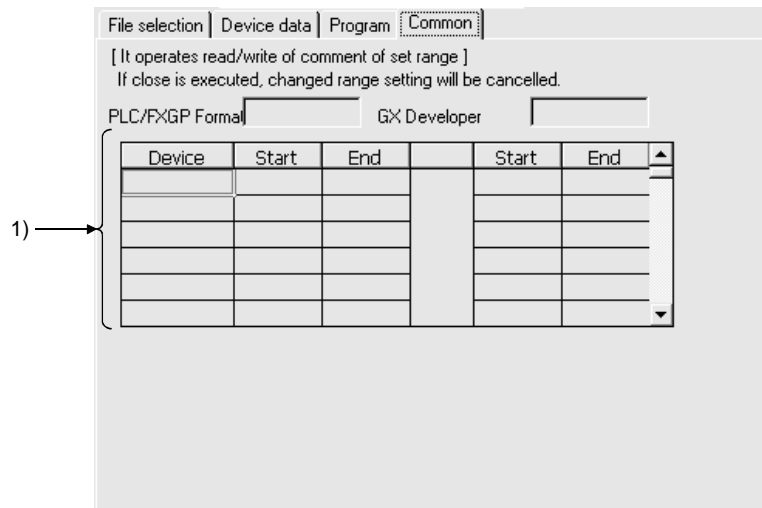

- FX series PLC write <<Common>> sheet:

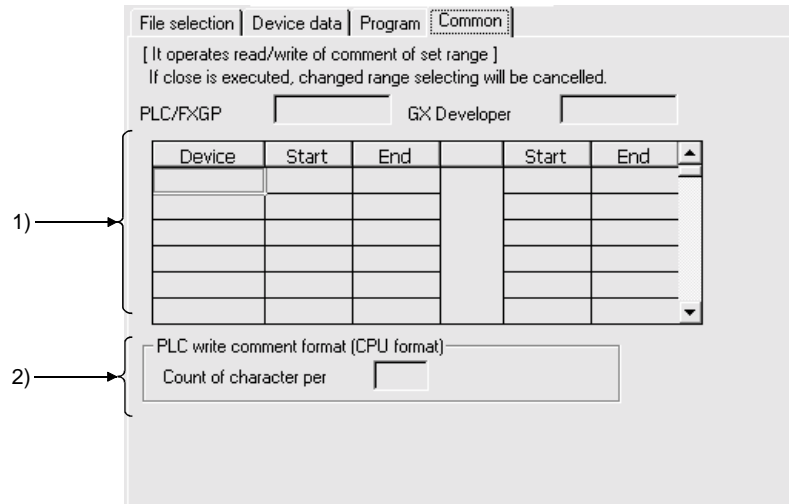

[Description]

1) Device range setting

Sets the range of device comments to be read (written) when device comment data has been selected by file selection.

The details of comment range setting when editing device comments are set. If the read (write) range is incorrect, it is changed.

However, when the range is changed, the comment range setting for device comment editing is also automatically changed.

For details on comment range setting, see Section 9.7.

When writing with the A series, always carry out range setting. Note, however, that no range designation is required when the entire range is to be read.

When reading (writing) the entire range with the QnA series, no range designation is required.

For the Q series, up to 64k points can be written to the PLC. There are no restrictions on saving onto the HD/FD of the personal computer.

When reading with the FX series, all that is required is to select the comment data file: range setting is not necessary.

2) PLC write comment form (Q/QnA series only)

Sets the number of characters of comments written to a Q/QnA series PLC.

In device comment editing, comments of up to 32 characters can be created, but memory capacity can be saved by reducing the number of characters written to the PLC.

The setting range is 2 to 32 characters.

There is no setting for reading.

This setting is not possible with the A series.

POINTS

- There are two types of device comment: comments common to all programs and program-specific comments. This is not the case with previous packages (GPPA, GPPQ, FXGP(DOS), FXGP(WIN)). Therefore, first read Section 9 "SETTING DEVICE COMMENTS" before reading (writing) device comments.
- With the A series, it is not possible to read (write) device comments unless a comment memory capacity setting has been made. Make the PLC parameter memory capacity setting by referring to the comment capacity displayed under the range designation.
- With the Q/QnA series, device comment reading is CPU format.

16.4 Verifying the Peripheral Side and PLC Side Data

| | | |
|-----------------------|-----------------------|-----------------------|
| A | Q/QnA | FX |
| <input type="radio"/> | <input type="radio"/> | <input type="radio"/> |

[Purpose]

Compares and verifies the program, parameters and device comments in the PLC CPU and the data on the personal computer side.

[Operating Procedure]

[Online] → [Verify with PLC]

[Dialog Box]

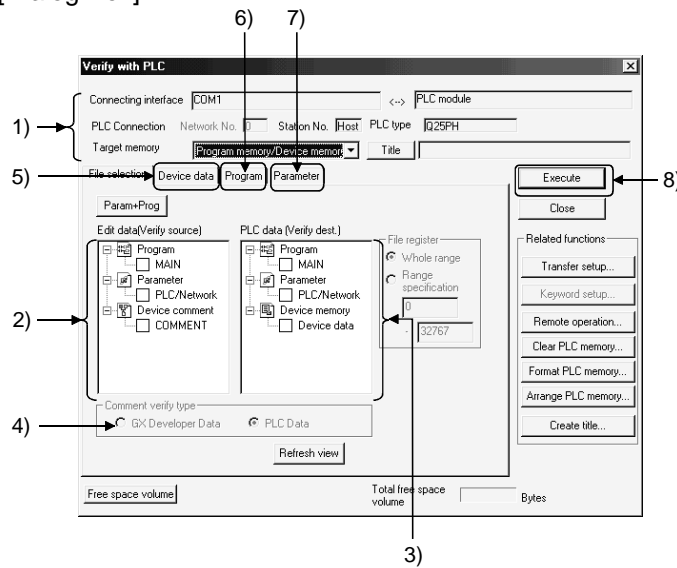

[Description]

- 1) Connection destination information
Shows the connected interface and accessed station.
For the QnA series, set the corresponding memory.
- 2) Edited data (verify source)
Lists the programs and parameter data of the project.
Check the data name check box to make selection.
- 3) PLC data (verify destination)
Lists the programs and parameter data in the PLC CPU.
Check the data name check box to make selection.
If extended comments have not been written to the PLC CPU, the extended comment item does not appear.

- 4) Comment verify type
 Select whether the device comments of the edited data (verify source) comments or those of the PLC data (verify destination) are used as the basis of verify.

The verify basis is indicted below.

| PLC Data | |
|---|---|
| ACPU QCPU (A mode), Motion Controller | QCPU (Q mode), QnA |
| Edited data area=PLC data area Comments outside the PLC data area are not verified. | |
| Edited data area=PLC data area All devices will be the target of verify. | |
| Edited data area=PLC data area Comment sections not existing in the edited data are handled as "no comment". | |
| Verify is executed in the device area set to the comments of the comment type (kana/kanji, extended) selected in the PLC data and written to the PLC CPU. | Verify is executed in the device area set to the comment file selected in the PLC data. |

| Gppw Data | |
|--|--|
| ACPU QCPU (A mode), Motion Controller | QCPU (Q mode), QnA |
| Edited data area=PLC data area Comments outside the PLC data area are not verified. | |
| Edited data area=PLC data area All devices will be the target of verify. | |
| Edited data area=PLC data area Comment sections not existing in the edited data are handled as "no comment". | |
| Verify is executed in the device area set in the PLC write range setting of the comments of the comment type (kana/kanji, extended) selected in the PLC data. If PLC write range setting has not been made, verify is executed in the whole edit device area in GX Developer. | Verify is executed in the device area set in the PLC write range setting of the comments selected in the edit data. If PLC write range setting has not been made, verify is executed in the whole edit device area in GX Developer. |

| POINTS |
|---|
| <ul style="list-style-type: none"> • The following instruction applies to the verify of comments on the QnA series. When selecting multiple comment files, verify the identical file names. • The M, L and S of the ACPU or QCPU (A mode) must be verified when the device range setting has been made with reference to the editing data range. Otherwise, the verify results of the M, L and S will be illegal. |

- 5) <<Device data>>tab
Refer to Section16.3.2.
- 6) <<Program>>tab
Refer to Section16.3.3.
- 7) <<Parameter>>tab (Q/QnA series only)
Select the parameter verify level.
The default is "Level 1".

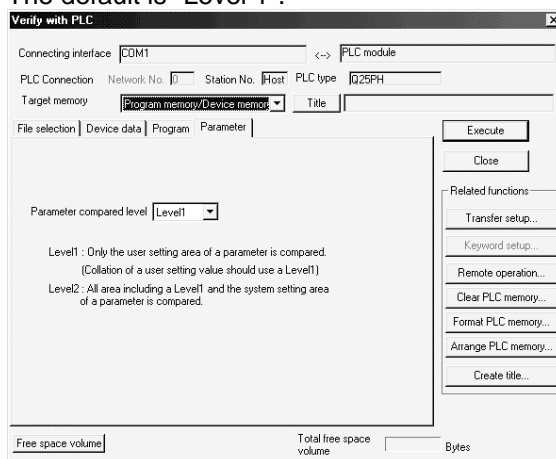

When verify is performed on "Level 2"

On "Level 2", the parameter area other than the user setting area is also verified.

The following message appears if any mismatch is detected as a result of verifying the parameter area other than the user setting area.

Take corrective action according to the message of the verify result.

| Message | Corrective Action |
|--|--|
| The header information of the parameter block is inconsistent. | A mismatch exists in other than the user setting area.(*1) Write the parameters to the PLC CPU again. |
| This parameter block can't analyze. | The GX Developer version used to create the project differs between the PLC CPU and GX Developer. This does not affect the operation of the PLC CPU. When matching the verify results of Level 2, install the latest version of GX Developer, then read the parameters from the PLC CPU, and write them to the PLC CPU again to ensure safety. |

(*1): The area other than the user setting area of the PLC CPU may become illegal due to the influence of noise, etc.
In that case, a parameter-related error may occur in the PLC CPU, but no mismatches are detected if verify is performed on "Level 1".

- 8) **Execute** button
Click this button when the setting is finished.

[Setting Procedure]

1. Set the access destination in Transfer setup.
2. Show the PLC verify screen.
3. Check the desired data check boxes at 2) and 3) to make selection.
4. When verifying programs, set the area at 5).
5. After the setting is over, click 8).
After completion, the verify result dialog box appears.

| |
|--------|
| POINTS |
|--------|

- When multiple pieces of data have been chosen in file selection, verify is performed between identical data names. Also, if the data names selected do not correspond between the verify source and destination, an error message appears.
When sequence programs are to be verified one by one between the verify source and destination, you can specify different data names.
- If more than 100 discrepancies are found in the verify results, the results of up to 100 discrepancies are displayed and verify is suspended at that point.
Before restarting verify of the area at and after the point of verify suspension, specify the range or correct the verify data.

16.5 Write to PLC (Flash ROM)

16.5.1 Write the program memory to ROM

| A | Q/QnA | FX |
|----|-------|----|
| ○* | ○* | × |

*: Compatible with the QCPU (Q mode).

*: Compatible with the QCPU (A mode).

[Purpose]

Batch-writes the data of the program memory to the standard ROM or linear flash ROM. (Q series only)

To write to the ATA card, choose [Online] → [Write to PLC].

[Operating Procedure]

Select [Online] → [Write to PLC (Flash ROM)] → [Write the program memory to ROM].

[Dialog Box]

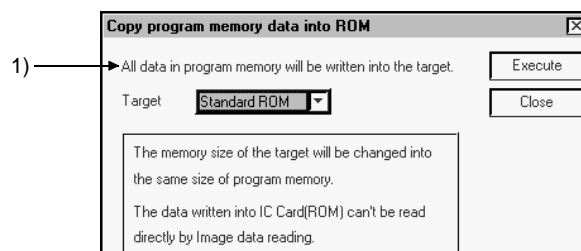

[Description]

1) Target

Choose Standard ROM or IC Card (ROM) (for linear flash ROM).

POINTS

- Data of the program memory written to the ROM cannot be read in image data reading.
Read it directly from the PLC.
- If program memory data is written to the ROM, device memory data cannot be written to the ROM.

16.5.2 Write to PLC (Flash ROM)

| | | |
|---|-------|----|
| A | Q/QnA | FX |
| × | ○* | × |

*: Compatible with the QCPU (Q mode).

[Purpose]

Writes data to the standard ROM or flash ROM. (Q series only)
 Since transfer/write may take time depending on the performance of the personal computer, use the following menu to write a program to the ROM.

When writing the program memory data of the PLC to ROM
 Select [Online] → [Write to PLC (Flash ROM)] → [Write the program memory to ROM].

When writing the project data to ROM (PLC card slot required)
 Select [Tools] → [IC memory card] → [Write IC memory card].

To write to the ATA card, choose [Online] → [Write to PLC].
 As the corresponding memory, choose Memory card (ROM).

[Operating Procedure]

Select [Online] → [Write to PLC (Flash ROM)] → [Write to PLC (Flash ROM)].

[Dialog Box]

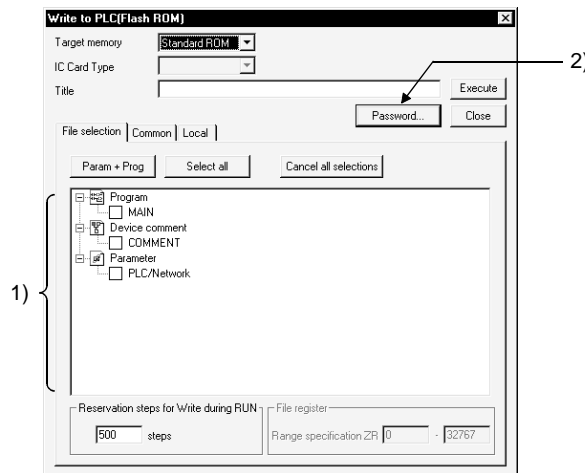

[Description]

- 1) PLC write setting
 Refer to Section 16.5.
- 2) **Password** button
 Refer to Section 19.2.

POINT

For Write to PLC (Flash ROM) with the other station specified, set the time check (seconds) to 45 seconds on the Transfer setup screen.

16.6 Deleting Data in the PLC

| | | |
|---|-------|----|
| A | Q/QnA | FX |
| × | ○ | × |

[Purpose]

Deletes data such as programs and parameters in the PLC when using the QnA series.

[Operating Procedure]

Select [Online] → [Delete PLC data].

[Dialog Box]

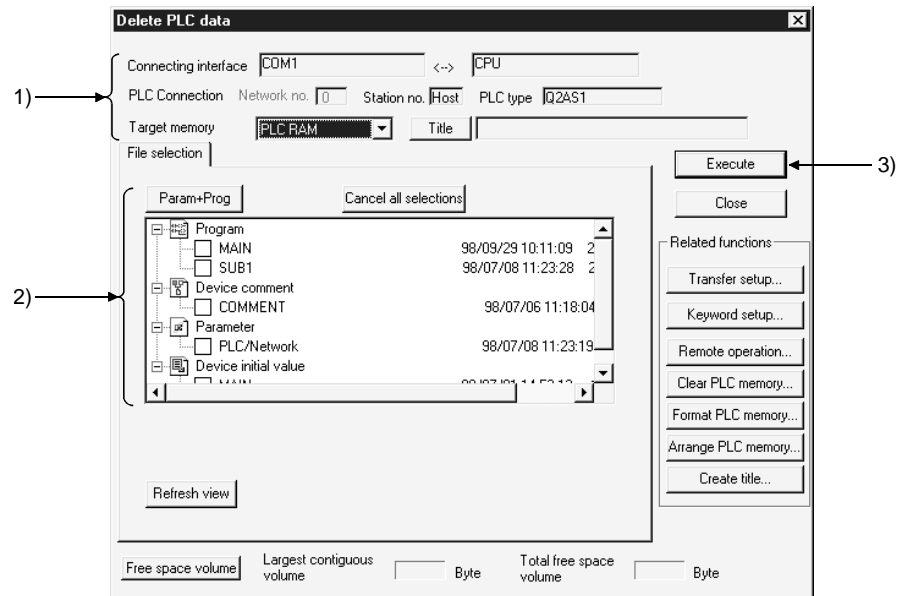

[Description]

- 1) Connection destination information
Displays the connected interface/applicable station for access.
Set the applicable memory.
- 2) PLC data
Displays the list of data in the applicable memory.
Check the checkbox for the data name to be deleted to select it.
Select the project parameters and all programs by clicking the **Param + Prog** buttons.
Cancel all data by clicking the **Cancel all selections** button.
- 3) **Execute** button
Click this button after setting the necessary settings.

[Operating Procedure]

1. Set the access destination as described in "Transfer setup."
2. Display the PLC file delete dialog box.
3. Check the checkbox for the data name to be deleted in 2) to select it.
4. After making the necessary settings, click 3).

| |
|-------|
| POINT |
|-------|

| |
|--|
| <p>PLC file deletion is possible for the Q/QnA series only. When using the A series, select [Online] → [clear PLC memory] to all-clear the data in the memory cassette, then write only the necessary data again. For details on PLC memory clear, see Section 20.1.1.</p> |
|--|

16.7 Changing PLC Data Attributes

| | | |
|---|-------|----|
| A | Q/QnA | FX |
| × | ○* | × |

*: Compatible with the QnACPU.

[Purpose]

Changes the attributes to "writing disabled" and "display disabled" in order to protect programs, parameter data and other data in QnA series PLC from unwanted access. (QnA series only)

[Operating Procedure]

Select [Online] → [Change PLC data attributes].

[Dialog Box]

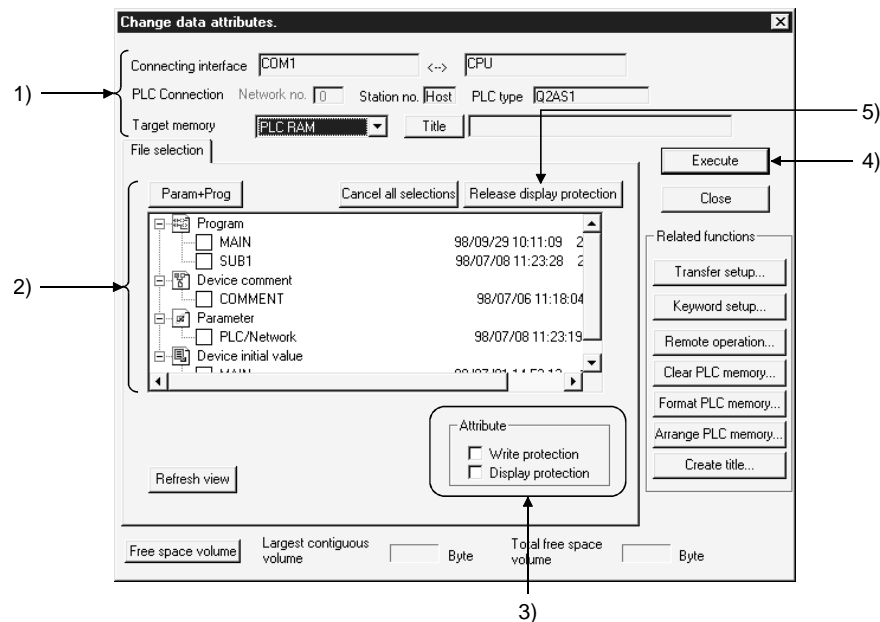

[Description]

- 1) Connection destination information
Displays the connected interface/applicable station for access.
Set the applicable memory.
- 2) PLC data
Displays the list of data in the applicable memory.
Check the checkbox for the data name whose attributes are to be changed to select it.
Select the project parameters and all programs by clicking the **Param + Prog** buttons.
Cancel all data by clicking the **Cancel all selections** button.

- 3) **Attribute**
Sets the data attributes.
If both the Display prohibited and Write prohibited checkboxes are selected by checking them, data is neither written nor displayed.
- When write disable is selected:
Data cannot be written or deleted by access from a personal computer.
 - When display disable is selected:
The existence of the data is not indicated in the display on accessing from a personal computer.
- 4) **Execute** button
Click this button after setting the necessary settings.
- 5) **Release display prohibition** button
Releases data for which the display disable or write disable status is set from the disabled status.
On clicking the **Release display prohibition** button, the dialog box shown below is displayed.

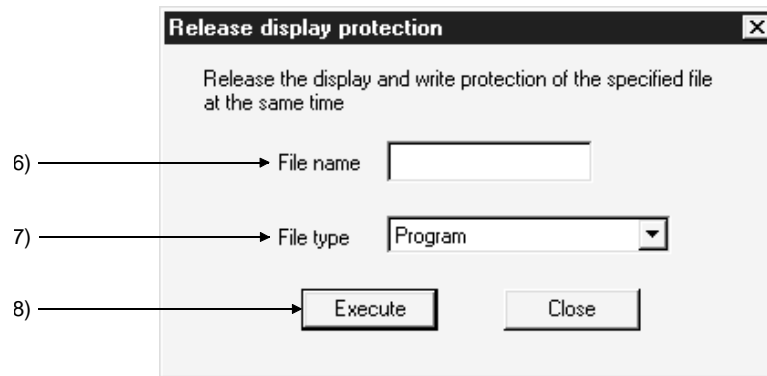

- 6) **File name**
Set the file name for which the display disable or write disable status is to be canceled.
If the file name for which the parameter has been changed and the set file name do not match, the "disabled" status cannot be released.
- 7) **File type**
Set the file type for which the disabled status is to be cancelled.
- 8) **Execute** button
After setting the file name and file type, click the **Execute** button.
If the set file name or file type does not agree with that at the PLC side, the disabled status cannot be canceled.

[Operating Procedure]

- Changing to the "write disabled"/"display disabled" status
 1. Set the access destination by as described in "Specifying the Connection Destination."
 2. Display the PLC data attribute change dialog box.
 3. Check the checkbox for the data name to be deleted at 2) to select it.
 4. Set the type of attribute at 3).
 5. Click 4).
- Canceling the write disabled or display disabled status
 1. Set the access destination as described in "Specifying the Connection Destination."
 2. Display the PLC data attribute change dialog box.
 3. Click 5) to display the display disabled cancellation dialog box.
 4. Set 6) and 7).
 5. After setting the necessary settings, click 8).

| |
|--------|
| POINTS |
|--------|

- | |
|---|
| <ul style="list-style-type: none">• Be sure not to forget a data name whose display has been disabled. If the correct data name cannot be set, it will not be possible to designate the data for access, making reading and writing impossible. To delete or change display disabled data when you have forgotten the name, initialize the memory by selecting [Online] → [format PLC memory], then write the necessary data again. See Section 20.2 for details on PLC memory formatting.• It is possible to change the same attribute of several data at the same time, but disabled statuses have to be canceled one by one.• If neither selection has been made in attribute designation, the write disabled status of the selected data is canceled. |
|---|

16.8 Reading/Writing PLC User Data

16.8.1 Reading

| | | |
|---|-------|----|
| A | Q/QnA | FX |
| × | ○* | × |

*: Compatible with the Q02(H)/Q06H/Q12H/Q25H CPU.

[Purpose]

Reads CSV format and other files written on the IC memory card to the personal computer.

Refer to the following manual for the way to use the user data with the sequence program.

QCPU (Q mode)/QnA programming manual (common instructions manual)

[Operating Procedure]

Select [Online] → [PLC user data] → [Read PLC user data].

[Dialog Box]

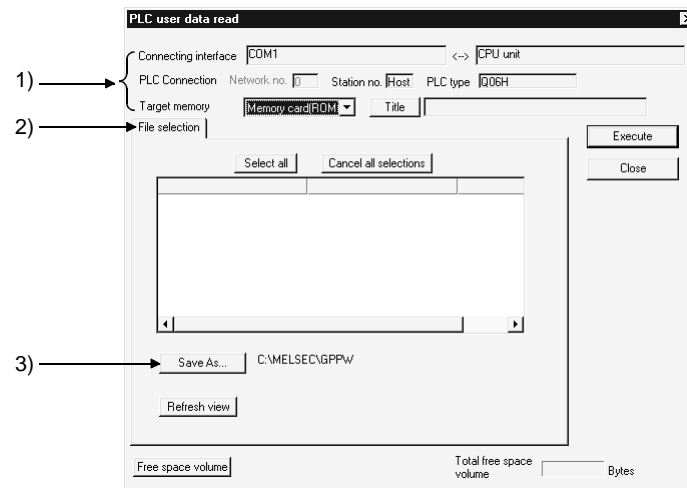

[Description]

- 1) Memory card read target setting
Set the read destination of data.
- 2) Read data setting
Refer to Section 16.3.
- 3) **Save As** button
Set the save target of the read data.

REMARKS

Use Delete PLC user data to delete data.

16.8.2 Writing PLC user data

| | | |
|---|-------|----|
| A | Q/QnA | FX |
| × | ○* | × |

*: Compatible with the Q02(H)/Q06H/Q12H/Q25HCPU.

[Purpose]

Writes data created in the CSV format and others to the ATA card.
(Q series only)

[Operating Procedure]

Select [Online] → [PLC user data] → [Write PLC user data].

[Dialog Box]

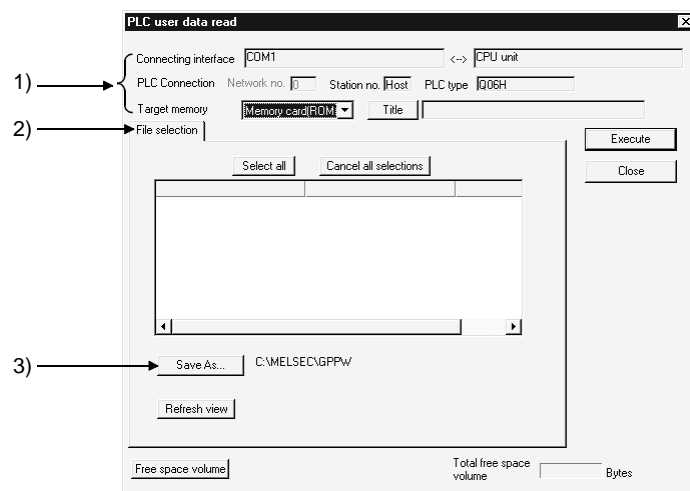

[Description]

- 1) Memory card write target setting
Set the write destination of data.
- 2) Written data setting
Refer to Section 16.3.
- 3) **Save As** button
Set the save target of the written data.

POINTS

- Use Format PLC memory to format the IC memory card.
- The attributes (read only, hidden file) of a project file are invalid if they are set on Windows[®] Explorer or the like.

16.9 Executing Online Change

| | | |
|-----------------------|-----------------------|-----------------------|
| A | Q/QnA | FX |
| <input type="radio"/> | <input type="radio"/> | <input type="radio"/> |

[Purpose]

In the ladder editing window, changes a part of a sequence program and then writes it to the PLC while it is in the RUN status.

Online change is possible in the write mode and in the monitor write mode.

Online change cannot be made when the PLC is in the STEP-RUN mode.

The Caution points for executing Write during RUN are listed on the next page.

Read these points before executing a Write during RUN.

There are the following two types of online change.

- When making online change frequently
Online change is executed by simply selecting [Tools] → [Options] to preset online change and then making conversion.
- When not making online change frequently
Choose the [Convert (Online change)] menu at the time of program conversion to execute online change.

[Operating Procedure]

By performing Verify PLC, make sure in advance that the programs match.

Online change cannot be made if there is a mismatch in the part written to the PLC CPU.

- Setting online change by menu operation before conversion.
 1. Change and correct the program.
 2. Convert the program by selecting [Convert] → [Convert (Online change)] (**Shift** + **F4**).

Confirm online change in the dialog box shown below.
- Executing online change at program conversion by options setting
 1. Select [Tools] → [Options] → <<Common>> and then set the online change setting to "Write during RUN (while PLC is running)." See Section 15.11 for details on the online change setting.
 2. Change and correct the program.
 3. Convert the program by selecting [Convert] (**F4**).

Execute online change in the dialog box shown below.

Online change confirmation dialog box

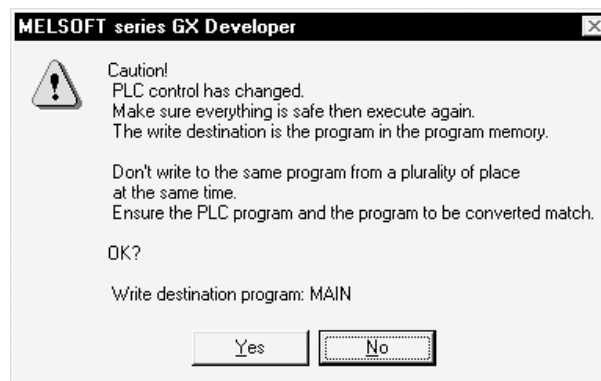

The following tables list precautions for making online change.
 (1) For A series

| Item | Description |
|---|--|
| EEP-ROM of other than AnUCPU | <ul style="list-style-type: none"> Online change cannot be made to EEP-ROM of other than AnUCPU. |
| Online change to other stations | <ul style="list-style-type: none"> Online change can be made to other stations via the MELSECNET (II, /10). However, note that the sequence program will be corrupted if online change is made from multiple personal computers to a single PLC. |
| A2CCPU, A2CJCPU | <ul style="list-style-type: none"> To make online change, select [Tools] → [Options] → (Common) sheet and set the edit object (shift forward setting) to "1 ladder block (Don't shift the program forward)" on the (Common) sheet. Otherwise, an error will occur, bringing the PLC down. For shift forward setting, refer to Section 15.11. |
| Deletion of corresponding device from program | <ul style="list-style-type: none"> If a deletion during execution of the OUT instruction or changing a device No. has removed the corresponding device from the program, the output status is held. Force the unnecessary coil outputs for control to be switched off by selecting [Online] → [Debug] → [Device test]. For the device test, refer to Section 18.1 "Carrying Out a Device Test". |

Perform Verify PLC when making online change to the PLC CPU for the first time or if an error occurred during online change processing.

(2) For Q/QnA series

| Item | Description |
|---|--|
| Online change to other stations | <ul style="list-style-type: none"> Online change can be made to other stations via the MELSECNET (II, /10) or Ethernet. |
| Online change to built-in RAM during boot operation | <ul style="list-style-type: none"> If online change has been made to the built-in RAM during boot operation, write the converted program to the IC memory cared after STOP using Write to PLC. |
| Deletion of corresponding device from program | <ul style="list-style-type: none"> If a deletion during execution of the OUT instruction or changing a device No. has removed the corresponding device from the program, the output status is held. Force the unnecessary coil outputs for control to be switched off by selecting [Online] → [Debug] → [Device test]. For the device test, refer to Section 18.1 " Carrying Out a Device Test ". |
| Steps secured for online change | |
| QnA series | <ul style="list-style-type: none"> Online change cannot be made beyond the number of steps set as those secured for online change on the (Program/SFC program) sheet after selecting [Online] → [Write to PLC] → (Sequence/SFC program) sheet. The number of secured steps for online change is reduced for each online change. If the currently set number of secured steps is exceeded by online change, convert the program offline and select [Online] → [Write to PLC]. If the number of steps is greatly increased by online change, preset a large number of steps secured for online change during program write. |
| Q series | <ul style="list-style-type: none"> If the currently set number of secured steps is exceeded by online change, the following dialog box appears. Set new secured steps. If the number of secured steps is set to 0 in the following dialog box, only the sequence program which has exceeded the secured step range is written. If online change is made to the sequence program whose password has been set, the password deletion dialog box appears. Start online change after deleting the password. If the password cannot be deleted, online change cannot be made. The secured steps newly set in the following dialog box do not appear on the (program) sheet of Write to PLC. <div data-bbox="635 1697 954 1921" data-label="Image"> </div> <p>When you selected the Q00J/Q00/Q01CPU, the above dialog box does not appear since the steps secured for online change are automatically secured.</p> |

Q/QnA Series Table Continued

| Item | Description |
|--|--|
| Online change during slow execution type program run | <p>While the slow execution type program is run, online change is started on all completion of the slow execution type program. During online change, the slow execution type program run is suspended.</p> <p>However, online change cannot be made if "PRG TIME OVER(5010)" keeps occurring during slow execution type program run.</p> <p>In this case, after setting the PLC CPU to STOP, increase the settings of the constant scan and slow execution type program run time in the PLC parameters, and perform write to PLC again.</p> |

(3) For FX series

| Item | Description | |
|-------------------------------------|--|--|
| CPU which can make online change | | |
| Model name | FX2C series/FX2 series (version No. V2.1 or later), FX0N series (version No. V1.10 or later), FX2N/FX2NC series | |
| Memory type | FX2N series | Built-in RAM, optional RAM cassette or optional EEPROM cassette (protect switch OFF) |
| | FX2NC series | Built-in RAM or optional memory card (protect switch OFF) |
| | FX2/FX2C series | Built-in RAM or optional RAM cassette |
| | FX0N series | Built-in EEPROM |
| Use of FX0N, FX2, FX2C, FX2N, FX2NC | <ul style="list-style-type: none"> Corrected ladders do not have additions, deletions and changes to labels P, I. Change cannot be made if any ladder before or after corrections includes the output (OUT) instruction of high-speed counter C235 to 255 or the application instruction FNC90 to 98. There should be no new 1ms retentive timers inserted. If contact deletion or like has made the number of steps in the new ladder block program less than that in the old ladder block program, the number of steps in the ladder block program does not change and the corresponding steps are converted into NOP instructions. If "Continuous ladder block (Shift the program forward)" has been specified in the option setting, the latter ladder block is not shifted up. | |
| Use of FX2 (V3.07 or later), FX2c | <ul style="list-style-type: none"> A substitute instruction for a new instruction cannot be inserted into a program or rewritten. If a substitute instruction has already been programmed, the function of this substitute instruction is lost by executing online change at that part. FNC10 to 12 (CMP, ZCP, MOV) and FNC20 to 25 (ADD, SUB, MUL, DIV, INC, DEC) instructions are increased in operation speed when neither a word device with digit designation nor index qualification is used. However, when online change or insertion is made, the high-speed processing function of this part is lost. The OFF execution time of the application instructions of the FX2 (V3.07 or later) and FX2C is shortened. However, when online change or insertion is executed, the shortening function of this part is lost, and the value becomes approximately 60% of that of the FX2 (V2.30 or earlier) series. | |
| Use of FX2 (V2.1 to V2.30) | <ul style="list-style-type: none"> When additional application instructions and device numbers are written with the FX2 (V3.07 or later) PLC, these instructions are written directly to the program memory of the PLC. At this time, the PLC continues running, handling them as no operations. However, as soon as the operation mode of the PLC is switched from STOP to RUN, a program check is performed and the "PROG-E LED" flickers. In this case, change the incompatible application instructions and device numbers, then batch-transfer a correct program. If a device number not supported by the FX2 (V2.1 to V2.30) is specified as the operand of an application instruction, this instruction is written directly to the program memory of the PLC. At this time, an operation error occurs because the device number for this instruction is outside the range, but the PLC continues running, handling it as a no operation. However, as soon as the operation mode of the PLC is switched from STOP to RUN, a program check is performed and the "PROG-E LED" flickers. In this case, batch-transfer a program with a correct operand set for the application instruction. | |
| Use of FX0N (V1.10 or later) | <ul style="list-style-type: none"> When a device number that is not compatible with the FX0N is written, the "It cannot write during RUN because order or device that cannot write in changed program during RUN is included" message appears and changes to the program are suspended. Since the FX0N has no pulse execution type application instructions, writing this type of instruction displays the "Write bad" message and suspends changes to the program. | |

*1: Each function is restored by switching the PLC from STOP to RUN after online change has been made.

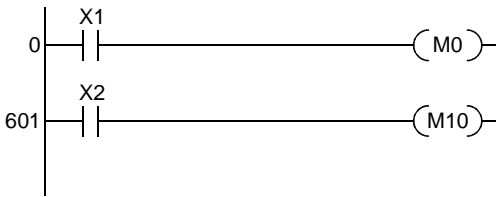
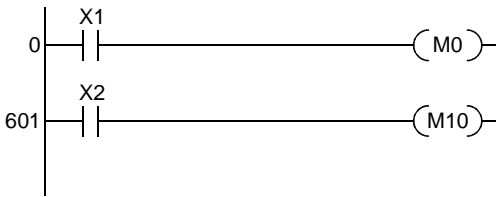
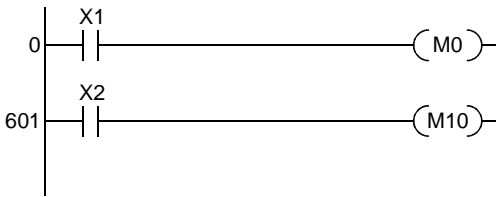
| POINTS | | | |
|---|---|---|---|
| | <p>The following numbers of steps can be written by a single online change.</p> <p>(1) Q/QnA/A series A series Number of program steps after editing (addition/deletion): Within 250 steps Q/QnA series Number of program steps after editing (addition/deletion): Within 512 steps However, if the existing program is not modified but a program is added to it by pasting and line insertion, the maximum number of steps cannot be written by a single online change. In this case, reduce the number of steps written at one time and make online change several times. Also be careful when the following corrections have been made. If a correction is made to step 2 in a program and an addition made to step 540, online change cannot be made since steps 2 to 540 will be the object of a single online change. In this case, perform online change every time a correction is made. Also be careful when the following corrections have been made. If a correction is made to step 2 in a program and an addition made to step 540, online change cannot be made since steps 2 to 540 will be the object of a single online change. In this case, perform online change every time a correction is made.</p> <p>(2) FX series (FX0N/FX2/FX2C/FX2N/FX2NC only) Ladder modification is made within a single ladder block once and the number of program steps after editing (addition/deletion) is within 127 steps. (Including the NOP immediately after the ladder block, but with the exception of the last ladder) Program modifications exceeding the above should be batch-transferred.</p> <p>Precautions for online change The case where online change cannot be made and its correction method are described below.</p> <ul style="list-style-type: none"> • If the ladder block has no NOP instructions and the number of steps is greater than 250 (ACPU)/512 (Q/QnACPU)/127 (FXCPU), delete unnecessary instructions before starting online change. • If NOP instructions exist after the ladder block and the online change range is exceeded, choose "Don't shift the program forward" and start online change. <p>Refer to Section 15.11 for shift forward setting. Note that when step 0 (LD X1) of the following program is to be changed to LD X3, online change cannot be made if "Shift the program forward" has been selected.</p> <table style="width: 100%; border: none;"> <tr> <td style="width: 50%; vertical-align: top; padding: 5px;"> <p>Ladder mode</p>  </td> <td style="width: 50%; vertical-align: top; padding: 5px;"> <p>List mode</p> <pre> 0 LD X1 1 OUT MO 2 NOP 3 NOP to 600 NOP 601 LD X2 602 OUT M10 </pre> </td> </tr> </table> <p>Shift the program forward Online change cannot be made as steps 0 to 600 will be the target of online change. Don't shift the program forward Online change can be made as steps 0 to 1 will be the target of online change.</p> <p>(3) When multiple sequence programs are specified for file write If there is an online change-disabled file, set the PLC to a remote stop and write to that file. For the Q series, online change can be made to the PLC program-by-program. This is useful when there are many corrections and additions in a program being debugged. However, if online change has made the memory area of the PLC short, STOP the PLC, then delete the program in the PLC, and perform write to PLC.</p> | <p>Ladder mode</p>  | <p>List mode</p> <pre> 0 LD X1 1 OUT MO 2 NOP 3 NOP to 600 NOP 601 LD X2 602 OUT M10 </pre> |
| <p>Ladder mode</p>  | <p>List mode</p> <pre> 0 LD X1 1 OUT MO 2 NOP 3 NOP to 600 NOP 601 LD X2 602 OUT M10 </pre> | | |

POINTS

(4) If there is a pulse instruction in the ladder*1 block to be converted, that instruction is executed when the pulse execution condition turns from OFF to ON after online change.
 For Rise/Fall commands, refer to the programming manual for each series. The commands below are given as examples.
 Rise instructions PLS, MOVP, LDP, MEP, FROMP, TOP, etc.
 Fall instructions..... PLF, LDF, ANDF, ORF, MEF, EGF, FCALLP

| Continuity at Online Change | Rise Instruction | | Fall Instruction | |
|-----------------------------|------------------|--------|--|---|
| | RAM | EEPROM | RAM | EEPROM |
| OFF | Not executed | | Only the pulse instruction to be edited is executed. | Pulse instructions having the numbers of the one to be edited and later are executed. |
| ON | Not executed | | Not executed | |

*1: When a new ladder block is inserted without the existing program being modified, the added program and next ladder block are written together to the PLC CPU. (If the next ladder block does not exist, the added program and preceding ladder block are written together.)
 Therefore, write during RUN may not be performed at only one time depending on the number of steps of the added program and preceding or next program. In this case, reduce the number of steps to be written at one time, and perform write during RUN at several times.

<Example>

(5) The following dialog box appears if the T/C coils of the same number exist in the program within the PLC CPU. (This does not apply to the extended T/C.)

If the T/C coil set values of the same number exist in the edited program, the last T/C coil set value in the edited program is used to perform online program change.

Note: If a program (MAIN-SFC) has not been created, it is displayed as a message.

16.10 Concept of the Routing Parameters

| | | |
|---|-------|----|
| A | Q/QnA | FX |
| ○ | ○ | ○ |

The routing function is used by the station of the PLC in a multi-level system to make transient transmission to the station of another network No.
 To perform the routing function, the "Routing parameters" must be set to associate the network No.s and stations acting as bridges.
 For communication via the MELSECNET II, the routing function cannot be used.

- (1) The routing parameters must be set to the request source and relay station of the PLC.
 - (a) The request source must be set to make access to the request target.
 - (b) The relay station must be set to make access from the request source to the request target and to make access from the request target to the request source.
 - (c) The request target needs no setting.

For example, to make transient transmission from 1Ns3 to 3Ns4 in the following diagram, the routing parameters must be set to the PLC 1Ns3 which makes transient transmission, to the PLCs 1Ns4 and 2Mp1 which serve as bridges, and to the PLCs 2Ns4 and 3Ns5.

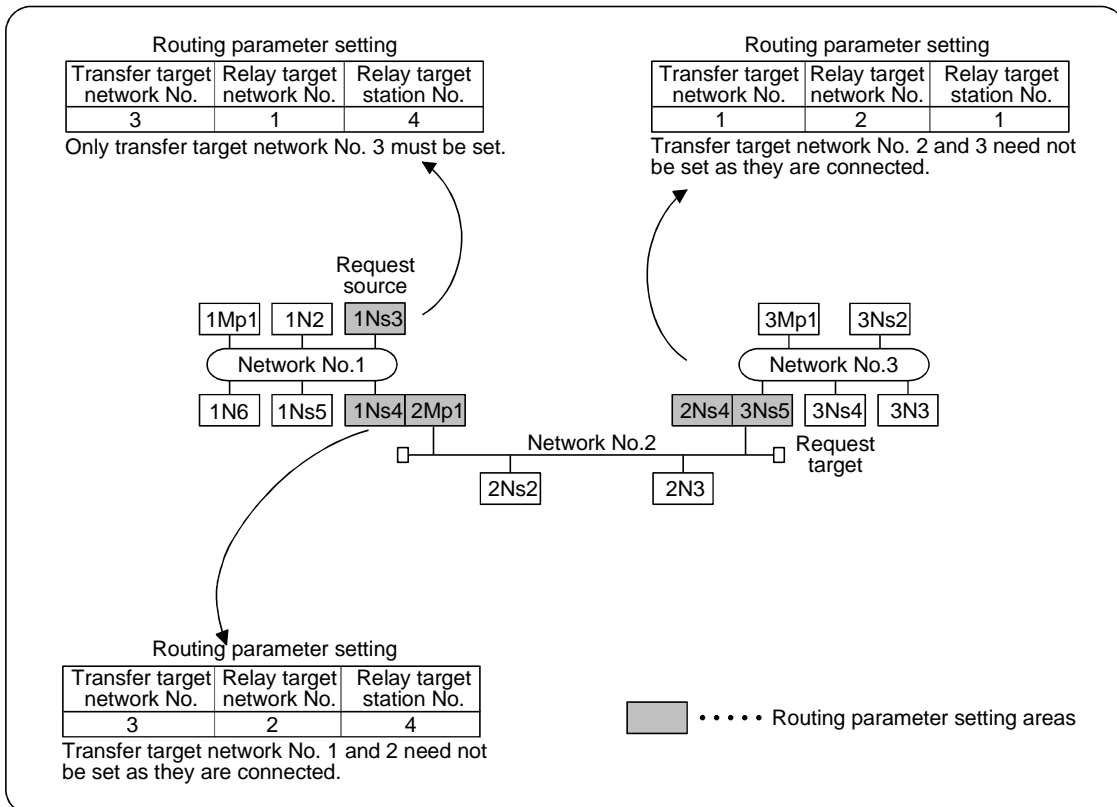

- (2) Up to 16 "transfer target network No.s" can be set to the PLC. 64 different network No.s allow the own station to be a request source or other stations to be accessed via the own station.

- (3) Routing parameter setting areas and data
For transient transmission, the routing parameter setting areas depend on the system.

- (a) Two-level system

The routing parameters need not be set because transient transmission is made to within the same network.

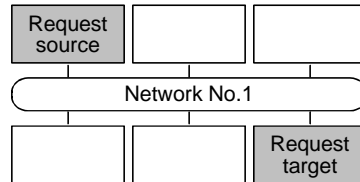

- (b) Multi-level 1 (two networks)

Set the routing parameters only to the station of the request source. To the request source, set the data to access the request target (network No. 2).

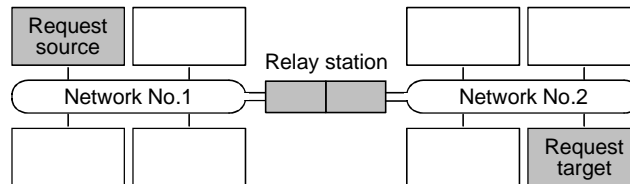

- (c) Multi-level 2 (three networks)

Set the routing parameters to the request source and relay stations. To the request source, set the data to access the request target (network No. 3). To the relay station 1), set the data to access the request target (network No. 3). To the relay station 2), set the data to access the request source (network No. 1).

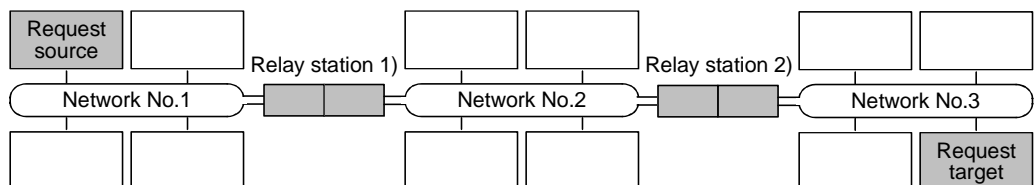

- (d) Multi-level 3 (four or more networks)

Set the routing parameters to the request source and relay stations. To the request source, set the data to access the request target (network No. 4). To the relay station 1) (the nearest relay station to the request source), set the data to access the request target (network No. 4). To the relay station 2) (the nearest relay station to the request target), set the data to access the request source (network No. 1). To the relay station 3) (relay station other than 1) and 2)), set the data to access the request target (network No. 4) and request source (network No. 1).

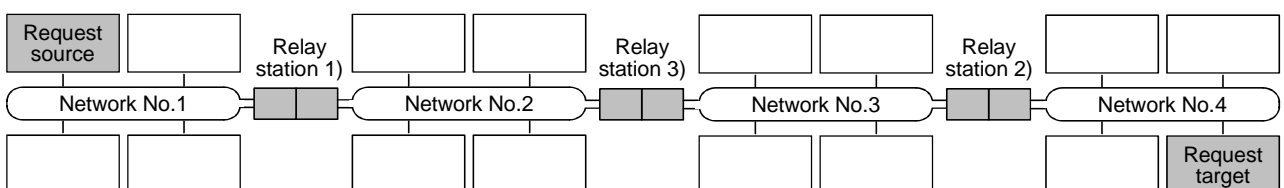

17. MONITORING

This section describes the monitoring of the operation processing of the PLC through an online connection between the personal computer and PLC.

(1) Monitor mode

In the monitor mode, the monitor status dialog box shown below is displayed whether during monitoring or when monitoring is stopped.

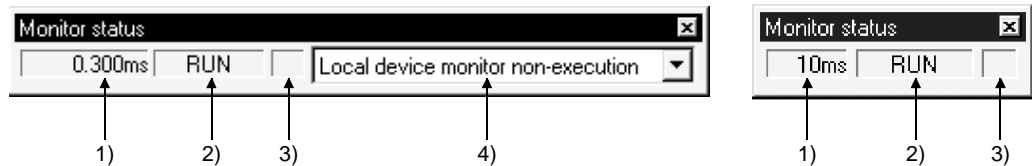

- 1) Scan time
Indicates the maximum scan time of the monitored PLC.
For the A series, it is in 10 ms units.
For the QnA series, it is in 1ms units.
For the Q series, it is in 0.1ms units.
- 2) PLC status
Indicates the operating state of the PLC, as determined by the PLC key switch or by remote operation from a personal computer.
- 3) Monitor execution status
Flashes while monitoring is in progress.
- 4) Local device monitor target selection field (Q02(H)/Q06H/Q12H/Q25H/QnACPU only)
Set the program name whose local devices you want to monitor.

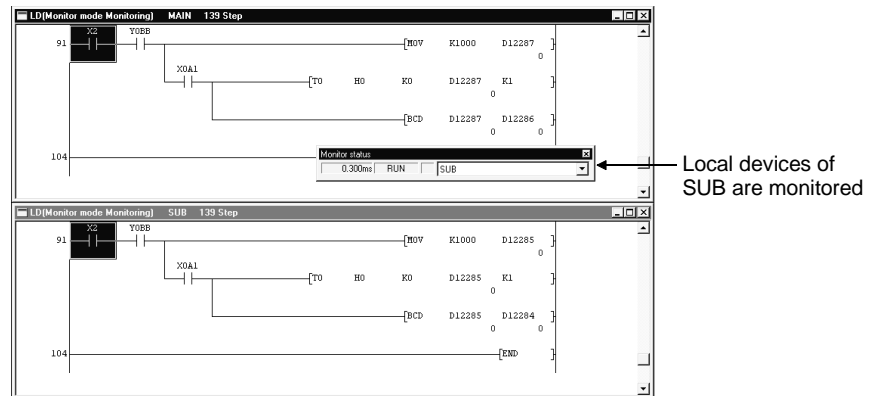

Choosing AUTO (program name) automatically monitors the program on the active screen.

(2) ON/OFF status

The ladder ON/OFF status is determined as follows.

OFF  *



ON  *

* : Only comparison instructions which are equivalent to contacts, and SET, RST, PLS, PLF, SFT, SFTP, MC, FF, DELTA, DELTAP instructions, which are equivalent to coils, are supported.
(FF, DELTA, and DELTAP are QnA series instructions.)

In list mode

In the list mode, the ON and OFF states are displayed as follows.

- For bit device
The device name and monitor status are displayed under the row where the list instruction is displayed.
OFF: [X0=OFF], ON: [X0=ON]
- For word device
The present value is displayed.
Refer to Section 17.1 for the list monitor screen.

| POINTS |
|---|
| <ul style="list-style-type: none"> • The display of ON/OFF statuses and present values is maintained while monitoring is stopped. • The indication for the monitoring of RST instructions is the ON/OFF status of the device being reset. When the device to be reset is OFF  When the device to be reset is ON  • Note that the following functions will not be monitored properly if they are monitored from two or more personal computers simultaneously. Program monitor list, Interrupt program monitor list, Monitor condition setup, Monitor stop condition setup, Scan time measurement • For points to note about monitoring display when the FX series is selected see Appendix 11. • For the AnACPU or AnUCPU, the status at execution of the END instruction is monitored. For the AnACPU or AnUCPU, however, note that the status at any point during scan execution may be monitored. Though the monitor result may differ, the program run is not different. |

17.1 Monitoring, and Stopping/Resuming Monitoring



| | | |
|---|-------|----|
| A | Q/QnA | FX |
| ○ | ○ | ○ |

[Purpose]

Monitors the continuity, energized state, and ON/OFF states of contacts and coils while displaying the ladder.

Also stops monitoring and resumes monitoring after it has been stopped.

[Operating Procedure]

- For monitoring
 Select [Online] → [Monitor] → [Monitor mode], or click  ([F3]).
- To stop monitoring
 Select [Online] → [Monitor] → [Stop Monitor], or click  ([Alt] + [F3]).
- To resume monitoring
 Select [Online] → [Monitor] → [Start Monitor], or click  ([F3]).

[Window]

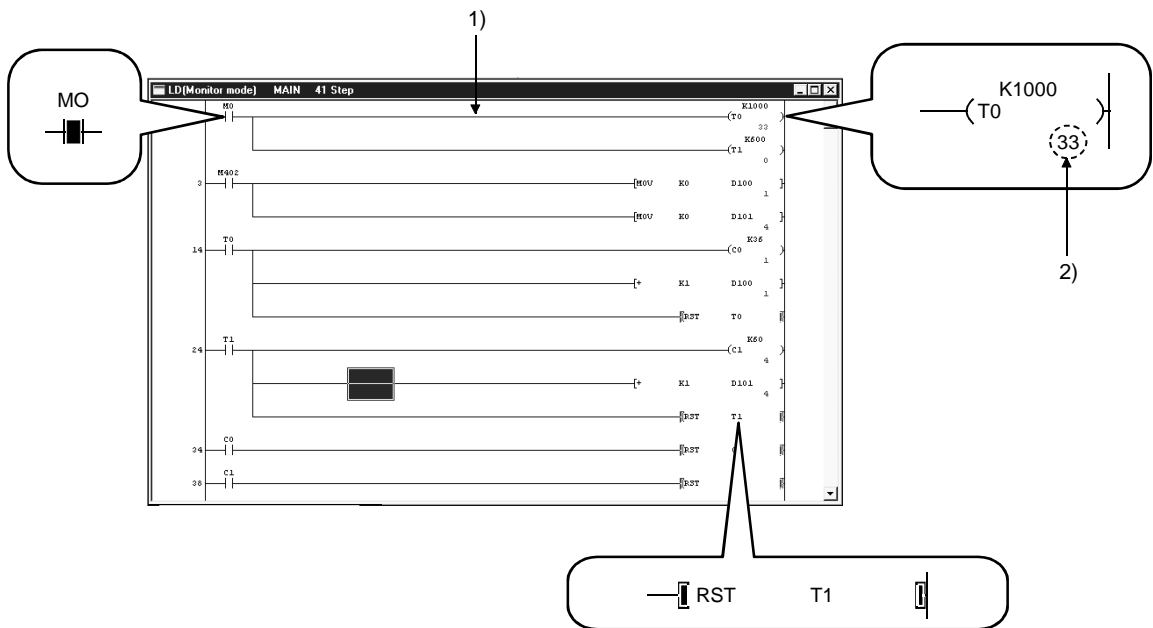

List monitor screen example

```

List(Monitor mode Monitoring) MAIN 615 Step
80 OUT      YOBB
   <YOBB    = ON      >
81 LD       X2
   <X2       = ON      >
82 AND      YOBB
   <YOBB     = ON      >
83 MOV      K1000 D12287
   <D12287   = 1000    >
85 AND      X0A1
   <X0A1     = OFF     >
86 TO       D12286 K0 D12287 K1
   <D12286   = 0       >
   <D12287   = 1000    >
91 BCD      D12287 D12285
   <D12287   = 1000    >

```

[Description]

1) Ladder monitoring

During monitoring, the ON/OFF states of contacts and coils and the present values of devices are displayed, and they change in accordance with the operating state of the PLC.

When monitoring is stopped the display is maintained, and is updated when monitoring is resumed.

2) Present value

Displays the present values of word devices.

The present values can be switched between decimal and hexadecimal.

For details on this switching of present values, see Section 17.4.

When monitoring a double word containing ten or more characters, it is displayed by making the characters smaller.

Present values can be displayed in double words or as real numbers in accordance with the data type used with an instruction.

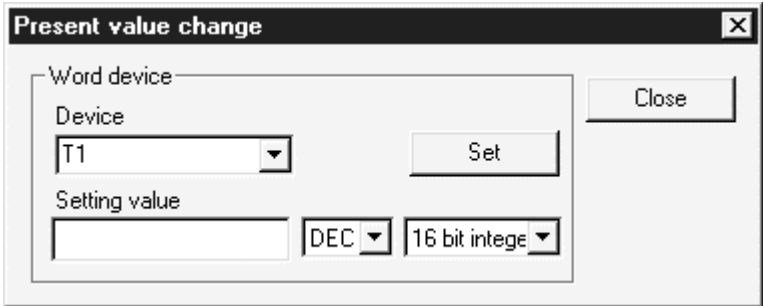
| POINTS |
|---|
| <ul style="list-style-type: none"> • In the monitor mode, check whether the status is "monitoring in progress" or "monitoring stopped" either in the monitor status dialog box display or from the Tool button display shown below. <div style="text-align: center; margin: 5px 0;"> Monitoring in progress Monitoring stopped </div> • Contacts in the ladder monitor window can be forcibly switched ON/OFF by using [Shift] key + double click ([Enter]). • When a word device being monitored is [Shift] key + double-clicked ([Enter]), the present value change dialog box shown below is displayed. <div style="text-align: center; margin: 10px 0;">  </div> <ul style="list-style-type: none"> • Enter the value to be changed, then click the [Set] button. • The present values of double word instructions (DMOV, DFRO, etc.) are displayed as double words. Check the values of double words in device batch monitoring or registered device monitoring. For details on device batch monitoring, see Section 17.5. For details on registered device monitoring, see Section 17.6. • Ladder monitoring, device entry monitoring and ladder entry monitoring allow devices with digits, e.g. MOV D0 K4Y20, to be monitored. • The FD device is monitored as a word value. • During the ladder monitoring or device batch-monitoring, connection setup and change of PLC type cannot be performed. |

17.2 Monitoring/Stopping Monitoring in All Windows

| | | |
|---|-------|----|
| A | Q/QnA | FX |
| ○ | ○ | ○ |

[Purpose]

Starts monitoring in all open windows: ladder monitor, device batch monitor, registered device monitor, and buffer memory batch monitor.
Also stops monitoring in all the windows where monitoring is in progress.

[Operating Procedure]

- To monitor in all windows:
Select [Online] → [Monitor] → [Start monitor (All windows)].
- To stop monitoring in all windows:
Select [Online] → [Monitor] → [Stop Monitor (All windows)].

[Window]

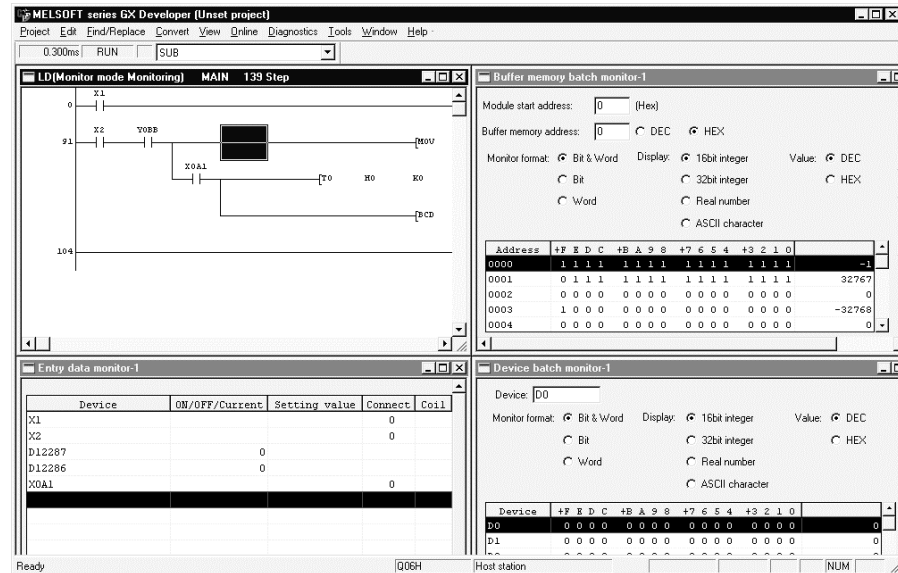

| |
|--|
| POINT |
| <p>When monitoring multiple windows, if the windows are overlapped they are difficult to view. By selecting [Window] → [Tile horizontally] ([Tile vertically]), the windows are not overlapped and are easier to view.</p> |

17.3 Editing Programs During Ladder Monitoring

| | | |
|---|-------|----|
| A | Q/QnA | FX |
| ○ | ○ | ○ |

[Purpose]

Allows programs to be edited while ladder monitoring is in progress by setting the ladder window to the monitor writing mode.

[Operating Procedure]

Select [Online] → [Monitor] → [Monitor (Write mode)], or click  ([Shift] + [F3]).

[Dialog Box]

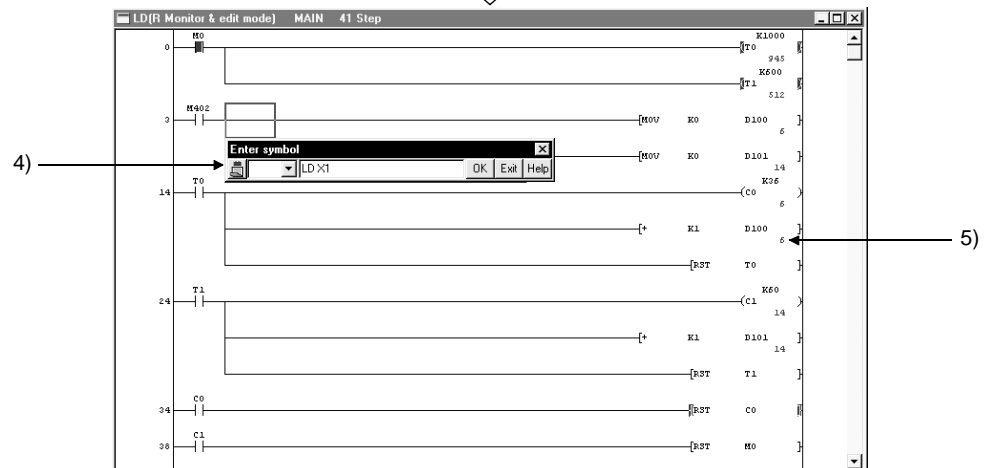
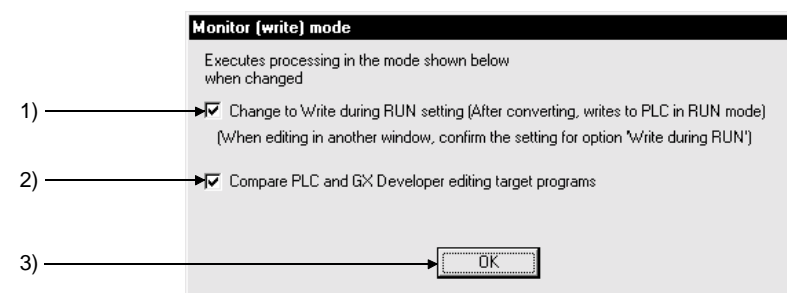

[Description]

- 1) Change to Write during RUN setting (while PLC is running)".
When the checkbox is checked, on changing to the monitor write mode the online change setting is also changed simultaneously.
See Section 15.11 for details on online change setting.
- 2) Compare PLC and GX Developer editing target programs
When the checkbox is checked, on changing to the monitor write mode the program in the connected PLC is verified against that at GX Developer.
By verifying the program in advance, it is possible to avoid program mismatches during online change.

- 3) button
Clicking this button sets the ladder window in the monitor write mode.
- 4) Ladder input window
Opened to create, and change, ladder programs.
See Section 6 "CREATING CIRCUITS"
- 5) Ladder (monitor write) window
Allows ladder monitoring while displaying ON/OFF statuses and present values.

[Operating Procedure]

1. Use the "operating procedure" above while the ladder window is displayed to display the dialog box.
2. Click (1)/(2) as required.
3. Click (3).
4. The ladder window enters the monitor write mode.
5. Create/change the ladder program.
6. Convert the ladder.
If the online change setting is "Write during RUN (while PLC is running)" at this time, online change is executed on pressing "convert" ().
Online change can also be executed by pressing [+].
See Section 16.9 "Executing Online Program Change (Write During RUN)"

| POINTS |
|--|
| <ul style="list-style-type: none">• If, simultaneously with switching to the monitor write mode, the online change setting is made "Write during RUN (while PLC is running)", the online change (write during RUN) setting will remain in effect thereafter, even if the write mode is changed.• When using the FX series, program editing during ladder monitoring is only possible when a PLC that supports online change is in the online change enabled status (see Section 16.9.). |

17.4 Switching Present Values Between Decimal and Hexadecimal

| | | |
|-----------------------|-----------------------|-----------------------|
| A | Q/QnA | FX |
| <input type="radio"/> | <input type="radio"/> | <input type="radio"/> |

[Purpose]

Displays the device present values in the ladder monitor window in decimal or in hexadecimal format.

[Operating Procedure]

- For display in decimal:
Select [Online] → [Monitor] → [Change current value monitor (Decimal)].
- For display in hexadecimal:
Select [Online] → [Monitor] → [Change current value monitor (Hexadecimal)].

[Window]

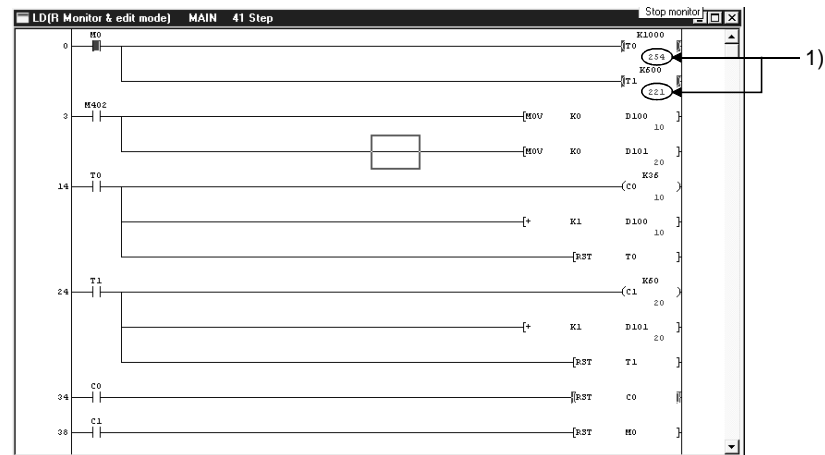

[Description]

- 1) Device present value
Sets display in decimal or hexadecimal notation.

| |
|--|
| POINT |
| Convert numbers stored in binary coded decimal (BCD) to hexadecimal. |

17.5 Batch Monitoring Devices/Buffer Memories

17.5.1 Batch monitoring devices/buffer memories

| | | |
|-----------------------|-------------------------|-----------------------|
| A | Q/QnA | FX |
| <input type="radio"/> | <input type="radio"/> * | <input type="radio"/> |

*: Also compatible with the remote I/O of the QCPU (Q mode).

[Purpose]

In device batch monitoring, one designated type of device is monitored.
 In buffer memory batch monitoring, a special function module is designated and its buffer memory is monitored.
 When using FXCPU, note that the only PLCs that support buffer memory monitoring are the FX2N series and the FX2NC series.
 However, when the GX Simulator is connected, buffer memory monitoring can also be done on FX2, FX2C and FX0N series.
 To monitor the buffer memory or link memory, select [Tool] → [Options], and select "Monitor buffer memory/link memory" in the <<Program common>> tab sheet.

[Operating Procedure]

- For device batch monitoring:
 Select [Online] → [Monitor] → [Device batch], or click .
- For buffer memory batch monitoring:
 Select [Online] → [Monitor] → [Buffer memory batch].

[Dialog Box]

The dialog box for device batch monitoring is shown here; the dialog box for buffer memory batch monitoring is of the same type.

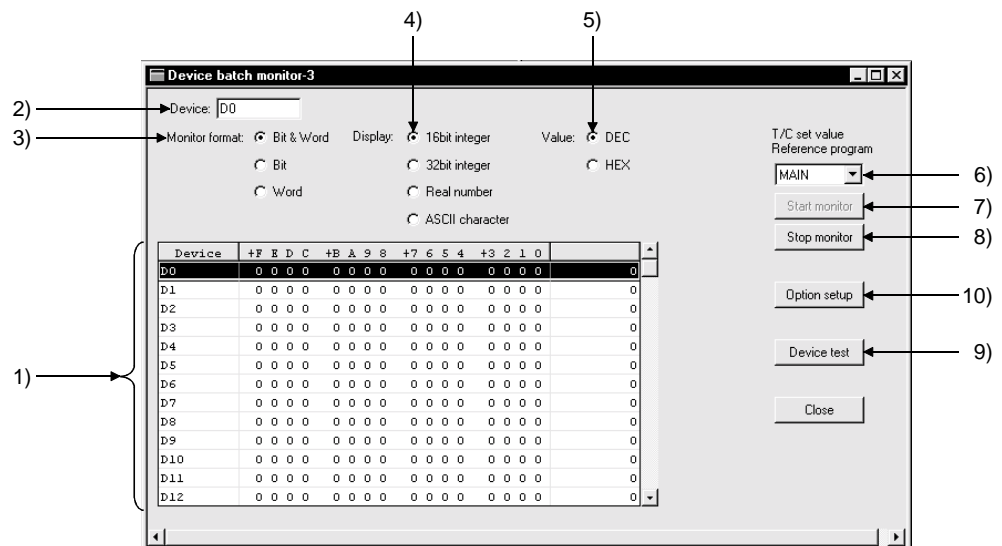

[Description]

Items in parentheses relate to buffer memory batch monitoring.

- 1) Device batch monitor (buffer memory batch monitor)
 The designated device (buffer memory) is displayed in accordance with the monitor format, display, value, and option settings.
 The range not currently displayed can also be monitored by using the scroll bar.
 However, when T or C devices are designated for device batch monitoring, the timer/counter multi-point format is used.

2) Device (buffer memory) designation

- For device batch monitoring:
Designate the device type and actual device number.
Device designation by qualification (index, digit designation, and word device bit designation) is not possible.
- For buffer memory batch monitoring:
The following is displayed for buffer memory batch monitoring.

The screenshot shows a software interface with two input fields. The first field is labeled 'Unit start address:' and is empty. The second field is labeled 'Buffer memory address:' and contains a dropdown menu with 'HEX' selected. The interface is light gray with black text.

Designate the first I/O number (lowest digit not required) of the special function module used for monitoring, and the buffer memory address (decimal/hexadecimal).

If using the FX series, enter the block number (0 to 7) of the special expansion device for the module's first address.

However, FX_{0N}-3A, FX_{2N}-2AD, and FX_{2N}-2DA do not come into the scope of monitoring of the buffer memory.

For the buffer memory address, enter the BFM No. (0 to 32766).

3) Monitor format

Sets the monitoring format.

When T or C is designated for device batch monitoring, the format is automatically set as timer/counter multi-point format.

Bit & WordDevices (buffer memories) are monitored as both bits and words.

Bit multi-pointDevices (buffer memories) are monitored as bits.

Word multi-point Devices (buffer memories) are monitored as words.

4) Display

Sets the word device (buffer memory) display when monitoring in the Bit & Word or Word multi-point format.

16bit integerDisplayed as 16-bit integers.

32bit integerDisplayed as 32-bit integers.

Real numberDisplayed as real numbers.

ASCII Displayed as ASCII characters

5) Value

Sets the format of numbers to be displayed when monitoring in the 16bit integer or 32bit integer format.

Decimal Displayed in decimal notation.

HexadecimalDisplayed in hexadecimal notation.

6) T/C set value Reference

Designates the program whose set values are to be displayed when batch monitoring T or C devices.

- 7) **Start monitor** button
Clicking this button after setting the device (buffer memory address) starts monitoring.
- 8) **Stop monitor** button
Stops device (buffer memory) batch monitoring.
- 9) **Device test** button
Clicking this button displays the device test dialog box.
See Section 18.1 "Carrying Out a Device Test"

- 10) **Option setup** button
Clicking this button displays the option setting dialog box shown below.

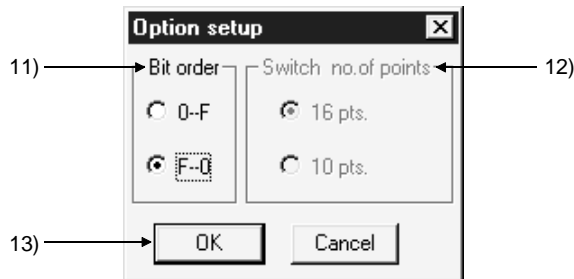

- 11) **Bit order**
Sets the order in which the bit devices are arranged when "Bit & Word" is selected as the monitoring format.
 - 0-F
Display in ascending order from the right
Suited to the monitoring of bit devices.
 - F-0
Display in ascending order from the left
Suited to the monitoring of the bits of word devices (buffer memories).
- 12) **Switch no. of point**
Set the number of bit device points displayed in the Bit & Word format for device/word batch monitoring.
 - In Bit & Word/Bit multi-point/Word multi-point format
 - 16 pts.
Set when monitoring hexadecimal devices such as X and Y.
 - 10 pts.
Set when monitoring decimal devices such as M and L.
 - In Word multi-point format
 - 8 pts.
Set when monitoring hexadecimal devices such as B and W.
 - 10 pts.
Set when monitoring decimal devices such as M and D.
- 13) **OK** button
Click this button after setting the option settings.

[Monitor format]

Indicates the monitoring format for device batch monitoring and buffer memory batch monitoring.

Bit & Word format

| Device | +F E D C | +B A 9 8 | +7 6 5 4 | +3 2 1 0 | ^ |
|--------|----------|----------|----------|----------|-----|
| D40 | 0 0 0 0 | 0 0 0 0 | 0 0 0 0 | 0 0 0 0 | 0 |
| D41 | 0 0 0 0 | 0 0 0 0 | 0 0 1 0 | 0 1 0 1 | 37 |
| D42 | 0 0 0 0 | 0 0 0 0 | 1 0 0 1 | 0 0 0 0 | 144 |
| D43 | 0 0 0 0 | 0 0 0 0 | 0 1 0 0 | 1 0 0 0 | 72 |
| D44 | 0 0 0 0 | 0 0 0 0 | 0 0 0 1 | 0 1 1 0 | 22 |
| D45 | 0 0 0 0 | 0 0 0 0 | 0 1 1 0 | 1 1 1 0 | 110 |
| ... | ... | ... | ... | ... | ... |

A B C

Bit multi-point format

| Device | +1 F E D C | BA98 | 7654 | 3210 | +0 F E D C | BA98 | 7654 | 3210 | ^ |
|--------|------------|------|------|------|------------|------|------|------|------|
| D40 | 0000 | 0000 | 0010 | 0101 | 0000 | 0000 | 0000 | 0000 | 0000 |
| D42 | 0000 | 0000 | 0100 | 1000 | 0000 | 0000 | 1001 | 0000 | 0000 |
| D44 | 0000 | 0000 | 0110 | 1110 | 0000 | 0000 | 0001 | 0110 | 0000 |
| D46 | 0000 | 0000 | 0001 | 0101 | 0000 | 0000 | 0001 | 1000 | 0000 |
| D48 | 0000 | 0000 | 0000 | 0000 | 0000 | 0000 | 0101 | 1010 | 0000 |
| D50 | 0000 | 0000 | 0000 | 1010 | 0000 | 0000 | 0000 | 0101 | 0000 |
| ... | ... | ... | ... | ... | ... | ... | ... | ... | ... |

A B

Word multi-point format

| Device | +0 | +1 | +2 | +3 | +4 | +5 | +6 | +7 | ^ |
|--------|-----|-------|-------|-------|------|-------|-----|-----|---|
| D40 | 0 | 37 | 144 | 72 | 22 | 110 | 24 | 21 | |
| D48 | 90 | 0 | 5 | 10 | 0 | 0 | 0 | 0 | |
| D56 | 0 | 0 | 0 | 0 | 2400 | 0 | 0 | 0 | |
| D64 | 0 | 0 | 0 | 0 | 0 | 0 | 10 | 0 | |
| D72 | 100 | 50 | 0 | 0 | 0 | 0 | 0 | 0 | |
| D80 | 0 | 31580 | 20724 | 32340 | 2886 | -4784 | 0 | 0 | |
| ... | ... | ... | ... | ... | ... | ... | ... | ... | |

A C

Timer/counter multi-point format (for device batch monitoring)

| Device | Contact | Coil | Setting | Current | ^ |
|--------|---------|------|---------|---------|---|
| T0 | 1 | 1 | 25 | 25 | |
| T1 | 0 | 1 | 25 | 3 | |
| T2 | 0 | 0 | ----- | 0 | |
| T3 | 0 | 0 | ----- | 0 | |
| T4 | 0 | 0 | ----- | 0 | |
| T5 | 0 | 0 | ----- | 0 | |
| ... | ... | ... | ... | ... | |

A D E F G

- A Indicates the device (buffer memory address)
In the case of bit multi-point format and word multi-point format, this indicates the first number of each line.
- B Indicates the bit ON/OFF status. (1 : ON 0 : OFF)
- C Displays word device data as 16-bit integral values, 32-bit integral values, real numbers, or ASCII characters.
- D Indicates the ON/OFF status of T or C contacts. (1 : ON 0 : OFF)
- E Indicates the ON/OFF status of T or C coils. (1 : ON 0 : OFF)
- F Indicates the set values of T or C coils.
- G Indicates the present values of T or C coils.

POINTS

- [Shift] key+ doubling clicking ([Enter]) at the monitored part displays the device test dialog box, enabling devices to be forcibly turned ON or OFF, and their present values to be changed.

See Section 18.1 "Carrying Out a Device Test"
- If device batch monitoring or buffer memory batch monitoring is started up several times, the time lapse until monitoring starts, and the monitoring interval, may become longer.
- The monitoring result is shown "FFFFH" if you specified the device which cannot be monitored during ladder monitoring (e.g. J □ \ □).
- The maximum number of points displayed for file register batch monitoring is the maximum number of points of the corresponding PLC CPU.
The monitor value in the range exceeding the maximum number of points of the PLC CPU is indefinite (-1).

17.5.2 Batch-monitoring the multi-CPU buffer memory

| | | |
|---|-------|----|
| A | Q/QnA | FX |
| × | ○* | × |

*: Compatible with the Q02(H)/Q06H/Q12H/Q25H CPU.

[Purpose]

Monitors the buffer memory of the own or other PLC CPU module.

[Operating Procedure]

Select [Online] → [Monitor] → [Device batch].

[Dialog Box]

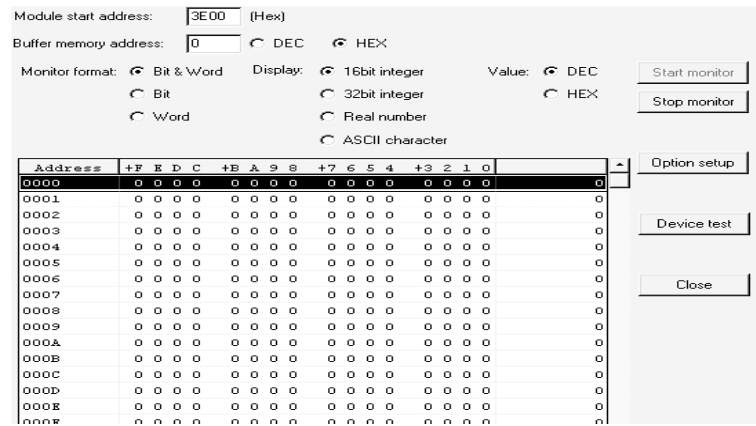

[Description]

- 1) Module start address
Specify the buffer memory of the PLC CPU to be monitored.
Specifying method: No. 1 module ... 3E00, No. 2 module ... 3E10,
No. 3 module ... 3E20, No. 4 module ... 3E30
- 2) Buffer memory address
Set the buffer memory address.

The following table indicates accessibility to the multi-CPU shared memory (buffer memory) of the multiple CPUs.

| Item | Accessibility |
|------------------------------|---------------|
| Monitor mode | × |
| Device batch | × |
| Entry data monitor | × |
| Buffer memory monitor | ○ |
| Monitor condition setup | × |
| Monitor stop condition setup | × |
| Partial execution | × |
| Device test | × |

Devices (e.g. U3E0Z0¥G0) indexing the multi-CPU shared memory cannot be monitored.

17.6 Monitoring after Registering Devices

| | | |
|---|-------|----|
| A | Q/QnA | FX |
| ○ | ○* | ○ |

*: Compatible with the remote I/O of the QCPU (Q mode).

[Purpose]

Simultaneously monitors devices at some distance from each other within the ladder, or multiple types of device, in the same display.

[Operating Procedure]

Select [Online] → [Monitor] → [Device registration], or click .

[Dialog Box]

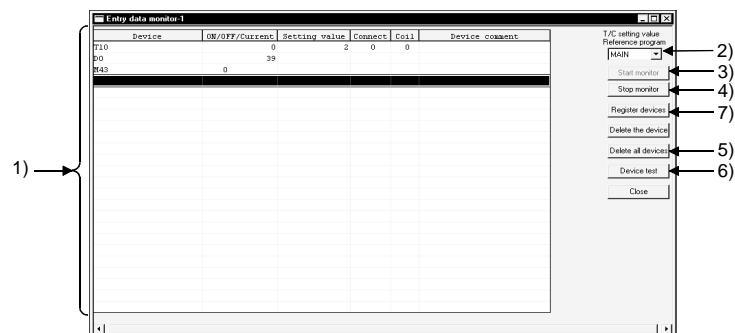

[Description]

1) Registered device monitor

- Displays up to 64 registered device points in accordance with the device type.
 - Doubling clicking (Enter) on a vacant field opens the device registration dialog box.
 - T and C devices are displayed in the counter/timer format.
 - 32-bit integral values are displayed with "D" appended after the device as follows: D100 (D).
 - For real values, (E) is appended and for ASCII characters, (S) is appended.
 - For the QCPU/QnA, FD devices to be registered cannot be specified in the real number format.
 - For a remote I/O project, the comment field is displayed blank.
 - For label programming, device entry monitoring-enabled conditions are indicated:
 - (a) Set global or local variables.
 - (b) Compile the label program.

2) T/C setting value Reference program

Sets the program whose set values are to be displayed when T or C values are registered and monitored.

3) Start monitor button

Click this button after completing device registration to start monitoring.

4) Stop monitor button

Click this button to stop monitoring.

5) Delete all device button

Clicking this button cancels the registration of a device.

- 6) **Device test** button

Clicking this button displays the device test dialog box.

See Section 18.1 "Carrying Out a Device Test"

- 7) **Register devices** button

Clicking this button displays the device registration dialog box.

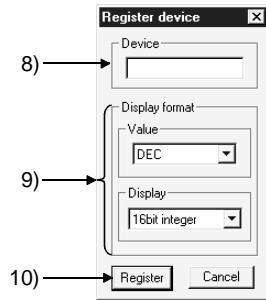

- 8) **Device**
Sets the device to be registered.

- 9) **Display format**
Set when word devices are monitored.
Numeric values can be set in decimal or hexadecimal format.
The available display settings are: 16-bit integral value, 32-bit integral value, real number, ASCII characters.

- 10) **Register** button
Click this button after setting the necessary settings.

[Monitor format]

| | Device | ON/OFF/Current | Setting value | Connect | Coil |
|------------------------|--------|----------------|---------------|---------|------|
| Counter/timer format → | T0 | | 25 | 1 | 1 |
| | C0 | | 24 | 111 | 1 |
| Bit format → | X0 | 0 | | | |
| Word format → | D100 | | 0 | | |
| | A | B | C | D | |

A Indicates the registered device.

B Indicates the ON/OFF status or present value of the registered device.
(1 : ON 0 : OFF).

C When T or C devices are registered, the set value is indicated.

D When T or C devices are registered, the ON/OFF statuses of contacts and coils are indicated (1 : ON 0 : OFF)

[Operating Procedure]

1. Click 7) to display the device registration dialog box.
2. Set 8) and 9) in the device registration dialog box.
3. Click 10): the devices are displayed at 1).
4. By following steps 2 and 3, register all the devices to be monitored.
5. On completion of device registration, close the device registration dialog box.
6. Click 3).

POINTS

- When the ladder window is set to the read or monitor mode, devices can be registered by dropping and dragging with the **[Ctrl]** key pressed after the area to be registered has been selected. It is also possible to batch drag and drop a range selected by **[Shift]** key + clicking from the ladder cursor position.

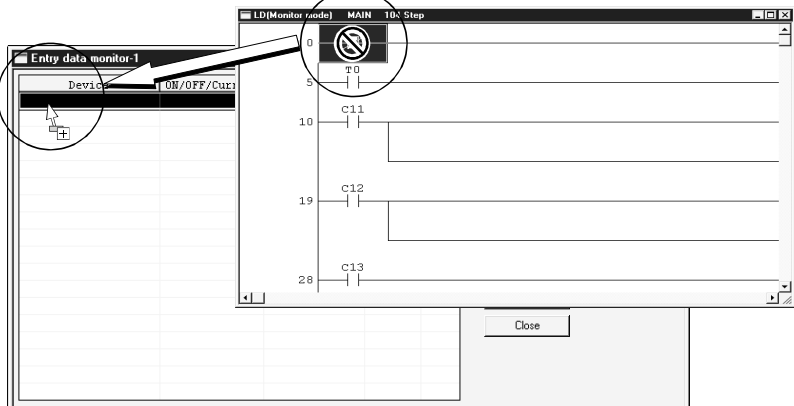

- When registered device monitoring, device batch monitoring, or buffer memory batch monitoring is started up several times, the time lapse until monitoring starts, and the monitoring interval, may become longer.
- **[Shift]** key + double clicking (**[Enter]** key) on a device name in the registration monitoring area displays the device test dialog box.
See Section 18.1"Carrying Out a Device Test"
- With the QnA series, apart from actual device numbers, it is also possible to register words with bit designations, bit designated within a word, index qualifications, and buffer memories. An example of device registration is given below.

| Device to be Registered | Example |
|--|---------|
| Monitoring M0 to M15 by digit designation | K4M0 |
| D100F that monitors b15 of D100 using bit designation | D100.F |
| Monitoring Xn by index qualification with Z1 | X0Z1 |
| Monitoring a special function module buffer memory with first I/O number 40 and address K30(H2E) | U4\G30 |

See the QnACPU Programming Manual (Common Instructions).

- Setting a 32-bit integer/real number to the FD device will result in an error.

17.7 Setting Monitor Conditions/Stop Conditions

| | | |
|---|-------|----|
| A | Q/QnA | FX |
| × | ○* | × |

*: The Q00J, Q00 and Q01CPUs are incompatible.

[Purpose]

Sets the conditions under which monitoring is started and stopped on the ladder monitor window.
 This setting is not possible with the A series.

[Operating Procedure]

- For setting monitor conditions:
 Select [Online] → [Monitor] → [Monitor condition setup].
- For setting monitor stop conditions:
 Select [Online] → [Monitor] → [Monitor stop condition setup].

[Dialog Box]

Monitor condition dialog box

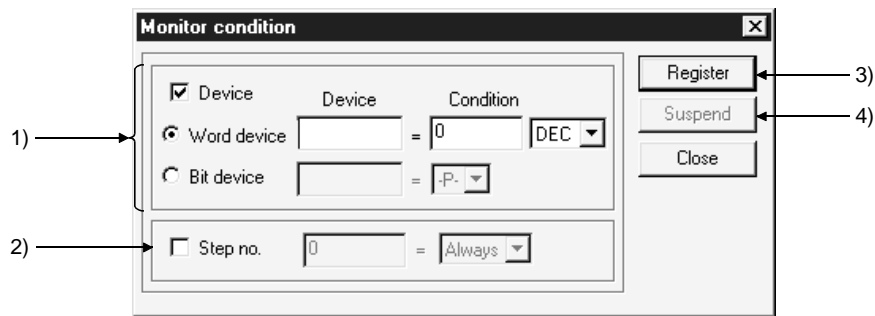

Monitor stop condition dialog box

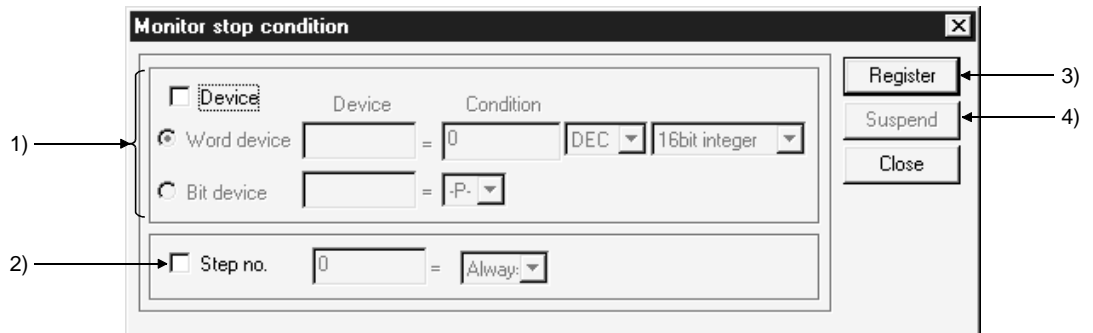

[Description]

1) Device

Sets a device condition as the monitor condition (monitor stop condition).
 The device that is to act as the condition can be a word device or bit device.

○ Word device

Set the word device and numeric value (decimal or hexadecimal integral value) that is to be the condition.

For a stop condition, set a 16-bit integral value, 32-bit integral value, or real number.

○ Bit device

Set a bit device and condition (-P- : at leading edge -F- : at trailing edge)

- 2) Step no.
Sets, as the condition, the execution status of a designated step number in the program.
Select the execution status from among the following:
-P-..... Transition from OFF to ON
-F-..... Transition from ON to OFF
ON.....During ON status
OFF.....During OFF status
Always..... At all times during execution (if the relevant step is jumped the condition is not satisfied)
- 3) button
Clicking this button registers the set condition.
- 4) button
Clicking this button cancels the registered condition.

| POINTS |
|--|
| <ul style="list-style-type: none">• If both device and step No. conditions are set at the same time, the monitor condition (monitor stop condition) is met when both are satisfied.• If the device condition has been designated (including when both device and step No. conditions are set at the same time), monitoring may not stop at the point when the condition is met first after condition designation.• Monitor condition/monitor stop condition setting is enabled only under the following conditions:<ol style="list-style-type: none">1. Own station connection2. MELSECNET/10 or MELSECNET/H other station accessThis function cannot be set when the other station is specified via Ethernet, CC-Link or the like. |

17.8 Program List Monitor

| | | |
|---|-------|----|
| A | Q/QnA | FX |
| × | ○* | × |

*: The Q00J, Q00 and Q01CPUs are incompatible.

[Purpose]

Displays the processing time of the program currently being executed.

[Operating Procedure]

Select [Online] → [Monitor] → [Program monitor list].

[Dialog Box]

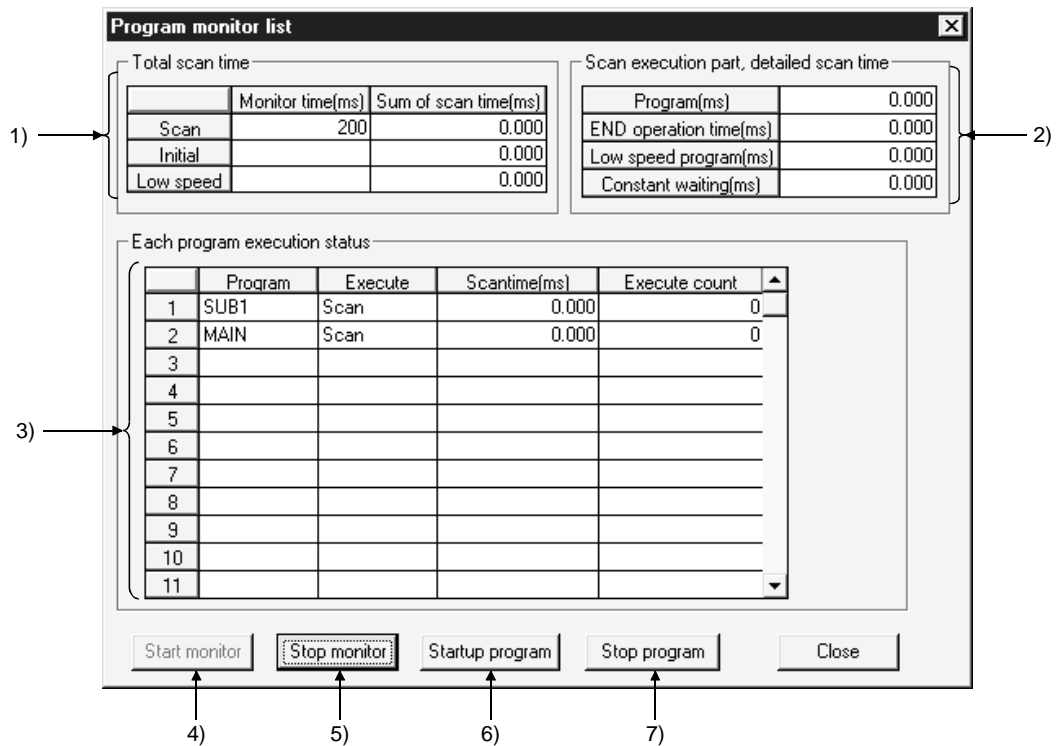

[Description]

- 1) Total scan time

Indicates the time set for the WDT setting in the PLC RAS settings of the PLC parameters.

 - Monitor time

Indicates the monitor time for each of the scan programs, initial programs and low-speed programs.

The CPU displays a WDT error if the scan time exceeds the monitor time. However, the constant scan execution program is not displayed.

Use scan time measurement to display the scan time of the constant scan execution program.
 - Sum of scan time

Indicates the total time for each item in "Scan execution part detailed scan time."

- 2) Scan execution part, detailed scan time

Indicates the processing execution time for each item.

"Constant" indicates the constant scan waiting time when the setting is for constant scan.

However, if a low-speed program execution time is also set, this becomes 0.000 ms.

- 3) Each program execution status
Indicates the execution status of the program set in program setting in the PLC parameters.
- Program
Indicates program names in the order set in the parameters.
 - Execute
Indicates the program type set in the parameters.
 - Scan time
Indicates the actual scan time (present value). In the program stop (standby) status, the scan time is indicated as 0.000 ms.
 - Execute count
Indicates the number of times a program has been executed, taking the count when counting starts to be "0."
(When the maximum count of 65536 is reached, the count returns to 0.) The count is retained during the program stop status.
- 4) **Start Monitor** button
Clicking this button starts a stopped program.
- 5) **Stop Monitor** button
Stops monitoring.
- 6) **Startup program** button
Clicking this button displays the dialog box shown below.

[Dialog Box]

Program startup dialog box

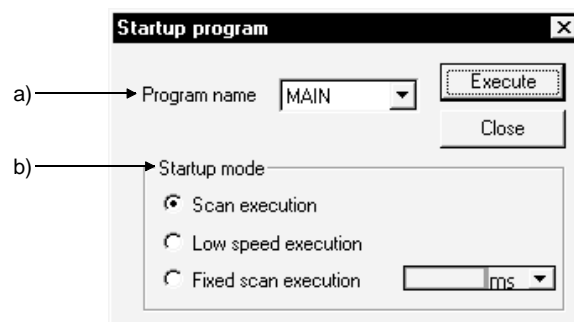

- a) Program name
Only programs that have been set in PLC parameter program selection can be selected.
It is not possible to type any required program name.
- b) Startup mode
"Scan", "Low speed" or "Fixed scan" can be selected for a standby program.
The value set in [PLC parameter] - <Program> is displayed as the default of fixed scan execution. ms or s can be selected as the unit.

7) **Stop program** button

Clicking the Stop program button displays the following dialog box.

[Dialog Box]

Stop program screen

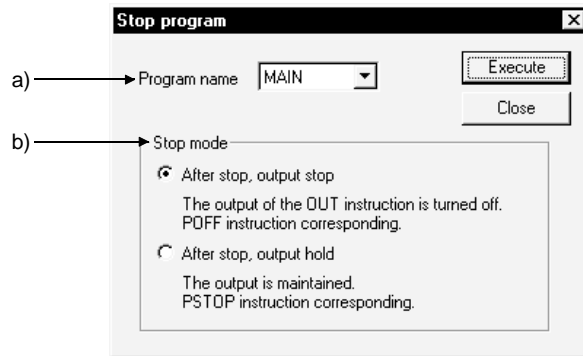

a) Program name

You can choose only the program that was set on the <Program> tab in the PLC parameter dialog box.

You cannot enter a program name as desired.

b) Stop mode

- Execution of "After stop, output stop" for the scan execution type turns OFF (non-execution processing) the output at the next scan. The standby status is established at and after the scan that follows. (Same operation as that of the POFF instruction.)
- Execution of "After stop, output stop" for the low speed execution type suspends the execution of the low speed execution type and turns OFF the output at the next scan. The standby status is established at and after the scan that follows. (Same operation as that of the POFF instruction.)
- Execution of "After stop, output stop" for the standby program executes 1-scan OFF as scan execution and then make a stop. Hence, the "execution count" is also incremented by 1.
- If an error occurs in the RET/IRET instruction during execution of 1-scan OFF in the standby program, the "execution count" is also incremented by 1. At this time, the execution type changes to "Scan".

POINTS

If "After stop, output stop" is executed, the output may not turn OFF depending on the instruction.
 For details, refer to the POFF instruction item of the following manual.

- QCPU (Q Mode)/QnACPU Programming Manual (Common Instructions)

17.9 Monitoring the Interrupt Program List

| | | |
|---|-------|----|
| A | Q/QnA | FX |
| × | ○ | × |

[Purpose]

Indicates the number of times interrupt programs have been executed.

[Operating Procedure]

Select [Online] → [Monitor] → [Interrupt program monitor list].

[Dialog Box]

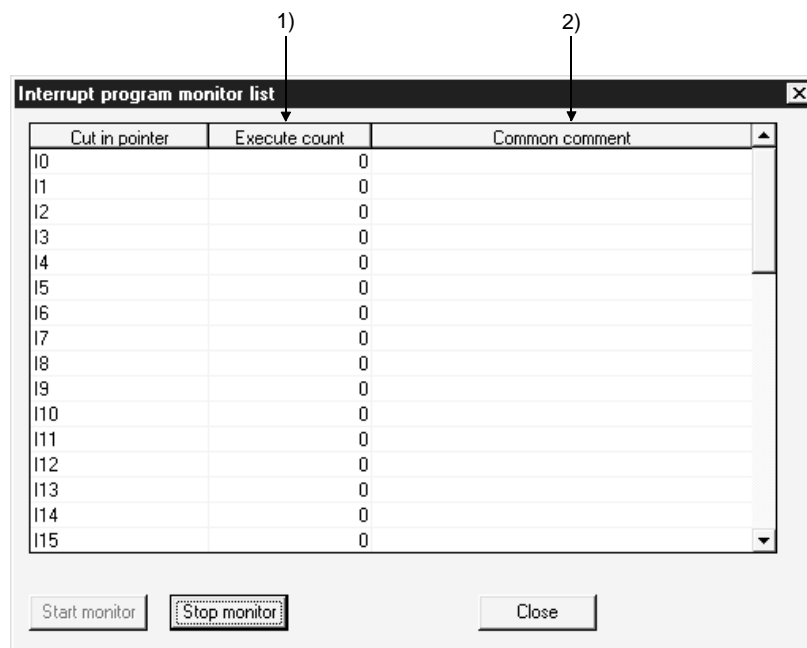

[Description]

1) Execute count

Indicates the number of times a program has been executed, taking the count when counting starts to be "0."

(When the maximum count of 65536 is reached, the count returns to 0.)

The count is cleared to zero when the operating state of the PLC is set to RUN.

2) Common comment

Indicates comments created as device comments.

Only common comments can be indicated.

17.10 Measuring Scan Time

| | | |
|---|-------|----|
| A | Q/QnA | FX |
| × | ○* | × |

*: The Q00J, Q00 and Q01CPUs are incompatible.

[Purpose]

Indicates the processing time for any required section of program.

[Operating Procedure]

Select [Online] → [Monitor] → [Scan time measurement].

[Dialog Box]

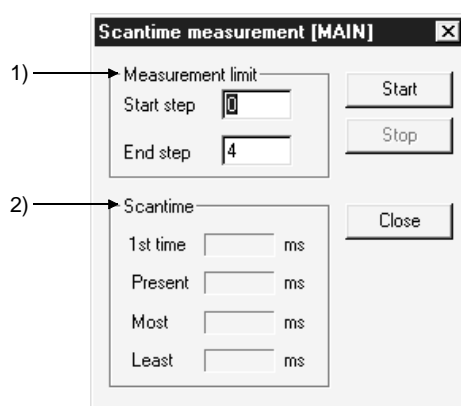

[Description]

- 1) Measurement limit
Set so that the start step is smaller than the end step.
- 2) Scantime
It is not possible to measure times that straddle different program files.
If the measured time is within 0.100 ms, it is indicated as 0.000 ms.

| |
|--|
| POINT |
| <p>Selection range</p> <ol style="list-style-type: none"> 1 Move the cursor to a position outside the left bus line and [Shift] key+ click to set the range. During dragging the selected range turns blue. (END instructions cannot be selected.) 2 On selecting [Online] → [Monitor] → [Scan time measurement], the start step and end step are set in the part of the program defined by the selected range. |

17.11 Executing Sampling Trace

| A | Q/QnA | FX |
|---|-------|----|
| ○ | ○* | ○ |

*: The Q00J, Q00 and Q01CPUs are incompatible.

[Purpose]

Samples the contents of the designated device (ON/OFF status and present value) at constant intervals, and stores the result in the sampling trace area of the memory.

Reads and displays this stored data.

By using this function, it is possible to follow changes in the data contents of the designated device, and to monitor the ON/OFF timing of contacts and coils.

[Operating Procedure]

- 1 Set the trace count on the <<Conditions>> sheet.
- 2 Set the trace point on the <<Conditions>> sheet.
- 3 Set the trigger point on the <<Conditions>> sheet.
(When executing an STRA instruction (A/QnA series) or when performing trigger operation at a personal computer (Q/QnA series), set the TRACE instruction (Q series) or make detailed settings (Q/QnA series).)
- 4 Set the device setting on the <<Trace data>> sheet.
- 5 Write the set data to the PLC.
- 6 Select Start trace on the <<Execute and status>> sheet.
- 7 Write the execution result after tracing to the PLC.
- 8 Read the result with the button.

| POINTS |
|---|
| <ul style="list-style-type: none"> • When using AnNCPUs, set the memory capacity in the PLC parameters. • The setting data and trace result data is in GX Developer format and there is therefore no compatibility with GPPA or GPPQ data. • When using the A series, it is not possible to set Execute trigger on the <<Execute and status>> sheet, or the Trace data (Conditions + Results) storing data. • When using the A series, it is not possible to set the Information with trace or trigger point setting on the <<Conditions>> sheet. • When using extension file registers with AnACPU or AnUCPU, there may be blocks that cannot be used, depending on the memory cassette. Block numbers other than No. 0 to 24, 29 to 40, and 45 to 48 of A3AMCA-96, A4AMCA-128, and A4AMCA-128E cannot be used. |

17.11.1 Setting execution & status display

| | | |
|---|-------|----|
| A | Q/QnA | FX |
| ○ | ○ | ○ |

[Purpose]

Facilitates operations such as those for trace start and trigger execution when "When a peripheral trigger operations" is set for the trigger point setting in the trace condition settings.

Sets the storage destination for trace data (condition + result).

[Operating Procedure]

Select [Online] → [Trace] → [Sampling trace].

[Dialog Box]

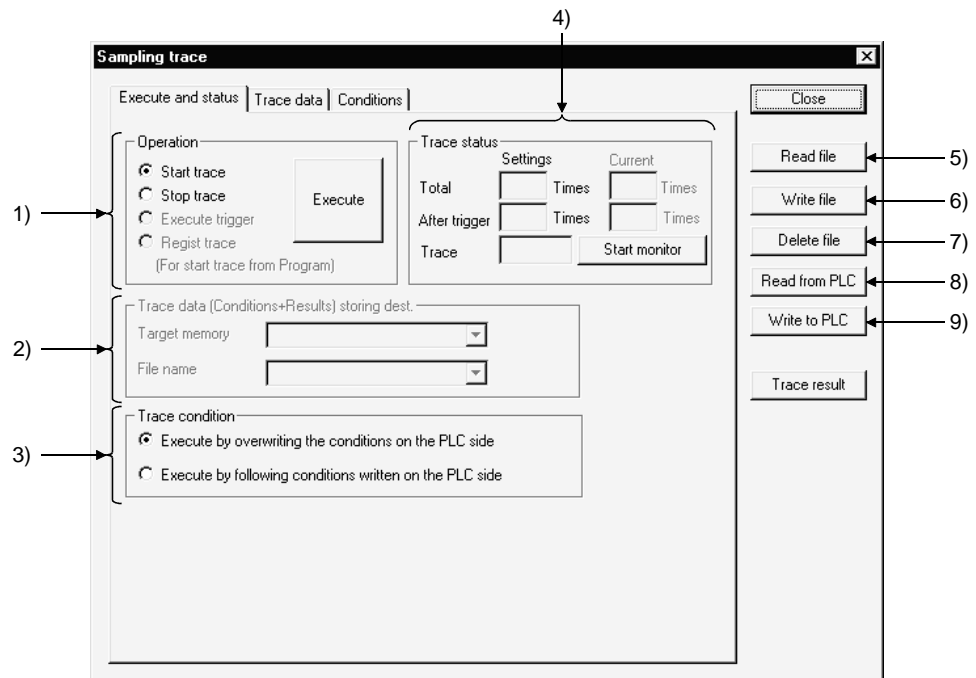

[Description]

1) Operation

When using the A series, trigger execution cannot be set.

The Q/QnA series allows a trace to be triggered from the sequence program.

(Regist trace)

Clicking the Execute button, starts trace status monitoring.

2) Trace data (Conditions + Results) storing data (QnA series only)

Select the ROM, RAM of the IC memory card.

Designate an arbitrary name for the file name for storage.

The currently active sequence program name is displayed as the default.

This setting is not possible with the FX series.

3) Trace condition

Sets whether the trace is to be executed using the conditions set at the personal computer or the settings at the PLC side.

- 4) Trace status
Indicates the current trace status.
<Total count>
Indicates the setting count after the trigger presently being executed, and the present trace count.
The count set at the GX Developer side is displayed.
In cases where, for example, "Execute by following conditions written on the PLC side" is selected, the field is blank.
(For example when the count is undefined.)

<Count after trigger>
Indicates the setting count after the trigger currently being executed and the execution count after the present trigger.

<Trace status>
Indicates the execution status of the present trace.
- 5) Read file
Reads the sampling trace condition + trace result.
- 6) Write file
Writes the sampling trace condition + trace result.
- 7) Delete file
Deletes the sampling trace condition + trace result.
- 8) Read from PLC
Reads the sampling trace condition + trace result to the PLC.
- 9) Write to PLC
Writes the sampling trace condition + trace result to the PLC.

POINTS

- Points to check at trace execution
If sampling trace cannot be executed check the following points.

<Common points>
If the communicating PLC is of a different type, the trace cannot be executed.
Trace execution status check (trace execution command cannot be given during trace)

<Check when conditions are overwritten at the PLC side>
Device check (checks for consistency with the parameter settings)
Trace condition setting check (checks for omissions in trace condition setting, and inconsistency)
Capacity check (checks if the trace result can be accommodated in the setting capacity)
The PLC parameter and personal computer parameter settings are checked. If there is a mismatch the trace cannot be executed.
Applicable memory check (checks whether the selected applicable memory can be used or not)
File name check (checks if a file name is set)
Extension file register block use possibility check (checked for AnACPU and AnUCPU, QCPU(Amode)).
- When the PLC type is changed, the sampling trace data written to file (settings + results) are deleted. (Even if the project is not saved, they are deleted and cannot be recovered.)

Example: A2N → A3A Deleted
 A2A → A3A Not deleted

17.11.2 Setting trace data

| | | |
|-----------------------|-----------------------|-----------------------|
| A | Q/QnA | FX |
| <input type="radio"/> | <input type="radio"/> | <input type="radio"/> |

[Purpose]

Sets devices for sampling trace (bit devices, word devices).

[Operating Procedure]

Select [Online] → [Trace] → [Sampling trace] → <<Trace data>> sheet.

[Dialog Box]

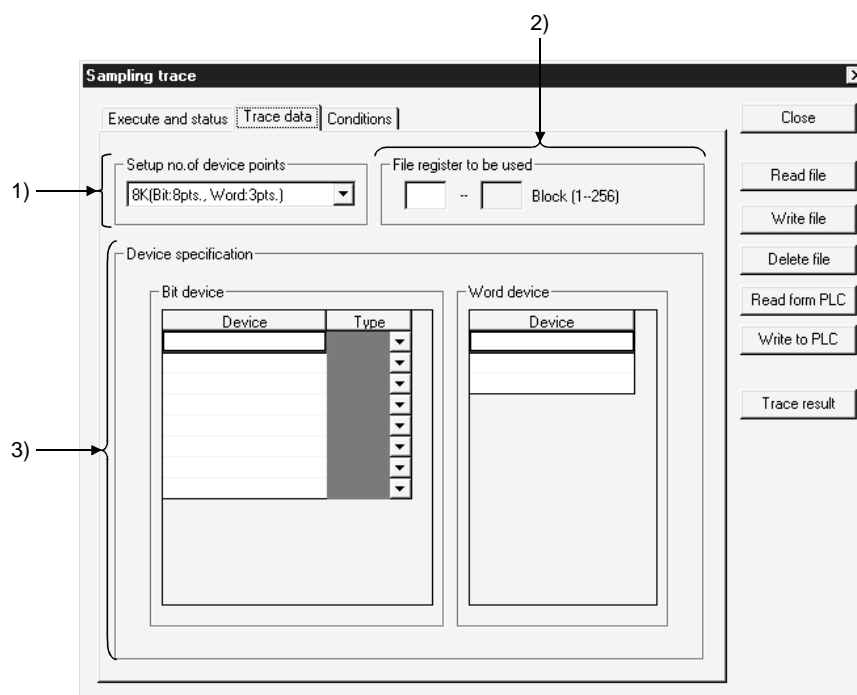

[Description]

- 1) Setup no. of device points
Set for AnACPU and AnUCPU, QCPU(Amode) only.
The relationship between the number of points and capacity in the settings is as follows.
8 K (8 bit points, 3 word points 1 block)
15 K (16 bit points, 6 word points 1 block)
23 K (16 bit points, 10 word points 2 blocks)
- 2) File register to be used
Designates the number of the extension file register used to store result data when executing an online sampling trace with AnACPU or AnUCPU, QCPU(Amode).
For the setting, designate the first number of the extension file register.

- 3) Device specification
 Sets the devices (bit devices, word devices) for executing a trace.
 The devices, and number of points, that can be set differ for each PLC.

| | Bit Devices That can be Set | Word Devices That can be Set | Devices That can be Registered |
|---|---|---|--|
| AnNCPU | 8 points | 3 points | X,Y,M,L,S,B,F,T,C T,C,D,W,R,A,Z,V |
| AnACPU AnUCPU QCPU-A | Depends on the number of device points setting | | |
| QnACPU Required memory capacity: up to 60K | 50 points The maximum number of input characters is 16 characters (bit device) | 50 points The maximum number of input characters is 17 characters (bit device) | |
| QCPU (Qmode) | 50 points The maximum number of input characters is 16 characters (bit device) | 50 points The maximum number of input characters is 17 characters (bit device) | X,Y, M, L, F, SM, FX, FY, V, DX, DY, T, C, ST, D, SD, FD, B, SB, W, SW, R, Z, RZ, constant, U□G, J□X, J□Y, J□B, J□SB, J□W, J□SW, BL□S, BL□TR Extension designation, bit designation for word devices with index qualification Digit designation for bit devices Indirect designation is not possible. |
| FXCPU *1 | 10 points | 3 points | Contacts : X,Y,M,S,T,C Coils : T,C(Y,M *2) Present values : T,C,D,V,Z |

*1 : The PLCs that support sampling trace are the FX₂, FX_{2C}, FX_{2N}, and FX_{2NC} series.
 *2 : It is also possible to register Y and M as coils, but - depending on the details of operation of the PLC the ON/OFF operation of the coil may not be reflected in the sampling results.)
 Therefore, Y and M are usually registered as contacts.

| POINTS |
|---|
| <ul style="list-style-type: none"> About M, L, S of A series CPUs: When using an A/QCPU(Amode), M, L, and S devices are automatically corrected in accordance with the parameters when they are input and displayed in the device setting field. After registration, even if, for example, there are changes in the parameter settings, on redisplay the display is automatically corrected in accordance with the parameters. About the type setting field: Setting is not possible if there has been no device input, or if devices other than T, C have been input. |

17.11.3 Setting trace conditions

| A | Q/QnA | FX |
|---|-------|----|
| ○ | ○ | ○ |

[Purpose]

Sets trace counts, trace points, and trigger points.

[Operating Procedure]

Select [Online] → [Trace] → [Sampling trace] → <<Conditions>> sheet.

[Dialog Box]

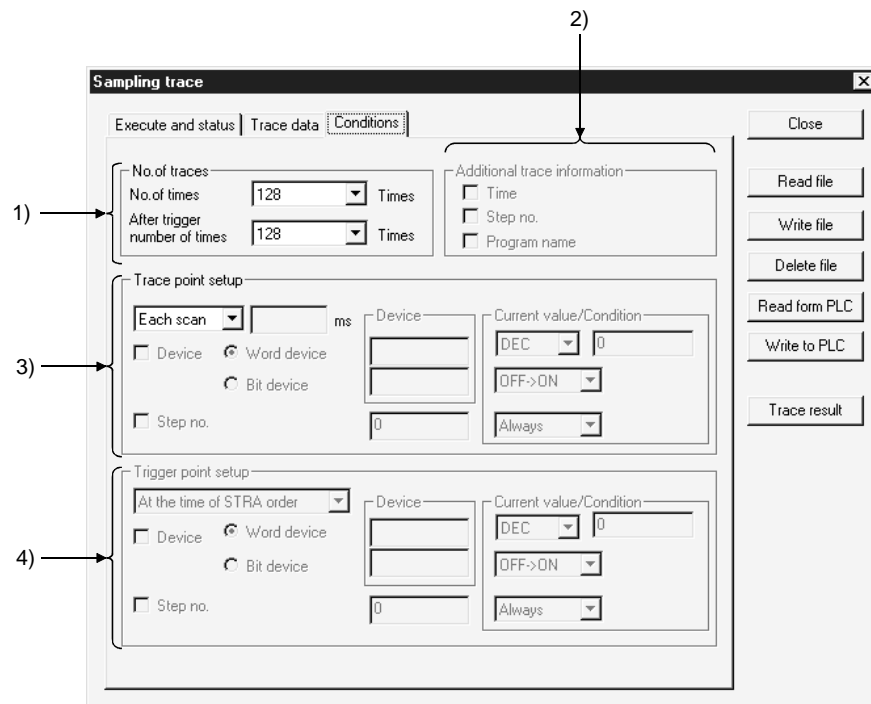

[Description]

1) No. of traces

Set so that the total count is larger than the count after the trigger.
 When using the A series, the count can only be selected from the menu.
 With the Q/QnA series, any required count up to 8192 can be set.
 With the FX series, it is not possible to set a total count. The count after the trigger can be set in the range of 1 to 512 from the menu, or alternatively any required count can be set.

2) Additional trace Information (QnA series only)

As information when the trace is executed, the time, step, and program name can displayed with the results.

3) Trace point setup

With A series
 The per time setting range is 10 to 2000 ms.
 Settings can be made in 10 ms units.

With QnA series

The per time setting range is 5 to 10000 ms.
Settings can be made in 5 ms units.

With FX series

When a per scan setting is made, it is not possible to make settings in the detailed setting field.

When per scan is designated, the execution of the END instruction by the PLC becomes the trace point.

The per time setting range is 10 to 2000 ms.
Settings can be made in 10 ms units.

Detailed setting

It is possible to set both a device and step number as the trace point at the same time.

In this case, sampling trace is executed with an AND condition.

4) Trigger point setup (QnA series, FX series only)

Sets the trigger (condition) that is the origin (0 point) for trace execution.

In the input area, only those input areas that are required for the selected trigger condition are valid.

With FX series

Read the expressions associated with the sampling trace function of FXGP (DOS) or FXGP (WIN) and the expressions associated with GX Developer in the following way.

| | |
|------------------------|-----------------------|
| FXGP (DOS), FXGP (WIN) | GX Developer |
| Without trigger | → Wentrigger actuated |
| Win trigger | → Detailed settings |

For details on the detailed settings, see the trace point settings.

POINT**Note on repeated execution of a sampling trace:**

If a trace count of 2000 is set and the trace is actually completed at a count of 1000, note that the results of 1000 traces from the previous execution will remain.

17.12 Monitoring the Ladders Registered

| | | |
|---|-------|----|
| A | Q/QnA | FX |
| ○ | ○ | ○ |

[Purpose]

You can batch-monitor related multiple ladder blocks.

[Operating Procedure]

[Online] → [Monitor] → [Entry ladder monitor]

[Dialog Box]

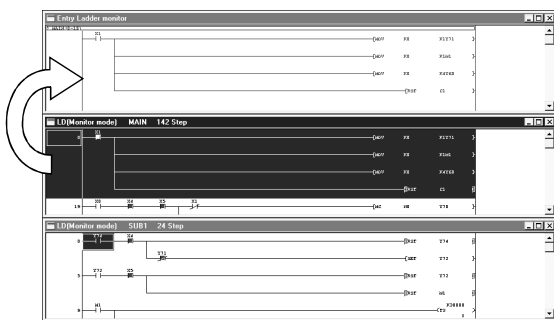

} Ladder registration monitor screen
 *The ladder block registered to the ladder registration screen is shown in blue.

[Description]

- You can register ladders by copy and paste or drag and drop.
- Registration may be made only from the ladder screen.
 (Registration from the list screen or listing of the registered ladders cannot be made.)
- The registerable ladder size is up to 6K steps for any series.
- Functions that can be performed on the ladder registration screen
 1. Ladder deletion on ladder block basis
 2. Device search, instruction search, character string search
 3. Comment/statement/note display
 4. Device test
 5. Screen magnification/reduction
 6. Drag and drop to device registration monitor

17.13 Deleting All Ladders Registered

| A | Q/QnA | FX |
|-----------------------|-----------------------|-----------------------|
| <input type="radio"/> | <input type="radio"/> | <input type="radio"/> |

[Purpose]

You can batch-delete the ladder blocks registered.

[Operating Procedure]

[Online] → [Monitor] → [Delete all entry ladder]

18. DEBUGGING PROGRAMS

After a program has been written to the PLC, you can check it by carrying out a device test, partial operation, and step run. However, note that when using the FX series, the partial operation, step run and skip run functions are only valid when the GX Simulator is connected.

Also note that if skip run is set before partial operation and step run, the program range designated for skip run will not be processed.

The following shows the operation status during partial operation and step run operation, and an example of the execution range when skip run is set.

For the Q series, you can use the GX Simulator to perform partial execution, step execution or skip execution. (When it is connected to the PLC, partial execution, step execution and skip execution cannot be performed.)

<Partial operation>

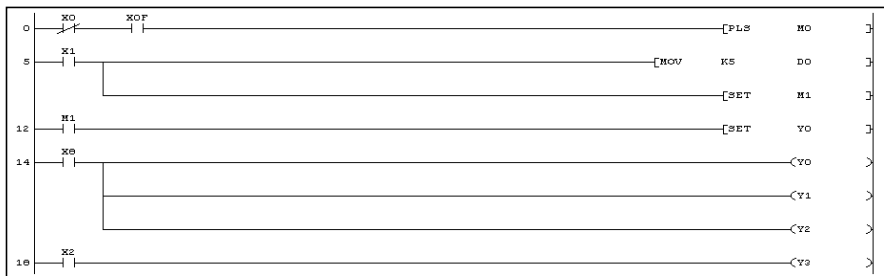

Runs the program from the designated step or pointer to the set stop condition.

See Section 18.3 "Carrying Out Partial Operation."

<Step run>

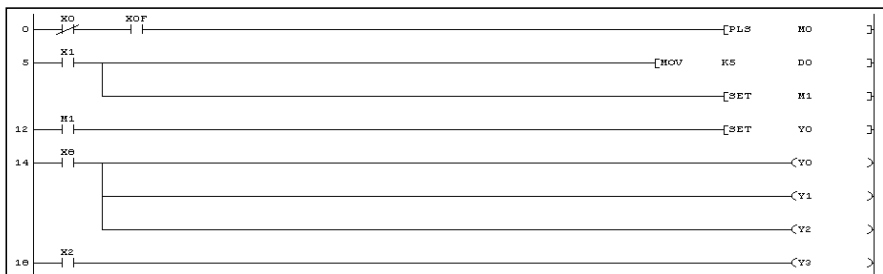

Executes the designated program range one instruction at a time.

See Section 18.4 "Executing Step Run."

When skip run is set with the Q/QnA series or FX series, partial operation or step run is executed without processing the program range designated for this function.

<Skip run>



Executes partial operation or step run while skipping (not processing) the part of the program between the designated steps.

See Section 18.5 "Setting the Scan Range."

18.1 Carrying Out a Device Test

| | | |
|---|-------|----|
| A | Q/QnA | FX |
| ○ | ○ | ○ |

[Purpose]

Forcibly turns ON/OFF the bit devices of the PLC, and changes the present values of word devices.

[Operating Procedure]

Select [Online] → [Debug] → [Device test], or click  ([Alt] + [1]).

[Dialog Box]

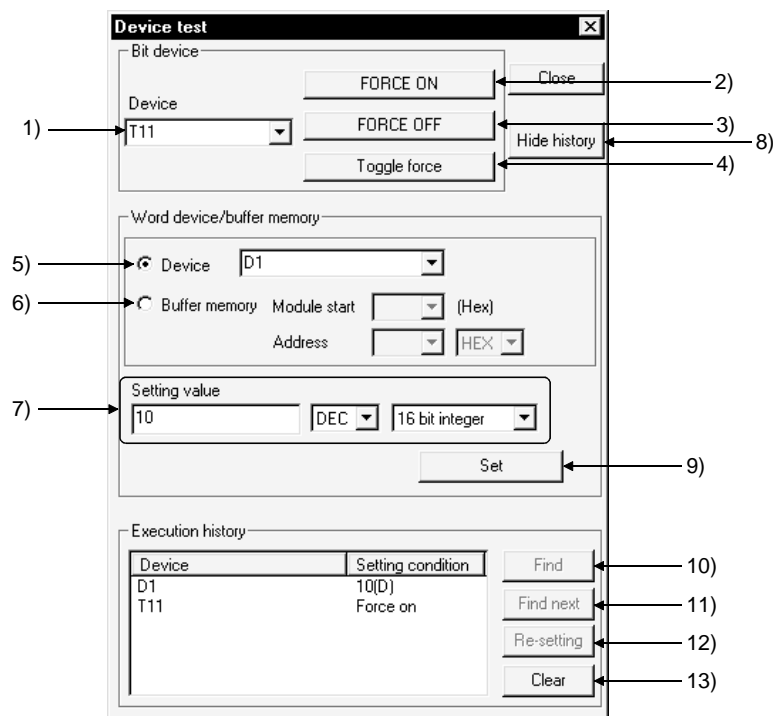

[Description]

- 1) **Bit device**
Designates the bit device to be forcibly turned ON or OFF.
- 2) **FORCE ON** button
Forcibly turns the designated bit device ON.
- 3) **FORCE OFF** button
Forcibly turns the designated bit device OFF.
- 4) **FORCE ON/OFF inversion** button
Forcibly inverts the ON/OFF statuses of designated bit devices.
- 5) **Device**
Designates the word device whose present value is to be changed.
- 6) **Buffer memory**
Designates the first I/O number (lowest digit unnecessary) and buffer memory address (decimal/hexadecimal) of the monitoring special function module.

- 7) **Setting value**
Sets the value to be changed.
Before setting the value, designate decimal or hexadecimal, and 16-bit integral value, 32-bit integral value, or real number.
- 8) **Hide history (Display history)**
Select whether the execution result of device test is to be displayed or hidden.
When the screen display area of the personal computer is 800×600 pixels, it is recommended to choose Hide since a large dialog box appears if the execution result is displayed.
- 9) **Set** button
Click this button after making the necessary settings.
The word device present value change operation is executed.
- 10) **Find** button
When the device is specified in the history field, the corresponding ladder program appears.
- 11) **Find next** button
Continuously searches for the device found by clicking the **Find** button.
When there are two or more sequence programs, these programs are searched for the device.
- 12) **Re-setting**
Clicking the Re-setting button after specifying the device in the history field sets data in the Bit device setting field for the bit device, or in the Word device setting field for the word device/buffer memory.
The device can be re-set by double-clicking after specifying the device in the history field.
- 13) **Clear** button
Deletes all devices displayed in the history field.

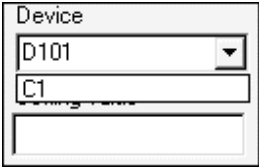
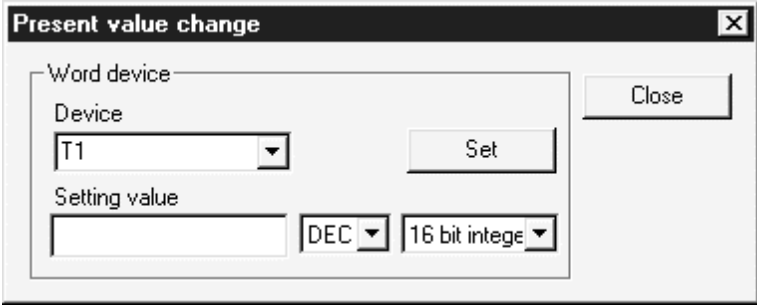
| POINTS |
|---|
| <ul style="list-style-type: none"> Executing a device may change the control of the PLC. Check safety carefully before executing the test. When a coil whose output condition input signal is OFF is forcibly turned ON while the PLC is in the RUN state, the execution of the program is given priority and the coil output comes ON only momentarily. Since the device designated for a device test is temporarily stored in memory, it can be selected the second and subsequent times with button while the project continues. |
|  |
| <ul style="list-style-type: none"> With the Q/QnA series, a device test can be carried out by bit designation of word devices, or by digit designation of bit devices. In addition, a link module memory can be designated as follows "J*\B**" "J*\W**", and the buffer memory of a special function module can be designated as follows: "U*\G**." <p style="margin-left: 40px;">See the QnACPU Programming Manual (Common Instructions)</p> <ul style="list-style-type: none"> key + doubling-clicking () a contact in the ladder monitor window forcibly switches it between ON and OFF. key + double-clicking () a word device that is being monitored displays the present value change dialog box shown below. |
|  |
| <p>After entering the value to be changed, click the button.</p> <ul style="list-style-type: none"> When making a device test during label programming, compile the label program. |

18.2 Registering/Canceling the Forced I/O

18.2.1 Registration to PLC CPU

| | | |
|---|-------|----|
| A | Q/QnA | FX |
| × | ○* | × |

*: Compatible with the Q02(H)/Q06H/Q12H/Q25H CPU.

[Purpose]

If the program is running, a device X/Y can be forced to turn ON/OFF without influence of the input (X) from the external device and the output (Y) from the program.

For the PLC CPU version which can perform this function, check Appendix 7.

[Operating Procedure]

Select [Online] → [Debug] → [Forced input output registration/cancellation]

[Dialog Box]

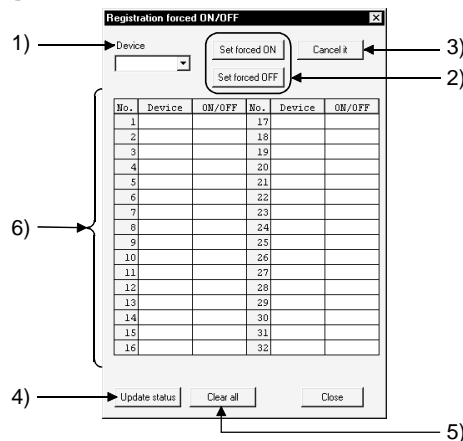

[Description]

- 1) Device
Enter the device to be forced to turn ON/OFF or to be canceled.
- 2) [Set forced ON], [Set forced OFF] button
Register the set device to turn ON/OFF.
- 3) [Cancel it] button
Cancels the device X/Y registered to the PLC CPU.
- 4) [Update status] button
Reads the updated registration status.
- 5) [Clear all] button
Cancels all forced I/Os registered to the PLC CPU.
- 6) Registration status display area
Shows the forced I/O registration status registered to the PLC CPU.
When this function is performed for one PLC CPU by two or more persons via the other station, the forced I/O registration status is read from the accessed PLC CPU to confirm it.

POINT

Note that since exclusive control is not exercised on the PLC CPU side, forced device I/O registration may cause the registration to be changed from multiple GX Developer programs or from the equipment which can register/cancel forced I/O.

18.2.2 Registration/cancellation to remote I/O station

| | | |
|---|-------|----|
| A | Q/QnA | FX |
| × | ○* | × |

※: This function is compatible with the Q series remote I/O.

[Purpose]

Disables the refresh of the device Y between the MELSECNET/H remote master and remote I/O stations or the device X in the input module on the remote station to enable a device test.

[Operating Procedure]

Select [Online] → [Debug] → [Forced input output registration/cancellation]

[Dialog Box]

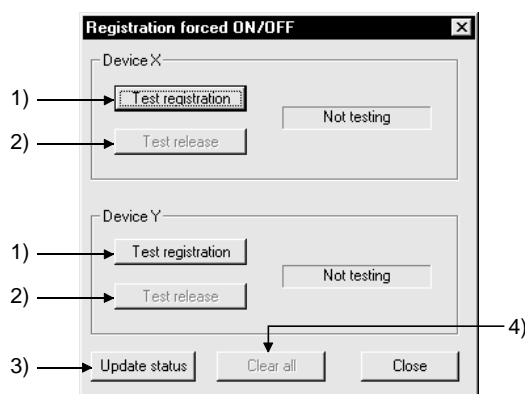

[Description]

- 1) Test registration
Disables the refresh of X/Y for the remote I/O station.
- 2) Test release
Cancels refresh disable.
- 3) Update status
Reads the latest registration status.
- 4) Clear all
Cancels all forced I/Os registered to the PLC CPU.

18.3 Carrying Out Partial Operation

| | | |
|-----------------------|-----------------------|-----------------------|
| A | Q/QnA | FX |
| <input type="radio"/> | <input type="radio"/> | <input type="radio"/> |

[Purpose]

Executes a program from the designated step or pointer to the point where the set condition is established.

When Q/FX series is selected, only GX Simulator is applicable.

[Operating Procedure]

1. Select [Online] → [Debug] → [Debug] (Choose the STEP-RUN mode).
2. Select [Online] → [Debug] → [Partial operation], or click  ([Alt] + [3]).

[Dialog Box]

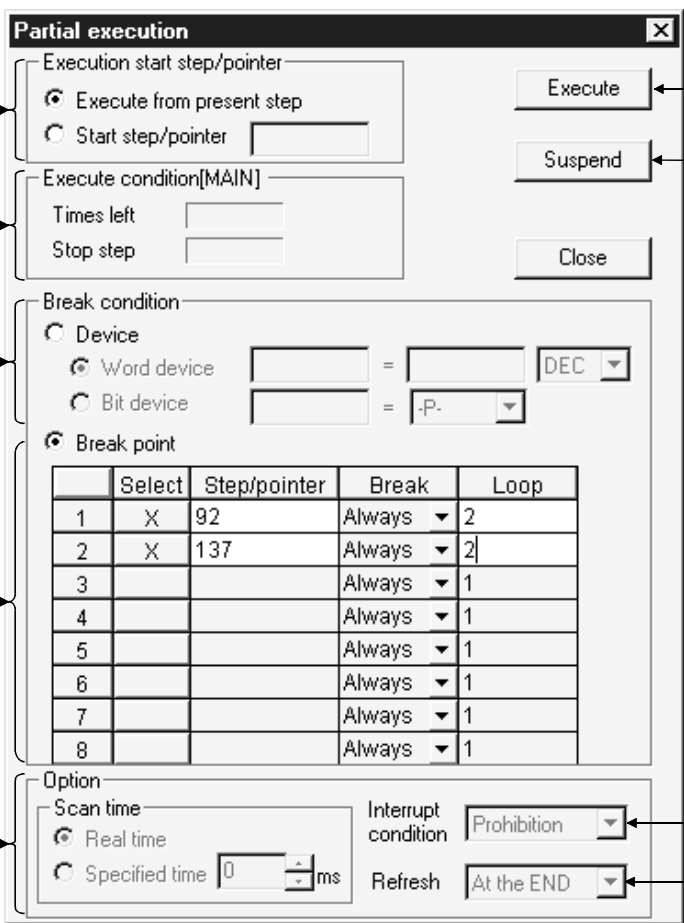

The dialog box is titled "Partial execution" and contains the following sections:

- 1) Execution start step/pointer:** Includes radio buttons for "Execute from present step" (selected) and "Start step/pointer" with an adjacent text input field.
- 2) Execute condition[MAIN]:** Includes "Times left" and "Stop step" text input fields.
- 3) Break condition:** Includes radio buttons for "Device", "Word device" (selected), and "Bit device". The "Word device" section has two input fields and a "DEC" dropdown. The "Bit device" section has an input field and a "-P-" dropdown.
- 4) Break point:** A table with columns: Select, Step/pointer, Break, and Loop.

| | Select | Step/pointer | Break | Loop |
|---|--------|--------------|--------|------|
| 1 | X | 92 | Always | 2 |
| 2 | X | 137 | Always | 2 |
| 3 | | | Always | 1 |
| 4 | | | Always | 1 |
| 5 | | | Always | 1 |
| 6 | | | Always | 1 |
| 7 | | | Always | 1 |
| 8 | | | Always | 1 |
- 5) Option:** Includes "Scan time" with radio buttons for "Real time" (selected) and "Specified time" with a numeric input field and "ms" unit. It also includes "Interrupt condition" and "Refresh" dropdown menus.

Buttons on the right side include "Execute" (8), "Suspend" (9), and "Close".

[Description]

- 1) Execution start step/pointer
 - Execution from present step
The program is executed from the step at which execution is presently stopped.
 - Start step/pointer
The program is executed from the designated step or pointer.
For step designation : **
For pointer designation : P**
 I**

** = Number of designated step or pointer

- 2) Execution condition
Indicates the execution status of the program.
- 3) Break condition
Sets the device condition that stops partial operation.
 - ⊙ Word device
The condition is satisfied when the set device has the same value as the set value.
Set the device and numeric value (decimal or hexadecimal).
 - ⊙ Bit device
The condition is satisfied when the set device is in the set condition.
Set the device status (-P-: leading edge, -F-: trailing edge).
- 4) Break point
Sets the break condition and loop count for a partial operation range.
With the A series and FX series, the condition can only be "Always."

| | Select | Step/pointer | Break | Loop |
|---|--------|--------------|----------|------|
| 1 | X | 92 | -P- ▼ | 2 |
| 2 | X | 137 | ON ▼ | 2 |
| 3 | | | Always ▼ | 1 |
| 4 | | | Always ▼ | 1 |
| 5 | | | Always ▼ | 1 |
| 6 | | | Always ▼ | 1 |
| 7 | | | Always ▼ | 1 |
| 8 | | | Always ▼ | 1 |

A

B

C

D

- A: Selection
Setting causes it to be executed as the break point.
- B: Step/pointer
Set the step/pointer number that defines the range for partial operation.
- C: Break
Set a status of the designated step/pointer as the break condition after the number of scans set by the loop count.
 - Always : On reaching the number of loops indicated by the designated count, execution stops.
 - ON : Execution stops when the designated step/pointer is ON.
 - OFF : Execution stops when the designated step/pointer is OFF.
 - ↑ : Execution stops when the status of the designated step/pointer changes from OFF to ON.
 - ↓ : Execution stops when the status of the designated step/pointer changes from ON to OFF.
- D: Loop
Sets the number of scans until the break.
The setting range is 1 to 32767.

- 5) Scan time (Q/QnA series only)
Sets the processing time for a program that is executing partial operation.
This setting is not possible with the A series and FX series.
- Ⓒ Real time
The program is executed at intervals corresponding to normal RUN operation.
 - Ⓒ Specified time
The program is executed at the designated interval.
The setting range is 10 ms to 2000 ms in 10 ms units.
- 6) Interrupt condition (Q/QnA series only)
Sets whether or not the interrupt program is executed when an interrupt cause occurs during partial operation.
This setting is not possible with the A series and FX series.
By programming..... Depends on the execution results of EI and DI instructions.
Prohibition..... The execution of the interrupt program is disabled.
- 7) Refresh (Q/QnA series only)
Sets the refresh timing for I/O devices (X/Y).
This setting is not possible for the A series and FX series.
One by one..... Direct I/O refresh
At the END..... Batch refresh at END processing
- 8) button
Click this button after setting the necessary settings.
Partial operation is executed.
- 9) button
Aborts partial operation.

[Operating Procedure]

1. Display the ladder monitor window.
2. Set the PLC to the STEP-RUN operating state by remote operation or with the key switch.
3. Set 1) through 7).
4. Click 8) to execute.
5. Operation stops when the break condition is established.
6. To quit, click the button.
A dialog box is displayed and the PLC returns to the RUN state.

| POINTS |
|--|
| <ul style="list-style-type: none">• When executing partial operation with a range encompassing several programs, if there is a break in a program that is not displayed, execution stops at the position of the same step number in the program that is displayed.• When the PLC is switched from RUN to STEP-RUN, the final output status under RUN is held.• When a break point is designated as a step, if the designated step is part way through an instruction, execution stops at the first step of the instruction.• If a step designated as a stopped step is passed without execution in a conditional jump or interrupt program, the scan count cannot be counted as "1." For example, if the break point is set at step 1000, the scan count is set as 1, and there is an instruction for a conditional jump to step 1200 at step 800, execution cannot stop at step 1000.• With the A series and FX series, it is not possible to set a device break condition and a step/pointer break point at the same time.• With the Q/QnA series, it is possible to set a device break condition and a step/pointer break point at the same time. If they are set at the same time, partial operation stops when both conditions are satisfied.• When more than one program is being executed with the Q/QnA series, partial operation starts from the program being monitored and is executed in the order in which programs are set in the PLC parameters.• With the Q/QnA series the following types of setting are possible for a break condition: bit device digit designation, word device bit designation, index qualification. |

18.4 Executing Step Run

| | | |
|---|-------|----|
| A | Q/QnA | FX |
| ○ | ○ | ○ |

[Purpose]

Executes the designated range of the PLC program one instruction at a time. When using the Q/FX series, step run is valid only when the GX Simulator is connected.



[Operating Procedure]

1. Select [Online] → [Debug] → [Debug] (Choose the STEP-RUN mode).
2. Select [Online] → [Debug] → [Step execution], or click  ([Alt] + [4]).

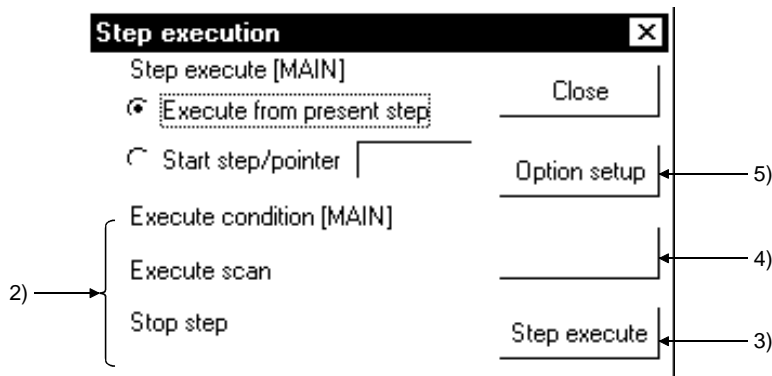
[Dialog Box]



[Description]

- 1) Step execute
 - Execute from present step
Execute the program from the step where it is currently stopped.
 - Start step/pointer
Execute the program from the designated step or pointer.
For step designation : **
For pointer designation : P**
 I**
 ** = Number of designated step or pointer
- 2) Execute condition
Indicates the execution status of the program.
- 3)  button
Clicking this button starts execution of a number of steps corresponding to the repetition count set in the option dialog box. On completion of repetition count execution, clicking this button once causes execution of one instruction.
- 4)  button
Aborts execution of step run.

- 5) **Option setup** button
 Displays the step run option setting dialog box shown below.
 Set the repetition count, repetition interval, and break point.

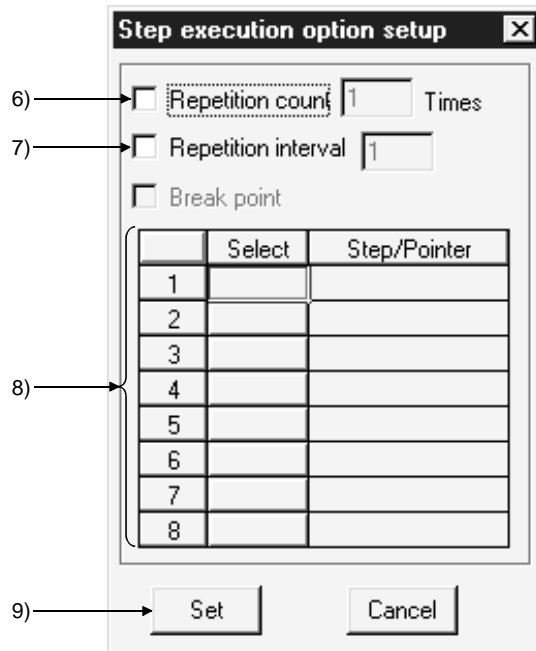

- 6) **Repetition count**
 On checking the check box to select it, step run is executed for the number of instructions corresponding to the set count only.
 After execution of this number of steps, each time the **Step execute** button is clicked program execution proceeds by one instruction.
 The setting range is 1 to 32767.

- 7) **Repetition interval**
 On checking the check box to select it, step run is executed at intervals of the set value. The unit for the interval is equivalent to the interval in which one interruption is issued from the personal computer to the PLC. If step run is executed with only the repetition interval set in the option settings, execution proceeds with no limit on the repetition count.
 The setting range is 1 to 32767.

- 8) **Break point**
 Sets the step or pointer at which step run operation stops.
 This setting is not possible for the A series or FX series.
 Note also that if step run is executed with only the break point set and no repetition count setting, it will be executed from the start step to the break point.
 After the break, program execution will proceed by one instruction each time the **Step execute** button is clicked.

For step designation : **
 For pointer designation : P**
 I**
 ** = Number of designated step or pointer

- 9) **Set** button
 Click this button after making the necessary settings; the display returns to the step run dialog box.

[Operating Procedure]

1. Display the ladder monitor window.
2. Set the PLC to the STEP-RUN operating state by remote operation or with the key switch.
3. In the step run dialog box, set 1), and - as necessary - 6) to 8).
4. Click 3) to execute.
5. To quit, click the **Close** button.
A dialog box is displayed and the operating state of the PLC can be set to RUN in remote operation.

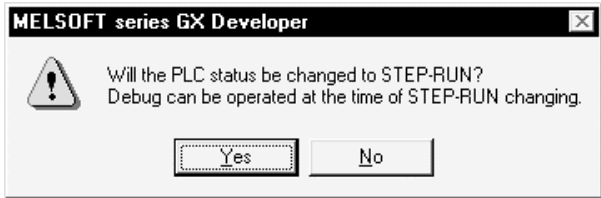
| POINTS | | | | | | | | | | | | | | | | | | | | | | | | | |
|--------------------------------------|---|-------------|------------------------------|--------------------------------------|------------------------------------|--------------------------|---------------------------|--------------------------|----------------------------|------------------------|----------------------------|------------------------|-----------------------------|------------------------|------------------------------|--------------------------|---------------------------|--------------------------|----------------------------|------------------------|----------------------------|------------------------|-----------------------------|------------------------|--------------------------------|
| | <ul style="list-style-type: none"> • When executing step run with a range encompassing several programs, if there is a break in a program that is not displayed, execution stops at the position of the same step number in the program that is displayed. • The following dialog box will appear if step run is performed when the PLC CPU is in other than the STEP-RUN mode. | | | | | | | | | | | | | | | | | | | | | | | | |
| |  | | | | | | | | | | | | | | | | | | | | | | | | |
| | <p>When the PLC CPU is in the RUN mode, it cannot be switched to STEP-RUN.</p> <ul style="list-style-type: none"> • The timer present values during step run are as follows. <table border="1" style="width: 100%; border-collapse: collapse; margin-bottom: 10px;"> <tbody> <tr> <td style="width: 50%;">10 ms timer</td> <td>Incremented by one each scan</td> </tr> <tr> <td>100 ms timer, 100 ms retentive timer</td> <td>Incremented by one every ten scans</td> </tr> </tbody> </table> <ul style="list-style-type: none"> • The special relay timing clocks during step run are as follows. <p>A series</p> <table border="1" style="width: 100%; border-collapse: collapse; margin-bottom: 10px;"> <tbody> <tr> <td style="width: 50%;">M9030 (0.1 second clock)</td> <td>Goes ON/OFF every 5 scans</td> </tr> <tr> <td>M9031 (0.2 second clock)</td> <td>Goes ON/OFF every 10 scans</td> </tr> <tr> <td>M9032 (1 second clock)</td> <td>Goes ON/OFF every 50 scans</td> </tr> <tr> <td>M9033 (2 second clock)</td> <td>Goes ON/OFF every 100 scans</td> </tr> <tr> <td>M9034 (1 minute clock)</td> <td>Goes ON/OFF every 3000 scans</td> </tr> </tbody> </table> <p>Q/QnA series</p> <table border="1" style="width: 100%; border-collapse: collapse;"> <tbody> <tr> <td style="width: 50%;">SM410 (0.1 second clock)</td> <td>Goes ON/OFF every 5 scans</td> </tr> <tr> <td>SM411 (0.2 second clock)</td> <td>Goes ON/OFF every 10 scans</td> </tr> <tr> <td>SM412 (1 second clock)</td> <td>Goes ON/OFF every 50 scans</td> </tr> <tr> <td>SM413 (2 second clock)</td> <td>Goes ON/OFF every 100 scans</td> </tr> <tr> <td>SM414 (n second clock)</td> <td>Goes ON/OFF every n x 50 scans</td> </tr> </tbody> </table> | 10 ms timer | Incremented by one each scan | 100 ms timer, 100 ms retentive timer | Incremented by one every ten scans | M9030 (0.1 second clock) | Goes ON/OFF every 5 scans | M9031 (0.2 second clock) | Goes ON/OFF every 10 scans | M9032 (1 second clock) | Goes ON/OFF every 50 scans | M9033 (2 second clock) | Goes ON/OFF every 100 scans | M9034 (1 minute clock) | Goes ON/OFF every 3000 scans | SM410 (0.1 second clock) | Goes ON/OFF every 5 scans | SM411 (0.2 second clock) | Goes ON/OFF every 10 scans | SM412 (1 second clock) | Goes ON/OFF every 50 scans | SM413 (2 second clock) | Goes ON/OFF every 100 scans | SM414 (n second clock) | Goes ON/OFF every n x 50 scans |
| 10 ms timer | Incremented by one each scan | | | | | | | | | | | | | | | | | | | | | | | | |
| 100 ms timer, 100 ms retentive timer | Incremented by one every ten scans | | | | | | | | | | | | | | | | | | | | | | | | |
| M9030 (0.1 second clock) | Goes ON/OFF every 5 scans | | | | | | | | | | | | | | | | | | | | | | | | |
| M9031 (0.2 second clock) | Goes ON/OFF every 10 scans | | | | | | | | | | | | | | | | | | | | | | | | |
| M9032 (1 second clock) | Goes ON/OFF every 50 scans | | | | | | | | | | | | | | | | | | | | | | | | |
| M9033 (2 second clock) | Goes ON/OFF every 100 scans | | | | | | | | | | | | | | | | | | | | | | | | |
| M9034 (1 minute clock) | Goes ON/OFF every 3000 scans | | | | | | | | | | | | | | | | | | | | | | | | |
| SM410 (0.1 second clock) | Goes ON/OFF every 5 scans | | | | | | | | | | | | | | | | | | | | | | | | |
| SM411 (0.2 second clock) | Goes ON/OFF every 10 scans | | | | | | | | | | | | | | | | | | | | | | | | |
| SM412 (1 second clock) | Goes ON/OFF every 50 scans | | | | | | | | | | | | | | | | | | | | | | | | |
| SM413 (2 second clock) | Goes ON/OFF every 100 scans | | | | | | | | | | | | | | | | | | | | | | | | |
| SM414 (n second clock) | Goes ON/OFF every n x 50 scans | | | | | | | | | | | | | | | | | | | | | | | | |

18.5 Setting the Scan Range

| | | |
|---|-------|----|
| A | Q/QnA | FX |
| × | ○ | ○ |

[Purpose]

Sets the range to be skipped (not processed) when executing partial operation or step run.

When using the Q/FX series, this setting is only effective when the GX Simulator is connected.

[Operating Procedure]

1. Select [Online] → [Debug] → [Debug] (Choose the STEP-RUN mode).
2. Select [Online] → [Debug] → [Skip execution], or click  (Alt + 2).

[Dialog Box]

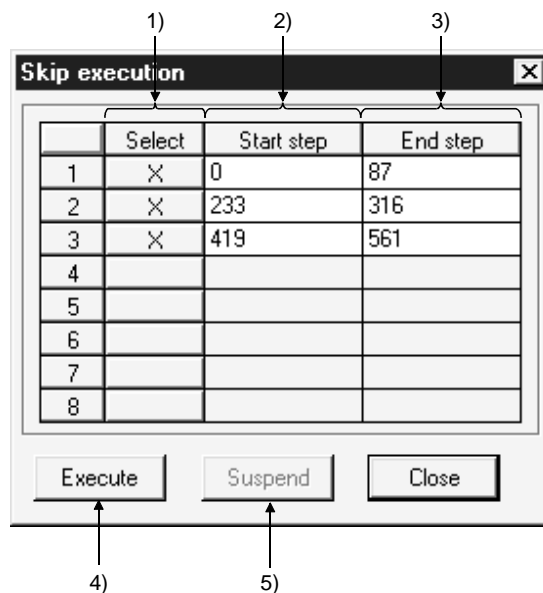

[Description]

- 1) Select
On setting, the designated range is skipped.
The skip range is in instruction units.
- 2) Start step
Designates the beginning of the skip range.
Set the first step number of the first instruction.
Pre-selecting the area in the ladder and choosing the step execution menu sets the step number at the first step.



- 3) **End step**
 Designates the end of the skip range.
 Set the first step number of the final instruction.
 Pre-selecting the area in the ladder and choosing the step execution menu sets the step number at the last step.



- 4) **Execute** button
 Registers the skip range.
 If the PLC is in an operating state other than STEP-RUN at this time, a dialog box allowing the state to be changed to STEP-RUN is displayed.
 To continue with partial operation or step run, set the state to STEP-RUN.
 However, if the PLC is in a state other than RUN it is not possible to change to STEP-RUN.
- 5) **Suspend** button
 Cancels registration of the skip range.

[Operating Procedure]

1. Display the ladder monitor window.
2. Set 1), 2), and 3) in the skip execution dialog box.
3. Click 4).
 A dialog box is displayed: to continue with partial operation or step run, set to STEP-RUN.
4. Close the skip execution window.
5. Execute partial operation or step run.

POINT

To cancel the STEP-RUN state, either turn the key switch momentarily to RESET, or change the state by remote operation.

See Section 18.6 "Operating the PLC Remotely."

18.6 Operating the PLC Remotely

| | | |
|---|-------|----|
| A | Q/QnA | FX |
| ○ | ○ | ○ |

[Purpose]

Switches the execution status of the PLC from the personal computer. However, with the A series and the Q/QnA series, remote operation is possible only when the PLC is in the RUN state. When using the FX series, remember that only the FX_{1N} FX_{2N} and FX_{2NC} support remote operation. Remote operation is possible when the CPU is in either the RUN or STOP state.

[Operating Procedure]

Select [Online] → [Remote operation] (**[Alt] + [6]**).

[Dialog Box]

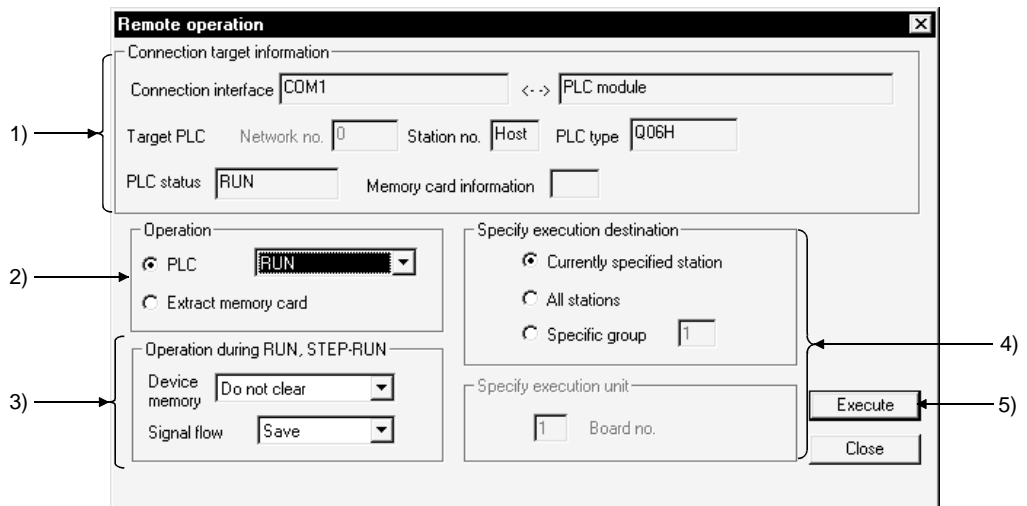

[Description]

- 1) Connection target information
Indicates information on the connection destination designation. For details on the connection destination designation, see Section 16.1.
- 2) Operation
Designates the operating state of the PLC. For the A series and Q/QnA series, the following designations are possible: STOP, PAUSE, STEP-RUN, RUN. With the Q/QnA series, RESET and latch clear can also be designated. With the FX series, STOP and RUN can be designated. Do not execute "Extract memory card" for the Q00J/Q00/Q01CPU.
- 3) Operation during RUN,STEP-RUN
Sets the operation with respect to the device memory and signal flow in the RUN and STEP-RUN states. This setting is not possible with the FX series.

- 4) Specify execution destination
Sets the applicable station for remote operation.
Currently specified station..... Executed only at the station with the connection destination designation.
- All stations..... Executed at all stations of the network designated as the presently designated station. 1 to 4 modules can be set for execution module designation.
- Specific group..... Executed in a specific group of the network designated as the presently designated station. Set 1 to 4 modules for execution module designation and set the group number.
This setting is not possible with the FX series.
- 5) button
Click this button after setting the necessary settings.

| POINTS | | | | | | | | | | | | | | | | | | | | | | | | | | | | | | | | | | | | | | | | | | | | | | | | | | | | |
|-------------------------------|---|-----------------------|-------------------|------|---------------------------|---------------------------|---|----------|---|-----|---|-------------------------------|-----|-------|------|-----|-----|-------|------|----------|----------|-------|------|-------|-------|-------|------|------|------|------|------|-------------------------------|-----|-------------|-------|------|----------|-------------|-----|-----|----------|-------|------|---------------------------|---------------------------|------|------|------|------|------|-------|-------------|
| | <ul style="list-style-type: none"> Remote operation is valid when the PLC is in the RUN state. However, since the remote operation setting is memorized when the key switch is set to STOP, on setting the key switch to RUN, the state set in remote operation applies. For example, if remote operation is set to STOP while the key switch is at STOP, the PLC will remain in the STOP state even if the key switch is set to RUN. Similarly, if STEP-RUN is set in remote operation while the key switch is set to STOP, when the key switch is set to RUN the PLC enters the STEP-RUN state. In this kind of case, the RUN state has to be established by remote operation. If there is any disagreement in the key switch, remote operation, and remote RUN/PAUSE contact operations at the PLC, the following order of priority applies. <table border="1" style="margin: 10px auto; border-collapse: collapse;"> <thead> <tr> <th style="width: 60%;">Operations to the PLC</th> <th style="width: 40%;">Order of Priority</th> </tr> </thead> <tbody> <tr> <td>STOP</td> <td>1</td> </tr> <tr> <td>PAUSE</td> <td>2</td> </tr> <tr> <td>STEP-RUN</td> <td>3</td> </tr> <tr> <td>RUN</td> <td>4</td> </tr> </tbody> </table> <ul style="list-style-type: none"> The PLC operation is determined by the combination of the key switch position and remote operation as follows. <p>A series</p> <table border="1" style="margin: 10px auto; border-collapse: collapse;"> <thead> <tr> <th style="width: 40%;">Remote operation \ Key switch</th> <th style="width: 15%;">RUN</th> <th style="width: 15%;">PAUSE</th> <th style="width: 15%;">STOP</th> </tr> </thead> <tbody> <tr> <td>RUN</td> <td>RUN</td> <td>PAUSE</td> <td>STOP</td> </tr> <tr> <td>STEP-RUN</td> <td>STEP-RUN</td> <td>PAUSE</td> <td>STOP</td> </tr> <tr> <td>PAUSE</td> <td>PAUSE</td> <td>PAUSE</td> <td>STOP</td> </tr> <tr> <td>STOP</td> <td>STOP</td> <td>STOP</td> <td>STOP</td> </tr> </tbody> </table> <p>Q/QnA series</p> <table border="1" style="margin: 10px auto; border-collapse: collapse;"> <thead> <tr> <th style="width: 10%;">Remote operation \ Key switch</th> <th style="width: 10%;">RUN</th> <th style="width: 10%;">STEP-RUN *3</th> <th style="width: 10%;">PAUSE</th> <th style="width: 10%;">STOP</th> <th style="width: 15%;">RESET *1</th> <th style="width: 15%;">Latch clear</th> </tr> </thead> <tbody> <tr> <td>RUN</td> <td>RUN</td> <td>STEP-RUN</td> <td>PAUSE</td> <td>STOP</td> <td>Operation not possible *2</td> <td>Operation not possible *2</td> </tr> <tr> <td>STOP</td> <td>STOP</td> <td>STOP</td> <td>STOP</td> <td>STOP</td> <td>RESET</td> <td>Latch clear</td> </tr> </tbody> </table> <p>*1 : Remote reset must be enabled by PLC system setting in the PLC parameters. *2 : Operation possible when set to STOP by remote operation. *3 : STEP-RUN cannot be performed for the Q series.</p> <ul style="list-style-type: none"> In remote operation of the FX2N and FX2NC CPU, M8035 (forced RUN mode), M8036 (forced RUN) and M8037 (forced STOP) are controlled. Note that remote operation is possible regardless of the status of the RUN, STOP switches at the PLC side. When removing the memory card, switch on SM605. If you remove the memory card with removal not yet authorized, the PLC will result in an error. | Operations to the PLC | Order of Priority | STOP | 1 | PAUSE | 2 | STEP-RUN | 3 | RUN | 4 | Remote operation \ Key switch | RUN | PAUSE | STOP | RUN | RUN | PAUSE | STOP | STEP-RUN | STEP-RUN | PAUSE | STOP | PAUSE | PAUSE | PAUSE | STOP | STOP | STOP | STOP | STOP | Remote operation \ Key switch | RUN | STEP-RUN *3 | PAUSE | STOP | RESET *1 | Latch clear | RUN | RUN | STEP-RUN | PAUSE | STOP | Operation not possible *2 | Operation not possible *2 | STOP | STOP | STOP | STOP | STOP | RESET | Latch clear |
| Operations to the PLC | Order of Priority | | | | | | | | | | | | | | | | | | | | | | | | | | | | | | | | | | | | | | | | | | | | | | | | | | | |
| STOP | 1 | | | | | | | | | | | | | | | | | | | | | | | | | | | | | | | | | | | | | | | | | | | | | | | | | | | |
| PAUSE | 2 | | | | | | | | | | | | | | | | | | | | | | | | | | | | | | | | | | | | | | | | | | | | | | | | | | | |
| STEP-RUN | 3 | | | | | | | | | | | | | | | | | | | | | | | | | | | | | | | | | | | | | | | | | | | | | | | | | | | |
| RUN | 4 | | | | | | | | | | | | | | | | | | | | | | | | | | | | | | | | | | | | | | | | | | | | | | | | | | | |
| Remote operation \ Key switch | RUN | PAUSE | STOP | | | | | | | | | | | | | | | | | | | | | | | | | | | | | | | | | | | | | | | | | | | | | | | | | |
| RUN | RUN | PAUSE | STOP | | | | | | | | | | | | | | | | | | | | | | | | | | | | | | | | | | | | | | | | | | | | | | | | | |
| STEP-RUN | STEP-RUN | PAUSE | STOP | | | | | | | | | | | | | | | | | | | | | | | | | | | | | | | | | | | | | | | | | | | | | | | | | |
| PAUSE | PAUSE | PAUSE | STOP | | | | | | | | | | | | | | | | | | | | | | | | | | | | | | | | | | | | | | | | | | | | | | | | | |
| STOP | STOP | STOP | STOP | | | | | | | | | | | | | | | | | | | | | | | | | | | | | | | | | | | | | | | | | | | | | | | | | |
| Remote operation \ Key switch | RUN | STEP-RUN *3 | PAUSE | STOP | RESET *1 | Latch clear | | | | | | | | | | | | | | | | | | | | | | | | | | | | | | | | | | | | | | | | | | | | | | |
| RUN | RUN | STEP-RUN | PAUSE | STOP | Operation not possible *2 | Operation not possible *2 | | | | | | | | | | | | | | | | | | | | | | | | | | | | | | | | | | | | | | | | | | | | | | |
| STOP | STOP | STOP | STOP | STOP | RESET | Latch clear | | | | | | | | | | | | | | | | | | | | | | | | | | | | | | | | | | | | | | | | | | | | | | |

19. REGISTERING KEYWORD/PASSWORDS

Entry code registration (for A/QnA/FX series) or password registration (for Q series) protects data in the PLC.

19.1 Registering Keyword

19.1.1 Registering new keyword/changing keyword

| | | |
|-----------------------|-------------------------|-----------------------|
| A | Q/QnA | FX |
| <input type="radio"/> | <input type="radio"/> * | <input type="radio"/> |

*: Compatible with the QnACPU.

[Purpose]

For the A/QnA/FX series, registers a new keyword to the PLC or changes the entry code.

[Operating Procedure]

Select [Online] → [Keyword setup] → [Register keyword].

[Dialog Box]

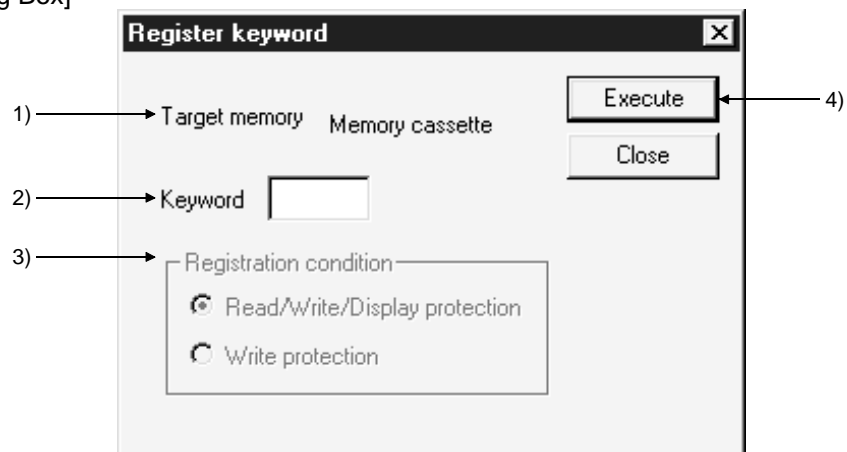

[Description]

- 1) Target memory (Except FX series)
Sets the memory whose keyword is to be registered or changed.
For the A series, this is a memory cassette.
- 2) Keyword
A series : Set the keyword (6 numeric characters and A through F).
QnA series : Set the keyword (6 numeric characters).
FX series : Set the keyword (8 numeric characters and A through F).
- 3) Registration condition (Except FX series)
Select the functions restricted by the keyword.
For the A series this is reading/writing and disabling of the display only.
 - Read/Write/Display protection
Writing, reading, verification, deletion, and list display are restricted by the keyword.
 - Write protection
Writing is restricted by the keyword.

- 4) **Execute** button
 Click this button after setting the necessary settings.
 However, in the case of an keyword change or condition change, the dialog box shown below is displayed.

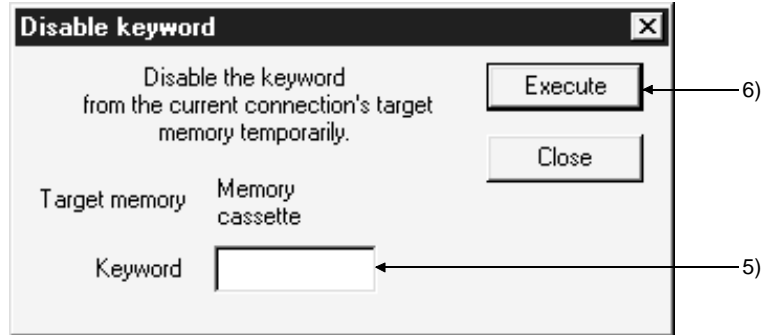

- 5) **Keyword**
 Sets the keyword that has been registered for the PLC.
- 6) **Execute** button
 Click this button after setting the necessary settings.

[Operating Procedure]

1. Set 2) in the Register new keyword dialog box.
 With the QnA series, set 1) and 3) also.
2. Click 4).
 For an keyword change, the present keyword is now displayed in the dialog box.
3. Set 5) and click 6).

| POINTS |
|--|
| <ul style="list-style-type: none"> • If you forget the entry code when using the A series or FX series, all-clear the data in the memory cassette with "PLC all clear." With the QnA series, format the PLC memory. However, note that regardless of whether you are using the A series, QnA series or the FX series, all the data apart from the keyword is also deleted, and therefore all the data must be rewritten. • On executing the registration condition function before releasing an keyword, the current entry code dialog box is automatically displayed. Enter the keyword and release it. • Since the keyword is written directly into the PLC on registration, there is no need to write parameters or other data to the PLC. Note that the keyword becomes functional immediately after registration. • With the A series and FX series, parameters for which an keyword is registered can be written to the ROM. |

POINT

Password protection level designation for the FX series

For devices capable of online operations with respect to the PLC, models such as the FX-10P and FX-20P permit the setting of three levels of protection for these operations. In cases where monitoring, setting changes, etc. are required to be done by an online device, set an entry code that takes this into consideration.

·All operations prohibited (personal computer operation disabled)

:A□□□□□□□ or ■□□□□□□□

↑ Alphanumeric letter other than "A", "B", and "C"

·Theft prevention (restricted to monitoring and changing the present value)

:B□□□□□□□

·Protection against erroneous writing (restricted to reading, monitoring and changing the present value)

:C□□□□□□□

In the part of the keyword, designate 7 alphanumeric digits selected from among A to F and 0 to 9.

19.1.2 Canceling a keyword

| | | |
|---|-------|----|
| A | Q/QnA | FX |
| ○ | ○* | ○ |

*: Compatible with the QnACPU.

[Purpose]

For the A/QnA/FX series, cancels (deletes) the keyword registered to the PLC.

[Operating Procedure]

Select [Online] → [Keyword setup] → [Delete keyword].

[Dialog Box]

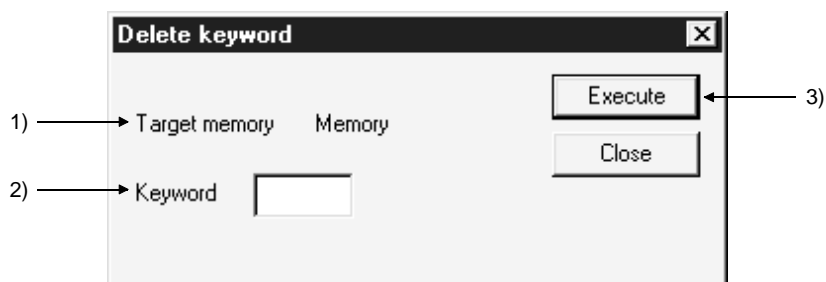

[Description]

- 1) Target memory (Except FX series)
Sets the applicable memory for the keyword cancellation.
For the A series, this is a memory cassette.
- 2) Keyword
Sets the currently registered keyword.
- 3) **Execute** button
Click this button after setting the necessary settings.

19.1.3 Releasing a keyword

| | | |
|-----------------------|-------------------------|-----------------------|
| A | Q/QnA | FX |
| <input type="radio"/> | <input type="radio"/> * | <input type="radio"/> |

*: Compatible with the QnACPU.

[Purpose]

For the A/QnA/FX series, releases the lock imposed by a keyword in order to allow access to the PLC for which the keyword is registered.

After a keyword has been released, there is free access to the PLC until the project is quit.

[Operating Procedure]

Select [Online] → [Keyword setup] → [Disable keyword].

[Dialog Box]

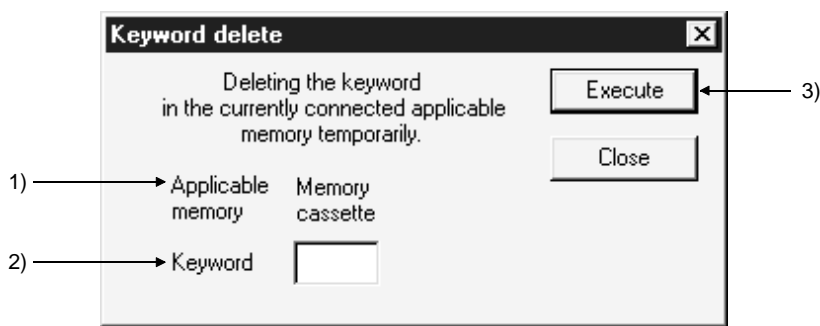

[Description]

- 1) Target memory (Except FX series)
Indicates the currently connected memory.
For the A series this is a memory cassette.
- 2) Keyword
Sets the keyword registered for the PLC.
- 3) **Execute** button
Click this button after setting the necessary settings.

19.2 Registering Passwords

| | | |
|---|-------|----|
| A | Q/QnA | FX |
| × | ○* | × |

*: Compatible with the QCPU (Q mode).

For the Q series, you can set a password to each of the programs, comments and device inits in a project.

The passwords are set to the PLC and the project currently open on GX Developer.

States of Passwords and Registration Conditions for Operations Performed

| Operation | States of Password and Registration Condition |
|--|---|
| Read from/Write to PLC | |
| Read from PLC | If passwords exist in the read source PLC, the password settings are also read. |
| Write to PLC (to read source PLC) | Password settings are written to the write destination PLC. |
| Write to PLC (to other than read source PLC) | Password settings are written to the write destination PLC. |
| Write to PLC (read from IC card and write to PLC) | Password settings are written to the write destination PLC. |
| Edit project | |
| Open project | If passwords exist in the read source, the password settings are also read. |
| Save | If passwords exist in the save source, the password settings are also saved. |
| Save as | If passwords exist in the save source, the password settings are also saved. |
| Delete project | Passwords are deleted together with the project. |
| Copy project | If passwords exist in the copy source, the password settings are also copied. |
| Copy data | If passwords exist in the copy source, the password settings are also copied. |
| Save and write after data name change | If passwords exist in the old data name, the password settings are also saved. |
| Edit ladder (paste ladder to other GX Developer) | Password settings are not added. |
| Merge data | Password settings are not added. |
| Automatic save | If passwords exist in the save source, the password settings are also saved. |
| Change PLC type | |
| Save and write after PLC type change QCPU → QCPU | If passwords exist in the old PLC type, the password settings are also saved. |
| Save and write after PLC type change QCPU → other than QCPU | Password settings are not added. |
| Read/write IC card | |
| Read IC card | If passwords exist in the read source IC card, the password settings are also read. |
| Write IC card (to read source IC card) | Password settings are written to the write destination IC card. |
| Write IC card (to other than read source IC card) | Password settings are written to the write destination IC card. |
| Write IC card (read from PLC and write to IC card) | Password settings are written to the write destination IC card. |

19.2.1 Register new passwords/changing passwords

| | | |
|---|-------|----|
| A | Q/QnA | FX |
| × | ○ | × |

*: Compatible with the QCPU (Q mode).

[Purpose]

Registering passwords protects the data in the PLC (corresponding memory). (Q series only)

[Operating Procedure]

Select [Online] → [Password setup] → [Register password].

[Dialog Box]

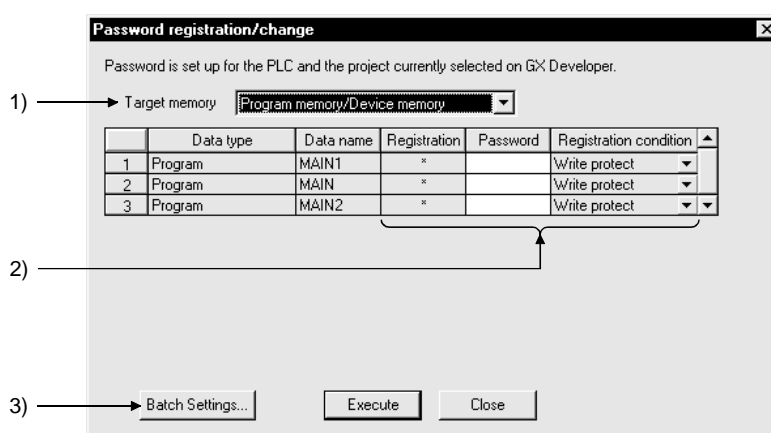

[Description]

1) Target memory

Set the memory whose password is to be registered or changed.

2) Registration, Password, Registration condition

○ Registration condition

× appears if a password has already been registered.

If you have selected [Register password] in Password setup, the data written to the PLC appears.

If you have chosen [Write to PLC], [Write IC memory card] or [Write image data], the data opening on the personal computer appears.

○ Password

Register four ASCII alphanumeric characters.

(Upper- and lower-case characters are differentiated.)

○ Registration condition

• Write protect

Write operation is restricted by the password.

• Read/Write protect

Write/read operation is restricted by the password.

• Clear

Password is cleared.

3) Batch settings

Batch-sets the same password and registration condition to each data.

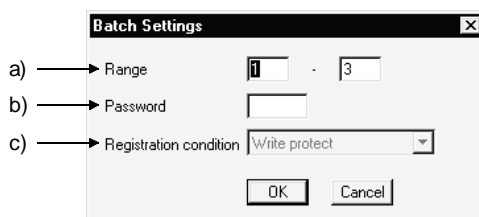

- a) Range
Set the range where the same password will be batch-set.
- b) Password
Register four alphanumeric characters in ASCII code.
(Upper- and lower-case characters are differentiated.)
- c) Registration condition
 - Write protect
Write operation is restricted by the password.
 - Read/Write protect
Write/read operation is restricted by the password.
 - Clear
Password is cleared.

POINTS

- When changing the password
After setting a new password in the Register/Change password dialog box, set the old password in the Check password dialog box.
- If you forgot the password
Format the PLC memory.
However, this also clears all data including the passwords, all data should be written once more.
- When erasing the passwords in the project data
Choose "Clear" as the registration condition in the password setting for Write IC memory card or Write to PLC, and save the project.
- "Checking password" appears during communications with the PLC, but it is also displayed when no password has been set.
Checking password : Passwords and setting conditions of all files are checked.

19.2.2 Delete the passwords

| | | |
|---|-------|----|
| A | Q/QnA | FX |
| × | ○* | × |

*: Compatible with the QCPU (Q mode).

[Purpose]

Deletes the passwords which have been set in the files within the PLC. (Q series only)

[Operating Procedure]

Select [Online] → [Password setup] → [Delete password].

[Dialog Box]

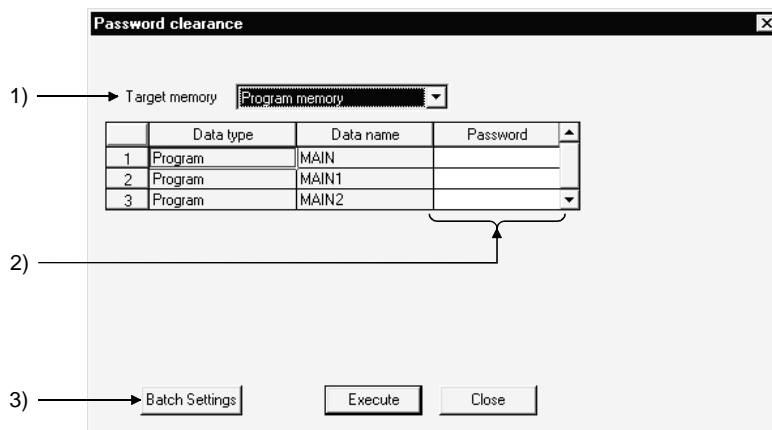

[Description]

- 1) Target memory
Set the memory whose passwords will be deleted.
- 2) Password
Set the passwords currently registered.
- 3) Batch settings
Batch-deletes the passwords and registration conditions.

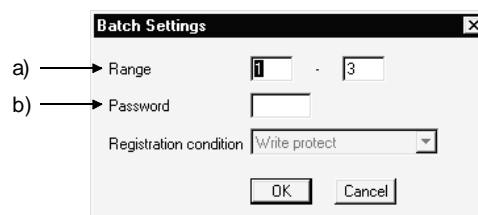

- a) Range
Set the range where the passwords and registration conditions will be batch-deleted.
- b) Password
Set the password currently registered.
Take care to differentiate between the upper- and lower-case characters.

POINT

If the same data name exists in the project, the password of the project data will also be deleted.

19.2.3 Disable the passwords

| | | |
|---|-------|----|
| A | Q/QnA | FX |
| × | ○* | × |

*: Compatible with the QCPU (Q mode).

[Purpose]

Disables the passwords which have been set in the files within the PLC. Disabling does not delete the passwords which have been set to the data in the PLC. It enables access to the PLC. (Q series only)

[Operating Procedure]

Select [Online] → [Password setup] → [Disable password].

[Dialog Box]

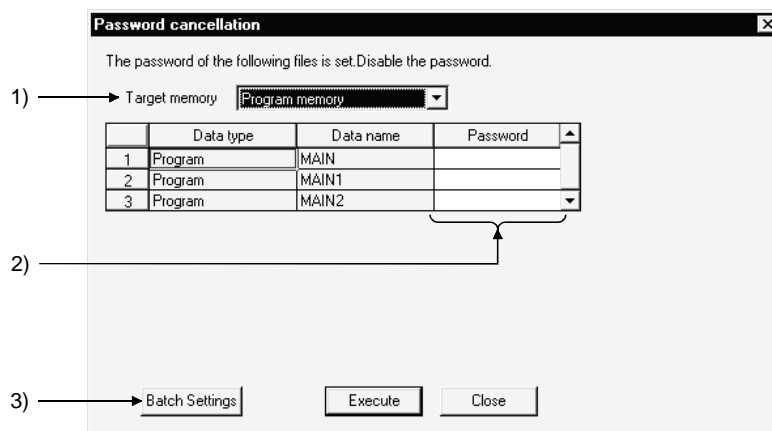

[Description]

- 1) Target memory
Set the memory whose passwords will be disabled.
- 2) Password
Set the passwords currently registered.
- 3) Batch settings
Batch-disables the passwords and registration conditions.

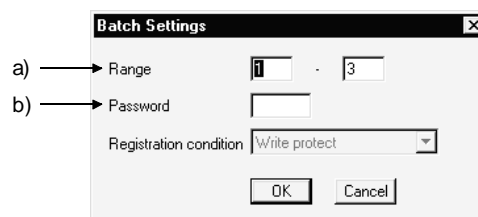

- a) Range
Set the range where the passwords and registration conditions will be batch-disabled.
- b) Password
Set the password currently registered.
Take care to differentiate between the upper- and lower-case characters.

POINT

Note that the password disable setting is not made valid unless the project where the passwords have been set is closed.

20. PLC MEMORY

This chapter describes PLC memory all-clear, formatting, memory area sorting, and time setting for the internal clock of the PLC.

20.1 Clearing the PLC Memory

20.1.1 All-clearing on ACPU memory

| A | Q/QnA | FX |
|---|-------|----|
| ○ | × | × |

[Purpose]

All-clears the device memory and memory cassette of A series PLCs.

[Operating Procedure]

Select [Online] → [Memory Clear PLC memory]

[Dialog Box]

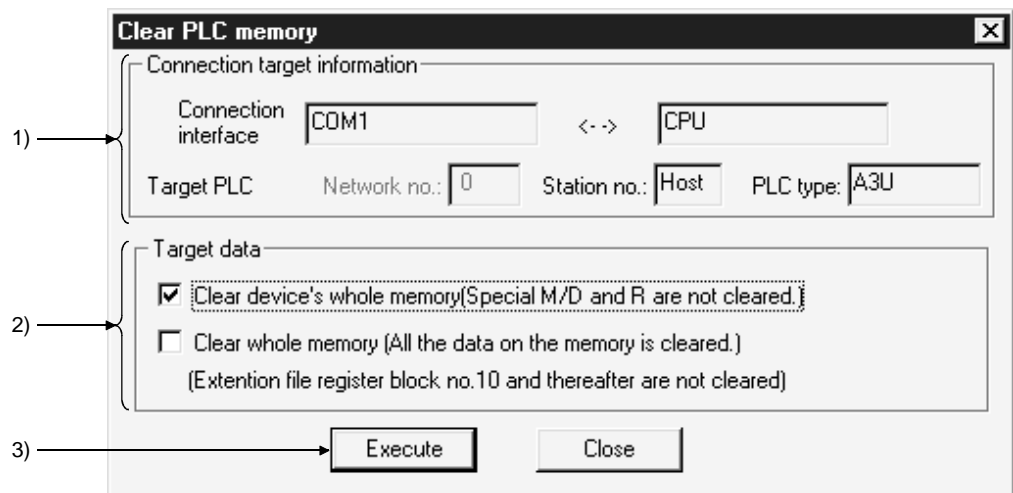

[Description]

1) Connection target information

Indicates information on the connection destination designation.

2) Target data

Clear device's whole memory (Special M/D and R are not cleared.)

Checking this check box to select it clears all the data in the device memory in the PLC.

However, special relays, special registers, and file registers are excepted.

Clear whole memory (All the data on the memory is cleared.)

Checking this check box to select it clears all the data in the memory cassette of the PLC with the exception of block No. 10 onward of the extension file registers.

- 3) **Execute** button
Click this button after setting the necessary settings.

| POINTS |
|--|
| <ul style="list-style-type: none">• Device memory all clear can only be executed when the PLC is in the STOP state• When the data in a memory cassette is all-cleared, the range cleared is 144K bytes. Data beyond the 144K byte range (from extension file register block 10 onward) is not cleared.• After all-clearing the data in a memory cassette, all of the data values in the memory cassette are "1." When file registers (R) are set and read after all clear, the result is HFFF (K-1). |

20.1.2 All-clearing the QCPU, QnACPU device memory

| | | |
|---|-------|----|
| A | Q/QnA | FX |
| × | ○ | × |

[Purpose]

All-clears the device memory of a Q/QnA series PLC.
The flash ROM cannot be all-cleared.

[Operating Procedure]

Select [Online] → [Clear PLC memory].

[Dialog Box]

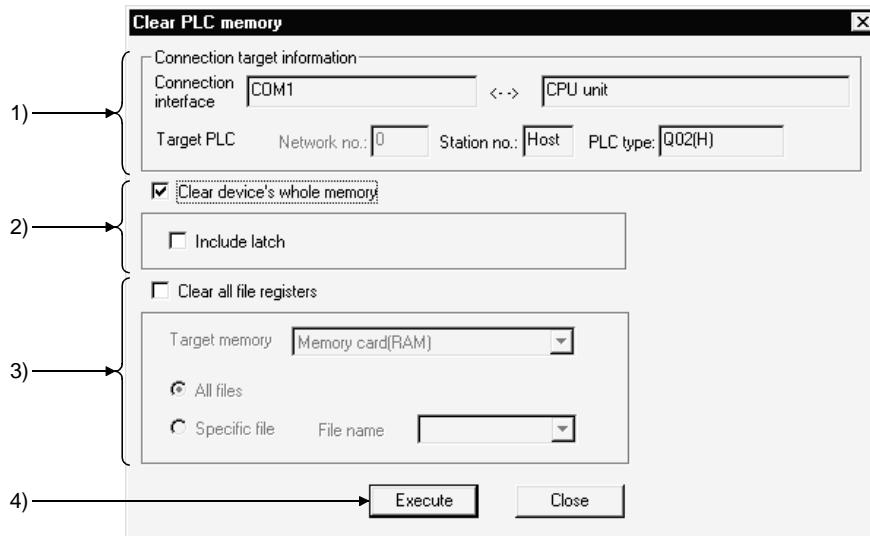

[Description]

- 1) **Connection target information**
Indicates information on the connection destination designation.
- 2) **Clear device's whole memory**
When this check box is checked to select it, the device memory is all-cleared.
You can set whether or not the devices designated in latch range designation are cleared.
- 3) **Clear all file registers**
Sets all file register data to "0."
The area and file names are not cleared.
To designate a file, designate the applicable memory and the file name.
- 4) **Execute button**
Click this button after setting the necessary settings.

| |
|---|
| POINTS |
| <ul style="list-style-type: none"> • If the latched range is included in the device memory all clear operation, the latch clear key invalid area is also cleared. • All clear is not possible when the PLC is in the RUN state. |

20.1.3 All-clearing an FXCPU memory

| | | |
|---|-------|----|
| A | Q/QnA | FX |
| × | × | ○ |

[Purpose]

All-clears the memory in an FX series PLC.

[Operating Procedure]

Select [Online] → [Clear PLC memory].

[Dialog Box]

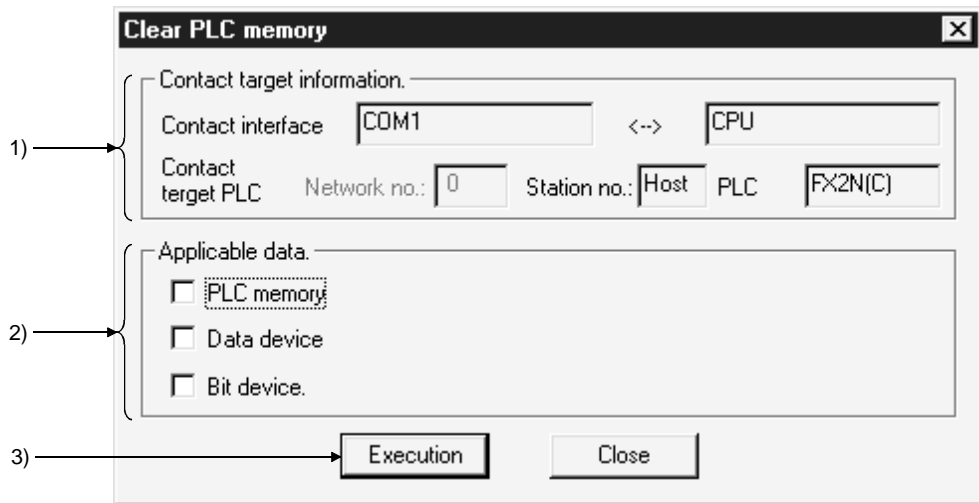

[Description]

- 1) **Connect target information**
Indicates information about the connection destination designation.

- 2) **Applicable data**
 - PLC memory**
When this check box is checked to select it, all of the data in the PLC is cleared. (Programs, comments, parameters, file registers, device memory)

 - Data device**
When this check box is checked to select it, the registers in the PLC are cleared to "0."
(Data registers, file registers, RAM file registers, special registers)

 - Bit device**
When this check box is checked to select it, all of the bit devices in the PLC are turned OFF.
(X, Y, M, S, T, C)
The present values of T and C devices are also set to 0.

- 3) **Execution** button
Click this button after setting the necessary settings.

| |
|--------|
| POINTS |
|--------|

Execution conditions

• PLC memory

Memory : Internal memory, RAM/EEPROM (protect switch: OFF) cassette.
All clear cannot be executed with an EEPROM (protect switch ON)
or EPROM cassette.

• Data device

Memory : Same as the execution conditions for "PLC memory."

• Bit device

Memory : Can be executed with all memories

Operate the PLC in the STOP state. The memory cannot be cleared in the RUN state.

20.2 Formatting a QCPU(Qmode), QnACPU Memory

| A | Q/QnA | FX |
|---|-------|----|
| × | ○ | × |

[Purpose]

Formats the PLC internal RAM or IC memory card of Q/QnA series models.
 SRAM card and ATA card can be formatted.
 The flash ROM cannot be formatted.

[Operating Procedure]

Select [Online] → [Format PLC Memory].

[Dialog Box]

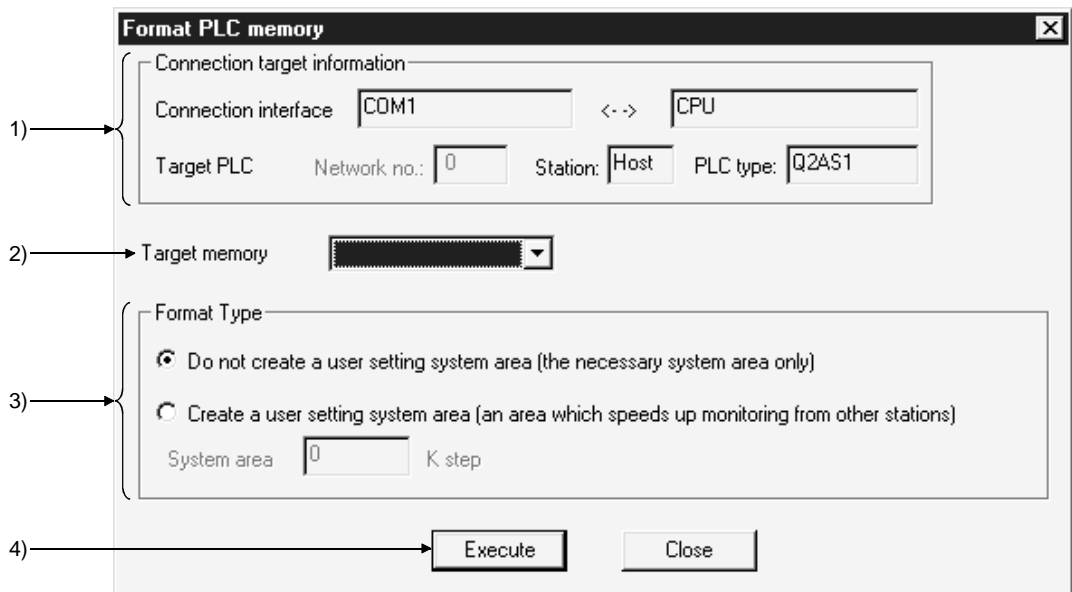

[Description]

- 1) **Connection target information**
 Indicates information on the connection destination designation.
- 2) **Target memory**
 Sets the object of PLC memory formatting.
- 3) **Format Type**
 - Do not create a user setting system area (the necessary system area only)
 Only the system area that is essential for the applicable memory is created.
 - Create a user setting system area (an area which speeds up monitoring from other stations)
 A mandatory system area and a system area for high-speed monitoring from other stations (user-set) are created.
 The setting range is 0 to 15K steps.
- 4) **Execute** button
 Click this button after setting the necessary settings.

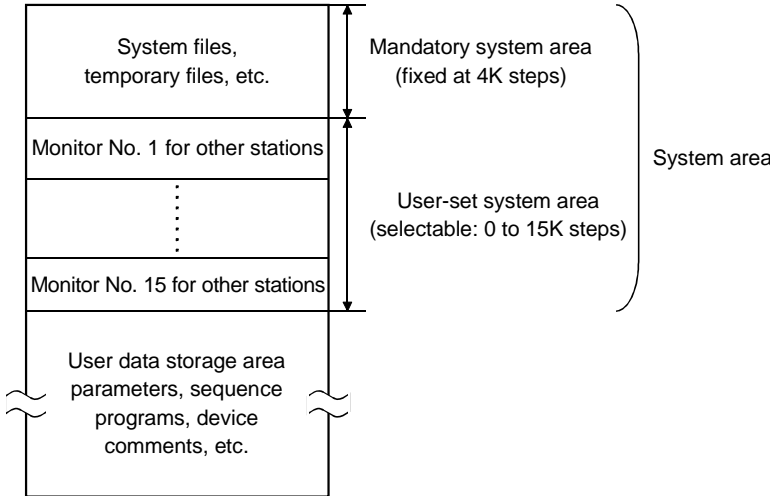
| POINTS | |
|---|--|
| <ul style="list-style-type: none"> • There are two types of system area: "mandatory" and "user-set." The mandatory system area is automatically created during formatting, but the user-set system area is created according to the user's required settings. • When the user-set system area is created, the data storage area for sequence programs and other data is reduced. Check the data capacity before setting the range for the user-set system area. | <p style="text-align: center;">QnACPU internal RAM</p>  |
| <ul style="list-style-type: none"> • Files in the system area cannot be displayed as a data list. • Create the user-set system area in the internal RAM. If it is set in an IC memory card, the speed of other station monitoring will not change. | |

20.3 Sorting the QCPU(Qmode), QnACPU Memory

| | | |
|---|-------|----|
| A | Q/QnA | FX |
| × | ○ | × |

[Purpose]

Sorts the data in the internal RAM or IC memory card of a Q/QnA series PLC to secure contiguous free memory.
The flash ROM cannot be sorted.

[Operating Procedure]

Select [Online] → [Arrange PLC memory].

[Dialog Box]

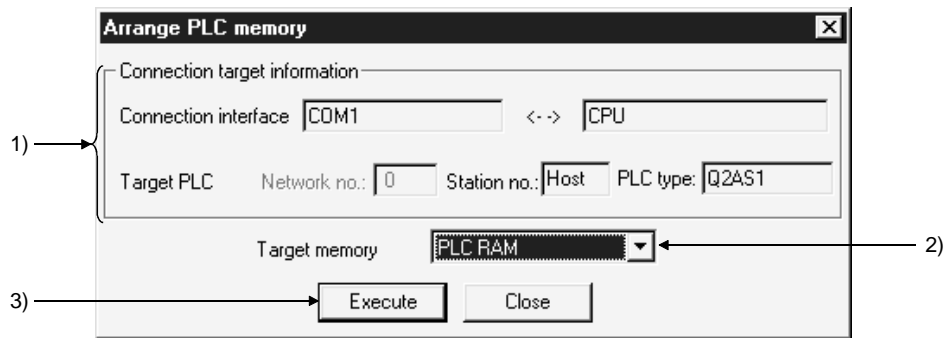

[Description]

- 1) Connection target information
Indicates information on the connection destination designation.
- 2) Target memory
Sets the PLC memory that is to be sorted.
- 3) **Execute** button
Click this button after setting the necessary settings.

| | POINT | | |
|-----|--|---|--|
| | An example of the execution of PLC memory sorting is given below. | | |
| 28K | | | |
| | <p>Program B deleted</p> | <p>PC memory sort</p> | |
| | <ul style="list-style-type: none"> • Total free capacity 8K • Max. contiguous free area 8K | <ul style="list-style-type: none"> • Total free capacity 14K • Max. contiguous free area 8K | <ul style="list-style-type: none"> • Total free capacity 14K • Max. contiguous free capacity 14K |
| | <p>Note that PLC memory sorting is not possible in the following cases.</p> <ol style="list-style-type: none"> 1. When the drive memory is faulty. 2. When one file is not stored in a single contiguous area. | | |

20.4 Setting for the PLC's Clock

| | | |
|---|-------|----|
| A | Q/QnA | FX |
| ○ | ○ | ○ |

[Purpose]

Sets the time for the internal clock of the PLC.

[Operating Procedure]

Select [Online] → [Set time]

[Dialog Box]

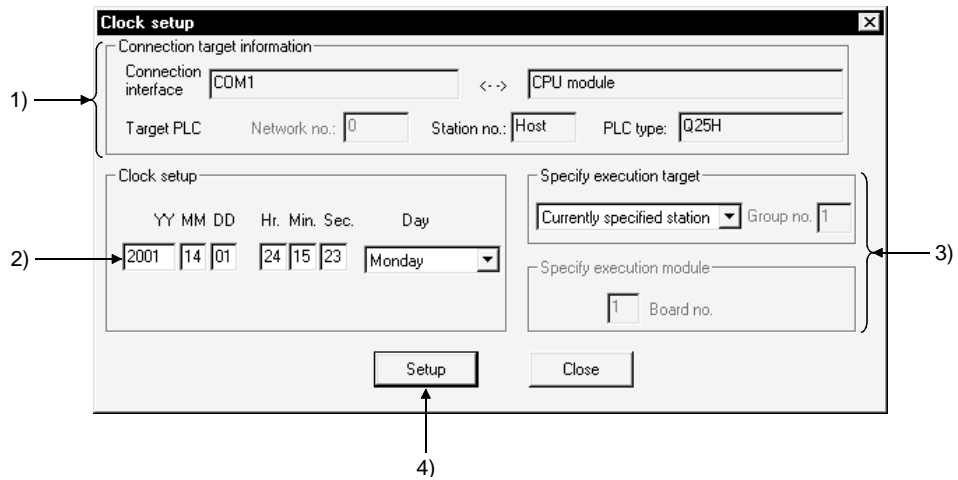

[Description]

- 1) Connection target information
Indicates information on the connection destination designation.

- 2) Clock setup
Sets the date, time, and day of the week.
For the Q series, enter the year in four digits. (Example: 2000)
You cannot set the year 2038 or later.

- 3) Specify execution target
Sets the location where the clock setting is to be made.

| | |
|-----------------------------|---|
| Currently specified station | Executed only at the station with the connection destination designation. |
| Specify all station | Executed at all stations of the network designated as the presently designated station. 1 to 4 modules can be set for execution module designation. |
| Specify group | Executed in a specific group of the network designated as the presently designated station. Set 1 to 4 modules for execution module designation and set the group number. |

This setting is not possible with the FX series.

4) **Setup** button

Click this button after setting the necessary settings.

With the A series, clock setting can only be executed when the PLC is in the STOP state.

With the Q/QnA series and FX series, it can be executed even when the PLC is in the RUN state.

POINTS

- Clock setting is not possible for A0J2HCPU, A2CCPU and A2CJCPU since they do not have a clock function.
- With the A series, when the applicable station is in the RUN state, first set it to the STOP state using remote operation or other means, then carry out clock setting.
- With the A series, clock setting is possible regardless of the ON/OFF setting of the special relay for clock setting "M9028."
However, after execution, "M9208" goes OFF.
- With the Q/QnA series, clock setting is possible regardless of the ON/OFF status of the device for clock setting "SM1028."
Note that the ON/OFF status of "SM1028" does not change after execution.
- The applicable PLCs in the FX series are as follows.
FX_{2N} series (internal clock)
FX, FX₂, FX_{2C} (only when RTC cassette is mounted)
- With the FX series, clock setting is possible regardless of the ON/OFF status of the special relay for clock setting.
- Note that in clock setting, an error equivalent to the transmission time is generated.

21. DIAGNOSIS

Diagnosis displays the error statuses, fault history, etc. of the programmable controller, and carries out checks which depend on the network, including system status checks.

21.1 Diagnosing the PLC

21.1.1 Diagnosing an ACPU

| | | |
|---|-------|----|
| A | Q/QnA | FX |
| ○ | × | × |

[Purpose]

Displays the status and error codes of an A series CPU.
 Present ERROR indicates the error normally monitored, and Error log indicates the history status when the PLC Diagnostics window has opened.

[Operating Procedure]

Select [Diagnostics] → [Diagnostics PLC].

[Dialog Box]

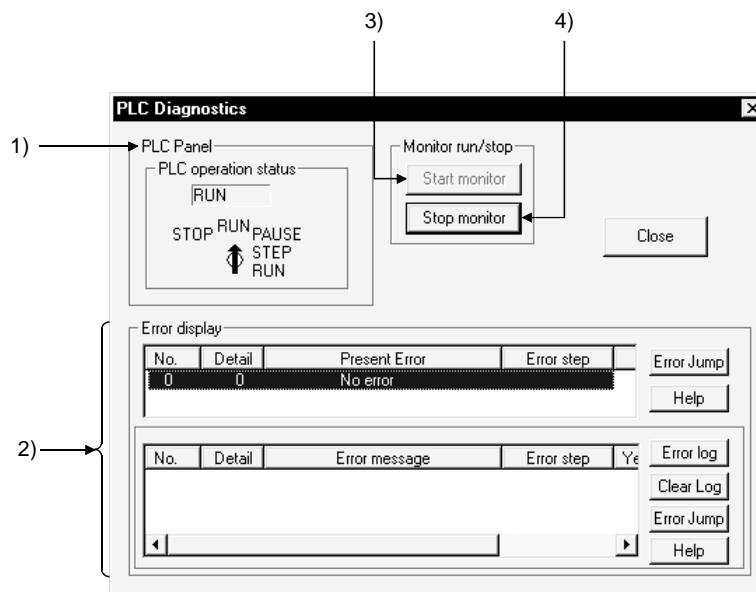

[Description]

- 1) CPU Panel
 Indicates the status of the PLC designated as the connection destination.

- 2) Error display explanation
 The upper error display field shows the current error.
 The lower error display field shows the error history.
 No. indicates the error code and Detail indicates the detailed error code.
 With the **PLC error** button, you can confirm the error detail.

For the QCPU-A, AnUCPU and AnACPU, clicking the **Error log** button displays up to 16 latest errors.

For the QCPU-A, AnUCPU and AnACPU, clicking the **Clear log** button clears the error history.

Choosing the error item and clicking the **Error Jump** button causes a jump to the corresponding sequence program. A jump takes place for any of the following errors that occurred from the ACPU.

10 INSTRUCT CODE ERR

13 CAN'T EXECUTE(P)

15 CAN'T EXECUTE(I)

46 SP. UNIT ERROR

50 OPERATION ERROR

A jump does not occur for SFC and SUB program errors.

The occurrence of a sequence program error causes a jump to MAIN.

- 3) **Start monitor** button
 Clicking this button initiates communication with the PLC and updates the display.
 On clicking the **Current error** button or the **Error log** button, monitoring is automatically stopped.
- 4) **Stop monitor** button
 Clicking this button stops communication with the PLC and holds the display.

| |
|-------|
| POINT |
|-------|

| |
|---|
| Display and clearance of the error history is possible only with QCPU-A, AnACPU and AnUCPU. |
|---|

21.1.2 Diagnosing a QCPU(Qmode), QnACPU

| | | |
|---|-------|----|
| A | Q/QnA | FX |
| × | ○* | × |

*: Compatible with the QnACPU.

[Purpose]

Checks the status and errors of a Q/QnA PLC.

[Operating Procedure]

Select [Diagnostis] → [Diagnostics PLC]

[Diagnosis]

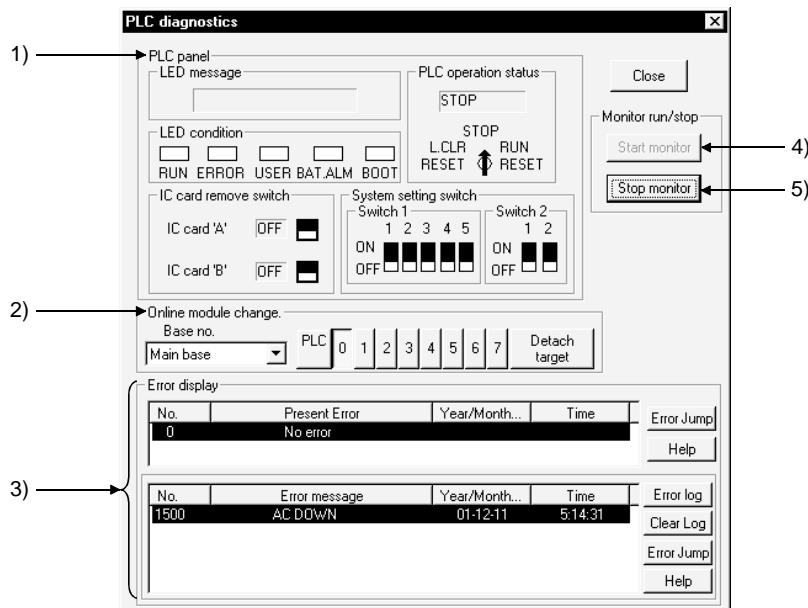

[Description]

1) CPU panel

Indicates the status of the PLC designated as the connection destination. When the Q2AS(H)/Q2AS(H)S1CPU is diagnosed, the positions of Switches 1 and 2 are displayed on GX Developer as indicated below.

| Switch 1 of PLC CPU | — | Switch 1 of GX Developer |
|---------------------|---|--------------------------|
| 1 is set to ON | → | 5 is displayed ON |
| 2 is set to ON | → | 4 is displayed ON |
| 3 is set to ON | → | 3 is displayed ON |
| 4 is set to ON | → | 2 is displayed ON |
| 5 is set to ON | → | 1 is displayed ON |

| Switch 2 of PLC CPU | — | Switch 2 of GX Developer |
|---------------------|---|--------------------------|
| 1 is set to ON | → | 2 is displayed ON |
| 2 is set to ON | → | 1 is displayed ON |

2) Online module change

Set the base and slot number for the module to be mounted or removed in the RUN status, then click the [Detach target] button. Masked for the QCPU(Qmode).

3) Error display

Clicking the [Error log] button displays up to 16 of the most recent errors.

Clicking the [Clear log] button clears the error history in the PLC.

Clicking the [Error jump] button causes a jump to the sequence program step number at which the currently selected error occurred.

- 4) **Start monitor** button
Clicking this button initiates communication with the PLC and updates the panel display.
- 5) **Stop monitor** button
Clicking this button initiates communication with the PLC and updates the display.
On clicking the **Current error** button or the **Error log** button, monitoring stops automatically.

[Operating Procedure]

The procedure for mounting/removing a module in the RUN status is as follows.

1. Set the applicable base and slot at 2) and click the **Detach target** button: the RUN module mount/remove dialog box is displayed.
2. Mount or remove the module at the designated slot of the designated base.
3. After completing mounting/removal of the module, click the **End substitution** button in the RUN module mount/remove dialog box.

POINT

By double-clicking the current error in the error display list box, the Common error information dialog box opens and displays the contents of SD5 to 15 (common information for errors), and SD16 to 26 (information on an individual error) of the PLC.

| No. | Error message | Year/Month... | Time |
|------|---------------|---------------|----------|
| 2110 | SP.UNIT ERROR | 98-9-28 | 18:13:27 |

← Double-click the list item

Error details X

| | | | |
|--------------------------|---|------------------------------|-----------|
| Common error information | | Individual error information | |
| Unit no. | 0 | File name | MAIN .QPG |
| I/O No | 0 | SFC block | Nothing |
| | | SFC step | Nothing |
| | | SFC switching | Nothing |
| | | Block no. | 0 |
| | | Step | 0 |
| | | Sequence step | 30 |

21.1.3 Diagnosing the QCPU (Qmode)

| | | |
|---|-------|----|
| A | Q/QnA | FX |
| × | ○* | × |

*: Compatible with the QCPU (Q mode).

[Purpose]

Checks the PLC CPU for abnormal conditions and errors.
 When the function version B of the PLC CPU is used, No. 1 to No. 4 modules can be diagnosed.

[Operating Procedure]

Select [Diagnostics] → [PLC diagnostics]

[Diagnosis]

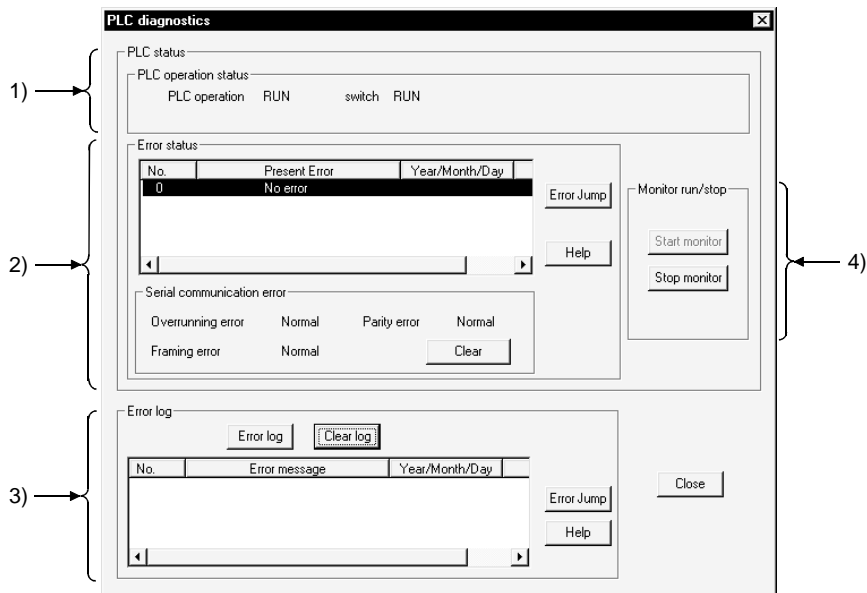

[Description]

- 1) **PLC operation status**
 None appears when a slot is empty in a multi-CPU system configuration.
- 2) **Present Error**
 Clicking the **Error Jump** button jumps to the sequence program step number in the currently selected error.
 Clicking the **Help** button shows the explanation screen corresponding to the error number selected in the Present Error display field.
 If two or more HELPs of the same error number exist, the search result screen starts.
 Choose the topic you want to display, and double-click (the **View** button).

3) Error log

Clicking the **Error log** button shows the latest error history.

Clicking the **Clear log** button clears the currently displayed error list.

Clicking the **Error Jump** button jumps to the sequence program step number in the currently selected error.

Clicking the **Help** button shows the explanation screen corresponding to the error number selected in the Present Error display field.

If two or more HELPs of the same error number exist, the search result screen starts.

Choose the topic you want to display, and double-click (the **View** button).

4) Serial communication error (Q00/Q01CPU only)

To be monitored when the serial communication function has been set.

Clicking the **Clear** button displays the following dialog box.



Click the **Yes** button to clear the error.

5) Monitor run/stop

Clicking the **Start monitor** button starts communications with the PLC CPU and updates the panel indication.

Clicking the **Stop monitor** button starts communications with the PLC CPU and stops the indication.

Clicking the current error button or **Error log** button automatically stops monitoring.

POINT

Double-clicking the current error in the error display area shows the definitions of SD5 to 15 (error common information) and SD16 to 26 (error individual information) of the PLC CPU in the error detail dialog box.

| No. | Error message | Year/Month... | Time |
|------|---------------|---------------|----------|
| 2110 | SP.UNIT ERROR | 98-9-28 | 18:13:27 |

← Double-click the list item

↓

Error details [X]

| Common error information | | Individual error information | |
|--------------------------|---|------------------------------|-----------|
| Unit no. | 0 | File name | MAIN .QPG |
| I/O No | 0 | SFC block | Nothing |
| | | SFC step | Nothing |
| | | SFC switching | Nothing |
| | | Block no. | 0 |
| | | Step | 0 |
| | | Sequence step | 30 |

[Close]

21.1.4 Diagnosing an FXCPU

| | | |
|---|-------|----|
| A | Q/QnA | FX |
| × | × | ○ |

[Purpose]

Displays the status and error codes of an FX series PLC.

[Operating Procedure]

Select [Diagnostics] → [Diagnostics PLC].

[Dialog Box]

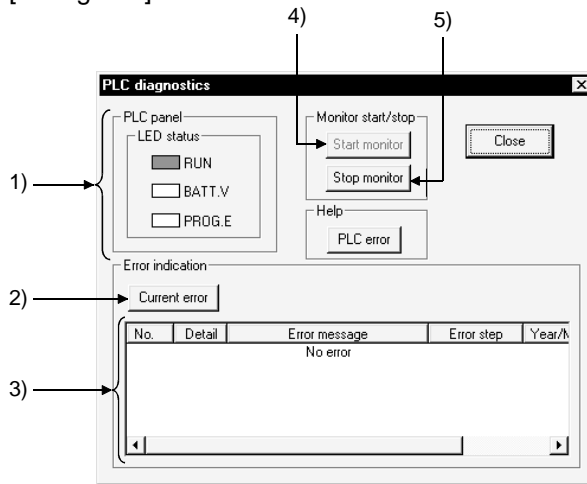

[Description]

1) PLC Panel

Indicates the status of the connected PLC.

RUN : Lit in green when the PLC is in the RUN status.

BATT.V : Lit in red when the voltage of the battery for memory back up has dropped.

PROG.E : Lit in red when an error has occurred (when one of the following is ON: M8061, M8064, M8065, M8066).

2) Current error button

Clicking this button displays errors that have occurred at the PLC.

The date and time values are not those when the error occurred but when the Current error button was clicked.

3) Error indication

Displays current errors at the PLC.

The error details are displayed as the error code and error message.

4) Start monitor button

Clicking this button initiates communication with the PLC and updates the display.

5) Stop monitor button

Clicking this button initiates communication with the PLC and holds the display.

21.2 Diagnosing a Network

| | | |
|---|-------|----|
| A | Q/QnA | FX |
| ○ | ○ | × |

[Purpose]

Checks the status of MELSECNET (II) or MELSECNET/10, MELSECNET/H from the host station, which is designated the connection destination.

[Operating Procedure]

Select [Diagnostics] → [Diagnostics network].

[Dialog Box]

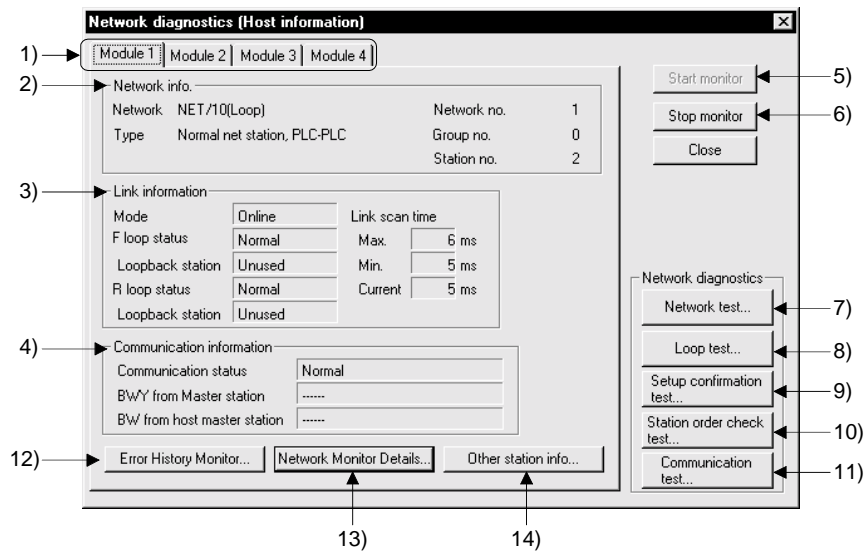

[Description]

- 1) Link module selection tabs
Switch among network diagnosis result displays for the first to fourth link modules.
With AnNCPU and AnACPU, there are only module 1 and module 2.
- 2) Network info.
Indicates the network information of the host station set in connection destination designation.
With MELSECNET (II), the network No. and group No. are not displayed.
- 3) Link information
Indicates the network status.
- 4) Communication information
Indicates the communication status of the applicable network.
For MELSECNET/10, MELSECNET/H only the communication status is indicated.

- 5) **Start monitor** button
Clicking this button starts network diagnostics.
During monitoring, the indication is updated.
- 6) **Stop monitor** button
Clicking this button stops network diagnostics.
During a monitoring stop, the indication is held.
- 7) **Network test** button
Refer to Section 21.2.1.
- 8) **Loop test** button
Refer to Section 21.2.2.
- 9) **Setup confirmation test** button
Refer to Section 21.2.3
- 10) **Station order check test** button
Refer to Section 21.2.4
- 11) **Transmission Test** button
Refer to Section 21.2.5
- 12) **Error History Monitor** button
Refer to Section 21.2.6.
- 13) **Network Monitor Details** button
Refer to Section 21.2.7.
- 14) **Other station info** button
Refer to Section 21.2.8.

POINTS

- Indicates the number of link modules that can be mounted for each network type.
MELSECNET (II) 2
MELSECNET/10, MELSECNET/H 4
- The object of network diagnosis is the network of the connected host station.
To change the network that is the object of diagnosis, change the applicable station in the connection destination designation.
- About host station information and other station information:
When the routing is through E71, an AnUCPU executes monitoring equivalent to that of an AnACPU, which means that MELSECNET (II) information can be monitored but MELSECNET/10, MELSECNET/H modules cannot be monitored.

21.2.1 Testing a network

| | | |
|---|-------|----|
| A | Q/QnA | FX |
| ○ | ○ | × |

[Purpose]

Starts/stops link operation for the MELSECNET/10, MELSECNET/H host station/designated station/ all stations.

[Operating Procedure]

Select [Diagnostics] → [Diagnostics network] → then click the **Network test** button.

[Dialog Box]

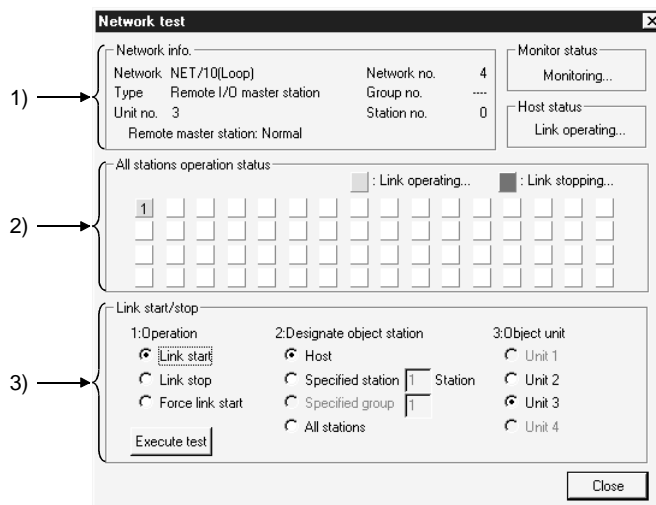

[Description]

1) Network info.

Indicates the network information of the host station designated in the connection destination designation.

2) All stations operation status

Indicates the link status of the modules for which the test is executed.

3) Link start/stop

The order of priority for link start/stop is as follows:
Link start < Link stop < Forced link start

<Start>

- Stations that have been stopped from the host station can be started.
- Stations that have been stopped from an other station cannot be started.

<Stop>

- Stations can be stopped from the host station or other stations.

<Forced start>

- Stations can be started regardless of whether they were stopped from the host station or an other station.
However, forced starting in station units is not possible when all stations are stopped.
- Forced start is not possible when there is an other station designation for the connection destination.
- Whether or not execution is possible at a personal computer can be checked by monitoring SB and SW; whether execution has been started/stopped at the host station can be checked by monitoring SW0000 to SW0004 and SB0000 to SB0003.
- When the connection destination is routed through C24, UC24, or QC24, execution is possible.
- Execution is not possible when using a MELSECNET (II)/MELSECNET/10 board.
- Execution is not possible with routing through E71/QE71.

21.2.2 Performing a loop test

| | | |
|---|-------|----|
| A | Q/QnA | FX |
| ○ | ○ | × |

[Purpose]

Checks the status of the MELSECNET/10, MELSECNET/H loop.

[Operating Procedure]

Select [Diagnostics] → [Diagnostics network] → **Loop test** button.

[Dialog Box]

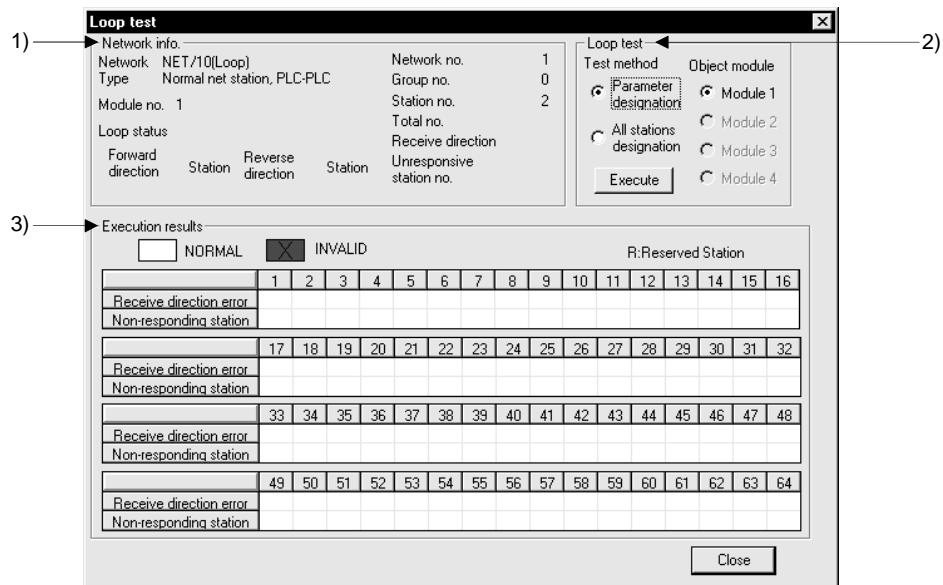

[Description]

1) Network Information

Shows own station's network information set in Connection destination specification.

2) Loop Test

Set the test enact method and target module, and click the **Execute** button to start a loop test.

A loop test made with connection of remote stations may be conducted only on the connected remote I/O network.

A change in target module will result in an error.

• Test enact method

○ Parameter settings

Tests the parameter-set stations (except the reserved stations).

When there are no parameter settings, all stations will be tested.

○ Set all nodes

Tests all stations.

• Object unit

Choose the module on which a loop test will be conducted.

The default is the module selected in line monitor (own station).

3) Execution Result

Shows the number of stations and results (normal/abnormal, reserved stations: R).

21.2.3 Performing a setting confirmation test

| | | |
|---|-------|----|
| A | Q/QnA | FX |
| ○ | ○ | × |

[Purpose]

Checks the status of the following settings made for each station: station number, network number, group number.

[Operating Procedure]

Select [Diagnostics] → [Diagnostics network] → then click the **Setup confirmation test** button.

[Dialog Box]

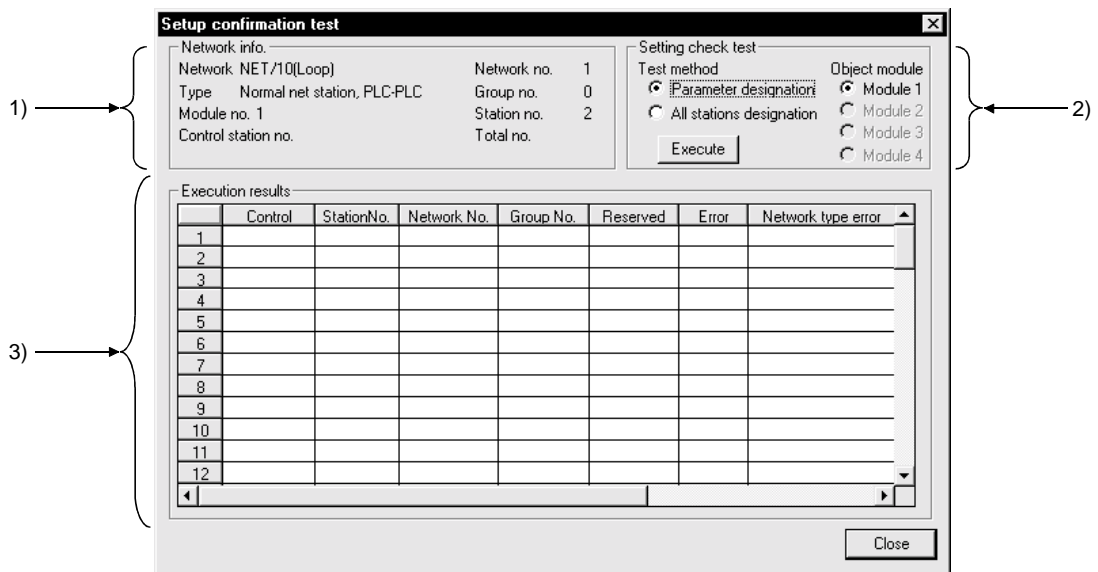

[Description]

1) Network info.

Indicates the network information of an other station designated at the connection destination.

2) Setting check test

• Test method

○ Parameter designation

All the stations set in the parameters, with the exception of reserve stations, are subject to the setting confirmation test.

If no network settings have been set (default), all stations are subject to the test.

○ All stations designation

All stations are subject to the setting confirmation test.

There is no number of stations designation.

• Object unit

The module selected for the line monitor (own station) is set as the default. If there is no MELSENET/10, MELSENET/H module, an error occurs.

3) Execution results

<Station No.>

Indicates station numbers up to that subject to the setting confirmation test.
Up to 64 stations are indicated.

<Control>

If control stations have been set at two or more locations, " * " is displayed.

<Station No.>

If stations have been set at two or more locations, " * " is displayed.

<Network No. >

If the same station number has been set at two or more locations, " * " is displayed.

Stations whose network number differs from the network number of the host station are indicated in red.

<Group No.>

Indicates the group number of the station where the setting confirmation test is carried out.

In the case of a remote I/O net, the indication for stations with errors is blank.

<Reserve stations>

" * " is displayed for stations set as reserve stations in the parameters.

(Where "Parameter designation" has been set as the test execution designation.)

<Error>

If a station is reserved in the parameter settings, or a module in all station designation is faulty, " * " is displayed.

<Network type error> QnA series only

" * " is displayed for stations whose parameter setting and actual connection type do not agree.

<Multiplex remote master station duplication> QnA series only

" * " is displayed for stations where there is more than one submaster station of the same network.

<Parallel remote submaster station duplication> QnA series only

" * " is displayed for stations where there is more than one submaster station of the same network.

| POINTS |
|---|
| <ul style="list-style-type: none">• The test cannot be executed at more than one station at the same time.• Note that cyclic transmission is stopped while the test is being executed. |

21.2.4 Performing a station order confirmation test

| | | |
|---|-------|----|
| A | Q/QnA | FX |
| ○ | ○ | × |

[Purpose]

Confirms the station order in the forward/reverse loops of a MELSECNET/10, MELSECNET/H system.

[Operating Procedure]

Select [Diagnostics] → [Diagnostics network] → click the **Station order check test** button.

[Dialog Box]

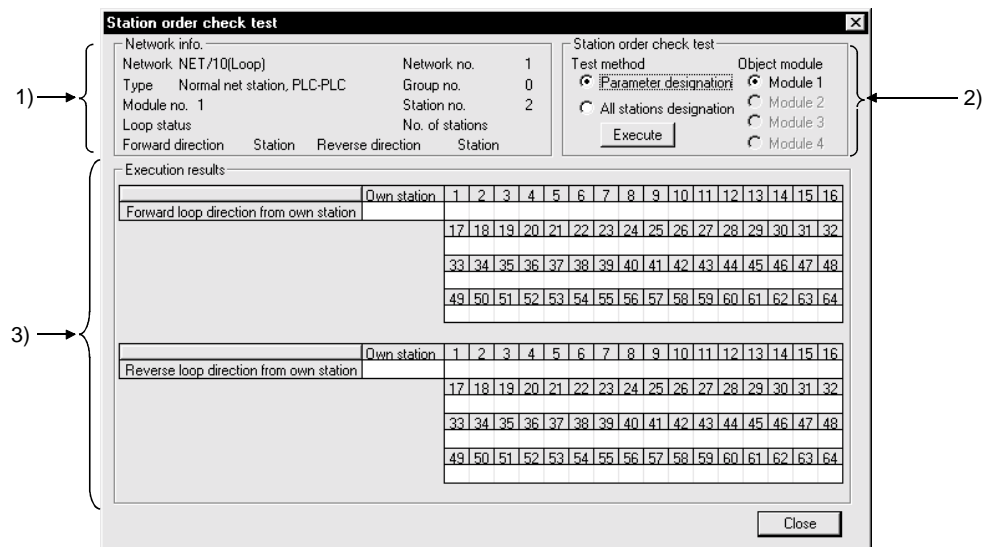

[Description]

1) Network info.

Indicates the network information of an other station designated at the connection destination.

For the loop status, the forward/reverse loop / forward loop / reverse loop / loopback status is indicated.

The total number of stations indicated is that determined by including the reserve stations in the test.

2) Loop test

• Test method

○ Parameter designation

Stations set in the parameters, with the exception of reserve stations, are subject to the test.

If the network parameters have not been set (default), all stations are subject to the test.

○ All stations designation

All stations are subject to the station order confirmation test.

There is no number of stations designation.

○ Object unit

The module selected for the line monitor (own station) is set as the default. If there is no MELSECNET/10, MELSECNET/H module, an error occurs.

3) Execution results

The order of stations in the forward loop direction and reverse loop direction, starting from the host station, is indicated.

For loopback, only the order in the forward loop direction from the host station is indicated.

The station numbers of reserve stations are not indicated.

| |
|--------|
| POINTS |
|--------|

- | |
|---|
| <ul style="list-style-type: none">• The test cannot be executed at more than one station at the same time.• Note that cyclic transmission is stopped while the test is being executed. |
|---|

21.2.5 Performing a transmission test

| | | |
|---|-------|----|
| A | Q/QnA | FX |
| ○ | ○ | × |

[Purpose]

Conducts a transmission test between networks on the MELSECNET/10(H).

[Operating Procedure]

Select [Diagnostics] → [Diagnostics network] → **Transmission test** button.

[Dialog Box]

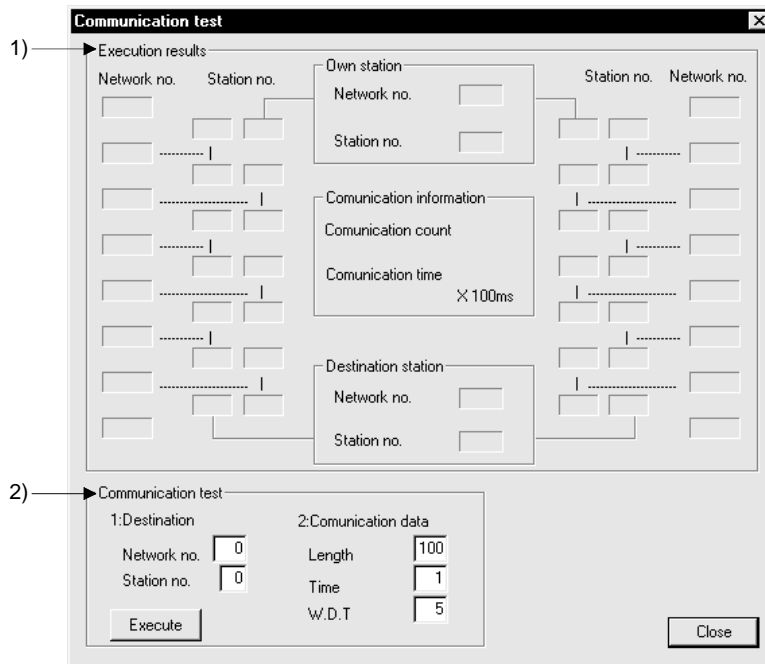

[Description]

- 1) Execution Result
Shows the transmission test results between the networks.
- 2) Communication Test
Set Destination Setting, Transmission Data Setting and Target Module, and click the **Execute** button to start a transmission test.
A change in target module will result in an error.
 - Destination Setting
Set the network No. (1 to 255 for A series, 1 to 239 for Q/QnA series) and station number (1 to 64).
 - Transmission Data Setting
Set Data length (1 to 900 bytes), Number of Transmission (1 to 100 times) and Transmission Inspection Time (1 to 100 seconds).

21.2.6 Monitoring the error history

| | | |
|---|-------|----|
| A | Q/QnA | FX |
| ○ | ○ | × |

[Purpose]

Shows the error history of the MELSECNET/10(H).

[Operating Procedure]

Select [Diagnostics] → [Diagnostics network] → **Error History Monitor** button.

[Dialog Box]

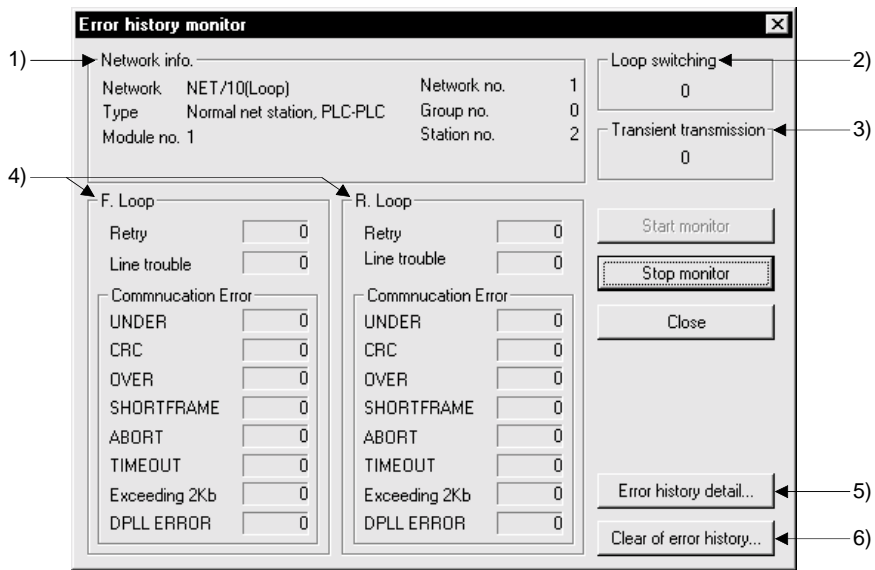

[Description]

- 1) Network Information
Shows each information of the network.
- 2) Loop switching
Shows the number of loop conversions.
- 3) Transient transmission
Shows the number of transient transmission errors.
- 4) F Loop/R Loop
Shows each item for monitoring execution.

- 5) **Error History Details** button
Shows the details of Number of Loop Conversions and Peer to Peer Transmission Error.

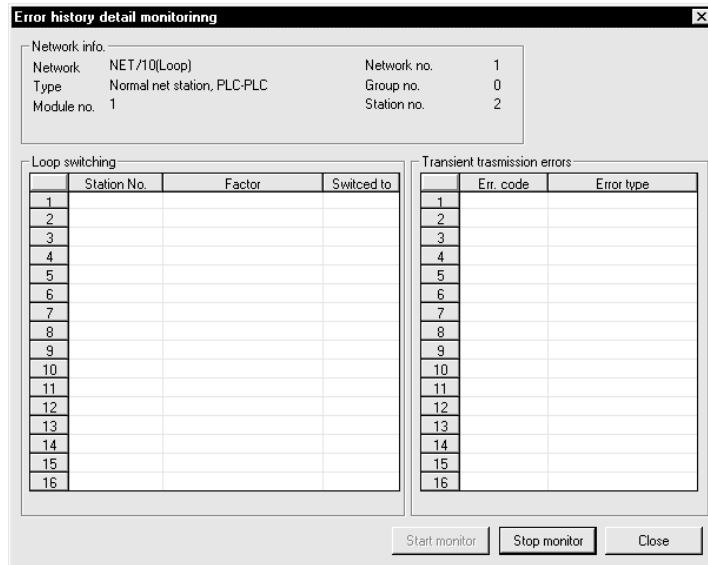

- 6) **Clear of Error History** button

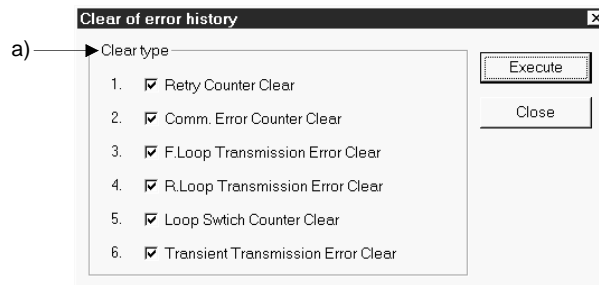

- a) Clear type
Choose any item to be cleared.

21.2.7 Network monitor details

| | | |
|---|-------|----|
| A | Q/QnA | FX |
| ○ | ○ | × |

[Purpose]

Shows the network line status of the MELSECNET/10(H).

[Operating Procedure]

Select [Diagnostics] → [Diagnostics network] → **Network Monitor Details** button.

[Dialog Box]

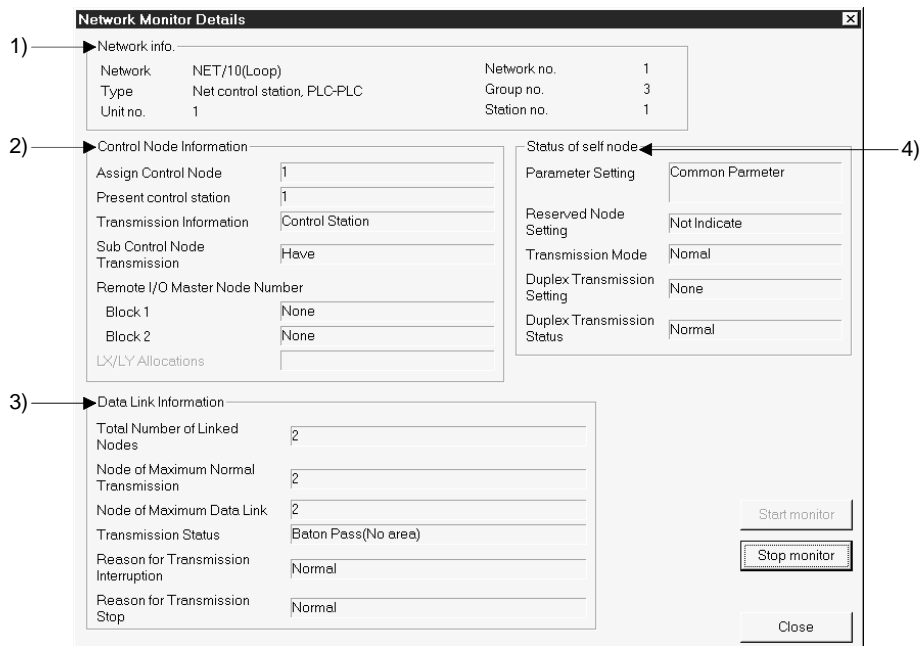

[Description]

- 1) **Network Information**
Shows each information of the network.
- 2) **Control Node Information**
Shows each information of the control station.
Remote I/O master station appears only for the inter-PLC network.
LX/LY assignment appears only for the remote I/O network.
- 3) **Data Link Information**
Shows each information of data link.
- 4) **Status of self node**
Shows each status of the own station.
Parameter setting appears only for the inter-PLC network.

21.2.8 Monitoring other station information

| | | |
|---|-------|----|
| A | Q/QnA | FX |
| ○ | ○ | × |

[Purpose]

Monitors other stations connected to MELSECNET(II), MELSECNET/10, MELSECNET/H.

[Operating Procedure]

Select **[Diagnostics]** → **[Diagnostics network]** → then click the **[Other station information]** button.

[Dialog Box]

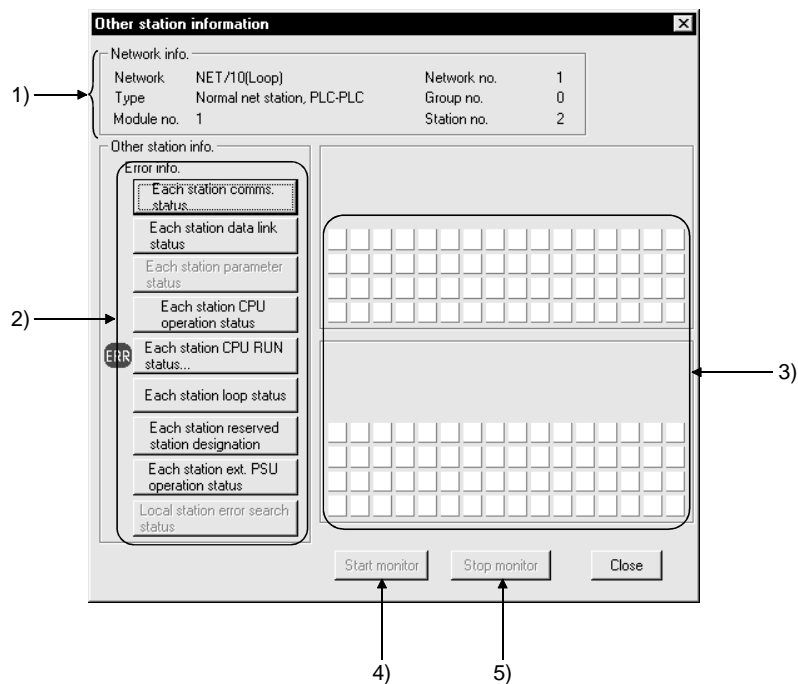

[Description]

- 1) **Network info.**
Indicates the network information of the other station designated at the connection destination.
- 2) **Error info.**
"ERR" will appear in the error information display field when the faulty station, STOP station, reserved station and station supplied with external power are detected for the corresponding items.
"RSV" will appear in the error information display field when the reserved station is specified.
Choose the corresponding item buttons to display their details in 3).
- 3) **Detailed error information display field**
When a station information item is selected, indicates the station status relevant to that item.
- 4) **[Start monitor] button**
Starts monitoring if it is stopped.
Not effective if monitoring is in progress.

- 5) **Stop monitor** button
 Stops monitoring when it is in progress.
 Not effective if monitoring is already stopped.

- The following other station information items cannot be selected with the A series.

| | | MELSECNET/10 | | | | | | MELSECNET(II) | |
|---|---|-----------------|-----|----------------|-----|----------------|-----|---------------|-------|
| | | MELSECNET/10 | | | | MELSECNET(II) | | — | |
| | | Control Station | | Normal Station | | Master Station | | Master | Local |
| | | Loop | Bus | Loop | Bus | Loop | Bus | — | — |
| 1 | Communication status for each station | ○ | ○ | ○ | ○ | ○ | ○ | ○ | × |
| 2 | Data link status for each station | ○ | ○ | ○ | ○ | ○ | ○ | × | × |
| 3 | Parameter status for each station | ○ | ○ | × | × | ○ | ○ | ○ | × |
| 4 | CPU operating state for each station | ○ | ○ | ○ | ○ | × | × | × | × |
| 5 | CPU RUN state for each station | ○ | ○ | ○ | ○ | × | × | ○ | ○ |
| 6 | Loop status for each station | ○ | × | ○ | × | ○ | × | ○ | × |
| 7 | Reserve station designation for each station | ○ | ○ | ○ | ○ | ○ | ○ | × | × |
| 8 | External power supply operation status for each station | × | × | × | × | × | × | × | × |
| 9 | Local station error detection status | × | × | × | × | × | × | ○ | × |

○: Can be selected ×: Cannot be selected (mask display)
 [Grey Box]: Different selection to GPPA, GPPQ possible/not possible

- The following other station information items cannot be selected with the Q/QnA series.

| | | MELSECNET/10, MELSECNET/H | | | | | | MELSECNET(II) | |
|---|---|---------------------------|-----|----------------|-----|----------------|-----|---------------|-------|
| | | MELSECNET/10, MELSECNET/H | | | | MELSECNET(II) | | — | |
| | | Control Station | | Normal Station | | Master Station | | Master | Local |
| | | Loop | Bus | Loop | Bus | Loop | Bus | — | — |
| 1 | Communication status for each station | ○ | ○ | ○ | ○ | ○ | ○ | ○ | × |
| 2 | Data link status for each station | ○ | ○ | ○ | ○ | ○ | ○ | × | × |
| 3 | Parameter status for each station | ○ | ○ | × | × | ○ | ○ | ○ | × |
| 4 | CPU operating state for each station | ○ | ○ | ○ | ○ | × | × | × | × |
| 5 | CPU RUN state for each station | ○ | ○ | ○ | ○ | × | × | ○ | ○ |
| 6 | Loop status for each station | ○ | × | ○ | × | ○ | × | ○ | × |
| 7 | Reserve station designation for each station | ○ | ○ | ○ | ○ | ○ | ○ | × | × |
| 8 | External power supply operation status for each station | ○ | × | ○ | × | ○ | × | × | × |
| 9 | Local station error detection status | × | × | × | × | × | × | ○ | × |

○: Can be selected ×: Cannot be selected (mask display)

■: Different selection from GPPA, GPPQ possible/not possible

21.3 Running CC-Link, CC-Link/LT Diagnostics

CC-Link, CC-Link/LT diagnostics monitor the network information of each station and diagnose and test the network status.

CC-Link diagnostics can be run via the PLC CPU when the CC-Link module is the master station/standby master station/local station.

| POINTS |
|--|
| <ul style="list-style-type: none"> The QCPU diagnoses the QJ61BT11 only. Use the AJ61BT11/A1SJ61BT11 module with the QCPU-A. When refresh parameters have been created in a sequence program for the A series, Data link start and Monitoring Other station, Network test are disabled. |

21.3.1 Monitoring the line (own station)

| A | Q/QnA | FX |
|---|-------|----|
| ○ | ○* | × |

*: Also compatible with the QCPU (Q mode) remote I/O.

[Purpose]

Monitors the own station line of CC-Link connected to the PLC CPU.

[Operating Procedure]

Select [Diagnostics] → [CC-Link / CC-Link LT diagnostics].

[Dialog Box]

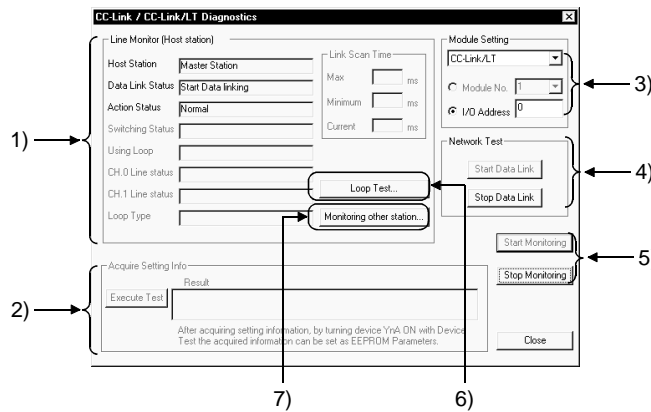

[Description]

- Own station information
The special M (SB) and special D (SW) assigned to the display items will be described below.
- Acquire the setting information (A/QnA series only)
Executing this item sets the CC-Link system status set to the work area of the CC-Link module.

- 3) **Module setting**
Select the CC-Link or CC-Link/LT to be monitored. (QCPU (Q mode) only)

Module No.

The setting is valid for CC-Link.

As the first to fourth modules, specify the modules set in [*].

I/O address No.

Specify the I/O address of the master module to be monitored.

POINTS

About module number setting

When the A/QnA series module of function version A is used or the CC-Link/LT is specified, the number of modules cannot be set, and therefore, make setting with the I/O address.

- 4) **Network test** (Test cannot be conducted when MELSECNET/H remote station is installed)
A data link start/stop is made for the CC-Link modules (all stations specified) set in Unit setting.

IMPORTANT

In the following system configuration, making a "data link stop" for the master station disables communications from GX Developer.

To make a data link start or resume communications from GX Developer, the PLC CPU of the station whose data link was stopped must be reset.

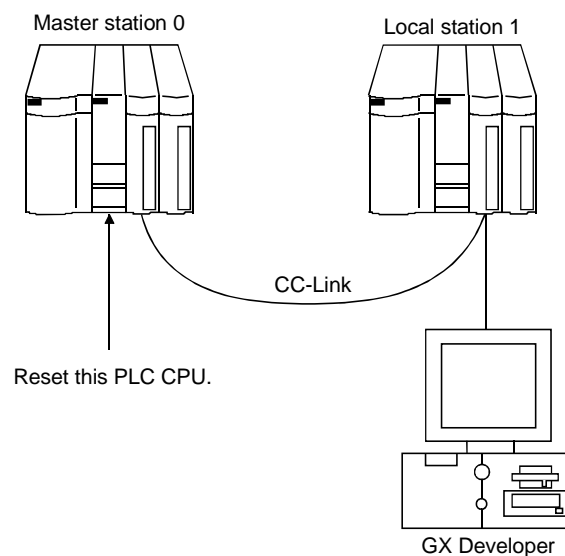

- 5) **Monitor start** / **stop** button
Used to start/stop the own station monitoring.
- 6) **Loop test** button
Refer to Section 21.3.2.
- 7) **Monitoring other station** button
Refer to Section 21.3.3.

POINTS

Do not perform a sequence program-based line test at the same time.

If performed at the same time, the line test may not be performed properly.

21.3.2 Conducting a line test

| | | |
|---|-------|----|
| A | Q/QnA | FX |
| ○ | ○* | × |

*: Also compatible with the QCPU (Q mode) remote I/O.

[Purpose]

Tests all stations or the specified station.
Valid only when the master station has been specified in Transfer setup.

[Operating Procedure]

Select [Diagnostics] → [CC-Link / CC-Link LT diagnostics]. → **Loop test** button.

[Dialog Box]

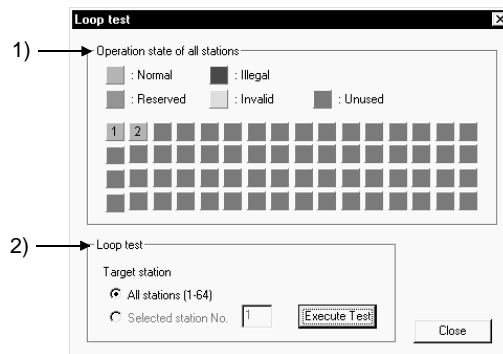

[Description]

1) All station monitor

Monitors the operating statuses of all stations connected to the specified master module.
Normal: Light blue, Illegal: Red, Reserved: Green, Invalid: Yellow, Unused: Gray

2) Loop test

A line test is made by specifying the own station or another station (station number).

All station: Test will be run on all 64 stations.
Selected station: Test will be conducted on the specified stations.
Specify the first one of the occupied stations.

<Example>

- When there are 4 and 2 occupied stations connected

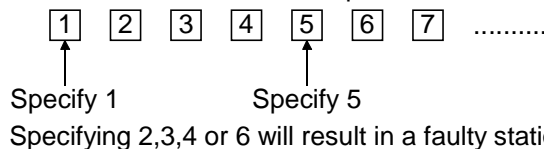

POINT

Do not perform a sequence program-based line test at the same time.
If performed at the same time, the line test may not be performed properly.

21.3.3 Monitoring the lines (other stations)

| | | |
|---|-------|----|
| A | Q/QnA | FX |
| ○ | ○* | × |

*: Also compatible with the QCPU (Q mode) remote I/O.

[Purpose]

Monitors the other station lines of CC-Link connected to the PLC CPU.
Can be executed only during Linking Data.

[Operating Procedure]

Select [Diagnostics] → [CC-Link / CC-Link LT diagnostics] →
[Monitoring other station] button.

[Dialog Box]

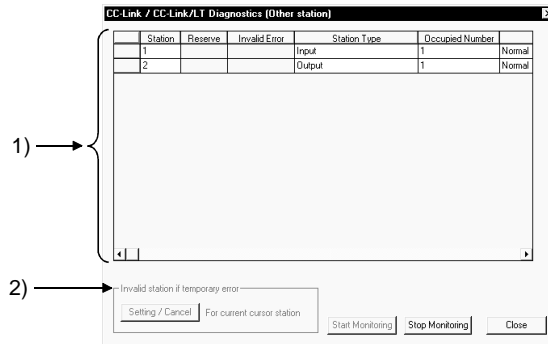

[Description]

- 1) Other station information
Displays the other station information.
If the host is a local station, other station monitor monitors the CC-Link mounting status and therefore the stations set as reserved stations are not displayed.
If the CC-Link/LT has been selected, the reserve setting, error invalid setting, transient error, company name and temporary error invalid station setting are masked.
- 2) Invalid station if temporary error (Setting cannot be conducted when MELSECNET/H remote station is installed)
A module is changed without the corresponding remote station being error-detected while it is online.

The temporary error invalidation setting must be made by specifying the first station number.

Therefore, when there is no parameter setting, the status and transient error information is shown on the assumption that one station occupies 32 points, and you must make this setting by specifying the station number for which you want to make the invalidation setting.

(The invalidation setting is ignored if it is made for the station which is not in the first position of actual assignment.)

3) Maker code

- The maker name or maker code of the equipment connected by CC-Link is displayed.
- The maker code appears if the maker name is not entered in the maker code list.
- The remote I/O is displayed blank since it does not have a maker name and a maker code.
- The maker code list (PARTNER.DAT) is saved in the installation destination of GX Developer and can be edited using a text editor or like available on the market.

Note that some maker codes may not be published for reasons of the partner makers.

When editing the file on the user side, follow the specifications of the following file format.

| | Maker Code | Company Name |
|---------------------------|--|---|
| | | English version |
| Max. number of characters | 5 characters | 255 characters |
| Usable characters* 1 | 0 to 9 | <ul style="list-style-type: none"> • Alphanumeric • Symbol |
| Remarks | Maker code not in 5 digits is ignored. | The display varies with the screen width. Up to about 75 characters in small font are displayed, but not more than that. |

*1: Any company name including , should be enclosed by "".

Example: "##### Co., Ltd."

The following is an example of displaying PARTNER.DAT using a text editor.

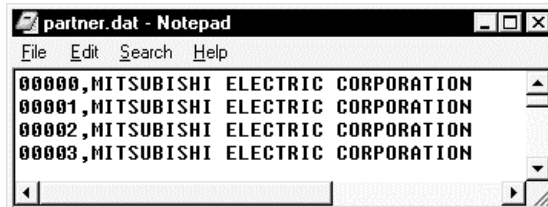

The following message appears if the maker code list does not exist in the installation destination of GX Developer or has been damaged.



POINT

Do not make a sequence program-based temporary error disabled station setting at the same time.
If performed at the same time, the temporary error disabled station setting may not be performed properly.

21.4 Making Ethernet Diagnostics

You can check various settings of the Ethernet module.

For details, refer to the sections which explain the error codes and buffer memory in the corresponding items of the following manuals.

- Q-Compatible Ethernet Interface Module User's Manual (Fundamentals)
- QnA-Compatible Ethernet Interface Module User's Manual (Details)
- AJ71E71-S3, A1SJ71E71-B2-S3, A1SJ71E71-B5-S3 Ethernet Interface Module User's Manual (Details)

21.4.1 Ethernet diagnostics

| | | |
|---|-------|----|
| A | Q/QnA | FX |
| ○ | ○* | × |

*: Also compatible when MELSECNET/H remote station is installed

[Purpose]

You can check the parameter status, error log, status of each connection, status of each protocol, LED status, received e-mail information and send e-mail information.

[Operating Procedure]

Select [Diagnostics] → [Ethernet diagnostics]

[Dialog Box]

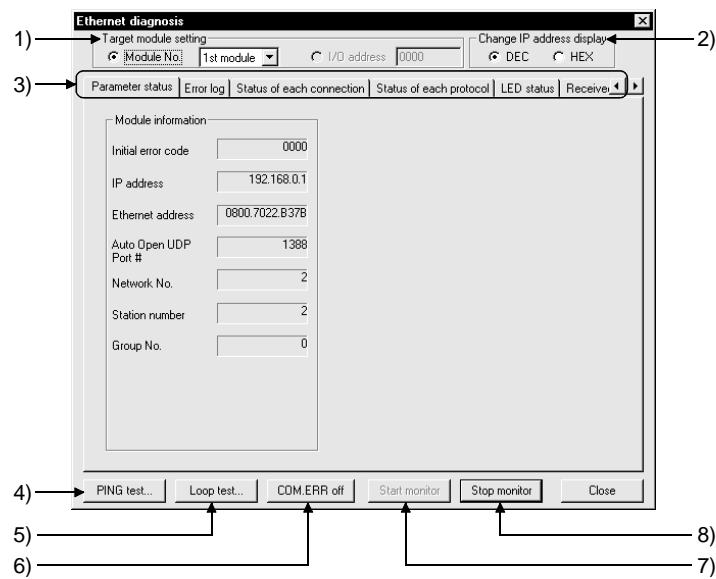

[Description]

- 1) Target module setting
Specify the Ethernet module to be monitored.
The setting range is 1 to 4 modules.
When the A/QnA series module of function version A is used, the number of modules cannot be set. Set the I/O address.
- 2) Change IP address display
Change the IP address indication between decimal and hexadecimal.
- 3) Selection of information monitor
Various information on the Ethernet module can be monitored.
- 4) PING test
Used to perform a PING test on the equipment on other end.
Refer to Section 21.4.9.
- 5) Loop test
Used to perform a loopback test on the network.
Refer to Section 21.4.10.
- 6) COM. ERR off
Click this button to extinguish the [COM ERR] LED.
- 7) Start monitor
Click this button to start Ethernet diagnostics.
The display is updated during monitoring.
- 8) Stop monitor
Click this button to stop Ethernet diagnostics.
The display is held during monitoring stop.

21.4.2 Parameter status

| | | |
|---|-------|----|
| A | Q/QnA | FX |
| ○ | ○* | × |

*: Also compatible when MELSECNET/H remote station is installed

[Purpose]

Monitors the parameter status of the Ethernet module.

[Operating Procedure]

Select [Diagnostics] → [Ethernet diagnostics] → <<Parameter status>> tab.

[Dialog Box]

For Q series

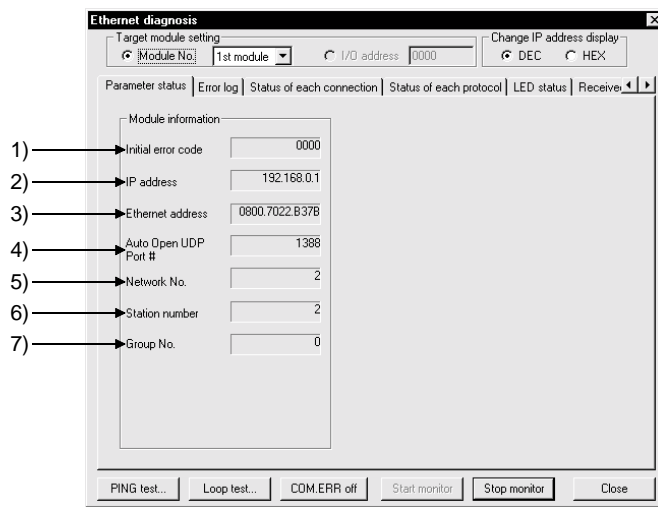

For QnA series

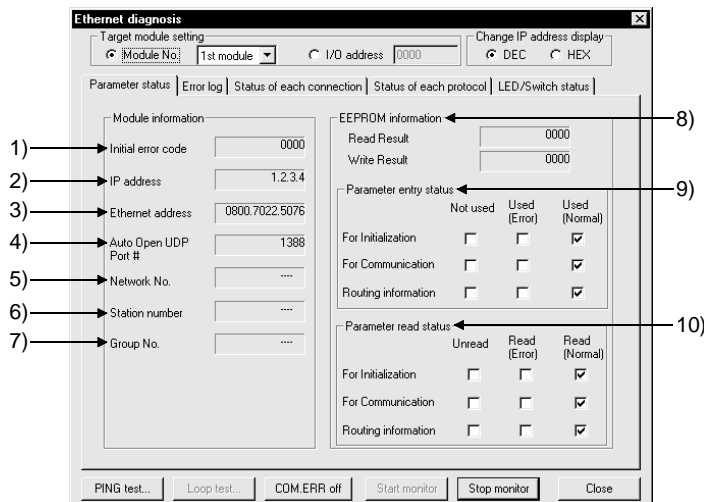

For A series

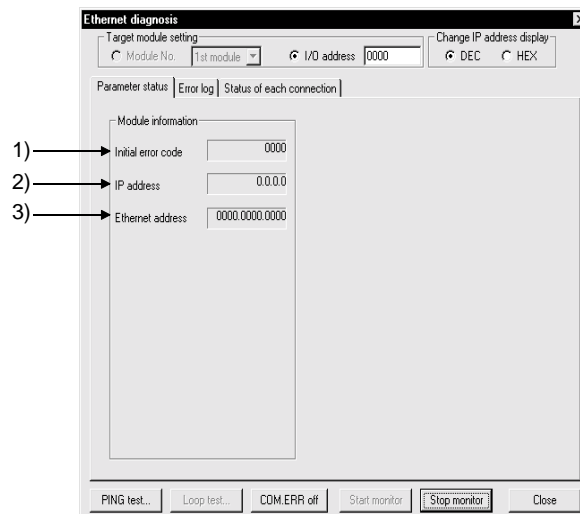

[Description]

- 1) Initial error code
Displays the initial error code.
- 2) IP address
Displays the own station IP address.
- 3) Ethernet address
Displays the own station Ethernet address.
- 4) Auto Open UDP Port #
Displays the automatic OPEN UDP port number.
- 5) Network No.
Displays the target module-specified network number.
- 6) Station number
Displays the target module-specified station number.
- 7) Group No.
Displays the target module-specified group number.
- 8) EEPROM information
0000 appears when normal.
The error code appears when abnormal.
Refer to the manual of the corresponding model and take corrective action.
- 9) Parameter entry status
Displays the preset parameter status.
- 10) Parameter read status
Displays the preset parameter status.

21.4.3 Error history

| | | |
|---|-------|----|
| A | Q/QnA | FX |
| ○ | ○* | × |

*: Also compatible when MELSECNET/H remote station is installed

[Purpose]
Monitors the error log area.

[Operating Procedure]
Select [Diagnostics] → [Ethernet diagnostics] → <<Error log>> tab.

[Dialog Box]
For Q/QnA series

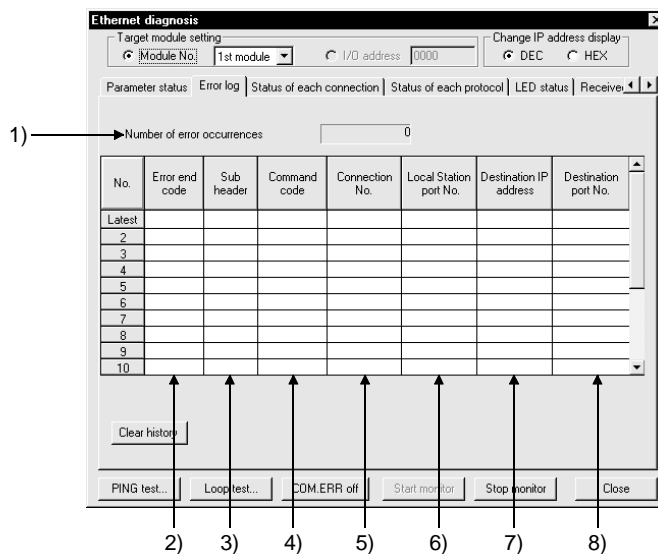

For A series

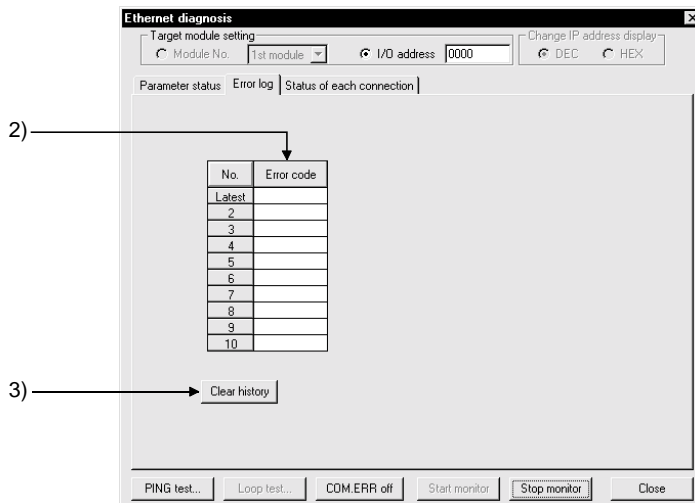

[Description]

- 1) Number of error occurrences
Displays the number of error occurrences.
- 2) Error end code
Displays the error/termination code.
Displays only the error code for the A series.
- 3) Sub header
Displays the sub header.
- 4) Command Code
Displays the command code.
- 5) Connection No.
Displays the connection number.
- 6) Local Station port No.
Displays the own station port number.
- 7) Destination IP address
Displays the IP address on the other end of communication.
- 8) Destination Port No.
Displays the port number on the other end of communication.
- 9) Clear history button
Clears the error history.

21.4.4 Status of each connection

| | | |
|---|-------|----|
| A | Q/QnA | FX |
| ○ | ○* | × |

*: Also compatible when MELSECNET/H remote station is installed

[Purpose]

Monitors the status of each connection.
 Up to numbers 16 are displayed for the Q series.
 Up to numbers 8 are displayed for the QnA/A series.

[Operating Procedure]

Select [Diagnostics] → [Ethernet diagnostics] → <<Status of each connection>> tab.

[Dialog Box]

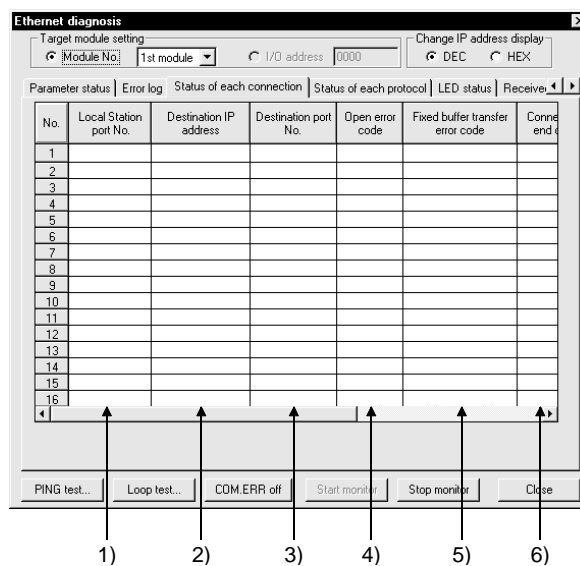

[Description]

- 1) Local Station port No.
Displays the own station port number.
- 2) Destination IP address
Displays the IP address on the other end of communication.
- 3) Destination port No.
Displays the port number on the other end of communication.
- 4) Open error code
Displays the open error code.
- 5) Fixed buffer transfer error code
Displays the fixed buffer send error code.
- 6) Connection end code
Displays the connection termination code.
- 7) Protocol
Displays the UDP or TCP.
- 8) Open system
Displays Active, Unpassive or Full passive.
- 9) Pairing open
Displays whether pairing is made or not.
- 10) Existence confirmation
Displays whether check is made or not.

21.4.5 Status of each protocol

| | | |
|---|-------|----|
| A | Q/QnA | FX |
| × | ○* | × |

*: Also compatible when MELSECNET/H remote station is installed

[Purpose]

Monitors the status of each protocol.

[Operating Procedure]

Select [Diagnostics] → [Ethernet diagnostics] → <<Status of each protocol>> tab.

[Dialog Box]

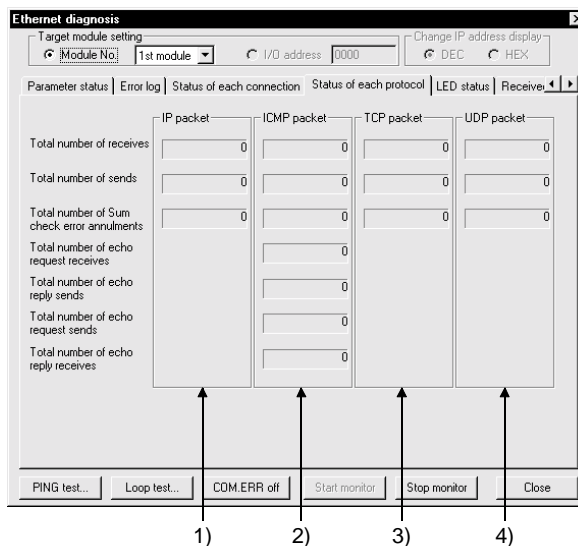

[Description]

1) IP Packet

Total number of receivesDisplays the total number of receive IP packets.

Total number of sends.....Displays the total number of send IP packets.

Total number of Sum

check error annulments.....Displays the number of times when the receive IP packets were discarded due to sumcheck error.

- 2) ICMP Packet
- Total number of receivesDisplays the total number of receive ICMP packets.
 - Total number of sendsDisplays the total number of send ICMP packets.
 - Total number of Sum check error annulmentsDisplays the number of times when the receive ICMP packets were discarded due to sumcheck error.
 - Total number of echo request receivesDisplays the total number of receive ICMP's echo requests.
 - Total number of echo reply sendsDisplays the total number of send ICMP's echo replies.
 - Total number of echo request sendsDisplays the total number of send ICMP's echo requests.
 - Total number of echo reply receivesDisplays the total number of receive ICMP's echo replies.
- 3) TCP Packet
- Total number of receivesDisplays the total number of receive TCP packets.
 - Total number of sendsDisplays the total number of send TCP packets.
 - Total number of Sum check error annulmentsDisplays the number of times when the receive TCP packets were discarded due to sumcheck error.
- 4) UDP Packet
- Total number of receivesDisplays the total number of receive UDP packets.
 - Total number of sendsDisplays the total number of send UDP packets.
 - Total number of Sum check error annulmentsDisplays the number of times when the receive UDP packets were discarded due to sumcheck error.

21.4.6 LED status

| | | |
|---|-------|----|
| A | Q/QnA | FX |
| × | ○* | × |

*: Also compatible when MELSECNET/H remote station is installed

[Purpose]

Monitors the LED light-up status on the Ethernet module front.

[Operating Procedure]

Select [Diagnostics] → [Ethernet diagnostics] → <<LED status>> tab.

[Dialog Box]

Q series

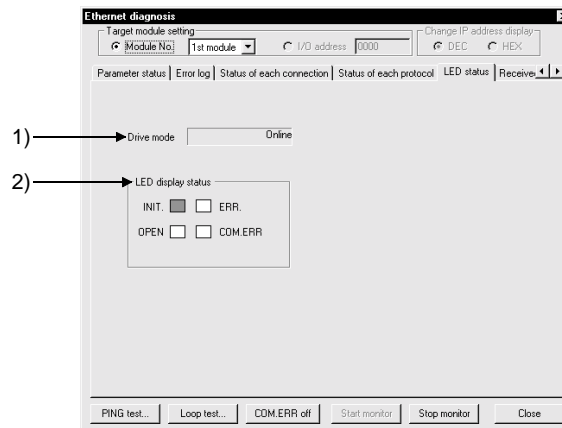

QnA series

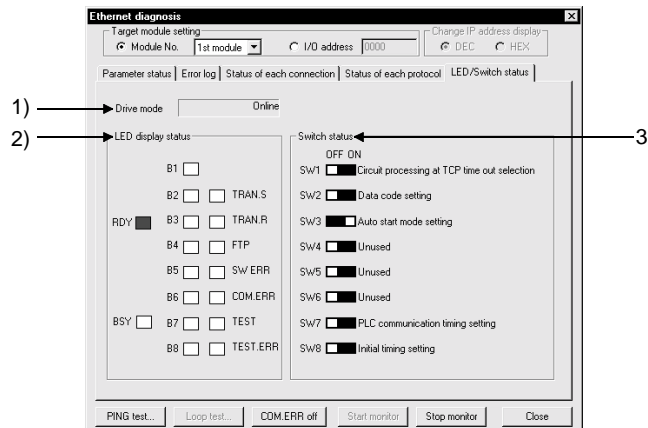

[Description]

- 1) Drive mode
Displays the switch status (operation mode setting).
A PLC communication error will occur if a RAM or ROM test is preset by the switch setting of the Ethernet module.
- 2) LED display status
Displays the statuses of the INIT, OPEN, ERR. and COM.ERR LEDs.
- 3) Switch status (QnA series only)
Displays the DIP switch statuses of the QE71.

21.4.7 Received e-mail information

| | | |
|---|-------|----|
| A | Q/QnA | FX |
| × | ○* | × |

*: Compatible with the QCPU (Q mode).

*: Also compatible when MELSECNET/H remote station is installed

[Purpose]

Monitors the received e-mail information.

[Operating Procedure]

Select [Diagnostics] → [Ethernet diagnostics] → <<Received e-mail information>> tab.

[Dialog Box]

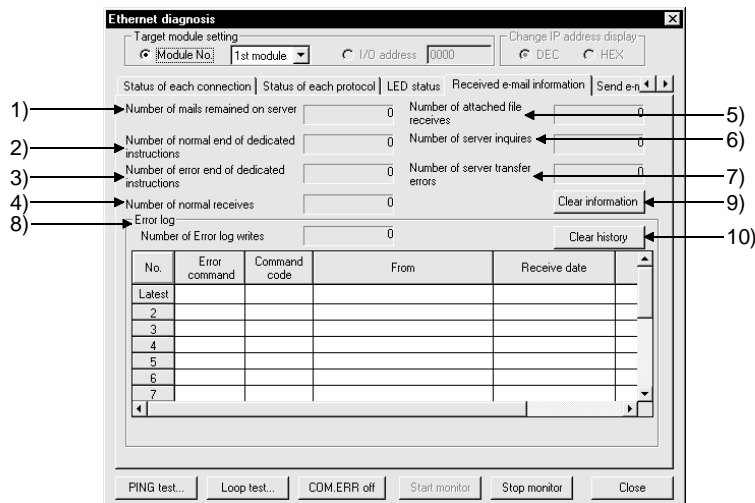

[Description]

- 1) Number of mails remained on server
Displays the number of mails remaining in the server.
- 2) Number of normal end of dedicated instructions
Displays the number of times when dedicated instructions were completed normally.
- 3) Number of error end of dedicated instructions
Displays the number of times when dedicated instructions were completed abnormally.
- 4) Number of normal receives
Displays the number of times when mails were received normally.
- 5) Number of attached file receives
Displays the number of times when attached files were received.
- 6) Number of server inquiries
Displays the number of server inquiries.
- 7) Number of server transfer errors
Displays the number of server communication errors.

- 8) Error log
Displays the number of error log write times.
The error log items are indicated below.
 - Error command
 - Command code
 - Sender
 - Receiving date/hour
 - Subject
- 9) button
Clears the count to zero.
- 10) button
Clears the error log write count to zero and clears all error history.

21.4.8 Send e-mail information

| | | |
|---|-------|----|
| A | Q/QnA | FX |
| × | ○* | × |

*: Compatible with the QCPU (Q mode).

*: Also compatible when MELSECNET/H remote station is installed

[Purpose]

Monitors the send e-mail information.

[Operating Procedure]

Select [Diagnostics] → [Ethernet diagnostics] → <<Send e-mail information>> tab.

[Dialog Box]

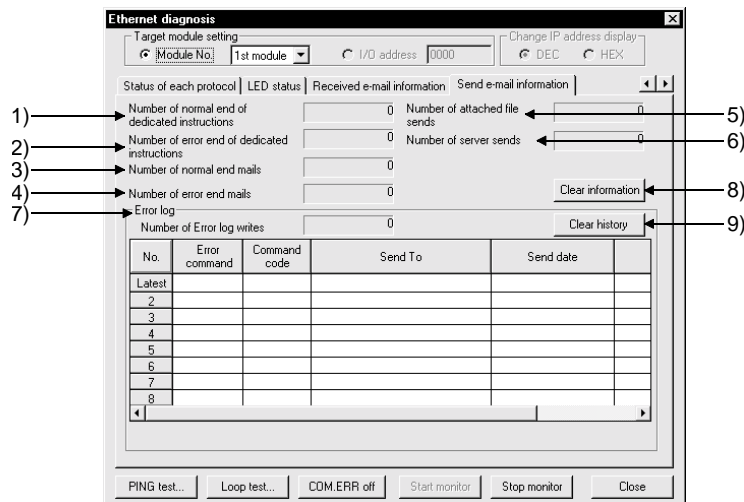

[Description]

- 1) Number of normal end of dedicated instructions
Displays the number of times when dedicated instructions were completed normally.
- 2) Number of error end of dedicated instructions
Displays the number of times when dedicated instructions were completed abnormally.
- 3) Number of normal end mails
Displays the number of mails which were completed normally.
- 4) Number of error end mails
Displays the number of mails which were completed abnormally.
- 5) Number of attached file sends
Displays the number of times when attached files were sent.
- 6) Number of server sends
Displays the number of server send times.

- 7) Error log
Displays the number of error log write times.
The error log items are indicated below.
 - Error command
 - Command code
 - Send destination
 - Sending date/hour
 - Subject
- 8) button
Clears the count to zero.
- 9) button
Clears the error log write count to zero and clears all error history.

21.4.9 PING test

| A | Q/QnA | FX |
|---|-------|----|
| ○ | ○ | × |

[Purpose]

This test checks the Ethernet module which has completed initial processing on the Ethernet line or the existence of the specified IP address.

A PING test can be conducted either via an Ethernet board or in direct connection with the PLC CPU.

[Operating Procedure]

Select [Diagnostics] → [Ethernet diagnostics] → **PING test** button.

Select [Diagnostics] → [Ethernet diagnostics] → **Loop back test** button → **PING test** button.

[Required Setting Items]

- Before starting a PING test, always set the Ethernet parameters and MNET/10 routing information.
Refer to Section 16.2.1 for the setting example.
- Make sure that the RUN and INIT LEDs of the Ethernet module are lit.

[PING Test Image Diagram]

- A PING test from GX Developer is valid for the Q, QnA and A series Ethernet modules.
- Performing a PING test on the system consisting of the Q series allows you to check:
 - (1) Whether the line between the own station and the equipment on other end are connected properly.
 - (2) Whether parameter setting for the own station Ethernet modules was made properly.
 - (3) Whether initial processing for the own station Ethernet modules was completed normally.

Via Ethernet board (Q, QnA, A series)

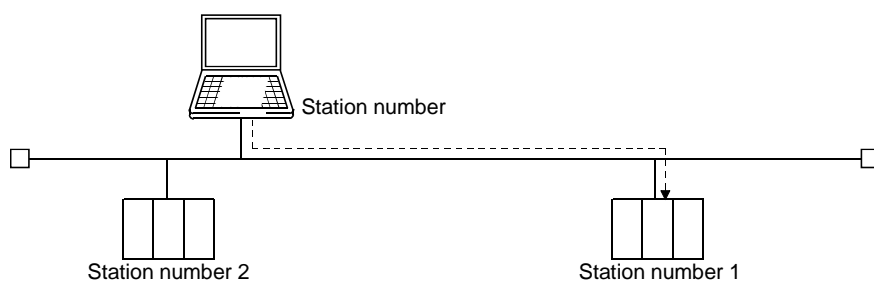

A PING test can be made only within the same segment.

In direct connection with PLC CPU (Q series only)

In direct connection with the PLC CPU, a PING test can be conducted only when the connected Ethernet module (station number 3 in the following system example) is the Q series E71 (function version B).

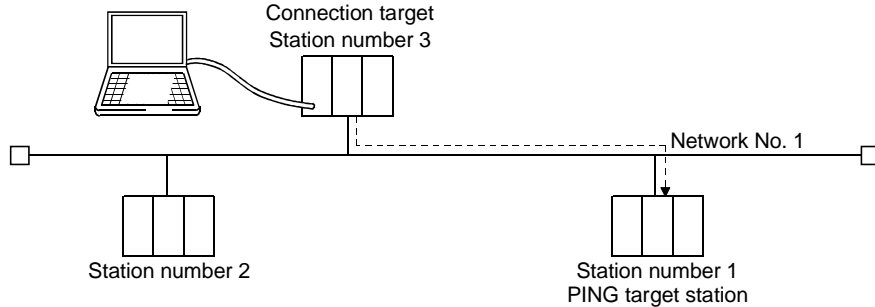

A PING test can be made only on the Ethernet module in the same segment as that of the PING test target station.

Make the connection setup setting as shown below to conduct a PING test on station number 2 of network No. 2 in the following system configuration.

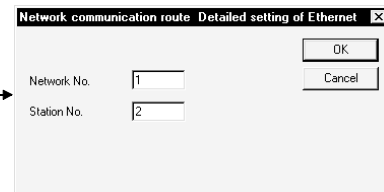
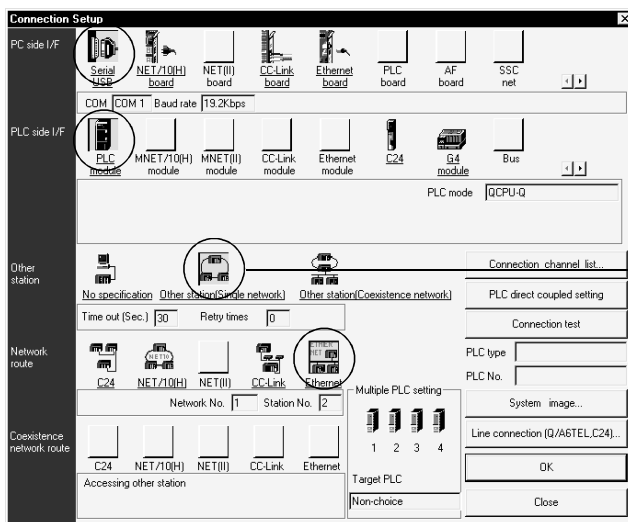
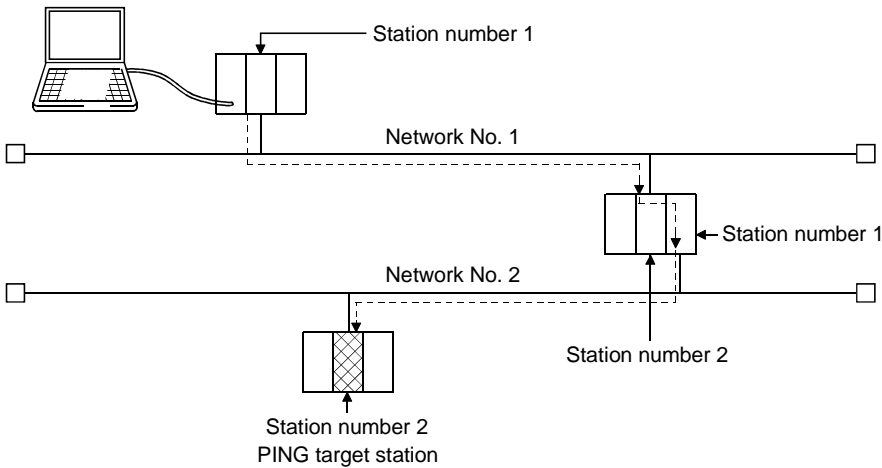

POINTS

A PING test cannot be made via the MELSECNET/10, MELSECNET/H, CC-Link, computer link or the like.

[Dialog Box]

Ethernet board

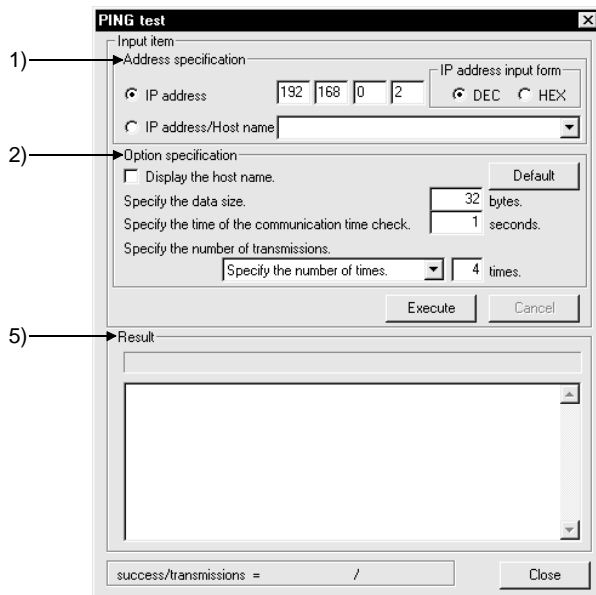

When directly connecting PLC CPU

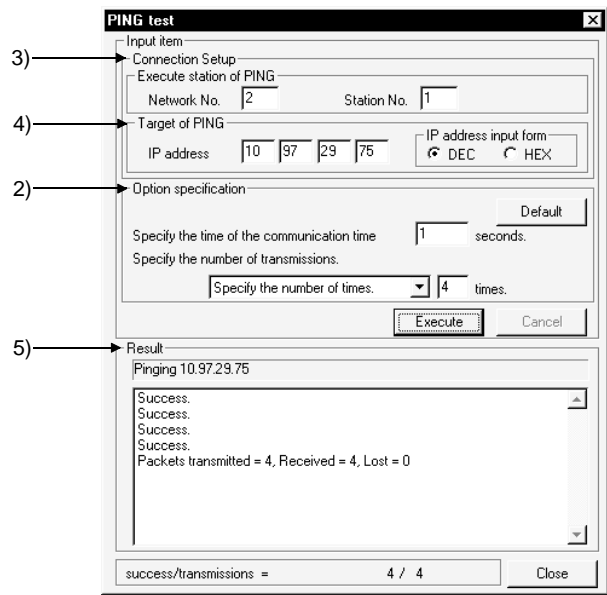

[Description]

- 1) Address specification
Set the IP address of the module to be PING tested.
- 2) Option specification
Turning on Display the host name displays the host name in Result.
The range setting for specifying the data size is 1 to 8192 bytes.
Communication time check period: 1 to 30 seconds
Send count: 1 to 50 times or executed until a stop.
- 3) Execute station of PING
Set the network number and station number to be PING tested.
- 4) Target of PING
Set the IP address of the Ethernet module to be tested.
- 5) Result
 Ethernet board
 When OK
 Pinging Host name [192.168.0.2] with 32 bytes of data:
 Reply from 192.168.0.2: bytes = 32 time < 10ms TTL = 32
 When NG
 Request timed out.
 When directly connecting PLC CPU
 When OK
 Success
 Packet transmitted = 4, Received = 4, Lost = 0
 When NG
 Timeout
 Packets transmitted = 4, Received = 0, Lost = 4

21.4.10 Loopback test

| | | |
|---|-------|----|
| A | Q/QnA | FX |
| × | ○* | × |

*: Compatible with the QCPU (Q mode).

[Purpose]

This test sends a loopback test message to the Q-compatible E71s (function version B) of the specified network number and station number in due order to check whether the initial processing of each module has been completed.

A loopback test is compatible with only the function version B of the Q-compatible E71.

The response of the Q-compatible E71 of function version A and the QnA/A series Ethernet modules are handled as no response if they are connected actually.

A loopback test can be conducted either via an Ethernet board or in direct connection with the PLC CPU.

[Operating Procedure]

Select [Diagnostics] → [Ethernet diagnostics] → **Loopback test** button.

[Required Setting Items]

- Before starting a loopback test, always set the Ethernet parameters and MNET/10 routing information. Refer to Section 16.2.1 for the setting example.
- Make sure that the RUN and INIT LEDs of the Ethernet modules are lit.

[Loopback Test Image Diagram]

Via Ethernet board

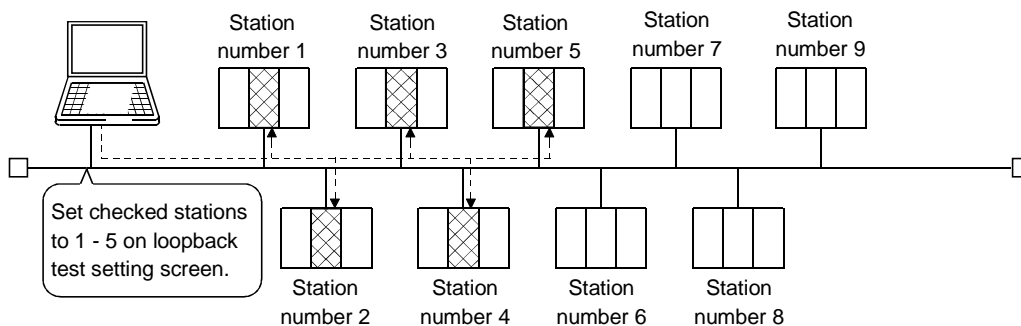

A loopback test can be made on the other network No.

If a loopback test is performed on station numbers 2 to 4 of network No. 2 in the following system configuration, the response of station 2 acting as a test conducting station is handled as "no response".

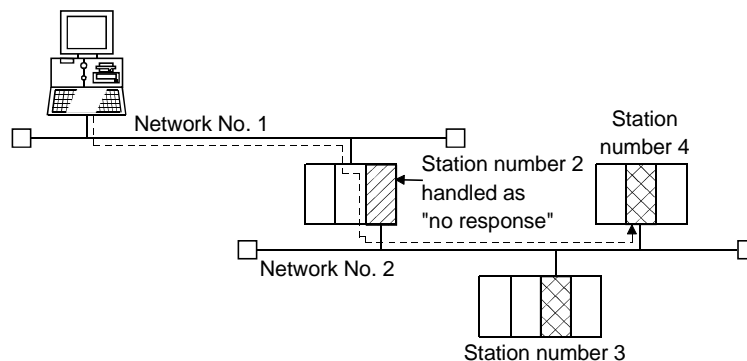

In direct connection with PLC CPU

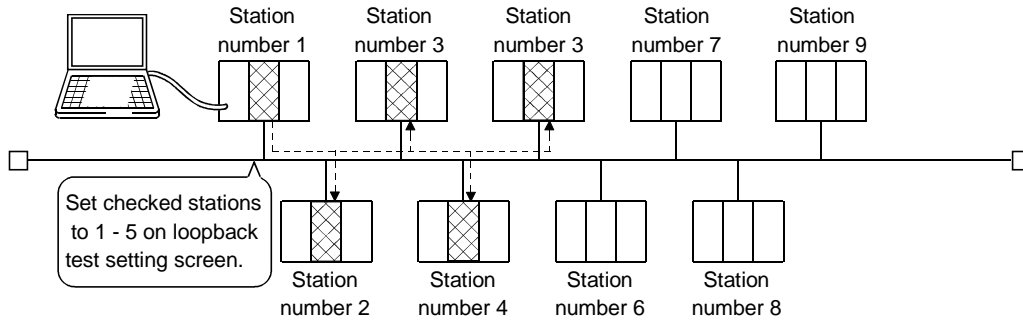

A loopback test can be made only on the Ethernet modules of the loopback test target network No.

Make the connection setup setting as shown below to conduct a loopback test on the Ethernet modules of network No. 2 in the following system configuration.

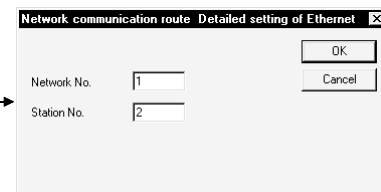
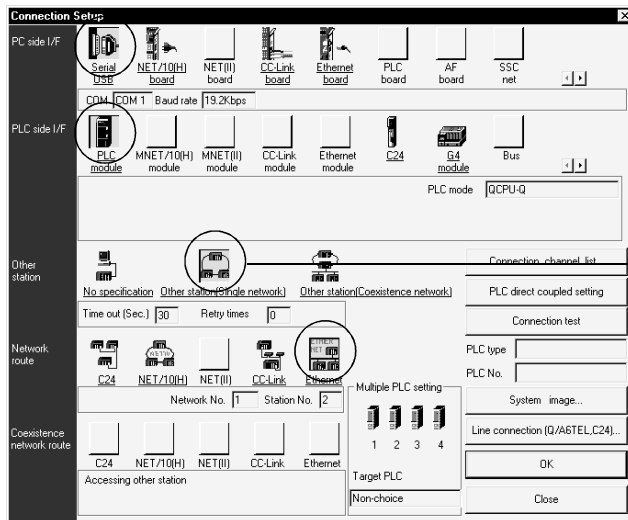
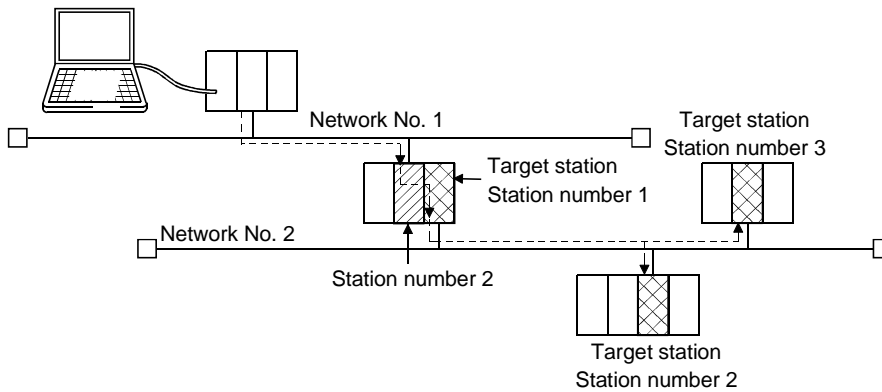

POINTS

A loopback test is valid for only the system consisting of Ethernet only.
 A loopback test cannot be made via the MELSECNET/10, MELSECNET/H, CC-Link, computer link or the like.

[Dialog Box]

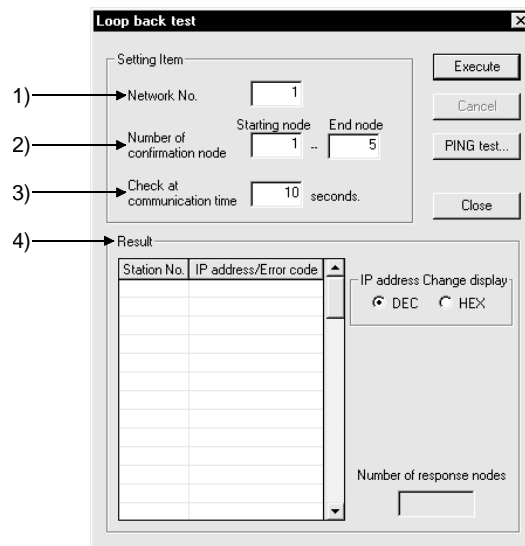

[Description]

- 1) Network No.
Set the network number to be loopback tested.
The setting range is 1 to 239.
- 2) Number of confirmation node
Specify the station numbers you want to check.
The setting range is 1 to 64.
- 3) Check at communication time
The setting range is 1 to 99 seconds.
The Ethernet parameters have TCP re-send timer in Initial settings Unless the communication time check period setting of a loopback test is longer than the TCP re-send timer setting, the Ethernet module may be regarded as non-existing if its connection is proper.
- 4) Result
A loopback test is made in order, starting from station 1, and whether a response is given or not within the communication time check period is displayed in order of station numbers.
Overlapping IP addresses, if any, are displayed red.

21.5 System Monitor

| | | |
|---|-------|----|
| A | Q/QnA | FX |
| × | ○* | × |

*: Compatible with the QCPU (Q mode).

*: Compatible with the Q series remote I/O.

[Purpose]

Monitors the system status of the PLC.

This function may be selected for the Q series only.

[Operating Procedure]

[Diagnostics] → [System monitor].

[Dialog Box]

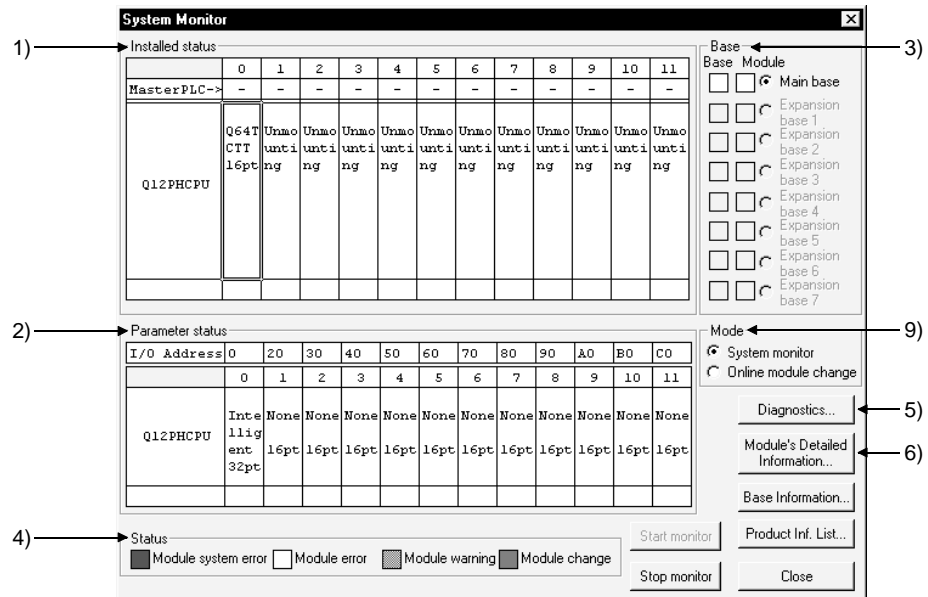

[Description]

1) Installed status

Shows the special and similar modules loaded to the base selected among the main base and extension bases 1 to 7. (Double-clicking the model name indication shows the module detail information dialog box.)

When the A series is added to connect the special function modules of the A, "A intelli" appears on the screen.

The following table indicates the error status display categories for the PLC CPUs in a multi-CPU configuration.

| Display Color | Category | Error Definition | PLC CPU Status |
|---------------|--------------|--------------------|---|
| Red | Major error | MAIN CPU down | CPU reset, etc. |
| Orange | Middle error | Stop error | Parameter error Instruction code error CPU STOP, etc. |
| Yellow | Minor error | Continuation error | Battery error Annunciator error ON CPU RUN enable error, etc. |

- 2) Parameter status
Shows the parameter settings written to the PLC. The parameters not set do not appear.
- 3) Base
Normal bases are shown white and abnormal bases red.
For the modules, refer to 4) Status.
- 4) Status
 - Unit system error
Indicates that a module hardware fault (error equivalent to WDT error) has occurred or a module inoperative condition is detected.
 - Unit error
Indicates that the environment required for the module to function is not completed. (Error equivalent to parameter error has occurred)
 - Unit warning
Indicates inadequacy in user operation or sequence program (e.g. FROM, TO).

| | Display Color | PLC Status |
|-------------------|---------------|------------|
| Unit normal | White | RUN |
| Unit system error | Red | STOP |
| Unit error | Yellow | RUN |
| Unit warning | Orange | RUN |

- 5) **PLC diagnostics** button
Move the cursor to the special module displayed in Installed status and click the **PLC diagnostics** button to show the Diagnostics screen.
The Diagnostics screen does not appear if the utility package has not been installed.
For the diagnostic details of the corresponding special module, refer to the manual of the corresponding utility.

<Example> Serial communication module monitoring

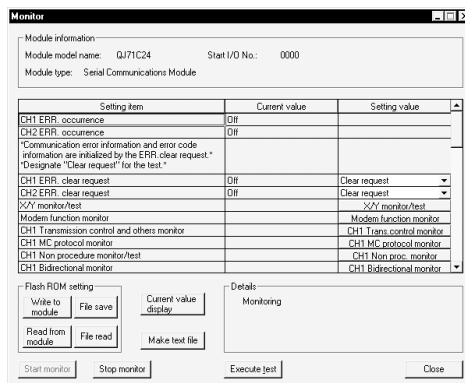

6) **Module Detail Information** button

When you choose the module model name displayed in Installed status, the following dialog box appears.

"-B" in Product information indicates the function version of the module.

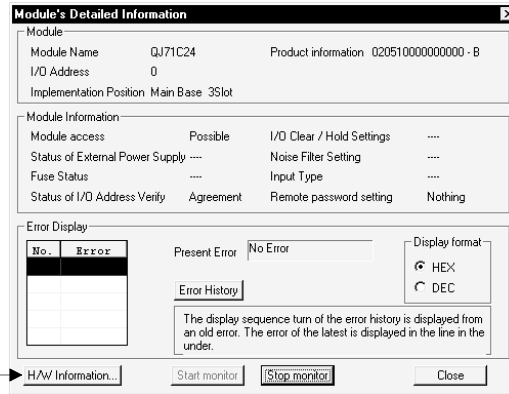

a) →

a) **H/W Information** button

H/W LED: As the module status is displayed, refer to the corresponding module manual for details.

H/W SW Information: Shows the hardware switch states.

Data changes with the combination of GX Developer SW4D5-GPPW-E, GX Developer SW5D5-GPPW-E, GX Developer SW6D5-GPPW-E and module version.

For details, refer to the corresponding module user's manual.

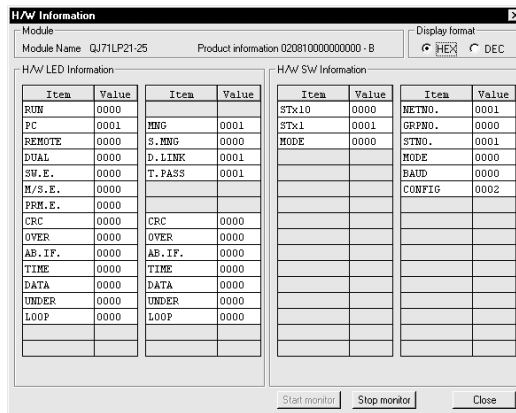

7) **Base Information**

Shows the following information on the base.

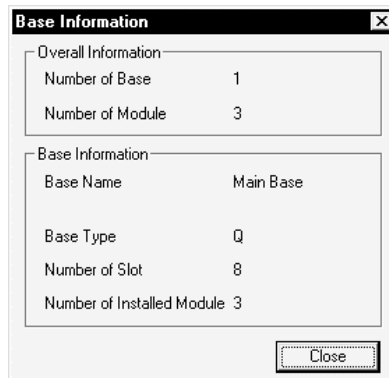

- 8) Product Information List
Shows the product information list of the modules mounted on the base.

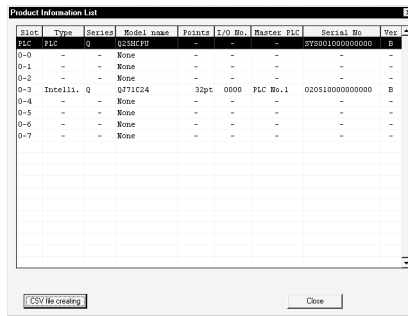

As clicking the **CSV file creating** button shows the [Save as] screen, set the file name.

The file can be opened using Excel or the like.

- 9) Modet

- System monitor
Choose when performing system monitor.
- Online module change (can be selected only for the Q12PH or Q25PHCPU)
Choose when making online module change.
After the following confirmation dialog box for switching to the online module change mode has appeared, click the **Yes** button.

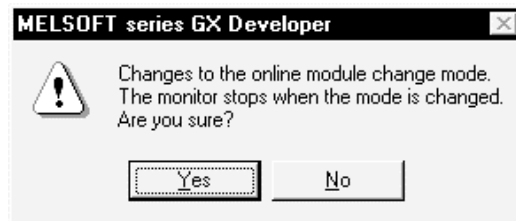

Refer to Section 21.6 for the explanation of online module change operation after the above operation.

POINTS

The following table appears if there are differences between PLC parameter I/O assignment and actual Installed status. Therefore, set the PLC parameter I/O assignment to meet the actual Installed status.

System monitor display status

| Assignment | Actual Loading | Empty | Input | Output | Intelli |
|------------------|------------------|----------------|------------------|------------------|------------------|
| 0 empty points | Installed status | Unmounting | m input points | m output points | m intelli points |
| | Parameter status | 0 empty points | 0 empty points | 0 empty points | 0 empty points |
| n empty points | Installed status | Unmounting | m input points | m output points | m intelli points |
| | Parameter status | n empty points | n empty points | n empty points | n empty points |
| 0 input points | Installed status | Unmounting | m input points | m output points | m intelli points |
| | Parameter status | 0 empty points | 0 empty points | 0 empty points | Assignment error |
| n input points | Installed status | Unmounting | m input points | m output points | m intelli points |
| | Parameter status | n empty points | n input points | n input points | Assignment error |
| 0 output points | Installed status | Unmounting | m input points | m output points | m intelli points |
| | Parameter status | 0 empty points | 0 empty points | 0 empty points | Assignment error |
| n output points | Installed status | Unmounting | m input points | m output points | m intelli points |
| | Parameter status | n empty points | n output points | n output points | Assignment error |
| 0 intelli points | Installed status | Unmounting | m input points | m output points | m intelli points |
| | Parameter status | 0 empty points | Assignment error | Assignment error | Assignment error |
| n intelli points | Installed status | Unmounting | m input points | m output points | m intelli points |
| | Parameter status | n empty points | Assignment error | Assignment error | n intelli points |
| No assignment | Installed status | Unmounting | m input points | m output points | m intelli points |
| | Parameter status | p empty points | m input points | m output points | m intelli points |

n points : Number of assignment points
 m points : Number of actual loading points
 p points : Number of empty slot points

21.6 Online Module Change

| | | |
|---|-------|----|
| A | Q/QnA | FX |
| × | ○* | × |

*: Compatible with Q12PH and Q25PH only

[Purpos]

You can change a module without stopping the system.

[Operating Procedure]

[Diagnosis] → [Online module change].

[Dialog Box]

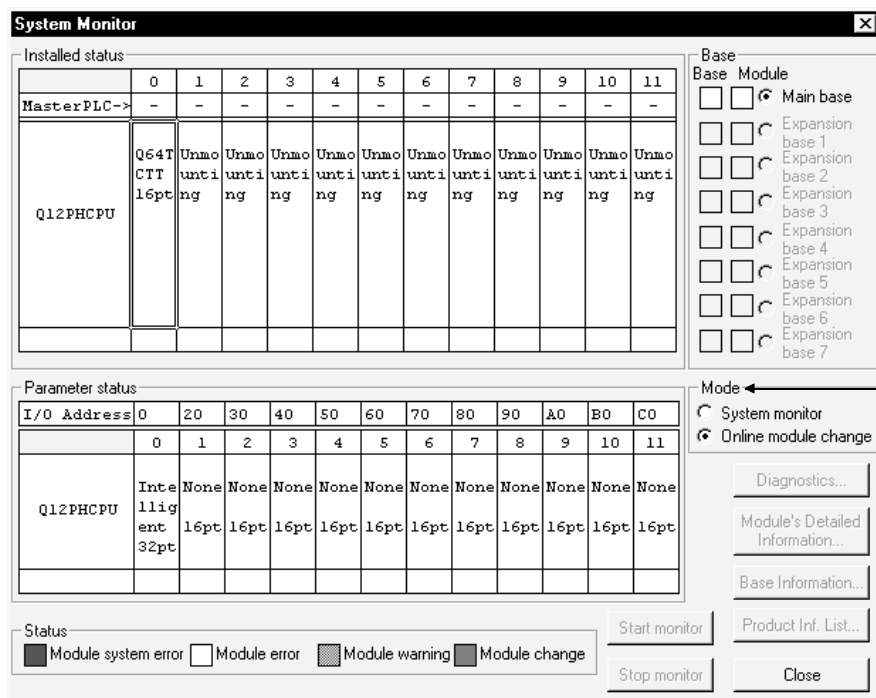

[Description]

1) Mode

- System monitor
Choose when performing system monitor.
- Online module change (Default)
Choose when making online module change.
Can be selected only for the Q12PH or Q25PHCPU

The following explains a sequence of operations for making online module change from System monitor.

Step 1 Choose the module you want to change from Mounting status on the System monitor screen. (Module selection waiting status)

| System Monitor | | | | | | | | | | | | |
|------------------|-----------------|------------|------------|------------|------------|------------|------------|------------|------------|------------|------------|------------|
| Installed status | | | | | | | | | | | | |
| | 0 | 1 | 2 | 3 | 4 | 5 | 6 | 7 | 8 | 9 | 10 | 11 |
| MasterPLC-> | - | - | - | - | - | - | - | - | - | - | - | - |
| Q12PHCPU | Q64TCTT 16pt | Unmounting | Unmounting | Unmounting | Unmounting | Unmounting | Unmounting | Unmounting | Unmounting | Unmounting | Unmounting | Unmounting |

Step 2 After the Online module change dialog box has appeared, click the **Execution** button. (Online module change execution confirmation)

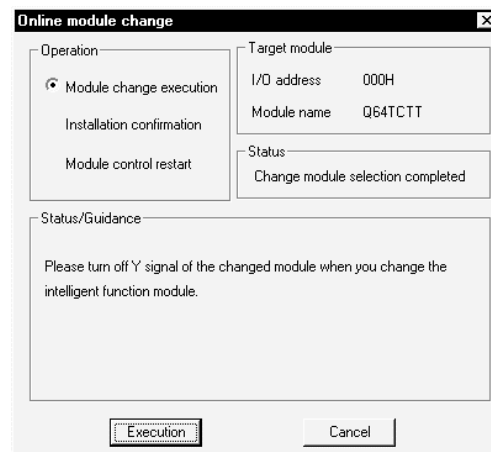

- Depending on the faulty condition of the module to be changed, the type of the module may not be acquired. In that case, "Unknown" appears in the Target module name display field.

Step 3 The dialog box indicating that online module change can be made appears. (Online module change completion confirmation)

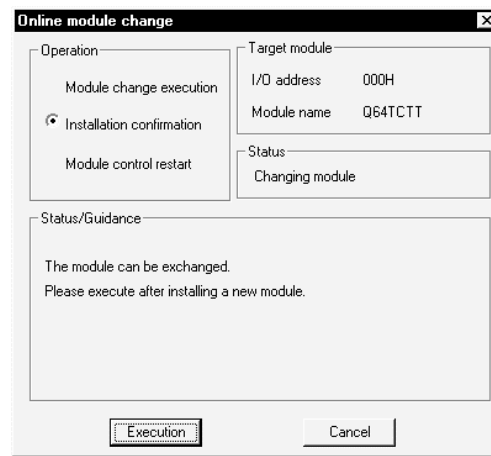

Step 4 After changing the module, click the **Execution** button.

Step 5 If online module change is completed properly, the following dialog box appears. (Module control resumption confirmation)

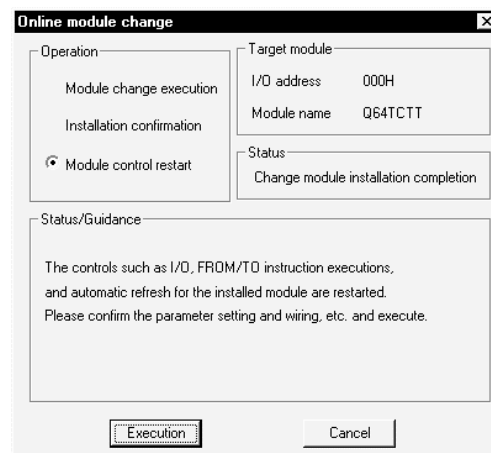

- If it is not completed properly, the following dialog box appears.

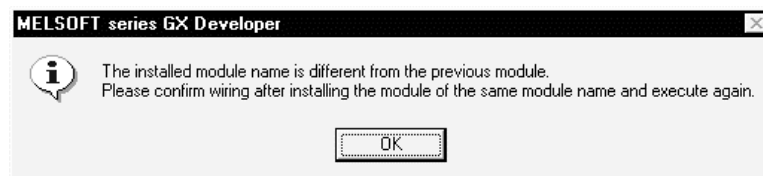

Click the **OK** button. As clicking that button displays the Online module change dialog box, restart the procedure from **Step 2**.

POINTS

When performing ladder monitor or device test during online module change

1. Temporary stop of online module change

By clicking **Cancel** during online module change, you can temporarily stop online module change and perform ladder monitor or device test to check the system status.

2. Continuation of online module change

By choosing **[Diagnosis] - [Online module change]**, you can continue online module change from the temporary stop status.

When you exited from GX Developer during online module change, you can restart GX Developer to continue online module change similarly.

Restrictions on online module change

- (1) GX Developer cannot perform the online module change of multiple modules simultaneously.
- (2) Note that if the Q12PH or Q25PHCPU is in either of the following statuses, online module change cannot be performed.
 1. The key switch of the Q12PH or Q25PHCPU is in the reset position.
 2. A stop error has occurred and the Q12PH or Q25PHCPU is in a stop status.
- (3) If online module change is performed from two personal computers to one PLC CPU, the following dialog box appears on the personal computer where online module change was performed later.

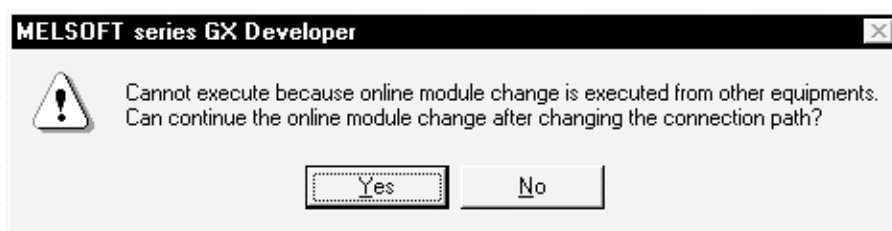

Clicking shifts the right to perform online module change to the personal computer that made access later.

- (4) If the PLC CPU is reset or powered off while the Online module change execution dialog box is being displayed, online module change cannot be continued and the following dialog box appears.

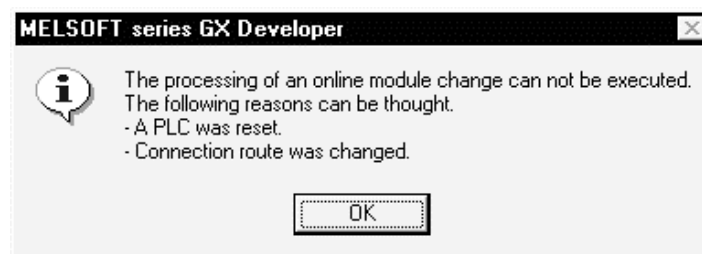

22. SETTING A6TEL/Q6TEL/FX DATA

The telephone line can be used for connection with the PLC. When the telephone line is used to make communication, it is made via the modem interface module (A6TEL/Q6TEL modem interface module), serial communication.

The following table lists the modules usable with each series. Modem Interface.

| | interface module | | Serial Communication | |
|-----------|------------------|-------|----------------------|----------|
| | A6TEL | Q6TEL | QnA Series | Q Series |
| Qseries | — | — | ○ | — |
| QnAseries | — | ○ | — | ○ |
| Aseries | ○ | ○ | — | — |
| FXseries | — | — | — | — |

*1: Since the QCPU (A mode) cannot use the A6TEL/Q6TEL, make communication via the serial communication module (Q series).

*2: Communication can be made by connecting a modem to the RS-232 connector of the FX_{2N}.

REMARK

For connection of telephone lines through QC24N and QJ71C24, refer to Section 16.2.4.

22.1 Function Setting Item List

| | | |
|---|-------|----|
| A | Q/QnA | FX |
| ○ | ○* | ○ |

*:Compatible with the QnACPU

(1) Q6TEL/A6TEL

The following setting item list indicates what data may be created and written to the personal computer and A6TEL/Q6TEL when performing any function. (A/QnA series)

| A6TEL/Q6TEL Connection Method | | Proximate Connection | Remote Access | Pager Notice | Q6TEL-Q6TEL Communication |
|---------------------------------------|-------|--|--|--|--|
| PLC side | A6TEL | 1) Cable connection 2) Switch setting | 1) AT command registration 2) Switch setting 3) Cable connection 4) TEL data registration (a) AT command (b) Phone number | 1) AT command registration 2) Phone number book creation 3) Switch setting 4) Cable connection 5) TEL data registration (a) AT command (b) Phone number (c) Notice data | No setting |
| | Q6TEL | 1) Cable connection 2) Switch setting | 1) AT command registration 2) Switch setting 3) Cable connection 4) TEL data registration (a) AT command (b) Phone number | 1) AT command registration 2) Phone number book creation 3) Switch setting 4) Cable connection 5) TEL data registration (a) AT command (b) Phone number (c) Notice data | 1) AT command registration 2) Phone number book creation 3) Switch setting 4) Cable connection 5) TEL data registration (a) AT command (b) Phone number (c) Q6TEL-Q6TEL communication data registration |
| Personal computer side (GX Developer) | | No setting | 1) AT command registration 2) Phone number book creation | No setting | No setting |

Switch setting: For the A6TEL/Q6TEL DIP switch setting, refer to Appendix 13. For connection cable details, refer to Section 2.1, 16.2.4.

(2) FXCPU series

Only remote access may be made. (Pager notices and Q6TEL-Q6TEL communication cannot be made.)

| | Remote Access |
|------------------------|---|
| PLC side | 1) PC system setting (1) 2) PC system setting (2) 3) If you set modem initialization to the user registration mode in PC system setting (1), you must set the AT command in the sequence program. |
| Personal computer side | 1) AT command registration 2) Phone number registration |

22.2 Preparations for Connecting the Telephone Line

This section provides the procedures to start the remote access function, notice function and Q6TEL-Q6TEL communication function (QnA mode only) in a system using the A6TEL/Q6TEL.

22.2.1 Making remote access/pager notice (for ACPU)

| A | Q/QnA | FX |
|---|-------|----|
| ○ | × | × |

Since the A modes of the A6TEL and Q6TEL are the same, read "Q6TEL" as "A6TEL" when using the A6TEL.

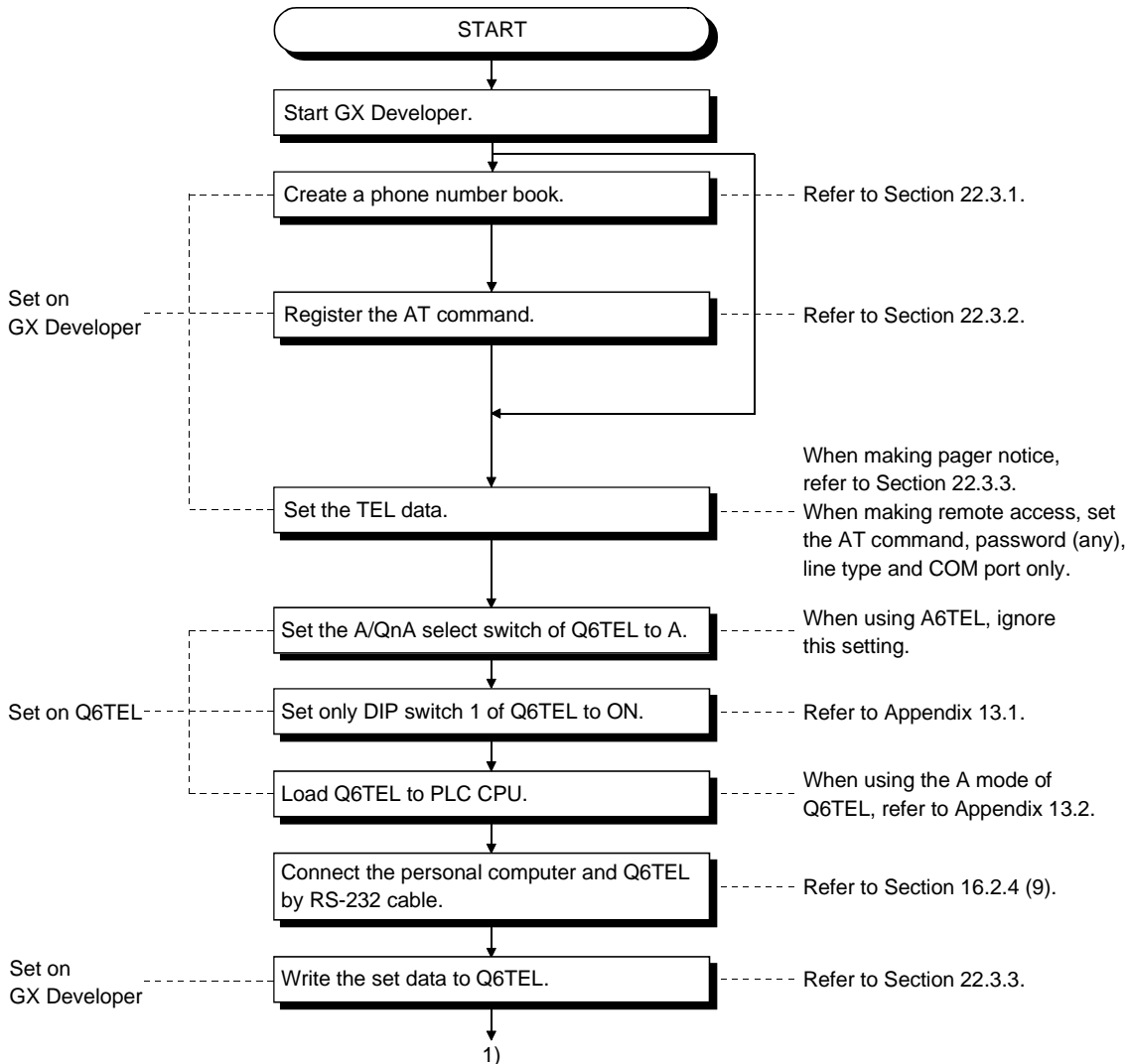

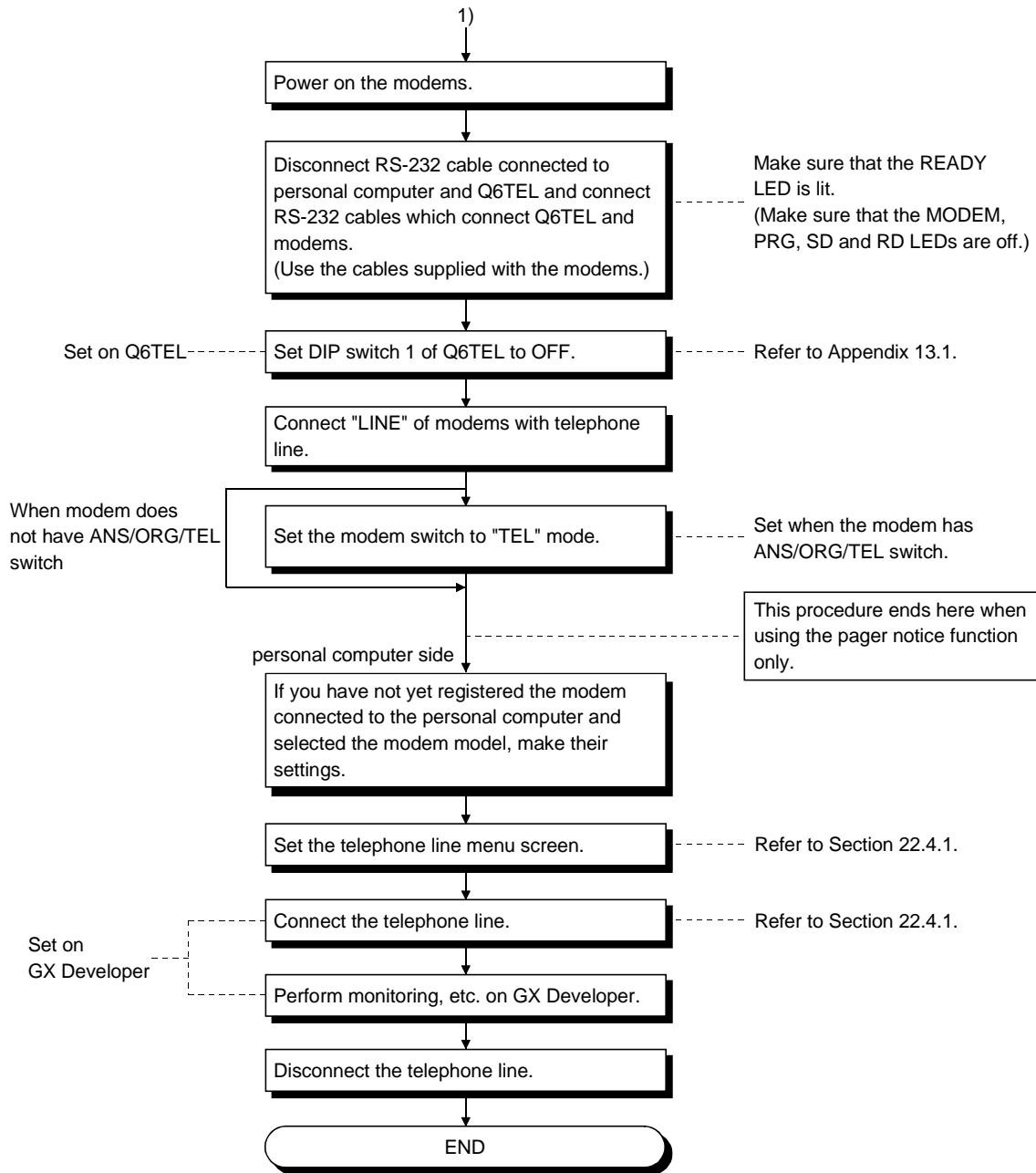

POINT
Set the connection destination before connecting the telephone line.

22.2.2 Making remote access/pager notice (for QnACPU)

| | | |
|---|-------|----|
| A | Q/QnA | FX |
| × | ○* | × |

*:Compatible with the QnACPU

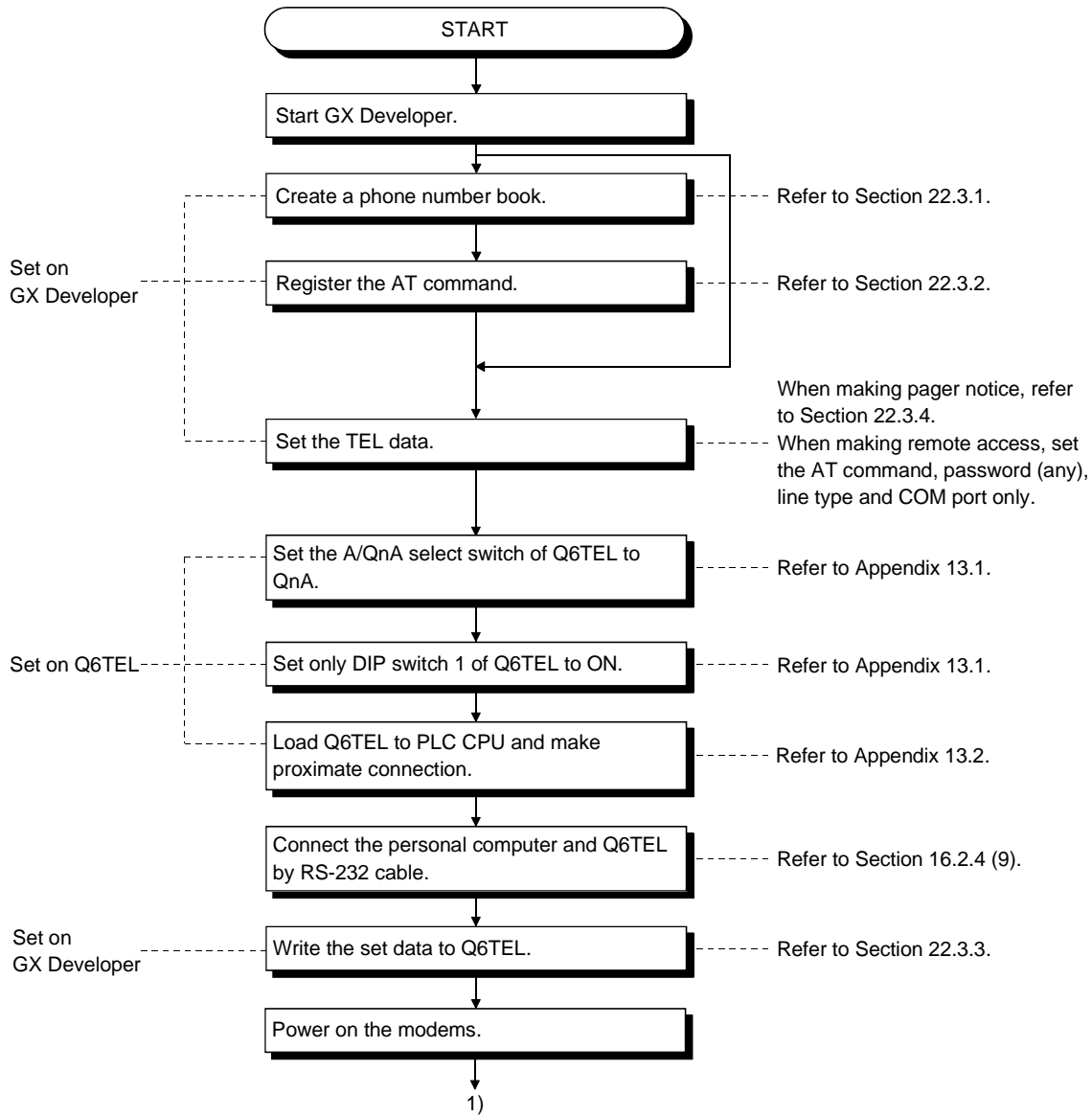

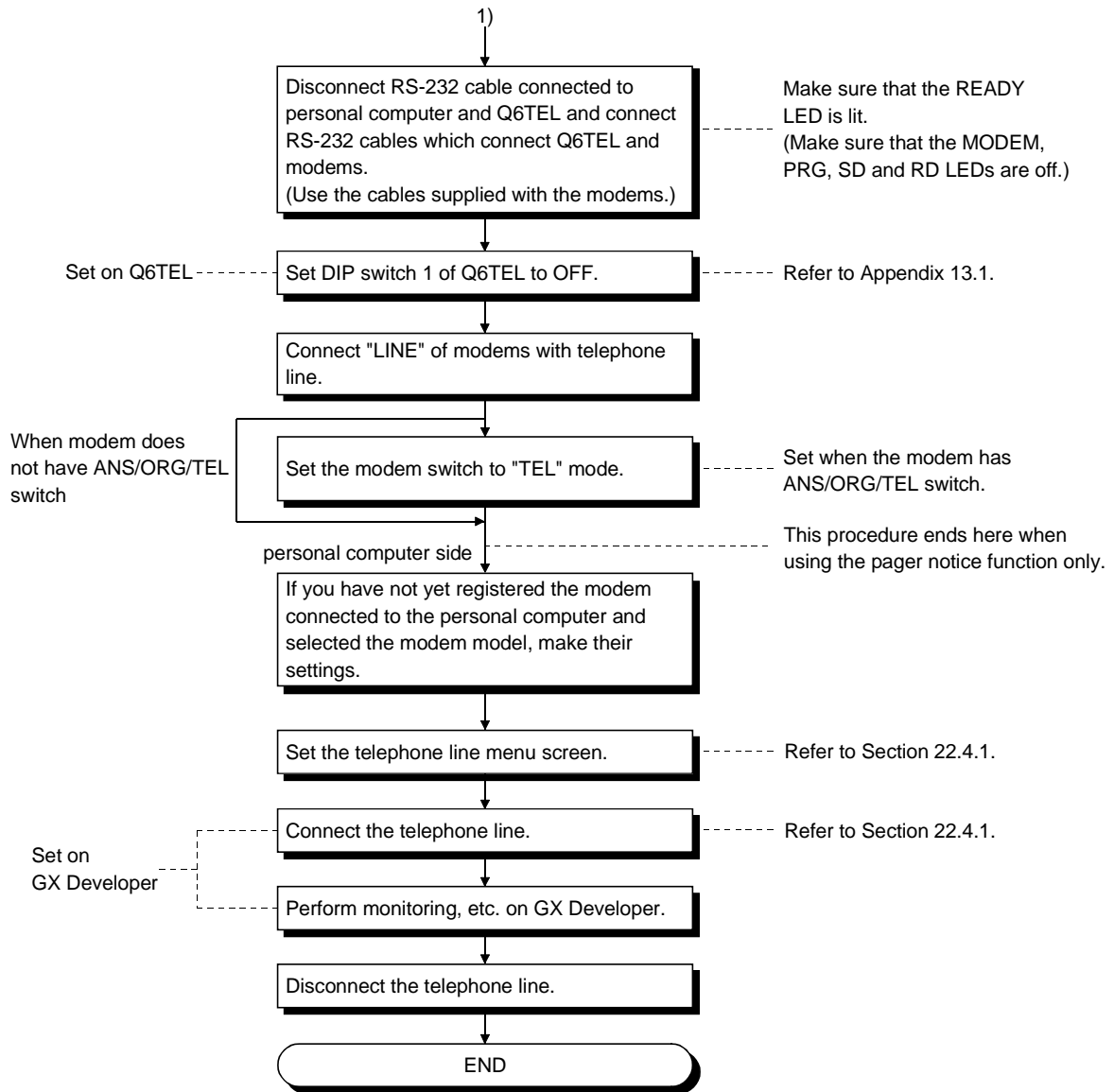

POINT
Set the connection destination before connecting the telephone line.

22.2.3 Making remote access to FXCPU

| A | Q/QnA | FX |
|---|-------|----|
| × | × | ○ |

FX1s, FX1N, FX1NC, FX2N, FX2NC PLC side operation procedure

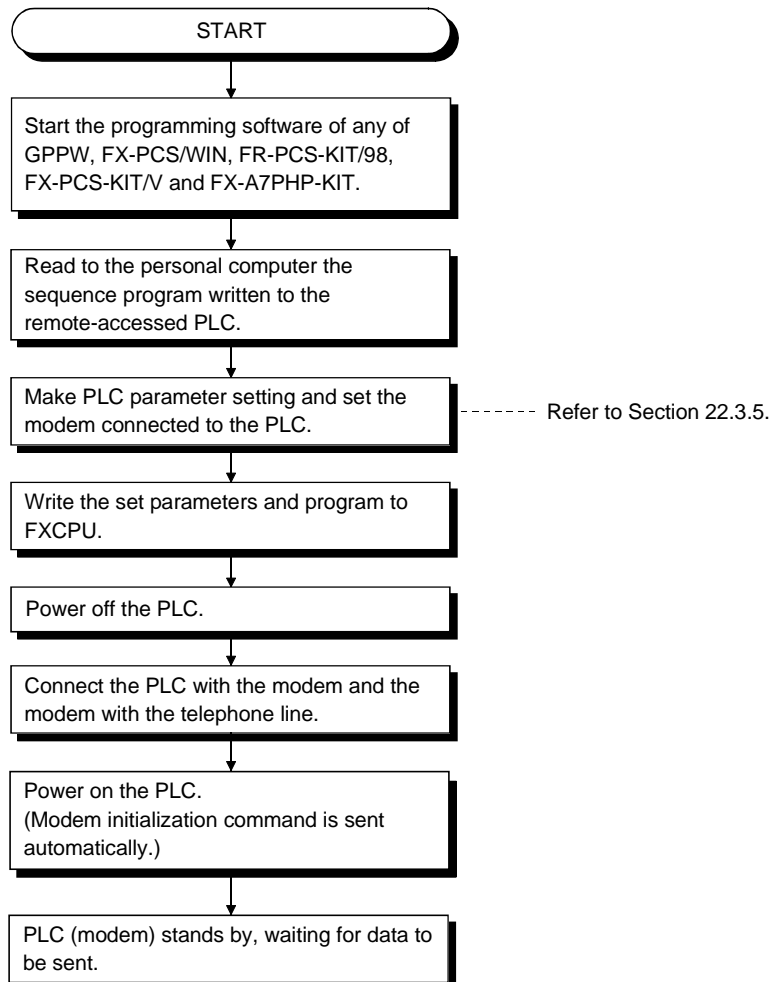

- Always power on in the modems and PLC in this order.
If the PLC is powered on earlier than the modems, the initialization command sent to the modems at power-on of the PLC is made invalid, and a communication error will occur at the time of remote access. Also, if only the modems are powered on after power-on, the initialization command is cleared, resulting in a communication error similarly. In this case, switch power on again in the order of modems and PLC.
- The PLC which was placed in the standby status in this procedure can be remote-controlled by FX-PCS/WIN programming software.

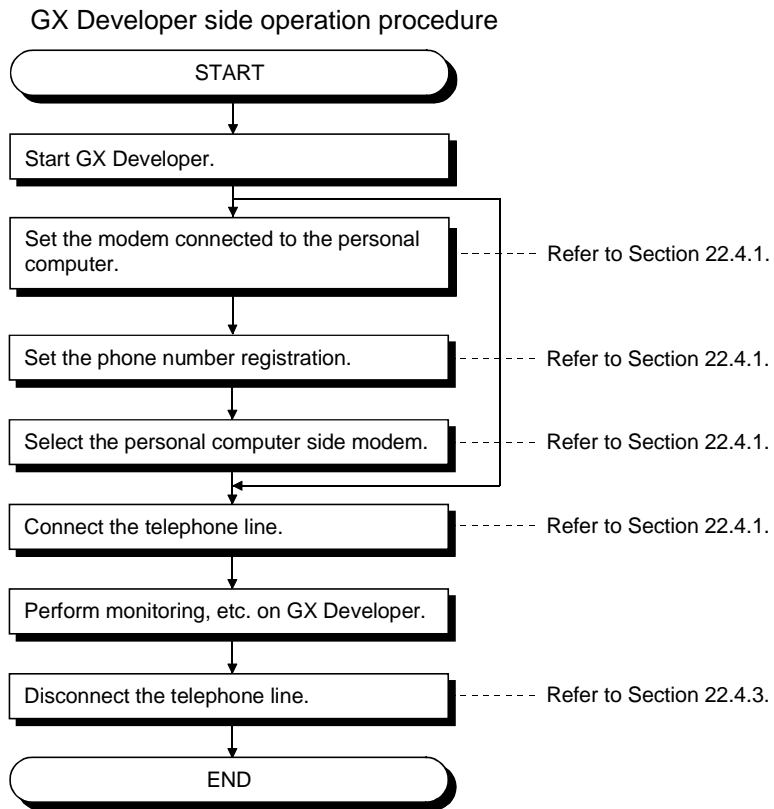

22.2.4 Making Q6TEL-Q6TEL communication

| A | Q/QnA | FX |
|---|-------|----|
| × | ○* | × |

*:Compatible with the QnACPU

(1) Send side

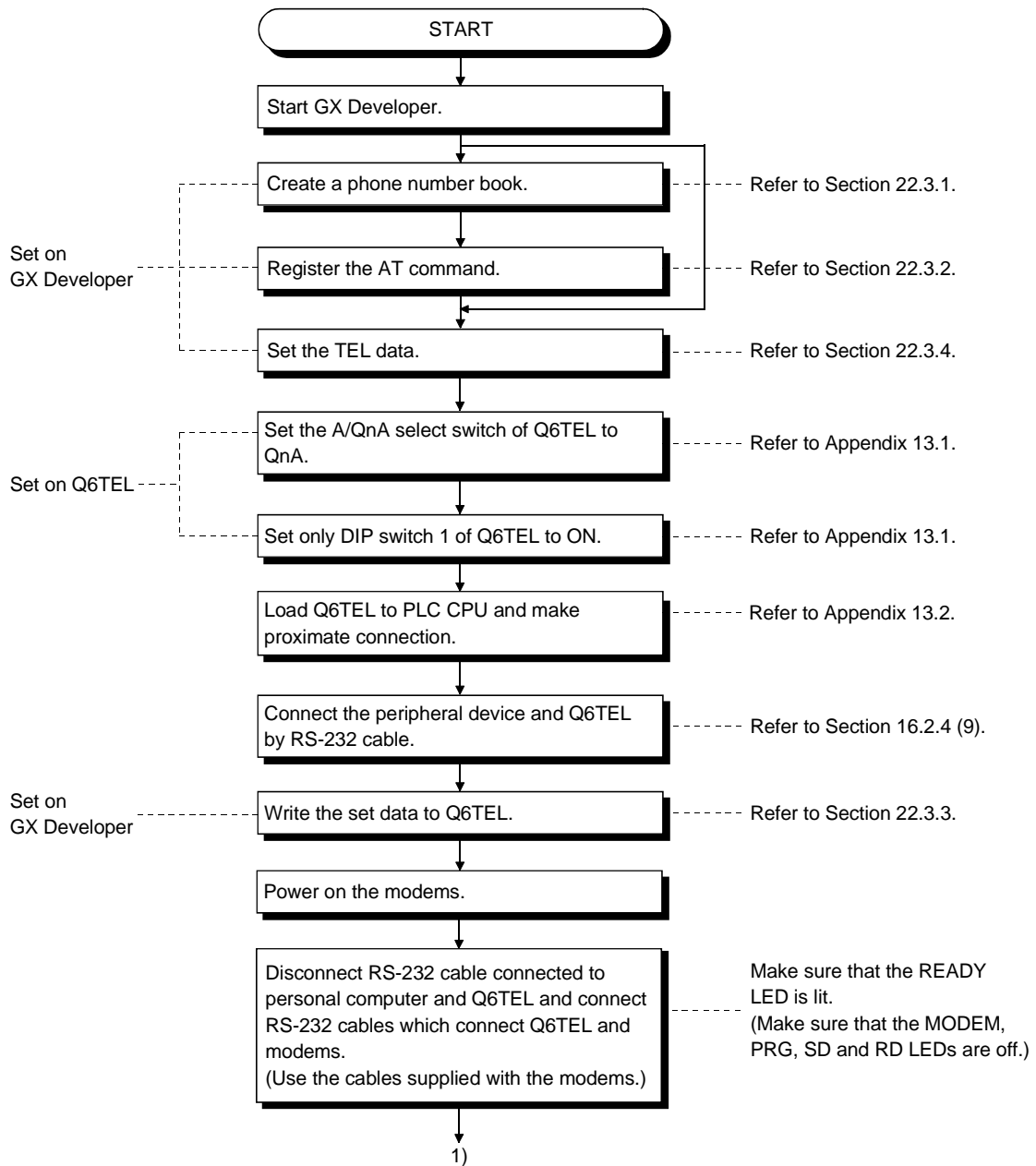

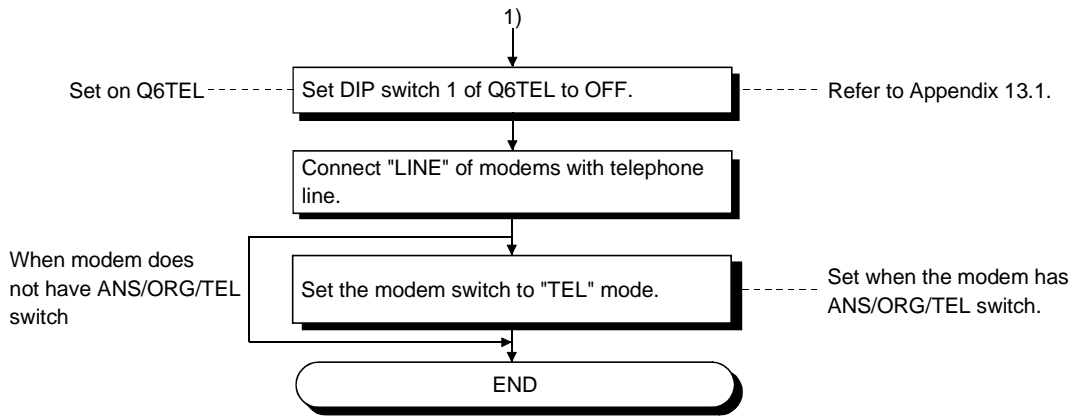

(2) Receive side

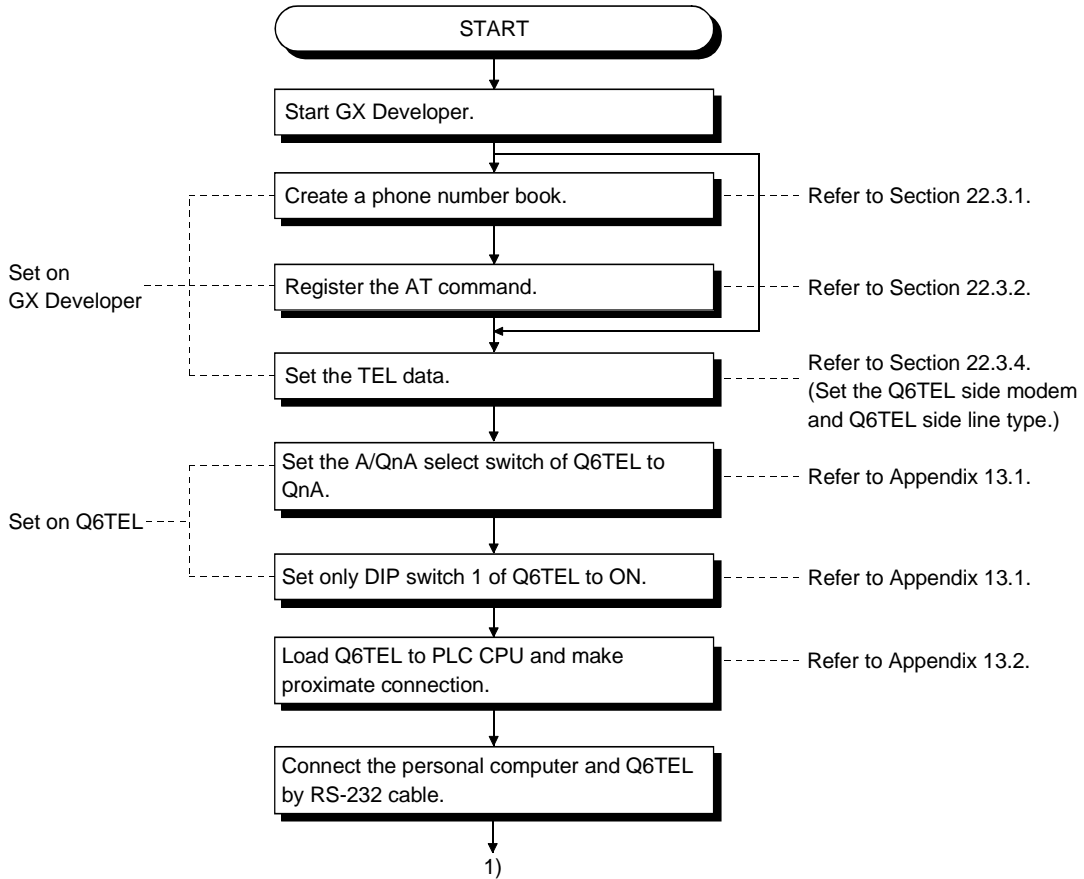

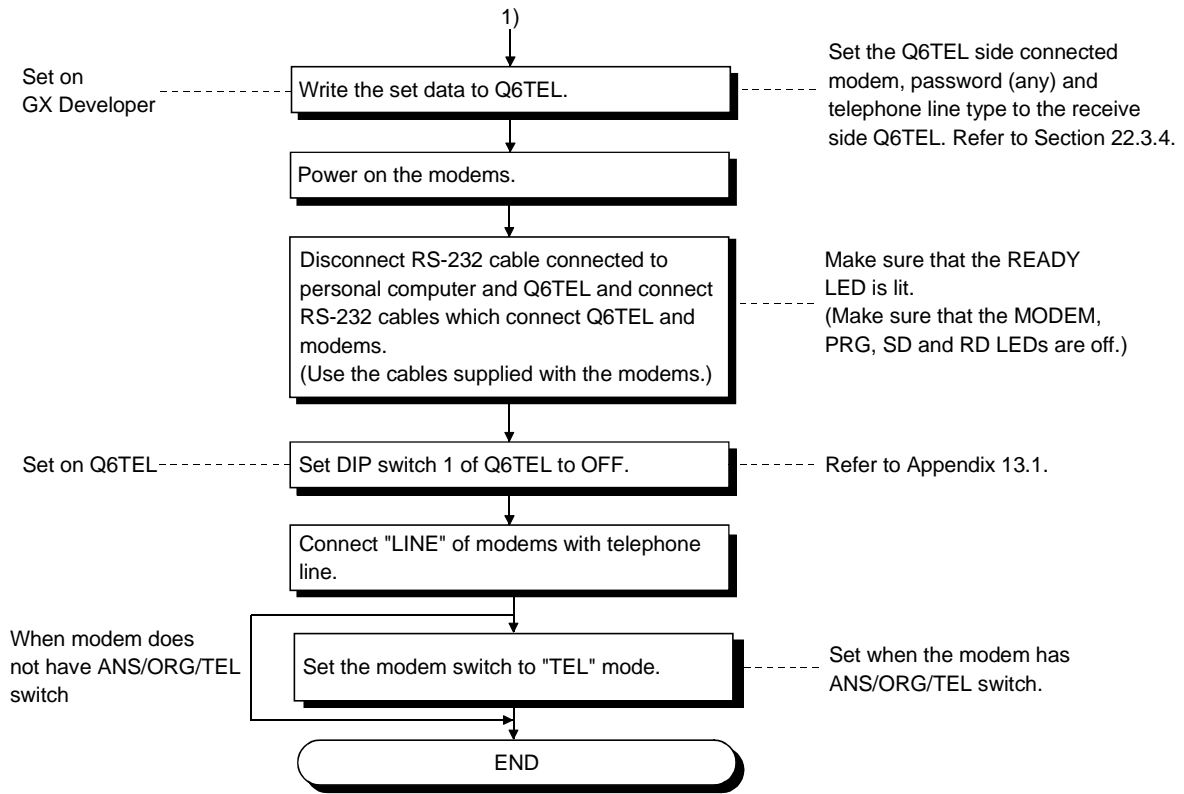

22.3 Making Initial Setting of Data

22.3.1 Creating a phone number book

| A | Q/QnA | FX |
|---|-------|----|
| ○ | ○ | ○ |

[Purpose]
Registers phone numbers.

[Operating Procedure]
[Tools] → [Set TEL data] → [Call book]

[Window]



[Description]

- 1) Registered phone number display list
Shows the group names and the other end names of the phone numbers.
Registered phone number 18 or more characters
Outside line access number2 or more characters
- 2) Display cursor position field
Shows the registered data selected in the registered phone number display list.

- 3) **New call number** button
Register a new phone number.

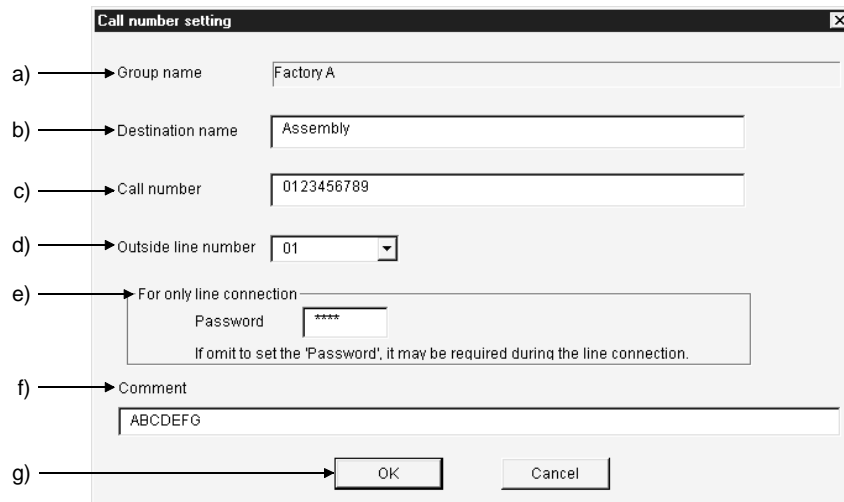

- a) **Group name**
Shows the group name of the registered number.
 - b) **Destination name**
Enter the other end name of the phone number to be set.
The number of set characters is within 50.
 - c) **Call number**
Enter the phone number.
The number of set characters is within 50.
 - d) **Outside line number**
Set the outside line access number.
The number of set characters is within 10.
 - e) **For only connection**
When a password has been set to the A6TEL/Q6TEL/Q Series C24, making this setting automatically starts password processing and connects the line.
When a password has not been set to the A6TEL/Q6TEL, making this setting connects the line.
 - f) **Comment**
Enter the memo to the registered data.
The number of set characters is within 60.
 - g) **OK** button
Click this button when the setting is finished.
- 4) **New group** button
Create a new group.
Clicking the New group button shows the group setting dialog box.
Enter and set the group name.
The number of set characters is within 50.

- 5) **Edit** button
Edits the registered data.
Choose the registered data you want to edit in the registered phone number display list.
Clicking the Edit button shows the phone number setting dialog box.
Edit each data.
- 6) **Copy** button
Copies the registered phone numbers to another group.
Choose the registered data you want to copy in the registered phone number display list.
Clicking the Copy button shows the group setting dialog box.
Choose the copy destination group and click the **OK** button.
- 7) **Move** group button
Moves the registered phone numbers to another group.
Choose the registered data you want to copy in the registered phone number display list.
Clicking the Move group button shows the group setting dialog box.
Choose the move destination group and click the **OK** button.
- 8) **Delete** button
Deletes the registered group and phone numbers.
(You cannot batch-delete on a group basis.)
- 9) **Find** button
Searches for the registered phone number. (Search match condition is partial match.)
All registered data are searched.
 - Searching advance
When search conditions are entered into both the other end and phone number, data which satisfies both search conditions is searched for.
- 10) **Select** button
Performs the phone number setting selection processing when the line connection dialog box is browsed.
- 11) **Read** file button
Reads to GX Developer the phone number data registered to GPPA or GPPQ.
The operation method is the same as the TEL data creation file reading operation.
- 12) **Write** file button
Writes the created phone number book to any folder specified.
- 13) **Close** button
Saves the edited data and terminates the phone number book function.

[Setting Procedure]

1. Click the New group button. (When newly creating data)
Enter the group name and create the group.
2. Choose the group where you want to register the phone number from the registered phone number display list.
3. Click the new phone number button.
Enter and set each data (other end name, phone number, outside line access number, memo).

22.3.2 Registering the AT command

| | | |
|---|-------|----|
| A | Q/QnA | FX |
| ○ | ○ | ○ |

[Purpose]
 Register the AT command.

[Operating Procedure]
 [Tools] → [Set TEL data] → [AT command]

[Dialog Box]

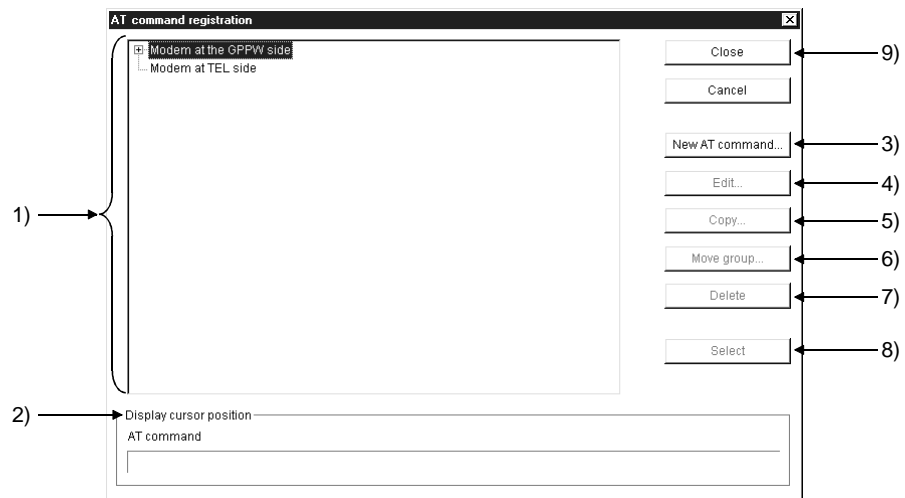

- [Description]
- 1) Registered AT command display list
 Shows the headings of the AT commands.
 - 2) Display cursor position field
 Shows the registered data selected in the registered AT command display list.

- 3) **New AT** command button
Registers a new AT command.

The screenshot shows a dialog box titled "AT command registration". It contains three text input fields. The first field, labeled "Group name", contains the text "Modem at the GPPW side". The second field, labeled "Title", contains "ABCD Modem". The third field, labeled "AT command", contains "ATQ0E1VX1S0=1". At the bottom of the dialog are three buttons: "OK", "Cancel", and "Help of AT command...". Arrows labeled "a)", "b)", and "c)" point to the "Group name", "Title", and "AT command" fields respectively.

- a) **Group name**
Shows the group name of the new command.
- b) **Heading**
Enter the heading for the AT command to be registered.
- c) **AT command**
Enter the AT command for modem initialization.
The number of entered characters is up to 70 (70 for A6TEL/40 for Q6TEL).
- 4) **Edit** button
Edits the registered data.
Choose the registered data you want to edit in the registered AT command display list.
Clicking the Edit button shows the AT command registration dialog box.
Edit each data.
- 5) **Copy** button
Copies the registered AT command to any other end.
Choose the registered data you want to copy in the registered AT command display list.
Clicking the Copy button shows the group specifying dialog box.
Choose the copy destination (any other end) and click the **OK** button.
- 6) **Move group** button
Moves the registered AT command to any other end.
Choose the registered data you want to move in the registered AT command display list.
Clicking the Move group button shows the group specifying dialog box.
Choose the move destination (any other end) and click the **OK** button.

- 7) **Delete** button
Deletes the registered AT commands.
(You cannot batch-delete on a group basis.)
- 8) **Select** button
Performs the AT command selection processing when the line connection dialog box or TEL data creation dialog box is browsed.
- 9) **Close** button
Saves the edited data and terminates the AT command registration function.

[Setting Procedure]

1. Choose the side where you want to register the AT command from the registered AT command display list.
2. Click the New AT command button.
Enter the heading and AT command to create the AT command.

22.3.3 Registering A6TEL data

| | | |
|---|-------|----|
| A | Q/QnA | FX |
| ○ | × | × |

[Purpose]
Register the A6TEL data.

[Operating Procedure]
[Tools] → [Set TEL data] → [TEL data]

[Dialog Box] (For use of A series)

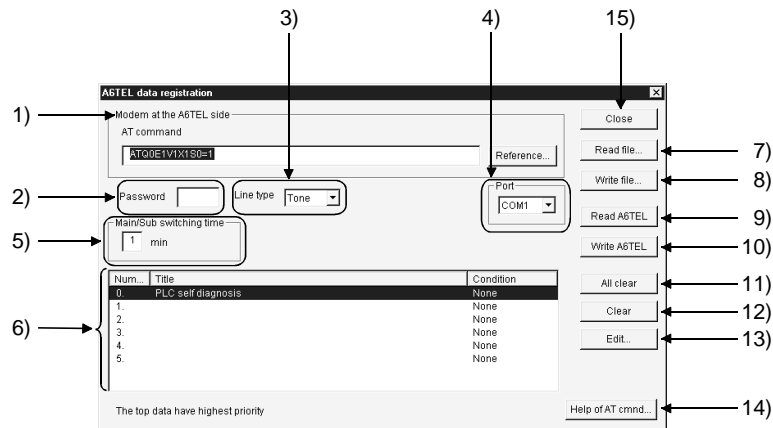

[Description] (For use of A series)

- 1) Modem at the A6TEL side
Set the AT command of the A6TEL side modem.
Direct input
Enter directly. The number of set characters is 70.
Browse (Only the AT command of the TEL side connection modem may be browsed)
Clicking the Browse button shows the AT command dialog box.
Choose the AT command you want to set, and click the Select button.
- 2) Password (Set any password)
Set the password for access to the A6TEL.
Set in four characters.
- 3) Line type
Choose the tone or pulse.

- 4) Port
Set the communication port number used to read/write the A6TEL data.

- 5) Main/Sub switching time
Regular and sub phone numbers can be set.
 - Notice destination when the regular and sub phone numbers have been registered

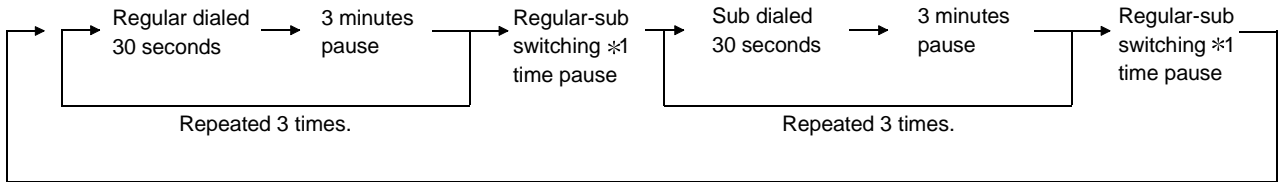

Repeated until the handset is made on-hook at notice destination.

- Notice destination when only the regular phone number has been registered

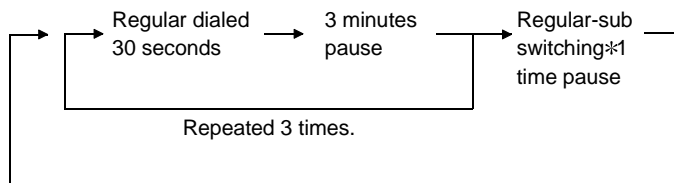

Permanent notice *2

- *1: Time can be set within the range 0 to 99 in increments of 1 minute.
- *2: Notice continues if the handset is made off-hook at notice destination.
Clear the permanent notice by
 - Placing the personal computer and A6TEL online (telephone line connected), or
 - Moving the DIP switch 1 or 2 of the A6TEL from ON to OFF.

- 6) Notice data list
Shows the titles and set conditions of the notice data.
- 7) **Read file** button
Reads the A6TEL data file or GPPA format A6TEL data file.
- 8) **Write file** button
Saves the TEL data created with GX Developer onto HD, FD or the like.
- 9) **Read A6TEL** button
Reads the TEL data set to the A6TEL.
The read data appears on the screen.
- 10) **Write A6TEL** button
Writes the TEL data created with GX Developer to the A6TEL.

- 11) **Clear all** button
Deletes all notice data registered.
- 12) **Clear** button
Deletes only the notice data selected in the notice data list.
- 13) **Edit** button

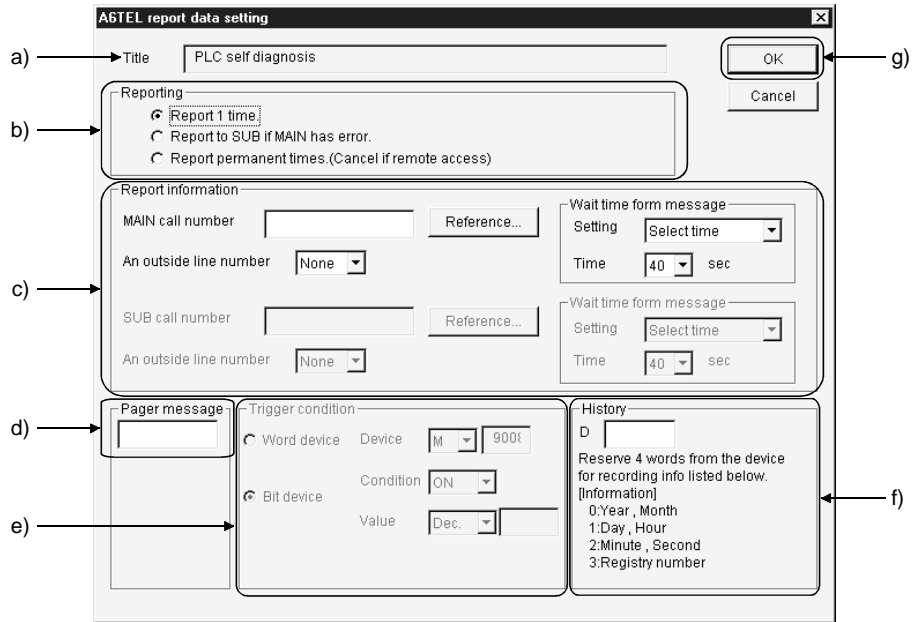

- a) **Heading**
Sets the heading to the data to be set as the notice destination of the A6TEL.
When the data written to the A6TEL once is reread, the heading is not displayed. (Since it is written to the personal computer only.)
The number of set characters is 60.
- b) **Reporting**
Choose the processing performed after the trigger conditions hold.
- c) **Notice destination information**
Set the notice destination information.
Phone number
Set the phone number of the notice destination.
 - Only 0 to 9, *, # and - may be used.
 - The number of set characters is 17.**Outside line access number**
 - Set the outside line access number of the notice destination.
0 to 9, # and * may be selected.**Pager announcement time**
 - **Setting**
Choose the time setting.
 - **Set time (dial message pause time)**
Set pause time when it is needed from when the A6TEL make a phone call until it sends a message.
The time that may be set is 0 to 99 seconds.

- d) **Pager message**
Set the message to be sent to the pager.
Message
 - Up to 10 characters may be set using 0 to 9, # and *.
- e) **Trigger condition**
Set the trigger device, the device number, and the status (ON/OFF) for a bit device, or the device value for a word device, which are used when the A6TEL performs notice processing.
- f) **History**
Set the data registers which store the other end, date and time when the A6TEL notified the pager. The setting range is D0 to 25980.

| | | | | | | |
|------|--------------------|----|--------|----|----|----|
| | b15 | to | b8 | b7 | to | b0 |
| Dn | Year | | Month | | | |
| Dn+1 | Day | | Hour | | | |
| Dn+2 | Minute | | Second | | | |
| Dn+3 | Notice destination | | | | | |

- g) **OK** button
Click this button when the setting is over.

- 14) **Help of AT command** button
Gives instructions for AT command setting.
- 15) **Close** button
Saves the edited data and terminates the TEL data registration function.

POINT

When using the A6TEL as a converter, double-click the PC side I/F icon on the Connection Setup screen and set the items of the following screen.

Also, the setting status appears on the Connection Setup screen.

22.3.4 Registering Q6TEL data

| | | |
|---|-------|----|
| A | Q/QnA | FX |
| × | ○* | × |

*: Compatible with the QCPU (Q mode).

[Purpose]
Register the TEL data.

[Operating Procedure]
[Tools] → [Set TEL data] → [TEL data]

[Dialog Box] (For use of QnA series)

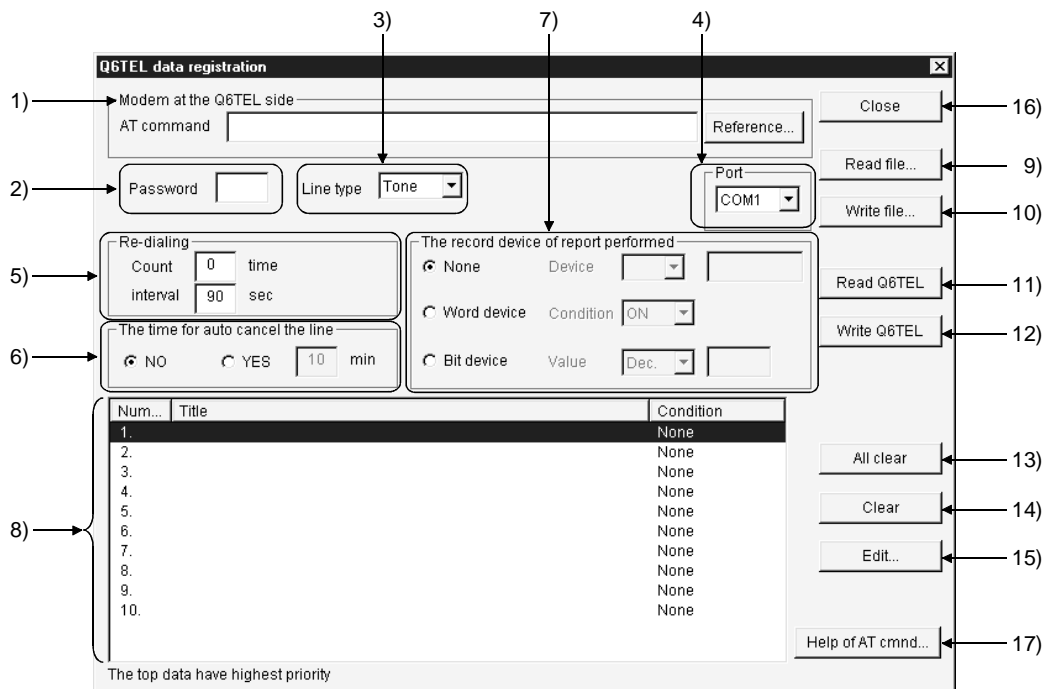

[Description] (For use of QnA series)

- 1) Modem at the Q6TEL side
Set the AT command of the Q6TEL side modem.
Direct input
Enter directly.
The number of set characters is 40.
Browse (Only the AT command of the TEL side connection modem may be browsed)
Clicking the Browse button shows the AT command dialog box.
Choose the AT command you want to set, and click the Select button.
- 2) Password (may be omitted)
Set the password for access to the Q6TEL.
Set in four characters.
- 3) Line type
Choose the tone, pulse or ISDN.

- 4) Port
Set the communication port number used to read/write the Q6TEL data.
- 5) Redial
Set the redialing function.
Number of times that may be set
Any number of times can be set between 1 and 99.
Interval that may be set
Any seconds can be set between 90 and 255 seconds.
- 6) The time for auto cancel the line
Set the line disconnection time at no response.
Time that may be set (The line is disconnected if there is no response after the set time has elapsed.)
Any minutes can be set between 1 and 120 minutes.
- 7) The record device of report performed
Set the device records of whether the Q6TEL has notified or not.
 - Ⓐ No
Device record is not made.
 - Ⓑ Word device
The set value of the word device is used for recording.
Set the device/device number and device value.
Usable device/device number
 - D0 to D25983
 - R0 to 32767
 - W0 to 657F
 - ZR0 to 65535Usable device value
 - Decimal -32768 to 32767
 - Hexadecimal 0 to FFFF (K0 to K32767 for T/C)
 - Ⓒ Bit device
The set value of the bit device is used for recording.
Set the device/device number and device status (ON, OFF).
Usable device/device number
 - X0 to 1FFF
 - Y0 to 1FFF
 - M0 to 32767
 - L0 to 32767
 - B0 to B7FFF
 - F0 to 32767
 - D0.0 to 25983.F
 - W0.0 to 657F.F
 - R0.0 to 32767.F
 - ZR0.0 to 1042431.F
 - SM0 to 2047
 - SB0 to 7FF
 - SD0.0 to SD2047.F
 - SW0.0 to 7FF.F
- 8) Notice data list
Shows the titles and set conditions of the notice data.
- 9) Read file button
Reads the Q6TEL data file or GPPQ format Q6TEL data file.

- 10) **Write file** button
Writes the Q6TEL data to a file as GX Developer format Q6TEL data.
- 11) **Read Q6TEL** button
Reads the TEL data set to the Q6TEL.
The read data appears on the screen.
- 12) **Write Q6TEL** button
Writes the TEL data created with GX Developer to the Q6TEL.
- 13) **Clear all** button
Deletes all notice data registered.
- 14) **Clear** button
Deletes only the notice data selected in the notice data list.
- 15) **Edit** button

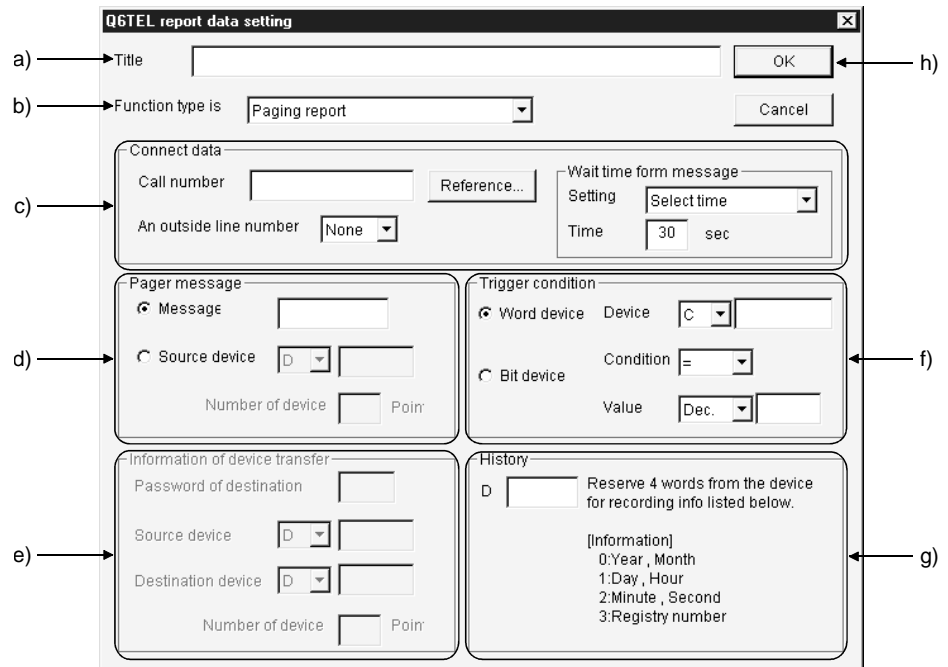

- a) **Heading**
Sets the heading to the data to be set as the notice destination of the Q6TEL.
When the data written to the Q6TEL once is reread, the heading is not displayed. (Since it is written to the personal computer only.)
The number of set characters is 60.
- b) **Function type is**
Set the notice destination.

- c) Notice destination information
Set the notice destination information.
- Phone number
- Set the phone number of the notice destination.
 - Only 0 to 9, *, # and - may be used.
(* and # are used for ISDN sub-address)
 - The number of set characters is 17.
- Outside line access number
- Set the outside line access number of the notice destination.
- Pager announcement time
- Setting
Choose the time setting.
 - Set time (dial message pause time)
Set pause time when it is needed from when the Q6TEL make a phone call until it sends a message.
The time that may be set is 0 to 99 seconds.
- d) Pager message
Set the message to be sent to the pager.
- Message
- 0 to 9, # and * may be selected.
 - Set within 10 characters.
- Transfer device
- When specifying the device, specify the first device of the transfer source and set how many points will be transferred.
- Transferable device
- D0 to D25983 • ZR0 to ZR65535
 - W0 to 657F • R0 to R32767
- The number of device points set is between 1 to 480.
Note that the number of characters displayed on the pager depends on the pager used.
- e) Device transfer information (may be set only when Q6TEL-Q6TEL communication is set)
Set the device whose data will be transferred between the Q6TELS.
- D0 to D25983 • R0 to R32767
 - ZR0 to ZR65535 • W0 to 657F
- f) Trigger condition
Set the trigger device, the device number, and the status (ON/OFF) for a bit device, or the device value for a word device, which are used when the Q6TEL performs notice processing.

- g) History
Set the data registers which store the other end, date and time when the Q6TEL notified the pager. The setting range is D0 to 25980.

| | | | | | | |
|------|--------------------|----|----|--------|----|----|
| | b15 | to | b8 | b7 | to | b0 |
| Dn | Year | | | Month | | |
| Dn+1 | Day | | | Hour | | |
| Dn+2 | Minute | | | Second | | |
| Dn+3 | Notice destination | | | | | |

- h) button
Click this button when the setting is over.
- 16) command button
Gives instructions for AT command setting.
- 17) button
Saves the edited data and terminates the TEL data registration function.

| |
|---|
| POINT |
| Note that the device settings in the notice completion record device setting, transfer devices, device transfer information and history depend on the PLC parameter device setting. |

22.3.5 Setting the FX PLC

| A | Q/QnA | FX |
|---|-------|----|
| × | × | ○ |

[Purpose]

Set the modem function of the FX1S, FX1N, FX1NC, FX2N or FX2NC PLC.

[Operating Procedure]

[PLC parameter] → <<PLC system (1)>>, <<PLC system (2)>> tab

[Dialog Box]

<<PLC system (1)>>

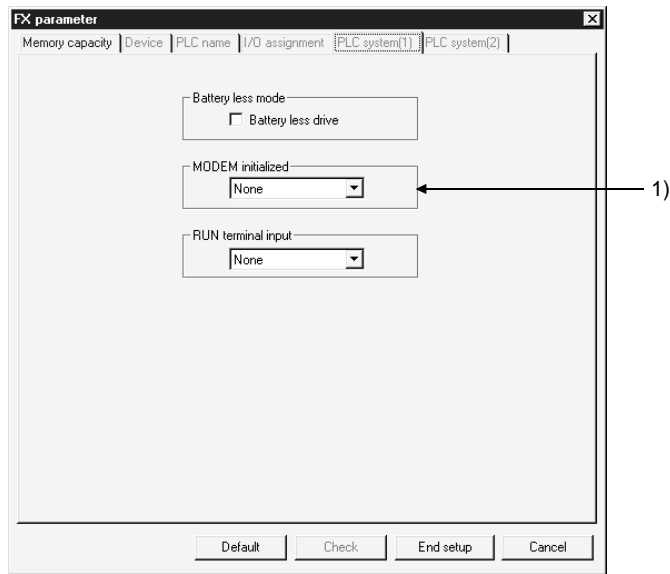

<<PLC system (2)>>

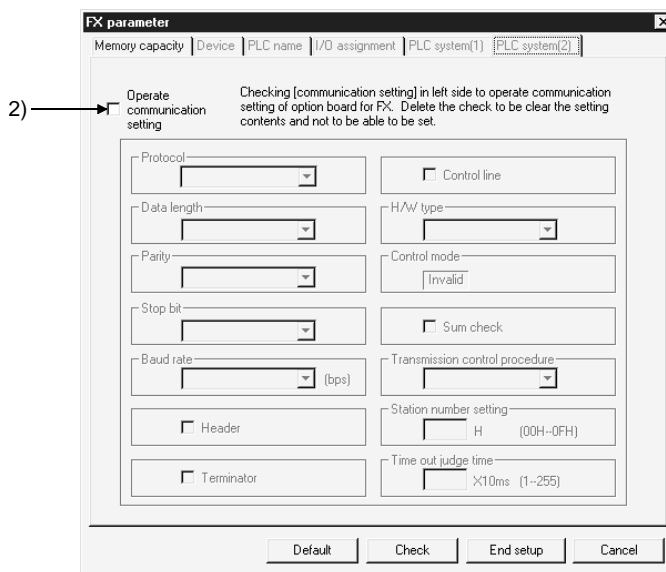

[Description]

- 1) MODEM initialized
Set the command to initialize the PLC side modem used for remote access to the PLC.

- 2) Operate communication setting
Uncheck the check box to set the PLC to be remote-accessed.

[Instructions for sequence program]

To make remote access, the special data register D8120 (communication format) value of the PLC must be set to "0".

This setting can be cleared to "0" by unchecking the "Operate communication setting" check box in PLC system. However, remote access cannot be made if any value other than "0" is written in D8120 in the sequence program. In this case, correct the sequence program so that a specific value is not written to D8120.

[User setting of the modem]

If you set the modem initialization to the "user setting mode" in PLC system, set the AT command of the modem in the following procedure.

- Initialization command system
To initialize the modem, use the AT command developed by Hayes, U.S.A. This command is generally represented in the following format.

| | | | | | | | |
|---|---|-------------------|-------------------|-------------------|-------|----|----|
| A | T | Command+parameter | Command+parameter | Command+parameter | ----- | CR | LF |
|---|---|-------------------|-------------------|-------------------|-------|----|----|

Confirm the details of the AT command in the manual of the modem used.

- If you choose the "user registration mode" in the aforementioned "PLC mode setting", FX1N, FX2N, or FX2NC PLC transmits the contents of data registers D1000 to D1059 and FX1S transmits the contents of data registers D200 to D255 as the modem initialization command to the modem via the RS-232 communication device after it has sent the AT&F (initialization to factory setting) command at power-on of the PLC.

Write the user-specified modem initialization command in advance to data registers D1000 to D1059 (FX1N, FX2N, FX2NC) and D200 to D255 (FX1S) using the personal computer current value changing function or sequence program.

Initialization command entry example: ATE0S0=2Q1&D0&M4Q0JO&W

| Register No. | ASCII | Hexadecimal | Register No. | ASCII | Hexadecimal |
|--------------|-------|-------------|--------------|-------|-------------|
| D1000 | A | 41 | D1013 | & | 26 |
| D1001 | T | 54 | D1014 | M | 4D |
| D1002 | E | 45 | D1015 | 4 | 34 |
| D1003 | 0 | 30 | D1016 | \ | 5C |
| D1004 | S | 53 | D1017 | Q | 51 |
| D1005 | 0 | 30 | D1018 | 0 | 30 |
| D1006 | = | 3D | D1019 | \ | 5C |
| D1007 | 2 | 32 | D1020 | J | 4A |
| D1008 | Q | 51 | D1021 | 0 | 30 |
| D1009 | 1 | 31 | D1022 | & | 26 |
| D1010 | & | 26 | D1023 | W | 57 |
| D1011 | D | 44 | D1024 | CR | 0D |
| D1012 | 0 | 30 | D1025 | LF | 0A |

The initialization command registered by the user may be specified in D1000 and subsequent (FX1N, FX2N, FXNC) and in D200 and subsequent (FX1S), but its transmission is ended as soon as "0" is read at any point during transmission.

In creating a sequence program, note that the input area of this initialization command for the modem should not overlap the area of the data registers used in a general sequence program.

- Settings of registered modem
The following table lists the setting items and their data of the AT command of the modem pre-registered to the PLC.
The setting items and their data may change with the modem. Confirm the actual settings in the manual of the modem used.

| Setting Item | PV-AF288 (AIWA) ATE0S0=2Q1&D0&M5\Q0\JO&W | ME3314 (OMRON) * ATE0S0=2Q1&D0&H0&R1S15=8&W |
|---|---|--|
| Command echo setting | E0 (no) | E0 (no) |
| Number of automatic incoming call ringers | S0=2 (twice) | S0=2 (twice) |
| Result code indication | Q1 (no) | Q1 (no) |
| DTR control | &D0 (normally ON) | &D0 (normally ON) |
| Communication mode | &M5 (V.42bis) | S15=8 (V.42bis) |
| Terminal flow control system | \Q0 (no) | &R1 (no) |
| Send data flow control | — | &H0 (no) |
| Terminal speed fixed mode | \J0 (fixed) | — |
| Write to nonvolatile memory | &W | &W |

*: The setting of the AT command compatible with the ME3314 (OMRON) has been added to version V2.01 or later (serial No. 78 or later) of the FX_{2N} PLC.
The FX_{1S}, FX_{1N}, FX_{2NC} PLC is compatible from its first products.

[Setting by programming software other than GX Developer]

- The FX_{2N} or FX_{2NC} PLC side setting may also be made using any of the following programming software.
FX-PCS/WIN Version V2.10 or later (for Windows®)
FX-PCS-KIT/98 Version V4.00 or later (for PC-9800)
FX-PCS-KIT/V Version V2.00 or later (for PC/AT)
FX-A7PHP-KIT Version V3.00 or later (for A7PHP)
- Set the modem to be used in the "PLC mode setting" of any software.
- If D8120 (communication format) must be cleared to zero in the software other than FX-PCS/WIN, clear all PLC parameters and then re-set the parameters other than [], the keywords, etc.
- Use the user setting method, etc. for the modem as described in this manual.

22.4 Connecting/Disconnecting the Line

22.4.1 Connecting the line automatically

| | | |
|---|-------|----|
| A | Q/QnA | FX |
| ○ | ○ | ○ |

[Purpose]

The connection method (automatic/callback/manual) for remote access is described.

[Operating Procedure]

[Tools] → [Set TEL data] → [Connection]

[Dialog Box]

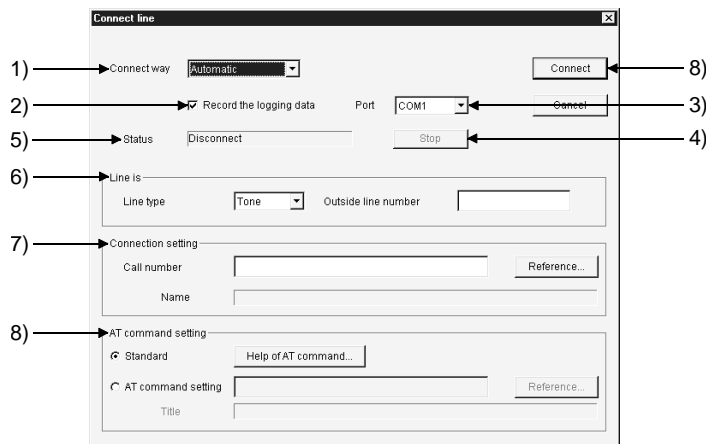

[Description]

1) Connect way

Choose Automatic/callback/manual (line connection via switchboard).
 Set the telephone number setting field when specifying the telephone number of the callback destination.
 For connection using the callback function, refer to Section 22.4.2.
 For manual connection, refer to Section 22.4.3.

2) Line is

Line type
 Choose Tone, Pulse or ISDN.
 Outside line number
 Set this number as necessary when making an outside call.
 Port
 Choose the COM port No. connected with the modem.

- 3) Connection destination designation
Set the phone number of the other end.
Also, presetting the phone number in the phone number book allows the phone number of the other end to be set from the **[Browse]** button.
- 4) AT command designation
 - ⊙ Standard
Specify the standard command of the modem.
 - ⊙ AT command designation
If the line does not connect properly using the standard AT command, refer to the data displayed by pressing the **[AT command help]** button and the manual of the modem, and create the AT command.
When the FX PLC is connected, create the AT command in accordance with the information of Help.
- 5) Record the logging data
In the log file, you can check the line connection time, line disconnection time, line usage time, line connection destination name, other end phone number, callback, and error status or normal connection.
The storage place and file name of the log file are as follows.
Storage place : GX Developer installation destination¥log
(Default: Melsec¥Gppw¥log)
Log file name : Year/Month/Day.dat (e.g. 980929.log)
- 6) Connect
The line connection status is displayed.
 - The equipment being accessed flickers.
When normal access is made, the equipment is displayed.

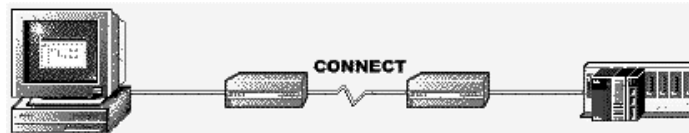

- If an error occurs at any point during connection, the error-related location is indicated by **[+]**. (The corresponding equipment is grayed.)
In addition, the error-related cause is displayed as a message. Confirm the corresponding location.

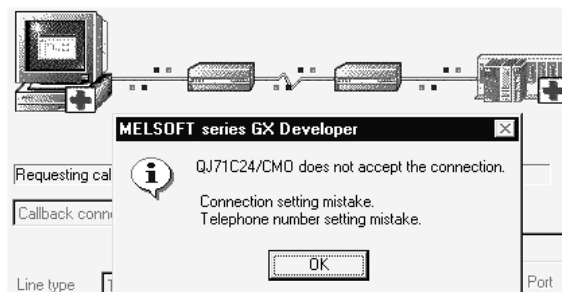

7) Init modem

Initialize the modem when it did not respond to line connection.
Clicking the **Init modem** button displays the following dialog box.



Click the **Yes** button to initialize the modem (default: AT&F).
The modem initialization command can be changed by choosing [Tools] - [Options] - <TEL function> tab-"Modem initialization AT command".
If any problem occurs in modem initialization, the following dialog appears.

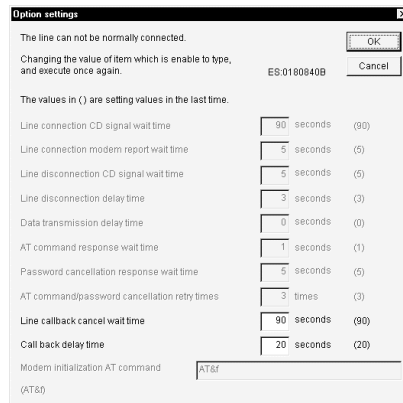

The settings of only the items that will pose a problem in line connection can be changed.
For details of the setting items, refer to the <TEL> tab setting in Section 15.12.

8) **Cancel** button

Used to stop line connection while it is in progress.

9) Connect

Clicking the **Connect** button connects the line.
If a problem comes up in line connection, the option setting dialog box appears.
For details of the setting items, refer to the <TEL> tab setting in Section 15.12.

[Setting Procedure]

For automatic

1. Set the line connection system.
2. Set the line type, outside line number and port.
3. Set the phone number of the other end.
4. Specify the AT command. (Normally set the standard command.)
5. Click the **Connect** button.
If the line could not be connected, initialize the modem.

Refer to the following manual for precautions for using the callback function to make line connection.

Q-Compatible Serial Communication Module User's Manual (Application)

POINTS

- Telephone line connection may also be made from "Online" → "Transfer setup".
- If a password has been set to the A6TEL/Q6TEL, the following dialog box appears to clear the password.
If the password is wrong, the line is not connected.



- If the line being connected is disconnected due to disturbance, the following dialog box appears to select whether the line is to be connected or disconnected.

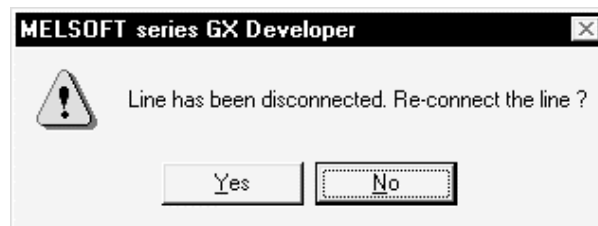

- When the line is connected, the line usage time dialog box appears. The connection time is shown in increments of 5 seconds, and the dialog box closes after the line is disconnected. To select whether the dialog box is shown or hidden, use "View" → "Elapsed time".
- If the connection destination is changed to another COM port or communication board (e.g. MELSECNET/10) by the connection destination designation during telephone line connection, the telephone line is kept connected and communication can be made in any communication path.

REMARKS

The following items are to be set on the PLC and personal computer sides when a telephone line is used for serial communication (for the Q/QnA series).

Serial communication (Q series)

| | Remote Access |
|-------------------|---|
| PLC | 1) I/O assignment setting Set the following items by software switching setting. <ul style="list-style-type: none"> • Baudrate, transmission specifications, transmission speed, mode, station number. 2) Set the following items in a sequence program. <ul style="list-style-type: none"> • Write the initialization command (ATS0=1). • Set the initialization request. Write the initialization command (ATS0=1) in a sequence program. |
| Personal computer | 1) AT command registration 2) Telephone number registration |

Serial communication (QnA series)

| | Remote Access |
|-------------------|---|
| PLC | 1) Set the DIP switches of the module. 2) Set the following items in a sequence program. <ul style="list-style-type: none"> • Write the initialization command (ATS0=1). • Set the initialization request. |
| Personal computer | 1) AT command registration 2) Telephone number registration |

22.4.2 Using callback function to make line connection

| A | Q/QnA | FX |
|---|-------|----|
| × | ○* | × |

*: Compatible when QACPU (Q mode) is selected

The callback function is designed to make line reconnection (callback) from the Q series C24 or Q series CMO after line connection from GX Developer to enable access from GX Developer to the QCPU (Q mode).

For 1) to 3), 9), the personal computer bears the call charge.

For 4) to 8), the Q series C24 or Q series CMO bears the call charge.

Refer to the following manual for details.

- Q-Compatible Serial Communication Module User's Manual (Application)

- (1) Auto line connect
Choose this when the callback function has not been set to the Q series C24 or Q series CMO.
- (2) Auto line connect (Callback fixation)
When the callback function has been set to the Q series C24 or Q series CMO, choosing this connects the line without using the callback function.
Connection can be made from only the personal computer having the telephone number registered to the buffer memory (2101H).
- (3) Auto line connect (Callback number specification)
When the callback function has been set to the Q series C24 or Q series CMO, choosing this connects the line without using the callback function.
Connection can be made from any personal computer.
- (4) Callback connect (Fixation)
Choosing this calls back only the personal computer having the telephone number registered to the buffer memory (2101H) of the Q series C24 or Q series CMO.
- (5) Callback connect (Number specification)
Choosing this calls back any personal computer.
- (6) Callback request (Fixation)
Choosing this gives a callback request from any personal computer and calls back the personal computer having the telephone number registered to the buffer memory (2101H) of the Q series C24 or Q series CMO. (The personal computer that was connected first is not called back.)
- (7) Callback request (Number specification)
Choosing this gives a callback request from any personal computer and calls back any personal computer.
(GX Developer that was connected first is not called back.)
- (8) Callback reception waiting
When a callback request [fixation or number specification] is given to connect the line, choosing this causes the personal computer at the callback destination to select "Callback reception waiting" and connect the line.
- (9) Manual line connect
This is independent of callback connection.
Choose this when connecting the line via a switchboard.

Making the "Call back function designation" setting of GX Configurator-SC on the Q series C24 or Q series CMO enables line connection to be performed in any of the GX Developer connection systems given in the following table.

The following are the correspondences between the setting items of "Call back function designation" of GX Configurator-SC and those of the connection systems on the GX Developer side.

| GX Developer Side Connection System (*1) | 1) | 2) | 3) | 4) | 5) | 6) | 7) | 8) | 9) |
|---|----|----|----|----|----|----|----|----|----|
| Q Series C24 or Q series CMO Side Callback Function Designation | | | | | | | | | |
| Auto line connect | ○ | | | | | | | | ○ |
| Setting 1: Auto line connect / Callback connect [Fixation] | | ○ | | ○ | | ○ | | ○ | |
| Setting 2: Auto line connect / Callback connect [Number specification] | | ○ | ○ | ○ | ○ | ○ | ○ | ○ | |
| Setting 3: Auto line connect / Callback connect [Number specification, max. 10 units] | | | ○ | | ○ | | ○ | ○ | |
| Setting 4: Callback connect [Fixation] | | | | ○ | | ○ | | ○ | |
| Setting 5: Callback connect [Number specification] | | | | ○ | ○ | ○ | ○ | ○ | |
| Setting 6: Callback connect [Number specification, max. 10 units] | | | | | ○ | | ○ | ○ | |

○: Connectable

*1 The following gives the connection systems of GX Developer.

Connection system menu on [Connect line] screen

- 1) Auto line connect
- 2) Auto line connect (Callback fixation)
- 3) Auto line connect (Callback number specification)
- 4) Callback connect(Fixation)
- 5) Callback connect(Number specification)
- 6) Callback request (Fixation)
- 7) Callback request (Number specification)
- 8) Callback reception waiting
- 9) Manual line connect

- | | |
|--|--|
| 1) Auto line connect | 6) Callback request (Fixation) |
| 2) Auto line connect (Callback fixation) | 7) Callback request (Number specification) |
| 3) Auto line connect (Callback number specification) | 8) Callback reception waiting |
| 4) Callback connect (Fixation) | 9) Manual line connect |
| 5) Callback connect (Number specification) | |

The following example assumes that Callback request (Number specification) was used to connect the line.

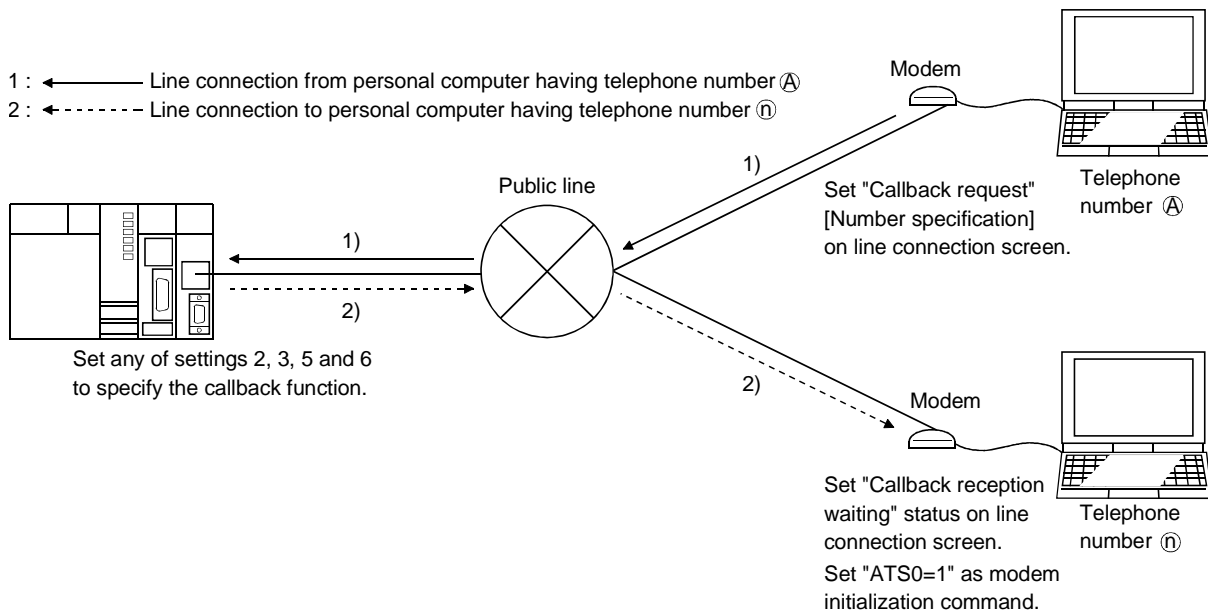

22.4.3 Connecting the line via a switchboard (manual connection)

| A | Q/QnA | FX |
|---|-------|----|
| ○ | ○ | ○ |

This section explains the way to connect to a private branch line via a switchboard. Manual line connection cannot be made if the modem does not have the ANS/ORG/TEL select switch.

(1) System configuration

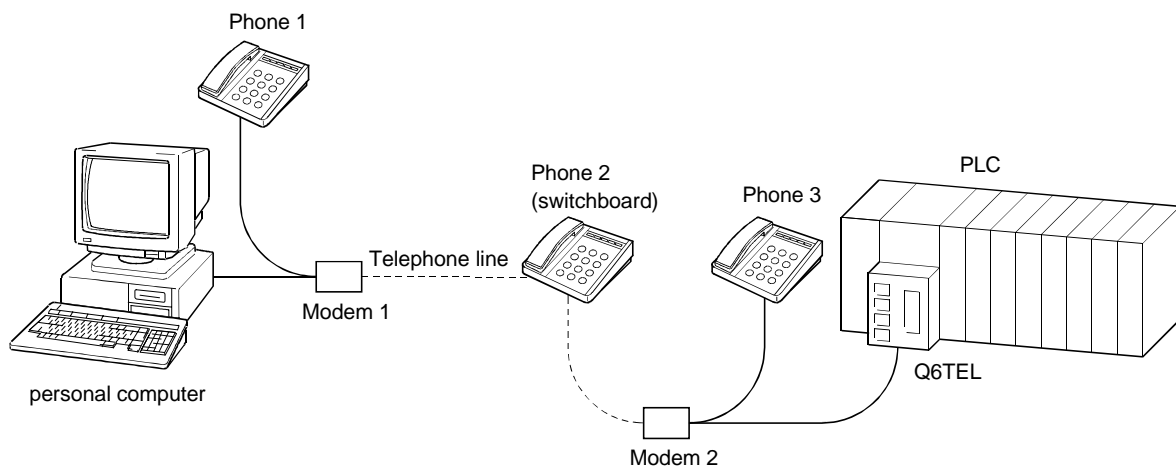

(2) Operation procedure

1. [Tools] → [Set TEL data] → [Connection]
(Choose "Manual" as the line connection system in the line connection dialog box. For the operation procedure, refer to Section 23.4.1.)
2. Set modem 1 on the phone 1 side to the ORG mode and place modem 2 on the phone 3 side to the ANS mode.
3. Make a call from phone 1 to phone 2 (switchboard).
4. Connect phone 1 and phone 3 to the line at phone 2 (switchboard).
5. In conversation between phone 1 and phone 3, determine that the A6TEL/Q6TEL will be connected to the line.
6. Turn on the DATA switch of modem 2 on the phone 3 side.
7. After confirming the "beep" of modem 1 on the phone 1 side, turn on the DATA switch.
8. As soon as the "beep" of modem 1 on the phone 1 side has gone, press the **Connection** button of the personal computer.

When the line is connected properly, the "Line connected" dialog box appears.

- (3) Instructions
- 1) The operation timings in steps 6 and 7 are delicate.
If connection is not made well, repeat the operation several times to adjust the timings.
 - 2) The modems for manual line connection must have the "ANS ↔ ORG" select switch.
AIWA PV-AF3361WW
 - 3) For manual line connection, the automatic incoming call mode must have been cleared in the A6TEL/Q6TEL/FX CPU side modem.
 - For the modem which uses a switch to set to the automatic incoming call mode
Set the automatic incoming call mode switch to the clear position.
 - Change "S0" to "S0=0" in the initialization command.
When "S0" has already been set to other than 0, change it to "S0=0".
 - If the modem has been set to other than the user registration mode in the PC system setting (1) of the FX2N or FX2CN PLC, "S0=2" is set in the initialization command.
When making manual line connection, place the modem in the user registration mode and program the initialization command including "S0=0" for D1000 to D1059.
Refer to Section 22.3.5.

22.4.4 Disconnecting the line

| A | Q/QnA | FX |
|-----------------------|-----------------------|-----------------------|
| <input type="radio"/> | <input type="radio"/> | <input type="radio"/> |

[Purpose]

The disconnection of the telephone line being connected is described.

[Operating Procedure]

[Tools] → [Set TEL data] → [Disconnection]

[Dialog Box]



APPENDICES

Appendix 1 GPP Function Access Ranges in MELSECNET(II/10) Systems

1.1 Access Range with MELSECNET (II)

APP

| A | Q/QnA | FX |
|---|-------|----|
| ○ | ○ | × |

[PLC No. Designation Example]
For MELSECNET (II), MELSECNET/B:

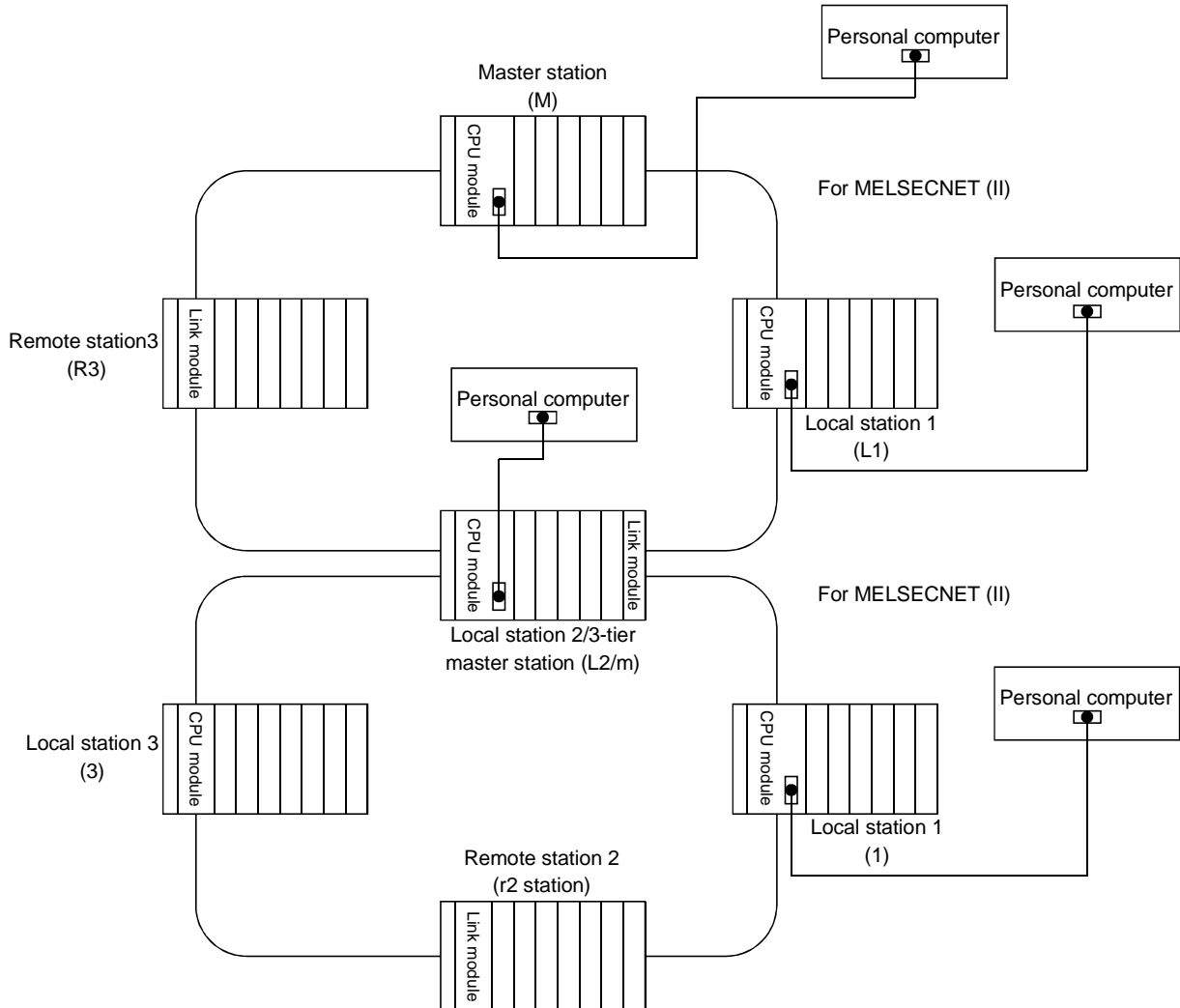

Designated PLC number

| Personal computer-connected Station | PLC Accessed by Personal computer | | | | | | |
|-------------------------------------|-----------------------------------|----|------|----|----|----|----|
| | M | L1 | L2/m | R3 | I1 | r2 | I3 |
| M | ○ | ○ | ○ | × | × | × | × |
| L1 | ○ | ○ | × | × | × | × | × |
| L2/m | ○ | × | ○ | × | ○ | × | ○ |
| R3 | ○ | × | × | × | × | × | × |
| I1 | × | × | ○ | × | ○ | × | × |
| r2 | × | × | ○ | × | × | × | × |
| I3 | × | × | ○ | × | × | × | ○ |

○ ... Designating the PLC number (station number) of the relevant programmable controller allows access to all devices.

APP

| | |
|--------------|---|
| POINT | Even if any tier in the figure above is MELSECNET/B, the designated numbers are the same. |
|--------------|---|

1.2 Access Range for an A Series Start

| | | |
|---|-------|----|
| A | Q/QnA | FX |
| ○ | ○ | × |

For PLC to PLC network
When using a MELSECNET/10 2-tier system:

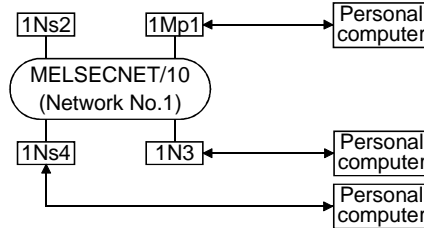

| Personal computer-connected station | Station Accessible from Personal computer | | | |
|-------------------------------------|---|------|-----|------|
| | 1Mp1 | 1Ns2 | 1N3 | 1Ns4 |
| 1Mp1 | FF | 1-2 | 1-3 | 1-4 |
| 1N3 | 1-1 | × | FF | × |
| 1Ns4 | 1-1 | 1-2 | 1-3 | FF |

- [MELSECNET/10]
- [PLC to PLC network]
- Mp station...Control station
- Ns station...Normal station (AnUCPU)
- N station...Normal station (CPUs excluding AnU (AnA/AnNCPU))
- [MELSECNET (II)]
- M station...Master station
- L station...Local station
- R station...Remote station
- FF: Host station

• When using a MELSECNET/10 multi-tier system:

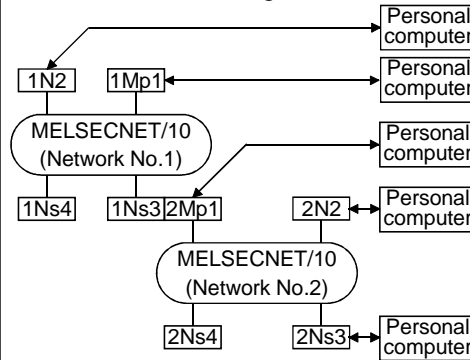

| Personal computer-connected Station | Station Accessible from Personal computer | | | | | | |
|-------------------------------------|---|-----|-----------|------|-----|------|------|
| | 1Mp1 | 1N2 | 1Ns3/2Mp1 | 1Ns4 | 2N2 | 2Ns3 | 2Ns4 |
| 1Mp1 | FF | 1-2 | 1-3 | 1-4 | 2-2 | 2-3 | 2-4 |
| 1N2 | 1-2 | FF | × | × | × | × | × |
| 1Ns3/2Mp1 | 1-1 | 1-2 | FF | 1-4 | 2-2 | 2-3 | 2-4 |
| 2N2 | × | × | 2-1 | × | FF | × | × |
| 2Ns3 | 1-1 | 1-2 | 2-1 | 1-4 | 2-2 | 2-3 | FF |

• When using a MELSECNET/10 / MELSECNET(II) composite system:

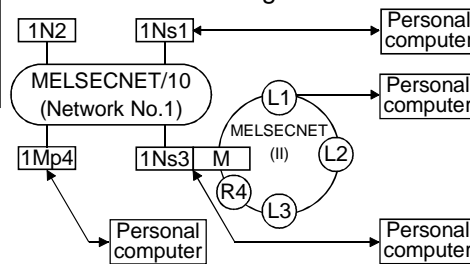

| Personal computer-connected Station | Station Accessible from Personal computer | | | | | | | |
|-------------------------------------|---|-----|--------|------|----|----|----|----|
| | 1Ns1 | 1N2 | 1Ns3/M | 1Mp4 | L1 | L2 | L3 | R4 |
| 1Ns1 | FF | 1-2 | 1-3 | 1-4 | × | × | × | × |
| 1Ns3/M | 1-1 | 1-2 | FF | 1-4 | 1 | 2 | 3 | × |
| 1Mp4 | 1-1 | 1-2 | 1-3 | FF | × | × | × | × |
| L1 | × | × | 0 | × | FF | × | × | × |

"Station accessible from Personal computer" in the tables:
<Example>

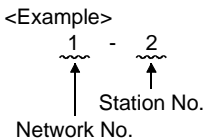

• When using an AnA/AnNCPU as an intermediate station:

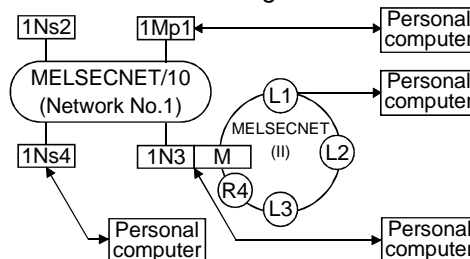

| Personal computer-connected station | Station Accessible from Personal computer | | | | | | | |
|-------------------------------------|---|------|-------|------|----|----|----|----|
| | 1Mp1 | 1Ns2 | 1N3/M | 1Ns4 | L1 | L2 | L3 | R4 |
| 1Mp1 | FF | 1-2 | 1-3 | 1-4 | × | × | × | × |
| 1N3/M | 1-1 | × | 1-3 | × | 1 | 2 | 3 | × |
| 1Ns4 | 1-1 | 1-2 | 1-3 | FF | × | × | × | × |
| L1 | × | × | 0 | × | FF | × | × | × |

For remote I/O network

- When using a MELSECNET/10 2-tier system:

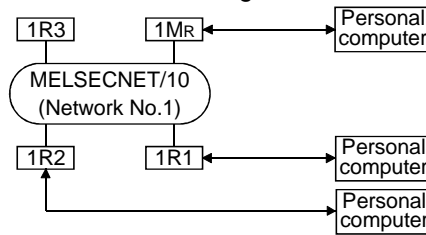

| Personal computer-connected Station | Station Accessible from Personal computer | | | |
|-------------------------------------|---|-----|-----|-----|
| | 1MR | 1R1 | 1R2 | 1R3 |
| 1MR | FF | × | × | × |
| 1R1 | 0 | × | × | × |
| 1R2 | 0 | × | × | × |

- When using a MELSECNET/10 multi-tier system:

[MELSECNET/10]
[PLC to PLC network]
 Mp station....Control station
 Ns station....Normal station (AnUCPU)
 N station.....Normal station (CPUs excluding AnU) (AnA/AnNCPU)
[MELSECNET/10]
[Remote I/O network]
 MR station...Master station (AnUCPU)
 R station.....Remote station
[MELSECNET (II)]
 M station.....Master station
 L station.....Local station
 R station.....Remote station
 FF: Host station

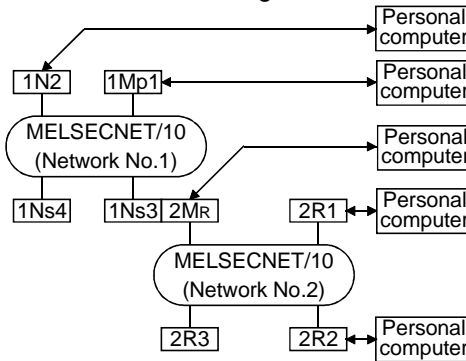

| Personal computer-connected Station | Station Accessible from Personal computer | | | | | | |
|-------------------------------------|---|-----|----------|------|-----|-----|-----|
| | 1Mp1 | 1N2 | 1Ns3/2MR | 1Ns4 | 2R1 | 2R2 | 2R3 |
| 1Mp1 | FF | 1-2 | 1-3 | 1-4 | × | × | × |
| 1N2 | × | FF | × | × | × | × | × |
| 1Ns3/2MR | 1-1 | 1-2 | FF | 1-4 | × | × | × |
| 2R1 | 1-1 | 1-2 | 0 | 1-4 | × | × | × |
| 2R2 | 1-1 | 1-2 | 0 | 1-4 | × | × | × |

- When using a MELSECNET/10, MELSECNET (II) composite system:

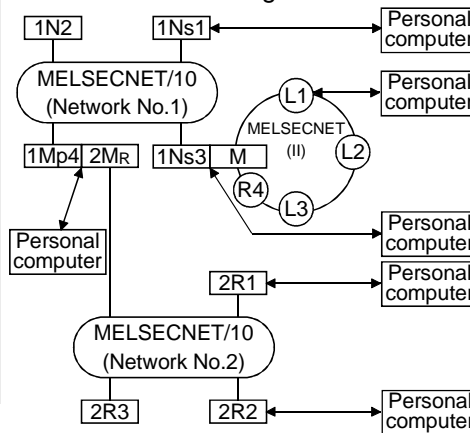

| Personal computer-connected Station | Station Accessible from Personal computer | | | | | | | | | | |
|-------------------------------------|---|-----|--------|----------|-----|-----|-----|----|----|----|----|
| | 1Ns1 | 1N2 | 1Ns3/M | 1Mp4/2MR | 2R1 | 2R2 | 2R3 | L1 | L2 | L3 | R4 |
| 1Ns1 | FF | 1-2 | 1-3 | 1-4 | × | × | × | × | × | × | × |
| 1Ns3/M | 1-1 | 1-2 | FF | 1-4 | × | × | × | 1 | 2 | 3 | × |
| 1Mp4/2MR | 1-1 | 1-2 | 1-3 | FF | × | × | × | × | × | × | × |
| 2R1 | 1-1 | 1-2 | 1-3 | 0 | × | × | × | × | × | × | × |
| 2R2 | 1-1 | 1-2 | 1-3 | 0 | × | × | × | × | × | × | × |
| L1 | × | × | 0 | × | × | × | × | FF | × | × | × |

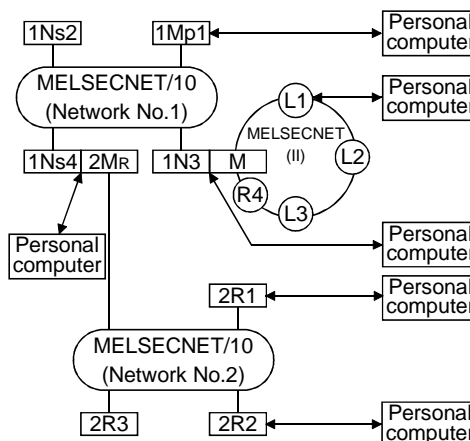

| Personal computer-connected Station | Station Accessible from Personal computer | | | | | | | | | | |
|-------------------------------------|---|------|-------|----------|-----|-----|-----|----|----|----|----|
| | 1Mp1 | 1Ns2 | 1N3/M | 1Ns4/2MR | 2R1 | 2R2 | 2R3 | L1 | L2 | L3 | R4 |
| 1Mp1 | FF | 1-2 | 1-3 | 1-4 | × | × | × | × | × | × | × |
| 1N3/M | × | × | FF | × | × | × | × | 1 | 2 | 3 | × |
| 1Ns4/2MR | 1-1 | 1-2 | 1-3 | FF | × | × | × | × | × | × | × |
| 2R1 | 1-1 | 1-2 | 1-3 | 0 | × | × | × | × | × | × | × |
| 2R2 | 1-1 | 1-2 | 1-3 | 0 | × | × | × | × | × | × | × |
| L1 | × | × | 0 | × | × | × | × | FF | × | × | × |

1.3 Access Range for a QnA Series Start

| | | |
|---|-------|----|
| A | Q/QnA | FX |
| × | ○* | × |

*: This function is compatible with the QnACPU

For MELSECNET/10 PLC to PLC network

- When using a MELSECNET/10 2-tier system:

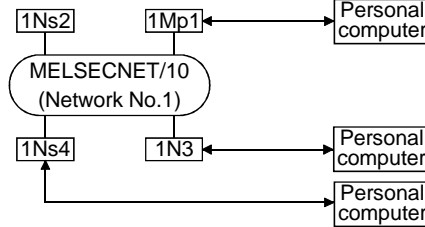

Designated PLC number

| Personal computer-connected Station | Station Accessible from Personal computer | | | |
|-------------------------------------|---|------|-----|------|
| | 1Mp1 | 1Ns2 | 1N3 | 1Ns4 |
| 1Mp1 | FF | 1-2 | × | 1-4 |
| 1N3 | × | × | × | × |
| 1Ns4 | 1-1 | 1-2 | × | FF |

× : Access not possible

- When using a MELSECNET/10 multi-tier system:

Mp station...Control station
Ns station...Normal station (QnACPU)
N station...Normal station (CPUs excluding QnA (AnU/AnA/AnNCPU))

In the figure to the right, the first digit for each station indicates the network number and the final line indicates the station number.
FF: Host station

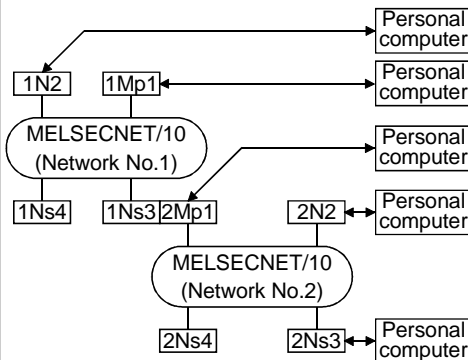

Designated PLC number

| Personal computer-connected Station | Station Accessible from Personal computer | | | | | | |
|-------------------------------------|---|-----|-----------|------|-----|------|------|
| | 1Mp1 | 1N2 | 1Ns3/2Mp1 | 1Ns4 | 2N2 | 2Ns3 | 2Ns4 |
| 1Mp1 | FF | × | 1-3 | 1-4 | × | 2-3 | 2-4 |
| 1N2 | × | × | × | × | × | × | × |
| 1Ns3/2Mp1 | 1-1 | × | FF | 1-4 | × | 2-3 | 2-4 |
| 2N2 | × | × | × | × | × | × | × |
| 2Ns3 | 1-1 | × | 2-1 | 1-4 | × | FF | 2-4 |

× : Access not possible

- When using a MELSECNET/10, MELSECNET (II) composite system: (Intermediate station: QnACPU)

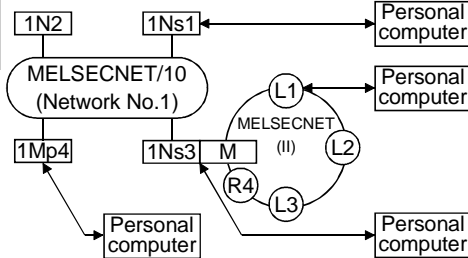

Designated PLC number

| Personal computer-connected Station | Station Accessible from Personal computer | | | | | | | |
|-------------------------------------|---|-----|--------|------|----|----|----|----|
| | 1Ns1 | 1N2 | 1Ns3/M | 1Mp4 | L1 | L2 | L3 | R4 |
| 1Ns1 | FF | × | 1-3 | 1-4 | × | × | × | × |
| 1Ns3/M | 1-1 | × | FF | 1-4 | 1 | 2 | 3 | × |
| 1Mp4 | 1-1 | × | 1-3 | FF | × | × | × | × |
| L1 | × | × | 0 | × | FF | × | × | × |

× : Access not possible

(Intermediate station: AnU/AnA/AnNCPU)

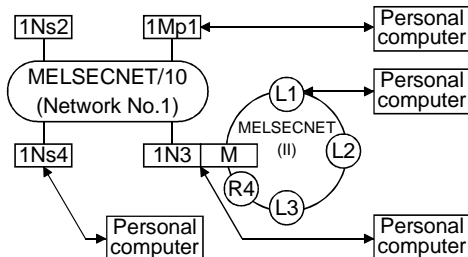

Designated PLC number

| Personal computer-connected Station | Station Accessible from Personal computer | | | | | | | |
|-------------------------------------|---|------|-------|------|----|----|----|----|
| | 1Mp1 | 1Ns2 | 1N3/M | 1Ns4 | L1 | L2 | L3 | R4 |
| 1Mp1 | FF | 1-2 | × | 1-4 | × | × | × | × |
| 1N3/M | × | × | × | × | × | × | × | × |
| 1Ns4 | 1-1 | 1-2 | × | FF | × | × | × | × |
| L1 | × | × | × | × | FF | × | × | × |

× : Access not possible

"Station accessible from Personal computer" in the tables:

<Example>

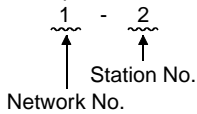

| POINT |
|-------|
|-------|

| |
|--|
| <p>To access a PLC in another station, routing parameters must be set by using the Personal computer function.</p> |
|--|

| |
|---|
| <p>For details on setting network parameters, refer to the "online" manual.</p> |
|---|

| |
|---|
| <p>For details of the network parameters themselves, refer to the MELSECNET/10 Network System Reference Manual.</p> |
|---|

For MELSECNET/10 remote I/O network

- When using a MELSECNET/10 2-tier system

[MELSECNET/10 PLC to PLC network]
 Mp station.....Control station
 Ns station.....Normal station (QnACPU)
 N station.....Normal station (CPUs excluding QnA (AnU/AnA/AnNCPU))

[MELSECNET/10 Remote I/O network]
 Mr station...Master station (QnACPU)
 R station.....Remote station

[MELSECNET (II)]
 M station.....Master station
 L station.....Local station
 R station.....Remote station

In the figure to the right, the first digit for each station indicates the network number and the final line indicates the station number. However, the station number of Mr (master station) is not shown because it is "0."

FF: Host station

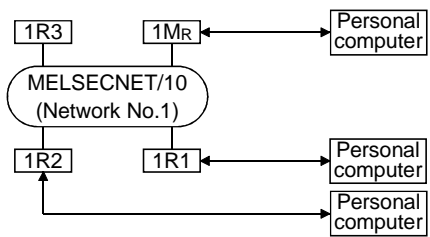

Designated PLC number

| Personal computer-connected Station | Station Accessible from Personal computer | | | |
|-------------------------------------|---|-----|-----|-----|
| | 1Mr | 1R1 | 1R2 | 1R3 |
| 1Mr | FF | × | × | × |
| 1R1 | 0 | × | × | × |
| 1R2 | 0 | × | × | × |

× : Access not possible

1. The following devices of a remote I/O station connected to GX Developer can be monitored : X, Y, B, W.
2. Ladder monitoring, status monitoring (in remote I/O stations connected to GX Developer, the CPU connected to the master station can be monitored).
3. Loop test, setting confirmation test, station order confirmation test, communication test (testing with a remote station treated as the host station is possible).

- When using a MELSECNET/10 multi-tier system:

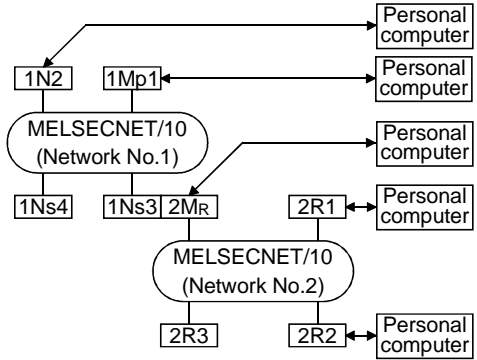

Designated PLC number

| Personal computer-connected Station | Station Accessible from Personal computer | | | | | | |
|-------------------------------------|---|-----|----------|------|-----|-----|-----|
| | 1Mp1 | 1N2 | 1Ns3/2Mr | 1Ns4 | 2R1 | 2R2 | 2R3 |
| 1Mp1 | FF | × | 1-3 | 1-4 | × | × | × |
| 1N2 | × | × | × | × | × | × | × |
| 1Ns3/2Mr | 1-1 | × | FF | 1-4 | × | × | × |
| 2R1 | 1-1 | × | 1-3 | 1-4 | × | × | × |
| 2R2 | 1-1 | × | 0 | 1-4 | × | × | × |

× : Access not possible

- When using a MELSECNET/10, MELSECNET (II) composite system:

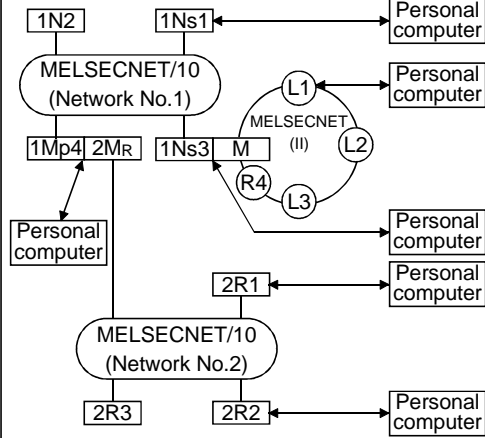

Designated PLC number

| Personal computer-connected Station | Station Accessible from Personal computer | | | | | | | | | | |
|-------------------------------------|---|-----|--------|----------|-----|-----|-----|----|----|----|----|
| | 1Ns1 | 1N2 | 1Ns3/M | 1Mp4/2Mr | 2R1 | 2R2 | 2R3 | L1 | L2 | L3 | R4 |
| 1Ns1 | FF | × | 1-3 | 1-4 | × | × | × | × | × | × | × |
| 1Ns3/M | 1-1 | × | FF | 1-4 | × | × | × | 1 | 2 | 3 | × |
| 1Mp4/2Mr | 1-1 | × | 1-3 | FF | × | × | × | × | × | × | × |
| 2R1 | 1-1 | × | 1-3 | 0 | × | × | × | × | × | × | × |
| 2R2 | 1-1 | × | 1-3 | 0 | × | × | × | × | × | × | × |
| L1 | × | × | 0 | × | × | × | × | FF | × | × | × |

× : Access not possible

"Station accessible from Personal computer" in the tables:

<Example>

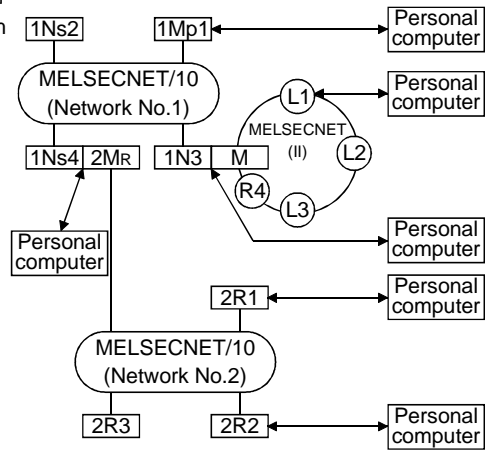
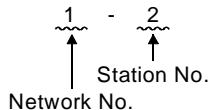

Designated PLC number

| Personal computer-connected Station | Station Accessible from Personal computer | | | | | | | | | | |
|-------------------------------------|---|------|-------|----------|-----|-----|-----|----|----|----|----|
| | 1Mp1 | 1Ns2 | 1N3/M | 1Ns4/2Mr | 2R1 | 2R2 | 2R3 | L1 | L2 | L3 | R4 |
| 1Mp1 | FF | 1-2 | × | 1-4 | × | × | × | × | × | × | × |
| 1N3/M | × | × | × | × | × | × | × | × | × | × | × |
| 1Ns4/2Mr | 1-1 | 1-2 | × | FF | × | × | × | × | × | × | × |
| 2R1 | 1-1 | 1-2 | × | 0 | × | × | × | × | × | × | × |
| 2R2 | 1-1 | 1-2 | × | 0 | × | × | × | × | × | × | × |
| L1 | × | × | 0 | × | × | × | × | FF | × | × | × |

× : Access not possible

1.4 Access Range at Q Series Start

| | | |
|---|-------|----|
| A | Q/QnA | FX |
| × | ○ | × |

For inter-PLC network of MELSECNET/10
 • MELSECNET/10 two-tier system:

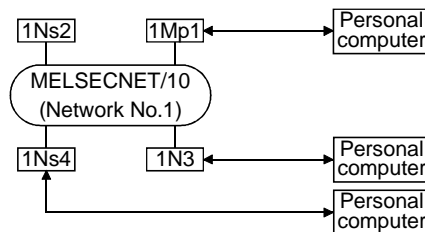

PLC numbers to be specified

| Personal computer Connection Station | Station Accessible from Personal computer | | | |
|--------------------------------------|---|------|-----|------|
| | 1Mp1 | 1Ns2 | 1N3 | 1Ns4 |
| 1Mp1 | FF | 1-2 | × | 1-4 |
| 1N3 | × | × | × | × |
| 1Ns4 | 1-1 | 1-2 | × | FF |

× : Access not possible

Mp station...Control station
 Ns station...Normal station (QCPU)
 N station....Ordinary station (CPU except Q/QnA (QCPU-A, AnU, AnA, AnNCPU))
 The first digit of each station shown on the right indicates the network number, and the last digit the station number.

• MELSECNET/10 multi-tier system:

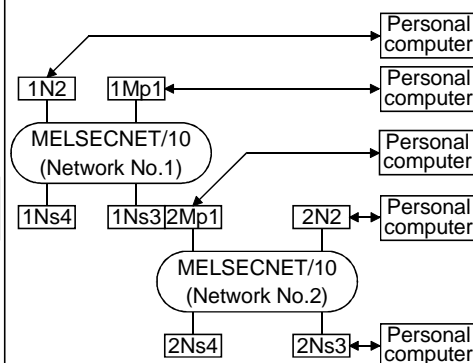

PLC numbers to be specified

| Personal computer-connected Station | Station Accessible from Personal computer | | | | | | |
|-------------------------------------|---|-----|-----------|------|-----|------|------|
| | 1Mp1 | 1N2 | 1Ns3/2Mp1 | 1Ns4 | 2N2 | 2Ns3 | 2Ns4 |
| 1Mp1 | FF | × | 1-3 | 1-4 | × | 2-3 | 2-4 |
| 1N2 | × | × | × | × | × | × | × |
| 1Ns3/2Mp1 | 1-1 | × | FF | 1-4 | × | 2-3 | 2-4 |
| 2N2 | × | × | × | × | × | × | × |
| 2Ns3 | 1-1 | × | 2-1 | 1-4 | × | FF | 2-4 |

× : Access not possible

"Station accessible from Personal computer" in the tables:

<Example>

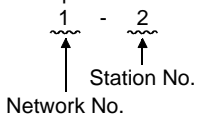

For remote I/O network of MELSECNET/H

• MELSECNET/H two-tier system

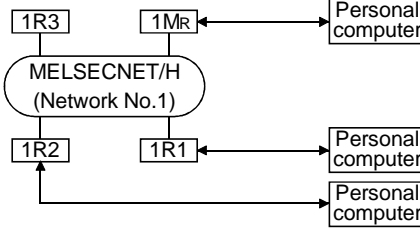

PLC numbers to be specified

| Personal computer-connected Station | Station Accessible from Personal computer | | | |
|-------------------------------------|---|-----|-----|-----|
| | 1Mr | 1R1 | 1R2 | 1R3 |
| 1Mr | FF | 1-1 | 1-2 | 1-3 |
| 1R1 | 0 | FF | 1-2 | 1-3 |
| 1R2 | 0 | 1-1 | FF | 1-3 |

- *1: 1. The devices X, Y, B and W of the remote I/O station connected with GX Developer can be monitored.
- 2. Line monitoring
- 3. Loop test, setting check test, station order check test, communication test (test can be made when remote station is connected to own station)

× : Access not possible

[MELSECNET/10 inter-PLC network]
 Mp station....Control station
 Ns station.... Ordinary station (QCPU (Q mode))
 N station..... Ordinary station (CPU except Q/QnA (AnU/AnA/AnNCPU))
 [MELSECNET/10 remote I/O network]
 Mr station...Master station (QCPU (Q mode))
 R station.....Remote station

The first digit of each station in the network area indicated on the right denotes the network number, and the last digit the station number.
 However, the station number of Mr (master station) is not given since it is 0.

• MELSECNET/H multi-tier system

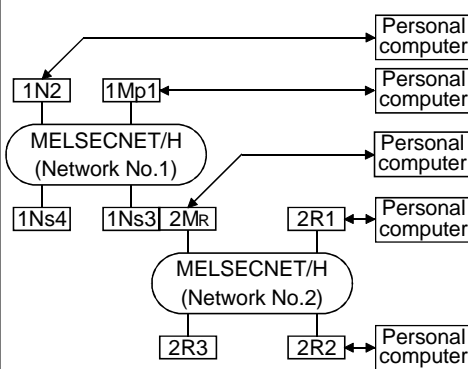

PLC numbers to be specified

| Personal computer-connected Station | Station Accessible from Personal computer | | | | | | |
|-------------------------------------|---|-----|----------|------|-----|-----|-----|
| | 1Mp1 | 1N2 | 1Ns3/2Mr | 1Ns4 | 2R1 | 2R2 | 2R3 |
| 1Mp1 | FF | × | 1-3 | 1-4 | 2-1 | 2-2 | 2-3 |
| 1N2 | × | × | × | × | × | × | × |
| 1Ns3/2Mr | 1-1 | × | FF | 1-4 | 2-1 | 2-2 | 2-3 |
| 2R1 | 1-1 | × | 0 | 1-4 | FF | 2-2 | 2-3 |
| 2R2 | 1-1 | × | 0 | 1-4 | 2-1 | FF | 2-3 |

× : Access not possible

"Station accessible from Personal computer" in the tables:

<Example>

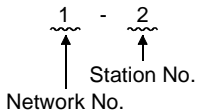

Appendix 2 MELSECNET/10, MELSECNET/H Board Access Ranges

2.1 MELSECNET/10 Board, MELSECNET/H Board

| | | |
|---|-------|----|
| A | Q/QnA | FX |
| ○ | ○ | × |

When using a MELSECNET/10 board, confirm the MELSECNET board model names and driver versions indicated below.

| | Board | Driver |
|---------------------------|---|---------------|
| MELSECNET board for PC/AT | A70BDE-J71QLP23 (Optical loop) A70BDE-J71LP23GE A70BDE-J71QBR13 (Coaxial bus) A70BDE-J71QLR23 (Coaxial loop) | SW3DNF-MNET10 |

When using a MELSECNET/10 board, confirm the MELSECNET board model names and driver versions indicated below.

| | Board | Driver |
|---------------------------|--|-----------------|
| MELSECNET board for PC/AT | Q80BD-J71BR11 (Coaxial loop) Q80BD-J71LP21-25 (Optical loop) Q80BD-J71LP21G (Optical loop) Q80BD-J71LP21GE (Optical loop) | SW0DNC-MNETTH-B |

2.1.1 A series start

| | | |
|---|-------|----|
| A | Q/QnA | FX |
| ○ | × | × |

For MELSECNET/10 PLC-to-PLC network

- When using a MELSECNET/10 2-tier system:

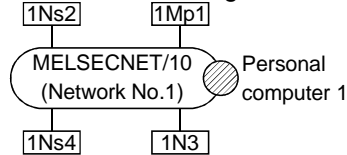

Designated PLC number

| | Station Accessible from Personal computer | | | |
|---------------------|---|------|-----|------|
| | 1Mp1 | 1Ns2 | 1N3 | 1Ns4 |
| Personal computer 1 | 1-1 | 1-2 | 1-3 | 1-4 |

× : Access not possible

- When using a MELSECNET/10 multi-tier system:

Mp station...Control station
Ns station...Normal station (AnUCPU)
N station....Normal station
(CPUs excluding AnU) (AnA/AnNCPU)
Peripheral devices 1 and 2 are peripheral devices that incorporate a MELSECNET/10 board.
In the figure to the right, the first digit for each station indicates the network number and the final line indicates the station number.

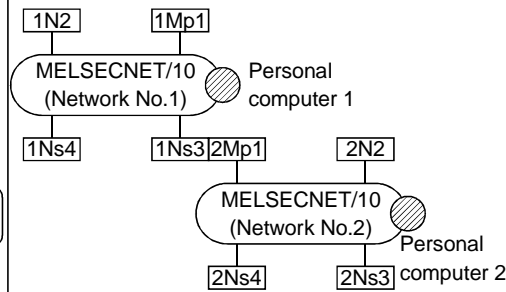

Designated PLC number

| | Station Accessible from Personal computer | | | | | | | | |
|---------------------|---|-----|-----------|---------------------|------|-----|------|------|---------------------|
| | 1Mp1 | 1N2 | 1Ns3/2Mp1 | Personal computer 1 | 1Ns4 | 2N2 | 2Ns3 | 2Ns4 | Personal computer 2 |
| Personal computer 1 | 1-1 | 1-2 | 1-3 | × | 1-4 | 2-2 | 2-3 | 2-4 | × |
| Personal computer 2 | 1-1 | 1-2 | 1-3 | × | 1-4 | 2-2 | 2-3 | 2-4 | × |

× : Access not possible

- When using a MELSECNET/10 / MELSECNET (II) composite system:

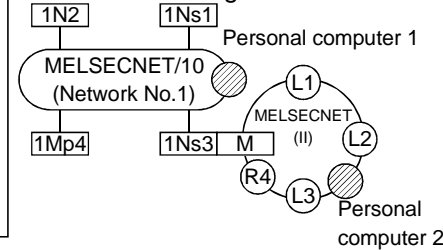

Designated PLC number

| | Station Accessible from Personal computer | | | | | | | | |
|---------------------|---|-----|-----------|------|---------------------|----|----|----|---------------------|
| | 1Mp1 | 1N2 | 1Ns3/2Mp1 | 1Ns4 | Personal computer 1 | L1 | L2 | R4 | Personal computer 2 |
| Personal computer 1 | 1-1 | 1-2 | 1-3 | 1-4 | × | × | × | × | × |
| Personal computer 2 | × | × | × | × | × | × | × | × | × |

× : Access not possible

"Station accessible from Personal computer" in the tables:
<Example>

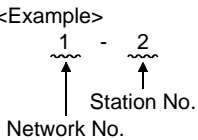

(Intermediate station: AnA/AnNCPU)

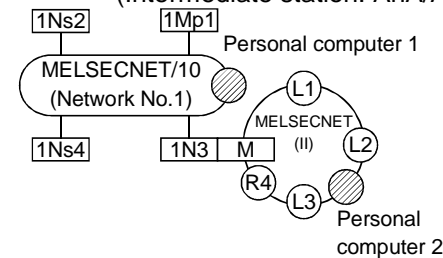

Designated PLC number

| | Station Accessible from Personal computer | | | | | | | | |
|---------------------|---|-----|-----------|------|---------------------|----|----|----|---------------------|
| | 1Mp1 | 1N2 | 1Ns3/2Mp1 | 1Ns4 | Personal computer 1 | L1 | L2 | R4 | Personal computer 2 |
| Personal computer 1 | 1-1 | 1-2 | 1-3 | 1-4 | × | × | × | × | × |
| Personal computer 2 | × | × | × | × | × | × | × | × | × |

× : Access not possible

POINT
To access a PLC in another station, routing parameters must be set by using the GX Developer.
For details of the network parameters themselves, refer to the MELSECNET/10 Network System Reference Manual.

For MELSECNET/10 remote I/O network

- When using a MELSECNET/10 multi-tier system:

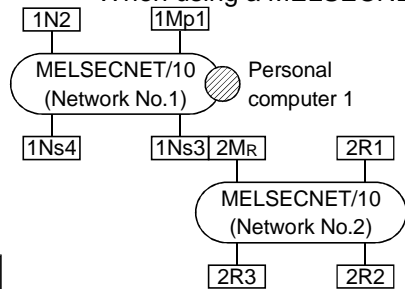

Designated PLC number

| | Station Accessible from Personal computer | | | | | | |
|---------------------|---|-----|--------------------------|------|-----|-----|-----|
| | 1Mp1 | 1N2 | 1Ns3/ 2M _R | 1Ns4 | 2R1 | 2R2 | 2R3 |
| Personal computer 1 | 1-1 | 1-2 | 1-3 | 1-4 | × | × | × |

× : Access not possible

- MELSECNET/10 /MELSECNET (II) composite system

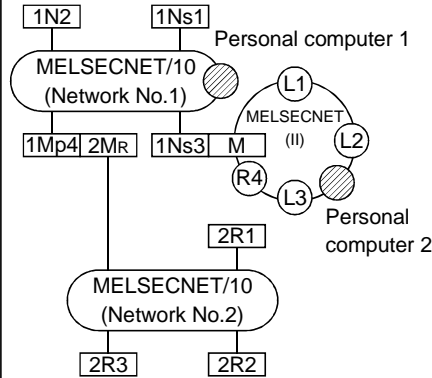

Designated PLC number

| | Station Accessible from Personal computer | | | | | | | | | | |
|---------------------|---|-----|------------|--------------------------|-----|-----|-----|----|----|----|----|
| | 1Ns1 | 1N2 | 1Ns3/ M | 1Mp4/ 2M _R | 2R1 | 2R2 | 2R3 | L1 | L2 | L3 | R4 |
| Personal computer 1 | 1-1 | 1-2 | 1-3 | 1-4 | × | × | × | × | × | × | × |
| Personal computer 2 | × | × | × | × | × | × | × | × | × | × | × |

× : Access not possible

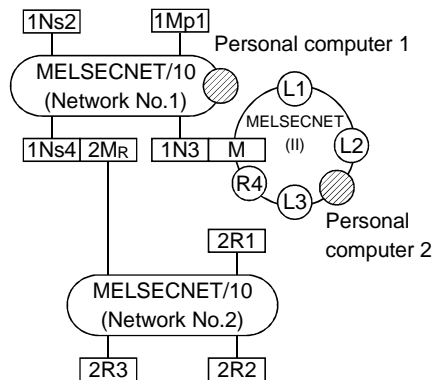

Designated PLC number

| | Station Accessible from Personal computer | | | | | | | | | | |
|---------------------|---|------|-------|--------------------------|-----|-----|-----|----|----|----|----|
| | 1Mp1 | 1Ns2 | 1N3/M | 1Ns4/ 2M _R | 2R1 | 2R2 | 2R3 | L1 | L2 | L3 | R4 |
| Personal computer 1 | 1-1 | 1-2 | 1-3 | 1-4 | × | × | × | × | × | × | × |
| Personal computer 2 | × | × | × | × | × | × | × | × | × | × | × |

× : Access not possible

[MELSECNET/10
PLC to PLC network]
Mp station....Control station
Ns station....Normal station (AnUCPU)
N station.....Normal station
(CPUs excluding AnU (AnA/AnNCPU))
[MELSECNET/10
Remote I/O network]
Mr station...Master station (AnUCPU)
R station.....Remote station

[MELSECNET (II)]
M station.....Master station
L station.....Local station
R station.....Remote station

Peripheral devices 1 and 2 are peripheral devices that incorporate a MELSECNET/10 board.
In the figure to the right, the first digit for each station indicates the network number and the final line indicates the station number.
However, the station number of Mr (master station) is not shown because it is "0."

"Station accessible from Personal computer" in the tables:

<Example>

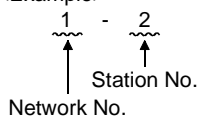

2.1.2 QnA series start

| | | |
|---|-------|----|
| A | Q/QnA | FX |
| × | ○ | × |

For MELSECNET/10 PLC-to-PLC network

- When using a MELSECNET/10 2-tier system:

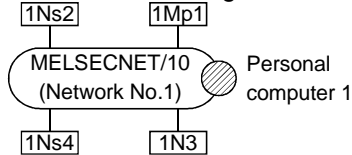

Designated PLC number

| | Station Accessible from Personal computer | | | |
|---------------------|---|------|-----|------|
| | 1Mp1 | 1Ns2 | 1N3 | 1Ns4 |
| Personal computer 1 | 1-1 | 1-2 | × | 1-4 |

× : Access not possible

- When using a MELSECNET/10 multi-tier system:

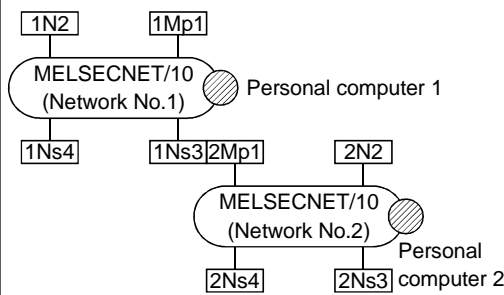

Designated PLC number

| | Station Accessible from Personal computer | | | | | | | | |
|---------------------|---|-----|-----------|---------------------|------|-----|------|------|---------------------|
| | 1Mp1 | 1N2 | 1Ns3/2Mp1 | Personal computer 1 | 1Ns4 | 2N2 | 2Ns3 | 2Ns4 | Personal computer 2 |
| Personal computer 1 | 1-1 | × | 1-3 | × | 1-4 | × | 2-3 | 2-4 | × |
| Personal computer 2 | 1-1 | × | 1-3 | × | 1-4 | × | 2-3 | 2-4 | × |

× : Access not possible

- When using a MELSECNET/10 / MELSECNET (II) composite system:

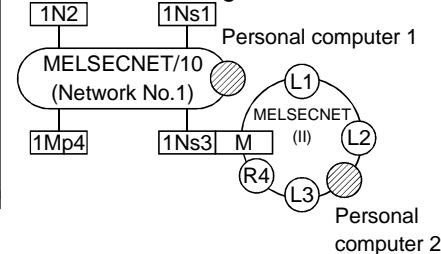

Designated PLC number

| | Station Accessible from Personal computer | | | | | | | | |
|---------------------|---|-----|-----------|------|---------------------|----|----|----|---------------------|
| | 1Mp1 | 1N2 | 1Ns3/2Mp1 | 1Ns4 | Personal computer 1 | L1 | L2 | R4 | Personal computer 2 |
| Personal computer 1 | 1-1 | × | 1-3 | 1-4 | × | × | × | × | × |
| Personal computer 2 | × | × | × | × | × | × | × | × | × |

× : Access not possible

(Intermediate station: AnU/AnA/AnNCPU)

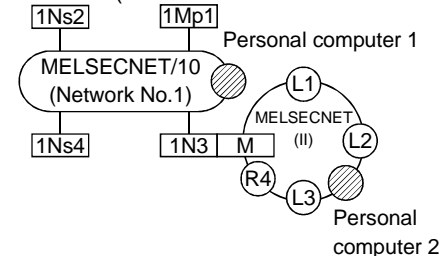

Designated PLC number

| | Station Accessible from Personal computer | | | | | | | | |
|---------------------|---|------|-----------|------|---------------------|----|----|----|---------------------|
| | 1Mp1 | 1Ns2 | 1Ns3/2Mp1 | 1Ns4 | Personal computer 1 | L1 | L2 | R4 | Personal computer 2 |
| Personal computer 1 | 1-1 | 1-2 | × | 1-4 | × | × | × | × | × |
| Personal computer 2 | × | × | × | × | × | × | × | × | × |

× : Access not possible

Mp station...Control station
Ns station...Normal station (QnACPU)
N station...Normal station (CPUs excluding AnU (AnU/AnA/AnNCPU))
Peripheral devices 1 and 2 are peripheral devices that incorporate a MELSECNET/10 board.
In the figure to the right, the first digit for each station indicates the network number and the final line indicates the station number accessible from "Station accessible from Personal computer" in the tables:

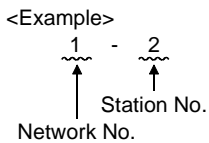

POINT

To access a PLC in another station, routing parameters must be set by using the GX Developer.
For details of the network parameters themselves, refer to the MELSECNET/10 Network System Reference Manual.

For MELSECNET/10 remote I/O network

- When using a MELSECNET/10 multi-tier system:

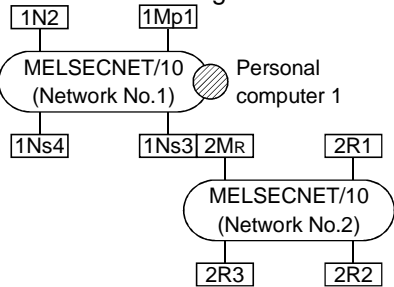

Designated PLC number

| | Station Accessible from Personal computer | | | | | | |
|---------------------|---|-----|--------------|------|-----|-----|-----|
| | 1Mp1 | 1N2 | 1Ns3/ 2MR | 1Ns4 | 2R1 | 2R2 | 2R3 |
| Personal computer 1 | 1-1 | × | 1-3 | 1-4 | × | × | × |

× : Access not possible

- MELSECNET/10 /MELSECNET (II) composite system

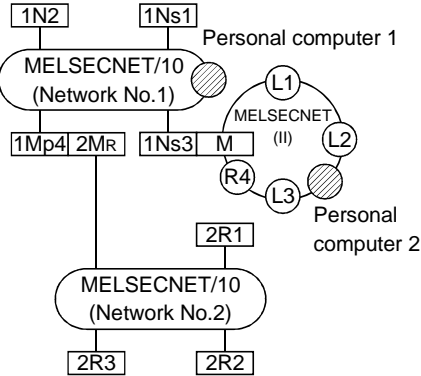

Designated PLC number

| | Station Accessible from Personal computer | | | | | | | | | | |
|---------------------|---|-----|------------|--------------|-----|-----|-----|----|----|----|----|
| | 1Ns1 | 1N2 | 1Ns3/ M | 1Mp4/ 2MR | 2R1 | 2R2 | 2R3 | L1 | L2 | L3 | R4 |
| Personal computer 1 | 1-1 | × | 1-3 | 1-4 | × | × | × | × | × | × | × |
| Personal computer 2 | × | × | × | × | × | × | × | × | × | × | × |

× : Access not possible

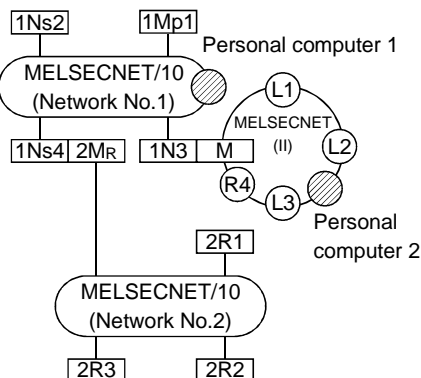

Designated PLC number

| | Station Accessible from Personal computer | | | | | | | | | | |
|---------------------|---|------|-------|--------------|-----|-----|-----|----|----|----|----|
| | 1Mp1 | 1Ns2 | 1N3/M | 1Ns4/ 2MR | 2R1 | 2R2 | 2R3 | L1 | L2 | L3 | R4 |
| Personal computer 1 | 1-1 | 1-2 | × | 1-4 | × | × | × | × | × | × | × |
| Personal computer 2 | × | × | × | × | × | × | × | × | × | × | × |

× : Access not possible

**[MELSECNET/10
PLC to PLC network]**
 Mp station....Control station
 Ns station....Normal station (QnACPU)
 N station.....Normal station
 (CPUs excluding QnA) (AnU/AnA/AnNCPU)
**[MELSECNET/10
Remote I/O network]**
 Mr station...Master station (QnACPU)
 R station.....Remote station
[MELSECNET (II)]
 M station.....Master station
 L station.....Local station
 R station.....Remote station
 Peripheral devices 1 and 2 are peripheral devices that incorporate a MELSECNET/10 board.
 In the figure to the right, the first digit for each station indicates the network number and the final line indicates the station number.
 However, the station number of Mr (master station) is not shown because it is "0."

"Station accessible from Personal computer" in the tables:

<Example>

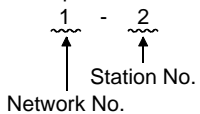

2.1.3 Q series start

| | | |
|---|-------|----|
| A | Q/QnA | FX |
| × | ○ | × |

For inter-PLC network of MELSECNET/10

- MELSECNET/10 two-tier system:

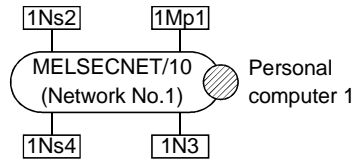

PLC numbers to be specified

| | Station Accessible from Personal computer | | | |
|---------------------|---|------|-----|------|
| | 1Mp1 | 1Ns2 | 1N3 | 1Ns4 |
| Personal computer 1 | 1-1 | 1-2 | × | 1-4 |

× : Access not possible

- MELSECNET/10 multi-tier system:

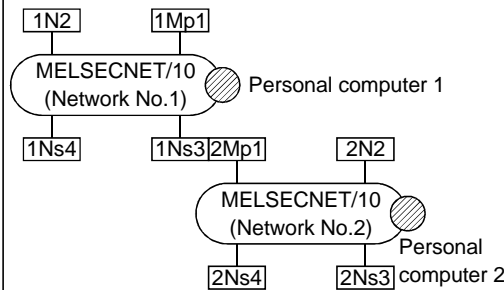

PLC numbers to be specified

| | Station Accessible from Personal computer | | | | | | | | |
|---------------------|---|-----|---------------|---------------------------------|------|-----|------|------|---------------------------------|
| | 1Mp1 | 1N2 | 1Ns3/ 2Mp1 | Periph- -eral Device 1 | 1Ns4 | 2N2 | 2Ns3 | 2Ns4 | Periph- -eral Device 2 |
| Personal computer 1 | 1-1 | × | 1-3 | × | 1-4 | × | 2-3 | 2-4 | × |
| Personal computer 2 | 1-1 | × | 1-3 | × | 1-4 | × | 2-3 | 2-4 | × |

× : Access not possible

For MELSECNET/10 remote I/O network

- MELSECNET/H multi-tier system

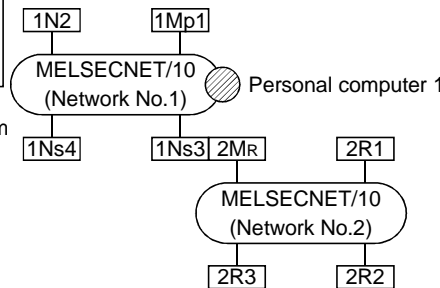

PLC numbers to be specified

| | Station Accessible from Personal computer | | | | | | |
|---------------------|---|-----|--------------|------|-----|-----|-----|
| | 1Mp1 | 1N2 | 1Ns3/ 2MR | 1Ns4 | 2R1 | 2R2 | 2R3 |
| Personal computer 1 | 1-1 | × | 1-3 | 1-4 | × | × | × |

× : Access not possible

Mp station...Control station
Ns station...Ordinary station
QCPU
N station...Ordinary station
CPU except Q/QnA (QCPU-A, AnU, AnA, AnNCPU)
Peripheral devices 1, 2 are those which have built-in MELSECNET/10 boards.
The first digit of each station shown on the right indicates the network number, and the last digit the station number.

"Station accessible from Personal computer" in the tables:

<Example>

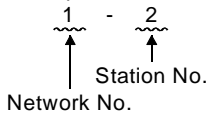

| |
|--|
| POINT |
| <p>To access the other station PLC, routing parameter setting must be made using the GX Developer.</p> <p>For network parameter setting, refer to the Offline Manual.</p> <p>For details of the network parameters, refer to the MELSECNET/10 Network System Reference Manual.</p> |

2.2 Access Range via an Ethernet Board

| A | Q/QnA | FX |
|---|-------|----|
| ○ | ○ | × |

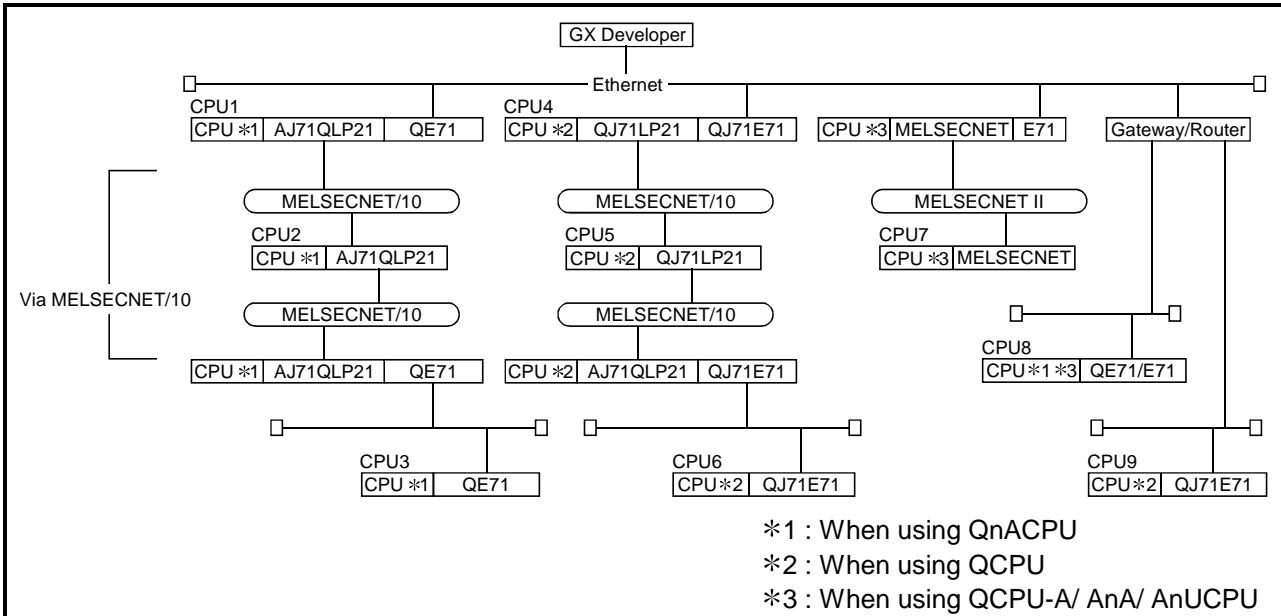

- The access range to master stations/local stations/remote stations/control stations/normal stations via MELSECNET (II)/MELSECNET/10 is the same as via a PLC direct link (via MELSECNET).

| Function \ Applicable PLC | CPU1 | CPU2 | CPU3 | CPU4 | CPU5 | CPU6 | CPU7 | CPU8 | CPU9 |
|----------------------------------|------|------|------|------|------|------|------|------|------|
| PLC read/write | ○ | ○ | ○ | ○ | ○ | ○ | ○ | × | ○ |
| Compare with PLC | ○ | ○ | ○ | ○ | ○ | ○ | ○ | × | ○ |
| Delete PLC *1 | ○ | ○ | ○ | ○ | ○ | ○ | ○ | × | ○ |
| Change PLC data attributes *1 | ○ | ○ | ○ | ○ | ○ | ○ | ○ | × | ○ |
| Keyword setup | ○ | ○ | ○ | ○ | ○ | ○ | ○ | × | ○ |
| Clear PLC memory | ○ | ○ | ○ | ○ | ○ | ○ | ○ | × | ○ |
| Format PLC memory *1 | ○ | ○ | ○ | ○ | ○ | ○ | ○ | × | ○ |
| Arrange PLC memory *1 | ○ | ○ | ○ | ○ | ○ | ○ | ○ | × | ○ |
| Set time | ○ | ○ | ○ | ○ | ○ | ○ | ○ | × | ○ |
| Remote operation | ○ | ○ | ○ | ○ | ○ | ○ | ○ | × | ○ |
| Ladder monitor | ○ | ○ | ○ | ○ | ○ | ○ | ○ | × | ○ |
| Batch monitor | ○ | ○ | ○ | ○ | ○ | ○ | ○ | × | ○ |
| Registration monitor | ○ | ○ | ○ | ○ | ○ | ○ | ○ | × | ○ |
| Buffer memory | ○ | ○ | ○ | ○ | ○ | ○ | ○ | × | ○ |
| Monitor condition/stop condition | × | × | × | × | × | × | × | × | × |
| Device test | ○ | ○ | ○ | ○ | ○ | ○ | ○ | × | ○ |
| Step execution | ○ | ○ | ○ | ○ | ○ | ○ | ○ | × | ○ |
| Partial execution | ○ | ○ | ○ | ○ | ○ | ○ | ○ | × | ○ |
| Skip execution *1 | ○ | ○ | ○ | ○ | ○ | ○ | ○ | × | ○ |
| Sampling trace | ○ | ○ | ○ | ○ | ○ | ○ | ○ | × | ○ |
| Diagnostics PLC | ○ | ○ | ○ | ○ | ○ | ○ | ○ | × | ○ |
| Diagnostics network *2 | ○ | ○ | ○ | ○ | ○ | ○ | ○ | × | ○ |
| Online change*1 | ○ | ○ | ○ | ○ | ○ | ○ | ○ | × | ○ |
| Change TC setting | ○ | ○ | ○ | ○ | ○ | ○ | ○ | × | ○ |

○: Access possible ×: Access not possible

*1: Accessible only to Q/QnACPU.

*2: Accessible only to network monitoring own and other stations.
(AnUCPU is handled as equivalent to AnACPU.)

A series

| Corresponding Models | Corresponding Versions | Remarks |
|-----------------------------|--|--|
| AJ71E71,AJ71E71-B5 | Initially shipped version and later versions | If a remote I/O is installed, or during communication, the error LED lights. |
| A1SJ71QE71-B2,A1SJ71QE71-B5 | Initially shipped version and later versions | |

- The following restrictions apply for access to AnUCPU via Ethernet.
 - (1) The PLC type must be set as "AnACPU."
 - (2) Sequence programs, device memories, etc. can be used with the AnACPU specification range.
This means that subprogram 2, subprogram 3, devices extended with AnUCPU, and network parameters, cannot be accessed.

QnA series

| Corresponding Models | Corresponding Versions | Remarks |
|-----------------------------|------------------------|---------|
| AJ71QE71,AJ71QE71-B5 | E and later | — |
| A1SJ71QE71-B2,A1SJ71QE71-B5 | E and later | — |

Q series

| Corresponding Models | Corresponding Versions | Remarks |
|-------------------------------------|--|---------|
| QJ71E71, QJ71E71-B2, QJ71E71-100 | Initially shipped version and later versions | — |

2.3 Access Range via CC-Link (AJ65BT-G4)

| | | |
|---|-------|----|
| A | Q/QnA | FX |
| ○ | ○ | × |

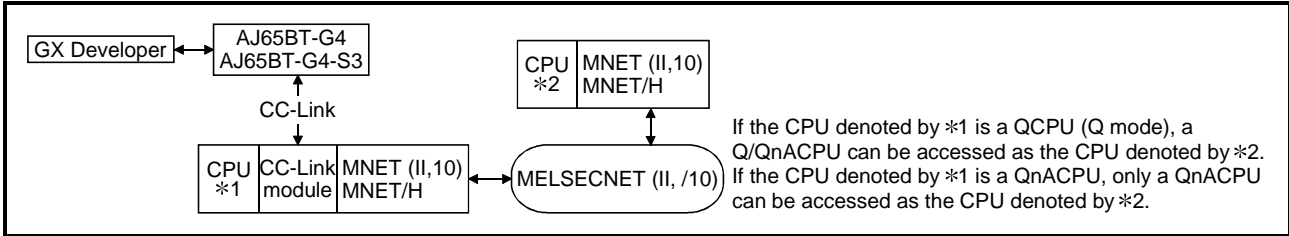

- The access range to master stations/local stations/remote stations/control stations/normal stations via MELSECNET (II)/MELSECNET/10 is the same as via a PLC direct link (via MELSECNET).
- When connecting to ACPU, routing through MELSECNET (II) or MELSECNET/10 is not possible.

○: Access possible ×: Access not possible – : Function not supported by ACPU

| Applicable PLC Function | ACPU | QnACPU | QCPU(Q mode) |
|----------------------------------|------|--------|--------------|
| PLC read/write | ○ | ○ | ○ |
| Compare with PLC | ○ | ○ | ○ |
| Delete PLC | — | ○ | ○ |
| Change PLC data attributes | — | ○ | ○ |
| Keyword setup | ○ | ○ | ○ |
| Clear PLC memory | ○ | ○ | ○ |
| Format PLC memory | — | ○ | ○ |
| Arrange PLC memory | — | ○ | ○ |
| Set time | ○ | ○ | ○ |
| Remote operation | ○ | ○ | ○ |
| Ladder monitor | ○ | ○ | ○ |
| Batch monitor | ○ | ○ | ○ |
| Registration monitor | ○ | ○ | ○ |
| Buffer memory | ○ | ○ | ○ |
| Monitor condition/stop condition | — | × | × |
| Device test | ○ | ○ | ○ |
| Step execution | ○ | ○ | ○ |
| Partial execution | ○ | ○ | ○ |
| Skip execution | — | ○ | ○ |
| Sampling trace | ○ | ○ | ○ |
| Diagnostics PLC | ○ | ○ | ○ |
| Diagnostics network | × | ○ *1 | ○ *1 |
| Online change | ○ | ○ | ○ |
| Change TC setting | ○ | ○ | ○ |

* 1: Only the network monitor host station and other stations can be accessed.
(AnUCPU is treated as equivalent to AnACPU.)

Confirm that the AJ65BT-G4 is running one of the following software versions.

| CPU | Module Name | AJ65BT-G4 Software Version |
|--------|-------------|----------------------------|
| ACPU | AJ65BT-G4 | A and later |
| QnACPU | | B and later |

2.4 Access Range via Computer Link

| A | Q/QnA | FX |
|---|-------|----|
| ○ | × | × |

The table below shows whether or not each function can be performed via the computer link module.

When accessing the master station, local station, remote station, control station or normal station via MELSECNET II or MELSECNET/10, the access range will be the same as when it is directly connected to the PLC CPU (via MELSECNET).

Some functions cannot be used depending on the type of the PLC CPU. For details on the availability of each function, see the user's manual of each PLC CPU.

| Function | Applicable PLC | ACPU |
|----------------------------------|----------------|------|
| PLC read/write | | ○ |
| Compare with PLC | | ○ |
| Delete PLC | | — |
| Change PLC data attributes | | — |
| Keyword setup | | ○ |
| Clear PLC memory | | × |
| Format PLC memory | | — |
| Arrange PLC memory | | — |
| Set time | | ○ |
| Remote operation | | ○ |
| Ladder monitor | | ○ |
| Batch monitor | | ○ |
| Registration monitor | | ○ |
| Buffer memory | | × |
| Monitor condition/stop condition | | — |
| Device test | | ○ |
| Step execution | | × |
| Partial execution | | × |
| Skip execution | | — |
| Sampling trace | | × |
| PLC Diagnostics | | ○ |
| Network Diagnostics | | × |
| Ethernet Diagnostics | | × |
| CC-Link Diagnostics | | × |
| Online change | | × |
| Change TC setting | | ○ |

○: Access possible ×, —: Access not possible

The restrictions when executing ladder monitoring, batch monitoring, registration monitoring, device tests, or TC set value changes from a PLC via a computer link module are indicated below.

| Connected PLC \ Computer Link | For AnACPU *2 | For AnUCPU |
|-------------------------------|---------------------------------|------------|
| AnACPU | ○ | ○ |
| AnUCPU | Possible within AnACPU range *1 | ○ |
| Other than AnACPU, AnUCPU | ○ | ○ |

*1 : Network parameters cannot be read.

*2 : When for AnA (C24) has been designated in connection destination designation when using a computer link module for AnUCPU.

- Setting of transmission specification setting switch

The setting switches at the C24 side are shown below.

| Setting Item | Setting Made | Remarks |
|---|------------------------------------|---|
| Main channel setting | RS-232 | — |
| Data bit setting | 8 bits | — |
| Transmission speed | Match with setting at GX Developer | — |
| Parity yes/no setting | Match with setting at GX Developer | — |
| Even/odd parity | Match with setting at GX Developer | — |
| Stop bits | 1 bit | — |
| Sum check yes/no | Match with setting at GX Developer | — |
| Online program change (write during RUN) yes/no | Match with setting at GX Developer | — |
| Send side terminal resistor yes/no | Depends on system configuration *1 | — |
| Receive side terminal resistor yes/no | Depends on system configuration *1 | — |
| Computer link/multidrop setting | Computer link | AJ71UC24 A1SJ71UC24-R4 A1SJ71C24-R4 |

*1: Refer to the Computer Link/Multidrop Link Module User's Manual (Computer Link/Function, Printer Function).

2.5 Access Range via Serial Communication

| | | |
|---|-------|----|
| A | Q/QnA | FX |
| × | ○ | × |

The following table indicates whether each function that can be performed via serial communication is possible or not.

| Function | Applicable PLC | QCPU | QnACPU |
|----------------------------------|----------------|------|--------|
| PLC read/write | | ○ | ○ |
| Compare with PLC | | ○ | ○ |
| Delete PLC | | ○ | ○ |
| Change PLC data attributes | | ○ | ○ |
| Keyword setup | | — | ○ |
| Password setup | | ○ | — |
| Clear PLC memory | | ○ | ○ |
| Format PLC memory | | ○ | ○ |
| Arrange PLC memory | | ○ | ○ |
| Set time | | ○ | ○ |
| Remote operation | | ○ | ○ |
| Ladder monitor | | ○ | ○ |
| Batch monitor | | ○ | ○ |
| Registration monitor | | ○ | ○ |
| Buffer memory | | ○ | ○ |
| Monitor condition/stop condition | | × | × |
| Device test | | ○ | ○ |
| Step execution | | ○ | ○ |
| Partial execution | | ○ | ○ |
| Skip execution | | ○ | ○ |
| Sampling trace | | ○ | ○ |
| PLC Diagnostics | | ○ | ○ |
| Network Diagnostics | | ○ | ○ |
| Ethernet Diagnostics | | ○ | ○ |
| CC-Link Diagnostics | | ○ | ○ |
| Online change | | ○ | ○ |
| Change TC setting | | ○ | ○ |

○: Access possible

2.6 Access Range for Mixed System

| A | Q/QnA | FX |
|---|-------|----|
| × | ○ | × |

A combination example of Ethernet, MELSECNET/10 and CC-Link will be described. Set the network parameters (network numbers, station numbers, etc.) to CPU1 - CPU4, and write them to the PLC. (For parameter details, refer to Chapter 14.)

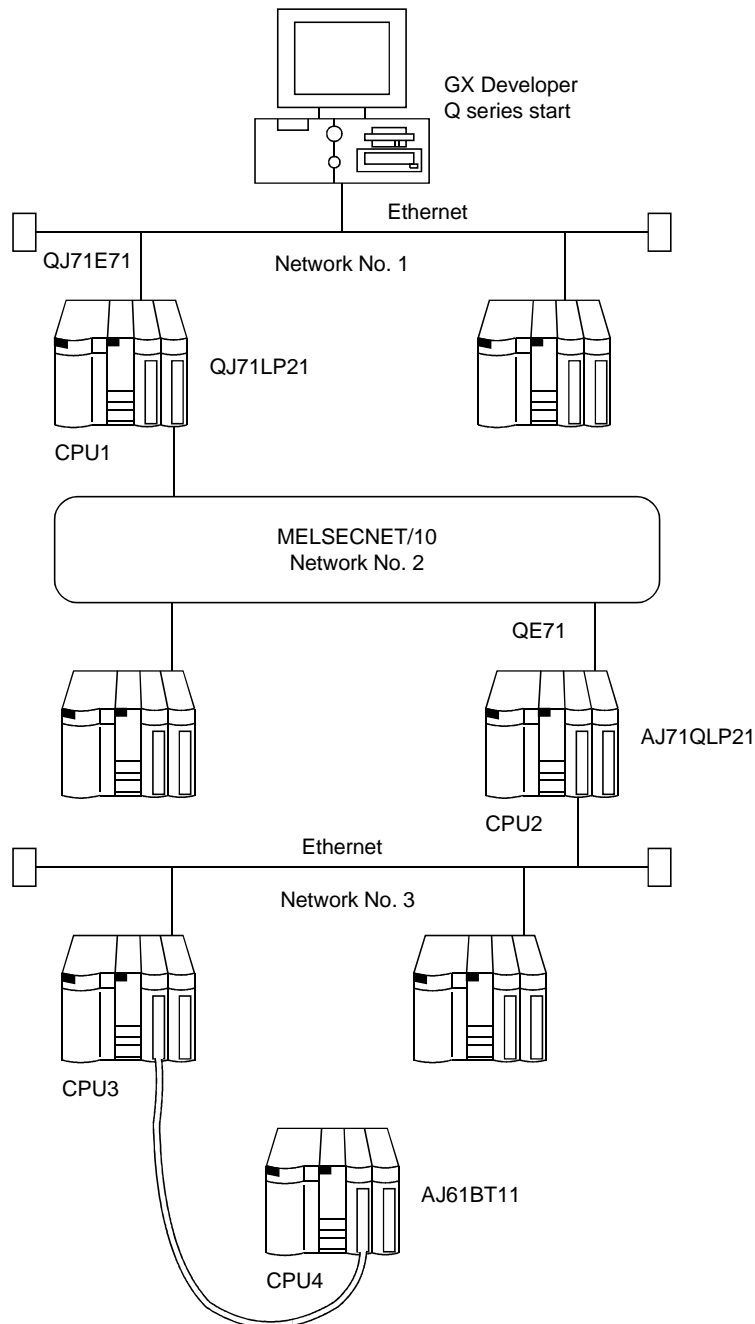

POINT
 Ethernet is equivalent to MELSECNET/10.
 Set the network numbers and station numbers with the network parameters.

| Function \ Applicable PLC | CPU1 | CPU2 | CPU3 | CPU4 |
|----------------------------------|------|------|------|------|
| PLC read/write | ○ | ○ | ○ | ○ |
| Compare with PLC | ○ | ○ | ○ | ○ |
| Delete PLC | ○ | ○ | ○ | ○ |
| Change PLC data attributes | ○ | ○ | ○ | ○ |
| Keyword setup | ○ | ○ | ○ | ○ |
| Clear PLC memory | ○ | ○ | ○ | ○ |
| Format PLC memory | ○ | ○ | ○ | ○ |
| Arrange PLC memory | ○ | ○ | ○ | ○ |
| Set time | ○ | ○ | ○ | ○ |
| Remote operation | ○ | ○ | ○ | ○ |
| Ladder monitor | ○ | ○ | ○ | ○ |
| Batch monitor | ○ | ○ | ○ | ○ |
| Registration monitor | ○ | ○ | ○ | ○ |
| Buffer memory | ○ | ○ | ○ | ○ |
| Monitor condition/stop condition | × | × | × | × |
| Device test | ○ | ○ | ○ | ○ |
| Step execution | ○ | ○ | ○ | ○ |
| Partial execution | ○ | ○ | ○ | ○ |
| Skip execution | ○ | ○ | ○ | ○ |
| Sampling trace | ○ | ○ | ○ | ○ |
| Diagnostics PLC | ○ | ○ | ○ | ○ |
| Diagnostics network | ○ | ○ | ○ | ○ |
| Online change | ○ | ○ | ○ | ○ |
| Change TC setting | ○ | ○ | ○ | ○ |

○: Access possible
 ×: Access not possible

POINT

If the E71 module is connected to network No. 2 or No. 3, it cannot be accessed from GX Developer.

Appendix 3 Using Data of Other Applications

3.1 Using Excel Files as Device Comments

| | | |
|---|-------|----|
| A | Q/QnA | FX |
| ○ | ○ | ○ |

[Purpose]

Uses data created with Excel as device comments.

[Operating Procedure]

This explanation assumes that you have already started up Excel and GX Developer.

- (1) Drag the Excel cell and designate the range that will enable it to be used as a comment in GX Developer.

(Operation in Excel)

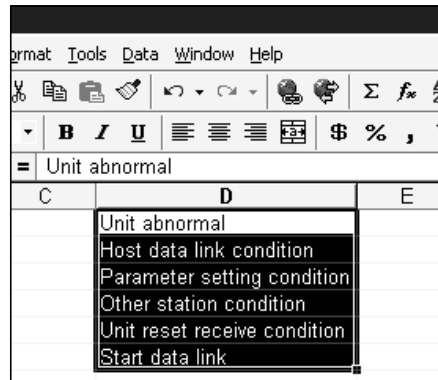

- (2) In Excel, select [Edit] → [Copy], or click ([Ctrl] + [C]).

- (3) Click the position where the comment is to be pasted and move the cursor.

(Operation at GX Developer)

| Device | Comment | Label |
|--------|---------|-------|
| X0 | | |
| X1 | | |
| X2 | | |
| X3 | | |
| X4 | | |
| X5 | | |
| X6 | | |
| X7 | | |
| X8 | | |

(4) In GX Developer, select [Edit] → [Paste], or click  ([Ctrl] + [V]) to paste the Excel comment to GX Developer.

| Device X0 Display | | | |
|------------------------|------------------------------|-------|--|
| Device | Comment | Label | |
| X0 | Unit abnormal | | |
| X1 | Host data link condition | | |
| X2 | Parameter setting condition | | |
| X3 | Other station condition | | |
| X4 | Unit reset receive condition | | |
| X5 | Start data link | | |
| X6 | | | |
| X7 | | | |
| X8 | | | |

3.2 Using a Word File as a Device Comment

| | | |
|---|-------|----|
| A | Q/QnA | FX |
| ○ | ○ | ○ |

[Purpose]

Uses data created in Word as device comments.

[Operating Procedure]

This explanation assumes that you have already started up Word and GX Developer.

- (1) Enter the comments in Word.
After each device comment, press the **Enter** key to insert a carriage return.
- (2) Drag the created comments and designate the range for their use as GX Developer comments.

(Operation in Word)

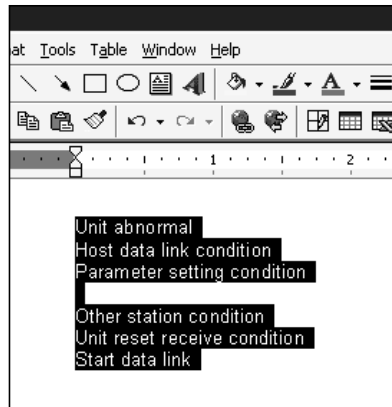

(2) In Word, select [Edit] → [Copy], or click (**Ctrl** + **C**).

(3) Click the location where the comment is to be pasted and move the cursor.

(Operation at GX Developer)

| Device | X0 | Display |
|--------|---------|---------|
| Device | Comment | Label |
| X0 | | |
| X1 | | |
| X2 | | |
| X3 | | |
| X4 | | |
| X5 | | |
| X6 | | |
| X7 | | |
| X8 | | |

(4) In GX Developer, select [Edit] → [Paste], or click  ([Ctrl] + [V]) to paste the Word comment in GX Developer.

| Device | Comment | Label |
|--------|------------------------------|-------|
| X0 | Unit abnormal | |
| X1 | Host data link condition | |
| X2 | Parameter setting condition | |
| X3 | | |
| X4 | Other station condition | |
| X5 | Unit reset receive condition | |
| X6 | Start data link | |
| X7 | | |
| X8 | | |

| POINTS |
|---|
| <ul style="list-style-type: none"> • When entering device comments, inserting a carriage return between two comments makes one line of the comment table blank. • When creating comments in Word, if they are entered continuously without carriage returns they are handled as a single comment: always insert carriage returns between individual comments. |

Appendix 4 Restrictions on PLC Type Change

| | | |
|---|-------|----|
| A | Q/QnA | FX |
| ○ | ○ | ○ |

When the PLC series/type is changed, there are the following restrictions.

(1) Restrictions on PLC series/type change

Refer to the following table for the restrictions on PLC series/type change.

| After Change / Before Change | A | QnA | Q (A mode) *1 | Q (Q mode) *2 | Motion controller (SCPU) *3 | FX |
|------------------------------|--|------------------------------|--|--|--|-----------------------------|
| A | Table 1/Table 1.1 | Table 2 | Table 1 (A→A4U equivalent) | Table 2/ Table 3 *4 (A→QnA equivalent) | Table 1 (A→A equivalent) | Table 6 |
| QnA | Table 2 | No restrictions | Table 2 (QnA→A4U equivalent) | Table 4 | Table 2 (QnA→A equivalent) | Change not possible |
| Q (A mode) *1 | Table 1 (A4U→A equivalent) | Table 2 (A4U→QnA equivalent) | No restrictions | Table 2/ Table 3 *4 (A4U→QnA equivalent) | Table 1 (A4U→A equivalent) | Table 4 (A4U→FX equivalent) |
| Q (Q mode) *2 | Table 2/ Table 3 *4 (QnA→A equivalent) | Table 4 | Table 2/ Table 3 *4 (QnA→A4U equivalent) | Table 8/ Table 9 | Table 2/ Table 3 *4 (QnA→A4U equivalent) | Change not possible |
| Motion controller (SCPU) *3 | Table 5 (A→A equivalent) | Table 5 (A→QnA equivalent) | Table 5 (A→A4U equivalent) | Table 5 (A→QnA equivalent) | Table 1 (A→A equivalent) | Table 5 (A→FX equivalent) |
| FX | Table 6 | Change not possible | Table 4 (FX→A4U equivalent) | Change not possible | Table 4 (FX→A equivalent) | Table 7/Table 7.1 |

*1: The QCPU-A has the specifications equivalent to those of the A4U.

For the restrictions on any change from/to the QCPU-A, regard it as the A4U and refer to the table.

*2: The QCPU has the specifications equivalent to those of the QnA series.

For the restrictions on any change from/to the QCPU, regard it as the QnA series and refer to the table.

*3: The motion controller (SCPU) has the specifications equivalent to those of the A series.

For the restrictions on any change from/to the motion controller (SCPU), regard it as the A series and refer to the table.

*4: Refer to Table 2 (A↔QnA) and Table 3 (A↔QCPU) from the specifications as listed above (*1, *2, *3).

*5: When multi-CPU related setting has been made, the programs, parameters and device comments are handled as follows.

Parameters

(1) The multi CPU setting is deleted.

(2) When the multiple CPUs have been I/O assigned, the multi CPU setting is deleted and the special and I/O module assignment is shifted forward.

(3) When the PLC type is changed to the A series, the type data is deleted if characters other than alphanumeric characters are set in the type setting field of I/O assignment.

Device comments

(1) The device ranges (U200 to U3FF, U3E0¥G** to U3FF¥G**) increased for multiple CPUs are deleted.

(2) Unchangeable instructions/devices

Unchangeable instructions/devices are changed into M1255/D1255, etc.

In this case, refer to search/replacement or Appendix 12 and correct them to instructions/devices usable with the PLC series/type after change.

(3) PLC type change in label program

During label programming, the PLC type change may be converted only between the same series CPUs, i.e. between QCPU (Q mode) and QCPU (Q mode) or between QnACPU and QnACPU.

| |
|--|
| POINT |
| For CPU details, refer to the corresponding User's Manual. |

Table 1 Restrictions on PLC Type Change between ACPU and ACPU

| Item | Restrictions | | | | | | | | | | | | | | | | | | |
|---|--|----------|---|-------------|-----|---|---------------------------------|---------------------------------|---|-----|---|---|---------------------------------|---|-----|---|---|---|---|
| Programs | <ul style="list-style-type: none"> If there are devices that are outside the PLC handling range, write a program to the PLC after making corrections. Devices outside the range may be displayed on the ladder display screen but an error will occur at the time of PLC RUN. When the PLC type after change is the one which cannot create subprograms, subprograms are deleted. | | | | | | | | | | | | | | | | | | |
| PLC parameters | | | | | | | | | | | | | | | | | | | |
| Memory capacity | <ul style="list-style-type: none"> If the PLC type capacity before change is smaller than the PLC type capacity after change, the capacity of the PLC type before change is used. If the PLC type capacity before change is larger than the PLC type capacity after change, the capacity of the PLC type after change is used. In this case, part of the program before change may sometimes be deleted. When the PLC type after change is the one which cannot create subprograms, sub sequence programs are deleted. If the sequence + microcomputer program capacity exceeds the capacity of the PLC type after change, the microcomputer capacity is zeroed. Also, part of the program before change may sometimes be deleted. | | | | | | | | | | | | | | | | | | |
| PLC RAS, PLC system, devices | <ul style="list-style-type: none"> If the PLC type after change has the same item or range, the data of the PLC type before change is retained. However, if there are devices that cannot be used at the PLC type after change, the default is set. | | | | | | | | | | | | | | | | | | |
| I/O allocation | <ul style="list-style-type: none"> All cleared. | | | | | | | | | | | | | | | | | | |
| Network parameters | | | | | | | | | | | | | | | | | | | |
| MELSECNET, MELSECNET(II), MELSECNET(II) combination, MELSECNET/10, MELSECNET/MINI | <table border="1"> <thead> <tr> <th colspan="2" data-bbox="448 1133 751 1169">PLC Type</th> <th data-bbox="751 1133 1398 1169">Description</th> </tr> </thead> <tbody> <tr> <td data-bbox="448 1169 560 1330" rowspan="3">AnN</td> <td data-bbox="560 1169 635 1330" rowspan="3">→</td> <td data-bbox="635 1169 1398 1218">AnN • Settings are retained.</td> </tr> <tr> <td data-bbox="635 1218 1398 1256">AnA • Settings are retained.</td> </tr> <tr> <td data-bbox="635 1256 1398 1330">AnU • Settings are retained. However, the module's first I/O No. is set to 00H.</td> </tr> <tr> <td data-bbox="448 1330 560 1525" rowspan="3">AnA</td> <td data-bbox="560 1330 635 1525" rowspan="3">→</td> <td data-bbox="635 1330 1398 1413">AnN • MELSECNET master station settings are retained. Other station settings but the above are deleted.</td> </tr> <tr> <td data-bbox="635 1413 1398 1451">AnA • Settings are retained.</td> </tr> <tr> <td data-bbox="635 1451 1398 1525">AnU • Settings are retained. However, the module's first I/O No. is set to 00H.</td> </tr> <tr> <td data-bbox="448 1525 560 1906" rowspan="3">AnU</td> <td data-bbox="560 1525 635 1906" rowspan="3">→</td> <td data-bbox="635 1525 1398 1608">AnN • MELSECNET master station settings are retained. Other station settings but the above are deleted.</td> </tr> <tr> <td data-bbox="635 1608 1398 1715">AnA • MELSECNET master station, MELSECNET(II) combination master station and MELSECNET(II) settings are retained. Other station settings but the above are deleted.</td> </tr> <tr> <td data-bbox="635 1715 1398 1906">AnU • Settings are retained. However, if there is any one module whose setting of the network's first I/O No exceeds that of the actual I/O of the PLC after change, 0H, 20H, 40H or 60H is automatically assigned to the first I/O No.</td> </tr> </tbody> </table> | PLC Type | | Description | AnN | → | AnN • Settings are retained. | AnA • Settings are retained. | AnU • Settings are retained. However, the module's first I/O No. is set to 00H. | AnA | → | AnN • MELSECNET master station settings are retained. Other station settings but the above are deleted. | AnA • Settings are retained. | AnU • Settings are retained. However, the module's first I/O No. is set to 00H. | AnU | → | AnN • MELSECNET master station settings are retained. Other station settings but the above are deleted. | AnA • MELSECNET master station, MELSECNET(II) combination master station and MELSECNET(II) settings are retained. Other station settings but the above are deleted. | AnU • Settings are retained. However, if there is any one module whose setting of the network's first I/O No exceeds that of the actual I/O of the PLC after change, 0H, 20H, 40H or 60H is automatically assigned to the first I/O No. |
| | PLC Type | | Description | | | | | | | | | | | | | | | | |
| | AnN | → | AnN • Settings are retained. | | | | | | | | | | | | | | | | |
| | | | AnA • Settings are retained. | | | | | | | | | | | | | | | | |
| | | | AnU • Settings are retained. However, the module's first I/O No. is set to 00H. | | | | | | | | | | | | | | | | |
| | AnA | → | AnN • MELSECNET master station settings are retained. Other station settings but the above are deleted. | | | | | | | | | | | | | | | | |
| | | | AnA • Settings are retained. | | | | | | | | | | | | | | | | |
| | | | AnU • Settings are retained. However, the module's first I/O No. is set to 00H. | | | | | | | | | | | | | | | | |
| | AnU | → | AnN • MELSECNET master station settings are retained. Other station settings but the above are deleted. | | | | | | | | | | | | | | | | |
| | | | AnA • MELSECNET master station, MELSECNET(II) combination master station and MELSECNET(II) settings are retained. Other station settings but the above are deleted. | | | | | | | | | | | | | | | | |
| | | | AnU • Settings are retained. However, if there is any one module whose setting of the network's first I/O No exceeds that of the actual I/O of the PLC after change, 0H, 20H, 40H or 60H is automatically assigned to the first I/O No. | | | | | | | | | | | | | | | | |

Table 1.1 PLC Parameter Settings for PLC Type Change between ACPU and ACPU

| After Change Before Change | A0J2H | A1FX | A1N | A2N A2N-S1 | A3N | A1S A1SJ | A1SH A1SJH | A2S (S1) | A2SH | A2C A2CJ | A2A-S1 | A2A | A3A | A2USH-S1 | A2U A2U-S1 A2US A2US-S1 A2AS-S30 A2AS-S60 | A3U | A4U |
|----------------------------------|-------|------|-----|---------------|-----|-------------|---------------|----------|------|-------------|--------|-----|-----|----------|--|-----|-----|
| A0J2H | ○ | - | ○ | ○ | ○ | - | ○ | ○ | ○ | - | - | - | - | - | - | - | - |
| A1FX | - | ○ | - | ○ | ○ | - | ○ | ○ | ○ | - | - | - | - | - | - | - | - |
| A1N | ○ | - | ○ | ○ | ○ | ○ | ○ | ○ | ○ | - | - | - | - | - | - | - | - |
| A2N A2N-S1 | - | - | - | ○ | ○ | - | ○ | ○ | ○ | - | - | - | - | - | - | - | - |
| A3N | - | - | - | - | ○ | - | - | - | - | - | - | - | - | - | - | - | - |
| A1S A1SJ | - | - | - | ○ | ○ | ○ | ○ | ○ | ○ | - | - | - | - | - | - | - | - |
| A1SH A1SJH | - | - | - | - | ○ | - | ○ | - | ○ | - | - | - | - | - | - | - | - |
| A2S | - | - | - | ○ | ○ | - | ○ | ○ | ○ | - | - | - | - | - | - | - | - |
| A2SH | - | - | - | - | ○ | - | ○ | ○ | ○ | - | - | - | - | - | - | - | - |
| A2C A2CJ | - | - | - | - | - | - | - | - | - | ○ | - | - | - | - | - | - | - |
| A2A A2A-S1 | - | - | - | - | - | - | - | - | - | - | ○ | ○ | ○ | ○ | ○ | ○ | ○ |
| A3A | - | - | - | - | - | - | - | - | - | - | - | ○ | ○ | ○ | ○ | ○ | ○ |
| A2U A2U-S1 A2US A2US-S1 | - | - | - | - | - | - | - | - | - | - | - | - | - | ○ | ○ | ○ | ○ |
| A2USH-S1 | - | - | - | - | - | - | - | - | - | - | - | - | - | ○ | ○ | ○ | ○ |
| A3U | - | - | - | - | - | - | - | - | - | - | - | - | - | - | - | ○ | ○ |
| A4U | - | - | - | - | - | - | - | - | - | - | - | - | - | - | - | ○ | ○ |

○: Settings of PLC type before change are retained

-: Default to settings of PLC type after change, or partial deletion

Table 2 Restrictions on PLC Type Change between ACPU and QnACPU

| Item | Restrictions | | | | | | | | | | | | | | | | | | | | | | | | | | | | | | | | | | | | | | | | | | | |
|---|--|--|--------------|-----------------------|-----------------------|----------------------|---|------|-----------------------------------|---|---|--------------------|-----------|---|-----------------------|------------------|-----------|---|-----------------------|---------------|---------------|---|------------------|---------------|---------------|----|-----------------------|---------------|---------------|---|---|---------------|---------------|---|---|--|---|-----------------------|---|---|---|----------------------|--|---|
| | A → QnA | QnA → A | | | | | | | | | | | | | | | | | | | | | | | | | | | | | | | | | | | | | | | | | | |
| Programs | All programs are changed. | <ul style="list-style-type: none"> • Unchangeable data names (other than MAIN, SUB1, etc.) are deleted. • If the maximum number of steps is exceeded, part of the program is deleted. Note that if the same instruction is used, the number of steps of the A series may become greater. | | | | | | | | | | | | | | | | | | | | | | | | | | | | | | | | | | | | | | | | | | |
| Instructions, devices | <ul style="list-style-type: none"> • Unchangeable instructions and devices are changed into SM1255/SD1255. | <ul style="list-style-type: none"> • Unchangeable instructions and devices are changed into M9255/D9255. | | | | | | | | | | | | | | | | | | | | | | | | | | | | | | | | | | | | | | | | | | |
| | <ul style="list-style-type: none"> • Changeable only when "special module's first I/O number designation" or "network's other station number designation" has been constant specified using changeable dedicated instructions (e.g. ZCOM). <Example> <table border="1" style="width: 100%; border-collapse: collapse;"> <thead> <tr> <th style="width: 50%;">Changeable</th> <th style="width: 50%;">Unchangeable</th> </tr> </thead> <tbody> <tr> <td>LEDA ZCOM</td> <td>LEDA ZCOM</td> </tr> <tr> <td>SUB H0</td> <td>LEDC D0 Unchangeable since the network module's first</td> </tr> <tr> <td>LEDR</td> <td>LEDR I/O No. is device specified.</td> </tr> </tbody> </table> | Changeable | Unchangeable | LEDA ZCOM | LEDA ZCOM | SUB H0 | LEDC D0 Unchangeable since the network module's first | LEDR | LEDR I/O No. is device specified. | | | | | | | | | | | | | | | | | | | | | | | | | | | | | | | | | | | |
| Changeable | Unchangeable | | | | | | | | | | | | | | | | | | | | | | | | | | | | | | | | | | | | | | | | | | | |
| LEDA ZCOM | LEDA ZCOM | | | | | | | | | | | | | | | | | | | | | | | | | | | | | | | | | | | | | | | | | | | |
| SUB H0 | LEDC D0 Unchangeable since the network module's first | | | | | | | | | | | | | | | | | | | | | | | | | | | | | | | | | | | | | | | | | | | |
| LEDR | LEDR I/O No. is device specified. | | | | | | | | | | | | | | | | | | | | | | | | | | | | | | | | | | | | | | | | | | | |
| Comments, device memories | <ul style="list-style-type: none"> • All of them are changed. | <ul style="list-style-type: none"> • Device comments which exceed the device range of the PLC type after change and non-existing device comments are deleted. Comments other than the above are retained intact. | | | | | | | | | | | | | | | | | | | | | | | | | | | | | | | | | | | | | | | | | | |
| Device initial values | <ul style="list-style-type: none"> • Ignored as the ACPU has none. | <ul style="list-style-type: none"> • Deleted as the ACPU has none. | | | | | | | | | | | | | | | | | | | | | | | | | | | | | | | | | | | | | | | | | | |
| Parameters | | | | | | | | | | | | | | | | | | | | | | | | | | | | | | | | | | | | | | | | | | | | |
| Memory capacity | <ul style="list-style-type: none"> • No change | <ul style="list-style-type: none"> • For any of MAIN, SUB1, SUB2 and SUB3, set the maximum capacity of the PLC after change. • For comments, extension comments, etc., set them to the default. | | | | | | | | | | | | | | | | | | | | | | | | | | | | | | | | | | | | | | | | | | |
| Latch range | <table border="1" style="width: 100%; border-collapse: collapse;"> <thead> <tr> <th style="width: 30%;">A</th> <th style="width: 10%;"></th> <th style="width: 30%;">QnA</th> <th style="width: 10%;"></th> <th style="width: 30%;">A</th> </tr> </thead> <tbody> <tr> <td>L</td> <td rowspan="10" style="text-align: center; vertical-align: middle;">→</td> <td>No change</td> <td rowspan="10" style="text-align: center; vertical-align: middle;">→</td> <td>B</td> </tr> <tr> <td>Extension counters</td> <td>No change</td> <td>F</td> <td>Not subject to change</td> </tr> <tr> <td>Retentive timers</td> <td>No change</td> <td>V</td> <td>Not subject to change</td> </tr> <tr> <td>C latch range</td> <td>C latch range</td> <td>T</td> <td>Low-speed timers</td> </tr> <tr> <td>D latch range</td> <td>D latch range</td> <td>ST</td> <td>Not subject to change</td> </tr> <tr> <td>B latch range</td> <td>B latch range</td> <td>C</td> <td>C</td> </tr> <tr> <td>W latch range</td> <td>W latch range</td> <td>D</td> <td>D</td> </tr> <tr> <td>Lowest device number of: Low-speed timers High-speed timers Extension low-speed timers Extension high-speed timers</td> <td rowspan="2" style="text-align: center; vertical-align: middle;">→</td> <td rowspan="2">Head of T latch range</td> <td rowspan="2" style="text-align: center; vertical-align: middle;">→</td> <td>W</td> </tr> <tr> <td>Highest device number of: Low-speed timers High-speed timers Extension low-speed timers Extension high-speed timers</td> <td>End of T latch range</td> <td></td> </tr> </tbody> </table> | A | | QnA | | A | L | → | No change | → | B | Extension counters | No change | F | Not subject to change | Retentive timers | No change | V | Not subject to change | C latch range | C latch range | T | Low-speed timers | D latch range | D latch range | ST | Not subject to change | B latch range | B latch range | C | C | W latch range | W latch range | D | D | Lowest device number of: Low-speed timers High-speed timers Extension low-speed timers Extension high-speed timers | → | Head of T latch range | → | W | Highest device number of: Low-speed timers High-speed timers Extension low-speed timers Extension high-speed timers | End of T latch range | | <ul style="list-style-type: none"> • Set the device numbers exceeding the ACPU's device ranges to the maximum values of the corresponding devices. |
| | A | | QnA | | A | | | | | | | | | | | | | | | | | | | | | | | | | | | | | | | | | | | | | | | |
| L | → | No change | → | B | | | | | | | | | | | | | | | | | | | | | | | | | | | | | | | | | | | | | | | | |
| Extension counters | | No change | | F | Not subject to change | | | | | | | | | | | | | | | | | | | | | | | | | | | | | | | | | | | | | | | |
| Retentive timers | | No change | | V | Not subject to change | | | | | | | | | | | | | | | | | | | | | | | | | | | | | | | | | | | | | | | |
| C latch range | | C latch range | | T | Low-speed timers | | | | | | | | | | | | | | | | | | | | | | | | | | | | | | | | | | | | | | | |
| D latch range | | D latch range | | ST | Not subject to change | | | | | | | | | | | | | | | | | | | | | | | | | | | | | | | | | | | | | | | |
| B latch range | | B latch range | | C | C | | | | | | | | | | | | | | | | | | | | | | | | | | | | | | | | | | | | | | | |
| W latch range | | W latch range | | D | D | | | | | | | | | | | | | | | | | | | | | | | | | | | | | | | | | | | | | | | |
| Lowest device number of: Low-speed timers High-speed timers Extension low-speed timers Extension high-speed timers | | → | | Head of T latch range | → | W | | | | | | | | | | | | | | | | | | | | | | | | | | | | | | | | | | | | | | |
| Highest device number of: Low-speed timers High-speed timers Extension low-speed timers Extension high-speed timers | | | | | | End of T latch range | | | | | | | | | | | | | | | | | | | | | | | | | | | | | | | | | | | | | | |
| I/O allocation | | Settings are retained intact. | | | | | | | | | | | | | | | | | | | | | | | | | | | | | | | | | | | | | | | | | | |

(To the next page)

Table 2 Restrictions on PLC Type Change between ACPU and QnACPU (Continue)

| Item | Restrictions | |
|--------------------|---|--|
| | A → QnA | QnA → A |
| Network parameters | | |
| MELSECNET(II, 10) | AnA/AnN → QnA • Settings are retained. • Module's first I/O No. is set to 00H because there is no module's first I/O No. in the network parameters of the AnN/AnA. AnU → QnA • Settings are retained. | QnA → AnN • MELSECNET master station settings are retained. QnA → AnA • MELSECNET master station, MELSECNET(II) combination master station and MELSECNET(II) settings are retained. QnA → AnU • Any of the following items set is deleted. MELSECNET/10 (standby station) MELSECNET/10 (multiple remote master station) MELSECNET (parallel remote master station) MELSECNET/10 (multiple remote sub station) MELSECNET/10 (parallel remote sub station) Ethernet, CC-Link Settings but the above are deleted. |
| MELSECNET/MINI | • Settings are retained. | • Settings are retained. However, the transmission status at line error is deleted. |

Table 3 Restrictions on PLC Type Change between ACPU and QCPU

| Item | Restrictions | |
|---------------------------|--|--|
| | A → Q (Q mode) | Q (Q mode) → A |
| Programs | • All programs are changed. | • Unchangeable data names (other than MAIN, SUB1, etc.) are deleted. • If the maximum number of steps is exceeded, part of the program is deleted. Note that if the same instruction is used, the number of steps of the A series may become greater. |
| Instructions, devices | • Unchangeable instructions and devices are changed into M1255/D1255. | • Unchangeable instructions and devices are changed into M9255/D9255. |
| Comments, device memories | • All are changed. | • Unchangeable SD/SM are deleted. |
| Parameters | • All are changed. | • Unchangeable parameters are deleted. However, the type, points, model name, first I/O of I/O allocation are changed. Also, when the base mode setting for the QCPU is 8 or more modules, the on-base positions and first I/O number may differ from the actual ones. |
| Network parameters | | |
| MELSECNET(II) | • MELSECNET(II) parameters are deleted. | _____ |
| MELSECNET/10(H) | • MELSECNET/10 parameters are changed into those in MELSECNET/10 mode. | • Setting of relay station number in MELSECNET/10(H) routing parameters is discarded. |
| MELSECNET/MINI | • MELSECNET/MINI parameters are deleted. | _____ |
| CC-Link | _____ | • CC-Link parameters are deleted. |
| Ethernet | _____ | • Ethernet parameters are deleted. |

Table 4 Restrictions on PLC Type Change between QnACPU and QCPU

| Item | Restrictions | |
|--------------------------|--|---|
| | QnA → Q (Q mode) | Q (Q mode) → QnA |
| Instructions | <ul style="list-style-type: none"> Unchangeable instructions are changed into SM1255. | |
| Devices, device comments | <ul style="list-style-type: none"> All are changed. | |
| Parameters | <ul style="list-style-type: none"> All are changed. | <ul style="list-style-type: none"> Unchangeable parameters are deleted. However, only the type, points, model name, first I/O of I/O allocation are changed. Also, when the base mode setting for the QCPU is 8 or more modules, the on-base positions and first I/O number may differ from the actual ones. |
| Network parameters | | |
| MELSECNET(II) | <ul style="list-style-type: none"> MELSECNET(II) parameters are deleted. | ————— |
| MELSECNET/10(H) | <ul style="list-style-type: none"> MELSECNET/10 parameters are changed into those in MELSECNET/10 mode. | <ul style="list-style-type: none"> Setting of the relay station number in MELSECNET/10(H) routing parameters is discarded. Only 0 to 1FFF(H) of the MELSECNET/10(H) common parameters are changed. Station settings of 2000(H) and later are deleted. |
| MELSECNET/MINI | <ul style="list-style-type: none"> MELSECNET/MINI parameters are deleted. | ————— |
| CC-Link | <ul style="list-style-type: none"> When the CC-Link parameters of 5 or more modules have been set, those of the fifth module and later are deleted. | <ul style="list-style-type: none"> Unchangeable CC-Link parameters are deleted. |
| Ethernet | ————— | <ul style="list-style-type: none"> Ethernet parameters are deleted. |

*: When Q12PH/Q25PHCPU data are converted into QnACPU data, the following items of the network parameters are deleted.

- When the network range assignment has been set in the multiplexed remote sub-master setting
- Management station/control station switching parameter.
- Group No.

Table 5 Restrictions on PLC Type Change between Motion Controller (SCPU) and Other CPU

The A171SHCPU has specifications equivalent to those of the A2HCPU, the A172SHCPU has specifications equivalent to those of the A2SHCPU memory or I/O enhancement, and the A273UHCPU(S3) has specifications equivalent to those of the A3UCPU.

| Other CPU | Restrictions | |
|---------------------|--|--|
| | Motion controller (SCPU) → Other PLC series | Other PLC series → Motion controller (SCPU) |
| A series | <ul style="list-style-type: none"> Motion controller-dedicated instructions are changed as they are. However, making a program check results in instruction code error. | Equivalent to A series → A series. Refer to Table 1. |
| QnA series/Q series | <ul style="list-style-type: none"> Motion controller-dedicated instructions are changed into M1255. | Equivalent to QnA series → A series. Refer to Table 2. Equivalent to Q series → A series. Refer to Tables 2 and 3. |
| FX series | <ul style="list-style-type: none"> Motion controller-dedicated instructions are changed into M8255. | Equivalent to FX series → A series. Refer to Table 6. |

Table 6 Restrictions on PLC Type Change between ACPU and FXCPU

| Item | Restrictions | |
|--|--|---|
| | A → FX | FX → A |
| Programs | <ul style="list-style-type: none"> AnA and AnU dedicated instructions are deleted. Subprograms are deleted. Excess program part after change is deleted. | |
| | <ul style="list-style-type: none"> Unchangeable devices are changed into M8255/D8255. Unchangeable instructions are changed into OUT M8255. | <ul style="list-style-type: none"> Unchangeable devices are changed into M9255/D9255. Unchangeable instructions are changed into OUT M9255. However, LDP, LDF, ORP, ORF, ANDP and ANDF instructions become contact instructions without P and F, and devices are changed into M9255. Also, INV is changed into AND M9255, and STL into OUT M9255. |
| | <ul style="list-style-type: none"> The instructions and devices which have been changed into M9255/D9255 and M8255/D8255 should be corrected by the device check of the program check function. However, when the FX0(S), FX0N or FX1 PLC CPU has been selected, replacement for these device numbers cannot be made. In this case, execute the device check of the program check function. | |
| Memory capacity | <ul style="list-style-type: none"> Changed into the maximum capacity of the PLC type after change. | |
| File register capacity, comment capacity | <ul style="list-style-type: none"> Set to 0 blocks if the PLC type after change is not compatible with this function. | <ul style="list-style-type: none"> Set to the defaults of the PLC type after change. |
| Network parameters | <ul style="list-style-type: none"> Not changed because of absence in the FX. | <ul style="list-style-type: none"> Set to the defaults of the PLC type after change. |
| Statements, notes | Settings are retained intact. However, the range in excess of the setting capacity is deleted. | |
| Device comments, device memories | Settings are retained intact. However, devices not existing in the PLC after change or the data in excess of the range are deleted. | |

Table 7 Restrictions on PLC Type Change between FXCPU and FXCPU

| Item | Restrictions |
|--|--|
| Programs | <ul style="list-style-type: none"> Unchangeable element numbers and application instructions are not changed. Therefore, correct programs properly before or after change and make a program check. (If programs before corrections are transferred to the PLC, a program error will occur.) Excess program part is deleted. If the PLC type after change is the FX0/FX0sCPU, the memory capacity is set to 2000. The part exceeding this CPU's actual step count of 800 is deleted. For the file registers and RAM file registers, their settings are retained intact. After change, therefore, correct them by search/replacement to have proper device numbers. |
| Memory capacity | <ul style="list-style-type: none"> If the maximum capacity of the PLC type before change is larger than that of the PLC type after change, the maximum capacity of the PLC type after change is used. |
| File register capacity, comment capacity | <ul style="list-style-type: none"> Set to 0 blocks if the PLC type after change is not compatible with this function. |

Table 7.1 Changes Made between PLC Types (FXCPU ↔ FXCPU)

| Change Type | Memory Capacity | Comment Capacity | File Register Capacity | Latch Range | Entry Code | Title | PLC mode: Serial Setting | I/O Allocations |
|-------------------------------------|-------------------|------------------|------------------------|-------------|------------|-------|--------------------------|-----------------|
| FX _{1N} → FX ₀ | ● (2000) | ● (Block 0) | ● (Block 0) | ● | ◎ | ● | ● | ● |
| FX _{1N} → FX _{0N} | ● (2000) | ★ (Block 0 to 3) | ★ (Block 0 to 3) | ● | ◎ | ◎ | ● | ● |
| FX _{1N} → FX ₁ | ★ (2000 to 4000) | ★ | ● (Block 0) | ● | ◎ | ◎ | ● | ● |
| FX _{1N} → FX _{1S} | ● (2000) | ★ (Block 0 to 3) | ★ (Block 0 to 3) | ● | ◎ | ◎ | ◎ | ● |
| FX _{1N} → FX ₂ | ★ (2000 to 8000) | ★ | ★ | ● | ◎ | ◎ | ● | ● |
| FX _{1N} → FX _{2N} | ★ (2000 to 16000) | ★ | ★ | ● | ◎ | ◎ | ◎ | ● |
| FX _{1S} → FX ₀ | ● (2000) | ● (Block 0) | ● (Block 0) | ● | ◎ | ● | ● | ● |
| FX _{1S} → FX _{0N} | ● (2000) | ★ (Block 0 to 3) | ★ (Block 0 to 3) | ● | ◎ | ◎ | ● | ● |
| FX _{1S} → FX ₁ | ★ (2000 to 4000) | ★ | ● (Block 0) | ● | ◎ | ◎ | ● | ● |
| FX _{1S} → FX _{1N} | ★ (2000 to 8000) | ★ | ★ | ● | ◎ | ◎ | ◎ | ● |
| FX _{1S} → FX ₂ | ★ (2000 to 8000) | ★ | ★ | ● | ◎ | ◎ | ● | ● |
| FX _{1S} → FX _{2N} | ★ (2000 to 16000) | ★ | ★ | ● | ◎ | ◎ | ◎ | ● |
| FX ₀ → FX _{0N} | ● (2000) | ★ (Block 0 to 3) | ★ (Block 0 to 3) | ● | ◎ | ◎ | ● | ● |
| FX ₀ → FX ₁ | ★ (2000 to 4000) | ★ | ● (Block 0) | ● | ◎ | ◎ | ● | ● |
| FX ₀ → FX _{1N} | ★ (2000 to 8000) | ★ | ★ | ● | ◎ | ◎ | ● | ● |
| FX ₀ → FX _{1S} | ● (2000) | ★ (Block 0 to 3) | ★ (Block 0 to 3) | ● | ◎ | ◎ | ● | ● |
| FX ₀ → FX ₂ | ★ (2000 to 8000) | ★ | ★ | ● | ◎ | ◎ | ● | ● |
| FX ₀ → FX _{2N} | ★ (2000 to 16000) | ★ | ★ | ● | ◎ | ◎ | ● | ● |
| FX _{0N} → FX ₀ | ● (2000) | ● (Block 0) | ● (Block 0) | ● | ◎ | ● | ● | ● |
| FX _{0N} → FX ₁ | ★ (2000 to 4000) | ★ | ● (Block 0) | ● | ◎ | ◎ | ● | ● |
| FX _{0N} → FX _{1S} | ● (2000) | ★ (Block 0 to 3) | ★ (Block 0 to 3) | ● | ◎ | ◎ | ● | ● |
| FX _{0N} → FX _{1N} | ★ (2000 to 8000) | ★ | ★ | ● | ◎ | ◎ | ● | ● |
| FX _{0N} → FX ₂ | ★ (2000 to 8000) | ★ | ★ | ● | ◎ | ◎ | ● | ● |
| FX _{0N} → FX _{2N} | ★ (2000 to 16000) | ★ | ★ | ● | ◎ | ◎ | ● | ● |
| FX ₁ → FX ₀ | ● (2000) | ● (Block 0) | ● (Block 0) | ● | ◎ | ● | ● | ● |
| FX ₁ → FX _{0N} | ● (2000) | ★ (Block 0 to 3) | ★ (Block 0 to 3) | ● | ◎ | ◎ | ● | ● |
| FX ₁ → FX _{1S} | ● (2000) | ★ (Block 0 to 3) | ★ (Block 0 to 3) | ● | ◎ | ◎ | ● | ● |
| FX ₁ → FX _{1N} | ★ (2000 to 8000) | ★ | ★ | ● | ◎ | ◎ | ● | ● |
| FX ₁ → FX ₂ | ★ (2000 to 8000) | ★ | ★ | ● | ◎ | ◎ | ● | ● |
| FX ₁ → FX _{2N} | ★ (2000 to 16000) | ★ | ★ | ● | ◎ | ◎ | ● | ● |
| FX ₂ → FX ₀ | ● (2000) | ● (Block 0) | ● (Block 0) | ● | ◎ | ● | ● | ● |
| FX ₂ → FX _{0N} | ● (2000) | ★ (Block 0 to 3) | ★ (Block 0 to 3) | ● | ◎ | ◎ | ● | ● |
| FX ₂ → FX _{1S} | ● (2000) | ★ (Block 0 to 3) | ★ (Block 0 to 3) | ● | ◎ | ◎ | ● | ● |
| FX ₂ → FX _{1N} | ★ (2000 to 8000) | ★ | ★ | ● | ◎ | ◎ | ● | ● |
| FX ₂ → FX _{2N} | ★ (2000 to 16000) | ★ | ★ | ● | ◎ | ◎ | ● | ● |

| Change Type | Memory Capacity | Comment Capacity | File Rregister Capacity | Latch Range | Entry Code | Title | PLC mode: Serial Setting | I/O Allocations |
|-------------------------------------|------------------|------------------|-------------------------|-------------|------------|-------|--------------------------|-----------------|
| FX _{2N} → FX ₀ | ● (2000) | ● (Block 0) | ● (Block 0) | ● | ⊙ | ● | ● | ● |
| FX _{2N} → FX _{0N} | ● (2000) | ★ (Block 0 to 3) | ★ (Block 0 to 3) | ● | ⊙ | ⊙ | ● | ● |
| FX _{2N} → FX _{1S} | ● (2000) | ★ (Block 0 to 3) | ★ (Block 0 to 3) | ● | ⊙ | ⊙ | ● | ● |
| FX _{2N} → FX _{1S} | ● (2000) | ★ (Block 0 to 3) | ★ (Block 0 to 3) | ● | ⊙ | ⊙ | ⊙ | ● |
| FX _{2N} → FX _{1N} | ★ (2000 to 8000) | ★ | ★ | ● | ⊙ | ⊙ | ⊙ | ● |
| FX _{2N} → FX ₂ | ★ (2000 to 8000) | ★ | ★ | ● | ⊙ | ⊙ | ● | ● |

⊙: Settings before change are retained.

●: Defaults of the CPU type after change are set.

★: Change can be designated in a dialog box.

When the comment or file register capacities can be changed in a dialog box, the range of setting may vary according to the memory capacity setting.

Table 8 Restrictions on Changing between Q00J/Q00/Q01CPU and Q02(H)/Q06H/Q12H/Q25HCPU

| Item | | Restrictions | |
|----------------------------------|--------------|---|---|
| | | Q00J/Q00/Q01CPU → Q02(H)/Q06H/Q12H/Q25HCPU | Q02(H)/Q06H/Q12H/Q25HCPU → Q00J/Q00/Q01CPU |
| Programs | Instructions | <ul style="list-style-type: none"> No restrictions | <ul style="list-style-type: none"> SFC programs are deleted. Incompatible instructions are converted into SM999. Incompatible devices (SM1024, SD1024) are converted into SD999. For conversion to the Q00J, file registers (R, ZR) are converted into SD999. (This also applies to conversion from Q00/Q01 to Q00J) |
| | Devices | | |
| Device memory Device comments | | <ul style="list-style-type: none"> Incompatible devices are deleted. | <ul style="list-style-type: none"> Common comments, if present, are deleted. |
| PLC parameters | | <ul style="list-style-type: none"> Serial communication function setting is deleted. * 1 | <ul style="list-style-type: none"> Inconvertible parameters are deleted. However, only the I/O assignment type, number of points, type and first I/O are converted. When 8 or more modules have been set in the base mode for the QCPU (Q mode), the on-the-base positions and first I/O number may differ from the setting. Device initial values are deleted. Remote parameters are deleted. |
| Network parameters | | | |
| MELSECNET/H MELSECNET/10 | | <ul style="list-style-type: none"> No restrictions | <ul style="list-style-type: none"> When 2 or more modules have been specified in the MELSECNET/H or MELSECNET/10 setting, the second and latter modules are deleted. |
| CC-Link * 2 | | <ul style="list-style-type: none"> No restrictions | <ul style="list-style-type: none"> When 3 or more modules have been specified in the CC-Link setting, the third and latter modules are deleted. When the first I/O of the conversion source data is more than 800H, automatic setting is made to within the range that can be handled by the Q00J/Q00/Q01CPU. Inconvertible parameters are deleted. |
| Ethernet | | <ul style="list-style-type: none"> No restrictions | <ul style="list-style-type: none"> When 2 or more modules have been specified in the Ethernet setting, the second and latter modules are deleted. Inconvertible parameters are deleted. |

* 1: When the Q00/Q01CPU is changed to the Q00J, the setting is converted into no check (not used).

* 2: When the CC-Link parameters have not been set, the refresh destinations of RX/RX are automatically assigned to X/Y400-7FF automatically.

Note that when the Q02(H)/Q06H/Q12H/Q25H is changed to the Q00J/Q00/Q01CPU, X/Y400-7FF that were used as free memory are overwritten by link refresh.

Table 9 Restrictions on Changing between Q00J/Q00/Q01/Q02(H)/Q06H/Q12H/Q25HCPU and Q12PH/Q25PHCPU.

| Item | | Restrictions | |
|----------------------------------|--------------|--|---|
| | | Q12PH/Q25PHCPU → Q00J/Q00/Q01/Q02(H)/Q06H/Q12H/Q25HCPU | Q00J/Q00/Q01/Q02(H)/Q06H/Q12H/Q25HCPU → Q12PH/Q25PHCPU |
| Programs | Instructions | <ul style="list-style-type: none"> No restrictions | <ul style="list-style-type: none"> The PID instruction deleted on the Q12PH/Q25PHCPU is converted into SM1255. |
| | Devices | | <ul style="list-style-type: none"> No restrictions |
| Device memory Device comments | | <ul style="list-style-type: none"> No restrictions | <ul style="list-style-type: none"> No restrictions |
| PLC parameters | | <ul style="list-style-type: none"> No restrictions | <ul style="list-style-type: none"> Deselect "Perform internal arithmetic operations in double precision" if it has been selected in PLC system settings. |
| Network parameters | | | |
| MELSECNET/H MELSECNET/10 | | <ul style="list-style-type: none"> Delete MNET/H multiplexed remote master or MNET/H multiplexed remote sub-master. | <ul style="list-style-type: none"> No restrictions |

Appendix 5 Examples of Wiring RS-232 Cable for Connection of C24 and Personal computer

5.1 A Series

| | | |
|---|-------|----|
| A | Q/QnA | FX |
| ○ | × | × |

- Connection of RS-232 interface
 - (1) When a 25-pin connector is used in a computer link module

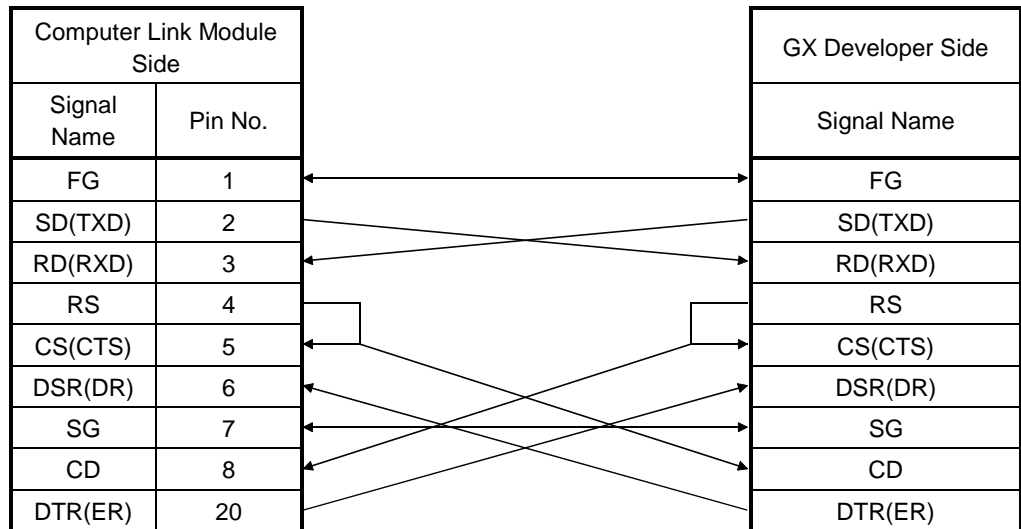

- (2) When a 25-pin connector is used in a computer link module

If the connection between the computer link module and the GX Developer is made in the manner shown below, designate "without CD terminal check".

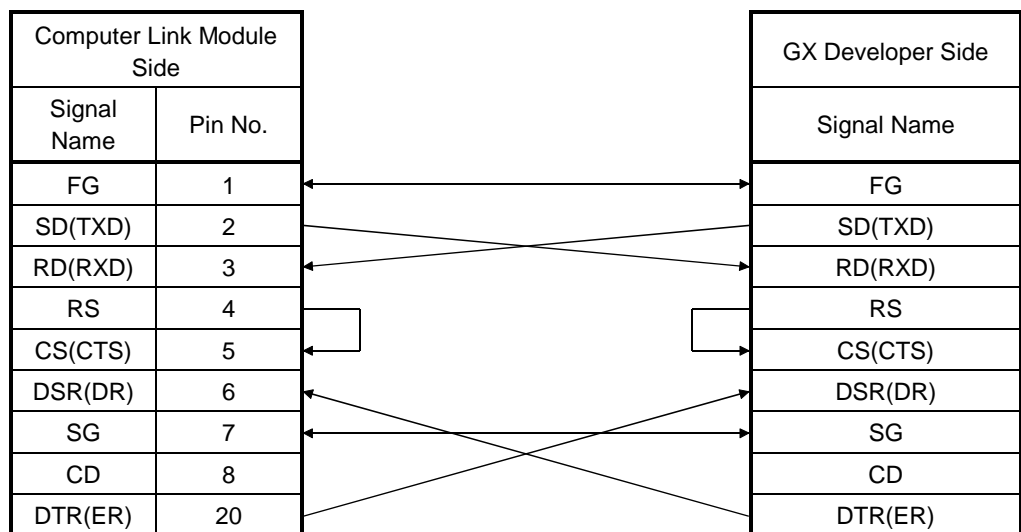

Buffer memory setting

CD terminal check (address 10Bh): Without check

DTR control (address 11Ah): Yes (C24-S8, UC24)

(3) When an 9-pin connector is used in a computer link module
 (Example of connection)

| Computer Link Module Side | | Cable Connection and Signal Direction | External Device Side |
|---------------------------|---------|---------------------------------------|----------------------|
| Signal Name | Pin No. | | Signal Name |
| CD | 1 | | CD |
| RD(RXD) | 2 | | RD(RXD) |
| SD(TXD) | 3 | | SD(TXD) |
| DTR(ER) | 4 | | DTR(ER) |
| SG | 5 | | SG |
| DSR(DR) | 6 | | DSR(DR) |
| RS(RTS) | 7 | | RS(RTS) |
| CS(CTS) | 8 | | CS(CTS) |

Set "without CD terminal check".

(4) When an 9-pin connector is used in a computer link module
 (Example of connection)

| Computer Link Module Side | | Cable Connection and Signal Direction | External Device Side |
|---------------------------|---------|---------------------------------------|----------------------|
| Signal Name | Pin No. | | Signal Name |
| CD | 1 | | CD |
| RD(RXD) | 2 | | RD(RXD) |
| SD(TXD) | 3 | | SD(TXD) |
| DTR(ER) | 4 | | DTR(ER) |
| SG | 5 | | SG |
| DSR(DR) | 6 | | DSR(DR) |
| RS(RTS) | 7 | | RS(RTS) |
| CS(CTS) | 8 | | CS(CTS) |

※: DC code control or DTR/DSR control is enabled by connecting the DTR and DSR signals of the computer link module to an external device as shown above.

5.2 QnA Series

| | | |
|---|-------|----|
| A | Q/QnA | FX |
| × | ○* | × |

*:Compatible with the QnACPU only.

- (1) When a 25-pin connector is used in a serial communication module
 - (a) Example of connection to an external device that allows the CD signal (No. 8 pin) to be turned ON/OFF

| Serial communication module Side | | Cable Connection and Signal Direction (Full-/Half-Duplex Communication) | GX Developer Side |
|----------------------------------|---------|--|-------------------|
| Signal Name | Pin No. | | Signal Name |
| FG | 1 | ↔ | FG |
| SD(TXD) | 2 | ↔ | SD(TXD) |
| RD(RXD) | 3 | ↔ | RD(RXD) |
| RS | 4 | ↔ | RS |
| CS(CTS) | 5 | ↔ | CS(CTS) |
| DSR(DR) | 6 | ↔ | DSR(DR) |
| SG | 7 | ↔ | SG |
| CD | 8 | ↔ | CD |
| DTR(ER) | 20 | ↔ | DTR(ER) |

DC code control or DTR/DSR control is enabled by connecting the QC24 (N) to an external device as shown above.

- (b) Example of connection to an external device that does not allow the CD signal (No. 8 pin) to be turned ON/OFF

| Serial communication module Side | | Cable Connection and Signal Direction (Full-Duplex Communication) | GX Developer Side |
|----------------------------------|---------|--|-------------------|
| Signal Name | Pin No. | | Signal Name |
| FG | 1 | ↔ | FG |
| SD(TXD) | 2 | ↔ | SD(TXD) |
| RD(RXD) | 3 | ↔ | RD(RXD) |
| RS | 4 | ↔ | RS |
| CS(CTS) | 5 | ↔ | CS(CTS) |
| DSR(DR) | 6 | ↔ | DSR(DR) |
| SG | 7 | ↔ | SG |
| CD | 8 | ↔ | CD |
| DTR(ER) | 20 | ↔ | DTR(ER) |

DC code control or DTR/DSR control is enabled by connecting the QC24 (N) to an external device as shown above.

- (2) When a 9-pin connector is used in a serial communication module
 - (a) Example of connection to an external device that allows the CD signal (No. 1 pin) to be turned ON/OFF

| Serial communication module Side | | Cable Connection and Signal Direction (Full- / Half-Duplex Communication) | GX Developer Side |
|----------------------------------|---------|--|-------------------|
| Signal Name | Pin No. | | Signal Name |
| CD | 1 | | CD |
| RD(RXD) | 2 | | RD(RXD) |
| SD(TXD) | 3 | | SD(TXD) |
| DTR(ER) | 4 | | DTR(ER) |
| SG | 5 | | SG |
| DSR(DR) | 6 | | DSR(DR) |
| RS(RTS) | 7 | | RS(RTS) |
| CS(CTS) | 8 | | CS(CTS) |

DC code control or DTR/DSR control is enabled by connecting the QC24 (N) to an external device as shown above.

- (b) Example of connection to an external device that does not allow the CD signal (No. 1 pin) to be turned ON/OFF

| Serial communication module Side | | Cable Connection and Signal Direction (Full-Duplex Communication) | GX Developer Side |
|----------------------------------|---------|--|-------------------|
| Signal Name | Pin No. | | Signal Name |
| CD | 1 | | CD |
| RD(RXD) | 2 | | RD(RXD) |
| SD(TXD) | 3 | | SD(TXD) |
| DTR(ER) | 4 | | DTR(ER) |
| SG | 5 | | SG |
| DSR(DR) | 6 | | DSR(DR) |
| RS(RTS) | 7 | | RS(RTS) |
| CS(CTS) | 8 | | CS(CTS) |

DC code control or DTR/DSR control is enabled by connecting the QC24 (N) to an external device as shown above.

5.3 Q Series

| | | |
|---|-------|----|
| A | Q/QnA | FX |
| × | ○* | × |

*: Compatible with the QCPU (Q mode) only.

The connector specifications are indicated below.

| Pin Number | Signal Code | Signal Name | Signal Direction Q-compatible C24 ↔ external device |
|------------|-------------|---------------------------|---|
| 1 | CD | Receive carrier detection | ← |
| 2 | RD (RXD) | Receive data | ← |
| 3 | SD (TXD) | Send data | → |
| 4 | DTR (ER) | Data terminal ready | → |
| 5 | SG | Send ground | ↔ |
| 6 | DSR (DR) | Data set ready | ← |
| 7 | RS (RTS) | Request to send | → |
| 8 | CS (CTS) | Clear to send | ← |
| 9 | RI (CI) | Call indication | ← |

(1) Connection example which can turn ON/OFF CD signal (No. 1 pin)

| Serial communication module Side | | Cable Connection and Signal Direction (Connection example for full duplex/half duplex communication) | GX Developer Side |
|----------------------------------|---------|---|-------------------|
| Signal Name | Pin No. | | Signal Name |
| CD | 1 | | CD |
| RD (RXD) | 2 | | RD (RXD) |
| SD (TXD) | 3 | | SD (TXD) |
| DTR (ER) | 4 | | DTR (ER) |
| SG | 5 | | SG |
| DSR (DR) | 6 | | DSR (DR) |
| RS (RTS) | 7 | | RS (RTS) |
| CS (CTS) | 8 | | CS (CTS) |
| RI (CI) | 9 | | |

(2) Connection example which cannot turn ON/OFF CD signal (No. 1 pin)
 Connection example for exercising DC code control or DTR/DSR control

| Serial communication module Side | | Cable Connection and Signal Direction (Connection example for full duplex communication) | GX Developer Side |
|----------------------------------|---------|---|-------------------|
| Signal Name | Pin No. | | Signal Name |
| CD | 1 | | CD |
| RD (RXD) | 2 | | RD (RXD) |
| SD (TXD) | 3 | | SD (TXD) |
| DTR (ER) | 4 | | DTR (ER) |
| SG | 5 | | SG |
| DSR (DR) | 6 | | DSR (DR) |
| RS (RTS) | 7 | | RS (RTS) |
| CS (CTS) | 8 | | CS (CTS) |
| RI (CI) | 9 | | |

Appendix 6 ROM Writer Wiring Examples

| | | |
|---|-------|----|
| A | Q/QnA | FX |
| ○ | × | ○ |

The wiring of the RS-232 cable that connects a personal computer and ROM writer is shown here.

Make the cable used for the wiring shown below yourself in accordance with the specifications of the ROM writer to be used.

| Personal computer | | Cable Connection and Signal Direction | ROM WRITER | |
|-------------------|---------|---------------------------------------|------------|-------------|
| Signal Name | Pin No. | | Pin No. | Signal Name |
| FG | - | | 1 | FG |
| SD | 3 | | 2 | SD |
| RD | 2 | | 3 | RD |
| RST | 7 | | 4 | RTS |
| CTS | 8 | | 5 | CTS |
| DSR | 6 | | 6 | DSR |
| SG | 5 | | 7 | SG |
| DTR | 4 | | 20 | DTR |

An example of wiring of the RS-232 cable that connects a personal computer and ROM writer is shown here.

If RTS and CTS are not used at the ROM writer side, short RTS and CTS at the personal computer side.

Appendix 7 PLC CPU Version Correspondence Chart

7.1 About QnA series function versions

| | | |
|---|-----|----|
| A | QnA | FX |
| × | ○ | × |

When using the functions shown in the table, use the module for function version B. To use the functions in this manual listed following, each version of QnACPU (except Q4ARCPU), Ethernet interface module, and CC-Link system master/local modules have restrictions. (See Appendix 7.1.2 for more information about Q4ARCPU.) If there is a version higher than those listed in the table, the corresponding functions can be used.

| Module \ Function | PLC Q2ACPU, Q2AS1CPU, Q3ACPU, Q4A CPU, Q2AS(H)CPU, Q2AS(H)S1 | Ethernet AJ71QE71(B5), A1SJ71QE71-B2, A1SJ71QE71-B5 | CC-Link AJ61QBT11, A1SJ61QBT11 |
|---------------------------------|---|--|-----------------------------------|
| Local device Monitoring/testing | 9707B or later | — | — |
| High-speed communication | 9707B or later | — | — |
| Ethernet parameters | 9707B or later | 9707B or later | — |
| CC-Link parameters | 9707B or later | — | 9707B or later |

—: Irrelevant function

POINT

- When using the functions above, use a module that has the following code (9707B or later) inscribed in the DATE entry on the ratings nameplate.



Year/month of manufacture: 9707
Function version: B

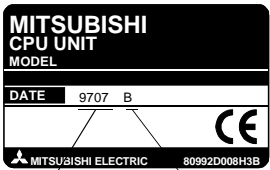

Year/month of manufacture: 9707
Function version: B

7.2 About Q4ARCPU function version

| | | |
|---|-----|----|
| A | QnA | FX |
| × | ○ | × |

The table below explains the items listed following.

1. Comparisons between QnACPU functions of other than Q4ARCPU and Q4ARCPU.
2. Comparisons of the differences between versions of Q4ARCPU.

When connecting to the Ethernet, use the improved version of the Q4ARCPU (production date (last two numbers of the Western calendar year and the two numbers for the month) is "0012" or later, that software product is version B or higher) and QE71 function version B.

Because the Q4ARCPU does not support the settings, do not make settings for the Ethernet parameters FTP parameters/routing information.

| | PLC CPU Version | Ethernet Connection | | CC-Link Parameters | High Speed Communication | Local Device Monitor/Test |
|--|---|---------------------|---------------|--------------------|--------------------------|---------------------------|
| | | Local Station | Other Station | | | |
| Q2ACPU, Q2AS1CPU, Q3ACPU, Q4ACPU, Q2AS(H)CPU, Q2AS(H)S1 | Function Version A | ×*1 | ×*1 | ×*1 | × | × |
| | Function Version B | ○ | ○ | ○ | ○ | ○ |
| Q4ARCPU | Production date is "0012", software product is version A or earlier | ×*1 | ×*1 | ×*1 | × | × |
| | Production date is "0012", software product is version B or later | ○ | ○ | ×*1 | × | × |

*1: Parameters can be set by the GX Developer

Even if you write parameters set with GX Developer (SW6D5C-GPPW-E 6.04E or earlier product) to the Q4ARCPU, the Q4ARCPU will ignore the set parameters.

7.3 About the Q series function version

| | | |
|---|---|----|
| A | Q | FX |
| × | ○ | × |

The following is how to confirm the function version of the module.
 If the version of your module is as indicated in the table or later, the corresponding functions are available.

| Function | Module | PLC CPU | Q-Compatible E71 | Serial Communication Module (Q Series) |
|--------------------------------|--------|---|-----------------------|--|
| | | Q02(H), Q06H Q12H, Q25H | QJ71E71 QJ71E71-B2 | QJ71C24 QJ71C24-R2 |
| Multi CPU setting | | Function version B | — | — |
| Remote password | | Function version A Product whose upper 5 digits of serial No. 02092***** is 02092 or later | Function version B | Function version B |
| Forced I/O registration/cancel | | Function version A Product whose upper 5 digits of serial No. 02092***** is 02092 or later | — | — |

The function version of the module can be checked by confirming the rating plate on the right hand side of the module and GX Developer.

- (1) To make check in the "SERIAL field of the rating plate" on the right hand side of the module

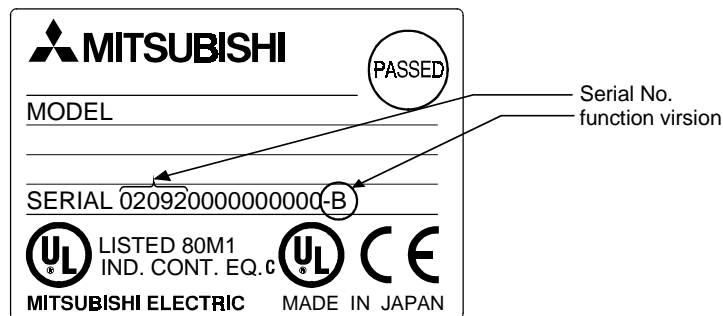

- (2) To make check on GX Developer
 [Operating Procedure]

Choose [Diagnostics] → [System monitor] → Module's Detailed Information button → "Product information".
 For details, refer to Section 21.4 "System Monitor".

Appendix 8 Restrictions and Cautions

| | | |
|---|-------|----|
| A | Q/QnA | FX |
| ○ | ○ | × |

The following is a list of restrictions and cautions to be observed when operating GX Developer.

Read these restrictions before attempting GX Developer operations.

The symbol "^" is appended to those restrictions in the list that also apply to GPPA/GPPQ.

Items in the list that are marked "<Caution>" are cautions relating to GX Developer only.

[Interpreting the Lists]

Example:

| | |
|------|------|
| GPPA | GPPQ |
| ○ | — |

..... Indicates that the restriction when using ACPU with GX Developer is the same as that which applies when using GPPA.

| | |
|----------------|------|
| GPPA | GPPQ |
| ○ <Caution> | — |

..... Indicates that the caution when using ACPU with GX Developer is the same as that which applies when using GPPA.

| | |
|----------------|------|
| GPPA | GPPQ |
| — <Caution> | — |

..... Indicates that the caution when using ACPU with GX Developer is exclusive to GX Developer.

| Item | Restrictions/Cautions | GPPA | GPPQ |
|-------------------------|--|----------------|------|
| Comment reading/writing | When editing comments there is no particular need to set a comment capacity. However, an error is displayed on writing to the CPU if no capacity is found to be set on checking the parameters of the personal computer. | — <Caution> | — |
| | When extension comments have been designated for a program created with GPPA (valid program setting), when these extension comments are read by GX Developer, they are assigned to common comments regardless of the GPPA designation. | — <Caution> | — |
| | When a file created with ACPU or GPPA is written to GX Developer, if there is any duplication between the comments for common devices and extension comments, the extension comments take priority and therefore the common device comments cannot be read. | — | — |
| | When comments created with GX Developer are written in GPPA format to the FD or HD of a personal computer, the comments can be written regardless of the comment capacity in the parameters. The comments can be used when GPPA is started up by carrying out comment memory capacity setting, then reading the comments in the file maintenance mode. | ○ | — |
| | With GX Developer, device comments and device memories can be created within the ranges designated in the parameters, but even after completing writing to the GPPQ format, it may not be possible to write to GPPQ. In this case the size of the data to be written must be reduced. | — | — |
| | When second half M comments for main and sub use are read to GX Developer, since the range setting is included in S, they are allocated to S. | — | — |

| Item | Restrictions/Cautions | GPPA | GPPQ |
|-------------------------|---|-----------|----------------|
| Comment reading/writing | If X/Y comments 2 are written without range setting at GX Developer, reading is carried out in accordance with the X and Y attributes respectively. | — | — |
| | The restriction on sub-system names is up to 10 characters for GPPQ and up to 8 characters for GX Developer. On reading subsystem names from GPPQ format, they are shortened to 8 characters. If these subsystem names are written back to GPPQ, they are written as 8 characters. | — | ○ |
| | When peripheral statements/notes created with GPPQ are written to a PLC, they cannot be read out with GX Developer; they must be read with GPPQ. | — | — <Caution> |
| | When comments are written in GPPA format, one of the original files at the GPPA side is deleted. When writing comments 2, comments 1 are deleted; when writing comments 1, comments 2 are deleted. | <Caution> | — |
| | When comments are written to an A1NCPU, if MAIN (program-classified comment) is selected when writing to the PLC, comments F0 to F127 are written unconditionally to the PLC, regardless of range selection. Reading is carried out in the same way. | <Caution> | — |
| | When comments edited as comments 2 at GX Developer are written to an ACPU/GPPA format file as comments 1, they are displayed as incorrect characters by GPPA. | <Caution> | — |
| | When comments are written to an ACPU/GPPA format file, if a two-byte character starts at the 16th character (for comments 2)/15th character (for comments 1), writing is carried out with the 16th/15th character left blank. | — | — |
| | ZR comment data cannot be created in excess of 32 points. However, when created as program-by-program comments and common comments, respectively, comment data can be created up to 64k points. | — | — |
| Parameter setting | When using a memory cassette larger than A3MCA-18, if the total capacity - excluding extension comments - set in capacity setting in the parameters exceeds 144 K bytes, when the extension comments are written it may not be possible to write the second half. In this case the first half 1024 points must be divided into 64-point units. | ○ | — |
| | When local device or latch clear key valid/invalid designations are made in the parameters, set a range in device setting. | — | ○ |
| | When file registers are set, a file register capacity must be set in the parameters. | ○ | — |
| | When parameters for which no settings have been made with GPPA, or whose parameter screens have been opened in GPPA but then closed with "END" without making any settings, are verified - in GPPA - against GX Developer parameters set in the same way, a verification mismatch may occur. The mismatch occurs due errors, for example, in the initial value data of blank items, but there is no difference in operation when the parameter data is written to a PLC and executed, so there is no problem in actual use. | — | — |
| | When file registers are designated in the MELSECNET/10 refresh parameter settings, a capacity setting must be made for file registers in the memory capacity settings. | ○ | — |
| | Since MELSECNET/10 network parameters store the time at which the parameter settings were made with GX Developer, when network parameters are verified between GPPA/GPPQ and GX Developer, the result may be a setting time mismatch even if the set data matches. | <Caution> | ○ |
| | If MELSECNET/10 (multiplex remote master) or MNET/10 (parallel remote master) is set for four modules in the network parameters and these settings are written in GPPQ format and verified against the same parameter settings in GPPQ, a verification error will occur. Since the parameters themselves are correct, there is no problem in actual use. | — | — |

| Item | Restrictions/Cautions | GPPA | GPPQ | | | | | | | | |
|--|--|----------------|------------|-------------|--|-------------|---------------|-------------|--|---|---|
| Parameter settings | If a blanks are set for "refresh parameters" and "link parameter constant scan (GPPA only)" in the GPPA/GPPQ and GX Developer parameters, this is the same as settings of "0 points" and "0 ms." respectively at GPPA. | — | — | | | | | | | | |
| | When the device settings are changed, the following files that have already been written to the PLC must be written again: Sequence programs, SFC programs, monitor registration, sampling trace data, device initial values. | — | ○ | | | | | | | | |
| | With regard to PLC data reading of the network parameters: 1. When parameters are set (written) in the PLC, the written parameters are read. 2. When parameters have not been set in the PLC, the actual link module mounting status detected by the PLC is read. | — | ○ | | | | | | | | |
| | When verification against parameters created with SW0IVD-GPPQ or SW1IVD-GPPQ is executed, a "parameter mismatch" may occur even if the settings match. If this happens, first read the parameters with SW2IVD-GPPQ, then write the parameters again. | — | ○ | | | | | | | | |
| | To create a subsequence, a capacity of 2K or more must be set in the parameter mode. | ○ | — | | | | | | | | |
| Change PLC type | If a PLC type change is made to a PLC type that does not allow the creation of subprograms, subprograms are deleted. | — <Caution> | — | | | | | | | | |
| | When a program is written to the PLC after changing the PLC type, out-of-range devices/instructions cause an error and cannot be written. When data is written to a GPPA format file and read with GPPA, instruction code abnormalities are displayed. The same applies when data is written to a GPPQ format file and read with GPPQ. | — | — | | | | | | | | |
| | If the PLC type is changed in the network system shown below, all the network parameters before the change are retained. However, in the case of AnUCPU, if there is even one module for which the first network I/O number exceeds the actual I/O range of the PLC type changed to, the first I/O numbers are automatically allocated to 0H, 20H, 40H, 60H (assuming there are four modules). (Where A4U changes to A3U, A4U changes to A2U, A3U changes to A2U) For changes between network systems, the changes are to the defaults. | — | — | | | | | | | | |
| | <table border="1" style="margin-left: auto; margin-right: auto;"> <thead> <tr> <th>Network system</th> <th>PLC system</th> </tr> </thead> <tbody> <tr> <td>AnN systems</td> <td>A0J2H, A1N, A2N, A3N, A1S, A1SH, A2S (S1), A2SH, A2C</td> </tr> <tr> <td>AnA systems</td> <td>A2A (S1), A3A</td> </tr> <tr> <td>AnU systems</td> <td>A2U, A2USH-S1, A3U, A4U, A2AS (S1), A2AS-S30, A2AS-S60</td> </tr> </tbody> </table> | Network system | PLC system | AnN systems | A0J2H, A1N, A2N, A3N, A1S, A1SH, A2S (S1), A2SH, A2C | AnA systems | A2A (S1), A3A | AnU systems | A2U, A2USH-S1, A3U, A4U, A2AS (S1), A2AS-S30, A2AS-S60 | — | — |
| | Network system | PLC system | | | | | | | | | |
| AnN systems | A0J2H, A1N, A2N, A3N, A1S, A1SH, A2S (S1), A2SH, A2C | | | | | | | | | | |
| AnA systems | A2A (S1), A3A | | | | | | | | | | |
| AnU systems | A2U, A2USH-S1, A3U, A4U, A2AS (S1), A2AS-S30, A2AS-S60 | | | | | | | | | | |
| If microcomputer programs cannot be accommodated when a PLC type change is made, all microcomputer programs are deleted. | — | — | | | | | | | | | |
| If the capacity before the change is smaller than the maximum capacity of the PLC type changed to, the memory capacity is set as that before the change. If it is larger than the maximum memory capacity of the PLC type to be changed to, the memory capacity is set as the maximum memory capacity of the PLC type changed to. | ○ | — | | | | | | | | | |

| Item | Restrictions/Cautions | GPPA | GPPQ |
|--|--|------|------|
| Change PLC type | If the program capacity decreases, the programs are curtailed at the number of steps equivalent to the reduced capacity. (If this curtailment occurs part way through a ladder program, the entire block is eliminated.) | — | — |
| | If the sequence programs + microcomputer programs exceed the capacity of the PLC type changed to, the microcomputer program capacity is set to 0. | — | — |
| | To execute "PLC read" when connected to a CPU that is not in the PLC type list, carry out a PLC type change as follows. <ul style="list-style-type: none"> When connecting to A1SCPU with a PLC type other than A1S at the GX Developer side, read by changing the PLC type to A2N. | — | — |
| | When a PLC type change is executed, if there are devices that cannot be used at the PLC after the change, that range of devices is automatically deleted. (For the "A" series, this includes device comments.) | ○ | — |
| | When a PLC type change is executed, if a setting that exceeds the maximum device range for the PLC after the change is made, the setting is automatically changed to the maximum possible. (For the "A" series, this includes device comments.) | ○ | — |
| PLC type | A connected CPU that does not support A1, A2, or A3 is recognized as AnN but cannot be used. | — | — |
| Ladder input | The ladder block has 24 lines of parallel contacts and line insertion is not possible. | — | ○ |
| | The line return destination and source must have the same number. The same number cannot be used more than once. | ○ | ○ |
| | The line return numbers must be serial numbers. It is not possible to insert a ladder between the line return source and destination. | ○ | ○ |
| | If the contacts/coils to be overwritten straddle multiple contacts, ladder input is not possible. | — | ○ |
| | Inserting a contact in the first row does not make it possible to make an insertion at a line return. | — | ○ |
| | If a vertical line that crosses an instruction is drawn, conversion will not be possible. | — | ○ |
| | In a ladder block with two or more lines where an instruction cannot be accommodated on one line, you must create a line return and input the instruction on the next line. | — | — |
| | <input type="text" value="Enter"/> When ladder information has been read into the key-in data field by pressing the [Enter] key, the cursor cannot be moved. | — | — |
| | The maximum number of instruction and device characters that can be written at one contact is eight. If the total number of characters is more than this, multiple rows must be used. | — | — |
| | If a vertical line that crosses a statement is drawn, a conversion error occurs on attempting conversion. | — | ○ |
| A CHG instruction input check is not performed on programs of PLCs that do not allow the creation of subprograms, such as A2ACPU and A2UCPU. When the PLC is set to RUN an error occurs. | — | — | |
| Online change | When online change is executed with respect to an A4UMCA-128E memory cassette, the transmission may take several minutes. During the transmission, operation continues in accordance with the program before the change. After the transmission, sequence processing stops for a maximum of 2 seconds. | ○ | — |
| | When online change is executed with respect to an A3NCP, the CHG instruction is automatically disabled. On completion of conversion, the CHG instruction is executed. | ○ | — |
| | During online change, RUN/STOP/PAUSE/STEP RUN key switch operations are prohibited. | ○ | ○ |
| | If there is a pulse instruction in the program to be written, the PLC does not execute this instruction after the PLC write operation. It is executed after its execution condition changes from OFF to ON. | ○ | ○ |

| Item | Restriction/Note | GPPA | GPPQ |
|--------------------------|---|------|------|
| Import file /Export file | <p>Depending on the GPPA, there are versions that cannot be selected although the same model name exists in the PLC type list.</p> <p>If the PLC type is not represented with GPPA, change to a PLC type that is represented with GPPA (at GX Developer) and then write the data.</p> <p>Example:</p> <div style="border: 1px solid black; padding: 5px; display: inline-block;"> <p style="text-align: center;">GX Developer side</p> <p style="text-align: center;">Create with A2U□ change to A2A</p> </div> → <div style="border: 1px solid black; padding: 5px; display: inline-block;"> <p style="text-align: center;">SW0SRXV-GPPA side</p> <p style="text-align: center;">write in GPPA format</p> </div> → <p style="margin-left: 10px;">treated as A2A</p> | — | — |
| | <p>Since they are not represented in the PLC type list at the GPPA side, files created with models such as A3HCPU cannot be read with GX Developer. (It is not possible to read or write files of incompatible PLCs.)</p> | — | — |
| | <p>When a GPPA/GPPQ format program that contains an END instruction part way through is read to GX Developer, the part of the program up to the END instruction is read. The part after the END instruction is not read.</p> | — | — |
| | <p>On reading a device memory from ACPU/GPPA format with GX Developer, the information of the preceding coils of T/C devices is not read out, and consequently when the data is written again to ACPU/GPPA format and verified at GPPA, a preceding coil mismatch occurs.</p> | — | — |
| Device test | <p>When a forced set/reset operation is executed while the PLC is in the RUN state, program execution at the PLC is given priority.</p> | ○ | ○ |
| | <p>When an input (X) is forcibly reset, the PLC operates as though it were ON even if program input is OFF. If a process input is ON the PLC will process it as ON even if a forced reset is executed.</p> | ○ | ○ |
| | <p>The local device test requires a range to be set in the parameters in advance.</p> | — | ○ |
| | <p>Even if the present value is set to a smaller value than the set value after time up of a timer or counter, the time up status is retained.</p> | ○ | ○ |
| PLC write/read | <p>When a ladder with peripheral statements is written to a PLC, the statements are not written to the PLC, and the ladder must therefore be stored in the HD.</p> | ○ | ○ |
| | <p>When the PLC read dialog box is opened again after writing a ladder to the PLC and displaying the list, and then using another programming tool (GX Developer/GPPA/GPPQ, etc.) to, for example, delete PLC data, the contents of the data list may differ from the current status of the PLC data.</p> <p>In this case the list must be updated.</p> | — | — |
| PLC communication | <p>When communicating with a PLC, no distinction is made between A2US(S1)CPU and A2U(S1)CPU, and therefore access to a CPU when using an A2US(S1)/A2U(S1) is dealt with as access to A2U(S1)CPU.</p> | — | — |
| | <p>PLC communication is not possible with a GX Developer started up.</p> <p>PLC communication is possible with one of these only, under the conditions indicated below.</p> <ul style="list-style-type: none"> • When GX Developer is used, check if there is a system (control panel) COM port. If there is not, one must be registered. In this state, PLC communication using GPPA/GPPQ is not possible. • When using GPPA/GPPQ, eliminate the system (control panel) COM port. In this state, PLC communication using GX Developer is not possible. • PLC communication with respect to A2USH-S1 with two GX Developers started up is not possible. <div style="border: 1px solid black; padding: 5px; display: inline-block; margin-top: 10px;"> <div style="display: flex; align-items: center; gap: 10px;"> <div style="border: 1px solid black; padding: 2px 5px;">GX Developer</div> <div style="border: 1px solid black; padding: 2px 5px;">GX Developer</div> × <div style="border: 1px solid black; padding: 2px 5px;">A2USH-S1</div> </div> </div> | — | — |
| | <p>During communication, e.g. PLC read/PLC write, do not disconnect the cable for connection of the personal computer and PLC CPU and connect it to another PLC.</p> | — | — |

| Item | Restriction/Note | GPPA | GPPQ |
|----------------------|---|------|----------------|
| TC set value | When a TC set value change is applied twice, the change is made to the first set value. If there is a duplicated set value change, the program contents must be checked in a program data check. | — | — |
| | Since GPPA allows reading/writing of T/C set values alone, there are T/C set values that are not used in the program. Since GX Developer only reads and writes set values for T/C values that exist in the program, set values that do not exist in the program cannot be handled. (When T/C set values are read and written, unused T/C set values at an ACPU are deleted.) | — | — |
| | T/C set values used in SAP2 are not handled by GX Developer and they are therefore cleared to 0 when written to an APC/GPPA format file. | — | — |
| Printing | Data is not printed and displayed in accordance with PAGE# (the designated No. becomes the printed page number). | — | — |
| | GPPA/ACPU print titles are not read/written. | — | — |
| | Since #CPU# prints the data for the CPU type from the designated position, if the CPU type exceeds 5 characters, blanks must be created at the rear. | — | — |
| File reading/writing | For file reading/writing with respect to a GPPA that does not allow selection of the same PLC model name, the PLC is treated as a PLC type within the range supported by the GPPA. | — | — |
| | Reading/writing to files created with SW0S is not possible. | — | — |
| Note creation | Notes cannot be created for instructions that straddle multiple lines. | — | — |
| | Notes cannot be created for dedicated instructions. | — | — |
| | If the coil associated with a note is deleted, the note is also deleted. | — | ○ <Caution> |
| | The note of the first coil in a ladder block is made to correspond to the first step of the ladder block. Other notes are written to the steps of individual coils. | — | — |
| Find/Replace | It is not possible to search for character strings in comments and device names in the ladder display window. (This is possible for notes and statements only.) | — | ○ |
| | When the device with the searched device name has both common and program-specific device name settings, the comment reflection destination/reference destination in the options is not followed. | — | — |
| | When an online change setting is made for a write conversion setting, the find/Replace menu cannot be selected. | — | ○ |
| Statements/notes | P/I statements that are not used in a program with GPPA are not written to GX Developer. | — | — |
| | When multiple P,I statements have been created for the same P,I with GX Developer, the first P,I statement encountered is written in GPPA format. The other, redundant, P,I statements are not written. | — | — |
| | When line statements/notes are created other than at the head of a ladder block with GPPA, statements at steps part way through a block are not written to GX Developer. | — | — |
| | If a note is allocated to the first step of a ladder block, it is read in association with the first coil of the ladder block. For other notes, if the step they are assigned to is a coil, they are read in association with that coil. | — | — |

| Item | Restriction/Note | GPPA | GPPQ |
|--|---|------|----------------|
| Use of other packages at the same port | It is not possible to communicate with a PLC while using GPPA/GPPQ at the same port. Either use a different port or quit GPPA/GPPQ (close the DOS prompt too), before using the port. | — | — |
| | When using the Windows version of, for example, SW[]NIW-GOT800P, simultaneous access to the same port is not possible. Communication with one of the packages only is possible. | — | — |
| Step execution/ Partial execution | After the set break condition has been satisfied, the PLC breaks operation after running for several steps. | — | ○ |
| | Step run via A7BD-J71AP21/AR21 is only possible with A2ACPU and A3ACPU. | ○ | — |
| Fault history | If storing the fault history file at a location other than the internal RAM, use the drive name and file name. | — | ○ |
| Video card | When using an S3 TRIO64V+ video card, the display may not be normal; in this case "none" must be set for "hardware accelerator" in the graphics detailed setting dialog box. | — | — |
| Ladder display | Out-of-range devices can be displayed in the ladder display. However, an error occurs if an out-of-range designation is made in ladder editing. Out-of-range devices can be checked in the program check. | — | ○ <Caution> |
| | For an illegal ladder that has no MPP corresponding to MPS, a ladder error is displayed by GPPA, but GX Developer displays the ladder, treating this as a ladder creation fault. | — | — |
| Processing at GX Developer | When operations that take some time, such as PLC memory clear, are executed, it may not be possible to redisplay the GX Developer display, or the operation of another application may be held up. | — | — |
| Device memory clear | Since latch clear/non-clearance follows the latch range of the PLC parameters of the project that is currently opened at the personal computer, if there is a discrepancy between the parameters stored in the CPU and the latch range, the latch range may be cleared even if latched devices are designated as not included in the range for clearance. | — | — |
| Writing to a memory cassette | When using an A4UMCA-*E EEPROM, the memory setting switch must be set to the ROM side. | ○ | — |
| Device name registration | With GPPA, the first 8 characters of a comment are input as the device name, but with GX Developer the device name must be registered. Similarly, when printing with device names, the device names must be registered. | — | — |
| Starting the initialization file | The maximum number of windows that can be automatically opened by starting program restart or initialization files is 20. | — | — |
| Instruction input by device name | When instructions are input in a ladder by using device names (LD, 'LS11), they are input by searching for the device that corresponds to the device name from the comment data, but when the same device name is set more than once, the device found first in the search is used. | — | — |
| Short cut keys | Numeric keys cannot be used as shortcut keys. | — | — |
| Windows | Up to ten monitor windows (ladder monitor, registration monitor, etc.) can be displayed. When more than one GX Developer is started up, up to ten windows can be used with each GX Developer. | — | — |

| Item | Restriction/Note | GPPA | GPPQ |
|---|--|------|------|
| Windows task bar | When GX Developer is started up while "Always on Top" or "Auto hide" is not specified in the property settings of the Windows task bar, nothing can be displayed in front of the task bar. To display in front of the task bar, set " Always on Top " or " Auto hide " for the task bar. | — | — |
| Parameter mismatch | When the same data as parameter data written in GPPA format is created with GPPA, there may be a mismatch in the data contents. However, both are correct as parameters and can be used without problems. | — | — |
| Memory capacity setting | When A1NCPU is selected with GPPA, the default for the comment capacity in memory capacity setting is 64K bytes, but the GX Developer default for comment capacity is 0K bytes. | — | — |
| Window No. | When the device batch monitor, registration monitor, or buffer memory batch monitor window is opened, the window whose number is one higher than the window last opened is displayed. Even if you close the open window and open another one, the number of the window opened last is counted up. | — | — |
| Compare | If verification is executed when there is an END instruction part way through the program in the PLC, the part of the program up to the END instruction is verified. | — | — |
| Duplicate coil result display | The duplicate coil check result display displays details of the step positions where duplicate coils were found in a search from the head of the program. | — | — |
| About access to remote I/O | When a cable is connected to a master station/control station/remote I/O and remote I/O is designated, communication is not possible. A master station/other station that is not remote I/O must be designated. | — | — |
| Printing | When printing with device names, device comments and contact use destinations appended on the right, characters in the final line of device comments may be missing, depending on the printer. This problem can be avoided by making the left and right margins smaller in page setting. | — | — |
| | When printing a large quantity of data, set the printer spool setting to "send printing data directly to the printer." | — | — |
| Monitoring | When ladder monitoring is executed after setting a monitor condition and monitor stop condition, it is not possible to carry out device test/batch/registration monitoring, or PLC diagnosis. When multiple GX Developers are started on the same personal computer and access to the same PLC is made from the same port, the following functions are not executed concurrently. Monitor values may become abnormal. <ul style="list-style-type: none"> • Program list monitor, monitoring the interrupt program list, setting monitor conditions, setting monitor stop conditions, measuring scan time. | — | — |
| Personal computer | Depending on the personal computer, the GX Developer may be sent incorrect information on the remaining capacity of the main memory, leading to problems with starting and operation. In this case, you must close other applications and increase the free memory area. | — | — |
| Import file (reading immediately after starting GX Developer) | This applies to A series. When a project has been created at the reading destination PLC type and the data is read (the status is "project name not set"), comments are read in accordance with the comment range at the GPPA side. | — | — |
| Monitoring with Ethernet | It is not possible to simultaneously monitor with another GPP via an Ethernet connection. | — | — |

| Item | Restriction/Note | GPPA | GPPQ |
|------------------------------------|---|------|------|
| Open project | Read-only and write-protected (e.g. FD) projects cannot be opened. When a project which was saved when displayed in a large GX Developer window on a personal computer with high resolution is opened on a low-resolution personal computer, it may be displayed at the original large window size and project off the screen. Projects that are saved in their maximized state present no problem. | — | — |
| Connection destination designation | QCPU-A is inaccessible in the following case. GX Developer ↔ AF board or CPU board ↔ MELSECNET/10 other station QCPU-A | — | — |
| Label program/FB | When a label program or FB is read using GX Developer of any other language, it cannot be read properly if the label name has been created in other than alphanumeric characters. | — | — |
| | When the already compiled label program or FB is read using GX Developer of any other language, it will return to a not yet compiled status. In this case, recompile it and write it to the PLC. | — | — |
| Data such as program | When handling a project using GX Developer of any other language, use alphanumeric characters in the program name and data name. | — | — |

Appendix 9 About SW D5-GPPW Compatibility

- (1) When opening the GX Developer (SW6D5C-GPPW-E) created data in the package of GX Developer (SW2D5C-GPPW-E) or earlier

| Function, Data | Restrictions |
|----------------|--|
| SFC program | SFC data cannot be read. |
| Macro | Macro-registered (with device comments) device comments are developed as line-to-line comments. |
| Project name | If the project name of 9 or more characters has been set on GX Developer (SW4D5C-GPPW-E), 8 and latter characters are not displayed when the project name is read on the version of GX Developer (SW2D5C-GPPW-E) or earlier. |

- (2) When opening the GX Developer (SW6D5C-GPPW-E) created data in the package of GX Developer (SW3D5C-GPPW-E) or earlier

| Function, Data | Restrictions |
|-----------------|--|
| Comment display | Comment display format is fixed to 3×5. (Cannot be changed to 2×8 or 4×8) |

- (3) When using the package of GX Developer (SW3D5C-GPPW-E) or earlier to open the data created on GX Developer (SW6D5C-GPPW-E)

| Function, Data | Restrictions |
|----------------|--|
| Project | When the Q series project was created on GX Developer (SW6D5C-GPPW-E), it cannot be handled on the version of GX Developer (SW3D5C-GPPW-E) or earlier. |

- (4) When opening the GX Developer (SW6D5C-GPPW-E) created data in the package of GX Developer (SW4D5C-GPPW-E) or earlier

| Function, Data | Restrictions |
|----------------|--|
| Device memory | If multiple device memories have been created with GX Developer (SW5D5C-GPPW-E), they cannot be handled on the version of GX Developer (SW4D5C-GPPW-E) or earlier. (For details, refer to Section 2.4.) |

- (5) When using the package of GX Developer (SW5D5C-GPPW-E) or earlier to open the data created on GX Developer (SW6D5C-GPPW-E)

| Function, Data | Restrictions |
|----------------|---|
| Parameters | When multi-CPU parameter setting was made on GX Developer (SW6D5C-GPPW-E), parameters cannot be handled on the version of GX Developer (SW5D5C-GPPW-E) or earlier. (Refer to Section 2.5.2 for details.) |

(6) When opening the GX Developer (SW6D5C-GPPW-E) created data in the package of GX Developer (SW5D5C-GPPW-E or earlier)

| Function, Data | Restrictions |
|--------------------|---|
| Parameters | When multi-CPU parameters were set, for example, they cannot be handled on the GX Developer (SW5D5C-GPPW-E or earlier) version. (Refer to Section 2.5.2 for details.) |
| Label program | On GX Developer (SW5D5C-GPPW-E or earlier), only actual programs converted from label programs may be read. |
| Remote I/O project | Remote I/O projects cannot be handled on the GX Developer (SW5D5C-GPPW-E or earlier) version. |

(7) When opening data created in GX Developer SW6D5C-GPPW-E 6.05F in an older version of GX Developer package (SW6D5C-GPPW-E 6.04E or older)

| Function, Data | Restrictions |
|----------------|--|
| Parameter | When the Ethernet parameter "MELSOFT connection" is enabled, the data cannot be handled in certain versions of GX Developer (SW6D5C-GPPW-E 6.04E or older). (See 2.4.3 for details.) |

(8) When opening the GX Developer (SW7D5C-GPPW-E) created data in the package of GX Developer (SW6D5C-GPPW-E or earlier)

| Function, Data | Restrictions |
|----------------|--|
| Project | The project created on the Q00J/Q00/Q01CPU cannot be handled on GX Developer (SW6D5C-GPPW-E or earlier). |
| | The project created by specifying "Use Label + FB" cannot be handled on GX Developer (SW6D5C-GPPW-E or earlier). |
| Parameters | When the "MELSOFT" connection" Ethernet parameter has been set, it cannot be handled on the GX Developer (SW6D5C-GPPW-E 6.04E or earlier) version. (Refer to Section 2.5.3 for details.) |

(9) When the data created using GX Developer Version 7.10L (SW7D5C-GPPW-E) or later is opened using the package of GX Developer Version 7.09K (SW7D5C-GPPW-E) or earlier

| Function, Data | Restrictions |
|----------------|---|
| Project | If the project has been created with the Q12PH or Q25PHCPU, it cannot be handled by GX Developer Version 7.09K (SW7D5C-GPPW-E) or earlier. |
| Parameters | The parameters cannot be handled using GX Developer Version 7.09K (SW7D5C-GPPW-E) or earlier. Following settings such as "High speed interrupt setting", "NET/H(multiplexed remote master)", "NET/H(multiplexed remote sub) and "Online module change" within "Multiple PLC settings" are not relevant. (Refer to section 2.6.4. for details) |

Appendix 10 GX Developer and GX Simulator Operations

| | | |
|---|-----|----|
| A | QnA | FX |
| ○ | ○ | ○ |

The following table indicates the version combinations for use of GX Developer and GX Simulator.

| | | GX Developer |
|--------------|-----------|------------------------------|
| GX Simulator | SW2D5-LLT | (1), (2), (3), (4), (5), (6) |
| | SW3D5-LLT | (2), (3), (4), (5), (6) |
| | SW4D5-LLT | (3), (4), (5), (6) |
| | SW5D5-LLT | (4), (5), (6) |
| | SW6D5-LLT | (6) |

- (1): When the ACPU is selected as the PLC series using GX Developer, buffer memory monitor using GX Simulator cannot be executed from GX Developer.
- (2): When the QCPU (Q mode, A mode) is selected as the PLC series using GX Developer, GX Simulator cannot be started from GX Developer.
- (3): When the FXCPU is selected as the PLC series and the FX1s or FX1N(C) is selected as the PLC type using GX Developer, GX Simulator cannot be started from GX Developer.
- (4): Multiple PLC operation cannot be performed.
Label programming and forced I/O registration/cancel are not supported, either.
- (5): GX Simulator Version 5 or earlier does not support the Q00J/Q00/Q01CPU.
- (6): GX Simulator Version 6.09K or earlier does not support the Q12PH/Q25PHCPU.

Appendix 11 Notes on FX Series Programming

The points to note when programming with the FX series are given here. For general points of difference and notes, see Section 1.3.

11.1 Ladder Monitor Display

| | | |
|---|-------|----|
| A | Q/QnA | FX |
| × | × | ○ |

The differences between the FXGP(DOS)/FXGP(WIN) monitor display and GX Developer monitor display are indicated here.

- Differences in monitor display of PLS and PLF instructions**
 In GX Developer, the GX Developer format display method is set as the default, but if the "PLSPLF instruction ladder monitor" check box in the [Tools] → [Options] <<program common>> sheet is checked, display is in the FXGP(DOS) or FXGP(WIN) format. Whichever display is selected, there is no effect on the actual operation of FXCPU.

Example: Comparison of monitor displays according to setting contents

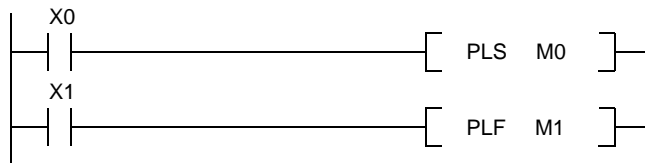

(1) Monitoring PLS instructions

- GX Developer format display

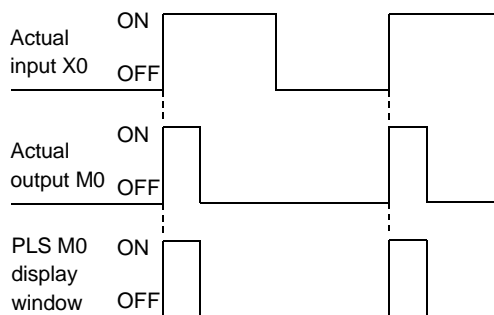

- FXGP(DOS), FXGP(WIN) format display

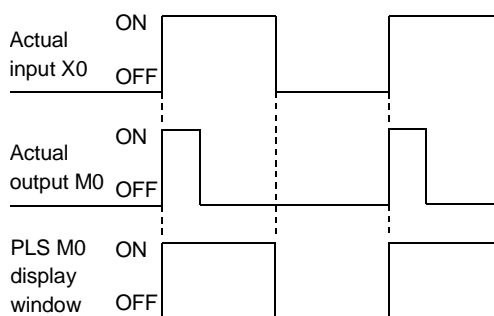

Monitoring PLF instructions

- GX Developer format display

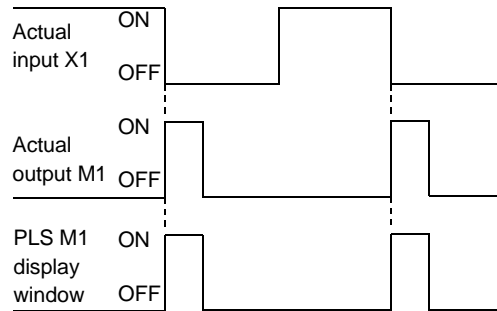

- FXGP(DOS), FXGP(WIN) format display

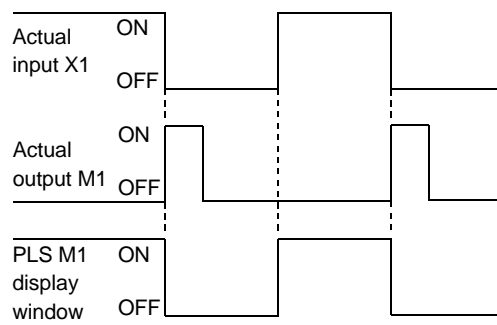

- Differences in monitoring OUT T and OUT C instructions
The OUT coil monitor display on resetting timer and counter present values is different when using the "A" series or QnA series than it is when using the FX series.

- Display when using the "A" series or QnA series

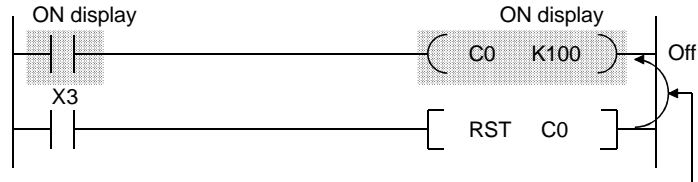

When RST C0 is driven with X3 ON, the present value of C0 is reset and the display of OUT C0 is also turned off.

- Display when using the FX series

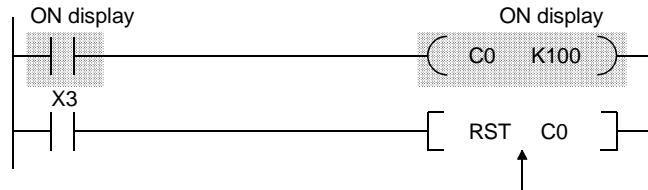

When RST C0 is driven with X3 ON, the present value of C0 is reset but the display of OUT C0 remains unchanged. (ON display continues until the drive contact of OUT C0 goes OFF.)

11.2 Handling of Comments

| | | |
|---|-------|----|
| A | Q/QnA | FX |
| × | × | ○ |

- With FXGP(DOS), a distinction is made when entering comments: comments written in the PLC are called "comments 1", and comments held only at the Personal computer side are called "comments 2."
 With GX Developer, all comments are managed as device comments, and the distinction between comments 1 and comments 2 does not exist.
 When device comments are written to a PLC, a comment capacity must be secured in "PLC parameter setting" (see Section 13.1), and the comment range among the device comments to be written to the PLC must be set in "comment range setting" (see Section 9.7.)
- Comments of up to 16 characters can be written to a PLC, but some models, such as FXGP(DOS) and A6GPP, can only handle up to 15 characters, which means that the 16th character cannot be displayed. When comments are used in common, enter device comments of up to 15 characters (see Section 9.1.6).
- Comparison of comment configuration

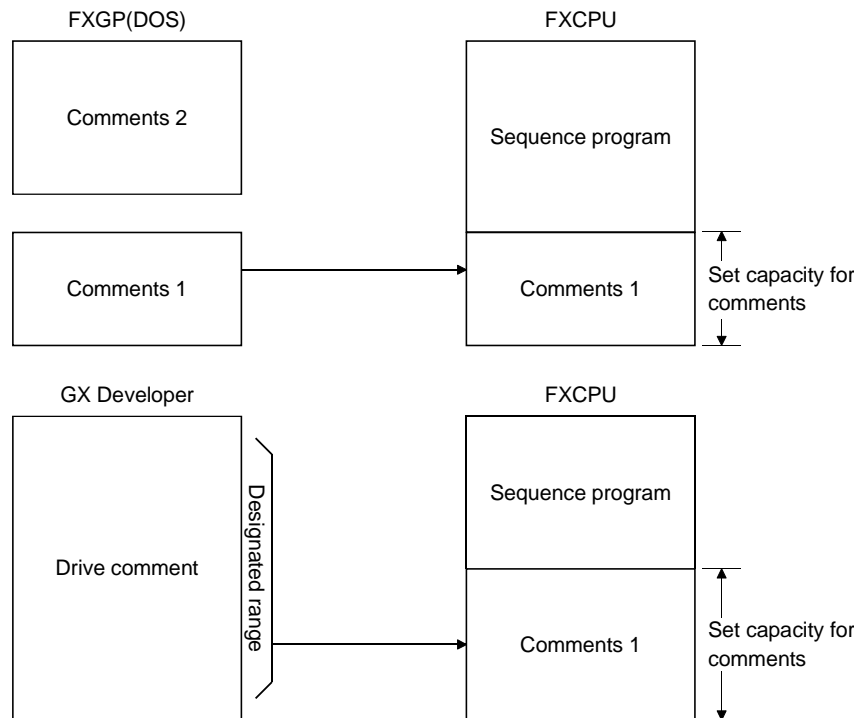

Appendix 12 Instruction Conversion Lists

12.1 Instruction Conversion List for A ↔ Q/QnA Conversions

| | | |
|---|-------|----|
| A | Q/QnA | FX |
| ○ | ○ | × |

A ↔ Q/QnA conversions will not be successful under the following conditions: in these cases make the necessary correction after executing the conversion instruction by referring to the following lists.

The instruction conversion list for conversions from A to Q/QnA is given in pages 51 to 66. The instruction conversion list for conversions from Q/QnA to A is given in pages 67 to 79. The indications *, *1, *2, *3, *4, *5, *6, and *7 in the lists refer to sources and destinations.

Device correspondence table for A → QnA conversions

| A Series | Q/QnA Series | Remarks |
|----------|--------------|--|
| M | M | |
| M9000 to | SM1000 to | |
| L | L | |
| F | F | |
| S | M | |
| X | X | |
| Y | Y | |
| B | B | |
| D | D | |
| D9000 to | SD1000 to | |
| A0, 1 | SD718, 719 | |
| R | R | |
| W | W | |
| T | T, ST | ST is governed by the parameter settings |
| C | C | |

Device correspondence table for A → Q/QnA conversions (continued)

| A Series | QnA Series | Remarks |
|-------------|------------|---|
| P | P | If out-of-range, the instruction becomes OUT SM1255 |
| I | I | If out-of-range, the instruction becomes OUT SM1255 |
| N | N | If out-of-range, the instruction becomes OUT SM1255 |
| K | K | |
| H | H | |
| “ “ | “ “ | Character strings are handled |
| Z, Z1~Z6 | Z0~Z6 | |
| K | K | |
| V, V1 to V6 | Z7 to Z13 | |

Devices that contain out-of-range device parts or extension parts are changed to SM1255 if bits and SD1255 if words.

Converting "A" standard instructions to Q/QnA series:

| A Series | Q/QnA Series | Remarks |
|------------------|---------------|---|
| OUT T* *2 | OUT T* *2 | H(OUTH) and ST are governed by the parameter settings |
| | OUT ST* *2 | |
| | OUT C* *2 | |
| OUT C* *2 | OUTH T* *2 | |
| | OUTH ST* *2 | |
| | OUTH C* *2 | |
| SUB *1 | OUT SM1255 | A dedicated instructions are excepted. |
| CHG | OUT SM1255 | |
| SUM *1 | SUM *1 SD718 | |
| DSUM *1 | DSUM *1 SD718 | |
| ASC *1 *2 | OUT SM1255 | |
| LRDP *1 *2 *3 *4 | OUT SM1255 | |
| LWTP *1 *2 *3 *4 | OUT SM1255 | |
| RFRP *1 *2 *3 *4 | OUT SM1255 | |
| RTOP *1 *2 *3 *4 | OUT SM1255 | |

Converting "A" standard instructions to QnA series:

| A Series | QnA Series | Remarks |
|-----------|------------|--|
| LEDA *1 | OUT SM1255 | "A" dedicated instructions are excepted. |
| LEDB *2 | OUT SM1255 | "A" dedicated instructions are excepted. |
| CHK *1 *2 | OUT SM1255 | |
| STC | OUT SM1255 | |
| CLC | OUT SM1255 | |

Converting structured program dedicated instructions to QnA series:

Refer to the QCPU (Q mode)/QnACPU Programming Manual (Common Instructions) (for AnACPU/AnUCPU)

| A Series | Q/QnA Series | Remarks |
|----------------------------------|-------------------------------|--|
| LEDA(LEDB) IX LEDC *1 LEDR | OUT SM1255 LEDC *1 LEDR | Section 7.6.9 Index qualification of entire ladder |
| LEDA IXEND | OUT SM1255 | |
| LEDA CHK | OUT SM1255 | Section 7.10.1 Special format failure checks |
| LEDA CHKEND | OUT SM1255 | Section 7.10.2 Changing check format of CHK instruction |

Converting character string processing instructions to QnA series (for AnACPU/AnUCPU)

| A Series | Q/QnA Series | Remarks |
|---|---|--|
| LEDA/LEDB SCMP LEDC *1 LEDC *2 LEDC *3 LEDR | OUT SM1255 LEDC *1 LEDC *2 LEDC *3 LEDR | Section 6.1.4 Character string data comparisons |

Converting instructions for file registers to QnA series (for AnACPU/AnUCPU)

| A Series | Q/QnA Series | Remarks |
|--|--|---|
| LEDA/LEDB RSET LEDC/SUB *1 LEDR | OUT SM1255 LEDC *1/OUT SM1255 LEDR | Section 7.14.1 Switching file register numbers |
| LEDA/LEDB BMOVR LEDC *1 LEDC *2 LEDC/SUB *3 LEDR | OUT SM1255 LEDC *1 LEDC *2 LEDC *3/OUT SM1255 LEDR | Section 6.4.5 Block 16-bit data transfers |
| LEDA/LEDB BXCHR LEDC *1 LEDC *2 LEDC/SUB *3 LEDR | OUT SM1255 LEDC *1 LEDC *2 LEDC *3/OUT SM1255 LEDR | Section 6.4.8 Block 16-bit data exchanges |
| LEDA/LEDB ZRRD | OUT SM1255 | Section 7.18.3 Direct 1-byte read from file register |
| LEDA/LEDB ZRWR | OUT SM1255 | Section 7.18.4 File register direct 1-byte write |
| LEDA/LEDB ZRRDB | OUT SM1255 | Section 7.18.3 Direct 1-byte read from file register |
| LEDA/LEDB ZRWRB | OUT SM1255 | Section 7.18.4 File register direct 1-byte write |

Converting instructions for data link to Q/QnA series (for AnACPU/AnUCPU)

| A Series | Q/QnA Series | Remarks |
|--|--|--|
| LEDA/LEDB LRDP SUB *1 LEDC *2 LEDC *3 SUB *4 LEDC *5 LEDR | OUT SM1255 OUT SM1255 LEDC *2 LEDC *3 OUT SM1255 LEDC *5 LEDR | Section 8.3.2 Reading device data from local stations (MELSECNET) |
| LEDA/LEDB LWTP SUB *1 LEDC *2 LEDC *3 SUB *4 LEDC *5 LEDR | OUT SM1255 OUT SM1255 LEDC *2 LEDC *3 OUT SM1255 LEDC *5 LEDR | Section 8.3.4 Writing data to devices at local stations (MELSECNET) |
| LEDA/LEDB ZNFR SUB K/H* SUB *1 LEDC *2 SUB *3 SUB *4 LEDC *5 LEDR | OUT SM1255 OUT SM1255 OUT SM1255 LEDC *2 OUT SM1255 OUT SM1255 LEDC *5 LEDR | Section 8.2.8 Reading data from special function modules at remote I/O stations |
| LEDA/LEDB ZNTO SUB K/H* SUB *1 LEDC *2 SUB *3 SUB *4 LEDC *5 LEDR | OUT SM1255 OUT SM1255 OUT SM1255 LEDC *2 OUT SM1255 OUT SM1255 LEDC *5 LEDR | Section 8.2.9 Writing data to special function module of remote I/O station |

Converting program switching instructions to Q/QnA series (for AnACPU/AnUCPU)

| A Series | QnA Series | Remarks |
|------------|------------|--|
| LEDA ZCHG0 | OUT SM1255 | Model Q2AS(H) CPU(S1) User's Manual Appendix 4.5 |
| LEDA ZCHG1 | OUT SM1255 | |
| LEDA ZCHG2 | OUT SM1255 | |
| LEDA ZCHG3 | OUT SM1255 | Q2A(S1)/Q3A/Q4ACPU User's Manual Appendix 4.5 |

Converting instructions for CC-Link to Q/QnA series

Refer to the CC-Link System Master Local Module type AJ61QBT11 /A1SJQBT11 User's Manual (for AnSHCPU)

| A Series | Q/QnA Series | Remarks |
|--|---|---|
| LEDA/LEDB RLPA SUB K/H* LEDC *1 LEDC *2 LEDR | OUT SM1255 OUT SM1255 LEDC *1 LEDC *2 LEDR | Q/QnACPU PROGRAMING MANUAL (Common Instructions) Section 7.8.1 Special function modules 1-and 2- word data read operations Section 7.8.2 Special function modules 1-and 2- word data write operations. |
| LEDA/LEDB RRPA SUB K/H* LEDC *1 LEDR | OUT SM1255 OUT SM1255 LEDC *1 LEDR | |
| LEDA/LEDB RITO SUB K/H* SUB *1 LEDC *2 LEDC *3 LEDR | OUT SM1255 OUT SM1255 OUT SM1255 LEDC *2 LEDC *3 LEDR | Section 15.6.9 RITO instruction |
| LEDA/LEDB RIWT SUB K/H* SUB *1 LEDC *2 LEDC *3 LEDR | OUT SM1255 OUT SM1255 OUT SM1255 LEDC *2 LEDC *3 LEDR | Section 15.6.5 RIWT instruction |
| LEDA/LEDB RIRCV SUB K/H* SUB *1 LEDC *2 LEDC *3 LEDC *4 LEDR | OUT SM1255 OUT SM1255 OUT SM1255 LEDC *2 LEDC *3 LEDC *4 LEDR | Section 15.6.7 RIRCV instruction |

Converting instructions for CC-Link to Q/QnA series (for AnSHCPU) (Continued)

| A Series | Q/QnA Series | Remarks |
|---|---|--------------------------------------|
| LEDA/LEDB RISEND SUB K/H* SUB *1 LEDC *2 LEDC *3 LEDC *4 LEDR | OUT SM1255 OUT SM1255 OUT SM1255 LEDC *2 LEDC *3 LEDC *4 LEDR | Section 15.6.6 RISEND instruction |
| LEDA/LEDB RDGET SUB K/H* SUB *1 LEDC *2 LEDC *3 LEDR | OUT SM1255 OUT SM1255 OUT SM1255 LEDC *2 LEDC *3 LEDR | Section 15.6.10 RDGET instruction |
| LEDA/LEDB RDPUT SUB K/H* SUB *1 LEDC *2 LEDC *3 LEDR | OUT SM1255 OUT SM1255 OUT SM1255 LEDC *2 LEDC *3 LEDR | Section 15.6.11 RDPUT instruction |
| LEDA/LEDB RDMON SUB K/H* SUB *1 LEDC *2 LEDC *3 LEDR | OUT SM1255 OUT SM1255 OUT SM1255 LEDC *2 LEDC *3 LEDR | Section 15.6.12 RDMON instruction |

Device correspondence table for Q/QnA → A conversions

| Q/QnA Series | A Series | Remarks |
|--------------|-------------|--|
| M | M | |
| SM | M9255 | |
| SM1000 to | M9000 to | |
| L | L | |
| F | F | |
| V | M9255 | |
| S | M9255 | |
| TR | M9255 | |
| X | X | |
| Y | Y | |
| FX | M9255 | |
| FY | M9255 | |
| B | B | |
| SB | M9255 | |
| DX | X | |
| DY | Y | |
| D | D | |
| SD | D9255 | |
| SD718, 719 | A0, 1 | |
| SD1000 to | D9000 to | |
| FD | D9255 | |
| G | D9255 | |
| SG | D9255 | |
| VD | D9255 | |
| A | D9255 | |
| R | R | |
| ZR0 to 8191 | R0 to 8191 | |
| ZR8192 to | D9255 | |
| W | W | |
| SW | D9255 | |
| T | T | |
| C | C | |
| ST | T | |
| Z0 to Z6 | Z, Z1 to Z6 | |
| Z7 to Z13 | V, V1 to V6 | |
| Z14 to | D9255 | |
| P | P | If out-of-range, the instruction becomes OUT M9255 |
| I | I | If out-of-range, the instruction becomes OUT M9255 |
| N | N | If out-of-range, the instruction becomes OUT M9255 |
| U | M9255 | All instructions become OUT M9255 |
| J | M9255 | All instructions become OUT M9255 |
| BL | M9255 | All instructions become OUT M9255 |
| K | K | |
| H | H | |

Device correspondence table for Q/QnA → A conversions (Continued)

| Q/QnA Series | A Series | Remarks |
|--------------|--------------|--|
| E | D9255 | |
| “ “ | “ “ | |
| Z0 to Z6 | Z, Z1 to Z6 | If the device part is a device that cannot be converted, all devices containing this code become M9255 or D9255. |
| Z7 to Z13 | V, V1 to V6 | If the device part is a device that cannot be converted, all devices containing this code become M9255 or D255. |
| Z14 to | M9255, D9255 | All devices containing this code become M9255 or D9255. |
| K | K | If the device part is a device that cannot be converted, all devices containing this code become M9255 or D255. |
| . | M9255, D9255 | All devices containing this code become M9255 or D9255. |
| @ | M9255, D9255 | All devices containing this code become M9255 or D9255. |
| U | M9255, D9255 | All devices containing this code become M9255 or D9255. |
| J | M9255, D9255 | All devices containing this code become M9255 or D9255. |
| BL | M9255, D9255 | All devices containing this code become M9255 or D9255. |

Devices that contain out-of-range device parts or extension parts are changed to M9255 if bits and D9255 if words.

Converting Q/QnA series instructions to A series instructions

| Q/QnA Series | A Series | |
|-------------------|---------------------|--|
| | Common Instructions | Dedicated Instructions (for AnA, AnUCPU) |
| LDP *1 | LD M9255 | |
| LDF *1 | LD M9255 | |
| ORP *1 | OR M9255 | |
| ORF *1 | OR M9255 | |
| ANDP *1 | AND M9255 | |
| ANDF *1 | AND M9255 | |
| EGP *1 | AND M9255 | |
| EGF *1 | AND M9255 | |
| MEP | AND M9255 | |
| MEF | AND M9255 | |
| INV | AND M9255 | |
| OUT DY * | OUT M9255 | LEDA DOUT LEDC Y* LEDR |
| OUT T/ST/C256 *2 | OUT M9255 | |
| OUTH T/ST/C256 *2 | OUT M9255 | |
| SET DY* | OUT M9255 | LEDA/LEDB DSET LEDC Y* LEDR |

Converting Q/QnA series instructions to A series instructions (continued)

| Q/QnA Series | A Series | |
|---|---|--|
| | Common Instructions | Dedicated Instructions (for AnA, AnUCPU) |
| RST DY* | OUT M9255 | LEDA/LEDB DRST LEDC Y* LEDR |
| FF *1 | OUT M9255 | LEDB FF LEDC *1 LEDR |
| DELTA *1 | OUT M9255 | |
| PAGE *1 | OUT M9255 | |
| LDE= *1 *2 ORE= *1 *2 ANDE= *1 *2 | LD= D9255 D9255 OR= D9255 D9255 AND= D9255 D9255 | |
| LDE<> *1 *2 ORE<> *1 *2 ANDE<> *1 *2 | LD<> D9255 D9255 OR<> D9255 D9255 AND<> D9255 D9255 | |
| LDE> *1 *2 ORE> *1 *2 ANDE> *1 *2 | LD> D9255 D9255 OR> D9255 D9255 AND> D9255 D9255 | |
| LDE>= *1 *2 ORE>= *1 *2 ANDE>= *1 *2 | LD>= D9255 D9255 OR>= D9255 D9255 AND>= D9255 D9255 | |
| LDE< *1 *2 ORE< *1 *2 ANDE< *1 *2 | LD< D9255 D9255 OR< D9255 D9255 AND< D9255 D9255 | |
| LDE<= *1 *2 ORE<= *1 *2 ANDE<= *1 *2 | LD<= D9255 D9255 OR<= D9255 D9255 AND<= D9255 D9255 | |
| LD\$= *1 *2 OR\$= *1 *2 AND\$= *1 *2 | LD= D9255 D9255 OR= D9255 D9255 AND= D9255 D9255 | |
| LD\$<> *1 *2 OR\$<> *1 *2 AND\$<> *1 *2 | LD<> D9255 D9255 OR<> D9255 D9255 AND<> D9255 D9255 | |
| LD\$> *1 *2 OR\$> *1 *2 AND\$> *1 *2 | LD> D9255 D9255 OR> D9255 D9255 AND> D9255 D9255 | |
| LD\$>= *1 *2 OR\$>= *1 *2 AND\$>= *1 *2 | LD>= D9255 D9255 OR>= D9255 D9255 AND>= D9255 D9255 | |
| LD\$< *1 *2 OR\$< *1 *2 AND\$< *1 *2 | LD< D9255 D9255 OR< D9255 D9255 AND< D9255 D9255 | |
| LD\$<= *1 *2 OR\$<= *1 *2 AND\$<= *1 *2 | LD<= D9255 D9255 OR<= D9255 D9255 AND<= D9255 D9255 | |

Converting Q/QnA series instructions to A series instructions (continued)

| Q/QnA Series | A Series | |
|----------------------|---------------------|---|
| | Common Instructions | Dedicated Instructions (for AnA, AnUCPU) |
| BKCMPE *1 *2 *3 *4 | OUT M9255 | |
| BKCMPE<> *1 *2 *3 *4 | OUT M9255 | |
| BKCMPE> *1 *2 *3 *4 | OUT M9255 | |
| BKCMPE>= *1 *2 *3 *4 | OUT M9255 | |
| BKCMPE< *1 *2 *3 *4 | OUT M9255 | |
| BKCMPE<= *1 *2 *3 *4 | OUT M9255 | |
| E+ *1 *2 | OUT M9255 | |
| E+ *1 *2 *3 | OUT M9255 | LEDA/LEDB ADD LEDC *1 LEDC *2 LEDC *3 LEDR |
| E- *1 *2 | OUT M9255 | |
| E- *1 *2 *3 | OUT M9255 | LEDA/LEDB SUB LEDC *1 LEDC *2 LEDC *3 LEDR |
| E* *1 *2 *3 | OUT M9255 | LEDA/LEDB MUL LEDC *1 LEDC *2 LEDC *3 LEDR |
| E/ *1 *2 *3 | OUT M9255 | LEDA/LEDB DIV LEDC *1 LEDC *2 LEDC *3 LEDR |
| \$+ *1 *2 | OUT M9255 | |
| \$+ *1 *2 *3 | OUT M9255 | LEDA/LEDB SADD LEDC *1 LEDC *2 LEDC *3 LEDR |
| BK+ *1 *2 *3 *4 | OUT M9255 | |
| BK- *1 *2 *3 *4 | OUT M9255 | |
| INT *1 *2 | OUT M9255 | LEDA/LEDB INT LEDC *1 LEDC *2 LEDR |
| DINT *1 *2 | OUT M9255 | LEDA/LEDB DINT LEDC *1 LEDC *2 LEDR |

Converting Q/QnA series instructions to A series instructions (continued)

| Q/QnA Series | A Series | |
|-------------------|---------------------|---|
| | Common Instructions | Dedicated Instructions (for AnA, AnUCPU) |
| FLT *1 *2 | OUT M9255 | LEDA/LEDB FLOAT LEDC/SUB *1 LEDC *2 LEDR |
| DFLT *1 *2 | OUT M9255 | LEDA/LEDB DFLOAT LEDC/DXNR *1 LEDC *2 LEDR |
| DBL *1 *2 | OUT M9255 | |
| WORD *1 *2 | OUT M9255 | |
| GRY *1 *2 | OUT M9255 | |
| DGRY *1 *2 | OUT M9255 | |
| GBIN *1 *2 | OUT M9255 | |
| DGBIN *1 *2 | OUT M9255 | |
| DNEG *1 | OUT M9255 | |
| ENEG *1 | OUT M9255 | |
| BKBCD *1 *2 *3 | OUT M9255 | |
| BKBIN *1 *2 *3 | OUT M9255 | |
| EMOV *1 *2 | OUT M9255 | |
| \$MOV *1 *2 | OUT M9255 | LEDA/LEDB SMOV LEDC *1 LEDC *2 LEDR |
| BXCH *1 *2 | OUT M9255 | |
| SWAP *1 | OUT M9255 | LEDA/LEDB SWAP LEDC *1 LEDR |
| GOEND | OUT M9255 | |
| RFS *1 *2 | OUT M9255 | |
| DAND *1 *2 *3 | OUT M9255 | |
| DOR *1 *2 *3 | OUT M9255 | |
| DXOR *1 *2 *3 | OUT M9255 | |
| DXNR *1 *2 *3 | OUT M9255 | |
| BKAND *1 *2 *3 *4 | OUT M9255 | |
| BKOR *1 *2 *3 *4 | OUT M9255 | |
| BKXOR *1 *2 *3 *4 | OUT M9255 | |
| BKXNR *1 *2 *3 *4 | OUT M9255 | |
| TEST *1 *2 *3 | OUT M9255 | LEDA/LEDB TEST LEDC *1 LEDC/SUB *2 LEDC *3 LEDR |

Converting Q/QnA series instructions to A series instructions (continued)

| Q/QnA Series | A Series | |
|----------------------|---------------------|--|
| | Common Instructions | Dedicated Instructions (for AnA, AnUCPU) |
| DTEST *1 *2 *3 | OUT M9255 | LEDA/LEDB DTEST LEDC *1 LEDC/SUB *2 LEDC *3 LEDR |
| BKRST *1 *2 | OUT M9255 | |
| DSER *1 *2 *3 *4 | OUT M9255 | LEDA/LEDB DSER LEDC *1 LEDC *2 LEDC/SUB *4 LEDR |
| NDIS *1 *2 *3 | OUT M9255 | LEDA/LEDB DIS LEDC *1 LEDC *2 LEDC *3 LEDR |
| NUNI *1 *2 *3 | OUT M9255 | LEDA/LEDB UNI LEDC *1 LEDC *2 LEDC *3 LEDR |
| WTOB *1 *2 *3 | OUT M9255 | LEDA/LEDB WTOB LEDC *1 LEDC *2 LEDC/SUB *3 LEDR |
| BTOW *1 *2 *3 | OUT M9255 | LEDA/LEDB BTOW LEDC *1 LEDC *2 LEDC/SUB *3 LEDR |
| MAX *1 *2 *3 | OUT M9255 | |
| DMAX *1 *2 *3 | OUT M9255 | |
| MIN *1 *2 *3 | OUT M9255 | |
| DMIN *1 *2 *3 | OUT M9255 | |
| SORT *1 *2 *3 *4 *5 | OUT M9255 | |
| DSORT *1 *2 *3 *4 *5 | OUT M9255 | |
| WSUM *1 *2 *3 | OUT M9255 | |
| DWSUM *1 *2 *3 | OUT M9255 | |
| BREAK *1 *2 | OUT M9255 | |
| CALL *1 *2 | OUT M9255 | |
| CALL *1 *2 *3 | OUT M9255 | |
| CALL *1 *2 *3 *4 | OUT M9255 | |
| CALL *1 *2 *3 *4 *5 | OUT M9255 | |

Converting Q/QnA series instructions to A series instructions (continued)

| Q/QnA Series | A Series | |
|-----------------------------|---------------------|---|
| | Common Instructions | Dedicated Instructions (for AnA, AnUCPU) |
| CALL *1 *2 *3 *4 *5 *6 | OUT M9255 | |
| FCALL *1 | OUT M9255 | |
| FCALL *1 *2 | OUT M9255 | |
| FCALL *1 *2 *3 | OUT M9255 | |
| FCALL *1 *2 *3 *4 | OUT M9255 | |
| FCALL *1 *2 *3 *4 *5 | OUT M9255 | |
| FCALL *1 *2 *3 *4 *5 *6 | OUT M9255 | |
| ECALL *1 *2 | OUT M9255 | |
| ECALL *1 *2 *3 | OUT M9255 | |
| ECALL *1 *2 *3 *4 | OUT M9255 | |
| ECALL *1 *2 *3 *4 *5 | OUT M9255 | |
| ECALL *1 *2 *3 *4 *5 *6 | OUT M9255 | |
| ECALL *1 *2 *3 *4 *5 *6 *7 | OUT M9255 | |
| EFCALL *1 *2 | OUT M9255 | |
| EFCALL *1 *2 *3 | OUT M9255 | |
| EFCALL *1 *2 *3 *4 | OUT M9255 | |
| EFCALL *1 *2 *3 *4 *5 | OUT M9255 | |
| EFCALL *1 *2 *3 *4 *5 *6 | OUT M9255 | |
| EFCALL *1 *2 *3 *4 *5 *6 *7 | OUT M9255 | |
| IXSET *1 *2 | OUT M9255 | |
| FPOP *1 *2 | OUT M9255 | |
| FINS *1 *2 *3 | OUT M9255 | |
| FDEL *1 *2 *3 | OUT M9255 | |
| CHKST | OUT M9255 | |
| CHK | OUT M9255 | |
| CHKCIR | OUT M9255 | |
| CHKEND | OUT M9255 | |
| PTRA | OUT M9255 | |
| PTRAR | OUT M9255 | |
| PTRAEXE | OUT M9255 | |
| BINDA *1 *2 | OUT M9255 | LEDA/LEDB BINDA LEDC/SUB *1 LEDC *2 LEDR |
| DBINDA *1 *2 | OUT M9255 | LEDA/LEDB DBINDA LEDC/DXNR *1 LEDC *2 LEDR |
| BINHA *1 *2 | OUT M9255 | LEDA/LEDB BINHA LEDC/SUB *1 LEDC *2 LEDR |

Converting Q/QnA series instructions to A series instructions (continued)

| Q/QnA Series | A Series | |
|--------------|---------------------|---|
| | Common Instructions | Dedicated Instructions (for AnA, AnUCPU) |
| DBINHA *1 *2 | OUT M9255 | LEDA/LEDB DBINHA LEDC/DXNR *1 LEDC *2 LEDR |
| BCDDA *1 *2 | OUT M9255 | LEDA/LEDB BCDDA LEDC/SUB *1 LEDC *2 LEDR |
| DBCDDA *1 *2 | OUT M9255 | LEDA/LEDB DBCDDA LEDC/DXNR *1 LEDC *2 LEDR |
| DABIN *1 *2 | OUT M9255 | LEDA/LEDB DABIN LEDC *1 LEDC *2 LEDR |
| DDABIN *1 *2 | OUT M9255 | LEDA/LEDB DDABIN LEDC *1 LEDC *2 LEDR |
| HABIN *1 *2 | OUT M9255 | LEDA/LEDB HABIN LEDC *1 LEDC *2 LEDR |
| DHABIN *1 *2 | OUT M9255 | LEDA/LEDB DHABIN LEDC *1 LEDC *2 LEDR |
| DABCD *1 *2 | OUT M9255 | LEDA/LEDB DABCD LEDC *1 LEDC *2 LEDR |
| DDABCD *1 *2 | OUT M9255 | LEDA/LEDB DDABCD LEDC *1 LEDC *2 LEDR |
| COMRD *1 *2 | OUT M9255 | LEDA/LEDB COMRD LEDC *1 LEDC *2 LEDR |

Converting Q/QnA series instructions to A series instructions (continued)

| Q/QnA Series | A Series | |
|-------------------|---------------------|--|
| | Common Instructions | Dedicated Instructions (for AnA, AnUCPU) |
| LEN *1 *2 | OUT M9255 | LEDA/LEDB LEN LEDC *1 LEDC *2 LEDR |
| STR *1 *2 *3 | OUT M9255 | LEDA/LEDB STR LEDC *1 LEDC/SUB *2 LEDC *3 LEDR |
| DSTR *1 *2 *3 | OUT M9255 | LEDA/LEDB DSTR LEDC *1 LEDC/DXNR *2 LEDC *3 LEDR |
| VAL *1 *2 *3 | OUT M9255 | LEDA/LEDB VAL LEDC *1 LEDC *2 LEDC *3 LEDR |
| DVAL *1 *2 *3 | OUT M9255 | LEDA/LEDB DVAL LEDC *1 LEDC *2 LEDC *3 LEDR |
| ESTR *1 *2 *3 | OUT M9255 | |
| EVAL *1 *2 | OUT M9255 | |
| ASC *1 *2 *3 | OUT M9255 | LEDA/LEDB ASC LEDC *1 LEDC *2 LEDC/SUB *3 LEDR |
| HEX *1 *2 *3 | OUT M9255 | LEDA/LEDB HEX LEDC *1 LEDC *2 LEDC/SUB *3 LEDR |
| RIGHT *1 *2 *3 | OUT M9255 | |
| LEFT *1 *2 *3 | OUT M9255 | |
| MIDR *1 *2 *3 | OUT M9255 | |
| MIDW *1 *2 *3 | OUT M9255 | |
| INSTR *1 *2 *3 *4 | OUT M9255 | |
| EMOD *1 *2 *3 | OUT M9255 | |
| EREXP *1 *2 *3 | OUT M9255 | |

Converting Q/QnA series instructions to A series instructions (continued)

| Q/QnA Series | A Series | |
|--------------|---------------------|--|
| | Common Instructions | Dedicated Instructions (for AnA, AnUCPU) |
| SIN *1 *2 | OUT M9255 | LEDA/LEDB SIN LEDC *1 LEDC *2 LEDR |
| COS *1 *2 | OUT M9255 | LEDA/LEDB COS LEDC *1 LEDC *2 LEDR |
| TAN *1 *2 | OUT M9255 | LEDA/LEDB TAN LEDC *1 LEDC *2 LEDR |
| ASIN *1 *2 | OUT M9255 | LEDA/LEDB ASIN LEDC *1 LEDC *2 LEDR |
| ACOS *1 *2 | OUT M9255 | LEDA/LEDB ACOS LEDC *1 LEDC *2 LEDR |
| ATAN *1 *2 | OUT M9255 | LEDA/LEDB ATAN LEDC *1 LEDC *2 LEDR |
| RAD *1 *2 | OUT M9255 | LEDA/LEDB RAD LEDC *1 LEDC *2 LEDR |
| DEG *1 *2 | OUT M9255 | LEDA/LEDB DEG LEDC *1 LEDC *2 LEDR |
| SQR *1 *2 | OUT M9255 | LEDA/LEDB SQR LEDC *1 LEDC *2 LEDR |
| EXP *1 *2 | OUT M9255 | LEDA/LEDB EXP LEDC *1 LEDC *2 LEDR |

Converting Q/QnA series instructions to A series instructions (continued)

| Q/QnA Series | A Series | |
|-------------------|---------------------|---|
| | Common Instructions | Dedicated Instructions (for AnA, AnUCPU) |
| LOG *1 *2 | OUT M9255 | LEDA/LEDB LOG LEDC *1 LEDC *2 LEDR |
| BSQR *1 *2 | OUT M9255 | LEDA/LEDB BSQR LEDC/SUB *1 LEDC *2 LEDR |
| BDSQR *1 *2 | OUT M9255 | LEDA/LEDB BDSQR LEDC/DXNR *1 LEDC *2 LEDR |
| BSIN *1 *2 | OUT M9255 | LEDA/LEDB BSIN LEDC/SUB *1 LEDC *2 LEDR |
| BCOS *1 *2 | OUT M9255 | LEDA/LEDB BCOS LEDC/SUB *1 LEDC *2 LEDR |
| BTAN *1 *2 | OUT M9255 | LEDA/LEDB BTAN LEDC/SUB *1 LEDC *2 LEDR |
| BASIN *1 *2 | OUT M9255 | LEDA/LEDB BASIN LEDC *1 LEDC *2 LEDR |
| BACOS *1 *2 | OUT M9255 | LEDA/LEDB BACOS LEDC *1 LEDC *2 LEDR |
| BATAN *1 *2 | OUT M9255 | LEDA/LEDB BATAN LEDC *1 LEDC *2 LEDR |
| LIMIT *1 *2 *3 *4 | OUT M9255 | LEDA/LEDB LIMIT LEDC/SUB *1 LEDC/SUB *2 LEDC/SUB *3 LEDC *4 LEDR |

Converting Q/QnA series instructions to A series instructions (continued)

| Q/QnA Series | A Series | |
|--------------------|---------------------|---|
| | Common Instructions | Dedicated Instructions (for AnA, AnUCPU) |
| DLIMIT *1 *2 *3 *4 | OUT M9255 | LEDA/LEDB DLIMIT LEDC/DXNR *1 LEDC/DXNR *2 LEDC/DXNR *3 LEDC *4 LEDR |
| BAND *1 *2 *3 *4 | OUT M9255 | LEDA/LEDB BAND LEDC/SUB *1 LEDC/SUB *2 LEDC/SUB *3 LEDC *4 LEDR |
| DBAND *1 *2 *3 *4 | OUT M9255 | LEDA/LEDB DBAND LEDC/DXNR *1 LEDC/DXNR *2 LEDC/DXNR *3 LEDC *4 LEDR |
| ZONE *1 *2 *3 *4 | OUT M9255 | LEDA/LEDB ZONE LEDC/SUB *1 LEDC/SUB *2 LEDC/SUB *3 LEDC *4 LEDR |
| DZONE *1 *2 *3 *4 | OUT M9255 | LEDA/LEDB DZONE LEDC/DXNR *1 LEDC/DXNR *2 LEDC/DXNR *3 LEDC *4 LEDR |
| RSET *1 | OUT M9255 | |
| QDRSET *1 | OUT M9255 | |
| QCDSET *1 | OUT M9255 | |
| DATERD *1 | OUT M9255 | LEDA/LEDB DATERD LEDC *1 LEDR |
| DATEWR *1 | OUT M9255 | LEDA/LEDB DATEWR LEDC *1 LEDR |
| DATE+ *1 *2 *3 | OUT M9255 | |
| DATE- *1 *2 *3 | OUT M9255 | |
| SECOND *1 *2 | OUT M9255 | |
| HOUR *1 *2 | OUT M9255 | |

Converting Q/QnA series instructions to A series instructions (continued)

| Q/QnA Series | A Series | |
|---------------------|---------------------|--|
| | Common Instructions | Dedicated Instructions (for AnA, AnUCPU) |
| PIDINIT *1 | OUT M9255 | LEDA/LEDB PIDINIT LEDC *1 LEDR |
| PIDCONT *1 | OUT M9255 | LEDA PIDCONT LEDC *1 LEDR |
| PID57 *1 *2 *3 | OUT M9255 | LEDA PID57 SUB *1 LEDC/SUB *2 LEDC *3 LEDR |
| PIDSTOP *1 | OUT M9255 | |
| PIDRUN *1 | OUT M9255 | |
| PIDPRMW *1 *2 | OUT M9255 | |
| MSG *1 | OUT M9255 | |
| PKEY *1 | OUT M9255 | |
| PSTOP *1 | OUT M9255 | |
| POFF *1 | OUT M9255 | |
| PSCAN *1 | OUT M9255 | |
| PLOW *1 | OUT M9255 | |
| ZRRDB *1 *2 | OUT M9255 | |
| ZRWRB *1 *2 | OUT M9255 | |
| ADRSET *1 *2 | OUT M9255 | |
| KEY *1 *2 *3 *4 | OUT M9255 | LEDA KEY LEDC *1 LEDC *2 LEDC *3 LEDC *4 LEDR |
| UDCNT1 *1 *2 *3 | OUT M9255 | |
| UDCNT2 *1 *2 *3 | OUT M9255 | |
| TTMR *1 *2 | OUT M9255 | |
| STMR *1 *2 *3 | OUT M9255 | |
| ROTC *1 *2 *3 *4 | OUT M9255 | |
| RAMP *1 *2 *3 *4 *5 | OUT M9255 | |
| SPD *1 *2 *3 | OUT M9255 | |
| PLSY *1 *2 *3 | OUT M9255 | |
| PWM *1 *2 *3 | OUT M9255 | |
| MTR *1 *2 *3 *4 | OUT M9255 | |
| IMASK *1 | OUT M9255 | |
| IX *1 | OUT M9255 | |
| IXEND | OUT M9255 | |

Converting Q/QnA series instructions to A series instructions (continued)

| Q/QnA Series | A Series | |
|--------------|---------------------|--|
| | Common Instructions | Dedicated Instructions (for AnA, AnUCPU) |
| IXDEV | OUT M9255 | |
| S. **** | OUT M9255 | |
| Z. **** | OUT M9255 | |
| G. **** | OUT M9255 | |
| J. **** | OUT M9255 | |

12.2 A Instruction Conversion List for FX Series Conversions

| | | |
|---|-------|----|
| A | Q/QnA | FX |
| ○ | × | ○ |

The rules for device and instruction conversions when performing A ↔ FX conversions are given here.

For instructions that cannot be converted, make a correction after instruction conversion by referring to the lists.

The instruction conversion list for conversions from A to FX is given in pages 72 to 77.

The instruction conversion list for conversions from FX to A is given in pages 78 to 84.

The indications *1, *2, *3, *4, *5, *6, and *7 in the lists refer to sources and destinations.

Device correspondence table for A → FX conversions

| A Series | FX Series | Remarks |
|-------------|-------------|---|
| M | M | |
| M9000 to | M8255 | |
| L | M8255 | |
| F | M8255 | |
| S | S | |
| X | X | The hexadecimal input numbers of the "A" series are condensed as octal numbers headed by X0 for the FX series |
| Y | Y | The hexadecimal input numbers of the "A" series are condensed as octal numbers headed by X0 for the FX series |
| B | M8255 | |
| D | D | |
| D9000 to | D8255 | |
| A0□1 | D8255 | |
| R | D1000 to | |
| W | D8000 to | |
| T | T | |
| C | C | |
| Z, Z1 to Z6 | Z, Z1 to Z6 | |
| 172.16. | V, V1 to V6 | |
| P | P | If out-of-range, the instruction becomes OUT M8255 |
| I | I | If out-of-range, the instruction becomes OUT M8255 |
| N | N | If out-of-range, the instruction becomes OUT M8255 |
| K | K | |
| H | H | |
| " " | " " | |
| Z, Z1 to Z6 | Z, Z1 to Z6 | |
| K | K | |
| V, V1 to V6 | V, V1 to V6 | |

Devices that contain out-of-range device parts or extension parts are changed to M8255 if bits and D8255 if words.

Converting A series to FX series

| A Series | FX Series | Remarks |
|-------------|-------------|---|
| NOP | NOP | |
| LD *1 | LD *1 | |
| LDI *1 | LDI *1 | |
| OR *1 | OR *1 | |
| ORI *1 | ORI *1 | |
| AND *1 | AND *1 | |
| ANI *1 | ANI *1 | |
| ORB | ORB | |
| ANB | ANB | |
| MPS | MPS | |
| MRD | MRD | |
| MPP | MPP | |
| OUT *1 | OUT *1 | |
| OUT T/C* *2 | OUT T/C* *2 | |
| SET *1 | SET *1 | |
| RST *1 | RST *1 | |
| PLS *1 | PLS *1 | |
| PLF *1 | PLF *1 | |
| SFT *1 | OUT M8255 | |
| SFTP *1 | OUT M8255 | |
| MC *1 *2 | MC *1 *2 | |
| STOP | OUT M8255 | |
| MCR *1 | MCR *1 | |
| FEND | FEND | |
| END | END | |
| NOPLF | OUT M8255 | |
| P*,I* | P*,I* | |
| LD= *1 *2 | LD= *1 *2 | |
| OR= *1 *2 | OR= *1 *2 | For models other than FX1S, FX1N, FX2N(C): LD/OR/AND M8255 |
| AND= *1 *2 | AND= *1 *2 | |
| LD<> *1 *2 | LD<> *1 *2 | |
| OR<> *1 *2 | OR<> *1 *2 | For models other than FX1S, FX1N, FX2N(C): LD/OR/AND M8255 |
| AND<> *1 *2 | AND<> *1 *2 | |
| LD> *1 *2 | LD> *1 *2 | |
| OR> *1 *2 | OR> *1 *2 | For models other than FX1S, FX1N, FX2N(C): LD/OR/AND M8255 |
| AND> *1 *2 | AND> *1 *2 | |
| LD>= *1 *2 | LD>= *1 *2 | |
| OR>= *1 *2 | OR>= *1 *2 | For models other than FX1S, FX1N, FX2N(C): LD/OR/AND M8255 |
| AND>= *1 *2 | AND>= *1 *2 | |
| LD< *1 *2 | LD< *1 *2 | |
| OR< *1 *2 | OR< *1 *2 | For models other than FX1S, FX1N, FX2N(C): LD/OR/AND M8255 |
| AND< *1 *2 | AND< *1 *2 | |

(continued on next page)

| A Series | FX Series | Remarks |
|--------------|------------------|--|
| LD<= *1 *2 | LD<= *1 *2 | |
| OR<= *1 *2 | OR<= *1 *2 | For models other than FX1S, FX1N, FX2N(C): |
| AND<= *1 *2 | AND<= *1 *2 | LD/OR/AND M8255 |
| LDD= *1 *2 | LDD= *1 *2 | |
| ORD= *1 *2 | ORD= *1 *2 | For models other than FX1S, FX1N, FX2N(C): |
| ANDD= *1 *2 | ANDD= *1 *2 | LD/OR/AND M8255 |
| LDD<> *1 *2 | LDD<> *1 *2 | |
| ORD<> *1 *2 | ORD<> *1 *2 | For models other than FX1S, FX1N, FX2N(C): |
| ANDD<> *1 *2 | ANDD<> *1 *2 | LD/OR/AND M8255 |
| LDD> *1 *2 | LDD> *1 *2 | |
| ORD> *1 *2 | ORD> *1 *2 | For models other than FX1S, FX1N, FX2N(C): |
| ANDD> *1 *2 | ANDD> *1 *2 | LD/OR/AND M8255 |
| LDD>= *1 *2 | LDD>= *1 *2 | |
| ORD>= *1 *2 | ORD>= *1 *2 | For models other than FX1S, FX1N, FX2N(C): |
| ANDD>= *1 *2 | ANDD>= *1 *2 | LD/OR/AND M8255 |
| LDD< *1 *2 | LDD< *1 *2 | |
| ORD< *1 *2 | ORD< *1 *2 | For models other than FX1S, FX1N, FX2N(C): |
| ANDD< *1 *2 | ANDD< *1 *2 | LD/OR/AND M8255 |
| LDD<= *1 *2 | LDD<= *1 *2 | |
| ORD<= *1 *2 | ORD<= *1 *2 | For models other than FX1S, FX1N, FX2N(C): |
| ANDD<= *1 *2 | ANDD<= *1 *2 | LD/OR/AND M8255 |
| + *1 *2 | ADD *1 *2 D8255 | |
| + *1 *2 *3 | ADD *1 *2 *3 | |
| - *1 *2 | SUB *1 *2 D8255 | |
| - *1 *2 *3 | SUB *1 *2 *3 | |
| D+ *1 *2 | DADD *1 *2 D8255 | |
| D+ *1 *2 *3 | DADD *1 *2 *3 | |
| D- *1 *2 | DSUB *1 *2 D8255 | |
| D- *1 *2 *3 | DSUB *1 *2 *3 | |
| * *1 *2 *3 | MUL *1 *2 *3 | |
| / *1 *2 *3 | DIV *1 *2 *3 | |
| D* *1 *2 *3 | DMUL *1 *2 *3 | |
| D/ *1 *2 *3 | DDIV *1 *2 *3 | |
| B+ *1 *2 | OUT M8255 | |
| B+ *1 *2 *3 | OUT M8255 | |
| B- *1 *2 | OUT M8255 | |
| B- *1 *2 *3 | OUT M8255 | |
| DB+ *1 *2 | OUT M8255 | |
| DB+ *1 *2 *3 | OUT M8255 | |
| DB- *1 *2 | OUT M8255 | |
| DB- *1 *2 *3 | OUT M8255 | |
| B* *1 *2 *3 | OUT M8255 | |
| B/ *1 *2 *3 | OUT M8255 | |

(continued on next page)

| A Series | FX Series | Remarks |
|---------------|------------------|--|
| DB* *1 *2 *3 | OUT M8255 | |
| DB/ *1 *2 *3 | OUT M8255 | |
| INC *1 | INC *1 | |
| DINC *1 | DINC *1 | |
| DEC *1 | DEC *1 | |
| DDEC *1 | DDEC *1 | |
| BCD *1 *2 | BCD *1 *2 | |
| DBCD *1 *2 | DBCD *1 *2 | |
| BIN *1 *2 | BIN *1 *2 | |
| DBIN *1 *2 | DBIN *1 *2 | |
| NEG *1 | NEG *1 | FX _{1N} , FX _{1S} , FX ₁ , FX _{0N} , FX ₀ : OUT M8255 |
| MOV *1 *2 | MOV *1 *2 | |
| DMOV *1 *2 | DMOV *1 *2 | |
| CML *1 *2 | CML *1 *2 | For FX _{1N} , FX _{1S} , FX ₁ , FX _{0N} , FX ₀ : OUT M8255 |
| DCML *1 *2 | DCML *1 *2 | For FX _{1N} , FX _{1S} , FX ₁ , FX _{0N} , FX ₀ : OUT M8255 |
| BMOV *1 *2 *3 | BMOV *1 *2 *3 | For FX _{1N} , FX _{1S} , FX ₁ , FX ₀ : M8255 |
| FMOV *1 *2 *3 | FMOV *1 *2 *3 | For FX _{1N} , FX _{1S} , FX ₁ , FX _{0N} , FX ₀ : OUT M8255 |
| XCH *1 *2 | XCH *1 *2 | For FX _{1N} , FX _{1S} , FX ₁ , FX _{0N} , FX ₀ : OUT M8255 |
| DXCH *1 *2 | DXCH *1 *2 | For FX _{1N} , FX _{1S} , FX ₁ , FX _{0N} , FX ₀ : OUT M8255 |
| CJ *1 | CJ *1 | |
| SCJ *1 | CJ *1 | |
| SUB *1 | OUT M8255 | |
| CHG | OUT M8255 | |
| WAND *1 *2 | WAND *1 *2 D8255 | |
| WAND *1 *2 *3 | WAND *1 *2 *3 | |
| WOR *1 *2 | WOR *1 *2 D8255 | |
| WOR *1 *2 *3 | WOR *1 *2 *3 | |
| WXOR *1 *2 | WXOR *1 *2 D8255 | |
| WXOR *1 *2 *3 | WXOR *1 *2 *3 | |
| WXNR *1 *2 | OUT M8255 | |
| WXNR *1 *2 *3 | OUT M8255 | |
| DAND *1 *2 | DAND *1 *2 D8255 | |
| DOR *1 *2 | DOR *1 *2 D8255 | |
| DXOR *1 *2 | DXOR *1 *2 D8255 | |
| DXNR *1 *2 | OUT M8255 | |
| ROR *1 | ROR D8255 *1 | For FX _{1N} , FX _{1S} , FX ₁ , FX _{0N} , FX ₀ : OUT M8255 |
| RCR *1 | RCR D8255 *1 | For FX _{1N} , FX _{1S} , FX ₁ , FX _{0N} , FX ₀ : OUT M8255 |
| ROL *1 | ROL D8255 *1 | For FX _{1N} , FX _{1S} , FX ₁ , FX _{0N} , FX ₀ : OUT M8255 |
| RCL *1 | RCL D8255 *1 | For FX _{1N} , FX _{1S} , FX ₁ , FX _{0N} , FX ₀ : OUT M8255 |
| DROR *1 | OUT M8255 | |
| DRCR *1 | OUT M8255 | |
| DROL *1 | OUT M8255 | |
| DRCL *1 | OUT M8255 | |

(continued on next page)

| A Series | FX Series | Remarks |
|------------------|--------------------|--|
| SFR *1 *2 | OUT M8255 | |
| SFL *1 *2 | OUT M8255 | |
| BSFR *1 *2 | OUT M8255 | |
| BSFL *1 *2 | OUT M8255 | |
| DSFR *1 *2 | OUT M8255 | |
| DSFL *1 *2 | OUT M8255 | |
| BSET *1 *2 | OUT M8255 | |
| BRST *1 *2 | OUT M8255 | |
| DECO *1 *2 *3 | DECO *1 *2 *3 | |
| ENCO *1 *2 *3 | ENCO *1 *2 *3 | |
| SEG *1 *2 | SEGD *1 *2 | For FX _{1N} , FX _{1s} , FX ₁ , FX _{0N} , FX ₀ : OUT M8255 |
| DIS *1 *2 *3 | OUT M8255 | |
| UNI *1 *2 *3 | OUT M8255 | |
| SER *1 *2 *3 | SER *1 *2 D8255 *3 | For FX _{1N} , FX _{1s} , FX ₁ , FX _{0N} , FX ₀ : OUT M8255 |
| SUM *1 | SUM *1 D8255 | For FX _{1N} , FX _{1s} , FX ₁ , FX _{0N} , FX ₀ : OUT M8255 |
| DSUM *1 | DSUM *1 D8255 | For FX _{1N} , FX _{1s} , FX ₁ , FX _{0N} , FX ₀ : OUT M8255 |
| ASC *1 *2 | ASC *1 *2 | For FX _{1N} , FX _{1s} , FX ₁ , FX _{0N} , FX ₀ : OUT M8255 |
| CALL *1 | CALL *1 | For FX _{1N} , FX _{1s} , FX _{0N} , FX ₀ : M8255 |
| FIFW *1 *2 | OUT M8255 | |
| FIFR *1 *2 | OUT M8255 | |
| FROM *1 *2 *3 *4 | FROM *1 *2 *3 *4 | For FX _{1s} , FX ₁ , FX ₀ : M8255 |
| DFRO *1 *2 *3 *4 | DFROM *1 *2 *3 *4 | For FX _{1s} , FX ₁ , FX ₀ : M8255 |
| TO *1 *2 *3 *4 | TO *1 *2 *3 *4 | For FX _{1s} , FX ₁ , FX ₀ : M8255 |
| DTO *1 *2 *3 *4 | DTO *1 *2 *3 *4 | For FX _{1s} , FX ₁ , FX ₀ : M8255 |
| LRDP *1 *2 *3 *4 | OUT M8255 | |
| LWTP *1 *2 *3 *4 | OUT M8255 | |
| RFRP *1 *2 *3 *4 | OUT M8255 | |
| RTOP *1 *2 *3 *4 | OUT M8255 | |
| PR *1 *2 | PR *1 *2 | For FX _{1N} , FX _{1s} , FX _{0N} , FX ₀ : M8255 |
| PRC *1 *2 | OUT M8255 | |
| LED *1 | OUT M8255 | |
| LEDC *1 | OUT M8255 | |
| LEDR | OUT M8255 | |
| LEDA *1 | OUT M8255 | |
| LEDB *1 | OUT M8255 | |
| SLT | OUT M8255 | |
| SLTR | OUT M8255 | |
| STRA | OUT M8255 | |
| STRAR | OUT M8255 | |
| WDT | WDT | |
| DUTY *1 *2 *3 | OUT M8255 | |
| CHK *1 *2 | OUT M8255 | |
| STC | SET M8022 | |

(continued on next page)

| A Series | FX Series | Remarks |
|----------|-----------|---------------------|
| CLC | RST M8022 | |
| JMP *1 | CJ *1 | |
| DI | DI | |
| EI | EI | |
| IRET | IRET | |
| FOR *1 | FOR *1 | |
| NEXT | NEXT | |
| RET | SRET | For FX1, FX0: M8255 |
| COM | OUT M8255 | |

Device correspondence table for FX → A conversions

| FX Series | A Series | Remarks |
|-------------|--------------|---|
| M | M | |
| M8000 to | M9255 | |
| S | M9255 | The octal input numbers of the FX series are condensed as hexadecimal numbers headed by X0 for the "A" series |
| X | X | The octal input numbers of the FX series are condensed as hexadecimal numbers headed by X0 for the "A" series |
| Y | Y | |
| D | D | |
| D8000 to | D9255 | |
| T | T | |
| C | C | |
| Z, Z1 to Z6 | Z, Z1 to Z6 | |
| V, V1 to V6 | V, V1 to V6 | |
| V7, Z7 | D9255 | |
| P | P | If out-of-range, the instruction becomes OUT M9255 |
| I | I | If out-of-range, the instruction becomes OUT M9255 |
| N | N | If out-of-range, the instruction becomes OUT M9255 |
| K | K | |
| H | H | |
| "" | "" | |
| Z, Z1 to Z6 | Z, Z1 to Z6 | If the device part is a device that cannot be converted, all devices containing this code become M9255 or D255. |
| V, V1 to V6 | V, V1 to V6 | If the device part is a device that cannot be converted, all devices containing this code become M9255 or D255. |
| V7, Z7 | M9255, D9255 | All devices containing this code become M9255 or D9255. |
| K | K | If the device part is a device that cannot be converted, all devices containing this code become M9255 or D255. |

Devices that contain out-of-range device parts or extension parts are changed to M9255 if bits and D9255 if words.

Converting FX series to A series

| FX Series | A Series | Remarks |
|--------------------|-------------|----------------------------------|
| NOP | NOP | |
| LD *1 | LD *1 | |
| LDI *1 | LDI *1 | |
| LDP *1 | LD M9255 | |
| LDF *1 | LD M9255 | |
| OR *1 | OR * | |
| ORI *1 | ORI *1 | |
| ORP *1 | OR M9255 | |
| ORF *1 | OR M9255 | |
| AND *1 | AND *1 | |
| ANI *1 | ANI *1 | |
| ANDP *1 | AND M9255 | |
| ANDF *1 | AND M9255 | |
| INV | AND M9255 | |
| ORB | ORB | |
| ANB | ANB | |
| MPS | MPS | |
| MRD | MRD | |
| MPP | MPP | |
| OUT *1 | OUT *1 | |
| OUT T/C0 to 199 *2 | OUT T/C *2 | |
| OUT C200 to *2 | OUT M9255 | 32-bit counters are not changed. |
| SET *1 | SET *1 | |
| RST *1 | RST *1 | |
| PLS *1 | PLS * | |
| PLF *1 | PLF * | |
| MC *1 *2 | MC *1 *2 | |
| MCR *1 | MCR *1 | |
| FEND | FEND | |
| END | END | |
| P*,I* | P*,I* | |
| LD= *1 *2 | LD= *1 *2 | |
| OR= *1 *2 | OR= *1 *2 | |
| AND= *1 *2 | AND= *1 *2 | |
| LD<> *1 *2 | LD<> *1 *2 | |
| OR<> *1 *2 | OR<> *1 *2 | |
| AND<> *1 *2 | AND<> *1 *2 | |
| LD> *1 *2 | LD> *1 *22 | |
| OR> *1 *2 | OR> *1 *2 | |
| AND> *1 *2 | AND> *1 *2 | |
| LD>= *1 *2 | LD>= *1 *2 | |
| OR>= *1 *2 | OR>= *1 *2 | |
| AND>= *1 *2 | AND>= *1 *2 | |

(continued on next page)

| FX Series | A Series | Remarks |
|----------------|--------------|---------|
| LD< *1 *2 | LD< *1 *2 | |
| OR< *1 *2 | OR< *1 *2 | |
| AND< *1 *2 | AND< *1 *2 | |
| LD<= *1 *2 | LD<= *1 *2 | |
| OR<= *1 *2 | OR<= *1 *2 | |
| AND<= *1 *2 | AND<= *1 *2 | |
| LDD= *1 *2 | LDD= *1 *2 | |
| ORD= *1 *2 | ORD= *1 *2 | |
| ANDD= *1 *2 | ANDD= *1 *2 | |
| LDD<> *1 *2 | LDD<> *1 *2 | |
| ORD<> *1 *2 | ORD<> *1 *2 | |
| ANDD<> *1 *2 | ANDD<> *1 *2 | |
| LDD> *1 *2 | LDD> *1 *2 | |
| ORD> *1 *2 | ORD> *1 *2 | |
| ANDD> *1 *2 | ANDD> *1 *2 | |
| LDD>= *1 *2 | LDD>= *1 *2 | |
| ORD>= *1 *2 | ORD>= *1 *2 | |
| ANDD>= *1 *2 | ANDD>= *1 *2 | |
| LDD< *1 *2 | LDD< *1 *2 | |
| ORD< *1 *2 | ORD< *1 *2 | |
| ANDD< *1 *2 | ANDD< *1 *2 | |
| LDD<= *1 *2 | LDD<= *1 *2 | |
| ORD<= *1 *2 | ORD<= *1 *2 | |
| ANDD<= *1 *2 | ANDD<= *1 *2 | |
| CMP | OUT M9255 | |
| DCMP | OUT M9255 | |
| ZCP | OUT M9255 | |
| DZCP | OUT M9255 | |
| DECMP | OUT M9255 | |
| DEZCP | OUT M9255 | |
| ADD *1 *2 *2 | + *1 *2 *3 | |
| SUB *1 *2 *2 | - *1 *2 *3 | |
| DADD *1 *2 *2 | D+ *1 *2 *3 | |
| DSUB *1 *2 *2 | D- *1 *2 *3 | |
| MUL *1 *2 *3 | * *1 *2 *3 | |
| DIV *1 *2 *3 | / *1 *2 *3 | |
| DMUL *1 *2 *3 | D* *1 *2 *3 | |
| DDIV *1 *2 *3 | D/ *1 *2 *3 | |
| DEADD *1 *2 *3 | OUT M9255 | |
| DESUB *1 *2 *3 | OUT M9255 | |
| DEMUL *1 *2 *3 | OUT M9255 | |
| DEDIV *1 *2 *3 | OUT M9255 | |
| INC *1 | INC *1 | |
| DINC *1 | DINC *1 | |

(continued on next page)

| FX Series | A Series | Remarks |
|----------------|---------------|---------|
| DEC *1 | DEC *1 | |
| DDEC *1 | DDEC *1 | |
| BCD *1 *2 | BCD *1 *2 | |
| DBCD *1 *2 | DBCD *1 *2 | |
| BIN *1 *2 | BIN *1 *2 | |
| DBIN *1 *2 | DBIN *1 *2 | |
| INT *1 *2 | OUT M9255 | |
| DINT *1 *2 | OUT M9255 | |
| GRY *1 *2 | OUT M9255 | |
| DGRY *1 *2 | OUT M9255 | |
| GBIN *1 *2 | OUT M9255 | |
| DGBIN *1 *2 | OUT M9255 | |
| NEG *1 | NEG *1 | |
| DNEG *1 | OUT M9255 | |
| DEBCD | OUT M9255 | |
| DEBIN | OUT M9255 | |
| MOV *1 *2 | MOV *1 *2 | |
| DMOV *1 *2 | DMOV *1 *2 | |
| CML *1 *2 | CML *1 *2 | |
| DCML *1 *2 | DCML *1 *2 | |
| BMOV *1 *2 *3 | BMOV *1 *2 *3 | |
| FMOV *1 *2 *3 | FMOV *1 *2 *3 | |
| XCH *1 *2 | XCH *1 *2 | |
| DXCH *1 *2 | DXCH *1 *2 | |
| SWAP *1 | OUT M9255 | |
| SMOV | OUT M9255 | |
| DSWAP *1 | OUT M9255 | |
| DFMOV *1 *2 *3 | OUT M9255 | |
| CJ *1 | CJ *1 | |
| REF | OUT M9255 | |
| REFF | OUT M9255 | |
| HSCS | OUT M9255 | |
| DHSCS | OUT M9255 | |
| HSCR | OUT M9255 | |
| DHSCR | OUT M9255 | |
| HSZ | OUT M9255 | |
| DHSZ | OUT M9255 | |
| WAND *1 *2 *3 | WAND *1 *2 *3 | |
| WOR *1 *2 *3 | WOR *1 *2 *3 | |
| WXOR *1 *2 *3 | WXOR *1 *2 *3 | |
| DAND *1 *2 *3 | DAND *1 *2 | |
| DOR *1 *2 *3 | DOR *1 *2 | |
| DXOR *1 *2 *3 | DXOR *1 *2 | |

(continued on next page)

| FX Series | A Series | Remarks |
|------------------------|------------------|---------|
| ROR *1 *2 | ROR *2 | |
| RCR *1 *2 | RCR *2 | |
| ROL *1 *2 | ROL *2 | |
| RCL *1 *2 | RCL *2 | |
| DROR *1 *2 | DROR *2 | |
| DRCR *1 *2 | DRCR *2 | |
| DROL *1 *2 | DROL *2 | |
| DRCL *1 *2 | DRCL *2 | |
| SFTR *1 *2 *3 *4 | OUT M9255 | |
| SFTL *1 *2 *3 *4 | OUT M9255 | |
| WSFR *1 *2 *3 *4 | OUT M9255 | |
| WSFL *1 *2 *3 *4 | OUT M9255 | |
| SFWR *1 *2 *3 | OUT M9255 | |
| SFRD *1 *2 *3 | OUT M9255 | |
| SER *1 *2 *3 *4 | SER *1 *2 *4 | |
| DSER *1 *2 *3 *4 | OUT M9255 | |
| DECO *1 *2 *3 | DECO *1 *2 *3 | |
| ENCO *1 *2 *3 | ENCO *1 *2 *3 | |
| SORT *1 *2 *3 *4 *5 | OUT M9255 | |
| ASC *1 *2 | ASC *1 *2 | |
| ZRST *1 *2 | OUT M9255 | |
| SUM *1 *2 | SUM *1 | |
| DSUM *1 *2 | DSUM *1 | |
| BON *1 *2 *3 | OUT M9255 | |
| DBON *1 *2 *3 | OUT M9255 | |
| MEAN *1 *2 *3 | OUT M9255 | |
| DMEAN *1 *2 *3 | OUT M9255 | |
| ANS *1 *2 *3 | OUT M9255 | |
| ANR | OUT M9255 | |
| FLT *1 *2 | OUT M9255 | |
| DFLT *1 *2 | OUT M9255 | |
| CALL *1 | CALL *1 | |
| FROM *1 *2 *3 *4 | FROM *1 *2 *3 *4 | |
| DFROM *1 *2 *3 *4 | DFRO *1 *2 *3 *4 | |
| TO *1 *2 *3 *4 | TO *1 *2 *3 *4 | |
| DTO *1 *2 *3 *4 | DTO *1 *2 *3 *4 | |
| PR *1 *2 | PR *1 *2 | |
| HEX *1 *2 *3 | OUT M9255 | |
| ASCI *1 *2 *3 | OUT M9255 | |
| SQR *1 *2 | OUT M9255 | |
| DSQR | OUT M9255 | |
| DESQR *1 *2 | OUT M9255 | |

(continued on next page)

| FX Series | A Series | Remarks |
|------------|-----------|---------|
| DSIN *1 *2 | OUT M9255 | |
| DCOS *1 *2 | OUT M9255 | |
| DTAN *1 *2 | OUT M9255 | |
| TCMP | OUT M9255 | |
| TZCP | OUT M9255 | |
| TADD | OUT M9255 | |
| TSUB | OUT M9255 | |
| TRD | OUT M9255 | |
| TWR | OUT M9255 | |
| PID | OUT M9255 | |
| TKY | OUT M9255 | |
| DTKY | OUT M9255 | |
| HKY | OUT M9255 | |
| DHKY | OUT M9255 | |
| DSW | OUT M9255 | |
| SEGD | OUT M9255 | |
| SEGL | OUT M9255 | |
| ARWS | OUT M9255 | |
| RS | OUT M9255 | |
| PRUN | OUT M9255 | |
| DPRUN | OUT M9255 | |
| CCD | OUT M9255 | |
| VRRD | OUT M9255 | |
| VRSC | OUT M9255 | |
| MNET | OUT M9255 | |
| ANRD | OUT M9255 | |
| ANWR | OUT M9255 | |
| RMST | OUT M9255 | |
| RMWR | OUT M9255 | |
| DRMWR | OUT M9255 | |
| RMRD | OUT M9255 | |
| DRMRD | OUT M9255 | |
| RMMN | OUT M9255 | |
| BLK | OUT M9255 | |
| MCDE | OUT M9255 | |
| WDT | WDT | |
| TTMR | OUT M9255 | |
| STMR | OUT M9255 | |
| ROTC | OUT M9255 | |
| SPD | OUT M9255 | |
| PLSY | OUT M9255 | |
| PWM | OUT M9255 | |

(continued on next page)

| FX Series | A Series | Remarks |
|-----------|-----------|---------|
| MTR | OUT M9255 | |
| DPLSY | OUT M9255 | |
| IST | OUT M9255 | |
| ABSD | OUT M9255 | |
| DABSD | OUT M9255 | |
| INCD | OUT M9255 | |
| ALT | OUT M9255 | |
| RAMP | OUT M9255 | |
| PLSR | OUT M9255 | |
| DPLSR | OUT M9255 | |
| DI | DI | |
| EI | EI | |
| IRET | IRET | |
| SRET | RET | |
| FOR *1 | FOR *1 | |
| NEXT | NEXT | |
| STL *1 | OUT M9255 | |
| RET | OUT M9255 | |
| DABS | OUT M9255 | |
| ZRN | OUT M9255 | |
| DZRN | OUT M9255 | |
| PLSV | OUT M9255 | |
| DPLSV | OUT M9255 | |
| DRVI | OUT M9255 | |
| DDRVI | OUT M9255 | |
| DRVA | OUT M9255 | |
| DDRVA | OUT M9255 | |
| HOUR | OUT M9255 | |
| DHOUR | OUT M9255 | |
| RD3A | OUT M9255 | |
| WR3A | OUT M9255 | |

12.3 List of Instruction Conversions for Change between Q Series and A/QnA Series

| | | |
|---|-------|----|
| A | Q/QnA | FX |
| ○ | ○ | × |

When the PC type is changed from QCPU to ACPU or from QCPU to QnACPU, the instructions added newly to the Q series are all changed into M9255 (A series) or SM1255 (QnA series).

The following instructions have become compatible with the Q series.

| Instruction | Description |
|-------------|---|
| UNIRD | Reads module information |
| TRACE | Sets trace |
| TRACER | Resets trace |
| S.FWRITE | Writes binary data |
| S.FREAD | Reads binary data |
| S.FORMAT | Reads word devices from other PLC |
| G.READ | |
| G.SREAD | Writes word devices from other PLC |
| G.SWRITE | |
| S.REQ | Transient request from other PLC |
| GINT | Interrupt instruction from other PLC |
| PLOAD | Program load from memory card |
| PUNLOAD | Program unload from SPM |
| PSWAP | Load + unload |
| RBMMOV | High-speed file register block transfer |

| |
|--|
| POINT |
| <p>When the A series is changed to the Q series, any instruction device existing in the A series but not existing in the Q series is converted into SM999 (Q00J/Q00/Q01CPU) or SM1255 (Q02(H)/Q06H/Q12H/Q25HCPU).</p> <p>In addition, some types of instructions are converted into SM999 or SM1255 on more than one line.</p> |

Because of incompatibility with the Q series, the following instructions are changed into SM1255 when the QnA series is changed to the Q series.

| | Description | Instruction Name |
|----------------------------------|--|--------------------|
| AD57/A58 control instructions | Display mode setting | MCODE |
| | Canvas screen display | CPS1 |
| | VRAM display address change | CPS2 |
| | Canvas transfer | CMOV |
| | Screen clear | CLS |
| | VRAM clear | CLV |
| | Scroll up/down | CSCRU, CSCRD |
| | Cursor display | CON1, CON2 |
| | Cursor erasure | COFF |
| | Cursor locating | LOCATE |
| | Normal/reverse display of displayed characters | CNOR, CREV |
| | Normal/reverse character display switching | CRDSP, CRDSPV |
| | Character color designation | COLOR |
| | Character color changing | CCDSP, CCDSPV |
| | ASCII character display | PRN, PR |
| | ASCII character write | PRNV, PRV |
| | Character display | EPRN, EPRV |
| | Character write | EPRNV, EPRV |
| | Continuous display of the same character | CR1, CR2, CC1, CC2 |
| | Minus display | CINMP |
| | Hyphen display | CINHP |
| | Period display | CINTP |
| | Numeric character display | CIN0 to CIN9 |
| | Alphabetic character display | CINA to CINZ |
| | Space display | CINP |
| | Designated field clear | CINCLR |
| | ASCII code conversion | INPUT |
| VRAM data read | GET | |
| VRAM data write | PUT | |
| Display status read | STAT | |
| PID monitor | PID57 | |
| AJ71PT32-S3 control instructions | Key input from operation box | INPUT |
| | Data transmission of the specified number of bytes in no-protocol mode | PRN |
| | Data transmission up to 00H code in no-protocol mode | PR |
| | Data receive in no-protocol mode | INPUT |
| | Communication to/from remote terminal module | MINI |
| | Error reset to remote terminal module | MINIERR |
| | Communication status read | SPBUSY |
| | Forced suspension of communication processing | SPCLR |

| | Description | Instruction Name |
|---|---|------------------|
| AJ71C21(S1) control instructions | Data transmission of the specified number of bytes | PRN2, PRN4 |
| | Data transmission up to 00H | PR2, PR4 |
| | Data receive | INPUT2, INPUT4 |
| | Access to RAM memory | GET, PUT |
| | Communication status read | SPBUSY |
| | Forced suspension of communication processing | SPCLR |
| AD59(S1) control instructions | Printer output | PRN, PR |
| | Data read/write from/to memory card | GET, PUT |
| Write to EEPROM | Write to EEPROM | EROMWR |
| Sampling trace, status latch related instructions | Sampling trace | STRA |
| | Sampling trace reset | STRAR |
| | Status latch set | SLT |
| | Status latch reset | SLTR |
| Program trace related instructions | Program trace trigger | PTRA |
| | Program trace reset | PTRAR |
| | Program trace execution | PTRAEXE |
| LED indication related instructions | LED indication of ASCII code | LED |
| | LED indication instruction for comment | LEDC |
| | LED indication of comment | LEDC |
| AJ71C24(S3, S6, S8)/AJ71UC24 control instructions | Data transmission | PR, PRN |
| | Data receive | INPUT |
| | Communication status read | SPBUSY |
| | Forced suspension | SPCLR |
| AD61(S1) high-speed counter module control instructions | Preset value data setting | PVWR1, PVWR2 |
| | Magnitude, coincidence judging set value data write | SVWR1, SVWR2 |
| | Current value read | PVRD1, PVRD2 |
| Program changing instruction (A4UCPU only) | Changing to specified program | ZCHG |
| CC-Link dedicated instructions | Network parameter setting | RLPA |
| | Automatic refresh parameter setting | RRPA |
| | Automatically updated buffer memory read | RITO |
| | Write to remote I/O station buffer memory | RIWT |
| | Read from intelligent device station buffer memory (with handshake) | RIRCV |
| | Write to intelligent device station buffer memory (with handshake) | RISEND |
| Data link instructions | Local station word device read | LRDP |
| | Local station word device write | LWTP |
| | Data read from remote I/O station special function module | ZNFR |
| | Data write to remote I/O station special function module | ZNTO |

| | Description | Instruction Name |
|--|---|---------------------------------------|
| Structured program instructions*1 | Ladder index qualification | IX, IXEND |
| | Fault check pattern changing | CHK, CHKEND |
| BCD type real number processing instructions*1 | Square root | BSQR, BDSQR |
| | Trigonometric function | BSIN, BCOS, BTAN, BASIN, BACOS, BATAN |
| Floating-point type real number processing*1 | Real number → integer | INT, DINT |
| | Integer → real number | FLORT, DFLOAT |
| | Four arithmetic operations | ADD, SUB, MUL, DIV |
| | Angle → radian | RAD |
| | Radian → angle | DEG |
| | Trigonometric function | SIN, COS, TAN, ASIN, ACOS, ATAN |
| | Square root | SQR |
| | Exponent | EXP |
| Character string processing instructions*1 | Natural logarithm | LOG |
| | BIN → ASCII | BINDA, DBINDA, BINHA, DBINHA |
| | BCD → ASCII | BCDDA, DBCDDA |
| | ASCII → BIN | DABIN, DDABIN, HABIN, DHABIN |
| | ASCII → BCD | DABCD, DDABCD |
| | Device comment read | COMRD |
| | Character string length detection | LEN |
| | BIN → decimal character string | STR, DSTR |
| | Decimal character string → BIN | VAL, DVAL |
| | Character string transfer | SMOV |
| | Character string association | SADD |
| Character string comparison | SCMP | |
| Extended file register instructions*1 | Block number designation | RSET |
| | Block transfer | BMOVR |
| | Block exchange | BXCHR |
| | Single word-based direct read/write | ZRRD, ZRWR |
| | Single byte-based direct read/write | ZRRDB, ZRWRB |
| PID operation instructions*1 | Control data setting | PIDINT |
| | PID operation | PIDCONT |
| AD61 instructions | Preset value data setting | PVWR |
| | Magnitude, coincidence judging set value data setting | SVWR |
| | Current value read | PVRD |

*1: Since the Q00J/Q00/Q01CPU does not have these instructions, they are converted into SM999.

When the instructions are converted into those of the Q02(H)/Q06H/Q12H/Q25HCPU, they are converted into the corresponding instructions.

Appendix 13 About the A6TEL/Q6TEL

13.1 A6TEL/Q6TEL Switch Settings

(1) A6TEL

A6TEL right side face

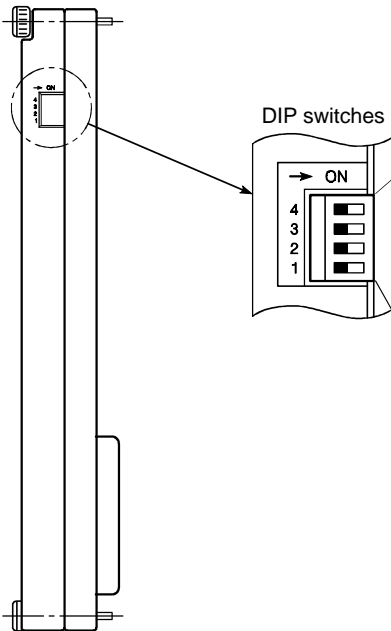

| Switch No. | Setting | Description |
|------------|---------|---|
| 4 | — | Unused (kept in OFF) |
| 3 | OFF | Remote access enable mode (when telephone line connection is enabled from peripheral device) |
| | ON | Remote access disable mode (notice processing may be executed) |
| 2 | OFF | Notice processing execution mode |
| | ON | Proximate connection enable mode |
| 1 | OFF | Telephone line connection mode/proximate connection mode |
| | ON | EEPROM write mode (for initial setting, password, notice data write) |

(2) Q6TEL

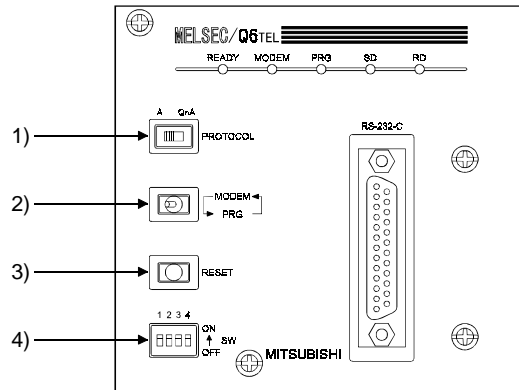

1) A/QnA select switch

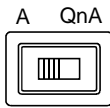

| Setting | Description |
|---------|----------------------------------|
| QnA | When the connected CPU is QnACPU |
| A | When the connected CPU is ACPU |

2) MODEM/PRG select switch

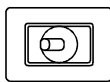

| Setting | Description |
|---------------------------------|--|
| MODEM/PRG (remote/proximate) | The switch is an alternate switch. The "MODEM" LED is lit to indicate remote access. The "PRG" LED is lit to indicate the proximate connection mode. |

3) RESET switch

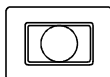

Resets the Q6TEL.

4) DIP switches

The following table explains the DIP switches for QnACPU access.



| Switch No. | Setting | Description |
|------------|---------|---|
| 1 | OFF | Telephone line connection mode/GPP function (proximate connection mode) |
| | ON | Q6TEL data (E2PROM write) setting mode (for initial setting, password, notice data write) |
| 2 | — | — |
| 3 | — | — |
| 4 | — | — |

Note: When "A" is selected with the A/QnA select switch, the description is the same as that of the DIP switches of the A6TEL.

The following table explains the DIP switch for ACPU access.

| Switch No. | Setting | Description |
|------------|---------|--|
| 1 | OFF | Telephone line connection mode/proximate connection mode |
| | ON | A6TEL data (E ² PROM write) setting mode (for initial setting, password, notice data write) |
| 2 | OFF | Notice processing execution mode (also set DIP switch 1 to OFF) |
| | ON | Proximate connection mode |
| 3 | OFF | Remote access enable mode (when telephone line connection from A7PHP/LM series is enabled) |
| | ON | Remote access disable mode (notice processing may be executed) |
| 4 | — | Unused (keep in OFF) |

[Q6TL's DIP switch settings] (for ACPU access)

| Switch No. | Remote Access | Notice Processing | E ² PROM Mode | Proximate Connection |
|------------|---------------|-------------------|--------------------------|----------------------|
| 1 | OFF | OFF | ON | OFF |
| 2 | OFF | OFF | ON/OFF | ON |
| 3 | OFF | ON/OFF | ON/OFF | ON/OFF |
| 4 | OFF | | | |

ON/OFF indicates that the corresponding switch may either be ON or OFF.

13.2 How to Change the Proximate Mode of the Q6TEL

This section gives the way to choose the proximate connection mode with the Q6TEL fitted to the PLC CPU.

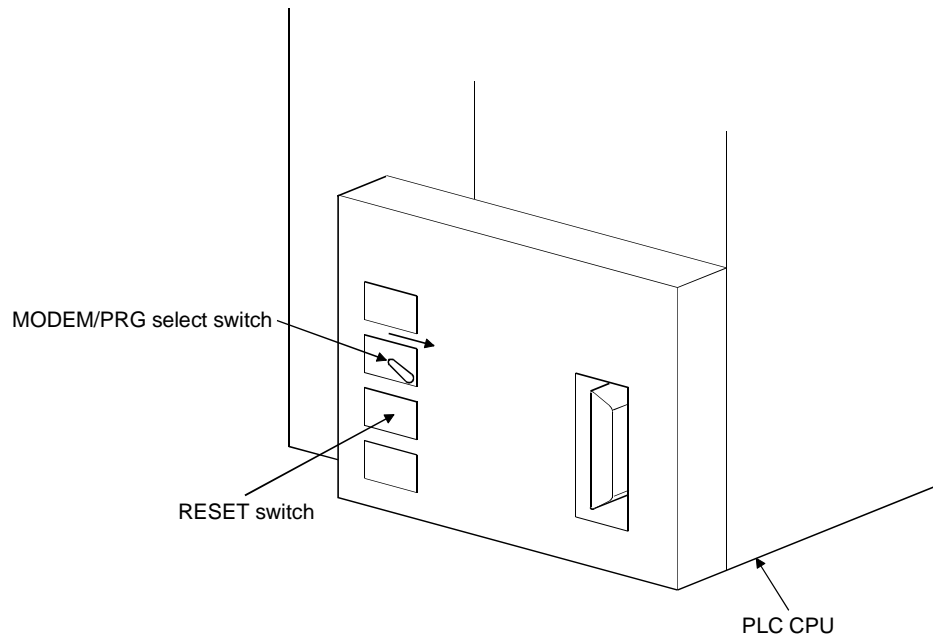

Operation procedure

- 1) Hold the MODEM/PRG select switch in the right position and press the RESET switch.
- 2) Release only the RESET switch.
- 3) After making sure that the "READY" LED and "PRG" LED are lit (about 3 seconds until they turn on), release the MODEM/PRG select switch.
This operation selects the proximate connection mode.

Appendix 14 Functions Added to Update from Previous Version

The following functions, which were not available for GX Developer Version 7.00A (SW7D5-GPPW-E), were added to GX Developer Version 7.10L (SW7D5-GPPW).

| Item | Description | Refer To |
|---------------|--|----------------|
| PLC CPU | Q12PH and Q25PHCPU are supported. | — |
| PLC Parameter | "High speed interrupt setting" is added. | Section 13.1.2 |
| Diagnosis | Online module change can be performed. | Section 21.6 |

The following functions, which were not available for GX Developer Version 7.10L (SW7D5C-GPPW), have been added to GX Developer Version 7.17T (SW7D5C-GPPW).

| Item | Description | Refer To |
|-----------|--|----------------|
| Print | Batch printing of device use lists is supported. | Section 14.5.6 |
| Diagnosis | CC-Link/LT diagnostics can be run. | Section 21.3 |

| The strings which can not be used in label programming | |
|--|---|
| W | W,WORD,WORD(P),WORD_TO_BOOL(BYTE,DINT,DWORD,INT,REAL,SINT,UDINT,UINT,USINT), WRITE,WSTRING,W_BCD_TO_DINT(INT,SINT) |
| X | X,XCH(P),XOR,XORN |
| Y | Y |
| Z | Z,ZCOM,ZNRD,ZNRF,ZNTO,ZNWR,ZR |

The error may occurred when a string which perfectly matches with the above strings.
But, the error may occurred when of device name contains the hexadecimal characters from 0 to F is after it.

Ex. XFFF, M100

Other points to note regarding the label definition

1. Can not use the space character.
2. Can not use the numerals as the starting character.
3. Can not use the following:

(), *, /, +, -, <, >, =, &, !, ", #, \$, %, ', ^, |, @, [,], {, }, :, ;, ,, ., . . ., ?, \, _

But, in case of underscore character, an error may occurred when it is present at the end or two or more underscore characters are used consecutively

INDEX

[A]

| | |
|---|-------------|
| Access range | |
| "Access ranges for MELSECNET(II), MELSECNET/10, MELSECNET/H" | |
| For A series | Appendix- 3 |
| For MELSECNET(II) | Appendix- 1 |
| For Q series | Appendix- 8 |
| For QnA series | Appendix- 5 |
| For mixed system | Appendix-24 |
| Via an Ethernet board | Appendix-16 |
| Via CC-Link (G4 module) | Appendix-19 |
| Additional function list..... | 1- 3 |
| Alias | |
| Display | 3-22 |
| All-clearing the parameters | 15- 8 |

[C]

| | |
|---|-------|
| Checking parameters | 15- 7 |
| Checking programs | 15- 1 |
| Circuit | |
| Alias display | 3-22 |
| Changing T/C setting values | 6-25 |
| Changing the display color in circuit and list | |
| Comment display | 3-21 |
| Creating and editing circuits | 6-12 |
| "Cutting, copying and pasting circuits" | 6-21 |
| Deleting connecting lines | 6-17 |
| Deleting contacts and application instructions | |
| | 6-16 |
| Deleting NOPs | 6-20 |
| Inputting contacts and application instructions | |
| | 6-12 |
| Inputting lines (vertical and horizontal) | 6-14 |
| Inserting and deleting in circuit blocks | 6-18 |
| Inserting into existing circuit | 6- 3 |
| Inserting NOPs | 6-20 |
| Ladder creation method | 6- 1 |
| Note display | 3-21 |
| Restrictions in circuit display window | 6- 7 |
| Restrictions in circuit edit window | 6- 8 |
| Restrictions on circuit creation | 6- 7 |
| Returning to the status after ladder conversion | |
| | 6-24 |
| Statement display | 3-21 |
| Switching circuit and list modes | 6- 2 |

| | |
|---|-------|
| Switching read/write modes | 6- 2 |
| Switching to write mode | 6- 2 |
| Undo the last operation | 6-23 |
| Concept of the routing parameters | 16-86 |
| Connection from the interface boards | 2- 4 |
| Connection from the serial port | 2- 1 |
| Contacts | |
| Changing A and B contacts | 6-41 |
| Conversion | |
| Changing the ladder and SFC with each other | |
| | 4-17 |
| Converting an edit program | 8- 1 |
| Converting multiple edit programs | 8- 1 |
| Customizing keys | 15-26 |

[D]

| | |
|--|-------|
| Debugging | |
| Device test | 18- 2 |
| Executing step run | 18-11 |
| Operating the PLC CPU remotely | 18-16 |
| Partial operation | 18- 7 |
| Registering/canceling the forced I/O | 18- 5 |
| Setting the scan range | 18-14 |
| Deleting data in the PLC CPU | 16-73 |
| Device comments | |
| Batch-deleting the unused device comments | |
| | 15-25 |
| Comment format | 3-22 |
| Common comments and comments by program | |
| | 9-13 |
| Creating device comments | 9-16 |
| Creating device comments after creating a | |
| circuit | 9-19 |
| Creating device comments for the created circuit | |
| | 9-18 |
| Creating device comments on the device | |
| Comment edit window | 9-16 |
| Deleting all device comments and alias | 9-21 |
| Deleting device comments | 9-21 |
| Deleting display device comments and alias | |
| | 9-21 |
| Display | 3-21 |
| Editing comments on the ladder editing screen | |
| | 9-20 |

- Editing comments only on GX Developer.. 9- 4
- List of device comments..... 9-12
- List of used devices 6-49
- Points to be noted before comment creation
..... 9- 1
- Setting comment ranges 9-24
- Setting comment types..... 9-22
- Using a Word file Appendix-28
- Using Excel files Appendix-26
- Writing to personal computer
 - "FXGP(DOS), FXGP(WIN) format file" . 9-10
 - GPPA format file 9- 6
 - GPPQ format file..... 9- 9
- Reading from PLC CPU
 - Reading from ACPU 9- 7
 - Reading from FXCPU 9-11
 - "Reading from QCPU (Q mode), QnACPU"
..... 9- 9
- Writing to PLC CPU
 - Writing to ACPU..... 9- 6
 - Writing to FXCPU..... 9-10
 - "Writing to QCPU (Q mode), QnACPU" . 9- 9
- Device memory
 - All clear 11- 5
 - Clearing all devices 11- 5
 - Clearing all display devices 11- 5
 - Device memory..... 11- 1
 - Device value input 11- 2
 - Making fill settings 11- 6
- Diagnosis
 - Diagnosing a network..... 21- 9
 - Loop test..... 21-12
 - Monitoring other station information.... 21-21
 - Monitoring the error history..... 21-18
 - Network monitor details 21-20
 - Setting confirmation test 21-13
 - Station order confirmation test 21-15
 - Testing a network..... 21-11
 - Transmission test..... 21-17
 - Diagnosing the PLC CPU
 - Diagnosing a QnACPU..... 21- 3
 - Diagnosing an ACPU..... 21- 1
 - Diagnosing an FXCPU 21- 8
 - QCPU (Q mode) 21- 5
 - Ethernet diagnostics 21-29
 - Error history..... 21-33
 - LED status..... 21-38
 - Loopback test..... 21-46

- Parameter status21-31
- PING test21-43
- Received e-mail information.....21-39
- Send e-mail information21-41
- Status of each connection.....21-35
- Status of each protocol.....21-36
- Running CC-Link diagnostics21-24
 - Conducting a line test.....21-26
 - Monitoring the line (other stations).....21-27
 - Monitoring the line (own station)21-24
- System monitor21-49
- Displaying multiple windows..... 15-36
- [E]
 - Exporting other format files
 - "GPPQ, GPPA, FXGP(DOS) or FXGP(WIN)
files"4-27
- [F]
 - Finding
 - Contact coil use list6-47
 - Finding a contact/coil6-35
 - Finding a device6-29
 - Finding a step No.6-32
 - Finding data.....6-36
 - Finding a character string
 - Device comment6-33
 - Device memory6-33
 - Ladder/list6-33
 - Finding an instruction.....6-33
 - FX series
 - Handling of comments Appendix-64
 - Ladder monitor display..... Appendix-61
 - Notes on programming Appendix-61
 - Programming..... 1-13
- [G]
 - GX Developer
 - About project compatibility Appendix-58
 - Added functions Appendix-106
 - Basic key specifications 1-13
 - Customizing keys 15-26
 - Displaying multiple windows 15-36
 - Exiting GX Developer.....4-31
 - Functions lists..... 1- 3
 - GX Developer and GX Simulator operations
..... Appendix-60

| | |
|--|-------------|
| List of shortcut keys and access keys | 3- 1 |
| Outline of help function..... | 15-38 |
| Project data list | 3-19 |
| Restrictions and cautions | Appendix-49 |
| Status bar..... | 3-17 |
| Toolbar..... | 3-16 |
| [H] | |
| Help..... | 15-38 |
| [I] | |
| IC memory card | |
| Reading data | 15-11 |
| Writing data..... | 15-12 |
| Intelligent function utility | 15-13 |
| Instruction conversion lists | |
| For A ↔ FX conversions..... | Appendix-85 |
| For A ↔ QnA conversions..... | Appendix-65 |
| For change between Q series and A/QnA series | Appendix-98 |
| Instruction help | 6- 4 |
| [J] | |
| Keyword | |
| Canceling | 19- 4 |
| Registering new/changing..... | 19- 1 |
| Releasing | 19- 5 |
| [L] | |
| Label program | |
| All deletion of variables | 5-14 |
| Automatic device setting | 5-13 |
| Converting label programs into actual programming (Compile) | 5-18 |
| Deleting external..... | 5-14 |
| Device display format | 5-20 |
| Exporting device comments | 5-16 |
| Global variable setting..... | 5- 9 |
| Importing device comments | 5-15 |
| Label programming input method..... | 5- 7 |
| Label programming sequence | 5- 6 |
| List | |
| Changing T/C setting values..... | 7-11 |
| Changing the existing program in overwrite mode | 7- 4 |
| Common notes on instruction list creation | 7- 1 |
| Creating a program instruction list..... | 7- 3 |

| | |
|--|-------------|
| Deleting NOPs | 7- 7 |
| Deleting the existing program list | 7- 6 |
| Displaying an alias | 7-10 |
| Inserting NOPs..... | 7- 7 |
| Inserting or adding the existing program.... | 7- 5 |
| List monitoring | 17- 4 |
| Switching circuit and list modes..... | 6- 2 |
| Switching to read and write modes | 7-11 |
| Switching to read mode | 7-11 |
| Switching to write mode..... | 6- 2 |
| Writing a contact or application instruction | 7- 3 |
| [M] | |
| Macro | |
| About macros | 5-21 |
| Deleting a macro | 5-27 |
| Displaying macro references | 5-28 |
| Registering a macro..... | 5-23 |
| Utilizing a macro..... | 5-25 |
| "MELSECNET/10, MELSECNET/H boards" | |
| For A series | Appendix-11 |
| For Q series..... | Appendix-15 |
| For QnA series | Appendix-13 |
| Memory card | |
| Reading the data of the IC memory card | 15-11 |
| Writing data to the IC memory card..... | 15-12 |
| Merging programs..... | 15- 3 |
| Monitoring | |
| Batch monitoring devices/buffer memories | 17-10 |
| Deleting all ladders registered | 17-34 |
| Editing programs during ladder monitoring | 17- 7 |
| Executing sampling trace..... | 17-25 |
| Setting execution & status display | 17-26 |
| Setting trace conditions | 17-31 |
| Setting trace data | 17-29 |
| Hexadecimal..... | 17- 9 |
| Measuring scan time..... | 17-24 |
| Monitoring after registering devices | 17-15 |
| Monitoring and stopping/resuming monitoring | 17- 3 |
| Monitoring/stopping monitoring in all windows | 17- 6 |
| Monitoring the interrupt program list..... | 17-23 |

| | |
|---|-------|
| Monitoring the ladders registered | 17-33 |
| Program list monitor | 17-20 |
| Setting monitor conditions/stop conditions | 17-18 |
| Switching present values between decimal and Hexadecimal | 17- 9 |
| Monitoring/stopping monitoring in all windows | 17- 6 |
| Multiple CPUs | |
| About network access via multiple CPUs | 16-13 |
| Access to other multiple CPU modules .. | 16-11 |
| Monitoring the multi-CPU buffer memory | 17-14 |
| Parameter setting | 13- 6 |
| [N] | |
| Network parameters | |
| About common items..... | 13-18 |
| "Cutting, copying and pasting" | 3-14 |
| Explanation for setting screen..... | 13-25 |
| Network parameter item lists..... | 13-20 |
| Setting the network parameters | 13-17 |
| Notes | |
| About the notes..... | 10- 1 |
| Batch-editing the notes..... | 10-17 |
| Creating notes in the circuit edit window | 10-10 |
| Creating notes in the list edit window | 10-12 |
| Creating notes in the note edit mode..... | 10-14 |
| Deleting notes in the circuit edit window | 10-13 |
| Deleting notes in the list edit window..... | 10-15 |
| Display | 3-21 |
| [O] | |
| Online change | 16-80 |
| Online module change | 21-54 |
| [P] | |
| Parameters | |
| Common notes on parameters | 13- 4 |
| Explanations for PLC parameter setting screen | 13-16 |
| Items common to the network parameters | 13-18 |
| Network parameter item lists..... | 13-20 |
| PLC parameter item lists..... | 13- 7 |
| Setting the remote password | 13-26 |

| | |
|---|-------|
| Password | |
| Delete | 19- 9 |
| Disable..... | 19-10 |
| Register new/changing | 19- 7 |
| PLC CPU module | 2- 7 |
| PLC memory | |
| Clearing the PLC memory | |
| For ACPU | 20- 1 |
| For FXCPU | 20- 4 |
| For QCPU (Q mode)/QnACPU | 20- 3 |
| Formatting the PLC memory | 20- 6 |
| Setting for the PLC's clock..... | 20- 9 |
| Sorting the PLC memory | 20- 8 |
| PLC parameters | |
| Common notes on parameters..... | 13- 4 |
| Explanations for PLC parameter setting screen | 13-16 |
| PLC parameter item lists | 13- 7 |
| PLC read/write | |
| Read/write of comment..... | 16-64 |
| Read/write of data | 16-53 |
| Read/write of device data | 16-61 |
| Read/write of program | 16-63 |
| PLC user data | |
| Reading data | 16-78 |
| Writing data | 16-79 |
| Precautions | |
| Using SW4D5C-GPPW or earlier to handle project | 2-10 |
| Using SW5D5C-GPPW or earlier to handle project | 2-11 |
| Using SW6D5C-GPPW or earlier to handle project | 2-12 |
| Using SW7D5C-GPPW or earlier to handle project | 2-13 |
| Printing | |
| Creating a title | 14-12 |
| Displaying a project contents list | 14-29 |
| Previewing a print image | 14- 7 |
| Print examples..... | 14-33 |
| Printing..... | 14- 9 |
| Printing labels..... | 14-32 |
| Product information list | 14-31 |
| Setting a device comment print range..... | 14-19 |
| Setting a device initial value print range.. | 14-24 |
| Setting a device memory print range..... | 14-23 |
| Setting a device use list print range..... | 14-21 |

- Setting a ladder print range..... 14-13
- Setting a list of contact coil used..... 14-28
- Setting a network parameter print item... 14-27
- Setting a page layout..... 14- 4
- Setting a PLC parameter print item 14-26
- Setting a TC setting value print range 14-18
- Setting an instruction list print range..... 14-16
- Setting the TEL data print area 14-30
- Setting up a printer 14- 2

Project

- Adding data to a project 4-12
- Changing the PLC type of a project..... 4-18
- Closing a project file 4- 5
- Comment format..... 3-22
- Copying a project..... 4-10
- Copying data within a project..... 4-14
- Creating a project 4- 1
- "Cutting, copying and pasting" 3-10
- Deleting a project..... 4- 6
- Deleting data in a project..... 4-15
- Opening a project 3- 9
- Opening a specific project using a shortcut
..... 15-37
- Opening the existing project file..... 4- 3
- Precautions..... 2-10
- Project designation 3- 5
- Renaming data in a project 4-16
- Restrictions on PLC type change
..... Appendix-30
- Saving a project..... 4- 5
- Saving a project..... 3- 6
- Saving a project with a new name 4- 6
- Starting multiple projects 4-31
- Verifying data in projects 4- 7
- Zooming in on or out of the edit screen 3-18

[S]

- Setting device initialization values 12- 1
- Setting method for communication via a modem
Interface module..... 16-45
- Starting the Ladder Logic Test Tool 15-38

[T]

- Telephone line
 - A6TEL/Q6TEL switch settings ... Appendix-102
 - Connecting the line automatically 22-32
 - Connecting the line via a switchboard (manual
connection) 22-39

- Creating a phone number book.....22-12
- Disconnecting the line.....22-41
- Function setting item list22- 2
- How to change the proximate mode of the
Q6TEL Appendix-105
- Making Q6TEL-Q6TEL communication ...22- 9
- Making remote access/pager notice
 - For ACPU22- 3
 - For QnACPU22- 5
- Making remote access to FXCPU22- 7
- Setting method for communication via telephone
line 16-45
- Using callback function22-37
- Registering A6TEL data.....22-19
- Registering Q6TEL data22-23
- Registering the AT command.....22-16
- Setting the FX PLC22-28

[R]

- Reading other format files
 - "GPPQ, GPPA, FXGP(DOS) or FXGP(WIN)
files"4-19
 - MELSEC MEDOC format file.....4-24
- Replace
 - Changing A and B contacts6-41
 - Changing the statement or note type6-45
 - Module's first I/O number.....6-44
 - Replacing a device.....6-37
 - Replacing data6-46
 - Replacing a character string
 - Device comment.....6-42
 - Device memory.....6-42
 - Ladder/list6-42
 - Replacing an instruction.....6-39
 - "ROM reading, writing, and verification"..... 15-21
 - ROM writer wiring examples Appendix-45
 - RS-232 cable
 - Connecting A series C24 and peripheral device
..... Appendix-40
 - Connecting QnA series C24 and peripheral
device Appendix-42
 - Connecting Q series C24 and peripheral device
..... Appendix-44

| | |
|--|-------|
| [S] | |
| Setting method for communication via G4 module or G4-S3 | |
| For A series..... | 16-28 |
| For Q series | 16-35 |
| For QnA series..... | 16-31 |
| Setting method for communication via the Ethernet board | |
| For A series..... | 16-17 |
| For Q series | 16-25 |
| For QnA series..... | 16-22 |
| Setting method for communication via C24 | |
| 1:n connection | 16-40 |
| connection in the form of one-for-one | 16-38 |
| Setting options..... | 15-28 |
| Specifying the connection target | |
| Accessing multiple CPUs | 16-11 |
| When accessing the other station..... | 16- 4 |
| When accessing the own station | 16- 1 |
| Starting CC-Link Configurator..... | 15-39 |
| Statements | |
| About merging operation procedure | 10- 6 |
| About the statements | 10- 1 |
| Batch-editing the statements..... | 10-17 |
| Creating statements in the statement edit mode | 10-11 |
| Creating statements when editing the circuit window | 10- 7 |
| Creating statements when editing the list window | 10- 9 |
| Deleting statements in the circuit edit window | 10- 8 |
| Deleting statements in the list edit window | 10- 9 |
| Display | 3-21 |
| Editing statements in the circuit edit window | 10- 7 |
| Editing statements in the list edit window | 10- 9 |
| System equipment lists | 2- 7 |
| [T] | |
| Transferring ROM data | 15-15 |
| [V] | |
| Verifying the personal computer side and PLC side data | 16-67 |

| | |
|---|-------------|
| Version correspondence chart | |
| About Q4ARCPU function version | Appendix-47 |
| Q series version correspondence chart | Appendix-48 |
| QnA series version correspondence chart | Appendix-46 |
| "Via Q-compatible C24, QC24" | Appendix-23 |
| "Via UC24, C24" | Appendix-21 |

| | |
|--------------------------------------|-------|
| [W] | |
| Write the program memory to ROM..... | 16-71 |
| Write to PLC (flash ROM)..... | 16-72 |
| Writing to files in ROM format | 15-23 |

Microsoft Windows, Microsoft Windows NT are registered trademarks of Microsoft Corporation in the United States and other countries.

Pentium is a registered trademark of Intel Corporation in the United States and other countries.

Other company and product names herein are either trademarks or registered trademarks of their respective owners.

SPREAD

Copyright (C) 1998 Farpoin Technologies, Inc.

GX Developer Version 7

Operating Manual

| | |
|--------------------------|----------------|
| MODEL | SW7D5-GPPW-O-E |
| MODEL CODE | 13JU14 |
| SH(NA)-080166-E(0211)MEE | |

 **MITSUBISHI ELECTRIC CORPORATION**

HEAD OFFICE : 1-8-12, OFFICE TOWER Z 14F HARUMI CHUO-KU 104-6212, JAPAN
NAGOYA WORKS : 1-14, YADA-MINAMI 5, HIGASHI-KU, NAGOYA, JAPAN

When exported from Japan, this manual does not require application to the Ministry of Economy, Trade and Industry for service transaction permission.

Specifications subject to change without notice.