

Engineering Software

GX RemoteService-I Version2 Operating Manual

-SW2D5C-RAS-E

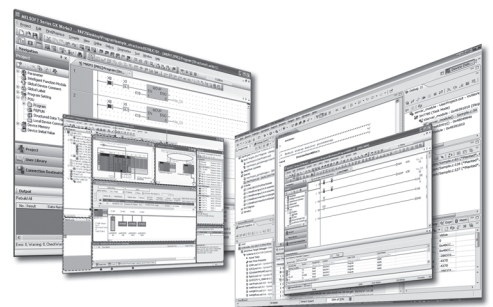

• SAFETY PRECAUTIONS •

(Always read these instructions before using this equipment.)

Before using this product, please read this manual and the relevant manuals introduced in this manual carefully and pay full attention to safety to handle the product correctly.

The instructions given in this manual are concerned with this product. For the safety instructions of the programmable controller system, please read the CPU module user's manual.

In this manual, the safety instructions are ranked as "⚠WARNING" and "⚠CAUTION".



WARNING

Indicates that incorrect handling may cause hazardous conditions, resulting in death or severe injury.



CAUTION

Indicates that incorrect handling may cause hazardous conditions, resulting in minor or moderate injury or property damage.

Note that the ⚠CAUTION level may lead to a serious consequence according to the circumstances. Always follow the instructions of both levels because they are important to personal safety.

Please save this manual to make it accessible when required and always forward it to the end user.

[Design Instructions]



CAUTION

- The user should take necessary measures when the PLC system must be secured against illegal access from external devices via the Internet.

• CONDITIONS OF USE FOR THE PRODUCT •

- (1) Mitsubishi programmable controller ("the PRODUCT") shall be used in conditions;
- i) where any problem, fault or failure occurring in the PRODUCT, if any, shall not lead to any major or serious accident; and
 - ii) where the backup and fail-safe function are systematically or automatically provided outside of the PRODUCT for the case of any problem, fault or failure occurring in the PRODUCT.

- (2) The PRODUCT has been designed and manufactured for the purpose of being used in general industries.

MITSUBISHI SHALL HAVE NO RESPONSIBILITY OR LIABILITY (INCLUDING, BUT NOT LIMITED TO ANY AND ALL RESPONSIBILITY OR LIABILITY BASED ON CONTRACT, WARRANTY, TORT, PRODUCT LIABILITY) FOR ANY INJURY OR DEATH TO PERSONS OR LOSS OR DAMAGE TO PROPERTY CAUSED BY the PRODUCT THAT ARE OPERATED OR USED IN APPLICATION NOT INTENDED OR EXCLUDED BY INSTRUCTIONS, PRECAUTIONS, OR WARNING CONTAINED IN MITSUBISHI'S USER, INSTRUCTION AND/OR SAFETY MANUALS, TECHNICAL BULLETINS AND GUIDELINES FOR the PRODUCT.

("Prohibited Application")

Prohibited Applications include, but not limited to, the use of the PRODUCT in;

- Nuclear Power Plants and any other power plants operated by Power companies, and/or any other cases in which the public could be affected if any problem or fault occurs in the PRODUCT.
- Railway companies or Public service purposes, and/or any other cases in which establishment of a special quality assurance system is required by the Purchaser or End User.
- Aircraft or Aerospace, Medical applications, Train equipment, transport equipment such as Elevator and Escalator, Incineration and Fuel devices, Vehicles, Manned transportation, Equipment for Recreation and Amusement, and Safety devices, handling of Nuclear or Hazardous Materials or Chemicals, Mining and Drilling, and/or other applications where there is a significant risk of injury to the public or property.

Notwithstanding the above, restrictions Mitsubishi may in its sole discretion, authorize use of the PRODUCT in one or more of the Prohibited Applications, provided that the usage of the PRODUCT is limited only for the specific applications agreed to by Mitsubishi and provided further that no special quality assurance or fail-safe, redundant or other safety features which exceed the general specifications of the PRODUCTS are required. For details, please contact the Mitsubishi representative in your region.

REVISIONS

* The manual number is given on the bottom left of the back cover.

Print Date	* Manual Number	Revision
May, 2004	SH (NA) 080465ENG-A	First edition
Jul., 2004	SH (NA) 080465ENG-B	<p>Correction</p> <p>About the Generic Terms and Abbreviations, Section 2.1.1, Section 2.3.1, Section 4.3, Section 5.4, Section 6.2, Section 7.2, Section 8.1, Chapter 10</p>
Oct., 2004	SH (NA) 080465ENG-C	<p>Correction</p> <p>Section 5.3, Section 5.4, Section 8.1</p>
Jun., 2008	SH (NA) 080465ENG-D	<p>Correction</p> <p>Section 9.2</p>
Sep., 2008	SH (NA) 080465ENG-E	<p>Correction</p> <p>How to Use This Manual, Section 1.1, Section 2.3.1, Section 5.1 to Section 5.4, Section 9.1.1</p>
Nov., 2009	SH (NA) 080465ENG-F	<p>Addition</p> <p>CONDITIONS OF USE FOR THE PRODUCT</p> <p>Correction</p> <p>SAFETY PRECAUTIONS, About Manuals, Product Makeup, Section 4.2.1</p> <p>Deletions</p> <p>SOFTWARE USER REGISTRATION</p>

Japanese Manual Version SH-080437-G

This manual confers no industrial property rights or any rights of any other kind, nor does it confer any patent licenses. Mitsubishi Electric Corporation cannot be held responsible for any problems involving industrial property rights which may occur as a result of using the contents noted in this manual.

© 2004 MITSUBISHI ELECTRIC CORPORATION

INTRODUCTION

Thank you for choosing the Mitsubishi MELSOFT series Integrated FA software.
Read this manual and make sure you understand the functions and performance of MELSOFT series thoroughly in advance to ensure correct use.
Please make this manual available to the end user.

CONTENTS

SAFETY PRECAUTIONS.....	A- 1
CONDITIONS OF USE FOR THE PRODUCT	A- 2
REVISIONS	A- 3
CONTENTS.....	A- 4
About Manuals	A- 7
How to Use This Manual.....	A- 8
About the Generic Terms and Abbreviations	A-11
Product Makeup	A-12
1. OVERVIEW	1- 1 to 1- 6
1.1 Features	1- 1
1.2 About Automatic Operation and Manual Operation.....	1- 5
2. SYSTEM CONFIGURATION	2- 1 to 2-26
2.1 Device List for Server (personal computer) side.....	2- 1
2.1.1 Connection from the serial/USB port.....	2- 2
2.1.2 Connection from the interface boards	2- 7
2.1.3 System equipment lists	2- 9
2.1.4 Connection from the PC CPU module.....	2-13
2.1.5 Connection from the Web server module.....	2-19
2.2 Network Connection Method	2-20
2.2.1 Connection configuration	2-20
2.2.2 Connection configuration devices.....	2-21
2.3 Operating Environment.....	2-22
2.3.1 Server (personal computer)	2-22
2.3.2 Personal computer	2-25
3. FUNCTION LIST	3- 1 to 3- 2
3.1 Server (Personal Computer) Function List.....	3- 1
3.2 Personal Computer Side Function List.....	3- 2
3.2.1 Monitor functions	3- 2
3.2.2 Functions to cut off server (personal computer) line from personal computer	3- 2

4. PRE-OPERATION SETTINGS AND PROCEDURES	4- 1 to 4- 15
4.1 Server (Personal Computer) Setting Procedure	4- 2
4.2 INSTALLATION AND UNINSTALLTION	4- 4
4.2.1 Installation.....	4- 4
4.2.2 Uninstallation	4- 9
4.3 Installing the USB Driver	4-11
4.4 Personal Computer Setting Procedure	4-15
5. INSTALLATION OF WEB SERVER SOFTWARE	5- 1 to 5-13
5.1 Windows® 98	5- 1
5.2 Windows NT® 4.0.....	5- 3
5.3 Windows® 2000 (Professional).....	5- 5
5.4 Windows® XP (Professional).....	5- 9
6. SETTING THE GX RemoteService-I FUNCTIONS	6- 1 to 6-20
6.1 Setting Wizard	6- 2
6.2 Main Screen	6- 3
6.3 Setting the Server (Personal Computer) Functions	6- 5
6.3.1 Security setting	6- 5
6.3.2 E-mail setting.....	6- 6
6.3.3 Network setting.....	6- 8
6.3.4 PLC type setting	6-10
6.3.5 Connection setup	6-11
6.3.6 Device range setting	6-15
6.3.7 Tag setting	6-16
6.3.8 Automatic operation setting	6-18
6.3.9 Device display format setting	6-20
7. ABOUT THE PERSONAL COMPUTER	7- 1 to 7- 6
7.1 List of Personal Computer Setting Items.....	7- 1
7.2 Providing Tag Display	7- 3
7.3 Monitoring the Devices	7- 4
7.4 Setting the Server (Personal Computer) Line Connection	7- 6
8. GETTING STARTED WITH GX RemoteService-I (Web function)	8- 1 to 8-17
8.1 Setting GX RemoteService-I to the Server (Personal Computer).....	8- 1
8.2 Varying of Monitor Devices and Arrival of E-mail.....	8-12
8.3 Receiving E-mail and Looking at Devices on Personal Computer.....	8-13
8.3.1 Until looking at tag.....	8-13
8.3.2 Until looking at devices	8-15

9. MELSOFT CONNECTION FUNCTION	9- 1 to 9- 7
--------------------------------	--------------

9.1 Using the MELSOFT connection function.....	9- 1
9.1.1 When the server is personal computer/PC CPU module	9- 1
9.1.2 When the server is Web server module	9- 4
9.2 Application example of the MELSOFT connection function	9- 5

10. TROUBLESHOOTING	10- 1 to 10- 3
---------------------	----------------

APPENDICES	App- 1 to App- 2
------------	------------------

APPENDIX 1 RESTRICTIONS.....	App- 1
------------------------------	--------

INDEX	Index- 1 to Index- 2
-------	----------------------

About Manuals

The following lists the manuals for this software package.
Refer to the following table when ordering manuals.

Related Manuals

Manual Name	Manual Number (Model Code)
Web Server Module User's Manual Describes the system configuration, specifications, functions, dedicated instructions and troubleshooting of Web server module. (Sold separately)	SH-080320E (13JR58)
GX Developer Version 8 Operating Manual Describes the GX Developer functions including programming, printing-out, monitoring and debugging. (Sold separately)	SH-080373E (13JU41)
GX Explorer Version 2 Operating Manual Describes the system configuration, functions and operations of GX Explorer. (Sold separately)	SH-080464ENG (13JU49)

Note: The Operating Manuals are included on the CD-ROM of the software package in a PDF file format.
Manuals in printed form are sold separately for single purchase. Order a manual by quoting the manual number (model code) listed in the table above.

How to Use This Manual

"How to Use This Manual" is described purpose by purpose for use of GX RemoteService-I. Refer to the following description and use this manual.

This system is divided into a personal computer and a server (personal computer). The system can be introduced smoothly by making actual setting while checking the purposes and setting sequence in the following flowchart.

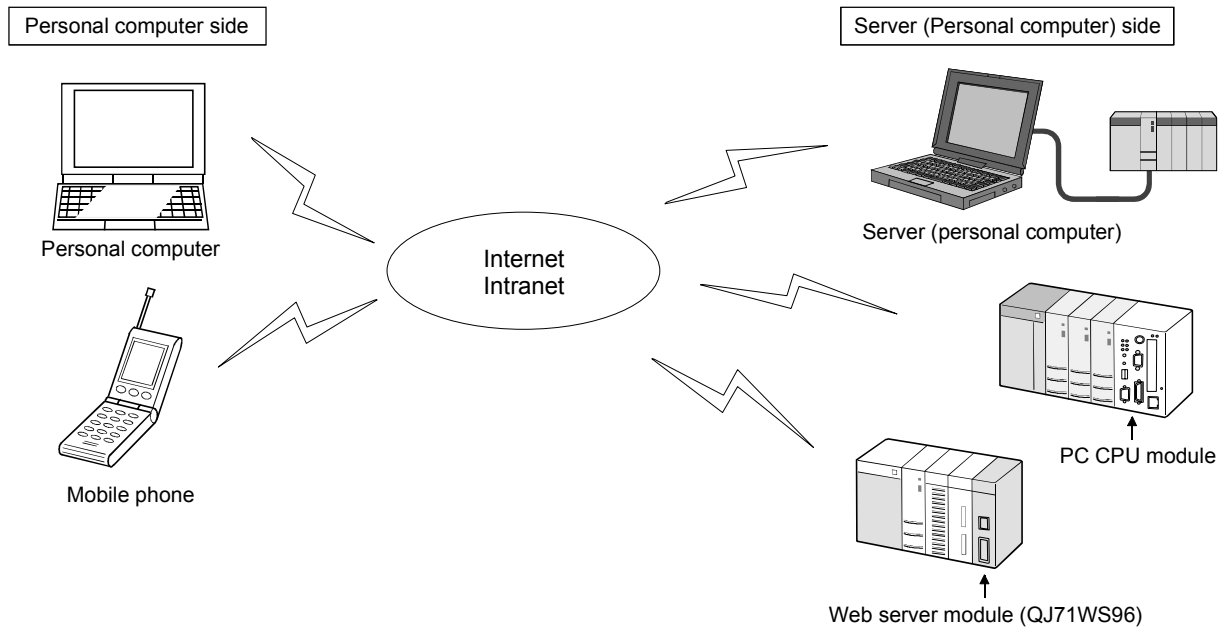

For the server (personal computer) setting, set the automatic or manual operation mode.

The personal computer side setting is required.

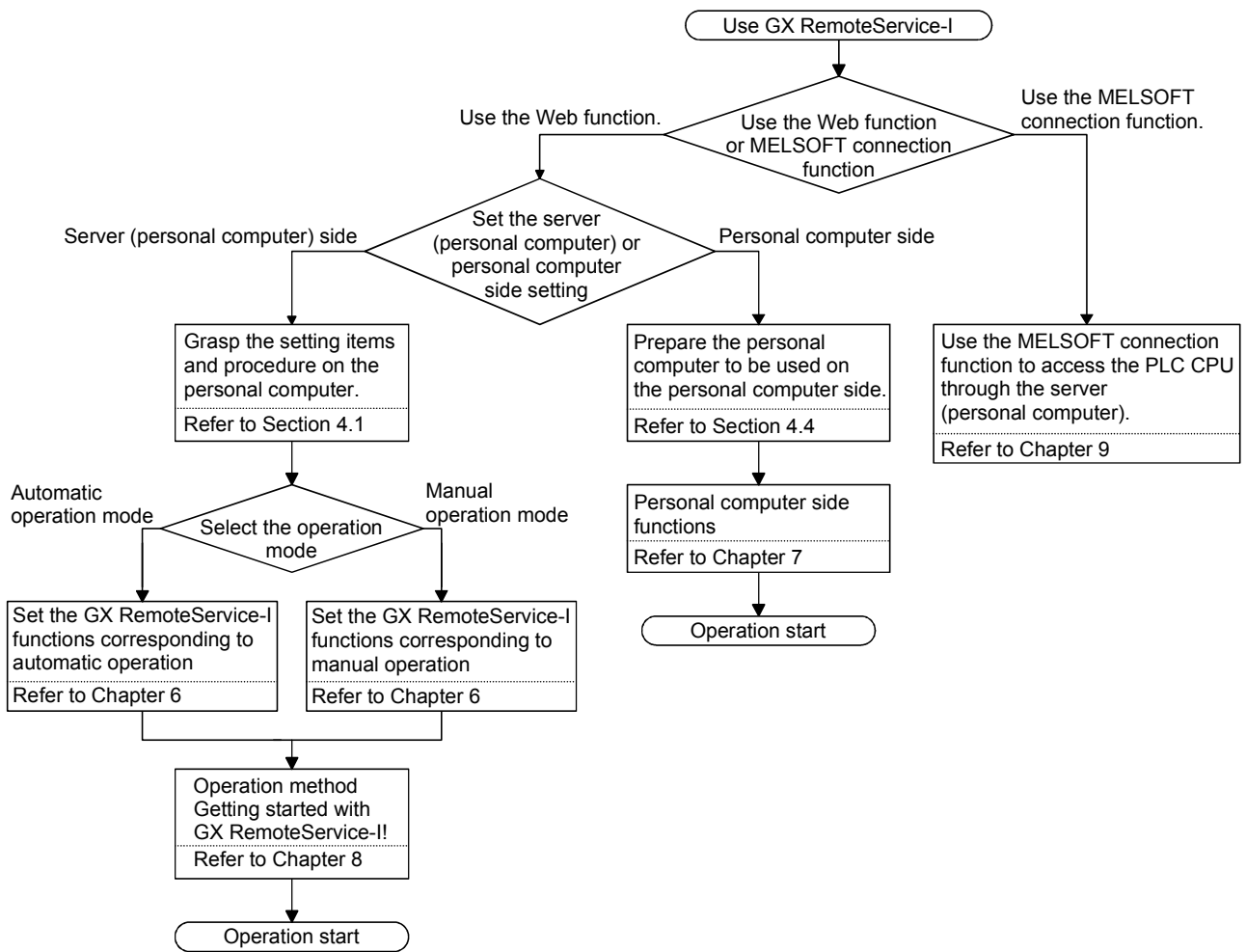

- (1) When you want to know features or automatic or manual operation (Section 1.1, Section 1.2)
Section 1.1 gives the features.
Section 1.2 describes automatic operation and manual operation.
- (2) When you want to know the operating environment of GX RemoteService-I (Section 2.3)
Describes the specifications of the personal computer used on the server (personal computer) side.
- (3) When you want to know the initial setting of the server (personal computer) and personal computer (Section 4.1, Section 4.2)
Describes the procedures for setting the personal computer used on the server (personal computer) side and the personal computer used on the personal computer side.
- (4) When you want to know the functions set with the server (Chapter 6)
Provides the detailed explanation of the functions to be set.
Also gives the explanation of the easy and convenient Wizard for use.
- (5) When you want to know the functions of the personal computer (Section 7.1 to Section 7.4)
Describes the procedure for monitoring devices and comments from the personal computer.
- (6) When you want to operate GX RemoteService-I (Chapter 8)
Explains the procedures for setting the server (personal computer), sending e-mail and making access from the personal computer to the server (personal computer).
- (7) When you want to know the MELSOFT connection function (Chapter 9)
Describes how to access the PLC CPU through the server (personal computer) from the client (personal computer) in which a MELSOFT connection function-compatible software package^{*1} is installed, and provides the application examples.
^{*1}: GX Explorer Version 2 is a MELSOFT connection function-compatible software package.
- (8) When you want to know the actions to be taken at occurrence of problems (Chapter 10)
Describes the troubleshooting to avoid trouble.
- (9) When you want to know restrictions (Appendices)
Describes the restrictions on use of GX RemoteService-I.

About the Generic Terms and Abbreviations

Unless otherwise specified, this manual uses the following generic terms and abbreviations to describe GX RemoteService-I.

Generic Term/Abbreviation		Description
GX RemoteService-I		Generic term for the product types SW2D5C-RAS-E, SW2D5C-RAS-EA.
GX Explorer		Generic term for the product types SW2D5C-EXP-E, SW2D5C-EXP-EA.
PWS		Generic term for Personal Web Server.
IIS		Generic term for Internet Information Server.
Web server software		Generic term for Personal Web Server, Internet Information Server, Peer Web Service.
Windows® 2000		Microsoft® Windows® 2000 Professional Operating System.
WindowsNT® 4.0		Microsoft® WindowsNT® Workstation 4.0 Operating System.
Windows® 98		Microsoft® Windows® 98 Operating System. Microsoft® Windows® 98 Second Edition Operating System.
Windows® XP		Microsoft® Windows® XP Professional Operating System.
Windows®		Microsoft® Windows® 98 Operating System. Microsoft® Windows® 98 Second Edition Operating System. Microsoft® WindowsNT® Workstation 4.0 Operating System. Microsoft® Windows® 2000 Operating System. Microsoft® Windows® XP Professional Operating System.
Provider		Internet Service Provider (ISP).
Sever		Personal computer/PC CPU module/Web server module in which GX RemoteService-I Version 2 is installed.
PC CPU module		MELSEC-Q series-compatible PC CPU module (CONTAC CO., Ltd.)
Web server module		QJ71WS96 Web server module.
ACPU		Generic term for A0J2H,A1S,A1FX,A1SJ,A1SH,A1SJH,A1N,A2C,A2CJ,A2N(S1),A2S,A2SH,A3N. Including PLC CPU modules with MELSECNET datalink functions, QCPU (A mode) and motion controller (SCPU).
AnACPU		Generic term for A2A,A2A-S1,A3A,A2AP21/R21,A2AP21/R21-S1,A3AP21/R21.
AnUCPU		Generic term for A2U,A2U-S1,A3U,A4U,A2US,A2US-S1,A2USH-S1.
QCPU (A mode)		Generic term for Q02(H)-A,Q06H-A.
QnACPU		Generic term for Q2A,Q2AS(H),Q2AS1,Q2AS(H)S1,Q3A,Q4A,Q4AR.
QCPU (Q mode)		Generic term for Q00J,Q00,Q01,Q02(H),Q06H,Q12H,Q12PH,Q25H,Q25PHCPU.
FXCPU		Generic term for FX0,FX0s,FX0N,FX1,FX2,FX2C,FX1s,FX1N,FX1NC,FX2N,FX2NC.
Computer link Unit	For A series	Generic term for A1SJ71C24-R2,A1SJ71C24-R4,A1SJ71C24-PRF,A2CCPUC24,A2CCPUC24-PRF,A1SCPUC24-R2,AJ71C24-S,AJ71C24-S8.
	For AnU	Generic term for AJ71UC24,A1SJ71UC24-R2,A1SJ71UC24-R4,A1SJ71UC24-PRF.
Serial communication unit	For QnA series	Generic term for AJ71QC24,AJ71QC24-R2,AJ71QC24-R4,AJ71QC24N,A1SJ71QC24,A1SJ71QC24-R2,AJ71QC24N-R2,AJ71QC24N-R4,A1SJ71QC24N,A1SJ71QC24N-R2.
	For Q series	Generic term for QJ71C24,QJ71C24-R2,QJ71C24N,QJ71C24N-R2,QJ71C24N-R4.
C24		Computer link module, Serial Communication module.
QE71		Generic term for AJ71QE71AJ71QE71-B2AJ71QE71-B5A1SJ71QE71-B5.
E71		Generic term for AJ71E71-S3,A1SJ71E71-B2-S3,A1SJ71E71-B5-S3,A1SJ71E71-B2,A1SJ71E71-B5.
Q series-compatible E71		Generic term for QJ71E71,QJ71E71-B2,QJ71E71-100.
MELSECNET/10 board		Generic term for A70BDE-J71QLP23/A70BDE-J71QLP23G/A70BDE-J71QLR23/A70BDE-J71QBR13 MELSECNET/10 interface board.
MELSECNET/H board		Generic term for Q80BD-J71LP21-25/Q80BD-J71LP21G(E)/Q80BD-J71BR11 MELSECNET/H interface board.
Ethernet board		Ethernet PC card, Ethernet I/F board.
CC-Link board		Generic term for A80BDE-J61BT11/A80BDE-J61BT13 CC-Link interface board.
CPU board		Generic term for A80BDE-A2USH-S1 PLC CPU board.

Product Makeup

GX RemoteService-I are made up of the following products.

Type	Product Name	Quantity
SW2D5C-RAS-E(V)	GX RemoteService-I Version 2 (1-license product) (CD-ROM)	1
	License agreement	1
	End-user software license agreement	1
	Method of installing the MELSOFT series	1
	Software registration notice	1
SW2D5C-RAS-E(V)A	GX RemoteService-I Version 2 (Multiple license product) (CD-ROM)	1
	License agreement	n* ¹
	End-user software license agreement	1
	Method of installing the MELSOFT series	1
	Software registration notice	1

*1: The number of included license agreements is equivalent to the number of licenses.

1. OVERVIEW

This manual explains the system configuration, functions, setting method and operations of MELSEC PLC-compatible remote access tool, GX RemoteService-I.

1.1 Features

GX RemoteService-I is the software package (needed to be installed in the server) that makes a connection between the PLC CPU at the site and the client (personal computer or mobile phone) in a remote location via the Internet (or Intranet).

GX RemoteService-I includes the Web function and MELSOFT connection function, which can realize the excellent remote maintenance of PLC CPU.

- Web function
Notifies of the PLC CPU device status by sending an e-mail to a mobile phone or personal computer.
Also, enables the PLC CPU device status or relevant comments to be checked from Web browser of a mobile phone or personal computer.
- MELSOFT connection function
Connects to the PLC CPU from the software package*¹ in the client (personal computer) via the Internet (or Intranet).
Also, enables the PLC CPU, which is in a remote location from the client (personal computer), to be maintained using the software package*².

*1: GX Explorer Version 2 is a MELSOFT connection function-compatible software package.

*2: For usable functions, refer to the operating manual of the software package used.

• Web function

▶ Applications needed to be installed in the server (personal computer)

- GX RemoteService-I Version 2 (this product)
- Web browser (supplied by Microsoft®)
Internet Explorer 6.0 or later.

▶ Applications needed to be installed in the server (personal computer) for use of the Web function

- Web server software (supplied by Microsoft®)
Personal Web Server 4.0 or later (PWS) : Windows®98
Internet Information Server 5.0 or later (IIS): Windows®2000/XP
Peer Web Service 4.0 or later : WindowsNT®4.0

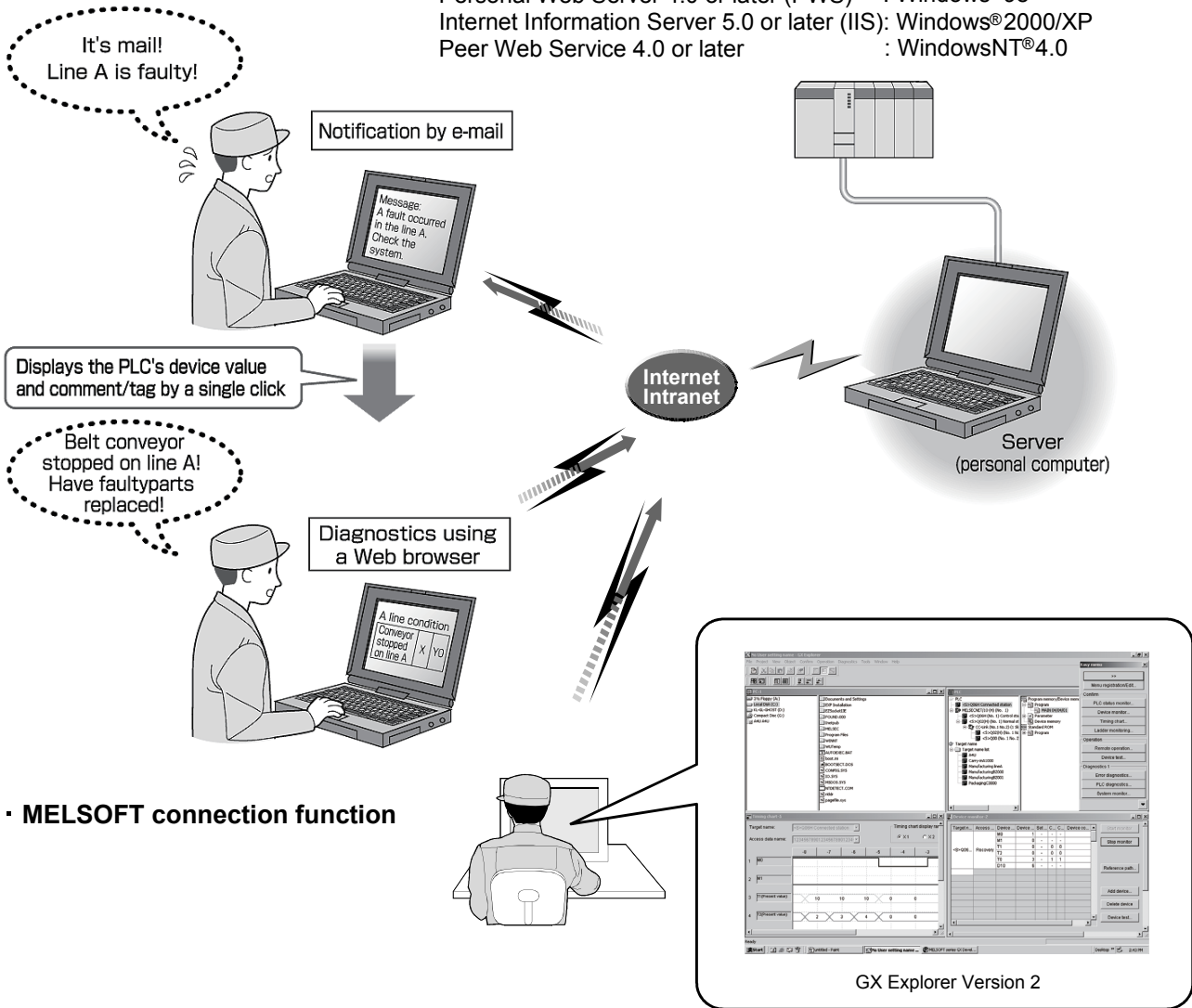

• MELSOFT connection function

- (1) PLC CPU can be monitored/diagnosed via the Internet or Intranet
The personal computer allows you to know the PLC status.
- (2) This system can be introduced without any modification to the existing system
No dedicated special modules are required to use this product.
In addition, you need not change the parameter values since this product does not require I/O points.
- (3) Wide range of operating environments (Compatible with Internet and Intranet)
A Windows-based personal computer, PC CPU module and Web server module are applicable for the operating environment of the server. Also, the following networks, Internet and Intranet are applicable. In addition, the connection methods are selectable from analogue, mobile phone, DSL and LAN. With this wide range of operating environments, the system can be constructed according the needs, and GX RemoteService-I can be introduced into the existing system easily.

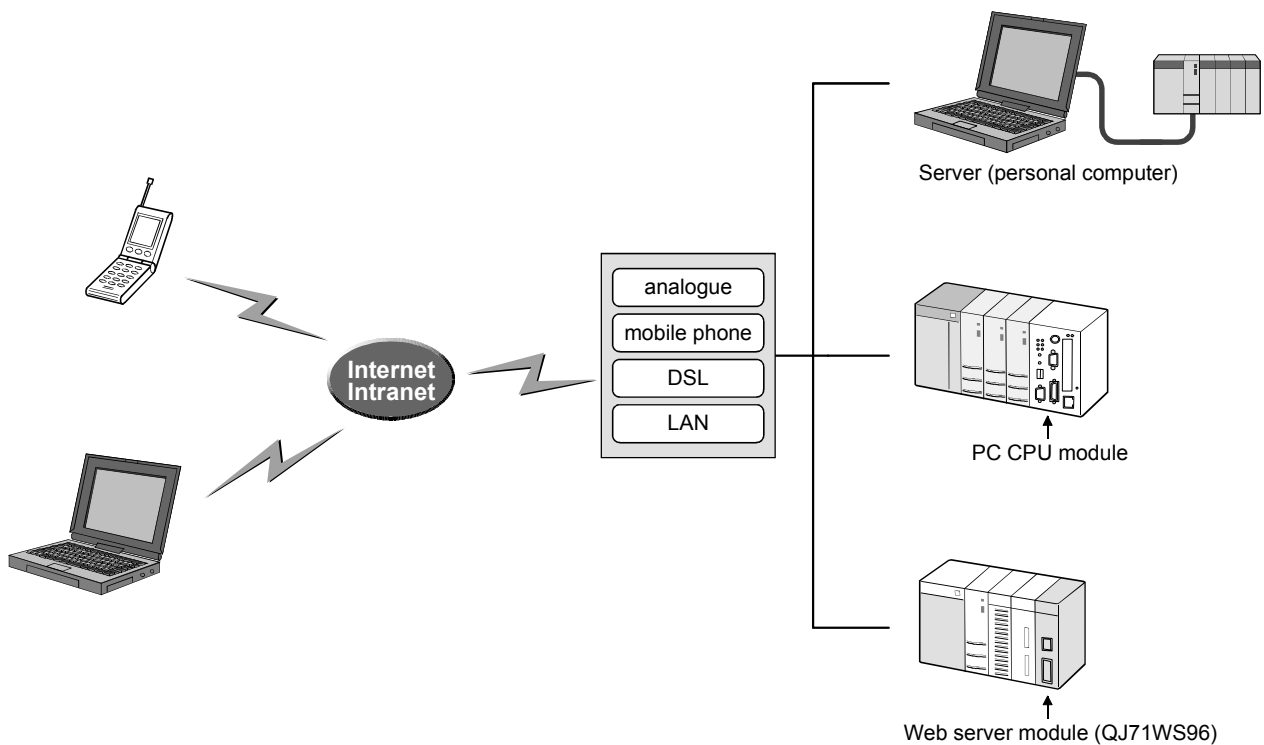

For Internet connection, a contract with ISP (Internet Service Provider) is required.

(4) Remote maintenance by MELSOFT connection function

Installing GX RemoteService-I into the server enables remote maintenance of the PLC CPU from the client (personal computer in which MELSOFT connection-compatible software package*1 is installed) via the Internet or intranet.

*1: GX Explorer Version 2 is a MELSOFT connection function-compatible software package.

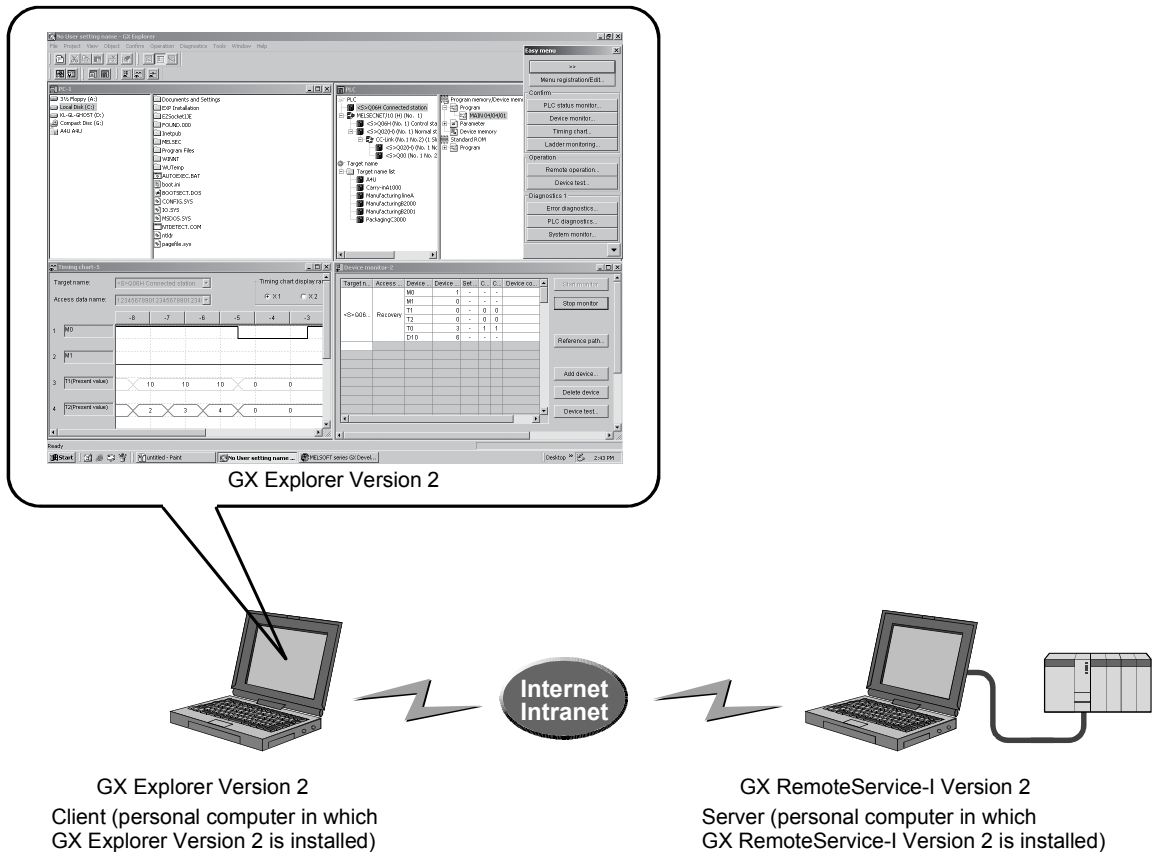

(5) Illegal access prevention by security function

The user authentication function checks the user name and password in order to prevent an illegal access to the server, when a client connects to the server.

1.2 About Automatic Operation and Manual Operation

GX RemoteService-I allows you to select the automatic or manual operation mode. The features of the automatic and manual operation modes are explained below. They will be helpful for you when constructing a system.

(1) When the server (personal computer) is always connected to the system for monitoring (automatic operation mode)

GX RemoteService-I always monitors the PLC CPU devices.

When an error occurs in the system, GX RemoteService-I sends an e-mail to the personal computer, i.e., notifies of the system error.

(The condition for triggering the transmission of e-mail that notifies the personal computer of a system fault is to be set to the server (personal computer).)

Hence, a serviceman can be notified of an error definition within a short time after occurrence of a fault.

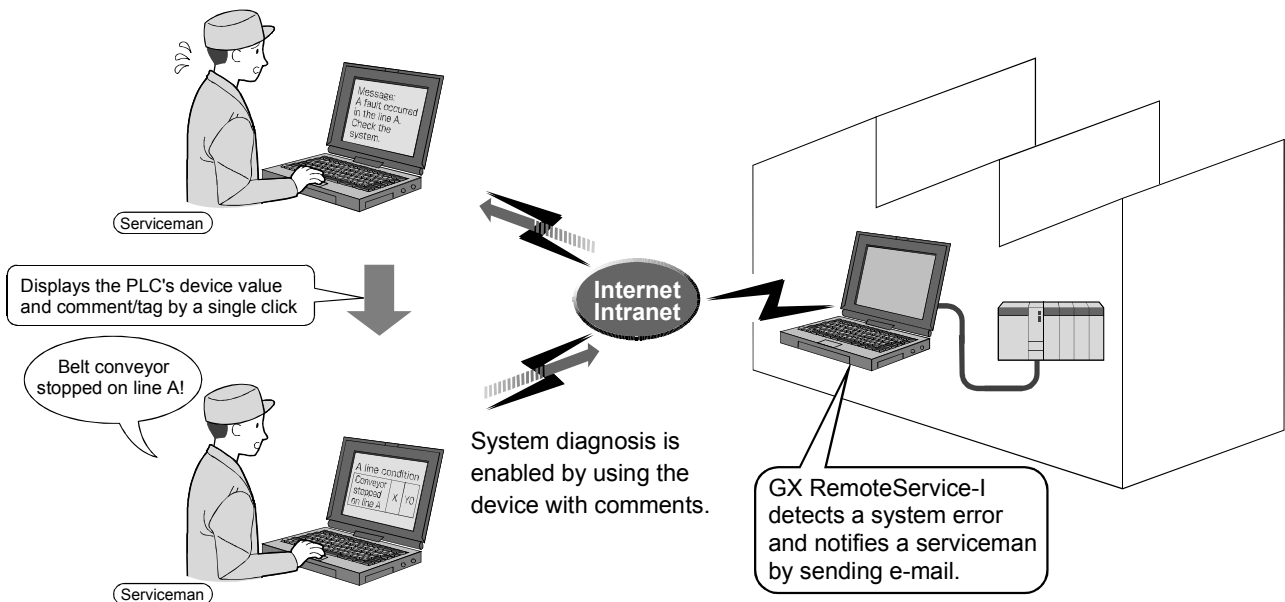

(2) When an operator judges a fault and contacts a serviceman (manual operation mode)

If a fault has occurred in the system, an operator can make judgment to notify a serviceman of the faulty condition.

The serviceman can diagnose the actual system from a remote location to run more in-depth diagnostics.

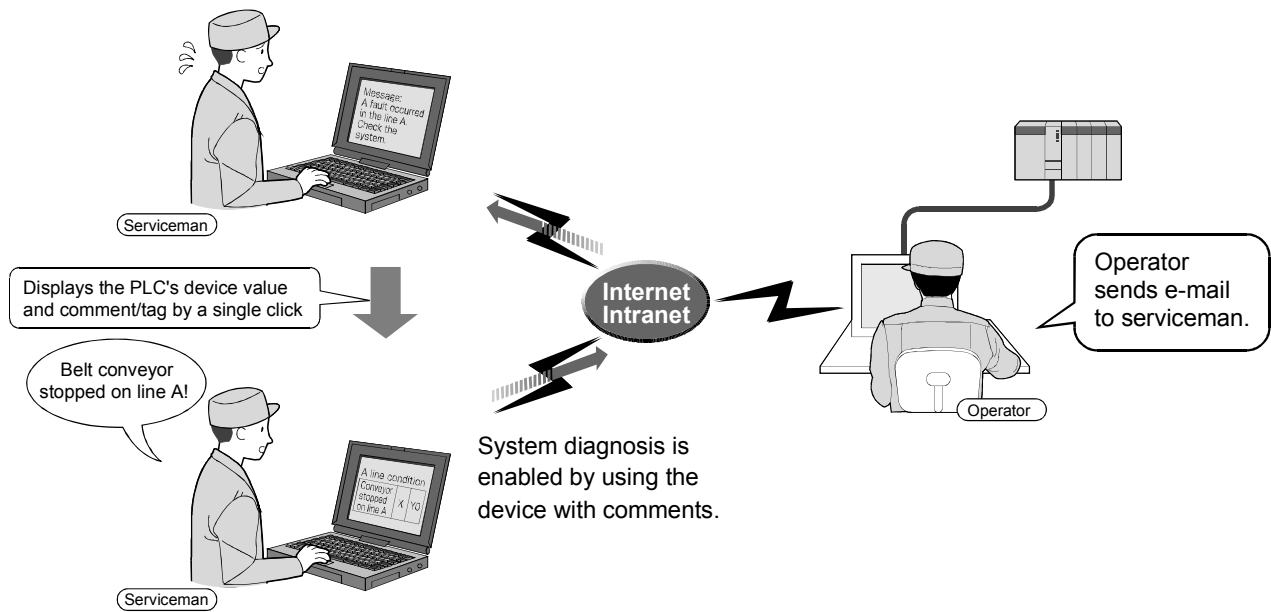

2. SYSTEM CONFIGURATION

2.1 Device List for Server (personal computer) side

This section explains the system configuration that uses GX RemoteService-I.
Refer to Section 2.1.1, Section 2.1.2, Section 2.1.3 and Section 2.1.4 for the system device lists of the server (personal computer) side.

Refer to Section 2.3.2 for the system device list of the personal computer side.

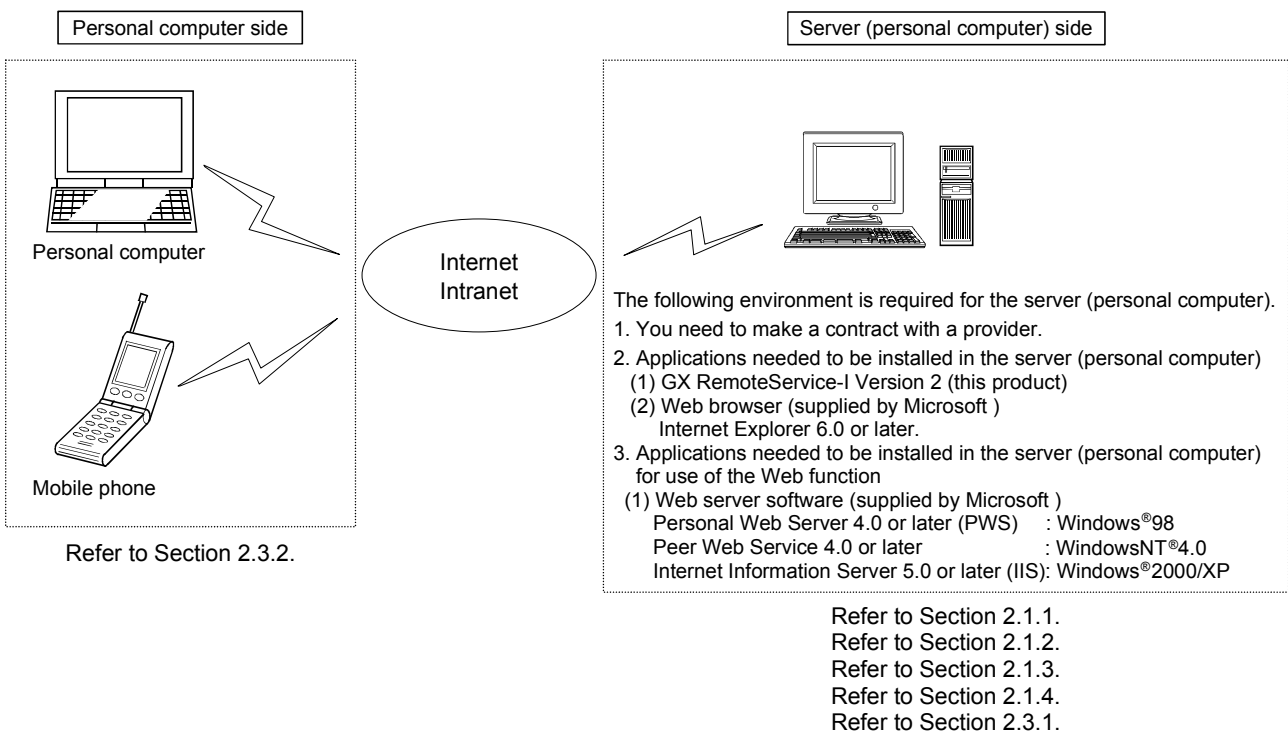

2.1.1 Connection from the serial/USB port

The following shows the system configuration that can be connected from the serial/USB port of personal computer.

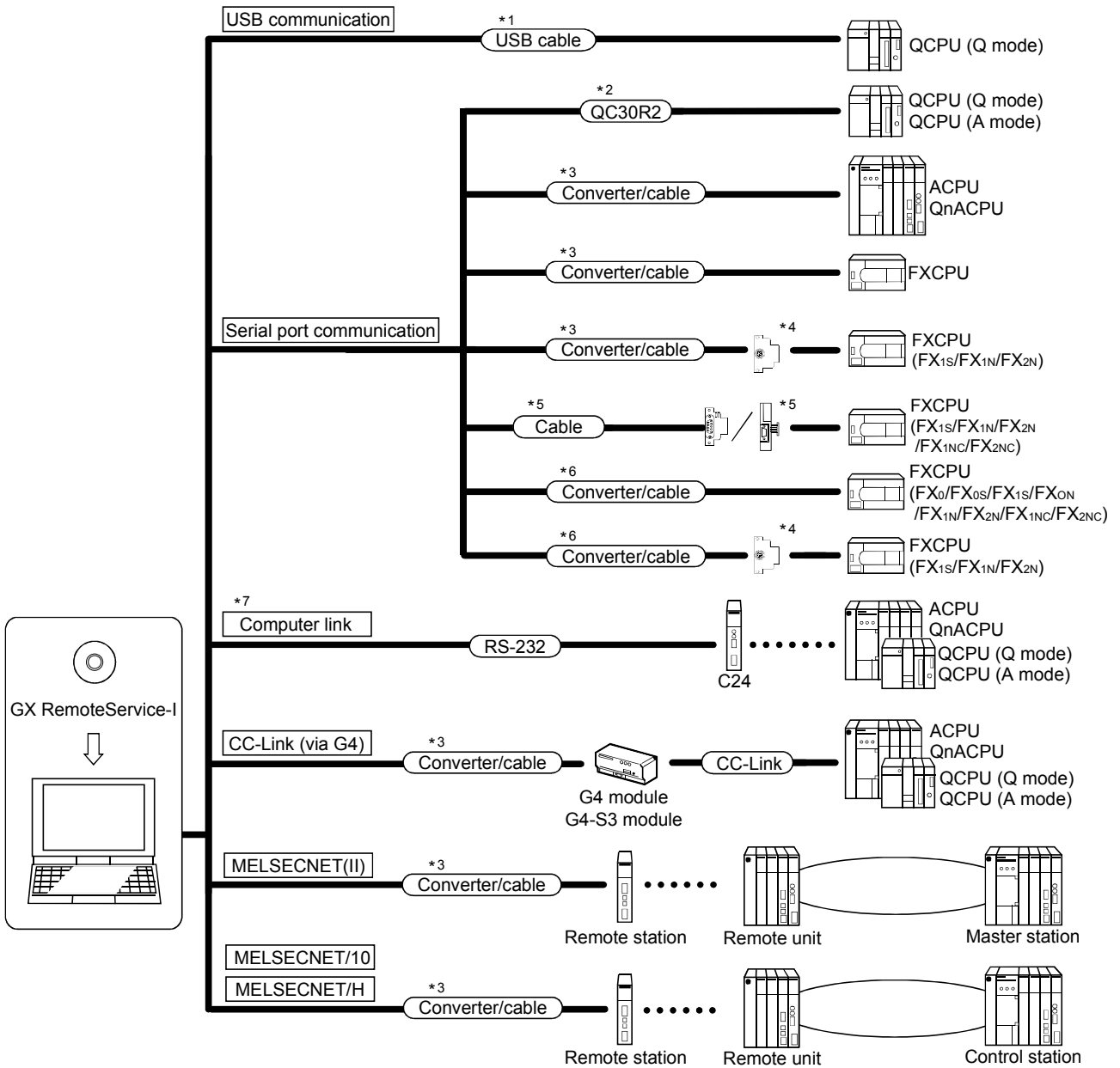

*1: About the USB cable (QCPU (Q mode) compatible)

- (1) Usable when either of Windows® 98, Windows® 2000 Professional or Windows® XP Professional is used, and the USB driver is installed.
- (2) Unusable for Windows® 95, WindowsNT® 4.0.
- (3) Use of the USB cable allows only one PLC CPU to be connected.
- (4) Use the UBS cable which conforms to the USB Standard Rev. 1.1.
- (5) The following indicates the precautions for and restrictions on communications made using the USB cable.
 - 1) A communication error may occur if you set the resume function, suspend setting, power saving function or standby mode of the server (personal computer) to make communications with the PLC CPU. Hence, do not set any of the above functions when making communications with the PLC CPU.
 - 2) Frequently connecting/disconnecting the USB cable, resetting the PLC CPU or switching power OFF/ON during communications with the PLC CPU may cause a communication error from which the system may not be recovered.
Where possible, therefore, exit from GX RemoteService-I before connecting/disconnecting the USB cable, resetting the PLC CPU or switching power OFF/ON.
If the system cannot be recovered from the communication error, completely disconnect the USB cable once and reconnect it after more than five seconds have elapsed. (An error may occur at the first communication after this operation, but the system will function properly after the second time and later.)
 - 3) A communication error may occur depending on the combination of the server (personal computer) model, USB cable and others. In that case, refer to the messages and perform operation again.

*2: About the cable (QCPU (Q mode), QCPU(A mode) compatible)

For communication in 115.2/57.6kbps

Fast communication cannot be made if the Personal computer used is not compatible with the communication speed of 115.2/57.6kbps.

If a communication error occurs, reduce the baud rate setting and restart communication.



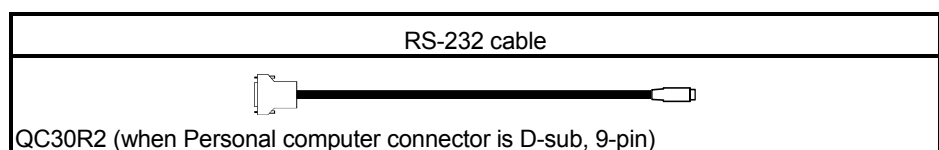

The following cable has been confirmed by Mitsubishi Electric that it will work properly.

Using the cable of Mitsubishi Electric make

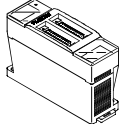

*3: About the converter/cable (ACPU, QnACPU, FXCPU compatible)

(1) Using the products of Mitsubishi Electric make.

Personal computer Side (RS-232 cable)	RS-232/RS-422 Converter	PLC Side (RS-422 cable)
 F2-232CAB-1 (when Personal computer connector is D-sub, 9-pin)	 FX-232AW	For ACPU, QnACPU, FX1/FXu, FX2cCPU  FX-422CAB (0.3m) FX-422CAB-150 (1.5m)
	 FX-232AWC	For FX0/FX0s/FX0N/FX1s/FX1N/FX2N/FX2NCPU  FX-422CABO (1.5m)
	 FX-232AWC-H (FX series only)	

- How to identify compatibility of the F2-232CAB and F2-232CAB-1 cables with the ACPU and QnACPU

Check the indication of the model label attached to the cable.

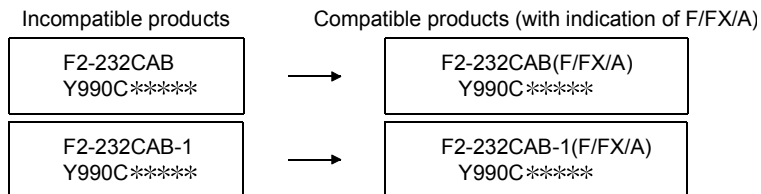

- When connecting to FX series, make sure to use the device in the above table.

Example of connecting IBM-PC/AT-compatible personal computer and QnACPU using EX-232AW(C)

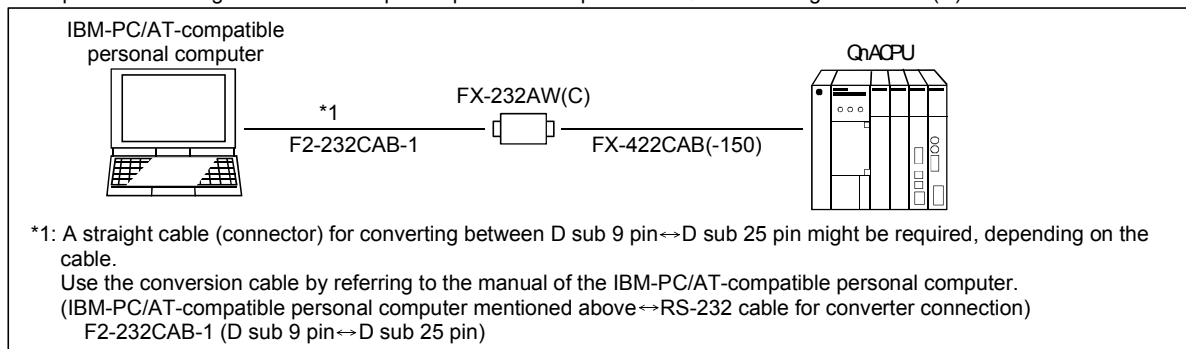

*4: Function expansion board

Series	Function expansion board
FX _{2N}	FX2N-422-BD
FX _{1S} , FX _{1N}	FX1N-422-BD

*5: RS-232 cable and function expansion board (special adapter)

Shape of serial port for personal computer	Series	Required function expansion board and special adapter	RS-232 cable
D sub 9 pin	FX _{2N}	FX0N-232ADP + FX2N-CNV-BD	F2-232CAB-1
		FX2N-232-BD	FX-232CAB-1
		FX2NC-232ADP + FX2N-CNV-BD	FX-232CAB-1
	FX _{1NC} , FX _{2NC}	FX0N-232ADP	F2-232CAB-1
		FX2NC-232ADP	FX-232CAB-1
FX _{1S} , FX _{1N}	FX0N-232ADP + FX1N-CNV-BD	F2-232CAB-1	
	FX1N-232-BD	FX-232CAB-1	
	FX2NC-232ADP + FX1N-CNV-BD	FX-232CAB-1	
D sub 25 pin	FX _{2N}	FX0N-232ADP + FX2N-CNV-BD	F2-232CAB
		FX2N-232-BD	F2-232CAB-1
		FX2NC-232ADP + FX2N-CNV-BD	F2-232CAB-1
	FX _{1NC} , FX _{2NC}	FX0N-232ADP	F2-232CAB
		FX2NC-232ADP	F2-232CAB-1
	FX _{1S} , FX _{1N}	FX0N-232ADP + FX1N-CNV-BD	F2-232CAB
		FX1N-232-BD	F2-232CAB-1
		FX2NC-232ADP + FX1N-CNV-BD	F2-232CAB-1

*6: Converter/cable (FXCPU compatible)

(1) System configuration

FX-USB-AW

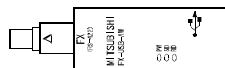

USB cable (packed)



- (2) When Windows[®] 98, Windows[®] Me, Windows[®] 2000 Professional, Windows[®] XP Professional or Windows[®] XP Home Edition is used, the converter/cable is available if the driver on the CD-ROM packed with the FX-USB-AW or FX_{3U}-USB-BD has been installed.
- (3) The converter and cable are unavailable for Windows[®] 95 or Windows NT[®] Workstation 4.0.
- (4) On GX Developer, choose [Online] - [Transfer setup] and set the serial COM port number.
- (5) For the precautions and restrictions on use of the FX-USB-AW, refer to the manual packed with the FX-USB-AW.

***7: Computer link**

The program that uses V, Z (Indexing) cannot be monitored if routing through a computer link module when A Series is used.

POINT

- Before handling the RS-422 interface conversion cable/converter, please read its specifications, precautions, etc. carefully in the manual of the corresponding product and handle it correctly.
- When disconnecting or reconnecting the conversion cable/converter that receives 5VDC power from the RS-422 interface, switch power off on the PLC CPU side before starting work.
- When disconnecting or reconnecting the peripheral device or conversion cable that does not receive 5VDC power from the RS-422 interface (whose power is supplied from an external power supply), be sure to use an earth band or touch a grounded metal object, etc. before starting work to discharge static electricity from the cable, human body, etc. After that, handle it in the following procedure.
 - 1) Switch power off on the personal computer side.
 - 2) Power off the conversion cable/converter. When it has an FG terminal, ground it.
 - 3) Connect/disconnect the conversion cable/converter between the personal computer and PLC CPU.
 - 4) Power on the conversion cable/converter.
 - 5) Power on the personal computer.
 - 6) Start up the software package.

2.1.2 Connection from the interface boards

The following system configuration is made up by connection from the interface boards.

Refer to the corresponding board manuals for the way to connect the boards and install the drivers.

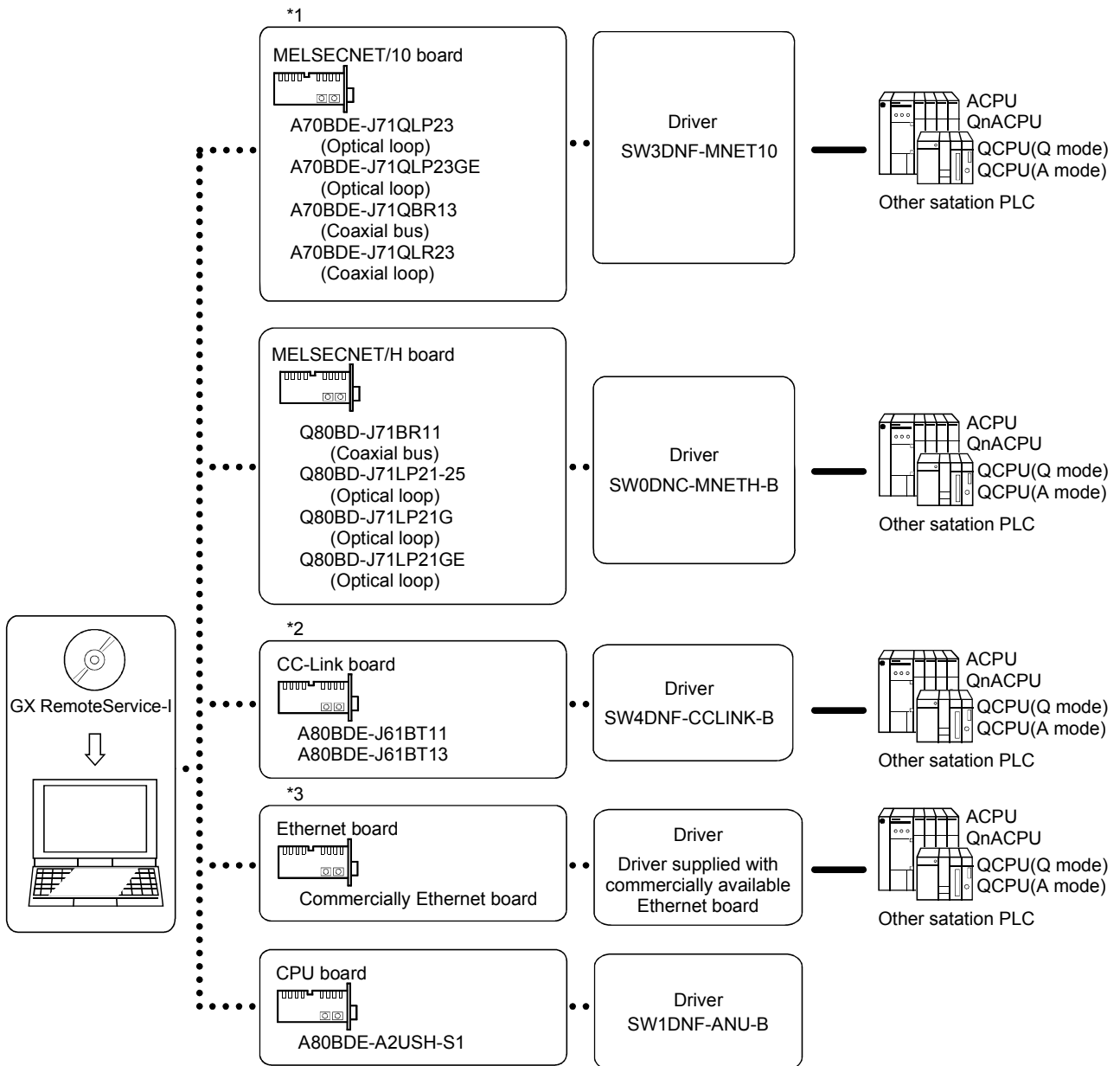

*1: MELSECNET/10 board

The following table indicates the drivers that cannot be used with the specific Operating Systems.

Driver Name	Operating Systems
SW3DNF-MNET10	Cannot be used with Windows® Me/2000.
SW0DNC-MNETH-B	Cannot be used with Windows® Me.

If a communications error takes place, an error code is indicated in the least significant 4 digits.

Refer to the error code list of the MELSECNET/10 board manual.

*2: CC-Link board

The A80BDE-J61BT11 allows setting of the master/local station.

The A80BDE-J61BT13 is accessible only when local station setting has been made.

*3: Ethernet board

(1) The following Ethernet boards/cards have been confirmed by Mitsubishi Electric to operate properly.

Maker Name	Model
3COM	Ethernet Link III LAN PC Card
Allied Telesis	Centre COM LA-PCM Ethernet PC Card LAN Adapter
	RE2000 (ISA)
TDK make	10BASE-T LAN card (Model: LAN-CD021BX)

2.1.3 System equipment lists

(1) The following list indicates module connectable from the serial port.

PC Series	Module Name	Module Model
Q Series	PLC CPU module	Q00J, Q00, Q01, Q02(H), Q06H, Q12H, Q25H Q02(H)-A, Q06H-A
	Serial communication module * ¹	QJ71C24, QJ71C24-R2, QJ71C24N, QJ71C24N-R2, QJ71C24N-R4
	MELSECNET/H network remote I/O module	QJ72LP25, QJ72BR15
	G4-S3 module	AJ65BT-G4-S3
QnA Series	PLC CPU module	Q2A, Q2AS(H), Q2AS1, Q2AS(H)S1, Q3A, Q4A, Q4AR
	Serial communication module * ²	AJ71QC24, AJ71QC24-R2, AJ71QC24-R4, AJ71QC24N, A1SJ71QC24, A1SJ71QC24-R2, AJ71QC24N-R2, AJ71QC24N-R4, A1SJ71QC24N, A1SJ71QC24N-R2
	MELSECNET/10 network remote I/O module	AJ72QLP25, AJ72QBR15, A1SJ72QLP25, A1SJ72QBR15
	G4 module	AJ65BT-G4, AJ65BT-G4-S3
A Series	PLC CPU module	A0J2H, A1S(S1), A1FX, A1SJ, A1SH, A1SJH, A1N, A2C, A2CJ, A2N(S1)A2S(S1), A2SH(S1), A3N, A2A(S1), A3A, A2U(S1), A2AS(S1), A2AS-S30, A2AS-S60, A3U, A4U
	Computer link module * ³	AJ71UC24, A1SJ71UC24-R2, A1SJ71UC24-PRF, A1SJ71C24-R2, A1SJ71C24-R4, A1SJ71C24-PRF, AJ71C24-S6, AJ71C24-S8, A1SCPUC24-R2, A2CCPUC24, A2CCPUC24-PRF, A1SJ71UC24-R4
	MELSECNET/B data link remote I/O module	AJ72T25B, A1SJ72T25B
	MELSECNET/10 data link remote I/O module	AJ72LP25, AJ72LP25, AJ72BR15
	G4 module	AJ65BT-G4, AJ65BT-G4-S3
FX Series	PLC CPU module	FX ₀ (S), FX ₀ N, FX ₁ , FX _U , FX ₂ C, FX ₁ S, FX ₁ N, FX ₁ N, FX ₂ N(C)
MOTION (SCPU)	PLC CPU module	A171SH, A172SH, A173UH(S1), A273UH(S3)

- (2) The following table indicates the modules which can be connected from the MELSECNET/10 or MELSECNET/H (MELSECNET/10 mode) board.

PC Series	Module Name
Q Series	QJ71LP21, QJ71LP21G, QJ71BR11, QJ71LP21-25, QJ71LP21S-25
QnA Series	AJ71QLP21, AJ71QBR11, A1SJ71QLP21, A1SJ71QBR11
A Series	AJ71LP21, AJ71BR11, A1SJ71LP21, A1SJ71BR11

- (3) The following table indicates the modules which can be connected from the MELSECNET/H board.

PC Series	Module Name
Q Series	QJ71LP21, QJ71BR11, QJ71LP21-25

- (4) The following list indicates modules connectable from the CC-Link board.

PC Series	Module Name
Q Series	QJ61BT11, QJ61BT11N
QnA Series	AJ61QBT11, A1SJ61QBT11
A Series	AJ61BT11, A1SJ61BT11

- (5) The following list indicates modules connectable from the Ethernet board.

PC Series	Module Name
Q Series	QJ71E71, QJ71E71-B2, QJ71E71-100, QJ71E71-B5
QnA Series	AJ71QE71, AJ71QE71-B5, A1SJ71QE71-B2, A1SJ71QE71-B5, AJ71QE71N-T, A1SJ71QE71N-T, AJ71QE71N-B5, A1SJ71QE71N-B5, AJ71QE71N-B2, A1SJ71QE71N-B2, AJ71QE71N-B5T, A1SJ71QE71N-B5T
A Series	AJ71E71-S3, A1SJ71E71-B2-S3, A1SJ71E71-B5-S3, A1SJ71E71-B2, A1SJ71E71-B5, AJ71E71N-B2, AJ71E71N-B5T, A1SJ71E71N-B2, A1SJ71E71N-B5, AJ71E71N-T, A1SJ71E71N-T, AJ71E71N-B5, A1SJ71E71N-B5

- *1: When accessing the PLC CPU from the server (personal computer) through a serial communication module (for Q series), note that some modules are inapplicable for connection to a personal computer.
Even if a module cannot be directly connected to the server (personal computer), it might be usable as "n"th device in the multidrop connection.

Type	Interface	1:1 Connection	Multidropping	
			First module	"n"th module
QJ71C24	RS-232C	○	○	×
	RS-422/485	×	×	○
QJ71C24-R2	RS-232C	○	×	×
	RS-232C	×	×	×

- *2: The following table indicates whether the interfaces may be connected to the personal computer when the PLC CPU is accessed from the personal computer via the serial communication module (QC24).
If the module cannot be connected directly with the personal computer, it may be usable as the "n"th module of multidropping.

Type	Interface	1:1 Connection	Multidropping	
			First module	"n"th module
AJ71QC24	RS-232C	○	○	×
	RS-422/485	×	×	○
AJ71QC24N	RS-232C	○	○	×
	RS-422/485	×	×	○
AJ71QC24-R2	RS-232C	○	×	×
	RS-232C	×	×	×
AJ71QC24N-R2	RS-232C	○	×	×
	RS-232C	×	×	×
AJ71QC24-R4	RS-422	×	×	×
	RS-422/485	×	×	○
AJ71QC24N-R4	RS-422	×	×	×
	RS-422/485	×	×	○
A1SJ71QC24	RS-232C	○	○	×
	RS-422/485	×	×	○
A1SJ71QC24N	RS-232C	○	○	×
	RS-422/485	×	×	○
A1SJ71QC24-R2	RS-232C	○	×	×
	RS-232C	×	×	×
A1SJ71QC24N-R2	RS-232C	○	×	×
	RS-232C	×	×	×

*3: About the computer link module

Note that when the PLC CPU is accessed from the personal computer via the computer link module, the modules that may be connected directly with the personal computer are limited.

If the module cannot be connected directly with the personal computer, it may be usable as the "n"th module of multidropping.

Type	Interface	1:1 Connection	Multidropping	
			First module	"n"th module
AJ71UC24	RS-232C	○	○	×
	RS-422/485	×	×	○
AJ71C24-S6	RS-232C	○	○	×
	RS-422	×	×	○
AJ71C24-S8	RS-232C	○	○	×
	RS-422	×	×	○
A1SJ71UC24-R2	RS-232C	○	×	×
A1SJ71C24-R2	RS-232C	○	×	×
A1SJ71UC24-PRF	RS-232C	○	×	×
A1SJ71C24-PRF	RS-232C	○	×	×
A1SJ71UC24-R4	RS-422/485	×	×	○
A1SJ71C24-R4	RS-422/485	×	×	○
A1SCPUC24-R2	RS-232C	○	×	×
A2CCPUC24	RS-232C	○	○	×
	RS-422	×	×	×
	RS-422/485	×	×	○
A2CCPUUC24-PRF	RS-232C	○	○	×
	RS-422	×	×	×
	RS-422/485	×	×	○

2.1.4 Connection from the PC CPU Module

The following shows the system configuration that can be connected from the PC CPU module.

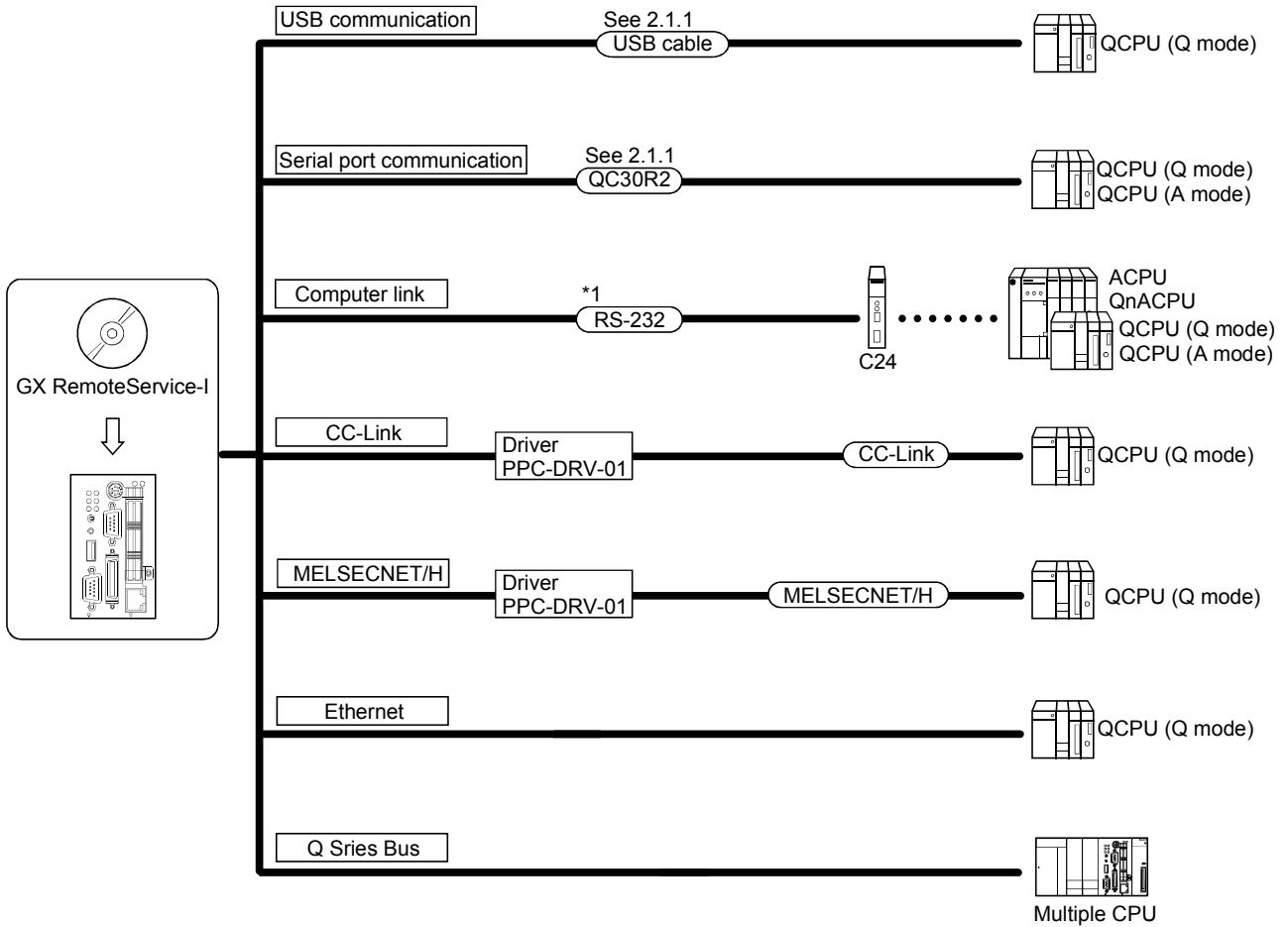

POINT
The PC CPU module is applicable for the MELSOFT connection only.

*1: Examples of Wiring RS-232 Cable for Connection of C24 and Personal computer

A Series

(1) When a 25-pin connector is used in a computer link module

(Connection example 1)

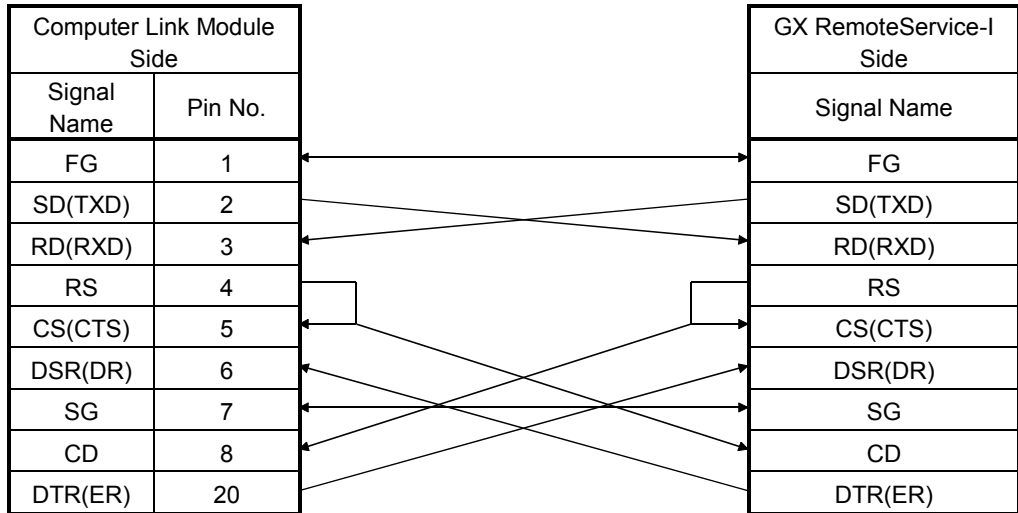

If the connection between the computer link module and the GX RemoteService-I is made in the manner shown below, designate "without CD terminal check".

(Connection example 2)

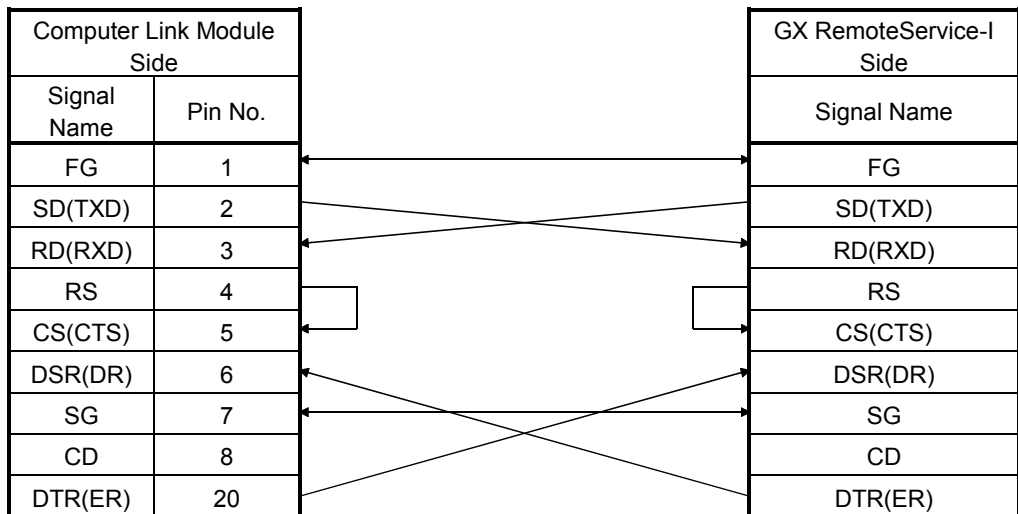

Buffer memory setting

CD terminal check (address 10Bh): Without check

DTR control (address 11Ah): Yes (C24-S8, UC24)

(2) When a 9-pin connector is used in a computer link module

(Example of connection)

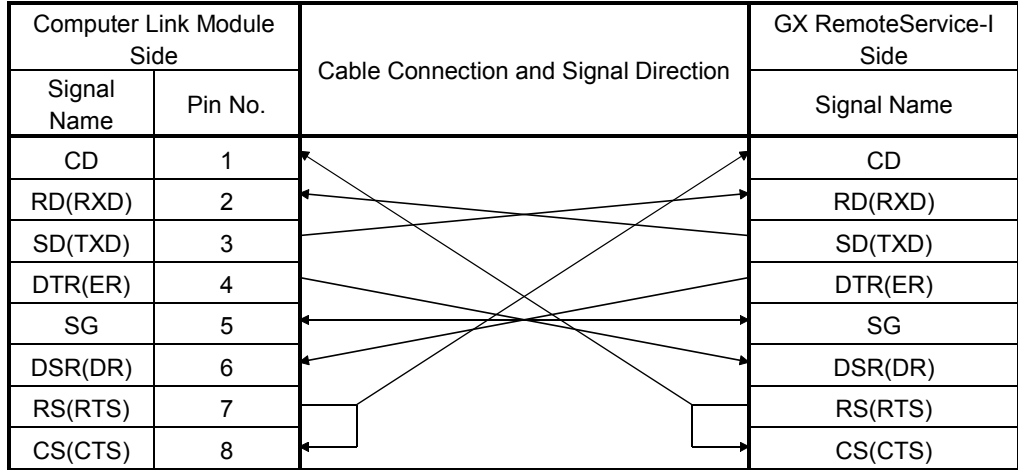

(Example of connection)

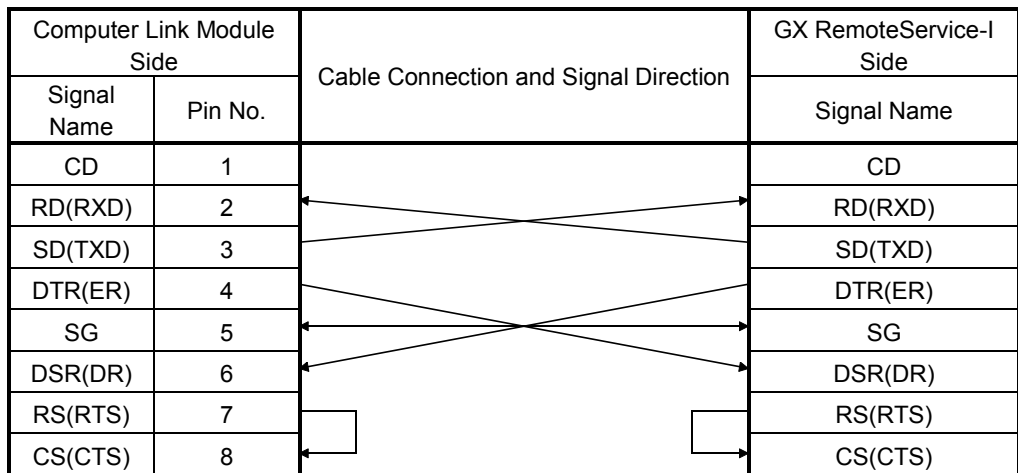

DC code control or DTR/DSR control is enabled by connecting the DTR and DSR signals of the computer link module to an external device as shown above.

QnA Series

- (1) When a 25-pin connector is used in a serial communication module
 - (a) Example of connection to an external device that allows the CD signal (No. 8 pin) to be turned ON/OFF

Serial communication module Side		Cable Connection and Signal Direction (Full-/Half-Duplex Communication)	GX RemoteService-I Side
Signal Name	Pin No.		Signal Name
FG	1	↔	FG
SD(TXD)	2	↔	SD(TXD)
RD(RXD)	3	↔	RD(RXD)
RS	4	↔	RS
CS(CTS)	5	↔	CS(CTS)
DSR(DR)	6	↔	DSR(DR)
SG	7	↔	SG
CD	8	↔	CD
DTR(ER)	20	↔	DTR(ER)

DC code control or DTR/DSR control is enabled by connecting the QC24 (N) to an external device as shown above.

- (b) Example of connection to an external device that does not allow the CD signal (No. 8 pin) to be turned ON/OFF

Serial communication module Side		Cable Connection and Signal Direction (Full-Duplex Communication)	GX RemoteService-I Side
Signal Name	Pin No.		Signal Name
FG	1	↔	FG
SD(TXD)	2	↔	SD(TXD)
RD(RXD)	3	↔	RD(RXD)
RS	4	↔	RS
CS(CTS)	5	↔	CS(CTS)
DSR(DR)	6	↔	DSR(DR)
SG	7	↔	SG
CD	8	↔	CD
DTR(ER)	20	↔	DTR(ER)

DC code control or DTR/DSR control is enabled by connecting the QC24 (N) to an external device as shown above.

- (2) When a 9-pin connector is used in a serial communication module
 - (a) Example of connection to an external device that allows the CD (a)signal (No. 1 pin) to be turned ON/OFF

Serial communication module Side		Cable Connection and Signal Direction (Full- / Half-Duplex Communication)	GX RemoteService-I Side
Signal Name	Pin No.		Signal Name
CD	1		CD
RD(RXD)	2		RD(RXD)
SD(TXD)	3		SD(TXD)
DTR(ER)	4		DTR(ER)
SG	5		SG
DSR(DR)	6		DSR(DR)
RS(RTS)	7		RS(RTS)
CS(CTS)	8		CS(CTS)

DC code control or DTR/DSR control is enabled by connecting the QC24 (N) to an external device as shown above.

- (b) Example of connection to an external device that does not allow the CD signal (No. 1 pin) to be turned ON/OFF

Serial communication module Side		Cable Connection and Signal Direction (Full-Duplex Communication)	GX RemoteService-I Side
Signal Name	Pin No.		Signal Name
CD	1		CD
RD(RXD)	2		RD(RXD)
SD(TXD)	3		SD(TXD)
DTR(ER)	4		DTR(ER)
SG	5		SG
DSR(DR)	6		DSR(DR)
RS(RTS)	7		RS(RTS)
CS(CTS)	8		CS(CTS)

DC code control or DTR/DSR control is enabled by connecting the QC24 (N) to an external device as shown above.

Q Series

The connector specifications are indicated below.

Pin Number	Signal Code	Signal Name	Signal Direction Q-compatible C24 ↔ external device
1	CD	Receive carrier detection	←
2	RD (RXD)	Receive data	←
3	SD (TXD)	Send data	→
4	DTR (ER)	Data terminal ready	→
5	SG	Send ground	↔
6	DSR (DR)	Data set ready	←
7	RS (RTS)	Request to send	→
8	CS (CTS)	Clear to send	←
9	RI (CI)	Call indication	←

(1) Connection example which can turn ON/OFF CD signal (No. 1 pin)

Serial communication module Side		Cable Connection and Signal Direction (Connection example for full duplex/half duplex communication)	GX RemoteService-I Side
Signal Name	Pin No.		Signal Name
CD	1		CD
RD (RXD)	2		RD (RXD)
SD (TXD)	3		SD (TXD)
DTR (ER)	4		DTR (ER)
SG	5		SG
DSR (DR)	6		DSR (DR)
RS (RTS)	7		RS (RTS)
CS (CTS)	8		CS (CTS)
RI (CI)	9		

(2) Connection example which cannot turn ON/OFF CD signal (No. 1 pin)
 Connection example for exercising DC code control or DTR/DSR control

Serial communication module Side		Cable Connection and Signal Direction (Connection example for full duplex communication)	GX RemoteService-I Side
Signal Name	Pin No.		Signal Name
CD	1		CD
RD (RXD)	2		RD (RXD)
SD (TXD)	3		SD (TXD)
DTR (ER)	4		DTR (ER)
SG	5		SG
DSR (DR)	6		DSR (DR)
RS (RTS)	7		RS (RTS)
CS (CTS)	8		CS (CTS)
RI (CI)	9		

2.1.5 Connection from the Web server module

The following shows the system configuration that can be connected from the Web server module.

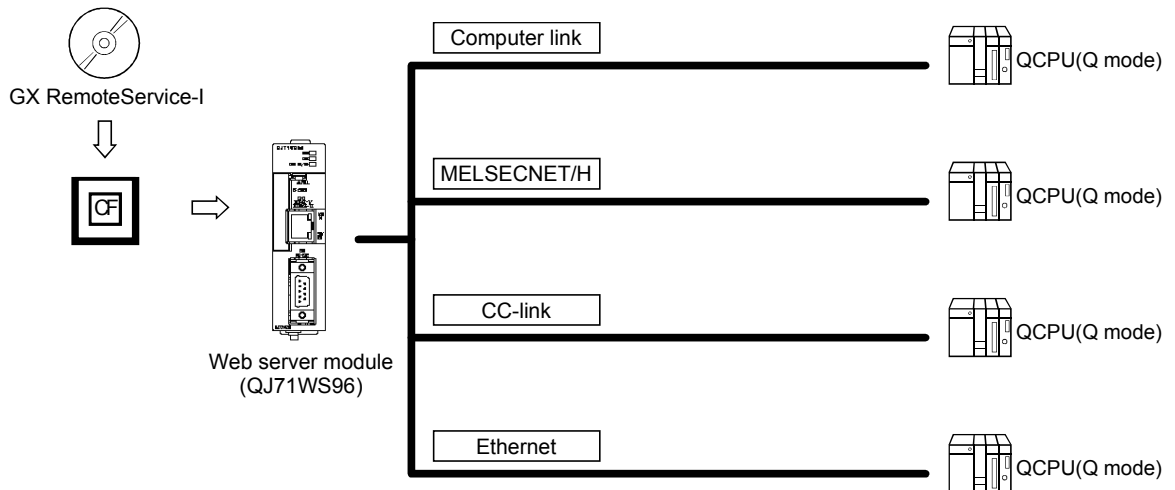

POINT

- For information on the compact flash card (TYPE I storage card that meets CompactFlash™ specifications) supported by the Web server module, please contact your local Mitsubishi representative.
- Make sure to use a compact flash card of 64MB or more for the Web server module.
- Make sure to use the format function of the Web server module to format a compact flash card. For details, refer to the Web server module user's manual.
- When installing GX RemoteService-I into a compact flash card, specify only the compact flash card drive in the destination selection dialog box. Do not add the folder name after the drive name, as this will result in an error.
- The Web server module takes 90 seconds to start, if a compact flash card in which GX RemoteService-I has been installed is set.

2.2 Network Connection Method

2.2.1 Connection configuration

The following describes the methods of connecting a server that uses GX RemoteService-I to network.

Connection method	Device	Automatic acquisition of server IP address	Supplementary explanation
Analogue	Sever ↔ Analogue modem	Possible	
	Sever ↔ Broadband router ↔ Analogue modem	Possible depending on the router	An IP address can be automatically acquired only when a UPnP-compatible router is used. In this case, both variable IP address and fixed IP address are available.
	Sever ↔ Dial-up router	Possible depending on the router	When the router is incompatible with UPnP, only the fixed IP address is available.
Mobile phone	Sever ↔ Modem for mobile phone + Mobile phone	Possible	
DSL	Sever ↔ Bridge type DSL modem	Possible	
	Sever ↔ Broadband router ↔ Bridge type DSL modem	Possible depending on the router	An IP address can be automatically acquired only when a UPnP-compatible router is used. In this case, both variable IP address and fixed IP address are available.
	Sever ↔ Router type DSL modem	Possible depending on the router	When the router is incompatible with UPnP, only the fixed IP address is available.
LAN	Sever ↔ LAN cable (twisted pair)	Possible	

2.2.2 Connection configuration devices

- (1) The following explains the devices to be used to connect a server that includes GX RemoteService-I to network.

Connection method	Devices used	Connection type	REMARK
Analogue line	Analogue modem <ul style="list-style-type: none"> • Hayes AT-command compatible product • Turns DR(DSR) signal ON independently • Meets the QJ71WS96 RS-232 transmission specifications 	Dial-up connection	RS-232C connection (RS-232C standard compliant product)
Mobile phone line	Mobile phone modem	Dial-up connection	RS-232C connection (RS-232C standard compliant product) PCMCIA card connection USB connection
DSL	DSL modem <ul style="list-style-type: none"> • Compatible with the following communication method: PPPoA(RFC2364 standard) or PPPoE (RFC2516 standard) • Compatible with the following communication standard: G.992.1/G992.2 and AnnexA. (For compatible provider, refer to the next page.) 	Continuous connection	LAN cable (twisted pair) connection IEEE802.3, 10BASE-T/100BASE-TX standard compliant product <ul style="list-style-type: none"> • For 10Mbps UTP cable (category 5), STP cable (category 5) • For 100Mbps
LAN	LAN cable (twisted pair)	LAN connection	UTP cable (category 3 or higher), STP cable (category 3 or higher)

- (2) Contract with a provider

Note the following points when making a contract with a provider.

GX RemoteService-I supports the optical communication (optical communication compatible provider and relevant device) as shown below.

- (a) Provider
PPPoE (RFC2516 standard) compatible product only.
- (b) Line terminal device
Product recommended for each provider only.

GX RemoteService-I supports the DSL (DSL compatible provider and relevant device) as shown below.

- (a) Provider
PPPoA (RFC2364 standard)/ PPPoE (RFC2516 standard) compatible product only.
- (b) DSL modem
G.992.1/G992.2 and AnnexA compatible product only.

2.3 Operating Environment

2.3.1 Server (personal computer)

A contract with a provider is required for use of server.

- (1) The following shows the operating environment for personal computer.

Item		Description
Computer main unit		Pentium 200MHz or higher (recommended) IBM-PC/AT-compatible personal computer installed with applicable Windows® . However, a Pentium 300MHz processor or higher is recommended when using Windows® XP Professional.
Required memory		64 MB or more, However, 128 MB or more when using Windows® XP Professional.
Free hard disk area	For installation	100 MB or more
	For operation	100 MB or more
Disk drive		CD-ROM drive
Display		Resolution: 1024 × 768 pixels or higher (XGA or higher)
Operating system *1		Web function-compatible Microsoft® Windows® 98 Microsoft® Windows® 98 Second Edition Microsoft® WindowsNT® Workstation 4.0 *2 Microsoft® Windows® 2000 Professional *2 Microsoft® Windows® XP Professional *2
		MELSOFT connection function-compatible*3 Microsoft® WindowsNT® Workstation 4.0 *2 Microsoft® Windows® 2000 Professional *2 Microsoft® Windows® XP Professional *2
Web browser		Microsoft® Internet Explorer 6.0 or later

*1: This product does not work with Windows® Me and Windows® XP HomeEdition, as the Web server is incompatible.

*2: Administrator privilege is required to install GX RemoteService-I into the following operating systems, WindowsNT® Workstation4.0, Windows® 2000 Professional and Windows® XP Professional. In addition, Administrator privilege is required to use GX RemoteService-I in Windows® XP Professional.

*3: GX Explorer Version 2 is a MELSOFT connection function-compatible software package on the client (personal computer) side.

- (2) The following shows the operating environment for PC CPU module.

Item		Description
Module		PPC CPU686 (MS)
Free hard disk area	For installation	100 MB or more
	For operation	100 MB or more
Disk drive		CD-ROM drive (PPC-CDD-01)
Display		Resolution: 1024 × 768 pixels or higher (XGA or higher)
Operating system		Microsoft® WindowsNT® Workstation 4.0 Microsoft® Windows® 2000 Professional Microsoft® Windows® XP Professional
Web browser		Microsoft® Internet Explorer 6.0 or later

- (3) The following shows the operating environment for Web server module.

Item	Description
Module	QJ71WS96
Compact flash card	64MB or more

Install GX RemoteService-I Version 2 into a compact flash card, and then set it to the Web server module. (Refer to POINT.)

Note that a compact flash card is compatible with the Web server module with first five digits of serial number "05112" or later.

Check the serial number as shown below.

- (a) At SERIAL section in the rating plate, which is situated on the side of module.

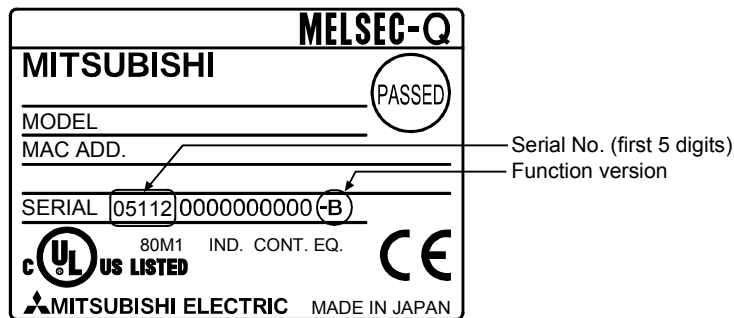

- (b) Using GX Developer or GX Explorer. The serial number is shown in "Product Information" or "Module's Detailed Information" screen.

- "Product Information" screen
 [Diagnostics] – [System Monitor] – Product Information
- "Module's Detailed Information" screen
 [Diagnostics] – [System Monitor] – Module's Detailed Information

For details of operation method, refer to the operating manual of each software package.

POINT

- For information on the compact flash card (TYPE I storage card that meets CompactFlash™ specifications) supported by the Web server module, please contact your local Mitsubishi representative.
- Make sure to use the format function of the Web server module to format a compact flash card. For details, refer to the Web server module user's manual. Note that formatting deletes all files. When deleting GX RemoteService-I-relevant files only, delete the following folder and files.
 ¥SYSTEM (Delete of both folder and files), ADDIN.KEY, STARTUP.KEY, IJE.CMD, STARTUP.CMD
- When installing GX RemoteService-I into a compact flash card, double-click "SETUP. EXE" within the CD-ROM and proceed to install according to the displayed screen. Specify only the compact flash PC card drive in the destination selection dialog box, and do not add the folder name after the drive name, as this will result in an error.
- The Web server module takes 90 seconds to start, if a compact flash card in which GX RemoteService-I has been installed is set.

IMPORTANT

A Web server software must be installed to use the Web function.

Make sure that the Web server software is compatible with the operating system (OS) before installation.

For installation method, refer to Chapter 5.

The following shows the applicable Web server software.

Operating system (OS)	Compatible software
Microsoft® Windows® 98	Personal Web Server Version 4.0 or later
Microsoft® WindowsNT® Workstation 4.0	Peer Web Service Version 4.0 or later
Microsoft® Windows® 2000 Professional Microsoft® Windows® XP Professional	Internet Information Server Version 5.0 or later

- Web server software other than above is inapplicable.
- Windows® 98, Windows® 2000 and Windows® XP must be set up at the time of installation.
- Set up WindowsNT® 4.0 when installing Service Pack 3 or later and Option Pack. (WindowsNT® 4.0 Service Pack 3 or later and Option Pack are available by downloading them from the Microsoft Corporation home page or by CD-ROM sending service.)
- Refer to the help function of Windows® for the installation method and others of the server software.

POINT

- Permission of access to folders and files
Use of this product may change the files within the installation destination folder and sub folders.
Therefore, the user must be granted write access to these folders and files, if either of the following operating systems is used.
Without this setting, product may not operate correctly.
Microsoft® Windows® XP Professional
Microsoft® Windows® 2000 Professional
Microsoft® WindowsNT® Workstation 4.0
It is recommended to log on as an administrators group user, who is granted to control the computer, to use this product.
- New functions of Windows® XP
Note that this product may not operate correctly when any of the following new Microsoft® Windows® XP Professional functions is used, as they are unsupported.
Compatibility mode (The application supported by earlier version of Windows is run using this mode.)
Fast user switching
Remote desktop
Desktop themes change (Larger font is selected.)

2.3.2 Personal computer

The necessary environment is as follows.

Used Device	Description
When using a personal computer.	Personal computer where the Web browser has been installed (Microsoft® Corporation's Internet Explorer 5.5 or later or Netscape Communication Corporation's Netscape Communicator 4.5 or later)
When using a mobile phone.*1	i mode compatible mobile phone J-Sky compatible mobile phone Ezweb compatible mobile phone

*1: This product can be used only in Japan.

- You need to make a contract with a provider.

3. FUNCTION LIST

The following provides lists of setting items for the server (personal computer) and for personal computer.

3.1 Server (Personal Computer) Function List

The following table lists the functions to be set on the server (personal computer).^{*1}

Function Name	Description	Necessity of setting/operation		Reference
		For Web function	For MELSOFT connection	
Operating mode	Sets the automatic or manual operation mode.	○	×	Chapter 6
Starts AUTO drive	Starts the continuous monitoring of devices in the automatic operation mode.	△	×	Section 6.2
Dial-up execute	Makes dial-up connection to connect with the Internet.	○	×	
URL copy	Copies the URL of the server (personal computer).	—	—	
Send e-mail	Sends e-mail created with GX RemoteService-I.	○	×	
Product information	Displays the version and others of the product.	—	—	
Security setting	Makes settings related to the security for server access.	○	△	Section 6.3.1
E-mail setting	Makes settings related to e-mail (mail server, account name, etc.). Also creates a message for manual operation.	○	×	Section 6.3.2
Network setting	Sets the connection type, HTTP port number for MELSOFT connection and HTTP port number for Web facility.	○	○	Section 6.3.3
PLC type selection	Selects the PLC type of the PLC to be monitored on the personal computer.	○	×	Section 6.3.4
Transfer setup	Selects the path of the PLC to be monitored on the personal computer.	○	×	Section 6.3.5
Device range setting	Makes settings related to the device to be monitored on the personal computer.	○	×	Section 6.3.6
Tag setting	Makes setting for handling the read devices as tags.	○	×	Section 6.3.7
Auto drive setting	Sets the device to be monitored continuously in the automatic operation mode.	○	×	Section 6.3.8
Dev. disp. setting	Changes the display format of the screen displayed on the personal computer.	○	×	Section 6.3.9

○ : Necessary
 × : Unnecessary
 △ : Might be necessary
 — : Irrelevant

*1: For the Web function and MELSOFT connection, refer to Chapter 8 and 9.

3.2 Personal Computer Side Function List

3.2.1 Monitor functions

The following table lists the functions to be set with the personal computer.

Reference	Description	Reference
Tag display	Performs one-shot monitoring of the tag set on the server (personal computer) side.	Section 7.2
Transfer setup	Sets the PLC series, PC side I/F, PLC side I/F and other station.	Section 7.1
Device display	Device range setting	Sets the device to be monitored.
	Device comment search	Makes a device comment search.
	Word (Dec)	Displays devices in a word multi-point decimal format.
	Word (Hex)	Displays devices in a word multi-point hexadecimal format.
	Bit	Displays devices in a bit multi-point format.
	Comment Dec	Displays devices in a commented decimal format.
	Comment Hex	Displays devices in a commented hexadecimal format.
	Comment Bin	Displays devices in a commented binary format.
		Section 7.3

3.2.2 Functions to cut off server (personal computer) line from personal computer

The following table lists the functions that disconnect the server (personal computer) line from the personal computer.

Reference	Description	Reference
Server Side Circuit Settings Time to disconnect the circuit	Sets the server (personal computer) line disconnection timer.	Section 7.4
Server side dial-up disconnect execution	Disconnects the server (personal computer) line.	

4. PRE-OPERATION SETTINGS AND PROCEDURES

This chapter explains the setting items and procedures necessary for the server (personal computer) and personal computer.

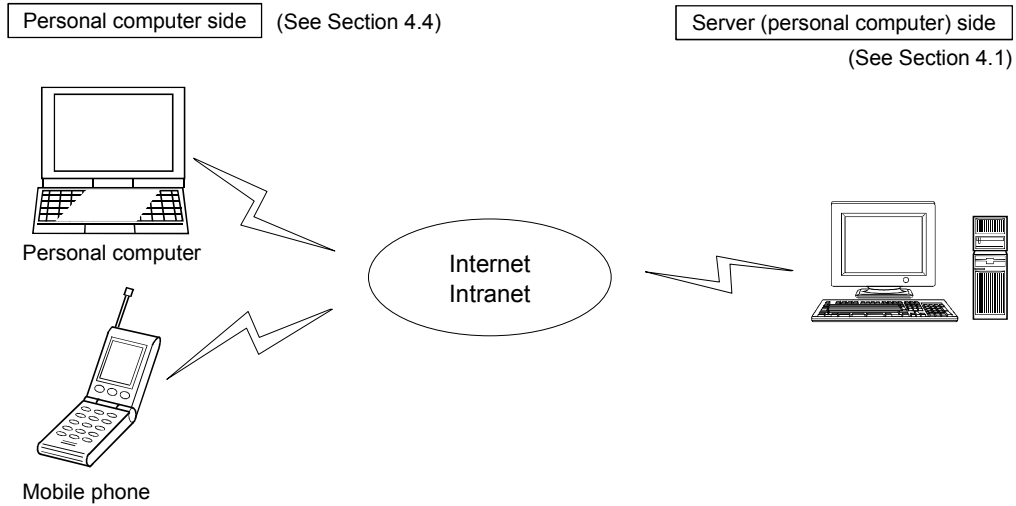

4.1 Server (Personal Computer) Setting Procedure

This section explains the procedure for setting the server (personal computer).

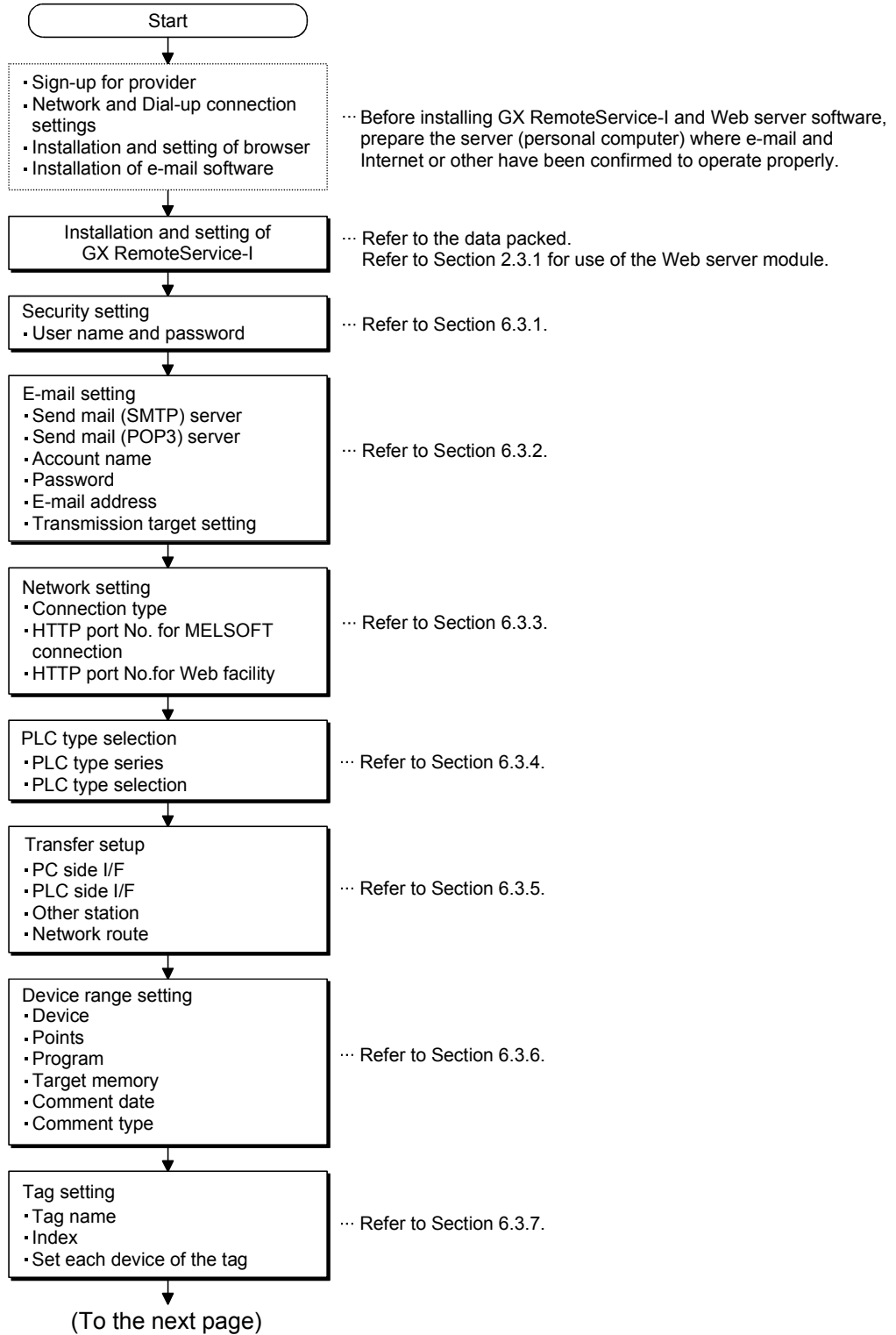

(From the previous page)

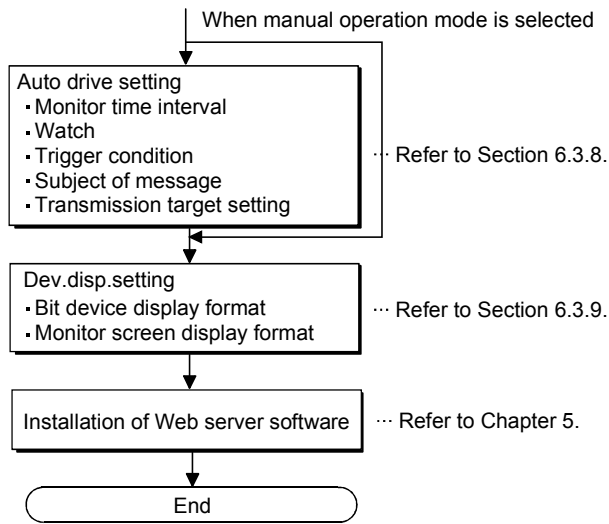

4.2 INSTALLATION AND UNINSTALLATION

This chapter explains how to install and uninstall the product.

4.2.1 Installation

Install the product according to the following procedure.

(1) Installing Procedure

Install any of GX RemoteService-I in the following procedure.

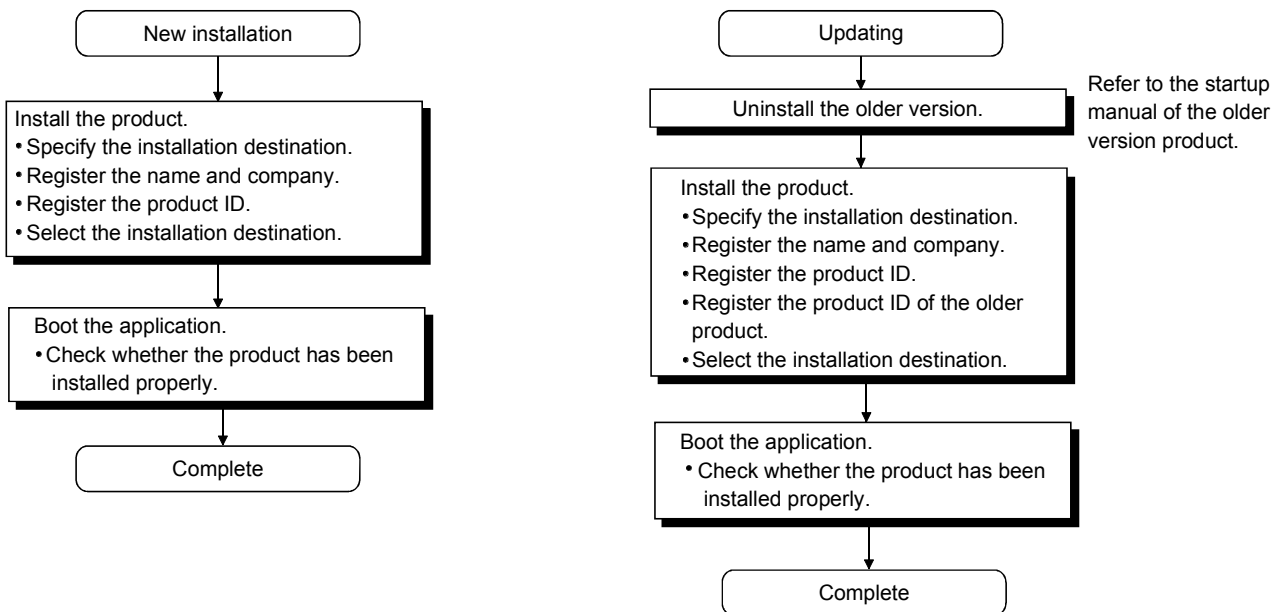

POINT

If the DLL overwrite confirmation message appears during installation, choose "Yes" to overwrite the DLLs.
If they are not overwritten, GX Developer may not be run properly.

(2) Installing the product

Before starting installation, confirm the following.

POINT
<ul style="list-style-type: none"> • Terminate all the other applications running under Microsoft® Windows® Operating System before installation. • When using Windows® XP Professional, Windows® XP Home Edition, Windows® 2000 Professional or Windows NT® Workstation 4.0, logon as a user who has the attributes of an administrator (for computer management).

(The screens of Windows® 2000 are used in the explanation.)

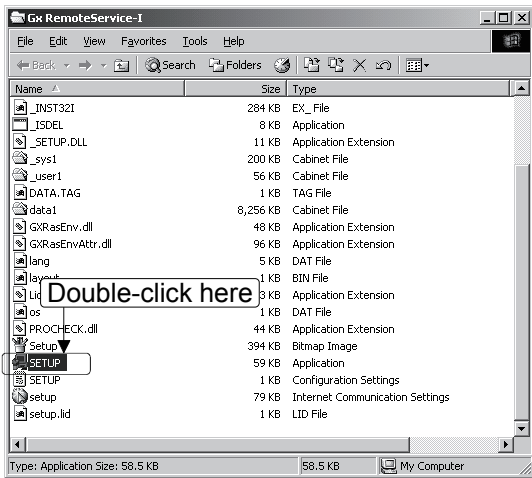

- 1) Start Windows® Explorer and click the drive in which the disk has been inserted. Double-click "Setup.exe". In the case of Windows® 2000 Professional, right-click [Start] and select [Explorer].

- 2) If either of the following messages appears, perform operation as shown below.

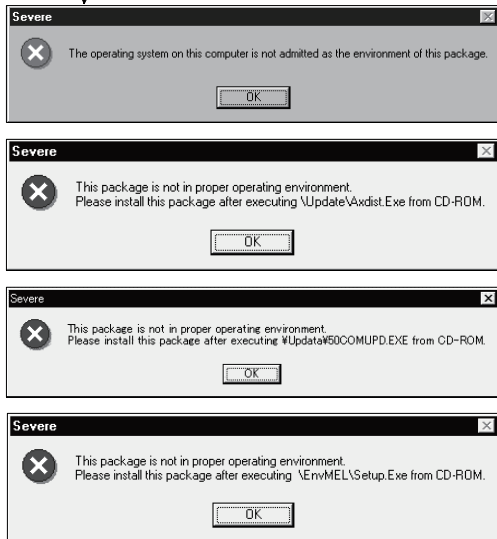

Message	Reference
The operating system on this computer is not admitted as the environment of this package.	(a) in "When a message appears at start of installation" of this section.
This package is not in proper operating environment. Please install this package after executing \Update\Axdist.Exe from CD-ROM.	(b) in "When a message appears at start of installation" of this section.
This package is not in proper operating environment. Please install this package after executing \Update\50COMUPD.EXE from CD-ROM.	(c) in "When a message appears at start of installation" of this section.
This package is not in proper operating environment. Please install this package after executing \EnvMEL\Setup.Exe from CD-ROM.	(d) in "When a message appears at start of installation" of this section.

(To the next page)

- 3) As the installation destination selection screen appears, select the installation destination according to the screen.

(From the previous page)

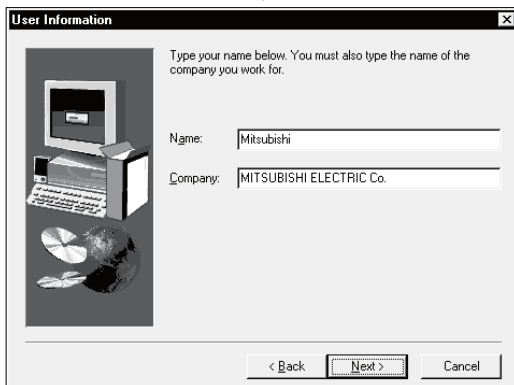

- 4) Type the name and company, and click **Next>**.
As the confirmation dialog box appears, perform operation in accordance with the message.

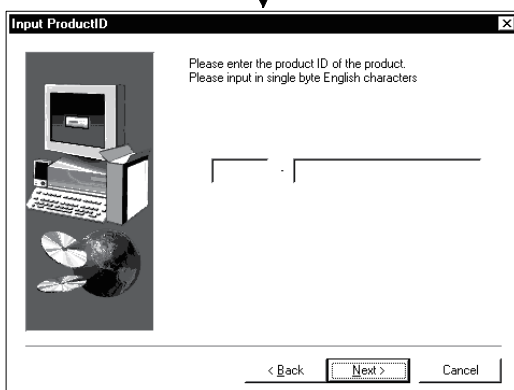

- 5) Type the product ID and click **Next>**.
The product ID is described on the "License agreement" included in the product.

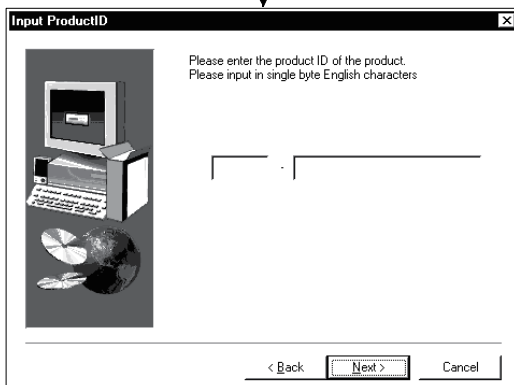

- 6) When the product is to be updated, the screen shown on the left appears. Type the product ID of the older product and click **Next>**.
The product ID is described on the "Software Registration Card" or "License agreement" included in the older product.

When the product is to be installed anew, the screen shown on the left does not appear.

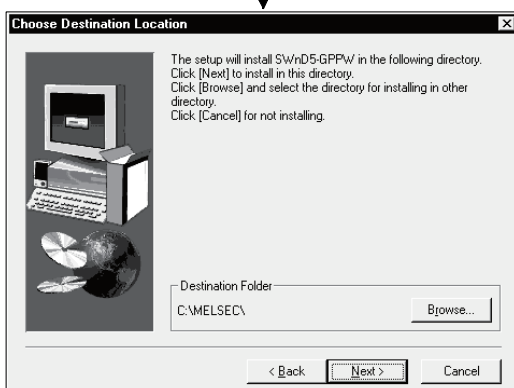

- 7) Specify the installation Destination Folder.
If the installation Destination Folder displayed is correct, click **Next>**.

If you change the destination folder, click **Browse** and specify a new drive and folder.

(To the next page)

(From the previous page)



8) This completes installation.
Click **OK**.

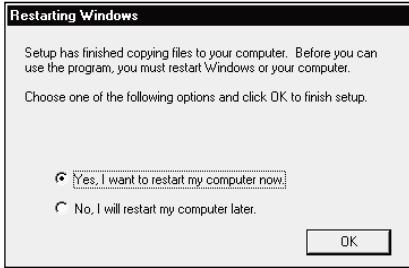

9) Windows® must be rebooted if the screen shown on the left appears.

Installation of GX RemoteService-I registers the icon as shown below.

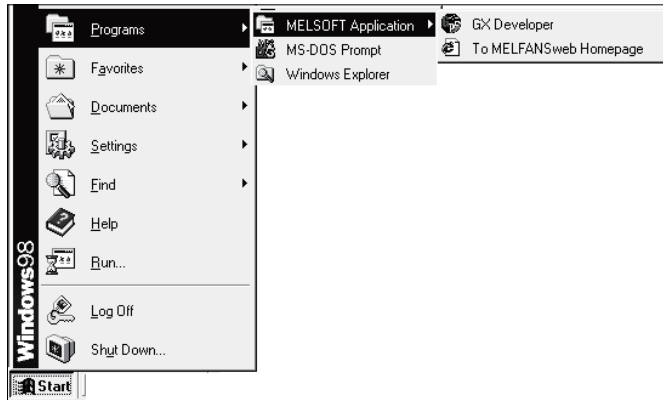

When a message appears at start of installation

In some cases, a message may appear at installation of this product, resulting in the installation failure.

If this occurs, make sure to close all running applications, and carry out either of the operations (a) to (d).

- (a) Supported operating system
This product does not support Windows® 95.
Reinstall this product into the personal computer in which the supported operating system has been installed.
- (b) Installation of Jaaxdist.exe
Use "Update/Jaaxdist.exe" within this product (CD-ROM) to update Windows® .
Execute Jaaxdist.exe included within this product (CD-ROM). Then, restart the personal computer and install this product.
The following shows the exe files to be executed for each operating system.

Supported operating system	File name
Microsoft® Windows® 98	JaaxDist.exe
Microsoft® Windows® 98 Second Edition	
Microsoft® Windows NT® Workstation 4.0	

(JaaxDist.exe is included in "Update" folder, which is within this product, CD-ROM.)

(c) Installation of 50comupd.exe

This section explains the updating operation of Windows® using "Update\50comupd.exe" on the CD-ROM.

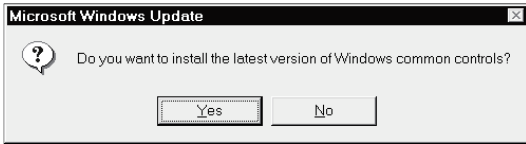

1) Click the **Yes** button to start updating Windows.



2) Accept the agreement on the left screen and click the **Yes** button.

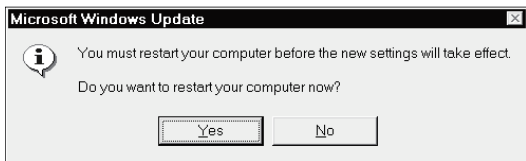

3) Click the **Yes** button to restart the personal computer. After the personal computer is restarted, start the installation operation from step (2) 1).

(d) Installation of EnvMEL

Execute Setup.exe in the "EnvMEL" folder on this product CD-ROM. Install GX Developer after executing the "Setup.exe".

After executing the above exe file, install the product again. If this product is not installed properly at this time, reboot the personal computer.

4.2.2 Uninstallation

This section explains deleting this product from the hardware.

Uninstallation of the product

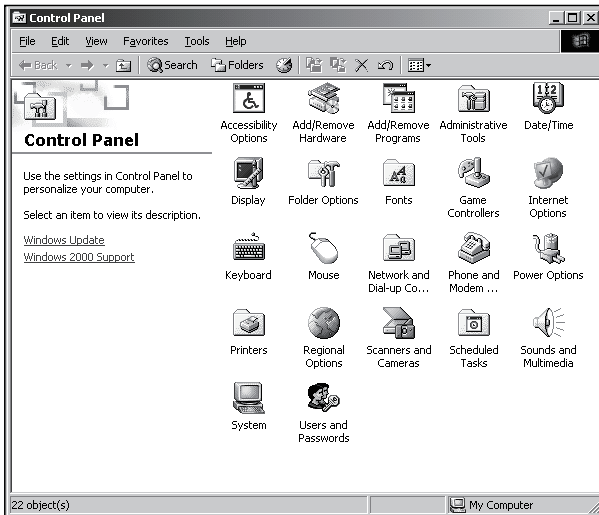

- 1) Select [Start] – [Settings] – [Control Panel]. Then, select and double-click "Add/Remove Programs" in the Control Panel.

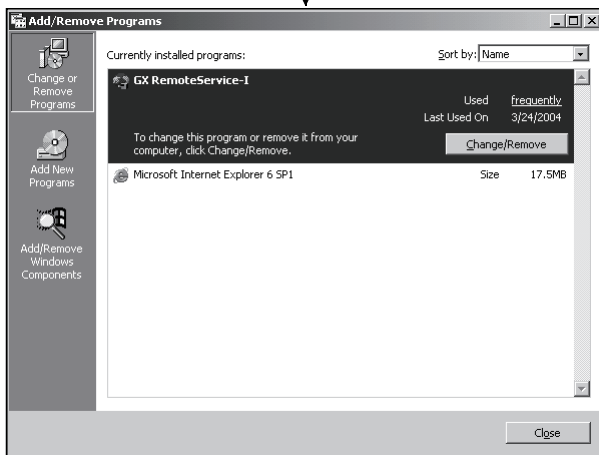

- 2) Select "GX RemoteService-1". Then, click the **Add/Remove** button. The screen shown on the left is the one for Windows® 2000 Professional. The displayed screen varies with the operating system.

When using Windows® 2000 Professional perform the following operation.

- (a) Click **Change/Remove Programs**.
- (b) Click "GX Configurator-AP".
- (c) Click the **Change/Remove**.

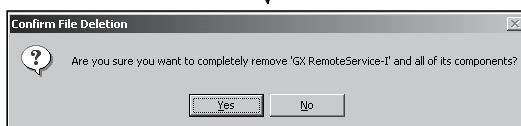

(To the next page)

- 3) Check whether you will remove the software package or not. When uninstalling it, click **Yes**. Uninstallation starts. When not uninstalling it, click **No**. This returns to the preceding screen.

* Components indicate the icons and files installed.

(From the previous page)

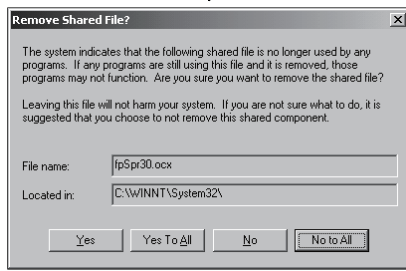

- 4) If the left screen has appeared, click the **No To All** button.

If you click the **Yes** or **Yes To All** button, the shared file of the Windows® compatible MELSOFT software is removed. Therefore, click the **No To All** button when removing GX RemoteService-I only.

POINT

If files common to MELSOFT products are deleted, a MELSOFT product may be unusable.

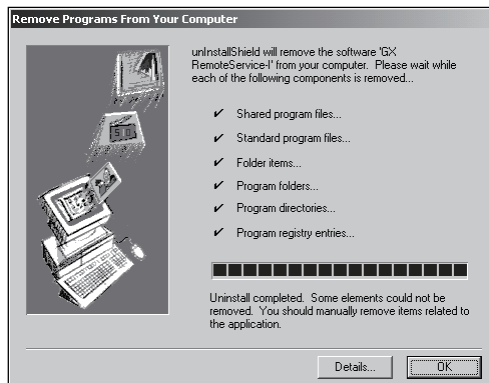

- 5) Click the **OK** button when the message indicating the end of removal has appeared.

When the message indicating completion has appeared, uninstallation is complete.

4.3 Installing the USB Driver

When Windows® 2000 Professional, Windows® XP Professional and Windows® XP Home Edition is used, the USB driver must be installed to make CPU USB communication.

The following is the USB driver installation procedure.

POINT

If the USB driver cannot be installed, check the following setting.

- When Windows® 2000 Professional is used
If you have selected "Block-Prevent installation of unsigned files" after [Control Panel] - [System] - [Hardware] - [Driver Signing], the USB driver may not be installed.
Choose "Ignore-Install all files, regardless of file signature" or "Warn-Display a message before installing an unsigned file" for [Driver Signing], and install the USB driver.
- When Windows® XP Professional or Windows® XP Home Edition is used
If you have selected "Block-Never install unsigned driver software" after [Control Panel] - [System] - [Hardware] - [Driver Signing], the USB driver may not be installed.
Choose "Ignore-Install the software anyway and don't ask for my approval" or "Warn-Prompt me each time to choose an action" for [Driver Signing], and install the USB driver.

[1] When Windows® 2000 Professional is used

The following indicates the procedure for installing the USB driver when using Windows® 2000 Professional.



(To the next page)

- 1) The screen shown on the left appears when you connect the personal computer and QCPU (Q mode) by the USB cable.
Click the **Next>**.

(From the previous page)



- 2) Choose "Search for a suitable driver for my device (recommended)" and click the **Next>**.



- 3) Check "Specify a location" and click the **Next>**.



- 4) As the screen on the left appears, set the GX Developer installation destination "Easysocket\USBdrivers" and click the **OK**.

The screen shown on the left shows the example of setting C:\MELSEC\Easysocket\USBdrivers. If volume MELSOFT products have been installed, browse the installation destination of the first product.



- 5) The screen on the left appears to indicate completion of installation. Click the **Finish>** to terminate installation.

(Completion)

[2] When Windows® XP Professional and Windows® XP Home Edition is used

The following indicates the procedure for installing the USB driver when using Windows® XP Professional or Windows® XP Home Edition.



- 1) The screen shown on the left appears when you connect the personal computer and QCPU (Q mode) by the USB cable. Choose "Install from a list or specific location [Advanced]" and click the **Next>**.



- 2) As the screen on the left appears, choose "Include this location in the search". Check "Include this location in the search" and set "Easysocket\USBDrivers" of the folder where GX Developer was installed. After setting, click the **Next>**.

The screen shown on the left shows the example of setting C: \MELSEC\Easysocket\USBDrivers. If volume MELSOFT products have been installed, browse the installation destination of the first product.

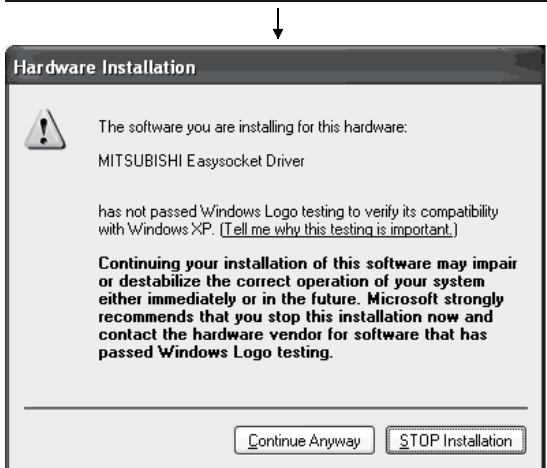

- 3) As the screen on the left appears, click the **Continue Anyway**

REMARK

Though the screen on the left appears during installation of the USB driver, we have confirmed that the USB driver operates properly using Windows® XP Professional or Windows® XP Home Edition. (No problem will occur after installation of the USB driver.)

Click **Continue Anyway** to continue the installation of the USB driver.

(To the next page)

(From the previous page)



(Completion)

- 4) The screen on the left appears to indicate completion of installation.
Click the **Finish** to terminate installation.

4.4 Personal Computer Setting Procedure

This section explains the items to be set on the personal computer.
When making access from the personal computer to the server (personal computer),
make a contract to use the Internet with the personal computer.

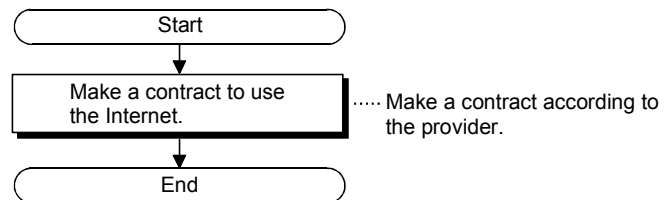
**POINT**

Refer to Section 2.3.2 for the environment of the usable personal computer.

5. INSTALLATION OF WEB SERVER SOFTWARE

For installation and uninstallation operations of this product (GX RemoteService-I), refer to "Method of installing the MELSOFT Series" included in the product.

5.1 Windows® 98

The following indicates how to set up the Web server.

(Start)

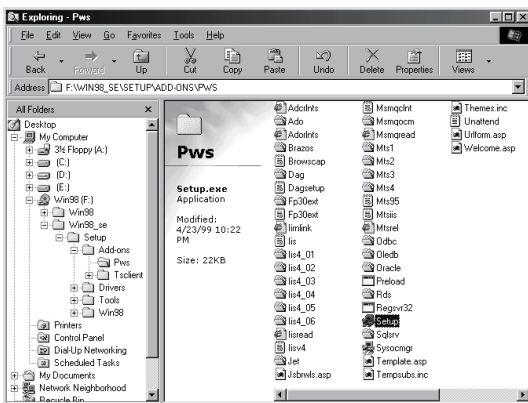

- 1) Set the CD-ROM included with the used server (personal computer) into the CD-ROM drive and execute Setup.exe.
Installation starts.
If the above file is not found on the CD-ROM, the installer is stored in \Windows\Options\Cabs \Pws in the drive where Windows® 98 has been installed. (Screen shown on the left)

5

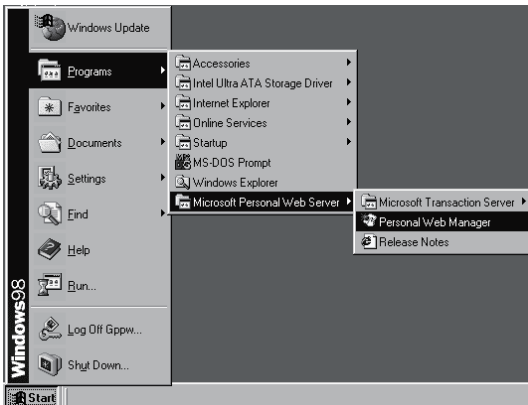

- 2) Choose [Programs] - [Microsoft Personal Web Server] - [Personal Web Manager].

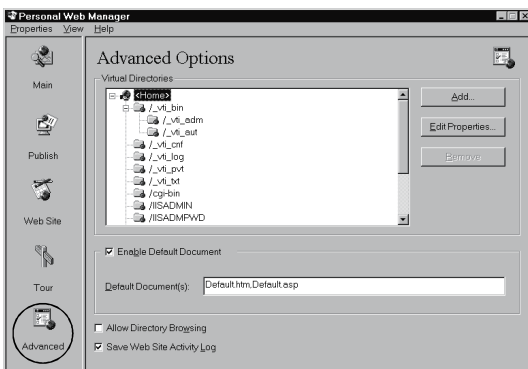

- 3) As the screen on the left appears, click [Advanced].

(To the next page)

(From the previous page)

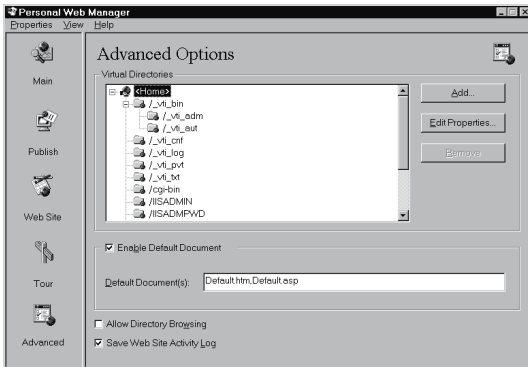

4) Choose Home from the Virtual Directories and click the **Add** button.

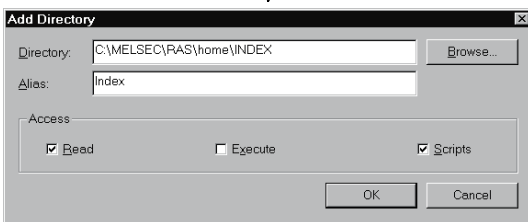

5) As the Add Directory dialog box appears, make the following settings.
 Directory: Specify "C:\MELSEC\RAS\home\INDEX". (When you changed the installation destination folder at the installation of GX RemoteService-I, specify the folder.)
 Alias: Enter "Index".
 Access: Enable "Read" and "Scripts".
 Click the **OK** button.

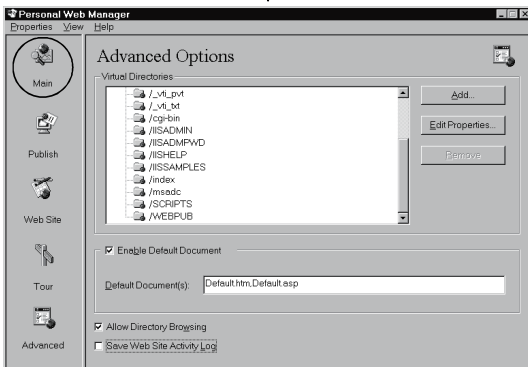

6) An alias (index) is added to the virtual directory. Click [Main] after confirming that the alias has been added.

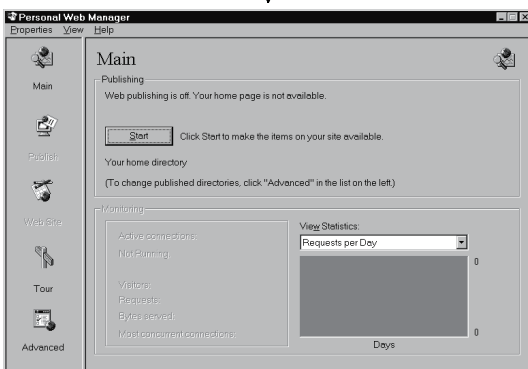

7) Click the **Start** button in the "Publishing" list.

(Completion)

POINT

If you have added the alias with Web issue ON, stop Web issue once and click the **Start** button again to turn Web issue ON.

5.2 Windows NT® 4.0

The following indicates how to set up the Web server.

(Start)

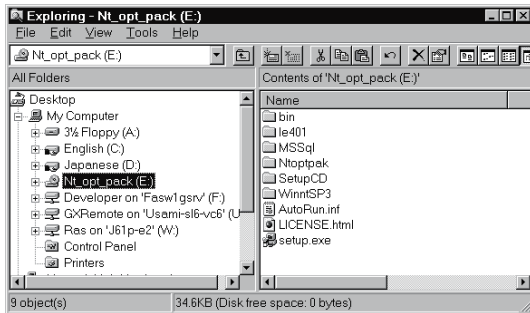

- 1) Set the CD-ROM included with the used server (personal computer) into the CD-ROM drive and execute setup.exe.
Installation starts.

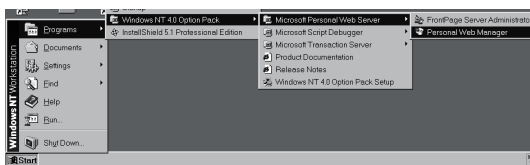

- 2) Choose [Programs] - [Windows NT 4.0 Option Pack] - [Microsoft Personal Web Server] - [Personal Web Manager].

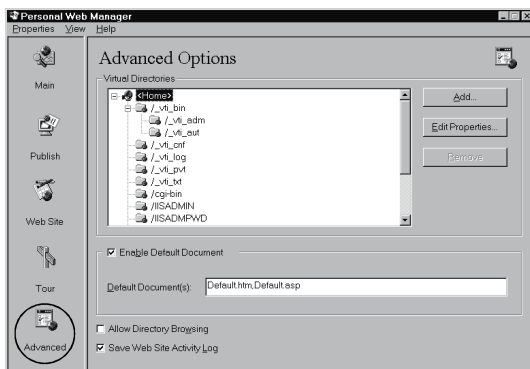

- 3) As the screen on the left appears, click [Advanced].

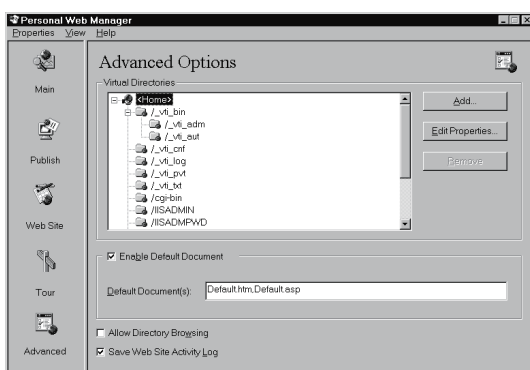

- 4) Choose Home from the Virtual Directories and click the **Add** button.



(To the next page)

(From the previous page)

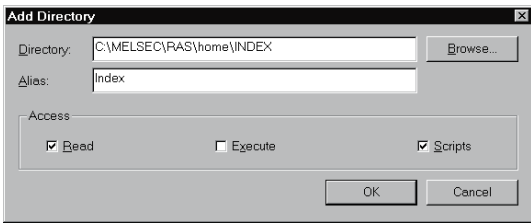

- 5) As the Add Directory dialog box appears, make the following settings.
 Directory: Specify "C:\MELSEC\RAS\home\INDEX". (When you changed the installation destination folder at the installation of GX RemoteService-I, specify the folder.)
 Alias: Enter "Index".
 Access: Enable "Read" and "Scripts".
 Click the **OK** button.

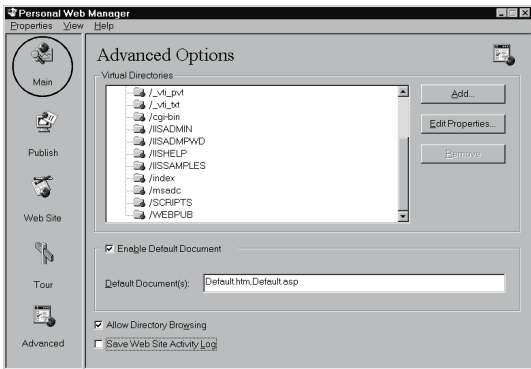

- 6) An alias (index) is added to the virtual directory. Click [Main] after confirming that the alias has been added.

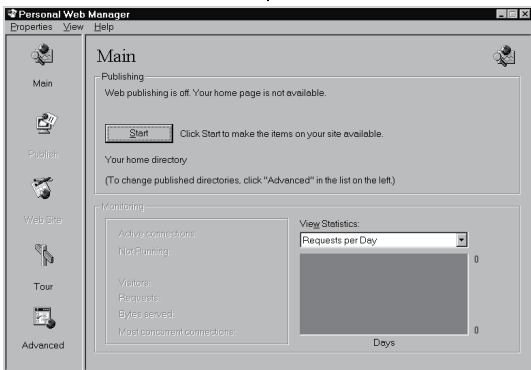

- 7) Click the **Start** button in the "Publishing" list.

(Completion)

5.3 Windows® 2000 (Professional)

The following indicates how to set up the Web server.

(Start)

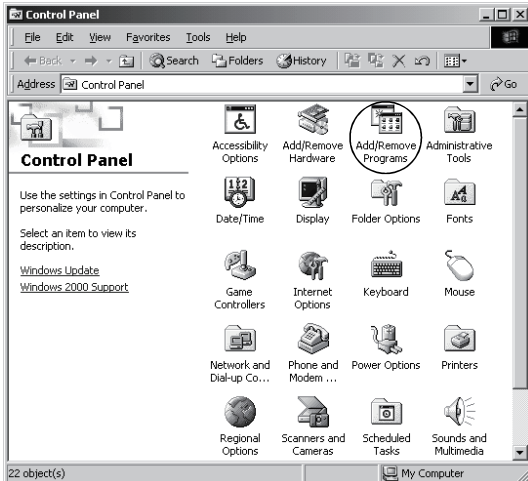

- 1) Set the CD-ROM included with the used server (personal computer) into the CD-ROM drive and open [Add/Remove Programs] from [Control panel].

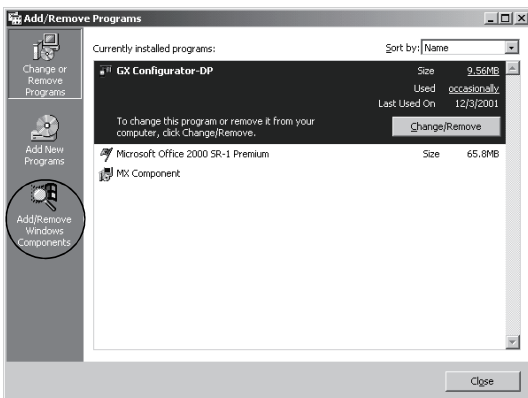

- 2) Click [Add/Remove Windows Components].

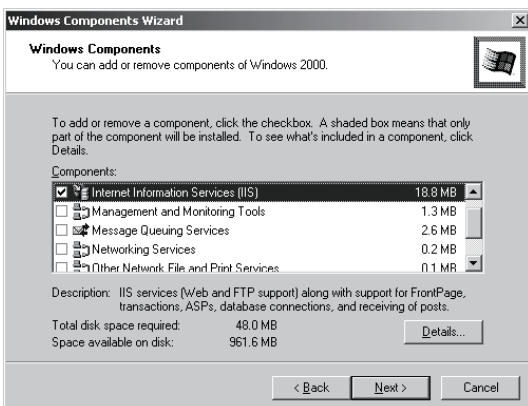

- 3) Since the Windows Components Wizard screen starts, enable [Internet Information Service (IIS)] and click the button. (Installation starts. Installation ends when the completion screen appears.)



(To the next page)

(From the previous page)

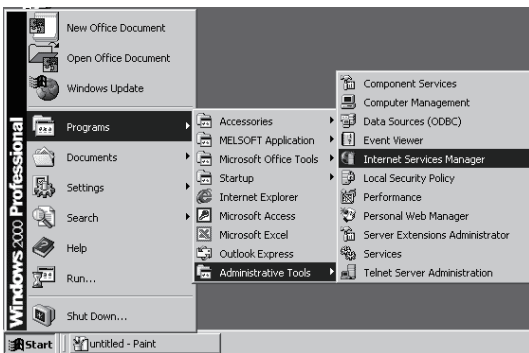

- 4) Choose [Start] - [Programs] - [Administrative Tool] - [Internet Services Manager]. Since [Administrative Tool] in the Start menu is hidden by default on Windows® 2000, display it in the following operation method.

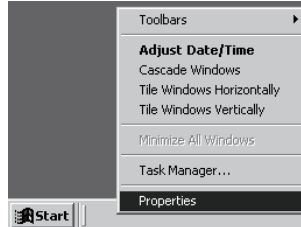

Right-click on the taskbar to display the above menu, and choose [Properties]. Enable "Display Administrative Tools" in the [Taskbar and Start Menu Properties].

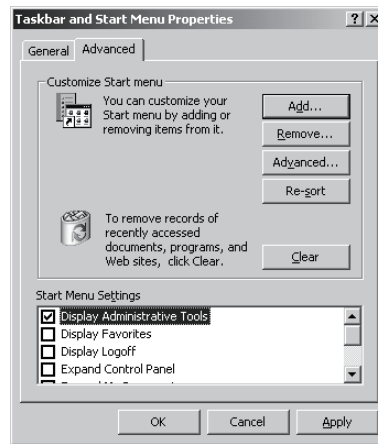

Internet Service Manager starts.

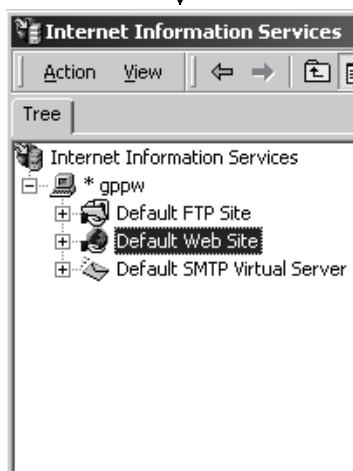

- 5) On the screen shown on the left, choose [Default Web Site] and right-click to choose [New] - [Virtual Directory].

(To the next page)

(From the previous page)



6) Virtual Directory Creation Wizard starts.

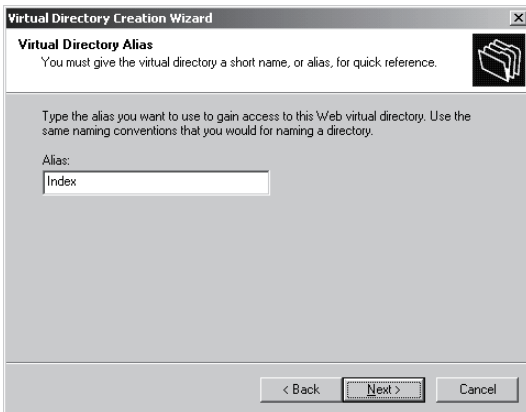

7) Enter "Index" in [Alias] and click the **Next>** button.

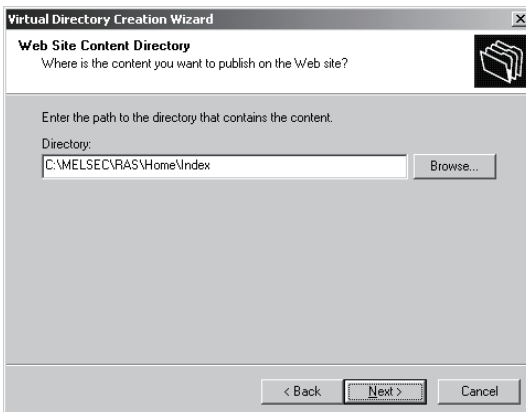

8) Enter "C:\MELSEC\RAS\Home\Index" in [Directory] and click the **Next>** button.

(When you changed the installation destination folder at the installation of GX RemoteService-I, specify the folder.)



(To the next page)

(From the previous page)

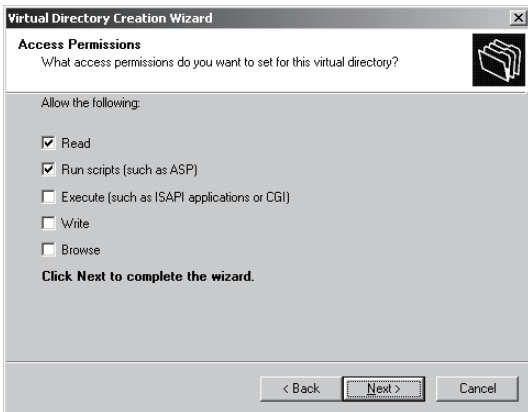

9) Check "Read", "Run scripts (such as ASP)" and click the **Next>** button.



10) The virtual directory creation has been completed as the screen shown on the left appears. Click the **Finish** button to finish the wizard.



(Completion)

5.4 Windows® XP (Professional)

The following indicates how to set up the Web server.

(Start)

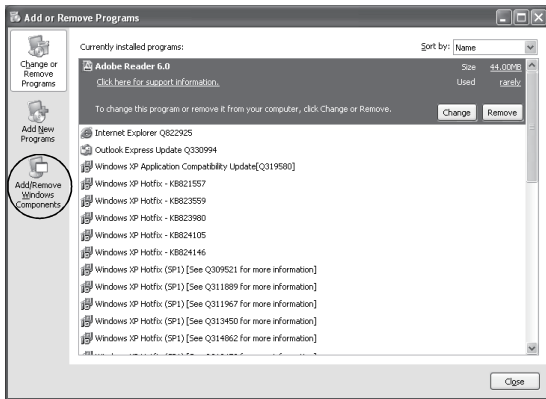

- 1) Select [Start] – [Control Panel] – [Add/Remove Programs] to display "Add/Remove Programs" screen.

Click "Add/Remove Windows Components" icon, which is situated in the left of the screen.

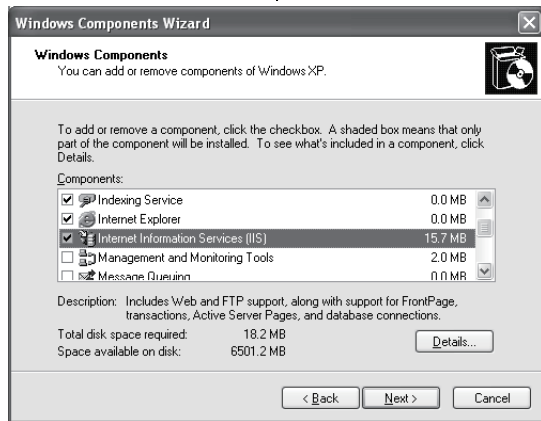

- 2) Check [Internet Information Service (IIS)].

When installing IIS with the default setting, click the **Next>** button and proceed to step 6.

When setting which sub components will be installed or not, click the **Details** button with [Internet Information Service (IIS)] checked, and proceed to step 3.

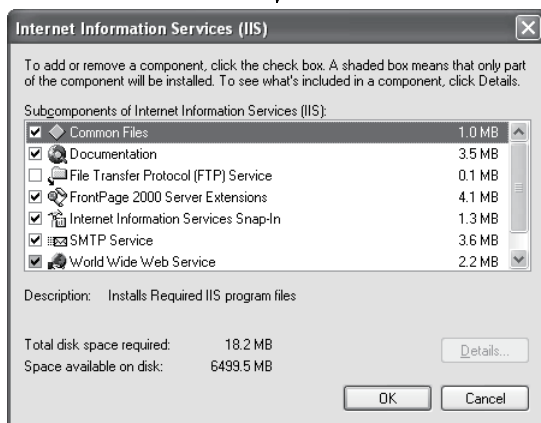

- 3) [Make the settings if necessary.]
Select which sub components will be installed or not by checking or unchecking the corresponding boxes, respectively.

After the settings are completed, click the **OK** button to return to step 2.

"SMTP Service" and "WWW (World Wide Web) Service" include respective sub components. When selecting which sub components will be installed or not, click the **Details** button.

When setting "SMTP Service" sub components, proceed to step 4; "WWW (World Wide Web) Service" sub components, step 5.

(To the next page)

(From the previous page)

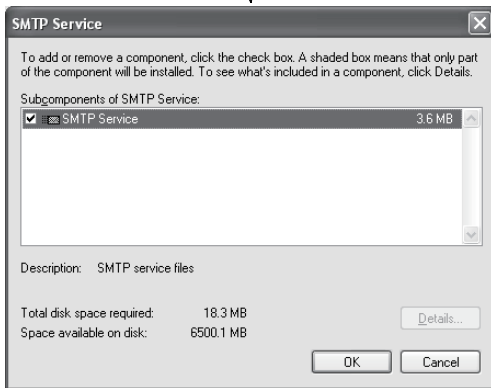

- 4) [Make the settings if necessary.] Set which sub components will be installed or not by checking or unchecking the corresponding boxes, respectively.

For details of sub components, refer to Description section.

After the settings are made, click the **OK** button to go back to step 3.

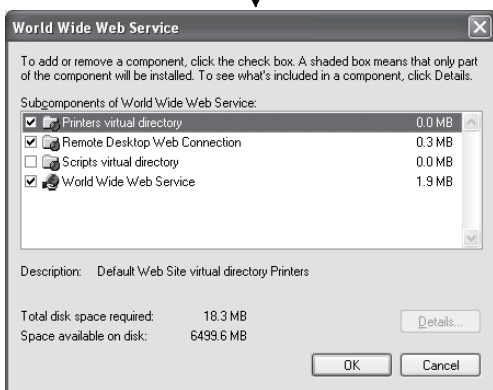

- 5) [Make the settings if necessary.] Set which sub components will be installed or not, by checking or unchecking the corresponding boxes, respectively.

For details of sub components, refer to Explanation section.

After the settings are made, click the **OK** button to go back to step 3.

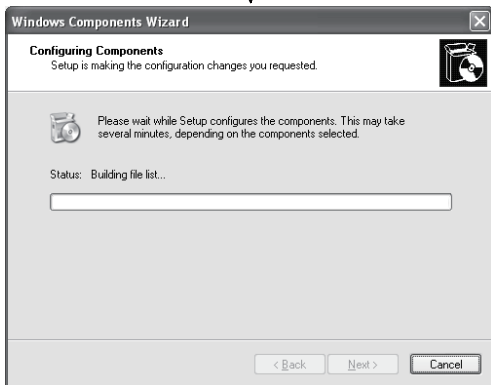

- 6) Clicking the **Next>** button at step 2 displays the left screen and installation of IIS will be started.



- 7) If the installation of IIS is completed, the left screen appears. Click the **Finish** button to close Windows Components Wizard screen.

(To the next page)

(From the previous page)

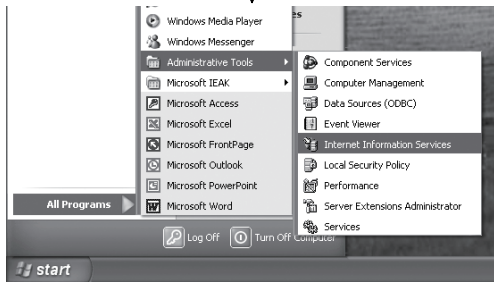

- 8) Choose [Start] - [Programs] - [Administrative Tools] - [Internet Information Services].
 Since [Administrative Tools] in the Start menu is hidden by default on Windows® XP, display it in the following operation method.

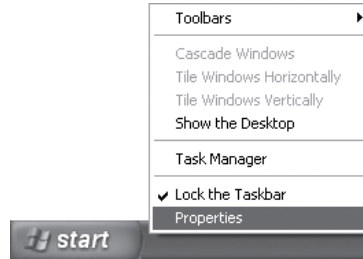

Right-click on the taskbar to display the above menu, and choose [Properties].

Click the [Customize] button in the <Start Menu> tab of the [Taskbar and Start Menu Properties].

Choose "Display on the All Programs menu and Start menu" in the [Customize Start Menu].

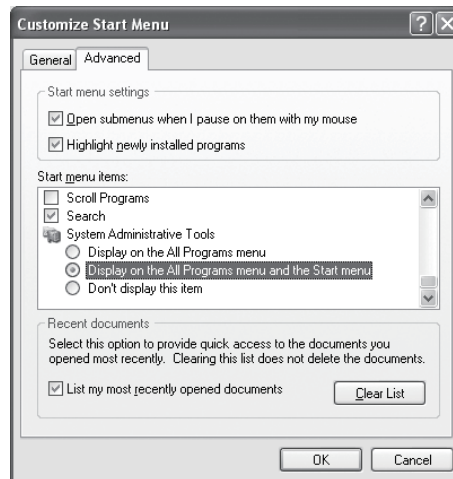

Internet Information Services starts.

- 9) On the screen shown on the left, choose [Default Web Site] and right-click to choose [New] - [Virtual Directory].

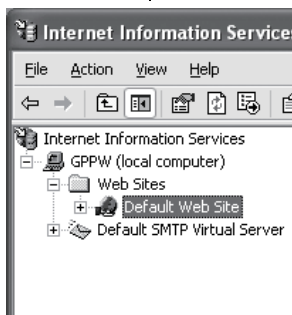

(To the next page)

(From the previous page)



10) Virtual Directory Creation Wizard starts.

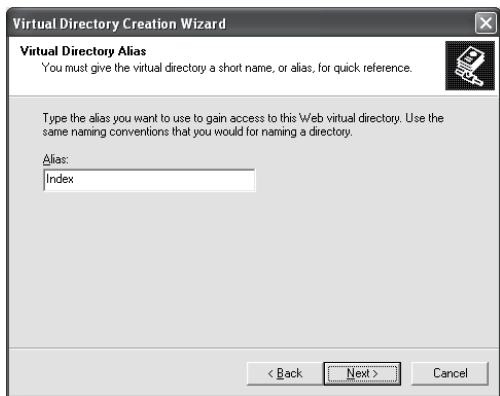

11) Enter "Index" in [Alias] and click the **Next>** button.

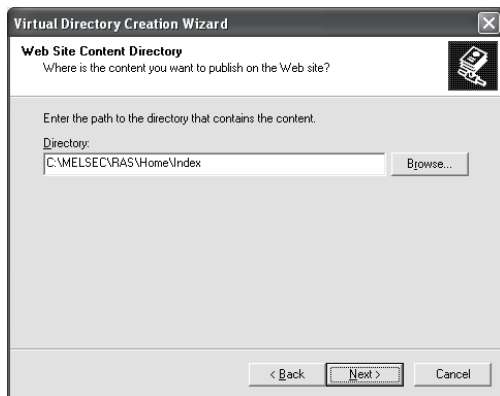

12) Enter "C:\MELSEC\RAS\Home\Index" in [Directory] and click the **Next>** button.

(When you changed the installation destination folder at the installation of GX RemoteService-I, specify the folder.)

(To the next page)

(From the previous page)

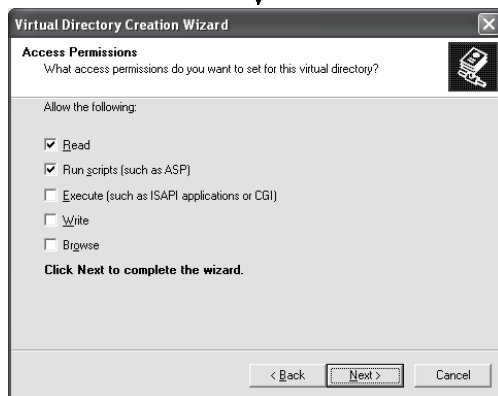

- 13) Check "Read" and "Run scripts (such as ASP)", and click the **Next>** button.



- 14) The virtual directory creation has been completed as the screen shown on the left appears. Click the **Finish** button to finish the wizard.

(Completion)

6. SETTING THE GX RemoteService-I FUNCTIONS

This chapter explains the function settings to be made on the server (personal computer).

You may make each setting as desired, but using the Wizard allows you to make settings easily.

Refer to Chapter 4 for the setting items and procedures.

Starting GX RemoteService-I displays the following screen.

Refer to Section 6.2 and Sections 6.3.1 to 6.3.9 for detailed explanation of the corresponding setting screens.

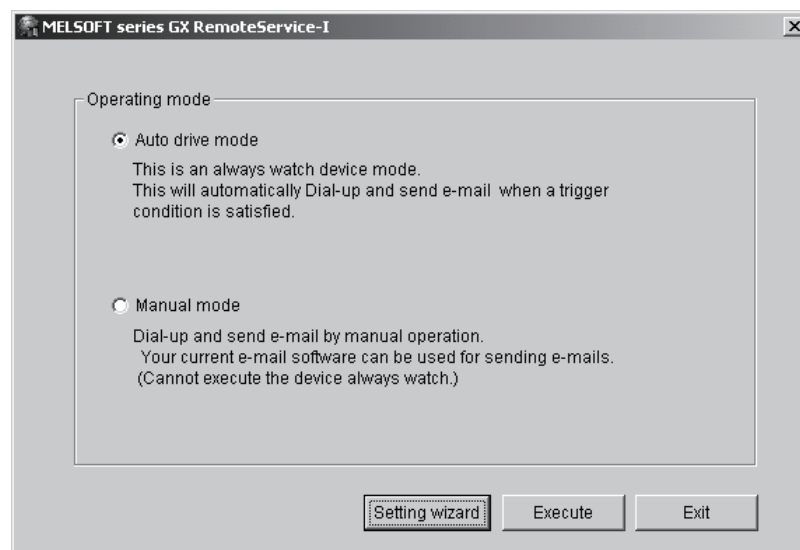

Select the automatic or manual operation mode and then click the **Setting wizard** button to display the Wizard screen.

Whether the setting items must be set or not in the automatic and manual operation modes is as indicated in the following table.

Setting item	Operation mode		Description
	Auto	Manual	
Security setting	△	△	Settings for client authentication. With the settings, the server identifies a client when the client connects to the server.
E-mail setting	○	△	Settings for using the GX RemoteService-I mail function. Not required when using Microsoft® Outlook Express or other mail software in manual operation mode.
Network setting	○	○	Settings for network connection method of the server.
PLC type selection	○	○	Settings for PLC series and PLC type of the PLC CPU that a client accesses first.
Specify target	○	○	Settings for connection method between the server and PLC CPU.
Device range setting	△	△	Settings for the first device that will be monitored by the client.
Tag setting	△	△	Settings for handling devices monitored by the client as tags.
Auto drive setting	○	—	Settings for e-mail transmission triggers and e-mail message. Required when using auto operation mode.
Dev. Disp. setting	△	△	Settings for screen that appears in the client.

○ : Necessary △ : Might be necessary — : Unnecessary.

6.1 Setting Wizard

The following screen is displayed by clicking the [setting wizard] button on the operation mode selection screen. Follow the messages to make setting.

The check mark moves in accordance with the setting item.

The focus moves to the item to be set to indicate which is being set.

Click here to open the corresponding setting screen.

Click here to return to the previous setting screen.

Click here to set the next item.

6

POINT

Refer to Section 6.3 for the explanation of detailed items to be set with the Setting Wizard.

6.2 Main Screen

This section explains the server URL, dial-up execution, e-mail send and other functions.

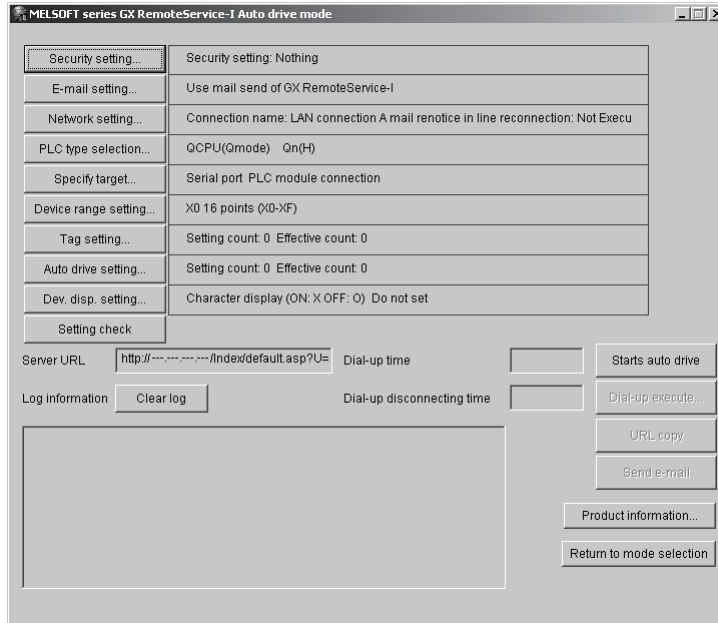

Item	Description
Server URL	Shows the URL with the IP address. Shows "---.---.---.---" instead of the IP address if the IP address assigned by the Internet service provider cannot be acquired. This product cannot be used when the IP address is not displayed.
Log information	Shows error definition in the automatic operation mode. <ul style="list-style-type: none"> • Shows the errors and operation of the personal computer. • Shows the time and date. • The log can be copied in the selected range. • The log is up to 100 lines long. If it exceeds 100 lines, the older lines are deleted in due order.
"Clear log" button	Clears the message in log information.
Dial-up time	Shows the elapsed time after dial-up execution. The time is updated at intervals of five seconds. "--:--:--" appears if: <ul style="list-style-type: none"> • Dial-up is not executed; or • Dial-up is executed from other than GX RemoteService-I. If the time has exceeded 9999:59:59 (9999 hours 59 minutes 59 seconds), it returns to 00:00:00.
Dial-up disconnection time	Appears when the automatic line disconnection system is access time monitoring or dial-up disconnection timer in the line disconnection setting. ("--:--:--" appears if the setting is not made.) Counts down to zero. The time is updated at intervals of five seconds. For access time monitoring, countdown starts from the preset time every time access is made. The line is disconnected when the time is zeroed.
"Starts auto drive" button	Always executes monitoring. The button name changes to "stop auto drive" during automatic operation, and clicking it terminates the automatic operation.
"Dial-up execute" button	Starts dial-up connection with the preset connection name (this button is masked when the dial-up connection name is not yet set).

(Continued on next page)

(From the previous page)

Item	Description
"URL copy" button	Copies the address displayed in the Server URL. When sent from the e-mail function of GX RemoteService-I, the address is added to the mail text automatically.
"Send e-mail" button	Sends e-mail to the preset send destination.
"Product information" button	Displays the version of the product.
"Return to mode selection" button	Returns to the automatic operation mode/manual operation mode selection screen.

REMARK

The following gives a procedure for sending in the manual operation mode using the e-mail software such as Microsoft® Outlook Express.

(Start)

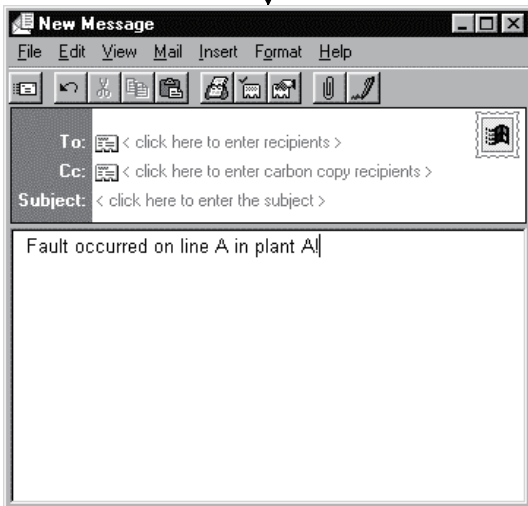

(1) Start the mail software and create a mail text.

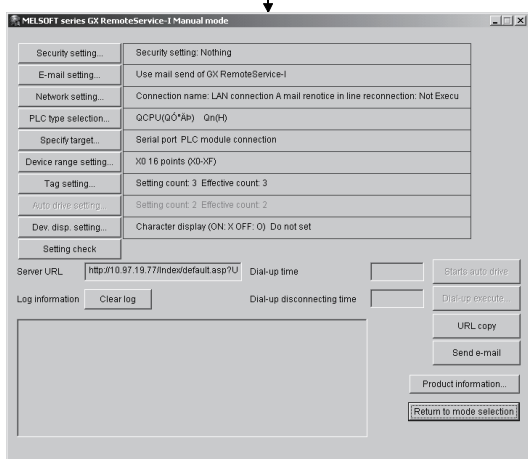

(2) Click the "URL copy" button on GX RemoteService-I.

<http://000.000.000.000/index/default.asp>

(3) Paste the URL copied from GX RemoteService-I to the created mail text.

Fault occurred on line A in plant A!

(Completion)

6.3 Setting the Server (Personal Computer) Functions

6.3.1 Security setting

When a connection is made to the server, this function identifies the client based on the user names and passwords registered within the server, in order to prevent an illegal access. Note that this function is not available while the Web function is used.

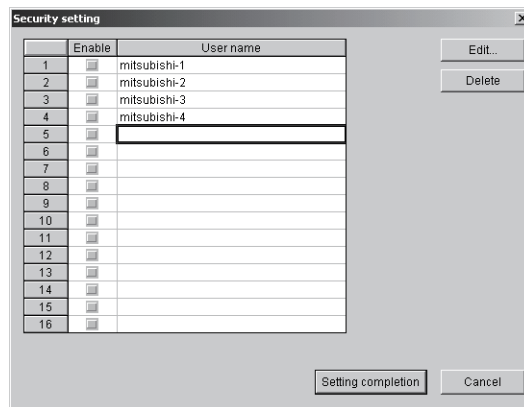

Item	Description								
Enable	Used to enable/disable the registered name.								
User name	User names registered in "User name/Password setting" screen are displayed.								
"Edit" button	Used to set the user name and password. <div style="text-align: center;"> </div> <table border="1" style="margin-left: auto; margin-right: auto;"> <thead> <tr> <th>Item</th> <th>Description</th> </tr> </thead> <tbody> <tr> <td>User name</td> <td>Enter a user name (1 to 20 alphanumeric characters/symbols).</td> </tr> <tr> <td>Password</td> <td>Enter a password (8 to 14 alphanumeric characters/symbols).</td> </tr> <tr> <td>Password for confirmation</td> <td>Enter the above password for confirmation.</td> </tr> </tbody> </table> <p>There are following three setting patterns:</p> <ol style="list-style-type: none"> 1) Both of user name and password are set. 2) Only user name is set. 3) Neither of user name or password is set. 	Item	Description	User name	Enter a user name (1 to 20 alphanumeric characters/symbols).	Password	Enter a password (8 to 14 alphanumeric characters/symbols).	Password for confirmation	Enter the above password for confirmation.
Item	Description								
User name	Enter a user name (1 to 20 alphanumeric characters/symbols).								
Password	Enter a password (8 to 14 alphanumeric characters/symbols).								
Password for confirmation	Enter the above password for confirmation.								
"Delete" button	Used to delete the selected user name and the corresponding password.								

POINT

For security setting using the Web server module, refer to the Web server module user's manual.

6.3.2 E-mail setting

Set as required since the items to be set differ between the automatic and manual operation modes.

We recommend you to read "Description for Use" or like sent from the provider to make settings.

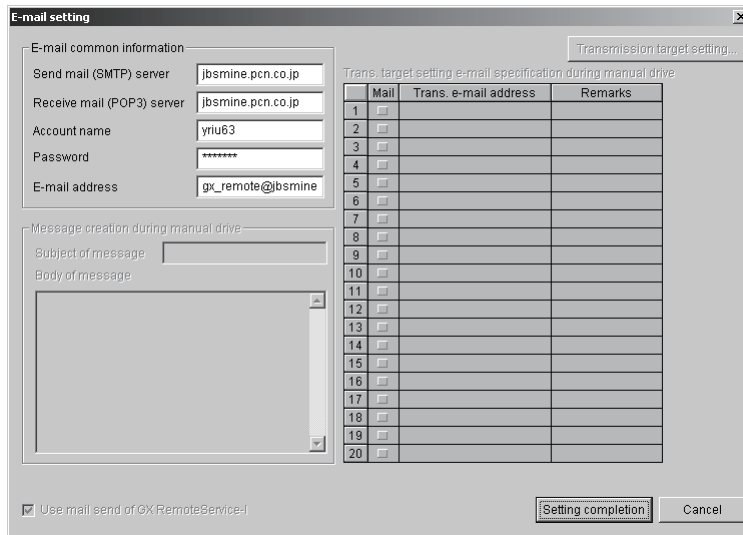

Item	Description
Send mail (SMTP) server	Specify the server to be used when sending e-mail from GX RemoteService-I. Set the address supplied by the provider. Number of acceptable characters: 1 to 256 characters
Send mail (POP3) server	Enter the server to be used when receiving e-mail. Set the address supplied by the provider. Number of acceptable characters: 1 to 256 characters
Account name	Specify the account name for POP3 server authentication. Set the account name supplied by the provider. Number of acceptable characters: 1 to 255 characters
Password	Specify the password of the account name for POP3 server authentication. Set the password of the account name supplied by the provider. Number of acceptable characters: 1 to 255 characters
E-mail address	Specify the returning mail address. You can set 1 to 255 characters. Note: Though GX RemoteService-I does not have the function to receive e-mail, set this address since it is needed when sending e-mail.
Subject of message	Set the subject of e-mail. Number of acceptable characters: 1 to 256 characters Note: All the subject may not be displayed depending on the model used.

(Continued on next page)

(From the previous page)

Item	Description																		
Body of message	Enter the text of e-mail. Number of acceptable characters: 0 to 256 characters Since the URL of the server is added to the character string sent actually, create a message in consideration of the number of URL characters. Description																		
"Transmission target setting" button	You can set the send destination in the manual mode only. <div data-bbox="580 562 1265 981" style="text-align: center;"> </div> <table border="1" data-bbox="432 1016 1409 1688"> <thead> <tr> <th data-bbox="437 1016 647 1059">Item</th> <th data-bbox="647 1016 1404 1059">Description</th> </tr> </thead> <tbody> <tr> <td data-bbox="437 1059 647 1126">Trans. e-mail address</td> <td data-bbox="647 1059 1404 1126">Set the e-mail address of the personal computer. Set it within the range 1 to 255 characters.</td> </tr> <tr> <td data-bbox="437 1126 647 1193">Remarks</td> <td data-bbox="647 1126 1404 1193">Can be used to make a memo of a company name, person's name and like. Enter them within 256 characters.</td> </tr> <tr> <td data-bbox="437 1193 647 1323">Mail</td> <td data-bbox="647 1193 1404 1323">Can be set in the manual operation mode only. Set whether e-mail will be sent or not. In the automatic operation mode, the status set for automatic operation setting appears.</td> </tr> <tr> <td data-bbox="437 1323 647 1417">watch 1 to watch 10</td> <td data-bbox="647 1323 1404 1417">Can be set in the automatic operation mode only. Set whether the system will be monitored or not in the automatic operation detail setting.</td> </tr> <tr> <td data-bbox="437 1417 647 1518">"Copy" button</td> <td data-bbox="647 1417 1404 1518">Used to copy the selected row. To choose the row, click any of numbers 1 to 20. You cannot copy the row unless the whole row is selected.</td> </tr> <tr> <td data-bbox="437 1518 647 1552">"Paste" button</td> <td data-bbox="647 1518 1404 1552">Used to paste the copied row.</td> </tr> <tr> <td data-bbox="437 1552 647 1653">"Delete" button</td> <td data-bbox="647 1552 1404 1653">Used to delete the selected row. To choose the row, click any of numbers 1 to 20. You cannot delete the row unless the whole row is selected.</td> </tr> <tr> <td data-bbox="437 1653 647 1688">"All clear" button</td> <td data-bbox="647 1653 1404 1688">Used to delete all rows.</td> </tr> </tbody> </table>	Item	Description	Trans. e-mail address	Set the e-mail address of the personal computer. Set it within the range 1 to 255 characters.	Remarks	Can be used to make a memo of a company name, person's name and like. Enter them within 256 characters.	Mail	Can be set in the manual operation mode only. Set whether e-mail will be sent or not. In the automatic operation mode, the status set for automatic operation setting appears.	watch 1 to watch 10	Can be set in the automatic operation mode only. Set whether the system will be monitored or not in the automatic operation detail setting.	"Copy" button	Used to copy the selected row. To choose the row, click any of numbers 1 to 20. You cannot copy the row unless the whole row is selected.	"Paste" button	Used to paste the copied row.	"Delete" button	Used to delete the selected row. To choose the row, click any of numbers 1 to 20. You cannot delete the row unless the whole row is selected.	"All clear" button	Used to delete all rows.
Item	Description																		
Trans. e-mail address	Set the e-mail address of the personal computer. Set it within the range 1 to 255 characters.																		
Remarks	Can be used to make a memo of a company name, person's name and like. Enter them within 256 characters.																		
Mail	Can be set in the manual operation mode only. Set whether e-mail will be sent or not. In the automatic operation mode, the status set for automatic operation setting appears.																		
watch 1 to watch 10	Can be set in the automatic operation mode only. Set whether the system will be monitored or not in the automatic operation detail setting.																		
"Copy" button	Used to copy the selected row. To choose the row, click any of numbers 1 to 20. You cannot copy the row unless the whole row is selected.																		
"Paste" button	Used to paste the copied row.																		
"Delete" button	Used to delete the selected row. To choose the row, click any of numbers 1 to 20. You cannot delete the row unless the whole row is selected.																		
"All clear" button	Used to delete all rows.																		
Trans. target setting e-mail specification during manual drive	Mail : Select whether e-mail will be sent or not. Can be set in the manual operation mode only. Trans. e-mail address : Shows the e-mail send destination. Remarks : You can set the additional information on the e-mail send destination.																		
Use mail send of GX RemoteService-I	Can be selected in the manual operation mode. Automatically set in the automatic operation mode.																		

6.3.3 Network setting

This section explains the network setting.

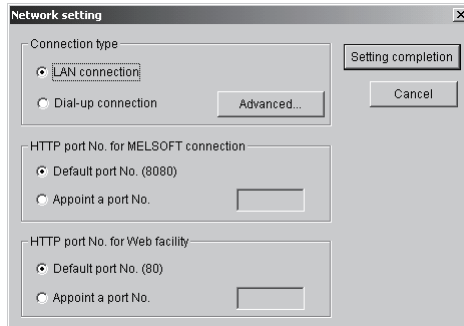

Item	Description										
"Advanced" button for "LAN connection"	<div data-bbox="676 869 1201 1111" data-label="Image"> </div> <table border="1" data-bbox="472 1146 1406 1877"> <thead> <tr> <th data-bbox="472 1146 778 1189">Item</th> <th data-bbox="778 1146 1406 1189">Description</th> </tr> </thead> <tbody> <tr> <td data-bbox="472 1200 778 1267">Acquire IP address automatically</td> <td data-bbox="778 1200 1406 1339">Select this option when an IP address can be automatically acquired. For whether an IP address can be automatically acquired or not, refer to Section 2. 2.1.</td> </tr> <tr> <td data-bbox="472 1350 778 1417">Acquire IP address from a router(UPnP)</td> <td data-bbox="778 1350 1406 1489">Select this option when using a UPnP-compatible router or router type DSL modem. An IP address can be automatically acquired in a system including a router or other intermediary device.</td> </tr> <tr> <td data-bbox="472 1500 778 1568">Use the next IP address</td> <td data-bbox="778 1500 1406 1720">For Intranet or fixed IP, specify the IP address. However, select "Acquire IP address from a router (UPnP)" for the internet system including a UPnP-compatible router, router type DSL modem or other intermediary device, even if it uses a fixed IP address. Only numeric characters are applicable for an IP address.</td> </tr> <tr> <td data-bbox="472 1731 778 1839">In IP address modification by line reconnection, notify of a mail automatically</td> <td data-bbox="778 1731 1406 1870">When the server IP address is changed by line-reconnection (due to line-disconnection) in auto drive mode, GX Remote Service-I will detect the new IP address to notify the client.</td> </tr> </tbody> </table>	Item	Description	Acquire IP address automatically	Select this option when an IP address can be automatically acquired. For whether an IP address can be automatically acquired or not, refer to Section 2. 2.1.	Acquire IP address from a router(UPnP)	Select this option when using a UPnP-compatible router or router type DSL modem. An IP address can be automatically acquired in a system including a router or other intermediary device.	Use the next IP address	For Intranet or fixed IP, specify the IP address. However, select "Acquire IP address from a router (UPnP)" for the internet system including a UPnP-compatible router, router type DSL modem or other intermediary device, even if it uses a fixed IP address. Only numeric characters are applicable for an IP address.	In IP address modification by line reconnection, notify of a mail automatically	When the server IP address is changed by line-reconnection (due to line-disconnection) in auto drive mode, GX Remote Service-I will detect the new IP address to notify the client.
Item	Description										
Acquire IP address automatically	Select this option when an IP address can be automatically acquired. For whether an IP address can be automatically acquired or not, refer to Section 2. 2.1.										
Acquire IP address from a router(UPnP)	Select this option when using a UPnP-compatible router or router type DSL modem. An IP address can be automatically acquired in a system including a router or other intermediary device.										
Use the next IP address	For Intranet or fixed IP, specify the IP address. However, select "Acquire IP address from a router (UPnP)" for the internet system including a UPnP-compatible router, router type DSL modem or other intermediary device, even if it uses a fixed IP address. Only numeric characters are applicable for an IP address.										
In IP address modification by line reconnection, notify of a mail automatically	When the server IP address is changed by line-reconnection (due to line-disconnection) in auto drive mode, GX Remote Service-I will detect the new IP address to notify the client.										

(Continued on next page)

(From the previous page)

Item	Description												
<p>"Advanced" button for "Dial-up connection"</p>	<div data-bbox="730 353 1166 741" style="text-align: center;"> </div> <table border="1" data-bbox="491 763 1406 1720"> <thead> <tr> <th data-bbox="491 763 740 801">Item</th> <th data-bbox="740 763 1406 801">Description</th> </tr> </thead> <tbody> <tr> <td data-bbox="491 801 740 880">Dial-up cnt. name</td> <td data-bbox="740 801 1406 880">Select the connection name set in the Dial-up setting. Up to 16 characters can be displayed.</td> </tr> <tr> <td data-bbox="491 880 740 1111">Redial option</td> <td data-bbox="740 880 1406 1111">Set the number of times to execute redial for reconnection to the provider after line disconnection, and the redial execution intervals. Also set whether to redial (reconnection) in line disconnecting and notify you of the changed IP address. Count: Set the number in the range of 0 to 99. Interval: Set the number in the range of 0 to 999.</td> </tr> <tr> <td data-bbox="491 1111 740 1341">Access timer watch</td> <td data-bbox="740 1111 1406 1341">Check this item to disconnect the Dial-up connection if no access is made to the server (personal computer) for a certain time. Hour: Set the number in the range of 0 to 99. Minutes: Set the number in the range of 0 to 59. Note that "0 Hour 0 Minutes" cannot be set.</td> </tr> <tr> <td data-bbox="491 1341 740 1525">Dial-up disconnection timer</td> <td data-bbox="740 1341 1406 1525">Check this item to disconnect the dial-up connection after a certain time has passed. Hour: Set the number in the range of 0 to 99. Minutes: Set the number in the range of 0 to 59. Note that "0 Hour 0 Minutes" cannot be set.</td> </tr> <tr> <td data-bbox="491 1525 740 1720">Enable disconnection of Dial-up connection on client side.</td> <td data-bbox="740 1525 1406 1720">Check this item to enable a mobile phone to disconnect the Dial-up connection of the server (personal computer). Devices other than the mobile phone that disconnected the connection are not allowed to connect to the server (personal computer), as the line was disconnected without notice.</td> </tr> </tbody> </table>	Item	Description	Dial-up cnt. name	Select the connection name set in the Dial-up setting. Up to 16 characters can be displayed.	Redial option	Set the number of times to execute redial for reconnection to the provider after line disconnection, and the redial execution intervals. Also set whether to redial (reconnection) in line disconnecting and notify you of the changed IP address. Count: Set the number in the range of 0 to 99. Interval: Set the number in the range of 0 to 999.	Access timer watch	Check this item to disconnect the Dial-up connection if no access is made to the server (personal computer) for a certain time. Hour: Set the number in the range of 0 to 99. Minutes: Set the number in the range of 0 to 59. Note that "0 Hour 0 Minutes" cannot be set.	Dial-up disconnection timer	Check this item to disconnect the dial-up connection after a certain time has passed. Hour: Set the number in the range of 0 to 99. Minutes: Set the number in the range of 0 to 59. Note that "0 Hour 0 Minutes" cannot be set.	Enable disconnection of Dial-up connection on client side.	Check this item to enable a mobile phone to disconnect the Dial-up connection of the server (personal computer). Devices other than the mobile phone that disconnected the connection are not allowed to connect to the server (personal computer), as the line was disconnected without notice.
Item	Description												
Dial-up cnt. name	Select the connection name set in the Dial-up setting. Up to 16 characters can be displayed.												
Redial option	Set the number of times to execute redial for reconnection to the provider after line disconnection, and the redial execution intervals. Also set whether to redial (reconnection) in line disconnecting and notify you of the changed IP address. Count: Set the number in the range of 0 to 99. Interval: Set the number in the range of 0 to 999.												
Access timer watch	Check this item to disconnect the Dial-up connection if no access is made to the server (personal computer) for a certain time. Hour: Set the number in the range of 0 to 99. Minutes: Set the number in the range of 0 to 59. Note that "0 Hour 0 Minutes" cannot be set.												
Dial-up disconnection timer	Check this item to disconnect the dial-up connection after a certain time has passed. Hour: Set the number in the range of 0 to 99. Minutes: Set the number in the range of 0 to 59. Note that "0 Hour 0 Minutes" cannot be set.												
Enable disconnection of Dial-up connection on client side.	Check this item to enable a mobile phone to disconnect the Dial-up connection of the server (personal computer). Devices other than the mobile phone that disconnected the connection are not allowed to connect to the server (personal computer), as the line was disconnected without notice.												
<p>HTTP port No. for MELSOFT connection</p>	<p>When "Appoint a port No." is selected, set the port No. in the range of 1024 to 65535. However, when the Web server module is used as operating environment, the port number is fixed to "8080".</p>												
<p>HTTP port No. for Web facility</p>	<p>When "Appoint a port No." is selected, set the port No. in the range of 1024 to 65535. However, when the Web server module is used as operating environment, set the port number using the Web server module as follows: Select [Administrative menu] – [System setting]. For details, refer to the Web server module user's manual.</p>												

6.3.4 PLC type setting

As the PLC type, set the PLC series and PLC type of the PLC to be accessed first from the personal computer.

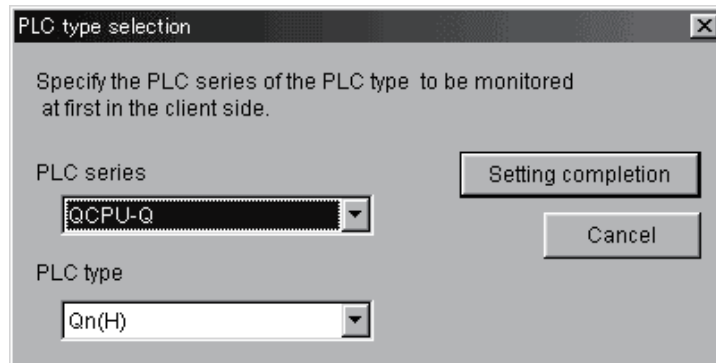

Item	Description		
PLC series PLC type	Set the items when selecting or changing the PLC Series and/or PLC type of the PLC to be accessed first from the personal computer.		
	PLC series	PLC type	Remark
	ACPU	AnN, AnA, AnS, AnSH	A0J2H, A1FX, A1S, A1SJ, A1SH, A1SJH, A1N, A2C, A2CJ, A2N(S1), A2S, A2SH, A3N, A2A(S1), A3A
		AnU, A2AS	A2U(S1), A2AS(S1), A2AS-S30, A2AS-S60, A3U, A4U
	QnACPU	—	Q2A, Q2AS(H), Q2AS1, Q2AS(H)S1, Q3A, Q4A, Q4AR
	QCPU-Q	Qn (H)	Q02(H), Q06H, Q12H, Q12PH, Q25H, Q25PH
		Q00J, Q00, Q01	Q00J, Q00, Q01
	QCPU-A	—	Q02(H)-A, Q06H-A
	SCPU	A171SH	A171SH
		A172SH	A172SH
		A173UH (S1)	A173UH(S1)
		A273UH (S3)	A273UH(S3)
	FXCPU	—	FX0(S), FX0N, FX1, FXU, FX2C, FX1S, FX1N, FX2N(C)
<p>If you have chosen the PLC Series and/or PLC type other than the one currently set, the following dialog box appears for confirmation.</p>			
<p>Click the "Yes" button to change the following settings and indications.</p> <ul style="list-style-type: none"> • Changes the PLC type. • Changes the connection setup to the PLC CPU direct-coupled path. • Changes the device range setting to the default value. • Changes the tag setting to the default value. • Changes the automatic operation setting to the default value. <p>Clicking the "No" button does not change the settings.</p>			

6.3.5 Connection setup

Set the connection setup between the server (personal computer) and PLC.
 This setting also specifies the PLC to be accessed first from the personal computer.

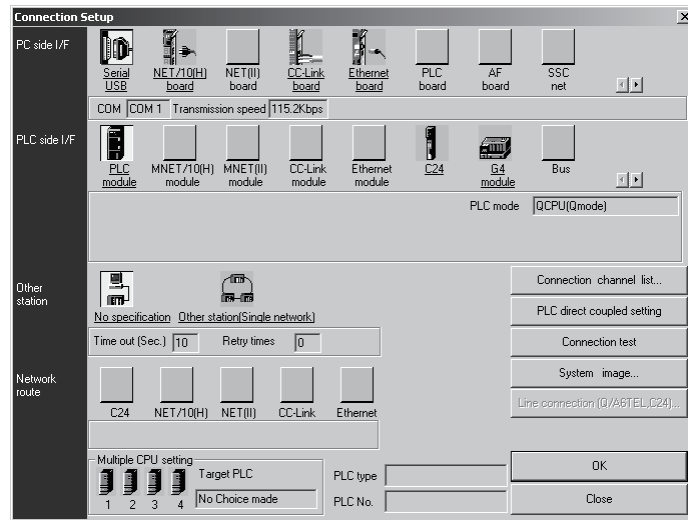

(1) Access to the host

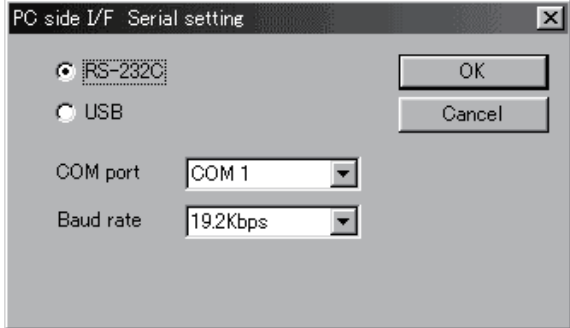
Item	Description
PC side I/F	<p>For Q series</p>  <ul style="list-style-type: none"> • USB may be set only when the QCPU (Q mode) has been selected. • Precautions for communication at 115.2/57.6kbps Fast communication cannot be made if the personal computer used is not compatible with the communication speed of 115.2/57.6kbps. If communications delay due to communications tries or a communication error occurs, reduce the baud rate setting and restart communication. • Precautions for making USB communication Refer to the GX Developer Operating Manual.

(Continued on next page)

(From the previous page)

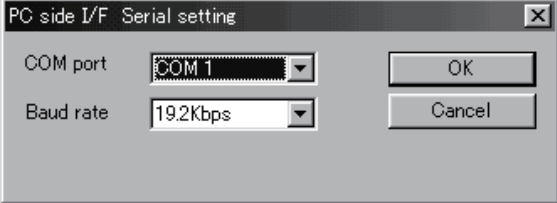
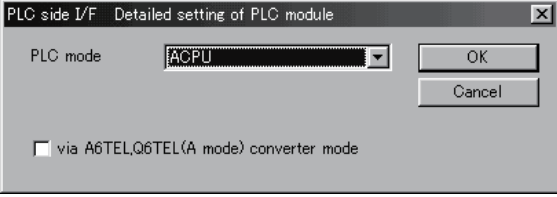
Item	Description
PC side I/F	<p>QnA/A/FX series</p>  <ul style="list-style-type: none"> • The baud rate that can be selected depends on the PLC Series and PLC type. • Choose 9.6kbps for the A Series. • For the QnA Series, the PLC CPU that can communicate at the 38.4kbps speed is the QnACPU of unction version B or later. Refer to the GX Developer Operating Manual for the way to identify the module version. • When using the A6TEL as a converter, refer to the GX Developer Operating Manual.
PLC side I/F	<p>Choose the PLC series of the PLC to be connected with GX RemoteService-I.</p> 
Other station	<p>No specification</p> <p>Specify when the access target is in a multiple PLC system.</p> <p>Other station (Single network)</p> <p>It indicates a system which is configured by a single network and a multilevel system, e.g., only MELSECNET/10 or only Ethernet. (Since Ethernet is regarded as the MELSECNET/10, specify Single network for an MELSECNET/10 and Ethernet mixed system.)</p> <p>If a time-out or other error occurs in communications with the PLC CPU, set a longer communications time check period.</p> <p>Until the error appears, during execution is displayed in Monitor status.</p> <p>The longest time until the error appears can be found by the following expression. $(\text{Time specified for communications time check}) \times 3 \times (\text{Count specified for the number of retries} + 1)$</p> <p>For example, when the communications time check is specified as 30 seconds and the number of retries as 0 times, the resultant time is $(30 \text{ seconds}) \times 3 \times (0 + 1) = 90 \text{ seconds}$, and the error appears after a maximum of 90 seconds have elapsed.</p> <p>Choose No specification when specifying the own station.</p> <p>When power-off, hardware reset or the like of the PLC CPU is performed during ladder monitor, it will take time until a communications error appears.</p>
Network route	<p>Choose the network type, network No., station number and first I/O No. to be accessed.</p> <p>The setting items depend on the network type that has been set.</p>
Multiple PLC Setting	<p>Specify when the access target is in a multiple PLC system.</p>

(Continued on next page)

(From the previous page)

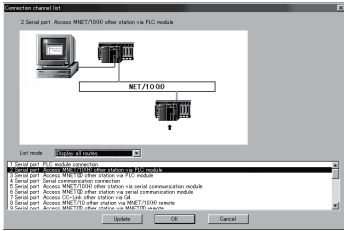
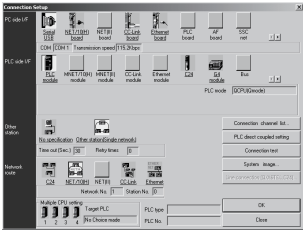
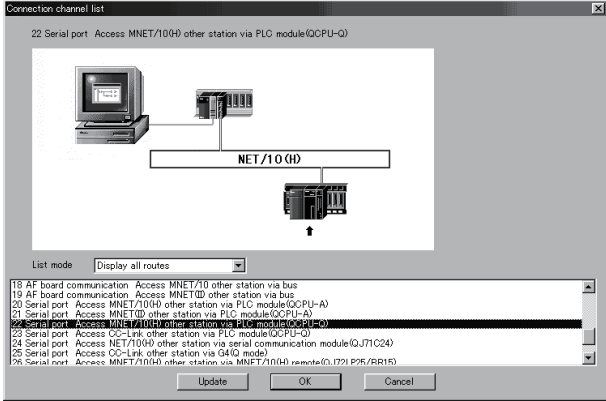
Item	Description								
<p>Connection channel list</p>	<p>You can set the connection target while looking at the Connection channel list. As clicking the [OK] button automatically sets the connection channel on the Connection Setup screen, settings can be made easily if a complicated system is configured. Set the network number, station number and others as desired according to the access target.</p> <div style="display: flex; align-items: center; justify-content: center;">  <div style="margin: 0 20px; text-align: center;"> <p>Click the OK button</p> </div>  </div> <p>Clicking the [OK] button automatically sets the connection path (area enclosed by a circle) on the Connection setup screen.</p> <p>About display changing Convenient use of display selected routes Specifying the PC side I/F and PLC side I/F and selecting the display selected routes on the Connection setup screen displays only the paths within the accessible ranges in the other station, network communication path and mixed network communication path.</p> <p>A system configuration list of different series can also be displayed.</p> <table border="1" data-bbox="435 1055 1406 1216" style="width: 100%; border-collapse: collapse;"> <thead> <tr> <th style="width: 25%;">Request Source</th> <th style="width: 45%;">Server (Personal Computer) Connected PLC</th> <th style="width: 30%;">Access Target</th> </tr> </thead> <tbody> <tr> <td rowspan="3" style="text-align: center;">Server (personal computer)</td> <td rowspan="3" style="text-align: center;">QCPU (Q mode)</td> <td style="text-align: center;">Q Series</td> </tr> <tr> <td style="text-align: center;">QnA Series</td> </tr> <tr> <td style="text-align: center;">A Series</td> </tr> </tbody> </table> 	Request Source	Server (Personal Computer) Connected PLC	Access Target	Server (personal computer)	QCPU (Q mode)	Q Series	QnA Series	A Series
Request Source	Server (Personal Computer) Connected PLC	Access Target							
Server (personal computer)	QCPU (Q mode)	Q Series							
		QnA Series							
		A Series							
<p>PLC direct coupled setting</p>	<p>Useful for changing Other station to Host.</p>								
<p>Connection test</p>	<p>Tests whether normal access can be made to the access target PLC CPU set on the Connection setup screen.</p> <p>When normal access can be made, the type of the access target PLC CPU appears in the CPU type display field.</p>								
<p>System image</p>	<p>Illustrates the set connection target path.</p>								
<p>Line connection (Q/A6TEL, C24)</p>	<p>Cannot be set.</p>								

POINT

Screen setting for MELSECNET/10 and Ethernet combined system (Single network)

In an MELSECNET/10 and Ethernet mixed system configuration, specify Single network to access the other station. (Since Ethernet is equivalent to the MELSECNET/10)

An example of the Connection Setup setting screen is provided for the following system configuration (Q/QnA only).

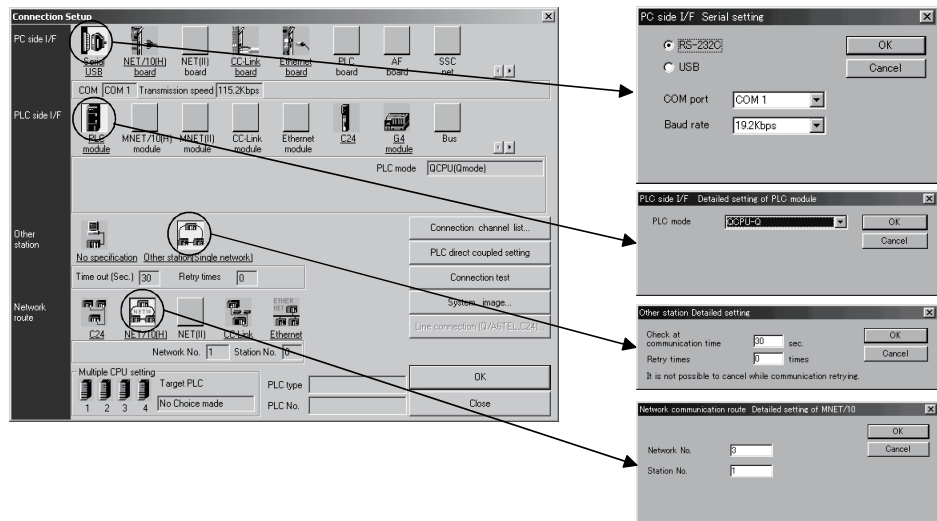
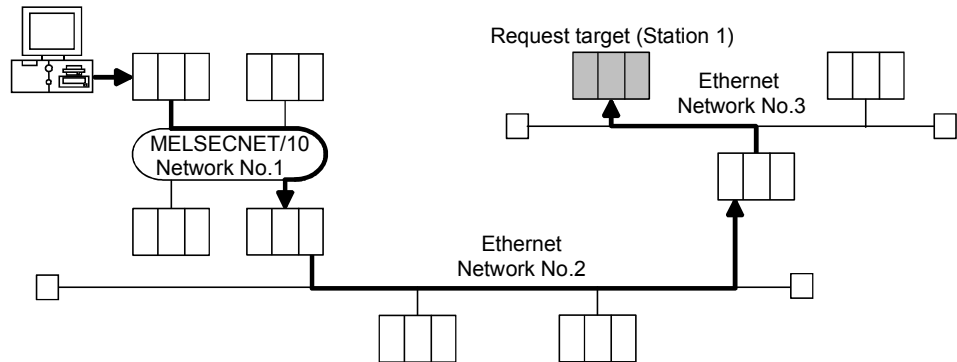

For access to the other station or multilevel system, not only the Connection Setup but also the routing parameters should be set to enable communications.

POINT

When connecting the PLC to be accessed to the server (personal computer) via Ethernet, CC-Link or serial communication, refer to GX Developer Operating Manual.

6.3.6 Device range setting

This section explains the name, points and others of the device to be read first from the PLC CPU.

Screen examples

When Qn(H)CPU is selected

When ACPU is selected (AnU, AnUS, AnUSHCPU)

Item	Description												
Device	Set the device + device No.												
Points	Set any of 1, 16, 32, 64, 128 and 256 points.												
Program	Set the program name when monitoring the T/C.												
Target memory	<p>When you have set the Qn(H)CPU or QnACPU, make selection from the following memories. You cannot make setting when the set PLC Series is other than the Qn(H)CPU or QnACPU.</p> <table border="1" style="margin-left: 40px;"> <thead> <tr> <th>Qn(H)CPU</th> <th>QnACPU</th> </tr> </thead> <tbody> <tr> <td>Program memory/Device memory</td> <td>PLC RAM/Device memory</td> </tr> <tr> <td>Memory card (RAM)</td> <td>IC Card A (RAM)</td> </tr> <tr> <td>Memory card (ROM)</td> <td>IC Card A (ROM)</td> </tr> <tr> <td>Standard RAM</td> <td>IC Card B (RAM)</td> </tr> <tr> <td>Standard ROM</td> <td>IC Card B (ROM)</td> </tr> </tbody> </table>	Qn(H)CPU	QnACPU	Program memory/Device memory	PLC RAM/Device memory	Memory card (RAM)	IC Card A (RAM)	Memory card (ROM)	IC Card A (ROM)	Standard RAM	IC Card B (RAM)	Standard ROM	IC Card B (ROM)
Qn(H)CPU	QnACPU												
Program memory/Device memory	PLC RAM/Device memory												
Memory card (RAM)	IC Card A (RAM)												
Memory card (ROM)	IC Card A (ROM)												
Standard RAM	IC Card B (RAM)												
Standard ROM	IC Card B (ROM)												
Comment data	Set the comment data name to be displayed or searched for by the personal computer. Fixed to "COMMENT" when the set PLC Series is other than the Qn(H)CPU or QnACPU.												
Comment type	Set the comment data name to be displayed or searched for by the personal computer. You need not make setting when the Qn(H)CPU or QnACPU has been set as the PLC Series.												

6.3.7 Tag setting

Setting tags allows you to display different devices you want to read (up to 10 device types) together on the personal computer.

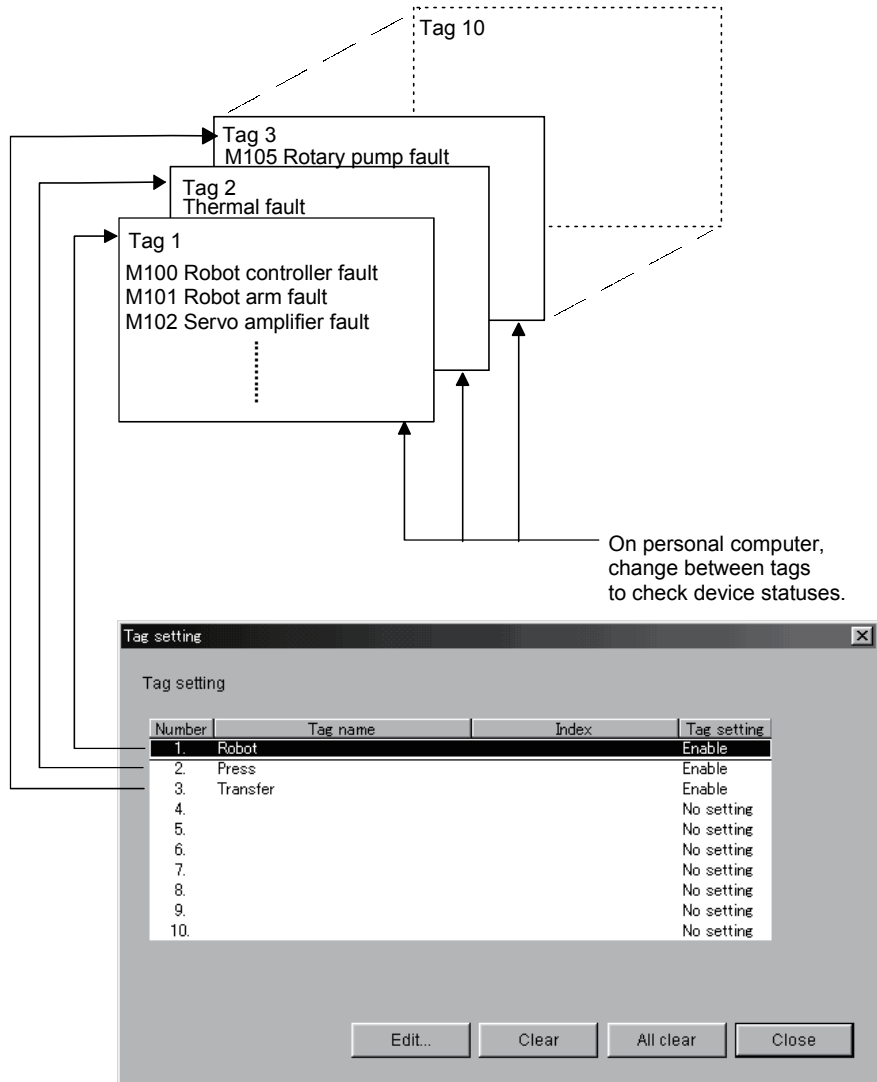

Item	Description																																																																							
Tag name	Set within 1 to 16 characters.																																																																							
Index	Set within 0 to 64 characters.																																																																							
Tag setting	Shows the tag setting status.																																																																							
"Edit" button	<div data-bbox="451 443 1289 1048" style="border: 1px solid black; padding: 5px;"> <p>Tag detailed setting 1/10</p> <p>Tag name <input type="text" value="Line status"/></p> <p>Index <input type="text" value="Line A"/></p> <p><input checked="" type="checkbox"/> Enable tag settings</p> <table border="1" data-bbox="485 667 1193 913"> <thead> <tr> <th></th> <th>Device name</th> <th>display</th> <th>Display name</th> <th>Program</th> </tr> </thead> <tbody> <tr><td>1</td><td>D0</td><td>Dec</td><td>Production quantity</td><td></td></tr> <tr><td>2</td><td>D2</td><td>Dec</td><td>Temperature</td><td></td></tr> <tr><td>3</td><td>T100</td><td>Dec</td><td>Watchdog timer</td><td>MAIN</td></tr> <tr><td>4</td><td></td><td></td><td></td><td></td></tr> <tr><td>5</td><td></td><td></td><td></td><td></td></tr> <tr><td>6</td><td></td><td></td><td></td><td></td></tr> <tr><td>7</td><td></td><td></td><td></td><td></td></tr> <tr><td>8</td><td></td><td></td><td></td><td></td></tr> <tr><td>9</td><td></td><td></td><td></td><td></td></tr> <tr><td>10</td><td></td><td></td><td></td><td></td></tr> </tbody> </table> <p style="text-align: right;"> <input type="button" value="Setting completion"/> <input type="button" value="Cancel"/> </p> </div> <table border="1" data-bbox="451 1086 1289 1518"> <thead> <tr> <th>Item</th> <th>Description</th> </tr> </thead> <tbody> <tr> <td>Tag name</td> <td>Set within 1 to 64 characters.</td> </tr> <tr> <td>Index</td> <td>Set within 0 to 64 characters.</td> </tr> <tr> <td>Tag setting</td> <td>Check this item to enable the tag function.</td> </tr> <tr> <td>Device name</td> <td>Set the device + device No.</td> </tr> <tr> <td>Display</td> <td>Set decimal or hexadecimal. You cannot set a bit device.</td> </tr> <tr> <td>Display name</td> <td>Set the device name that will be displayed on the personal computer. Set within 1 to 32 characters.</td> </tr> <tr> <td>Program</td> <td>When you set the T/C as the device name, set the program name to be referred to.</td> </tr> </tbody> </table>		Device name	display	Display name	Program	1	D0	Dec	Production quantity		2	D2	Dec	Temperature		3	T100	Dec	Watchdog timer	MAIN	4					5					6					7					8					9					10					Item	Description	Tag name	Set within 1 to 64 characters.	Index	Set within 0 to 64 characters.	Tag setting	Check this item to enable the tag function.	Device name	Set the device + device No.	Display	Set decimal or hexadecimal. You cannot set a bit device.	Display name	Set the device name that will be displayed on the personal computer. Set within 1 to 32 characters.	Program	When you set the T/C as the device name, set the program name to be referred to.
	Device name	display	Display name	Program																																																																				
1	D0	Dec	Production quantity																																																																					
2	D2	Dec	Temperature																																																																					
3	T100	Dec	Watchdog timer	MAIN																																																																				
4																																																																								
5																																																																								
6																																																																								
7																																																																								
8																																																																								
9																																																																								
10																																																																								
Item	Description																																																																							
Tag name	Set within 1 to 64 characters.																																																																							
Index	Set within 0 to 64 characters.																																																																							
Tag setting	Check this item to enable the tag function.																																																																							
Device name	Set the device + device No.																																																																							
Display	Set decimal or hexadecimal. You cannot set a bit device.																																																																							
Display name	Set the device name that will be displayed on the personal computer. Set within 1 to 32 characters.																																																																							
Program	When you set the T/C as the device name, set the program name to be referred to.																																																																							
"Clear" button	Used to clear the selected tag.																																																																							
"All clear" button	Used to clear all tags.																																																																							

6.3.8 Automatic operation setting

When performing automatic operation, set an e-mail sending trigger condition, an e-mail message, etc.

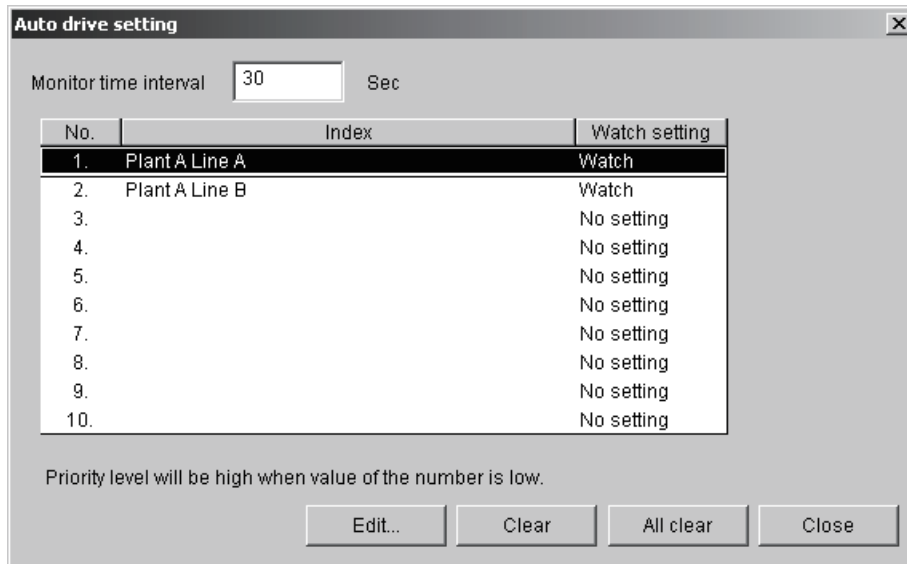

Item	Description																																																																																				
Monitor time interval	Set within the range 30 to 9999 seconds.																																																																																				
Index	Set within 0 to 64 characters.																																																																																				
Watch setting	Shows the monitor setting status.																																																																																				
"Edit" button	<table border="1"> <thead> <tr> <th></th> <th>Mail</th> <th>Trans. e-mail address</th> <th>Remarks</th> </tr> </thead> <tbody> <tr> <td>1</td> <td><input type="checkbox"/></td> <td>aaa@***.co.jp</td> <td>A co. Mr. A</td> </tr> <tr> <td>2</td> <td><input type="checkbox"/></td> <td>bbb@***.co.jp</td> <td>A co. Mr. B</td> </tr> <tr> <td>3</td> <td><input type="checkbox"/></td> <td></td> <td></td> </tr> <tr> <td>4</td> <td><input type="checkbox"/></td> <td></td> <td></td> </tr> <tr> <td>5</td> <td><input type="checkbox"/></td> <td></td> <td></td> </tr> <tr> <td>6</td> <td><input type="checkbox"/></td> <td></td> <td></td> </tr> <tr> <td>7</td> <td><input type="checkbox"/></td> <td></td> <td></td> </tr> <tr> <td>8</td> <td><input type="checkbox"/></td> <td></td> <td></td> </tr> <tr> <td>9</td> <td><input type="checkbox"/></td> <td></td> <td></td> </tr> <tr> <td>10</td> <td><input type="checkbox"/></td> <td></td> <td></td> </tr> <tr> <td>11</td> <td><input type="checkbox"/></td> <td></td> <td></td> </tr> <tr> <td>12</td> <td><input type="checkbox"/></td> <td></td> <td></td> </tr> <tr> <td>13</td> <td><input type="checkbox"/></td> <td></td> <td></td> </tr> <tr> <td>14</td> <td><input type="checkbox"/></td> <td></td> <td></td> </tr> <tr> <td>15</td> <td><input type="checkbox"/></td> <td></td> <td></td> </tr> <tr> <td>16</td> <td><input type="checkbox"/></td> <td></td> <td></td> </tr> <tr> <td>17</td> <td><input type="checkbox"/></td> <td></td> <td></td> </tr> <tr> <td>18</td> <td><input type="checkbox"/></td> <td></td> <td></td> </tr> <tr> <td>19</td> <td><input type="checkbox"/></td> <td></td> <td></td> </tr> <tr> <td>20</td> <td><input type="checkbox"/></td> <td></td> <td></td> </tr> </tbody> </table>		Mail	Trans. e-mail address	Remarks	1	<input type="checkbox"/>	aaa@***.co.jp	A co. Mr. A	2	<input type="checkbox"/>	bbb@***.co.jp	A co. Mr. B	3	<input type="checkbox"/>			4	<input type="checkbox"/>			5	<input type="checkbox"/>			6	<input type="checkbox"/>			7	<input type="checkbox"/>			8	<input type="checkbox"/>			9	<input type="checkbox"/>			10	<input type="checkbox"/>			11	<input type="checkbox"/>			12	<input type="checkbox"/>			13	<input type="checkbox"/>			14	<input type="checkbox"/>			15	<input type="checkbox"/>			16	<input type="checkbox"/>			17	<input type="checkbox"/>			18	<input type="checkbox"/>			19	<input type="checkbox"/>			20	<input type="checkbox"/>		
	Mail	Trans. e-mail address	Remarks																																																																																		
1	<input type="checkbox"/>	aaa@***.co.jp	A co. Mr. A																																																																																		
2	<input type="checkbox"/>	bbb@***.co.jp	A co. Mr. B																																																																																		
3	<input type="checkbox"/>																																																																																				
4	<input type="checkbox"/>																																																																																				
5	<input type="checkbox"/>																																																																																				
6	<input type="checkbox"/>																																																																																				
7	<input type="checkbox"/>																																																																																				
8	<input type="checkbox"/>																																																																																				
9	<input type="checkbox"/>																																																																																				
10	<input type="checkbox"/>																																																																																				
11	<input type="checkbox"/>																																																																																				
12	<input type="checkbox"/>																																																																																				
13	<input type="checkbox"/>																																																																																				
14	<input type="checkbox"/>																																																																																				
15	<input type="checkbox"/>																																																																																				
16	<input type="checkbox"/>																																																																																				
17	<input type="checkbox"/>																																																																																				
18	<input type="checkbox"/>																																																																																				
19	<input type="checkbox"/>																																																																																				
20	<input type="checkbox"/>																																																																																				

(Continued on next page)

(From the previous page)

Item	Description																											
"Edit" button	<table border="1" data-bbox="454 394 1386 1335"> <thead> <tr> <th data-bbox="459 400 724 441">Item</th> <th data-bbox="724 400 1382 441">Description</th> </tr> </thead> <tbody> <tr> <td data-bbox="459 441 724 481">Watch</td> <td data-bbox="724 441 1382 481">Check this item to perform monitoring.</td> </tr> <tr> <td data-bbox="459 481 724 521">Index</td> <td data-bbox="724 481 1382 521">Set within 1 to 64 characters.</td> </tr> <tr> <td data-bbox="459 521 724 1178">Trigger condition</td> <td data-bbox="724 521 1382 1178"> Set the trigger condition for bit or word device. The following are the condition enabled examples when the present value of D33 is 100. <table border="1" data-bbox="759 633 1347 1137"> <thead> <tr> <th data-bbox="764 640 927 680">Display</th> <th data-bbox="927 640 1342 680">Description</th> </tr> </thead> <tbody> <tr> <td data-bbox="764 680 927 754">=</td> <td data-bbox="927 680 1342 754">Condition is enabled when the value is equal to 100.</td> </tr> <tr> <td data-bbox="764 754 927 828"><</td> <td data-bbox="927 754 1342 828">Condition is enabled when the value is less than 99.</td> </tr> <tr> <td data-bbox="764 828 927 902">></td> <td data-bbox="927 828 1342 902">Condition is enabled when the value is more than 101.</td> </tr> <tr> <td data-bbox="764 902 927 976"><=</td> <td data-bbox="927 902 1342 976">Condition is enabled when the value is not more than 100.</td> </tr> <tr> <td data-bbox="764 976 927 1050">>=</td> <td data-bbox="927 976 1342 1050">Condition is enabled when the value is not less than 100.</td> </tr> <tr> <td data-bbox="764 1050 927 1124"><></td> <td data-bbox="927 1050 1342 1124">Condition is enabled when the value is other than 100.</td> </tr> </tbody> </table> </td> </tr> <tr> <td data-bbox="459 1178 724 1218">Subject of message</td> <td data-bbox="724 1178 1382 1218" rowspan="4">Refer to Section 6.3.2.</td> </tr> <tr> <td data-bbox="459 1218 724 1258">Body of message</td> </tr> <tr> <td data-bbox="459 1258 724 1332">"Transmission target setting" button</td> </tr> <tr> <td data-bbox="459 1332 724 1370"></td> </tr> </tbody> </table>	Item	Description	Watch	Check this item to perform monitoring.	Index	Set within 1 to 64 characters.	Trigger condition	Set the trigger condition for bit or word device. The following are the condition enabled examples when the present value of D33 is 100. <table border="1" data-bbox="759 633 1347 1137"> <thead> <tr> <th data-bbox="764 640 927 680">Display</th> <th data-bbox="927 640 1342 680">Description</th> </tr> </thead> <tbody> <tr> <td data-bbox="764 680 927 754">=</td> <td data-bbox="927 680 1342 754">Condition is enabled when the value is equal to 100.</td> </tr> <tr> <td data-bbox="764 754 927 828"><</td> <td data-bbox="927 754 1342 828">Condition is enabled when the value is less than 99.</td> </tr> <tr> <td data-bbox="764 828 927 902">></td> <td data-bbox="927 828 1342 902">Condition is enabled when the value is more than 101.</td> </tr> <tr> <td data-bbox="764 902 927 976"><=</td> <td data-bbox="927 902 1342 976">Condition is enabled when the value is not more than 100.</td> </tr> <tr> <td data-bbox="764 976 927 1050">>=</td> <td data-bbox="927 976 1342 1050">Condition is enabled when the value is not less than 100.</td> </tr> <tr> <td data-bbox="764 1050 927 1124"><></td> <td data-bbox="927 1050 1342 1124">Condition is enabled when the value is other than 100.</td> </tr> </tbody> </table>	Display	Description	=	Condition is enabled when the value is equal to 100.	<	Condition is enabled when the value is less than 99.	>	Condition is enabled when the value is more than 101.	<=	Condition is enabled when the value is not more than 100.	>=	Condition is enabled when the value is not less than 100.	<>	Condition is enabled when the value is other than 100.	Subject of message	Refer to Section 6.3.2.	Body of message	"Transmission target setting" button	
Item	Description																											
Watch	Check this item to perform monitoring.																											
Index	Set within 1 to 64 characters.																											
Trigger condition	Set the trigger condition for bit or word device. The following are the condition enabled examples when the present value of D33 is 100. <table border="1" data-bbox="759 633 1347 1137"> <thead> <tr> <th data-bbox="764 640 927 680">Display</th> <th data-bbox="927 640 1342 680">Description</th> </tr> </thead> <tbody> <tr> <td data-bbox="764 680 927 754">=</td> <td data-bbox="927 680 1342 754">Condition is enabled when the value is equal to 100.</td> </tr> <tr> <td data-bbox="764 754 927 828"><</td> <td data-bbox="927 754 1342 828">Condition is enabled when the value is less than 99.</td> </tr> <tr> <td data-bbox="764 828 927 902">></td> <td data-bbox="927 828 1342 902">Condition is enabled when the value is more than 101.</td> </tr> <tr> <td data-bbox="764 902 927 976"><=</td> <td data-bbox="927 902 1342 976">Condition is enabled when the value is not more than 100.</td> </tr> <tr> <td data-bbox="764 976 927 1050">>=</td> <td data-bbox="927 976 1342 1050">Condition is enabled when the value is not less than 100.</td> </tr> <tr> <td data-bbox="764 1050 927 1124"><></td> <td data-bbox="927 1050 1342 1124">Condition is enabled when the value is other than 100.</td> </tr> </tbody> </table>	Display	Description	=	Condition is enabled when the value is equal to 100.	<	Condition is enabled when the value is less than 99.	>	Condition is enabled when the value is more than 101.	<=	Condition is enabled when the value is not more than 100.	>=	Condition is enabled when the value is not less than 100.	<>	Condition is enabled when the value is other than 100.													
Display	Description																											
=	Condition is enabled when the value is equal to 100.																											
<	Condition is enabled when the value is less than 99.																											
>	Condition is enabled when the value is more than 101.																											
<=	Condition is enabled when the value is not more than 100.																											
>=	Condition is enabled when the value is not less than 100.																											
<>	Condition is enabled when the value is other than 100.																											
Subject of message	Refer to Section 6.3.2.																											
Body of message																												
"Transmission target setting" button																												
"Clear" button	Used to delete the selected continuous monitoring setting.																											
"All clear" button	Used to delete all continuous monitoring settings.																											

POINT
<ul style="list-style-type: none"> • If the device set for the trigger condition has already met its condition before a start of automatic operation, e-mail is sent immediately after automatic operation is started. • E-mail is sent when the status of the device set for the trigger condition turns from OFF to ON. Note that once e-mail is sent, next e-mail will not be sent until the device status changes from ON to OFF to ON.

6.3.9 Device display format setting

Set the formats in which the devices read on the personal computer will be displayed.

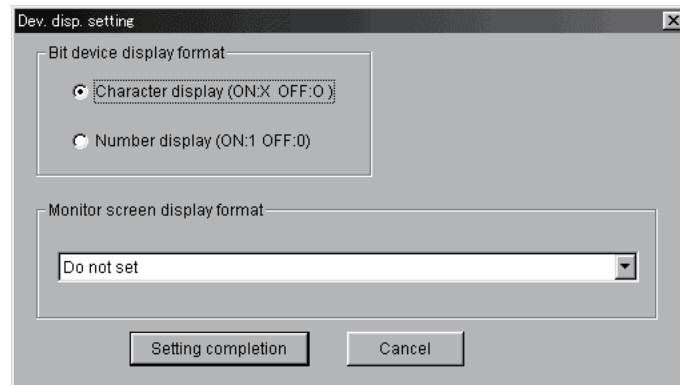

Item	Description
Bit device display format	Choose the bit device display format.
Monitor screen display format	Choose the combination of the character color and background color.

7. ABOUT THE PERSONAL COMPUTER

This chapter explains the setting items and display methods on the personal computer.

7.1 List of Personal Computer Setting Items

Making access to the address added to e-mail displays the following screen.

- 1) { Return to target connection specification Implement server side circuit setting } 2)

Serial port Access serial communication other station via serial communication module
- 3) 
- 4) { PC side I/F
Serial I/F setting
COM port
COM1
Baud rate
9.6Kbps }

5) { PLC side I/F
Detailed setting of C24
Station No.
Parity
 Odd
 Even
 None
- 6) { Other station
Check at communication time(sec)
Retry times
- 7) { Network route
Detailed setting of Computer link
Head I/O
Station No.
- 8) { Module specification
 No Choice mode
 C 1
 C 2
 C 3
 C 4
- 9) { Display format
 Word (Dec)
 Word (Hex)
 Bit
 Comment Dec
 Comment Hex
 Comment Bin
- 10) { Device range
Device
- 11) { Bit device is 16 point units
Points
Point1 is possible to select only in word device.
- 12) { Program name
Set only in case of TC monitor
- 13) { Target memory
- 14) { Comment data name
- 15) { Device comment search
- 16) {
- 17) { Tag monitor

No.	Description
1)	Set the PLC series, PC side I/F, PLC side I/F and other station.
2)	Set the time when the line is disconnected from the personal computer.
3)	Shows the connection form between the server (personal computer) and PLC.
4)	Set the details of the port or board used by the server (personal computer).
5)	Set the details of the module used on the PLC side. (The screen on the left is an example of a serial communication screen.)
6)	Set within the range 1 to 9999. Set within the range 0 to 5.
7)	Set the head I/O No., station number and network No. of the module. The setting items change depending on the module selected for the PLC side I/F.
8)	Specify the PLC No. to be accessed when a multi PLC system is configured.
9)	Choose the display format on the personal computer.
10)	Set the device to be read and its number of points.
11)	Choose the number of read points of the device to be diagnosed.
12)	Choose the program to be diagnosed.
13)	Choose the memory to be accessed.
14)	Choose the comment data to be diagnosed.
15)	Set the keyword for device comment search. (Within 32 characters)
16)	Execution makes access to the PLC.
17)	Choose when monitoring the tag.

7.2 Providing Tag Display

This section explains the tag display screen.

1) {

Production A fau		
Production number	0	D0
Various statuses	0	D1
Manual operation flag	0	M1
Watch timer(Contact)	0	T0
Watch timer(Coil)	0	T0
Watch timer(Setting value)	---	T0
Watch timer(Current value)	0	T0

- 2) { Tag select
 Production A fau ▾
- 3) { Start
- 4) { Device monitor

No.	Description
1)	When TC is displayed, (Contact), (Coil), (Set value) or (Present value) is added to its display name.
2)	Select the tag you want to display from the tag list.
3)	Monitors a list of devices chosen by tag selection. Note that the statuses of the devices read to the personal computer are those when start is clicked. Note: The read devices do not vary in real time.
4)	Moves to the device monitor page.

7.3 Monitoring the Devices

This section explains the device display formats.

The following gives the examples of the Web browser and personal computer displays provided when the remote device monitor function is used.

(a) Word multi-point decimal

CPU:Q02(H)
D0-D15

Device	+0	+1	+2	+3	+4	+5	+6	+7
D0	0	0	0	0	0	0	0	0
D8	0	0	0	0	0	0	0	0

(b) Word multi-point hexadecimal

CPU:Q02(H)
D0-D15

Device	+0	+1	+2	+3	+4	+5	+6	+7
D0	0000	0000	0000	0000	0000	0000	0000	0000
D8	0000	0000	0000	0000	0000	0000	0000	0000

(c) Bit multi-point

CPU:Q02(H)
X0-XF

Device	FEDC	BA98	7654	3210
X0	0000	0000	0000	0000

(d) Commented decimal

CPU:Q02(H)
D0-D15

Device	Current value	Comment
D0	0	A line production conditions
D1	0	B line production conditions
D2	0	C line production conditions
D3	0	D line production conditions
D4	0	
D5	0	
D6	0	
D7	0	
D8	0	
D9	0	
D10	0	
D11	0	
D12	0	
D13	0	
D14	0	
D15	0	

(e) Commented hexadecimal

CPU:Q02(H)
D0-D15

Device	Current value	Comment
D0	0000	A line production conditions
D1	0000	B line production conditions
D2	0000	C line production conditions
D3	0000	D line production conditions
D4	0000	
D5	0000	
D6	0000	
D7	0000	
D8	0000	
D9	0000	
D10	0000	
D11	0000	
D12	0000	
D13	0000	
D14	0000	
D15	0000	

(f) Commented binary

CPU:Q02(H)
D0-D15

Device	FEDC	BA98	7654	3210	Comment
D0	0000	0000	0000	0000	A line production conditions
D1	0000	0000	0000	0000	B line production conditions
D2	0000	0000	0000	0000	C line production conditions
D3	0000	0000	0000	0000	D line production conditions
D4	0000	0000	0000	0000	
D5	0000	0000	0000	0000	
D6	0000	0000	0000	0000	
D7	0000	0000	0000	0000	
D8	0000	0000	0000	0000	
D9	0000	0000	0000	0000	
D10	0000	0000	0000	0000	
D11	0000	0000	0000	0000	
D12	0000	0000	0000	0000	
D13	0000	0000	0000	0000	
D14	0000	0000	0000	0000	
D15	0000	0000	0000	0000	

7.4 Setting the Server (Personal Computer) Line Connection

This section explains the server (personal computer) side line disconnection timer setting and line disconnection on the personal computer.

Server Side Circuit Settings
Time to disconnect the circuit 00:06:32

Time to disconnect the circuit
Time (0-99)
Minutes (0-59)

[Return to target connection specification](#)

[Server side dialup disconnect execution](#)

It cannot connect if server side dial up disconnect is executed. Please make sure before executing it.

Item	Description
Server Side Circuit Settings Time to disconnect the circuit	Set the time until the line is disconnected. When making this setting, preset "Enable disconnection of dial-up connection on client side" on the dial-up setting screen.
Server side dial-up disconnect execution	Disconnects the dial-up connection.

8. GETTING STARTED WITH GX RemoteService-I (Web function)

This chapter describes the setting of GX RemoteService-I functions on the server (personal computer) under the conditions presented in Section 8.1 and the confirmation of tag displays and device displays on the personal computer.

Section 8.1 explains the setting of GX RemoteService-I.

Section 8.2 explains the varying of the monitor devices and the arrival of e-mail.

Section 8.3 explains the operation procedure of looking at the server (personal computer) after the arrival of e-mail.

8.1 Setting GX RemoteService-I to the Server (Personal Computer)

Outline of setting example

(1) Setting of e-mail sending conditions

When the trigger condition is enabled, make settings to send e-mail to two persons.

- When M1000 turns on, Mr. A is informed of a "robot" fault.
- When M1001 turns on, Mr. B is informed of a "press" fault.

(2) Setting of devices read by the personal computer

- Make tag settings (three tags) for confirming the system status.
- Make setting to read the annunciator (F) first for checking the fault status of the system.

Conditions

Setting item		Setting
Operating mode		Automatic operation mode
Security setting		Must not be set.
E-mail setting	Send mail (SMTP) server	Refer to "Description for Use" or like sent from the provider and make settings.
	Receive mail (POP3) server	
	Account name	
	Password	
	E-mail address	
Network setting		Connection type: LAN connection In IP address modification by line reconnection, notify of a mail automatically: Unchecked.
PLC type		QCPU (Q mode), Qn (H)CPU
Transfer setup		PLC direct connection
Device range setting	Device	F0 Note: Set the F0 comment on GX Developer and write it to the PLC CPU in advance.
	Points	16 points
	Program	MAIN
	Target memory	Program memory/device memory
	Comment data	COMMENT

(Continued on next page)

(From the previous page)

Setting item		Setting			
Tag setting	Tag name	Device name	Display format	Display name	
	Robot (Tag 1)	M100	—	Robot controller fault	
		M101	—	Robot arm fault	
		M102	—	Servo amplifier fault	
	Press (Tag 2)	X100	—	Thermal fault	
		D100	Decimal	Coolant pressure low	
		X130	—	Die fault	
	Transfer (Tag 3)	M105	—	Rotary pump fault	
		X150	—	Stocker cylinder fault	
		D110	Decimal	Transfer motor speed	
Auto drive setting	1	Index	Plant A Line A		
		Trigger condition	M1000 turns on		
		Subject of message	Fault occurred in robot.		
		Body of message	A fault occurred in the line A robot. Check the system.		
		Trans. e-mail address	Mr. A aaa@***.co.jp		
	2	Index	Plant A Line B		
		Trigger condition	M1001 turns on		
		Subject of message	Fault occurred in press		
		Body of message	A fault occurred in the line B press. Check the system.		
		Trans.e-mail address	Mr. B bbb@***.ne.jp		
Dev. disp. setting		Character display (ON: × OFF: ○)			

Conceptual diagram of system

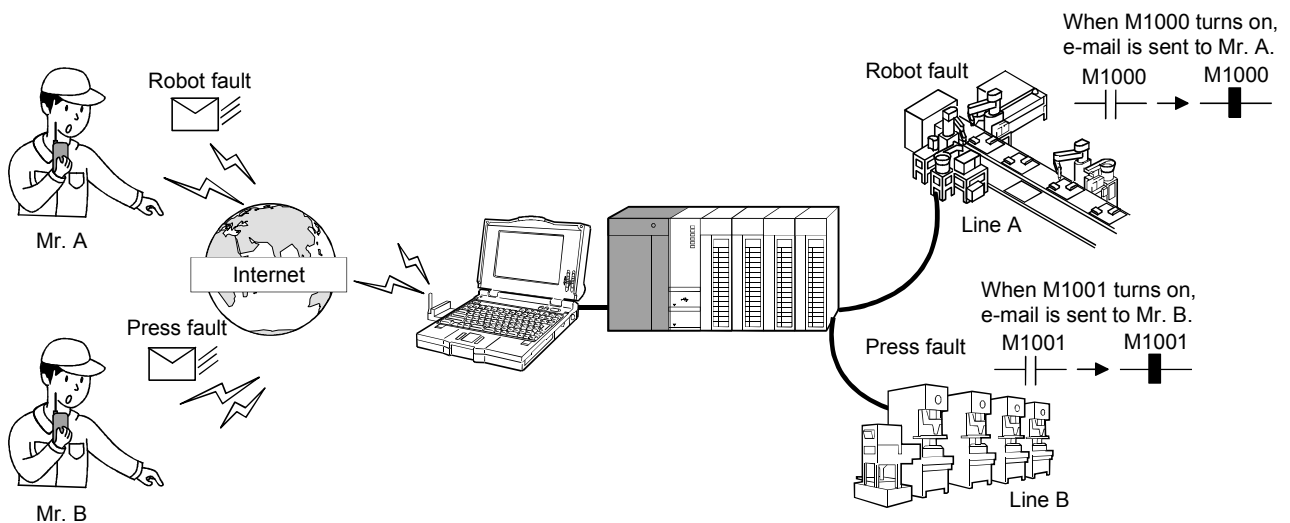

(Start)

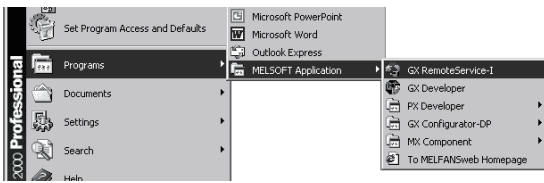

1) Start GX RemoteService-I.

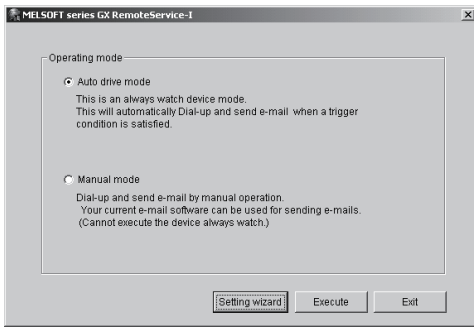

2) Choose the Auto run mode and click the **Setting wizard** button.

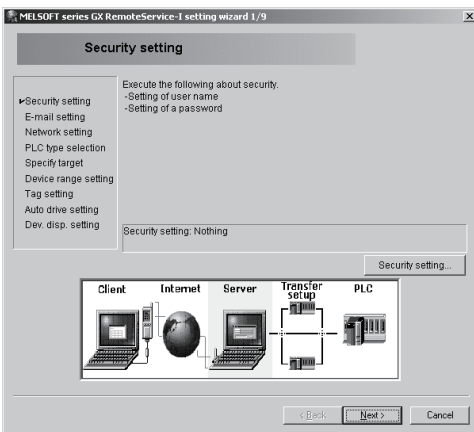

3) This screen is for the security setting to prevent an illegal access.
If this setting is not necessary, click the **Next>** button.

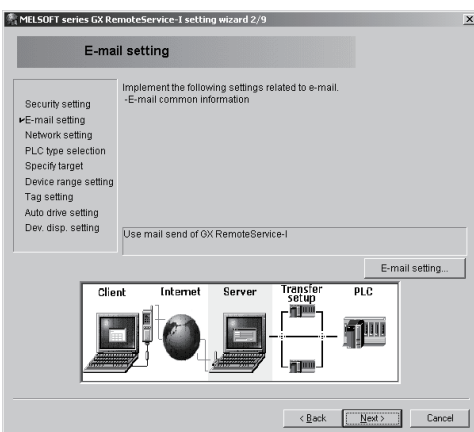

4) Set e-mail to notify the personal computer.
Click the **E-mail setting** button.

(To the next page)

(From the previous page)

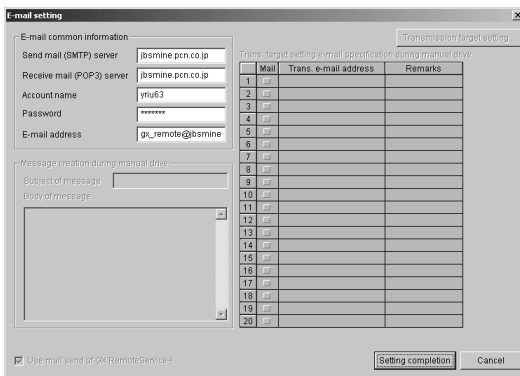

- 5) Set the e-mail common information.
Set the following data of the provider with whom you have contracted.
- Send mail (SMTP) server
 - Receive mail (POP3) server
 - E-mail address
 - Account name
 - Password

After the setting is finished, click the **Setting completion** button.

REMARK

For the settings, refer to "Description for Use" or like sent from the provider.

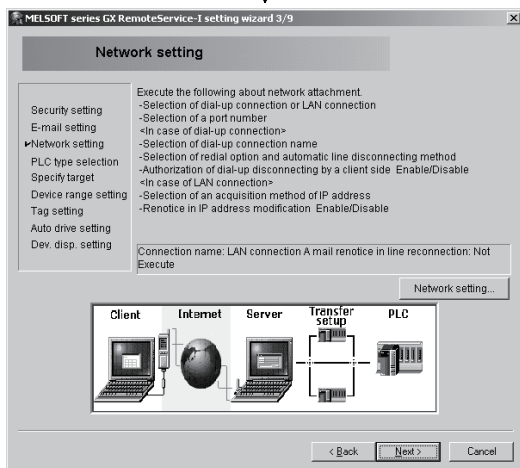

- 6) Set the details of Network.

Click the **Network setting** button.

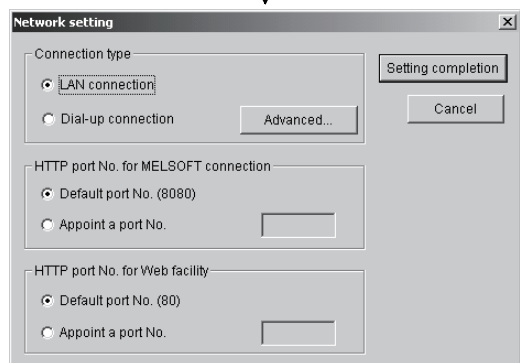

- 7) Set Connection type/HTTP port No. for MELSOFT connection/ HTTP port No. for Web facility.

Select "LAN connection" this time, and click the **Setting completion** button.

The operations after the **Advanced** button is clicked are explained on the next page.

(To the next page)

(From the previous page)



- In the case where LAN connection is selected and the **Advanced** button is clicked.

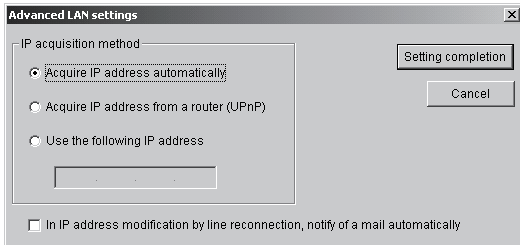

- In the case where Dial-up connection is selected and the **Advanced** button is clicked.

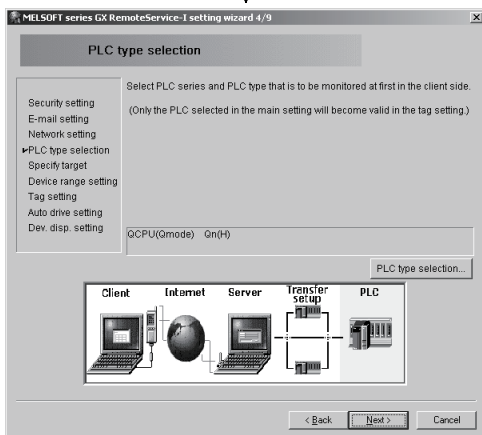
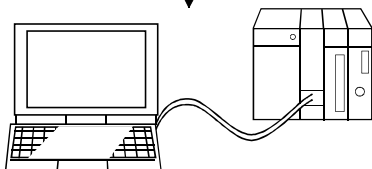
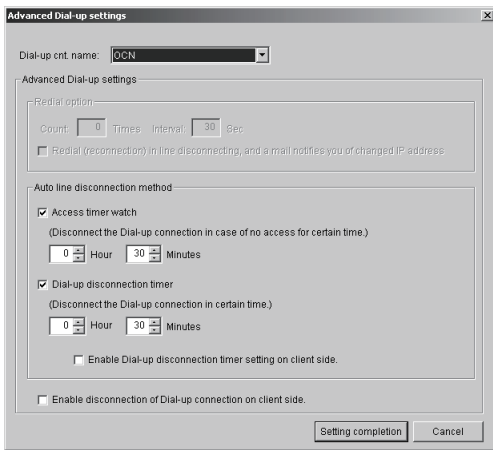

(To the next page)

Select an IP acquisition method.
After the settings are completed, click the **Setting completion** button.

This returns to "Network setting" screen.

Set the dial-up connection target and line disconnection method.

After the settings are completed, click the **Setting completion** button.

This returns to "Network setting" screen.

REMARK

Be sure to make the dial-up settings before making the advanced dial-up settings.
Without the settings, the following screen appears and the dial-up setting screen cannot be opened.



- 8) Connect the server (personal computer) and PLC CPU.

Prepare a program that can turn on M1000 and M1001 beforehand for the PLC CPU.

- 9) Set the PLC series and PLC type of the PLC CPU to be accessed first by the personal computer.

Click the **PLC type selection** button.

(From the previous page)

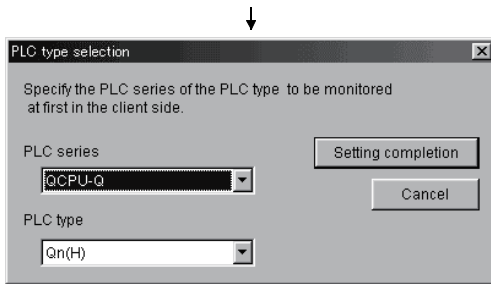

- 10) Choose the PLC series and PLC type of the PLC CPU to be connected to the server (personal computer). After the setting is finished, click the **Setting completion** button.

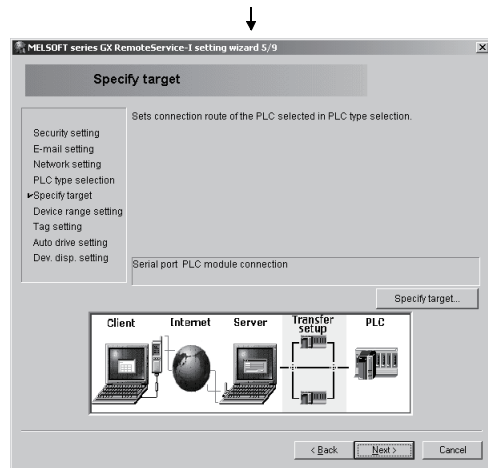

- 11) Set the connection path from the server (personal computer) to the PLC CPU. Click the **Specify target** button.

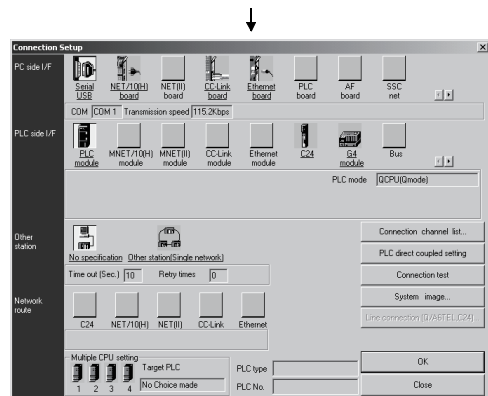

- 12) Set the path for connection of the server (personal computer) and PLC CPU. After the setting is finished, click the **Connection test** button to start a communication test. When normal communication is made, the CPU type appears in the CPU Type display field. After the setting is finished, click the **OK** button.

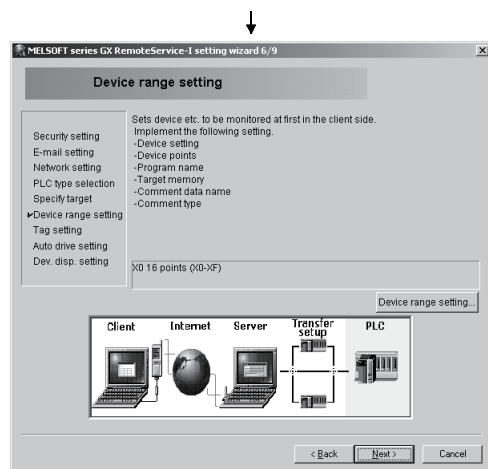

- 13) Set the device, number of points, and program name to be read first when the PLC CPU is accessed by the personal computer. Click the **Device range setting** button.

(To the next page)

(From the previous page)

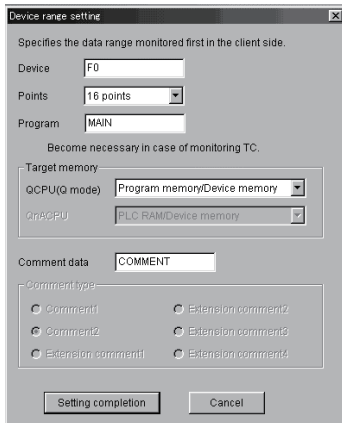

- 14) Set the device name (F0), number of points (16 points), and program name (MAIN). Refer to Section 6.3.6 for detailed explanation of the target memory and comment. After the setting is finished, click the **Setting completion** button.

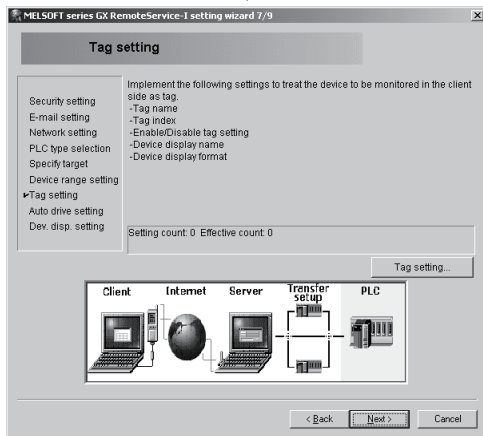

- 15) Make setting to read different types of devices (up to 10 types) together to the personal computer. Click the **Tag setting** button.

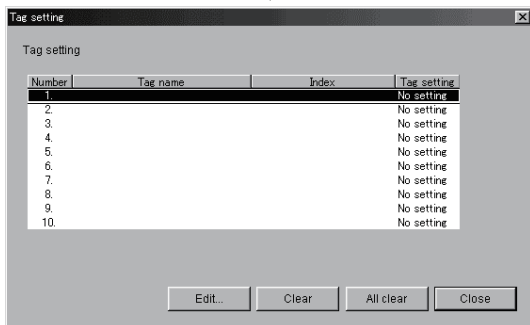

- 16) Choose No. 1 and click the **Edit** button.

Out of the three tags to be set, Tag 1 will only be explained here.

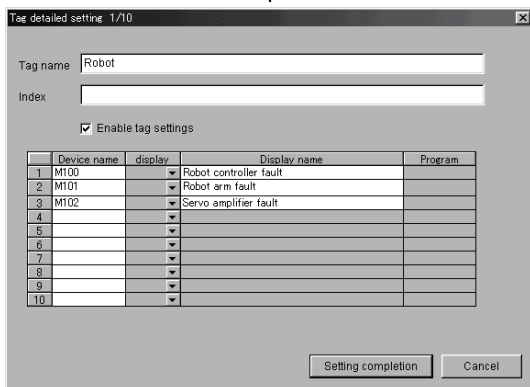

- 17) Set the tag name, device names and display names. After the setting is finished, click the **Setting completion** button. (Set Tag 2 and Tag 3 in the same procedure.)

(To the next page)

(From the previous page)

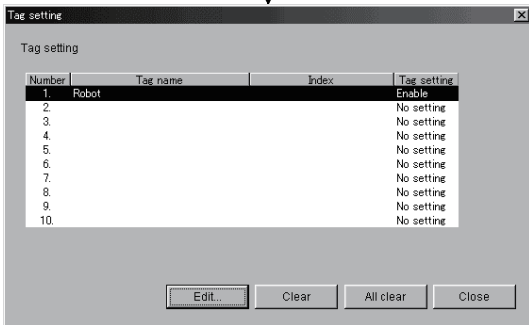

18) When editing Tag 2 or Tag 3, move the cursor to No. 2 or 3 and click the **Edit** button.

To end, click the **Close** button.

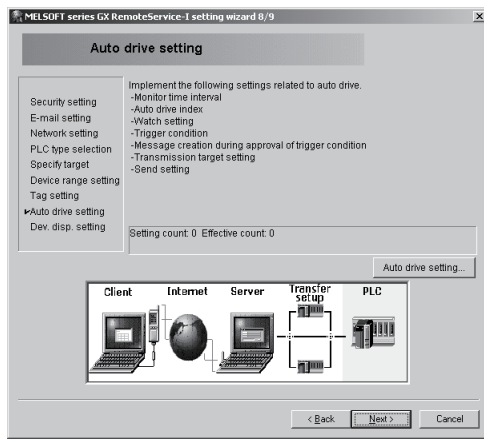

19) Make setting to monitor the system automatically.

Click the **Auto drive setting** button.

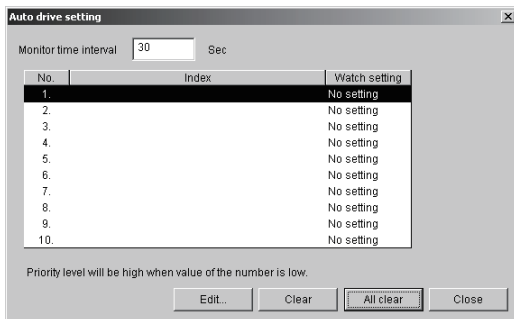

20) Choose No. 1 and click the **Edit** button.

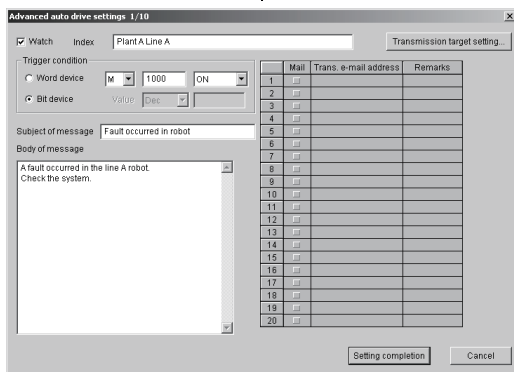

21) Set the Watch, Index, Trigger condition (M1000), Subject of message, Body of message.

Click the **Transmission target setting** button.

(To the next page)

(From the previous page)

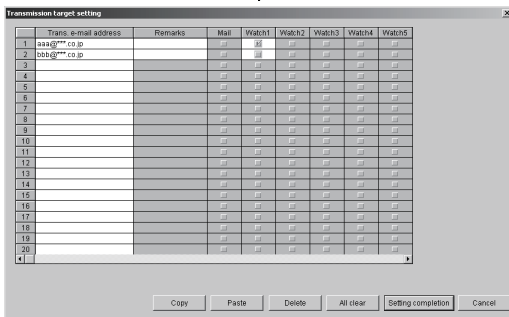

- 22) Set the Trans. e-mail address. Setting Mr.A at watch 1. After the setting is finished, click the **Setting completion** button.

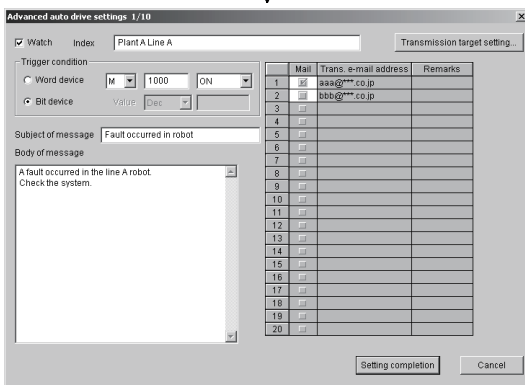

- 23) Click the **Setting completion** button.

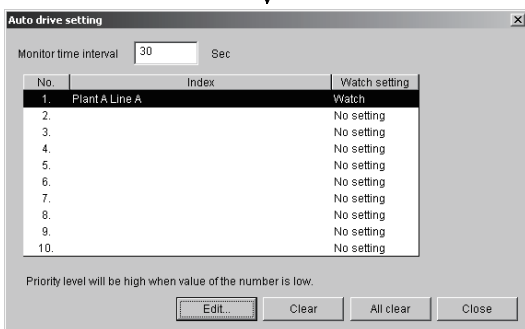

- 24) Move the cursor to No. 2 and click the **Edit** button.

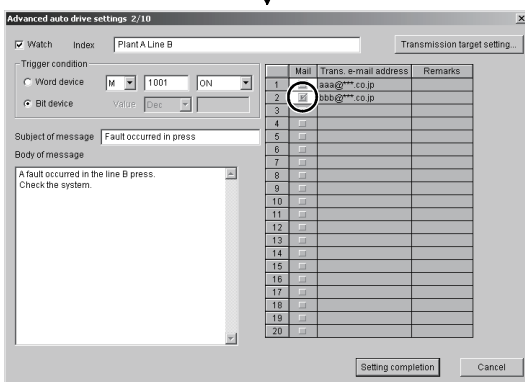

- 25) Set the Watch, Index, Trigger condition (M1001), Subject of message, Body of message. Enable 2 under "Mail". Click the **Transmission target setting** button.

(To the next page)

(From the previous page)

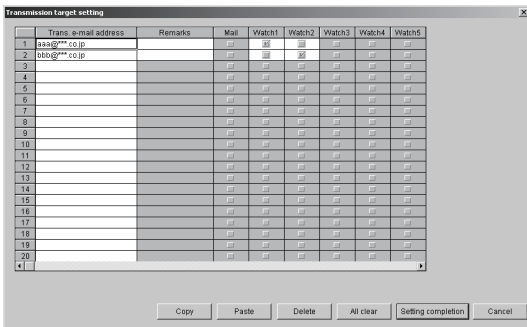

26) You can check the combinations for sending e-mail on the left screen.

When the check is finished, click the **Setting completion** button.

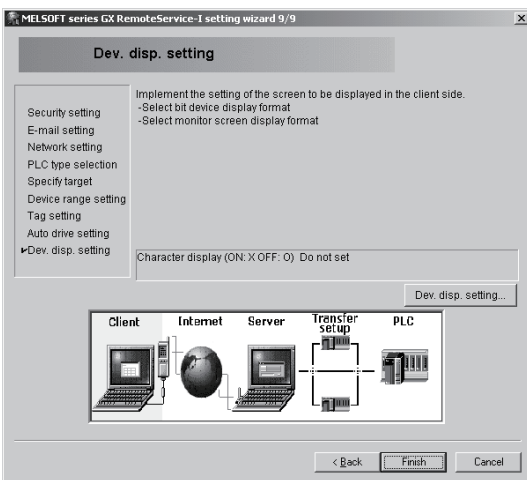

27) Set the display format of the screen to be displayed on the personal computer.

Click the **Dev. disp. setting** button.

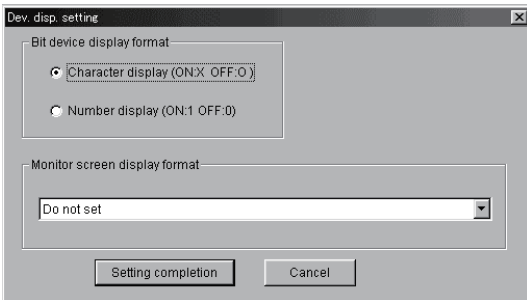

28) Choose "Character display (ON: X OFF: O)" and click the **Setting completion** button.



(To the next page)

(From the previous page)

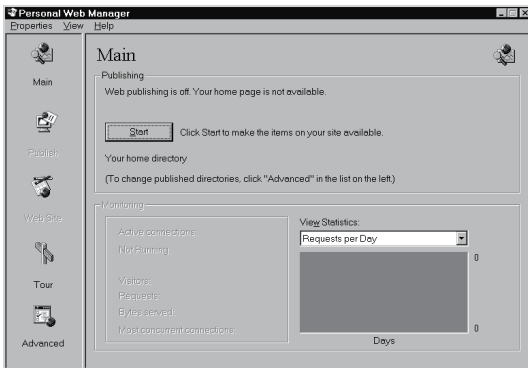

- 29) Start the Web server software and click the **Start** button.
Refer to Chapter 5 for starting the Web server software.

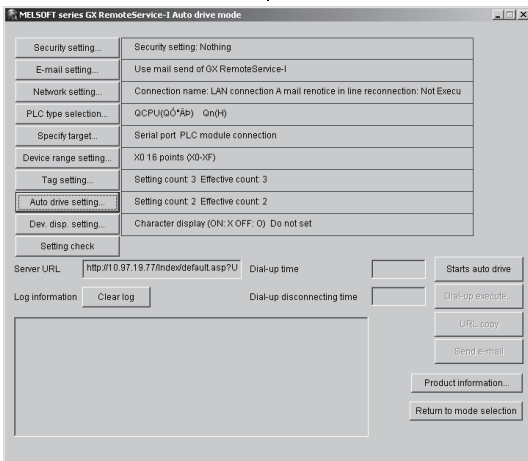

- 30) Click the **Start auto drive** button.



(Completion)

8.2 Varying of Monitor Devices and Arrival of E-mail

Using the device test function of GX Developer, vary the monitor devices set on GX RemoteService-I and make sure that e-mail arrives.

Preinstall GX Developer into the server (personal computer).

(Start)

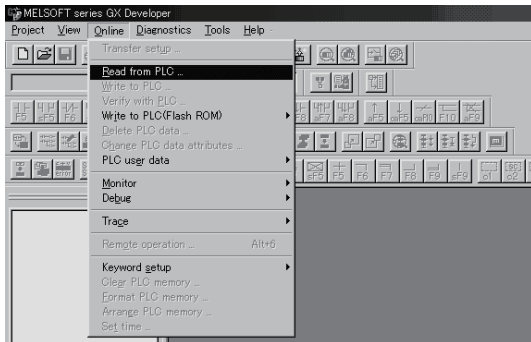

- 1) Start GX Developer installed in the server (personal computer).
Read the PLC program from [Online] - [Read from PLC].

For program reading operation, refer to the GX Developer Operating Manual.

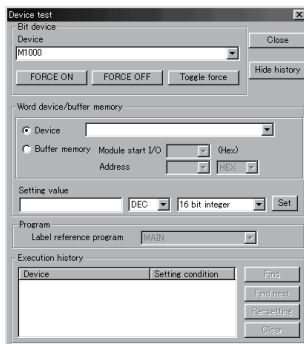

- 2) After stating program monitoring from GX Developer, choose [Online] - [Debug] - [Device test] and set M1000 for "ON" and M1001 for "ON" on the left screen.

When M1000 is turned "ON", e-mail is sent to Mr. A.
When M1001 is turned "ON", e-mail is sent to Mr. B.

For GX Developer operation, refer to the GX Developer Operating Manual.

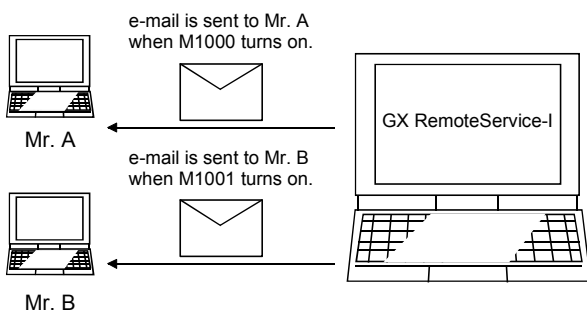

- 3) E-mail is sent from GX RemoteService-I and notifies the personal computers.

(Completion)

8.3 Receiving E-mail and Looking at Devices on Personal Computer

This section explains how to perform operation to check the e-mail sent from GX RemoteService-I and check the tag and device displays.

8.3.1 Until looking at tag

Outline of operation

The following operation example explains how to choose Tag 2 (press) and check the operating status of the system after receipt of e-mail.

(Start)

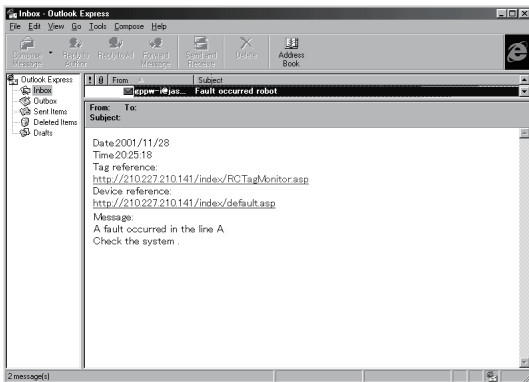

- 1) The e-mail sent from GX RemoteService-I is received. Check the received e-mail. After confirming the message, click the URL of "Tag reference".

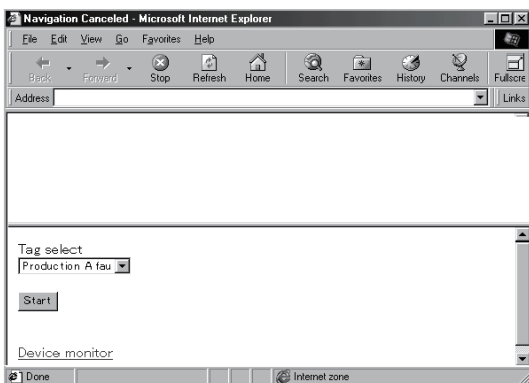

- 2) The left screen appears. Choose [Tag select].



(To the next page)

(From the previous page)

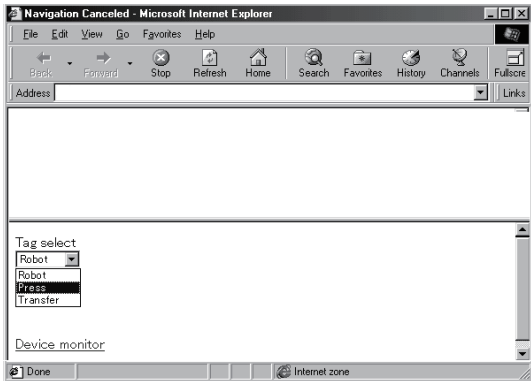

3) As a list of tag names appears, choose "Press".

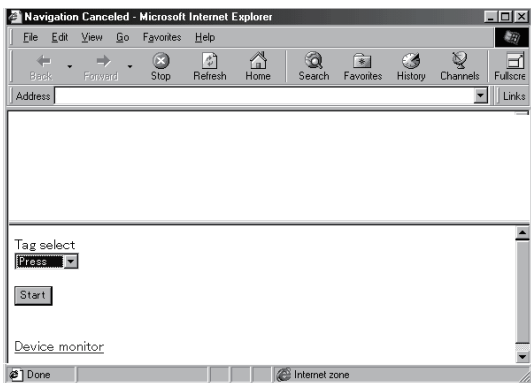

4) Choose **Start**.

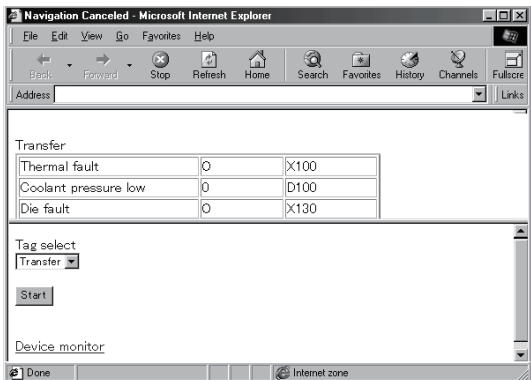

5) The devices set for the press are read.



(Completion)

8.3.2 Until looking at devices

Outline of operation

Following the operation in Section 8.3.1, monitor the device (F) using "Device reference" to check the details of the faulty status. The following operation example explains how to change the monitored device to the data register (D).

(Start)

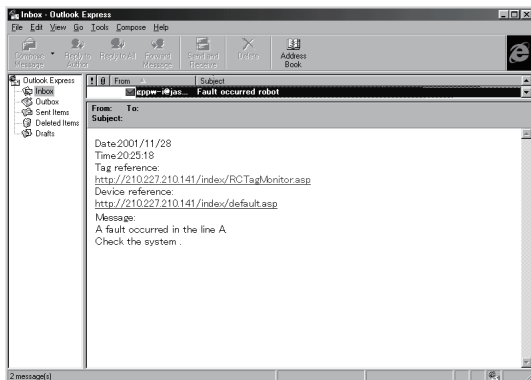

- 1) The e-mail sent from GX RemoteService-I is received. Check the received e-mail.
After confirming the message, click the URL of "Device reference".

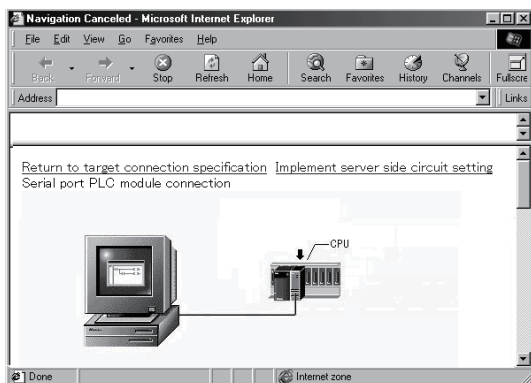

- 2) Scroll the screen down.

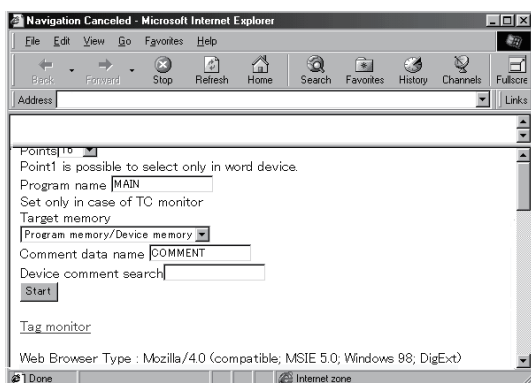

- 3) Choose **Start**.

(To the next page)

(From the previous page)

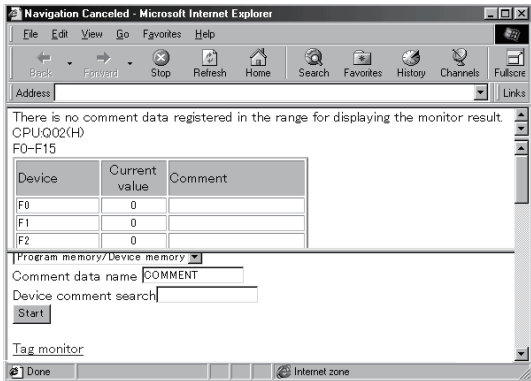

- 4) 16 points, starting from F0, in the MAIN program where the device range has been set on the server (personal computer) are read.

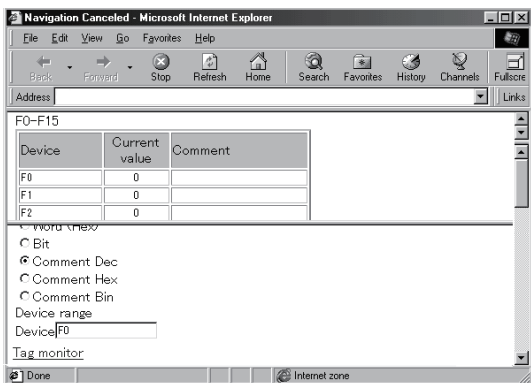

- 5) After confirming the contents of F0, change the device data to D100.

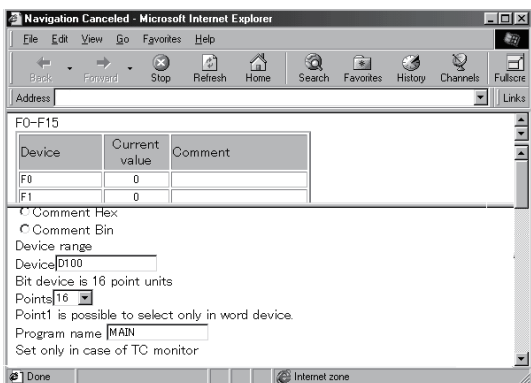

- 6) Change F0 to D100.



(To the next page)

(From the previous page)

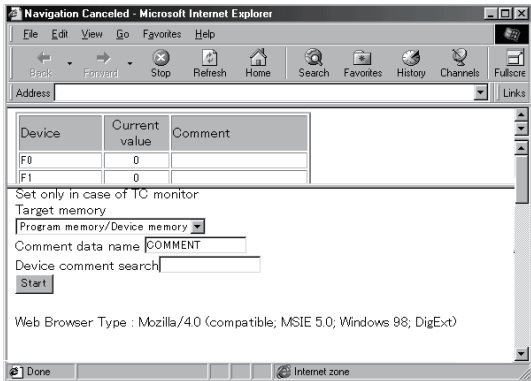

7) Choose **Start**.

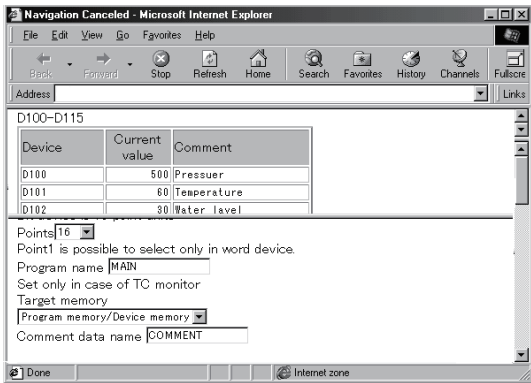

8) The D100 value can be read.



(Completion)

9. MELSOFT CONNECTION FUNCTION

The MELSOFT connection function is to access the PLC CPU via Internet/Intranet using a software package (MELSOFT) installed in the client side.

9.1 Using the MELSOFT connection function

9.1.1 When the server is personal computer/PC CPU module

The following explains the procedure to access the PLC CPU through a personal computer/PC CPU module.

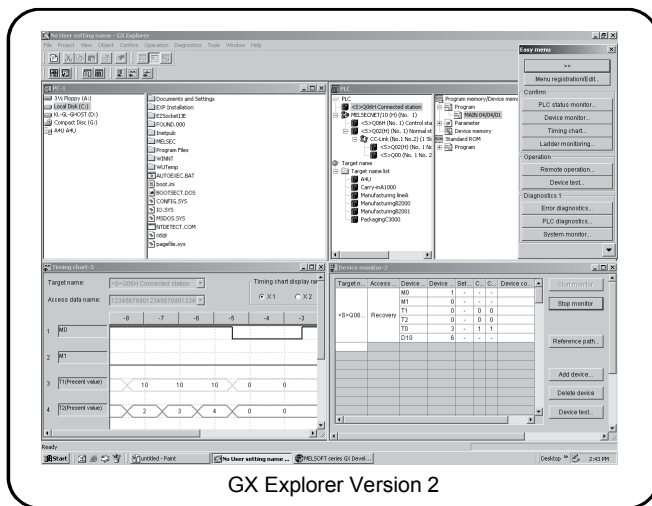

GX Explorer Version 2
Client (personal computer in which GX Explorer Version 2 is installed)

GX RemoteService-I Version 2
Server (personal computer in which GX RemoteService-I Version 2 is installed)

• Remote access operation procedure

- : Indicates the operation by the operator.
- : Indicates the automatic operation by the server.

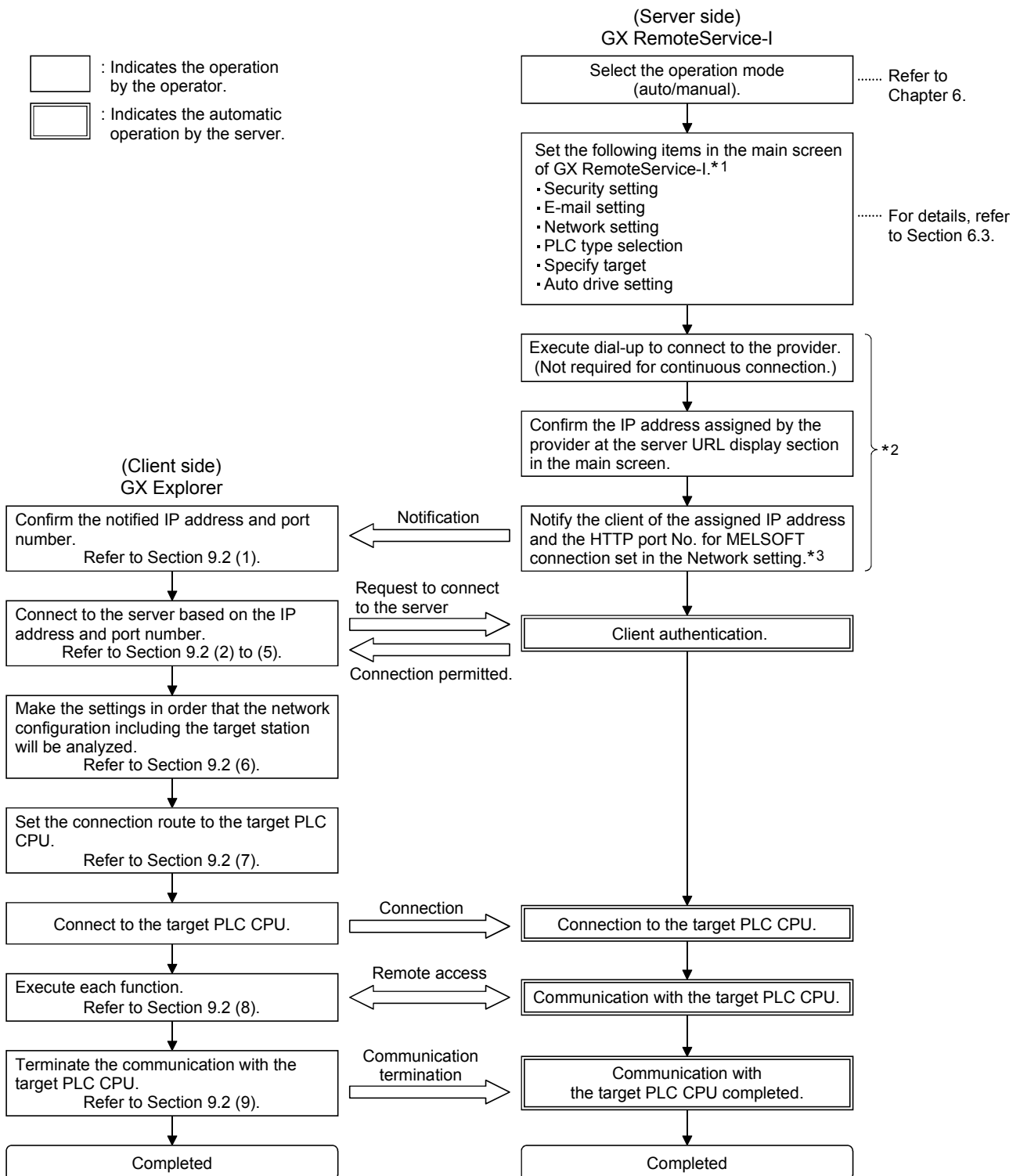

*1: The following items must be set using GX RemoteService-I installed in the server, in order to access the PLC CPU from the client using the MELSOFT connection function.

Setting item	Operation mode		Description
	Auto	Manual	
Security setting	△	△	Settings for client authentication. With the settings, the server identifies a client when the client connects to the server.
E-mail setting	○	△	Settings for using the GX RemoteService-I mail function. Not required when using Microsoft® Outlook Express or other mail software in manual operation mode.
Network setting	○	○	Settings for network connection method of the server.
PLC type selection	○	○	Settings for PLC series and PLC type of the PLC CPU that a client access first.
Specify target	○	○	Settings for connection method between the server and PLC CPU.
Auto drive setting	○	—	Settings for e-mail transmission triggers and e-mail message. Required when using auto operation mode.

○ : Necessary △ : Might be necessary —: Unnecessary.

*2: Manual mode: The operations are performed by the operator. (Refer to Section 6.2)

Auto drive mode: The operations are automatically performed when trigger conditions (set in the auto drive setting) are met.

*3: For auto drive mode, make the e-mail setting and auto drive setting. With these settings, the mail including the server IP address and HTTP port No. for MELSOFT connection will be automatically sent to the client when trigger conditions (set in the auto drive setting) are met.

9.1.2 When the server is Web server module

The following explains the procedure to access the PLC CPU through the Web server module. In the explanation, GX Explorer Version 2 is taken as an example. When using the Web server module as the server, set a compact flash card in which GX RemoteService-I has been installed into the Web server module.

• Remote access operation procedure

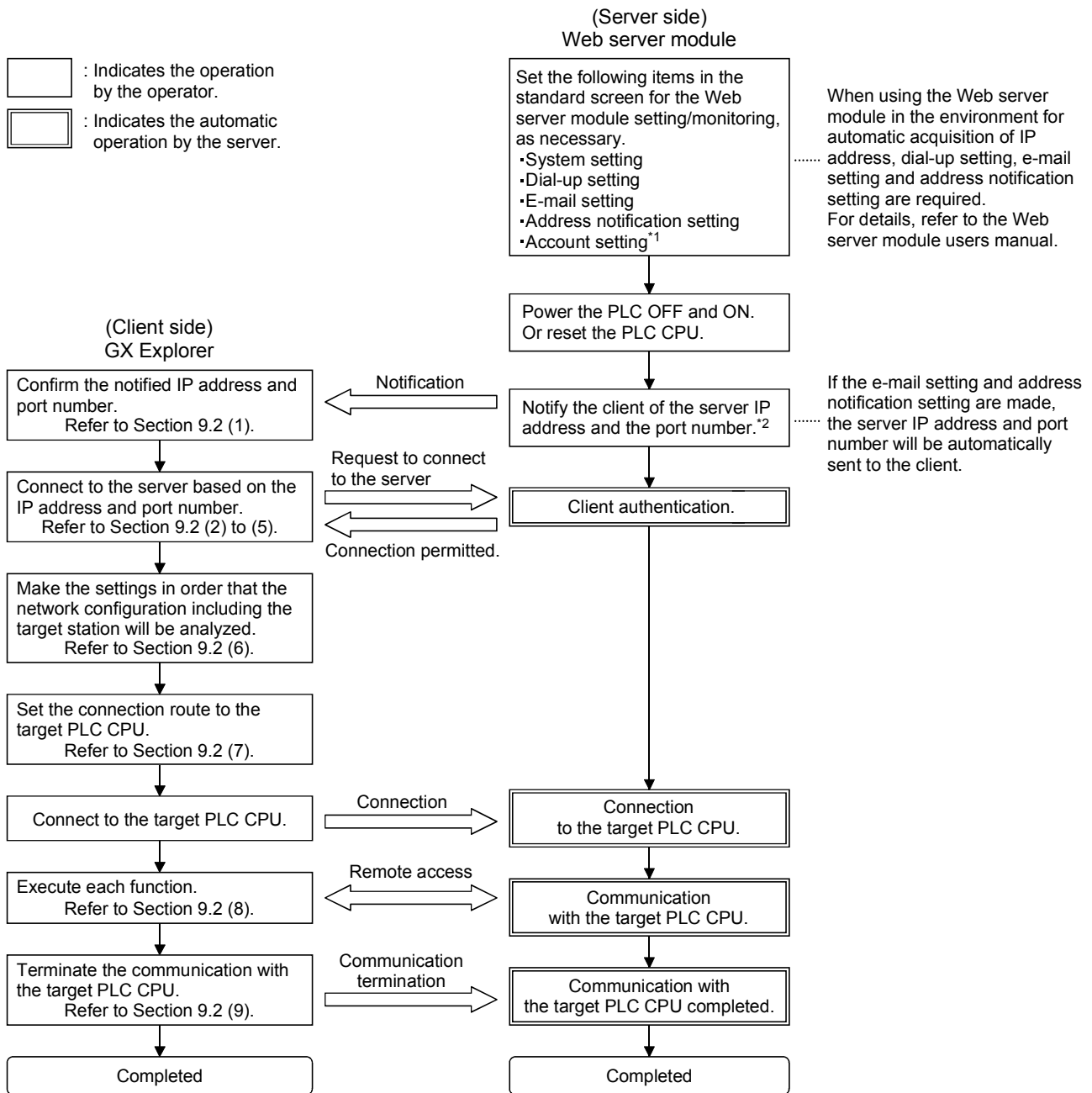

*1: Make the account setting as necessary.

*2: If the e-mail transmission is not available, confirm the Network connection of the server module by checking the buffer memory using GX Developer. For details, refer to the GX Developer Version 8 operating manual.

9.2 Application example of the MELSOFT connection function

The following explains how to connect to the server based on the e-mail sent from the server; to make a remote access to the PLC CPU through the server; to complete the communication with the PLC CPU.

In the explanation, GX Explorer Version 2 is taken as an example.

(Start)

(Example of received-mail)

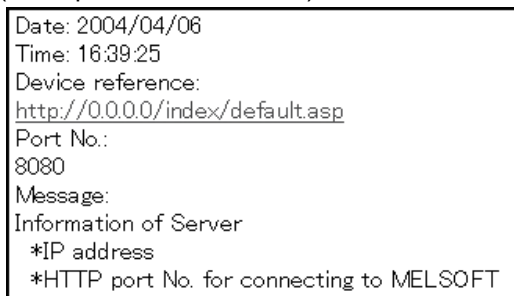

- (1) This screen is for the security setting to prevent an illegal access.
If this setting is not necessary, click button.
The e-mail sent from the server provides the server information (IP address and HTTP port No. for MELSOFT connection).
IP address follows "http:// ".
(For the left message, it corresponds to "0.0.0.0")

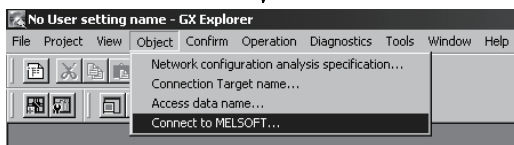

- (2) Start GX Explorer Version 2 from the personal computer (client).
Select [Object] – [MELSOFT connection] from the menu to display "MELSOFT connection" dialog box.

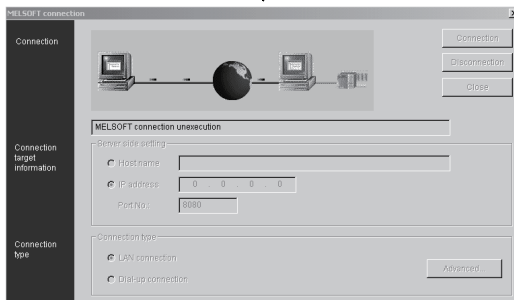

- (3) Specify the connection target server by setting the host name or the IP address and port number, and click the **Connection** button.

(To the next page)

(From the previous page)

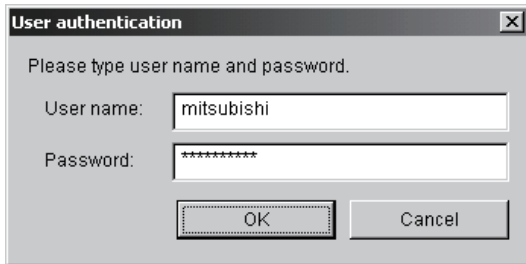

- (4) If Security setting has been made using GX RemtoeService-I, the left message appears. Enter the preset user name and password and click the **OK** button.

When the Web server module is used as the server, "Enter Network Password" dialog box appears. For details, refer to the Web server module user's manual.

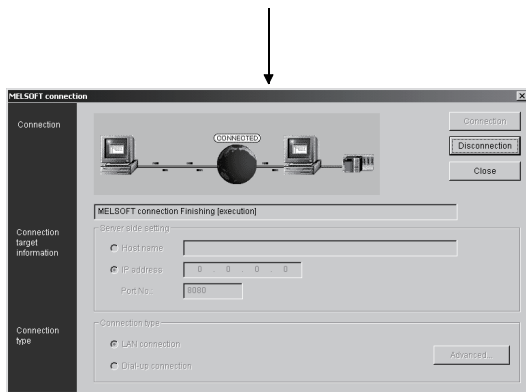

- (5) When the connection is completed, the screen changes as shown left.

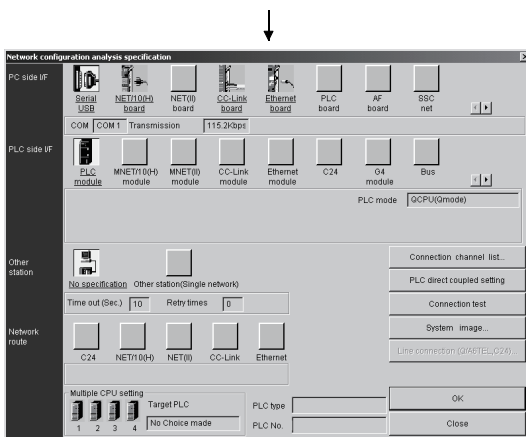

- (6) Set information from the server to the station targeted for an analysis of network configuration. For details, refer to "Network Configuration Analysis Specification" provided in the GX Explorer Version 2 operating manual.

When the server is Web server module, set "Q Series Bus" in PC side I/F, and "Web Server Unit" in PLC side I/F.

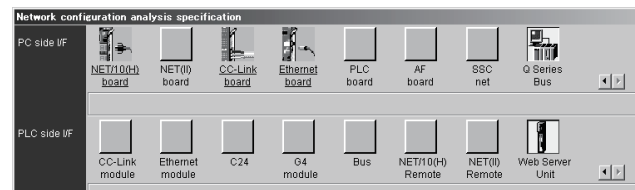

(To the next page)

(From the previous page)

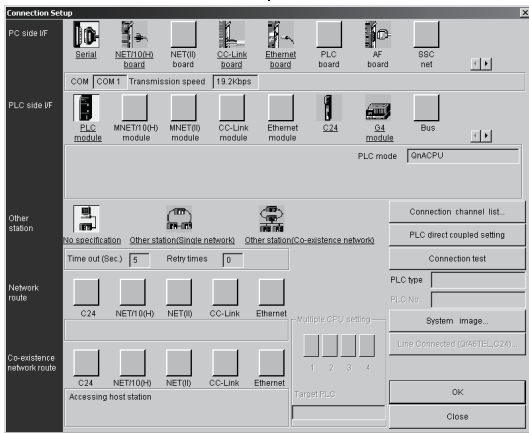

- (7) Set information from the server to the station targeted for an analysis of network configuration. For details, refer to "CONNECTION TARGET SPECIFICATION" provided in the GX Explorer Version 2 operating manual.

When the server is Web server module, items set in PC side I/F and PLC side I/F are the same with the items described in (6).

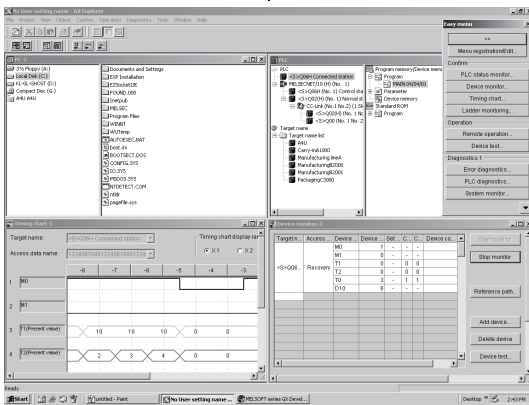

- (8) A remote access can be made to the target PLC CPU in order to execute each GX Explorer Version 2 function.

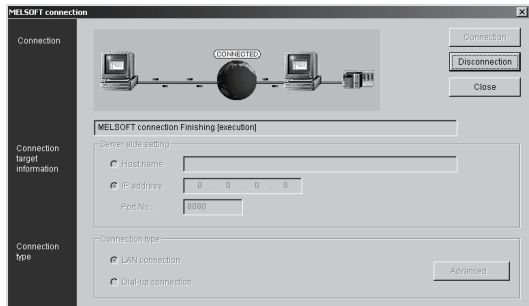

- (9) When terminating the remote access communication with the PLC CPU, click the **Disconnection** button to disconnect the connection to the server.

(Completion)

10. TROUBLESHOOTING

The following is the troubleshooting of the server (personal computer).

Phenomenon	Check	Corrective Action
Connection cannot be made from the dial-up network to the provider.	Check that the dial-up network has been installed.	Make sure that the dial-up network exists in the Control Panel.
	Check that "Dial-up connection name" of the dial-up network has been set.	Make sure that the connection target has been registered within the dial-up network in the Control Panel.
	Check that the modem driver has been installed.	Make sure that the modem used for the modem properties in the Control Panel is displayed.
	The modem does not dial.	Check by clicking the icon of the connection target within the dial-up network in the Control Panel.
	The modem dials but connection cannot be made to the host.	Check by clicking the icon of the connection target within the dial-up network in the Control Panel.
	The line was connected but you cannot log in.	Check by clicking the icon of the connection target within the dial-up network in the Control Panel.
Dial-up connection is instable. (Connection cannot be made sometimes.)	Connection is made from a place of weak radio wave with a mobile, or a local line is used.	For dial-up connection, enter ", (pause)" before the phone number.
e-mail cannot be sent from GX RemoteService-I.	Check that the e-mail of GX RemoteService-I has been set.	Make sure that correct values have been set to the e-mail of GX RemoteService-I.
	<ul style="list-style-type: none"> • Check that mail can be set to the specified destination from commercially available e-mail. • Check that the software can send mail. 	Check the settings for error. Contact the provider for confirmation.
	Check that the SMTP and POP3 server settings are correct.	<ul style="list-style-type: none"> • Check that the set character string is correct (e.g. periods, colons). • Check the SMTP and POP3 server settings presented by the provider.
	Check that the account name and password have been set.	Confirm the account name and password presented by the provider.

The following is the troubleshooting of the personal computer.

	Phenomenon	Check	Corrective Action
Common to clients	Error appears in commented monitor.	Check that device comments are written to the PLC CPU.	Using GX Developer, check that device comments have been written.
		Check that the device comments are correct.	Display the device setting screen of the server (personal computer) and check the registered device comment names.
	Error appears in T/C device monitor.	Check that the program name is correct.	Display the device setting screen of the server (personal computer) and check the registered program name.
	Tag names cannot be displayed.	Check that tag setting has been made to the server (personal computer).	Display the tag setting screen of the server (personal computer) and make sure that the tag names have been registered and the setting is valid.
	The line cannot be disconnected.	Check that disconnection from the personal computer is enabled on the server (personal computer).	Display the dial-up setting screen of the server (personal computer) and make sure that "Server Side Circuit Settings Time to disconnect the circuit" has been turned on.
	The dial-up disconnection timer cannot be set.	Check that dial-up disconnection timer setting from the personal computer is enabled on the server (personal computer).	Display the dial-up setting screen of the server (personal computer) and make sure that "Server Side Circuit Settings Time to disconnect the circuit" has been turned on.
	When devices or comments are displayed, a time-out occurs frequently and they cannot be displayed on the browser.	Check the script time-out period on the server (personal computer).	Change the script time-out period. Refer to REMARKS for the changing method.
	Communication cannot be made with the PLC. 01802001 01802002 01802005 010*4030 010*4031 010*4032 (*: Any of 0 to F enters.)	An unusable device name or range is used.	Check the device name and range in the PLC CPU manual.

REMARK

The following is the way to change the script time-out period.

(Start)

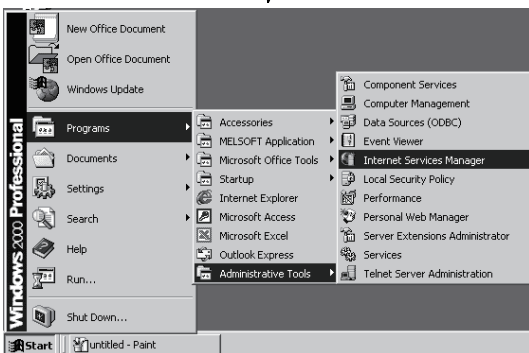

1) Start Internet Information Service.

(To next page)

(From previous page)

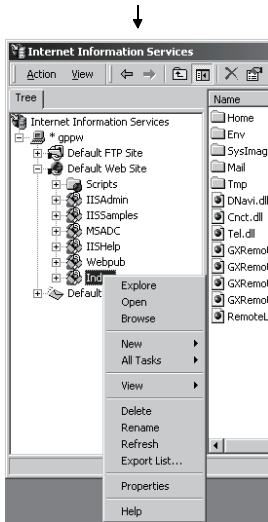

- 2) Right-click the virtual directory [Index] of GX RemoteService-I and choose [Properties].

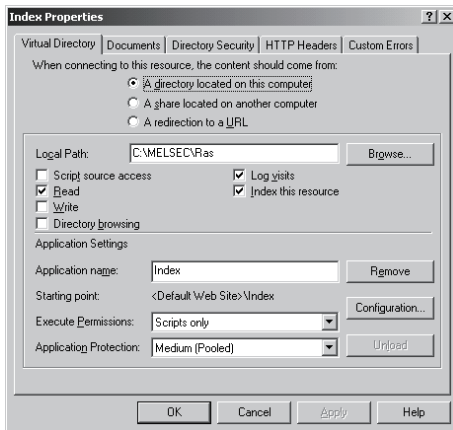

- 3) Click the "Configuration" button in the <Virtual Directory> tab.

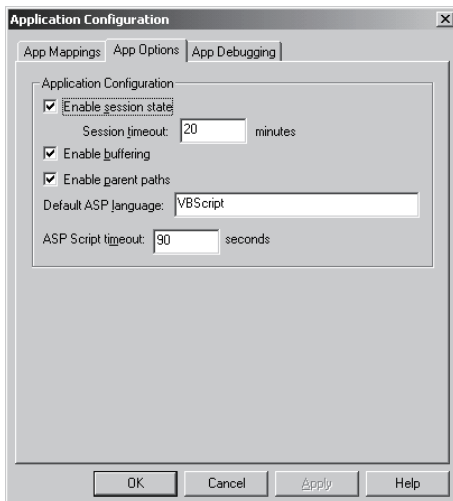

- 4) Change [ASP Script timeout] to about 200 seconds in the <App Options> tab and click the **OK** button.

(Completion)

APPENDICES

APPENDIX 1 RESTRICTIONS

The following table indicates the restrictions on use of GX RemoteService-I.

Item	Restrictions
Monitor	The monitor display or like (inquiry to the personal computer) is slow or the monitor display results in a time-out.
Setting check	Checks on set values, such as device names and ranges, are made by the server (personal computer).
Search	Comment search may not be executed using a mobile phone, depending on the line condition.
Web server module	Web server module with first five digits of serial number "05112" or later is applicable to this software package.
MELSOFT connection function	When performing the MELSOFT connection, install Internet Explorer 6.0 or later into the operating environment of server. (Installed in Windows® XP by default.)
Connection set up	Only global IP is applicable for a dial-up router. (IP masquerade is unsupported.)
Web function	The Web function can be executed by the Windows personal computer or PC CPU module. In the case of the Web server module, use functions included in the module as standard.
Performance (communication speed)	Update operation for the client may be delayed or communication time out error may occur during remote access, depending on the line condition.
Server connection	It is required to notify the client of the server IP address and HTTP port number for each dial-up connection.
LAN connection	When acquiring an IP address from DHCP server, note that the server changes the IP address regularly. Because of this character, if "Acquire IP address automatically" is set for LAN connection, this setting will not be supported.
Number of connected servers	One client cannot connect to multiple servers (personal computers) simultaneously.
Max number of connections	The number of allowable connections (clients) varies with the execution environment. Therefore, if many clients are connecting to the server, an error occurs and the corresponding dialog box appears. In this case, disconnect the unnecessary connections or execute re-connection after a certain time has passed.
Number of objects that can be monitored	Up to 20 objects can be monitored through a connection to the server (personal computer). (One client is allowed to request to connect to more than two objects. In object unit.)
Installation	Installation of this software package into a personal computer/PC CPU module is allowed to the user who has logged on as an administrators group only.

Item	Restrictions
Modem connection	When performing the MELSOFT connection, note that connection route via modem within the connection between the server and PLC system is not supported. (e.g., via Q6TEL or QJ71CMO)
Ethernet board/card	This software package may not work correctly in the personal computer that uses multiple Ethernet boards/cards.
IP address	Multiple IP addresses cannot be assigned to the personal computer/PC CPU module including this software package.
Line connection	The URL of the server (personal computer) must be mailed to the personal computer every time the server (personal computer) dials up.
	The IP address assigned by the provider that the server (personal computer) dials up must be the global IP address.
	The number of personal computers connectable to PWS simultaneously is up to 10. If there are more than 10, HTTP error 403 is displayed on the browser.
	When connection is made from the browser designed for the server (personal computer), PWS counts the number of connected personal computers as 2.
	A response from the server (personal computer) may be slow depending on the line conditions and like of the provider and between the relayed Internet servers.

INDEX

- [A]
 Automatic operation mode
 About automatic operation 1- 5
 Automatic operation setting 6-18
- [C]
 Connection setup 6-11
- [D]
 Device/comment display examples 7- 4
 Device display format setting 6-20
 Device range setting 6-15
 Displaying tags 7- 3
- [E]
 E-mail setting 6- 6
- [F]
 Function list
 Personal computer 3- 2
 Server (personal computer) 3- 1
- [M]
 Main screen 6- 3
 Manual operation mode
 About manual operation 1- 5
- [N]
 Network setting 6- 8
- [O]
 Operating environment
 Personal computer 2-25
 Server (personal computer) 2-22
- [P]
 Personal computer
 Line connection setting 3- 2, 7- 6
 PLC type setting 6-10
- [S]
 Setting and procedure
 Personal computer4-15
 Server (personal computer)4- 2
 Setting GX RemoteService-I to server
 (personal computer)8- 1
 System device list
 Connection from interface board2- 7
 Connection from serial/USB port2- 2
 Setting Wizard6- 2
 Types of usable modules2- 9
- [T]
 Tag setting6-16
- [U]
 Until looking at devices8-15
 Until looking at tags8-13
- [W]
 Web server installation
 Windows® 20005- 5
 Windows® 985- 1
 Windows NT® 4.05- 3
 Windows® XP5- 9

Microsoft, Windows, Windows NT are registered trademarks of Microsoft Corporation in the United States and other countries.

Adobe and Acrobat are registered trademarks of Adobe Systems Incorporation.

Pentium and Celeron are trademarks of Intel Corporation in the United States and other countries.

Ethernet is a trademark of Xerox Co., Ltd. in the United States.

Other company names and product names used in this document are trademarks or registered trademarks of respective owners.

SPREAD

Copyright (C) 1999 Farpoint Technologies, Inc.

SH(NA)-080465ENG-F(0911)MEE

MODEL: SW2D5-RAS-O-E

MODEL CODE: 13JU50

MITSUBISHI ELECTRIC CORPORATION

HEAD OFFICE : TOKYO BUILDING, 2-7-3 MARUNOUCHI, CHIYODA-KU, TOKYO 100-8310, JAPAN
NAGOYA WORKS : 1-14, YADA-MINAMI 5-CHOME, HIGASHI-KU, NAGOYA, JAPAN

When exported from Japan, this manual does not require application to the
Ministry of Economy, Trade and Industry for service transaction permission.

Specifications subject to change without notice.