

MELSOFT

Engineering Software

# GX Simulator Version 7 Operating Manual

---

-SW7D5C-LLT-E

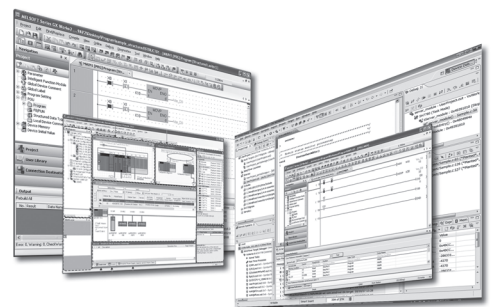



## ● SAFETY PRECAUTIONS ●

(Read these precautions before using this product.)

Before using this product, please read this manual and the relevant manuals carefully and pay full attention to safety to handle the product correctly.

In this manual, the safety precautions are classified into two levels: "⚠ WARNING" and "⚠ CAUTION".



Indicates that incorrect handling may cause hazardous conditions, resulting in death or severe injury.



Indicates that incorrect handling may cause hazardous conditions, resulting in minor or moderate injury or property damage.

Under some circumstances, failure to observe the precautions given under "⚠ CAUTION" may lead to serious consequences.

Observe the precautions of both levels because they are important for personal and system safety.

Make sure that the end users read this manual and then keep the manual in a safe place for future reference.

### [Cautions Regarding Test Operation]

#### ⚠ WARNING

- GX Simulator simulates an actual PLC CPU to debug the created programs; however, it does not guarantee the operation of the debugged sequence program.  
Be sure to connect the PC with PLC CPU to debug the program as usual prior to actual operation, after debugging with GX Simulator.  
Failure to observe this may result in accidents due to misoutput or misoperation.
- The simulated result may differ from actual operation because GX Simulator cannot access I/O modules or special function modules, and do not support some instructions or device memory.  
Be sure to connect the PC with PLC CPU to debug the program as usual prior to actual operation, after debugging with GX Simulator.  
Failure to observe this may result in accidents due to misoutput or misoperation.
- GX Simulator includes serial communication function to respond to the demands from external devices; however, it does not guarantee the actual operation of the external devices using the response data.  
Do not use the response data from the running GX Simulator for other than the checking by performing the serial communication function for the external device such as PC.  
Failure to observe this may result in accidents due to misoutput or misoperation.

## [Security Precautions]

### **WARNING**

- To maintain the security (confidentiality, integrity, and availability) of the programmable controller and the system against unauthorized access, denial-of-service (DoS) attacks, computer viruses, and other cyberattacks from external devices via the network, take appropriate measures such as firewalls, virtual private networks (VPNs), and antivirus solutions.

## • CONDITIONS OF USE FOR THE PRODUCT •

- (1) MELSEC programmable controller ("the PRODUCT") shall be used in conditions;
- i) where any problem, fault or failure occurring in the PRODUCT, if any, shall not lead to any major or serious accident; and
  - ii) where the backup and fail-safe function are systematically or automatically provided outside of the PRODUCT for the case of any problem, fault or failure occurring in the PRODUCT.

- (2) The PRODUCT has been designed and manufactured for the purpose of being used in general industries.

MITSUBISHI ELECTRIC SHALL HAVE NO RESPONSIBILITY OR LIABILITY (INCLUDING, BUT NOT LIMITED TO ANY AND ALL RESPONSIBILITY OR LIABILITY BASED ON CONTRACT, WARRANTY, TORT, PRODUCT LIABILITY) FOR ANY INJURY OR DEATH TO PERSONS OR LOSS OR DAMAGE TO PROPERTY CAUSED BY the PRODUCT THAT ARE OPERATED OR USED IN APPLICATION NOT INTENDED OR EXCLUDED BY INSTRUCTIONS, PRECAUTIONS, OR WARNING CONTAINED IN MITSUBISHI ELECTRIC USER'S, INSTRUCTION AND/OR SAFETY MANUALS, TECHNICAL BULLETINS AND GUIDELINES FOR the PRODUCT.

("Prohibited Application")

Prohibited Applications include, but not limited to, the use of the PRODUCT in;

- Nuclear Power Plants and any other power plants operated by Power companies, and/or any other cases in which the public could be affected if any problem or fault occurs in the PRODUCT.
- Railway companies or Public service purposes, and/or any other cases in which establishment of a special quality assurance system is required by the Purchaser or End User.
- Aircraft or Aerospace, Medical applications, Train equipment, transport equipment such as Elevator and Escalator, Incineration and Fuel devices, Vehicles, Manned transportation, Equipment for Recreation and Amusement, and Safety devices, handling of Nuclear or Hazardous Materials or Chemicals, Mining and Drilling, and/or other applications where there is a significant risk of injury to the public or property.

Notwithstanding the above restrictions, Mitsubishi Electric may in its sole discretion, authorize use of the PRODUCT in one or more of the Prohibited Applications, provided that the usage of the PRODUCT is limited only for the specific applications agreed to by Mitsubishi Electric and provided further that no special quality assurance or fail-safe, redundant or other safety features which exceed the general specifications of the PRODUCTS are required. For details, please contact the Mitsubishi Electric representative in your region.

- (3) Mitsubishi Electric shall have no responsibility or liability for any problems involving programmable controller trouble and system trouble caused by DoS attacks, unauthorized access, computer viruses, and other cyberattacks.

REVISIONS

\* The manual number is given on the bottom left of the back cover.

Print Date	* Manual Number	Revision
Sep., 2004	SH (NA)-080468ENG-A	First edition
Nov., 2004	SH (NA)-080468ENG-B	Correction Section 11.1
Feb., 2005	SH (NA)-080468ENG-C	Correction Section 1.2, Section 3.4.3, Section 3.4.6
Aug., 2005	SH (NA)-080468ENG-D	Correction Chapter 1, Section 1.1, Section 1.2, Section 2.2, Section 2.3, Section 3.1, Section 3.2, Section 3.4.4, Section 3.4.6, Section 4.1, Section 4.3, Chapter 7, Appendix 4
Nov., 2005	SH (NA)-080468ENG-E	Addition mode FX <sub>3U</sub> CPU, FX <sub>3UC</sub> CPU Correction About the Generic Terms and Abbreviations, Section 1.1, Section 1.2, Section 3.4.1, Section 3.4.4, Section 7.1.4, Section 9.2, Section 11.1, Appendix 1.3, Appendix 1.5, Appendix 2.3, Appendix 3.1, Appendix 3.2, Appendix 4
Apr., 2006	SH (NA)-080468ENG-F	Correction Section 3.4.1, Section 3.4.3, Section 3.4.6, Section 4.3, Appendix 3.1, Appendix 3.2
May., 2007	SH (NA)-080468ENG-G	Correction Appendix 2.2, Appendix 2.5
Feb., 2008	SH (NA)-080468ENG-H	Correction About the Generic Terms and Abbreviations, Section 2.3, Section 3.4.6, Appendix 4
Apr., 2008	SH (NA)-080468ENG-I	Addition mode Q02PHCPU, Q06PHCPU Correction About the Generic Terms and Abbreviations, Appendix 5
Jul., 2008	SH (NA)-080468ENG-J	Addition mode FX <sub>3G</sub> CPU Correction About the Generic Terms and Abbreviations, Section 3.4.4, Appendix 1.3, Appendix 1.5, Appendix 2.3, Appendix 5

Print Date	* Manual Number	Revision
Dec., 2008	SH (NA)-080468ENG-K	<p><b>Addition mode</b></p> <p>Q00UJCPU, Q00UCPU, Q01UCPU, Q02UCPU, Q03UDCPU, Q03UDECPU, Q04UDHCPU, Q04UDEHCPU, Q06UDHCPU, Q06UDEHCPU, Q10UDHCPU, Q10UDEHCPU, Q13UDHCPU, Q13UDEHCPU, Q20UDHCPU, Q20UDEHCPU, Q26UDHCPU, Q26UDEHCPU</p> <p><b>Correction</b></p> <p>About the Generic Terms and Abbreviations, Section 1.2, Section 3.2, Section 3.4.1, Section 3.4.6, Section 5.5.3, Section 5.5.6, Section 7.1.4, Section 7.1.5, Section 7.1.6, Section 7.1.7, Section 7.2.8, Appendix 1.5, Appendix 2.5, Appendix 5 changed to Appendix 4</p> <p><b>Deletion</b></p> <p>Appendix 4</p>
Sep., 2009	SH (NA)-080468ENG-L	<p><b>Correction</b></p> <p>SAFETY PRECAUTIONS, About Manuals, Product Makeup, Appendix 1.1, Appendix 1.2, Appendix 1.5, Appendix 2.3</p> <p><b>Deletion</b></p> <p>SOFTWARE USER REGISTRATION</p>
Dec., 2010	SH (NA)-080468ENG-M	<p><b>Addition</b></p> <p>CONDITIONS OF USE FOR THE PRODUCT</p> <p><b>Correction</b></p> <p>About the Generic Terms and Abbreviations, Section 1.2, Section 2.2, Section 2.3, Section 3.1, Section 3.4.1, Section 3.4.6, Chapter 5, Section 5.5.6, Section 7.2.6, Section 11.1, Appendix 1.5, Appendix 2.5, Appendix 4</p>
Dec., 2012	SH(NA)-080468ENG-N	<p><b>Correction</b></p> <p>Appendix 1.1, Appendix 1.5</p>
Jul., 2017	SH(NA)-080468ENG-O	<p><b>Correction</b></p> <p>Section 3.4.6</p>
Oct., 2021	SH(NA)-080468ENG-P	<p><b>Correction</b></p> <p>SAFETY PRECAUTIONS, CONDITIONS OF USE FOR THE PRODUCT, About Manuals, About the Generic Terms and Abbreviations, Section 2.3, Appendix 1.3</p>

Japanese Manual Version SH-080467-R

This manual confers no industrial property rights or any rights of any other kind, nor does it confer any patent licenses. Mitsubishi Electric Corporation cannot be held responsible for any problems involving industrial property rights which may occur as a result of using the contents noted in this manual.

© 2004 MITSUBISHI ELECTRIC CORPORATION

## INTRODUCTION

Thank you for purchasing the engineering software, MELSOFT series.  
Read this manual and make sure you understand the functions and performance of MELSOFT series thoroughly in advance to ensure correct use.

## CONTENTS

SAFETY PRECAUTIONS.....	A- 1
CONDITIONS OF USE FOR THE PRODUCT .....	A- 3
REVISIONS .....	A- 4
INTRODUCTION .....	A- 6
CONTENTS.....	A- 6
About Manuals .....	A-10
About the Generic Terms and Abbreviations .....	A-11
Product Makeup .....	A-13
<b>1. OUTLINE OF GX Simulator</b> .....	<b>1- 1 to 1- 12</b>
1.1 Features of the GX Simulator .....	1- 2
1.2 Differences To Debugging with an Actual PLC Connected.....	1- 8
<b>2. SYSTEM CONFIGURATION</b> .....	<b>2- 1 to 2- 3</b>
2.1 System Configuration.....	2- 1
2.2 Combination with MELSOFT Products .....	2- 1
2.3 Operating Environment.....	2- 2
<b>3. SPECIFICATIONS</b> .....	<b>3- 1 to 3-26</b>
3.1 Table of Functions.....	3- 1
3.2 Function List .....	3- 3
3.3 Devices and Instructions Supported by the GX Simulator .....	3- 8
3.4 GX Simulator Restrictions and Cautions.....	3- 9
3.4.1 Restrictions and cautions common to each type of CPU .....	3- 9
3.4.2 Restrictions and cautions for the A series CPU functions .....	3-12
3.4.3 Restrictions and cautions for the QnA series CPU functions .....	3-14
3.4.4 Restrictions and cautions for the FX series CPU functions .....	3-17
3.4.5 Restrictions and cautions for the Motion controller functions .....	3-20
3.4.6 Restrictions and precautions for the Q series CPU functions .....	3-21
3.5 GX Simulator Safety and Handling Precautions .....	3-26
<b>4. COMMON OPERATIONS FOR THE GX Simulator</b> .....	<b>4- 1 to 4- 7</b>
4.1 Procedure from Installation to Debugging.....	4- 1
4.2 GX Developer Operations before Debugging .....	4- 3
4.3 Description of the Initial Screen Display.....	4- 5
4.4 Ending the GX Simulator .....	4- 7



**5. SIMULATION OF EXTERNAL DEVICE OPERATION - I/O SYSTEM SETTING FUNCTIONS 5- 1 to 5-35**

5.1 I/O System Setting Operation Procedure.....	5- 4
5.2 Starting/Ending I/O System Setting.....	5- 5
5.3 Configuration of I/O System Settings Screen .....	5- 6
5.4 Setting by Using Timing Chart.....	5- 8
5.5 Operation of Timing Chart Format Input Screen.....	5-10
5.5.1 Operation procedure of timing chart format input screen .....	5-10
5.5.2 Configuration of timing chart format input screen .....	5-11
5.5.3 Entering/Deleting device .....	5-13
5.5.4 Setting/Editing timing .....	5-15
5.5.5 Setting scan number of timing chart.....	5-21
5.5.6 Other operations.....	5-22
5.6 Setting by Entering Device Value.....	5-25
5.7 Starting/Stopping the Simulation .....	5-27
5.8 Other Operations.....	5-29
5.8.1 Operating the file .....	5-29
5.8.2 Cutting, copying and pasting all settings in the set No. ....	5-31
5.8.3 Batch-enabling/disabling settings .....	5-32
5.8.4 Executing monitoring.....	5-33
5.8.5 Reading I/O system setting file for SW5 or earlier versions .....	5-35

**6. COMMUNICATION WITH EXTERNAL DEVICE - SERIAL COMMUNICATION FUNCTION 6- 1 to 6-12**

6.1 Operation Procedures for Serial Communication Function.....	6- 2
6.2 Starting/Ending the Serial Communication Function .....	6- 3
6.3 Layout of the Serial Communication Function Screen .....	6- 4
6.4 Transmission Specifications .....	6- 6
6.5 Usable Frames .....	6- 7
6.6 Command Lists .....	6- 8
6.6.1 Usable A-compatible 1C frame commands .....	6- 8
6.6.2 Usable QnA-compatible 3C/4C frame commands.....	6- 9
6.7 Communication Status.....	6-10
6.8 Error Code Lists .....	6-11
6.8.1 When the A-compatible 1C frame is used.....	6-11
6.8.2 When the QnA-compatible 3C/4C is used .....	6-12

**7. MONITORING, TESTING DEVICE MEMORY - MONITOR FUNCTION 7- 1 to 7-29**

7.1 Monitoring, Testing the Device Memory.....	7- 1
7.1.1 Operation Procedure of Monitoring Device Memory.....	7- 2
7.1.2 Starting/Ending Monitoring Device Memory.....	7- 3
7.1.3 Specifying the station to be monitored .....	7- 4
7.1.4 Batch-monitoring the devices .....	7- 5
7.1.5 Monitoring the buffer memory.....	7- 8
7.1.6 Monitoring the registered devices.....	7-11
7.1.7 Conducting a device test (Device write).....	7-13

7.2 Using Timing Chart .....	7-15
7.2.1 Operation procedure of timing chart .....	7-15
7.2.2 Starting/Exiting timing chart .....	7-16
7.2.3 Using timing chart .....	7-17
7.2.4 Entering/Deleting device to be monitored .....	7-20
7.2.5 Starting/Stopping monitoring .....	7-23
7.2.6 Operating file .....	7-24
7.2.7 Setting sampling period .....	7-26
7.2.8 Other operations .....	7-27

<b>8 SETTING THE DEVICES FOR SIMULATION - DEVICE MANAGER FUNCTION</b>	<b>8- 1 to 8-26</b>
---	---------------------

8.1 Device Manager Operation Procedure .....	8- 3
8.2 Starting/Exiting Device Manager .....	8- 4
8.3 Setting the Other Station Devices .....	8- 5
8.3.1 Other station device setting .....	8- 5
8.4 Setting the Device Values for Simulation .....	8- 7
8.4.1 Device control setting .....	8- 7
8.4.2 Device value check setting .....	8-12
8.5 Starting/Stopping Simulation .....	8-14
8.6 Displaying the Results of Access to Devices (Log Display) .....	8-15
8.7 Other Operations .....	8-17
8.7.1 Performing the file operation of setting data .....	8-17
8.7.2 Editing the settings .....	8-19
8.7.3 Printing the log information and setting information .....	8-22
8.7.4 Searching for log information .....	8-24
8.7.5 Saving the log information into file .....	8-25
8.7.6 Clearing the log information .....	8-26

<b>9. SAVING AND READING THE DEVICE AND BUFFER MEMORIES, OPTION SETTING - TOOL FUNCTIONS</b>	<b>9- 1 to 9- 6</b>
--	---------------------

9.1 Saving the Device and Buffer Memories .....	9- 1
9.2 Reading Saved Device Memory or Buffer Memory Data .....	9- 3
9.3 Option Setting .....	9- 6

<b>10. EXAMPLES OF GX Simulator APPLICATIONS</b>	<b>10- 1 to 10-15</b>
--	-----------------------

10.1 Debugging Using GX Developer Step Execution Function .....	10- 4
10.2 Using Timing Chart Display for Debugging .....	10- 6
10.3 Using I/O System Settings for Debugging .....	10-10

<b>11. TROUBLESHOOTING</b>	<b>11- 1 to 11- 8</b>
----------------------------	-----------------------

11.1 Error Messages Displayed on the LED Indicators .....	11- 1
---	-------

Appendix 1 List of Supported Devices .....	App- 1
Appendix 1.1 The A series CPU function GX Simulator .....	App- 1
Appendix 1.2 The QnA series CPU function GX Simulator .....	App- 5
Appendix 1.3 FX series CPU function GX Simulator .....	App-11
Appendix 1.4 GX Simulator for Q series CPU (A mode) functions.....	App-35
Appendix 1.5 GX Simulator for Q series CPU (Q mode) functions .....	App-35
Appendix 2 List of Supported Instruction.....	App-50
Appendix 2.1 A series CPU function GX Simulator .....	App-50
Appendix 2.2 QnA series function GX Simulator .....	App-52
Appendix 2.3 FX series function GX Simulator .....	App-54
Appendix 2.4 GX Simulator for Q series CPU (A mode) functions.....	App-61
Appendix 2.5 GX Simulator for Q series CPU (Q mode) functions .....	App-61
Appendix 3 List of Devices Usable with the I/O System Settings .....	App-64
Appendix 3.1 Condition area.....	App-64
Appendix 3.2 Simulation device area .....	App-66
Appendix 4 Functions Added to Upgraded from Previous Versions .....	App-70

## About Manuals

The following manuals are related to this product.  
Refer to the following table and request the necessary manuals.

### **Related Manuals**

Manual Name	Manual Number (Model Code)
GX Simulator Version 7 Operating Manual Describes the functions and operation methods of GX Simulator. (this manual) (Sold separately)	SH-080468ENG (13JU51)
GX Developer Version 8 Operating Manual Describes the online functions of GX Developer including the programming procedure, printing out procedure, monitoring procedure, and debugging procedure. (Sold separately)	SH-080373E (13JU41)

### **REMARK**

The GX Simulator Version 7 Operating Manual is included in the software package in PDF file.

For the user who wants the GX Simulator Version 7 Operating Manual as a single item, it is available in a printed form as an option.

## About the Generic Terms and Abbreviations

Unless otherwise specified, the following generic terms and abbreviations are used in this manual.

Generic Term/Abbreviation	Description
GX Simulator	Generic product name of the products SWnD5C-LLT-E, SWnD5C-LLT-EA, SWnD5C-LLT-EV and SWnD5C-LLT-EVA. (n indicates any of versions 2 to 7.) -EA indicates a multiple-license product, and -EV an updated product.
GX Developer	Generic product name of the products SWnD5C-GPPW-E, SWnD5C-GPPW-EA, SWnD5C-GPPW-EV and SWnD5C-GPPW-EVA. (n indicates any of versions 2 to 8.) -EA indicates a multiple-license product, and -EV an updated product.
MX Component	Generic product name of the products SWnD5C-ACT-E and SWnD5C-ACT-EA (n means any of Versions 1 to 3) -EA means a multiple-license product.
MX Sheet	Generic product name of the products SWnD5C-SHEET-E and SWnD5C-SHEET-EA (n means Version 1) -EA means a multiple-license product.
Debug	Locating and correcting errors in a sequence program to create a correct program.
Device memory	Areas to store device data in the GX Simulator, including inputs (X), outputs (Y), relays (M), timers (T), data registers (D), etc.
Monitor	Monitoring to determine the ON/OFF status of bit devices or the PV of word devices.
Simulations	Test execution of a program on a personal computer with the GX Simulator installed, instead of execution in an actual PLC.
Timing chart	Functions to visually confirm ON/OFF status of a bit device or the change in value of a word device.
WDT error	An error issued when a sequence program is written in such a way that it runs an infinite loop.
Pseudo-sequence program	Indicates a sequence program created by the GX Simulator to realize the settings of I/O System Settings.
Basic model QCPU	Generic term of the Q00JCPU, Q00CPU, and Q01CPU.
High Performance model QCPU	Generic term of the Q02(H)CPU, Q06HCPU, Q12HCPU, and Q25HCPU.
Universal model QCPU	Generic term of the Q00UJCPU, Q00UCPU, Q01UCPU, Q02UCPU, Q03UDCPU, Q03UDECPU, Q04UDHCPU, Q04UDEHCPU, Q06UDHCPU, Q06UDEHCPU, Q10UDHCPU, Q10UDEHCPU, Q13UDHCPU, Q13UDEHCPU, Q20UDHCPU, Q20UDEHCPU, Q26UDHCPU and Q26UDEHCPU.
Process CPU	Generic term of the Q02PHCPU, Q06PHCPU, Q12PHCPU and Q25PHCPU.
Redundant CPU	Generic term of the Q12PRHCPU and Q25PRHCPU.
A series CPU function	Function that simulates a project when the PLC series is the A series CPU or Q series CPU (A mode).
QnA series CPU function	Function that simulates a project when the PLC series is the QnA series CPU.
FX series CPU function	Function that simulates a project when the PLC series is the FX series CPU.
Motion controller function	Function that simulates a project when the PLC series is the motion controller (SCPU).
Q series CPU function	Function that simulates a project when the PLC series is the Q series CPU (Q mode).
A series CPU	Generic term of the A0J2HCPU, A1FXCPU, A1SCPU, A1SJCPU, A1SHCPU, A1SJHCPU, A1NCP, A2CCPU, A2CJCPU, A2NCP, A2NCP-S1, A2SCPU, A2SHCPU, A3NCP, A2ACPU, A2ACPU-S1, A3ACPU, A2UCPU, A2UCPU-S1, A2USCPU, A2USCPU-S1, A2ASCPU, A2ASCPU-S1, A2ASCPU-S30, A2ASCPU-S60, A2USHCPU-S1, A3UCPU and A4UCPU.

Generic Term/Abbreviation	Description
QnA series CPU	Generic term of the Q2ACPU, Q2ASCPU, Q2ASCPU-S1, Q2ASHCPU, Q2ASHCPU-S1, Q3ACPU, Q4ACPU and Q4ARCPU.
FX series CPU	Generic term of the FX0CPU, FX0sCPU, FX0nCPU, FX1CPU, FX2CPU, FX2cCPU, FX1sCPU, FX1nCPU, FX1ncCPU, FX2nCPU, FX2ncCPU, FX3gCPU, FX3uCPU and FX3ucCPU.
Motion controller	Generic term of the A171SHCPU, A172SHCPU, A173UHCPU, A173UHCPU-S1, A273UHCPU and A273UHCPU-S3.
Q series CPU (A mode)	Generic term of the Q02CPU-A, Q02HCPU-A and Q06HCPU-A.
Q series CPU (Q mode)	Generic term of the Q00JCPU, Q00UJCPU, Q00CPU, Q00UCPU, Q01CPU, Q01UCPU, Q02CPU, Q02HCPU, Q02PHCPU, Q02UCPU, Q03UDCPU, Q03UDECPU, Q04UDHCPU, Q04UDEHCPU, Q06HCPU, Q06PHCPU, Q06UDHCPU, Q06UDEHCPU, Q10UDHCPU, Q10UDEHCPU, Q12HCPU, Q12PHCPU, Q12PRHCPU, Q13UDHCPU, Q13UDEHCPU, Q20UDHCPU, Q20UDEHCPU, Q25HCPU, Q25PHCPU, Q25PRHCPU, Q26UDHCPU and Q26UDEHCPU.
Windows Vista® or later	Generic term for Windows Vista and Windows 7.

## Product Makeup

GX Simulator is made up of the following products.

Type	Product Name	Quantity
SW7D5C-LLT-E(V)	GX Simulator (1 license product) (CD-ROM)	1
	End-user software license agreement	1
	License agreement	1
SW7D5C-LLT-E(V)A	GX Simulator (Multiple license product) (CD-ROM)	1
	End-user software license agreement	1
	License agreement	n*1

\* 1: The number of included license agreements are packed with the product which is equivalent to the number of licenses.

### NOTICES

- We do not guarantee the commercially-available Microsoft® Windows® Operating System-based software products that have been introduced in this manual.
- We hold the copyrights of this software package.
- No part of this manual may be transcribed or duplicated in any form without prior permission by Mitsubishi Electric Corporation.
- We have attempted to cover all the revisions of software and hardware, but this manual may not contain the latest revisions.
- The software of this product requires one license to be purchased per computer.
- We permit the user to use this software package (including this manual) based on the Software License Agreement.
- We are not liable for consequences or influences due to this software package (including this manual).
- The specifications of this software package and the descriptions in this manual may be altered in future without prior notice.





# 1. OUTLINE OF GX Simulator

This operating manual describes the functions and operation of the GX Simulator Version 7.

The GX Simulator is a software package, which runs under Microsoft® Windows® Operating System.

Offline debugging is possible by adding the GX Simulator to a computer in which the GX Developer is installed. The offline debugging functions include the monitor and the test of the host station/other station devices and simulated operation of external device I/Os.

As the GX Simulator allows sequence programs to be developed and debugged on a single computer, checking a modified program is quick and easy.

GX Developer must be installed before these functions can be used.

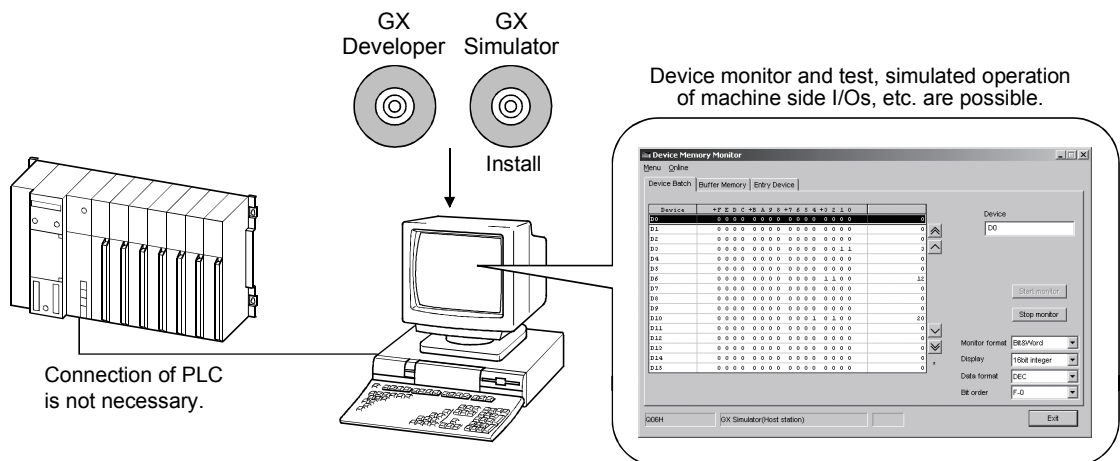

A sequence program created with GX Developer can be debugged by writing it to the GX Simulator.

The sequence program is automatically written to the GX Simulator when the GX Simulator are started up.

Refer to GX Developer Operating Manual for information on operations not covered in this manual:

1.1 Features of the GX Simulator

1

The main features of the GX Simulator are described below.

(1) Can be utilized as a single program debugging tool

Using the PLC for debugging in the conventional method required not only the PLC but also I/O and special function modules, external device, etc. to be prepared as needed.

When using the GX Simulator, you can perform debugging on a single personal computer because I/O System Settings for external device simulation and the simulation function for special function module buffer memory are available in addition to the simulation function for PLC.

Also, because of no connection to actual equipment, you can proceed with debugging safely if an abnormal output should occur due to a program bug.

Conventional debugging

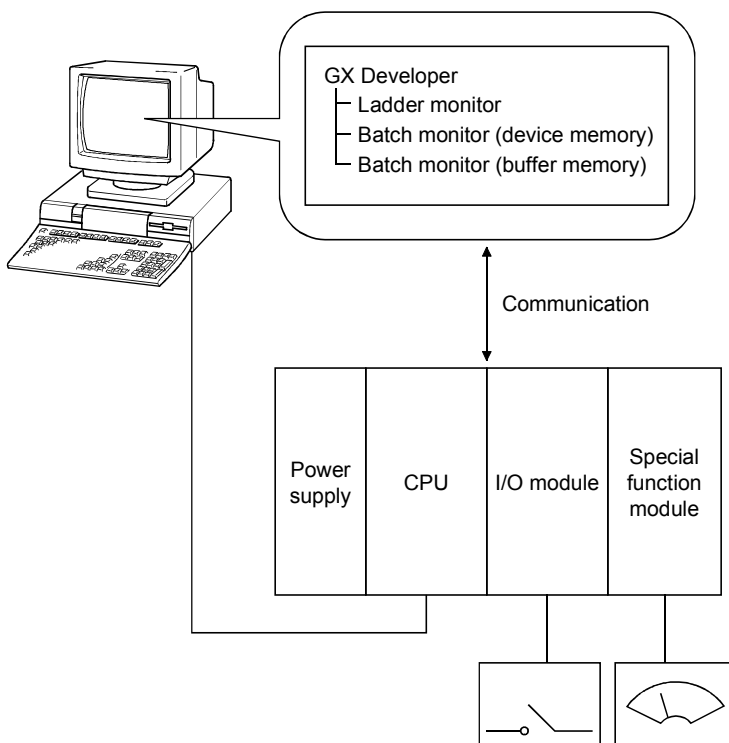

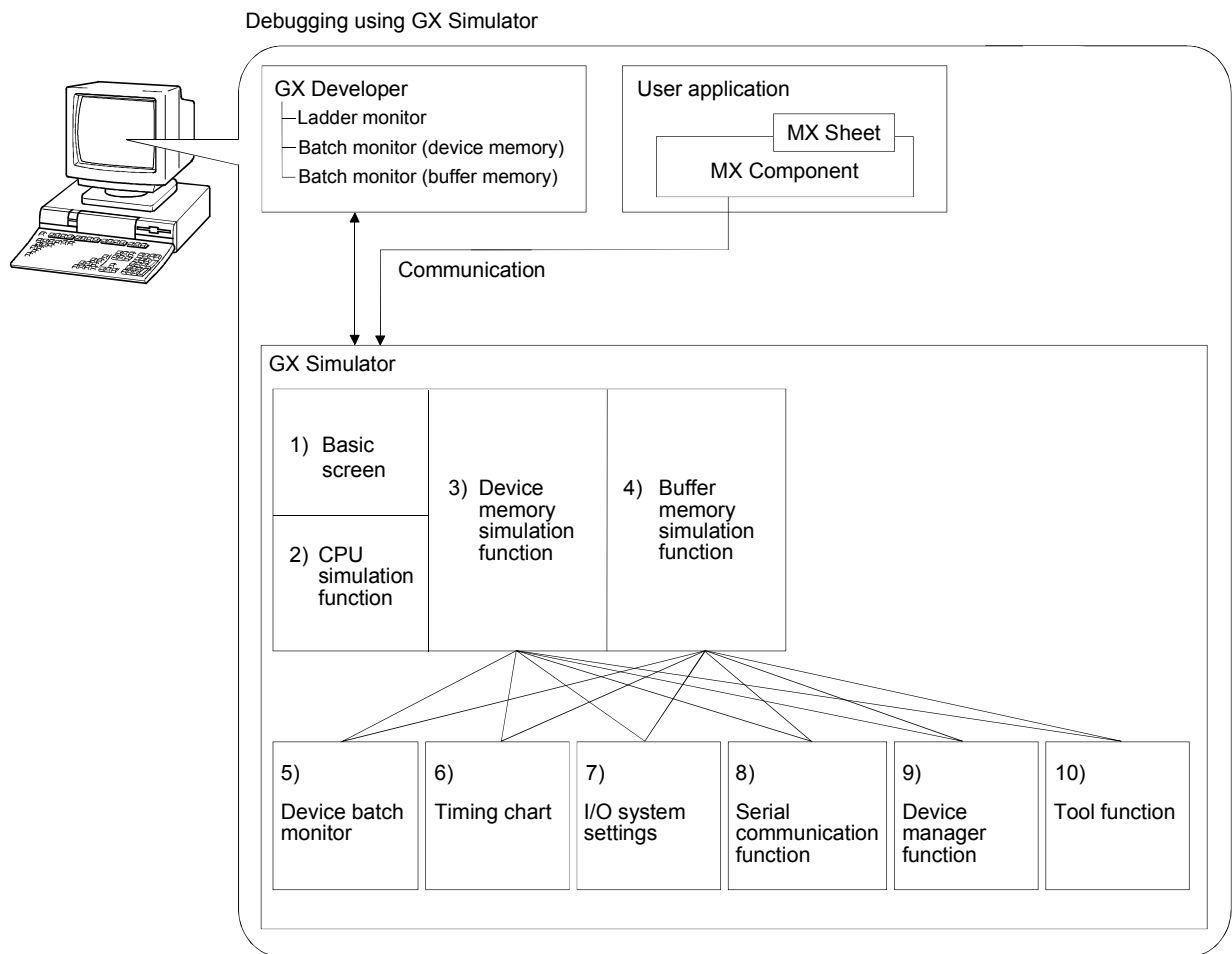

- 1) ... Key switch, indicator display function
- 2) ... Function that simulates CPU operation
- 3) ... Function that simulates CPU device memory
- 4) ... Function that simulates the buffer memory area of a special function module
- 5) ... Function that monitors a batch of device memory values
- 6) ... Function that displays device memory changes in a chart form
- 7) ... Function that simulates I/O operation of external device
- 8) ... Function that simulates communication with an external device
- 9) ... Function that checks the operation of the user application using the MELSOFT product
- 10) ... Function that saves/reads device memory or buffer memory data to/from a file

(2) Simulation of external device operation (I/O system setting function)

By setting the combination of bit device ON/OFF condition and word device value interactively in the I/O system settings of GX Simulator, an external input generated in response to a PLC output can be provided simulatively.

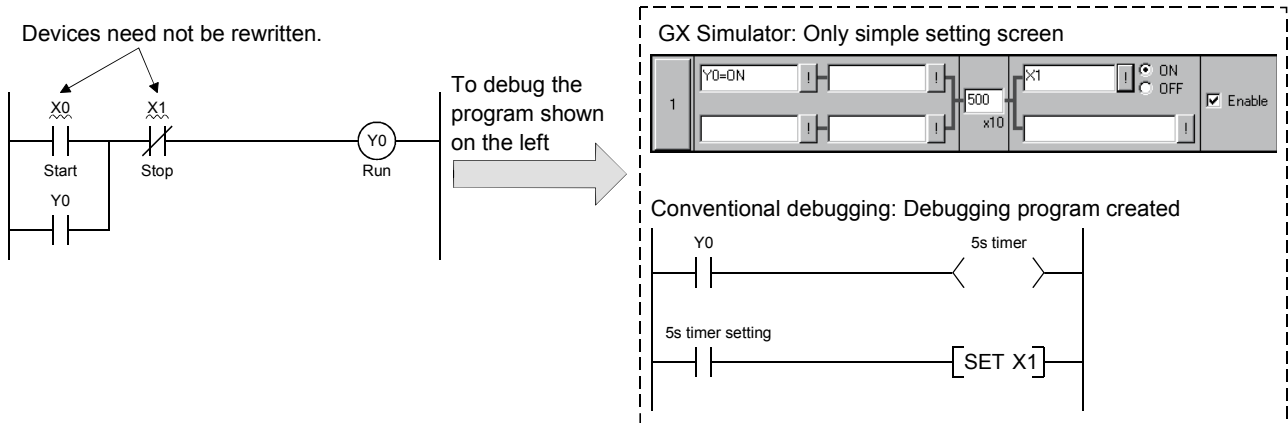

(3) Checking of message format of frame sent by external device (Serial communication function)

This function allows you to easily check whether the frame (A-compatible 1C frame, QnA-compatible 3C/4C frame) used for access from an external device to the PLC CPU via a serial communication module (computer link module) is in a correct message format or not.

Since this function also enables devices to be accessed, you can check/change device contents easily on an external device.

Conventionally, the serial communication module (computer link module) was actually connected with the external device to check operation. Using this function, however, you can easily check the message format and device contents between GX Simulator and external device.

<Conventional debugging>

Debugging was performed with the external device connected with the serial communication module (computer link module) actually.

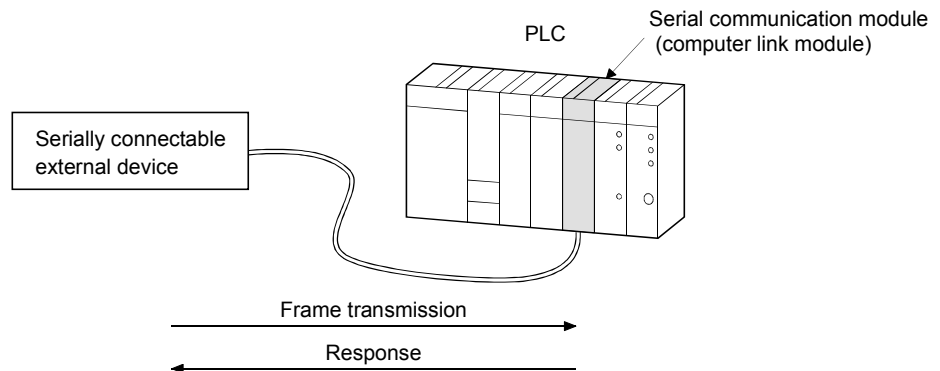

<Debugging using GX Simulator>

Since GX Simulator responds to the frame sent from the external device, the external device need not be connected to the serial communication module (computer link module) actually.

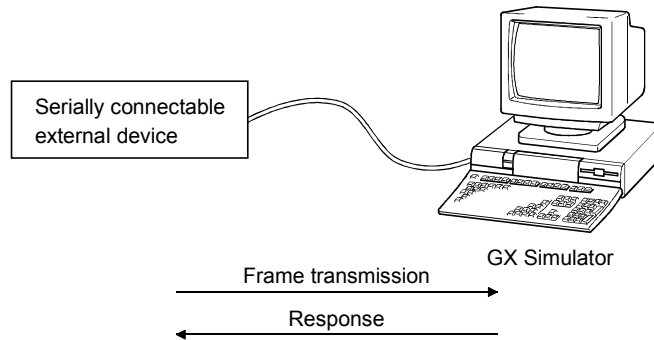

(4) Monitoring of device memory (monitor function)

You can monitor the states of the virtual CPU device memory and the buffer memory.

Like the device batch monitor and buffer memory batch monitor functions of GX Developer, you can not only monitor the ON/OFF states and values of devices but also perform forced ON/OFF and change current values.

This function also allows you to display the ON/OFF states and values in a timing chart format to grasp time series operation.

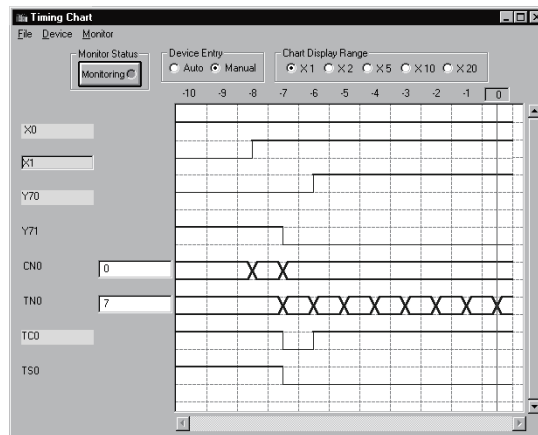

(5) Saving/reading of device/buffer memory data (tool function)

You can save the data of the device memory in the virtual CPU or the buffer memory of the special function module temporarily, and when resuming debugging, you can read and use the saved data.

(6) Support for offline debugging of user application (Device Manager function)

The operation of the user application using the MELSOFT product (e.g. MX Component) can be checked easily without use of the actual PLC.

(a) Checking the read operation of the host station/other station devices

Without creation of a program that will change device values for debugging, the operation of the user application can be checked on the basis of the device values that change with patterns.

Also, read operation from the host station/other station devices can be checked without changing the user application.

(Device change pattern setting screen)

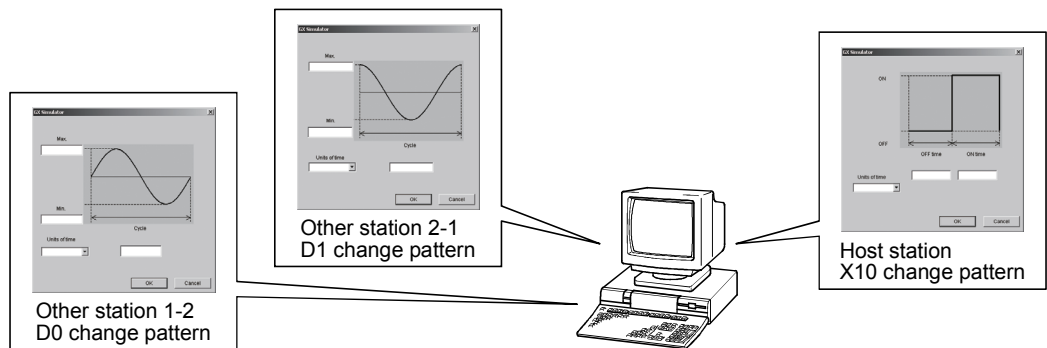

(b) Checking the written device values

Whether the values written from the user application to the host station/other station devices are within the user-assumed ranges or not can be checked.

This enables check for user application creation or setting mistakes.

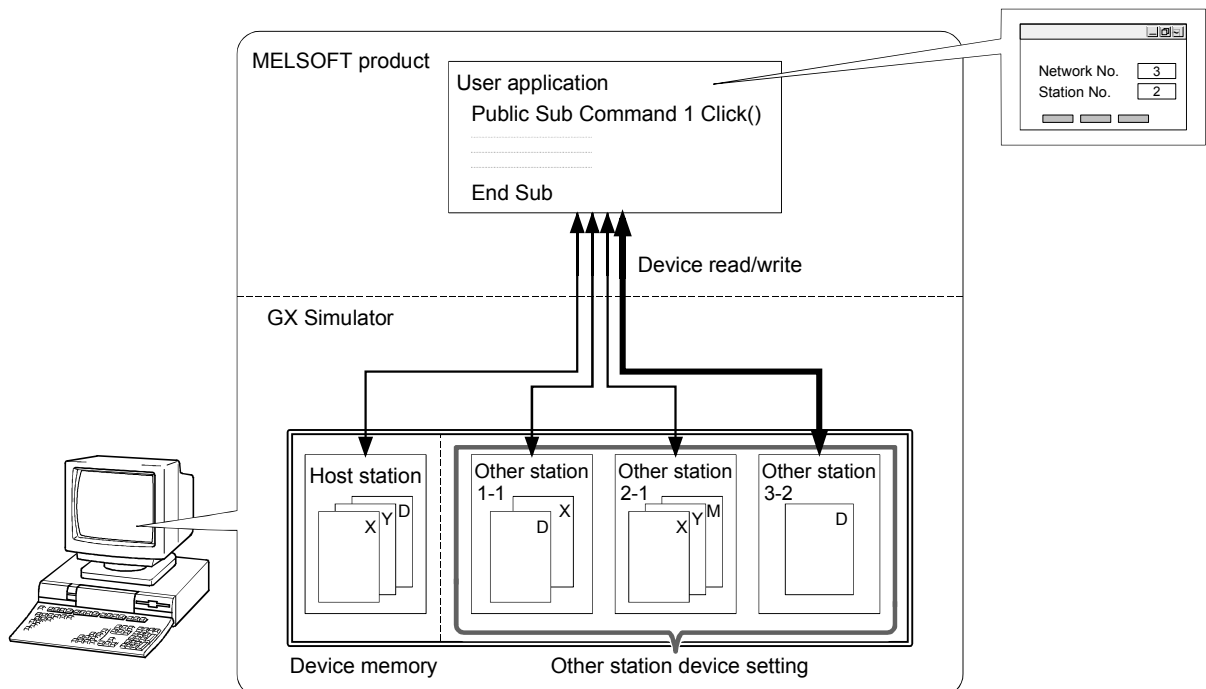

## (7) Writing a edited program in RUN (Online change function)

The operation of transferring edited sequence program to GX Simulator is unnecessary. Therefore, the transferred program operation can be momentarily checked.

Furthermore, debug can be smoothly continued since the device value before transfer operation has been retained.

- Brief operation procedure

- 1) Start GX Simulator.
- 2) Edit a sequence program in GX Developer.
- 3) Select [Convert] -[Convert (Online change)] from GX Developer menu and write the edited program to GX Simulator in RUN.

## (8) Can analyze the situation of trouble in a design room and quickly identify incorrect places (Device memory write function)

The PLC status in the field can be recreated based on the device memory data at the occurrence of trouble in a design room. The sequence program operation that cannot be checked in the field (e.g. device test) can be confirmed.

Therefore, incorrect places of sequence program can be quickly identified and the modification and the operation check are smoothly proceeded.

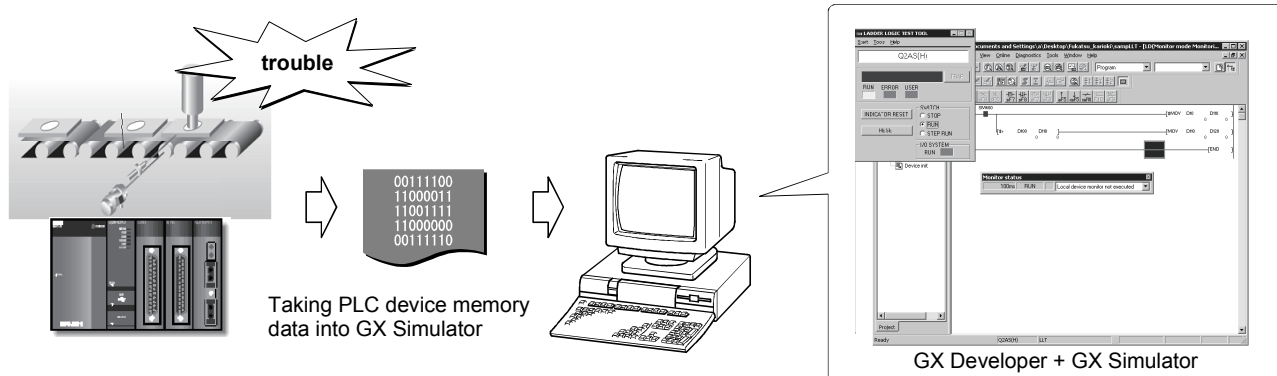

Analyzing PLC status and identifying incorrect places on personal computer.

- Brief operation procedure

(Operation in the field)

- 1) Read device memory from PLC CPU in GX Developer.
- 2) Save project data.

(Operation in a design room)

- 3) Open the project data saved in the field.
- 4) Start GX Simulator.
- 5) Change GX Simulator status to STOP using "Remote operation" in PLC write dialog box.
- 6) Write sequence program, parameter and device memory from GX Developer to GX Simulator.
- 7) Monitor ladder and device in GX Developer.



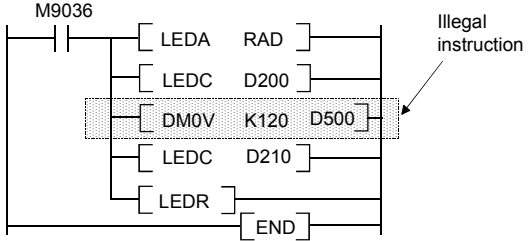

Item Name	Debugging with an Actual PLC Connected	Debugging with GX Simulator	Applicable CPU
Real number range check	Dedicated instructions to handle real numbers allow operation to continue when an illegal value occurs which cannot be evaluated as a real number.	Real number range checks are conducted rigorously. "OPERATION ERROR" is displayed if a value cannot be evaluated as a real number.	<ul style="list-style-type: none"> <li>• A series CPU</li> <li>• QnA series CPU</li> <li>• Motion controller</li> <li>• Q series CPU (Q mode)</li> <li>• Q series CPU (A mode)</li> </ul>
Number range check	Value 0 is given as a result of "0 divided by 0" by DIV instruction, floating point division, of the A series PLC. No error occurs.	The rigorous number range check can detect an illegal 0 denominator and "OPERATION ERROR" is generated if $0 \div 0$ is executed.	<ul style="list-style-type: none"> <li>• A series CPU</li> <li>• Motion controller</li> <li>• Q series CPU (A mode)</li> </ul>
Illegal instruction in a dedicated instruction	The illegal instruction is ignored and operation continues.	<p>The illegal instruction is checked and "INSTRCT CODE ERR." is displayed. Dedicated instructions must be described as blocks.</p> <p>(Example of illegal ladder)</p>  <p>The diagram shows a ladder logic network for M9036. It starts with a normally open contact labeled M9036. This is followed by a series of four parallel branches, each containing a normally open contact and a coil. The first branch has contacts LEDA and RAD, and coil D200. The second branch has contacts LEDC and D200, and coil D500. This second branch is highlighted with a dotted box and an arrow from the label 'Illegal instruction'. The third branch has contacts LEDC and D210, and coil D500. The fourth branch has contact LEDR and coil D500. The network ends with an END instruction.</p>	<ul style="list-style-type: none"> <li>• A series CPU</li> <li>• Motion controller</li> <li>• Q series CPU (A mode)</li> </ul>
Time concept	Actual time	As per constant scan setting.	<ul style="list-style-type: none"> <li>• A series CPU</li> <li>• QnA series CPU</li> <li>• FX series CPU</li> <li>• Motion controller</li> <li>• Q series CPU (Q mode)</li> <li>• Q series CPU (A mode)</li> </ul>
Supported instructions	All instructions can be used.	Since data refresh instructions, PID control instructions (QnA series, FX series CPUs), etc. cannot be used, they are processed as NOPs. (Refer to Appendix-2 for supported instructions.)	<ul style="list-style-type: none"> <li>• A series CPU</li> <li>• QnA series CPU</li> <li>• FX series CPU</li> <li>• Motion controller</li> <li>• Q series CPU (Q mode)</li> <li>• Q series CPU (A mode)</li> </ul>
Operating CPU type	According to CPU type used.	<ul style="list-style-type: none"> <li>• Operates as A4UCPU when A series CPU, motion controller or Q series CPU (A mode) is selected.</li> <li>• Operates as Q4ACPU when QnA series CPU is selected.</li> <li>• Operates as FX series CPU when FX series CPU is selected.</li> <li>• Operates as Q25HCPU when Q series CPU (Q mode) is selected.</li> </ul>	<ul style="list-style-type: none"> <li>• A series CPU</li> <li>• QnA series CPU</li> <li>• FX series CPU</li> <li>• Motion controller</li> <li>• Q series CPU (Q mode)</li> <li>• Q series CPU (A mode)</li> </ul>
Special function module (special function block)	Supported	Not supported. Only the buffer memory area of a special function module (special function block) is supported.	<ul style="list-style-type: none"> <li>• A series CPU</li> <li>• QnA series CPU</li> <li>• FX series CPU</li> <li>• Motion controller</li> <li>• Q series CPU (Q mode)</li> <li>• Q series CPU (A mode)</li> </ul>

Item Name	Debugging with an Actual PLC Connected	Debugging with GX Simulator	Applicable CPU
I/O module	Supported	Not supported	<ul style="list-style-type: none"> <li>• A series CPU</li> <li>• QnA series CPU</li> <li>• FX series CPU</li> <li>• Motion controller</li> <li>• Q series CPU (Q mode)</li> <li>• Q series CPU (A mode)</li> </ul>
Network	Supported	Not supported	<ul style="list-style-type: none"> <li>• A series CPU</li> <li>• QnA series CPU</li> <li>• FX series CPU</li> <li>• Motion controller</li> <li>• Q series CPU (Q mode)</li> <li>• Q series CPU (A mode)</li> </ul>
Memory cassette capacity	An error occurs in GX Developer if data exceeding the memory cassette capacity is written to the PLC.	No error occurs and normal operation continues if data exceeding the memory cassette capacity is written to the PLC.	<ul style="list-style-type: none"> <li>• A series CPU</li> <li>• QnA series CPU</li> <li>• Motion controller</li> <li>• Q series CPU (Q mode)</li> <li>• Q series CPU (A mode)</li> </ul>
Intelligent function module (intelligent parameters)	Supported	Only the initial setting, auto refresh setting * 1 and buffer memory area are supported.	<ul style="list-style-type: none"> <li>• Q series CPU (Q mode)</li> </ul>
In case "Use the file register" and "Use the following file" are set, but "Capacity" is not set	Operates according to capacity of the file register if the file register specified on "Use the following file" exists in the specified drive.	Operates with the capacity of the file register set as an OK point, whether the file used on "Use the following file" exist or not. Thus, "OPERATION ERROR" occurs if the file register is used in the program.	<ul style="list-style-type: none"> <li>• QnA series CPU</li> <li>• Q series CPU (Q mode)</li> </ul>
When "Use the same file name as the program" is selected for a file register.	(1) If the same name file register as the program is in the PLC CPU drive, the PLC CPU debugs the file register by the set capacity.	(1) If the same name file register as the program is in the PC drive, GX Simulator debugs the file register by the set capacity.	<ul style="list-style-type: none"> <li>• QnA series CPU</li> <li>• Q series CPU (Q mode)</li> </ul>
	(2) If the same name file register as the program is not in the PLC CPU drive, the PLC CPU will not debug.	(2) If the same name file register as the program is not in the PC drive, GX Simulator newly creates a file register of 1018k steps and debugs it.	
When the capacity of a file register is changed during program execution.	When "Use the same file name as the program" is selected for a file register, the PLC CPU monitors the file register within the changed capacity.	When "Use the same file name as the program" is selected for a file register, GX Simulator monitors a file register of 1018k steps (maximum).	<ul style="list-style-type: none"> <li>• QnA series CPU</li> <li>• Q series CPU (Q mode)</li> </ul>

\* 1: Not compatible with the extended parameter settings of the auto refresh setting for the Universal model QCPUs.

Item Name	Debugging with an Actual PLC Connected	Debugging with GX Simulator	Applicable CPU
When step execution is performed	(1) When performed, execution stops at each of the first instruction, P/I pointer, statement and note.	(1) When performed, execution stops at the first instruction and P/I pointer but does not stop at the first statement and note.	<ul style="list-style-type: none"> <li>• QnA series CPU</li> <li>• Q series CPU (Q mode)</li> </ul>
	(2) When the start position is a statement or note, execution stops at the first statement or note.	(2) When the start position is a statement or note, execution stops at the first instruction or P/I pointer immediately after that statement or note.	
	(3) When the repetition count of the option setup is set, each of the instruction, P/I pointer, statement and note is counted once.	(3) When the repetition count of the option setup is set, each of the instruction and P/I pointer is counted once. The statement and note are not counted.	
	(4) When a statement or note step is set to the break point of the option setup, execution stops at the statement or note step.	(4) When a statement or note step is set to the break point of the option setup, execution does not stop at this break point.	
When partial execution is performed	(1) When performed, execution stops at each of the first instruction, P/I pointer, statement and note.	(1) When performed, execution stops at the first instruction and P/I pointer but does not stop at the first statement and note.	<ul style="list-style-type: none"> <li>• QnA series CPU</li> <li>• Q series CPU (Q mode)</li> </ul>
	(2) When the start position is a statement or note, execution stops at the first statement or note.	(2) When the start position is a statement or note, execution stops at the first instruction or P/I pointer immediately after that statement or note.	
	(3) When a statement or note step is set to the break point of the break condition, execution stops at the statement or note step.	(3) When a statement or note step is set to the break point of the break condition, execution does not stop at this break point.	
When -0 is specified as floating-point real number	An error occurs in some CPU modules.	An error does not occur. (Operated as 0)	<ul style="list-style-type: none"> <li>• QnA series CPU</li> <li>• Q series CPU (Q mode)</li> </ul>
When dealing with a Character string constant	A maximum of 32 letters are possible as a Character string constant.	A maximum of 16 letters are possible as a Character string constant.	<ul style="list-style-type: none"> <li>• QnA series CPU</li> <li>• Q series CPU (Q mode)</li> <li>• FX series CPU</li> </ul>
When online change is performed	(1) Executable on ladder, ST, or SFC.	(1) Executable on ladder, ST. Error is displayed and online change is to be terminated on SFC (The program remains incomplete).	<ul style="list-style-type: none"> <li>• A series CPU</li> <li>• QnA series CPU</li> <li>• Motion controller</li> <li>• Q series CPU (Q mode)</li> <li>• Q series CPU (A mode)</li> </ul>

Item Name	Debugging with an Actual PLC Connected	Debugging with GX Simulator	Applicable CPU
When online change is performed	<p>(2) Online change is executed according to arbitrary setting that is set in the following items of Setting Options.</p> <ul style="list-style-type: none"> <li>• Step No. specification used in writing</li> <li>• Instruction setting for online change</li> <li>• Program memory transfer settings</li> </ul>	<p>(2) The following items of Setting Options cannot be set arbitrarily. They are performed based on the setting for GX Simulator (The following items).</p> <ul style="list-style-type: none"> <li>• Step No. specification used in writing "Absolute step No." is selected.</li> <li>• Instruction setting for online change Selected the status that "Trailing edge instructions are not executed" is checked.</li> <li>• Program memory transfer settings Selected the status that "Transfer to program memory after writing data is end" is not checked.</li> </ul> <p>(When pre-setting exists before a startup of GX Simulator, the setting recovers after closing the GX Simulator).</p>	<ul style="list-style-type: none"> <li>• A series CPU</li> <li>• QnA series CPU</li> <li>• Motion controller</li> <li>• Q series CPU (Q mode)</li> <li>• Q series CPU (A mode)</li> </ul>
When underflow occurs with the real number operation	"OPERATION ERROR" occurs	"OPERATION ERROR" occurs	<ul style="list-style-type: none"> <li>• Basic model QCPU</li> <li>• High Performance model QCPU</li> </ul>
	Represented as 0 without error occurrence. *2	Represented as 0 without error occurrence	<ul style="list-style-type: none"> <li>• Process CPU</li> <li>• Redundant CPU</li> </ul>
	Represented as 0 without error occurrence.	"OPERATION ERROR" occurs	<ul style="list-style-type: none"> <li>• Universal model QCPU</li> </ul>
Initialization of special function block in PLC parameter	Supported	Not supported However, only the buffer memory area in a special function module (special function block) is supported.	<ul style="list-style-type: none"> <li>• FX series CPU</li> </ul>
Positioning setting in PLC parameter	Supported	Not supported	<ul style="list-style-type: none"> <li>• FX series CPU</li> </ul>
Extension file register (ER)	Supported	Not supported	<ul style="list-style-type: none"> <li>• FX series CPU</li> </ul>
built-in high speed counter	Supported	Not supported	<ul style="list-style-type: none"> <li>• FX series CPU</li> </ul>
Input interrupt Counter interrupt Timer interrupt	Supported	Not supported	<ul style="list-style-type: none"> <li>• FX series CPU</li> </ul>
Process control instruction	<p>When specifying a device which cannot be applied to instruction argument, INSTRCT. CODE ERR (Error code 4004) will occur with the following timing.</p> <ul style="list-style-type: none"> <li>• Power-on</li> <li>• Reset</li> <li>• STOP → RUN</li> <li>• Instruction execution</li> </ul>	<p>When specifying a device which cannot be applied to instruction argument, INSTRCT. CODE ERR (Error code 4004) will occur only when executing an instruction.</p>	<ul style="list-style-type: none"> <li>• Q series CPU (Q mode)</li> </ul>

\*2: Operation error occurs with the Process CPU whose upper five digits of serial numbers are "07031" or earlier.

## 2. SYSTEM CONFIGURATION

### 2.1 System Configuration

The following shows the system configuration.

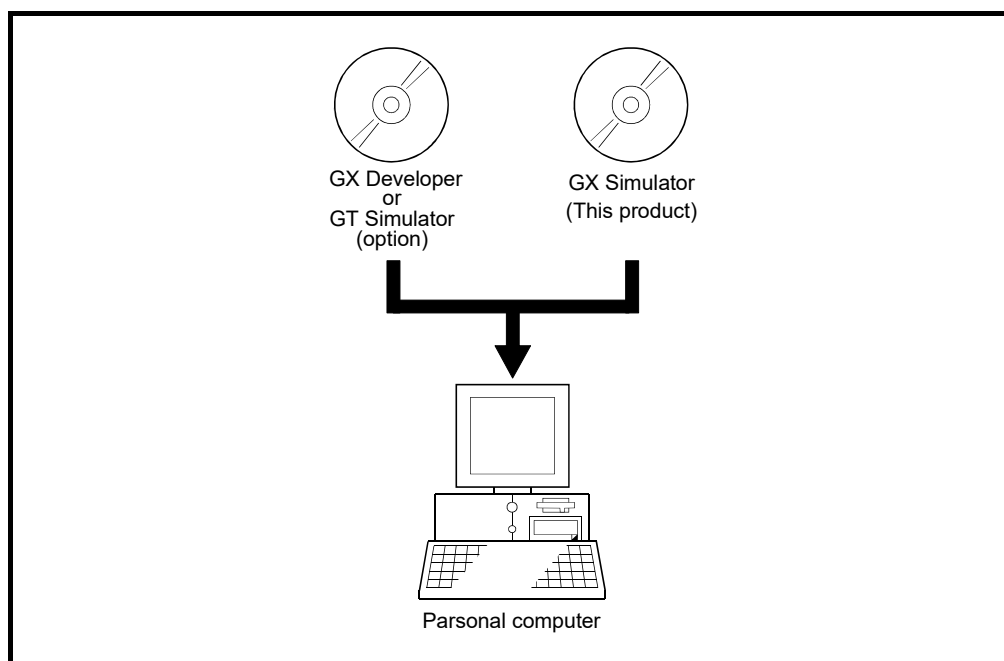

2

### 2.2 Combination with MELSOFT Products

The following describes combinations between GX Simulator Version 7 and MELSOFT product versions.

- (1) To use the function added to GX Simulator Version 7 (Device Manager function: Refer to Chapter 8), use the MELSOFT product compatible with GX Simulator Version 7.
- (2) Online change function is usable with GX Developer Version 8.27D or later.
- (3) When installing to Windows® 7, GX Developer Version 8.91V or later is required.
- (4) The simulation function of PX Developer is applicable to the following versions
  - PX Developer Version 1 (SW1D5C-FBDQ-E Version 1.28E or later)
  - GX Developer Version 8 (SW8D5C-GPPW-E Version 8.94Y or later)
  - GX Simulator Version 7 (SW7D5C-LLT-E Version 7.27D or later)

## 2.3 Operating Environment

The operating environment of GX Simulator is indicated below.

Item	Description
Installation (Add-in) destination	Added in to GX Developer (SW2D5C-GPPW-E or later, SW8D5C-GPPW-C).
Computer main unit	Personal computer on which Windows® operates.
CPU	Refer to the following table "Applicable operating system and required PC performance".
Required memory	
Hard disk free space	70MB or more *1
Disk drive	CD-ROM disk drive
Display	800 × 600 dot or more resolution. *2
Operating system (English version)	Windows® 7 (Starter, Home Premium, Professional, Ultimate, Enterprise)*3 Windows Vista® (Home Basic, Home Premium, Business, Ultimate, Enterprise) *3 Windows® XP (Professional, Home) *3 Windows® 2000 (Professional) Windows NT® Workstation 4.0 Windows® Millennium Edition Windows® 98 Windows® 95

\*1: 1MB is required to use a file register.

Make sure that the required space is secured within the driven in which this product has been installed, before using file register.

\*2: Resolution 1024 × 768 pixels or higher is recommended for Windows Vista® or Windows® 7.

\*3: 32-bit version only

### (1) Applicable operating system and required PC performance

Item	Required PC performance	
	CPU	Required memory
Windows® 95	Pentium® 133MHz or more	64MB or more
Windows® 98	Pentium® 133MHz or more	64MB or more
Windows® Me	Pentium® 150MHz or more	64MB or more
Windows NT® Workstation 4.0 (Service Pack 3 or more)	Pentium® 133MHz or more	64MB or more
Windows® 2000 Professional	Pentium® 133MHz or more	64MB or more
Windows® XP	Pentium® 300MHz or more	128MB or more
Windows Vista®	Pentium® 1GHz or higher	1GB or more
Windows® 7	Pentium® 1GHz or higher	1GB or more

POINT
-------

- |   |
|---|
| <ul style="list-style-type: none"><li>• When using PDF data or online manuals, adding memory of the personal computer enables more comfortable operation.</li></ul> |
|---|

## (2) Instructions for operating system

When the following functions are used, this product may not run properly.

- Application start-up in Windows compatibility mode
- Fast user switching
- Remote desktop
- Windows XP Mode
- Windows Touch or Touch

In the following cases, the screen of this product may not work properly.

- The size of the text and other items on the screen is other than 100% (96 DPI, 9 pt etc.).
- The resolution of the screen is changed in operation.
- Windows theme is changed in operation.
- The multi-display is set.

Surrogate pair characters and environment dependent characters are not available in GX Simulator.

Use the product as a standard user or an administrator for Windows Vista or later.

## 3. SPECIFICATIONS

### 3.1 Table of Functions

The functions supported by the GX Simulator are shown below.

The functions supported by the GX Simulator include functions executed from the GX Simulator menu and functions executed from the GX Developer menu.

The GX Simulator simulates the function of the CPU selected at the time of execution of the GX Simulator from the GX Developer menu: it supports CPU's of type A, QnA, and FX. Also, when the motion controller is selected, the corresponding function of the A series CPU operates. (Refer to Section 3.4.5(1) for the A series CPU corresponding to the motion controller.)

Also, when the Q series (Q mode) is selected, the Q series CPU functions operate, but when the Q series (A mode) is selected, the A series CPU functions operate as equivalent to those of the A4UCPU.

The functions supported by the GX Simulator are as indicated in Table 3.1.

Table 3.1 Functions Supported by GX Simulator

Function		Description	Reference
Functions executed from the GX Developer menu	Ladder monitor Device monitor	• Monitors the processing status of the GX Simulator	GX Developer Operating Manual
	Device test	• Forcibly write device values to the GX Simulator during monitoring.	
	Write to PLC	• Writes parameter file and program file to GX Simulator.	
	PLC diagnostics	• Checks the GX Simulator status and errors.	
	Skip execution	• Skips program execution in the range between two designated steps.	
	Partial execution	• Executes the part of the program in a designated step or pointer range.	
	Step execution	• Executes the sequence program one step at a time.	
	Remote operation	• Operates the GX Simulator execution status.	
	Program monitor list	• Monitors the program execution status and number of executions as a table, starts and stops the program execution in the table.	
	Online change	• Writes a program while a simulating CPU is in RUN status (Writes at ladder or ST conversion).	



Function		Description	Reference
Functions executed from PX Developer programming tool*1	Current Value Display of FB Property window	• Displays the current value on the FB Property window in the monitor mode.	PX Developer Version 1 Operating Manual (Programming Tool)
	Compile (Online Change)	• Adds processing to FBD program, or changes processing of FBD program without stopping system.	
	Download*2	• Downloads PX Developer program files, parameters and initial value data into a CPU module.	
	Starting/Stopping online monitor	• Monitors current values such as local variables, I/O values of tag FB, and global variables.	
	Program/FB monitor	• Monitors current values of variables on FBD sheets.	
	Change current value	• Changes the current variable value.	
	Pause/Restart of FB Execution	• Pauses/ restarts the operation of FB part during program execution.	
	Monitoring a tag FB with faceplate	• Monitors tag data status in tag FB with faceplate.	
	Read current value of FB property	• Reads FB property current value.	
	Entry variable monitor	• Displays a list of the current value of variables on the Entry Variable Monitor window.	
	FBD program diagnostics	• Checks the error that occurs on a CPU module and diagnostics FBD program.	
Functions executed from the GX Simulator menu	I/O system settings	• Simulates the operation of external devices by simple settings.	Chapter 5.
	Serial communication function	• Checks the operation of the frame that is sent from the external device to the serial communication module (computer link module).	Chapter 6.
	Monitor test	• Conducts testing by monitoring the device memory status. • Displaying the ON/OFF chart of the devices. • Forcing the devices ON/OFF, and changing present values.	Chapter 7.
	Device manager function	• Function that allows the user application operation to be checked by setting the external input-assumed device value change patterns and write-enabled device ranges. • Function that allows access from the user application using the MELSOFT product to the other station devices.	Chapter 8.
	Tools	• Reads the saved device memory/buffer memory data and makes option setting.	Chapter 9.
	Function equivalent to WDT	• Issues a WDT error if a sequence program is written in such a way that it runs an infinite loop.	—
	Error detail display function	• Displays detailed error information at occurrence of an error.	Chapter 4.
	Unsupported instruction list display function	• Lists the instructions which are not supported by the GX Simulator if they are included in a sequence program.	

\*1: All the functions which are executed on the menu of PX Developer monitor tool can be executed.

\*2: Only applicable to executable data download to PLC. Not applicable to symbolic data download to PLC and download setting.

### 3.2 Function List

This section provides the function list of each screen.

#### (1) Initial screen function list

		Reference
<b>Start</b>		
Monitor Function		
Device Memory Monitor.....	Monitors the device memory.	Section 7.1
Timing Chart Display .....	Displays the device change status.	Section 7.2
I/O System Settings.....	Simulates the external device operation.	Chapter 5
Serial Communication Function* <sup>1</sup> .....	Simulates communication with the external device.	Chapter 6
Device Manager* <sup>1</sup> .....	Sets the devices for simulation.	Chapter 8

\*1: Unavailable when the PLC series is the FX series CPU or Universal model QCPU.

<b>Tools</b>		
Backup Device Memory.....	Writes device memory data to a file.	Section 9.1
Backup Buffer Memory.....	Writes buffer memory data to a file.	Section 9.1
Restore Device Memory.....	Reads the saved device memory data.	Section 9.2
Restore Buffer Memory.....	Reads the saved buffer memory data.	Section 9.2
Option		
Display as minimized next time.....	Selects how to display the initial screen at the start of GX Simulator.	Section 9.3

<b>Help</b>		
Product information.....	Shows the product information.	

#### (2) Device Memory Monitor screen function list

<b>Menu</b>		
Device Batch monitor.....	Batch-monitors the devices.	Section 7.1.4
Buffer memory monitor.....	Monitors the buffer memory.	Section 7.1.5
Entry device monitor.....	Registers and monitors the devices.	Section 7.1.6
Exit.....	Exits from Device Memory Monitor.	Section 7.1.2

<b>Online</b>		
Transfer setup.....	Specifies the station to be monitored.	Section 7.1.3
Device write.....	Conducts a device test.	Section 7.1.7

(3) Timing Chart function list

File	Reference
— Open File.....	Reads the saved monitor device data. Section 7.2.6
— Save File As.....	Writes the device data currently monitored. Section 7.2.6
— Save Timing Data.....	Saves as the timing chart data file. Section 7.2.6
— Exit.....	Exits from Timing Chart. Section 7.2.2
<b>Device</b>	
— Enter Device.....	Registers the devices to be monitored. Section 7.2.4
— Delete Device.....	Deletes the selected devices. Section 7.2.4
— List Device.....	Lists the devices being monitored. Section 7.2.8
— Property.....	Change the display format of the selected device. Section 7.2.8
<b>Monitor</b>	
— Start/Stop.....	Starts/stops monitor. Section 7.2.5
— Sampling period.....	To change the Data accumulation interval. Section 7.2.7

(4) I/O system setting screen function list

	Reference
<b>File</b>	
New.....	Creates the new I/O system setting file. Section 5.8.1
Open.....	Opens current I/O system setting file. Section 5.8.1
Save.....	Overwrites and saves file being opened. Section 5.8.1
Save As.....	Gives the name to the file being opened and saves it. Section 5.8.1
Execute I/O System Settings.....	Executes the I/O system setting. Section 5.7
Cancel I/O system setting.....	Cancels the I/O system setting. Section 5.7
Import Earlier Version of I/O System File.....	Reads I/O system setting files from SW2 to SW5. Section 5.8.5
Exit I/O System Settings.....	Exits the I/O system setting. Section 5.2
<b>Edit</b>	
Cut.....	Cuts the selected setting No.. Section 5.8.2
Copy.....	Copies the selected setting No.. Section 5.8.2
Paste.....	Pastes the setting No. cut or copied. Section 5.8.2
Enable / Disable Settings	
Enable All.....	Enables all settings. Section 5.8.3
Disable All.....	Disables all settings. Section 5.8.3
<b>Online</b>	
Monitor Mode.....	Starts monitor. Section 5.8.4
Edit Mode.....	Stops monitor. Section 5.8.4
<b>View</b>	
Tool Bar.....	Set whether tool bar is displayed or not.
Status Bar.....	Set whether status bar is displayed or not.
<b>Window</b>	
Cascade.....	Cascades currently open screens.
Tile.....	Tiles currently open screens.
Arrange.....	Arranges screens reduced to icons.

(5) Timing chart format input screen function list

	Reference
<b>File</b>	
— Open File.....Opens the timing chart data file.	Section 5.5.6
— Exit.....Exits from timing format input.	Section 5.5.2
<b>Device</b>	
— Enter Device.....Registers the devices to be setting.	Section 5.5.3
— Delete Device.....Deletes the registered devices.	Section 5.5.3
— List Device.....Lists the registered devices.	Section 5.5.6
— Property.....Changes the display format of the selected device.	Section 5.5.6
<b>Edit</b>	
— Undo.....Returns to previous status one step before execution.	Section 5.5.6
— Bit Device.....Sets status of bit device.	Section 5.5.4
— Word Device.....Sets status of word device.	Section 5.5.4
— Wizard.....Activates setting of wizard screen.	Section 5.5.4
— Insert.....Inserts timing to selected section.	Section 5.5.4
— Delete.....Deletes timing of selected section.	Section 5.5.4
<b>Scan</b>	
— Scan Setting.....Specifies scan number.	Section 5.5.5

## (6) Device Manager screen function list

		Reference
<b>File</b>		
New.....	Creates new setting information.	Section 8.7.1
Open.....	Reads the saved setting information.	Section 8.7.1
Save.....	Saves the setting information.	Section 8.7.1
Save As.....	Saves the setting information with a name.	Section 8.7.1
Print.....	Prints the setting information or gives a print preview.	Section 8.7.3
Exit .....	Exits from Device Manager.	Section 8.2
<b>Edit</b>		
Undo.....	Undoes the last operation.	Section 8.7.2
Redo.....	Redoes the undone operation.	Section 8.7.2
Cut.....	Cuts the specified line.	Section 8.7.2
Copy.....	Copies the specified line.	Section 8.7.2
Paste.....	Pastes the cut or copied line.	Section 8.7.2
Insert.....	Inserts a line into the specified area.	Section 8.7.2
Delete.....	Deletes the specified line.	Section 8.7.2
Clear.....	Clears the specified line.	Section 8.7.2
Sort by Ascending.....	Sorts the settings in ascending order.	Section 8.7.2
Sort by Descending.....	Sorts the settings in descending order.	Section 8.7.2
Find.....	Searches for the log information and/or setting information.	Section 8.7.4
<b>Operation</b>		
Start.....	Starts each function of Device Manager.	Section 8.5
Stop.....	Stops the function being executed.	Section 8.5
Export Log.....	Saves the log result into the specified file.	Section 8.7.5
Clear Log.....	Clears the log result.	Section 8.7.6

### 3.3 Devices and Instructions Supported by the GX Simulator

GX Simulator operates in the following device ranges and with the following instructions.

CPU Type	Device	Instruction
A series CPU	Operates in the device range of the selected CPU type. (Refer to Appendix 1.1)	Operates with the instructions supported by the A series CPU. (Refer to Appendix 2.1)
QnA series CPU	Operates in the device range of the selected CPU type. (Refer to Appendix 1.2)	Operates with the instructions supported by the QnA series CPU. (Refer to Appendix 2.2)
FX series CPU	Operates in the device range of the selected CPU type. (Refer to Appendix 1.3)	Operates with the instructions supported by the FX series CPU. (Refer to Appendix 2.3)
Motion controller	Operates in the device range of the corresponding ACPU. (Refer to Appendix 1.1)	Operates with the instructions supported by the A series CPU. (Refer to Appendix 2.1) However, motion dedicated instructions (SVST, CHGA, CHGV, CHGT, SFCS, ITP) are not supported. They are not processed.
Q series CPU (A mode)	Operates in the device range of the A4UCPU.	Operates with the instructions supported by the A4UCPU. (Refer to Appendix 2.1)
Q series CPU (Q mode)	Operates in the device range of the selected CPU type. (Refer to Appendix 1.5)	Operates with the instructions supported by the Q series CPU (Q mode). (Refer to Appendix 2.5)

However, some devices and instructions are restricted or are not supported. Unsupported devices and instructions are not processed (NOP). These NOP instructions are shown on the initial screen of the GX Simulator as unsupported information. (Refer to Section 4.3)

#### POINT

In this manual, the PLC portion of the motion controller is described as a function of the motion controller.

In addition, the A171SH, A172SH, A173UH(S1), and A273UH(S3) are included in the device/instruction support range of the A2SH, A2SH(S1), A3U, and A3U respectively.

### 3.4 GX Simulator Restrictions and Cautions

The restrictions and cautions when debugging with the GX Simulator are described below.

#### 3.4.1 Restrictions and cautions common to each type of CPU

##### (1) GX Simulator Processing Time

The time set as constant scan is used to update the present value of the timer.

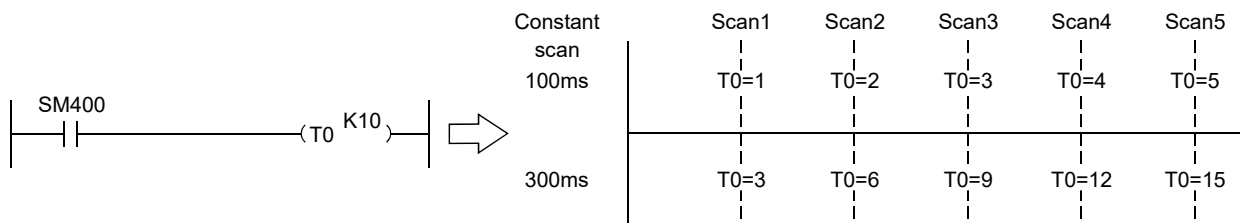

(To change the time, you can use D9020 for the A series CPU/Q series CPU (A mode)/motion controller functions, parameter setting for the QnA series CPU/Q series CPU (Q mode) functions, or D8039 for the FX series CPU functions.)

In the GX Simulator, the count made by the timer instruction during one scan changes with the constant scan setting. At the constant scan setting of 100ms, the 100ms timer counts +1 during one scan. At the constant scan setting of 300ms, the 100ms timer counts +3 during one scan.

##### (2) Restarting the GX Simulator

When restarting the GX Simulator immediately after ending it, it may take longer than the usual restarting time.

##### (3) Device Range Checks using I/O System Settings

Appendix 3 shows a table of devices supported by I/O system settings. The usable device ranges depend on the selected CPU model and parameter setting range. (For details, refer to Appendix-1.)

##### (4) Interrupt Programs

Interrupt programs are not supported. Any sequence program created is not executed.

##### (5) Floating Decimal Point

Rounding errors can occur in the results of instructions using the floating decimal point. Therefore, the results may differ from calculations when a CPU is connected.

##### (6) Read from PLC, Compare with PLC

Not supported by the GX Simulator.



- (7) **Comments**  
Not supported by the GX Simulator.
- (8) **LED Reset Button**  
The LED display is cleared when the LED reset button on the initial screen is clicked. However, the display immediately reappears if the cause of the error has not been removed, so it appears that the LED display is not reset when the button is clicked.
- (9) **Automatic Writing of the GX Simulator**  
Parameters and sequence programs are written when the GX Simulator is started up.  
As the file register and device initial values are not automatically written, write them to the GX Simulator using write to PLC.  
(If you do not perform Write to PLC on GX Developer of SW0D5□-GPPW-E, the file register/device initial values used are the values which were automatically retained when the GX Simulator was ended last time.)
- (10) **About Restrictions on GX Simulator Installation**  
It is not possible to install an English version of the GX Simulator when a Japanese version GX Developer is already installed.
- (11) **Using the I/O system setting file**  
To use the I/O system settings of SW5 or earlier, you need to choose [File] - [Import Earlier Version of I/O System File] in the I/O system settings to read the I/O system setting file.  
Refer to Section 5.8.5 for operation details.
- (12) **Task Bar Settings**  
If Auto Hide is set in the Microsoft® Windows® Operating System task bar settings, the task bar is hidden and not displayed at the bottom of the screen if the GX Developer screen is displayed at its maximum size and the GX Simulator initial screen is active.  
The task bar is displayed when the GX Developer screen is reduced or the GX Developer screen is set active.
- (13) **About device range check**  
If the device range is exceeded in indirect designation using the index register, "OPERATION ERROR" occurs in the GX Simulator.  
If "Continue" is selected for [PLC parameter] → <PLC RAS> tab → [Operating mode when there is an error] on GX Developer, GX Simulator stops when this error occurs.
- (14) **About real number range check**  
The GX Simulator checks the real number range strictly. If any value cannot be evaluated as a real number, "OPERATION ERROR" occurs.

(15) About supported instructions and devices

In the GX Simulator, some instructions and devices are unusable and processed as NOPs.

(Refer to Appendix-1 and Appendix-2 for the supported instructions and devices.)

(16) About operating CPU types

When selected, the A series CPU/Q series CPU (A mode) operates as the A4UCPU, the QnA series CPU as the Q4ACPU, the FX series CPU as the FX series CPU, the motion controller as the A4UCPU, and the Q series CPU (Q mode) as the Q25HCPU.

(17) About I/O modules

The GX Simulator does not support I/O modules.

(18) About networks

The GX Simulator does not support networks.

(19) I/O System setting

I/O System setting does not support the local devices. Set the device point that can be executed(valid setting)at a time to 25000 point or less, for device value input on I/O system setting dialog box.

Refer to Section 5.6. for details.

(20) Display of PLC CPU status

When the read SD device from PLC CPU is written to GX Simulator, the PLC CPU status before the writing will be displayed in the monitor status dialog box. \*1

Therefore, the PLC CPU status display may differ from the execution status of GX Simulator immediately after the SD device write to the GX Simulator.

(The display will not be modified until the execution status of the GX Simulator is changed.)

When the SD device read from PLC CPU is written to GX Simulator in STOP status, the display changes as the following.

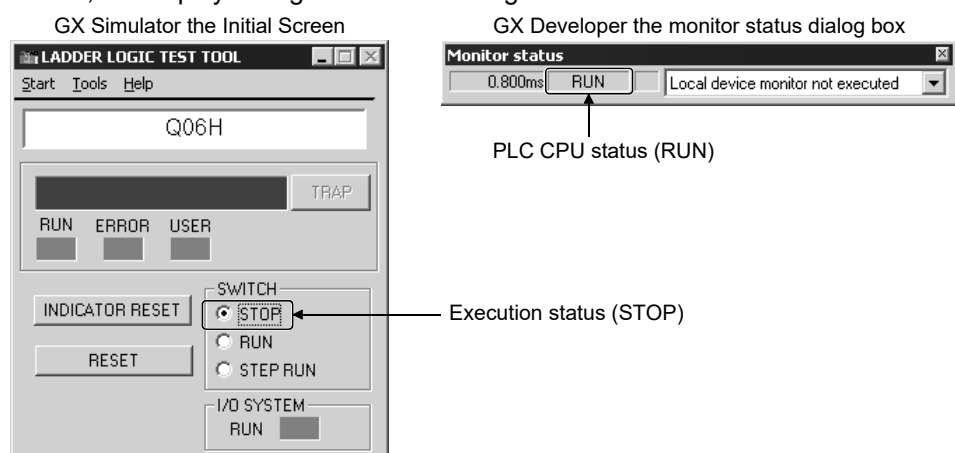

\*1: The PLC CPU status in monitor status dialog box is displayed based on the information of SD device.

(21) Execution of pulse instructions at the timing of switching the PLC CPU status

If a sequence program includes pulse instructions, they are reexecuted when the PLC CPU status is switched RUN to STEP-RUN or STEP-RUN to RUN.

### 3.4.2 Restrictions and cautions for the A series CPU functions

(1) **Special function module Compatibility**

The GX Simulator does not support the special function modules.

The special function module buffer memory area capacity is 16 k points × 64 units. It is possible to save to and read from this area but any other access results in an error.

(2) **Saving To and Reading From Buffer Memory**

Make I/O assignments with GX Developer before saving or reading the special function module buffer memory. (Refer to the GX Developer Operating Manual)  
It is not possible to save to and read from the buffer area unless I/O assignments are made.

(3) **Enabling and Disabling the Parameter Setting Items**

Some GX Developer parameter settings are disabled by the GX Simulator even if data is set for them.

The settings disabled by the GX Simulator are shown below.

Parameter		Setting
PLC parameter	Memory capacity	Disabled other than Sequence and "File register" of "program capacity".
	PLC system	"Output modes except for STOP→RUN" are disabled.
	PLC RAS	<ul style="list-style-type: none"> <li>• "Annunciator display mode" is disabled.</li> <li>• Only "Operation error" and "Special function module access error" in the "operating mode when there is an error" are enabled.</li> </ul>
	I/O assignment	All valid.
	Device	"Latch Start" is disabled.
Network Parameter		All disabled.

(4) **Microcomputer Programs**

Not supported by the GX Simulator.

(5) **PLC Memory Clear**

Execute to clear all user data written to the GX Simulator and initialize.

Also execute this function when unstable GX Simulator operation occurs.

(6) **A1FXCPU Built-in Functions**

If the A1FXCPU type CPU is selected, the A1FXCPU I/O signals become general I/O signals during debugging with the GX Simulator.

Consequently, the A1FX functions are identical to the I/O module functions.

(7) **About numeric value range check**

Checking the numeric value range strictly, the GX Simulator detects any illegal operation whose divisor is 0.

Execution of  $0 \div 0$  will result in "OPERATION ERROR".

(8) About illegal instructions in dedicated instructions

The GX Simulator checks the dedicated instructions for illegal instructions and displays "INSTRUCT CODE ERR.", if any.

(9) About special function module (special function block)

The GX Simulator supports only the buffer memory area of a special function module (special function block).

(10) About memory cassette capacity

The GX Simulator has no memory cassette capacity. A lot of data which would result in an excess of capacity on the actual device will not result in an error and will be written properly.

(11) SFC Programs

Not supported by the GX Simulator.

### 3.4.3 Restrictions and cautions for the QnA series CPU functions

#### (1) Special Function Module Compatibility

The GX Simulator does not support the special function modules.

The special function module buffer memory area capacity is 16 k points × 64 modules. It is possible to save to and read from this area but any other access results in an error.

#### (2) Saving To and Reading From Buffer Memory

Make I/O assignments with GX Developer before saving or reading the special function module buffer memory. (Refer to the GX Developer Operating Manual) It is not possible to save to and read from the buffer area unless I/O assignments are made.

#### (3) Enabling and Disabling the Parameter Setting Items

Some GX Developer parameter settings are disabled by the GX Simulator even if data is set for them.

The settings disabled by the GX Simulator are shown below.

Parameter		Setting
PLC parameter	PLC name	All disabled.
	PLC system	Disabled, except for "Output mode at STOP to RUN" and "Common pointer No."
	PLC file	<ul style="list-style-type: none"> <li>• The corresponding memory for the "file register" is disabled.</li> <li>• The "comment file used in a command" is disabled.</li> <li>• The "corresponding memory" for the "device initial value" is disabled.</li> <li>• The "corresponding memory" for the "file for local device" is disabled.</li> </ul>
	PLC RAS	<ul style="list-style-type: none"> <li>• "Error Check" is disabled.</li> <li>• Only "Operation error" and "Special function module access error" in the "operating mode when there is an error" are enabled.</li> <li>• "Annunciator display mode" is disabled.</li> <li>• "Break down history" and "Low-speed program execution time" are disabled.</li> </ul>
	I/O assignment	"Standard settings" (base, Power supply unit, Increase cable) are all disabled.
	Device	"Latch Start" is disabled.
	Program	All valid.
	Boot file	All disabled.
	SFC	All disabled.
Network Parameter		All disabled.

#### (4) Monitoring

- When the [Local device monitor non-execution] monitor status is selected in the local device monitor of GX Developer, GX Simulator monitors the devices of the program executed at the end of each scan.

However, when a low-speed execution type program is used, it is always executed at the end of each scan. Therefore, GX Simulator monitors the devices processed by the low-speed execution type program. Refer to (5) in this section for details.

- When monitoring devices by specifying the program in the local device monitor of GX Developer, GX Simulator monitors the local devices of the specified program, regardless of whether a scan execution type program exists or not.

(5) About operation of Low-speed execution type Programs

Regardless of the constant scan setting or setting of the low-speed execution type program execution time, the GX Simulator always executes the low-speed execution type programs after the scan execution type programs.

The program execution sequence is show below. (This sequence is identical during step operation.)

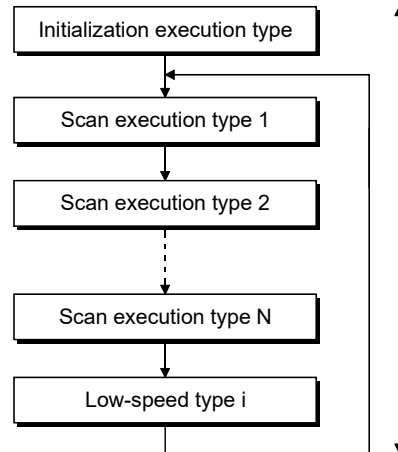

(Assume 1 scan uses 100 ms, then execution of 5 scans 500 ms. Changing of a reference time is possible by changing the constant scan time (Refer to Section 3.4.1, (1)).

During each scan, all scan execution type programs are executed before one low-speed execution type program is executed. Consequently, if N low-speed execution type programs are set, N scans are required to execute them all.

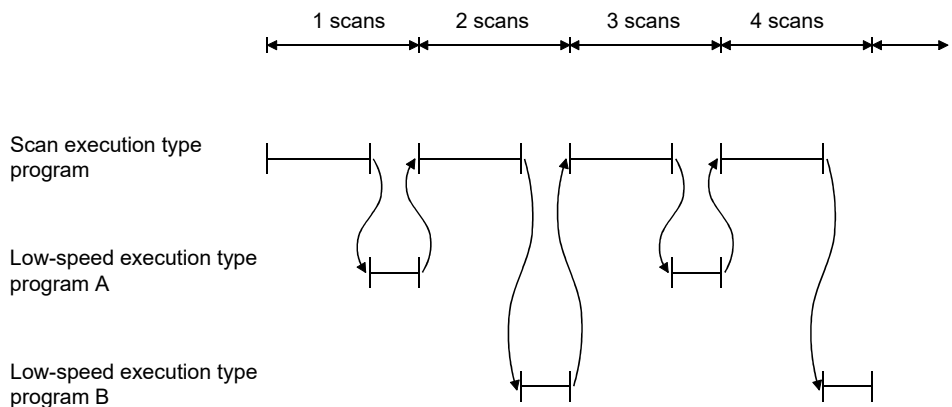

**POINT**  
 Since a low-speed execution type program is always completed within one scan, the monitor value of SM510 is always OFF.

(6) Device Memory Monitor Device Range Check

T31744 to T32767, SB800 to SB7FFF, and SW800 to SW7FFF are used by the system and are unavailable for monitoring or testing.

(7) Function register (FD) monitor

Monitor of function register (FD) cannot be executed from menu of GX Simulator: Execute only from menu of GX Developer.

(8) TTMR Instruction Restrictions

A present value cannot be changed during TTMR instruction execution.

- (9) **I/O System Setting Device Range Check**  
SB800 to SB7FFF and SW800 to SW7FFF are used by the system and cannot be assigned.
- (10) **SFC Programs**  
Not supported by the GX Simulator.
- (11) **PLC Memory Format**  
Execute to clear all user data written to the GX Simulator and initialize.  
Also execute this function when unstable GX Simulator operation occurs.
- (12) **About special function module (special function block)**  
The GX Simulator supports only the buffer memory area of a special function module (special function block).
- (13) **About built-in RAM/memory cassette capacity**  
The GX Simulator has no built-in RAM/memory cassette capacity.  
A lot of data which would result in an excess of capacity on the actual device will not result in an error and will be written properly.
- (14) **About Write to PLC of file register data**  
When performing Write to PLC of file register data to GX Simulator, always set the execution status to STOP before starting execution.
- (15) **About forced input output registration/cancellation function**  
Not supported by the GX Simulator.

### 3.4.4 Restrictions and cautions for the FX series CPU functions

#### (1) CPU Type Selection and FX series CPU Operation

The GX Simulator for the FX series CPU functions operate according to the CPU functions and device range of the selected CPU.

Application instructions not supported by the selected CPU operate with the GX Simulator.

In cases where the sequence program may contain instructions not supported by the actual PLC due to conversion of a program for a higher model to a program for a lower model or due to input in the list mode, a program error occurs when the sequence program is written to the actual PLC, even if the program runs with the GX Simulator.

For example, the FX<sub>0</sub>, FX<sub>0</sub>s and FX<sub>0</sub>N PLCs do not support pulse-execution application instructions, but these instructions run with the GX Simulator.

Even so, a program error occurs when this program is written to the actual PLC because it contains non-supported instructions.

#### (2) STOP → RUN Program Check

A program error is detected by the STOP → RUN program check only if MC/MCR exists in the STL instruction or if no RET instruction is input for a STL instruction.

No other items are detected by the STOP → RUN program check. Therefore, use the GX Developer program check functions in advance to check for these other errors.

#### (3) Enabling and Disabling the Parameter Setting Items

Some GX Developer parameter settings are disabled by the GX Simulator even if data is set for them.

Parameter		Setting Items
PLC parameter	Memory capacity	All valid
	Device	All valid
	PLC name	All invalid
	I/O assignment	<ul style="list-style-type: none"> <li>• Input/output settings are valid.</li> <li>• Setting of special module *1 is invalid.</li> </ul>
	PLC system (1)	All invalid
	PLC system (2)	All invalid
	Positioning*1	All invalid

\*1: Parameters for FX<sub>3</sub>G CPU, FX<sub>3</sub>U CPU and FX<sub>3</sub>UC CPU.

#### (4) Program Memory Capacity

The maximum step capacity for each model is set.

#### (5) Watchdog Timer

The watchdog timer (D8000) operates every 200 ms for all CPUs. It can be rewritten but the written value has no effect on its operation.



**(6) Debugging**

The step execution, skip execution and partial execution functions are only valid when using the GX Simulator.

They cannot be used when an actual PLC is connected.

**(7) Buffer Memory Monitor**

The special extension device buffer memory in the GX Simulator operates as general registers which allow reading and writing using FROM/TO instructions. This memory does not possess any special functions from the special extension devices.

**(8) Analog Volume**

The data registers (D8013, D8030 and D8031) storing the analog volume values for the FX<sub>0</sub>, FX<sub>0S</sub>, FX<sub>0N</sub>, FX<sub>1S</sub> and FX<sub>1N</sub> PLCs operate as normal data registers. Use the GX Developer device test functions to write values between 0 and 255 to these registers for testing.

**(9) High-speed counter**

GX Simulator do not support high-speed counter.

**(10) SORT, SORT2 Instruction**

The SORT, SORT2 instruction is executed in the actual PLC over multiple scans. However, it is executed completely in a single scan in the GX Simulator and M8029 (complete flag) operates immediately.

**(11) SFC Programs**

Testing of SFC program for FX series CPU described as STL instructions is possible with GX Simulator of SW2D5□-LLT-E or later version.

SFC programs for FX series CPU corresponding to GX Developer later than SW5D5C-GPPW-E can also be tested with GX Simulator of SW2D5□-LLT-E or later version.

However, when debugging is to be executed with step execution from SFC display screen of GX Developer, GX Simulator of SW5D5C-LLT-E or later version must be used.

**(12) Handling Keep Devices**

Contents are maintained at a GX Simulator STOP.

Contents are cleared when the GX Simulator is quit.

**(13) Handling Non-Keep Devices**

Contents are cleared at a GX Simulator STOP or when the GX Simulator are quit.

**(14) Memory Clear**

Execute to clear all user data written to the GX Simulator and initialize.

Also execute this function when unstable GX Simulator operation occurs.

- (15) Quick startup of the GX Simulator with the FX series CPU  
When the GX Simulator is used combining SW5D5C-LLT-E or later and SW5D5C-GPPW-E or later, the GX Developer executes quick startup of the GX Simulator. When other combinations are used, it starts up the GX Simulator at normal speed.
- (16) About step execution, skip execution and partial execution  
Compatible with step execution, skip execution and partial execution, the GX Simulator ensures more efficient debugging.  
Refer to (9) for the step execution of SFC programs.
- (17) About Character string constant  
A maximum number of letters for a character string constant used in the program is 16 digits.  
Having 17 or more letters, the letters on and after 17 digits will be ignored.  
(Example)  
\$+ "12345678901234567" "abcdefghijklmnopq" D0  
When performing the above operations, the following data will be stored after D0.  
D0 to D15 = "1234567890123456abcdefghijklmnop"  
(("7" and "q"), on and after 17 digits for each character string constant, will be disregarded.)
- (18) About PLC write of device memory  
If the FX series CPU is used, the following items do not support PLC write function of device memory.
- input (X)
  - output (Y)
  - Special relay (SM)
  - Special register (SD)
- (19) About special function module (special function block)  
The GX Simulator supports only the buffer memory area of a special function module (special function block).
- (20) About online change  
When the FX series CPU is used, online change function is not supported.
- (21) About serial communication function  
When the FX series CPU is used, serial communication function is not supported.
- (22) About device manager function  
When the FX series CPU is used, device manager function is not supported.

### 3.4.5 Restrictions and cautions for the Motion controller functions

(1) Motion controller Type Selection and Applicable CPU Type

The range of devices or instructions of a motion controller are those of the applicable CPU.

The table below shows the types of CPU applicable to the motion controller.

Motion Controller	Applicable CPU
A171SH	A2SH
A172SH	A2SH (S1)
A173UH (S1)	A3U
A273UH (S3)	A3U

(2) Motion dedicated instructions

The GX Simulator does not support motion dedicated instructions. Thus, when an attempt is made to use motion dedicated instructions on the GX Simulator, nothing will be processed. (NOP)

Motion dedicated instructions are only the following six; SVST, CHGA, CHGV, CHGT, SFCS, and ITP.

(3) SFC Programs

Not supported by the GX Simulator.

**REMARK**

Any restrictions and cautions other than the ones described above are the same as those for the A series CPU functions. For the restrictions and cautions for the A series CPU functions, refer to Section 3.4.2.

For details of the motion controller, refer to the Motion Controller User's Manual.

### 3.4.6 Restrictions and precautions for the Q series CPU functions

#### 1) A mode

For the Q series CPU (A mode) functions, the A series CPU functions perform as equivalent to those of the A4U, and therefore, refer to the restrictions on the A series CPU.

#### 2) Q mode

##### (1) Compatibility with the special function module

The GX Simulator does not support the special function module.

However, it has the area of 64k points×64 modules for the buffer memory of the special function module. This area can be accessed, but access beyond that will result in an error.

##### (2) About saving/reading the buffer memory data

When saving/reading the buffer memory data of the special function module, always make I/O assignment on GX Developer. (Refer to the GX Developer Operating Manual.)

Without I/O assignment, buffer memory data cannot be saved/read.

##### (3) About validity of parameter setting items

Among the parameter setting items of GX Developer, there are setting items which will be invalid for the GX Simulator if their data have been set.

The following setting items are invalid for the GX Simulator.

	Parameters	Setting Item
PLC parameter	PLC name setting	All invalid.
	PLC system setting	Items except "timer time limit setting", "STOP-RUN/output mode" and "common pointer No." are invalid.
	PLC file setting	<ul style="list-style-type: none"> <li>• "Target memory" of "file register" is invalid.</li> <li>• "Comment file used for instructions" is invalid.</li> <li>• "Target memory" of "device initial value" is invalid.</li> <li>• "Target memory" of "file for local devices" is invalid.</li> </ul>
	PLC RAS setting	<ul style="list-style-type: none"> <li>• "Error check" is invalid.</li> <li>• Items other than "operation error" and "special function module access error" in "error-time operation mode" are invalid.</li> <li>• "Error history" and "low-speed program running time" are invalid.</li> </ul>
	I/O assignment	<ul style="list-style-type: none"> <li>• "Model", "switch setting" and "detail setting" of "I/O assignment" are invalid.</li> <li>• "Basic setting" (base, power supply module, extension cable) is invalid.</li> </ul>
	Device setting	"Latch range" is invalid.
	Program setting	<ul style="list-style-type: none"> <li>• "Comment" of "file using method setting" is invalid.</li> <li>• "I/O refresh setting" is invalid.</li> </ul>
	Boot file setting	All invalid.
	SFC setting	All invalid.
	Multiple PLC setting	Invalid except "No. of PLC".
Network parameters		All invalid.
Redundant parameters* 1		All invalid.

\* 1: Parameters for Q12PRHCPU and Q25PRHCPU.

(4) Monitoring

- When the [Local device monitor non-execution] monitor status is selected in the local device monitor of GX Developer, GX Simulator monitors the devices of the program executed at the end of each scan.  
However, when a low-speed execution type program or cyclic execution type program is used, GX Simulator may monitor the devices processed by the low-speed execution type program or cyclic execution type program at the end of each scan. Refer to (5) or (6) in this section for details.
- When monitoring devices by specifying the program in the local device monitor of GX Developer, GX Simulator monitors the local devices of the specified program, regardless of whether a scan execution type program exists or not.

(5) About operation of Low-speed execution type Programs

Regardless of the constant scan setting or setting of the low-speed execution type program execution time, the GX Simulator always executes the low-speed execution type programs after the scan execution type programs.

The program execution sequence is show below. (This sequence is identical during step operation.)

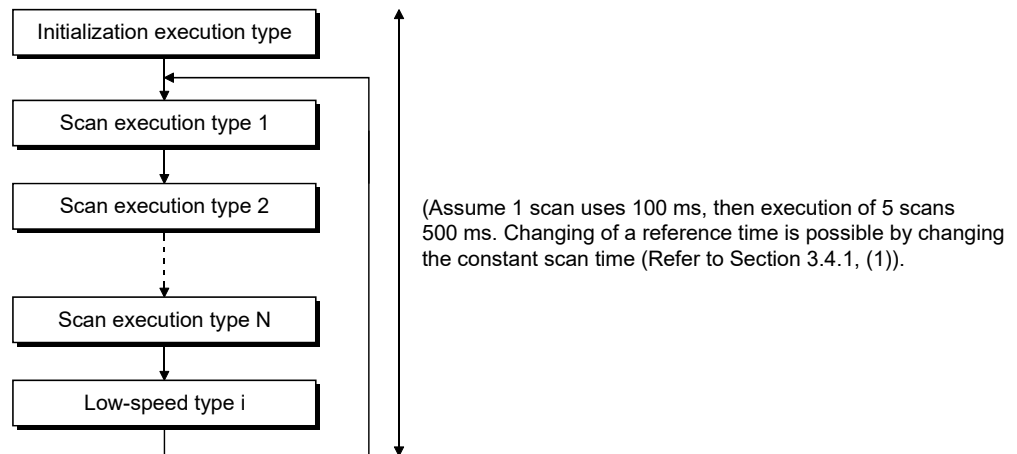

During each scan, all scan execution type programs are executed before one low-speed execution type program is executed. Consequently, if N low-speed execution type programs are set, N scans are required to execute them all.

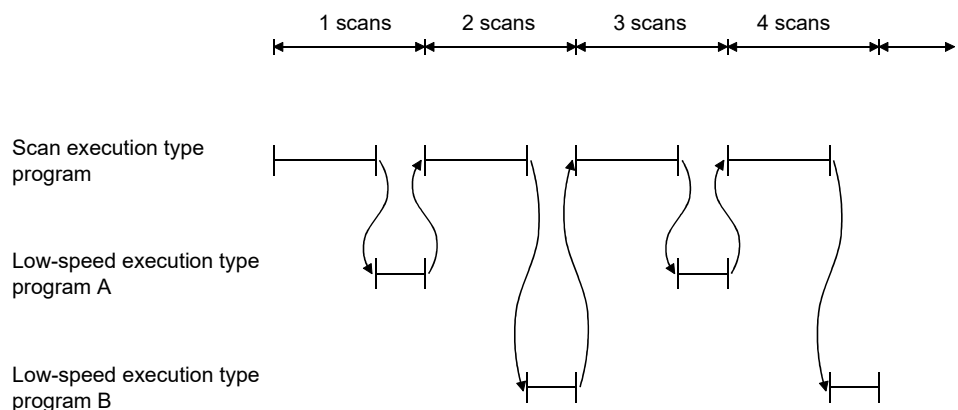

**POINT**

Since a low-speed execution type program is always completed within one scan, the monitor value of SM510 is always OFF.

(6) About operation of cyclic execution type program

A cyclic execution type program judges whether it can run or not by measuring time after the end of a scan execution type and a low-speed execution type. The following timing chart shows the GX Simulator processing timing at the scan time setting of 100 milliseconds and the cyclic execution type program setting of every 200 milliseconds.

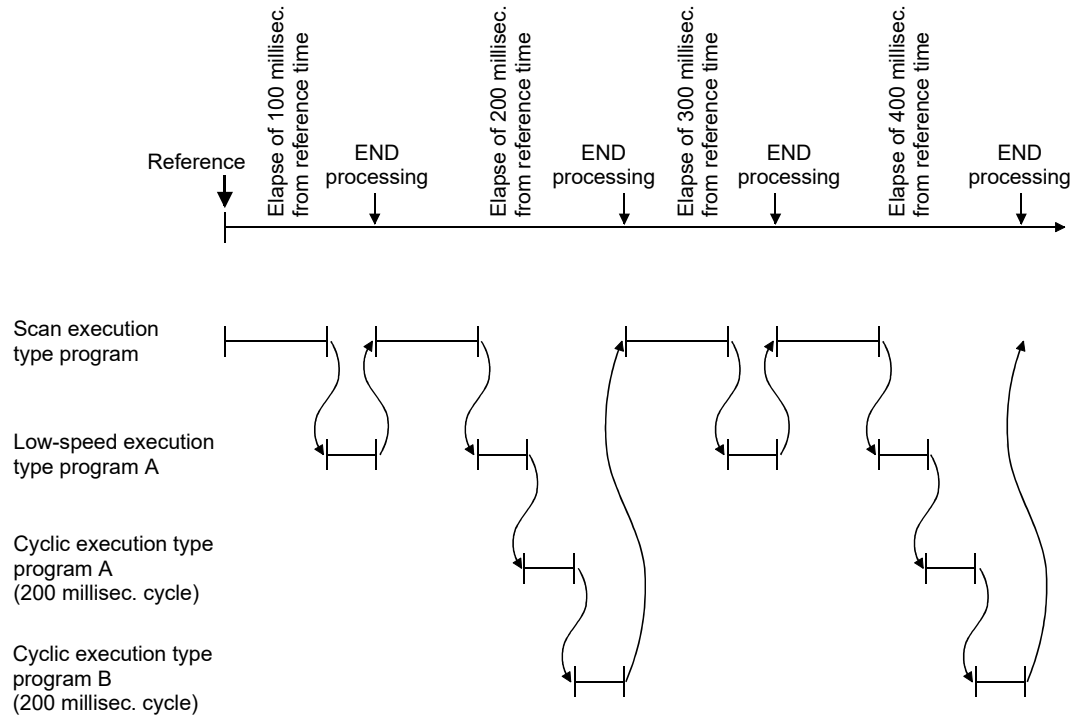

When the cycle of cyclic execution type program is shorter than the constant scan time of 100 milliseconds, the processing timing is once per scan.

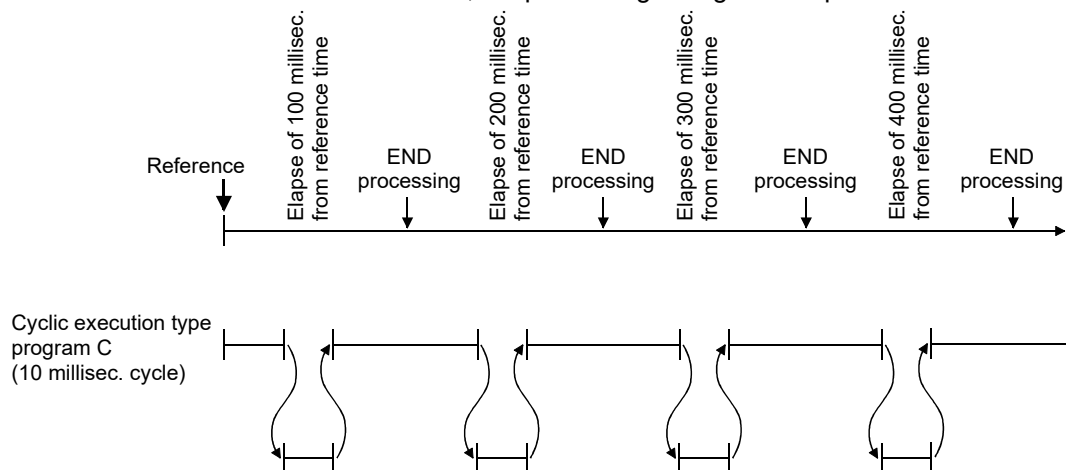

(7) About monitoring the function register (FD)

The function register (FD) cannot be monitored from the GX Simulator menu. Monitor it from the GX Developer menu.

(8) About restrictions on TTMR instruction

During execution of the TTMR instruction, the current value cannot be changed.

- (9) About SFC program  
Not supported by the GX Simulator.
- (10) About PLC memory format  
Execute to clear all user data written to the GX Simulator and initialize.  
Also execute this function when unstable GX Simulator operation occurs.
- (11) About built-in RAM/memory cassette capacity  
The GX Simulator has no built-in RAM/memory cassette capacity.  
A lot of data which would result in an excess of capacity on the actual device will not result in an error and will be written properly.
- (12) About Write to PLC of file register data  
When performing Write to PLC of file register data to GX Simulator, always set the execution status to STOP before starting execution.
- (13) About forced input output registration/cancellation function  
Not supported by the GX Simulator.
- (14) About Character string constant  
A maximum number of letters for a character string constant used in the program is 16 digits.  
Having 17 or more letters, the letters on and after 17 digits will be ignored.  
(Example)  
\$+ "12345678901234567" "abcdefghijklmnopq"  
When performing the above operations, the following data will be stored after D0.  
D0 to D15 = "1234567890123456abcdefghijklmnop"  
(("7" and "q"), on and after 17 digits for each Character string constant, will be disregarded.)
- (15) About online change  
When trailing edge instructions are included in a sequence program, the operation performed immediately after online change may differ from the debugging operation by connecting PLC CPU. For details, refer to the QnUCPU User's Manual (Function Explanation, Program Fundamentals), Qn(H)/QnPH/QnPRHCPU User's Manual (Function Explanation, Program Fundamentals).
- (16) Precaution for process control instruction  
When specifying a device which cannot be applied to instruction argument, INSTRCT. CODE ERR (Error code 4004) will occur.  
This error occurs with the timing of power-on, reset, STOP → RUN, instruction execution in PLC CPU. On the other hand, in GX Simulator, the error occurs in instruction execution only.  
Therefore, the error will not occur if the instruction mentioned above is not executed in GX Simulator, however, if downloading the program to PLC CPU, the error will occur even though the instruction is not executed.

### (17) VAL(P)/DVAL(P)/EVAL(P) instructions

For a high performance model QCPU, when the last character string that is specified for an argument of an instruction is '2EH' ("."), for example '0000.', the operation error (4100) occurs on a programmable controller CPU. But on the simulation function, no error occurs and the instruction is executed.

## 3) Q mode (multiple PLC system)

### (1) About the GX Simulator Compatibility with multiple PLC system

The GX Simulator cannot be compatible with multiple PLC action itself.

There are reasons that the GX Simulator does not support multiple starts and is not conscious of the number of own machine which is necessary for multiple CPU action. (Consciousness of what number the own machine is in some CPUs.)

It is only the part of the minimum requirements (it run as a single CPU sequence program) to run sequence program (project) for applicable multiple CPU which was written by the GX Developer.

### (2) I/O assignment

I/O assignment parameter of the GX Developer appoints control CPU to each I/O and intelligent function units.

Although it is able to read the control information to the GX Simulator, the function is not compatible without consciousness of own machine. (If it is multiple PLC applicable parameter, it is not the error for I/O assignment of the GX Simulator original.)

### (3) Difference between the GX Simulator and the practical machine under the access instruction to the shared memory of multiple PLC

Although we use description of own machine/the other machine for expression of difference between the GX Simulator and the practical machine, the GX Simulator have no discrimination between own machine/the other machine. The GX Simulator allows read from own machine with the FROM command.



### 3.5 GX Simulator Safety and Handling Precautions

---

The safety and handling precautions for the GX Simulator are described below.

- (1) The GX Simulator simulates the actual PLC to debug sequence programs. However, the correct operation of a debugged sequence program cannot be guaranteed.
- (2) The calculated results may differ from actual operation because the GX Simulator does not access the I/O modules or special function modules and do not support some instructions and devices.

<b>POINT</b>
--------------

After debugging has been performed by GX Simulator, it is necessary to execute normal debugging by connecting the PLC CPU before starting actual operation.
---

## 4. COMMON OPERATIONS FOR THE GX Simulator

### 4.1 Procedure from Installation to Debugging

This section describes the procedures from installing the GX Simulator to debugging a sequence program.

Procedure 1

Install GX Developer and the GX Simulator in the personal computer.  
For the installation operation, refer to the "Method of installing the MELSOFT Series" packed with the package.

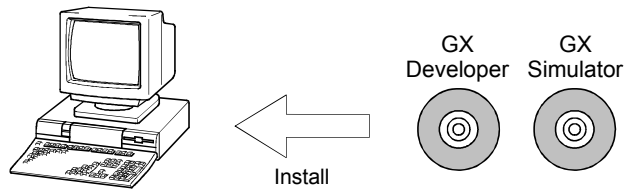

Procedure 2

Use GX Developer to create a sequence program.

Refer to the GX Developer Operating Manual.

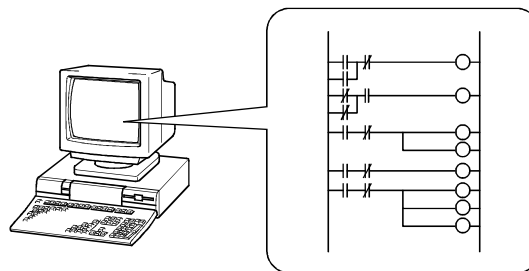

Procedure 3

In GX Developer, set the parameters to assign the I/Os (for A/QnA/Q series CPU functions) and make the program settings (for QnA series/ Q series (Q mode) CPU functions).

Refer to the GX Developer Operating Manual.

#### POINTS

- (1) Always do the program settings for the QnA series/Q series CPU function.  
If you do not make the program settings and the GX Developer is of version later than SW2D5□-GPPW-E the following will occur.
  - 1) The ladder sequence (list) of the active screen of GX Developer will be written.
  - 2) The sequence program will not be written, if the active screen is not a ladder (list) screen or if there are no active screens.
- (2) Please set the I/O assignments (for A/QnA/Q series CPU function) before reading/writing the buffer memory of special function module.  
Refer to Section 4.2 (4).

(To next page)

(From previous page)

Procedure 4

Select the [Tools] → [Start ladder logic test] GX Developer menu items to start the GX Simulator. The sequence program and parameters created with GX Developer are automatically written to the GX Simulator (equivalent to write to PLC).

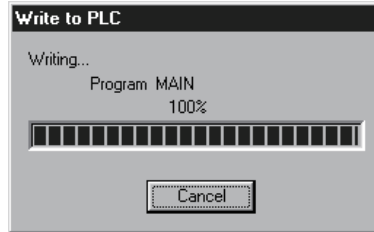

Procedure 5

Set various devices that support the offline debugging of the user application.

Refer to "Chapter 8 Device Manager Function".

Procedure 6

Debug the sequence program using the GX Simulator and GX Developer functions. Debugging is possible by using the device monitor, changing arbitrary device values, or simulation of machine operation.

Refer to "Chapter 5 I/O SYSTEM SETTING FUNCTIONS" and "Chapter 7 MONITOR FUNCTION".

Refer to the GX Developer Operating Manual.

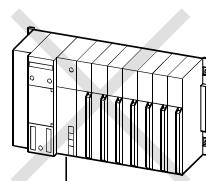

Connection of actual PLC is not necessary

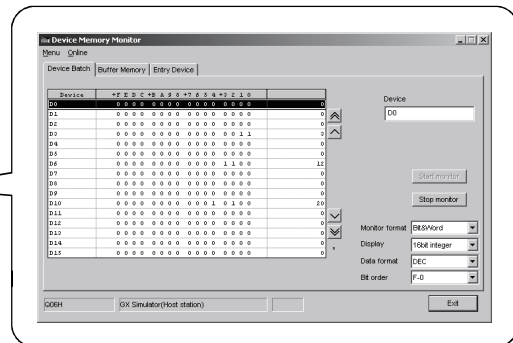
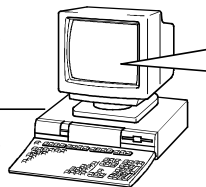

When checking the operation of the frame sent from the external device, you can use the serial communication function for debugging.

Refer to "Chapter 6 SERIAL COMMUNICATION FUNCTION".

Procedure 7

After debugging, modify the sequence program.

Refer to the GX Developer Operating Manual.

Procedure 8

Set the execution status in the initial screen to STOP.

If necessary, save the contents of the device memory and special function module buffer memory.

Refer to "Chapter 9 TOOL FUNCTIONS".

Procedure 9

Select the [Online] → [Write to PLC] GX Developer menu items to write the modified program to the GX Simulator.

Refer to the GX Developer Operating Manual.

To debug the program again, repeat Procedures 5 to 9.

**POINTS**

After debugging has been performed by GX Simulator, it is necessary to execute normal debugging by connecting the PLC CPU before starting actual operation.

## 4.2 GX Developer Operations before Debugging

This section describes the GX Developer operations required before debugging with the GX Simulator.

Conduct the operations described below before debugging a program with the GX Simulator.

### (1) Make the Project to Create the Sequence Program.

To create a new project, select [Project] → [New project] from the GX Developer menus and make the required settings.

To read an existing project, select [Project] → [Open project] from the GX Developer menus and select the project.



### (2) Create the Sequence Program.

### (3) On the GX Developer side, make parameter settings for I/O assignment (for A/QnA/Q series CPU functions), program setting (for QnA series/Q series (Q mode) CPU functions), etc.

#### POINT

Always do the program settings for the QnA series CPU function.

If you do not make the program settings and the GX Developer is of version later than SW2D5□-GPPW-E the following will occur.

- (1) The ladder sequence (list) of the active screen of GX Developer will be written.
- (2) The sequence program will not be written, if the active screen is not a ladder (list) screen or if there are no active screens.

- (4) When making I/O assignment on the <I/O assignment> tab screen in the [PLC Parameters] dialog box of GX Developer, set the types and the numbers of points of all modules.

"SP. UNIT LAY ERR." occurs if any of the following settings has been made.

- 1) Any of settings (a) to (c) on the following screen has been made.
  - (a) The type has been set but the number of points has not been set.
  - (b) With the settings made to slot 2 and later, the type and the number of points of slot 1 have not been set.
  - (c) The number of points has been set but the type has not been set.
- 2) X/Y settings are overlapped.

Setting screen example (Q series CPU (Q mode))

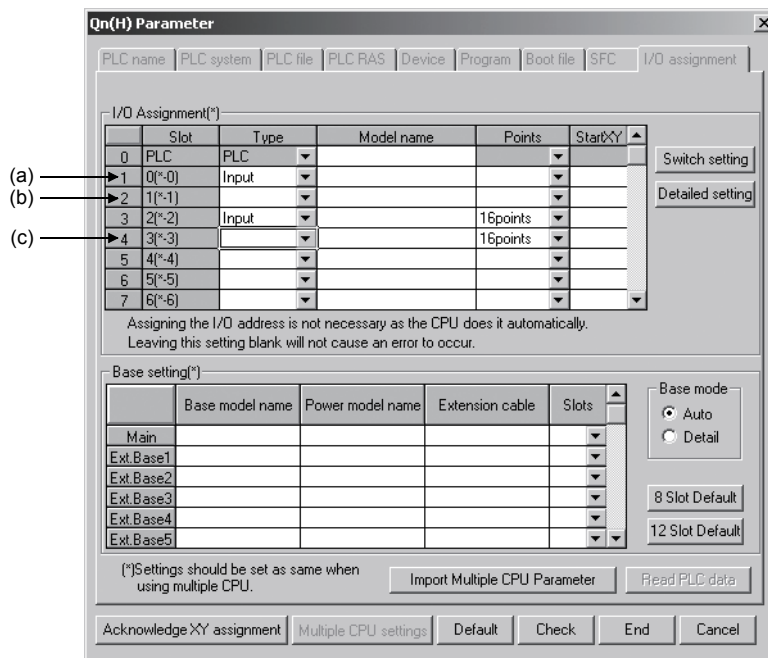

- (5) Select the [Tools] → [Start ladder logic test] GX Developer menu items to start the GX Simulator. An initial screen as shown below is displayed.

The sequence program and parameters are automatically written to the GX Simulator when the GX Simulator are started by GX Developer.

Offline debugging of the sequence program using the GX Simulator is now possible.



### 4.3 Description of the Initial Screen Display

A GX Simulator initial screen as shown below is displayed when the GX Simulator is started. This section describes the items displayed in the GX Simulator initial screen.

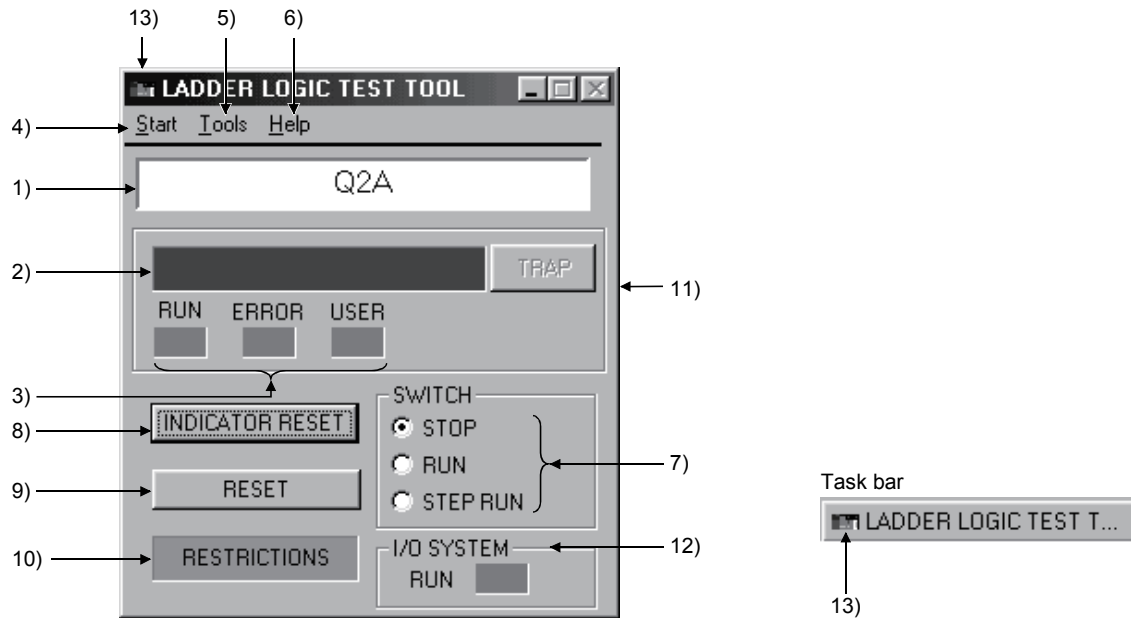

Number	Name	Description						
1)	CPU type	Displays the currently selected CPU type.						
2)	LED Indicators	<ul style="list-style-type: none"> <li>Can display up to 16 characters.</li> <li>The indicator display is equivalent to the display of CPU operation errors.</li> </ul>						
3)	Operation Status LEDs	<ul style="list-style-type: none"> <li>RUN/ERROR: Valid for all of the QnA, A, FX, Q series CPU and motion controller functions.</li> <li>USER : Appears only for the QnA series/Q series (Q mode) CPU functions.</li> </ul>						
4)	Start	Makes available the Monitor function, I/O System Settings, Serial Communication Function and Device Manager.						
5)	Tools	Use the Tools menu to execute the tool functions. Refer to Chapter 9 Tool Functions.						
6)	Help	Displays the GX Simulator licensee name and software version.						
7)	Switch Display and Settings	Displays the execution status of the GX Simulator. Click on the radio buttons to change the execution status.						
8)	INDICATOR RESET button	Click to clear the LED display.						
9)	RESET button	<ul style="list-style-type: none"> <li>Click to reset the GX Simulator</li> <li>Displayed only for the A, QnA, Q, and Motion controller series functions.</li> </ul>						
10)	Unsupported information indicator lamp	<ul style="list-style-type: none"> <li>Displayed only when unsupported instructions or devices for the GX Simulator is found.</li> <li>By double clicking, display the unsupported instructions that have been changed to NOP instructions and their steps on another screen. (Refer to (1) in this Section.)</li> </ul>						
11)	Error advance display button	Clicking this button will display the descriptions of issued errors, error steps, and the name of files in which the error is issued on another screen. (Refer to (2) in this Section.)						
12)	I/O system setting LED	<ul style="list-style-type: none"> <li>LED lights up during execution of I/O system setting.</li> <li>Double clicking this will show the contents of current I/O system settings.</li> </ul>						
13)	Icon	Displays the current status (normal or error occurrence). (At error occurrence, the icon is enclosed by yellow.) <table border="1" style="margin-left: 20px;"> <thead> <tr> <th>Icon</th> <th>Current Status</th> </tr> </thead> <tbody> <tr> <td></td> <td>Normal</td> </tr> <tr> <td></td> <td>Error occurrence</td> </tr> </tbody> </table>	Icon	Current Status		Normal		Error occurrence
Icon	Current Status							
	Normal							
	Error occurrence							

(1) Unsupported instruction list display function

Displays a list of program name and step No. when unsupported instructions/devices are included in the program or I/O system setting.

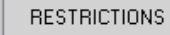
To display the list display screen, double click unsupported information indicator lamp (  ). (The lamp is displayed only when unsupported instructions/devices by GX Simulator exist in a sequence program.)

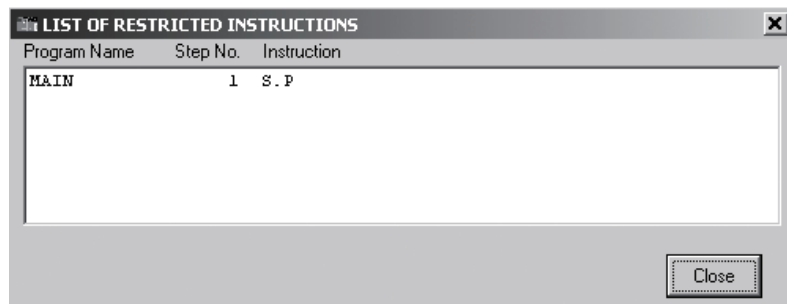

Note when unsupported devices are included in the I/O system setting, "iosys" and "0" are displayed in the Program Name area and Step No. area respectively. In case online change is processed during the display of unsupported instruction list screen, the displayed information will not be renewed. For displaying the latest information, close the screen and open the screen again.

(2) Error advance display function

Displays error detail on error advance screen by clicking error advance display button when ERROR LED is in an ERROR status.

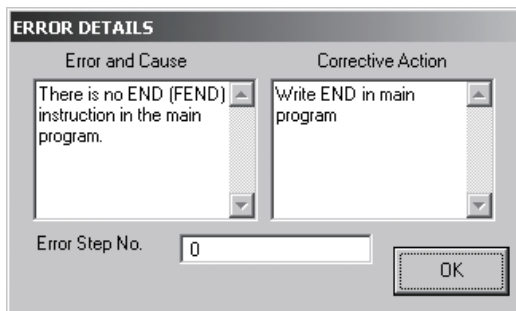

A series CPU/FX series CPU/Motion controller /Q series CPU (A mode)

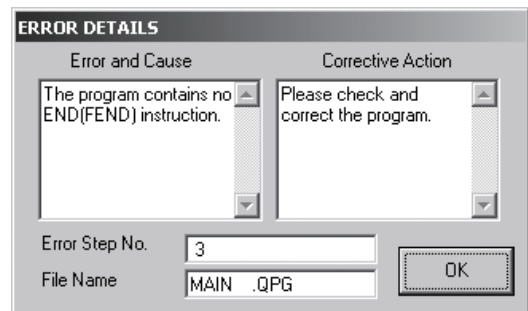

QnA series CPU/Q series CPU (Q mode)  
(Displays a file name)

## 4.4 Ending the GX Simulator

### [Purpose]

To end the GX Simulator.

### [Operation procedure]

#### POINT

Before exiting from GX Simulator, save the I/O System setting data and Device Manager setting data.

If the setting data are not saved, they will be deleted at exit from GX Simulator.

- (1) Select [Tools] - [End ladder logic test] of GX Developer menu.

You can also click  of GX Developer for above.

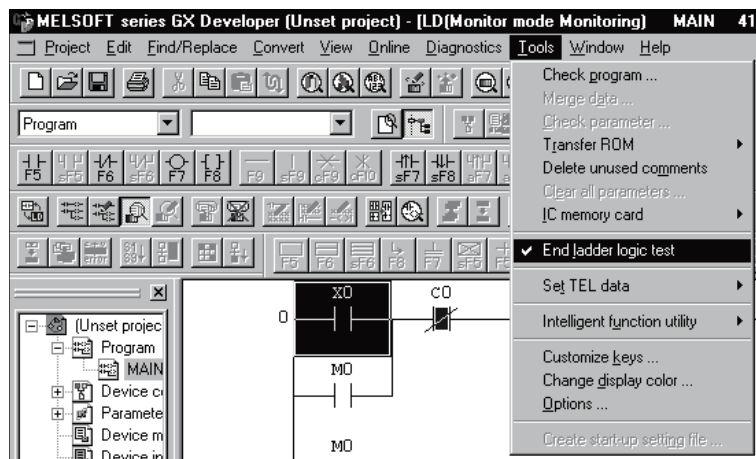

- (2) When the dialog box appears, click the **OK** button.

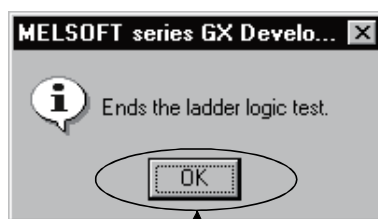

Click!



## 5. SIMULATION OF EXTERNAL DEVICE OPERATION - I/O SYSTEM SETTING FUNCTIONS

The I/O system setting functions allow simulation of the operation of external devices. In conventional debugging, a debugging sequence program was created to simulate the operation of the external devices. Using the I/O system setting functions, the operation of the external devices can be automatically simulated without the requirement to create a special debugging sequence program.

### (1) Differences between Conventional Debugging and Debugging with the I/O System Setting Functions

A comparison between conventional debugging with an actual PLC connected and debugging using the I/O system setting functions is shown below.

#### (a) Conventional Debugging

The program must be modified as follows for debugging:

- Add a debugging sequence program to simulate operation of the external devices.
- As an input (X) can be turned ON/OFF only with an external device connected to the I/O unit, modify the program by changing X0 → M0, X1 → M1, etc. to conduct debugging with no external device connected.

#### (b) Debugging using the I/O System Settings

The I/O system setting function allows sequence program settings and changes to be made for debugging from the setting screen.

It is unnecessary to add a sequence program. It is not necessary to rewrite the devices (X0 → M0) as the inputs (X) can be directly turned ON/OFF from GX Developer.

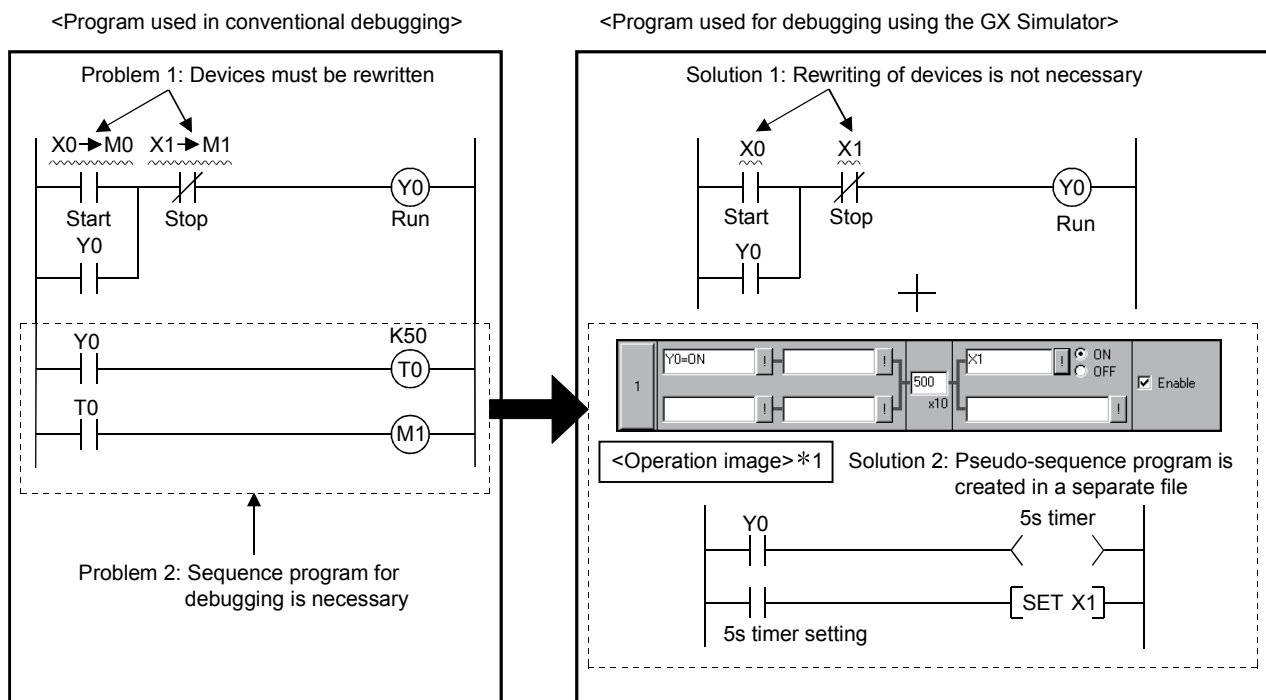

\*1: The program is operation image.

(2) Conditions for simulation

With I/O system setting, optional operation will be performed after the condition is fulfilled.

By combining conditions, conditions equivalent to the following circuits can be set.

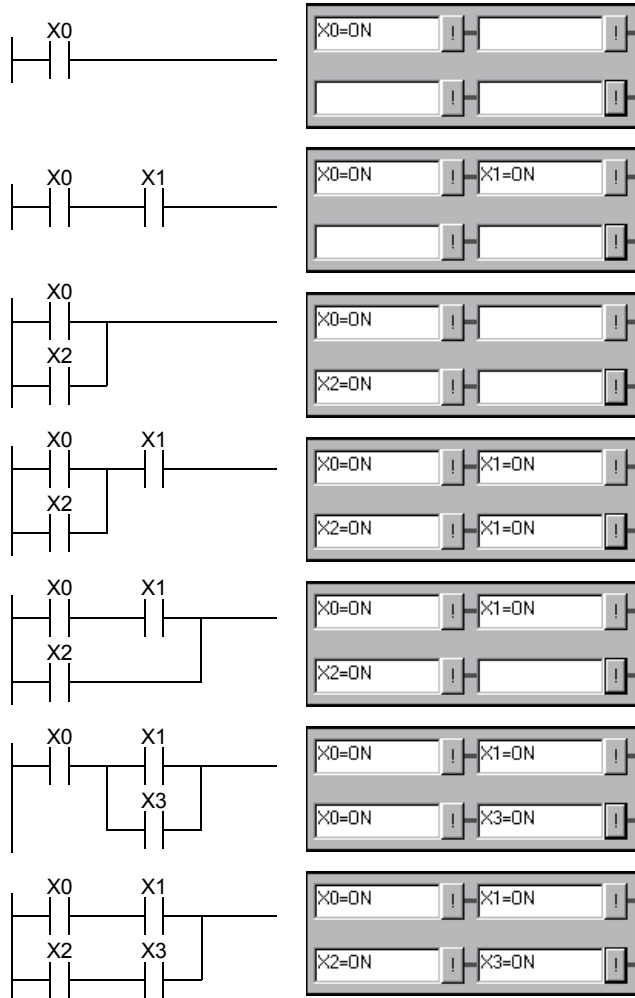

(3) Timing chart input and device value input

With I/O system setting, there are two inputs: one is timing chart input to execute timing chart prepared by user after condition is fulfilled; the other is device value input to set optional device value after specified time has elapsed.

Differences between the above two inputs are described below.

(a) Timing chart input

When condition set by user has been fulfilled, timing chart set by the user can be operated.

With this input, complicated operations, such as "When Y0 is turned ON, D0 is counted up, Y0 is turned OFF when X0 is turned ON", can be set.

However, the timer cannot be set: If timer is to be used, select device value input.

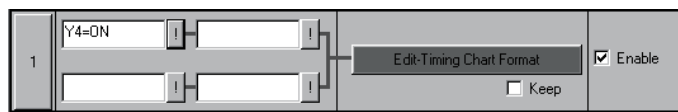

<Timing chart format input screen>

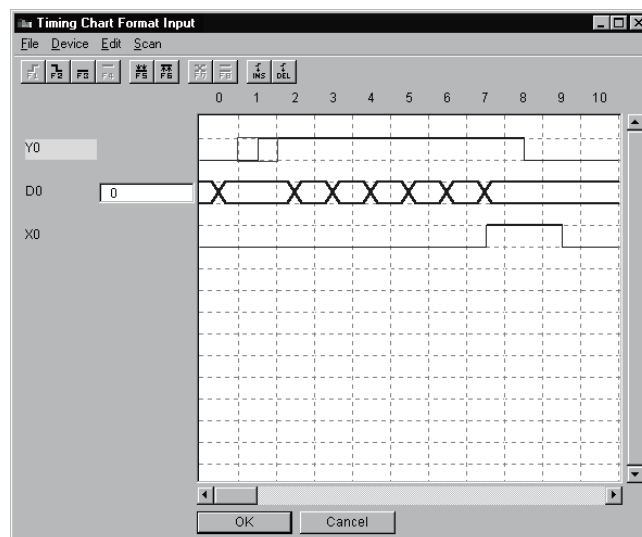

(b) Device value input

After the setting condition is satisfied and then time which is set in timer elapsed, the specified device value can be changed.

With this input, an operation such as "When Y0 is turned ON, 5 seconds later X0 and X3 are turned ON" can be set.

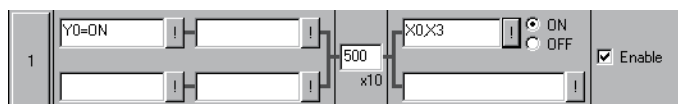

**POINT**

After starting timer, the operation becomes for changing the specified device value, does not pause the timer even though changed the status to unsatisfied condition.

### 5.1 I/O System Setting Operation Procedure

Operation procedure for I/O system setting is shown below.

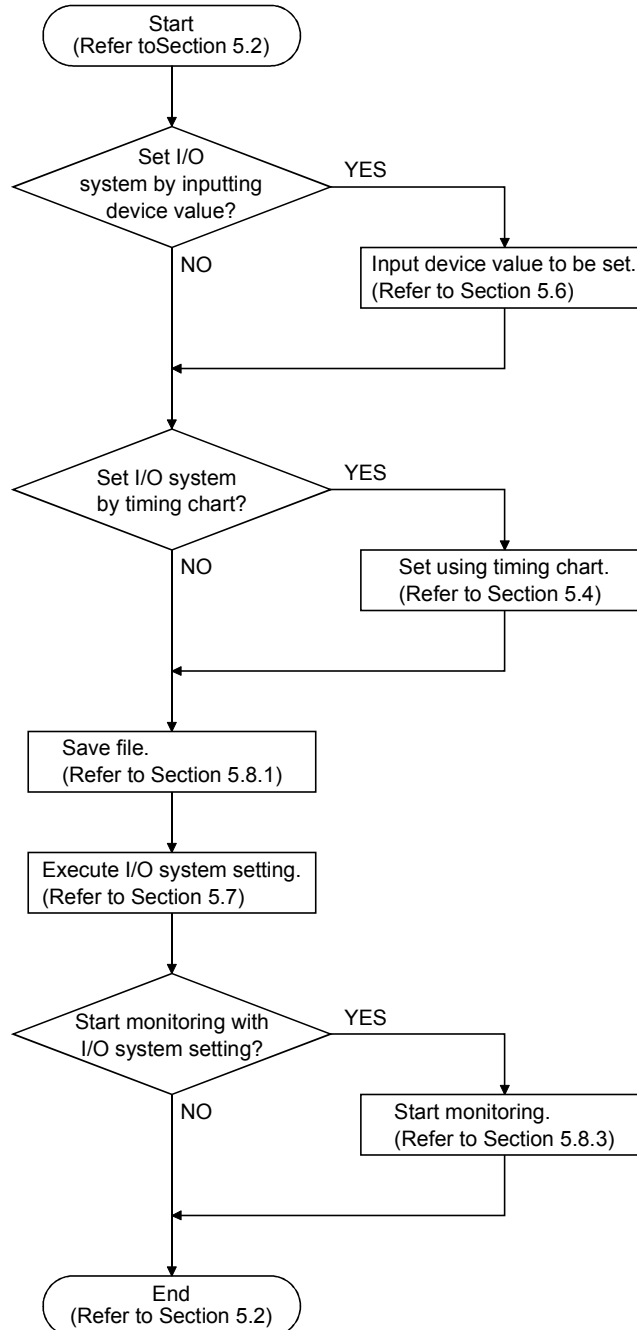

5.2 Starting/Ending I/O System Setting

(1) Starting I/O system setting

[Purpose]

To start I/O system setting.

[Operation procedure]

Select [Start] - [I/O System Settings] from the initial screen.

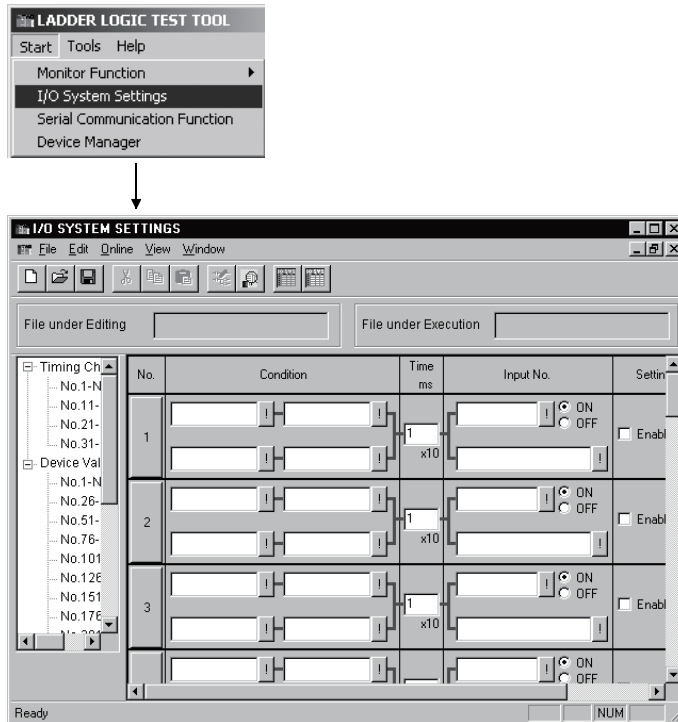

(2) Ending I/O system setting

[Purpose]

To end I/O system settings.

[Operation procedure]

Select [File] - [Exit I/O System Settings] from I/O system settings screen.

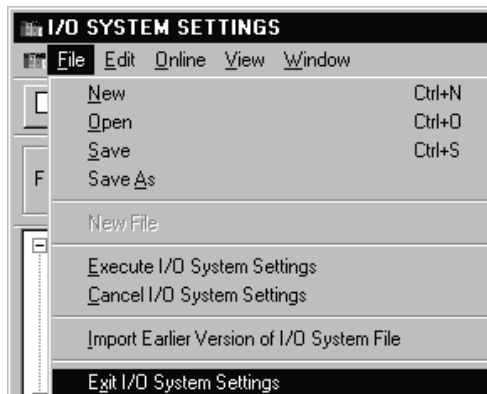

### 5.3 Configuration of I/O System Settings Screen

I/O system settings screen is opened by clicking [Start] - [I/O System Settings] of initial screen. Configuration of I/O system settings screen is shown below.

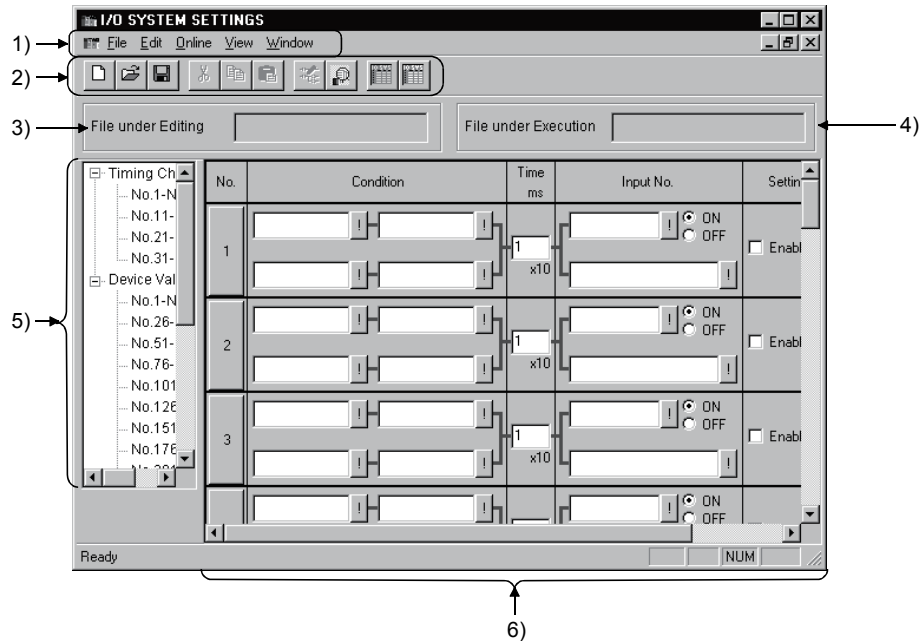

- 1) **Menu bar**  
Name of menu that can be used in I/O system settings is displayed. When menu has been selected, drop-down menu will be displayed and various functions from this menu can be used.
- 2) **Tool bar**  
From functions assigned by menu bar, those most frequently used are displayed with buttons.
- 3) **File under Editing**  
Displays name of file being edited.
- 4) **File under Execution**  
Displays name of file registered as I/O system execution file.

5) I/O system settings tree

Selects setting method of I/O system settings.

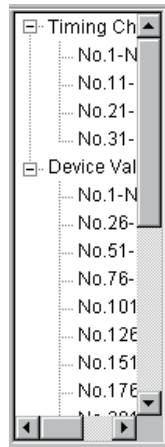

- Timing chart input

Double-click column of number to be set: I/O system setting with timing chart format can now be performed.

Ups to 40 settings (from No. 1 to No. 40) are possible.

- Device value input

Double-click column of number to be set: I/O system setting with device value set can now be performed.

<When using the A/QnA/Q series CPU or motion controller>

You can make 500 settings, No. 1 to No. 500.

<When using the FX series CPU>

You can make 100 settings, No. 1 to No. 100.

6) Edit/monitor screen

Editing and monitoring of I/O system settings are performed using this screen.

- In timing chart input mode (Refer to Section 5.4)

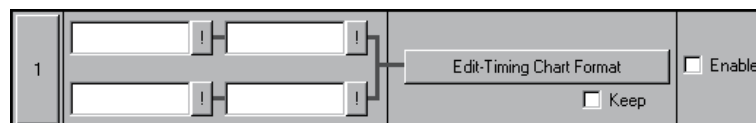

- In device value input mode (Refer to Section 5.6)

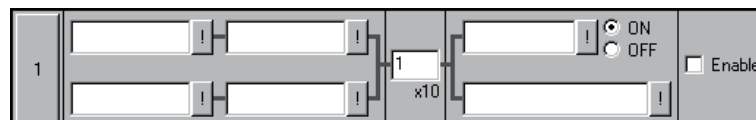

## 5.4 Setting by Using Timing Chart

This section describes how to perform I/O system settings using timing chart.

### [Operation procedure]

- (1) Select [Start] - [I/O System Settings] from initial screen.
- (2) Double-click column of number to set timing chart as shown below.

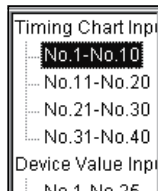

### [Setting screen]

Make the setting below in I/O system setting dialog box.

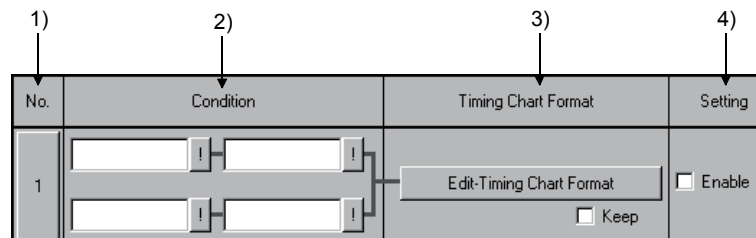

### [Description of items]

#### 1) No.

The number of settings in the I/O system setting dialog box.  
Up to 40 settings can be chosen.  
When clicked, set No. is made object of Cut, Copy or Paste.

#### 2) Condition

Designates the input condition from GX Simulator.  
The input conditions can be designated as either a bit device or a word device.  
For a bit device, designation condition is ON/OFF; for a word device, designation condition is a comparison (=, <, >, <=, >=) with a constant or another word device.  
In addition, relational conditions can be set by specifying AND/OR operation.

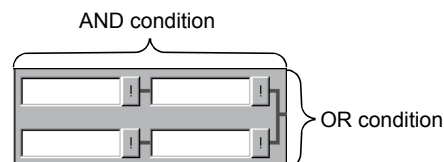

AND ..... The condition will be fulfilled if both designated conditions on the left and right are achieved. Otherwise, the condition will not be fulfilled.

OR ..... The condition will be fulfilled if either or both of designated conditions in upper and lower columns are achieved.



- Input method (direct input)  
Entering condition expression directly can perform setting.  
<Example>  
For a bit device: X0=OFF, M10=ON  
For a word device: D5<20, D15<>5, D20=2, D25>=10, D0=D50

- Input method (entering by using dialog box)  
Click  button and enter device name, device No., designated condition, etc.

Object of comparison is handled as a 16 bits hexadecimal integer.  
When designated as K○○, setting is done using decimal number, and designated as H○○, a hexadecimal number. If neither K nor H is designated, decimal number setting will be selected.

Refer to Appendix 3.1 for devices that can be entered in the Condition area.

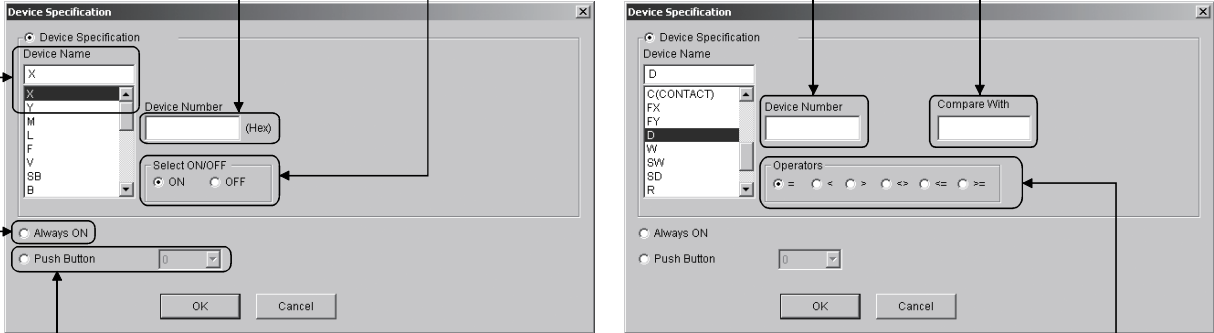

When a bit device is selected:

- Selects device name.
- Enters device No.
- Selects ON or OFF condition.
- When a bit device is selected: Selects to use as Push button in monitor mode. With Push button, you can make 500 settings, 0 to 499 (100 settings, 0 to 99, when using the FX series CPU). User can fulfill conditions with optional timing by using the push button.
- Selects when "Normally ON" is set.

When a word device is selected:

- Enter object device name and value.
- Enters device No.
- Selects comparison designation.

**POINT**  
Index representation (eg. D0Z0), representation of a word device in bits form (eg. D0,0), and sets of bits device representation (eg. K4X0) are not allowed in the Condition area.

### 3) Timing Chart Format

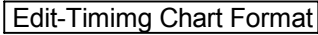
-  button  
Click this button: The timing chart format input screen will appear.  
Refer to Section 5.5 for operation of screen/
- Continuing  
When timing set by timing chart input is to be executed continuously, apply check mark  to check box.

### 4) Setting

Designates enable or disable for each setting.  
Apply a check mark  to enable the setting.

## 5.5 Operation of Timing Chart Format Input Screen

This section describes operation of timing chart format input screen.

### 5.5.1 Operation procedure of timing chart format input screen

The operation procedure of timing chart format input screen is indicated below.

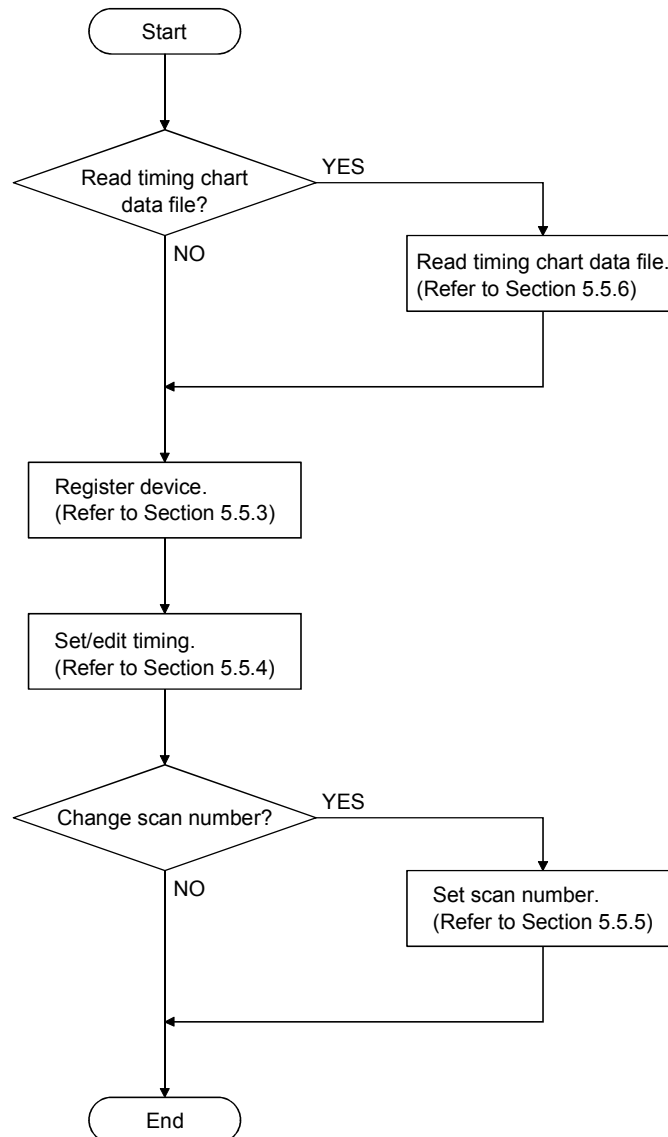

### 5.5.2 Configuration of timing chart format input screen

Configuration of timing chart format input screen is described below.

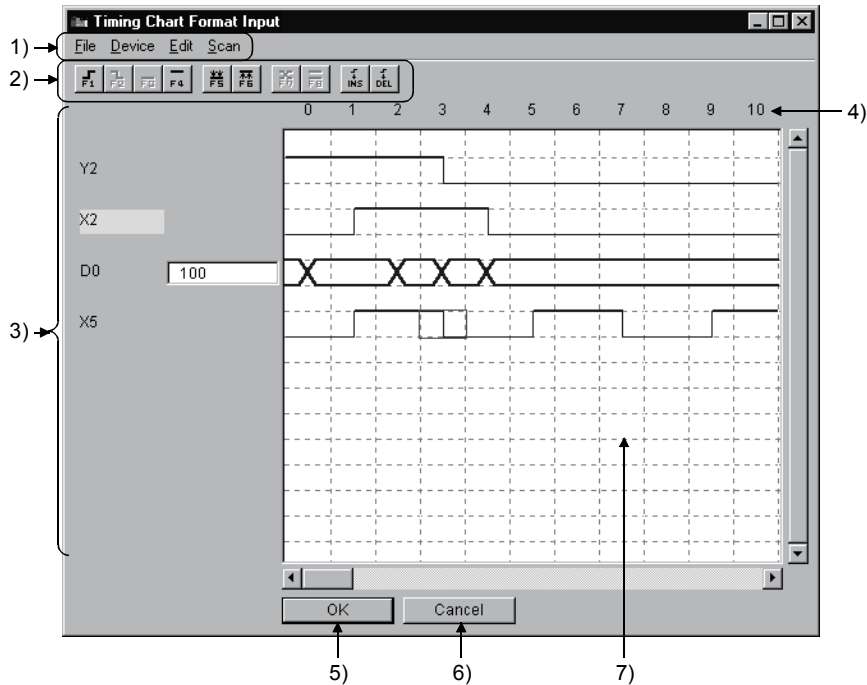

1) **Menu bar**

Name of menu, which can be used in timing chart format input screen, is displayed.

When menu has been selected, drop-down menu will be displayed and various functions from this menu can be used.

2) **Tool bar**

From functions assigned by menu bar, those most frequently used will be displayed with buttons.

3) **Device name/device value**

Bit device: When timing at cursor position is ON, device name lights (Yellow).

Word device: Device value, with the timing at cursor position, will be displayed in the text box on the right of device name.

POINT	
<p>(1) Buffer register and extension file register are displayed as shown below.</p> <div style="display: flex; justify-content: space-around;"> <div style="text-align: center;"> <p>&lt;Buffer register &gt;</p> <p>The first I/O number of a special function module</p> <p>U ▼ \ G ▲</p> <p>Address</p> <p>When first I/O No. is 4, and address is K30, "U4\G30" will be displayed.</p> </div> <div style="text-align: center;"> <p>&lt;Extension file register&gt;</p> <p>Block No.</p> <p>ER ▼ \ R ▲</p> <p>Address</p> <p>When block No. is 2, and address is K30, "ER2\R30" will be displayed.</p> </div> </div>	
<p>(2) When a word device is designated as a 32-bit integer, (D) is added to the device name. Example: D0(D), W6(D)</p>	

4) Scan number

Shows scan number of timing.

When scan number is set by selecting [Scan] - [Scan setting], disabled scans will be displayed with shading.

When applying check mark to "Keep" on the right of Edit-Timing Chart Format button, the enabled scans can be repeated while the condition is being fulfilled.

Example: For continuation with 6 scans designated:

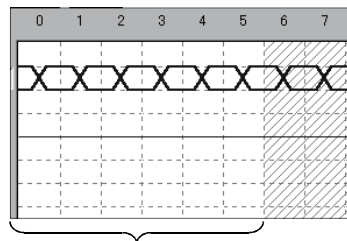

Only 6 scans from 0 to 5 are enabled.

Scans 0 to 5 will be executed repeatedly while the condition is being fulfilled.

5) OK button

Defines settings and exits from this screen.

6) Cancel button

Cancels settings and exits from this screen.

7) Status

Displays state of timing chart being set.

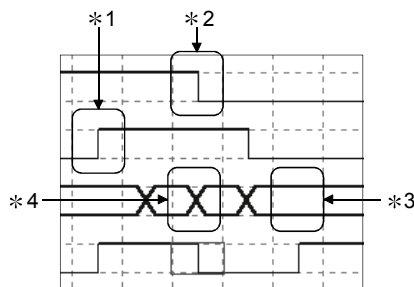

- \*1: Shows that object device was turned ON from OFF.
- \*2: Shows that object device was turned OFF from ON.
- \*3: Shows that object device remains unchanged.
- \*4: Shows that object device has changed.

5.5.3 Entering/Deleting device

(1) Entering device to be simulated

[Purpose]

To enter device for setting timing.

[Operation procedure]

(a) Select [Device] - [Enter Device].



(b) Dialog shown below will appear. After setting each item, click **Enter** button.

A maximum of 16 devices can be entered.

[Bit device selected]

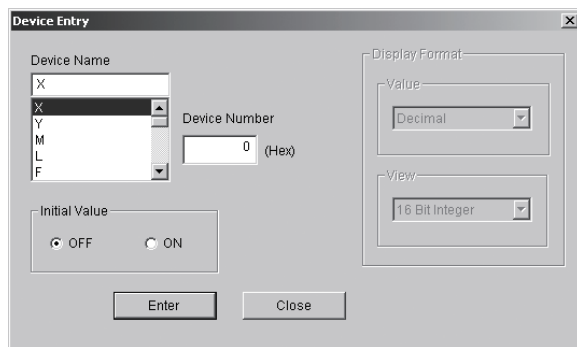

[Word device selected]

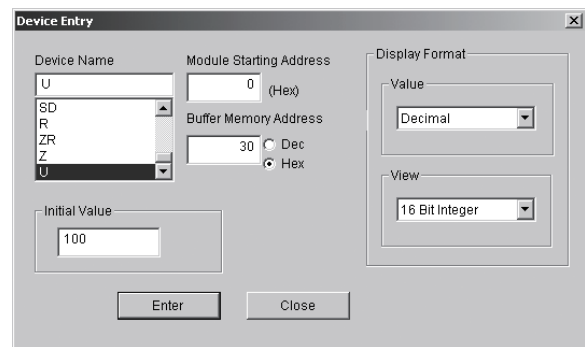

Item	Contents
Device name	Selects name of device to be entered.
Device No.	Enters device No.
Unit initial address	Displayed when "U" is selected with device name. Enter the higher two digits when initial I/O No. is expressed in three digits. Example: In case of X/YIF0, enter "IF".
Initial value	Sets initial value. For a bit device, select ON/OFF. For a word device, enter value.
Displayed format	Sets display format of word device to be displayed. Both decimal and hexadecimal numbers can be set. Display can be selected from 16 Bit integers, 32 Bit integers, real numbers (single precision), and real numbers (double precision).
<b>Enter</b> button	Enters device.
<b>Close</b> button	Closes this screen.

(2) Deleting entered device

[Purpose]

To delete entered device.

[Operation procedure]

(a) Select device to be deleted.

Deleting Y1F is described here, as example.

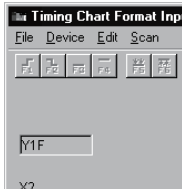

(b) Select [Device] - [Delete Device].

Device has been deleted.

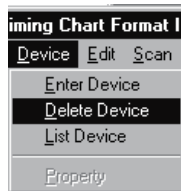











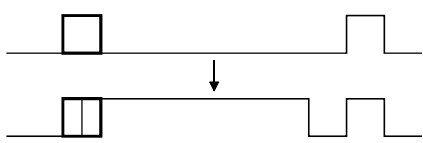

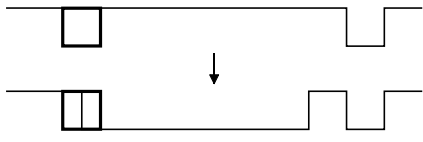

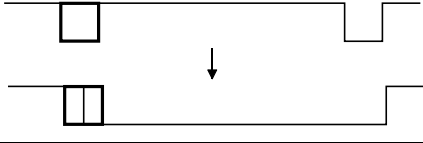
### 5.5.4 Setting/Editing timing

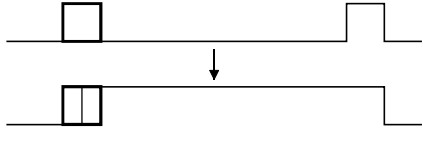
This section describes setting and editing method of timing.

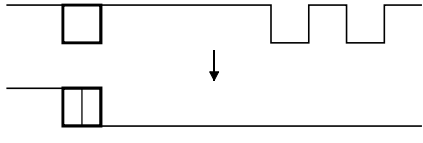
#### (1) Setting the timing of bit device

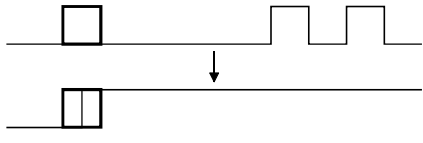
Timing of bit device can be set following the procedure shown below.

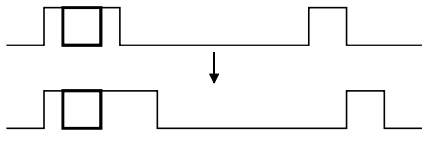
Move cursor to the timing to be set and operate using any tool button, menu or short-cut key.

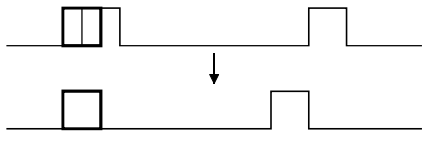
Operation	Tool button	Menu	Short-cut key	Timing
To turn ON designated timing		<ul style="list-style-type: none"> <li>• [Edit] - [Bit Device] - [Device ON]</li> <li>• Right-click, then [Device ON]</li> </ul> (Also can be done by double-clicking cursor position.)	F1	
To turn OFF designated timing		<ul style="list-style-type: none"> <li>• [Edit] - [Bit Device] - [Device OFF]</li> <li>• Right-click, then [Device OFF]</li> </ul> (Also possible to double-click cursor position.)	F2	
To turn OFF until next ON timing		<ul style="list-style-type: none"> <li>• [Edit] - [Bit Device] - [Progressive OFF].</li> <li>• Right-click, then [Progressive OFF].</li> </ul>	F3	
To turn ON until next OFF timing		<ul style="list-style-type: none"> <li>• [Edit] - [Bit Device] - [Progressive ON].</li> <li>• Right-click, then [Progressive ON].</li> </ul>	F4	
To turn OFF designated timing and all later		<ul style="list-style-type: none"> <li>• [Edit] - [Bit Device] - [All OFF].</li> <li>• Right-click, then [All OFF].</li> </ul>	F5	
To turn ON designated timing and all later		<ul style="list-style-type: none"> <li>• [Edit] - [Bit Device] - [All ON].</li> <li>• Right-click, then [All ON].</li> </ul>	F6	
To insert timing		<ul style="list-style-type: none"> <li>• [Edit] - [Insert]</li> <li>• Right-click, then [Insert].</li> </ul>	Insert	
To delete timing		<ul style="list-style-type: none"> <li>• [Edit] - [Delete]</li> <li>• Right-click, then [Delete].</li> </ul>	Delete	

 shows cursor position.

(a) Setting ON/OFF period

[Purpose]

To set ON/OFF continuously, with optional period after designated timing.

[Operation procedure]

- 1) Select initial bit device timing.

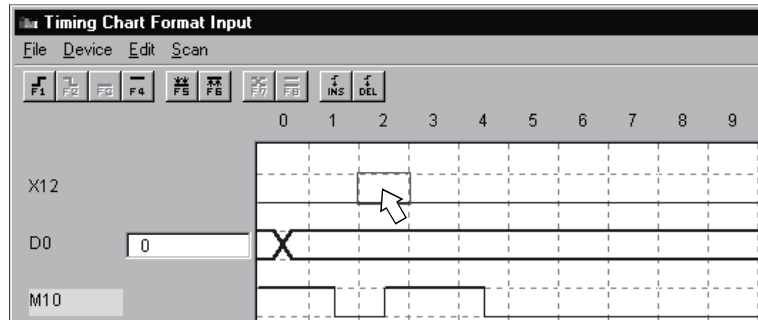

- 2) Operate either of operations shown below.

- Select [Edit] - [Wizard] menu.
- Right-click, select [Wizard] menu.

- 3) Bit device setting wizard screen will appear. Enter scan number and click  button.

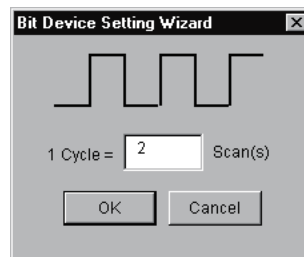

- 4) Bit device ON/OFF has been set periodically.

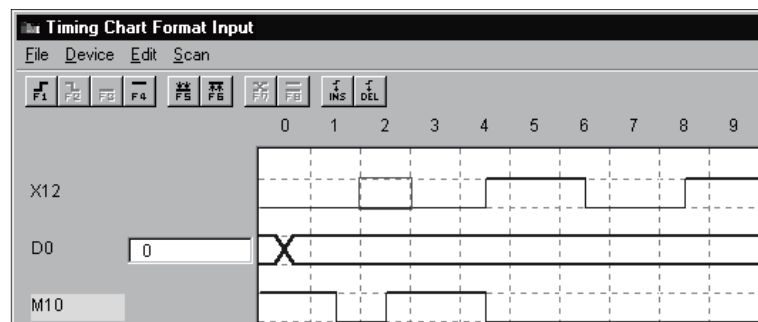



- (2) Setting the timing of word device
  - (a) Changing the designated timing value

[Purpose]

To change the timing value of designated word device.

[Operation procedure]

- 1) Select timing of word device to be changed.

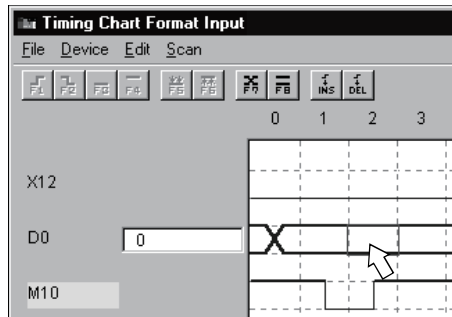

- 2) Operate any one of the following operations:

- Select [Edit] - [Word Device] - [Change] menu.
- Right-click, then select [Change] menu.
- Click .
- Enter "F7" key.
- Double-click designated timing.

- 3) Word device setting wizard screen will appear: Set each item and click **OK** button.

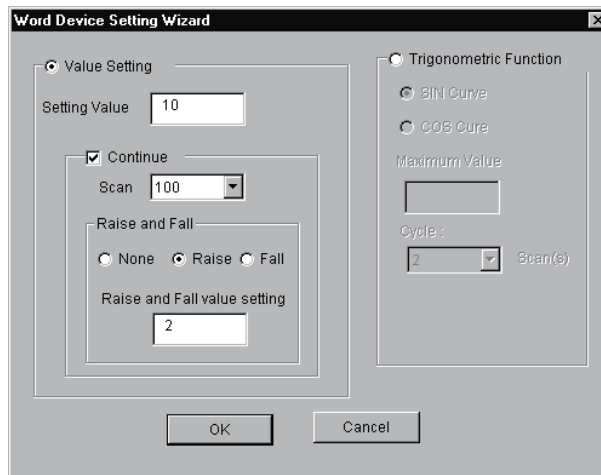

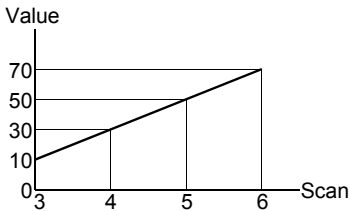
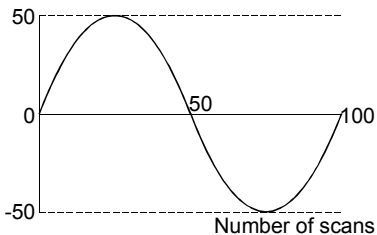
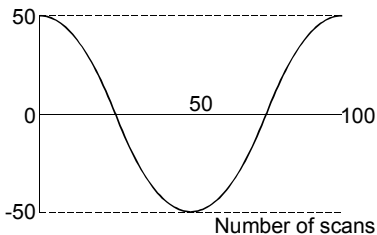
Item	Contents
Value setting	
Set value	Enter set value of word device.
Continuation	Apply check mark when setting is to be performed continuously. (Example) Cursor position is scan No. 3, set value is 10, scan number is 4, changed value is 20 increased. 
Scan	Select number of scans to be continued.
Increase & decrease	Set to change set value when setting is to be performed continuously. • Increase: Select when value is to be increased. • Decrease: Select when value is to be decreased.
Changed value	Set increased/decreased value.
Trigonometric functions	
SIN curve, COS curve	Set when device value is changed as shown below. (Example) Maximum value is 50, periodical scans are 100. • SIN curve  • COS curve 
Maximum value	Enter maximum value. When maximum value is set, minimum value will be set as "-maximum value".
Periodic scan	Select number of scans corresponding to 1 period of SIN/COS curve.

4) Word device value has been set.

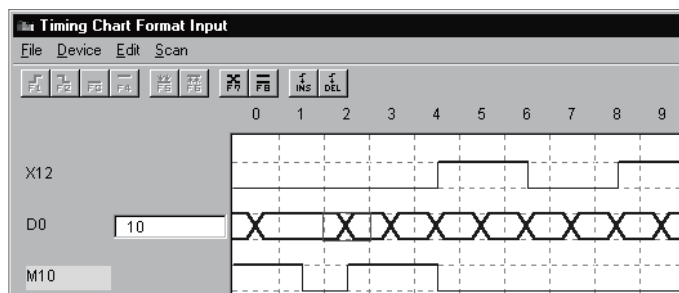

(b) Fixing unchanged designated timing value

[Purpose]

To make certain word device value of designated timing is not changed.

[Operation procedure]

- 1) Select word device timing that is not to be changed.

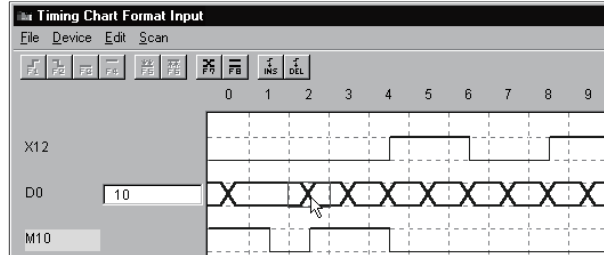

- 2) Operate any one of following operations:

- Select [Edit] - [Word Device] - [No change] menu.
- Right-click, then select [No change] menu.
- Click .
- Enter "F8" key.

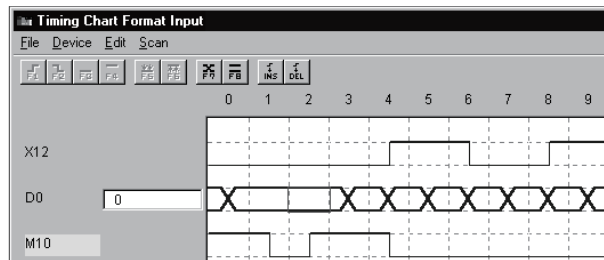

Mark of scan No.2 has been changed.

(c) Inserting timing

[Purpose]

Insert the timing before designated timing.

Timing is inserted to the left side of cursor position.

[Operation procedure]

- 1) Select the timing at the right side of the position where timing is to be inserted.

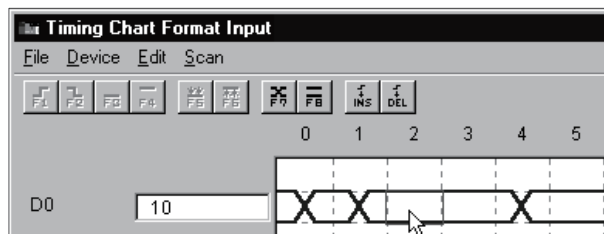

- 2) Operate any one of the following operations.
  - Select [Edit] - [Insert] menu.
  - Right-click, then select [Insert] menu.
  - Click .
  - Enter "Insert" key.

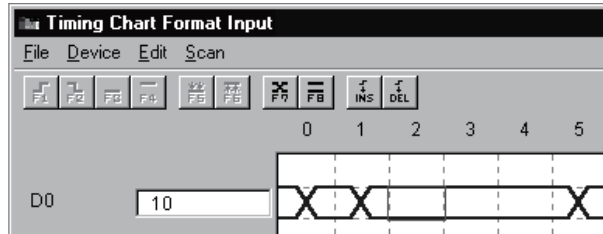

After timing has been inserted, timing will shift to the right.

(d) Deleting the timing

[Purpose]

To delete designated timing.

[Operation procedure]

- 1) Select timing of the position to be deleted.

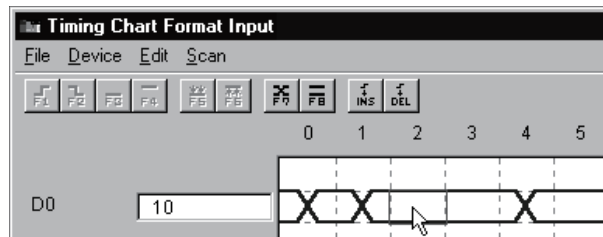

- 2) Operate any one of the following operations:

- Select [Edit] - [Delete] menu.
- Right-click, then select [Delete] menu.
- Click .
- Enter "Delete" key.

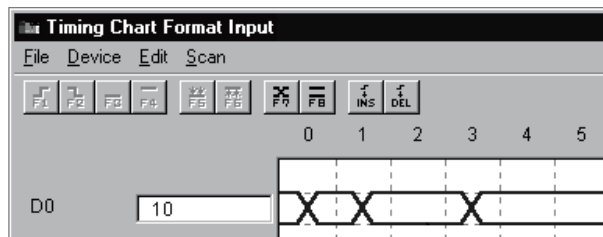

After timing is deleted, timing will shift to the left.

### 5.5.5 Setting scan number of timing chart

**[Purpose]**

To set scan number of timing input from external device.

**[Operation procedure]**

- (1) Select [Scan] - [Scan Setting].



- (2) Scan number setting screen will appear: Enter scan number.

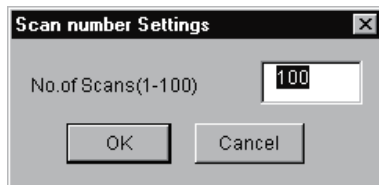

**(Example)**

When Scan number is set to 5, and timing chart is set to "Keep", scanning from 0 to 4 will be repeated as long as the condition is fulfilled.

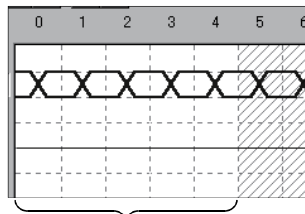

Only 5 scans from 0 to 4 are effective.

Scanning from 0 to 4 will be repeated as long as the condition is fulfilled.

### 5.5.6 Other operations

(1) Reading data saved using timing chart of device memory monitor

[Purpose]

To read and use timing chart data file (\*.DAT) saved with timing chart.

When the file is read, device and timing will be automatically registered. It is not necessary to re-enter them.

[Operation procedure]

Select [File] - [Open File].

[Setting screen]

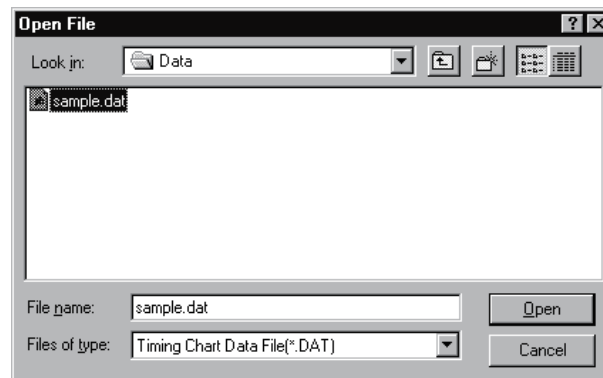

Designate optional file with "Look in", click file to be opened and click **Open** button.

**POINT**

- Device points that can be read with timing chart data file  
The timing chart data which can be saved with the timing chart function is for 16 points from the point which is registered on the screen.  
Therefore, when creating timing chart data, move the data within 16 points from the point which is registered on the screen beforehand, then save the data.
- The number of scan times which are read with timing chart data file  
0 to 99 scans are validated in a timing chart format edit screen chart of I/O system setting.  
When after 100 scan chart data exist in timing chart data file which is created with the timing chart function scans after 100 scans will be deleted.

(2) Returning to original state before operation

[Purpose]

To return to previous state before last operation performed.

Only the operation immediately before can be regained.

[Operation procedure]

Select [Edit] - [Undo].

(3) Displaying registered device list

Select [Device] - [List Device]. Registered device list will be displayed.

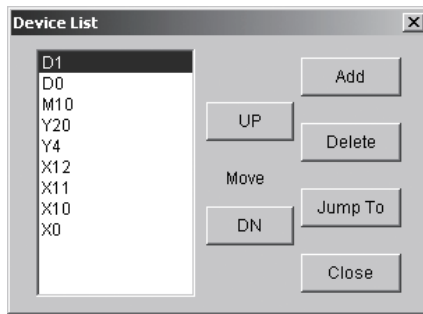

- Click **Add** button. Device registration dialog will be displayed. Refer to Section 5.5.3 (1) for details.
- By clicking **Delete** button, the device is deleted from object of monitoring.  
Two or more devices can be deleted by using "**Shift** key + Select" or "**Ctrl** key + Select".
- By clicking **Jump To** button, display of timing chart format input screen jumps to device being selected.
- By clicking **UP**/**Down** button, device being selected moves up or down.
- Selecting Two or more devices  
(Two or more devices cannot be selected and moved simultaneously.)

(4) Changing display format of word device

Select [Word Device]. Then select [Device] - [Property]. Dialog shown below will appear: Display format can be changed.

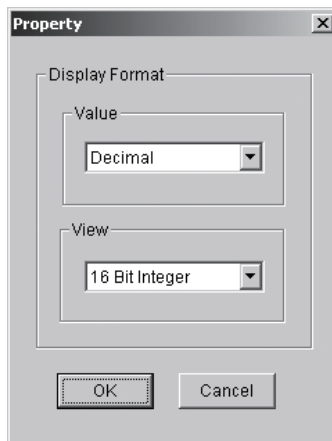

- Value  
Selects decimal or hexadecimal number display.
- View  
Selects 16 Bit, 32 Bit, real number (single precision) or real number (double precision).

(5) Exchanging device display position

Display position of device can be exchanged by drag & Drop.

- (a) Drag the device name in the timing chart format input screen.  
Dotted line frame will appear during dragging.

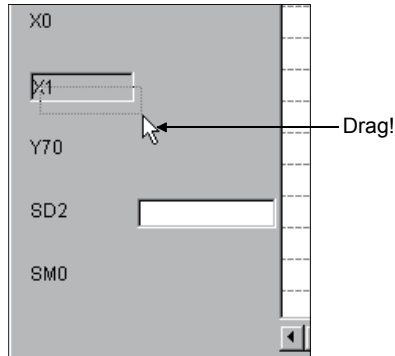

- (b) Superimpose dotted line frame on the device name to be exchanged. Device name can now be exchanged.

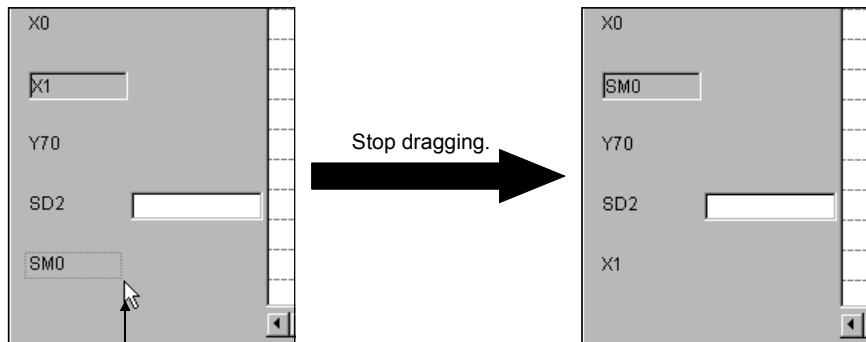

Superimpose dotted line frame.



## 5.6 Setting by Entering Device Value

This section describes I/O system setting by entering device value.

### [Operation procedure]

- (1) Select [Start] - [I/O System Settings] from initial screen.
- (2) Double-click column of number to which device value is to be set.

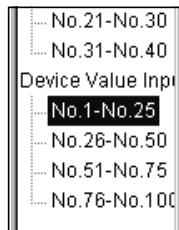

### [Setting screen]

Perform setting in I/O system setting dialog box as shown below.

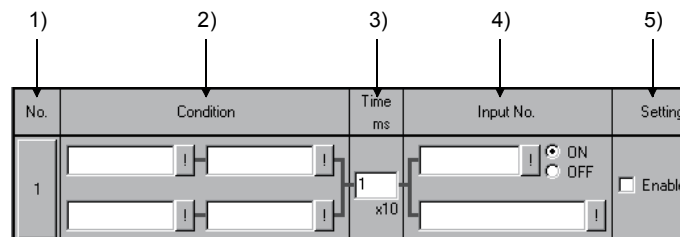

### [Description of items]

- 1) No.  
Number of settings in I/O system setting dialog box.  
Maximum 100 settings can be chosen.  
Once the set No. has been clicked, it can be cut, copied or pasted.
- 2) Condition  
Since the conditions are the same as those when timing chart is used, refer to Section 5.4 2).
- 3) Timer  
Sets the time from the point when designated condition is fulfilled until the input is issued. Enter the time in 10 ms units. The setting range is 1 to 1000 (×10 ms).
- 4) Input No.  
Designates the bit device which is turned ON/OFF once designated condition has been fulfilled. Also designates word device whose value is to be changed.

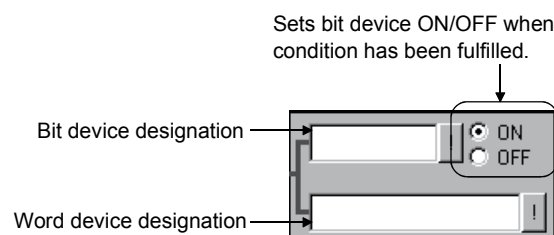

- Input method (Direct input)
  - Independent device designation.... Designates non-consecutive devices, separated by commas (.).  
(Example: D0=10,D2=20,D3=50)
  - Consecutive device designation.... Designates the first and last of a series of consecutive devices, separated by a hyphen (-).  
(Example: X0-100)
  - Mixed device designation ..... Designates a mixture of independent and consecutive devices.  
(Example: X0, X2, M10-20)
- Input method (using dialog box)
  - Click  button and enter device name and device No., etc.
  - Refer to Appendix 3.2 for devices that can be entered in the input No. area.

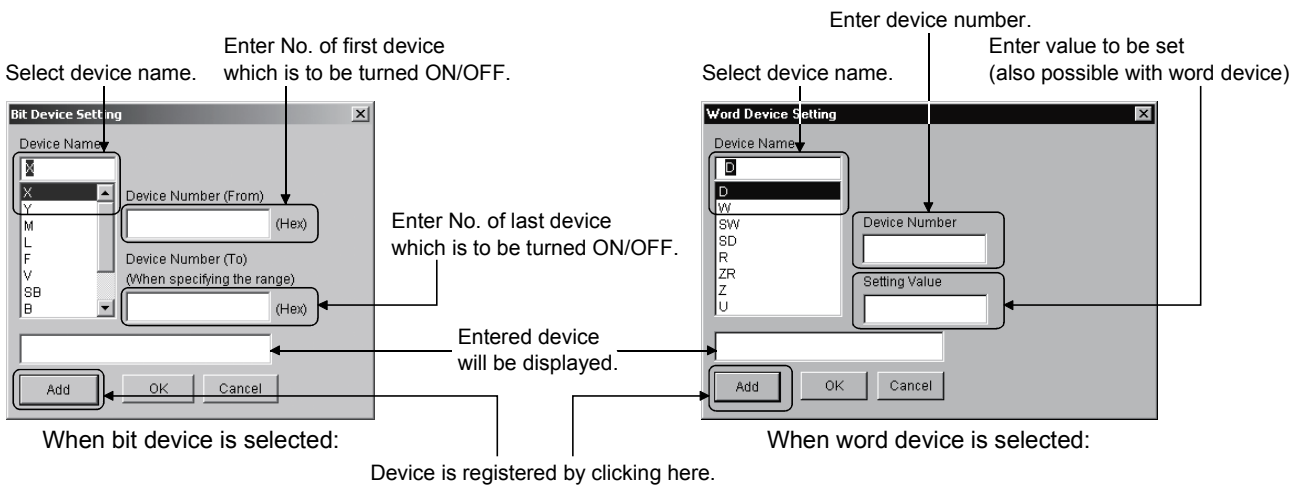

### 5) Setting

Designates whether each setting is to be enabled or disabled. Apply check mark  to check box for the setting to be enabled.

#### POINT

Set the device point that can be executed (valid setting) at a time to 25000 point or less, for device value input on I/O system setting dialog box. The following error message displays if "Execute I/O System Settings" is executed when the device point exceeds 25001 points.

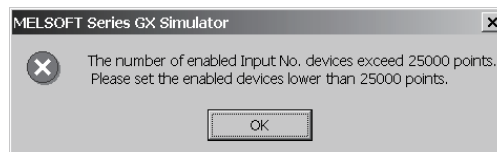

The cursor moves to 25001<sup>st</sup> point device setting area where "Enable" is set on "Edit/monitor" screen.

## 5.7 Starting/Stopping the Simulation

Refer to "Section 10.3 Using I/O System Settings for Debugging" for example of simulation.

### (1) Starting the simulation

#### [Purpose]

To start simulation with contents in I/O system settings.

#### [Operation procedure]

- (a) Select [File] - [Open] to open I/O system setting file (\*.IOS).

Refer to Section 5.8.1 for details of operation.

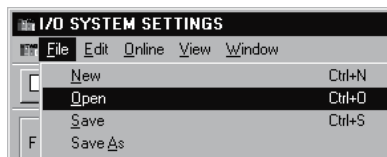

- (b) Select [File] - [Execute I/O System Settings].

 (Yellow) can also be clicked instead of above.

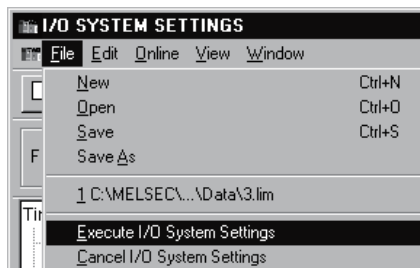

- (c) Dialog box for confirmation will appear: Click **OK** button.

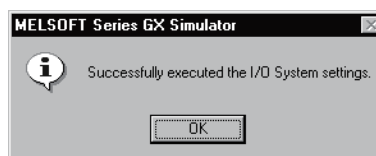
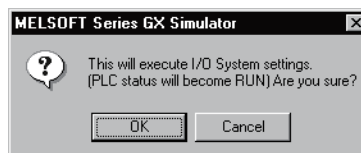

### POINT

After changing I/O system setting of a file being opened, the file can automatically be saved by executing the I/O system settings.

If I/O system setting file is not to be saved, save the file under a different file name and execute I/O system settings.

- (d) When A series/QnA series/Q series CPU is used, execution state will automatically change from STOP to RUN mode, and simulation will start.

When FX series CPU is used, simulation is started by switching the setting in the initial screen from STOP to RUN.

- When GX Developer is SW2D5□-GPPW-E or later  
 After the GX Simulator is started, the set I/O system settings will remain enabled until they are deleted or the GX Simulator is quit.  
 To use the same I/O system settings when the GX Simulator is restarted, read the I/O system setting data from the saved file, and then execute the I/O system setting again.

**POINT**  
 For FX series CPU: If settings are made in RUN status, the status must be switched to STOP once before returning to RUN, to enable the new settings.

(2) Stopping the simulation

[Purpose]

To stop the I/O system setting operation currently being executed.

[Operation procedure]

- (a) Select [File] - [Cancel I/O System Settings].

Also  (White) can be clicked instead of above.

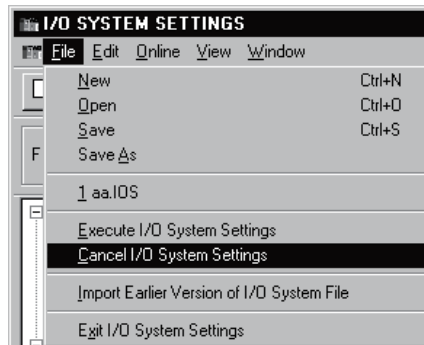

**POINT**  
 When I/O System Settings are not being executed, the I/O system setting LED on the initial screen will turn off.

## 5.8 Other Operations

### 5.8.1 Operating the file

#### (1) Creating a new file

##### [Purpose]

To create a new file (\*.IOS) to be used for I/O system settings.

##### [Operation procedure]

Select [File] - [New].

Also  can be clicked instead of above.

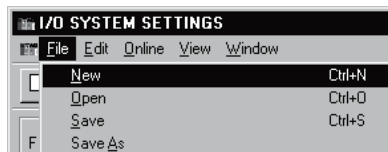

#### (2) Opening saved file

##### [Purpose]

To open an I/O system setting file (\*.IOS) which has been saved.

##### [Operation procedure]

Select [File] - [Open].

Also  can be clicked instead of above.

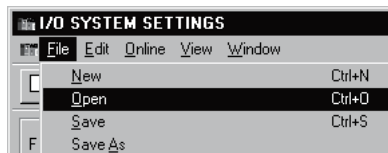

##### [Setting screen]

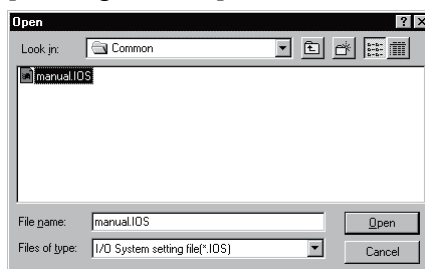

Designate optional holder with "Look in", click the file to be opened, then click

**Open** button.

(3) Saving the file

[Purpose]

To over-write and save the I/O system setting file (\*.IOS) being opened.

[Operation procedure]

Select [File] - [Save].



can also be clicked instead of above.

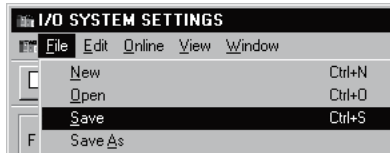

If file being opened has not been saved, "Save As" dialog will be displayed: Save with optional name entered. Refer to (4) for details.

(4) Saving with new name

[Purpose]

To save I/O system setting file (\*.IOS) that is being opened with new name entered.

[Operation procedure]

Select [File] - [Save As].

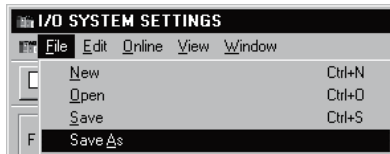

[Setting screen]

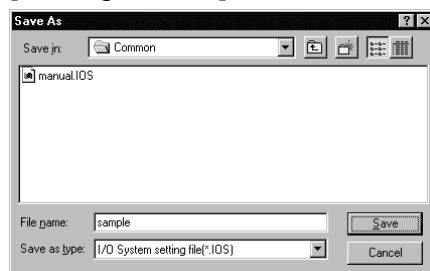

Designate optional folder with "Save in", and enter file name to be saved in "File name".

If setting is to be over-written on existing file, select the file to be saved by clicking: Then click **Save** button.

5.8.2 Cutting, copying and pasting all settings in the set No.

(1) Cutting and copying the selected set No.

[Purpose]

To cut and copy selected set No. and save on clipboard.

[Operation procedure]

(a) Select the set No. to be cut/copied by clicking.

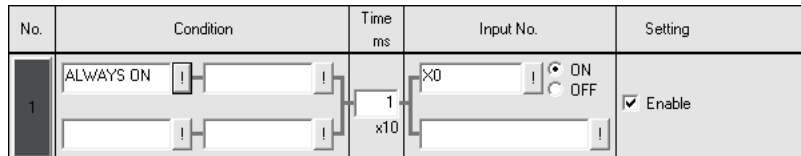

(b) For cutting, select [Edit] - [Cut].



can also be clicked instead of above.

For copying, select [Edit] - [Copy].



can also be clicked instead of above.

(2) Pasting the cut/copied set No.

[Purpose]

To paste cut/copied set No. to optional position.

[Operation procedure]

(a) Select the set No. to be pasted by clicking.

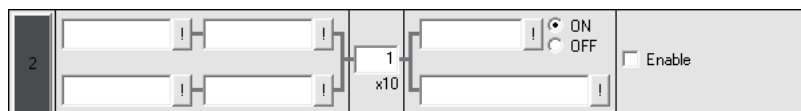

(b) Select [Edit] - [Paste].



can also be clicked instead of above.

(c) Cut/copied set No. has been pasted.

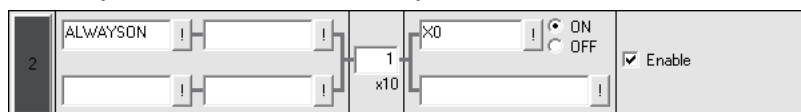

POINT

The set No. copied or cut by device value input cannot be pasted by timing chart input.

In addition, the set No. copied or cut by timing chart input cannot be pasted by device value input, either.

5.8.3 Batch-enabling/disabling settings

(1) Batch-enabling settings

[Purpose]

To enable all set Nos. whose conditions and timing chart formats (or input Nos.) have both been set.

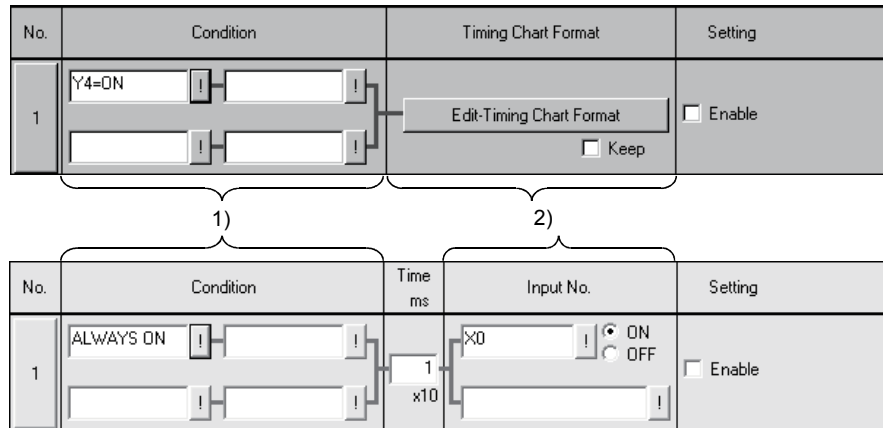

[Operation procedure]

Choose [Edit] - [Enable/Disable Settings] - [Enable All].

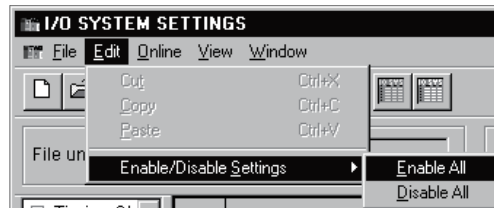

(2) Batch-disabling settings

[Purpose]

To disable all settings.

[Operation procedure]

Choose [Edit] - [Enable/Disable Settings] - [Disable All].

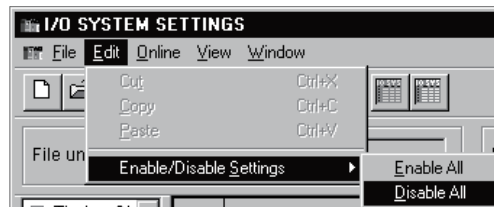



5.8.4 Executing monitoring

(1) Starting monitoring

[Purpose]

To start monitoring a device on the I/O system settings screen.

[Operation procedure]

(a) Select [Online] - [Monitor mode].



can also be clicked instead of above.



(b) Monitoring will start.

Refer to (3) for details of operation on the screen during monitoring.

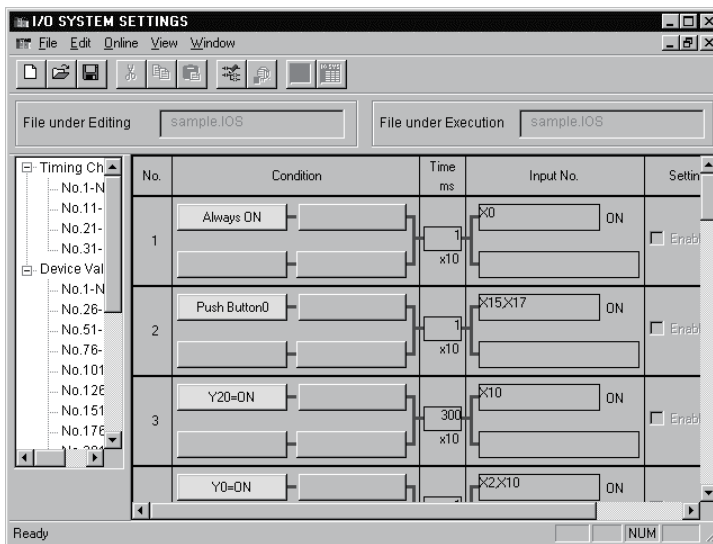

(2) Stopping monitoring

[Purpose]

To stop monitoring with I/O system setting screen.

[Operation procedure]

Select [Online] - [Edit mode].



can also be clicked instead of above.

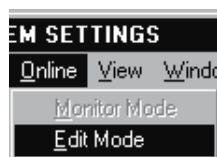

(3) Screen during monitoring

When monitoring is started, I/O system settings screen will appear as shown below:

Area displayed in yellow is effective.

No.	Condition	Timing Chart Format	Setting
3)	Always ON	Timing Chart Preview	<input type="checkbox"/> Enable
1)	Y4=ON	Timing Chart Preview	<input type="checkbox"/> Enable
2)	D0=30	Timing Chart Preview	<input type="checkbox"/> Enable
3)	Push Button0, Push Button1	Timing Chart Preview	<input type="checkbox"/> Enable

1) Bit device

The status of displayed bit device can be inverted by clicking. As shown on the screen, when "Y4=ON" is indicated, yellow display will show ON status. If "Y4=OFF" is indicated, yellow display will show OFF status.

2) Word device

Following dialog box is displayed by clicking: Displayed value can be changed.

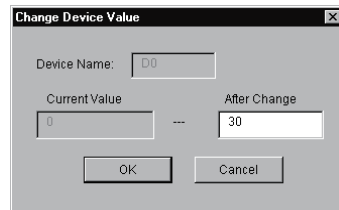

3) Normally ON

Since ON is normally set, nothing changes even if clicked.

4) Push button

Push button state is inverted by clicking. If there are push buttons with the same number, all buttons are linked for operation.

5) **Timing chart preview** button

Timing chart format input screen is displayed by clicking and the set contents can be confirmed. However, the contents of this displayed screen cannot be edited.

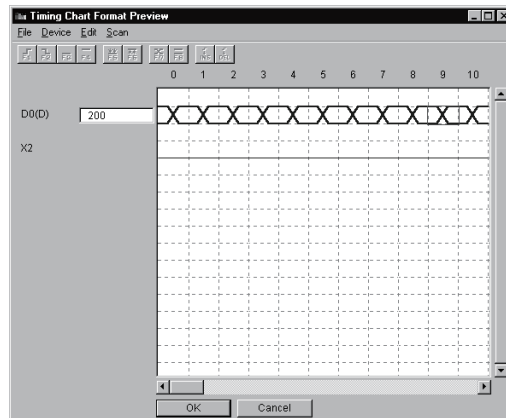

### 5.8.5 Reading I/O system setting file for SW5 or earlier versions

[Purpose]

To read I/O system setting file for SW2D5□-LLT-E to SW5D5C-LLT-E.

[Operation procedure]

Select [File] - [Import Earlier Version of I/O System File].

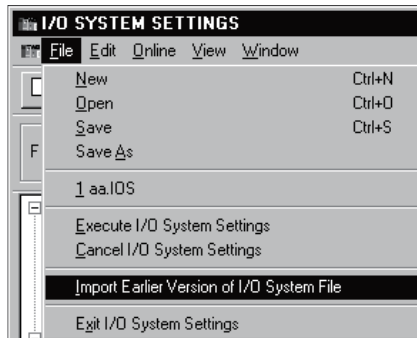

[Setting screen]

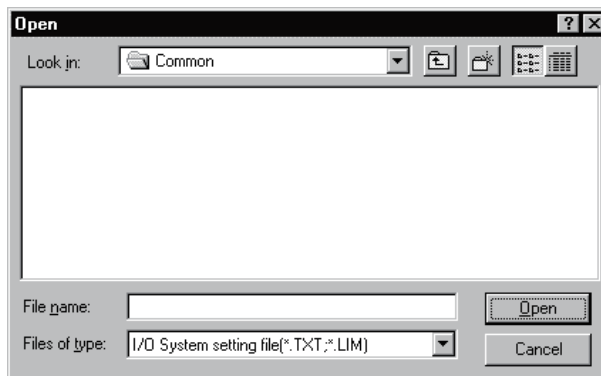

Specify any folder in "Look in", click the file to be opened (\*.TXT, \*.LIM), and then click the **Open** button.

**POINT**

When reading a SW5D5 format file, specify a LIM file (\*.LIM).

## 6. COMMUNICATION WITH EXTERNAL DEVICE - SERIAL COMMUNICATION FUNCTION

The serial communication function allows you to easily check whether the frame (A-compatible 1C frame, QnA-compatible 3C/4C frame) used for access from an external device to the PLC CPU via a serial communication module (computer link module) is in a correct message format or not.

Since this function also enables devices to be accessed, you can check/change device contents easily on an external device.

Conventionally, the serial communication module (computer link module) was actually connected with the external device to check operation. Using this function, however, you can easily check the message format and device contents between GX Simulator and external device.

### <Conventional debugging>

Debugging was performed with the external device connected with the serial communication module (computer link module) actually.

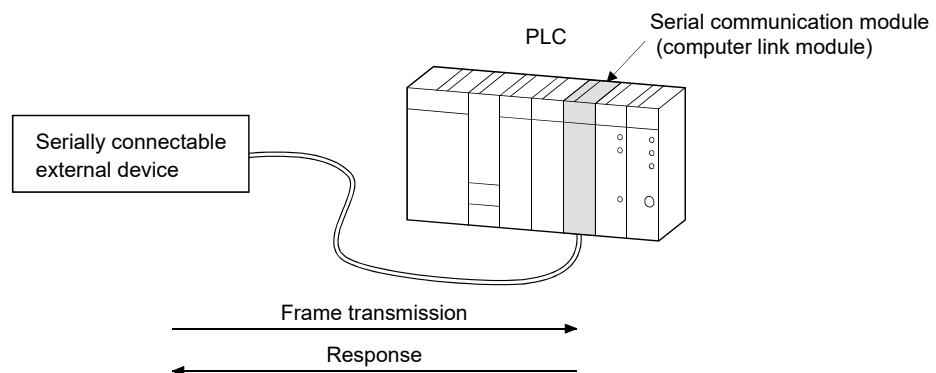

### <Debugging using GX Simulator>

Since GX Simulator responds to the frame sent from the external device, the external device need not be connected to the serial communication module (computer link module) actually.

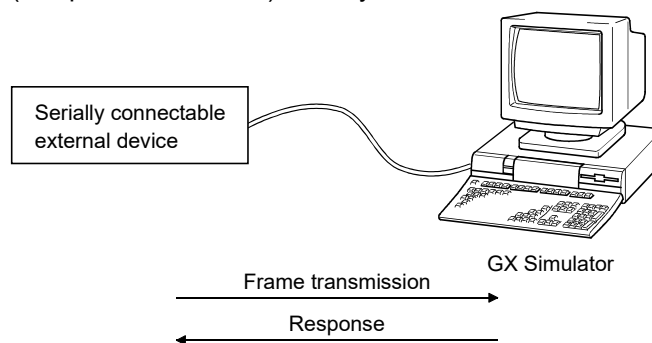

### POINT

The serial communication function does not support the serial communication module's no-procedure protocol created by sequence programming.

6.1 Operation Procedures for Serial Communication Function

The following are the operation procedures for the serial communication function.

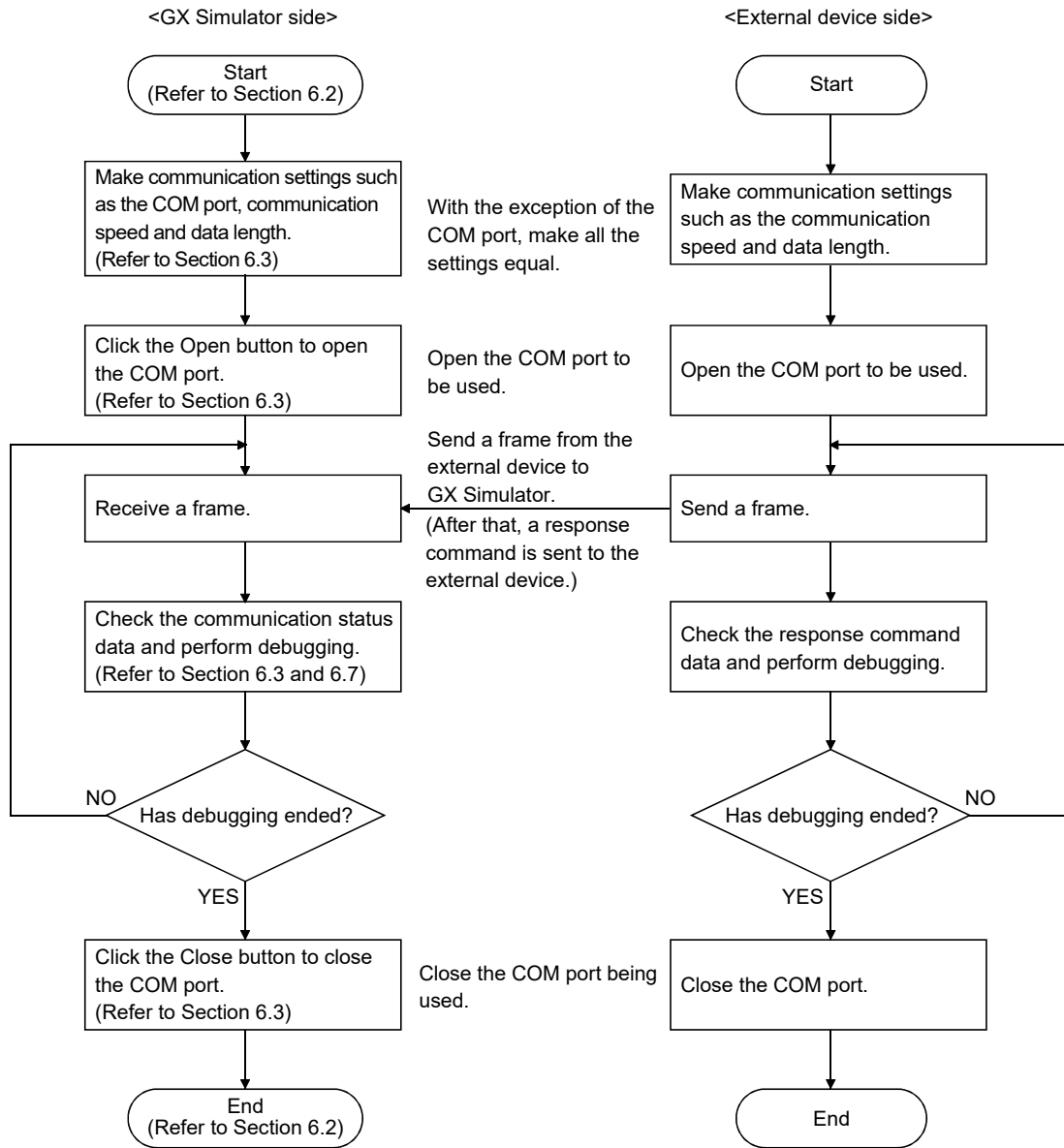

## 6.2 Starting/Ending the Serial Communication Function

### (1) Starting the serial communication function

#### [Purpose]

To start the serial communication function.

#### [Operation procedure]

Choose [Start] - [Serial Communication Function] on the initial screen.

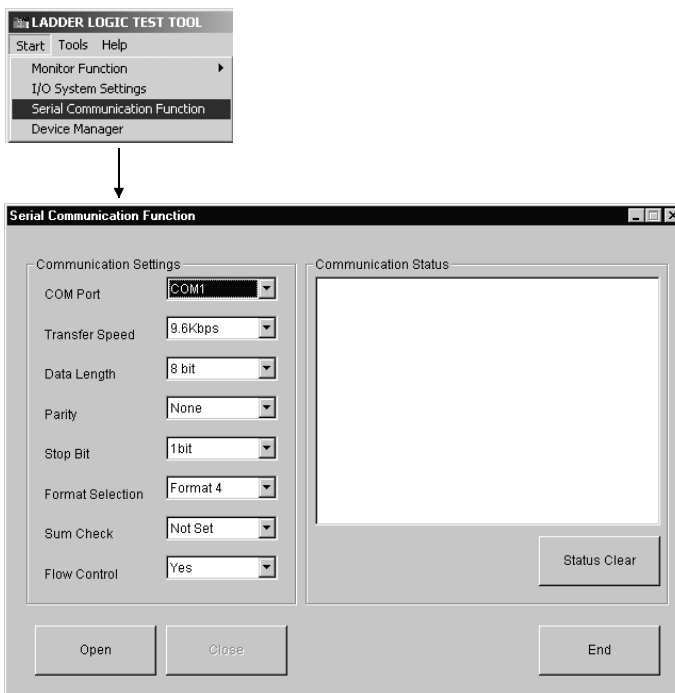

### (2) Ending the serial communication function

#### [Purpose]

To end the serial communication function.

#### [Operation procedure]

Click the **End** button on the Serial Communication Function screen.

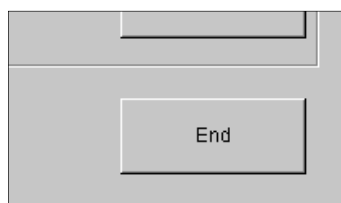

### 6.3 Layout of the Serial Communication Function Screen

This section describes the layout of the Serial Communication Function screen that opens when you click [Start] - [Serial Communication Function].

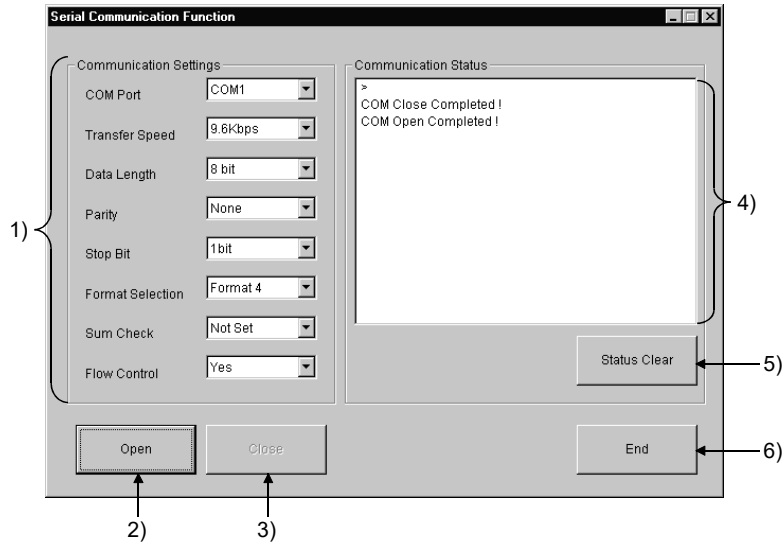

- 1) Set the GX Simulator side environment for communication with the external device.

With the exception of the COM port, make all settings equal to those of the external device side.

Item	Description
COM Port	Choose the COM port to be used.
Transfer Speed	Choose the transfer speed.
Data Length	Choose the data length.
Parity	Choose the parity.
Stop Bit	Choose the stop bit.
Format Selection	Choose the frame format. GX Simulator supports only the following formats. <ul style="list-style-type: none"> <li>• A-compatible 1C frame format 3, format 4</li> <li>• QnA-compatible 3C frame format 3, format 4</li> <li>• QnA-compatible 4C frame format 3, format 4</li> </ul>
Sum Check	Choose whether to make sum check or not.
Flow Control	Choose whether to exercise flow control or not. The flow control exercised is RS/CS control.

- 2) **Open** button  
Used to open the COM port as set in the communication settings.  
Open the COM port first before starting communication with the external device.
- 3) **Close** button  
Used to close the opened COM port.

- 4) **Communication Status**  
Displays the communication result. Refer to Section 6.7 for details.
- 5) **Status Clear** button  
Used to clear the communication status.
- 6) **End** button  
Used to clear the communication status.



## 6.4 Transmission Specifications

The following are the transmission specifications of the serial communication function.

### (1) Transmission specifications

Item	Specifications	PLC Series	
		A series CPU/ Q series CPU (A mode)/ motion controller	QnA series CPU/ Q series CPU (Q mode)
Communication system		Half duplex communication	
Synchronization system		Asynchronous system	
Transmission speed		9.6kbps	
Compatible frames		A-compatible 1C frame format 3 A-compatible 1C frame format 4	QnA-compatible 3C frame format 3 QnA-compatible 3C frame format 4 QnA-compatible 4C frame format 3 QnA-compatible 4C frame format 4
Usable commands		Refer to Section 6.6.	
Transmission control	DTR/DSR (ER/DR) control	Compatible	
	RS/CS (RTS/CTS) control	Selectable	
	CD signal control	Disabled	
	DC1/DC3 (Xon/Xoff) control	Disabled	
	DC2/DC4 control	Disabled	
Connection target		All handled as host	

#### POINT

When the PLC series is the FX series CPU, the serial communication function is unavailable.

### (2) Cable wiring

Connect the external device and GX Simulator with the cable wired as shown below.

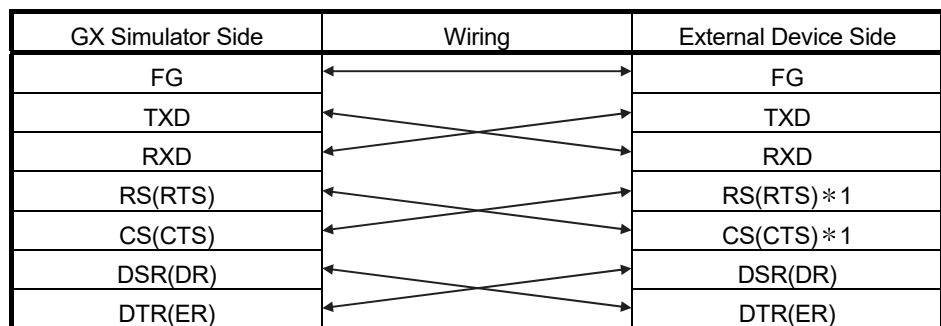

\* 1: Needed for flow control only

## 6.5 Usable Frames

This section describes the frames usable with the serial communication function.

### (1) Usable frames

The following frames are usable.

The message format sent from the external device is analyzed to judge the frame automatically.

(Example: When the PLC series is the A series CPU, the A-compatible 1C frame format 3 and A-compatible 1C frame format 4 are judged automatically. However, the QnA-compatible 3C/4C frame is unusable.)

Frame \ PLC Series	A series CPU/ Q series CPU (A Mode)/ Motion Controller	QnA series/ Q series CPU (Q Mode)	FX series CPU
A-compatible 1C frame format 3	○	×	×
A-compatible 1C frame format 4	○	×	×
QnA-compatible 3C frame format 3	×	○	×
QnA-compatible 3C frame format 4	×	○	×
QnA-compatible 4C frame format 3	×	○	×
QnA-compatible 4C frame format 4	×	○	×

○ : Usable, × : Unusable

Refer to the following manuals for details of the frames.

- Computer Link Module (Com.link func./Print.func.) User's Manual ..SH-3511
- Serial Communication Module User's Manual  
(Modem Function Additional Version) ..... IB-66612
- MELSEC Communication Protocol Reference Manual ..... SH-080008

### (2) Devices usable with the frames

The following frames are usable.

	Device Type		Remarks
	Bit devices	Word devices	
A-compatible 1C frame	X, Y, M, L, S, B, F, M, TS, TC, C, S, CC, Special M	TN, CN, D, W, R, D, Special D	For extended registers, access can always be made to a maximum of 64 blocks regardless of the CPU. Note that the capacity depends on the parameter setting.
QnA-compatible 3C frame	X, Y, M, L, F, V, B, TS, TC, SS, SC, CS, CC, SB, DX, DY	D, W, TN, SN, CN, SW, Z, R, ZR	DX/DY is similar to X/Y.
QnA-compatible 4C frame			

## 6.6 Command Lists

This section explains the commands of the frames supported by GX Simulator.  
Refer to the following manuals for details of the commands.

Refer to the following manuals for details of the frames.

- Computer Link Module (Com.link func./Print.func.) User's Manual ..SH-3511
- Serial Communication Module User's Manual  
(Modem Function Additional Version) ..... IB-66612
- MELSEC Communication Protocol Reference Manual ..... SH-080008

### 6.6.1 Usable A-compatible 1C frame commands

The following are the A-compatible 1C frame commands usable with GX Simulator.

Function			Command		Max. Number of Points	
			Symbol	ASCII code		
Device memory	Batch read	Bit unit	BR JR *2	42H, 52H 4AH, 52H	256 bits	
		Word unit	WR QR *2	57H, 52H 51H, 52H	32 words 64 words	
	Batch write	Bit unit	BW JW *2	42H, 57H 4AH, 57H	160 bits	
		Word unit	WW QW *2	57H, 57H 51H, 57H	10 words 64 words	
	Test (Random write)	Bit unit	BT JT *2	42H, 54H 4AH, 54H	20 bits	
		Word unit	WT QT *2	57H, 54H 51H, 54H	10 words 10 words	
	Monitor data registration	Bit unit *1	BM JM *2	42H, 4DH 4AH, 4DH	40 bits	
		Word unit *1	WM QM *2	57H, 4DH 51H, 4DH	20 words 20 words	
	Monitor	Bit unit	MB MJ *2	4DH, 42H 4DH, 4AH	—	
		Word unit	MN MQ *2	4DH, 4EH 4DH, 51H		
	Extended file register	Batch read		ER	45H, 52H	64 words
		Batch write		EW	45H, 57H	64 words
Test (Random write)		ET	45H, 54H	10 words		
Monitor data registration		EM	45H, 4DH	20 words		
Monitor		Word unit	ME	4DH, 45H	—	
Intelligent function module	Batch read		TR	54H, 52H	128 bytes	
	Batch write		TW	54H, 57H	128 bytes	
Loopback test			TT	54H, 54H	—	
Remote operation	Remote RUN		RR	52H, 52H	—	
	Remote STOP		RS	52H, 53H	—	

\*1: When the AnNCPU is used, the number of used points is calculated as twice larger if device X is used in bit unit monitor data registration (BM) or word unit monitor data registration (WM).

For device X, therefore, the number of usable points is halved.

\*2: Not supported when the AnNCPU is used.

6.6.2 Usable QnA-compatible 3C/4C frame commands

The following are the QnA-compatible 3C/4C frame commands usable with GX Simulator.

Function		Command (Sub command)	Max. Number of Points		
			QnA series CPU	Q series CPU (Q mode)	
Device memory	Batch read	Bit unit	0401(00□1)	3952 bits	7904 bits
		Word unit	0401(00□0)	480 words	960 words
	Batch write	Bit unit	1401(00□1)	3952 bits	7904 bits
		Word unit	1401(00□0)	480 words	960 words
	Random read	Word unit	0403(00□0)	96 words	192 words
				96 words	192 words
	Test (Random write)	Bit unit	1402(00□1)	94 bits	188 bits
		Word unit	1402(00□0)	96 words	192 words
	Monitor data registration	Word unit	0801(00□0)	96 words	192 words
				96 words	192 words
	Monitor	Word unit	0802(0000)	—	—
	Multiple block batch read	Word unit	0406(00□0)	480 words	960 words
Multiple block batch write	Word unit	1406(00□0)			
Intelligent function module	Batch read	0601(0000)	960 words	1920 words	
	Batch write	1601(0000)	960 words	1920 words	
PLC CPU	Remote RUN	1001(0000)	—	—	
	Remote STOP	1002(0000)	—	—	
	CPU type read *1	0101(0000)	—	—	
Loopback test		0619(0000)	—	—	

\* 1: Unusable when the PLC series is the QnA series CPU

## 6.7 Communication Status

The following are the statuses displayed in Communication Status on the Serial Communication Function screen.

Communication Status shows the latest status at top and can display up to 100 communication logs.

Displayed Status	Definition
Can not connect (ES * * * *)	A COM opening error occurred. The status is displayed with the error code that indicates the definition of the error that occurred.
COM Open Completed!	COM opened as set in the communication settings.
COM Close completed!	COM closed normally.
Command Packet (command character) * 1	A command was received from the connection target.
Acknowledge Packet (command character) * 1	A command was sent from the serial communication function to the connection target.
NAK Send	NAK was returned in a response message. The status is displayed with the error No.
Sum check error	In communication with sum check made, the sum check code was wrong. No response is given since GX Simulator side cannot recognize the frame format.
Unsupported command received	The command not supported was issued. GX Simulator side returns NAK in a response message.
Can not distinguish frame	The frame identification number cannot be recognized. No response is given. Check whether the PLC series and used frame are correct.
Buffer full error	response is given. Reduce the total number of data sent from the external device to less than 10000 bytes.

\* 1: The communication command symbol is displayed.

## 6.8 Error Code Lists

This section explains the codes, definitions and corrective actions of errors that may occur during communication.

### 6.8.1 When the A-compatible 1C frame is used

The following table indicates the error codes that may occur when the A-compatible 1C frame is used.

Error Code (Hexadecimal)	Error Item	Error Definition	Corrective Action
02H	Sum check error	<ul style="list-style-type: none"> <li>The calculated sum check does not match the sent sum check.</li> </ul>	<ul style="list-style-type: none"> <li>Reexamine the sum check on the other end device.</li> </ul>
03H	Protocol error	<ul style="list-style-type: none"> <li>The frame format is incorrect. (When the data length is shorter than the header length)</li> <li>Data does not exist in the character part.</li> </ul>	<ul style="list-style-type: none"> <li>Restart communication after checking and correcting the message sent by the other end device.</li> </ul>
06H	Character part error	<ul style="list-style-type: none"> <li>A non-existing command was specified.</li> <li>The requested number of points exceeded the range permitted for the command.</li> <li>A non-existing device was specified.</li> <li>The command of the AnACPU/AnUCPU was sent to the AnNCP.</li> <li>The device unusable in the instruction was specified.</li> <li>Monitor read was executed without monitor registration.</li> </ul>	<ul style="list-style-type: none"> <li>Restart communication after checking and correcting the message sent by the other end device.</li> </ul>
07H	Character error	<ul style="list-style-type: none"> <li>Unusable data was received.                             <ol style="list-style-type: none"> <li>The data outside the range usable with the instruction was received.</li> <li>The bit device is not headed by a multiple of 16.</li> </ol> </li> </ul>	
12H	Special function module specifying error	<ul style="list-style-type: none"> <li>The specified position is not I/O-assigned correctly.</li> </ul>	<ul style="list-style-type: none"> <li>Make I/O assignment of the specified position.</li> </ul>

### 6.8.2 When the QnA-compatible 3C/4C is used

The following table indicates the error codes that may occur when the QnA-compatible 3C/4C frame is used.

Error Code (Hexadecimal)	Error Item	Error Definition	Corrective Action
7140H	Request data error	<ul style="list-style-type: none"> <li>The requested number of points exceeded the range permitted for the command.</li> <li>A word device was specified for the bit unit command.</li> <li>The last device number exceeded the range.</li> <li>Last number of corresponding device <math>\geq</math> specified starting device number + specified number of points</li> <li>The command size is illegal.</li> <li>The device name is NULL.</li> <li>The number of device points exceeded the maximum.</li> <li>The bit device is not headed by a multiple of 16 in the word unit random read command or multiple block batch read command.</li> </ul>	<ul style="list-style-type: none"> <li>Restart communication after checking and correcting the message sent by the other end device.</li> </ul>
		<ul style="list-style-type: none"> <li>Buffer memory read/write was executed with a non-existing module number specified (without I/O assignment).</li> </ul>	<ul style="list-style-type: none"> <li>Make I/O assignment and access the existing module number.</li> </ul>
7142H	Device name error	<ul style="list-style-type: none"> <li>The device that could not be specified was specified in the corresponding command.</li> </ul>	<ul style="list-style-type: none"> <li>Restart communication after checking and correcting the message sent by the other end device.</li> </ul>
7144H	Monitor registration error	<ul style="list-style-type: none"> <li>A monitor request was made before monitor registration.</li> </ul>	<ul style="list-style-type: none"> <li>Make a monitor request after registering the device to be monitored.</li> </ul>
7147H	Monitor registration point count excess error	<ul style="list-style-type: none"> <li>The number of points for monitor registration exceeded the range.</li> </ul>	<ul style="list-style-type: none"> <li>Restart communication after checking and correcting the message sent by the other end device.</li> </ul>
7E40H	Command error	<ul style="list-style-type: none"> <li>A non-existing command or sub command was specified.</li> <li>F8 (QnA-compatible 4C frame) was specified as the frame identification number of the QnA-compatible 3C frame, or F9 (QnA-compatible 3C frame) was specified as the frame identification number of the QnA-compatible 4C frame.</li> </ul>	<ul style="list-style-type: none"> <li>Restart communication after checking and correcting the message sent by the other end device.</li> </ul>
7E43H	Device error	<ul style="list-style-type: none"> <li>A non-existing device was specified.</li> </ul>	<ul style="list-style-type: none"> <li>Restart communication after checking and correcting the message sent by the other end device.</li> </ul>
7E4FH	Device point count error	<ul style="list-style-type: none"> <li>The limit of the device point count was exceeded.</li> </ul>	<ul style="list-style-type: none"> <li>Restart communication after checking and correcting the message sent by the other end device.</li> </ul>
7F20H	ASCII-binary conversion error	<ul style="list-style-type: none"> <li>A character unconvertible into binary was used in the command.</li> <li>The sub command is illegal.</li> </ul>	<ul style="list-style-type: none"> <li>For communication in ASCII-binary conversion, always send data in an even byte unit.</li> </ul>
7F23H	MC protocol message error	<ul style="list-style-type: none"> <li>After the character part, data (e.g. ETX, CR-LF) does not exist or incorrect data was specified.</li> </ul>	<ul style="list-style-type: none"> <li>Restart communication after checking and correcting the message sent by the other end device.</li> </ul>
7F24H	Sum check error	<ul style="list-style-type: none"> <li>The calculated sum check does not match the received sum check.</li> </ul>	<ul style="list-style-type: none"> <li>Reexamine the sum check on the other end device.</li> </ul>

## 7. MONITORING, TESTING DEVICE MEMORY - MONITOR FUNCTION

---

The device memory monitor function and timing chart display function are available as the monitor functions.

- Device memory monitor function  
This function monitors the device memory status stored in GX Simulator or tests a device, e.g. forcibly turn a bit device ON/OFF or changes the current value of a word device.
- Timing chart display function  
This function samples the ON/OFF or values of the host station devices and displays the device status per scan.

### 7.1 Monitoring, Testing the Device Memory

---

The operation method for monitoring, testing the device memory will be explained below.

This section describes the device batch monitor, buffer memory monitor and entry device monitor functions that are executed from the GX Simulator menu.

The following are the precautions for monitor execution.

POINT
(1) After changing the PLC parameter value or other station device setting during monitor, perform the following operation. <ul style="list-style-type: none"><li>• After changing the PLC parameter value during monitor of the host station, perform PLC write and restart monitor.</li><li>• After changing the other station device setting during monitor of the other station, restart monitor.</li></ul>
(2) When monitoring the other station devices, only the devices set in the "Other station device setting" can be monitored. The monitor range is only the preset number of consecutive points.
(3) Transfer Setup cannot be made during monitor.



### 7.1.1 Operation Procedure of Monitoring Device Memory

Operation procedure of monitoring device memory is shown below:

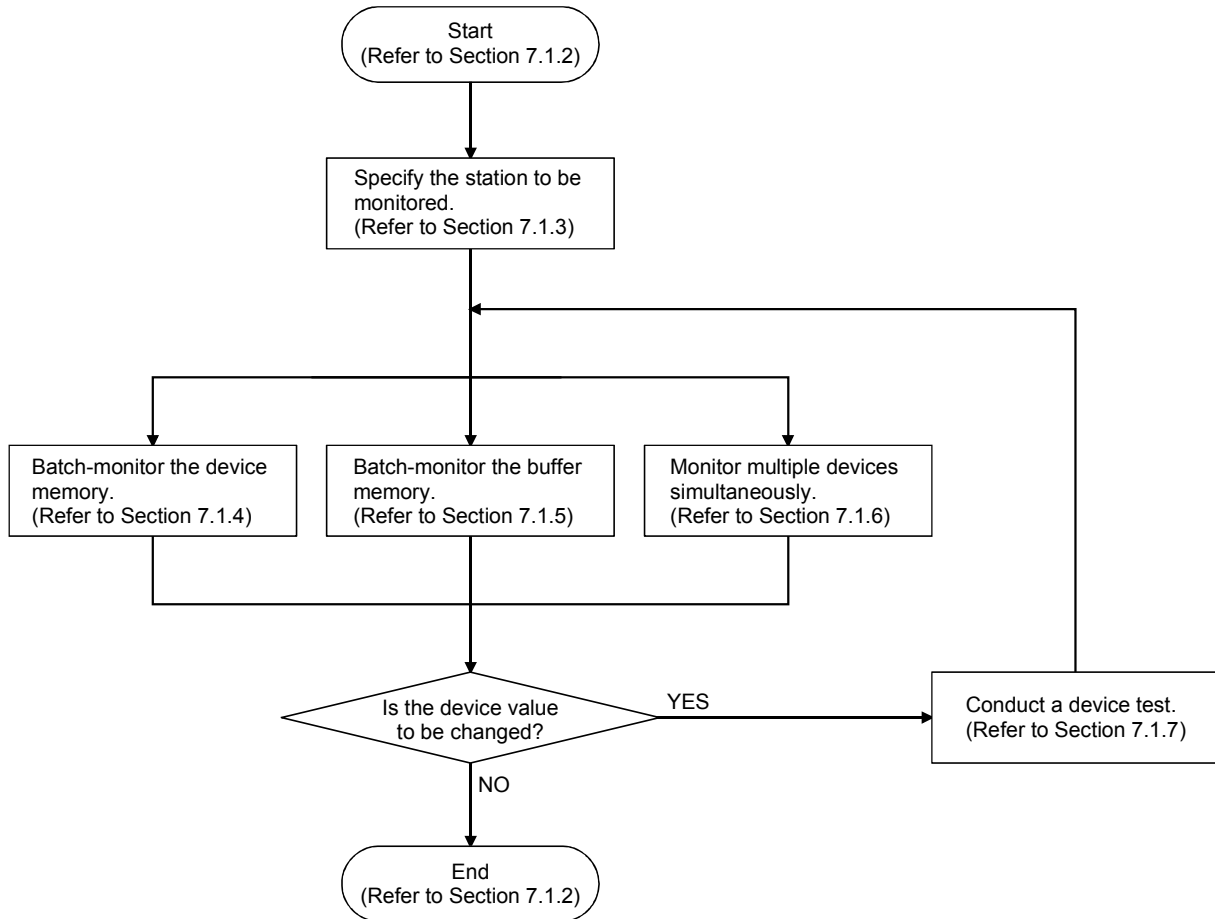

## 7.1.2 Starting/Ending Monitoring Device Memory

### (1) Starting monitoring device memory

#### [Purpose]

To start monitoring device memory.

#### [Operation procedure]

Select [Start] - [Monitor Function] - [Device Memory Monitor] from initial screen.

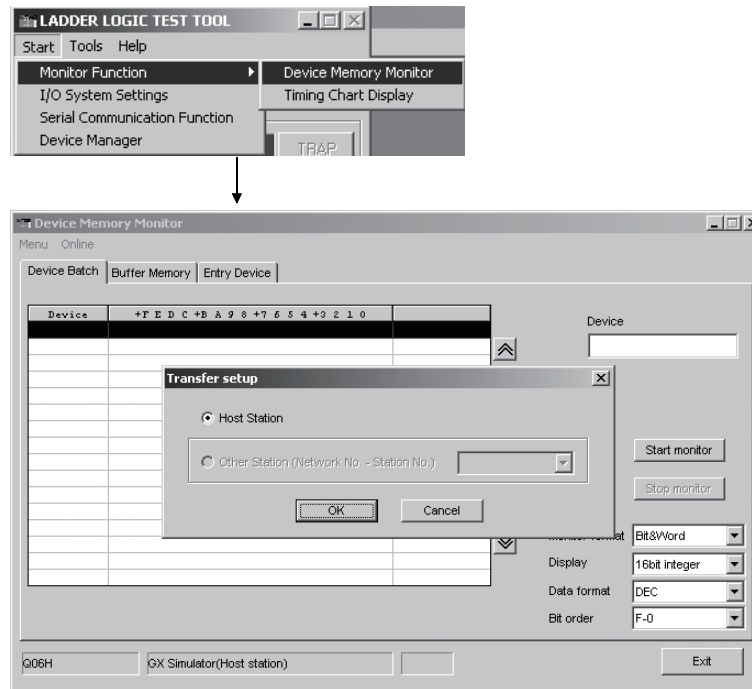

#### POINT

- (1) When Device Memory Monitor starts, the Transfer Setup screen of GX Simulator appears. Specify the station to be monitored. Refer to Section 7.1.3 for Transfer Setup.
- (2) Up to eight Device Memory Monitor screens can be started.

### (2) Ending monitoring device memory

#### [Purpose]

To end monitoring device memory.

#### [Operation procedure]

Select [Menu] - [Exit] from Device Memory Monitor screen.

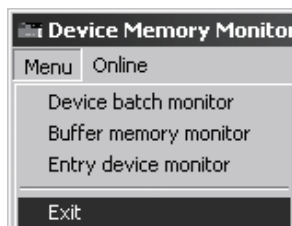

### 7.1.3 Specifying the station to be monitored

---

**[Purpose]**

Specify the station of monitor target.

**[Operation procedure]**

Choose [Online] - [Transfer Setup] on the Device Memory Monitor screen.

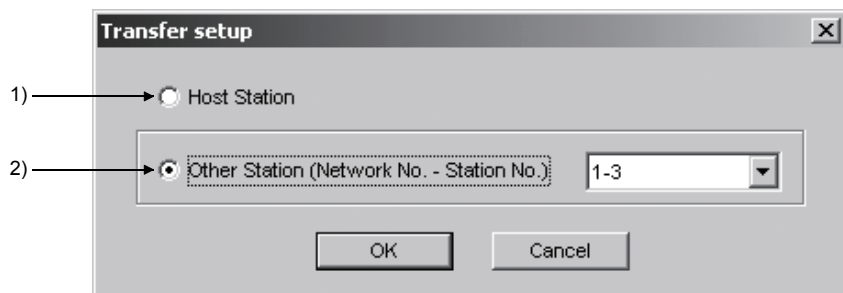
**[Setting screen]****[Explanation]****1) Host Station**

Select here when reading/writing the devices of the host station.

**2) Other Station (Network No. - Station No.)**

Select here when reading/writing the devices of the other station.

Specify the target station in the combo box.

To make selection, it is necessary to set the information on the other station in the "Other station device setting" of Device Manager and start Device Manager from the [Operation] - [Start] menu in advance.

Refer to Section 8.3.1 for the other station device setting.

## 7.1.4 Batch-monitoring the devices

## [Purpose]

Specify and batch-monitor devices.

## [Operation procedure]

Choose [Menu] - [Device batch monitor] on the Device Memory Monitor screen.  
Alternatively, click the <<Device Batch>> Tab.

## [Setting screen]

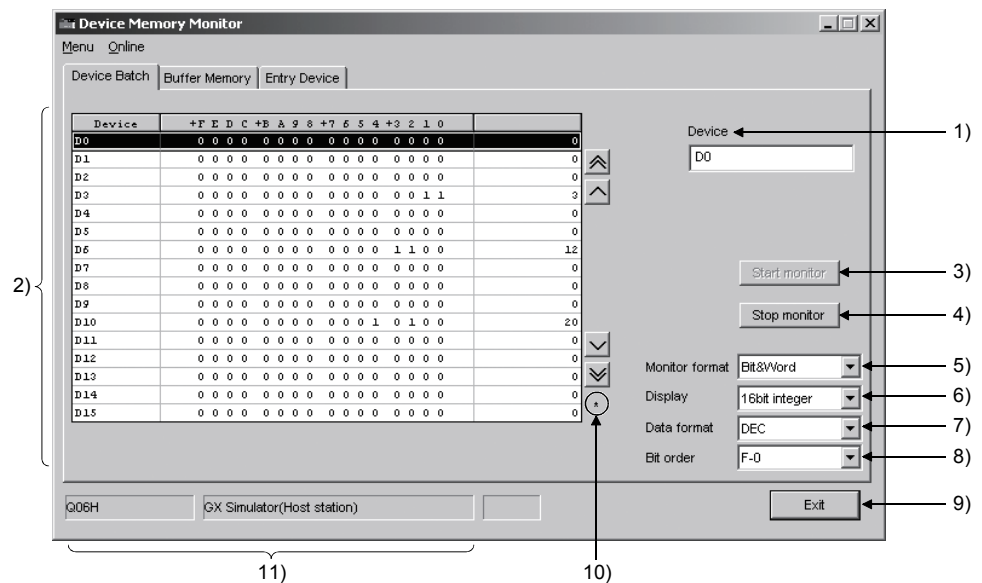

## [Explanation]

## 1) Device

Specify the device name and device number.

- Indexing, digit specification, word device bit specification and indirect designation cannot be executed.

For the A series CPU, specify the extension file register in the ER□\R□ format.

Refer to Appendix 1 for the supported devices.

Take the following precautions when monitoring the bit devices of the other station.

- If three or less devices are set, they cannot be batch-monitored.
- As the device number, enter a multiple of 16 into the Device field.  
(Example) X0, X10, M0, M16, etc.

2) Device batch display field

The specified devices are displayed.

- As the bit device status, 1 indicates an ON status and 0 an OFF status.
- The bit devices are displayed in units of 16 points.
- If the 16 points include the device not supported by the PLC CPU, its value is displayed "0".
- For the C devices of the FX series CPU, C0 to C199 (16 bits) and C200 and later (32 bits) are separately displayed.

Set the display format to the Monitor format, Display and Data format items. Double-clicking the Device batch display field during monitor displays the Device write dialog box.

Refer to Section 7.1.7 for the Device write dialog box.

3) **Start monitor** button

Starts monitor.

4) **Stop monitor** button

Stops monitor being executed.

5) Monitor format

Set the monitor format.

When the timer (T), counter (C) or retentive timer (ST) is specified, the monitor format is automatically set to the Timer/Counter format.

Bit & Word .... Devices are monitored in both bit and word formats.

Bit ..... Devices are monitored in bit format.

Word ..... Devices are monitored in word format.

Bit & Word format

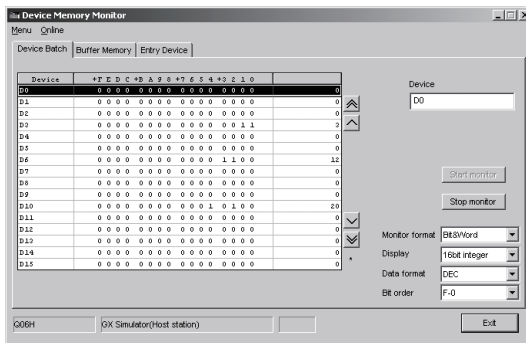

Bit format

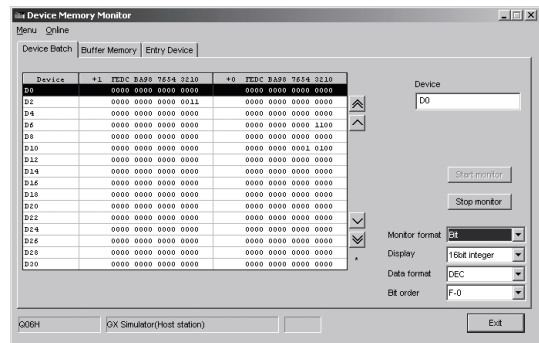

Word format

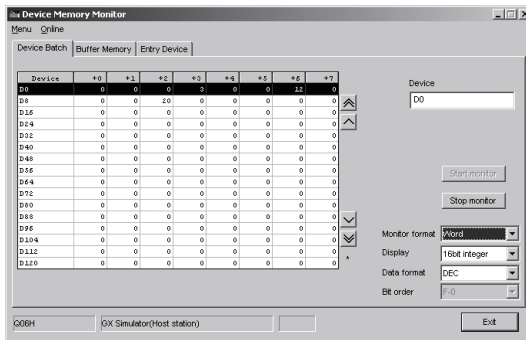

Timer/Counter format

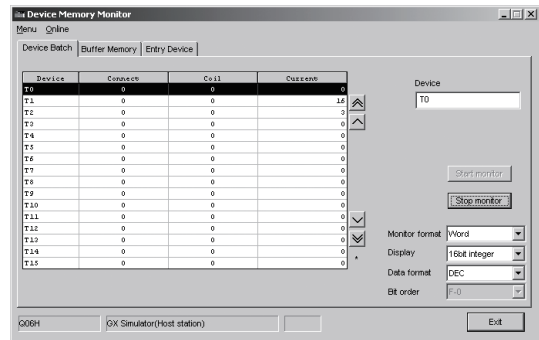

## 6) Display

When the monitor format is "Bit & Word" or "Word", set the word device (buffer memory) display format.

Make selection from among 16 bit integer, 32 bit integer, Real number (single precision), Real number (double precision) and ASCII character.

## 7) Data format

When the display format is "16 bit integer" or "32 bit integer", set the value display format.

Make selection from between "DEC" and "HEX".

## 8) Bit order

Set the order of the bit devices being monitored.

F-0 The bit devices are arranged in order of F, E to 1, 0 from left to right.

0-F The bit devices are arranged in order of 0, 1 to E, F from left to right.

9)  button

Ends Device Memory Monitor.

## 10) Monitor execution status

While monitor is being executed, "\*" flickers under the scroll button.

## 11) Connection target display field

Displays the CPU name and station number of the station currently connected.

POINT
-------

When specifying the timer (T), counter (C) or retentive timer (ST), enter T** (C**, ST**).
--

## 7.1.5 Monitoring the buffer memory

**[Purpose]**

Batch-monitor the buffer memory.

**[Operation procedure]**

Choose [Menu] - [Buffer memory monitor] on the Device Memory Monitor screen.  
Alternatively, click the <<Buffer Memory>> Tab.

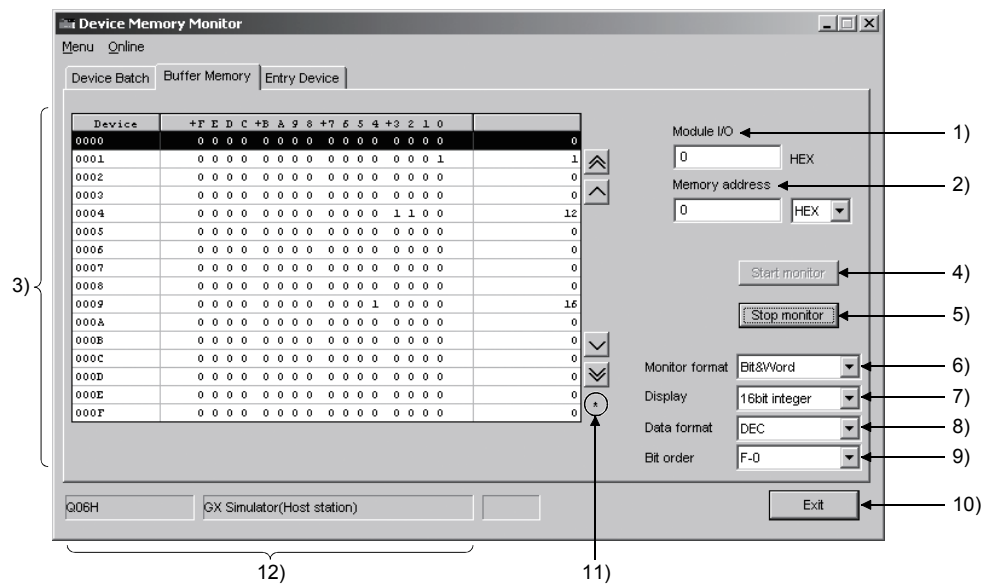
**[Setting screen]****[Explanation]**1) **Module I/O**

Enter the starting I/O number of the special function module to be monitored.

When making access to the FX series CPU, enter the block No. of the special expansion device into Module I/O.

2) **Memory address**

Specify the buffer memory address.

Selection can be made between "DEC" and "HEX".

3) **Buffer memory display field**

The specified devices are displayed according to the settings of the Monitor format, Display and Data format.

As the bit device status, 1 indicates an ON status and 0 an OFF status.

Double-clicking the Buffer memory display field during monitor displays the Device write dialog box.

Refer to Section 7.1.7 for the Device write dialog box.

4) **Start monitor** button

Starts monitor.

5) **Stop monitor** button

Stops monitor being executed.

6) Monitor format

Set the monitor format.

Bit & Word .... Devices are monitored in both bit and word formats.

Bit ..... Devices are monitored in bit format.

Word ..... Devices are monitored in word format.

Bit & Word format

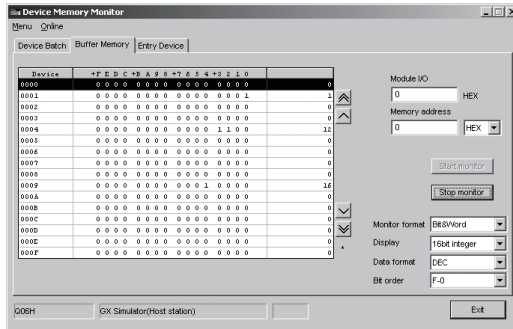

Bit format

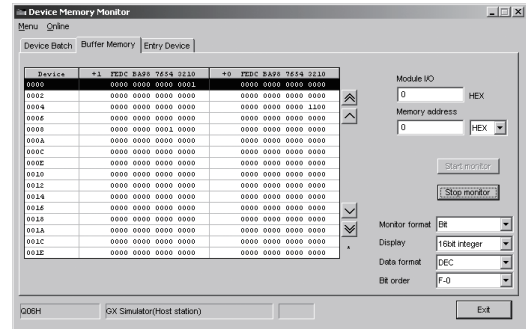

Word format

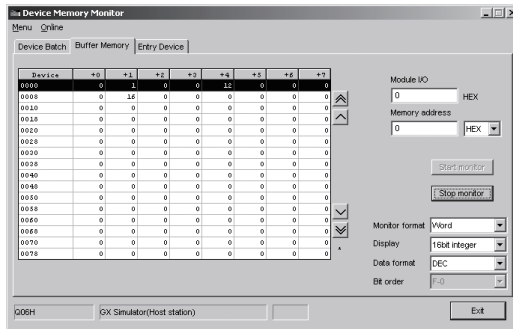

7) Display

When the monitor format is "Bit & Word" or "Word", set the word device (buffer memory) display format.

Make selection from among 16 bit integer, 32 bit integer, Real number (single precision), Real number (double precision) and ASCII character.

8) Data format

When the display format is "16 bit integer" or "32 bit integer", set the value display format.

Make selection from between "DEC" and "HEX".

9) Bit order

Set the order of the bit devices being monitored.

F-0 The bit devices are arranged in order of F, E to 1, 0 from left to right.

0-F The bit devices are arranged in order of 0, 1 to E, F from left to right.

10) Exit button

Ends Device Memory Monitor.

11) Monitor execution status

While monitor is being executed, "\*" flickers under the scroll button.

12) Connection target display field

Displays the CPU name and station number of the station currently connected.



**POINT**

- (1) When monitoring the buffer memory, make the following setting in advance.
- When monitoring the host station  
Set the I/O assignment on the [PLC Parameters] - <<I/O assignment>> Tab screen of GX Developer.
  - When monitoring the other station  
Set the buffer memory to be monitored in the other station device setting of GX Simulator.  
Refer to Section 8.3.1 for the other station device setting.

7.1.6 Monitoring the registered devices

[Purpose]

Monitor multiple devices simultaneously.

[Operation procedure]

Choose [Menu] - [Entry device monitor] on the Device Memory Monitor screen.  
Alternatively, click the <<Entry Device>> Tab.

[Setting screen]

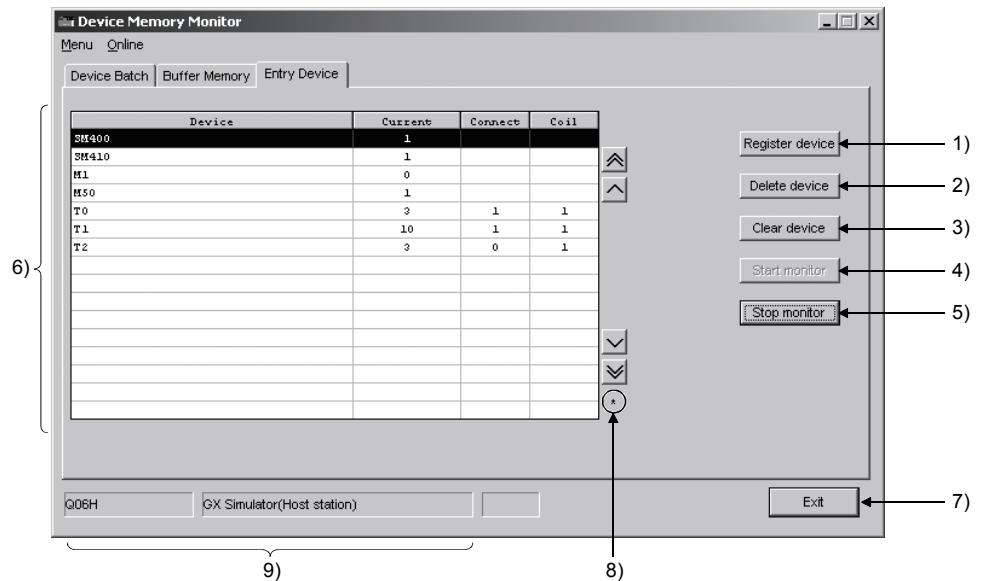

[Explanation]

1) Register device button

Register the device to be monitored in the Register device dialog box.



a) Device

Set the device to be registered.

- Word device bit specification and bit device digit specification can also be executed.

Enter the device as described below.

Word bit specification:

[Word device].[Bit No.] Example: D0.5

Bit word specification:

[Number of digits] Bit device starting number Example: K1X0

For the A series CPU, specify the extension file register in the ER□R□ format.

Refer to Appendix 1 for the entry method.

- b) Value  
Set the input format when monitoring the word device.  
Make selection from between "DEC" and "HEX".
- c) Display  
Set the display format when monitoring the word device.
- Devices T, C are displayed in only "16 bit integer" format. (For the FXCPU, C200 and later are displayed in only "32 bit integer" format.)
  - When "Real number" is selected, the value is "Decimal".
- Make selection from among 16 bit integer, 32 bit integer, Real number (single precision), Real number (double precision) and ASCII character.  
The set display format is displayed in the Device registration display field as shown below.
- |                                |                                 |
|--------------------------------|---------------------------------|
| 16 bit integer                 | → "Device" Example: D0          |
| 32 bit integer                 | → "Device (D)" Example: D0(D)   |
| Real number (single precision) | → "Device (E)" Example: D0(E)   |
| Real number (double precision) | → "Device (ED)" Example: D0(ED) |
| ASCII character                | → "Device (S)" Example: D0(S)   |
- d)  button  
Registers the set device.
- 2)  button  
Deletes the selected device.
- 3)  button  
Deletes all the registered devices.
- 4)  button  
Starts monitor.
- 5)  button  
Stops monitor being executed.
- 6) Device registration display field  
The registered devices are displayed.  
Up to 64 devices can be registered.  
Click the scroll button to monitor the devices that are not displayed on the screen.  
Double-clicking the Device registration display field during monitor displays the Device write dialog box.  
Refer to Section 7.1.7 for the Device write dialog box.
- 7)  button  
Ends Device Memory Monitor.
- 8) Monitor execution status  
While monitor is being executed, "\*" flickers under the scroll button.
- 9) Connection target display field  
Displays the CPU name and station number of the station currently connected.

**POINT**

When specifying the timer (T), counter (C) or retentive timer (ST), enter T\*\* (C\*\*, ST\*\*).

### 7.1.7 Conducting a device test (Device write)

#### [Purpose]

Change the ON/OFF status of a bit device or the current value of a word device or buffer memory.

#### [Operation procedure]

Choose [Online] - [Device write] on the Device Memory Monitor screen.  
Alternatively, double-click the device being displayed during monitor.

#### [Setting screen]

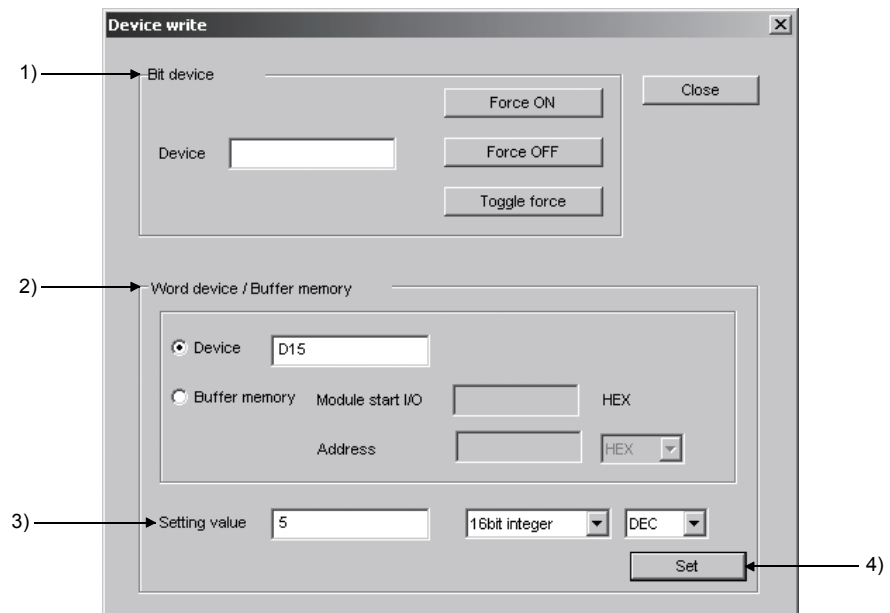

#### [Explanation]

##### 1) Bit device

Enter the bit device.

Click **Force ON**, **Force OFF** or **Toggle Force** to change the status of the specified device.

##### 2) Word device/Buffer memory

Device:

Specify the device name and device number.

The buffer register can also be specified in U□G□ format.

Buffer memory:

Specify the starting I/O number and buffer memory address of the special function module.

## 3) Setting value

Specify the value to be written to the specified word device or buffer memory.

Any of the following values can be set.

16 bit integer .....-32768 to 32767

32 bit integer .....-2147483648 to 2147483647

Real number (single precision).....Decimal number with 16 digits or less  
including a sign and decimal number

Real number (double precision) .....Decimal number with 16 digits or less  
including a sign and decimal number

4)  button

When the word device or buffer memory is specified, write to device is executed.

POINT
-------

When specifying the timer (T), counter (C) or retentive timer (ST), enter T** (C**, ST**).
--

## 7.2 Using Timing Chart

By using timing chart, timing of ON/OFF for bit device and change in word device value can be confirmed easily.

### 7.2.1 Operation procedure of timing chart

Operation procedure of timing chart is shown below:

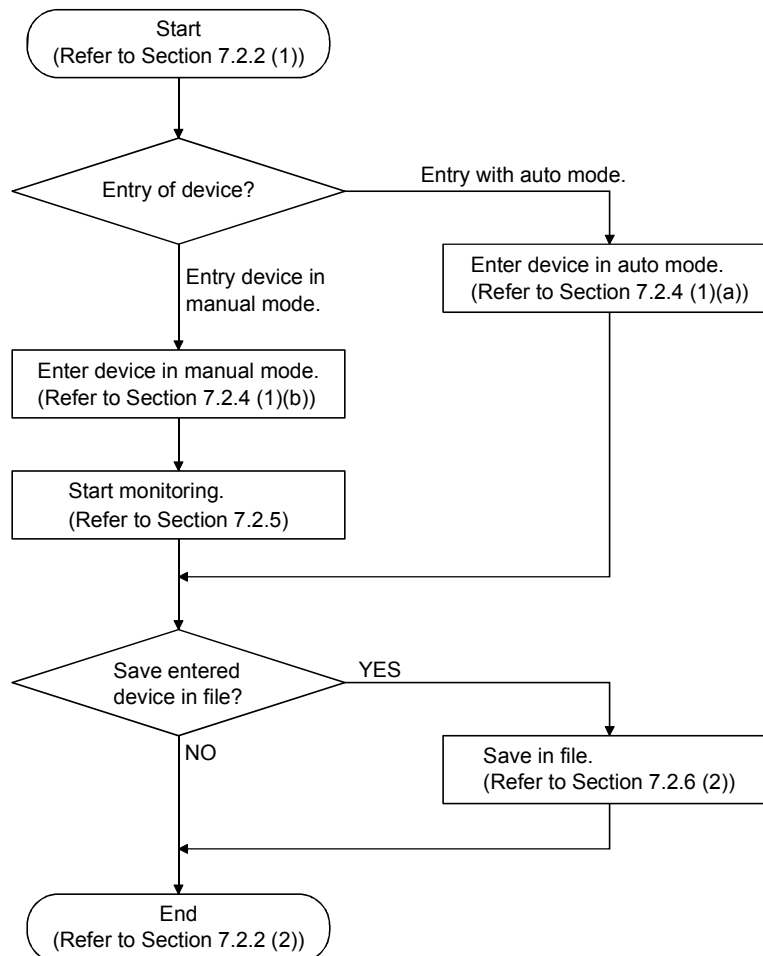

#### REMARK

When sampling period is to be set, refer to Section 7.2.7.  
Refer to Section 7.2.6 (3) if saved as timing chart data file.

## 7.2.2 Starting/Exiting timing chart

### (1) Starting timing chart

#### [Purpose]

To start timing chart.

#### [Operation procedure]

Select [Monitor Function] - [Timing Chart Display] from the initial screen.

Maximum 4 timing charts can be started.

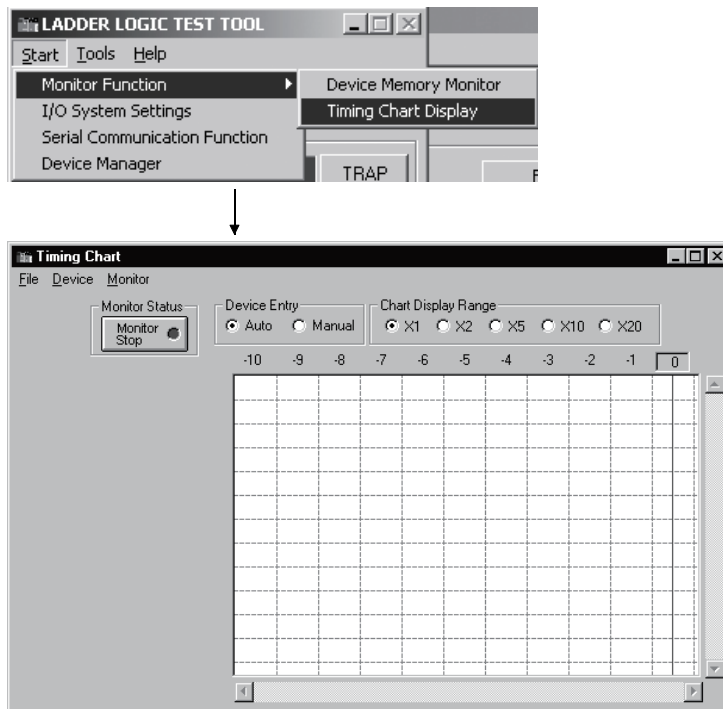

### (2) Exit timing chart

#### [Purpose]

To exit timing chart.

#### [Operation procedure]

Select [File] - [Exit] from timing chart screen.

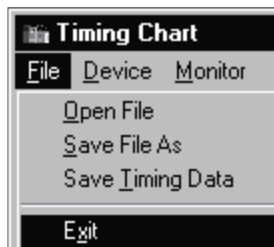

### 7.2.3 Using timing chart

#### (1) Screen display/operation

When you run Timing Chart, the following Timing Chart screen appears.

The following gives the explanations of the display data of the Timing Chart screen.

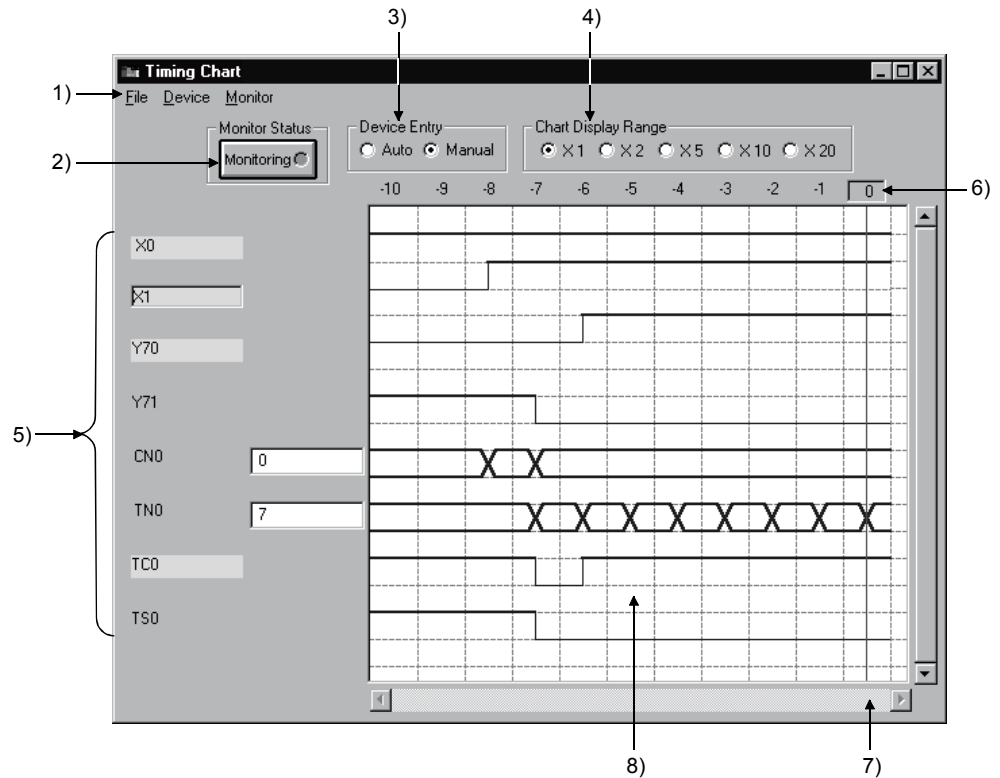

#### 1) Menu bar

Names of menu that can be used in timing chart are displayed.

When menu is selected, drop-down menu will be displayed and you can use various functions from this menu.

#### 2) **Status** button

By clicking the "Status" button, you can start/stop monitoring.

For the details, refer to Section 7.2.5.

#### 3) Device Entry

Selects auto or manual entry of device to be monitored.

For the details, refer to Section 7.2.4.

#### 4) Range of Chart Display

When the sampling interval is set to per scan, the chart display range is enlarged by 1, 2, 5, 10, and 20 times.



5) Device name/Device value

Bit device ..... When a device is in ON status, the device name lights up (Yellow). Clicking on the device name will highlight either ON and OFF of the device.

Word device ..... Displays the device value in an edit box at the right side of the device name. Double clicking on the device value will edit the device value.

POINTS			
(1) The expressions in the timing chart are timer (T), counter (C), and retentive timer (ST), and each of them has three types; contact, coil, and present value. In the timing chart, they are expressed as follows.			
	Expressions used in the timing chart		
	Timer	Counter	Retentive timer
Contact	TS	CS	STS (SS)
Coil	TC	CC	STC (SC)
Present value	TN	CN	STN (SN)

(2) Buffer register and extension file register are displayed as follows.

<Buffer register >

The first I/O number of a special function module

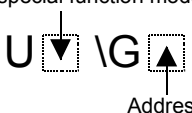

When the first I/O number is 4 and the address is K30, they are displayed as "U4\G30".

<Extension file register>

Block No.

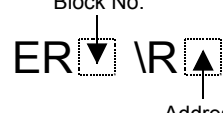

When the block No. is 2 and the address is K30, they are displayed as "ER2\R30".

(3) When word device is designated as 32 bit integer, (D) is added to the end of device name.  
Example: D0(D), W6(D)

6) Reference line/scale

The scale displayed indicates the past scan count. Clicking the scale moves the reference line (vertical line) and shows the device values at that scan in 5).

7) Scroll bar

Up to 1000 sampled past states of devices area saved. By operating the scroll bar, you can confirm the past states of devices.

## 8) Status display

Shows the states of the monitor devices.

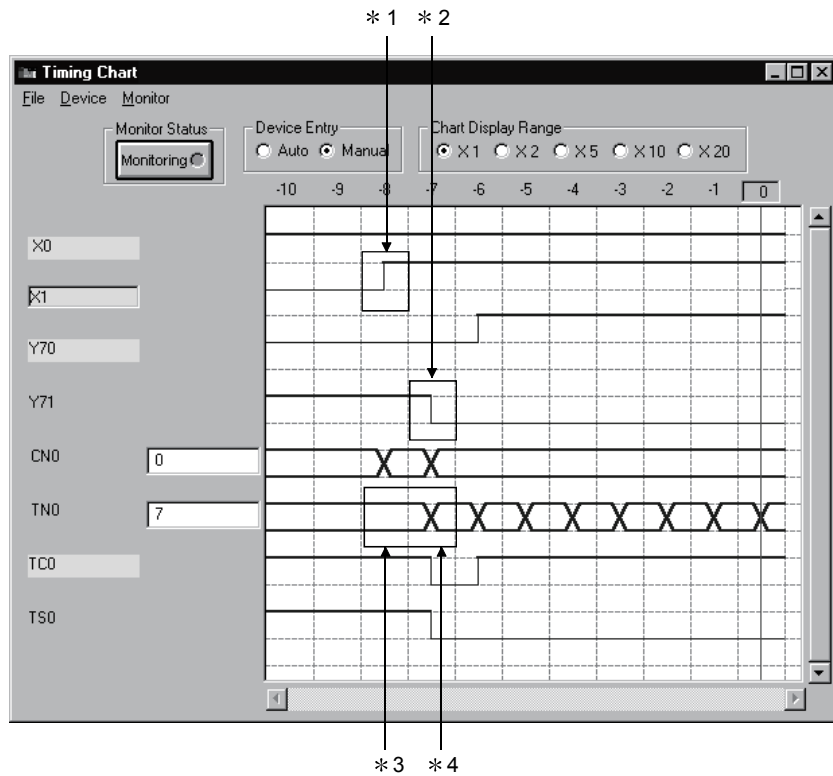

\*1 denotes that the corresponding device turned from OFF to ON.

\*2 denotes that the corresponding device turned from ON to OFF.

\*3 denotes that the value of the corresponding device remains unchanged.

\*4 denotes that the value of the corresponding device has changed.

7.2.4 Entering/Deleting device to be monitored

(1) Entering device to be monitored

(a) Automatic setting

[Purpose]

Automatically enters device used with sequence program.

[Operation procedure]

1) Make sure that device entry is set to "Auto":

If set to "Manual", switch to "Auto".



2) Select [Monitor] - [Start/Stop] to set to monitor mode.

You can also click [Monitor Stop] button instead of above.



3) Device displayed on GX Developer screen will automatically be registered as device, and monitoring will start. (Maximum 64 devices can be entered.)

If displayed device is changed by scrolling the screen, device entry will automatically change.

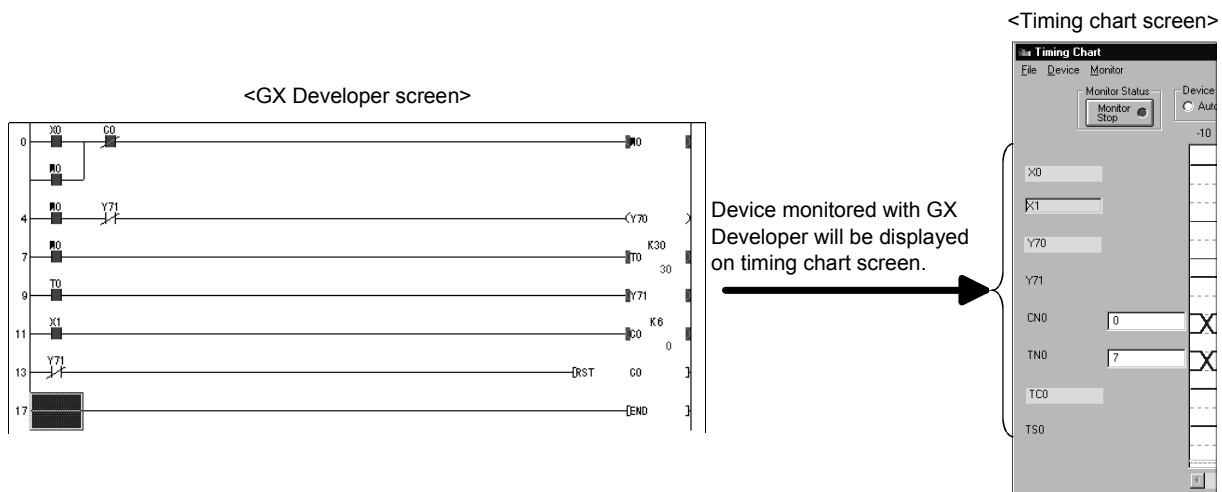

POINTS
(1) If devices registered using GX Developer do not appear in the timing chart screen, switch the device entry setting from <b>Auto</b> to <b>Manual</b> , and execute device entry.
(2) For any instruction whose argument occupies double-word positions, two word devices will be displayed on the timing chart screen. (For DINC D0, D0 and D1 are entered.)
(3) When batch monitor of GX Developer is used to monitor a bit device, this bit device will not be entered.
(4) When the A series/FX series /Q series (A mode) CPU/motion controller is selected, the bit digit-specified/index-qualified device will not be entered.
(5) When QnA series /Q series CPU (Q mode) is selected, directly designated buffer memory will not be entered.
(6) When FX series CPU is selected, the following instructions displayed on GX Developer circuit monitor screen will not be entered. ( RST T, RST C ) ( PLS Y, PLS M ) ( PLF Y, PLF M )

(b) Manual entry

[Purpose]

Manually enters device to be monitored in timing chart.

[Operation procedure]

- 1) Select [Device] - [Enter Device].

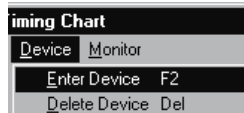

- 2) The dialog shown below will appear: After setting each item, click **Enter** button.

Maximum 64 devices can be entered.

<"Selection" selected>

<"Key input" selected>

## (2) Deleting registered device

## [Purpose]

To delete registered devices.

## [Operation procedure]

## (a) Select the device to be deleted:

For example, X0 is deleted here.

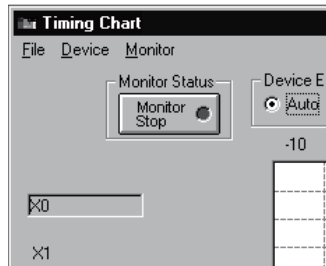

## (b) Select [Device] - [Delete Device].

Device has been deleted.

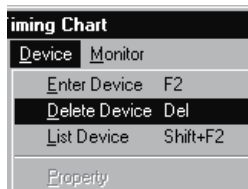

## 7.2.5 Starting/Stopping monitoring

---

### (1) Starting monitoring

#### [Purpose]

To start monitoring the timing chart.

#### [Operation procedure]

After registering device, select [Monitor] - [Start/Stop] while monitor is stopped.

You can also click **Monitor Stop** button instead of above.

However, if device is registered in auto mode, monitoring will start when device is registered.

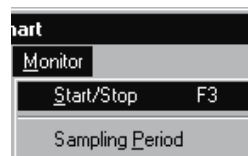

### (2) Stopping monitoring

#### [Purpose]

To stop monitoring timing chart.

#### [Operation procedure]

Select [Monitor] - [Start/Stop] during monitoring.

You can also click **Monitoring** button instead of above.

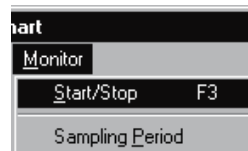

## 7.2.6 Operating file

---

### (1) Opening saved file

#### [Purpose]

To open device registration file (\*.mon) that have been saved.

#### [Operation procedure]

Select [File] - [Open file].

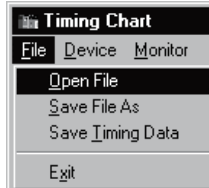

#### [Setting screen]

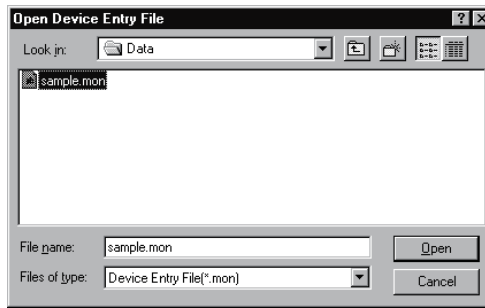

Designate optional folder with "Look in", click file to be opened, then click **Open** button.

### (2) Saving in file

#### [Purpose]

To save entered device as a device registration file (\*.mon).

#### [Operation procedure]

Select [File] - [Save File As].

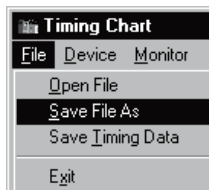

## [Setting screen]

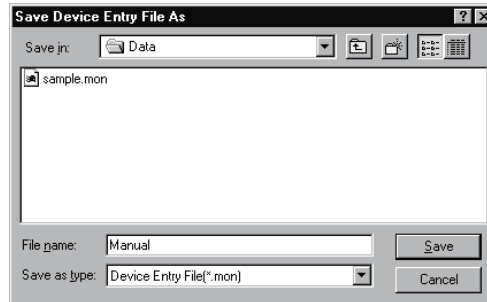

Designate optional folder with "Save in", and enter new file name in "File name".  
If data is to be overwritten on existing file, select the file by clicking.

After setting, click **Save** button.

## (3) Saving as timing chart data file

## [Purpose]

To save as a timing chart data file.

Timing chart data file can be read using timing chart format input of I/O system settings.

For details of the number of data files which can be read, refer to Section 5.5.6.

## [Operation procedure]

Select [File] - [Save Timing data].

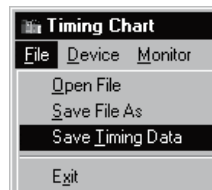

## [Setting screen]

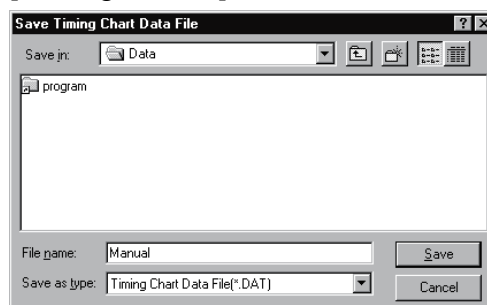

Designate optional folder with "Save in", and enter new file name in "File name".  
If data is to be overwritten on existing file, select the file by clicking.

After setting, click **Save** button.



## 7.2.7 Setting sampling period

---

### [Purpose]

To set collection interval of device value in the range between 1 and 20 scans.

### [Operation procedure]

- (1) Select [Monitor] - [Sampling Period].

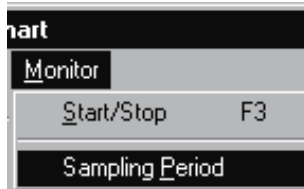

- (2) Sampling period setting screen will appear: Input data collection interval.

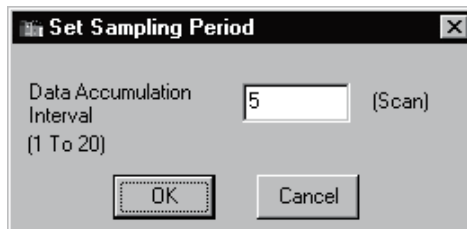

### <Example>

When Data Accumulation Interval is set to 5 scans, the device value will be collected every 5 scans and displayed in the timing chart display screen.

(The default value is 1 scan.)

### REMARK

Every time you change the sampling period, the data displayed in the timing chart will be cleared.

## 7.2.8 Other operations

### (1) Displaying the list of registered devices

Select [Device] - [List Device]: The list of registered devices will be displayed.

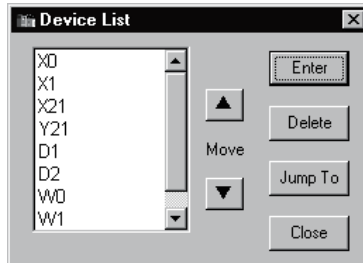

- Click **[Enter]** button: Device entry dialog will appear.  
Refer to Section 7.2.4 for details.
- Click **[Delete]** button: The device will be deleted from target of monitoring.  
By using "**[Shift]** key + Select" or "**[Ctrl]** key + Select", two or more devices can be deleted simultaneously.
- Click **[Jump To]** button: Timing chart being displayed will jump to selected device.
- Click **▲/▼** button: Device being selected will move up/down.
- Selecting two or more devices  
(You cannot select two or more devices for moving.)

### (2) Changing word device display format

Select "Word Device" and select [Device] - [Property]. The dialog shown below will appear: Display format can now be changed.

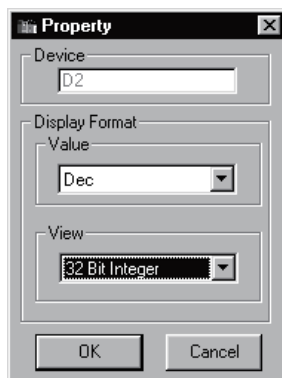

- Value  
Changes between decimal and hexadecimal.
- View  
Changes between 32 bit integer, Real number (single precision), and Real number (double precision).  
(Effective only when selected device is a double word)

## (3) Exchanging device display position

Display position of device can be exchanged by drag & Drop.

- (a) Drag the device name in the timing chart format input screen. Dotted line frame will appear during dragging.

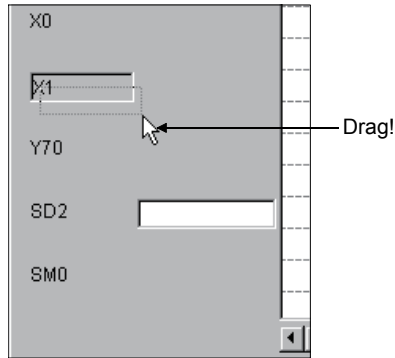

- (b) Superimpose dotted line frame on the device name to be exchanged. Device name can now be exchanged.

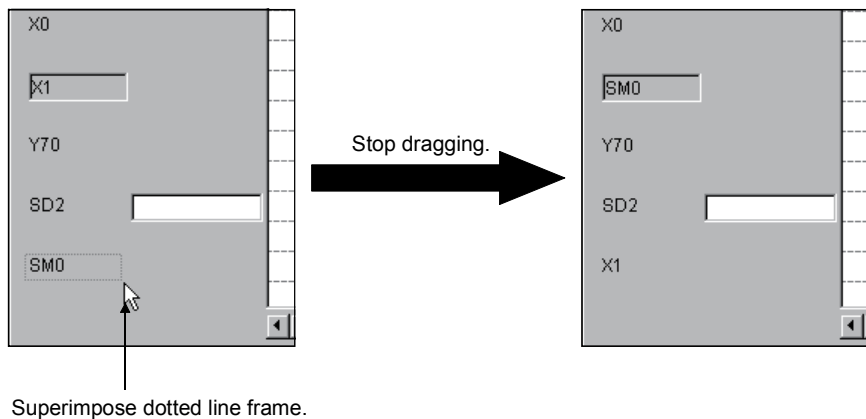

(4) Viewing the status changes of the devices monitored

The GX Simulator can save up to 1000 samples of past states of devices.

The following example shows how to confirm the device status of 260 scans before.

(a) Set the monitoring state of timing chart to stop.

(b) Operate the scroll bar until -260 appears on the timing chart screen.

Click "-260" on the screen.

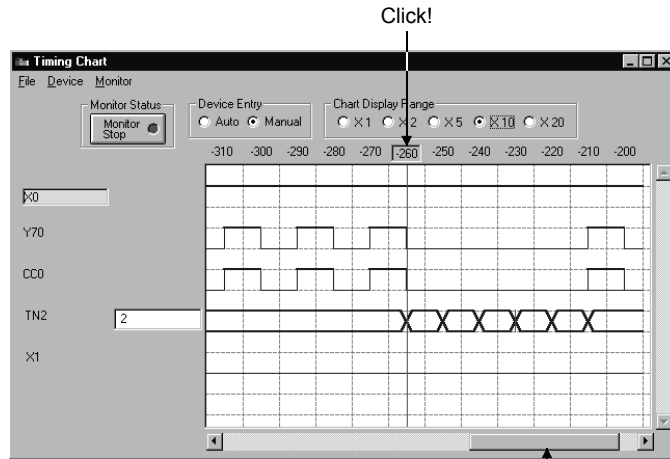

Operate the scroll bar.

(c) By clicking "-260", the device status of 260 scans before will appear in \*1.

In \*1, the bit device ON/OFF status and word device value are displayed.

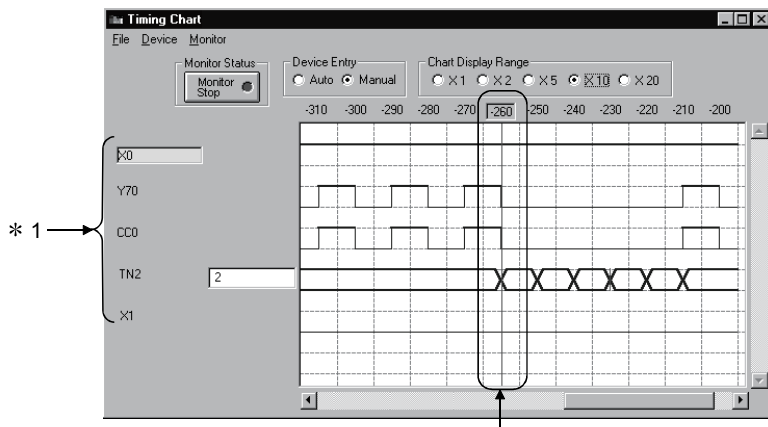

This indicates that when both Y70 and C0 turned OFF, TN2 started count.

# 8. SETTING THE DEVICES FOR SIMULATION - DEVICE MANAGER FUNCTION

The Device Manager function is designed to facilitate the offline debugging of the user application using the MELSOFT product.

This function enables the user application to be debugged without a network being configured or program/setting being changed for the actual PLC.

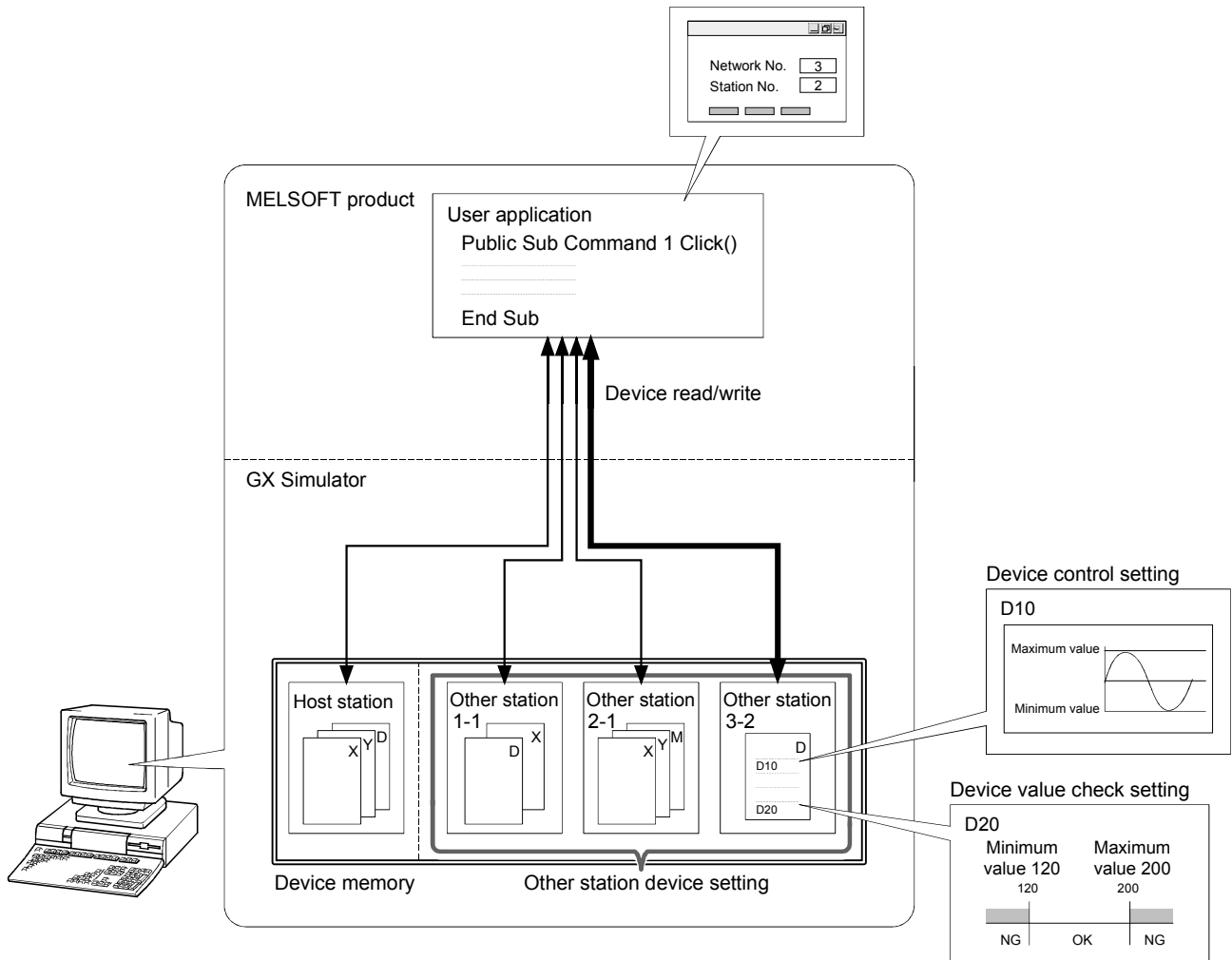

The Device Manager function can execute the following.

(1) Device control setting

Make this setting to select a pattern and change a device value.

With this setting, the device-changed operation of the user application can be checked without creation of a device value changing program for debugging.

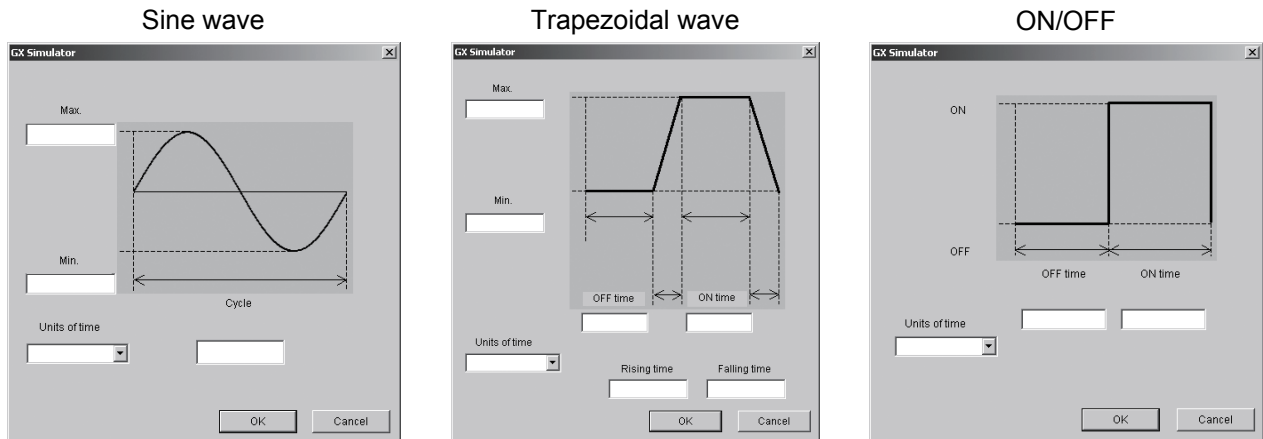

(2) Device value check setting

Set a valid range/bit pattern to check for unexpected values written from the user application to devices.

With this setting, illegal values written can be checked on the Log display screen to check for user application creation or setting mistakes.

Device value check setting screen

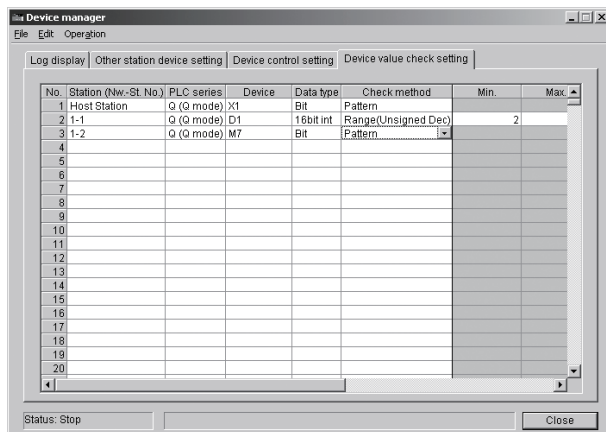

Log display screen

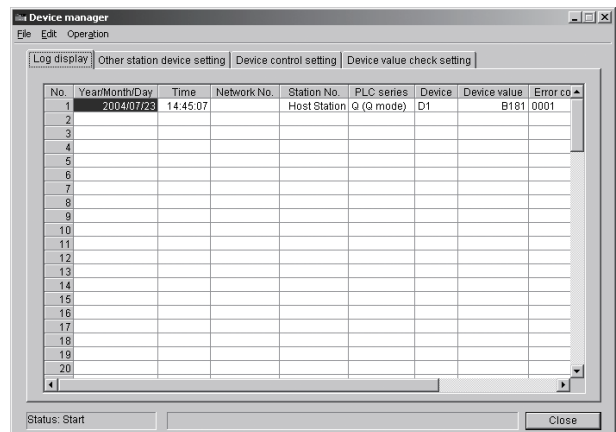

(3) Other station device setting

Set the other station device memory to make access from the user application to the other stations.

With this setting, the operation of the user application for accessing the other station devices can be checked.

8.1 Device Manager Operation Procedure

The following shows a Device Manager operation procedure.

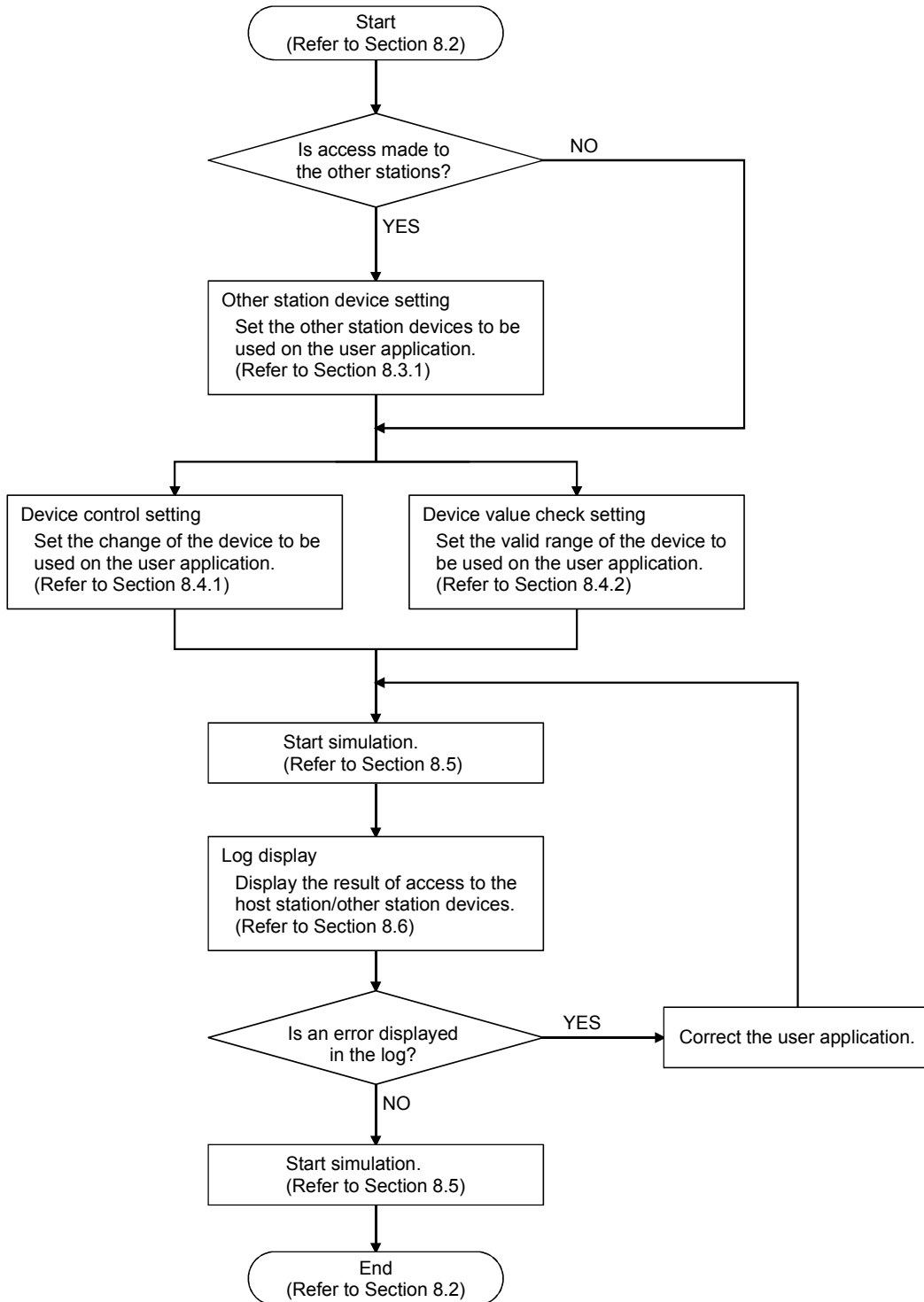

8.2 Starting/Exiting Device Manager

(1) Starting Device Manager

[Purpose]  
Start Device Manager.

[Operation procedure]  
Choose [Start] - [Device Manager] on the initial screen.

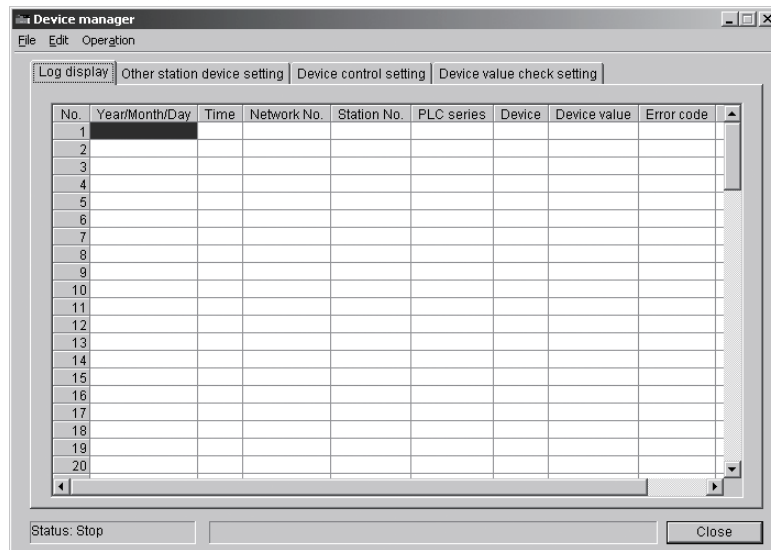
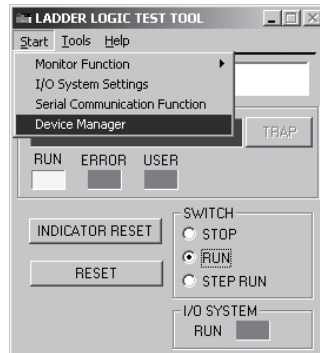

(2) Exiting Device Manager

[Purpose]  
Exit Device Manager.

[Operation procedure]  
Choose [File] - [Exit] on the Device Manager screen.

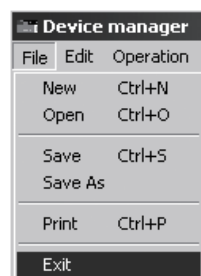



### 8.3 Setting the Other Station Devices

Set the device memories of the other stations to be accessed by the user application.

#### 8.3.1 Other station device setting

**[Purpose]**

Set the device memories of the other stations.

**[Operation procedure]**

Choose the <<Other station device setting>> Tab on the Device Manager screen.

**[Setting screen]**

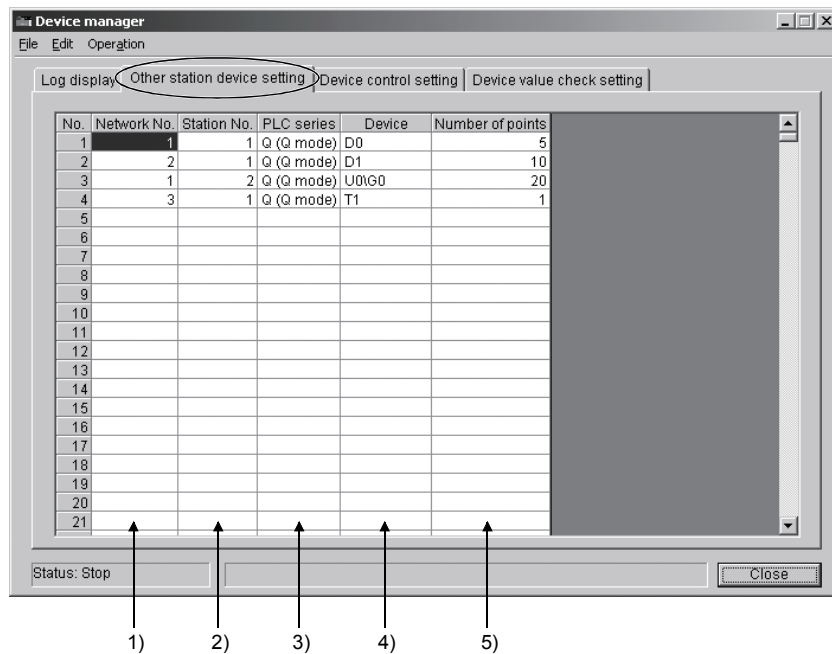

**[Explanation]**

- 1) Network No.  
Specify the network No. of the station to be accessed.  
The input range is 1 to 255.
- 2) Station No.  
Specify the station No. of the station to be accessed.  
The input range is 0 to 64.
- 3) PLC series  
Specify the PLC series of the station to be accessed.

4) Device

Specify the starting device of the station to be accessed.

- When the T, C or ST device is set, the contact, coil and current value device memories are batch-created.
- When the buffer register is set, it can be specified in the U□\G□ format. When the extension file register is set, it can be specified in the ER□\R□ format.

Refer to Appendix 1 for the input method.

5) Number of points

Specify how many points will be secured from the starting device of the specified device.

The input range is 1 to 32767.

POINT
(1) Make a registration in the other station device setting within the following range: Number of stations: 1 to 1024 Number of device points: 1 to 1000k Make sure that the total number of bit device points and word device points is within 1000k. * Count one point of timer, retentive time or counter as 3 points.
(2) Different ranges of the same device can be set separately. Set the device range that the simulation target user application will access. Example: Setting different ranges of data register No.1: 100 points starting from D0 (D0 to D99), No.2: 100 points starting from D200 (D200 to D299).
(3) Any cell that has wrong input data is displayed red.

## 8.4 Setting the Device Values for Simulation

Set the change pattern or device value range to the specified device.  
A change pattern is to set the change of a word device value while a bit device is ON/OFF within any predetermined time.

### 8.4.1 Device control setting

**[Purpose]**

The operation of the user application using the change pattern-set device can be checked.

The following tables indicate whether setting can be input to each setting field or not according to the change pattern and the range where setting can be input to each setting field in the device control setting.

List of whether setting can be input to each setting field or not according to the change pattern

Change pattern	Data type			Units of time	Min.	Max.	OFF time	Rising time	ON time	Falling time	Constant	Source station	Source device	Cycle	Preview
	32 bit int	16 bit int	Bit												
Sine wave	○	○	×	○	○	○	×	×	×	×	×	×	×	○	○
Cosine wave	○	○	×	○	○	○	×	×	×	×	×	×	×	○	○
Trapezoidal wave	○	○	×	○	○	○	○	○	○	○	×	×	×	×	○
Constant	○	○	×	×	×	×	×	×	×	×	○	×	×	×	×
Copy	○	○	○	○	×	×	×	×	×	×	×	○	○	○	×
ON/OFF	○	○	○	○	×	×	○	×	○	×	×	×	×	×	○
ON	○	○	○	×	×	×	×	×	×	×	×	×	×	×	×
OFF	○	○	○	×	×	×	×	×	×	×	×	×	×	×	×

○: Can be input    ×: Cannot be input

#### Setting range according to units of time

Units of time	OFF time	Rising time	ON time	Falling time	Cycle
Seconds (sec.)	0 to 3600				1 to 3600
Minutes (min.)	0 to 60				1 to 60

#### Setting range according to data type

Data type	Min.	Max.	Constant
Bit	—		
16 bit int	-32768 to 32767		
32 bit int	-2147483648 to 2147483647		

[Operation procedure]

Choose the <<Device control setting>> Tab on the Device Manager screen.

[Setting screen]

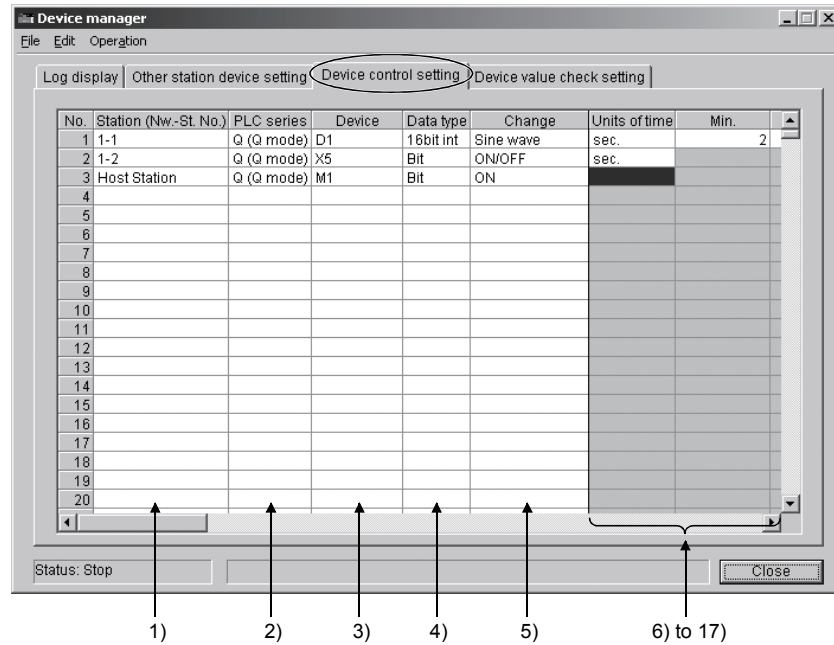

Items displayed by right scrolling

Units of time	Min.	Max.	OFF time	Rising time	ON time	Falling time	Constant	Source station	Source device	Cycle	Preview
↑	↑	↑	↑	↑	↑	↑	↑	↑	↑	↑	↑
6)	7)	8)	9)	10)	11)	12)	13)	14)	15)	16)	17)

[Explanation]

- 1) **Station (Nw. - St. No.)**  
Specify the station of the device whose change pattern will be set.  
To set the other station, set the information on the other station in the "Other station device setting" of Device Manager in advance.  
Refer to Section 8.3.1 for the other station device setting.
- 2) **PLC series**  
Displays the PLC series of the PLC CPU on the specified station.  
When the host station is selected:  
Series of the station set on GX Developer  
When the other station is selected:  
Series of the station set in "Other station device setting"
- 3) **Device**  
Specify the device whose change pattern will be set.  
Enter the device set in the other station device setting.
- 4) **Data type**  
Specify the data type of the device whose change pattern will be set.  
Make selection from among Bit, 16 bit int and 32 bit int.

- 5) **Change**  
Specify the change pattern of the value of the specified device.  
Make selection from among Sine wave, Cosine wave, Trapezoidal wave, Constant, Copy, ON/OFF, ON and OFF.  
Refer to 17) for details of each change pattern.
- 6) **Units of time**  
Specify the unit of the cycle, OFF time, rising time, ON time or falling time.  
Make selection from between "sec." and "min.".
- 7) **Min.**  
Specify the minimum value of the change pattern of the specified device.  
Set the minimum value to satisfy the following condition: minimum value  $\leq$  maximum value.
- 8) **Max.**  
Specify the maximum value of the change pattern of the specified device.  
Set the maximum value to satisfy the following condition: minimum value  $\leq$  maximum value.
- 9) **OFF time**  
Specify the time when the minimum value continues.
- 10) **Rising time**  
Specify the time when the device value changes from the minimum value to the maximum value.
- 11) **ON time**  
Specify the time when the maximum value continues.
- 12) **Falling time**  
Specify the time when the device value changes from the maximum value to the minimum value.
- 13) **Constant**  
Specify the data to be stored into the device.
- 14) **Source station**  
Specify the station of the device that will be the source of copying the change pattern.
- 15) **Source device**  
Specify the device that will be the source of copying the change pattern.
- 16) **Cycle**  
Specify the time of one cycle of the change pattern.
- 17) **Preview**  
Clicking the Preview button displays the change pattern selected in 5) in graph format.  
The value of the item in the displayed dialog box can be changed.  
Details of each change pattern will be provided on the next page.

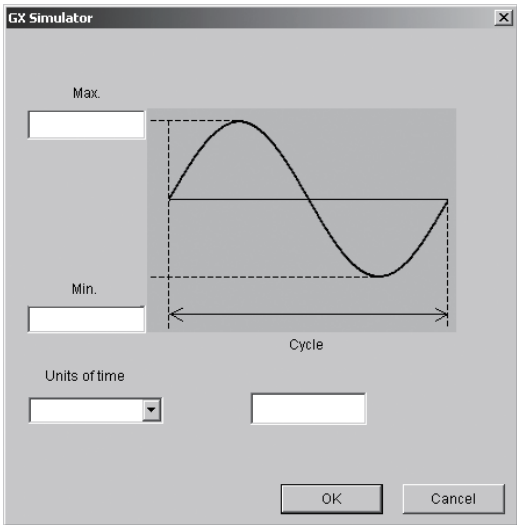
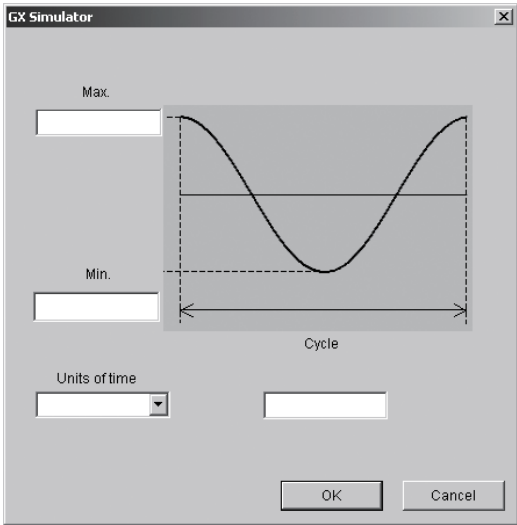
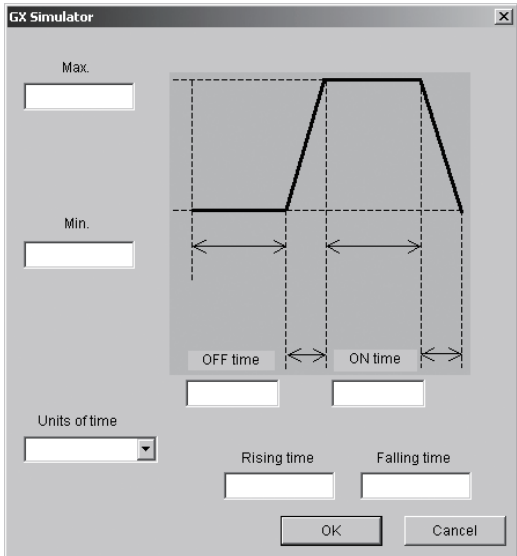
Change pattern	Description	Preview
Sine wave	Device update is repeated between the specified minimum value and maximum value in the specified cycle according to the sine wave.	
Cosine wave	Device update is repeated between the specified minimum value and maximum value in the specified cycle according to the cosine wave.	
Trapezoidal wave	Device update is repeated between the specified minimum value and maximum value at the OFF time, Rising time, ON time and Falling time according to the trapezoidal wave.	

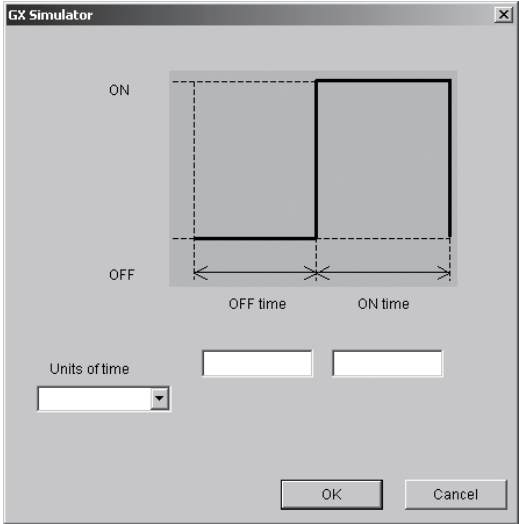
Change pattern	Description	Preview
Constant	The specified constant value is written when device control starts.	None
Copy	The value of the copy source device is copied to the corresponding device at the specified cycle interval.	None
ON/OFF	Device ON/OFF is repeated at the specified OFF time/ON time.	
ON	The device is turned ON (1) when device control starts.	None
OFF	The device is turned OFF (0) when device control starts.	None

**POINT**

- Any cell that has wrong input data is displayed red.
- An error will occur if "0" is entered into all of the OFF time, rising time, ON time and falling time.
- In the device control setting, the update interval of the device value is 500ms.

### 8.4.2 Device value check setting

**[Purpose]**

Whether the value written from the user application is within the user-set range or not can be checked.

The following table indicates the ranges where the minimum value, maximum value, and pattern can be input according to the check method and data type in the device value check setting.

Check method	Data type	Input range
Range (Unsigned Dec)	Bit	0, 1
	16 bit int	0 to 65535
	32 bit int	0 to 4294967295
Range (Signed Dec)	Bit	0, 1
	16 bit int	-32768 to 32767
	32 bit int	-2147483648 to 2147483647
Range (Hex)	Bit	0, 1
	16 bit int	0 to FFFF
	32 bit int	0 to FFFFFFFF
Pattern	Bit	0, 1
	16 bit int	0 to FFFF
	32 bit int	0 to FFFFFFFF

**[Operation procedure]**

Choose the <<Device value check setting>> Tab on the Device Manager screen.

**[Setting screen]**

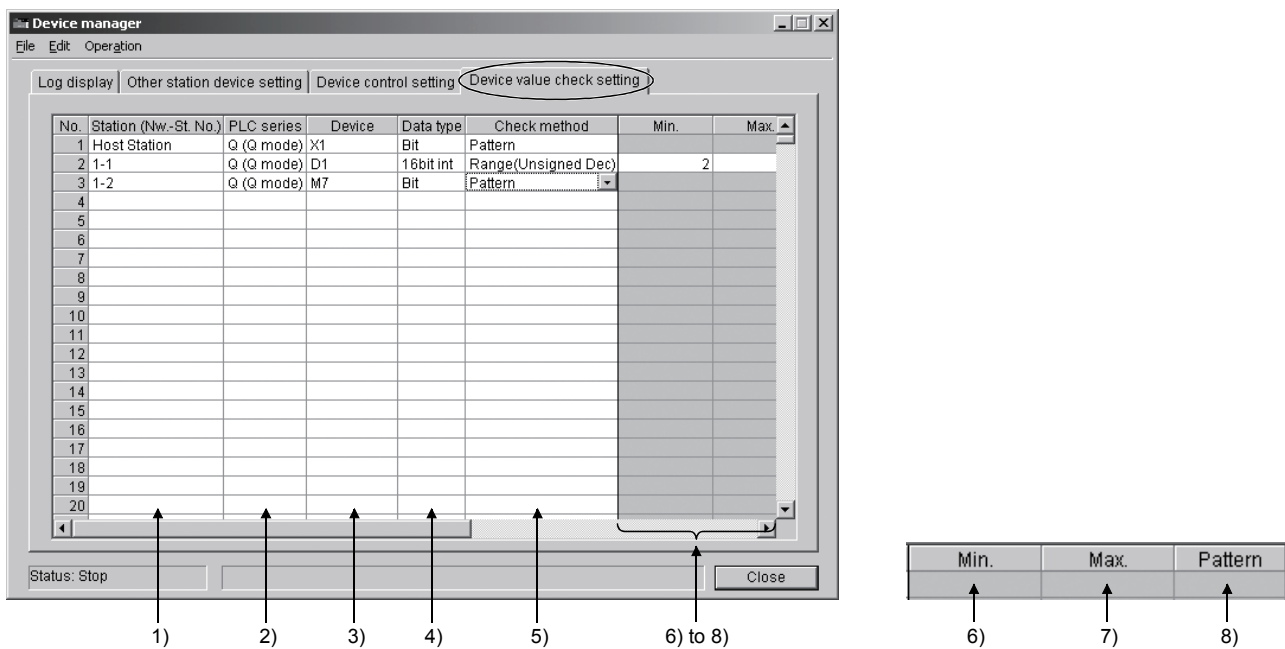

**[Explanation]**

- 1) Station (Nw. – St. No.)  
Specify the station of the device to be set.  
When specifying the other station, set the information on the other station in the "Other station device setting" of Device Manager in advance.  
Refer to Section 8.3.1 for the other station device setting.



- 2) **PLC series**  
Displays the PLC series of the PLC CPU on the specified station.  
When the host station is selected:  
Series of the station set on GX Developer  
When the other station is selected:  
Series of the station set in "Other station device setting"
- 3) **Device**  
Specify the device on which a device value check will be made.
- 4) **Data type**  
Specify the data type when the set device value will be displayed.  
Make selection from among Bit, 16 bit int and 32 bit int.
- 5) **Check method**  
Select how to specify the value to be set as the minimum value or maximum value from Range (Unsigned Dec), Range (Signed Dec), Range (Hex) and Pattern.
- 6) **Min.**  
Specify the minimum value of the valid range handled by the specified device.
- 7) **Max.**  
Specify the maximum value of the valid range handled by the specified device.
- 8) **Pattern**  
Specify as 0 the bit position that must not be turned ON when a value is stored, and as 1 the bit position that may be turned ON/OFF.  
Example: 16 bit integer  
To cause an error when a negative value is stored, specify 7FFFH in Pattern.

**Value set to Pattern**

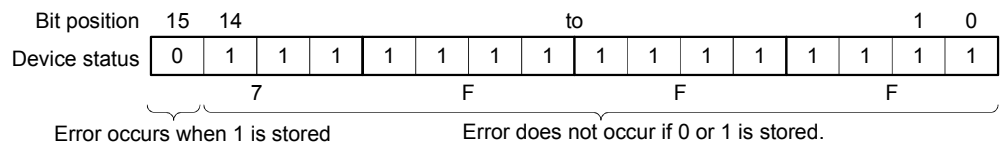

**Actually stored value (when error occurs)**

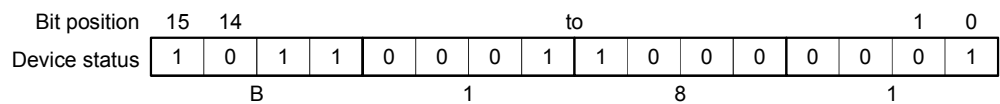

**Actually stored value (when error does not occur)**

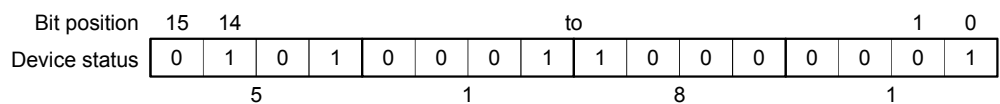

**POINT**  
Any cell that has wrong input data is displayed red.

## 8.5 Starting/Stopping Simulation

### (1) Starting simulation

**[Purpose]**

Start simulation using the Device Manager function.

**[Operation procedure]**

<b>POINT</b>
When a log result is being displayed on the log display screen, save the log result before starting simulation. The log result is deleted when simulation starts.

After setting the setting information of each function, choose [Operation] - [Start] on the Device Manager screen.

After selection, start the user application.

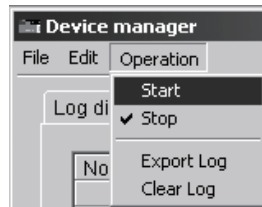

When simulation starts, the operating status of the function is displayed on the status bar of the Device Manager dialog box.

When an error occurs, an error message is displayed.

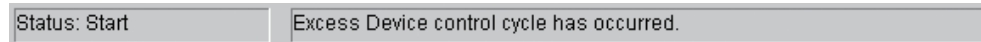

#### Operating status of function

Operating status	Description
Stop	Status in which simulation has not started.
Start	Status in which simulation is operating normally according to the set values.

#### Displayed error message

Error message	Error occurrence condition	Corrective action
Excess Device control cycle has occurred.	The device could not change in the cycle specified in the device control setting.	<ul style="list-style-type: none"> <li>Exit the resident program.</li> <li>Review the operating environment of the personal computer.</li> </ul>

### (2) Stopping simulation

**[Purpose]**

Stop simulation using the Device Manager function.

**[Operation procedure]**

After stopping the user application, choose [Operation] - [Stop] on the Device Manager screen that is executing the function.

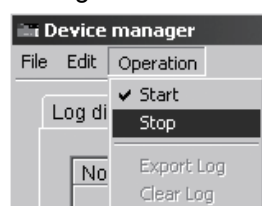

## 8.6 Displaying the Results of Access to Devices (Log Display)

### [Purpose]

Display the error details detected by GX Simulator in the setting device value check.

This enables a check for an illegal value written to the set device.

### [Operation procedure]

Select the <<Log display>> Tab on the Device Manager screen.

### [Setting screen]

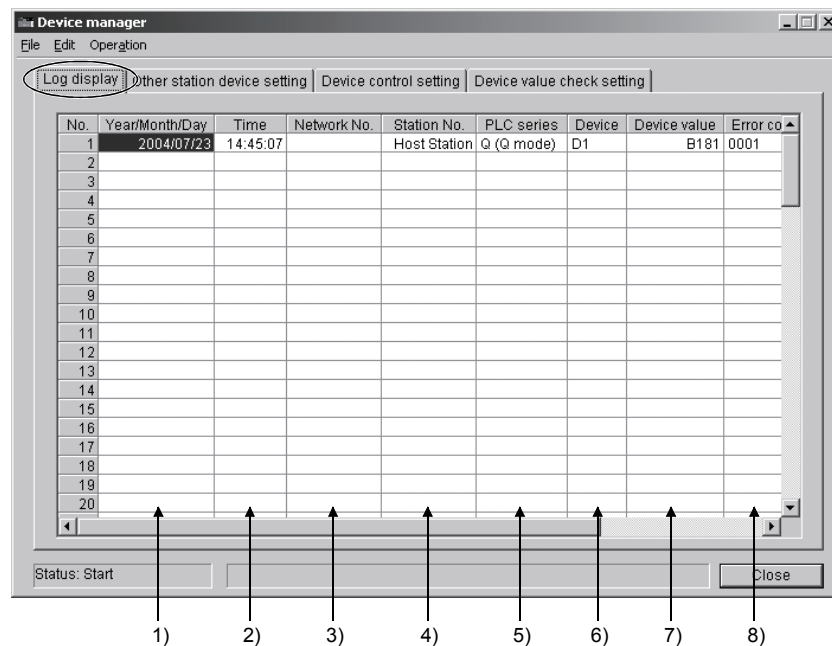

### [Explanation]

- 1) Year/Month/Day  
The year, month and day when an error occurred are displayed.
- 2) Time  
The time of day when the error occurred is displayed.
- 3) Network No.  
The network No. of the station being accessed when the error occurred is displayed.
- 4) Station No.  
The station No. of the station being accessed when the error occurred is displayed.
- 5) PLC series  
The series of the PLC CPU on the station where the error occurred is displayed.

- 6) Device  
The device specified as the access destination is displayed.
- 7) Device value  
The device value at error occurrence is displayed.
- 8) Error code  
The code number for error classification is displayed.  
Refer to 9) for the error code number.
- 9) Message  
The details of the error that occurred are displayed.  
The error details are described below.

Error code	Message	Error occurrence condition	Corrective action
0001	Range outside value write	The value was not written within the range set in the device value check.	• Review the user application.

POINT
<ul style="list-style-type: none"> <li>• Log display is not provided if an error occurs during a stop.</li> <li>• A maximum of 100 pieces of information are displayed. However, when more information is generated, older error information is deleted.</li> <li>• At exit from Device Manager, the displayed log information is deleted. When saving the log information, export the log (refer to Section 8.7.5).</li> </ul>

## 8.7 Other Operations

### 8.7.1 Performing the file operation of setting data

#### (1) Creating a new file

##### [Purpose]

Create a new setting data file (other station device setting, device control setting, device value check setting).

##### [Operation procedure]

Choose [File] - [New] on the Device Manager screen.

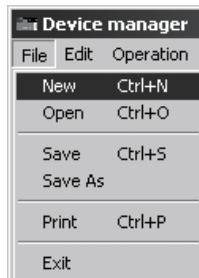

#### (2) Opening the existing file

##### [Purpose]

Open the saved setting data file.

##### [Operation procedure]

Choose [File] - [Open] on the Device Manager screen.

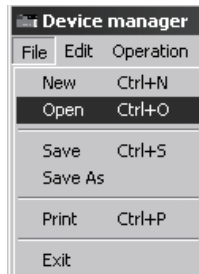

##### [Setting screen]

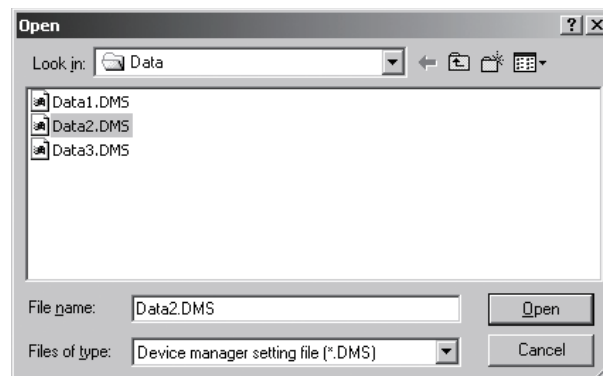

Specify any folder in "Look in", click the file to be opened, and then click the **Open** button.

For "Files of type", only Device manager setting file (\*.DMS) is available.

(3) Save

[Purpose]

Save the open setting data file.

[Operation procedure]

Choose [File] - [Save] on the Device Manager screen.

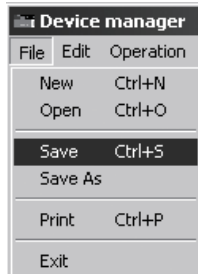

When the open file has not been saved, the "Save As" dialog box appears. Attach a name and save the file. Refer to (4) for details.

(4) Save As

[Purpose]

Save the open setting data file with a new name.

[Operation procedure]

Choose [File] - [Save As] on the Device Manager screen.

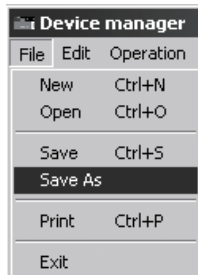

[Setting screen]

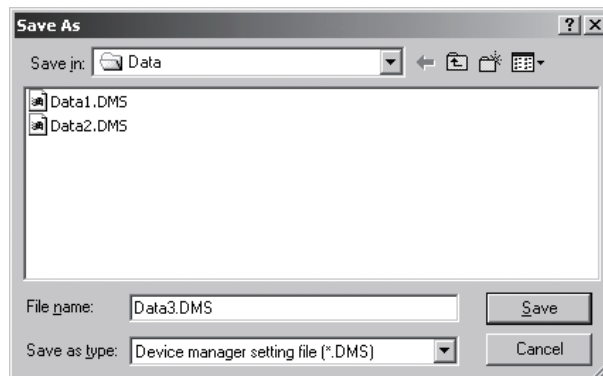

Specify the save destination folder in "Save in".  
Enter the name of the file to be saved in "File name".  
When overwriting the existing file, click the file to be saved to make selection.  
After setting, click the **Save** button.  
For "Files of type", only Device manager setting file (\*.DMS) is available.

### 8.7.2 Editing the settings

Edit the settings in units of line or cell.

#### (1) Cutting or copying a line

##### [Purpose]

Cut or copy the line of the selected setting No. and save it into the clipboard.

##### [Operation procedure]

- (a) Click and select the line of the setting No. to be cut or copied.

No.	Network No.	Station No.	PLC series	Device
1	1	1	Q (Q mode)	X10
2	1	3	QnA	T1
3	2	2	Q (Q mode)	D0
4	3	1	QnA	M1

- (b) When cutting, choose [Edit] - [Cut].

When copying, choose [Edit] - [Copy].

No.	Network No.	Station No.	PLC series	Device
1	1	1	Q (Q mode)	X10
2	1	3	QnA	T1
3	2	2	Q (Q mode)	D0
4	3	1	QnA	M1

#### (2) Pasting the cut or copied line

##### [Purpose]

Paste the line of the cut or copied setting No. to any position.

##### [Operation procedure]

- (a) Click and select the No. of the paste destination line.

No.	Network No.	Station No.	PLC series	Device
1	1	1	Q (Q mode)	X10
2	1	3	QnA	T1
3	2	2	Q (Q mode)	D0
4	3	1	QnA	M1
5				

- (b) Choose [Edit] - [Paste].

- (c) The line of the cut or copied setting No. is pasted.

No.	Network No.	Station No.	PLC series	Device
1				
2	1	3	QnA	T1
3	2	2	Q (Q mode)	D0
4	3	1	QnA	M1
5	1	1	Q (Q mode)	X10

When data already exists on the paste destination line, it is overwritten.

(3) Inserting the cut or copied line

[Purpose]

Insert the line of the cut or copied setting No. into any position.

[Operation procedure]

- (a) Select the No. of the insertion destination line.

No.	Network No.	Station No.	PLC series	Device
1	1	1	Q (Q mode)	X10
2	1	3	QnA	T1
3	2	2	Q (Q mode)	D0
4	3	1	QnA	M1

- (b) Choose [Edit] - [Insert Cut Cells] or [Insert Copied Cells].

- (c) The cut or copied setting No. is inserted into the position one line above the selected line.

When the line of the setting No. has not been cut or copied before insertion, a blank line is inserted into the selected line.

No.	Network No.	Station No.	PLC series	Device
1	1	1	Q (Q mode)	X10
2	3	1	QnA	M1
3	1	3	QnA	T1
4	2	2	Q (Q mode)	D0

(4) Deleting or clearing the specified line

[Purpose]

Delete the line of the specified setting No.

[Operation procedure]

- (a) Select the line of the setting No. to be deleted.

No.	Network No.	Station No.	PLC series	Device
1	1	1	Q (Q mode)	X10
2	3	1	QnA	M1
3	1	3	QnA	T1
4	2	2	Q (Q mode)	D0

- (b) When deleting, choose [Edit] - [Delete].

The data of the setting No. shifts up.

No.	Network No.	Station No.	PLC series	Device
1	1	1	Q (Q mode)	X10
2	1	3	QnA	T1
3	2	2	Q (Q mode)	D0

When clearing, choose [Edit] - [Clear].

The line of the specified setting No. is blanked.

No.	Network No.	Station No.	PLC series	Device
1	1	1	Q (Q mode)	X10
2				
3	1	3	QnA	T1
4	2	2	Q (Q mode)	D0



(5) Sorting the lines

[Purpose]

Sort the lines of the setting No.

Sort the lines on the basis of the network No. and station No.

[Operation procedure]

No.	Network No.	Station No.	PLC series	Device
1	1	1	Q (Q mode)	X10
2	3	1	QnA	M1
3	1	3	QnA	T1
4	5	3	A	D10
5	2	2	Q (Q mode)	D0

When sorting the lines in ascending order, choose [Edit] - [Sort by Ascending].

No.	Network No.	Station No.	PLC series	Device
1	1	1	Q (Q mode)	X10
2	1	3	QnA	T1
3	2	2	Q (Q mode)	D0
4	3	1	QnA	M1
5	5	3	A	D10

When sorting the lines in descending order, choose [Edit] - [Sort by Descending].

No.	Network No.	Station No.	PLC series	Device
1	5	3	A	D10
2	3	1	QnA	M1
3	2	2	Q (Q mode)	D0
4	1	3	QnA	T1
5	1	1	Q (Q mode)	X10

(6) Undoing the last operation

[Purpose]

Undo the last operation.

Undo is valid for only the last operation.

[Operation procedure]

Choose [Edit] - [Undo].

(7) Redoing the undone operation

[Purpose]

Redo the undone operation.

Redo is valid for the last undone operation.

[Operation procedure]

Choose [Edit] - [Redo].

### 8.7.3 Printing the log information and setting information

**[Purpose]**

Print the log information generated by each function and/or the setting information set for each function.

A print image can be checked on the print preview.

**[Operation procedure]**

Choose [Edit] - [Print] on the Device Manager screen.

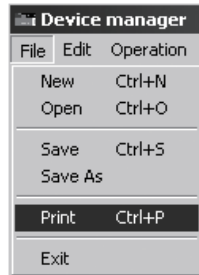

**[Setting screen]**

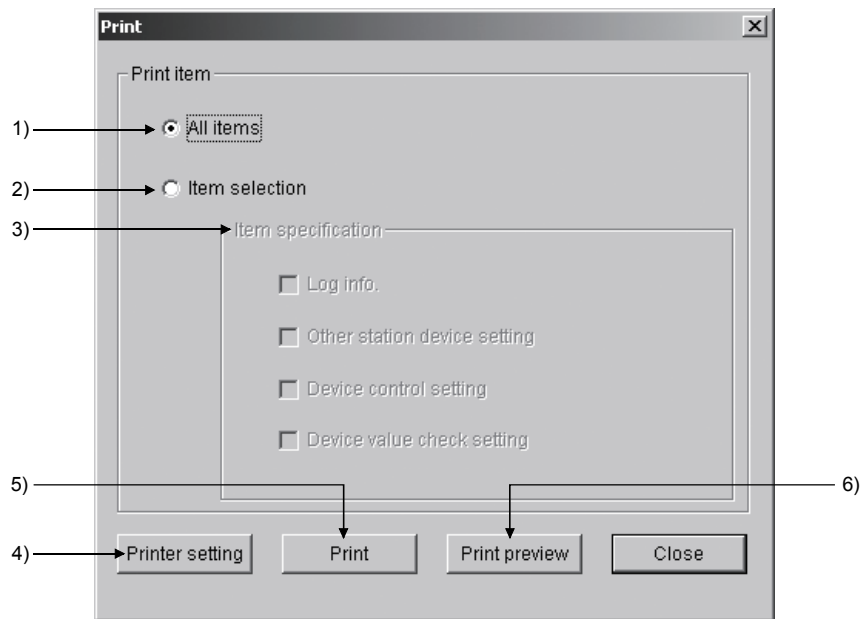

**[Explanation]**

- 1) All items  
Log information and/or setting information (other station device setting, device control setting, device value check setting) is to be printed.
- 2) Item selection  
Only the selected item is to be printed.
- 3) Item specification  
Select the target of print.
  - Log info.  
The data displayed on the log screen are printed.
  - Other station device setting  
The settings on the other station device setting screen are printed.
  - Device control setting  
The settings on the device control setting screen are printed.
  - Device value check setting  
The settings on the device value check setting screen are printed.

- 4) Printer setting  
The Windows® standard printer setting dialog box is displayed.  
Set the printer used for printing.
- 5) Print  
Starts printing.
- 6) Print preview  
A print image is displayed.

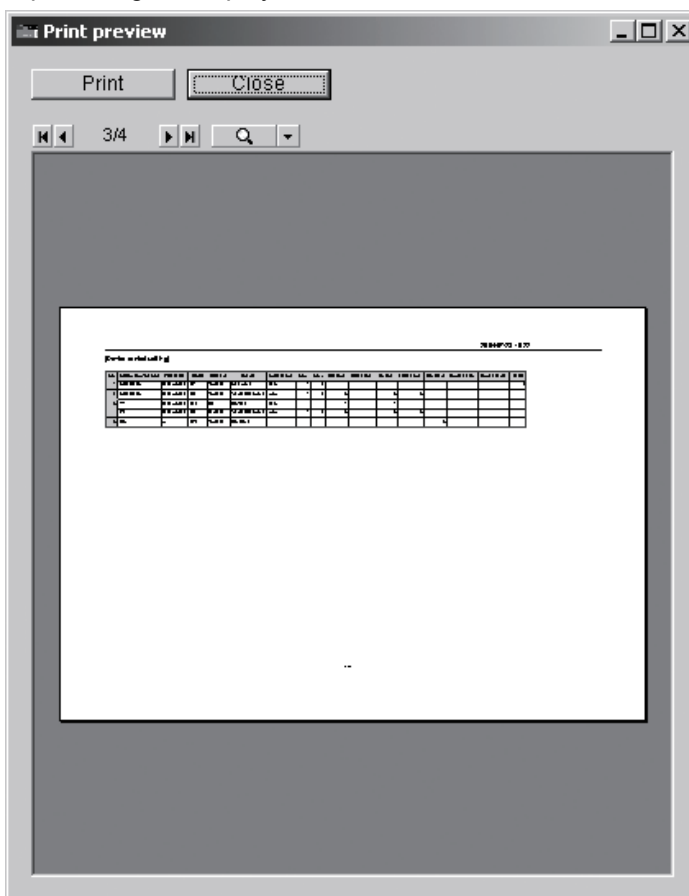

- **Print** button  
Closes the print preview and prints the item specified in the print dialog.
- Changes the preview display page to the first page.
- Changes the preview display page to the previous page.
- Changes the preview display page to the next page.
- Changes the preview display page to the last page.
- Changes the preview display format and display size.

### 8.7.4 Searching for log information

---

**[Purpose]**

From the error details output to the log, search for the character string entered in the Search dialog box.

**[Operation procedure]**

Choose [Edit] - [Find] on the Device Manager screen.

**[Setting screen]**

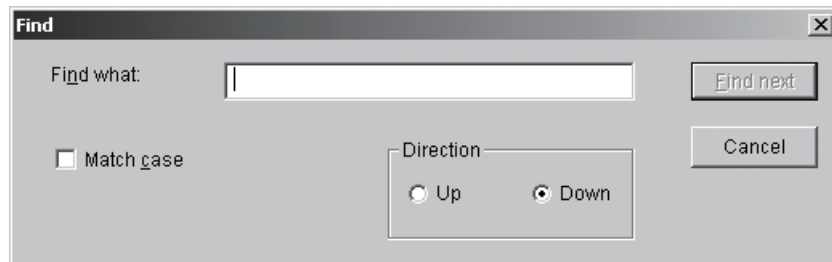

**[Explanation]**

- 1) **Find what**  
Enter the character string to be searched for.
- 2) **Match case**  
When the entered character string is searched for, the characters are discriminated between uppercase and lowercase.
- 3) **Direction**  
Set the searching direction.

### 8.7.5 Saving the log information into file

**[Purpose]**

Save the log information into the specified place.

**[Operation procedure]**

Choose [Operation] - [Export Log] on the Device Manager screen.



**[Setting screen]**

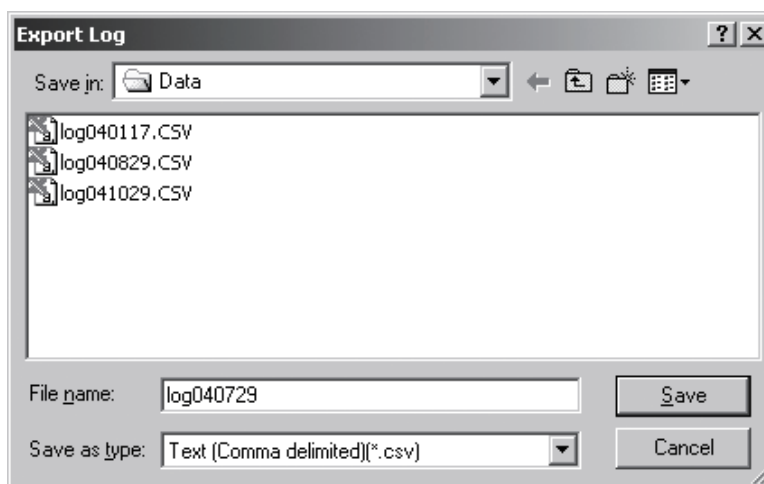

Specify the save destination folder in "Save in".

Enter the name of the file to be exported in "File name".

When overwriting the existing file, click the file to be saved to make selection.

For "Save as type", only Text (Comma delimited) (\*.csv) is available.

After setting, click the **Save** button.

### 8.7.6 Clearing the log information

---

**[Purpose]**

Clear the log information.

**[Operation procedure]**

Choose [Operation] - [Clear Log] on the Device Manager screen.



Immediately before clearing, the following message appears.

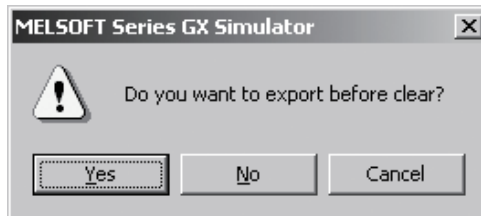

**Yes** : The log information is cleared after the log is exported.

**No** : The log information is cleared without the log being exported.

## 9. SAVING AND READING THE DEVICE AND BUFFER MEMORIES, OPTION SETTING - TOOL FUNCTIONS

---

The following three functions are available as the tool functions.

- **Function to save device memory/buffer memory data**  
Function that saves the contents of the device memory or special function module buffer memory temporarily at any timing.
- **Function to read the saved device memory/buffer memory data**  
Function that reads the saved data onto GX Simulator.

With these functions, the contents of the GX Simulator device memory or special function module buffer memory can be saved midway through debugging and the saved data can be read onto GX Simulator when debugging is restarted, allowing debugging to be continued from the status when the data was saved.

- **Option setting function**  
Function to select how to display the initial window at the start of GX Simulator  
  
With this function, whether the initial window displayed at the start of GX Simulator is minimized or not can be selected.

### 9.1 Saving the Device and Buffer Memories

---

#### [Purpose]

To temporarily save the contents of the device memory and buffer memory to allow debugging to continue after the personal computer is re-booted.

#### [Operation procedure]

- 1) Set the execution status in the initial window to STOP when the device memory or buffer memory contents are to be saved.
- 2) Select [Tools] → [Backup device memory] or [Backup buffer memory].

[Setting screen]



Click on the  **Yes** button, to save the entire device memory or the buffer memory for the slots allocated to special function modules in the I/O assignment settings. The buffer memory data is saved to the following directories:

- **A series CPU Functions**  
(Directory where the GX Simulator are installed) \Acpu\Devmem
- **QnA series CPU Functions**  
(Directory where the GX Simulator are installed) \QnAcpu\Devmem
- **FX series CPU Functions**  
(Directory where the GX Simulator are installed) \FXcpu\Devmem
- **Motion controller Functions**  
(Directories where the GX Simulator are installed)\Acpu\Devmem
- **Q series CPU Functions**  
(Directory where the GX Simulator are installed) \Qcpu\Devmem

[Example]

If C:\MELSEC is designated as the directory where the GX Simulator are installed, then the buffer memory data is saved to the following directories:

A series CPU Functions	C:\Melsec\LLT\Acpu\Devmem
QnA series CPU Functions	C:\Melsec\LLT\QnAcpu\Devmem
FX series CPU Functions	C:\Melsec\LLT\FXcpu\Devmem
Motion controller Functions	C:\Melsec\LLT\Acpu\Devmem
Q series CPU Functions	C:\Melsec\LLT\Qcpu\Devmem

**POINTS**

- (1) If the execution status is RUN, device memory/buffer memory cannot be saved.  
To save the device memory/buffer memory, change the status to STOP.
- (2) The GX Simulator can save only one file.  
If data already exists in the GX Simulator, the new file overwrites the existing data (file).



## 9.2 Reading Saved Device Memory or Buffer Memory Data

### [Purpose]

To read the stored data of device memory and buffer memory.

### [Operation procedure]

Set the execution status in the initial window to STOP. Select [Tools] → [Restore device memory] or [Restore buffer memory].

### [Setting screen]

#### Reading device memory

<A series CPU, Motion controller and Q series CPU (A Mode)>

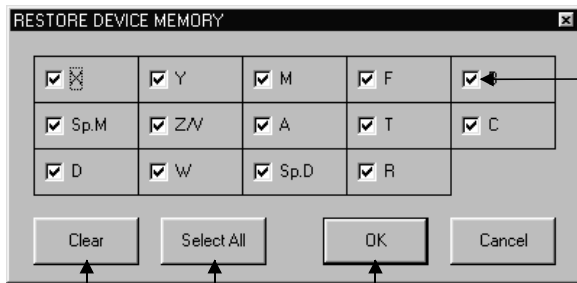

3)

4)

5)

<QnA series CPU and Q series CPU (Q Mode)>

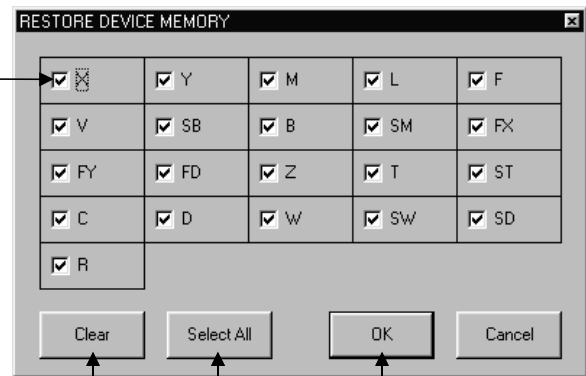

3)

4)

5)

<FX series CPU>

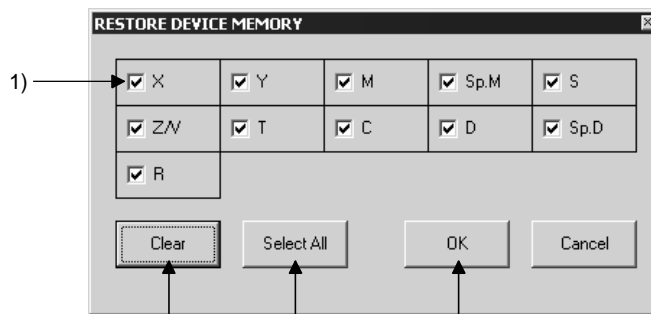

1)

3)

4)

5)

Reading buffer memory

<A series CPU, QnA series CPU, Motion controller and Q series CPU >

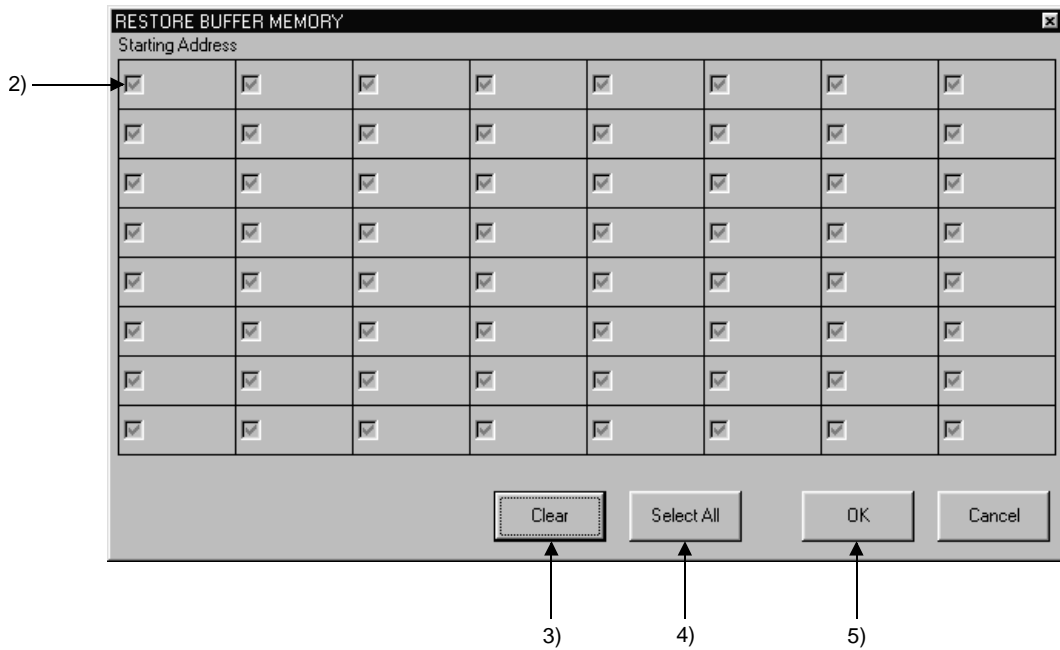

<FX series CPU>

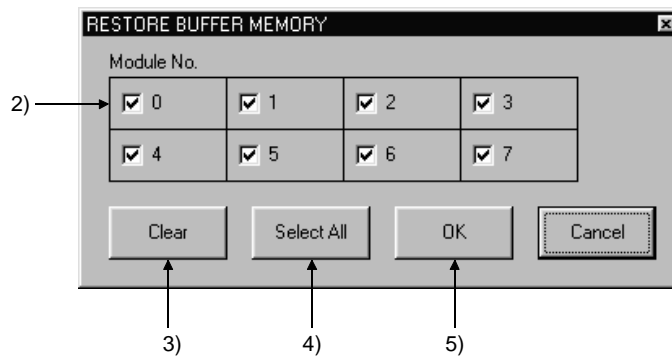

[Description]

1) Read Device Check Boxes

Click in the check boxes to select the devices read to GX Simulator.  
Click on a check box again to cancel a selection.  
All devices are selected by default.

2) Read Special Function Module Check Boxes

For A series, QnA series, Q series CPU function or motion controller function, the first I/O number to the special function module is displayed on the screen.

The special function module block number or module block number is displayed at the top of the FX series window.

Click the check box to select the special function module to be read to the GX Simulator.

Click on a check box again to cancel a selection.

All special function modules are selected by default.

Only the special function module buffer memory can be read.

3)  button

Click to clear all device or special function module selections.

4)  button

Click to select all devices or special function modules.

5)  button

Click this button after completing all settings.

**POINTS**

- (1) Device memory/buffer memory read is not allowed while the execution status is RUN.  
Change the execution status to STOP before reading device memory/buffer memory.
- (2) With the A series CPU function, QnA series CPU function, Q series CPU function or Motion controller function, selection of a slot that is not assigned to a special function module using the GX Developer I/O assignment setting is not possible.  
Before reading buffer memory, set the GX Developer I/O assignment.

### 9.3 Option Setting

**[Purpose]**

Selects how to display the initial window at the start of GX Simulator.

**[Operation procedure]**

Choose [Tools] - [Option] - [Display as minimized next time].

Every time it is chosen, the check box on the left of the menu alternates between ON and OFF.

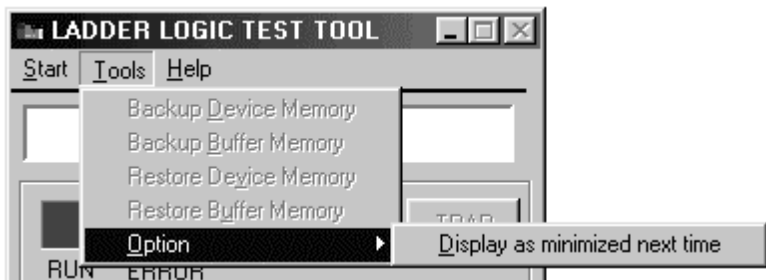

When check box is ON



When check box is OFF

When you exit from GX Simulator with the check box ON, starting GX Simulator next time displays the initial window on the task bar in the minimized status.



**POINT**

- (1) The initial setting is a "check box OFF" status.
- (2) Making selection merely turns the check box ON/OFF in the menu. At this time, the initial window is not minimized.

# 10. EXAMPLES OF GX Simulator APPLICATIONS

This chapter provides examples of debugging an actual program using the GX Simulator.

In this manual, explanations are given using the system configuration shown below and program shown on page 10-2.

### [Simulation example]

The following shows the system where sheet is fed using roller and cut by cutter. Rotation amount of roller is taken into high-speed counter unit (Channel 1 is used), roller stops when the value reaches "1000" and sheet is cut by Y20 (cut request).

Roller turns again by X10 (cut completion) from cutter to feed sheet.

### [System configuration]

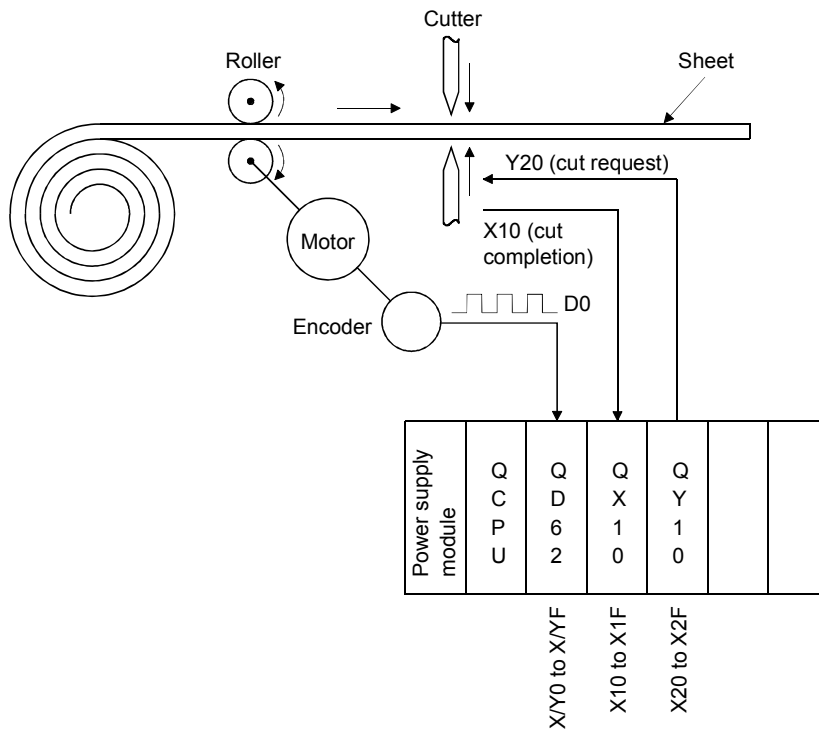

#### POINT

Program, device registration file (\*.mon), and I/O system setting file (\*.IOS) are stored in "Manual" folder of CD-ROM for the product.  
 When using them, copy them once onto the hard disk.  
 Since the sample files copied are read-only, cancel the read-only settings of all files.

[Sequence program]

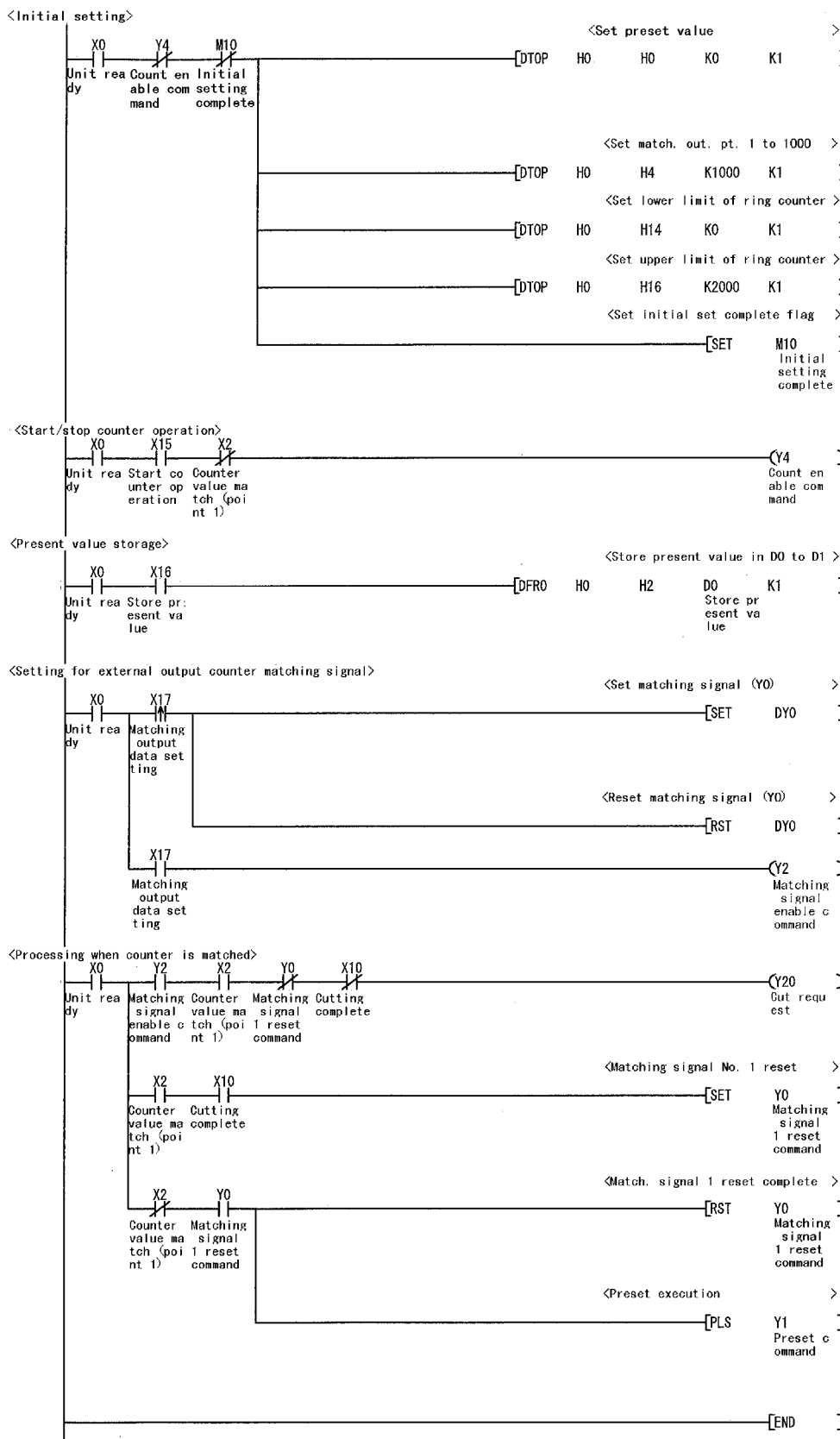

## [Devices used]

	Device No.	Signal name	Contents
High-speed counter unit signals	X0	Unit ready	Turns ON when high-speed counter unit is ready for start.
	X2	Counter value matching (point No.1)	Turns ON when present value matches the preset value of matching output point. Turns ON when value reaches "1000" in this example.
	Y0	Matching signal No. 1 reset command	Turns ON to turn X2 OFF.
	Y1	Preset command	Turns ON when executing preset functions. In this example, present value is set to "0" when preset is executed.
	Y2	Matching signal enable command	Turns ON when matching signal is output to external terminal. In this example, it can be ignored.
	Y4	Count enable command	Starts high-speed counter unit. Count can be executed only when this signal is turned ON.
Cutter operation control signals	X10	cutting complete	Turns ON when cutting of sheet is completed. Turns OFF when Y20 is turned OFF.
	Y20	Cut request	Turns ON when sheet cutting is to be executed.
Signals for ON/OFF by user	X15	Count operation start	Turns ON when executing count with high-speed counter unit.
	X16	Present value reading	Turns ON when reading present value of high-speed counter unit.
	X17	Matching output data setting	Turns ON when matching signal is externally output. Normally turns ON when matching signal is used.
Other devices	M10	Initial setting complete	Signal to inhibit initial setting at scan 2 or after.
	D0 to D1	Present value storage	Device to store present value.

## 10.1 Debugging Using GX Developer Step Execution Function

Using GX Developer independently, it is not possible to turn arbitrary devices ON/OFF or to change device values during step execution. However, using the GX Simulator allows the device values to be easily changed during step execution.

In this section, example of debugging with step execution jointly used with following program is described.

Running the program on page 10-2 and turning on X0 causes "SP. UNIT ERROR" to occur.

Carry out step execution to find out the step at which the error has taken place.

### (1) Pre-debugging operation

- 1) Start GX Developer and create the program on page 10-2.
- 2) Choose [Tools] → [Start ladder logic test] on GX Developer to start the GX Simulator.  
(At a start, the parameters and program are automatically written and SWITCH changes to RUN.)

### (2) Step execution

- 1) Set SWITCH of the GX Simulator to STEP RUN.



- 2) Turn on X0.
- 3) Move the cursor to the position where step execution will be started (step 0).
- 4) Select [Online] → [Debug] → [Debug] on GX Developer.  
In addition, select [Online] → [Debug] → [Step execution] on GX Developer. The Step Execution dialog box then appears.



- 5) Every time you click the **Step execute** button in the Step Execution dialog box, one instruction is executed.
- 6) As you click the **Step execute** button to run the program on an instruction-by-instruction basis, you will know that "SP. UNIT ERROR" occurs when [DTOP H0 H0 K0 K1] is executed.

**POINT**

"SP. UNIT ERROR" occurred because you attempted to write a value to the buffer memory using the TO instruction, without making I/O assignment. Section 9.2 gives a debugging example in which I/O assignment is made and the buffer memory is used.

- 7) Double-click "Parameter" - "Set PLC parameter" from project data list on GX Developer and click "I/O assignment" tab so that I/O assignment is as shown below.

	Slot	Type	Model	Points
0	0 (*-0)	Special	QD62	16 points
1	0 (*-1)	Input	QX10	16 points
2	0 (*-2)	Output	QY10	16 points

- 8) By updating parameter with PLC writing and setting to RUN after resetting, error will not occur even if X0 is turned ON.

## 10.2 Using Timing Chart Display for Debugging

This section explains how to check device value changing timings with the timing chart which displays the device chart using the GX Simulator.

### (1) Pre-debugging operation

- 1) Start GX Developer and create the program on page 10-2.
- 2) Double-click "Parameter" - "PLC parameter" of project data list on GX Developer, click the <<I/O assignment>> tab, and make I/O assignment as indicated below.

	Slot	Type	Model	Points
0	0 (*-0)	Special	QD62	16 points
1	0 (*-1)	Input	QX10	16 points
2	0 (*-2)	Output	QY10	16 points

- 3) Choose [Tools] → [Start ladder logic test] on GX Developer to start the GX Simulator.  
(At a start, the parameters and program are automatically written and SWITCH changes to RUN.)
- 4) Select [Start] – [Monitor Function] - [Device Memory Monitor] from initial window of GX Simulator, and start device memory monitor.

### (2) Displaying the timing chart

- 1) Running the timing chart  
Select [Start] – [Monitor Function] - [Timing Chart Display] from initial window, and start timing chart.
- 2) Register device and start monitoring.  
Register the following devices and click  button to start monitoring.  
• X0, X2, X10, X15, X16, X17, Y0, Y1, Y2, Y4, Y20, M10, D0 (Double word)
- 3) Turning X0, X15 and X17 ON (initial setting)  
X0, X15 and X17 are turned ON in sequence.  
When X0 is turned ON, M10 is turned ON, in like manner X15: Y4, and X17: Y2.

#### POINT

The timing chart retains data of up to 1000 scans.

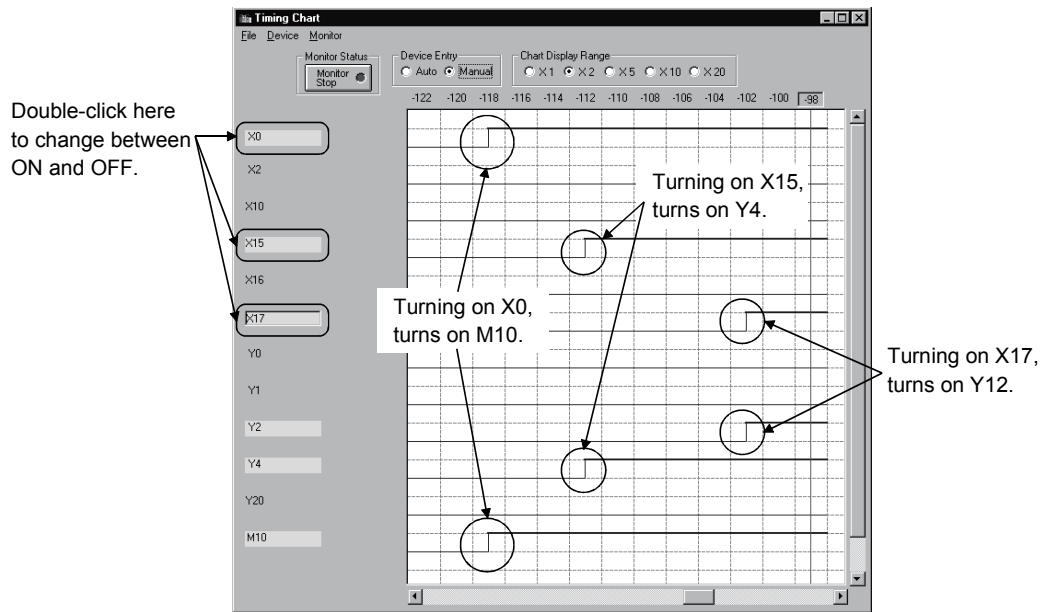

<Actual machine state>

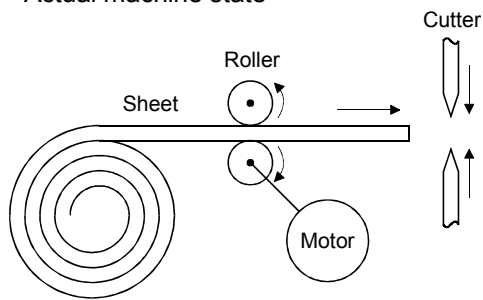

- 4) Turning X2 ON (Sheet feeding complete → start cutting)  
 Assuming that present value of high-speed counter unit matches the matching output point No. 1 (reaches 1000), turn X2 ON.  
 When X2 is turned ON, Y4 is turned OFF to stop roller operation, and cutter executes cutting by turning Y20 ON.

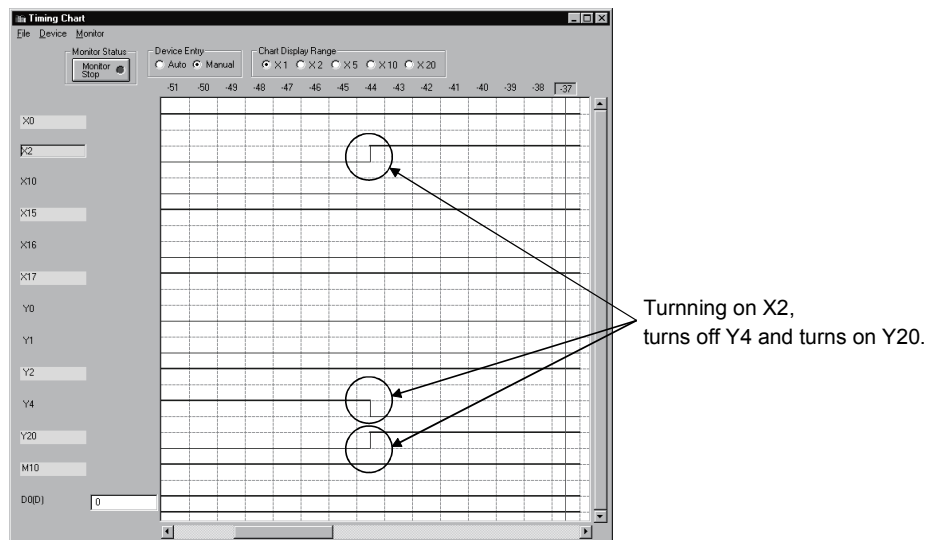

<Actual machine state>

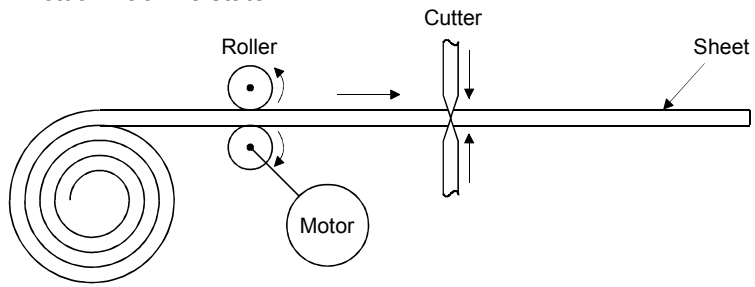

5) Turn X10 ON (cutting complete)

Assuming that cutting is complete, signal X10 sent from cutter turns ON.

When X10 is turned on, Y20 is turned OFF and Y0 is turned ON.

When Y20 is turned ON, cutter turns OFF X10. Turn X10 OFF manually.

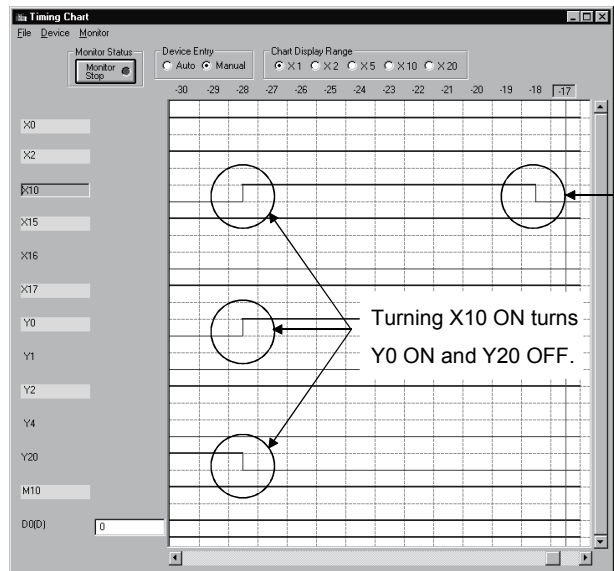

Turn X10 OFF manually.

Turning X10 ON turns Y0 ON and Y20 OFF.

<Actual machine state>

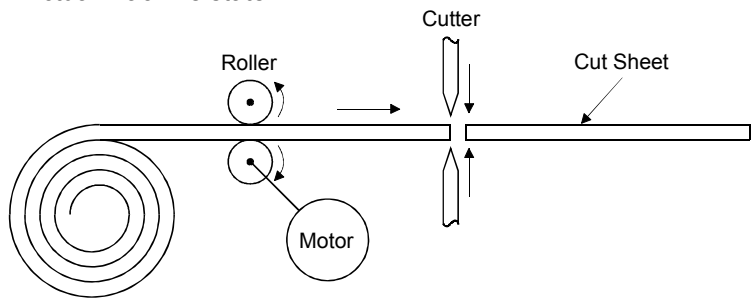

6) Turn X2 OFF (Re-starting operation)

When Y0 is turned ON, high-speed counter unit turns X2 OFF. Turn X2 OFF manually.

When X2 is turned OFF, Y0 is turned OFF, Y1 ON and then OFF and Y4 ON.

By turning Y4 ON, roller re-starts operation.

General operation of program is now complete.

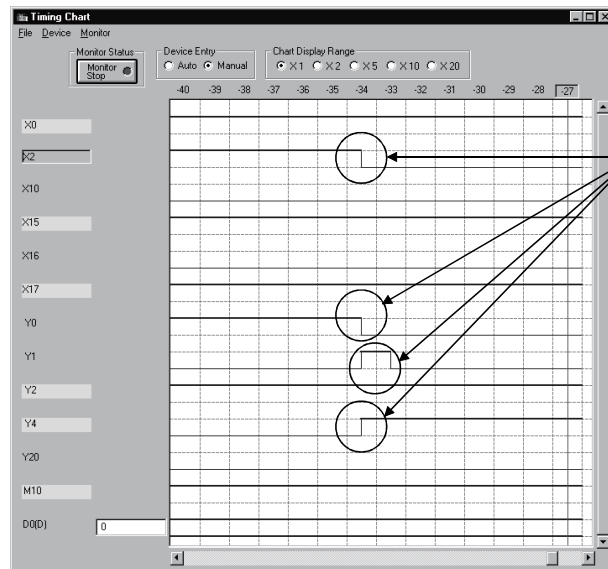

When X2 is turned OFF, Y0 is turned OFF, Y1 is turned ON for one scan and Y4 is turned ON.

<Actual machine state>

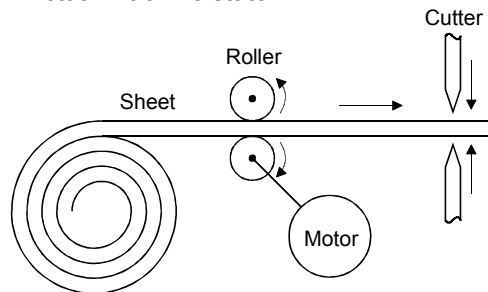

### 10.3 Using I/O System Settings for Debugging

This section describes the operation to perform simulation of external equipment using the I/O system setting.

(1) Pre-debugging operation

- 1) Start GX Developer and create the program on page 10-2.
- 2) Double-click [Parameter] - [PLC parameter] of project data list on GX Developer and click <<I/O assignment>> tab so that I/O assignment is as shown below.

	Slot	Type	Model	Points
0	0 (*-0)	Special	QD62	16 points
1	0 (*-1)	Input	QX10	16 points
2	0 (*-2)	Output	QY10	16 points

- 3) Select [Tool] - [Start ladder logic test] on GX Developer to start GX Simulator.  
(Once started, parameter and program will be automatically written and execution state is set to RUN.)
- 4) Select [Start] - [I/O System Settings] on initial window of GX Simulator to start I/O system setting.

(2) Operation of I/O system settings

1) Make the following settings.

- Timing chart input

The following setting is performed: D0 is counted up by turning Y4 ON, and X2 turns ON when count reaches 1000 (matching output).

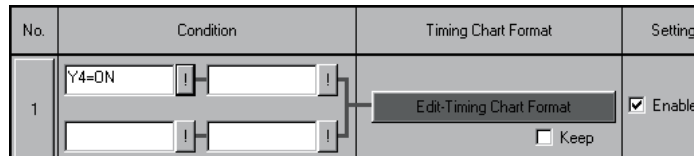

<Timing chart format input screen>

Count up D0 (32 bit integer) assuming present value.

Turn ON X2 at the moment D0 reaches 1000.

D0: Counted up in 20 count units from 0 to 49th scan.

20 (0 scan), 40, 60, 80 to 1000 (49th scan)

X2: Turned OFF 0 to 48th scan, turned ON only for 49th scan.

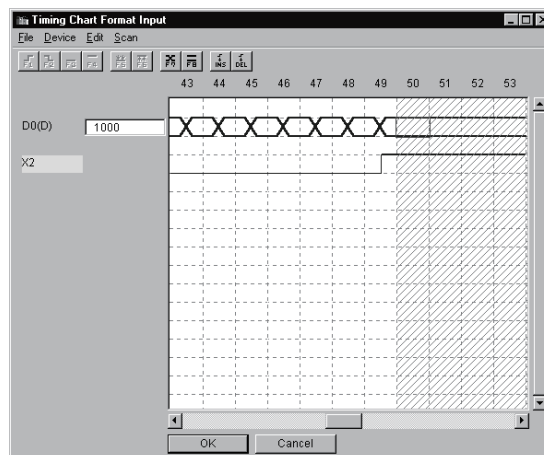

• Device value input

No.	Condition	Time ms	Input No.	Setting
1	ALWAYS ON	1 x10	X0 ON OFF	<input checked="" type="checkbox"/> Enable
2	PUSH BUTTO	1 x10	X15,X17 ON OFF	<input checked="" type="checkbox"/> Enable
3	Y20=ON	300 x10	X10 ON OFF	<input checked="" type="checkbox"/> Enable
4	Y0=ON	1 x10	X2,X10 ON OFF	<input checked="" type="checkbox"/> Enable
5	Y1=ON	1 x10	D0=0,D1=0	<input checked="" type="checkbox"/> Enable

Set No.	Contents
1	X0 (unit ready) is normally turned ON.
2	By clicking push button 0, X15 (count operation start) and X17 (matching data setting) which must be turned ON by user, can be turned ON. Operation will start by clicking push button 0.
3	When Y20 (cut request) is turned ON, X10 (cut complete) turns ON 3 seconds later. This assumes the operation through cutting has been completed, after requesting cut.
4	When Y0 (matching signal No. 1 reset command) is turned ON, X2 (counter value matching (point No. 1)) and X10 (cutting complete) are turned OFF. Operation in which turning Y0 ON turns X2 OFF assumes the operation of high-speed counter unit. Turning X10 OFF assumes the operation to return cutter signal to initial value.
5	When Y1 (preset command) is turned ON, D0 and D1 are set to "0". This assumes the preset operation of high-speed counter unit.

- 2) Save I/O system settings.
- 3) Select [File] - [Execute I/O System Settings] to execute I/O system setting.  
Execution state of GX Simulator is set to RUN.

4) Select [Online] - [Monitor Mode] to set I/O system setting to monitor mode.

When I/O system setting has been performed, the following pseudo program is created.

When running program, the pseudo program will be executed after the created program is executed.

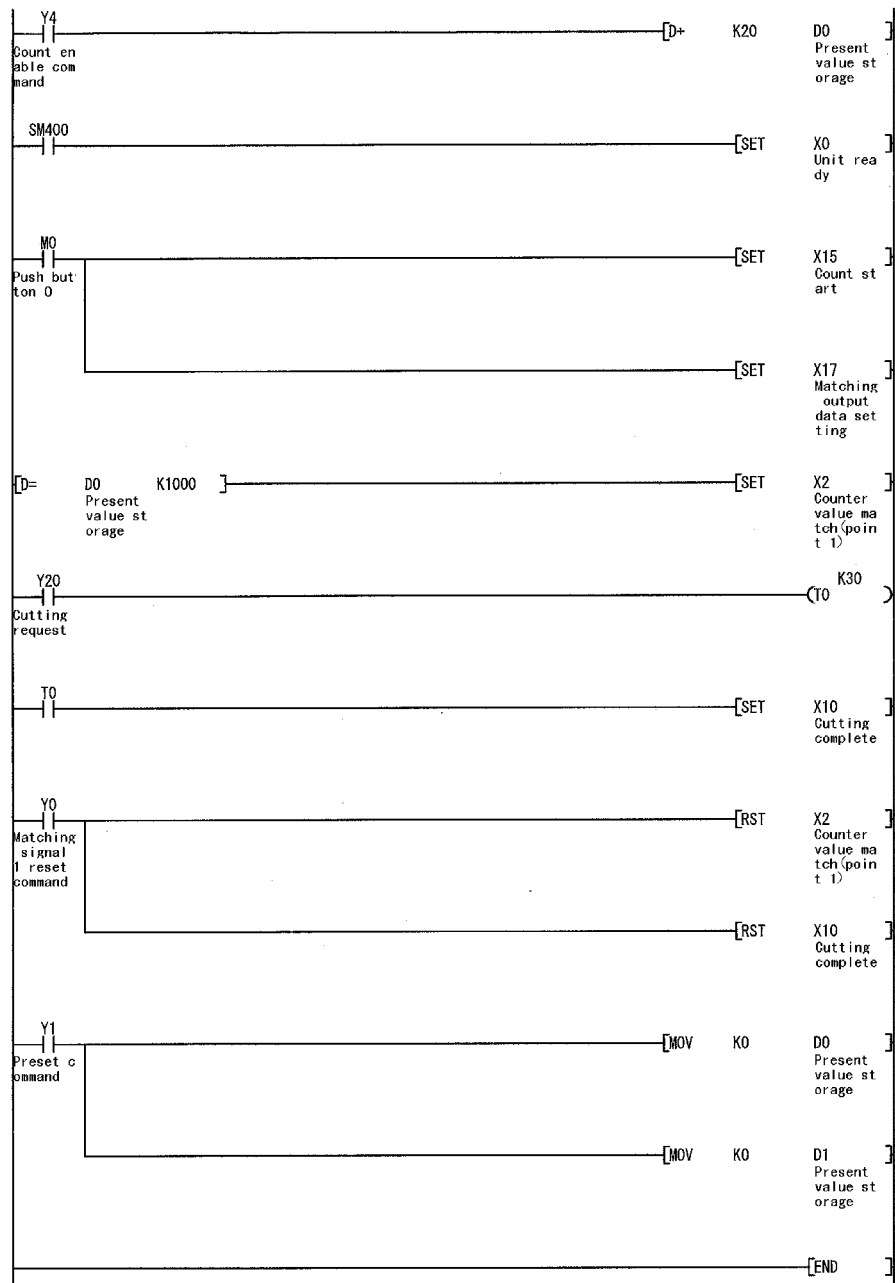



(3) Displaying timing chart

To confirm the device value, monitor using timing chart.

1) Starting the timing chart

Select [Start] – [Monitor Function] - [Timing Chart Display] from initial window to start timing chart.

2) Registering device and starting monitoring

Register the devices shown below and click **Monitor Stop** button to start monitoring.

- X0, X2, X10, X15, X16, X17, Y0, Y1, Y2, Y4, Y20, M10, D0 (Double word)

(4) Confirming the program operation

1) Click Push button 1. (Initial setting)

When Push button 0 of I/O system settings is clicked, operation will start.

By clicking Push button 0, X15 and X17 are turned ON.

Turning X15 ON turns Y4 ON, and turning X17 ON turns Y2 ON. In addition, DO will be counted up in 20-count units by turning ON Y4.

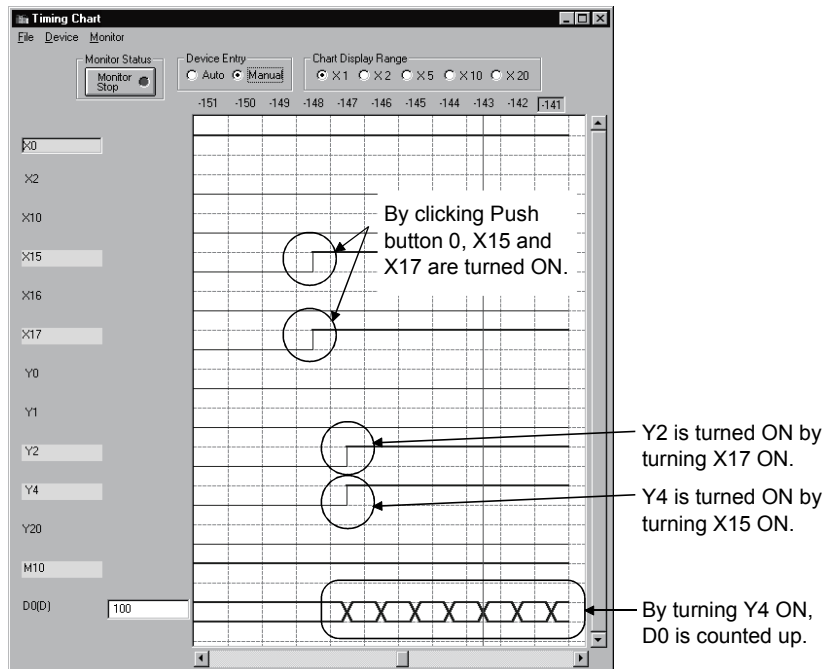
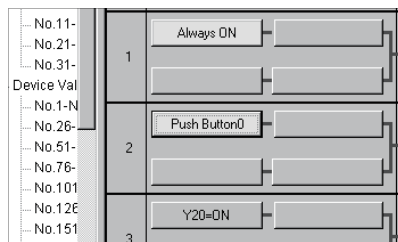

<Actual machine status>

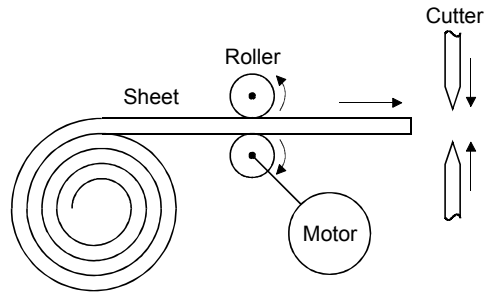

2) Turning X2 ON (Sheet feeding complete → Start cutting)

X2 is turned ON the moment D0 reaches 1000.

Y4 is turned OFF by turning X2 ON to stop roller operation, and cutting is executed by cutter when Y20 is turned ON.

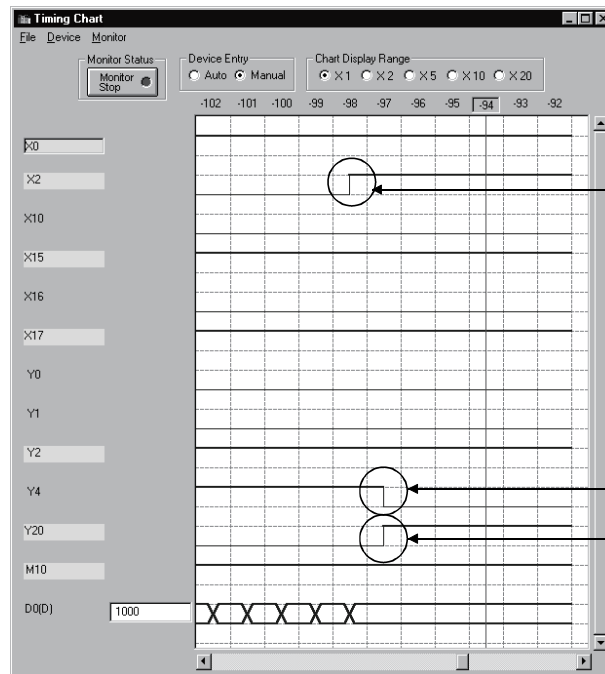

<Actual machine status>

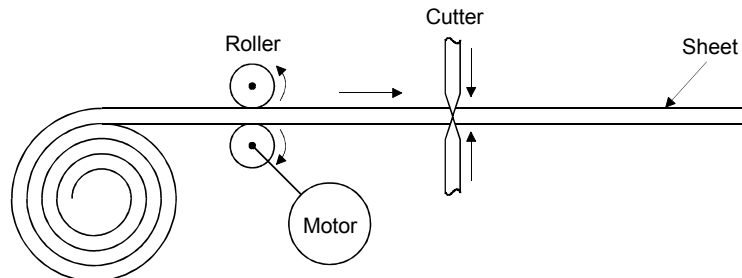

3) Turning X10 ON 3 seconds after Y20 is turned ON (Cutting completed)

Assuming that 3 seconds is needed until cutting operation is complete, X10 should be turned ON 3 seconds after Y20 is turned ON.

When X10 is turned ON, Y20 is turned OFF and Y0 is turned ON.

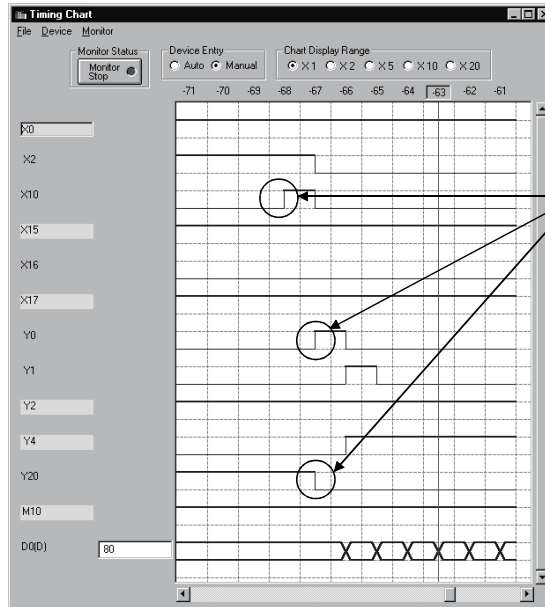

Turning on X10, turns on Y0 and turns off Y20.

<Actual machine status>

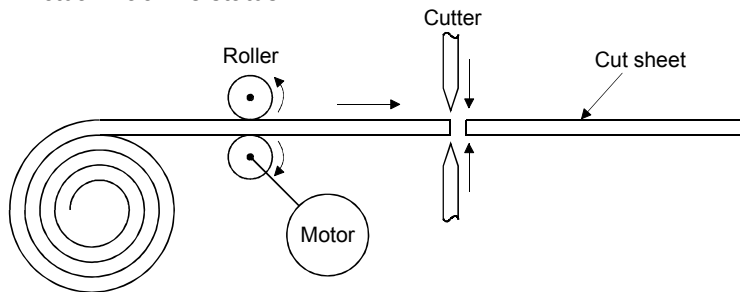

# 11. TROUBLESHOOTING

If wrong sequence programs or parameters are used, GX Simulator displays the relevant error messages on the initial window, in the following order, (1), (2).

- (1) When an error occurs and the program is stopped, the error message is displayed that indicates the cause of program stop.
- (2) If errors occur when the operating mode is set to "Continue", the error message for the first error is displayed.

## 11.1 Error Messages Displayed on the LED Indicators

This section describes error messages and error codes occurring in the GX Simulator, gives a description and cause of the error, and suggests remedies.

### (1) GX Simulator for A series CPU Functions

Error Message Table

Error Message	Error Code (D9008) * 1	Details Error Code (D9091) * 1	Error Description and Cause	Remedy
"INSTRCT CODE ERR."  (Checked at RUN → STOP or at the execution of an instruction)	10	101	The program contains an instruction code which could not be decoded by the GX Simulator.	Read the error step using GX Developer and modify the program step.
		102	Index qualification used for a 32-bit constant.	
		103	The device specified in the dedicated instruction is incorrect.	
		104	The program structure of the dedicated instruction is incorrect.	
		105	The command name of the dedicated instruction is incorrect.	
		107	(1) The index qualification used for the device number and SV in timer or counter OUT instructions. (2) The index qualification used for the label number of the pointer (P) added at the start of an instruction jump destination or for the label number of the interrupt pointer (I) added at the start of an interrupt program for the following instructions. C  SC  CALL  JMP  LEDA/B FCALL  LEDA/B  BREAK	
"MISSING END INS."  (Checked at RUN → STOP)	12	121	There is no END (FEND) instruction in the main program.	Write END in the end of main program.
		122	A sub program has been allocated in the parameters and there is no END (FEND) instruction.	Write END in the end of the sub-program.

Error Message Table (cont.)

Error Message	Error Code (D9008) * 1	Details Error Code (D9091) * 1	Error Description and Cause	Remedy
"CAN'T EXECUTE(P)"  ( Checked at the execution of the instruction )	13	131	The device number of the pointer (P) or the interrupt pointer (I) used as a label added to the destination head is duplicating.	Remove the duplicated number of pointer (P) with the destination head and correct so that the number is not duplicated.
		132	The label of the pointer (P) specified by <code>CJ</code> , <code>SCJ</code> , <code>CALL</code> , <code>CALLP</code> , <code>JMP</code> , <code>LEDA/B</code> , <code>FCALL</code> and <code>LEDA/B</code> <code>BREAK</code> instructions is not specified prior to the END instruction.	Read the error step using GX Developer, check the step and insert the destination pointer (P).
		133	(1) There is no <code>CALL</code> instruction for the <code>RET</code> instruction in the program. (2) There is no <code>FOR</code> instruction for the <code>NEXT</code> , <code>LEDA/B</code> <code>BREAK</code> instructions in the program. (3) The nesting level of <code>CALL</code> , <code>CALLP</code> , or <code>FOR</code> exceeds the nesting limit six (6) and is executing the sixth level. (4) There is no <code>RET</code> or <code>NEXT</code> instructions for the <code>CALL</code> or <code>FOR</code> instruction.	(1) Read the error step using GX Developer. Check and modify the program step. (2) Nesting level for the <code>CALL</code> , <code>CALLP</code> and <code>FOR</code> instructions must be five (5) or less.
		134	There is no parameter settings for the sub program. Can not execute the <code>CHG</code> instruction.	Read the error step using GX Developer. Delete the line containing the <code>CHG</code> instruction.
		136	There is no parameter settings for sub program 1. Can not execute the <code>ZCHG1</code> instruction.	Read the error step using GX Developer. Delete the line containing the <code>ZCHG1</code> instruction.
		137	There is no parameter settings for sub program 2. Can not execute the <code>ZCHG2</code> instruction.	Read the error step using GX Developer. Delete the line containing the <code>ZCHG2</code> instruction.
		138	There is no parameter settings for sub program 3. Can not execute the <code>ZCHG3</code> instruction.	Read the error step using GX Developer. Delete the line containing the <code>ZCHG3</code> instruction.
"WDT ERROR" ( Checked at the execution of the sequence program. )	22	220	A program instruction is executed infinitely in a single scan.	Read the error step and confirm there is no occurrence of an infinite loop.
"END NOT EXECUTE" ( Checked at the execution of the instruction. )	24	241	The entire program has been executed without executing the END instruction. (1) There is no END instruction. (2) The END instruction is replaced with some other instruction.	Please write the program to PLC again.

Error Message Table (cont.)

Error Message	Error Code (D9008) * 1	Details Error Code (D9091) * 1	Error Description and Cause	Remedy
"SP.UNIT ERROR" ( Checked at the execution of the FROM/TO instruction or special function module dedicated instruction. )	46	461	There is no special function module in the area specified by the FROM/TO instruction.	(1) Read the error step using GX Developer. Check and modify the FROM/TO instruction in the program step. (2) Correct the I/O unit allocation parameter settings.
"OPERATION ERROR"  ( Checked at the execution of the instruction )	50	501	(1) Operations using the file register (R), are executed with the device number or block number exceeding the range specified for the file register (R). (2) The file register is used in the program without setting necessary parameters for the file register (R).	(1) Read the error step using GX Developer. Check and modify the program step. (2) Set the parameters for the file register (R).
		502	The combination of devices specified by instruction is incorrect.	Read the error step using GX Developer. Check and modify the program step.
		503	The storage data or constants are not within the usable range.	
		504	The number of data handling settings exceeds the usable range.	

\* 1 Characters in parentheses ( ) indicate the special register number where the information is saved.

## (2) GX Simulator for QnA series CPU

Error Message Table

Error Message	Error Code (SD0)* 1	Error Description and Cause	Remedy
SP.UNIT LAY ERR.	2107	(1) The starting X/Y setting in the I/O allocation setting of parameter overlaps with the X/Y setting of some other module. (2) There is some data missing in the Type or Points in the I/O allocation setting of parameter.	(1) Reset the I/O allocation setting of parameter according to the actual status. (2) Set the missing data in the Type or Points in the I/O allocation setting of parameter.
SP.UNIT ERROR	2110	There is no special function module in the area specified by the FROM/TO instruction.	(1) Read the error step and correct the contents of the FROM/TO instruction. (2) Correct the I/O unit parameter settings.
MISSING PARA.	2200	Parameter file is missing.	Please write the parameter again.
FILE SET ERROR	2400	The file specified in the parameter settings is not available.	(1) Please delete the file name from the parameter settings. (2) Make a file as specified in the parameter settings.
FILE OPE.ERROR	2410	The file specified in the sequence program is not available.	(1) Check and modify the specified file name. (2) Create the specified file.
CAN'T EXE.PRG.	2501	Multiple program files exist. But, the program settings parameter is set to "None".	Change the parameter settings to "Present" or delete unnecessary programs.
	2503	No program files exist.	Please check the program configuration.
PARAMETER ERROR	3001	Parameter data is corrupted.	Please write the parameter again.
MISSING END INS.	4010	The program contains no "END (FEND)" instruction.	Please check and correct the program.
CAN'T SET(P)	4020	The total number of pointers used in the program files exceeds the maximum allowable number defined in the parameter settings.	Check the error step and correct the program.
	4021	• The common pointer Nos. assigned to files overlap. • The local pointer Nos. assigned to files overlap.	
OPERATION ERROR	4100	An instruction contains data that cannot be processed.	Check the error step and correct the program.
	4101	The instruction data exceeds the allowable number of data handled. Or the storage data constants specified in the instruction exceeds the usable range.	
FOR NEXT ERROR	4200	A FOR instruction is executed without NEXT instruction. Or the number of NEXT instructions is lower than the number of FOR instruction.	Check the error step and correct the program.
	4201	A NEXT instruction is executed without a FOR instruction. Or the number of NEXT instructions is greater than the number of FOR instructions.	
	4202	The nesting exceeds 16 loops.	Reduce nesting count to 16 or less loops.
	4203	A BREAK instruction is executed when there is no FOR instruction.	Check the error step and correct the program.
CAN'T EXECUTE (P)	4210	A CALL instruction is executed without a destination pointer.	Check the error step and correct the program.
	4211	The executed subroutine program contains no RET instruction.	
	4212	A RET instruction is existing before the FEND instruction.	
	4213	The nesting exceeds 16 loops.	Reduce nesting count to 16 or less loops.

Error Message Table (cont.)

Error Message	Error Code (SD0)*1	Error Description and Cause	Remedy
INST. FORMAT ERROR	4231	Mismatch in the number of IX and IXEND instructions.	Check the error step and correct the program.
WDT ERROR	5000	An instruction in a program of initial execution type is infinitely executed in a single scan.	Read the error step and confirm there is no occurrence of an infinite loop.
	5001	An instruction in the program is infinitely executed in a single scan.	Read the error step and confirm there is no occurrence of an infinite loop.
F* * * *	9000	The program turns ON annunciator.	Check the user condition that turns On the annunciator and make corrective action for that condition.

\*1 Characters in parentheses ( ) indicate the special register number where the information is saved.



## (3) GX Simulator for FX series CPU Functions

Error Message Table

Error Message	Error Code (D8065, D8066) * 1	Error Description and Cause	Remedy
WDT ERROR	6105	Occurrence of an infinite loop.	Check the program or contents of the operands in the application instruction.
FILE NOT FOUND	6409	Illegal parameter settings.	Correct the parameter settings and write parameters again.
INVALID CODE ERROR	6503	Data instruction code is corrupted.	Transfer the program from GX Developer again.
EXIST SAME LABEL No.	6504	Overlapping label numbers.	Check the program and correct the overlapping label numbers.
STL-MC INST.ERROR	6505	(1) There is no <b>[RET]</b> instruction. (2) MC and MCR instructions are designated within an STL state.	Check the program and correct the mutual instructions.
FOR NEXT ERROR	6607	Illegal occurrence of FOR to NEXT instructions. FOR to NEXT nesting exceeds the maximum nesting level of 6.	Check the program or contents of the operands in the application instruction.
OPERATION ERROR	6701	No jump destination is specified for CJ or CALL instruction.	Check the program or contents of the operands in the application instruction.
CAN'T EXECUTE (P)	6702	The nestings of CALL instructions exceed the maximum nesting level of 6.	Check the program or contents of the operands in the application instruction.
FOR NEXT ERROR	6704	FOR - NEXT nestings exceed the maximum nesting level of 6.	Check the program or contents of the operands in the application instruction.
OPERATION ERROR	6705	An incompatible device is specified as an operand of an application instruction.	Check the program or contents of the operands in the application instruction.
	6706	A device is specified outside the allowable range of an application instruction operand.	
	6707	A file register which is not defined in the parameter settings is accessed.	
SP. UNIT ERROR	6708	FROM - TO instruction error.	Check the program or contents of the operands in the application instruction.
OPERATION ERROR	6709	(1) Illegal nesting of FOR - NEXT instructions. (2) Illegal nesting of CALL - SRET instructions.	Check the program or contents of the operands in the application instruction.

\* 1 Characters in parentheses ( ) indicate the special register number where the information is saved.

Errors not displayed on the LED indicators are stored as operation error codes in the special data register D8067.

For devices related to error displays, refer to Appendix 1.3.

## (4) GX Simulator for Q series CPU (A Mode) Functions

The error codes of the Q series CPU (A mode) are the same as those of the A series CPU. Refer to the error message list of the GX Simulator for A series CPU functions in Section 11.1(1).

## (5) GX Simulator for Q series CPU (Q Mode) Functions

Refer to the QnA for the error message list.

Note that the following error message is specific to the Q mode.

Error Message	Error Code	Error Description and Cause	Remedy
SP PARA. ERROR	3301	There is an error in the intelligent function utility settings.	(1) Check and correct the intelligent function unit settings. (2) Check and correct the parameter settings (I/O allocation, Device settings).
INSTRCT. CODE ERR	4003	The number of devices for the dedicated instruction in the program is incorrect.	Check the error step and correct the program.
INSTRCT. CODE ERR	4004	The device which cannot be used in the dedicated instruction in the program is specified.	Check the error step and correct the program.



# APPENDICES

## Appendix 1 List of Supported Devices

The GX Simulator supports the devices for an A series CPU, QnA series CPU, Q series CPU, and FX series CPU.

For the motion controller, refer to the compatible devices of the A series CPU. For the compatible CPU, refer to Section 3.3.

The devices supported by the GX Simulator are listed in Appendix Table 1.1 to Appendix Table 1.15.

### Appendix 1.1 The A series CPU function GX Simulator

#### (1) Device list

Appendix Table 1.1 List of Devices Supported by the GX Simulator

Device * 1	Device range (Number of points)							
	A0J2H A1FX	A1N A1S A1SJ	A2C A2CJ A1S(S1)	A2N(S1) * 4	A3N A1SH A1SJH A2SH	A2A(S1)	A3A	A2U(S1) A2US(S1) A2USH-S1 A2AS(S1) A2AS-S30 A2AS-S60 A3U A4U
Input (X) * 2	X0 to X1FF (512 points)	X0 to XFF (256 points)	X00 to X1FF (512 points)	X00 to X3FF (1024 points)	X0 to X7FF (2048 points)	X00 to X3FF (1024 points)	X00 to X7FF (2048 points)	X00 to X1FFF (8192 points)
Output (Y) * 2	Y0 to Y1FF (512 points)	Y0 to YFF (256 points)	Y00 to Y1FF (512 points)	Y00 to Y3FF (1024 points)	Y0 to Y7FF (2048 points)	Y00 to Y3FF (1024 points)	Y00 to Y7FF (2048 points)	Y00 to Y1FFF (8192 points)
Internal relay (L/M/S)	M0 to M2047 (2048 points) (Usable as L/M/S by making setting)					M0 to M8191 (8192 points) (Usable as L/M/S by making setting)		
Special relay (M)	M9000 to M9255 (256 points)							
Link relay (B)	B0 to B3FF (1024 points)					B0 to BFFF (4096 points)		B0 to B1FFF (8192 points)
Annunciator (F)	F0 to F255 (256 points)					F0 to F2047 (2048 points)		
Timer (T)	T0 to T255 (256 points)					T0 to T2047 (2048 points)		
Counter (C)	C0 to C255 (256 points)					C0 to C1023 (1024 points)		
Data register (D)	D0 to D1023 (1024 points)					D0 to D6143 (6144 points)		D0 to D8191 (8192 points)
Special register (D)	D9000 to D9255 (256 points)							
Link register (W)	W0 to W3FFF (1024 points)					W0 to WFFF (8192 points)		W0 to W1FFF (8192 points)
File register (R)	R0 to R8191 (8192 points)							
Extension file register * 9	Block 1 to 64 (8k points) * 3							
Buffer register (Um\Gn) * 10	Module start address (Um) When host station is specified, m = 0 to FC (16k points), when other station is specified, m = 0 to 3F (16k points) Buffer register address (Gn) n = 0 to 16383 (16384 points)							
Accumulator (A)	A0, A1 (2 points)							
Index register (Z, V)	Z, V (2 points)					Z, Z1 to Z6, V, V1 to V6 (14 points)		
Nesting (N)	N0 to N7 (8 points)							
Pointer (P)	P0 to P255 (256 points)							
Decimal constant (K)	K-2147483648 to K2147483647							
Hexadecimal constant (H)	H0 to HFFFFFFF							

○: Compatible, ×: Incompatible, -: Irrelevant

Compatibility with functions						Remarks
Monitor function * 5	I/O system settings	Serial communication function	Device backup	Device manager		
○	○	○	○	○	○	Actual input is invalid.
○	○	○	○	○	○	Actual input is invalid.
○	○*7	○	○	○	○	—
○	○	○	○	○	○	Refer to (2) Special relay list for the supported special relays.
○	○	○	○	○	○	—
○	○	○	○	○	○	—
○	○*6	○*6	○*6	○*6	○*8	No operation is performed in real time.
○	○*6	○*6	○*6	○*6	○*8	—
○	○	○	○	○	○	—
○	○	○	○	○	○	Refer to (3) Special register list for the supported special registers.
○	○	○	○	○	○	—
○	○	○	○	○	○	File register setting of parameter is required.
○	○	○	×	×	○	—
○	○	○	×	○	○	I/O assignment setting of parameter is required.
○	○	○	×	○	○	—
○	○	○	×	○	○	—
×	×	×	×	×	×	—
×	×	×	×	×	×	—
—	—	—	—	—	—	—
—	—	—	—	—	—	Up to 8 characters per instruction

\* 1: Device I is not supported.  
 \* 2: Remote I/O included.  
 \* 3: On GX Developer of SW2D5□-GPPW or earlier, data can be written to the file registers of only block No. 1 to 48.  
 \* 4: A2NCPU operates in the device range of the A2NCPU-S1.  
 \* 5: Bit data digit specification, word data bit specification, and index qualification are available. In device memory monitor, however, they are limited to the Entry Device tab and Timing Chart.  
 \* 6: Contact/Coil/Current Value can be set. Representations are as follows. Timer: TS/TC/TN, Counter: CS/CC/CN.  
 \* 7: Specify all internal relays (M, L, S) as M. (Example) Specify L1000 as M1000.

\* 8: On the Other station device setting tab, only T/C can be represented. In the device control setting or device value check setting, only Contact/Coil/Current Value (refer to \*6 for representations) can be represented.

\* 9: How to enter the extension file register data

Entry in ER□\R□ format is applicable to only Device Batch monitor, Entry Device monitor, Timing Chart Display and Device Manager.

<Extension file register>

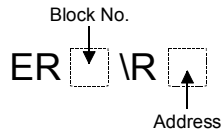

For block No. 2 and address K30, enter "ER2\R30".

\* 10: How to enter buffer register data

Entry in U□\G□ format is applicable to only Timing Chart Display, I/O System Settings and Device Manager.

<Buffer register>

Starting I/O No. of special function module

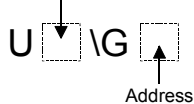

For starting I/O No. 4 and address K30, enter "U4\G30".

## (2) Special Relay List

Appendix Table 1.2 lists the special relays supported by the GX Simulator for the A series CPU functions. See the A series actual PLC User's Manual for details about the special relays.

Appendix Table 1.2 List of Special Relays Supported by the GX Simulator

Number	Name	Description
M9008	Self-diagnostic error	OFF :No error ON :Error
M9009	Annunciator detected	OFF :Not detected ON :Detected
M9010	Operation error flag	OFF :No error ON :Error
M9011	Operation error flag	OFF :No error ON :Error
M9012	Carry flag	OFF :Carry OFF ON :Carry ON
M9020	User timing clock No. 0	
M9021	User timing clock No. 1	
M9022	User timing clock No. 2	
M9023	User timing clock No. 3	
M9024	User timing clock No. 4	
M9028	Clock data read request	OFF :No processing ON :Read request
M9030 *1	0.1-second clock	
M9031 *1	0.2-second clock	

Number	Name	Description
M9032 *1	1-second clock	
M9033 *1	2-second clock	
M9034 *1	1-minute clock	
M9036	Normally ON	ON _____ OFF _____
M9037	Normally OFF	ON _____ OFF _____
M9038	ON one scan only after RUN	ON OFF _____
M9039	RUN flag (OFF one scan only after RUN)	ON _____ OFF _____
M9042	Stop status contact	OFF :Not stop status ON :Stop status
M9051	CHG instruction execution disabled	OFF :Enabled ON :Disabled
M9054	STEP RUN flag	OFF :Not STEP RUN ON :STEP RUN
M9091	Instruction error flag	OFF :No error ON :Error

\* 1: When the constant scan set value is an integral multiple of the clock time, the special relay status is OFF for every scan. For the ON/OFF setting of the special relay clock, refer to the POINT in Appendix 1.5 (2).

(3) Special Register List

Appendix Table 1.3 lists the special registers supported by the GX Simulator for the A series CPU functions. See the A series actual PLC User's Manual for details about the special registers.

Appendix Table 1.3 List of Special Registers Supported by the GX Simulator

Number	Name	Description
D9008	Self-diagnostic error	Self-diagnostic error number
D9009	Annunciator detected	F number from external breakdown
D9010	Error step	Step number where operation error occurred
D9011	Error step	Step number where operation error occurred
D9015	CPU operation status	CPU operation status
D9016	Program number	Saves the BIN value of the executing sequence program.
D9017 *1	Scan time	Minimum scan time (10 ms units)
D9018 *1	Scan time	Scan time (10ms units)
D9019 *1	Maximum scan time	Maximum scan time (10ms units)
D9020 *2	Constant scan	Constant scan time (user settable in 10 ms units)
D9021 *1	Scan time	Scan time (1 ms units)
D9022 *1	1-second counter	Number of counts in 1-second intervals
D9025	Clock data	Clock data (year, month)

Number	Name	Description
D9026	Clock data	Clock data (day, hour)
D9027	Clock data	Clock data (minute, second)
D9028	Clock data	Clock data ( , day of week)
D9035	Extension file register	Block No. used
D9036	Designates device number of extension file register.	Device number for direct access of each extension file registers device.
D9037		
D9091	Detailed error number	Self-diagnosis detailed error number
D9124	Quantity of annunciators detected	Quantity of annunciators detected
D9125	Number of detected annunciators	Number of detected annunciators
D9126		
D9127		
D9128		
D9129		
D9130		
D9131		
D9132		

\*1: Value equal to all constant scan set values. Default value is 100 ms.

\*2: The set constant time becomes the time for one scan.

Appendix 1.2 The QnA series CPU function GX Simulator

(1) Device list

Appendix Table 1.4 List of Devices Supported by the GX Simulator

Device * 1	Host station device range (Number of points)	Setting range	Other station device range (Number of points)	
Bit device	Input (X)	X0 to X1FFF (8192 points)	Fixed X0 to X1FFF (8192 points)	
	Output (Y)	Y0 to Y1FFF (8192 points)	Fixed Y0 to Y1FFF (8192 points)	
	Internal relay (M) * 4	M0 to M8191 (8192 points)	Changeable M0 to M32767 (32768 points)	
	Latch relay (L)	L0 to L8191 (8192 points)	Changeable L0 to L32767 (32768 points)	
	Annunciator (F)	F0 to F2047 (2048 points)	Changeable F0 to F32767 (32768 points)	
	Edge relay (V) * 4	V0 to V2047 (2048 points)	Changeable V0 to V32767 (32768 points)	
	Link special relay (SB)	SB0 to SB7FF (2048 points)	Fixed SB0 to SB7FFF (32768 points)	
	Link relay (B)	B0 to B1FFF (8192 points)	Changeable B0 to B7FFF (32768 points)	
	Special relay (SM)	SM0 to SM2047 (2048 points)	Fixed SM0 to SM2047 (2048 points)	
	Function input (FX) * 9	When program is used: FX0 to FX4 (5 points) Other than above: FX0 to FXF (16 points)	Fixed	When program is used: FX0 to FX4 (5 points) Other than above: FX0 to FXF (16 points)
Function output (FY) * 9	When program is used: FY0 to FY4 (5 points) Other than above: FY0 to FYF (16 points)	Fixed	When program is used: FY0 to FY4 (5 points) Other than above: FY0 to FYF (16 points)	
Word device	Data register (D) * 4	D0 to D12287 (12288 points)	Changeable D0 to D32767 (32768 points)	
	Special register (SD)	SD0 to SD2047 (2048 points)	Fixed SD0 to SD2047 (2048 points)	
	Link register (W)	W0 to W1FFF (8192 points)	Changeable W0 to W7FFF (32768 points)	
	Link special register (SW)	SW0 to SW7FF (2048 points)	Fixed SW0 to SW7FFF (32768 points)	
	Timer (T) * 4	T0 to T2047 (2048 points)	Changeable T0 to T32767 (32768 points)	
	Retentive timer (ST) * 4	From ST0 on (none)	Changeable ST0 to ST32767 (32768 points)	
	Counter (C) * 4	C0 to C1023 (1024 points)	Changeable C0 to C32767 (32768 points)	
	Function register (FD) * 2 * 9	FD0 to FD4 (5 points)	Fixed FD0 to FD4 (5 points)	
	File register (R)	From R0 on (none)	Changeable	R0 to R32767 (32768 points)
		From ZR0 on (none)		ZR0 to ZR1042431 (1042432 points)
	Buffer register (Um\Gn) * 3	Module start address (Um) m = 0 to FE	Fixed	Module start address (Um) m = 0 to FE
		Buffer register address (Gn) n = 0 to 16383 (16384 points)		Buffer register address (Gn) n = 0 to 16383 (16384 points)
	Index register (Z)	Z0 to Z15 (16 points)	Fixed Z0 to Z15 (16 points)	
Nesting (N)	N0 to N14 (15 points)	Fixed N0 to N14 (15 points)		
Pointer (P)	P0 to P4095 (4096 points)	Fixed P0 to P4095 (4096 points)		
Decimal constant (K)	K-2147483648 to K2147483647	Fixed K-2147483648 to K2147483647		
Hexadecimal constant (H)	H0 to HFFFFFFFF	Fixed H0 to HFFFFFFFF		
Real number constant	E±1.17549-38 to E±3.40282+38	Fixed E±1.17549-38 to E±3.40282+38		
Character string constant	"ABC", "123"	Fixed "ABC", "123"		



○: Compatible, ×: Incompatible, —: Irrelevant

	Compatibility with functions					Remarks
	Monitor function *7	I/O system settings	Serial communication function	Device backup	Device Manager	
	○	○	○*5	○	○	Actual input is invalid.
	○	○	○*5	○	○	Actual input is invalid.
	○	○	○	○	○	—
	○	○	○	○	○	—
	○	○	○	○	○	—
	○	○	○	○	○	—
	○	○	○	○	○	—
	○	○	○	○	○	—
	○	○	○	○	○	—
	○	○	×	○	○	Refer to (2) Special relay list for the supported special relays.
	○	○	×	○	○	—
	○	○	×	○	○	—
	○	○	○	○	○	—
	○	○	×	○	○	Refer to (3) Special register list for the supported special registers.
	○	○	○	○	○	—
	○	○	○	○	○	—
	○	○*6	○*6	○*8	○*8	No operation is performed in real time. High-speed timer can be set in 0.1ms units (by parameter).
	○	○*6	○*6	○*8	○*8	No operation is performed in real time. High-speed timer can be set in 0.1ms units (by parameter).
	○	○*6	○*6	○*8	○*8	—
	×	×	×	○	×	—
	○	○	○	○ ×	○	File register setting of parameter is required.
	○	○	×	○	○	I/O assignment setting of parameter is required.
	○	○	○	○	○	—
	×	×	×	×	×	—
	×	×	×	×	×	—
	—	—	—	—	—	—
	—	—	—	—	—	—
	—	—	—	—	—	—
	—	—	—	—	—	Up to 16 characters per instruction

\*1: Devices S, Jn\X, Jn\Y, Jn\B, Jn\SB, Jn\W, Jn\SW, I, BL and TR are not supported.  
 \*2: Cannot be monitored in Device Memory Monitor of GX Simulator. Execute the monitor/test function from GX Developer.  
 \*3: If index qualification is added to the module number, e.g. "U0Z0\G0", in the ladder, it is ignored and processed as U0\G0.  
 \*4: Device applicable as local device.  
 \*5: DX/DY can be specified.  
 \*6: Contact/Coil/Current Value can be set.  
 Representations are as follows. Timer: TS/TC/TN, Retentive timer: SS/SC/SN. However, STS/STC/STN can also be set.  
 Counter: CS/CC/CN  
 \*7: On the Entry Device monitor tab and timing chart, bit data digit specification, word data bit specification, and index qualification are available. Indirect specification is unavailable.  
 \*8: On the Other station device setting tab, only T/C can be represented. In the device control setting or device value check setting, only Contact/Coil/Current Value (refer to \*6 for representations) can be represented.  
 \*9: The function input (FX), function output (FY) and function register (FD) of only the host station are supported.

(2) Special Relay List

Appendix Table 1.5 lists the special relays supported by the GX Simulator for the QnA series CPU functions. See the QnA series actual PLC User's Manual for details about the special relays.

Appendix Table 1.5 List of Special Relays Supported by the GX Simulator

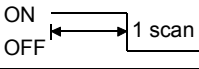
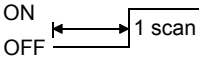
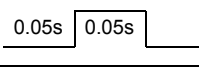
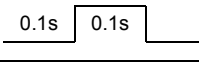
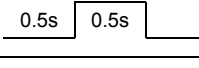
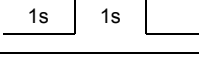
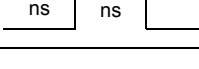
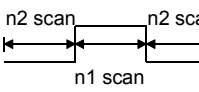
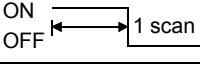
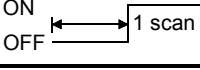
Number	Name	Description	Number	Name	Description
SM0	Diagnostic error	OFF :No error ON :Error	SM404	ON one scan only after RUN	ON  OFF
SM1	Self-diagnostic error	OFF :No self-diagnostic error ON :Self-diagnostic error	SM405	OFF one scan only after RUN	ON  OFF
SM5	Error common information	OFF :No error common information ON :Error common information	SM410 *1	0.1-second clock	
SM16	Error individual information	OFF :No error individual information ON :Error individual information	SM411 *1	0.2-second clock	
SM50	Error reset	OFF → ON :Error reset	SM412 *1	1-second clock	
SM56	Operation error	OFF :Normal ON :Operation error	SM413 *1	2-second clock	
SM62	Annunciator detected	OFF :Not detected ON :Detected	SM414 *1	2n-second clock	
SM203	STOP contacts	STOP status	SM420	User timing clock No.0	
SM205	STEP-RUN contacts	STEP-RUN status	SM421	User timing clock No.1	
SM213	Clock data read request	OFF :No processing ON :Read request	SM422	User timing clock No.2	
SM250	Max. loaded I/O read	OFF :No processing ON :Read	SM423	User timing clock No.3	
SM400	Normally ON	ON _____ OFF _____	SM424	User timing clock No.4	
SM401	Normally OFF	ON _____ OFF _____	SM430	User timing clock No.5	
SM402	ON one scan only after RUN	ON  OFF	SM431	User timing clock No.6	
SM403	OFF one scan only after RUN	ON  OFF	SM432	User timing clock No.7	
			SM433	User timing clock No.8	
			SM434	User timing clock No.9	
			SM510	Low-speed program execution flag	OFF :Complete or no execution ON :Executing

Appendix Table 1.5 List of Special Relays Supported by the GX Simulator (cont.)

Number	Name	Description
SM620	Memory card B usability flag	OFF :Unusable ON :Usable
SM621	Memory card B protection flag	OFF :Without protection ON :With protection
SM622	Drive 3 flag	OFF :Without drive 3 ON :With drive 3
SM623	Drive 4 flag	OFF :Without drive 4 ON :With drive 4
SM640	Use file register	OFF :File registers not used ON :File registers used
SM700	Carry flag	OFF :Carry OFF ON :Carry ON
SM703	Sort order	OFF :Ascending ON :Descending
SM704	Block comparison	OFF :Some do not match ON :All match
SM715	EI flag	OFF :DI ON :EI
SM1008	Self-diagnostic error	OFF :No error ON :Error
SM1009	Annunciator detected	OFF :Not detected ON :Detected
SM1011	Operation error flag	OFF :Normal ON :Operation error
SM1020	User timing clock No.0	
SM1021	User timing clock No.1	
SM1022	User timing clock No.2	
SM1023	User timing clock No.3	
SM1024	User timing clock No.4	
SM1030	0.1-second clock	
SM1031	0.2-second clock	

Number	Name	Description
SM1032	1-second clock	
SM1033	2-second clock	
SM1034	2n-second clock	
SM1036	Normally ON	ON _____ OFF _____
SM1037	Normally OFF	ON _____ OFF _____
SM1038	ON one scan only after RUN	ON OFF _____
SM1039	OFF one scan only after RUN	ON _____ OFF
SM1042	Stop status contact	OFF :Not stop status ON :Stop status
SM1054	STEP RUN flag	ON :STEP RUN OFF :Not STEP RUN

\*1: When the constant scan set value is an integral multiple of the clock time, the special relay status is OFF for every scan. For the ON/OFF setting of the special relay clock, refer to the POINT in Appendix 5.1.

(3) Special Register List

Appendix Table 1.6 lists the special registers supported by the GX Simulator for the QnA series CPU functions. See the QnA series actual PLC User's Manual for details about the special registers.

Appendix table 1.6 List of Special Registers Supported by the GX Simulator

Number	Name	Description	Number	Name	Description		
SD0	Diagnostic error	Diagnostic error number	SD70	Annunciator detected number table	Annunciator detected number		
SD1	Time the diagnostic error occurred	Time the diagnostic error occurred	SD71				
SD2			SD72				
SD3			SD73				
SD4			SD74				
SD5	Error information class	Error information class code	SD75				
SD6			SD76				
SD7			SD77				
SD8			SD78				
SD9			SD79				
SD10			Error common information	Error common information	SD200	Switch status	CPU switch status
SD11					SD203	CPU operating status	CPU operating status *3
SD12					SD210	Clock data	Clock data (year, month)
SD13					SD211	Clock data	Clock data (day, hour)
SD14					SD212	Clock data	Clock data (minute, second)
SD15	SD213	Clock data			Clock data ( , day of week)		
SD16	Error independent information	Error independent information	SD290	Device assignment	No. of X points assigned		
SD17			SD291		No. of Y points assigned		
SD18			SD292		No. of M points assigned		
SD19			SD293		No. of L points assigned		
SD20			SD294		No. of B points assigned		
SD21			SD295		No. of F points assigned		
SD22			SD296		No. of SB points assigned		
SD23			SD297		No. of V points assigned		
SD24			SD298		No. of S points assigned		
SD25			SD299		No. of T points assigned		
SD26							
SD50	Error reset	Reset error number					
SD62	Annunciator No.	Annunciator No.					
SD63	Annunciator quantity	Annunciator quantity					
SD64	Annunciator detected number table	Annunciator detected number					
SD65							
SD66							
SD67							
SD68							
SD69							

Appendix Table 1.6 List of Special Registers Supported by the GX Simulator (cont.)

Number	Name	Description
SD300	Device assignment	No. of ST points assigned
SD301		No. of C points assigned
SD302		No. of D points assigned
SD303		No. of W points assigned
SD304		No. of SW points assigned
SD412 *1	1-second counter	Number of counts in 1-second intervals
SD414 *1	2n-second clock setting	2n-second clock units
SD420	Scan counter	Number of scans counted
SD430	Low-speed scan counter	Number of scans counted
SD500	Executed program number	Program execution type.
SD510	Low-speed program number	Current low-speed execution file name
SD520 *2	Present scan time	Present scan time (1 ms units)
SD521 *2		Present scan time (1 μs units)
SD522 *2	Initial scan time	Initial scan time (1 ms units)
SD523 *2		Initial scan time (1 μs units)
SD524 *2	Minimum scan time	Minimum scan time (1 ms units)
SD525 *2		Minimum scan time (1 μs units)
SD526 *2	Maximum scan time	Maximum scan time (1 ms units)
SD527 *2		Maximum scan time (1 μs units)
SD528 *2	Current low-speed scan time	Current scan time (1 ms units)
SD529 *2		Current scan time (1 μs units)

Number	Name	Description
SD532 *2	Minimum low-speed scan time	Minimum low-speed scan time (1 ms units)
SD533 *2		Minimum scan time (1 μs units)
SD534 *2	Maximum low-speed scan time	Maximum scan time (1 ms units)
SD535 *2		Maximum scan time (1 μs units)
SD647	File register capacity	File register capacity
SD648	File register block number	File register block number
SD1008	Self-diagnostic error	Self-diagnostic error number
SD1009	Annunciator No.	Annunciator No.
SD1015	CPU operation status	CPU operation status
SD1017 *2	Scan time	Minimum scan time (10 ms units)
SD1018 *2	Scan time	Scan time (10 ms units)
SD1019 *2	Scan time	Maximum scan time (10 ms units)
SD1021 *2	Scan time	Scan time (1 ms units)
SD1022 *2	1-second counter	Number of counts of 1-second units
SD1035	Extension file register	Used block number
SD1124	Number of annunciators detected	Number of annunciators detected
SD1125	Number of annunciators detected	Number of annunciators detected
SD1126		
SD1127		
SD1128		
SD1129		
SD1130		
SD1131		
SD1132		

\*1: Value derived from the constant scan setting value and number of scans.

\*2: Values equal to all constant scan setting values.

\*3: SD203 supports the CPU operation status only. STOP/PAUSE cause is fixed at 0.

**POINT**

Special relays/registers that have contents different from those of Q4ACPU will operate by the contents of special relays/registers of Q4ACPU.

Appendix 1.3 FX series CPU function GX Simulator

(1) Device list

Appendix Table 1.7 List of Devices Supported by the GX Simulator (CPU type: FX0/FX0S)

Device		Device range (Number of points)	Compatibility with functions		
			Monitor function*2	I/O system settings	
Bit device	Input (X)	X000 to X017 (16 points)	○	○	
	Output (Y)	Y000 to Y015 (14 points)	○	○	
	Auxiliary relay (M)	General	M0 to M495 (496 points)	○	○
		Latched*1	M496 to M511 (16 points)	○	○
		Special	M8000 to M8255 (57 points)	○	○
	State (S)	Initial	S0 to S9 (10 points)	○	○
		General	S10 to S63 (54 points)	○	○
Word device	Timer (T)	100ms	T0 to T31 (32 points)	○	○
		100ms/10ms	T32 to T55 (24 points)	○	○
	Counter (C)	16 bit up	C0 to C13 (14 points)	○	○
		16 bit up*1	C14 to C15 (2 points)	○	○
	Data register (D) (32 bits when used in pairs)	16 bit general	D0 to D29 (30 points)	○	○
		16 bit latched*1	D30 to D31 (2 points)	○	○
		16 bit special	D8000 to D8255 (27 points)	○	○
16 bit index		V, Z (2 points)	○	○	
Nesting (N)	For master control	N0 to N7 (8 points)	×	×	
Pointer (P)	For JUMP, CALL branch	P0 to P63 (64 points)	×	×	
Decimal constant (K)	16 bit	-32768 to 32767	—	—	
	32 bit	-2147483648 to 2147483647	—	—	
Hexadecimal constant (H)	16 bit	H0 to HFFFF	—	—	
	32 bit	H0 to HFFFFFFFF	—	—	

○: Compatible, ×: Incompatible, -: Irrelevant

	Compatibility with functions			Remarks
	Serial communication function	Device backup	Device Manager	
	-	○	-	Octal number. Actual input is invalid.
	-	○	-	Octal number. Actual output is invalid.
	-	○	-	-
	-	○	-	
	-	○	-	
	-	○	-	-
	-	○	-	
	-	○	-	T32 to T55 are changed by M8028 drive.
	-	○	-	
	-	○	-	-
	-	○	-	
	-	○	-	-
	-	○	-	
	-	○	-	
	-	○	-	
	-	×	-	-
	-	×	-	-
	-	-	-	-
	-	-	-	-
	-	-	-	-
	-	-	-	-

\*1: Area fixed to back up for interruption: This area cannot be changed.

\*2: Bit data digit specification and word data bit specification are available.

In device memory monitor, however, they are limited to the Entry Device tab and Timing Chart.

Appendix Table 1.8 List of Devices Supported by the GX Simulator (CPU type: FX0N)

Device		Device range (Number of points)	Compatibility with functions			
			Monitor function*2	I/O system settings		
Bit device	Input (X)	Total number of points for combined use with extension	X000 to X177 (128 points)	○	○	
	Output (Y)	Total number of points for combined use with extension	Y000 to Y177 (128 points)	○	○	
	Auxiliary relay (M)	General	M0 to M383 (384 points)	○	○	
		Latched*1	M384 to M511 (128 points)	○	○	
		Special	M8000 to M8255 (67 points)	○	○	
	State (S)	Initial*1	S0 to S9 (10 points)	○	○	
Latched*1		S10 to S127 (118 points)	○	○		
Word device	Timer (T)	100ms	T0 to T31 (32 points)	○	○	
		100ms/10ms	T32 to T62 (31 points)	○	○	
		1ms	T63 (1 point)	○	○	
	Counter (C)	16 bit up	C0 to C15 (16 points)	○	○	
		16 bit up*1	C16 to C31 (16 points)	○	○	
	Data register (D) (32 bits when used in pairs)	16 bit general	D0 to D127 (128 points)	○	○	
		16 bit latched*1	D128 to D255 (128 points)	○	○	
		16 bit special	D8000 to D8255 (106 points)	○	○	
		File*1	D1000 to D2499 (1500 points)	○	○	
16 bit index		V, Z (2 points)	○	○		
Nesting (N)	For master control	N0 to N7 (8 points)	×	×		
Pointer (P)	For JUMP, CALL branch	P0 to P63 (64 points)	×	×		
Decimal constant (K)	16 bit	-32768 to 32767	-	-		
	32 bit	-2147483648 to 2147483647	-	-		
Hexadecimal constant (H)	16 bit	H0 to HFFFF	-	-		
	32 bit	H0 to HFFFFFFFF	-	-		



○: Compatible, ×: Incompatible, -: Irrelevant

	Compatibility with functions			Remarks
	Serial communication function	Device backup	Device Manager	
	-	○	-	Octal number. Actual input is invalid.
	-	○	-	Octal number. Actual output is invalid.
	-	○	-	-
	-	○	-	
	-	○	-	
	-	○	-	-
	-	○	-	
	-	○	-	T32 to T62 are changed by M8028 drive.
	-	○	-	
	-	○	-	
	-	○	-	-
	-	○	-	
	-	○	-	-
	-	○	-	
	-	○	-	
	-	○	-	
	-	○	-	
	-	×	-	-
	-	×	-	-
	-	-	-	-
	-	-	-	-
	-	-	-	-
	-	-	-	-

\*1: Area fixed to back up for interruption: This area cannot be changed.

\*2: Bit data digit specification and word data bit specification are available.

In device memory monitor, however, they are limited to the Entry Device tab and Timing Chart.

Appendix Table 1.9 List of Devices Supported by the GX Simulator (CPU type: FX1)

Device		Device range (Number of points)	Compatibility with functions			
			Monitor function*4	I/O system settings		
Bit device	Input (X)	Total number of points for combined use with extension X000 to X177 (128 points)	○	○		
	Output (Y)	Total number of points for combined use with extension Y000 to Y177 (128 points)	○	○		
	Auxiliary relay (M)	General	M0 to M499 (500 points)	○	○	
		Latched*1	M500 to M1023 (524 points)	○	○	
		Special	M8000 to M8255 (156 points)	○	○	
	State (S)	Initial*1	S0 to S9 (10 points)	○	○	
		General*1	S10 to S499 (490 points)	○	○	
		Latched*2	S500 to S899 (400 points)	○	○	
		Annunciator*3	S900 to S999 (100 points)	○	○	
	Word device	Timer (T)	100ms	T0 to T199 (200 points)	○	○
			10ms	T200 to T245 (46 points)	○	○
		Counter (C)	16 bit up*1	C0 to C99 (100 points)	○	○
16 bit up*2			C100 to C125 (36 points)	○	○	
Data register (D) (32 bits when used in pairs)		16 bit general*1	D0 to D99 (100 points)	○	○	
		16 bit latched*2	D100 to D127 (28 points)	○	○	
		16 bit special	D8000 to D8255 (106 points)	○	○	
		16 bit index	V, Z (2 points)	○	○	
Nesting (N)	For master control	N0 to N7 (8 points)	×	×		
Pointer (P)	For JUMP, CALL branch	P0 to P63 (64 points)	×	×		
Decimal constant (K)	16 bit	-32768 to 32767	-	-		
	32 bit	-2147483648 to 2147483647	-	-		
Hexadecimal constant (H)	16 bit	H0 to HFFFF	-	-		
	32 bit	H0 to HFFFFFFFF	-	-		

○: Compatible, ×: Incompatible, -: Irrelevant

	Compatibility with functions			Remarks
	Serial communication function	Device backup	Device Manager	
	-	○	-	Octal number. Actual input is invalid.
	-	○	-	Octal number. Actual output is invalid.
	-	○	-	-
	-	○	-	
	-	○	-	
	-	○	-	-
	-	○	-	
	-	○	-	
	-	○	-	
	-	○	-	-
	-	○	-	
	-	○	-	-
	-	○	-	
	-	○	-	
	-	○	-	
	-	×	-	-
	-	×	-	-
	-	-	-	-
	-	-	-	-
	-	-	-	-
	-	-	-	-

\*1: Area not backed up for interruption. However, this area can be changed to area backed up for interruption by using parameter settings.

\*2: Area backed up for interruption. This area can be changed to area not backed up for interruption by using parameter settings.

\*3: Area fixed to back up for interruption: This area cannot be changed.

\*4: Bit data digit specification and word data bit specification are available.

In device memory monitor, however, they are limited to the Entry Device tab and Timing Chart.

Appendix Table 1.10 List of Devices Supported by the GX Simulator (CPU type: FX2/FX2c)

Device		Device range (Number of points)	Compatibility with functions		
			Monitor function*4	I/O system settings	
Bit device	Input (X)	Total number of points for combined use with extension X000 to X377 (256 points)	○	○	
	Output (Y)	Total number of points for combined use with extension Y000 to Y377 (256 points)	○	○	
	Auxiliary relay (M)	General*1	M0 to M499 (500 points)	○	○
		Latched*2	M500 to M1023 (524 points)	○	○
		Latched*3	M1024 to M1535 (512 points)	○	○
		Special	M8000 to M8255 (156 points)	○	○
	State (S)	Initial*1	S0 to S9 (10 points)	○	○
		General*1	S10 to S499 (490 points)	○	○
		Latched*2	S500 to S899 (400 points)	○	○
		Annunciator*3	S900 to S999 (100 points)	○	○
Word device	Timer (T)	100ms	T0 to T199 (200 points)	○	○
		10ms	T200 to T245 (46 points)	○	○
		1ms retentive type*3	T246 to T249 (4 points)	○	○
		100ms retentive type*3	T250 to T255 (6 points)	○	○
	Counter (C)	16 bit up*1	C0 to C99 (100 points)	○	○
		16 bit up*2	C100 to C199 (100 points)	○	○
		32 bit bidirectional*1	C200 to C219 (20 points)	○	○
		32 bit bidirectional*2	C220 to C234 (15 points)	○	○
	Data register (D) (32 bits when used in pairs)	16 bit general*1	D0 to D199 (200 points)	○	○
		16 bit latched*2	D200 to D511 (312 points)	○	○
		16 bit latched*3	D512 to D999 (488 points)	○	○
		16 bit special	D8000 to D8255 (106 points)	○	○
		File*3	D1000 to D2999 (2000 points)	○	○
RAM file		D6000 to D7999 (2000 points)	○	○	
16 bit index		V, Z (2 points)	○	○	
Nesting (N)	For master control	N0 to N7 (8 points)	×	×	
Pointer (P)	For JUMP, CALL branch	P0 to P63 (64 points)	×	×	
Decimal constant (K)	16 bit	-32768 to 32767	-	-	
	32 bit	-2147483648 to 2147483647	-	-	
Hexadecimal constant (H)	16 bit	H0 to HFFFF	-	-	
	32 bit	H0 to HFFFFFFFF	-	-	

○: Compatible, ×: Incompatible, -: Irrelevant

	Compatibility with functions			Remarks
	Serial communication function	Device backup	Device Manager	
	-	○	-	Octal number. Actual input is invalid.
	-	○	-	Octal number. Actual output is invalid.
	-	○	-	-
	-	○	-	
	-	○	-	
	-	○	-	
	-	○	-	-
	-	○	-	
	-	○	-	
	-	○	-	
	-	○	-	-
	-	○	-	
	-	○	-	
	-	○	-	
	-	○	-	-
	-	○	-	
	-	○	-	
	-	○	-	
	-	○	-	
	-	○	-	
	-	○	-	
	-	×	-	-
	-	×	-	-
	-	-	-	-
	-	-	-	-
	-	-	-	-
	-	-	-	-

\*1: Area not backed up for interruption. However, this area can be changed to area backed up for interruption by using parameter settings.

\*2: Area backed up for interruption. This area can be changed to area not backed up for interruption by using parameter settings.

\*3: Area fixed to back up for interruption: This area cannot be changed.

\*4: Bit data digit specification and word data bit specification are available.

In device memory monitor, however, they are limited to the Entry Device tab and Timing Chart.

Appendix Table 1.11 List of Devices Supported by the GX Simulator (CPU type: FX1s)

Device		Device range (Number of points)	Compatibility with functions			
			Monitor function*2	I/O system settings		
Bit device	Input (X)	Total number of points for combined use with extension X000 to X017 (16 points)	○	○		
	Output (Y)	Total number of points for combined use with extension Y000 to Y015 (14 points)	○	○		
	Auxiliary relay (M)	General	M0 to M383 (384 points)	○	○	
		Latched*1	M384 to M511 (128 points)	○	○	
		Special	M8000 to M8255 (256 points)	○	○	
	State (S)	Initial*1	S0 to S9 (10 points)	○	○	
		Latched*1	S10 to S127 (118 points)	○	○	
	Word device	Timer (T)	100ms	T0 to T31 (32 points)	○	○
100ms/10ms			T32 to T62 (31 points)	○	○	
1ms			T63 (1 point)	○	○	
Counter (C)		16 bit up	C0 to C15 (16 points)	○	○	
		16 bit up*1	C16 to C31 (16 points)	○	○	
Data register (D) (32 bits when used in pairs)		16 bit general	D0 to D127 (128 points)	○	○	
		16 bit latched*1	D128 to D255 (128 points)	○	○	
		16 bit special	D8000 to D8255 (256 points)	○	○	
		File*1	D1000 to D2499 (1500 points)	○	○	
		16 bit index	V0 to V7, Z0 to Z7 (16 points)	○	○	
Nesting (N)	For master control	N0 to N7 (8 points)	×	×		
Pointer (P)	For JUMP, CALL branch	P0 to P63 (64 points)	×	×		
Decimal constant (K)	16 bit	-32768 to 32767	—	—		
	32 bit	-2147483648 to 2147483647	—	—		
Hexadecimal constant (H)	16 bit	H0 to HFFFF	—	—		
	32 bit	H0 to HFFFFFFFF	—	—		

○: Compatible, ×: Incompatible, -: Irrelevant

	Compatibility with functions			Remarks
	Serial communication function	Device backup	Device Manager	
	-	○	-	Octal number. Actual input is invalid.
	-	○	-	Octal number. Actual output is invalid.
	-	○	-	-
	-	○	-	
	-	○	-	
	-	○	-	-
	-	○	-	
	-	○	-	T32 to T62 are changed by M8028 drive.
	-	○	-	
	-	○	-	-
	-	○	-	-
	-	○	-	
	-	○	-	-
	-	○	-	
	-	○	-	
	-	○	-	
	-	○	-	
	-	×	-	-
	-	×	-	-
	-	-	-	-
	-	-	-	-
	-	-	-	-
	-	-	-	-

\*1: Area fixed to back up for interruption: This area cannot be changed.

\*2: Bit data digit specification and word data bit specification are available.

In device memory monitor, however, they are limited to the Entry Device tab and Timing Chart.

Appendix Table 1.12 List of Devices Supported by the GX Simulator (CPU type: FX1N / FX1NC)

Device		Device range (Number of points)	Compatibility with functions		
			Monitor function*2	I/O system settings	
Bit device	Input (X)	Total number of points for combined use with extension X000 to X177 (128 points)	○	○	
	Output (Y)	Total number of points for combined use with extension Y000 to Y177 (128 points)	○	○	
	Auxiliary relay (M)	General	M0 to M383 (384 points)	○	○
		Latched*1	M384 to M511 (128 points)	○	○
		Latched*1	M512 to M1535 (1024 points)	○	○
		Special	M8000 to M8255 (256 points)	○	○
	State (S)	Initial latched*1	S0 to S9 (10 points)	○	○
		Latched*1	S10 to S127 (118 points)	○	○
		Latched*1	S128 to S999 (872 points)	○	○
	Word device	Timer (T)	100ms	T0 to T199 (200 points)	○
10ms			T200 to T245 (46 points)	○	○
For 1ms retentive type latched*1			T246 to T249 (4 points)	○	○
For 100ms retentive type latched*1			T250 to T255 (6 points)	○	○
Counter (C)		16 bit up	C0 to C15 (16 points)	○	○
		16 bit up*1	C16 to C31 (16 points)	○	○
		16 bit up*1	C32 to C199 (168 points)	○	○
		32 bit bidirectional	C200 to C219 (20 points)	○	○
		32 bit bidirectional*1	C220 to C234 (15 points)	○	○
Data register (D) (32 bits when used in pairs)		16 bit general	D0 to D127 (128 points)	○	○
		16 bit latched*1	D128 to D255 (128 points)	○	○
		16 bit latched*1	D256 to D7999 (7744 points)	○	○
		16 bit special	D8000 to D8255 (256 points)	○	○
		16 bit index	V0 to V7, Z0 to Z7 (16 points)	○	○
Nesting (N)		For master control	N0 to N7 (8 points)	×	×
Pointer (P)	For JUMP, CALL branch	P0 to P127 (128 points)	×	×	
Decimal constant (K)	16 bit	-32768 to 32767	—	—	
	32 bit	-2147483648 to 2147483647	—	—	
Hexadecimal constant (H)	16 bit	H0 to HFFFF	—	—	
	32 bit	H0 to HFFFFFFFF	—	—	



○: Compatible, ×: Incompatible, -: Irrelevant

	Compatibility with functions			Remarks
	Serial communication function	Device backup	Device Manager	
	-	○	-	Octal number. Actual input is invalid.
	-	○	-	Octal number. Actual output is invalid.
	-	○	-	-
	-	○	-	
	-	○	-	
	-	○	-	
	-	○	-	-
	-	○	-	
	-	○	-	
	-	○	-	-
	-	○	-	
	-	○	-	
	-	○	-	
	-	○	-	
	-	○	-	D1000 and later can be specified as file registers.
	-	○	-	
	-	○	-	
	-	○	-	
	-	○	-	
	-	×	-	-
	-	×	-	-
	-	-	-	-
	-	-	-	-
	-	-	-	-
	-	-	-	-

\*1: Area fixed to back up for interruption: This area cannot be changed.

\*2: Bit data digit specification and word data bit specification are available.

In device memory monitor, however, they are limited to the Entry Device tab and Timing Chart.

Appendix Table 1.13 List of Devices Supported by the GX Simulator  
(CPU type: FX2N/FX2NC)

Device			Device range (Number of points)	Compatibility with functions	
				Monitor function*4	I/O system settings
Bit device	Input (X)	Total number of points for combined use with extension	X000 to X377 (256 points)	○	○
	Output (Y)	Total number of points for combined use with extension	Y000 to Y377 (256 points)	○	○
	Auxiliary relay (M)	General*1	M0 to M499 (500 points)	○	○
		Latched*2	M500 to M1023 (524 points)	○	○
		Latched*3	M1024 to M3071 (2048 points)	○	○
		Special	M8000 to M8255 (156 points)	○	○
	State (S)	Initial*1	S0 to S9 (10 points)	○	○
		General*1	S10 to S499 (490 points)	○	○
		Latched*2	S500 to S899 (400 points)	○	○
		Annunciator*3	S900 to S999 (100 points)	○	○
Word device	Timer (T)	100ms	T0 to T199 (200 points)	○	○
		10ms	T200 to T245 (46 points)	○	○
		1ms retentive type*3	T246 to T249 (4 points)	○	○
		100ms retentive type*3	T250 to T255 (6 points)	○	○
	Counter (C)	16 bit up*1	C0 to C99 (100 points)	○	○
		16 bit up*2	C100 to C199 (100 points)	○	○
		32 bit bidirectional*1	C200 to C219 (20 points)	○	○
		32 bit bidirectional*2	C220 to C234 (15 points)	○	○
	Data register (D) (32 bits when used in pairs)	16 bit general*1	D0 to D199 (200 points)	○	○
		16 bit latched*2	D200 to D511 (312 points)	○	○
		16 bit latched*3	D512 to D7999 (7488 points)	○	○
		16 bit special	D8000 to D8255 (256 points)	○	○
		16 bit index	V0 to V7, Z0 to Z7 (16 points)	○	○
	Nesting (N)	For master control	N0 to N7 (8 points)	×	×
Pointer (P)	For JUMP, CALL branch	P0 to P127 (128 points)	×	×	
Decimal constant (K)	16 bit	-32768 to 32767	-	-	
	32 bit	-2147483648 to 2147483647	-	-	
Hexadecimal constant (H)	16 bit	H0 to HFFFF	-	-	
	32 bit	H0 to HFFFFFFFF	-	-	

○: Compatible, ×: Incompatible, -: Irrelevant

	Compatibility with functions			Remarks
	Serial communication function	Device backup	Device Manager	
	-	○	-	Octal number. Actual input is invalid.
	-	○	-	Octal number. Actual output is invalid.
	-	○	-	-
	-	○	-	
	-	○	-	
	-	○	-	
	-	○	-	-
	-	○	-	
	-	○	-	
	-	○	-	
	-	○	-	-
	-	○	-	
	-	○	-	
	-	○	-	
	-	○	-	-
	-	○	-	
	-	○	-	
	-	○	-	
	-	○	-	
	-	×	-	-
	-	×	-	-
	-	-	-	-
	-	-	-	-
	-	-	-	-
	-	-	-	-

\*1: Area not backed up for interruption. However, this area can be changed to area backed up for interruption by using parameter settings.

\*2: Area backed up for interruption. This area can be changed to area not backed up for interruption by using parameter settings.

\*3: Area fixed to back up for interruption: This area cannot be changed.

\*4: Bit data digit specification and word data bit specification are available.

In device memory monitor, however, they are limited to the Entry Device tab and Timing Chart.

Appendix Table 1.14 List of Devices Supported by the GX Simulator  
(CPU type: FX3G)

Device		Device range (Number of points)	Compatibility with functions		
			Monitor function*4	I/O system settings	
Bit device	input (X)	Total number of points for combined use with extension X000 to X177 (128 points)	○	○	
	output (Y)	Total number of points for combined use with extension Y000 to Y177 (128 points)	○	○	
	Auxiliary relay (M)	General	M0 to M383 (384 points)	○	○
		Latched*3	M384 to M7679 (7296 points)	○	○
		Special	M8000 to M8511 (512 points)	○	○
	State (S)	Initial*1	S0 to S9 (10 points)	○	○
Latched*3		S10 to S4095 (4086 points)	○	○	
Word device	Timer (T)	100ms	T0 to T199 (200 points)	○	○
		10ms	T200 to T245 (46 points)	○	○
		1ms retentive type*3	T246 to T249 (4 points)	○	○
		100ms retentive type*3	T250 to T255 (6 points)	○	○
		1ms*3	T256 to T319 (64 points)	○	○
	Counter (C)	16 bit up*1	C0 to C15 (16 points)	○	○
		16 bit up*2	C16 to C199 (184 points)	○	○
		32 bit bidirectional*1	C200 to C219 (20 points)	○	○
		32 bit bidirectional*2	C220 to C234 (15 points)	○	○
	Data register (D) (32 bits when used in pairs)	16 bit general*1	D0 to D127 (128 points)	○	○
		16 bit latched*2	D128 to D255 (128 points)	○	○
		16 bit latched*3	D256 to D7999 (7744 points)	○	○
		16 bit special	D8000 to D8511 (512 points)	○	○
	Data register (R)	16 bit index	V0 to V7, Z0 to Z7 (16 points)	○	○
		16 bit latched	R0 to D23999 (24000 points)	○	○
Nesting (N)	For master control	N0 to N7 (8 points)	×	×	
Pointer (P)	For JUMP, CALL branch	P0 to P2047 (2048 points)	×	×	
Decimal constant (K)	16 bit	-32768 to 32767	-	-	
	32 bit	-2147483648 to 2147483647	-	-	
Hexadecimal constant (H)	16 bit	H0 to HFFFF	-	-	
	32 bit	H0 to HFFFFFFFF	-	-	

○: Compatible, ×: Incompatible, -: Irrelevant

	Compatibility with functions			Remarks
	Serial communication function	Device backup	Device Manager	
	-	○	-	Octal number, Actual Input is invalid.
	-	○	-	Octal number, Actual Output is invalid.
	-	○	-	-
	-	○	-	
	-	○	-	
	-	○	-	-
	-	○	-	
	-	○	-	
	-	○	-	-
	-	○	-	
	-	○	-	
	-	○	-	-
	-	○	-	
	-	○	-	
	-	○	-	-
	-	○	-	
	-	○	-	
	-	○	-	-
	-	○	-	
	-	○	-	
	-	×	-	-
	-	×	-	-
	-	-	-	-
	-	-	-	-
	-	-	-	-
	-	-	-	-

- \*1: Area not backed up for interruption. This area cannot be changed to area backed up for interruption by using parameter settings.
- \*2: Area backed up for interruption. This area cannot be changed to area not backed up for interruption by using parameter settings.
- \*3: Area fixed to back up for interruption: This area cannot be changed.
- \*4: Bit data digit specification and word data bit specification are available. In device memory monitor, however, they are limited to the Entry Device tab and Timing Chart.

Appendix Table 1.15 List of Devices Supported by the GX Simulator  
(CPU type: FX3U/FX3UC)

Device		Device range (Number of points)	Compatibility with functions			
			Monitor function*5	I/O system settings		
Bit device	input (X)	Total number of points for combined use with extension	X000 to X377 (256 points)	○	○	
	output (Y)	Total number of points for combined use with extension	Y000 to Y377 (256 points)	○	○	
	Auxiliary relay (M)	General*1	M0 to M499 (500 points)	○	○	
		Latched*2	M500 to M1023 (524 points)	○	○	
		Latched*3	M1024 to M7679 (6656 points)	○	○	
		Special	M8000 to M8511 (512 points)	○	○	
	State (S)	Initial*1	S0 to S9 (10 points)	○	○	
		General*1	S10 to S499 (490 points)	○	○	
		Latched*2	S500 to S899 (400 points)	○	○	
		Annunciator*3	S900 to S999 (100 points)	○	○	
		Latched*3	S1000 to S4095 (3096 points)	○	○	
	Word device	Timer (T)	100ms	T0 to T199 (200 points)	○	○
			10ms	T200 to T245 (46 points)	○	○
			1ms retentive type*3	T246 to T249 (4 points)	○	○
			100ms retentive type*3	T250 to T255 (6 points)	○	○
1ms*3			T256 to T511 (256 points)	○	○	
Counter (C)		16 bit up*1	C0 to C99 (100 points)	○	○	
		16 bit up*2	C100 to C199 (100 points)	○	○	
		32 bit bidirectional*1	C200 to C219 (20 points)	○	○	
		32 bit bidirectional*2	C220 to C234 (15 points)	○	○	
Data register (D) (32 bits when used in pairs)		16 bit general*1	D0 to D199 (200 points)	○	○	
		16 bit latched*2	D200 to D511 (312 points)	○	○	
		16 bit latched*3	D512 to D7999 (7488 points)	○	○	
		16 bit special	D8000 to D8511 (512 points)	○	○	
Data register (R)		16 bit index	V0 to V7, Z0 to Z7 (16 points)	○	○	
		16 bit latched	R0 to D32767 (32768 points)	○	○	
Buffer register*4	16 bit	Un\G0 to Un\G32767 (32768 points)	○	○		
Nesting (N)	For master control	N0 to N7 (8 points)	×	×		
Pointer (P)	For JUMP, CALL branch	P0 to P4095 (4096 points)	×	×		
Decimal constant (K)	16 bit	-32768 to 32767	—	—		
	32 bit	-2147483648 to 2147483647	—	—		
Hexadecimal constant (H)	16 bit	H0 to HFFFF	—	—		
	32 bit	H0 to HFFFFFFF	—	—		
Real number constant		E ±1.17549-37 to E ±3.40282+38	—	—		
Character string constant		"ABC", "123"	—	—		



(2) Special Relay List

Appendix Table 1.16 lists the special relays supported by the GX Simulator for the FX series CPU functions. See the FX series actual PLC Programming Manual for details about the special relays.

Appendix Table 1.16 List of Special Relays Supported by the GX Simulator

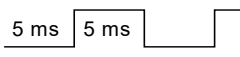
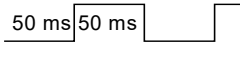
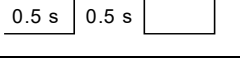
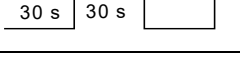
No.	Name	Description	FX0, FX0S	FX0N	FX1	FX2, FX2C	FX1S	FX1N, FX1NC	FX2N, FX2NC	FX3G	FX3U, FX3UC
M8000	RUN monitor N/O contact	OFF: STOP ON : RUN					○				
M8001	RUN monitor N/C contact	OFF: RUN ON : STOP					○				
M8002	Initial pulse N/O contact	ON one scan after RUN					○				
M8003	Initial pulse N/C contact	OFF one scan after RUN					○				
M8004	Error occurred	ON if any of M8060 to M8067 operates.					○				
M8011	10 ms clock						○				
M8012	100 ms clock						○				
M8013	1 s clock						○				
M8014	1 min clock						○				
M8018	Internal real-time clock detected	Normally ON	-	-	-	△	○	○	△	○	○
M8020	Zero	ON if counting result is 0					○				
M8021	Borrow	ON if counting result is less than maximum minus value.					○				
M8022	Carry	ON if counting result increases a digit.					○				
M8023	Decimal-point operation instruction	ON when floating decimal-point instruction is executed.	-	-	-	○	-	-	-	-	-
M8024	Designate BMOV direction	ON : Write OFF: Read	-	-	-	-	-	○	○	○	○
M8026	RAMP mode designation	ON : Hold output value OFF: Reset output value	-	-	-	○	-	-	○	-	○
M8028	Switch timer instruction	OFF: 100 ms base ON : 10 ms base	○	○	-	-	○	-	-	-	-
M8029	Instruction execution complete	OFF: Executing ON : Execution complete					○				
M8031	Non-hold memory all clear instruction	OFF: Hold ON : Clear					○				



Appendix Table 1.16 List of Special Relays Supported by the GX Simulator (cont.)

No.	Name	Description	FX <sub>0</sub> , FX <sub>0S</sub>	FX <sub>0N</sub>	FX <sub>1</sub>	FX <sub>2</sub> , FX <sub>2C</sub>	FX <sub>1S</sub>	FX <sub>1N</sub> , FX <sub>1NC</sub>	FX <sub>2N</sub> , FX <sub>2NC</sub>	FX <sub>3G</sub>	FX <sub>3U</sub> , FX <sub>3UC</sub>
M8032	Hold memory all clear instruction	OFF: Hold ON : Clear					○				
M8033	Memory hold stop instruction	OFF: Clear ON : Hold					○				
M8034	Disable all outputs instruction	OFF: Output enabled ON : Output OFF					○				
M8038	RAM file clear instruction	OFF: Hold ON : Clear	—	—	—	○	—	—	—	—	○
M8039	Constant scan mode designation	OFF: Normal scan ON : Constant scan mode					○				
M8040	Disable transition instruction	OFF: Transition enabled ON : Transition disabled					○				
M8041	Transition start instruction (for IST command)	OFF: Stop ON : Transition start					○				
M8042	Start pulse instruction (for IST command)	ON : IST command start instruction					○				
M8043	Home position return complete instruction (for IST command)	ON : IST command home position return instruction					○				
M8044	Home position condition (for IST command)	ON : Home position OFF: Home position return not complete					○				
M8045	All output reset disabled (for IST command)	ON : Reset disabled OFF: Reset enabled					○				
M8046	STL state operation	ON if any of S0 to S899 operates.					○				
M8047	STL monitor enable	ON : D8040 to D8047 enabled					○				
M8048	Annunciator operation	ON if any of S900 to S999 operates.	—	—	○	○	—	—	○	○	○
M8049	Annunciator enable instruction	ON : D8049 enabled OFF: D8049 enabled	—	—	○	○	—	—	○	○	○
M8067	Operation error occurred	ON : Operation error OFF: No operation error					○				
M8068	Operation error latch	Holds M8067 status					○				
M8074	RAM file register setting	ON : Use OFF: Do not use	—	—	—	○	—	—	—	—	—
M8090	BKCOMP instruction - block comparison signal	ON : Comparison result all matched OFF: Comparison result unmatched	—	—	—	—	—	—	—	—	○
M8091	Output character number selector	ON : No change OFF: Storing 00H (NULL)	—	—	—	—	—	—	—	—	○

Appendix Table 1.16 List of Special Relays Supported by the GX Simulator (cont.)

No.	Name	Description	FX <sub>0</sub> , FX <sub>0S</sub>	FX <sub>0N</sub>	FX <sub>1</sub>	FX <sub>2</sub> , FX <sub>2C</sub>	FX <sub>1S</sub>	FX <sub>1N</sub> , FX <sub>1NC</sub>	FX <sub>2N</sub> , FX <sub>2NC</sub>	FX <sub>3G</sub>	FX <sub>3U</sub> , FX <sub>3UC</sub>
M8160	XCH SWAP function setting	ON : 8-bit conversion OFF: Normal mode	—	—	—	○	—	—	○	—	○
M8161	8-bit processing mode	ASC, ASCII, HEX processing method	—	○	—	○	○	○	○	○	○
M8164	Change number of FROM/TO instruction transfer points	Transfer points switch instruction	—	—	—	—	—	—	○	—	○
M8168	SMOV HEX data handling functions	Digit shift in 4-bit unit	—	—	—	○	—	—	○	○	○
M8200	Counting direction of counter	ON : C200 down OFF: C200 up	—	—	—	○	—	○	○	○	○
M8201	Counting direction of counter	ON : C201 down OFF: C201 up	—	—	—	○	—	○	○	○	○
M8202	Counting direction of counter	ON : C202 down OFF: C202 up	—	—	—	○	—	○	○	○	○
M8203	Counting direction of counter	ON : C203 down OFF: C203 up	—	—	—	○	—	○	○	○	○
M8204	Counting direction of counter	ON : C204 down OFF: C204 up	—	—	—	○	—	○	○	○	○
M8205	Counting direction of counter	ON : C205 down OFF: C205 up	—	—	—	○	—	○	○	○	○
M8206	Counting direction of counter	ON : C206 down OFF: C206 up	—	—	—	○	—	○	○	○	○
M8207	Counting direction of counter	ON : C207 down OFF: C207 up	—	—	—	○	—	○	○	○	○
M8208	Counting direction of counter	ON : C208 down OFF: C208 up	—	—	—	○	—	○	○	○	○
M8209	Counting direction of counter	ON : C209 down OFF: C209 up	—	—	—	○	—	○	○	○	○
M8210	Counting direction of counter	ON : C210 down OFF: C210 up	—	—	—	○	—	○	○	○	○
M8211	Counting direction of counter	ON : C211 down OFF: C211 up	—	—	—	○	—	○	○	○	○
M8212	Counting direction of counter	ON : C212 down OFF: C212 up	—	—	—	○	—	○	○	○	○
M8213	Counting direction of counter	ON : C213 down OFF: C213 up	—	—	—	○	—	○	○	○	○
M8214	Counting direction of counter	ON : C214 down OFF: C214 up		—	—	—	○	—	○	○	○
M8215	Counting direction of counter	ON : C215 down OFF: C215 up		—	—	—	○	—	○	○	○

Appendix Table 1.16 List of Special Relays Supported by the GX Simulator (cont.)

No.	Name	Description	FX <sub>0</sub> , FX <sub>0S</sub>	FX <sub>0N</sub>	FX <sub>1</sub>	FX <sub>2</sub> , FX <sub>2C</sub>	FX <sub>1S</sub>	FX <sub>1N</sub> , FX <sub>1NC</sub>	FX <sub>2N</sub> , FX <sub>2NC</sub>	FX <sub>3G</sub>	FX <sub>3U</sub> , FX <sub>3UC</sub>
M8216	Counting direction of counter	ON : C216 down OFF: C216 up	—	—	—	○	—	○	○	○	○
M8217	Counting direction of counter	ON : C217 down OFF: C217 up	—	—	—	○	—	○	○	○	○
M8218	Counting direction of counter	ON : C218 down OFF: C218 up	—	—	—	○	—	○	○	○	○
M8219	Counting direction of counter	ON : C219 down OFF: C219 up	—	—	—	○	—	○	○	○	○
M8220	Counting direction of counter	ON : C220 down OFF: C220 up	—	—	—	○	—	○	○	○	○
M8221	Counting direction of counter	ON : C221 down OFF: C221 up	—	—	—	○	—	○	○	○	○
M8222	Counting direction of counter	ON : C222 down OFF: C222 up	—	—	—	○	—	○	○	○	○
M8223	Counting direction of counter	ON : C223 down OFF: C223 up	—	—	—	○	—	○	○	○	○
M8224	Counting direction of counter	ON : C224 down OFF: C224 up	—	—	—	○	—	○	○	○	○
M8225	Counting direction of counter	ON : C225 down OFF: C225 up	—	—	—	○	—	○	○	○	○
M8226	Counting direction of counter	ON : C226 down OFF: C226 up	—	—	—	○	—	○	○	○	○
M8227	Counting direction of counter	ON : C227 down OFF: C227 up	—	—	—	○	—	○	○	○	○
M8228	Counting direction of counter	ON : C228 down OFF: C228 up	—	—	—	○	—	○	○	○	○
M8229	Counting direction of counter	ON : C229 down OFF: C229 up	—	—	—	○	—	○	○	○	○
M8230	Counting direction of counter	ON : C230 down OFF: C230 up	—	—	—	○	—	○	○	○	○
M8231	Counting direction of counter	ON : C231 down OFF: C231 up	—	—	—	○	—	○	○	○	○
M8232	Counting direction of counter	ON : C232 down OFF: C232 up	—	—	—	○	—	○	○	○	○
M8233	Counting direction of counter	ON : C233 down OFF: C233 up	—	—	—	○	—	○	○	○	○
M8234	Counting direction of counter	ON : C234 down OFF: C234 up	—	—	—	○	—	○	○	○	○
M8316	Unconnected I/O designation error	Turns ON when designating an unconnected I/O.	—	—	—	—	—	—	—	○	○
M8329	Instruction execution abnormal end	Turns ON when instructions abnormally ended.	—	—	—	—	—	—	—	○	○

○: This device or function is supported by the actual PLC.

—: This device or function is not supported by the actual PLC.

△: This device is supported by actual PLCs with a clock function.

For the GX Simulator, always ON regardless whether the actual PLC has a clock function.

(3) Special Register List

Appendix Table 1.17 lists the special registers supported by the GX Simulator for the FX series CPU functions. See the FX series actual PLC Programming Manual for details about the special registers.

Appendix Table 1.17 List of Special Registers Supported by the GX Simulator

No.	Name	Description	FX0, FX0S	FX0N	FX1	FX2, FX2C	FX1S	FX1N, FX1NC	FX2N, FX2NC	FX3G	FX3U, FX3UC
D8000	Watchdog timer	200 ms *1	○								
D8001	PLC type and system version	*2	○								
D8002	Memory capacity	Maximum value for model	○								
D8004	Error M number	M8060 to M8068	○								
D8006	Low battery voltage detection level	30 (0.1 V units)	—	—	○	○	—	—	○	○	○
D8010	Scan present value	0.1 ms units *3	○								
D8011	Minimum scan time	0.1 ms units *3	○								
D8012	Maximum scan time	0.1 ms units *3	○								
D8013	Seconds	Operates as 1-second clock	—	—	—	△	○	○	△	○	○
D8014	Minutes	Time data	—	—	—	△	○	○	△	○	○
D8015	Hours	Time data	—	—	—	△	○	○	△	○	○
D8016	Day	Time data	—	—	—	△	○	○	△	○	○
D8017	Month	Time data	—	—	—	△	○	○	△	○	○
D8018	Year	Time data	—	—	—	△	○	○	△	○	○
D8019	Day of week	Time data	—	—	—	△	○	○	△	○	○
D8028	Z register contents	Z register contents	○								
D8029	V register contents	V register contents	○								
D8030	Analog volume 1	*4	—	○	—	—	○	○	—	○	—
D8031	Analog volume 2	*4	—	○	—	—	○	○	—	○	—
D8039	Constant scan time	Initial value: 100 ms (1 ms units) *5	○								
D8040	ON state number 1	STL monitor contents	○								
D8041	ON state number 2	STL monitor contents	○								
D8042	ON state number 3	STL monitor contents	○								
D8043	ON state number 4	STL monitor contents	○								
D8044	ON state number 5	STL monitor contents	○								
D8045	ON state number 6	STL monitor contents	○								
D8046	ON state number 7	STL monitor contents	○								
D8047	ON state number 8	STL monitor contents	○								
D8049	ON state minimum number	STL monitor contents	○								
D8067	Operation error code number	Error code number	○								
D8068	Operation error occurred step number latch	Saves step number where error occurred	○								

Appendix Table 1.17 List of Special Registers Supported by the GX Simulator (cont.)

No.	Name	Description	FX <sub>0</sub> , FX <sub>0S</sub>	FX <sub>0N</sub>	FX <sub>1</sub>	FX <sub>2</sub> , FX <sub>2C</sub>	FX <sub>1S</sub>	FX <sub>1N</sub> , FX <sub>1NC</sub>	FX <sub>2N</sub> , FX <sub>2NC</sub>	FX <sub>3G</sub>	FX <sub>3U</sub> , FX <sub>3UC</sub>
D8069	M8067 error occurred step number	Step number where error occurred	○								
D8101	PLC type and system version	*6	—	—	—	—	—	—	—	○	○
D8102	Memory capacity	Maximum value for model	—	—	—	—	○	○	○	○	○
D8164	Designate number of FROM/TO instruction transfer points	Write transfer points	—	—	—	—	—	—	○	○	○
D8182	Z1 register contents	Z1 register contents	—	—	—	—	○	○	○	○	○
D8183	V1 register contents	V1 register contents	—	—	—	—	○	○	○	○	○
D8184	Z2 register contents	Z2 register contents	—	—	—	—	○	○	○	○	○
D8185	V2 register contents	V2 register contents	—	—	—	—	○	○	○	○	○
D8186	Z3 register contents	Z3 register contents	—	—	—	—	○	○	○	○	○
D8187	V3 register contents	V3 register contents	—	—	—	—	○	○	○	○	○
D8188	Z4 register contents	Z4 register contents	—	—	—	—	○	○	○	○	○
D8189	V4 register contents	V4 register contents	—	—	—	—	○	○	○	○	○
D8190	Z5 register contents	Z5 register contents	—	—	—	—	○	○	○	○	○
D8191	V5 register contents	V5 register contents	—	—	—	—	○	○	○	○	○
D8192	Z6 register contents	Z6 register contents	—	—	—	—	○	○	○	○	○
D8193	V6 register contents	V6 register contents	—	—	—	—	○	○	○	○	○
D8194	Z7 register contents	Z7 register contents	—	—	—	—	○	○	○	○	○
D8195	V7 register contents	V7 register contents	—	—	—	—	○	○	○	○	○
D8312	Operation error step number latched (Lower)		—	—	—	—	—	—	—	—	○
D8313	Operation error step number latched (Upper)		—	—	—	—	—	—	—	—	○
D8314	Error step number of M8065 to M8067 (Lower)		—	—	—	—	—	—	—	—	○
D8315	Error step number of M8065 to M8067 (Upper)		—	—	—	—	—	—	—	—	○
D8316	Unconnected I/O designation error step number latched (Lower)		—	—	—	—	—	—	—	○	○
D8317	Unconnected I/O designation error step number latched (Upper)		—	—	—	—	—	—	—	○	○

- : This device or function is supported by the actual PLC.
- : This device or function is not supported by the actual PLC.
- △: This device is supported by actual PLCs with a clock function.  
For the GX Simulator, stores internal clock data of PC (personal computer).
- \*1: Initial value: 200 ms for all models. Can be changed but no watchdog timer check is conducted.
- \*2: FX<sub>0</sub>, FX<sub>0S</sub> ..... 20000  
FX<sub>0N</sub>..... 20000  
FX<sub>1</sub>..... 21000  
FX<sub>2</sub>, FX<sub>2C</sub> .....20000  
FX<sub>1S</sub> ..... 22000  
FX<sub>1N</sub>, FX<sub>1NC</sub>.....26000  
FX<sub>2N</sub>, FX<sub>2NC</sub>.....24000  
FX<sub>3G</sub>..... 26000  
FX<sub>3U</sub>, FX<sub>3UC</sub>.....24000
- \*3: Values equal to all constant scan setting values. Default value is 100 ms.
- \*4: Operates as a general data register. Test by writing values from 0 to 255 using the GX Developer device test functions.
- \*5: The set constant time becomes the time for one scan.
- \*6: FX<sub>3U</sub>, FX<sub>3UC</sub> ..... 16000

Appendix 1.4 GX Simulator for Q series CPU (A mode) functions

- (1) Device list  
Since the devices of the Q series CPU (A mode) are the same as those of the A4UCPU, refer to A4U in "Appendix Table 1.1 List of Devices Supported by the GX Simulator".
- (2) Special relay list  
Since the special relays of the Q series CPU (A mode) are the same as those of the A series CPU, refer to "Appendix Table 1.2 List of Special Relays Supported by the GX Simulator".
- (3) Special register list  
Since the special registers of the Q series CPU (A mode) are the same as those of the A series CPU, refer to "Appendix Table 1.3 List of Special Registers Supported by the GX Simulator".

Appendix 1.5 GX Simulator for Q series CPU (Q mode) functions

- (1) Device list
  - (a) Other than Universal model QCPUs

Appendix Table 1.18 List of Devices Supported by the GX Simulator

Device*1	Host station device range (Number of points)	Setting range	Other station device range (Number of points)	
Bit device	Input (X)	X0 to X1FFF (8192 points)	Fixed	X0 to X1FFF (8192 points)
	Output (Y)	Y0 to Y1FFF (8192 points)	Fixed	Y0 to Y1FFF (8192 points)
	Internal relay (M)*4	M0 to M8191 (8192 points)	Changeable	M0 to M32767 (32768 points)
	Latch relay (L)	L0 to L8191 (8192 points)	Changeable	L0 to L32767 (32768 points)
	Annunciator (F)	F0 to F2047 (2048 points)	Changeable	F0 to F32767 (32768 points)
	Edge relay (V)*4	V0 to V2047 (2048 points)	Changeable	V0 to V32767 (32768 points)
	Link special relay (SB)	SB0 to SB7FFF (2048 points)	Fixed	SB0 to SB7FFF (32768 points)
	Link relay (B)	B0 to B1FFF (8192 points)	Changeable	B0 to B7FFF (32768 points)
	Special relay (SM)	SM0 to SM2047 (2048 points)	Fixed	SM0 to SM2047 (2048 points)
	Function input (FX)*9	When program is used:FX0 to FX4 (5 points) Other than above:FX0 to FXF (16 points)	Fixed	When program is used:FX0 to FX4 (5 points) Other than above:FX0 to FXF (16 points)
	Function output (FY)*9	When program is used:FY0 to FY4 (5 points) Other than above:FY0 to FYF (16 points)	Fixed	When program is used:FY0 to FY4 (5 points) Other than above:FY0 to FYF (16 points)
Word device	Data register (D)*4	D0 to D12287 (12288 points)	Changeable	D0 to D32767 (32768 points)
	Special register (SD)	SD0 to SD2047 (2048 points)	Fixed	SD0 to SD2047 (2048 points)
	Link register (W)	W0 to W1FFF (8192 points)	Changeable	W0 to W7FFF (32768 points)
	Link special register (SW)	SW0 to SW7FFF (2048 points)	Fixed	SW0 to SW7FFF (32768 points)
	Timer (T)*4	T0 to T2047 (2048 points)	Changeable	T0 to T32767 (32768 points)

○: Compatible, ×: Incompatible, -: Irrelevant

	Compatibility with functions					Remarks
	Monitor function *7	I/O system settings	Serial communication function	Device backup	Device Manager	
	○	○	○*5	○	○	Actual input is invalid.
	○	○	○*5	○	○	Actual output is invalid.
			○			-
			○			-
			○			-
			○			-
			○			-
	○	○	×	○	○	Refer to (2) Special Relay List for the supported special relays.
	○	○	×	○	○	-
	○	○	×	○	○	-
	○	○	○	○	○	-
	○	○	×	○	○	Refer to (3) Special Device List for the supported special registers.
			○			-
			○			-
	○	○*6	○*6	○*8	○*8	No operation is performed in real time. High-speed timer can be set in 0.1ms units (by parameter). 1ms units for conventional GX Simulator.

- \*1: Devices S, Jn\X, Jn\Y, Jn\B, Jn\SB, Jn\W, Jn\SW, I, BL and TR are not supported.
- \*4: Device applicable as local device.
- \*5: DX/DY can be specified.
- \*6: Contact/Coil/Current Value can be set.  
Representations are as follows. Timer: TS/TC/TN, Retentive timer: SS/SC/SN. However, STS/STC/STN can also be set.  
Counter: CS/CC/CN
- \*7: On the Entry Device tab and timing chart, bit data digit specification, word data bit specification, and indexing are available. Indirect designation is unavailable.
- \*8: On the Other station device setting tab, only T/C can be represented. In the device control setting or device value check setting, only Contact/Coil/Current Value (refer to \*6 for representations) can be represented.
- \*9: The function input (FX), function output (FY) and function register (FD) of only the host station are supported.

Appendix Table 1.18 List of Devices Supported by the GX Simulator (cont.)

Device*1	Host station device range (Number of points)	Setting range	Other station device range (Number of points)	
Word device	Retentive timer (ST)*4	From ST0 on (none)	Changeable	ST0 to ST32767 (32768 points)
	Counter (C)*4	C0 to C1023 (1024 points)	Changeable	C0 to C32767 (32768 points)
	Function register (FD)*2*9	FD0 to FD4 (5 points)	Fixed	FD0 to FD4 (5 points)
	File register (R/ZR)	From R0 on (none)	Changeable	R0 to R32767 (32768 points) ZR0 to ZR1042431 (1042432 points)
		From ZR0 on (none)		
	Buffer register (Um\Gn)*3	Module start address (Um) m = 0 to FE (255 points)	Fixed	Module start address (Um) m = 0 to FE (255 points)
		Buffer register address (Gn) n = 0 to 65535 (65536 points)		Buffer register address (Gn) n = 0 to 65535 (65536 points)
Index register (Z)	Z0 to Z15 (16 points)	Fixed	Z0 to Z15 (16 points)	
CPU shared memory (Um\Gn)	m = 3E0 to 3E3 n = 0 to 4095 (4096 points)	Fixed	m = 3E0 to 3E3 n = 0 to 4095 (4096 points)	
Nesting (N)	N0 to N14 (15 points)	Fixed	N0 to N14 (15 points)	
Pointer (P)	P0 to P4095 (4096 points)	Fixed	P0 to P4095 (4096 points)	
Decimal constant (K)	K-2147483648 to K2147483647	Fixed	K-2147483648 to K2147483647	
Hexadecimal constant (H)	H0 to HFFFFFFFF	Fixed	H0 to HFFFFFFFF	
Real number constant	E±1.17549-38 to E±3.40282+38	Fixed	E±1.17549-38 to E±3.40282+38	
Character string constant	"ABC", "123"	Fixed	"ABC", "123"	



○: Compatible, ×: Incompatible, —: Irrelevant

	Compatibility with functions					Remarks
	Monitor function*7	I/O system settings	Serial communication function	Device backup	Device Manager	
	○	○*6	○*6	○*8	○*8	No operation is performed in real time. High-speed retentive timer can be set in 0.1ms units (by parameter). 1ms units for conventional GX Simulator
	○	○*6	○*6	○*8	○*8	—
	○*2	×	×	○	×	—
	○	○	○	○	○	—
	○	○	×	○	○	I/O assignment setting of parameter is required.
	○		○			—
	×		×			Valid for only multiple PLC setting on the own machine.
	×		×			—
	×		×			—
	—		—			—
	—		—			—
	—		—			—
	—		—			Up to 16 characters per instruction

\*1: Devices S, Jn\X, Jn\Y, Jn\B, Jn\SB, Jn\W, Jn\SW, I, BL and TR are not supported.

\*2: Can be monitored by the device memory monitor function. Cannot be monitored by the timing chart display function.

\*3: If indexing is added to the module number, e.g. "U0Z0\G0", in the ladder, it is ignored and processed as U0\G0.

\*4: Device applicable as local device.

\*5: DX/DY can be specified.

\*6: Contact/Coil/Current Value can be set.

Representations are as follows. Timer: TS/TC/TN, Retentive timer: SS/SC/SN. However, STS/STC/STN can also be set.

Counter: CS/CC/CN

\*7: On the Entry Device monitor tab and timing chart, bit data digit specification, word data bit specification, and index qualification are available. Indirect specification is unavailable.

\*8: On the Other station device setting tab, only T/C can be represented. In the device control setting or device value check setting, only Contact/Coil/Current Value (refer to \*6 for representations) can be represented.

\*9: The function input (FX), function output (FY) and function register (FD) of only the host station are supported.

(b) Universal model QCPUs

Appendix Table 1.19 List of Devices Supported by the GX Simulator

Device*1	Host station device range (Number of points)	Setting range	Other station device range (Number of points)		
Bit device	Input (X)	X0 to X1FFF (8192 points)	Fixed	X0 to X1FFF (8192 points)	
	Output (Y)	Y0 to Y1FFF (8192 points)	Fixed	Y0 to Y1FFF (8192 points)	
	Internal relay (M)*3	M0 to M8191 (8192 points)	Changeable	M0 to M61439 (61440 points)	
	Latch relay (L)	L0 to L8191 (8192 points)	Changeable	L0 to L32767 (32768 points)	
	Annunciator (F)	F0 to F2047 (2048 points)	Changeable	F0 to F32767 (32768 points)	
	Edge relay (V)*3	V0 to V2047 (2048 points)	Changeable	V0 to V32767 (32768 points)	
	Link special relay (SB)	SB0 to SB7FF (2048 points)	Fixed	SB0 to SB7FFF (32768 points)	
	Link relay (B)	B0 to B1FFF (8192 points)	Changeable	B0 to BEFFF (61440 points)	
	Special relay (SM)	SM0 to SM2047 (2048 points)	Fixed	SM0 to SM2047 (2048 points)	
	Function input (FX)*4	When program is used:FX0 to FX4 (5 points) Other than above:FX0 to FXF (16 points)	Fixed	When program is used:FX0 to FX4 (5 points) Other than above:FX0 to FXF (16 points)	
	Function output (FY)*4	When program is used:FY0 to FY4 (5 points) Other than above:FY0 to FYF (16 points)	Fixed	When program is used:FY0 to FY4 (5 points) Other than above:FY0 to FYF (16 points)	
Word device	Data register (D)*3	D0 to D12287 (12288 points)	Changeable	D0 to D32767 (32768 points)	
	Special register (SD)	SD0 to SD2047 (2048 points)	Fixed	SD0 to SD2047 (2048 points)	
	Link register (W)	W0 to W1FFF (8192 points)	Changeable	W0 to W7FFF (32768 points)	
	Link special register (SW)	SW0 to SW7FF (2048 points)	Fixed	SW0 to SW7FFF (32768 points)	
	Timer (T)*3	T0 to T2047 (2048 points)	Changeable	T0 to T32767 (32768 points)	

○: Compatible, ×: Incompatible, -: Irrelevant

	Compatibility with functions					Remarks
	Monitor function*2	I/O system settings	Serial communication function	Device backup	Device Manager	
	○	○	-	○	-	Actual input is invalid.
	○	○	-	○	-	Actual output is invalid.
	○	○	-	○	-	-
	○	○	-	○	-	-
	○	○	-	○	-	-
	○	○	-	○	-	-
	○	○	-	○	-	-
	○	○	-	○	-	-
	○	○	-	○	-	Refer to (2) Special Relay List for the supported special relays.
	○	○	-	○	-	-
	○	○	-	○	-	-
	○	○	-	○	-	Refer to (3) Special Device List for the supported special registers.
	○	○	-	○	-	-
	○	○	-	○	-	-
	○	○*5	-	○*6	-	No operation is performed in real time. High-speed timer can be set in 0.1ms units (by parameter). 1ms units for conventional GX Simulator.

- \*1: Devices S, Jn\X, Jn\Y, Jn\B, Jn\SB, Jn\W, Jn\SW, I, BL and TR are not supported.
- \*2: On the Entry Device tab and timing chart, bit data digit specification, word data bit specification, and indexing are available. Indirect designation is unavailable.
- \*3: Device applicable as local device.
- \*4: The function input (FX), function output (FY) and function register (FD) of only the host station are supported.
- \*5: Contact/Coil/Current Value can be set.  
Representations are as follows. Timer: TS/TC/TN, Retentive timer: SS/SC/SN. However, STS/STC/STN can also be set.  
Counter: CS/CC/CN
- \*6: On the Other station device setting tab, only T/C can be represented. In the device control setting or device value check setting, only Contact/Coil/Current Value (refer to \*5 for representations) can be represented.

Appendix Table 1.19 List of Devices Supported by the GX Simulator (cont.)

Device*1	Host station device range (Number of points)	Setting range	Other station device range (Number of points)	
Word device	Retentive timer (ST)*3	From ST0 on (none)	Changeable	ST0 to ST32767 (32768 points)
	Counter (C)*3	C0 to C1023 (1024 points)	Changeable	C0 to C32767 (32768 points)
	Function register (FD)*4*7	FD0 to FD4 (5 points)	Fixed	FD0 to FD4 (5 points)
	File register (R/ZR)	From R0 on (none)	Changeable	R0 to R32767 (32768 points)
		From ZR0 on (none)		ZR0 to ZR4184063 (4184064 points)
	Extended data register(D)	D0 to D12287 (12288 points)	Changeable	D0 to D4184063 (4184064 points)
	Extended link register(W)	W0 to W1FFF (8192 points)	Changeable	W0 to W3FD7FF (4184064 points)
	Intelligent function module device (Um\Gn)*8	Module start address (Um) m = 0 to FE (255 points)	Fixed	Module start address (Um) m = 0 to FE (255 points)
		Buffer register address (Gn) n = 0 to 65535 (65536 points)		Buffer register address (Gn) n = 0 to 65535 (65536 points)
	Index register (Z)	Z0 to Z19 (20 points)	Fixed	Z0 to Z19 (20 points)
CPU shared memory (Um\Gn)	m = 3E0 to 3E3 n = 0 to 4095 (4096 points)	Fixed	m = 3E0 to 3E3 n = 0 to 4095 (4096 points)	
	m = 3E0 to 3E3 n = 10000 to 24335 (14336 points)		m = 3E0 to 3E3 n = 10000 to 24335 (14336 points)	
Nesting (N)	N0 to N14 (15 points)	Fixed	N0 to N14 (15 points)	
Pointer (P)	P0 to P4095 (4096 points)	Fixed	P0 to P4095 (4096 points)	
Decimal constant (K)	K-2147483648 to K2147483647	Fixed	K-2147483648 to K2147483647	
Hexadecimal constant (H)	H0 to HFFFFFFFF	Fixed	H0 to HFFFFFFFF	
Real number constant	E±1.17549-38 to E±3.40282+38	Fixed	E±1.17549-38 to E±3.40282+38	
	E±2.2250738585072014-308 to E±1.7976931348623157+308		E±2.2250738585072014-308 to E±1.7976931348623157+308	
Character string constant	"ABC", "123"	Fixed	"ABC", "123"	

○: Compatible, ×: Incompatible, —: Irrelevant

	Compatibility with functions					Remarks
	Monitor function*2	I/O system settings	Serial communication function	Device backup	Device Manager	
	○	○*5	—	○*6	—	No operation is performed in real time. High-speed retentive timer can be set in 0.1ms units (by parameter). 1ms units for conventional GX Simulator.
	○	○*5	—	○*6	—	—
	○*8	×	—	○	—	—
	○	○	—	○	—	—
	○	○	—	×	—	—
	○	○	—	○	—	—
	○	○	—	○	—	—
	○	○	—	○	—	I/O assignment setting of parameter is required.
	○	—	—	○	—	—
	×	—	—	×	—	Valid for only multiple PLC setting on the own machine.
	×	—	—	×	—	—
	×	—	—	×	—	—
	×	—	—	×	—	—
	—	—	—	—	—	—
	—	—	—	—	—	—
	—	—	—	—	—	In the single precision representation.
	—	—	—	—	—	In the double precision representation. A double precision real number is invalid for the same precision as one in actual PLCs cannot be kept in GX Simulator.
	—	—	—	—	—	Up to 16 characters per instruction.

\*1: Devices S, Jn\X, Jn\Y, Jn\B, Jn\SB, Jn\W, Jn\SW, I, BL and TR are not supported.

\*2: On the Entry Device monitor tab and timing chart, bit data digit specification, word data bit specification, and index qualification are available. Indirect specification is unavailable.

\*3: Device applicable as local device.

\*4: The function input (FX), function output (FY) and function register (FD) of only the host station are supported.

\*5: Contact/Coil/Current Value can be set.

Representations are as follows. Timer: TS/TC/TN, Retentive timer: SS/SC/SN. However, STS/STC/STN can also be set.  
Counter: CS/CC/CN

\*6: On the Other station device setting tab, only T/C can be represented. In the device control setting or device value check setting, only Contact/Coil/Current Value (refer to \*5 for representations) can be represented.

\*7: Can be monitored by the device memory monitor function. Cannot be monitored by the timing chart display function.

\*8: If indexing is added to the module number, e.g. "U0Z0\G0", in the ladder, it is ignored and processed as U0\G0.

(2) Special Relay List

Appendix Table 1.20 lists the special relays supported by GX Simulator for the Q series CPU (Q mode) functions. For details of the special relays, refer to the Q Series CPU (Q Mode) PLC CPU User's Manual.

Appendix Table 1.20 List of Special Relays Supported by the GX Simulator

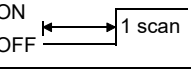
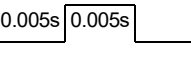
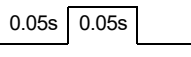
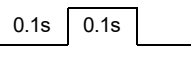
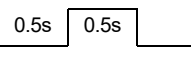
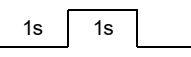
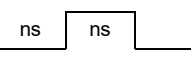
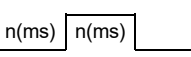
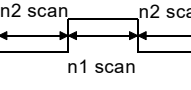
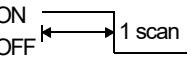
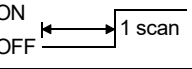
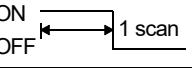
Number	Name	Description	Number	Name	Description
SM0	Diagnostic error	OFF :No error ON :Error	SM405	OFF one scan only after RUN	ON  OFF
SM1	Self-diagnostic error	OFF :No self-diagnostic error ON :Self-diagnostic error	SM409 *1	0.01-second clock	
SM5	Error common information	OFF :No error common information ON :Error common information	SM410 *1	0.1-second clock	
SM16	Error individual information	OFF :No error individual information ON :Error individual information	SM411 *1	0.2-second clock	
SM50	Error reset	OFF → ON :Error reset	SM412 *1	1-second clock	
SM56	Operation error	OFF :Normal ON :Operation error	SM413 *1	2-second clock	
SM62	Annunciator detected	OFF :Not detected ON :Detected	SM414 *1	2n-second clock	
SM203	STOP contacts	STOP status	SM415 *1	2n(ms)-clock	
SM205	STEP-RUN contacts	STEP-RUN status	SM420	User timing clock No.0	
SM213	Clock data read request	OFF :No processing ON :Read request	SM421	User timing clock No.1	
SM250	Max. loaded I/O read	OFF :No processing ON :Read	SM422	User timing clock No.2	
SM254	All station refresh command	OFF :Reached station refresh ON :All station refresh	SM423	User timing clock No.3	
SM400	Normally ON	ON _____ OFF	SM424	User timing clock No.4	
SM401	Normally OFF	ON _____ OFF _____	SM430	User timing clock No.5	
SM402	ON one scan only after RUN	ON  OFF	SM431	User timing clock No.6	
SM403	OFF one scan only after RUN	ON  OFF	SM432	User timing clock No.7	
SM404	ON one scan only after RUN	ON  OFF	SM433	User timing clock No.8	
			SM434	User timing clock No.9	
			SM510	Low-speed program execution flag	OFF :Complete or no execution ON :Executing

Appendix Table 1.20 List of Special Relays Supported by the GX Simulator (cont.)

Number	Name	Description	Number	Name	Description
SM620	Memory card B usability flag	OFF :Unusable ON :Usable	SM1030 *2	0.1-second clock	
SM621	Memory card B protection flag	OFF :Without protection ON :With protection	SM1031 *2	0.2-second clock	
SM622	Drive 3 flag	OFF :Without drive 3 ON :With drive 3	SM1032 *2	1-second clock	
SM623	Drive 4 flag	OFF :Without drive 4 ON :With drive 4	SM1033 *2	2-second clock	
SM640	Use file register	OFF :File registers not used ON :File registers used	SM1034 *2	2n-second clock	
SM700	Carry flag	OFF :Carry OFF ON :Carry ON	SM1036 *2	Normally ON	
SM703	Sort order	OFF :Ascending ON :Descending	SM1037 *2	Normally OFF	
SM704	Block comparison	OFF :Some do not match ON :All match	SM1038 *2	ON one scan only after RUN	
SM715	EI flag	OFF :DI ON :EI	SM1039 *2	OFF one scan only after RUN	
SM722	BIN/DBIN error processing switching	OFF :Error OK ON :Error NG	SM1042 *2	Stop status contact	OFF :Not stop status ON :Stop status
SM1008 *2	Self-diagnostic error	OFF :No error ON :Error	SM1054 *2	STEP RUN flag	ON :STEP RUN OFF :Not STEP RUN
SM1009 *2	Annunciator detected	OFF :Not detected ON :Detected			
SM1011 *2	Operation error flag	OFF :Normal ON :Operation error			
SM1020 *2	User timing clock No.0				
SM1021 *2	User timing clock No.1				
SM1022 *2	User timing clock No.2				
SM1023 *2	User timing clock No.3				
SM1024 *2	User timing clock No.4				

Appendix Table 1.20 List of Special Relays Supported by the GX Simulator (cont.)

SM1500 to 1501 are for process control instructions.  
 Process control instructions are only applicable to Process CPU and Redundant CPU.  
 When writing a program which uses process control instructions in CPU other than Process CPU and Redundant CPU, INSTRCT.CODE ERR (error code 4002) occurs and the CPU stops.

Number	Name	Description
SM1500	Process control instruction S.IN Hold mode	OFF :No-hold ON :Hold
SM1501	Process control instruction S.OUT Hold mode	OFF :No-hold ON :Hold

Appendix Table 1.20 List of Special Relays Supported by the GX Simulator (cont.)

SM1510 to 1516 can be used only in operation of the Q12PRHCPU or Q25PRHCPU.  
 In GX Simulator, the values of SM1510 to 1516 are fixed to those enclosed by parentheses in the following table.

Number	Name	Description												
SM1510	Operation mode	(Fixed to OFF) OFF :Redundant system backup mode, debug mode ON :Redundant system separate mode												
SM1511	System A identification flag	(Fixed to System A, SM1511: ON, SM1512:OFF) <ul style="list-style-type: none"> <li>Indicates System A/B of the redundant system.</li> </ul> <table border="1"> <thead> <tr> <th></th> <th>System A</th> <th>System B</th> <th>At the time of TRK.CABLE ERR.(Error code: 6120) occurrence (System not determined.)</th> </tr> </thead> <tbody> <tr> <td>SM1511</td> <td>ON</td> <td>OFF</td> <td>OFF</td> </tr> <tr> <td>SM1512</td> <td>OFF</td> <td>ON</td> <td>OFF</td> </tr> </tbody> </table>		System A	System B	At the time of TRK.CABLE ERR.(Error code: 6120) occurrence (System not determined.)	SM1511	ON	OFF	OFF	SM1512	OFF	ON	OFF
	System A	System B	At the time of TRK.CABLE ERR.(Error code: 6120) occurrence (System not determined.)											
SM1511	ON	OFF	OFF											
SM1512	OFF	ON	OFF											
SM1512	System B identification flag													
SM1513	Debug mode status flag	(Fixed to ON) OFF :Not in debug mode ON :Debug mode												
SM1515	Control/Standby system status	(Fixed to Control system, SM1515: ON, SM1516: OFF) <ul style="list-style-type: none"> <li>Indicates operation system status.</li> </ul> <table border="1"> <thead> <tr> <th></th> <th>Control system</th> <th>Standby system</th> <th>At the time of TRK.CABLE ERR.(Error code: 6120) occurrence (System not determined.)</th> </tr> </thead> <tbody> <tr> <td>SM1515</td> <td>ON</td> <td>OFF</td> <td>OFF</td> </tr> <tr> <td>SM1516</td> <td>OFF</td> <td>ON</td> <td>OFF</td> </tr> </tbody> </table>		Control system	Standby system	At the time of TRK.CABLE ERR.(Error code: 6120) occurrence (System not determined.)	SM1515	ON	OFF	OFF	SM1516	OFF	ON	OFF
		Control system	Standby system	At the time of TRK.CABLE ERR.(Error code: 6120) occurrence (System not determined.)										
SM1515		ON	OFF	OFF										
SM1516	OFF	ON	OFF											
SM1516														

\*1: When the constant scan set value is an integral multiple of the clock time, the special relay status is OFF for every scan.  
 For the ON/OFF setting of the special relay clock, refer to the POINT in Appendix 1.5 (2).

\*2: Not compatible with the Universal model QCPUs.



<b>POINT</b>
--------------

- To turn ON/OFF the special relay clock, prevent setting the constant scan set value to be an integral multiple of the clock time as shown in the example (1) below.

(1) The operation of 0.1-second clock when the constant scan is 50ms. (Example of non-integral multiple)  
 The special relay repeats ON and OFF.

(2) The operation of 0.1-second clock when the constant scan is 100ms (initial value). (Example of integral multiple)  
 The special relay status is OFF for every scan.

- Use the following settings to set a constant scan.  
 For ACPU/QCPU (A mode): D9020  
 For QnACPU/QCPU (Q mode): [PLC parameter] → <PLC RAS> tab

(3) Special Device List

Appendix Table 1.21 lists the special devices supported by GX Simulator for the Q series CPU (Q mode) functions. For details of the special devices, refer to the Q Series CPU (Q Mode) PLC CPU User's Manual.

Appendix table 1.21 List of Special Registers Supported by the GX Simulator

Number	Name	Description	Number	Name	Description
SD0	Diagnostic error	Diagnostic error number	SD70	Annunciator detected number table	Annunciator detected number
SD1	Time the diagnostic error occurred	Time the diagnostic error occurred	SD71		
SD2					
SD3					
SD4	Error information class	Error information class code	SD72		
SD5	Error common information	Error common information	SD73		
SD6					
SD7					
SD8					
SD9					
SD10					
SD11					
SD12					
SD13					
SD14			Error independent information	Error independent information	SD74
SD15					
SD16					
SD17					
SD18					
SD19					
SD20					
SD21					
SD22					
SD23					
SD24					
SD25					
SD26					
SD50	Error reset	Reset error number	SD200	Switch status	CPU switch status
SD62	Annunciator No.	Annunciator No.	SD201	LED status	CPU LED status
SD63	Annunciator quantity	Annunciator quantity	SD203	CPU operating status	CPU operating status *7
SD64	Annunciator detected number table	Annunciator detected number	SD210 *1	Clock data	Clock data (year, month)
SD65					
SD66					
SD67					
SD68					
SD69					
			SD211 *1		Clock data (day, hour)
			SD212 *1		Clock data (minute, second)
			SD213 *1		Clock data (higher digits of year, day of week)
			SD220	Display device data	Display device data
			SD221		
			SD222		
			SD223		
			SD224		
			SD225		
			SD226		
			SD227		
			SD286 *2	Device assignment	Points assigned to M (for extension)
			SD287 *2		
			SD288 *2		Points assigned to B (for extension)
			SD289 *2		
			SD290	Device assignment (Same as parameter contents)	No. of X points assigned
			SD291		No. of Y points assigned

Appendix Table 1.21 List of Special Registers Supported by the GX Simulator (cont.)

Number	Name	Description	Number	Name	Description
SD292 *3	Device assignment (Same as parameter contents)	No. of M points assigned	SD430	Low-speed scan counter	Number of scans counted
SD293		No. of L points assigned	SD500	Executed program number	Program execution type.
SD294 *3		No. of B points assigned	SD510	Low-speed program number	Current low-speed execution file name
SD295		No. of F points assigned	SD520 *6	Present scan time	Present scan time (1 ms units)
SD296		No. of SB points assigned	SD521 *6		Present scan time (1 μs units)
SD297		No. of V points assigned	SD522 *6	Initial scan time	Initial scan time (1 ms units)
SD298		No. of S points assigned	SD523 *6		Initial scan time (1 μs units)
SD299		No. of T points assigned	SD524 *6	Minimum scan time	Minimum scan time (1 ms units)
SD300		No. of ST points assigned	SD525 *6		Minimum scan time (1 μs units)
SD301		No. of C points assigned	SD526 *6	Maximum scan time	Maximum scan time (1 ms units)
SD302		No. of D points assigned	SD527 *6		Maximum scan time (1 μs units)
SD303		No. of W points assigned	SD528 *6	Current low-speed scan time	Current scan time (1 ms units)
SD304		No. of SW points assigned	SD529 *6		Current scan time (1 μs units)
SD305 *2		Device assignment (index register)	16 bit modification No. of points assigned for Z	SD532 *6	Minimum low-speed scan time
SD306 *2	Device assignment (Same as parameter contents)	No. of points assigned for ZR (extension)	SD533 *6	Minimum scan time (1 μs units)	
SD307 *2			SD534 *6	Maximum scan time (1 ms units)	
SD308 *2	Device assignment (Including extended data register (D) and extended link register (W))	No. of points assigned for D (internal + extension)	SD535 *6	Maximum low- speed scan time	Maximum scan time (1 μs units)
SD309 *2			No. of points assigned for W (internal + extension)	SD647	File register capacity
SD310 *2		SD648		File register block number	File register block number
SD311 *2		SD1008	Self-diagnostic error	Self-diagnostic error number	
SD412 *5	1-second counter	Number of counts in 1-second intervals	SD1009	Annunciator No.	Annunciator No.
SD414 *5	2n-second clock setting	2n-second clock units	SD1015	CPU operation status	CPU operation status
SD415 *5	2n(ms) clock	2n(ms) clock units	SD1017 *6	Scan time	Minimum scan time (10 ms units)
SD420	Scan counter	Number of scans counted	SD1018 *6	Scan time	Scan time (10 ms units)

Appendix Table 1.21 List of Special Registers Supported by the GX Simulator (cont.)

Number	Name	Description
SD1019 *6	Scan time	Maximum scan time (10 ms units)
SD1021 *6	Scan time	Scan time (1 ms units)
SD1022 *6	1-second counter	Number of counts of 1-second units
SD1035	Extension file register	Used block number
SD1124	Number of annun- ciators detected	Number of annun- ciators detected
SD1125	Number of annun- ciators detected	Number of annun- ciators detected
SD1126		
SD1127		
SD1128		
SD1129		
SD1130		
SD1131		
SD1132		

\*1: Clock data is read by Clock data read request (SM213).

\*2: Only compatible with Universal mode Q CPUs.

\*3: K32768(H8000) is stored when the points assigned to M are 32769 points or more in the Universal model QCPUs.

\*4: K32768(H8000) is stored when the points assigned to B are 32769 points or more in the Universal model QCPUs.

\*5: Value derived from the constant scan setting value and number of scans.

\*6: Values equal to all constant scan setting values.

\*7: SD203 supports the CPU operation status only.

STOP/PAUSE cause is fixed at 0.

Appendix Table 1.21 List of Special Registers Supported by the GX Simulator (cont.)

SD1500 to 1501 are for process control instructions.

Process control instructions are only applicable to Process CPU and Redundant CPU.

When writing a program which uses process control instructions in CPU other than Process CPU and Redundant CPU, INSTRCT.CODE ERR (error code 4002) occurs and the CPU stops.

Number	Name	Description
SD1500	Process control instruction basic period	Process control instruction basic period
SD1501		
SD1502	Process control instruction detail error code	Process control instruction detail error code
SD1503	Process control instruction generated error location	Process control instruction generated error location
SD1506	Dummy device	Dummy device
SD1507		
SD1508	Function availability selection for process control instruction	b0 Bumpless function availability setting for the S.PIDP instruction 0: Enabled 1: Disabled (Default: 0)

## Appendix 2 List of Supported Instruction

The GX Simulator supports the A series CPU/QnA series CPU/Q series CPU instructions.

However, some instructions are subject to restrictions and some are not supported.

Unsupported instructions are not processed (NOP).

See Appendices Table 2.1 to 2.4 for the instructions supported by the GX Simulator.

POINT
Unsupported instructions are not processed (NOP), and the "Unsupported information indicator lamp" lights up on the initial screen of the GX Simulator functions. (Refer to the display contents in "Section 4.3 Description of the Initial Window Display".)

### Appendix 2.1 A series CPU function GX Simulator

Appendix Table 2.1 List of Supported Instructions (A Series CPU Function)

#### (1) Sequence Instructions

Class	Instruction Symbol	Restriction
Contact instructions	LD, LDI, AND, ANI, OR, ORI	—
Coupling instructions	ANB, ORB, MPS, MRD, MPP	—
Output instructions	OUT, OUT T, OUT C, SET, RST, PLS, PLF	—
Shift instruction	SFT(P)	—
Master control instructions	MC, MCR	—
End instructions	FEND, END	—
Other instructions	STOP, NOP	—

#### (2) Basic Instructions

Class	Instruction Symbol	Restriction
Comparative operation instructions	=, <>, >, <=, <, >=, D=, D<>, D>, D<=, D<, D>=	—
Arithmetic operation instructions	+(P), -(P), D+(P), D-(P), *(P), /(P), D*(P), D/(P), B+(P), B-(P), DB+(P), DB-(P), B*(P), B/(P), DB*(P), DB/(P), INC(P), DEC(P), DINC(P), DDEC(P)	—
BCD ↔ BIN conversion instructions	BCD(P), DBCD(P), BIN(P), DBIN(P)	—
Data transfer instruction	MOV(P), DMOV(P), CML(P), DCML(P), BMOV(P), FMOV(P), XCH(P), DXCH(P)	—
Program branching instructions	CJ, SCJ, JMP, CALL(P), RET	—
Program switching instructions	CHG	—



## Appendix 2.2 QnA series function GX Simulator

Appendix Table 2.2 List of Supported Instructions (QnA series CPU functions)

## (1) Sequence Instructions

Class	Instruction Symbol	Restriction
Contact instructions	LD, LDI, AND, ANI, OR, ORI, LDP, LDF, ANDP, ANDF, ORP, ORF	—
Coupling instructions	ANB, ORB, MPS, MRD, MPP, INV, MEP, MEF, EGP, EGF	—
Output instructions	OUT, OUT T, OUT C, OUTH T, SET, RST, PLS, PLF, FF	—
Shift instructions	SFT(P)	—
Master control instructions	MC, MCR	—
End instructions	FEND, END	—
Other instructions	STOP, NOP, NOPLF, PAGE	—

## (2) Basic Instructions

Class	Instruction Symbol	Restriction
Comparative operation instructions	=, <>, >, <=, <, >=, D=, D<>, D>, D<=, D<, D>=, E=, E<>, E>, E<=, E<, E>=, \$=, \$<>, \$>, \$<=, \$<, \$>=, BKCMP□(P)	—
Arithmetic operation instructions	+(P), -(P), D+(P), D-(P), *(P), /(P), D*(P), D/(P), B+(P), B-(P), DB+(P), DB-(P), B*(P), B/(P), DB*(P), DB/(P), E+(P), E-(P), E*(P), E/(P), BK+(P), BK-(P), \$+(P), INC(P), DEC(P), DINC(P), DDEC(P)	—
Data conversion instructions	BCD(P), DBCD(P), BIN(P), DBIN(P), INT(P), DINT(P), FLT(P), DFLT(P), DBL(P), WORD(P), GRY(P), DGRY(P), GBIN(P), DGBIN(P), NEG(P), DNEG(P), ENEG(P), BKBCD(P), BKBIN(P)	—
Data transfer instructions	MOV(P), DMOV(P), EMOV(P), \$MOV(P), CML(P), DCML(P), BMOV(P), FMOV(P), XCH(P), DXCH(P), BXCH(P), SWAP(P)	—
Program branching instructions	CJ, SCJ, JMP, GOEND	—
Other convenient instructions	TTMR, STMR, RAMP, MTR	—

Appendix Table 2.2 List of supported instructions (QnA series CPU functions) (cont.)

## (3) Applied Instructions

Class	Instruction Symbol	Restriction
Logical arithmetic instructions	WAND(P), DAND(P), BKAND(P), WOR(P), DOR(P), BKOR(P), WXOR(P), DXOR(P), BKXOR(P), WXNR(P), DXNR(P), BKNXR(P)	—
Rotation instructions	ROR(P), RCR(P), ROL(P), RCL(P), DROR(P), DROR(P), DROR(P), DROR(P), DROR(P), DROR(P), DROR(P)	—
Shift instructions	SFR(P), SFL(P), BSFR(P), BSFL(P), DSFR(P), DSFL(P),	—
Bit processing instructions	BSET(P), BRST(P), TEST(P), DTEST(P), BKRST(P)	—
Data processing instructions	SER(P), DSER(P), SUM(P), DSUM(P), DECO(P), ENCO(P), SEG(P), DIS(P), UNI(P), NDIS(P), NUNI(P), WTOB(P) BTOW(P), MAX(P), MIN(P), DMAX(P), DMIN(P), SORT, DSORT, WSUM(P), DWSUM(P)	SORT, DSORT are executed one scan.
Structural instructions	FOR, NEXT, BREAK(P), CALL(P), RET, FCALL(P), ECALL(P), EFCALL(P)	—
Data table operation instruction	FIFW(P), FIFR(P), FPOP(P), FINS(P), FDEL(P)	—
Buffer memory access instructions	FROM(P), DFRO(P), TO(P), DTO(P)	—
Character string processing instructions	BINDA(P), DBINDA(P), BINHA(P), DBINHA(P), BCDDA(P), DBCDDA(P), DABIN(P), DDABIN(P), HABIN(P), DHABIN(P), DABCD(P), DDABCD(P) LEN(P), STR(P), DSTRT(P), VAL(P), DVAL(P), ESTR(P), EVAL(P), ASC(P), HEX(P), RIGHT(P), LEFT(P), MIDR(P), MIDW(P), INSTR(P), EMOD(P), EREXP(P)	—
Special function instructions	SIN(P), COS(P), TAN(P), ASIN(P), ACOS(P), ATAN(P), RAD(P), DEG(P), SQR(P), EXP(P), LOG(P), BSQR(P), BDSQR(P), BSIN(P), BCOS(P), BTAN(P), BASIN(P), BACOS(P), BATAN(P)	—
Data control instructions	LIMIT(P), DLIMIT(P), BAND(P), DBAND(P), ZONE(P), DZONE(P)	—
Switching instructions	RSET(P), QDRSET (P)	—
Clock instructions	DATERD(P), DATE+(P), DATE-(P), SECOND(P), HOUR(P)	DATERD(P) reads the computer clock data.
Program control instructions	PSTOP(P), POFF(P), PSCAN(P), PLOW(P)	—
Display instructions	LED, LEDR	—
Other instructions	DUTY, ZRRDB(P), ZRWBR(P), ADRSET(P)	—



Appendix 2.3 FX series function GX Simulator

Appendix Table 2.3 List of Supported Instructions (FX series CPU functions)

(1) Sequence Instructions

Class	Instruction Symbol	Restriction
Contact instructions	LD, LDI, LDP, LDF, AND, ANI, ANDP, ANDF, OR, ORI, ORP, ORF	*1
Coupling instructions	ANB, ORB, MPS, MRD, MPP, INV	*1
Output instructions	OUT, SET, RST, PLS, PLF	—
Master control instructions	MC, MCR	—
Step ladder instructions	STL, RET	—
Other instructions	END, NOP	—

\*1: The LDP, LDF, ANDP, ANDF, ORP, ORF, and INV instructions are only compatible with FX1S, FX1N, FX1NC, FX2N, FX2NC, FX3U and FX3UC PLC.

(2) Applied Instructions

Class	FNC No.	Instruction Symbol	32-bit Instruction	Pulses Execution Instruction	Applicable PLCs									Compatibility with GX Simulator	
					FX0, FX0S	FX0N	FX1	FX2, FX2C	FX1S	FX1N, FX1NC	FX2N, FX2NC	FX3G	FX3U, FX3UC		
Program flowchart	00	CJ	—	△	○	○	○	○	○	○	○	○	○	○	●
	01	CALL	—	YES	—	—	○	○	○	○	○	○	○	○	●
	02	SRET	—	—	—	—	○	○	○	○	○	○	○	○	●
	03	IRET	—	—	○	○	○	○	○	○	○	○	○	○	×
	04	EI	—	—	○	○	○	○	○	○	○	○	○	○	×
	05	DI	—	—	○	○	○	○	○	○	○	○	○	○	×
	06	FEND	—	—	○	○	○	○	○	○	○	○	○	○	●
	07	WDT	—	△	○	○	○	○	○	○	○	○	○	○	×
	08	FOR	—	—	○	○	○	○	○	○	○	○	○	○	●
09	NEXT	—	—	○	○	○	○	○	○	○	○	○	○	●	
Transition/Comparison	10	CMP	YES	△	○	○	○	○	○	○	○	○	○	○	●
	11	ZCP	YES	△	○	○	○	○	○	○	○	○	○	○	●
	12	MOV	YES	△	○	○	○	○	○	○	○	○	○	○	●
	13	SMOV	—	YES	—	—	—	○	—	—	○	○	○	○	●
	14	CML	YES	YES	—	—	—	○	—	—	○	○	○	○	●
	15	BMOV	—	△	—	○	—	○	○	○	○	○	○	○	●
	16	FMOV	YES	YES	—	—	—	○	—	—	○	○	○	○	●
	17	XCH	YES	YES	—	—	—	○	—	—	○	—	○	○	●
	18	BCD	YES	△	○	○	○	○	○	○	○	○	○	○	●
	19	BIN	YES	△	○	○	○	○	○	○	○	○	○	○	●

Appendix Table 2.3 List of Supported Instructions (FX series CPU functions) (cont.)

Class	FNC No.	Instruction symbol	32-bit Instruction	Pulses Execution Instruction	Applicable PLCs									Compatibility with GX Simulator
					FX0, FX0s	FX0N	FX1	FX2, FX2c	FX1s	FX1N, FX1NC	FX2N, FX2NC	FX3G	FX3U, FX3UC	
Arithmetic/logical operations	20	ADD	YES	△	○	○	○	○	○	○	○	○	○	●
	21	SUB	YES	△	○	○	○	○	○	○	○	○	○	●
	22	MUL	YES	△	○	○	○	○	○	○	○	○	○	●
	23	DIV	YES	△	○	○	○	○	○	○	○	○	○	●
	24	INC	YES	△	○	○	○	○	○	○	○	○	○	●
	25	DEC	YES	△	○	○	○	○	○	○	○	○	○	●
	26	WAND	YES	△	○	○	○	○	○	○	○	○	○	●
	27	WOR	YES	△	○	○	○	○	○	○	○	○	○	●
	28	WXOR	YES	△	○	○	○	○	○	○	○	○	○	●
Rotation shift	29	NEG	YES	YES	—	—	—	○	—	—	○	—	○	●
	30	ROR	YES	YES	—	—	—	○	—	—	○	○	○	●
	31	ROL	YES	YES	—	—	—	○	—	—	○	○	○	●
	32	RCR	YES	YES	—	—	—	○	—	—	○	—	○	●
	33	RCL	YES	YES	—	—	—	○	—	—	○	—	○	●
	34	SFTR	—	△	○	○	○	○	○	○	○	○	○	●
	35	SFTL	—	△	○	○	○	○	○	○	○	○	○	●
	36	WSFR	—	YES	—	—	—	○	—	—	○	○	○	●
	37	WSFL	—	YES	—	—	—	○	—	—	○	○	○	●
Data processing	38	SFWR	—	YES	—	—	—	○	○	○	○	○	○	●
	39	SFRD	—	YES	—	—	—	○	○	○	○	○	○	●
	40	ZRST	—	△	○	○	○	○	○	○	○	○	○	●
	41	DECO	—	△	○	○	○	○	○	○	○	○	○	●
	42	ENCO	—	△	○	○	○	○	○	○	○	○	○	●
	43	SUM	YES	YES	—	—	—	○	—	—	○	○	○	●
	44	BON	YES	YES	—	—	—	○	—	—	○	○	○	●
	45	MEAN	YES	YES	—	—	—	○	—	—	○	○	○	●
	46	ANS	—	—	—	—	—	○	—	—	○	○	○	●
High-speed processing	47	ANR	—	YES	—	—	—	○	—	—	○	○	○	●
	48	SOR	YES	YES	—	—	—	○	—	—	○	—	○	●
	49	FLT	YES	YES	—	—	—	○	—	—	○	—	○	●
	50	REF	—	△	○	○	○	○	○	○	○	○	○	×
	51	REFF	—	YES	—	—	○	○	—	—	○	—	○	×
	52	MTR	—	—	—	—	—	○	○	○	○	○	○	×
	53	HSCS	YES	—	○	○	○	○	○	○	○	○	○	×
	54	HSCR	YES	—	○	○	○	○	○	○	○	○	○	×
	55	HSZ	YES	—	—	—	—	○	—	—	○	○	○	×
56	SPD	—	—	—	—	—	○	○	○	○	○	○	×	
57	PLSY	YES	—	○	○	—	○	○	○	○	○	○	×	
58	PWM	—	—	○	○	—	○	○	○	○	○	○	×	
59	PLSR	YES	—	—	—	—	—	○	○	○	○	○	×	

Appendix Table 2.3 List of Supported Instructions (FX series CPU functions) (cont.)

Class	FNC No.	Instruction symbol	32-bit Instruction	Pulses Execution Instruction	Applicable PLCs									Compatibility with GX Simulator		
					FX0, FX0s	FX0N	FX1	FX2, FX2c	FX1s	FX1N, FX1NC	FX2N, FX2NC	FX3G	FX3U, FX3UC			
Convenient instructions	60	IST	—	—	○	○	○	○	○	○	○	○	○	●		
	61	SER	YES	YES	—	—	—	○	—	—	○	○	○	●		
	62	ABSD	YES	—	—	—	—	○	○	○	○	○	○	●		
	63	INCD	—	—	—	—	—	○	○	○	○	○	○	●		
	64	TTMR	—	—	—	—	—	○	—	—	○	—	○	●		
	65	STMR	—	—	—	—	—	○	—	—	○	—	○	●		
	66	ALT	—	—	○	○	—	○	○	○	○	○	○	○	●	
	67	RAMP	—	—	○	○	—	○	○	○	○	○	○	○	●	
	68	ROTC	—	—	—	—	—	○	—	—	○	—	○	○	×	
69	SORT	—	—	—	—	—	○	—	—	○	—	○	○	●		
External devices, I/O	70	TKY	YES	—	—	—	—	○	—	—	○	—	○	○	×	
	71	HKY	YES	—	—	—	○	—	—	○	—	○	○	○	×	
	72	DSW	—	—	—	—	—	○	○	○	○	○	○	○	×	
	73	SEGD	—	YES	—	—	—	○	—	—	○	—	○	○	×	
	74	SEGL	—	—	—	—	—	○	○	○	○	○	○	○	×	
	75	ARWS	—	—	—	—	—	○	—	—	○	—	○	○	×	
	76	ASC	—	—	—	—	—	○	—	—	○	—	○	○	●	
	77	PR	—	—	—	—	—	○	—	—	○	—	○	○	×	
	78	FROM	YES	YES	—	○	—	○	—	○	○	○	○	○	○	●
79	TO	YES	YES	—	○	—	○	—	○	○	○	○	○	○	●	
External devices, SER	80	RS	—	—	—	○	—	○	○	○	○	○	○	○	×	
	81	PRUN	YES	YES	—	—	—	○	○	○	○	○	○	○	×	
	82	ASCI	—	YES	—	○	—	○	○	○	○	○	○	○	○	●
	83	HEX	—	YES	—	○	—	○	○	○	○	○	○	○	○	●
	84	CCD	—	YES	—	○	—	○	○	○	○	○	○	○	○	×
	85	VRRD	—	YES	—	—	○	○	○	○	○	○	○	○	○	×
	86	VRSC	—	YES	—	—	—	○	○	○	○	○	○	○	○	×
	87	RS2	—	—	—	—	—	—	—	—	—	○	○	○	×	
	88	PID	—	—	—	—	—	○	○	○	○	○	○	○	×	
89	—	—	—	—	—	—	—	—	—	—	—	—	—	—	—	
External devices, F2	90	MNET	—	YES	—	—	—	—	—	—	—	—	—	—	×	
	91	ANRD	—	YES	—	—	—	—	—	—	—	—	—	—	×	
	92	ANWR	—	YES	—	—	—	—	—	—	—	—	—	—	×	
	93	RMST	—	—	—	—	—	○	—	—	—	—	—	—	×	
	94	RMWR	YES	YES	—	—	—	○	—	—	—	—	—	—	×	
	95	RMRD	YES	YES	—	—	—	○	—	—	—	—	—	—	×	
	96	RMMN	—	YES	—	—	—	○	—	—	—	—	—	—	×	
	97	BLK	—	YES	—	—	—	—	—	—	—	—	—	—	×	
	98	MCDE	—	YES	—	—	—	—	—	—	—	—	—	—	×	
99	—	—	—	—	—	—	—	—	—	—	—	—	—	—		

Appendix Table 2.3 List of Supported Instructions (FX series CPU functions) (cont.)

Class	FNC No.	Instruction symbol	32-bit Instruction	Pulses Execution Instruction	Applicable PLCs									Compatibility with GX Simulator
					FX0, FX0s	FX0N	FX1	FX2, FX2c	FX1s	FX1N, FX1NC	FX2N, FX2NC	FX3G	FX3U, FX3UC	
Data transfer 2	102	ZPUSH	—	YES	—	—	—	—	—	—	—	—	○	●
	103	ZPOP	—	YES	—	—	—	—	—	—	—	—	○	●
Floating decimal-point	110	ECMP	YES	YES	—	—	—	—	—	—	○	—	○	●
	111	EZCP	YES	YES	—	—	—	—	—	—	○	—	○	●
	112	EMOV	YES	YES	—	—	—	—	—	—	—	—	○	●
	116	ESTR	YES	YES	—	—	—	—	—	—	—	—	○	●
	117	EVAL	YES	YES	—	—	—	—	—	—	—	—	○	●
	118	EBCD	YES	YES	—	—	—	—	—	—	○	—	○	●
	119	EBIN	YES	YES	—	—	—	—	—	—	○	—	○	●
	120	EADD	YES	YES	—	—	—	—	—	—	○	—	○	●
	121	ESUB	YES	YES	—	—	—	—	—	—	○	—	○	●
	122	EMUL	YES	YES	—	—	—	—	—	—	○	—	○	●
	123	EDIV	YES	YES	—	—	—	—	—	—	○	—	○	●
	124	EXP	YES	YES	—	—	—	—	—	—	—	—	○	●
	125	LOGE	YES	YES	—	—	—	—	—	—	—	—	○	●
	126	LOG10	YES	YES	—	—	—	—	—	—	—	—	○	●
	127	ESQR	YES	YES	—	—	—	—	—	—	○	—	○	●
	128	ENEG	YES	YES	—	—	—	—	—	—	—	—	○	●
	129	INT	YES	YES	—	—	—	—	—	—	○	—	○	●
130	SIN	YES	YES	—	—	—	—	—	—	○	—	○	●	
131	COS	YES	YES	—	—	—	—	—	—	○	—	○	●	
132	TAN	YES	YES	—	—	—	—	—	—	○	—	○	●	
133	ASIN	YES	YES	—	—	—	—	—	—	—	—	○	●	
134	ACOS	YES	YES	—	—	—	—	—	—	—	—	○	●	
135	ATAN	YES	YES	—	—	—	—	—	—	—	—	○	●	
136	RAD	YES	YES	—	—	—	—	—	—	—	—	○	●	
137	DEG	YES	YES	—	—	—	—	—	—	—	—	○	●	
Data processing 2	140	WSUM	YES	YES	—	—	—	—	—	—	—	—	○	●
	141	WTOB	—	YES	—	—	—	—	—	—	—	—	○	●
	142	BTOW	—	YES	—	—	—	—	—	—	—	—	○	●
	143	UNI	—	YES	—	—	—	—	—	—	—	—	○	●
	144	DIS	—	YES	—	—	—	—	—	—	—	—	○	●
	147	SWAP	YES	YES	—	—	—	—	—	—	○	—	○	●
	149	SORT2	YES	—	—	—	—	—	—	—	—	—	○	●

Appendix Table 2.3 List of Supported Instructions (FX series CPU functions) (cont.)

Class	FNC No.	Instruction symbol	32-bit Instruction	Pulses Execution Instruction	Applicable PLCs									Compatibility with GX Simulator	
					FX0, FX0S	FX0N	FX1	FX2, FX2C	FX1S	FX1N, FX1NC	FX2N, FX2NC	FX3G	FX3U, FX3UC		
Positioning	150	DSZR	—	—	—	—	—	—	—	—	—	—	○	○	×
	151	DVIT	YES	—	—	—	—	—	—	—	—	—	—	○	×
	152	TBL	YES	—	—	—	—	—	—	—	—	—	○	○	×
	155	ABS	YES	—	—	—	—	—	○	○	○	○	○	○	×
	156	ZRN	YES	—	—	—	—	—	○	○	—	○	○	○	×
	157	PLSV	YES	—	—	—	—	—	○	○	—	○	○	○	×
	158	DRVI	YES	—	—	—	—	—	○	○	—	○	○	○	×
	159	DRVA	YES	—	—	—	—	—	○	○	—	○	○	○	×
Clock operations	160	TCMP	—	YES	—	—	—	—	○	○	○	○	○	○	●
	161	TZCP	—	YES	—	—	—	—	○	○	○	○	○	○	●
	162	TADD	—	YES	—	—	—	—	○	○	○	○	○	○	●
	163	TSUB	—	YES	—	—	—	—	○	○	○	○	○	○	●
	164	HTOS	YES	YES	—	—	—	—	—	—	—	—	—	○	●
	165	STOH	YES	YES	—	—	—	—	—	—	—	—	—	○	●
	166	TRD	—	YES	—	—	—	—	○	○	○	○	○	○	●
	167	TWR	—	YES	—	—	—	—	○	○	○	○	○	○	×
	169	HOUR	YES	—	—	—	—	—	○	○	○	○	○	○	●
External devices	170	GRY	YES	YES	—	—	—	—	—	—	○	○	○	○	●
	171	GBIN	YES	YES	—	—	—	—	—	—	○	○	○	○	●
	176	RD3A	—	YES	—	—	—	—	—	○	○	○	○	○	×
	177	WR3A	—	YES	—	—	—	—	—	○	○	○	○	○	×
Extension function	180	EXTR	—	YES	—	—	—	—	—	—	○	—	—	×	
Other	182	COMRD	—	YES	—	—	—	—	—	—	—	—	○	×	
	184	RND	—	YES	—	—	—	—	—	—	—	—	○	×	
	186	DUTY	—	—	—	—	—	—	—	—	—	—	○	×	
	188	CRC	—	YES	—	—	—	—	—	—	—	—	○	×	
	189	HCMOV	YES	—	—	—	—	—	—	—	—	—	○	×	

Appendix Table 2.3 List of Supported Instructions (FX series CPU functions) (cont.)

Class	FNC No.	Instruction symbol	32-bit Instruction	Pulses Execution Instruction	Applicable PLCs									Compatibility with GX Simulator
					FX0, FX0s	FX0N	FX1	FX2, FX2c	FX1s	FX1N, FX1NC	FX2N, FX2NC	FX3G	FX3U, FX3UC	
Block data operation	192	BK+	YES	YES	—	—	—	—	—	—	—	—	○	●
	193	BK-	YES	YES	—	—	—	—	—	—	—	—	○	●
	194	BKCMP=	YES	YES	—	—	—	—	—	—	—	—	○	●
	195	BKCMP>	YES	YES	—	—	—	—	—	—	—	—	○	●
	196	BKCMP<	YES	YES	—	—	—	—	—	—	—	—	○	●
	197	BKCMP<>	YES	YES	—	—	—	—	—	—	—	—	○	●
	198	BKCMP<=	YES	YES	—	—	—	—	—	—	—	—	○	●
	199	BKCMP>=	YES	YES	—	—	—	—	—	—	—	—	○	●
Character string control	200	STR	YES	YES	—	—	—	—	—	—	—	—	○	●
	201	VAL	YES	YES	—	—	—	—	—	—	—	—	○	●
	202	\$+	—	YES	—	—	—	—	—	—	—	—	○	●
	203	LEN	—	YES	—	—	—	—	—	—	—	—	○	●
	204	RIGHT	—	YES	—	—	—	—	—	—	—	—	○	●
	205	LEFT	—	YES	—	—	—	—	—	—	—	—	○	●
	206	MIDR	—	YES	—	—	—	—	—	—	—	—	○	●
	207	MIDW	—	YES	—	—	—	—	—	—	—	—	○	●
	208	INSTR	—	YES	—	—	—	—	—	—	—	—	○	●
	209	\$MOV	—	YES	—	—	—	—	—	—	—	—	○	●
Data processing 3	210	FDEL	—	YES	—	—	—	—	—	—	—	—	○	●
	211	FINS	—	YES	—	—	—	—	—	—	—	—	○	●
	212	POP	—	YES	—	—	—	—	—	—	—	—	○	●
	213	SFR	—	YES	—	—	—	—	—	—	—	—	○	●
	214	SFL	—	YES	—	—	—	—	—	—	—	—	○	●
Contact comparison	224	LD=	YES	—	—	—	—	—	○	○	○	○	○	●
	225	LD>	YES	—	—	—	—	—	○	○	○	○	○	●
	226	LD<	YES	—	—	—	—	—	○	○	○	○	○	●
	228	LD<>	YES	—	—	—	—	—	○	○	○	○	○	●
	229	LD≤	YES	—	—	—	—	—	○	○	○	○	○	●
	230	LD≥	YES	—	—	—	—	—	○	○	○	○	○	●
	232	AND=	YES	—	—	—	—	—	○	○	○	○	○	●
	233	AND>	YES	—	—	—	—	—	○	○	○	○	○	●
	234	AND<	YES	—	—	—	—	—	○	○	○	○	○	●
	236	AND<>	YES	—	—	—	—	—	○	○	○	○	○	●
	237	AND≤	YES	—	—	—	—	—	○	○	○	○	○	●
	238	AND≥	YES	—	—	—	—	—	○	○	○	○	○	●
	240	OR=	YES	—	—	—	—	—	○	○	○	○	○	●
	241	OR>	YES	—	—	—	—	—	○	○	○	○	○	●
242	OR<	YES	—	—	—	—	—	○	○	○	○	○	●	
244	OR<>	YES	—	—	—	—	—	○	○	○	○	○	●	
245	OR≤	YES	—	—	—	—	—	○	○	○	○	○	●	
246	OR≥	YES	—	—	—	—	—	○	○	○	○	○	●	

Appendix Table 2.3 List of Supported Instructions (FX series CPU functions) (cont.)

Class	FNC No.	Instruction symbol	32-bit Instruction	Pulses Execution Instruction	Applicable PLCs									Compatibility with GX Simulator	
					FX <sub>0</sub> , FX <sub>0S</sub>	FX <sub>0N</sub>	FX <sub>1</sub>	FX <sub>2</sub> , FX <sub>2C</sub>	FX <sub>1S</sub>	FX <sub>1N</sub> , FX <sub>1NC</sub>	FX <sub>2N</sub> , FX <sub>2NC</sub>	FX <sub>3G</sub>	FX <sub>3U</sub> , FX <sub>3UC</sub>		
Data table operation	256	LIMIT	YES	YES	—	—	—	—	—	—	—	—	○	●	
	257	BAND	YES	YES	—	—	—	—	—	—	—	—	○	●	
	258	ZONE	YES	YES	—	—	—	—	—	—	—	—	○	●	
	259	SCL	YES	YES	—	—	—	—	—	—	—	—	○	×	
	261	DABIN	YES	YES	—	—	—	—	—	—	—	—	○	●	
	262	BINDA	YES	YES	—	—	—	—	—	—	—	—	○	●	
	269	SCL2	YES	YES	—	—	—	—	—	—	—	—	○	●	
External device communication	270	IVCK	—	—	—	—	—	—	—	—	—	○	○	●	
	271	IVDR	—	—	—	—	—	—	—	—	—	○	○	●	
	272	IVRD	—	—	—	—	—	—	—	—	—	○	○	●	
	273	IVWR	—	—	—	—	—	—	—	—	—	○	○	●	
	274	IVBWR	—	—	—	—	—	—	—	—	—	—	○	●	
Data processing 3	278	RBFM	—	—	—	—	—	—	—	—	—	—	○	●	
	279	WBFM	—	—	—	—	—	—	—	—	—	—	○	●	
High-speed processings 2	280	HSCT	YES	—	—	—	—	—	—	—	—	—	○	×	
Extension file register	290	LOADR	—	YES	—	—	—	—	—	—	—	—	○	○	×
	291	SAVER	—	YES	—	—	—	—	—	—	—	—	○	○	×
	292	INITR	—	YES	—	—	—	—	—	—	—	—	○	○	×
	293	LOGR	—	YES	—	—	—	—	—	—	—	—	○	○	×
	294	RWER	—	YES	—	—	—	—	—	—	—	—	○	○	×
	295	INITER	—	YES	—	—	—	—	—	—	—	—	○	○	×

● : Supported by GX Simulator.

× : Not supported by GX Simulator.

○ : Instruction supported by the actual PLC.

△ : FX<sub>0</sub>, FX<sub>0S</sub>, and FX<sub>0N</sub> actual PLCs do not support pulse-executed instructions.

— : Instruction not supported by the actual PLC.

## Appendix 2.4 GX Simulator for Q series CPU (A mode) functions

Since the supported instructions of the Q series CPU (A mode) are the same as those of the A series CPU, refer to "Appendix Table 2.1 List of Supported Instructions (A series CPU Function)".

## Appendix 2.5 GX Simulator for Q series CPU (Q mode) functions

Appendix Table 2.4 List of Supported Instructions (Q Series CPU (Q Mode) Function)

### (1) Sequence Instructions

Class	Instruction Symbol	Restriction
Contact instructions	LD, LDI, AND, ANI, OP, ORI, LDP, LDPI, LDF, LDFI, ANDP, ANDPI, ANDF, ANDFI, ORP, ORPI, ORF, ORFI	*1
Coupling instructions	ANB, ORB, MPS, MRD, MPP, INV, MEP, MEF, EGP, EGF	—
Output instructions	OUT, OUT T, OUT C, OUTH T, SET, RST, PLS, PLF, FF	—
Shift instruction	SFT(P)	—
Master control instructions	MC, MCR	—
End instructions	FEND, END	—
Other instructions	STOP, NOP	—

\*1: The LDPI, LDFI, ANDPI, ANDFI, ORPI, and ORFI instructions are only compatible with the Universal model QCPU.

### (2) Basic Instructions

Class	Instruction Symbol	Restriction
Comparative operation instructions	=, <>, >, <=, <, >=, D=, D<>, D>, D<=, D<, D>=, E=, E<>, E>, E<=, E<, E>=, BKCMP□(P)	—
	\$=, \$<>, \$>, \$<=, \$<, \$>=	*1
Arithmetic operation instructions	+(P), -(P), D+(P), D-(P), *(P), /(P), D*(P), D/(P), B+(P), B-(P), DB+(P), DB-(P), B*(P), B/(P), DB*(P), DB/(P), E+(P), E-(P), E*(P), E/(P), BK+(P), BK-(P), INC(P), DEC(P), DINC(P), DDEC(P)	—
	\$(P)	*1
Data conversion instructions	BCD(P), DBCD(P), BIN(P), DBIN(P), INT(P), DINT(P), FLT(P), DFLT(P), DBL(P), WORD(P), GRY(P), DGRY(P), GBIN(P), DGBIN(P), NEG(P), DNEG(P), ENEG(P), BKBCD(P), BKBIN(P)	—
Data transfer instructions	MOV(P), DMOV(P), EMOV(P), \$MOV(P), CML(P), DCML(P), BMOV(P), FMOV(P), XCH(P), DXCH(P), BXCH(P), SWAP(P)	—
Program branch instructions	CJ, SCJ, JMP, GOEND	—
Other convenient instructions	TTMR, STMR, RAMP, MTR	*1,*2

\*1: Unusable when the Q00JCPU, Q00CPU or Q01CPU is used.

\*2: Unusable when the Q12PRHCPU or Q25PRHCPU is used.





Appendix Table 2.4 List of Supported Instructions (Q Series CPU (Q Mode) Function) (cont.)

Class	Instruction Symbol	Restriction
Process control instructions	S.IN, S.OUT1, S.PID, S.PHPL, S.LLAG, S.I, S.D, S.DED, S.FG, S.IFG, S.FLT, S.ENG, S.IENG, S.ABS, S.OUT2, S.MOUT, S.R, S.PIDP, S.SPI, S.IPD, S.BPI, S.HS, S.LS, S.MID, S.AVE, S.LIMIT, S.VLMT1, S.VLMT2, S.ONF2, S.ONF3, S.DBND, S.PGS, S.SEL, S.BUMP, S.AMR, S.SUM, S.TPC, S.ADD, S.SUB, S.MUL, S.DIV, S.SQR, S.>, S.<, S.=, S.>=, S.<=, S.DUTY, S.BC, S.2PID, S.PSUM, S.AT1	*3

\*3: Only applicable to Process CPU and Redundant CPU.

When writing a program in CPU other than Process CPU and Redundant CPU, INSTRCT.CODE ERR (error code 4002) occurs and the CPU stops.

### Appendix 3 List of Devices Usable with the I/O System Settings

Some devices designated in the condition setting area and simulation device area by the I/O system settings are subject to restrictions.

A list of the devices which can be used with the I/O system settings is shown below.

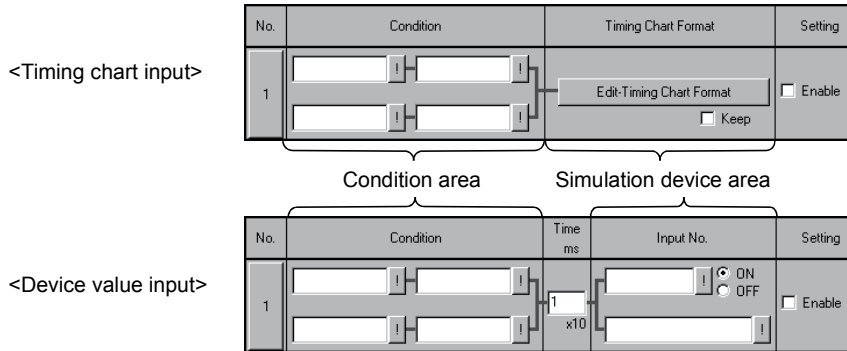

#### Appendix 3.1 Condition area

Devices which can be designated in condition area are the same for both timing chart input and device value input.

Device Name		Function					
		A series CPU	QnA series CPU	Q series CPU (A mode)	Q series CPU (Q mode)	FX series CPU	
Bit device	Input (X)	○	○	○	○	○	
	Output (Y)	○	○	○	○	○	
	Internal relay (M)	○	○	○	○	○	
	Latch relay (L)	×	○	×	○	—	
	Step relay (S)	×	—	×	—	—	
	Step relay (S) (for SFC)	—	×	—	×	—	
	State (S)	—	—	—	—	○	
	Annunciator (F)	○	○	○	○	—	
	Edge relay (V)	—	○	—	○	—	
	Link special relay (SB)	—	○	—	○	—	
	Link relay (B)	○	○	○	○	—	
	Special relay	(M)	○	—	○	—	○
		(SM)	—	○	—	○	—
	Timer (T)	Contacts	○ *1	○ *1	○ *1	○ *1	○ *1
Coil		×	×	×	×	×	

Device Name		Function					
		A series CPU	QnA series CPU	Q series CPU (A mode)	Q series CPU (Q mode)	FX series CPU	
Bit device	Retentive timer (ST)	Contacts	—	○ *1	—	○ *1	○ *1*2
		Coil	—	×	—	×	×
	Counter (C)	Contacts	○ *1	○ *1	○ *1	○ *1	○ *1
		Coil	×	×	×	×	×
	Function input (FX)		—	○	—	○	—
	Function output (FY)		—	○	—	○	—
	Link input (Jn\X)		—	×	—	×	—
	Link output (Jn\Y)		—	×	—	×	—
	Link relay (Jn\B)		—	×	—	×	—
	Link special relay (Jn\SB)		—	×	—	×	—
SFC block (BL)		—	×	—	×	—	
SFC transition device(TR)		—	×	—	×	—	
Word device	Data register (D)		○	○	○	○	○
	Special register	(D)	○	—	○	—	○
		(SD)	—	○	—	○	—
	Link register (W)		○	○	○	○	—
	Link special register (SW)		—	○	—	○	—
	Timer (present value) (T)		×	×	×	×	×
	Retentive timer (present value) (ST)		—	×	—	×	—
	Counter (present value) (C)		×	×	×	×	×
	Function register (FD)		—	×	—	×	—
	File register (R or D)		○	○	○	○	○ *3
	Extension file register	(ER)	×	—	×	—	×
		(ZR)	—	○	—	○	—
	Buffer register (Un\G)		—	○	—	○ *5	○ *4
	Link register (Jn\W)		—	×	—	×	—
	Link direct device (Jn\SW)		—	×	—	×	—
	Index register	(Z)	○	○	○	○	○
(V)		○	—	○	—	○	
Accumulator (A)		○	—	○	—	—	

○.....Can be used.  
 ×.....Cannot be used.  
 —.....Is not supported.

\*1: Only T, ST, and C contacts can be designated.

\*2: In the FX series, the device name becomes "T".

\*3: Only compatible with FX<sub>3U</sub>, FX<sub>3UC</sub> PLCs.

In FX<sub>3U</sub>, FX<sub>3UC</sub> PLCs, device name R represents extension register.

\*4: Only compatible with FX<sub>3U</sub>, FX<sub>3UC</sub> PLCs.

\*5: When I/O assignment is not set, the buffer register is treated as an unsupported device.

Appendix 3.2 Simulation device area

(1) Timing chart input

Device Name		Function					
		A series CPU	QnA series CPU	Q series CPU (A mode)	Q series CPU (Q mode)	FX series CPU	
Bit device	Input (X)	○	○	○	○	○	
	Output (Y)	○	○	○	○	○	
	Internal relay (M)	○	○	○	○	○	
	Latch relay (L)	×	○	×	○	—	
	Step relay (S)	×	—	×	—	—	
	Step relay (S) (for SFC)	—	×	—	×	—	
	State (S)	—	—	—	—	○	
	Annunciator (F)	○	○	○	○	—	
	Edge relay (V)	—	○	—	○	—	
	Link special relay (SB)	—	○	—	○	—	
	Link relay (B)	○	○	○	○	—	
	Special relay	(M)	○	—	○	—	○
		(SM)	—	○	—	○	—
	Timer (T)	Contacts	○	○	○	○	×
		Coil	×	×	×	×	×
	Retentive timer (ST)	Contacts	—	○	—	○	×
		Coil	—	×	—	×	×
	Counter (C)	Contacts	○	○	○	○	×
		Coil	×	×	×	×	×
	Function input (FX)	—	○	—	○	—	
	Function output (FY)	—	○	—	○	—	
	Link input (Jn\X)	—	×	—	×	—	
	Link output (Jn\Y)	—	×	—	×	—	
	Link relay (Jn\B)	—	×	—	×	—	
	Link special relay (Jn\SB)	—	×	—	×	—	
	SFC block (BL)	—	×	—	×	—	
	SFC transition device(TR)	—	×	—	×	—	

○.....Can be used.  
 ×.....Cannot be used.  
 —.....Is not supported.

Device Name		Function					
		A series CPU	QnA series CPU	Q series CPU (A mode)	Q series CPU (Q mode)	FX series CPU	
Word device	Data register (D)	○	○	○	○	○	
	Special register	(D)	○	—	○	—	○
		(SD)	—	○	—	○	—
	Link register (W)	○	○	○	○	—	
	Link special register (SW)	—	○	—	○	—	
	Timer (present value) (T)	×	×	×	×	×	
	Retentive timer (present value) (ST)	—	×	—	×	—	
	Counter (present value) (C)	×	×	×	×	×	
	Function register (FD)	—	×	—	×	—	
	File register (R or D)	○	○	○	○	○ *1	
	Extension file register	(ER)	○	—	○	—	×
		(ZR)	—	○	—	○	—
	Buffer register (Un\G)	—	○	—	○ *3	○ *2	
	Link register (Jn\W)	—	×	—	×	—	
	Link direct device (Jn\SW)	—	×	—	×	—	
	Index register	(Z)	○	○	○	○	○
		(V)	○	—	○	—	○
	Accumulator (A)	○	—	○	—	—	

○.....Can be used.  
 ×.....Cannot be used.  
 —.....Is not supported.

\*1: Only compatible with FX<sub>3U</sub>, FX<sub>3UC</sub> PLCs.

In FX<sub>3U</sub>, FX<sub>3UC</sub> PLCs, device name R represents extension register.

\*2: Only compatible with FX<sub>3U</sub>, FX<sub>3UC</sub> PLCs.

\*3: When I/O assignment is not set, the buffer register is treated as an unsupported device.

(2) Device value input

Device Name		Function					
		A series CPU	QnA series CPU	Q series CPU (A mode)	Q series CPU (Q mode)	FX series CPU	
Bit device	Input (X)	○	○	○	○	○	
	Output (Y)	○	○	○	○	○	
	Internal relay (M)	○	○	○	○	○	
	Latch relay (L)	×	○	×	○	—	
	Step relay (S)	×	—	×	—	—	
	Step relay (S) (for SFC)	—	×	—	×	—	
	State (S)	—	—	—	—	○	
	Annunciator (F)	○	○	○	○	—	
	Edge relay (V)	—	○	—	○	—	
	Link special relay (SB)	—	○	—	○	—	
	Link relay (B)	○	○	○	○	—	
	Special relay	(M)	○	—	○	—	○
		(SM)	—	○	—	○	—
	Timer (T)	Contacts	×	×	×	×	×
		Coil	×	×	×	×	×
	Retentive timer (ST)	Contacts	—	×	—	×	×
		Coil	—	×	—	×	×
	Counter (C)	Contacts	×	×	×	×	×
		Coil	×	×	×	×	×
	Function input (FX)	—	○	—	○	—	
	Function output (FY)	—	○	—	○	—	
	Link input (Jn\X)	—	×	—	×	—	
	Link output (Jn\Y)	—	×	—	×	—	
	Link relay (Jn\B)	—	×	—	×	—	
	Link special relay (Jn\SB)	—	×	—	×	—	
	SFC block (BL)	—	×	—	×	—	
	SFC transition device(TR)	—	×	—	×	—	

○.....Can be used.  
 ×.....Cannot be used.  
 —.....Is not supported.

Device Name		Function					
		A series CPU	QnA series CPU	Q series CPU (A mode)	Q series CPU (Q mode)	FX series CPU	
Word device	Data register (D)	○	○	○	○	○	
	Special register	(D)	○	—	○	—	○
		(SD)	—	○	—	○	—
	Link register (W)	○	○	○	○	—	
	Link special register (SW)	—	○	—	○	—	
	Timer (present value) (T)	×	×	×	×	×	
	Retentive timer (present value) (ST)	—	×	—	×	—	
	Counter (present value) (C)	×	×	×	×	×	
	Function register (FD)	—	×	—	×	—	
	File register (R or D)	○	○	○	○	○ *1	
	Extension file register	(ER)	×	—	×	—	×
		(ZR)	—	○	—	○	—
	Buffer register (Un\G)	○	○	—	○ *3	○ *2	
	Link register (Jn\W)	—	×	—	×	—	
	Link direct device (Jn\SW)	—	×	—	×	—	
	Index register	(Z)	○	○	○	○	○
		(V)	○	—	○	—	○
	Accumulator (A)	○	—	○	—	—	

○.....Can be used.  
 ×.....Cannot be used.  
 —.....Is not supported.

\*1: Only compatible with FX<sub>3U</sub>, FX<sub>3UC</sub> PLCs.

In FX<sub>3U</sub>, FX<sub>3UC</sub> PLCs, device name R represents extension register.

\*2: Only compatible with FX<sub>3U</sub>, FX<sub>3UC</sub> PLCs.

\*3: When I/O assignment is not set, the buffer register is treated as an unsupported device.



## Appendix 4 Functions Added to Upgraded from Previous Versions

The following indicates a history of main functions added to the previous versions.

Version	Distribution Time	Description	Reference	
Ver.7	7.27D	Dec., 2010	Compatible with Windows® 7.	Section 3.1
			Compatible with PX Developer simulation function. (Compatible with GX Developer Version 8.94Y or later.)	Section 2.2 Appendix 1.5
			Compatible with process control instruction.	Appendix 2.5
	7.23Z	Dec., 2008	Compatible with Universal model QCPU. (Compatible with GX Developer Version 8.78G or later.)	—
	7.22Y	Jul., 2008	Compatible with FX <sub>3G</sub> CPU. (Compatible with GX Developer Version 8.72A or later.)	—
	7.20W	Apr., 2008	Compatible with Q02PHCPU and Q06PHCPU. (Compatible with GX Developer Version 8.68W or later.)	—
	7.19V	Feb., 2008	Compatible with Windows Vista® .	Section 2.3
	7.08J	Nov., 2005	Compatible with FX <sub>3U</sub> CPU and FX <sub>3UC</sub> CPU. (Compatible with GX Developer Version 8.23Z or later.)	Section 3.4.4 Appendix 1.3 Appendix 2.3
	7.07H	Sep., 2005	Compatible with online change function. (Compatible with GX Developer Version 8.27D or later.)	Section 1.1 Section 3.1
	7.00A	Sep., 2004	Added function of writing X, Y, SM, SD to device memory from GX Developer. (Compatible with GX Developer Version 8.29F or later.)	Section 1.1 Section 3.4.1
Added function of reading/writing other station device from MX series.			Section 8.3.1	
Ver.6	6.20W	Jun., 2004	Compatible with Redundant CPU.	Section 3.4.6 Appendix 1.5 Appendix 2.5
	6.13P	Jan., 2003	Compatible with Basic model QCPU of function version B.	Section 3.4.6 Appendix 1.5 Appendix 2.5
			Compatible with Windows® XP.	Section 2.3
	6.12N	Oct., 2002	Added initial window minimum function.	Section 9.3
	6.10L	Mar., 2002	Compatible with Process CPU.	Section 3.4.6 Appendix 1.5 Appendix 2.5
	6.02C	Jul., 2001	Added serial communication function.	Chapter 6
			Compatible with Windows® 2000/Me.	Section 2.3
Compatible with Basic model QCPU.			Section 3.4.6 Appendix 1.5 Appendix 2.5	
Ver.5	5.01B	Feb., 2000	Compatible with FX <sub>1S</sub> CPU and FX <sub>1N</sub> CPU.	Section 3.4.4 Appendix 1.3 Appendix 2.3
			Compatible with SFC program in FX series.	Section 3.4.4
			Compatible with Motion controller SCPU.	Section 3.4.5
			Improved I/O system setting functions.	Chapter 5

Version	Distribution Time	Description	Reference
Ver.4	Aug., 1999	Compatible with High performance model QCPU.	Section 3.4.6 Appendix 1.5 Appendix 2.5
Ver.3	Apr., 1999	Added timing chart function.	Section 7.2
Ver.2	Nov., 1998	Compatible with FX series.	Section 3.4.4 Appendix 1.3 Appendix 2.3
		Compatible with Windows NT <sup>®</sup> 4.0.	Section 2.3
		Improved device memory monitor functions.	Chapter 7
		Improved I/O system setting functions.	Chapter 5

## INDEX

- [A]
- A-compatible 1C frame commands ..... 6- 8
  - A series CPU
    - Device list.....App- 1
    - List of Supported instruction.....App-50
    - Restrictions and cautions ..... 3-12
- [B]
- Batch-enabling/disabling setting ..... 5-32
  - Buffer memory ..... 7- 8
  - Buffer memory monitor ..... 7- 8
- [C]
- Cautions..... 3- 9
    - A series CPU ..... 3-12
    - Common ..... 3- 9
    - FX series CPU..... 3-17
    - Handling..... 3-26
    - Motion controller ..... 3-20
    - Q series CPU..... 3-21
    - QnA series CPU ..... 3-14
  - Clear log ..... 8-26
  - Combination with MELSOFT Products ..... 2- 1
  - Condition area .....App-64
  - Conditions..... 5- 2
  - Configuration of screen
    - I/O system settings..... 5- 6
    - Serial communication function ..... 6- 3
    - Timing chart format input screen ..... 5-11
    - Timing chart screen ..... 7-15
  - COS curve ..... 5-18
  - Cutting, copying, pasting set No. .... 5-31
- [D]
- Device batch..... 7- 5
  - Device batch monitor ..... 7- 5
  - Device control setting ..... 8- 7
  - Device display position exchange ..... 5-24, 7-28
  - Device entering/deleting ..... 5-13, 7-20
  - Device list ..... 5-23, 7-27
    - A series CPU .....App- 1
    - Condition area .....App-64
    - FX series CPU .....App-11
    - Q series CPU ..... App-35
    - QnA series CPU..... App- 5
    - Simulation device area..... App-66
    - Usable with the I/O system settings ..... App-64
- [E]
- Device manager.....8- 1
    - Clear log .....8-26
    - Device control setting.....8- 7
    - Device value check setting .....8-12
    - Editing settings .....8-19
    - Export log ..... 8-25
    - Find.....8-24
    - Log display .....8-15
    - Other station device setting .....8- 5
    - Print .....8-22
    - Setting data file operation .....8-17
    - Simulation starting/stopping..... 8-14
  - Device memory monitor
    - Buffer memory monitor .....7- 8
    - Device batch monitor .....7- 5
    - Device write .....7-13
    - Entry device monitor .....7-11
    - Operation procedure .....7- 2
    - Outline .....7- 1
    - Starting/ending .....7- 3
    - Transfer Setup .....7- 4
  - Device memory/buffer memory
    - Reading .....9- 3
    - Saving.....9- 1
  - Device selection.....7- 4
  - Device test .....7-13
  - Device value check setting .....8-12
  - Device value input.....5-25
  - Devices and instructions.....3- 8
- [E]
- Ending
    - Device memory monitor .....7- 3
    - GX Simulator .....4- 7
    - I/O system settings.....5- 5
    - Serial communication function.....6- 3
    - Timing chart.....7-15
  - Entry device .....7-11
  - Entry device memory .....7-11

Error code lists.....	6-11		
A-compatible 1C frame .....	6-11		
QnA-compatible 3C/4C frame.....	6-12		
Error message.....	11- 1		
Export log.....	8-25		
<b>[F]</b>			
Features.....	1- 2		
Function Added to Upgraded from Previous			
Version.....	App-70		
Function list .....	3- 3		
FX series CPU			
Device list.....	App-11		
List of supported instruction .....	App-54		
Restrictions and precautions.....	3-17		
<b>[G]</b>			
GX Developer operations.....	4- 3		
<b>[H]</b>			
Handling precautions .....	3-26		
<b>[I]</b>			
I/O system settings			
Condition area .....	App-64		
Configuration of screen .....	5- 6		
Cutting, copying, pasting set No. ....	5-31		
List of Devices Usable with the I/O System			
Settings .....	App-64		
Operation procedure .....	5- 4		
Outline.....	5- 1		
Reading setting files of SW5 or earlier ....	5-35		
Starting and Ending.....	5- 1		
Setting file operation.....	5-29		
Using timing chart.....	5- 8		
Initial window .....	4- 5		
Instruction list			
A series CPU .....	App-50		
FX series CPU.....	App-54		
Q series CPU.....	App-61		
QnA series CPU .....	App-52		
<b>[L]</b>			
Log display .....	8-15		
<b>[M]</b>			
Monitor starting/stopping .....	7-23		
Motion controller			
Restrictions and cautions.....	3-20		
<b>[O]</b>			
Online Change .....	1-10, 3- 1		
Operation procedure			
Common.....	4- 1		
Device memory monitor.....	7- 2		
I/O system settings.....	5- 4		
Serial communication function.....	6- 2		
Timing chart.....	7-15		
Timing chart format input screen .....	5-10		
Option.....	9- 6		
Other station device setting.....	8- 5		
Outline .....	1- 1		
<b>[Q]</b>			
Q series CPU			
Device list .....	App-35		
List of supported instruction.....	App-61		
Restrictions and precautions .....	3-21		
QnA-compatible 3C/4C frame commands....	6- 9		
QnA series CPU			
Device list .....	App- 5		
List of supported instruction.....	App-52		
Restrictions and cautions.....	3-14		
<b>[R]</b>			
Restrictions .....	3- 9		
A series CPU.....	3-12		
Common.....	3- 9		
FX series CPU .....	3-17		
Motion controller.....	3-20		
Q series CPU .....	3-21		
QnA series CPU.....	3-14		
<b>[S]</b>			
Sampling period.....	7-26		
Scan number.....	5-12, 5-21		
Serial communication function .....	6- 1		
Configuration of screen.....	6- 4		
Operation procedure .....	6- 2		
Outline .....	6- 1		
Simulation device area .....	App-66		
Simulation example .....	10- 1		

SIN curve .....	5-18
Specifications .....	3- 1
Starting	
Device memory monitor .....	7- 3
I/O system settings .....	5- 5
Timing chart .....	7-15
Supported devices and instructions.....	3- 8

[T]

Timing chart	
Configuration of screen.....	7-17
Device display position exchange.....	7-27
Device entering/deleting.....	7-20
File operation .....	7-24
Monitor starting/stopping .....	7-23
Operation procedure .....	7-15
Sampling period.....	7-26
Starting and Exiting .....	7-16
Timing chart format input screen	
Configuration of screen.....	5-11
Device display position exchange.....	5-24
Device entering/deleting.....	5-13
Device value input .....	5-25
File operation .....	5-29
Operation procedure .....	5-10
Scan number .....	5-12, 5-21
Simulation starting/stopping .....	5-27
Timing setting/editing .....	5-15
Timing chart input.....	5- 8
Timing data saving .....	7-25
Timing setting/editing	
Bit device .....	5-15
Word device.....	5-17
Transfer Setup.....	7- 4
Troubleshooting.....	11- 1

# TRADEMARKS

---

Microsoft, Windows, Windows NT, Windows Vista, and Windows XP are either registered trademarks or trademarks of Microsoft Corporation in the United States and/or other countries.

Pentium is either a registered trademark or a trademark of Intel Corporation in the United States and/or other countries.

The company names, system names and product names mentioned in this manual are either registered trademarks or trademarks of their respective companies.

In some cases, trademark symbols such as <sup>™</sup> or <sup>®</sup> are not specified in this manual.



SH(NA)-080468ENG-P(2110)KWIX

MODEL: SW7D5-LLT-O-E

MODEL CODE: 13JU51

## **MITSUBISHI ELECTRIC CORPORATION**

HEAD OFFICE : TOKYO BUILDING, 2-7-3 MARUNOUCHI, CHIYODA-KU, TOKYO 100-8310, JAPAN  
NAGOYA WORKS : 1-14, YADA-MINAMI 5-CHOME, HIGASHI-KU, NAGOYA, JAPAN

When exported from Japan, this manual does not require application to the  
Ministry of Economy, Trade and Industry for service transaction permission.

Specifications subject to change without notice.