

Programmable Controller

MELSEC **Q** series

Loop Control Module User's Manual

-Q62HLC
-GX Configurator-TC (SW0D5C-QTCU-E)

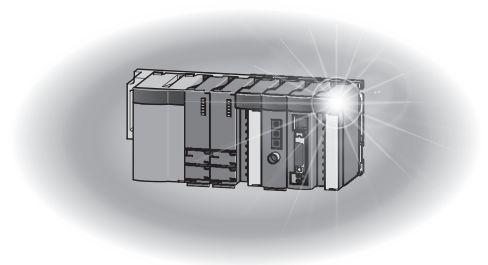

• SAFETY PRECAUTIONS •

(Read these precautions before using this product.)

Before using this product, please read this manual carefully and pay full attention to safety to handle the product correctly.

The precautions given in this manual are concerned with this product only.

For the safety precautions of the programmable controller system, refer to the user's manual for the CPU module used.

In this manual, the safety precautions are classified into two levels: "⚠ WARNING" and "⚠ CAUTION".

 **WARNING**

Indicates that incorrect handling may cause hazardous conditions, resulting in death or severe injury.

 **CAUTION**

Indicates that incorrect handling may cause hazardous conditions, resulting in minor or moderate injury or property damage.

Under some circumstances, failure to observe the precautions given under "⚠ CAUTION" may lead to serious consequences.

Observe the precautions of both levels because they are important for personal and system safety.

Make sure that the end users read this manual and then keep the manual in a safe place for future reference.

[Design Precautions]

WARNING

- Do not write any data to the "system area" and "write-protect area" of the buffer memory in the intelligent function module.
Also, do not use any "use prohibited" signals as input or output signals from the intelligent function module to the CPU module.
Doing so may cause malfunction of the programmable controller system.
- Due to failure of the output element or internal circuit, normal output may not be obtained correctly. Configure an external circuit for monitoring output signals that could cause a serious accident.

CAUTION

- Do not install the control lines or communication cables together with the main circuit lines or power cables.
Keep a distance of 100mm or more between them.
Failure to do so may result in malfunction due to noise.
- At power-on or power-off, a current may flow between output terminals momentarily.
In this case, start the control after analog outputs become stable.

[Security Precautions]

WARNING

- To maintain the security (confidentiality, integrity, and availability) of the programmable controller and the system against unauthorized access, denial-of-service (DoS) attacks, computer viruses, and other cyberattacks from external devices via the network, take appropriate measures such as firewalls, virtual private networks (VPNs), and antivirus solutions.

[Installation Precautions]

CAUTION

- Use the programmable controller in an environment that meets the general specifications in the user's manual for the CPU module used.
Failure to do so may result in electric shock, fire, malfunction, or damage to or deterioration of the product.
- To mount the module, while pressing the module mounting lever located in the lower part of the module, fully insert the module fixing projection(s) into the hole(s) in the base unit and press the module until it snaps into place.
Incorrect mounting may cause malfunction, failure or drop of the module.
When using the programmable controller in an environment of frequent vibrations, fix the module with a screw.
- If the screws are tightened too much, it may cause damage to the screw and/or the module, resulting in fallout, short circuits or malfunction.
Tighten the screws within the specified torque range.
Undertightening can cause drop of the screw, short circuit or malfunction.
Overtightening can damage the screw and/or module, resulting in drop, short circuit, or malfunction.
- Shut off the external power supply (all phases) used in the system before mounting or removing the module.
Failure to do so may result in damage to the product. A module can be replaced online (while power is on) on any MELSECNET/H remote I/O station or in the system where a CPU module supporting the online module change function is used.
Note that there are restrictions on the modules that can be replaced online, and each module has its predetermined replacement procedure.
For details, refer to the relevant chapter in this manual.
- Do not directly touch any conductive parts and electronic components of the module.
Doing so can cause malfunction or failure of the module.

[Wiring Precautions]

CAUTION

- Prevent foreign matter such as dust or wire chips from entering the module. Such foreign matter can cause a fire, failure, or malfunction.
- A protective film is attached to the top of the module to prevent foreign matter, such as wire chips, from entering the module during wiring. Do not remove the film during wiring. Remove it for heat dissipation before system operation.
- Place the cables in a duct or clamp them. If not, dangling cable may swing or inadvertently be pulled, resulting in damage to the module or cables or malfunction due to poor contact.
- When disconnecting the cable from the module, do not pull the cable by the cable part. For the cable connected to the terminal block, loosen the terminal screw. Pulling the cable connected to the module may result in malfunction or damage to the module or cable.
- Individually ground the FG terminal and shielded cables of the programmable controller with a ground resistance of 100Ω or less.
Failure to do so may result in electric shock or malfunction.
- After wiring, attach the included terminal cover to the module before turning it on for operation.
Failure to do so may result in electric shock.
- Use applicable solderless terminals and tighten them within the specified torque range.
If any spade solderless terminal is used, it may be disconnected when the terminal screw comes loose, resulting in failure.
- Check the rated voltage and terminal layout before wiring to the module, and connect the cables correctly.
Connecting a power supply with a different voltage rating or incorrect wiring may cause a fire or failure.

[Startup and Maintenance Precautions]

CAUTION

- Do not disassemble or modify the modules.
Doing so may cause failure, malfunction, injury, or a fire.
- Shut off the external power supply (all phases) used in the system before mounting or removing the module.
Failure to do so may cause the module to fail or malfunction.
A module can be replaced online (while power is on) on any MELSECNET/H remote I/O station or in the system where a CPU module supporting the online module change function is used.
Note that there are restrictions on the modules that can be replaced online, and each module has its predetermined replacement procedure.
For details, refer to the relevant chapter in this manual.
- After the first use of the product, do not mount/remove the module to/from the base unit, and the terminal block to/from the module more than 50 times (IEC 61131-2 compliant) respectively.
Exceeding the limit of 50 times may cause malfunction.
- Do not touch any terminal while power is on.
Failure to do so may cause malfunction.
- Shut off the external power supply (all phases) used in the system before cleaning the module or retightening the terminal screws or module fixing screws.
Failure to do so may cause the module to fail or malfunction.
Undertightening can cause drop of the screw, short circuit or malfunction.
Overtightening can damage the screw and/or module, resulting in drop, short circuit, or malfunction.
- Before handling the module, touch a grounded metal object to discharge the static electricity from the human body.
Failure to do so may cause the module to fail or malfunction.

[Disposal Precaution]

CAUTION

- When disposing of the product, handle it as industrial waste.

• CONDITIONS OF USE FOR THE PRODUCT •

- (1) MELSEC programmable controller ("the PRODUCT") shall be used in conditions;
- i) where any problem, fault or failure occurring in the PRODUCT, if any, shall not lead to any major or serious accident; and
 - ii) where the backup and fail-safe function are systematically or automatically provided outside of the PRODUCT for the case of any problem, fault or failure occurring in the PRODUCT.

- (2) The PRODUCT has been designed and manufactured for the purpose of being used in general industries.

MITSUBISHI ELECTRIC SHALL HAVE NO RESPONSIBILITY OR LIABILITY (INCLUDING, BUT NOT LIMITED TO ANY AND ALL RESPONSIBILITY OR LIABILITY BASED ON CONTRACT, WARRANTY, TORT, PRODUCT LIABILITY) FOR ANY INJURY OR DEATH TO PERSONS OR LOSS OR DAMAGE TO PROPERTY CAUSED BY the PRODUCT THAT ARE OPERATED OR USED IN APPLICATION NOT INTENDED OR EXCLUDED BY INSTRUCTIONS, PRECAUTIONS, OR WARNING CONTAINED IN MITSUBISHI ELECTRIC USER'S, INSTRUCTION AND/OR SAFETY MANUALS, TECHNICAL BULLETINS AND GUIDELINES FOR the PRODUCT.

("Prohibited Application")

Prohibited Applications include, but not limited to, the use of the PRODUCT in;

- Nuclear Power Plants and any other power plants operated by Power companies, and/or any other cases in which the public could be affected if any problem or fault occurs in the PRODUCT.
- Railway companies or Public service purposes, and/or any other cases in which establishment of a special quality assurance system is required by the Purchaser or End User.
- Aircraft or Aerospace, Medical applications, Train equipment, transport equipment such as Elevator and Escalator, Incineration and Fuel devices, Vehicles, Manned transportation, Equipment for Recreation and Amusement, and Safety devices, handling of Nuclear or Hazardous Materials or Chemicals, Mining and Drilling, and/or other applications where there is a significant risk of injury to the public or property.

Notwithstanding the above restrictions, Mitsubishi Electric may in its sole discretion, authorize use of the PRODUCT in one or more of the Prohibited Applications, provided that the usage of the PRODUCT is limited only for the specific applications agreed to by Mitsubishi Electric and provided further that no special quality assurance or fail-safe, redundant or other safety features which exceed the general specifications of the PRODUCTS are required. For details, please contact the Mitsubishi Electric representative in your region.

- (3) Mitsubishi Electric shall have no responsibility or liability for any problems involving programmable controller trouble and system trouble caused by DoS attacks, unauthorized access, computer viruses, and other cyberattacks.

REVISIONS

* The manual number is given on the bottom left of the back cover.

Print Date	* Manual Number	Revision
Aug., 2005	SH (NA)-080573ENG-A	First edition
Jan., 2008	SH (NA)-080573ENG-B	<p>Correction</p> <p>SAFETY PRECAUTION, CONTENTS, ABOUT THE GENERIC TERMS AND ABBREVIATIONS, Chapter 1, Section 1.1, 2.1 to 2.3, 3.1.1, 3.2, 3.2.1, 3.2.10, 3.2.13, 3.5.1, 3.5.3, 3.5.14, 3.5.15, 3.5.49, 3.5.50, 3.5.57, 3.5.65, 5.1, 5.2.2, 6.2.1, 6.2.2, 8.1, INDEX</p>
Apr., 2008	SH (NA)-080573ENG-C	<p>Correction</p> <p>COMPLIANCE WITH THE EMC AND LOW VOLTAGE DIRECTIVES, Section 2.1, 2.3, 3.1.1, 3.2.10, 3.2.16, 3.5.15, 3.5.46, 3.5.47, 3.5.64, 4.5, 5.2.1, 5.3.3, 5.4, 5.5, 6.2, 6.3, 7.1, 8.1, 8.13</p> <p>Addition</p> <p>Appendix 2</p>
May, 2008	SH (NA)-080573ENG-D	<p>Correction</p> <p>SAFETY PRECAUTIONS, ABOUT THE GENERIC TERMS AND ABBREVIATIONS, Section 2.1, 2.3, 4.1, 5.2.1, 5.3.1, 5.3.3, Chapter 7, Section 7.1</p>
Feb., 2011	SH (NA)-080573ENG-E	<p>Correction</p> <p>SAFETY PRECAUTIONS, ABOUT THE GENERIC TERMS AND ABBREVIATIONS, Section 1.1, 2.1 to 2.3, 3.1.1, 3.2.15, 3.5.1, 3.5.11, 3.5.14, 3.5.15, 3.5.55, 4.1, 4.3, 4.4.1, 4.4.2, 5.2.1, 5.4 to 5.6, 6.3.1, 6.3.2, 7.3.1, 7.3.2, 8.2, 8.13, Appendix 1, WARRANTY</p> <p>Addition</p> <p>CONDITIONS OF USE FOR THE PRODUCT</p>
Apr., 2012	SH (NA)-080573ENG-F	<p>Correction</p> <p>SAFETY PRECAUTIONS, COMPLIANCE WITH EMC AND LOW VOLTAGE DIRECTIVES, ABOUT THE GENERIC TERMS AND ABBREVIATIONS, PRODUCT STRUCTURE, Chapter 1, Section 1.1, 1.2, 1.3, 1.3.1, 1.3.2, 1.3.3, 1.3.4, 1.3.5, 1.3.6, 2.1, 2.2, 2.3, 3.2, 3.2.1, 3.2.9, 3.2.12, 3.2.19, 3.4.1, 3.5.1, 3.5.5, 3.5.8, 3.5.9, 3.5.11, 3.5.14, 3.5.21, 3.5.28, 3.5.37, 3.5.44, 3.5.61, 3.5.62, 3.5.64, 3.5.65, 3.5.66, 3.5.67, 3.5.68, Chapter 4, Section 4.1, 4.2, 4.3, 4.4.1, 4.4.2, 4.5, 5.1, 5.2.1, 5.2.2, 5.3.1, 5.3.2, 5.4, 5.5, 5.6, 6.2, 6.2.1, 6.2.2, 6.3, 6.3.1, 6.3.2, Chapter 7, Section 7.1, 7.2, 7.3.1, 7.3.2, 7.4, 7.4.1, 7.4.2, 7.4.3, 8.1, 8.2, 8.3, 8.4, 8.5, 8.6, 8.7, 8.8, 8.9, 8.10, 8.11, 8.12, 8.13, Appendix 1, Appendix 2</p> <p>Addition</p> <p>Section 3.2.15, 3.2.16, 3.2.18, 3.5.50, 3.5.51, 3.5.52, 3.5.63, 3.5.69</p>

* The manual number is given on the bottom left of the back cover.

Print Date	* Manual Number	Revision
Dec., 2012	SH (NA)-080573ENG-G	<p><u>Correction</u> COMPLIANCE WITH EMC AND LOW VOLTAGE DIRECTIVES, Section 2.1, 3.2.9, 3.2.12, 3.2.13, 3.5.13, 3.5.28, 3.5.67, 3.5.68, 3.5.69, 8.13</p>
Oct., 2020	SH (NA)-080573ENG-H	<p><u>Correction</u> SAFETY PRECAUTIONS, CONDITIONS OF USE FOR THE PRODUCT, ABOUT THE GENERIC TERMS AND ABBREVIATIONS, Section 1.3.1, 1.3.5, 2.1, 2.3, 3.1.1, 3.5.14, 4.3, Appendix 1, WARRANTY</p>

Japanese Manual Version SH-080547-H

This manual confers no industrial property rights or any rights of any other kind, nor does it confer any patent licenses. Mitsubishi Electric Corporation cannot be held responsible for any problems involving industrial property rights which may occur as a result of using the contents noted in this manual.

© 2005 MITSUBISHI ELECTRIC CORPORATION

INTRODUCTION

Thank you for purchasing the Mitsubishi Electric MELSEC-Q series programmable controller. Before using the equipment, please read this manual carefully to develop full familiarity with the functions and performance of the Q series programmable controller you have purchased, so as to ensure correct use.

CONTENTS

SAFETY PRECAUTIONS	A- 1
CONDITIONS OF USE FOR THE PRODUCT	A- 5
REVISIONS	A- 6
INTRODUCTION.....	A- 8
CONTENTS.....	A- 8
COMPLIANCE WITH EMC AND LOW VOLTAGE DIRECTIVES	A-13
ABOUT THE GENERIC TERMS AND ABBREVIATIONS	A-14
PRODUCT STRUCTURE.....	A-14

1 OVERVIEW	1- 1 to 1-11
-------------------	---------------------

1.1 Features	1- 2
1.2 PID Control System	1- 5
1.3 PID Operation.....	1- 6
1.3.1 Operation method and formula	1- 6
1.3.2 Actions in the Q62HLC	1- 7
1.3.3 Proportional action (P-action)	1- 8
1.3.4 Integral action (I-action)	1- 9
1.3.5 Derivative action (D-action).....	1-10
1.3.6 PID action	1-11

2 SYSTEM CONFIGURATION	2- 1 to 2- 8
-------------------------------	---------------------

2.1 Applicable Systems.....	2- 1
2.2 For Using the Q62HLC with Redundant CPUs.....	2- 5
2.3 Checking Function Version, Production Information, Serial Number, and Software Version	2- 6

3 SPECIFICATIONS	3- 1 to 3-115
-------------------------	----------------------

3.1 Performance Specifications	3- 1
3.1.1 Performance specifications of the Q62HLC	3- 1
3.1.2 Operation at input disconnection	3- 5
3.2 Functions	3- 6
3.2.1 Auto tuning function	3- 7
3.2.2 Auto tuning setting function.....	3-12
3.2.3 Reverse/forward action select function	3-13
3.2.4 RFB limiter function	3-13
3.2.5 Sensor compensation function	3-13
3.2.6 Unused channel setting function	3-14
3.2.7 Forced PID control stop function	3-14
3.2.8 Loop disconnection detection function	3-15
3.2.9 Data storage in FeRAM function	3-16

3.2.10 Alert function.....	3-18
3.2.11 Control output setting at CPU stop error occurrence function.....	3-23
3.2.12 Program control function.....	3-24
3.2.13 Cascade control function	3-37
3.2.14 Scaling function.....	3-39
3.2.15 SV tracking function	3-41
3.2.16 Forced output function	3-44
3.2.17 Simplified analog I/O function.....	3-48
3.2.18 Parameter change in program control function.....	3-49
3.2.19 Q62HLC control status controlling output signal and buffer memory settings and control status	3-52
3.3 Sampling Period.....	3-56
3.4 I/O Signals Transferred to/from the Programmable Controller CPU.....	3-57
3.4.1 I/O signals.....	3-57
3.4.2 Input signal functions	3-58
3.4.3 Output signal functions.....	3-62
3.5 Buffer Memory.....	3-65
3.5.1 Buffer memory areas.....	3-65
3.5.2 Error code (buffer memory address 0: Un\G0)	3-76
3.5.3 Alert definition (buffer memory address 5, 6: Un\G5, Un\G6)	3-77
3.5.4 Measured value (PV) (buffer memory address 9, 10: Un\G9, Un\G10).....	3-77
3.5.5 Manipulated value (MV) (buffer memory address 13, 14: Un\G13, Un\G14)	3-78
3.5.6 Approach flag (buffer memory address 17, 18: Un\G17, Un\G18).....	3-78
3.5.7 Set value monitor (buffer memory address 25, 26: Un\G25, Un\G26).....	3-78
3.5.8 Cold junction temperature measured value (buffer memory address 29: Un\G29).....	3-78
3.5.9 Control mode monitor (buffer memory address 30: Un\G30).....	3-79
3.5.10 PID constant read/write completion flag from FeRAM (buffer memory address 31: Un\G31).....	3-80
3.5.11 Input range (buffer memory address 32, 64: Un\G32, Un\G64).....	3-82
3.5.12 Stop mode setting (buffer memory address 33, 65: Un\G33, Un\G65).....	3-84
3.5.13 Set value (SV) setting (buffer memory address 34, 66: Un\G34, Un\G66).....	3-84
3.5.14 PID constant setting (buffer memory address 35 to 37, 67 to 69: Un\G35 to Un\G37, Un\G67 to Un\G69)	3-85
3.5.15 Alert set value 1 to 4 (buffer memory address 38 to 41, 70 to 73: Un\G38 to Un\G41, Un\G70 to Un\G73)	3-87
3.5.16 Upper/lower output limiter (buffer memory address 42, 43, 74, 75: Un\G42, Un\G43, Un\G74, Un\G75).....	3-87
3.5.17 Output variation limiter (buffer memory address 44, 76: Un\G44, Un\G76).....	3-88
3.5.18 Sensor compensation value setting (buffer memory address 45, 77: Un\G45, Un\G77).....	3-88
3.5.19 AT differential gap (buffer memory address 46, 78: Un\G46, Un\G78)	3-89
3.5.20 AT additional lag (buffer memory address 47, 79: Un\G47, Un\G79).....	3-89
3.5.21 Primary delay digital filter setting (buffer memory address 48, 80: Un\G48, Un\G80)	3-90
3.5.22 Control response parameter (buffer memory address 49, 81: Un\G49, Un\G81)	3-91
3.5.23 Control mode (buffer memory address 50, 82: Un\G50, Un\G82)	3-92
3.5.24 MAN output setting (buffer memory address 51, 83: Un\G51, Un\G83).....	3-93
3.5.25 Setting change rate limiter (buffer memory address 52, 84: Un\G52, Un\G84).....	3-93
3.5.26 AT bias (buffer memory address 53, 85: Un\G53, Un\G85).....	3-94
3.5.27 Forward/reverse action setting (buffer memory address 54, 86: Un\G54, Un\G86).....	3-94

3.5.28 Upper/lower setting limiter (buffer memory address 55, 56, 87, 88: Un\G55, Un\G56, Un\G87, Un\G88).....	3-95
3.5.29 Program control run/reset (buffer memory address 57, 89: Un\G57, Un\G89).....	3-95
3.5.30 Loop disconnection detection judgment time (buffer memory address 59, 91: Un\G59, Un\G91).....	3-96
3.5.31 Loop disconnection detection dead band (buffer memory address 60, 92: Un\G60, Un\G92).....	3-96
3.5.32 Unused channel setting (buffer memory address 61, 93: Un\G61, Un\G93).....	3-97
3.5.33 PID constant read command from FeRAM (buffer memory address 62, 94: Un\G62, Un\G94).....	3-97
3.5.34 Automatic backup setting after auto tuning of PID constants (buffer memory address 63, 95: Un\G63, Un\G95).....	3-98
3.5.35 Alert dead band setting (buffer memory address 164: Un\G164)	3-98
3.5.36 Alert delay count (buffer memory address 165: Un\G165).....	3-98
3.5.37 Approach range setting (buffer memory address 167: Un\G167)	3-99
3.5.38 Approach soak time setting (buffer memory address 168: Un\G168).....	3-99
3.5.39 PID continuation flag (buffer memory address 169: Un\G169)	3-99
3.5.40 Cascade ON/OFF (buffer memory address 176: Un\G176).....	3-99
3.5.41 Cascade gain (buffer memory address 177: Un\G177).....	3-100
3.5.42 Cascade bias (buffer memory address 178: Un\G178).....	3-100
3.5.43 Cascade monitor (buffer memory address 179: Un\G179)	3-100
3.5.44 Alert 1 to 4 mode setting (buffer memory address 192 to 195, 208 to 211: Un\G192 to Un\G195, Un\G208 to Un\G211)	3-101
3.5.45 Scaling value (buffer memory address 196, 212: Un\G196, Un\G212)	3-101
3.5.46 Scaling range upper/lower limit value (buffer memory address 197, 198, 213, 214: Un\G197, Un\G198, Un\G213, Un\G214)	3-102
3.5.47 Scaling width upper/lower limit value (buffer memory address 199, 200, 215, 216: Un\G199, Un\G200, Un\G215, Un\G216)	3-102
3.5.48 Hold command (buffer memory address 201, 217: Un\G201, Un\G217)	3-103
3.5.49 Command advancing (buffer memory address 202, 218: Un\G202, Un\G218)	3-104
3.5.50 SV tracking setting (buffer memory address 203, 219: Un\G203, Un\G219)	3-104
3.5.51 Forced output command (buffer memory address 204, 220: Un\G204, Un\G220)	3-105
3.5.52 Forced output manipulated value (MV) (buffer memory address 205, 221: Un\G205, Un\G221)	3-105
3.5.53 Segment monitor (buffer memory address 256, 512: Un\G256, Un\G512).....	3-105
3.5.54 Segment remaining time (buffer memory address 257, 513: Un\G257, Un\G513).....	3-105
3.5.55 Execution times monitor (buffer memory address 258, 514: Un\G258, Un\G514).....	3-106
3.5.56 Pattern end output flag (buffer memory address 259, 515: Un\G259, Un\G515).....	3-106
3.5.57 End status flag (buffer memory address 260, 516: Un\G260, Un\G516).....	3-106
3.5.58 Wait status flag (buffer memory address 261, 517: Un\G261, Un\G517).....	3-106
3.5.59 Hold status flag (buffer memory address 262, 518: Un\G262, Un\G518).....	3-106
3.5.60 Advancing completion flag (buffer memory address 263, 519: Un\G263, Un\G519).....	3-107
3.5.61 Execution pattern monitor (buffer memory address 264, 520: Un\G264, Un\G520)	3-107
3.5.62 Zone PID monitor (buffer memory address 265, 521: Un\G265, Un\G521)	3-107
3.5.63 Forced output status flag (buffer memory address 266, 522: Un\G266, Un\G522)	3-107
3.5.64 Execution pattern (buffer memory address 272, 528: Un\G272, Un\G528)	3-108
3.5.65 Start mode (buffer memory address 273, 529: Un\G273, Un\G529)	3-108
3.5.66 Time scale (buffer memory address 274, 530: Un\G274, Un\G530)	3-109

3.5.67 Zone setting (buffer memory address 275 to 313, 531 to 569: Un\G275 to Un\G313, Un\G531 to Un\G569)	3-109
3.5.68 Program pattern (buffer memory address 320 to 500, 576 to 756: Un\G320 to Un\G500, Un\G576 to Un\G756)	3-111
3.5.69 Set value at program control start (SV_PCS) setting (buffer memory address: 501, 757: Un\G501, Un\G757)	3-115

4 PROCEDURES AND SETTINGS BEFORE SYSTEM OPERATION	4- 1 to 4- 9
--	---------------------

4.1 Handling Precautions	4- 1
4.2 Procedures before Operation	4- 2
4.3 Part Names	4- 3
4.4 Wiring.....	4- 5
4.4.1 Wiring precautions.....	4- 5
4.4.2 External wiring	4- 6
4.5 Intelligent Function Module Switch Setting	4- 8

5 UTILITY PACKAGE (GX Configurator-TC)	5- 1 to 5-23
---	---------------------

5.1 Utility Package Functions	5- 1
5.2 Installing and Uninstalling the Utility Package	5- 4
5.2.1 Handling precautions	5- 4
5.2.2 Operating environment	5- 6
5.3 Utility Package Operation	5- 8
5.3.1 Common utility package operations	5- 8
5.3.2 Operation overview	5-10
5.3.3 Starting the intelligent function module utility	5-12
5.4 Initial Settings	5-14
5.5 Auto Refresh	5-18
5.6 Monitoring/Test	5-20

6 PROGRAMMING	6- 1 to 6-49
----------------------	---------------------

6.1 Programming Procedure.....	6- 1
6.2 For Use in Normal System Configuration	6- 2
6.2.1 Program example using the utility package	6- 5
6.2.2 Program example without using the utility package.....	6-10
6.3 For Use on Remote I/O Network	6-20
6.3.1 Program example using the utility package	6-23
6.3.2 Program example without using the utility package.....	6-34

7 ONLINE MODULE CHANGE	7- 1 to 7-17
-------------------------------	---------------------

7.1 Online Module Change Conditions.....	7- 2
7.2 Operations When an Online Module Change is Performed	7- 3
7.3 Online Module Change Procedure	7- 4
7.3.1 When GX Configurator-TC is used for the initial setting	7- 4
7.3.2 When a sequence program is used for the initial setting	7- 9

7.4 Precautions for Online Module Change	7-14
7.4.1 Precautions before module change.....	7-14
7.4.2 Precautions after module change.....	7-16
7.4.3 Precautions depending on parameter setting method.....	7-17

8 TROUBLESHOOTING	8- 1 to 8-10
--------------------------	---------------------

8.1 Error Codes	8- 1
8.2 Processing Performed by the Q62HLC at Error Occurrence	8- 4
8.3 When the RUN LED Flashes or Turns Off	8- 5
8.4 When the ERR. LED Turns On or Flashes	8- 5
8.5 When the ALM LED Turns On or Flashes	8- 6
8.6 When Watchdog Timer Error Flag (Xn0) Is On.....	8- 6
8.7 When Error Flag (Xn2) Is On.....	8- 6
8.8 When Module Ready Flag (Xn3) Does Not Turn On.....	8- 7
8.9 When FeRAM Write Failure Flag (XnA) Is On.....	8- 7
8.10 When Auto Tuning Does Not Start (When Auto Tuning Status Flag (Xn4, Xn5) Does Not Turn On).....	8- 7
8.11 When Auto Tuning Does Not Complete (When Auto Tuning Status Flag (Xn4, Xn5) Remains to Be On and Does Not Turn Off).....	8- 7
8.12 When Alert Flag (XnC and XnD) is On.....	8- 8
8.13 Checking the Q62HLC Status by System Monitor of GX Developer	8- 9

APPENDICES	Appendix- 1 to Appendix- 3
-------------------	-----------------------------------

Appendix 1 External Dimensions.....	Appendix- 1
Appendix 2 New Functions of the Q62HLC	Appendix- 2

INDEX	Index- 1 to Index- 3
--------------	-----------------------------

COMPLIANCE WITH EMC AND LOW VOLTAGE DIRECTIVES

(1) Method of ensuring compliance

To ensure that Mitsubishi programmable controllers maintain EMC and Low Voltage Directives when incorporated into other machinery or equipment, certain measures may be necessary. Please refer to one of the following manuals.

- QCPU User's Manual (Hardware Design, Maintenance and Inspection)
- Safety Guidelines
(This manual is included with the CPU module or base unit.)

The CE mark on the side of the programmable controller indicates compliance with EMC and Low Voltage Directives.

(2) Additional measures

The following wiring is required for the compliance of this product with the EMC and Low Voltage Directives.

- (a) Use shielded cables for all external wiring and ground them to the control panel with the AD75CK cable clamp.

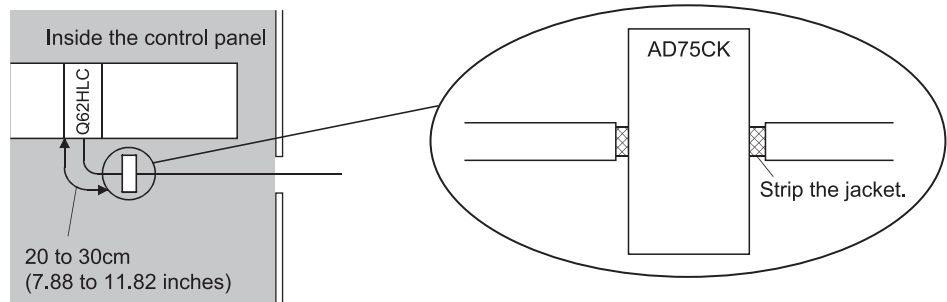

- (b) Four cables can be grounded together with the AD75CK cable clamp when the diameter of each cable is approximately 7mm (0.28 inch).

ABOUT THE GENERIC TERMS AND ABBREVIATIONS

Unless otherwise specified, this manual uses the following generic terms and abbreviations to describe the Loop control module.

Generic term/abbreviation	Description
Personal computer	DOS/V-compatible personal computer of IBM PC/AT [®] or its compatible
GX Developer	Product name of MELSEC programmable controller software package
GX Works2	
QCPU (Q mode)	Generic term of the Q00JCPU, Q00CPU, Q01CPU, Q02CPU, Q02HCPU, Q06HCPU, Q12HCPU, Q25HCPU, Q02PHCPU, Q06PHCPU, Q12PHCPU, Q25PHCPU, Q12PRHCPU, Q25PRHCPU, Q00UJCPU, Q00UCPU, Q01UCPU, Q02UCPU, Q03UDCPU, Q04UDHCPU, Q06UDHCPU, Q10UDHCPU, Q13UDHCPU, Q20UDHCPU, Q26UDHCPU, Q03UDECPU, Q04UDEHCPU, Q06UDEHCPU, Q10UDEHCPU, Q13UDEHCPU, Q20UDEHCPU, Q26UDEHCPU, Q50UDEHCPU and Q100UDEHCPU
Process CPU	Generic term of the Q02PHCPU, Q06PHCPU, Q12PHCPU and Q25PHCPU
Redundant CPU	Generic term for the Q12PRHCPU and Q25PRHCPU
GX Configurator-TC	Generic term of temperature control module setting/monitoring tool GX Configurator-TC(SW0D5C-QTCU-E)
Q62HLC	Abbreviation of Type Q62HLC loop control module

PRODUCT STRUCTURE

The product structure of the product is given in the table below.

Model	Product	Quantity
Q62HLC	Type Q62HLC loop control module	1
SW0D5C-QTCU-E	GX Configurator-TC Version 1 (Single license product) (CD-ROM)	1
SW0D5C-QTCU-EA	GX Configurator-TC Version 1 (Volume license product) (CD-ROM)	1

1 OVERVIEW

This manual describes the specifications, handling, wiring, and programming of the loop control module Q62HLC (hereinafter abbreviated as Q62HLC) that is used with the MELSEC-Q series programmable controller CPU.

(1) About Q62HLC

(a) The Q62HLC is intelligent function module for the continuous proportional control.

The Q62HLC converts analog input from various external sensors (temperature, humidity, pressure, and flow rate) into a measured value (16-bit signed binary data), performs PID operations to attain the target set value, and outputs the calculated manipulated value to external operation devices with current output.

(b) The Q62HLC has the following five control functions.

- Normal control (Normal control mode)
- Program control (Program control mode)
- Cascade control
- Manual control (Manual control mode 1)
- Manual control (Manual control mode 2)

(c) The Q62HLC automatically sets the proportional band (P), integral time (I), and derivative time (D) for PID operations using the auto tuning function.

(d) Thermocouples (K, J, T, B, S, E, R, N, PLII, and W5Re/W26Re type) and sensors compatible with the input ranges of micro voltage, voltage, and current can be connected to the Q62HLC.

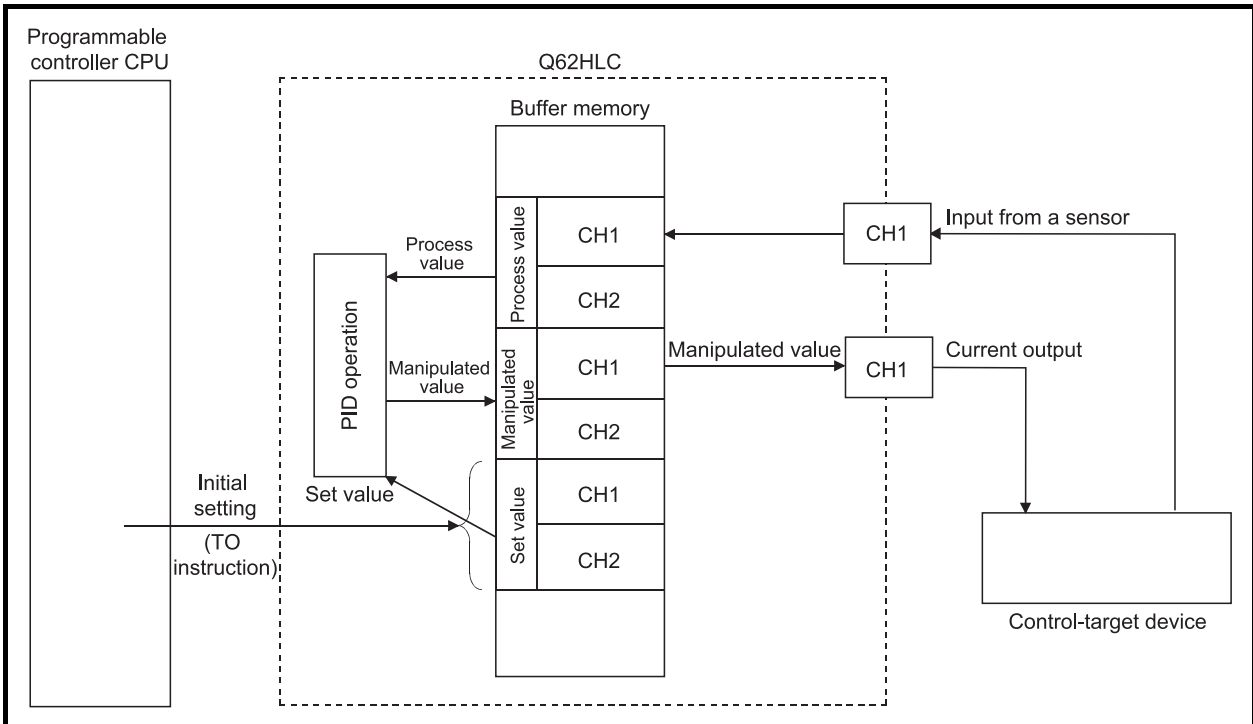

Fig. 1.1 Processing outline of the Q62HLC

1.1 Features

1

The Q62HLC has the following features.

(1) High speed PID control

The Q62HLC is an intelligent function module that performs the continuous proportional control.

With the Q62HLC, the high speed sampling cycle (25ms), analog input (thermocouple, micro voltage, voltage, and current) with high accuracy and resolution, and the current output are available.

This enables the control that requires high-speed response, such as the high-speed rising and falling temperature control, pressure control and flow rate control.

(2) Optimum PID control

(a) The Q62HLC automatically performs PID control by setting the PID constants (proportional band (P), integral time (I), derivative time (D)) and the set value (SV) required for PID operations.

No special instruction is required to perform PID control.

(b) Five control functions are available for the Q62HLC. The Q62HLC can select the most suitable control function for the control target.

1) Normal mode (Normal control mode)

: The Q62HLC controls the control target using the manipulated values calculated in PID operations as the control output.

2) Program control (Program control mode)

: The Q62HLC changes the set values automatically and performs the control, following the set program pattern. The manipulated value calculated in PID operations is used as the control output.

3) Cascade control

: The Q62HLC performs the control using the channel 1 as master and the channel 2 as slave.

4) Manual control (Manual control mode 1)

: The Q62HLC controls the control target using the numerical value written in the manual output setting (-5.0 to 105.0%) as the control output.

5) Manual control (Manual control mode 2)

: The Q62HLC controls the control target using the numerical value written in the manual output setting (0 to 4000) as the control output.

This mode is for the simplified analog I/O function.

(c) The Q62HLC automatically set PID constants by using the auto tuning function in normal control mode.

This enables the use of PID constants without considering cumbersome PID operation expressions (refer to Section 3.2.1).

- (3) Connection of thermocouples compatible with JIS, IEC, NBS and ASTM Standards
 - (a) Thermocouples compatible with the JIS, IEC, NBS, and ASTM Standards can be connected to the Q62HLC.
 - JIS Standards : R, K, J, S, B, E, T
 - IEC Standards: R, K, J, S, B, E, T, N
 - NBS Standards : PL II
 - ASTM Standards: W5Re, W26Re
- (4) Connection of sensors compatible with the input ranges of micro voltage, voltage and current

Analog input of the following ranges can be measured using the micro voltage, voltage, and current input sensors.

 - Micro voltage : 0 to 10mV, 0 to 100mV, -10 to 10mV, -100 to 100mV
 - Voltage : 0 to 1V, 1 to 5V, 0 to 5V, 0 to 10V, -1 to 1V, -5 to 5 V, -10 to 10V
 - Current : 4 to 20mA, 0 to 20mA
- (5) RFB limiter function

The RFB (reset feed back) limiter suppresses overshooting that may occur at a start-up or when the set value (SV) is increased (refer to Section 3.2.4).
- (6) Sensor compensation function

By setting a sensor compensation value, a difference, if any, between the measured value (PV) and actual temperature, humidity, pressure, flow rate, or others can be eliminated (refer to Section 3.2.5).
- (7) Program control function

The control can be performed automatically, changing the set value (SV) and PID constants (proportional band (P), integral time (I), derivative time (D)) by setting a program pattern (refer to Section 3.2.12).
- (8) Cascade control function

The cascade control can be performed using the channel 1 as master and the channel 2 as slave (refer to Section 3.2.13).
- (9) Scaling function

The scaled measured value (PV) can be automatically stored in the buffer memory (refer to Section 3.2.14).
- (10) Simplified analog I/O function

The Q62HLC can be used as a simplified thermocouple/micro voltage input module, analog-digital conversion module, or digital-analog conversion module by monitoring the measured value and setting the manipulated value manually (refer to Section 3.2.17).
- (11) Auto tuning mode setting function

The auto tuning mode according to a control target can be specified by setting AT differential gap and AT additional lag (refer to Section 3.2.2).

(12) Online module change function

The Q62HLC can be replaced without the system being stopped (refer to Chapter 7).

(13) Storing setting values in FeRAM

The setting data in the buffer memory can be stored into FeRAM for backup. When the data is directly written to the buffer memory using the test functions of GX Developer, the sequence program required is only "LD**" + "OUT Yn1" (refer to Section 3.2.9).

(14) Easy settings with GX Configurator-TC

The number of sequence programs can be reduced by using GX Configurator-TC (sold separately) because the settings for the loop control module can be configured on the screen.

In addition, the setting status and operating status of the module can be checked easily with GX Configurator-TC.

1.2 PID Control System

(1) PID control system

Figure 1.2 shows the system configuration to perform PID control.

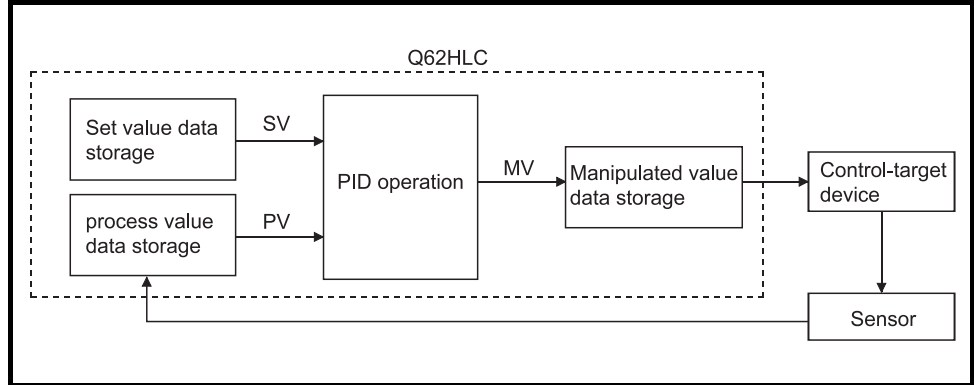

Fig. 1.2 PID control system

(2) PID control procedure

Figure 1.3 describes the PID control procedure.

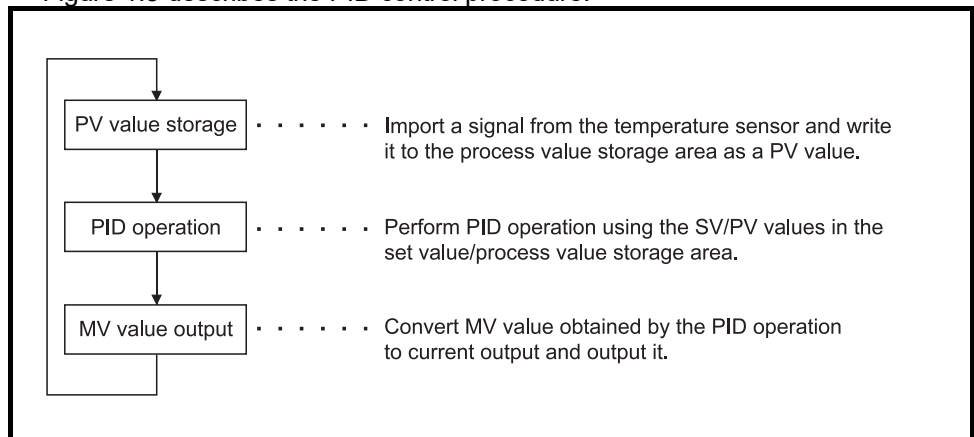

Fig. 1.3 PID control procedure

(3) PID control (simplified two-degree-of-freedom control)

Generally in the PID control, when the P, I, and D constants to improve the "response to the setting" are set, the "response to the disturbance" degrades. In contrast, when the P, I, and D constants to improve the "response to the disturbance" are set, the "response to the setting" degrades.

In the PID control (simplified two-degree-of-freedom control) of this module, when the P, I, and D constants to improve the "response to the disturbance" are set, the performance to the "response to the setting" can be specified ("fast", "normal", or "slow").

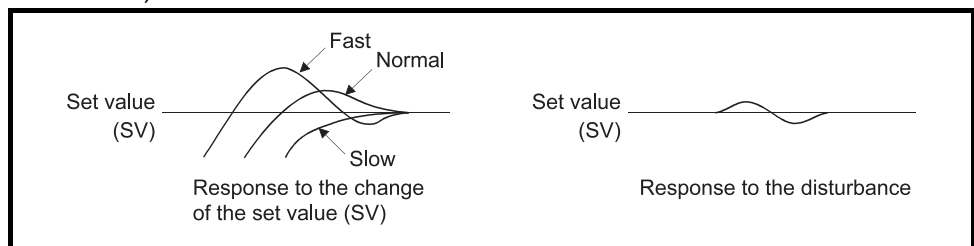

Fig. 1.4 Simplified two-degree-of-freedom PID control

1.3 PID Operation

The Q62HLC can perform PID control in measured value incomplete differentiation.

1.3.1 Operation method and formula

The PID control in measured value incomplete differentiation is an operation method which puts the primary delay filter as the input for derivative control action, and performs PID operation with the deviation (E) after eliminating the high-frequency noise component.

(1) The algorithm of the PID control in measured value incomplete differentiation is shown in Figure 1.5.

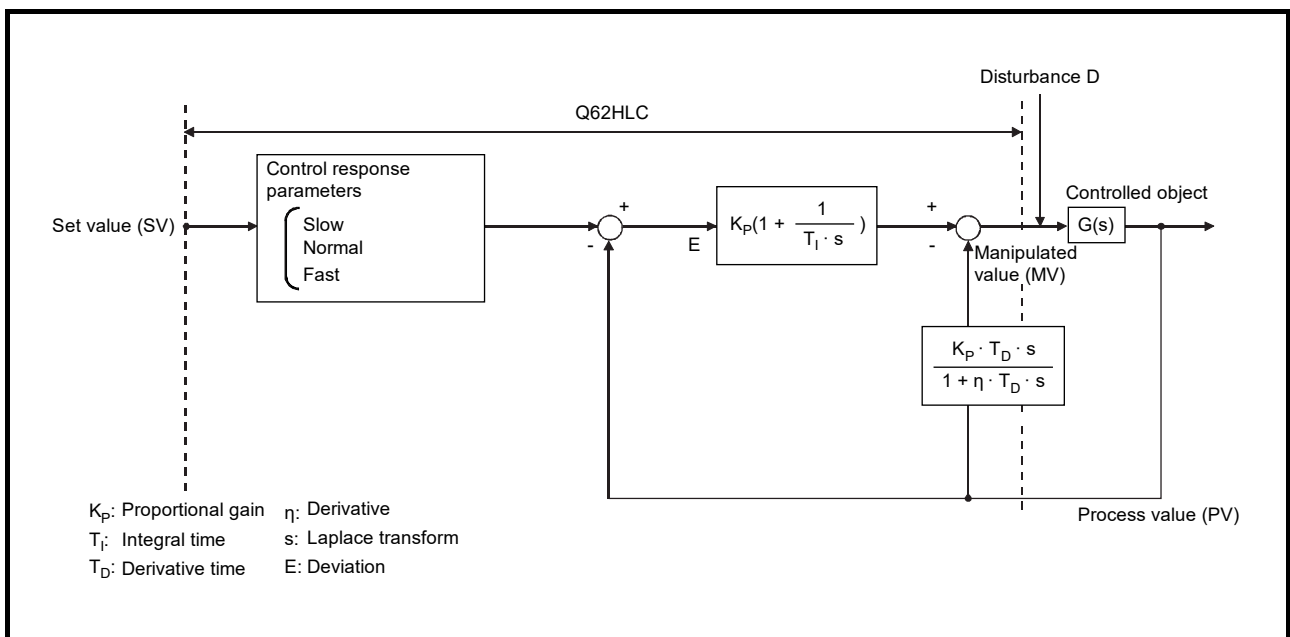

Fig. 1.5 Algorithm of PID control in measured value incomplete differentiation

(2) The formula used for the Q62HLC is shown below:

$$MV_n = K_p \left\{ E_n + \left(\frac{\tau}{T_i} E_n + I_{n-1} \right) + \left(\frac{\eta T_D}{\tau + \eta T_D} D_{n-1} - \frac{T_D}{\tau + \eta T_D} (PV_n - PV_{n-1}) \right) \right\}$$

- E: Deviation (SV-PV)
- τ : Sampling cycle
- MV: PID control in measured value incomplete differentiation output
- PV: Process value
- K_p : Proportional gain
- T_i : Integral time
- T_D : Derivative time
- η : Derivative
- I: Integral value
- D: Derivative value

1.3.2 Actions in the Q62HLC

The Q62HLC performs PID operations in reverse action and forward action.

(1) Reverse action

In a reverse action, the measured value (PV) increases toward the set value (SV) as the manipulated value (MV) increases.

The reverse action is effective for heat control.

(2) Forward action

In a forward action, the measured value (PV) decreases toward the set value (SV) as the manipulated value (MV) increases.

The forward action is effective for cooling control.

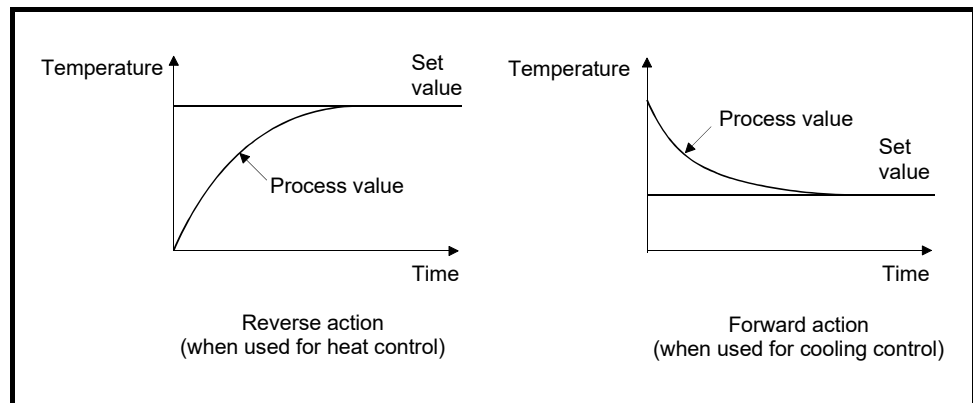

Fig. 1.6 Process control example in reverse action and forward action

1.3.3 Proportional action (P-action)

- (1) The proportional action calculates the manipulated value proportional to the deviation (difference between the set value and measured value).
- (2) With the proportional action, the relationship between the changes in the deviation and manipulated value can be expressed in the following formula:
$$MV = K_P \cdot E$$
 K_P is a proportional constant and is called the proportional gain.
- (3) Figure 1.7 shows the proportional action for the step response with a constant deviation.
- (4) The manipulated value changes between -5.0% and 105.0%.
As the K_P increases, the manipulated value for the same deviation becomes larger, and the corrective action becomes stronger.
- (5) The proportional action will generate an offset (residual deviation).

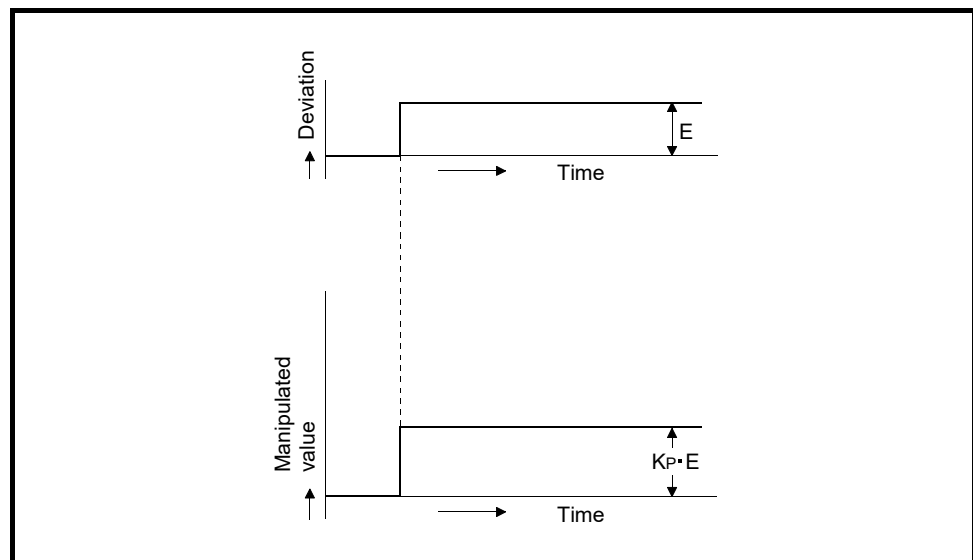

Fig. 1.7 Proportional action for step response

1.3.4 Integral action (I-action)

- (1) When a deviation occurs, the integral action continuously changes the manipulated value to eliminate the deviation.
The offset produced by the proportional action can be eliminated.
- (2) In the integral action, the time from the deviation occurrence until the manipulated value of the integral action becomes that of the proportional control action is called the integral time, and is indicated by T_I .
- (3) Figure 1.8 shows the integral action for the step response with a constant deviation.
- (4) The integral action is used in the PI action in combination with the proportional action, or the PID action in combination with the proportional and derivative actions.
The integral action cannot be used alone.

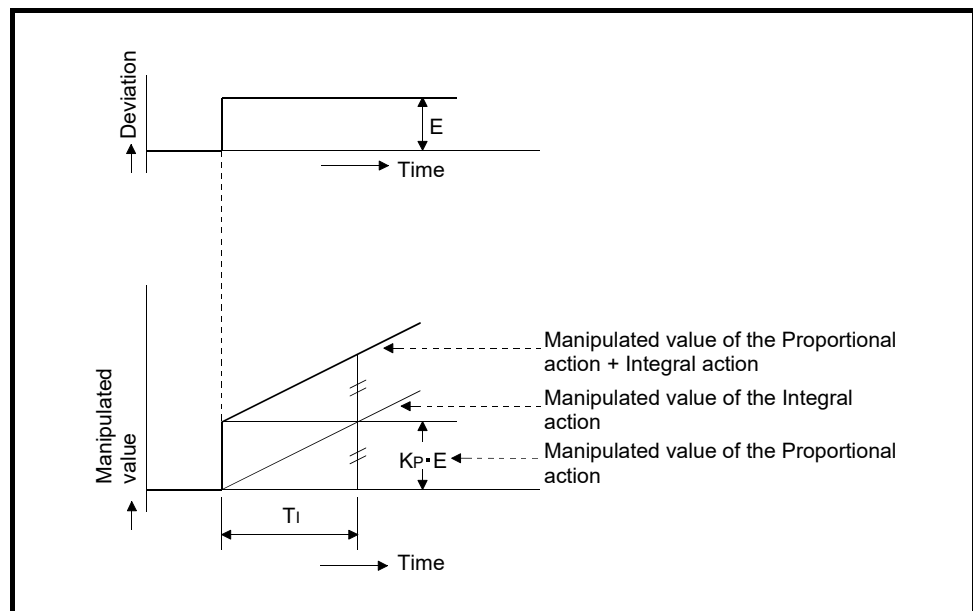

Fig. 1.8 Integral action for step response

1.3.5 Derivative action (D-action)

- (1) When a deviation occurs, the derivative action adds the manipulated value proportional to the change speed to eliminate the deviation.
This can protect the control target from a sudden change due to disturbance.
- (2) In the derivative action, the time from the deviation occurrence until the manipulated value of the derivative action becomes that of the proportional action is called the derivative time, and is indicated by T_D .
- (3) Figure 1.9 shows the derivative action for the step response with a constant deviation.
- (4) The derivative action is used in the PID action in combination with the proportional and integral actions.
The PD action in combination with the proportional action, or the derivative action by itself is not available.

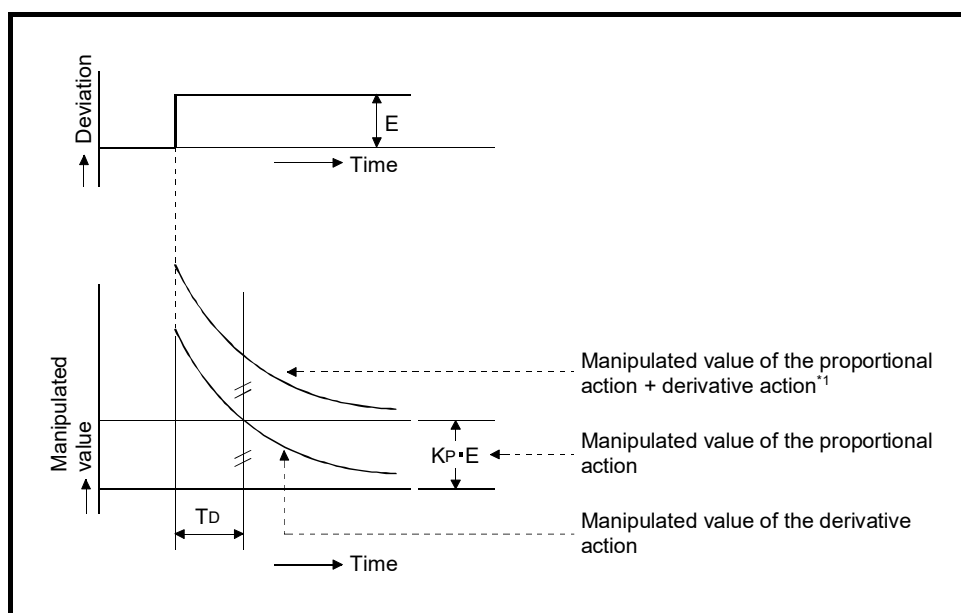

Fig. 1.9 Derivative action for step response

*1: The PD action is not available for this module.

1.3.6 PID action

- (1) The PID action performs control using the manipulated value calculated by proportional action, integral action, and derivative action.
- (2) The PID action for the step response when the deviation is constant is shown in Figure 1.10.

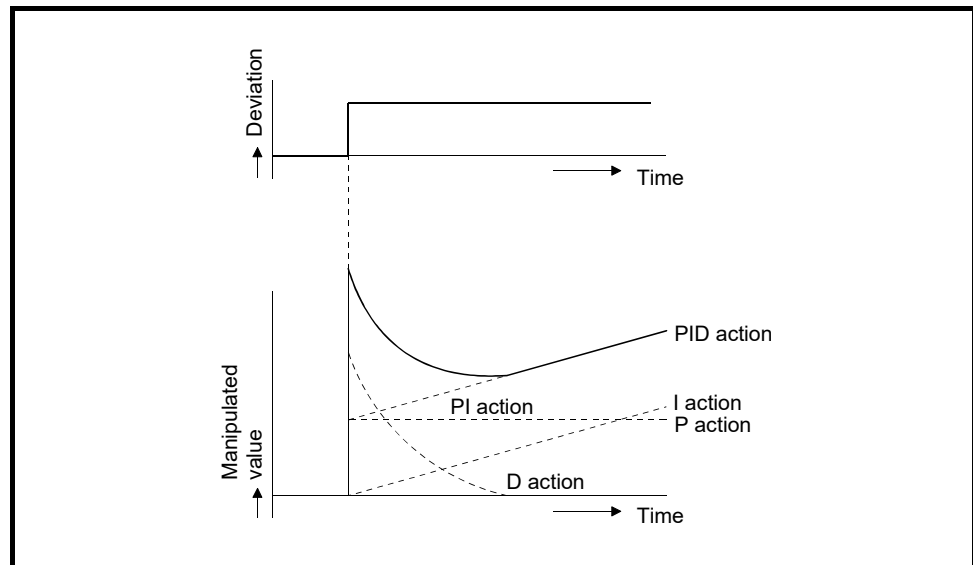

Fig. 1.10 PID action for step response

2 SYSTEM CONFIGURATION

This chapter describes the system configuration of the Q62HLC.

2.1 Applicable Systems

This section describes the applicable systems.

(1) Applicable modules and base units, and number of modules

(a) When mounted with a CPU module

The following table lists the CPU modules and base units applicable to the Q62HLC and quantities for each CPU model.

Depending on the combination with other modules or the number of mounted modules, power supply capacity may be insufficient.

Pay attention to the power supply capacity before mounting modules, and if the power supply capacity is insufficient, change the combination of the modules.

Applicable CPU module		Number of modules*1	Base unit*2		
CPU type	CPU model		Main base unit	Extension base unit	
Programmable controller CPU	Basic model QCPU	Q00JCPU	○	○	
		Q00CPU			
		Q01CPU			
	High Performance model QCPU	Q02CPU	Up to 64	○	○
		Q02HCPU			
		Q06HCPU			
		Q12HCPU			
		Q25HCPU			
	Process CPU	Q02PHCPU	Up to 64	○	○
		Q06PHCPU			
		Q12PHCPU			
		Q25PHCPU			
	Redundant CPU	Q12PRHCPU	Up to 53	×	○
		Q25PRHCPU			
	Universal model QCPU	Q00UJCPU	Up to 16	○	○
		Q00UCPU	Up to 24		
		Q01UCPU			
		Q02UCPU	Up to 36		
		Q03UDCPU	Up to 64		
Q04UDHCPU					
Q06UDHCPU					
Q10UDHCPU					
Q13UDHCPU					
Q20UDHCPU					
Q26UDHCPU					

○ Applicable × Not applicable

Applicable CPU module		Number of modules*1	Base unit*2	
CPU type	CPU model		Main base unit	Extension base unit
Programmable controller CPU	Universal model QCPU	Q03UDECPU	○	○
		Q04UDEHCPU		
		Q06UDEHCPU		
		Q10UDEHCPU		
		Q13UDEHCPU		
		Q20UDEHCPU		
		Q26UDEHCPU		
		Q50UDEHCPU		
	Q100UDEHCPU			
Safety CPU	QS001CPU	Not applicable	×	×*3
C Controller module	Q06CCPU-V	Up to 64	○	○
	Q06CCPU-V-B			
	Q12DCCPU-V			

○ Applicable × Not applicable

*1: Limited within the range of I/O points of the CPU module.

*2: Can be installed to any I/O slot on a base unit.

*3: Extension base units are not connected to the safety CPU module.

REMARKS

For using the Q62HLC with the C Controller module, refer to the C Controller Module User's Manual.

(b) Mounting to a MELSECNET/H remote I/O station

The following table lists the network modules and base units applicable to the Q62HLC and quantities for each network module model.

Depending on the combination with other modules or the number of mounted modules, power supply capacity may be insufficient.

Pay attention to the power supply capacity before mounting modules, and if the power supply capacity is insufficient, change the combination of the modules.

Applicable network module	No. of modules*1	Base unit*2	
		Main base unit of remote I/O station	Extension base unit of remote I/O station
QJ72LP25-25	Up to 64	○	○
QJ72LP25G			
QJ72LP25GE			
QJ72BR15			

○ Applicable × Not applicable

*1: Limited within the range of I/O points of the network module.

*2: Can be installed to any I/O slot on a base unit.

REMARKS

The Basic model QCPU or C Controller module cannot create the MELSECNET/H remote I/O network.

(2) Support of the multiple CPU system

When using the Q62HLC in a multiple CPU system, refer to the following manual first.

- QCPU User's Manual (Multiple CPU System)

(a) Intelligent function module parameters

Write intelligent function module parameters to the control CPU of the Q62HLC.

(3) Support of online module change

The function version of the Q62HLC has been "C" from the first release, supporting online module change.

For details, refer to CHAPTER 7.

(4) Supported software packages

Relation between the system containing the Q62HLC and software package is listed in the following table.

GX Developer or GX Works2 is necessary when the Q62HLC is used.

		Software version ^{*1}				
		GX Developer	GX Configurator-TC	GX Works2		
Q00J/Q00/Q01CPU	Single CPU system	Version 7 or later	Version 1.20W or later			
	Multiple CPU system	Version 8 or later				
Q02/Q02H/Q06H/ Q12H/Q25HCPU	Single CPU system	Version 4 or later				
	Multiple CPU system	Version 6 or later				
Q02PH/Q06PHCPU	Single CPU system	Version 8.68W or later				
	Multiple CPU system					
Q12PH/Q25PHCPU	Single CPU system	Version 7.10L or later				
	Multiple CPU system					
Q12PRH/ Q25PRHCPU	Redundant CPU system	Version 8.45X or later				
Q00UJ/Q00U/ Q01UCPU	Single CPU system	Version 8.78G or later			Version 1.23Z or later	Refer to the GX Works2 Version 1 Operating Manual (Common).
	Multiple CPU system					
Q02U/Q03UD/ Q04UDH/ Q06UDHCPU	Single CPU system	Version 8.48A or later				
	Multiple CPU system					
Q10UDH/ Q20UDHCPU	Single CPU system	Version 8.78G or later				
	Multiple CPU system					
Q13UDH/ Q26UDHCPU	Single CPU system	Version 8.62Q or later				
	Multiple CPU system					
Q03UDE/Q04UDEH/ Q06UDEH/Q13UDEH/ Q26UDEHCPU	Single CPU system	Version 8.68W or later				
	Multiple CPU system					
Q10UDEH/ Q20UDEHCPU	Single CPU system	Version 8.76E or later				
	Multiple CPU system					
Q50UDEH/ Q100UDEHCPU	Single CPU system	Cannot be used.	Cannot be used.			
	Multiple CPU system	Cannot be used.	Cannot be used.			
If installed in a MELSECNET/H remote I/O station		Version 6 or later	Version 1.20W or later			

*1: GX Configurator-TC does not support functions added to products with a serial number (first five digits) of "13102" or later. Set those functions using sequence programs or GX Works2 of version 1.73B or later. For the functions added to products with a serial number (first five digits) of "13102" or later, refer to Appendix 2 (2).

POINT
(1) Supported system and CPU module differ according to the version of GX Configurator-TC. (2) When using GX Works2, refer to the following. <ul style="list-style-type: none"> • GX Works2 Version 1 Operating Manual (Common) • GX Works2 Version 1 Operating Manual (Intelligent Function Module)

2.2 For Using the Q62HLC with Redundant CPUs

This section describes the Q62HLC with Redundant CPUs.

(1) GX Configurator-TC

GX Configurator-TC cannot be used when the Redundant CPU is accessed via an intelligent function module on an extension base unit from GX Developer. Connect a personal computer to the Redundant CPU with a communication path indicated below.

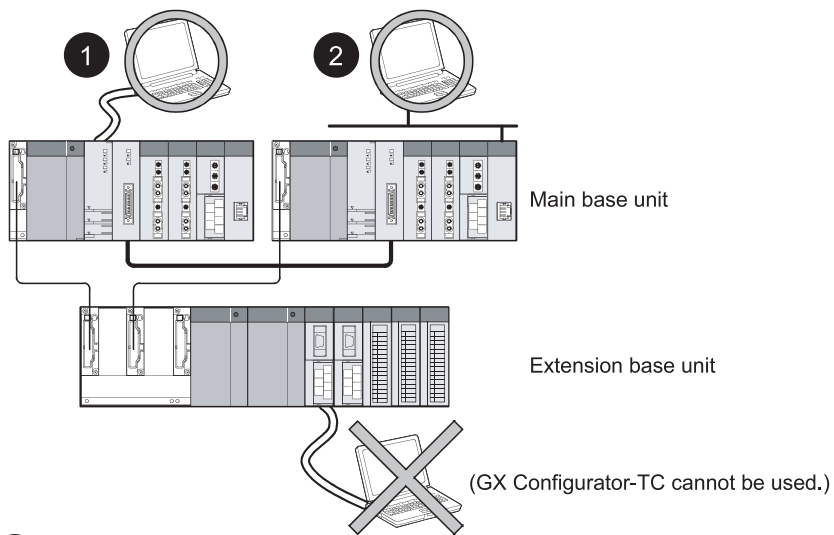

- 1 Direct connection to the CPU module
- 2 Connection through an intelligent function module on the main base unit (Through Ethernet module, MELSECNET/H module, or CC-Link module)

2.3 Checking Function Version, Production Information, Serial Number, and Software Version

This section describes how to check the function version, production information and product information of the Q62HLC and the GX Configuration-TC software version.

- (1) Checking the function version and serial number of the Q62HLC
 The serial number and function version of the Q62HLC can be checked on the rating plate, on the front part of the module, and the System monitor window of GX Developer.

- (a) Checking on the rating plate

The rating plate is located on the side of the Q62HLC.

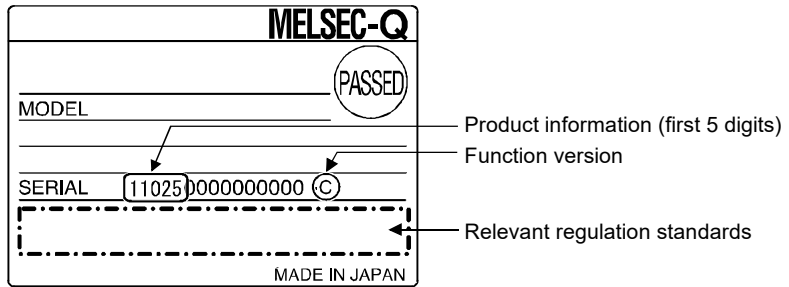

- (b) Checking on the front of the module

The serial number and function version on the rating plate is printed on the front (at the bottom) of the module.

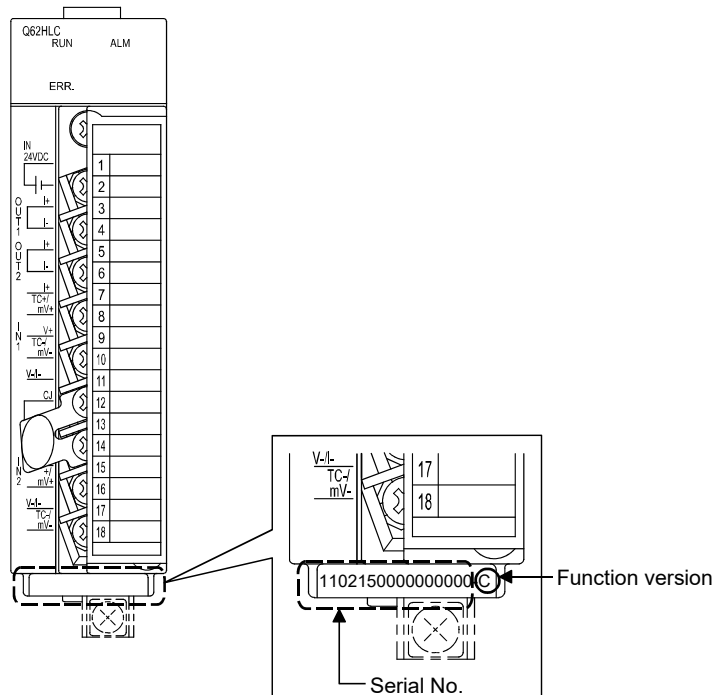

- (c) Checking the System monitor window (Product Information List)
 To display the system monitor, select [Diagnostics] → [System monitor] and click the **Product Information List** button of GX Developer.

Slot	Type	Series	Model name	Points	I/O No.	Master PLC	Serial No.	Ver.	Product No.
0-0	Intelli.	Q	Q06UDHCPU	-	0000	-	1101300000000000	C	091013092955015-B
0-1	-	-	None	-	-	-	-	-	-
0-2	-	-	None	-	-	-	-	-	-
0-3	-	-	None	-	-	-	-	-	-
0-4	-	-	None	-	-	-	-	-	-

- 1) Displaying the product number
 Since the Q62HLC does not support the display function, "-" is displayed in the "Product No." field.

POINT
<p>The serial number displayed on the Product Information List screen of GX Developer may differ from that on the rating plate and on the front of the module.</p> <ul style="list-style-type: none"> • The serial number on the rating plate and front part of the module indicates the management information of the product. • The serial number displayed on the Product Information List window of GX Developer indicates the function information of the product. <p>The function information of the product is updated when a new function is added.</p>

(2) Checking the software version of GX Configurator-TC

The software version of GX Configurator-TC can be checked by selecting [Help]

→ [Product information] of GX Developer.

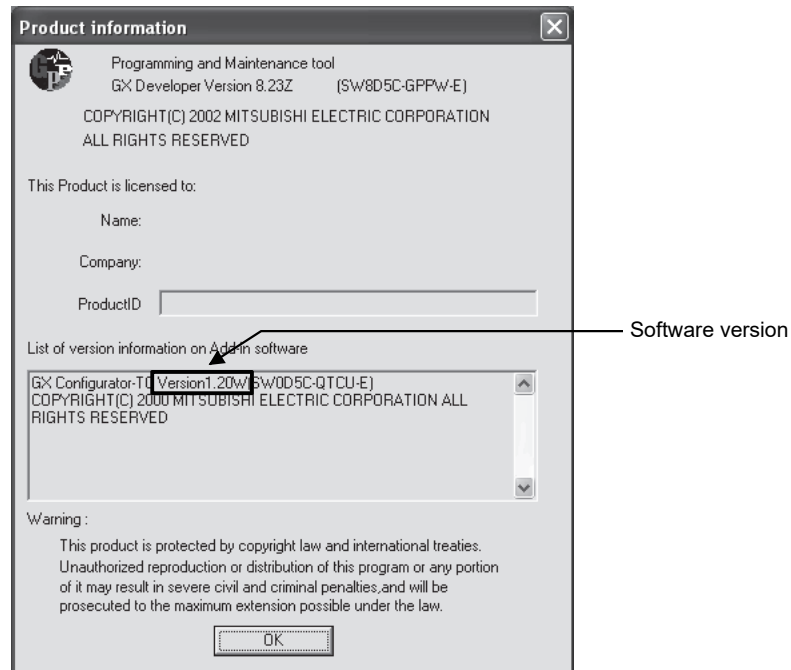

(In the case of GX Developer Version 8)

3 SPECIFICATIONS

This chapter describes the performance specifications, I/O signals transferred to/from the programmable controller CPU, and buffer memory areas of the Q62HLC.

For the general specifications of the Q62HLC, refer to the user's manual (hardware) for the CPU module used.

3.1 Performance Specifications

3.1.1 Performance specifications of the Q62HLC

Table 3.1 Performance specifications

Item		Specifications			
Number of analog I/O points		2 channels/module			
For analog input		For analog output			
Number of input points		2 (2 channels)		Number of output points	
Analog input		Refer to this section (1).		2 (2 channels)	
Digital output		16-bit signed binary		Digital input	
Applicable thermocouple		K, J, T, S, R, N, E, B, PLII, W5Re/W26Re		16-bit signed binary	
Input characteristics		Refer to this section (1).		Analog output	
Maximum resolution		Refer to this section (1).		Current	
Accuracy*1		Refer to this section (2).		-	
Indicated accuracy	Ambient temperature: 23°C±2°C	Refer to this section (2).		-	
	Ambient temperature: 0°C to 55°C	Refer to this section (2).		-	
Cold junction temperature compensation accuracy	Ambient temperature: 23°C±2°C	±0.5°C		-	
	Ambient temperature: 0°C to 55°C	±1.0°C		-	
Sampling period		25ms/2 channels (Stable regardless of the number of used channels)		Control output updating period	
Absolute maximum input		Micro voltage: ±12V Voltage: ±15V Current: ±30mA		25ms/2 channels (Stable regardless of the number of used channels)	
Input impedance		Thermocouple, micro voltage, voltage: 1M Ω Current: 250Ω		Allowable load resistance	
Normal mode rejection ratio		60dB or more (50/60Hz)		600Ω or less	
Common mode rejection ratio		120dB or more (50/60Hz)		Output impedance	
Input filter (primary delay digital filter)		0.0 to 100.0s (0: Input filter OFF)		5MΩ	
Sensor compensation value setting		Thermocouple: -500.0 to 500.0°C Micro voltage, voltage, current: -50.00 to 50.00%		-	
Operation at input disconnection		Refer to Section 3.1.2.		-	

(To the next page)

* 1: Calculate the accuracy in the following method.

(Accuracy) = (Indication accuracy) + (Cold junction temperature compensation accuracy)

Example) Accuracy when measuring a temperature in the following conditions:

- Input sensor used: Thermocouple T type (-200 to 400°C) (Input range setting: 2)
- Operating ambient temperature: 35°C
- Temperature measurement value: 300°C

The accuracy values will become as follows from the above conditions.

- Indicated accuracy : ±1.0°C (Refer to Table 3.4.)
- Cold junction compensation temperature accuracy : ±1.0°C (Refer to Table 3.1.)

Accuracy = (±1.0°C) + (±1.0°C) = ±2.0°C

Table 3.1 Performance specifications (continued)

Item		Specifications											
Control method		Continuous proportional control											
PID constant range	PID constant setting	Auto tuning setting available											
	Proportional band (P)	Thermocouple: 0.1 to Full-scale °C Micro voltage, voltage, current: 0.1 to 1000.0%											
	Integral time (I)	0.0 to 3276.7s											
	Derivative time (D)	0.0 to 3276.7s											
Set value setting range		Thermocouple: Input range of the thermocouple used Micro voltage, voltage, current: Input range set by a user											
Dead band setting range		Thermocouple: 0.0 to 100.0°C Micro voltage, voltage, current: 0.00 to 10.00%											
Time accuracy		±0.2%											
Noise immunity		*2											
Insulation	<table border="1"> <thead> <tr> <th>Insulation part</th> <th>Insulation method</th> <th>Dielectric withstand voltage</th> <th>Insulation resistance</th> </tr> </thead> <tbody> <tr> <td>Between input and earth</td> <td>Transformer insulation</td> <td rowspan="2">500VAC for 1 minute</td> <td rowspan="2">500VDC, 20M Ω or more</td> </tr> <tr> <td>Between input channels</td> <td>Transformer insulation</td> </tr> </tbody> </table>			Insulation part	Insulation method	Dielectric withstand voltage	Insulation resistance	Between input and earth	Transformer insulation	500VAC for 1 minute	500VDC, 20M Ω or more	Between input channels	Transformer insulation
	Insulation part	Insulation method	Dielectric withstand voltage	Insulation resistance									
	Between input and earth	Transformer insulation	500VAC for 1 minute	500VDC, 20M Ω or more									
Between input channels	Transformer insulation												
FeRAM read/write count		Max. 10 ¹⁰ times											
Number of occupied I/O points		16 points/slot (I/O assignment: intelligent 16 points)											
External connection system		18-point terminal block											
Applicable wire size		0.3 to 0.75mm ²											
Applicable solderless terminal		R1.25-3, RAV1.25-3											
External power supply		24VDC, +20%, -15%											
		Ripple, spike 500mV _{P-P} or less											
		Inrush current: 3.6A, 4ms or less											
		0.07A											
Internal current consumption		0.27A											
Weight		0.25kg											
External dimensions		27.4 (W)×98(H)×112(D)mm											

*2: For the noise immunity, dielectric withstand voltage, insulation resistance and others of the programmable controller system including this module, refer to the power supply module specifications given in the user's manual for the CPU module used.

(1) Types, measurement ranges, and resolution of applicable input sensors

Table 3.2 lists types, measurement ranges, and resolution of input sensors applicable to the Q62HLC.

Table 3.2 Types, measurement ranges, and resolution of applicable input sensors

Input		Input range	Digital value	Resolution
Thermocouple	K	-200 to 1372°C	-2000 to 13720	0.1°C
	J	-200 to 1200°C	-2000 to 12000	
	T	-200 to 400°C	-2000 to 4000	
	S	-50 to 1768°C	-500 to 17680	
	R	-50 to 1768°C	-500 to 17680	
	N	0 to 1300°C	0 to 13000	
	E	-200 to 1000°C	-2000 to 10000	
	B	0 to 1800°C	0 to 18000	
	PLII	0 to 1390°C	0 to 13900	
	W5Re/W26Re	0 to 2300°C	0 to 23000	
Micro voltage	0 to 10mV		0 to 20000	0.5μV
	0 to 100mV			5μV
	-10 to 10mV		-10000 to 10000	1μV
	-100 to 100mV			10μV
Voltage	0 to 1V		0 to 20000	0.05mV
	1 to 5V			0.2mV
	0 to 5V			0.25mV
	0 to 10V			0.5mV
	-1 to 1V		-10000 to 10000	0.1mV
	-5 to 5V			0.5mV
	-10 to 10V			1mV
Current	4 to 20mA		0 to 20000	0.8μA
	0 to 20mA			1μA

(2) Indication accuracy

Table 3.3 and Table 3.4 list the indication accuracy against ambient temperature.

(a) At ambient temperature 23±2°C

Table 3.3 Indication accuracy at ambient temperature 23±2°C

Item		Error	
Thermocouple	K, J, T, E, PLII	Less than -100°C	±1.0°C
		-100 to less than 500°C	±0.5°C
		500 °C or more	± (Indication value × (0.1%) +1 digit)
	S, R, N, W5Re/ W26Re	-50 to less than 1000°C	±1.0°C
		1000°C or more	± (Indication value × (0.1%) +1 digit)
	B	Less than 400 °C	±70.0°C
		400 to less than 1000 °C	±1.0°C
		1000°C or more	± (Indication value × (0.1%) +1 digit)
	Micro voltage		Full-scale × (±0.1%)
Voltage			
Current			

(b) At ambient temperature 0 to 55°C

Table 3.4 Indication accuracy at ambient temperature 0 to 55°C

Item		Error	
Thermocouple	K, J, T, E, PLII	Less than -100°C	±2.0°C
		-100 to less than 500°C	±1.0°C
		500°C or more	± (Indication value × (0.2%) +1 digit)
	S, R, N, W5Re/ W26Re	-50 to less than 1000°C	±2.0°C
		1000°C or more	± (Indication value × (0.2%) +1 digit)
	B	Less than 400 °C	±140.0°C
		400 to less than 1000 °C	±2.0°C
		1000°C or more	± (Indication value × (0.2%) +1 digit)
	Micro voltage		Full-scale × (±0.2%)
Voltage			
Current			

3.1.2 Operation at input disconnection

Table 3.5 lists the operations of each input at input disconnection.

Table 3.5 Operations at input disconnection

Input	Input range	Operation
Thermocouple	All	Up scale* ¹
Micro voltage		
Voltage	1 to 5V	Down scale* ²
	0 to 1V, -1 to 1V, 0 to 5V, -5 to 5V, 0 to 10V, -10 to 10V	A value near 0V is displayed.* ³
Current	4 to 20mA	Down scale
	0 to 20mA	A value near 0mA is displayed.* ³

*1: "Input range upper limit + (Full-scale × 5%)" is displayed.

*2: "Input range lower limit - (Full-scale × 5%)" is displayed.

*3: In this case, no alert occurs at the channel where a sensor is not connected because the measured value is within the input range.

REMARKS

To judge an error, select the range actually used by the sensor so that values near 0V/0mA are not displayed unless the sensor is connected.

(Example)

To use the 0 to 5V voltage input range, set the input range actually used by the sensor to 1 to 4V.

3.2 Functions

Table 3.6 lists the functions of the Q62HLC.

Table 3.6 List of functions

Item	Description	Reference
Auto tuning function	• Automatically sets the optimal PID constants for the loop control module.	3.2.1
Auto tuning mode setting function	• Sets the auto tuning mode according to the control target by setting AT (auto tuning) differential gap and AT additional lag.	3.2.2
Forward action/reverse action selection function	• Sets heat control (reverse action) or cooling control (forward action).	3.2.3
RFB limiter function	• Limits the manipulation value overshoot which frequently occurs when the set value (SV) is changed or control target is changed.	3.2.4
Sensor compensation function	• Compensates a difference between measured values and actual temperature, humidity, pressure, flow rate or others, if any, according to the measured status, etc.	3.2.5
Unused channel setting function	• Disables the PID operation of a channel where no control is performed.	3.2.6
PID control forced stop function	• Forcibly stops the PID operation of a channel where the control is being performed.	3.2.7
Loop disconnection detection function	• Detects an error in the control system (control loop) caused by a load (heater) disconnection, abnormal external operation device (such as magnet relay), or a Input Sensor disconnection.	3.2.8
Data storage in FeRAM function	• Reduces the load of a sequence program by storing data in the buffer memory to FeRAM.	3.2.9
Alert function	• Monitors the measured value (PV) and alerts the user.	3.2.10
Control output setting at CPU stop error occurrence function	• Selects the control output status (continue or stop) when a stop error occurs in a programmable controller CPU.	3.2.11
Program control function	• Performs the control changing the set value, following the time schedule.	3.2.12
Cascade control function	• Performs the cascade control using the channel 1 as master and the channel 2 as slave.	3.2.13
Scaling function	• Scales the measured value and stores it in the buffer memory.	3.2.14
SV tracking function	• Prevents a sudden change of the set value (SV) when control is switched.	3.2.15
Forced output function	• Forcibly outputs an analog value of the specified manipulated value (MV) regardless of the control mode.	3.2.16
Simplified analog I/O input function	• Uses the Q62HLC as a simplified thermocouple/micro voltage input module, analog-digital converter module, digital-analog converter module by monitoring the measured value and setting the manipulated value manually.	3.2.17
Parameter change in program control function	• Changes a setting in the buffer memory without stopping program control and reflects the changed value to the control in execution.	3.2.18
Control function of the Q62HLC	• Performs control using the output signal and buffer memory area setting.	3.2.19
Online module change function	• Replaces the module without the system being stopped.	Chapter 7

3.2.1 Auto tuning function

(1) What is the auto tuning function?

- (a) The auto tuning function is designed for the Q62HLC to set the optimum PID constants automatically.

In auto tuning, a manipulated value turns on/off and the PID constants are calculated according to the hunting cycle and amplitude, which take place when the measured value to a set value alternates between overshooting and undershooting.

- (b) To execute the function, set values to the following buffer memory addresses in normal mode.

Buffer memory area name	Buffer memory address (decimal)	
	CH1	CH2
Input range	32	64
Set value (SV) setting	34	66
AT differential gap	46	78
AT additional lag	47	79
AT bias	53	85

Note that actual control starts upon completion of auto tuning. Set values used for actual operation to other buffer memory addresses as well.

Buffer memory area name	Buffer memory address (decimal)	
	CH1	CH2
Upper output limiter	42	74
Lower output limiter	43	75
Output variation limiter	44	76
Sensor compensation value setting	45	77
Primary delay digital filter setting	48	80
Forward/reverse action setting	54	86

- (c) Upon completion of auto tuning, calculated values are set to the following buffer memory addresses.

Buffer memory area name	Buffer memory address (decimal)	
	CH1	CH2
Proportional band (P) setting	35	67
Integral time (I)	36	68
Derivative time (D)	37	69
Loop disconnection detection judgment time ^{*1}	59	91

* 1: A value twice greater than the calculated integral time is set.

If 0 is set when the auto tuning starts, the value remains unchanged.

(2) Executing auto tuning

(a) Conditions for starting auto tuning

When any of the following conditions is met, auto tuning can not be executed.

- 1) In Unused channel setting (buffer memory address: 61, 93), 1 (Unused) is set for the channel.
- 2) Control mode (buffer memory address: 50, 82) is set in any of manual control mode 1, manual control mode 2 or program control mode.
- 3) Forced PID control stop command (YnC, YnD) is on.
- 4) A hardware failure is being detected. (The ERR. LED is on.)
- 5) A write error is being detected. (Xn2: ON)
- 6) The sensor is not connected correctly.
- 7) FeRAM backup start command (Yn8) is on.
- 8) Default setting registration start command (Yn9) is on.
- 9) In PID constant read command from FeRAM (buffer memory address: 62, 94), 1 (With command) is set.
- 10) A bit of write flag (b4, b5) in PID constant read/write completion flag from FeRAM (buffer memory address: 31) is on.

(b) Auto tuning procedure

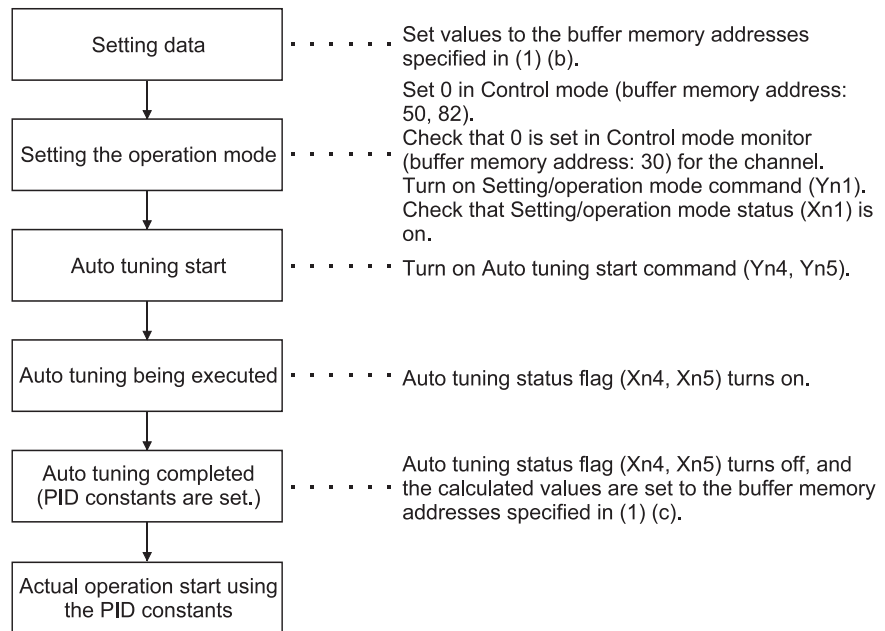

POINT
<p>Perform the following operation to use the set PID constants even after the programmable controller CPU is powered off.</p> <ul style="list-style-type: none"> • Write the values directly to the buffer memory using a sequence program. • Store the PID constants into FeRAM and transfer them when the programmable controller CPU is powered on. • Use the initial settings of GX Configurator-TC.

(c) Auto tuning operation

The following figure shows the auto tuning operation.

- 1) Auto tuning output is provided.
- 2) Data collection starts when the measured value meets the set value after the first overshoot and undershoot.
- 3) After data collection, auto tuning ends when PID constants and loop disconnection detection judgment time are set.

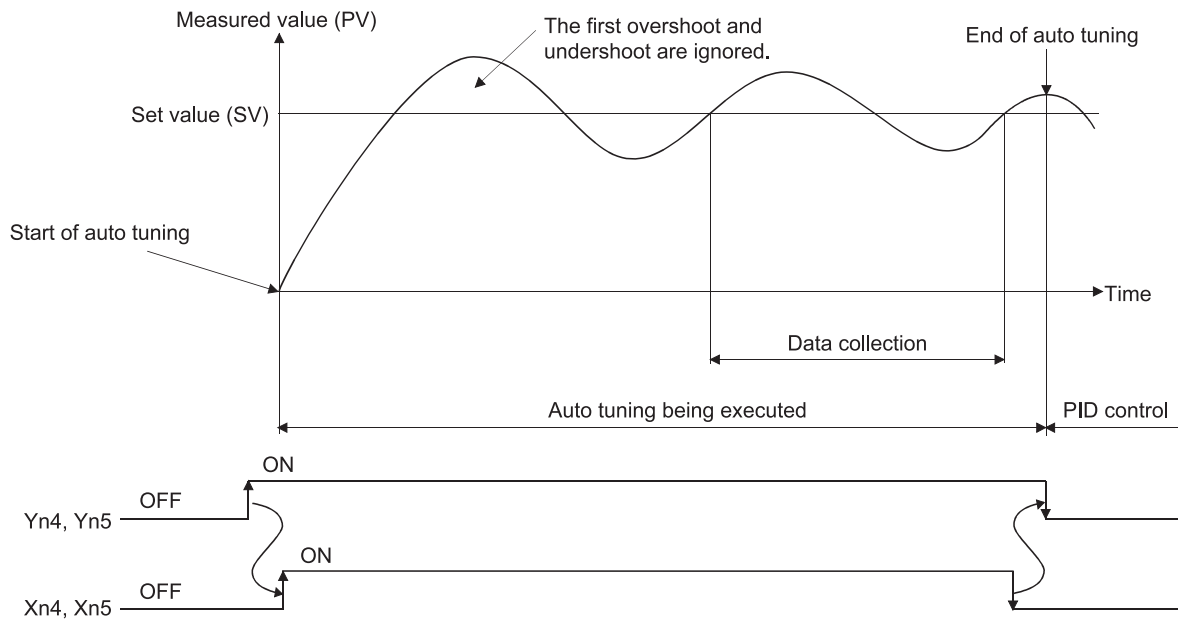

(d) Precautions for auto tuning

The following indicate the conditions under which auto tuning will result in abnormal termination.

- 1) Any of the following setting items for the channel has been changed during auto tuning.

Buffer memory area name	Buffer memory address (decimal)	
	CH1	CH2
Input range	32	64
Set value (SV) setting	34	66
Upper output limiter	42	74
Lower output limiter	43	75
Output variation limiter	44	76
Sensor compensation value setting	45	77
AT differential gap	46	78
AT additional lag	47	79
Primary delay digital filter setting	48	80
AT bias	53	85
Forward/reverse action setting	54	86

- 2) Forced PID control stop command (YnC, YnD) has been turned on.
 - 3) The mode is changed to other than the normal control mode (setting mode, manual control mode1/2, program control mode). (Exception: when PID continuation flag (buffer memory address: 169) is set to "Continue" and the mode is changed to the setting mode)
 - 4) A hardware failure has been detected.
 - 5) The measured value has exceeded the input range.
 - 6) The following time has exceeded 2 hours.
 - Time elapsed from the auto tuning start until the set value is reached at the first time.
 - A half of the hunting cycle
 - 7) The calculated PID constants have exceeded any of the following ranges.
 - Proportional band (P): 0.1 to full-scale (°C)
0.1 to 1000.0 (%)
 - Integral time (I): 0.1 to 3276.7 (s)
 - Derivative time (D): 0.0 to 3276.7 (s)
- (3) Operation at termination of auto tuning
- (a) Operation at normal termination
 - Auto tuning status flag (Xn4, Xn5) turns off.
 - The PID constants are set.
 - Loop disconnection detection judgment time (buffer memory address: 59, 91) is set. (If 0 is set when the auto tuning starts, the value remains unchanged.)
 - (b) Operation at abnormal termination
 - Auto tuning status flag (Xn4, Xn5) turns off.
 - The PID constants and loop disconnection judgement time are not set.
 - The error code and factor code of the corresponding error are stored in Error code (buffer memory address: 0), and the ERR. LED flashes. (Exception: when Forced PID control stop command (YnC, YnD) are turned on and when the mode is changed to the setting mode)
For details of error codes and factor codes, refer to Section 8.1.
- (4) Adjustment after auto tuning
- (a) Specific readjustment is not required for the PID constants calculated by auto tuning.
 - (b) Use Control response parameter (buffer memory address: 49, 81) to change the control response for the PID constants calculated by auto tuning.

REMARKS

- 1) The time required for auto tuning differs depending on the control-target device.
- 2) The completion of auto tuning can be checked with the status change (on to off) of Auto turning status flag (Xn4, Xn5).
- 3) When Automatic backup setting after auto tuning of PID constants (buffer memory address: 63, 95) is set to enabled in advance at the start of auto tuning, the PID constants and loop disconnection detection judgment time are automatically stored in FeRAM at completion of auto tuning.
- 4) If the auto tuning does not complete after long period, take any of the corrective actions below.
 - (a) When the measured value (PV) does not change properly
 - 1) Check if load and external operation device are properly connected. If not, connect them properly and then perform the auto tuning.
 - 2) If using in the reverse action, check whether the set value is set not to change the manipulated vale. If so, set the set value in the value to control and perform the auto tuning.
 - (b) When the measured value (PV) changes properly
 - 1) If the response of the control target is slow, wait until the completion of the auto tuning.
- 5) If the PID constants have not changed after the completion of the auto tuning, check if the PID constants are constantly written using the sequence program. If written, delete the sequence program of corresponding parts.

3.2.2 Auto tuning setting function

This function sets the auto tuning mode according to the control target by setting AT differential gap (buffer memory address: 46, 78) and AT additional lag (buffer memory address: 47, 79).

AT differential gap and AT additional lag can be set within the setting range.

However, almost all control targets are accepted by the following setting of "Standard mode" and "Fast response mode".

(1) Standard mode (Default)

This mode is compatible with almost all control targets.

Especially, this mode is effective for control targets which give an extremely slow response or which may be affected by noise or disturbance.

However, when the control target that either the on or off time during auto tuning is about 10 seconds only, slow-response (low-gain) PID constants may be calculated. In this case, fast-response PID constants can be calculated by executing auto tuning in the fast response mode.

To perform auto tuning in the standard mode, set AT differential gap and AT additional lag to 10 (0.1s).

(2) Fast response mode

This mode calculates faster-response (higher-gain) PID constants for the control targets which gives a fast response that the on or off time during auto tuning is about 10 seconds only.

Note that the gains of the calculated PID constants may become so high that the measured value (PV) may oscillate near the set value (SV). In this case, execute auto tuning in the standard mode.

To perform auto tuning in the fast response mode, set AT differential gap and AT additional lag to 1 (0.01s).

3.2.3 Reverse/forward action select function

With the Q62HLC, "reverse action" or "forward action" can be selected to perform the PID operations.

(1) Default setting

The default is set to "reverse action".

To perform PID operations with the forward action, set "forward action" in Forward/reverse action setting (buffer memory address: 54, 86).

(2) Control details

(a) Reverse action: The manipulated value decreases as the measured value increases. This action is effective for heating control to increase temperature.

(b) Forward action: The manipulated value increases as the measured value increases. This action is effective for cooling control to decrease temperature.

REMARKS

The Q62HLC does not support heating/cooling control. If a target device is controlled using two channels of the Q62HLC, the temperature does not stabilize.

3.2.4 RFB limiter function

(1) RFB (reset feed back) limiter function

The RFB limiter function prevents the PID operation result (manipulated value (MV)) from exceeding the range by the integral control action when a deviation continues for a long time.

If the PID operation result exceeds the upper/lower output limiter value, this function feeds back the exceeded value to the integral value, and holds the PID operation result within the specified range.

Setting is not necessary as the RFB limiter function is automatically operated at PID control execution.

3.2.5 Sensor compensation function

(1) Sensor compensation function

The sensor compensation function compensates the difference between the measured value and actual temperature, humidity, pressure, and flow rate caused by measurement conditions.

(2) Sensor compensation value setting

When there is a difference between the measured and actual temperature, set a temperature (-500.0 to 500.0°C) in Sensor compensation value setting (buffer memory: 45, 77). When there is a difference between the measured and actual humidity, pressure, or flow rate, set a full-scale percentage (-50.00 to 50.00%) in Sensor compensation value setting (buffer memory: 45, 77).

For example, when there is a 0.3V deviation with the input range 0 to 10V, set 3% ($0.3 \div 10 \times 100 = 3\%$) because the full-scale is 10V. (Set 300 in the corresponding buffer memory area.)

3.2.6 Unused channel setting function

(1) Unused channel setting

This function sets the channel status (used/unused).

(a) When a channel of the Q62HLC is set to be unused, an alert will not occur at the channel where no sensor is connected and the ALM LED does not flash.

The sampling period remains unchanged even if the unused channel setting is configured.

(b) To set a channel to be unused, write 1 in Unused channel setting (buffer memory address: 61, 93).

(2) Channel where no sensor is connected

When no sensor is connected to the channel, The Q62HLC performs the same processing as that of input disconnection. For details, refer to Section 3.1.2.

3.2.7 Forced PID control stop function

(1) Forced PID control stop

This function temporarily stops PID operations of the programmable controller CPU.

For details of the Q62HLC control status with the forced PID control stop, refer to Section 3.2.19.

(2) Normal control mode, manual control mode

(a) Executing forced PID control stop

To execute a forced PID control stop, turn on Forced PID control stop command (YnC, YnD).

When the PID operation is stopped, the operation of the Q62HLC differs depending on Stop mode setting (buffer memory address: 33, 65).

The value in Manipulated value (MV) (buffer memory address: 13, 14) will be -50 (-5.0%).

(b) Cancelling forced PID control stop

When Forced PID control stop command (YnC, YnD) is turned off, a forced PID control stop is cancelled and the PID operation restarts from setting value of Lower output limiter (buffer memory address: 43, 75).

(3) Program control mode

(a) Executing forced PID control stop

To execute a forced PID control stop, turn on Forced PID control stop command (YnC, YnD). When the PID operation is stopped during program control, the operation of the Q62HLC is reset.

(b) Cancelling forced PID control stop.

When Forced PID control stop command (YnC, YnD) is turned off, the forced PID control stop is cancelled, and program control is executed.

3.2.8 Loop disconnection detection function

The loop disconnection detection function detects errors in the control system (control loop) caused by a load (heater) disconnection, external operation device (e.g. magnetic relay) fault, input disconnection and others.

The execution of the loop disconnection detection is performed with the setting of Loop disconnection detection judgment time (buffer memory address: 59, 91).

When the manipulated value has reached 100% or 0%, this function starts monitoring the variation of the measured value per loop disconnection detection judgment time and detects errors in the control loop. *1

If the following variation has not been seen within the set loop disconnection detection judgment time, the corresponding bit (b13) of Alert definition (buffer memory address: 5, 6) becomes 1, and ALM LED flickers, and it is output as an alert. If an alert occurs during control, the control continues its operation. Output doesn't turn off.

The variation ranges of the measured value of loop disconnection detection judgment are 2°C for thermocouple input and 0.2% for micro voltage, voltage and current.

The loop disconnection detection judgment function will be an alert status in the following cases.

(1) When the manipulated value has reached 0%

Forward operation: The measured value does not increase over the variation range within loop disconnection detection judgment time.

Reverse operation: The measured value does not decrease over the variation range within loop disconnection detection judgment time.

(2) When the manipulated value has reached 100%

Forward operation: The measured value does not decrease over the variation range within loop disconnection detection judgment time.

Reverse operation: The measured value does not increase over the variation range within loop disconnection detection judgment time.

*1: In the manual control mode, when the manipulated value is not 0% or 100%, the loop disconnection detection cannot be performed.

POINT
<p>(1) To disable the loop disconnection detection function, set 0 in Loop disconnection detection judgment time (buffer memory address: 59, 91).</p> <p>(2) If Loop disconnection detection dead band (buffer memory address: 60, 92) is set, a loop disconnection is not detected even if there is no temperature variation of 2°C or more when the control output is provided 100% or 0% at the set value (refer to Section 3.5.31).</p> <p>(3) If a loop disconnection alert occurs frequently despite normal operation of a sensor, load, and external operation device, check the following and take a corrective action.</p> <ul style="list-style-type: none"> • Check if the capacity of a load (heater) and external operation device (cooling fan) is enough. If not, set a time value in Loop disconnection detection judgment time (buffer memory address: 59, 91) longer than time required for varying 2°C or 0.2% with manipulated value 100%. • Check that the set value is above the ambient temperature if the function is used for heating control. If not, set Loop disconnection detection dead band (buffer memory address: 60, 92) so that an alert will not occur near the ambient temperature.

3.2.9 Data storage in FeRAM function

(1) Storing data in FeRAM

- (a) Data in the buffer memory of the Q62HLC can be stored in FeRAM for backup. The backup target is the entire write-enable area excluding the following areas.

For details of the buffer memory areas, refer to Section 3.5.

Buffer memory area name	Buffer memory address (decimal)
Program control	57, 89
PID constant read command from FeRAM	62, 94
Automatic backup setting after auto tuning of PID constants	63, 95
Hold command	201, 217
Command advancing	202, 218
Cascade ON/OFF	176
Forced output command	204, 220
Forced output manipulated value (MV)	205, 221

Write to FeRAM can be used to back up the PID constants set by auto tuning and the data written directly to the buffer memory using a peripheral device.

- (b) The backed-up data is automatically transferred from FeRAM to the buffer memory areas when the programmable controller CPU is powered on or reset.

Using this function, users can execute PID control without writing data when the programmable controller CPU is powered on or reset. A program for setting data to the Q62HLC can be deleted.

(2) Writing data to FeRAM

- (a) To write data to FeRAM, turn on FeRAM backup start command (Yn8).
- FeRAM write completion flag (Xn8) turns on at completion of data write to FeRAM. After FeRAM backup start command (Yn8) is turned on, it takes more than 10 seconds until FeRAM write completion flag (Xn8) turns on.
 - FeRAM write failure flag (XnA) turns on if the write processing is not completed successfully.
- (b) Make changes to buffer memory when FeRAM write completion flag (Xn8) is off.

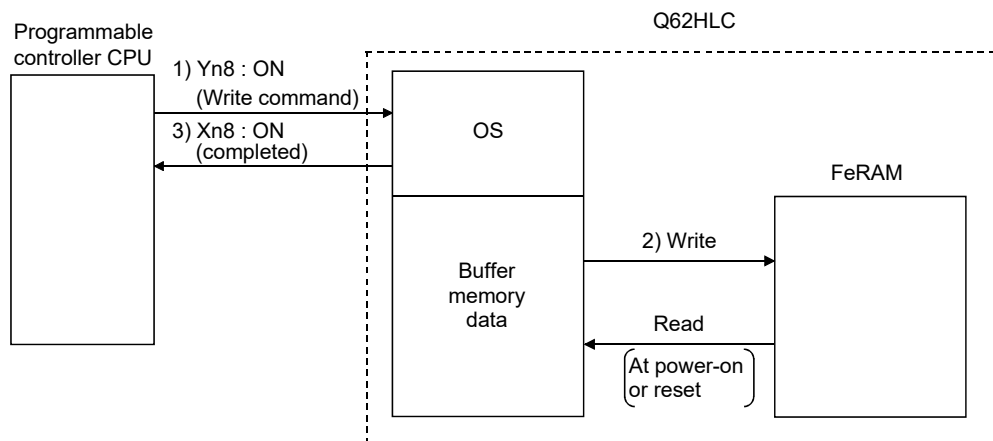

(3) Reading data from FeRAM

Data is read from FeRAM under the following conditions.

- When the programmable controller CPU is powered on or reset.
- When PID constant read command from FeRAM (buffer memory address: 62, 94) turns on. Note that the read data are only the PID constants and loop disconnection detection judgment time of the corresponding channel.

3.2.10 Alert function

- (1) The alert function sets the system in an alert status when the measured value (PV) or deviation reaches the alert set value. It is used to turn on the device's hazard signal or operate the safety device.

The alert function is classified as follows:

- Input alerts Upper limit input alert, lower limit input alert
- Deviation alerts Upper limit deviation alert, lower limit deviation alert, upper/lower limit deviation alert, within-range alert

If an alert occurs during the control, the Q62HLC continues its operation. Output doesn't turn off.

(a) Input alerts

1) Upper limit input alert

When the measured value (PV) is equal to or greater than the alert set value, the system is put in alert status. The setting range is the same as the input range.

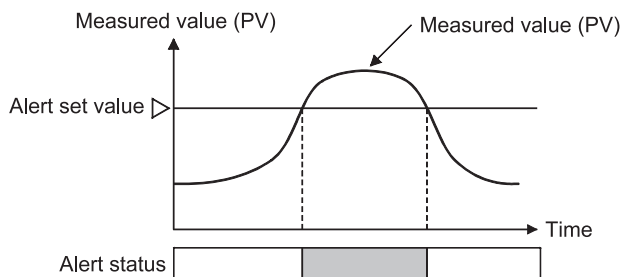

2) Lower limit input alert

When the measured value (PV) is equal to or smaller than the alert set value, the system is put in alert status. The setting range is the same as the input range.

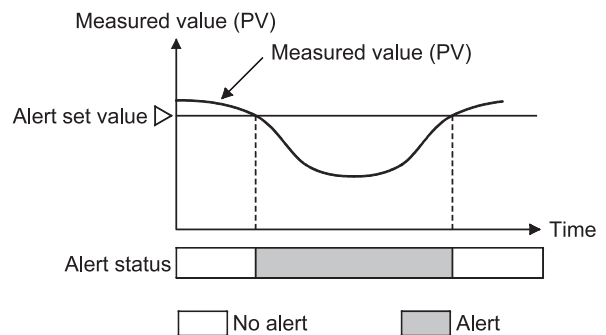

(b) Deviation alerts

1) Upper limit deviation alert

When the deviation [measured value (PV) - set value (SV)] is equal to or greater than the alert set value, the system is put in alert status.

The setting range is \pm full-scale.

[When alert set value is positive]

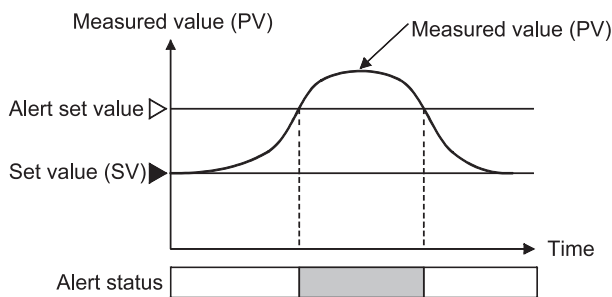

[When alert set value is negative]

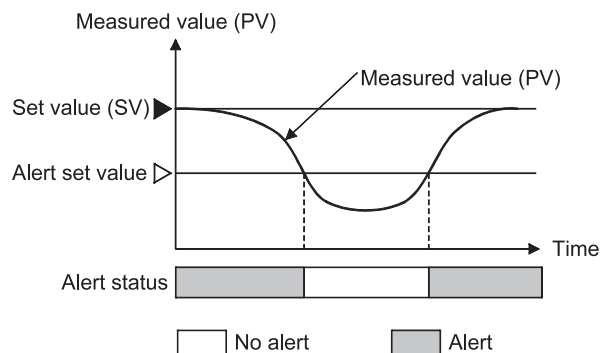

2) Lower limit deviation alert

When the deviation [measured value (PV) - set value (SV)] is equal to or smaller than the alert set value, the system is put in alert status.

The setting range is \pm full-scale.

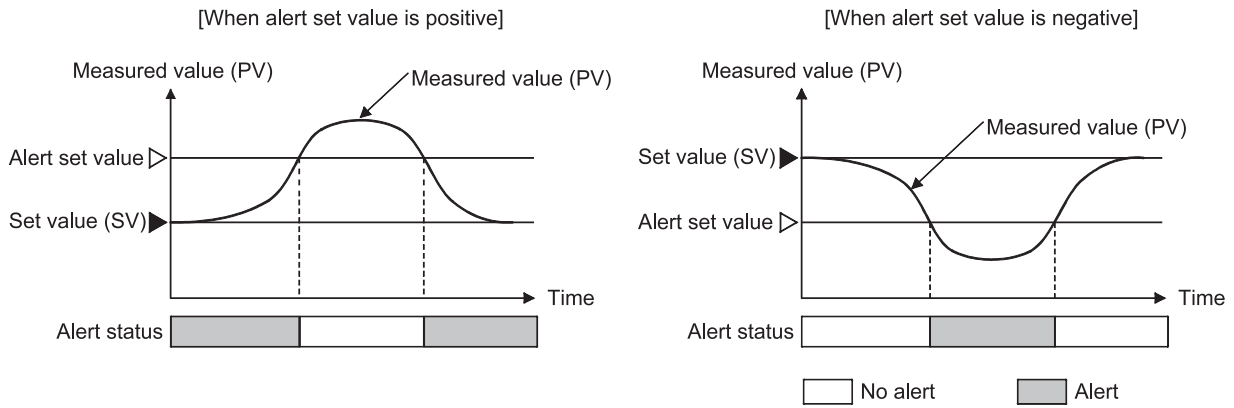

3) Upper/lower limit deviation alert

When the absolute value of deviation [measured value (PV) - set value (SV)] is equal to or greater than the alert set value, the system is put in alert status.

The setting range is 0 to +full-scale.

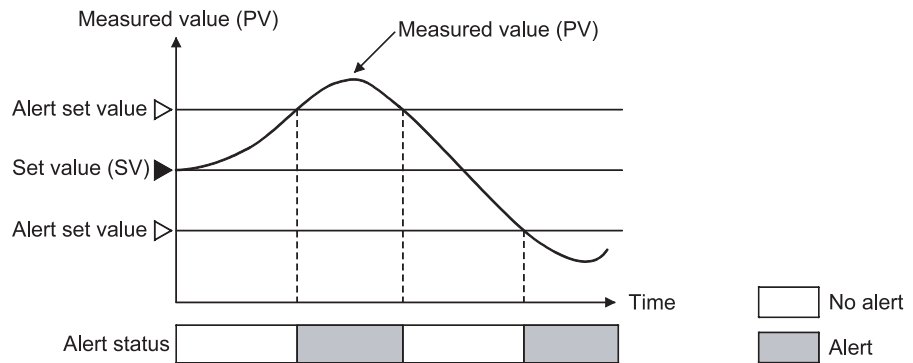

4) Within-range alert

When the absolute value of deviation [measured value (PV) - set value (SV)] is equal to or smaller than the alert set value, the system is put in alert status.

The setting range is 0 to +full-scale.

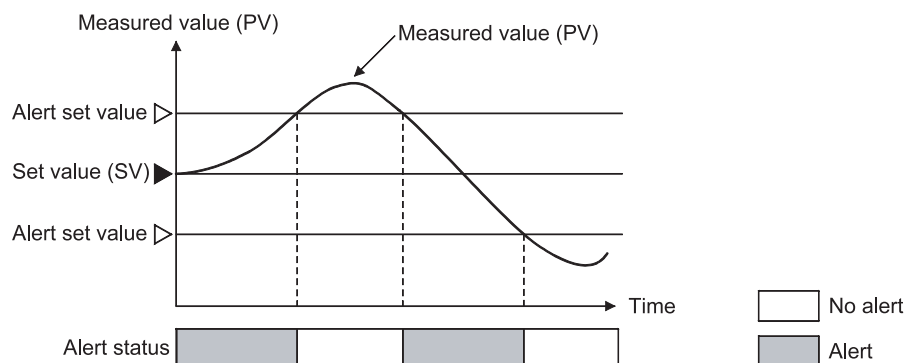

- (2) When the Q62HLC uses the alert function, additional settings (alert dead band, alert delay count, and wait/re-wait settings) can be configured. The following table lists the alert functions which can be used with the addition of alert dead band, alert delay count and wait/re-wait.

Alert function		Dead band setting	Alert delay count	Wait	Re-wait
Input alert	Upper limit alert	○	○	○	———
	Lower limit alert	○	○	○	———
Deviation alert	Upper limit deviation alert	○	○	○	○
	Lower limit deviation alert	○	○	○	○
	Upper/lower limit deviation alert	○	○	○	○
	Within-range alert	○	○	———	———

(a) Alert dead band setting

When the measured value (PV)/deviation is close to the alert set value, the alert status may alternate with the non-alert status due to input instability or the like.

Setting an alert dead band can prevent this from happening.

An alert dead band can be set in Alert dead band setting (buffer memory address: 164).

Example: When the dead band value is set to the upper limit input alert, the system is placed in the alert status when the upper limit of the input rises to or above the alert set value. The system is put in the non-alert status when the upper limit falls below the alert dead band.

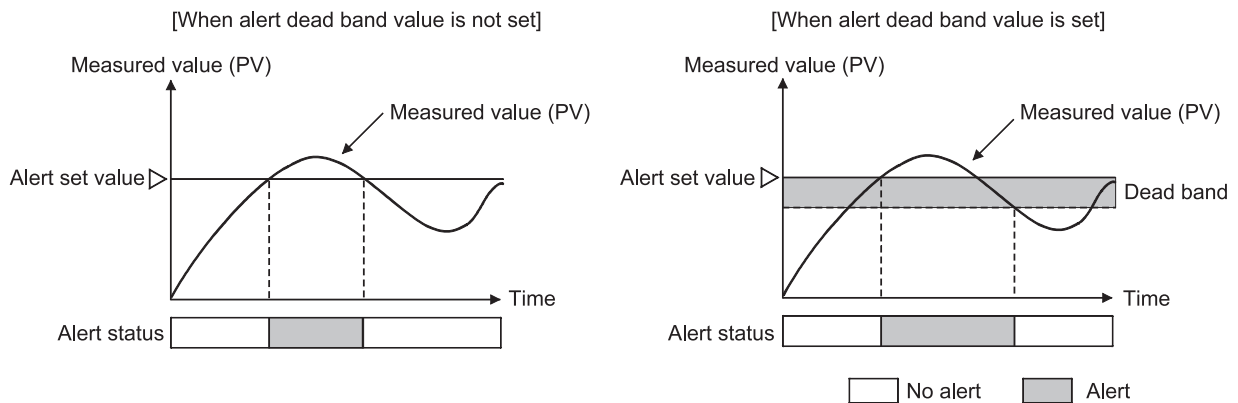

(b) Alert delay count setting

The system is set in the alert status when the measured value (PV) that has reached the alert set value remains in the alert range until the sampling count becomes equal to or greater than the alert delay count.

An alert dead band can be set in Alert delay count (buffer memory address: 165).

Example: When the alert delay count set to the input upper limit alert is 5, the system is not placed in the alert status if the sampling count is 4 or less.

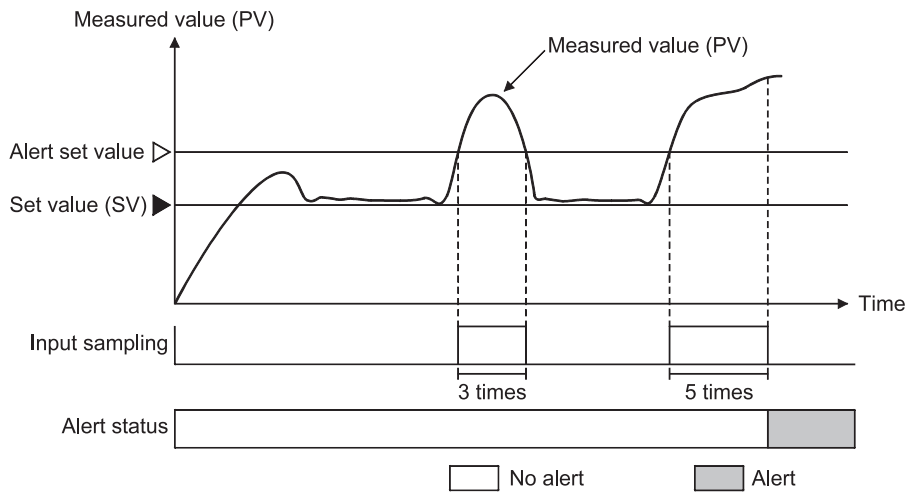

(c) Wait alert

Choosing the wait alert ignores the alert status if the measured value (PV)/deviation is in that status when the setting mode is changed to the operation mode, and makes the alert function invalid until the measured value comes out of the alert status.

Example: Selecting the lower limit deviation alert with wait makes the alert function invalid until the process value exceeds the alert set value.

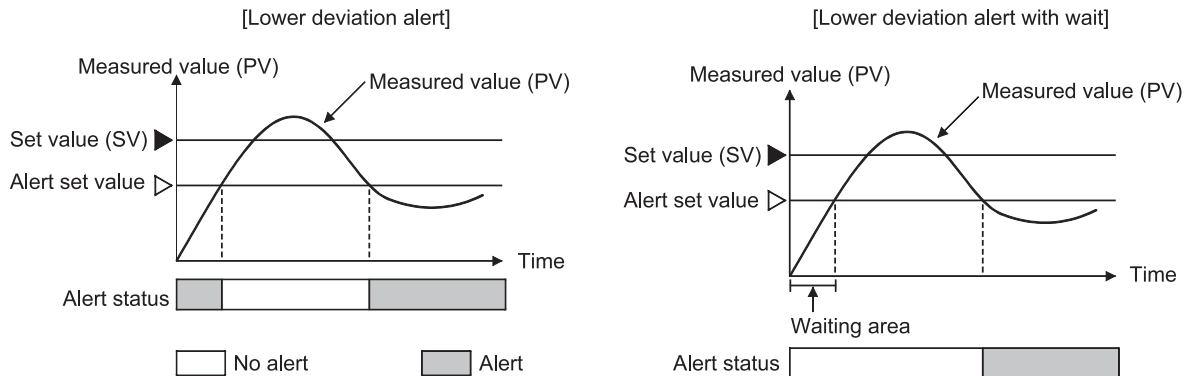

POINT
 After the alert mode is set and an alert judgment starts, if the system has reached the non-alert status even once, the wait function no longer operates.

(d) Re-wait alert

The re-wait alert is a wait alert-based feature which has the additional function to make the alert function invalid again when the set value (SV) is changed.

For the control required the set value change, the alert status that may occur when the set value is changed can be avoided by setting this function.

Example: If the measured value (PV) is at the position as shown below before the setting is changed, changing the set value (SV) for deviation alert will put the measured value in the alert region and turn on the alert. To prevent this, the function makes the alert wait operation valid and the alert output to wait.

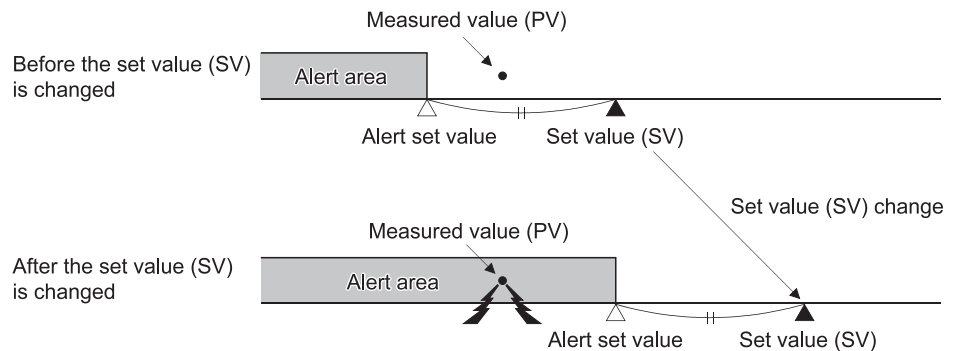

- (3) The Q62HLC uses four alerts (Alert 1 to 4) among alert, alert with wait, and alert with re-wait.

Alert modes for Alert 1 to 4 can be set in the following buffer memory areas.

Channel No.	Buffer memory address (decimal)			
	Alert 1	Alert 2	Alert 3	Alert 4
1	192	193	194	195
2	208	209	210	211

- (4) An alert set value, alert dead band, and alert delay count can be set in the following buffer memory areas.

Channel No.	Buffer memory address (decimal)		
	Alert set value	Alert dead band	Alert delay count
1	38 to 41	164	165
2	70 to 73		

3.2.11 Control output setting at CPU stop error occurrence function

- (1) This function sets the control output status (HOLD/CLEAR) of the Q62HLC at a stop error of the programmable controller CPU.
- (2) To make this setting, use the intelligent function module switch setting on GX Developer.
- CLEAR : Stops the PID control, temperature judgement and alert judgement functions and turns off external output.
 - HOLD : Continues the control status prior to a programmable controller CPU stop. For example, when PID control was exercised before a programmable controller CPU stop, PID control is continued even after the programmable controller CPU stops.

Refer to Section 4.5 for details of the setting method.

3.2.12 Program control function

(1) Program control function

The Q62HLC performs PID control changing the set value (SV), according to the schedule set by users.

Program control function performs the control according to the settings of the following items.

Setting item	Description
Control data	Set program pattern to be executed, starting method of set value at the start of control, and unit of segment execution time.
Program pattern data	Set maximum of 16 segments on which PID control is executed consecutively. Specify a set value, execution time, and zone PID data No. to be used for each segment.
Zone PID data	Divide input range into 8 zones, and then set PID constants and control response parameters for each zone.

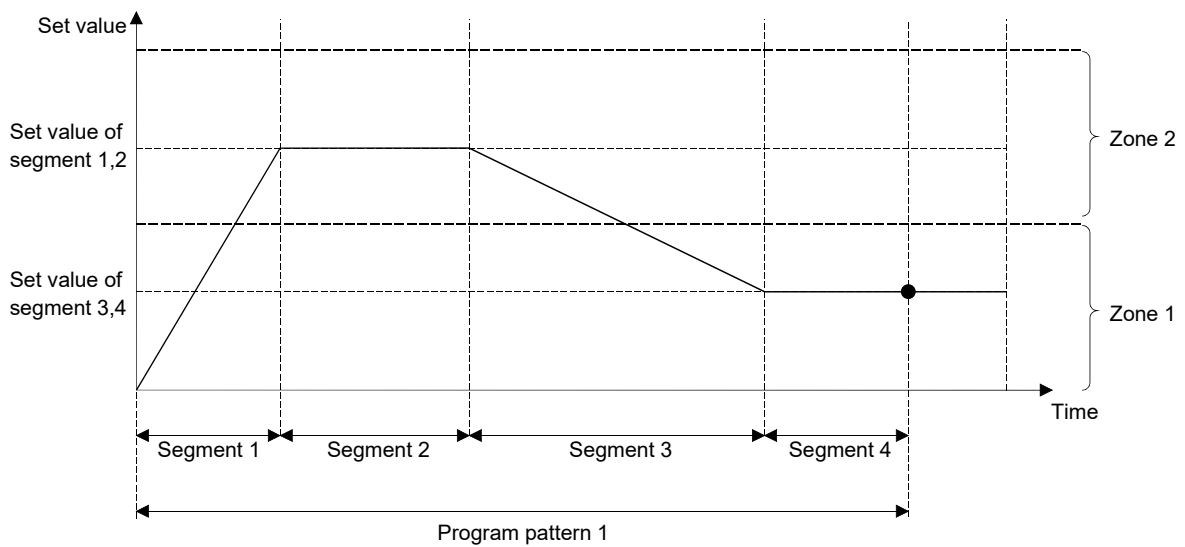

The following gives the detailed explanation of control data, program pattern, and zone PID data.

(a) Control data

Common data required for executing the program control are set.

Buffer memory area name	Description	Buffer memory address (decimal)	
		CH1	CH2
Execution pattern	Select a program pattern to be executed from the program patterns 1 to 3.	272	528
Start mode	Set a starting method of the set value (SV) at a control start. For details, refer to (2) in this section.	273	529
Time scale	Set the execution time unit of each segment set in program pattern data.	274	530
Set value at program control start (SV_PCS) setting	Set the set value (SV) at a program control start when a starting method is specified. For details, refer to (2) in this section.	501	757

(b) Program pattern data

A program pattern consists of segments, which have a set value (SV), executing time (execution time), and zone PID data No.

The Q62HLC can set three patterns of program pattern data with up to 16 segments.

Several program patterns can be linked by pattern link (refer to the next page for buffer memory areas).

• Program pattern data

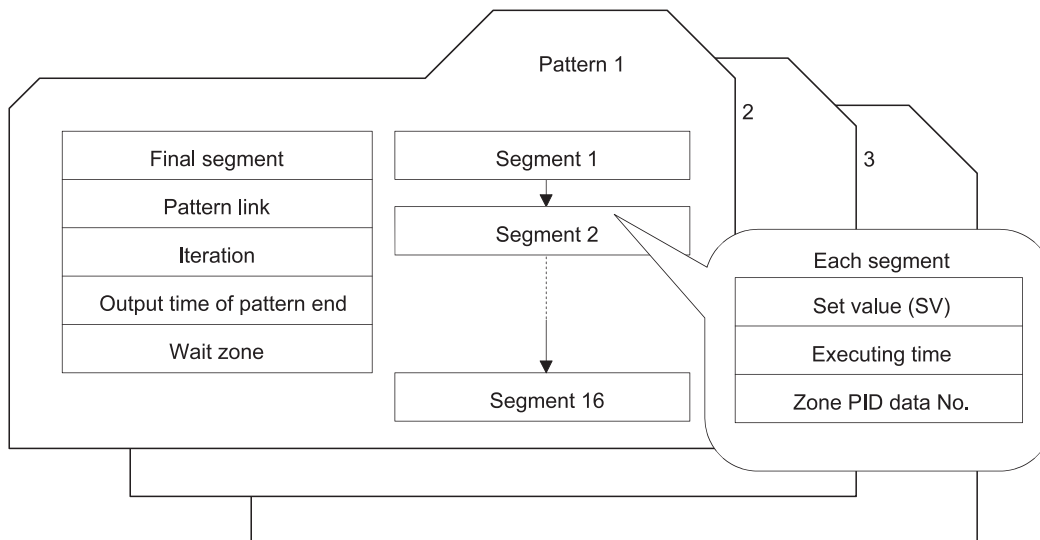

Buffer memory area name	Description	CH	Buffer memory address (decimal)		
			Program pattern		
			1	2	3
Final segment	Sets the final segment to complete the program pattern.	1	320	384	448
		2	576	640	704
Pattern link	Sets the program pattern of link destination when linking several program patterns.	1	321	385	449
		2	577	641	705
Iteration* ¹	Sets the number of execution times for the program control.	1	322	386	450
		2	578	642	706
Output time of pattern end* ¹	Sets the pattern end output time when completing the program pattern.	1	323	387	451
		2	579	643	707
Wait zone setting* ²	Sets a zone where the program control waits before moving to next segment when the measured value cannot follow the progress of the program control.	1	324	388	452
		2	580	644	708

*1: When the program pattern has been linked, the program pattern setting, which is set in Execution pattern (buffer memory address: 272, 528), becomes valid.

*2: When the program pattern has been linked, the setting of the executing program pattern becomes valid.

Buffer memory area name	Description	Segment	Buffer memory address (decimal)					
			Program pattern					
			1		2		3	
			CH1	CH2	CH1	CH2	CH1	CH2
Set value (SV) setting	Sets the set value of segment.	1	325	581	389	645	453	709
		2	328	584	392	648	456	712
		3	331	587	395	651	459	715
		4	334	590	398	654	462	718
		5	337	593	401	657	465	721
		6	340	596	404	660	468	724
		7	343	599	407	663	471	727
		8	346	602	410	666	474	730
		9	349	605	413	669	477	733
		10	352	608	416	672	480	736
		11	355	611	419	675	483	739
		12	358	614	422	678	486	742
		13	361	617	425	681	489	745
		14	364	620	428	684	492	748
		15	367	623	431	687	495	751
		16	370	626	434	690	498	754

(To the next page)

(From the previous page)

Buffer memory area name	Description	Segment	Buffer memory address (decimal)					
			Program pattern					
			1		2		3	
			CH1	CH2	CH1	CH2	CH1	CH2
Executing time	Sets the execution time of segment.	1	326	582	390	646	454	710
		2	329	585	393	649	457	713
		3	332	588	396	652	460	716
		4	335	591	399	655	463	719
		5	338	594	402	658	466	722
		6	341	597	405	661	469	725
		7	344	600	408	664	472	728
		8	347	603	411	667	475	731
		9	350	606	414	670	478	734
		10	353	609	417	673	481	737
		11	356	612	420	676	484	740
		12	359	615	423	679	487	743
		13	362	618	426	682	490	746
		14	365	621	429	685	493	749
		15	368	624	432	688	496	752
		16	371	627	435	691	499	755
Zone PID data No.	Sets the PID data No. used in segment.	1	327	583	391	647	455	711
		2	330	586	394	650	458	714
		3	333	589	397	653	461	717
		4	336	592	400	656	464	720
		5	339	595	403	659	467	723
		6	342	598	406	662	470	726
		7	345	601	409	665	473	729
		8	348	604	412	668	476	732
		9	351	607	415	671	479	735
		10	354	610	418	674	482	738
		11	357	613	421	677	485	741
		12	360	616	424	680	488	744
		13	363	619	427	683	491	747
		14	366	622	430	686	494	750
		15	369	625	433	689	497	753
		16	372	628	436	692	500	756

- 1) The number of execution times for when patterns are linked
 The following setting example is used to explain the number of execution times for when patterns and linked.

Setting item	Buffer memory address	Setting value	Remarks
CH1 Execution pattern	272	1 (executed from the pattern 1)	-
CH1 Program pattern 1 pattern link	321	2 (link to the pattern 2)	-
CH1 Program pattern 1 iteration	322	10	This setting value is referred to.
CH1 Program pattern 2 pattern link	385	3 (link to the pattern 3)	-
CH1 Program pattern 2 iteration	386	20	Ignored
CH1 Program pattern 3 pattern link	449	0 (link not performed)	-
CH1 Program pattern 3 iteration	450	30	Ignored

According to the program patterns 1 to 3 pattern link, the pattern of executing the program is in the order of the pattern 1, pattern 2, and pattern 3. This is one cycle.

The cycle of the pattern 1, pattern 2, and pattern 3 is repeated 10 times to control the program. (Control is not performed by repeating the pattern 1 10 times, the pattern 2 20 times, and the pattern 3 30 times.)

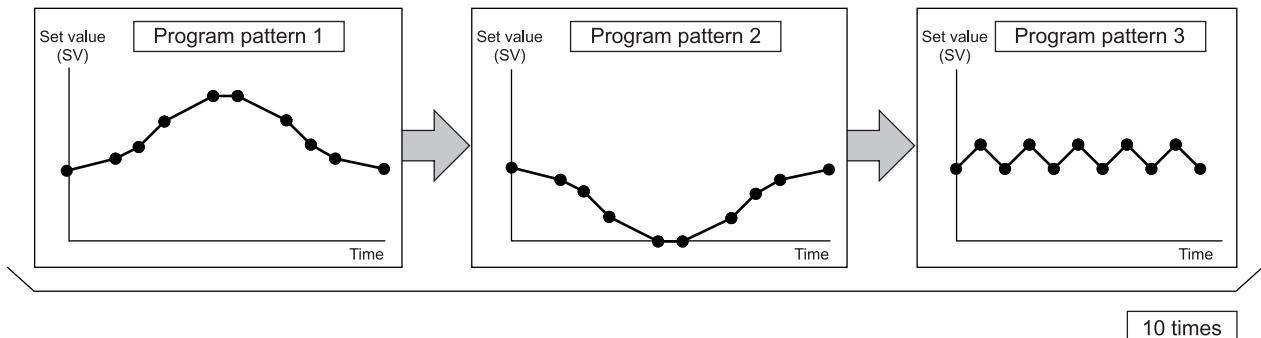

The value set in CH1 Execution pattern (buffer memory address: 272) is 1 in this setting example; therefore, the pattern 1 is a starting point. CH1 Program pattern 1 iteration (buffer memory address: 322) is referred to for the number of execution times. In this case, 10 is the setting value. (CH1 Program pattern 2 iteration (buffer memory address: 386) and CH1 Program pattern 3 iteration (buffer memory address: 450) are ignored.)

(c) Zone PID data

The zone PID data divides input range into 8 zones by zone upper limit setting, and then sets the PID constants and control response parameters used for each zone.

Zone dividing is performed by the upper limit setting (refer to the table on the next page for the buffer memory area) of zone 1 to 8.

Selecting the PID constants and control response parameters used in each segment is performed by the zone PID data No. (refer to the table on the previous page for the buffer memory area) in the program pattern data.

There are following three types for selecting the method.

1) When selecting optionally the PID constants and control response parameters
Set 1 to 8 to the zone PID data No. for each segment.

The Q62HLC performs the control using the PID constants and control response parameter of zone 1 to 8.

2) When selecting automatically the PID constants and control response parameters
Set 0 to the zone PID data No.

The Q62HLC performs the control after automatically selecting the zone including the set value of segment in execution.

If the characteristics of control target differ depending on the zone, the control performance can be improved being compared with the case where a single PID constant is used for controlling.

3) When controlling with a single PID constant and control response parameter
Set Zone 1 upper limit is as input range upper limit, and set 0 to Zone PID data No. for each segment.

The Q62HLC performs the control using the PID constant and control response parameter of zone 1.

Example) When the input range is divided into 3 zones, and then 2 is set to Zone PID data No. for the segment 1 and 2, 3 is set for the segment 3 and 4, and 1 is set for the segment 5 and 6 (refer to the table on the following page for the buffer memory area)

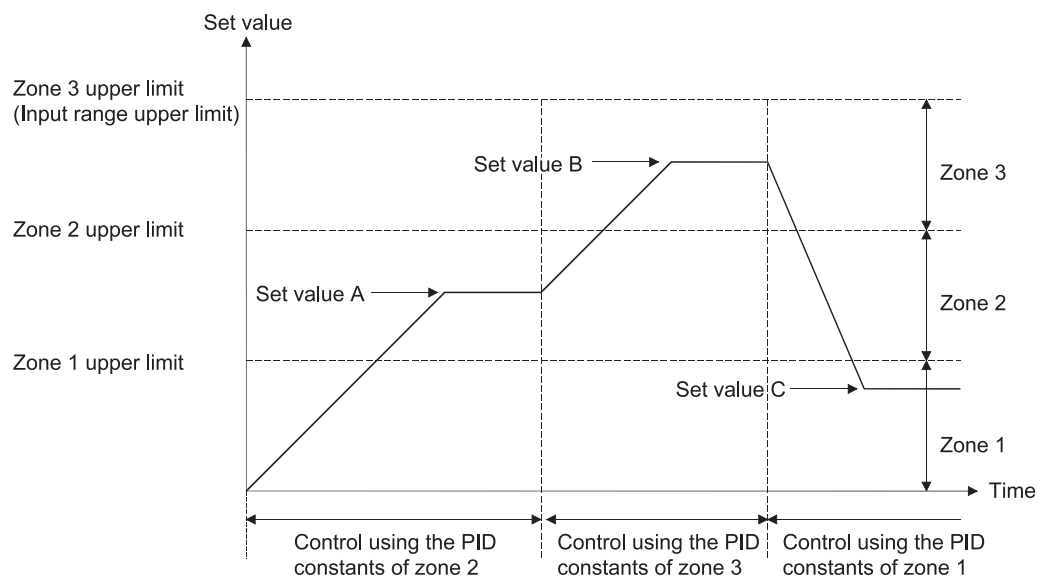

Buffer memory area name	Description	CH	Buffer memory address (decimal)							
			Zone							
			1	2	3	4	5	6	7	8
Upper limit	Sets the upper limit for each zone to divide input range into zones.	1	275	276	277	278	279	280	281	-
		2	531	532	533	534	535	536	537	-
Proportional band (P) setting	Sets the constants of proportional band (P) for zones.	1	282	286	290	294	298	302	306	310
		2	538	542	546	550	554	558	562	566
Integral time (I)	Sets the constants of integral time (I) for zones.	1	283	287	291	295	299	303	307	311
		2	539	543	547	551	555	559	563	567
Derivative time (D)	Sets the constants of derivative time (D) for zones.	1	284	288	292	296	300	304	308	312
		2	540	544	548	552	556	560	564	568
Control response parameter	Sets the 3-step responses to the set value change of PID control.	1	285	289	293	297	301	305	309	313
		2	541	545	549	553	557	561	565	569

(2) Program control starting method

A starting method of program control can be selected. Set one of the following starting methods in Start mode (buffer memory address: 273, 529).

- 0: Zero start
- 1: PV start 1 (time fixed)
- 2: PV start 2 (time shortened)
- 3: PV start 3 (time shortened/find type)
- 4: SV start

(a) Zero start

Program control starts from time 0, specifying 0 as the set value (SV) at time 0.

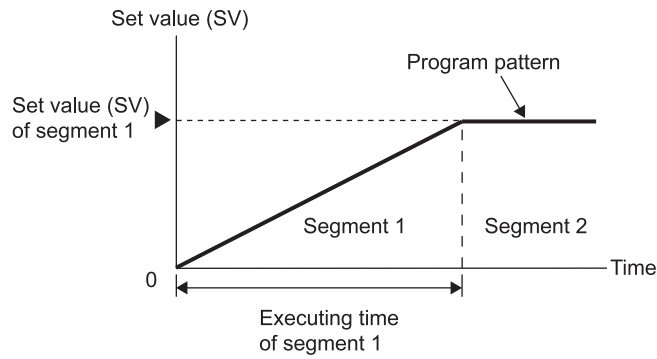

POINT

When the set value of Lower setting limiter (buffer memory address: 56, 88) is greater than 0, program control starts from the value set in Lower setting limiter (buffer memory address: 56, 88).

(b) PV start 1 (time fixed)

Program control starts from time 0, specifying the measured value (PV) at the start of program control as the set value (SV) at time 0.

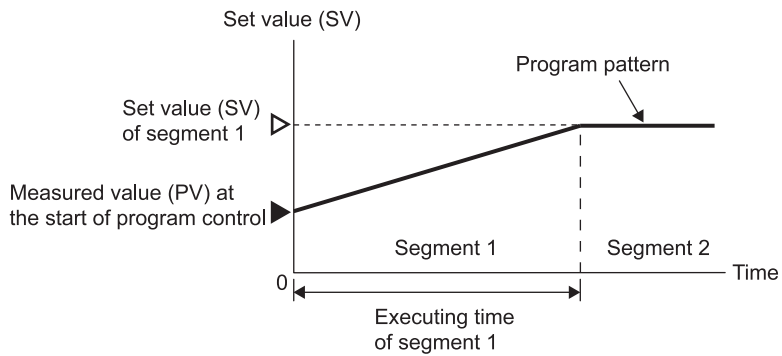

POINT

When the setting value of Lower setting limiter (buffer memory address: 56, 88) is greater than the measured value (PV) at the start of program control, program control starts from the value set in Lower setting limiter (buffer memory address: 56, 88).

(c) PV start 2 (time shortened)

Specifying 0 as the set value (SV) at time 0, program control starts from where the straight line connecting 0 and the set value (SV) of the segment 1 reaches the measured value (PV) at the start of program control. The time of the segment 1 is shortened by the time takes to reach the measured value (PV) at the start of control in the case of zero start.

The time of the segment 1 is shortened when the measured value (PV) and the set value (SV) satisfy one of the following conditions:

- 1) $0 \leq \text{Measured value (PV) at the start of program control} \leq \text{Set value (SV) of the segment 1}$

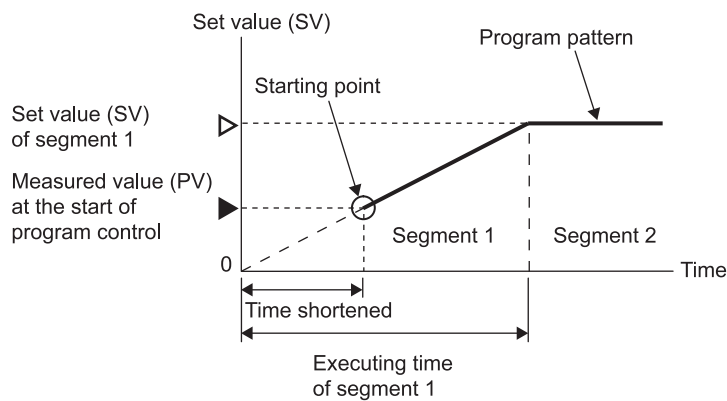

- 2) $\text{Set value (SV) of the segment 1} \leq \text{Measured value (PV) at the start of program control} \leq 0$

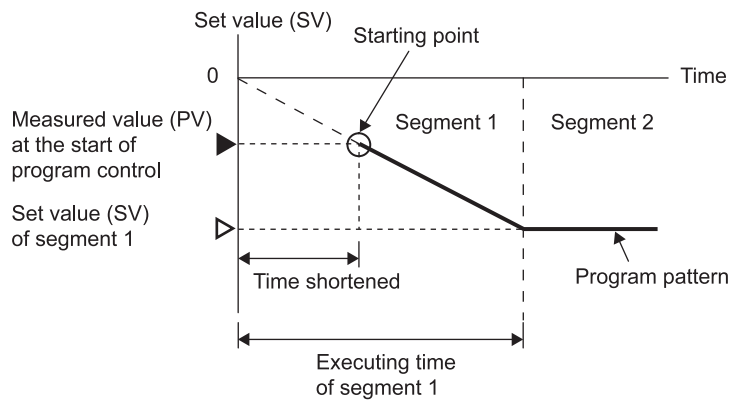

POINT

For PV start 2 (time shortened), program control start varies as below depending on the relationship of the measured value (PV) at the start of program control and the set value (SV) of the segment 1.

Condition		Program control start
Set value (SV) of the segment 1	Measured value (PV) at the start of program control	
Greater than 0	Smaller than 0	Zero start
	Greater than the set value (SV) of the segment 1	Starts from the set value (SV) of the segment 1
Smaller than 0	Greater than 0	Zero start
	Smaller than the set value (SV) of the segment 1	Starts from the set value (SV) of the segment 1

(d) PV start 3 (time shortened/find type)

Through the entire program pattern, the Q62HLC searches the point where the measured value (PV) at the start of program control and the set value (SV) of each segment match. When a matching point is found, program control starts from that point. When multiple matching points are found, the first point is prioritized.

To use PV start 3 (time shortened/find type), Set value at program control start (SV_PCS) setting (buffer memory address: 501, 757) must be set in advance.

1) When a match point was found

Program control starts from the first matching point, shortening time.

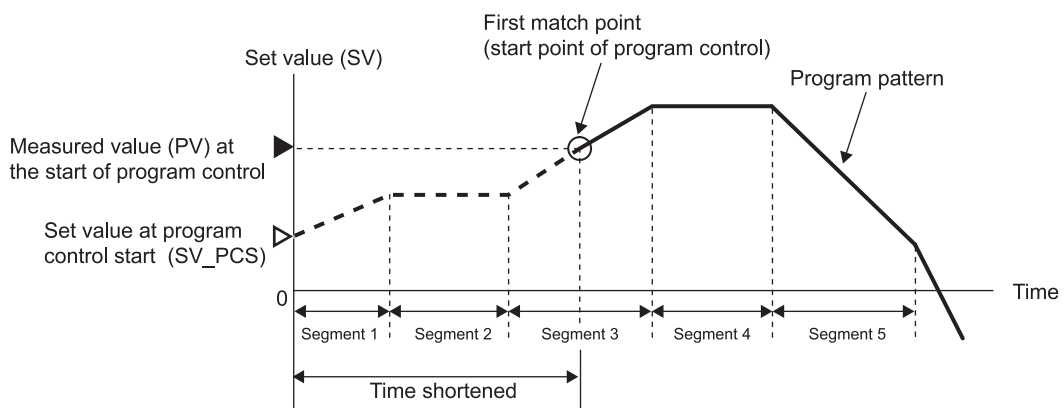

2) When no match point was found

Program control starts from time 0, specifying the set value in Set value at program control start (SV_PCS) setting (buffer memory address: 501, 757) as a set value (SV).

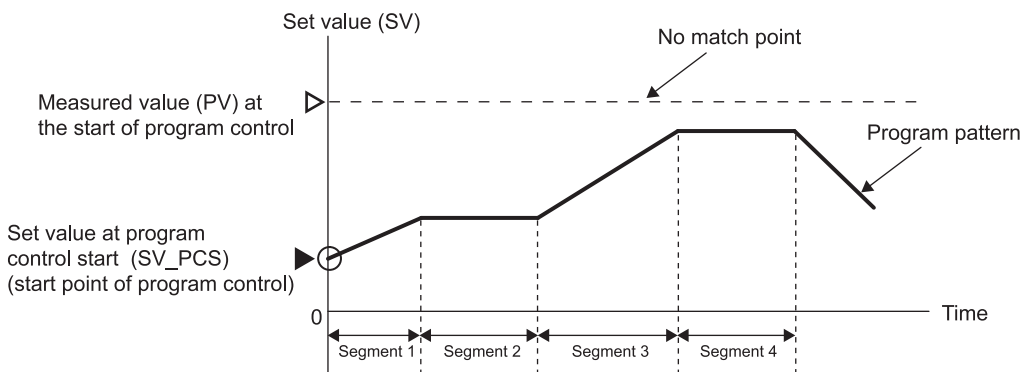

POINT

Only the program pattern that is executed first is searched for a match point. Even if the link setting is configured, the program pattern of the link destination is not searched for.

(e) SV start

Program control starts from the set value in Set value at program control start (SV_PCS) setting (buffer memory address: 501, 757) regardless of the measured value (PV) at the start of program control and the program pattern.

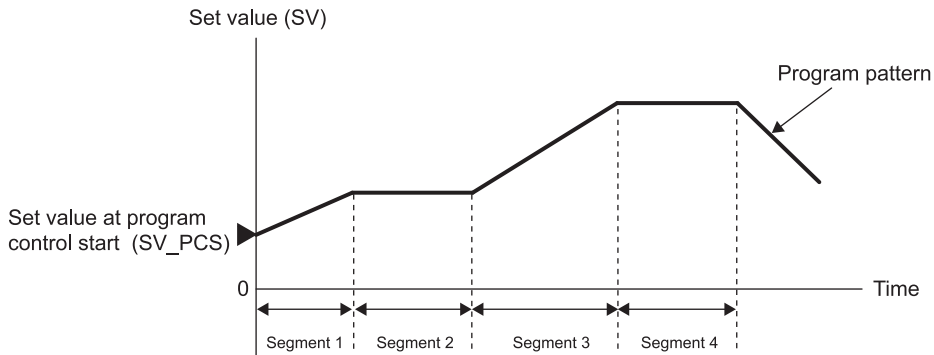

(3) Execution of program control

(a) The following is the program control execution procedure.

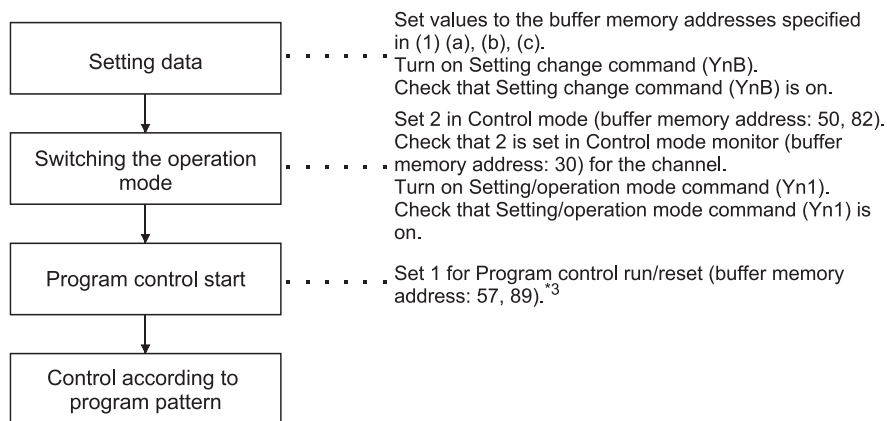

*3: If the mode is switched to the program control mode with this setting, the program control is started as it is.

After switching to the program control mode, written data error of the control data, program pattern data and zone PID data will be checked.

(b) Operation of program control

If starting the program control, the control by the program patterns specified in Execution pattern (buffer memory address: 272, 528) is executed in the order of segment 1→segment 2→.....→segment 16. Each segment performs the control using the set value and zone PID data No. within the execution time set in Executing time.

The following is the example of program pattern 1 controlled by the PID control in the order of segment 1→2→3→4. This section explains the program pattern data, control data, and zone PID data No. using this example.

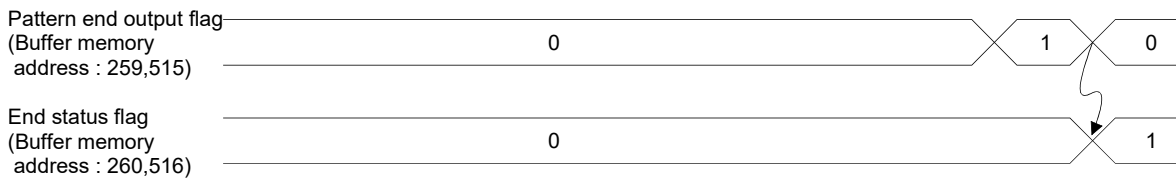
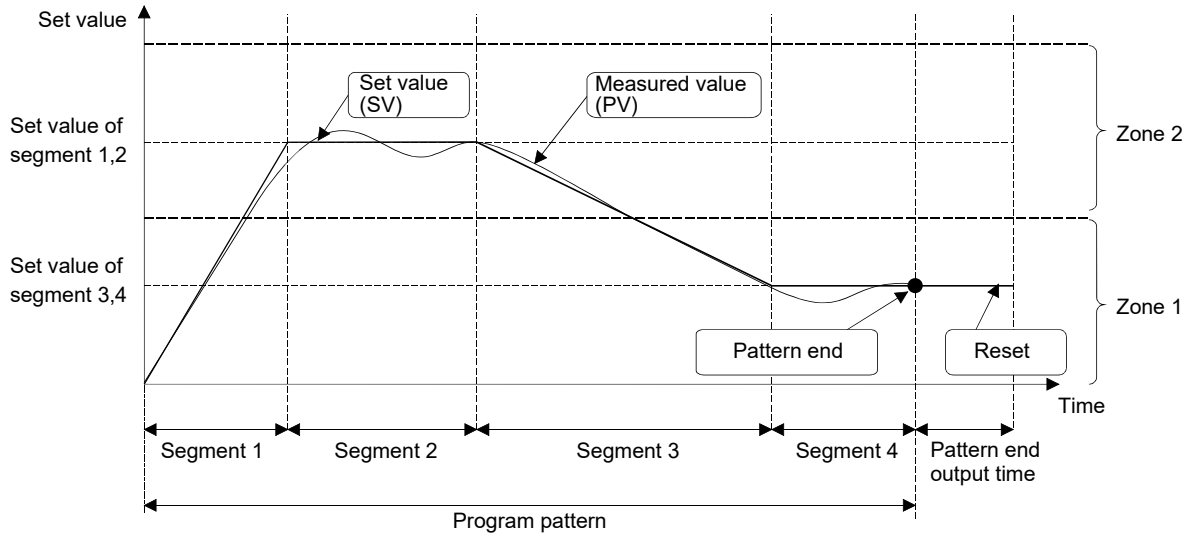

- 1) Set a program pattern to be executed with the control data.
Set a program pattern 1.
- 2) Create a program pattern to be executed.
 - Set the information in the segment 1, 2, 3 and 4 of the program pattern 1, and execute in the order of segment 1→2→3→4.
 - As the zone PID data No. used by each segment, set 2 for segment 1 and 2, and 1 for segment 3 and 4.
 - Set the segment 4 for the final segment which completes the program pattern.
- 3) Set the PID constants and control response parameters used for the PID control with the zone PID data.
Set the PID constants and control response parameters for the zone 1 and zone 2.

(c) Operation at the completion of program control

After the PID control of the final segment set by the final segment completes and reaches the pattern end, the pattern end output is performed.

- The pattern end output continues the PID control at the set value of the final segment for the time set in Output time setting of pattern end (buffer memory address: 323, 387, 451, 579, 643, 707).
- During the pattern end output, 1 is stored in Pattern end output flag (buffer memory address: 259, 515).
- After the completion of the pattern end output, the program control completes, 1 is stored in End status flag (buffer memory address: 260, 516), and the program control becomes a RESET status.
- At the RESET status, the PID control is stopped, the set value becomes 0, and the output turns off^{*4}.

*4: The current value output at the RESET status is the value set in Lower output limiter (buffer memory address: 43, 75).

POINT

To execute the program control in a row, wait for more than 0.05 second after the status of the first program control changes to RESET, and then set 1 (RUN) in Program control run/reset (buffer memory address: 57, 89).
--

3.2.13 Cascade control function

(1) Cascade control function

The cascade control can perform the control with the channel 1 as master and the channel 2 as slave. The channel 2 cannot be used as master and the channel 1 cannot be used as slave.

The master performs PID operations by inputting the measured value (PV1) of targets that are controlled at the last, converts the manipulated value (MV1) to cascade signals by bias and gain, and corrects the set value (SV2) of the slave. The slave performs the PID control according to the set value (SV2) corrected into the cascade signals.

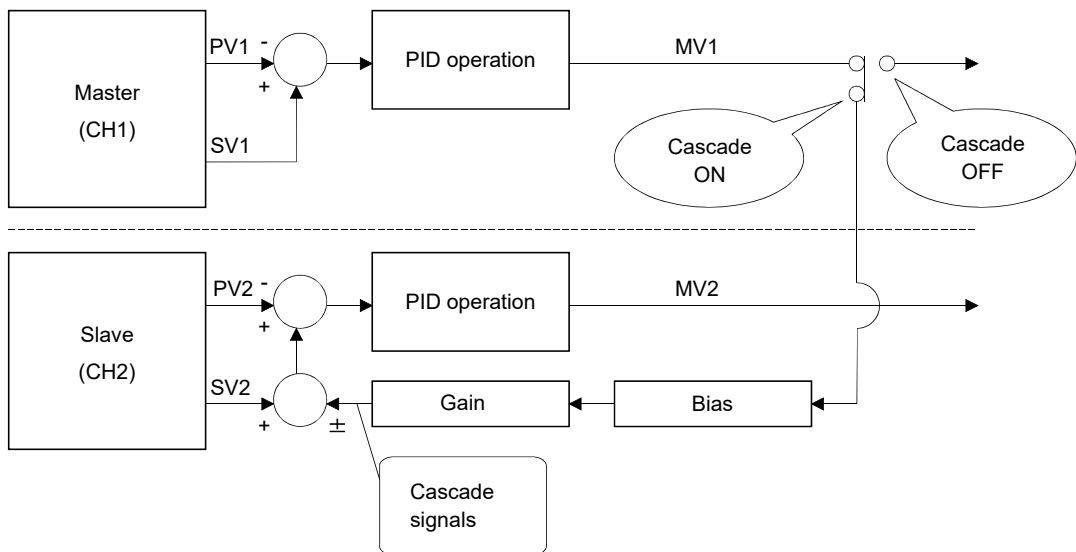

The cascade control is suitable for when there is a large time delay between the heater and the part where needs temperature stabilized.

Example) Resin temperature control of a nozzle part of an extrusion machine

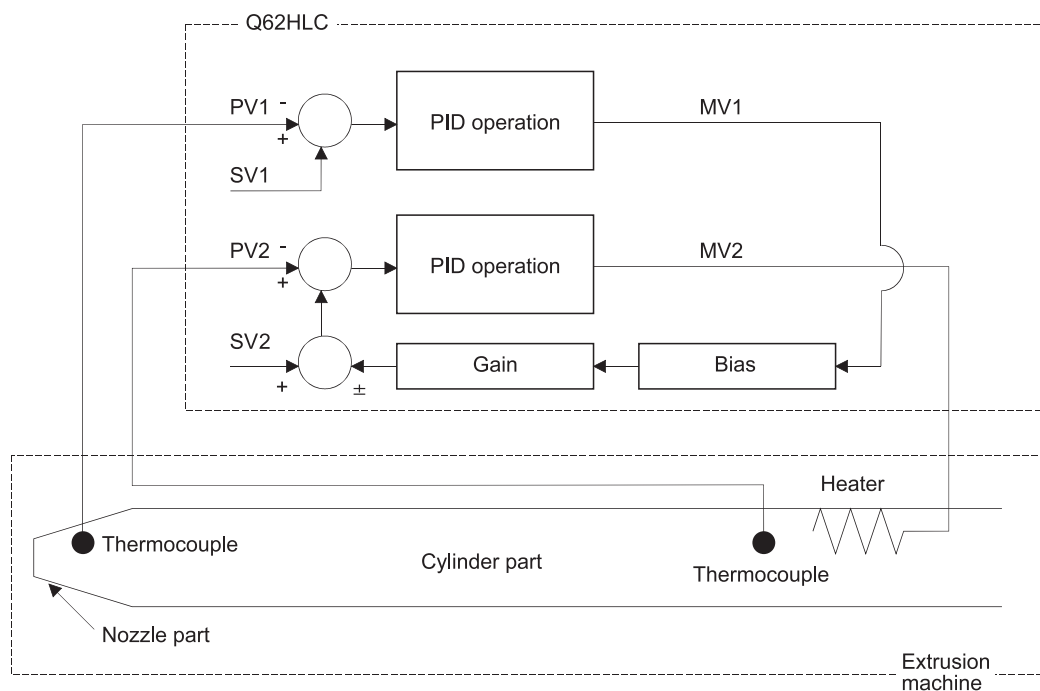

(2) Cascade control and control mode

The cascade control function can only be used with the combination of the following three control modes.

When the control modes are combined with other ones in the following table, the cascade control is not performed even if Cascade ON/OFF (buffer memory address: 176) is set to 1 (ON).

When control modes are combined with other control modes other than the following three, each channel operates individually.

No.	Control mode	
	CH1	CH2
1	Normal control mode	Normal control mode
2	Manual control mode 1	Normal control mode
3	Program control mode*1	Program control mode*1

*1: When the program control is reset, each cascade control cannot be performed.

(3) Execution of cascade control

The following is the cascade control procedure.

During the cascade control, the cascade signal is monitored with Cascade monitor (buffer memory address: 179).

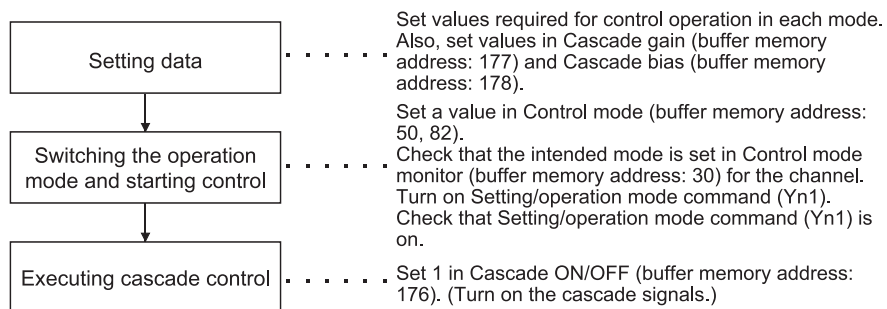

POINT
<ul style="list-style-type: none"> Auto tuning cannot be executed during cascade control. To execute auto tuning, set Cascade ON/OFF (buffer memory address: 176) to 0 (OFF). The cascade control stop status can be checked in Cascade monitor (buffer memory address: 179). (The value 0 indicates the stop status.) Auto tuning can be executed on the slave channel only.

3.2.14 Scaling function

The scaling function scales the measured value and stores it in Scaling value (buffer memory address: 196, 212).

The conversion method differs for thermocouple input and for micro voltage, voltage, and current input.

The conversion method is automatically selected depending on the setting of Input range (buffer memory address: 32, 64).

(1) Thermocouple input

The measured value within the scaling range set by Scaling range upper limit value (buffer memory address: 197, 213) and Scaling range lower limit value (buffer memory address: 198, 214) is scaled to the scaling width set by Scaling width upper limit value (buffer memory address: 199, 215) and Scaling width lower limit value (buffer memory address: 200, 216).

The following describes the calculation method of scaling value.

$$SCV = (SCWU - SCWL) \times \frac{TEPV - SCRL}{SCRU - SCRL} + SCWL$$

SCV : Scaling value
 SCWU : Scaling width upper limit value
 SCWL : Scaling width lower limit value
 TEPV : Measured temperature value
 SCRU : Scaling range upper limit value
 SCRL : Scaling range lower limit value

Example) When scaling the temperature to a percentage (%)

When scaling the temperature 360°C (temperature conversion value: 3600) with the following setting.

Scaling range: -100 to 500°C (lower limit value = -1000, upper limit value = 5000)

Scaling width: 0 to 100% (lower limit value = 0, upper limit value = 100)

$$\begin{aligned} \text{Scaling value} &= (100 - 0) \times \frac{3600 - (-1000)}{5000 - (-1000)} + 0 \\ &= 76.6666 \cdot \cdot \cdot \\ &= 77 (\%) \end{aligned}$$

Rounded to the whole number.

POINT

The scaling is performed by the above method even if the upper limit value is set smaller than the lower limit value for the scaling range upper/lower limit value and scaling width upper/lower limit value.

When the upper limit value is set equal to the lower limit value, the scaling is not performed.

When the measured value out of the scaling range is measured, the values set with the scaling width upper/lower limit value are stored.

(2) Micro voltage, voltage, current input

The value converted from the digital output value within the range between Scaling range lower limit value (buffer memory address: 198, 214) and Scaling range upper limit value (buffer memory address: 197, 213) is stored in the scaling value.

Full-scale*1 should be set to a value 20000 or less.

The scaling width upper limit and scaling width lower limit are not used.

*1 The absolute value of (Scaling range upper limit - Scaling range lower limit)

If the scaling upper/lower limit values of which full-scale is larger than 20000 are set, a write data error (error code 4) occurs.

In this case, the scaling is performed for the set upper limit value and the lower limit value of (the upper limit value -20000).

POINT

The scaling is performed even if the scaling range upper/lower limit value is set as the upper limit value is smaller than the lower limit value.

Example) When the lower limit value 5000 and upper limit value 1000 are set in the range of 1 to 5V

1.000V → 1.001V → ... → 4.999V → 5.000V

5000 → 4999 → ... → 1001 → 1000

3.2.15 SV tracking function

(1) SV tracking function

When control is switched, drastic change of the set value (SV) is prevented. In case of the following control shifts, this function is executed.

- Switching from the program control mode (RUN) to the normal control mode, manual control mode 1, or manual control mode 2
- Switching cascade control from ON to OFF while it is executed in the normal control mode

Depending on the condition in which control was switched, the set value (SV) may change drastically, causing the manipulated value (MV) to do so as well. Processing the set value (SV) as described below, the Q62HLC prevents system instability caused by drastic change of the manipulated value (MV).

Control shift		Processing
Before	After	
Program control mode (RUN)	<ul style="list-style-type: none"> • Normal control mode • Manual control mode 1 • Manual control mode 2 	Changes the set value (SV) to the value that was in Set value monitor (buffer memory address: 25, 26) right before the control shift.
Cascade control ON (normal control mode)	Cascade control OFF (normal control mode)	Changes the set value (SV) of the slave channel to the value that was in CH2 Set value monitor (buffer memory address: 26) right before the control shift. The set value (SV) of the master channel does not change.

(Example) When the mode is switched from the program control mode to the normal control mode

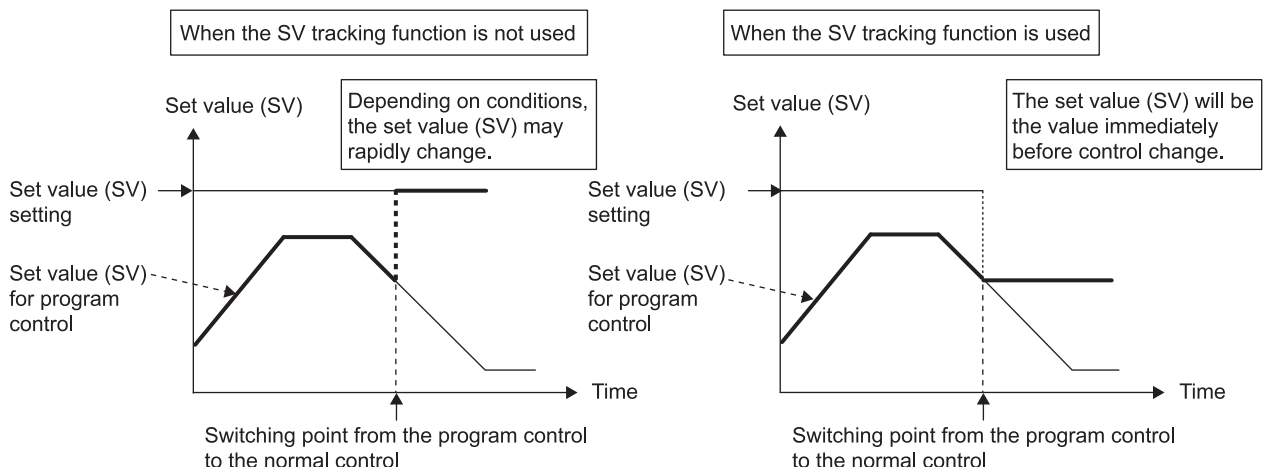

When the SV tracking function is used, the value right before the mode shift is stored as the set value (SV) after the mode is switched from the program control mode to the normal control mode.

This processing prevents drastic change of the set value (SV) and maintains stable control.

After checking the stored set value (SV), change it to the one to be controlled, then start the control.

(2) Execution of SV tracking

The SV tracking function is enabled by setting 1 (Enable SV tracking) in SV tracking setting (buffer memory address: 203, 219). To execute SV tracking in cascade control, set 1 (Enable SV tracking) in only CH2 SV tracking setting (buffer memory address: 219).

(3) Operation of SV tracking

The operation of the SV tracking function is as shown below.

(a) Control mode shift from the program control mode

The SV tracking function operates as shown below.

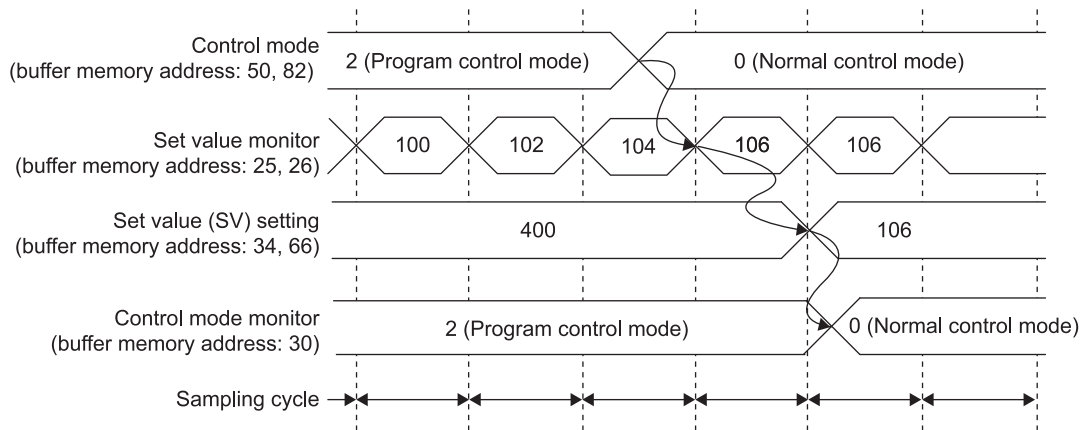

The value in Set value monitor (buffer memory address: 25, 26) at the shift to the normal control mode is set as the set value (SV). Then, the value in Control mode monitor (buffer memory address: 30) is changed.

To change the set value (SV) after the control shift, check that the mode has shifted from the program control mode before changing a setting. The control mode can be checked in Control mode monitor (buffer memory address: 30).

(b) Cascade control shift from ON to OFF

The SV tracking function operates as shown below.

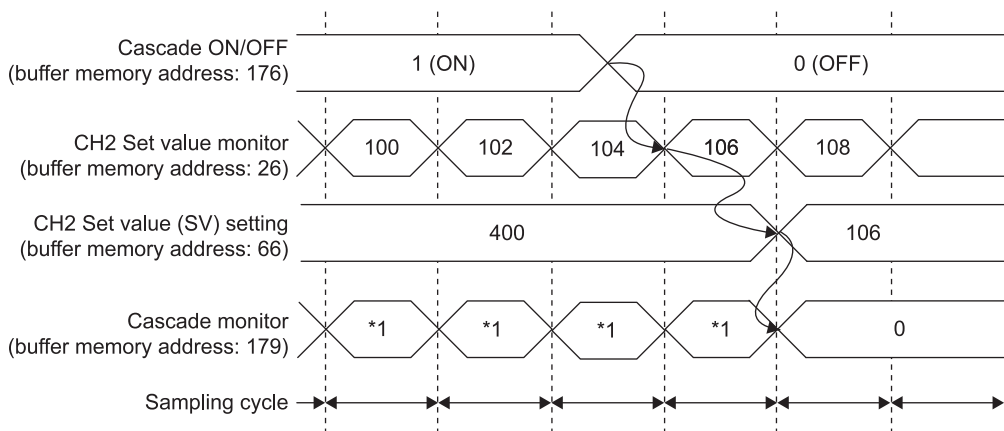

*1 The manipulated value (MV) for the master channel that was converted using cascade gain and cascade bias is stored.

The value in CH2 Set value monitor (buffer memory address: 26) at the cascade control shift to OFF is set as the set value (SV) of the slave channel. Then, the value in Cascade monitor (buffer memory address: 179) is changed.

To change the set value (SV) after the control shift, check that the cascade control has stopped before changing a setting. The cascade control stop status can be checked in Cascade monitor (buffer memory address: 179). (The value 0 indicates the stop status.)

(4) Restrictions

The following is the restrictions on the SV tracking function. If the following applies, the function is not executed.

(a) Shift from the program control mode

- If the control mode is switched while program control is being reset
- If the control mode is switched after the program control is completed

Mode after control mode shift	Program control			
	RESET	RUN	End output	Completed
Normal control mode	Ignored	Depends on the setting of SV tracking setting (buffer memory address: 203, 219).		Ignored
Manual control mode 1				
Manual control mode 2				

(b) Cascade control shift from ON to OFF

- If cascade control is being executed in the program control mode

Control mode in cascade control		SV tracking operation
CH1	CH2	
Normal control mode	Normal control mode	Depends on the setting of SV tracking setting (buffer memory address: 203, 219)
Manual control mode 1	Normal control mode	
Program control mode	Program control mode	Ignored

3.2.16 Forced output function

(1) Forced output function

Specified manipulated value (MV) can be forcibly output regardless of the control mode. Using this function, analog output can be processed forcibly without being affected by the operation result of the control. This function is enabled only when the bit 0 of the switch 3 is set to 1 (Enable) in the intelligent function module switch setting.

(2) Execution of the forced output function

The following is the forced output function procedure.

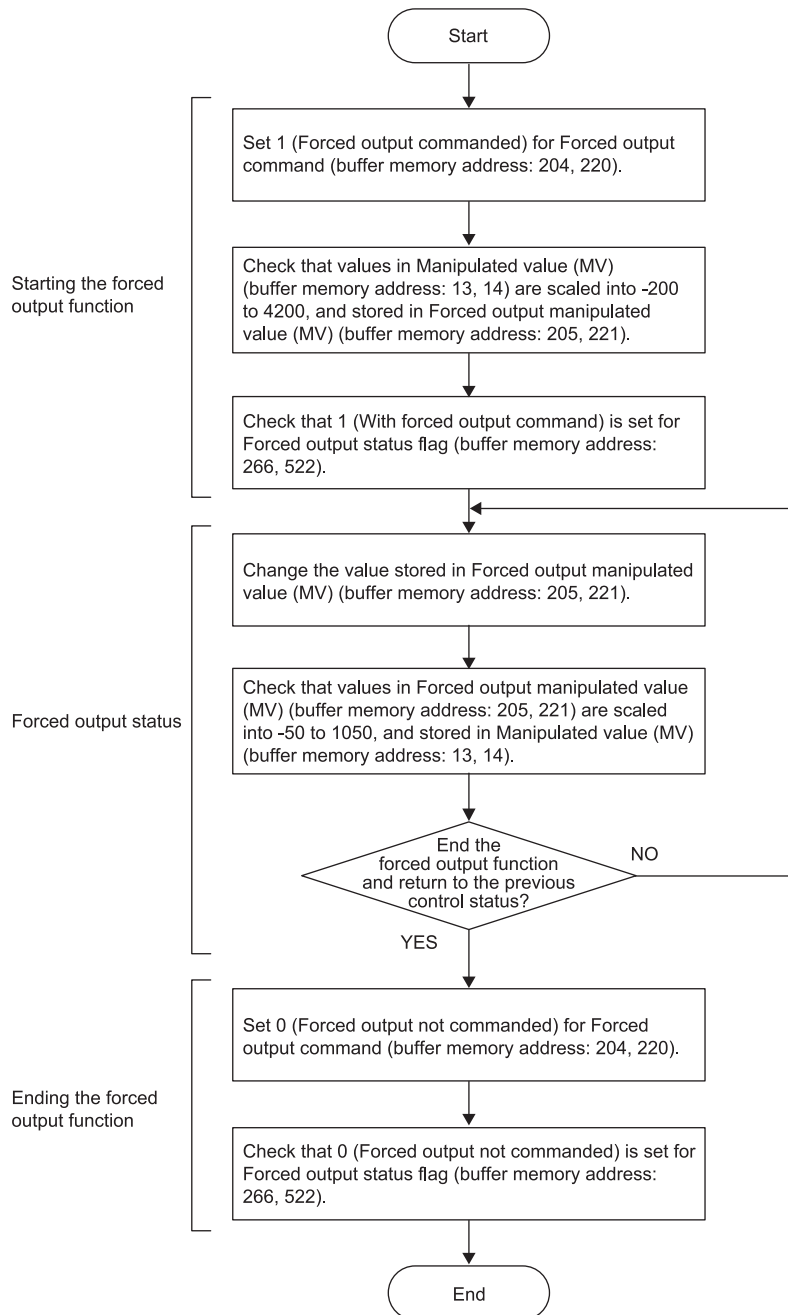

(3) Operation of the forced output function

The forced output function operates as follows.

(a) Shift to a forced output status

When the value in Forced output command (buffer memory address: 204, 220) is changed to 1 (Forced output commanded), the manipulated value (MV) at that point is stored in Forced output manipulated value (MV) (buffer memory address: 205, 221). The value to be stored is Manipulated value (MV) (buffer memory address: 13, 14) (-50 to 1050) scaled into a value range of -200 to 4200.

(Example) When the manipulated value (MV) is 250 (25%), 1000 is stored in Forced output manipulated value (MV) (buffer memory address: 205, 221). (Refer to the part*1 in the following figure.)

After a manipulated value (MV) was stored, 1 (With forced output command) is stored into Forced output status flag (buffer memory address: 266, 522).

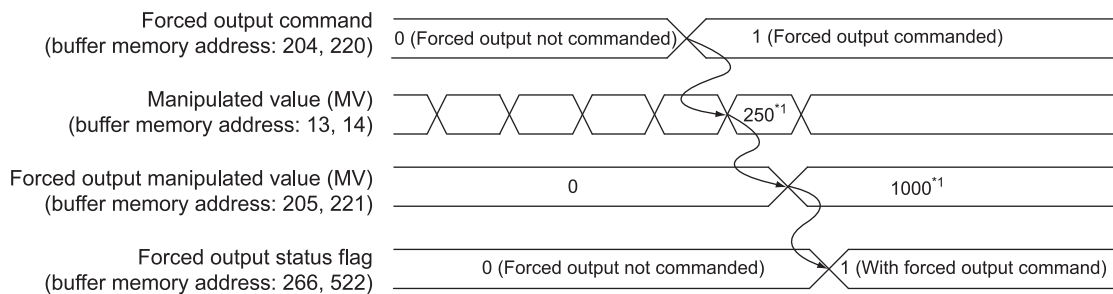

(b) In a forced output status

After 1 (With forced output command) is stored in Forced output status flag (buffer memory address: 266, 522), any value can be set to Forced output manipulated value (MV) (buffer memory address: 205, 221).

Setting a value into the area stores a manipulated value scaled into a value range of -50 to 1050 (-5.0 to 105.0%) in Manipulated value (MV) (buffer memory address: 13, 14).

The following figure is an example of when 1000 is set to Forced output manipulated value (MV) (buffer memory address: 205, 221).

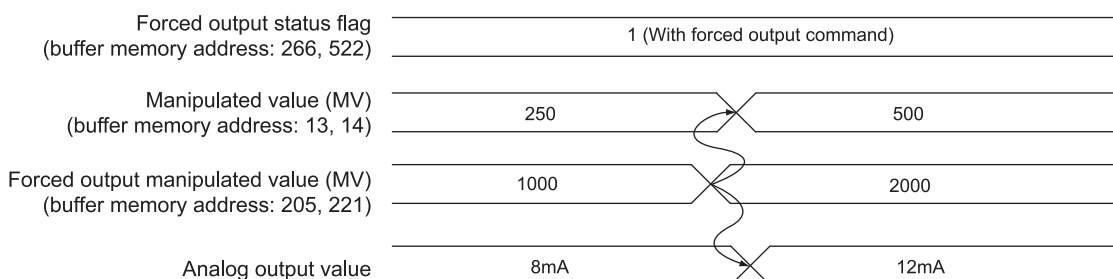

The following table lists the relationship of Forced output manipulated value (MV) (buffer memory address: 205, 221), Manipulated value (MV) (buffer memory address: 13, 14), and analog output value.

Manipulated value (MV) (buffer memory address: 13, 14)	Forced output manipulated value (MV) (buffer memory address: 205, 221)	Analog output value
-50 (-5.0%)	-200	3.2mA
0 (0.0%)	0	4.0mA
1000 (100.0%)	4000	20.0mA
1050 (105.0%)	4200	20.8mA

While Forced output manipulated value (MV) (buffer memory address: 205, 221) is unchanged, the manipulated value (MV) at the start of forced output continues to be output.

(c) End of a forced output status

When the value in Forced output command (buffer memory address: 204, 220) is changed to 0 (Forced output not commanded), the value 0 is stored in Forced output status flag (buffer memory address: 266, 522).

After that, forced output ends and the operation shifts back to the control before the execution of the forced output function.

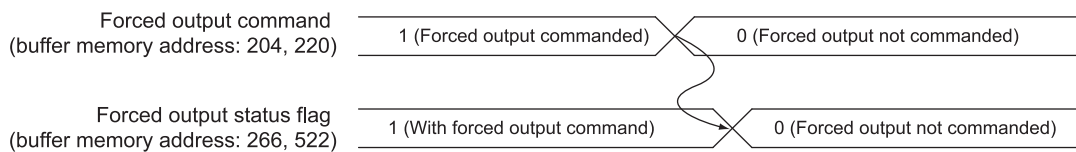

(4) Operation during program control

When Forced output command (buffer memory address: 204, 220) is set to 1 (Forced output commanded) while Program control run/reset (buffer memory address: 57, 89) is 1(RUN), the module goes into a forced output status.

Meanwhile, the program control operation continues inside the module.

When the value in Forced output command (buffer memory address: 204, 220) is set to 0 (Forced output not commanded), the mode returns to the program control mode. The program control resumes operation that continued while forced output was in execution.

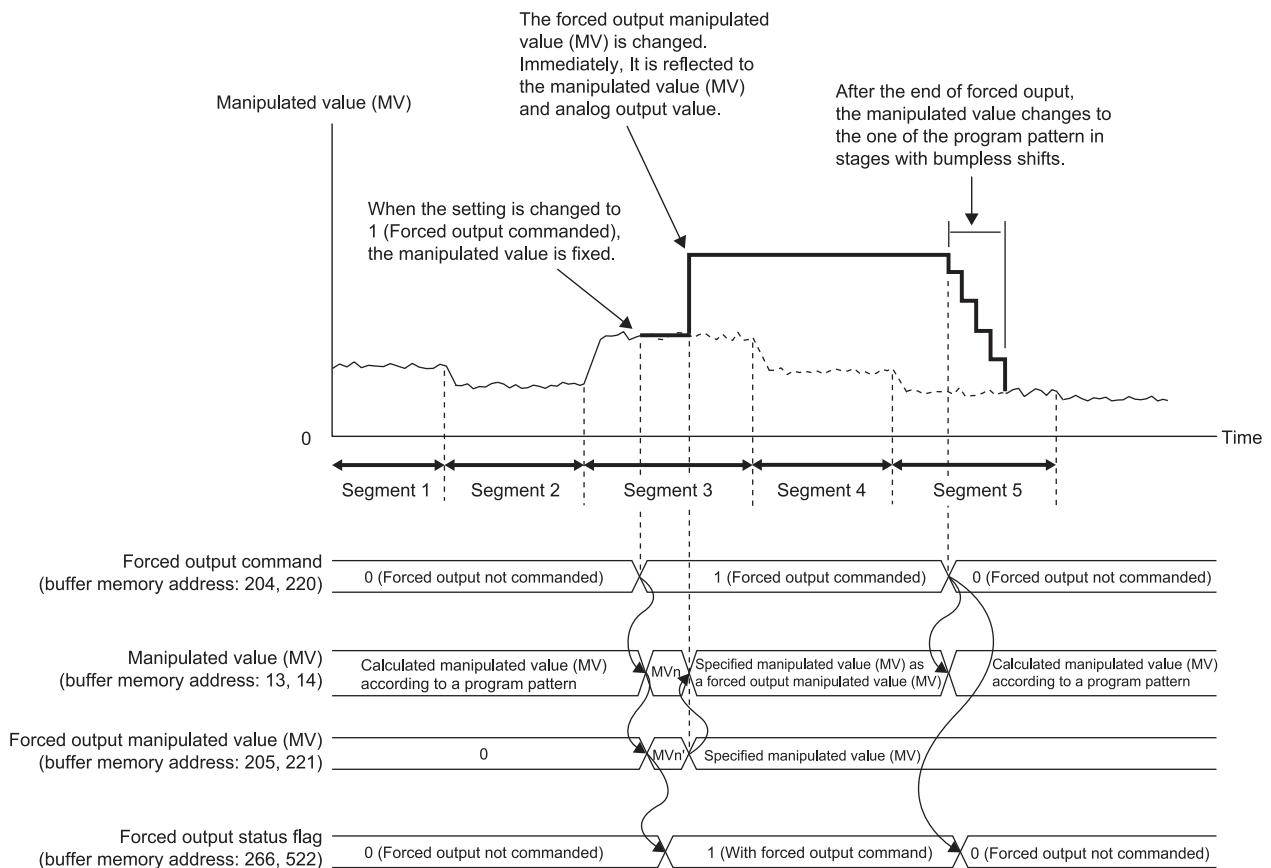

MVn : Manipulated value (MV) of when Forced output command (buffer memory address: 204, 220) is changed from 0 to 1

MVn': A value scaled into -200 to 4200 from the value of MVn

POINT

- When Forced output manipulated value (MV) (buffer memory address: 205, 221) is changed during forced output processing, the change is reflected to the manipulated value (MV) immediately. (Bumpless shifting does not operate.)
- When Forced output command (buffer memory address: 204, 220) is changed to 0 (Forced output not commanded) during forced output processing, bumpless shifting operates gradually changing back to the original operation by each control output update cycle.
- The forced output function cannot be used during auto tuning. Even if Forced output command (buffer memory address: 204, 220) is changed to 1 (Forced output commanded), Forced output status flag (buffer memory address: 266, 522) does not become 1 (Forced output not commanded).
- Even if Auto tuning start command (Yn4, Yn5) is turned on during forced output processing, auto tuning is not executed. At this time, an error does not occur.

3.2.17 Simplified analog I/O function

This function enables an unused channel of the Q62HLC to be used as a simplified thermocouple/micro voltage input module, analog-digital converter module, or digital-analog converter module.*¹

The execution of the simplified analog I/O function is performed in manual control mode 2. Set 3 in Control mode (buffer memory address: 50, 82).

The following describes how to use the analog input and analog output.

(1) Analog input

Monitors Measured value (PV) (buffer memory address: 9, 10).

(2) Analog output

Set the digital value 0 to 4000 (current value is 4 to 20mA) of the analog output to MAN output setting (buffer memory address: 51, 83).

When not using the analog output, set a value in the range of -32768 and -1.*²

*1: Functions equivalent to the analog-digital converter module or digital-analog converter module are not available.

*2: The output is near 0mA.

REMARKS

The following describes the specifications of conversion speed for the simplified analog I/O function.

Item		Specifications
Conversion speed	Analog input	355ms/2 channels (The speed is constant regardless of the number of channels used.)
	Analog output	60ms/2 channels (The speed is constant regardless of the number of channels used.)

Specifications other than the conversion speed of the simplified analog I/O function follow the performance specifications in Section 3.1.1.

3.2.18 Parameter change in program control function

(1) Parameter change in program control function

Buffer memory settings can be changed and reflected to the control in execution without stopping program control.

This function is enabled only when the bit 1 of the switch 3 is set to 1 (Enable) in the intelligent function module switch setting. When the bit 1 of the switch 3 is 0 (Disable), and if a buffer memory setting is changed during program control, a write data error occurs.

(2) Execution of the parameter change in program control function

When this function is enabled, control data, zone PID data, and pattern data can be changed during program control. Turning Setting change command (YnB) from off to on reflects the change to the control.

If a write data error occurs during setting change, the program control proceeds with the setting before the change.

The buffer memory areas that can be changed are described under (a) to (c).

(a) Control data

Buffer memory address (decimal)		Buffer memory area name	Reflection timing*1
CH1	CH2		
272	528	Execution pattern	<ul style="list-style-type: none"> When the program pattern being executed is processed until END RESET → RUN
273	529	Start mode	RESET → RUN
274	530	Time scale	Setting change command (YnB) OFF → ON
501	757	Set value at program control start (SV_PCS) setting	RESET → RUN

*1: Regardless of reflection timing of each, turning Setting change command (YnB) from off to on checks whether each setting is within the setting range.

(b) Zone PID data

CH	Buffer memory address (decimal)								Buffer memory area name	Reflection timing*1
	Zone									
	1	2	3	4	5	6	7	8		
1	275	276	277	278	279	280	281	-	Upper limit	Setting change command (YnB) OFF → ON
2	531	532	533	534	535	536	537	-		
1	282	286	290	294	298	302	306	310	Proportional band (P) setting	
2	538	542	546	550	554	558	562	566		
1	283	287	291	295	299	303	307	311	Integral time (I)	
2	539	543	547	551	555	559	563	567		
1	284	288	292	296	300	304	308	312	Derivative time (D)	
2	540	544	548	552	556	560	564	568		
1	285	289	293	297	301	305	309	313	Control response parameter	
2	541	545	549	553	557	561	565	569		

*1: Regardless of reflection timing of each, turning Setting change command (YnB) from off to on checks whether each setting is within the setting range.

(c) Pattern data

Buffer memory address (decimal)						Segment	Buffer memory area name	Reflection timing ^{*1}
Program pattern								
1		2		3				
CH1	CH2	CH1	CH2	CH1	CH2			
320	576	384	640	448	704	-	Final segment ^{*2}	Setting change command (YnB) OFF → ON
321	577	385	641	449	705		Pattern link	
322	578	386	642	450	706		Iteration	
323	579	387	643	451	707		Output time of pattern end	
324	580	388	644	452	708		Wait zone setting	
325	581	389	645	453	709	1	Set value (SV) setting	
328	584	392	648	456	712	2		
331	587	395	651	459	715	3		
334	590	398	654	462	718	4		
337	593	401	657	465	721	5		
340	596	404	660	468	724	6		
343	599	407	663	471	727	7		
346	602	410	666	474	730	8		
349	605	413	669	477	733	9		
352	608	416	672	480	736	10		
355	611	419	675	483	739	11		
358	614	422	678	486	742	12		
361	617	425	681	489	745	13		
364	620	428	684	492	748	14		
367	623	431	687	495	751	15		
370	626	434	690	498	754	16		
326	582	390	646	454	710	1	Executing time	
329	585	393	649	457	713	2		
332	588	396	652	460	716	3		
335	591	399	655	463	719	4		
338	594	402	658	466	722	5		
341	597	405	661	469	725	6		
344	600	408	664	472	728	7		
347	603	411	667	475	731	8		
350	606	414	670	478	734	9		
353	609	417	673	481	737	10		
356	612	420	676	484	740	11		
359	615	423	679	487	743	12		
362	618	426	682	490	746	13		
365	621	429	685	493	749	14		
368	624	432	688	496	752	15		
371	627	435	691	499	755	16		

(To the next page)

*1: Regardless of reflection timing of each, turning Setting change command (YnB) from off to on checks whether each setting is within the setting range.

*2: When a smaller value than the segment number in process is set to this area, the module shifts its operation to output pattern end immediately. The set value (SV) at the pattern end output is the one in Set value (SV) monitor at the setting change.

(From the previous page)

Buffer memory address (decimal)						Segment	Buffer memory area name	Reflection timing ^{*1}
Program pattern								
1		2		3				
CH1	CH2	CH1	CH2	CH1	CH2			
327	583	391	647	455	711	1	Zone PID data No.	Setting change command (YnB) OFF → ON
330	586	394	650	458	714	2		
333	589	397	653	461	717	3		
336	592	400	656	464	720	4		
339	595	403	659	467	723	5		
342	598	406	662	470	726	6		
345	601	409	665	473	729	7		
348	604	412	668	476	732	8		
351	607	415	671	479	735	9		
354	610	418	674	482	738	10		
357	613	421	677	485	741	11		
360	616	424	680	488	744	12		
363	619	427	683	491	747	13		
366	622	430	686	494	750	14		
369	625	433	689	497	753	15		
372	628	436	692	500	756	16		

*1: Regardless of reflection timing of each, turning Setting change command (YnB) from off to on checks whether each setting is within the setting range.

(3) Operation

After turning Setting change command (YnB) from off to on, the changed data is not reflected to the program control until Setting change completion flag (XnB) turns on. Starting from the ON timing of Setting change completion flag (XnB), program control resumes and operates by sampling cycle.

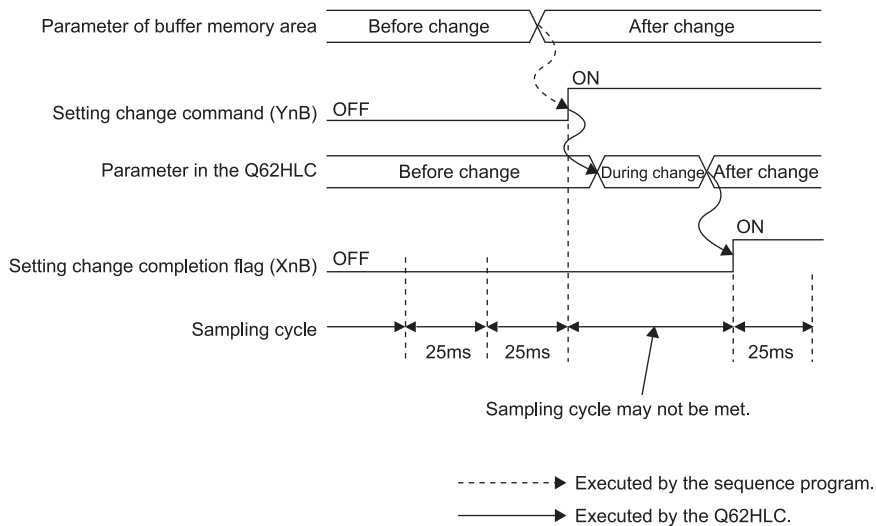

3.2.19 Q62HLC control status controlling output signal and buffer memory settings and control status

The Q62HLC has the output signals (Y), buffer memory and intelligent function module switch setting which set its control status. The control status of the Q62HLC differs depending on the mode of the Q62HLC.

The control status of the Q62HLC on each mode is governed as indicated below by the settings of the output signals, buffer memory and intelligent function module switch setting.

(1) Switching of modes

The Q62HLC has a setting mode and an operation mode.

- The setting mode is a mode to make a setting of control conditions.
- The operation mode is a mode to execute the control (control mode).
The operation modes consist of the normal control mode, manual control mode, and program control mode.
- The mode is set to the setting mode when the programmable controller CPU is powered on or reset.

(a) Setting mode → Operation mode (1) to 4) in the figure below)

After setting a value in Control mode (buffer memory address: 50, 82), the mode is switched by turning on Setting/operation mode command (Yn1). After the mode is switched, the new control mode is stored in Control mode monitor (buffer memory address: 30) and Setting/operation mode status (Xn1) turns on.

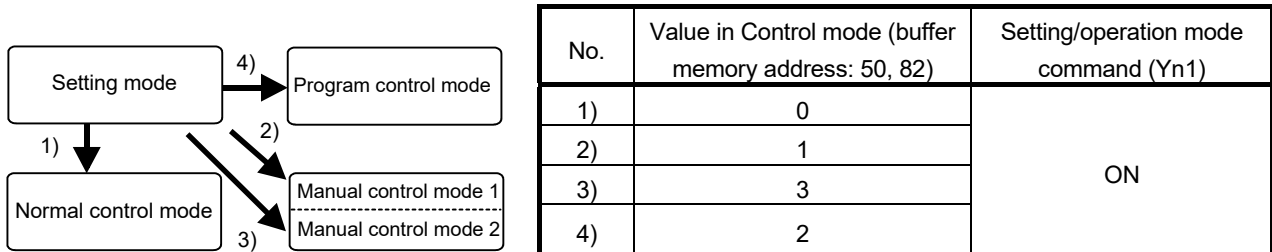

*1: The settings and setting ranges of MAN output setting differ between the manual control mode 1 and 2 (refer to Section 3.5.24).

(b) Operation mode → Setting mode (5) to 7) in the figure below)

The mode is switched by turning off Setting/operation mode command (Yn1). After the completion of the switching, Setting/operation mode status (Xn1) turns off.

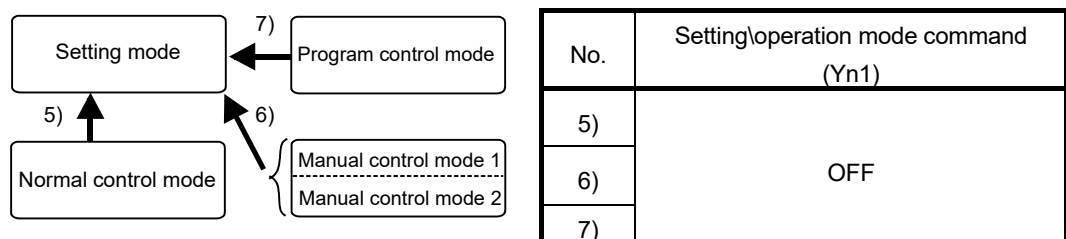

(c) Between control modes (8) to 15) in the figure below)

The mode is switched by setting a value in Control mode (buffer memory address: 50, 82) when Setting/operation mode status (Xn1) is set to on.

After the mode is switched, the new control mode is stored in Control mode monitor (buffer memory address: 30)

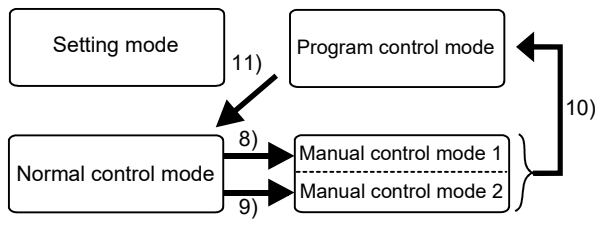

No.	Value in Control mode (buffer memory address: 50, 82)
8)	1
9)	3
10)	2 ²
11)	0

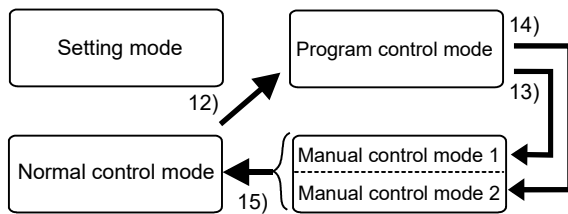

No.	Value in Control mode (buffer memory address: 50, 82)
12)	2 ²
13)	1
14)	3
15)	0

*2: The control status at switching differs depending on the intelligent function module switch setting (refer to (3) in this section).

(2) Control status

The Q62HLC has three control status: PID control, temperature judgment, and alert judgment.

The control status of the Q62HLC is as listed below.

(a) Intelligent function module switch setting

Output setting at CPU stop error (refer to Section 4.5)	Control status		
	PID control	Temperature judgment	Alert judgment
Intelligent function module switch setting			
If a CPU stop error occurs at the setting of "CLEAR"	—	—	—
Other than above	In accordance with control status of other setting items		

○: Executed, —: Not executed

(b) Unused channel setting

Unused channel setting (buffer memory address 61, 93:) (refer to Section 3.5.32)	Control status		
	PID control	Temperature judgment	Alert judgment
Unused	—	—	—
Used	In accordance with control status of other setting items		

○: Executed, —: Not executed

(c) Other settings

Setting/operation mode command (refer to Section 3.4) ^{*3} Yn1, Xn1	PID continuation flag (refer to Section 3.5.39) Buffer memory address (decimal) 169	Forced PID control stop command (refer to Section 3.4.3) YnC, YnD	Stop mode setting (refer to Section 3.5.12) Buffer memory address (decimal) 33, 65	Control status			
				PID control	Temperature judgment	Alert judgment	
1) Setting mode (at power-on)	Stop/continue	OFF/ON	Stop	—	—	—	
			Monitor	—	○	—	
			Alert	—	○	○	
2) Operation mode (during operation of normal control, Manual control 1, Manual control 2)	Stop/continue	OFF	Stop/monitor/alert	○	○	○	
		ON	Stop	—	—	—	
			Monitor	—	○	—	
2)' Operation mode (during operation of program control)	Stop/continue	OFF	Stop/monitor/alert	○	○	○	
		ON	Stop/monitor/alert	— ^{*4}	○	—	
3) Setting mode (after operation of normal control, Manual control 1, Manual control 2)	Stop	OFF/ON	Stop	—	—	—	
			Monitor	—	○	—	
			Alert	—	○	○	
	Continue	OFF/ON	OFF	Stop/monitor/alert	○	○	○
			ON	Stop	—	—	—
				Monitor	—	○	—
Alert	ON	Alert	—	○	○		
		Alert	—	○	○		
3)' Setting mode (after operation of program control)	Stop	OFF/ON	Stop/monitor/alert	— ^{*4}	○	—	
			OFF	Stop/monitor/alert	○	○	○
			ON	Stop/monitor/alert	— ^{*4}	○	—

○: Executed, —: Not executed

*3: The settings of the setting/operation mode command will be explained in the following three different modes.

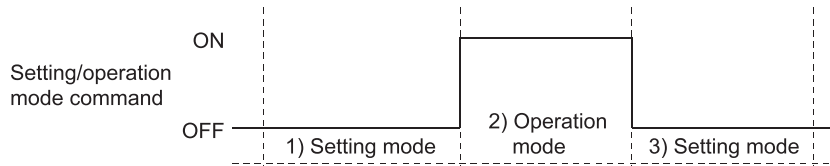

*4: The PID control becomes RESET during operation of program control.

(3) Control status selection when switching to program control

When the normal control mode is switched to the program control mode or the manual control mode is switched to the program control mode in the operation mode (Xn1: on), the control status at switching can be selected.

Set the control status at switching with the intelligent function module switch setting (Switch 2).

Refer to Section 4.5 for the intelligent function module switch setting.

(a) When Program control run/reset (buffer memory address: 57, 89) is set to 1

Control details	Control status	
	Set 1 for switch 2	Set other than 1 for switch 2
PID control	Continue	Suspends PID control. The manipulated value (MV) becomes -50 while suspending the control (for 25ms).
Alert status	Continues the processing in accordance with the set and measured values.	Clear
Loop disconnection alert		
Approach flag		
Cascade control	Suspends cascade control. Perform PID control while suspending the control.	Suspends PID and cascade controls. Resume the cascade control from a maximum of 25ms after resuming the PID control.

(b) When Program control run/reset (buffer memory address: 57, 89) is set to 0

The control status become as follows regardless of the setting of the Intelligent function module switch setting (Switch 2).

Control details	Control status
PID control	Stop
Alert status	Clear
Loop disconnection alert	
Approach flag	
Cascade control	Stop

POINT

Check the following when the mode is switched to the program control mode in the operation mode (Xn1: on).

- 1) Set the start mode setting to PV starting 1 (Time fixed) or PV starting 2 (Time shortened).
- 2) Check that there is no error in each parameter setting for the program control.

3.3 Sampling Period

(1) Sampling period

- (a) This is the time taken from the channel (CHn) where PID operations are currently executed until restart of PID operations of the current channel (CHn).

The time is fixed at 25ms regardless of the number of channels used.

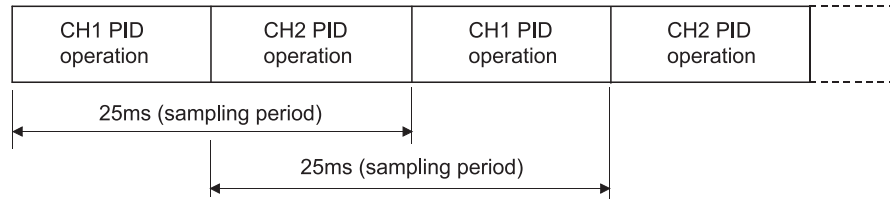

3.4 I/O Signals Transferred to/from the Programmable Controller CPU

This section describes the I/O signal assignment and the applications of each signal.

3.4.1 I/O signals

- (1) The Q62HLC uses 16 input points and 16 output points to transfer signals to/from the programmable controller CPU.
- (2) Table 3.7 lists the I/O signals of the Q62HLC.
Input (X) is a signal from the Q62HLC to the programmable controller CPU, and output (Y) is a signal from the programmable controller CPU to the Q62HLC.
- (3) The I/O signals (X, Y) explained in this manual are those for when the Q62HLC is mounted on the I/O slot 0 of the main base unit.
If the Q62HLC is mounted on a slot other than the I/O slot 0, change the I/O signals to those of the slot where the module is mounted.

Table 3.7 I/O signal list

Input signal (Signal direction: Q62HLC →programmable controller CPU)		Output signal (Signal direction: programmable controller CPU →Q62HLC)	
Device No.	Signal name	Device No.	Signal name
Xn0	Watchdog timer error flag	Yn0	Use prohibited
Xn1	Setting/operation mode status	Yn1	Setting/operation mode command
Xn2	Error flag	Yn2	Error reset command
Xn3	Module ready flag	Yn3	Use prohibited
Xn4	CH1 Auto tuning status flag	Yn4	CH1 Auto tuning start command
Xn5	CH2 Auto tuning status flag	Yn5	CH2 Auto tuning start command
Xn6	Use prohibited	Yn6	Use prohibited
Xn7	Use prohibited	Yn7	Use prohibited
Xn8	FeRAM write completion flag	Yn8	FeRAM backup start command
Xn9	Default value write completion flag	Yn9	Default setting registration start command
XnA	FeRAM write failure flag	YnA	Use prohibited
XnB	Setting change completion flag	YnB	Setting change command
XnC	CH1 Alert flag	YnC	CH1 Forced PID control stop command
XnD	CH2 Alert flag	YnD	CH2 Forced PID control stop command
XnE	Use prohibited	YnE	Use prohibited
XnF	Use prohibited	YnF	Use prohibited

POINT

The functional performance of the Q62HLC cannot be guaranteed if any of the use prohibited signal is turned on/off in a sequence program.

3.4.2 Input signal functions

(1) Watchdog timer error flag (Xn0)

This signal turns on when the Q62HLC detects a watchdog timer error.

(2) Setting/operation mode status (Xn1)

This signal turns on in the operation mode and turns off in the setting mode. Modes can be switched using Setting/operation mode command (Yn1). Do not change the setting value during mode shift processing.

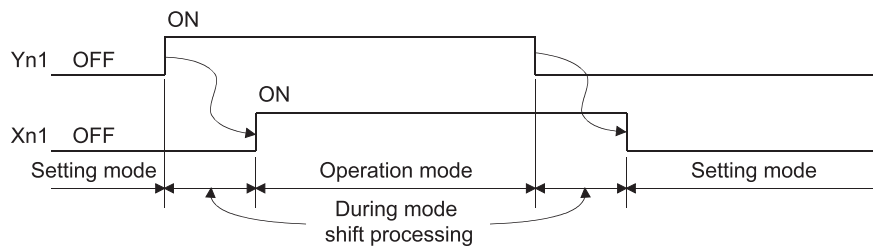

(3) Error flag (Xn2)

(a) This signal turns on when a write error to the buffer memory has occurred, the hardware has failed, or auto tuning has not completed successfully. A write error occurs under any of the following conditions.

- Data is set to the use prohibited signal.
- The setting value of the signal where data change is enabled only in the setting mode is changed in the operation mode.
- A value out of the setting range is set.
- The setting value is changed during default setting registration.

At the occurrence of error, the corresponding error code and error cause are stored in Error code (buffer memory address: 0).

(b) By turning on Error reset command (Yn2), Error flag (Xn2) is turned off, and the error code is cleared.

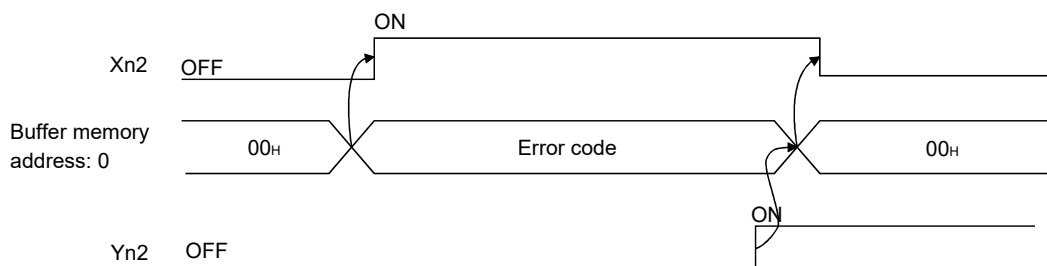

(4) Module ready flag (Xn3)

- (a) This signal turns on when the Q62HLC is ready for operation after the programmable controller CPU is powered on or reset.
- (b) To read/write data in the buffer memory of the Q62HLC from/to the programmable controller CPU, Module ready flag (Xn3) needs to be on.

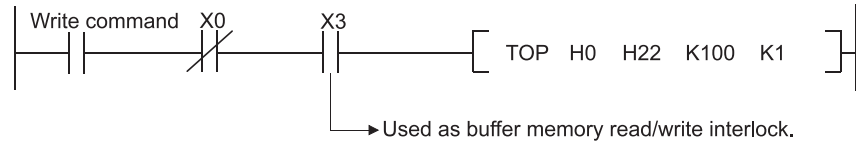

- (c) When this signal turns off, check the status of Watchdog timer error flag (Xn0).
If Watchdog timer error flag (Xn0) is on, take a corrective action referring to Section 8.6.

(5) Auto tuning status flag (Xn4, Xn5)

- (a) This signal turns on when auto tuning of the corresponding channel is executed.

Channel	Auto tuning status flag	On/off status
1	Xn4	ON : Auto tuning in execution OFF: Auto tuning not in execution or completed
2	Xn5	

- (b) Auto tuning is executed using Auto tuning start command (Yn4, Yn5).
- (c) This signal turns on while auto tuning is being executed, and turns off automatically when completed.
If the auto tuning is not completed successfully, the signal automatically turns off and the corresponding error code is stored in Error code (buffer memory address: 0).
For error codes, refer to Section 8.1.

(6) FeRAM write completion flag (Xn8)

- (a) This signal turns on when data in the buffer memory is successfully written to FeRAM after FeRAM backup start command (Yn8) is turned on.
After turning on Yn8, it takes more than ten seconds until Xn8 turns on.
- (b) When FeRAM backup start command (Yn8) turns off, this flag (Xn8) also turns off.

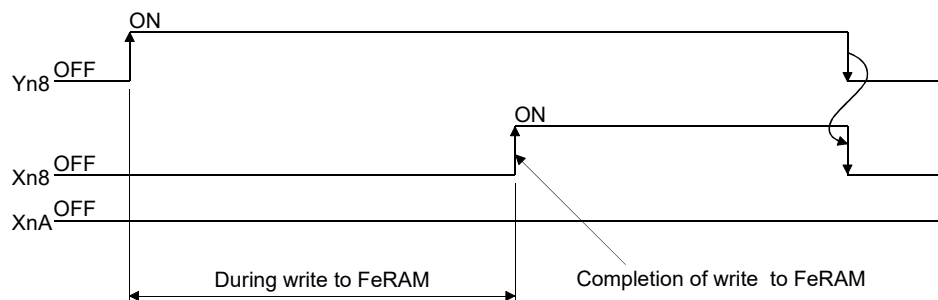

(7) Default value write completion flag (Xn9)

(a) This signal turns on when default values of the Q62HLC are successfully written to the buffer memory after Default setting registration start command (Yn9) is turned on.

(b) When Default setting registration start command (Yn9) turns off, this flag (Xn9) also turns off.

(c) Perform unused channel setting to an unused channel after default values are written.

If the setting is not performed to the unused channel, the ALM LED of the Q62HLC turns on.

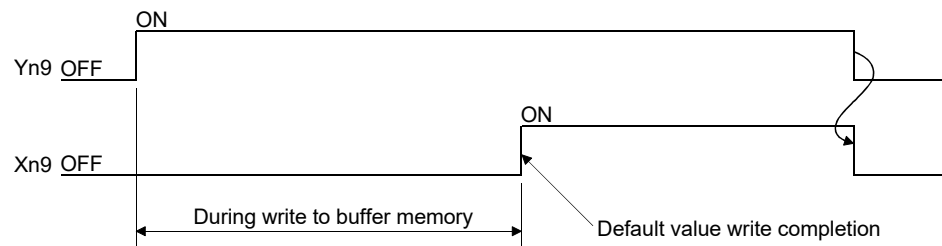

(8) FeRAM write failure flag (XnA)

(a) This signal turns on when writing data in the buffer memory to FeRAM failed after FeRAM backup start command (Yn8) is turned on.

- OFF : Writing data to FeRAM completed successfully
- ON : Writing data to FeRAM failed

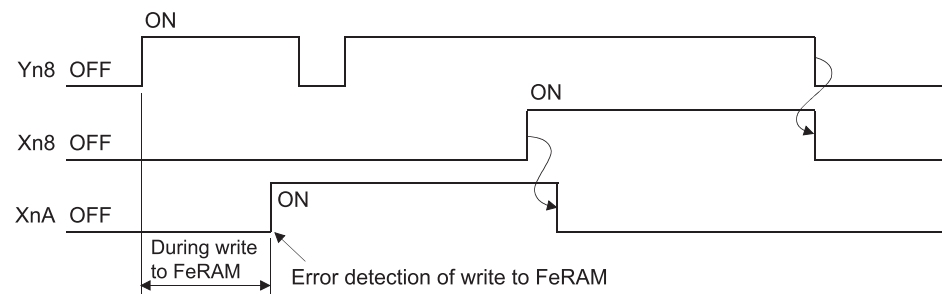

(b) FeRAM write failure flag (XnA) turns off when data is successfully written to FeRAM.

(c) When FeRAM write failure flag (XnA) turns on, the FeRAM contents are undefined.

If the programmable controller CPU is powered on or reset with the flag (XnA) on, the buffer memory contents become undefined as well. For this reason, the Q62HLC operates with the default values.

(9) Setting change completion flag (XnB)

- (a) This signal turns on when any setting value of the buffer memory areas is changed and reflected to the control after Setting change command (YnB) is turned on.
- (b) When Setting change command (YnB) turns off, this flag (XnB) also turns off.

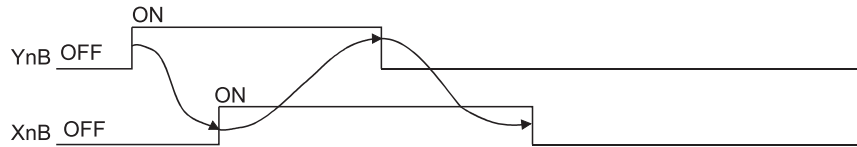

(10) Alert flag (XnC, XnD)

- (a) This signal turns on when an alert occurs on the channel.

Channel	Alert flag	On/off status	Corresponding buffer memory address (decimal)
1	XnC	OFF: Without alarm occurrence	5
2	XnD	ON : With alarm occurrence	6

- (b) When an alert occurs, the alert content is stored in Alert definition (buffer memory address: 5, 6) and Alert flag (XnC, XnD) turns on.

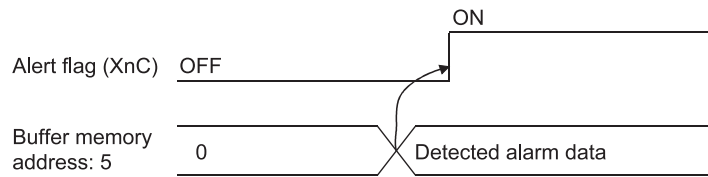

3.4.3 Output signal functions

(1) Setting/operation mode command (Yn1)

(a) This signal sets the mode of the Q62HLC.

During the process of switching the modes, the setting value cannot be changed.

- OFF : Setting mode
- ON : Operation mode

(b) This signal is set to all 2 channels together.

(c) The setting values of the following setting items can be changed only when Yn1 is off.

A write data error (error code: 3) will occur if the values are changed in the operation mode.

- Input range (buffer memory address: 32, 64)
- Alert 1 to 4 mode setting (buffer memory address: 192 to 195, 208 to 211)
- Control data used for the program control, zone PID data, program pattern data*¹

*1: For details, refer to Section 3.2.12.

(d) For the Q62HLC operation by the on/off status of the Setting/operation mode command (Yn1), refer to Section 3.2.19.

(2) Error reset command (Yn2)

This signal clears (resets) Error code (buffer memory address: 0) and turns off Error flag (Xn2).

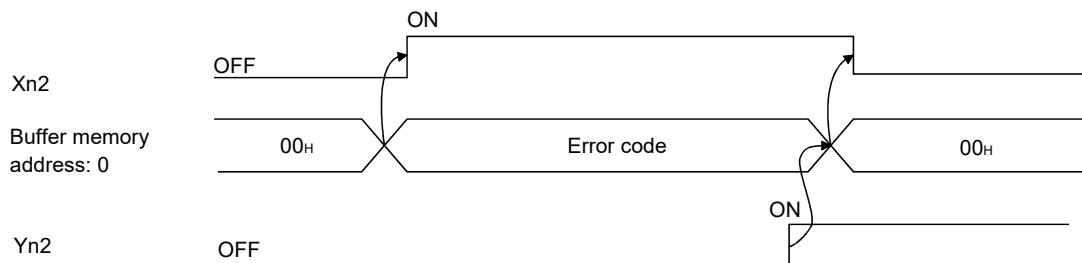

(3) Auto tuning start command (Yn4, Yn5)

(a) This signal starts auto tuning.

(b) Turning on this command (Yn4, Yn5) starts auto tuning and turns on Auto tuning status flag (Xn4, Xn5).

When auto tuning is completed, Auto tuning status flag (Xn4, Xn5) turns off.

(c) Keep this command on while auto tuning is being executed and turn it off on completion of auto tuning.

(d) Turning off this command (Yn4, Yn5) during auto tuning execution stops auto tuning.

When auto tuning is stopped, the PID constants in buffer memory do not change.

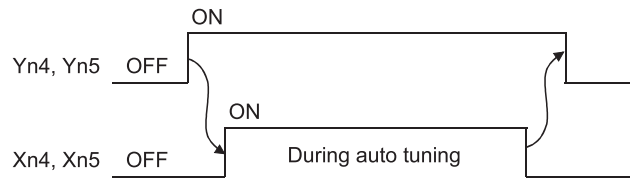

POINT
 To execute auto tuning in a row, wait for more than 1 second after the first auto tuning is completed (this command turns off), and then turn on this command for the second auto tuning.

(4) FeRAM backup start command (Yn8)

(a) This signal writes data in the buffer memory to FeRAM.

(b) To write data in the buffer memory to FeRAM, turn on this signal.

1) FeRAM write completion flag (Xn8) turns on when the write processing is completed successfully.

2) FeRAM write failure flag (XnA) turns on when the write processing is not completed successfully. When XnA turns on, turn on this signal (Yn8) again to write data to FeRAM.

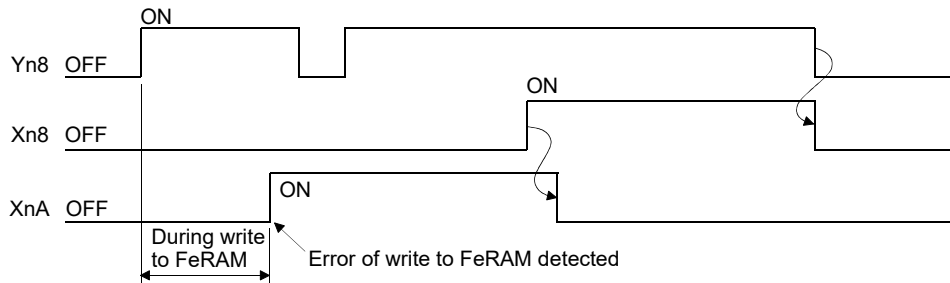

(5) Default setting registration start command (Yn9)

(a) This signal returns data in the buffer memory to default values.

When this signal is turned on, the default values of the Q62HLC are written to the buffer memory. When the processing completes successfully, Default value write completion flag (Xn9) turns on.

(b) Set default values in the setting mode (Xn1: OFF).

Default values cannot be set in the operation mode (Yn1: ON).

If the data setting is changed while default values are written, a write error occurs.

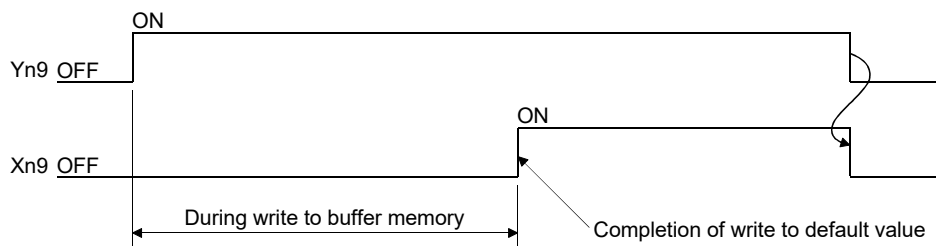

- (6) Setting change command (YnB)
- (a) This signal determines the values in the following buffer memory areas (areas where values can be changed only in the setting mode) as setting values.
- Input range (buffer memory address: 32, 64)
 - Alert 1 to 4 mode setting (buffer memory address: 192 to 195, 208 to 211)
 - Control data used for the program control, zone PID data, program pattern data^{*1}
- ^{*1}: For details, refer to Section 3.2.12.
- (b) The values of the items in (a) are not reflected to the operation of the Q62HLC even when they are written to the corresponding buffer memory areas. To determine them as setting values, turn on this signal after the values are written to the buffer memory areas.
- (c) When this signal is turned on, the Q62HLC starts the operation using the values set in each buffer memory area. Setting change completion flag (XnB) turns on at completion of the setting change.
For setting items other than the above (1), their setting values are determined when the values are written to the buffer memory areas.
- (d) This signal can be used as an interlock for Setting/operation mode command (Yn1).
- (7) Forced PID control stop command (YnC, YnD)
- (a) This signal forcibly stops PID operation of each channel.
- (b) The operation status in which PID operation stops is set in Stop mode setting (buffer memory address: 33, 65). For details of the operation status, refer to Section 3.2.19.

3.5 Buffer Memory

3.5.1 Buffer memory areas

The following table lists the buffer memory areas of the Q62HLC.
 Areas not listed are use prohibited areas. Do not write any data into the use prohibited areas.
 Doing so may cause malfunction of the programmable controller CPU.

Address (decimal (hexadecimal))		Item	Range	Default	Write condition ^{*1}			Reference	
CH1	CH2				Always	Setting mode	Disabled		
0 (0H)		Error code	—	0	—	—	○	Section 3.5.2	
5 (5H)	6 (6H)	Alert definition	—	0	—	—	○	Section 3.5.3	
9 (9H)	10 (AH)	Measured value (PV)	In accordance with input range	—	—	—	○	Section 3.5.4	
13 (DH)	14 (EH)	Manipulated value (MV)	Normal control mode, Manual control mode 1, Program control mode	-50 to 1050 (×0.1%)	-50	—	—	○	Section 3.5.5
			Manual control mode 2						
17 (11H)	18 (12H)	Approach flag	—	0	—	—	○	Section 3.5.6	
25 (19H)	26 (1AH)	Set value monitor	—	0	—	—	○	Section 3.5.7	
29 (1DH)		Cold junction temperature measured value	-20 to 100 (°C)	—	—	—	○	Section 3.5.8	
30 (1EH)		Control mode monitor	—	0	—	—	○	Section 3.5.9	
31 (1FH)		PID constant read/write completion flag FeRAM	—	0	—	—	○	Section 3.5.10	
32 (20H)	64 (40H)	Input range	0 to 22	0	—	○	—	Section 3.5.11	
33 (21H)	65 (41H)	Stop mode setting	0: Stop, 1: Monitor, 2: Warning	1	○	—	—	Section 3.5.12	
34 (22H)	66 (42H)	Set value (SV) setting	Input range	0	○	—	—	Section 3.5.13	
35 (23H)	67 (43H)	Proportional band (P) setting	Thermocouples (°C)	1 to full-scale (×0.1°C)	100	○	—	—	Section 3.5.14
			Micro voltage (mV), voltage (V), current input (mA)						
36 (24H)	68 (44H)	Integral time (I) setting	0 to 32767 (×0.1s)	400	○	—	—	Section 3.5.15	
37 (25H)	69 (45H)	Derivative time (D) setting	0 to 32767 (×0.1s)	100	○	—	—		
38 (26H)	70 (46H)	Alert set value 1	In accordance with alert mode setting and input range setting	0	○	—	—	Section 3.5.15	
39 (27H)	71 (47H)	Alert set value 2							
40 (28H)	72 (48H)	Alert set value 3							
41 (29H)	73 (49H)	Alert set value 4							
42 (2AH)	74 (4AH)	Upper output limiter	-50 to 1050 (×0.1%)	1050	○	—	—	Section 3.5.16	
43 (2BH)	75 (4BH)	Lower output limiter		-50	○	—	—		
44 (2CH)	76 (4CH)	Output variation limiter	0 to 1000 (×0.1%/s)	0	○	—	—	Section 3.5.17	

(To the next page)

*1: Reading data is always available regardless of the write conditions. The setting value of the item to which "Setting mode" is given as the condition for writing data can be changed only in the setting mode. Note that changing the value in the operation mode causes a write data error. In addition, it is necessary to turn on Setting change command (YnB) to change the setting value.

(From the previous page)

Address (decimal (hexadecimal))		Item	Range	Default	Write condition ^{*1}			Reference	
CH1	CH2				Always	Setting mode	Disabled		
45 (2DH)	77 (4DH)	Sensor compensation value setting	-5000 to 5000 ($\times 0.1^{\circ}\text{C}$, $\times 0.01\%$)	0	<input type="radio"/>	—	—	Section 3.5.18	
46 (2EH)	78 (4EH)	AT differential gap	0 to 10000 ($\times 0.01\text{s}$)	10	<input type="radio"/>	—	—	Section 3.5.19	
47 (2FH)	79 (4FH)	AT additional lag	0 to 1000 ($\times 0.01\text{s}$)	10	<input type="radio"/>	—	—	Section 3.5.20	
48 (30H)	80 (50H)	Primary delay digital filter setting	0 to 1000 ($\times 0.1\text{s}$)	0	<input type="radio"/>	—	—	Section 3.5.21	
49 (31H)	81 (51H)	Control response parameter	0: Slow, 1: Normal, 2: Fast	0	<input type="radio"/>	—	—	Section 3.5.22	
50 (32H)	82 (52H)	Control mode	0: Normal control 1: Manual control 1 2: Program control 3: Manual control 2	0	<input type="radio"/>	—	—	Section 3.5.23	
51 (33H)	83 (53H)	MAN output setting	Manual control 1	-50 to 1050 ($\times 0.1\%$)	-50	<input type="radio"/>	—	—	Section 3.5.24
			Manual control 2	0 to 4000					
52 (34H)	84 (54H)	Setting change rate limiter	Thermocouples ($^{\circ}\text{C}$)	1 to 10000 ($\times 0.1^{\circ}\text{C}/\text{min}$)	0	<input type="radio"/>	—	—	Section 3.5.25
			Micro voltage (mV), voltage (V), current input (mA)	0 to 1000 ($\times 0.1\%/ \text{min}$)					
53 (35H)	85 (55H)	AT bias	\pm full-scale	0	<input type="radio"/>	—	—	Section 3.5.26	
54 (36H)	86 (56H)	Forward/reverse action setting	0: Forward action, 1: Reverse action	1	<input type="radio"/>	—	—	Section 3.5.27	
55 (37H)	87 (57H)	Upper setting limiter	Input range	13720	<input type="radio"/>	—	—	Section 3.5.28	
56 (38H)	88 (58H)	Lower setting limiter		-2000	<input type="radio"/>	—	—		
57 (39H)	89 (59H)	Program control run/reset	0: RESET, 1: RUN	0	<input type="radio"/>	—	—	Section 3.5.29	
59 (3BH)	91 (5BH)	Loop disconnection detection judgement time	0 to 7200 (s)	80	<input type="radio"/>	—	—	Section 3.5.30	
60 (3CH)	92 (5CH)	Loop disconnection detection dead band	0 to full-scale	0	<input type="radio"/>	—	—	Section 3.5.31	
61 (3DH)	93 (5DH)	Unused channel setting	0: Used, 1: Unused	0	<input type="radio"/>	—	—	Section 3.5.32	
62 (3EH)	94 (5EH)	PID constant read command from FeRAM	0: Without, 1: With command	0	<input type="radio"/>	—	—	Section 3.5.33	
63 (3FH)	95 (5FH)	Automatic backup setting after auto tuning of PID constants	0: OFF, 1: ON	0	<input type="radio"/>	—	—	Section 3.5.34	
164 (A4H)		Alert dead band setting	Thermocouples ($^{\circ}\text{C}$)	0 to 1000 ($\times 0.1^{\circ}\text{C}$)	5	<input type="radio"/>	—	—	Section 3.5.35
			Micro voltage (mV), voltage (V), current input (mA)	0 to 1000 ($\times 0.01\%$)					
165 (A5H)		Alert delay count	0 to 255	0	<input type="radio"/>	—	—	Section 3.5.36	

(To the next page)

*1: Reading data is always available regardless of the write conditions. The setting value of the item to which "Setting mode" is given as the condition for writing data can be changed only in the setting mode. Note that changing the value in the operation mode causes a write data error. In addition, it is necessary to turn on Setting change command (YnB) to change the setting value.

(From the previous page)

Address (decimal (hexadecimal))		Item	Range	Default	Write condition ^{*1}			Reference	
					Always	Setting mode	Disabled		
CH1	CH2								
167 (A7H)		Approach range setting	Thermocouples (°C)	0 to 100 (×0.1°C)	1	○	—	—	Section 3.5.37
			Micro voltage (mV), voltage (V), current input (mA)	1 to 100 (×0.1%)					
168 (A8H)		Approach soak time setting	0 to 32767 (×0.1s)	0	○	—	—	Section 3.5.38	
169 (A9H)		PID continuation flag	0:Stop, 1:Continue	0	○	—	—	Section 3.5.39	
176 (B0H)		Cascade ON/OFF	0: OFF, 1: ON	0	○	—	—	Section 3.5.40	
177 (B1H)		Cascade gain	-10000 to 10000 (×0.001)	1000	○	—	—	Section 3.5.41	
178 (B2H)		Cascade bias	-1000 to 1000 (×0.1%)	0	○	—	—	Section 3.5.42	
179 (B3H)		Cascade monitor	—	—	—	—	○	Section 3.5.43	
192 (C0H)	208 (D0H)	Alert 1 mode setting	0 to 14	0	—	○	—	Section 3.5.44	
193 (C1H)	209 (D1H)	Alert 2 mode setting							
194 (C2H)	210 (D2H)	Alert 3 mode setting							
195 (C3H)	211 (D3H)	Alert 4 mode setting							
196 (C4H)	212 (D4H)	Scaling value	—	—	—	—	○	Section 3.5.45	
197 (C5H)	213 (D5H)	Scaling range upper limit value	Refer to Section 3.5.46	0	○	—	—	Section 3.5.46	
198 (C6H)	214 (D6H)	Scaling range lower limit value		0	○	—	—		
199 (C7H)	215 (D7H)	Scaling width upper limit value	-32768 to 32767	0	○	—	—	Section 3.5.47	
200 (C8H)	216 (D8H)	Scaling width lower limit value		0	○	—	—		
201 (C9H)	217 (D9H)	Hold command	0: without command, 1: hold	0	○	—	—	Section 3.5.48	
202 (CAH)	218 (DAH)	Command advancing	0: without command, 1: advancing	0	○	—	—	Section 3.5.49	
203 (CBH)	219 (DBH)	SV tracking setting	0: Disable SV tracking, 1: Enable SV tracking	0	○	—	—	Section 3.5.50	
204 (CCH)	220 (DCH)	Forced output command	0: Forced output not commanded, 1: Forced output commanded	0	○	—	—	Section 3.5.51	
205 (CDH)	221 (DDH)	Forced output manipulated value (MV)	-200 to 4200 (If a value in the range of -32768 to -201 is set, the analog output value becomes 0mA.)	0	○	—	—	Section 3.5.52	
256 (100H)	512 (200H)	Segment monitor	—	—	—	—	○	Section 3.5.53	
257 (101H)	513 (201H)	Segment remaining time	—	—	—	—	○	Section 3.5.54	
258 (102H)	514 (202H)	Execution times monitor	—	—	—	—	○	Section 3.5.55	
259 (103H)	515 (203H)	Pattern end output flag	—	—	—	—	○	Section 3.5.56	
260 (104H)	516 (204H)	End status flag	—	—	—	—	○	Section 3.5.57	

(To the next page)

*1: Reading data is always available regardless of the write conditions. The setting value of the item to which "Setting mode" is given as the condition for writing data can be changed only in the setting mode. Note that changing the value in the operation mode causes a write data error. In addition, it is necessary to turn on Setting change command (YnB) to change the setting value.

(From the previous page)

Address (decimal (hexadecimal))		Item	Range	Default	Write condition*1			Reference	
CH1	CH2				Always	Setting mode	Disabled		
261 (105H)	517 (205H)	Wait status flag	—	—	—	—	○	Section 3.5.58	
262 (106H)	518 (206H)	Hold status flag	—	—	—	—	○	Section 3.5.59	
263 (107H)	519 (207H)	Advancing completion flag	—	—	—	—	○	Section 3.5.60	
264 (108H)	520 (208H)	Execution pattern monitor	—	—	—	—	○	Section 3.5.61	
265 (109H)	521 (209H)	Zone PID monitor	—	—	—	—	○	Section 3.5.62	
266 (10AH)	522 (20AH)	Forced output status flag	0: Forced output not commanded 1: With forced output command	—	—	—	○	Section 3.5.63	
272 (110H)	528 (210H)	Execution pattern	1 to 3	1	—	○	—	Section 3.5.64	
273 (111H)	529 (211H)	Start mode	0: Zero start 1: PV start 1 (time fixed) 2: PV start 2 (time shortened) 3: PV start 3 (time shortened/find type) 4: SV start	0	—	○	—	Section 3.5.65	
274 (112H)	530 (212H)	Time scale	0: 0.01s, 1: 0.1s, 2: 1s, 3: 1min	0	—	○	—	Section 3.5.66	
275 (113H)	531 (213H)	Zone 1 upper limit	Input range lower limit to Zone 2 upper limit	Input range upper limit	—	○	—	Section 3.5.67	
276 (114H)	532 (214H)	Zone 2 upper limit	Zone 1 upper limit to Zone 3 upper limit	Input range upper limit	—	○	—		
277 (115H)	533 (215H)	Zone 3 upper limit	Zone 2 upper limit to Zone 4 upper limit	Input range upper limit	—	○	—		
278 (116H)	534 (216H)	Zone 4 upper limit	Zone 3 upper limit to Zone 5 upper limit	Input range upper limit	—	○	—		
279 (117H)	535 (217H)	Zone 5 upper limit	Zone 4 upper limit to Zone 6 upper limit	Input range upper limit	—	○	—		
280 (118H)	536 (218H)	Zone 6 upper limit	Zone 5 upper limit to Zone 7 upper limit	Input range upper limit	—	○	—		
281 (119H)	537 (219H)	Zone 7 upper limit	Zone 6 upper limit to Input range upper limit	Input range upper limit	—	○	—		
282 (11AH)	538 (21AH)	Zone 1	Proportional band (P) setting	Thermocouple (°C) 1 to full-scale (×0.1°C) Micro voltage (mV), voltage (V), current (mA) 1 to 10000 (×0.1%)	100	—	○		—
283 (11BH)	539 (21BH)		Integral time (I)	0 to 32767 (×0.1s)	400	—	○		—
284 (11CH)	540 (21CH)		Derivative time (D)	0 to 32767 (×0.1s)	100	—	○		—
285 (11DH)	541 (21DH)		Control response parameter	0: Slow, 1: Normal, 2: Fast	0	—	○	—	
286 (11EH)	542 (21EH)		Zone 2	Proportional band (P) setting	Thermocouple (°C) 1 to full-scale (×0.1°C) Micro voltage (mV), voltage (V), current (mA) 1 to 10000 (×0.1%)	100	—	○	—
287 (11FH)	543 (21FH)	Integral time (I)		0 to 32767 (×0.1s)	400	—	○	—	
288 (120H)	544 (220H)	Derivative time (D)		0 to 32767 (×0.1s)	100	—	○	—	
289 (121H)	545 (221H)	Control response parameter		0: Slow, 1: Normal, 2: Fast	0	—	○	—	

(To the next page)

*1: Reading data is always available regardless of the write conditions. The setting value of the item to which "Setting mode" is given as the condition for writing data can be changed only in the setting mode. Note that changing the value in the operation mode causes a write data error. In addition, it is necessary to turn on Setting change command (YnB) to change the setting value.

(From the previous page)

Address (decimal (hexadecimal))		Item	Range	Default	Write condition*1			Reference				
CH1	CH2				Always	Setting mode	Disabled					
290 (122H)	546 (222H)	Zone 3 Proportional band (P) setting	Thermocouple (°C)	1 to full-scale (×0.1°C)	100	—	○	—				
			Micro voltage (mV), voltage (V), current (mA)	1 to 10000 (×0.1%)								
			Integral time (I)	0 to 32767 (×0.1s)					400	—	○	—
			Derivative time (D)	0 to 32767 (×0.1s)					100	—	○	—
291 (123H)	547 (223H)											
292 (124H)	548 (224H)											
293 (125H)	549 (225H)	Control response parameter	0: Slow, 1: Normal, 2: Fast	0	—	○	—					
294 (126H)	550 (226H)	Zone 4 Proportional band (P) setting	Thermocouple (°C)	1 to full-scale (×0.1°C)	100	—	○	—				
			Micro voltage (mV), voltage (V), current (mA)	1 to 10000 (×0.1%)								
			Integral time (I)	0 to 32767 (×0.1s)					400	—	○	—
			Derivative time (D)	0 to 32767 (×0.1s)					100	—	○	—
295 (127H)	551 (227H)											
296 (128H)	552 (228H)											
297 (129H)	553 (229H)	Control response parameter	0: Slow, 1: Normal, 2: Fast	0	—	○	—					
298 (12AH)	554 (22AH)	Zone 5 Proportional band (P) setting	Thermocouple (°C)	1 to full-scale (×0.1°C)	100	—	○	—				
			Micro voltage (mV), voltage (V), current (mA)	1 to 10000 (×0.1%)								
			Integral time (I)	0 to 32767 (×0.1s)					400	—	○	—
			Derivative time (D)	0 to 32767 (×0.1s)					100	—	○	—
299 (12BH)	555 (22BH)											
300 (12CH)	556 (22CH)											
301 (12DH)	557 (22DH)	Control response parameter	0: Slow, 1: Normal, 2: Fast	0	—	○	—					
302 (12EH)	558 (22EH)	Zone 6 Proportional band (P) setting	Thermocouple (°C)	1 to full-scale (×0.1°C)	100	—	○	—				
			Micro voltage (mV), voltage (V), current (mA)	1 to 10000 (×0.1%)								
			Integral time (I)	0 to 32767 (×0.1s)					400	—	○	—
			Derivative time (D)	0 to 32767 (×0.1s)					100	—	○	—
303 (12FH)	559 (22FH)											
304 (130H)	560 (230H)											
305 (131H)	561 (231H)	Control response parameter	0: Slow, 1: Normal, 2: Fast	0	—	○	—					
306 (132H)	562 (232H)	Zone 7 Proportional band (P) setting	Thermocouple (°C)	1 to full-scale (×0.1°C)	100	—	○	—				
			Micro voltage (mV), voltage (V), current (mA)	1 to 10000 (×0.1%)								
			Integral time (I)	0 to 32767 (×0.1s)					400	—	○	—
			Derivative time (D)	0 to 32767 (×0.1s)					100	—	○	—
307 (133H)	563 (233H)											
308 (134H)	564 (234H)											
309 (135H)	565 (235H)	Control response parameter	0: Slow, 1: Normal, 2: Fast	0	—	○	—					
310 (136H)	566 (236H)	Zone 8 Proportional band (P) setting	Thermocouple (°C)	1 to full-scale (×0.1°C)	100	—	○	—				
			Micro voltage (mV), voltage (V), current (mA)	1 to 10000 (×0.1%)								
			Integral time (I)	0 to 32767 (×0.1s)					400	—	○	—
			Derivative time (D)	0 to 32767 (×0.1s)					100	—	○	—
311 (137H)	567 (237H)											
312 (138H)	568 (238H)											
313 (139H)	569 (239H)	Control response parameter	0: Slow, 1: Normal, 2: Fast	0	—	○	—					

Section 3.5.67

(To the next page)

*1: Reading data is always available regardless of the write conditions. The setting value of the item to which "Setting mode" is given as the condition for writing data can be changed only in the setting mode. Note that changing the value in the operation mode causes a write data error. In addition, it is necessary to turn on Setting change command (YnB) to change the setting value.

(From the previous page)

Address (decimal (hexadecimal))		Item	Range	Default	Write condition ^{*1}			Reference	
					Always	Setting mode	Disabled		
CH1	CH2								
320 (140H)	576 (240H)	Final segment	1 to 16	16	—	○	—	Section 3.5.68	
321 (141H)	577 (241H)	Pattern link	0 to 3 (0: No link)	0	—	○	—		
322 (142H)	578 (242H)	Iteration	1 to 999 times, 1000: Endless	1	—	○	—		
323 (143H)	579 (243H)	Output time of pattern end	0 to 30000 (×0.01s, ×0.1s, ×1s, ×1min)	0	—	○	—		
324 (144H)	580 (244H)	Wait zone setting	0 to full-scale	0	—	○	—		
325 (145H)	581 (245H)	Segment 1	Set value(SV) setting	Input range	0	—	○		—
326 (146H)	582 (246H)		Executing time	0 to 30000 (×0.01s, ×0.1s, ×1s, ×1min)	0	—	○		—
327 (147H)	583 (247H)		Zone PID data No.	0 to 8 (0: Specifies zones including current set value)	0	—	○		—
328 (148H)	584 (248H)	Segment 2	Set value(SV) setting	Input range	0	—	○		—
329 (149H)	585 (249H)		Executing time	0 to 30000 (×0.01s, ×0.1s, ×1s, ×1min)	0	—	○		—
330 (14AH)	586 (24AH)		Zone PID data No.	0 to 8 (0: Specifies zones including current set value)	0	—	○		—
331 (14BH)	587 (24BH)	Segment 3	Set value(SV) setting	Input range	0	—	○		—
332 (14CH)	588 (24CH)		Executing time	0 to 30000 (×0.01s, ×0.1s, ×1s, ×1min)	0	—	○		—
333 (14DH)	589 (24DH)		Zone PID data No.	0 to 8 (0: Specifies zones including current set value)	0	—	○		—
334 (14EH)	590 (24EH)	Segment 4	Set value(SV) setting	Input range	0	—	○		—
335 (14FH)	591 (24FH)		Executing time	0 to 30000 (×0.01s, ×0.1s, ×1s, ×1min)	0	—	○		—
336 (150H)	592 (250H)		Zone PID data No.	0 to 8 (0: Specifies zones including current set value)	0	—	○		—
337 (151H)	593 (251H)	Segment 5	Set value(SV) setting	Input range	0	—	○		—
338 (152H)	594 (252H)		Executing time	0 to 30000 (×0.01s, ×0.1s, ×1s, ×1min)	0	—	○		—
339 (153H)	595 (253H)		Zone PID data No.	0 to 8 (0: Specifies zones including current set value)	0	—	○		—
340 (154H)	596 (254H)	Segment 6	Set value(SV) setting	Input range	0	—	○		—
341 (155H)	597 (255H)		Executing time	0 to 30000 (×0.01s, ×0.1s, ×1s, ×1min)	0	—	○		—
342 (156H)	598 (256H)		Zone PID data No.	0 to 8 (0: Specifies zones including current set value)	0	—	○		—
343 (157H)	599 (257H)	Segment 7	Set value(SV) setting	Input range	0	—	○		—
344 (158H)	600 (258H)		Executing time	0 to 30000 (×0.01s, ×0.1s, ×1s, ×1min)	0	—	○		—
345 (159H)	601 (259H)		Zone PID data No.	0 to 8 (0: Specifies zones including current set value)	0	—	○		—

(To the next page)

*1: Reading data is always available regardless of the write conditions. The setting value of the item to which "Setting mode" is given as the condition for writing data can be changed only in the setting mode. Note that changing the value in the operation mode causes a write data error. In addition, it is necessary to turn on Setting change command (YnB) to change the setting value.

(From the previous page)

Address (decimal (hexadecimal))		Item	Range	Default	Write condition*1			Reference	
CH1	CH2				Always	Setting mode	Disabled		
346 (15AH)	602 (25AH)	Segment 8	Set value(SV) setting	Input range	0	—	○	—	Section 3.5.68
347 (15BH)	603 (25BH)		Executing time	0 to 30000 (×0.01s, ×0.1s, ×1s, ×1min)	0	—	○	—	
348 (15CH)	604 (25CH)		Zone PID data No.	0 to 8 (0: Specifies zones including current set value)	0	—	○	—	
349 (15DH)	605 (25DH)	Segment 9	Set value(SV) setting	Input range	0	—	○	—	
350 (15EH)	606 (25EH)		Executing time	0 to 30000 (×0.01s, ×0.1s, ×1s, ×1min)	0	—	○	—	
351 (15FH)	607 (25FH)		Zone PID data No.	0 to 8 (0: Specifies zones including current set value)	0	—	○	—	
352 (160H)	608 (260H)	Segment 10	Set value(SV) setting	Input range	0	—	○	—	
353 (161H)	609 (261H)		Executing time	0 to 30000 (×0.01s, ×0.1s, ×1s, ×1min)	0	—	○	—	
354 (162H)	610 (262H)		Zone PID data No.	0 to 8 (0: Specifies zones including current set value)	0	—	○	—	
355 (163H)	611 (263H)	Segment 11	Set value(SV) setting	Input range	0	—	○	—	
356 (164H)	612 (264H)		Executing time	0 to 30000 (×0.01s, ×0.1s, ×1s, ×1min)	0	—	○	—	
357 (165H)	613 (265H)		Zone PID data No.	0 to 8 (0: Specifies zones including current set value)	0	—	○	—	
358 (166H)	614 (266H)	Segment 12	Set value(SV) setting	Input range	0	—	○	—	
359 (167H)	615 (267H)		Executing time	0 to 30000 (×0.01s, ×0.1s, ×1s, ×1min)	0	—	○	—	
360 (168H)	616 (268H)		Zone PID data No.	0 to 8 (0: Specifies zones including current set value)	0	—	○	—	
361 (169H)	617 (269H)	Segment 13	Set value(SV) setting	Input range	0	—	○	—	
362 (16AH)	618 (26AH)		Executing time	0 to 30000 (×0.01s, ×0.1s, ×1s, ×1min)	0	—	○	—	
363 (16BH)	619 (26BH)		Zone PID data No.	0 to 8 (0: Specifies zones including current set value)	0	—	○	—	
364 (16CH)	620 (26CH)	Segment 14	Set value(SV) setting	Input range	0	—	○	—	
365 (16DH)	621 (26DH)		Executing time	0 to 30000 (×0.01s, ×0.1s, ×1s, ×1min)	0	—	○	—	
366 (16EH)	622 (26EH)		Zone PID data No.	0 to 8 (0: Specifies zones including current set value)	0	—	○	—	
367 (16FH)	623 (26FH)	Segment 15	Set value(SV) setting	Input range	0	—	○	—	
368 (170H)	624 (270H)		Executing time	0 to 30000 (×0.01s, ×0.1s, ×1s, ×1min)	0	—	○	—	
369 (171H)	625 (271H)		Zone PID data No.	0 to 8 (0: Specifies zones including current set value)	0	—	○	—	
370 (172H)	626 (272H)	Segment 16	Set value(SV) setting	Input range	0	—	○	—	
371 (173H)	627 (273H)		Executing time	0 to 30000 (×0.01s, ×0.1s, ×1s, ×1min)	0	—	○	—	
372 (174H)	628 (274H)		Zone PID data No.	0 to 8 (0: Specifies zones including current set value)	0	—	○	—	

(To the next page)

*1: Reading data is always available regardless of the write conditions. The setting value of the item to which "Setting mode" is given as the condition for writing data can be changed only in the setting mode. Note that changing the value in the operation mode causes a write data error. In addition, it is necessary to turn on Setting change command (YnB) to change the setting value.

(From the previous page)

Address (decimal (hexadecimal))		Item	Range	Default	Write condition*1			Reference	
					Always	Setting mode	Disabled		
CH1	CH2								
384 (180H)	640 (280H)	Final segment	1 to 16	16	—	○	—	Section 3.5.68	
385 (181H)	641 (281H)	Pattern link	0 to 3 (0: No link)	0	—	○	—		
386 (182H)	642 (282H)	Iteration	1 to 999 times, 1000: Endless	1	—	○	—		
387 (183H)	643 (283H)	Output time of pattern end	0 to 30000 (×0.01s, ×0.1s, ×1s, ×1min)	0	—	○	—		
388 (184H)	644 (284H)	Wait zone setting	0 to full-scale	0	—	○	—		
389 (185H)	645 (285H)	Segment 1	Set value(SV) setting	Input range	0	—	○		—
390 (186H)	646 (286H)		Executing time	0 to 30000 (×0.01s, ×0.1s, ×1s, ×1min)	0	—	○		—
391 (187H)	647 (287H)		Zone PID data No.	0 to 8 (0: Specifies zones including current set value)	0	—	○		—
392 (188H)	648 (288H)	Segment 2	Set value(SV) setting	Input range	0	—	○		—
393 (189H)	649 (289H)		Executing time	0 to 30000 (×0.01s, ×0.1s, ×1s, ×1min)	0	—	○		—
394 (18AH)	650 (28AH)		Zone PID data No.	0 to 8 (0: Specifies zones including current set value)	0	—	○		—
395 (18BH)	651 (28BH)	Segment 3	Set value(SV) setting	Input range	0	—	○		—
396 (18CH)	652 (28CH)		Executing time	0 to 30000 (×0.01s, ×0.1s, ×1s, ×1min)	0	—	○		—
397 (18DH)	653 (28DH)		Zone PID data No.	0 to 8 (0: Specifies zones including current set value)	0	—	○		—
398 (18EH)	654 (28EH)	Segment 4	Set value(SV) setting	Input range	0	—	○		—
399 (18FH)	655 (28FH)		Executing time	0 to 30000 (×0.01s, ×0.1s, ×1s, ×1min)	0	—	○		—
400 (190H)	656 (290H)		Zone PID data No.	0 to 8 (0: Specifies zones including current set value)	0	—	○		—
401 (191H)	657 (291H)	Segment 5	Set value(SV) setting	Input range	0	—	○		—
402 (192H)	658 (292H)		Executing time	0 to 30000 (×0.01s, ×0.1s, ×1s, ×1min)	0	—	○		—
403 (193H)	659 (293H)		Zone PID data No.	0 to 8 (0: Specifies zones including current set value)	0	—	○		—
404 (194H)	660 (294H)	Segment 6	Set value(SV) setting	Input range	0	—	○		—
405 (195H)	661 (295H)		Executing time	0 to 30000 (×0.01s, ×0.1s, ×1s, ×1min)	0	—	○		—
406 (196H)	662 (296H)		Zone PID data No.	0 to 8 (0: Specifies zones including current set value)	0	—	○		—
407 (197H)	663 (297H)	Segment 7	Set value(SV) setting	Input range	0	—	○		—
408 (198H)	664 (298H)		Executing time	0 to 30000 (×0.01s, ×0.1s, ×1s, ×1min)	0	—	○		—
409 (199H)	665 (299H)		Zone PID data No.	0 to 8 (0: Specifies zones including current set value)	0	—	○		—

(To the next page)

*1: Reading data is always available regardless of the write conditions. The setting value of the item to which "Setting mode" is given as the condition for writing data can be changed only in the setting mode. Note that changing the value in the operation mode causes a write data error. In addition, it is necessary to turn on Setting change command (YnB) to change the setting value.

(From the previous page)

Address (decimal (hexadecimal))		Item	Range	Default	Write condition*1			Reference	
CH1	CH2				Always	Setting mode	Disabled		
410 (19AH)	666 (29AH)	Segment 8	Set value(SV) setting	Input range	0	—	○	—	Section 3.5.68
411 (19BH)	667 (29BH)		Executing time	0 to 30000 (×0.01s, ×0.1s, ×1s, ×1min)	0	—	○	—	
412 (19CH)	668 (29CH)		Zone PID data No.	0 to 8 (0: Specifies zones including current set value)	0	—	○	—	
413 (19DH)	669 (29DH)	Segment 9	Set value(SV) setting	Input range	0	—	○	—	
414 (19EH)	670 (29EH)		Executing time	0 to 30000 (×0.01s, ×0.1s, ×1s, ×1min)	0	—	○	—	
415 (19FH)	671 (29FH)		Zone PID data No.	0 to 8 (0: Specifies zones including current set value)	0	—	○	—	
416 (1A0H)	672 (2A0H)	Segment 10	Set value(SV) setting	Input range	0	—	○	—	
417 (1A1H)	673 (2A1H)		Executing time	0 to 30000 (×0.01s, ×0.1s, ×1s, ×1min)	0	—	○	—	
418 (1A2H)	674 (2A2H)		Zone PID data No.	0 to 8 (0: Specifies zones including current set value)	0	—	○	—	
419 (1A3H)	675 (2A3H)	Segment 11	Set value(SV) setting	Input range	0	—	○	—	
420 (1A4H)	676 (2A4H)		Executing time	0 to 30000 (×0.01s, ×0.1s, ×1s, ×1min)	0	—	○	—	
421 (1A5H)	677 (2A5H)		Zone PID data No.	0 to 8 (0: Specifies zones including current set value)	0	—	○	—	
422 (1A6H)	678 (2A6H)	Segment 12	Set value(SV) setting	Input range	0	—	○	—	
423 (1A7H)	679 (2A7H)		Executing time	0 to 30000 (×0.01s, ×0.1s, ×1s, ×1min)	0	—	○	—	
424 (1A8H)	680 (2A8H)		Zone PID data No.	0 to 8 (0: Specifies zones including current set value)	0	—	○	—	
425 (1A9H)	681 (2A9H)	Segment 13	Set value(SV) setting	Input range	0	—	○	—	
426 (1AAH)	682 (2AAH)		Executing time	0 to 30000 (×0.01s, ×0.1s, ×1s, ×1min)	0	—	○	—	
427 (1ABH)	683 (2ABH)		Zone PID data No.	0 to 8 (0: Specifies zones including current set value)	0	—	○	—	
428 (1ACH)	684 (2ACH)	Segment 14	Set value(SV) setting	Input range	0	—	○	—	
429 (1ADH)	685 (2ADH)		Executing time	0 to 30000 (×0.01s, ×0.1s, ×1s, ×1min)	0	—	○	—	
430 (1AEH)	686 (2AEH)		Zone PID data No.	0 to 8 (0: Specifies zones including current set value)	0	—	○	—	
431 (1AFH)	687 (2AFH)	Segment 15	Set value(SV) setting	Input range	0	—	○	—	
432 (1B0H)	688 (2B0H)		Executing time	0 to 30000 (×0.01s, ×0.1s, ×1s, ×1min)	0	—	○	—	
433 (1B1H)	689 (2B1H)		Zone PID data No.	0 to 8 (0: Specifies zones including current set value)	0	—	○	—	
434 (1B2H)	690 (2B2H)	Segment 16	Set value(SV) setting	Input range	0	—	○	—	
435 (1B3H)	691 (2B3H)		Executing time	0 to 30000 (×0.01s, ×0.1s, ×1s, ×1min)	0	—	○	—	
436 (1B4H)	692 (2B4H)		Zone PID data No.	0 to 8 (0: Specifies zones including current set value)	0	—	○	—	

(To the next page)

*1: Reading data is always available regardless of the write conditions. The setting value of the item to which "Setting mode" is given as the condition for writing data can be changed only in the setting mode. Note that changing the value in the operation mode causes a write data error. In addition, it is necessary to turn on Setting change command (YnB) to change the setting value.

(From the previous page)

Address (decimal (hexadecimal))		Item	Range	Default	Write condition*1			Reference	
					Always	Setting mode	Disabled		
CH1	CH2								
448 (1C0H)	704 (2C0H)	Final segment	1 to 16	16	—	○	—	Section 3.5.68	
449 (1C1H)	705 (2C1H)	Pattern link	0 to 3 (0: No link)	0	—	○	—		
450 (1C2H)	706 (2C2H)	Iteration	1 to 999 times, 1000: Endless	1	—	○	—		
451 (1C3H)	707 (2C3H)	Output time of pattern end	0 to 30000 (×0.01s, ×0.1s, ×1s, ×1min)	0	—	○	—		
452 (1C4H)	708 (2C4H)	Wait zone setting	0 to full-scale	0	—	○	—		
453 (1C5H)	709 (2C5H)	Segment 1	Set value(SV) setting	Input range	0	—	○		—
454 (1C6H)	710 (2C6H)		Executing time	0 to 30000 (×0.01s, ×0.1s, ×1s, ×1min)	0	—	○		—
455 (1C7H)	711 (2C7H)		Zone PID data No.	0 to 8 (0: Specifies zones including current set value)	0	—	○		—
456 (1C8H)	712 (2C8H)	Segment 2	Set value(SV) setting	Input range	0	—	○		—
457 (1C9H)	713 (2C9H)		Executing time	0 to 30000 (×0.01s, ×0.1s, ×1s, ×1min)	0	—	○		—
458 (1CAH)	714 (2CAH)		Zone PID data No.	0 to 8 (0: Specifies zones including current set value)	0	—	○		—
459 (1CBH)	715 (2CBH)	Segment 3	Set value(SV) setting	Input range	0	—	○		—
460 (1CCH)	716 (2CCH)		Executing time	0 to 30000 (×0.01s, ×0.1s, ×1s, ×1min)	0	—	○		—
461 (1CDH)	717 (2CDH)		Zone PID data No.	0 to 8 (0: Specifies zones including current set value)	0	—	○		—
462 (1CEH)	718 (2CEH)	Segment 4	Set value(SV) setting	Input range	0	—	○		—
463 (1CFH)	719 (2CFH)		Executing time	0 to 30000 (×0.01s, ×0.1s, ×1s, ×1min)	0	—	○		—
464 (1D0H)	720 (2D0H)		Zone PID data No.	0 to 8 (0: Specifies zones including current set value)	0	—	○		—
465 (1D1H)	721 (2D1H)	Segment 5	Set value(SV) setting	Input range	0	—	○		—
466 (1D2H)	722 (2D2H)		Executing time	0 to 30000 (×0.01s, ×0.1s, ×1s, ×1min)	0	—	○		—
467 (1D3H)	723 (2D3H)		Zone PID data No.	0 to 8 (0: Specifies zones including current set value)	0	—	○		—
468 (1D4H)	724 (2D4H)	Segment 6	Set value(SV) setting	Input range	0	—	○		—
469 (1D5H)	725 (2D5H)		Executing time	0 to 30000 (×0.01s, ×0.1s, ×1s, ×1min)	0	—	○		—
470 (1D6H)	726 (2D6H)		Zone PID data No.	0 to 8 (0: Specifies zones including current set value)	0	—	○		—
471 (1D7H)	727 (2D7H)	Segment 7	Set value(SV) setting	Input range	0	—	○		—
472 (1D8H)	728 (2D8H)		Executing time	0 to 30000 (×0.01s, ×0.1s, ×1s, ×1min)	0	—	○		—
473 (1D9H)	729 (2D9H)		Zone PID data No.	0 to 8 (0: Specifies zones including current set value)	0	—	○		—

(To the next page)

*1: Reading data is always available regardless of the write conditions. The setting value of the item to which "Setting mode" is given as the condition for writing data can be changed only in the setting mode. Note that changing the value in the operation mode causes a write data error. In addition, it is necessary to turn on Setting change command (YnB) to change the setting value.

(From the previous page)

Address (decimal (hexadecimal))		Item	Range	Default	Write condition ^{*1}			Reference	
CH1	CH2				Always	Setting mode	Disabled		
474 (1DAH)	730 (2DAH)	Segment 8	Set value(SV) setting	Input range	0	—	○	—	Section 3.5.68
475 (1DBH)	731 (2DBH)		Executing time	0 to 30000 (×0.01s, ×0.1s, ×1s, ×1min)	0	—	○	—	
476 (1DCH)	732 (2DCH)		Zone PID data No.	0 to 8 (0: Specifies zones including current set value)	0	—	○	—	
477 (1DDH)	733 (2DDH)	Segment 9	Set value(SV) setting	Input range	0	—	○	—	
478 (1DEH)	734 (2DEH)		Executing time	0 to 30000 (×0.01s, ×0.1s, ×1s, ×1min)	0	—	○	—	
479 (1DFH)	735 (2DFH)		Zone PID data No.	0 to 8 (0: Specifies zones including current set value)	0	—	○	—	
480 (1E0H)	736 (2E0H)	Segment 10	Set value(SV) setting	Input range	0	—	○	—	
481 (1E1H)	737 (2E1H)		Executing time	0 to 30000 (×0.01s, ×0.1s, ×1s, ×1min)	0	—	○	—	
482 (1E2H)	738 (2E2H)		Zone PID data No.	0 to 8 (0: Specifies zones including current set value)	0	—	○	—	
483 (1E3H)	739 (2E3H)	Segment 11	Set value(SV) setting	Input range	0	—	○	—	
484 (1E4H)	740 (2E4H)		Executing time	0 to 30000 (×0.01s, ×0.1s, ×1s, ×1min)	0	—	○	—	
485 (1E5H)	741 (2E5H)		Zone PID data No.	0 to 8 (0: Specifies zones including current set value)	0	—	○	—	
486 (1E6H)	742 (2E6H)	Segment 12	Set value(SV) setting	Input range	0	—	○	—	
487 (1E7H)	743 (2E7H)		Executing time	0 to 30000 (×0.01s, ×0.1s, ×1s, ×1min)	0	—	○	—	
488 (1E8H)	744 (2E8H)		Zone PID data No.	0 to 8 (0: Specifies zones including current set value)	0	—	○	—	
489 (1E9H)	745 (2E9H)	Segment 13	Set value(SV) setting	Input range	0	—	○	—	
490 (1EAH)	746 (2EAH)		Executing time	0 to 30000 (×0.01s, ×0.1s, ×1s, ×1min)	0	—	○	—	
491 (1EBH)	747 (2EBH)		Zone PID data No.	0 to 8 (0: Specifies zones including current set value)	0	—	○	—	
492 (1ECH)	748 (2ECH)	Segment 14	Set value(SV) setting	Input range	0	—	○	—	
493 (1EDH)	749 (2EDH)		Executing time	0 to 30000 (×0.01s, ×0.1s, ×1s, ×1min)	0	—	○	—	
494 (1EEH)	750 (2EEH)		Zone PID data No.	0 to 8 (0: Specifies zones including current set value)	0	—	○	—	
495 (1EFH)	751 (2EFH)	Segment 15	Set value(SV) setting	Input range	0	—	○	—	
496 (1F0H)	752 (2F0H)		Executing time	0 to 30000 (×0.01s, ×0.1s, ×1s, ×1min)	0	—	○	—	
497 (1F1H)	753 (2F1H)		Zone PID data No.	0 to 8 (0: Specifies zones including current set value)	0	—	○	—	
498 (1F2H)	754 (2F2H)	Segment 16	Set value(SV) setting	Input range	0	—	○	—	
499 (1F3H)	755 (2F3H)		Executing time	0 to 30000 (×0.01s, ×0.1s, ×1s, ×1min)	0	—	○	—	
500 (1F4H)	756 (2F4H)		Zone PID data No.	0 to 8 (0: Specifies zones including current set value)	0	—	○	—	
501 (1F5H)	757 (2F5H)	Set value at program control start (SV_PCS) setting	Input range	0	—	○	—	Section 3.5.69	

*1: Reading data is always available regardless of the write conditions. The setting value of the item to which "Setting mode" is given as the condition for writing data can be changed only in the setting mode. Note that changing the value in the operation mode causes a write data error. In addition, it is necessary to turn on Setting change command (YnB) to change the setting value.

3.5.2 Error code (buffer memory address 0: Un\G0)

An error code is stored when an error occurs in the Q62HLC.

When checking the error code on the system monitor of GX Developer, monitor with hexadecimal. The numeric value at the last digit shows the error code.

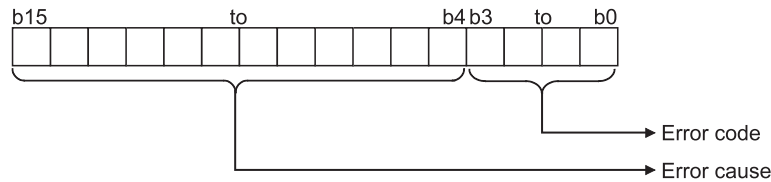

- (1) When data is written from the programmable controller CPU, the Q62HLC checks:
 - Whether write data range is proper or not
- (2) The following operations are performed at error occurrence.
 - Error code is stored (refer to Section 8.1).
When a write data error occurs, the buffer memory address is stored in the error cause part.
When an auto tuning error completion or a hardware failure occurs, the factor code is stored in the error cause part.
 - Error flag (Xn2) is turned on.
- (3) If more than one error has occurred, the error code and error occurrence address of the error having the highest priority are stored. (Refer to Section 8.1.)
- (4) For the error clear method, refer to Section 8.1.

3.5.3 Alert definition (buffer memory address 5, 6: Un\G5, Un\G6)

- (1) When the cause of the alert is removed, the bit is set to "0".
The bit corresponding to the alert detected on the channel is set to 1. When the cause of the alert is removed, the bit is set to 0.

Bit number	Definition
b0	PV rose above the up scale of the preset input range.
b1	PV fell below the down scale of the preset input range.
b2 to b7	Unused
b8	Alert 1 turned on.
b9	Alert 2 turned on.
b10	Alert 3 turned on.
b11	Alert 4 turned on.
b12	Unused
b13	Loop disconnection was detected.
b14	Unused
b15	Unused

- (2) When an alert is detected during control, the control is continued. Output does not turn off.

3.5.4 Measured value (PV) (buffer memory address 9, 10: Un\G9, Un\G10)

- (1) Stores the Q62HLC-detected value on which the following processes have been performed:
- Linearization
 - Sensor compensation
- (2) Measurement range is from the down scale^{*1} to the up scale^{*2} of input range. When the measured value exceeds the up scale or the down scale, then the value of the up scale or the down scale is stored.
- *1: Input range lower limit value – (full-scale × 5%)
*2: Input range upper limit value + (full-scale × 5%)
- (3) For values to be stored for each input range, refer to Section 3.1.1 (1).

3.5.5 Manipulated value (MV) (buffer memory address 13, 14: Un\G13, Un\G14)

- (1) The result of PID operations, which are performed based on the measured value, is stored.
- (2) The stored value differs depending on the control mode. For control modes, refer to Control mode monitor (buffer memory address: 30) and Control mode (buffer memory address: 50, 82) (Section 3.5.9 and 3.5.23).

The following explains the value to be stored for each control mode.

- (a) Normal control mode, manual control mode 1, and program control mode
The value to be stored is in the range of -50 to 1050 (-0.5 to 105.0%). The manipulated value (MV) is the rate (%) against the full scale (16mA) of the output range (4 to 20mA). The output value is 4mA for 0%, 12mA for 50%, or 20mA for 100%.

- (b) Manual control mode 2
The value to be stored is in the range of 0 to 4000. The manipulated value (MV) is the digital output value corresponds to the output range (4 to 20mA). The output value is 4mA for 0, 12mA for 2000, or 20mA for 4000.

3.5.6 Approach flag (buffer memory address 17, 18: Un\G17, Un\G18)

- (1) This flag checks if the measured value (PV) is within the approach band.
- (2) When the measured value (PV) is within the approach band, the flag is set to 1. If Approach soak time setting (buffer memory address: 168) is set, the flag is set to 1 when the measured value (PV) stays within the approach band only for the set period of time.

3.5.7 Set value monitor (buffer memory address 25, 26: Un\G25, Un\G26)

- (1) The current set value is stored.
When Setting change rate limiter (buffer memory address: 52, 84) is set, the transitional change of the set value during the program control is monitored.

3.5.8 Cold junction temperature measured value (buffer memory address 29: Un\G29)

- (1) The measured temperature of cold junction temperature compensation resistor mounted on the Q62HLC is stored.
The value to be stored is in the range of -20 to 100 (-20 to 100°C).

3.5.9 Control mode monitor (buffer memory address 30: Un\G30)

- (1) After a control mode shift is completed, the value corresponds to the new control mode is stored.

A value of a control mode consists of 4-bit data for each channel, and the data are stored in the lower 8 bits. The value of channel 1 is stored in bit 0 to 3, and the value of channel 2 is stored in bit 4 to 7.

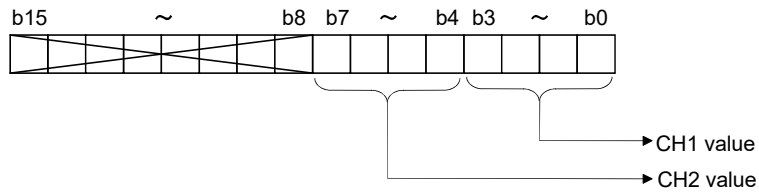

- (2) The following lists the values to be stored.

Control mode	Stored value
Normal control mode	0
Manual control mode 1	1
Program control mode	2
Manual control mode 2	3

- (3) Set the manipulated value (MV) in manual control mode 1 and manual control mode 2 after checking that the stored value is changed to 1 or 3.

3.5.10 PID constant read/write completion flag from FeRAM (buffer memory address 31: Un\G31)

- (1) This flag indicates a normal completion or failure of the following functions.
 - PID constant read command from FeRAM (buffer memory address: 62, 94)
 - Automatic backup setting after auto tuning of PID constants (buffer memory address: 63, 95)

The following table lists the definition of each bit.

Bit number	Definition	Bit number	Definition
b0	Channel 1 read completion	b8	Channel 1 read failure
b1	Channel 2 read completion	b9	Channel 2 read failure
b2	Unused	b10	Unused
b3	Unused	b11	Unused
b4	Channel 1 write completion	b12	Channel 1 write failure
b5	Channel 2 write completion	b13	Channel 2 write failure
b6	Unused	b14	Unused
b7	Unused	b15	Unused

- (2) The following chart shows the on/off timings of this flag relative to PID constant read command from FeRAM (buffer memory address: 62, 94). (For channel 1)

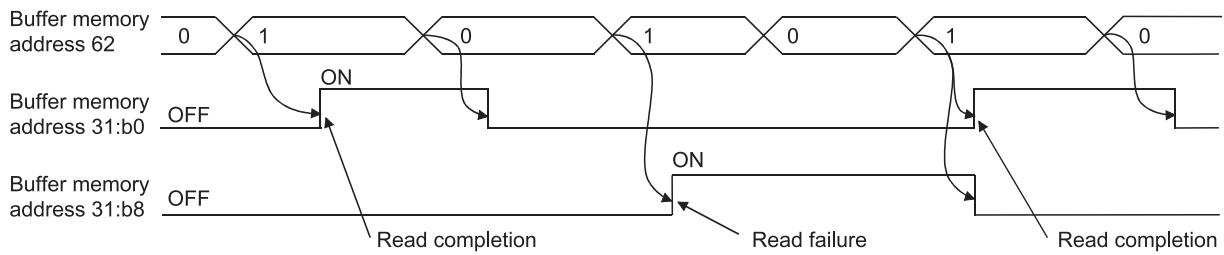

The read failure flag (b8, b9) turns off when data of the corresponding channel is successfully read.

- (3) The following chart shows the on/off timings of this flag relative to Automatic backup setting after auto tuning of PID constants (buffer memory address: 63, 95). (For channel 1)

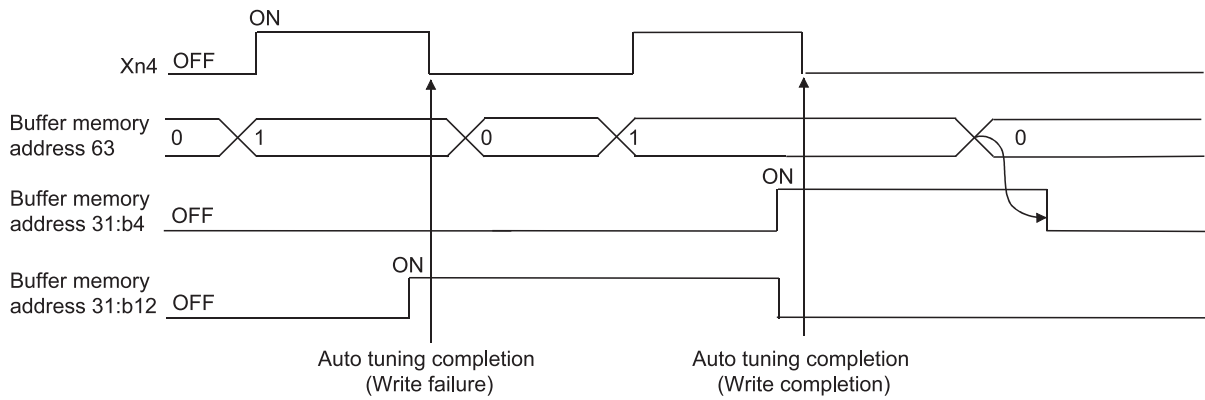

The automatic backup completion status can be checked by checking this flag upon completion of auto tuning.

The write failure flag (b12, b13) turns off when data of the corresponding channel is successfully written.

After checking the write flag, always set 0 (OFF) to Automatic backup setting after auto tuning of PID constants (buffer memory address: 63, 95).

If auto tuning is executed while 1 (ON) is set, even if internal processing of auto tuning is completed and PID constants are stored, Auto tuning status flag (Xn4, Xn5) does not turn off and auto tuning is not completed normally.

3.5.11 Input range (buffer memory address 32, 64: Un\G32, Un\G64)

- (1) Set the input range setting value according to the sensor and measuring range used. The following table lists the types of input sensor connectable to the Q62HLC and their setting ranges.

Input	Input range	Setting value	
Thermocouples	K	-200 to 1372°C	0 (default)
	J	-200 to 1200°C	1
	T	-200 to 400°C	2
	S	-50 to 1768°C	3
	R	-50 to 1768°C	4
	N	0 to 1300°C	5
	E	-200 to 1000°C	6
	B	0 to 1800°C	7
	PL II	0 to 1390°C	8
	W5Re/ W26Re	0 to 2300°C	9
Micro voltage	0 to 10mV	10	
	0 to 100mV	11	
	-10 to 10mV	12	
	-100 to 100mV	13	
Voltage	0 to 1V	14	
	1 to 5V	15	
	0 to 5V	16	
	0 to 10V	17	
	-1 to 1V	18	
	-5 to 5V	19	
	-10 to 10V	20	
Current	4 to 20mA	21	
	0 to 20mA	22	

- (2) Set the input range in the setting mode (Yn1: OFF).
To enable the setting value after change, turn on Setting change command (YnB).
- (3) For about five seconds after the input range setting is changed, 0 is set to Measured value (PV) (buffer memory address: 9, 10), and then the control is resumed.

- (4) After the input range setting is changed, the setting ranges of the following items will change accordingly. As a result, the previous setting value may become out of the setting range and a write data error may be detected. Before changing the input range, set the values of the following items within the expected setting range after change.
- Set value (SV) setting (buffer memory address: 34, 66)
 - Proportional band (P) setting (buffer memory address: 35, 67)
 - Alert set value 1 to 4 (buffer memory address: 38 to 41, 70 to 73)
 - AT bias (buffer memory address: 53, 85)
 - Upper setting limiter (buffer memory address: 55, 87)
 - Lower setting limiter (buffer memory address: 56, 88)
 - Loop disconnection detection dead band (buffer memory address: 60, 92)
 - Scaling range upper limit value (buffer memory address: 197, 213)
 - Scaling range lower limit value (buffer memory address: 198, 214)
 - Zone 1 to 8 proportional band (P) setting^{*1}
 - Segment 1 to 16 set value (SV) setting^{*2}
 - Set value at program control start (SV_PCS) setting (buffer memory address: 501, 757)
- *1: Set values to the buffer memory addresses: 282 to 313, 538 to 569 (refer to Section 3.5.1).
- *2: Set values to the buffer memory addresses: 320 to 372, 576 to 628, 384 to 436, 640 to 692, 448 to 500, 704 to 756 (refer to Section 3.5.1).

(Example) When changing the input range from thermocouple K to J at the set value (SV) 1300°C.

Thermocouple	Write data error
K	As the set value (1300°C) is within the input range (-200 to 1372°C), a write data error is not detected.
J	As the set value (1300°C) is outside the input range (-200 to 1200°C), a write data error is detected.

3.5.12 Stop mode setting (buffer memory address 33, 65: Un\G33, Un\G65)

- (1) A mode when the PID operation is stopped by Forced PID control stop command (YnC, YnD) is set.
The default is set to "Monitor".

- (2) The following table describes the setting modes and operations of each mode.

Setting mode	Setting value	Operation		
		PID operation	Measured value judgment	Alert judgment
Stop	0	×	×	×
Monitor	1	×	○	×
Alert	2	×	○	○

○: Executed
×: Not executed

Note that the operation differs depending on the unused channel setting, setting/operation mode status, PID continuation flag, forced PID control stop command, and control output setting at CPU stop error (refer to Section 3.2.19).

- (a) Measured value judgment: Checks if the measured value is within the input range.
- (b) Alert judgment: Checks if there is any alert (1 to 4).

POINT

The default is set to "Monitor".
Because of this, if no temperature sensor is connected to a channel, a sensor input disconnection occurs and the ALM LED flashes.
Set "1 (unused)" to Unused channel setting (buffer memory address: 61, 93) for such channel.

3.5.13 Set value (SV) setting (buffer memory address 34, 66: Un\G34, Un\G66)

- (1) The set value of PID operation is set. The default is set to 0.
- (2) The setting range is within the input range specified in the input range setting (refer to Section 3.1.1 (1), 3.5.11).
Set a value that satisfies the following condition in Upper/lower setting limiter (buffer memory address: 55, 56, 87, 88):
• Lower setting limiter ≤ Set value (SV) setting ≤ Upper setting limiter
- (3) If a value out of the setting range is set, a write error occurs. Then Error flag (Xn2) turns on and the error code 4 is stored to Error code (buffer memory address: 0).

3.5.14 PID constant setting

(buffer memory address 35 to 37, 67 to 69: Un\G35 to Un\G37, Un\G67 to Un\G69)

- (1) The proportional band (P), integral time (I), and derivative time (D) for performing PID operation in normal control mode are set.
- (2) For thermocouple input, set the proportional band (P) with temperature. For micro voltage, voltage and current, set with % for full-scale.
- (3) Set the proportional band (P), integral time (I), and derivative time (D) within the following ranges.
 - (a) For PI control, set the derivative time to 0.
 - (b) For P control, set the derivative time and the integral time to 0.

Item	Address		Default	Setting range	
	CH1	CH2			
Proportional band (P) setting	35	67	100	Thermocouple	1 to full scale (×0.1°C)
				Micro voltage, voltage, current	1 to 10000 (0.1 to 1000.0%)
Integral time (I)	36	68	400	0 to 32767 (0.0 to 3276.7s)	
Derivative time (D)	37	69	100	0 to 32767 (0.0 to 3276.7s)	

POINT

Proportional band (P) is the variation width of deviation (E), required to change the manipulated value (MV) from 0% to 100%.

With the proportional action, the relationship between the changes in the deviation (E) and manipulated value (MV) can be expressed in the following formula:

$$MV = K_p \cdot E \quad (K_p: \text{proportional gain})$$

From the formula above, the proportional band (P) is directed as shown below.

$$P = \frac{1}{K_p} \cdot 100$$

Widening the proportional band (P) leads to the reduction of the proportional gain (Kp). Thus, this reduces the changes in the manipulated value (MV) corresponding to the changes in the deviation (E).

Narrowing the proportional band (P) leads to the increase of the proportional gain (Kp). Thus, this increases the changes in manipulated value (MV) corresponding to the changes in the deviation (E).

[Proportional band in the reverse action]

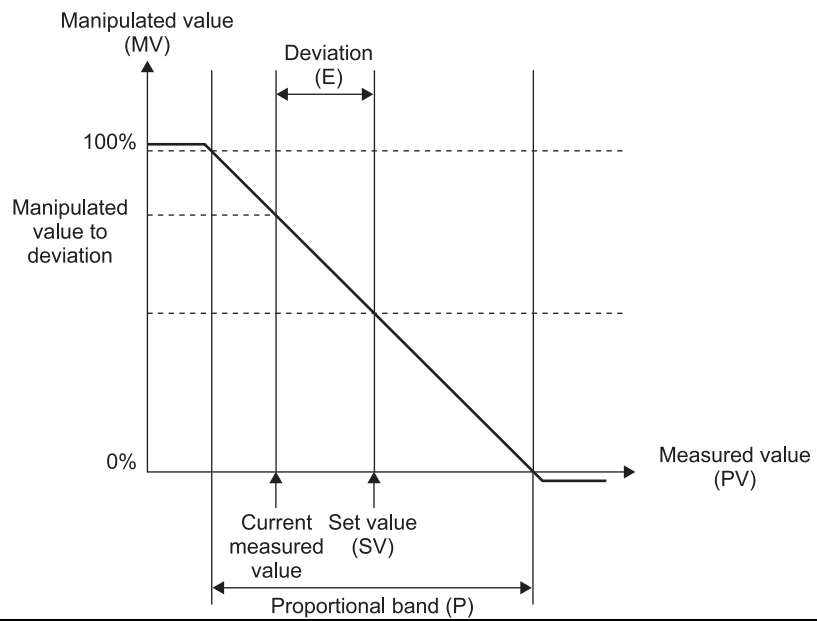

3.5.15 Alert set value 1 to 4

(buffer memory address 38 to 41, 70 to 73: Un\G38 to Un\G41, Un\G70 to Un\G73)

- (1) Set the conditions to turn alerts 1 to 4 on, before setting the alert set values.
The alert mode used in the alerts 1 to 4 is set in Alert 1 to 4 mode setting (buffer memory address: 192 to 195, 208 to 211).

Before setting this buffer memory address value, refer to Section 3.2.10.

- 1) Input alert (upper limit input alert, lower limit input alert)
Alert set value • • • measured value (PV)
- 2) Deviation alert (upper limit deviation alert, lower limit deviation alert)
Alert set value • • • deviation [measured value (PV) - set value (SV)]
- 3) Deviation alert (upper/lower limit deviation alert, within-range alert)
Alert set value • • • absolute value of deviation [measured value (PV) - set value (SV)]^{*1}

*1: A value less than 0 cannot be set to the alert set value 1 to 4.

- (2) Set the alert set value 1 to 4 for the following buffer memory.

Channel No.	Buffer memory address (decimal)			
	Alert 1	Alert 2	Alert 3	Alert 4
1	38	39	40	41
2	70	71	72	73

Set the value within the digital value corresponding to the input sensor used, referring to Section 3.1.1 (1).

- (3) If a value out of the setting range is set or a value other than 0 is set when the alert is set to be unused (Alert mode setting: 0), a write error occurs. Then Error flag (Xn2) turns on and the error code 4 is stored to Error code (buffer memory address: 0).

3.5.16 Upper/lower output limiter

(buffer memory address 42, 43, 74, 75: Un\G42, Un\G43, Un\G74, Un\G75)

- (1) The upper and lower limits of the manipulated value (MV) that is actually output to an external device is set.
- (2) The setting range is -50 to 1050 (-5.0% to 105.0%).
Set the values so that the lower output limiter value becomes less than the upper output limiter value.
- (3) When output is off (PID control stop), the current value output from the Q62HLC depends on the lower output limiter value.

Setting value	Current value
1 to upper output limiter value	4mA
-50 to 0	3.2 to 4mA (depending on setting value)
-32768 to -51	Near 0mA

3.5.17 Output variation limiter (buffer memory address 44, 76: Un\G44, Un\G76)

- (1) A sudden change in the manipulated value is controlled by setting this value.
Set the variation of the manipulated value per second.

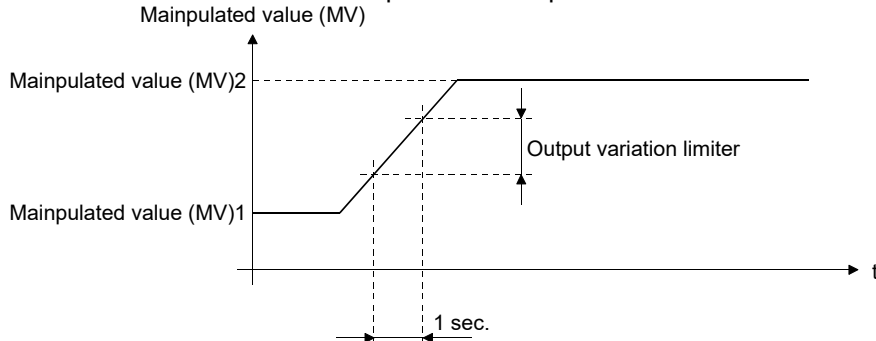

- (2) The setting range is 0 to 1000 (0.1 to 100.0%).
For example, when the output variation limiter is set to 10 (1.0%), the output variation will be 1% per second at a sudden manipulated value change of 50%, and it will take 50 seconds until the output value changes to 50% actually.
- (3) The default is set to 0. With the default setting, a sudden change cannot be controlled.

3.5.18 Sensor compensation value setting (buffer memory address 45, 77: Un\G45, Un\G77)

- (1) A sensor compensation value is set. The value is used when there is an error between the measured value and the actual measured value due to measurement conditions (refer to Section 3.2.5).
- (2) For thermocouple input, the setting range is -5000 to 5000 (-500.0 to 500.0 °C).
For micro voltage, voltage, and current input, the setting range is -5000 to 5000 (-50.00 to 50.00 %) for full-scale of the set input range.

3.5.19 AT differential gap (buffer memory address 46, 78: Un\G46, Un\G78)

- (1) The waiting time required from the output on/off status change to the next status change during auto tuning is set.
- (2) The setting range is 0 to 10000 (0.00 to 100.00s).
- (3) The target setting value for standard mode is 10 (0.1s), for fast response mode is 1 (0.01s).

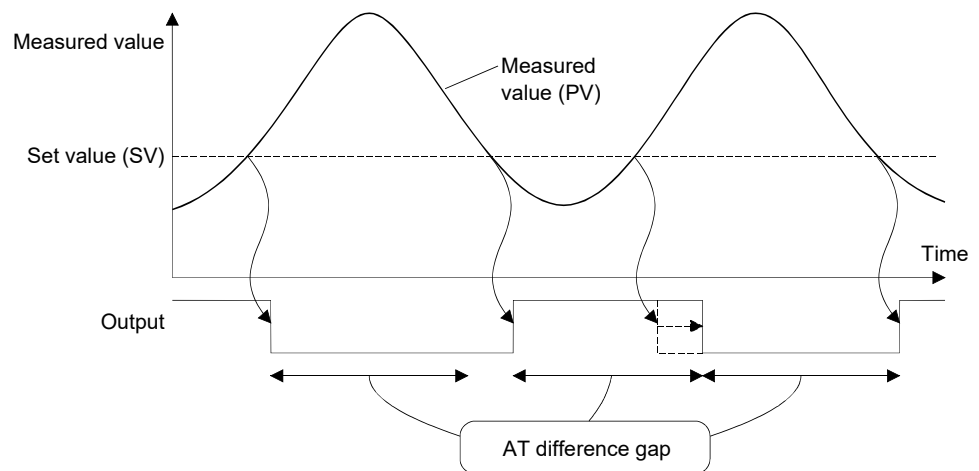

3.5.20 AT additional lag (buffer memory address 47, 79: Un\G47, Un\G79)

- (1) The waiting time required for the output on/off status being changed after the measured value (PV) has passed the set value (SV) during auto tuning is set.
- (2) The setting range is 0 to 1000 (0.00 to 10.00s).
- (3) The target setting value for standard mode is 10 (0.1s), for fast response mode is 1 (0.01s).

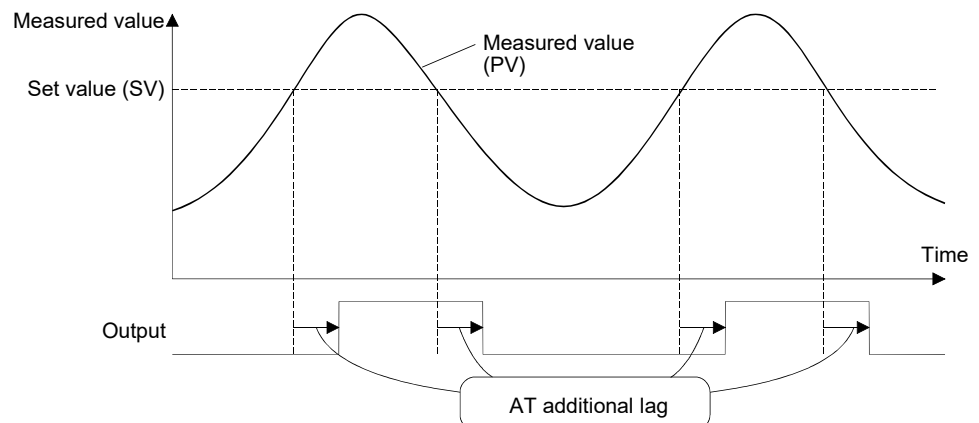

3.5.21 Primary delay digital filter setting (buffer memory address 48, 80: Un\G48, Un\G80)

- (1) The primary delay digital filter is designed to absorb sudden changes when the measured value (PV) is input in a pulse format.

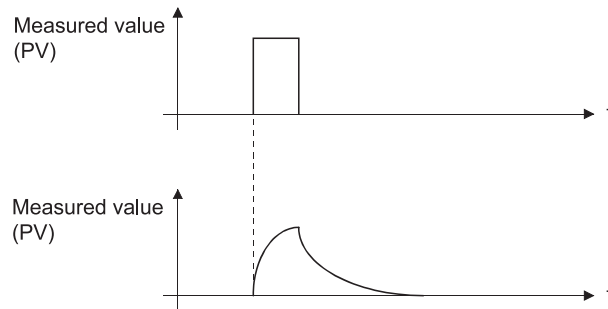

- (2) The time required for 63.3% of the measured value (PV) to change is set. When 0 is set, the primary delay digital filter turns off.

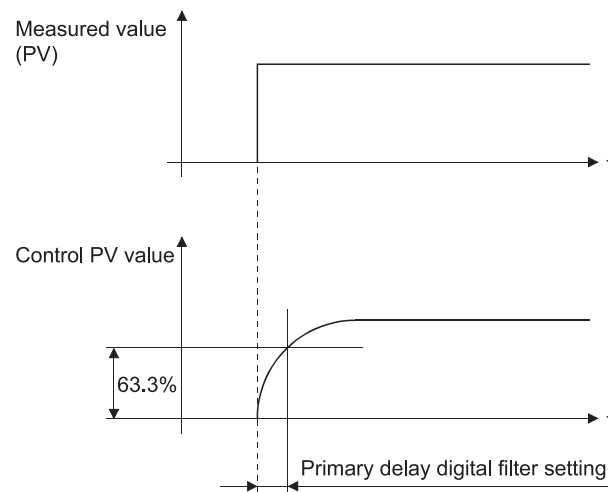

3.5.22 Control response parameter (buffer memory address 49, 81: Un\G49, Un\G81)

- (1) The response level to the PID control set value (SV) change is set.
- (a) Slow : Set 0.
Set this level to suppress the overshooting caused by the set value change.
Note that this will increase the settling time.
 - (b) Normal: Set 1.
Set this level to obtain intermediate characteristics between "Fast" and "Slow".
 - (c) Fast : Set 2.
Set this level to give a faster response to the set value change.
Note that overshoot increases.

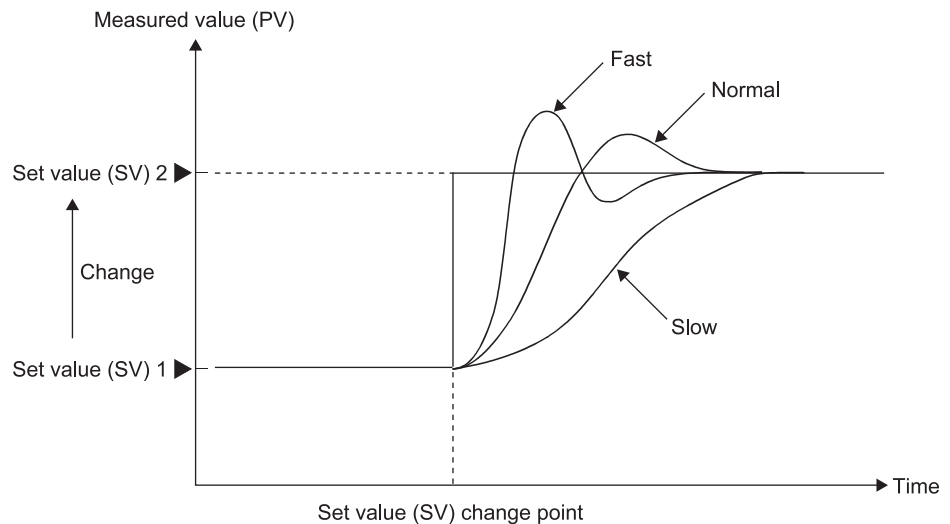

3.5.23 Control mode (buffer memory address 50, 82: Un\G50, Un\G82)

- (1) A control mode (normal control mode, manual control mode, or program control mode) is set.
- Normal control mode : Set 0.
The manipulated value calculated in PID operations is used for control output.
The set value needs to be changed manually.
 - Manual control mode 1 : Set 1.
The manipulated value written in MAN output setting (buffer memory address: 51, 83) is used for control output.*1
 - Program control mode : Set 2.
The control is performed changing the set value automatically in accordance with the program pattern. The manipulated value calculated in PID operations is used for control output.
 - Manual control mode 2 : Sets 3.
The manipulated value written in MAN output setting (buffer memory address: 51, 83) is used for control output.*1
- *1: The settings and setting ranges of MAN output setting differ between the manual control mode 1 and 2 (refer to Section 3.5.24).
- (2) The mode switching completion can be checked with Control mode monitor (buffer memory address: 30).
- (3) When switching normal control/program control to manual control, the manipulated value calculated in PID operations is transferred to MAN output setting (buffer memory address: 51, 83) to prevent a sudden change of the manipulated value. (Bumpless switching)
After the mode is switched, the value of Control mode monitor (buffer memory address: 30) is updated.
The manipulated value of the manual control mode 1 and 2 should be set after the updated value is checked.
- (4) Select "Normal control mode" at auto tuning execution.
If any other mode is selected, auto tuning is not executed.

3.5.24 MAN output setting (buffer memory address 51, 83: Un\G51, Un\G83)

- (1) The manipulated value in manual control mode is set.
- (2) MAN output setting is valid for the manual control mode 1 and 2 only.
The changed setting value is not output in the normal control mode and the program control mode even if the setting value has been changed, as the system overwrites it with the manipulated value calculated in PID operations.
- (3) The settings and setting ranges of MAN output setting differ between the manual control mode 1 and 2.

Mode	Setting range	Settings
Manual control mode 1	-50 to 1050 (-5.0 to 105.0%)* ¹	Set the manipulated value for manual control with %.
Manual control mode 2	0 to 4000* ²	Set the analog output for using the simplified analog I/O function with digital value.

- *1: -50 to 0 is output as 3.2 to 4mA, and 1000 to 1050 as 20 to 20.8mA. Set the value within -32768 to -51 to turn off the output. In this case, the output is near 0mA.
- *2: Set the value within -32768 to -1 to turn off the output. In this case, the output is near 0mA.

3.5.25 Setting change rate limiter (buffer memory address 52, 84: Un\G52, Un\G84)

- (1) This setting is made to set the variation of the set value per minute to a set value (SV) change. This will suppress a derivative kick (sudden change in the manipulated value).

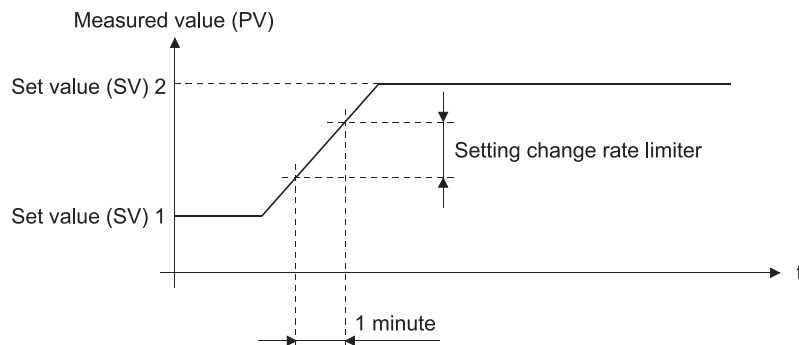

- (2) For thermocouple input, set the value with temperature.
For micro voltage, voltage, and current, set the value with % for full-scale.
The following lists the setting ranges.

Input	Setting range
Thermocouples	0 to 10000 (0.0 to 1000.0°C/min)
Micro voltage/ Voltage/ Current	0 to 1000 (0 to 100.0%/min)

3.5.26 AT bias (buffer memory address 53, 85: Un\G53, Un\G85)

- (1) The auto tuning decides each PID constant by executing the ON/OFF operation of control output and hunching the measured value.
Set the AT bias, if the overshoot of this hunching is not suitable for the control target.
- (2) When the AT bias is set, the center point of auto tuning is shifted. (The shifted point is called AT point.)
- (3) Set the range which has minimal PID operation fluctuations and will not affect the control results.
Otherwise, exact PID constants may not be provided depending on the control target.

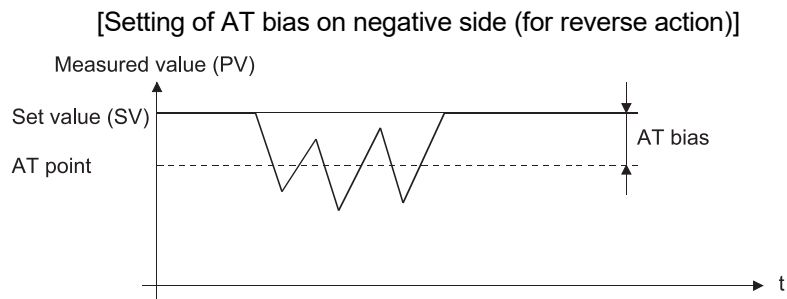

- (4) The setting range is \pm full-scale.

3.5.27 Forward/reverse action setting (buffer memory address 54, 86: Un\G54, Un\G86)

- (1) An action type (forward or reverse) is set for each channel.
 - Forward action (cooling control): Set 0.
 - Reverse action (heating control): Set 1.

3.5.28 Upper/lower setting limiter

(buffer memory address 55, 56, 87, 88: Un\G55, Un\G56, Un\G87, Un\G88)

- (1) The upper and lower limits of the set value (SV) are set.
- (2) Set a value within the input range specified for the input range.
Set the value so that the lower output limiter value becomes smaller than the upper output limiter value.

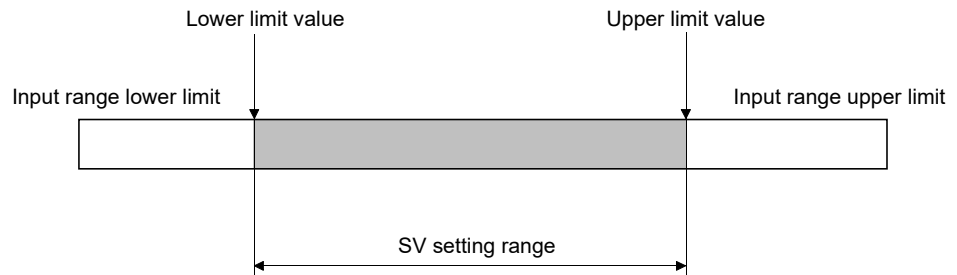

- (3) If the setting value is incorrect, a write error occurs, Error flag (Xn2) turns on, and the error code is stored in Error code (buffer memory address: 0).

Error code	Description
4	A value out of the setting range is set.
5	The lower setting limiter value is equal to or greater than the upper setting limiter value.

REMARKS

Set values equal to or greater than Lower setting limiter (buffer memory address: 56, 88) and equal to or smaller than Upper setting limiter (buffer memory address: 55, 87) in the following buffer memory areas.

- Set value (SV) setting (buffer memory address: 34, 66)
- Set value (SV) settings for segment 1 to 16 of program pattern 1 to 3
- Set value at program control start (SV_PCS) setting (buffer memory address: 501, 757)

If the value set does not satisfy the conditions above, a write error occurs. Then Error flag (Xn2) turns on and the error code 4 is stored to Error code (buffer memory address: 0). Note that a setting value in the buffer memory not used for control also must satisfy the conditions above.

3.5.29 Program control run/reset (buffer memory address 57, 89: Un\G57, Un\G89)

- (1) The program control status (RUN or RESET) is set.
 - RESET : Set 0.
The program control stops. When control stops, only the measured value judgment is performed. If the pattern end output is being executed, the output is turned off.
 - RUN : Set 1.
The program control is executed.
- (2) When a mode other than the program control mode is switched to the program control mode at "RUN" status, the program control starts immediately after the mode is switched.

3.5.30 Loop disconnection detection judgment time
(buffer memory address 59, 91: Un\G59, Un\G91)

- (1) The loop disconnection detection function detects errors in the control system due to a load disconnection, external operation device fault, sensor disconnection and the like.
No temperature change of greater than 2°C for thermocouple input and greater than 0.2% of full-scale for micro voltage, voltage and current within the loop disconnection detection judgment time is judged as a loop disconnection.
- (2) Set a value longer than the time taken to vary the temperature 2°C (2°F) or that of 0.2%.
- (3) When auto tuning is performed, a value twice longer than the integral time is set automatically as the loop disconnection detection judgment time.
However, if the loop disconnection detection judgment time is set to 0 before auto tuning is performed, the loop disconnection detection judgment time is not stored.
- (4) The setting range is 0 to 7200 (0 to 7200s).

POINT	<p>If loop disconnection alert occurs frequently despite normal operation of a sensor and external operation device, check if the capacity of external device (such as heater and cooling fan) is enough.</p> <p>If not, set a time value longer than time required for varying 2°C or 0.2% with manipulated value 100%.</p>
--------------	--

3.5.31 Loop disconnection detection dead band
(buffer memory address 60, 92: Un\G60, Un\G92)

- (1) To prevent the false alert of loop disconnection detection, set the no alert area (area where no loop disconnection will be detected) around the set value.
- (2) The setting range is ± full-scale.

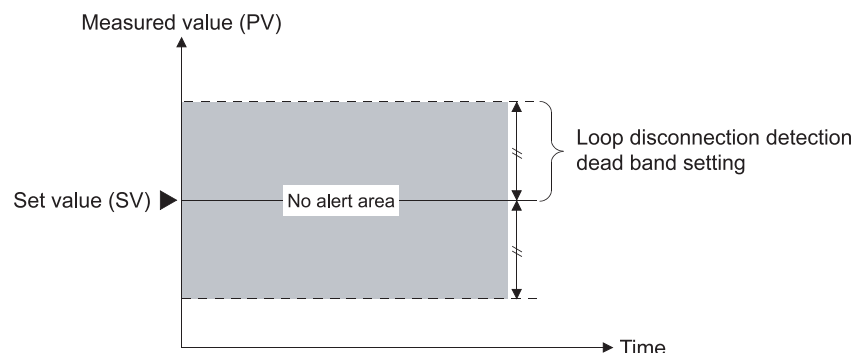

3.5.32 Unused channel setting (buffer memory address 61, 93: Un\G61, Un\G93)

- (1) This setting is used for making unused channels where the PID control will not be performed and sensors will not be connected.
 - Used : Set 0 (default).
 - Unused : Set 1.
- (2) For the channels set as unused, the ALM LED will not flash even if a sensor is not connected.
- (3) When Default setting registration start command (Yn9) is turned on, the value returns to a default value.
If there is any channel where the PID control is not performed or a sensor is not connected, change the value and set the channel as unused.

3.5.33 PID constant read command from FeRAM (buffer memory address 62, 94: Un\G62, Un\G94)

- (1) This command reads PID constants from FeRAM to buffer memory.
Set this command to 1 (With command) to read FeRAM values to the following buffer memory addresses.

Buffer memory address name	Address	
	CH1	CH2
Proportional band (P) setting	35	67
Integral time (I)	36	68
Derivative time (D)	37	69
Loop disconnection detection judgment time	59	91

- (2) This function is useful to use the initial setting of GX Configurator-TC and the PID constants stored in FeRAM together.
Using this function, the items set in the initial setting of GX Configurator-TC at the Q62HLC startup can be changed afterwards.
- (3) When this command is set to 1 (With command), do not change the setting value, backup data in FeRAM, or perform default setting registration.
- (4) To execute auto tuning, set 0 (Without command). If auto tuning is executed with a setting value 1 (With command), auto tuning will not complete even if internal processing of auto tuning completes and PID constants are stored. (Auto tuning status flag (Xn4, Xn5) does not turn off.)

3.5.34 Automatic backup setting after auto tuning of PID constants (buffer memory address 63, 95: Un\G63, Un\G95)

- (1) This function backs up PID constants set at the completion of auto tuning automatically in FeRAM.

When 1 is set and auto tuning is started, data in the following buffer memory addresses are automatically backed up to FeRAM at the completion of auto tuning.

Buffer memory address name	Address	
	CH1	CH2
Proportional band (P) setting	35	67
Integral time (I)	36	68
Derivative time (D)	37	69
Loop disconnection detection judgment time	59	91

Auto tuning status flag (Xn4, Xn5) turns off at the completion of auto tuning. Write 0 in this setting when the flag turns off.

- (2) Do not change this setting during execution of auto tuning.
- (3) While auto tuning is being executed with this function enabled, do not change the setting value, backup data in FeRAM, or perform default setting registration.

3.5.35 Alert dead band setting (buffer memory address 164: Un\G164)

- (1) A dead band for alerts is set. For details, refer to Section 3.2.10.
- (2) For thermocouple input, the setting range is 0 to 1000 (0.0 to 100.0°C).
For micro voltage, voltage and current input, the setting range is 0 to 1000 (0.00 to 10.00%) for full-scale of the input range.

3.5.36 Alert delay count (buffer memory address 165: Un\G165)

- (1) The sampling count for generating an alert is set.
When the value is set, the system is placed in alert status if the sampling count remains within the alert range between when the measured value (PV) has fallen within the alert range and when the sampling count reaches or exceeds the alert delay count.
For details, refer to Section 3.2.10.
- (2) The setting range is 0 to 255 (0 to 255 times).

3.5.37 Approach range setting (buffer memory address 167: Un\G167)

- (1) The approach range is set. Set the rise/fall values for thermocouple, the rise/fall % of full-scale for micro voltage, voltage and current, at which a rise will be judged as completed, relative to the set value.

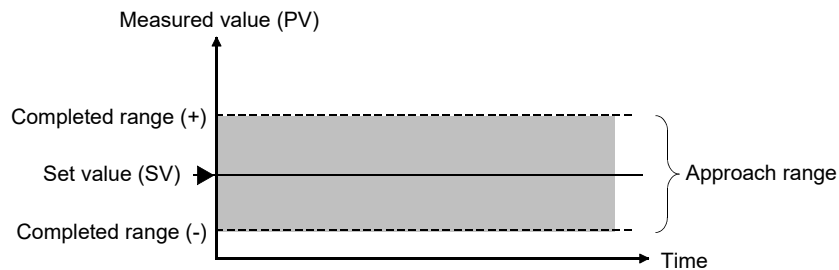

- (2) For thermocouple input, the setting range is 1 to 100 (0.1 to 10.0°C).
For micro voltage, voltage and current input, the setting range is 1 to 100 (0.1 to 10.0%) for full-scale of the input range.

3.5.38 Approach soak time setting (buffer memory address 168: Un\G168)

- (1) A delay time (between when a set value is reached and when Approach flag (buffer memory address: 17, 18) turns on) is set.
- (2) The setting range is 0 to 32767 (0.0 to 3276.7s).

3.5.39 PID continuation flag (buffer memory address 169: Un\G169)

- (1) The operation status when Setting/operation mode command (Yn1) turns off is set.
- Stop : Set 0 (default).
 - Continue : Set 1.
- (2) For the control status by the on/off status of the PID continuation flag, Refer to Section 3.2.19.

3.5.40 Cascade ON/OFF (buffer memory address 176: Un\G176)

- (1) The cascade control status (on/off) is set.
- Cascade OFF : Set 0 (default).
 - Cascade ON : Set 1.
- (2) Refer to Section 3.2.13 for the cascade control.

3.5.41 Cascade gain (buffer memory address 177: Un\G177)

- (1) This is a gain for converting to the cascade signal after adding cascade bias in manipulated value of master and converting to full-scale of slave input range on the cascade control.

Example: When manipulated value of master is 10%, slave input is set to T thermocouple (-200 to 400°C), cascade bias is set to -8% and cascade gain is set to 1.5.

$$\begin{aligned}\text{Cascade signal} &= ((\text{Manipulated value}) - (\text{Cascade bias})) \times (\text{Full-scale of input range}) \times (\text{Cascade gain}) \\ &= (0.1 - 0.08) \times 600 \times 1.5 \\ &= 18^\circ\text{C}\end{aligned}$$

The cascade signal added to the set value of slave is 18°C.

- (2) The setting range is -10000 to 10000 (-10.000 to 10.000).
- (3) Refer to Section 3.2.13 for the cascade control.

3.5.42 Cascade bias (buffer memory address 178: Un\G178)

- (1) This is a bias to be added in the manipulated value of master on the cascade control.
- (2) The setting range is -1000 to 1000 (-100.0 to 100.0%).
- (3) Refer to Section 3.2.13 for the cascade control.

3.5.43 Cascade monitor (buffer memory address 179: Un\G179)

- (1) The manipulated value (cascade signal) of master, which is added in the set value of slave on the cascade control and converted with the cascade gain and cascade bias, is stored.
- (2) Refer to Section 3.2.13 for the cascade control.
- (3) When the setting value of Cascade ON/OFF (buffer memory address: 176) is 0, 0 is stored in this area.

3.5.44 Alert 1 to 4 mode setting

(buffer memory address 192 to 195, 208 to 211: Un\G192 to Un\G195, Un\G208 to Un\G211)

This setting is available in the setting mode only.

To activate the change, turn on Setting change command (YnB).

- (1) The alert mode is set.
- (2) The values of Alert 1 to 4 are set in the following buffer memory addresses.
 - Channel 1: 38 to 41
 - Channel 2: 70 to 73
- (3) The correspondences between buffer memory addresses and channels are listed below.

Mode setting item	CH1	CH2
Alert 1	192	208
Alert 2	193	209
Alert 3	194	210
Alert 4	195	211

- (4) The following table lists the alert modes and setting values.
Refer to Section 3.2.10 for the alert functions of the Q62HLC.

Alert mode	Setting	Alert mode	Setting	Alert mode	Setting
Upper limit input alert	1	Upper limit input alert with wait	7	—	—
Lower limit input alert	2	Lower limit input alert with wait	8	—	—
Upper limit deviation alert	3	Upper limit deviation alert with wait	9	Upper limit deviation alert with re-wait	12
Lower limit deviation alert	4	Lower limit deviation alert with wait	10	Lower limit deviation alert with re-wait	13
Upper/lower limit deviation alert	5	Upper/lower limit deviation alert with wait	11	Upper/lower limit deviation alert with re-wait	14
Within-range alert	6	—	—	—	—

- (5) The alert function is not executed with the default value 0.

3.5.45 Scaling value (buffer memory address 196, 212: Un\G196, Un\G212)

- (1) The value which scaled the measured value (PV) is stored.
- (2) The scaling method differs depending on thermocouple input or micro voltage/voltage/current input.
For details of the scaling function, refer to Section 3.2.14.

3.5.46 Scaling range upper/lower limit value (buffer memory address 197, 198, 213, 214: Un\G197, Un\G198, Un\G213, Un\G214)

- (1) The upper limit value and lower limit value of the scaling range is set.
The setting range is within the input range.
 - (a) Thermocouple input
Set the scaling range of measured temperature value.
When the upper limit value is set equal to the lower limit value, the scaling is not performed.
 - (b) Micro voltage, voltage, current input
Set the digital value corresponding to the upper and lower limit values of the input range.
However, the full-scale of the setting value is 20000.
- (2) The following lists the setting ranges.
 - Thermocouple input : within the input range
 - Micro voltage, voltage, current input : -32768 to 32767
(However, the full-scale is 20000.)
- (3) The scaling is not performed with the default value 0.
- (4) For details of the scaling function, refer to Section 3.2.14.

3.5.47 Scaling width upper/lower limit value (buffer memory address 199, 200, 215, 216: Un\G199, Un\G200, Un\G215, Un\G216)

- (1) The upper limit value and lower limit value of the scaling width is set.
 - (a) Thermocouple input
Set the scaling width of measured temperature value.
 - (b) Micro voltage, voltage, current input
Not used.
If the setting is made, it is ignored.
- (2) The following lists the setting ranges.
 - Thermocouple input : -32768 to 32767
 - Micro voltage, voltage, current input : - (The setting is ignored.)
- (3) The scaling is not performed with the default value 0.
- (4) For details of the scaling function, refer to Section 3.2.14.

3.5.48 Hold command (buffer memory address 201, 217: Un\G201, Un\G217)

- (1) This is the command to pause and restart the program control.
 - Hold OFF : Set 0 (default).
When the program control has paused, it restarts from the set value at the point where it paused.
 - Hold ON : Set 1.
The program control pauses and becomes a hold status.

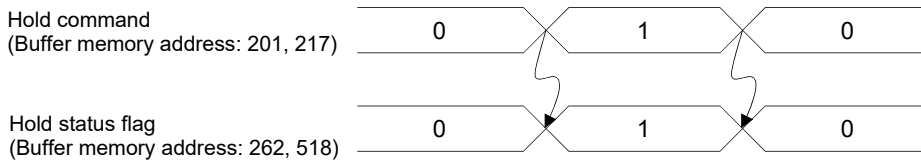
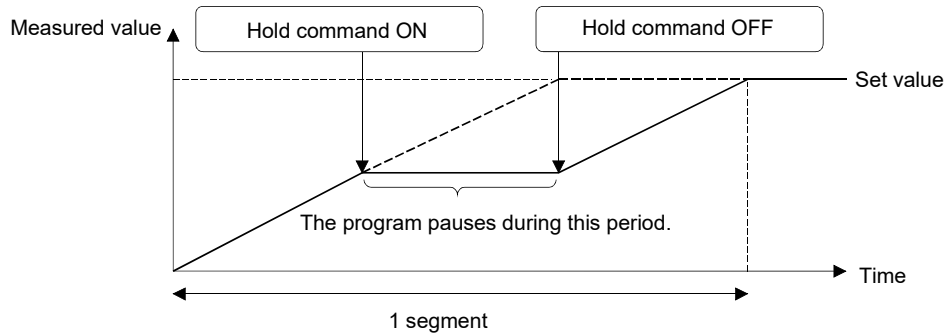

- (2) The hold status can be checked in Hold status flag (buffer memory address: 262, 518).
- (3) This command is enabled in the program control mode only.

3.5.49 Command advancing (buffer memory address 202, 218: Un\G202, Un\G218)

- (1) This is the command of the advancing operation to carry the progress of the program control forward to the next segment.
 - Advancing OFF : Set 0 (default).
The advancing operation is not performed.
 - Advancing ON : Set 1.
The advancing operation is performed. The progress of the program is advanced by one segment and the program starts from the next segment.

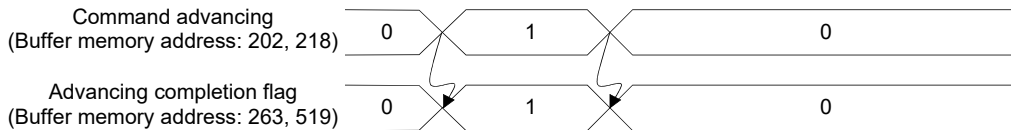
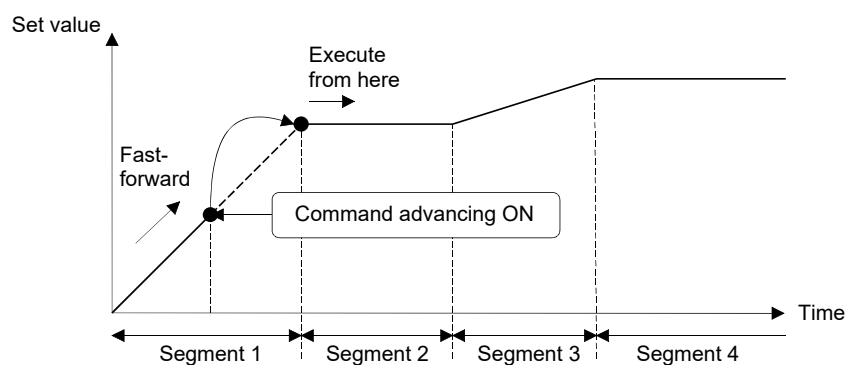

- (2) The completion of the advancing operation can be checked in Advancing completion flag (buffer memory address: 263, 519).
- (3) This command is disabled when the program control is in the hold status.

3.5.50 SV tracking setting (buffer memory address 203, 219: Un\G203, Un\G219)

- (1) Whether to use the SV tracking function or not is set.
 - Disable SV tracking: Set 0 (default).
 - Enable SV tracking: Set 1.

3.5.51 Forced output command (buffer memory address 204, 220: Un\G204, Un\G220)

- (1) This is the command to execute the forced output function.
 - Forced output not commanded: Set 0 (default).
 - Forced output commanded: Set 1. The forced output function is executed.
- (2) The status of the forced output function can be checked in Forced output status flag (buffer memory address: 266, 522).
- (3) This command is enabled only when the bit 0 of the switch 3 is set to 1 (Enable) in the intelligent function module switch setting.

3.5.52 Forced output manipulated value (MV) (buffer memory address 205, 221: Un\G205, Un\G221)

- (1) The manipulated value (MV) targeted for forced output is set when forced output is executed in normal control mode, manual control mode 1, program control mode, or manual control mode 2.
- (2) The setting range is -200 to 4200. If values -32768 to -201 are set, the analog output values become close to 0mA.
For relationship of the setting value in this area, Manipulated value (MV) (buffer memory address: 13, 14), and analog output value, refer to Section 3.2.16 (3).
- (3) This setting is enabled only when the bit 0 of the switch 3 is set to 1 (Enable) in the intelligent function module switch setting.
- (4) Check that Forced output status flag (buffer memory address: 266, 522) is 1 (With forced output command) before writing data into this area.

3.5.53 Segment monitor (buffer memory address 256, 512: Un\G256, Un\G512)

- (1) The currently operated segment No. is stored.
The stored values are 1 to 16.

3.5.54 Segment remaining time (buffer memory address 257, 513: Un\G257, Un\G513)

- (1) The remaining time of the currently operated segment is stored.
- (2) The time scale of the segment remaining time is the scale set in Time scale (buffer memory address: 274, 530) (refer to Section 3.5.66).

3.5.55 Execution times monitor (buffer memory address 258, 514: Un\G258, Un\G514)

- (1) Execution times of the currently executed program pattern are stored.
- (2) Execution times are updated at the pattern end.
When the program pattern is linked, execution times are updated at the pattern end of the final program pattern.
- (3) Upper limit of the storage value is 30000. If any value greater than 30000, the monitor goes back to 0 and starts to count again.

3.5.56 Pattern end output flag (buffer memory address 259, 515: Un\G259, Un\G515)

- (1) This is a flag to check the pattern end output status at the completion of the program control of the final segment.
The pattern end output status at the completion of the program control of the final segment can be checked.
 - Pattern end output OFF: 0 is stored.
 - During pattern end output: 1 is stored.

3.5.57 End status flag (buffer memory address 260, 516: Un\G260, Un\G516)

- (1) This is a flag to notify the completion of the program control.
- (2) This flag turns on (or becomes 1) at the completion of the program control.
When 1 (RESET) is set in Program control run/reset (buffer memory address: 57, 89), this flag turns off (or becomes 0).

3.5.58 Wait status flag (buffer memory address 261, 517: Un\G261, Un\G517)

- (1) This is a flag to check the wait status of the program control.
 - Cancelling wait status: 0 is stored.
 - Wait status: 1 is stored.

3.5.59 Hold status flag (buffer memory address 262, 518: Un\G262, Un\G518)

- (1) This is a flag to check if the program control is in hold status.
- (2) This flag will be 1 when the program control is paused (when 1 is set in Hold command (buffer memory address: 201, 217)).
 - Cancel hold status: 0 is stored.
 - In hold status: 1 is stored.

3.5.60 Advancing completion flag (buffer memory address 263, 519: Un\G263, Un\G519)

- (1) This is a flag to check if the advancing operation according to the setting in Command advancing (buffer memory address: 202, 218) is completed in the program control.
 - Advancing operation uncompleted or no command: 0 is stored.
 - Advancing operation completed: 1 is stored.
- (2) This flag is reset to 0 by turning off the command advancing.

3.5.61 Execution pattern monitor (buffer memory address 264, 520: Un\G264, Un\G520)

- (1) For program control, the program pattern No. in execution is stored. When program control is in RUN, values are stored as follows.
 - Pattern 1: 1 is stored.
 - Pattern 2: 2 is stored.
 - Pattern 3: 3 is stored.When program control is in RESET, 0 (default value) is stored.

3.5.62 Zone PID monitor (buffer memory address 265, 521: Un\G265, Un\G521)

- (1) The zone No. of the zone PID data used for the control in the program control is stored.
 - Zone 1: 1 is stored.
 - Zone 2: 2 is stored.
 - Zone 3: 3 is stored.
 - Zone 4: 4 is stored.
 - Zone 5: 5 is stored.
 - Zone 6: 6 is stored.
 - Zone 7: 7 is stored.
 - Zone 8: 8 is stored.When program control is in RESET, 0 (default value) is stored.

3.5.63 Forced output status flag (buffer memory address 266, 522: Un\G266, Un\G522)

- (1) This is a flag to check the status of the forced output command.
 - Forced output not commanded: 0 (default value) is stored.
 - With forced output command: 1 is stored.
- (2) Changing Forced output command (buffer memory address: 204, 220) from 1 (Forced output commanded) to 0 (Forced output not commanded) resets this flag to 0.

3.5.64 Execution pattern (buffer memory address 272, 528: Un\G272, Un\G528)

This setting is available only in the setting mode. However, when the parameter change in program control function is enabled, this setting can be changed in the operation mode also. For details on the parameter change in program control function, refer to Section 3.2.18.

To activate the change, turn on Setting change command (YnB).

(1) This setting specifies the program pattern to be executed in the program control.

(2) The following lists the setting values.

- Program pattern 1: Set 1 (default).
- Program pattern 2: Set 2.
- Program pattern 3: Set 3.

3.5.65 Start mode (buffer memory address 273, 529: Un\G273, Un\G529)

This setting is available only in the setting mode. However, when the parameter change in program control function is enabled, this setting can be changed in the operation mode also. For details on the parameter change in program control function, refer to Section 3.2.18.

To activate the change, turn on Setting change command (YnB).

(1) A starting method of the set value (SV) at program control start can be selected from the following.

- Zero start: Set 0 (default).
- PV start 1 (time fixed): Set 1.
- PV start 2 (time shortened): Set 2.
- PV start 3 (time shortened/find type): Set 3.
- SV start: Set 4.

For details on each starting method, refer to Section 3.2.12 (2).

3.5.66 Time scale (buffer memory address 274, 530: Un\G274, Un\G530)

This setting is available only in the setting mode. However, when the parameter change in program control function is enabled, this setting can be changed in the operation mode also. For details on the parameter change in program control function, refer to Section 3.2.18.

To activate the change, turn on Setting change command (YnB).

- (1) The time scale sets the scales for the set value of the time scale for each segment and for the stored value of Segment remaining time (buffer memory address: 257,513) and for the output time scale of the pattern END for each program pattern.
- (2) The following lists the setting values.
 - 0.01s: Set 0 (default).
 - 0.1s: Set 1.
 - 1s: Set 2.
 - 1min: Set 3.

3.5.67 Zone setting (buffer memory address 275 to 313, 531 to 569: Un\G275 to Un\G313, Un\G531 to Un\G569)

A zone used for the program control function is set.

The following three items (1) to (3) need to be set. For the buffer memory addresses of each item, refer to Section 3.5.1. For details on the program control function, refer to Section 3.2.12.

This setting is available only in the setting mode. However, when the parameter change in program control function is enabled, this setting can be changed in the operation mode also. For details on the parameter change in program control function, refer to Section 3.2.18.

To activate the change, turn on Setting change command (YnB).

- (1) Zone 1 to 7 upper limit
 - (a) The upper limits of each zone is set to divide input range into zones.
 - (b) By using this setting, the input range can be divided into up to 8 zones.
 - (c) For the program control, the PID constants and control response parameters are set for each zone. When they are within the range of the zone having the measured value, the control is executed by the PID constants and control response parameters set for the zone.

(d) The following lists the setting ranges.

The default value is the upper limit of the input range.

- Zone 1 upper limit: Lower limit of the input range to upper limit of the input range
 - Zone 2 upper limit: Zone 1 upper limit to upper limit of the input range
 - Zone 3 upper limit: Zone 2 upper limit to upper limit of the input range
 - Zone 4 upper limit: Zone 3 upper limit to upper limit of the input range
 - Zone 5 upper limit: Zone 4 upper limit to upper limit of the input range
 - Zone 6 upper limit: Zone 5 upper limit to upper limit of the input range
 - Zone 7 upper limit: Zone 6 upper limit to upper limit of the input range
- Make the setting in the order of the zone 1 → zone 2 → ••• → zone 8 allocating from the lower limit of the input range.

(Example) Thermocouple input

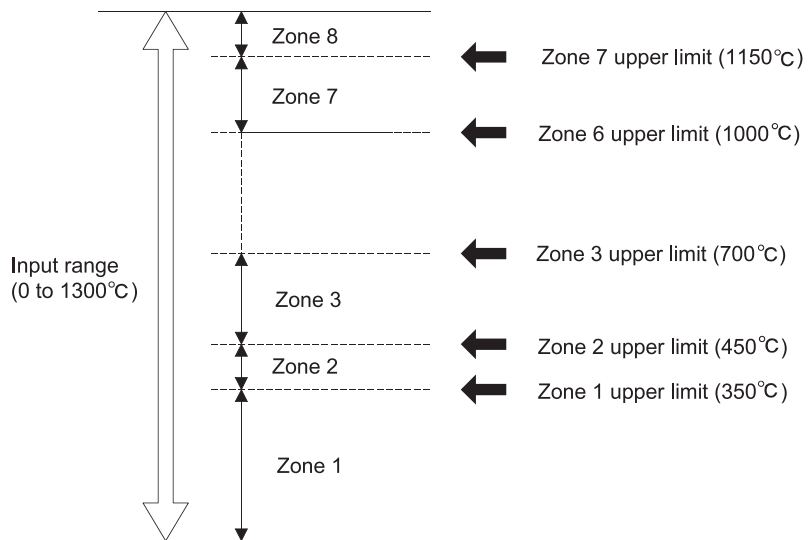

POINT

- To divide a zone into four, set the upper limit values for the zone 1 to 3, and set the upper limit value of the input range (default) for the zone 4 to 7.
- Upper/lower setting limiter (buffer memory address: 55, 56, 87, 88) does not give any restriction on setting values in Zone 1 to 7 upper limit. Note, however, that a write error occurs if a value out of the range is set. Then Error flag (Xn2) turns on and the error code 4 is stored to Error code (buffer memory address: 0).

- (2) Zone 1 to 8 PID constant setting
 - (a) The PID constants of proportional band (P), integral time (I), and derivative time (D) corresponding to each zone are set.
 - (b) For details of the setting range, refer to Section 3.5.14.
- (3) Zone 1 to 8 PID control response parameters
 - (a) The control response parameters corresponding to each zone are set.
 - (b) For details of the setting value, refer to Section 3.5.22.

3.5.68 Program pattern (buffer memory address 320 to 500, 576 to 756: Un\G320 to Un\G500, Un\G576 to Un\G756)

The program pattern used for the program control function is set. There are three program patterns and the following eight items (1) to (8) need to be set.

For the buffer memory addresses of each item, refer to Section 3.5.1.

For details on the program control function, refer to Section 3.2.12.

This setting is available only in the setting mode. However, when the parameter change in program control function is enabled, this setting can be changed in the operation mode also. For details on the parameter change in program control function, refer to Section 3.2.18.

To activate the change, turn on Setting change command (YnB).

(1) Program pattern final setting

(a) The final segment for the program pattern is set.

At link setting, each program pattern execution will complete at the final segment.

(b) The default value is 16.

The setting range is 1 to 16.

(2) Program pattern link setting

(a) The Q62HLC can link program patterns and set a program pattern with up to 48 segments. (One program pattern consists of 16 segments.) The pattern link specifies the program pattern of the link destination.

(b) When the program pattern has been linked, the program pattern of the link destination is executed in sequential order starting from segment 1. The link destination program pattern of the segment 1 set value starts from the set value at the pattern end of the link source.*1 The pattern end output of the link source is not performed.

*1: The same operation as the PV starting 1 of Section 3.5.65 "Start mode"

Example: When the program pattern 2 is specified according to the link setting of the program pattern 1

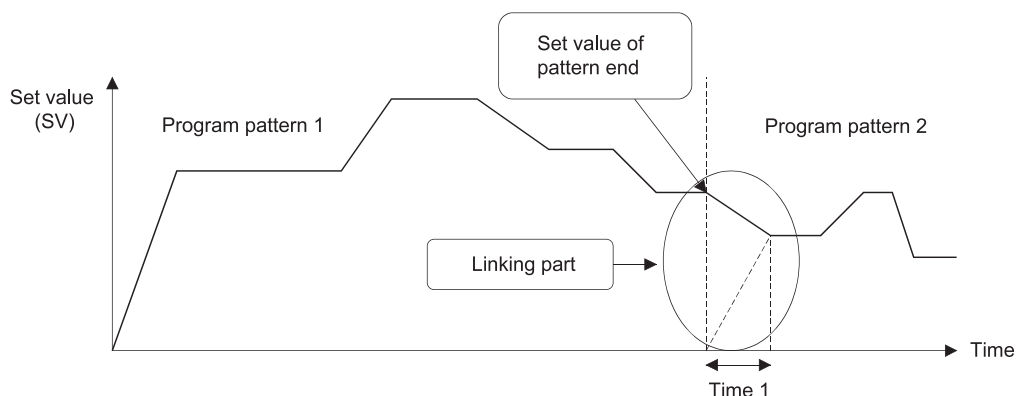

Execution pattern monitor
(Buffer memory address: 264, 520)



- (c) The following lists the setting ranges.
- No link: Set 0 (default).
 - Patten 1: Set 1.
 - Patten 2: Set 2.
 - Patten 3: Set 3.
- (d) The program pattern and segment No. in execution can be monitored in Execution pattern monitor (buffer memory address: 264, 520) and Segment monitor (buffer memory address: 256, 512).
- (e) When a program pattern of the link source is set, the program pattern will be repeated endlessly.
- (3) Program pattern iteration
- (a) The number of execution times (cycles) of the program control is set.
- (b) If the value 2 or more is set, the Q62HLC executes the program pattern repeatedly.
- When the program pattern is executed repeatedly, the set value of the segment 1 starts from the set value at the pattern end after the second execution or later.

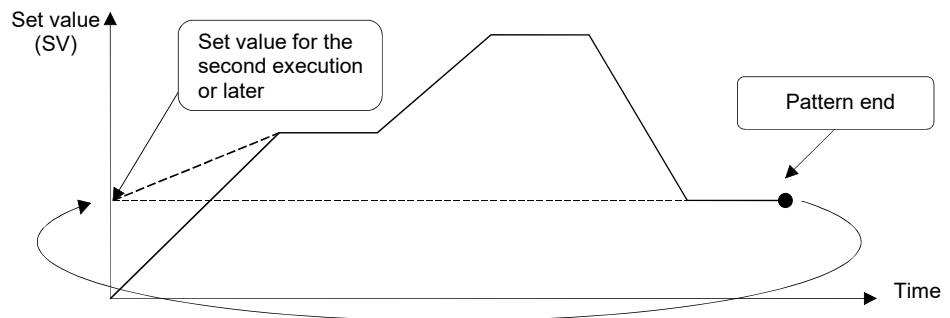

- (c) When the program pattern has been linked, all patterns are executed repeatedly.
- In this case, the number of execution times of the program pattern specified in Execution pattern (buffer memory address: 272, 528) becomes valid.
- (d) The pattern end output is performed only for the final execution.
- (e) The current number of execution times of the program pattern can be checked in Execution times monitor (buffer memory address: 258, 514).
- (f) The setting range is 1 to 1000 (1 to 999 times, endless).
- When 1000 is set, the program pattern will be repeated endlessly.

- (4) Pattern end output time of program pattern
 - (a) The time required for the pattern end output at the completion of the program pattern is set.
The default value is 0.
 - (b) When the program pattern is completed, the Q62HLC holds the set value at the pattern end and continues the PID control only for the pattern end output time.

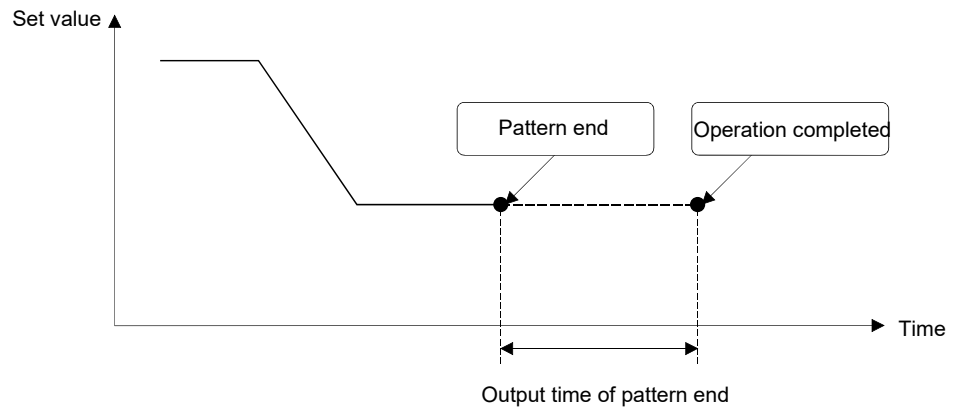

- (c) The setting range is 0 to 30000.
When 0 is set, however, the output of pattern end continues until the program control is reset.
- (d) The time scale is set in Time scale (buffer memory address: 274, 530).
- (e) When the program pattern has been linked, the program pattern setting specified in Execution pattern (buffer memory address: 272, 528) becomes valid.

- (5) Wait zone setting of program pattern
 - (a) A zone for the program to stay in the operating segment is set. This setting is useful when the measured value cannot reach the set value even after the processing time set to the segment has passed.
 - (b) By setting the wait zone, the Q62HLC stops the progress of the program control per segment, and stays in the segment without moving to the next segment until the measured value reaches the range of the wait zone. (This status is defined as wait status.)

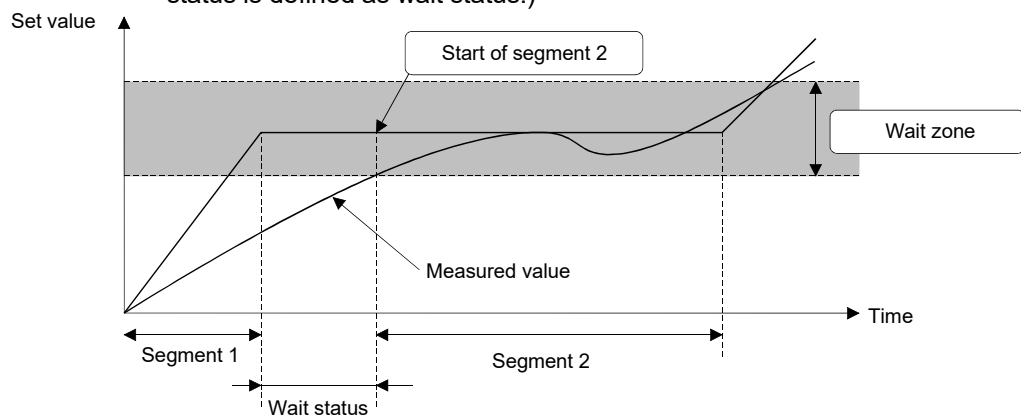

Wait status flag
(Buffer memory address: 261, 517)



- (c) The wait zone is set to the zone where the setting value of the wait zone is divided into the plus side and the minus side for the set value.
For example, in the case where the set value is 100°C and the setting value of the wait zone is 10°C, the actual wait zone will be 90 to 110°C.
- (d) If Command advancing (buffer memory address: 202, 218) is set to on in wait status, this setting is cancelled, the advancing operation is performed, and the control starts from the next segment.
- (e) The setting range is 0 to full-scale.
However, when 0 is set, it will be "No wait zone".
- (f) When the program pattern has been linked, the wait zone setting of the executing program pattern is valid for the wait zone setting.
- (g) The wait status can be checked in Wait status flag (buffer memory address: 261, 517).
- (6) Segment set value (SV) setting
- (a) The set value of the segment 1 to 16 is set.
The default value is 0.
- (b) The setting range is within the input range.
Set a value that satisfies the following condition in Upper/lower setting limiter (buffer memory address: 55, 56, 87, 88):
- Lower setting limiter \leq Set value (SV) setting of the segment n \leq Upper setting limiter
- (c) When the segment n is a number after the final segment, the set value (SV) setting of the segment n is not used for control. Note, however, that the set value (SV) setting of the segment n must satisfy the condition (b) even if not used for control.
- (d) If the value set does not satisfy the condition (b) or (c) when Setting change command (YnB) is turned off and on, a write error occurs. Then Error flag (Xn2) turns on and the error code 4 is stored to Error code (buffer memory address: 0).
- (7) Segment time scale
- (a) The time scale (execution time) of the segment 1 to 16 is set.
The default value is 0.
- (b) The time unit is set in Time scale (buffer memory address: 274, 530).
- (c) The setting range is 0 to 30000.
- (8) Segment Zone PID data No.
- (a) The zone PID data used in the segment 1 to 16 is set.
The default value is 0.
- (b) The setting range is 0 to 8.
When 0 is set, however, the zone PID data of the zone including the current set value is automatically selected.

3.5.69 Set value at program control start (SV_PCS) setting (buffer memory address: 501, 757: Un\G501, Un\G757)

This setting is available only in the setting mode. However, when the parameter change in program control function is enabled, this setting can be changed in the operation mode also. For details on the parameter change in program control function, refer to Section 3.2.18.

To activate the change, turn on Setting change command (YnB).

(1) Use this area for the following.

To set the set value (SV) at the start of program control when:

- SV start is set in Start mode (buffer memory address: 273, 529).
- PV start 3 (time shortened/find type) is set in Start mode (buffer memory address: 273, 529), and no point matches the measured value (PV) at the start of program control is found.

(2) The setting range is within the input range.

Set a value that satisfies the following condition in Upper/lower setting limiter (buffer memory address: 55, 56, 87, 88):

- Lower setting limiter \leq Set value at program control start (SV_PCS) setting \leq Upper setting limiter

The condition above must be also satisfied even if Start mode (buffer memory address: 273, 529) is set to Zero start, PV start 1 (time fixed), or PV start 2 (time shortened).

If the value set does not satisfy the condition above, a write error occurs. Then Error flag (Xn2) turns on and the error code 4 is stored to Error code (buffer memory address: 0).

4 PROCEDURES AND SETTINGS BEFORE SYSTEM OPERATION

The following describes the procedure prior to the Q62HLC operation, the name and setting of each part of the Q62HLC, and wiring method.

4.1 Handling Precautions

The following are the precautions for handling the Q62HLC.

- (1) Do not drop the module casing or connector, or do not subject it to strong impact.
- (2) Do not remove the PCB of each module from its case. Doing so can cause failure of the module.
- (3) Prevent foreign matter such as dust or wire chips from entering the module. Such foreign matter can cause a fire, failure, or malfunction.
- (4) A protective film is attached to the top of the module to prevent foreign matter, such as wire chips, from entering the module during wiring. Do not remove the film during wiring.
Remove it for heat dissipation before system operation.
- (5) Tighten the screws such as module fixing screws within the following ranges. Undertightening can cause short circuit, failure, or malfunction.

Screw	Tightening torque range
Module fixing screw*1 (M3 screw)	0.36 to 0.48N·m
Terminal block screw (M3 screw)	0.42 to 0.58N·m
Terminal block mounting screw (M3.5 screw)	0.66 to 0.89N·m
FG terminal screw (M3 screw)	0.42 to 0.58N·m

*1: The module can be easily fixed onto the base unit using the hook at the top of the module.

However, it is recommended to secure the module with the module fixing screw if the module is subject to significant vibration.

- (6) To mount the module, while pressing the module mounting lever located in the lower part of the module, fully insert the module fixing projection(s) into the hole(s) in the base unit and press the module until it snaps into place.
Incorrect mounting may cause malfunction, failure or drop of the module.
When using the programmable controller in an environment of frequent vibrations, fix the module with a screw.

4.2 Procedures before Operation

Follow the instructions below to operate the Q62HLC.

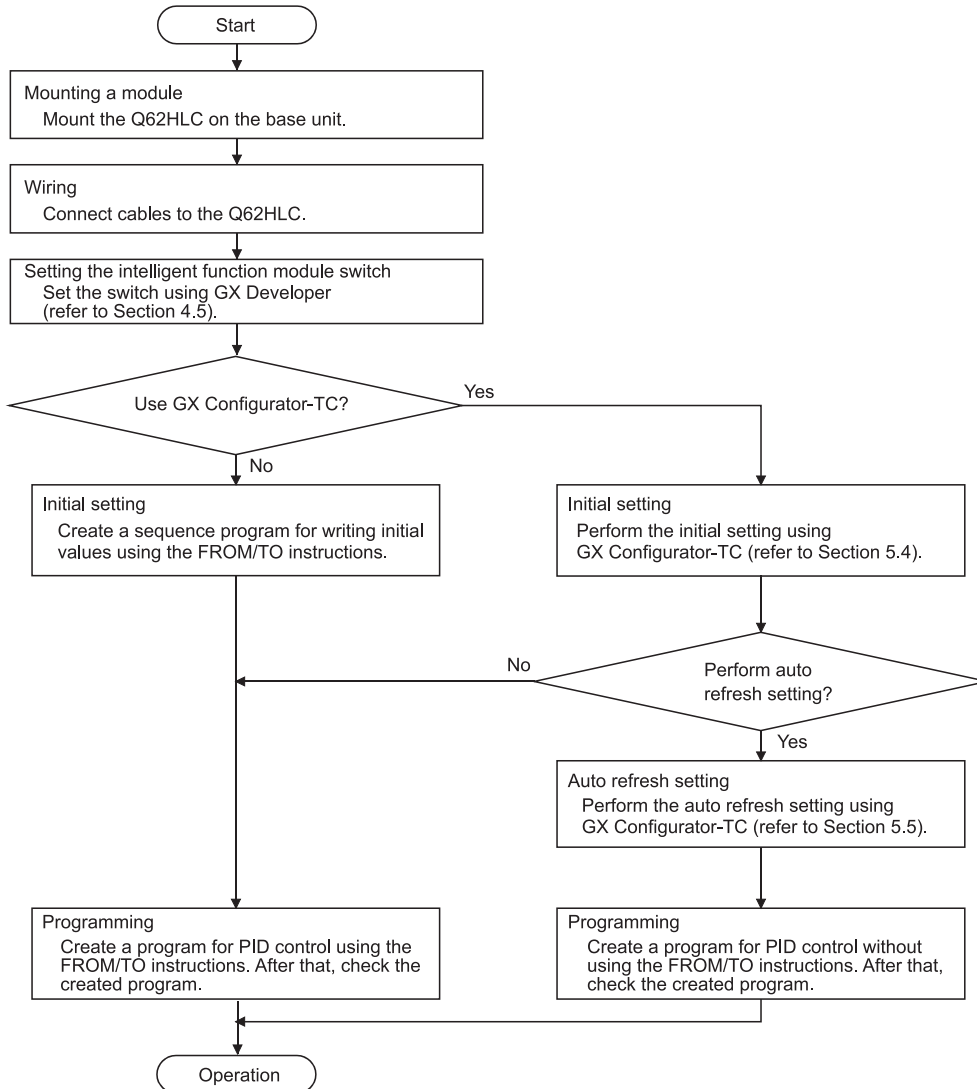

POINT

When executing temperature control as a temperature sensor, perform warmup operation about 5 minutes before starting operation to make temperature compensation properly.

4.3 Part Names

This section explains the names of the Q62HLC parts.

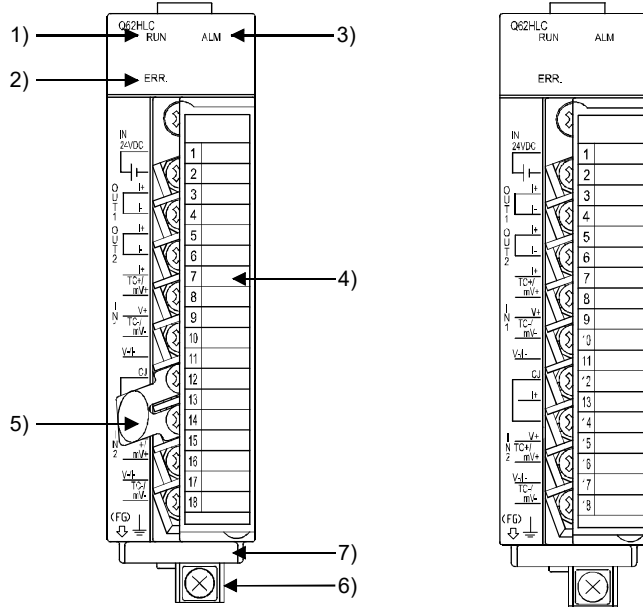

[Without a cold junction temperature compensation resistor]

No.	Name	Application
1)	RUN LED	Indicates the operating status of the Q62HLC. On: Operating normally. Off: 5V power is off, watchdog timer error occurred, or changing online module is allowed.
2)	ERR. LED	Indicates the error status of the Q62HLC. On : Hardware failure (Includes the case of cold junction temperature compensation resistor is not connected) Flashing : Write data error occurring*1 When auto tuning is abnormally completed Off : Operating normally.
3)	ALM LED	Indicates the alert status of the Q62HLC. On : Alert occurring Flashing : Measured value (PV) came out of measured temperature range. Loop disconnection was detected. Sensor is not connected*2. Off : Alert not occurring
4)	Terminal block	Used for input to various sensors, current output, and external power supply.
5)	Cold junction temperature compensation resistor	Used when cold junction temperature compensation is made.
6)	FG terminal	Terminals for frame ground
7)	Serial number plate	Indicates the serial No. of the Q62HLC.

*1: For details, check the error code (refer to Section 8.1).

*2: An alert may not be detected depending on the input range used. For details, refer to Section 3.1.2.

(1) Terminal number and signal name

Terminal No.	Signal name		Description	
1	24VDC+		24VDC+external power supply for current output	
2	24VDC-		24VDC- external power supply for current output	
3	OUT1	I +	CH1	Current output+
4		I -		Current output-
5	OUT2	I +	CH2	Current output+
6		I -		Current output-
7	IN1	I +	CH1	Current input+
8		TC+/mV+		Thermocouple/micro voltage input+
9		V+		Voltage input+
10		TC-/mV-		Thermocouple/micro voltage input-
11		V-/I-		Voltage/current input-
12	CJ		Cold junction temperature compensation resistor	
13	IN2	I+	CH2	Current input+
14	CJ		Cold junction temperature compensation resistor	
15	IN2	V+	CH2	Voltage input+
16		TC/mV+		Thermocouple/micro voltage input+
17		V-/I-		Voltage/current input-
18		TC-/mV-		Thermocouple/micro voltage input-

4.4 Wiring

This section describes wiring instructions and module connection examples.

4.4.1 Wiring precautions

External wiring must be noise-resistant as one of the conditions to fully exhibit the Q62HLC functions and configure a highly reliable system.

The instructions given below should be followed in wiring.

- (1) Use separate cables with the AC control circuit and the Q62HLC's external I/O signals to avoid the influence of AC side surges and induction.
- (2) Do not run the cables close to, or bundle them with, the main circuit and high-voltage cables and the load cables from other than the programmable controller. Always keep thermocouple/micro voltage signal line at least 100mm (3.94inch) away from the main circuit cables and AC control circuit. Fully keep them away from high-voltage cables and circuits which include higher harmonics, e.g. inverter load's main circuit. Failure to do so will make the cables susceptible to noise, surges and induction.
- (3) Ground a shielded cable to the FG terminal of the programmable controller. Note that it may be better to establish a ground on the external side depending on the external noise conditions.
- (4) To ensure that this product maintains EMC and Low Voltage Directives, refer to "COMPLIANCE WITH EMC AND LOW VOLTAGE DIRECTIVES" in this manual and carry out wiring.

4.4.2 External wiring

(1) Input

(a) Thermocouple input

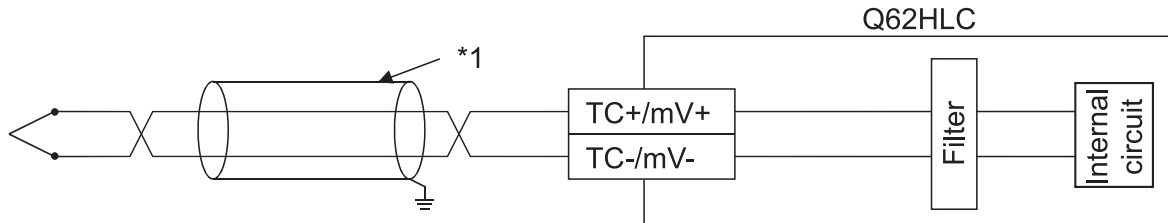

*1: Use a shielded compensating lead wire.

POINT

Use a compensating lead wire for a thermocouple cable. Otherwise, when there is a distance between the cold junction temperature compensation resistor and the end part of the thermocouple, the measured value (PV) may be abnormal due to the ambient temperature difference.

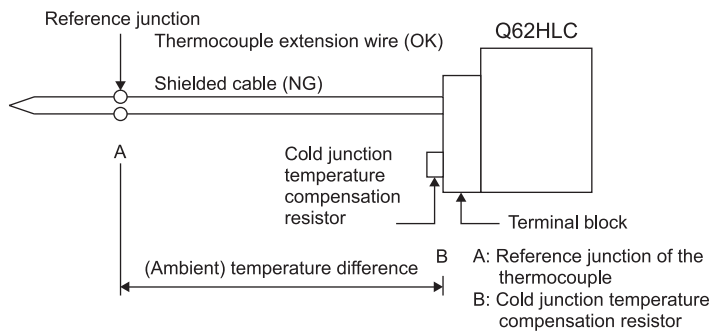

(b) Micro voltage input

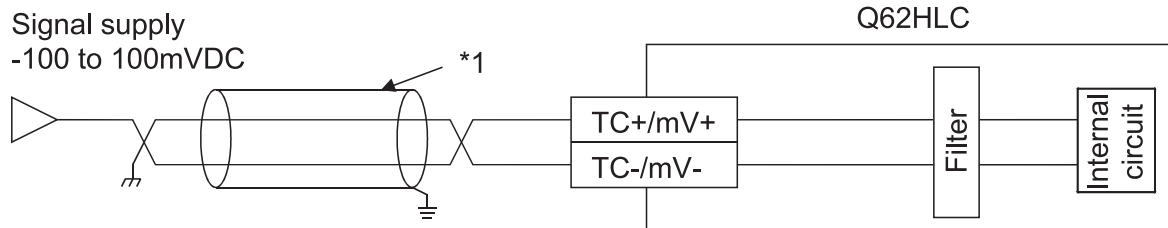

*1: Use a shielded cable.

(c) Voltage input

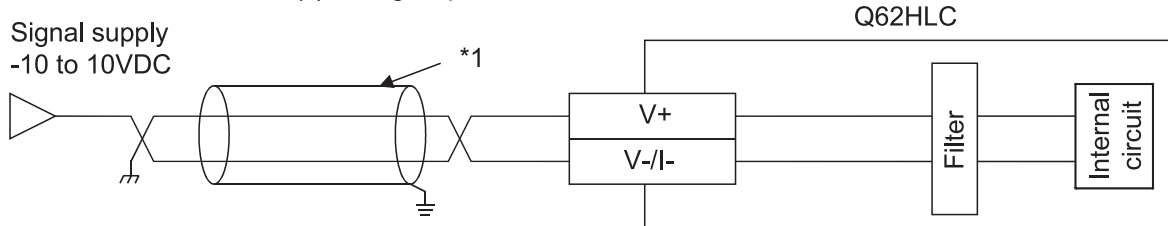

*1: Use a shielded cable.

(d) Current input

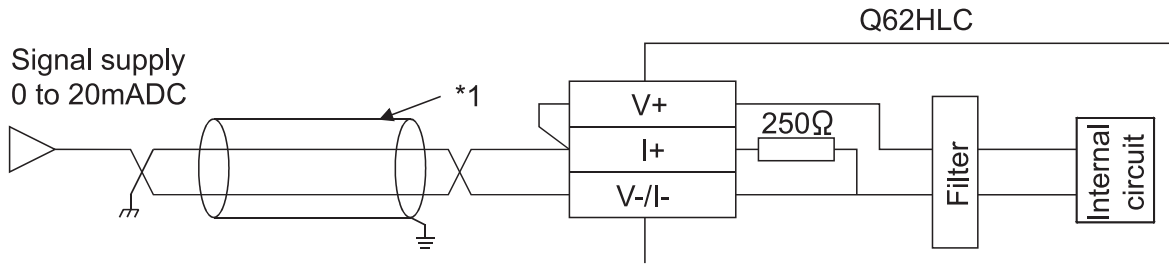

*1: Use a shielded cable.

(2) Output

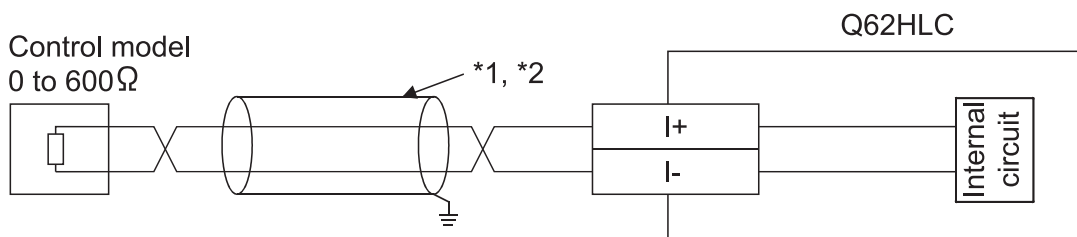

*1: Use a shielded cable.

*2: Separate the wiring of each channel between the control devices and Q62HLC. If not, the current cannot be output correctly.

(3) External power supply

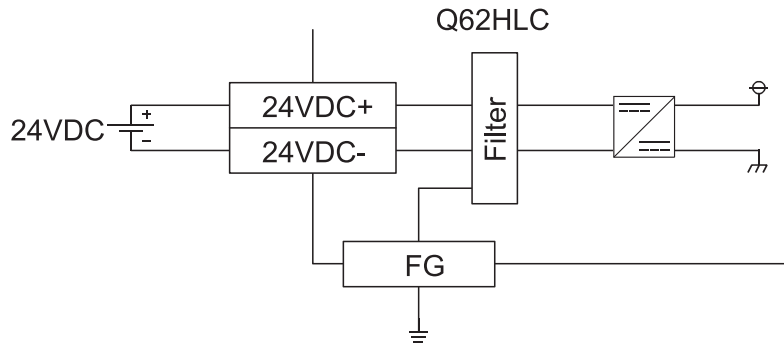

REMARKS

For saving an installation space, when wiring to a FG terminal is difficult, install a FG terminal L-shaped bracket.

4.5 Intelligent Function Module Switch Setting

This section explains the intelligent function module switch settings.

Configure intelligent function module switch settings with I/O assignment setting on GX Developer.

Using intelligent function module switch settings, the Q62HLC output status can be set when an error stop occurred in the programmable controller CPU.

For setting details, refer to Section 3.2.11.

(1) Setting items

Five switches (switch numbers 1 to 5) are available for the intelligent function module and they are set with 16 bit data.

If the switches for the intelligent function module are not set, the default value of 0 is used for switches 1 to 5.

	Setting items	
Switch 1		Output setting for CPU stop error 0 : CLEAR Other than 0 : HOLD
Switch 2*1	Control status when switching to program control 1 : Switch with executing control Other than 1 : Switch with suspending control	
Switch 3*2		
Switch 4	Use prohibited (fixed to 0)	
Switch 5	Use prohibited (fixed to 0)	

*1: The Q62HLC with production information (first five digits) of "10022" or later, or the serial number (first five digits) of "10011" or later is compatible. (For the checking method of production information and serial number, refer to Section 2.3.)

When a Q62HLC incompatible with this setting is used, set 0.

*2: The Q62HLC with serial number (first five digits) of "13102" or later is compatible. (For the checking method of serial number, refer to Section 2.3.)

When a Q62HLC incompatible with this setting is used, set 0.

(2) Operating procedure

Start the settings with GX Developer I/O assignment setting window.

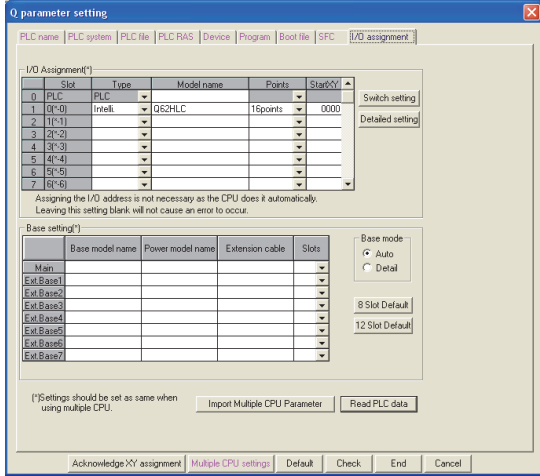

(a) I/O assignment window

Specify the following for the slot where the Q62HLC is mounted.

- Type : Select "Intelli."
- Model name : Enter the module's model name.
- Points : Select 16 points.
- Start XY : Enter the start I/O signal for the Q62HLC.

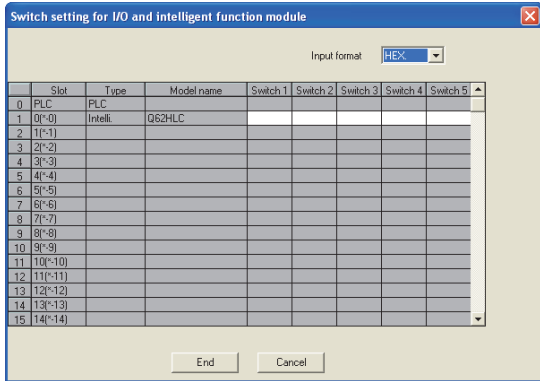

(b) Switch setting for I/O and intelligent function module

Click on **Switch Setting** on the I/O assignment setting window to display the window at the left and set switches 1 to 5.

The setting can easily be done if values are entered in hexadecimal. Change the input format to hexadecimal and enter values.

REMARKS

Do not set the "error-time output mode" and "hardware error-time CPU operation mode" in the intelligent function module detailed setting as they are invalid for the Q62HLC.

5 UTILITY PACKAGE (GX Configurator-TC)

5.1 Utility Package Functions

The following table lists the utility package functions.

Table 5.1 Utility Package (GX Configurator-TC) Function List

Function	Description	Reference
Initial setting	<p>(1) Configure initial setting for Q62HLC in each channel. Set the values of the items which require the initial setting.</p> <ul style="list-style-type: none"> •CH <input type="checkbox"/> Input range •CH <input type="checkbox"/> Sensor compensation value setting •CH <input type="checkbox"/> Primary delay digital filter setting •Cold junction temperature compensation mode setting •CH <input type="checkbox"/> Unused channel setting •CH <input type="checkbox"/> Upper setting limiter •CH <input type="checkbox"/> Lower setting limiter •CH <input type="checkbox"/> Setting change rate limiter •CH <input type="checkbox"/> Upper output limiter •CH <input type="checkbox"/> Lower output limiter •CH <input type="checkbox"/> Output variation limiter •CH <input type="checkbox"/> Alert 1 to 4 mode setting •CH <input type="checkbox"/> Alert set value 1 to 4 •Alert dead band setting •Alert delay count •CH <input type="checkbox"/> Loop disconnection detection judgment time •CH <input type="checkbox"/> Loop disconnection detection dead band •CH <input type="checkbox"/> Forward/reverse action setting •CH <input type="checkbox"/> Control mode •Approach range setting •Approach soak time setting •CH <input type="checkbox"/> Stop mode setting •PID continuation flag •CH <input type="checkbox"/> AT bias •CH <input type="checkbox"/> AT differential gap •CH <input type="checkbox"/> AT additional lag •CH <input type="checkbox"/> Set value (SV) setting •CH <input type="checkbox"/> Proportional band (P) setting •CH <input type="checkbox"/> Integral time (I) <p>(2) The data set the initial setting are registered to the programmable controller CPU parameters, and when the programmable controller CPU is set to the RUN mode, they are written automatically to the Q62HLC.</p>	<p>Section 5.4</p>

(To the next page)

(From the previous page)

Function	Description	Reference
Auto refresh setting	<p>(1) Set the Q62HLC buffer memory performed the auto refresh in each channel</p> <ul style="list-style-type: none"> •Error Code •CH <input type="checkbox"/> Measured value (PV) •CH <input type="checkbox"/> Manipulated value (MV) •CH <input type="checkbox"/> Set value monitor •CH <input type="checkbox"/> Approach flag •CH <input type="checkbox"/> Alert definition •CH <input type="checkbox"/> Alert set value 1 to 4 •CH <input type="checkbox"/> Set value (SV) setting •CH <input type="checkbox"/> Proportional band (P) setting •CH <input type="checkbox"/> Integral time (I) •CH <input type="checkbox"/> Derivative time (D) •CH <input type="checkbox"/> Loop disconnection detection judgment time •CH <input type="checkbox"/> Execution times monitor •CH <input type="checkbox"/> Execution pattern monitor •CH <input type="checkbox"/> Segment monitor •CH <input type="checkbox"/> Segment remaining time •CH <input type="checkbox"/> Zone PID monitor •CH <input type="checkbox"/> Wait status flag •CH <input type="checkbox"/> Hold status flag •CH <input type="checkbox"/> Advancing completion flag •CH <input type="checkbox"/> Pattern end output flag •CH <input type="checkbox"/> End status flag •Cascade monitor •CH <input type="checkbox"/> Scaling value <p>(2) The values stored in the Q62HLC buffer memory where the auto refresh setting was set are automatically read when the END instruction of the programmable controller CPU is executed.</p>	Section 5.5
Monitor/test	<p>Monitors and tests the buffer memory and I/O signals for the Q62HLC. The auto tuning function can be used.</p> <ul style="list-style-type: none"> •Error code •CH <input type="checkbox"/> Measured value (PV) •CH <input type="checkbox"/> Manipulated value (MV) •CH <input type="checkbox"/> Set value monitor •Cold junction temperature measured value •CH <input type="checkbox"/> Approach flag •CH <input type="checkbox"/> Input range •CH <input type="checkbox"/> Sensor compensation value setting •CH <input type="checkbox"/> Primary delay digital filter setting •CH <input type="checkbox"/> Unused channel setting •CH <input type="checkbox"/> PID constant read command from FeRAM •CH <input type="checkbox"/> PID constant read completion flag from FeRAM •CH <input type="checkbox"/> PID constant read failure completion flag from FeRAM •X00: Watchdog timer error flag •X01: Setting/operation mode status •X02: Error flag •X03: Module ready flag •X04:CH1 Auto tuning status •X05:CH2 Auto tuning status •X08: FeRAM write completion flag •X09: Default value write completion flag •X0A: FeRAM write failure flag •X0B: Setting change completion flag •X0C: CH1 Alert flag •X0D: CH2 Alert flag •Y01: Setting/operation mode command •Y02: Error reset command •Y04: CH1 Auto tuning start command •Y05: CH2 Auto tuning start command •Y08: FeRAM backup start command •Y09: Default setting registration start command •Y0B: Setting change command •Y0C: CH1 Forced PID control stop command •Y0D: CH2 Forced PID control stop command •CH <input type="checkbox"/> Upper setting limiter •CH <input type="checkbox"/> Lower setting limiter •CH <input type="checkbox"/> Setting change rate limiter •CH <input type="checkbox"/> Upper output limiter •CH <input type="checkbox"/> Lower output limiter •CH <input type="checkbox"/> Output variation limiter •CH <input type="checkbox"/> Alert definition Measured value (PV) is above upper limit of measurable range (up scale) Measured value (PV) is above lower limit of measurable range (down scale) Alert1 Alert2 Alert3 Alert4 Loop disconnection warning 	Section 5.6

(To the next page)

(From the previous page)

Function	Description	Reference
Monitor/test	<ul style="list-style-type: none"> •CH <input type="checkbox"/> Alert 1 mode setting •CH <input type="checkbox"/> Alert set value 1 •CH <input type="checkbox"/> Alert 2 mode setting •CH <input type="checkbox"/> Alert set value 2 •CH <input type="checkbox"/> Alert 3 mode setting •CH <input type="checkbox"/> Alert 3 set value •CH <input type="checkbox"/> Alert 4 mode setting •CH <input type="checkbox"/> Alert 4 set value •Alert dead band setting •Alert delay count •CH <input type="checkbox"/> Loop disconnection detection judgment time •CH <input type="checkbox"/> Loop disconnection detection dead band •CH <input type="checkbox"/> Forward/reverse action setting •CH <input type="checkbox"/> Control mode •CH <input type="checkbox"/> Control mode monitor •Approach range setting •Approach soak time setting •CH <input type="checkbox"/> Stop mode setting •PID continuation flag •Auto tuning • Setting/operation mode status • Setting/operation mode command •CH <input type="checkbox"/> Set value (SV) setting •CH <input type="checkbox"/> Proportional band (P) setting •CH <input type="checkbox"/> Integral time (I) •CH <input type="checkbox"/> Derivative time (D) •CH <input type="checkbox"/> Control response parameter •CH <input type="checkbox"/> MAN output setting •CH <input type="checkbox"/> Program control run/reset •CH <input type="checkbox"/> Hold command •CH <input type="checkbox"/> Command advancing •CH <input type="checkbox"/> Execution times monitor •CH <input type="checkbox"/> Execution pattern monitor •CH <input type="checkbox"/> Segment monitor •CH <input type="checkbox"/> Segment remaining time •CH <input type="checkbox"/> Zone PID monitor •CH <input type="checkbox"/> Wait status flag •CH <input type="checkbox"/> Hold status flag •CH <input type="checkbox"/> Advancing completion flag •CH <input type="checkbox"/> Pattern end output flag •CH <input type="checkbox"/> End status flag •Setting change command •CH <input type="checkbox"/> Execution pattern •CH <input type="checkbox"/> Start mode •CH <input type="checkbox"/> Time scale •CH <input type="checkbox"/> Zone <input type="checkbox"/> Upper limit Proportional band (P) setting Integral time (I) Derivative time (D) Control response parameter •CH <input type="checkbox"/> Program pattern <input type="checkbox"/> Final segment Pattern link Iteration Output time of pattern end Wait zone setting Segment <input type="checkbox"/> Set value (SV) setting Executing time Zone PID data No. •Cascade monitor •Cascade bias •Cascade gain •Cascade ON/OFF •CH <input type="checkbox"/> Scaling value •CH <input type="checkbox"/> Scaling range upper limit value •CH <input type="checkbox"/> Scaling range lower limit value •CH <input type="checkbox"/> Scaling width upper limit value •CH <input type="checkbox"/> Scaling width lower limit value 	Section 5.6

POINT

GX Configurator-TC does not support functions added to products with the serial number (first five digits) of "13102" or later. Set those functions using sequence programs or GX Works2 of version 1.73B or later. For the functions added to products with the serial number (first five digits) of "13102" or later, refer to Appendix 2 (2).

5.2 Installing and Uninstalling the Utility Package

For how to install or uninstall the utility package, refer to "Method of installing the MELSOFT Series" included in the utility package.

5.2.1 Handling precautions

The following explains the precautions on using the utility package.

(1) For safety

Since the utility package is add-in software for GX Developer, read "SAFETY PRECAUTIONS" and the basic operating procedures in the GX Developer Operating Manual.

(2) About installation

GX Configurator-TC is add-in software for GX Developer Version 4 or later. Therefore, GX Configurator-TC must be installed on the personal computer that has already GX Developer Version 4 or later installed.

(3) Screen error of the intelligent function module utility

Insufficient system resource may cause the screen to be displayed inappropriately while using the intelligent function module utility.

If this occurs, close the intelligent function module utility, GX Developer (such as a program and comment), and other applications, and then start GX Developer and the intelligent function module utility again.

(4) To start the intelligent function module utility

(a) In GX Developer, select "QCPU (Q mode)" for PLC series and specify a project. If any PLC series other than "QCPU (Q mode)" is selected, or if no project is specified, the intelligent function module utility will not start.

(b) Multiple intelligent function module utilities can be started.

However, [Open parameters] and [Save parameters] operations under [Intelligent function module parameter] are allowed for one Intelligent function module utility only. Only the [Monitor/test] operation is allowed for the other utilities.

(5) Switching between two or more Intelligent function module utility windows

When two or more Intelligent function module utility windows cannot be displayed side by side, select a screen to be displayed on the top of others using the task bar.



(6) Number of parameters that can be set in GX Configurator-TC

When multiple intelligent function modules are mounted, the number of parameter settings must not exceed the following limit.

When intelligent function modules are installed to:	Maximum number of parameter settings	
	Initial setting	Auto refresh setting
Q00J/Q00/Q01CPU	512	256
Q02/Q02H/Q06H/Q12H/Q25HCPU	512	256
Q02PH/Q06PH/Q12PH/Q25PHCPU	512	256
Q12PRH/Q25PRHCPU	512	256
Q00UJ/Q00U/Q01UCPU	512	256
Q02UCPU	2048	1024
Q03UD/Q04UDH/Q06UDH/ Q10UDH/Q13UDH/Q20UDH/ Q26UDH/Q03UDE/Q04UDEH/ Q06UDEH/Q10UDEH/Q13UDEH/ Q20UDEH/Q26UDEHCPU	4096	2048
Q50UDEH/Q100UDEHCPU	Use prohibited	Use prohibited
MELSECNET/H remote I/O station	512	256

For example, if multiple intelligent function modules are installed in the MELSECNET/H remote I/O station, configure the settings in GX Configurator-TC so that the number of parameter settings for all the intelligent function modules does not exceed the limit of the MELSECNET/H remote I/O station. Calculate the total number of parameter settings separately for the initial setting and for the auto refresh setting.

The number of parameters that can be set for one module in GX Configurator-TC is as shown below.

Target module	Initial setting	Auto refresh setting
Q62HLC	22 (Fixed)	52 (Max.)

Example) Counting the number of parameter settings in Auto refresh setting

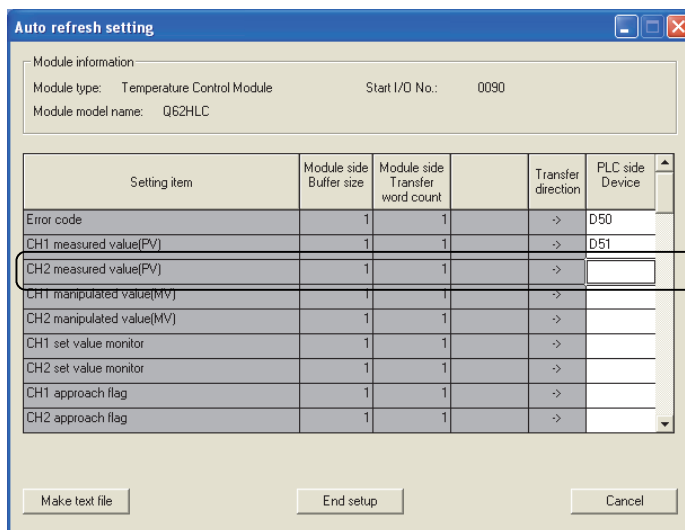

— This one row is counted as one setting. Blank rows are not counted. Count up all the setting items on this screen, and add the total to the number of settings for other intelligent function modules to get a grand total.

5.2.2 Operating environment

This section describes the operating environment of the personal computer that runs GX Configurator-TC.

Item	Description
Installation (Add-in) target* ¹	Add-in to GX Developer Version 4 (English version) or later* ²
Personal computer	A personal computer with any of the operating systems below
CPU	Refer to the next page "Operating system and performance required for personal computer".
Required memory	
Hard disk space	65 MB or more
For installation	10 MB or more
For operation	
Display	800 × 600 dots or more resolution* ³
Operating system	Microsoft® Windows® 95 Operating System (English version) Microsoft® Windows® 98 Operating System (English version) Microsoft® Windows® Millennium Edition Operating System (English version) Microsoft® Windows NT® Workstation Operating System Version 4.0 (English version) Microsoft® Windows® 2000 Professional Operating System (English version) Microsoft® Windows® XP Professional Operating System (English version) SP1 or later Microsoft® Windows® XP Home Edition Operating System (English version) SP1 or later Microsoft® Windows Vista® Home Basic Operating System (English version) Microsoft® Windows Vista® Home Premium Operating System (English version) Microsoft® Windows Vista® Business Operating System (English version) Microsoft® Windows Vista® Ultimate Operating System (English version) Microsoft® Windows Vista® Enterprise Operating System (English version) Microsoft® Windows® 7 Starter Operating System (English version)* ⁴ Microsoft® Windows® 7 Home Premium Operating System (English version)* ⁴ Microsoft® Windows® 7 Professional Operating System (English version)* ⁴ Microsoft® Windows® 7 Ultimate Operating System (English version)* ⁴ Microsoft® Windows® 7 Enterprise Operating System (English version)* ⁴

*1: Install GX Configurator-TC in GX Developer Version 4 or later in the same language.

GX Configurator-TC (Japanese version) cannot be installed in GX Developer (English version), and GX Configurator-TC (English version) cannot be installed in GX Developer (Japanese version).

*2: GX Configurator-TC cannot be installed in GX Developer Version 3 or earlier.

*3: When Windows Vista® or Windows® 7 is used, resolution of 1024 × 768 dots or more is recommended.

*4: When 32-bit Windows® 7 is used, add GX Configurator-TC Version 1.24AA or later in GX Developer Version 8.91V or later.

When 64-bit Windows® 7 is used, add GX Configurator-TC Version 1.24AA or later in GX Developer Version 8.98C or later.

Operating system and performance required for personal computer

Operating system	Performance required for personal computer	
	CPU	Memory
Windows® 95	Pentium® 133MHz or more	32MB or more
Windows® 98	Pentium® 133MHz or more	32MB or more
Windows® Me	Pentium® 150MHz or more	32MB or more
Windows NT® Workstation 4.0	Pentium® 133MHz or more	32MB or more
Windows® 2000 Professional	Pentium® 133MHz or more	64MB or more
Windows® XP	Pentium® 300MHz or more	128MB or more
Windows Vista®	Pentium® 1GHz or more	1GB or more
Windows® 7	Pentium® 1GHz or more	1GB or more (32-bit) 2GB or more (64-bit)

POINT

- The functions listed below are not available for Windows® XP, Windows Vista®, and Windows® 7.
If any of the following functions is attempted, this product may not operate normally.
 - Start of application in Windows® compatible mode
 - Fast user switching
 - Remote desktop
 - Large fonts (Details setting of Display Properties)
 - DPI setting other than 100%
 Also, GX Configurator-TC is not supported by 64-bit Windows® XP and 64-bit Windows Vista® .
- A user with USER authority or higher can access GX Configurator-TC for Windows Vista® and Windows® 7.
- When Windows® 7 is used, the following functions are not available.
 - Windows XP Mode
 - Windows Touch

5.3 Utility Package Operation

5.3.1 Common utility package operations

(1) Control keys

Special keys that can be used for operations of the utility package and their applications are listed in the table below.

Key	Application
Esc	Cancels the current entry in a cell. Closes the window.
Tab	Moves between controls in the window.
Ctrl	Used in combination with the mouse operation to select multiple cells for test execution.
Delete	Deletes the character where the cursor is positioned. When a cell is selected, clears all of the setting contents in the cell.
Back space	Deletes the character where the cursor is positioned.
↑ ↓ ← →	Moves the cursor.
Page Up	Moves the cursor one page up.
Page Down	Moves the cursor one page down.
Enter	Completes the entry in the cell.

(2) Data created with the utility package

The following data or files that are created with the utility package can be also handled in GX Developer. Figure 5.1 shows respective data or files are handled in which operation.

<Intelligent function module parameter>

- (a) This represents the data created in Auto refresh setting, and they are stored in an intelligent function module parameter file in a project created by GX Developer.

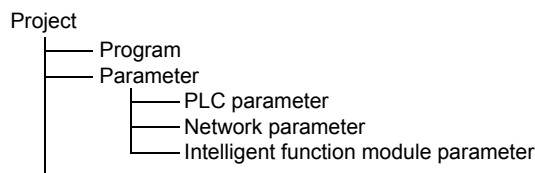

- (b) Steps 1) to 3) shown in Figure 5.1 are performed as follows:

- 1) From GX Developer, select:
[Project] → [Open project] / [Save] / [Save as]
- 2) On the intelligent function module selection window of the utility, select:
[Intelligent function module parameter] → [Open parameters] / [Save parameters]

- 3) From GX Developer, select:
 [Online] → [Read from PLC] / [Write to PLC] → "Intelligent function module parameters"
 Alternatively, from the intelligent function module selection window of the utility, select:
 [Online] → [Read from PLC] / [Write to PLC]

<Text files>

A text file can be created by clicking the **Make text file** button on the initial setting, Auto refresh setting, or Monitor/Test screen.
 Text files can be utilized to create user documents.

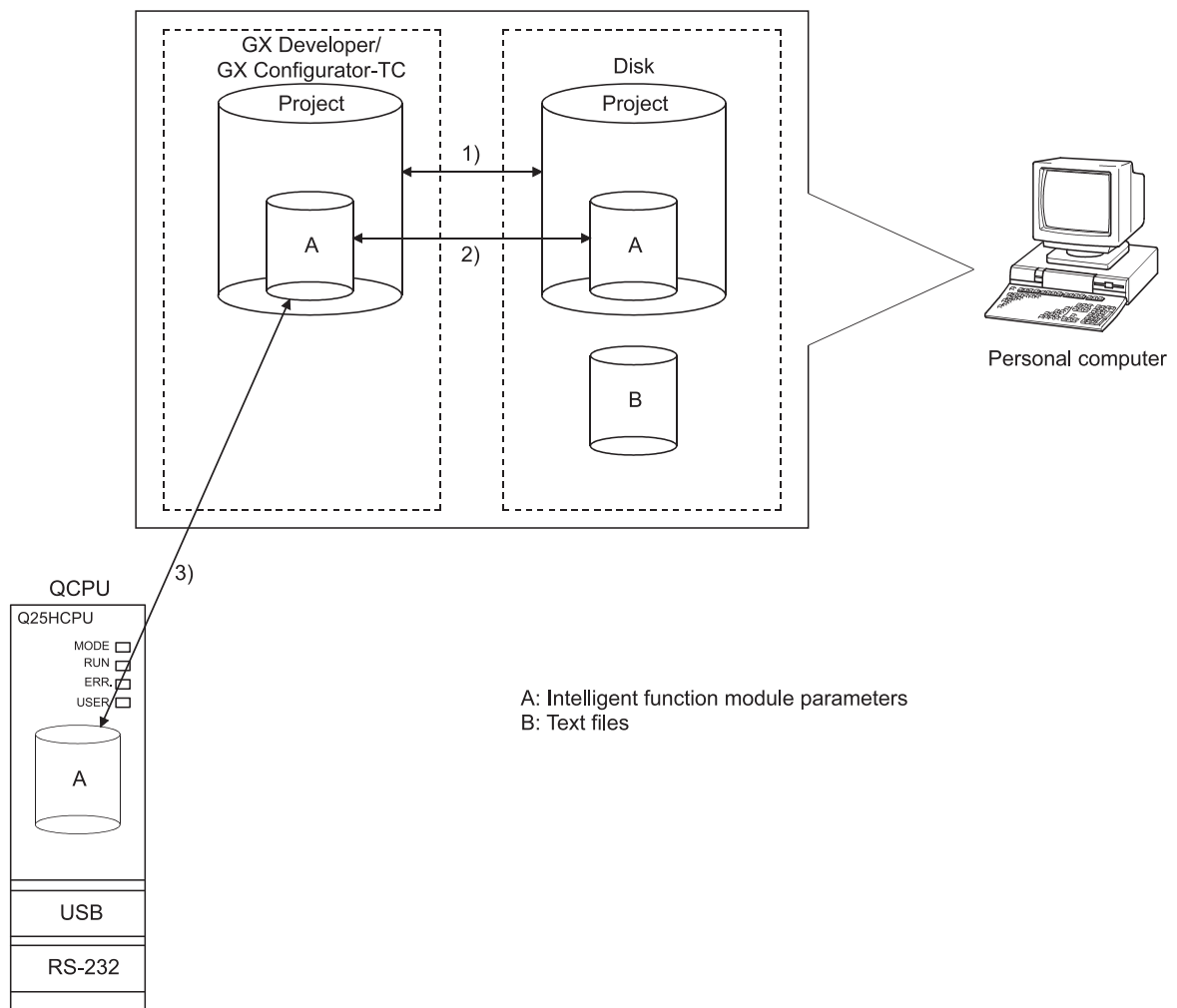
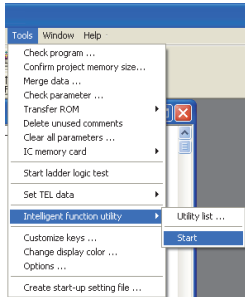

Figure 5.1 Correlation chart for data created with the utility package

5.3.2 Operation overview

GX Developer screen



[Tools] – [Intelligent function utility] – [Start]

Screen for selecting a target intelligent function module

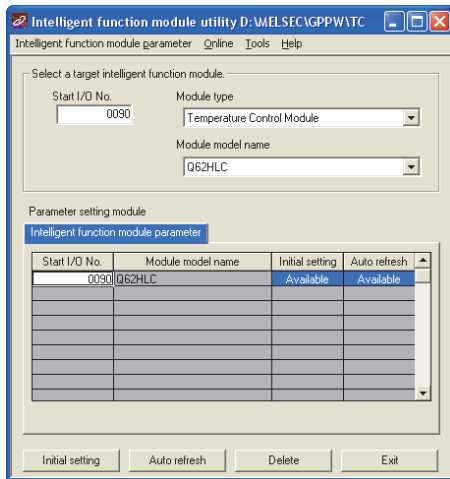

Refer to Section 5.3.3.

Enter "Start I/O No.", and select "Module type" and "Module model name".

Initial setting

Auto refresh

Initial setting screen

Auto refresh setting screen

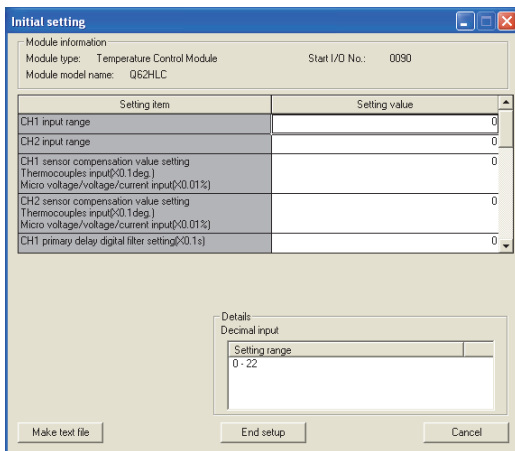

Refer to Section 5.4.

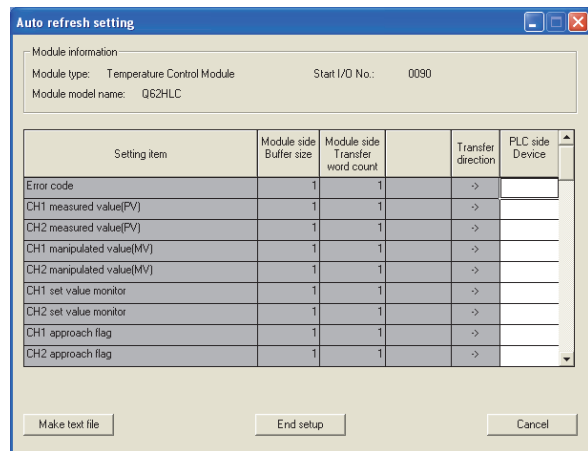

Refer to Section 5.5.

1) [Online] – [Monitor/Test]

Select monitor/test module screen

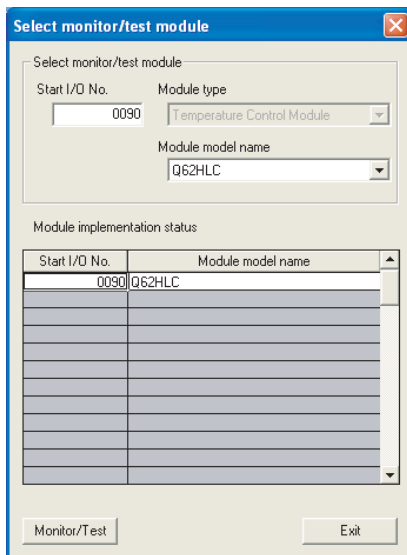

Monitor/Test Select a module to be monitored/tested.

Monitor/Test screen

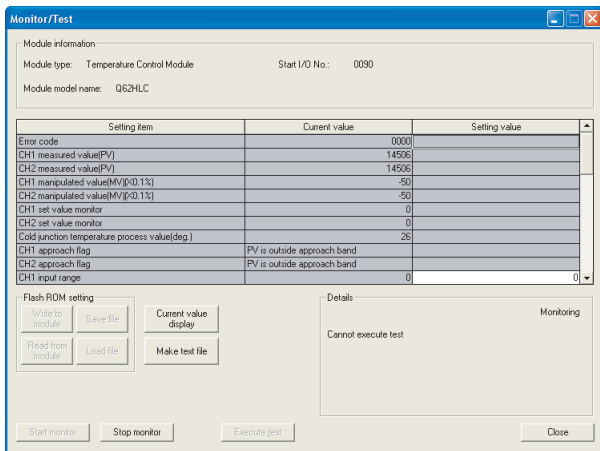

Refer to Section 5.6.

5.3.3 Starting the intelligent function module utility

[Operating procedure]

Intelligent function module utility is started from GX Developer.

[Tools] → [Intelligent function utility] → [Start]

[Setting screen]

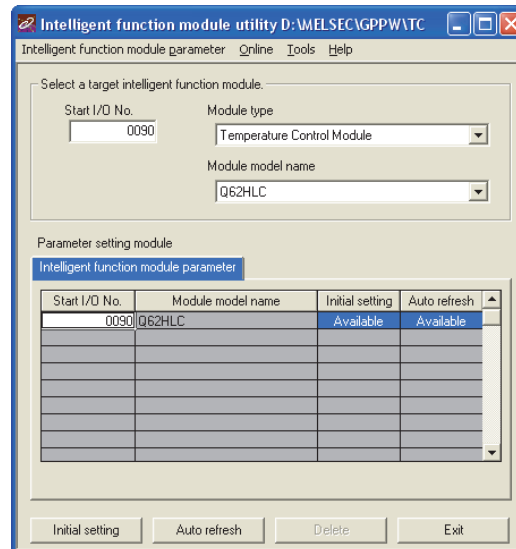

[Explanation of items]

(1) Activation of other windows

Following screens can be displayed from the intelligent function module utility window.

(a) Initial setting screen

"Start I/O No."^{*1} → "Module type" → "Module model name" →

Initial setting

(b) Auto refresh setting window

"Start I/O No."^{*1} → "Module type" → "Module model name" →

Auto refresh

(c) Select monitor/test module window

[Online] → [Monitor/Test]

*1: Enter the start I/O No. in hexadecimal.

(2) Command buttons

Delete Deletes the initial settings and auto refresh setting of the selected module.

Exit Closes this window.

(3) Menu bar

(a) Intelligent function module's parameter items

Intelligent function module parameters of the project opened by GX Developer are handled.

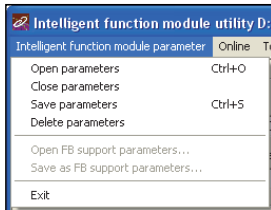

[Open parameters] : Reads a parameter file.

[Close parameters] : Closes the parameter file. If any data are modified, a dialog asking for file saving will appear.

[Save parameters] : Saves the parameter file.

[Delete parameters] : Deletes the parameter file.

[Exit] : Closes this window.

(b) Online menu

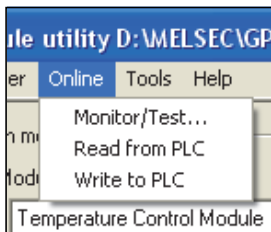

[Monitor/Test] : Activates the Select monitor/test module window.

[Read from PLC] : Reads intelligent function module parameters from the CPU module.

[Write to PLC] : Writes intelligent function module parameters to the CPU module.

POINT

(1) Saving intelligent function module parameters in a file

Since intelligent function module parameters cannot be saved in a file by the project saving operation of GX Developer, save them on the shown module selection screen.

(2) Reading/writing intelligent function module parameters from/to a programmable controller using GX Developer

(a) Intelligent function module parameters can be read from and written into a programmable controller after having been saved in a file.

(b) Set a target programmable controller CPU in GX Developer: [Online] → [Transfer setup].

(c) When mounting the Q62HLC on a remote I/O station, use [Read from PLC] and [Write to PLC] of GX Developer.

(3) Checking the required utility

While the start I/O is displayed on the Intelligent function module utility setting screen, "*" may be displayed for the model name.

This means that the required utility has not been installed or the utility cannot be started from GX Developer.

Check the required utility, selecting [Tools] - [Intelligent function utility] - [Utility list...] in GX Developer.

5.4 Initial Settings

[Purpose]

Configure initial settings for operating the Q62HLC in each channel.

For the initial setting parameter types, refer to Section 5.1.

Setting parameters in the Initial setting window can omit parameter settings with sequence program.

[Operating procedure]

"Start I/O No.*1" → "Module type" → "Module model name" → **Initial setting**

*1: Enter the start I/O No. in hexadecimal.

[Setting screen]

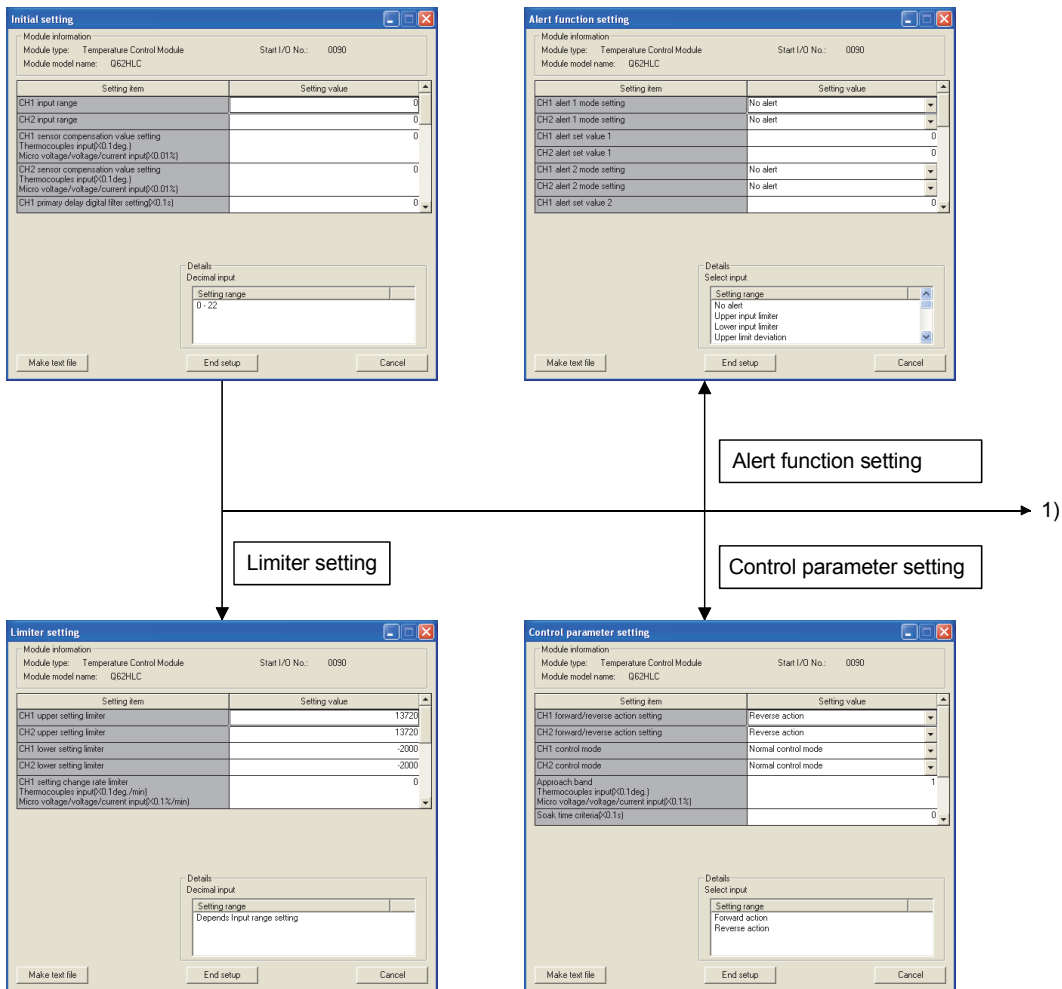

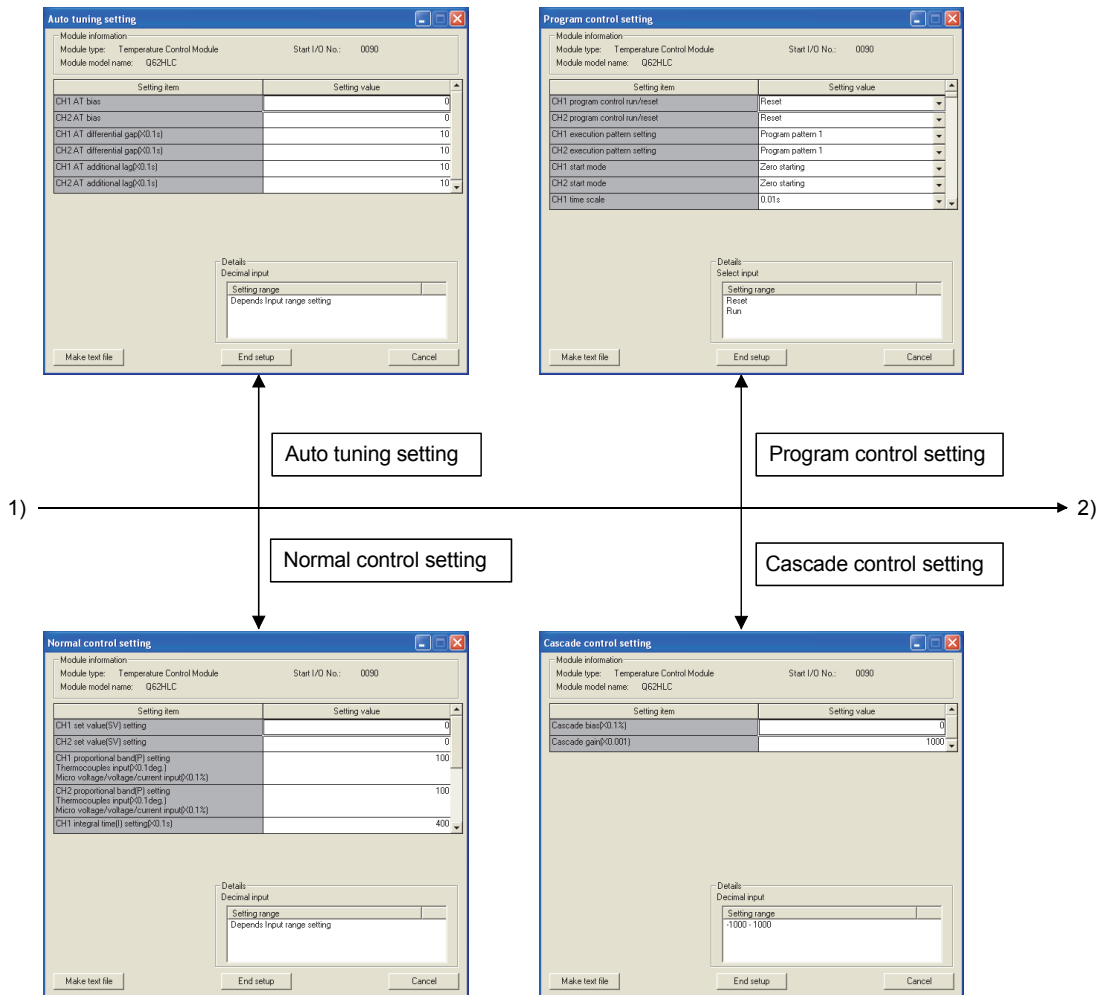

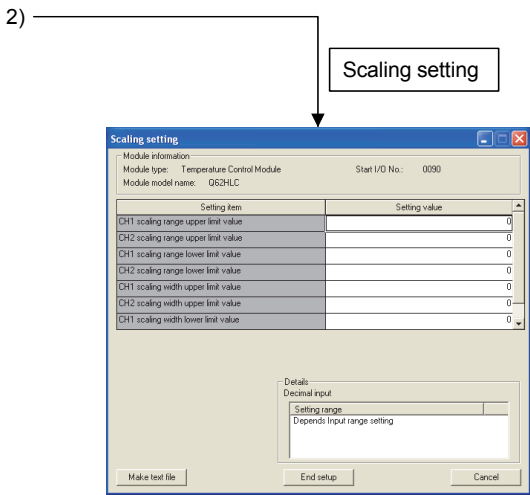

[Explanation of items]

(1) Command buttons

<input type="button" value="Make text file"/>	Creates a file containing the window data in the text file format.
<input type="button" value="End setup"/>	Saves the set data and ends the operation.
<input type="button" value="Cancel"/>	Cancels the setting and ends the operation.

POINT

Initial settings are stored in the intelligent module parameters. After being written to the CPU module, the initial setting is made effective by either (1) or (2).

(1) Cycle the RUN/STOP switch of the CPU module: STOP → RUN → STOP → RUN.

(2) With the RUN/STOP switch set to RUN, turn off and then on the power or reset the CPU module.

When writing the initial setting using a sequence program, the initial settings will be executed during the STOP → RUN of the CPU module and the value will be written in. So, execute the initial setting by the sequence program again during the STOP → RUN of the CPU module.

5.5 Auto Refresh Setting

[Purpose]

Configure the Q62HLC buffer memory for automatic refresh in each channel.
 For the automatic refresh setting types, refer to Section 5.1.
 This auto refresh setting eliminates the need for reading and writing by sequence programs.

[Operating procedure]

"Start I/O No.*1" → "Module type" → "Module model name" → Auto refresh

*1: Enter the start I/O No. in hexadecimal.

[Setting window]

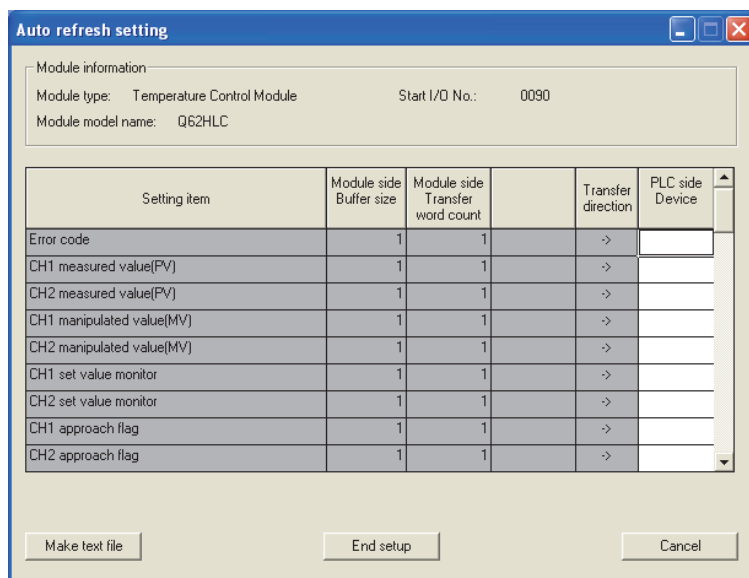

[Explanation of items]

(1) Items

- Module side Buffer size : Displays the buffer memory size of the setting item.
- Module side Transfer word count : Displays the number of words to be transferred.
- Transfer direction : "←" indicates that data are written from the programmable controller CPU to the buffer memory. "→" indicates that data are loaded from the buffer memory to the programmable controller CPU.
- PLC side Device : Enter a CPU module side device that is to be automatically refreshed.
Applicable devices are X, Y, M, L, B, T, C, ST, D, W, R, and ZR. When using bit devices, X, Y, M, L or B, set a number that can be divided by 16 points (examples: X10, Y120, M16, etc.).
Also, buffer memory data are stored in a 16-point area, starting from the specified device number. For example, if X10 is entered, data are stored in X10 to X1F.

(2) Command buttons

- Creates a file containing the window data in the text file format.
- Saves the set data and ends the operation.
- Cancels the setting and ends the operation.

POINT

The auto refresh settings are stored in an intelligent function module parameter file.

- (1) Cycle the RUN/STOP switch of the CPU module: STOP → RUN → STOP → RUN.
- (2) With the RUN/STOP switch set to RUN, turn off and then on the power or reset the CPU module.

5.6 Monitoring/Test

[Purpose]

Start the buffer memory monitoring/testing and I/O signals monitoring/testing from this screen.

[Operating procedure]

Select monitor/test module window → "Start I/O No.*1" → "Module type" → "Module model name" → **Monitor/test**

*1: Enter the start I/O No. in hexadecimal.

The window can also be started from System monitor of GX Developer Version 6 or later.

For details, refer to the GX Developer Operating Manual.

[Setting window]

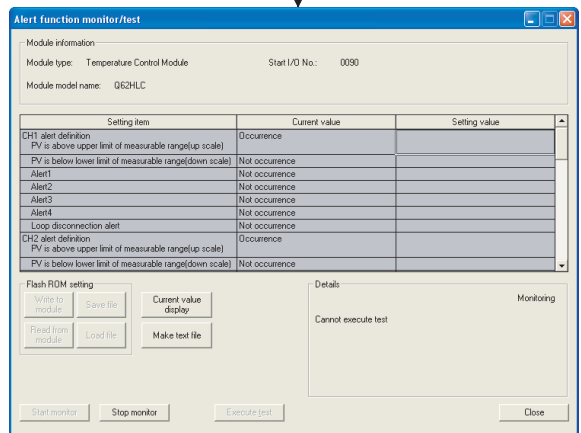
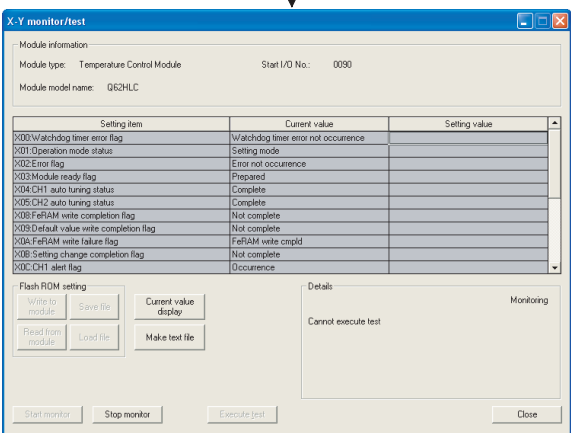
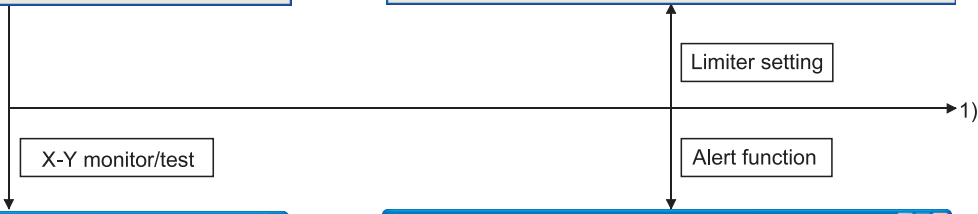
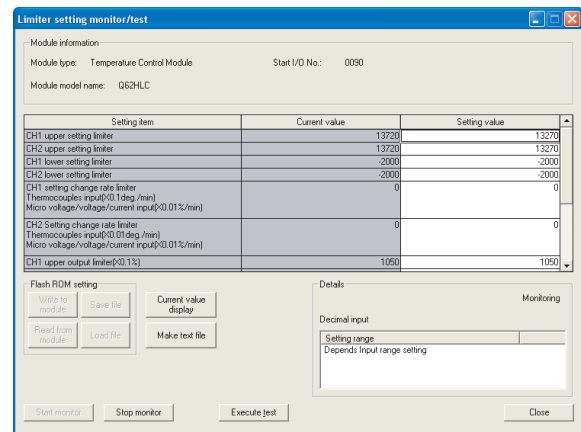
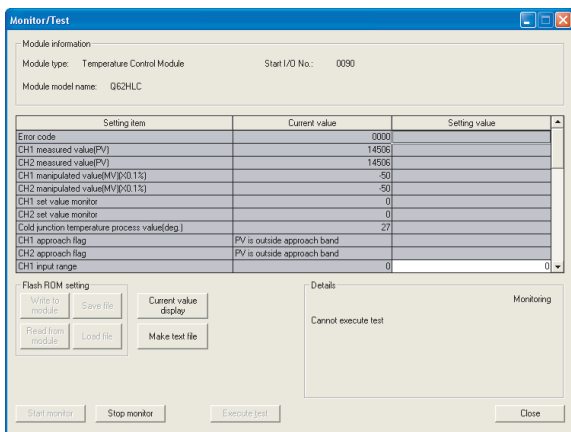

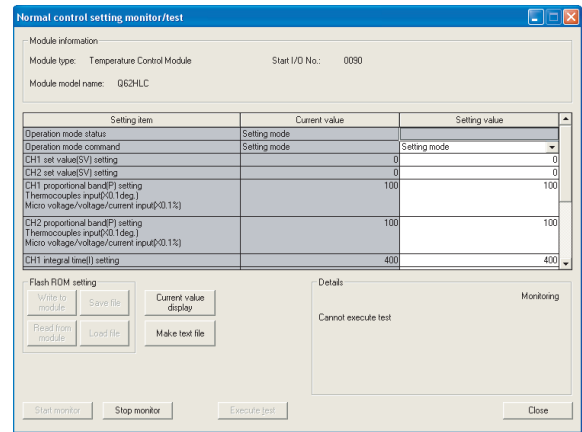
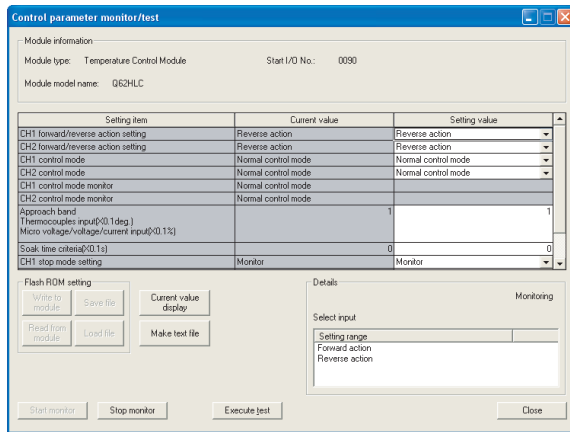

Control parameter

Normal control setting

1)

2)

Auto tuning

Manual control setting

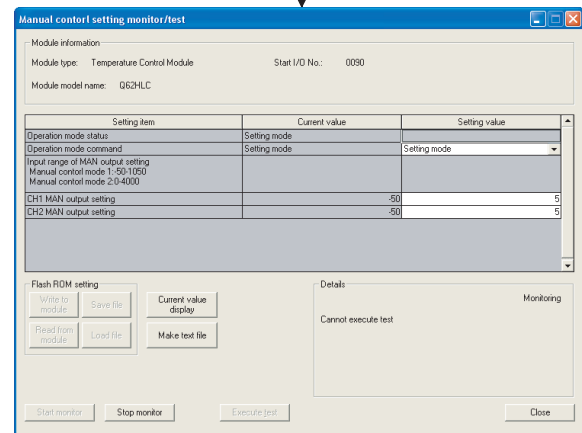
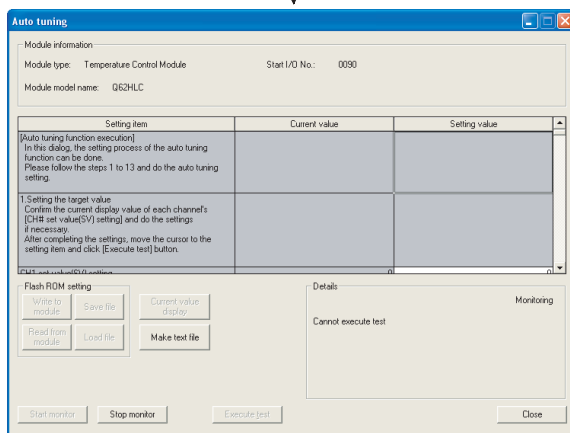

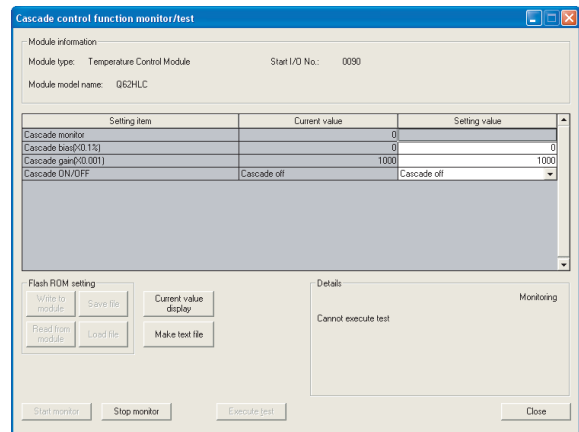
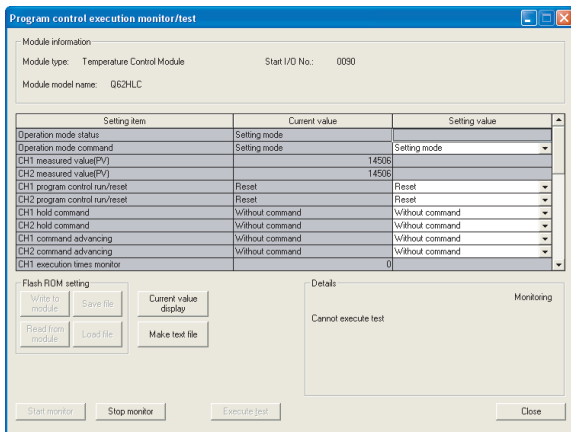

2) ←

Program control execution

Cascade control function

Program control setting

Scaling function

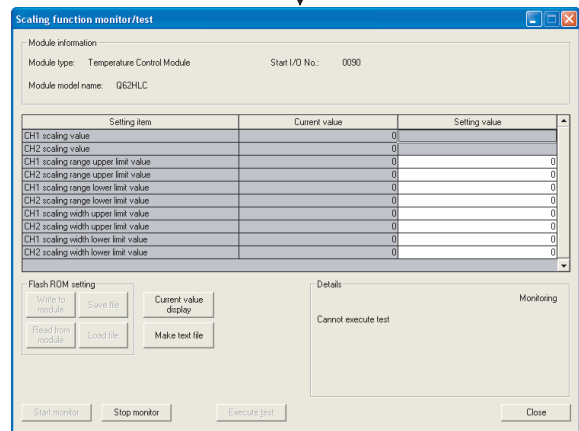
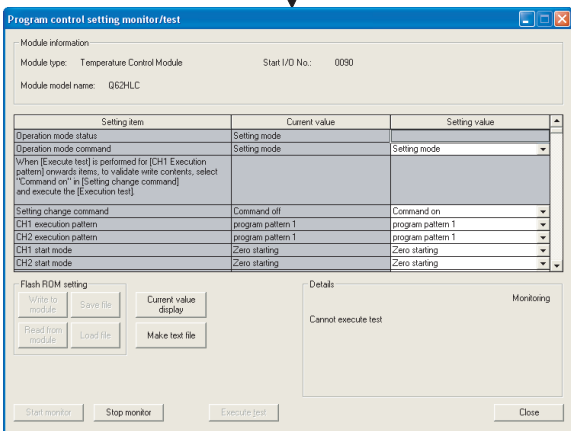

[Explanation of items]

(1) Items

Setting item : Displays I/O signals and buffer memory names.

Current value : Monitors the I/O signal states and present buffer memory values.

Setting value : Enters or selects values to be written into the buffer memory for test operation.

(2) Command buttons

Displays the current value of the item selected. (This is used to check the text that cannot be displayed in the current value field. However, in this utility package, all items can be displayed in the display fields).

Creates a file containing the window data in the text file format.

/

Selects whether or not to monitor current values.

Performs a test on the selected items. To select more than one item, select them while holding down the key.

Closes the currently open window and returns to the previous screen.

(3) Example of "Execute test"

The following explains the case of writing data to CH1 set value (SV) setting.

(a) Click and choose the set value field of CH1 set value (SV) setting.

(b) After entering a value, press the key.

Nothing is written to the Q62HLC at this point.

(c) Click on the field, of which setting value has been changed in step (b). (When multiple items have been changed in operation (b), select the setting (value) fields where setting values were changed, while holding down the key. Multiple fields can also be selected by dragging the mouse over them.)

(d) Click to execute the write operation.

Upon completion of writing, the written value appears in the current value field.

6 PROGRAMMING

This chapter describes the programs of the Q62HLC.

When applying any of the program examples introduced in this chapter to the actual system, verify the applicability and confirm that no problems will occur in the system control.

6.1 Programming Procedure

Create the programs for various controls to be executed on the Q62HLC in accordance with the following procedure.

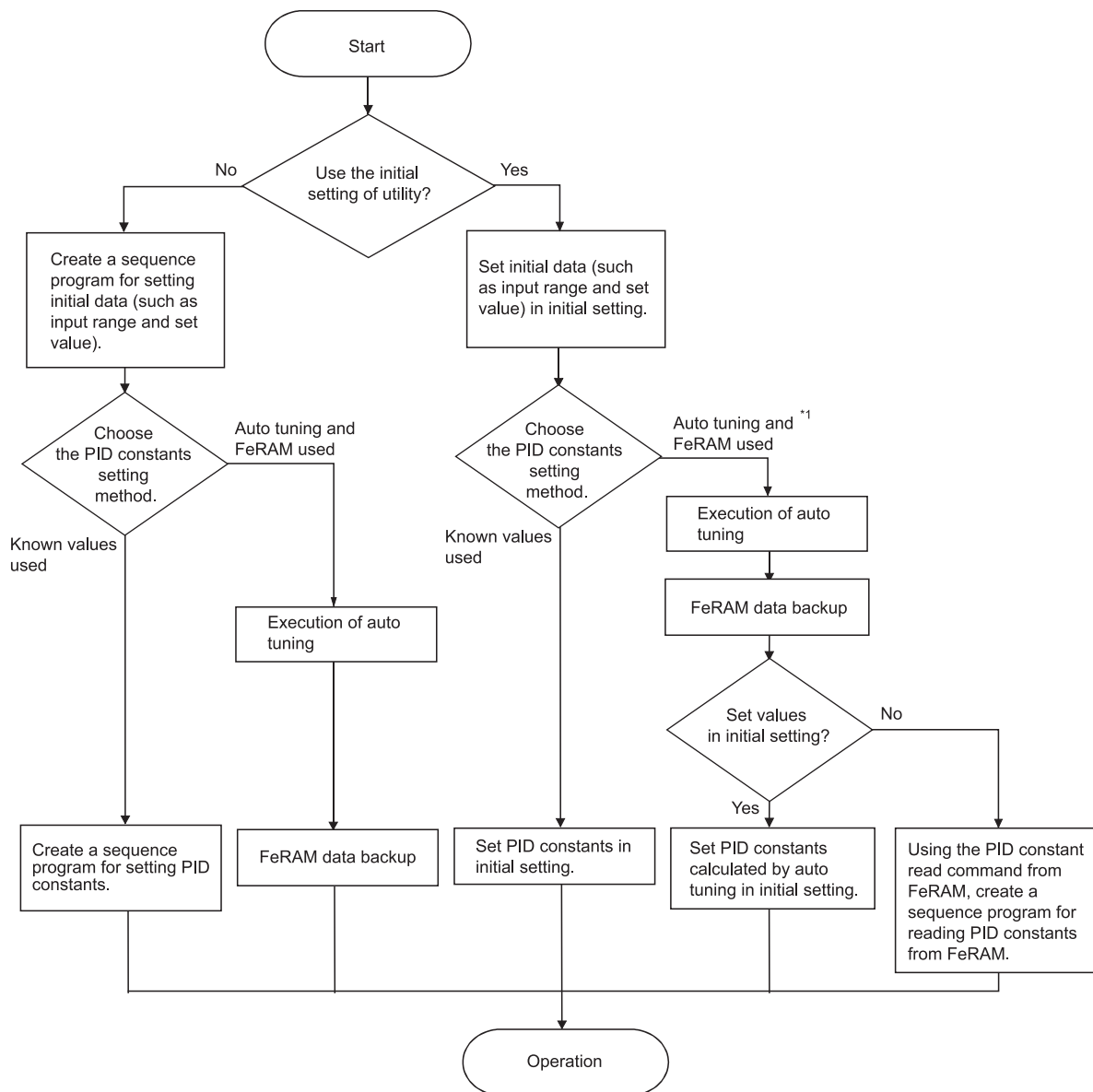

*1: If zone PID data are used for program control, execute the auto tuning for each zone.

6.2 For Use in Normal System Configuration

System configuration for program explanation

(1) System configuration

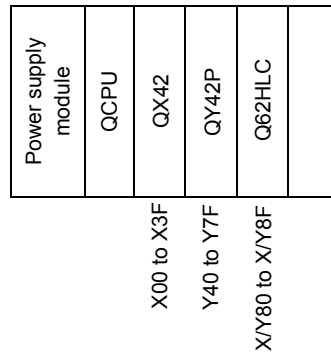

(2) Program conditions

The programs are written to control the temperature measured by the thermocouple (K: -200 to 1372 °C) connected to the channel 1.

- According to input signals, normal control/program control/manual control 2 (simplified analog I/O)/cascade control is executed.
- They include write data error code reading and error code resetting programs.

(3) Intelligent function module switch setting

Configure the intelligent function module switch setting as follows.

For details of the intelligent function module switch setting, refer to Section 4.5.

Switch setting for I/O and intelligent function module

Input format: HEX.

	Slot	Type	Model name	Switch 1	Switch 2	Switch 3	Switch 4	Switch 5
0	PLC	PLC						
1	0(*-0)	Input	QX42					
2	1(*-1)	Output	QX42P					
3	2(*-2)	Intelli.	Q62HLC	0000	0000			
4	3(*-3)							

(a) Devices used by user

Device	Function	Description
X0	Setting value write command	Sets the parameter to execute normal control and program control using CH 1 and writes into FeRAM.
X1	PID constant read command from FeRAM (when GX Configurator-TC is used)	Reads PID constant set by auto tuning from FeRAM.
	Auto tuning execution command (when GX Configurator-TC is not used)	Executes auto tuning for the specified set value. Operates only in the normal control mode.
X2	Error code reset command	Clears (0) error codes.
X3	Setting mode switching command	Switches into the setting mode by turning off then on.
X4	Normal control mode switching command	Switches into the normal control mode by turning off then on. Needs to set parameters for normal control before switching.
X5	Program control mode switching command	Switches into the program control mode by turning off then on. Needs to set parameters for program control before switching.
X7	Manual control mode 2 switching command	Switches into the manual control mode 2 by turning off then on. After the switching, the operation is performed by the values of manual output settings (X20 to X2F).
X8	Cascade control switching command	Switches into the cascade control mode by turning off then on. Needs to set parameters for cascade control before switching.
X11	Program control auto tuning execution command	Executes auto tuning for program control. ¹
X12	Program control pattern data setting command	Sets the pattern data for executing program control. ²
X15	Cascade control setting command	Sets parameters for executing cascade control. ³
X20 to X2F	Manual output setting	Specifies the manipulated value (MV) when manual control mode 2 is operated.
Y40 to Y4F	Error code output	Outputs error codes as BCD value.
Y50 to Y5F	Measured value output	Outputs measured value as BCD value.
Y60	FeRAM read failure output (when GX Configurator-TC is used)	Outputs when reading from FeRAM has failed.
	FeRAM write failure output (when GX Configurator-TC is not used)	Outputs when writing into FeRAM has failed.
D50	Error code	Stores error codes that are read out when the error has occurred.
D51	Measured value	Stores measured values that are read out.

When turning on the setting value write command X0, the parameters, which are set in this program example, are as follows.

- CH2 Unused channel setting : 1 (Unused. However, set "used" when used for cascade control. In this case, parameter is set to the same as CH1.)
- CH1 Input range : 0 (K: -200 to 1372°C)
- CH1 Alert 1 mode setting : 1 (UpLmt Input Alert)
- CH1 Alert set value 1 : 1800 (180°C)
- CH1 Set value setting : 800 (80°C)
- CH1 Upper setting limiter : 2000 (200°C)
- CH1 Lower setting limiter : 0 (0°C)

When program control is used, turn on X0 after turning on X12 (program control pattern data setting command).

*1: PID constants of zone 1 and zone 2 that are used for program control are set.

By turning on X11, the auto tuning is executed after switching into normal control mode. Then, PID constant of zone is set when the auto tuning ends.

*2: Before executing program control, the PID constants of zone 1 and zone 2 need to be set by the program control auto tuning (X11).

When program control is executed by the set pattern, it operates as follows.

Segment number	Setting value		
	Set value	Executing time	Zone PID data No.
Segment 1	1500 (150°C)	200 (200s)	2 (Zone 2)
Segment 2	1500 (150°C)	100 (100s)	2 (Zone 2)
Segment 3	500 (50°C)	100 (100s)	1 (Zone 1)
Segment 4	500 (50°C)	100 (100s)	1 (Zone 1)

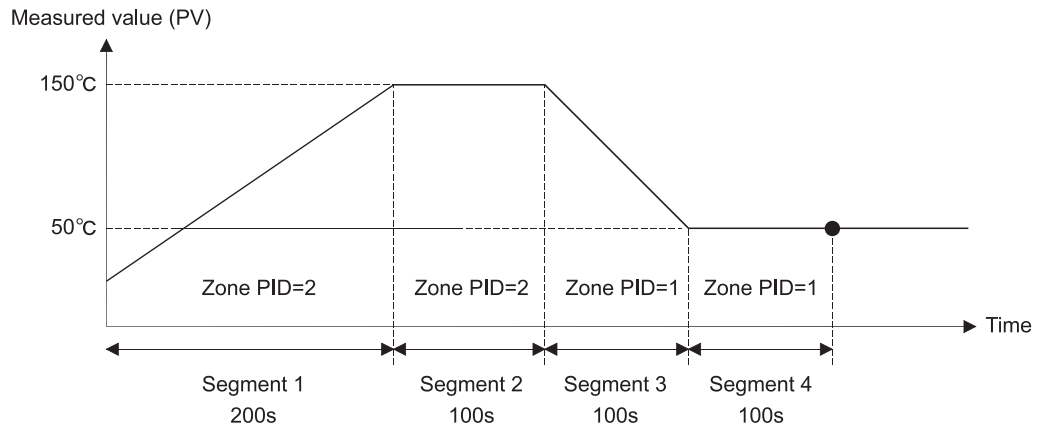

*3: After setting parameter by the cascade control setting command (X15), execute cascade control by turning on the cascade control switching command (X8).

In this program example, the parameter setting for cascade control and the other parameter settings (normal control, program control, and manual control 2) cannot be set at the same time.

After setting the parameter for cascade control, do not use the normal control mode switching command (X4), program control mode switching command (X5), and manual control mode 2 switching command (X7).

6.2.1 Program example using the utility package

(1) Operation of utility package

(a) Initial setting (refer to Section 5.4)

<When cascade control is not executed>

CH1 Input range "0"
 CH2 Unused channel setting "Not Used"

[Limiter setting]

CH1 Upper setting limiter "2000"
 CH1 Lower setting limiter "0"

[Alert function setting]

CH1 Alert 1 mode setting "Upper limit input"
 CH1 Alert set value 1 "1800"

[Normal control setting]

CH1 Set value (SV) setting "800"

[Program control setting]

CH1 Execution pattern "Program Pattern 1"
 CH1 Time scale "1s"

CH1 Program pattern 1

Final segment "4"
 Segment 1 Set value (SV) setting "1500"
 Segment 1 Executing time "200"
 Segment 1 Zone PID data No. "2"
 Segment 2 Set value (SV) setting "1500"
 Segment 2 Executing time "100"
 Segment 2 Zone PID data No. "2"
 Segment 3 Set value (SV) setting "500"
 Segment 3 Executing time "100"
 Segment 3 Zone PID data No. "1"
 Segment 4 Set value (SV) setting "500"
 Segment 4 Executing time "100"
 Segment 4 Zone PID data No. "1"

<When cascade control is executed>

CH1 Input range "0"
 CH2 Input range "0"
 CH1 Unused channel setting "Used"
 CH2 Unused channel setting "Used"

[Limiter setting]

CH1 Upper setting limiter "2000"
 CH1 Lower setting limiter "0"
 CH2 Upper setting limiter "2000"
 CH2 Lower setting limiter "0"

[Normal control setting]

CH1 Set value (SV) setting "1000"

[Cascade control setting]

Cascade bias....."-500"
 Cascade gain....."2000"

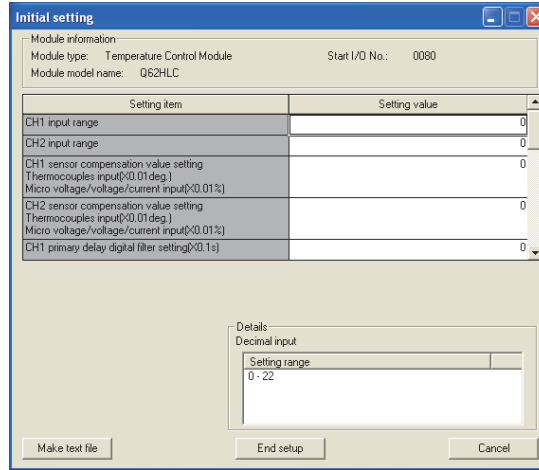

(b) Auto refresh setting (refer to Section 5.5)

Error code "D50"
 CH1 measured value (PV)..... "D51"

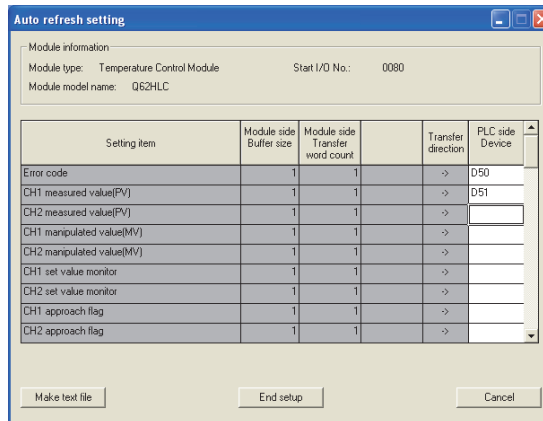

(c) Writing intelligent function module parameters (refer to Section 5.3.3)

Write the parameter values of the intelligent function module to the programmable controller CPU.

Perform this operation on the intelligent function module parameter setting module selection screen.

(d) Executing auto tuning by selecting [Online], [Monitor/test] from the menu (refer to Section 5.6)

Execute auto tuning following the procedure shown on the screen.

CH1 Automatic backup setting after AT of PID constants "Yes"

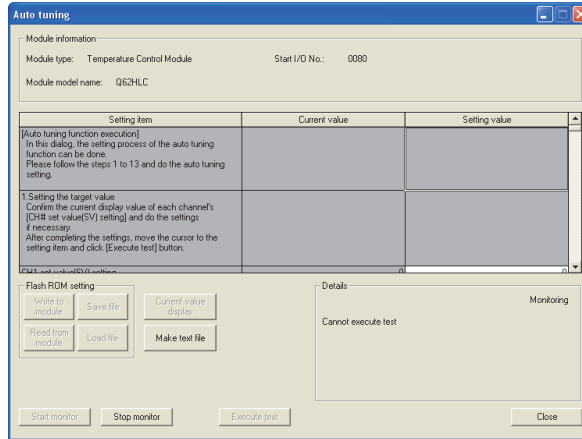

After completing auto tuning, change the following setting items.

- Operation mode command: [Operation mode] to [Setting mode]
- CH1 Auto tuning: [Start] to [Stop]

(2) Program example

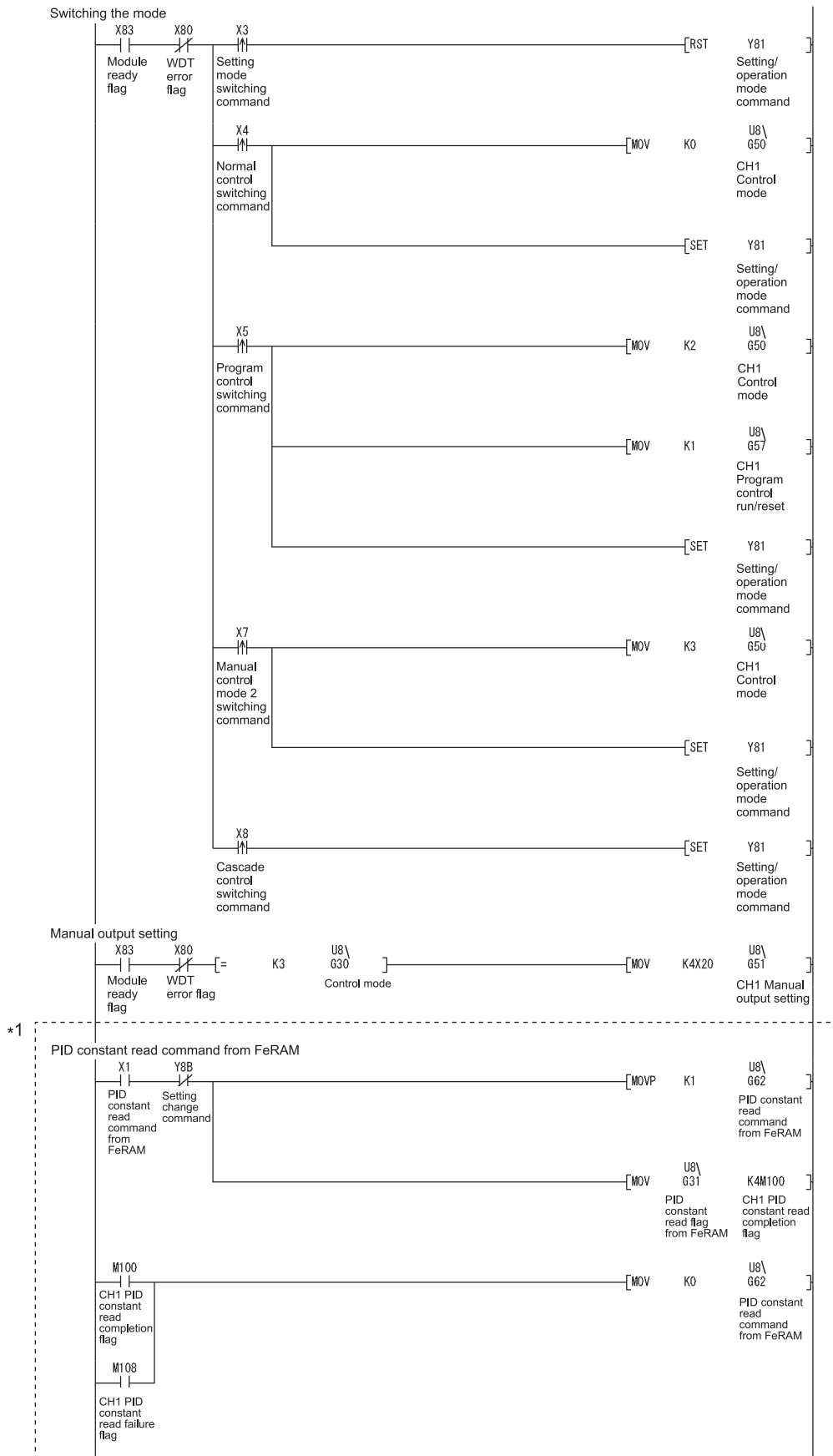

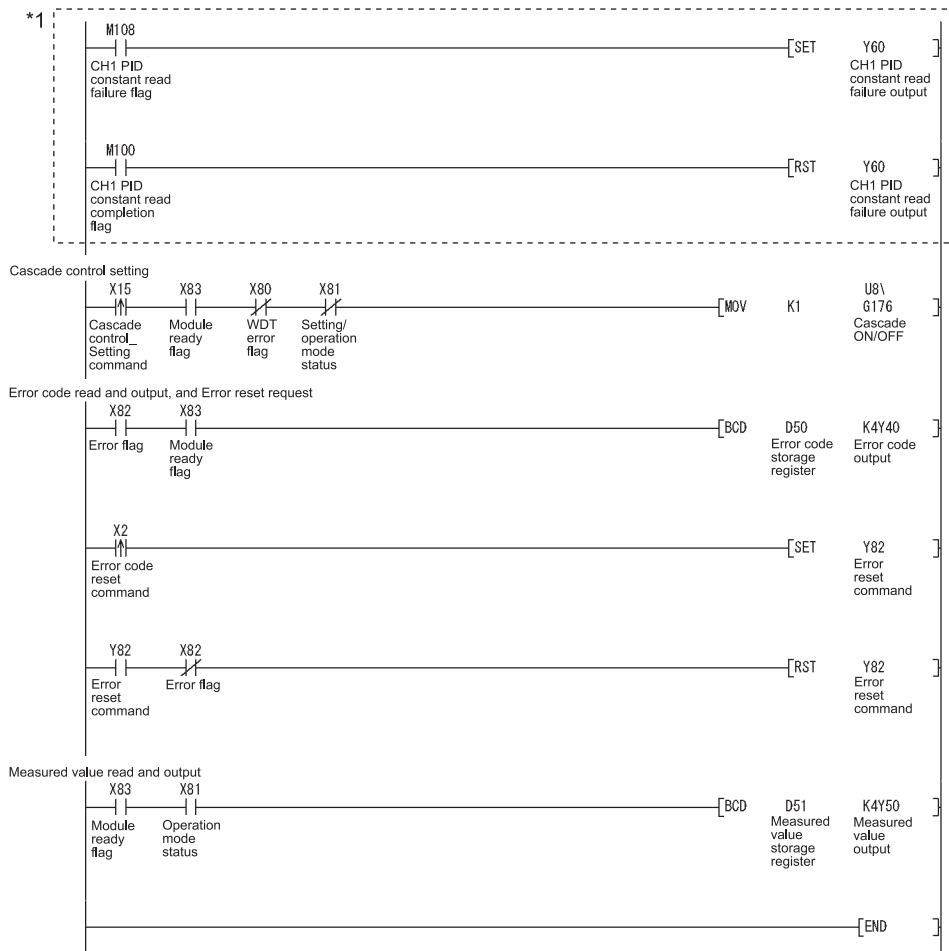

*1: The program in this area is executed when the PID constants in FeRAM are different from those set in intelligent function module parameter.

6.2.2 Program example without using the utility package

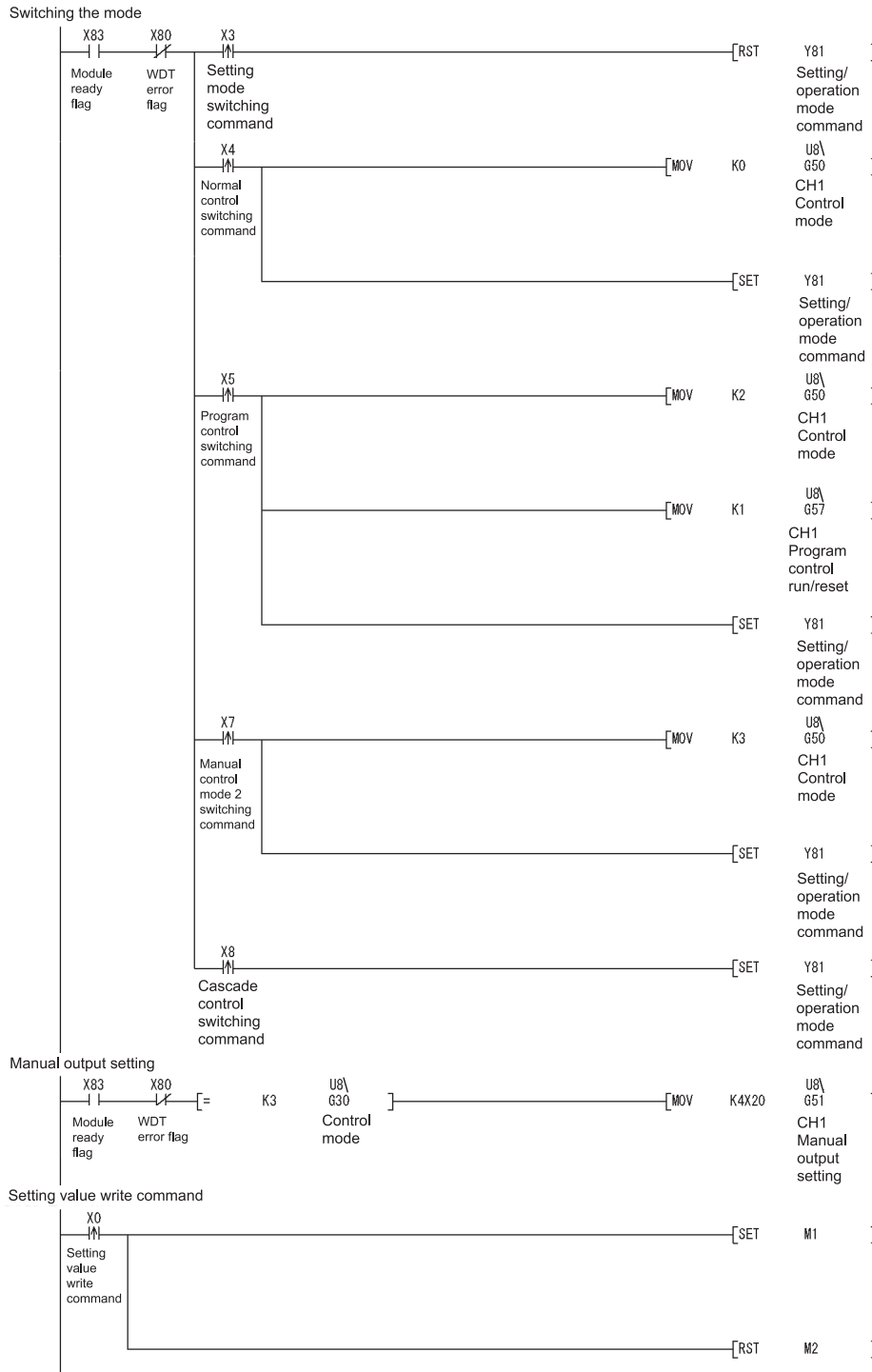

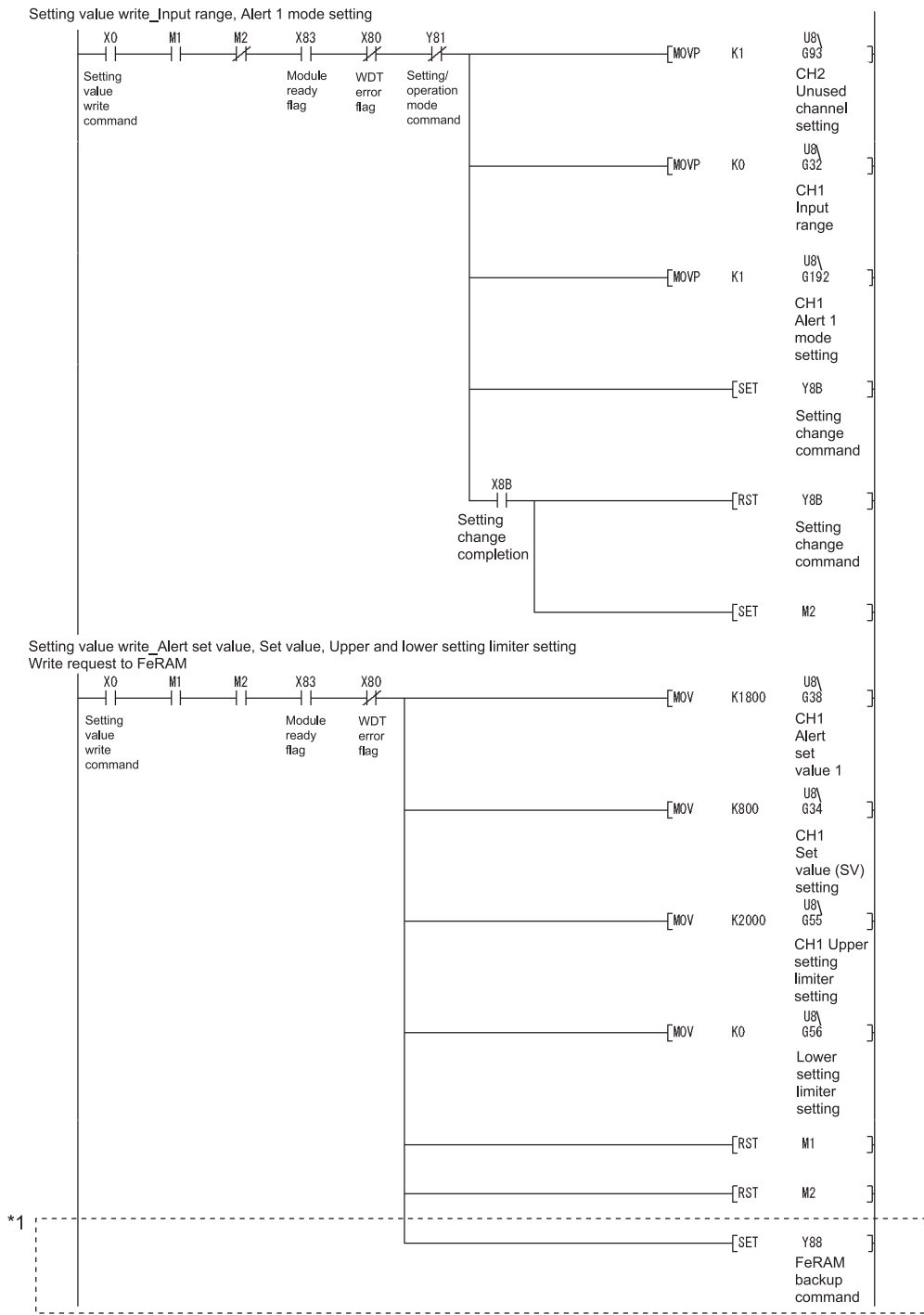

*1: The program in this area is required to write the input range, alert setting, set value, and other values to FeRAM. These values do not need to be written to FeRAM if initial settings of GX Configurator-TC are used or these values are written using a sequence program at power-on.

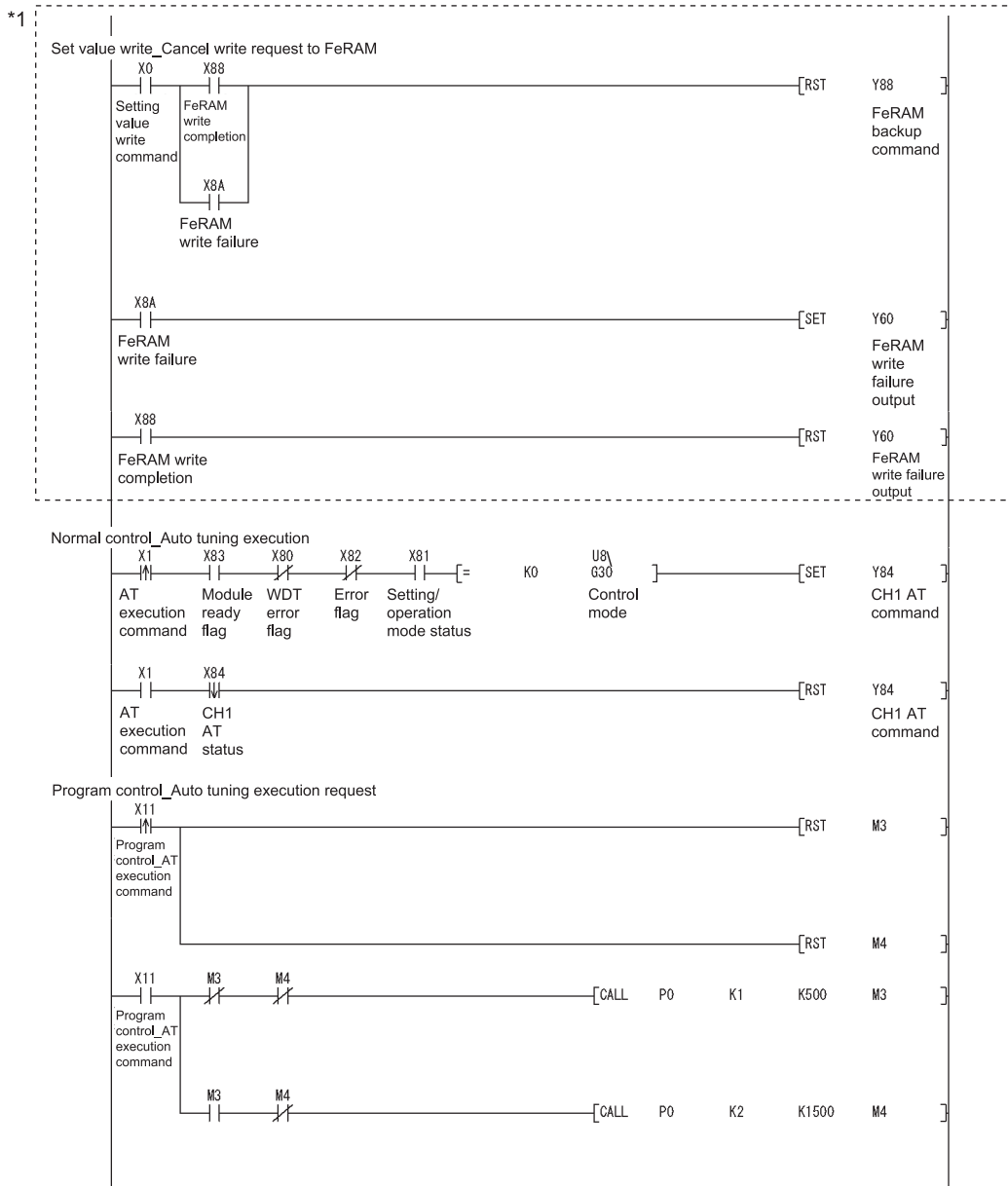

*1: The program in this area is required to write the input range, alert setting, set value, and other values to FeRAM. These values do not need to be written to FeRAM if initial settings of GX Configurator-TC are used or these values are written using a sequence program at power-on.

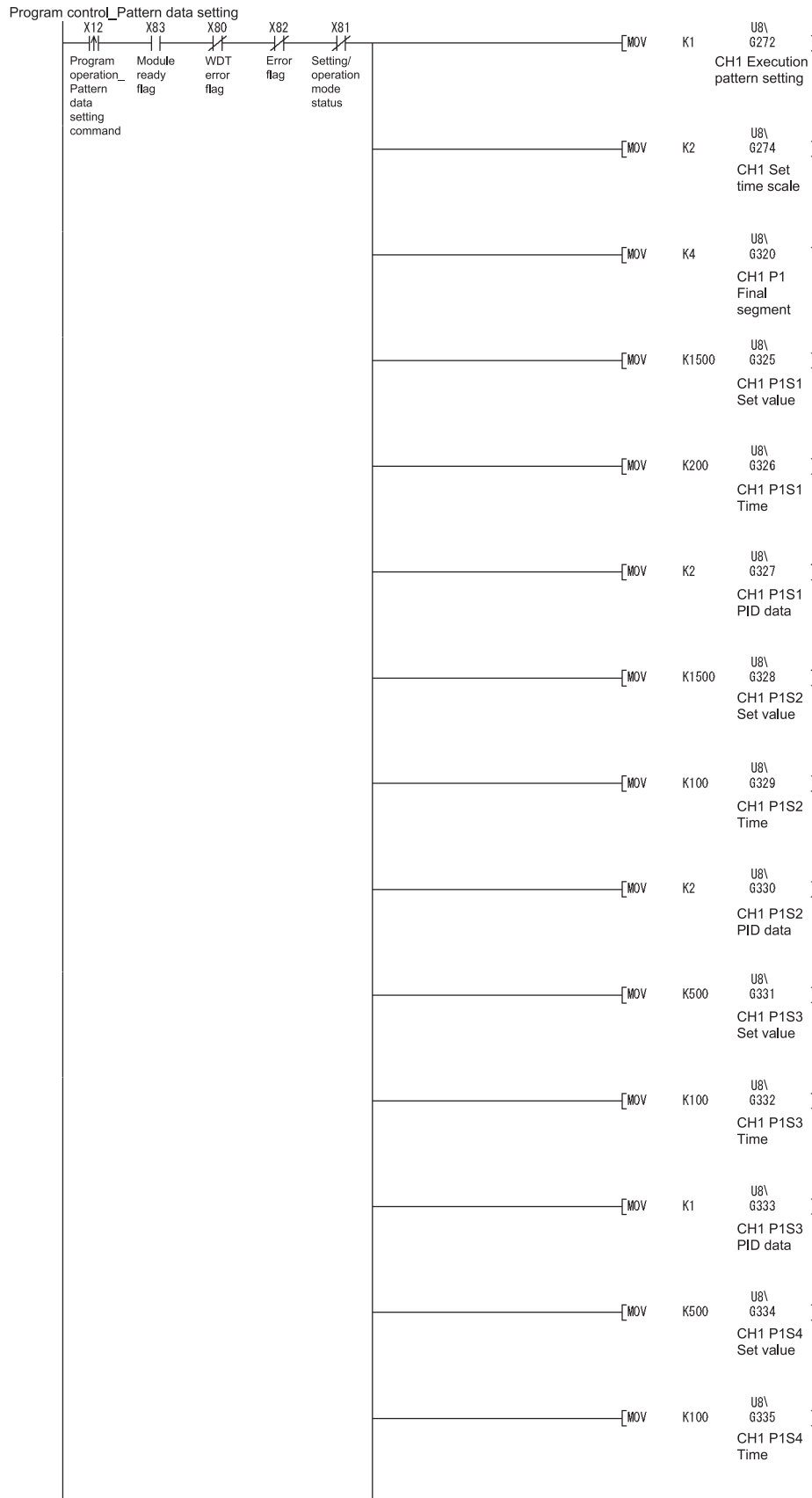

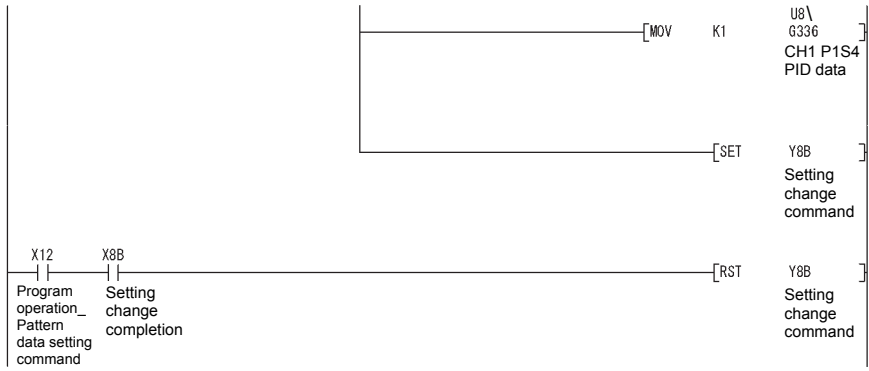

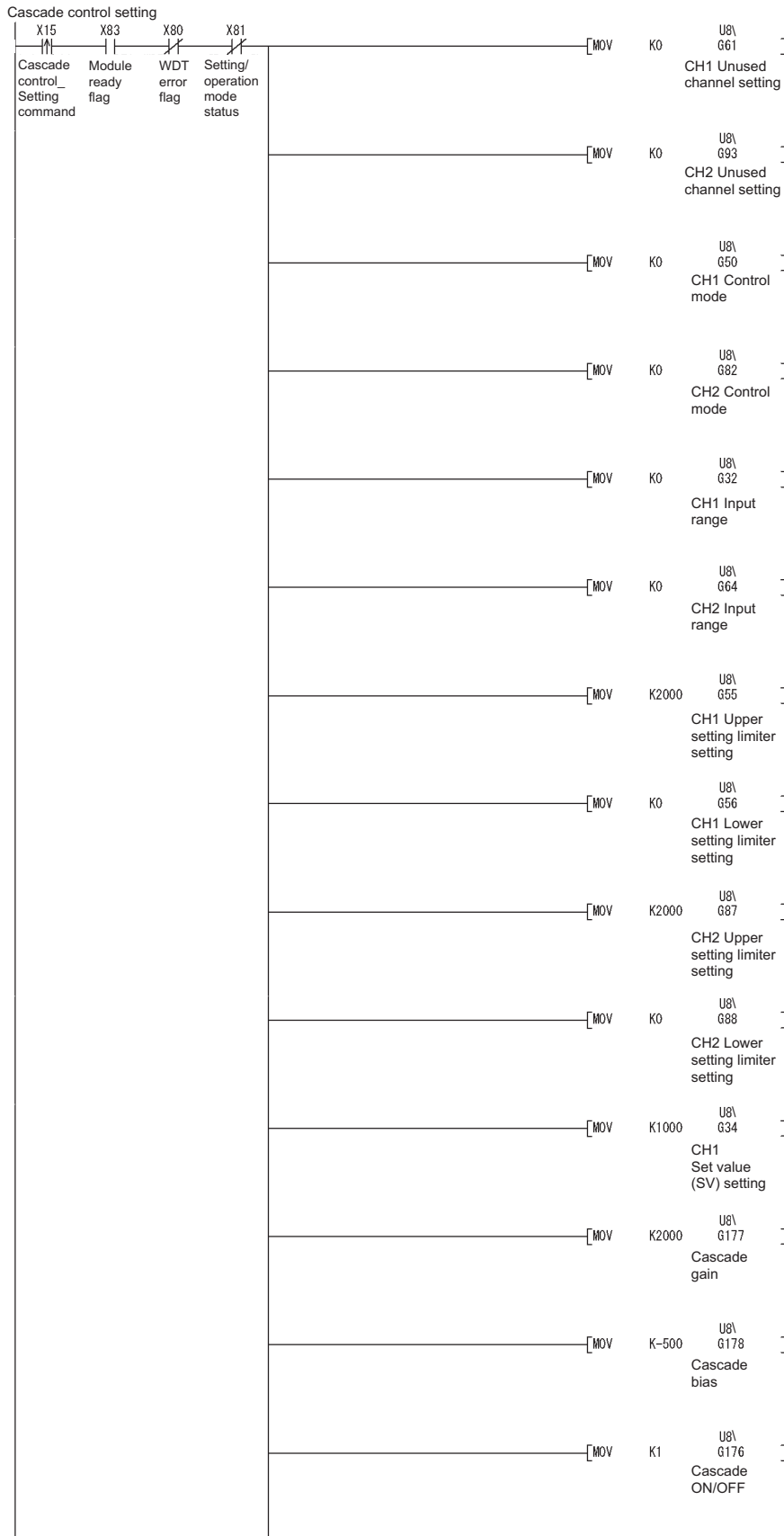

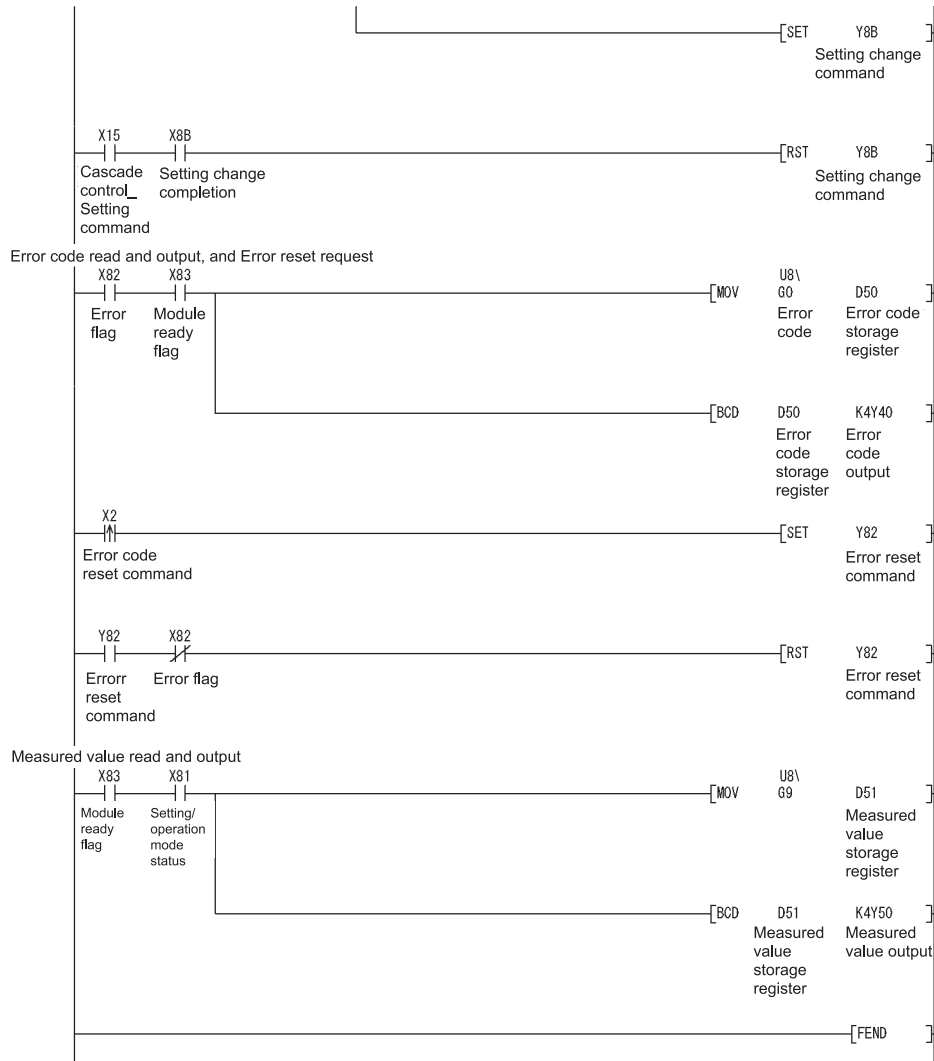

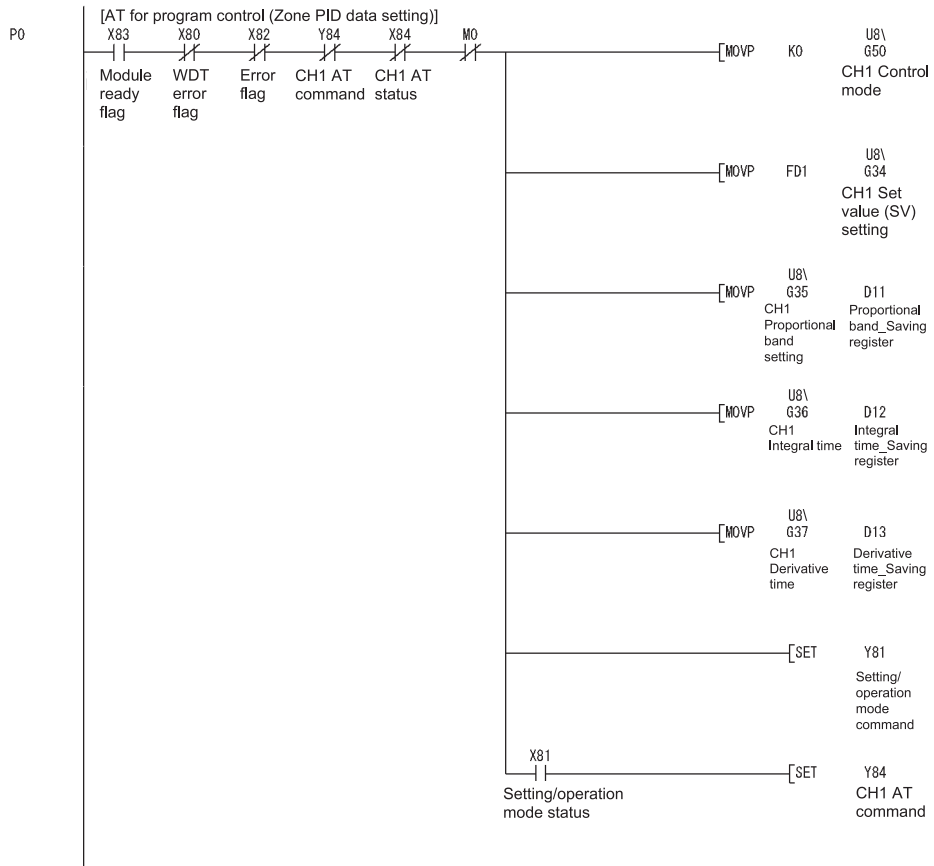

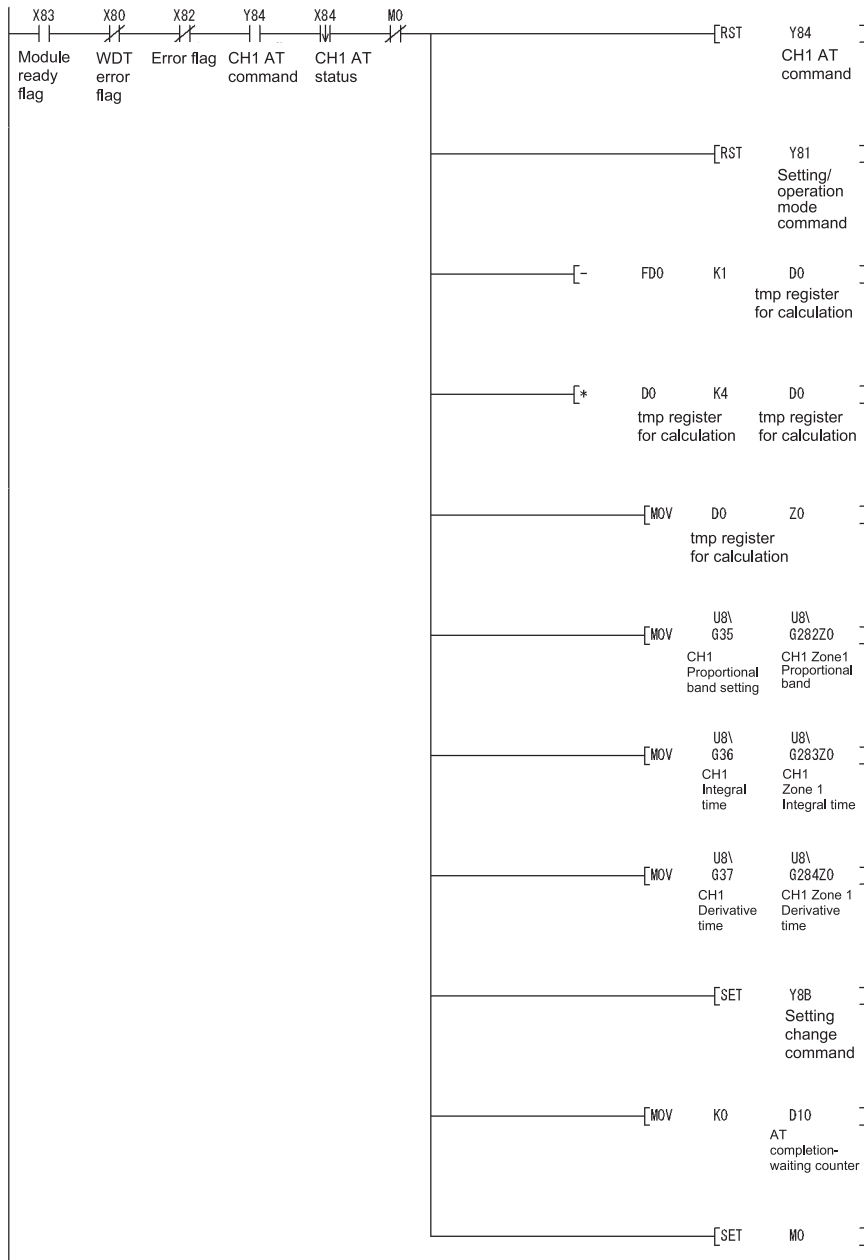

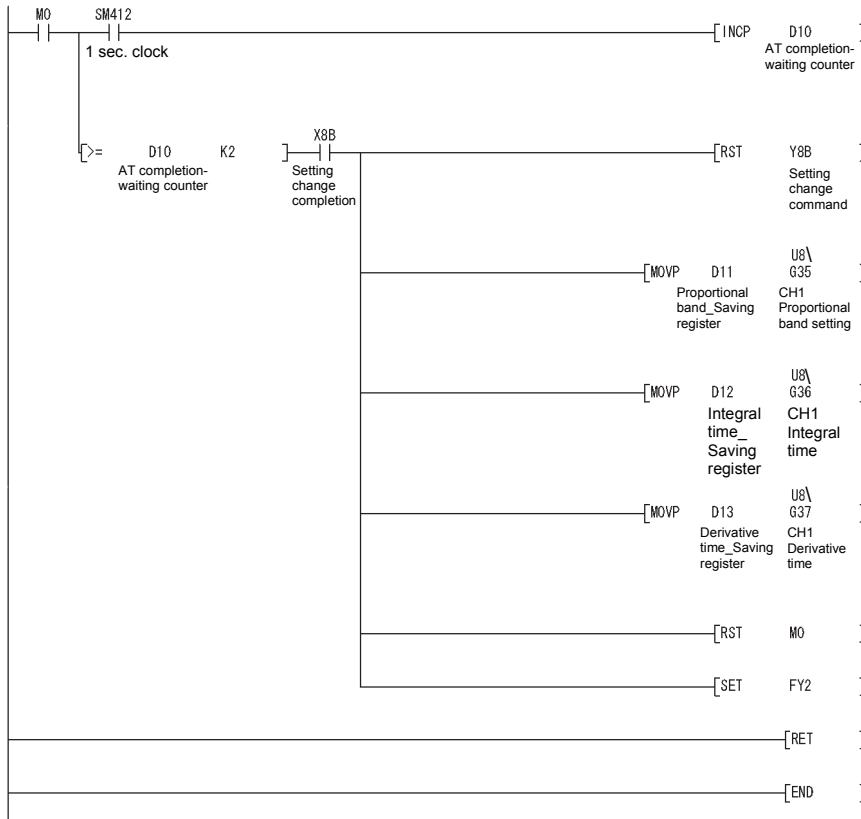

6.3 For Use on Remote I/O Network

System configuration used in the program explanation

(1) System configuration

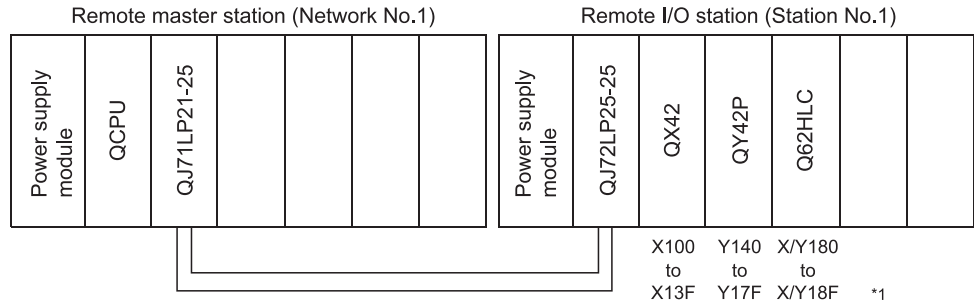

*1: Device numbers are on the basis of the remote I/O master station.

The following table lists the device numbers on the basis of the remote station.

Module	Device numbers on the basis of master station	Device numbers on the basis of remote station
QX42	X100 to X13F	X0 to X3F
QY42P	Y140 to Y17F	Y40 to Y7F
Q62HLC	X/Y180 to X/Y18F	X/Y80 to X/8F

(2) Program conditions

The programs are executed to control the temperature measured by the thermocouple (K: -200 to 1372°C) connected to channel 1.

- According to input signals, normal control/program control/manual control 2 (simplified analog/digital conversion)/cascade control is executed.
- They include write data error code reading and error code resetting programs.

(3) Intelligent function module switch setting

Configure the intelligent function module switch setting as follows.

For details of the intelligent function module switch setting, refer to Section 4.5.

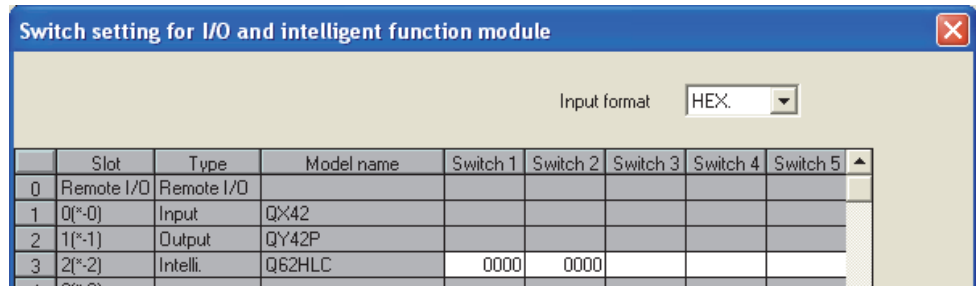

(a) Devices used

Device	Function	Description
X100	Setting value write command	Sets the parameter to execute normal control and program control using CH 1 and writes into FeRAM.
X101	PID constant read command from FeRAM (when GX Configurator-TC is used)	Reads PID constant set by auto tuning from FeRAM.
	Auto tuning execution command (when GX Configurator-TC is not used)	Executes auto tuning for the specified set value. Operates only in the normal control mode.
X102	Error code reset command	Clears(0) error codes.
X103	Setting mode switching command	Switches into the setting mode by turning off then on.
X104	Normal control mode switching command	Switches into the normal control mode by turning off then on. Needs to set parameters for normal control before switching.
X105	Program control mode switching command	Switches into the program control mode by turning off then on. Needs to set parameters for program control before switching.
X107	Manual control mode 2 switching command	Switches into the manual control mode 2 by turning off then on. After the switching, the operation is performed by the values of manual output settings (X20 to X2F).
X108	Cascade control switching command	Switches into the cascade control mode by turning off then on. Needs to set parameters for cascade control before switching.
X111	Program control auto tuning execution command	Executes auto tuning for program control. ¹⁾
X112	Program control pattern data setting command	Sets the pattern data for executing program control. ²⁾
X115	Cascade control setting command	Sets parameters for executing cascade control. ³⁾
X120 to X12F	Manual output setting	Specifies the manipulated value when manual control mode 2 is operated.
Y140 to Y14F	Error code output	Outputs error codes as BCD value.
Y150 to Y15F	Measured value output	Outputs measured value as BCD value.
Y160	FeRAM read failure output (when GX Configurator-TC is used)	Outputs when reading from FeRAM has failed.
	FeRAM write failure output (when GX Configurator-TC is not used)	Outputs when writing into FeRAM has failed.
D50	Error code	Stores error codes that are read out when the error has occurred.
D51	Measured value	Stores measured values that are read out.

When turning on the setting value write command X100, the parameters, which are set in this program example, are as follows.

- CH2 Unused channel setting : 1 (Unused. However, set "used" when used for cascade control. In this case, parameter is set to the same as CH1.)
- CH1 Input range : 0 (K: -200 to 1372°C)
- CH1 Alert 1 mode setting : 1 (UpLmt Input Alert)
- CH1 Alert set value 1 : 1800 (180°C)
- CH1 Set value setting : 800 (80°C)
- CH1 Upper setting limiter : 2000 (200°C)
- CH1 Lower setting limiter : 0 (0°C)

When program control is used, turn on X100 after turning on X112 (program control pattern data setting command).

- *1: PID constants of zone 1 and zone 2 that are used for program control are set.
By turning on X11, the auto tuning is executed after switching into normal control mode.
Then PID constant of zone is set when the auto tuning ends.

*2: Before executing program control, PID constants of zone 1 and zone 2 need to be set by the program control auto tuning execution command (X111).

When program control is executed by the set pattern, it operates as follows.

Segment number	Setting value		
	Set value	Executing time	Zone PID data No.
Segment 1	1500 (150°C)	200 (200s)	2 (Zone 2)
Segment 2	1500 (150°C)	100 (100s)	2 (Zone 2)
Segment 3	500 (50°C)	100 (100s)	1 (Zone 1)
Segment 4	500 (50°C)	100 (100s)	1 (Zone 1)

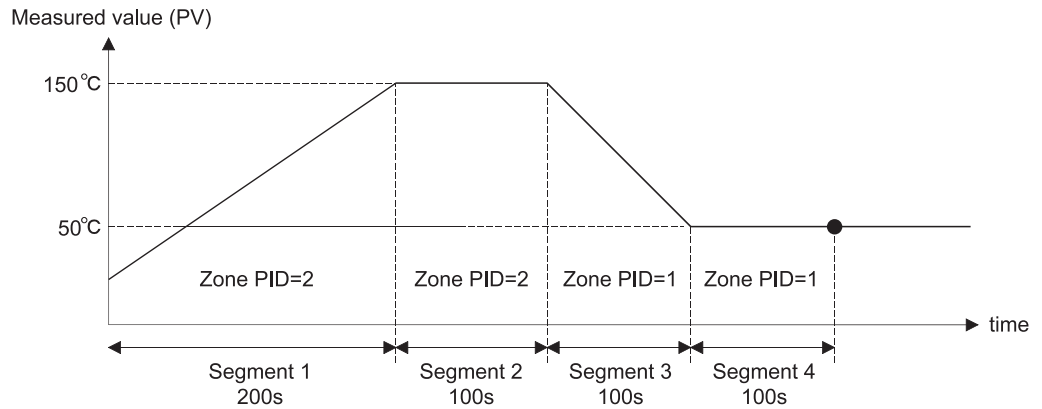

*3: After setting parameter by the cascade control setting command (X115), execute cascade control by turning on the cascade control switching command (X108).

In this program example, the parameter setting for cascade control and the other parameter settings (normal control, program control, and manual control 2) cannot be set at the same time.

After setting the parameter for cascade control, do not use the normal control mode switching command (X104), program control mode switching command (X105), and manual control mode 2 switching command (X107).

POINT

For details on the MELSECNET/H remote I/O network, refer to the Q Corresponding MELSECNET/H Network System Reference Manual (Remote I/O Network).

6.3.1 Program example using the utility package

(1) Operating GX Developer

(a) Network parameter setting

- Network type : MNET/H (remote master)
- Start I/O No. : 0000H
- Network No. : 1
- Total number of (slave) stations : 1
- Mode : Online
- Network range assignment :

StationNo.	M station -> R station						M station <- R station					
	Y			Y			X			X		
	Points	Start	End	Points	Start	End	Points	Start	End	Points	Start	End
1	256	0100	01FF	256	0000	00FF	256	0100	01FF	256	0000	00FF

StationNo.	M station -> R station			M station <- R station			M station -> R station			M station <- R station		
	B			B			W			W		
	Points	Start	End	Points	Start	End	Points	Start	End	Points	Start	End
1										256	0500	05FF

- Refresh parameters :

	Link side						PLC side			
	Dev. name	Points	Start	End	Dev. name		Points	Start	End	
Transfer SB	SB	512	0000	01FF	↔	SB	512	0000	01FF	
Transfer S/W	S/W	512	0000	01FF	↔	S/W	512	0000	01FF	
Random cyclic	LB				↔					
Random cyclic	LW				↔					
Transfer1	LX	512	0000	01FF	↔	X	512	0000	01FF	
Transfer2	LY	512	0000	01FF	↔	Y	512	0000	01FF	
Transfer3	LW	256	0500	05FF	↔	W	256	0500	05FF	
Transfer4					↔					
Transfer5					↔					
Transfer6					↔					

(2) Operating the utility package

(a) Initial setting (refer to Section 5.4)

<When cascade control is not executed>

CH1 Input range "0"
 CH2 Unused channel setting "Not Used"

[Limiter setting]

CH1 Upper setting limiter "2000"
 CH1 Lower setting limiter "0"

[Alert function setting]

CH1 Alert 1 mode setting "UprLmt Input"
 CH1 Alert set value 1 "1800"

[Normal control setting]

CH1 Set value (SV) setting "800"

[Program control setting]

CH1 Execution pattern "Program Pattern 1"
 CH1 Time scale "1s"

CH1 Program pattern 1

Final segment..... "4"
 Segment 1 Set value (SV) setting "1500"
 Segment 1 Executing time..... "200"
 Segment 1 Zone PID data No. "2"
 Segment 2 Set value (SV) setting "1500"
 Segment 2 Executing time..... "100"
 Segment 2 Zone PID data No. "2"
 Segment 3 Set value (SV) setting "500"
 Segment 3 Executing time..... "100"
 Segment 3 Zone PID data No. "1"
 Segment 4 Set value (SV) setting "500"
 Segment 4 Executing time..... "100"
 Segment 4 Zone PID data No. "1"

<When cascade control is executed>

CH1 Input range "0"
 CH2 Input range "0"
 CH1 Unused channel setting "Used"
 CH2 Unused channel setting "Used"

[Limiter setting]

CH1 Upper setting limiter "2000"
 CH1 Lower setting limiter "0"
 CH2 Upper setting limiter "2000"
 CH2 Lower setting limiter "0"

[Normal control setting]

CH1 Set value (SV) setting "1000"

[Cascade control setting]

Cascade bias "-500"
 Cascade gain "2000"

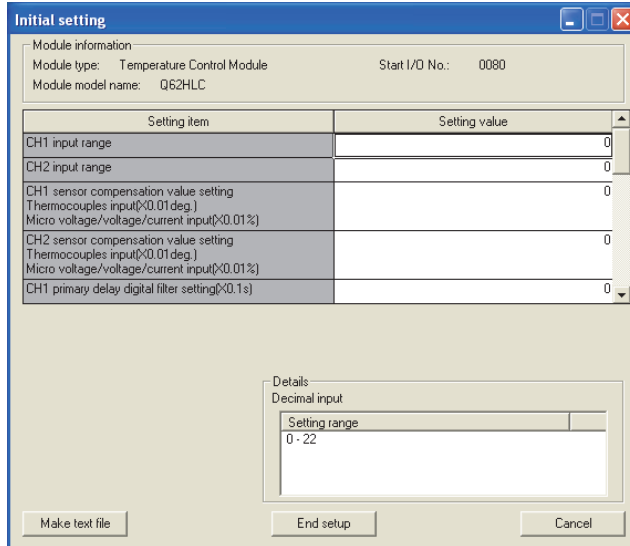

(b) Auto refresh setting (refer to Section 5.5)

Error code "W500"
 CH1 measured value (PV) "W501"

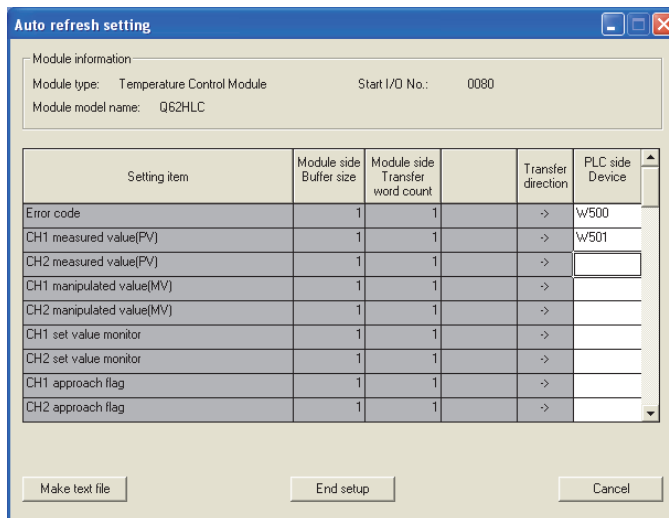

(c) Writing intelligent function module parameters (refer to Section 5.3.3)

Write the parameter values of the intelligent function module to the remote I/O station.

Perform this operation on the intelligent function module parameter setting module selection screen.

- (d) Executing auto tuning by selecting [Online], [Monitor/test] from the menu (refer to Section 5.6)

Execute auto tuning following the procedure shown on the screen.
CH1 Automatic backup after AT of PID contents....."Yes"

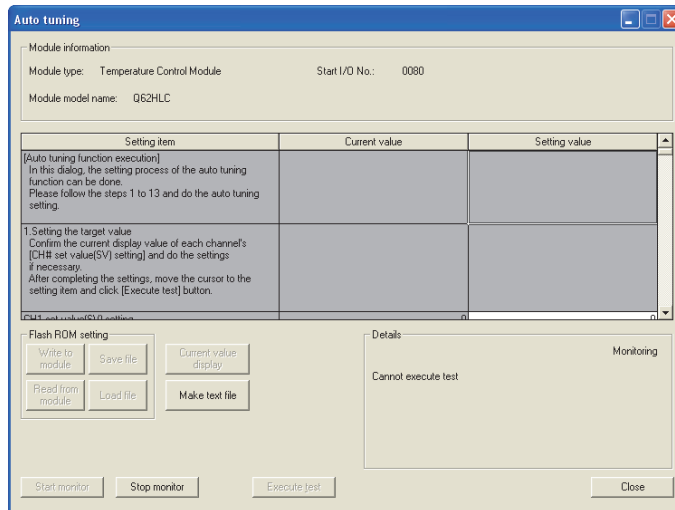

After completing auto tuning, change the following setting items.

- Operation mode command: [Operation mode] to [Setting mode]
- CH1 Auto tuning: [Start] to [Stop]

(3) Program example

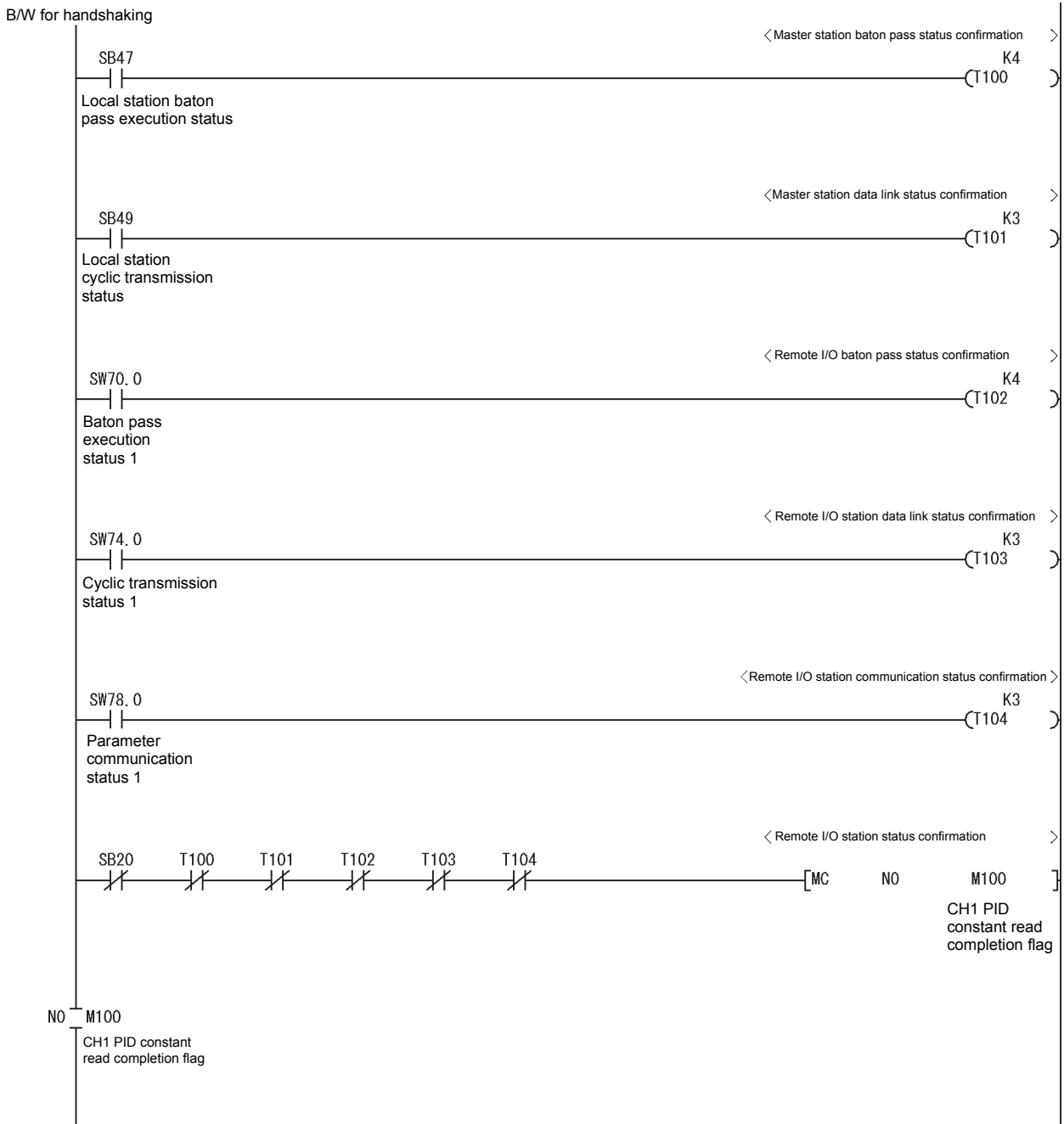

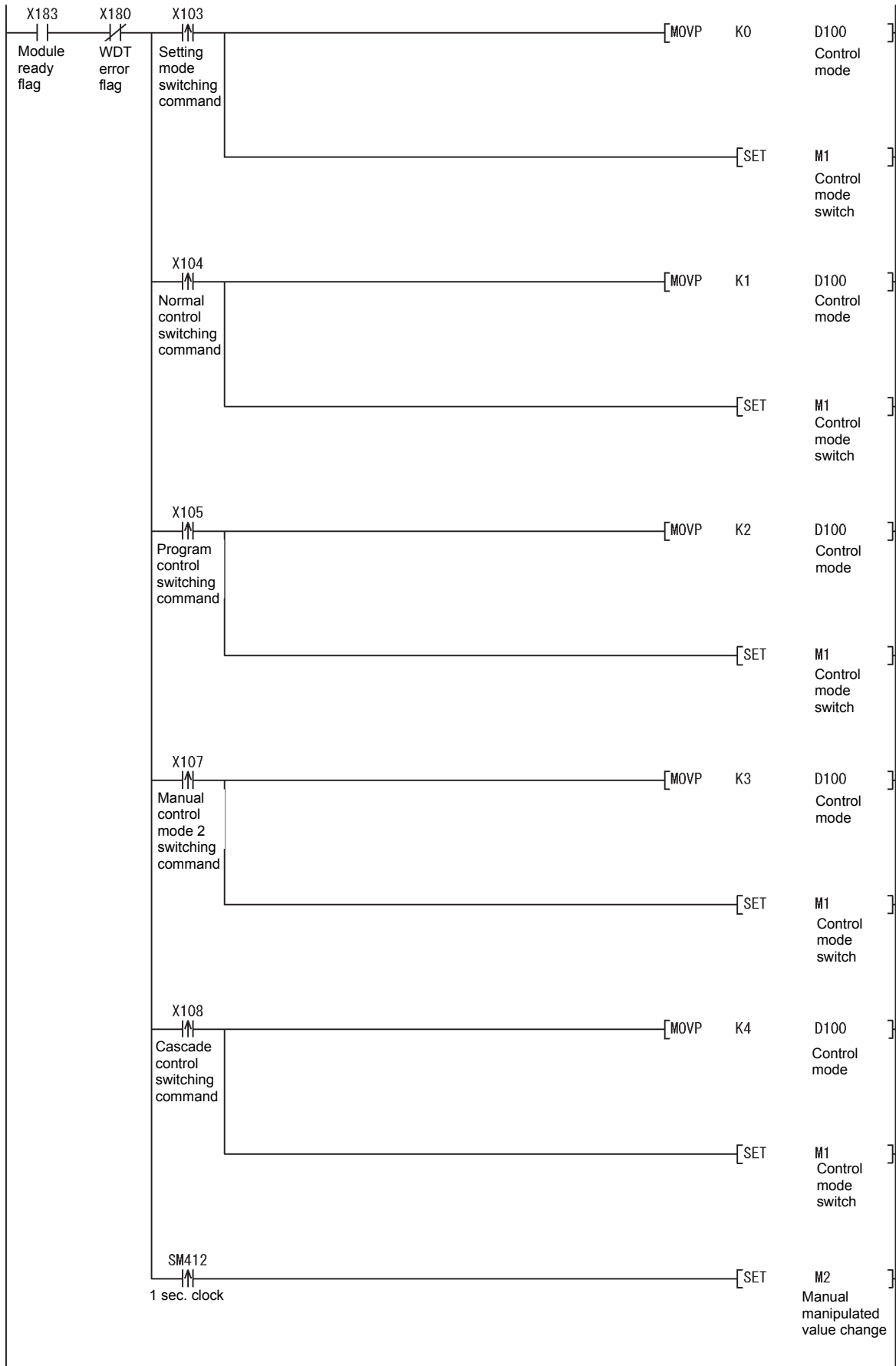

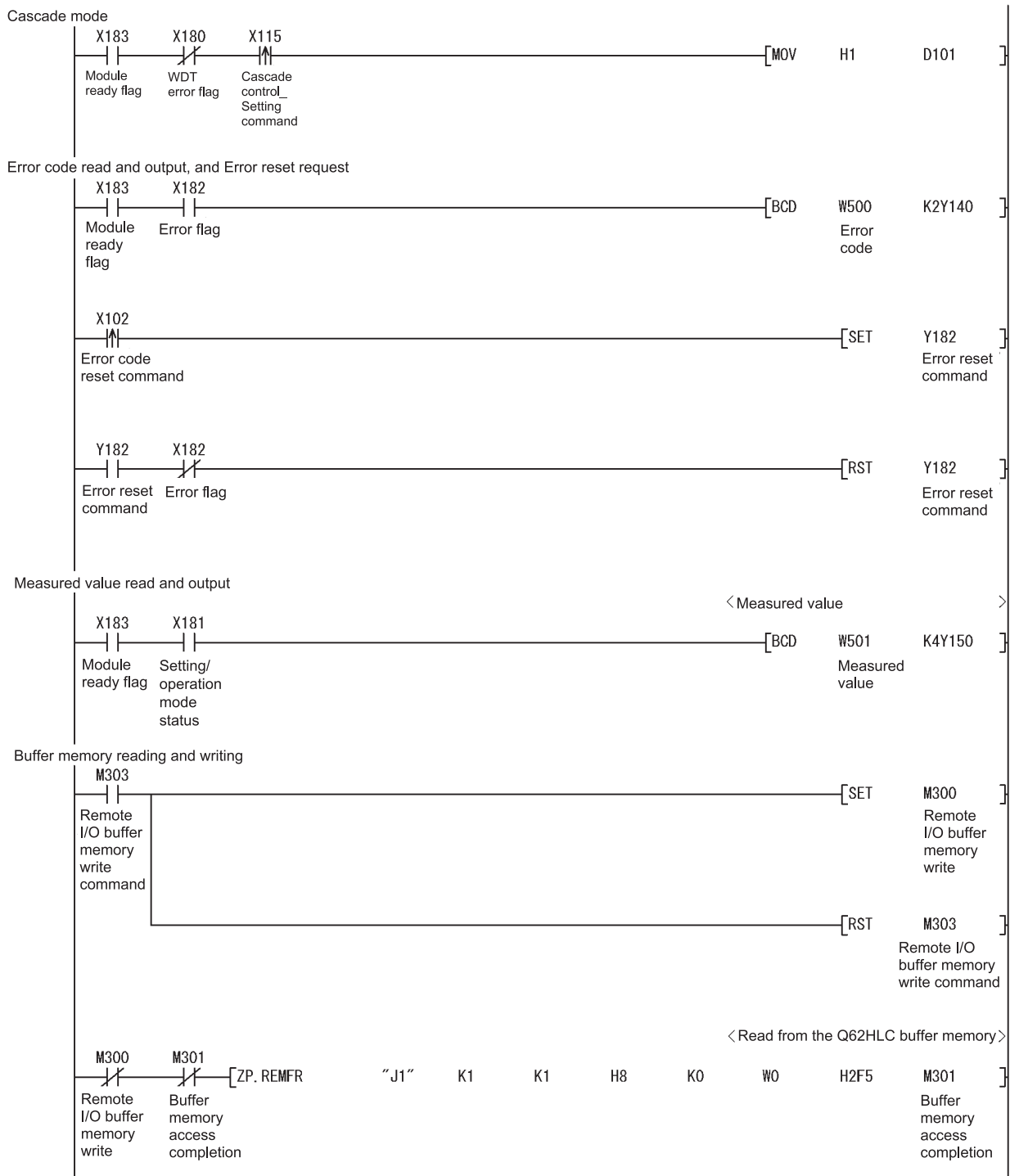

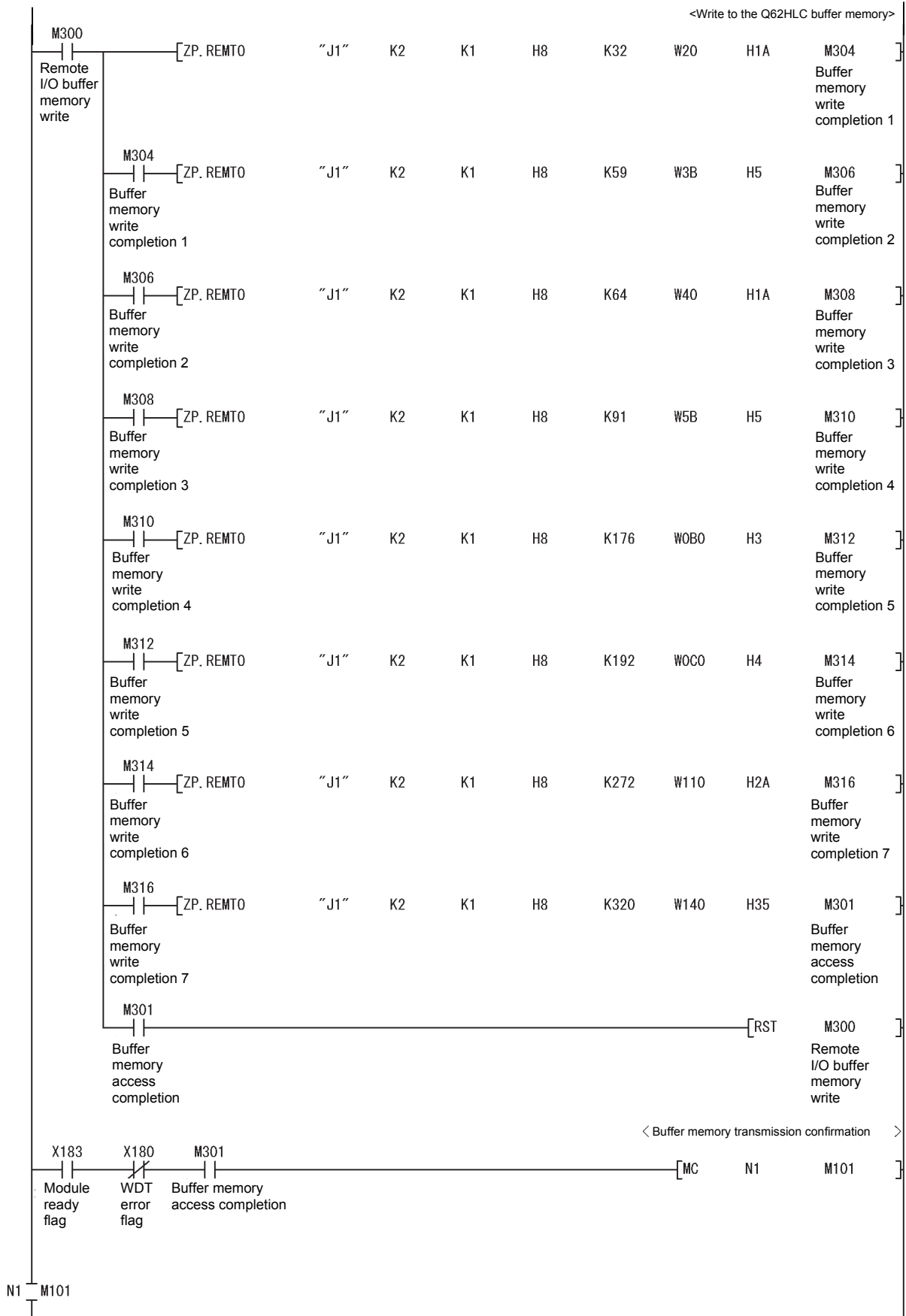

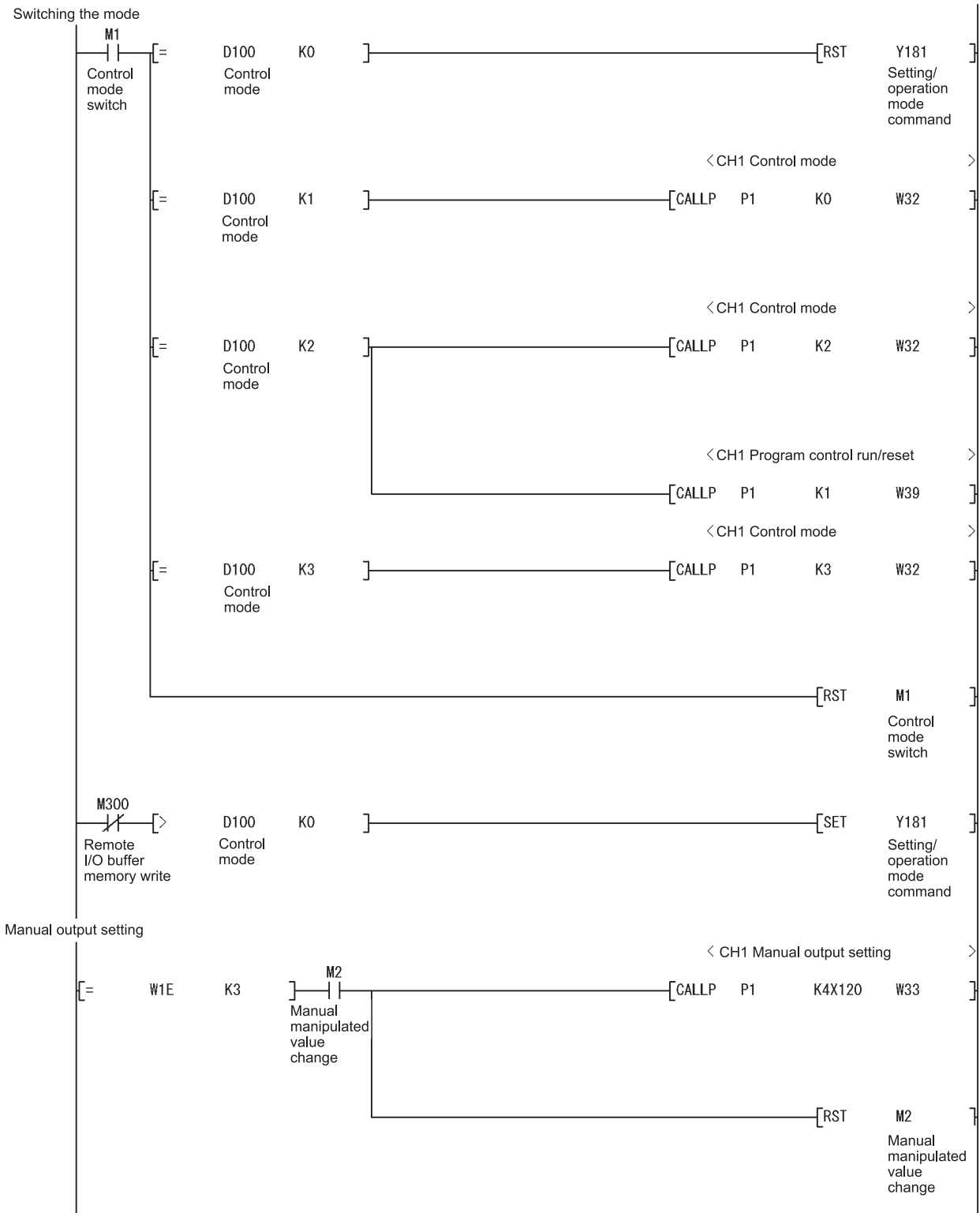

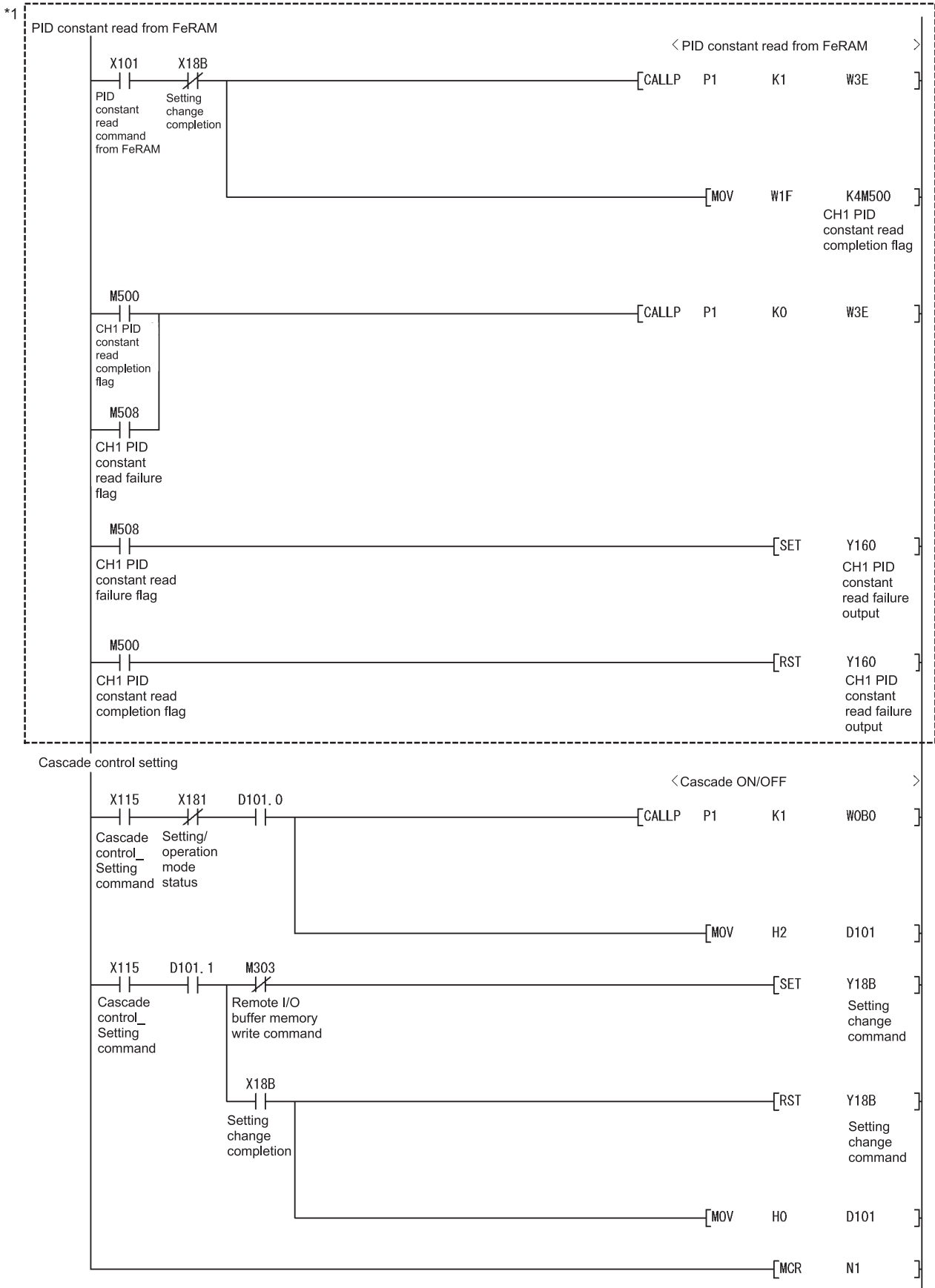

*1: The program in this area is executed when the PID constants in FeRAM are different from those set in intelligent function module parameter.

6.3.2 Program example without using the utility package

(1) Operation of GX Developer (Network parameter setting)

- Network type : MNET/H (remote master)
- Start I/O No. : 0000H
- Network No. : 1
- Total number of (slave) stations : 1
- Mode : Online
- Network range assignment :

StationNo.	M station -> R station						M station <- R station					
	Y			Y			X			X		
	Points	Start	End	Points	Start	End	Points	Start	End	Points	Start	End
1	256	0100	01FF	256	0000	00FF	256	0100	01FF	256	0000	00FF

- Refresh parameters :

	Link side					PLC side			
	Dev. name	Points	Start	End		Dev. name	Points	Start	End
Transfer SB	SB	512	0000	01FF	↔	SB	512	0000	01FF
Transfer Sw	Sw	512	0000	01FF	↔	Sw	512	0000	01FF
Random cyclic	LB				↔				
Random cyclic	LW				↔				
Transfer1	LX	512	0000	01FF	↔	X	512	0000	01FF
Transfer2	LY	512	0000	01FF	↔	Y	512	0000	01FF
Transfer3					↔				
Transfer4					↔				
Transfer5					↔				
Transfer6					↔				

(2) Program example

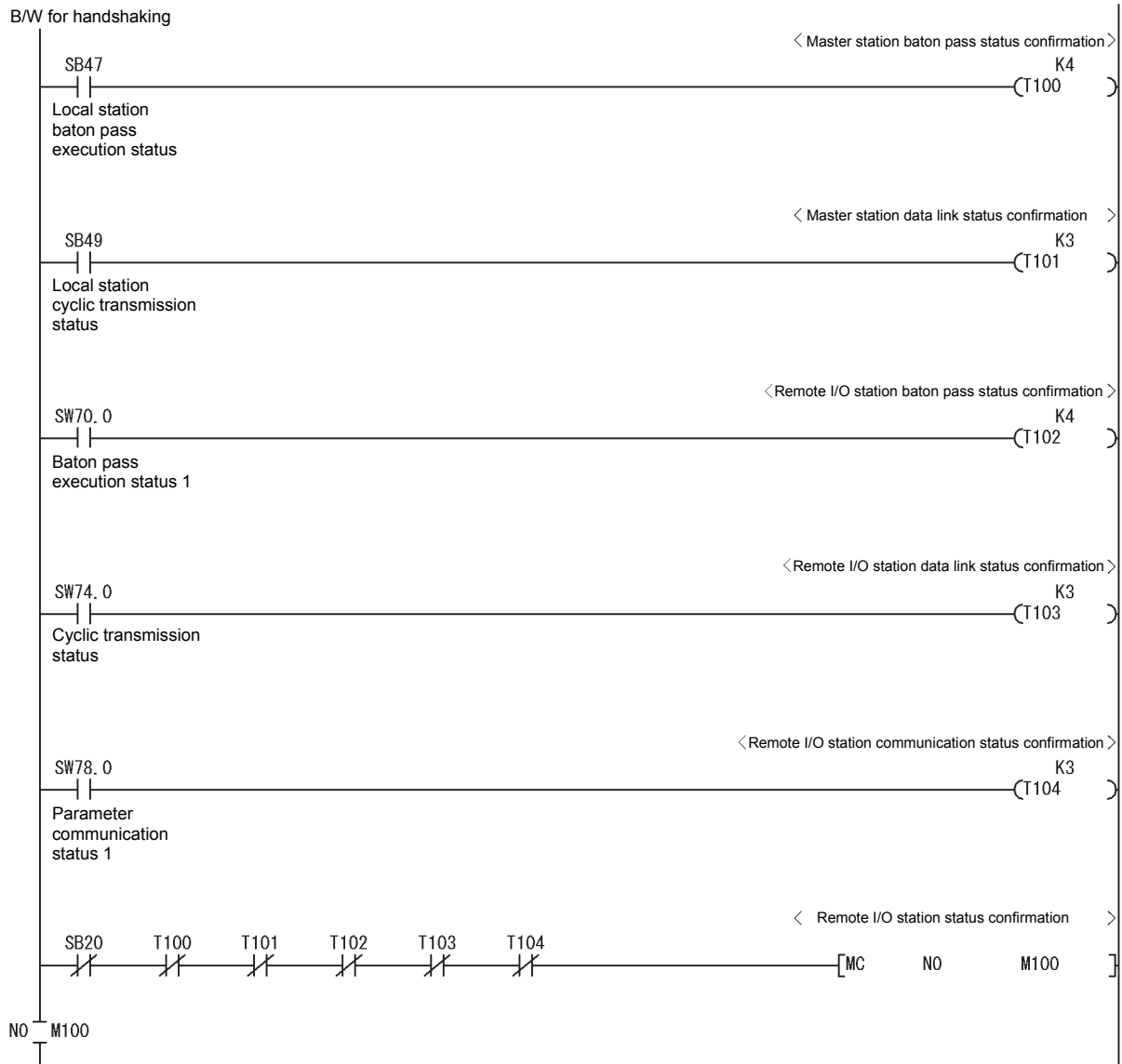

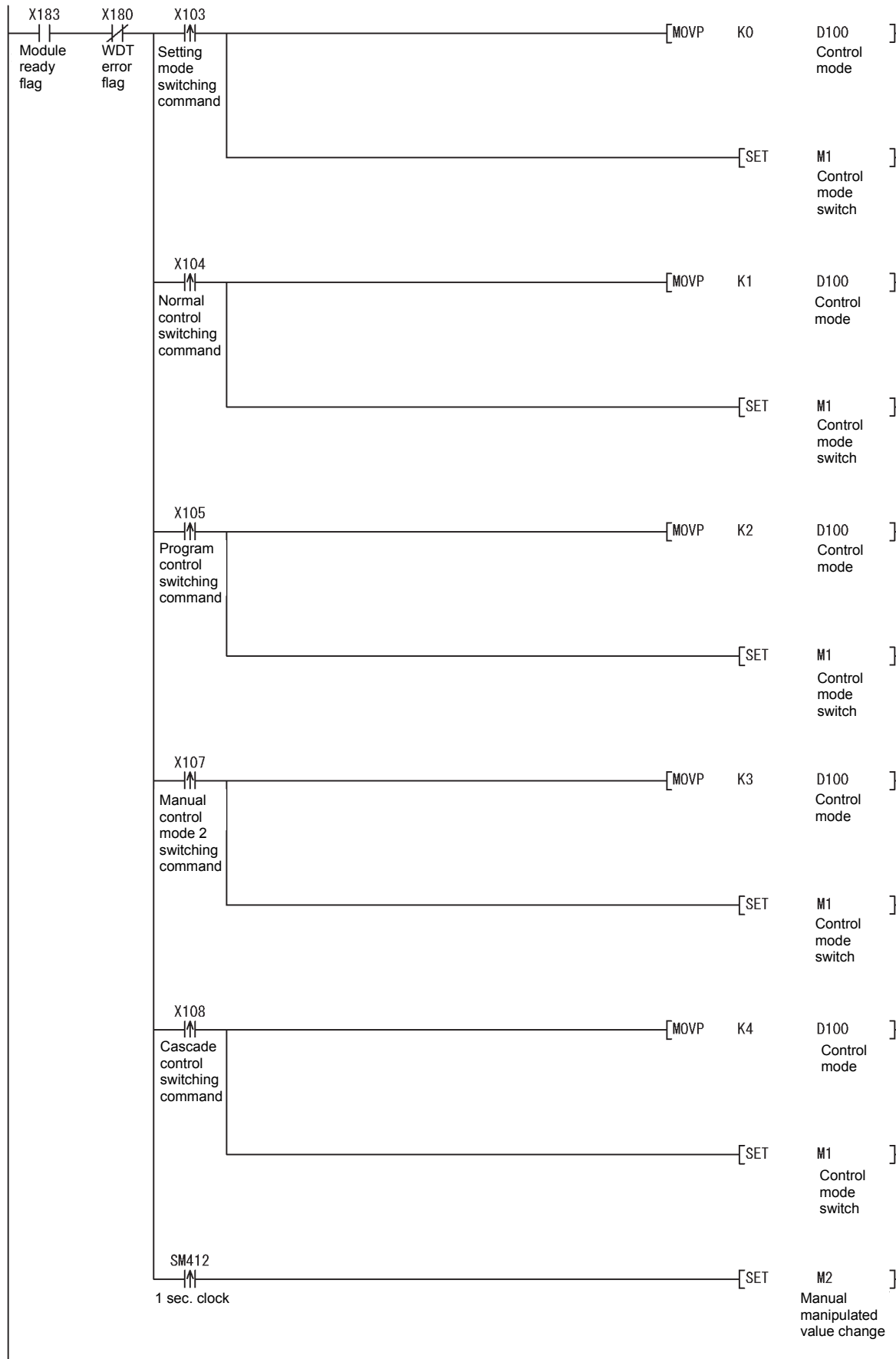

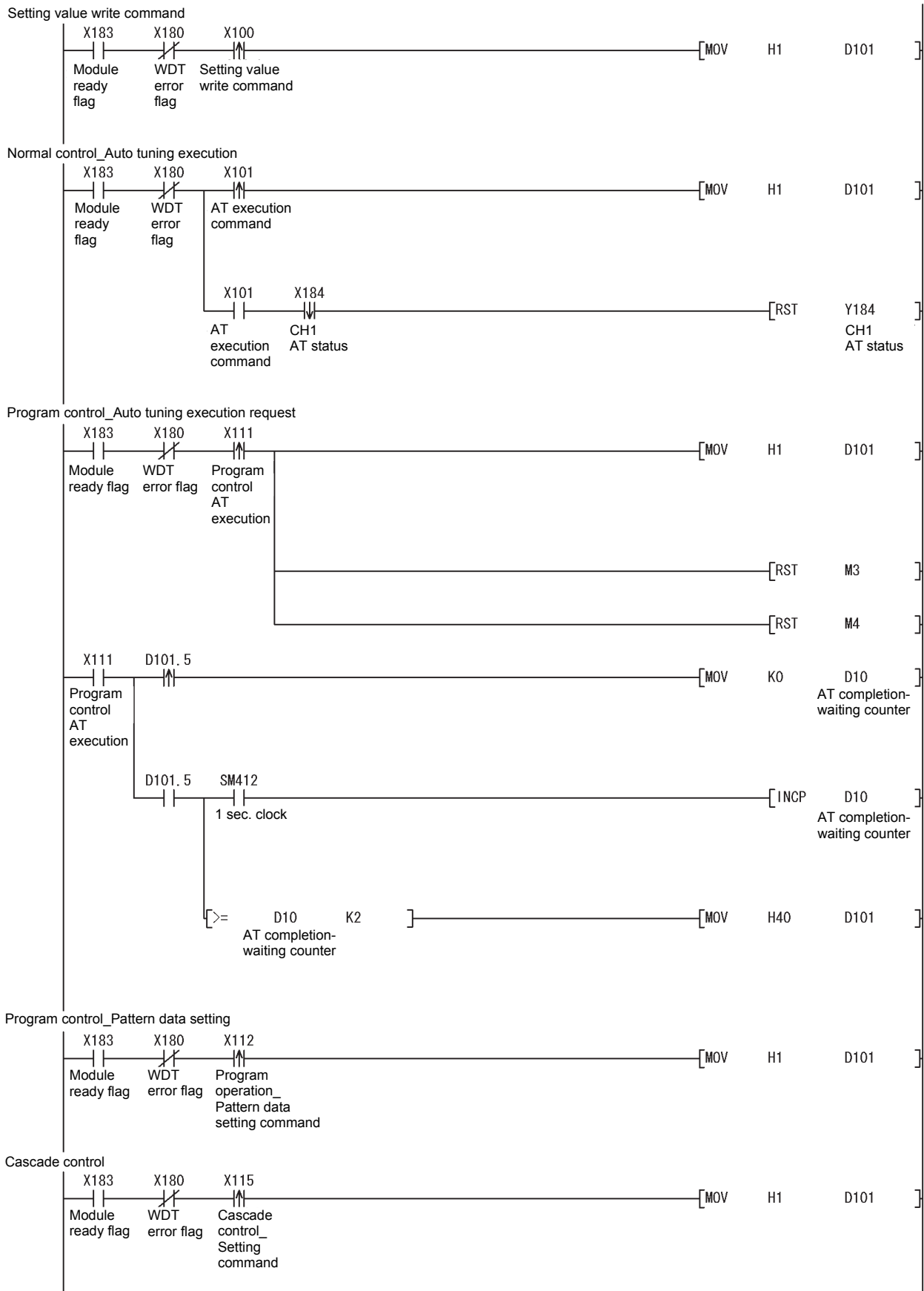

Error code read and output, and Error reset request

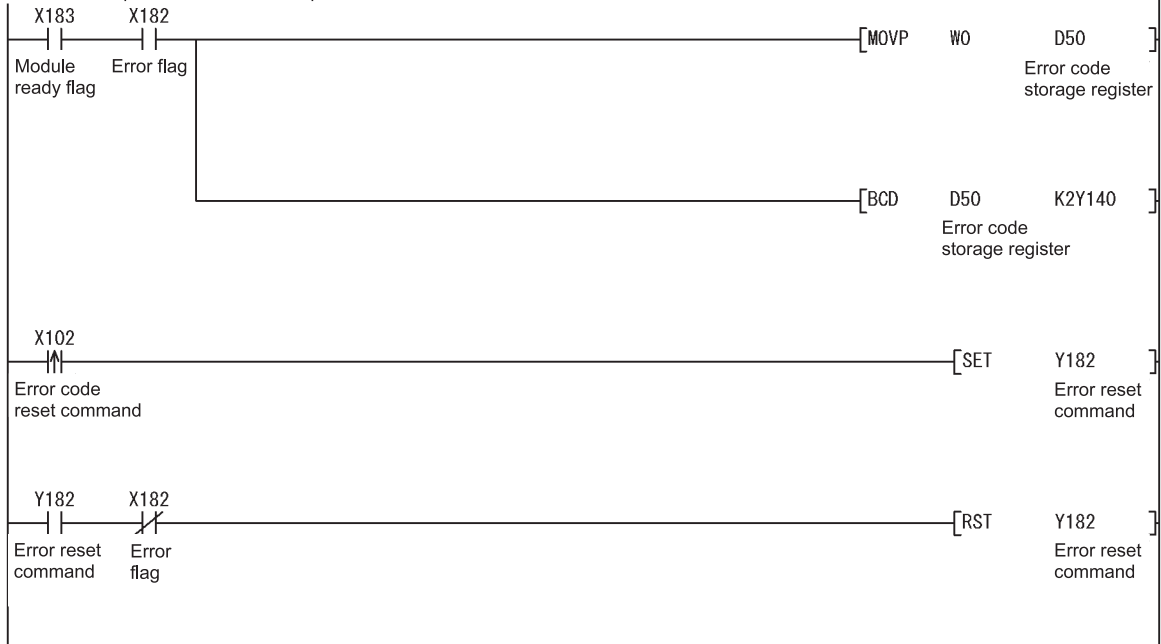

Measured value read and output

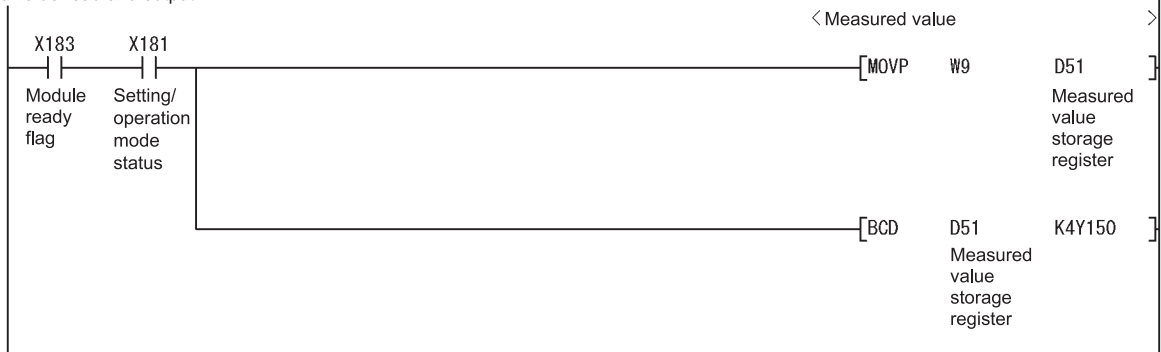

Buffer memory reading and writing

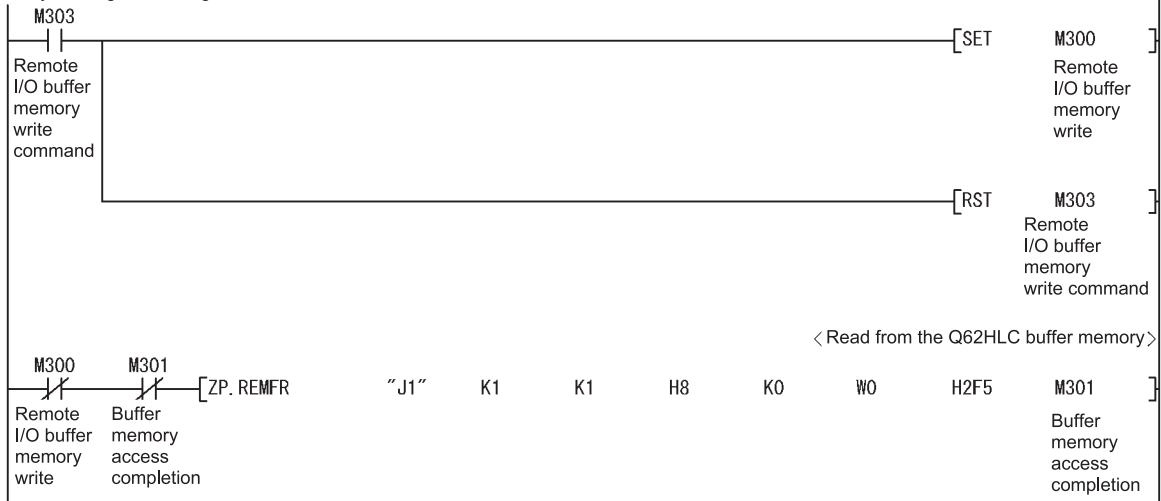

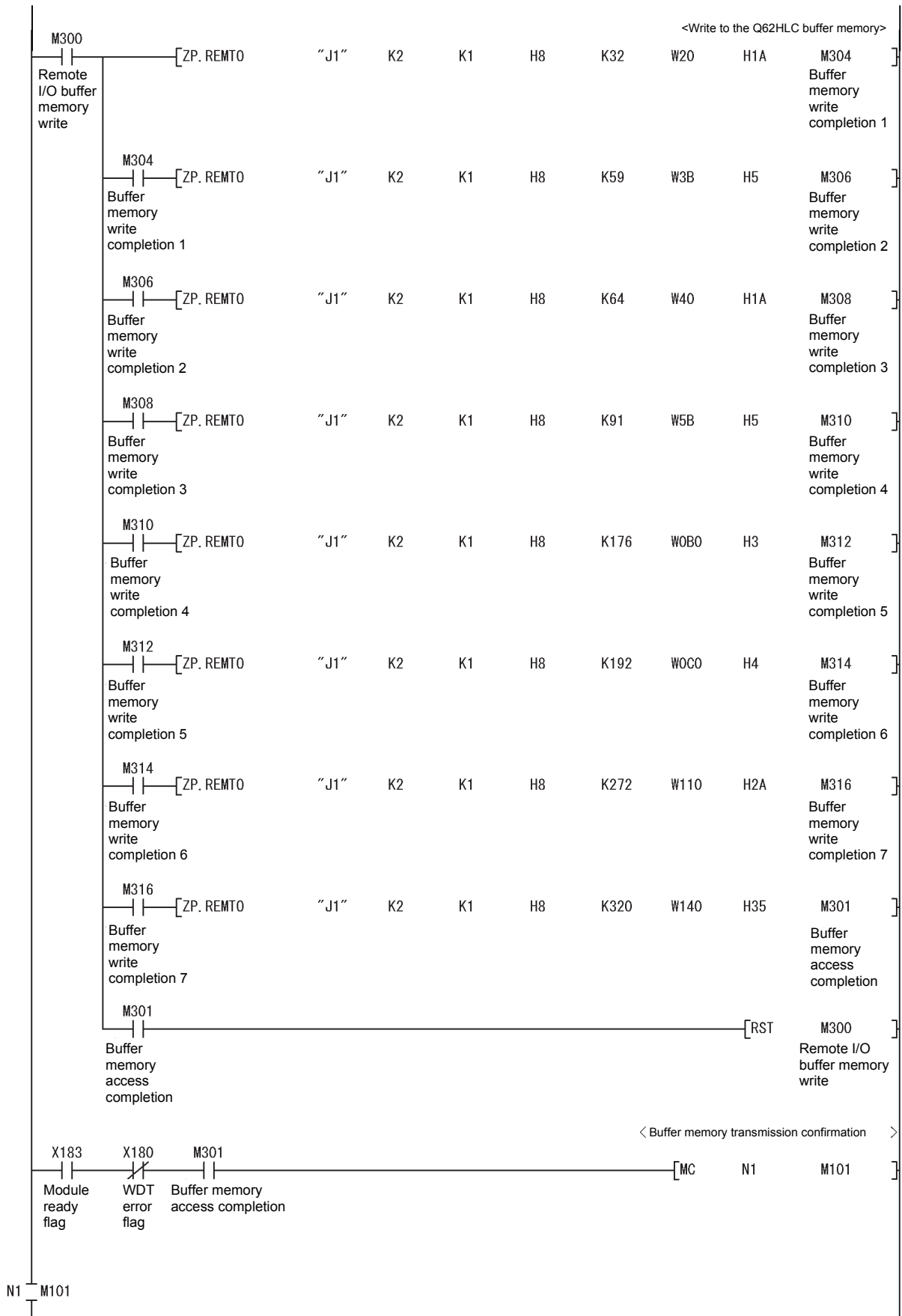

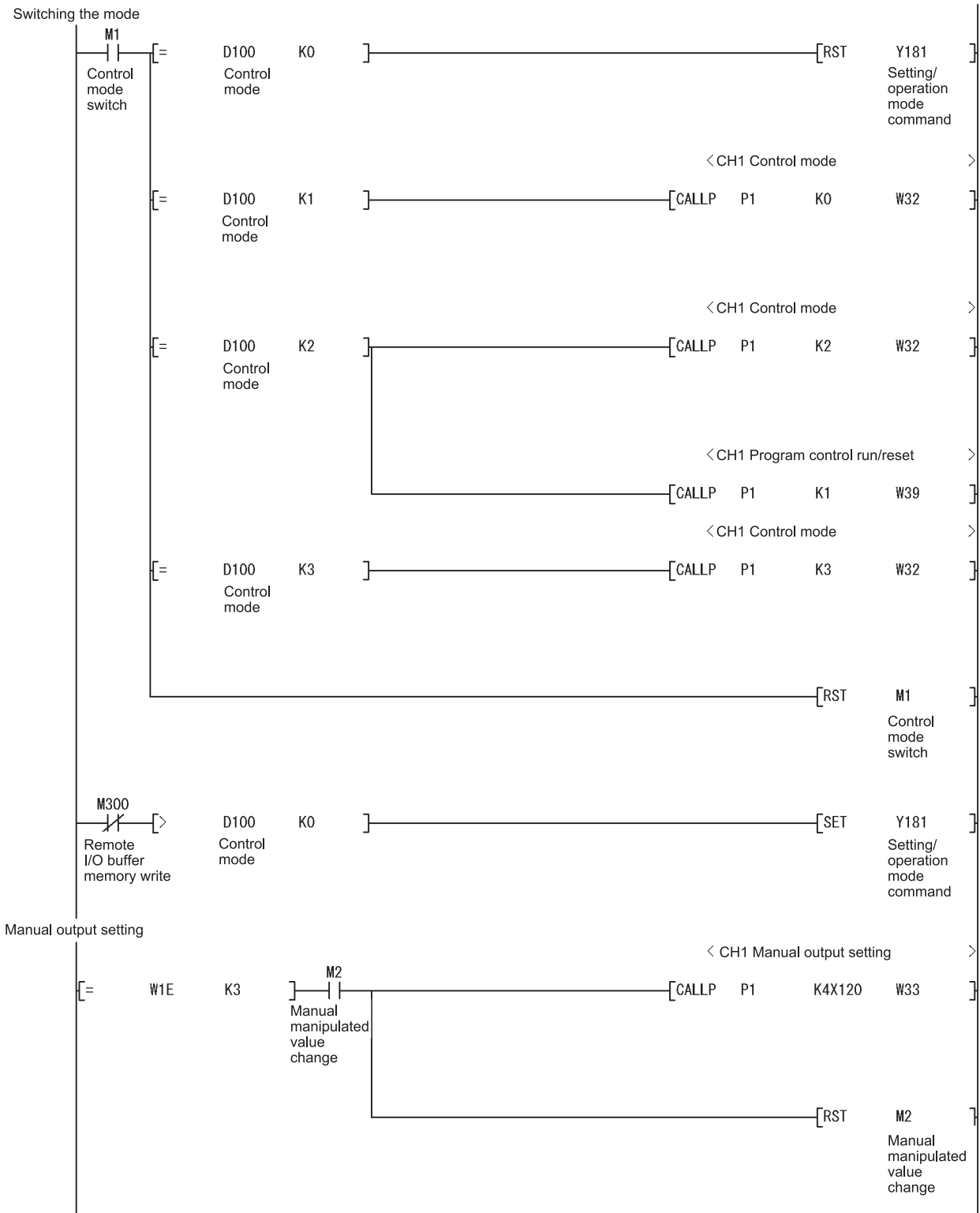

Setting value write_Input range, Alert 1 mode setting

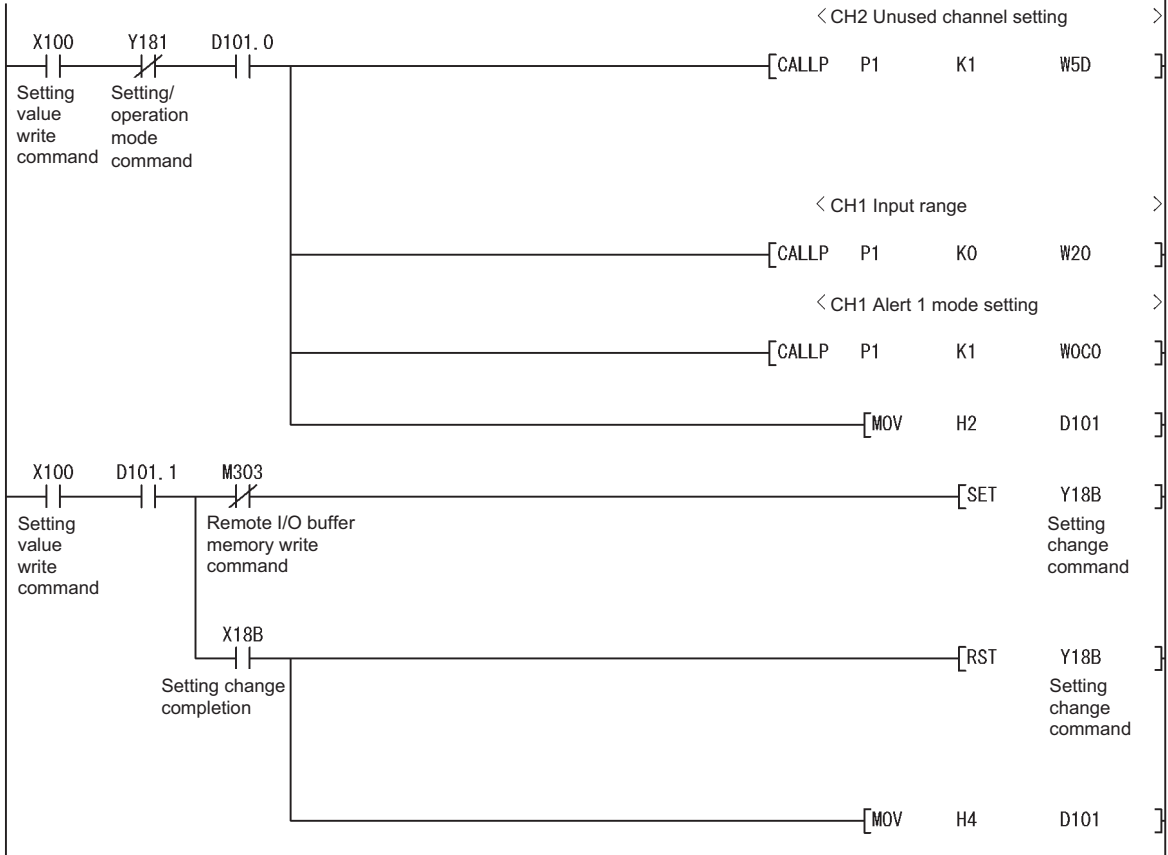

Setting value write_Alert set value, Set value, Upper and lower setting limiter setting, Write request to FeRAM

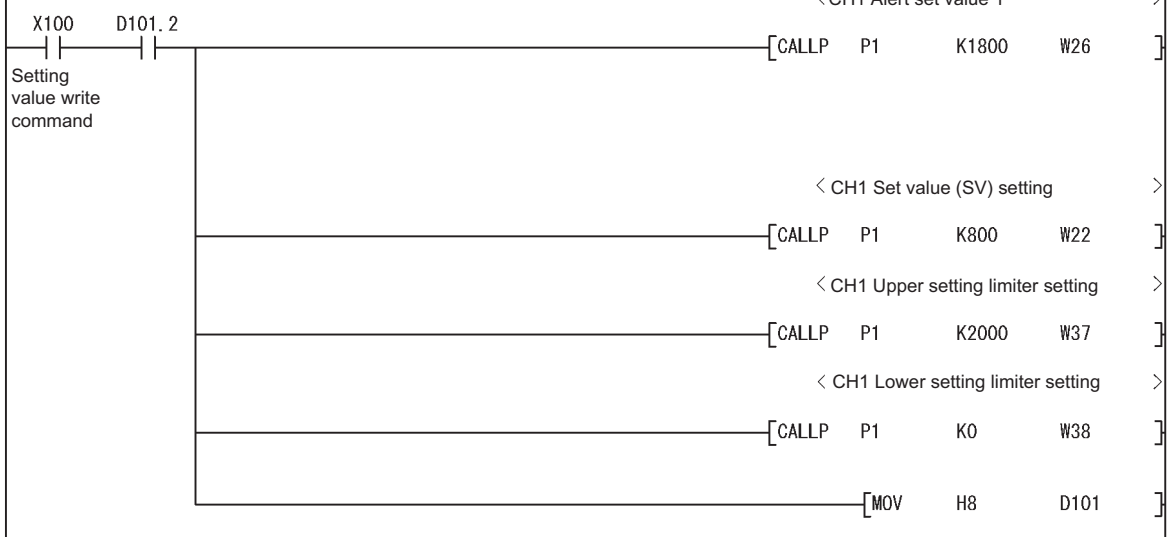

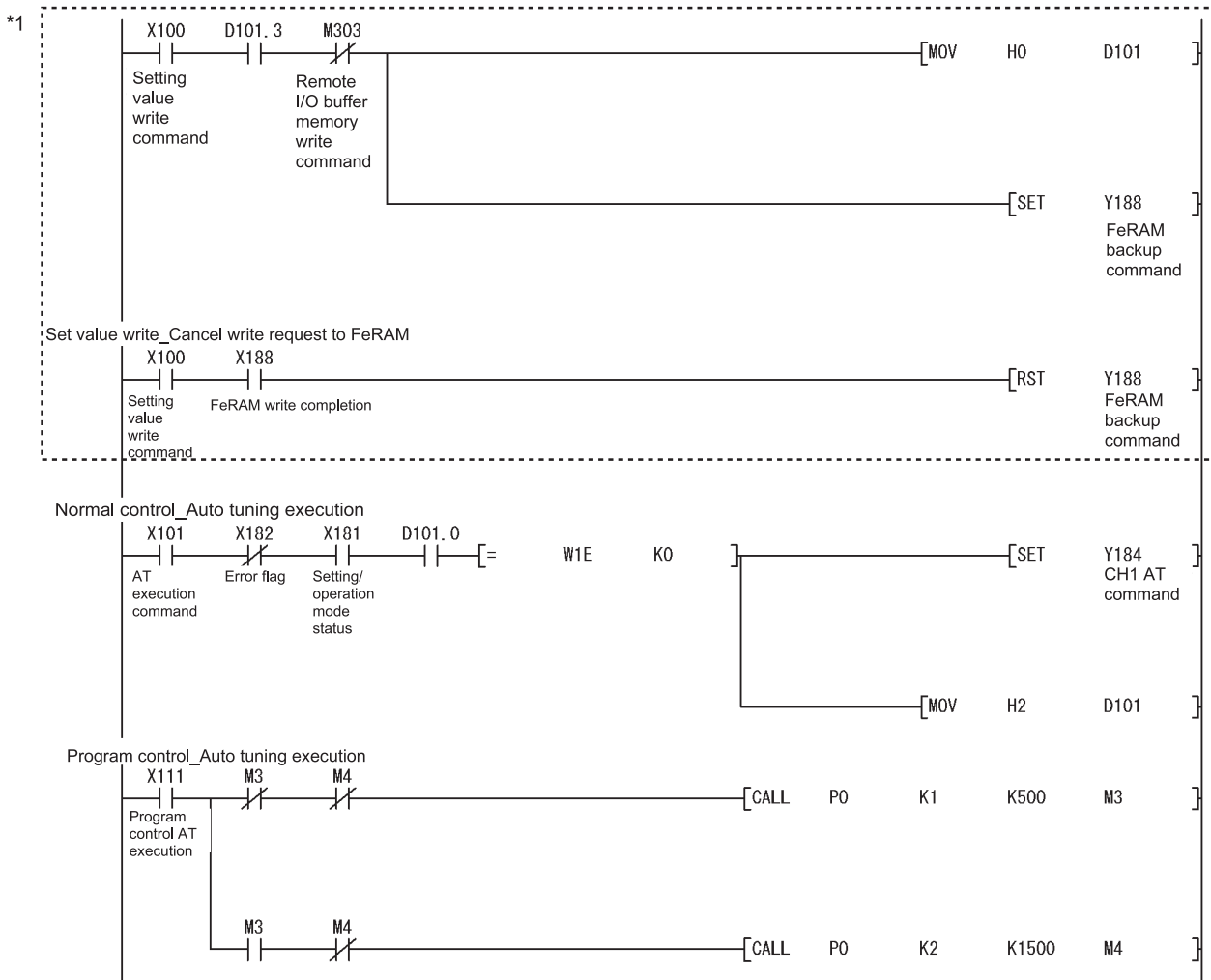

*1: The program in this area is required to write the input range, alert setting, set value, and other values to FeRAM. These values do not need to be written to FeRAM if initial settings of GX Configurator-TC are used or these values are written using a sequence program at power-on.

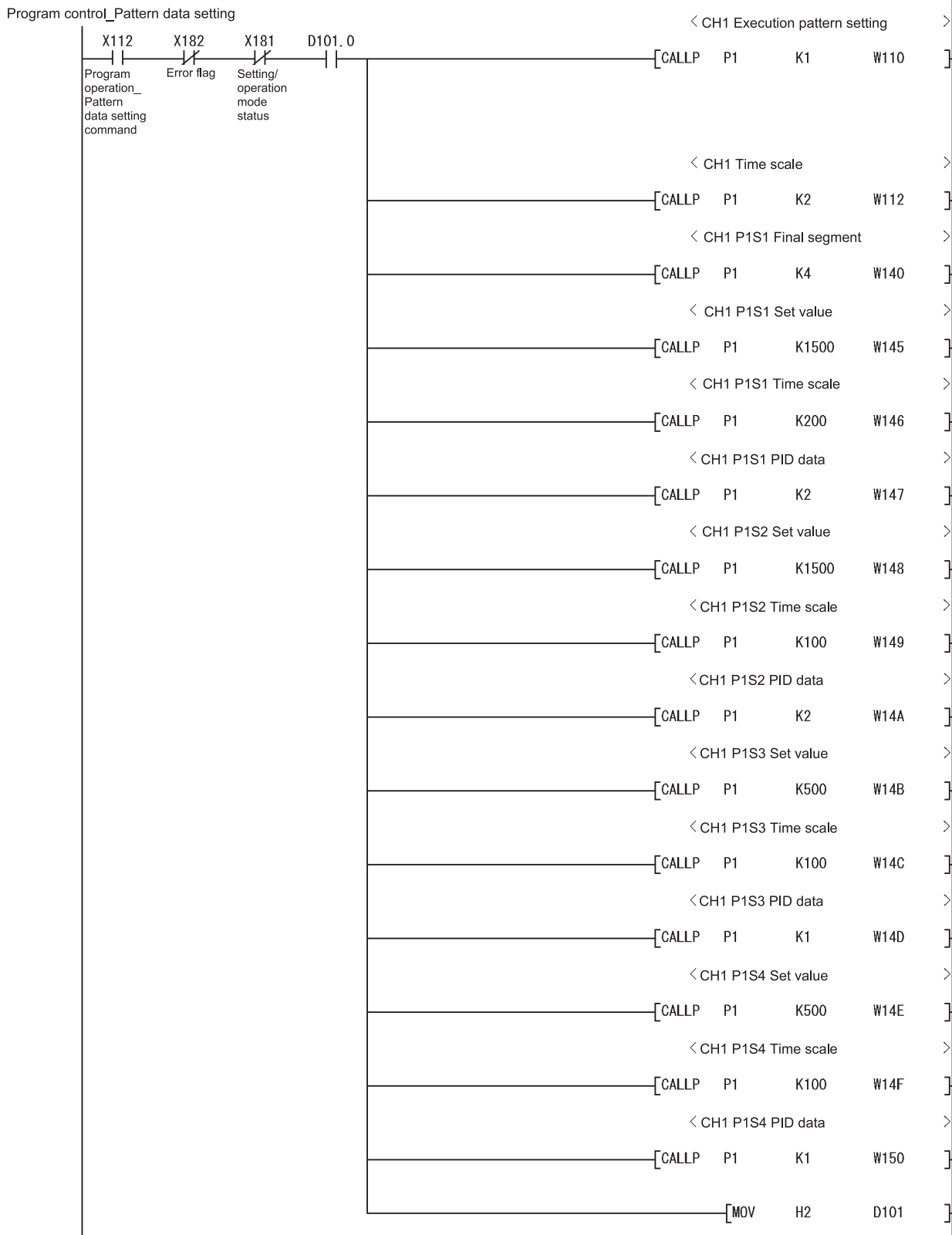

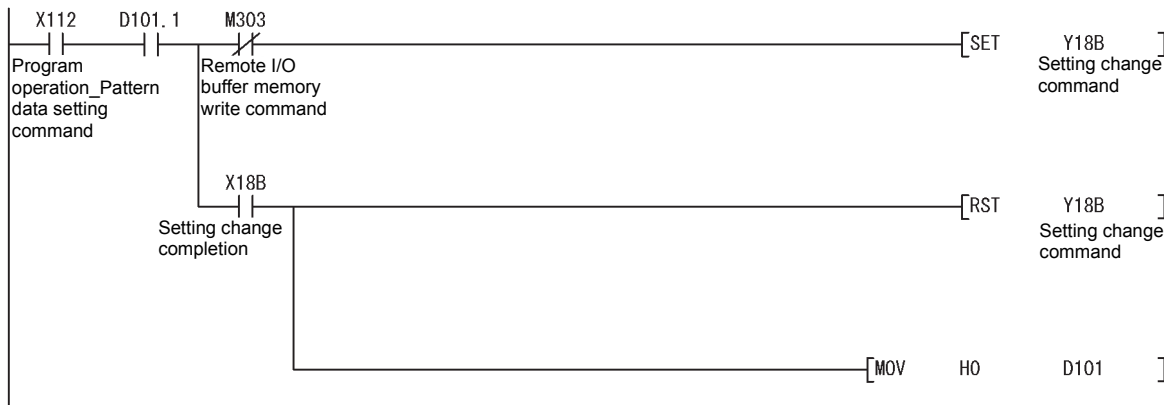

Cascade control setting

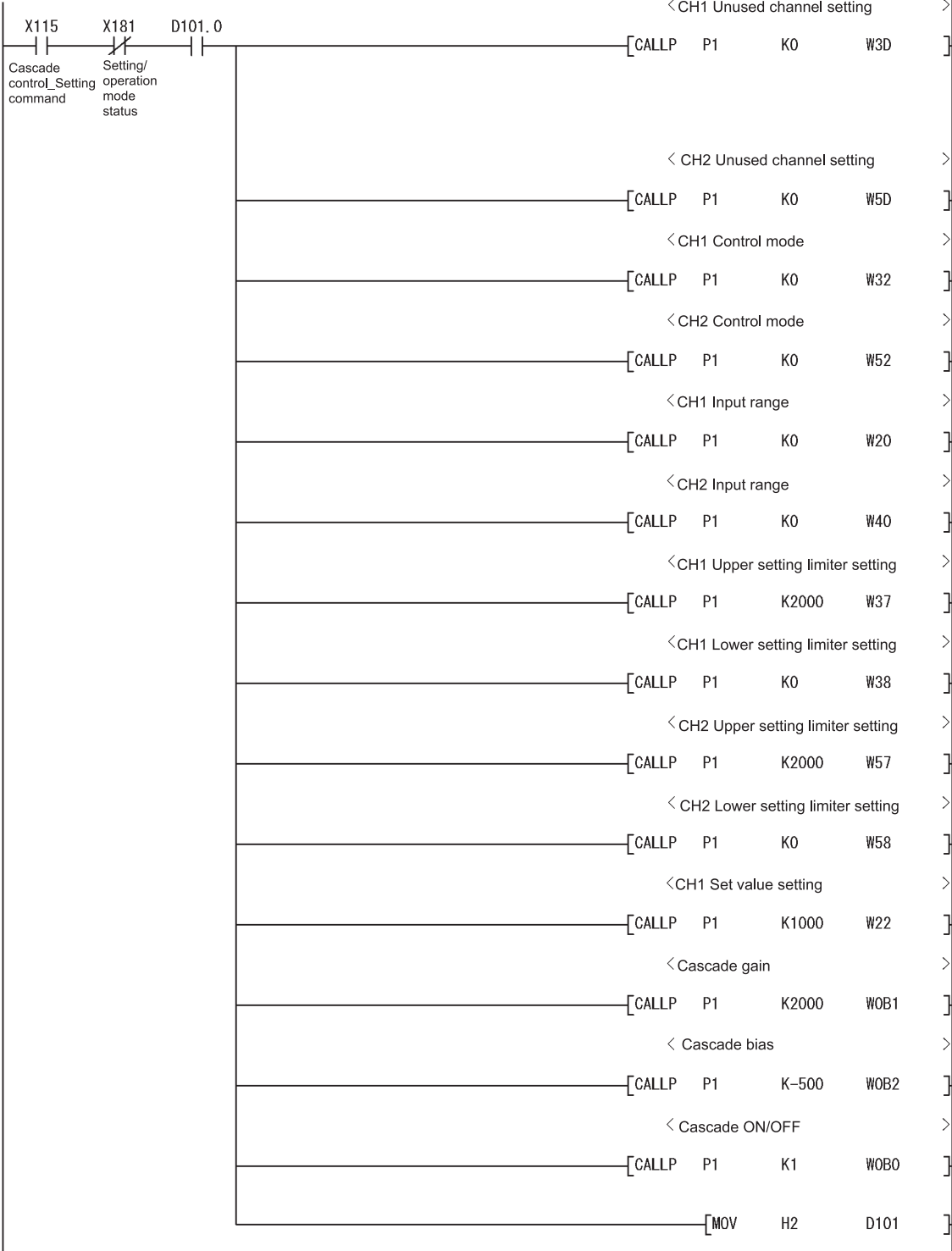

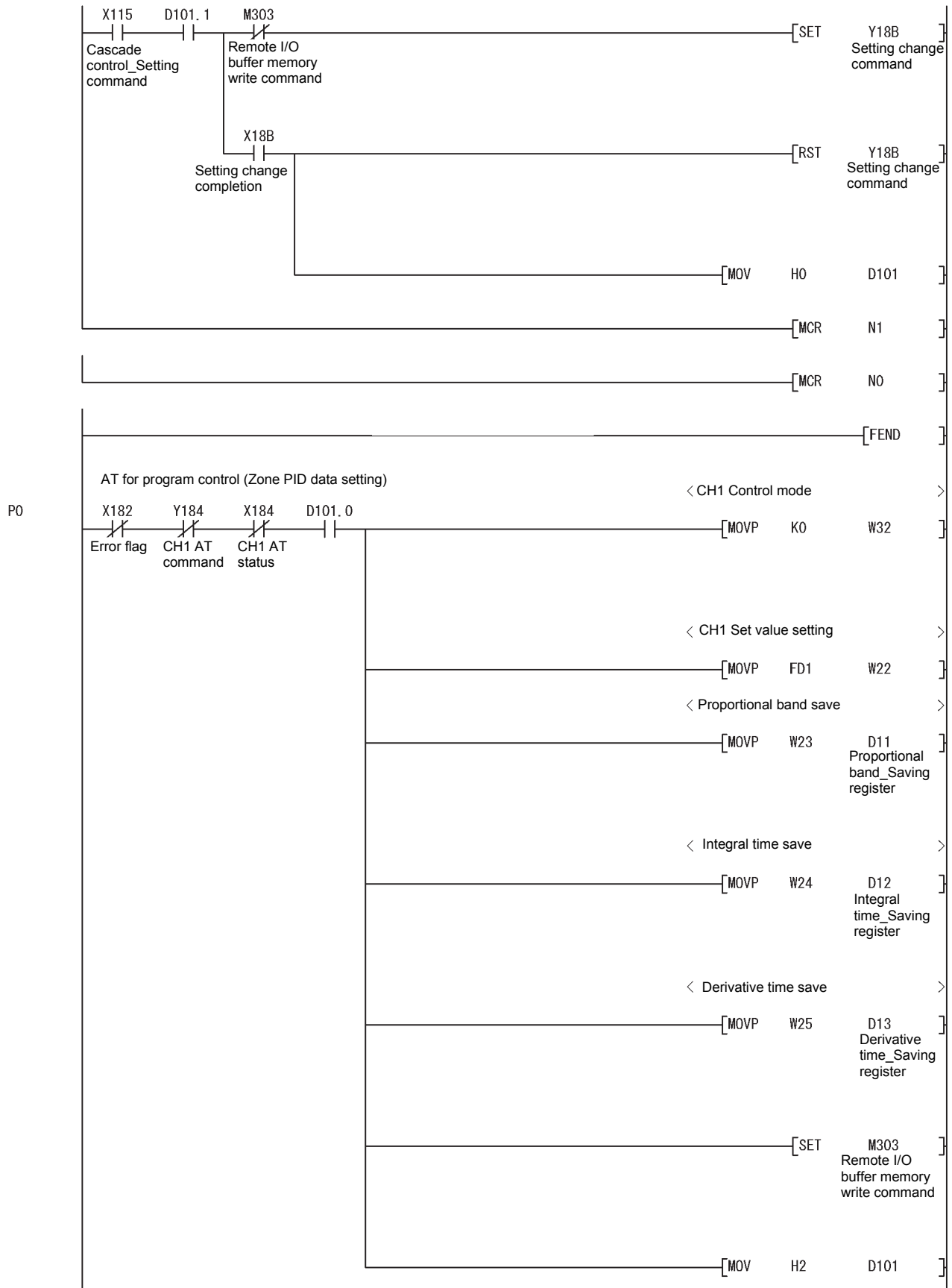

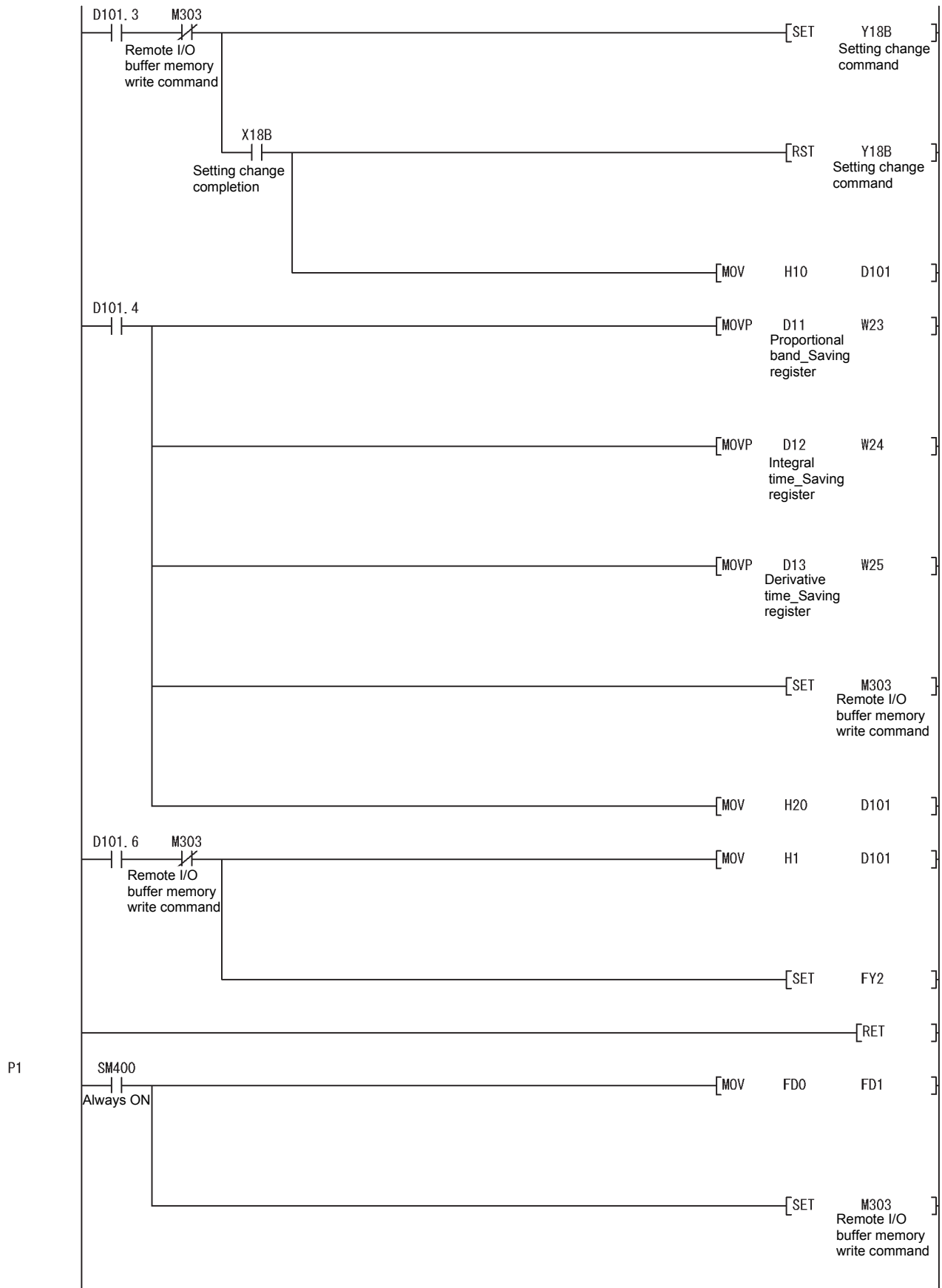

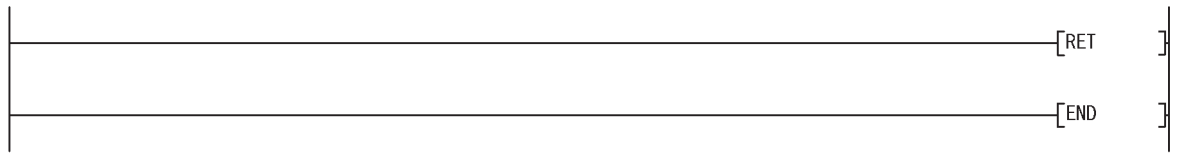

7 ONLINE MODULE CHANGE

To change a module online, read the "Online Module Change" section of the QCPU User's Manual (Hardware Design, Maintenance and Inspection).

This chapter describes the specifications of an online module change.

- (1) Perform an online module change by operating GX Developer.
- (2) To continue the same operation with a new module after the module is replaced, save and restore the data in the buffer memory.

POINT
(1) Perform an online module change after making sure that the system outside the programmable controller will not malfunction.
(2) To prevent an electric shock and malfunction of operating modules, provide means such as switches for powering off each of the external power supply and external devices connected to the module to be replaced online.
(3) After the module becomes faulty, the data may not be saved properly. Back up the save-target data (the entire write-enable area in the buffer memory) in advance (refer to Section 3.5.1).
(4) It is recommended to perform an online module change in the actual system in advance to ensure that it would not affect the other modules by checking the following: <ul style="list-style-type: none">• Means of cutting off the connection to external devices and its configuration are correct.• Switching on/off does not bring any undesirable effect.
(5) After the first use of the product, do not mount/remove the module to/from the base unit, and the terminal block to/from the module more than 50 times (IEC 61131-2 compliant) respectively. Exceeding the limit of 50 times may cause malfunction.

7.1 Online Module Change Conditions

To change the Q62HLC online, the following programmable controller CPU, MELSECNET/H remote I/O module, GX Developer, and base unit are required.

- (1) **Programmable controller CPU**
The Process CPU or Redundant CPU is required.
For precautions for multiple CPU system configuration, refer to the QCPU User's Manual (Multiple CPU System).
For precautions for redundant system configuration, refer to the QnPRHCPU User's Manual (Redundant System).
- (2) **MELSECNET/H remote I/O module**
The module with a function version D or later is required.
- (3) **GX Developer**
GX Developer Version 7.10L or later is required.
To perform an online module change on a remote I/O station, GX Developer Version 8.18U or later is required.
- (4) **Base unit**
 - (a) When the slim type main base unit (Q3□SB) is used, an online module change cannot be performed.
 - (b) When the extension base unit (type requiring no power supply module) (Q5□B) is used, an online module change cannot be performed for the modules on all the base units connected.

REMARKS

The Q62HLC supports the online module change function from its original version (function version C).

7.2 Operations When an Online Module Change is Performed

The following table lists the operations of the Q62HLC when an online module change is performed.

Programmable controller CPU operation ○: Executed ×: Not executed					(User operation) ^{*3}	(Intelligent function module operation)
X/Y refresh	FROM/TO instruction ^{*1}	Device test	GX Configurator			
			Initial setting parameter	Monitor/test		
○	○	○	×	○	<p>(1) Operation stop</p> <p>Turn off all Y signals that were turned on by a sequence program.</p> <p>(2) Dismounting of module</p> <p>Operate GX Developer to start an online module change.</p> <p>Click the [Execution] button of GX Developer to make the module dismountable.</p> <p>Dismount the corresponding module.</p> <p>(3) Mounting of new module</p> <p>Mount a new module.</p> <p>After mounting the module, click the [Execution] button of GX Developer.</p> <p>Operation check before control start</p> <p>(4) Operation check</p> <p>Click the [Cancel] button of GX Developer to leave the online mode.</p> <p>Conduct an operation test on the new module using "Device test" of GX Developer or "Monitor/test" of GX Configurator.</p> <p>Operation check completed</p> <p>(5) Resumption of control</p> <p>Operate GX Developer to resume the online module change mode, and click the [Execution] button to resume control.</p> <p>Terminate the online module change operation.</p>	<p>Module is operating as usual.</p> <p>Module stops operating.</p> <ul style="list-style-type: none"> • RUN LED turns off. <p>X/Y refresh resumes and the module starts.</p> <ul style="list-style-type: none"> • RUN LED turns on. • Default operation (Xn3 remains.) <p>(When there are initial setting parameters, operation is performed according to the initial setting parameters at this point.)</p> <p>Module operates according to test operation.^{*2}</p> <p>Xn3 (Module ready flag) turns on.</p> <p>Start is made when Xn3 turns from off to on. Operation is performed according to the initial setting sequence.^{*2}</p>
×	×	×	×	×		
○	×	×	○	×		
○	×	○	×	○		
○	○	○	×	○		

*1: An access to the intelligent function module device (U□G□) is included.

*2: The intelligent function module operates according to the previous setting when the user does not perform any operation.

*3: The numbers (1) to (5) correspond to the steps of the online module change procedure in Section 7.3.

7.3 Online Module Change Procedure

This section describes two online module change procedures: configuring the initial settings using GX Configurator-TC and configuring the initial settings using a sequence program.

7.3.1 When GX Configurator-TC is used for the initial setting

(1) Stopping operation

- (a) Turn off the following output signals to stop module operation.

Device No.	Signal name
Yn1	Setting/operation mode command
Yn8	FeRAM backup start command
Yn9	Default setting registration start command
YnB	Setting change command

POINT

Control may not stop even when Setting/operation mode command (Yn1) is turned off.

To stop control without fail, set 0 (Stop) in PID continuation flag (buffer memory address: 169) and turn off Setting/operation mode command (Yn1).

The stop status can be checked with Setting/operation mode status (Xn1) (off: Stop).

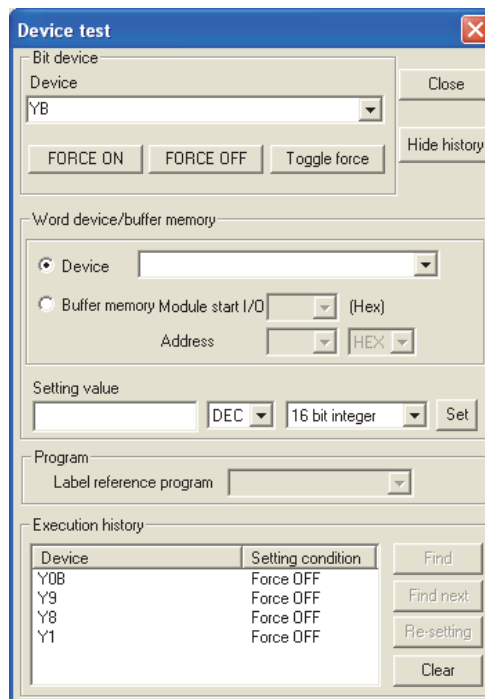

(2) Removing a module

- (a) Select [Diagnosis] - [Online module change] from the menu of GX Developer. Select "Online module change" under "Mode" and double-click the module to be changed online to display the "Online module change" screen.

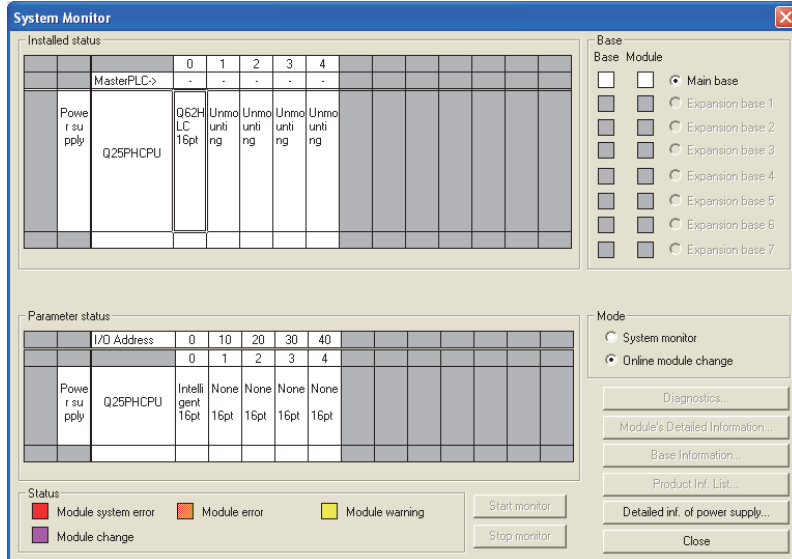

- (b) Click the "Execution" button to enable a module change.

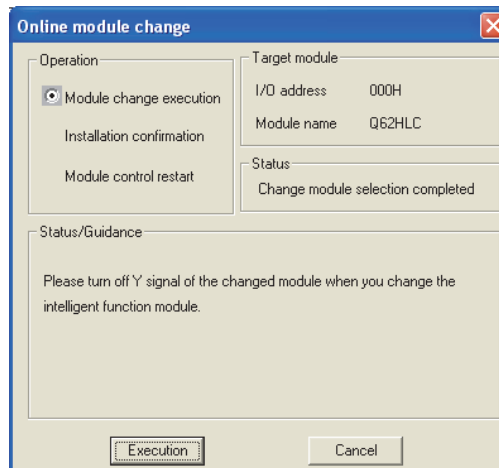

If the following error screen appears, click the "OK" button and perform the operation in (2)(c) and later.



- (c) Check that the RUN LED of the module is off, disconnect the external cable, and remove the module.

POINT

- (1) If the terminal block is removed, the measured temperature may vary within the accuracy range due to the individual differences of the cold junction temperature compensation resistors (for the thermocouple input only).
- (2) Do not forget to remove the module. If the installation confirmation is executed without removing the module, the module does not start up properly and the RUN LED does not turn on.

(3) Mounting a new module

- (a) Mount a new module in the same slot and connect external cables.
- (b) When the module is mounted, click the [Execution] button and check that the RUN LED is on. Module ready flag (Xn3) remains off.

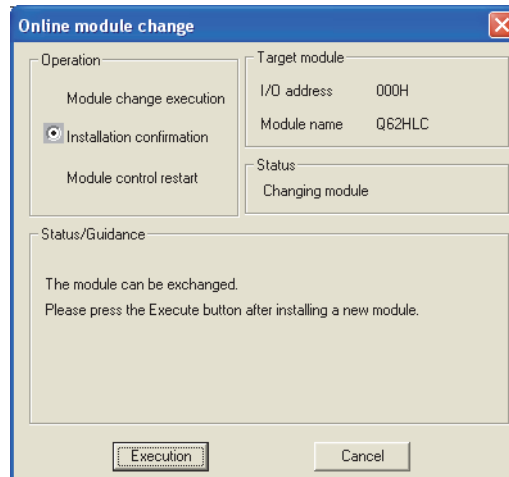

(4) Checking operation

- (a) To check the operation, click the [Cancel] button and cancel the control restart.

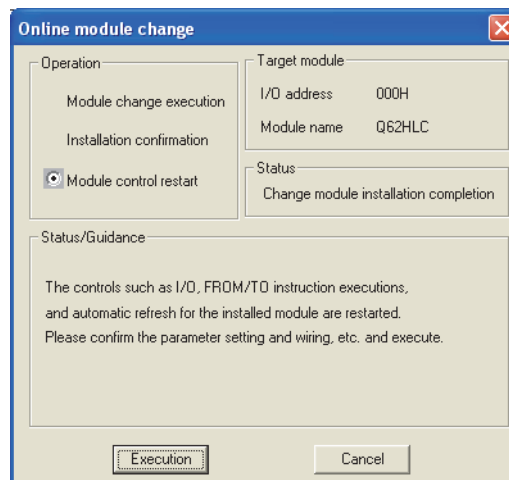

- (b) Click the [OK] button to leave the "Online module change" mode.

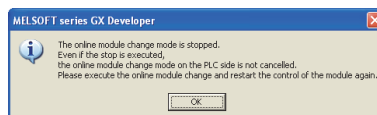

- (c) Click the [Close] button to close the System monitor screen.

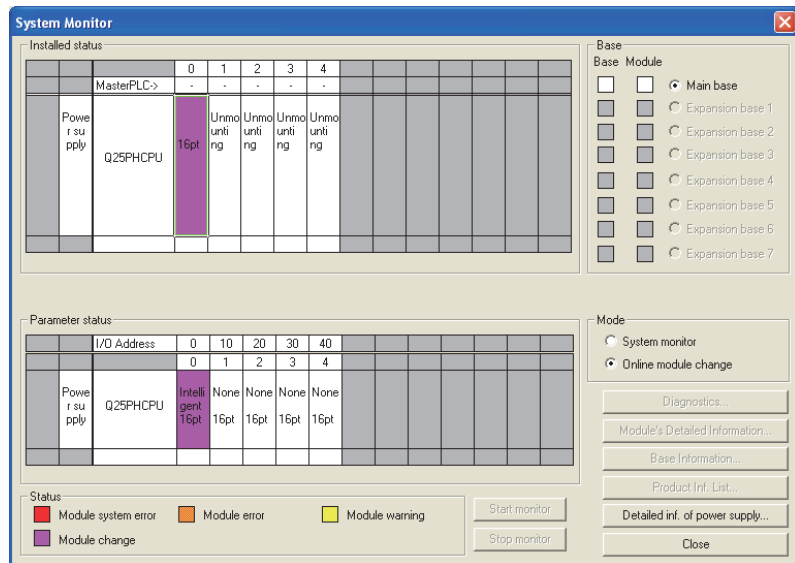

- (d) Before restarting the control, check the following on the Q62HLC. If there is any problem, refer to Chapter 8 and take a corrective action.
- 1) The RUN LED is on.
 - 2) The ERR. LED is off.
 - 3) Watchdog timer error flag (Xn0) is off.
 - 4) Error flag (Xn2) is off.

(5) Restarting control

- (a) Select [Diagnosis] - [Online module change] from the menu of GX Developer to display the Online module change screen again. Click the [Execution] button and restart the control. Module ready flag (Xn3) turns on.

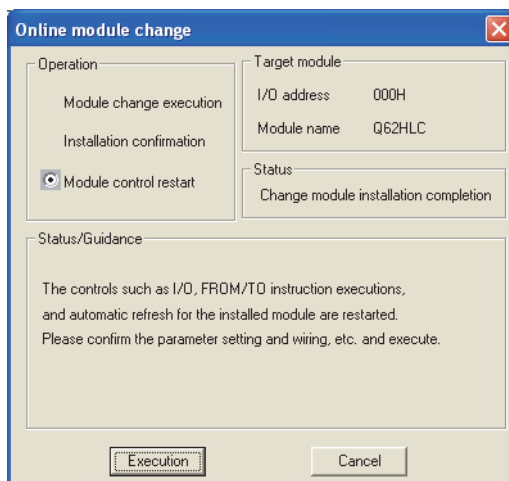

- (b) The Online module change completed screen appears.



7.3.2 When a sequence program is used for the initial setting

(1) Stopping operation

- (a) Turn off the following output signals to stop module operation.

Device No.	Signal name
Yn1	Setting/operation mode command
Yn8	FeRAM backup start command
Yn9	Default setting registration start command
YnB	Setting change command

POINT

Control may not stop even when Setting/operation mode command (Yn1) is turned off.
 To stop control without fail, set 0 (Stop) in PID continuation flag (buffer memory address: 169) and turn off Setting/operation mode command (Yn1).
 The stop status can be checked with Setting/operation mode status (Xn1) (off: Stop).

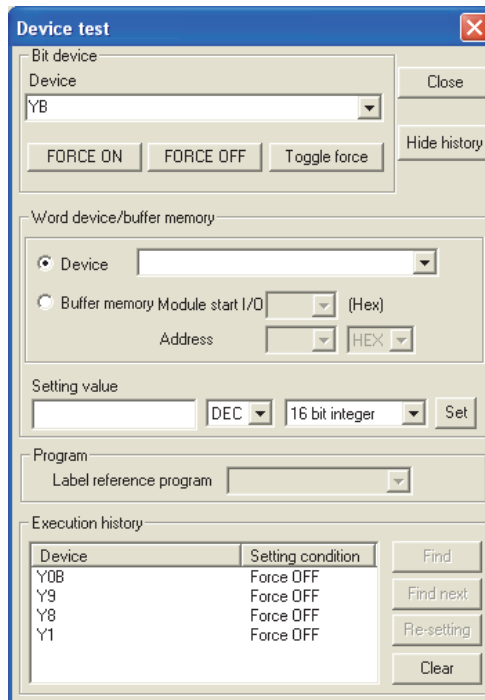

- (b) If data in the buffer memory areas to be saved are not backed up in advance, select [Online] - [Monitor] - "Buffer memory batch" from the menu of GX Developer to monitor the buffer memory, and backup the data.

POINT

If a CPU continuation error (such as SP. UNIT DOWN, UNIT VERIFY ERR.) has occurred due to an error in the change-target module, data in the buffer memory cannot be saved.

(2) Removing a module

- (a) Select [Diagnosis] - [Online module change] from the menu of GX Developer. Select "Online module change" under "Mode" and double-click the module to be changed online to display the "Online module change" screen.

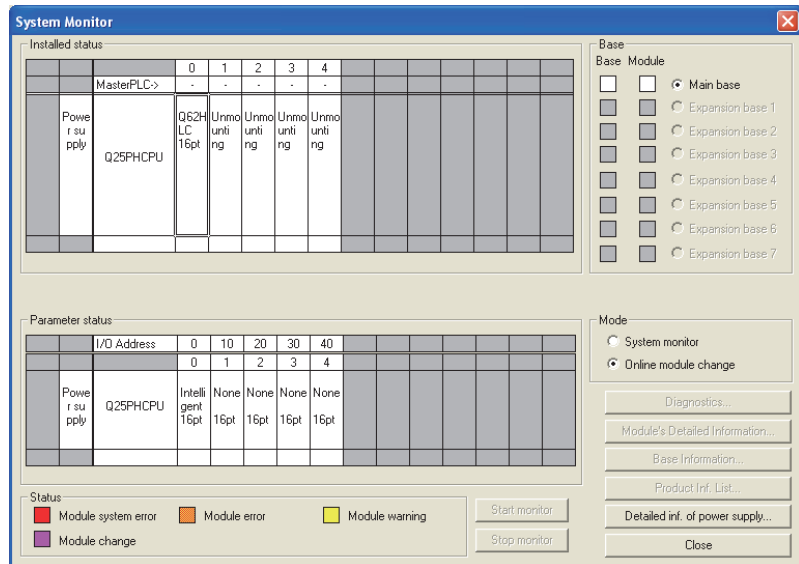

- (b) Click the "Execution" button to enable a module change.

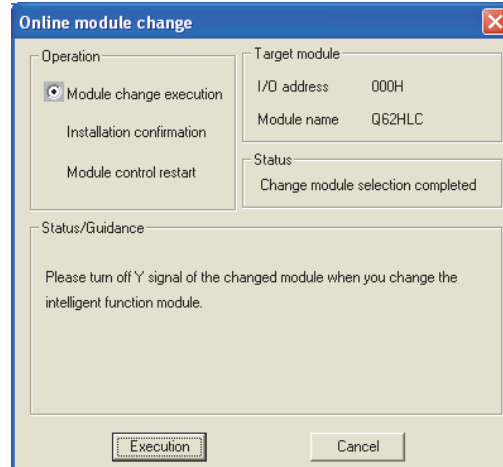

If the following error screen appears, click the "OK" button and perform the operation in (2)(c) and later.



- (c) Check that the RUN LED of the module is off, disconnect the external cable, and remove the module.

POINT

- (1) If the terminal block is removed, the measured temperature may vary within the accuracy range due to the individual differences of the cold junction temperature compensation resistors (for the thermocouple input only).
- (2) Do not forget to remove the module. If the installation confirmation is executed without removing the module, the module does not start up properly and the RUN LED does not turn on.

(3) Mounting a new module

- (a) Mount a new module in the same slot and connect external cables.
- (b) When the module is mounted, click the [Execution] button and check that the RUN LED is on. Module ready flag (Xn3) remains off.

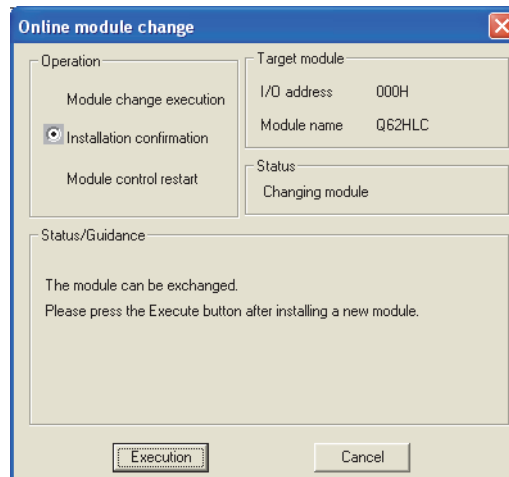

(4) Checking operation

- (a) To check the operation, click the [Cancel] button and cancel the control restart.

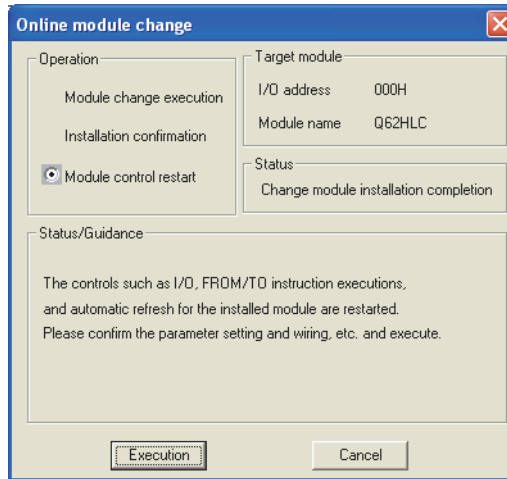

- (b) Click the [OK] button to leave the "Online module change" mode.

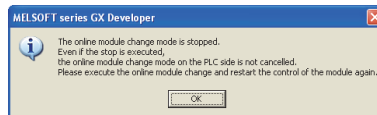

- (c) Click the [Close] button to close the System monitor screen.

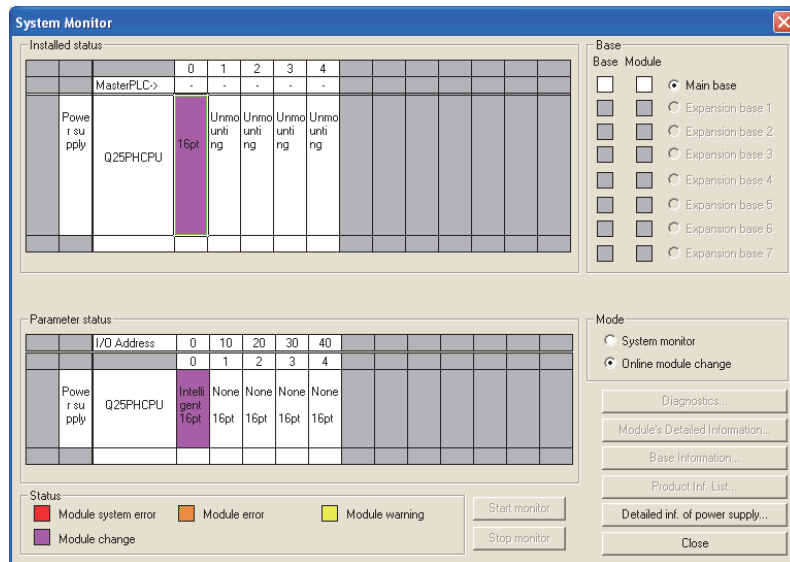

- (d) Select [Online] - [Debug] - [Device test] from the menu of GX Developer and set the stored data to the buffer memory.
- (e) To back up the data in FeRAM, turn off and on FeRAM backup start command (Yn8).

- (f) Before restarting the control, check the following on the Q62HLC. If there is any problem, refer to Chapter 8 and take a corrective action.
- 1) The RUN LED is on.
 - 2) The ERR. LED is off.
 - 3) Watchdog timer error flag (Xn0) is off.
 - 4) Error flag (Xn2) is off.
- (g) Since the new module is in the default status, the initial settings need to be configured using a sequence program after the control is restarted. Before configuring the initial settings, check that the initial setting program is created correctly.
- 1) Normal system configuration
Create a sequence program so that the initial settings are configured when Module ready flag (Xn3) of the Q62HLC turns on.
When the control is restarted, Module READY flag (Xn0) turns on and the initial settings are configured. (In a sequence program where the initial settings are configured only for a single scan after RUN, the initial settings are not configured.)
 - 2) When used on remote I/O network
Include a user device (initial setting request signal) that configures the initial settings at any timing in a sequence program. After the control is restarted, turn on the initial setting request signal and configure the initial settings. (In a sequence program where the initial settings are configured only for a single scan after a data link start of the remote I/O network, the initial settings are not configured.)

(5) Restarting control

- (a) Select [Diagnosis] - [Online module change] from the menu of GX Developer to display the Online module change screen again. Click the [Execution] button and restart the control. Module ready flag (Xn3) turns on.

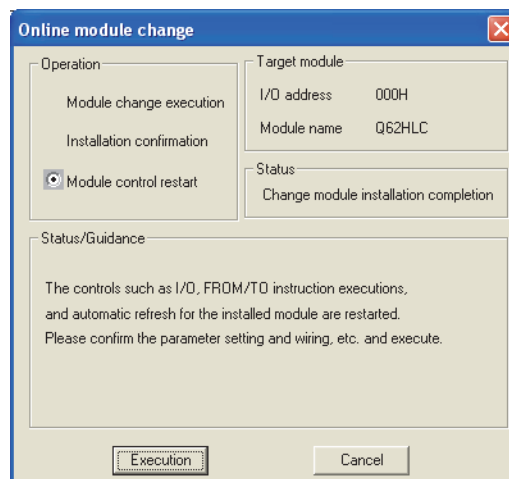

- (b) The Online module change completed screen appears.



7.4 Precautions for Online Module Change

This section lists precautions for changing a module online.

- (1) Perform an online module change following the correct procedure. Not doing so may cause malfunction or failure.
- (2) Even if pre-recorded data are set to the buffer memory in the module that was changed online and control is restarted, control cannot be restarted in the same control status since the data in Manipulated value (MV) (buffer memory address: 13, 14) is cleared once control is stopped
- (3) Even if an alert occurs before performing an online module change, the same alert does not necessarily occur when the control is restarted. For example, if an upper limit alert with wait is set and the alert occurs before performing an online module change, the module goes into the wait status and the alert does not occur when the control is restarted after performing the online module change.

7.4.1 Precautions before module change

(1) Stopping module operation

Turn off the following output signals and stop module operation before changing a module.

Device No.	Signal name
Yn1	Setting/operation mode command (Refer to the REMARKS below.)
Yn8	FeRAM backup start command
Yn9	Default setting registration start command
YnB	Setting change command

REMARKS

Control may not stop even when Setting/operation mode command (Yn1) is turned off.

To stop control without fail, set 0 (Stop) in PID continuation flag (buffer memory address: 169) and turn off Setting/operation mode command (Yn1).

The stop status can be checked with Setting/operation mode status (Xn1) (off: Stop).

(2) Continuing control

Set 1 (Continue) in PID continuation flag (buffer memory address: 169) before performing an online module change to continue control in the module until it is removed even during the online module change.

Shut off the external power supply (all phases) and ensure safety before removing a module.

(3) Saving data

After a module is changed, values in the buffer memory areas return to default (values read from FeRAM). Save and restore data in the buffer memory to continue previous operating status in the changed module.

However, if data can be restored using sequence programs or initial settings, the save and restore processing is not required.

Data in the entire write-enable buffer memory area are required to continue the operating status. There are two methods to save the data in the buffer memory.

- (a) Specify the buffer memory of the change-target module on the Read from PLC screen ("Device data" tab) of GX Developer and read data from the buffer memory.
- (b) Monitor the buffer memory of the change-target module on the Buffer memory batch monitor screen of GX Developer and write down data in the buffer memory.

Each operation should be performed before online module change, because they cannot be performed after online module change has started. For operating procedure, refer to Section 7.3.

(4) Wiring

Perform wiring after checking that the external power supply of current output is off.

7.4.2 Precautions after module change

(1) Restoring data

Once a module is changed successfully, the online module change mode is terminated and restoration of data is enabled before restart of the control. Since the direct device access (MOV Un\G*) using a sequence program, FROM/TO instructions, and auto refresh setting are disabled at this point, restore data manually with test operation of GX Developer or GX Configurator-TC. Control operation can be checked and data can be written to FeRAM at this moment if needed.

If initial setting parameters has been set using GX Configurator-TC, the initial setting data are stored in the buffer memory when a module is changed successfully.

(2) Checking the status before restarting control

Before restarting control, check the status of the following items. If any error is detected, refer to Chapter 8 and take a corrective action.

- (a) The RUN LED is on.
- (b) The ERR. LED is off.
- (c) Watchdog timer error flag (Xn0) is off.
- (d) Error flag (Xn2) is off.

REMARKS

Note that, unlike normal startup, Module ready flag (Xn3) does not turn on immediately after a new module is mounted during an online module change. This flag (Xn3) turns on after control is restarted. If there is any sequence program that configures the initial settings on the rising edge of this flag (Xn3), the program is executed upon restart of the control.

7.4.3 Precautions depending on parameter setting method

○ : Used, × : Not used

Parameter setting method			Precautions	
FeRAM backup	GX Configurator-TC initial setting	Sequence program for writing initial values ^{*1}	When saving and restoring data in the buffer memory	When not saving and restoring data in the buffer memory
×	×	×	None	None
×	×	○	*2	None
×	○	×	None	None
×	○	○	*2	None
○	×	×	*3	None
○	×	○	*2, *3	None
○	○	×	*2	None
○	○	○	*2, *3	None

*1: This indicates the sequence program that is executed on the rising edge of Module ready flag (Xn3).

*2: Even if the restore processing is performed at any timing between the steps "After mounting the module, click the [Execution] button of GX Developer" and "Operate GX Developer to resume the online module change mode, and click the [Execution] button to resume control" of user operation in Section 7.2, the buffer memory is overwritten by sequence program for writing initial values. Perform the restore processing after the step "Operate GX Developer to resume the online module change mode, and click the [Execution] button to resume control" is completed.

*3: Perform the restore processing after the step "After mounting the module, click the [Execution] button of GX Developer" of user operation in Section 7.2 is executed and data in FeRAM is restored. Data in FeRAM can be restored by setting values in the buffer memory and turning on FeRAM backup start command (Yn8) by test operation of GX Developer.

8 TROUBLESHOOTING

8.1 Error Codes

The error has the following three types.

- Write data error (□□□3H, □□□4H, □□□5H, □□□6H)*¹
- AT error completion (001EH, 002EH, 003EH, 004EH, 005EH)
- Hardware error (001FH, 002FH, 003FH)

*1 The buffer memory address occurring write data error is displayed at □□□ in hexadecimal.

Example) 0234H expresses that data out of the range are written to Proportional band (P) setting (buffer memory address: 35 (23H)).

The error codes of the Q62HLC are stored into the buffer memory address 0. Display them in hexadecimal for check.

(1) Error code to be stored when multiple errors occur

- (a) If higher priority error occurs during occurrence of lower priority error, the error code of the higher one is overwritten.

[Priority order]
 [High] Hardware error ← AT error completion ← Write data error [Low]

- (b) If multiple errors have been detected at hardware error/AT error completion, the error code of the first occurred error is retained.

- (c) In write data error, if higher priority error occurs during occurrence of lower priority error, the error code of the higher one is overwritten.

[Priority order]
 [High] □□□6H ← □□□3H ← □□□5H ← □□□4H [Low]

If the last one digit of the error codes is the same, the smallest buffer memory address among the ones where data were mistakenly written is stored by priority.

However, if the error code is □□□6H, the buffer memory address where data were mistakenly written first is held.

[Example of priority order of error code to be stored]
 [High] 0A46H ← 0203H ← 0403H ← 0575H ← 0334H [Low]
 ↑
 "0A46H" is held even when "0346H" occurs.

(2) Error code list

Error code (hexadecimal) *1	Error type	Error cause	Error-time operation	Action
□□□3 _H	Write data error	<ul style="list-style-type: none"> Write to the area write-enabled in the setting mode only was performed in the operation mode. Any of the following error codes occurred during setting mode; however, the mode is changed to operation mode without resetting the error. <ul style="list-style-type: none"> The write data error to input range (error code: 0204_H, 0404_H) The write error to alert mode setting (error code: 0C04_H, 0C14_H, 0C24_H, 0C34_H, 0D04_H, 0D14_H, 0D24_H, 0D34_H) 	<ul style="list-style-type: none"> The written data is held as is. If data are written to multiple write areas, the smallest buffer memory address among the ones where data were mistakenly written is stored by priority. 	<ul style="list-style-type: none"> Reset an error in the following procedure: <ol style="list-style-type: none"> Choose the setting mode. Set a correct value. Reset an error. When changing from the operation mode to the setting mode, make sure that PID continuation flag (buffer memory address: 169) is 0 (STOP), and turn off Setting/operation mode command (Yn1).
□□□4 _H		<ul style="list-style-type: none"> Data outside the setting range was written. 	<ul style="list-style-type: none"> The written data is held as is. When write area setting is over the upper and lower limit values, the upper and lower limit values are used to exercise the control. If multiple data outside the setting range were written, the smallest buffer memory address among the ones where data were mistakenly written is stored by priority. 	<ul style="list-style-type: none"> Set data within the range.
□□□5 _H		<ul style="list-style-type: none"> The setting of the upper/lower output limiter or upper/lower setting limiter is illegal. 	<ul style="list-style-type: none"> The written data is held as is. The upper and lower limit values that may be set are used to exercise control. If data are written to multiple limiter setting area, the smallest buffer memory address among the ones where data were mistakenly written is stored by priority. 	<ul style="list-style-type: none"> Configure the setting so that the upper limit value is greater than the lower limit value.
□□□6 _H		<ul style="list-style-type: none"> The set value was changed during default setting registration. 	<ul style="list-style-type: none"> The written data is ignored. Any set value cannot be changed until error reset is made. If another write error occurs, Error code (buffer memory address: 0) data does not change. 	<ul style="list-style-type: none"> After making Error reset command (Yn2: ON), change the set value.

*1: The address of the buffer memory where a write data error has occurred is displayed at □□□ in hexadecimal.

Example) 0234_H expresses that data out of the range are written to Proportional band (P) setting (buffer memory address: 35 (23_H)).

Error code (hexadecimal) *1	Error type	Error cause	Error-time operation	Action
001EH	AT error completion	• The measured value is out of the input range during AT.	<ul style="list-style-type: none"> • Auto tuning status flag (Xn4, Xn5) turns off. • PID constants and loop disconnection detection judgment time do not change. 	<ul style="list-style-type: none"> • Remove an error cause after Error reset command (Yn2: ON), and execute AT again.
002EH		• Control mode switched to the mode other than normal control mode during AT.		
003EH		The following buffer memory of applicable channel is changed during AT. <ul style="list-style-type: none"> • Set value (SV) setting • Upper output limiter • Lower output limiter • Output variation limiter • Sensor compensation value setting • Primary delay digital filter setting • Control mode • AT bias 		
		The following buffer memory of applicable channel is changed, and the set value is out of the range during AT. <ul style="list-style-type: none"> • Upper setting limiter • Lower setting limiter 		
		• The half sine of data collection wave exceeded two hours during AT.		
004EH		• The half sine of data collection wave exceeded two hours during AT.		
005EH	• PID constant calculated value exceeded the range.			
001FH	Hardware error	• Adjustment data error is detected.	<ul style="list-style-type: none"> • It depends on hardware error case. 	<ul style="list-style-type: none"> • For the temperature compensation error (error code: 003FH), make sure that the terminal block/cold junction temperature compensation resistor is not disconnected. If it is disconnected, connect correctly. • Replace the module. • Please consult your local Mitsubishi representative.
002FH		• Analog/Digital conversion value error is detected.		
003FH		• Temperature compensation error is detected. (Including when the cold junction temperature compensation resistance is not connected)		

8.2 Processing Performed by the Q62HLC at Error Occurrence

The Q62HLC performs processing as explained below if an error occurs in the Q62HLC/programmable controller CPU or when the programmable controller CPU is switched from RUN to STOP.

Status	Processing			
	CLEAR		HOLD	
	Stop	Continue	Stop	Continue
Control output setting for CPU stop error				
PID continuation flag	Stop	Continue	Stop	Continue
At Q62HLC write error occurrence	Follows the error-time operation described in Section 8.1.			
At Q62HLC AT error completion				
At Q62HLC hardware error occurrence				
At programmable controller CPU stop error occurrence	Stops the operation and turns off external output.		Follows stop mode setting.	Continues the operation and performs external output.
When programmable controller CPU is switched from RUN to STOP	Follows stop mode setting.	Continues the operation and performs external output.	Follows stop mode setting.	Continues the operation and performs external output.
During programmable controller CPU reset	Does not perform external output, as module itself becomes inoperative.			

 <p>WARNING</p>	<ul style="list-style-type: none"> • Do not write any data to the "system area" and "write-protect area" of the buffer memory in the intelligent function module. Also, do not use any "use prohibited" signals as input or output signals from the intelligent function module to the CPU module. Doing so may cause malfunction of the programmable controller system. • Be extremely careful when setting the PID continuation flag which controls the external output. • Due to failure of the output element or internal circuit, normal output may not be obtained correctly. Configure an external circuit for monitoring output signals that could cause a serious accident.
---	---

8.3 When the RUN LED Flashes or Turns Off

Check item	Action
Is 5VDC supplied?	<ul style="list-style-type: none"> • Check the power supply module. • Mount the module securely.
Is the sum of current capacities of the modules mounted on the base unit equal to or less than the current capacity of the power supply module?	Make the sum of current capacities of the modules mounted on the base unit equal to or less than the current capacity of the power supply module.
Has a watchdog timer error occurred?	<ul style="list-style-type: none"> • Reset the programmable controller CPU or turn on the power supply module again. • Change the Q62HLC.
Is a module change enabled during an online module change?	Refer to Chapter 7 and handle it.

8.4 When the ERR. LED Turns On or Flashes

(1) When the LED turns on

Check item	Action
Is cold junction temperature compensation resistance disconnected?	Connect cold junction temperature compensation resistance.
—	Q62HLC hardware failure. Please consult your local Mitsubishi representative.

(2) When the LED flashes

Check item	Action
Has a write data error occurred?	Check the error code list in Section 8.1 and correct the sequence program.

8.5 When the ALM LED Turns On or Flashes

(1) When the LED turns on

Check item	Action
Has Alert flag (XnC and XnD) turned on?	Check the contents of Alert definition (buffer memory address: 5, 6) and take action for it.

(2) When the LED flashes

Check item	Action
Is the process value beyond the measured range specified for the input range?	Change the input range setting to the operating ambient range setting.
Is there any channel where a sensor is not connected?	Set the channels, where the sensors are disconnected, to unused at Unused channel setting (buffer memory address: 61, 93).
Has a loop disconnection been detected?	Check for a load disconnection, external operation device failure, sensor disconnection.

8.6 When Watchdog Timer Error Flag (Xn0) Is On

Check item	Action
—	Reset the programmable controller CPU or turn on the power supply module again. If the watchdog timer error turned on again, it represents the Q62HLC hardware failure. Please consult your local Mitsubishi representative.

8.7 When Error Flag (Xn2) Is On

Check item	Action
Has a write data error occurred?	Check the error code list in Section 8.1 and correct the sequence program.
Has AT error completion occurred?	Check the error code list in Section 8.1 and correct the sequence program.
Has a hardware error occurred?	<ul style="list-style-type: none"> • When cold junction temperature compensation resistor is disconnected, connect it. • It represents the Q62HLC hardware failure. Please consult your local Mitsubishi representative.

8.8 When Module Ready Flag (Xn3) Does Not Turn On

Check item	Action
Has an error occurred on the programmable controller?	Refer to the user's manual for the programmable controller CPU module used and handle it.

8.9 When FeRAM Write Failure Flag (XnA) Is On

Check item	Action
—	Execute writing into FeRAM again. If FeRAM write failure flag (XnA) does not turn off, it represents the Q62HLC hardware failure. Please consult your local Mitsubishi representative.

8.10 When Auto Tuning Does Not Start (When Auto Tuning Status Flag (Xn4, Xn5) Does Not Turn On)

Check item	Action
Are start conditions for auto tuning met?	Check whether all the conditions are met with referring to Section 3.2.1 (2) (a).
Has auto tuning been completed abnormally?	Check whether the auto tuning has completed abnormally with referring to Section 3.2.1 (2) (d).

8.11 When Auto Tuning Does Not Complete (When Auto Tuning Status Flag (Xn4, Xn5) Remains to Be On and Does Not Turn Off)

Check item	Action
Is PID constant read/write completion flag from FeRAM (buffer memory address: 31) set to 1 (ON)?	Set 0 (OFF) to Automatic backup setting after auto tuning of PID constants (buffer memory address: 63, 95), and turn off PID constant read/write completion flag from FeRAM (buffer memory address: 31).
Is PID constant read command from FeRAM (buffer memory address: 62, 94) set to 1 (With command)?	Set PID constant read command from FeRAM (buffer memory address: 62, 94) to 0 (Without command).
Is the set value (SV) set correctly? (Does the manipulated value (MV) remain 0% since the set value (SV) is small?)	Set arbitrary control value to the set value (SV).

8.12 When Alert Flag (XnC and XnD) is On

Check item	Action
Is the measured value error/alert set value beyond the range?	Check Alert definition (buffer memory address: 5, 6) and take action for the alert that occurred.
Is a disconnection detected?	

8.13 Checking the Q62HLC Status by System Monitor of GX Developer

When the detailed information of the Q62HLC in system monitor of GX Developer is chose, the error codes and LED lit-up states can be checked.

(1) Operating GX Developer

[Diagnostics] → [System monitor] → Select the "Q62HLC" →

Module Detailed Information

(2) Module's Detailed Information

(a) Checking the function version

The function version of the Q62HLC is displayed in the product information field.

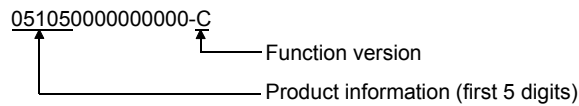

(b) Checking the error code

The error code stored in buffer memory address 0 of the Q62HLC is displayed in the latest error code field (refer to Section 8.1).

If the error code is indicated in hexadecimal, the last 1 digit indicates the error code and the last 2 to 4 digits indicate the error occurrence cause. The error occurrence cause includes the following information.

- For a write data error: buffer memory address that detected the error
- For an AT error completion or hardware error: factor code

(When the Error History button is pressed, the contents displayed in the latest error code are displayed in the No. 1 field.)

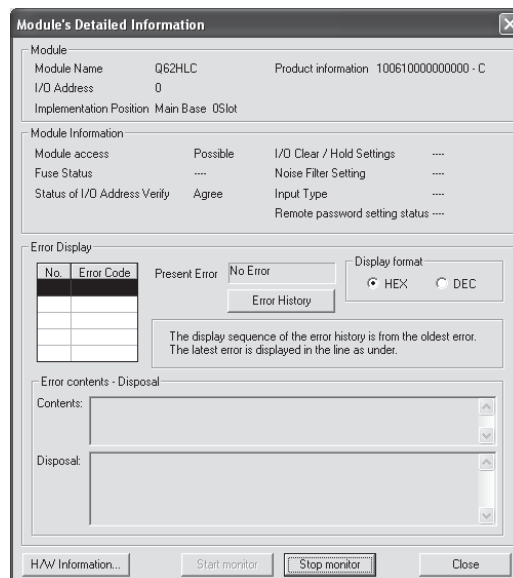

(3) H/W Information

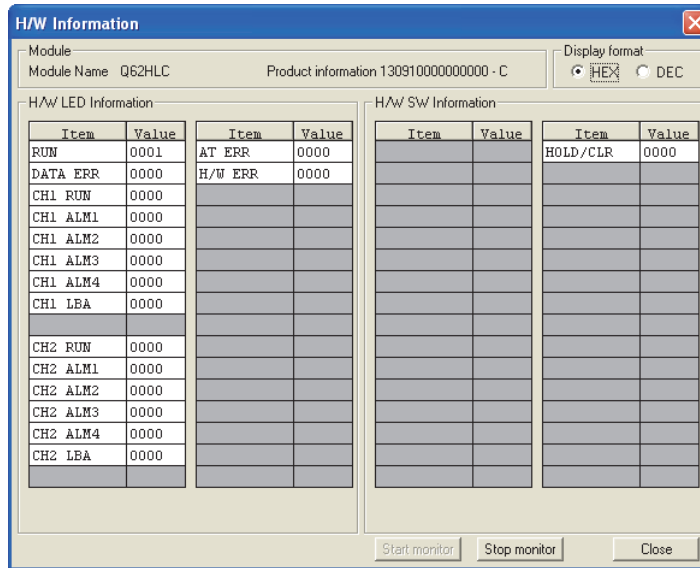

(a) H/W LED information

The H/W LED information gives the following information.

Item	Description (condition where the value becomes 1)	Item	Description (condition where the value becomes 1)
RUN	When the RUN LED is on	AT ERR	AT error completion (refer to Section 8.1)
DATA ERR	A write error (refer to Section 8.1)	H/W ERR	A hardware error (refer to Section 8.1)
CH1 RUN	When CH1 PID control is being executed	-	-
CH1 ALM1	When CH1 alert 1 is on	-	-
CH1 ALM2	When CH1 alert 2 is on	-	-
CH1 ALM3	When CH1 alert 3 is on	-	-
CH1 ALM4	When CH1 alert 4 is on	-	-
CH1 LBA	When CH1 loop disconnection has been detected	-	-
-	-	-	-
CH2 RUN	When CH2 PID control is being executed	-	-
CH2 ALM1	When CH2 alert 1 is on	-	-
CH2 ALM2	When CH2 alert 2 is on	-	-
CH2 ALM3	When CH2 alert 3 is on	-	-
CH2 ALM4	When CH2 alert 4 is on	-	-
CH2 LBA	When CH2 loop disconnection has been detected	-	-
-	-	-	-

(b) H/W Switch information

Shows the status of the intelligent function module switch setting (Switch 1).

Appendix 2 New Functions of the Q62HLC

The following describes the new function of the Q62HLC.

- (1) Functions added to products with product information (first five digits) of "10022" or later, or a serial number (first five digits) of "10011" or later

Item	Description		Reference
	Existing model	Model (product information (first five digits) of "10022" or later, or serial number (first five digits) of "10011" or later)	
Intelligent function module switch setting (Switch 2)	Use prohibited (fixed to 0)	Control status when switching to program control can be selected. 1: Switch with executing control Other than 1: Switch with suspending control	Section 4.5
Manipulated value (MV)	The manipulated value (MV) becomes -50 for 25ms when switching to program control. (Suspends the PID control to switch into program control.)	The control status when switching to program control can be selected in the intelligent function module switch setting (Switch 2).	Section 3.2.19

(2) Functions added to products with a serial number (first five digits) of "13102" or later

Item	Description		Applicable software package	Reference
	Existing model	Model (serial number (first five digits) of "13102" or later)		
Program control function	A starting method of program control can be selected from the following. 0: Zero start 1: PV start 1 (time fixed) 2: PV start 2 (time shortened) PV start 3 (time shortened/find type) and SV start are not available.	A starting method of program control can be selected from the following. 0: Zero start 1: PV start 1 (time fixed) 2: PV start 2 (time shortened) 3: PV start 3 (time shortened/find type) 4: SV start	GX Works2 Version 1.73B or later	Section 3.2.12
SV tracking function	None	When control is switched, drastic change of the set value (SV) is prevented.		Section 3.2.15 Section 3.2.51
Forced output function	None	Specified manipulated value (MV) can be forcibly output regardless of the control mode.		Section 3.2.16 Section 3.2.52 Section 3.2.53
Parameter change in program control function	None	Buffer memory settings can be changed and reflected to the control in execution without stopping program control.		Section 3.2.18
Intelligent function module switch setting (Switch 3)	Use prohibited (fixed to 0)	The forced output function and the parameter change in program control function can be enabled or disabled.		Section 4.5

INDEX

[A]

Advancing completion flag	3-107
Alert 1 to 4 mode setting	3-101
Alert dead band setting	3-98
Alert definition	3-77
Alert delay count	3-98
Alert flag (XnC, XnD)	3-61
Alert function	3-18
Alert set value 1 to 4	3-87
Applicable systems	2-1
Approach flag	3-78
Approach range setting	3-99
Approach soak time setting	3-99
AT additional lag	3-89
AT bias	3-94
AT differential gap	3-89
Auto tuning start command (Yn4, Yn5)	3-62
Auto tuning function	3-7
Auto tuning status flag (Xn4, Xn5)	3-59
Automatic backup setting after auto tuning of PID constants	3-98
Auto tuning setting function	3-12
Fast response mode	3-12
Standard mode	3-12

[B]

Buffer memory areas	3-65
---------------------------	------

[C]

Cascade bias	3-100
Cascade control function	3-37
Cascade gain	3-100
Cascade monitor	3-100
Cascade ON/OFF	3-99
Cold junction temperature measured value	3-78
Command advancing	3-104
Control mode	3-92
Control mode monitor	3-79
Control output setting at CPU stop error occurrence function	3-23
Control response parameter	3-91

[D]

Data resolution	3-3
Data storage in FeRAM function	3-16
Default setting registration start command (Yn9)	3-63
Default value write completion flag (Xn9)	3-60
Derivative action (D-action)	1-10

[E]

Error code	3-76
Error codes	8-1
End status flag	3-106
Error flag (Xn2)	3-58
Error reset command (Yn2)	3-62
Execution pattern	3-108
Execution pattern monitor	3-107
Execution times monitor	3-106
External dimensions	App-1
External wiring	4-6

[F]

FeRAM backup start command (Yn8)	3-63
FeRAM write completion flag (Xn8)	3-59
FeRAM write failure flag (XnA)	3-60
Forced output command	3-105
Forced output function	3-44
Forced output manipulated value (MV)	3-46, 3-105
Forced output status flag	3-107
Forced PID control stop command (YnC, YnD)	3-64
Forced PID control stop function	3-14
Forward/reverse action setting	3-94
Functions	3-6
Function version	2-6

[G]

GX Configurator-TC	2-4
GX Developer	2-4
GX Works2	2-4

[H]
 Handling precautions 4-1
 Hold command 3-103
 Hold status flag 3-106

[I]
 I/O signals 3-57
 Indication accuracy 3-4
 Input range 3-82
 Input sensor 3-3
 Integral action (I-action) 1-9
 Intelligent function module switch setting 4-8
 Internal current consumption 3-2

[L]
 Loop disconnection detection dead band
 3-96
 Loop disconnection detection function 3-15
 Loop disconnection detection judgment time
 3-96

[M]
 MAN output setting 3-93
 Manipulated value (MV) 3-78
 Measured value (PV) 3-77
 Module ready flag (Xn3) 3-59

[O]
 Online module change 7-1
 Operation at input disconnection 3-5
 Output variation limiter 3-88

[P]
 Parameter change in program control function
 3-49
 Part names 4-3
 Pattern end output flag 3-106
 Performance specifications 3-1
 PID action 1-11
 PID constant setting 3-85
 PID constant read command from FeRAM... 3-97
 PID constant read/write completion flag from
 FeRAM 3-80
 PID control system 1-5
 PID continuation flag 3-99
 PID operation 1-6
 Primary delay digital filter setting 3-90
 Procedures before operation 4-2

Program control function 3-24
 Program control run/reset 3-95
 Program pattern 3-111
 Pattern end output time of program
 pattern 3-113
 Program pattern final segment 3-111
 Program pattern iteration 3-112
 Program pattern link setting 3-111
 Segment set value (SV) setting 3-114
 Segment time scale 3-114
 Segment Zone PID data No 3-114
 Wait zone setting of program pattern 3-113
 Programming 6-1
 Proportional action (P-action) 1-8

[Q]
 Q62HLC control status controlling output
 signal and buffer memory settings and
 control status 3-52

[R]
 Reverse/forward action select function 3-13
 RFB limiter function 3-13

[S]
 Sampling period 3-56
 Scaling function 3-39
 Scaling range upper/lower limit value 3-102
 Scaling value 3-101
 Scaling width upper/lower limit value 3-102
 Segment monitor 3-105
 Segment remaining time 3-105
 Sensor compensation value setting 3-88
 Set value (SV) setting 3-84
 Set value at program control start (SV_PCS)
 setting 3-115
 Set value monitor 3-78
 Setting change command (YnB) 3-64
 Setting change completion flag (XnB) 3-61
 Setting change rate limiter 3-93
 Setting/operation mode command
 (Yn1) 3-62
 Setting/operation mode status (Xn1) 3-58
 Simplified analog I/O function 3-48
 Start mode 3-108
 Stop mode setting 3-84

[T]	
Time scale	3-109
Troubleshooting.....	8-1

[U]	
Unused channel setting	3-14, 3-97
Upper/lower output limiter	3-87
Upper/lower setting limiter	3-95
Utility package	5-1
Utility package functions	5-1
Auto refresh setting	5-2, 5-18
Initial setting	5-1, 5-14
Monitor/test	5-2, 5-20
Utility package operating environment	5-6

[W]	
Wait status flag	3-106
Watchdog timer error flag (Xn0)	3-58
Weight.....	3-2
Wiring precautions	4-5

[Z]	
Zone PID monitor	3-107
Zone setting	3-109
Upper limit setting	3-109
Proportional band (P) setting	3-110
Integral time (I).....	3-110
Derivative time (D).....	3-110
Response parameters	3-110

WARRANTY

Please confirm the following product warranty details before using this product.

1. Gratis Warranty Term and Gratis Warranty Range

If any faults or defects (hereinafter "Failure") found to be the responsibility of Mitsubishi occurs during use of the product within the gratis warranty term, the product shall be repaired at no cost via the sales representative or Mitsubishi Service Company.

However, if repairs are required onsite at domestic or overseas location, expenses to send an engineer will be solely at the customer's discretion. Mitsubishi shall not be held responsible for any re-commissioning, maintenance, or testing on-site that involves replacement of the failed module.

[Gratis Warranty Term]

The gratis warranty term of the product shall be for one year after the date of purchase or delivery to a designated place. Note that after manufacture and shipment from Mitsubishi, the maximum distribution period shall be six (6) months, and the longest gratis warranty term after manufacturing shall be eighteen (18) months. The gratis warranty term of repair parts shall not exceed the gratis warranty term before repairs.

[Gratis Warranty Range]

- (1) The range shall be limited to normal use within the usage state, usage methods and usage environment, etc., which follow the conditions and precautions, etc., given in the instruction manual, user's manual and caution labels on the product.
- (2) Even within the gratis warranty term, repairs shall be charged for in the following cases.
 1. Failure occurring from inappropriate storage or handling, carelessness or negligence by the user. Failure caused by the user's hardware or software design.
 2. Failure caused by unapproved modifications, etc., to the product by the user.
 3. When the Mitsubishi product is assembled into a user's device, Failure that could have been avoided if functions or structures, judged as necessary in the legal safety measures the user's device is subject to or as necessary by industry standards, had been provided.
 4. Failure that could have been avoided if consumable parts (battery, backlight, fuse, etc.) designated in the instruction manual had been correctly serviced or replaced.
 5. Failure caused by external irresistible forces such as fires or abnormal voltages, and Failure caused by force majeure such as earthquakes, lightning, wind and water damage.
 6. Failure caused by reasons unpredictable by scientific technology standards at time of shipment from Mitsubishi.
 7. Any other failure found not to be the responsibility of Mitsubishi or that admitted not to be so by the user.

2. Onerous repair term after discontinuation of production

- (1) Mitsubishi shall accept onerous product repairs for seven (7) years after production of the product is discontinued. Discontinuation of production shall be notified with Mitsubishi Technical Bulletins, etc.
- (2) Product supply (including repair parts) is not available after production is discontinued.

3. Overseas service

Overseas, repairs shall be accepted by Mitsubishi's local overseas FA Center. Note that the repair conditions at each FA Center may differ.

4. Exclusion of loss in opportunity and secondary loss from warranty liability

Regardless of the gratis warranty term, Mitsubishi shall not be liable for compensation to:

- (1) Damages caused by any cause found not to be the responsibility of Mitsubishi.
- (2) Loss in opportunity, lost profits incurred to the user by Failures of Mitsubishi products.
- (3) Special damages and secondary damages whether foreseeable or not, compensation for accidents, and compensation for damages to products other than Mitsubishi products.
- (4) Replacement by the user, maintenance of on-site equipment, start-up test run and other tasks.

5. Changes in product specifications

The specifications given in the catalogs, manuals or technical documents are subject to change without prior notice.

TRADEMARKS

Intel and Pentium are either registered trademarks or trademarks of Intel Corporation in the United States and/or other countries.

Microsoft, Windows, Windows NT, Windows Vista, and Windows XP are either registered trademarks or trademarks of Microsoft Corporation in the United States and/or other countries.

The company names, system names and product names mentioned in this manual are either registered trademarks or trademarks of their respective companies.

In some cases, trademark symbols such as [™] or [®] are not specified in this manual.

SPREAD

Copyright © 1996 FarPoint Technologies, Inc.

SH(NA)-080573ENG-H(2010)KWIX

MODEL: Q62HLC-U-SY-E

MODEL CODE: 13JR85

MITSUBISHI ELECTRIC CORPORATION

HEAD OFFICE : TOKYO BUILDING, 2-7-3 MARUNOUCHI, CHIYODA-KU, TOKYO 100-8310, JAPAN
NAGOYA WORKS : 1-14, YADA-MINAMI 5-CHOME, HIGASHI-KU, NAGOYA, JAPAN

When exported from Japan, this manual does not require application to the
Ministry of Economy, Trade and Industry for service transaction permission.

Specifications subject to change without notice.