

MELSOFT

Engineering Software

GX Developer Version 8 Operating Manual (Safety Programmable Controller)

-SW8D5C-GPPW-E

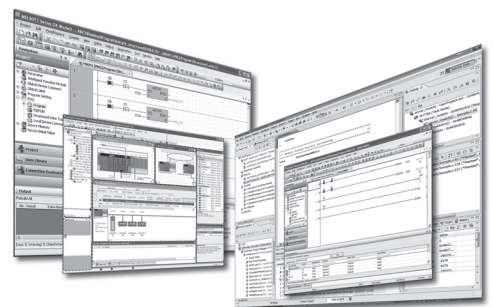

• SAFETY PRECAUTIONS •

(Read these precautions before using this product.)

Before using this product, please read this manual and the relevant manuals carefully and pay full attention to safety to handle the product correctly. If products are used in a different way from that specified by manufacturers, the protection function of the products may not work properly.

The precautions given in this manual are concerned with this product only. For the safety precautions for the programmable controller system, refer to the user's manual for the CPU module.

In this manual, the safety precautions are classified into two levels: "⚠️ WARNING" and "⚠️ CAUTION".



Indicates that incorrect handling may cause hazardous conditions, resulting in death or severe injury.



Indicates that incorrect handling may cause hazardous conditions, resulting in minor or moderate injury or property damage.

Under some circumstances, failure to observe the precautions given under "⚠️ CAUTION" may lead to serious consequences.

Observe the precautions of both levels because they are important for personal and system safety.

Make sure that the end users read this manual and then keep the manual in a safe place for future reference.

[Design Precautions]

⚠️ WARNING

- When data change, program change, or status control is performed from a personal computer to a running programmable controller, create an interlock circuit outside the programmable controller to ensure that the whole system always operates safely.
Furthermore, for the online operations performed from a personal computer to a programmable controller CPU, the corrective actions against a communication error due to such as a cable connection fault should be predetermined as a system.

[Security Precautions]

⚠️ WARNING

- To maintain the security (confidentiality, integrity, and availability) of the programmable controller and the system against unauthorized access, denial-of-service (DoS) attacks, computer viruses, and other cyberattacks from external devices via the network, take appropriate measures such as firewalls, virtual private networks (VPNs), and antivirus solutions.

[Startup/Maintenance Precautions]

CAUTION

- The online operations performed from a personal computer to a running programmable controller CPU (program change when a programmable controller CPU is RUN, forced I/O operation, operating status change such as RUN-STOP switching, and remote control operation) have to be executed after the manual has been carefully read and the safety has been ensured.

When changing a program while a programmable controller CPU is RUN (Online program change), it may cause a program corruption in some operating conditions. Fully understand the precautions described in Section 16.9 before use.

- Note that exchangeable modules online (while the power is on) are restricted and each of the modules has its predetermined replacement procedure. For details, refer to the online module change section in the manual of the module supporting the function.

• CONDITIONS OF USE FOR THE PRODUCT •

- (1) MELSEC programmable controller ("the PRODUCT") shall be used in conditions;
- i) where any problem, fault or failure occurring in the PRODUCT, if any, shall not lead to any major or serious accident; and
 - ii) where the backup and fail-safe function are systematically or automatically provided outside of the PRODUCT for the case of any problem, fault or failure occurring in the PRODUCT.

- (2) The PRODUCT has been designed and manufactured for the purpose of being used in general industries.

MITSUBISHI ELECTRIC SHALL HAVE NO RESPONSIBILITY OR LIABILITY (INCLUDING, BUT NOT LIMITED TO ANY AND ALL RESPONSIBILITY OR LIABILITY BASED ON CONTRACT, WARRANTY, TORT, PRODUCT LIABILITY) FOR ANY INJURY OR DEATH TO PERSONS OR LOSS OR DAMAGE TO PROPERTY CAUSED BY the PRODUCT THAT ARE OPERATED OR USED IN APPLICATION NOT INTENDED OR EXCLUDED BY INSTRUCTIONS, PRECAUTIONS, OR WARNING CONTAINED IN MITSUBISHI ELECTRIC USER'S, INSTRUCTION AND/OR SAFETY MANUALS, TECHNICAL BULLETINS AND GUIDELINES FOR the PRODUCT.

("Prohibited Application")

Prohibited Applications include, but not limited to, the use of the PRODUCT in;

- Nuclear Power Plants and any other power plants operated by Power companies, and/or any other cases in which the public could be affected if any problem or fault occurs in the PRODUCT.
- Railway companies or Public service purposes, and/or any other cases in which establishment of a special quality assurance system is required by the Purchaser or End User.
- Aircraft or Aerospace, Medical applications, Train equipment, transport equipment such as Elevator and Escalator, Incineration and Fuel devices, Vehicles, Manned transportation, Equipment for Recreation and Amusement, and Safety devices, handling of Nuclear or Hazardous Materials or Chemicals, Mining and Drilling, and/or other applications where there is a significant risk of injury to the public or property.

Notwithstanding the above restrictions, Mitsubishi Electric may in its sole discretion, authorize use of the PRODUCT in one or more of the Prohibited Applications, provided that the usage of the PRODUCT is limited only for the specific applications agreed to by Mitsubishi Electric and provided further that no special quality assurance or fail-safe, redundant or other safety features which exceed the general specifications of the PRODUCTS are required. For details, please contact the Mitsubishi Electric representative in your region.

- (3) Mitsubishi Electric shall have no responsibility or liability for any problems involving programmable controller trouble and system trouble caused by DoS attacks, unauthorized access, computer viruses, and other cyberattacks.

REVISIONS

*The manual number is given on the bottom left of the back cover.

Print Date	*Manual Number	Revision
Sep., 2006	SH(NA)-080576ENG-A	First edition
Oct., 2007	SH(NA)-080576ENG-B	<p>[Addition]</p> <p>Chapter 6</p> <p>[Correction]</p> <p>GENERIC TERMS AND ABBREVIATIONS IN THIS MANUAL, Section 5.8</p>
Mar., 2008	SH(NA)-080576ENG-C	<p>[Correction]</p> <p>Section 1.2.1, Section 1.2.2, Chapter 2, Section 5.5.2, Appendix 1</p>
Jun., 2008	SH(NA)-080576ENG-D	<p>[Correction]</p> <p>Section 6.1.1</p>
Apr., 2009	SH(NA)-080576ENG-E	<p>[Correction]</p> <p>Chapter 6</p>
Apr., 2011	SH(NA)-080576ENG-F	<p>[Addition]</p> <p>CONDITIONS OF USE FOR THE PRODUCT, Section 2.2, Section 5.6.2</p> <p>[Correction]</p> <p>SAFETY PRECAUTIONS, MANUALS, GENERIC TERMS AND ABBREVIATIONS IN THIS MANUAL, Section 1.2.1, Section 1.2.2, Section 2.1, Section 5.4.1, Section 5.4.2, Section 5.5.1, Section 5.5.2, Section 5.6.1, Appendix 1</p>
May, 2012	SH(NA)-080576ENG-G	<p>[Addition]</p> <p>Section 5.5.2</p>
Nov., 2022	SH(NA)-080576ENG-H	<p>[Correction]</p> <p>SAFETY PRECAUTIONS, CONDITIONS OF USE FOR THE PRODUCT</p>

Japanese Manual Version SH-080575-H

This manual confers no industrial property rights or any rights of any other kind, nor does it confer any patent licenses. Mitsubishi Electric Corporation cannot be held responsible for any problems involving industrial property rights which may occur as a result of using the contents noted in this manual.

INTRODUCTION

Thank you for purchasing the engineering software, MELSOFT series.

Before using this product, please read this manual and the relevant manuals carefully and develop familiarity with the functions and performance of the MELSOFT series to handle the product correctly.

CONTENTS

SAFETY PRECAUTIONS.....	A - 1
CONDITIONS OF USE FOR THE PRODUCT	A - 3
REVISIONS	A - 4
INTRODUCTION.....	A - 5
CONTENTS.....	A - 5
MANUALS	A - 7
HOW TO USE THIS MANUAL	A - 8
GENERIC TERMS AND ABBREVIATIONS	A -11

Chapter 1 GENERAL DESCRIPTION	1- 1 to 1- 30
--------------------------------------	----------------------

1.1 Features	1- 1
1.1.1 Access level.....	1- 2
1.1.2 User registration and login certification	1- 3
1.1.3 CPU access password.....	1- 4
1.1.4 Safety CPU operation mode (SAFETY MODE and TEST MODE).....	1- 5
1.1.5 Operation lock	1- 5
1.2 Functions Lists	1- 6
1.2.1 Functions lists.....	1- 6
1.2.2 Restricting operations by using safety CPU operation mode/access level.....	1-23

Chapter 2 SYSTEM CONFIGURATION	2- 1 to 2- 2
---------------------------------------	---------------------

2.1 Connecting to Safety CPU.....	2- 1
2.2 Connecting to Another CPU via Safety CPU	2- 2

Chapter 3 RESTRICTIONS AND PRECAUTIONS	3- 1 to 3- 2
---	---------------------

3.1 Precautions for the GX Developer Version Earlier than the Safety CPU Compatible Version	3- 1
3.2 Precautions for Management	3- 2

Chapter 4 PROCEDURES TO OPERATION	4- 1 to 4- 2
--	---------------------

4.1 When Creating a Safety Project.....	4- 1
4.2 When Modifying the Safety Project in Operation	4- 2

Chapter 5 ADDED FUNCTIONS TO CORRESPOND TO A SAFETY PROGRAMMABLE CONTROLLER

5- 1 to 5-50

5.1 Security Operations.....	5- 1
5.1.1 Registering the user when creating a new project	5- 1
5.1.2 Registering/deleting/changing a login user	5- 3
5.1.3 Logging in to a project.....	5- 9
5.1.4 Locking operations	5-11
5.2 Safety CPU Operation	5-15
5.2.1 Switching safety CPU operation mode.....	5-15
5.2.2 Displaying ROM information	5-16
5.2.3 Registering or changing a CPU access password.....	5-18
5.2.4 PLC memory initialization	5-21
5.2.5 Switching the CPU to be monitored.....	5-22
5.3 Detecting the Damaged Project Data.....	5-23
5.4 Highlighting Safety Devices	5-25
5.4.1 Safety devices	5-25
5.4.2 Highlighting safety devices	5-26
5.5 Setting Parameters	5-28
5.5.1 Setting PLC parameters.....	5-28
5.5.2 Setting network parameters.....	5-29
5.6 Diagnosing a Safety Programmable Controller	5-34
5.6.1 Diagnosing a safety CPU.....	5-34
5.6.2 Diagnosing CC-Link IE Field Network	5-38
5.7 Writing Program Memory to ROM.....	5-49
5.8 Checking Devices for Duplication Use	5-50

Chapter 6 SAFETY FUNCTION BLOCK

6- 1 to 6- 9

6.1 Programming Using Safety Function Blocks.....	6- 2
6.1.1 Incorporating safety function blocks in a project	6- 3
6.1.2 Pasting safety function blocks to the sequence program	6- 5
6.1.3 Checking I/O variables for safety function block	6- 6
6.2 Restricting the Safety Function Block Operations/Displays	6- 7

APPENDICES

Appendix- 1 to Appendix-12

Appendix 1 Differences with the Q Series Project	Appendix- 1
Appendix 2 Functions for which CPU Access Password Certification is Performed	Appendix-11
Appendix 3 ASCII Code Table.....	Appendix-12

INDEX

Index- 1 to Index- 2

MANUALS

Introductory Manual

Make sure to read the following manual before configuring/designing a safety system.

Manual Name	Manual No. (Model Code)
Safety Application Guide Explains the overview and construction method of the safety system, laying and wiring examples, application programs and others. (Sold separately.)	SH-080613ENG (13JR90)

Related Manuals

The following lists the manuals for this software package.
Refer to the following table when ordering manuals.

Manual Name	Manual No. (Model Code)
GX Developer Version 8 Operating Manual Explains the online functions of the GX Developer, such as the programming, printout, monitoring, and debugging methods. (Sold separately.)	SH-080373E (13JU41)
GX Developer Version 8 Operating Manual (Startup) Explains the system configuration, installation and starting methods of the GX Developer. (Sold separately.)	SH-080372E (13JU40)
QSCPU User's Manual (Function Explanation, Program Fundamentals) Explains the functions, programming methods, devices and others that are necessary to create programs with the QSCPU. (Sold separately.)	SH-080627ENG (13JR93)
QSCPU Programming Manual (Common Instructions) Explains how to use the sequence instructions, basic instructions, and QSCPU dedicated instructions. (Sold separately.)	SH-080628ENG (13JW01)
CC-Link Safety System Master Module User's Manual Explains the specifications, procedures and settings up to operation, parameter settings and trouble shootings of the QS0J61BT12-type CC-Link Safety system master module. (Sold separately.)	SH-080600ENG (13JR88)
CC-Link Safety System Remote I/O Module User's Manual Explains the specifications, procedures and settings up to operation, parameter settings and trouble shootings of the CC-Link Safety Remote I/O Module. (Sold separately.)	SH-080612ENG (13JR89)
MELSEC-QS CC-Link IE Field Network Master/Local Module User's Manual Explains the specifications, procedures and settings up to operation, parameter settings and trouble shootings of the QS0J71GF11-T2 CC-Link IE Field Network master/local module. (Sold separately.)	SH-080969ENG (13J253)

REMARK

Printed materials are separately available for single item purchase. Order the manual by quoting the manual number on the table above (Model Code).

HOW TO USE THIS MANUAL

The availability of the menu selection/operation, differs depend on the combination of safety CPU operation mode and an access level, is described. (🔑 (1))

5.2.3 Registering or changing a CPU access password

	Admin.	Develop.	Users
SAFETY	△	×	×
TEST	△	×	×

△: Registration to a safety CPU is disabled in the safety mode. Can perform in the test mode only when a safety CPU is in STOP status.

The restriction on the setting/operation is described. (🔑 (1))

What to set in the section is described.

[Purpose]
Registers the access password for certification (CPU access password) with a project and safety CPU.
Matching the project password with the CPU access password enables the safety CPU operation.
(For the functions for which CPU access password certification is performed 🔑 Appendix 2)

Following the direction, open the setting screen.

[Operating Procedure]
Select [Online] → [Safety CPU operation] → [CPU access password registration/change].

[Dialog Box]

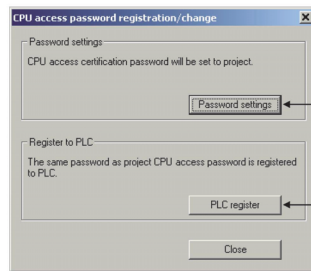

The screen for the setting is indicated. The numbered items are described in [Description].

The items and buttons numbered in [Dialog Box] are described.

[Description]
1) **Password settings** button
Displays the Password settings screen. (🔑 (1) in this section)
2) **PLC register** button
Registers the CPU access password set in a project with a safety CPU. (🔑 (2) in this section)

Reference: The Chapter or Section including the relative explanation is indicated.

POINT
Be sure to carefully manage a CPU access password.
(For actions when losing a CPU access password 🔑 Section 3.2 (2))

This gives the information related to the topic discussed and also the helpful information.

- (1) Availability of menu selection/operation (Upper right of the page)
 In each operation explained in the Chapter 5, the availability of the menu selection/operation, differs depend on the combination of safety CPU operation mode and an access level, is listed as the table below on the upper right corner of the first pages for each section.

Safety CPU operation mode {		Admin.	Develop.	Users	← Access level
	SAFETY	○	△	×	} Availability of menu selection/operation
	TEST	○	△	×	

- (a) Safety CPU operation mode
 SAFETY : Indicates the SAFETY MODE.
 TEST : Indicates the TEST MODE.
- (b) Access level
 Admin. : Indicates "Administrators".
 Develop. : Indicates "Developers".
 Users : Indicates "Users".
- (c) Availability of menu selection/operation
 ○ : Menu selection/operation is available.
 △ : Menu selection/operation is available with restrictions.
 Restrictions are described under the table.
 × : Menu selection/operation is not available.

- (2) Symbols used for GX Developer screen and function explanation
 Symbols used in this manual, and their contents and examples are shown below.

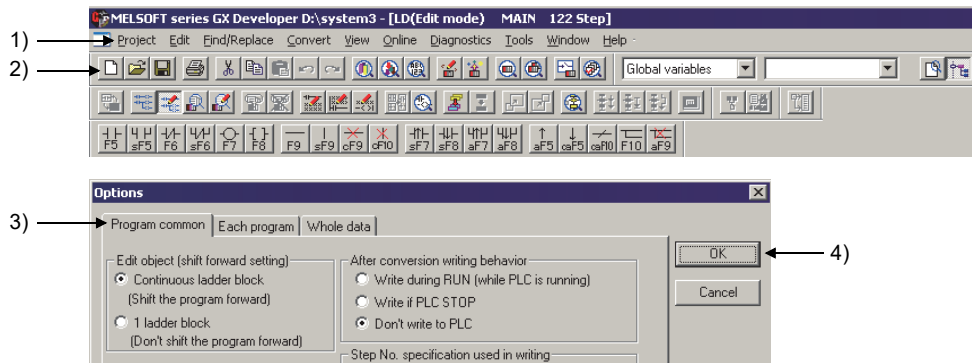

No.	Symbol	Contents	Example
1)	[]	Menu name of menu bar	[Project]
2)		Icon in toolbar	
3)	<< >>	Tab name of dialog box	<<Program common>>
4)		Command button in dialog box	button

- (3) Functions that cannot be operated by GX Developer
The functions that cannot be operated using the GX Developer are grayed (masked) and cannot be selected. There are the following reasons why they are not selectable.
- (a) The programmable controller CPU used does not have the functions.
For example, when the QSCPU is chosen in the "PLC series", selecting the [Project] → [Change PLC type] is disabled since the QSCPU does not have another programmable controller type.
To see if the programmable controller CPU has the operable functions, refer to the specifications in the User's Manual of the programmable controller CPU.
 - (b) The functions that cannot be selected because they cannot be used with the currently operated function.
For example, when the monitor screen is open, Change PLC type, Transfer setup, Change PLC data attributes, Marge data, Check parameter, and Clear all parameters cannot be performed.

GENERIC TERMS AND ABBREVIATIONS

This manual uses the abbreviations and generic terms listed in the following table to explain a software package and module such as programmable controller CPU. In addition, the following table lists the module model according to need.

Abbreviation/generic term	Description/target module
GX Developer	Generic product name of the product types SW8D5C-GPPW-E, SW8D5C-GPPW-EA, SW8D5C-GPPW-EV and SW8D5C-GPPW-EVA
Safety programmable controller	Generic term for QS034B safety main base unit, QS061P-A1, QS061P-A2 safety power supply module, safety CPU module, CC-Link Safety master module, CC-Link Safety remote I/O module, and QS071GF11-T2 CC-Link IE Field Network master/local module.
Safety system	System which executes the required safety functions
Safety function block	Safety-approved function block which represents safety control logic such as emergency stop and two-hand switch control in function block
Safety project	Project for a safety programmable controller created with GX Developer
Safety remote I/O station	Remote station which treats only bitwise information This station is compliant with the safety system.
Safety CPU	Abbreviation for a safety CPU module (QS001CPU type safety CPU module)
QSCPU	
Standard remote I/O station	Remote station which treats only bitwise information This station is not compliant with safety system.
Remote I/O station	Generic term for safety remote I/O station and standard remote I/O station
CC-Link Safety	Safety-approved CC-Link network compliant with safety standards This network is configured with CC-Link Safety master module and CC-Link Safety remote I/O module.
CC-Link Safety master module	Abbreviation for the QS0J61BT12 CC-Link Safety master module.
CC-Link Safety remote I/O module	Generic term for QS0J65BTS2-8D, QS0J65BTS2-4T, and QS0J65BTB2-12DT CC-Link Safety remote I/O module.
CC-Link IE Field Network master/local module (with safety functions)	Abbreviation for the QS071GF11-T2 CC-Link IE Field Network master/local module.
CC-Link IE Field Network master/local module	Abbreviation for the QJ71GF11-T2 CC-Link IE Field Network master/local module.
CC-Link IE Field Network board	Abbreviation for Q81BD-J71GF11-T2 CC-Link IE Field Network interface board.
Head module	Abbreviation for the LJ72GF15-T2 CC-Link IE Field Network head module.
Ethernet adapter module	Abbreviation for the NZ2GF-ETB CC-Link IE Field Network Ethernet adapter module.
FB	Abbreviation for function block

1. GENERAL DESCRIPTION

This manual explains the added and updated GX Developer functions to support a safety programmable controller.

Be sure to read this manual before using a safety programmable controller.

For any unchanged functions, refer to the GX Developer Version 8 Operating Manual.

1.1 Features

The following shows the features of the GX Developer supporting a safety programmable controller.

(1) Security functions

The main feature of the GX Developer is that only the defined users can edit project data and operate a safety programmable controller.

The following shows the functions for protecting data and restricting operations.

- (a) User registration and login certification (👉 Section 1.1.1 and 1.1.2)
- (b) CPU access password (👉 Section 1.1.3)
- (c) Safety CPU operation mode (👉 Section 1.1.4)
- (d) Operation lock (👉 Section 1.1.5)

(2) Improvement in project data reliability

If the project data saved in a PC have been damaged, the damage is detected when opening the data.

(3) Improvement of reliability in communications with a safety CPU

The function for detecting a transmission error in communications with a safety CPU is enhanced.

(4) Efficiency in the creation and maintenance of a user program

The efficiency for the creation and maintenance of a user program has been increased by highlighting the safety I/O devices on a ladder.

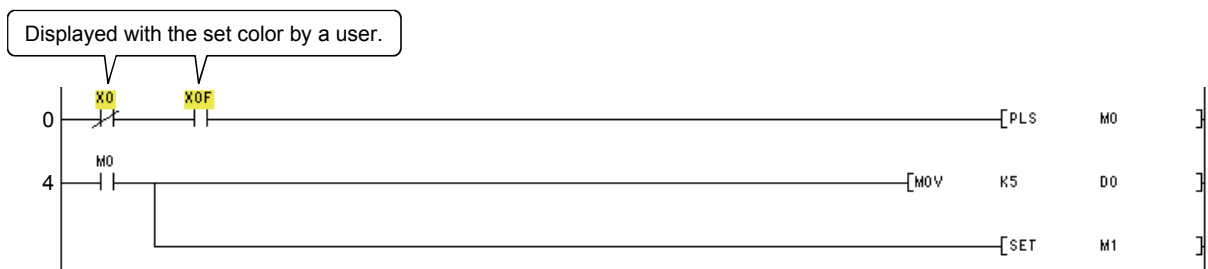

(5) Display and save of operation/error logs





The operation/error logs saved in a safety CPU can be read and displayed. They can also be saved in a CSV file.

1.1.1 Access level

1

An access level designates the operation authority given to a user who logs in to a project.

The access level is classified into the following three levels, in order from the highest level where all of operations are allowed to project data and a safety programmable controller.

Access Level		Operation Authority
High  Low	Administrators 	<Manager level> Can perform all operations. Only Administrators can perform user management and security settings.
	Developers 	<Developer level> Can perform all the operations except for user management and security settings.
	Users 	<Operator level> Can edit but cannot overwrite the project data in a PC. Can read (e.g. monitoring) but cannot write data as for the online operation to a safety programmable controller.

1.1.2 User registration and login certification

A safety programmable controller performs login certification when opening a project for the purpose of preventing unauthorized users from illegally accessing.

(1) User registration

A system manager has to define the person in charge, and then register the user information required for login certification with the project. The following information is required in user registration.

- 1) User name
- 2) Access level (☞ Section 1.1.1)
- 3) Password (Omissible if access level is set to "Users".)

Maximum 128 users can be registered with each project, and the operation authority for each user is determined by the user's access level.

For example, the user whose access level is Users is not authorized to rewrite a safety programmable controller program.

(2) Login certification

When opening a project, a user name and password are required.

After inputting them, login certification is performed based on the set user registration information.

The available operations determined by the user's access level can be performed after login.

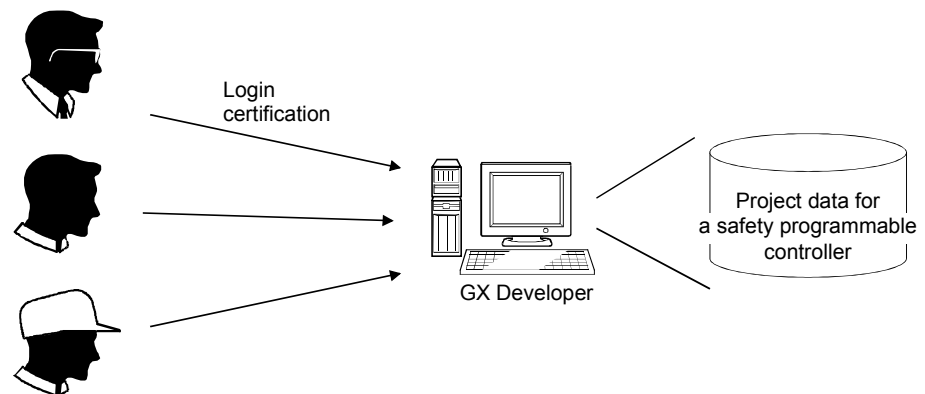

Note that login certification is performed to the operation such as "Delete project". (☞ Section 5.1.3)

POINT

- The users unregistered with a project cannot open the project.
- The users registered with a project can only perform the operations enabled in the given access level. (☞ Section 1.2.2)

1.1.3 CPU access password

A safety CPU performs access certification by using a password to prevent the misconnected GX Developer from illegally operating. The password is referred to a CPU access password.

The CPU access password has to be set to both the GX Developer project and safety CPU.

When performing the operation that changes control (e.g. program change) from the GX Developer, the CPU access password of the GX Developer project is compared with that of the safety CPU.

Only when they are identical, the operation will be allowed.

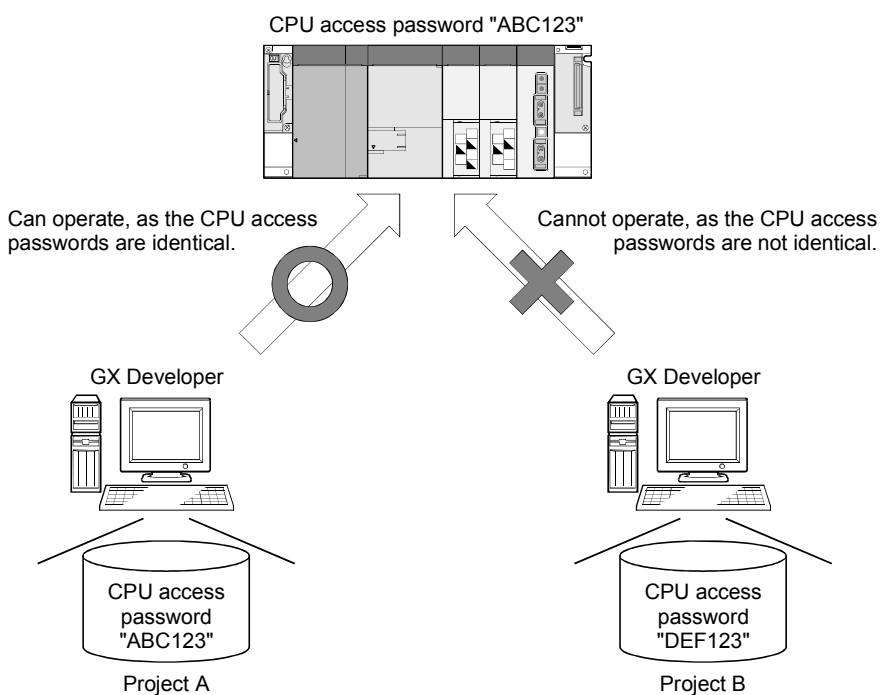

POINT
Set different CPU access passwords for each safety CPU.

1.1.4 Safety CPU operation mode (SAFETY MODE and TEST MODE)

A safety CPU operation mode includes a SAFETY MODE and TEST MODE. The safety CPU operation mode can be switched from the GX Developer.

(1) SAFETY MODE

The SAFETY MODE is used when operating a safety system.

In this mode, the operations may lead a safety programmable controller to a control change (e.g. Write to PLC, Device test) are inhibited so that the running system is protected.

(2) TEST MODE

The TEST MODE is used when starting or maintaining a system.

In this mode, all operations including "Write to PLC" and "Device test" are available. (The available functions depend on the login user's access level.)

1.1.5 Operation lock

An operation lock inhibits other users from operating the open project. The operation lock has the following two methods.

Method	Contents
Automatic operation lock	Automatically locks operation if the GX Developer has not been operated for a certain period of time.
Manual operation lock	Manually locks operation.

The following Operation lock screen appears at operation lock.

The user during login or user whose access level is Administrators can unlock the setting.

(Operation lock screen)

1.2 Functions Lists

1.2.1 Functions lists

The GX Developer functions are listed below.

(1) Common functions list

The following shows the fixed functions independent of the editing and the type of setting target.

Project (Common function)		Only for monitoring *1	QSCPU *2	Reference *3
New project	Creates a new project.	×	●	5.1.1
Open project	Opens the existing project.	○	●	5.1.3
Close project	Closes an open project.	○	●	1.2.2
Save	Saves a project.	○	●	1.2.2
Save as	Names and saves a project.	○	●	3
Delete project	Deletes the existing project.	×	●	3 5.1.3
Verify	Verifies data between projects.	○	●	5.1.3
Copy	Copies data between projects.	×	●	5.1.3
Change PLC type	Changes a programmable controller type.	×	×	Appendix 1
Import file		—	—	—
Import from GPPQ format file	Reads a GPPQ file.	×	×	—
Import from GPPA format file	Reads a GPPA file.	×	×	—
Import from FXGP(WIN) format file	Reads a FXGP(WIN) format file.	×	×	—
Import from FXGP(DOS) format file	Reads a FXGP(DOS) format file.	×	×	—
Import from Melsec Medoc format file (Print out)	Reads a Melsec Medoc printing format file.	×	×	—
Import from TEXT, CSV format file...	Reads a text and CSV file.	×	×	—
Export file		—	—	—
Export to GPPQ format file	Writes data to a GPPQ file.	×	×	—
Export to GPPA format file	Writes data to a GPPA file.	×	×	—
Export to FXGP(WIN) format file	Writes data to a FXGP(WIN) format file.	×	×	—
Export to FXGP(DOS) format file	Writes data to a FXGP(DOS) format file.	×	×	—
Export to TEXT, CSV format file...	Writes data to a text and CSV file.	×	×	—

(To the next page)

* 1: Indicates the availability when the GX Developer is installed as "Only for monitoring GX Developer".

○: Available, ×: Unavailable

* 2: Indicates the menu selectability when using the QSCPU.

◎: Selectable (Only for the QSCPU),

●: Selectable (Some changes for the QSCPU in the function common to all models),

○: Selectable (No changes for the QSCPU in the function common to all models),

×: Cannot be selected.

* 3: For functions without references, refer to the GX Developer Version 8 Operating Manual.

(Continued from the previous page.)

Project (Common function)		Only for monitoring *1	QSCPU *2	Reference *3
Macro		—	—	—
Registration macros	Registers macros.	×	×	—
Macro utilize	Utilizes macros.	×	×	—
Delete macros	Deletes a macro file.	×	×	—
Macro reference path	Changes the macro instruction reference path.	×	×	—
Security operation		—	—	—
User management	Registers/deletes/changes a login user.	○	◎	5.1.2
Wait time settings	Sets the wait time to an operation lock.	○	◎	5.1.4
Operation lock	Manually locks operation.	○	◎	5.1.4
Printer setup	Changes printer settings.	○	○	—
Print	Prints data.	○	●	Appendix 1
Start new GX Developer session	Starts a new GX Developer session.	○	○	—
Exit GX Developer	Exits the GX Developer.	○	○	—
View		Only for monitoring *1	QSCPU *2	Reference *3
Toolbar	Displays or hides the toolbar.	○	○	—
Status bar	Displays or hides the status bar.	○	○	—
Project data list	Displays or hides the project data list.	○	○	—
Project data display format		—	—	—
Not sort	Does not sort the project data list.	○	○	—
Sort data name ascending	Sorts the project data list in ascending order.	○	○	—
Sort data name descending	Sorts the project data list in descending order.	○	○	—
Elapsed time	Displays the Elapsed time dialog box.	×	×	—

(To the next page)

*1: Indicates the availability when the GX Developer is installed as "Only for monitoring GX Developer".
○: Available, ×: Unavailable

*2: Indicates the menu selectability when using the QSCPU.
◎: Selectable (Only for the QSCPU),
●: Selectable (Some changes for the QSCPU in the function common to all models),
○: Selectable (No changes for the QSCPU in the function common to all models),
×: Cannot be selected.

*3: For functions without references, refer to the GX Developer Version 8 Operating Manual.

(Continued from the previous page.)

Online (Common function)		Only for monitoring *1	QSCPU *2	Reference *3
Transfer setup	Specifies a programmable controller CPU destination from the GX Developer.	○	○	Appendix 1
Read from PLC	Reads data from a programmable controller CPU.	○	○	—
Write to PLC	Writes data to a programmable controller CPU.	×	○	—
Verify with PLC	Verifies data with programmable controller CPU data.	○	○	—
Write to PLC (Flash ROM)		—	—	—
Write the program memory to ROM	Writes program memory data to standard ROM/IC memory card (ROM).	×	●	5.7
Write to PLC (Flash ROM)	Writes data to standard ROM/IC memory card (ROM).	×	×	—
Delete PLC data	Deletes the data in a programmable controller CPU.	×	○	—
Change PLC data attributes	Changes programmable controller CPU data attributes.	×	×	—
PLC user data		—	—	—
Read PLC user data	Reads user data from a programmable controller CPU.	×	×	—
Write PLC user data	Writes user data to a programmable controller CPU.	×	×	—
Delete PLC user data	Deletes the user data in a programmable controller CPU.	×	×	—
Monitor		—	—	Appendix 1
Monitor mode	Places the ladder editing screen in the monitor mode.	○	○	—
Monitor (Write mode)	Sets the ladder (Monitor write) mode.	×	○	—
Start monitor (All windows)	Starts monitoring all open windows.	○	○	—
Stop monitor (All windows)	Stops monitoring all open windows.	○	○	—
Local device monitor	Switches the execute/non-execute of the local device monitor.	×	×	—
Device batch	Monitors devices in the batch mode.	○	○	—
Entry data monitor	Monitors devices in one screen.	○	○	—
Buffer memory batch	Monitors buffer memory in the batch mode.	○	○	—
Program monitor list	Monitors a program list.	×	○	—
Interrupt program monitor list	Lists interrupt programs.	×	×	—
Debug (ladder)		—	—	—
Device test	Turns on/off the device or changes the value.	×	●	Appendix 1
Forced input output registration/cancellation	Registers/cancels the forced I/O of input relays (X)/output relays (Y).	×	×	—
Trace	Performs sampling trace.	×	×	—
Remote operation	Remotely operates a programmable controller CPU.	×	●	Appendix 1
Redundant operation	Performs redundant operation.	×	×	—

(To the next page)

*1: Indicates the availability when the GX Developer is installed as "Only for monitoring GX Developer".
○: Available, ×: Unavailable

*2: Indicates the menu selectability when using the QSCPU.
◎: Selectable (Only for the QSCPU),
●: Selectable (Some changes for the QSCPU in the function common to all models),
○: Selectable (No changes for the QSCPU in the function common to all models),
×: Cannot be selected.

*3: For functions without references, refer to the GX Developer Version 8 Operating Manual.

(Continued from the previous page.)

Online (Common function)		Only for monitoring *1	QSCPU *2	Reference *3
Safety CPU operation		—	—	—
Switch safety CPU operation mode	Switches a programmable controller CPU mode.	×	◎	5.2.1
ROM information	Displays the ROM information of a project/programmable controller CPU.	×	◎	5.2.2
CPU access password registration/change	Registers/changes a CPU access password.	×	◎	5.2.3
PLC memory initialization	Initializes programmable controller CPU memory.	×	◎	5.2.4
Monitor destination select option	Switches the CPU to be monitored.	○	◎	5.2.5
Password		—	—	—
Register password	Registers/changes a password.	×	×	—
Delete password	Cancels the password.	×	×	—
Disable password	Temporarily unlocks the password.	×	×	—
Clear PLC memory	Clears the memory cassette or device memory in a programmable controller CPU.	×	○	—
Format PLC memory	Formats the programmable controller CPU memory.	×	○	—
Arrange PLC memory	Arranges the data area in programmable controller CPU memory.	×	○	—
Set clock	Sets the time of a programmable controller CPU.	○	○	—
Diagnostics (Common function)		Only for monitoring *1	QSCPU *2	Reference *3
PLC diagnostics	Diagnoses a programmable controller CPU.	○	●	5.6.1 Appendix 1
MELSECNET diagnostics	Diagnoses the network.	○	●	Appendix 1
CC IE Control diagnostics	Diagnoses the CC-Link IE Controller Network.	○	●	Appendix 1
CC IE Field diagnostics	Diagnoses the CC-Link IE Field Network.	○	●	5.6.2
Ethernet diagnostics	Diagnoses the Ethernet.	○	●	Appendix 1
CC-Link / CC-Link/LT diagnostics	Diagnoses the CC-Link or CC-Link/LT.	○	○	Appendix 1
System monitor	Monitors the system status of a programmable controller CPU.	○	○	—
Online module change	Changes a module during online.	×	×	—

(To the next page)

*1: Indicates the availability when the GX Developer is installed as "Only for monitoring GX Developer".
○: Available, ×: Unavailable

*2: Indicates the menu selectability when using the QSCPU.
◎: Selectable (Only for the QSCPU),
●: Selectable (Some changes for the QSCPU in the function common to all models),
○: Selectable (No changes for the QSCPU in the function common to all models),
×: Cannot be selected.

*3: For functions without references, refer to the GX Developer Version 8 Operating Manual.

(Continued from the previous page.)

Tools (Common function)		Only for monitoring *1	QSCPU *2	Reference *3
Confirm project memory size	Calculates the file size to be written to a programmable controller CPU.	×	×	—
Merge data	Merges data.	×	●	Appendix 1
Check parameter	Checks parameters.	○	○	—
Transfer ROM		—	—	—
Read	Reads data from ROM.	×	×	—
Write	Writes data to ROM.	×	×	—
Compare	Compares the data in a PC with the ROM data.	×	×	—
Write to file	Writes ROM data to a file.	×	×	—
Delete unused comments	Deletes the unused device comments in a program.	×	○	—
Clear all parameters	Deletes parameters.	×	○	—
IC memory card		—	—	—
Read IC memory card	Reads data from an IC memory card.	×	×	—
Write IC memory card	Writes data to an IC memory card.	×	×	—
Read image data...	Reads image data.	×	×	—
Write image data...	Writes image data.	×	×	—
Start ladder logic test	Starts/stops the ladder logic test.	×	×	—
Set TEL data		—	—	—
Connection	Connects the line for the A6TEL/Q6TEL.	×	×	—
Disconnect	Disconnects the line.	×	×	—
TEL data	Sets the notice destination data of the A6TEL or Q6TEL.	×	×	—
AT command	Registers the modem.	×	×	—
Call book	Sets phone numbers.	×	×	—
Intelligent function utility		—	—	—
Utility list	Shows the utility names required to edit the intelligent function unit parameters.	×	×	—
Customize keys	Changes the key assignment for ladder symbol input.	○	○	—
Options	Sets the options.	○	●	Appendix 1
Create start-up settings file	Creates a file to save the initial settings of a project.	○	○	—
Window (Common function)		Only for monitoring *1	QSCPU *2	Reference *3
Cascade	Overlaps windows.	○	○	—
Tile vertically	Vertically arranges windows.	○	○	—
Tile horizontally	Horizontally arranges windows.	○	○	—
Arrange icons	Arranges icons at the bottom of the window.	○	○	—
Close all Windows	Closes all open windows.	○	○	—

*1: Indicates the availability when the GX Developer is installed as "Only for monitoring GX Developer".
○: Available, ×: Unavailable

*2: Indicates the menu selectability when using the QSCPU.

◎: Selectable (Only for the QSCPU),

●: Selectable (Some changes for the QSCPU in the function common to all models),

○: Selectable (No changes for the QSCPU in the function common to all models),

×: Cannot be selected.

*3: For functions without references, refer to the GX Developer Version 8 Operating Manual.

(Continued from the previous page.)

Help (Common function)		Only for monitoring *1	QSCPU *2	Reference *3
CPU error	Displays the description of each programmable controller CPU error code.	○	○	—
Special relay/register	Displays the description of special relays or special registers.	○	○	—
Key operation list	Displays the description of each key operation.	○	○	—
Product information	Displays product information such as a version number.	○	○	—
Connect to MELFANSweb	Connects to the MELFANSweb.	○	○	—

*1: Indicates the availability when the GX Developer is installed as "Only for monitoring GX Developer".

○: Available, ×: Unavailable

*2: Indicates the menu selectability when using the QSCPU.

⊙: Selectable (Only for the QSCPU),

●: Selectable (Some changes for the QSCPU in the function common to all models),

○: Selectable (No changes for the QSCPU in the function common to all models),

×: Cannot be selected.

*3: For functions without references, refer to the GX Developer Version 8 Operating Manual.

(2) Ladder editing functions list

The following functions can be performed to edit ladders, operation outputs, and transition conditions.

When installing the GX Developer with its functions limited, the ladder symbols can be used for searching.

Project		Only for monitoring *1	QSCPU *2	Reference *3
Edit data		—	—	—
New	Adds data to a project.	×	○	—
Copy	Copies the data in a project.	×	×	—
Delete	Deletes the data in a project.	×	○	—
Rename	Renames the data in a project.	×	○	—
Change program type	Changes a ladder and SFC with each other.	×	×	—
Function Block		—	—	—
Diversion	Diverts the FB to a ladder program.	×	○	—
Rename	Renames the diverted FB.	×	○	—
FB change module address	Sets the module start I/O No. used in FB definition.	×	○	—
Edit		Only for monitoring *1	QSCPU *2	Reference *3
Undo	Reverses the last operation.	×	○	—
Restore after ladder conversion	Restores a program to the status after ladder conversion.	×	○	—
Cut	Moves the selected data to the clipboard.	×	○	—
Copy	Copies the selected data to the clipboard.	○	●	Appendix 1
Paste	Pastes the clipboard contents at the cursor position.	×	●	Appendix 1
Insert line	Inserts a row at the cursor position.	×	○	—
Delete line	Deletes a row at the cursor position.	×	○	—
Insert row	Inserts a column at the cursor position.	×	○	—
Delete row	Deletes a column at the cursor position.	×	○	—
Insert NOP batch	Inserts NOP before the ladder block at the cursor position.	×	○	—
Delete NOP batch	Deletes all the NOPs in a program at a time.	×	○	—
Draw line	Inserts a line.	×	○	—
Delete line	Deletes a line.	×	○	—
Change TC setting	Changes the setting value of the timer/counter.	×	●	Appendix 1
Read mode	Places a ladder screen in the read mode.	○	○	—
Write mode	Places a ladder screen in the write mode.	×	○	—

(To the next page)

*1: Indicates the availability when the GX Developer is installed as "Only for monitoring GX Developer".

○: Available, ×: Unavailable

*2: Indicates the menu selectability when using the QSCPU.

◎: Selectable (Only for the QSCPU),

















●: Selectable (Some changes for the QSCPU in the function common to all models),

○: Selectable (No changes for the QSCPU in the function common to all models),

×: Cannot be selected.

*3: For functions without references, refer to the GX Developer Version 8 Operating Manual.

(Continued from the previous page.)

Edit		Only for monitoring *1	QSCPU *2	Reference *3
Ladder symbol		—	—	—
Open contact	Inserts  at the cursor position.	×	○	—
Close project contact	Inserts  at the cursor position.	×	○	—
Open branch	Inserts  at the cursor position.	×	○	—
Close project branch	Inserts  at the cursor position.	×	○	—
Coil	Inserts  at the cursor position.	×	○	—
Application instruction	Inserts  at the cursor position.	×	○	—
Vertical line	Inserts  at the cursor position.	×	○	—
Horizontal line	Inserts  at the cursor position.	×	○	—
Delete vertical line	Inserts  at the cursor position.	×	○	—
Delete Horizontal line	Inserts  at the cursor position.	×	○	—
Rising pulse	Inserts  at the cursor position.	×	○	—
Falling pulse	Inserts  at the cursor position.	×	○	—
Rising pulse Open branch	Inserts  at the cursor position.	×	○	—
Falling pulse Close branch	Inserts  at the cursor position.	×	○	—
Invert operation results	Inserts  at the cursor position.	×	○	—
Convert operation results to rising pulse	Inserts  at the cursor position.	×	○	—
Convert operation results to falling pulse	Inserts  at the cursor position.	×	○	—
Documentation		—	—	—
Comment	Edits the comment at the cursor position.	×	○	—
Statement	Edits the statement at the cursor position in a ladder.	×	○	—
Note	Edits the note at the cursor position in a ladder.	×	○	—
Statement/Note block edit	Edits the statement/note under program at a time.	×	○	—

(To the next page)

*1: Indicates the availability when the GX Developer is installed as "Only for monitoring GX Developer".
○: Available, ×: Unavailable

*2: Indicates the menu selectability when using the QSCPU.
⊙: Selectable (Only for the QSCPU),
●: Selectable (Some changes for the QSCPU in the function common to all models),
○: Selectable (No changes for the QSCPU in the function common to all models),
×: Cannot be selected.

*3: For functions without references, refer to the GX Developer Version 8 Operating Manual.

(Continued from the previous page.)

Find/Replace		Only for monitoring *1	QSCPU *2	Reference *3
Find device	Searches for a device.	○	○	—
Find instruction	Searches for an instruction.	○	○	—
Find step No.	Searches for a step number.	○	○	—
Find character string	Searches for the character string in a comment, note, or statement.	○	○	—
Find contact or coil	Searches for a contact or coil.	○	○	—
Replace device	Searches for and replaces a device.	×	○	—
Device block replacement	Searches for and replaces multiple devices at a time.	×	○	—
Replace instruction	Searches for and replaces an instruction.	×	○	—
Change open/close contact	Searches for and replaces a contact a with a contact b.	×	○	—
Replace character string	Searches for and replaces the character string in a comment, note, or statement.	×	○	—
Change module start address	Searches for and replaces the module start I/O No. of the buffer memory address instructions.	×	○	—
Replace statement/note type	Searches for and replaces the type of a note/statement.	×	○	—
Cross reference window display	Displays where the specified device or label is used.	○	○	—
Cross reference list	Lists the step numbers and usage types of the specified device.	○	○	—
List of used devices	Finds where the device is used.	○	○	—
Convert		Only for monitoring *1	QSCPU *2	Reference *3
Convert	Converts a program.	×	○	—
Convert (All programs being edited)	Converts all the programs (not converted yet) at a time.	×	○	—
Convert block (All programs)	Converts all programs at a time.	×	○	—
Convert block (Online change)	Converts a program and writes it to a programmable controller CPU during RUN.	×	●	Appendix 1

(To the next page)

*1: Indicates the availability when the GX Developer is installed as "Only for monitoring GX Developer".
○: Available, ×: Unavailable

*2: Indicates the menu selectability when using the QSCPU.

◎: Selectable (Only for the QSCPU),

●: Selectable (Some changes for the QSCPU in the function common to all models),

○: Selectable (No changes for the QSCPU in the function common to all models),

×: Cannot be selected.

*3: For functions without references, refer to the GX Developer Version 8 Operating Manual.

(Continued from the previous page.)

View		Only for monitoring *1	QSCPU *2	Reference *3
Comment	Displays or hides comments.	○	○	—
Statement	Displays or hides statements.	○	○	—
Note	Displays or hides notes.	○	○	—
Alias	Displays or hides device names.	○	○	—
Display device program	Displays or hides the device display screen.	○	○	—
Macro instruction format display	Displays the instructions in the user macro instruction format.	×	×	—
Display current monitored values	Displays or hides the current monitored values.	○	○	—
Comment format		—	—	—
4 × 8 characters, 2 × 8 characters	Displays comments in 4 × 8 or 2 × 8 characters.	○	○	—
3 × 5 characters	Displays comments in 3 × 5 characters.	○	○	—
Alias format display		—	—	—
Displayed instead of device	Displays the machine name at the device name display position.	○	○	—
Displayed with device	Arranges and displays the machine name above the device name.	○	○	—
Device program display mode		—	—	—
Below	Vertically splits the screen in two in the zoom/device display.	○	○	—
Right	Horizontally splits the screen in two in the zoom/device display.	○	○	—
Number of comment lines	Displays device comments in the specified number of rows (1 to 4 rows).	○	○	—
Zoom	Displays a ladder in the specified magnification.	○	○	—
Instruction list/Ladder	Switches between the ladder mode and list mode.	×	×	—
Set the contact		—	—	—
9 contacts	Displays a ladder in 9 contacts.	○	○	—
11 contacts	Displays a ladder in 11 contacts.	○	○	—
Elapsed time	Displays the Elapsed time dialog box.	×	×	—
Display step synchronization	Synchronizes the steps of label display with those of device display.	○	○	—

(To the next page)

- *1: Indicates the availability when the GX Developer is installed as "Only for monitoring GX Developer".
○: Available, ×: Unavailable
- *2: Indicates the menu selectability when using the QSCPU.
◎: Selectable (Only for the QSCPU),
●: Selectable (Some changes for the QSCPU in the function common to all models),
○: Selectable (No changes for the QSCPU in the function common to all models),
×: Cannot be selected.
- *3: For functions without references, refer to the GX Developer Version 8 Operating Manual.

(Continued from the previous page.)

Online		Only for monitoring *1	QSCPU *2	Reference *3
Monitor		—	—	—
Monitor mode	Places the ladder editing screen in the monitor mode.	○	○	—
Monitor (Write mode)	Sets the ladder (Monitor write) mode.	×	○	—
Start monitor	Restarts monitoring.	○	○	—
Stop monitor	Stops monitoring.	○	○	—
Change current value monitor (Decimal)	Displays the current device values of a ladder monitor in decimal form.	○	○	—
Change current value monitor (Hexadecimal)	Displays the current device values of a ladder monitor in hexadecimal form.	○	○	—
Monitor condition setup	Sets monitor execution conditions.	×	×	—
Monitor stop condition setup	Sets monitor stop conditions.	×	×	—
Scan time measurement	Measures scan time.	×	×	—
Entry ladder monitor	Registers ladder blocks.	○	○	—
Delete all entry ladder	Deletes all the registered ladder blocks.	○	○	—
Debug		—	—	—
Debug	Performs/disables the debugging function.	×	×	—
Skip execution	Makes settings for skip.	×	×	—
Partial execution	Makes settings for partial execution.	×	×	—
Step execution	Makes settings for step execution.	×	×	—
Tools		Only for monitoring *1	QSCPU *2	Reference *3
Check program	Checks a program.	○	○	—
Change display color	Changes a display color.	○	●	5.4.2

*1: Indicates the availability when the GX Developer is installed as "Only for monitoring GX Developer".
○: Available, ×: Unavailable

*2: Indicates the menu selectability when using the QSCPU.

◎: Selectable (Only for the QSCPU),

●: Selectable (Some changes for the QSCPU in the function common to all models),

○: Selectable (No changes for the QSCPU in the function common to all models),

×: Cannot be selected.

*3: For functions without references, refer to the GX Developer Version 8 Operating Manual.

(3) Label program editing functions list

The following functions can be performed to edit a label program.

Project		Only for monitoring *1	QSCPU *2	Reference *3
Edit data		—	—	—
New	Adds data to a project.	×	○	—
Copy	Copies the data in a project.	×	○	—
Delete	Deletes the data in a project.	×	○	—
Rename	Renames the data in a project.	×	○	—
Change program type	Changes a ladder and SFC with each other.	×	×	—
Function Block		—	—	—
Diversion	Diverts the FB to a ladder program.	×	×	—
Rename	Renames the diverted FB.	×	×	—
FB change module address	Sets the module start I/O No. used in FB definition.	×	×	—
Edit		Only for monitoring *1	QSCPU *2	Reference *3
Undo	Reverses the last operation.	○	○	—
Cut	Moves the selected data to the clipboard.	○	○	—
Copy	Copies the selected data to the clipboard.	○	○	—
Paste	Pastes the clipboard contents at the cursor position.	○	○	—
Insert line	Inserts a row at the cursor position.	○	○	—
Add line	Adds a row under the cursor position.	○	○	—
Delete line	Deletes a row at the cursor position.	○	○	—
Delete Auto External (Au)	Deletes all Auto External.	○	○	—
Delete all	Deletes all variables.	○	○	—
Auto device setting	Sets the ranges for the devices to be automatically assigned.	○	○	—
Global variable setting	Opens the global variable setting screen.	○	○	—
Import the device comment	Imports device comments (Local label variables only).	○	○	—
Export the device comment	Exports label comments.	○	○	—
Find/Replace		Only for monitoring *1	QSCPU *2	Reference *3
Find device	Searches for the device in the label variable setting screen.	○	○	—
Find character string	Searches for the character string in the label variable setting screen.	○	○	—
Replace device	Searches for and replaces the device in the label variable setting screen.	○	○	—
Replace character string	Searches for and replaces the character string in the label variable setting screen.	○	○	—

(To the next page)

*1: Indicates the availability when the GX Developer is installed as "Only for monitoring GX Developer".
○: Available, ×: Unavailable

*2: Indicates the menu selectability when using the QSCPU.
◎: Selectable (Only for the QSCPU),
●: Selectable (Some changes for the QSCPU in the function common to all models),
○: Selectable (No changes for the QSCPU in the function common to all models),
×: Cannot be selected.

*3: For functions without references, refer to the GX Developer Version 8 Operating Manual.

(Continued from the previous page.)

Convert (Function for local label variable/global label variable editing)		Only for monitoring *1	QSCPU *2	Reference *3
Convert/Compile	Compiles a label program.	×	○	—
Convert/Compile (All programs being edited)	Compiles all the label programs (not compiled yet).	×	○	—
Convert/Compile (All programs)	Compiles all label programs.	×	○	—
Online		Only for monitoring *1	QSCPU *2	Reference *3
Monitor				
Monitor mode	Sets the monitor mode.	×	×	—
Monitor (Write mode)	Sets the write mode during ladder monitoring.	×	×	—
Start monitor	Starts monitoring.	×	×	—
Stop monitor	Stops monitoring.	×	×	—
Change current value monitor (Decimal)	Displays the current device values of a ladder monitor in decimal form.	×	×	—
Change current value monitor (Hexadecimal)	Displays the current device values of a ladder monitor in hexadecimal form.	×	×	—
Monitor condition setup	Sets monitor execution conditions.	×	×	—
Monitor stop condition setup	Sets monitor stop conditions.	×	×	—
Scan time measurement	Measures scan time.	×	×	—
Entry ladder monitor	Registers ladder blocks.	×	×	—
Delete all entry ladder	Deletes all the registered ladder blocks.	×	×	—
Debug				
Debug	Performs/disables the debugging function.	×	×	—
Skip execution	Makes settings for skip.	×	×	—
Partial execution	Makes settings for partial execution.	×	×	—
Step execution	Makes settings for step execution.	×	×	—
Tools		Only for monitoring *1	QSCPU *2	Reference *3
Check program	Checks a program.	×	×	—
Sort				
Label order	Sorts by label.	×	○	—
Device/Constant order	Sorts by device/constant.	×	○	—
Device type order	Sorts by device type.	×	○	—
Change display color	Changes a display color.	×	×	—

*1: Indicates the availability when the GX Developer is installed as "Only for monitoring GX Developer".
○: Available, ×: Unavailable

*2: Indicates the menu selectability when using the QSCPU.

◎: Selectable (Only for the QSCPU),

●: Selectable (Some changes for the QSCPU in the function common to all models),

○: Selectable (No changes for the QSCPU in the function common to all models),

×: Cannot be selected.

*3: For functions without references, refer to the GX Developer Version 8 Operating Manual.

(4) Device comment editing functions list

The following functions can be performed to edit device comments.

Project		Only for monitoring *1	QSCPU *2	Reference *3
Edit data		—	—	—
New	Adds data to a project.	×	○	—
Copy	Copies the data in a project.	×	○	—
Delete	Deletes the data in a project.	×	○	—
Rename	Renames the data in a project.	×	○	—
Change program type	Changes a ladder and SFC with each other.	×	×	—
Function Block		—	—	—
Diversion	Diverts the FB to a ladder program.	×	×	—
Rename	Renames the diverted FB.	×	×	—
FB change module address	Sets the module start I/O No. used in FB definition.	×	×	—
Edit		Only for monitoring *1	QSCPU *2	Reference *3
Cut	Moves the selected data to the clipboard.	×	○	—
Copy	Copies the selected data to the clipboard.	×	○	—
Paste	Pastes the clipboard contents at the cursor position.	×	○	—
Clear all (all devices)	Deletes the comments or device names of all devices.	○	○	—
Clear all (displayed devices)	Deletes the displayed device comments or device names.	○	○	—
Setup comment	Sets a comment type to common comments/comments by program.	○	○	—
Setup comment range	Sets comment ranges.	○	○	—
Find/Replace		Only for monitoring *1	QSCPU *2	Reference *3
Find character string	Searches for the character string in the device comment screen.	○	○	—
Replace character string	Searches for and replaces the character string in the device comment screen.	○	○	—
Convert		Only for monitoring *1	QSCPU *2	Reference *3
Convert (All programs being edited)	Converts/compiles all programs at a time.	×	×	—

(To the next page)

*1: Indicates the availability when the GX Developer is installed as "Only for monitoring GX Developer".
○: Available, ×: Unavailable

*2: Indicates the menu selectability when using the QSCPU.

◎: Selectable (Only for the QSCPU),

●: Selectable (Some changes for the QSCPU in the function common to all models),

○: Selectable (No changes for the QSCPU in the function common to all models),

×: Cannot be selected.

*3: For functions without references, refer to the GX Developer Version 8 Operating Manual.

(Continued from the previous page.)

Online		Only for monitoring *1	QSCPU *2	Reference *3
Monitor		—	—	—
Monitor mode	Sets the monitor mode.	×	×	—
Monitor (Write mode)	Sets the write mode during ladder monitoring.	×	×	—
Start monitor	Starts monitoring.	×	×	—
Stop monitor	Stops monitoring.	×	×	—
Change current value monitor (Decimal)	Displays the current device values of a ladder monitor in decimal form.	×	×	—
Change current value monitor (Hexadecimal)	Displays the current device values of a ladder monitor in hexadecimal form.	×	×	—
Monitor condition setup	Sets monitor execution conditions.	×	×	—
Monitor stop condition setup	Sets monitor stop conditions.	×	×	—
Scan time measurement	Measures scan time.	×	×	—
Entry ladder monitor	Registers ladder blocks.	×	×	—
Delete all entry ladder	Deletes all the registered ladder blocks.	×	×	—
Debug		—	—	—
Debug	Performs/disables the debugging function.	×	×	—
Skip execution	Makes settings for skip.	×	×	—
Partial execution	Makes settings for partial execution.	×	×	—
Step execution	Makes settings for step execution.	×	×	—
Tools		Only for monitoring *1	QSCPU *2	Reference *3
Check program	Checks a program.	×	×	—
Change display color	Changes a display color.	×	×	—

*1: Indicates the availability when the GX Developer is installed as "Only for monitoring GX Developer".

O: Available, ×: Unavailable

*2: Indicates the menu selectability when using the QSCPU.

⊙: Selectable (Only for the QSCPU),

●: Selectable (Some changes for the QSCPU in the function common to all models),

O: Selectable (No changes for the QSCPU in the function common to all models),

×: Cannot be selected.

*3: For functions without references, refer to the GX Developer Version 8 Operating Manual.

(5) Device memory editing functions list

The following functions can be performed to edit device memory.

Project		Only for monitoring *1	QSCPU *2	Reference *3
Edit data		—	—	—
New	Adds data to a project.	×	○	—
Copy	Copies the data in a project.	×	○	—
Delete	Deletes the data in a project.	×	○	—
Rename	Renames the data in a project.	×	○	—
Change program type	Changes a ladder and SFC with each other.	×	×	—
Function Block		—	—	—
Diversion	Diverts the FB to a ladder program.	×	×	—
Rename	Renames the diverted FB.	×	×	—
FB change module address	Sets the module start I/O No. used in FB definition.	×	×	—
Edit		Only for monitoring *1	QSCPU *2	Reference *3
Cut	Moves the selected data to the clipboard.	×	○	—
Copy	Copies the selected data to the clipboard.	×	○	—
Paste	Pastes the clipboard contents at the cursor position.	×	○	—
Clear all (all devices)	Deletes all device data.	○	○	—
Clear all (displayed devices)	Deletes the displayed device data.	○	○	—
FILL	Sets all data to the specified value.	○	○	—
Find/Replace		Only for monitoring *1	QSCPU *2	Reference *3
Finding data	Searches for the data in the device memory screen.	○	○	—
Find character string	Searches for the character string in the device memory screen.	○	○	—
Replacing data	Searches for and replaces the data in the device memory screen.	○	○	—
Replace character string	Searches for and replaces the character string in the device memory screen.	○	○	—
Convert		Only for monitoring *1	QSCPU *2	Reference *3
Convert (All programs being edited)	Converts/compiles all programs at a time.	×	×	—

(To the next page)

*1: Indicates the availability when the GX Developer is installed as "Only for monitoring GX Developer".
○: Available, ×: Unavailable

*2: Indicates the menu selectability when using the QSCPU.

◎: Selectable (Only for the QSCPU),

●: Selectable (Some changes for the QSCPU in the function common to all models),

○: Selectable (No changes for the QSCPU in the function common to all models),

×: Cannot be selected.

*3: For functions without references, refer to the GX Developer Version 8 Operating Manual.

(Continued from the previous page.)

Online		Only for monitoring *1	QSCPU *2	Reference *3
Monitor		—	—	—
Monitor mode	Sets the monitor mode.	×	×	—
Monitor (Write mode)	Sets the write mode during ladder monitoring.	×	×	—
Start monitor	Starts monitoring.	×	×	—
Stop monitor	Stops monitoring.	×	×	—
Change current value monitor (Decimal)	Displays the current device values of a ladder monitor in decimal form.	×	×	—
Change current value monitor (Hexadecimal)	Displays the current device values of a ladder monitor in hexadecimal form.	×	×	—
Monitor condition setup	Sets monitor execution conditions.	×	×	—
Monitor stop condition setup	Sets monitor stop conditions.	×	×	—
Scan time measurement	Measures scan time.	×	×	—
Entry ladder monitor	Registers ladder blocks.	×	×	—
Delete all entry ladder	Deletes all the registered ladder blocks.	×	×	—
Debug		—	—	—
Debug	Performs/disables the debugging function.	×	×	—
Skip execution	Makes settings for skip.	×	×	—
Partial execution	Makes settings for partial execution.	×	×	—
Step execution	Makes settings for step execution.	×	×	—
Tools		Only for monitoring *1	QSCPU *2	Reference *3
Check program	Checks a program.	×	×	—
Change display color	Changes a display color.	×	×	—

*1: Indicates the availability when the GX Developer is installed as "Only for monitoring GX Developer".

O: Available, ×: Unavailable

*2: Indicates the menu selectability when using the QSCPU.

⊙: Selectable (Only for the QSCPU),

●: Selectable (Some changes for the QSCPU in the function common to all models),

O: Selectable (No changes for the QSCPU in the function common to all models),

×: Cannot be selected.

*3: For functions without references, refer to the GX Developer Version 8 Operating Manual.

1.2.2 Restricting operations by using safety CPU operation mode/access level

This section explains the operability and restrictions of each GX Developer function differ depends on the combination of safety CPU operation mode and an access level.

(1) Common functions

Menu Item	SAFETY MODE			TEST MODE			Restrictions
	Admin.	Develop.	Users	Admin.	Develop.	Users	
Project							—
New project	—	—	—	—	—	—	—
Open project	○	○	○	○	○	○	—
Close project	○	○	○	○	○	○	—
Save	○	○	×	○	○	×	—
Save as	△	△	△	△	△	△	△: Refer to *1.
Delete project	△	△	△	△	△	△	△: Refer to *2.
Verify	○	○	○	○	○	○	—
Copy	○	○	○	○	○	○	—
Security operation							—
User management	○	×	×	○	×	×	—
Wait time settings	○	×	×	○	×	×	—
Operation lock	○	○	○	○	○	○	—
Printer setup	○	○	○	○	○	○	—
Print	○	○	○	○	○	○	—
Start new GX Developer session	○	○	○	○	○	○	—
Exit GX Developer	○	○	○	○	○	○	—
View							—
Toolbar	○	○	○	○	○	○	—
Status bar	○	○	○	○	○	○	—
Project data list	○	○	○	○	○	○	—
Project data display format							—
Not sort	○	○	○	○	○	○	—
Sort data name ascending	○	○	○	○	○	○	—
Sort data name descending	○	○	○	○	○	○	—

(To the next page)

○: Can be operated. △: Can be operated with restrictions. ×: Cannot be operated.
—: Can perform independent of the access level.

*1: When overwriting the existing project, logging in to the project is required.
"Save as" can be performed, when the access level of the login user is "Administrators" or "Developers".

*2: Log in to the project to be deleted is required.
"Delete project" can be performed, when the access level of the login user is "Administrators" or "Developers".

(Continued from the previous page.)

Menu Item	SAFETY MODE			TEST MODE			Restrictions
	Admin.	Develop.	Users	Admin.	Develop.	Users	
Online							—
Transfer setup	○	○	○	○	○	○	—
Read from PLC	△	×	×	△	×	×	△: Refer to *3.
Write to PLC	×	×	×	○	○	×	—
Verify with PLC	○	○	○	○	○	○	—
Write to PLC (Flash ROM)							—
Write the program memory to ROM	×	×	×	○	○	×	—
Delete PLC data	×	×	×	○	○	×	—
Monitor							—
Start monitor (All windows)	○	○	○	○	○	○	—
Stop monitor (All windows)	○	○	○	○	○	○	—
Device batch	○	○	○	○	○	○	—
Entry data monitor	○	○	○	○	○	○	—
Buffer memory batch	○	○	○	○	○	○	—
Program monitor list	○	○	○	○	○	○	—
Debug							—
Device test	×	×	×	○	○	×	Refer to Appendix 1.
Remote operation	○	○	×	○	○	×	Refer to Appendix 1.
Safety CPU operation							—
Switch safety CPU operation mode	○	○	×	○	○	×	—
ROM information	○	○	○	○	○	○	—
CPU access password registration/change	△	×	×	○	×	×	△: Refer to *4.
PLC memory initialization	○	×	×	○	×	×	—
Monitor destination select option	△	△	△	△	△	△	△: Refer to *5.
Clear PLC memory	×	×	×	○	○	×	—
Format PLC memory	×	×	×	○	○	×	—
Arrange PLC memory	×	×	×	○	○	×	—
Set clock	○	○	×	○	○	×	—

(To the next page)

○: Can be operated. △: Can be operated with restrictions. ×: Cannot be operated.
 —: Can perform independent of the access level.

*3: "Read from PLC" cannot be newly performed from the safety CPU.

*4: Cannot register a CPU access password with a safety CPU.

*5: The CPU to be monitored cannot be switched during monitoring.

(Continued from the previous page.)

Menu Item	SAFETY MODE			TEST MODE			Restrictions
	Admin.	Develop.	Users	Admin.	Develop.	Users	
Diagnostics							Refer to Appendix 1.
PLC diagnostics	△	△	△	○	○	△	△: Refer to *6.
Ethernet diagnostics	△	△	△	○	○	△	△: Refer to *7.
CC IE Control diagnostics	△	△	△	○	○	△	△: Refer to *8.
CC IE Field diagnostics	△	△	△	○	○	△	△: Refer to *9.
MELSECNET diagnostics	△	△	△	○	○	△	△: Refer to *10.
CC-Link / CC-Link/LT diagnostics	△	△	△	○	○	△	△: Refer to *11.
System monitor	○	○	○	○	○	○	—
Tools							—
Marge data	○	○	○	○	○	○	Refer to Appendix 1.
Check parameter	○	○	○	○	○	○	—
Delete unused comments	○	○	○	○	○	○	—
Clear all parameters	○	○	○	○	○	○	—
Customize keys	○	○	○	○	○	○	—
Options	○	○	×	○	○	×	Refer to Appendix 1.
Create start-up settings file	○	○	○	○	○	○	—
Window							—
Cascade	○	○	○	○	○	○	—
Tile vertically	○	○	○	○	○	○	—
Tile horizontally	○	○	○	○	○	○	—
Arrange icons	○	○	○	○	○	○	—
Close all Windows	○	○	○	○	○	○	—
Help							—
CPU error	○	○	○	○	○	○	—
Special relay/register	○	○	○	○	○	○	—
Key operation list	○	○	○	○	○	○	—
Product information	○	○	○	○	○	○	—
Connect to MELFANSweb	○	○	○	○	○	○	—

(To the next page)

○: Can be operated. △: Can be operated with restrictions. ×: Cannot be operated.
 —: Can perform independent of the access level.

*6: "Clear log" cannot be performed in the PLC Diagnostics screen.

*7: The COM. ERR off button of the Ethernet diagnostics cannot be selected.
 "Clear history" on the <<Error log>> tab cannot be performed.

*8: "Clear error info" cannot be performed in the Logging screen of the CC IE Control diagnostics.

*9: The following operations cannot be performed in the CC IE Field Diagnostics.

- Setting the station number for number unspecified station.
- Execution of link start, link stop, or forced link start
- Execution of clearing network event history, setting history acquisition
- Reserved station function enable setting
- Temporary error invalid station setting/restore

*10: "Clear of error history" cannot be performed in the Error history monitor screen of the MELSECNET diagnostics.

*11: "Loop test" cannot be performed in the CC-Link / CC-Link/LT diagnostics screen.

(2) Ladder editing functions

Menu Item	SAFETY MODE			TEST MODE			Restrictions
	Admin.	Develop.	Users	Admin.	Develop.	Users	
Project							—
Edit data							—
New	○	○	○	○	○	○	—
Delete	○	○	○	○	○	○	—
Rename	○	○	○	○	○	○	—
Function Block							—
Diversion	○	○	○	○	○	○	—
Rename	○	○	○	○	○	○	—
FB change module address	○	○	○	○	○	○	—
Edit							—
Undo	○	○	○	○	○	○	—
Restore after ladder conversion	○	○	○	○	○	○	—
Cut	○	○	○	○	○	○	—
Copy	○	○	○	○	○	○	Refer to Appendix 1.
Paste	○	○	○	○	○	○	Refer to Appendix 1.
Insert line	○	○	○	○	○	○	—
Delete line	○	○	○	○	○	○	—
Insert row	○	○	○	○	○	○	—
Delete row	○	○	○	○	○	○	—
Insert NOP batch	○	○	○	○	○	○	—
Delete NOP batch	○	○	○	○	○	○	—
Draw line	○	○	○	○	○	○	—
Delete line	○	○	○	○	○	○	—
Change TC setting	○	○	○	○	○	○	Refer to Appendix 1.
Read mode	○	○	○	○	○	○	—
Write mode	○	○	○	○	○	○	—
Ladder symbol	○	○	○	○	○	○	—
Documentation	○	○	○	○	○	○	—

(To the next page)

○: Can be operated. △: Can be operated with restrictions. ×: Cannot be operated.
 -: Can perform independent of the access level.

(Continued from the previous page.)

Menu Item	SAFETY MODE			TEST MODE			Restrictions	
	Admin.	Develop.	Users	Admin.	Develop.	Users		
Find/Replace								—
Find device	○	○	○	○	○	○	—	
Find instruction	○	○	○	○	○	○	—	
Find step No.	○	○	○	○	○	○	—	
Find character string	○	○	○	○	○	○	—	
Find contact or coil	○	○	○	○	○	○	—	
Replace device	○	○	○	○	○	○	—	
Device block replacement	○	○	○	○	○	○	—	
Replace instruction	○	○	○	○	○	○	—	
Change open/close contact	○	○	○	○	○	○	—	
Replace character string	○	○	○	○	○	○	—	
Change module start address	○	○	○	○	○	○	—	
Replace statement/note type	○	○	○	○	○	○	—	
Cross reference window display	○	○	○	○	○	○	—	
Cross reference list	○	○	○	○	○	○	—	
List of used devices	○	○	○	○	○	○	—	
Convert								—
Convert	○	○	○	○	○	○	—	
Convert (All programs being edited)	○	○	○	○	○	○	—	
Convert block (All programs)	○	○	○	○	○	○	—	
Convert block (Online change)	×	×	×	○	○	×	—	
View								—
Comment	○	○	○	○	○	○	—	
Statement	○	○	○	○	○	○	—	
Note	○	○	○	○	○	○	—	
Alias	○	○	○	○	○	○	—	
Display device program	○	○	○	○	○	○	—	
Display current monitored values	○	○	○	○	○	○	—	
Comment format	○	○	○	○	○	○	—	
Alias format display	○	○	○	○	○	○	—	
Device program display mode	○	○	○	○	○	○	—	
Number of comment lines	○	○	○	○	○	○	—	
Zoom	○	○	○	○	○	○	—	
Set the contact	○	○	○	○	○	○	—	
Display step synchronization	○	○	○	○	○	○	—	

(To the next page)

○: Can be operated. △: Can be operated with restrictions. ×: Cannot be operated.
 -: Can perform independent of the access level.

(Continued from the previous page.)

Menu Item	SAFETY MODE			TEST MODE			Restrictions
	Admin.	Develop.	Users	Admin.	Develop.	Users	
Online							—
Monitor							—
Monitor mode	○	○	○	○	○	○	—
Monitor (Write mode)	○	○	×	○	○	×	—
Start monitor	○	○	○	○	○	○	—
Stop monitor	○	○	○	○	○	○	—
Change current value monitor (Decimal)	○	○	○	○	○	○	—
Change current value monitor (Hexadecimal)	○	○	○	○	○	○	—
Entry ladder monitor	○	○	○	○	○	○	—
Delete all entry ladder	○	○	○	○	○	○	—
Tools							—
Check program	○	○	○	○	○	○	—
Change display color	○	○	○	○	○	○	—

○: Can be operated. △: Can be operated with restrictions. ×: Cannot be operated.
 —: Can perform independent of the access level.

(3) Label program editing functions

Menu Item	SAFETY MODE			TEST MODE			Restrictions
	Admin.	Develop.	Users	Admin.	Develop.	Users	
Project							—
Edit data							—
New	○	○	○	○	○	○	—
Copy	○	○	○	○	○	○	—
Delete	○	○	○	○	○	○	—
Rename	○	○	○	○	○	○	—
Edit							
Undo	○	○	○	○	○	○	—
Cut	○	○	○	○	○	○	—
Copy	○	○	○	○	○	○	—
Paste	○	○	○	○	○	○	—
Insert line	○	○	○	○	○	○	—
Add line	○	○	○	○	○	○	—
Delete line	○	○	○	○	○	○	—
Delete Auto External (Au)	○	○	○	○	○	○	—
Delete all	○	○	○	○	○	○	—
Auto device setting	○	○	○	○	○	○	—
Global variable setting	○	○	○	○	○	○	—
Import the device comment	○	○	○	○	○	○	—
Export the device comment	○	○	○	○	○	○	—
Find/Replace							—
Find device	○	○	○	○	○	○	—
Find character string	○	○	○	○	○	○	—
Replace device	○	○	○	○	○	○	—
Replace character string	○	○	○	○	○	○	—
Convert							—
Convert/Compile	○	○	○	○	○	○	—
Convert/Compile (All programs being edited)	○	○	○	○	○	○	—
Convert/Compile (All programs)	○	○	○	○	○	○	—
Tools							—
Sort							—
Label order	○	○	○	○	○	○	—
Device/Constant order	○	○	○	○	○	○	—
Device type order	○	○	○	○	○	○	—

○: Can be operated. △: Can be operated with restrictions. ×: Cannot be operated.
 —: Can perform independent of the access level.

(4) Device comment editing functions

Menu Item	SAFETY MODE			TEST MODE			Restrictions
	Admin.	Develop.	Users	Admin.	Develop.	Users	
Project							—
Edit data							—
New	○	○	○	○	○	○	—
Copy	○	○	○	○	○	○	—
Delete	○	○	○	○	○	○	—
Rename	○	○	○	○	○	○	—
Edit							—
Cut	○	○	○	○	○	○	—
Copy	○	○	○	○	○	○	—
Paste	○	○	○	○	○	○	—
Clear all (all devices)	○	○	○	○	○	○	—
Clear all (displayed devices)	○	○	○	○	○	○	—
Setup comment	○	○	○	○	○	○	—
Setup comment range	○	○	○	○	○	○	—
Find/Replace							—
Find character string	○	○	○	○	○	○	—
Replace character string	○	○	○	○	○	○	—

○: Can be operated. △: Can be operated with restrictions. ×: Cannot be operated.
 —: Can perform independent of the access level.

(5) Device memory editing functions

Menu Item	SAFETY MODE			TEST MODE			Restriction
	Admin.	Develop.	Users	Admin.	Develop.	Users	
Project							—
Edit data							—
New	○	○	○	○	○	○	—
Copy	○	○	○	○	○	○	—
Delete	○	○	○	○	○	○	—
Rename	○	○	○	○	○	○	—
Edit							—
Cut	○	○	○	○	○	○	—
Copy	○	○	○	○	○	○	—
Paste	○	○	○	○	○	○	—
Clear all (all devices)	○	○	○	○	○	○	—
Clear all (displayed devices)	○	○	○	○	○	○	—
FILL	○	○	○	○	○	○	—
Find/Replace							—
Finding data	○	○	○	○	○	○	—
Find character string	○	○	○	○	○	○	—
Replacing data	○	○	○	○	○	○	—
Replace character string	○	○	○	○	○	○	—

○: Can be operated. △: Can be operated with restrictions. ×: Cannot be operated.
 —: Can perform independent of the access level.

2. SYSTEM CONFIGURATION

This section explains the system configuration to connect GX Developer and a safety CPU.

For details of connection cable, refer to GX Developer Version 8 Operating Manual.

2

2.1 Connecting to Safety CPU

The following explains the system configuration when GX Developer is connected to a safety CPU.

(1) Direct coupling to a safety CPU

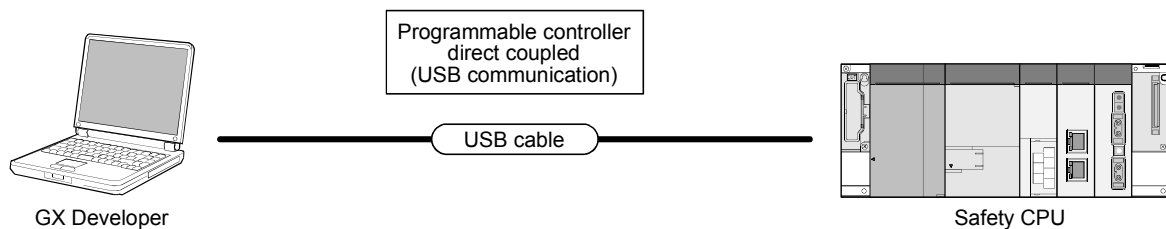

- (a) Compatible GX Developer
Use the GX Developer Version 8.40S or later.

(2) Connecting via Ethernet, CC-Link IE Controller Network, MELSECNET/H

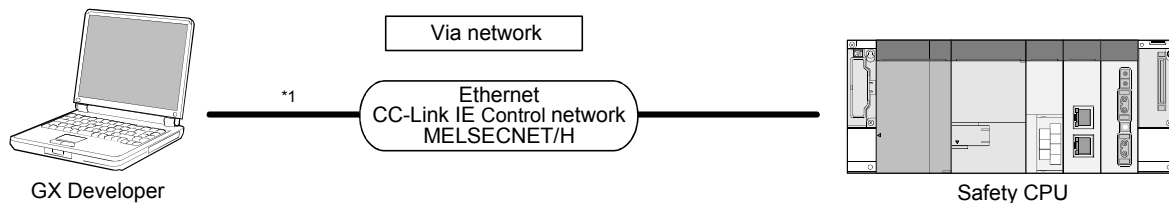

*1: For details of connecting a personal computer to each network, refer to the following manual.

 GX Developer Version 8 Operating Manual

- (a) Compatible GX Developer
Via QCPU:
Use the GX Developer Version 8.65T or later.
Via LCPU:
Use the GX Developer Version 8.88S or later.
Via safety CPU:
Use the GX Developer Version 8.98C or later.
- (b) Compatible safety CPU
Via QCPU or LCPU:
Use safety CPU whose first 5 digits of the serial number are "10032" or later.
Via safety CPU:
Use safety CPU whose first 5 digits of the serial number are "10042" or later.

(3) Connecting via CC-Link IE Field Network

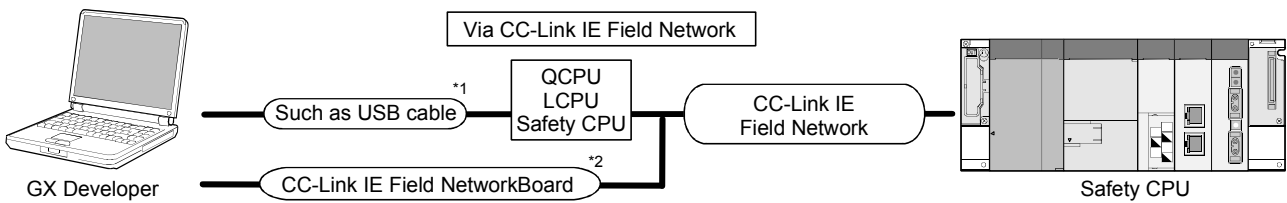

*1: For details of connecting a personal computer to each CPU, refer to (1) and (2) in this section, and the following manual.

GX Developer Version 8 Operating Manual

*2: For details, refer to the following manual.

CC-Link IE Field Network Interface Board User's Manual

- (a) Compatible GX Developer
Use the GX Developer Version 8.98C or later.
- (b) Compatible safety CPU
Use safety CPU whose first 5 digits of the serial number are "13042" or later.

POINT

A CPU cannot be connected via a head module or an Ethernet adapter module.

2.2 Connecting to Another CPU via Safety CPU

The following explains the system configuration when GX Developer is connected to another CPU via a safety CPU.



- (a) Compatible GX Developer
Use the GX Developer Version 8.98C or later.
- (b) Compatible safety CPU
Use safety CPU whose first 5 digits of the serial number are "13042" or later.

POINT

An ACPU or QnACPU cannot be accessed via a safety CPU.

3 RESTRICTIONS AND PRECAUTIONS

3.1 Precautions for the GX Developer Version Earlier than the Safety CPU Compatible Version



- (1) Precautions for saving and deleting a project
When using the GX Developer whose version is earlier than the safety CPU compatible version (Version 8.39R or earlier), the login certification to a safety project cannot be performed to the following operations.
Therefore, take care not to lose a safety project due to malfunctions.

[Relevant Operation]

- Overwriting a safety project and then saving it by using "Save as".
- Deleting a safety project by using "Delete project".

- (2) Precautions for opening a project
When using the GX Developer whose version is earlier than the safety CPU compatible version (Version 8.39R or earlier), the safety project cannot be opened.

3.2 Precautions for Management

- (1) Precautions for project data management
Be sure to read the Safety Application Guide for correct management/operation of project data.
A system manager has to back up the project and save the backup data so that the data restoration is always possible.
- (2) Precautions for password management
A system manager has to manage the user information (e.g. user name, login password, and CPU access password) registered to a project with attention.
If losing a login password or CPU access password, either of the following actions is required.
- (a) Losing a login password
The project cannot be opened.
If a system manager has lost the password, re-creating a project is required.
- (b) Losing a CPU access password
When a CPU access password has been set to a safety CPU, "Write to PLC" cannot be performed unless the same password is set to the project.
Note that the CPU access password that has been set to a safety CPU cannot be changed.
If losing a CPU access password, initialize the safety CPU by using "PLC memory initialization" and then rewrite the project to the programmable controller.
(For "PLC memory initialization"  Section 5.2.4)
- (3) Precautions for ROM information management
A system manager has to record and store "ROM information" each time program memory is written to ROM.
When the ROM information in a safety CPU matches with the previously saved one, a system manager can judge that the data have not been changed.
(For "ROM information confirmation"  Section 5.2.2)
- (Main display contents of ROM information)
- The year/month/day/hour/minute/second when program memory is written to ROM.
 - The parameters and program ID when program memory is written to ROM.
 - The user who wrote program memory to ROM.

4 PROCEDURES TO OPERATION

This section explains the procedures from creating to operating a project for a safety programmable controller (Safety project).

4.1 When Creating a Safety Project

The following shows the procedure from creating to operating the safety project.

Creating the new project	Reference
1) Create a new project.	GX Developer Operating Manual
2) Register the user(s) whose access level is/are Administrators.	Section 5.1.1
3) Create a program and parameters.	GX Developer Operating Manual
4) Register the user(s) who log(s) in to the project.	Section 5.1.2



Safety CPU STOP	Reference
Switch the safety CPU to STOP.	—



Safety CPU initial settings	Reference
1) Register a CPU access password for both the project and safety CPU. * 1	Section 5.2.3
2) Format the program memory.	GX Developer Operating Manual



* 1: If the previous CPU access password has been registered with the safety CPU, initialize the programmable controller memory in advance. (🔑 Section 5.2.4)

Writing the parameters and program	Reference
1) Write the parameters and program to the programmable controller.	GX Developer Operating Manual
2) Reset the safety CPU.	—



Operation check	Reference
Switch the safety CPU to RUN and check the operation.	GX Developer Operating Manual



Switching to the SAFETY MODE	Reference
1) Switch the safety CPU to STOP.	—
2) Write the program memory to the ROM.	Section 5.7
3) Switch the safety CPU operation mode to the SAFETY MODE.	Section 5.2.1
4) Reset the safety CPU.	—



Switching the safety CPU to RUN	Reference
Switch the safety CPU to RUN and confirm the RUN LED turns ON.	—



Operation

4.2 When Modifying the Safety Project in Operation

The following shows the procedure from modifying the safety project in operation to operating the project.

Open project	Reference
Open the operating project.	Section 5.1.3



Changing the parameters and program	Reference
Change the parameters and program.	GX Developer Operating Manual



Switching to the TEST MODE	Reference
Switch the safety CPU operation mode to the TEST MODE.	Section 5.2.1



Writing the parameters and program	Reference
1) Switch the safety CPU to STOP.	—
2) Write the parameters and program to the programmable controller.	GX Developer Operating Manual
3) Reset the safety CPU.	—



Operation check	Reference
Switch the safety CPU to RUN and check the operation.	GX Developer Operating Manual



Switching to the SAFETY MODE	Reference
1) Switch the safety CPU to STOP.	—
2) Write the program memory to the ROM.	Section 5.7
3) Switch the safety CPU operation mode to the SAFETY MODE.	Section 5.2.1
4) Reset the safety CPU.	—



Switching the safety CPU to RUN	Reference
Switch the safety CPU to RUN and confirm the RUN LED turns ON.	—



Operation

5 ADDED FUNCTIONS TO CORRESPOND TO A SAFETY PROGRAMMABLE CONTROLLER

5.1 Security Operations

5.1.1 Registering the user when creating a new project

A system manager has to create a new project for a safety programmable controller. When creating a new project, the following screen appears. A system manager has to register the login user whose access level is Administrators.

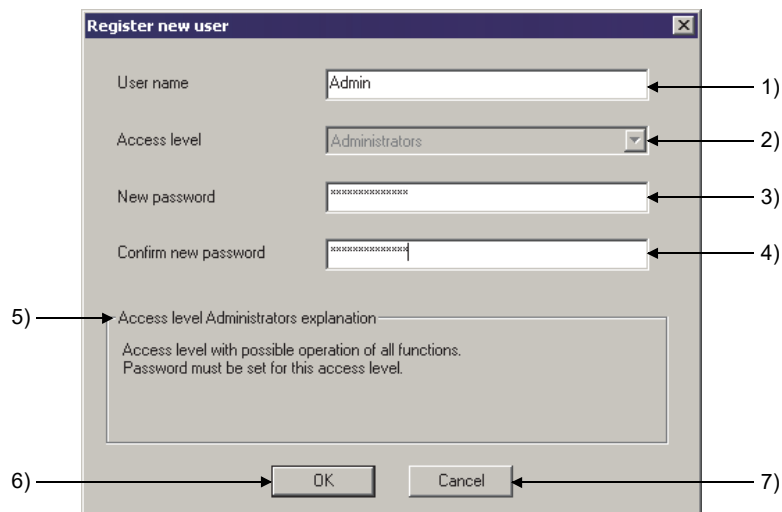

[Description]

- 1) User name
Input a user name within 20 characters with the alphabets, numbers, and symbols corresponding to ASCII code (Appendix 3) 20H to 7EH.
(For alphabets, an upper-case character is differentiated from a lower-case character.)
- 2) Access level
"Administrators" has been set to the access level (Fixed).
- 3) New password
Input a CPU access password within 6 to 14 characters with the alphabets, numbers, and symbols corresponding to ASCII code (Appendix 3) 20H to 7EH.
(For alphabets, an upper-case character is differentiated from a lower-case character.)
- 4) Confirm new password
Input the same password with 3) for confirmation.
- 5) Access level explanation field
Displays the explanation for Administrators.

6) button

Closes the screen when the setting is correct.

The login to the project is performed with the registered user.

In addition, the new user is registered with the User management screen described in Section 5.1.2.

7) button

Cancels the setting and returns to the New Project screen.

POINT

For the additional registration of login users, refer to Section 5.1.2.

5.1.2 Registering/deleting/changing a login user

	Admin.	Develop.	Users
SAFETY	○	×	×
TEST	○	×	×

[Purpose]

Registers/deletes/changes the login user of the project for a safety programmable controller.



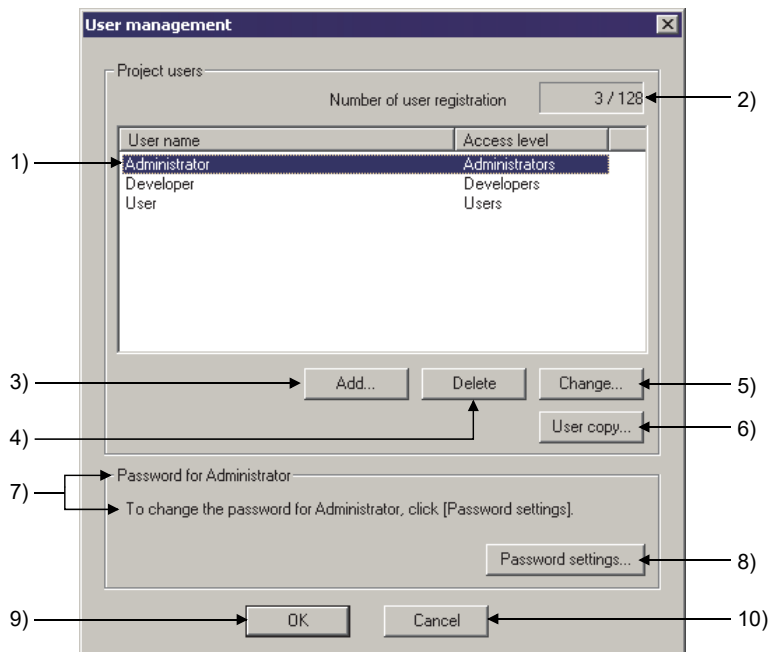

[Operating Procedure]

Select [Project] → [Security operation] → [User management].

[Dialog Box]



[Description]

- 1) User list/selection field
 - Display/Selection
Displays the user names with their access levels registered with the project. Select the registered user to be deleted or the user whose information is to be changed.
 - Search
Inputting the first character of a user name finds the user name(s) having the same first character.
 - Sort
Clicking the title (User name or access level) by using a mouse sorts the list based on the title.
The list is alternatively sorted between ascending order and descending order.
- 2) Number of user registration
Displays the number of the users registered to the project (Max. 128).
- 3) button
Displays the Add new user screen. ( (1) in this section)
- 4) button
Deletes the selected user.
- 5) button
Displays the User change screen. ( (2) in this section)
- 6) button
Copies (Adds or overwrites) the user information registered with other project to the open project.
(For operating procedure  (4) in this section)
- 7) Password for *****
Displays the user name selected in the list of 1).
- 8) button
Displays the Password settings screen. ( (3) in this section)
- 9) button
Registers the set user information, and closes the screen.
- 10) button
Cancels the set user information, and closes the screen.

(1) Adding a new user

[Purpose]

Adds the user who can log in to the project under editing.

[Operating Procedure]

Select [Project] → [Security operation] → [User management] → **Add** button.

[Dialog Box]

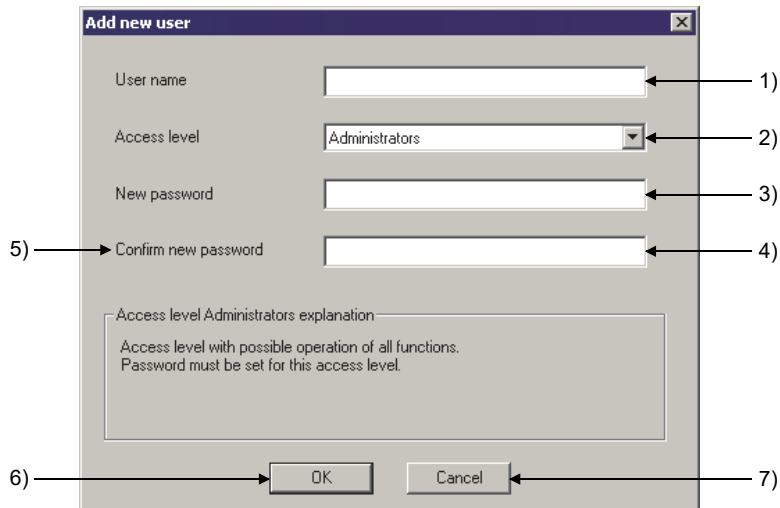

[Description]

- 1) **User name**
Input a user name within 20 characters with the alphabets, numbers, and symbols corresponding to ASCII code (Appendix 3) 20H to 7EH.
(For alphabets, an upper-case character is differentiated from a lower-case character.)
- 2) **Access level**
Select an access level for the new user from the combo box.
- 3) **New password**
Input a CPU access password within 6 to 14 characters with the alphabets, numbers, and symbols corresponding to ASCII code (Appendix 3) 20H to 7EH.
(For alphabets, an upper-case character is differentiated from a lower-case character.)
When the access level is set to "Users", the password input can be skipped.
- 4) **Confirm new password**
Input the same password with 3) for confirmation.
- 5) **Access level explanation field**
Displays the explanation for the access level selected in 2).
- 6) **OK** button
Closes the screen when the setting is correct.
The new user is registered with the User management screen.
- 7) **Cancel** button
Cancels the setting, and closes the screen.

(2) Changing the registered user information

[Purpose]

Changes the registered user information.

[Operating Procedure]

Select [Project] → [Security operation] → [User management] → **Change** button.

[Dialog Box]

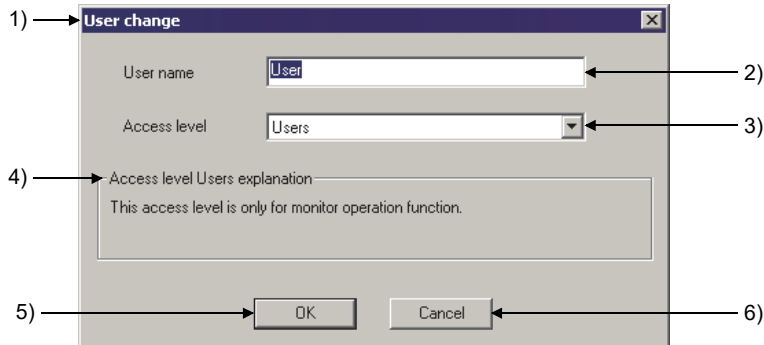

[Description]

- 1) Title bar
Displays the user whose information is to be changed.
- 2) User name
Displays the user whose information is to be changed.
To change the user name, input a new user name within 20 characters with the alphabets, numbers, and symbols corresponding to ASCII code (Appendix 3) 20H to 7EH.
(For alphabets, an upper-case character is differentiated from a lower-case character.)
- 3) Access level
Displays the access level for the user whose information is to be changed.
To change the access level, select the desired level from the combo box.
- 4) Access level explanation field
Displays the explanation for the access level selected in 3).
- 5) **OK** button
Closes the screen when the setting is correct.
The new user information is registered with the User management screen.
- 6) **Cancel** button
Cancels the setting, and closes the screen.

POINT
<ul style="list-style-type: none"> • Changing user information The information on the user (User name and access level) during login cannot be changed. • Changing access level When changing the access level to other than "Users", the "Password settings" screen appears. Then, set a password in the screen. When changing the access level to "Users", the password settings can be skipped.

(3) Setting/changing a password

[Purpose]

Sets/changes the registered user password.

[Operating Procedure]

Select [Project] → [Security operation] → [User management] →

button.

[Dialog Box]

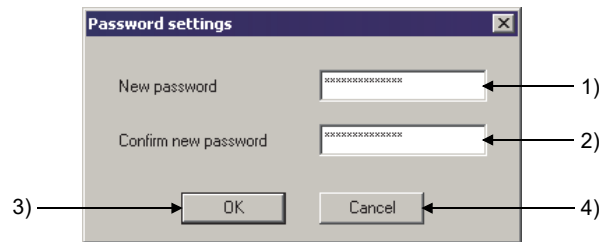

[Description]

- 1) New password
Input a CPU access password within 6 to 14 characters with the alphabets, numbers, and symbols corresponding to ASCII code (Appendix 3) 20H to 7EH.
(For alphabets, an upper-case character is differentiated from a lower-case character.)
- 2) Confirm new password
Input the same password with 1) for confirmation.
- 3) button
Closes the screen when the setting is correct.
The new password is set.
- 4) button
Cancels the setting, and closes the screen.

(4) Copying user information

[Purpose]

Copies (Adds or overwrites) the user information registered with other project to the open project.

[Operating Procedure]

Select [Project] → [Security operation] → [User management] → **User copy** button.

[Dialog Box]

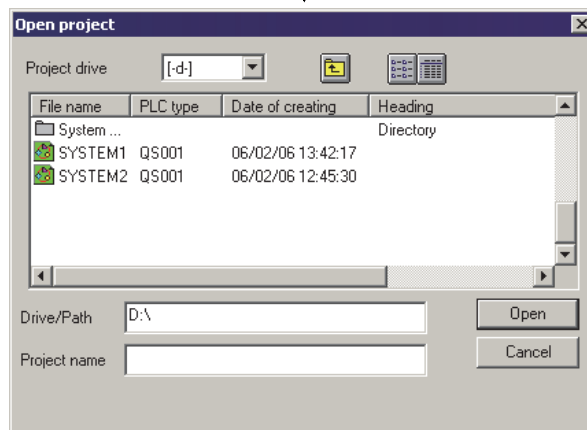
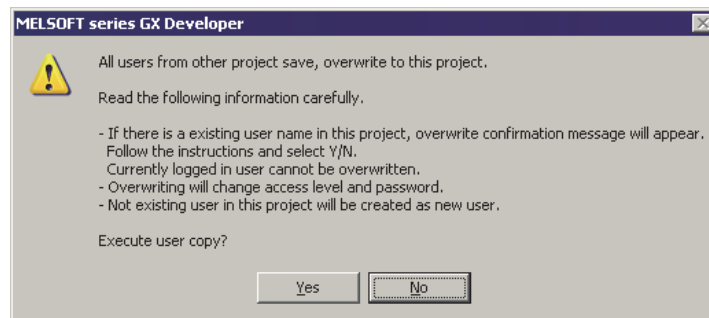

Select the original project in the screen above.

POINT

Copying user information

- Selecting the original project displays the Login certification screen. Input the user name and password for logging in to the original project. Only the users whose access levels are Administrators can log in to the project. (For login certification  Section 5.1.3)

5.1.3 Logging in to a project

- (1) Functions require login certification
 The following functions require login certification to the project for a safety programmable controller.

Function	
Project	Open project
	Save as (When selecting the existing safety project as the "Project name")
	Delete project
	Verify (When selecting a safety project as a verify source)
	Copy (When selecting a safety project as a copy source)
	When selecting: Security operation → User management → <input type="button" value="User copy"/> button  Section 5.1.2)
Tool	Marge data

- (2) Login operation
 When performing the functions require login certification, the following setting screen appears.
 Then, perform login operation with the user name and password.

[Dialog Box]

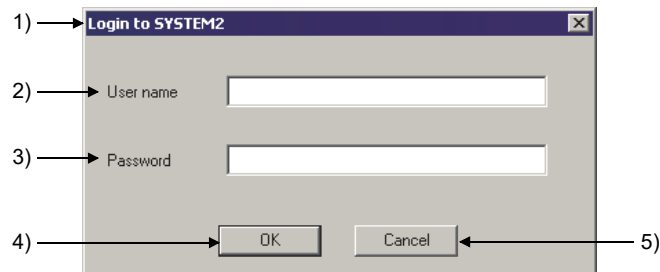

[Description]

- 1) Title bar
 Displays the project to be logged in.
- 2) User name
 Input the user name registered with the project to be logged in.
 (For alphabets, an upper-case character is differentiated from a lower-case character.)
- 3) Password
 Input the login password for the user of 2).
- 4) button
 Perform login certification with the input user name and password. If the user is allowed to operate the function, the function is performed.
- 5) button
 Closes the screen without login certification.

(3) Displaying login user information

Login information is displayed on the bottom of the Project data list screen.

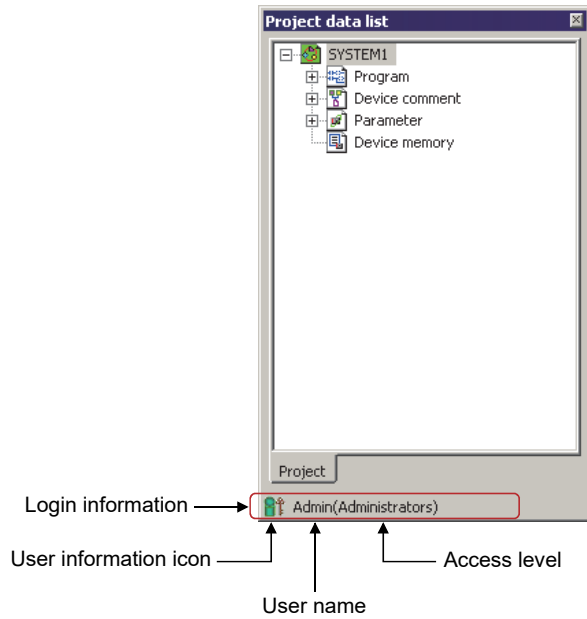

5.1.4 Locking operations

The GX Developer operations by other than the login users are inhibited. An operation lock has two types, automatic operation lock and manual operation lock.

This section explains how to use the operation lock function.

(1) Setting wait time for the automatic operation lock

	Admin.	Develop.	Users
SAFETY	○	×	×
TEST	○	×	×

[Purpose]

Sets the wait time to inhibit the GX Developer operations.

When the GX Developer has not been operated over the set time, the Operation lock screen appears, and the GX Developer operation is locked.

[Operating Procedure]

Select [Project] → [Security operation] → [Wait time settings].

[Dialog Box]

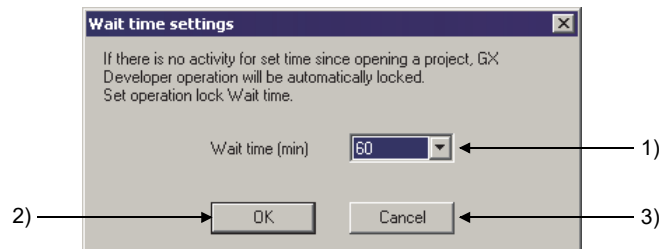

[Description]

- 1) Wait time (min)
Select the wait time for automatic operation lock from the combo box. The time can be set between 10 and 120 minutes (10-minute intervals).
- 2) button
Registers the set wait time, and closes the screen.
- 3) button
Cancels the set wait time, and closes the screen.

POINT

- The wait time for the automatic operation lock is counted while the GX Developer has not been operated, and is reset when operating the GX Developer. However, the wait time is not reset in the following operations.

<Selecting a menu item when a pull-down menu is displayed>

Example) When displaying the pull-down menu of the Project

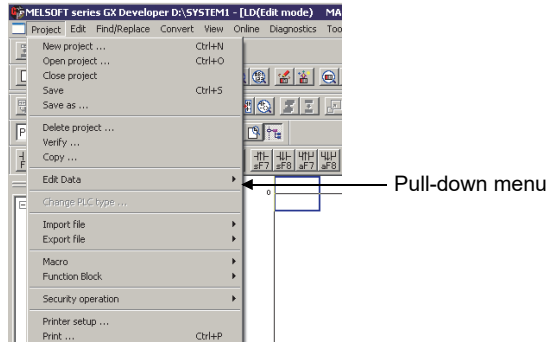

<All the operations when a message box is displayed>

Example) The message box displayed when exiting the GX Developer

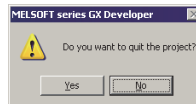

<All the operations when a dialog box is displayed>

Example) When the New Project dialog box is displayed

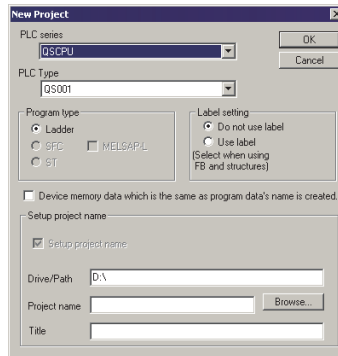

Note when the key/mouse operation outside the open dialog box is enabled (Designated as a modeless dialog box), the monitoring time is reset.

Example) When the "Cross reference list" dialog box is displayed

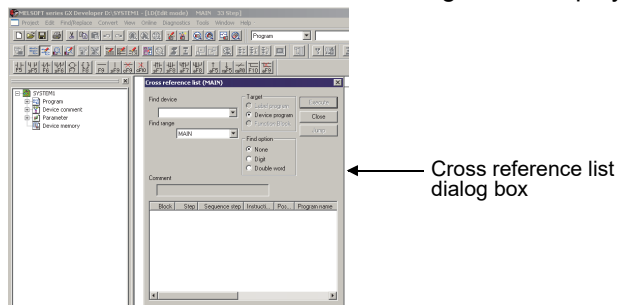

- Unlocking the operation lock enables to operate the GX Developer. (🖱️ (3) in this section)
- When saving the project, the set wait time is treated as project data.
- The monitor screen displayed before the operation lock keeps updated even during operation lock.

(2) Locking operation manually

	Admin.	Develop.	Users
SAFETY	○	○	○
TEST	○	○	○

[Purpose]

Manually locks operation when not operating the GX Developer.

[Operating Procedure]

Select [Project] → [Security operation] → [Operation lock].

[Dialog Box]

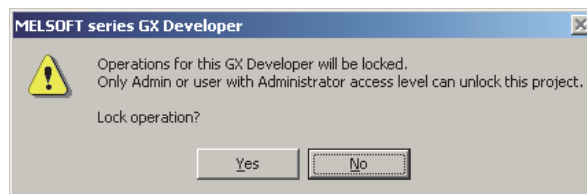

Clicking the button displays the Operation lock screen and locks the GX Developer operation.

POINT

- The monitor screen displayed before the operation lock keeps updated even during operation lock.
- Unlocking the operation lock enables to operate the GX Developer. (👉 (3) in this section)

(3) Unlocking an operation lock

	Admin.	Develop.	Users
SAFETY	○	○	○
TEST	○	○	○

[Purpose]

Unlocks an operation lock to enable the GX Developer operation.
 Only the users during login or whose access levels are Administrators can unlock the operation lock.

[Dialog Box]

After performing the operation lock, the following Operation lock screen appears.

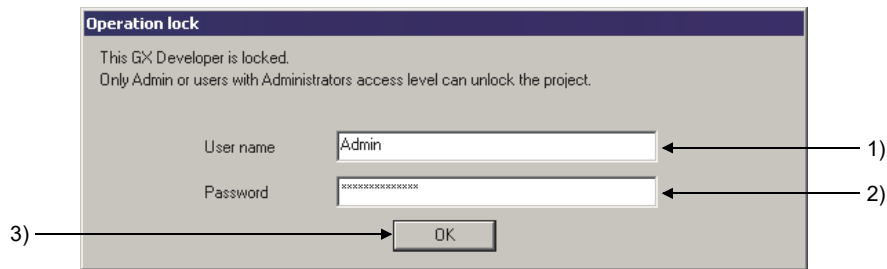

[Description]

- 1) User name
Input the user name who unlocks the operation lock.
- 2) Password
Input the password of the user who unlocks the operation lock.
- 3) button
Checks the user name and password, and then unlocks the operation lock (Closes the Operation lock screen.)

5.2 Safety CPU Operation

5.2.1 Switching safety CPU operation mode

	Admin.	Develop.	Users
SAFETY	△	△	×
TEST	△	△	×

△: Can perform only when the safety CPU is in STOP.

[Purpose]

Switches safety CPU operation mode (SAFETY MODE/TEST MODE).

[Operating Procedure]

Select [Online] → [Safety CPU operation] → [Switch safety CPU operation mode].

[Dialog Box]

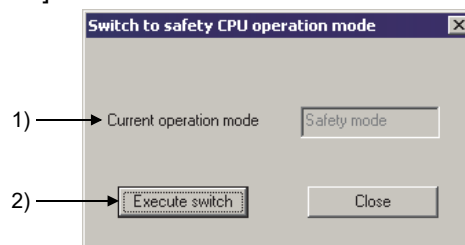

[Description]

- 1) Current operation mode
Displays the current safety CPU operation mode.
- 2) **Execute switch** button
Switches the current safety CPU operation mode.
Switches to TEST MODE when the current operation mode is set to SAFETY MODE, and vice versa.

POINT

- Switching of safety CPU operation mode is only possible when the safety CPU is in STOP.
- Write the program memory to the ROM before switching from TEST MODE to SAFETY MODE.
If trying to switch to the safety mode without the writing, the following confirmation message appears.
Clicking the **Yes** button starts the writing to the standard ROM.

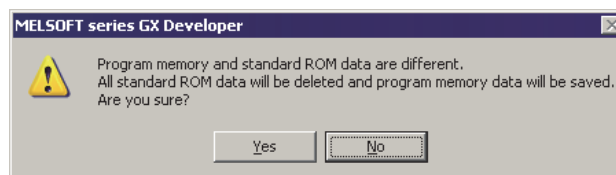

- Restarting the safety CPU is required to enable the safety mode after switching from TEST MODE to SAFETY MODE.
For restarting the safety CPU, refer to the QSCPU User's Manual (Function Explanation, Program Fundamentals).

5.2.2 Displaying ROM information

	Admin.	Develop.	Users
SAFETY	<input type="radio"/>	<input type="radio"/>	<input type="radio"/>
TEST	<input type="radio"/>	<input type="radio"/>	<input type="radio"/>

[Purpose]

Displays the ROM information on a project and safety CPU.

[Operating Procedure]

Select [Online] → [Safety CPU operation] → [ROM information].

[Dialog Box]

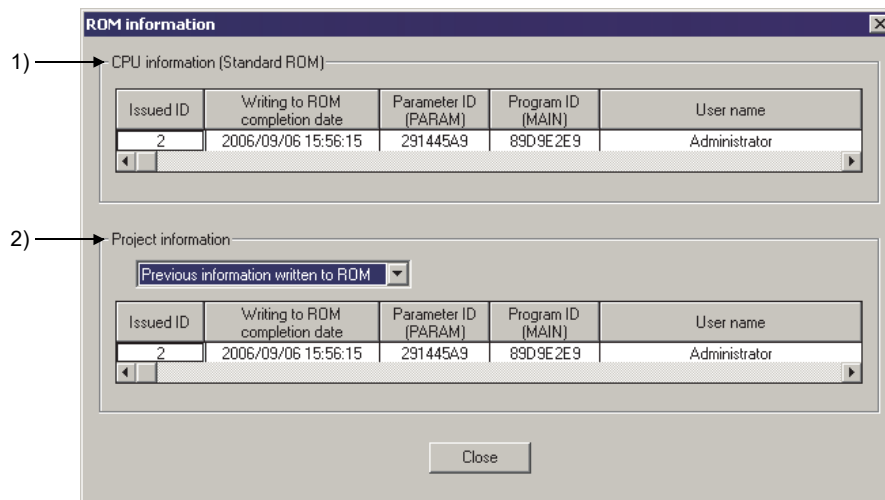

[Description]

1) CPU information (Standard ROM)

Displays the information on the connecting safety CPU, such as the date, parameter ID, and program ID when the program memory was written to the ROM, and the user who wrote the program memory to the ROM.

2) Project information

Displays the ROM information on the selected item.

- When selecting "Currently edited information"
Displays the parameter ID, program ID, and login user of the open project. * 1

Issued ID	Writing to ROM completion date	Parameter ID (PARAM)	Program ID (MAIN)	User name
		291445A9	89D9E2E9	Administrator

* 1: When a program is not created, the Program ID field is not displayed.

- When selecting "Previous information written to ROM"
Displays the issued ID, date, parameter ID, and program ID when the program memory was previously written to the ROM, and the user who wrote the program memory to the ROM.

Issued ID	Writing to ROM completion date	Parameter ID (PARAM)	Program ID (MAIN)	User name
2	2006/09/06 15:56:15	291445A9	89D9E2E9	Administrator

REMARK

The fields are left in blank when the program memory has not been written in the ROM, the information cannot be received from the CPU due to a communication error, or the information cannot be read from the file.

Issued ID	Writing to ROM completion date	User name

5.2.3 Registering or changing a CPU access password

	Admin.	Develop.	Users
SAFETY	△	×	×
TEST	△	×	×

△: Registration to a safety CPU is disabled in the SAFETY MODE.
Can perform in the TSET MODE only when a safety CPU is in STOP status.

[Purpose]

Registers the access password for certification (CPU access password) with a project and safety CPU.
Matching the project password with the CPU access password enables the safety CPU operation.
(For the functions for which CPU access password certification is performed  Appendix 2)



[Operating Procedure]

Select [Online] → [Safety CPU operation] → [CPU access password registration/change].

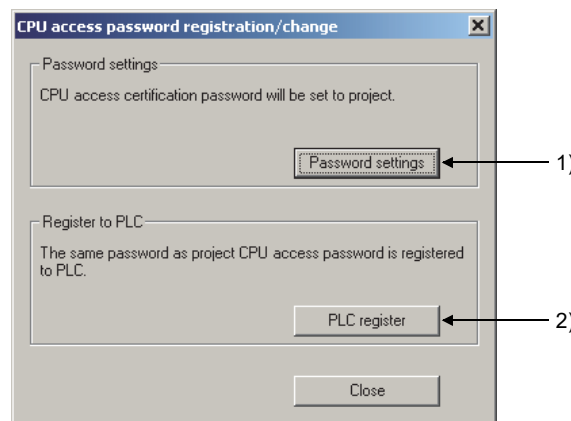
[Dialog Box]



[Description]

- 1) **Password settings** button
Displays the Password settings screen. ( (1) in this section)
- 2) **PLC register** button
Registers the CPU access password set in a project with a safety CPU. ( (2) in this section)

POINT

Be sure to carefully manage a CPU access password.
(For actions when losing a CPU access password  Section 3.2 (2))

(1) Password settings

[Purpose]

Sets a CPU access password to a project.

[Operating Procedure]

Select [Online] → [Safety CPU operation] → [CPU access password registration/change] → **Password settings** button.

[Dialog Box]

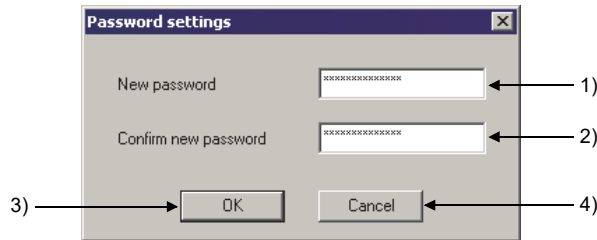

[Description]

- 1) New password
Input a password within 6 to 14 characters with the alphabets, numbers, and symbols corresponding to ASCII code (Appendix 3) 20H to 7EH.
(For alphabets, an upper-case character is differentiated from a lower-case character.)
- 2) Confirm new password
Input the same password with 1) for confirmation.
- 3) **OK** button
Sets the CPU access password to the project if the password 1) and 2) are identical.
- 4) **Cancel** button
Cancels the input password and closes the screen.

POINT

After the CPU access password setting to the project, the confirmation message to register the password with the safety CPU appears. (2) in this section)
Following the message, register the password with the safety CPU.

(2) PLC register

[Purpose]

Registers the CPU access password set in a project with a safety CPU.

[Operating Procedure]

Select [Online] → [Safety CPU operation] → [CPU access password registration/change] → PLC register button.

[Dialog Box]

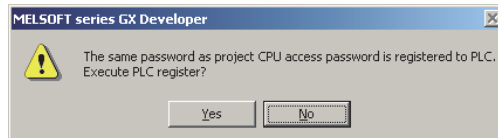



Clicking the button registers the CPU access password set to the project with the safety CPU.

POINT

When a CPU access password has been registered with a safety CPU, the following screen appears at PLC register. Therefore, input the registered password.

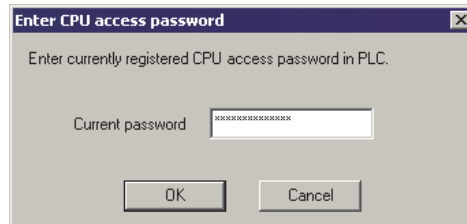
(The screen displayed at password certification)



(For actions when losing a CPU access password  Section 3.2 (2))

5.2.4 PLC memory initialization

	Admin.	Develop.	Users
SAFETY	△	×	×
TEST	△	×	×

△: Can perform only when the safety CPU is in STOP.

[Purpose]

Initializes a safety CPU memory and returns it to the factory default.
(Refer to the following table for the processing contents of the initialization.)

[Operating Procedure]

Select [Online] → [Safety CPU operation] → [PLC memory initialization].

[Dialog Box]

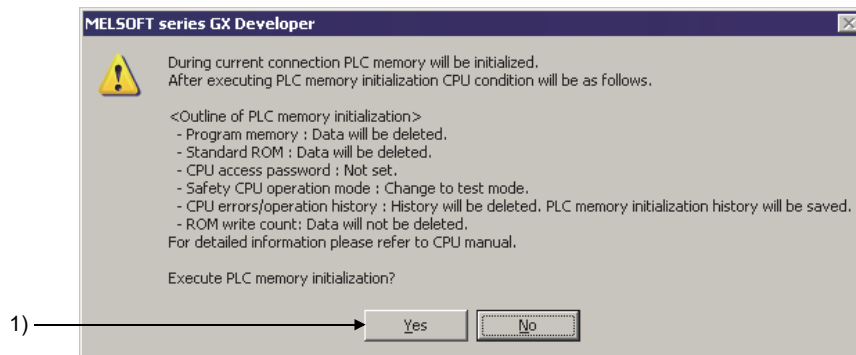

Clicking the button initializes the safety CPU memory. (The following table shows the contents of the initialization.)

For details, refer to the QSCPU User's Manual (Function Explanation, Program Fundamentals).

Item	Processing Contents
Program memory	The data are deleted.
Standard ROM	The data are deleted.
CPU access password	Not set.
Safety CPU operation mode	Switched to TSET MODE.
Operation/error log of a safety CPU	After clearing the current logs, the operation log of PLC memory initialization is written.
ROM write count	The data are not deleted.

POINT

- PLC memory initialization can be used only when the safety CPU is in STOP.
- When PLC memory initialization has been completed, the safety CPU error LED blinks.
For failure prevention, do not turn off the safety CPU power until the LED blinks.
- After initializing the programmable controller memory, set a CPU access password first, and then writing data to the CPU.
- Use the "Format PLC memory" function when deleting only the data written in the program memory.
The data other than program memory (Standard ROM, CPU access password, safety CPU operation/error log, and ROM write count) retain the current status.
(For "Format PLC memory" GX Developer Version 8 Operating Manual)

5.2.5 Switching the CPU to be monitored

	Admin.	Develop.	Users
SAFETY	△	△	△
TEST	△	△	△

△: Cannot perform during monitoring.

[Purpose]

Switches the CPU to be monitored for checking the information on "CPU A" or "CPU B" individually.

The relevant functions are as follows.

- Ladder monitor
- Device batch monitor
- Entry data monitor
- PLC diagnostics

[Operating Procedure]

Select [Online] → [Safety CPU operation] → [Monitor destination select option].

[Dialog Box]

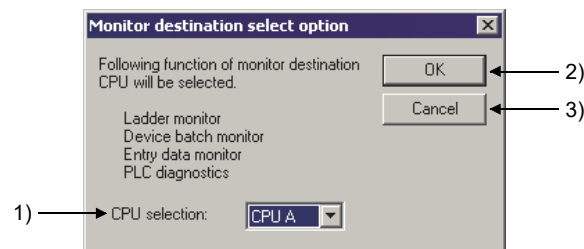

[Description]

- 1) CPU selection
Specify the CPU to be monitored.
CPU A (Default)
CPU B
- 2) button
Switches the CPU to be monitored.
- 3) button
Cancels the CPU selection setting and closes the screen.

5.3 Detecting the Damaged Project Data

The GX Developer checks that the project data for a safety programmable controller are not damaged before accessing it.

This section explains about the target project data of damage detection, the target operation of damage detection, and the actions when damaged data are detected.

(1) Target project data of damage detection

The following items show the target project data of damage detection.

- Parameter
- Program
- Device comment
- Device memory
- Label program (Function block, structure)
- Project management information *1

*1: Includes necessary information for performing login certification to the user who logs in to the project.

(2) Target operation of damage detection

Damage detection is performed at the following operations.

Target Operation of Damage Detection	
1	Open project
2	Save as (When overwriting the existing safety project and save it)
3	Delete project
4	Copying a project
5	Copying user information (Copying the information in the User management screen)
6	Verifying a project
7	Marge data

- (3) Displays and actions when damaged data are detected
The following shows the display screens and actions when damaged data are detected.

(a) Display screen



(b) Action

- Click the button.
- If the data is backed up, restore the project from the backup data.
- If the data is not backed up, recreate the project. (👉 Section 5.1.1)

POINT

When damaged project data is detected, restoring it from the backup data is recommended.

A system manager has to back up the project and save the backup data so that the data restoration is always possible.

5.4 Highlighting Safety Devices

	Admin.	Develop.	Users
SAFETY	○	○	○
TEST	○	○	○

5.4.1 Safety devices

(1) Safety device in CC-Link safety

The safety device designates the refresh device of the remote I/O in safety remote station.

The refresh device ranges for the number of occupied station in safety remote station (occupies 32 points/station) is used for safety devices.

(Example) When the safety remote stations occupy one station are connected

The ranges indicated in are highlighted as safety devices.

The following device ranges that are not input/output to the safety remote I/O stations are also used as safety devices.

Station No.1: X110 to X11F, Y100 to Y11F

Station No.3: X140 to X15F, Y150 to Y15F

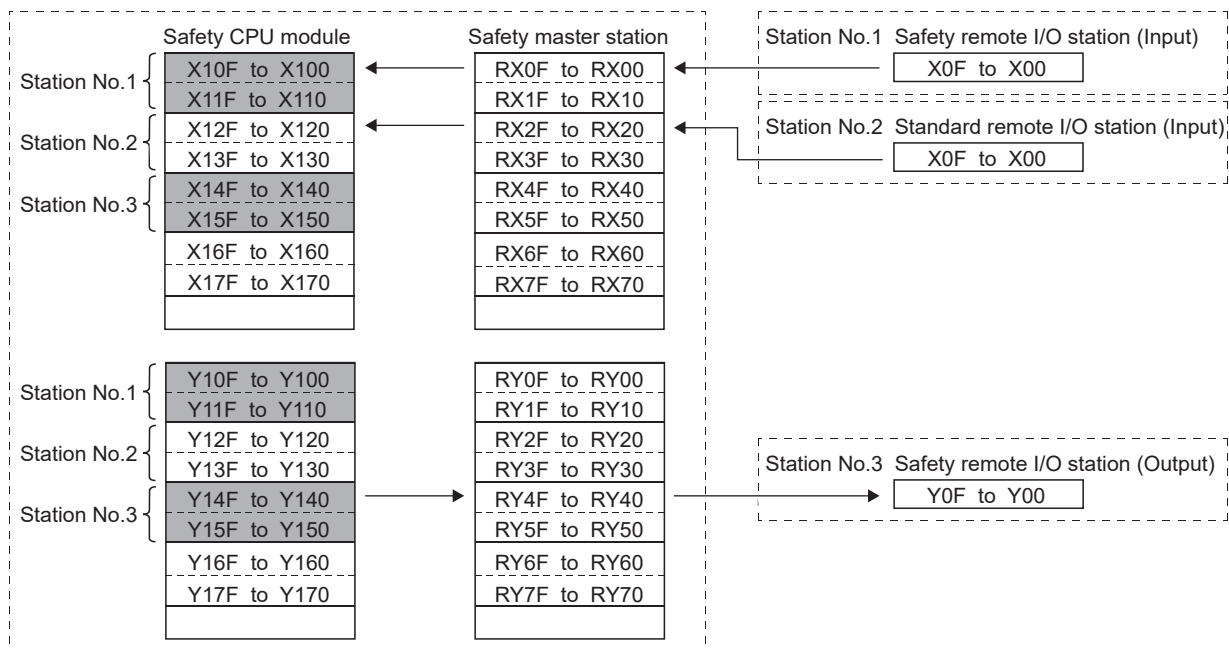

POINT

- The labels assigned to refresh devices are also used as safety devices.
- Refresh devices can be set in the "CC-Link" of "Network parameter".

(2) Safety device in CC-Link IE Field Network

A device which is set in the receive data storage device/send data storage device of the safety communication setting is called safety device. The safety communication setting can be set when selecting "CC IE Field (Master station [Safety])" or "CC IE Field (Local station [Safety])" for network type.

POINT
<ul style="list-style-type: none"> • The labels which are assigned to the receive data storage device/send data storage device are regarded as safety device, • The setting of the receive data storage device/send data storage device is set in the Ethernet/CC IE/MELSECNET setting of the network parameter.

5.4.2 Highlighting safety devices

In a program for safety programmable controller, the safety devices are highlighted on a ladder program.

(1) Highlighting safety devices

Safety devices are highlighted on a ladder program as follows.

Device Type	Highlighting Description
Bit device	<p>The safety device names are filled with yellow (Default).</p> <pre> graph LR X100[X100] --- SET[SET D0.0] </pre> <p>Start command CPU No.1 Production instruction flag</p>
Word device bit specification	
Word device	<p>The safety device names are filled with yellow (Default).</p> <pre> graph LR M0[M0] --- MOV[MOV D0 K2M1000] </pre> <p>Start-1 flag Production instruction flag Production instruction status</p>
Digit specification for bit device	<p>When all the bits specified by digit specification are safety devices, the device names are filled with yellow (Default).</p> <pre> graph LR M1[M1] --- MOV[MOV K4X100 D500] </pre> <p>Flag stop instruction Start command CPU No.1 status</p>
Digit specification for bit device (Safety/normal mixed device)	<p>When the safety device(s) is/are included in the information of the bit, specified by digit specification, the device names are filled with green (Default).</p> <pre> graph LR M2[M2] --- DMOV[DMOV K8X110 D510] </pre> <p>Machining status CPU No.1 Machining status</p>

POINT

- When a label program is not compiled, the safety devices are not highlighted.
- The program can be printed for highlighting (Appendix 1).
- When using the instruction which processes word devices with multiple points, the safety device is not highlighted if the safety device(s) is/are included but the device specified as the argument to the instruction is not a safety device.

(Example) Transferring the D0 to D9 data with the block 16-bit data transfer instruction (BMOV)

(When D0 is a safety device and D1 to D9 are normal devices)

(When D0 is a normal device and D1 to D9 are safety devices)

(2) Changing the highlight color

The highlight color for a safety device can be changed in the Change display color screen, displayed by selecting [Tool] → [Change display color].

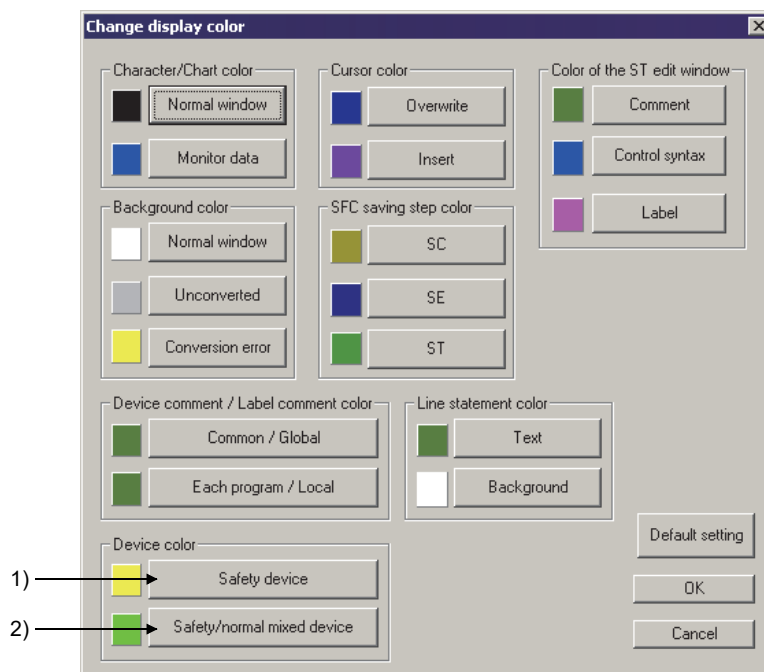

1) **Safety device** button

Sets the display color for a safety device. The default color is yellow.

2) **Safety/normal mixed device** button

Sets the display color for the device where (a) safety device(s) and (a) normal device(s) are mixed together. The default color is green.

5.5 Setting Parameters

	Admin.	Develop.	Users
SAFETY	○	○	○
TEST	○	○	○

This section explains the setting items for safety CPU parameters.

For basic operations and common notes in the parameter setting screen, refer to GX Developer Version 8 Operating Manual.

5.5.1 Setting PLC parameters

(1) PLC parameter items list

The following shows the PLC parameter items list. For information and details required for the parameter settings, refer to the QSCPU User's Manual (Function Explanation, Program Fundamentals).

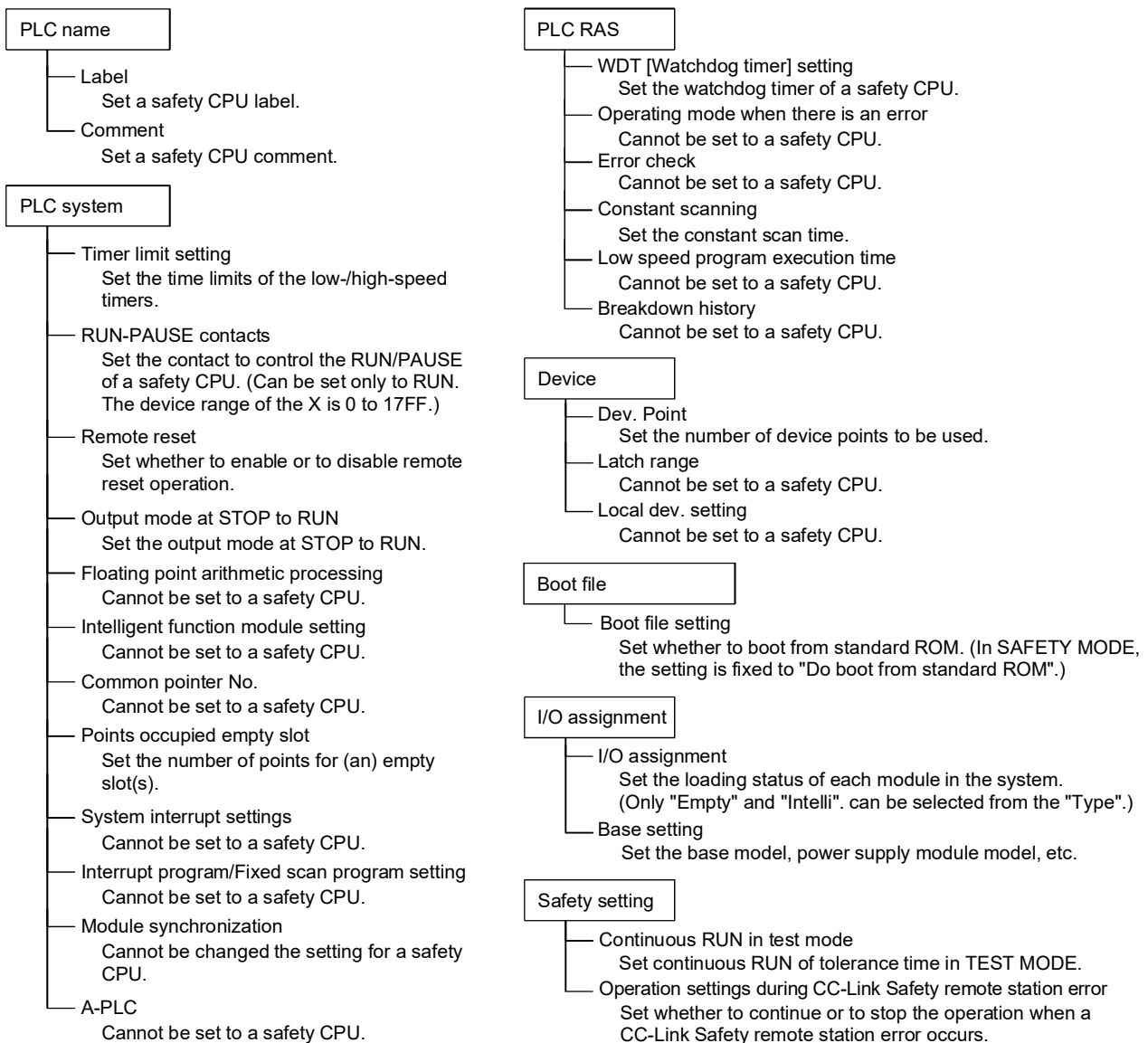

5.5.2 Setting network parameters

The following shows the network parameter items list. For information and details required for the parameter settings, refer to the user's manual of the corresponding network module.

(1) Network parameter items of MELSECNET/10, MELSECNET/H, and CC-Link IE Controller Network

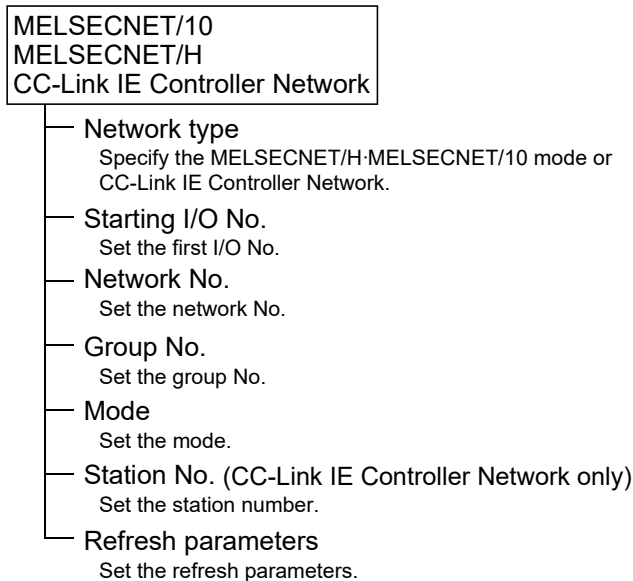

(2) Network parameter items of Ethernet

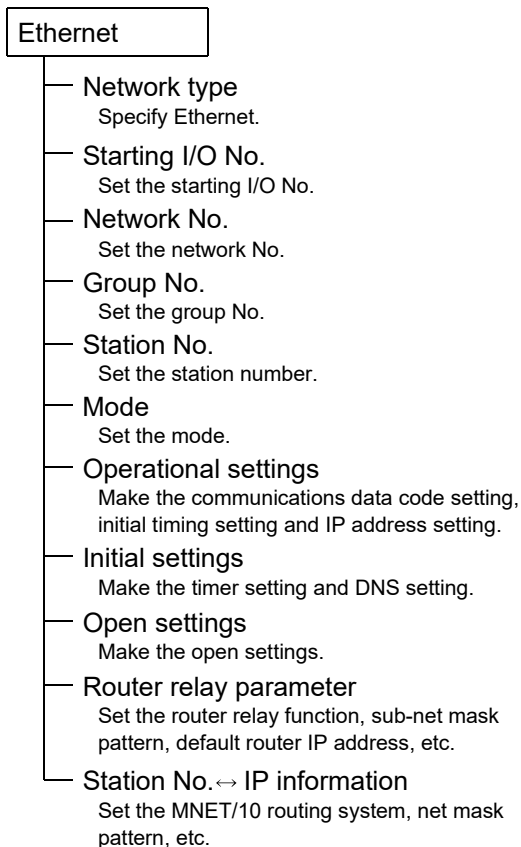

(3) Network parameter items of CC-Link Safety

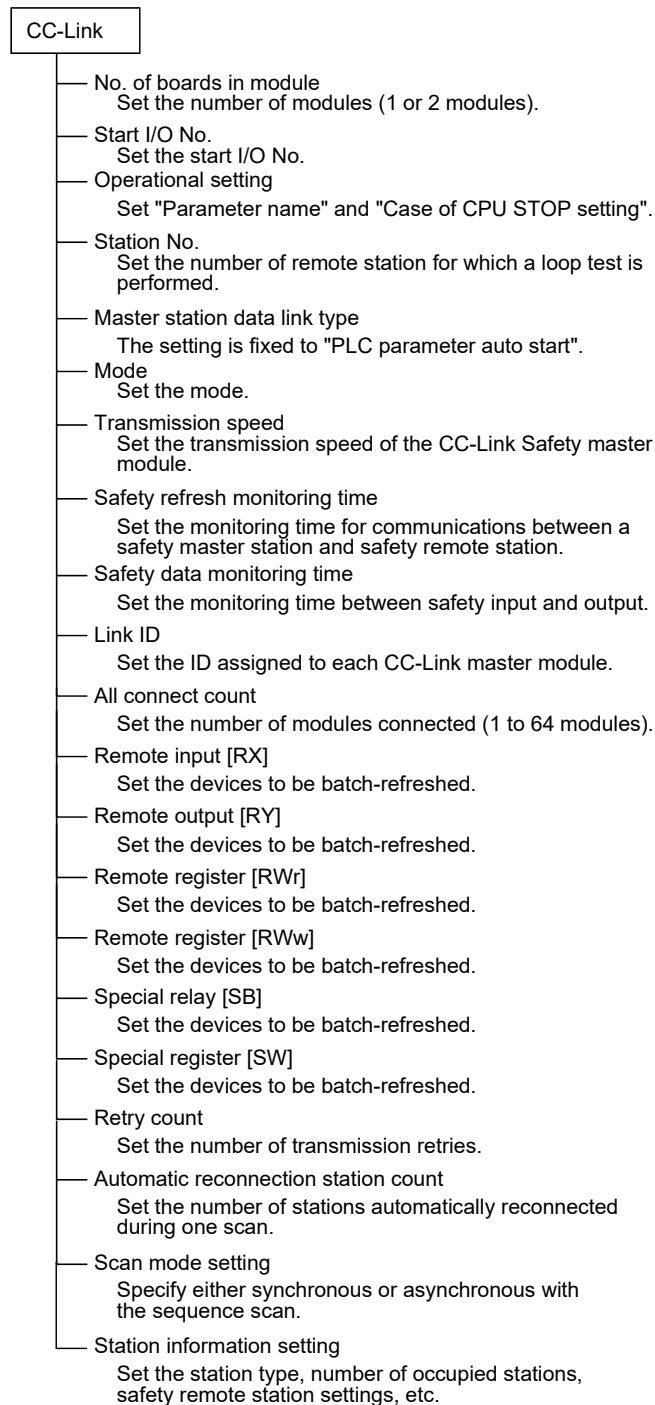

POINT

- Information and details required for the parameter settings
For information and details required for the parameter settings, refer to the following manuals.
(CC-Link Safety parameter settings)
CC-Link Safety System Master Module User's Manual QS0J61BT12
(Parameter settings for a safety remote station)
CC-Link Safety System Remote I/O Module User's Manual QS0J65BTB2-12DT
- Safety CSP file
A safety CSP file refers to a file where the information for setting the parameters of a safety remote station has been defined.
If the CSP file compatible with the safety remote I/O module technical version does not exist, the parameters of the safety remote station cannot be set.
Refer to the following manual for the methods of obtaining/registering the safety CSP file compatible with the safety remote I/O module technical version.
CC-Link Safety System Remote I/O Module User's Manual QS0J65BTB2-12DT

(4) Network parameter items of CC-Link IE Field Network

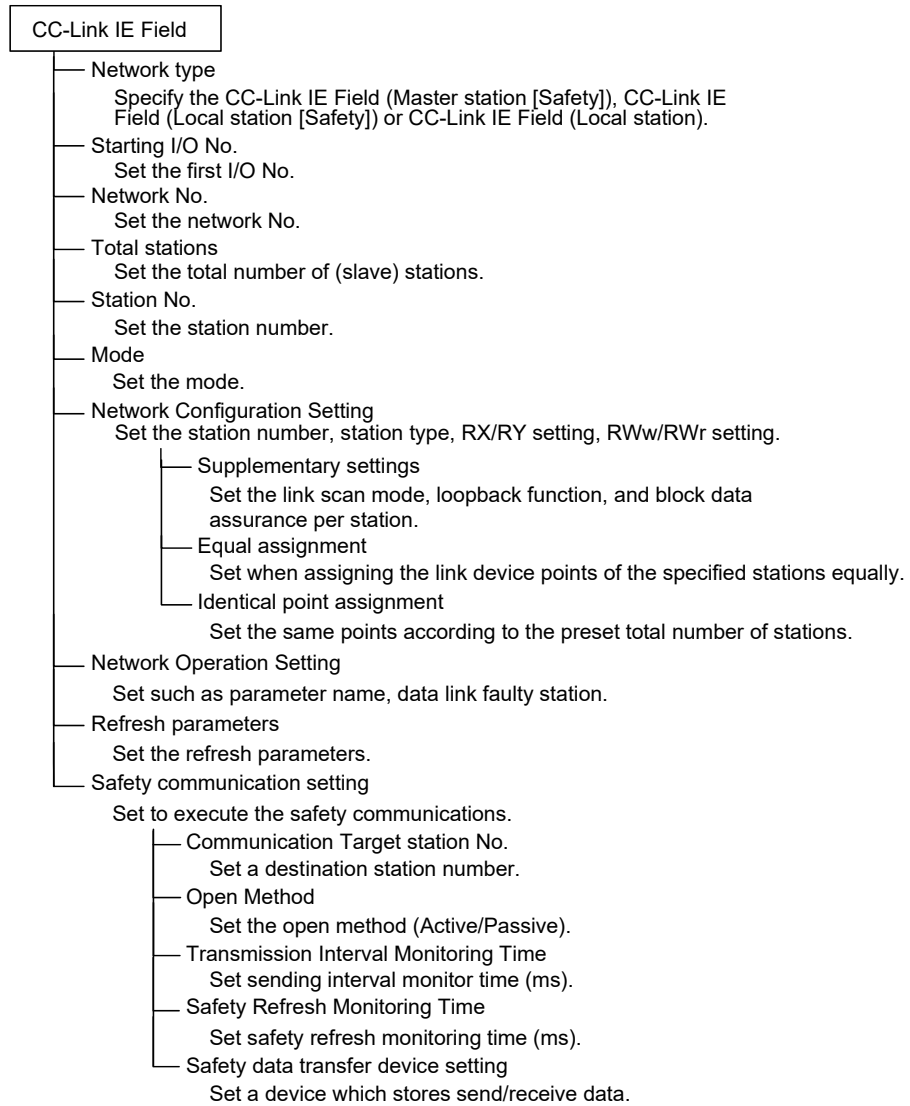

(5) Network parameter items of CC-Link IE Controller Network

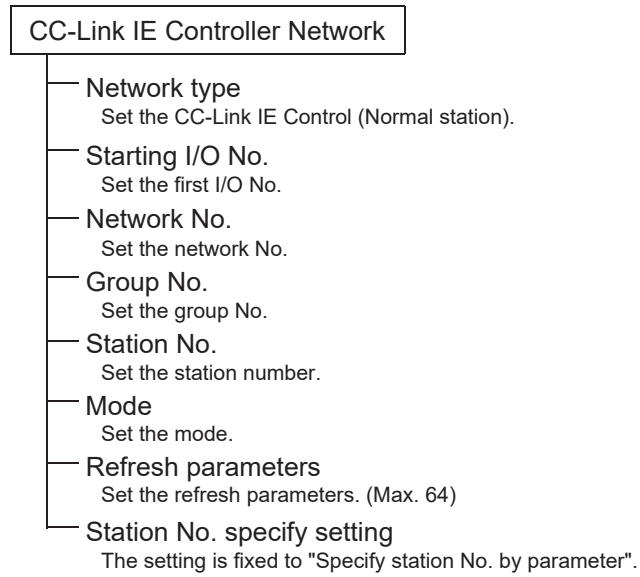

5.6 Diagnosing a Safety Programmable Controller

5.6.1 Diagnosing a safety CPU

	Admin.	Develop.	Users
SAFETY	△	△	△
TEST	○	○	△

△: Cannot use "Clear log".

[Purpose]

Checks safety CPU operation status, a present error, and operation/error logs (Including the error log of a CC-Link Safety system).
The display contents of operation/error logs can be saved in a CSV file.

[Operating Procedure]

Select [Diagnostics] → [PLC diagnostics].

[Dialog Box]

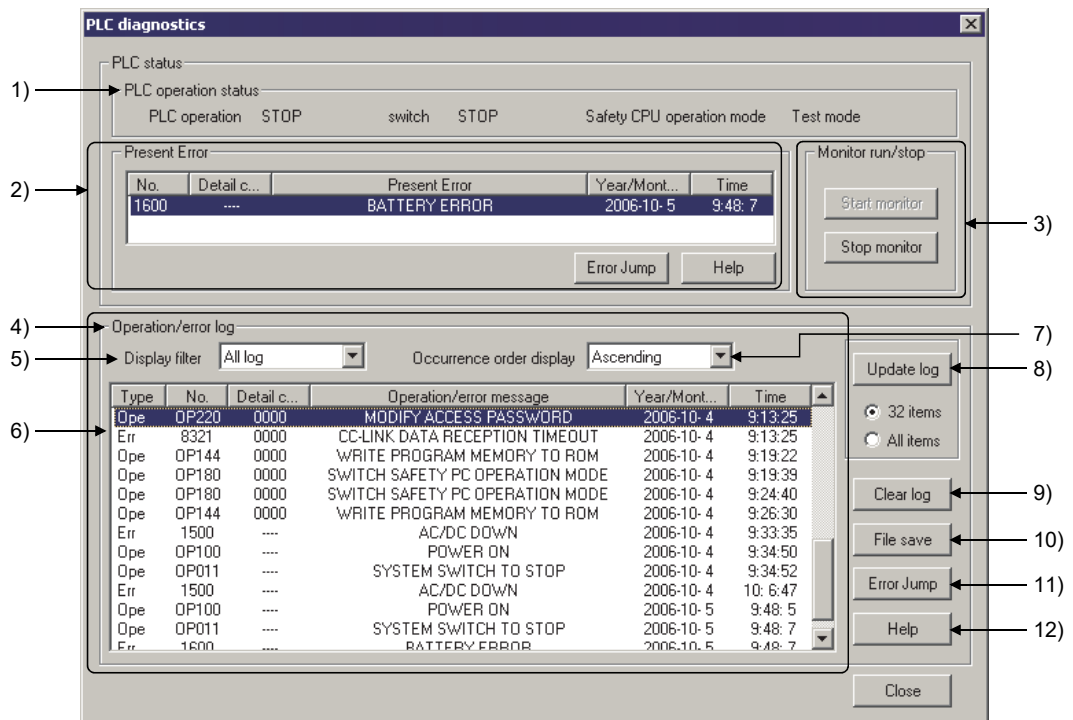

[Description]

- 1) PLC operation status
Displays the operation status of a safety CPU and safety CPU operation mode.
- 2) Present Error
Displays the current error.
Double-clicking the error displays the Error details screen.
Clicking the **Error Jump** button jumps to the step number corresponding to the displayed error in the sequence program.
Clicking the **Help** button displays the Help screen about the error.

3) Monitor run/stop

Clicking the **Start monitor** button initiates communications with a safety CPU and updates the screen display.

Clicking the **Stop monitor** button stops monitoring.

4) Operation/error log

Displays the logs of the operation to a safety CPU and error occurred in a safety CPU.

5) Display filter

Specify the log type to be displayed on the log list.

Type	Log List display
All log	Displays all logs.
Operation log	Displays only operation logs.
Error log	Displays only error logs.

6) Log list

Displays the logs selected in the Display filter.

Item	Contents
Type	Displays the log type. Ope: Operation log Err: Error log
No.	Displays the operation/error number.
Detail code	Displays the 4-digit code of the operation log or the error log for the error occurred in a CC-Link Safety remote I/O module. Displays ---- when no detail code exists.
Operation/error message	Displays the operation contents or error message. Displays the following message when the log data has been damaged. "BROKEN OPERATION/ERROR LOG"

Double-clicking the log in the log list displays the Operation details screen or the Error details screen about the log.

- Operation details screen

Displays the detailed operating information, according to the operation log information saved in a safety CPU.

(Example) The Operation details screen for a file

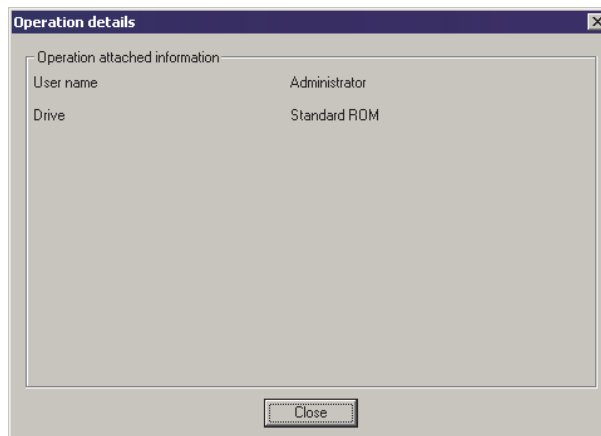

- Error details screen
 Displays common error information and individual error information, based on the information stored in the SD4 and SD5 or later of a safety CPU. For details of common error information and individual error information, refer to the QSCPU User's Manual (Function Explanation, Program Fundamentals).

(Example) Error details screen for a safety CPU error

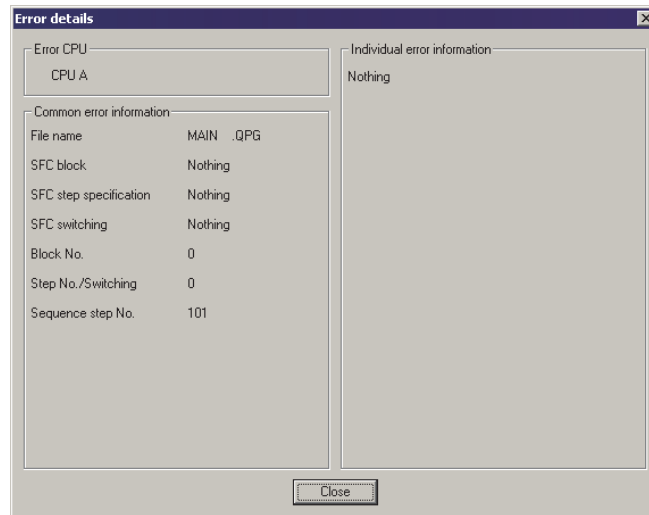

For safety remote I/O station, such as error name, the date of error occurrence, description, and solutions are displayed.

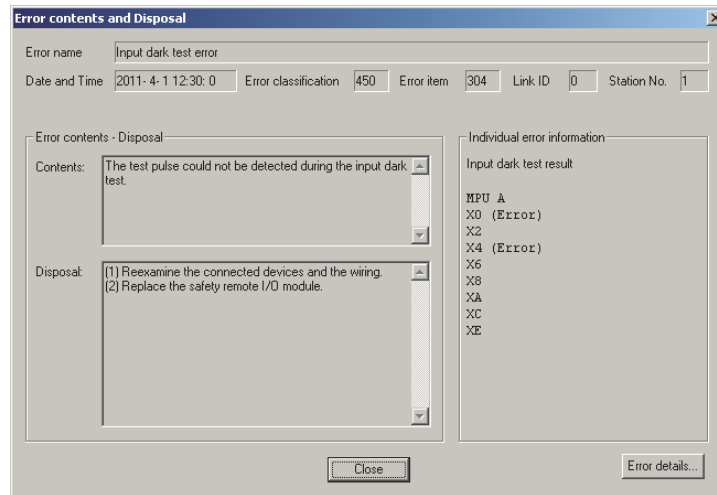

Clicking the **Error details** button opens the Error details screen.

7) Occurrence order display
Sorts the log list in ascending/descending order.

8) button
Updates the log list with the radio button.

Radio Button	Log List display
32 items	Displays the latest 32 logs.
All items	Displays all the registered logs (Max. 3000 logs).

9) button
Deletes all the logs registered with a safety CPU.
Logs can be deleted in the following situations.

- The access level of the current login user is Administrators or Developers.
- The safety CPU operation mode is set to TEST MODE.

10) button
Saves the logs displayed in the log list as a CSV file.

11) button
Jumps to the step number corresponding to the selected error log in the sequence program.

12) button
Displays the help screen about the selected error in the present error field.

POINT
<ul style="list-style-type: none"> • The "CPU A" or "CPU B" information in a safety CPU that is selected in the Monitor destination select option screen is displayed in the PLC diagnostics/Error details/Operation details screen. To confirm the CPU information that is not displayed, switch the CPU to be monitored in the Monitor destination select option screen in advance. ( Section 5.2.5) • The following operating information is displayed as operation log.*1 Power on Write the program memory to ROM Remote operation (Remote RUN, remote STOP) Switch safety CPU operation mode Clearing error log or operation log Set clock CPU access password registration <p>*1:Except for the information above, the information on a safety CPU processing (Corresponding to the operation code OP001 to OP100) is also displayed. For safety CPU processing and operation code, refer to the QSCPU User's Manual (Function Explanation, Program Fundamentals).</p>

5.6.2 Diagnosing CC-Link IE Field Network

CC-Link IE Field Network diagnostics performs the network status check and the troubleshooting when starting CC-Link IE Field Network, and performing maintenance/operation.

CC-Link IE Field Network diagnostics executes when transfer target is own station QSCPU, and network module mode is online or loop test.

POINT	When transfer setup is other station, CC-Link IE Field Network diagnostics cannot perform.
--------------	--

(1) Diagnostic target

The following shows the stations to be a target of CC-Link IE Field Network diagnostics.

○: Diagnosed ×: Not diagnosed

Station type	Module, Board	Model name	Connected station	Selected station*1
Master station/ Local station	CC-Link IE Field Network master/local module (with safety functions)	QS0J71GF11-T2	○	○
	CC-Link IE Field Network master/local module	QJ71GF11-T2	×	○
	CC-Link IE Field Network board	Q81BD-J71GF11-T2	×	○
Intelligent Device Station	Head module	LJ72GF15-T2	×	○
	Ethernet adapter module	NZ2GF-ETB	×	○

*1: Station selected on the network configuration diagram of the CC IE Field Diagnostics screen ( (2) in this section)

POINT	For details of CC-Link IE Field Network, refer to the User's Manual of each module.
--------------	---

(2) Diagnostic screen

	Admin.	Develop.	Users
SAFETY	△	△	△
TEST	○	○	△

△: Cannot set the station number for number unspecified station

[Purpose]

Check the status of disconnected cable and disconnected station on the network configuration diagram that displays the current status of CC-Link IE Field Network. Open screens such as "Operation Test" for troubleshooting and the "Information Confirmation/Set" with buttons.

[Operating Procedure]

Select [Diagnostics] → [CC IE Field Diagnostics].

[Dialog Box]

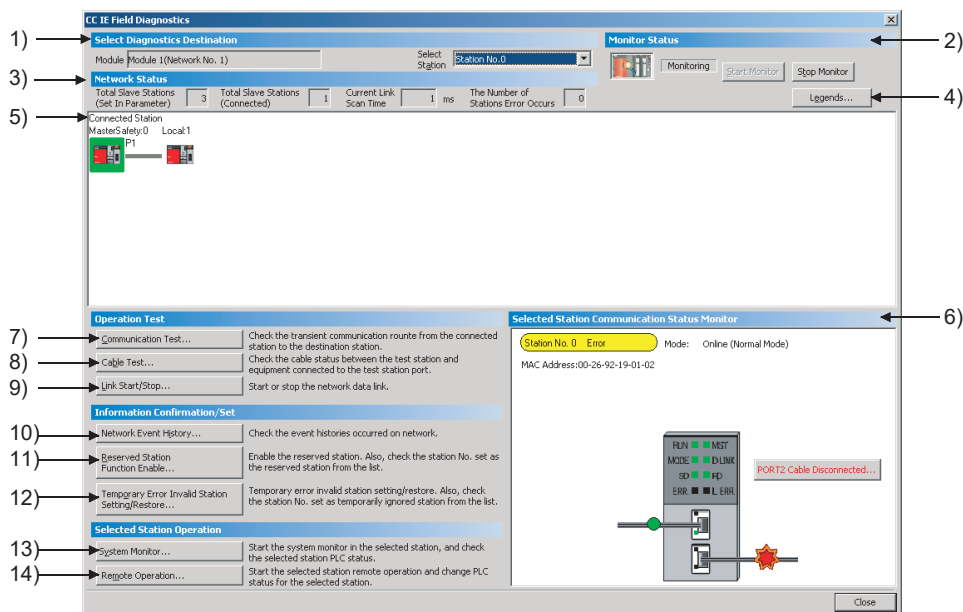

[Description]

- 1) Select Diagnostics Destination
Displays the module and network number of the diagnostics target, and station number of the station selected in the network information.
- 2) Monitor Status
Displays the current monitor status.
Clicking the **Start monitor** button communicates with the module to be diagnosed and updates the display.
Clicking the **Stop monitor** button stops the monitoring.

- 3) Network Status
Displays the total number of slave stations, the link scan time (in units of ms), and the number of stations error occurs on the network being displayed.
- 4) **Legends** button
Displays the explanation for icons displayed on the diagnostics screen.

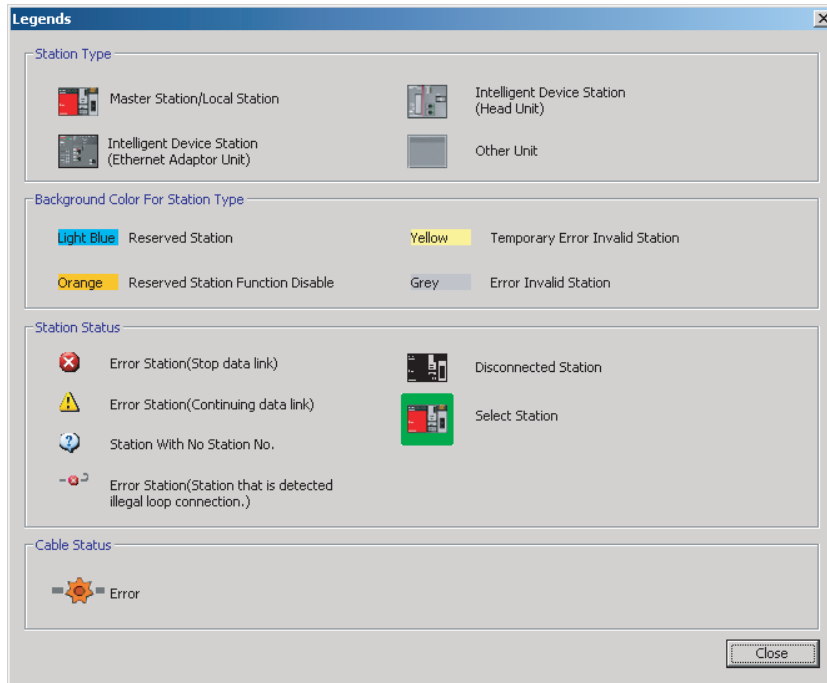

- 5) Network configuration
Displays the state of the network. The status of stations is displayed with icon. Clicking an icon selects the station and displays the details on the "Selected Station Communication Status Monitor". Move the focus to the module to be diagnosed with left/right arrow button, and determine it with the **Space** or **Enter** key.

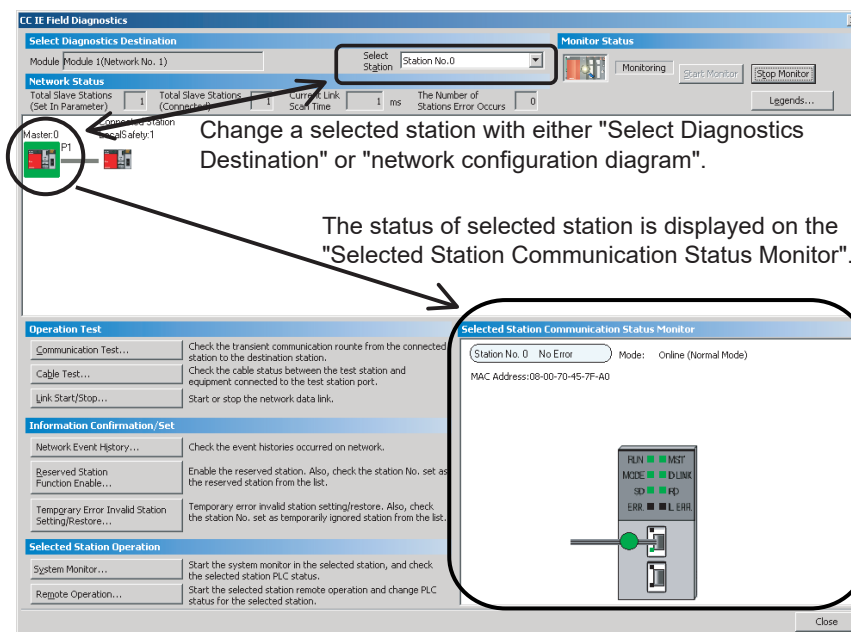

- 6) Selected Station Communication Status Monitor
 Displays the communication status of the own station.
 The following explains the display that is given if an error occurs with the CC-Link IE Field Network module or in the connection cable. In this case, a button is displayed in "Selected Station Communication Status Monitor" as shown below. The detailed information, error factor, and troubleshooting can be displayed by clicking the button. In addition, the icon (🔴) is displayed as shown below when a destination station is being disconnected.

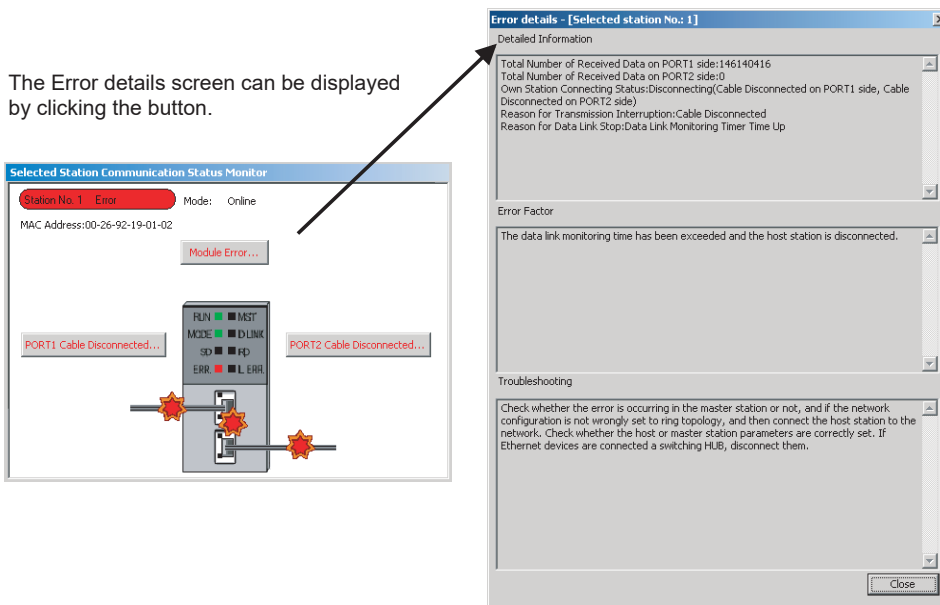





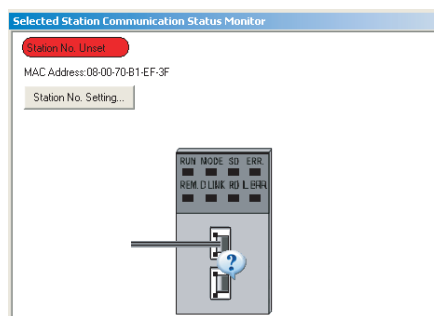

POINT

When the station number of the selected station is unspecified, the **Station No. Setting** button is displayed in "Selected Station Communication Status Monitor". To specify the station number, click this button and display the Set Station No. screen.



The following indicates the conditions for station number setting.

- The safety CPU operation mode is set to TEST MODE.
- The access level is other than Users.
- The connected station is master station.
- The selected station is a head module whose station number has not been set.

- 7) **Communication Test** button
Displays the Communication Test screen.
 (3) in this section
- 8) **Cable Test** button
Displays the Cable Test screen.
 (4) in this section
- 9) **Link Start/Stop** button
Displays the Link Start/Stop screen.
 (5) in this section
- 10) **Network Event History** button
Displays the Network Event History screen.
 (6) in this section
- 11) **Reserved Station Function Enable** button
Displays the Reserved Station Function Enable screen.
 (7) in this section
- 12) **Temporary Error Invalid Station Setting/Restore** button
Displays the Temporary Error Invalid Station Setting/Restore screen.
 (8) in this section
- 13) **System Monitor** button
Displays the System Monitor screen.
- 14) **Remote Operation** button
Displays the Remote Operation screen.

POINT

In the following cases, the System monitor, the Remote operation screens are not displayed.

- CPU of selected station is not supported by GX Developer
- Selected station is remote I/O (head module, Ethernet adapter module) or CC-Link IE Field Network board
- The station number of the selected station is unspecified

For details of the System monitor, the Remote operation screens, refer to GX Developer Version 8 Operating Manual.

(3) Communication Test

	Admin.	Develop.	Users
SAFETY	○	○	○
TEST	○	○	○

[Purpose]

Executes the communication test between CC-Link IE Field Networks.

[Operating Procedure]

Select [Diagnostics] → [CC IE Field Diagnostics] → Communication Test button.

[Dialog Box]

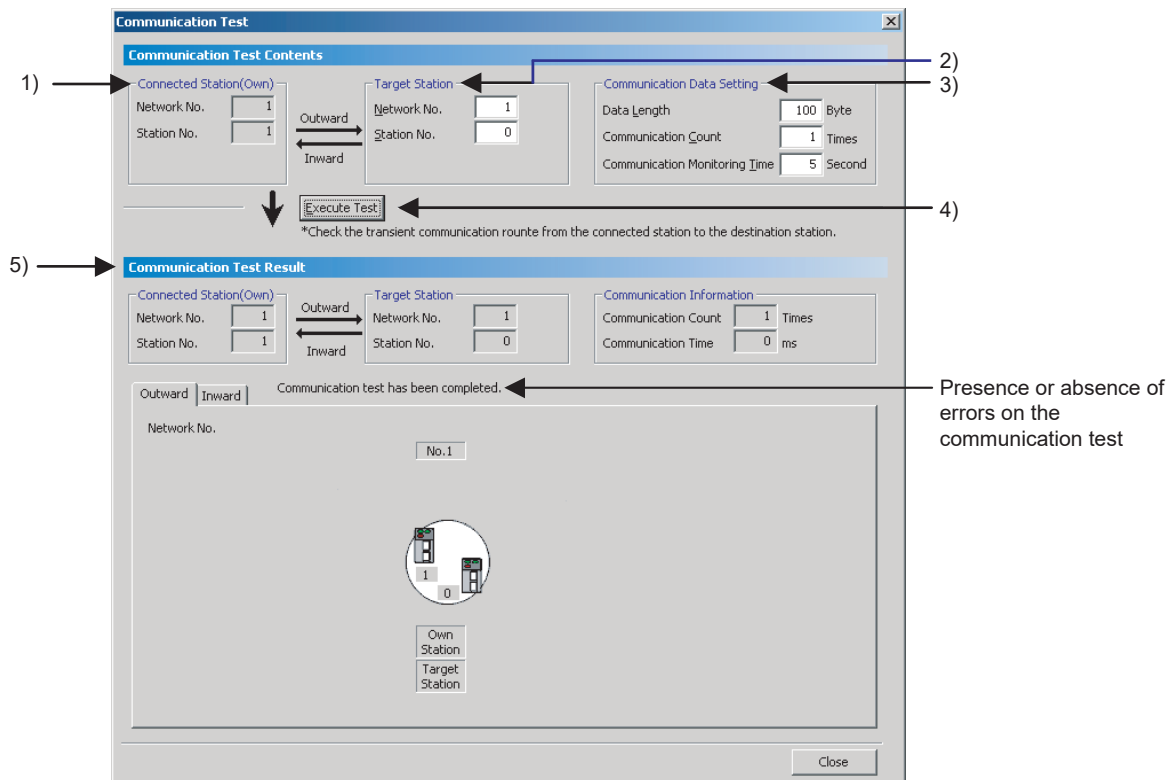

[Description]

- 1) Connected Station (Own)
Displays the network number and station number of the connected station.
- 2) Target Station
Set the network number and station number.
- 3) Communication Data Setting
Set the data length (1 to 900 bytes), the number of communications (1 to 100 times), and monitoring time (1 to 100 seconds) to execute the test.
- 4) Execute Test button
Executes the communication test in accordance with the settings.
- 5) Communication Test Result
Displays the result of inter-network communication test.
Also in 'Presence or absence of errors on the communication test', displays whether the communication test has been executed normally.
Networks and stations routed from the connected station (own station) to the target station are displayed in the <<Outward>> tab and those routed from the target station to the connected station (own station) are displayed in the <<Inward>> tab.

(4) Cable Test

	Admin.	Develop.	Users
SAFETY	○	○	○
TEST	○	○	○

[Purpose]

Tests the cable connection status between testing station and equipment connected to the testing station port.

[Operating Procedure]

Select [Diagnostics] → [CC IE Field Diagnostics] → **Cable Test** button.

[Dialog Box]

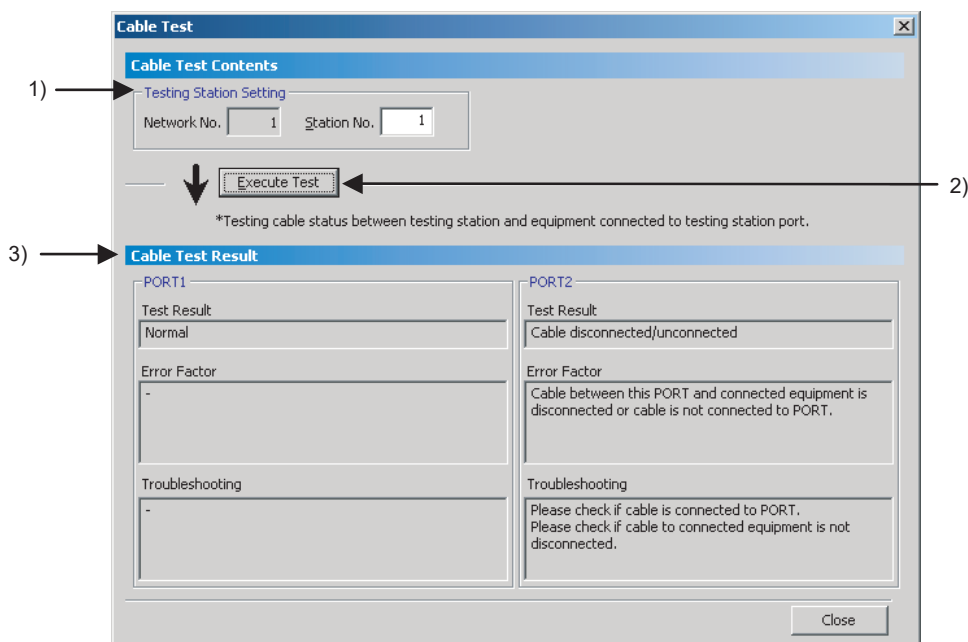

[Description]

- 1) Testing Station Setting
Set the network number and station number of the station which executes the cable test.
- 2) **Execute Test** button
Executes the cable test of the testing station.
- 3) Cable Test Result
Displays the cable test result, error factor, and troubleshooting of each port.

(5) Link Start/Stop

	Admin.	Develop.	Users
SAFETY	△	△	△
TEST	○	○	△

△: Cannot execute link start/stop, forced link start

[Purpose]

Executes data link start/stop to the specified station. Disable receiving data from other stations and sending data of the own station in the case of such as debugging.

[Operating Procedure]

Select [Diagnostics] → [CC IE Field Diagnostics] → Link Start/Stop button.

[Dialog Box]

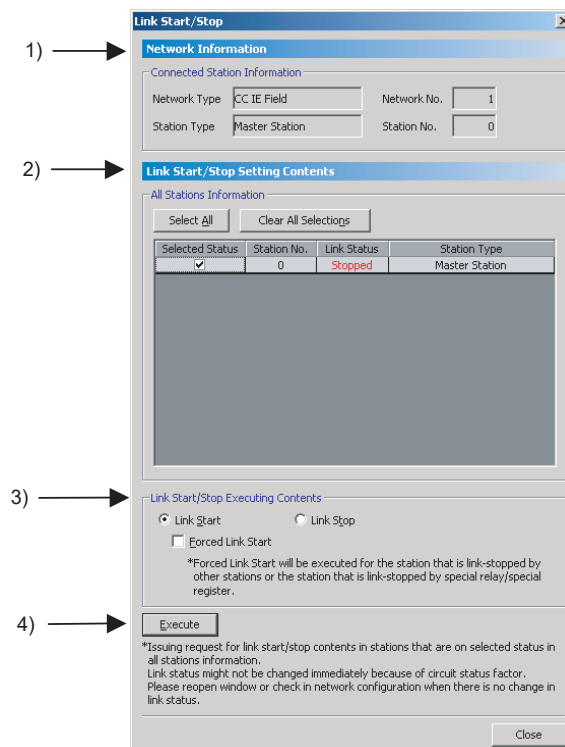

[Description]

- 1) **Connected Station Information**
Displays the network information of the connected station.
- 2) **All Stations Information**
Display the link status of all stations on the same network which are performing the data link with the connected station. Target stations of the link start/stop operation can be selected in "Selected Status".
- 3) **Link Start/Stop Executing Contents**
Select "Link Start"/"Link Stop".
To forcibly start the data link of a station which has been stopped by another station or a special relay/special register, check "Forced Link Start".
- 4) Execute button
Executes batch link start/stop to the specified station.
When the processing completed, clears the selected status and updates the "Link Status" display.

(6) Network Event History

	Admin.	Develop.	Users
SAFETY	△	△	△
TEST	○	○	△

△: Cannot perform clearing network event history, setting history acquisition

[Purpose]

The history list of events which occurred in own station or the networks is displayed. The display contents of network event history logs can be saved in a CSV file.

[Operating Procedure]

Select [Diagnostics] → [CC IE Field Diagnostics] → Network Event History button.

[Dialog Box]

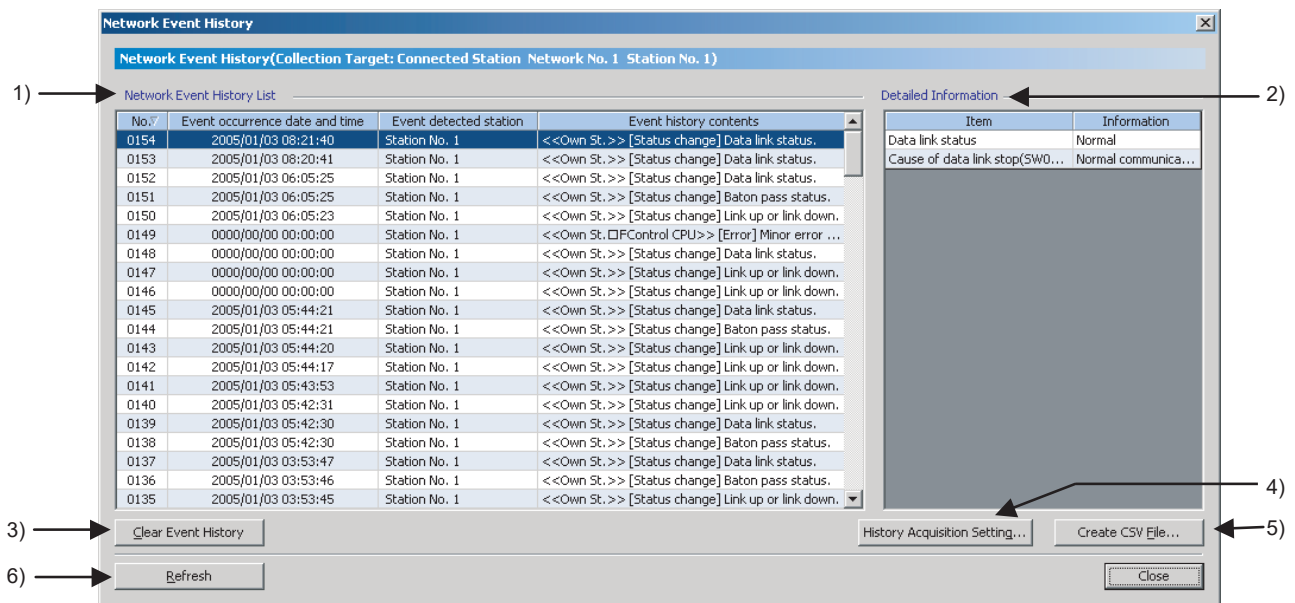

[Description]

- 1) Network Event History List
Displays the list of network event history. Each column can be sorted in ascending/descending order by clicking on the column header
- 2) Detailed Information
Displays the detailed information of an event selected in "Network Event History List".
- 3) Clear Event History button
Clears the network event history exists in the programmable controller CPU.
- 4) History Acquisition button
Displays the History Acquisition Setting screen.
- 5) Create CSV File button
Displays the Create CSV File screen.
- 6) Refresh button
Acquires the latest event history information from modules and updates the network event history list.

(7) Reserved Station Function Enable

	Admin.	Develop.	Users
SAFETY	△	△	△
TEST	○	○	△

△: Cannot perform temporary cancellation of a reserved station/restoring the reserved station.

[Purpose]

Temporarily cancels the reserved station/restores the reserved station.
If connected to a local station, cannot execute the temporarily cancellation/restoration of the reserved station.

[Operating Procedure]

Select [Diagnostics] → [CC IE Field Diagnostics] → [Reserved Station Function Enable] button.

[Dialog Box]

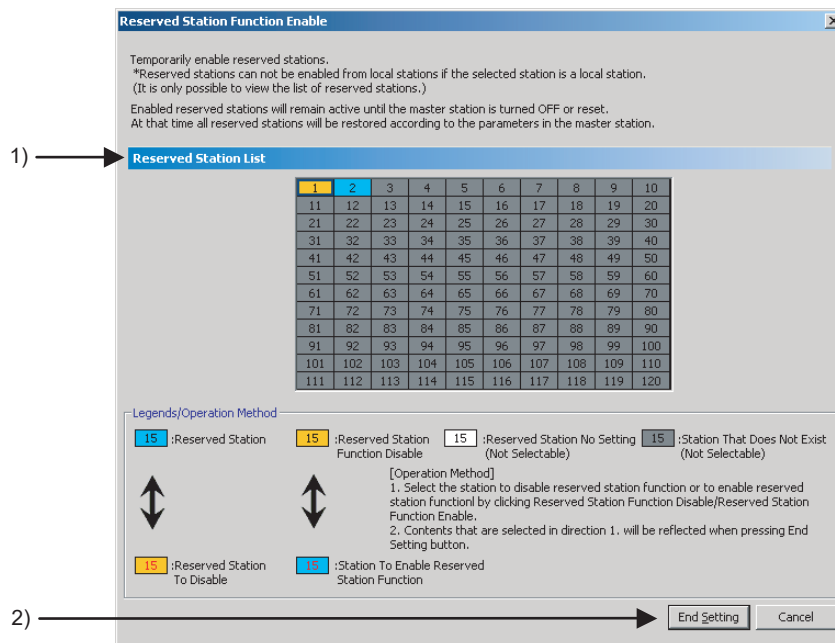

[Description]

1) Reserved Station List

Network configuration stations being diagnosed and reserved station/temporary cancellation of a reservation setting status are identified by colors.
Select the station to disable reserved station function or to enable reserved station function by clicking Reserved Station Function Disable/Reserved Station Function Enable.

2) [End Setting] button

Executes the temporarily cancellation/restoration of reserved station.
When the processing completed, updates the "Reserved Station List" display.

(8) Temporary Error Invalid Station Setting/Restore

	Admin.	Develop.	Users
SAFETY	△	△	△
TEST	○	○	△

△: Cannot perform temporary error invalid station setting /restoring temporary error invalid station setting

[Purpose]

Sets/restores the temporary error invalid station.

If connected to a local station, cannot execute the temporary error invalid station setting/restoration.

[Operating Procedure]

Select [Diagnostics] → [CC IE Field Diagnostics]

→ Temporary Error Invalid Station Setting/Restore button.

[Dialog Box]

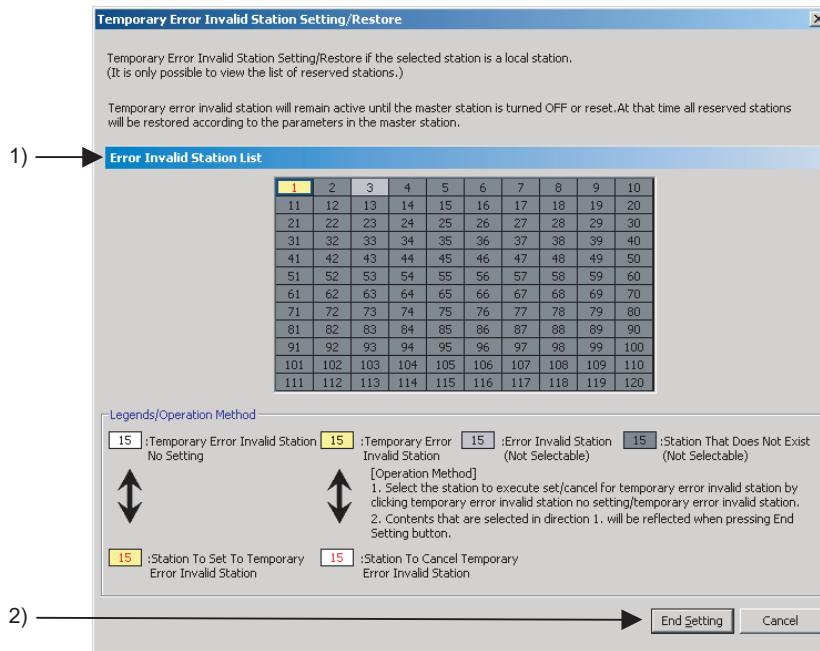

[Description]

1) Error Invalid Station List

Network configuration stations being diagnosed and error invalid station/temporary error invalid station setting status are identified by colors. Select the station to execute set/cancel for temporary error invalid station by clicking temporary error invalid station no setting/temporary error invalid station.

2) End Setting button

Executes the temporary error invalid station setting/restoration. When the processing completed, updates the "Error Invalid Station List" display.

5.7 Writing Program Memory to ROM

	Admin.	Develop.	Users
SAFETY	×	×	×
TEST	○	○	×

[Purpose]

Writes the data in program memory to standard ROM at a time.

[Operating Procedure]

Select [Online] → [Write to PLC (Flash ROM)] → [Write the program memory to ROM].

[Dialog Box]

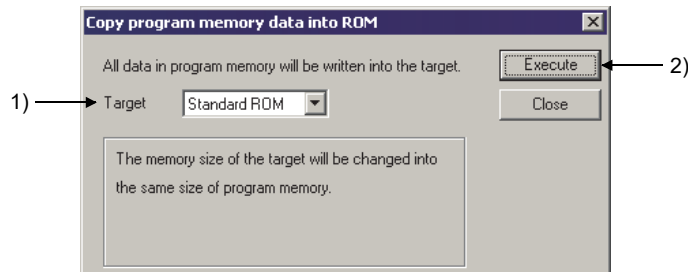

[Description]

1) Target

Only "Standard ROM" is displayed (Fixed).

2) **Execute** button

Writes the data in program memory to standard ROM at a time.

Note that before the writing, the project data and program memory in a PC are verified. If a mismatch has been detected by the verification, the following dialog box appears and the processing is suspended.

(When the verification between parameters and a program results in a mismatch)

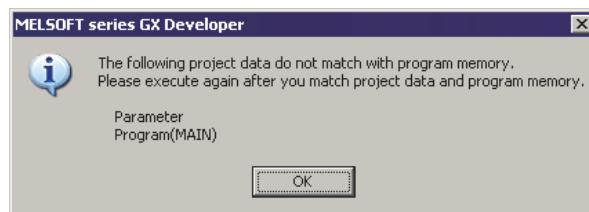

5.8 Checking Devices for Duplication Use

	Admin.	Develop.	Users
SAFETY	○	○	○
TEST	○	○	○

[Purpose]

Checks if devices in the range set in Auto device setting are not used in the user-created program during program check.

[Operating Procedure]

Select [Tools] → [Check program] or .

[Dialog Box]

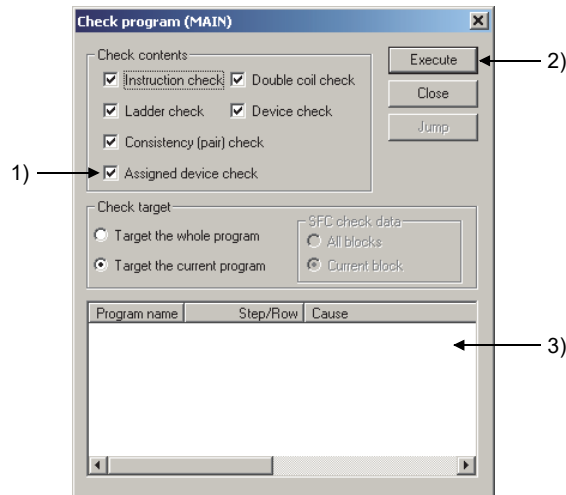

[Description]

- 1) Assigned device check
Select this item to check a device set by Auto device setting and a device used in the user-created program for duplication.
- 2) **Execute** button
Checks a program.
- 3) Check result
Displays the program check result.

6 SAFETY FUNCTION BLOCK

The safety function block represents safety control logic in function block for easier creation of a safety program.

The safety function has the following features.

- (1) Creating safety program easily
Basic safety ladders are provided as safety function blocks.
Using safety function blocks can create safety programs easily and surely.
- (2) Developing and maintaining safety programs easily
The number of steps in user-created programs is reduced with the use of safety function blocks, resulting in the reduction of development man-hours and the improvement of readable and maintenance performance of the program.
- (3) Ensuring safety of safety program
Users cannot change the program using safety function blocks of safety-approved.
Therefore, the safety is not blocked due to careless program change.
- (4) Shortening the time for safety review of user-created programs
As for safety review of user-created programs, preapproved safety function block programs are not subject to safety review.
Using safety function blocks can shorten the man-hours and time required for safety review.

POINT
<ul style="list-style-type: none">• Version 1 of safety function block can be used with GX Developer Version 8.58L (SW8D5C-GPPW-E) or later.• Version 2 of safety function block can be used when GX Developer Version 8.82L (SW8D5C-GPPW-E) or later and the QS001CPU having a serial number (first five digits) of "11042" or later are used together.

6.1 Programming Using Safety Function Blocks

The following flowchart shows creating procedure of the program using safety function blocks.

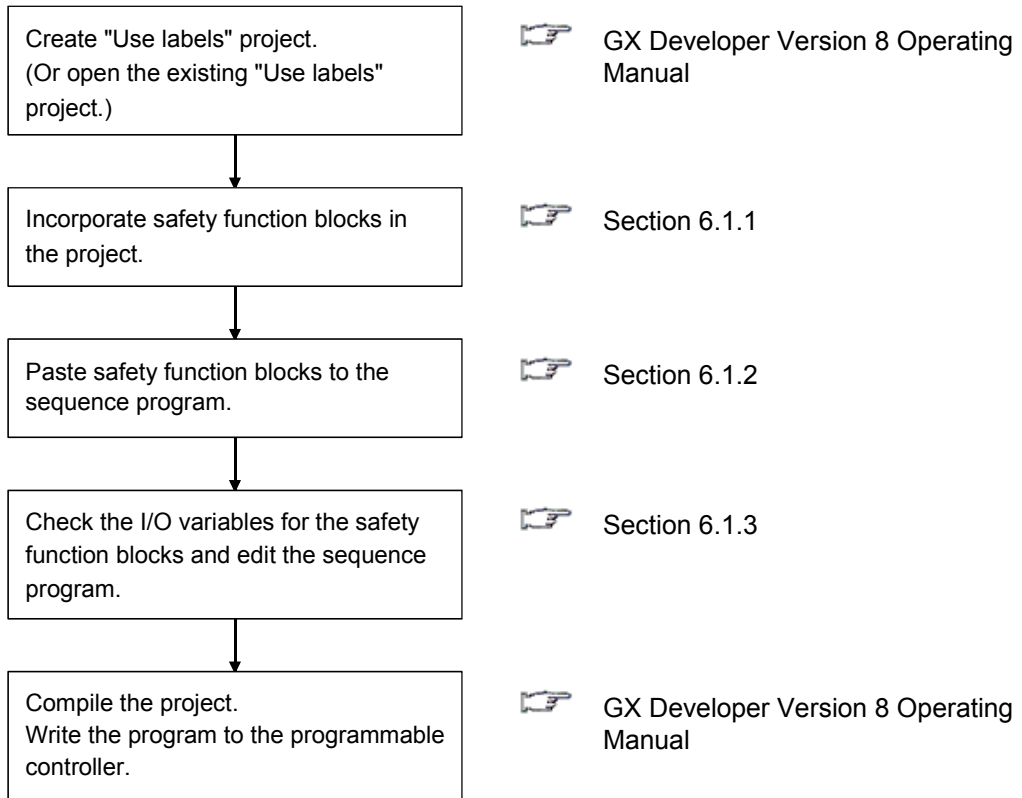

6.1.1 Incorporating safety function blocks in a project

	Admin.	Develop.	Users
SAFETY	○	○	○
TEST	○	○	○

[Purpose]

Incorporates safety function blocks to the project by copying them from the safety function library.

[Operating Procedure]

Select [Project] → [Copy].

[Dialog Box]

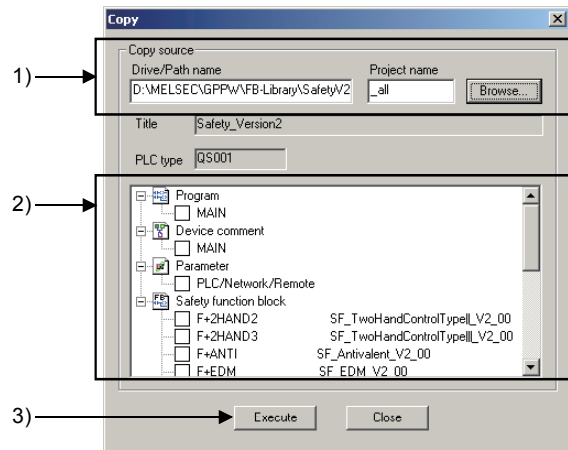

[Description]

1) Drive/Path name, Project name

Set the drive/path and project names.

The safety function library is installed to the following folder when GX Developer is installed.

Drive/Path name:

Version 1 : (Installed location)\GPPW\FB-Library\Safety

Version 2 : (Installed location)\GPPW\FB-Library\SafetyV2

Setting Drive/Path name and Project name of the safety function library displays the login screen.

Input the following in the login screen.

User name : SafetyFB

Password : Inputting data is unnecessary.

For procedure to open the safety function library, refer to POINT in this section.

2) Copy source data list

Select a safety function block to be used.

3) **Execute** button

Click this button after setting.

After copying the safety function block, the copied safety function block is added to the safety function block of the <<FB>> tab in the Project data list screen.

POINT

- If the safety function block having the same name exists on the open project, it is overwritten.
- To open the safety function library, perform the following procedure.

1) Select [Project] → [Copy].

Enter the following in the screen below.

<Drive/Path name>

Version 1 : "(Installed location)\GPPW\FB-Library\Safety"

Version 2 : "(Installed location)\GPPW\FB-Library\SafetyV2"

<Project name>

"_all"

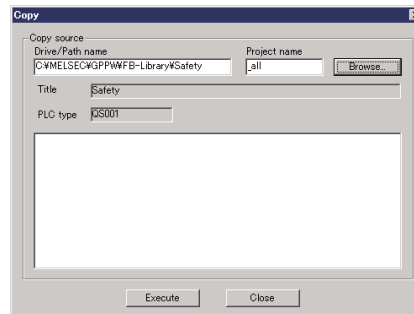

- 2) The following screen appears. Input "SafetyFB" in "User name".
No password is required.

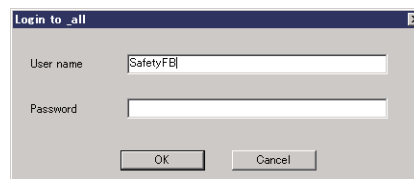

3) The safety function library opens.

- The first character of safety function block name depends on the function block version.

First character of Version 1: S

First character of Version 2: F

6.1.2 Pasting safety function blocks to the sequence program

Paste function blocks to the sequence program.

The following three methods are available for pasting the function blocks.

For details of each pasting method, refer to the GX Developer Version 8 Operating Manual (Function Block).

(1) Method by dragging and dropping from the <<FB>> tab

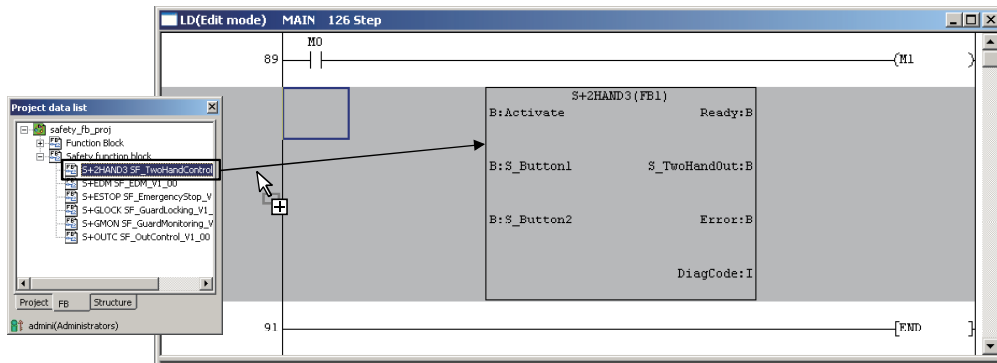

(2) Method using the Function block utilization dialog box

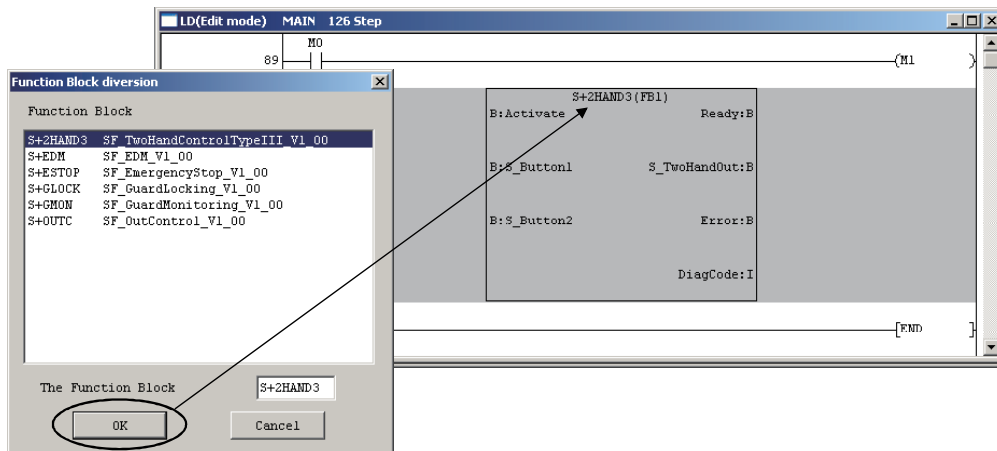

(3) Method using the instruction dialog box

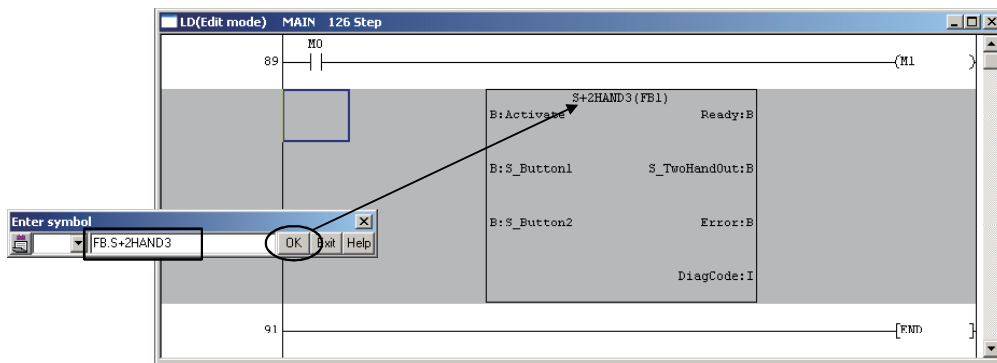

6.1.3 Checking I/O variables for safety function block

Check I/O variables to create input ladder section/output ladder section of the safety function block pasted to the sequence program.

Add other ladders to the safety function block on which input ladder section and output ladder section were created, and complete the sequence program.

For editing a program, refer to the GX Developer Version 8 Operating Manual.

The following two methods are available for opening the FB variable window.

- (1) Method by double-clicking the FB definition name
 Double-clicking the FB definition name of the safety function block on the <<FB>> tab opens the FB variable window.
 I/O variables for the safety function block can be seen.

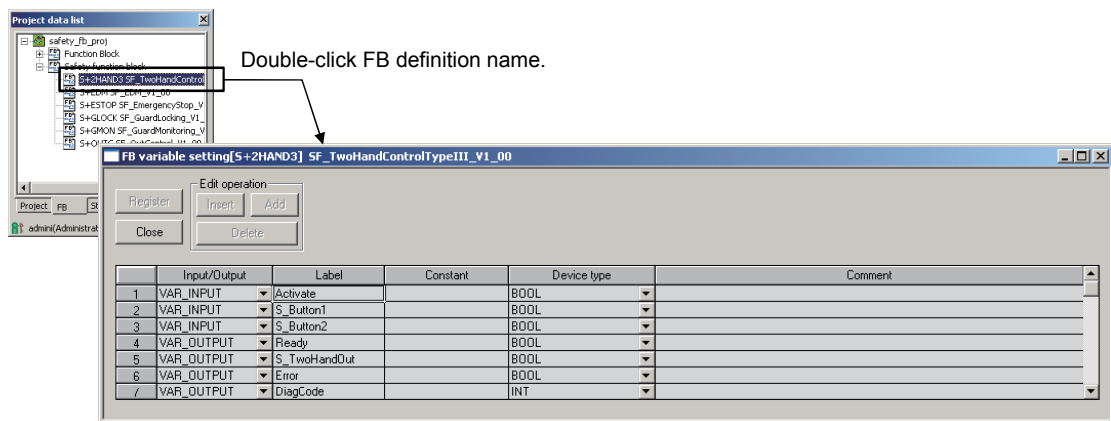

- (2) Method using the Project data list change toolbar
 Select "Safety FB". 'FB definition name (L)' for the safety function block is displayed. Then, select a FB definition name to be checked.
 The FB variable window appears and I/O variables for the safety function block can be seen.

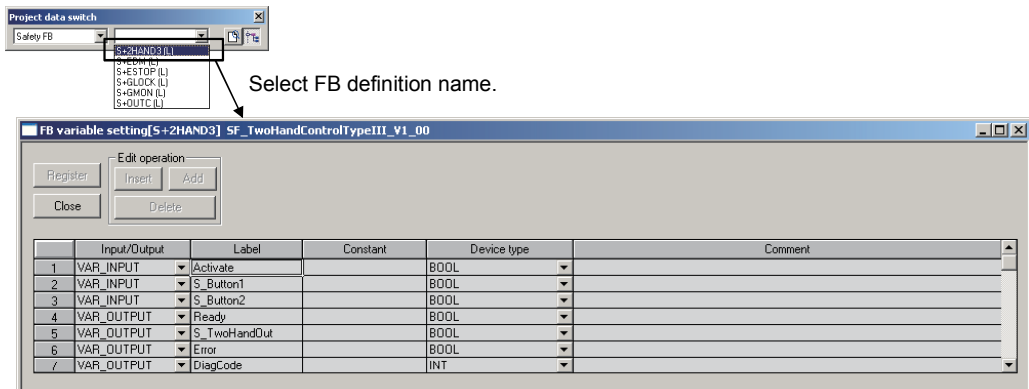

6.2 Restricting the Safety Function Block Operations/Displays

Some operations/displays of the safety function blocks are restricted for safety assurance.

The following table shows restrictions on operation/display in each function.

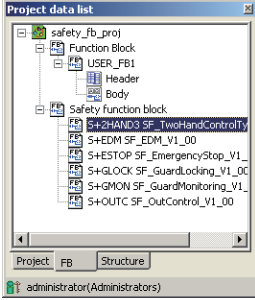
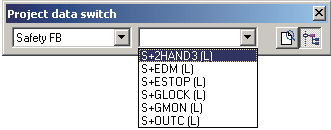
Function/screen	Restrictions on operation/display						
Project data list <<FB>> tab	Only FB definition name is displayed at the tree item of the safety function block. Double-clicking the FB definition name displays the FB variable window. <div style="text-align: center;">  </div>						
Project data list change toolbar	Only 'FB definition name (L)' (FB variable) can be selected in the safety function block. A program cannot be selected. <div style="text-align: center;">  </div>						
Ladder editing screen	Even double-clicking on the safety function block or pressing the Enter key, the safety function block program body is not displayed.						
FB variable window	Only input variable, output variable, and I/O variable are displayed. FB variable cannot be edited.						
Edit data	<table border="1" style="width: 100%; border-collapse: collapse;"> <tr> <td style="width: 100px;">New</td> <td>New safety function block cannot be added.</td> </tr> <tr> <td>Copy</td> <td>Safety function block cannot be copied.</td> </tr> <tr> <td>Rename</td> <td>Safety function block data cannot be renamed.</td> </tr> </table>	New	New safety function block cannot be added.	Copy	Safety function block cannot be copied.	Rename	Safety function block data cannot be renamed.
New	New safety function block cannot be added.						
Copy	Safety function block cannot be copied.						
Rename	Safety function block data cannot be renamed.						
Cross reference	Safety function block definition name cannot be specified at find range.						
Cross reference list							
List of used devices							

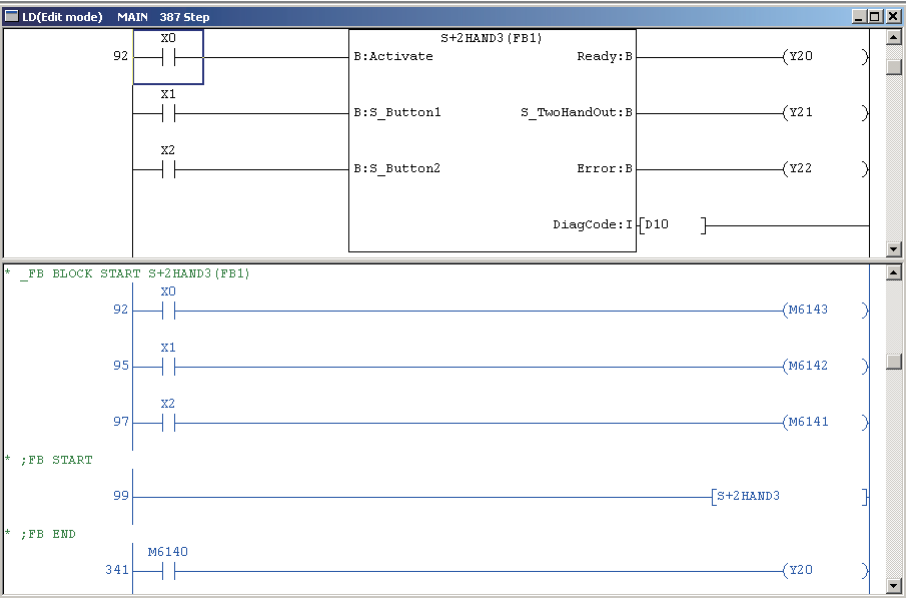
Function/screen	Restrictions on operation/display																																												
<p>Device display screen</p>	<p>As for safety function block, only FB definition name is displayed in application instruction format. *1</p> <p>The program contents of the safety function block are not displayed.</p> 																																												
<p>Verify</p>	<p>In a program including a safety function block, the program contents in the safety function block are not displayed.</p> <table border="1" data-bbox="555 1131 1369 1433"> <thead> <tr> <th>Step</th> <th>Instruction</th> <th>Step</th> <th>Instruction</th> </tr> </thead> <tbody> <tr> <td>92</td> <td>*_FB BLOCK START FB001(FB2)</td> <td>92</td> <td>*_FB BLOCK START S+2HAND3(FB1)</td> </tr> <tr> <td>93</td> <td>LD X0</td> <td>93</td> <td>LD M0</td> </tr> <tr> <td>100</td> <td>*;FB END</td> <td>100</td> <td>Display prohibition</td> </tr> <tr> <td>101</td> <td>LD M6140</td> <td>109</td> <td>Display prohibition</td> </tr> <tr> <td>102</td> <td>OUT Y20</td> <td>110</td> <td>Display prohibition</td> </tr> <tr> <td>103</td> <td>LD M6139</td> <td>111</td> <td>Display prohibition</td> </tr> <tr> <td>104</td> <td>OUT Y21</td> <td>113</td> <td>Display prohibition</td> </tr> <tr> <td>105</td> <td>LD M6138</td> <td>114</td> <td>Display prohibition</td> </tr> <tr> <td>106</td> <td>OUT Y22</td> <td>116</td> <td>Display prohibition</td> </tr> <tr> <td>107</td> <td>LD SH400</td> <td>119</td> <td>Display prohibition</td> </tr> </tbody> </table>	Step	Instruction	Step	Instruction	92	*_FB BLOCK START FB001(FB2)	92	*_FB BLOCK START S+2HAND3(FB1)	93	LD X0	93	LD M0	100	*;FB END	100	Display prohibition	101	LD M6140	109	Display prohibition	102	OUT Y20	110	Display prohibition	103	LD M6139	111	Display prohibition	104	OUT Y21	113	Display prohibition	105	LD M6138	114	Display prohibition	106	OUT Y22	116	Display prohibition	107	LD SH400	119	Display prohibition
Step	Instruction	Step	Instruction																																										
92	*_FB BLOCK START FB001(FB2)	92	*_FB BLOCK START S+2HAND3(FB1)																																										
93	LD X0	93	LD M0																																										
100	*;FB END	100	Display prohibition																																										
101	LD M6140	109	Display prohibition																																										
102	OUT Y20	110	Display prohibition																																										
103	LD M6139	111	Display prohibition																																										
104	OUT Y21	113	Display prohibition																																										
105	LD M6138	114	Display prohibition																																										
106	OUT Y22	116	Display prohibition																																										
107	LD SH400	119	Display prohibition																																										
<p>Verify with PLC</p>	<p>(This section is covered by the table above, showing the comparison between the main program and the safety function block program.)</p>																																												
<p>Print</p>	<p>Print Ladder (Device)</p> <p>As for safety function block section, the FB definition name is printed in application instruction format. The safety function block program body is not printed.</p> <p>Label/FB</p> <p>When printing "Header", only the input variable, output variable, and I/O variable of the safety function block are printed. When printing "Body", the safety function block program body is not printed.</p>																																												

*1: When the jump destination such as for searching exists in the safety function block program, the jump is made to the position where the FB definition name is displayed in application instruction format.

APPENDICES

Appendix 1 Differences with the Q Series Project

This chapter explains about the GX Developer functions, except for the functions described in Chapter 5 "ADDED FUNCTIONS TO CORRESPOND TO A SAFETY PROGRAMMABLE CONTROLLER", added to/updated from the Basic model QCPU project

(1) Differences with the parameters

- (a) [PLC RAS] setting on PLC parameter.
Consistency check for setting time on WDT setting and constant scanning. Setting time for constant scanning should not exceed WDT setting's setting time.

Constant scanning \leq WDT setting
- (b) [CC-Link] setting on Network parameter.
Default value for "Scan mode setting" is "Synchronous".

(2) Differences in the Project menu

- (a) Programmable controller type change
The project for a safety programmable controller cannot be changed its programmable controller type.
Furthermore, the programmable controller type of the project created by other than a safety programmable controller cannot be changed to the QSCPU.
- (b) Ladder copy/paste
The ladder created in a safety programmable controller project can only be copied to/pasted in (a) safety programmable controller project(s).
- (c) Print
The following functions have been added or updated.
 - 1) The print function of "Safety settings" of PLC parameter, "Safety remote station settings" of network parameter (CC-Link), "Network Configuration Setting", "Network Operation Setting", "safety communication settings" of network parameter (Ethernet/CC IE/MELSECNET) are added.
 - Print example of "Safety setting"

Safety setting

Cont. RUN of tol. time in Testmode	10s
Ope. set. during CC-Link Safety remote sta. err.	Stop

- Print example of "Safety remote station settings"
 The following shows the print example when the "Safety remote station settings" is being performed under the settings as the screen below.

(Setting example)

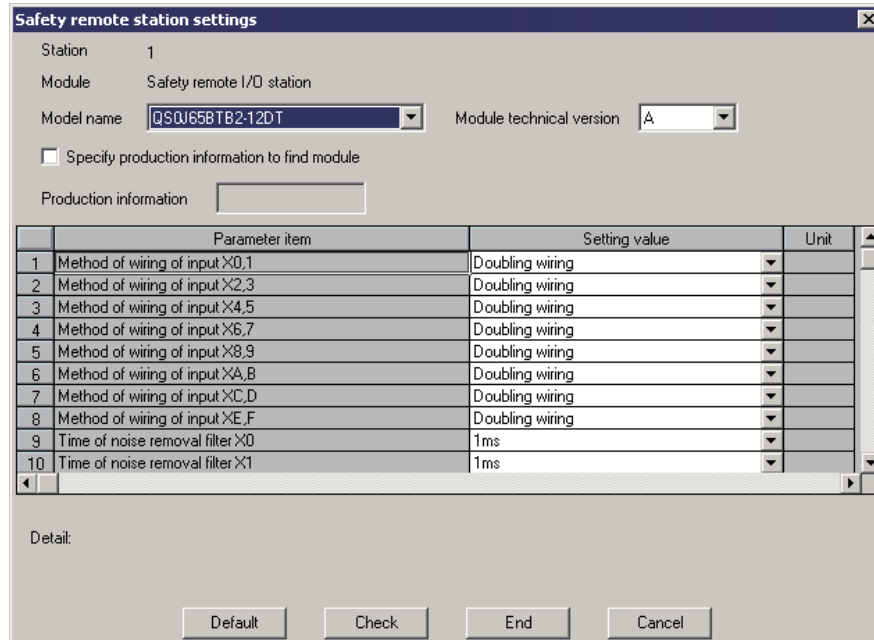

(Print example)

Safety remote station settings	
CC-L ink	1MMI
Start I/O No.	0000

1	Target station number	1
2	Module type	Safety remote I/O station
3	Model name	QS0J658TB2-12DT
4	Module technical version	A
5	Production information	-----
6	Parameter setting	
	Parameter item	Setting value
	Method of wiring of input X0,1	Doubling wiring
	Method of wiring of input X2,3	Doubling wiring
	Method of wiring of input X4,5	Doubling wiring
	Method of wiring of input X6,7	Doubling wiring
	Method of wiring of input X8,9	Doubling wiring
	Method of wiring of input XA,B	Doubling wiring
	Method of wiring of input XC,D	Doubling wiring
	Method of wiring of input XE,F	Doubling wiring
	Time of noise removal filter X0	1ms
	Time of noise removal filter X1	1ms



2) Safety device names are printed enclosed by a solid line or broken line.

Device Type	Highlighting Description
Bit device	The safety device names are printed enclosed by a solid line.
Word device bit specification	<pre> ----- X100 ----- [SET D0.0] ----- Start co mmand CP U No.1 ----- </pre>
Word device	The safety device names are printed enclosed by a solid line.
Digit specification for bit device	When all the bits specified by digit specification are safety devices, the safety device names are printed enclosed by a solid line.
Digit specification for bit device (Safety/normal mixed device)	When all the bits specified by digit specification include (a) safety device(s), the safety device name(s) is/are printed enclosed by a broken line.

(Print example)

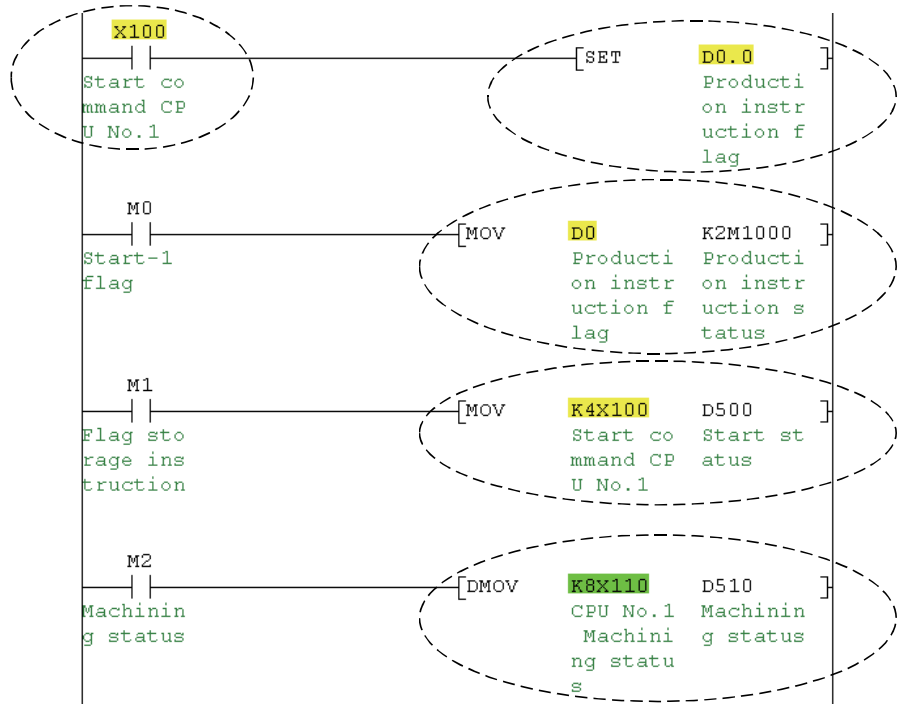

* Cannot be printed in the macro instruction format.

(3) Differences in the Online menu

(a) Transfer setup

The connection via CC-Link IE Field Network can be set. Connectable CPU to software package and the combination of networks are as shown below.

Software package	PC side I/F	Connection destination CPU and its network			
		QSCPU	Other than QSCPU	QSCPU	Other than QSCPU
		CC-Link IE Field Network		Other than CC-Link IE Field Network	
GX Developer	QSCPU	○	×	○	○
	Other than QSCPU	○	×	○	○
GX Works2	QSCPU	× (GX Works2 is not supported by QSCPU.)			
	Other than QSCPU	×	○	×	○

○:Connectable ×:Not connectable

(b) Monitor

The following monitors display the "CPU A" or "CPU B" information in a safety CPU selected in the Monitor destination select option screen.

- Ladder monitor
- Device batch monitor
- Entry data monitor

To confirm the CPU information that is not displayed, switch the CPU to be monitored in the Monitor destination select option screen in advance. (Section 5.2.5)

(c) Device test

When using a safety CPU, the project cannot be written to the buffer memory.

Cannot specify the intelligent function module device (Unn\Gmm)

Cannot select "Buffer memory".

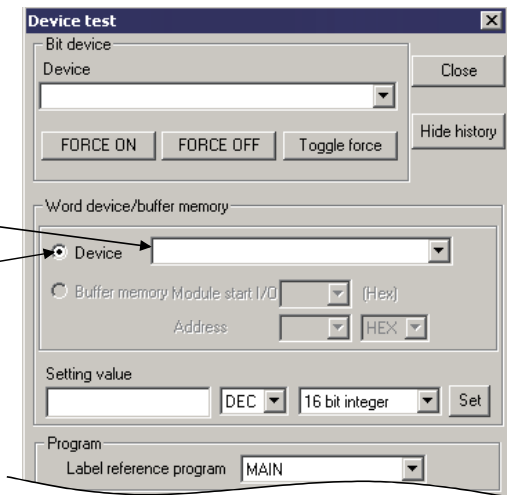

(d) Remote operation

To perform the remote RUN while the safety CPU operation mode is set to SAFETY MODE, make the following settings.

"Operation during RUN" setting items

Device memory: Not cleared

Signal flow: Hold

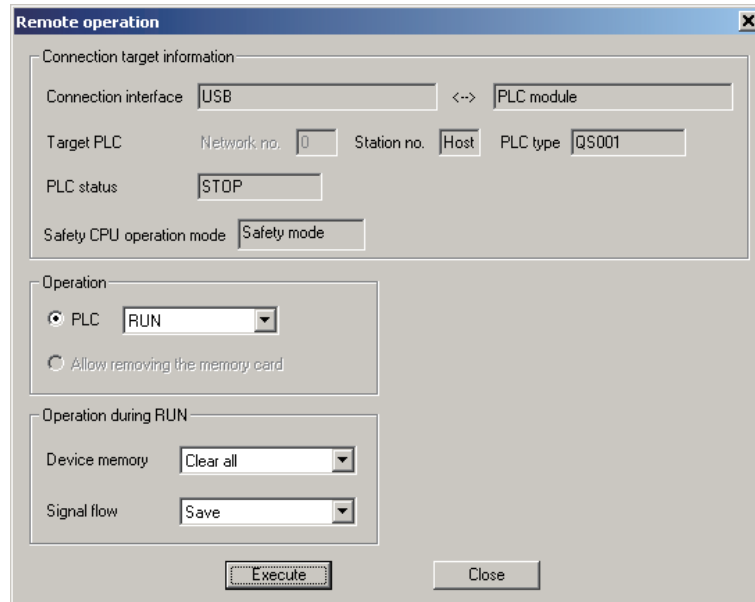

(e) Change TC setting

Setting values of counter/timer cannot be changed more than 32.

(f) Exclusive processing when simultaneously writing a program to a safety CPU from multiple GX Developers

For a safety CPU, the following processing cannot be simultaneously performed from multiple GX Developers.

- 1) Write to PLC
- 2) Online change
- 3) Change TC setting
(When selecting "Currently open program + PLC program")
- 4) Write the program memory to ROM
- 5) Switch safety CPU operation mode
- 6) Create title... (Write to PLC screen)
- 7) Delete PLC data

When other GX Developer is performing any of the processing above, the following message appears. After confirming the message, click the **Yes**

or **No** button.

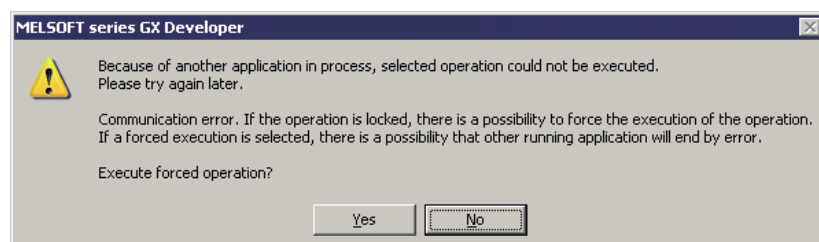

The **No** button: Suspends the processing.

The **Yes** button: Forcibly performs the processing.

In this case, other GX Developer's processing has been stopped and the following message appears.



(4) Differences in the Diagnostics menu

(a) PLC diagnostics

The PLC diagnostics screen displays the "CPU A" or "CPU B" information in a safety CPU selected in the Monitor destination select option screen. To confirm the CPU information that is not displayed, switch the CPU to be monitored in the Monitor destination select option screen in advance. (Section 5.2.5)

(b) MELSECNET(II)/10/H diagnostics

The following test cannot be performed.

- Network test
- Communication test

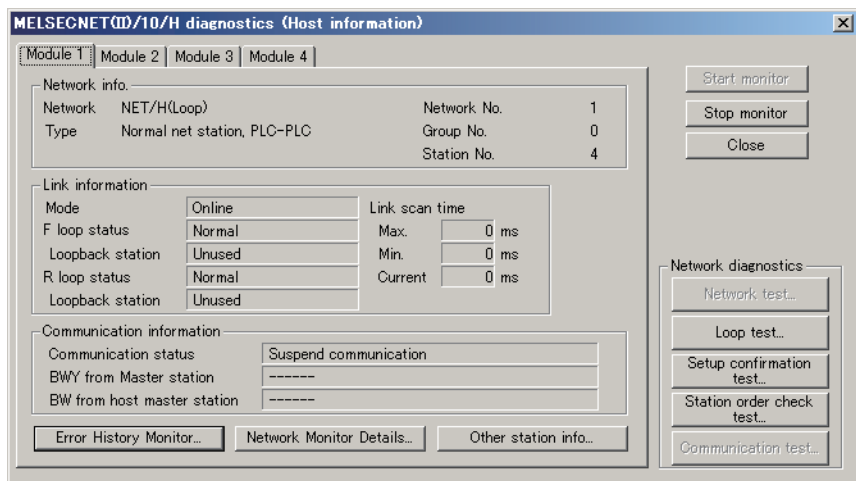

In addition to the network test and communication test, the following tests cannot be performed if the first 5 digits of QS0001CPU serial number are "10031" or lower.

- Loop test
- Setup confirmation test
- Station order check test

- (c) CC IE Control diagnostics
 The following function cannot be used.
- Link start/stop
 - Communication test

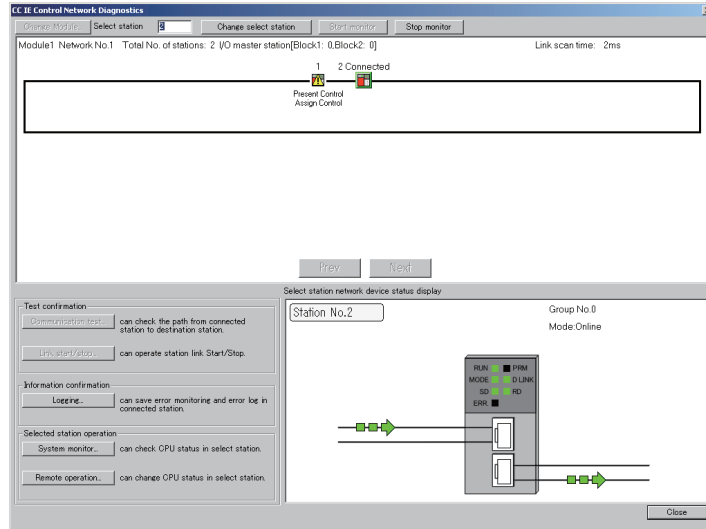

- (d) Ethernet diagnostics
 The following functions cannot be used.
- Received e-mail information
 - Send e-mail information

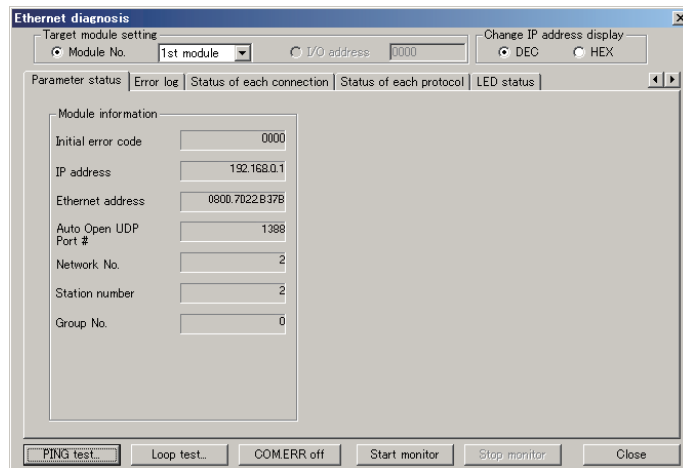

(e) CC-Link / CC-Link/LT diagnostics

- Network test cannot be performed.

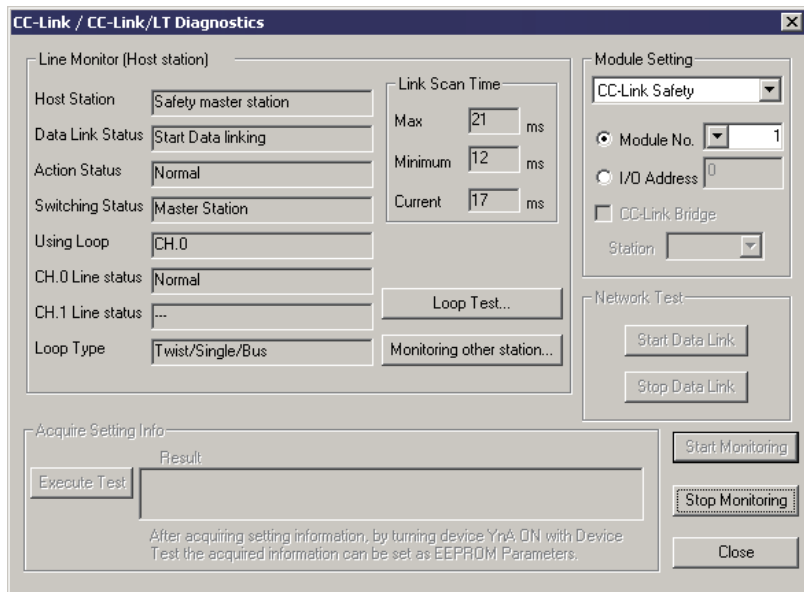

- "Invalid station if temporary error" in the CC-Link / CC-Link/LT diagnostics (Other station) screen cannot be set.

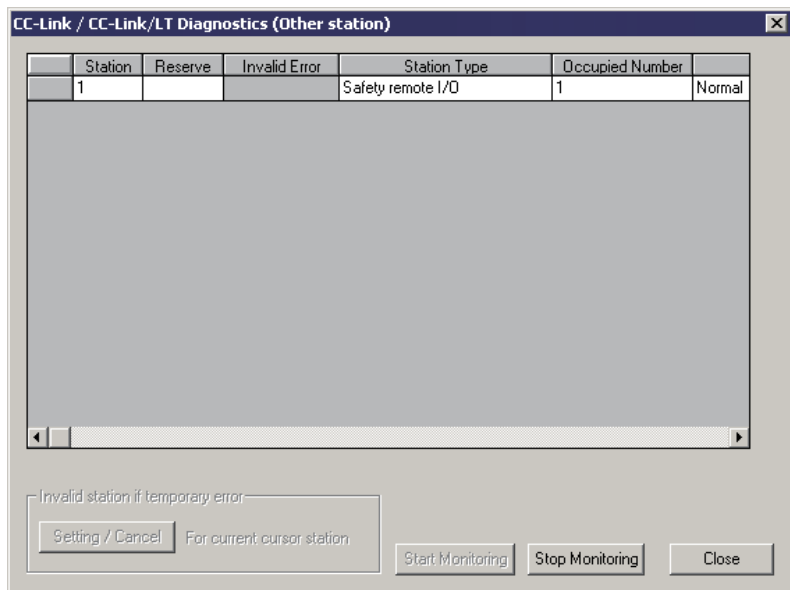

(5) Differences in the Tool menu

(a) Merge data

The program or comment data created in a safety programmable controller project can only be merged with (a) safety programmable controller project(s).

(b) Options

<<Program common>> tab

The following items cannot be selected for a safety CPU.

- Statement insertion method
- Step No. specification used in writing
- Instruction operational settings for online change/file online change
- Online change/TC setting value change program memory transfer settings
- Buffer, Link memory monitor
- Ladder monitor of PLS/PLF instruction

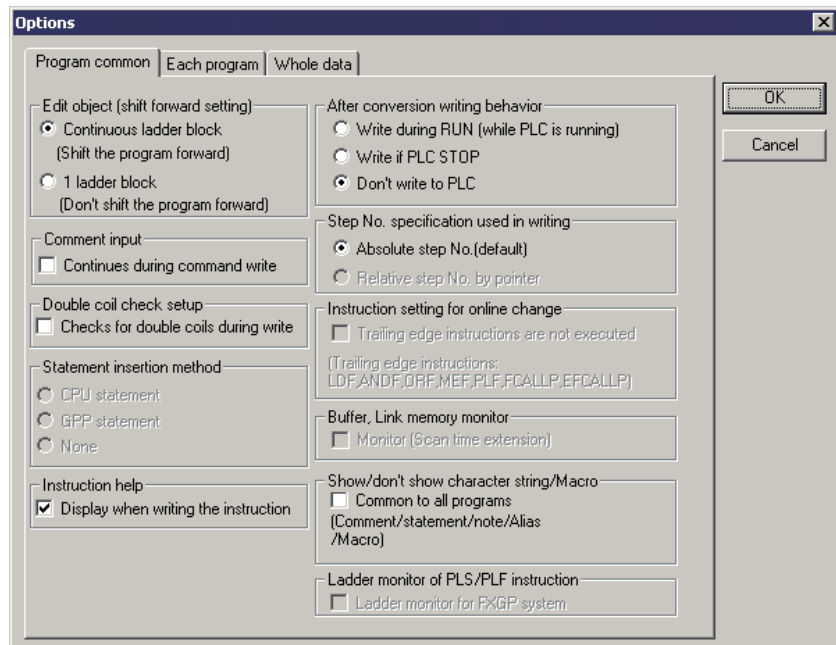

<<Each program>> tab

For a safety CPU, the "Device comment" field is fixed to "Comment for each program".

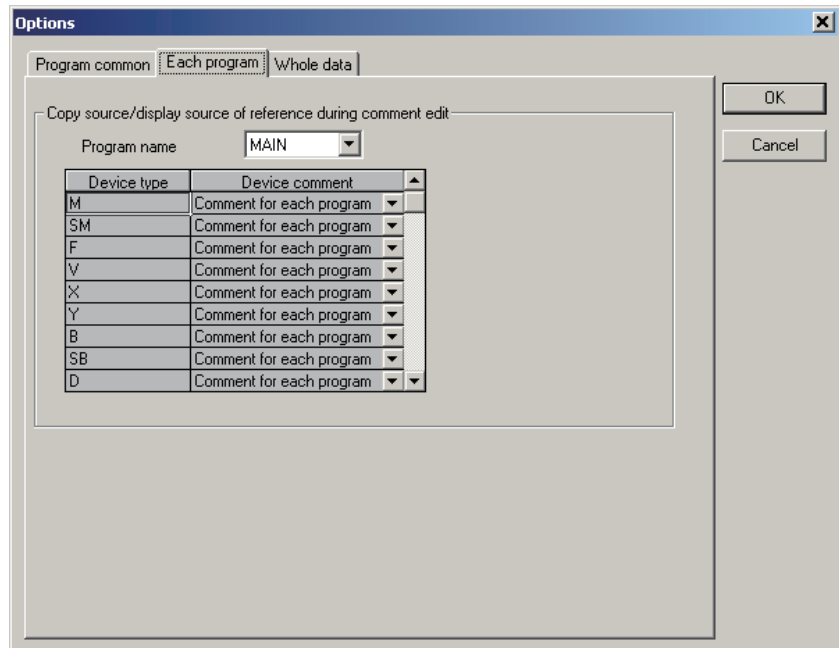

<<Whole data>> tab

For a safety CPU, "All common data" and "Extended setting" cannot be selected.

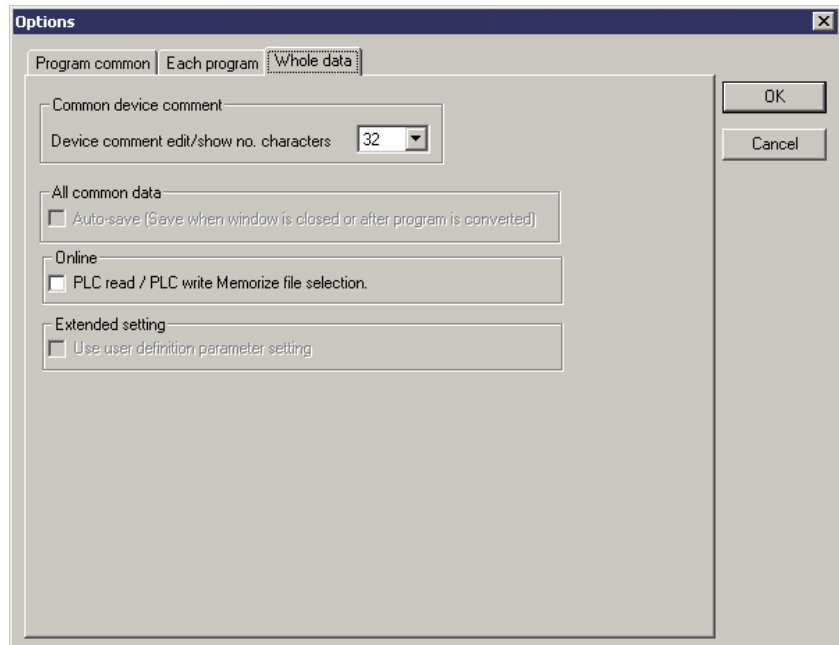

<<TEL>> tab

Since a safety CPU does not support the TEL function, the <<TEL>> tab cannot be displayed.

Appendix 2 Functions for which CPU Access Password Certification is Performed

CPU access password certification is performed when the safety CPU status is to be changed by the GX Developer operation.

Note when reading data from a safety CPU (e.g. Read from PLC, monitor), the CPU access password certification is not performed.

The following shows the GX Developer functions for which the CPU access password certification is performed.

Menu	Function
Edit	Change TC setting
Convert	Online change
Online	Write to PLC
	Delete PLC data
	Write the program memory to ROM
	Switch safety CPU operation mode
	CPU access password registration/change
	PLC memory initialization
	Remote operation
	Clear PLC memory
	Format PLC memory
	Arrange PLC memory
	Set clock
	Present value change
	Device test
	Diagnostics
MELSECNET(II)/10/H diagnostics – Clear of error history...	
CC-Link / CC-Link/LT diagnostics – Loop test	

Appendix 3 ASCII Code Table

MSD \ LSD		0	1	2	3	4	5	6	7
		000	001	010	011	100	101	110	111
0	0000	NUL	DLE	(SP)	0	@	P	`	p
1	0001	SOH	DC1	!	1	A	Q	a	q
2	0010	STX	DC2	"	2	B	R	b	r
3	0011	ETX	DC3	#	3	C	S	c	s
4	0100	EOT	DC4	\$	4	D	T	d	t
5	0101	ENQ	NAK	%	5	E	U	e	u
6	0110	ACK	SYN	&	6	F	V	f	v
7	0111	BEL	ETB	'	7	G	W	g	w
8	1000	BS	CAN	(8	H	X	h	x
9	1001	HT	EM)	9	I	Y	i	y
A	1010	LF	SUB	*	:	J	Z	j	z
B	1011	VT	ESC	+	;	K	[k	{
C	1100	FF	FS	,	<	L	\ (\)	l	
D	1101	CR	GS	-	=	M]	m	}
E	1110	SO	RS	.	>	N	^	n	~
F	1111	SI	US	/	?	O	_	o	DEL

INDEX

- [A]
 Access level..... 1- 2
 ASCII Code TableApp-12
- [C]
 Checking devices for duplication use 5-50
 Checking safety function block variable 6- 6
 Copying user information 5- 8
 CPU access password..... 1- 4
 CPU Access Password CertificationApp-11
- [D]
 Detecting the Damaged Project Data..... 5-23
 Diagnosing CC-Link IE Field Network 5-38
 Differences with the Q Series Project.....App- 1
 Displaying login user information..... 5- 10
 Displaying ROM information 5- 16
- [F]
 Functions Lists 1- 6
 Functions require login certification 5- 9
- [G]
 GX Developer.....A-11
- [H]
 Highlighting Safety Devices 5-25
- [I]
 Incorporating safety function blocks in a project
 6- 3
- [L]
 Locking operation manually 5-13
 Locking operations 5-11
 Login certification 1- 3
 Login operation..... 5- 9
 Losing a CPU access password..... 3- 2
 Losing a login password 3- 2
- [N]
 Network parameters..... 5-29
- [O]
 Operation/error log.....5-35
 Operation lock..... 1- 5
- [P]
 Pasting safety function blocks to the sequence
 program6- 5
 PLC memory initialization5-21
 PLC diagnostics5-34
 PLC parameter.....5-28
 Programming using safety function blocks ...6- 2
- [R]
 Registering/deleting/changing a login user...5- 3
 Registering or changing a CPU access password
5-18
 Registering the user when creating a new project
5- 1
 Restricting the safety function block operations/
 displays6- 6
 RESTRICTIONS AND PRECAUTIONS3- 1
- [S]
 Safety CPU operation mode..... 1- 5
 Safety function block.....6- 1
 SAFETY MODE1- 5
 Setting/changing a password5- 7
 Setting wait time for the automatic operation lock
5-11
 Switching the CPU to be monitored5-22
- [T]
 TEST MODE 1- 5
- [U]
 Unlocking an operation lock5-14
 User registration..... 1- 3
- [W]
 When Creating a Safety Project.....4- 1
 When Modifying the Safety Project in Operation
4- 2
 Writing Program Memory to ROM.....5-49

TRADEMARKS

The company names, system names and product names mentioned in this manual are either registered trademarks or trademarks of their respective companies.

In some cases, trademark symbols such as '™' or '®' are not specified in this manual.

COPYRIGHTS

SPREAD

Copyright(C)1999 Far Point Technologies, Inc.

VS-FlexGrid Pro 8.0J

Copyright (C) 2001-2003 ComponentOne LLC.

SH(NA)-080576ENG-H(2211)KWIX

MODEL:GXDEV8-O-SAF-E

MODEL CODE: 13JU53

MITSUBISHI ELECTRIC CORPORATION

HEAD OFFICE : TOKYO BUILDING, 2-7-3 MARUNOUCHI, CHIYODA-KU, TOKYO 100-8310, JAPAN
NAGOYA WORKS : 1-14, YADA-MINAMI 5-CHOME, HIGASHI-KU, NAGOYA, JAPAN

When exported from Japan, this manual does not require application to the Ministry of Economy, Trade and Industry for service transaction permission.

Specifications subject to change without notice.