

Mitsubishi Programmable Controller

MELSEC **Q** series

Multichannel High-Speed Counter Module User's Manual

-QD63P6
-GX Configurator-CT (SW0D5C-QCTU-E)

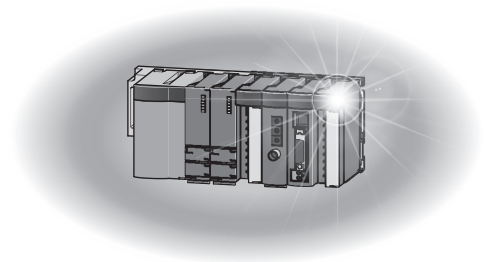

● SAFETY PRECAUTIONS ●

(Read these precautions before using this product.)

Before using this product, please read this manual and the relevant manuals carefully and pay full attention to safety to handle the product correctly.

The precautions given in this manual are concerned with this product. For the safety precautions of the programmable controller system, please read the User's Manual for the CPU module.

In this manual, the safety precautions are classified into two levels: "⚠ WARNING" and "⚠ CAUTION".



Indicates that incorrect handling may cause hazardous conditions, resulting in death or severe injury.



Indicates that incorrect handling may cause hazardous conditions, resulting in minor or moderate injury or property damage.

Under some circumstances, failure to observe the precautions given under "⚠ CAUTION" may lead to serious consequences.

Observe the precautions of both levels because they are important for personal and system safety. Make sure that the end users read this manual and then keep the manual in a safe place for future reference.

[Design Precautions]

⚠ WARNING

- Do not write data to "read-only area" or "reserved area" in the buffer memory of the intelligent function module. Also do not turn ON/OFF the "reserved" signal in I/O signals to the programmable controller CPU.
Doing any of these operations may cause a malfunction of the programmable controller system.

⚠ CAUTION

- Do not install the control lines and/or pulse input wiring together with the main circuit or power lines, and also do not bring them close to each other.
Keep a distance of 150 mm (5.91 inch) or more between them.
Failure to do so may cause a malfunction due to noise.

[Installation Precautions]

⚠ CAUTION

- Use the programmable controller in the environment conditions given in the general specifications of the User's Manual for the CPU module.
Failure to do so may cause an electric shock, fire, malfunction, or damage to or deterioration of the product.

[Installation Precautions]

CAUTION

- While pressing the installation lever located at the bottom of the module, fully insert the module fixing projection into the fixing hole in the base unit and press the module using the hole as a fulcrum. Incorrect module mounting may cause a malfunction, failure, or drop of the module. In an environment of frequent vibrations, secure the module with screws.
- The screws must be tightened within the specified torque range. If the screw is too loose, it may cause a drop, short circuit, or malfunction. Excessive tightening may damage the screw and/or the module, resulting in a drop, short circuit or malfunction.
- Be sure to shut off all phases of the external power supply used by the system before mounting or removing the module. Failure to do so may cause damage to the product.
- Do not directly touch any conductive part or electronic part of the module. Doing so may cause a malfunction or failure of the module.

[Wiring Precautions]

CAUTION

- When wiring/connecting the connector, properly press, crimp or solder the connector using the tools specified by the manufacturers and attach the connector to the module securely.
- Be careful to prevent foreign matter such as dust or wire chips from entering the module. Failure to do so may cause a fire, failure or malfunction.
- A protective film is attached to the top of the module to prevent foreign matter, such as wire chips, from entering the module during wiring. Do not remove the film during wiring. Remove it for heat dissipation before system operation.
- Be sure to place the cables connected to the module in a duct or clamp them. If not, dangling cables may swing or inadvertently be pulled, resulting in damage to the module and/or cables, or malfunctions due to poor cable connection.
- When disconnecting the cable, do not pull it by holding the cable part. Disconnect the cable with connector with holding the connector plugged into the module. Pulling the cable part with the cable still connected to the module may cause a malfunction or damage to the module and/or cable.

[Wiring precautions]

CAUTION

- Always ground the shielded cable on the encoder side (relay box).
Failure to do may cause a malfunction.
- Correctly wire cables to the module after checking the rated voltage and terminal layout of the product.
Connecting a voltage different from the rated voltage or incorrect wiring may result in a fire or failure.

[Startup and Maintenance Precautions]

CAUTION

- Do not disassemble or remodel each of the modules.
Doing so may cause failure, malfunctions, personal injuries and/or a fire.
- Be sure to shut off all phases of the external power supply used by the system before mounting or removing the module.
Not doing so may result in a failure or malfunction of the module.
- Do not install/remove the module to/from the base unit more than 50 times after the first use of the product. (IEC 61131-2 compliant)
Failure to do so may cause malfunction.
- Do not touch the terminal while the power is ON. Failure to do may cause a malfunction.
- Switch off all phases of the externally supplied power used in the system when cleaning the module or retightening the terminal or module fixing screws.
Not doing so may result in a failure or malfunction of the module.
If the screw is too loose, it may cause a drop, short circuit or malfunction.
Excessive tightening may damage the screw and/or the module, resulting in a drop, short circuit or malfunction.
- Before handling the module, touch a grounded metal object to discharge the static electricity from the human body.
Not doing so may result in a failure or malfunction of the module.

[Disposal Precautions]

CAUTION

- When disposing of this product, treat it as industrial waste.

● CONDITIONS OF USE FOR THE PRODUCT ●

- (1) Mitsubishi programmable controller ("the PRODUCT") shall be used in conditions;
 - i) where any problem, fault or failure occurring in the PRODUCT, if any, shall not lead to any major or serious accident; and
 - ii) where the backup and fail-safe function are systematically or automatically provided outside of the PRODUCT for the case of any problem, fault or failure occurring in the PRODUCT.

- (2) The PRODUCT has been designed and manufactured for the purpose of being used in general industries.

MITSUBISHI SHALL HAVE NO RESPONSIBILITY OR LIABILITY (INCLUDING, BUT NOT LIMITED TO ANY AND ALL RESPONSIBILITY OR LIABILITY BASED ON CONTRACT, WARRANTY, TORT, PRODUCT LIABILITY) FOR ANY INJURY OR DEATH TO PERSONS OR LOSS OR DAMAGE TO PROPERTY CAUSED BY the PRODUCT THAT ARE OPERATED OR USED IN APPLICATION NOT INTENDED OR EXCLUDED BY INSTRUCTIONS, PRECAUTIONS, OR WARNING CONTAINED IN MITSUBISHI'S USER, INSTRUCTION AND/OR SAFETY MANUALS, TECHNICAL BULLETINS AND GUIDELINES FOR the PRODUCT.

("Prohibited Application")

Prohibited Applications include, but not limited to, the use of the PRODUCT in;

- Nuclear Power Plants and any other power plants operated by Power companies, and/or any other cases in which the public could be affected if any problem or fault occurs in the PRODUCT.
- Railway companies or Public service purposes, and/or any other cases in which establishment of a special quality assurance system is required by the Purchaser or End User.
- Aircraft or Aerospace, Medical applications, Train equipment, transport equipment such as Elevator and Escalator, Incineration and Fuel devices, Vehicles, Manned transportation, Equipment for Recreation and Amusement, and Safety devices, handling of Nuclear or Hazardous Materials or Chemicals, Mining and Drilling, and/or other applications where there is a significant risk of injury to the public or property.

Notwithstanding the above, restrictions Mitsubishi may in its sole discretion, authorize use of the PRODUCT in one or more of the Prohibited Applications, provided that the usage of the PRODUCT is limited only for the specific applications agreed to by Mitsubishi and provided further that no special quality assurance or fail-safe, redundant or other safety features which exceed the general specifications of the PRODUCTS are required. For details, please contact the Mitsubishi representative in your region.

REVISIONS

*The manual number is given on the bottom left of the back cover.

Print date	*Manual number	Revision
Jun., 2007	SH(NA)-080692ENG-A	First edition
Jan., 2008	SH(NA)-080692ENG-B	<p>Correction</p> <p>CONTENTS, GENERIC TERMS AND ABBREVIATIONS, Section 2.1 to 2.3, Section 4.1, Section 6.2.1, Section 6.2.2, Section 6.2.3, Section 6.3.1 to 6.3.3, Section 6.4 to 6.6</p>
May, 2008	SH(NA)-080692ENG-C	<p>Correction</p> <p>SAFETY PRECAUTIONS, Compliance with the EMC and Low Voltage Directives, GENERIC TERMS AND ABBREVIATIONS, Section 2.1, Section 2.3, Section 4.1, Section 4.4.1, Section 6.2.1, Section 6.3.1 to 6.3.3.</p>
Aug., 2008	SH(NA)-080692ENG-D	<p>Correction</p> <p>Section 2.3, Section 4.3, Appendix 2</p>
Feb., 2012	SH(NA)-080692ENG-E	<p>Addition</p> <p>CONDITIONS OF USE FOR THE PRODUCT</p> <p>Correction</p> <p>SAFETY PRECAUTIONS, COMPLIANCE WITH EMC AND LOW VOLTAGE, GENERIC TERMS AND ABBREVIATIONS, Section 2.1 to 2.3, Section 3.2, 3.5, Section 4.4.1, Section 5.3, 5.6, Section 6.2.1, 6.2.2, Section 7.3</p>

Japanese Manual Version SH-080693-E

This manual confers no industrial property rights or any rights of any other kind, nor does it confer any licenses. Mitsubishi Electric Corporation cannot be held responsible for any problems involving industrial property rights which may occur as a result of using the contents noted in this manual.

INTRODUCTION

Thank you for purchasing the Mitsubishi programmable controller MELSEC-Q series.
Before using the product, please read this manual carefully to develop full familiarity with the functions and performance of the Q series programmable controller to ensure correct use.

CONTENTS

SAFETY PRECAUTIONS	A - 1
CONDITIONS OF USE FOR THE PRODUCT	A - 4
REVISIONS	A - 5
INTRODUCTION	A - 6
CONTENTS	A - 6
COMPLIANCE WITH EMC AND LOW VOLTAGE DIRECTIVES	A - 9
GENERIC TERMS AND ABBREVIATIONS	A - 10
PACKING LIST	A - 10

CHAPTER1 OVERVIEW	1 - 1 to 1 - 2
1.1 Features	1 - 2

CHAPTER2 SYSTEM CONFIGURATION	2 - 1 to 2 - 8
2.1 Applicable Systems	2 - 1
2.2 About Use of the QD63P6 with Redundant CPU	2 - 4
2.3 How to Check the Function Version/Serial No./Software Version	2 - 5

CHAPTER3 SPECIFICATIONS	3 - 1 to 3 - 18
3.1 Performance Specifications	3 - 1
3.2 Function List	3 - 2
3.3 I/O Signals to the Programmable Controller CPU	3 - 3
3.3.1 I/O signal list	3 - 3
3.3.2 Functions of I/O signals	3 - 5
3.4 Buffer Memory Assignment	3 - 9
3.4.1 List of buffer memory assignment	3 - 9
3.4.2 Details of the buffer memory	3 - 11
3.5 Interface with External Devices	3 - 17
3.6 Connectable Encoders	3 - 18

CHAPTER4 PROCEDURES AND SETTINGS BEFORE OPERATION	4 - 1 to 4 - 16
4.1 Handling Precautions	4 - 1
4.2 Procedures before Operation	4 - 2
4.3 Part Names	4 - 3
4.4 Wiring	4 - 5
4.4.1 Wiring precautions	4 - 5

4.4.2	Example of wiring the module and an encoder	4 - 8
4.5	Intelligent Function Module Switch Setting	4 - 14

CHAPTER5 FUNCTIONS **5 - 1 to 5 - 22**

5.1	Pulse Input and Count Methods	5 - 1
5.1.1	Types of the pulse input method	5 - 1
5.2	Selecting Counter Format	5 - 3
5.2.1	Selecting the linear counter	5 - 4
5.2.2	Selecting the ring counter	5 - 5
5.3	Using the Coincidence Detection Function	5 - 12
5.4	Using the Preset Function	5 - 17
5.5	Using the Periodic Pulse Counter Function	5 - 18
5.6	Response Delay Time	5 - 22

CHAPTER6 UTILITY PACKAGE (GX Configurator-CT) **6 - 1 to 6 - 20**

6.1	Utility Package Functions	6 - 1
6.2	Installing and Uninstalling the Utility Package	6 - 2
6.2.1	Handling precautions	6 - 2
6.2.2	Operating environment	6 - 4
6.3	Utility Package Operation	6 - 6
6.3.1	Common utility package operations	6 - 6
6.3.2	Operation overview	6 - 8
6.3.3	Starting the Intelligent function module utility	6 - 10
6.4	Initial Setting	6 - 13
6.5	Auto Refresh	6 - 15
6.6	Monitoring/Test	6 - 17
6.6.1	Monitoring/Test	6 - 17

CHAPTER7 PROGRAMMING **7 - 1 to 7 - 14**

7.1	Program Example when GX Configurator-CT is Used	7 - 3
7.1.1	GX Configurator-CT operation	7 - 3
7.1.2	Program example	7 - 5
7.2	Program Example when GX Configurator-CT is not Used	7 - 7
7.2.1	Program example when dedicated instructions are used	7 - 7
7.2.2	Program example when dedicated instructions are not used	7 - 10
7.3	Program Example when the Coincidence Detection Interrupt Function is Used	7 - 13

CHAPTER8 TROUBLESHOOTING **8 - 1 to 8 - 9**

8.1	Error Processing and Recovery Methods	8 - 1
8.1.1	Checking error description using System Monitor of GX Developer	8 - 1
8.1.2	When the RUN LED turns OFF	8 - 4
8.1.3	When the RUN LED and ERR. LED turn ON	8 - 4

8.2 When the QD63P6 Does Not Start Counting8 - 5

8.3 When the QD63P6 Does Not Normally Count8 - 6

8.4 When the Coincidence Detection Interrupt Does Not Occur8 - 7

8.5 Error Codes List8 - 8

APPENDICES **APPX - 1 to APPX - 5**

Appendix 1 Dedicated InstructionsAPPX - 1

 Appendix 1.1 Dedicated instructions listAPPX - 1

 Appendix 1.2 G(P). PPCVRD.....APPX - 2

Appendix 2 External DimensionsAPPX - 5

INDEX **INDEX - 1 to INDEX - 2**

COMPLIANCE WITH EMC AND LOW VOLTAGE DIRECTIVES

(1) Method of ensuring compliance

To ensure that Mitsubishi programmable controllers maintain EMC and Low Voltage Directives when incorporated into other machinery or equipment, certain measures may be necessary. Please refer to one of the following manuals.

- QCPU User's Manual (Hardware Design, Maintenance and Inspection)
- Safety Guidelines

(This manual is included with the CPU module or base unit.)

The CE mark on the side of the programmable controller indicates compliance with EMC and Low Voltage Directives.

(2) Additional measures

To ensure that this product maintains EMC and Low Voltage Directives, please refer to Section 4.4.1.

GENERIC TERMS AND ABBREVIATIONS

This manual describes the type QD63P6 multichannel high-speed counter module using the following generic terms and abbreviations, unless otherwise specified.

Generic term and abbreviation	Description
QD63P6	Abbreviation for the type QD63P6 multichannel high-speed counter module
Personal computer	Generic term for IBM-PC/AT-compatible personal computer
GX Developer	Product name of the software package for the MELSEC programmable controllers.
GX Works2	
QCPU (Q mode)	Generic term for Q00JCPU, Q00CPU, Q01CPU, Q02CPU, Q02HCPU, Q06HCPU, Q12HCPU, Q25HCPU, Q02PHCPU, Q06PHCPU, Q12PHCPU, Q25PHCPU, Q12PRHCPU, Q25PRHCPU, Q00UJCPU, Q00UCPU, Q01UCPU, Q02UCPU, Q03UDCPU, Q04UDHCPU, Q06UDHCPU, Q10UDHCPU, Q13UDHCPU, Q20UDHCPU, Q26UDHCPU, Q03UDECPU, Q04UDEHCPU, Q06UDEHCPU, Q10UDEHCPU, Q13UDEHCPU, Q20UDEHCPU, Q26UDEHCPU, Q50UDEHCPU, and Q100UDEHCPU.
Redundant CPU	Generic term for Q12PRHCPU, Q25PRHCPU.
GX Configurator-CT	Abbreviation for GX Configurator-CT (SW0D5C-QCTU-E) of counter module setting/monitor tool
Windows Vista®	Generic term for the following: Microsoft® Windows Vista® Home Basic Operating System, Microsoft® Windows Vista® Home Premium Operating System, Microsoft® Windows Vista® Business Operating System, Microsoft® Windows Vista® Ultimate Operating System, Microsoft® Windows Vista® Enterprise Operating System
Windows® XP	Generic term for the following: Microsoft® Windows® XP Professional Operating System, Microsoft® Windows® XP Home Edition Operating System
Windows® 7	Generic term for the following: Microsoft® Windows® 7 Starter Operating System, Microsoft® Windows® 7 Home Premium Operating System, Microsoft® Windows® 7 Professional Operating System, Microsoft® Windows® 7 Ultimate Operating System, Microsoft® Windows® 7 Enterprise Operating System Note that the 32-bit version is designated as "32-bit Windows® 7", and the 64-bit version is designated as "64-bit Windows® 7".

PACKING LIST

The product package contains the following.

Model	Product	Quantity
QD63P6	Type QD63P6 multichannel high-speed counter module	1
SW0D5C-QCTU-E	GX Configurator-CT Version 1 (single license product) (CD-ROM)	1
SW0D5C-QCTU-AE	GX Configurator-CT Version 1 (volume license product)(CD-ROM)	1

CHAPTER1 OVERVIEW

This User's Manual describes the specifications, handling, and programming methods for the type QD63P6 multichannel high-speed counter module used together with the MELSEC-Q series CPU module.

The QD63P6 can use the following methods in 1-phase/2-phase pulse inputs.

- 1 multiple of 1 phase pulse input
- 2 multiples of 1 phase pulse input
- CW/CCW
- 1 multiple of 2 phases pulse input
- 2 multiples of 2 phases pulse input
- 4 multiples of 2 phases pulse input

For details of the input methods, refer to Section 5.1.

Figure 1.1 shows the general operation of the QD63P6.

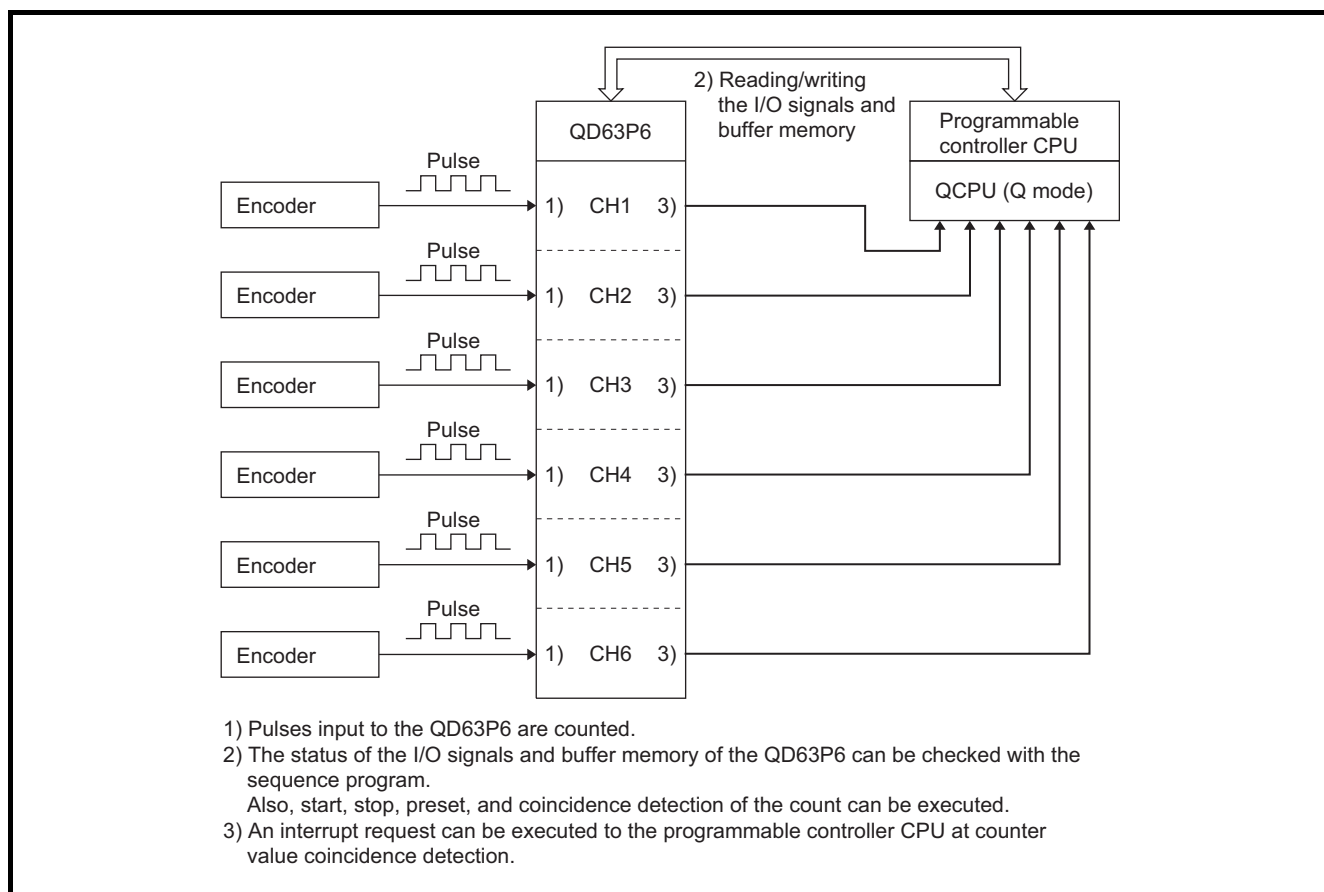

Figure 1.1 General operation of the QD63P6

1.1 Features

This section describes the features of the QD63P6.

(1) Wide range of expression on counting (from -2147483648 to 2147483647)

Count values can be stored in 6 channels and 32-bit signed binary.

(2) Switching of the maximum counting speed

Since the QD63P6 can switch between 200 k, 100 k, and 10 k, gradual rise/fall pulses can be correctly counted.

(3) Pulse input selection

Pulse input can be selected from 1 multiple of 1 phase, 2 multiples of 1 phase, 1 multiple of 2 phases, 2 multiples of 2 phases, 4 multiples of 2 phases, and CW/CCW.

(4) Counter format selection

Either of the following counter formats can be selected.

(a) Linear counter format

From -2147483648 to 2147483647 can be counted and an overflow can be detected when the count range is overrun.

(b) Ring counter format

Counts are repeatedly executed between the ring counter upper limit value and ring counter lower limit value.

(5) Coincidence detection

By presetting the coincidence detection point of an arbitrary channel, the detection point is compared to the present counter value, ON/OFF signal can be output according to the result, and an interrupt program can be started.

(6) The periodic pulse counter function is supported.

The periodic pulse counter function stores the present and previous counter values at every preset time while signals are input.

(7) Simple settings using the utility package

The utility package (GX Configurator-CT) is sold separately.

Although the usage of the utility package is arbitrary, it enables to make initial settings and auto refresh setting on the screen, which lead to load reduction of the sequence programs and simplicity in checking the setting status and operation status.

CHAPTER2 SYSTEM CONFIGURATION

This chapter explains the system configuration of the QD63P6.

2.1 Applicable Systems

This section describes the applicable systems.

(1) Applicable modules and base units, and No. of modules

(a) When mounted with a CPU module

The table below shows the CPU modules and base units applicable to the QD63P6 and quantities for each CPU model.

Depending on the combination with other modules or the number of mounted modules, power supply capacity may be insufficient.

Pay attention to the power supply capacity before mounting modules, and if the power supply capacity is insufficient, change the combination of the modules.

Table 2.1 Applicable modules, number of mountable modules, and applicable base units

Applicable CPU module		No. of modules ^{*1}	Base unit ^{*2}		
CPU type	CPU model		Main base unit	Extension base unit	
Programmable controller CPU	Basic model QCPU ^{*3}	Q00JCPU	Up to 8		
		Q00CPU	Up to 24	○	
		Q01CPU		○	
	High Performance model QCPU	Q02CPU	Up to 64	○	○
		Q02HCPU			
		Q06HCPU			
		Q12HCPU			
	Process CPU	Q25HCPU	Up to 64	○	○
		Q02PHCPU			
		Q06PHCPU			
		Q12PHCPU			
	Redundant CPU	Q25PHCPU	Up to 53 ^{*4}	×	○
		Q12PRHCPU			
	Universal model QCPU	Q25PRHCPU	Up to 8	○	○
		Q00UJCPU			
		Q00UCPU	Up to 24		
		Q01UCPU			
		Q02UCPU	Up to 36		
		Q03UDCPU	Up to 64		
		Q04UDHCPU			
Q06UDHCPU					
Q10UDHCPU					
Q13UDHCPU					
Q20UDHCPU					
Q26UDHCPU					

1	OVERVIEW
2	SYSTEM CONFIGURATION
3	SPECIFICATIONS
4	PROCEDURES AND SETTINGS BEFORE OPERATION
5	FUNCTIONS
6	UTILITY PACKAGE (GX Configurator-CT)
7	PROGRAMMING
8	TROUBLESHOOTING

Table 2.1 Applicable modules, number of mountable modules, and applicable base units (Continued)

Applicable CPU module		No. of modules ^{*1}	Base unit ^{*2}	
CPU type	CPU model		Main base unit	Extension base unit
Programmable controller CPU	Universal model QCPU	Q03UDECPU	○	○
		Q04UDEHCPU		
		Q06UDEHCPU		
		Q10UDEHCPU		
		Q13UDEHCPU		
		Q20UDEHCPU		
		Q26UDEHCPU		
		Q50UDEHCPU		
	Q100UDEHCPU			
Safety CPU	QS001CPU	N/A	×	×
C Controller module	Q06CCPU-V	Up to 64	○	○
	Q06CCPU-V-B			
	Q12DCCPU-V			

○: Applicable ×: N/A

- * 1 Limited within the range of I/O points for the CPU module.
- * 2 Can be installed to any I/O slot of a base unit.
- * 3 For the coincidence detection interrupt function, use the Basic model QCPU module of function version B or later.
- * 4 The coincidence detection interrupt function is not supported.

(b) Mounting to a MELSECNET/H remote I/O station

The table below shows the network modules and base units applicable to the QD63P6 and quantities for each network module model.

Depending on the combination with other modules or the number of mounted modules, power supply capacity may be insufficient.

Pay attention to the power supply capacity before mounting modules, and if the power supply capacity is insufficient, change the combination of the modules.

Table 2.2 Mountable network modules, No. of mountable modules, and mountable base unit

Applicable network module ^{*3*4}	No. of modules ^{*1}	Base unit ^{*2}	
		Main base unit of remote I/O station	Extension base unit of remote I/O station
QJ72LP25-25	Up to 64	○	○
QJ72LP25G			
QJ72LP25GE			
QJ72BR15			

○: Applicable ×: N/A

- * 1 Limited within the range of I/O points for the network module.
- * 2 Can be installed to any I/O slot of a base unit.
- * 3 The coincidence detection interrupt function is not supported.
- * 4 The dedicated instructions are not supported.

Remark

The Basic model QCPU or C Controller module cannot create the MELSECNET/H remote I/O network.

(2) Support of the multiple CPU system

The function version of the first released QD63P6 is B, and it supports multiple CPU systems.

When using the QD63P6 in a multiple CPU system, refer to the following manual first.

- QCPU User's Manual (Multiple CPU System)

(a) Intelligent function module parameters

Write intelligent function module parameters to only the control CPU of the QD63P6.

(3) Supported software packages

Relation between the system containing the QD63P6 and software package is shown in the following table.

GX Developer or GX Works2 are necessary when using the QD63P6.

Table 2.3 Software package version

Item	Software version		
	GX Developer	GX Configurator-CT	GX Works2
Q00J/Q00/Q01CPU	Single CPU system	Version 7 or later	Version 1.15R or later
	Multiple CPU system	Version 8 or later	
Q02/Q02H/Q06H/Q12H/Q25HCPU	Single CPU system	Version 4 or later	Version 1.15R or later
	Multiple CPU system	Version 6 or later	
Q02PH/Q06PHCPU	Single CPU system	Version 8.68W or later	Cannot be used
	Multiple CPU system		
Q12PH/Q25PHCPU	Single CPU system	Version 7.10L or later	Cannot be used
	Multiple CPU system		
Q12PRH/Q25PRHCPU	Redundant CPU system	Version 8.45X or later	Cannot be used
00UJ/Q00U/Q01UCPU	Single CPU system	Version 8.76E or later	
	Multiple CPU system		
Q02U/Q03UD/Q04UDH/Q06UDHCPU	Single CPU system	Version 8.48A or later	Version 1.25AB or later
	Multiple CPU system		
Q10UDH/Q20UDHCPU	Single CPU system	Version 8.76E or later	Version 1.15R or later
	Multiple CPU system		
Q13UDH/Q26UDHCPU	Single CPU system	Version 8.62Q or later	Version 1.15R or later
	Multiple CPU system		
Q03UDE/Q04UDEH/Q06UDEH/Q13UDEH/Q26UDEHCPU	Single CPU system	Version 8.68W or later	Version 1.15R or later
	Multiple CPU system		
Q10UDEH/Q20UDEHCPU	Single CPU system	Version 8.76E or later	Version 1.15R or later
	Multiple CPU system		
Q50UDEH/Q100UDEHCPU	Single CPU system	Use prohibited	Use prohibited
	Multiple CPU system	Use prohibited	Use prohibited
When mounted to the MELSECNET/H remote I/O station		Version 6 or later	Version 1.25AB or later
			Version 1.40S or later

(4) Connector

The connector is not included with the QD63P6.

Purchase it with reference to Section 4.3.

2.2 About Use of the QD63P6 with Redundant CPU

This section explains how to use the QD63P6 with the Redundant CPU.

(1) GX Configurator-CT

GX Configurator-CT cannot be used when accessing the Redundant CPU via an intelligent function module on an extension base unit from GX Developer.

Connect a personal computer with a communication path indicated below

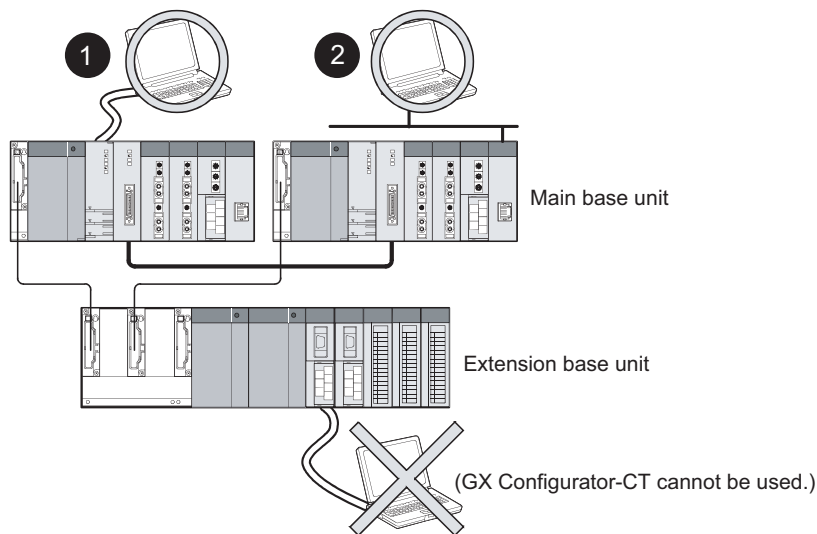

- 1 Direct connection to the CPU
- 2 Connection through an intelligent function module on the main base unit
(Through Ethernet module, MELSECNET/H module, or CC-Link module)

Figure 2.1 Communication path which GX Configurator-CT can use

(2) Restrictions when using the Redundant CPUs

- The coincidence detection interrupt function is not supported.
- The dedicated instruction cannot be used.

2.3 How to Check the Function Version/Serial No./Software Version

Check the function version and serial No. of the QD63P6 and the GX Configurator-CT software version by the following methods.

(1) Checking the rating plate on the module side

The rating plate is situated on the side face of the QD63P6.

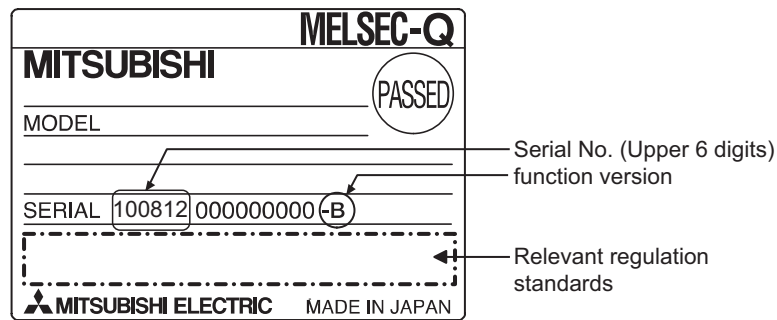

Figure 2.2 Checking the serial No. and function version (rating plate)

(2) Checking on the front of the module

The serial No. on the rating plate is also indicated on the front of the module (lower part).

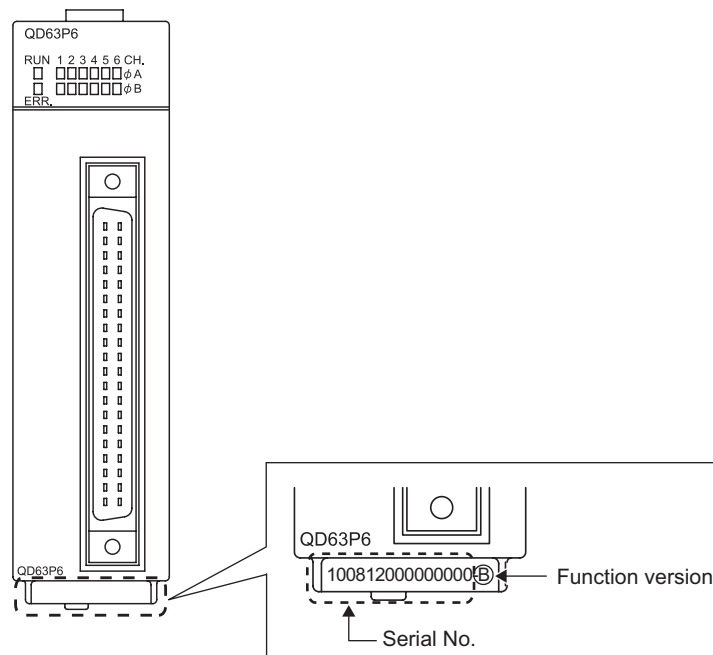

Figure 2.3 Display on the front of the module

(3) Confirming the serial number on the system monitor (Product Information List)

To display the screen for checking the serial number and function version, select [Diagnostics] → [System monitor] and click the "Product Inf. List" button in GX Developer.

Slot	Type	Series	Model name	Points	I/O No.	Master PLC	Serial No	Ver.
PLC	PLC	Q	Q25PHCPU	-	-	-	0610200000000000	C
0-0	Intelli. Q	QD63P6		32pt	0000	-	0904100000000000	B
0-1	-	-	None	-	-	-	-	-
0-2	-	-	None	-	-	-	-	-
0-3	-	-	None	-	-	-	-	-
0-4	-	-	None	-	-	-	-	-

Figure 2.4 System monitor

(a) Production No. display

Since the QD63P6 does not support the production number display, "-" is displayed.

POINT

The serial No. on the rating plate may be different from the serial No. displayed on the product information screen of GX Developer.

- The serial No. on the rating plate indicates the management information of the product.
- The serial No. displayed on the product information screen of GX Developer indicates the function information of the product. The function information of the product is updated when a new function is added.

(4) Checking the software version of GX Configurator-CT

The software version of GX Configurator-CT can be checked in GX Developer's "Product information" screen.

[Operating procedure]→

GX Developer → [Help] → [Product information]

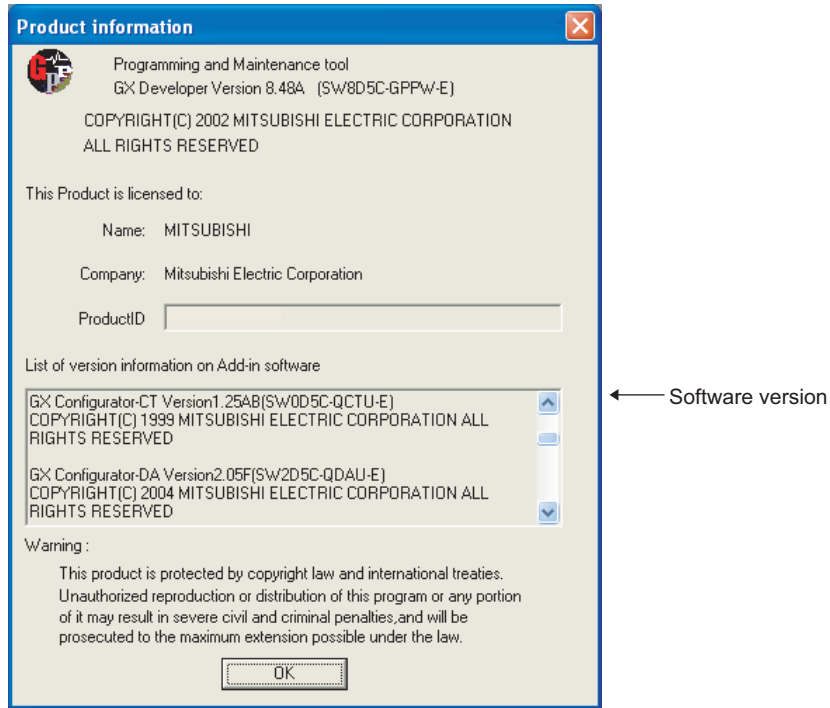

(In the case of GX Developer Version 8)

Figure 2.5 [Product information] screen of GX Developer

Remark

The version description for GX Configurator-CT has been changed as shown below from SW0D5C-QCTU-E 40E upgraded product.

Existing product		Products after the version upgrade
SW0D5C-QCTU-E 40E	→	GX Configurator-CT Version 1.10L

CHAPTER3 SPECIFICATIONS

This chapter describes the performance specifications of the QD63P6, I/O signals to the programmable controller CPU, specifications of the buffer memory.
 For general specifications of the QD63P6, refer to the User's Manual for the CPU module.

3.1 Performance Specifications

The following table shows the performance specifications of the QD63P6.

Table 3.1 Performance specifications of the QD63P6

Item	Model			
	QD63P6			
Counting speed switch setting*1	200 k (100 k to 200 kPPS)	100 k (10 k to 100 kPPS)	10 k (10 kPPS or less)	
Number of occupied I/O points	32 points (I/O assignment: Intelligent 32 points)			
Number of channels	6 channels			
Count input signal	Phase	1-phase input, 2-phase input		
	Signal level (ϕA , ϕB)	5 VDC 6.4 to 11.5 mA		
Counter	Counting speed (max.)*2	200 kPPS	100 kPPS	10 kPPS
	Counting range	32-bit signed binary (-2147483648 to 2147483647)		
	Model	UP/DOWN preset counter + Ring counter function		
	Minimum count pulse width (Duty ratio 50 %)	 (Unit: μs) (Minimum phase difference for 2-phase input: 1.25 μs)	 (Unit: μs) (Minimum phase difference for 2-phase input: 2.5 μs)	 (Unit: μs) (Minimum phase difference for 2-phase input: 25 μs)
Coincidence detection	Comparison range	32-bit signed binary		
	Comparison result	Setting value < Count value Setting value = Count value Setting value > Count value		
	Interrupt	With coincidence detection interrupt function		
5 VDC internal current consumption	0.59 A			
Weight	0.15 kg			

* 1 Make the counting speed switch setting with intelligent function module switch.

* 2 Counting speed is affected by pulse rise and fall time. Countable speeds are shown in Table 3.2.
 Note if a pulse with long rise and/or fall time is counted, a miscount may occur.

Table 3.2 Relation between rise/fall time and counting speed

Counting speed switch setting	200 k	100 k	10 k
Rise/fall time	Both 1 and 2-phase input		
$t = 1.25 \mu s$ or less	200 kPPS	100 kPPS	10 kPPS
$t = 2.5 \mu s$ or less	100 kPPS	100 kPPS	10 kPPS
$t = 25 \mu s$ or less	-	10 kPPS	10 kPPS
$t = 500 \mu s$	-	-	500 PPS

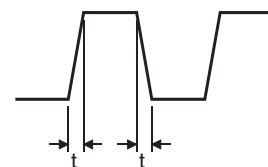

3.2 Function List

The following table shows the functions of the QD63P6.

I/O numbers (X/Y) and buffer memory addresses in Description describe only for channel 1.

For buffer memory addresses of channel 2 or later and I/O numbers (X/Y) of channel 2 or later, refer to Section 3.4.1 and Section 3.3.1, respectively.

Table 3.3 Function list of the QD63P6

Function	Description	Reference
Linear counter function	Countable from -2147483648 to 2147483647 and detects an overflow when the count range is overrun.	Section 5.2.1
Ring counter function	Repeats count between the ring counter upper limit value (Un\G2 and 3) and ring counter lower limit value (Un\G0 and 1).	Section 5.2.2
Coincidence detection function	Presets the coincidence detection point of an arbitrary channel, compares the detection point to the present counter value, and outputs the counter value coincidence (X02).	Section 5.3
Coincidence detection interrupt function	Inputs the interrupt signal to the programmable controller CPU when a coincidence is detected, and starts an interrupt program.	
Preset function	Rewrites the present counter value to an arbitrary value. Executes the preset with the sequence program.	Section 5.4
Periodic pulse counter function	Stores the present value A (Un\G10 and 11)/present value B (Un\G200 and 201) in the buffer memory at every preset period while the periodic pulse counter start command (Y05) is input.	Section 5.5

* The functions can be used in combination.
However, when using the linear counter function or ring counter function, select either of them.

3.3 I/O Signals to the Programmable Controller CPU

3.3.1 I/O signal list

The following table shows the I/O signals from the QD63P6 to the programmable controller CPU.

Note that that I/O numbers (X/Y) and I/O addresses mentioned in this and the subsequent chapters are assumed when the QD63P6 is mounted to the null I/O slot on the main base unit.

Table 3.4 I/O signal list

Input signal (Signal direction QD63P6 → Programmable controller CPU)		Output signal (Signal direction Programmable controller CPU → QD63P6)	
Device No.	Signal name	Device No.	Signal name
X00	Module READY	Y00	Reserved
X01	CH1	Y01	CH1
X02		Y02	
X03		Y03	
X04		Y04	
X05		Y05	
X06	CH2	Y06	CH2
X07		Y07	
X08		Y08	
X09		Y09	
X0A		Y0A	
X0B	CH3	Y0B	CH3
X0C		Y0C	
X0D		Y0D	
X0E		Y0E	
X0F		Y0F	
X10	CH4	Y10	CH4
X11		Y11	
X12		Y12	
X13		Y13	
X14		Y14	
X15	CH5	Y15	CH5
X16		Y16	
X17		Y17	
X18		Y18	
X19		Y19	
X1A	CH6	Y1A	CH6
X1B		Y1B	
X1C		Y1C	
X1D		Y1D	
X1E		Y1E	
X1F	Error occurrence	Y1F	Reserved

☒ POINT

The reserved devices above are for system use, not for users. If used (turning ON/OFF) by a user, the functions of the QD63P6 are not ensured.

3.3.2 Functions of I/O signals

The following table shows the I/O signals of the QD63P6.

I/O numbers (X/Y) and buffer memory addresses in Description describe only for channel 1.

For I/O numbers (X/Y) and buffer memory addresses from channels 2 to 6, refer to Section 3.3.1 and Section 3.4.1.

(1) I/O signals

Table 3.5 I/O signals



Device No.	Signal name QD63P6 → Programmable controller CPU	Description
X00	Module READY	<ul style="list-style-type: none"> •Turns ON at reset or power-ON of the programmable controller CPU when counting of the QD63P6 is ready, and the count processing is performed. •Turns OFF when watchdog timer error or an error which affects the system (error code: 810 to 850) occurs. •The count processing is not performed when the module READY (X00) is OFF. •This signal is used for an interlock of sequence programs.
X01	CH1	<ul style="list-style-type: none"> •Turns ON when the present value A (Un\G10 and 11)/present value B (Un\G200 and 201) > Coincidence detection point setting (Un\G6 and 7). •Turns OFF when the present value A (Un\G10 and 11)/present value B (Un\G200 and 201) ≤ Coincidence detection point setting (Un\G6 and 7). •For details of the general operation, refer to Section 5.3.
X06	CH2	
X0B	CH3	
X10	CH4	
X15	CH5	
X1A	CH6	

Table 3.5 I/O signals (Continued)

Device No.	Signal name QD63P6 → Programmable controller CPU		Description
X02	CH1	Counter value coincidence	<ul style="list-style-type: none"> •Turns ON and is the device is latched when the present value A (Un\G10 and 11)/present value B (Un\G200 and 201) = Coincidence detection point setting (Un\G6 and 7). •Turns OFF by the coincidence signal reset command (Y01). •The counter value coincidence (X02) turns ON immediately after power-ON or reset of the programmable controller CPU, since the present value A (Un\G10 and 11)/present value B (Un\G200 and 201) and coincidence detection point setting (Un\G6 and 7) are all '0'. •For general operation, refer to Counter value large (X01) or Section 5.3.
X07	CH2		
X0C	CH3		
X11	CH4		
X16	CH5		
X1B	CH6		
X03	CH1	Counter value small	<ul style="list-style-type: none"> •Turns ON when the present value A (Un\G10 and 11)/present value B (Un\G200 and 201) < Coincidence detection point setting (Un\G6 and 7). •Turns OFF when the present value A (Un\G10 and 11)/present value B (Un\G200 and 201) ≥ Coincidence detection point setting (Un\G6 and 7). •For general operation, refer to Counter value large (X01) or Section 5.3.
X08	CH2		
X0D	CH3		
X12	CH4		
X17	CH5		
X1C	CH6		
X1F	Error occurrence		<ul style="list-style-type: none"> •Turns ON when an error occurs at any of arbitrary channels. •To identify the channel where an error occurs, check the error code of the buffer memory (Un\G20). •Turns OFF when all channels are normal. <p style="text-align: right;">-----> Performed by the QD63P6.</p> <p>* Assumed that the errors have been reset with the error reset command of each channel.</p>

(2) Output signals

Table 3.6 Output signals

Device No.	Signal name Programmable controller CPU → QD63P6	Operation timing	Description
Y01	CH1		<ul style="list-style-type: none"> • Turn ON to reset the counter value coincidence (X02). • Note that the ON/OFF time must be 2ms or longer. *1 • Turn OFF the coincidence signal reset command (Y01) when the counter value coincidence (X02) is reset. • For general operation, refer to Counter value large (X01) or Section 5.3.
Y06	CH2		
Y0B	CH3		
Y10	CH4		
Y15	CH5		
Y1A	CH6		
Y02	CH1		<ul style="list-style-type: none"> • Turn ON to execute the preset function. • Note that the ON/OFF time must be 2ms or longer. *1 • Turn OFF the preset command (Y02) when the preset value setting (Un\G4 and 5) is stored to the present value A (Un\G10 and 11)/present value B (Un\G200 and 201). • For general operation, refer to "Section 5.4".
Y07	CH2		
Y0C	CH3		
Y11	CH4		
Y16	CH5		
Y1B	CH6		
Y03	CH1		<ul style="list-style-type: none"> • Turn ON to perform the subtraction count at 1-phase pulse input mode. • If either phase B pulse is input or the subtraction count command (Y03) turns ON, the subtraction count is performed. • Check that the phase B pulse is input and the subtraction count command (Y03) is OFF for addition. • This command operates as follows when the pulse input mode is 1 multiple of 1 phase.
Y08	CH2		
Y0D	CH3		
Y12	CH4		
Y17	CH5		
Y1C	CH6		

* 1 Set ON/OFF time such as the coincidence signal reset command (Y01) to 2ms or longer using the following methods.

- Using the timer (T) device
- Set the constant scan to 2 ms or longer.

Table 3.6 Output signals (Continued)

Device No.	Signal name Programmable controller CPU → QD63P6	Operation timing	Description
Y04	CH1		<p>•Turn ON to perform count operation.</p> <p>•This command operates as follows when the pulse input mode is 1 multiple of 1 phase.</p> <p>ϕA</p> <p>ϕB</p> <p>Count enable command (Y04)</p> <p>Present value A (Un\G10 and 11)</p>
Y09	CH2		
Y0E	CH3		
Y13	CH4		
Y18	CH5		
Y1D	CH6		
Y05	CH1		<p>Turn ON to execute the periodic pulse counter function.</p> <p>-----> Performed by the QD63P6.</p> <p>Present value A (Un\G10 and 11)</p> <p>Periodic pulse counter start command (Y05)</p> <p>Period setting (Un\G9)</p> <p>Previous periodic pulse count value (Un\G14 and 15)</p> <p>Present periodic pulse count value (Un\G16 and 17)</p> <p>Judgment value for updated periodic pulse count value (Un\G18 and 19)</p> <p>Periodic counter flag (Un\G13)</p> <p>*The period setting (Un\G9) is enabled when the periodic pulse counter start command (Y05) turns ON from OFF.</p>
Y0A	CH2		
Y0F	CH3		
Y14	CH4		
Y19	CH5		
Y1E	CH6		

Remark

Definitions of the expressions in Operation timing are as follows.

- Enabled while the signal is ON.
- Enabled when the signal turns from OFF to ON.

3.4 Buffer Memory Assignment

3.4.1 List of buffer memory assignment

The following table shows the buffer memory assignment of the QD63P6.

Table 3.7 List of buffer memory assignment

Address (decimal notation)						Setting contents	Initial value*1	Read/write	Reference	
CH1	CH2	CH3	CH4	CH5	CH6					
0	30	60	90	120	150	Ring counter lower limit value *2	(L)	0	Read/write are enabled.	Section 3.4.2 (1)
1	31	61	91	121	151		(H)			
2	32	62	92	122	152	Ring counter upper limit value *2	(L)			
3	33	63	93	123	153		(H)			
4	34	64	94	124	154	Preset value setting *2	(L)			Section 3.4.2 (2)
5	35	65	95	125	155		(H)			
6	36	66	96	126	156	Coincidence detection point setting *2	(L)			Section 3.4.2 (3)
7	37	67	97	127	157		(H)			
8	38	68	98	128	158	Coincidence detection point change request				
9	39	69	99	129	159	Period setting				Section 3.4.2 (4)
10	40	70	100	130	160	Present value A *2	(L)	Section 3.4.2 (5)		
11	41	71	101	131	161		(H)			
12	42	72	102	132	162	Overflow detection flag		Section 3.4.2 (6)		
13	43	73	103	133	163	Periodic counter flag		Section 3.4.2 (7)		
14	44	74	104	134	164	Previous periodic pulse count value *2	(L)	Section 3.4.2 (8)		
15	45	75	105	135	165		(H)			
16	46	76	106	136	166	Present periodic pulse count value *2	(L)			
17	47	77	107	137	167		(H)			
18	48	78	108	138	168	Judgment value for updated periodic pulse count value *2	(L)			
19	49	79	109	139	169		(H)			
20	50	80	110	140	170	Error code		Section 3.4.2 (9)		
21	51	81	111	141	171	Error reset command		Section 3.4.2 (10)		
22 to 29	52 to 59	82 to 89	112 to 119	142 to 149	172 to 179	Reserved	-	-	-	
200	202	204	206	208	210	Present value B *2	(L)	0	Read only	Section 3.4.2 (5)
201	203	205	207	209	211		(H)			

* 1 Initial value which is set when the programmable controller CPU is powered ON or reset.

POINT

- The reserved areas in the above table and areas not mentioned in the table are for system use, not for users. If written by a user, the functions of the QD63P6 are not ensured.
- All data in the buffer memory of the QD63P6 are initialized when the programmable controller CPU is powered ON or reset. To save necessary data, use the FROM/DFRO/TO/DTO instructions in the sequence program or make setting with the utility package for writing/reading the buffer memory data.

POINT

- Items with "*2" in Table 3.7 are stored in 32-bit signed binary to the buffer memory; therefore, make sure to read each value in units of 2 words.
 - Since the buffer memory contents are automatically updated by count operation, the latest count value can be read from the buffer memory.
-

3.4.2 Details of the buffer memory

This section describes details of the QD63P6 buffer memory.

Each item contains the I/O numbers (X/Y) and buffer memory addresses of channel 1 only. For buffer memory addresses of channel 2 or later and I/O numbers (X/Y) of channel 2 or later, refer to Section 3.4.1 and Section 3.3.1, respectively.

(1) Ring counter lower limit value (Un\G0 and 1) Ring counter upper limit value (Un\G2 and 3)

- This area is used for setting count range when the counter format is the ring counter. (Refer to Section 5.2.2.)
- Setting value when the count enable command (Y04) changes from OFF to ON becomes effective.
- Setting range is from -2147483648 to 2147483647 (32-bit signed binary).

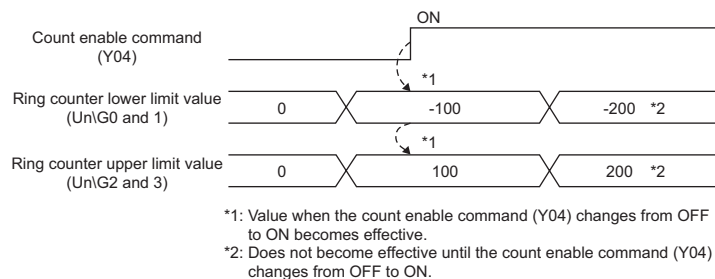

Figure 3.1 Timing chart for the ring counter lower limit value (Un\G0 and 1) and ring counter upper limit value (Un\G2 and 3)

(2) Preset value setting (Un\G4 and 5)

- This area is used for setting the preset value for the counter. (Refer to Section 5.4.)
- Setting value when the preset command (Y02) changes from OFF to ON becomes effective.
- Setting range is from -2147483648 to 2147483647 (32-bit signed binary).

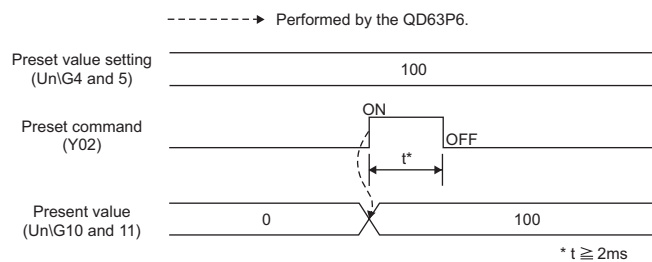

Figure 3.2 Timing chart for the preset value setting (Un\G4 and 5)

- For details of the general operation, refer to Section 5.4.

(3) Coincidence detection point setting (Un\G6 and 7)**Coincidence detection point change request (Un\G8)**

- Write the coincidence detection point setting value to be compared with the present value A (Un\G10 and 11)/counter present value B (Un\G200 and 201) for counter.
- When 1 (Change request) is written to the coincidence detection point change request (Un\G8), the value written to the coincidence detection point setting (Un\G6 and 7) becomes effective, the QD63P6 writes 0 (No change request) to the coincidence detection point change request (Un\G8), and then the coincidence detection point setting is started.
- Setting range of the coincidence detection point setting (Un\G6 and 7) is from -2147483648 to 2147483647 (32-bit signed binary).
- If 1 (Change request) is not written into the coincidence detection point change request (Un\G8), the coincidence detection point setting value (Un\G6 and 7) does not become effective.
- If 1 (Change request) is not written, the setting is not reflected.

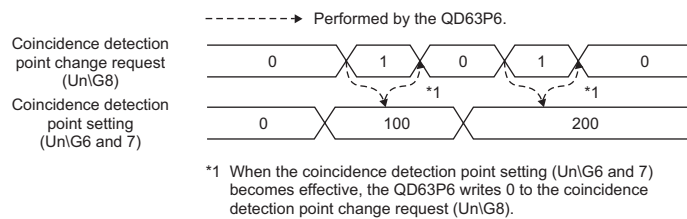

Figure 3.3 Timing chart for the coincidence detection point setting (Un\G6 and 7) and coincidence detection point change request (Un\G8)

- For details of the general operation, refer to Section 5.3.

(4) Period setting (Un\G9)

- This area is used for writing the cycle at which the periodic pulse counter function (refer to Section 5.5) is to be performed.
- Setting value when the periodic pulse counter start command (Y05) changes from OFF to ON becomes effective.
- Setting range is from 1 to 65535 (16-bit binary) and unit of the time is 10 [ms].

Example) Writing 420 to the period setting (Un\G9)

$$420 \times 10 = 4200 \text{ [ms]}$$

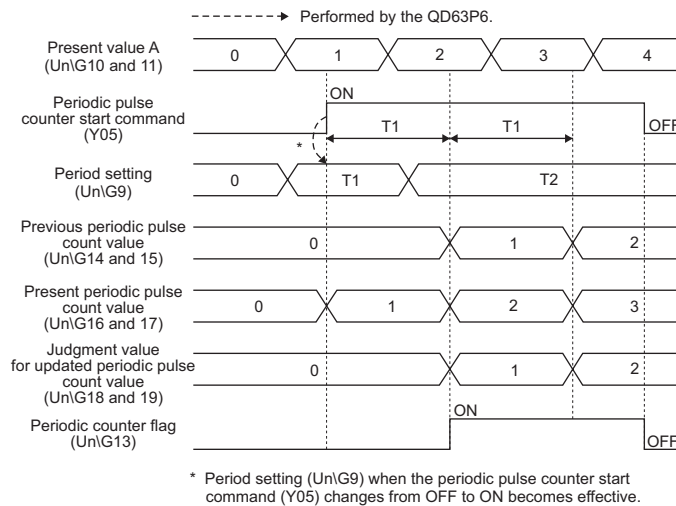

Figure 3.4 Timing chart for the period setting (Un\G9)

POINT

- When writing from 32768 to 65535 (8000H to FFFFH) in the period setting (Un\G9) (refer to (4) in this section), write it in hexadecimal number.
- If 0 is set to the period setting (Un\G9), the period setting error (error code: 600) is stored to the error code (Un\G20) and the periodic pulse counter function is not executed.

To execute the periodic pulse counter function, write a value within the setting range (1 to 65535) to the period setting (Un\G9) and turn the periodic pulse counter start command (Y05) ON, OFF and ON again. Note that the OFF time must be 2ms or longer.

(5) Present value A (Un\G10 and 11) and present value B (Un\G200 and 201)

- The present counter value is stored in this area.
- Select the present value A (Un\G10 and 11) to read such as the present value and overflow detection flag (Un\G12) for each channel, and select the present value B (Un\G200 and 201) to read the present values of multiple channels at a time. Set the storage location (present value A/present value B) with the intelligent function module switch. (Refer to Section 4.5.)
- The range of a value to be read is from -2147483648 to 2147483647 (32-bit signed binary).

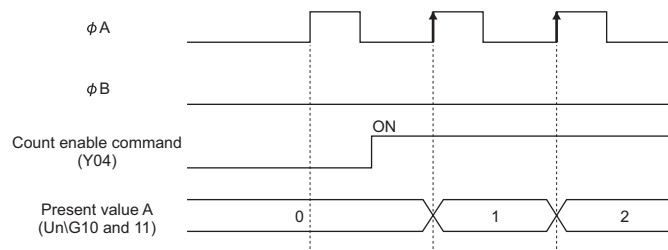

Figure 3.5 Timing chart for the present value A (Un\G10 and 11)

(6) Overflow detection flag (Un\G12)

- Overflow occurrence status is stored in this area when the counter format is the linear counter (refer to Section 5.2.2).
- According to the overflow occurrence status, 0 (No detection) or 1 (Overflow occurred) is stored to the overflow detection flag (Un\G12).
- This flag operates as follows. (when the pulse input mode is 1 multiple of 1 phase)

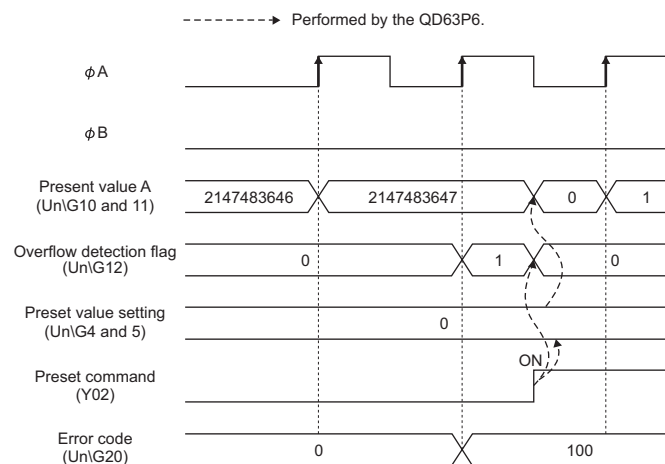

Figure 3.6 Timing chart for the overflow detection flag (Un\G12)

(7) Periodic counter flag (Un\G13)

- Operation status of the function is stored in this area during execution of the periodic pulse counter function (refer to Section 5.5).
- "0" is stored during stop of the periodic pulse counter function and "1" is stored during execution of the function in the periodic counter flag (Un\G13).

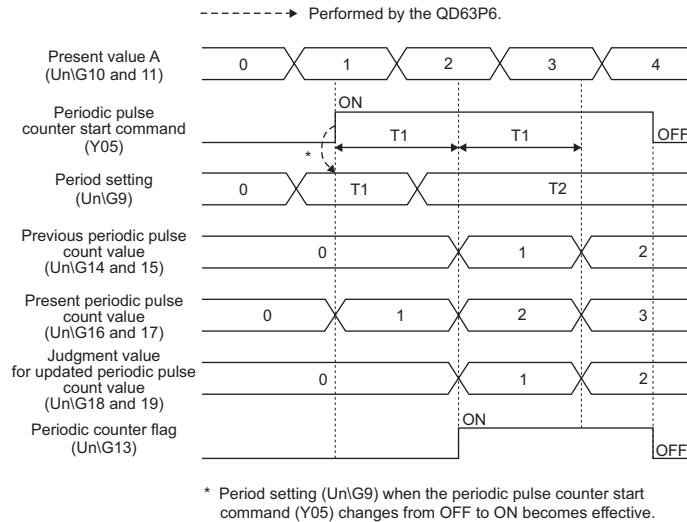

Figure 3.7 Timing chart for the periodic counter flag (Un\G13)

(8) Previous periodic pulse count value (Un\G14 and 15), present periodic pulse count value (Un\G16 and 17), and judgment value for updated periodic pulse count value (Un\G18 and 19)

- This area is used at the periodic pulse counter function (refer to Section 5.5) execution.
- For general operation, refer to the periodic pulse counter function (Section 5.5).
- After the update of the previous periodic pulse count value (Un\G14 and 15) and present periodic pulse count value (Un\G16 and 17), the previous periodic pulse count value (Un\G14 and 15) is stored in the judgment value for updated periodic pulse count value (Un\G18 and 19).
- If the previous periodic pulse count value (Un\G14 and 15) and judgment value for updated periodic pulse count value (Un\G18 and 19) are not equal, inconsistency occurs. Reread the previous periodic pulse count value (Un\G14 and 15), present periodic pulse count value (Un\G16 and 17), and judgment value for updated periodic pulse count value (Un\G18 and 19).
- The range of a value to be read is from -2147483648 to 2147483647 (32-bit signed binary).

(9) Error code (Un\G20)

- Code of the detected error (refer to Section 8.5) is stored in this area.
- For operations when multiple errors occur concurrently, refer to POINT in Section 8.5.

(10) Error reset command (Un\G21)

- This area is used for resetting the error code stored in the error code of buffer memory (Un\G20) by "0".
- Writing 1 (ON) to the error reset command (Un\G21) resets the error code.
- After an error code is reset, the QD63P6 writes 0 (OFF) to the error reset command (Un\G21).
- After fixing the error cause, make sure to reset the error code with the error reset command (Un\G21).

If a new error (error code: 100 to 600) occurs while an error code is still stored to the error code in buffer memory (Un\G20), the error code stored last is retained and the latest error code is not stored. (Refer to Section 8.5.)

- If the error code is reset with the error reset command (Un\G21) while the error cause has not yet been fixed, the error code is stored again to the error code in buffer memory (Un\G20) when the error cause is detected again. (Refer to Section 8.5.)
- If a value other than 1 (ON) is written to the error reset command (Un\G21), the error is not reset.

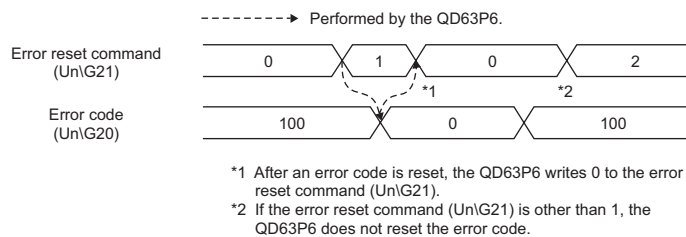

Figure 3.8 Timing chart for the error reset command (Un\G21)

3.5 Interface with External Devices

The following table shows the list of external device interface for the QD63P6.

Table 3.8 External device interface list for the QD63P6

I/O classification	Internal circuit	Terminal number	Signal name	Operation	Input voltage (guaranteed value)	Operating current (guaranteed value)
Input		Refer to Table 3.9.	Phase A pulse input +	ON	4.5 to 5.5 V	6.4 to 11.5 mA
			Phase A pulse input -	OFF	2 V or less	0.1 mA or less
			Phase B pulse input +	ON	4.5 to 5.5 V	6.4 to 11.5 mA
			Phase B pulse input -	OFF	2 V or less	0.1 mA or less

Table 3.9 Terminal layout of each channel

Terminal layout	Terminal number	Signal name	Terminal number	Signal name
	B20	Reserved	A20	Reserved
	B19	CH1 Phase A pulse input -	A19	CH1 Phase A pulse input +
	B18	CH1 Phase B pulse input -	A18	CH1 Phase B pulse input +
	B17	Reserved	A17	Reserved
	B16	CH2 Phase A pulse input -	A16	CH2 Phase A pulse input +
	B15	CH2 Phase B pulse input -	A15	CH2 Phase B pulse input +
	B14	Reserved	A14	Reserved
	B13	CH3 Phase A pulse input -	A13	CH3 Phase A pulse input +
	B12	CH3 Phase B pulse input -	A12	CH3 Phase B pulse input +
	B11	Reserved	A11	Reserved
	B10	CH4 Phase A pulse input -	A10	CH4 Phase A pulse input +
	B09	CH4 Phase B pulse input -	A09	CH4 Phase B pulse input +
	B08	Reserved	A08	Reserved
	B07	CH5 Phase A pulse input -	A07	CH5 Phase A pulse input +
	B06	CH5 Phase B pulse input -	A06	CH5Phase B pulse input +
	B05	Reserved	A05	Reserved
	B04	CH6 Phase A pulse input -	A04	CH6 Phase A pulse input +
	B03	CH6 Phase B pulse input -	A03	CH6 Phase B pulse input +
	B02	Reserved	A02	Reserved
	B01	Reserved	A01	Reserved

B20 0 0 A20
 B19 0 0 A19
 B18 0 0 A18
 B17 0 0 A17
 B16 0 0 A16
 B15 0 0 A15
 B14 0 0 A14
 B13 0 0 A13
 B12 0 0 A12
 B11 0 0 A11
 B10 0 0 A10
 B09 0 0 A09
 B08 0 0 A08
 B07 0 0 A07
 B06 0 0 A06
 B05 0 0 A05
 B04 0 0 A04
 B03 0 0 A03
 B02 0 0 A02
 B01 0 0 A01

Viewed from the front of the module

3.6 Connectable Encoders

The encoders connectable to the QD63P6 are described below.

- Open collector output type encoders
- CMOS level voltage output type encoders
(Confirm that the encoder output voltage meets the specifications for the QD63P6.)

☒POINT

The following encoder is not applicable for the QD63P6.

- TTL level voltage output type encoders
-

CHAPTER 4 PROCEDURES AND SETTINGS BEFORE OPERATION

This chapter describes the operating procedures before operation, part names, settings, and wiring of the QD63P6.

4.1 Handling Precautions

This section describes precautions on handling the QD63P6.

- (1) **Do not drop the module case and/or connector or apply a strong impact to it.**
- (2) **Do not remove the printed-circuit board of the module from the case. Doing so will cause failure.**
- (3) **Be careful to prevent foreign matter such as wire chips from entering the module. Failure to do so may cause a fire, failure or malfunction.**
- (4) **A protective film is attached to the module top to prevent foreign matter such as wire chips from entering the module during wiring. Do not remove the film during wiring. Be sure to remove it for heat dissipation before system operation.**
- (5) **Tighten the screws such as module fixing screws within the following ranges. If the screw is too loose, it may cause a drop, short circuit, or malfunction. Excessive tightening may damage the screw and/or the module, resulting in a drop, short circuit or malfunction.**

Table 4.1 Tightening torque range of module fixing screw

Screw	Tightening torque range
Module fixing screw (M3 screw)* ¹	0.36 to 0.48 N·m
Connector screw (M2.6 screw)	0.20 to 0.29 N·m

* 1 The module can be easily fixed onto the base unit using the hook at the top of the module. However, it is recommended to secure the module with the module fixing screw if the module is subject to significant vibration.

- (6) **To mount the module on the base unit, fully insert the module fixing projection into the fixing hole in the base unit and press the module using the hole as a fulcrum. Incorrect module mounting may cause a malfunction, failure, or drop of the module.**

4.2 Procedures before Operation

The following flowchart shows the procedures for operating the QD63P6.

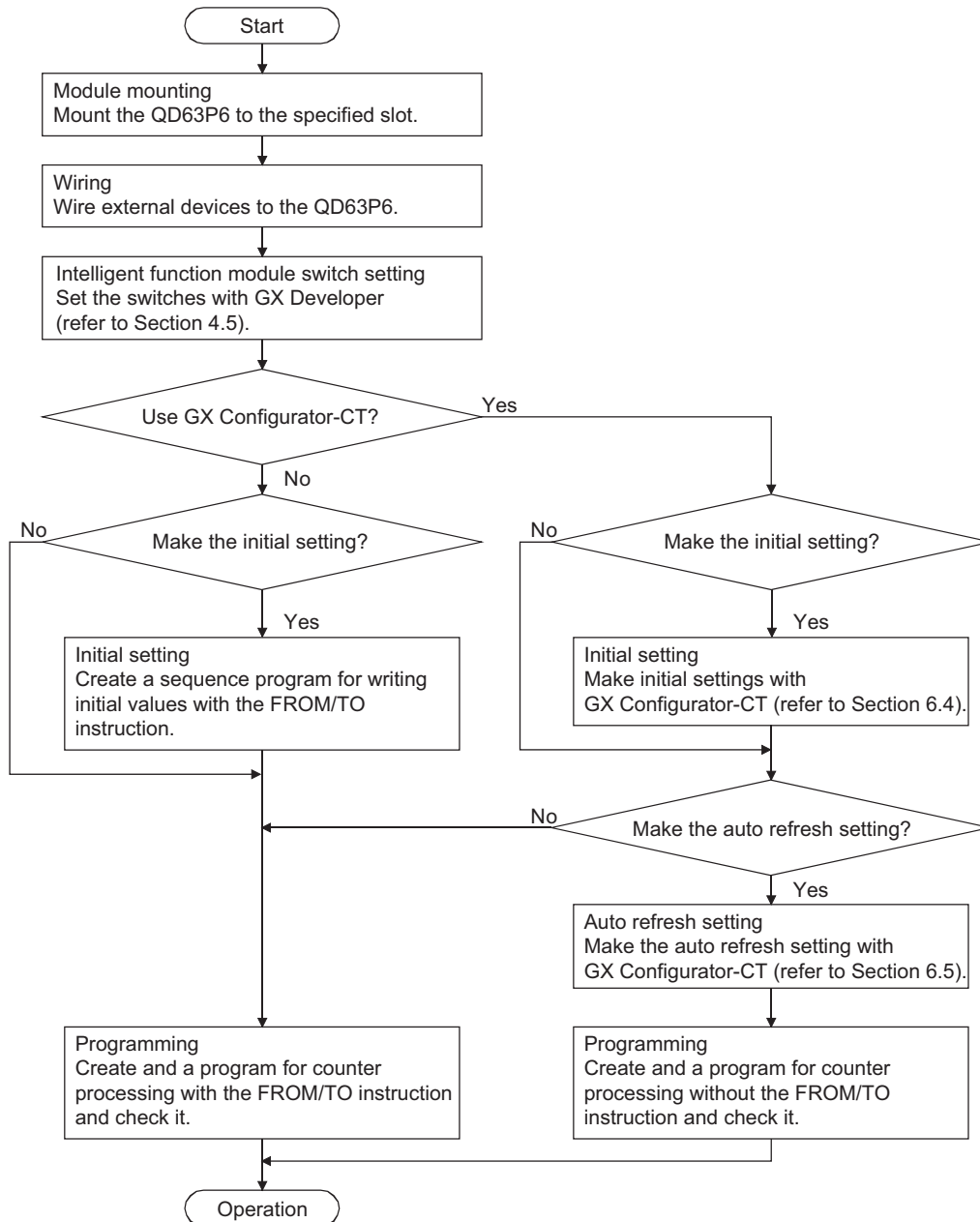

Figure 4.1 Procedures before operation

4.3 Part Names

The following explains the part names of the QD63P6.

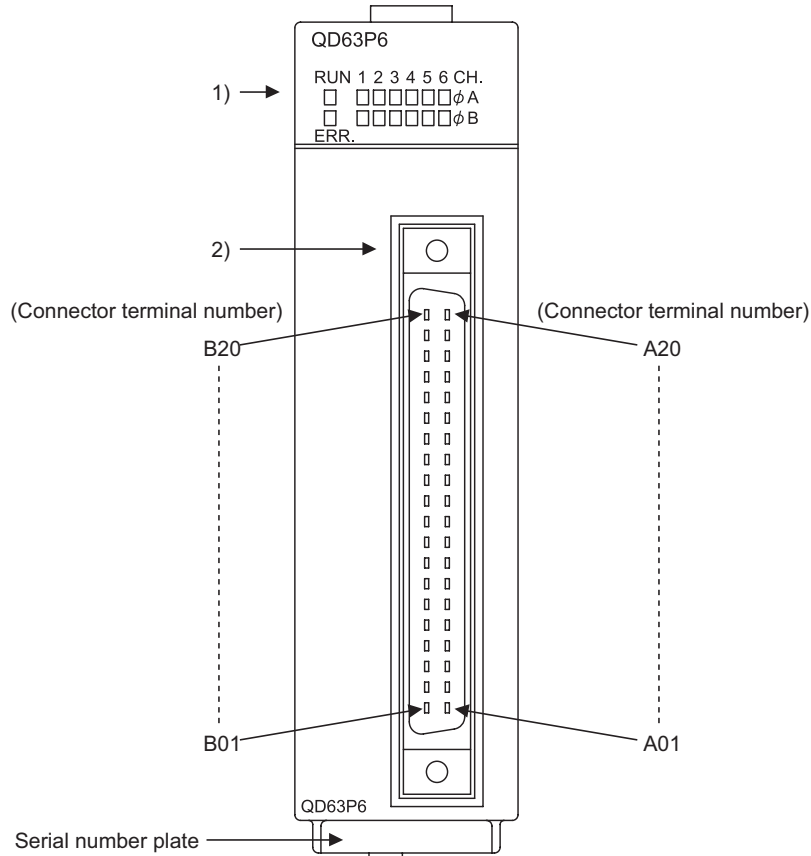

Figure 4.2 Appearance of the QD63P6

Table 4.2 Part names

Name		Description
1)	LED display	RUN ON: Normal operation OFF: Watchdog timer error
		ERR. ON: Error at 1 or later CH OFF: All channels in normal operation
		ϕA_CH1 to CH6 ON: Pulse ON OFF: Pulse OFF
		ϕB_CH1 to CH6 ON: Pulse ON OFF: Pulse OFF
2)	External device connector (40 pins)	Connector for connecting an encoder For terminal layout, refer to Section 3.5.

(1) Connectors for external wiring

Purchase the connector for the QD63P6 separately.

The following tables show the recommended connector types and crimp tool.

(a) Connector types

Table 4.3 Connector types

Type	Model
Soldering type, straight out	A6CON1
Crimp type, straight out	A6CON2
Soldering type, usable for both straight out and diagonal out	A6CON4

* The A6CON3 connector (pressure welding type, straight out) cannot be used for the QD63P6.

(b) Connector crimp tool

Table 4.4 Connector crimp tool

Type	Model	Applicable wire size	Contact
Crimp tool	FCN-363T-T005/H	28 to 24AWG	FUJITSU COMPONENT LIMITED

4.4 Wiring

This section describes wiring an encoder and controller to the QD63P6.

4.4.1 Wiring precautions

One of the conditions to maximize the QD63P6 functions and make the system high-reliable, the external wiring has to be laid so that the QD63P6 becomes less subject to noise.

This section describes the precautions on external wiring.

- (1) Inputting a signal of different voltage may result in a malfunction or mechanical failure.**
- (2) For 1-phase input, always perform pulse input wiring on the phase A side.**
- (3) When pulse status noise is input, the QD63P6 may miscount.**
- (4) Take the following measures against noise for high-speed pulse input.**
 - (a) Always use a shielded twisted pair cable and provide grounding.
 - (b) Wire the shielded twisted pair cables so as not to be in parallel with wires causing much noise such as power lines or I/O wires while keeping a distance of at least 150 mm (5.91 inch) between such wires. Also install the shielded twisted pair cables as short as possible.

(5) The following diagram shows an example of wiring for measures against noise.

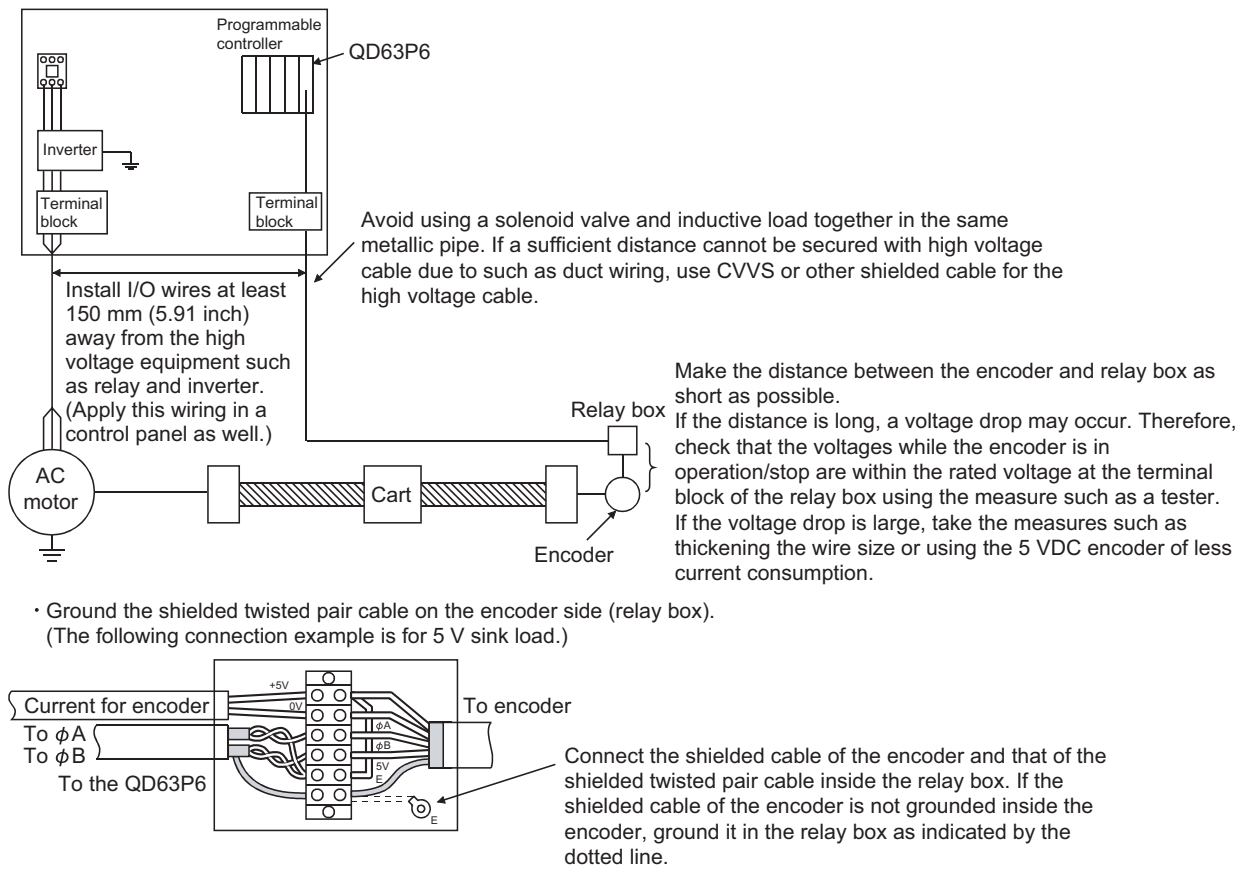

Figure 4.3 Example of wiring for measures against noise

(6) When wiring the QD63P6 and an encoder, separate the power supply cable and signal line. (Refer to POINT in Section 4.4.2.)

- (7) To conform the wiring to the EMC and Low Voltage Directives, ground the shielded twisted pair cables to a control panel with the AD75CK cable clamp (manufactured by Mitsubishi Electric Corporation).

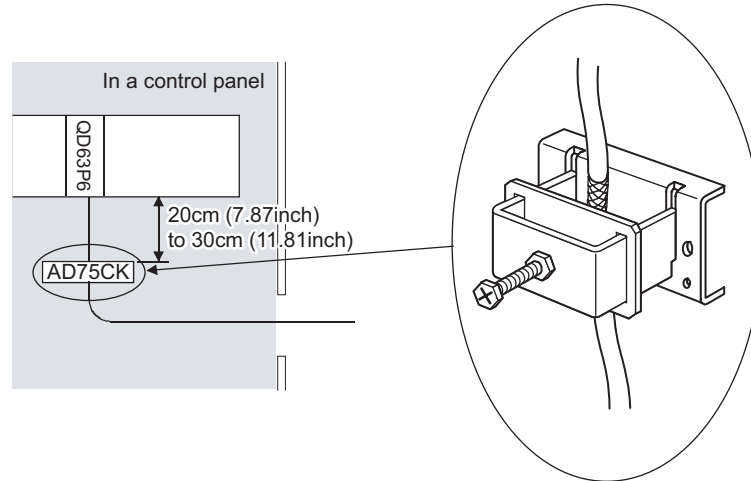

Figure 4.4 AD75CK cable clamp

For the AD75CK, refer to the following manual.

- AD75CK-type Cable Clamping Instruction Manual

4.4.2 Example of wiring the module and an encoder

(1) Example of wiring with an encoder of open collector output type (5 VDC)

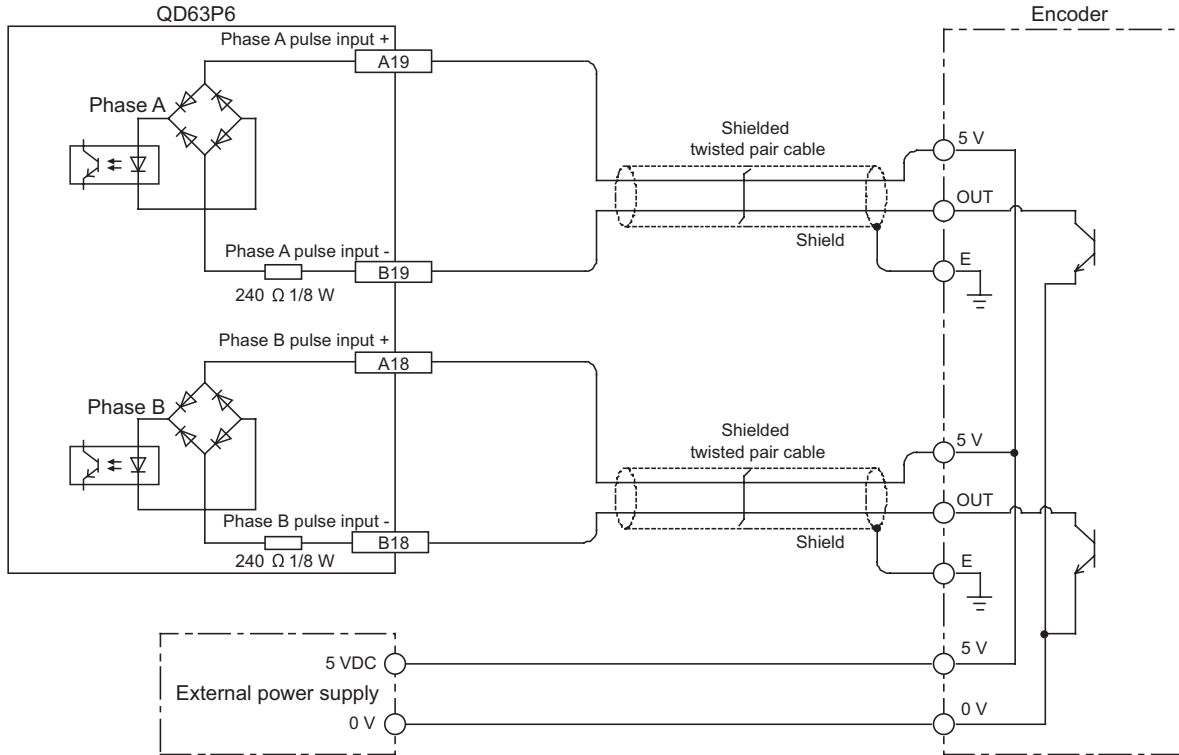

Figure 4.5 Example of wiring with an encoder (5 VDC)

POINT

When wiring the QD63P6 and an encoder, separate the power supply cable and signal line.

The following diagram shows an example of wiring with Phase A. (Wire Phase B as well).

[Wiring example]

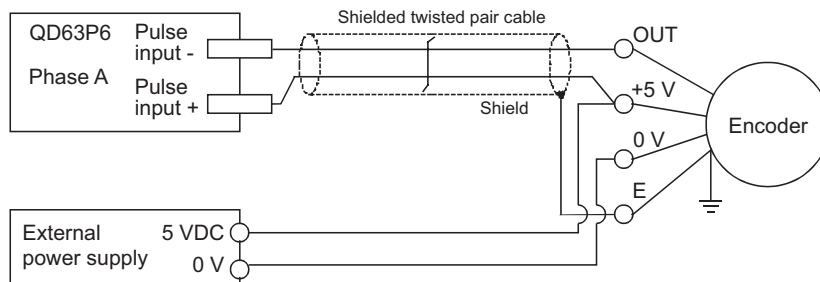

Figure 4.6 Wiring example

[Incorrect wiring example]

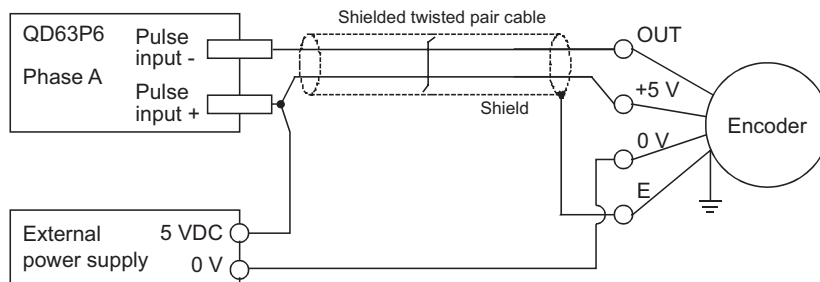

Figure 4.7 Incorrect wiring example

Since the current through the shielded twisted pair cable flows in the same direction, canceling effect does not work, which results in susceptibility to electromagnetic induction.

(2) Example of wiring with an encoder of open collector output type (12/24 VDC)

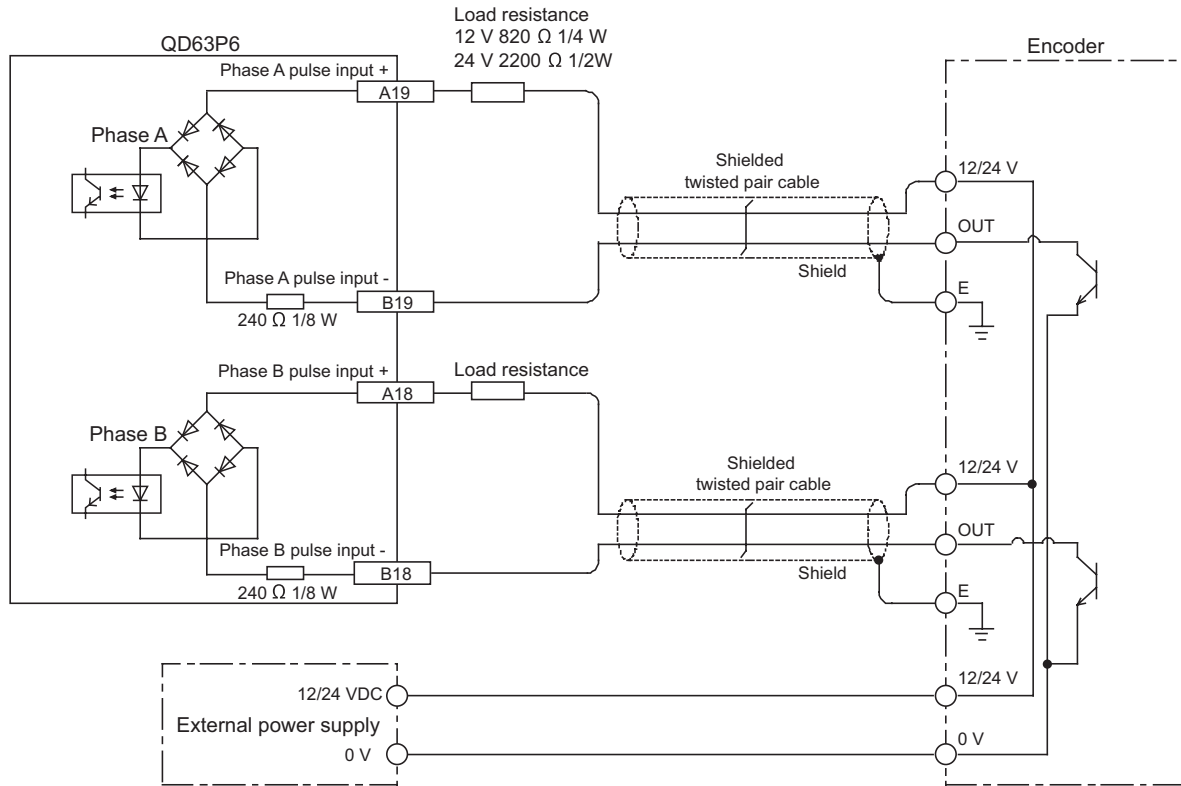

Figure 4.8 Example of wiring with an encoder (12/24 VDC)

According to external power supply voltage, connect load resistance between each pulse input terminal of the QD63P6 and shielded twisted pair cable. The following table shows conditions on load resistance.

Table 4.5 Conditions on load resistance

External voltage [V]	Load resistance [Ω]	Capacity [W]	Tolerance [%]
12	820	1/4	± 5
24	2200	1/2	± 5

POINT

When wiring the QD63P6 and an encoder, separate the power supply cable and signal line.

The following diagram shows an example of wiring with Phase A. (Wire Phase B as well).

[Wiring example]

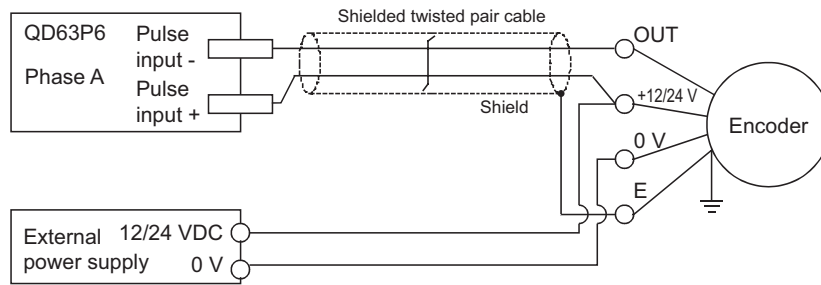
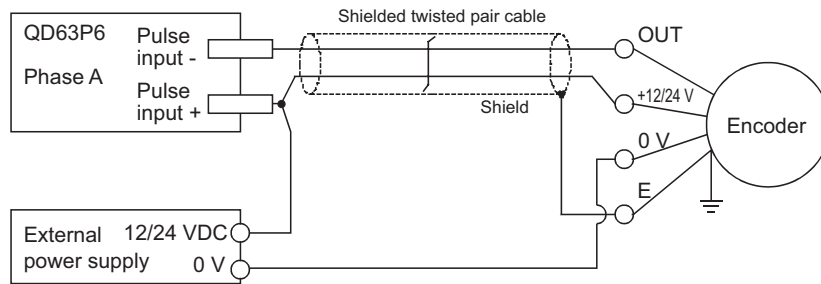

Figure 4.9 Wiring example

[Incorrect wiring example]



Since the current through the shielded twisted pair cable flows in the same direction, canceling effect does not work, which results in susceptibility to electromagnetic induction.

Figure 4.10 Incorrect wiring example

(3) Example of wiring with an encoder of voltage output type (5 VDC)

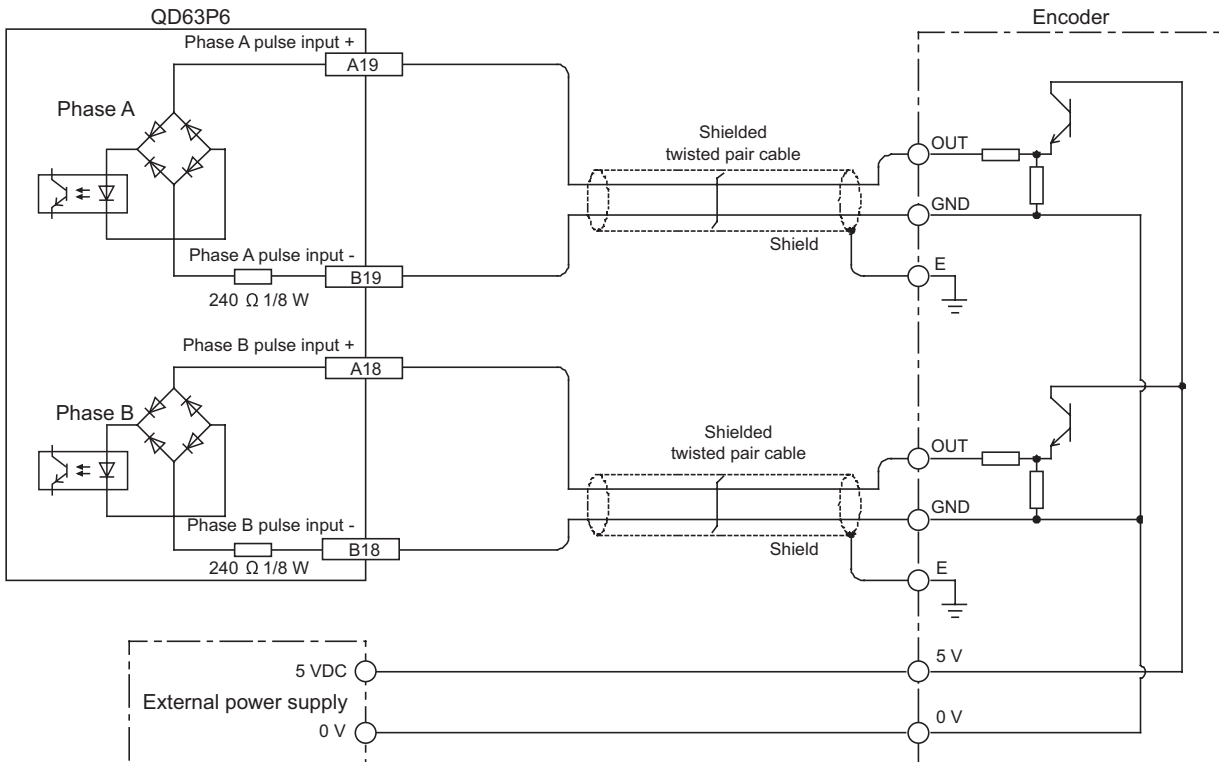

Figure 4.11 Example of wiring with an encoder (5 VDC)

(4) Example of wiring with an encoder of voltage output type (12/24 VDC)

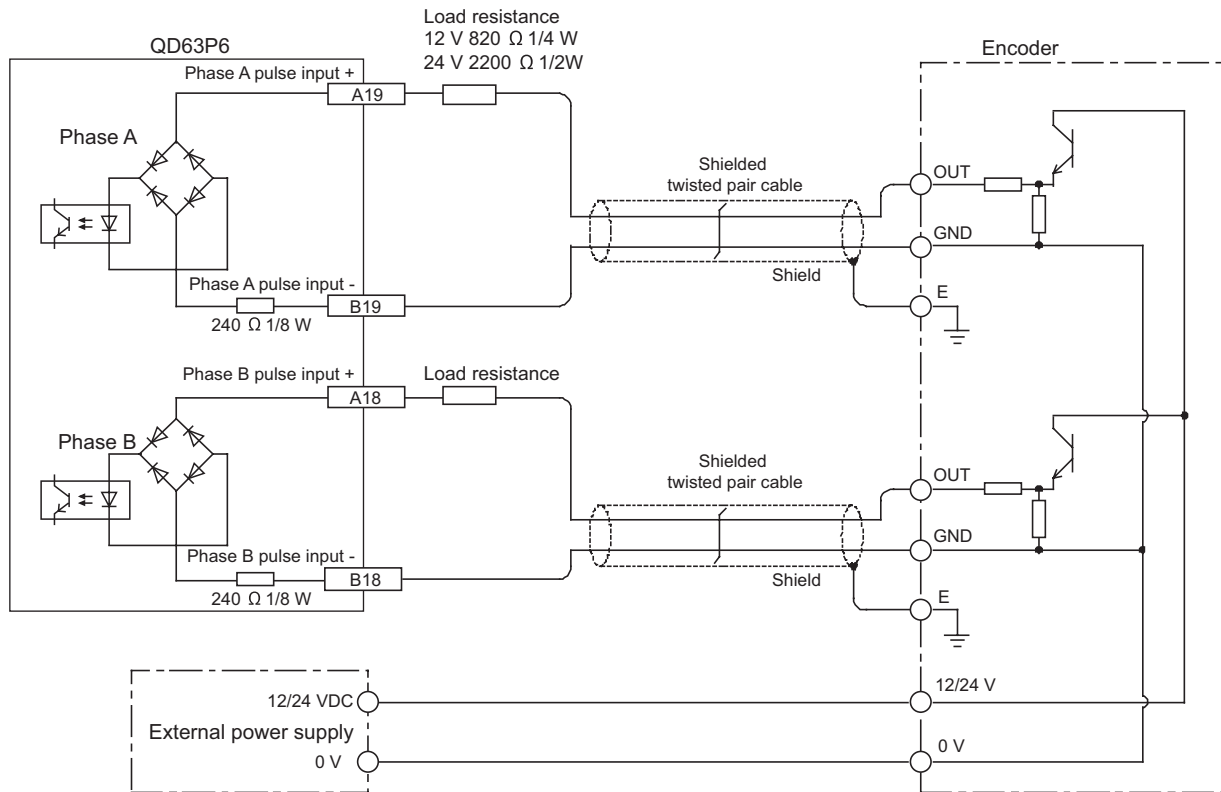

Figure 4.12 Example of wiring with an encoder (12/24 VDC)

According to external power supply voltage, connect load resistance between each pulse input terminal of the QD63P6 and shielded twisted pair cable. The following table shows conditions on load resistance.

Table 4.6 Conditions on load resistance

External voltage [V]	Load resistance [Ω]	Capacity [W]	Tolerance [%]
12	820	1/4	± 5
24	2200	1/2	± 5

4.5 Intelligent Function Module Switch Setting

This section describes the intelligent function module switch setting.
The switch setting is made on the [I/O assignment] screen of GX Developer.

(1) Intelligent function module switch setting

The switch has five switches and is set at 16-bit data.

When the switch setting is not made, the default values of the switches from 1 to 5 are 0.

Table 4.7 Intelligent function module switches

	Setting item	Setting value	Default value
Switch 1	Pulse input mode 	Pulse input mode (Refer to Section 5.1.1.) 0H: 1 multiple of 1 phase 1H: 2 multiples of 1 phase 2H: CW/CCW 3H: 1 multiple of 2 phases 4H: 2 multiples of 2 phases 5H: 4 multiples of 2 phases	0000 _H
Switch 2	Pulse input mode Reserved: CH6 CH5 Fixed to 0	0H: 1 multiple of 1 phase 1H: 2 multiples of 1 phase 2H: CW/CCW 3H: 1 multiple of 2 phases 4H: 2 multiples of 2 phases 5H: 4 multiples of 2 phases	0000 _H
Switch 3	Counting speed setting Reserved: Fixed to 0	Counting speed setting (Refer to Section 3.1.) Set the following bit pattern with hexadecimal. 00: 10 kPPS 01: 100 kPPS 10: 200 kPPS Example) CH1 and 2: 200 kPPS, CH3: 100 kPPS, and CH4 to 6 : 10 kPPS 00 00 00 01 10 10 → 001A _H	0000 _H
Switch 4	Counter format, present value selection setting Reserved: Fixed to 0	Counter format (Refer to Section 5.2.1 and Section 5.2.2.) Set the following bit pattern with hexadecimal. 0: Linear counter 1: Ring counter Example) Linear counter: CH1, CH2, and CH5 Ring counter: CH3, CH4, and CH6 00101100 → 2C _H	0000 _H
Switch 5	Reserved: Fixed to 0.		

(Example) Target channel: channel 1, pulse input mode setting: 1 multiple of 2 phases, counting speed setting: 200 kPPS, counter format: ring counter, and present value selection setting: setting value B

Set the switch 1 = 0003H.

Set the switch 3 = 0002H.

Set the switch 4 = 0101H.

POINT

The reserved bits in Table 4.7 are for system use, not for users. Therefore, always fix them to 0. If used (changed from 0 to 1) by a user, the operations of the QD63P6 are not ensured.

(2) Details of the intelligent function module switch setting

Table 4.8 Details of the intelligent function module switch setting

Setting item	Description	Reference
Pulse input mode	Set the pulse input mode for each channel. When setting 6H to FH, a switch setting error (error code: 810) occurs. (Refer to Section 8.5.)	Section 5.1.1
Counting speed setting	Set the counting speed for each channel. (When setting 11 (3H), a switch setting error (error code: 810) occurs. (Refer to Section 8.5.)	Section 3.1
Counter format	Set the counter format for each channel.	Section 5.2.1 Section 5.2.2
Present value selection setting	Set the same storage location of the present counter value (present value A (Un\G10 and 11)/present value B (Un\G200 and 201)) to all channels.	Section 3.4.2 (5)

(3) Operating procedure

Set the switches on the [I/O assignment] screen of GX Developer.

(a) [I/O assignment] screen

Make the following settings to the slot to which the QD63P6 is mounted.

[Type]: Select [Intelli].

[Model name]: Input the model of the module.

[Points]: Select [32points].

[Start XY]: Input the head I/O number of the QD63P6.

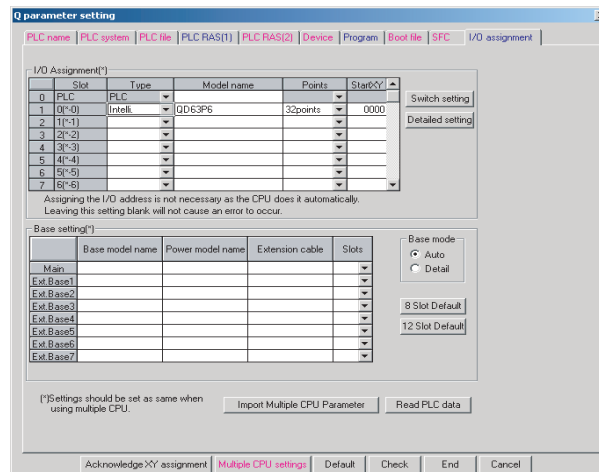

Figure 4.13 Setting example of [I/O assignment]

(b) [Switch setting for I/O and intelligent function module] screen

Click the **Switch setting** on the [I/O assignment] screen to display the screen below and set the switches from 1 to 5.

Entering the values in hexadecimal make the setting easier.

Change [Input format] to [HEX.] and enter values.

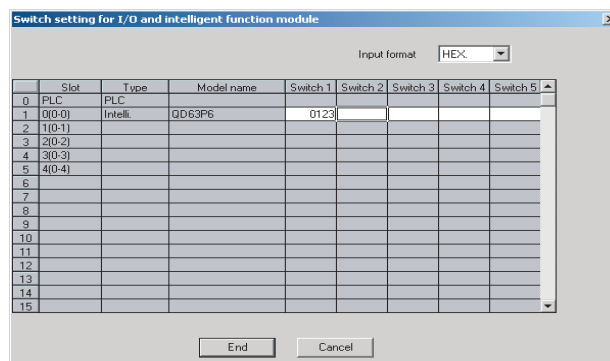

Figure 4.14 [Switch setting for I/O and intelligent function module] screen

POINT

Since [Error time output mode] and [H/W error time PLC operation mode] on the [Switch setting for I/O and intelligent function module] screen are disabled to the QD63P6, the settings are unnecessary.

CHAPTER5 FUNCTIONS

This chapter describes functions of the QD63P6.

5.1 Pulse Input and Count Methods

5.1.1 Types of the pulse input method

There are six kinds of the pulse input methods: 1 phase pulse input (1 or 2 multiples), CW/CCW pulse input, and 2 phases pulse input (1, 2 or 4 multiples). The pulse input methods and count timing are shown in Table 5.1.

This chapter describes I/O numbers (X/Y) of channel 1 only.

For I/O numbers of channels 2 to 6 (X/Y), refer to Section 3.3.1.

The count method is set in the intelligent function module switch setting of GX Developer. (Refer to Section 4.5.)

Table 5.1 Types of the pulse input method

Pulse input method	Count timing		
1 multiple of 1 phase	For addition count	<p>(and subtraction count command (Y03))</p>	Counts on the rising edge (↑) of φA. φB and the subtraction count command (Y03) are OFF.
	For subtraction count	<p>(or subtraction count command (Y03))</p>	Counts on the falling edge (↓) of φA. φB or the subtraction count command (Y03) is ON.
2 multiples of 1 phase	For addition count	<p>(and subtraction count command (Y03))</p>	Counts on the rising (↑) and falling (↓) edges of φA. φB and the subtraction count command (Y03) are OFF.
	For subtraction count	<p>(or subtraction count command (Y03))</p>	Counts on the rising (↑) and falling (↓) edges of φA. φB or the subtraction count command (Y03) is ON.
CW/CCW	For addition count		Counts on the rising edge (↑) of φA. φB is OFF.
	For subtraction count		φA is OFF. Counts on the rising edge (↑) of φB.
1 multiple of 2 phases	For addition count		When φB is OFF, counts on the rising edge (↑) of φA.
	For subtraction count		When φB is OFF, counts on the falling edge (↓) of φA.

Table 5.1 Types of the pulse input method (Continued)

Pulse input method	Count timing		
2 multiples of 2 phases	For addition count		When ϕB is OFF, counts on the rising edge (\uparrow) of ϕA . When ϕB is ON, counts on the falling edge (\downarrow) of ϕA .
	For subtraction count		When ϕB is ON, counts on the rising edge (\uparrow) of ϕA . When ϕB is OFF, counts on the falling edge (\downarrow) of ϕA .
4 multiples of 2 phases	For addition count		When ϕB is OFF, counts on the rising edge (\uparrow) of ϕA . When ϕB is ON, counts on the falling edge (\downarrow) of ϕA . When ϕA is ON, counts on the rising edge (\uparrow) of ϕB . When ϕA is OFF, counts on the falling edge (\downarrow) of ϕB .
	For subtraction count		When ϕB is ON, counts on the rising edge (\uparrow) of ϕA . When ϕB is OFF, counts on the falling edge (\downarrow) of ϕA . When ϕA is OFF, counts on the rising edge (\uparrow) of ϕB . When ϕA is ON, counts on the falling edge (\downarrow) of ϕB .

POINT

In the case of addition in 1-phase pulse input, make sure that phase B pulse input and the subtraction count command (Y03) are OFF before performing pulse input of phase A.

If either of phase B pulse input or the subtraction count command (Y03) is ON, subtraction count is performed in pulse input of phase A.

5.2 Selecting Counter Format

By selecting a counter format, the following counter operations are available.

(1) Linear counter

The linear counter generates an overflow error when the count value exceeds the count range of the QD63P6.

(2) Ring counter

- (a) Counting is repeated within the range between the arbitrarily-set ring counter upper limit value (Un\G2 and 3) and ring counter lower limit value (Un\G0 and 1).
- (b) When the same value is set to the ring counter upper limit value (Un\G2 and 3) and ring counter lower limit value (Un\G0 and 1), counting is repeated in the entire range of the QD63P6.

Select the linear counter or ring counter in the intelligent function module switch setting of GX Developer.

For setting details, refer to Section 4.5.

5.2.1 Selecting the linear counter

(1) Linear counter operation

When the linear counter is selected, counting is operated in a range between -2147483648 (lower limit value) and 2147483647 (upper limit value).

This can be used in combination with the preset function and the coincidence detection function.

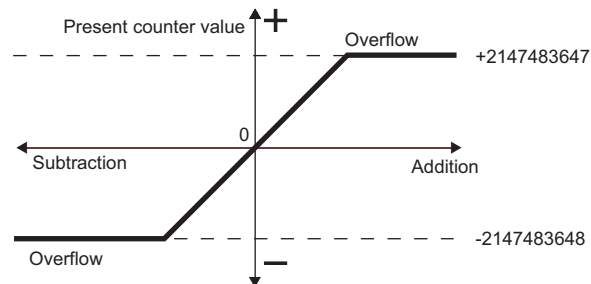

Figure 5.1 Operation image of the linear counter

(2) Overflow error

- (a) When the linear counter is selected for the counter format, if the present value A (Un\G10 and 11)/present value B (Un\G200 and 201) falls below -2147483648 (lower limit value) in subtraction or exceeds 2147483647 (upper limit value) in addition, an overflow error (error code: 100) will occur.
- (b) If an overflow error occurs, 1 is stored in the overflow detection flag (Un\G12) and the overflow error (error code: 100) is stored in the error code (Un\G20) in the buffer memory, and counting is stopped. Even if a pulse is input in that condition, the present value does not change from -2147483648 or 2147483647.
- (c) An overflow error is cancelled by the preset function. Executing preset stores 0 in the overflow detection flag (Un\G12) in the buffer memory, allowing restart of counting. Note that, since data in the error code (Un\G20) are retained until the error is reset, set 1 (ON) in the error reset command (Un\G21) to reset the error.
- (d) When system monitoring is performed during overflow error occurrence by clicking [Diagnostics] - [System monitor] in GX Developer, a module error can be identified.

5.2.2 Selecting the ring counter

(1) Ring counter operation

When the ring counter is selected, counting is repeated within the range between the ring counter lower limit value (Un\G0 and 1) and ring counter upper limit value (Un\G2 and 3), which are arbitrarily set in the buffer memory.

No overflow error will occur when the ring counter is selected.

This can be used in combination with the preset function and the coincidence detection function.

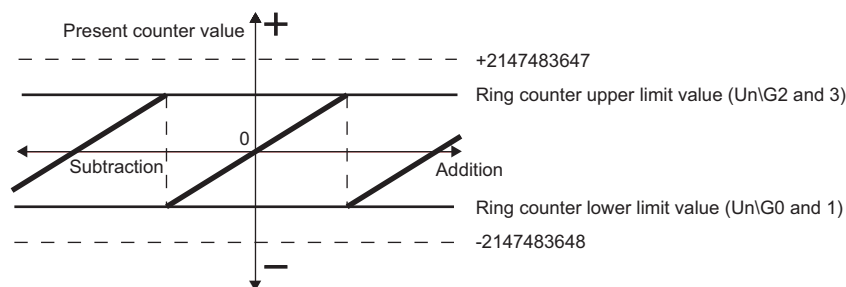

Figure 5.2 Operation image of the ring counter

(2) Count range of the ring counter

The count range varies depending on the present value A (Un\G10 and 11)/present value B (Un\G200 and 201), and the ring counter lower limit value (Un\G0 and 1) and upper limit value (Un\G2 and 3) at the time point of any of the following:

- Count enable command (Y04) changes from OFF to ON.
- Preset is executed.

POINT

- Set appropriate ring counter lower limit value (Un\G0 and 1)/upper limit value (Un\G2 and 3) so that the following condition is satisfied.

$$\text{"Ring counter lower limit value (Un\G0 and 1)} \leq \text{Ring counter upper limit value (Un\G2 and 3)"}$$

If the count enable command (Y04) is turned from OFF to ON with this condition not satisfied, a ring counter upper/lower limit value setting error (error code: 500) is stored in the error code (Un\G20), and counting does not start.

- To start the counting after occurrence of the ring counter upper/lower limit value setting error (error code: 500), set the ring counter lower limit value (Un\G0 and 1)/upper limit value (Un\G2 and 3) so that the following condition is satisfied, and turn the counter enable command (Y04) ON, OFF and ON again.

$$\text{"Ring counter lower limit value (Un\G0 and 1)} \leq \text{Ring counter upper limit value (Un\G2 and 3)"}$$

Note that the OFF time must be 2ms or longer.

(a) When using within the specified range

1) Normally the following range is applied.

$$\begin{array}{ccc} \text{"Ring counter lower limit value"} & \leq & \text{Present value A / present value B} & \leq & \text{Ring counter upper limit value"} \\ (\text{Un}\backslash\text{G0 and 1}) & & (\text{Un}\backslash\text{G10 and 11}) / (\text{Un}\backslash\text{G200 and 201}) & & (\text{Un}\backslash\text{G2 and 3}) \end{array}$$

a) General operation

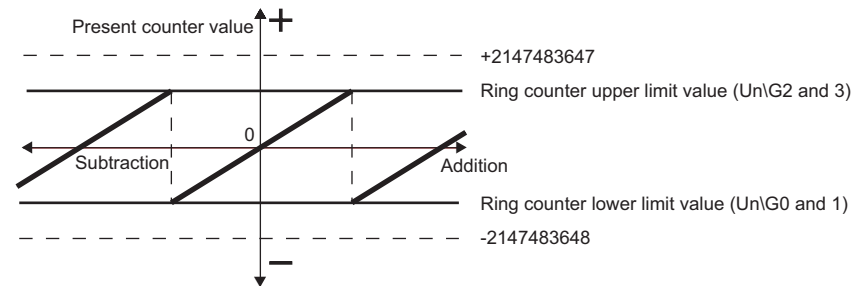

Figure 5.3 Ring counter operation image 1

b) Setting method

- Set the ring counter upper limit value (Un)\G2 and 3), ring counter lower limit value (Un)\G0 and 1) and preset value setting (Un)\G4 and 5) as shown below, and then turn ON the preset command (Y02).
- After the preset value setting (Un)\G4 and 5) became effective, turn OFF the preset command (Y02) and turn ON the count enable command (Y04).

$$\begin{array}{ccc} \text{"Ring counter lower limit value"} & \leq & \text{Preset value setting} & \leq & \text{Ring counter upper limit value"} \\ (\text{Un}\backslash\text{G0 and 1}) & & (\text{Un}\backslash\text{G4 and 5}) & & (\text{Un}\backslash\text{G2 and 3}) \end{array}$$

c) Count operation

- Addition count

When the present value A (Un)\G10 and 11)/present value B (Un)\G200 and 201) reaches the ring counter upper limit value (Un)\G2 and 3), the ring counter lower limit value (Un)\G0 and 1) is automatically stored in the present value A (Un)\G10 and 11)/present value B (Un)\G200 and 201).

- Subtraction count

Even if the present value A (Un)\G10 and 11)/present value B (Un)\G200 and 201) reaches the ring counter lower limit value (Un)\G0 and 1), the ring counter lower limit value (Un)\G0 and 1) is held as it is. And by the next subtraction pulse, "Ring counter upper limit value (Un)\G2 and 3) -1" is stored in the present value A (Un)\G10 and 11)/present value B (Un)\G200 and 201).

In both cases of addition and subtraction counts, the ring counter upper limit value (Un)\G2 and 3) is not stored in the present value A (Un)\G10 and 11)/present value B (Un)\G200 and 201) .

However, the operation is the same as for the case of counting from the ring counter lower limit value (Un)\G0 and 1) if the addition/subtraction count is performed when the count enable command (Y04) status changes from OFF to ON or the preset command (Y02) is executed while "Present value A (Un)\G10 and 11)/present value B (Un)\G200 and 201) = Ring counter upper limit value (Un)\G2 and 3) is satisfied.

d) Setting example

When the count is enabled with a ring counter lower limit value (Un\G0 and 1) of 0, ring counter upper limit value (Un\G2 and 3) of 2000, and present value A (Un\G10 and 11)/present value B (Un\G200 and 201) of 500

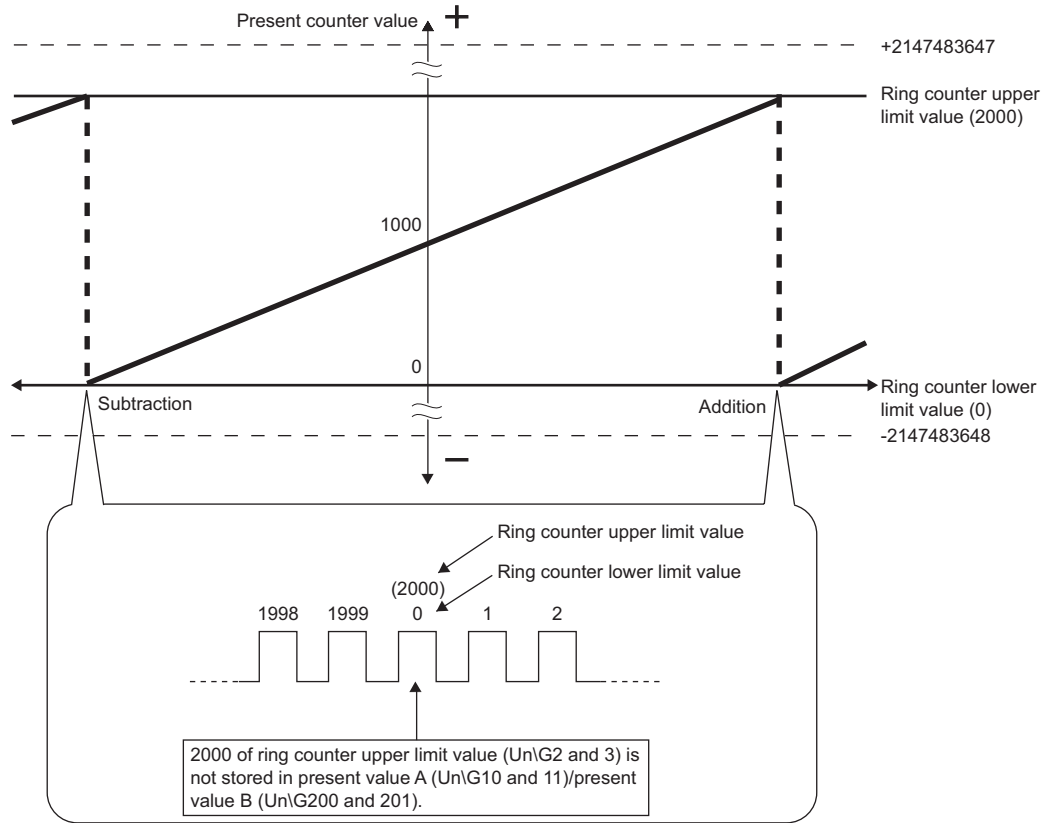

Figure 5.4 Ring counter operation example 1

2) When the following range is applied, the operation is as shown in Figure 5.5.

"Present value A/present value B < Ring counter lower limit value"
 (Un\G10 and 11)/
 (Un\G200 and 201)
 or,
 "Ring counter upper limit value < Present value A/present value B"
 (Un\G2 and 3) (Un\G10 and 11)/(Un\G200 and 201)

a) General operation

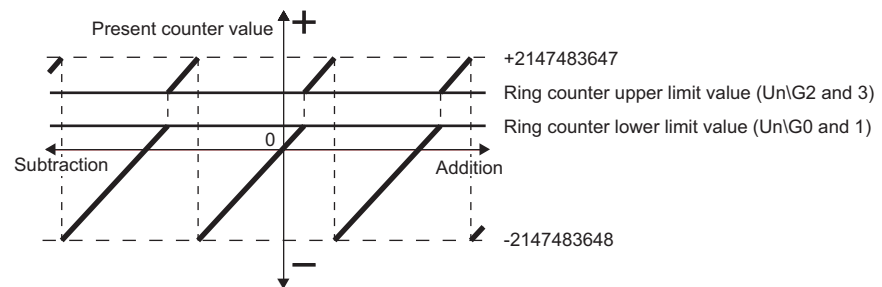

Figure 5.5 Ring counter operation image 2

b) Setting method

- Set the ring counter upper limit value (Un\G2 and 3), ring counter lower limit value (Un\G0 and 1) and preset value setting (Un\G4 and 5) as shown below, and then turn ON the preset command (Y02).
- After the preset value setting (Un\G4 and 5) became effective, turn OFF the preset command (Y02) and turn ON the count enable command (Y04).

"Preset value setting
 (Un\G4 and 5) < Ring counter lower limit value"
 (Un\G0 and 1)
 or,
 "Ring counter upper limit value < Preset value setting"
 (Un\G2 and 3) (Un\G4 and 5)

c) Count operation

- Addition count

Even if the present value A (Un\G10 and 11)/present value B (Un\G200 and 201) reaches the ring counter lower limit value (Un\G0 and 1), the ring counter lower limit value (Un\G0 and 1) is held as it is. And by the next addition pulse, "Ring counter upper limit value (Un\G2 and 3) +1" is stored in the present value A (Un\G10 and 11)/present value B (Un\G200 and 201).

- Subtraction count

When the present value A (Un\G10 and 11)/present value B (Un\G200 and 201) reaches the ring counter upper limit value (Un\G2 and 3), the ring counter lower limit value (Un\G0 and 1) is automatically stored in the present value A (Un\G10 and 11)/present value B (Un\G200 and 201).

In both cases of addition and subtraction counts, the ring counter upper limit value (Un\G2 and 3) is not stored in the present value A (Un\G10 and 11)/present value B (Un\G200 and 201).

d) Setting example

When the count is enabled with a ring counter lower limit value (Un\G0 and 1) of 0, ring counter upper limit value (Un\G2 and 3) of 2000, and present value A (Un\G10 and 11)/present value B (Un\G200 and 201) of 3000

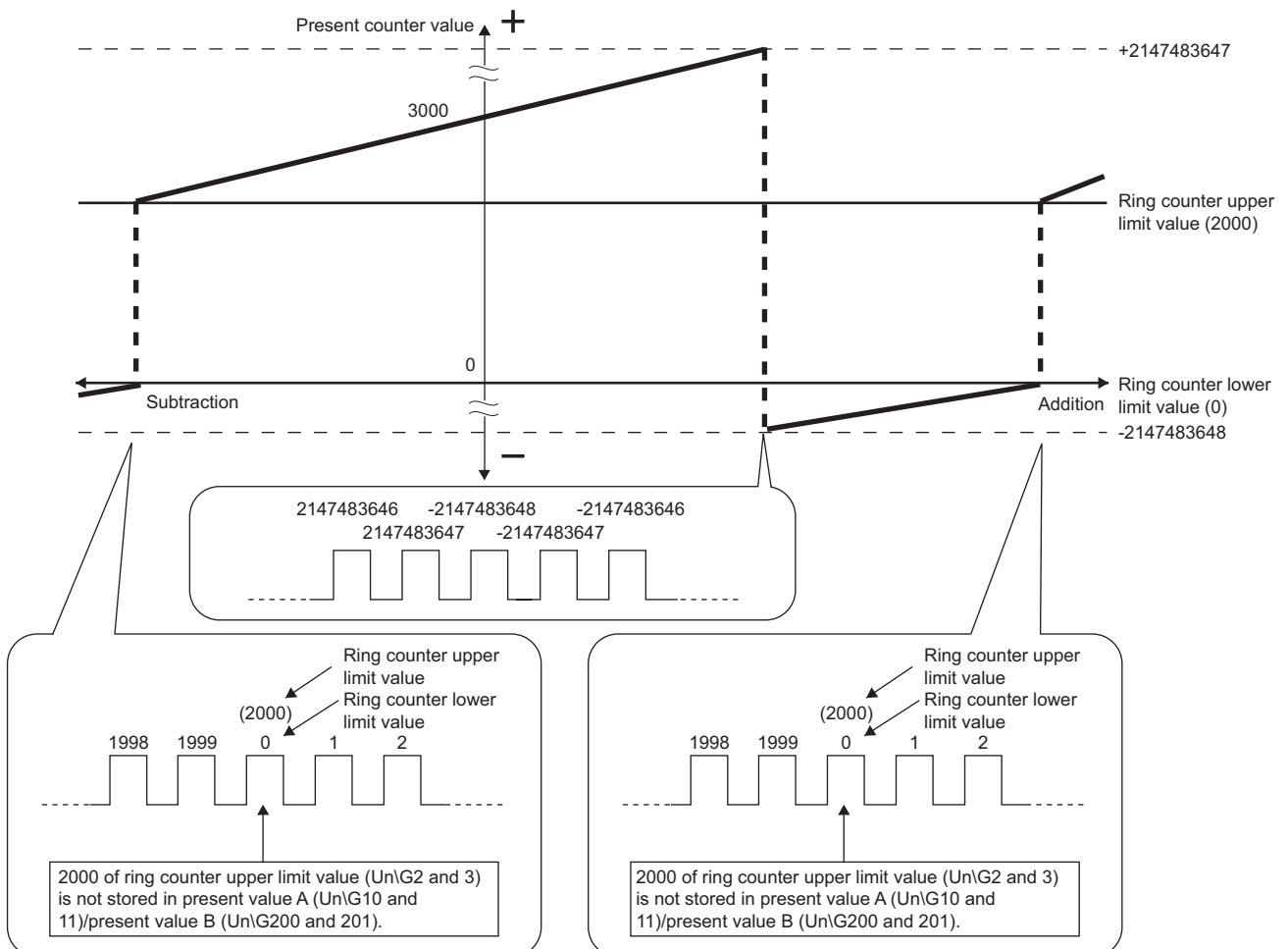

Figure 5.6 Ring counter operation example 2

(b) When using in the entire range

a) General operation

By setting the same value in the ring counter upper limit value (Un\G2 and 3) and ring counter lower limit value (Un\G0 and 1), the count operation is repeated in the entire range of the QD63P6 (from -2147483648 (lower limit value) to 2147483647 (upper limit value)).

Although it operates like the linear counter, no overflow error will occur even if the present value A (Un\G10 and 11)/present value B (Un\G200 and 201) reaches the counting range of the QD63P6.

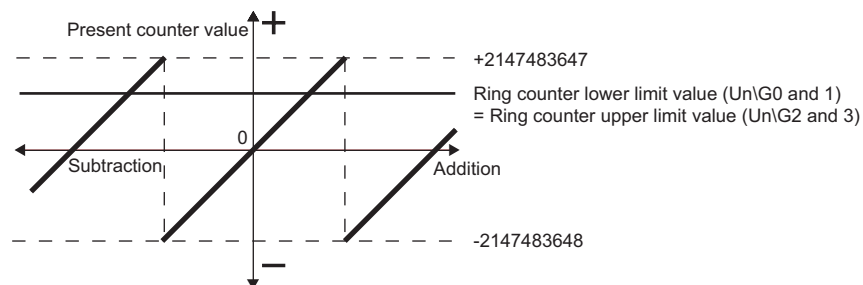

Figure 5.7 Ring counter operation image 3

b) Setting method

- Set any value in the preset value setting (Un\G4 and 5), set the ring counter upper limit value (Un\G2 and 3) and ring counter lower limit value (Un\G0 and 1) as shown below, and then turn ON the preset command (Y02).
- After the preset value setting (Un\G4 and 5) became effective, turn OFF the preset command (Y02) and turn ON the count enable command (Y04).

$$\text{"Ring counter lower limit value (Un\G0 and 1) = Ring counter upper limit value (Un\G2 and 3)"}$$

c) Count operation

When the following setting is made, regardless of the present value A (Un\G10 and 11)/present value B (Un\G200 and 201), the count range is the entire range of signed 32-bit binary numbers (-2147483648 to 2147483647).

$$\text{"Ring counter lower limit value (Un\G0 and 1) = Ring counter upper limit value (Un\G2 and 3)"}$$

d) Setting example

When the count is enabled with a ring counter lower limit value (Un\G0 and 1) of 1000, ring counter upper limit value (Un\G2 and 3) of 1000, and present value A (Un\G10 and 11)/present value B (Un\G200 and 201) of 3000, the count is operated in the entire range of the QD63P6 (-2147483648 (lower limit value) to 2147483647 (upper limit value)).

☒ POINT

(1) When changing the ring counter upper/lower limit value, perform the following:

- Turn OFF the count enable command (Y04) for 2ms or longer.
- Change the setting of the ring counter upper limit value (Un\G2 and 3) and/or ring counter lower limit value (Un\G0 and 1).
- Turn ON the count enable command (Y04) again.

While the count enable command (Y04) is ON, writing a setting value into the ring counter upper/lower limit value area (Un\G0 to 3) only stores it in the buffer memory and is not reflected to the QD63P6. Therefore, the QD63P6 operates based on the setting before the writing.

If a value was written to the ring counter lower limit value (Un\G2 and 3) or ring counter upper limit value (Un\G0 and 1) with the count enable command (Y04) set to ON, turn OFF the count enable command (Y04) for 2ms or longer and then back ON again. The set value becomes effective in the QD63P6 by this operation.

(2) When changing the count range by preset, to prevent a miscount, be sure to turn OFF the count enable command (Y04).

5.3 Using the Coincidence Detection Function

When using the coincidence detection function, set any count value in advance. Then, the QD63P6 compares the value with the present A (Un\G10 and 11)/present value B (Un\G200 and 201) of the counter, and outputs the counter value coincidence (X02) when they match.

The coincidence detection can be set for each channel in units of one points.

Figure 5.8 contains I/O numbers (X/Y) and buffer memory addresses for channel 1 only. For channels 2 to 6, refer to Section 3.3.1 and Section 3.4.1.

(1) Operation of coincidence detection

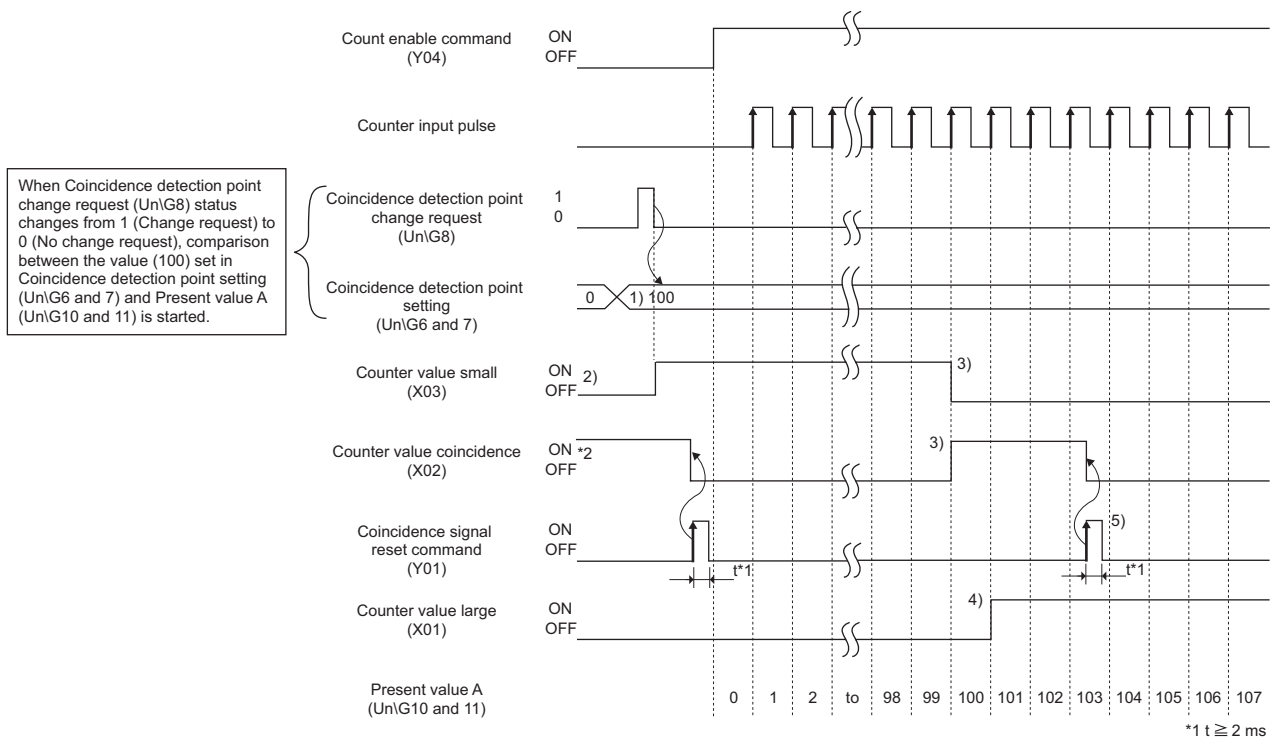

Figure 5.8 Operation example of the coincidence detection function

POINT

The counter value coincidence (X02) turns ON immediately after power-ON or reset of the programmable controller CPU since the coincidence detection point setting (Un\G6 and 7) is 0.

Therefore, perform the following operations.

- (1) Write any other than 0 into the coincidence detection point setting (Un\G6 and 7), and 1 into the coincidence detection point change request (Un\G8).
- (2) Turn the coincidence signal reset command (Y01) OFF, ON and OFF again. Note that the ON time must be 2ms or longer.

Table 5.2 Details of the coincidence detection operation example

No.	Description
1)*	<p>Coincidence detection is started by the following steps using the value set in the coincidence detection point setting (Un\G6 and 7).</p> <p>(1) Write a coincidence detection value (100) into the coincidence detection point setting (Un\G6 and 7).</p> <p>(2) Write 1 (Change request) into the coincidence detection point change request (Un\G8).</p> <p>(3) When the coincidence detection point change request (Un\G8) status changes from 1 (Change request) to 0 (No change request), coincidence detection is enabled with the value set in the coincidence detection point setting (Un\G6 and 7).</p>
2)	As long as the present value A (Un\G10 and 11)/present value B (Un\G200 and 201) is smaller than the coincidence detection point setting (Un\G6 and 7), the counter value small (X03) stays ON.
3)	When the present value A (Un\G10 and 11)/present value B (Un\G200 and 201) matches the coincidence detection point setting (Un\G6 and 7), the counter value small (X03) turns OFF, and the counter value coincidence (X02) turns ON.
4)	When the present value A (Un\G10 and 11)/present value B (Un\G200 and 201) becomes greater than the coincidence detection point setting (Un\G6 and 7), the counter value large (X01) turns ON.
5)	Turn ON the coincidence signal reset command (Y01), and reset the counter value coincidence (X02). If the counter value coincidence (X02) remains ON, the next counter value coincidence (X02) cannot be output.

* Without the operations given in 1), coincidence detection using the value stored in the coincidence detection point setting (Un\G6 and 7) is not performed.

☒ POINT

- When the sequence program scan time is less than 2ms, be sure to make the coincidence signal reset command (Y01) turn ON for 2ms or more by using a timer, etc.
- When the present value A (Un\G10 and 11)/present value B (Un\G200 and 201) matches the coincidence detection point setting (Un\G6 and 7), if the coincidence signal reset command (Y01) is turned ON and OFF, the counter value coincidence (X02) turns ON again.
- Coincidence detection processing inside the QD63P6 may cause the counter value large (X01) or the counter value small (X03) to turn ON when the counter value coincidence (X02) status changes from OFF to ON.

(2) Coincidence detection interrupt function

The coincidence detection interrupt function allows making an interrupt request to a programmable controller CPU at the time of coincidence detection to start the interrupt program.

(Depending on the programmable controller CPU used, the coincidence detection interrupt function cannot be used. For details, refer to CHAPTER 2.)

(a) Up to 16-point interrupt factors (SI) are allowed for a single MELSECNET-Q series intelligent function module.

As shown in Table 5.3, the QD63P6 has 6-point interrupt factors (SI) for coincidence detection.

Table 5.3 List of interrupt factors

SI No.	Interrupt factor
0	Channel 1: Coincidence detection of coincidence detection point
1	Channel 2: Coincidence detection of coincidence detection point
2	Channel 3: Coincidence detection of coincidence detection point
3	Channel 4: Coincidence detection of coincidence detection point
4	Channel 5: Coincidence detection of coincidence detection point
5	Channel 6: Coincidence detection of coincidence detection point
6 to 15	Reserved

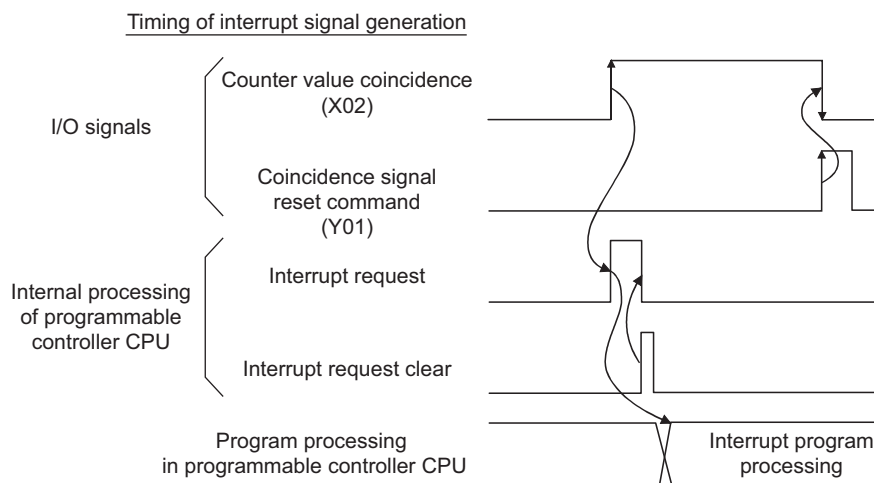

Figure 5.9 Timing of interrupt signal generation

(b) It takes approx. 150 μ s from when the QD63P6 detects coincidence until it makes an interrupt request to a programmable controller CPU.

(c) Select [PLC parameter] - [PLC system] - [Intelligent function module setting] - [Interrupt pointer settings] to set the interrupt factors (SI) of the QD63P6 and interrupt pointers of the programmable controller CPU.

- 1) CPU side [Interrupt pointer start No.]
Set the start interrupt pointer number of the programmable controller CPU.
Setting range: 50 to 255
- 2) CPU side [Interrupt pointer No. of module]
Set the number of interrupt factors (SI).
Setting range: 1 to 6

POINT

- A coincidence detection interrupt occurs when the counter value coincidence (X02) rises (from OFF to ON). This means that, if the coincidence signal is reset and unless the counter value coincidence (X02) is turned OFF, the next interrupt request will not be issued.
- Immediately after power-ON or reset of the programmable controller CPU, the counter value coincidence (X02) turns ON, however, no coincidence detection interrupt will occur.

For how to reset the counter value coincidence (X02), refer to Section 5.3 (Figure 5.8).

5.4 Using the Preset Function

The preset function is used to replace the counter's present value A (Un\G10 and 11)/ present value B (Un\G200 and 201) with any given value (preset value), from which the pulse counting can be started.

(1) Preset function operation

The preset function is activated by turning ON the preset command (Y02) on the sequence program.

Figure 5.11 contains the I/O numbers (X/Y) and buffer memory addresses of channel 1 only. For channels 2 to 6, refer to Section 3.3.1 and Section 3.4.1.

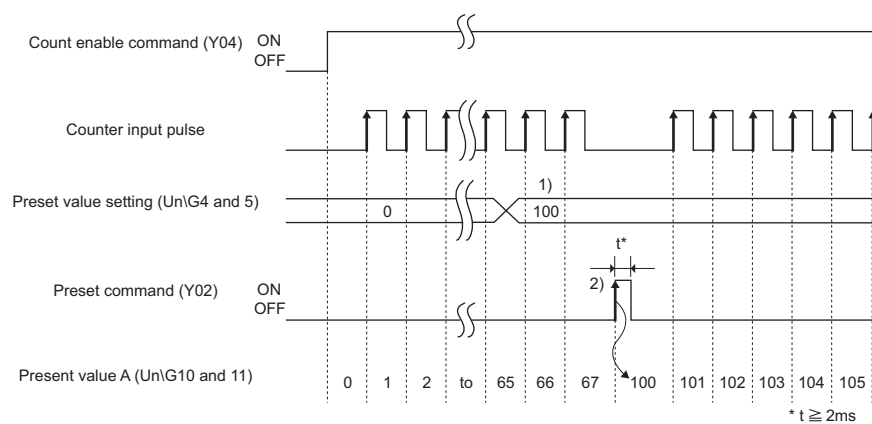

Figure 5.11 Preset function operation example

Table 5.4 Details of the preset function operation example

No.	Description
1)	Writes any value into the preset value setting (Un\G4 and 5) of the QD63P6 in the 32-bit binary format.
2)	When the preset command (Y02) rises (from OFF to ON), a value in the preset value setting (Un\G4 and 5) is stored in the present value A (Un\G10 and 11)/ present value B (Un\G200 and 201). The preset function can be executed regardless of the ON/OFF status of the count enable command (Y04).

5.5 Using the Periodic Pulse Counter Function

This function allows the present value A (Un\G10 and 11)/present value B (Un\G200 and 201) and the previous value to be stored in the present periodic pulse count value (Un\G16 and 17) and previous periodic pulse count value (Un\G14 and 15) respectively at intervals of the preset period time (Un\G9), while the periodic pulse counter start command (Y05) is ON.

(1) Periodic pulse counter operation

The following explains the relation between respective I/O signals and buffer memory areas used in the periodic pulse counter function.

The previous periodic pulse count value (Un\G14 and 15) is compared with the judgment value for updated periodic pulse count value (Un\G18 and 19), and if these stored values are equal, the present value is stored in the present periodic pulse count value (Un\G16 and 17).

Figure 5.12 contains the I/O numbers (X/Y) and buffer memory addresses of channel 1 only. For channels 2 to 6, refer to Section 3.3.1 and Section 3.4.1.

For the period setting (Un\G9), refer to Section 3.4.2 (4).

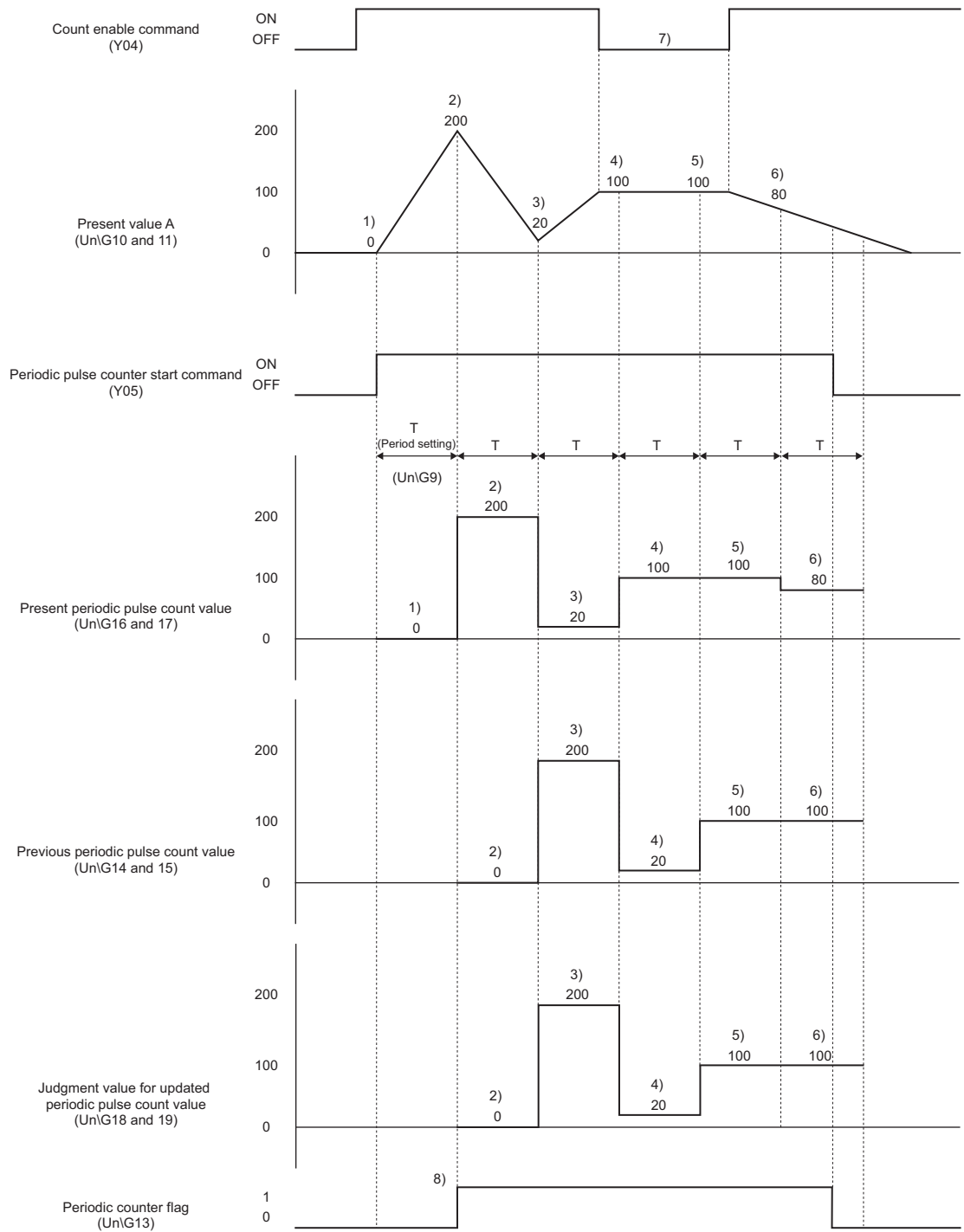

Figure 5.12 Periodic pulse counter function operation example

Table 5.5 Details of the periodic pulse counter function operation example

No.	Description
1)	The counter's present value A (Un\G10 and 11)/present value B (Un\G200 and 201), "0" is stored in the present periodic pulse count value (Un\G16 and 17).
2)	The counter's present value A (Un\G10 and 11)/present value B (Un\G200 and 201), "200" is stored in the present periodic pulse count value (Un\G16 and 17). The value "0" that was in the present periodic pulse count value (Un\G16 and 17) until then is now stored in the previous periodic pulse count value (Un\G14 and 15). After the update of the present periodic pulse count value (Un\G16 and 17) and the previous periodic pulse count value (Un\G14 and 15), "0" is stored in the judgment value for updated periodic pulse count value (Un\G18 and 19).
3)	The counter's present value A (Un\G10 and 11)/present value B (Un\G200 and 201), "20" is stored in the present periodic pulse count value (Un\G16 and 17). The value "200" that was in the present periodic pulse count value (Un\G16 and 17) until then is now stored in the previous periodic pulse count value (Un\G14 and 15). After the update of the present periodic pulse count value (Un\G16 and 17) and the previous periodic pulse count value (Un\G14 and 15), "200" is stored in the judgment value for updated periodic pulse count value (Un\G18 and 19).
4)	The counter's present value A (Un\G10 and 11)/present value B (Un\G200 and 201), "100" is stored in the present periodic pulse count value (Un\G16 and 17). The value "20" that was in the present periodic pulse count value (Un\G16 and 17) until then is now stored in the previous periodic pulse count value (Un\G14 and 15). After the update of the present periodic pulse count value (Un\G16 and 17) and the previous periodic pulse count value (Un\G14 and 15), "20" is stored in the judgment value for updated periodic pulse count value (Un\G18 and 19).
5)	The counter's present value A (Un\G10 and 11)/present value B (Un\G200 and 201), "100" is stored in the present periodic pulse count value (Un\G16 and 17). The value "100" that was in the present periodic pulse count value (Un\G16 and 17) until then is now stored in the previous periodic pulse count value (Un\G14 and 15). After the update of the present periodic pulse count value (Un\G16 and 17) and the previous periodic pulse count value (Un\G14 and 15), "100" is stored in the judgment value for updated periodic pulse count value (Un\G18 and 19).
6)	The counter's present value A (Un\G10 and 11)/present value B (Un\G200 and 201), "80" is stored in the present periodic pulse count value (Un\G16 and 17). The value "100" that was in the present periodic pulse count value (Un\G16 and 17) until then is now stored in the previous periodic pulse count value (Un\G14 and 15). After the update of the present periodic pulse count value (Un\G16 and 17) and the previous periodic pulse count value (Un\G14 and 15), "100" is stored in the judgment value for updated periodic pulse count value (Un\G18 and 19).
7)	The periodic pulse counter function is executed regardless of the ON/OFF status of the count enable command (Y04).
8)	During execution of the periodic pulse counter function, "1" (Operating) is stored in the periodic counter flag (Un\G13).

POINT

When reading a periodic pulse count value with the sequence program, use either of the following methods.

- (1) Read a data block of six words from the previous periodic pulse count value (Un\G14 and 15) using the DFRO instruction, and check that the previous periodic pulse count value (Un\G14 and 15) is equal to the judgment value for updated periodic pulse count value (Un\G18 and 19). If not equal, try reading again.

The following example program reads the periodic pulse count value of channel 1 of the QD63P6 that is mounted in the slot position of I/O number X/Y00 to X/Y1F when M0 is turned ON.



Figure 5.13 Periodic pulse counter value reading program example

- (2) Use the dedicated instruction, G(P).PPCVRD□. (Refer to Appendix 1.2.)
When the periodic pulse count value is read with the G(P).PPCVRD□ instruction, the determination on consistency in the sequence program is unnecessary.

If either of the above methods is not used, the previous and present values may be the same due to the update timing of the module and reading timing of the sequence program, and may cause inconsistency in the periodic pulse count values.

5.6 Response Delay Time

This section described the response delay time of I/O signals and buffer memory.

$$\begin{aligned}\text{Maximum delay time [ms]} &= [\text{Time of (1)}] + [\text{Maximum time of (2)}] \\ &= \text{Scan time of a sequence program} + 2 \text{ [ms]}\end{aligned}$$

(1) Scan time of a sequence program

The CPU module processes I/O signals by refreshing them all at once before the operation start of a sequence program. Therefore, the signals are delayed.

Use direct access input (DX) or direct access output (DY) to minimize the delay.

For details on direct access input (DX) or direct access output (DY), refer to the following:

- QnUCPU User's Manual (Function Explanation, Program Fundamentals)
- Qn(H)/QnPH/QnPRHCPU User's Manual (Function Explanation, Program Fundamentals)

(2) Control cycle (1ms) of the QD63P6

The QD63P6 reads out the output signals and buffer memory data updated by the sequence program and completes processing with up to 2ms (1 control cycle × 2) delay.

The update timing of the input signals and buffer memory data vary within the range of a control cycle.

CHAPTER6 UTILITY PACKAGE (GX Configurator-CT)

6.1 Utility Package Functions

Table 6.1 shows the functions of the utility package.

Table 6.1 Utility package (GX Configurator-CT) functions list

Function	Description	Reference
Initial setting	<p>(1) Make the initial settings for each channel to operate the QD63P6. Set the values of the items where initial settings are required.</p> <ul style="list-style-type: none"> ▪ CH□Preset value setting ▪ CH□Coincidence detection point change request ▪ CH□Coincidence detection point setting ▪ CH□Ring counter lower limit value ▪ CH□Ring counter upper limit value ▪ CH□Period setting <p>(2) Data with initial settings are registered to programmable controller CPU parameters and are automatically written to the QD63P6 when the programmable controller CPU is in RUN.</p>	Section 6.4
Auto refresh	<p>(1) Set the buffer memory of the QD63P6 to which auto refresh is to be performed for each channel.</p> <ul style="list-style-type: none"> ▪ CH□Present value A ▪ CH□Present value B ▪ CH□Overflow detection flag ▪ CH□Periodic counter flag ▪ CH□Previous periodic pulse count value ▪ CH□Present periodic pulse count value ▪ CH□Judgment value for updated periodic pulse count value ▪ CH□Error code <p>(2) The values stored in the QD63P6 buffer memory with auto refresh setting are automatically read when the programmable controller CPU executes the END instruction.</p>	Section 6.5
Monitor/Test	<p>(1) Monitors/tests the following buffer memories and I/O signals of the QD63P6.</p> <ul style="list-style-type: none"> ▪ Y device ▪ CH□Ring counter lower limit value ▪ CH□Ring counter upper limit value ▪ CH□Preset value setting ▪ CH□Coincidence detection point setting ▪ CH□Coincidence detection point change request ▪ CH□Period setting ▪ CH□Error reset command <p>(2) Monitors the following buffer memories of the QD63P6.</p> <ul style="list-style-type: none"> ▪ X device ▪ CH□Present value A ▪ CH□Present value B ▪ CH□Overflow detection flag ▪ CH□Error code ▪ CH□Periodic counter flag ▪ CH□Previous periodic pulse count value ▪ CH□Present periodic pulse count value ▪ CH□Judgment value for updated periodic pulse count value 	Section 6.6

6.2 Installing and Uninstalling the Utility Package

For how to install or uninstall the utility package, refer to "Method of installing the MELSOFT Series" included in the utility package.

6.2.1 Handling precautions

The following explains the precautions on using the utility package.

(1) For safety

Since the utility is add-in software for GX Developer, read "Safety Precautions" and the basic operating procedures in the GX Developer Operating Manual.

(2) About installation

GX Configurator-CT is add-in software for GX Developer Version 4 or later. Therefore, GX Configurator-CT must be installed on the personal computer that has already GX Developer Version 4 or later installed.

(3) Screen error of Intelligent function module utility

Insufficient system resource may cause the screen to be displayed inappropriately while using the Intelligent function module utility.

If this occurs, close the Intelligent function module utility, GX Developer (program, comments, etc.), and other applications, and then start GX Developer and Intelligent function module utility again.

(4) To start the Intelligent function module utility

(a) In GX Developer, select "QCPU (Q mode)" for "PLC series" and specify a project. If any "PLC series" other than "QCPU (Q mode)" is selected, or if no project is specified, the Intelligent function module utility will not start.

(b) Multiple Intelligent function module utilities can be started.

However, [Open parameters] and [Save parameters] operations under [Intelligent function module parameter] are allowed for one Intelligent function module utility only. Only the [Monitor/test] operation is allowed for the other utilities.

(5) Switching between two or more Intelligent function module utilities

When two or more Intelligent function module utility screens cannot be displayed side by side, select a screen to be displayed on the top of others using the task bar.



(6) Number of parameters that can be set in GX Configurator-CT

When multiple intelligent function modules are mounted, the number of parameter settings must not exceed the following limit.

Table 6.2 Maximum number of settable parameters using GX Configurator

When intelligent function modules are installed to:	Maximum number of parameter settings	
	Initial setting	Auto refresh setting
Q00J/Q00/Q01CPU	512	256
Q02/Q02H/Q06H/Q12H/Q25HCPU	512	256
Q02PH/Q06PH/Q12PH/Q25PHCPU	512	256
Q12PRH/Q25PRHCPU	512	256
Q00UJ/Q00U/Q01UCPU	512	256
Q02UCPU	2048	1024
Q03UD/Q04UDH/Q06UDH/Q10UDH/ Q13UDH/Q20UDH/Q26UDH/ Q03UDE/Q04UDEH/Q06UDEH/ Q10UDEH/Q13UDEH/Q20UDEH/ Q26UDEHCPU	4096	2048
Q50UDEH/Q100UDEHCPU	Use prohibited	Use prohibited
MELSECNET/H remote I/O station	512	256

For example, if multiple intelligent function modules are installed to the MELSECNET/H remote I/O station, configure the settings in GX Configurator so that the number of parameter settings for all the intelligent function modules does not exceed the limit of the MELSECNET/H remote I/O station. Calculate the total number of parameter settings separately for the initial setting and for the auto refresh setting. The number of parameters that can be set for one module in GX Configurator-CT is as shown below.

Table 6.3 Number of settable parameters per module

Target module	Initial setting	Auto refresh setting
QD63P6	6 (fixed)	48 (Max.)

Example) Counting the number of parameter settings in Auto refresh setting

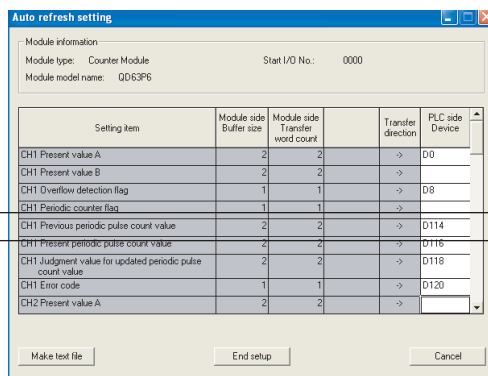

← This one row is counted as one setting.
Blank rows are not counted.
Count up all the setting items on this screen, and add the total to the number of settings for other intelligent function modules to get a grand total.

Figure 6.1 Numeration for the number of parameters set in auto refresh setting

6.2.2 Operating environment

This section explains the operating environment of the personal computer that runs GX Configurator-CT.

Table 6.4 Operating environment of the personal computer

Item	Description
Installation (Add-in) target* ¹	Add-in to GX Developer Version 4 (English version) or later.* ²
Computer	A personal computer with the operating systems below.
CPU	
Required memory	Refer to Table 6.5 "Operating system and performance required for personal computer".
Hard disk space	
For installation	65 MB or more
For operation	10 MB or more
Display	800 × 600 dots or more resolution* ³
Operating system	Microsoft® Windows® 95 Operating System (English version) Microsoft® Windows® 98 Operating System (English version) Microsoft® Windows® Millennium Edition Operating System (English version) Microsoft® Windows NT® Workstation Operating System Version 4.0 (English version) Microsoft® Windows® 2000 Professional Operating System (English version) Microsoft® Windows® XP Professional Operating System (English version) SP1 or later Microsoft® Windows® XP Home Edition Operating System (English version) SP1 or later Microsoft® Windows Vista® Home Basic Operating System (English version) Microsoft® Windows Vista® Home Premium Operating System (English version) Microsoft® Windows Vista® Business Operating System (English version) Microsoft® Windows Vista® Ultimate Operating System (English version) Microsoft® Windows Vista® Enterprise Operating System (English version) Microsoft® Windows® 7 Starter Operating System (English version)* ⁴ Microsoft® Windows® 7 Home Premium Operating System (English version)* ⁴ Microsoft® Windows® 7 Professional Operating System (English version)* ⁴ Microsoft® Windows® 7 Ultimate Operating System (English version)* ⁴ Microsoft® Windows® 7 Enterprise Operating System (English version)* ⁴

* 1 Install GX Configurator-CT in GX Developer Version 4 or higher in the same language. GX Developer (English version) and GX Configurator-CT (Japanese version) cannot be used in combination, and GX Developer (Japanese version) and GX Configurator-CT (English version) cannot be used in combination.

* 2 GX Configurator-CT is not applicable to GX Developer Version 3 or earlier.

* 3 When Windows Vista® or Windows® 7 is used, resolution of 1024 × 768 dots or more is recommended.

* 4 When 32-bit Windows® 7 is used, add GX Configurator-CT Version 1.29AF or later in GX Developer Version 8.91V or later.

When 64-bit Windows® 7 is used, add GX Configurator-CT Version 1.29AF or later in GX Developer Version 8.98C or later.

Table 6.5 Operating system and performance required for personal computer

Operating system	Performance required for personal computer	
	CPU	Memory
Windows® 95	Pentium® 133 MHz or more	32 MB or more
Windows® 98	Pentium® 133 MHz or more	32 MB or more
Windows® Me	Pentium® 150 MHz or more	32 MB or more
Windows NT® Workstation 4.0	Pentium® 133 MHz or more	32 MB or more
Windows® 2000 Professional	Pentium® 133 MHz or more	64 MB or more
Windows® XP	Pentium® 300 MHz or more	128 MB or more
Windows Vista®	Pentium® 1GHz or more	1GB or more
Windows® 7	Pentium® 1GHz or more	1GB or more (32-bit) 2GB or more (64-bit)

POINT

- (1) The functions shown below are not available for Windows® XP, Windows Vista® and Windows® 7.

If any of the following functions is attempted, this product may not operate normally.

- Start of application in Windows compatible mode
- Fast user switching
- Remote desktop
- Large fonts (Details setting of Display Properties)

Also, GX Configurator-CT is not supported by 64-bit Windows® XP and 64-bit Windows Vista®.

- (2) Use a USER authorization or higher in Windows Vista® and Windows® 7.
- (3) When Windows® 7 is used, the following functions are not available.
- Windows XP Mode
 - Windows Touch

6.3 Utility Package Operation

6.3.1 Common utility package operations

(1) Control keys

Table 6.6 shows the special keys that can be used in operations of the utility package and their applications.

Table 6.6 Control keys

Key	Application
Esc	Cancels the current entry in a cell. Closes the window.
Tab	Moves between controls in the window.
Ctrl	Used in combination with the mouse operation to select multiple cells for test execution.
Delete	Deletes the character where the cursor is positioned. When a cell is selected, clears all of the setting contents in the cell.
Back Space	Deletes the character where the cursor is positioned.
↑ ↓ ← →	Moves the cursor.
Page Up	Moves the cursor one page up.
Page Down	Moves the cursor one page down.
Enter	Completes the entry in the cell.

(2) Data created with the utility package

The following data or files that are created with the utility package can be also handled in GX Developer. Figure 6.3 shows respective data or files are handled in which operation.

(3) Intelligent function module parameter

(a) This represents the data created in Auto refresh setting, and they are stored in an intelligent function module parameter file in a project created by GX Developer.

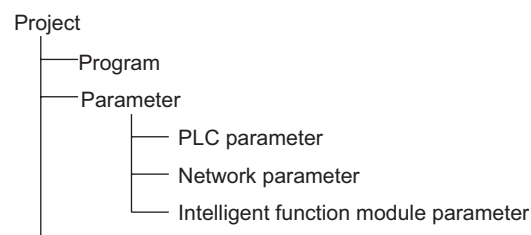

Figure 6.2 Project structure

(b) Steps 1) to 3) shown in Figure 6.3 are performed as follows:

- 1) From GX Developer, select:
[Project] → [Open project]/[Save]/[Save as]
- 2) On the intelligent function module selection screen of the utility, select:
[Intelligent function module parameter] → [Open parameters]/[Save parameters]
- 3) From GX Developer, select:
[Online] → [Read from PLC]/[Write to PLC] → "Intelligent function module parameters"
Alternatively, from the intelligent function module selection screen of the utility, select:
[Online] → [Read from PLC]/[Write to PLC]

(4) Text file

- (a) A text file can be created by clicking the button on the initial setting, Auto refresh setting, or Monitor/Test screen. The text files can be utilized to create user documents.
- (b) Text files can be saved in any directory. However, a path (folder where the file is to be saved) cannot be created during operation of . Therefore, create the folder beforehand using Windows® Explorer.

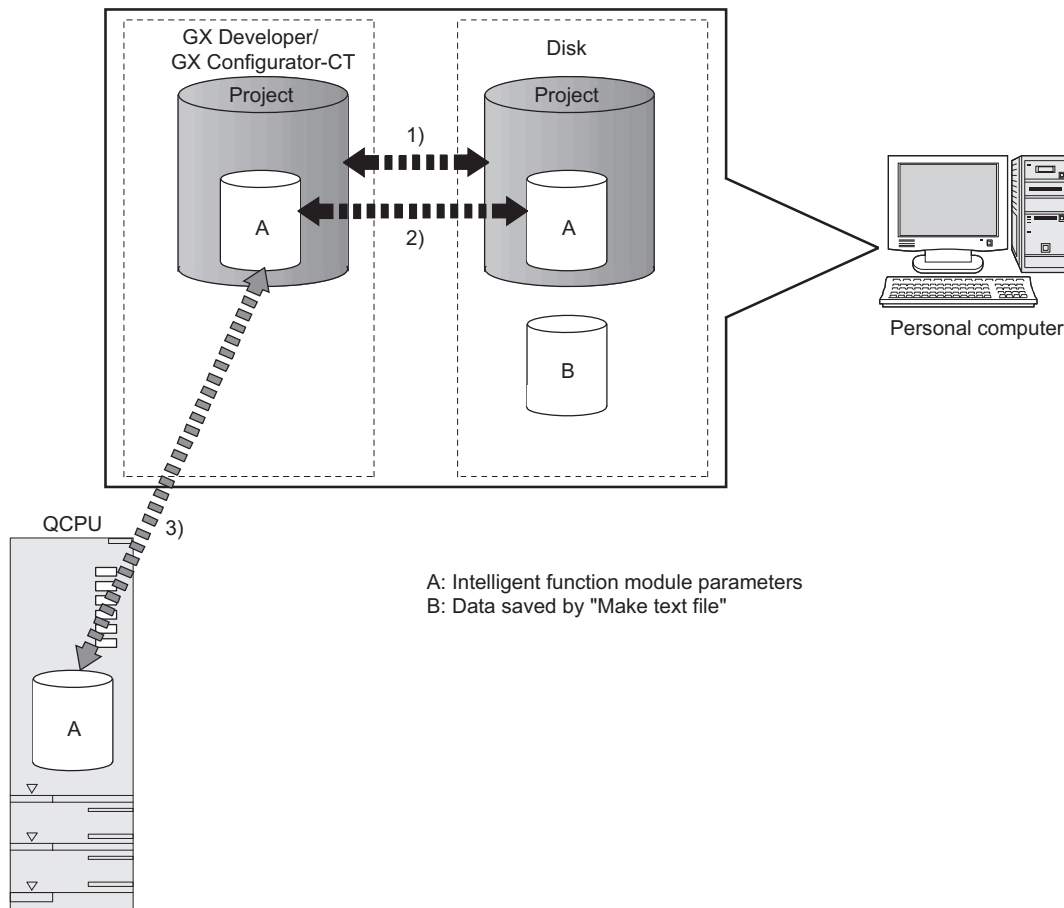
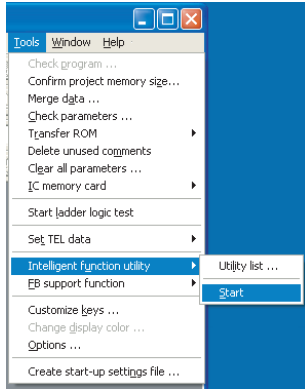

Figure 6.3 Correlation chart for data created with the utility package

6.3.2 Operation overview

GX Developer screen



[Tools] - [Intelligent function utility] - [Start]

Screen for selecting a target intelligent function module

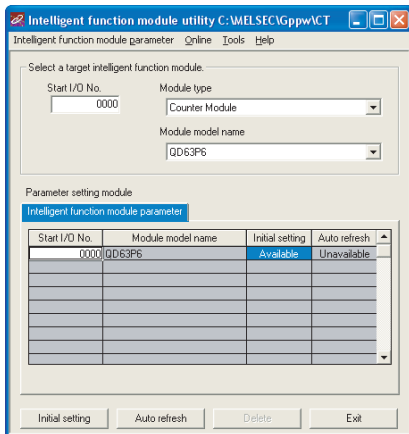

Refer to Section 6.3.3.

Enter "Start I/O No.", and select "Module type" and "Module model name".

Initial setting

Auto refresh

Initial setting screen

Auto refresh setting screen

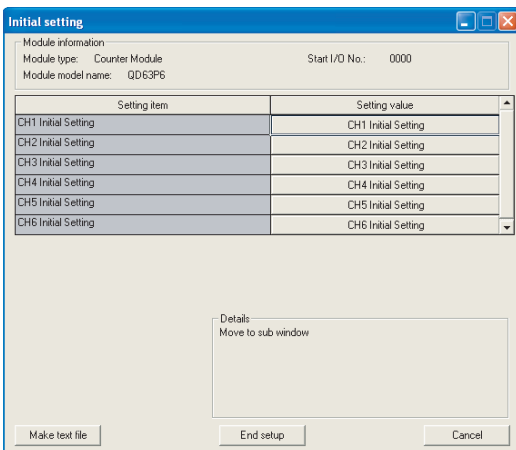

Refer to Section 6.4.

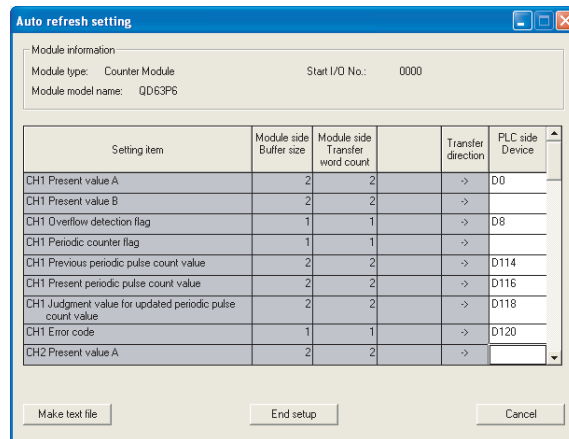

Refer to Section 6.5.

Figure 6.4 General operation

1) [Online] - [Monitor/Test]

Selecting monitor/test module screen

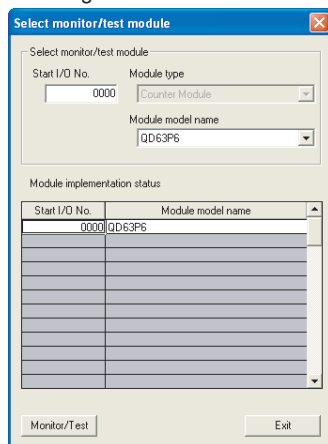

Monitor/Test

Select a module to be monitored/tested.

Monitor/Test screen

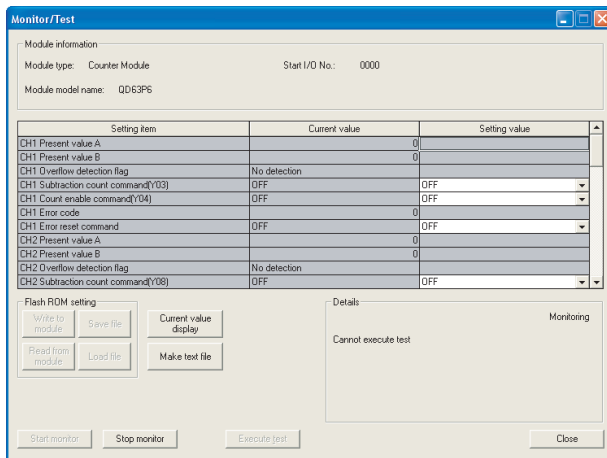

Refer to Section 6.6.

Figure 6.4 General operation (Continued)

6.3.3 Starting the Intelligent function module utility

[Operating procedure]

Intelligent function module utility is started from GX Developer.

[Tools] → [Intelligent function utility] → [Start]

[Setting screen]

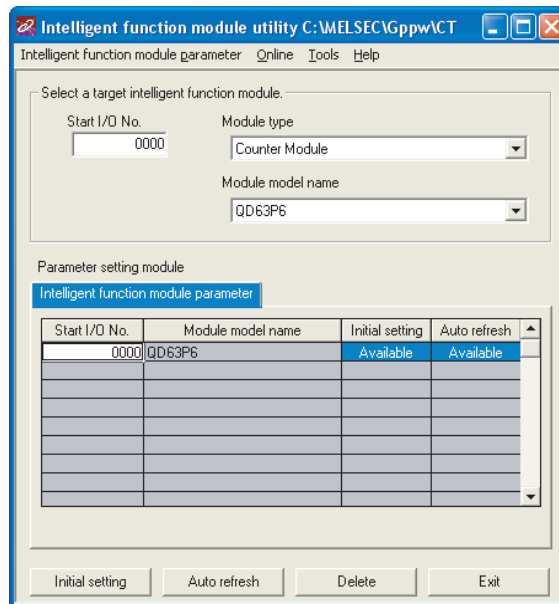

Figure 6.5 [Intelligent function module utility] screen

[Explanation of items]

(1) Activation of other screens

Following screens can be displayed from the intelligent function module utility screen.

(a) Initial setting screen

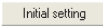
"Start I/O No.*1" → "Module type" → "Module model name" → 

(b) Auto refresh setting screen

"Start I/O No.*1" → "Module type" → "Module model name" → 

(c) Select monitor/test module screen

[Online] → [Monitor/Test]

* 1 Enter the start I/O No. in hexadecimal.

(2) Command buttons



Deletes the initial setting and auto refresh setting of the selected module.

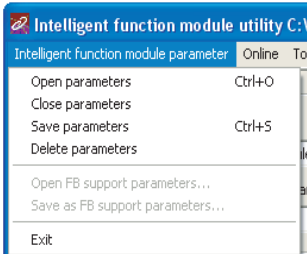

Closes this screen.

(3) Menu bar**(a) File menu**

Intelligent function module parameters of the project opened by GX Developer are handled.

- | | |
|---------------------------------|---|
| [Open parameters] | : Reads a parameter file. |
| [Close parameters] | : Closes the parameter file. If any data are modified, a dialog asking for file saving will appear. |
| [Save parameters] | : Saves the parameter file. |
| [Delete parameters] | : Deletes the parameter file. |
| [Open FB support parameters] | : Opens a FB support parameter file. |
| [Save as FB support parameters] | : Saves a FB support parameter. |
| [Exit] | : Closes this screen. |

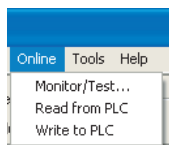
(b) Online menu

- | | |
|-----------------|---|
| [Monitor/Test] | : Activates the Select monitor/test module screen. |
| [Read from PLC] | : Reads intelligent function module parameters from the CPU module. |
| [Write to PLC] | : Writes intelligent function module parameters to the CPU module. |

POINT

- (1) Saving intelligent function module parameters in a file
Since intelligent function module parameters cannot be saved in a file by the project saving operation of GX Developer, save them on the shown module selection screen.
- (2) Reading/writing intelligent function module parameters from/to a programmable controller using GX Developer
 - Intelligent function module parameters can be read from and written into a programmable controller after having been saved in a file.
 - Set a target programmable controller CPU in GX Developer:
[Online] [Transfer setup].
 - When mounting the QD63P6 to the remote I/O station, use [Read from PLC]/[Write to PLC] of GX Developer.
- (3) Checking the required utility
While the start I/O is displayed on the Intelligent function module utility setting screen, " * " may be displayed for the model name.
This means that the required utility has not been installed or the utility cannot be started from GX Developer.
Check the required utility, selecting [Tools] - [Intelligent function utility] - [Utility list...] in GX Developer.

6.4 Initial Setting

[Purpose]

Make the initial settings for each channel to operate the QD63P6. The following setting items are available for parameters of [Initial setting].

- Preset value setting
- Coincidence detection point change request
- Coincidence detection point setting
- Ring counter lower limit value
- Ring counter upper limit value
- Period setting

By making the initial settings, the sequence program settings become unnecessary.

[Operating procedure]

"Start I/O No.*" → "Module type" → "Module model name" → Initial setting

* Enter the start I/O No. in hexadecimal.

[Setting screen]

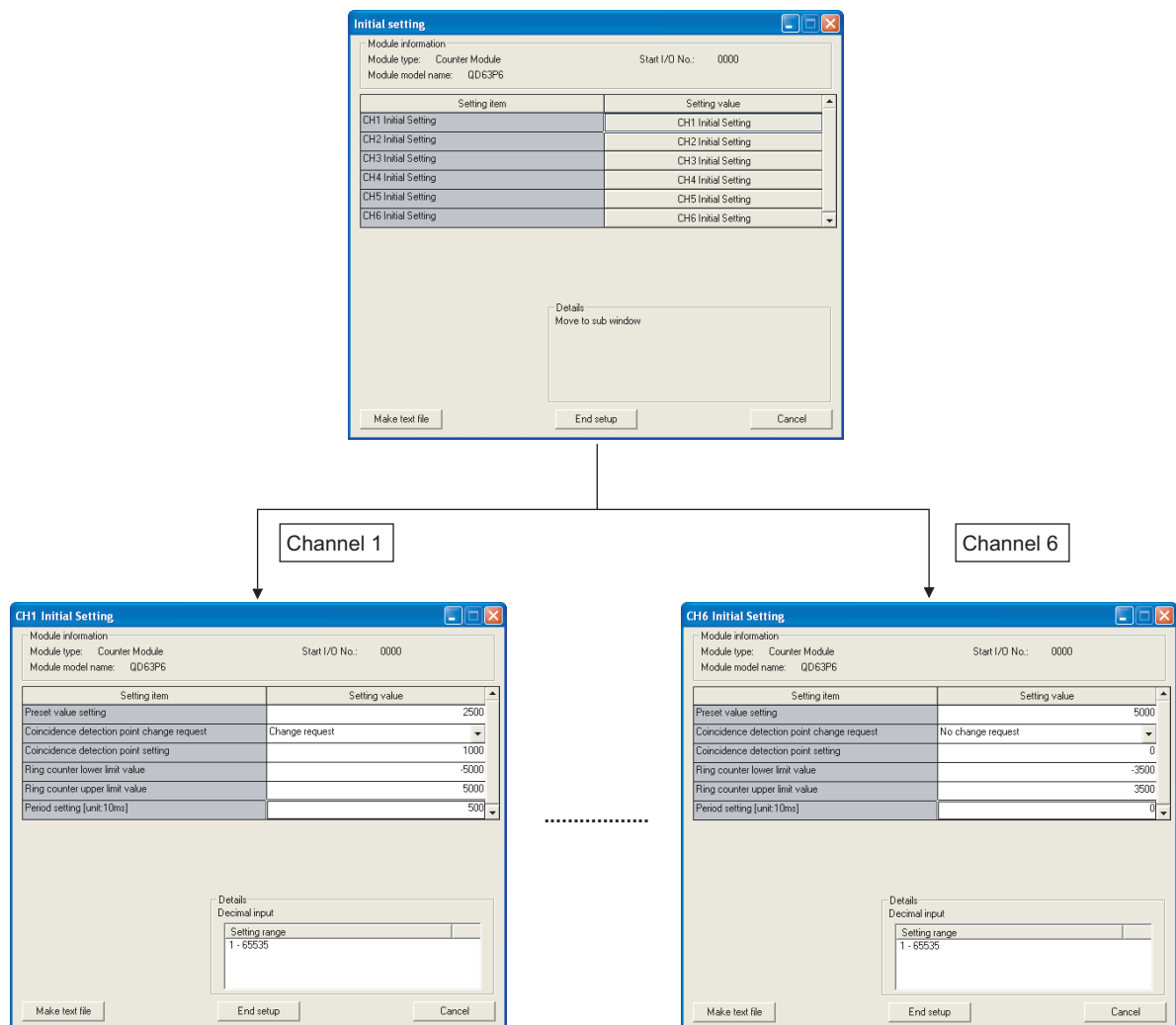

Figure 6.6 [Initial setting] screen

[Explanation of items]

(1) Command buttons

Make text file	Creates a file containing the screen data in text file format.
End setup	Saves the set data and ends the operation.
Cancel	Cancels the setting and ends the operation.

POINT

Initial settings are stored to the intelligent function module parameters.

The initial settings become effective after writing them to the CPU module and executing (1) or (2).

(1) Change RUN/STOP switch on the CPU module STOP, RUN, STOP, and RUN again.

(2) After changing the switch to RUN, power OFF and then ON the CPU module or reset it.

When the initial setting contents are written with the sequence program, the initial settings are executed when the RUN/STOP switch is changed to STOP and RUN again, and initial setting values are written.

When the CPU module is switched to STOP and RUN again, execute the initial settings with the sequence program again.

6.5 Auto Refresh

[Purpose]

Set the buffer memory of the QD63P6 to which auto refresh is to be performed for each channel.

The following setting items are available for parameters of [Auto refresh setting].

- Present value A
- Present value B
- Overflow detection flag
- Periodic counter flag
- Previous periodic pulse count value
- Present periodic pulse count value
- Judgment value for updated periodic pulse count value
- Error code

This auto refresh setting eliminates the need for reading by sequence programs.

[Operating procedure]

"Start I/O No.*" → "Module type" → "Module model name" →

* Enter the start I/O No. in hexadecimal.

[Setting screen]

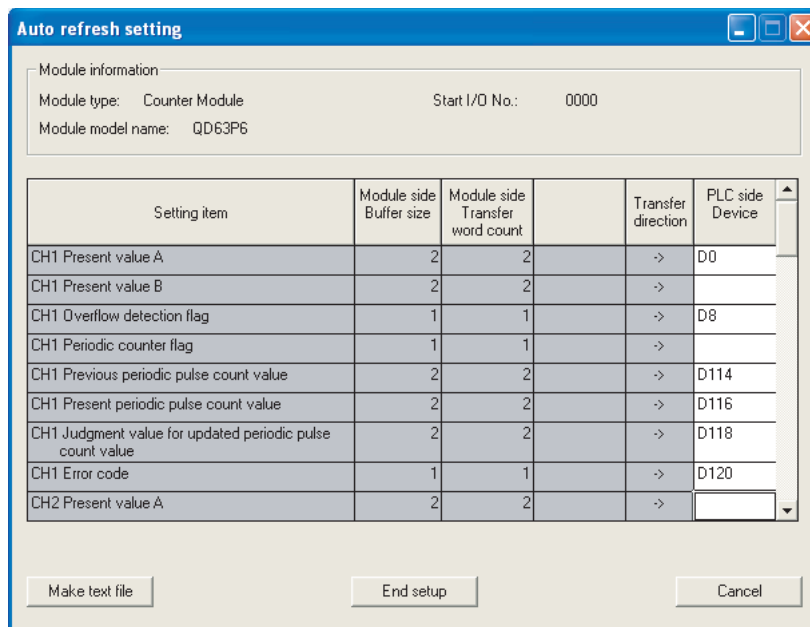

Figure 6.7 [Auto refresh setting] screen

[Explanation of items]

(1) Items

- Module side Buffer size : Displays the buffer memory size of the setting item.
- Module side Transfer word count : Displays the number of words to be transferred.
- Transfer direction : "←" indicates that data are written from the programmable controller CPU to the buffer memory.
"→" indicates that data are loaded from the buffer memory to the programmable controller CPU.
- PLC side Device : Enter a CPU module side device that is to be automatically refreshed.
Applicable devices are X, Y, M, L, B, T, C, ST, D, W, R, and ZR.
When using bit devices X, Y, M, L or B, set a number that can be divided by 16 points (examples: X10, Y120, M16, etc.)
Also, buffer memory data are stored in a 16-point area, starting from the specified device number. For example, if X10 is entered, data are stored in X10 to X1F.

(2) Command buttons

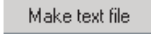
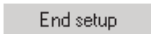
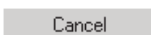
-  Creates a file containing the screen data in text file format.
-  Saves the set data and ends the operation.
-  Cancels the setting and ends the operation.

POINT

- The auto refresh settings are stored in an intelligent function module parameter file.
The auto refresh settings become effective by turning the power OFF and then ON or resetting the CPU module after writing the intelligent function module parameters to the CPU module.
- The auto refresh settings cannot be changed from sequence programs. However, processing equivalent to auto refresh can be added using the FROM/TO instruction in the sequence program.

6.6 Monitoring/Test

6.6.1 Monitoring/Test

[Purpose]

Start buffer memory monitoring/testing and I/O signal monitoring/testing from this screen.

[Operating procedure]

"Select monitor/test module" screen → "Start I/O No.*" → "Module type" → "Module model name" →

* Enter the start I/O No. in hexadecimal.

The screen can also be started from System monitor of GX Developer Version 6 or later.

Refer to the GX Developer Operating Manual for details.

[Setting screen]

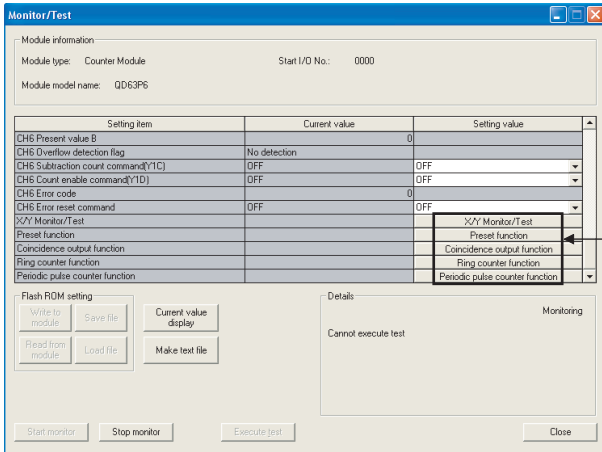

Selecting these buttons displays the following screens.

X/Y Monitor/Test

Preset function

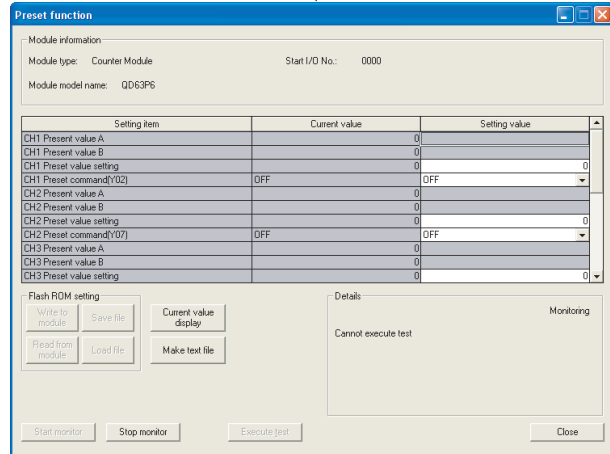
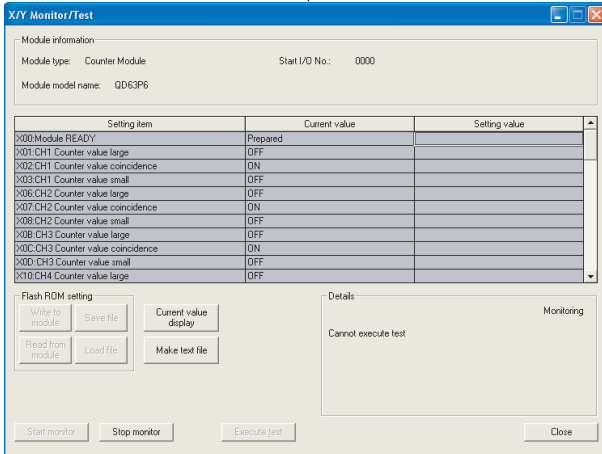

Figure 6.8 [Monitor/Test] screen

1) ←

Ring counter function

Module information
 Module type: Counter Module Start I/O No.: 0000
 Module model name: QD63P6

Setting item	Current value	Setting value
GH1 Ring counter lower limit value	0	0
GH1 Ring counter upper limit value	0	0
GH2 Ring counter lower limit value	0	0
GH2 Ring counter upper limit value	0	0
GH3 Ring counter lower limit value	0	0
GH3 Ring counter upper limit value	0	0
GH4 Ring counter lower limit value	0	0
GH4 Ring counter upper limit value	0	0
GH5 Ring counter lower limit value	0	0
GH5 Ring counter upper limit value	0	0
GH6 Ring counter lower limit value	0	0

Flash ROM setting
 Write to module Save file Current value display
 Read from module Load file Make text file

Details
 Monitoring
 Decimal input
 Setting range
 -2147483648 - 2147483647

Start monitor Stop monitor Execute test Close

Coincidence detection function

Module information
 Module type: Counter Module Start I/O No.: 0000
 Module model name: QD63P6

Setting item	Current value	Setting value
CH1 Present value A	0	0
CH1 Present value B	0	0
CH1 Coincidence detection point setting	0	0
CH1 Coincidence detection point change request	No change request	No change request
CH1 Coincidence signal reset command(Y01)	OFF:Release	OFF:Release
CH1 Counter value large(X01)	OFF	OFF
CH1 Counter value coincidence(X02)	OFF	OFF
CH1 Counter value small(X03)	OFF	OFF
CH1 Error code	820	
CH2 Present value A	0	0
CH2 Present value B	0	0

Flash ROM setting
 Write to module Save file Current value display
 Read from module Load file Make text file

Details
 Monitoring
 Cannot execute test

Start monitor Stop monitor Execute test Close

Periodic pulse counter function

Module information
 Module type: Counter Module Start I/O No.: 0000
 Module model name: QD63P6

Setting item	Current value	Setting value
CH1 Period setting	0	1
CH1 Periodic pulse counter start command(Y05)	OFF	OFF
CH1 Periodic counter flag	Idling function	
CH1 Previous periodic pulse count value	0	
CH1 Present periodic pulse count value	0	
CH1 Judgment value for updated periodic pulse count value	0	
CH2 Period setting	0	1
CH2 Periodic pulse counter start command(Y0A)	OFF	OFF
CH2 Periodic counter flag	Idling function	
CH2 Previous periodic pulse count value	0	

Flash ROM setting
 Write to module Save file Current value display
 Read from module Load file Make text file

Details
 Monitoring
 Decimal input
 Setting range
 1 - 65535

Start monitor Stop monitor Execute test Close

Figure 6.8 [Monitor/Test] screen (Continued)

[Explanation of items]

(1) Items

Setting item : Displays I/O signals and buffer memory names.

Current value : Monitors the I/O signal states and present buffer memory values.

Setting value : Enter or select values to be written into the buffer memory for test operation.

(2) Command buttons

Current value display

Displays the current value of the item selected. (This is used to check the text that cannot be displayed in the current value field. However, in this utility package, all items can be displayed in the display fields).

Make text file

Creates a file containing the screen data in text file format.

Start monitor / Stop monitor

Selects whether or not to monitor current values.

Execute test

Performs a test on the selected items. To select more than one item, select them while holding down the

key.

Closes the screen that is currently open and returns to the previous screen.

Close

Remark

The following describes an example when [Execute test] settings are changed as follows:

- Period setting: 3000 ms
- Periodic pulse counter start command (Y05): ON

(1) Click [Setting value] field for [CH□ Period setting] to select it.

(2) After inputting a period [unit: 10 ms] (input "300" in case of the above example), press the key.

At this moment, the input value has not yet been written to the QD63P6.

(3) Select [ON] in [Setting item] field of [CH□ Periodic pulse counter start command (Y05)].

(4) Select the [Setting value] fields input in (1) to (3) while pressing the key. Dragging operation using the mouse can also select multiple items.

(5) Click the button for writing.

After the writing, the written value is updated in the [Current value] field.

CHAPTER7 PROGRAMMING

This chapter describes programs using channel 1 of QD63P6, whose system configuration example shown below, in the following two cases:

- GX Configurator-CT is used
- GX Configurator-CT is not used

When applying any of the program examples introduced in this chapter to the actual system, verify the applicability and confirm that no problem occurs in the system control.

(1) System configuration

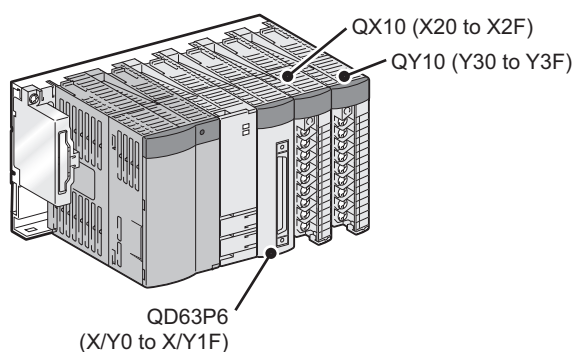

Figure 7.1 System configuration

(2) Setting conditions of the intelligent function module switch

Set the pulse input mode, counting speed setting, counter format, and present value selection setting with the intelligent function module switch on GX Developer. (Refer to Section 4.5.)

Table 7.1 Setting conditions of the intelligent function module switch

	Pulse input mode	Counting speed setting	Present value selection setting
CH1	1 multiple of 2 phases	200 kPPS	Present value A

(3) Program conditions

This program uses the QD63P6 to perform counting on the conditions listed below.

Table 7.2 Initial setting

Item	Setting value
Preset value setting	2500
Coincidence detection point change request	Change request
Coincidence detection point setting	1000
Ring counter lower limit value *1	-5000
Ring counter upper limit value *1	5000
Period setting *2	500 (5000ms)

* 1 Set this only when using the ring counter function.

* 2 Set this only when using the periodic pulse counter function.

Table 7.3 Auto refresh setting

Item	Setting value
CH1 Present value A	D0
CH1 Overflow detection flag *1	D8
CH1 Previous periodic pulse count value *2	D114
CH1 Present periodic pulse count value *2	D116
CH1 Judgment value for updated periodic pulse count value *2	D118
CH1 Error code	D120

* 1 Set this only when using the linear counter function.

* 2 Set this only when using the periodic pulse counter function.

Table 7.4 Devices used by users

Item	Device
Count operation start signal	X20
Present value read signal	X21
Preset command signal	X22
Count operation stop signal	X23
Coincidence LED clear signal	X24
Periodic pulse count data read signal *1	X25
Periodic pulse count start signal *1	X26
Error reset command	X27
Coincidence confirmation LED signal	Y30
Overflow occurrence confirmation LED signal *2	Y31
Error occurrence confirmation LED signal	Y32
Present value storage	D0 to D1
Previous periodic pulse count value storage *1	D2 to D3
Present periodic pulse count value storage *1	D4 to D5
Overflow status storage *2	D8
Error code storage *3	D9

* 1 Set this only when using the periodic pulse counter function.

* 2 Set this only when using the linear counter function.

* 3 Stores the last occurred error and retains even after error reset.

7.1 Program Example when GX Configurator-CT is Used

7.1.1 GX Configurator-CT operation

(1) Initial setting (refer to Section 6.4.)

Figure 7.2 shows settings have to be made.

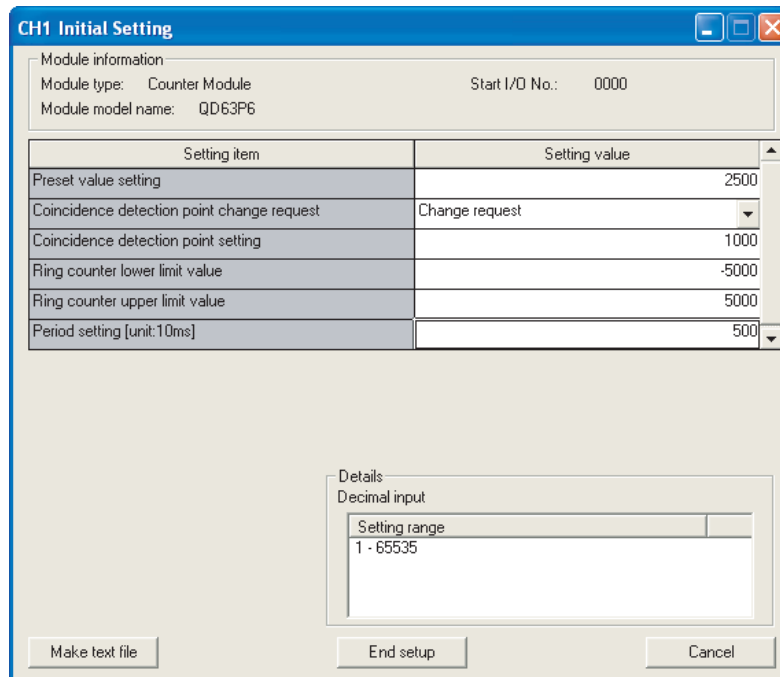

Figure 7.2 [Initial setting] screen

Table 7.5 Items on the [Initial setting] screen

Setting item	Description	Setting
Preset value setting	Set the preset value.	2500
Coincidence detection point change request	Set this to enable the coincidence detection point setting.	Change request
Coincidence detection point setting	Set the value for coincidence detection point.	1000
Ring counter lower limit value	Set this only when using the ring counter function.	-5000
Ring counter upper limit value	Set this only when using the ring counter function.	5000
Period setting [unit: 10ms]	Set this only when using the periodic pulse counter function.	500

(2) Auto refresh setting (refer to Section 6.5.)

Set the values on the screen as shown in Figure 7.3. (Channel 1 is used.)

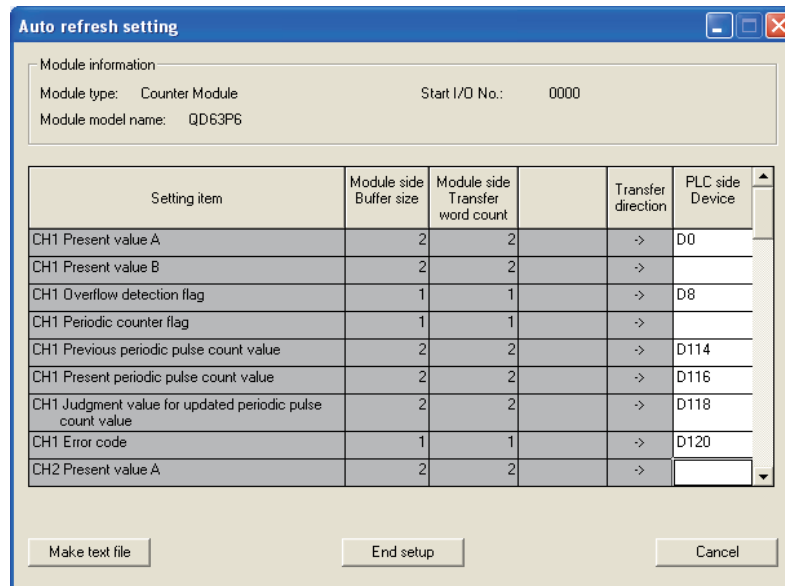

Figure 7.3 [Auto refresh setting] screen

Table 7.6 Items on the [Auto refresh setting] screen

Setting item	Description	Setting
CH1 Present value A	Set a device for storing the present value.	D0
CH1 Present value B	Not used.	-
CH1 Previous periodic pulse count value	Set a device for storing the previous periodic pulse count value when using the periodic pulse counter function.	D114
CH1 Present periodic pulse count value	Set a device for storing the present periodic pulse count value when using the periodic pulse counter function.	D116
CH1 Judgment value for updated periodic pulse count value	Set a device for storing the judgment value for updated periodic pulse count value when using the periodic pulse counter function.	D118
CH1 Periodic counter flag	Not used.	-
CH1 Overflow detection flag	Set a device for storing the overflow detection result when using the linear counter function.	D8
CH1 Error code	Set a device for storing the error code.	D120

(3) Writing the intelligent function module parameters (refer to Section 6.3.3.)

Write the intelligent function module parameters to the programmable controller CPU. Perform this operation on the [Intelligent function module parameter setting module select] screen.

7.1.2 Program example

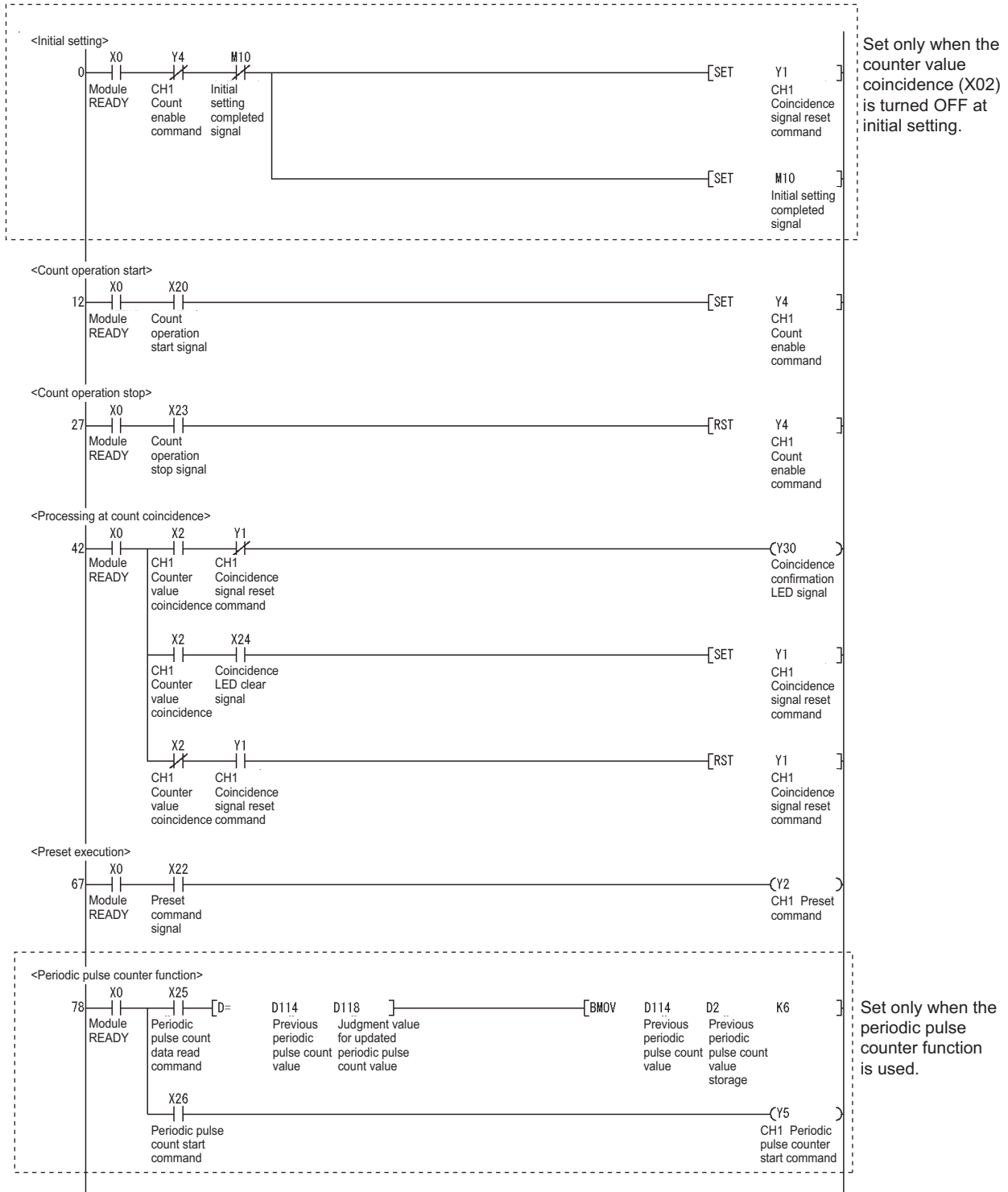

1	OVERVIEW
2	SYSTEM CONFIGURATION
3	SPECIFICATIONS
4	PROCEDURES AND SETTINGS BEFORE OPERATION
5	FUNCTIONS
6	UTILITY PACKAGE (GX Configurator-CT)
7	PROGRAMMING
8	TROUBLESHOOTING

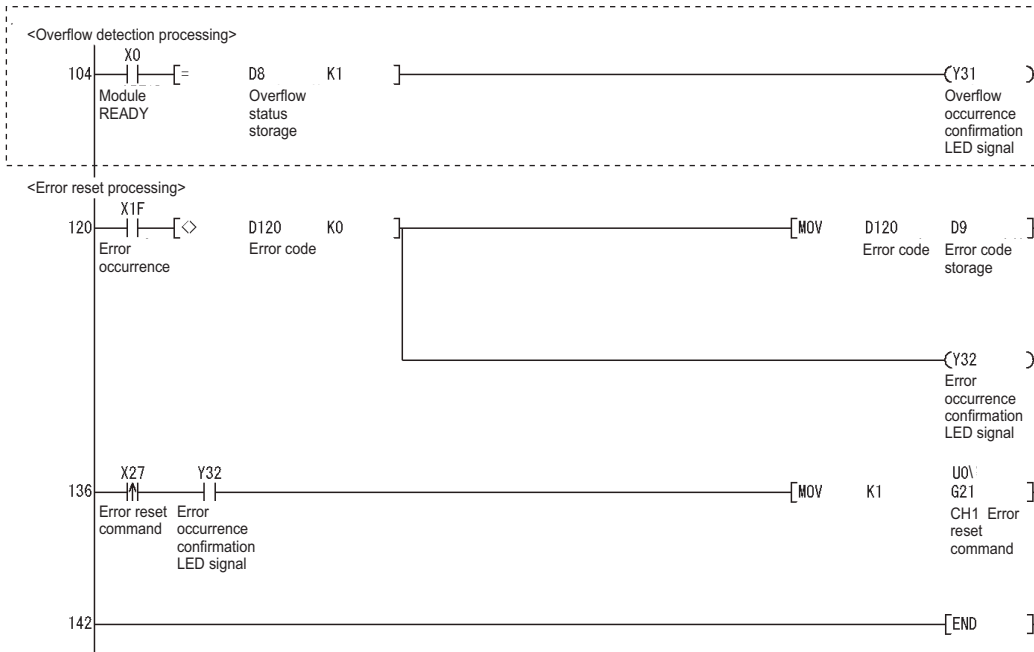

Set only when the linear counter function is used.

7.2 Program Example when GX Configurator-CT is not Used

7.2.1 Program example when dedicated instructions are used

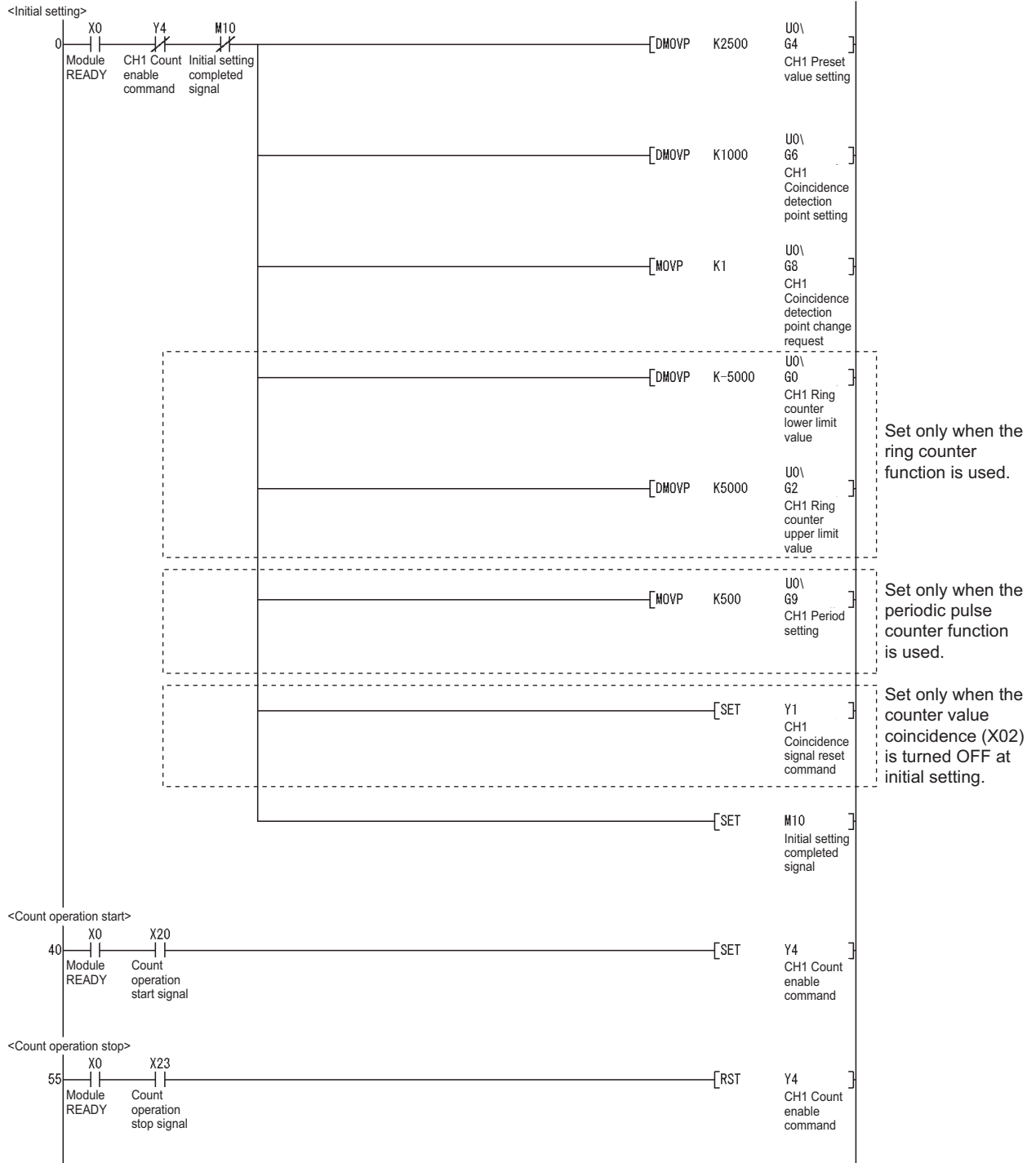

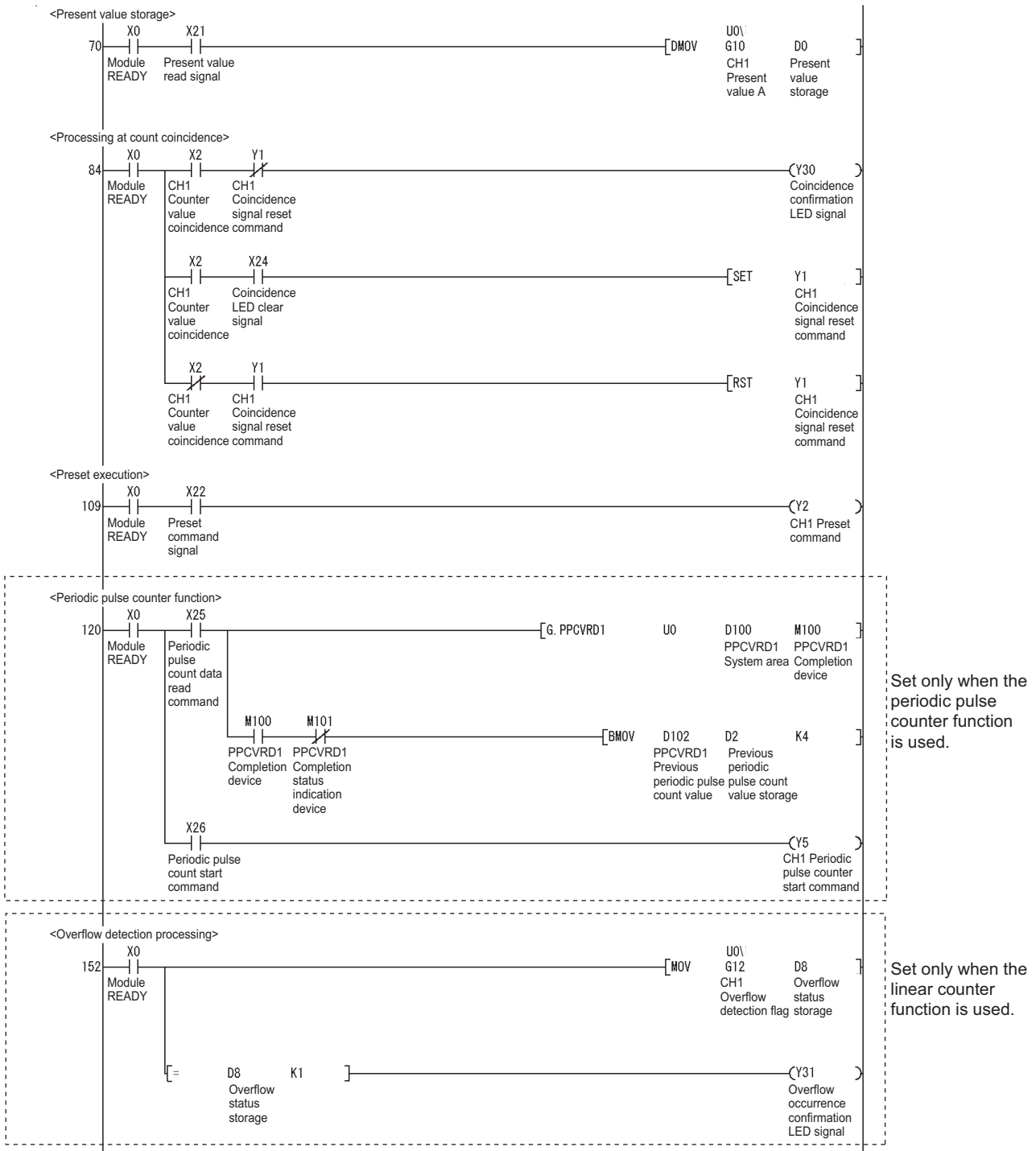

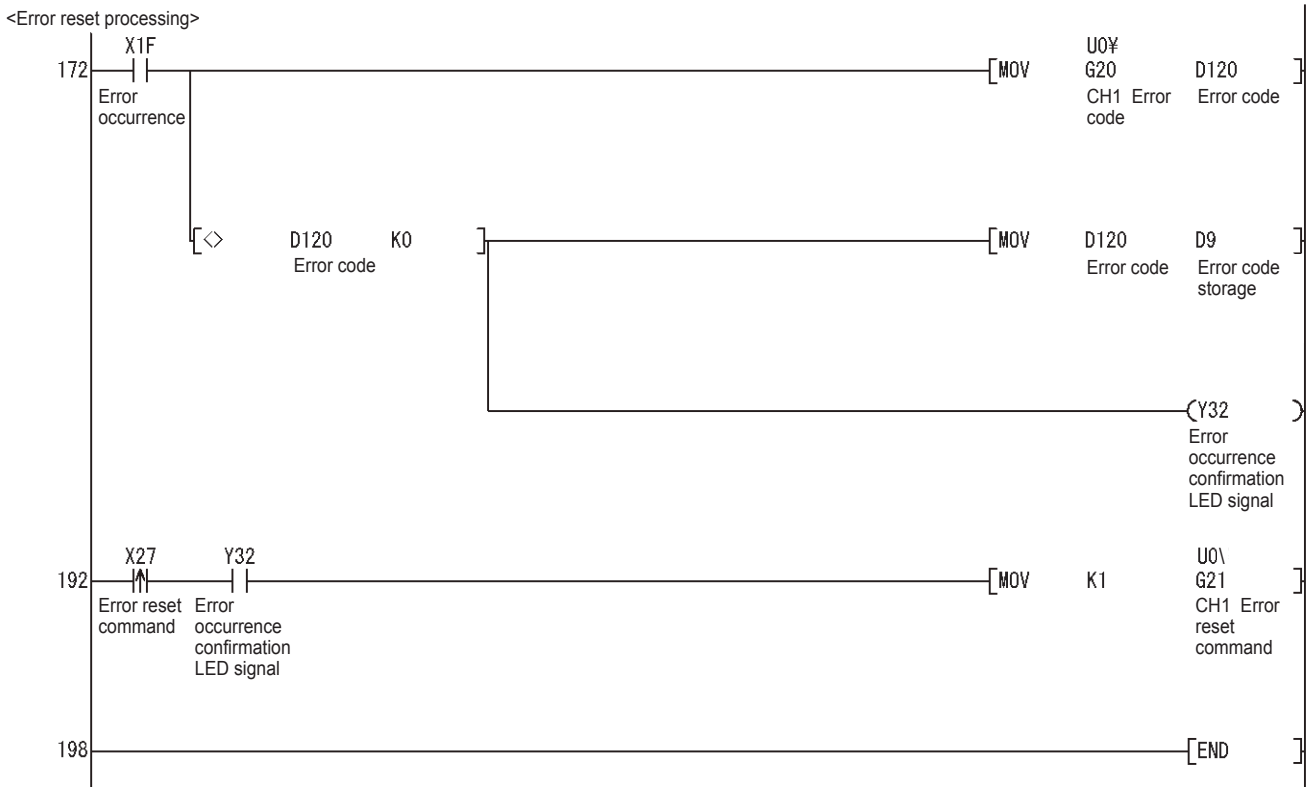

1

OVERVIEW

2

SYSTEM CONFIGURATION

3

SPECIFICATIONS

4

PROCEDURES AND SETTINGS BEFORE OPERATION

5

FUNCTIONS

6

UTILITY PACKAGE (GX Configurator-CT)

7

PROGRAMMING

8

TROUBLESHOOTING

7.2.2 Program example when dedicated instructions are not used

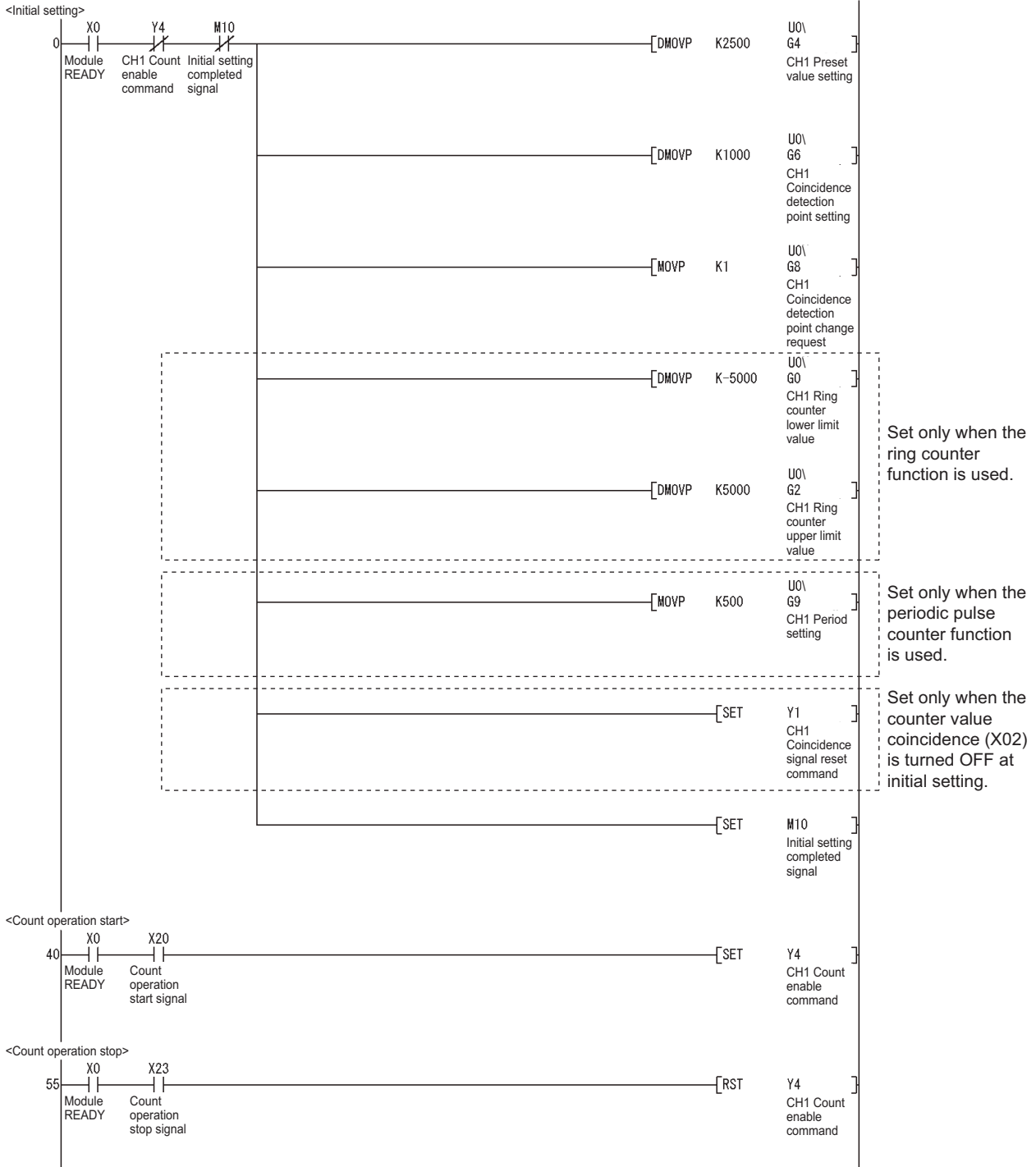

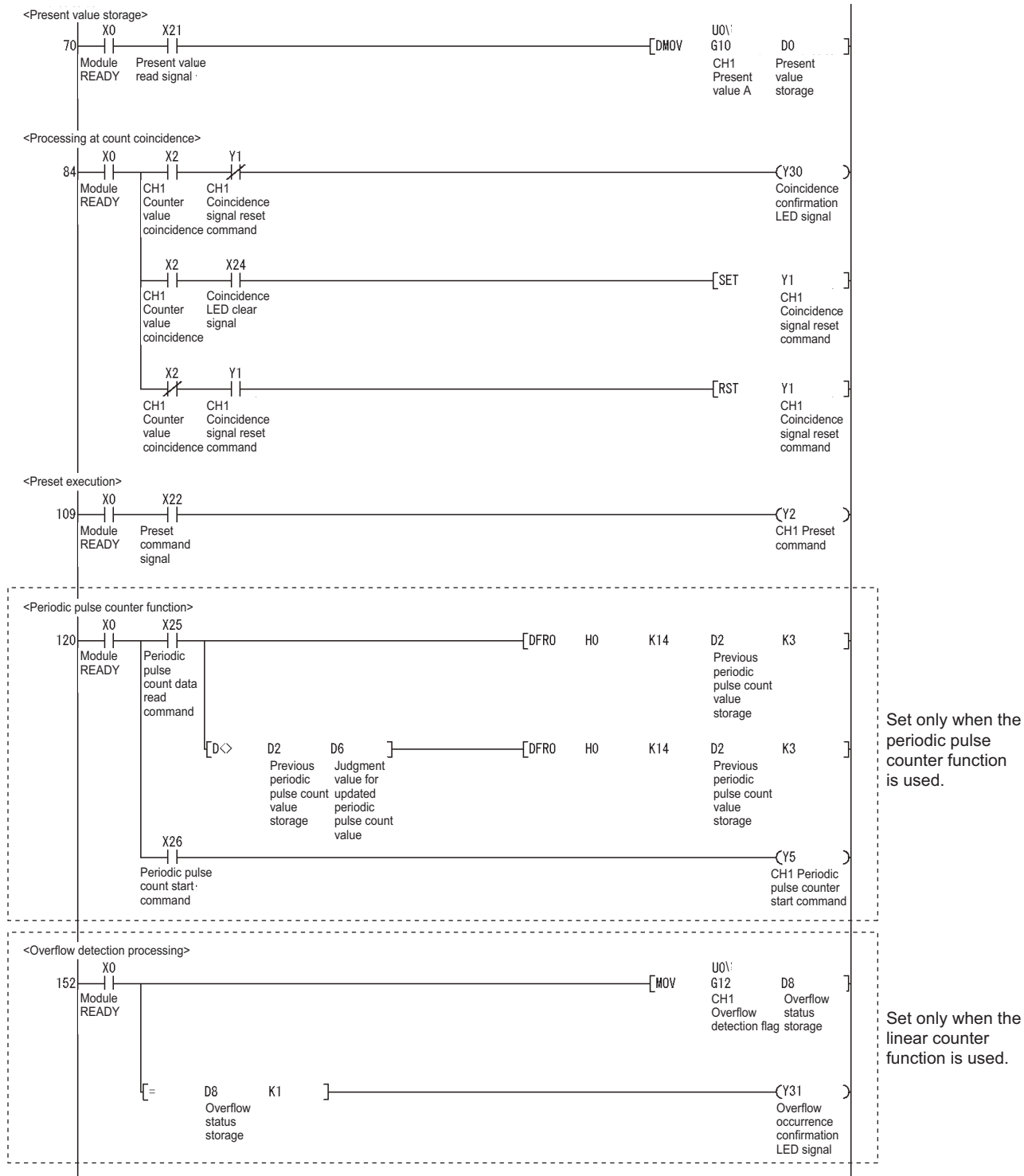

1	OVERVIEW
2	SYSTEM CONFIGURATION
3	SPECIFICATIONS
4	PROCEDURES AND SETTINGS BEFORE OPERATION
5	FUNCTIONS
6	UTILITY PACKAGE (GX Configurator-CT)
7	PROGRAMMING
8	TROUBLESHOOTING

(3) Program example

An interrupt must be enabled using the IMASK instruction before using an interrupt pointer.

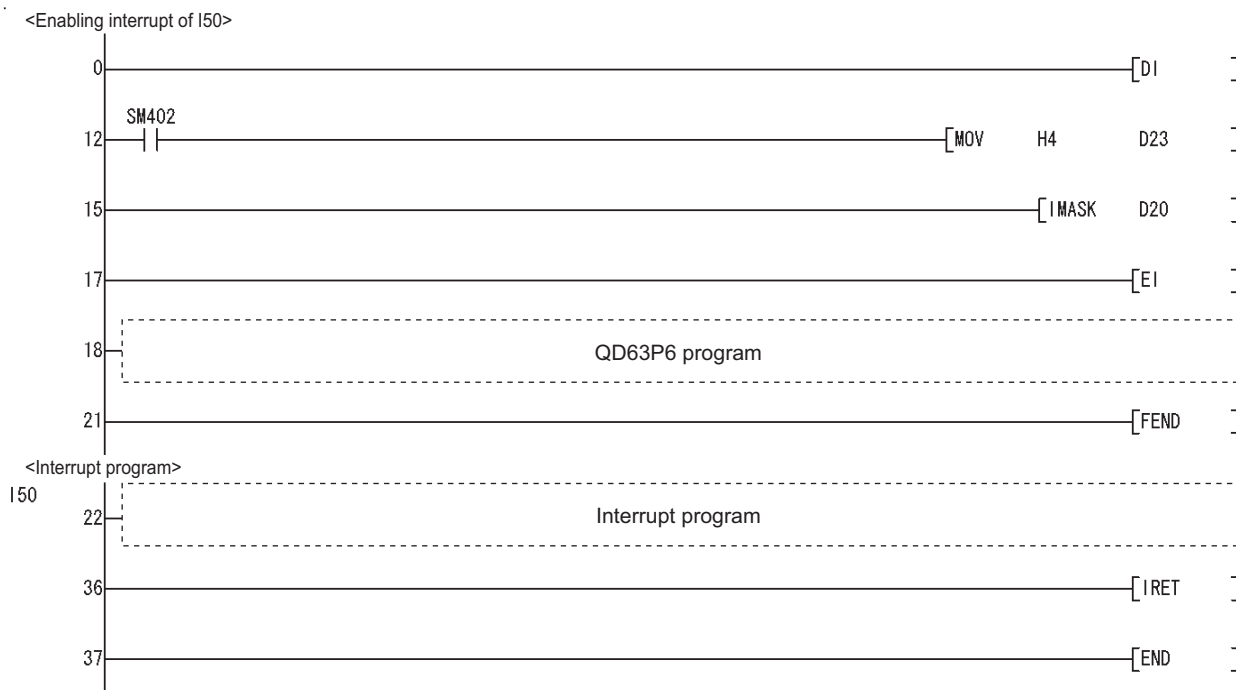

POINT

- When the above described program is executed, only I50 interrupt program is execution-enabled and other interrupt programs are execution-disabled.
When executing interrupt programs other than I50, set the corresponding bit for interrupt program to be executed to 1 (enabled).
- For details of the IMASK instruction, refer to MELSEC-Q/L Programming Manual (Common Instruction).

CHAPTER 8 TROUBLESHOOTING

This chapter describes the description of errors regarding the QD63P6 and troubleshooting for it.

8.1 Error Processing and Recovery Methods

8.1.1 Checking error description using System Monitor of GX Developer

Error codes can be checked by selecting [Module's Detailed Information...] on the [System Monitor] screen of GX Developer.

(1) GX Developer operation

Select [Diagnostics] → [System Monitor] → [QD63P6] → Module's Detailed Information....

(2) Checking error codes

The latest error code is displayed on [Present Error] field.

Clicking the Error History button displays the error code displayed on [Present Error] field in No.1 field as well.

Module's Detailed Information

Module Name: QD63P6 Product information: 09021000000000 - B
 I/O Address: 0
 Implementation Position: Main Base 0Slot

Module Information

Module access: Possible I/O Clear / Hold Settings: ---
 Status of External Power Supply: --- Noise Filter Setting: ---
 Fuse Status: --- Input Type: ---
 Status of I/O Address Verify: Agree Remote password setting status: ---

Error Display

No.	Error Code
1	500

Present Error: 500

Display format: HEX DEC

Error History

The display sequence of the error history is from the oldest error. The latest error is displayed in the line as under.

Error contents - Disposal

Contents: [Empty text area]

Disposal: [Empty text area]

H/W Information... Start monitor Stop monitor Close

[Display contents] [Present Error]
 Designates error code 500 "ring counter upper/lower limit value setting error".

↑ ↑
 Error code of CHn
 CHn (1 ≤ n ≤ 6)

[Display format]
 Select [DEC].
 (The error codes in Section 8.5 "Error Code List" are shown in decimal notation.)

Figure 8.1 [Module's Detailed Information] screen

1 OVERVIEW
2 SYSTEM CONFIGURATION
3 SPECIFICATIONS
4 PROCEDURES AND SETTINGS BEFORE OPERATION
5 FUNCTIONS
6 UTILITY PACKAGE (GX Configurator-CT)
7 PROGRAMMING
8 TROUBLESHOOTING

(3) Checking Module's Detailed Information

Check the status of LEDs and intelligent function module switch setting, and module information in [H/W status] on the [Module's Detailed Information] screen which can be displayed from [System Monitor] of GX Developer Version 7.17T or later.

[Setting procedure]

Select [Diagnostics] → [System monitor...] → [QD63P6] → [Module's Detailed Information...] → .

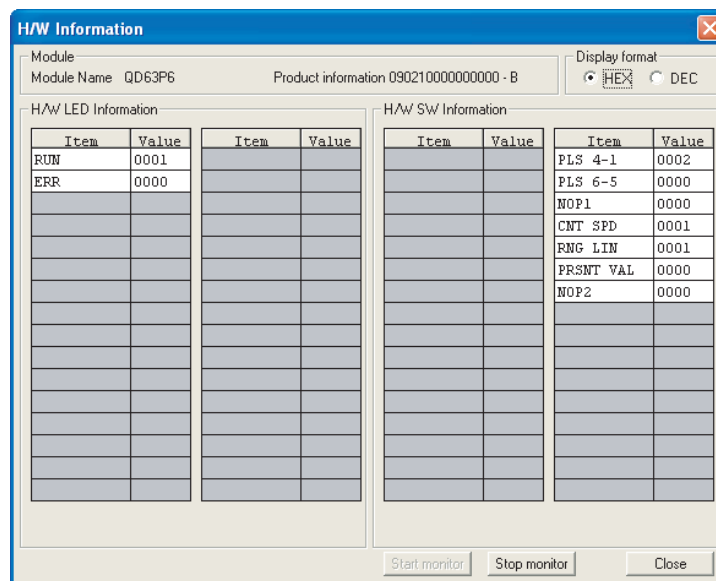

Figure 8.2 [H/W Information] screen

[H/W LED Information]

The following information is displayed on the [H/W LED Information] screen.

Table 8.1 H/W LED Information

Item	Signal	Value
RUN	"RUN" LED on the QD63P6	0: The LED is OFF.
ERR.	"ERR." LED on the QD63P6	1: The LED is ON.

[H/W SW Information]

The setting status of the intelligent function module switches is displayed.

Table 8.2 H/W SW Information

Item	Signal	Corresponding switch	Value	
PLS 4-1	Pulse input mode (CH4 to 1)	Switch 1	For details, refer to "Section 4.5 Intelligent Function Module Switch Setting".	
PLS 6-5	Pulse input mode (CH6 and 5)	Switch 2		Lower 8 bits
NOP1	-			Upper 8 bits
CNT SPD	Counting speed setting	Switch 3		
RNG LIN	Counter format	Switch 4		Lower 8 bits
PRSNT VAL	Present value selection setting			Upper 8 bits
NOP2	-	Switch 5		

The LED display changes according to the operation status of the QD63P6 as follows.

Table 8.3 LED display

Display contents	Display point	Operation status	Action
RUN 1 2 3 4 5 6 CH. □ □ □ □ □ □ □ ΦA □ □ □ □ □ □ □ ΦB ERR.	•RUN LED is OFF.	Hardware fault	If the RUN LED does not turn ON after the programmable controller is powered ON, the module is a failure. Replace it.
RUN 1 2 3 4 5 6 CH. ■ □ □ □ □ □ □ ΦA □ □ □ □ □ □ □ ΦB ERR.	•RUN LED is ON. •ERR. LED is OFF.	The module is normal.	-
RUN 1 2 3 4 5 6 CH. ■ □ □ □ □ □ □ ΦA ■ □ □ □ □ □ □ ΦB ERR.	ERR. LED is ON.	Error	Check the error code (refer to Section 8.5) and fix the error cause.
RUN 1 2 3 4 5 6 CH. ■ ■ □ □ □ □ □ ΦA □ □ □ □ □ □ □ ΦB ERR.	•φA_CH1 LED is ON. (LED corresponding to the CH turns ON.)	Phase A pulse is being input.	-
RUN 1 2 3 4 5 6 CH. ■ □ □ □ □ □ □ ΦA □ ■ □ □ □ □ □ ΦB ERR.	•φB_CH1 LED is ON. (LED corresponding to the CH turns ON.)	Phase B pulse is being input.	-

Symbols in the Display contents columns indicate the following status:

□: OFF, ■: ON

8.1.2 When the RUN LED turns OFF

Table 8.4 When the RUN LED turns OFF

Check item	Action	Reference
Is power supplied?	Check if the service voltage of the power supply module is within the rated range.	-
Is the capacity of the power supply module sufficient?	Calculate the consumption current of the modules mounted to the base unit such as CPU module, I/O module, and intelligent function module, and check that the current capacity is sufficient.	-
No watchdog timer error?	Reset the programmable controller CPU and check that the RUN LED turns ON. If the RUN LED remains OFF even doing so, the QD63P6 is a failure. Please consult your local Mitsubishi representative, explaining a detailed description of the problem.	Section 4.3
Are the modules correctly mounted to the base unit?	Check the module mounting status.	Section 4.1

8.1.3 When the RUN LED and ERR. LED turn ON

Table 8.5 When the RUN LED and ERR. LED turn ON

Check item	Action	Reference
No error?	Check the error code of the used channel (Un\G20) and take measures described in Error Codes List.	Section 8.5

8.2 When the QD63P6 Does Not Start Counting

Table 8.6 When the QD63P6 does not start counting

Check item	Action	Reference
Doesn't the programmable controller CPU indicate an error?	If the LED on the programmable controller CPU indicates an error, correct the error with reference to troubleshooting in the programmable controller CPU's manual for normal operation.	-
Do the LEDs of ϕA and ϕB turn ON by directly applying voltage using such as voltage stabilizer to pulse input terminals of ϕA and ϕB ?	If they turn ON, check the external wiring and encoder side and correct the error. If they remain OFF, it is a hardware failure. Please consult your local Mitsubishi representative, explaining a detailed description of the problem.	Section 4.3 Section 4.4
Is the external wiring of ϕA and ϕB normal?	Check the external wiring and correct the error.	
Is the count enable command (Y04) ON?	Turn the count enable command (Y04) ON with the sequence program.	Section 3.3.2
Are the present value A (Un\G10 and 11)/present value B (Un\G200 and 201) read by the sequence program the same with the value made on [Present value selection setting] of the intelligent function module switch setting?	Match the present value A (Un\G10 and 11)/present value B (Un\G200 and 201) to be read by the sequence program with the value made on [Present value selection setting] of the intelligent function module switch setting.	Section 3.4 Section 4.5
Are the pulse input method and pulse input mode set with the intelligent function module switch setting the same?	Match the pulse input method with the pulse input mode made on the intelligent function module switch setting.	Section 4.5 Section 5.1

8.3 When the QD63P6 Does Not Normally Count

Table 8.7 When the QD63P6 does not normally count

Check item		Action	Reference
Does the input pulse waveform meet the performance specifications?		Check the pulse waveform with synchronoscope. When the input pulse does not meet the performance specifications, input the pulse which meets the performance specifications.	Section 3.1
Is the maximum speed of input pulse within the range of the counting speed made on the intelligent function module switch setting?		Correct the counting speed setting in the intelligent function module switch setting to meet the maximum speed of the input pulse.	Section 4.5
When the count value same with another channel is input, does the count result become the same with that of another channel?		If they differ, it is a hardware failure. Please consult your local Mitsubishi representative, explaining a detailed description of the problem.	-
Noise reduction measures	Are the shielded twisted pair cables used for pulse input wiring?	Use the shielded twisted pair cables for pulse input wiring.	Section 4.4
	Has the measures against noise been taken to the adjacent devices and inside the control panel?	Take noise reduction measures (e.g. attach a CR surge suppressor to the magnet switch).	
	Is the distance between the high voltage equipment and pulse input line kept enough?	Bundle the pulse input lines and put them in a single tube, and keep a distance of 150 mm (5.91 inch) or more with the power line even inside the control panel.	
	Doesn't any noise come from the ground part of the QD63P6?	Separate the ground cable of the QD63P6 from the ground part. When the QD63P6 case touches to the ground part, separate it.	
Are the count value data treated in 32-bit binary in the sequence program?		Correct the sequence program so that the count value data can be treated in 32-bit binary.	Section 3.4 CHAPTER 7

8.4 When the Coincidence Detection Interrupt Does Not Occur

Table 8.8 When the coincidence detection interrupt does not occur

Check item	Action	Reference
Does the CPU module support the coincidence detection interrupt function?	Change the CPU module to the one which supports the intelligent function module event interrupt.	Section 2.1 (1)
Is the setting made on [Interrupt pointer setting] of [Intelligent function module setting] in [PLC parameter] correct?	Check the intelligent function module interrupt pointer setting.	Section 5.3 (2)
Is the way to use the program execution control instruction correct?	Check the sequence program.	Section 5.3 (2) CHAPTER 7
Does the counter value coincidence (X02) remain ON?	Turn ON the coincidence reset command (Y01), and reset the counter value coincidence (X02).	Section 3.3.2

8.5 Error Codes List

This section describes the descriptions and corrective actions for the errors detected by the QD63P6.

Table 8.9 Error codes list

Error code	Error name	Description	Operation at error		Action	Reference
			Error channel	Other channels		
0	(Normal)	-	-	-	-	-
100	Overflow error	The present value A (Un\G10 and 11)/present value B (Un\G200 and 201) exceeds the following range when the linear counter function is selected. -2147483648 to 2147483647	The linear counter function stops counting.	Normally operate if no error occurs.	Perform preset (Y02).	Section 3.3
500	Ring counter upper/lower limit value setting error	The setting which meets the condition "ring counter lower limit value (Un\G0 and 1) > ring counter upper limit value (Un\G2 and 3)" was made when the ring counter function was selected and the count enable command (Y04) was turned ON.	The ring counter function does not start counting.		Set them so that the condition "ring counter lower limit value (Un\G0 and 1) ≤ ring counter upper limit value (Un\G2 and 3)" is satisfied, and change the count enable command (Y04) from OFF to ON.	Section 3.3 Section 3.4 Section 5.2.2
600	Period setting error	The period setting (Un\G9) was set to 0 and the periodic pulse counter start command (Y05) was turned ON.	The periodic pulse counter function does not start.		Make the period setting (Un\G9) within the range from 1 to 65535 and change the periodic pulse counter start command (Y05) from OFF to ON.	Section 3.3 Section 3.4
810	Switch setting error	The value of the intelligent function module switch setting made with GX Developer is incorrect.			Set the correct value using GX Developer and perform [Write to PLC]. After that, power OFF and then ON the programmable controller CPU or reset it.	Section 4.5
820	Programmable controller CPU error	An error occurred in the programmable controller CPU.	<ul style="list-style-type: none"> •The linear counter function, ring counter function, and periodic pulse counter function stop counting. •The module READY (X00) turns OFF. 	Power OFF and then ON the programmable controller CPU or reset it.	-	
830	Watchdog timer error of programmable controller CPU	A watchdog timer error occurred in the programmable controller CPU.				
840	Module error	An error occurred in the module.				Power OFF and then ON the programmable controller CPU or reset it. If an error occurs again, replace the module.
850	Hardware error	An error occurred in the hardware.				Replace the module.

POINT

- (1) When another error occurs during error occurrence, take the following action.
- When an error code from 100 to 600 occurs, the latest error code is ignored and the error code stored before the latest error code is held.

- When an error code from 810 to 850 occurs, the error code is overwritten as the latest one.

(When an error code 810 occurs, it is stored to the error code (Un\G20) of the relevant channel. When an error code from 820 to 850 occurs, any of the error code from 820 to 850 is stored to the error codes (Un\G20) of all channels.)

- (2) An error code can be reset with the error reset command (Un\G21). After fixing the error cause, reset the error. If the error cause is not fixed, the error code is stored again to the error code in the buffer memory (Un\G20) when the error cause is detected again.

APPENDICES

Appendix 1 Dedicated Instructions

Appendix 1.1 Dedicated instructions list

The following table shows the dedicated instructions supported by the QD63P6.

Table APPX.1 Dedicated instructions supported by the QD63P6

No.	Function	Dedicated instruction	Description	Reference
1	Periodic pulse counter function	G(P).PPCVRD1	Reads the periodic pulse count value of CH1.	Appendix 1.2
2		G(P).PPCVRD2	Reads the periodic pulse count value of CH2.	
3		G(P).PPCVRD3	Reads the periodic pulse count value of CH3.	
4		G(P).PPCVRD4	Reads the periodic pulse count value of CH4.	
5		G(P).PPCVRD5	Reads the periodic pulse count value of CH5.	
6		G(P).PPCVRD6	Reads the periodic pulse count value of CH6.	

POINT

When the QD63P6 is mounted to the MELSECNET/H remote I/O station, Q12PRHCPU or Q25PRHCPU, the dedicated instructions cannot be used.

Appendix 1.2 G(P). PPCVRD

Table APPX.2 Available devices

Setting data	Available device									
	Internal device (system, user)		File register	Link direct device J□\□		Intelligent function module U□\G□	Index register Z□	Constant		Other
	Bit	Word		Bit	Word			K, H	\$	
(S)	-		○			-		-	-	-
(D)	○		○			-		-	-	-

[Instruction symbol] [Executing condition]

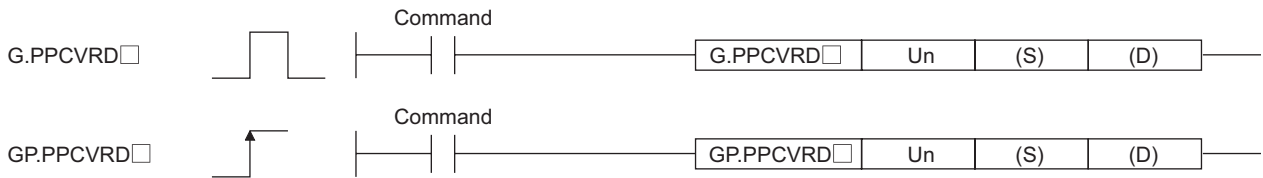

Figure APPX.1 Instruction format

Table APPX.3 Setting data

Setting data	Description	Setting range	Data type
Un	Module head I/O number	0000H to 00FEH	BIN 16 bits
(S)	Head number of the device storing the control data	Within the specified device range	Device name
(D)	Turns ON for one scan on completion of the dedicated instruction processing. Also turns ON (D)+1 at device error completion.	Within the specified device range	Bit

Table APPX.4 Control data

Device	Item	Description	Setting range	Data type
(S)	System area	-	-	-
(S) +1	Completion status	Stores the status on completion of the instruction. 0: Normal completion Other than 0: Error completion	-	System
(S) +2	Previous periodic pulse count value	Stores the previous periodic pulse count value.	-2147483648 to 2147483647	System
(S) +3				
(S) +4	Present periodic pulse count value	Stores the present periodic pulse count value.	-2147483648 to 2147483647	System
(S) +5				

(1) Function

- (a) Reads the periodic pulse count value.
- (b) When reading the periodic pulse count value with the G(P).PPCVRD□ instruction, consistency between the previous periodic pulse count value and the present periodic pulse count value is retained. (Refer to Section 5.5.)
- (c) Completion device (D) and completion status indication device (D) + 1 are available for the interlock signal of the G(P).PPCVRD□ instruction.
 - 1) Completion device
Turns ON at END processing in the scan where the G(P).PPCVRD□ instruction is completed, and turns OFF at the next END processing.
 - 2) Completion status indication device
Turns ON/OFF according to the status on completion of the G(P).PPCVRD□ instruction.
Normal completion: Remains OFF.
Error completion: Turns ON at END processing in the scan where the G(P).PPCVRD□ instruction is completed, and turns OFF at the next END processing.

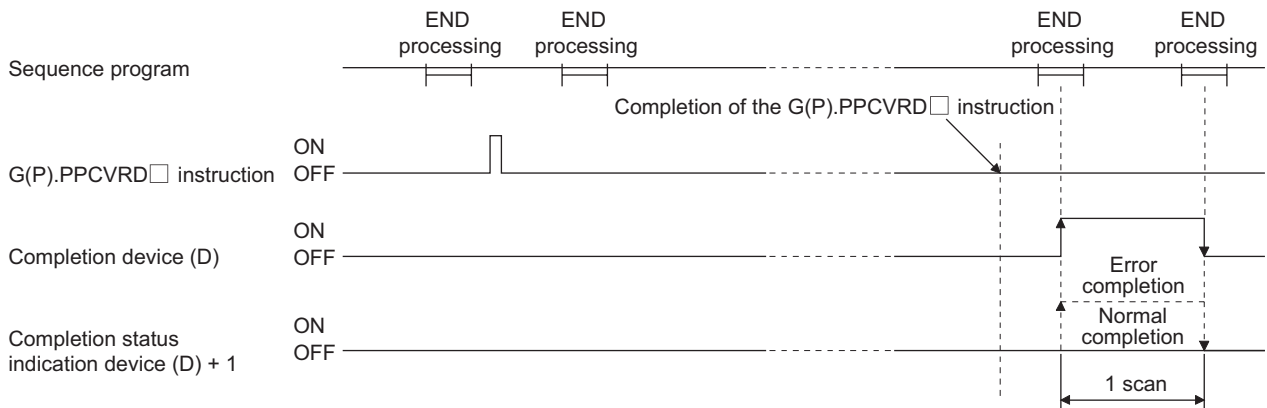

Figure APPX.2 Timing chart of the G(P).PPCVRD□ instruction

- (d) If the channels differ, the G(P).PPCVRD□ instructions can be executed concurrently. For example, the G(P).PPCVRD1 instruction and G(P).PPCVRD2 instruction can be executed concurrently.
- (e) The G(P).PPCVRD□ instruction can be executed while the module READY signal is ON. If executed while the signal is OFF, the instruction is ignored.

(2) Error

There are no errors regarding the instruction.

(3) Program example

The following example shows the program which reads the periodic pulse count value of CH 1 for the QD63P6 mounted to the slot where I/O number X/Y00 to X/Y1F are assigned when the read command M0 is turned ON.

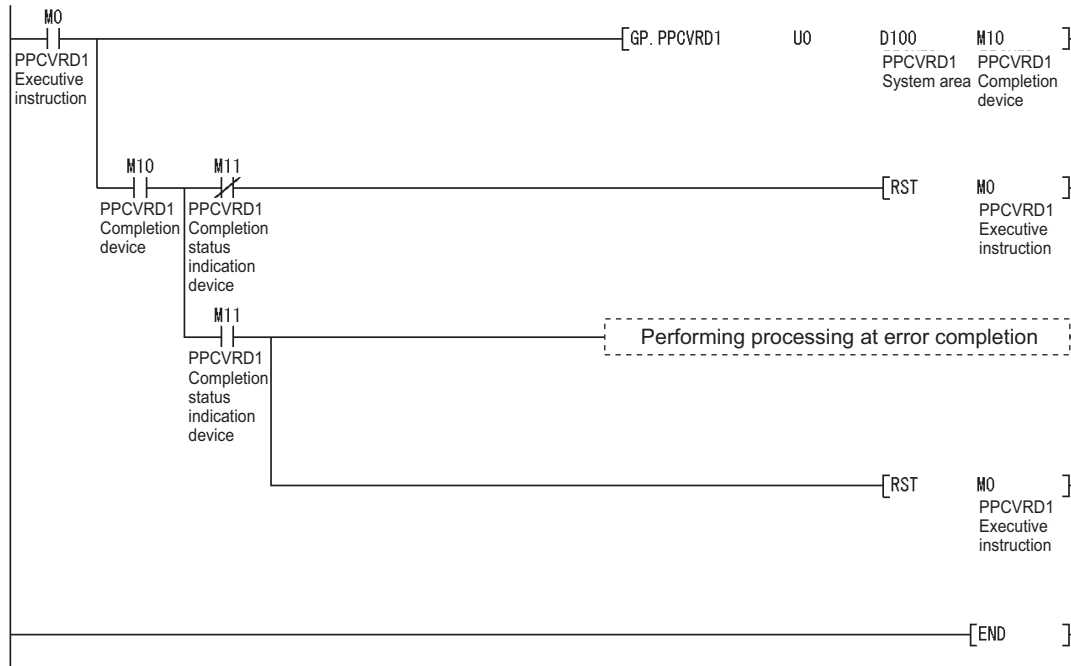

POINT

When the periodic pulse count value is read with the G(P).PPCVRD□ instruction, the determination on consistency in the sequence program is unnecessary.

Appendix 2 External Dimensions

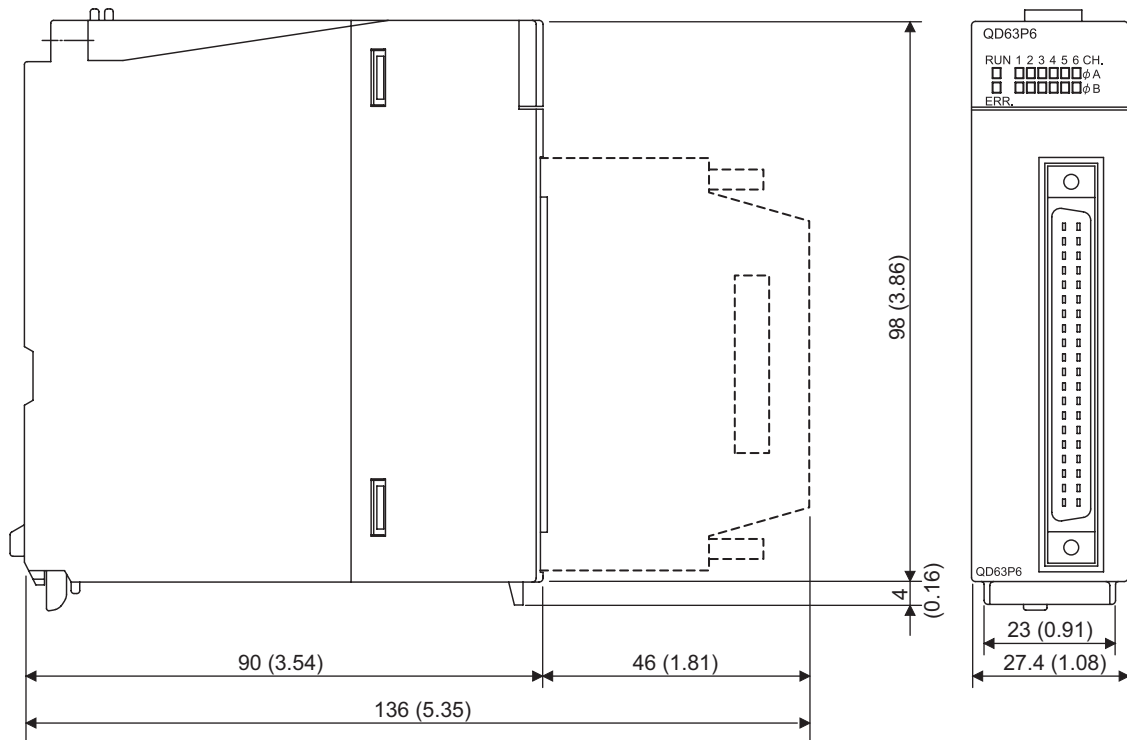

Unit: mm (inch)

INDEX

[A]

- Applicable System..... 2-1
- Auto refresh..... 6-15
- A6CON1..... 4-4
- A6CON2..... 4-4
- A6CON3..... 4-4
- A6CON4..... 4-4

[B]

- Buffer Memory Assignment..... 3-9

[C]

- Checking error description..... 8-1
- Coincidence detection function 3-2,5-12
- Coincidence detection interrupt function 3-2,5-14
- Coincidence detection point change request (Un\G8)
..... 3-12
- Coincidence detection point setting (Un\G6 and 7)
..... 3-12
- Coincidence signal reset command..... 3-7
- Common operation..... 6-6
- Connectable Encoders 3-18
- Connector 4-4
- Connectors for external wiring 4-4
- Count enable command (Y04)..... 3-8
- Count methods..... 5-1
- Count range 5-5
- Count timing 5-1
- Counter format 4-14,4-15,5-3
- Counter value coincidence (X02)..... 3-6
- Counter value large (X01) 3-5
- Counter value small (X03) 3-6
- Counting speed 3-1
- Counting speed setting 4-14,4-15
- Crimp tool 4-4
- CW/CCW..... 5-1

[D]

- Dedicated Instructions..... APPX-1
- Details of the buffer memory 3-11

[E]

- EMC Directive..... 4-7
- Error code (Un\G20) 3-15
- Error Codes List 8-8
- Error occurrence (X1F)..... 3-6
- Error Processing and Recovery Methods..... 8-1
- Error reset command (Un\G21)..... 3-16
- ERR. LED 4-3,8-3
- Example of wiring the module and an encoder 4-8
- External Dimensions APPX-5

[F]

- Features..... 1-2
- Function List 3-2
- Function version 2-3,2-5
- Functions of I/O signals 3-5
- Functions of the utility package 6-1

[G]

- G(P). PPCVRD..... APPX-2

[H]

- H/W LED Information 8-2
- H/W SW Information 8-2

[I]

- IMASK instruction 5-15,7-14
- Initial Setting 6-13
- Installation and uninstallation 6-2
- Intelligent function module interrupt pointer setting
..... 5-15,7-13
- Intelligent function module switch setting 4-14
- Interface with External Devices 3-17
- Interrupt pointer setting 7-13
- I/O signal list..... 3-3

[J]

- Judgment value for updated periodic pulse count
value (Un\G18 and 19) 3-15

[L]

- LED..... 4-3,8-3
- Linear counter function 3-2,5-4
- Low Voltage Directive..... 4-7

[M]

- Measures against noise 4-6
- Module READY (X00) 3-5
- Module's Detailed Information 8-2
- Monitor/Test 6-17

[O]

- Operating environment 6-4
- Operation overview..... 6-8
- Overflow 5-4
- Overflow detection flag (Un\G12)..... 3-14
- OVERVIEW..... 1-1

[P]

- Part Names 4-3
- Period setting (Un\G9)..... 3-13
- Periodic counter flag (Un\G13)..... 3-15
- Periodic pulse counter function 3-2,5-18

Periodic pulse counter start command	3-8
Present periodic pulse count value (Un\G16 and 17)	3-15
Present value A (Un\G10 and 11).....	3-14
Present value B (Un\G200 and 201).....	3-14
Present value selection setting	4-14,4-15
Preset command (Y02).....	3-7
Preset function	3-2,5-17
Preset value setting (Un\G4 and 5)	3-11
Previous periodic pulse count value (Un\G14 and 15)	3-15
Procedures.....	4-2
Program example.....	7-5
Program example when dedicated instructions are not used	7-10
Program example when dedicated instructions are used	7-7
Program Example when GX Configurator-CT is not Used	7-7
Program Example when GX Configurator-CT is Used	7-3
Program Example when the Coincidence Detection Interrupt Function is Used	7-13
PROGRAMMING	7-1
Pulse input method.....	5-1
Pulse input mode	4-14,4-15

[R]

Reading/writing buffer memory	3-9
Response delay time	5-22
Ring counter function	3-2,5-5
Ring counter lower limit value (Un\G0 and 1).....	3-11
Ring counter upper limit value (Un\G2 and 3)	3-11
RUN LED.....	4-3,8-3

[S]

SI	5-14
Software package	2-3
Software version	2-3,2-5
Starting the Intelligent function module utility	6-10
Subtraction count command (Y03).....	3-7
System Monitor	8-1

[T]

Text file	6-7
Tightening torque range	4-1
TROUBLESHOOTING	8-1

[V]

Version	2-3,2-5
---------------	---------

[W]

When Coincidence Detection Interrupt does not occur	8-7
When the QD63P6 does not normally count	8-6
When the QD63P6 does not start counting	8-5
When the RUN LED and ERR. LED turn ON	8-4

When the RUN LED turns OFF	8-4
Wiring	4-5
Wiring precautions.....	4-5

Numerics

1 multiple of 1 phase	5-1
1 multiple of 2 phases	5-1
2 multiples of 1 phase	5-1
2 multiples of 2 phases	5-2
4 multiples of 2 phases	5-2

WARRANTY

Please confirm the following product warranty details before using this product.

1. Gratis Warranty Term and Gratis Warranty Range

If any faults or defects (hereinafter "Failure") found to be the responsibility of Mitsubishi occurs during use of the product within the gratis warranty term, the product shall be repaired at no cost via the sales representative or Mitsubishi Service Company.

However, if repairs are required onsite at domestic or overseas location, expenses to send an engineer will be solely at the customer's discretion. Mitsubishi shall not be held responsible for any re-commissioning, maintenance, or testing on-site that involves replacement of the failed module.

[Gratis Warranty Term]

The gratis warranty term of the product shall be for one year after the date of purchase or delivery to a designated place.

Note that after manufacture and shipment from Mitsubishi, the maximum distribution period shall be six (6) months, and the longest gratis warranty term after manufacturing shall be eighteen (18) months. The gratis warranty term of repair parts shall not exceed the gratis warranty term before repairs.

[Gratis Warranty Range]

- (1) The range shall be limited to normal use within the usage state, usage methods and usage environment, etc., which follow the conditions and precautions, etc., given in the instruction manual, user's manual and caution labels on the product.
- (2) Even within the gratis warranty term, repairs shall be charged for in the following cases.
 1. Failure occurring from inappropriate storage or handling, carelessness or negligence by the user. Failure caused by the user's hardware or software design.
 2. Failure caused by unapproved modifications, etc., to the product by the user.
 3. When the Mitsubishi product is assembled into a user's device, Failure that could have been avoided if functions or structures, judged as necessary in the legal safety measures the user's device is subject to or as necessary by industry standards, had been provided.
 4. Failure that could have been avoided if consumable parts (battery, backlight, fuse, etc.) designated in the instruction manual had been correctly serviced or replaced.
 5. Failure caused by external irresistible forces such as fires or abnormal voltages, and Failure caused by force majeure such as earthquakes, lightning, wind and water damage.
 6. Failure caused by reasons unpredictable by scientific technology standards at time of shipment from Mitsubishi.
 7. Any other failure found not to be the responsibility of Mitsubishi or that admitted not to be so by the user.

2. Onerous repair term after discontinuation of production

- (1) Mitsubishi shall accept onerous product repairs for seven (7) years after production of the product is discontinued.

Discontinuation of production shall be notified with Mitsubishi Technical Bulletins, etc.
- (2) Product supply (including repair parts) is not available after production is discontinued.

3. Overseas service

Overseas, repairs shall be accepted by Mitsubishi's local overseas FA Center. Note that the repair conditions at each FA Center may differ.

4. Exclusion of loss in opportunity and secondary loss from warranty liability

Regardless of the gratis warranty term, Mitsubishi shall not be liable for compensation of damages caused by any cause found not to be the responsibility of Mitsubishi, loss in opportunity, lost profits incurred to the user by Failures of Mitsubishi products, special damages and secondary damages whether foreseeable or not, compensation for accidents, and compensation for damages to products other than Mitsubishi products, replacement by the user, maintenance of on-site equipment, start-up test run and other tasks.

5. Changes in product specifications

The specifications given in the catalogs, manuals or technical documents are subject to change without prior notice.

Microsoft, Windows, Windows NT, and Windows Vista are registered trademarks of Microsoft Corporation in the United States and other countries.

Pentium is a trademark of Intel Corporation in the United States and other countries.

Ethernet is a trademark of Xerox Corporation.

All other company names and product names used in this manual are trademarks or registered trademarks of their respective companies.

SPREAD

Copyright (C) 1996 Farpont Technologies, Inc.

SH(NA)-080692ENG-E(1202)MEE

MODEL: QD63P6-U-SY-E

MODEL CODE: 13JZ03

MITSUBISHI ELECTRIC CORPORATION

HEAD OFFICE : TOKYO BUILDING, 2-7-3 MARUNOUCHI, CHIYODA-KU, TOKYO 100-8310, JAPAN
NAGOYA WORKS : 1-14, YADA-MINAMI 5-CHOME, HIGASHI-KU, NAGOYA, JAPAN

When exported from Japan, this manual does not require application to the
Ministry of Economy, Trade and Industry for service transaction permission.

Specifications subject to change without notice.