

Programmable Controller

MELSEC **Q** series

High Speed Data Logger Module User's Manual

-QD81DL96
-SW1DNN-DLUTL-E (High Speed Data Logger Module Tool)

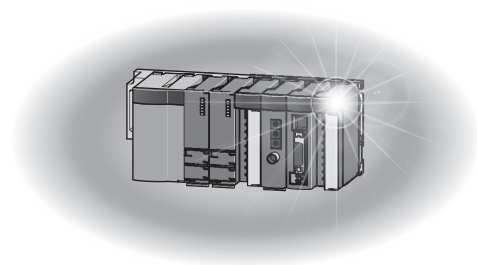

● SAFETY PRECAUTIONS ●

(Always read these precautions before using this equipment)

Before using this product, please read this manual and the relevant manuals introduced in this manual carefully and pay full attention to safety to handle the product correctly. If the equipment is used in a manner not specified by the manufacturer, the protection provided by the equipment may be impaired.

The precautions given in this manual are concerned with this product only. For the safety precautions of the programmable controller system, refer to the User's Manual for the CPU module used.

In this manual, the safety precautions are classified into two levels: "⚠ WARNING" and "⚠ CAUTION".



Indicates that incorrect handling may cause hazardous conditions, resulting in death or severe injury.



Indicates that incorrect handling may cause hazardous conditions, resulting in medium or slight personal injury or physical damage.

Note that the ⚠ CAUTION level may lead to a serious consequence according to the circumstances. Always follow the instructions of both levels because they are important to personal safety.

Please save this manual to make it accessible when required and always forward it to the end user.

[Design precautions]

⚠ WARNING

- Configure safety circuits external to the programmable controller to ensure that the entire system operates safely even when a fault occurs in the external power supply or the programmable controller. Failure to do so may result in an accident due to an incorrect output or malfunction.
- For the operating status of each station after a communication failure, refer to relevant manuals for the network. For the manuals, please consult your local Mitsubishi representative. Incorrect output or malfunction due to a communication failure may result in an accident.

[Design precautions]

WARNING

- When changing data of the running programmable controller from a peripheral connected to the CPU module or from a personal computer connected to an intelligent function module or special function module, configure an interlock circuit in the sequence program to ensure that the entire system will always operate safely. For program modification and operating status change, read relevant manuals carefully and ensure the safety before operation.
Especially in the above mentioned control operations that are performed from an external device to a remote programmable controller, any problems on the programmable controller side may not be dealt with promptly due to abnormal data communication. To prevent this, configure an interlock circuit in the sequence program, and determine corrective actions to be taken between the external device and CPU module in case of a communication failure.
- Do not write any data in the "system area" of the buffer memory in the intelligent function module. Also, do not use any "use prohibited" signals as an output signal from the programmable controller CPU to the intelligent function module.
Doing so may cause malfunction of the programmable controller system.

[Design precautions]

CAUTION

- Do not install the control lines or communication cables together with the main circuit lines or power cables. Doing so may result in malfunction due to electromagnetic interference. Keep a distance of 100mm or more between those cables.
- During registering each setting, do not power OFF the mounted module or reset the programmable controller CPU.
Otherwise, data in the CompactFlash card will be undefined. Therefore, resetting and re-registering data are required.
This may also cause a module failure or malfunctions.

[Security Precautions]

WARNING

- To maintain the security (confidentiality, integrity, and availability) of the programmable controller and the system against unauthorized access, denial-of-service (DoS) attacks, computer viruses, and other cyberattacks from external devices via the network, take appropriate measures such as firewalls, virtual private networks (VPNs), and antivirus solutions.

[Installation precautions]

CAUTION

- Use the programmable controller in an environment that meets the general specifications in the user's manual for the CPU module used. Using the programmable controller in any other operating environments may cause electric shocks, fires or malfunctions, or may damage or degrade the module.

- While pressing the installation lever located at the bottom of module, insert the module fixing tab into the fixing hole in the base unit until it stops. Then, securely mount the module with the fixing hole as a supporting point.
If the module is not installed properly, it may cause the module to malfunction, fail or fall off.
Secure the module with screws especially when it is used in an environment where constant vibrations may occur.
Be sure to tighten the screws using the specified torque. If the screws loose, it may cause the module to short-circuit, malfunction or fall off. If the screws are tightened excessively, it may damage the screws and cause the module to short-circuit, malfunction or fall off.

- Before mounting/dismounting the module, be sure to shut off all phases of external power supply used by the system.
Failure to do so may cause product damage.

- Do not directly touch any conductive part or electronic component of the module.
This may cause the module to malfunction or fail.

- Push the CompactFlash card into the CompactFlash card slot and install it securely.
After installing the CompactFlash card, check that it is inserted securely.
Failure to do so may cause malfunctions due to poor contact.

[Wiring precautions]

CAUTION

- Connectors for external connection must be crimped or pressed with the tool specified by the manufacturer, or must be correctly soldered.
If the connection is incomplete, it may cause the module to short circuit, catch fire, or malfunction.
- Install connectors securely to modules.
- Make sure to place the communication and power cables to be connected to the module in a duct or fasten them using a clamp. If the cables are not placed in a duct or fastened with a clamp, their positions may be unstable or moved, and they may be pulled inadvertently.
This may damage the module and the cables or cause the module to malfunction because of faulty cable connections.
- When disconnecting the communication and power cables from the module, do not pull the cables by hand.
When disconnecting a cable with a connector, hold the connector to the module by hand and pull it out to remove the cable.
When disconnecting a cable connected to a terminal block, loosen the screws on the terminal block first before removing the cable. If a cable is pulled while being connected to the module, it may cause the module to malfunction or damage the module and the cable.
- Be careful not to let any foreign matter such as wire chips get inside the module. They may cause fire, as well as breakdowns and malfunctions of the module.
- A protective sheet is pasted on the upper part of the module in order to prevent foreign matter such as wire chips to get inside the module while wiring.
Do not remove this protective sheet during wiring work.
However, be sure to remove the protective sheet before operating the module to allow heat radiation during operation.

[Startup and maintenance precautions]

WARNING

- Do not touch any terminal during power distribution.
Doing so may cause malfunctions.
- Always switch OFF the external supply power used by the system in all phases before cleaning or retightening terminal screws.
Failure to do so may cause a failure or malfunction of the module.
If the screws loose, it may cause the module to short-circuit, malfunction or fall off.
If the screws are tightened excessively, it may damage the screws and cause the module to short-circuit, malfunction or fall off.

CAUTION

- Do not disassemble or transform the module.
Doing so may cause a failure, malfunctions, personal injuries, and/or a fire.
- Before mounting/dismounting the module, be sure to shut off all phases of external power supply used by the system.
Failure to do so may cause product damage.
- Do not install/remove the module to/from the base unit more than 50 times after the first use of the product. (IEC 61131-2 compliant)
Failure to do so may cause malfunction.
- Before handling a module, touch a grounded metal object to discharge the static electricity from your body.
Failure to do so may cause a failure or malfunction of the module.

[Operating precautions]

WARNING

- Ensure safety before controlling a running programmable controller (e.g. data modification).
- Do not write any data in the "system area" of the buffer memory in the intelligent function module.
Also, do not use any "use prohibited" signals as an output signal from the programmable controller CPU to the intelligent function module.
Doing so may cause malfunction of the programmable controller system.

[Disposal precautions]

CAUTION

- Dispose of this product as an industrial waste.

● CONDITIONS OF USE FOR THE PRODUCT ●

- (1) MELSEC programmable controller ("the PRODUCT") shall be used in conditions;
- i) where any problem, fault or failure occurring in the PRODUCT, if any, shall not lead to any major or serious accident; and
 - ii) where the backup and fail-safe function are systematically or automatically provided outside of the PRODUCT for the case of any problem, fault or failure occurring in the PRODUCT.
- (2) The PRODUCT has been designed and manufactured for the purpose of being used in general industries. MITSUBISHI ELECTRIC SHALL HAVE NO RESPONSIBILITY OR LIABILITY (INCLUDING, BUT NOT LIMITED TO ANY AND ALL RESPONSIBILITY OR LIABILITY BASED ON CONTRACT, WARRANTY, TORT, PRODUCT LIABILITY) FOR ANY INJURY OR DEATH TO PERSONS OR LOSS OR DAMAGE TO PROPERTY CAUSED BY the PRODUCT THAT ARE OPERATED OR USED IN APPLICATION NOT INTENDED OR EXCLUDED BY INSTRUCTIONS, PRECAUTIONS, OR WARNING CONTAINED IN MITSUBISHI ELECTRIC USER'S, INSTRUCTION AND/OR SAFETY MANUALS, TECHNICAL BULLETINS AND GUIDELINES FOR the PRODUCT.
- ("Prohibited Application")
- Prohibited Applications include, but not limited to, the use of the PRODUCT in;
- Nuclear Power Plants and any other power plants operated by Power companies, and/or any other cases in which the public could be affected if any problem or fault occurs in the PRODUCT.
 - Railway companies or Public service purposes, and/or any other cases in which establishment of a special quality assurance system is required by the Purchaser or End User.
 - Aircraft or Aerospace, Medical applications, Train equipment, transport equipment such as Elevator and Escalator, Incineration and Fuel devices, Vehicles, Manned transportation, Equipment for Recreation and Amusement, and Safety devices, handling of Nuclear or Hazardous Materials or Chemicals, Mining and Drilling, and/or other applications where there is a significant risk of injury to the public or property.
- Notwithstanding the above restrictions, Mitsubishi Electric may in its sole discretion, authorize use of the PRODUCT in one or more of the Prohibited Applications, provided that the usage of the PRODUCT is limited only for the specific applications agreed to by Mitsubishi Electric and provided further that no special quality assurance or fail-safe, redundant or other safety features which exceed the general specifications of the PRODUCTS are required. For details, please contact the Mitsubishi Electric representative in your region.
- (3) Mitsubishi Electric shall have no responsibility or liability for any problems involving programmable controller trouble and system trouble caused by DoS attacks, unauthorized access, computer viruses, and other cyberattacks.

REVISIONS

*The manual number is given on the bottom left of the back cover.

Print date	*Manual number	Revision
Jun., 2009	SH-080818ENG-A	First edition
Jun., 2009	SH-080818ENG-B	<div style="border: 1px solid black; display: inline-block; padding: 2px;">Correction</div> Section 2.2
Oct., 2009	SH-080818ENG-C	<div style="border: 1px solid black; display: inline-block; padding: 2px;">Addition</div> Section 3.4.2, Section 11.4.9, Appendix 8 <div style="border: 1px solid black; display: inline-block; padding: 2px;">Correction</div> HOW TO USE THIS MANUAL, Section 1.1, Section 2.1.3, Section 2.1.4, Section 2.5, Section 3.1.1, Section 3.4, Section 3.8, Section 4.2.3, Section 4.5, Section 7.5.2, Section 9.1, Section 11.2.4, Section 11.2.6, Section 11.2.7, Section 11.2.9, Section 11.3.4, Section 11.4 to 11.4.8, Section 11.5.1, Section 11.5.4, Section 11.5.8 to 11.5.12, Section 11.5.15, Section 11.6.1, Section 11.6.4, Section 11.6.6 to 11.6.8, Section 11.6.10, Section 11.6.13, Section 11.7.1, Section 11.7.3 to 11.7.7, Section 12.3, Section 13.1 to 13.1.9, Section 14.3.4, Section 14.10.2, Section 14.10.3, Section 15.5, Section 15.6, Section 17.1.1, Section 17.1.2, Section 17.2, Section 17.3.2 to 17.3.5, Section 17.3.8, Section 17.3.9, Appendix 4.1, Appendix 5 Section 3.4.2 to 3.4.15 changed to Section 3.4.3 to 3.4.16 Appendix 8 changed to Appendix 9

Print date	*Manual number	Revision
Jun., 2010	SH-080818ENG-D	<p>Addition</p> <p>CONDITIONS OF USE FOR THE PRODUCT, RELATED MANUALS Section 3.4.9, Section 3.8, Section 7.2.1, Section 7.2.2, Section 10.5, Section 10.6, Section 11.2.10, Section 11.3.4, Section 11.3.5, Section 11.7.5, Section 13.1.10, Chapter 14, Section 15.6, Section 17.3.10, Appendix 10</p> <p>Correction</p> <p>PRECAUTIONS FOR USE, INTRODUCTION, HOW TO USE THIS MANUAL, GENERIC TERMS AND ABBREVIATIONS, DEFINITIONS AND DESCRIPTIONS OF TERMS, Section 1.1, Section 1.3, Section 2.1.1, Section 2.2, Section 2.3, Section 2.4, Section 2.5, Section 3.1, Section 3.2, Section 3.3.1, Section 3.3.2, Section 3.4, Section 3.4.12, Section 3.4.14, Section 3.4.16, Section 3.5, Section 4.2.1, Section 4.2.2, Section 4.5, Chapter 5, Section 5.1, Section 5.2.1 to 5.2.3, Section 5.4, Section 5.4.1 to 5.4.3, Chapter 6, Section 7.2, Section 7.5.4, Section 8.2, Section 8.4.4, Section 9.2, Section 9.5.3, Section 10.3, Section 11.2, Section 11.2.2, Section 11.2.6, Section 11.2.7, Section 11.2.9, Section 11.4.3 to 11.4.7, Section 11.5.1, Section 11.5.4 to 11.5.6, Section 11.5.12, Section 11.5.15, Section 11.6.1, Section 11.6.4, Section 11.6.7, Section 11.6.13, Section 11.6.14, Section 11.7.1, Section 11.7.3, Chapter 12, Chapter 13, Section 13.1, Section 13.1.1, Section 13.1.3, Section 13.1.4, Section 13.2, Section 15.5, Section 15.7, Chapter 17, Section 17.2, Section 17.3.2, Section 17.3.3, Section 17.3.8, Section 17.3.9, Appendix 4.1 to 4.3, Appendix 5, Appendix 9</p> <p>Section 3.4.9 to 3.4.16 changed to Section 3.4.10 to 3.4.17, Section 3.8 changed to 3.9, Section 5.2 to 5.3 changed to Section 5.1 to 5.2, Section 11.3.4 changed to Section 11.3.6, Section 11.7.5 to 11.7.8 changed to Section 11.7.6 to 11.7.9, Section 15.6 changed to Section 15.7</p> <p>Deletion</p> <p>Section 3.1.1, Section 3.1.2, Section 5.1, Section 5.5, Chapter 14</p>
Aug., 2010	SH-080818ENG-E	<p>Correction</p> <p>Section 2.3, Section 3.2, Section 3.3.2</p>
Dec., 2010	SH-080818ENG-F	<p>Addition</p> <p>Appendix 11</p> <p>Correction</p> <p>RELATED MANUALS, COMPLIANCE WITH THE EMC AND LOW VOLTAGE DIRECTIVES, Section 3.1, Section 3.6.2, Section 4.4.2, Section 10.5, Section 11.5.15, Section 11.6.13, Section 11.7.8, Section 15.7, Section 17.2, Section 17.3.4</p>
Jun., 2011	SH-080818ENG-G	<p>Correction</p> <p>Section 3.1, Section 4.3, Section 11.2.10, Section 11.4.5, Section 11.5.15, Section 11.6.13, Section 11.7.5, Section 11.7.8, Section 12.2, Section 17.1.2, Section 17.2, Section 17.3.5</p>

Print date	*Manual number	Revision
Sep., 2011	SH-080818ENG-H	<p>Addition</p> <p>Section 16.3.3</p> <p>Correction</p> <p>Section 2.4, Section 3.2, Section 5.2.1, Section 10.3, Section 11.2.7, Section 11.2.8, Section 11.2.9, Section 11.2.10, Section 11.3.4, Section 11.4.3, Section 11.4.4, Section 11.5.5, Section 11.5.6, Section 11.5.15, Section 11.6.7, Section 11.6.14, Section 11.7.5, Section 12.2, Section 12.4, Section 13.1.1, Section 13.2, Chapter 14, Section 14.2.1, Section 14.5.1, Section 14.5.2, Section 17.3.9</p>
Oct., 2011	SH-080818ENG-I	<p>Correction</p> <p>PRECAUTIONS FOR USE, Section 2.3, Section 4.5, Section 10.3, Section 15.3, Section 17.3.1, Section 17.3.4, Section 17.3.9, Appendix 5, Appendix 11</p>
Mar., 2012	SH-080818ENG-J	<p>Correction</p> <p>PRECAUTIONS FOR USE, GENERIC TERMS AND ABBREVIATIONS, Section 1.1, Section 2.1.1, Section 2.2, Section 2.4, Section 3.1, Section 3.2, Section 3.4.13, Section 3.6, Section 3.7.1, Section 3.7.2, Section 4.3, Section 4.5, Section 10.5, Section 10.6, Section 11.4.3, Section 11.5.1, Section 11.5.15, Section 11.6.1, Section 11.6.13, Section 11.7.4, Section 11.7.5, Section 17.2, Section 17.3.6, Section 17.3.9, Appendix 5, Appendix 10</p>
Dec., 2012	SH-080818ENG-K	<p>Addition</p> <p>Section 2.6.2, Section 5.3.3, Chapter 14, Section 18.3.10, Appendix 12</p> <p>Correction</p> <p>PRECAUTIONS FOR USE, GENERIC TERMS AND ABBREVIATIONS, Section 1.1, Section 1.3, Section 2.1.2, Section 2.1.4, Section 2.2, Section 2.3, Section 2.4, Section 3.1, Section 3.2, Section 3.6.3, Section 4.5, Section 5.1, Section 5.2, Chapter 6, Section 7.2.1, Section 7.2.2, Section 11.2.2, Section 11.4.2, Section 11.5.10, Section 11.5.11, Section 13.3.2, Chapter 14 to 17 changed to Chapter 15 to 18, Section 18.3.9, Appendix 4.1, Appendix 5</p>
Jun., 2013	SH-080818ENG-L	<p>Correction</p> <p>PRECAUTIONS FOR USE, Section 2.3, Section 16.3, Section 18.3.1</p>
Oct., 2013	SH-080818ENG-M	<p>Addition</p> <p>Section 2.7</p> <p>Correction</p> <p>PRECAUTIONS FOR USE, GENERIC TERMS AND ABBREVIATIONS, DEFINITIONS AND DESCRIPTIONS OF TERMS, Section 1.1, Section 2.2, Section 2.4, Section 2.5, Section 3.1, Section 3.2, Section 3.3.1, Section 3.3.2, Section 3.4.1, Section 5.2, Section 5.2.1 to Section 5.2.3, Section 5.3.2, Section 5.4, Section 7.2, Section 7.2.1, Section 8.2, Section 9.2, Section 10.1, Section 10.3, Section 11.4.2, Section 11.4.4, Section 11.4.5, Section 11.5.4, Section 11.5.15, Section 11.6.4, Section 11.6.13, Section 11.7.3 to Section 11.7.5, Section 11.7.7, Section 11.7.8, Section 17.2, Section 17.3.1, Section 17.3.3, Section 18.1.3, Section 18.2, Section 18.3.1 to Section 18.3.2, Section 18.3.6, Section 18.3.9, Appendix 5</p>

Print date	*Manual number	Revision
Nov., 2013	SH-080818ENG-N	<p>[Addition]</p> <p>Appendix 8.2</p> <p>[Correction]</p> <p>PRECAUTIONS FOR USE, Section 3.4.8, Section 4.5, Section 11.4.3, Section 18.2, Section 18.3.4, Section 18.3.5, Appendix 5, Appendix 8</p>
Apr., 2014	SH-080818ENG-O	<p>[Correction]</p> <p>PRECAUTIONS FOR USE, GENERIC TERMS AND ABBREVIATIONS, Section 2.4, Section 3.1, Section 3.2, Section 5.2, Section 5.3.2, Section 5.4, Section 10.3, Section 11.4.1, Section 13.3.2, Section 18.3.9, Appendix 5</p>
Aug., 2014	SH-080818ENG-P	Section 2.3, Section 11.4.1, Appendix 10
Dec., 2014	SH-080818ENG-Q	<p>[Addition]</p> <p>Section 2.6.3</p> <p>[Correction]</p> <p>Section 2.2, Section 3.2, Section 11.7.5, Section 18.3.2, Section 18.3.6</p>
Sep., 2015	SH-080818ENG-R	<p>[Addition]</p> <p>Section 2.6.4, Section 3.4.17</p> <p>[Correction]</p> <p>Section 3.1, Section 3.4, Section 4.3, Section 4.5, Section 11.4.4, Section 18.2, Appendix 5</p>
Mar., 2016	SH-080818ENG-S	<p>[Correction]</p> <p>PRECAUTIONS FOR USE, GENERIC TERMS AND ABBREVIATIONS, Section 2.2, Section 2.4, Section 3.2, Section 3.4.6, Section 3.4.7, Section 4.5, Section 4.6.1, Section 4.6.2, Section 5.2, Section 5.2.1, Section 5.3.1, Section 5.3.2, Section 5.4, Section 10.3, Section 10.4, Section 13.3.3, Section 18.1.1, Section 18.2, Section 18.3.2, Section 18.3.6, Section 18.3.9, Appendix 5, WARRANTY</p>
Oct., 2016	SH-080818ENG-T	<p>[Correction]</p> <p>PRECAUTIONS FOR USE, Section 10.5, Section 16.3, Section 18.3.8</p>
Dec., 2016	SH-080818ENG-U	<p>[Correction]</p> <p>PRECAUTIONS FOR USE, GENERIC TERMS AND ABBREVIATIONS, Section 2.1.3, Section 2.4, Section 2.5, Section 3.2, Section 3.4.1, Section 4.5, Section 4.6.1, Section 10.1, Section 11.7.4, Section 18.2, Section 18.3.6, Section 18.3.9, Appendix 5, Appendix 9</p>
Dec., 2018	SH-080818ENG-V	Partial correction
Dec., 2020	SH-080818ENG-W	<p>[Correction]</p> <p>SAFETY PRECAUTIONS, CONDITIONS OF USE FOR THE PRODUCT, Section 16.6</p>
Jul., 2022	SH-080818ENG-X	<p>[Correction]</p> <p>SAFETY PRECAUTIONS, PRECAUTIONS FOR USE, INTRODUCTION, GENERIC TERMS AND ABBREVIATIONS, Section 2.4, Section 3.1, Section 3.2, Section 3.3.2, Section 5.2, Section 5.3.1, Section 7.3.2, Section 10.3, Section 10.5, Section 10.6, Section 18.3.2, Section 18.3.4, Section 18.3.9, Appendix 5, COPYRIGHTS</p>

Print date	*Manual number	Revision
Nov., 2023	SH-080818ENG-Y	<div data-bbox="555 210 651 237" style="border: 1px solid black; padding: 2px;">Addition</div> INFORMATION AND SERVICES <div data-bbox="555 293 667 320" style="border: 1px solid black; padding: 2px;">Correction</div> Section 3.1
Mar., 2024	SH-080818ENG-Z	<div data-bbox="555 374 667 400" style="border: 1px solid black; padding: 2px;">Correction</div> SAFETY PRECAUTIONS, GENERIC TERMS AND ABBREVIATIONS, Section 2.4, Section 11.2.10, Section 11.7.4, Section 18.3.9, Appendix 5

Japanese Manual Version SH-080801-Z

This manual confers no industrial property rights or any rights of any other kind, nor does it confer any patent licenses. Mitsubishi Electric Corporation cannot be held responsible for any problems involving industrial property rights which may occur as a result of using the contents noted in this manual.

PRECAUTIONS FOR USE

This section explains the precautions in the order listed below.

- ① Network connection precautions
- ② Performance/specification precautions
- ③ Data logging, event logging, and report functions precautions
- ④ Other function precautions
- ⑤ Precautions when accessing the high speed data logger module
- ⑥ Security precautions
- ⑦ CompactFlash card precautions
- ⑧ Precautions when using a redundant system
- ⑨ Recipe function precautions
- ⑩ Precautions when using Logging File Conversion Tool

Network connection precautions

(1) Mail server and FTP server connections

When immediately turning the power ON after turning the power OFF, connections to mail servers or FTP servers may fail.

Turn the programmable controller OFF, wait several minutes then turn it ON.

Performance/specification precautions

(1) Programmable controller CPU sequence scan time

When using the high speed data logger module, the programmable controller CPU sequence scan time may increase. Design your system and programs keeping in mind this increase in sequence scan time.

☞ CHAPTER 17 PROCESSING TIME

(2) Network connection using Ethernet

When connecting to Ethernet network, basically configure the communication route to the access target via Ethernet (twisted pair) cables and hubs.

Note that when accessing via wireless LAN (Wi-Fi) or router, an error such as timeout or missing data occurs, and cannot be communicated properly depending on the status of the equipment (wireless LAN (Wi-Fi) or router) on the network or the access route.

(3) Time handled on the high speed data logger module

Two types of times handled on the high speed data logger module are available.

- ① Programmable controller CPU time
- ② Time obtained by the SNTP server function

For errors and the timing of setting the time, refer to the following sections.

☞ Section 3.1 Performance Specifications

☞ Section 11.4.2 Time synchronization setting

(4) High speed data sampling

The high speed data sampling function is not compatible with other stations' CPUs routing the network.

(1) Data logging, event logging, and report functions

- (a) The data logging, event logging, and report functions of the high speed data logger module are the best effort functions.
Since module processing time changes according to the settings and status of other devices, it may not operate with the set data sampling interval. Run the system by fully verifying the processing time of each function when constructing it. For processing time, refer to the following chapter.
☞ CHAPTER 17 PROCESSING TIME
- (b) If data logging, event logging, or report functions are used, they have an affect on the sequence scan time of the access target CPU. Run the system by fully verifying the affect to the sequence scan time when constructing it. For the affect to the sequence scan time, refer to the following section.
☞ Section 17.3 Effect on Sequence Scanning Time
- (c) If exponential format is selected for the data output format with the data logging, event logging, or report setting, rounding errors will occur in the range of the number of digits that exceed the number of digits set for the decimal part.
- (d) If the result of the linear function transformation with the scaling function exceeds the maximum or minimum range of the specified output format, the maximum or minimum value is output in binary format. Therefore, when outputting in the binary format, errors may occur in the output values.
- (e) E-mail transmissions/file transfers via the saved file transfer function may take a few seconds to tens of seconds depending on the network line/transmission size. Target files may be deleted before e-mail transmission/file transfer completes depending on the settings.
Review the file switching timing and the number of files saved setting and lengthen the time until the file is deleted.
- (f) When CSV files are opened with Excel, the date column's format is displayed in Excel's default setting. Set the cell format as necessary.
- (g) Since general data sampling specified data and report current value data are sampled asynchronously with the sequence scan, data separation may occur. If data separation must be prevented, set the number of device points sampled at one time to less than the access units, or set the module to use high speed data sampling.
- (h) When CSV files are opened with Microsoft® Excel® 2003, all the data may not be displayed depending on the number of the data setting or number of file switching lines.
In this case, open the CSV files with Microsoft® Excel® 2007 or later, or text editor.

(2) Data logging function

- (a) To log the device values of when a trigger occurs as one data row, the number of device points that can be sampled at once should be less than the access units or high speed sampling should be used. For the access units, refer to the following section.

☞ Section 3.2 (6) Access units

- (b) Immediately after switching the programmable controller system ON, if a trigger occurs before sampling the number of lines of data before the trigger, the data before the trigger may be a few lines less than the specified amount.
- (c) When triggers continuously occur with the trigger logging function, triggers may be discarded or the number of lines of data specified before the trigger may not be output. For operation when triggers continuously occur, refer to the following section.

☞ Section 7.3.2 Trigger logging

(3) Report function

- (a) Immediately after switching the programmable controller system ON, if a creation trigger occurs when data does not exist in the data logging file, an error occurs in the high speed data logger module. Configure and construct the system so that the creation trigger occurs after data are saved in the data logging file.

- (b) Report output takes time. Therefore, according to the data logging save setting, the data logging file, including the data when the creation trigger occurs, may be deleted before outputting the report has completed. In this situation, the data for the specified number of records are not output, and an error occurs in the high speed data logger module. Verify the points listed in the following section when configuring and creating the system.

☞ Section 9.3 Creation Trigger

- (c) When creation triggers continuously occur, they may be discarded. For operation when the creation trigger continuously occurs, refer to the following section.

☞ Section 9.3 Creation Trigger

- (d) When installing Microsoft Excel and Microsoft 365, install Visual Basic[®] for Applications (abbreviated as VBA below).

If VBA is not installed, the error message below is displayed when the layout setting screen is started, and the layout settings cannot be configured.

"This workbook has lost its VBA Project, ActiveX Controls and any other programmability-related features."

- (e) The save format of the report file output by the report function is the xls format. Some functions added from Microsoft[®] Excel[®] 2007 and later cannot be used.

- (f) One of the following operating systems is required with installing Microsoft® Excel® 2010 (32-bit version).
- Windows® XP Service Pack 3
 - Windows Vista® Service Pack 1 or later
 - Windows® 7 or later
- Note that Microsoft® Excel® 2010 (64-bit version) is not supported.
- (g) The following operating system is required with installing Microsoft® Excel® 2013 (32-bit version).
- Windows® 7 or later
- Note that Microsoft® Excel® 2013 (64-bit version) is not supported.
- (h) One of the following operating systems is required with installing Microsoft® Excel® 2016 (32-bit version)
- Windows® 7 Service Pack 1
 - Windows® 8 or later
- Note that Microsoft® Excel® 2016 (64-bit version) is not supported.
- (i) When using Microsoft Excel 2019 (32-bit version/64-bit version), Windows 10 is required.
- (j) When using Microsoft Excel 2021 (32-bit version/64-bit version), Windows 10 is required.
- (k) When using Microsoft 365 (32-bit version/64-bit version), Windows 10 is required.

Other function precautions

(1) Access target CPU setting (☞ Section 11.4.3)

(a) When rewriting the Configuration Tool settings, power OFF to ON, or resetting the CPU module, the high speed logger module prepares to communicate with the access target CPU. Therefore, if a large number of access target CPUs are set, several minutes are required for this preparation.

(b) The following conditions may affect the general sampling, FTP transfer function, and e-mail function: when the CPU which does not exist in the access target CPU is set, or the high speed data logger cannot communicate with the access target CPU temporary because of the power interruption of access target CPU or network failure.

Use high speed data logger modules with the status that can communicate with the CPU set as access target CPU.

(☞ Section 3.4.8 General data sampling delay time area (address: 800 to 805)

☞ Appendix 8.2 Processing time of FTP transfer function and e-mail function)

(2) Time synchronization function (☞ Section 10.1)

(a) If implementing synchronization with the programmable controller CPU or SNTP server time, the high speed data logger module's time is changed. When the programmable controller CPU's time is changed or when restored after communicating with the SNTP server fails, the high speed data logger module's time may be greatly changed.

(b) Since there is inaccuracy in the clock element in the programmable controller CPU and high speed data logger module, the time may be moved slightly forward or backward when the time is synchronized.

Since changing the high speed logger unit's time affects the data logging, event logging, and report cycles, the determination of time, and the time stamp, configure the module to synchronize its time as little as possible.

Precautions when accessing the high speed data logger module

(1) Web browser operations, settings

In the local area network (LAN) setting of the Web browser, do not set a proxy server for the local address. (☞ Section 5.3.1)

(2) FTP server function

(a) Because of FTP client side application restrictions, if the user name or password is input incorrectly, end the FTP operation and redo the FTP connection from the beginning.

FTP may not operate correctly by reentering the correct user name or password with the 'user' FTP command.

(b) The maximum number of simultaneous connections to the FTP server is 10. However, depending on the FTP client, it may make multiple simultaneous connections, so an FTP client may not be able to login even if 10 clients are not connected.

In this situation, shutdown all the FTP clients, then restart and connect them.

(c) If transferring many files at once with FTP, a 426 (Data connection error) may occur.

In this situation, split the files up over multiple transfers and retransfer them.

(d) When a web browser is used for FTP access, the user authentication screen may not be displayed due to the specification of the web browser.

To enable the high speed data logger module's access authentication function, enter the address in the following format.

```
ftp://<user name>:<password>@<high speed data logger module's address or hostname>/
```

(e) When a web browser is used for FTP access, Data logging files, Event logging files, Report files, and Recipe files may not be opened directly due to the specification of the web browser. Open those files after saving them to a personal computer.

(f) When a web browser is used for FTP access, due to the specification of the web browser, errors may not be displayed even if the transfer failed when files are transferred to the CompactFlash card which does not have enough free space. Update the display and check if the files are transferred normally.

(3) Replacing old version module with new one

When a high speed data logger module is replaced, make sure to delete the temporary Internet files of Web browser (cache) before accessing the high speed data logger module. (☞ Section 5.3.1)

(4) Connecting GX LogViewer

The maximum number of connections for GX LogViewer to access high speed data logger modules simultaneously is 2.

Security precautions

Although the high speed data logger module supports basic authentication (account setting) using user names and passwords, it does not completely protect the system from illegal access.

Avoid accounts (user name, password) consisting of simple alphanumeric characters only, and include some non-alphanumeric characters (\$, &, ?) to create a complicated user name and password.

CompactFlash card precautions

(1) CompactFlash card file/directory names

- (a) Do not create files^{*1} or folders on the CompactFlash card with a personal computer.

If files or folders are created on the CompactFlash card with a personal computer, they may be deleted.

*1: Excluding module operating files and recipe files

- (b) Do not store files with file name containing unusable characters to CompactFlash card.

For usable characters in file names, refer to the following section.

☞ Appendix 4.2 Characters usable in file names, folder (directory) names

(2) CompactFlash card to be used

Use CompactFlash cards listed in Section 2.3.

☞ Section 2.3 Connection System Equipment

If any other CompactFlash cards are used, a failure such as a data corruption on a CompactFlash card or a system shutdown (SP.UNIT DOWN occurs in the programmable controller CPU) may occur during an operation.

(3) When turning OFF or resetting programmable controller CPU

When a programmable controller CPU is turned OFF or reset while writing data to a CompactFlash card, the processing to write data to a CompactFlash card may not be completed. It may cause a loss of logging data during the processing, corruption of data in the CompactFlash card that is being accessed, or occurrence of a file system error. The file is automatically repaired when the high speed data logger module is turned ON again, but it will not succeed in some cases.

The operation, turning OFF or resetting the high speed data logger module after stopping file access, should be considered. For the important data, create backups by performing a backup operation such as saving data to other media.

☞ Section 16.6 (1) Stopping file access

(4) When ejecting or replacing the CompactFlash card

- (a) Be sure to stop file access before ejecting or replacing the CompactFlash card.
☞ Section 16.5 Operations for Ejecting and Reinserting CompactFlash Card
- (b) Not following the procedure shown in Section 16.5 may cause a loss of logging data during processing, corruption of data on the CompactFlash card while accessing, or a file system error.
- (c) If an error occurs on the CompactFlash card, refer to the following section.
☞ Section 18.3.8 Troubleshooting related to data management, CompactFlash cards
- (d) High speed data logger module settings are saved to the CompactFlash card. Therefore, the high speed logger module's IP address returns to the initial status (192.168.3.3) without a CompactFlash card inserted in the module or when turning the power OFF/ON or resetting the programmable controller CPU without the settings written to the CompactFlash card. When necessary, read the current settings before ejecting the CompactFlash card and after replacing the card, promptly write those settings to the new card.

(5) CompactFlash card capacity

- (a) Access speed to the CompactFlash card is affected by the amount of saved files. In particular, access speed becomes extremely slow when saving files up to the capacity limit of the CompactFlash card.
Use the CompactFlash card maintaining 10% or more free space on the card.
- (b) A minimum size of the occupied file on the hard disk varies depending on the CompactFlash card capacity. Therefore, the actual file size and the occupied file size on the hard disk may differ.

(6) CompactFlash card diagnostic time

- (a) The high speed data logger module performs a diagnostics (file recovery, etc.) of the inserted CompactFlash card contents at the times listed below.
 - ① When power OFF to ON, resetting the CPU module
 - ② Inserting a CompactFlash card when powered ON
- (b) The CompactFlash card diagnostic time takes longer when there are more files on the card.
100 files takes approximately 5 seconds, 1000 files takes approximately 10 seconds.
- (c) When many files are saved on the CompactFlash card, the following operations require longer time. Delete unnecessary files.
 - ① CompactFlash card status (X1) startup time
 - ② Time before the high speed data logger module can start processing (Module READY (X0) and module operating status (X5) startup time)

(7) CompactFlash card format

- (a) To format a CompactFlash card, use the high speed data logger module format function.
☞ Section 13.1.6 CompactFlash card diagnostics
- (b) Do not format a CompactFlash card using the Windows® format function.
- (c) Do not reset the control CPU or turn the power OFF when formatting a CompactFlash card.
- (d) High speed data logger module settings are saved to the CompactFlash card. Therefore, all settings are lost when formatting a card. When necessary, read the current settings before formatting and promptly write those settings after formatting. The high speed logger module's IP address returns to the initial status (192.168.3.3) when turning the power OFF/ON or resetting the programmable controller CPU without writing the settings to the CompactFlash card.

(8) CompactFlash card life duration (a limit for writing data)

The CompactFlash card has a life duration (a limit for writing data).

For details, refer to the following section.

☞ Section 16.7 CompactFlash Card Life Duration

(9) About RECIPE folder

- (a) A maximum number of recipe files that can be stored in the RECIPE folder is 256. Storing large number of files in the RECIPE folder causes a longer processing time for following operations. Delete unnecessary files.
 - ① Displaying or operating the file browser
 - ② Displaying a file list of recipe execution operation
 - ③ Recipe execution operation
- (b) Do not store files other than recipe files in the RECIPE folder.

Precautions when using a redundant system

(1) Mountable base unit

When using the high speed data logger module in a redundant system, be sure to mount the module to the extension base unit for CPU/redundant power supply.

The high speed data logger module cannot be mounted to the main base unit in a redundant system.

(2) "Access target CPU setting"

- (a) When the high speed data logger module is mounted to the Redundant CPU, it can only access the own station CPU. It cannot access CPUs of other stations.
- (b) When the high speed data logger module is mounted to a unit other than the Redundant CPU, it cannot access the Redundant CPU of other stations.

(3) Dedicated instructions

When the high speed data logger module is mounted to the Redundant CPU, the dedicated instructions cannot be used. If any of those instructions are used, an "OPERATION ERROR" occurs in the Redundant CPU.

Recipe function precautions

(1) Recipe files

- (a) When a recipe file to which 253 or more records are set is opened in Microsoft® Excel® 2003, the entire file cannot be displayed. Edit the data using Microsoft® Excel® 2007 or later, text editor or recipe editor.
- (b) For recipe file names, use the characters usable in file names and folder (directory) names only. (☞ Appendix 4.2)

(2) Recipe execution operation

- (a) Before performing the recipe execution operation, write the high speed data logger module settings using the Configuration Tool, and set the module operating status to "In operation".
The module operating status can be checked on the <<Module diagnostics>> tab of the "Diagnostics" screen.
☞ Section 13.1.1 Module diagnostics
- (b) The recipe execution operation is performed to an own station CPU only. It cannot be performed to other stations' CPUs.
- (c) Do not power OFF or reset the programmable controller CPU during the recipe execution operation. The recipe file being edited may be damaged.
Power OFF or reset the programmable controller CPU after confirming the completion of the recipe execution operation.

Precautions when using Logging File Conversion Tool

(1) Logging files that can be converted

The Logging File Conversion Tool can convert only binary format logging files created by high speed data logger module to CSV format logging files.
Other binary files cannot be converted.

(2) Conversion processing of float type

When the binary output format is [Float (single precision)] or [Float (double precision)], the following error may occur between CSV file data values that are created in the Conversion Tool and the high speed data logger module.

- Float (single precision):
Significant figures of 7th and later digits (the last digit for 7 significant figures)
- Float (double precision):
Significant figures of 15th and later digits (the last digit for less than 15 significant figures)

INTRODUCTION

Thank you for purchasing the Mitsubishi MELSEC-Q series/MELSEC-L series general purpose programmable controllers.

Before using the product, please read this manual and the relevant manuals carefully and develop familiarity with the functions and performance of the programmable controller to handle the product correctly.

Note that the menu names and operating procedures may differ depending on an operating system in use and its version. When reading this manual, replace the names and procedures with the applicable ones as necessary.

RELATED MANUALS

The manuals related to this product are shown below.

Refer to the following tables when ordering required manuals.

(1) CPU module user's manual

Manual name <Manual number, Model code>	Description
QCPU User's Manual (Hardware Design, Maintenance and Inspection) <SH-080483ENG, 13JR73>	Specifications of the hardware (CPU modules, power supply modules, base units, batteries, and memory cards), system maintenance and inspection, and troubleshooting.
Qn(H)/QnPH/QnPRHCPU User's Manual (Function Explanation, Program Fundamentals) <SH-080808ENG, 13JZ28>	Explains the programming methods, devices, and functions of Qn(H)/QnPH/QnPRHCPU module.
QnUCPU User's Manual (Function Explanation, Program Fundamentals) <SH-080807ENG, 13JZ27>	Explains the programming methods, devices, and functions of QnUCPU module.
MELSEC-L CPU Module User's Manual (Function Explanation, Program Fundamentals) <SH-080889ENG, 13JZ35>	Explains the programming methods, devices, and functions of LCPU module.
C Controller Module User's Manual (Hardware Design, Function Explanation) <SH-080766ENG, 13JZ17>	Explains the programming methods, and functions of C controller module.

(2) Operating manual

Manual name <Manual number, Model code>	Description
GX LogViewer Version 1 Operating Manual <SH-080915ENG, 13JU68>	Explains the system configuration, functions, and operating methods of GX LogViewer.
GX Works2 Version 1 Operating Manual (Common) <SH-080779ENG, 13JU63>	Explains the system configuration of GX Works2 and the functions common to Simple project and Structured project such as parameter setting, operation method for the online function.
GX Developer Version 8 Operating Manual <SH-080373E, 13JU41>	Explains the methods for programming, printing, monitoring, and debugging in GX Developer.

(3) Programming manual

Manual name < Manual number, Model code >	Description
MELSEC-Q/L Programming Manual (Common Instruction) <SH-080809ENG, 13JW10>	Explains the details of instructions used in programming.

(4) Intelligent function module user's manual

Manual name < Manual number, Model code >	Description
High Speed Data Logger Module User's Manual <SH-080818ENG, 13JZ30> (this manual)	Specifications and operations of the MELSEC-Q series high speed data logger module (QD81DL96) and settings for sampling data and events.

Remark

Manuals in printed form are sold separately for single purchase. Order a manual by quoting the manual number (model code) listed in the table above.

.....

CONTENTS

SAFETY PRECAUTIONS	A - 1
CONDITIONS OF USE FOR THE PRODUCT.....	A - 6
REVISIONS.....	A - 7
PRECAUTIONS FOR USE	A - 12
INTRODUCTION.....	A - 22
RELATED MANUALS	A - 22
CONTENTS	A - 24
COMPLIANCE WITH THE EMC AND LOW VOLTAGE DIRECTIVES.....	A - 32
HOW TO USE THIS MANUAL.....	A - 33
GENERIC TERMS AND ABBREVIATIONS.....	A - 35
DEFINITIONS AND DESCRIPTIONS OF TERMS	A - 36
PACKING LIST	A - 37

CHAPTER 1 OVERVIEW **1 - 1 to 1 - 14**

1.1 Features.....	1 - 1
1.2 Processing Overview	1 - 13
1.3 High Speed Data Logger Module Software Configuration.....	1 - 14

CHAPTER 2 SYSTEM CONFIGURATION **2 - 1 to 2 - 18**

2.1 System Configuration	2 - 1
2.1.1 Overall system configuration	2 - 1
2.1.2 System configuration when performing initial setup, maintenance, and inspection.....	2 - 2
2.1.3 System configuration during operation	2 - 3
2.1.4 Precautions when directly connecting	2 - 4
2.2 Applicable Systems	2 - 6
2.3 Connection System Equipment	2 - 9
2.4 Operating Environment.....	2 - 10
2.5 How to Check the Function Version, Serial Number	2 - 13
2.6 System Configuration Precautions	2 - 16
2.6.1 Precautions when using Redundant CPUs.....	2 - 16
2.6.2 Precautions when using C Controller modules.....	2 - 16
2.6.3 Precautions for using multiple CPU system.....	2 - 17
2.6.4 Precautions for using hubs	2 - 17
2.7 Software Packages	2 - 18

CHAPTER 3 SPECIFICATIONS **3 - 1 to 3 - 78**

3.1 Performance Specifications	3 - 1
3.2 Accessible Routes and Devices	3 - 7
3.3 I/O Signals for the Programmable Controller CPU	3 - 20

3.3.1	I/O signal list	3 - 20
3.3.2	I/O signal details	3 - 22
3.4	Buffer Memory List.....	3 - 26
3.4.1	Module status area (address: 0 to 20).....	3 - 27
3.4.2	CompactFlash card information area (address: 21 to 25).....	3 - 28
3.4.3	Network connection status area (address: 47 to 64).....	3 - 28
3.4.4	Common setting status area (address: 70 to 80).....	3 - 28
3.4.5	Time synchronization information area (address: 100 to 109).....	3 - 29
3.4.6	Current error area (address: 140 to 145).....	3 - 30
3.4.7	Error log area (address: 150 to 247).....	3 - 31
3.4.8	General data sampling delay time area (address: 800 to 805).....	3 - 32
3.4.9	Recipe file area (address: 810 to 841).....	3 - 34
3.4.10	Access target CPU setting status area (address: 1500 to 1593).....	3 - 35
3.4.11	Data logging status area (address: 2000 to 2989).....	3 - 37
3.4.12	Event logging status area (address: 3000 to 3989).....	3 - 41
3.4.13	Report creation status area (address: 4000 to 4989).....	3 - 45
3.4.14	E-mail transmission status area (address: 5000 to 5992).....	3 - 49
3.4.15	FTP server status area (address: 6000 to 6001).....	3 - 53
3.4.16	FTP client status (PUT) area (address: 6002 to 7457).....	3 - 54
3.4.17	FTP client setting area (address: 7999).....	3 - 58
3.4.18	Event logging area (address: 10000 to 14095).....	3 - 59
3.5	Directory Structure.....	3 - 60
3.6	CSV File Format	3 - 61
3.6.1	CSV format specification	3 - 61
3.6.2	Data logging file.....	3 - 61
3.6.3	Event logging file	3 - 65
3.7	Binary File Format	3 - 69
3.7.1	Data logging file.....	3 - 69
3.7.2	Event logging file	3 - 72
3.8	Recipe File Format	3 - 76
3.9	Range of Values per Output Format.....	3 - 78

CHAPTER 4 SETTINGS AND PROCEDURES UP TO OPERATION **4 - 1 to 4 - 21**

4.1	Handling Precautions.....	4 - 1
4.2	Configuration and Procedures Up to Operation.....	4 - 2
4.2.1	Procedure to operate by installing high speed data logger module Configuration Tool	4 - 2
4.2.2	Procedure to operate without installing high speed data logger module Configuration Tool....	4 - 5
4.2.3	High speed data logger module operation settings	4 - 9
4.3	Parts Names	4 - 10
4.4	Wiring.....	4 - 12
4.4.1	Wiring	4 - 12
4.4.2	Wiring precautions.....	4 - 12
4.5	Intelligent Function Module Switch Setting.....	4 - 14
4.6	Self-Diagnostics Tests	4 - 19
4.6.1	Self-loopback test	4 - 19
4.6.2	Hardware test	4 - 20

4.7	Operations to Return the High Speed Data Logger Module to the Factory Default Status	4 - 21
-----	--	--------

CHAPTER 5 HIGH SPEED DATA LOGGER MODULE TOOL STARTUP 5 - 1 to 5 - 20

5.1	Obtaining High Speed Data Logger Module Tool	5 - 1
5.2	Installation	5 - 2
5.2.1	Installation procedure	5 - 2
5.2.2	Upgrade procedure	5 - 7
5.2.3	Uninstallation procedure	5 - 9
5.3	Starting Configuration Tool	5 - 12
5.3.1	Online startup	5 - 13
5.3.2	Offline startup (starting from the Start menu)	5 - 20
5.3.3	Starting from GX LogViewer	5 - 20
5.4	Starting Conversion Tool	5 - 20

CHAPTER 6 FUNCTION LIST 6 - 1 to 6 - 2

CHAPTER 7 DATA LOGGING FUNCTION 7 - 1 to 7 - 22

7.1	Target Data	7 - 2
7.2	Target Data Sampling	7 - 3
7.2.1	High speed data sampling	7 - 4
7.2.2	General data sampling	7 - 7
7.3	Logging Types	7 - 9
7.3.1	Continuous logging	7 - 9
7.3.2	Trigger logging	7 - 10
7.3.3	Trigger conditions	7 - 14
7.4	Data Logging Periods	7 - 17
7.5	Data Logging Files	7 - 19
7.5.1	Data logging file save format	7 - 19
7.5.2	Saving data logging files	7 - 20
7.5.3	Data logging file save location	7 - 21
7.5.4	Transferring data logging files	7 - 21
7.6	Missing Data	7 - 22

CHAPTER 8 EVENT LOGGING FUNCTION 8 - 1 to 8 - 12

8.1	Events	8 - 2
8.1.1	Target data	8 - 2
8.1.2	Event conditions	8 - 3
8.2	Target Data Sampling	8 - 7
8.3	Event Logging Periods	8 - 9
8.4	Event Logging Files	8 - 10
8.4.1	Event logging file save format	8 - 10
8.4.2	Saving event logging files	8 - 10
8.4.3	Event logging file save location	8 - 10

8.4.4	Transferring event logging files	8 - 11
8.5	E-mail Notification	8 - 12

CHAPTER 9 REPORT FUNCTION 9 - 1 to 9 - 9

9.1	Target Data	9 - 2
9.2	Creation Trigger and Current Value Data Sampling	9 - 6
9.3	Creation Trigger	9 - 8
9.4	Report Periods	9 - 8
9.5	Report Files	9 - 9
9.5.1	Saving report files	9 - 9
9.5.2	Report file save location	9 - 9
9.5.3	Transferring report files	9 - 9

CHAPTER 10 OTHER FUNCTIONS 10 - 1 to 10 - 15

10.1	Time Synchronization Function	10 - 1
10.2	Auto Logging Function	10 - 5
10.3	File Access Function	10 - 7
10.4	Access Authentication Function	10 - 9
10.5	FTP Transfer Function	10 - 10
10.6	E-mail Function	10 - 13

CHAPTER 11 FUNCTIONS OF CONFIGURATION TOOL (MODULE SETTINGS) 11 - 1 to 11 - 239

11.1	Setting Operations Overview	11 - 1
11.2	Screen Configuration and Common Operations	11 - 2
11.2.1	Main screen configuration	11 - 2
11.2.2	Menu configuration	11 - 3
11.2.3	Toolbar configuration	11 - 5
11.2.4	Operations using the edit items tree	11 - 6
11.2.5	Status bar	11 - 7
11.2.6	Common table operations	11 - 8
11.2.7	Data list	11 - 10
11.2.8	Device batch replacement	11 - 12
11.2.9	Data setting screen	11 - 13
11.2.10	Importing global labels and device comments	11 - 15
11.3	Project Management	11 - 29
11.3.1	Creating a new project	11 - 29
11.3.2	Opening a project	11 - 29
11.3.3	Saving a project	11 - 30
11.3.4	Importing settings from project file	11 - 31
11.3.5	Exporting project to CSV file	11 - 33
11.3.6	Exporting module operating file	11 - 34
11.4	Common Setting	11 - 35
11.4.1	Network setting	11 - 36

11.4.2	Time synchronization setting	11 - 40
11.4.3	Access target CPU setting	11 - 46
11.4.4	FTP setting	11 - 59
11.4.5	E-mail setting	11 - 62
11.4.6	Account setting	11 - 66
11.4.7	Auto logging setting	11 - 71
11.4.8	High speed data sampling setting.....	11 - 74
11.4.9	CompactFlash card setting	11 - 75
11.5	Data Logging Setting	11 - 78
11.5.1	Data logging setting list.....	11 - 78
11.5.2	Data logging setting screen transitions.....	11 - 80
11.5.3	Logging type/file format	11 - 83
11.5.4	Sampling.....	11 - 84
11.5.5	Data setting list	11 - 87
11.5.6	Data setting.....	11 - 89
11.5.7	Data batch insertion.....	11 - 93
11.5.8	Period of time.....	11 - 95
11.5.9	Trigger	11 - 101
11.5.10	Trigger (single condition)	11 - 103
11.5.11	Trigger (compound condition).....	11 - 107
11.5.12	Number of logging lines	11 - 118
11.5.13	CSV output	11 - 122
11.5.14	Binary output.....	11 - 125
11.5.15	Save.....	11 - 126
11.5.16	Completion.....	11 - 144
11.6	Event Logging Setting.....	11 - 145
11.6.1	Event logging setting list.....	11 - 145
11.6.2	Event logging setting screen transitions	11 - 147
11.6.3	File format.....	11 - 149
11.6.4	Sampling.....	11 - 150
11.6.5	Event setting list.....	11 - 153
11.6.6	Event setting	11 - 154
11.6.7	Event setting (single condition).....	11 - 155
11.6.8	Event setting (compound condition)	11 - 159
11.6.9	Event batch insertion	11 - 169
11.6.10	Period of time.....	11 - 171
11.6.11	CSV output	11 - 177
11.6.12	Binary output.....	11 - 178
11.6.13	Save.....	11 - 179
11.6.14	E-mail notice	11 - 188
11.6.15	Completion.....	11 - 191
11.7	Report Setting	11 - 192
11.7.1	Report setting list.....	11 - 192
11.7.2	Report setting screen transitions	11 - 194
11.7.3	Sampling.....	11 - 196
11.7.4	Layout setting list.....	11 - 199
11.7.5	Layout setting	11 - 203
11.7.6	Creation trigger	11 - 220
11.7.7	Period of time.....	11 - 227
11.7.8	Save.....	11 - 233

11.7.9	Completion	11 - 239
--------	------------------	----------

CHAPTER 12 FUNCTIONS OF CONFIGURATION TOOL (WRITING/READING/VERIFYING DATA) 12 - 1 to 12 - 4

12.1	Transfer Setup	12 - 1
12.2	High Speed Data Logger Module Search	12 - 2
12.3	Writing Data	12 - 3
12.4	Reading Data	12 - 4
12.5	Verifying Data	12 - 4

CHAPTER 13 FUNCTIONS OF CONFIGURATION TOOL (CONFIRMING MODULE OPERATION) 13 - 1 to 13 - 19

13.1	Diagnostics	13 - 1
13.1.1	Module diagnostics	13 - 2
13.1.2	CPU access diagnostics	13 - 5
13.1.3	FTP transfer diagnostics	13 - 6
13.1.4	E-mail send diagnostics	13 - 7
13.1.5	Product information	13 - 8
13.1.6	CompactFlash card diagnostics	13 - 9
13.1.7	Data logging diagnostics	13 - 12
13.1.8	Event logging diagnostics	13 - 13
13.1.9	Report diagnostics	13 - 14
13.1.10	Ping test	13 - 15
13.2	File Browser	13 - 17
13.3	Verifying Product Information	13 - 19
13.3.1	Version information	13 - 19
13.3.2	Open the user's manual	13 - 19

CHAPTER 14 FUNCTIONS OF LOGGING FILE CONVERSION TOOL 14 - 1 to 14 - 6

14.1	Screen Configuration of Conversion Tool	14 - 1
14.1.1	Main screen	14 - 1
14.2	Configuration of Output Format Screens	14 - 3
14.2.1	Main screen configuration	14 - 3
14.2.2	Output format (bit) screen	14 - 5
14.2.3	Output format (integer/float) screen	14 - 6

CHAPTER 15 RECIPE FUNCTION 15 - 1 to 15 - 25

15.1	Recipe Function Execution Procedure	15 - 5
15.2	Screen Configuration	15 - 6
15.2.1	Recipe editor screen configuration	15 - 6
15.2.2	Menu configuration	15 - 7
15.2.3	Toolbar configuration	15 - 7
15.2.4	Recipe editor area	15 - 8
15.3	Creating Recipe Files	15 - 10
15.3.1	Starting recipe editor screen	15 - 10

15.3.2	Creating new recipe file	15 - 10
15.3.3	Opening recipe files	15 - 10
15.3.4	Saving recipe files.....	15 - 11
15.3.5	Editing recipe data	15 - 11
15.4	Transferring Recipe Files to Module	15 - 14
15.5	Executing Recipe Function	15 - 15
15.5.1	Executing recipe function using module dedicated instructions	15 - 15
15.5.2	Executing recipe function using Configuration Tool.....	15 - 15
15.6	Dedicated Instructions	15 - 19
15.6.1	Recipe read (RCPREAD)	15 - 20
15.6.2	Recipe Write (RCPWRITE).....	15 - 23

CHAPTER 16 CompactFlash CARD **16 - 1 to 16 - 17**

16.1	CompactFlash Card Specifications.....	16 - 1
16.2	CompactFlash Card Part Names	16 - 1
16.3	Precautions when Using CompactFlash Card	16 - 2
16.4	Operations for Inserting CompactFlash Card	16 - 5
16.5	Operations for Ejecting and Reinserting CompactFlash Card	16 - 6
16.6	Operations for Replacing New CompactFlash Card	16 - 8
16.7	CompactFlash Card Life Duration	16 - 14

CHAPTER 17 PROCESSING TIME **17 - 1 to 17 - 13**

17.1	Processing Time	17 - 1
17.1.1	Trigger logging.....	17 - 2
17.1.2	Continuous logging.....	17 - 4
17.2	Checking Processing Time	17 - 6
17.2.1	Checking sampling process time	17 - 7
17.2.2	Checking data logging process time.....	17 - 9
17.2.3	Checking event logging process time	17 - 9
17.2.4	Checking report process time	17 - 10
17.3	Effect on Sequence Scanning Time	17 - 11
17.3.1	For high speed data sampling	17 - 11
17.3.2	For general data sampling	17 - 12
17.3.3	Calculation example for time increase of scan time	17 - 13

CHAPTER 18 TROUBLESHOOTING **18 - 1 to 18 - 51**

18.1	Error Codes	18 - 2
18.1.1	Checking error codes.....	18 - 2
18.1.2	Error types	18 - 4
18.1.3	System monitor.....	18 - 5
18.2	Error Code List.....	18 - 7
18.3	Troubleshooting by Symptom	18 - 34
18.3.1	Troubleshooting related to LED indicators and I/O signals.....	18 - 34

18.3.2	Troubleshooting related to data logging, event logging, and reports.....	18 - 35
18.3.3	Troubleshooting related to network connection	18 - 39
18.3.4	Troubleshooting related to FTP	18 - 40
18.3.5	Troubleshooting related to e-mail	18 - 40
18.3.6	Troubleshooting related to communication between the high speed data logger module and access target CPU.....	18 - 41
18.3.7	Troubleshooting related to time synchronization function	18 - 41
18.3.8	Troubleshooting related to data management, CompactFlash cards.....	18 - 42
18.3.9	Troubleshooting related to Configuration Tool	18 - 44
18.3.10	Troubleshooting related to Logging File Conversion Tool	18 - 49
18.3.11	Troubleshooting related to recipe function	18 - 50

APPENDIX

App - 1 to App - 69

Appendix 1	External Dimensions.....	App - 1
Appendix 2	PING Test.....	App - 2
Appendix 3	Data Sampling Method for CPUs that cannot be Accessed Directly	App - 4
Appendix 4	Usable Characters.....	App - 7
Appendix 4.1	Characters usable in high speed data logger module tool	App - 7
Appendix 4.2	Characters usable in file names, folder (directory) names	App - 10
Appendix 4.3	Characters usable in output file	App - 10
Appendix 5	Adding Function to High Speed Data Logger Module	App - 12
Appendix 6	Numerical Type Comparison Accuracy	App - 15
Appendix 7	Precautions when Replacing Older Version of Module	App - 16
Appendix 8	Process Modifications.....	App - 16
Appendix 8.1	File switching timing	App - 16
Appendix 8.2	Processing time of FTP transfer function and e-mail function.....	App - 20
Appendix 9	Supported FTP Command.....	App - 21
Appendix 10	Setting information CSV File Format.....	App - 23
Appendix 11	FTP Transfer Directory Configuration.....	App - 65
Appendix 12	Sampling Processes of High Speed Data Logger Module	App - 67
Appendix 12.1	Data changes between data sampling processes.....	App - 67
Appendix 12.2	Detecting data condition establishment.....	App - 67

INDEX

Index - 1 to Index - 2

WARRANTY
INFORMATION AND SERVICES
TRADEMARKS
COPYRIGHTS

COMPLIANCE WITH THE EMC AND LOW VOLTAGE DIRECTIVES

(1) Method of ensuring compliance

To ensure that Mitsubishi Electric programmable controllers maintain the EMC and Low Voltage Directives or other regulations when incorporated into other machinery or equipment, certain measures may be necessary. Please refer to one of the following manuals.

- QCPU User's Manual(Hardware Design, Maintenance and Inspection)
(SH-080483ENG)
- Safety Guidelines (IB-0800423)

Certification marks on the side of the programmable controller indicate compliance with the relevant regulations.

(2) Additional measures

To ensure that this product maintains the EMC and Low Voltage Directives or other regulations, please refer to one of the manuals shown in (1).

HOW TO USE THIS MANUAL

Displaying a reference

Reference in this manual and reference manual are shown with .

Displaying a chapter title

Index on the right of a page clears the chapter of the page.

Operating procedure

Describes the operating procedure of the function.

Setting screen

Describes the operating screen when using the function.

Screen display

Describes the screen displayed when using the function.

11 FUNCTIONS OF CONFIGURATION TOOL (MODULE SETTINGS)

11.3.5 Exporting project to CSV file

Export settings (common settings, data logging settings, event logging settings, report settings) of the project being edited to the CSV file.
 For details on the formats of setting information CSV file, refer to the following section.
[Appendix 10 Setting information CSV file format](#)

Operating procedure

- ① Select [Project] →[Export] →[CSV File].
- ② On the "Browse For Folder" screen, specify the export destination and click the button.

Setting screen

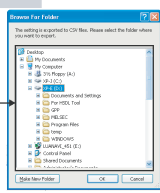

Folder tree →

Item	Description
Folder tree	Select a folder to which settings are exported.
<input type="button" value="Make New Folder"/>	Create a new folder in the directory displayed in the folder tree.
<input type="button" value="OK"/>	Exports CSV files to the selected folder, and closes the screen.
<input type="button" value="Cancel"/>	Cancel the export and closes the screen.

9 REPORT FUNCTION

10 OTHER FUNCTIONS

11 FUNCTIONS OF CONFIGURATION TOOL (MODULE SETTINGS)

12 COMMON FUNCTIONS

13 COMMON FUNCTIONS

14 COMMON FUNCTIONS

15 RECIPE FUNCTION

16 COMMON FUNCTIONS

PROCESSING TIME

11.3 Project Management 11 - 30

11.3.5 Exporting project to CSV file

Displaying a section title

The section in which the open page is included is clear.

The above is different from the actual page as it is provided for explanation only. In addition, this manual provides the following explanations.

POINT Explains matters to be made particularly aware of, functions or other information related to the description on that page.

Remark Provides references related to the description on that page and convenient information.

Additionally, lists, like the one below, which explain operation methods indicate that any of the operations can be performed.





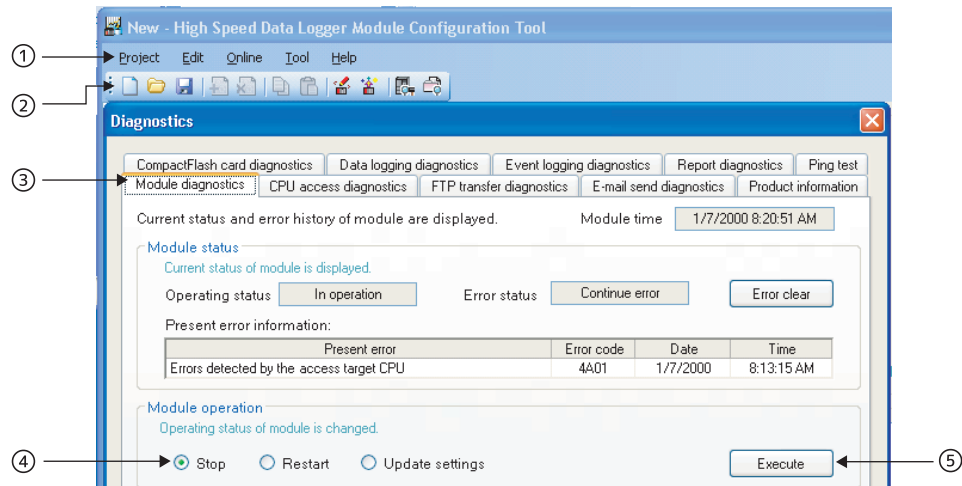

(Example)

Operation method

- [Event] → [Event Properties]
- Right click on the event list and select [Event Properties].

The following table shows the definitions and descriptions of the terms used in this manual.



No.	Notation	Description	Example
①	[]	Menu name on menu bar	[Project]
②		Toolbar icon	
③	<< >>	Tab name on screen	<<Module diagnostics>>
④	" "	Item name on screen	"Stop"
⑤		Button on screen	
-		Keyboard key	

GENERIC TERMS AND ABBREVIATIONS

Unless otherwise specified, this manual uses the following generic terms and abbreviations to explain the QD81DL96 high speed data logger module and high speed data logger module tool (SW1DNN-DLUTL-E).

Generic term/ abbreviation	Description
High speed data logger module	MELSEC-Q Series-compatible QD81DL96 high speed data logger module
High speed data logger module tool	Generic term for the high speed data logger module Configuration Tool (model: SW1DNN-DLUTL).
Configuration Tool	Abbreviation for the high speed data logger module Configuration Tool. This tool configures and maintains the high speed data logger module. The Configuration Tool is built-in to the high speed data logger module. The Configuration Tool is included with the high speed data logger module tool.
Conversion Tool	Abbreviation for the Logging File Conversion Tool. This tool converts binary format logging files to CSV format logging files. The Conversion Tool is included with the high speed data logger module tool.
Programming tool	Generic term for GX Works2 and GX Developer.
QnUDE(H)CPU	Generic term for Q03UDE, Q04UDEH, Q06UDEH, Q10UDEH, Q13UDEH, Q20UDEH, Q26UDEH, Q50UDEH, and Q100UDEH.
High-speed Universal model QCPU	Generic term for Q03UDV, Q04UDV, Q06UDV, Q13UDV, and Q26UDV.
Universal model process CPU	Generic term for Q04UDPV, Q06UDPV, Q13UDPV, and Q26UDPV.
QCPU(Q mode)	Generic term for Basic model QCPU, High Performance model QCPU, Process CPU, Redundant CPU, and Universal model QCPU.
LCPU	Generic term for L02S, L02S-P, L02, L02-P, L06, L06-P, L26, L26-P, L26-BT, and L26-PBT.
C Controller module	Generic term for Q12DCCPU-V, Q24DHCCPU-V and Q24DHCCPU-LS.
Built-in Ethernet port QCPU	Generic term for QnUDE(H)CPU and High-speed Universal model QCPU.
Ethernet Built-in CPU	Generic term for Built-in Ethernet port QCPU and LCPU.
Q series-compatible C24	Generic term for QJ71C24, QJ71C24-R2, QJ71C24N, QJ71C24N-R2, and QJ71C24N-R4
Q series-compatible E71	Generic term for QJ71E71, QJ71E71-B2, QJ71E71-B5, and QJ71E71-100.
Ethernet module	Generic term for Q series-compatible E71 and QJ71E71-100.
Ethernet communications	Abbreviation for performing communications with a programmable controller CPU using an Ethernet module or built-in Ethernet port CPU.
CC-Link IE Control	Abbreviation for CC-Link IE Controller Network.
CC-Link IE Field	Abbreviation for CC-Link IE Field Network.
CC-Link IE	Generic term for CC-Link IE Controller Network and CC-Link IE Field Network.
MELSECNET/H	Abbreviation for MELSECNET/H network system.
CC-Link	Abbreviation for Control & Communication Link.
Windows® 8 or later	Generic term for Windows® 8, Windows® 8.1, and Windows® 10
Windows® 7 or later	Generic term for Windows® 7, Windows® 8, Windows® 8.1, and Windows® 10
Windows Vista® or later	Generic term for Windows Vista®, Windows® 7, Windows® 8, Windows® 8.1, and Windows® 10
Microsoft® Excel® 2007 or later	Generic term for Microsoft® Excel® 2007, Microsoft Excel 2010 (32-bit version), Microsoft Excel 2013 (32-bit version), Microsoft Excel 2016 (32-bit version), Microsoft Excel 2019 (32-bit version/64-bit version), Microsoft Excel 2021 (32-bit version/64-bit version), and Microsoft 365 (32-bit version/64-bit version)
Personal computer	Generic term for personal computer on which Windows® operates.

DEFINITIONS AND DESCRIPTIONS OF TERMS

The following table shows the definitions and descriptions of the terms used in this manual.

Term	Description
Account	Designates the right to use the high speed data logger module or the ID necessary when using the module.
Device	The types of memory data in the programmable controller CPU. There are devices handled in units of bits and in units of words.
SNTP	Abbreviation for Simple Network Time Protocol. A protocol for synchronizing a personal computer's time via a TCP/IP network, the simple version of NTP. Since the SNTP protocol is included in NTP, the high speed data logger module can also synchronize time via NTP.
Time zone	The standard time zones for each region of the world. Each nation uses the time difference (within ± 12 hours) from the time at the Greenwich Observatory in England (GMT) as the standard time. Regions using the same time difference are called a time zone. The standard time for Japan is 9 hours ahead of GMT. Depending on the country, they may also use daylight saving time in summer.
Daylight saving time (summer time)	A system where clocks are set ahead for a specified period during summer.
URL	Abbreviation for Uniform Resource Locator. Notation method for indicating the location of information resources (documents, graphics, etc.) on the Internet.
CompactFlash card	A storage card regulated by the 'CF+ and CompactFlash Specification' issued by the CompactFlash Association. The memory card required for operating the high speed data logger module.
Direct connection	A connection method using an Ethernet cable to connect the high speed data logger module and a personal computer on a 1:1 basis. They can be easily connected without knowing the IP address.
Connection via a hub	A method of connecting the high speed data logger module and a personal computer to a local area network. The high speed data logger module's IP address must be specified when connecting. Multiple high speed data logger modules can be accessed from a personal computer over a network.
Host name	The name of a computer connected to the network which is easy for people to understand.
Web browser	Abbreviation for the software used to view web pages.
Data logging	The function to log programmable controller CPU device values at the specified data sampling interval.
Event logging	The function to monitor sampled device values from the programmable controller CPU and log events that occur.
Auto logging	A function to automatically start logging when a CompactFlash card with the auto logging settings written to it in advance is inserted in a running high speed data logger module.
Data logging file	The file where the data sampled by the high speed data logger module are saved in the format specified with the Configuration Tool.
Event logging file	The file where the events sampled by the high speed data logger module are saved in the format specified with the Configuration Tool.
Logging file	The general term for the data logging file and event logging file.
CSV file	A CSV format file used for high speed data logger module and high speed data logger module tool. (A text file in which data are organized by separating it with commas ("","").)
Binary file	A binary format file that is output from the high speed data logger module.
SMTP-Auth	One type of authorization method specified when sending e-mail. The user's account and password are authenticated between the SMTP server and user, and this method only sends e-mail if authenticated.
POP before SMTP	One type of authorization method specified when sending e-mail. By accessing the specified POP3 server in advance before sending an e-mail, this method grants permission to use the SMTP server.
Realtime trend	The current data sampled by high speed data logger module is displayed with the trend graph function. The data is always updated, and the display history from when the monitor is started to the present can be checked.
Best effort functions	The concept of deriving maximum performance depending on the state at that time.

PACKING LIST

The following table shows the product included to the QD81DL96 high speed data logger module.

Model	Product name	Quantity
QD81DL96	QD81DL96 High speed data logger module	1

CHAPTER 1 OVERVIEW

This manual explains the specifications procedures up to operation, functions, and troubleshooting of the high speed data logger module.

When applying the example programs introduced in this manual to an actual system, make sure to examine the applicability and confirm that it will not cause system control problems.

By easily configuring the high speed data logger module, it can save sampled programmable controller device data in the optimal file format to a CompactFlash card (sold separately, required) inserted in the module.

1.1 Features

This section explains the features of the high speed data logger module.

(1) Programmable controller device data can be easily logged without a personal computer

The high speed data logger module can log programmable controller devices without using a personal computer.

This can reduce costs, as well as provide peace of mind since you won't worry about personal computer down-time or connection cables disconnecting.

By easily configuring the module, sampled data can be saved in the optimal file format to a CompactFlash card.

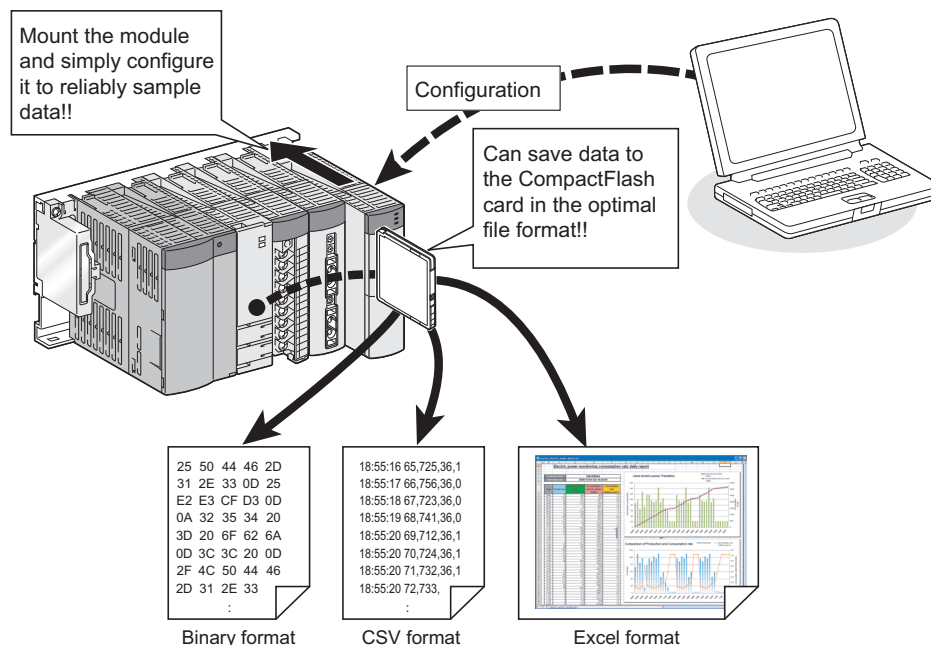

POINT

Binary format logging files can be converted to CSV format logging files using the Conversion Tool.

(2) Control data changes can be logged without misses (☞ Section 7.3.1)

The high speed data logger module can perform data logging per scan/in millisecond intervals.

Since the module is logging changes in the specified control data without misses, it demonstrates its effectiveness in determining the cause of problems when they occur. Since it can also perform high speed logging, you can perform high-precision equipment analysis.

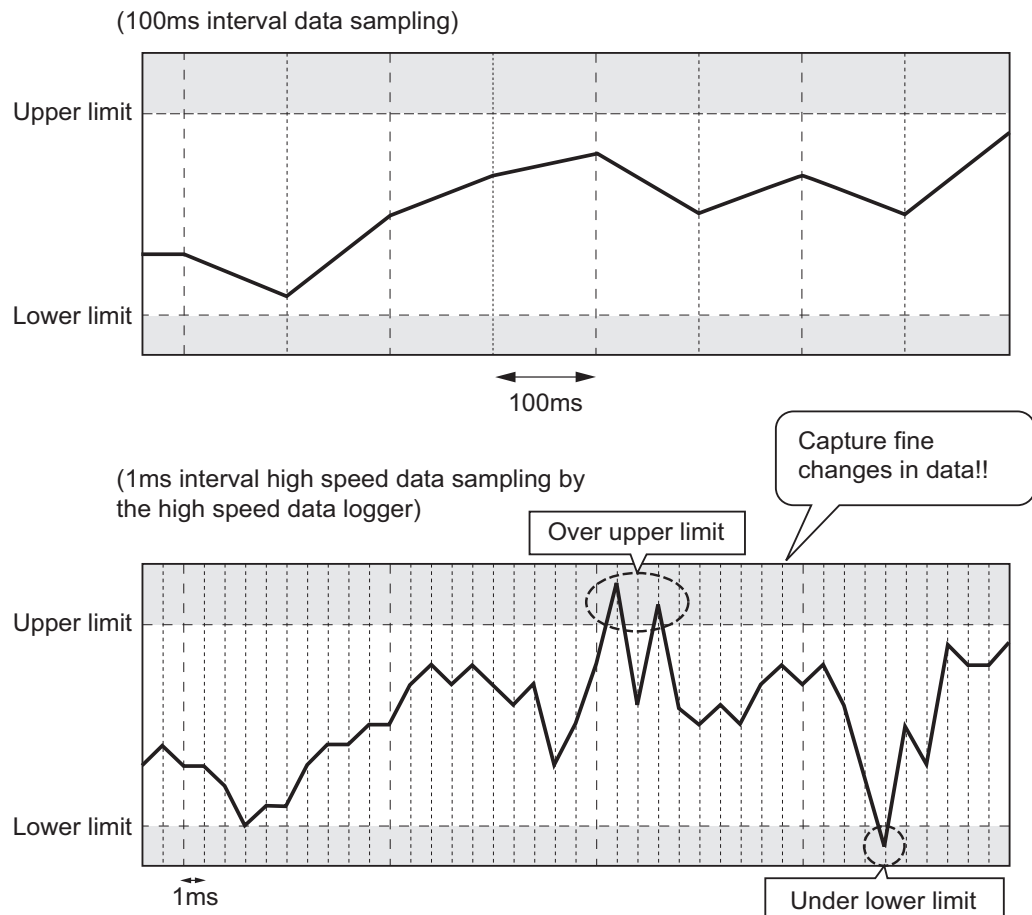

☒ POINT

- (1) In order to perform logging per scan/in millisecond intervals, a programmable controller CPU which supports the high speed data sampling function is required.

☞ Section 2.2 Applicable Systems

- (2) The data logging, event logging, and report functions of the high speed data logger module are the best effort functions.

Since module processing time changes according to the settings and status of other devices, it may not operate with the set data sampling interval. Run the system by fully verifying the processing time of each function when constructing it.

For processing time, refer to the following chapter.

☞ Chapter 17 PROCESSING TIME

(3) Accelerate problem analysis when problems occur (trigger logging function) (Section 7.3.2)

With data status/change triggers, the high speed data logger module can save the data before and after the trigger.

Since only the data before and after trouble occurs can be saved, you can quickly identify the data which is the cause of the problem and save file space.

:	:	:	:	:
2008/1/10 14:25:34	150	18	356	39
2008/1/10 14:25:34	200	18	330	39
2008/1/10 14:25:34	250	19	280	39
2008/1/10 14:25:34	300	18	310	42
2008/1/10 14:25:34	350	18	300	43
2008/1/10 14:25:34	400	19	285	46
2008/1/10 14:25:34	450	18	290	47
2008/1/10 14:25:34	500	15	310	48
2008/1/10 14:25:34	550	12	312	49
2008/1/10 14:25:34	600	11	333	50
2008/1/10 14:25:34	650	5	340	50
2008/1/10 14:25:34	700	3	352	51
2008/1/10 14:25:34	750	12	360	51
2008/1/10 14:25:34	800	14	362	50
2008/1/10 14:25:34	850	17	363	50
2008/1/10 14:25:34	900	18	363	50
2008/1/10 14:25:34	950	19	365	49
2008/1/10 14:25:35	0	18	370	49
:	:	:	:	:

} Data before trigger
} Location of trigger
} Data after trigger
} Data file save range

(4) Create lists/reports (report function) (Chapter 9)

By setting an Excel file template, such as layouts, graphs, and calculation formulas, in advance, the high speed data logger module can save data in list format or report format to the inserted CompactFlash card.

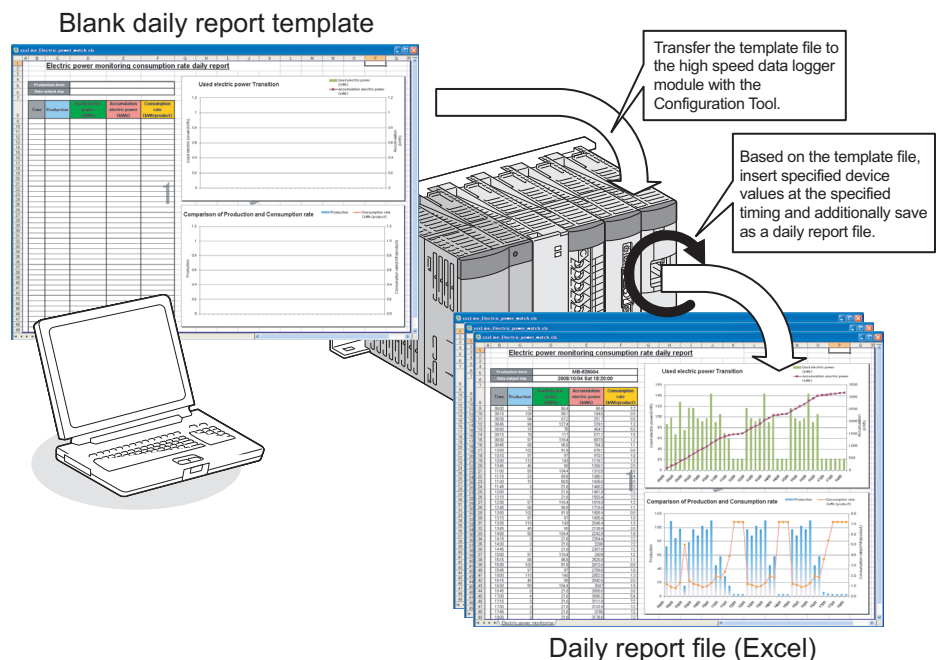

(5) Equipment error detection and failure prediction are possible (event logging function) (Chapter 8)

By setting monitoring target data and monitoring conditions, the high speed data logger module can log changes (events) for those conditions. This can be utilized for equipment error detection and failure prediction.

Not only data values can be set as monitoring conditions, the variation time and order of changes for each data can also be set.

A detected event occurrence can be notified with an e-mail.

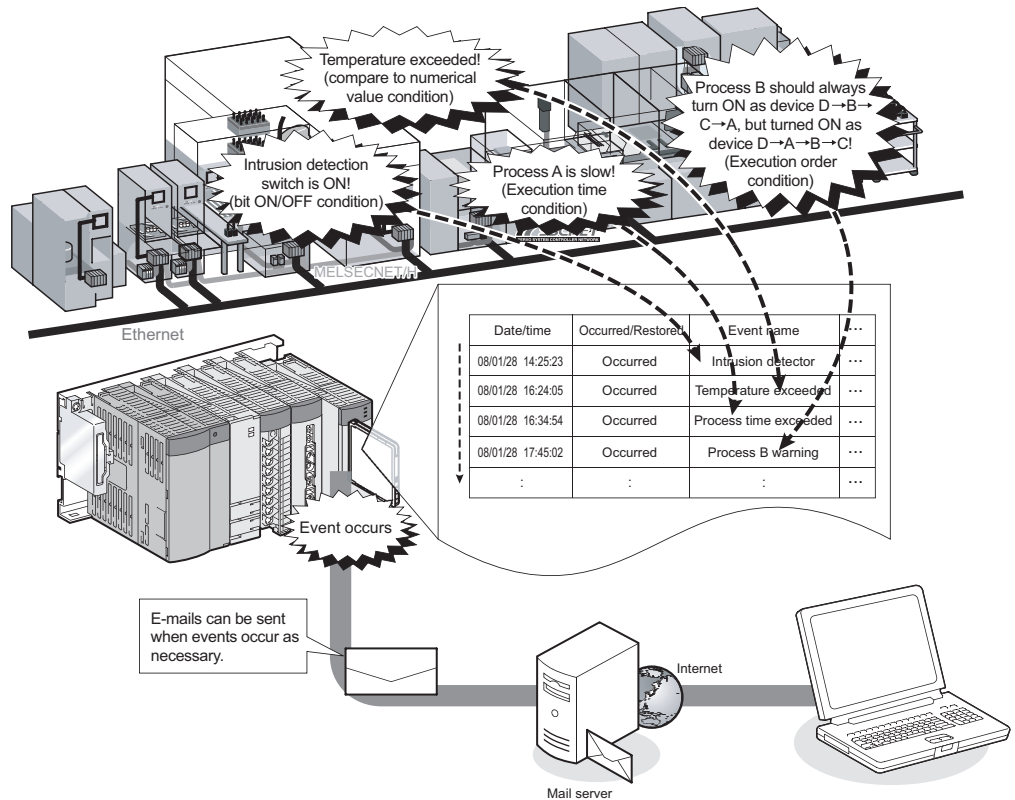

(6) Accessible over the network hierarchy

The high speed data logger module can access programmable controller CPUs hierarchically connected with networks such as CC-Link IE, MELSECNET/H, CC-Link, and Ethernet, and perform data logging.

A single high speed data logger module can access up to a maximum of 64 programmable controller CPUs.

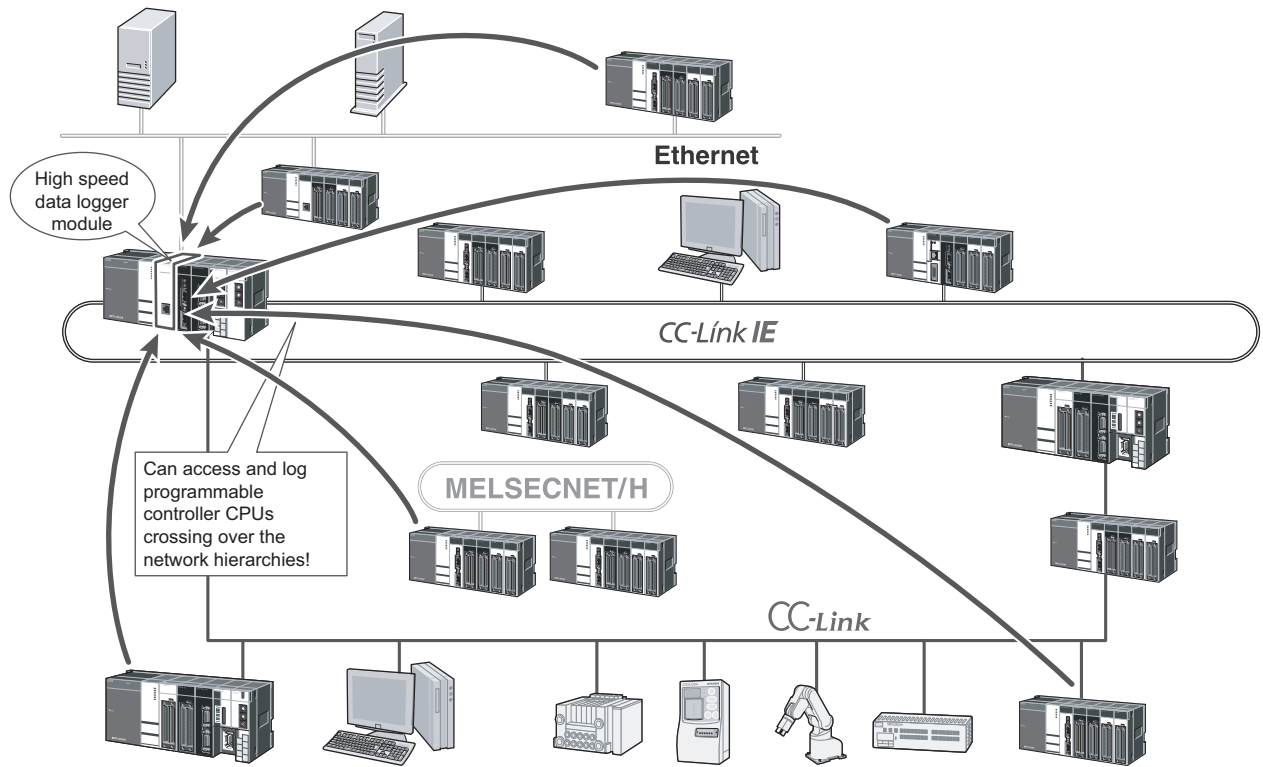

1 OVERVIEW

For Ethernet connections, since the high speed data logger module can access other station's programmable controller CPUs using its Ethernet port, it's not necessary to add a network module to the module mounting station.

If the access target station is also a built-in Ethernet port CPU or C Controller module, it's not necessary to add a network unit to the access target station.

This function can reduce costs.

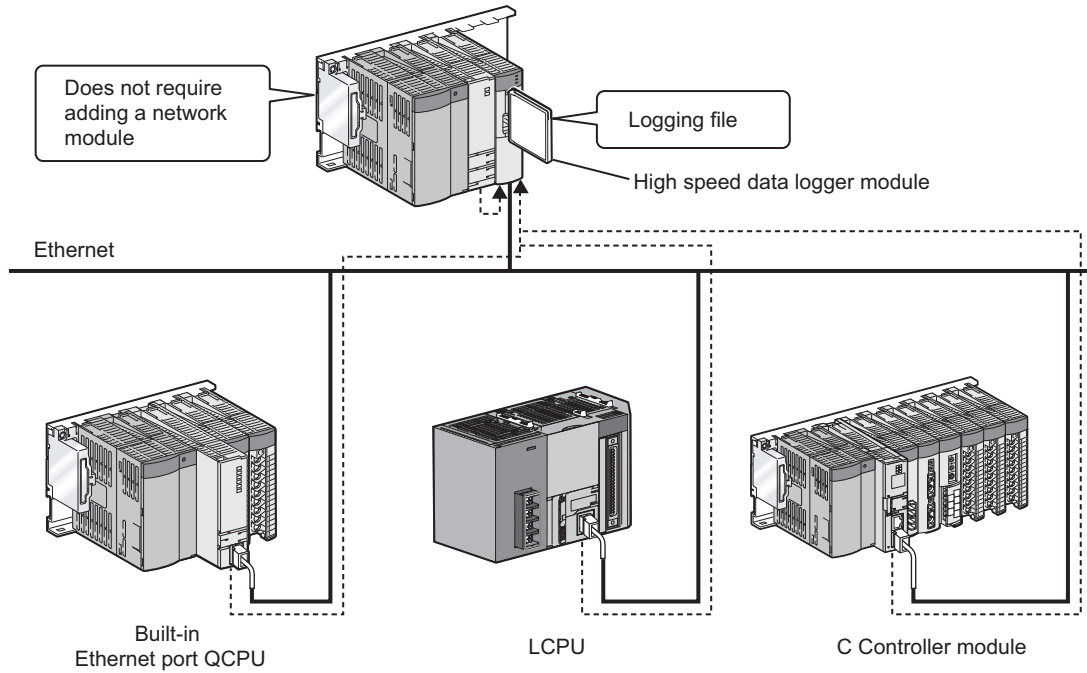

(7) Logging is possible with simple configuration

Logging settings can be easily configured with wizard format settings.

Since the Configuration Tool is built-in to the high speed data logger module, settings can be easily changed on-site by simply connecting a personal computer.

① Wizard format settings

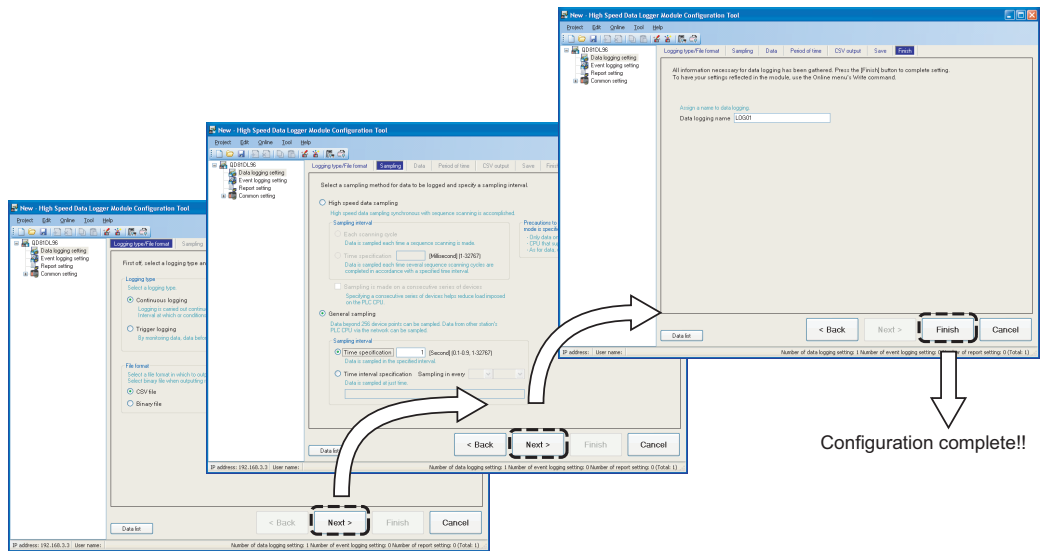

② Setting data are easily changed on-site

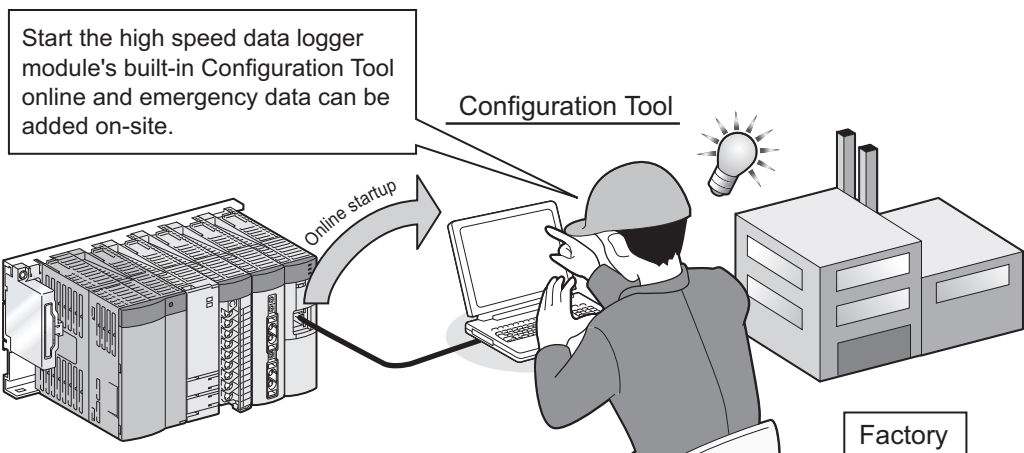

(8) Created data can be utilized as programming assets

(a) Utilize project data of programming tool (☞ Section 11.2.10)

Global labels and device comments created in the programming tool can be imported to the Configuration Tool.

Imported global labels are synchronized with the changes of global labels in the import source, and they can be updated easily.

Since global labels and device comments that can be imported are specified from the list displayed on the screen, input errors and work hours can be reduced.

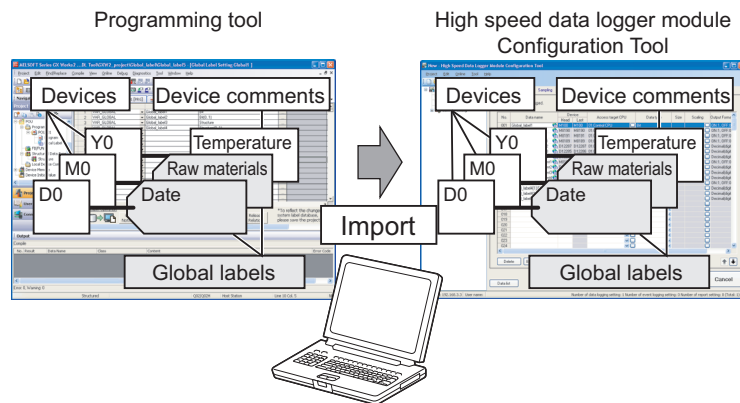

(b) Utilize existing project data in Configuration Tool (☞ Section 11.3.4)

Settings of existing project data in the Configuration Tool can be specified and imported.

This function reduces the setting work hours.

(c) Utilize tabular format data

A list of large-volume data created using Excel can be copied and pasted to the data list of Configuration Tool.

Create large-volume data on Excel. Large-volume data are pasted as they are.

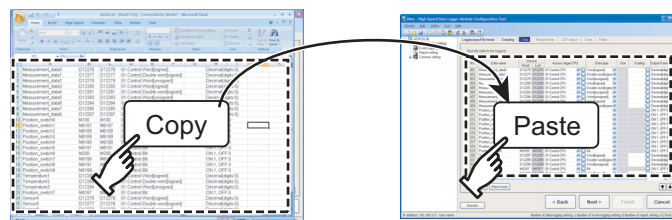

(9) Large-volume logging files can be saved

Since the high speed data logger module can use high-capacity CompactFlash cards up to a maximum of 8 GB, logging over long periods is possible.

Since the logging files saved on the CompactFlash card can also be transferred to a server, logging which exceeds the capacity of the CompactFlash card is possible. In addition, using the function which automatically deletes old files saved on the CompactFlash card according to the specified number of files or free capacity, logging can be continued without replacement of the CompactFlash card.

Even when the network is disconnected, logging files can be resent automatically.

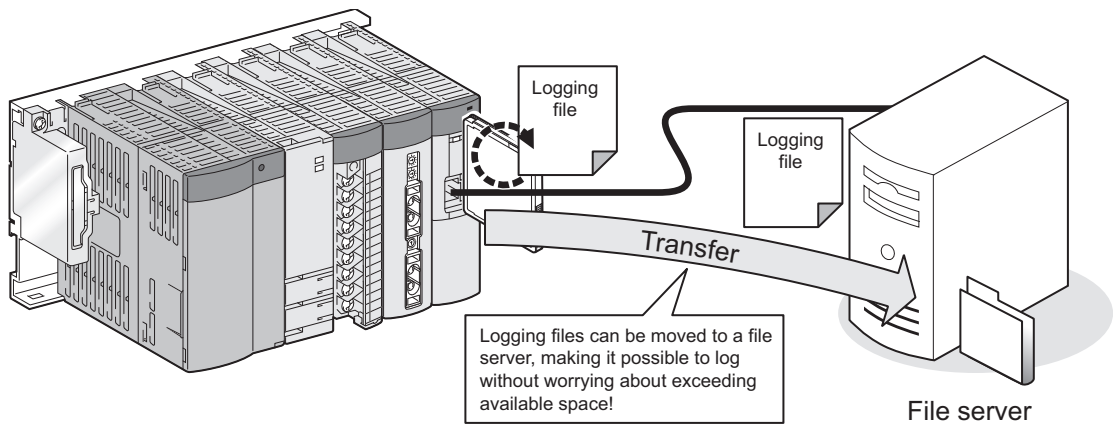

(10) Simple data sampling instructions for troubleshooting

(👉 Section 10.2)

Logging can be automatically started simply by installing a CompactFlash card. By only sending a CompactFlash card with the settings stored on it to the site and having a worker insert it in the high speed data logger module, the module can sample the necessary data.

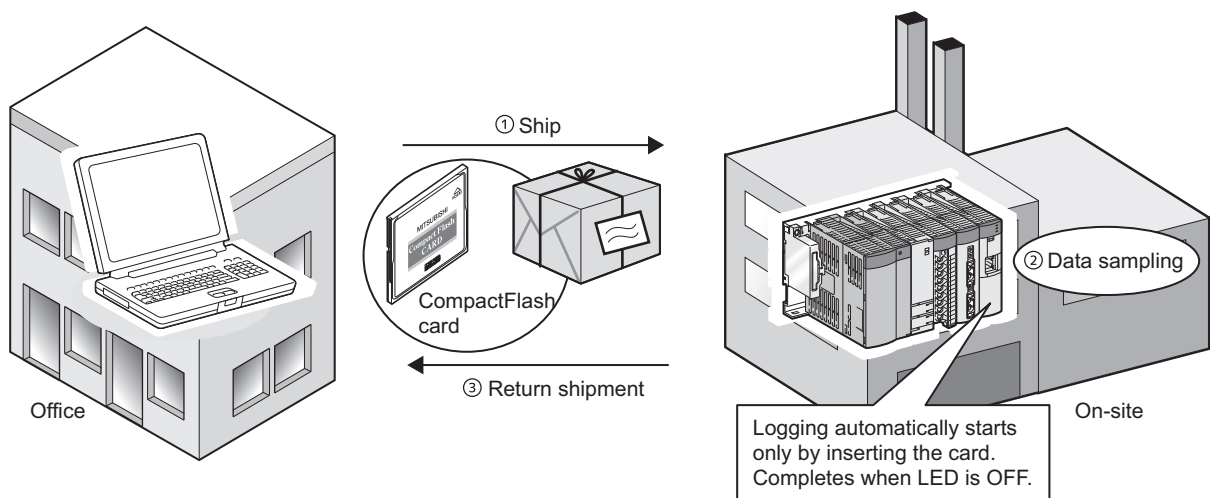

(11) Time synchronization using SNTP (☞ Section 10.1)

The time between a high speed data logger module and a programmable controller CPU can be set through communication with an SNTP server computer.

This enables synchronizing the time for the entire system.

(12) Displaying data and events matched to application

Using GX LogViewer, sampled data can be displayed as graphs and occurred/restored events can be displayed in a list.

(☞ GX LogViewer Version 1 Operating Manual)

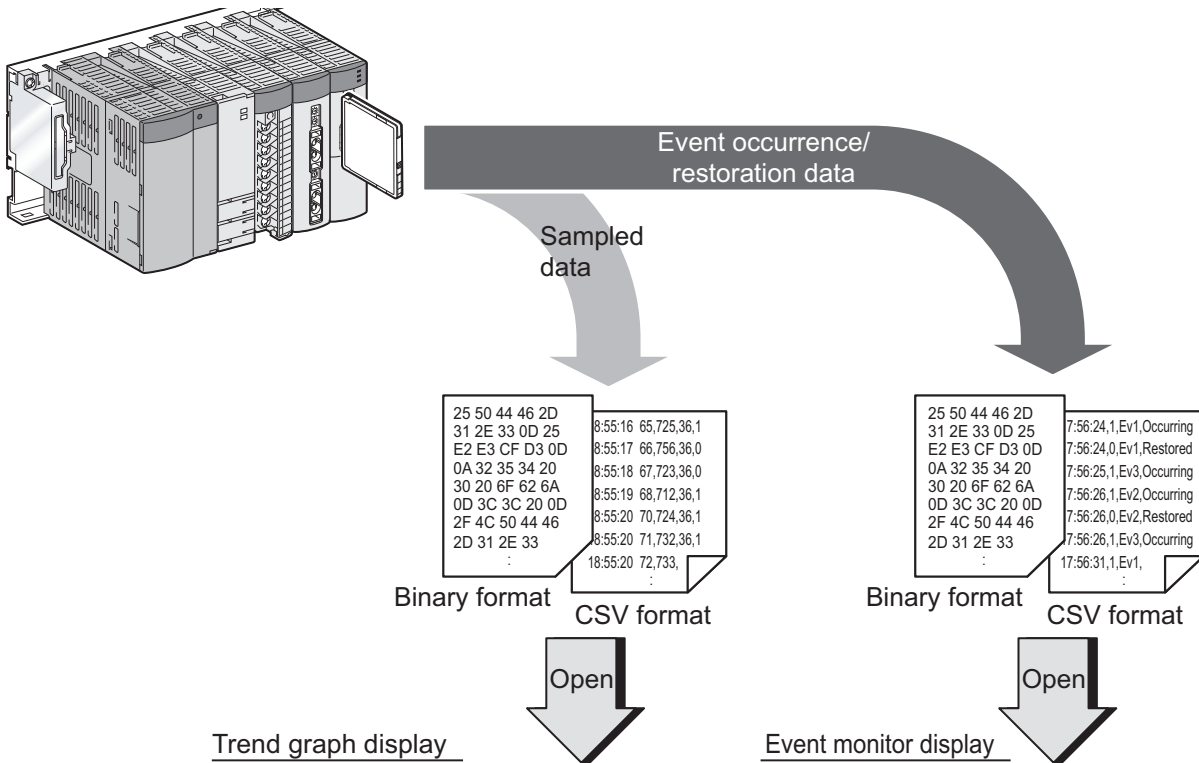

Trend graph display

The change in data can be checked easily.

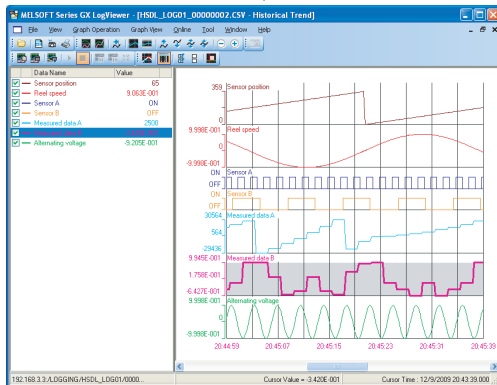

Event monitor display

The event occurrence/restoration can be checked.

The screenshot shows the 'Historical Event' window in GX LogViewer. It displays a list of events with columns for Date, No., Event Logging Name, Status, Comment, and Monitoring Date. The events include 'Sensor detected error', 'Voltage error', and 'Execution error occurred'.

Date	No.	Event Logging Name	Status	Comment	Monitoring Date
12/2/2009 20:57:32.000	001	Sensor detected error	0	Execution restored	00=0.000000
12/2/2009 20:57:27.000	001	Sensor detected error	1	Execution error occurred	00=29992.20679
12/2/2009 20:57:25.000	001	Sensor detected error	0	Execution restored	00=0.000000
12/2/2009 20:57:20.000	001	Sensor detected error	1	Execution error occurred	00=29992.16468
12/2/2009 20:57:18.000	001	Sensor detected error	0	Execution restored	00=0.000000
12/2/2009 20:57:13.000	001	Sensor detected error	0	Execution restored	00=3.18891791E+13
12/2/2009 20:57:24.000	001	Sensor detected error	1	Execution error occurred	00=2.02959148E+20
12/2/2009 20:57:20.000	001	Sensor detected error	0	Execution restored	00=0.000000
12/2/2009 20:57:20.000	001	Sensor detected error	1	Execution error occurred	00=1.462185791E+38
12/2/2009 20:57:19.000	001	Sensor detected error	0	Execution restored	00=0.000000
12/2/2009 20:57:18.000	001	Sensor detected error	1	Execution error occurred	00=2.79128978E+20
12/2/2009 20:57:13.000	001	Sensor detected error	0	Execution restored	00=0.000000
12/2/2009 20:57:10.000	001	Sensor detected error	1	Execution error occurred	00=29992.09647
12/2/2009 20:57:10.000	001	Sensor detected error	0	Execution restored	00=0.000000
12/2/2009 20:57:06.000	001	Sensor detected error	0	Execution restored	00=3.114984974E+13
12/2/2009 20:57:05.000	001	Sensor detected error	1	Execution error occurred	00=2.02959148E+20
12/2/2009 20:57:04.000	001	Sensor detected error	0	Execution restored	00=0.000000
12/2/2009 20:57:03.000	001	Sensor detected error	1	Execution error occurred	00=1.20269194E+20
12/2/2009 20:57:01.000	001	Sensor detected error	0	Execution restored	00=0.000000
12/2/2009 20:56:55.000	001	Sensor detected error	1	Execution error occurred	00=4.4398444E+48
12/2/2009 20:56:55.000	001	Voltage error	0	Voltage restored	01=45.707372115=0.000000
12/2/2009 20:56:50.000	001	Sensor detected error	0	Execution restored	00=0.000000
12/2/2009 20:56:50.000	001	Sensor detected error	1	Execution error occurred	00=29992.09647
12/2/2009 20:56:53.000	001	Sensor detected error	0	Execution restored	00=0.000000
12/2/2009 20:56:50.000	001	Sensor detected error	1	Execution error occurred	00=29992.16468
12/2/2009 20:56:50.000	001	Sensor detected error	0	Execution restored	00=0.000000
12/2/2009 20:56:50.000	001	Voltage error	1	Error occurred	01=45.8191912110=0.000000
12/2/2009 20:56:40.000	001	Sensor detected error	0	Execution restored	00=3.11898187E+13
12/2/2009 20:56:41.000	001	Sensor detected error	1	Execution error occurred	00=2.02959148E+20

1 OVERVIEW

(13) Data can be managed on a batch (lot) basis

By designating the programmable controller data which indicate the end of batches (lots) as the file switching timing, files can be created in units of batches (lots). In addition, attaching the batch (lot) number to the file name of the logging and report makes the batch-based (lot-based) data management easier.

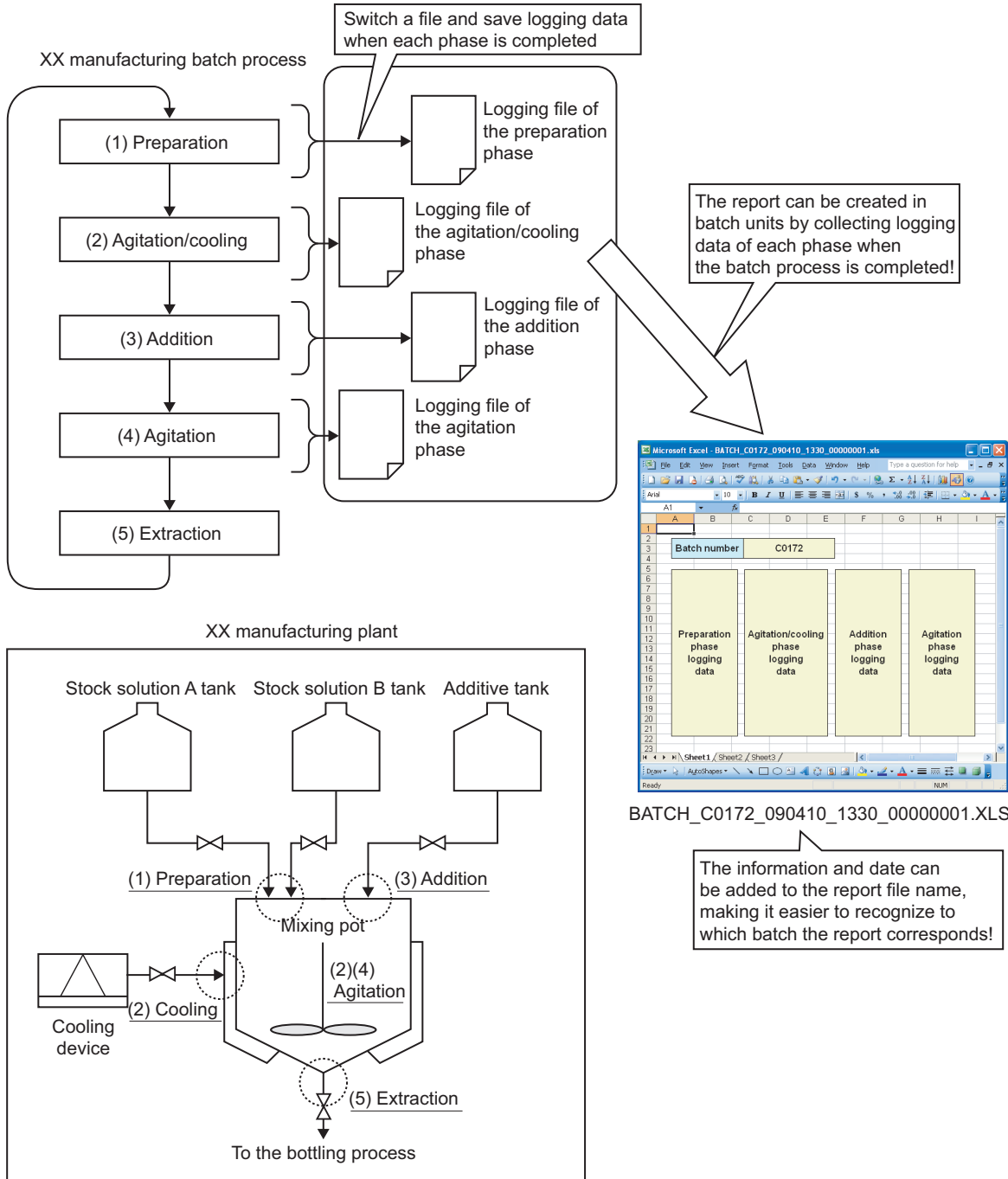

(14) Manufacturing data (device values) stored in programmable controller CPU can be changed

(Recipe function:  Chapter 15)

Device values can be transferred (read) from the recipe files (created in the Configuration Tool and stored) stored in the CompactFlash card to the programmable controller CPU at the specified time.

Furthermore, adjusted manufacturing data can be transferred (written) to recipe files and utilized.

Transferring (reading/writing) manufacturing data can be executed from ladder program using the dedicated instructions or from the Configuration Tool.

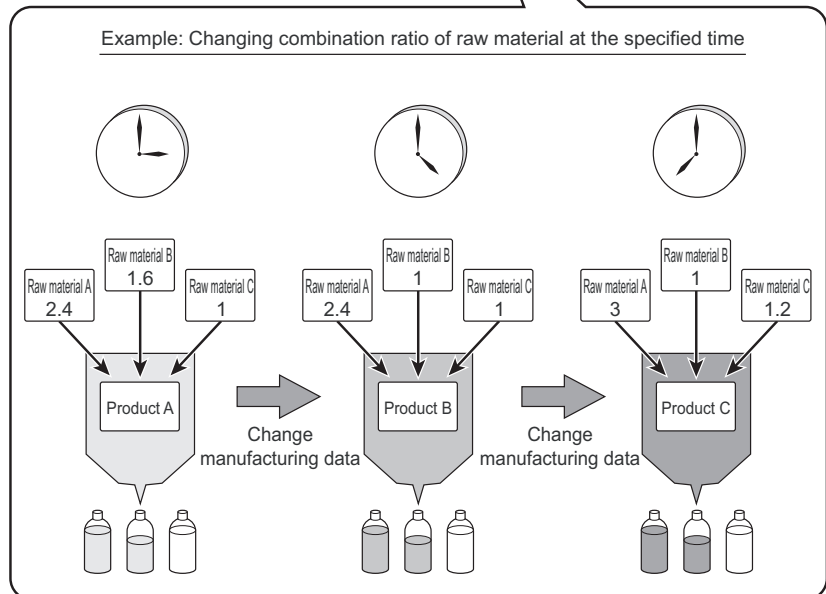
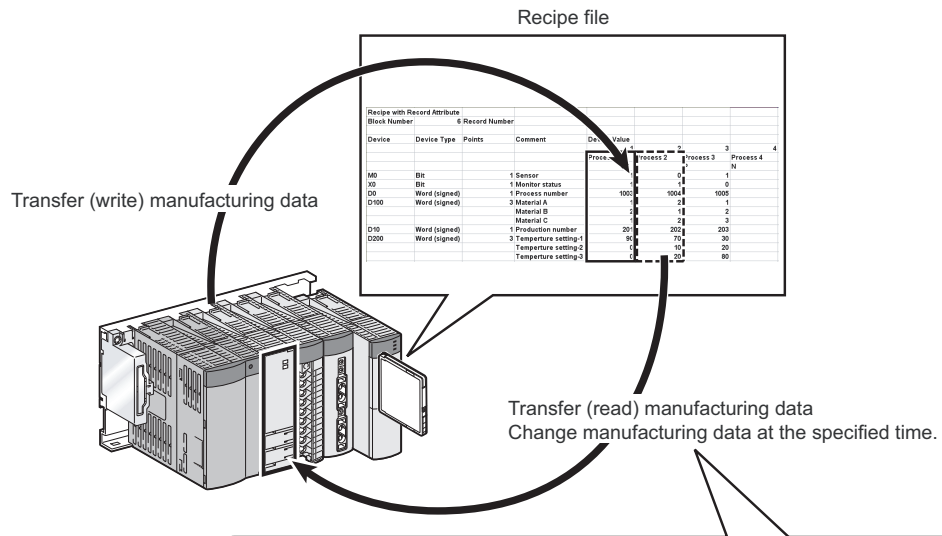

1 OVERVIEW

1.2 Processing Overview

The high speed data logger module logs (records/saves) device data sampled from a programmable controller CPU as files on a CompactFlash card.

Files which can be created are data logging files, event logging files, and report files.

In the data logging file, all the sampled data in the specified period can be saved. In this way, sampled data can be analyzed in depth. (Chapter 7)

In the event logging file, only the specified data correspond to the event condition can be saved. In this way, only necessary data can be identified. (Chapter 8)

In the report file, data can be saved as an Excel file. In this way, by only configuring the settings in advance, a report with desired graphs and layouts can be created automatically. (Chapter 9)

The overview up to creating a file is shown in the figure below.

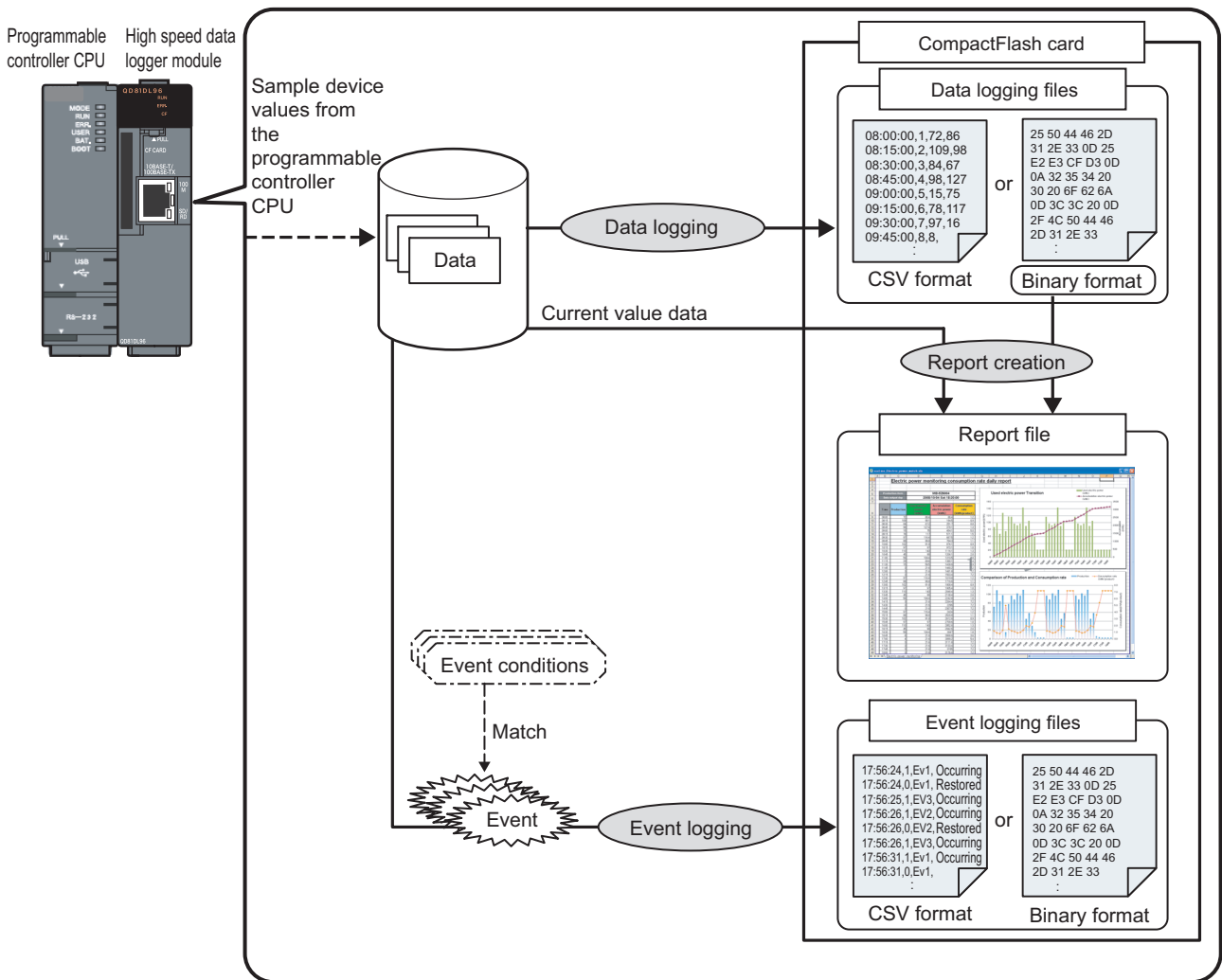

1.3 High Speed Data Logger Module Software Configuration

The high speed data logger module software configuration is shown in the table below.

Item	Description	Reference
High speed data logger module tool	This software is for installing 'high speed data logger module Configuration Tool' and 'Logging File Conversion Tool'.	Chapter 5
High speed data logger module Configuration Tool	This software configures and maintains the high speed data logger module. There is an online startup method and offline startup method (startup from the start menu) to start the tool.	Chapter 11
Logging File Conversion Tool	This software converts binary format logging files to CSV format logging files. There is an offline startup method (startup from the start menu) to start the tool.	Chapter 14

For the method for starting the high speed data logger module Configuration Tool and the Logging File Conversion Tool, refer to the following chapter.

 Chapter 5 HIGH SPEED DATA LOGGER MODULE TOOL STARTUP

CHAPTER 2 SYSTEM CONFIGURATION

This chapter explains the system configuration of the high speed data logger module.

2.1 System Configuration

2.1.1 Overall system configuration

This section explains the overall system configuration when using the high speed data logger module.

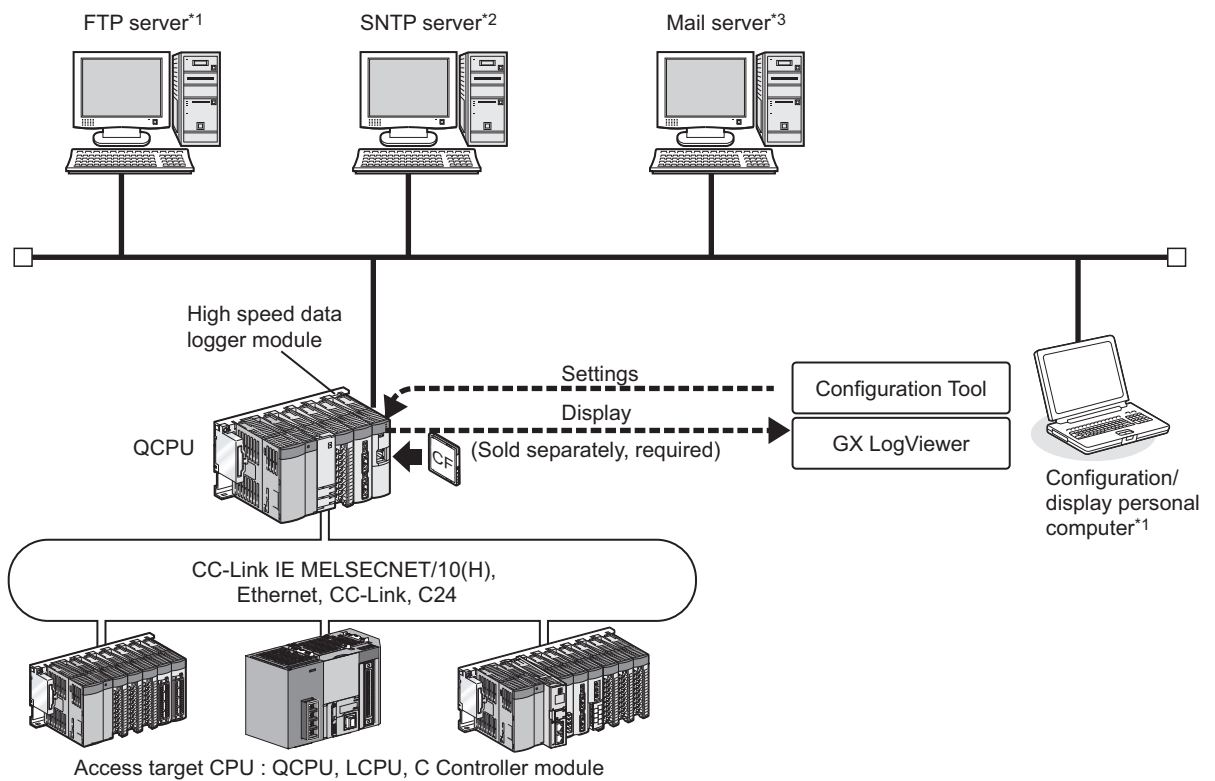

*1: Required when externally saving logged files.

*2: Required when synchronizing the high speed data logger module and programmable controller CPU time to a standard time.

*3: Required when sending e-mail.

2 SYSTEM CONFIGURATION

2.1.2 System configuration when performing initial setup, maintenance, and inspection

Connect a high speed data logger module and a personal computer directly to perform an initial setup, maintenance, and inspection. For the direct connection, refer to Section 2.1.3 (2) and Section 2.1.4.

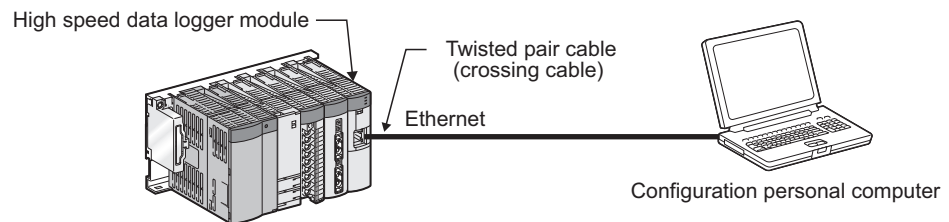

2.1.3 System configuration during operation

This section explains the system configuration when operating the high speed data logger module.

(1) For a connection via a hub

In this method, the high speed data logger module and a personal computer are connected through a local area network via a hub.

The high speed data logger module's IP address must be specified when connecting via a hub.

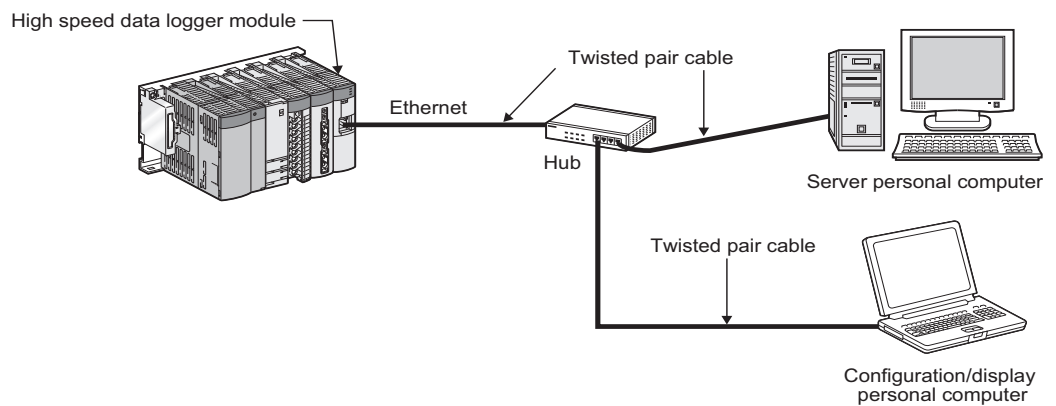

POINT

The operation of a high speed data logger module with the following connection methods is not guaranteed.

Check the operation before using the module.

- Connection using Internet (general public line) (Internet-access service offered by an Internet service provider or a telecommunications carrier)
- Connection using a firewall device
- Connection using a broadband router
- Connection using a wireless LAN

(2) For a direct connection

In this method, the high speed data logger module and a configuration/display personal computer are directly connected on a 1:1 basis through an Ethernet cable (crossing cable) without a hub.

The high speed data logger module's IP address does not need to be specified to perform communication when directly connecting. (The broadcast is used to perform communication.)

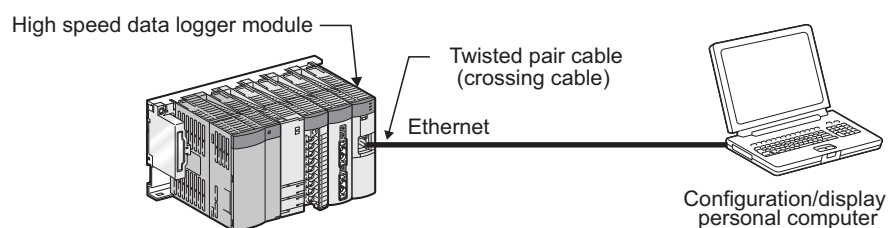

2.1.4 Precautions when directly connecting

This section explains precautions when directly connecting a configuration/display personal computer to the high speed data logger module.

(1) Connecting to a LAN line

Do not connect to a LAN line and communicate over a direct connection.
By communicating over a direct connection, a load is placed on the line and it can affect the communication of other devices.

(2) Connections which are not direct connections

Direct connection setup cannot be performed in a configuration where a single high speed data logger module and a single configuration/display personal computer are connected to a hub as shown in the following figure.

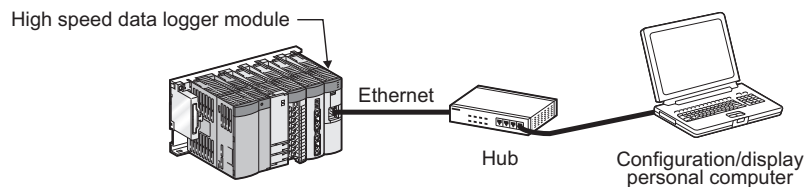

(3) Conditions where communication cannot be accomplished with a direct connection

If the conditions below match, communications cannot be performed with a direct connection.

If communications cannot be performed, review the high speed data logger module or configuration/display personal computer settings.

- (a) For each bit of the high speed data logger module's IP address, the bits corresponding to the configuration/display personal computer's subnet mask 0 portion are all ON or OFF

Example)

High speed data logger module IP address	:	64. 64.255.255
Configuration/display personal computer IP address	:	64. 64. 1. 1
Configuration/display personal computer subnet mask	:	255.255. 0. 0

- (b) For each bit of the high speed data logger module's IP address, the bits that correspond to the host address of each class for the configuration/display personal computer's IP address are all ON or OFF

Example)

High speed data logger module IP address	:	64. 64.255.255
Configuration/display personal computer IP address	:	192.168. 0. 1
Configuration/display personal computer subnet mask	:	255.255. 0. 0

- (c) The high speed data logger module's IP address is obtained automatically by DHCP

Remark

- The IP address of each class is listed below.
Class A: 0.x.x.x to 127.x.x.x, Class B: 128.x.x.x to 191.x.x.x
Class C: 192.x.x.x to 223.x.x.x
- The host address of each class is the 0 portion below.
Class A: 255.0.0.0, Class B: 255.255.0.0
Class C: 255.255.255.0

(4) Other precautions

- (a) When the Windows firewall is ON
Disable the Windows firewall.
- (b) When multiple IP addresses are enabled at the same time
Direct connection setup cannot be performed in a configuration where multiple IP addresses are enabled at the same time as shown below.
 - IP addresses are assigned to each of multiple Ethernet ports (network devices) of a configuration/display personal computer.
 - Aside from the Ethernet port of a configuration/display personal computer, a wireless LAN setting is enabled.
 - Multiple IP addresses are assigned to a single Ethernet port of a configuration/display personal computer.

2.2 Applicable Systems

(1) Mountable modules, mountable base units, and number of mountable modules

(a) When mounted to a CPU module

The following table shows mountable CPU modules and base units applicable to the high speed data logger module and the number of mountable modules.

Depending on the combination with other mounted modules or the number of mounted modules, power supply capacity may be insufficient.

When mounting modules, always take the power supply capacity into consideration.

If the power supply capacity is insufficient, review the combination of mounted modules.

2 SYSTEM CONFIGURATION

Mountable CPU modules		High speed data sampling support	Mountable base units ^{*1}		Number of mountable modules
CPU type	CPU model		Main base unit	Extension base unit	
Universal model QCPU	Q00UJCPU	×	○	○	1 mountable module for 1 control CPU
	Q00UCPU				
	Q01UCPU				
	Q02UCPU				
	Q03UD(E)CPU	Applicable when using a programmable controller CPU with a serial number whose first five digits are '11012' or higher. ^{*4}			
	Q04UD(E)HCPU				
	Q06UD(E)HCPU				
	Q10UD(E)HCPU				
	Q13UD(E)HCPU				
	Q20UD(E)HCPU				
	Q26UD(E)HCPU				
	Q50UDEHCPU	○ ^{*4}			
	Q100UDEHCPU				
	Q03UDVCPU ^{*5}				
Q04UDVCPU ^{*5}					
Q06UDVCPU ^{*5}	○				
Q13UDVCPU ^{*5}					
Q26UDVCPU ^{*5}					
Q00JCPU		×			
Q00CPU					
Q01CPU					
Q02CPU	○				
Q02HCPU					
Q06HCPU					
Q12HCPU					
High performance model QCPU ^{*2}	Q25HCPU	×			
	Q02PHCPU		○		
	Q06PHCPU				
	Q12PHCPU				
Process CPU	Q25PHCPU	×			
	Q12PRHCPU		○		
	Q25PRHCPU				
Redundant CPU	Q12DCCPU-V1 ^{*3}	×			
	Q24DHCCPU-V		○		
C Controller	Q24DHCCPU-LS				

○: Mountable, ×: Not mountable

*1: Can be mounted to any I/O slot of a mountable base unit.

*2: Can be mounted to the base unit with High performance model QCPU function version B or later only.

*3: Applicable when using Q12DCCPU-V with a serial number whose first five digits are '12042' or higher.

*4: The number of intelligent function module in which the high speed data sampling can be performed for one control CPU is one.

*5: Applicable when using QD81DL96 with a serial number whose first five digits are '14122' or higher.

- (b) When mounting to a MELSECNET/H remote I/O station
The high speed data logger module cannot be mounted to a MELSECNET/H remote I/O station.
Mount the high speed data logger module to a master station.

(2) Support for multiple CPU systems

- (a) The high speed data logger module supports multiple CPU systems.
- (b) The high speed data logger module can only perform high speed data sampling for the CPU controlling it.

Remark

When using the high speed data logger module in a multiple CPU system, refer to the following manual.

 QCPU User's Manual(Multiple CPU System)

2.3 Connection System Equipment

This section explains the equipment that can be connected to the high speed data logger module.

(1) CompactFlash card (sold separately, required)

The high speed data logger module requires one CompactFlash card.

Use one of the following CompactFlash cards manufactured by Mitsubishi.

If a CompactFlash card other than the following is used, a failure such as a data corruption on a CompactFlash card or a system shutdown (SP.UNIT DOWN occurs in the programmable controller CPU) may occur during an operation.

Model	Description
QD81MEM-512MBC	CompactFlash card 512MB
QD81MEM-1GBC	CompactFlash card 1GB
QD81MEM-2GBC	CompactFlash card 2GB
QD81MEM-4GBC	CompactFlash card 4GB
QD81MEM-8GBC	CompactFlash card 8GB

POINT

CompactFlash cards have a life span measured by writes.

For details about CompactFlash cards, refer to the following chapter.

☞ Chapter 16 CompactFlash CARD

(2) Ethernet (twisted pair) cable (sold separately)

Twisted pair cables which meet the IEEE802.3 10BASE-T/100BASE-TX standard can be used.

(a) For 100Mbps

(Unshielded twisted pair cable (UTP) or shielded twisted pair cable (STP))

- Straight cable: Category 5 or higher
- Crossing cable: Category 5 or 5e

(b) For 10Mbps

(Unshielded twisted pair cable (UTP) or shielded twisted pair cable (STP))

- Straight cable: Category 3 or higher
- Crossing cable: Category 3 to 5e

POINT

For precautions when wiring twisted pair cables, refer to the following section.

☞ Section 4.4.2 Wiring precautions

2.4 Operating Environment

(1) Operating environment for configuration personal computer

Item	Description
Computer	A personal computer on which Microsoft® Windows® operates
CPU	Refer to the following section. ☞ (2) in this section Performance requirements for personal computer and operating system
Required memory	
Free hard disk space	512MB or more
Display	Resolution 1024x768 pixels or higher
Operating system (English version)	Windows 10 (Home, Pro, Education, Enterprise) ^{*1} Windows 8.1, Windows 8.1 (Pro, Enterprise) ^{*1} Windows 8, Windows 8 (Pro, Enterprise) ^{*1} Windows 7 (Starter, Home Premium, Professional, Ultimate, Enterprise) ^{*2} Windows Vista® (Home Basic, Home Premium, Ultimate, Business, Enterprise) ^{*2, *3} Windows XP® (Professional SP 2 or later ^{*3} , Home SP2 or later) ^{*4}
Excel® (English version) ^{*5, *6}	Microsoft 365 ^{*7} Microsoft Excel 2021 Microsoft Excel 2019 Microsoft Excel 2016 ^{*3} Microsoft Excel 2013 ^{*3} Microsoft Excel 2010 ^{*3} Microsoft Excel 2007 Microsoft Excel 2003 ^{*8}
Web browser (English version) ^{*9}	Microsoft Edge ^{*10} Windows Internet Explorer® 11.0 Windows Internet Explorer 10.0 Windows Internet Explorer 9.0 Windows Internet Explorer 8.0 Windows Internet Explorer 7.0 Microsoft Internet Explorer 6.0
Interface	Ethernet port

- *1: Select "Don't do anything (turn off Windows SmartScreen)" on the Control Panel to use the online startup function.
- *2: When using the online startup function of a high speed data logger module with a serial number whose first five digits are '26032' or higher, .NET Framework 4.5 needs to be installed.
- *3: 32-bit version only
- *4 The online startup function of a high speed data logger module with a serial number whose first five digits are '26032' or higher cannot be used.
- *5: Required when using the report function.
The save format of the report file output with the report function is the xls format.
Some functions added from Microsoft Excel 2007 or later cannot be used.
- *6: One of the following operating environments is required:
- Microsoft 365: Windows 10
 - Excel 2021: Windows 10
 - Excel 2019: Windows 10
 - Excel 2016: Windows 7 Service Pack 1 or Windows 8 or later
 - Excel 2013: Windows 7 or later
 - Excel 2010: Windows XP Service Pack 3, Windows Vista Service Pack 1 or later, or Windows 7 or later
- *7: The version the operation of which has been checked is 'Semi-Annual Enterprise Channel Version 2308.'
- *8: Microsoft Office 2003 Service Pack 3 or later is required when using the Windows 7 operating system.
- *9: Required when using the online startup function.
- *10: Use Internet Explorer mode. Note that when using Microsoft Edge in Internet Explorer mode, it may take time to display the main page.

(2) Performance requirements for personal computer and operating system

Operating system	Personal computer performance requirements	
	CPU	Required memory
Windows® 10 (Home, Pro, Education, Enterprise)	Intel® Core™ 2 Duo 2GHz or higher is recommended	32-bit version :1BG or more 64-bit version :2BG or more
Windows® 8.1, Windows® 8.1 (Pro, Enterprise)		
Windows® 8, Windows® 8 (Pro, Enterprise)		
Windows® 7 (Starter, Home Premium, Professional, Ultimate, Enterprise)		
Windows Vista® (Home Basic, Home Premium, Ultimate, Business, Enterprise)		1GB or more
Windows® XP (Professional, Home)		

(3) Considerations for using operating systems

(a) User authority

Cannot be used if the user is logged in with Guest authority.

Cannot be used if the user is logged on with parental controls enabled.

(b) Functions that cannot be used

When the following functions are used, this product may not operate properly.

- Application start-up in Windows compatibility mode
- Fast user switching
- Remote desktop
- Windows XP Mode
- Touch function
- Modern UI
- Virtual environment such as Client Hyper-V
- Tablet mode
- Virtual Desktops
- Unified Write Filter

In the following cases, the screen of this product may not work properly.

- The size of the text and other items in the screen is other than 100% (96 DPI, 9 pt etc.).
- The resolution of the screen is changed in operation.
- The Windows theme is changed in operation.
- The multi-display is set.

(c) .NET Framework

1) For Windows 8 or later

- ".NET Framework 3.5 (includes .NET 2.0 and 3.0)" needs to be enabled in "Turn Windows features on or off" on the Control Panel.

2) For Windows XP

One of the following applications is required to be installed.

- .NET Framework 2.0 English Language Pack
- .NET Framework 3.5 English Language Pack
- GX Works2

(d) Firewall

If the Windows firewall setting is enabled, the "Find High Speed Data Logger Module function" and "Direct connection function" may not operate correctly. Disable the Windows firewall setting.

2.5 How to Check the Function Version, Serial Number

This section explains the method for checking the function version and serial number of the high speed data logger module.

(1) Checking 'SERIAL on the rating plate' on the side of the high speed data logger module

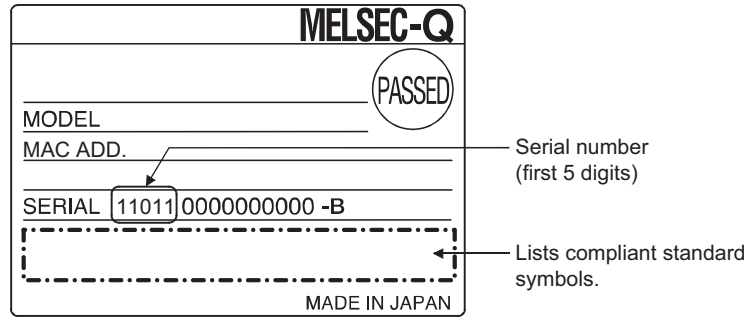

(2) Checking on the front of the module

The serial number is indicated on the serial number display on the front of the module (at the bottom).

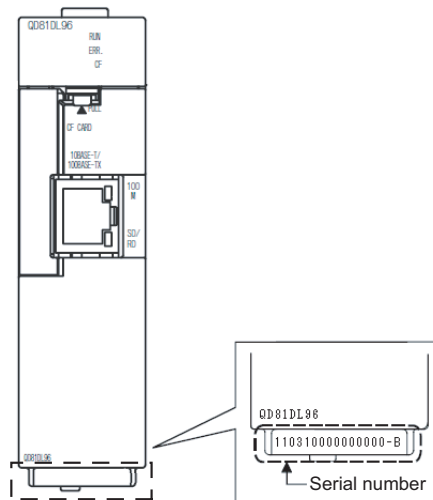

Remark

Serial number has been labeled on to the front of the module since March 2009. Note that, however, this labeling may not apply to some of modules manufactured around the time of modification.

(3) Checking with GX Developer

The function version and serial number can be checked with "Product Information List" or "Module's Detailed Information" in GX Developer.

The following explains the method for checking them with "Product Information List".
For "Module Detail Information", refer to the following section.

☞ Section 18.1.3 System monitor

Operating procedure

- ① Click [Diagnostics] → [System monitor] →  button.
- ② The [Product Information List] screen is displayed.

Screen display

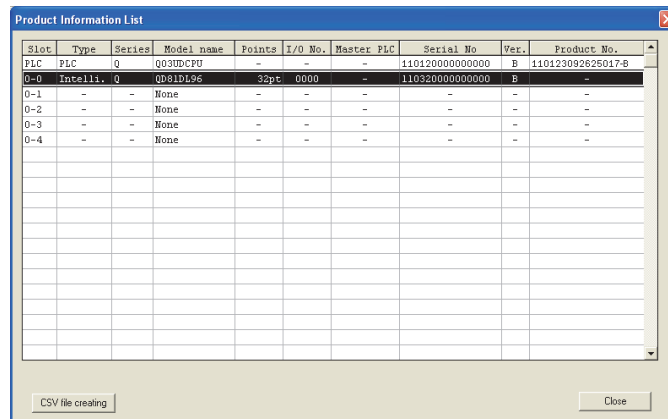

Slot	Type	Series	Model name	Points	I/O No.	Master PLC	Serial No	Ver.	Product No.
0	PLC	Q03UDCPU	Q03UDCPU	-	-	-	110320000000000	B	110123092625017-0
0-1	Intelli. Q	Q03UDL96	Q03UDL96	32pt	0000	-	110320000000000	B	-
0-2	-	-	None	-	-	-	-	-	-
0-3	-	-	None	-	-	-	-	-	-
0-4	-	-	None	-	-	-	-	-	-

(4) Checking with GX Works2

The function version and serial number can be checked with "Product Information List" or "Module's Detailed Information" in GX Works2.

The following explains the method for checking them with "Product Information List".

Operating procedure

- ① Click [Diagnostics] → [System Monitor] →  button.
- ② The [Product Information List] screen is displayed.

Screen display

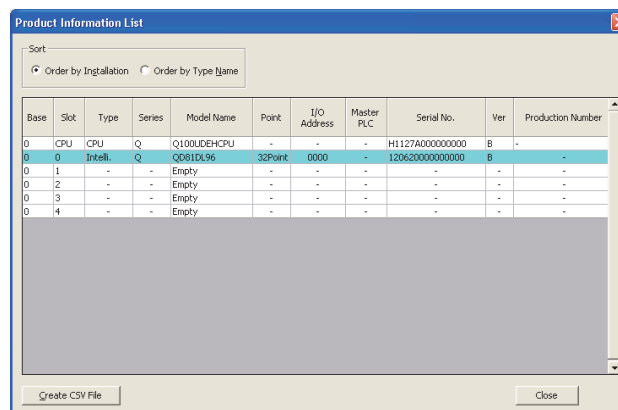

Base	Slot	Type	Series	Model Name	Point	I/O Address	Master PLC	Serial No.	Ver.	Production Number
0	CPU	CPU	Q	Q100UDEH-CPU	-	-	-	H1127A000000000	B	-
0	1	Intelli. Q	Q03UDL96	Q03UDL96	32Point	0000	-	120620000000000	B	-
0	2	-	-	Empty	-	-	-	-	-	-
0	3	-	-	Empty	-	-	-	-	-	-
0	4	-	-	Empty	-	-	-	-	-	-

POINT

- (1) The serial number displayed in Programming tool or Setting's product information may be different from the one on the rating plate.
 - The serial number on the rating plate indicates the management information of the product.
 - The serial number displayed in Programming tool or Setting's product information indicates the function information of the product.
The function information of the product is updated when functions are added.
- (2) The "Product No." column is displayed only when the CPU module is a Universal model QCPU.

(5) Checking with the Configuration Tool

The product information can be checked with "Product information" in the Configuration Tool.

Operating procedure

Click [Online] → [Diagnostics] → <<Product information>> tab.

Screen display

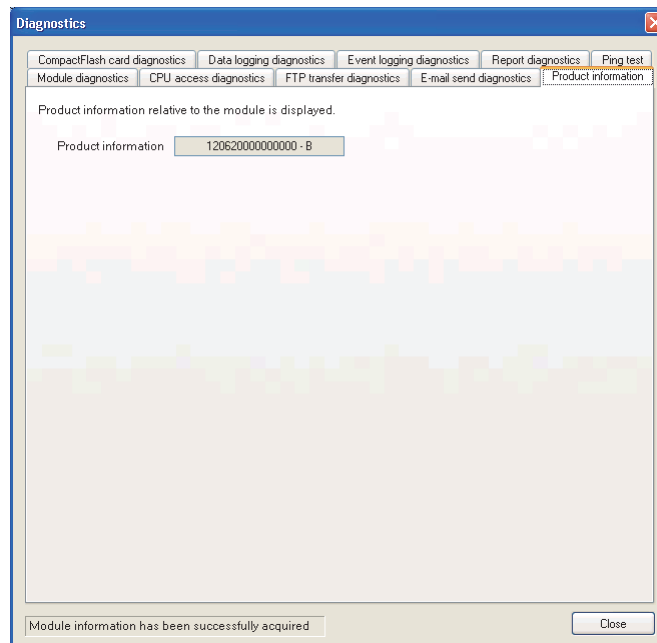

2.6 System Configuration Precautions

This section describes the system configuration precautions.

2.6.1 Precautions when using Redundant CPUs

The following describes precautions when using Redundant CPUs.

(1) Mountable base unit

When using the high speed data logger module in a redundant system, be sure to mount the module to the extension base unit for CPU/redundant power supply. The high speed data logger module cannot be mounted to the main base unit in a redundant system.

(2) "Access target CPU setting"

- When the high speed data logger module is mounted to the Redundant CPU, it can only access the own station CPU. It cannot access CPUs of other stations.
- The high speed data logger module cannot access Redundant CPUs of other stations.

2.6.2 Precautions when using C Controller modules

The following describes precautions when using C Controller modules.

(1) "Access target CPU setting"

- When the high speed data logger module is mounted to the C Controller module, it can only access the own station CPU. It cannot access CPUs of other stations.
- When the control CPU of the access target network module is a C Controller module, only the control CPU of the network module can be accessed.

(2) Network communication route

- When the network module is mounted to the C Controller module, the network module cannot be used as a relay station.

2.6.3 Precautions for using multiple CPU system

The following describes the precautions for using the multiple CPU system.

(1) Access to each CPU module at start-up of multiple CPU system

In the system in which a high speed data logger module is mounted in the multiple CPU system, an error may occur when accessing other CPU from the high speed data logger module or accessing the other station via a network module controlled by other CPU from the high speed data logger module due to the difference of start-up time of each CPU module. In this case, clear the error in the high speed data logger module after starting up other CPU.

☞ Section 18.1.2

The start-up of other CPUs can be checked with the special relays, SM220 to SM223. For the special relays, refer to the user's manual for the CPU module used.

2.6.4 Precautions for using hubs

The following describes the precautions for using the hub.

(1) IEEE802.3x flow control in full-duplex communication

The high speed data logger module does not support the IEEE802.3x flow control. Therefore, when the load of an Ethernet line is high in the connection with the hub supporting IEEE802.3x, the data to be sent to the module may be lost.

If the above mentioned phenomenon occurs, add the hubs and reduce the load on the Ethernet line applied on single hub.

2.7 Software Packages

The following software packages can be used for the High speed data logger module.

Software	Version
GX Works2	Version 1.44W or later
GX Developer	Version 8.90U or later
GX LogViewer	Version 1.00A or later

CHAPTER 3 SPECIFICATIONS

This chapter explains the specifications of the high speed data logger module. For the general specifications of the high speed data logger module, refer to the following manual.

☞ QCPU User's Manual(Hardware Design, Maintenance and Inspection)

3.1 Performance Specifications

This section explains the performance specifications of the high speed data logger module.

(1) Transmission and interface specifications

Item		Specifications	
Ethernet	Interface ^{*1}	10BASE-T	100BASE-TX
	Communication method	Full-duplex/half-duplex	
	Flow control	<ul style="list-style-type: none"> • Full-duplex: None (Does not support to the IEEE802.3x) • Half-duplex: Back pressure congestion control 	
	Data transmission rate	10Mbps	100Mbps
	Transmission method	Base band	
	No. of cascaded stages ^{*2}	Maximum 4 stages	Maximum 2 stages
	Max. segment length ^{*3}	100m	
	Supported function	Auto-negotiation function supported (automatically distinguishes 10BASE-T / 100BASE-TX)	
CompactFlash card	Supply power voltage	3.3 V±5%	
	Supply power capacity	Maximum 150mA	
	Card size	TYPE I card	
	Number of installable cards	1 card	
Number of occupied I/O points		32 points/slot (I/O assignment: Intelli. 32 points)	
Clock		<ul style="list-style-type: none"> • Obtained from a programmable controller CPU (in multiple CPU system, CPU No.1) or SNTP server • Time accuracy after obtaining the time is a daily variation of ±9.504 seconds^{*4} <p>☞ Section 10.1 Time Synchronization Function</p>	
Internal current consumption (5VDC)		0.58A ^{*5}	
External dimensions		98 (H) × 27.4 (W) × 90 (D) [mm]	
Weight		0.15 kg	

*1: The high speed data logger module distinguishes 10BASE-T from 100BASE-TX according to the external device.

For connection to a hub without an auto-negotiation function, set the hub to half-duplex communications mode.

*2: This item indicates the number of connectable stages for a repeater hub.

For the number of connectable stages for a switching hub, check with the manufacturer of the switching hub to be used.

*3: Distance between a hub and node.

*4: For programmable controller CPU, everyday (once in 24 hours); for SNTP server, re-obtains the time at the user specified interval.

*5: The internal current consumption with a CompactFlash card inserted to the module.

3 SPECIFICATIONS

(2) Function specifications

(a) Data sampling performance specifications

Item		Specifications	
Data sampling ^{*1}	Number of access target CPUs	Maximum of 64 CPUs	
	Data sampling interval ( Point)	High speed data sampling	<ul style="list-style-type: none"> • Sequence scan time synchronization • 1 to 32767 milliseconds (for trigger logging) • 3 to 32767 milliseconds (for continuous logging)
		General data sampling	<ul style="list-style-type: none"> • 0.1 to 0.9 seconds, 1 to 32767 seconds • Time interval specification (specify hour/minute/second)
	Amount of sampled data ^{*2*3*4}	High speed data sampling	<ul style="list-style-type: none"> • Overall amount of data: maximum of 8192 (per setting: 256) • Overall number of device points: maximum of 8192 (per setting: 256)
		General data sampling	<ul style="list-style-type: none"> • Overall amount of data: maximum of 16384 (per setting: 256) • Overall number of device points: maximum of 262144 (per setting: 4096)
	Data type ^{*5}	<ul style="list-style-type: none"> • Bit • Word (signed) • Double word (signed) • Word (unsigned) • Double word (unsigned) • Float (single precision) • Float (double precision) • 16 bit BCD • 32 bit BCD • String: 1 to 8192 characters • Raw: 1 to 8192 bytes 	
	Data output format (CSV file) ^{*6}	<ul style="list-style-type: none"> • Bit • Decimal format: 0 to 14 digits after the decimal point • Exponential format: 0 to 14 digits after the decimal point • Hexadecimal format • String • Raw 	
Scaling ^{*7}	Basic arithmetic operations: calculations combining (*, /) and (+, -)		

*1: The specification for target data sampling with the data logging function, event logging function, and report function.

*2: The number of device points available for 1 piece of data depends on the data type.

*3: The total number of data logging, event logging, and report data.

- Data logging : logging target data, trigger condition data, period condition data, file switching condition data, saved file name data, e-mail transmission data
- Event logging: monitoring data, period condition data, file switching condition data, saved file name data, e-mail transmission data
- Report : current value data, creation trigger condition data, period condition data, saved file name data, e-mail transmission data

*4: The amount of sampled data per single setting is as follows only when the creation trigger and current value data are not synchronized with the report setting.

Amount of data (per single setting): maximum of 65535, number of device points (per single setting): maximum of 65535.

However, note that, number of device points per setting of data excluding current value data is as follows.

High speed data sampling: maximum of 256, General data sampling: maximum of 4096

*5: The data type when reading data from the programmable controller CPU's device memory.

*6: The format when outputting data to a CSV file with data logging or event logging.

Binary files are output in the binary format.

Reports are output in Excel cell format.

*7: A function to perform data scaling and offset calculations.

POINT

The data logging, event logging, and report functions of the high speed data logger module are the best effort functions.

Since module processing time changes according to the settings and status of other devices, it may not operate with the set data sampling interval.

Run the system by fully verifying the processing time of each function when constructing it.

For processing time, refer to the following chapter.

☞ Chapter 17 PROCESSING TIME

(b) Data logging performance specifications

Item		Specifications	
Data logging	Number of settings	Maximum of 64 settings* ²	
	Logging type	<ul style="list-style-type: none"> • Continuous logging • Trigger logging 	
	File format	<ul style="list-style-type: none"> • CSV file (extension: .CSV) • Binary file (extension: .BIN)*³ 	
	Period	Specify applicable period or exclusion period. <ul style="list-style-type: none"> • Data condition: bit ON/OFF, compare data to constant value, compare data to data • Date range: specify start and/or end month/day • Time range: specify start and/or end hour/minute/second • Day of week/week condition: specify days of the week and/or weeks AND or OR combination of the above: up to 8 conditions* ⁴	
	Trigger logging	Trigger conditions <ul style="list-style-type: none"> • Condition • Comparison: bit ON/OFF, compare data to constant value, compare data to data • At the time of change of value • Fixed cycle: 1 to 86400 seconds • Time interval specification: specify hour/minute/second • Time of day specification: specify month/day/hour/minute/second • At module startup AND or OR combination of the above: up to 8 conditions* ⁴ <ul style="list-style-type: none"> • Condition execution count: 3 conditions*⁴ • Condition execution order (order and/or time conditions): up to 4 conditions*⁴ 	
		Number of logging lines* ⁵	<ul style="list-style-type: none"> • Before trigger occurs: 0 to 65534 lines • After trigger occurs: 1 to 65535 lines The sum of lines of before and after trigger occurrence is up to 65535 lines.
		File switching timing	<ul style="list-style-type: none"> • Number of lines (number of records) specification: 100 to 100000 lines*⁶ • File size specification: 10 to 16384 kilobytes • Condition specification <ul style="list-style-type: none"> • Comparison: bit ON/OFF, compare data to constant value, compare data to data • At the time of change of value • Fixed cycle: 1 to 86400 seconds • Time interval specification: specify hour/minute/second • Time of day specification: specify month/day/hour/minute/second • At module startup AND or OR combination of the above: up to 8 conditions* ⁴ <ul style="list-style-type: none"> • Trigger logging unit
	Number of save files	1 to 65535	

(Continued on the next page)

3 SPECIFICATIONS

(From the previous page)

- *2: Up to 64 settings can be configured for data logging, event logging, and report function combined. Of these, up to 32 settings can be configured for data logging, event logging, and report function when high speed data sampling is specified.
- *3: By using the report function, data can be re-output in the Excel file format.
- *4: When high speed data sampling is specified, period, trigger conditions, and file switching condition combined up to 5 conditions.
When general data sampling is specified, period, trigger conditions, and file switching condition combined up to 10 conditions.
- *5: The number of logging lines setting is affected by the amount of memory (trigger buffer) where sampled data are temporarily saved. Since the amount of trigger buffer has an upper limit, there may be situations where the listed number of logging lines cannot be set.
☞ Section 11.5.12 (3) Trigger buffer usage amount
- *6: When using a high speed data logger module with a serial number whose first five digits are '14041' or lower, the range of records is from 100 to 65535.

(c) Event logging performance specifications

Item		Specifications
Event logging	Number of settings	Maximum of 64 settings ^{*1}
	Number of events	Maximum of 64 events per single event logging setting
	File format	<ul style="list-style-type: none"> • CSV file (extension: .CSV) • Binary file (extension: .BIN)
	Event conditions	<ul style="list-style-type: none"> • Condition <ul style="list-style-type: none"> • Comparison: bit ON/OFF, compare data to constant value, compare data to data • At the time of change of value AND or OR combination of the above: up to 4 conditions • Condition execution count: 3 conditions • Condition execution order (order and/or time conditions): up to 4 conditions
	Period	Specify applicable period or exclusion period. <ul style="list-style-type: none"> • Data condition: bit ON/OFF, compare data to constant value, compare data to data • Date range: specify start and/or end month/day • Time range: specify start and/or end hour/minute/second • Day of week/week condition: specify days of the week and/or weeks AND or OR combination of the above: up to 8 conditions ^{*2}
	File switching timing	<ul style="list-style-type: none"> • Number of lines (number of records) specification: 100 to 100000 lines^{*3} • File size specification: 10 to 16384 kilobytes • Condition <ul style="list-style-type: none"> • Comparison: bit ON/OFF, compare data to constant value, compare data to data • At the time of change of value • Fixed cycle: 1 to 86400 seconds • Time interval specification: specify hour/minute/second • Time of day specification: specify month/day/hour/minute/second • At module startup AND or OR combination of the above: up to 8 conditions ^{*2}
Number of save files	1 to 65535	

- *1: Up to 64 settings can be configured for data logging, event logging, and report function combined. Of these, up to 32 settings can be configured for data logging, event logging, and report function when high speed data sampling is specified.
- *2: When high speed data sampling is specified, period and file switching condition combined up to 5 conditions.
When general data sampling is specified, period and file switching condition combined up to 10 conditions.
- *3: When using a high speed data logger module with a serial number whose first five digits are '14041' or lower, the range of records is from 100 to 65535.

3 SPECIFICATIONS

(d) Report function performance specifications

Item	Specifications
Number of settings	Maximum of 64 settings ^{*1}
File format	Excel format (extension: .xls)
Output data type	<ul style="list-style-type: none"> Data inside data logging file^{*2} Current value data Creation time
Amount of output data	64 layouts per single report setting, 65535 cells in total
Creation trigger conditions	<ul style="list-style-type: none"> Condition <ul style="list-style-type: none"> Comparison: bit ON/OFF, compare data to constant value, compare data to data At the time of change of value Fixed cycle: 1 to 86400 seconds Time interval specification: specify hour/minute/second Time of day specification: specify month/day/hour/minute/second At module startup At the time of the data logging file is switched AND or OR combination of the above: up to 8 conditions^{*3} Condition execution count: 3 conditions^{*3} Condition execution order (order and/or time conditions): up to 4 conditions^{*3}
Period	Specify applicable period or exclusion period. <ul style="list-style-type: none"> Data condition: bit ON/OFF, compare data to constant value, compare data to data Date range: specify start and/or end month/day Time range: specify start and/or end hour/minute/second Day of week/week condition: specify days of the week and/or weeks AND or OR combination of the above: up to 8 conditions ^{*3}
Layout file size	Maximum of 10MB (total of all report settings)
Number of save files	1 to 65535

*1: Up to 64 settings can be configured for data logging, event logging, and report function combined. Of these, up to 32 settings can be configured for data logging, event logging, and report function when high speed data sampling is specified.

*2: Only binary format data logging can be output to report function.

*3: When high speed data sampling is specified, period and creation trigger conditions combined up to 5 conditions.

When general data sampling is specified, period and creation trigger conditions combined up to 10 conditions.

1	OVERVIEW
2	SYSTEM CONFIGURATION
3	SPECIFICATIONS
4	SETTINGS AND PROCEDURES UP TO OPERATION
5	HIGH SPEED DATA LOGGER MODULE TOOL STARTUP
6	FUNCTION LIST
7	DATA LOGGING FUNCTION
8	EVENT LOGGING FUNCTION

3 SPECIFICATIONS

(e) Other performance specifications

Item		Specifications	
E-mail	Application	<ul style="list-style-type: none"> • Notification when event occurs • Transmit saved file 	
	Subject	<ul style="list-style-type: none"> • Event notification e-mail : user specified • Saved file transmission e-mail: automatically created/user specified 	
	Body	<ul style="list-style-type: none"> • Event notification e-mail : user specified • Saved file transmission e-mail: automatically created/user specified 	
	Attachment	<ul style="list-style-type: none"> • Event notification e-mail : none • Saved file transmission e-mail: <ul style="list-style-type: none"> • Saved file (CSV, binary, or Excel file) • Maximum of 512KB 	
	Attachment format	MIME format	
	MIME version	1.0	
	Communications with mail server	Port no.	25, 587, other (1 to 65535)
		Authentication method	<ul style="list-style-type: none"> • No authentication • SMTP-AUTH (PLAIN, LOGIN, CRAM-MD5) • POP before SMTP
	Target address	Maximum of 16 groups	
Operability verified e-mail client software	<ul style="list-style-type: none"> • Microsoft® Outlook® Express 6.0 • Microsoft® Windows® Mail 6.0 		
FTP server* ¹	Application	Read and delete saved files Write, read, and delete recipe files	
	Operability verified FTP client software	<ul style="list-style-type: none"> • Microsoft Edge • Windows Internet Explorer 11.0 • Windows Internet Explorer 10.0 • Windows Internet Explorer 9.0 • Windows Internet Explorer 8.0 • Windows Internet Explorer 7.0 • Microsoft Internet Explorer 6.0 	
	Session count* ²	10	
FTP client* ³	Application	Transfer saved files	
	Operability verified FTP server software	Microsoft® Internet Information Services	
Recipe	Number of data	Maximum of 256 data	
	Number of records	Maximum of 256 records	
	Data type	<ul style="list-style-type: none"> • Bit • Word [signed] • Double word [signed] • Word [unsigned] • Double word [unsigned] • FLOAT [single precision] • FLOAT [double precision] • 16bit BCD • 32bit BCD 	
	Recipe file	CSV file (extension: .csv) Maximum of 256 files	
	Execution type	Dedicated instructions (ladder program), Configuration Tool	

*1: A function to access the high speed data logger module (FTP server) from a personal computer's FTP client software. For details of supported FTP commands, refer to Appendix 9.

*2: The upper limit of the number of simultaneous connections to the high speed data logger module from FTP client software.
 FTP client software may use multiple connections per single access session.

*3: A function to access a personal computer's FTP server software from the high speed data logger module (FTP client).

3.2 Accessible Routes and Devices

This section explains accessible routes and devices.

(1) Accessible programmable controller CPUs

Programmable controller series		Model		
QCPU (Q mode)	Universal model QCPU	Q00UJCPU, Q00UCPU, Q01UCPU, Q02UCPU, Q03UDCPU	Q03UDECPU, Q04UDHCPU, Q04UDEHCPU, Q06UDHCPU, Q06UDEHCPU, Q10UDHCPU, Q10UDEHCPU, Q13UDHCPU, Q13UDEHCPU, Q20UDHCPU, Q20UDEHCPU, Q26UDHCPU, Q26UDEHCPU, Q50UDEHCPU, Q100UDEHCPU	Q03UDVCPU* ¹ , Q04UDVCPU* ¹ , Q06UDVCPU* ¹ , Q13UDVCPU* ¹ , Q26UDVCPU* ¹ , Q04UDPVCPU, Q06UDPVCPU, Q13UDPVCPU, Q26UDPVCPU
	Basic model QCPU	Q00JCPU, Q00CPU, Q01CPU		
	High Performance model QCPU	Q02CPU, Q02HCPU, Q06HCPU, Q12HCPU, Q25HCPU		
	Process CPU	Q02PHCPU, Q06PHCPU, Q12PHCPU, Q25PHCPU		
	Redundant CPU	Q12PRHCPU* ² , Q25PRHCPU* ²		
LCPU	L02SCPU, L02SCPU-P, L02CPU, L02CPU-P, L06CPU, L06CPU-P, L26CPU, L26CPU-P, L26CPU-BT, L26CPU-PBT			
C Controller module* ³	Q12DCCPU-V, Q24DHCCPU-V, Q24DHCCPU-LS			

*1: Applicable when using QD81DL96 with a serial number whose first five digits are '14122' or higher.

*2: Only the own station can be accessed. (☞ Section 2.6.1 Precautions when using Redundant CPUs)

*3: Applicable when using a Q12DCCPU-V with a serial number whose first five digits are '12042' or higher.

(2) Accessible routes

(a) Single network

This section explains single network accessible routes.

① For CC-Link IE, MELSECNET/10(H), Ethernet

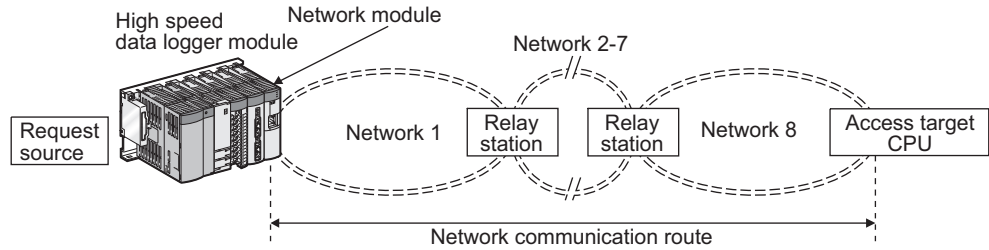

The following shows the CPU modules that can be accessed on the network communication routes.

Request source..... The control CPU of the high speed data logger module and the network module must be set to QCPU (Q mode).

Relay station..... The control CPU of the network module must be set to QCPU (Q mode).

Access target CPU .. For accessible programmable controller CPUs, refer to the following table.

Network communication route	Access target CPU (Programmable controller series)		
	QCPU (Q mode) ^{*1}	LCPU	C Controller module ^{*2}
CC-Link IE Control, MELSECNET/10(H)	○	×	○ ^{*3}
CC-Link IE Field	○ ^{*4}	○	○ ^{*5}
Ethernet (via own Ethernet module) ^{*6}	○ ^{*7*8}	○	×
Ethernet (via the high speed data logger module's built-in Ethernet port) ^{*13*14}	○ ^{*9*10}	○ ^{*10}	○ ^{*11*12}

○: Accessible ×: Inaccessible

- *1: The control CPU of the access target network module must be set to QCPU (Q mode).
- *2: When the control CPU of the access target network module is a C Controller module, only the control CPU of the network module can be accessed.
- *3: Cannot be accessed when the last network route (Network 8) is a CC-Link IE Field or an Ethernet.
- *4: Use Universal model QCPU with a serial number whose first five digits are '12012' or higher.
- *5: Cannot be accessed when the access target CPU is Q12DCCPU-V.
- *6: When accessing a programmable controller CPU via Ethernet, use an Ethernet module.
The Ethernet port of a built-in Ethernet port programmable controller CPU cannot be used.
- *7: For the network number and station number, set them to the parameter setting of the Q series-compatible E71 on the access target CPU side.
Also, set 'Station No. <-> IP information' in the parameter settings of the Q series-compatible E71.
For 'Station No. <-> IP information system', specify the IP address computation system, Table exchange system, or both.

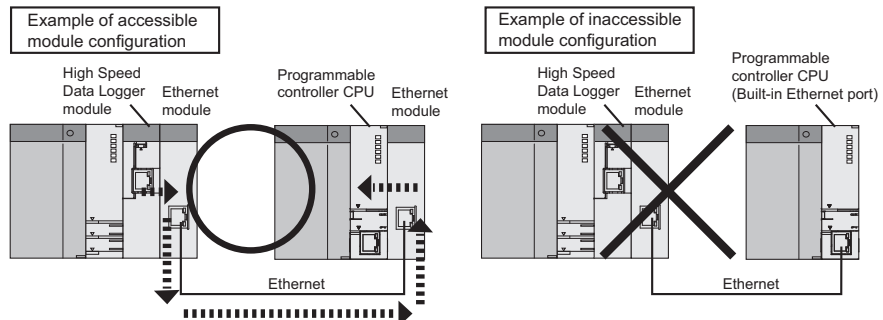

3 SPECIFICATIONS

- *8: The Ethernet port of a built-in Ethernet port QCPU cannot be accessed.
- *9: The Ethernet port of a built-in Ethernet port QCPU and an Ethernet module can be accessed.
- *10: UDP (MELSOFT Connection) must be added to the open setting of a built-in Ethernet port for the access target CPU.
- *11: For Q24DHCCPU-V, the system Ethernet port (S CH1) can be accessed.
- *12: For Q12DCCPU-V, setting to allow MELSOFT Connection in the open setting of the built-in Ethernet port is required.
- *13: The Ethernet mounted station, built-in Ethernet CPU, or C controller module can be accessed. The access via a relay station cannot be performed.
- *14: If network load is high, data will not be processed on the device on the access route (including access target CPU) and an error such as a timeout may occur. Do not use a high speed data logger module in the overloaded network conditions.

② For CC-Link, C24

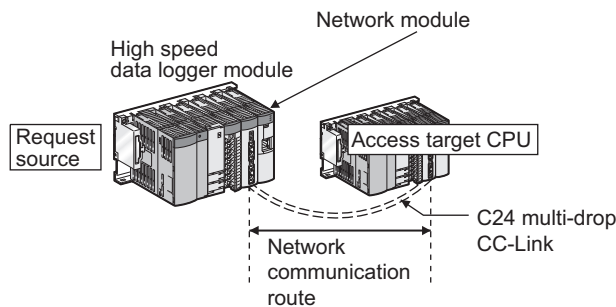

The following shows the CPU modules that can be accessed on the network communication routes.

Request source..... The control CPU of the high speed data logger module and the network module must be set to QCPU (Q mode).

Access target CPU .. For accessible programmable controller CPUs, refer to the following table.

Network communication route	Access target CPU (Programmable controller series)		
	QCPU (Q mode)*1	LCPU	C Controller module*2
CC-Link	○	○	○
C24	○	○	×

○: Accessible ×: Inaccessible

*1: The control CPU of the access target network module must be set to QCPU (Q mode).

*2: When the control CPU of the access target network module is a C Controller module, only the control CPU of the network module can be accessed.

3 SPECIFICATIONS

(b) Co-existence network

This section explains co-existence network accessible routes.

① For CC-Link IE , MELSECNET/10(H), Ethernet

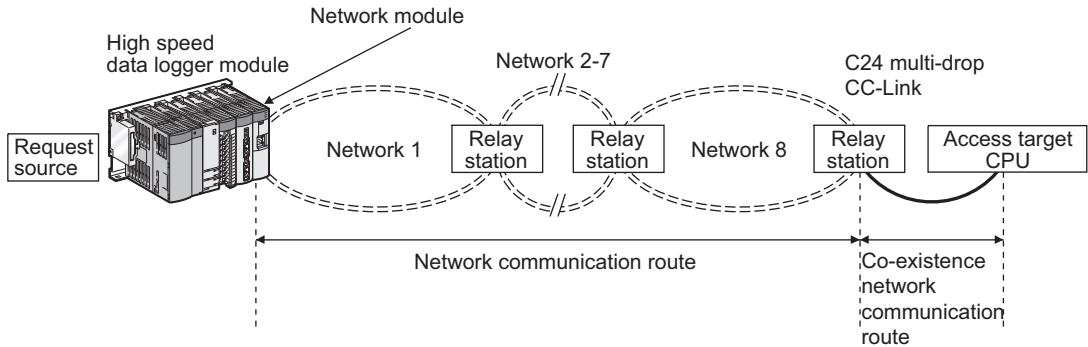

The following shows the CPU modules that can be accessed on the network communication routes and co-existence network communication routes.

Request source..... The control CPU of the high speed data logger module and the network module must be set to QCPU (Q mode).

Relay station..... The control CPU of the network module must be set to QCPU (Q mode).

Access target CPU .. For accessible programmable controller CPUs, refer to the following table.

Network communication route	Co-existence network communication route	Access target CPU (Programmable controller series)		
		QCPU (Q mode) ^{*1}	LCPU	C Controller module ^{*2}
CC-Link IE, MELSECNET/10(H)	CC-Link	○	○	○ ^{*3}
	C24	○	○	×
Ethernet (via own Ethernet module) ^{*4*6}	CC-Link	○ ^{*5}	○	○
	C24	○ ^{*5}	○	×

○: Accessible ×: Inaccessible

- *1: The control CPU of the access target network module must be set to QCPU (Q mode).
- *2: When the control CPU of the access target network module is a C Controller module, only the control CPU of the network module can be accessed.
- *3: Cannot be accessed when the last network route (Network 8) is a CC-Link IE Field or an Ethernet.
- *4: When accessing a programmable controller CPU via Ethernet, use an Ethernet module. The Ethernet port of a built-in Ethernet port programmable controller CPU cannot be used.

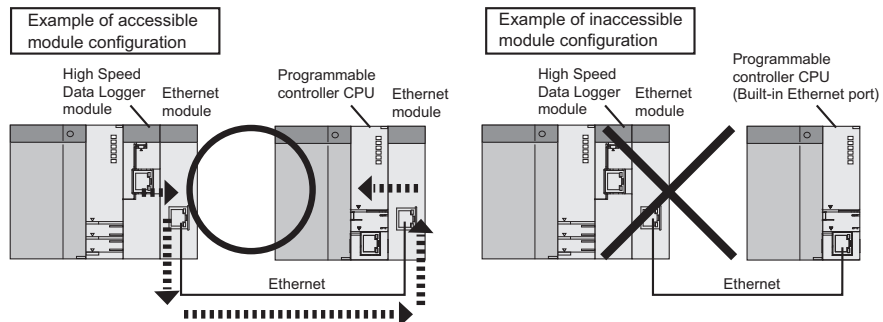

- *5: For the network number and station number, set them to the parameter setting of the Q series-compatible E71 on the access target CPU side. Also, set 'Station No. <-> IP information' in the parameter settings of the Q series-compatible E71. For 'Station No. <-> IP information system', specify the IP address computation system, Table exchange system, or both.

3 SPECIFICATIONS

*6: If network load is high, data will not be processed on the device on the access route (including access target CPU) and a timeout error may occur and data sampling may fail. If a timeout error occurs, adjust the network load.

② For CC-Link, C24

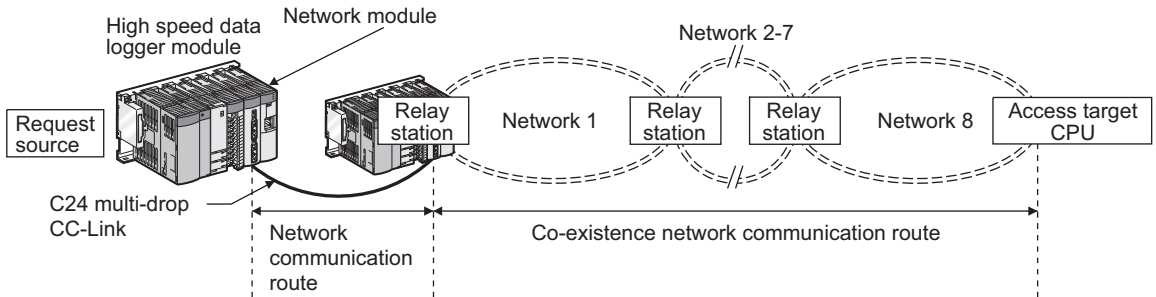

The following shows the CPU modules that can be accessed on the network communication routes and co-existence network communication routes.

Request source The control CPU of the high speed data logger module and the network module must be set to QCPU (Q mode).

Relay station The control CPU of the network module must be set to QCPU (Q mode).

Access target CPU .. For accessible programmable controller CPUs, refer to the following table.

Network communication route	Co-existence network communication route	Access target CPU (Programmable controller series)		
		QCPU (Q mode) ^{*1}	LCPU	C Controller module ^{*2}
CC-Link, C24	CC-Link IE Control	○	×	○ ^{*3}
	CC-Link IE Field	○ ^{*4}	○	○ ^{*5}
	MELSECNET/10(H)	○	×	○
	Ethernet ^{*6*8}	○ ^{*7}	○	×

○: Accessible ×: Inaccessible

*1: The control CPU of the access target network module must be set to QCPU (Q mode).

*2: When the control CPU of the access target network module is a C Controller module, only the control CPU of the network module can be accessed.

*3: Cannot be accessed when the last network route (Network 8) is a CC-Link IE Field or an Ethernet.

*4: Use Universal model QCPU with a serial number whose first five digits are '12012' or higher.

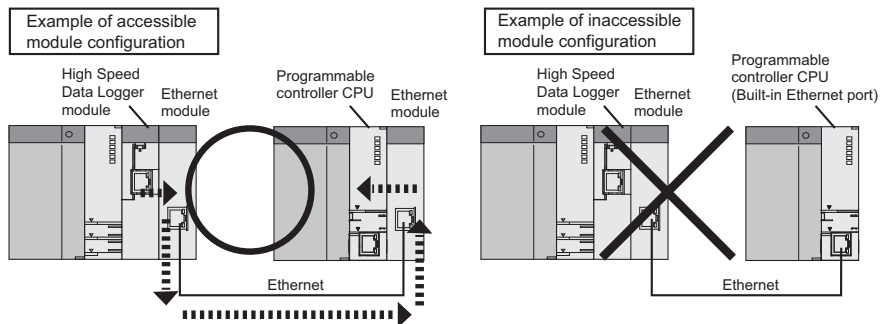

*5: Cannot be accessed when the access target CPU is Q12DCCPU-V.

*6: When accessing a programmable controller CPU via Ethernet, use an Ethernet module. The Ethernet port of a built-in Ethernet port programmable controller CPU cannot be used.

3 SPECIFICATIONS

- *7: For the network number and station number, set them to the parameter setting of the Q series-compatible E71 on the access target CPU side.
Also, set 'Station No. <-> IP information' in the parameter settings of the Q series-compatible E71.
For 'Station No. <-> IP information system', specify the IP address computation system, Table exchange system, or both.
- *8: If network load is high, data will not be processed on the device on the access route (including access target CPU) and a timeout error may occur and data sampling may fail. If a timeout error occurs, adjust the network load.

3 SPECIFICATIONS

(3) Accessible devices

For details of each device, refer to the following manuals.

☞ QnUCPU User's Manual (Function Explanation, Program Fundamentals)

☞ MELSEC-L CPU Module User's Manual (Function Explanation, Program Fundamentals)

(a) QCPU (Q mode)

Device ^{*1} (device name)		QCPU general data sampling	QCPU high speed data sampling
Function input (FX)		×	×
Function output (FY)		×	×
Function register (FD)		×	×
Special relay (SM)		○	○
Special register (SD)		○	○
Input relay (X)		○	○
Output relay (Y)		○	○
Internal relay (M) ^{*2}		○	○
Latch relay (L) ^{*2}		○	○
Annunciator (F)		○	○
Edge relay (V)		○	○
Link relay (B)		○	○
Data register (D)		○	○
Link register (W)		○	○
Extended data register (D)		○	○
Extended link register (W)		○	○
Timer	Contact (TS)	○	○
	Coil (TC)	○	○
	Current value (T/TN)	○	○
Counter	Contact (CS)	○	○
	Coil (CC)	○	○
	Current value (C/CN)	○	○
Retentive timer	Contact (SS)	○	○
	Coil (SC)	○	○
	Current value (ST/SN)	○	○
Link special relay (SB)		○	○
Link special register (SW)		○	○
Step relay (S)		×	×
Direct input (DX)		×	×
Direct output (DY)		×	×
Index register	(Z)	○	○
File register	(R)	○ ^{*3}	○ ^{*4}
	(ZR)	○ ^{*3}	○ ^{*4}
Link direct device	Link input (Jn\X)	○	×
	Link output (Jn\Y)	○	×
	Link relay (Jn\B)	○	×
	Link special relay (Jn\SB)	○	×
	Link register (Jn\W)	○	×
	Link special register (Jn\SW)	○	×
Intelligent function module device (Un\G)		○	×
Cyclic transmission area device	CPU shared memory (U3En\G)	○	×

○: Accessible ×: Inaccessible

3 SPECIFICATIONS

- *1: The local devices of the Q series programmable controller CPUs and file registers for individual programs cannot be accessed by specifying the program name.
Do not use local devices and file registers for individual programs since they may not be read/written correctly.
- *2: M and L devices are in the same region, regardless of the parameter device setting.
- *3: When using Q00JCPU, Q00UJCPU, access is not possible.
- *4: When accessed outside the range of the file register (ZR) region, the sampled value is -1 (FFFFH).

3 SPECIFICATIONS

(b) LCPU

Device*1 (device name)		LCPU general data sampling
Function input (FX)		×
Function output (FY)		×
Function register (FD)		×
Special relay (SM)		○
Special register (SD)		○
Input relay (X)		○
Output relay (Y)		○
Internal relay (M)*2		○
Latch relay (L)*2		○
Annunciator (F)		○
Edge relay (V)		○
Link relay (B)		○
Data register (D)		○
Link register (W)		○
Extended data register (D)		○
Extended link register (W)		○
Timer	Contact (TS)	○
	Coil (TC)	○
	Current value (T/TN)	○
Counter	Contact (CS)	○
	Coil (CC)	○
	Current value (C/CN)	○
Retentive timer	Contact (SS)	○
	Coil (SC)	○
	Current value (ST/SN)	○
Link special relay (SB)		○
Link special register (SW)		○
Step relay (S)		×
Direct input (DX)		×
Direct output (DY)		×
Index register	(Z)	○
	(R)	○
File register	(ZR)	○
	(Z)	○
Link direct device	Link input (Jn\X)	○
	Link output (Jn\Y)	○
	Link relay (Jn\B)	○
	Link special relay (Jn\SB)	○
	Link register (Jn\W)	○
	Link special register (Jn\SW)	○
Intelligent function module device (Un\G)		○

○: Accessible ×: Inaccessible

*1: The local devices of the L series programmable controller CPUs and file registers for individual programs cannot be accessed by specifying the program name.

Do not use local devices and file registers for individual programs since they may not be read/written correctly.

*2: M and L devices are in the same region, regardless of the parameter device setting.

1	OVERVIEW
2	SYSTEM CONFIGURATION
3	SPECIFICATIONS
4	SETTINGS AND PROCEDURES UP TO OPERATION
5	HIGH SPEED DATA LOGGER MODULE TOOL STARTUP
6	FUNCTION LIST
7	DATA LOGGING FUNCTION
8	EVENT LOGGING FUNCTION

3 SPECIFICATIONS

(c) C Controller module

Device ^{*1} (device name)		C Controller module general data sampling
Function input (FX)		×
Function output (FY)		×
Function register (FD)		×
Special relay (SM)		○ ^{*1*2}
Special register (SD)		○ ^{*1*2}
Input relay (X)		○ ^{*1}
Output relay (Y)		○ ^{*1}
Internal relay (M)		○ ^{*1*2}
Latch relay (L)		×
Annunciator (F)		×
Edge relay (V)		×
Link relay (B)		○ ^{*3}
Data register (D)		○ ^{*1*2}
Link register (W)		○ ^{*3}
Extended data register (D)		○ ^{*1*2}
Extended link register (W)		×
Timer	Contact (TS)	×
	Coil (TC)	×
	Current value (T/TN)	×
Counter	Contact (CS)	×
	Coil (CC)	×
	Current value (C/CN)	×
Retentive timer	Contact (SS)	×
	Coil (SC)	×
	Current value (ST/SN)	×
Link special relay (SB)		×
Link special register (SW)		×
Step relay (S)		×
Direct input (DX)		×
Direct output (DY)		×
Index register	(Z)	×
File register	(R)	×
	(ZR)	×
Link direct device	Link input (Jn\X)	○ ^{*1}
	Link output (Jn\Y)	○ ^{*1}
	Link relay (Jn\B)	○ ^{*1}
	Link special relay (Jn\SB)	○ ^{*1}
	Link register (Jn\W)	○ ^{*1}
	Link special register (Jn\SW)	○ ^{*1}
Intelligent function module device (Un\G)		○ ^{*1}
Cyclic transmission area device	CPU shared memory (U3En\G)	○ ^{*1}

○: Accessible ×: Inaccessible

*1: For Q12DCCPU-V, only modules with a serial number whose first five digits are '12042' or higher are accessible.

*2: For Q12DCCPU-V, specify "Use device function" on C Controller module.

*3: For Q12DCCPU-V, use Q12DCCPU-V (Extended mode).

(4) Device bit specification/digit specification

Device (device name)		Bit specification	Digit specification
Special relay (SM)		-	○
Special register (SD)		○	-
Input relay (X)		-	○
Output relay (Y)		-	○
Internal relay (M)		-	○
Latch relay (L)		-	○
Annunciator (F)		-	○
Edge relay (V)		-	○
Link relay (B)		-	○
Data register (D)		○	-
Link register (W)		○	-
Timer	Contact (TS)	-	×
	Coil (TC)	-	×
	Current value (T/TN)	×	-
Counter	Contact (CS)	-	×
	Coil (CC)	-	×
	Current value (C/CN)	×	-
Retentive timer	Contact (SS)	-	×
	Coil (SC)	-	×
	Current value (ST/SN)	×	-
Link special relay (SB)		-	○
Link special register (SW)		○	-
Index register (Z)		×	-
File register	(R)	○	-
	(ZR)	○	-
Link direct Device	Link input (Jn\X)	-	○
	Link output (Jn\Y)	-	○
	Link relay (Jn\B)	-	○
	Link special relay (Jn\SB)	-	○
	Link register (Jn\W)	○	-
	Link special register (Jn\SW)	○	-
Intelligent function module device (Un\G)		○	-

○: Specifiable ×: Not specifiable (CPU restriction) - : Not specifiable (device type restriction)

☒ POINT

- (1) When using the high speed data sampling function, bit specified/digit specified devices cannot be used.
- (2) Bit specified/digit specified devices cannot be used in current value data for reports.
- (3) When using the recipe function, bit specified/digit specified devices cannot be used.

3 SPECIFICATIONS

(5) Device specification with labels/comments

A device can be specified with a label or a comment by importing global labels (including module labels) set with a GX Works2 to a project of the configuration tool.

For details on importing labels, refer to the following manual.

(☞ Section 11.2.10 Importing global labels and device comments)

(6) Access units

The following table explains the number of device points (access units) that can be accessed in a single process when sampling a programmable controller CPU's device values.

When the access units are lower than the number of sampled device points, the module sampled the device values in the same sequence scan.

When the access units exceed the number of sampled device points, device values are sampled over multiple sequence scans, so there is a possibility of data separation (the mixture of the current device value and the old device value) occurrence.

If data separation must be prevented, set the number of devices sampled at one time to less than the access units, or set the module to use high speed data sampling.

For the operation when the number of device points sampled by the trigger logging function exceeds the access units and general sampling is specified for the data sampling method, refer to the following section.

(☞ Section 7.3.2 Trigger logging)

CPU type	High speed data sampling	General data sampling	Report current value data ^{*1}
Q03UD(E)CPU ^{*2} , Q03UDVCPU, Q04UD(E)HCPU ^{*2} , Q04UDVCPU, Q06UD(E)HCPU ^{*2} , Q06UDVCPU, Q10UD(E)HCPU ^{*2} , Q13UD(E)HCPU ^{*2} , Q13UDVCPU, Q20UD(E)HCPU ^{*2} , Q26UD(E)HCPU ^{*2} , Q26UDVCPU, Q50UDEHCPU, Q100UDEHCPU	Samples all device values in the same sequence scan.		
Q00UJCPU, Q00UCPU, Q01UCPU, Q02UCPU, Q02CPU, Q02HCPU, Q06HCPU, Q12HCPU, Q25HCPU, Q02PHCPU, Q06PHCPU, Q12PHCPU, Q25PHCPU, Q12PRHCPU, Q25PRHCPU	Cannot be set.	96 points	960 points
L02SCPU, L02SCPU-P, L02CPU, L02CPU-P, L06CPU, L06CPU-P, L26CPU, L26CPU-P, L26CPU-BT, L26CPU-PBT			
Q12DCCPU-V, Q24DHCCPU-V Q24DHCCPU-LS			
Q00JCPU Q00CPU Q01CPU		32 points	240 points

3 SPECIFICATIONS

- *1: Current value data when "Synchronize create trigger and current value data" is not checked.
When checked, refer to the access units for the specified data sampling method (high speed or general data sampling).
- *2: The high speed data sampling function can be used only when using a programmable controller with a serial number whose first five digits are '11012' or higher.

3 SPECIFICATIONS

3.3 I/O Signals for the Programmable Controller CPU

3.3.1 I/O signal list

The following table shows the list of high speed data logger module I/O signals for the programmable controller CPU.

The I/O signal allocation is shown for when the high speed data logger module is mounted on the 0 slot of the main base unit.

If the high speed data logger module is mounted on a slot other than slot 0, use by substituting the I/O signals of the slot on which the module is mounted.

Device X indicates an input signal from the high speed data logger module to the programmable controller CPU and device Y indicates an output signal from the programmable controller CPU to the high speed data logger module.

Signal direction High speed data logger module → programmable controller CPU		Signal direction Programmable controller CPU → high speed data logger module	
Device No.	Signal name	Device No.	Signal name
X0	Module READY ON: Module prepared OFF: -	Y0	Use prohibited
X1	CompactFlash card status ON: Inserted OFF: Not inserted		
X2	File access status ON: Stopped OFF: Running	Y2	File access stop request ON: Stop request OFF: -
X3	Use prohibited	Y3	Clear file access stop request ON: Clear stop request OFF: -
X4	Network connection status ON: Connected OFF: Not connected	Y4	Use prohibited
X5	Module operating status ON: Running OFF: Stopped	Y5	
X6	Use prohibited	Y6	
X7		Y7	
X8		Y8	
X9		Y9	
XA		YA	
XB	SNTP time synchronization timing ON: Synchronizing complete OFF: -	YB	Programmable controller CPU time synchronization request ON: Synchronization request OFF: -
XC	Use prohibited	YC	Use prohibited
XD		YD	
XE		YE	
XF		YF	
X10	ERR. LED status ON: Illuminated, flashing OFF: Off	Y10	Error clear request ON: Error clear request OFF: -

(Continued on the next page)

3 SPECIFICATIONS

(From the previous page)

Signal direction High speed data logger module → programmable controller CPU		Signal direction Programmable controller CPU → high speed data logger module	
Device No.	Signal name	Device No.	Signal name
X11	Use prohibited	Y11	Use prohibited
X12	Data logging error ON: Error OFF: Normal	Y12	
X13	Event logging error ON: Error OFF: Normal	Y13	
X14	Report creation error ON: Error OFF: Normal	Y14	
X15	Use prohibited	Y15	
X16	Access target CPU error ON: Error OFF: Normal	Y16	
X17	E-mail transmission error ON: Error OFF: Normal	Y17	
X18	FTP transfer error ON: Error OFF: Normal	Y18	
X19	Other error ON: Error OFF: Normal	Y19	
X1A	High speed data sampling failure ON: Occurred OFF: No occurrence	Y1A	
X1B	Processing overload occurrence ON: Occurred OFF: No occurrence	Y1B	
X1C	Trigger reoccurrence ON: Occurred OFF: No occurrence	Y1C	
X1D	Creation trigger reoccurrence ON: Occurred OFF: No occurrence	Y1D	
X1E	General data sampling delay occurrence ON: Occurred OFF: No occurrence	Y1E	
X1F	Watchdog timer error ON: Error OFF: Normal	Y1F	

POINT

For I/O signals for the programmable controller CPU, do not output (ON) a 'Use prohibited' signal.

Doing so may cause the programmable controller system to malfunction.

1	OVERVIEW
2	SYSTEM CONFIGURATION
3	SPECIFICATIONS
4	SETTINGS AND PROCEDURES UP TO OPERATION
5	HIGH SPEED DATA LOGGER MODULE TOOL STARTUP
6	FUNCTION LIST
7	DATA LOGGING FUNCTION
8	EVENT LOGGING FUNCTION

3 SPECIFICATIONS

3.3.2 I/O signal details

This section explains details about the I/O signals for the high speed data logger module.

(1) Input signal details

Device No.	Signal name	Description
X0	Module READY	Turns ON when the high speed data logger module becomes ready after the programmable controller is powered ON from OFF, or the programmable controller CPU is reset.
X1	CompactFlash card status	(1) Turns ON when the CompactFlash card is inserted and the file access status (X2) is OFF. (2) Turns OFF when the CompactFlash card is not inserted or the file access status (X2) is ON.
X2	File access status	<p>(1) Turns ON while file access is stopped.</p> <p>(a) The following operations are available while file access is stopped.</p> <ul style="list-style-type: none"> Inserting/ejecting CompactFlash card Chapter 16 CompactFlash CARD <p>(b) While file access is stopped, the module has the following status.</p> <ul style="list-style-type: none"> Reading from or writing to the CompactFlash card is stopped. Module operating status is stopped. <p>(2) Turns OFF during file access operation.</p> <p>File access stop request (Y2)</p> <p>Clear file access stop request (Y3)</p> <p>File access status (X2)</p> <p>Module operating status (X5)</p> <p>CompactFlash card status (X1)</p> <p>Restart module operation or update settings</p> <p>Replace CompactFlash card Power OFF programmable controller</p>
X4	Network connection status	Turns ON when the high speed data logger module becomes ready.

(Continued on the next page)

3 SPECIFICATIONS

(From the previous page)

Device No.	Signal name	Description
X5	Module operating status	<p>(1) Turns ON while the data logging function, event logging function, and report function are operating.</p> <p>(2) Turns OFF while the data logging function, event logging function, and report function are stopped.</p> <p>(3) Stop status in the following situations</p> <ul style="list-style-type: none"> (a) When module operation is stopped with the Configuration Tool. (b) When settings are not written to the high speed data logger module. (c) When a module stop error occurs. (d) When the file access status has stopped (X2 is ON). <p>(4) Data logging, event logging, and report logging function operating status are restored with the follow procedures.</p> <ul style="list-style-type: none"> (a) When module operation is stopped with the Configuration Tool^{*1} Restart module operation with the Configuration Tool. ☞ Section 13.1.1 Module diagnostics (b) When settings are not written to the high speed data logger module <ul style="list-style-type: none"> 1. Write settings to the high speed data logger module with the Configuration Tool. ☞ Section 12.3 Writing Data 2. Update the settings. ☞ Section 13.1.1 Module diagnostics (c) When a module stop error occurs^{*1} <ul style="list-style-type: none"> 1. Clear the error with the Configuration Tool (☞ Section 13.1.1 Module diagnostics) or error clear request (Y10). 2. Update the settings with the Configuration Tool. ☞ Section 13.1.1 Module diagnostics (d) When the file access status has stopped (X2 is ON)^{*1} <ul style="list-style-type: none"> 1. Turn clear file access stop request (Y3) ON. → File access status is operating (X2 is OFF). 2. Restart module operation or update the settings with the Configuration Tool. ☞ Section 13.1.1 Module diagnostics
XB	SNTP time synchronization timing	<p>(1) When "Synchronize with SNTP" is selected in "Time synchronization setting", turns ON after the time synchronization succeeds and the time is stored in the buffer memory.</p> <p>(2) While XB is ON, the time data can be read from the time synchronization result (buffer memory address: 101-107).</p> <p>(3) Turns OFF 1 second after XB turns ON.</p>

*1: The operating status can also be restored by power OFF to ON or by resetting the CPU module.

(Continued on the next page)

1 OVERVIEW

2 SYSTEM CONFIGURATION

3 SPECIFICATIONS

4 SETTINGS AND PROCEDURES UP TO OPERATION

5 HIGH SPEED DATA LOGGER MODULE TOOL STARTUP

6 FUNCTION LIST

7 DATA LOGGING FUNCTION

8 EVENT LOGGING FUNCTION

3 SPECIFICATIONS

(From the previous page)

Device No.	Signal name	Description
X10	ERR. LED status	(1) Turns ON while the ERR. LED is ON (during a module continuation error) or flashing (during a module stop error). (2) ERR. LED is turned OFF by turning ON error clear request (Y10) when ERR. LED is ON. (However, this is not possible while ERR. LED is flashing.) (3) While ERR. LED is ON or flashing (when X10 is ON), X12 to X14, X16 to X19 (one or many) turn ON.
X12	Data logging error	(1) Turns ON when an error regarding data logging occurs. (2) When this device is ON, the error code is stored in the data logging status area (☞ Section 3.4.11). (3) Turns OFF when the error clear request (Y10) is turned ON.
X13	Event logging error	(1) Turns ON when an error regarding event logging occurs. (2) When this device is ON, the error code is stored in the event logging status area (☞ Section 3.4.12). (3) Turns OFF when the error clear request (Y10) is turned ON.
X14	Report creation error	(1) Turns ON when an error regarding reports occurs. (2) When this device is ON, the error code is stored in the report creation status area (☞ Section 3.4.13). (3) Turns OFF when the error clear request (Y10) is turned ON.
X16	Access target CPU error	(1) Turns ON when a communication error occurs with the access target CPU. (2) When this device is ON, the error code is stored in the access target CPU setting status area (☞ Section 3.4.10). (3) Turns OFF when the error clear request (Y10) is turned ON.
X17	E-mail transmission error	(1) Turns ON when an error regarding e-mail transmission occurs. (2) When this device is ON, the error code is stored in the e-mail transmission status area (☞ Section 3.4.14). (3) Turns OFF when the error clear request (Y10) is turned ON.
X18	FTP transfer error	(1) Turns ON when an error regarding FTP transfers occurs. (2) When this device is ON, the error code is stored in the FTP client status (PUT) area (☞ Section 3.4.16). (3) Turns OFF when the error clear request (Y10) is turned ON.
X19	Other errors	(1) Turns ON when an error not corresponding to X12 to X14 or X16 to X18 occurs. (2) When this device is ON, the error code is stored in the error log area (☞ Section 3.4.7). (3) Turns OFF when the error clear request (Y10) is turned ON. (Only in case of a module continuation error)
X1A	High speed data sampling failure	(1) Turns ON when a high speed data sampling failure occurs in data logging, event logging, or report function. (☞ Chapter 17 PROCESSING TIME) (2) Turns OFF by updating the settings.
X1B	Processing overload occurrence	(1) Turns ON when processing overload occurs in data logging, event logging, or report function. (☞ Chapter 17 PROCESSING TIME) (2) Turns OFF by updating the settings.
X1C	Trigger reoccurrence	(1) Turns ON when the creation trigger reoccurs with data logging. (☞ Chapter 17 PROCESSING TIME) (2) Turns OFF by updating the settings.
X1D	Creation trigger reoccurrence	(1) Turns ON when the creation trigger reoccurs with report function. (☞ Chapter 17 PROCESSING TIME) (2) Turns OFF by updating the settings.
X1E	General data sampling delay occurrence	(1) Turns ON when a general data sampling delay has occurred in data logging, event logging, or report function. (☞ Chapter 17 PROCESSING TIME) (2) Turns OFF by either of the following. • When the settings are updated • When a value greater than the general data sampling delay time (maximum) is set in the allowed general data sampling delay time in the buffer memory.
X1F	Watchdog timer error	Turns ON when a watchdog timer error occurs.

(2) Output signal details

Device No.	Signal name	Description
Y2	File access stop request	<p>If turned ON, stops file access.</p> <p>File access stop request (Y2)</p> <p>Clear file access stop request (Y3)</p> <p>File access status (X2)</p> <p>CompactFlash card status (X1)</p> <p>(Operating) (Stopped) (Operating)</p> <p>↓ · Replace CompactFlash card · Power OFF programmable controller</p>
Y3	Clear file access stop request	If turned ON, clears the file access stop.* ¹ (For ON/OFF timing, refer to the row for Y2)
YB	Programmable controller CPU time synchronization request	<p>(1) When the time synchronization setting is set to programmable controller CPU synchronization, if turned on, the module synchronizes with the programmable controller CPU time.*²</p> <p>(2) Do not use when the time synchronization setting is set to "Synchronize with SNTP".</p>
Y10	Error clear request	<p>If turned ON when a module error has occurred, the following are executed.</p> <ul style="list-style-type: none"> • ERR.LED is turned OFF • X10, X12 to X14, X16 to X19 are turned OFF • Most recent error code is cleared <p>☞ Section 18.1.1 Checking error codes</p>

*1: When the auto logging function is enabled, the logging is restarted by turning Y3 ON.

*2: When the time data of the programmable controller CPU is updated, wait for more than one second, and turn YB ON.

☒ POINT

Output signal is enabled when the signal is changed from OFF to ON.
When enabling the output signal again, turn the signal OFF from ON or vice versa.

3.4 Buffer Memory List

The following table shows the buffer memory list.

Address (Decimal)	Application	Reference
0 to 20	Module status area	Section 3.4.1
21 to 25	CompactFlash card information area	Section 3.4.2
47 to 64	Network connection status area	Section 3.4.3
70 to 80	Common setting status area	Section 3.4.4
100 to 109	Time synchronization information area	Section 3.4.5
140 to 145	Current error area	Section 3.4.6
150 to 247	Error log area	Section 3.4.7
800 to 805	General data sampling delay time area	Section 3.4.8
810 to 841	Recipe file area	Section 3.4.9
1500 to 1593	Access target CPU setting status area	Section 3.4.10
2000 to 2989	Data logging status area	Section 3.4.11
3000 to 3989	Event logging status area	Section 3.4.12
4000 to 4989	Report creation status area	Section 3.4.13
5000 to 5992	E-mail transmission status area	Section 3.4.14
6000 to 6001	FTP server status area	Section 3.4.15
6002 to 7457	FTP client status (PUT) area	Section 3.4.16
7999	FTP client setting area	Section 3.4.17
10000 to 14095	Event logging area	Section 3.4.18

☒ POINT

- (1) Addresses not listed in the table above are areas used by the system.
Do not use these areas as there is a risk of malfunction when writing to them.
- (2) The values stored in the buffer memory are cleared when the programmable controller is powered ON from OFF, or the programmable controller CPU is reset.

3 SPECIFICATIONS

3.4.1 Module status area (address: 0 to 20)

The status of the high speed data logger module can be checked in this area.

Decimal address (Hexadecimal)	Name	Description	R/W	Initial value
0 (0H)	RUN LED status	0: OFF 1: ON 2: Flashing	R	0
1 (1H)	ERR. LED status	0: OFF 1: ON 2: Flashing	R	0
2 (2H)	CF LED status	0: OFF 1: ON 2: Flashing	R	0
3 (3H)	Switch 1 status	b0 to 1: 0: Online 1: H/W test 2: Self-loopback test	R	0
4 (4H)	Switch 2 status	b0: ON: Account default setting b1: ON: Connection default setting b12: FTP transfer directory setting 0: The same directory configuration as compact flash card 1: Fixed directory b13: FTP transfer port number setting 0: Access the default port (21) 1: Access the port of "FTP transfer port number" in the buffer memory b15: Periodic time synchronization disabling option 0: Synchronize time with a programmable controller CPU periodically (once in a 24 hours) 1: Do not synchronize time with a programmable controller CPU periodically	R	0
5 (5H)	Switch 3 status	15 to 255 (seconds): Response monitoring time	R	0
6 (6H)	Switch 4 status	b0: ON: Operates when the file switching timing of the module whose first five digits are '11101' or lower	R	0
20 (14H)	Module operating status	0: Initializing 1: Running 2: Stopping 3: Stopped	R	0

R: Read-only

1	OVERVIEW
2	SYSTEM CONFIGURATION
3	SPECIFICATIONS
4	SETTINGS AND PROCEDURES UP TO OPERATION
5	HIGH SPEED DATA LOGGER MODULE TOOL STARTUP
6	FUNCTION LIST
7	DATA LOGGING FUNCTION
8	EVENT LOGGING FUNCTION

3 SPECIFICATIONS

3.4.2 CompactFlash card information area (address: 21 to 25)

The free capacity and usage rate of the CompactFlash card installed on the high speed data logger module can be output to an HMI and checked.

Decimal address (Hexadecimal)	Name	Description	R/W	Initial value
21 to 22 (15H to 16H)	CompactFlash card Total capacity	Represented as a double word (32-bit value). (unit: KB)	R	0
23 to 24 (17H to 18H)	CompactFlash card Free capacity	Represented as a double word (32-bit value). (unit: KB)	R	0
25 (19H)	CompactFlash card Usage rate	Represented as a word (16-bit value). (unit: %)	R	0

R: Read-only

3.4.3 Network connection status area (address: 47 to 64)

The status of the high speed data logger module's connection to a network can be checked in this area.

Decimal address (Hexadecimal)	Name	Description	R/W	Initial value
47 to 54 (2FH to 36H)	IP address (string notation)	Represented as a string. Initial value is "192.168.3.3"	R	-
55 to 56 (37H to 38H)	IP address	Represented as a double word (32-bit value). Initial value is C0A80303H	R	-
57 to 58 (39H to 3AH)	Subnet mask	Represented as a double word (32-bit value). Initial value is FFFFFFF0H (255.255.255.0)	R	-
59 to 60 (3BH to 3CH)	Default gateway	Represented as a double word (32-bit value).	R	0
61 to 62 (3DH to 3EH)	DNS server (primary)	Represented as a double word (32-bit value).	R	0
63 to 64 (3FH to 40H)	DNS server (secondary)	Represented as a double word (32-bit value).	R	0

R: Read-only

3.4.4 Common setting status area (address: 70 to 80)

The status of the network setting ( Section 11.4.1) for the common setting can be checked in this area.

Decimal address (Hexadecimal)	Name	Description	R/W	Initial value
70 (46H)	IP address specification method	0: Auto-obtain, 1: Specify	R	0
71 to 72 (47H to 48H)	IP address	Represented as a double word (32-bit value).	R	0
73 to 74 (49H to 4AH)	Subnet mask	Represented as a double word (32-bit value).	R	0
75 to 76 (4BH to 4CH)	Default gateway	Represented as a double word (32-bit value).	R	0
77 to 78 (4DH to 4EH)	DNS server (primary)	Represented as a double word (32-bit value).	R	0
79 to 80 (4FH to 50H)	DNS server (secondary)	Represented as a double word (32-bit value).	R	0

R: Read-only

3 SPECIFICATIONS

3.4.5 Time synchronization information area (address: 100 to 109)

Information related to the time synchronization function (☞ Section 10.1) can be checked in this area.

Decimal address (Hexadecimal)	Name	Description	R/W	Initial value
100 (64H)	Time synchronization status	0: Synchronize with the programmable controller CPU time 1: Synchronize with SNTP	R	0
101 (65H)	Time synchronization result	Year	R	0
102 (66H)		Month	R	0
103 (67H)		Day	R	0
104 (68H)		Hour	R	0
105 (69H)		Minute	R	0
106 (6AH)		Second	R	0
107 (6BH)		Day of week	0: Sunday, 1: Monday, 2: Tuesday, 3: Wednesday, 4: Thursday, 5: Friday, 6: Saturday	R
108 (6CH)	Daylight saving time status	0: Not daylight saving time 1: Daylight saving time	R	0
109 (6DH)	SNTP time synchronization processing time	Time required for the SNTP time synchronization (unit: ms)	R	0

R: Read-only

(1) Time synchronization status (address: 100)

The operating status of the time synchronization setting (☞ Section 11.4.2) is stored.

The following table shows the relationship of the value stored in the time synchronization status to the time synchronization setting.

Time synchronization setting	Time data from SNTP server	Time synchronization status
Synchronize with the programmable controller CPU time	-	0: Synchronizing with programmable controller CPU time
Synchronize with SNTP	Unobtainable	0: Synchronizing with programmable controller CPU time
	Obtained	1: Synchronizing using SNTP

(2) Time synchronization result (address: 101 to 107)

When "Synchronize with SNTP" is selected with the "Time synchronization setting", the time information obtained from the SNTP server is stored.

When "Enable daylight saving" is selected, the time stored is the time after adjusting for daylight saving time during the daylight saving time period.

When "PLC CPU synchronization" is selected in "Time synchronization setting", the time information obtained from the programmable controller CPU is stored.

(3) Daylight saving time status (address: 108)

Information on whether or not the time synchronization result time is daylight savings time is stored.

When the time synchronization status is '0: Synchronize with programmable controller CPU time', '0: Not daylight saving time' is always stored.

(4) SNTP time synchronization processing time (address: 109)

The time required for SNTP time synchronization is stored. (unit: ms)

This area stores the time required for the last successful SNTP time synchronization. It indicates the maximum deviation for the obtained SNTP server time.

3.4.6 Current error area (address: 140 to 145)

The most recent error code which is currently occurring can be checked in this area.

Decimal address (Hexadecimal)	Name	Description	R/W	Initial value
140 (8CH)	Error code	The error code indicates the definition of the error.	R	0
141 (8DH)	System area	(Use prohibited)	-	-
142 (8EH)	Time	Bits 0 to 7 Last two digits of the year	R	0
		Bits 8 to 15 Month: 01 to 12	R	0
143 (8FH)		Bits 0 to 7 Day: 01 to 31	R	0
		Bits 8 to 15 Time: 00 to 23	R	0
144 (90H)		Bits 0 to 7 Minute: 00 to 59	R	0
		Bits 8 to 15 Second: 00 to 59	R	0
145 (91H)		Bits 0 to 7 Day of week (0: Sunday, 1: Monday, 2: Tuesday, 3: Wednesday, 4: Thursday, 5: Friday, 6: Saturday)	R	0
		Bits 8 to 15 First two digits of the year	R	0

R: Read-only

(1) Error code (address: 140)

The error code (☞ Section 18.2) which indicates the definition of the occurred error is stored.

(2) Time (address: 142 to 145)

The time the error occurred is stored in BCD code.

Buffer memory address:	b15 to b8	b7 to b0
142	Month (01H to 12H)	Year (00H to 99H) last 2 digits
143	Hour (00H to 23H)	Day (01H to 31H)
144	Second (00H to 59H)	Minute (00H to 59H)
145	Year (00H to 99H) first 2 digits	Day of week (0H to 6H)

Remark

(1) The current error area information can be checked with the following diagnostics screens.

- Configuration Tool: The <<Module diagnostics>> tab under [Online] - [Diagnostics] ☞ Section 13.1.1
- GX Works2 or GX Developer: "Error Code" under [System monitor] ☞ Section 18.1.3

(2) The current error information area can be cleared with the following methods.

- Configuration Tool: With the button on the <<Module diagnostics>> tab under [Online] - [Diagnostics] (☞ Section 13.1.1)
- Turn ON error clear request (Y10)
- Power ON from OFF or reset the CPU module

3 SPECIFICATIONS

3.4.7 Error log area (address: 150 to 247)

The history of errors which have occurred on the high speed data logger module can be checked in this area.

Decimal address (Hexadecimal)	Name	Description	R/W	Initial value	
150 (96H)	Error count	The cumulative number of errors registered in the error log area.	R	0	
151 (97H)	Error log write pointer	The error log number registered to the most recent error log. 0: No errors, 1 to 16: Error log number	R	0	
152 (98H)	Error log 1	Error code	R	0	
153 (99H)		System area	(Use prohibited)	-	-
154 (9AH)		Time	Bits 0 to 7	R	0
			Bits 8 to 15	R	0
155 (9BH)			Bits 0 to 7	R	0
			Bits 8 to 15	R	0
156 (9CH)			Bits 0 to 7	R	0
			Bits 8 to 15	R	0
157 (9DH)			Bits 0 to 7	R	0
			Bits 8 to 15	R	0
158 to 247 (9EH to F7H)	Error log 2 to 16	Details are the same as error log 1.	-	-	

R: Read-only

(1) Error log write pointer (address: 151)

The error log number registered to the most recent error log is stored. For example, when the value is '16', the most recent error log is registered to the area for error log 16.

(2) Error log 1 to 16 (address: 152 to 247)

The history of occurred errors is stored. It is comprised of 16 error logs with the same data configuration.

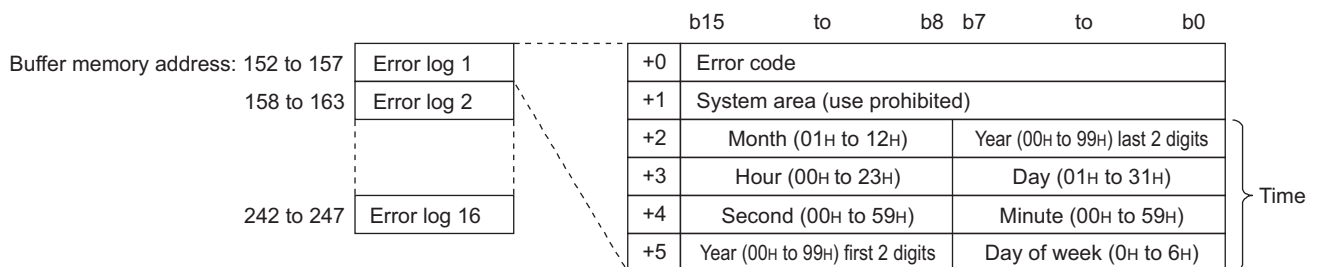

(a) Error code

The error code (Section 18.2) which indicates the definition of the occurred error is stored here.

(b) Time

The time the error occurred is stored in BCD code.

POINT

- (1) The error log area information can be checked with the following diagnostics screens.
 - Configuration Tool: With "Error log" on the <<Module diagnostics>> tab under [Online] - [Diagnostics] (☞ Section 13.1.1)
 - GX Works2 or GX Developer: "Error History" under [System monitor] (☞ Section 18.1.3)
- (2) The error log area can be cleared with the following methods.
 - Configuration Tool: With the button on the <<Module diagnostics>> tab under [Online] - [Diagnostics] (☞ Section 13.1.1)
 - Power ON from OFF or reset the CPU module
- (3) When 17 or more errors occur, errors are registered again from error log 1.
- (4) When an error that is already registered occurs, that error is not registered.

3.4.8 General data sampling delay time area (address: 800 to 805)

The data sampling monitoring interval actually operating on the high speed data logger module can be checked with this area.

The data sampling delay time of data logging, event logging, and report function in the operation of general data sampling can be checked with this area.

Decimal address (Hexadecimal)	Name	Description	R/W	Initial value
800 to 801 (320H to 321H)	General data sampling delay time (moving average)	The general data sampling delay time is stored as the moving average over 30 times. (unit: ms)	R	0
802 to 803 (322H to 323H)	General data sampling delay time (maximum)	The maximum value of general data sampling delay time up to the present is stored. (unit: ms)	R	0
804 to 805 (324H to 325H)	Allowed general data sampling delay time	Sets the allowed general data sampling delay time. (unit: ms)	R/W	0

R: Read-only R/W: Readable/Writable

(1) Allowed general data sampling delay time (address: 804 to 805)

Sets the allowed general data sampling delay time.

- 0 : Of the data sampling time for data logging, event logging, and report function when general data sampling is specified, the allowed time is half of the shortest data sampling time.
 Example: If the data sampling time is 0.1 second: Allowed time = 50 ms.
 Other than 0: The specified value is the allowed time. (unit: ms)

When general data sampling delay time (max) exceeds the allowed time, general data sampling delay (X1E) turns ON.

Remark

About general data sampling delay time:

- The high speed data logger module executes general data sampling of data logging, event logging, and report functions every 100ms. If the data sampling interval is set to 0.2s or higher, elapsed time is checked every 100ms and general data sampling executes as necessary.
- If there are many general data sampling settings or much data, data sampling takes time, and there may be cases where sampling each 0.1s or checking the elapsed time cannot be done. In this case, the general data sampling delay time is set as 100ms subtracted from the actual data sampling time.
- When a general data sampling delay occurs, at maximum, there is the possibility that a data sampling delay occurred of the amount of the general data sampling delay time in data logging, event logging, or report function. In this case, refer to the following section and take action.

☞ Section 17.2 Checking Processing Time

When access target CPU error (the power interruption or network failure) is detected, the sampling time is extended by maximum of the response monitoring time (☞ Section 4.5 (3) Response monitoring time setting (Switch 3 (lower byte))) at detection.

Example) Processing is shown when the data logging and event logging intervals are set to the same time.

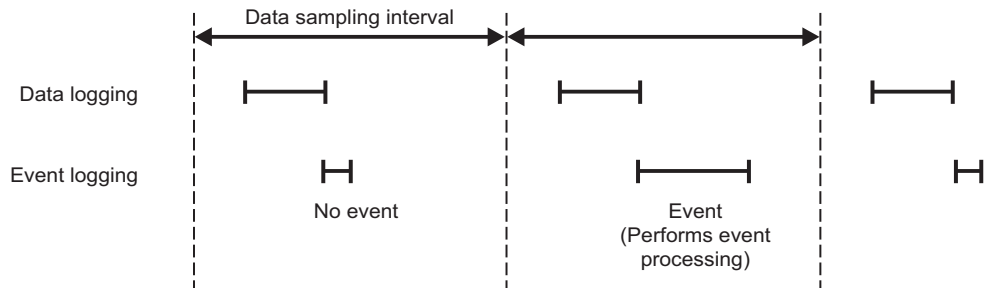

.....

3 SPECIFICATIONS

3.4.9 Recipe file area (address: 810 to 841)

The status of the recipe execution operation can be checked with this area.

Decimal address (Hexadecimal)	Name	Description	R/W	Initial value
810 (32AH)	Recipe execution information	The recipe execution information is stored. 0: Recipe execution operation is not executed 1: Recipe execution operation is executed	R	0
811 (32BH)	Error code	The error code which indicates the definition of the occurred recipe execution operation error is stored.	R	0
812 (32CH)	Type of recipe execution operation	The type of recipe execution operation is stored. 1: Reading the recipe file from the programmable controller CPU 100: Writing the recipe file to the programmable controller CPU	R	0
813 (32DH)	Record number	The record number which is the target of recipe execution operation is stored.	R	0
814 to 837 (32EH to 345H)	Recipe file name	The recipe file name which is the target of recipe execution operation is stored.	R	0
838 to 839 (346H to 347H)	Completed recipe execution operation count	The completed recipe execution operation count after power-ON is stored. When executing recipe execution operation to different recipe files, the total completed recipe execution operation count is counted.	R	0
840 to 841 (348H to 349H)	Failed recipe execution operation count	The failed recipe execution operation count after power-ON is stored.	R	0

3 SPECIFICATIONS

3.4.10 Access target CPU setting status area (address: 1500 to 1593)

The status of the access target CPU can be checked with this area.

Decimal address (Hexadecimal)	Name	Description	R/W	Initial value
1500 to 1503 (5DCH to 5DFH)	Access target CPU setting information	The corresponding bit for the access target CPU set is ON.	R	0
1504 to 1507 (5E0H to 5E3H)	Access target CPU error information	The corresponding bit for the access target CPU where the error occurred is ON.	R	0
1530 to 1593 (5FAH to 639H)	Error code of access target CPU 1 to 64	0: Normal, Other: Error code	R	0

R: Read-only

(1) Access target CPU setting information (address: 1500 to 1503)

The presence of an access target CPU setting is stored in the bit corresponding to the number of the access target CPU setting (☞ Section 11.4.3).

- 0: Not set
- 1: Set

Buffer memory address:	b15	b14	b13	b12	b11	b10	b9	b8	b7	b6	b5	b4	b3	b2	b1	b0
1500	16	15	14	13	12	11	10	9	8	7	6	5	4	3	2	1
1501	32	31	30	29	28	27	26	25	24	23	22	21	20	19	18	17
1502	48	47	46	45	44	43	42	41	40	39	38	37	36	35	34	33
1503	64	63	62	61	60	59	58	57	56	55	54	53	52	51	50	49

(2) Access target CPU error information (address: 1504 to 1507)

Access target CPU error information is stored in the bit corresponding to the number of the access target CPU setting.

- 0: No access target CPU error
- 1: Access target CPU error

Buffer memory address:	b15	b14	b13	b12	b11	b10	b9	b8	b7	b6	b5	b4	b3	b2	b1	b0
1504	16	15	14	13	12	11	10	9	8	7	6	5	4	3	2	1
1505	32	31	30	29	28	27	26	25	24	23	22	21	20	19	18	17
1506	48	47	46	45	44	43	42	41	40	39	38	37	36	35	34	33
1507	64	63	62	61	60	59	58	57	56	55	54	53	52	51	50	49

(3) Error code of access target CPU 1 to 64 (address 1530 to 1593)

The error code (see Section 18.2) which indicates the definition of the occurred error is stored in the area corresponding to the access target CPU where the error has occurred.

POINT

The following occur when an access target CPU error occurs.

(Example) When an error occurred in the access target CPU for access target CPU setting No. 16.

- Access target CPU error (X16) turns ON.
 - Bit 15 in the access target CPU error information area (address: 1504) in the buffer memory turns ON.
 - The error code is stored in access target CPU 16 error code area (address: 1545) in the buffer memory.
-

3 SPECIFICATIONS

3.4.11 Data logging status area (address: 2000 to 2989)

The status related to the data logging function (☞ Chapter 7) can be checked with this area.

Decimal address (Hexadecimal)	Name	Description	R/W	Initial value	
2000 to 2003 (7D0H to 7D3H)	Data logging setting information	The bit corresponding to the configured data logging setting is turned ON.	R	0	
2004 to 2007 (7D4H to 7D7H)	System area	(Use prohibited)	-	-	
2008 to 2011 (7D8H to 7DBH)	Data logging execution information	The bit corresponding to the data logging setting executing logging is turned ON.	R	0	
2012 to 2015 (7DCH to 7DFH)	Data logging error information	The bit corresponding to the data logging setting where a logging error is occurring is turned ON.	R	0	
2016 to 2019 (7E0H to 7E3H)	Number of saved files exceeded information	This area notifies of exceeding the setting for the number of saved files.	R	0	
2020 to 2029 (7E4H to 7EDH)	System area	(Use prohibited)	-	-	
2030 (7EEH)	Data logging information 1	Error code	0: Normal, Other: Error code	R	0
2031 to 2032 (7EFH to 7F0H)		Latest saved file number	Number of the latest saved file.	R	0
2033 to 2034 (7F1H to 7F2H)		Lowest saved file number	Number of the lowest saved file.	R	0
2035 (7F3H)		High speed data sampling failure count	Stores the number of times the module was late for high speed data sampling.	R	0
2036 (7F4H)		Processing overload count	Stores the number of times data logging processing was late for data sampling.	R	0
2037 (7F5H)		Unprocessed buffer size	Stores the buffer size to temporarily accumulate sampled data.	R	0
2038 (7F6H)		Unprocessed data count (current)	Stores the amount of data currently accumulated in the unprocessed buffer.	R	0
2039 (7F7H)		Unprocessed data count (maximum)	Stores the maximum amount of data accumulated in the unprocessed buffer.	R	0
2040 (7F8H)		Trigger detection count	The number of times the occurrence of a trigger was detected.	R	0
2041 (7F9H)		Trigger reoccurrence count	The number of triggers that occurred again and were ignored when outputting logging before and after a trigger.	R	0
2042 to 2044 (7FAH to 7FCH)		System area	(Use prohibited)	-	-
2045 to 2989 (7FDH to BADH)		Data logging information 2 to 64	Details are the same as data logging information 1.	-	-

R: Read-only

(1) Data logging setting information (address: 2000 to 2003)

The presence of a data logging setting is stored in the bit corresponding to the number of the data logging setting (☞ Section 11.5).

0: No setting

1: Setting

Buffer memory address:	2000	2001	2002	2003												
	b15	b14	b13	b12	b11	b10	b9	b8	b7	b6	b5	b4	b3	b2	b1	b0
	16	15	14	13	12	11	10	9	8	7	6	5	4	3	2	1
	32	31	30	29	28	27	26	25	24	23	22	21	20	19	18	17
	48	47	46	45	44	43	42	41	40	39	38	37	36	35	34	33
	64	63	62	61	60	59	58	57	56	55	54	53	52	51	50	49

(2) Data logging execution information (address: 2008 to 2011)

The logging execution status is stored in the bit corresponding to the number of the data logging setting.

0: Logging is not executed.

1: Logging is executed.

	b15	b14	b13	b12	b11	b10	b9	b8	b7	b6	b5	b4	b3	b2	b1	b0
Buffer memory address: 2008	16	15	14	13	12	11	10	9	8	7	6	5	4	3	2	1
2009	32	31	30	29	28	27	26	25	24	23	22	21	20	19	18	17
2010	48	47	46	45	44	43	42	41	40	39	38	37	36	35	34	33
2011	64	63	62	61	60	59	58	57	56	55	54	53	52	51	50	49

The following is the timing for data logging to be executed.

(a) If the logging type is 'continuous'.

The corresponding bit is turned ON during logging (if the period is specified, during the set period).

(b) If the logging type is 'trigger'.

The corresponding bit is turned ON from when the trigger occurs up to completion of file output.

(3) Data logging error information (address: 2012 to 2015)

The data logging error information is stored in the bit corresponding to the number of the data logging setting.

0: No error

1: Logging error

	b15	b14	b13	b12	b11	b10	b9	b8	b7	b6	b5	b4	b3	b2	b1	b0
Buffer memory address: 2012	16	15	14	13	12	11	10	9	8	7	6	5	4	3	2	1
2013	32	31	30	29	28	27	26	25	24	23	22	21	20	19	18	17
2014	48	47	46	45	44	43	42	41	40	39	38	37	36	35	34	33
2015	64	63	62	61	60	59	58	57	56	55	54	53	52	51	50	49

POINT

The following occur when a logging error occurs.

(Example) When an error occurs in logging execution of logging setting number 16

- Data logging error (X12) turns ON.
- Bit 15 in the data logging error information area (address: 2012) in the buffer memory turns ON.
- Error code is stored in data logging information 16 error code area (address: 2255) in the buffer memory.

3 SPECIFICATIONS

(4) Number of saved files exceeded information (address: 2016 to 2019)

A status whether the number of saved files was exceeded or not is stored in the bit corresponding to the data logging setting number if operation is set to "Stop" when the number of saved files is exceeded.

0: Within setting range

1: Exceeded setting

	b15	b14	b13	b12	b11	b10	b9	b8	b7	b6	b5	b4	b3	b2	b1	b0
Buffer memory address: 2016	16	15	14	13	12	11	10	9	8	7	6	5	4	3	2	1
2017	32	31	30	29	28	27	26	25	24	23	22	21	20	19	18	17
2018	48	47	46	45	44	43	42	41	40	39	38	37	36	35	34	33
2019	64	63	62	61	60	59	58	57	56	55	54	53	52	51	50	49

Delete saved files in order to continue logging.

(5) Data logging information 1 to 64 (address: 2030 to 2989)

Information about the error which occurred in the data logging function is stored.

It is comprised of 64 pieces of data logging information with the same data configuration.

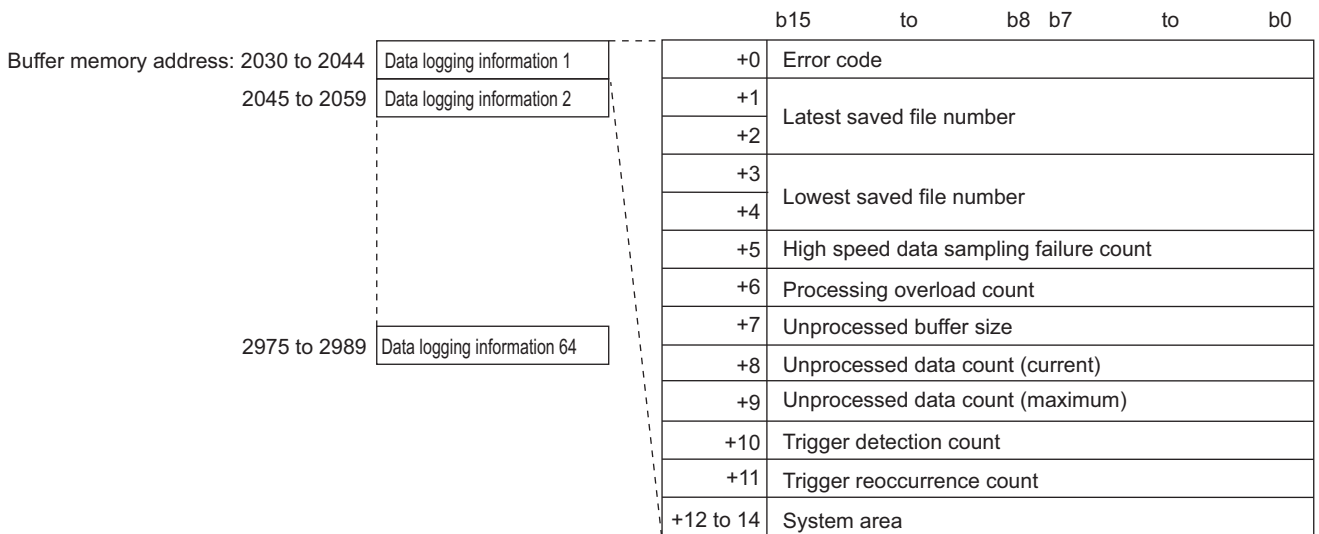

(a) Error code

Stores the error code (see Section 18.2) which indicates the definition of the occurred data logging error.

(b) Latest saved file number

Stores the latest saved file number.

(c) Lowest saved file number

Stores the lowest saved file number.

- (d) High speed data sampling failure count
If high speed data sampling is selected with the data sampling setting, the cumulative number of times data was missed is stored when the high speed data logger module's data sampling speed misses the sequence scan or specified time interval.
When high speed data sampling fails, the following items occur.
- Data misses inside the data logging file.
 - When setting trigger logging, a trigger execution may not be detected.
 - When setting the period as a data condition, a data condition establishment may not be detected.
 - Misses in data displayed with GX LogViewer.
- For details, refer to the following section and take action.
☞ Section 17.2 Checking Processing Time
- (e) Processing overload count
Stores the cumulative number of data misses when data logging processing is late for the data sampling processing speed. When processing overload occurs, the following items occur.
- Data misses inside the data logging file.
 - When setting trigger logging, a trigger execution may not be detected.
 - When setting the period as a data condition, a data condition establishment may not be detected.
 - Misses in data displayed with GX LogViewer.
- For details, refer to the following section and take action.
☞ Section 17.2 Checking Processing Time
- (f) Unprocessed buffer size
Stores the size of the unprocessed buffer (internal memory), which temporarily accumulates sampled data from the programmable controller CPU. (If the size is 20, the buffer can accumulate 20 times worth of data sampling processing.) The accumulated data are processed by the data logging processing. For details on the unprocessed buffer, refer to the following section.
☞ Section 17.2 Checking Processing Time
- (g) Unprocessed data count
Stores the amount of data accumulated in the unprocessed data buffer.
Current : Stores the newest unprocessed data count.
Maximum: Stores the maximum value of the unprocessed data count.
- If the unprocessed data count reaches the unprocessed buffer size, processing overload count occurs during the next data sampling process. When the unprocessed data count tends to increase, processing overload count may occur from the elapsed time.
For details, refer to the following section and take action.
☞ Section 17.2 Checking Processing Time
- (h) Trigger detection count
Stores the number of trigger occurrences detected.
The trigger reoccurrence count is not included.
- (i) Trigger reoccurrence count
After a trigger occurs, stores the number of triggers that were ignored because the trigger occurred again during sampling data for the amount of lines after the trigger.
For details, refer to the following section and take action.
☞ Section 17.2 Checking Processing Time
- For operation when triggers continuously occur, refer to the following section.
☞ Section 7.3.2 Trigger logging

3 SPECIFICATIONS

3.4.12 Event logging status area (address: 3000 to 3989)

The status related to the event logging function (Chapter 8) can be checked with this area.

Decimal address (Hexadecimal)	Name	Description	R/W	Initial value	
3000 to 3003 (BB8H to BBBH)	Event logging setting information	The bit corresponding to the configured event logging setting is turned ON.	R	0	
3004 to 3007 (BBCH to BBFH)	System area	(Use prohibited)	-	-	
3008 to 3011 (BC0H to BC3H)	Event logging error information	The bit corresponding to the event logging setting where an error is occurring is turned ON.	R	0	
3012 to 3015 (BC4H to BC7H)	Number of saved files exceeded information	This area notifies of exceeding the setting for the number of saved files.	R	0	
3016 to 3029 (BC8H to BD5H)	System area	(Use prohibited)	-	-	
3030 (BD6H)	Event logging information 1	Error code	0: Normal, Other: Error code	R	0
3031 to 3032 (BD7H to BD8H)		Latest saved file number	Number of the latest saved file.	R	0
3033 to 3034 (BD9H to BDAH)		Lowest saved file number	Number of the lowest saved file.	R	0
3035 (BDBH)		High speed data sampling failure count	The cumulative total of times buffer full occurs.	R	0
3036 (BDCH)		Processing overload count	Data sampling speed was not fast enough, the cumulative total of data misses.	R	0
3037 (BDDH)		Unprocessed buffer size	Stores the buffer size to temporarily accumulate sampled data.	R	0
3038 (BDEH)		Unprocessed data count (current)	Stores the amount of data currently accumulated in the unprocessed buffer.	R	0
3039 (BDFH)		Unprocessed data count (maximum)	Stores the maximum amount of data accumulated in the unprocessed buffer.	R	0
3040 to 3043 (BE0H to BE3H)		Event information	Event occurrence/restoration status.	R	0
3044 (BE4H)		System area	(Use prohibited)	-	-
3045 to 3989 (BE5H to F95H)	Event logging information 2 to 64	Details are the same as event logging information 1.	-	-	

R: Read-only

(1) Event logging setting information (address: 3000 to 3003)

The presence of a event logging setting is stored in the bit corresponding to the number of the event logging setting (Section 11.6).

0: No setting

1: Setting

Buffer memory address:	3000	3001	3002	3003	b15	b14	b13	b12	b11	b10	b9	b8	b7	b6	b5	b4	b3	b2	b1	b0
	16	15	14	13	12	11	10	9	8	7	6	5	4	3	2	1				
	32	31	30	29	28	27	26	25	24	23	22	21	20	19	18	17				
	48	47	46	45	44	43	42	41	40	39	38	37	36	35	34	33				
	64	63	62	61	60	59	58	57	56	55	54	53	52	51	50	49				

3 SPECIFICATIONS

(2) Event logging error information (address: 3008 to 3011)

The event logging error information is stored in the bit corresponding to the number of the event logging setting.

- 0: No error
- 1: Error

	b15	b14	b13	b12	b11	b10	b9	b8	b7	b6	b5	b4	b3	b2	b1	b0
Buffer memory address: 3008	16	15	14	13	12	11	10	9	8	7	6	5	4	3	2	1
3009	32	31	30	29	28	27	26	25	24	23	22	21	20	19	18	17
3010	48	47	46	45	44	43	42	41	40	39	38	37	36	35	34	33
3011	64	63	62	61	60	59	58	57	56	55	54	53	52	51	50	49

(3) Number of saved files exceeded information (address: 3012 to 3015)

A status whether the number of saved files was exceeded or not is stored in the bit corresponding to the event logging setting number if operation is set to "Stop" when the number of saved files is exceeded

- 0: Within setting range
- 1: Exceeded setting

	b15	b14	b13	b12	b11	b10	b9	b8	b7	b6	b5	b4	b3	b2	b1	b0
Buffer memory address: 3012	16	15	14	13	12	11	10	9	8	7	6	5	4	3	2	1
3013	32	31	30	29	28	27	26	25	24	23	22	21	20	19	18	17
3014	48	47	46	45	44	43	42	41	40	39	38	37	36	35	34	33
3015	64	63	62	61	60	59	58	57	56	55	54	53	52	51	50	49

Delete saved files in order to continue logging.

(4) Event logging information 1 to 64 (address: 3030 to 3989)

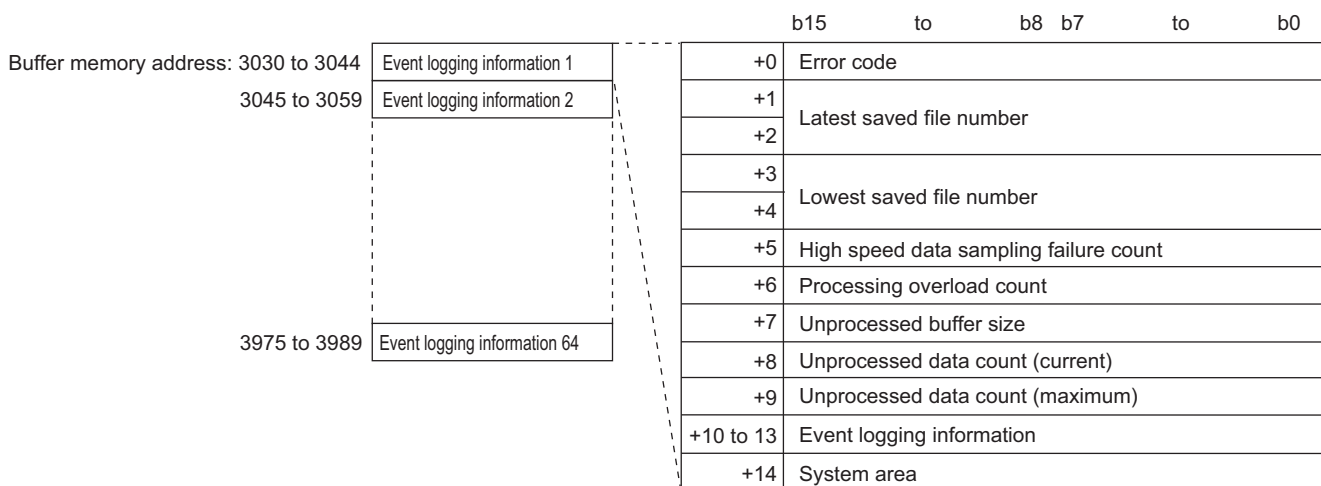

Information about the error which occurred in the event logging function is stored. It is comprised of 64 pieces of event logging information with the same data configuration.



(a) Error code

Stores the error code ( Section 18.2) which indicates the definition of the occurred event logging error.

3 SPECIFICATIONS

- (b) Latest saved file number
Stores the latest saved file number.
- (c) Lowest saved file number
Stores the lowest saved file number.
- (d) High speed data sampling failure count
If high speed data sampling is selected with the data sampling setting, the cumulative number of times data was missed is stored when the high speed data logger module's data sampling speed misses the sequence scan or specified time interval.
When high speed data sampling fails, the following items occur.
 - A event condition establishment may not be detected.
 - When setting the period as a data condition, a data condition establishment may not be detected.
 - Misses in events displayed with GX LogViewer.For details, refer to the following section and take action.
 Section 17.2 Checking Processing Time
- (e) Processing overload count
Stores the cumulative number of data misses when event logging processing is late for the data sampling processing speed. When processing overload occurs, the following items occur.
 - A event condition establishment may not be detected.
 - When setting the period as a data condition, a data condition establishment may not be detected.
 - Misses in events displayed with GX LogViewer.For details, refer to the following section and take action.
 Section 17.2 Checking Processing Time
- (f) Unprocessed buffer size
Stores the size of the unprocessed buffer (internal memory), which temporarily accumulates sampled data from the programmable controller CPU. (If the size is 20, the buffer can accumulate 20 times worth of data sampling processing.) The accumulated data are processed by the event logging processing. For details on the unprocessed buffer, refer to the following section.
 Section 17.2 Checking Processing Time
- (g) Unprocessed data count
Stores the amount of data accumulated in the unprocessed data buffer.
Current : Stores the newest unprocessed data count.
Maximum: Stores the maximum value of the unprocessed data count.

If the unprocessed data count reaches the unprocessed buffer size, processing overload count occurs during the next data sampling process. When the unprocessed data count tends to increase, processing overload count may occur from the elapsed time.
For details, refer to the following section and take action.
 Section 17.2 Checking Processing Time

1

OVERVIEW

2

SYSTEM CONFIGURATION

3

SPECIFICATIONS

4

SETTINGS AND PROCEDURES UP TO OPERATION

5

HIGH SPEED DATA LOGGER MODULE TOOL STARTUP

6

FUNCTION LIST

7

DATA LOGGING FUNCTION

8

EVENT LOGGING FUNCTION

3 SPECIFICATIONS

(h) Event information

The bit corresponding to the event number occurring turns ON. If the monitoring condition is "Value changes", "Number of times", "Order", the bit is always OFF.

0: Event restored

1: Event occurred

	b15	b14	b13	b12	b11	b10	b9	b8	b7	b6	b5	b4	b3	b2	b1	b0
Buffer memory address: 3040	16	15	14	13	12	11	10	9	8	7	6	5	4	3	2	1
3041	32	31	30	29	28	27	26	25	24	23	22	21	20	19	18	17
3042	48	47	46	45	44	43	42	41	40	39	38	37	36	35	34	33
3043	64	63	62	61	60	59	58	57	56	55	54	53	52	51	50	49

3 SPECIFICATIONS

3.4.13 Report creation status area (address: 4000 to 4989)

The status related to the report function (Chapter 9) can be checked with this area.

Decimal address (Hexadecimal)	Name	Description	R/W	Initial value	
4000 to 4003 (FA0H to FA3H)	Report setting information	The bit corresponding to the configured report setting is turned ON.	R	0	
4004 to 4007 (FA4H to FA7H)	System area	(Use prohibited)	-	-	
4008 to 4011 (FA8H to FABH)	Report creation execution information	The bit corresponding to the report executing create is turned ON.	R	0	
4012 to 4015 (FACH to FAFH)	Report creation error information	The bit corresponding to the report where an error is occurring is turned ON.	R	0	
4016 to 4019 (FB0H to FB3H)	Number of saved files exceeded information	This area notifies of exceeding the setting for the number of saved files.	R	0	
4020 to 4029 (FB4H to FBDH)	System area	(Use prohibited)	-	-	
4030(FBEH)	Report creation information 1	Error code	0: Normal, Other: Error code	R	0
4031 to 4032 (FBFH to FC0H)		Latest saved file number	Number of the latest saved file.	R	0
4033 to 4034 (FC1H to FC2H)		Lowest saved file number	Number of the lowest saved file.	R	0
4035 (FC3H)		High speed data sampling failure count	The cumulative total of times buffer full occurs.	R	0
4036 (FC4H)		Processing overload count	Data sampling speed was not fast enough, the cumulative total of data misses.	R	0
4037 (FC5H)		Unprocessed buffer size	Stores the buffer size to temporarily accumulate sampled data.	R	0
4038 (FC6H)		Unprocessed data count (current)	Stores the amount of data currently being accumulated in the unprocessed buffer.	R	0
4039 (FC7H)		Unprocessed data count (maximum)	Stores the maximum amount of data accumulated in the unprocessed buffer.	R	0
4040 (FC8H)		Creation trigger detection count	Stores the number of creation trigger occurrences detected.	R	0
4041 (FC9H)		Creation trigger reoccurrence count	After a creation trigger, stores the number of creation triggers that occur again during report creation. (The number of creation triggers is not stored when "At the time of the data logging file is switched" is set to the condition of the creation trigger.)	R	0
4042 (FCAH)		Report creation time (newest)	Stores the time required to create a report in seconds.	R	0
4043 (FCBH)		Report creation time (maximum)	Stores the time required to create a report in seconds.	R	0
4044 (FCCH)		System area	(Use prohibited)	-	-
4045 to 4989 (FCDH to 137DH)		Report creation information 2 to 64	Details are the same as report creation information 1.	-	-

R: Read-only

1	OVERVIEW
2	SYSTEM CONFIGURATION
3	SPECIFICATIONS
4	SETTINGS AND PROCEDURES UP TO OPERATION
5	HIGH SPEED DATA LOGGER MODULE TOOL STARTUP
6	FUNCTION LIST
7	DATA LOGGING FUNCTION
8	EVENT LOGGING FUNCTION

(1) Report setting information (address: 4000 to 4003)

Stores the presence of a report setting in the bit corresponding to the number of the report setting (☞ Section 11.7).

0: No setting

1: Setting

	b15	b14	b13	b12	b11	b10	b9	b8	b7	b6	b5	b4	b3	b2	b1	b0
Buffer memory address: 4000	16	15	14	13	12	11	10	9	8	7	6	5	4	3	2	1
4001	32	31	30	29	28	27	26	25	24	23	22	21	20	19	18	17
4002	48	47	46	45	44	43	42	41	40	39	38	37	36	35	34	33
4003	64	63	62	61	60	59	58	57	56	55	54	53	52	51	50	49

(2) Report creation execution information (address: 4008 to 4011)

The report creation execution status is stored in the bit corresponding to the number of the report setting. After the report creation trigger occurs, the corresponding bit is turned ON from report save complete until the next monitoring cycle.

0: Report creation is not executed.

1: Report creation is executed.

	b15	b14	b13	b12	b11	b10	b9	b8	b7	b6	b5	b4	b3	b2	b1	b0
Buffer memory address: 4008	16	15	14	13	12	11	10	9	8	7	6	5	4	3	2	1
4009	32	31	30	29	28	27	26	25	24	23	22	21	20	19	18	17
4010	48	47	46	45	44	43	42	41	40	39	38	37	36	35	34	33
4011	64	63	62	61	60	59	58	57	56	55	54	53	52	51	50	49

(3) Report creation error information (address: 4012 to 4015)

The report creation error information is stored in the bit corresponding to the number of the report setting.

0: No error

1: Error

	b15	b14	b13	b12	b11	b10	b9	b8	b7	b6	b5	b4	b3	b2	b1	b0
Buffer memory address: 4012	16	15	14	13	12	11	10	9	8	7	6	5	4	3	2	1
4013	32	31	30	29	28	27	26	25	24	23	22	21	20	19	18	17
4014	48	47	46	45	44	43	42	41	40	39	38	37	36	35	34	33
4015	64	63	62	61	60	59	58	57	56	55	54	53	52	51	50	49

POINT

The following occur when a report creation error occurs.

(Example) When an error occurs in report creation execution of report setting number 16

- Report creation error (X14) turns ON.
- Bit 15 in the report creation error information area (address: 4012) in the buffer memory turns ON.
- Error code is stored in report creation information 16 error code area (address: 4255) in the buffer memory.

3 SPECIFICATIONS

(4) Number of saved files exceeded information (address: 4016 to 4019)

A status whether the number of saved files was exceeded or not is stored in the bit corresponding to the report setting number if operation is set to "Stop" when the number of saved files is exceeded.

0: Within setting range

1: Exceeded setting

	b15	b14	b13	b12	b11	b10	b9	b8	b7	b6	b5	b4	b3	b2	b1	b0
Buffer memory address: 4016	16	15	14	13	12	11	10	9	8	7	6	5	4	3	2	1
4017	32	31	30	29	28	27	26	25	24	23	22	21	20	19	18	17
4018	48	47	46	45	44	43	42	41	40	39	38	37	36	35	34	33
4019	64	63	62	61	60	59	58	57	56	55	54	53	52	51	50	49

Delete saved files in order to continue report creation.

(5) Report creation information 1 to 64 (address: 4030 to 4989)

Information about the error which occurred in the report creation function is stored.

It is comprised of 64 pieces of report creation information with the same data configuration.

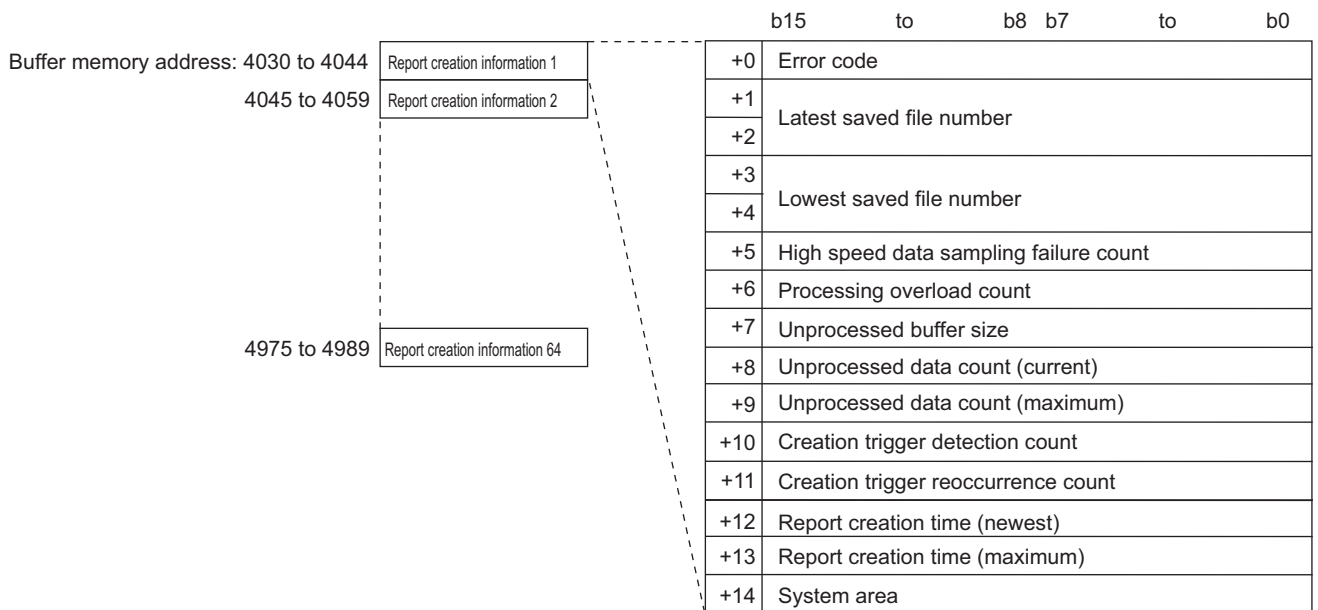

(a) Error code

Stores the error code (☞ Section 18.2) which indicates the definition of the occurred report information error.

(b) Latest saved file number

Stores the latest saved file number.

(c) Lowest saved file number

Stores the lowest saved file number.

- (d) High speed data sampling failure count
If high speed data sampling is selected with the data sampling setting, the cumulative number of times data was missed is stored when the high speed data logger module's data sampling speed misses the sequence scan or specified time interval.
When high speed data sampling fails, the following items occur.
- A creation trigger execution may not be detected.
 - When setting the period as a data condition, a data condition establishment may not be detected.
- For details, refer to the following section and take action.
☞ Section 17.2 Checking Processing Time
- (e) Processing overload count
Stores the cumulative number of data misses when report processing is late for the data sampling processing speed. When processing overload happens, the following items occur.
- A creation trigger execution may not be detected.
 - When setting the period as a data condition, a data condition establishment may not be detected.
- For details, refer to the following section and take action.
☞ Section 17.2 Checking Processing Time
- (f) Unprocessed buffer size
Stores the size of the unprocessed buffer (internal memory), which temporarily accumulates sampled data from the programmable controller CPU. (If the size is 20, the buffer can accumulate 20 times worth of data sampling processing.) The accumulated data are processed by the report processing.
For details on the unprocessed buffer, refer to the following section.
☞ Section 17.2 Checking Processing Time
- (g) Unprocessed data count
Stores the amount of data accumulated in the unprocessed data buffer.
Current : Stores the newest unprocessed data count.
Maximum: Stores the maximum value of the unprocessed data count.
If the unprocessed data count reaches the unprocessed buffer size, processing overload count occurs during the next data sampling process. When the unprocessed data count tends to increase, processing overload count may occur from the elapsed time.
For details, refer to the following section and take action.
☞ Section 17.2 Checking Processing Time
- (h) Creation trigger detection count
Stores the number of creation trigger occurrences detected.
The number of creation trigger recurrences is not included.
- (i) Creation trigger reoccurrence count
After a creation trigger, stores the number of creation triggers that were ignored because the creation trigger occurred again during report creation. (The number of creation triggers is not stored when "At the time of the data logging file is switched" is set to the condition of the creation trigger.)
For details, refer to the following section and take action.
☞ Section 17.2 Checking Processing Time
For operation when the creation trigger continuously occurs, refer to the following section.
☞ Section 9.3 Creation Trigger
- (j) Report creation time
Stores the time required to create a report in seconds.
Newest : The time required to create the newest report
Maximum: The maximum value of time required to create a report up to the present

3 SPECIFICATIONS

3.4.14 E-mail transmission status area (address: 5000 to 5992)

The e-mail transmission result can be checked with this area.

Decimal address (Hexadecimal)	Name	Description	R/W	Initial value	
5000 to 5001 (1388H to 1389H)	System area	(Use prohibited)	-	-	
5002 (138AH)	Normally completed e-mail count	The number of all e-mails that completed normally.	R	0	
5003 (138BH)	Attachment transmission count	The number of all e-mail attachment file transmissions (successful).	R	0	
5004 (138CH)	Abnormally completed e-mail count	The number of all e-mails that completed abnormally.	R	0	
5005 (138DH)	Error log write count	The cumulative number of errors registered in the error log area.	R	0	
5006 (138EH)	Error log write pointer	The error log number registered to the most recent error log. 0: No errors, 1 to 16: Error log number	R	0	
5007 (138FH)	Error log 1	Error code	R	0	
5008 (1390H)		To	R	0	
5009 to 5023 (1391H to 139FH)		Subject	R	0	
5024 (13A0H)		Date	Bits 0 to 7	R	0
			Bits 8 to 15	R	0
5025 (13A1H)			Day: 01 to 31	R	0
			Time: 00 to 23	R	0
5026 (13A2H)			Minute: 00 to 59	R	0
			Second: 00 to 59	R	0
5027 (13A3H)			Day of week (0: Sunday, 1: Monday, 2: Tuesday, 3: Wednesday, 4: Thursday, 5: Friday, 6: Saturday)	R	0
	Bits 8 to 15		R	0	
5028 to 5342 (13A4H to 14DEH)	Error log 2 to 16		Details are the same as error log 1.	-	-
5343 (14DFH)	Transmission log write count		The cumulative number of transmissions registered in the transmission log area.	R	0
5344 (14E0H)	Transmission log write pointer	The transmission log number registered to the most recent transmission log. 0: No transmissions, 1 to 32: Transmission log number	R	0	
5345 (14E1H)	Transmission log 1	To	R	0	
5346 to 5360 (14E2H to 14F0H)		Subject	R	0	
5361 (14F1H)		Date	Bits 0 to 7	R	0
			Bits 8 to 15	R	0
5362 (14F2H)			Day: 01 to 31	R	0
			Time: 00 to 23	R	0
5363 (14F3H)			Minute: 00 to 59	R	0
			Second: 00 to 59	R	0
5364 (14F4H)			Day of week (0: Sunday, 1: Monday, 2: Tuesday, 3: Wednesday, 4: Thursday, 5: Friday, 6: Saturday)	R	0
			Bits 8 to 15	R	0
5365 to 5984 (14F5H to 1760H)	Transmission log 2 to 32		Details are the same as transmission log 1.	-	-

R: Read-only
(Continued on the next page)

1 OVERVIEW
2 SYSTEM CONFIGURATION
3 SPECIFICATIONS
4 SETTINGS AND PROCEDURES UP TO OPERATION
5 HIGH SPEED DATA LOGGER MODULE TOOL STARTUP
6 FUNCTION LIST
7 DATA LOGGING FUNCTION
8 EVENT LOGGING FUNCTION

3 SPECIFICATIONS

(From the previous page)

Decimal address (Hexadecimal)	Name	Description	R/W	Initial value
5985 to 5986 (1761H to 1762H)	Resending buffer size	Displays the value specified as resending buffer size in the optional setting of the E-mail setting in double word (32-bit value). (unit: number of items)	R	0
5987 to 5988 (1763H to 1764H)	Buffering number (current value)	Displays the number of buffered data (the number of resending E-mails) stored in the current E-mail resending buffer in double word (32-bit value). (unit: number of items)	R	0
5989 to 5990 (1765H to 1766H)	Buffering number (maximum value)	Displays the maximum number of buffered data stored in the E-mail resending buffer up to the present in double word (32-bit value). (unit: number of items)	R	0
5991 (1767H)	Buffer usage rate (current value)	Displays the current E-mail resending buffer usage rate in word (16-bit value). (unit: %)	R	0
5992 (1768H)	Buffer usage rate (maximum value)	Displays the maximum value of the E-mail resending buffer usage rate up to the present in word (16-bit value). (unit: %)	R	0

R: Read-only

(1) Normally completed e-mail count (address: 5002)

Stores the cumulative number of times the high speed data logger module sends an e-mail to the mail server.

(2) Attachment transmission count (address: 5003)

Stores the cumulative number of times the high speed data logger module sends an e-mail with a file attachment.

(3) Abnormally completed e-mail count (address: 5004)

Stores the cumulative number of communication error occurrences returned when the e-mail send was requested to the mail server by the high speed data logger module.

Remark

About e-mail counts

- When e-mails are sent to all valid addresses
→ Transmission count is added up and stored in 'normally completed e-mail count'.
- When e-mails are sent to a portion of invalid addresses
→ Transmission count is added up and stored in 'abnormally completed e-mail count'.
- When e-mails are sent to all invalid addresses
→ Transmission count is added up and stored in 'abnormally completed e-mail count'.

However, depending on the mail server specifications, there may be situations where the transmission count is not added to 'abnormally completed e-mail count' even if an e-mail is sent to an invalid address.

(4) Error log write count (address: 5005)

Stores the cumulative number of times e-mail transmission completes abnormally and a error log is registered.

The error is registered to the error log when the e-mail transmission error (X17) is ON.

3 SPECIFICATIONS

(5) Error log write pointer (address: 5006)

Stores the error log number registered to the most recent error log.
For example, when the value is '16', the most recent error log is registered to the area for error log 16.

(6) Error log 1-16 (address: 5007-5342)

Stores the history of errors which occur when e-mail transmission completes abnormally.
It is comprised of 16 error logs with the same data configuration.

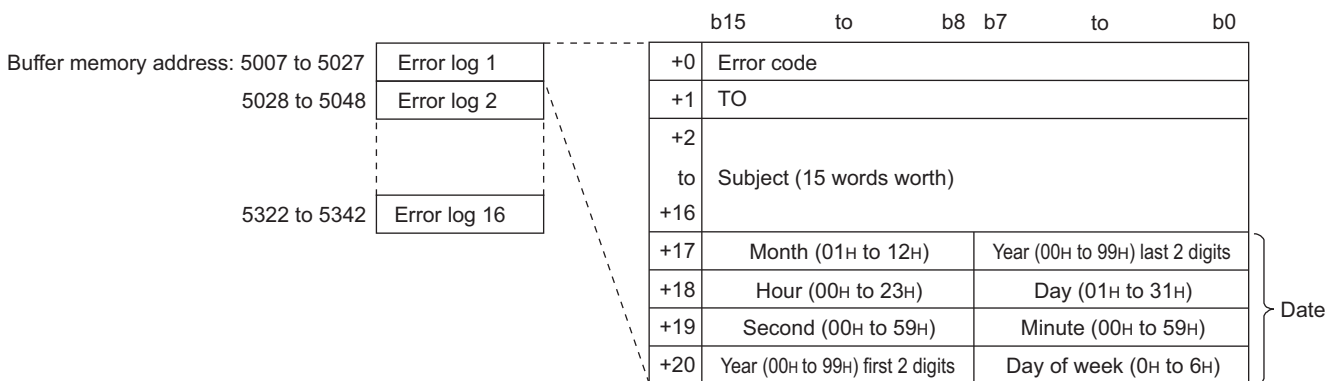

(a) Error code

Stores the error code (see Section 18.2) which indicates the definition of the occurred error.

(b) To (destination)

Stores the destination address number of an e-mail that had an error in communications with the mail server. The destination address number is set with the e-mail setting's "Target e-mail address setting".

(c) Subject

Stores 15 words worth of the e-mail subject from the beginning.

(d) Date (time)

Stores the time the e-mail was sent in BCD code.

POINT

When 17 or more errors occur, errors are registered again from error log 1.

(7) Transmission log write count (address: 5343)

Stores the cumulative number of times e-mail transmission completes normally and a transmission log is registered.

(8) Transmission log write pointer (address: 5344)

Stores the transmission log number registered to the most recent transmission log.
For example, when the value is '16', the most recent transmission log is registered to the area for transmission log 16.

3 SPECIFICATIONS

(9) Transmission log 1 to 32 (address: 5345 to 5984)

Stores the transmission history when e-mail transmission completes normally. It is comprised of 32 transmission logs with the same data configuration.

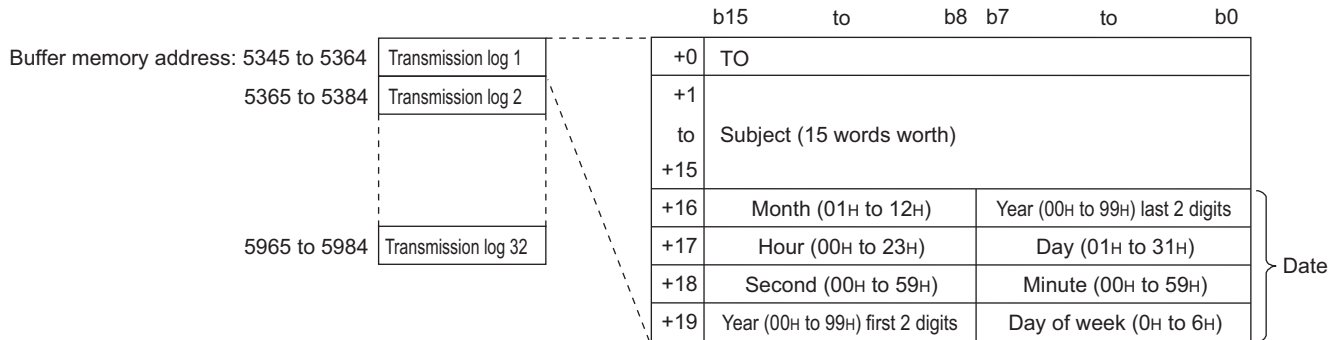

(a) To (destination)

Stores the destination address number of normally completed e-mails. The destination address number is set with the e-mail setting's "Target e-mail address setting".

(b) Subject

Stores 15 words worth of the e-mail subject from the beginning.

(c) Date (time)

Stores the time when the e-mail was sent in BCD code.

POINT

When 33 or more transmission logs occur, transmission logs are registered again from 1.

3 SPECIFICATIONS

3.4.15 FTP server status area (address: 6000 to 6001)

The connection status to a FTP server can be checked with this area.

Decimal address (Hexadecimal)	Name	Description	R/W	Initial value
6000 (1770H)	Login success count	The cumulative number of times logging in to a FTP server was succeeded.	R	0
6001 (1771H)	Login failure count	The cumulative number of times logging in to a FTP server failed.	R	0

R: Read-only

1

OVERVIEW

2

SYSTEM
CONFIGURATION

3

SPECIFICATIONS

4

SETTINGS AND
PROCEDURES UP TO
OPERATION

5

HIGH SPEED DATA
LOGGER MODULE
TOOL STARTUP

6

FUNCTION LIST

7

DATA LOGGING
FUNCTION

8

EVENT LOGGING
FUNCTION

3 SPECIFICATIONS

3.4.16 FTP client status (PUT) area (address: 6002 to 7457)

The result of file transfers to a FTP server can be checked with this area. If the file transfer completes normally, transfer contents are written to the 'transfer log', if it completes abnormally, transfer contents are written to the 'error log'.

Decimal address (Hexadecimal)	Name		Description	R/W	Initial value	
6002 to 6003 (1772H to 1773H)	System area		(Use prohibited)	-	-	
6004 (1774H)	Normally completed FTP transfer count		The number of all FTP transfers (PUT) normally completed.	R	0	
6005 (1775H)	Abnormally completed FTP transfer count		The number of all FTP transfers (PUT) abnormally completed.	R	0	
6006 (1776H)	Transfer result 1	Normally completed count	The number of transfers (PUT) by FTP setting 1 normally completed.	R	0	
6007 (1777H)		Abnormally completed count	The number of transfers (PUT) by FTP setting 1 abnormally completed.	R	0	
6008 to 6037 (1778H to 1795H)	Transfer result 2 to 16		Details are the same as transfer result 1.	-	-	
6038 (1796H)	Error log write count		The cumulative number of errors registered in the error log area.	R	0	
6039 (1797H)	Error log write pointer		The error log number registered to the most recent error log. 0: No errors, 1 to 16: Error log number	R	0	
6040 (1798H)	Error log 1	Error code	The error code indicates the definition of the error.	R	0	
6041 (1799H)		Destination	The destination FTP setting number.	R	0	
6042 to 6065 (179AH to 17B1H)		File name	Stores 15 words worth of the file name in ASCII code.	R	0	
6066 (17B2H)		Date	Bits 0 to 7	Last two digits of the year	R	0
			Bits 8 to 15	Month: 01 to 12	R	0
6067 (17B3H)			Bits 0 to 7	Day: 01 to 31	R	0
			Bits 8 to 15	Time: 00 to 23	R	0
6068 (17B4H)			Bits 0 to 7	Minute: 00 to 59	R	0
			Bits 8 to 15	Second: 00 to 59	R	0
6069 (17B5H)			Bits 0 to 7	Day of week (0: Sunday, 1: Monday, 2: Tuesday, 3: Wednesday, 4: Thursday, 5: Friday, 6: Saturday)	R	0
	Bits 8 to 15		First two digits of the year	R	0	
6070 to 6519 (17B6H to 1977H)	Error log 2 to 16		Details are the same as error log 1.	-	-	
6520 (1978H)	Transfer log write count		The cumulative number of transfer logs registered in the transfer log area.	R	0	
6521 (1979H)	Transfer log write pointer		The transfer log number registered to the most recent transfer log. 0: No transfers, 1 to 32: Transfer log number	R	0	
6522 (197AH)	Transfer log 1	Destination	The destination FTP setting number.	R	0	
6523 to 6546 (197BH to 1992H)		File name	Stores 15 words worth of the file name in ASCII code.	R	0	
6547 (1993H)		Date	Bits 0 to 7	Last two digits of the year	R	0
			Bits 8 to 15	Month: 01 to 12	R	0
6548 (1994H)			Bits 0 to 7	Day: 01 to 31	R	0
			Bits 8 to 15	Time: 00 to 23	R	0
6549 (1995H)			Bits 0 to 7	Minute: 00 to 59	R	0
			Bits 8 to 15	Second: 00 to 59	R	0
6550 (1996H)			Bits 0 to 7	Day of week (0: Sunday, 1: Monday, 2: Tuesday, 3: Wednesday, 4: Thursday, 5: Friday, 6: Saturday)	R	0
			Bits 8 to 15	First two digits of the year	R	0
6551 to 7449 (1997H to 1D19H)	Transfer log 2 to 32		Details are the same as transfer log 1.	-	-	

R: Read-only

(Continued on the next page)

3 SPECIFICATIONS

(From the previous page)

Decimal address (Hexadecimal)	Name	Description	R/W	Initial value
7450 to 7451 (1D1AH to 1D1BH)	Resending buffer size	Displays the value specified as resending buffer size in the optional setting of the FTP setting in double word (32-bit value). (unit: number of items)	R	0
7452 to 7453 (1D1CH to 1D1DH)	Buffering number (current value)	Displays the number of buffered data stored in the current FTP resending buffer in double word (32-bit value). (unit: number of items)	R	0
7454 to 7455 (1D1EH to 1D1FH)	Buffering number (maximum value)	Displays the maximum number of buffered data stored in the FTP resending buffer up to the present in double word (32-bit value). (unit: number of items)	R	0
7456 (1D20H)	Buffer usage rate (current value)	Displays the current FTP resending buffer usage rate in word (16-bit value). (unit: %)	R	0
7457 (1D21H)	Buffer usage rate (maximum value)	Displays the maximum value of the FTP resending buffer usage rate up to the present in word (16-bit value). (unit: %)	R	0

R: Read-only

(1) Normally completed FTP transfer count (address: 6004)

Stores the cumulative number of times the high speed data logger module transfers (PUT) a file to the FTP server.

(2) Abnormally completed FTP transfer count (address: 6005)

Stores the cumulative number of communication error occurrences returned when the file transfer was requested to the FTP server by the high speed data logger module.

(3) FTP 1 to 16 transfer result (address: 6006 to 6037)

Stores the cumulative number of transfer (PUT) results per FTP setting number.

(4) Error log write count (address: 6038)

Stores the cumulative number of times FTP transfers complete abnormally and an error log is registered.

Error logs are registered when FTP transfer error (X18) is ON.

(5) Error log write pointer (address: 6039)

Stores the error log number registered to the most recent error log is stored here.

For example, when the value is '16', the most recent error log is registered to the area for error log 16.

1 OVERVIEW
2 SYSTEM CONFIGURATION
3 SPECIFICATIONS
4 SETTINGS AND PROCEDURES UP TO OPERATION
5 HIGH SPEED DATA LOGGER MODULE TOOL STARTUP
6 FUNCTION LIST
7 DATA LOGGING FUNCTION
8 EVENT LOGGING FUNCTION

(6) Error log 1 to 16 (address: 6040 to 6519)

Stores the history of errors which occur when FTP transfers complete abnormally. It is comprised of 16 error logs with the same data configuration.

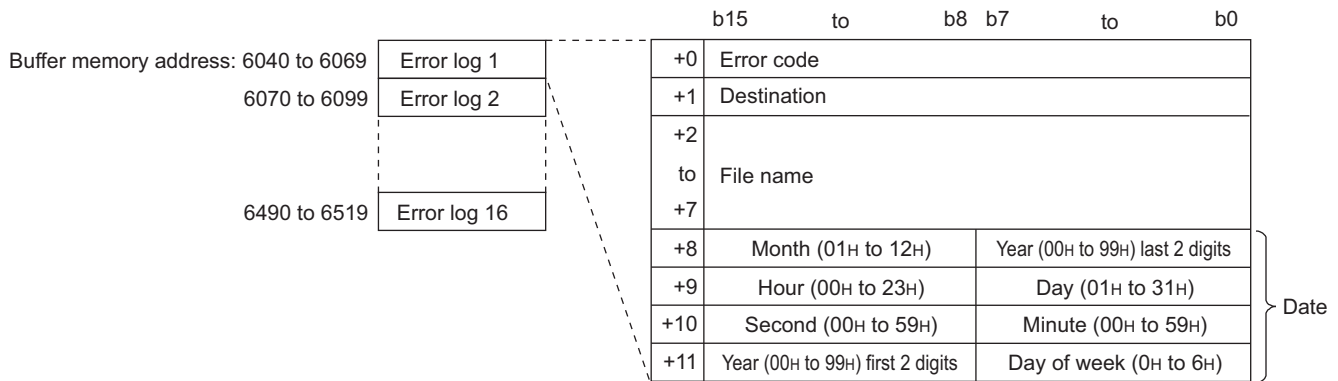

- (a) Error code
Stores the error code (☞ Section 18.2) which indicates the definition of the error which occurred.
- (b) Destination
Stores the destination FTP server number when a communications error occurs. Destination FTP server numbers are set with the FTP server setting.
- (c) File name
Stores the file name in ASCII code.
- (d) Date (time)
Stores the time when the file was transferred in BCD code.

☒ POINT

When 17 or more errors occur, errors are registered again from error log 1.

(7) Transfer log write count (address: 6520)

Stores the cumulative number of times file transfers complete normally and a transfer log is registered.

(8) Transfer log write pointer (address: 6521)

Stores the transfer log number registered to the most recent transfer log. For example, when the value is '16', the most recent transfer log is registered to the area for transfer log 16.

3 SPECIFICATIONS

(9) Transfer log 1 to 32 (address: 6522 to 7449)

Stores the transfer history when FTP transfer completes normally.
It is comprised of 32 transfer logs with the same data configuration.

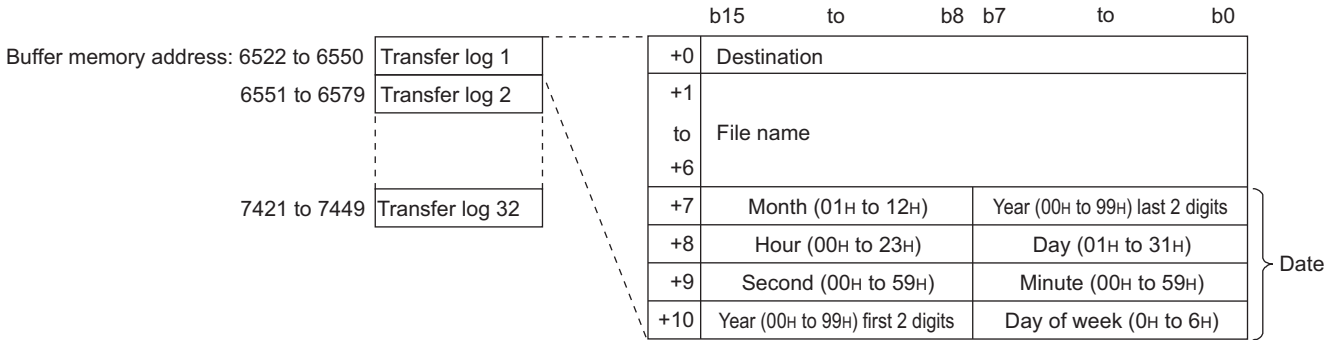

(a) Destination

Stores the destination FTP server number when a communications error occurs.
Destination FTP server numbers are set with the FTP server setting.

(b) File name

Stores the file name in ASCII code.

(c) Date (time)

Stores the time when the file was transferred in BCD code.

POINT

When 33 or more transfer logs occur, transfer logs are registered again from 1.

3 SPECIFICATIONS

3.4.17 FTP client setting area (address: 7999)

The setting of FTP client can be checked with this area.

Decimal address (Hexadecimal)	Name	Description	R/W	Initial value
7999 (1F3FH)	FTP transfer port number	Set the port number on the FTP server (personal computer) accessed by the FTP client. 0: Port 21 1 to 65535: Port 1 to 65535	R/W	0

R/W: Readable/Writable

(1) FTP transfer port number (address: 7999)

When FTP transfer port number is set to 1 by using the default operation setting (Section 4.5 (2)) of the intelligent function module switch setting, the FTP transfer port number set in this area will be enabled.

Set the FTP transfer port number by the sequence program when the module READY(X0) of the high speed data logger module turns ON from OFF

Example) A program to set the port number to 2000

(When I/O number of high speed data logger module: X/Y00 to X/Y1F)

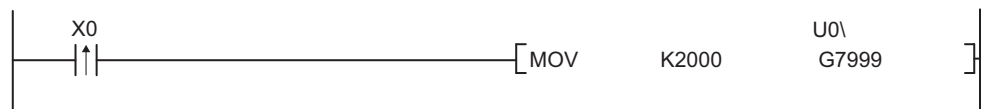

3 SPECIFICATIONS

3.4.18 Event logging area (address: 10000 to 14095)

The number of events which occurred can be checked with this area.

Decimal address (Hexadecimal)	Name	Description	R/W	Initial value
10000 (2710H)	Event logging information 1	Event 1 occurrence count	R	0
10001 to 10063 (2711H to 274FH)		Event 2 to 64 occurrence count	R	0
10064 to 14095 (2750H to 370FH)	Event logging information 2 to 64	Details are the same as event logging 1.	-	-

R: Read-only

(1) Event logging information 1 to 64 (address: 10000 to 14095)

Stores the number of times events occurs.

It is comprised of 64 pieces of event logging information with the same data configuration.

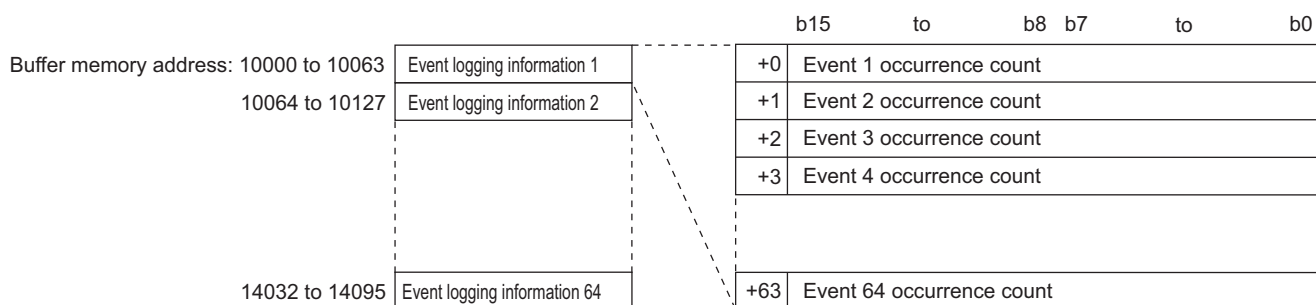

1	OVERVIEW
2	SYSTEM CONFIGURATION
3	SPECIFICATIONS
4	SETTINGS AND PROCEDURES UP TO OPERATION
5	HIGH SPEED DATA LOGGER MODULE TOOL STARTUP
6	FUNCTION LIST
7	DATA LOGGING FUNCTION
8	EVENT LOGGING FUNCTION

3.5 Directory Structure

The following figure shows the directory structure of the CompactFlash card inserted in the high speed data logger module.

When accessed with the FTP function, below '/' is the CompactFlash card root directory.

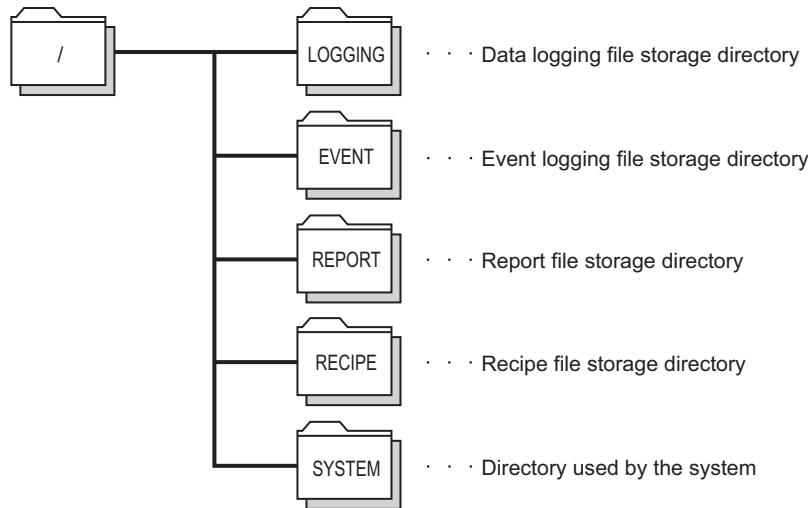

For the file access authority, refer to the following section.

☞ Section 11.4.6 (2) (a) File access authority (when using file browser or FTP)

3 SPECIFICATIONS

3.6 CSV File Format

3.6.1 CSV format specification

The CSV file format specification of data logging, event logging is listed below.

Item name	Description
Delimiter	Comma (,)
Linefeed code	CRLF (0x0D, 0x0A)
Character code	ASCII code
Field data	<ul style="list-style-type: none"> Not enclosed with double quotes ("). The data cannot use double quotes ("), commas (,). However, commas (,) can be included in the CSV output settings for "Date column". In this case, commas (,) are also included in the data type information line, data name line, and data line.
Number of lines	Maximum of 100003 (data lines + 3)*1
File size	Maximum of 16777216 bytes Can be specified in a range of 10 to 16384 x 1024 bytes.

*1: When using a high speed data logger module with a serial number whose first five digits are '14041' or lower, the maximum number of lines is 65538 (data lines + 3).

Remark

For the CSV file format of the setting information CSV file, refer to the following chapter.

➔ Appendix 10 Setting information CSV File Format

3.6.2 Data logging file

(1) Format overview

The following diagram shows the format of the data logging file.

The date, index, and trigger information column (shaded portions) can be specified not to be output. If they are not output, items are left aligned.

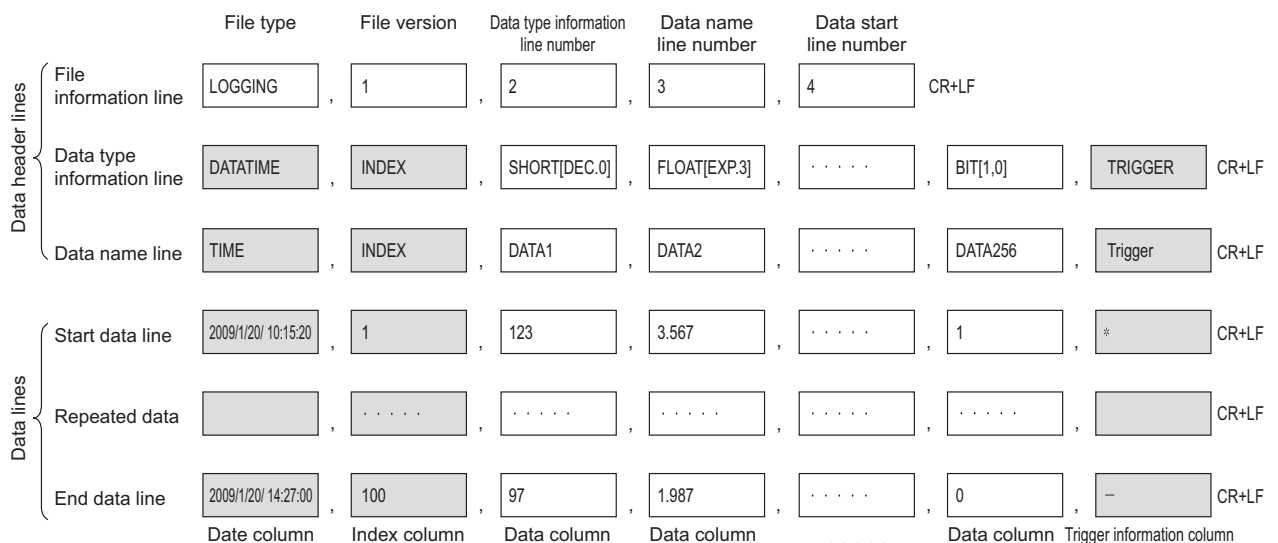

(2) Item descriptions

(a) File information line

Column name	Output content	Size (in bytes)
File type	Outputs 'LOGGING'.	9
File version	File version (1 constant)	1
Data type information line number	The value indicates the line number of the data type information line is entered. ('2' in the (1) format overview example)	1
Data name line number	The value indicates the line number of the data name line is entered. ('3' in the (1) format overview example)	1
Data start line number	The value indicates the start line number of the data line is entered. ('4' in the (1) format overview example)	1

The total size of the file information line is shown below.

$$\begin{aligned}
 \text{File information line size} &= 9 [\text{file type}] + 1 [\text{file version}] + \\
 &\quad 1 [\text{data type information line number}] + 1 [\text{data name line number}] + \\
 &\quad 1 [\text{data start line number}] + 4 [\text{number of commas}] + 2 [\text{CR+LF}] \\
 &= 19 [\text{bytes}]
 \end{aligned}$$

(b) Data type information line

Outputs in the format of (data type)[(additional information)].

① Data type

Column name	Output characters	Output content	Size (in bytes)
Date column	DATETIME	Outputs to the date column.	8
Index column	INDEX	Outputs to the index column.	5
Data column	BIT	Outputs when "Bit" is specified for the data type.	3
	SHORT	Outputs when "Word [signed]" is specified for the data type.	5
	USHORT	Outputs when "Word [unsigned]" is specified for the data type.	6
	LONG	Outputs when "Double word [signed]" is specified for the data type.	4
	ULONG	Outputs when "Double word [unsigned]" is specified for the data type.	5
	FLOAT	Outputs when "FLOAT (Single Precision)" is specified for the data type.	5
	DOUBLE	Outputs when "FLOAT (Double Precision)" is specified for the data type.	6
	BCD16	Outputs when "16bit BCD" is specified for the data type.	5
	BCD32	Outputs when "32bit BCD" is specified for the data type.	5
	STRING	Outputs when "String" is specified for the data type. ^{*1}	6
RAW	Outputs when "Raw" is specified for the data type. ^{*2}	3	
Trigger information column	TRIGGER	Indicates the trigger information column.	7

*1: Characters outside the ASCII range, double quotes ("), commas (,), and semicolons (;) are substituted with periods (.).

*2: Hexadecimal expressions are converted by byte to a string, packed, and output.

Example) For starting device D0, 4-byte raw type
D0:0x8A6B, D1:0x41C2 → "6B8AC241"

3 SPECIFICATIONS

② Additional information

Column name	Output content		Size (in bytes)
Date column	Outputs the data line output format specified with the CSV output setting. Example) [YYYY/MM/DD hh:mm:ss.s]		3 to 34
Index column	No additional information		0
BIT	[String when ON];[String when OFF]	Outputs when "Bit" is specified for the data type.	3 to 33
Data column	[DEC.digits]	Outputs when "Decimal format" is specified for the output format.	7 to 8 (Depends on digits)
	[EXP.digits]	Outputs when "Exponential format" is specified for the output format.	7 to 8 (Depends on digits)
	[HEX]	Outputs when "Hexadecimal format" is specified for the output format.	5
	Size	When "String" or "Raw" is specified for the data type, outputs the specified size.	1 to 4 (Depends on size)
Trigger information column	(String when trigger occurs); (String when trigger clears)	Outputs the string specified with the CSV output setting "When trigger condition rises" or "When trigger condition falls".*1	5 to 67 (Depends on CSV output setting)

*1: Semicolons (;), double quotes ("), and commas (,) cannot be used in the string when trigger occurs/string when trigger clears.

The size of the data type information line is calculated as shown below.

Example) For 256 points of signed 16-bit integer, decimal format (0 digits) data
(Date column YYYY/MM/DD hh:mm:ss.s, index column output)

$$\begin{aligned} \text{Data type information line size} &= (8+23) [\text{date column}] + 5 [\text{index column}] + \\ &\quad (5+7) \times 256 [\text{data column}] + 257 [\text{number of commas}] + 2 [\text{CR+LF}] \\ &= 3367 [\text{bytes}] \end{aligned}$$

(c) Data name line

Column name	Output content		Size (in bytes)
Date column	Outputs the 'data name line string' specified with the CSV output setting.		1 to 32 (Depends on CSV output setting)
Index column	Outputs "INDEX".		5
Data column	Outputs the 'data name' specified with the CSV output setting.		1 to 32 (Depends on data setting)
Trigger information column	Outputs the 'trigger information column' specified with the CSV output setting.		1 to 32 (Depends on CSV output setting)

The size of the data name line is calculated as shown below.

Example) For 256 points worth of data with a data name length of 10
(Date column YYYY/MM/DD hh:mm:ss.s, index column output)

$$\begin{aligned} \text{Data name line size} &= 21 [\text{date column}] + 5 [\text{index column}] + 10 \times 256 [\text{data column}] + \\ &\quad 257 [\text{number of commas}] + 2 [\text{CR+LF}] \\ &= 2845 [\text{bytes}] \end{aligned}$$

3 SPECIFICATIONS

(d) Data line

Column name	Output content		Size (in bytes)	
Date column	Outputs according to the data line output format specified with the CSV output setting. ^{*4} Example) 2009/1/15 10:15:20		1 to 32 (Depends on CSV output setting)	
Index column	Outputs a numerical value starting from 1 incremented in ascending order. When the value exceeds the upper limit of 4294967295, it is returned to 0 and increments again in the range of 0 to 4294967295. When missing sampling data occurs, the index is renumbered again from 1. ☞ Section 7.6 Missing Data		1 to 10 (Depends on size)	
Data column	Bit	Outputs when data is ON: (String when ON) When data is OFF : (String when OFF).	1 to 16 (Depends on data setting)	
	Word [unsigned] Word [signed] 16 bit BCD ^{*1*2}	Outputs data value according to the output format specified with the data setting.	Decimal format ^{*3}	1 to 21 (Depends on data value and digits)
			Exponential format	5 to 21 (Depends on data value and digits)
			Hexadecimal format	1 to 4 (Depends on data value)
	Double word [unsigned] Double word [signed] Float (single precision) ^{*1*2} Float (double precision) ^{*1*2} 32 bit BCD ^{*1*2}	Outputs data value according to the output format specified with the data setting.	Decimal format ^{*3}	1 to 26 (Depends on data value and digits)
			Exponential format	5 to 22 (Depends on data value and digits)
			Hexadecimal format	1 to 8 (Depends on data value)
String	Outputs a string of the specified size. ^{*5}		1 to 8192 (Depends on data value and size)	
Raw	Outputs the data values of the specified size in hexadecimal notation. Example)For a raw type from D0, size = 6 Device value D0=1234, D1=5678, D2=9ABC Output 34127856BC9A		2 to 16384 (Depends on size)	
Trigger information column	Outputs 'String when trigger occurs' when trigger occurs, and outputs 'String when trigger clears' when trigger clears. Does not output in other situations. (Outputs CR+LF immediately after the comma.)		0 to 32 (Depends on CSV output setting)	

- *1: If the device data value cannot be expressed with the data type specified for "Data type", or the operation result cannot be expressed with the specified data type, 'NaN' is output to the data line.
- *2: For arithmetic processing specified with scaling, all values are calculated as double precision floating point numbers, and the result is output in the format specified with output format. If the result of the linear function transformation with the scaling function exceeds the double precision floating point type upper limit value, 'Inf' is output. If the value is lower than the lower limit value, '-Inf' is output.
- *3: When output numerical values are outside the range of -2147483648.0 to 2147483647.0, they are expressed in a format same as 'exponential format and 9 digits in the decimal part'.
- *4: When CSV files are opened with Excel, the date column format is displayed in Excel's default setting. Set the cell format as necessary.
Example)To display year, month, date, hour, minute, second, millisecond information
Specify the user defined display format below.
m/d/yyyy hh:mm:ss.000
- *5: If there is a string terminator (0) halfway in the data, the data after it are not output.

The (maximum) size of the data line is calculated as shown below.

Example) For 256 points worth of word [unsigned] decimal format 0 digit data (date column YYYY/MM/DD hh:mm:ss.s, index column output)

$$\begin{aligned} \text{Data line size} &= 21 [\text{date column}] + 10 [\text{index column}] + 6 \times 256 [\text{data column}] + \\ &257 [\text{number of commas}] + 2 [\text{CR+LF}] \\ &= 1826 [\text{bytes}] \end{aligned}$$

3.6.3 Event logging file

(1) Format overview

The following diagram shows the format of event data logging file.
The date column (shaded portion) can be specified not to be output.
If they are not output, items are left aligned.

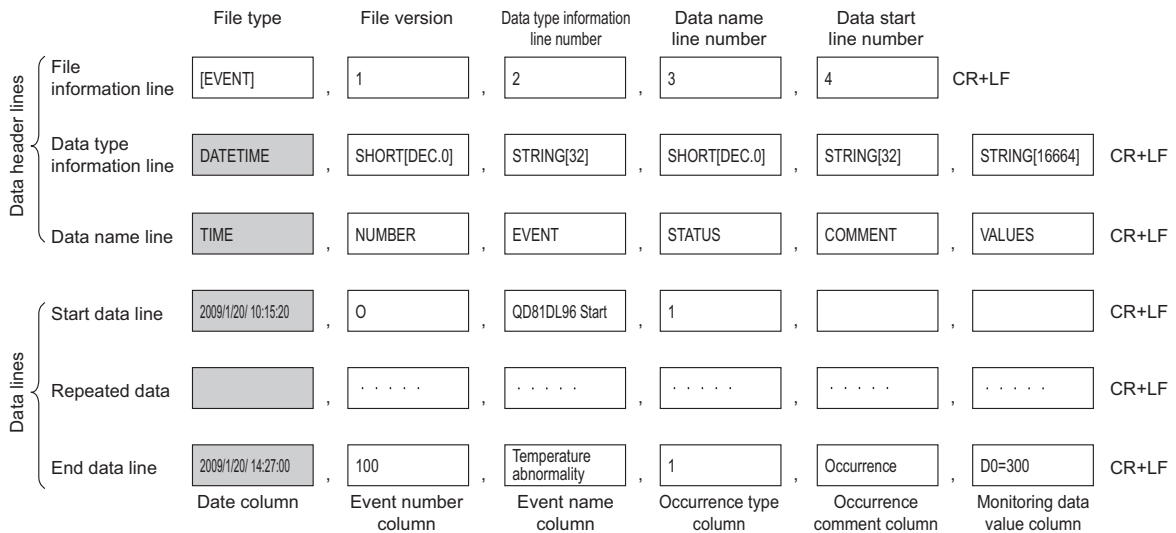

(2) Item descriptions

(a) File information line

Column name	Output content	Size (in bytes)
File type	Outputs 'EVENT'.	7
File version	File version (1 constant)	1
Data type information line number	The value indicates the line number of the data type information line is entered. ("2" in the format overview example)	1
Data name line number	The value indicates the line number of the data name line is entered. ("3" in the format overview example)	1
Data start line number	The value indicates the start line number of the data line is entered. ("4" in the format overview example)	1

The total size of the file information line is shown below.

$$\begin{aligned}
 \text{File information line size} &= 7 [\text{file type}] + 1 [\text{file version}] + \\
 &\quad 1 [\text{data type information line number}] + 1 [\text{data name line number}] + \\
 &\quad 1 [\text{data start line number}] + 4 [\text{number of commas}] + 2 [\text{CR+LF}] \\
 &= 17 [\text{bytes}]
 \end{aligned}$$

3 SPECIFICATIONS

(b) Data type information line

Outputs in the format of (data type)[(additional information)].

① Data type

Column name	Output characters	Output content	Size (in bytes)
Date column	DATETIME	Outputs to the date column.	8
Event number column	SHORT	Indicates the event number column is word type.	5
Event name column	STRING	Indicates the event name column is string type.	6
Occurrence type column	SHORT	Indicates the occurrence type column is word type.	6
Occurrence comment column	STRING	Indicates the occurrence comment column is string type.	6
Monitoring data value column	STRING	Indicates the monitoring data value column is string type.	6

② Additional information

Column name	Output content	Size (in bytes)
Date column	Outputs the data line output format specified with the CSV output setting. Example) [YYYY/MM/DD hh:mm:ss.s]	3 to 34
Event number column	[DEC.0] (constant)	7
Event name column	[32] (constant)	4
Occurrence type column	[DEC.0] (constant)	7
Occurrence comment column	[32] (constant)	6
Monitoring data value column	[16664] (constant)	7

The size of the data type information line is calculated as shown below.

Example) For date column [YYYY/MM/DD hh:mm:ss.s]

$$\begin{aligned}
 \text{Data type information line size} &= (8+23) [\text{date column}] + (5+7) [\text{event number column}] + \\
 &\quad (6+4) [\text{event name column}] + (6+7) [\text{occurrence type column}] + \\
 &\quad (6+6) [\text{occurrence comment column}] + \\
 &\quad (6+7) [\text{monitoring data value column}] + \\
 &\quad 5 [\text{number of commas}] + 2 [\text{CR+LF}] \\
 &= 98 [\text{bytes}]
 \end{aligned}$$

3 SPECIFICATIONS

(c) Data name line

Column name	Output content	Size (in bytes)
Date column	Outputs the 'data name line string' specified with the CSV output setting.	1 to 32
Event number column	Outputs 'NUMBER'.	6
Event name column	Outputs 'EVENT'.	5
Occurrence type column	Outputs 'STATUS'.	6
Occurrence comment column	Outputs 'COMMENT'.	7
Monitoring data value column	Outputs 'VALUES'.	6

The size of the data name line is calculated as shown below.

Example) If the title string for the date column is "TIME"

$$\begin{aligned}
 \text{Data name line size} &= 4 [\text{date column}] + 6 [\text{event number column}] + 5 [\text{event name column}] + \\
 &\quad 6 [\text{occurrence type column}] + 7 [\text{occurrence comment column}] + \\
 &\quad 6 [\text{monitoring data value column}] + 5 [\text{number of commas}] + 2 [\text{CR+LF}] \\
 &= 41 [\text{bytes}]
 \end{aligned}$$

(d) Data line

Column name	Output content	Size (in bytes)
Date column	Outputs according to the data line output format specified with the CSV output setting.*1 Example) 2009/1/15 10:15:20	1 to 32 (Depends on CSV output setting)
Event number column	Outputs the number of the event (1 to 64) which occurred or was restored. If the event type is "At startup of module", '0' is output.	1 to 2
Event name column	Outputs the name of the event which occurred or was restored. If the event type is "At startup of module", 'QD81DL96 Start' is output.	1 to 32
Occurrence type column	Outputs the type of event which occurred or was restored. When occurred : '1' is output. When restored : '0' is output. If the event type is "At startup of module", '1' is output.	1
Occurrence comment column	Outputs the occurrence/restoration comment configured on the Event setting screen.*2	1 to 32

*1: If the device data value specified with monitoring data cannot be expressed with the type specified for "Data type", 'NaN' is output in the data line.

*2: Outputs a blank when the high speed data logger module is restarted.
Does not output when the event type is "At startup of module".
(After the comma, the next comma is immediately output.)

(Continued on the next page)

1	OVERVIEW
2	SYSTEM CONFIGURATION
3	SPECIFICATIONS
4	SETTINGS AND PROCEDURES UP TO OPERATION
5	HIGH SPEED DATA LOGGER MODULE TOOL STARTUP
6	FUNCTION LIST
7	DATA LOGGING FUNCTION
8	EVENT LOGGING FUNCTION

3 SPECIFICATIONS

(From the previous page)

Column name	Output content	Size (in bytes)
Monitoring data value column *5*6	<p>The monitoring data value at occurrence/restoration is output in the following format.</p> <ul style="list-style-type: none"> For a single condition '(start device name)=(monitoring data value)*3 For a compound condition (comparison) '(<u>start device name</u>)=(<u>monitoring data value</u>)*1,*3 For a compound condition (number of times) 'Number of times=(count value); (<u>start device name</u>)=(<u>monitoring data value</u>)*2,*3 For a compound condition (order) '(completion information); (<u>start device name</u>)=(<u>monitoring data value</u>)*2,*3 <p>The following is output in the completion information.</p> <ul style="list-style-type: none"> When normal pattern is detected: 'Complete' When abnormal pattern is detected or timeout is detected: 'Phase=[condition location]' <p>The condition number which detected the abnormal pattern or timeout is output to condition location.</p> <p>1: 1st condition 2: 2nd condition 3: 3rd condition</p> <p>Not output when the event type is "At startup of module". (Outputs CR+LF immediately after the comma.)</p>	0 to 16664

*1: In the underlined portions, information of set amount of event condition is output delimited with a ';' (semicolon)'.
*2: In the underlined portions, information of start condition, end condition and count condition is output delimited with a '; (semicolon)'.

*3: If the monitoring data value is string type data, characters outside the ASCII range, double quotes ("), commas (,), and semicolons (;) are substituted with periods (.).

The size of the data line is calculated as shown below.

Example) For date column format of YYYY/MM/DD hh:mm:ss.s, event name length 10, occurrence comment length 4, single condition, monitoring data is word [unsigned] decimal format 0 digits

$$\begin{aligned}
 \text{Data size} &= 21 [\text{date column}] + 2 [\text{event number column}] + 10 [\text{event name column}] + \\
 &1 [\text{occurrence type column}] + 4 [\text{occurrence comment column}] + \\
 &13 [\text{monitoring data value column}^{*4}] + \\
 &5 [\text{number of commas}] + 2 [\text{CR+LF}] \\
 &= 58 [\text{bytes}]
 \end{aligned}$$

*4: When 'D12000=-23456' is set for the monitoring data value column, 13 bytes.

*5: When CSV files are opened with Excel, the date column format is displayed in Excel's default setting. Set the cell format as necessary.

Example) To display year, month, date, hour, minute, second, millisecond information

Specify the user defined display format below.

m/d/yyyy hh:mm:ss.000

*6: Not output when the data count is 0.

3.7 Binary File Format

This section explains about the binary data format of the data logging file and event logging file.

3.7.1 Data logging file

(1) Binary format configuration diagram

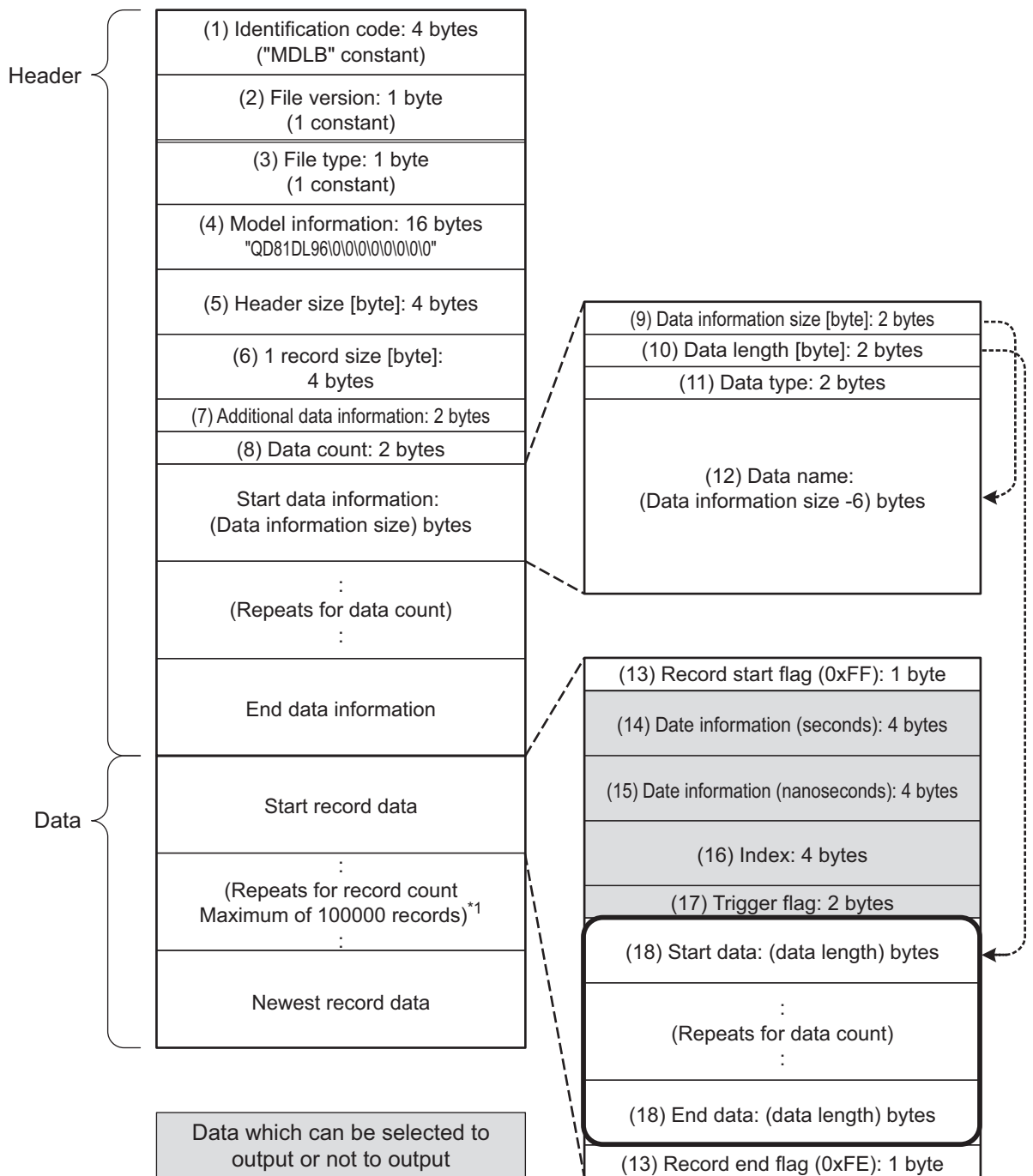

*1: When using a high speed data logger module with a serial number whose first five digits are '14041' or lower, the maximum number of records is 65535.

3 SPECIFICATIONS

(2) Binary format details

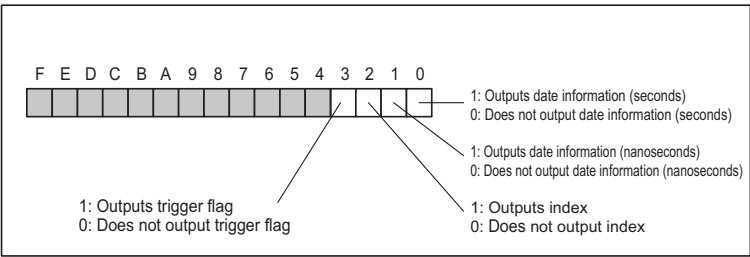
	Item	Description	Size (in bytes)
(1)	Identification code	Always outputs 'MDLB' as file identification.	4
(2)	File version	Outputs 1 as the file version.	1
(3)	File type	Outputs the file type. 1: Continuous/trigger logging 2: Event logging	1
(4)	Model information	Outputs the module model name which output the binary file. Outputs 'QD81DL96' in the first 8 bytes, packed with 0x00 in the second 8 bytes.	16
(5)	Header size	Outputs the size of the header portion.	4
(6)	1 record size	Outputs the size of 1 record.	4
(7)	Additional data information	For the data which can be selected to output, outputs information on whether they are being output. 	2
(8)	Data count	Outputs the logging data count configured in logging.	2
(9)	Data information size	Outputs the total size of the data information size (2 bytes) and each of the sizes of data length (10), data type (11), data name (12) per logging data.	2
(10)	Data length	Outputs the data length of logging data. (If the data type is bit type, outputs 1 byte.)	2
(11)	Data type ^{*1}	Matched to the data type specified with output format, outputs the following values. 0: Bit 1: Signed integer 2: Unsigned integer 3: Float 4: BCD 5: String 6: Raw	2
(12)	Data name	Outputs the logging data name specified with the settings in ASCII code.	1 to 32
(13)	Record start flag Record end flag	Outputs flags to identify the start and end of records. Matched to the start/end of records, outputs the following constant values. 0xFF: Record start 0xFF: Record end	1
(14)	Date information (seconds)	Outputs the number of elapsed seconds from January 1st 1970.	4
(15)	Date information (nanoseconds) ^{*2}	Outputs the remainder of time which is less than a second from the number of elapsed seconds from January 1st 1970 in nanoseconds.	4
(16)	Index	Outputs a numerical value starting from 1 incremented in ascending order. When the value exceeds the upper limit of 4294967295, it is returned to 0 and increments again in the range of 0 to 4294967295. When missing sampling data occurs, the index is renumbered again from 1. ☞ Section 7.6 Missing Data	4

(Continued on the next page)

3 SPECIFICATIONS

(From the previous page)

	Item	Description	Size (in bytes)
(17)	Trigger flag	Outputs trigger information. 0: Not occurred 1: Occurred 2: Cleared	2
(18)	Data* ¹	Logging data are output in binary according to the data type specified with data length (10) and output format (11). For details on the numerical range of output values, refer to the following section. ☞ Section 3.9 Range of Values per Output Format	-
	Bit	Outputs the following values. If data is ON : 1 If data is OFF: 0	1
	Word [unsigned]* ¹ Word [signed]* ¹ 16 bit BCD	Outputs the data value in word units.	2
	Double word [unsigned]* ¹ Double word [signed]* ¹ Float (single precision)* ³ Float (double precision)* ³ 32 bit BCD	Outputs the data value in double word units.	4
	String	Outputs a string of the specified size. If there is a string terminator (0) halfway in the data, NULL is output up to the end of the specified size after that terminator.	1 to 8192
	Raw	Outputs data values of the specified size.	1 to 8192

*1: If a value which cannot be correctly expressed in the specified data type is stored in the device's data value, '0' is output.

*2: Data value is rounded off to 0.1 millisecond unit when the high speed data sampling is specified, and to 100 millisecond unit when the general data sampling is specified.

*3: When the device data value output format is '16 bit BCD' or '32 bit BCD', if a value which cannot be correctly expressed in the BCD type is stored in the device's data value, the NaN value is output.

Output format	NaN
Float (single precision)	0xffffffff
Float (double precision)	0xffffffffffff

The size of the data logging binary file is calculated as shown below.

Example) For 256 points worth of word [unsigned] decimal format 0 digit data
(data name length: 10, date information: output in nanosecond units, index column: output)

$$\begin{aligned}
 \text{File size (maximum)} &= 4 [\text{identification code}] + 1 [\text{file version}] + 1 [\text{file type}] + \\
 &16 [\text{model information}] + 4 [\text{header size}] + 4 [1 \text{ record size}] + \\
 &2 [\text{additional data information}] + 2 [\text{data count}] + (2 [\text{data information size}] + \\
 &2 [\text{data length}] + 2 [\text{data type}] + 10 [\text{data name}]) \times 256 [\text{data count}] + \\
 &1 [\text{record start flag}] + 4 [\text{date information (seconds)}] + \\
 &4 [\text{date information (nanoseconds)}] \\
 &4 [\text{index}] + (2 [\text{data}] \times 256 [\text{data count}]) + \\
 &1 [\text{record end flag}] \\
 &= 4656 [\text{bytes}]
 \end{aligned}$$

1	OVERVIEW
2	SYSTEM CONFIGURATION
3	SPECIFICATIONS
4	SETTINGS AND PROCEDURES UP TO OPERATION
5	HIGH SPEED DATA LOGGER MODULE TOOL STARTUP
6	FUNCTION LIST
7	DATA LOGGING FUNCTION
8	EVENT LOGGING FUNCTION

3.7.2 Event logging file

(1) Binary format configuration diagram

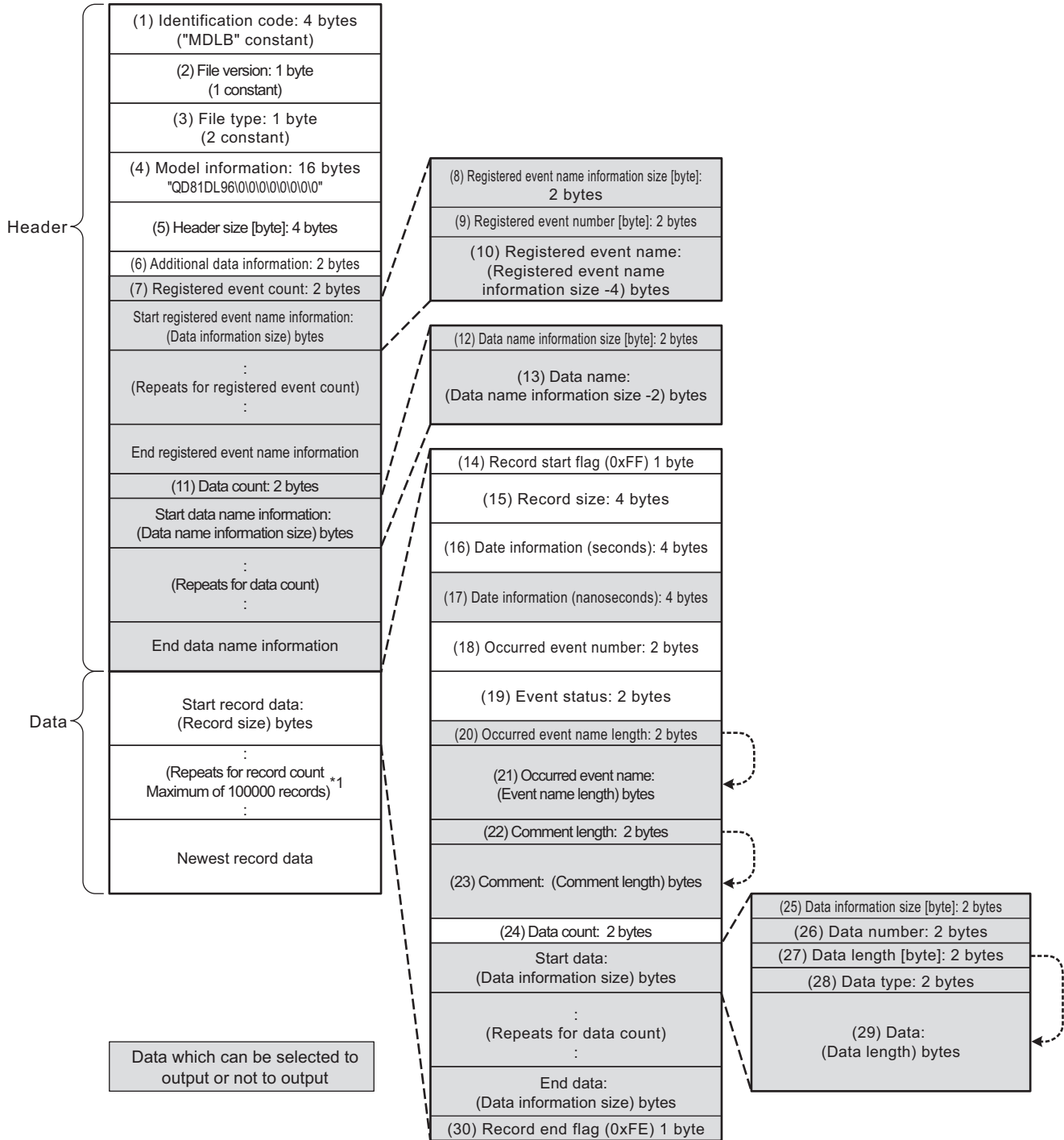

*1: When using a high speed data logger module with a serial number whose first five digits are '14041' or lower, the maximum number of records is 65535.

3 SPECIFICATIONS

(2) Binary format details

	Item	Description	Size (in bytes)
(1)	Identification code	Always outputs 'MDLB' as file identification.	4
(2)	File version	Outputs 1 as the file version.	1
(3)	File type	Outputs the file type. 1: Continuous/trigger logging 2: Event logging	1
(4)	Model information	Outputs the module model name which output the binary file. Outputs 'QD81DL96' in the first 8 bytes, packed with 0x00 in the second 8 bytes.	16
(5)	Header size	Outputs the size of the header portion.	4
(6)	Additional data information	For the data which can be selected to output, outputs information on whether they are being output. 	2
(7)	Registered event count	Outputs the number of monitoring events registered in the settings.	2
(8)	Registered event name information size	Outputs the size of information on event names including itself (2 bytes).	2
(9)	Registered event number	Outputs the event numbers registered in the settings. Use when obtaining the event name that corresponds to occurred event number (18) for occurred/restored events.	2
(10)	Registered event name	Outputs the event name registered with the settings in ASCII code. Use when obtaining the event name that corresponds to occurred event number (18) for occurred/restored events.	1 to 32
(11)	Data count	Outputs the amount of monitoring data registered in all the event settings.	2
(12)	Data name information size	Outputs the data name information size including itself (2 bytes). Use when obtaining the data name that corresponds to data number (26) for occurred/restored events.	2
(13)	Data name	Outputs the data name registered with the settings in ASCII code. Use when obtaining the data name that corresponds to data number (26) for occurred/restored events.	1 to 9
(14)	Record start flag Record end flag	Outputs flags to identify the start and end of records. Matched to the start/end of records, outputs the following constant values. 0xFF: Record start 0xFF: Record end	1
(15)	Record size	Outputs the record size including itself (4 bytes). Since occurred event name (21), comment (23), data (29) are output in variable lengths, outputs a different value per record.	4
(16)	Date information (seconds)	Outputs the number of elapsed seconds from January 1st 1970.	4
(17)	Date information (nanoseconds) ^{*1}	Outputs the remainder of time which is less than a second from the number of elapsed seconds from January 1st 1970 in nanoseconds.	4
(18)	Occurred event number	Outputs the event number for the occurred/restored event. (When the high speed data logger module is restarted, outputs the event number as 0.)	2

(Continued on the next page)

3 SPECIFICATIONS

The size of the event logging binary file is calculated as shown below.

Example) For monitoring word [unsigned] decimal format 0 digit data with single conditions (Event name length: 10, data name length: 2, "Event names are outputted into record data.": checked, "Comment is outputted into record data.": checked, comment length: 10, data length: 2)

$$\begin{aligned} \text{File size (maximum)} &= 4 [\text{identification code}] + 1 [\text{file version}] + 1 [\text{file type}] + \\ &16 [\text{model information}] + 4 [\text{header size}] + 2 [\text{additional data information}] + \\ &2 [\text{registered event count}] + (2 [\text{registered event name information size}] + \\ &2 [\text{register event number}] + 10 [\text{registered event name}]) \times 1 [\text{registered event count}] + \\ &(2 [\text{data count}] + 2 [\text{data name information size}] + 2 [\text{data name}]) \times \\ &1 [\text{data count}] + 1 [\text{record start flag}] + \\ &4 [\text{record size}] + 4 [\text{date information (seconds)}] + \\ &4 [\text{date information (nanoseconds)}] + 2 [\text{occurred event number}] + \\ &2 [\text{event status}] + 2 [\text{occurred event name length}] + \\ &10 [\text{occurred event name}] + 2 [\text{comment length}] + 10 [\text{comment}] + \\ &2 [\text{data count}] + (2 [\text{data information size}] + \\ &2 [\text{data number}] + 2 [\text{data length}] + 2 [\text{data type}] + \\ &2 [\text{data}]) \times 1 [\text{data count}] + 1 [\text{record end flag}] \\ &= 104 [\text{bytes}] \end{aligned}$$

1

OVERVIEW

2

SYSTEM CONFIGURATION

3

SPECIFICATIONS

4

SETTINGS AND PROCEDURES UP TO OPERATION

5

HIGH SPEED DATA LOGGER MODULE TOOL STARTUP

6

FUNCTION LIST

7

DATA LOGGING FUNCTION

8

EVENT LOGGING FUNCTION

3.8 Recipe File Format

(1) Format overview

The following figure shows the format of the recipe file.

Recipe with Record Attribute		① Block number	② Record number	③ Record attribute					
Block Number	6	Record Number	5	⑨ Record comment					
(Linefeed)									
Device	Device Type	Points	Comment	Device Valve	⑩ Record number				
					2	3	4	5	
					Process 1 setting / Process 2 setting / Process 3 setting / Process 4 setting / Process 5 setting				
					P			N	
D1	Word (signed)	1	Item name/Item number	1	2	3		5	
D11	Word (signed)	1	All process/Material	1000	2000	3000		5000	
M11	Bit	1	All process/Setting-1	1	1	0		1	
M12	Bit	1	All process/Setting-2	1	0	1		1	
D21	Word (signed)	2	Post-process/Shape	15	25	35		55	
			Post-process/Colour number	224	248	27		227	
M21	Bit	1	Post-process/Setting-1	1	1	0		0	
(a) Fixed string field									
(b) Read target field									
(c) Write target field									
(d) Read/Write target field									
(e) Comment field									

(a) Fixed string field

Fixed strings for the recipe function. Editing the strings causes the malfunction of the recipe execution operation.

(b) Read target field

Data are read to the programmable controller CPU when the data read function is executed. Data do not change even when the data write function is executed.

(c) Write target field

Device values are written from the programmable controller CPU when the data write function is executed. Records with N attribute are the write target field. The record attribute becomes no attribute and the field becomes the Read/Write target field after the data write function is executed.

(d) Read/Write target field

Device values are read to the programmable controller CPU when the data read function is executed, and device values from the programmable controller CPU are written to these fields when the data write function is executed.

(e) Comment field

Data are not read to the programmable controller CPU even when the data read function is executed. Fields can be left blank. Specify comments to determine the usage of devices and record files within the recipe file.

(2) Item descriptions

Item	Description
① Block number	Outputs the number of blocks. (1 to 256)
② Record number	Outputs the number of records. (1 to 256)
③ Device	Outputs the devices for the recipe execution operation. Specify the start device for data types which require multiple points, or when specifying series of multiple data.
④ Data type	Outputs any of the following data type.
	• Bit
	• Word (signed)
	• Double word (signed)
	• Word (unsigned)
	• Double word (unsigned)
	• Float (single precision)
	• Float (double precision)
⑤ Number of data ^{*1}	Outputs the number of sequential devices.
	The number of data that can be set differs depending on the device type. (Bit device: 1 point, Devices other than bit: 1 to 256 points)
⑥ Device comment (option)	Outputs the device comment. (Up to 32 characters)
⑦ Device value ^{*2*3}	Outputs device values used for the data read/write function. When the data read function is executed, data entered in this field are reflected to the specified devices in the programmable controller CPU. When the data write function is executed, the specified devices in the programmable controller CPU are reflected to the data in this field.
⑧ Record attribute	Outputs the record attribute. (☞ Chapter 15 (3) (c))
	• Blank: No attribute
	• N: N attribute • P: P attribute
⑨ Record comment (option)	Outputs the record comment. (Up to 32 characters)
⑩ Record number	Outputs the record number.
	Same record number cannot be set within the same recipe file.

*1: The total number of data in a single recipe file is 256.

*2: Fields of device values cannot be left blank except when N is specified for the record attribute.

*3: Set the device value in decimal notation.

Remark

(1) The items described above can be edited.

(2) Set a recipe file name within 32 characters.

For recipe file names, use the characters usable in file names and folder (directory) names only. (☞ Appendix 4.2)

3.9 Range of Values per Output Format

This section explains the range of values that can be output for each output format.

(1) Integer type

The following table shows the range of values that can be expressed with each integer type.

Output type	Lower limit	Upper limit
Word [unsigned]	0	65535
Word [signed]	-32768	32767
16 bit BCD	0000	9999
Double word [unsigned] ^{*1}	0	4294967295
Double word [signed] ^{*1}	-2147483648	2147483647
32 bit BCD	00000000	99999999

*1: When using a high speed data logger module with a serial number whose first five digits are '11101' or lower, the range of values that can be expressed for report output is as follows:

Output type	Lower limit	Upper limit
Double word [unsigned]	0	536870911
Double word [signed]	-536870912	536870911

POINT

If device data values or values after scaling exceed the value range, they are rounded to within the range.

- If the value exceeds the upper limit value, the upper limit value is output.
- If the value is lower than the lower limit value, the lower limit value is output.

(2) Float type

The following table shows the range of values that can be expressed with each float type.

Output type	Negative values		Positive values	
	Lower limit	Upper limit	Lower limit	Upper limit
Float (single precision)	-3.4028235E+38	-1.401298E-45	1.401298E-45	3.4028235E+38
Float (double precision)	-1.79769313486231570E+308	-4.94065645841246544E-324 ^{*1}	4.94065645841246544E-324 ^{*2}	1.79769313486231570E+308

*1: -1.79769313486231570E-308 with the report function.

*2: 1.79769313486231570E-308 with the report function.

POINT

If device data values or values after scaling exceed the value range, the following is output.

- If the value exceeds the upper limit value of positive value, '+Inf' is output.
- If the value is lower than the lower limit value of negative value, '-Inf' is output.
- For values in a range between the upper limit value of negative value and the lower limit value of positive value, '0' is output.

Output type	-Inf	0	+Inf
Float (single precision)	0xff800000	0x00000000	0x7f800000
Float (double precision)	0xffff000000000000	0x0000000000000000	0x7fff000000000000

CHAPTER 4 SETTINGS AND PROCEDURES UP TO OPERATION

This chapter explains the configuration and the procedures up to operating the high speed data logger module in a system.

POINT

- (1) Read the safety precautions in this manual when using the high speed data logger module.
- (2) The mounting and installation environment of the high speed data logger module is the same as that of the programmable controller CPU. For the mounting and installation environment of the high speed data logger module, refer to the following manual.

☞ QCPU Module User's Manual (Hardware Design, Maintenance and Inspection)

4.1 Handling Precautions

This section explains the precautions for handling the high speed data logger module itself.

- (1) **Do not drop or apply severe shock to the high speed data logger module case.**
- (2) **Tighten the module fixing screws within the following range.**

Screw location	Tightening torque range
Module fixing screw (M3) ^{*1}	0.36 to 0.48 N·m

^{*1}: The module can be easily fixed onto the base unit by using the hook at its top. However, it is recommended to secure the module with the module fixing screw if the module is subject to significant vibrations.

4 SETTINGS AND PROCEDURES UP TO OPERATION

4.2 Configuration and Procedures Up to Operation

This section explains the procedures for the high speed data logger module up to operation.

4.2.1 Procedure to operate by installing high speed data logger module Configuration Tool

This section explains the procedure for using the high speed data logger module with installing the high speed data logger module Configuration Tool.

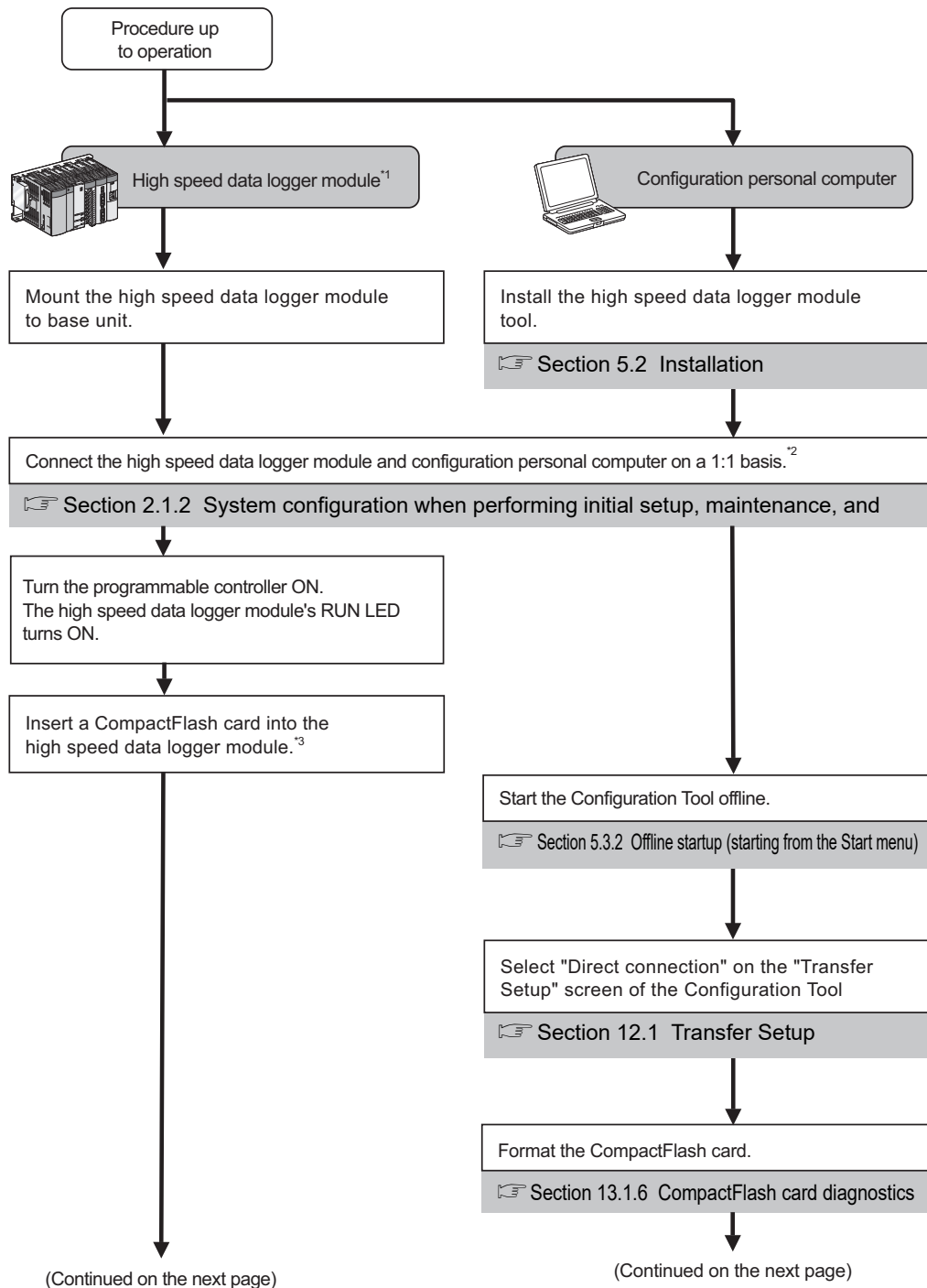

4 SETTINGS AND PROCEDURES UP TO OPERATION

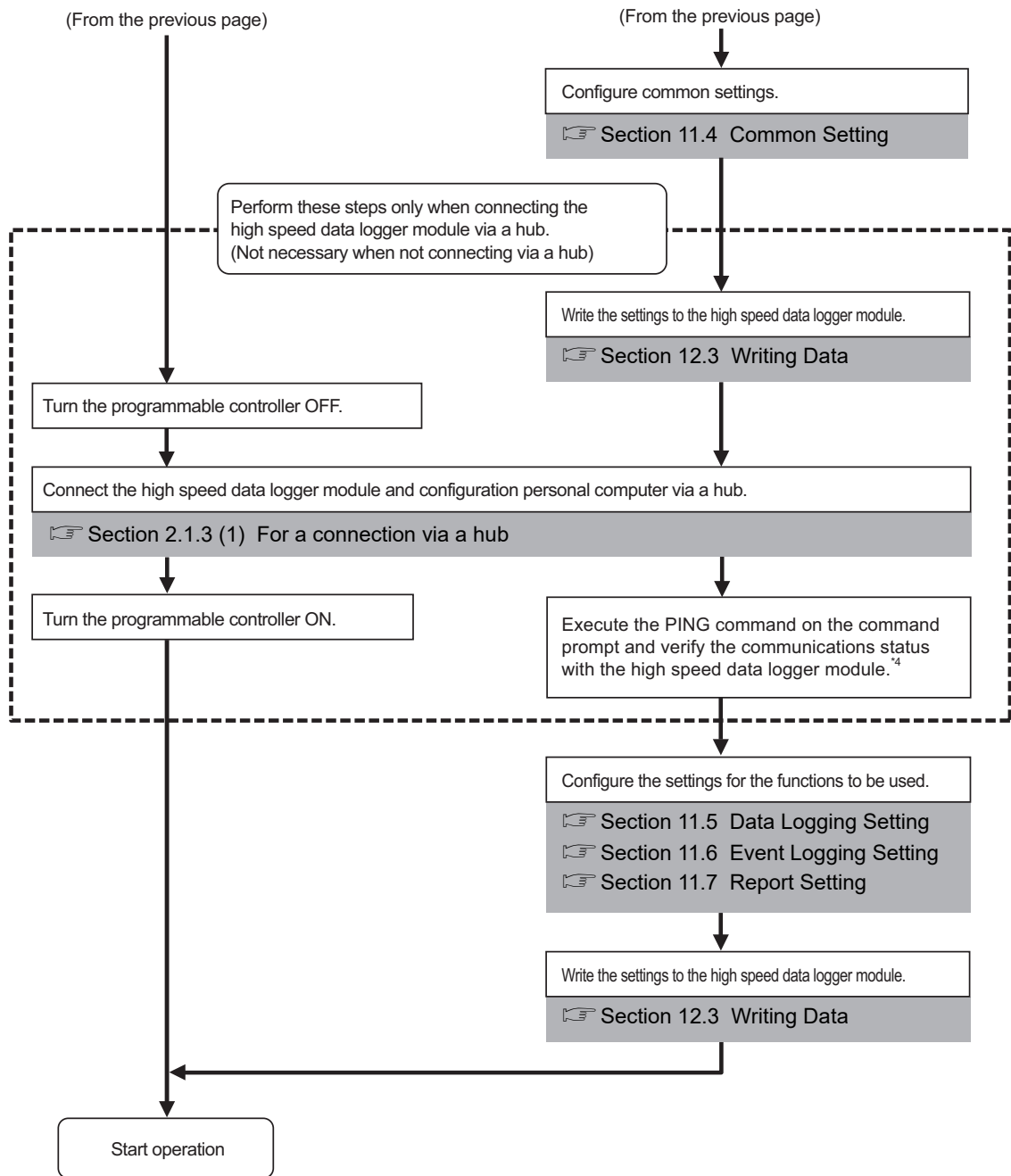

The procedures from the settings to execution of the recipe function, refer to the following section.

☞ Section 15.1 Recipe Function Execution Procedure

1	OVERVIEW
2	SYSTEM CONFIGURATION
3	SPECIFICATIONS
4	SETTINGS AND PROCEDURES UP TO OPERATION
5	HIGH SPEED DATA LOGGER MODULE TOOL STARTUP
6	FUNCTION LIST
7	DATA LOGGING FUNCTION
8	EVENT LOGGING FUNCTION

4 SETTINGS AND PROCEDURES UP TO OPERATION

- *1: To check the high speed data logger module hardware, perform a self-diagnostics test as necessary.
 - ☞ Section 4.6 Self-Diagnostics Tests
- *2: If you forget your account or cannot log in to the high speed data logger module, eject the CompactFlash card from the high speed data logger module, and continue the following steps. For the method for ejecting the CompactFlash card, refer to the following section.
 - ☞ Section 16.5 Operations for Ejecting and Reinserting CompactFlash Card
- *3: For precautions when using a CompactFlash card and the method for inserting it, refer to the following sections.
 - ☞ Section 16.3 Precautions when Using CompactFlash Card
 - ☞ Section 16.4 Operations for Inserting CompactFlash Card
- *4: When the settings are completed abnormally, check the following and execute the PING command again.
 - ☞ Appendix 2 PING Test
 - Network settings for the high speed data logger module and configuration personal computer
 - Connection status for the high speed data logger module and configuration personal computer

POINT

To check the logging results with graphs and lists, use GX LogViewer. For the procedure of using GX LogViewer, refer to the following manual.

☞ GX LogViewer Version 1 Operating Manual

4 SETTINGS AND PROCEDURES UP TO OPERATION

4.2.2 Procedure to operate without installing high speed data logger module Configuration Tool

This section explains the procedure for using the high speed data logger module without installing the high speed data logger module Configuration Tool.

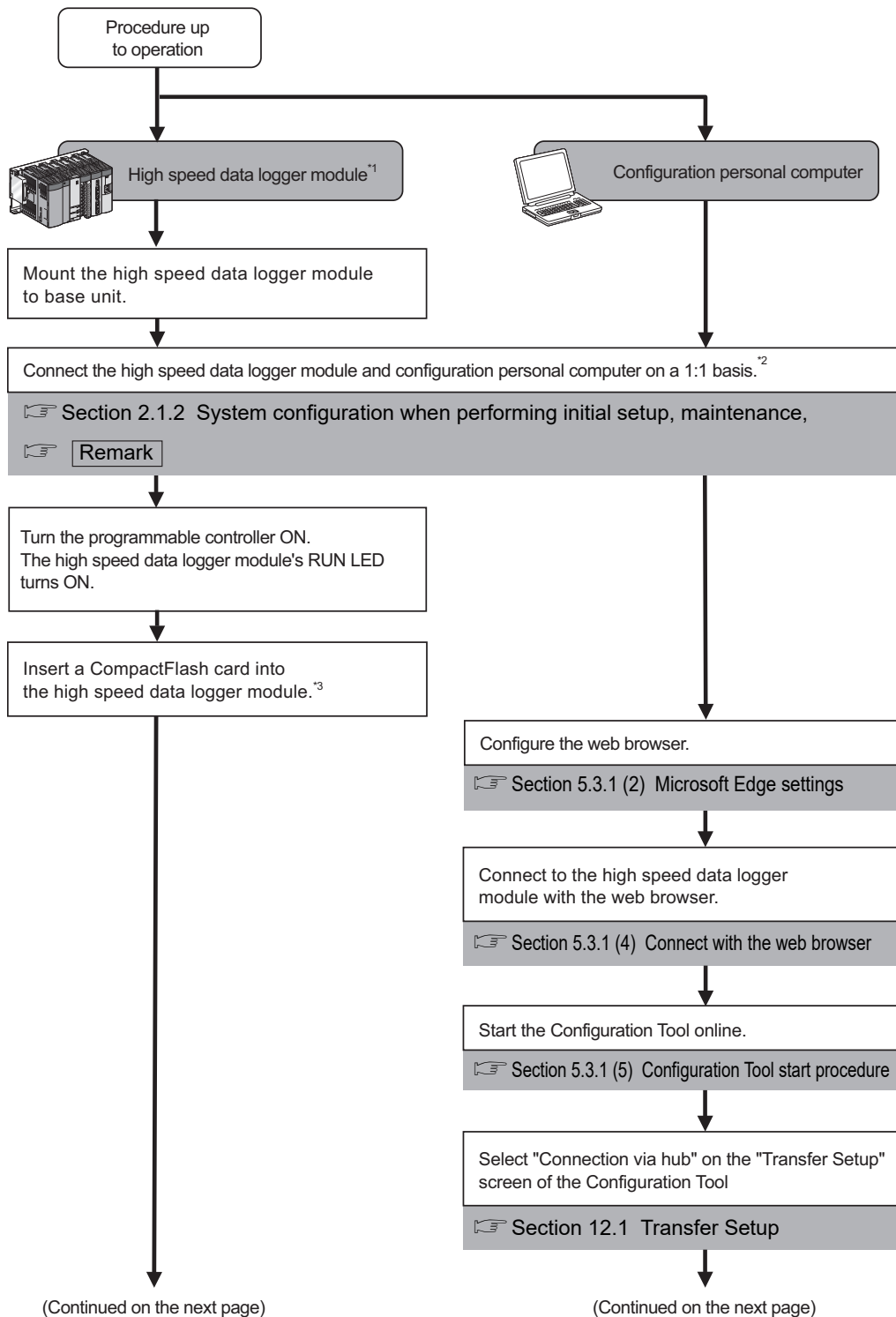

4 SETTINGS AND PROCEDURES UP TO OPERATION

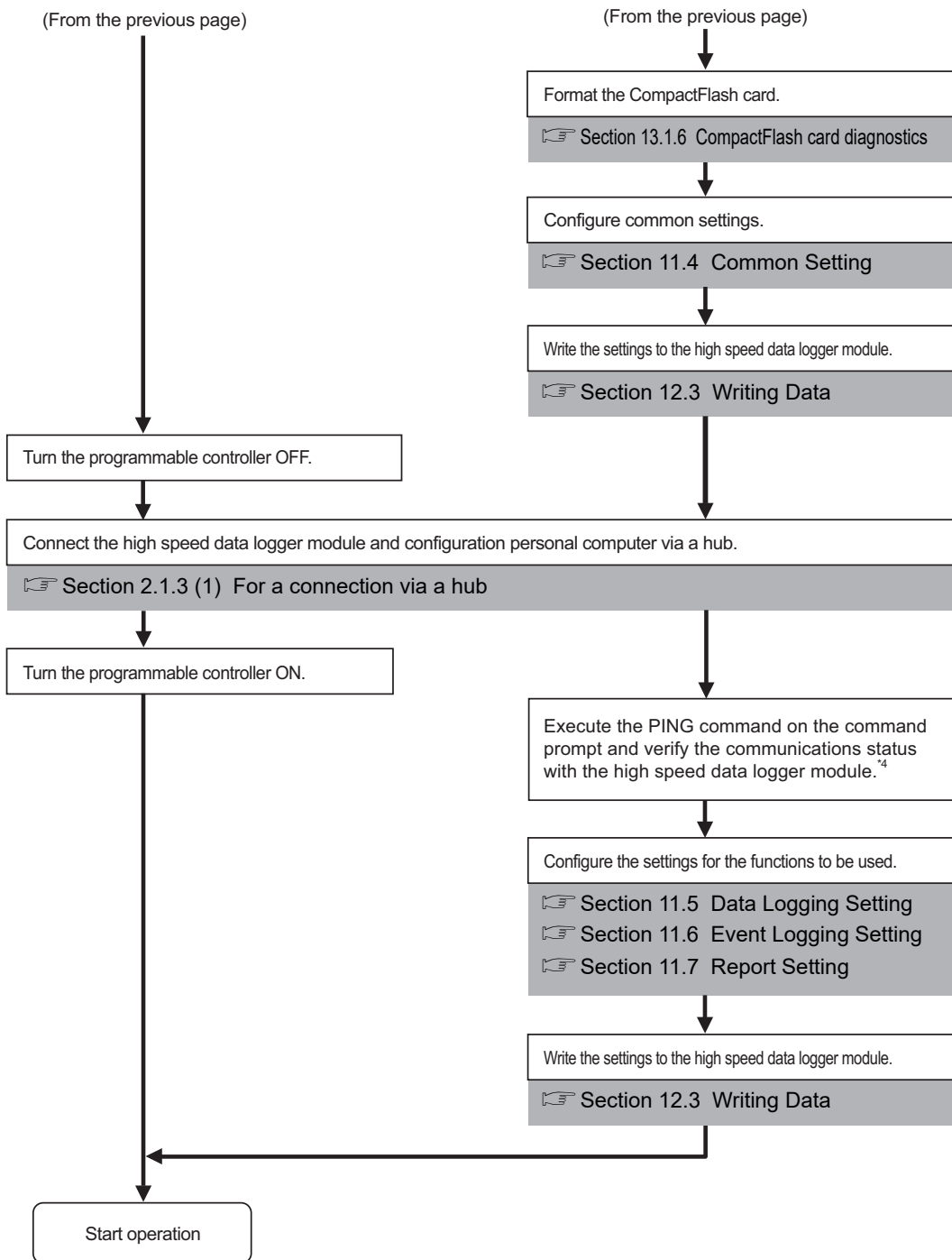

The procedures from the settings to execution of the recipe function, refer to the following section.

Section 15.1 Recipe Function Execution Procedure

4 SETTINGS AND PROCEDURES UP TO OPERATION

- *1: To check the high speed data logger module hardware, perform a self-diagnostics test as necessary.
 - ☞ Section 4.6 Self-Diagnostics Tests
- *2: If you forget your account or cannot log in to the high speed data logger module, eject the CompactFlash card from the high speed data logger module, and continue the following steps. For the method for ejecting the CompactFlash card, refer to the following section.
 - ☞ Section 16.5 Operations for Ejecting and Reinserting CompactFlash Card
- *3: For precautions when using a CompactFlash card and the method for inserting it, refer to the following sections.
 - ☞ Section 16.3 Precautions when Using CompactFlash Card
 - ☞ Section 16.4 Operations for Inserting CompactFlash Card
- *4: When the settings are completed abnormally, check the following and execute the PING command again.
 - ☞ Appendix 2 PING Test
 - Network settings for the high speed data logger module and configuration personal computer
 - Connection status for the high speed data logger module and configuration personal computer

Remark

The following explains the network settings of the configuration personal computer when connecting it to the high speed data logger module on a 1:1 basis.

- (1) Configure the personal computer's network address to be the same as the high speed data logger module's.

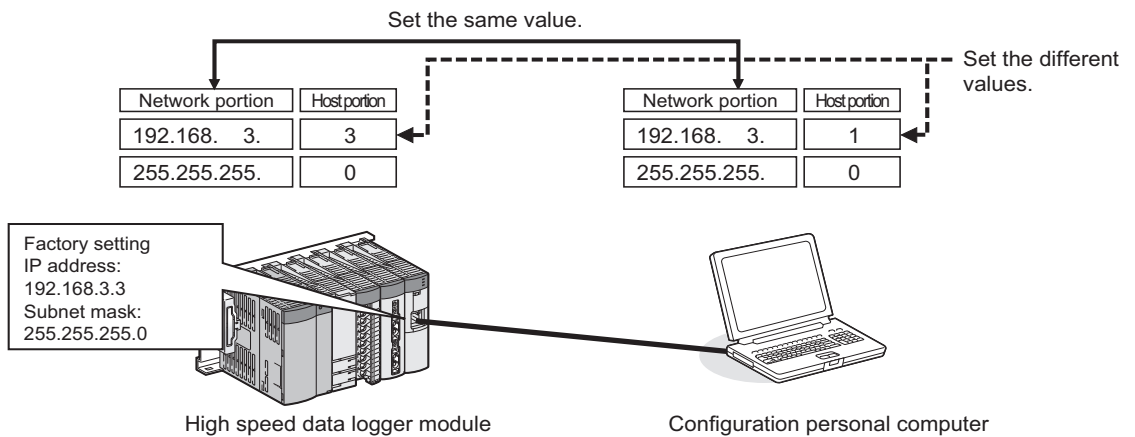

4 SETTINGS AND PROCEDURES UP TO OPERATION

(2) Make the network settings for the personal computer on the "Internet Protocol (TCP/IP) Properties" screen.

(Example) Network configuration procedure for Microsoft® Windows Vista® Business Operating System

- ① Select [Control Panel] → [View network status and tasks] → [Manage network connections].
- ② Select "Local Area Connection" and click [Properties] on the right click menu.
- ③ On the "Local Area Connection Properties" screen, select "Internet Protocol Version 4 (TCP/IPv4)" and click the button.
- ④ The "Internet Protocol Version 4 (TCP/IPv4) Properties" screen is displayed.

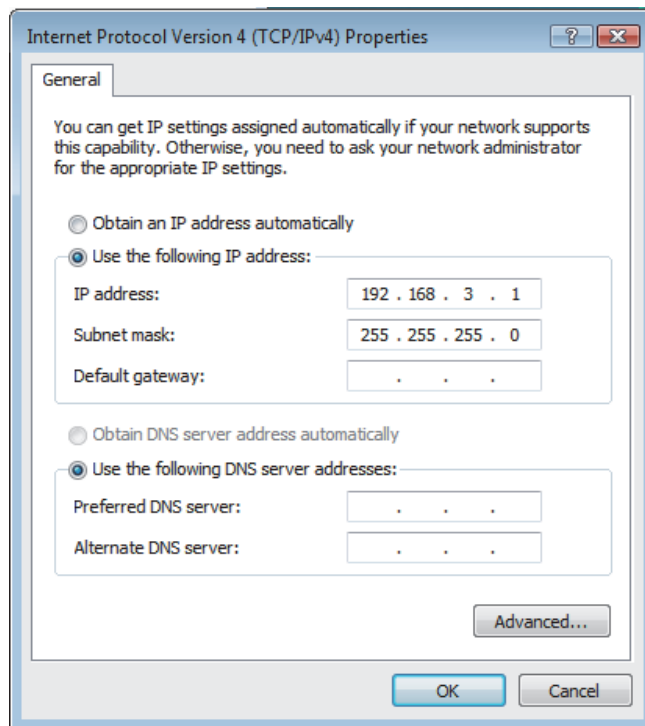

(3) Restart the personal computer to enable the network settings.

.....

4 SETTINGS AND PROCEDURES UP TO OPERATION

4.2.3 High speed data logger module operation settings

High speed data logger module operation settings are configured with the Configuration Tool. The following diagram shows a configuration operation overview of Configuration Tool.

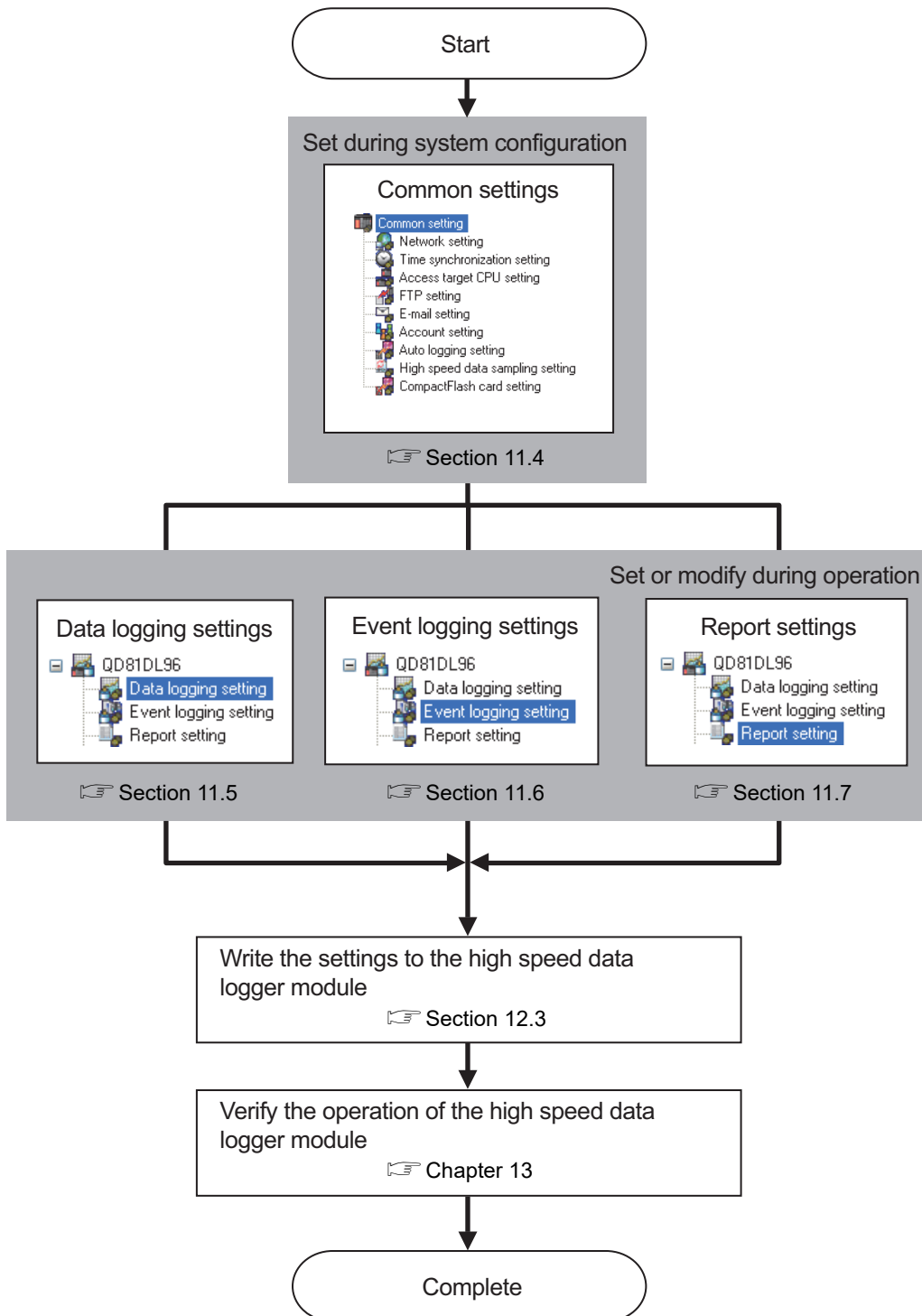

For the operation overview of the recipe function, refer to the following section.
☞ Section 15.1 Recipe Function Execution Procedure

4 SETTINGS AND PROCEDURES UP TO OPERATION

4.3 Parts Names

This section explains the parts of the high speed data logger module.

(1) With the LED cover closed

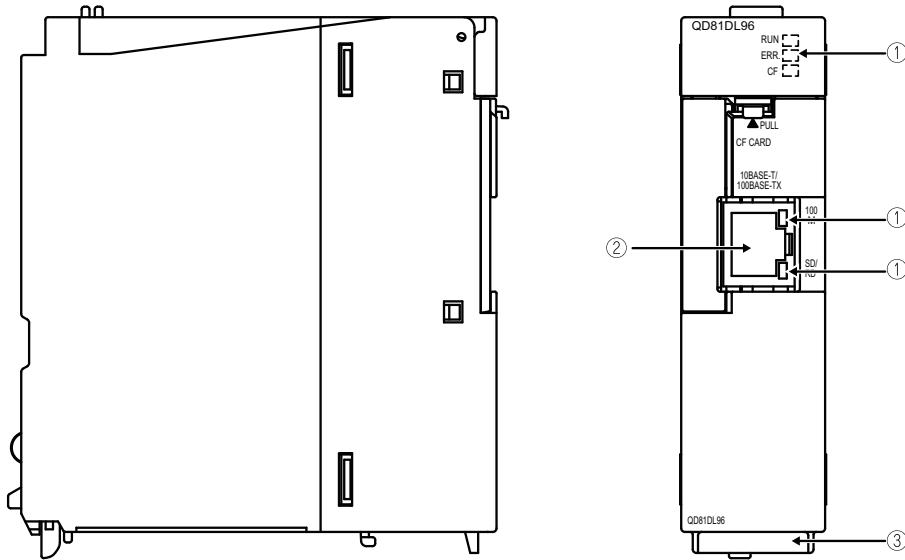

(2) With the LED cover open

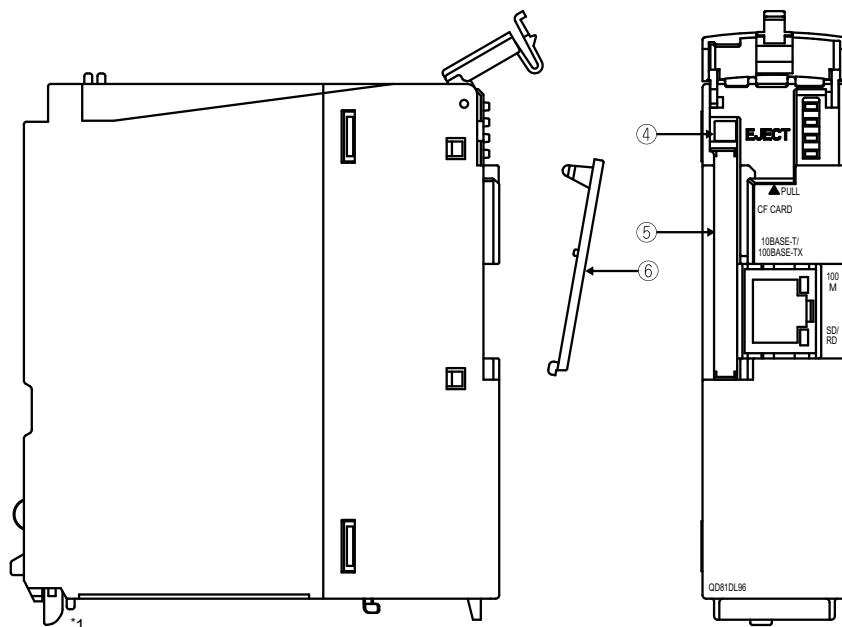

*1: A battery is not used with the high speed data logger module.

Parts names are shown on the next page.

4 SETTINGS AND PROCEDURES UP TO OPERATION

	Name	Description
①	Indicator LED	Refer to the indicator LED display ( (3) in this section)
②	10BASE-T/100BASE-TX Interface connector (RJ45)	A connector to connect the high speed data logger module to the 10BASE-T/100BASE-TX. (The high speed data logger module distinguishes 10BASE-T from 100BASE-TX according to the external device.)
③	Serial number indication plate	Indicates the serial number of QD81DL96.
④	EJECT button	This button ejects the CompactFlash card from the high speed data logger module.
⑤	CompactFlash card slot	Slot to insert the CompactFlash card into the high speed data logger module.
⑥	CompactFlash card slot cover	Cover for the CompactFlash card slot

*1: A battery is not used with the high speed data logger module.

(3) Indicator LED display

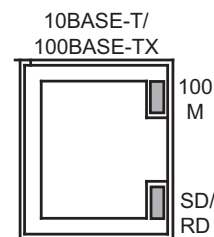
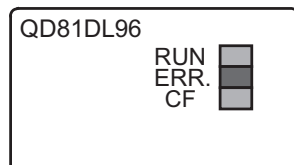

Name	LED status	Description
RUN	ON	Module operating normally*2
	OFF	<ul style="list-style-type: none"> Power OFF status Watchdog timer error (hardware failure)
	Flashing	Checking module (Flashes for 10 seconds when the  button is pressed on the "Find High Speed Data Logger Module" screen of the Configuration Tool or GX LogViewer.)
ERR.	OFF	Status normal
	ON	Module continuation error
	Flashing	Module stop error
CF	ON	CompactFlash card accessible status
	OFF	CompactFlash card inaccessible status (ejectable status)
	Flashing	Preparing CompactFlash card
100M	ON	100Mbps
	OFF	10Mbps
SD/RD	ON	Sending or receiving data
	OFF	Not transmitting data

*2: Since the module performs a diagnostics of the CompactFlash card at startup, it may take some time until the CF LED illuminates. ( Section 16.3 (6) CompactFlash card diagnostic time)

4 SETTINGS AND PROCEDURES UP TO OPERATION

4.4 Wiring

4.4.1 Wiring

This section explains the method for connecting cables to the high speed data logger module.

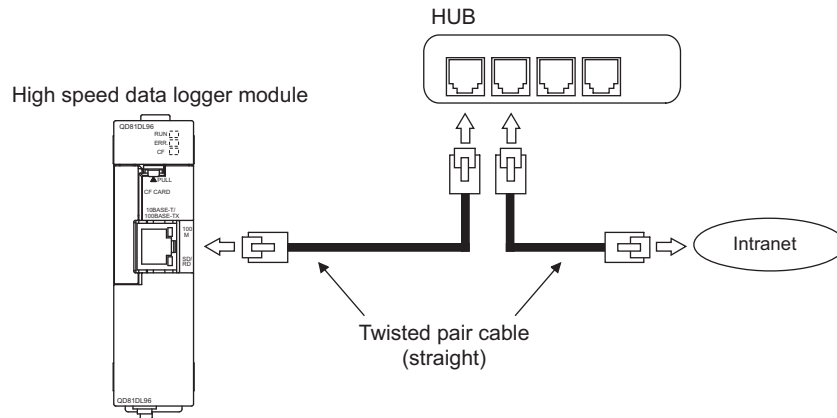

POINT

For the equipment required for a 10BASE-T/100BASE-TX connection and system configuration examples, refer to the following sections.

- ☞ Section 2.1.3 System configuration during operation
- ☞ Section 2.3 Connection System Equipment

4.4.2 Wiring precautions

To establish a reliable system and fully utilize the high speed data logger module functions, a wiring that does not easily receive the effects of noise is required.

- (1) **Sufficient safety measures must be taken when constructing the 100BASE-TX and 10BASE-T networks.**
Consult a specialist when handling connection cable terminals, installing trunk cables, etc.
- (2) **Use a 10BASE-T/100BASE-TX connection cable compliant with the following standards.**
☞ Section 2.3 Connection System Equipment
- (3) **The bending radius near the connector should be at least four times longer than the cable's outside diameter.**
- (4) **Connect the external device according to its specifications.**

4 SETTINGS AND PROCEDURES UP TO OPERATION

☒ POINT

During high speed data communication (100 Mbps) via 100BASE-TX connection, communication errors may occur due to the effect of high frequency noise generated from the equipment other than programmable controller, depending on the installation environment.

Take the following countermeasures on the high speed data logger module side to eliminate the effect of high frequency noise when constructing the network system.

(1) Wiring

- Do not install the twisted pair cables together with the main circuit or power lines, or bring them close to each other.
- Make sure to place the twisted pair cable in a duct.

(2) Cable

- In the environment where the cable is susceptible to noise, use the shielded twisted pair cable (STP cable).

(3) 10 Mbps communication

- Connect the 10 Mbps-compatible equipment with the high speed data logger module and transmit the data to the equipment at a transmission speed of 10 Mbps.

1

OVERVIEW

2

SYSTEM
CONFIGURATION

3

SPECIFICATIONS

4

SETTINGS AND
PROCEDURES UP TO
OPERATION

5

HIGH SPEED DATA
LOGGER MODULE
TOOL STARTUP

6

FUNCTION LIST

7

DATA LOGGING
FUNCTION

8

EVENT LOGGING
FUNCTION

4 SETTINGS AND PROCEDURES UP TO OPERATION

4.5 Intelligent Function Module Switch Setting

With the GX Works2 or GX Developer intelligent function module switch setting, configure the mode setting, default operation setting, response monitoring time setting, and compatibility setting.

POINT

After writing data to a personal computer, the contents of the intelligent function module switch settings are enabled by powering ON from OFF or by resetting the programmable controller CPU.

Remark

For the GX Works2 operation method, refer to the following manual.

☞ GX Works2 Version 1 Operating Manual (Common)

For the GX Developer operation method, refer to the following manual.

☞ GX Developer Version 8 Operating Manual

Operating procedure

- ① In the project view of GX works2 or in the project data list of GX Developer, select [Parameter] → [PLC parameter] → <<I/O assignment>> tab.
- ② On the slot where the high speed data logger module is mounted, set the items in the table below and click the **Switch setting** button.

Setting screen

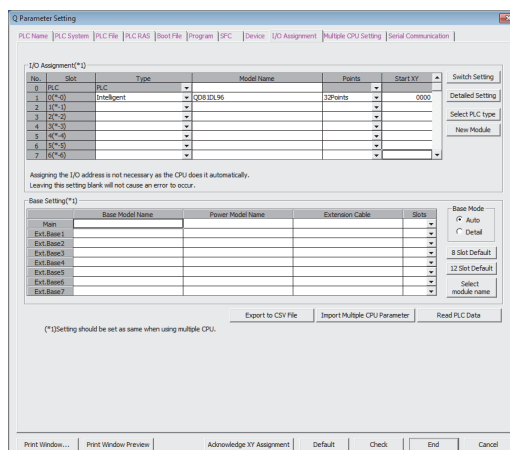

GX Works2

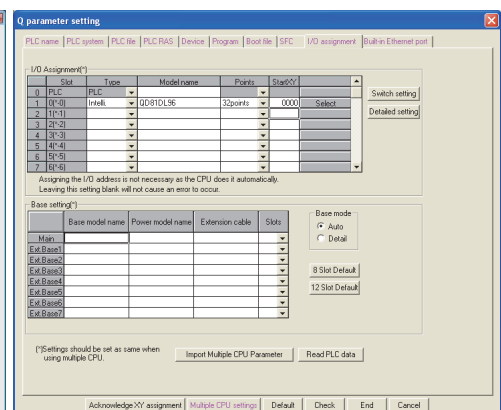

GX Developer

Item	Description
Type	Select "Intelli."
Module name	Enter the model name of the module.
Points	Select 32 points.
Start XY	Enter the high speed data logger module start I/O number.
Detailed setting button	For a multiple CPU system, specify the control CPU of the high speed data logger module.

4 SETTINGS AND PROCEDURES UP TO OPERATION

- ③ Configure switches with the "Switch setting for I/O and intelligent function module" setting.

Configure switch 1 to 4 shown in the table below.

They can be easily entered by switching the input format.

After configuring, click the button.

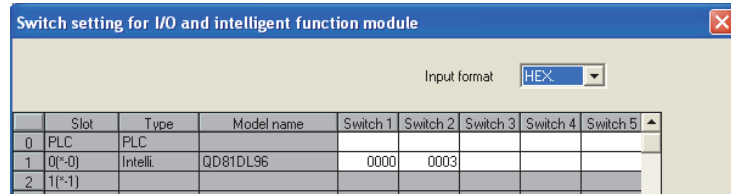

Switch number	Description	Reference
Switch 1	Mode setting	(1) in this section
Switch 2	Default operation setting	(2) in this section
Switch 3 (lower byte)	Response monitoring time setting	(3) in this section
Switch 4	Compatibility setting	(4) in this section
Switch 5	System use (do not set)	-

(1) Mode setting (Switch 1)

Select the high speed data logger module operation mode.

Setting number	Item	Description	Reference
0000H	Online	The normal operation mode.	-
0001H	Hardware test	Performs a test of ROM/RAM/switch settings.	Section 4.6.2
0002H	Self-loopback test	Performs a self-diagnostics test of the 10BASE-T/100BASE-TX interface.	Section 4.6.1

1

OVERVIEW

2

SYSTEM CONFIGURATION

3

SPECIFICATIONS

4

SETTINGS AND PROCEDURES UP TO OPERATION

5

HIGH SPEED DATA LOGGER MODULE TOOL STARTUP

6

FUNCTION LIST

7

DATA LOGGING FUNCTION

8

EVENT LOGGING FUNCTION

4 SETTINGS AND PROCEDURES UP TO OPERATION

(2) Default operation setting (Switch 2)

Set to temporarily operate the module with the default settings for the account setting and network setting. Moreover, set the port number and destination directory of the FTP transfer function.

For details of FTP transfer, refer to the following section.

☞ Section 3.4.17 (1) FTP transfer port number (address: 7999)

☞ Appendix 11 FTP Transfer Directory Configuration

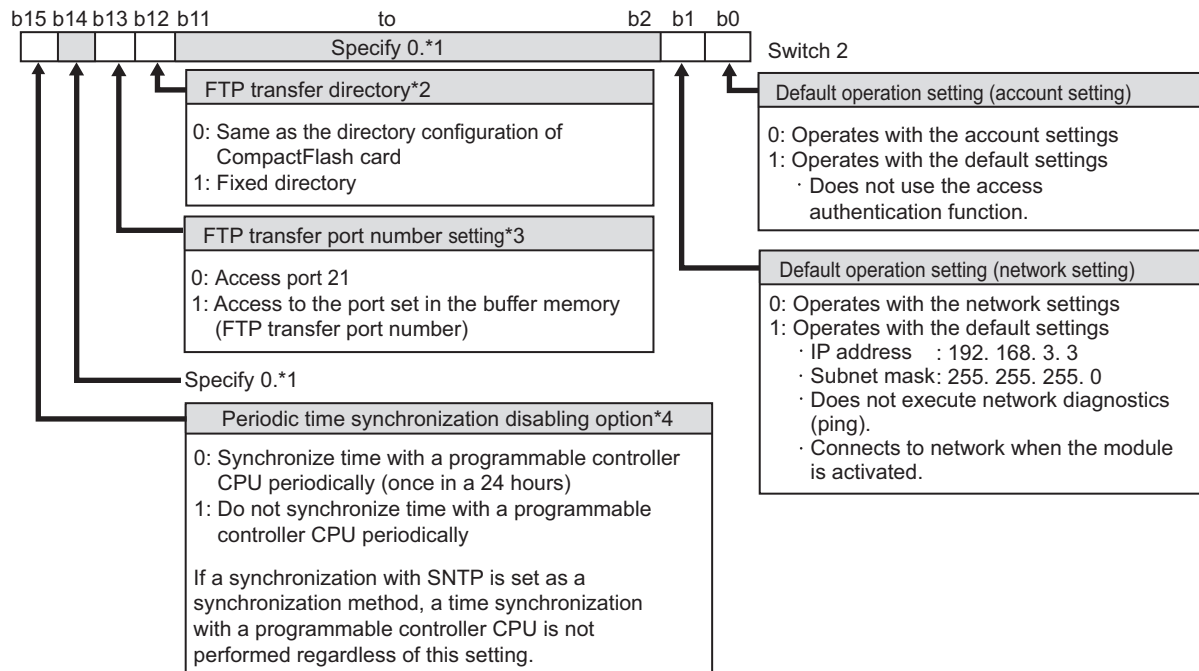

*1: If this area is other than 0, the switch setting error (0180H) occurs during hardware testing.

*2: You can specify 1 only for the modules whose first 5 digits of the serial number are "13092" or higher. Specify 0 for the other modules.

*3: You can specify 1 only for the modules whose first 5 digits of the serial number are "17092" or higher. Specify 0 for the other modules.

*4: You can specify 1 only for the modules whose first 5 digits of the serial number are "18122" or higher. Specify 0 for the other modules.

☒ POINT

The default operation setting is used to change the settings of the high speed data logger module connected to the configuration personal computer on a 1:1 basis.

4 SETTINGS AND PROCEDURES UP TO OPERATION

(3) Response monitoring time setting (Switch 3 (lower byte))

Set the timeout time (seconds) from when the high speed data logger module sends a request to the access target CPU until it receives a reply.

A response timeout error (0002H) occurs if the access target CPU does not respond within the response monitoring time.

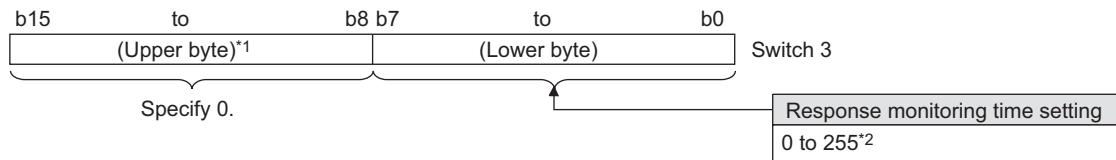

*1: Basically, the information of upper byte is ignored, however, when upper byte is other than '0', the switch setting error (0180H) occurs at hardware test.

*2: When 1 to 14 is specified as response monitoring time, the response monitoring time will differ depending on the network communication route.

The following table shows the response monitoring time.

Access source system	Access target system	Response monitoring time setting (Switch 3 (lower byte))		
		Blank or '0'	1 to 14	15 to 255
High speed data logger module Ethernet port	Built-in Ethernet port CPU	30 seconds	Specified value × 2	Specified value × 2
High speed data logger module Ethernet port	Ethernet module	15 seconds	Specified value	Specified value
Other than above	Other than above		15 seconds	

*3: Set [Access target CPU setting] - <<Network route>> tab (Section 11.4.3) of the common settings.

1	OVERVIEW
2	SYSTEM CONFIGURATION
3	SPECIFICATIONS
4	SETTINGS AND PROCEDURES UP TO OPERATION
5	HIGH SPEED DATA LOGGER MODULE TOOL STARTUP
6	FUNCTION LIST
7	DATA LOGGING FUNCTION
8	EVENT LOGGING FUNCTION

4 SETTINGS AND PROCEDURES UP TO OPERATION

(4) Compatibility setting (Switch 4)

Set this switch to make the process, which may differ depending on a function version (the first five digits of the serial number), the same as that on another function version (the first five digits of the serial number).

For details of functions whose operations differ, refer to the following section.

☞ Appendix 8 Process Modifications

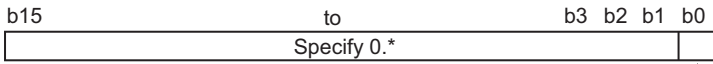

* If this area is a value other than 0, it will cause a switch setting error (0180H) during hardware testing.

Compatibility setting (File switching timing)
0: The module operates as the module with a serial number whose first 5 digits are '11102' or higher.
1: The module operates as the module with a serial number whose first 5 digits are '11101' or lower.

4.6 Self-Diagnostics Tests

This section explains the self-diagnostics tests designed for checking the high speed data logger module communication function and hardware.

4.6.1 Self-loopback test

By performing a hardware check of the high speed data logger module which includes the communications function of the 10BASE-T/100BASE-TX interface, the function of whether the module can send or receive data internally is checked.

(1) High speed data logger module operation mode setting

- ① On the "Switch setting for I/O and intelligent function module" screen of GX Works2 or GX Developer, set the mode setting to 'self-loopback test'. (Switch 1: 0002H)
- ② For other intelligent function module switch settings, match them to the settings used.

(2) Execute self-loopback test

- ① If a cable is connected to the 10BASE-T/100BASE-TX interface, disconnect it.
- ② Set the programmable controller CPU to STOP status.
- ③ Reset the programmable controller CPU.
- ④ After resetting the programmable controller CPU, the self-loopback test is executed automatically.
During the test, the ERR. LED flashes.

(3) Confirm the self-loopback test result

- ① Check the self-loopback test result by the ERR. LED status.

ERR. LED status	Self-loopback test result
OFF	Completed normally
ON	Completed abnormally

- ② When the test completes normally, set the mode setting to 'online' on the "Switch setting for I/O and intelligent function module" screen of GX Works2 or GX Developer and reset the programmable controller CPU. (Switch 1: 0000H)
- ③ When the test completes abnormally, perform the self-loopback test again.
If the switch setting is not set correctly, a switch setting error (0180H) is stored to the current error area (0140H) in the buffer memory.
If the test fails again, consult your local Mitsubishi representative, and provide them a detailed description of the problem.

4 SETTINGS AND PROCEDURES UP TO OPERATION

4.6.2 Hardware test

The hardware test performs testing related to the high speed data logger module ROM/RAM/intelligent function module switch settings.

(1) High speed data logger module operation mode setting

- ① On the "Switch setting for I/O and intelligent function module" screen of GX Works2 or GX Developer, set the mode setting to 'hardware test'. (Switch 1: 0001H)
- ② For the other intelligent function module switch settings, match them to the settings used.

(2) Execute hardware test

- ① Set the programmable controller CPU to STOP status.
- ② Reset the programmable controller CPU.
- ③ After the programmable controller CPU is reset, the following hardware tests are executed automatically. During the test, the ERR. LED flashes.
 - 1) ROM check
Reads the ROM data and checks the sum.
 - 2) RAM check
Reads the test data written to the RAM and checks the consistency.
 - 3) Switch setting check
Checks that the intelligent function module switch settings are set within the allowable range. However, the Switch 1 mode setting is not tested.

(3) Confirm the hardware test result

- ① Check the hardware test result by the ERR. LED status.

ERR. LED status	Hardware test result
OFF	Completed normally
ON	Completed abnormally

- ② When the test completes normally, set the mode setting to 'online' on the "Switch setting for I/O and intelligent function module" screen of GX Works2 or GX Developer and reset the programmable controller CPU. (Switch 1: 0000H)
- ③ When the test completes abnormally, check if the switch setting is correctly set and perform the hardware test again.
If the test fails again, consult your local Mitsubishi representative, and provide them a detailed description of the problem.

4 SETTINGS AND PROCEDURES UP TO OPERATION

4.7 Operations to Return the High Speed Data Logger Module to the Factory Default Status

The high speed data logger module saves and manages setting information, data logging files, event logging files, report files, and recipe files on a CompactFlash card.

The status of high speed data logger module can be returned to its factory default status by performing any of the following operations.

- Eject the CompactFlash card and replace it with another one
 ☞ Section 16.4 Operations for Inserting CompactFlash Card
- Format the CompactFlash card
 ☞ Section 13.1.6 CompactFlash card diagnostics

1	OVERVIEW
2	SYSTEM CONFIGURATION
3	SPECIFICATIONS
4	SETTINGS AND PROCEDURES UP TO OPERATION
5	HIGH SPEED DATA LOGGER MODULE TOOL STARTUP
6	FUNCTION LIST
7	DATA LOGGING FUNCTION
8	EVENT LOGGING FUNCTION

CHAPTER 5 HIGH SPEED DATA LOGGER MODULE TOOL STARTUP

Configuration Tool and Conversion Tool are included in high speed data logger module tool.

5.1 Obtaining High Speed Data Logger Module Tool

For the acquisition of the high speed data logger module tool, contact your local Mitsubishi representative.

POINT

There is a method to start the Configuration Tool directly from the high speed data logger module. In this case, it is not necessary to obtain the high speed data logger module tool.

For the method for starting the Configuration Tool, refer to the following section.

 Section 5.3.1 Online startup

5.2 Installation

This section explains the procedures to install, upgrade, and uninstall the Configuration Tool.

The Configuration Tool can be used by installing the obtained high speed data logger module installation files.

☒ POINT

- (1) Before installing the Configuration Tool, close any other applications running on Windows®.
- (2) The installer may not work normally because of the operating system's or other companies' update programs, such as Windows® Update or the Java update program, start automatically. Install the Configuration Tool after configuring those update programs not to start automatically.
- (3) When installing the Configuration Tool, log on as a user with the Administrator authority.
- (4) When using Windows® 8 or later
 - ".NET Framework 3.5 (includes .NET 2.0 and 3.0)" needs to be enabled in "Turn Windows features on or off" on the Control Panel.
 - Select "Don't do anything (turn off Windows SmartScreen)" on the Control Panel.

5.2.1 Installation procedure

The following explains the installation operating procedure.

Start installation

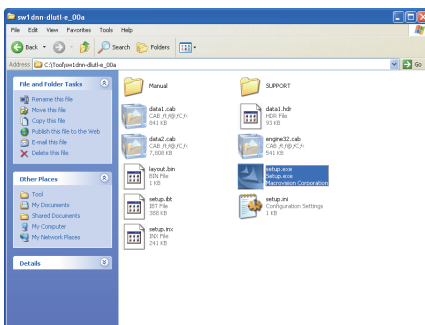

To the next page

- ① Double click on "setup.exe" inside the extracted folder to start the installer.

5 HIGH SPEED DATA LOGGER MODULE TOOL STARTUP

From the previous page



<Windows Vista®>

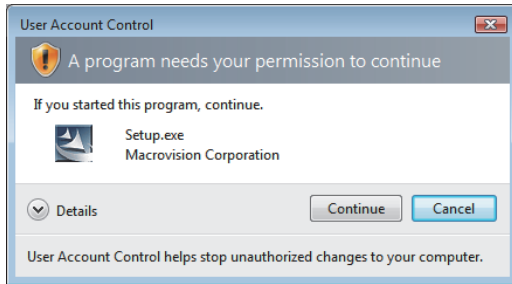

For Windows Vista® or later, the screen at left may be displayed.

- ② Click the or button.

<Windows® 7 or later>

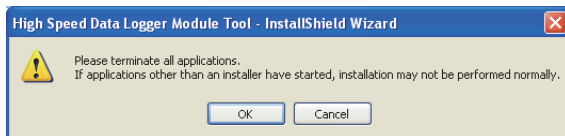
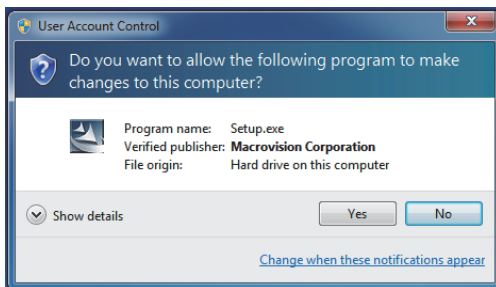

- ③ Check that no other applications are running.

- ④ Click the button.

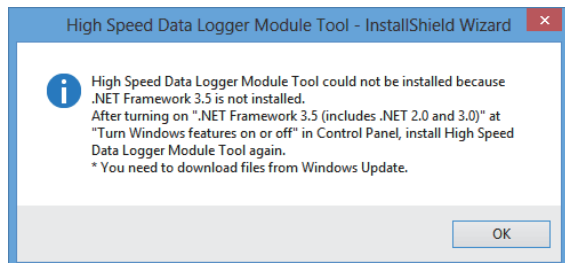

<When using Windows® 8 or later>

If .NET Framework 3.5 is disabled, the error message at left is displayed.

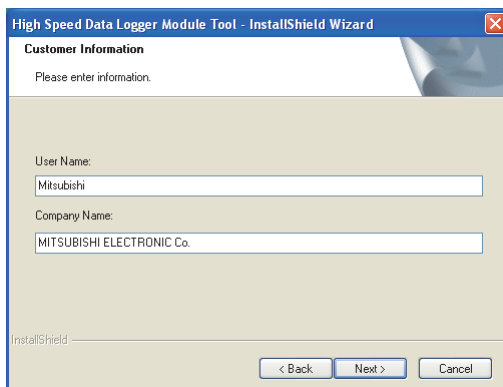

- ⑤ Enter the user information and click the button.



To the next page

5 HIGH SPEED DATA LOGGER MODULE TOOL STARTUP

From the previous page

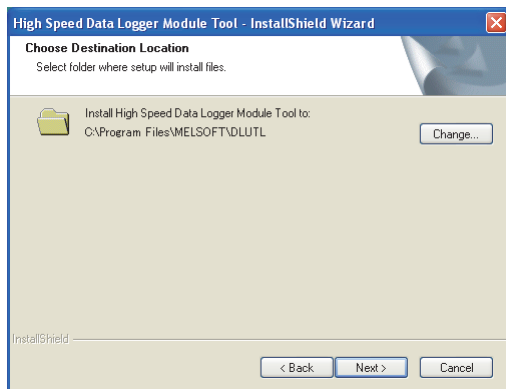

- ⑥ Select the installation target folder and click the **Next >** button.

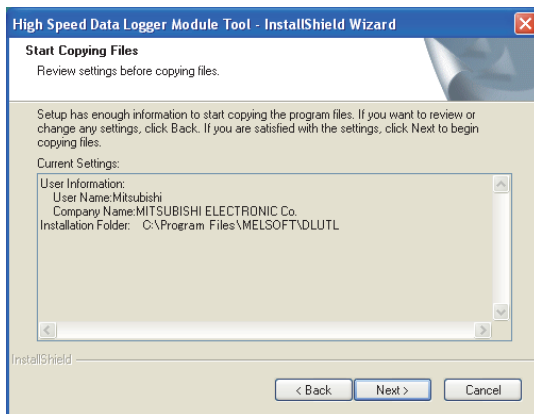

- ⑦ Verify "Current Settings" during installation and click the **Next >** button.

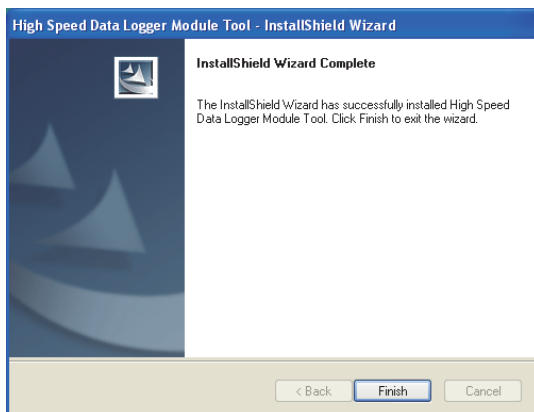

When the screen at left is displayed, installation is complete.

- ⑧ Click the **Finish** button and close the screen.

When the following screen is displayed, select "Yes, I want to restart my computer now."

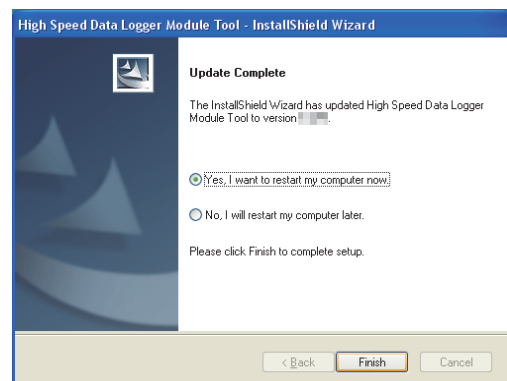

To the next page

1	OVERVIEW
2	SYSTEM CONFIGURATION
3	SPECIFICATIONS
4	SETTINGS AND PROCEDURES UP TO OPERATION
5	HIGH SPEED DATA LOGGER MODULE TOOL STARTUP
6	FUNCTION LIST
7	DATA LOGGING FUNCTION
8	EVENT LOGGING FUNCTION

5 HIGH SPEED DATA LOGGER MODULE TOOL STARTUP

From the previous page

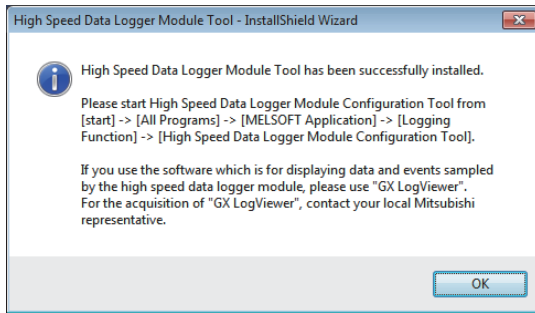

Installation complete

- ⑨ A screen for the startup method for High Speed Data Logger Module Configuration Tool and guidance to GX LogViewer appears. When Click the button, installation is complete.

Remark

For the required personal computer operating environment when installing the high speed data logger module tool, refer to the following section.

☞ Section 2.4 Operating Environment

POINT

Program Compatibility Assistant screen

When using Windows Vista® or later, the Program Compatibility Assistant screen may be displayed after the installation completion. Follow the procedure to finish the installation. (The following screen images are from Windows Vista®.)

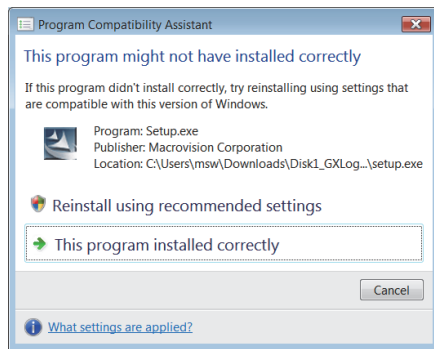

1. Select "This program installed correctly".
2. Restart the Windows® operating system.

If "Reinstall using recommended settings" is selected by mistake, the 'Windows XP SP2 compatibility mode' is automatically set. Disable the 'Windows XP SP2 compatibility mode' by following the procedure described below, and install the product again.

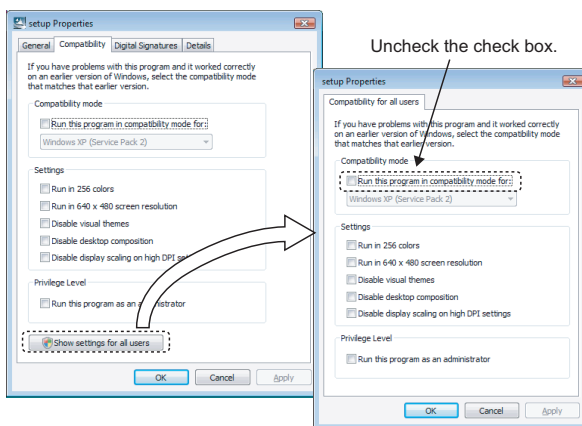

1. Right-click on the setup.exe icon of the installation target in the Windows explorer, and open the setup Properties screen.
2. Select the <<Compatibility>> tab and click the **Show settings for all users** button.
3. Uncheck the "Run this program in compatibility mode for:" check box of compatibility mode in the <<Compatibility for all users>> tab, and click the **OK** button.
4. Click the **OK** button on the setup Properties screen.
5. Install the product again. (☞ Section 4.2.1)

5.2.2 Upgrade procedure

The following explains the upgrade operating procedure.

Start the upgrade

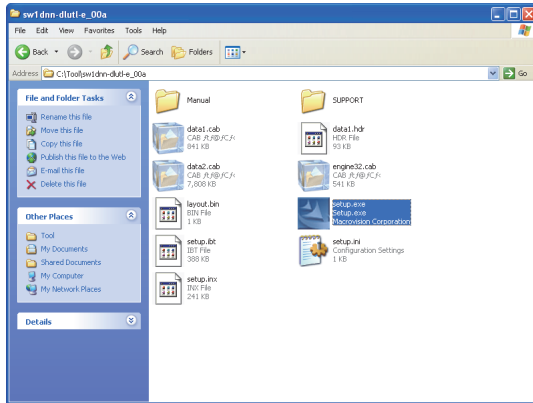

- ① Double click on "setup.exe" inside the extracted folder to start the installer.



<Windows Vista®>

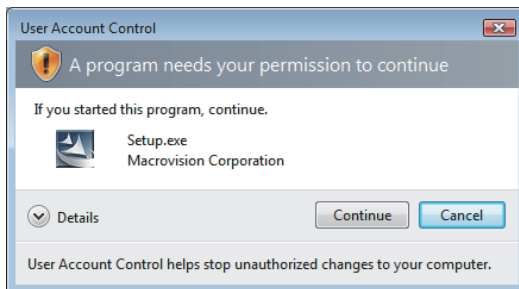

For Windows Vista® or later, the screen at left may be displayed.

- ② Click the or button.

<Windows® 7 or later>

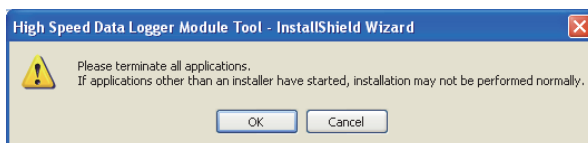
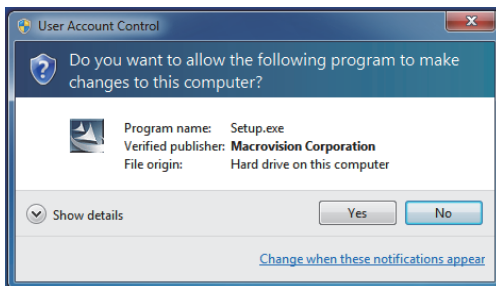

- ③ Check that no other applications are running.

- ④ Click the button.



To the next page

5 HIGH SPEED DATA LOGGER MODULE TOOL STARTUP

From the previous page

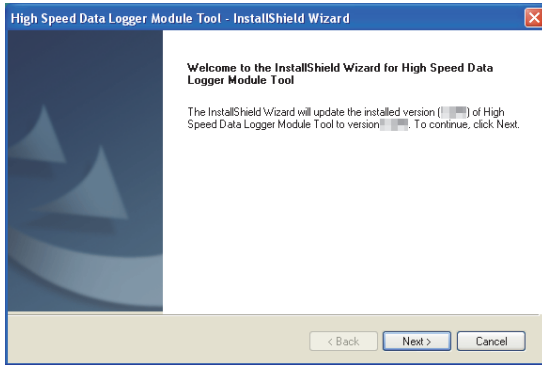

⑤ Click the **Next >** button.

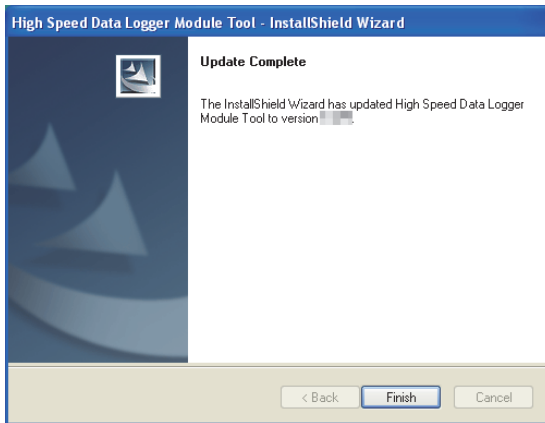

The upgrade complete screen is displayed.

⑥ Click the **Finish** button and close the screen.



Upgrade complete

❏ POINT

- Products that cannot be upgraded
Products with the version 1.02C or earlier cannot be upgraded to the version 1.03D or later.
Uninstall the product and install the higher version of high speed data logger module tool.
- Downgrade
Installation may not be complete successfully if the downgrade is executed.
If the product with older version is used, uninstall the product and install the higher version of high speed data logger module tool.
- If Program Compatibility Assistant is displayed, refer to the following point.
 Program Compatibility Assistant screen

1	OVERVIEW
2	SYSTEM CONFIGURATION
3	SPECIFICATIONS
4	SETTINGS AND PROCEDURES UP TO OPERATION
5	HIGH SPEED DATA LOGGER MODULE TOOL STARTUP
6	FUNCTION LIST
7	DATA LOGGING FUNCTION
8	EVENT LOGGING FUNCTION

5 HIGH SPEED DATA LOGGER MODULE TOOL STARTUP

5.2.3 Uninstallation procedure

The following explains the uninstallation operating procedure.

Start uninstallation

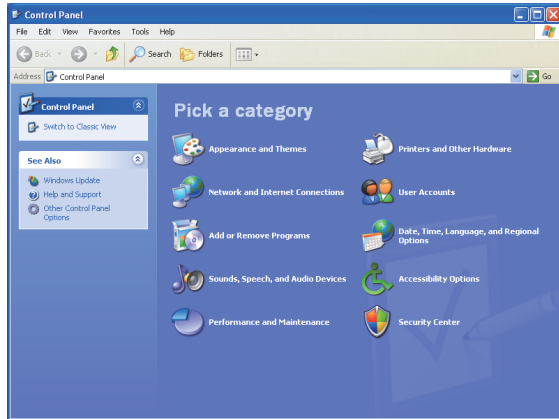

- ① Select [Control Panel] → "Add or Remove Programs".

<When using Windows Vista® or later>
Select [Control Panel] → "Uninstall a program"

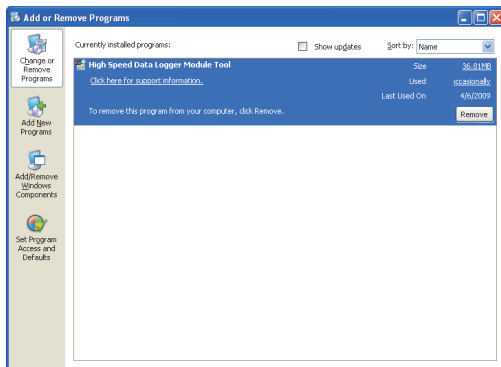

- ② Select "High Speed Data Logger Module Tool" from list of programs and click the button.

<When using Windows Vista® or later>
Select "High Speed Data Logger Module Tool" from the programs and click "Uninstall/Change".



To the next page

5 HIGH SPEED DATA LOGGER MODULE TOOL STARTUP

From the previous page



<Windows Vista®>

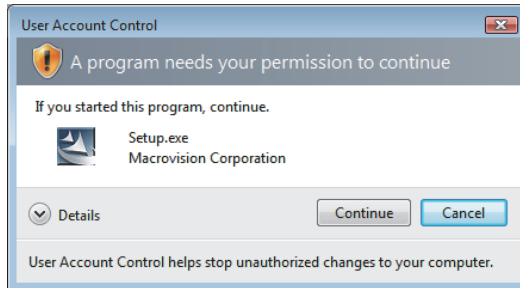

For Windows Vista® or later, the screen at left may be displayed.

- ③ Click the or button.

<Windows® 7 or later>

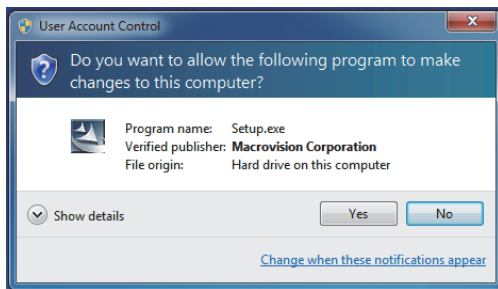

To the next page

5 HIGH SPEED DATA LOGGER MODULE TOOL STARTUP

From the previous page

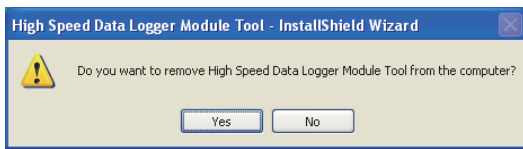

- ④ Click the button.

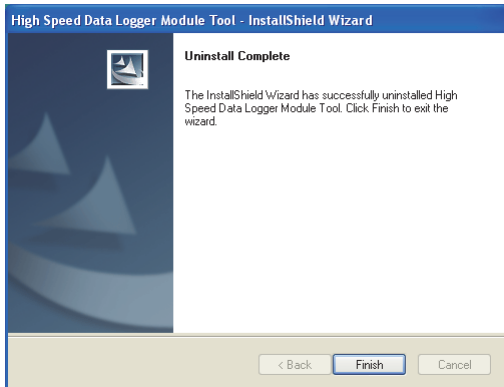

When the screen at left is displayed, uninstall is complete.

- ⑤ Click the button and close the screen.



Uninstall complete

5.3 Starting Configuration Tool

There are two methods to start the Configuration Tool; 'online startup' and 'offline startup'.

(1) Online startup

A method to start the Configuration Tool directly from the high speed data logger module.

(2) Offline startup

A method to start the Configuration Tool from the high speed data logger module tool installed on a personal computer.

The following table shows the features of these methods.

Startup method	Features	Reference
Online startup	<ul style="list-style-type: none">• Not necessary to install the high speed data logger module tool on a personal computer.	Section 5.3.1
Offline startup	<ul style="list-style-type: none">• Can be started without the high speed data logger module.• Can connect to the high speed data logger module without setting the IP address.• Can connect to the high speed data logger module even if the subnet masks of personal computer and high speed data logger module differ.	Section 5.3.2 Section 2.1.3 (2) Section 12.1

5.3.1 Online startup

This section explains the method for invoking the Configuration Tool from the high speed data logger module and starting it online.

(1) Operating procedure up to online startup

The following figure shows the operating procedure up to starting the Configuration Tool online.

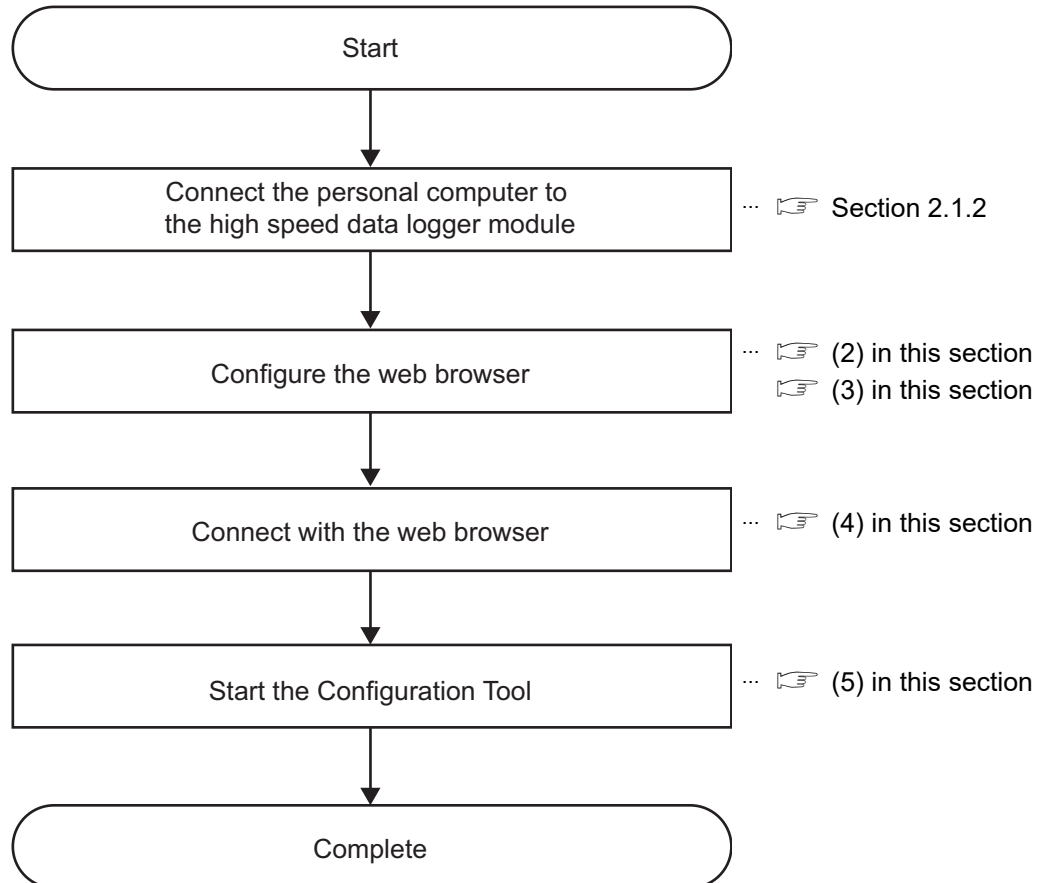

(2) Microsoft Edge settings

The following shows the procedures for setting Microsoft Edge.

The setting procedure and the name for each setting item may differ depending on its version.

For details, contact Microsoft Corporation.

(a) Setting proxy setup

1. Click [...] (Settings and more) in the upper-right corner of Microsoft Edge.
2. Select [Settings] → [System and performance] → [Open your computer's proxy settings].
3. Set the following to 'Off.'
 - "Automatically detect settings" under "Automatic proxy setup"
 - "Use setup script" under "Automatic proxy setup"
 - "Use a proxy server" under "Manual proxy setup"

(b) Deleting temporary internet files

1. Click [...] (Settings and more) in the upper-right corner of Microsoft Edge.
2. Select [History] → [Clear browsing data].
3. Select the checkbox of "Browsing history."
4. Click the [Clear now] button.

(c) Disabling SmartScreen

1. Click [...] (Settings and more) in the upper-right corner of Microsoft Edge.
2. Select [Settings] → [Privacy, search, and services].
3. Turn off "Microsoft Defender SmartScreen" under "Security."

(d) Enabling ClickOnce

1. Enter the following in the address bar of Microsoft Edge.
"edge://flags/#edge-click-once"
2. Set "ClickOnce Support" to "Enabled."
3. Restart Microsoft Edge to apply the settings.

(e) Setting Internet Explorer mode

1. Click [...] (Settings and more) in the upper-right corner of Microsoft Edge.
2. Select [Settings] → [Default browser].
3. Set "Allow sites to be reloaded in Internet Explorer mode" under "Internet Explorer compatibility" to "Allow."
4. If a URL is added for "Internet Explorer mode pages," the set page is opened in Internet Explorer mode.

☒ POINT

Even if a URL is not added for "Internet Explorer mode pages," the screen displayed on Microsoft Edge can be opened in Internet Explorer mode by the following operation.

Right-click a tab of a screen, and select [Reload tab in Internet Explorer mode] from the shortcut menu.

(3) Internet Explorer settings

(a) Setting a local area network (LAN)

Uncheck the "Automatically detect settings", "Use automatic configuration script", and "Use a proxy server for your LAN" setting on the Internet Explorer "Local Area Network (LAN) Settings" screen.

(Example) For Microsoft Windows Vista Business, Internet Explorer 7.0

On the <<Connections>> tab under [Tools] → [Internet Options], click the [LAN settings] button to display the "Local Area Network (LAN) Settings" screen

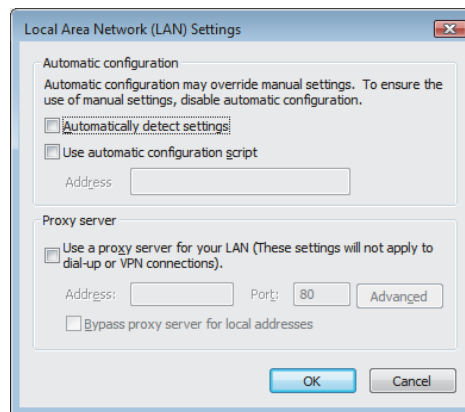

5 HIGH SPEED DATA LOGGER MODULE TOOL STARTUP

(b) Setting temporary internet files

Configure the setting for "Check for newer versions of stored pages".

- For Microsoft Internet Explorer 6.0
 1. Select [Tools] → [Internet Options] → <<General>> tab, and click the [Settings] button under "Temporary Internet files".
 2. Select "Every visit to the page".
- For Windows Internet Explorer
 1. Select [Tools] → [Internet Options] → <<General>> tab, and click the [Settings] button under "Browsing history".
 2. Select "Every time I visit the webpage".

(c) Deleting temporary internet files

Delete temporary Internet files.

- For Microsoft Internet Explorer 6.0
 1. Select [Tools] → [Internet Options] → <<General>> tab, and click the [Delete files] button under "Temporary Internet files".
 2. Check "Delete all offline content".
- For Windows Internet Explorer 7.0
 1. Select [Tools] → [Internet Options] → <<General>> tab, and click the [Delete] button under "Browsing history".
 2. Click the [Delete files] button.
- For Windows Internet Explorer 8.0, Windows Internet Explorer 9.0, Windows Internet Explorer 10.0, and Windows Internet Explorer 11.0
 1. Select [Tools] → [Internet Options] → <<General>> tab, and click the [Delete] button under "Browsing history".
 2. Check "Temporary Internet Files".
 3. Click the [Delete] button.

1

OVERVIEW

2

SYSTEM
CONFIGURATION

3

SPECIFICATIONS

4

SETTINGS AND
PROCEDURES UP TO
OPERATION

5

HIGH SPEED DATA
LOGGER MODULE
TOOL STARTUP

6

FUNCTION LIST

7

DATA LOGGING
FUNCTION

8

EVENT LOGGING
FUNCTION

(d) Setting security

Set the "Security level for this zone" of Internet Explorer to 'Medium' or lower.

(Example) For Microsoft Windows Vista Business, Internet Explorer 7.0

[Tools] → [Internet Options] → <<Security>> tab

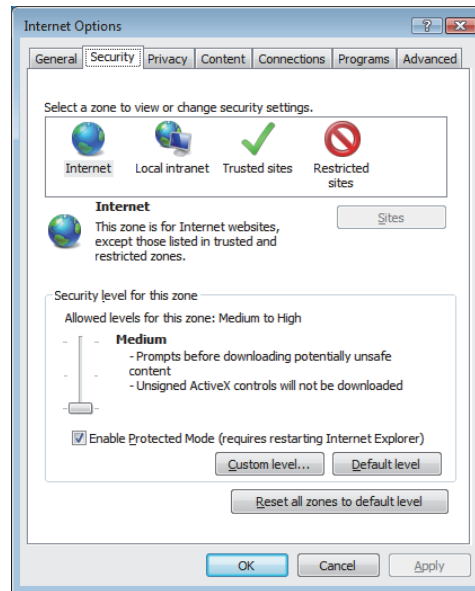

(e) Disabling SmartScreen

For Windows 8, Windows 8.1, and Windows 10, disable SmartScreen according to the following procedures.

- Windows 8, Windows 8.1
 1. Select [Control Panel] → [System and Security].
 2. Select "Action Center" on the "System and Security" screen.
 3. Select "Change Windows SmartScreen settings" on "Action Center" screen.
 4. Select "Don't do anything (turn off Windows SmartScreen)".
- Windows 10
 1. Select [Control Panel] → [System and Security].
 2. Select "Security and Maintenance" on the "System and Security" screen.
 3. Select "Change Windows SmartScreen settings" on "Security and Maintenance" screen.
 4. Select "Don't do anything (turn off Windows SmartScreen)".

5 HIGH SPEED DATA LOGGER MODULE TOOL STARTUP

(4) Connect with the web browser

Start the web browser on the personal computer and enter the high speed data logger module address.

<http://192.168.3.3/>

For the IP address setting, refer to the following section.

☞ Section 11.4.1 Network setting

If the module is connected normally, the main page is displayed.



☒ POINT

- If the personal computer cannot be connected to the high speed data logger module normally, issue the PING command from the personal computer to the high speed data logger module to verify the connection.
For the method for issuing the PING command, refer to (☞ Appendix 2).
- For Microsoft Edge, use Internet Explorer mode.
- When using Microsoft Edge in Internet Explorer mode, it may take time to display the main page.

5 HIGH SPEED DATA LOGGER MODULE TOOL STARTUP

(5) Configuration Tool start procedure



- ① Click "Start the Configuration Tool" on the main page.

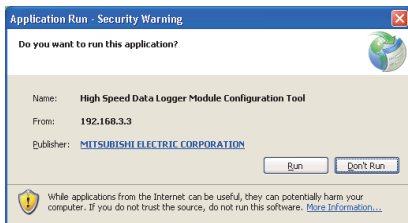

- ② Click the button.

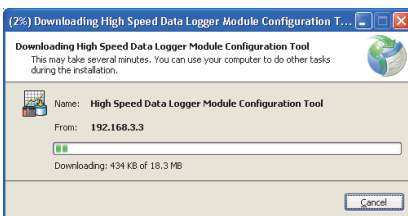

While downloading files, the dialog box at left is displayed.

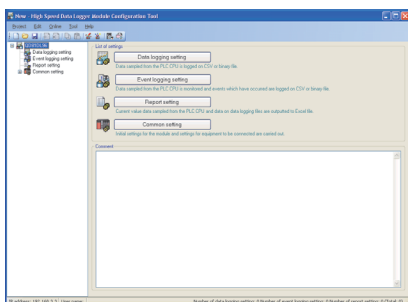

After the download completes, the Configuration Tool starts.

5 HIGH SPEED DATA LOGGER MODULE TOOL STARTUP

5.3.2 Offline startup (starting from the Start menu)

After installing the high speed data logger module tool, it can be started with the operation below.

Start High Speed Data Logger Module Configuration Tool from "MELSOFT Application" in Windows Start.

5.3.3 Starting from GX LogViewer

The Configuration Tool can also be started from GX LogViewer.

 GX LogViewer Version 1 Operating Manual

5.4 Starting Conversion Tool

The Logging File Conversion Tool can be started by selecting the following menus after installing the high speed data logger module tool.

Start Logging File Conversion Tool from "MELSOFT Application" in Windows Start.

1

OVERVIEW

2

SYSTEM
CONFIGURATION

3

SPECIFICATIONS

4

SETTINGS AND
PROCEDURES UP TO
OPERATION

5

HIGH SPEED DATA
LOGGER MODULE
TOOL STARTUP

6

FUNCTION LIST

7

DATA LOGGING
FUNCTION

8

EVENT LOGGING
FUNCTION

CHAPTER 6 FUNCTION LIST

The following tables show the list of major functions of the high speed data logger module. For details on the functions, check the reference.

(1) Function list of high speed data logger module

Item	Description	Reference
Data logging function	A function to log programmable controller CPU device values at the specified data sampling interval.	Chapter 7
Continuous logging function	A function to continuously log programmable controller CPU device values at the specified data sampling interval.	Section 7.3.1
Trigger logging function	A function to only log the specified number of lines worth of programmable controller CPU device values before and after a trigger occurs (specified condition is established).	Section 7.3.2
Save function	A function to save data logging target data to the CompactFlash card in the CSV format or binary format.	Section 7.5
Event logging function	A function to monitor sampled device values from the programmable controller CPU and log events that occur.	Chapter 8
Save function	A function to save event logging target data to the CompactFlash card in the CSV format or binary format.	Section 8.4
E-mail notification function	A function to notify events to the specified e-mail address by e-mail each time an event occurs.	Section 8.5
Report function	A function to output the data sampled by the high speed data logger module as an Excel file. Easily understood reports can be created using Excel graphs and calculation formulas.	Chapter 9
Layout function	A function to layout the contents of the data logging file, the current values when the report is created, and the creation time on the Excel cells.	Section 11.7.4
Save function	A function to save report files to the CompactFlash card.	Section 9.5.1
Other functions	-	Chapter 10
Time synchronization function	A function to synchronize the time of the high speed data logger module with a time server on the network or the programmable controller CPU.	Section 10.1
Auto logging function	A function to automatically start the data logging function, event logging function, and report function when a CompactFlash card with the auto logging settings written to it in advance is inserted in a running high speed data logger module.	Section 10.2
File access function	A function to download data logging files, event logging files, and report files from the CompactFlash card inserted in the high speed data logger module to a personal computer or delete them.	Section 10.3
Access authentication function	When accessing the high speed data logger module, a function to perform authentication by user name and password and restrict access to the module.	Section 10.4
FTP transfer function	A function to automatically transfer saved logging files to the FTP server.	Section 10.5
E-mail function	A function to automatically send saved logging files and notify event occurrences.	Section 10.6
Recipe function	A function to execute the following operations using recipe files stored in the CompactFlash card. <ul style="list-style-type: none"> • Reads device values written on the recipe files to devices in the programmable controller CPU. • Writes device values in the programmable controller CPU to the recipe files. 	Chapter 15

6 FUNCTION LIST

(2) Functions of high speed data logger module Configuration Tool

Item	Description	Reference
Online startup function	A function to start the Configuration Tool online from the high speed data logger module by connecting the personal computer to the high speed data logger module. It is not necessary to install the Configuration Tool on a personal computer.	Section 5.3.1
Module search function	A function to search for and connect to high speed data logger modules on the network.	Section 12.2
Direct connection function	A function to connect a personal computer to the high speed data logger module on a 1:1 basis using an Ethernet cable. They can be easily connected without concerning the IP address.	Section 2.1.2 Section 12.1
Module diagnostics function	A function to check the operating status of the high speed data logger module and operate it. The error status of the high speed data logger module can be checked, and access to the CompactFlash card can be stopped or restarted.	Chapter 13
Global label/Device comment import function	A function to import global labels and device comments created in the programming tool to the setting of the high speed data logger module.	Section 11.2.10

(3) Function of Logging File Conversion Tool

Item	Description	Reference
File conversion function	A function to convert binary format logging files to CSV format logging files.	Chapter 14

1

OVERVIEW

2

SYSTEM
CONFIGURATION

3

SPECIFICATIONS

4

SETTINGS AND
PROCEDURES UP TO
OPERATION

5

HIGH SPEED DATA
LOGGER MODULE
TOOL STARTUP

6

FUNCTION LIST

7

DATA LOGGING
FUNCTION

8

EVENT LOGGING
FUNCTION

CHAPTER 7 DATA LOGGING FUNCTION

Data logging is a function to log programmable controller CPU device values at the specified data sampling interval.

The logged 'target data' is saved to the CompactFlash card inserted in the high speed data logger module.

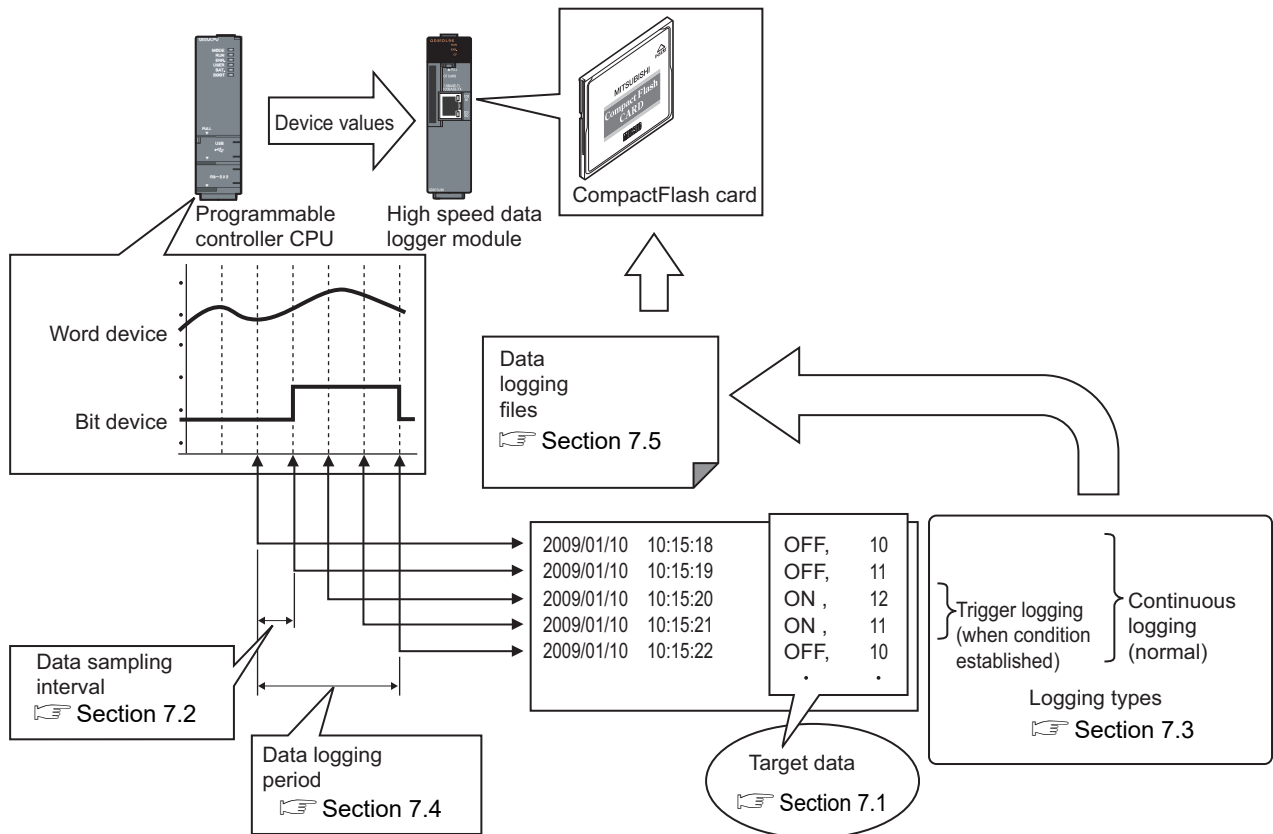

The group of target data sampled with the same 'data sampling interval' and 'logging type' configuration is called a 'data logging setting'.

The number of data logging settings which can be configured overall for the data logging function is a maximum of 64.

For data logging function settings, refer to the following section.

➔ Section 11.5 Data Logging Setting

7.1 Target Data

'Target data' are the contents of the programmable controller CPU's device memory saved to the CompactFlash card along with a time stamp.

(1) Device memory subject to data logging

Data logging can be performed for the device memory below.

- Control CPU devices X/Y/M/T/C/D/R/B/W and others
- The device memory of other CPUs when multiple CPU configurations
- The device memory of other stations' CPUs that was transmitted via the network

For details, refer to the following section.

☞ Section 3.2 (3) Accessible devices

(2) Data type

Device memory subject to data logging can be logged as the data types shown in the table below.

Data type	Number of occupied device points
Bit	1 point
Word [signed]	1 point
Double word [signed]	2 points
Word [unsigned]	1 point
Double word [unsigned]	2 points
Float (single precision)	2 points
Float (double precision)	4 points
16 bit BCD	1 point
32 bit BCD	2 points
String	(String count/2) points
Raw	(Binary size/2) points

(3) Number of target data settings

Up to 256 pieces of 'target data' can be set for a single 'data logging setting'.

7.2 Target Data Sampling

'Sampling' is a function performed with specifying the data sampling method and data sampling interval for the target data.

The following table shows data sampling methods.

Data sampling method	Overview	Reference
High speed data sampling (each scan)	Samples at each sequence scan of the programmable controller CPU.	Section 7.2.1 (2)
High speed data sampling (time specification)	Samples at the specified interval (milliseconds).	Section 7.2.1 (3)
General data sampling (time specification)	Samples at the specified interval (seconds).	Section 7.2.2 (1)
General data sampling (time interval specification)	Samples data at the time interval of every specified hour/minute/second.	Section 7.2.2 (2)

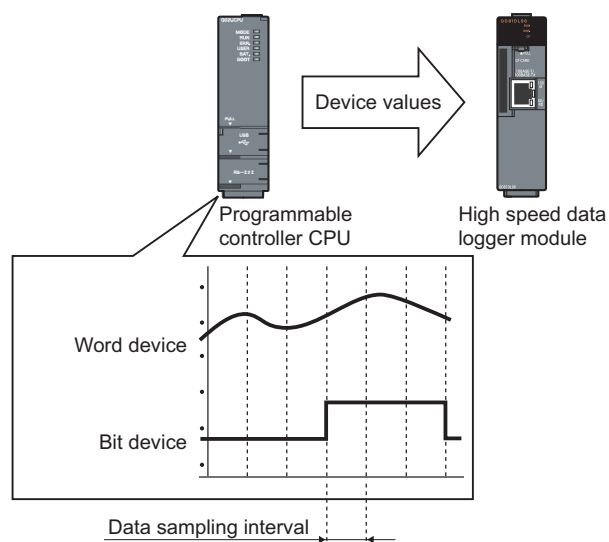

POINT

- (1) In order to perform high speed data sampling, a programmable controller CPU which supports the high speed data sampling function is required.
 ➔ Section 2.2 Applicable Systems
- (2) The data logging, event logging, and report functions of the high speed data logger module are best effort functions.
 Since module processing time changes according to the settings and status of other devices, it may not operate with the set data sampling interval. Run the system by fully verifying the processing time of each function when constructing it.
 For processing time, refer to the following chapter.
 ➔ Chapter 17 PROCESSING TIME
- (3) The total number of settings is 32 for each of the functions below when 'data sampling method' is specified as 'high speed data sampling'.
 - Data logging function
 - Event logging function
 - Report function
- (4) For a single 'data logging setting', device values that can be logged are up to 256 points in 'high speed data sampling' and up to 4096 points in 'general data sampling'.

7.2.1 High speed data sampling

This section is common to the 'high speed data sampling' for the event logging function and report function.

(1) System configurations compatible with high speed data sampling

High speed data sampling is only compatible with the following types of programmable controller CPUs, product information, and system configurations.

- Programmable controller CPUs (high speed data sampling function-compatible) described in Section 2.2 Applicable Systems
- Programmable controller CPU with a serial number whose first five digits are '11012' or higher.
- The high speed data logger module control CPU in a multiple CPU configuration
- Own station CPU (Other stations routing the network are not compatible)

'High speed data sampling' specification availability	○	×		×
'General data sampling' specification availability	○	○		○

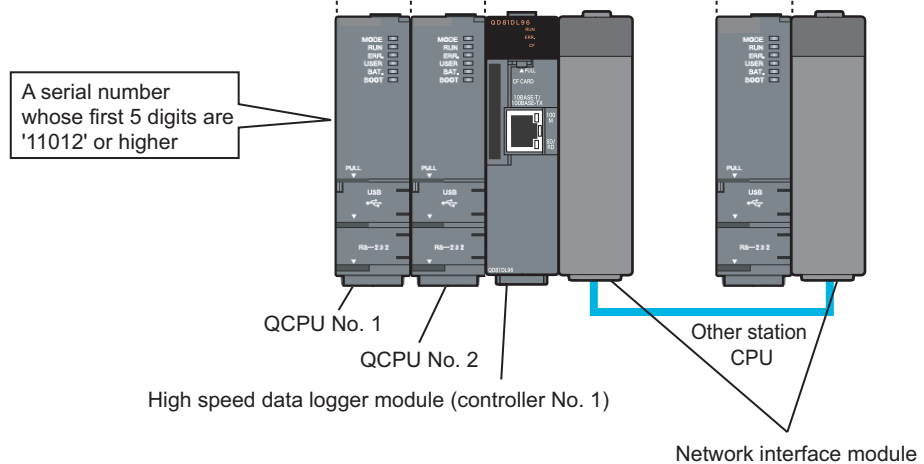

POINT

For devices which can be specified during high speed data sampling, refer to the following section.

☞ Section 3.2 (3) Accessible devices

(2) Timing of data sampling when "Each scanning cycle" is specified

Data sampling is executed at each sequence scan of the programmable controller CPU.*1

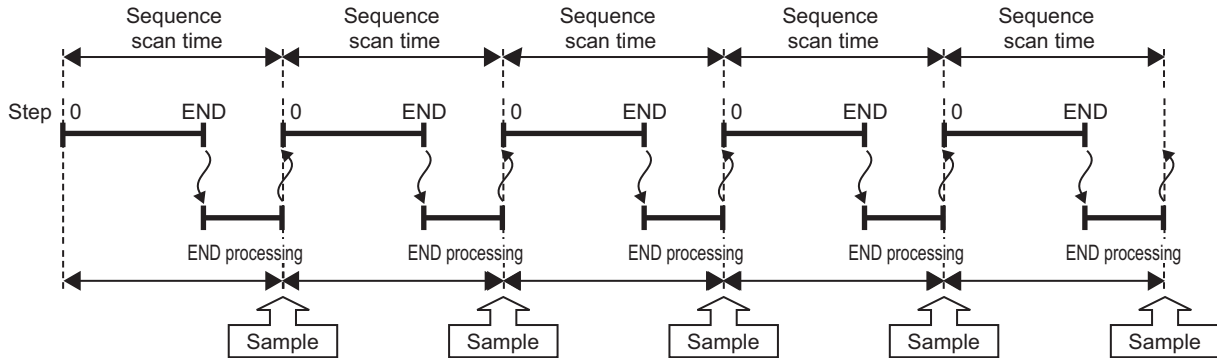

POINT

When "Each scanning cycle" is specified, scan time increases because of the data transfer from the programmable controller CPU to the high speed data logger module.

The sequence scan time delay can be adjusted with the high speed data sampling setting.

For details on delay time, refer to the following sections.

☞ Section 17.3 Effect on Sequence Scanning Time

☞ Section 11.4.8 High speed data sampling setting

(3) Timing of processing when "Time specification" is specified

Processing is performed after the first sequence scan of the programmable controller CPU for which the specified time has elapsed.

(a) When the sequence scan time is shorter than the specified interval

Processing is performed after the first sequence scan of the programmable controller CPU for which the specified time has elapsed.*1

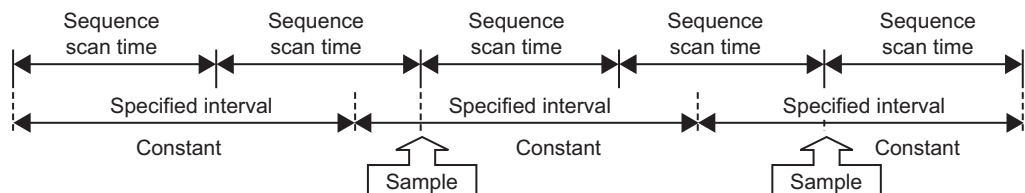

7 DATA LOGGING FUNCTION

(b) When the sequence scan time is longer than the specified interval
Processing is executed at each sequence scan time.*1

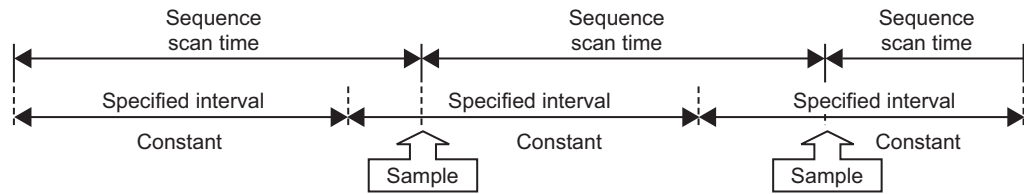

*1: When the following conditional expression is true, execute the data sampling, not with a sequence scan time (ST), but with a sampling interval (ST').

- (Conditional expression): $\alpha > 1$
 $\alpha = (\text{the numbers after the decimal point are rounded up}) = (0.4 \times \text{a number of specified high speed data sampling settings}^2 - 0.2) / ST$
- $ST' = ST \times \alpha$

Example) When a number of specified high speed data sampling settings is 20, and sequence scan time (ST) is 3ms

$$\alpha = (0.4 \times 20 - 0.2) / 3 = 3 \text{ (the value after the decimal point of 2.6 is rounded up)}$$

Since $\alpha > 1$, $ST' = 3 \times 3 = 9$

Execute the data sampling, not with a sequence scan time (3ms), but with the sampling interval (9ms).

*2: Total number of data logging, event logging, and report settings in which high speed data sampling is specified. When the split data sampling mode is selected on the high speed data sampling setting, calculate as 1.

POINT

Data changes occurred between the data sampling processes are not sampled because a high speed data logger module only samples data from a programmable controller CPU at the specified data sampling intervals.

➡ Appendix 12 Sampling Processes of High Speed Data Logger Module

7.2.2 General data sampling

This section is common to the 'general data sampling' for the event logging function and report function.

(1) Timing of processing when "Time specification" is specified

Processing is performed at the specified interval or at the time required to obtain data.

- (a) Processing is possible for other CPUs and CPUs in other stations.
- (b) More data points can be processed than 'high speed data sampling'.
- (c) If the time required to obtain data is longer than the specified interval, data are sampled at the time interval required to obtain data.

The buffer memory can be checked for the actual time required to obtain data.

☞ Section 3.4.8 General data sampling delay time area (address: 800 to 805)

If the time required to obtain data is longer than the specified interval, the time interval required to obtain data is the timing of processing as shown in the figure below.

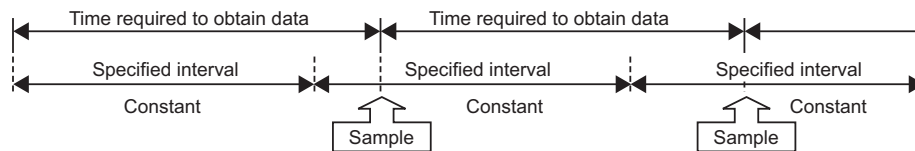

(2) Timing of processing when "Time interval specification" is specified

Samples data at the time interval of every specified hour/minute/second.^{*1}

*1: Depending on the amount of sampled data and the other settings of logging/report function, the specified sampling time may be delayed.

- (a) Available unit that can be specified

Hour: 1, 2, 3, 4, 6, 8, 12, 24

Minute: 1, 2, 3, 4, 5, 6, 10, 12, 15, 20, 30, 60

Second: 1, 2, 3, 4, 5, 6, 10, 12, 15, 20, 30, 60

- (b) Example of data sampling timing

Samples every half hour from the top of the hour.

Example: The time interval of half hour is specified and the power is turned ON at 10:15.

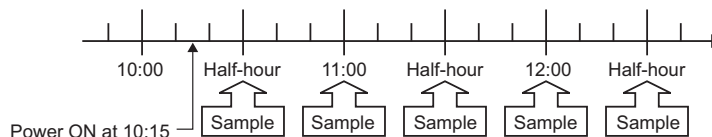

POINT

- (1) Since general data sampling is not synchronized with the control CPU's sequence scan, data separation may occur.
 - ☞ Section 3.2 (6) Access units
 - To perform data sampling synchronized to the sequence scan, use high speed data sampling.
- (2) Data changes occurred between the data sampling processes are not sampled because a high speed data logger module only samples data from a programmable controller CPU at the specified data sampling intervals.
 - ☞ Appendix 12 Sampling Processes of High Speed Data Logger Module

7 DATA LOGGING FUNCTION

7.3 Logging Types

The following are the two types of logging.

Logging type	Overview
Continuous logging	Logs continuously at the specified data sampling interval.
Trigger logging	Logs the specified number of lines worth of target data before and after a trigger occurs (specified condition is established).

7.3.1 Continuous logging

This function continuously logs programmable CPU module device values at the specified data sampling interval.

[Save target data in the specified interval]

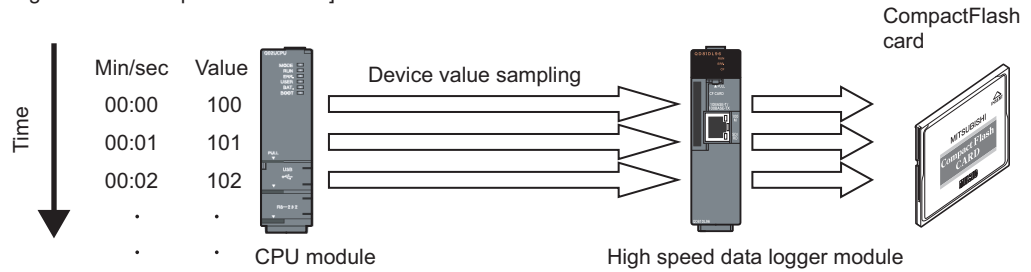

7 DATA LOGGING FUNCTION

7.3.2 Trigger logging

This function logs only the specified number of lines worth of CPU module device values before and after a trigger occurs (specified condition is established).

For trigger logging conditions, refer to the following section.

☞ Section 7.3.3 Trigger conditions

[Save target data when trigger occurs]

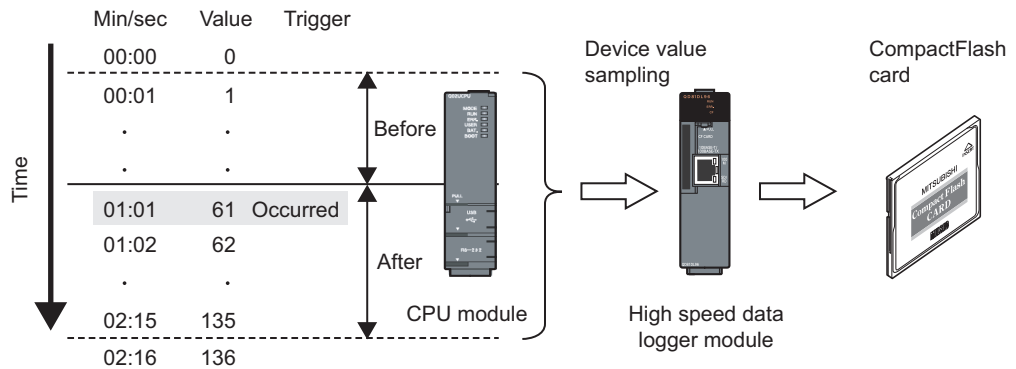

☒ POINT

When the number of device points to be sampled exceeds the access units and general sampling is specified for the data sampling method, device values are sampled over multiple sequence scans, and the values are logged as one data row.

Therefore, device values sampled in another sequence scan as the one where the trigger occurred may be included in one data row.

To avoid this, the number of device points that can be sampled at once should be less than the access units or high speed sampling should be used.

For the access units, refer to the following section.

☞ Section 3.2 (6) Access units

7 DATA LOGGING FUNCTION

The following are the two methods for specifying the number of lines in trigger logging.

(1) Logging the device values before and after the trigger condition rise

Specify the number of lines before and after the trigger condition rise.

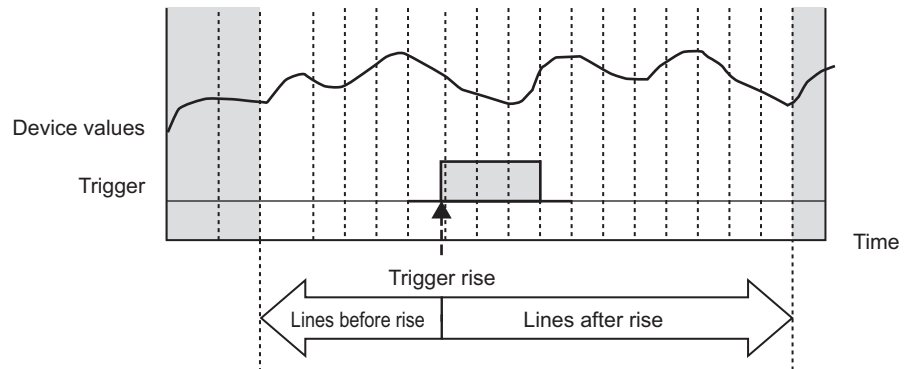

(2) Logging the data before the trigger condition rise, while trigger condition is established, and after the trigger condition fall

Specify the number of lines before the trigger condition rise and after the trigger condition fall, and the total number of lines.

The total number of lines is the maximum number of lines to be logged under this condition.

Specify the value more than the total of lines before the trigger condition rise and after the trigger condition fall.

The lines exceeding the total of lines before the trigger condition rise and after the trigger condition fall are assigned to the logging lines on which the trigger condition is established.

With this setting, the logging range differs according to the length of time that the trigger condition is established.

- (a) When the time that the trigger condition is established is long
 Logs the total number of lines worth of data.

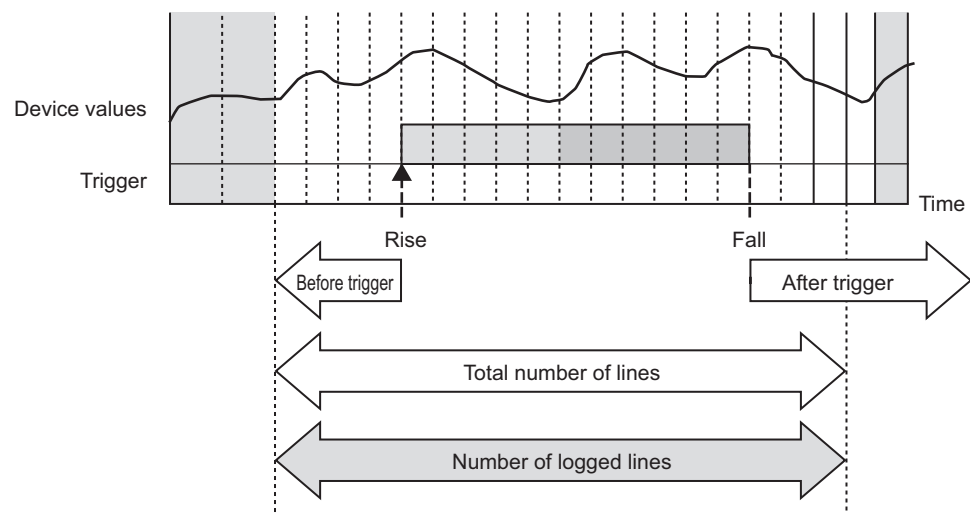

7 DATA LOGGING FUNCTION

- (b) When the time that the trigger condition is established is short
Logs the specified number of lines after the trigger.

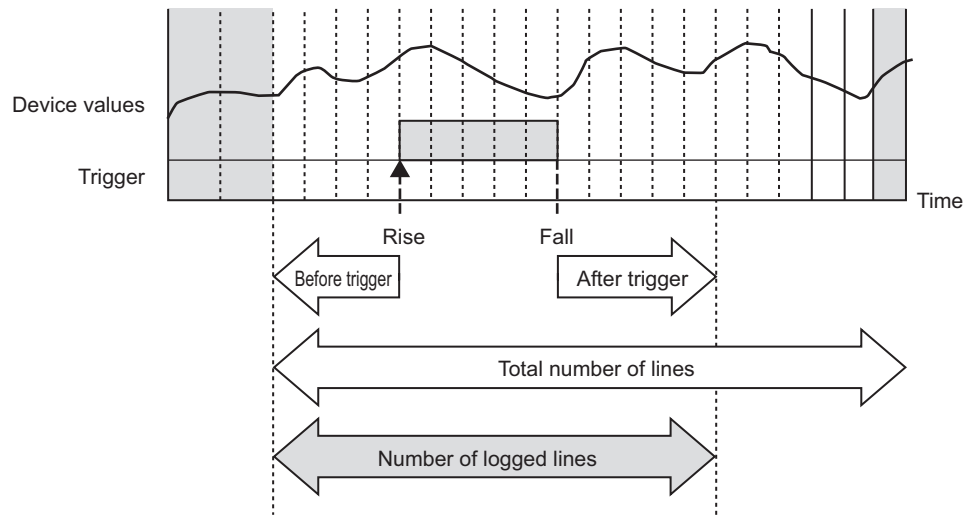

POINT

- (1) Immediately after switching the programmable controller system ON, if a trigger occurs before sampling the number of lines worth of data before the trigger, the data sampled before the trigger is less than the specified lines.
- (2) The following are the operations when triggers continuously occur.
 - After a trigger occurs, if the next trigger occurs before sampling the number of lines worth of data after the trigger, the next trigger is not detected (The trigger is ignored).

By checking the trigger reoccurrence count in 'data logging information 1 to 64' (☞ Section 3.4.11 (5)) in the buffer memory, the number of times that triggers were ignored can be checked.

Example) For data sampling interval: 10ms, number of lines after the trigger: 100 lines

Triggers which occur again within 1000ms after the trigger are not processed.

(Continued on the next page)

1

OVERVIEW

2

SYSTEM CONFIGURATION

3

SPECIFICATIONS

4

SETTINGS AND PROCEDURES UP TO OPERATION

5

HIGH SPEED DATA LOGGER MODULE TOOL STARTUP

6

FUNCTION LIST

7

DATA LOGGING FUNCTION

8

EVENT LOGGING FUNCTION

7 DATA LOGGING FUNCTION

(From the previous page)

- After the first trigger occurs, triggers which occur after the number of lines worth of data after the trigger are sampled, are detected. However, if the data in the lines after the first trigger overlaps with the data in the lines before the second trigger, the data at the time output by the first trigger is not detected with the second trigger. Therefore, the number of lines before the second trigger may be shortened.

Example Data sampling interval: 10ms
 Trigger period: 1500ms
 Number of lines before trigger: 100 lines
 Number of lines after trigger: 100 lines

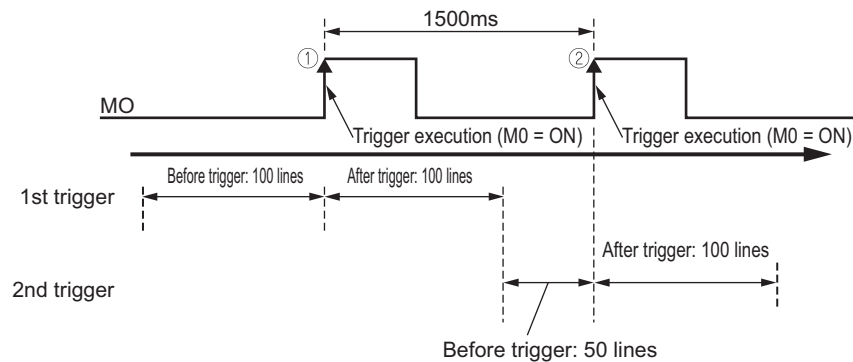

- After the trigger occurs, triggers which occur again within the period up until the file output completion, are processed only once. Trigger determination processing is not performed for two triggers in the period the file is output. Therefore, triggers are not detected which occur after that (after the third trigger counting from the first trigger). For this period, since later processing is not in time for the speed of processing data sampling, a processing overload error occurs. The processing overload count can be checked with the trigger reoccurrence count in 'data logging information 1 to 64' (Section 3.4.11 (5)) in the buffer memory. The period when data are being saved to a file can be checked with 'data logging execution information' (Section 3.4.11 (2)) in the buffer memory.

For a guide to time required to save data to a file, refer to (Section 17.1).

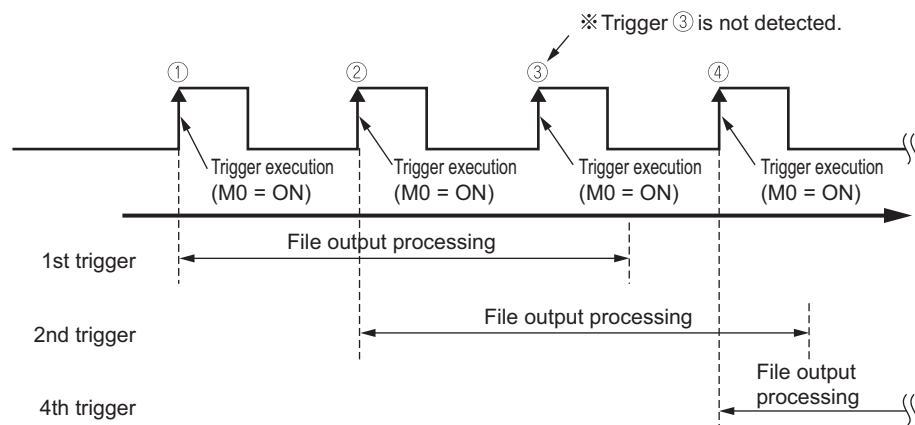

7.3.3 Trigger conditions

Conditions shown in the following table can be selected as the trigger conditions.

Condition	Trigger type	Detailed condition	Reference
Single condition	-	-	(1) in this section
Compound condition	OR combine	-	(2) (a) in this section
	AND combine	-	(2) (b) in this section
	Number of times	Number-of-times conditions to be noted when a terminal condition holds true.	(2) (c) in this section
		When a specified number of times is exceeded.	
	Order	Abnormal pattern is detected.	(2) (d) in this section
Normal pattern is detected.			
Timeout detected.			

(1) Single condition

For single conditions, triggers occur by establishing a single condition. Select one condition from the conditions shown in the table below.

Condition	Description	Reference
Data conditions	-	Section 11.5.10
Comparison	Compares device values or a device value and constant, and a trigger occurs when the condition is established. (=, ≠, <, ≤, >, ≥)	
At the time of change of value	A trigger occurs when the device value changes.	
Fixed cycle [seconds]	A trigger occurs at a fixed cycle (seconds).	
Time interval specification	A trigger occurs at the time interval of every specified hour/minute/second.	
Time specification	A trigger occurs at the specified time.	
At startup of module	A condition is established at either of the following timing. <ul style="list-style-type: none"> • When the programmable controller CPU is powered ON • After startup when the programmable controller CPU is reset 	

7 DATA LOGGING FUNCTION

(a) Comparison of a bit device value set as a condition

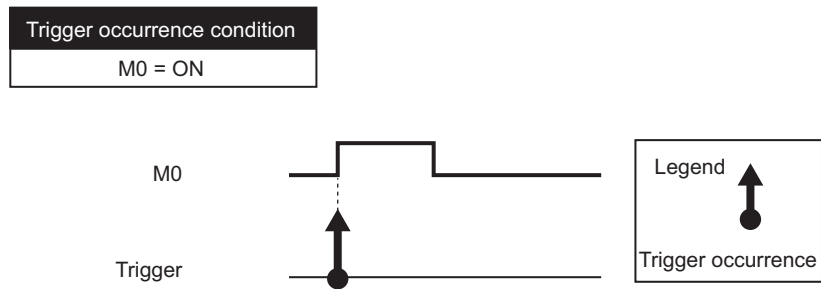

(b) Comparison of a word device value set as a condition

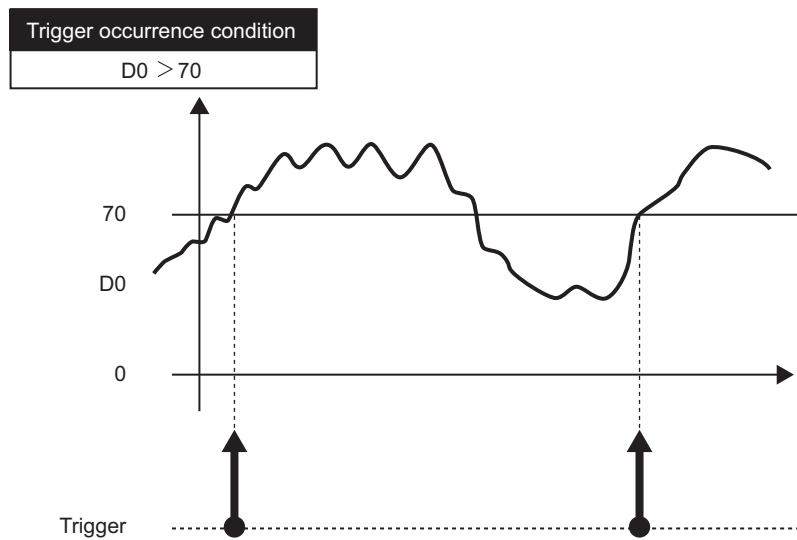

(c) Word device value change set as a condition

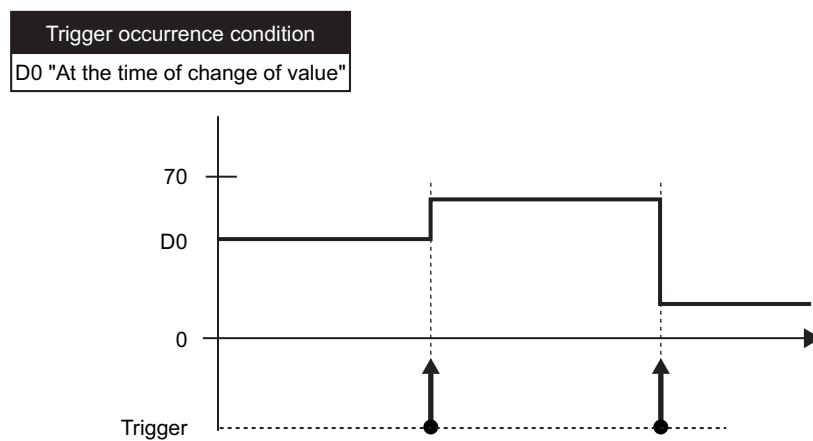

(2) Compound conditions

For compound conditions, triggers occur by establishing multiple conditions. The conditions which compose compound conditions are the same as the conditions which can be specified with single conditions.

(a) OR combine

Triggers occur by establishing any of the set conditions.

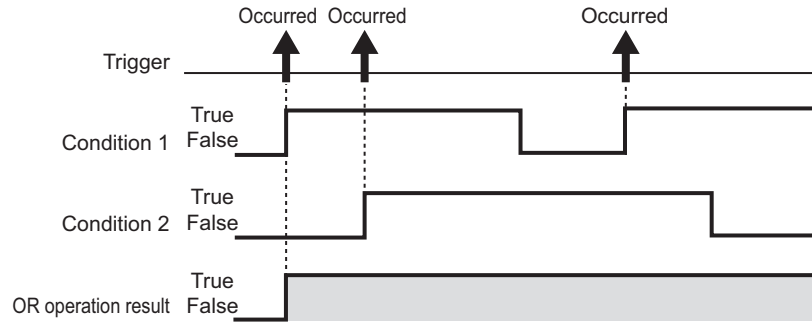

(b) AND combine

Triggers occur by establishing all of the set conditions.

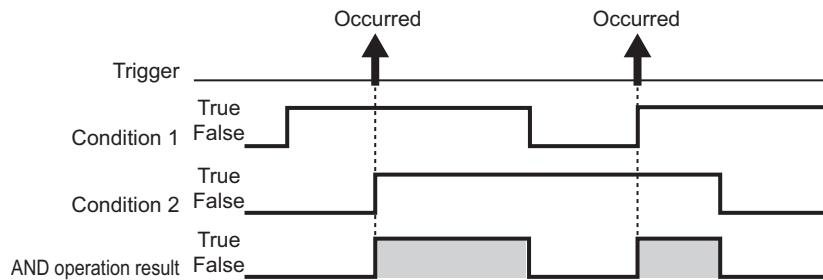

(c) Number of times

The number of times the condition is established (established counts) is compared with the specified counts and a trigger occurs.

The timing of the comparison of the established counts to the specified counts can be selected from the options below.

- Number-of-times conditions to be noted when a terminal condition holds true.
- When a specified number of times is exceeded.

For details on counts, refer to the following section.

☞ Section 11.5.11 Trigger (compound condition)(3) Number of times

(d) Order

Monitors the order of multiple conditions being established, a trigger occurs when the order is normal, when out of order, or when a timeout is detected.

For details on order, refer to the following section.

☞ Section 11.5.11 Trigger (compound condition)(4) Order

☒ POINT

OR and AND combines cannot be combined for the trigger conditions.

7 DATA LOGGING FUNCTION

7.4 Data Logging Periods

The periods to execute logging and the periods not to execute logging can be specified.

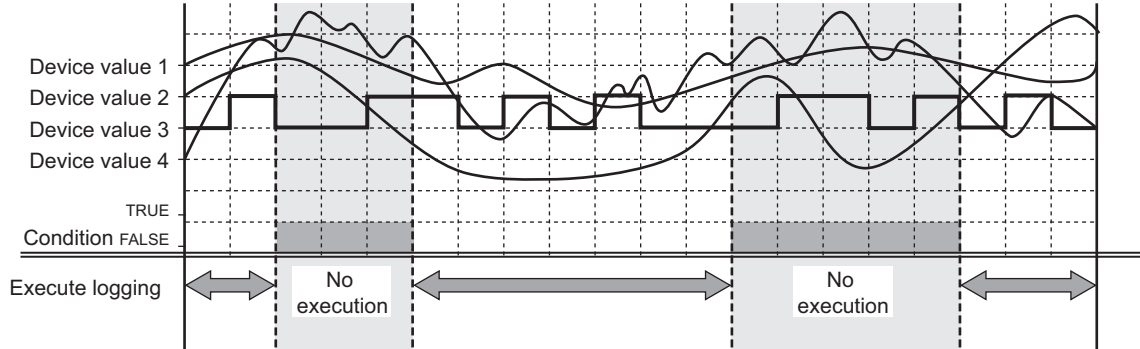

The following table shows the types of periods which can be specified.

Periods ① to ④ can be specified in combinations of up to a maximum of 8 conditions.

All periods can be combined with OR or AND combinations.

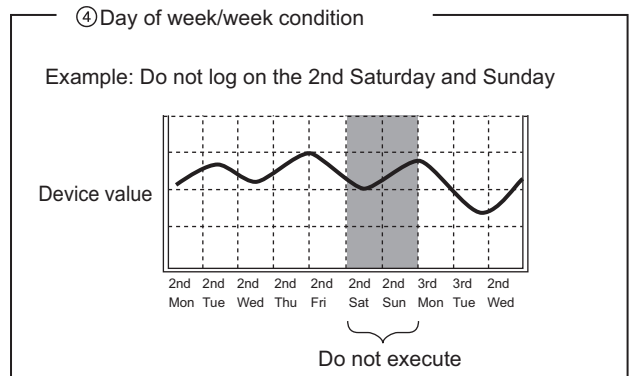
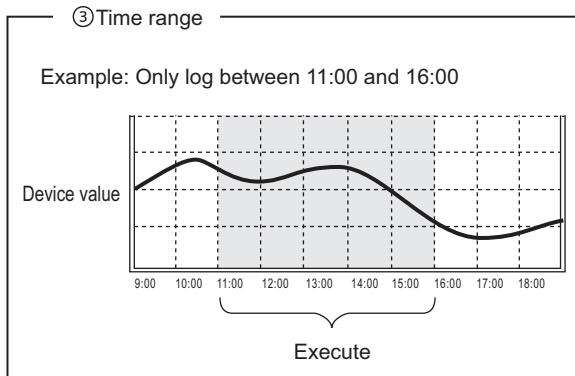
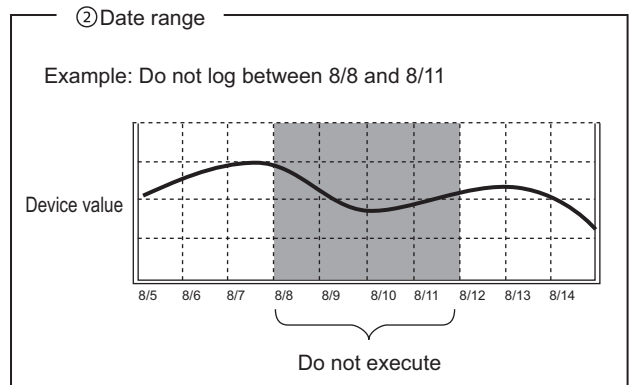
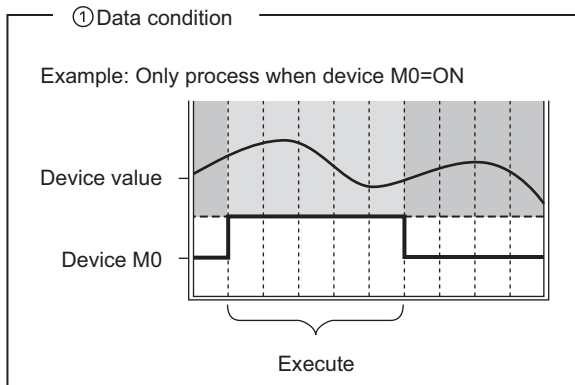

Periods ① to ④ can be combined up to a maximum of 8 types.

7 DATA LOGGING FUNCTION

(1) When all periods are combined with OR

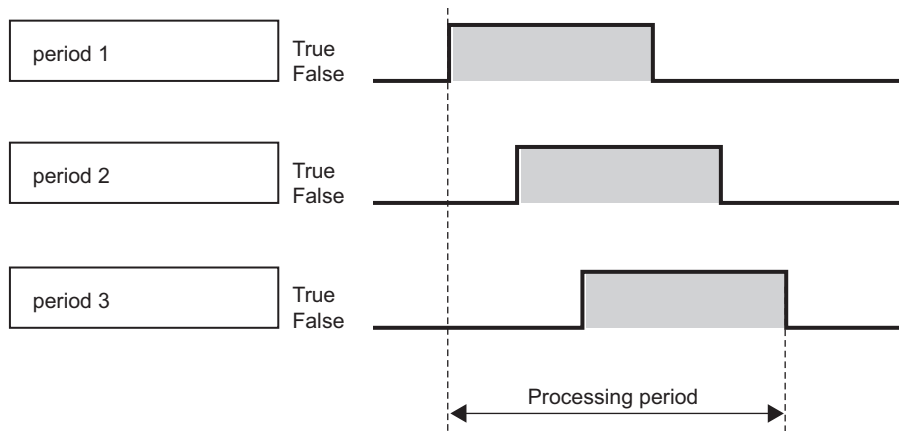

(2) When all periods are combined with AND

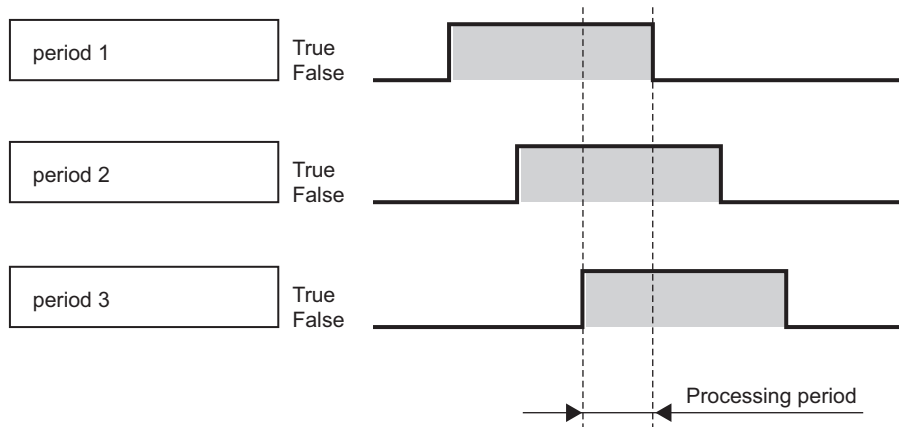

☒ POINT

- (1) If the data sampling interval is high speed data sampling, a maximum of 4 types of periods can be combined.
- (2) When specifying combinations of periods, a combination of AND and OR cannot be specified.

7.5 Data Logging Files

Data logging target data are saved in the data logging file.

7.5.1 Data logging file save format

Data logging files can be saved in the two types of file formats below.

- CSV file format (extension: '.CSV')
- Binary file format (extension: '.BIN')

(1) CSV file format

This file format can be opened by normal applications such as Excel and Notepad.

It can also be viewed with GX LogViewer.

For the CSV file format, refer to the following section.

 Section 3.6.2 Data logging file

(2) Binary file format

High-speed file access is possible with this format because it is smaller in size than the CSV file format.

It can also be viewed with GX LogViewer.

For the binary file format, refer to the following section.

 Section 3.7.1 Data logging file

7 DATA LOGGING FUNCTION

7.5.2 Saving data logging files

The high speed data logger module temporarily saves sampled data logging target data to the 'storing file' on the inserted CompactFlash card.

Since the size of the 'storing file' becomes larger with time, 'file switching' is performed at the specified conditions.

'File switching' is giving the 'storing file' a name to change it to a 'saved file'. (A new 'storing file' is created after the file name is changed.)

In addition to an eight-digit hexadecimal serial number, the specified information can be attached to the file name.

'Saved files' have a serial number added to the file name up to the specified number of files, and they are saved on the CompactFlash card.

When the specified number of 'saved files' is surpassed, old files are deleted in order.

For conditions to specify, refer to the following section.

☞ Section 11.5.15 Save

Example) Saving data logging files when the file count after the switch is set to an upper limit of 3

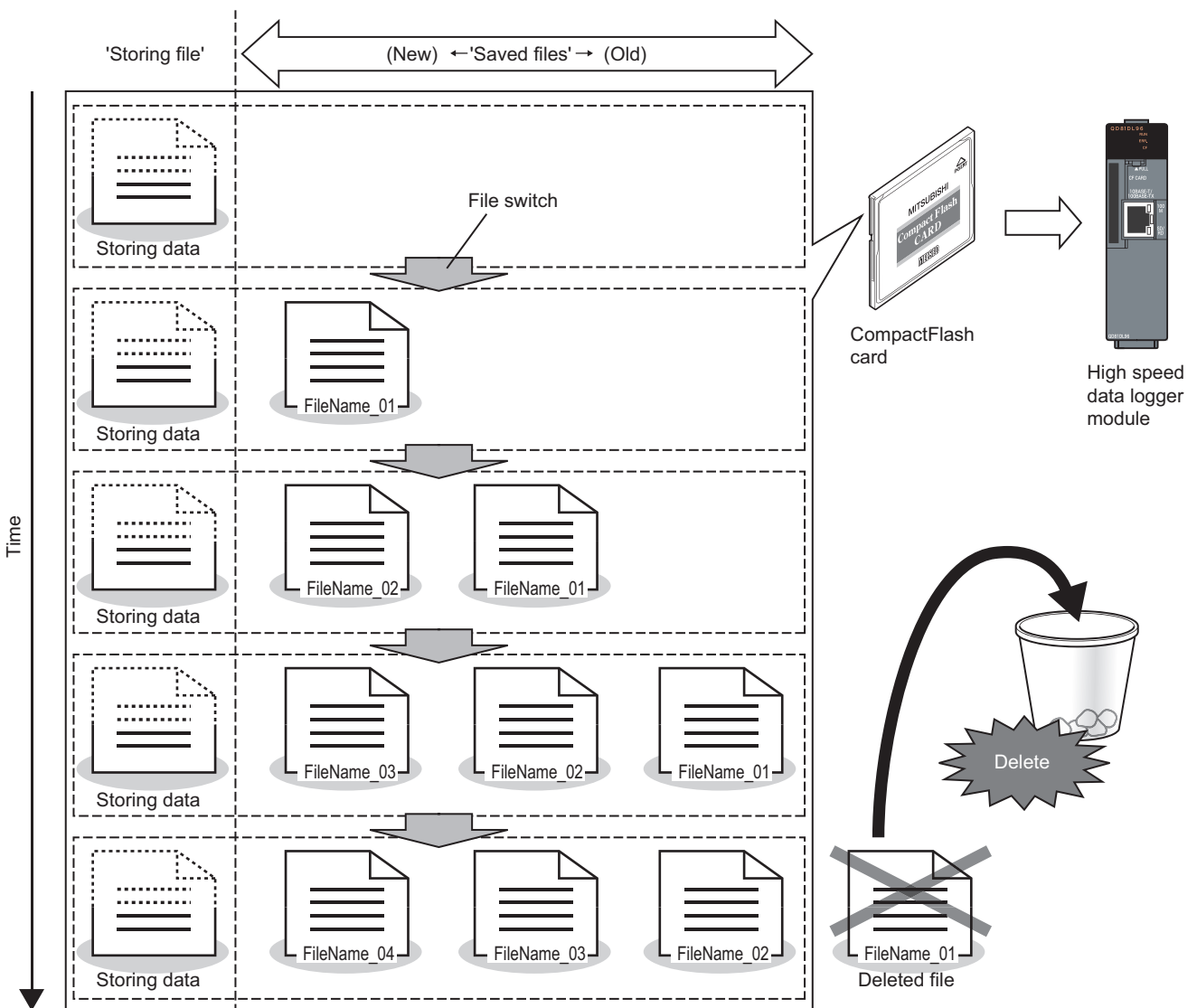

7.5.3 Data logging file save location

Data logging files are saved on the CompactFlash card.

For the CompactFlash card directory structure, refer to the following section.

 Section 3.5 Directory Structure

7.5.4 Transferring data logging files

Data logging files can be automatically transferred to an FTP server or mail server.

There are two methods for transferring data logging files.

(1) Transfer using FTP

For details, refer to the following sections.

- Function explanation: Section 10.5 FTP Transfer Function
- Setting method: Section 11.4.4 FTP setting

(2) Transfer using e-mail transmission

For details, refer to the following sections.

- Function explanation: Section 10.6 E-mail Function
- Setting method: Section 11.4.5 E-mail setting

7 DATA LOGGING FUNCTION

7.6 Missing Data

When sampled data are missing or data are not continuous, this is referred to as a data miss.

The occurrence of a data miss can be checked by the items below.

- Data logging file index information (☞ Section 3.6.2, ☞ Section 3.7.1)
- Two vertical dashed-dotted lines displayed in the trend window of GX LogViewer (☞ GX LogViewer Version 1 Operating Manual)

A data miss occurs in the situations shown in the table below.

Item	Description	Data Logging	Realtime Trend
High speed data sampling failure	The processing of sampling is not in time for the specified data sampling interval and a high speed data sampling failure occurs when high speed data sampling is specified. ☞ Section 17.2.1	○	○
Processing overload	The data logging processing (trigger determination and file saving) is not in time for the specified data sampling interval and a processing overload error occurs.	○	○
Sampling error	When an error occurs in the sampling process by a cause such as the connection cable being disconnected.	○	○
Programmable controller CPU operation	When the own station's programmable controller CPU is switched from STOP to RUN when high speed data sampling (each scan) is specified.	○	○
	When PLC parameters are being written to the own station's programmable controller CPU when high speed data sampling is specified.	○	○
Module operation	When "Update settings" is performed for the high speed data logger module.	○	○
	When "Restart" is performed for high speed data logger module operations.	○	○
Data logging period	When the data logging period is specified, the sampled data were not saved to a file because they are outside the period.	○	-
Trigger logging	The period when sampled data between triggers were not output to a file.	○	-
Realtime trend data	GX LogViewer data acquisition/display was not in time for the specified data sampling interval.	-	○

○ : Occurs, - : Does not occur

1

OVERVIEW

2

SYSTEM CONFIGURATION

3

SPECIFICATIONS

4

SETTINGS AND PROCEDURES UP TO OPERATION

5

HIGH SPEED DATA LOGGER MODULE TOOL STARTUP

6

FUNCTION LIST

7

DATA LOGGING FUNCTION

8

EVENT LOGGING FUNCTION

CHAPTER 8 EVENT LOGGING FUNCTION

Event logging is a function to monitor device values sampled by the programmable controller CPU and logs events that occur.

The logged 'target' data are saved to the CompactFlash card inserted in the high speed data logger module.

Occurred events can be notified by e-mail.

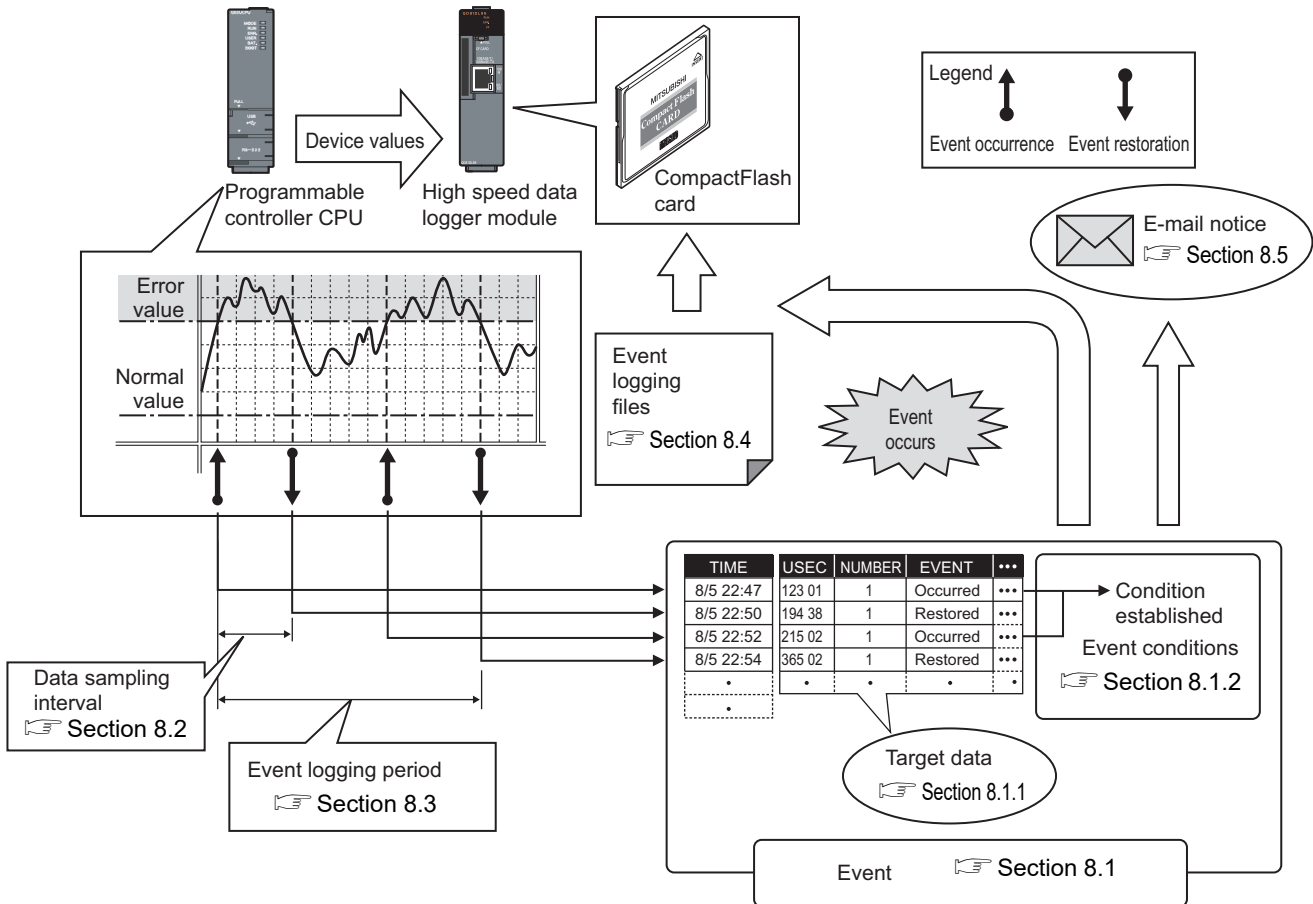

The group of target data sampled with the same 'data sampling interval' and 'monitoring conditions' configuration is called an 'event logging setting'.

The number of event logging settings which can be configured overall for the event logging function is a maximum of 64.

For event logging function settings, refer to the following section.

☞ Section 11.6 Event Logging Setting

8.1 Events

'Events' are the combination of 'target data' (☞ Section 8.1.1) and 'event conditions' (☞ Section 8.1.2).

8.1.1 Target data

'Target data' are data saved to the CompactFlash card along with a time stamp when the programmable controller CPU's device values are compared to 'event conditions' (☞ Section 8.1.2) and those conditions are established.

(1) Device memory subject to event logging

Event logging can be performed for the device memory below.

- Control CPU devices X/Y/M/T/C/D/R/B/W and others
- The device memory of other CPUs when multiple CPU configurations
- The device memory of other stations' CPUs that was transmitted via the network

For details, refer to the following section.

☞ Section 3.2 (3) Accessible devices

(2) Data type

Device memory subject to event logging can be logged as the data types shown in the table below.

Data type	Number of occupied device points
Bit	1 point
Word [signed]	1 point
Double word [signed]	2 points
Word [unsigned]	1 point
Double word [unsigned]	2 points
Float (single precision)	2 points
Float (double precision)	4 points
16 bit BCD	1 point
32 bit BCD	2 points
String	(String count/2) points
Raw	(Binary size/2) points

(3) Number of target data settings

Up to 64 pieces of 'target data' can be set for a single 'event logging setting'.

8.1.2 Event conditions

'Event conditions' are selected from the conditions shown in the table below.

Event condition	Event type	Detailed condition	Reference
Single condition	-	-	(1) in this section
Compound conditions	Comparison	AND combine	(2) (a) in this section
		OR combine	(2) (b) in this section
	Number of times	Number-of-times conditions to be noted when a terminal condition holds true.	(2) (c) in this section
		When a specified number of times is exceeded.	
	Order	Abnormal pattern is detected.	(2) (d) in this section
		Normal pattern is detected.	
Timeout detected.			

(1) Single condition

A single condition compares monitoring data and the trigger value (limited to constant values) with the monitoring condition.

When the condition changes from not being established to being established, the event occurs.

When the condition also changes from being established to not being established, the event is restored.

(a) Comparison of a bit device value set as an event condition

Event condition
M0 = ON

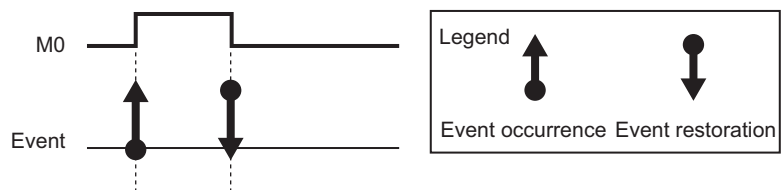

8 EVENT LOGGING FUNCTION

(b) Comparison of a word device value (restoration value not specified) set as an event condition

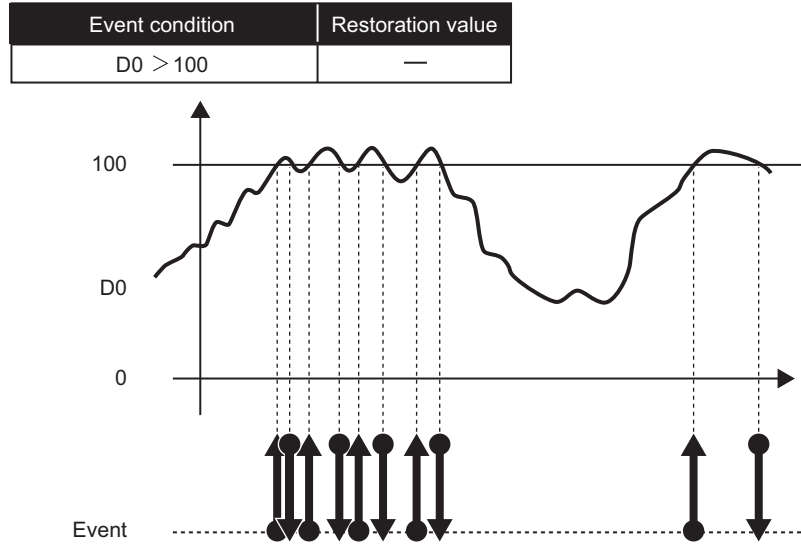

(c) Comparison of a word device value (restoration value specified) set as an event condition

Event condition	Restoration value
D0 > 100	70

The repetitions of event occurrence/restoration by the value fluctuation as shown in the figure below, can be prevented by specifying a restoration value.

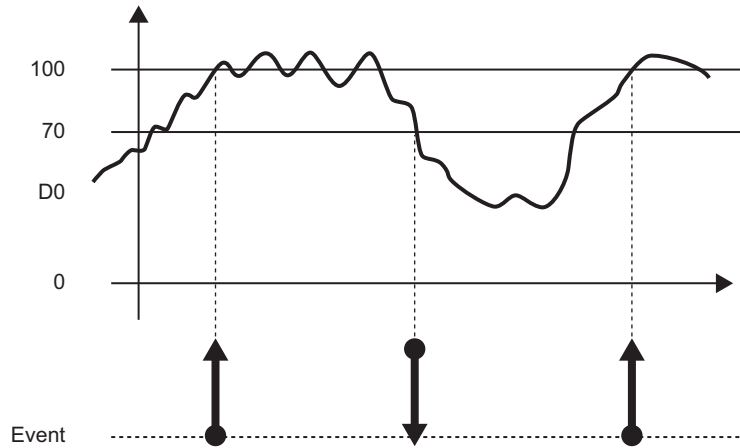

8 EVENT LOGGING FUNCTION

(d) Word device value change set as a condition

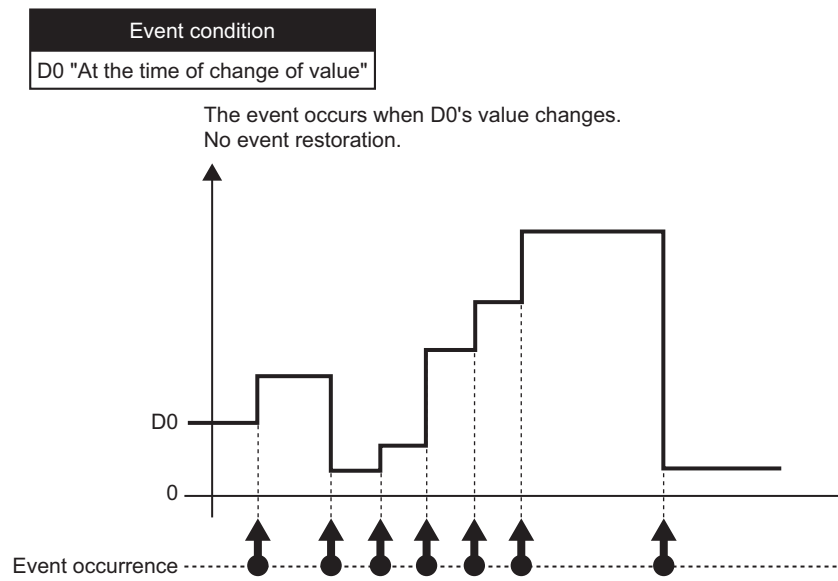

(2) Compound conditions

(a) AND combine

Events occur by establishing all of the set event conditions.
A maximum of 4 single conditions can be combined.

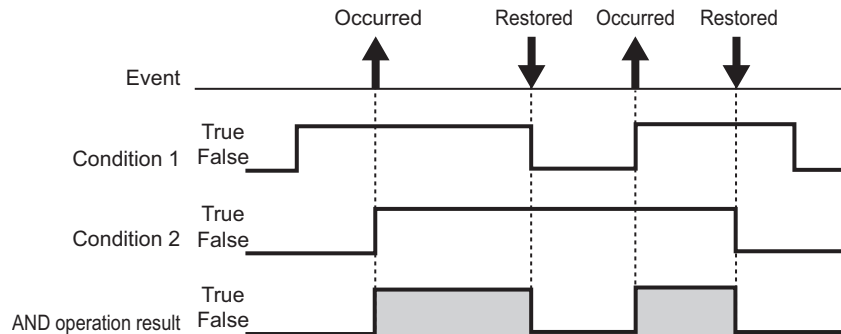

(b) OR combine

Events occur by establishing any of the set event conditions.
A maximum of 4 single conditions can be combined.

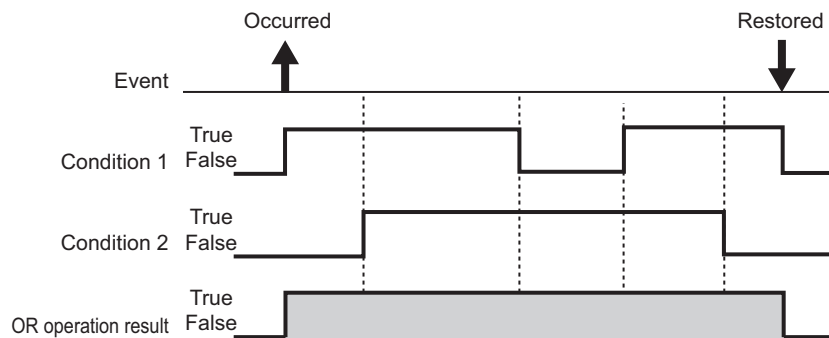

(c) Number of times

The number of times the condition is established (established counts) is compared with the specified counts and an event occurs.

The timing of the comparison of the established counts to the specified counts can be selected from the options below.

- Number-of-times conditions to be noted when a terminal condition holds true.
- When a specified number of times is exceeded.

For details on counts, refer to the following section.

☞ Section 11.5.11 Trigger (compound condition)(3) Number of times

(d) Order

Monitors the order of multiple conditions being established, an event occurs when the order is normal, when out of order, or when a timeout is detected.

For details on order, refer to the following section.

☞ Section 11.5.11 Trigger (compound condition)(4) Order

☒ POINT

OR and AND combines cannot be combined for event conditions.

8 EVENT LOGGING FUNCTION

8.2 Target Data Sampling

'Sampling' is a function performed with specifying the data sampling method and data sampling interval for the target data.

The following table shows data sampling methods.

Data sampling method	Overview
High speed data sampling (each scan)	Samples at each sequence scan of the programmable controller CPU.
High speed sampling (time specification)	Samples at the specified interval (milliseconds).
General data sampling (time specification)	Samples at the specified interval (seconds).
General data sampling (time interval specification)	Samples at the time interval of every specified hour/minute/second.

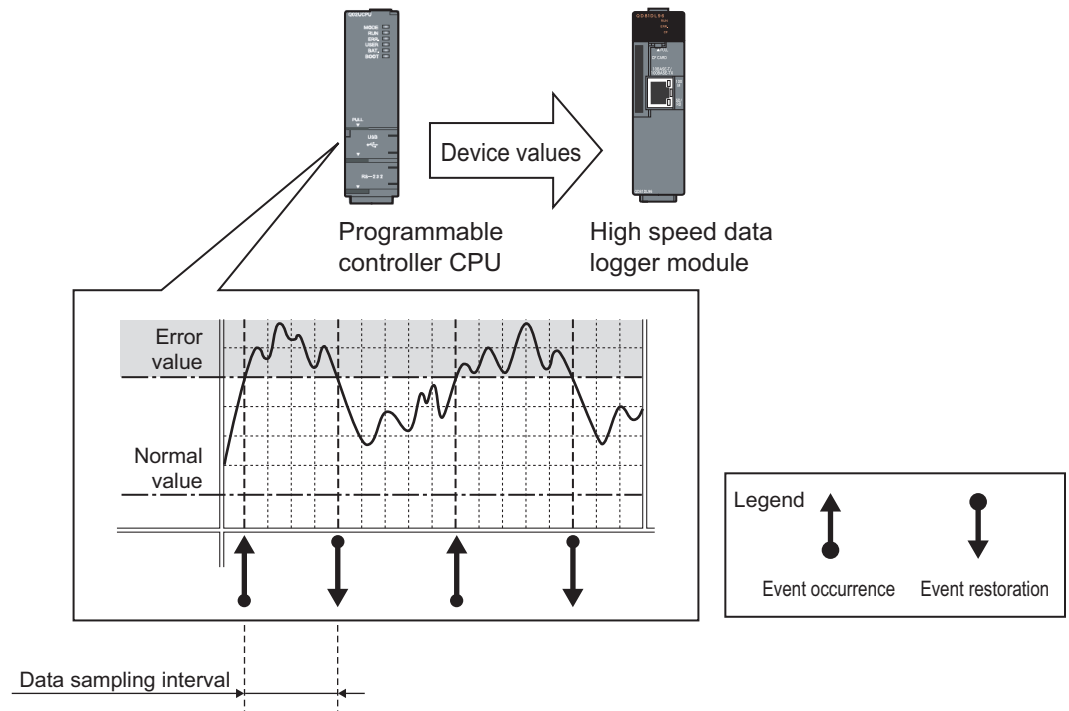

The system configuration and the process timing by the 'data sampling method' is the same as those of the data logging 'data sampling method'.

➔ Section 7.2 Target Data Sampling

POINT

- (1) In order to perform high speed data sampling, a programmable controller CPU which supports the high speed data sampling function is required.
☞ Section 2.2 Applicable Systems
- (2) The data logging, event logging, and report functions of the high speed data logger module are best effort functions.
Since module processing time changes according to the settings and status of other devices, it may not operate with the set data sampling interval. Run the system by fully verifying the processing time of each function when constructing it.
For processing time, refer to the following chapter.
☞ Chapter 17 PROCESSING TIME
- (3) The total number of settings is 32 for each of the functions below when 'data sampling method' is specified as 'high speed data sampling'.
 - Data logging function
 - Event logging function
 - Report function

8.3 Event Logging Periods

The periods to execute logging and the periods not to execute logging can be specified.

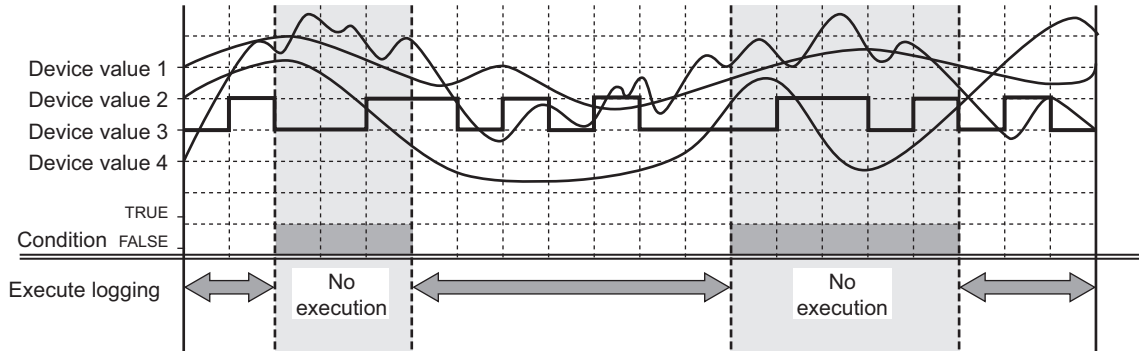

Conditions to specify the event logging period can be selected from the items below.

- ① Data condition
- ② Date range
- ③ Time range
- ④ Day of week/week condition

For details, refer to the following section.

☞ Section 7.4 Data Logging Periods

8.4 Event Logging Files

Event logging target data are saved in the event logging file.

8.4.1 Event logging file save format

Event logging files can be saved in the two types of file formats below.

- CSV file format
- Binary file format

(1) CSV file format

This file format can be opened by normal applications such as Excel and Notepad. It can also be viewed with GX LogViewer.

For the CSV file format, refer to the following section.

☞ Section 3.6.3 Event logging file

(2) Binary file format

High speed file access is possible with this format because it is smaller in size than the CSV file format.

It can also be viewed with GX LogViewer.

For the binary file format, refer to the following section.

☞ Section 3.7.2 Event logging file

8.4.2 Saving event logging files

The high speed data logger module temporarily saves events which occurred to the 'storing file' on the inserted CompactFlash card.

Since the size of the 'storing file' becomes larger with time, 'file switching' is performed at the specified conditions.

'File switching' and the method for saving files are the same as that of the data logging file.

For details, refer to the following section.

☞ Section 7.5.2 Saving data logging files

8.4.3 Event logging file save location

Event logging files are saved on the CompactFlash card.

For the CompactFlash card directory structure, refer to the following section.

☞ Section 3.5 Directory Structure

8.4.4 Transferring event logging files

Event logging files can be automatically transferred to an FTP server or mail server. There are two methods for transferring data logging files.

(1) Transfer using FTP

For details, refer to the following sections.

- Function explanation: Section 10.5 FTP Transfer Function
- Setting method: Section 11.4.4 FTP setting

(2) Transfer using e-mail transmission

For details, refer to the following sections.

- Function explanation: Section 10.6 E-mail Function
- Setting method: Section 11.4.5 E-mail setting

8 EVENT LOGGING FUNCTION

8.5 E-mail Notification

This function sends a notification of an event occurrence to the specified e-mail address using e-mail. It can be resent automatically when the e-mail send failed.

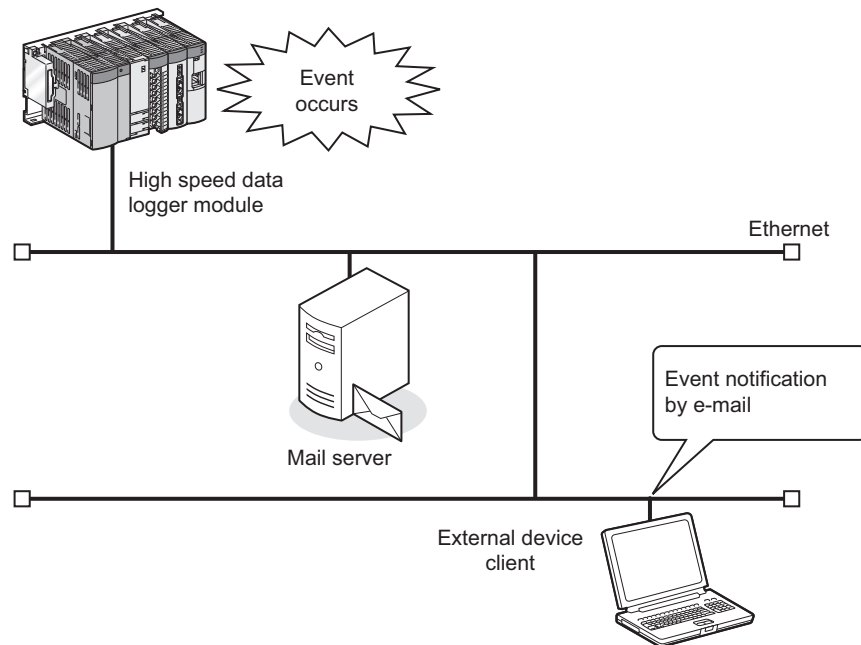

Sent e-mail example

Mail header	From: QD81DL96 [xxx@xxx.co.jp] Date: 10/12/2008 Wednesday 20:52 To: xxx@xxx.co.jp Subject: Information from the No.1 factory 10/12/2008 20:52:23
Message	The following error has been occurred. (The header specified by user) Furnace No. 1 Temperature decrease Occurrence (The event name specified by user) Perform the recovery operation immediately. (The footer specified by user)

1

OVERVIEW

2

SYSTEM CONFIGURATION

3

SPECIFICATIONS

4

SETTINGS AND PROCEDURES UP TO OPERATION

5

HIGH SPEED DATA LOGGER MODULE TOOL STARTUP

6

FUNCTION LIST

7

DATA LOGGING FUNCTION

8

EVENT LOGGING FUNCTION

CHAPTER 9 REPORT FUNCTION

The report function outputs reports laid out with graphs and calculation formulas as Excel files.

Set the Excel file layout in advance and create reports with values and graphs from data logging files and current value data sampled by the programmable controller CPU. Combined with graphs, the changes in data can be summarized in an easy-to-understand manner.

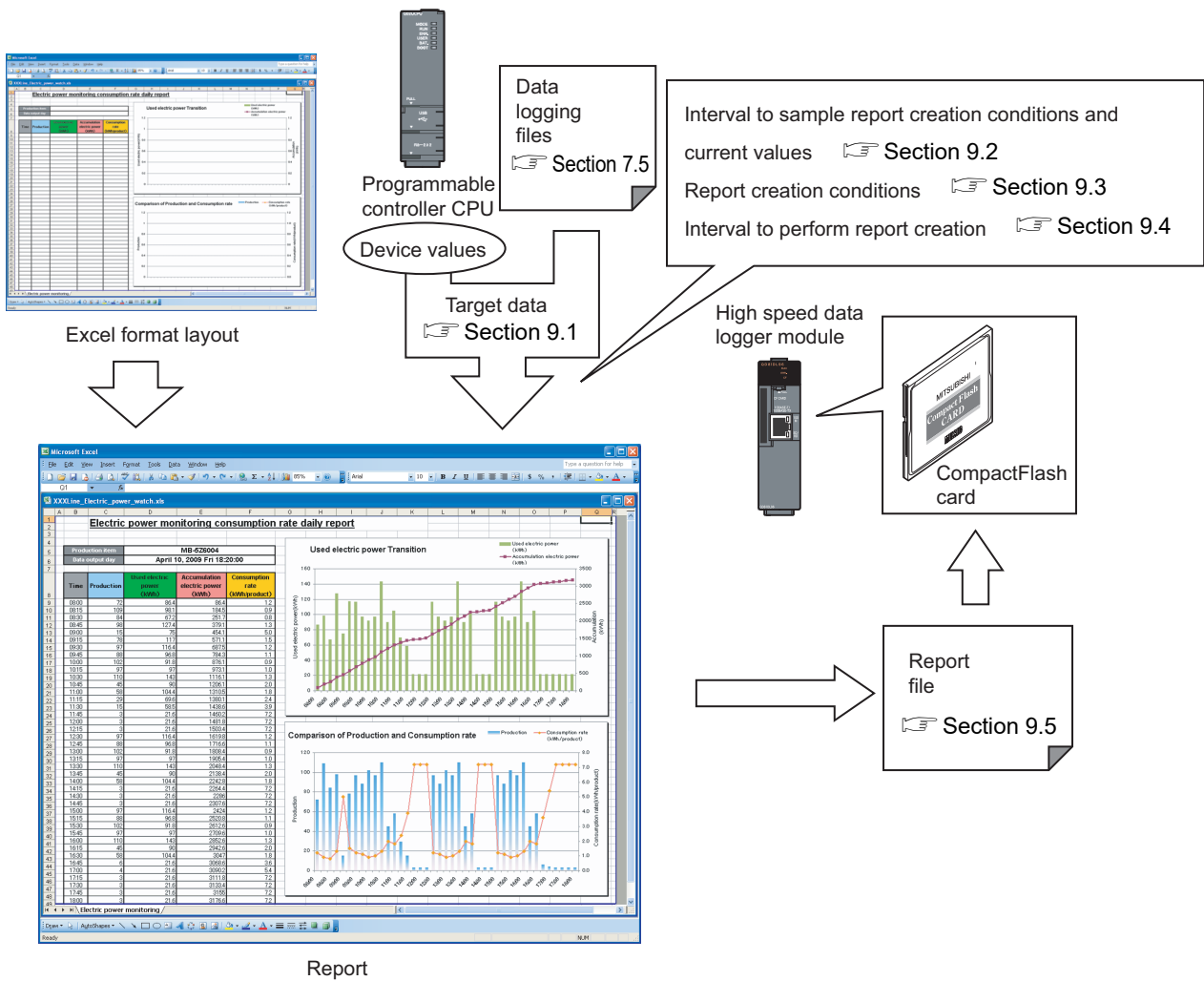

For report setting, refer to the following section.
[Section 11.7 Report Setting](#)

9 REPORT FUNCTION

9.1 Target Data

'Target data' are data which can be laid out on a report.

(1) Target data types

The following table shows the types of target data.

Target data type	Description
Data logging (POINT in this section)	The data inside a data logging file created by the data logging function can be selected. (Section 7.5) The data for the specified number of records are read from the data logging file and output to the report.
Current values	Programmable controller CPU device data at the time when the report was created.
Creation time	The date and time when the report was created.

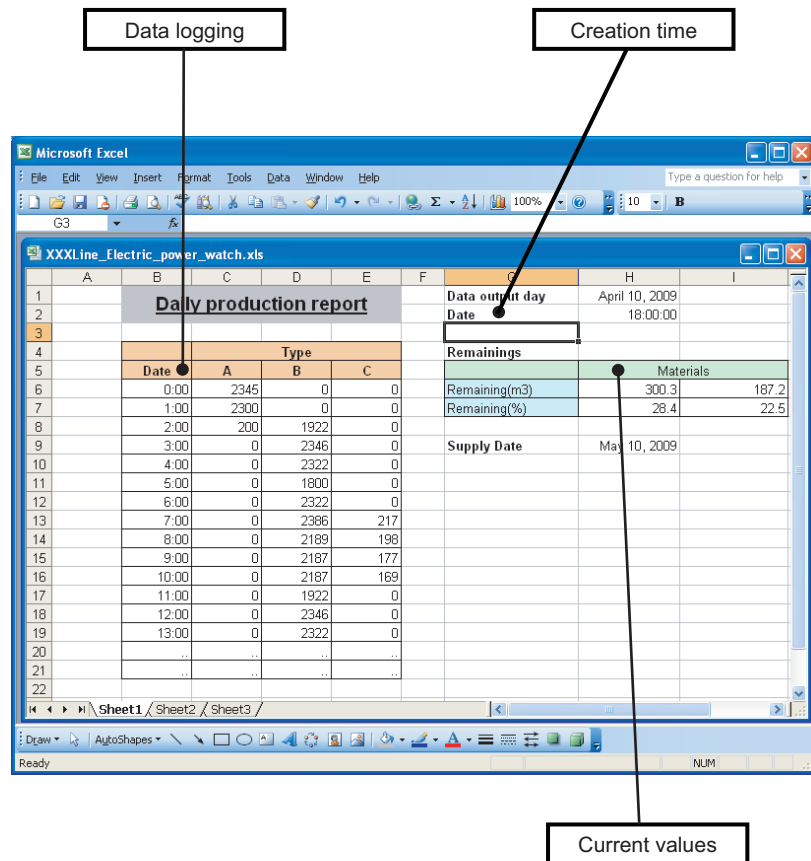

POINT

Be aware of the following points when laying out logged data in a report.

- (1) The data logging file format must be binary file.
- (2) If the total number of records in the source data logging files is not enough for the specified number of records, only the records that exist in the source files are output.
- (3) Immediately after switching the programmable controller system ON, if a creation trigger occurs when data does not exist in the data logging file, an error occurs in the high speed data logger module.

Configure and construct the system so that the creation trigger occurs after data are saved in the data logging file.

- (4) Report output requires time.

According to the data logging save setting, the data logging file, including the data when the creation trigger occurs, may be deleted before output to the report is completed.

The data for the specified number of records are not output and an error occurs in the high speed data logger module. Configure the high speed data logger module and construct the system as shown below.

- (a) Set the file switch timing in the data logging save settings to output a large number of lines (number of records) to the report.
- (b) Let the system run, and after reports have been generated a number of times, check the report creation time in the buffer memory.
Report creation time (maximum) (☞ Section 3.4.13 (5))
- (c) Set the file switch timing so that the time from the data logging file switch to the next file switch is much larger than the report creation time (Two times or more).

Example) When the report creation time is 2 seconds, data logging sampling interval is 5 milliseconds.

$$(2000 \text{ [ms]} \times 2) / 5 \text{ [ms]} = 800 \text{ [lines]}$$

Set the file switch timing to 800 lines or more.

(2) Output direction and order

(a) For data logging

When the target data are data logging, output direction and output order can be combined to output in 4 types of sequences.

- ① When output direction is "Vertical (top → bottom)", and output order is "Chronological order (old → new)"

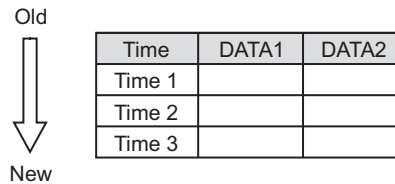

- ② When output direction is "Vertical (top → bottom)", and output order is "Reverse chronological order (new → old)"

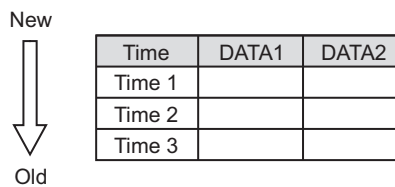

- ③ When output direction is "Horizontal (left → right)", and output order is "Chronological order (old → new)"

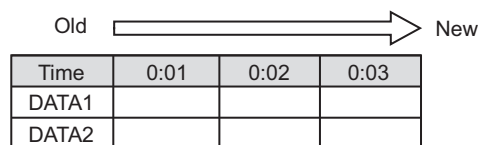

- ④ When output direction is "Horizontal (left → right)", and output order is "Reverse chronological order (new → old)"

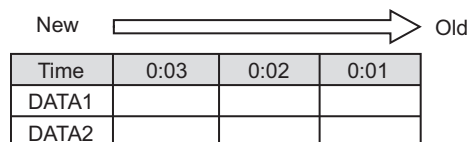

9 REPORT FUNCTION

(b) For current values

When the target data are current values, the values can be output with two types of orders according to the output directions.

① When output direction is "Horizontal (left → right)"

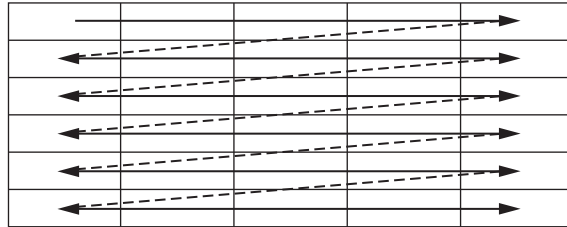

② When output direction is "Vertical (top → bottom)"

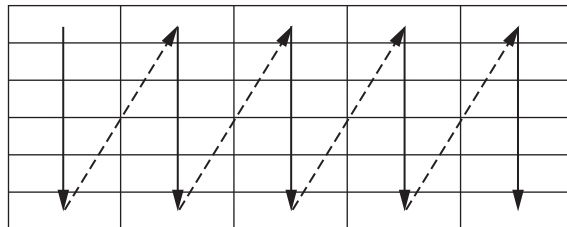

9.2 Creation Trigger and Current Value Data Sampling

'Sampling' in report creation is a function performed with specifying the data sampling method for creation trigger and current value, and data sampling interval.

The following table shows the data sampling methods.

Data sampling method	Overview
High speed data sampling (each scan)	Samples at each sequence scan of the programmable controller CPU.
High speed data sampling (time specification)	Samples at the specified interval (milliseconds).
General data sampling (time specification)	Samples at the specified interval (seconds).
General data sampling (time interval specification)	Samples at the time interval of every specified hour/minute/second.

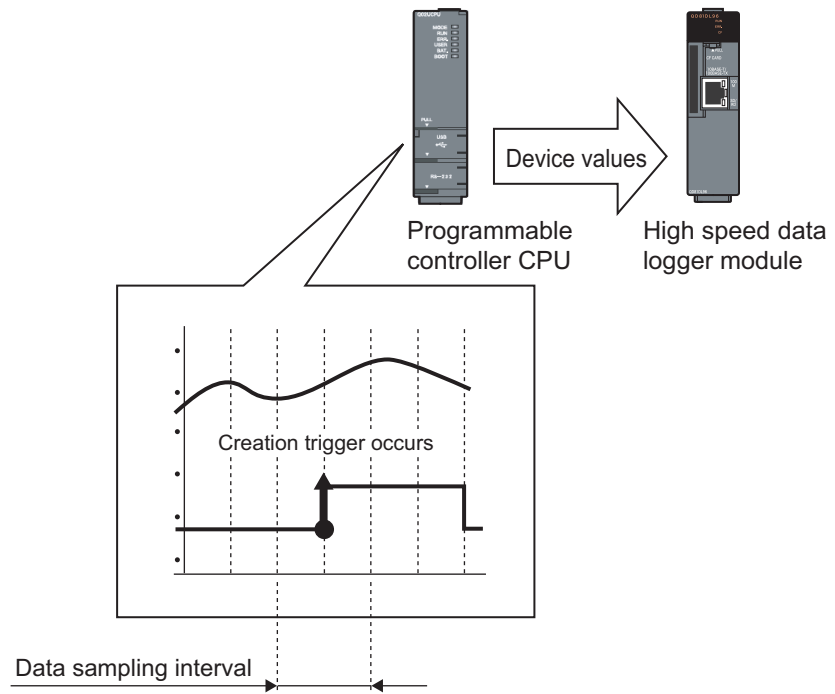

The system configuration and the process timing by the 'data sampling method' is the same as those of the data logging 'data sampling method'.

➔ Section 7.2 Target Data Sampling

POINT

- (1) In order to perform high speed data sampling, a programmable controller CPU which supports the high speed data sampling function is required.
☞ Section 2.2 Applicable Systems
 - (2) The data logging, event logging, and report functions of the high speed data logger module are best effort functions.
Since module processing time changes according to the settings and status of other devices, it may not operate with the set data sampling interval. Run the system by fully verifying the processing time of each function when constructing it.
For processing time, refer to the following chapter.
☞ Chapter 17 PROCESSING TIME
 - (3) The total number of settings is 32 for each of the functions below when 'data sampling method' is specified as 'high speed data sampling'.
 - Data logging function
 - Event logging function
 - Report function
-



9.3 Creation Trigger

This function specifies the conditions to create the report.

The method for specifying the creation trigger is the same as that of the trigger conditions of the data logging function.

 Section 7.3.3 Trigger conditions

POINT

- (1) The following are the operations when creation triggers continuously occur. After the creation trigger occurs, if the next creation trigger occurs while the report file is being created, report creation processing is not performed (the creation trigger is ignored). By checking the trigger reoccurrence count in 'report creation information 1 to 64' ( Section 3.4.13 (5)) in the buffer memory, the number of times the creation triggers were ignored can be checked.
The period when the report is being created can be checked with 'report creation execution information' ( Section 3.4.13 (2)) in the buffer memory. The time required to create the report can also be checked with report creation time in 'report creation information 1 to 64' in the buffer memory.
- (2) If "At startup of module" is selected for a creation trigger, data logging files output before the power was turned OFF or before the settings were updated can be output to a report depending on the data logging output setting. However, when configuring this setting when there are no data logging files, an error occurs because no output target data exists at module startup.

9.4 Report Periods

The periods to monitor the creation triggers can be specified.

Conditions to specify the report creation periods can be selected from the items below.

- ① Data condition
- ② Date range
- ③ Time range
- ④ Day of week/week condition

For details, refer to the following section.

 Section 7.4 Data Logging Periods

9.5 Report Files

The created reports are saved to the report files in Excel format.

9.5.1 Saving report files

The report files are saved on the CompactFlash card up to the specified number of files. When the number of report files exceeds the specified number of files, the operation to either; delete files from the oldest first or stop the module, can be selected.

9.5.2 Report file save location

Report files are saved on the CompactFlash card.

For the CompactFlash card directory structure, refer to the following section.

 Section 3.5 Directory Structure

9.5.3 Transferring report files

Report files can be automatically transferred to an FTP server or mail server. There are two methods for transferring data logging files.

(1) Transfer using FTP

For details, refer to the following sections.

- Function explanation: Section 10.5 FTP Transfer Function
- Setting method: Section 11.4.4 FTP setting

(2) Transfer using e-mail transmission

For details, refer to the following sections.

- Function explanation: Section 10.6 E-mail Function
- Setting method: Section 11.4.5 E-mail setting

CHAPTER 10 OTHER FUNCTIONS

This chapter explains functions other than the data logging function, event logging function, and report function.

10.1 Time Synchronization Function

The time synchronization function synchronizes the time of the high speed data logger module to that of a programmable controller CPU or SNTP server computer on the network.

Time information is used for the logging data time stamp, time of event occurrence/restoration, and report creation time.

(1) To synchronize with the programmable controller CPU time

The time is set to the time of the programmable controller CPU (in a multiple CPU system, CPU No.1).

The time is set to the time of the programmable controller CPU once in 24 hours. ^{*1}

^{*1}: By using the periodic time synchronization disabling option of the default operation setting (switch 2) in the intelligent function switch setting, the availability of time synchronization can be selected. (☞ Section 4.5)

Additionally, the time is also synchronized at the timings below.

- When the programmable controller system is powered ON
- When the programmable controller CPU is reset
- When the auto logging function starts
- When settings are updated (☞ Section 13.1.1)
- When YB (programmable controller CPU time synchronization request) turns OFF → ON

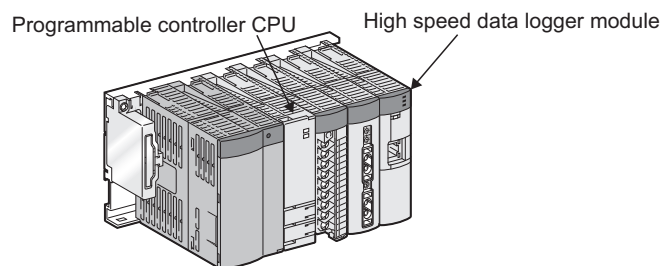

(2) To synchronize with the SNTP server time

The time is set to the time of the SNTP server computer on the network at the timing of the user specified 'fixed cycle (minutes)' or 'fixed time (time, day of week)'.

Additionally, the time is also synchronized at the timings below.

- When the programmable controller CPU is powered ON from OFF
- When the programmable controller CPU is reset
- When the auto logging function starts
- When settings are updated (☞ Section 13.1.1)

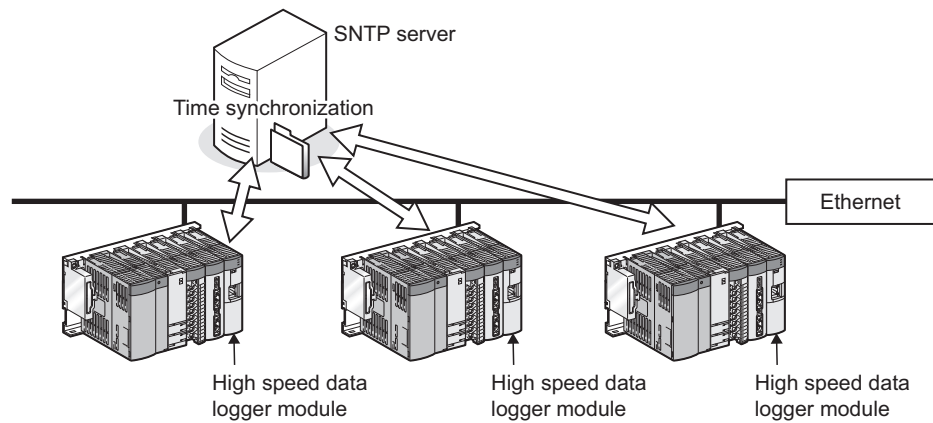

Remark

The time data can be written to the programmable controller CPU after synchronizing with the SNTP server.

For details, refer to the following section.

☞ Section 11.4.2 (6) How to write the time data to the programmable controller CPU after synchronizing with SNTP

(3) Precautions for time handled on the high speed data logger module

- (a) Before using the high speed data logger module, set the time data of CPU No. 1. For the time data settings, refer to the user's manual of the CPU module used.
- (b) There is a deviation in the time data of CPU No. 1 used by the high speed data logger module. For the time data accuracy, refer to the user's manual of the CPU module used.
- (c) When the high speed data logger module obtains the time data of CPU No. 1, a maximum of 1 second of delay occurs as the transfer time. Therefore, there may be rare situations where a 1-second deviation occurs in logging data time when setting the time.
(Example) Logging data time deviation

	2009/02/01 15:48:32.8	1028	30.5	21.8	15.9
Deviation	2009/02/01 15:48:32.9	1029	31.5	22.8	16.9
	2009/02/01 15:48:32.0	1030	32.5	23.8	17.9
	2009/02/01 15:48:32.1	1031	33.5	24.8	18.9
	2009/02/01 15:48:32.2	1032	34.5	25.8	19.9

Data are normally sampled in 100ms intervals.

- (d) The time data of CPU No. 1 is obtained by the high speed data logger module at the timings shown in (1).
When the time data of a running CPU No. 1 is updated, turn ON the programmable controller CPU time synchronization request (YB).

(4) Daylight saving time function

The daylight saving time function adjusts the time of the high speed data logger module to daylight saving time using the time of the SNTP server computer.

For daylight saving time function settings, refer to the following section.

☞ Section 11.4.2 Time synchronization setting

(a) About the daylight saving time function

When "Daylight saving setting" is set, one hour is added to the time at the start of daylight saving time, and one hour is subtracted from the time at the end of daylight saving time.

The following is an example of the start and end of daylight saving time.

(Example) When daylight saving time starts at 02:00 on the second Sunday in March and ends at 02:00 on the first Sunday in November

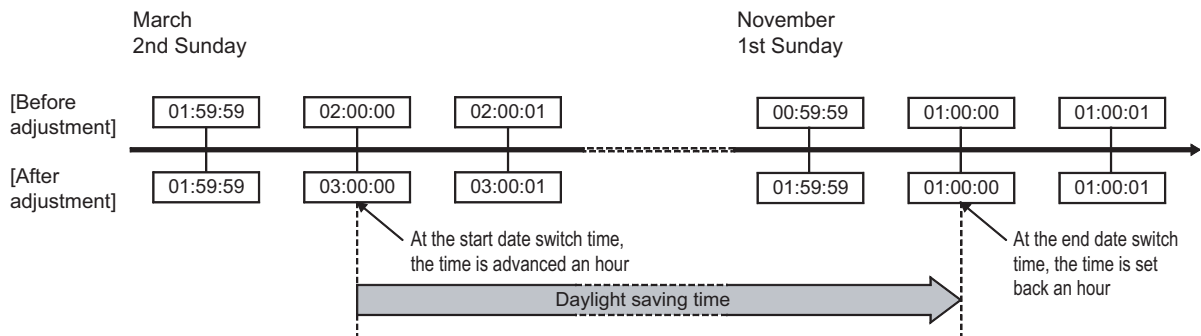

(b) Precautions

When specifying the time before and after the start or end time of daylight saving time with the data logging setting, event logging setting, or report setting, there may be situations where the correct time cannot be determined.

10.2 Auto Logging Function

The auto logging function can automatically start logging when a CompactFlash card with the auto logging settings written to it in advance is inserted in a running high speed data logger module.

The time to perform logging can also be specified to automatically stop logging.

For example, write the auto logging settings to a CompactFlash card at the office, send that CompactFlash card to the factory and by inserting it in the high speed data logger module on-site, logging can be started automatically.

After logging is finished, return the CompactFlash card to the office so the logging data can be analyzed.

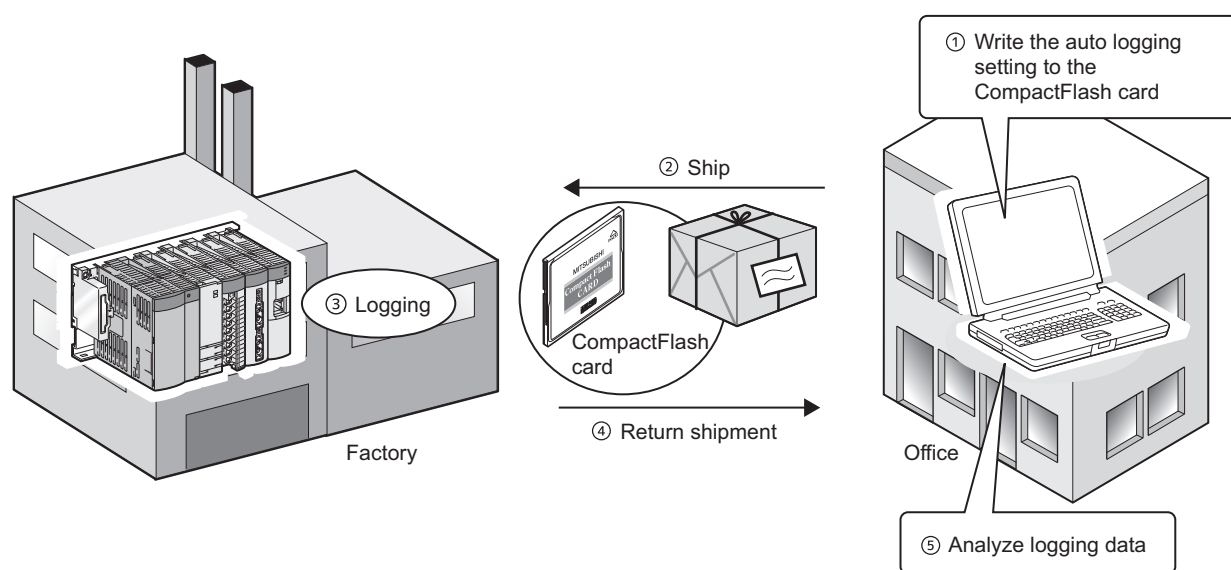

10 OTHER FUNCTIONS

The following figure shows the procedure for using the auto logging function. Before executing the auto logging function, refer to Section 11.4.7 and configure the auto logging settings using the Configuration Tool.

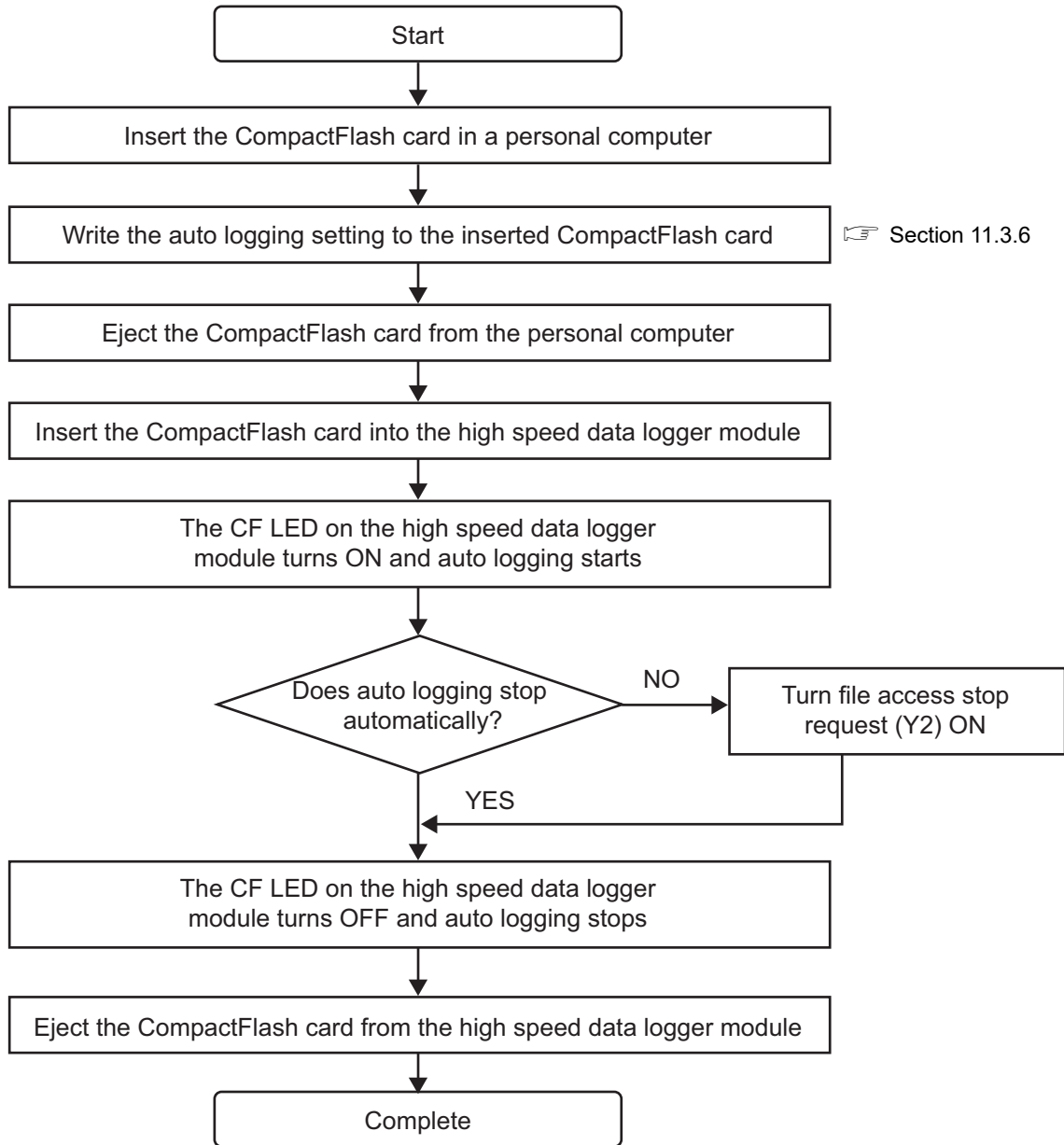

POINT

- (1) For the auto logging settings, refer to the following section.
☞ Section 11.4.7 Auto logging setting
- (2) To forcibly terminate auto logging, turn ON file access stop request (Y2) or stop the CompactFlash card with the Configuration Tool.
- (3) For operations to stop the CompactFlash card, refer to the following section.
☞ Section 13.1.6 CompactFlash card diagnostics

10.3 File Access Function

The file access function is used to access data logging files, event logging files, and report files stored in the CompactFlash card installed in the high speed data logger module to delete files, transfer files to modules*¹, or save files to a personal computer.

*1: Recipe files only

The following explains the access methods.

(1) File browser function (☞ Section 13.2 File Browser)

Delete files, transfer files to modules*², or save files to a personal computer using the screen below.

*2: Recipe files only

This function can be used when the connection method is either a direct connection or a connection via a hub.

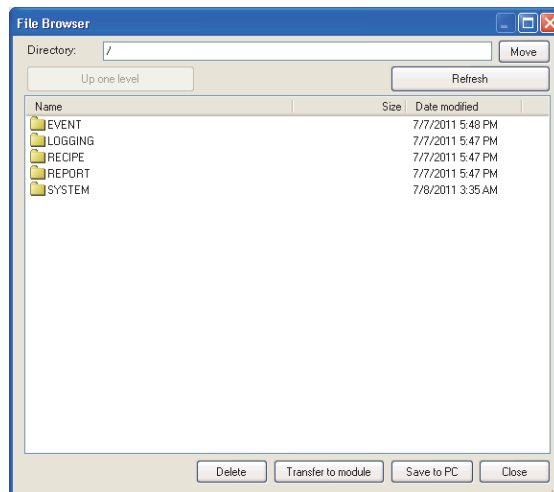

(2) FTP server function

Connect to a web browser in the same manner as when executing online startup (☞ Section 5.3.1).

Perform file operations in the web browser screen displayed by clicking "Open the list of files (FTP)" of the main page.

This function can only be used when the connection method is a connection via a hub.

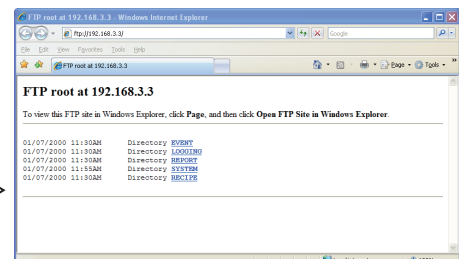

POINT

For Microsoft Edge, use Internet Explorer mode.

When using Microsoft Edge in Internet Explorer mode, it may take time to display the main page.

(a) Display format for file list (FTP)

Windows Internet Explorer displays the high speed data logger module files in text format.

Since some functions cannot be used when files are displayed in text format, open the FTP site in Explorer format by selecting the following menu.

- For Windows Internet Explorer 7.0 and Windows Internet Explorer 8.0
[Page] → [Open FTP Site in File Explorer]
- For Windows Internet Explorer 9.0, Windows Internet Explorer 10.0, and Windows Internet Explorer 11.0
[View] → [Open FTP Site in File Explorer]*1

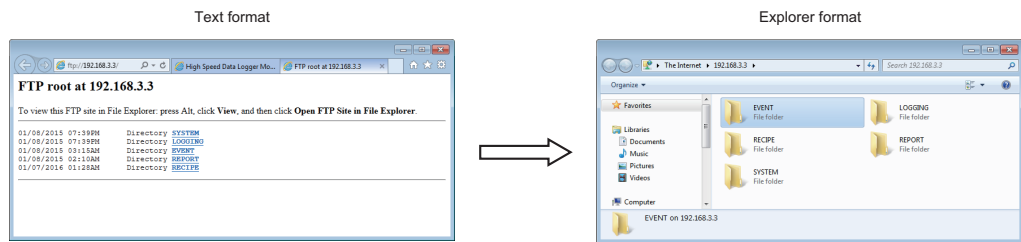

(b) RECIPE folder

A file with the '.TMP' extension may be displayed when the RECIPE folder is displayed during the 'Write' process of the recipe function. This TMP file is deleted at the completion of the 'Write' process.

For details on the 'Write' process of the recipe function, refer to the following chapter.

Chapter 15 RECIPE FUNCTION

*1: When using Windows® 10, the site may not open in Explorer format. In this case, start Explorer, and enter the address "ftp://192.168.3.3"*1 of the high speed data logger module.

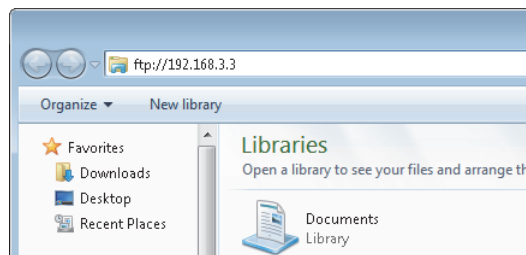

If the IP address has been changed, specify the IP address set in the network settings.
(Section 11.4.1 Network setting)

10.4 Access Authentication Function

A function to perform authentication by user name and password when accessing the high speed data logger module.

To perform access authentication, configure the account setting (☞ Section 11.4.6). Access authority can be selected from 3 levels (Administrator, Maintenance user, Normal user) as shown in the following figure.

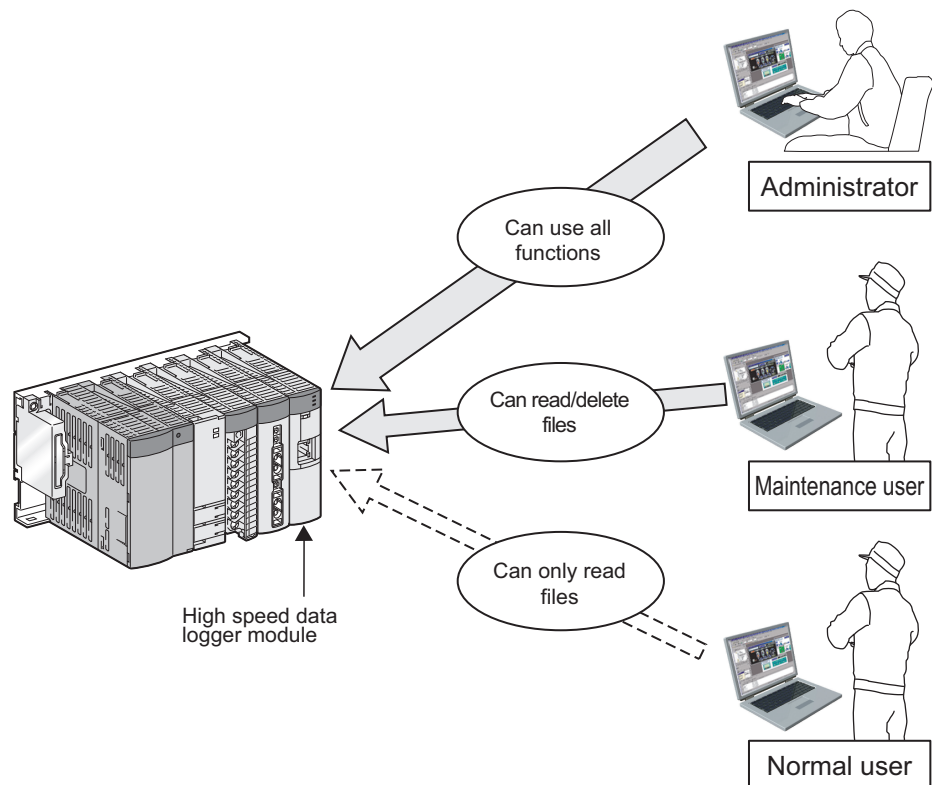

☒ POINT

The access authentication function is one of the methods for preventing illegal access (such as program or data corruption) from an external device. However, this function does not prevent illegal access completely.

Incorporate measures other than this function if the programmable controller system's safety must be maintained against illegal access from an external device. Mitsubishi Electric Corporation cannot be held responsible for any system problems that may occur from illegal access.

Examples of measures for illegal access are shown below.

- Install a firewall.
- Install a personal computer as a relay station, and control the relay of send/receive data with an application program.
- Install an external device for which the access rights can be controlled as a relay station. (For details on the external devices for which access rights can be controlled, consult the network provider or equipment dealer.)

10.5 FTP Transfer Function

A function to transfer logging files to the FTP server.

The following are the three functions of the FTP transfer.

- Transfer function: Transfers logging files to the specified FTP server automatically.
- Resend function: Resends logging files when the FTP transfer failed.
- Transfer completion notification function: Notifies the server when the transfer completed.

(1) Transfer function

The most recent 'saved file' is transferred to the FTP server using the FTP protocol.

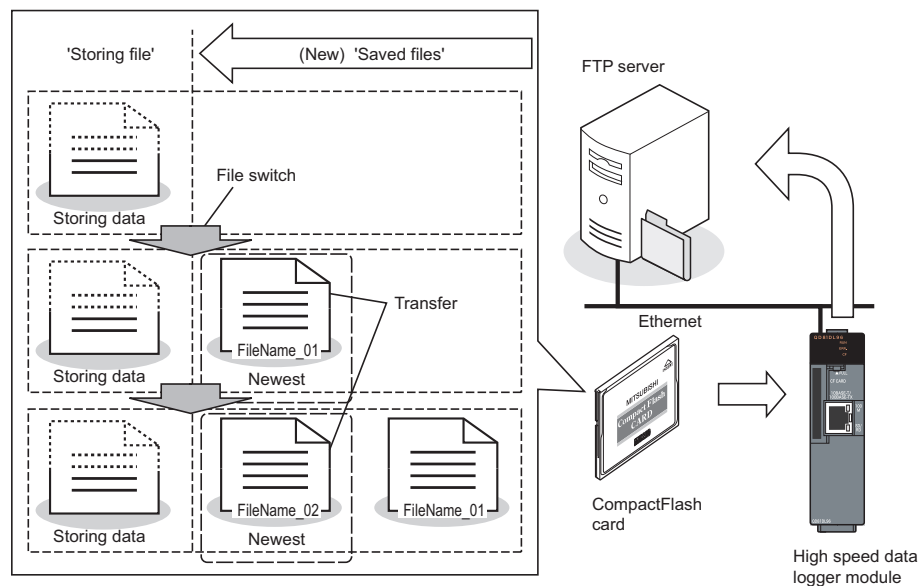

(2) Resend function

A file resend is attempted every 10 seconds when a module cannot access the FTP server and the FTP transfer failed due to a network failure.

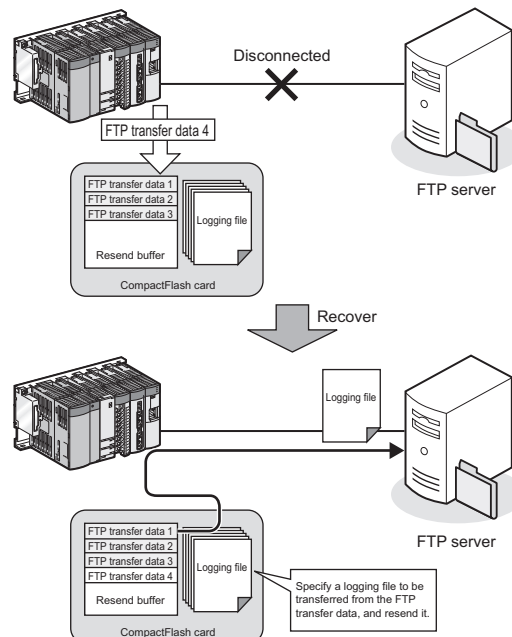

POINT

- (1) When the resend function is enabled, 'FTP file transfer error (0B03H)' is not detected even if a module cannot access the FTP server and the transfer failed.
However, 'FTP file transfer error (0B03H)' is detected even if the resend function is enabled when an FTP server processing error occurs and data cannot be transferred due to an error such as incorrect password settings or high load on the FTP server.
- (2) The transfer files which exceed the number of resending buffer specified with the FTP setting are not applicable to the resend function. Specify the sufficient send buffer size.
- (3) Buffer usage rate check and buffer clear can be executed by the FTP transfer diagnostics ( Section 13.1.3).
After writing the FTP setting, the buffer clear can also be executed by the reset of the programmable controller CPU or the update of the settings.
- (4) 'File transfer test' is not applicable to the resend function.
- (5) When the high speed data logger module is powered OFF during network disconnection with the FTP server, a file resend is attempted after the high speed data logger module is powered ON and the access to the FTP server is restored.
- (6) A file transfer by the transfer function may be executed during a file resend.

(3) Transfer completion notification function

When the logging file transfer completed, the transfer completion notification file which indicates the transfer completion is written to the same directory as the logging file destination directory.

Depending on the FTP server specification, files in the middle of transfer process may be referenced. The transfer completion can be determined by checking the stored status of the transfer completion notification file.

This function is used to detect the transfer completion of the logging file at the server side and process automatically after the logging file was transferred to the server.

The following table shows the extensions correspond to each file.

Extension for transfer file	Extension for transfer completion notification file
.BIN	.BTC
.CSV	.CTC
.XLS	.XTC

Remark

- For FTP settings, refer to the following section.
 - ☞ Section 11.4.4 FTP setting
- For the settings of the transfer, resend, and transfer completion notification, refer to the following sections.
 - ☞ Data logging: Section 11.5.15 Save
 - ☞ Event logging: Section 11.6.13 Save
 - ☞ Report: Section 11.7.8 Save



10.6 E-mail Function

A function to send logging files and notify event occurrences by e-mail.

The following are the three functions of e-mail.

- Transmission function: Sends logging files automatically.
- Resend function: Resends logging files when e-mail transmission failed.
- Notification function: Notifies event occurrences to the specified e-mail address.

(1) Transmission function

With the e-mail transmission function, e-mail with the most recent 'saved file' attached is sent to the mail server.

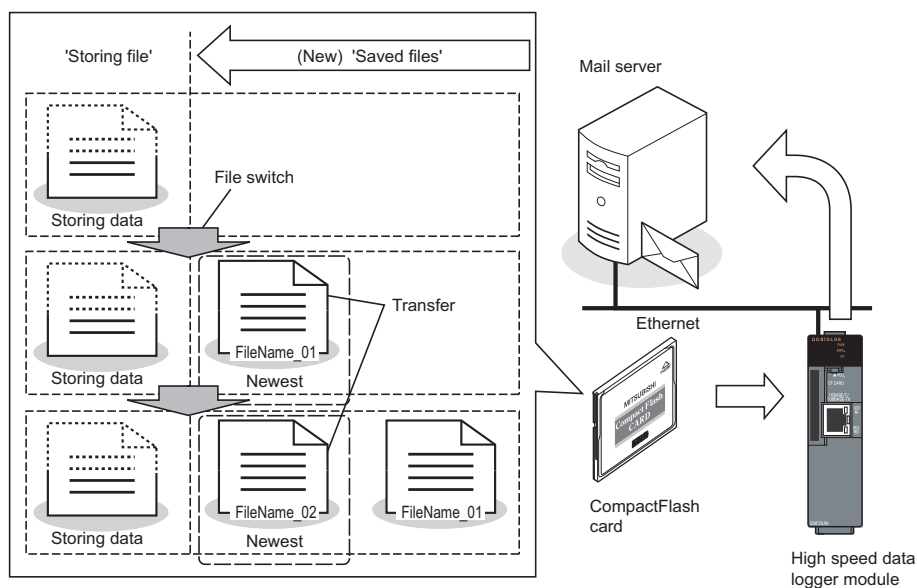

The following table shows the example of sent e-mail.

Mail header	From: QD81DL96 [xxx@ccc.co.jp] Date: 11/12/2008 Thursday 20:02 To: xxx@xxx.co.jp Subject: XXLOG_00000008.CSV 11/12/2008 20:02:23
Message	XXLOG_00000008.CSV 11/12/2008 20:02:23
Attached file	[XXLOG_00000008.CSV]

(2) Resend function

An e-mail resend is attempted every 10 seconds when a module cannot access the mail server and the e-mail transmission failed due to a network failure.

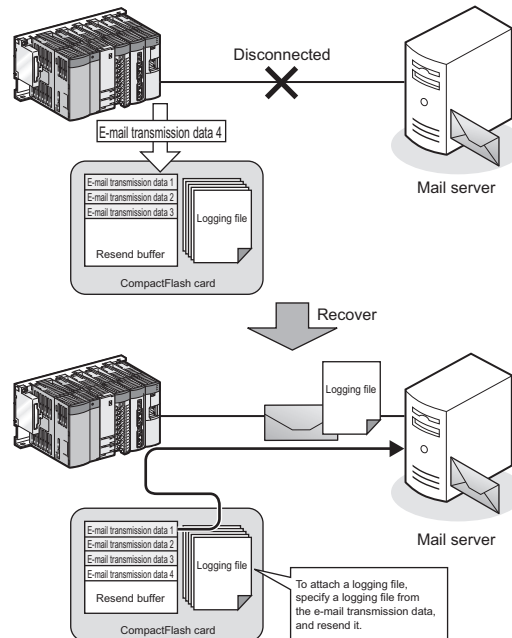

POINT

- (1) When the resend function is enabled, 'E-mail transmission error (0B13H)' is not detected even if a module cannot access the mail server and the e-mail transmission failed.
However, 'E-mail transmission error (0B13H)' is detected even if the resend function is enabled when a mail server processing error occurs and data cannot be transferred due to an error such as incorrect password settings or high load on the mail server.
- (2) The transmission files which exceed the number of resending buffer specified with the e-mail setting are not applicable to the resend function. Specify the sufficient send buffer size.
- (3) Buffer usage rate check and buffer clear can be executed by the E-mail send diagnostics (☞ Section 13.1.4).
After writing the e-mail setting, the buffer clear can also be executed by the reset of the programmable controller CPU or the update of the settings.
- (4) 'E-mail transmission test' is not applicable to the resend function.
- (5) When the high speed data logger module is powered OFF during network disconnection with the mail server, a file resend is attempted after the high speed data logger module is powered ON and the access to the mail server is restored.
- (6) An e-mail transfer by the transfer function may be executed during an e-mail resend.

(3) Notification function

For the notification function, refer to the following section.

☞ Section 11.6.14 E-mail notice

Remark

- For e-mail settings, refer to the following section.
☞ Section 11.4.5 E-mail setting
- For the settings of transmission and resend, refer to the following sections.
☞ Data logging: Section 11.5.15 Save
☞ Event logging: Section 11.6.13 Save
☞ Report: Section 11.7.8 Save

11 FUNCTIONS OF CONFIGURATION TOOL (MODULE SETTINGS)

CHAPTER 11 FUNCTIONS OF CONFIGURATION TOOL (MODULE SETTINGS)

This chapter explains the setting procedures and operations for the high speed data logger module.

11.1 Setting Operations Overview

The following figure shows the overview of configuration for the high speed data logger module.

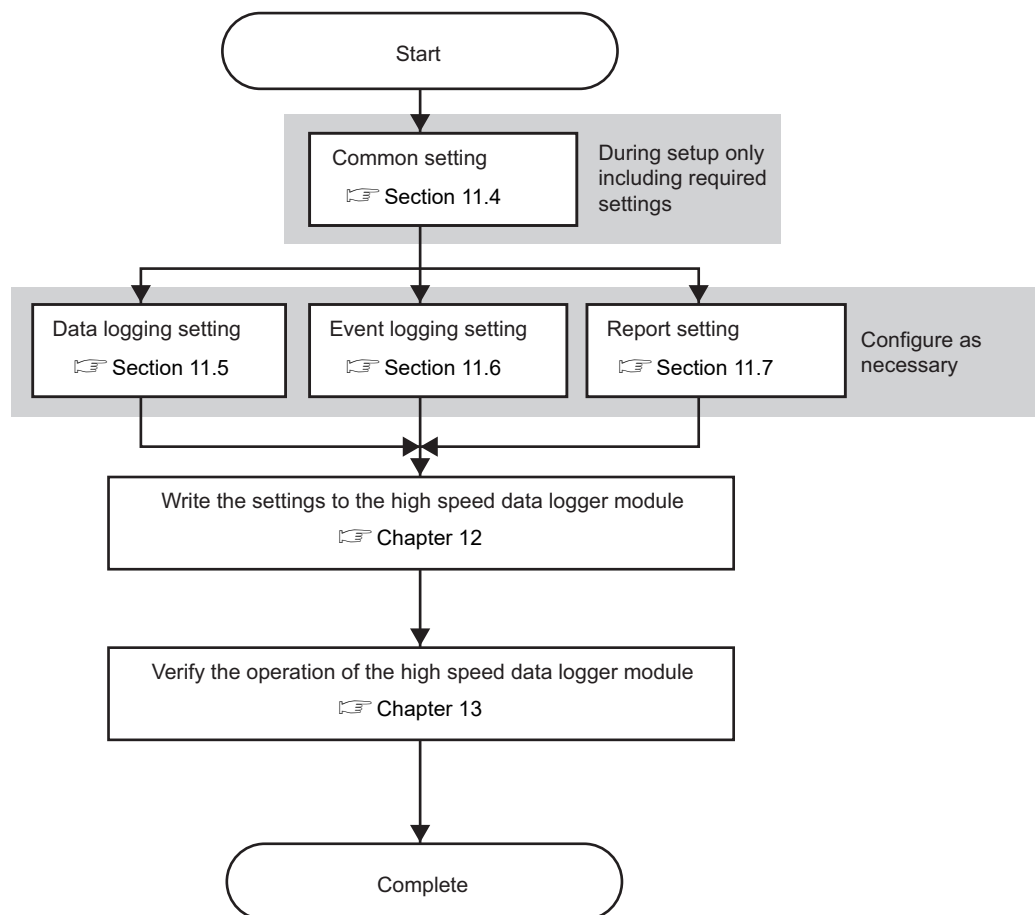

11 FUNCTIONS OF CONFIGURATION TOOL (MODULE SETTINGS)

11.2 Screen Configuration and Common Operations

11.2.1 Main screen configuration

The following figure shows the main screen configuration of the Configuration Tool.

Screen display

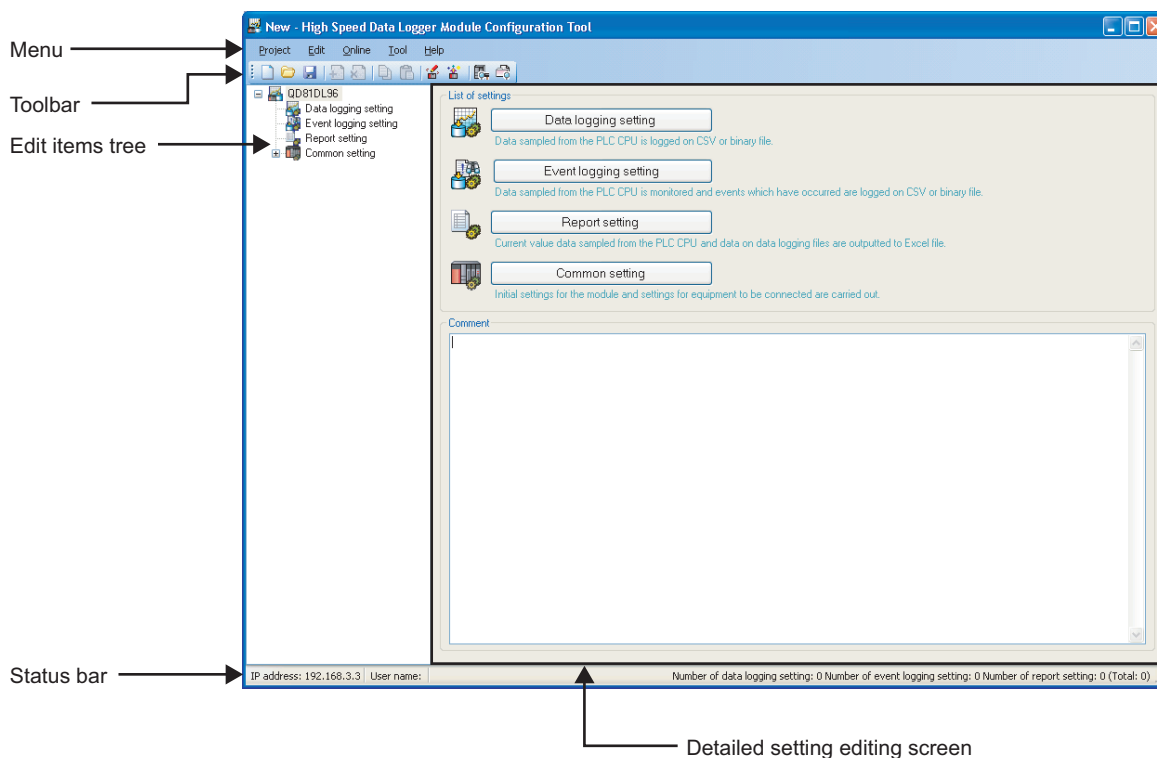

Name	Description	Reference
Menu	Displays the menu to execute various functions.	Section 11.2.2
Toolbar	Displays the tool buttons to execute various functions.	Section 11.2.3
Edit items tree	Displays the detailed setting editing screen when a tree item is selected.	Section 11.2.4
Comment	Write comments on the project. Up to 2048 characters can be entered. The first line of the comment (up to 160 characters) is displayed in the "Comment" column on the "Find High Speed Data Logger Module" screen.	-
Status bar	Displays information about the current project.	Section 11.2.5
Detailed setting editing screen	Displays the setting screen for each function.	-

11 FUNCTIONS OF CONFIGURATION TOOL (MODULE SETTINGS)

11.2.2 Menu configuration

The following table shows the menu configuration of the Configuration Tool.

(1) Project

Item	Description	Reference
New	Discards the project being edited and creates a new project.	Section 11.3.1
Open	Opens a project file saved in the personal computer.	Section 11.3.2
Save	Saves the edited project to a file.	Section 11.3.3
Save As	Saves the edited project under a new file name.	Section 11.3.3
Import	-	-
Project File	Imports the specified settings from the project files saved in the personal computer.	Section 11.3.4
Export	-	-
Module Operating File	Exports the edited project to a CompactFlash card inserted in to the personal computer in a format which can operate the module.	Section 11.3.6
CSV File	Exports the settings of the project being edited to CSV file (setting information CSV file).	Section 11.3.5
Recent Files	Opens files which were recently used by the Configuration Tool.	-
Exit	Exits the Configuration Tool.	-

(2) Edit

Item	Description	Reference
Add Item	Adds the item selected in the edit items tree.	Section 11.2.4 (2)
Delete Item	Deletes the item selected in the edit items tree.	Section 11.2.4 (3)
Replicate Item	Adds the item selected in the edit items tree by copying it.	Section 11.2.4 (4)
Copy Settings	Copies table format settings.	Section 11.2.6 (3)
Paste Settings	Pastes the copied table format settings.	Section 11.2.6 (3)
Move Settings Up To Top	Moves the selected table format settings upward.	Section 11.2.6 (4)
Device Batch Replacement	Replaces all the setting devices.	Section 11.2.8
Import Global Label	Imports global labels as data from the project file of GX Works2.	Section 11.2.10 (1)
Release Relation to Global Label	Disables relations between imported data and import source global labels.	Section 11.2.10 (2)
Update Related to Global Label Data	Updates the values of data when the values of import source global labels are changed.	Section 11.2.10 (3)
Import Device Comment	Imports device comments as data from the project file of GX Works2 or GX Developer.	Section 11.2.10 (4)

(3) Online

Item	Description	Reference
Transfer Setup	Configures the communications settings when connecting to the high speed data logger module.	Section 12.1
Read	Reads the settings from the high speed data logger module.	Section 12.4
Write	Writes the settings to the high speed data logger module.	Section 12.3
Verify	Verifies the Configuration Tool setting data with the high speed data logger module.	Section 12.5
Diagnostics	Performs high speed data logger module diagnostics.	Section 13.1
File Browser	Connects to the high speed data logger module and downloads files on the inserted CompactFlash card.	Section 13.2
Recipe Execution Operation	Writes/reads data using recipe files in a CompactFlash card installed on a high speed data logger module.	Section 15.5

11 FUNCTIONS OF CONFIGURATION TOOL (MODULE SETTINGS)

(4) Tool

Item	Description	Reference
Start GX LogViewer	Starts GX LogViewer.  GX LogViewer Version 1 Operating Manual	-
Display Recipe Editor	Displays the recipe editor.	Section 15.2

(5) Help

Item	Description	Reference
About Configuration Tool	Displays Configuration Tool product information.	Section 13.3.1
Open User's Manual	Displays the user's manual.	Section 13.3.2

9

REPORT FUNCTION

10

OTHER FUNCTIONS

11

FUNCTIONS OF CONFIGURATION TOOL (MODULE SETTINGS)

12

FUNCTIONS OF CONFIGURATION TOOL (WRITING/READING/VERIFYING DATA)

13

FUNCTIONS OF CONFIGURATION TOOL (CONFIRMING MODULE OPERATION)

14

FUNCTIONS OF CONFIGURATION TOOL (LOGGING FILE CONVERSION TOOL)

15

RECIPE FUNCTION











16

CompactFlash CARD

11 FUNCTIONS OF CONFIGURATION TOOL (MODULE SETTINGS)

11.2.3 Toolbar configuration

The following table shows the toolbar configuration of the Configuration Tool.

Icon	Corresponding menu	Reference
	[Project] → [New]	Section 11.3.1
	[Project] → [Open]	Section 11.3.2
	[Project] → [Save]	Section 11.3.3
	[Edit] → [Add Item]	Section 11.2.4 (2)
	[Edit] → [Delete Item]	Section 11.2.4 (3)
	[Edit] → [Copy Settings]	Section 11.2.6 (3)
	[Edit] → [Paste Settings]	Section 11.2.6 (3)
	[Online] → [Write]	Section 12.3
	[Online] → [Read]	Section 12.4
	[Online] → [Diagnostics]	Section 13.1
	[Online] → [File Browser]	Section 13.2

11 FUNCTIONS OF CONFIGURATION TOOL (MODULE SETTINGS)

11.2.4 Operations using the edit items tree

The edit items tree shows the overall project settings in a tree display. This section explains operations using the edit items tree.

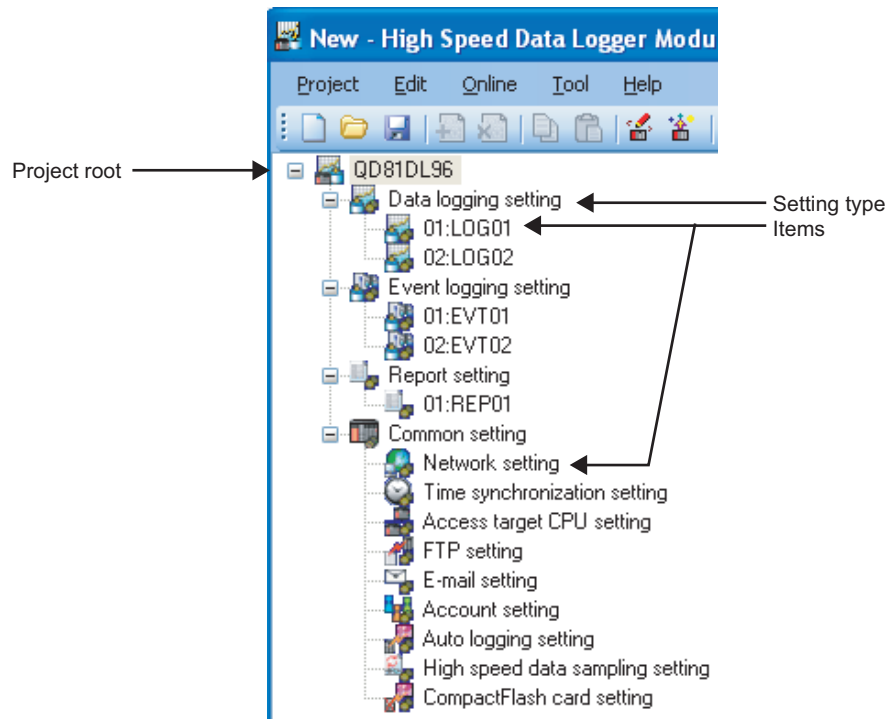

The following operations can be performed with the edit items tree of the Configuration Tool.

(1) Item selection

- ① Items are displayed by double clicking each setting type.
- ② When the displayed item is selected, the editing screen for the selected item is displayed in the detailed setting editing screen.

(2) Add item

- ① Select the setting type, and select [Edit] → [Add Item] () to add the item.
- ② When the item is added normally, it is automatically selected and the editing screen switches to the one for the added item.

(3) Delete item

Select the item to be deleted, and select [Edit] → [Delete Item] () to delete the item.

11 FUNCTIONS OF CONFIGURATION TOOL (MODULE SETTINGS)

(4) Replicating item

- ① Select the item to copy, and select [Edit] → [Replicate Item] to add a copy of the item.
- ② When the item is added normally, it is automatically selected and the editing screen switches to the one for the added item.

11.2.5 Status bar

This section explains the items displayed on the status bar of the Configuration Tool.

Screen display

IP address: 192.168.3.3 | User name: UserName | Number of data logging setting: 2 | Number of event logging setting: 2 | Number of report setting: 1 (Total: 5)

Item	Description
IP address	Displays the IP address of the high speed data logger module. [IP address: *.*.*] If "Transfer Setup" is "Direct connection", "Direct connection" is displayed.
User name	Displays the user name when using access authentication. [User name: ****]
Number of data logging setting	Displays n1, the number of data logging settings. [Number of data logging setting: n1]
Number of event logging setting	Displays n2, the number of event logging settings. [Number of event logging setting: n2]
Number of report setting	Displays n3, the number of report settings. [Number of report setting: n3]
Total	Displays n4, the total number of the above data logging setting, event logging setting, and report logging setting. [Total: n4]

11 FUNCTIONS OF CONFIGURATION TOOL (MODULE SETTINGS)

11.2.6 Common table operations

(1) Adjust column width

The column width can be adjusted in the table format on the detailed setting editing screen of the Configuration Tool.

Drag the right-side border of the column as shown in the following figure.

No.	CPU name	Other station specification
01	Control CPU	No
02	Heating System ARB-No.4	Yes
03		

No.	CPU name	Other station specification
01	Control CPU	No
02	Heating System ARB-No.4 Left	Yes
03		

(2) Tooltip display

If the mouse is placed on an item in a cell in the table format on the detailed setting editing screen of the Configuration Tool, the entire item name is displayed in a tooltip as shown in the following figure.

Use tooltips to verify item names when they are too long and cannot be entirely displayed.

No.	CPU name	Other station specification
01	Control CPU	No
02	Heating System ARB-No.4 Left	
03		
04		

(3) Copy/paste/clear/delete settings

Cells and rows can be copied, pasted, cleared or deleted in the table format on the detailed setting editing screen of the Configuration Tool.

(a) Copy/paste/clear settings in cell units

To copy/paste/clear cells, select Copy Settings/Paste Settings/Clear on the right-click menu while selecting the cells as shown in the following figure.

No.	Data name	Device		Access target CPU	Data type	Size	Scaling	Output Format
		Head	Last					
001	D0				Word[signed]			Decimal(digits:0)
002	Global_label				Bit			ON:1, OFF:0
003	Global_label				Word[signed]			Decimal(digits:0)
004	Global_label				Word[signed]			Decimal(digits:0)
005	Global_label				Bit			ON:1, OFF:0
006	Global_label				Word[signed]			Decimal(digits:0)
007	Global_label				Word[signed]			Decimal(digits:0)

(b) Copy/paste/clear/delete settings in row units

To copy/paste/clear rows, select Copy Settings/Paste Settings/Clear on the right-click menu while selecting the entire rows as shown in the following figure. To delete row(s), select cell(s), and select Delete on the right-click menu.

No.	Data name	Device		Access target CPU	Data type	Size	Scaling	Output Format
		Head	Last					
001	D0			01:Control CPU	Word[signed]			
002	Global_label	M1	M1	01:Control CPU	Bit			
003	Global_label	D10	D10	01:Control CPU	Word[signed]			
004	Global_label	D11	D11	01:Control CPU	Word[signed]			
005	Global_label	M2	M2	01:Control CPU	Bit			
006	Global_label	D12	D12	01:Control CPU	Word[signed]			
007	Global_label	D13	D13	01:Control CPU	Word[signed]			

11 FUNCTIONS OF CONFIGURATION TOOL (MODULE SETTINGS)

POINT

- (1) Settings can also be copied/pasted by selecting [Edit] → [Copy Settings]/[Edit] → [Paste Settings].
- (2) The following are setting items that can be copied/pasted/deleted in cell units. They can be copied/pasted in the table or among other applications.
 - [Data logging setting] → [data]
 - [Common setting] → [FTP setting]
 - [Common setting] → [E-mail setting]
 - [Edit] → [Device Batch Replacement]
 - [Tool] → [Display Recipe Editor]
- (3) Only a password copied from another application can be pasted to "Password" in the FTP setting.

(4) Move settings upward

Empty rows with no settings can be deleted and settings moved upward in the table format on the detailed setting editing screen of the Configuration Tool. To move settings upward, select [Edit] → [Move Settings Up To Top] as shown in the following figure.

No.	CPU name	Other station specification	Network route	Co-existence network route	Multiple CPU specification
01	Control CPU	No	-	-	Not specified
02	Heating System ARB-No.4 Left	Yes	CC IE Cont->CC IE Cont(Ne	-	Not specified
03					
04	Heating System ARB-No.4 Right	Yes	CC IE Cont->CC IE Cont(Ne	-	Not specified
05					
06	Heating System ARB-No.5 Left	Yes	CC IE Cont->CC IE Cont(Ne	-	Not specified
07					
08	Heating System ARB-No.5 Right	Yes	CC IE Cont->CC IE Cont(Ne	-	Not specified
09					
10					



Select [Edit] → [Move Settings Up To Top]

No.	CPU name	Other station specification	Network route	Co-existence network route	Multiple CPU specification
01	Control CPU	No	-	-	Not specified
02	Heating System ARB-No.4 Left	Yes	CC IE Cont->CC IE Cont(Ne	-	Not specified
03	Heating System ARB-No.4 Right	Yes	CC IE Cont->CC IE Cont(Ne	-	Not specified
04	Heating System ARB-No.5 Left	Yes	CC IE Cont->CC IE Cont(Ne	-	Not specified
05	Heating System ARB-No.5 Right	Yes	CC IE Cont->CC IE Cont(Ne	-	Not specified
06					
07					
08					
09					

11 FUNCTIONS OF CONFIGURATION TOOL (MODULE SETTINGS)

11.2.7 Data list

The data list displays a list of data used by the setting being edited.

Operating procedure

Click the button displayed in the lower left of the detailed setting editing screen for "Data logging setting", "Event logging setting", or "Report setting" selected on the edit items tree of the Configuration Tool.

Screen display

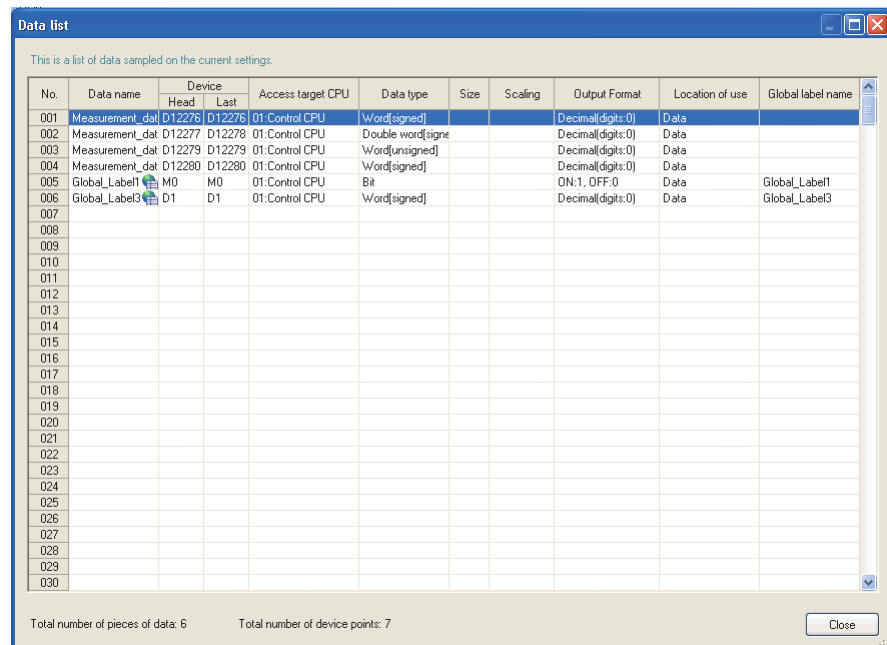

Item	Description	Reference
No.	Displays the data index.	(4) (a) in this section
Data name	Displays the data name. For related data, an icon () is appended.	-
Device	Displays the start device and the end device.	-
Access target CPU	Displays the access target CPU.	-
Data type	Displays the data type.	-
Size	Displays the data size.	-
Scaling	Displays the conversion equation for the scaling conversion.	-
Output Format	Displays the output format (such as decimal format, exponential format).	-
Location of use	Displays the location of data being used.	(4) (b) in this section
Global label Name	Displays the global label name for related data.	-
Total number of pieces of data	Displays the total number of data used by each setting.	-
Total number of device points	Displays the total device points for the data used by each setting.	-
<input type="button" value="Close"/> button	Closes the screen.	-

11 FUNCTIONS OF CONFIGURATION TOOL (MODULE SETTINGS)

(a) No. (Index)

Displays data index in the formats below according to the data type.

Data type	Format
Logging data (data logging)	nnn
Monitoring data (event logging)	
Current value data (report)	
Additional data *1*2	*nnn

*1: Data that are added by selecting "(Add)" from the list box and clicking the  button.

*2: Data added in the saved file name setting are only available for the saved file name setting.

(b) Location of use display

Displays the location of device data being used.

When multiple locations are specified, they are displayed with a delimiter ','.

The following figure shows an example display of the location of use.

Example) When D0 is specified for "Trigger" and D1 is specified for "Period of time" in the trigger logging

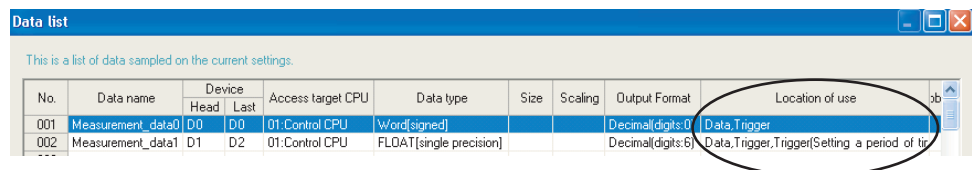

This is a list of data sampled on the current settings.

No.	Data name	Device		Access target CPU	Data type	Size	Scaling	Output Format	Location of use
		Head	Last						
001	Measurement_data0	D0	D0	01:Control CPU	Word[signed]			Decimal(digits:0)	Data,Trigger
002	Measurement_data1	D1	D2	01:Control CPU	FLOAT[single precision]			Decimal(digits:6)	Data,Trigger,Trigger(Setting a period of tr

11 FUNCTIONS OF CONFIGURATION TOOL (MODULE SETTINGS)

11.2.8 Device batch replacement

This function batch replaces devices used by data logging setting, event logging setting, and report setting of the Configuration Tool.

Operating procedure

Select [Edit] → [Device Batch Replacement].

Setting screen

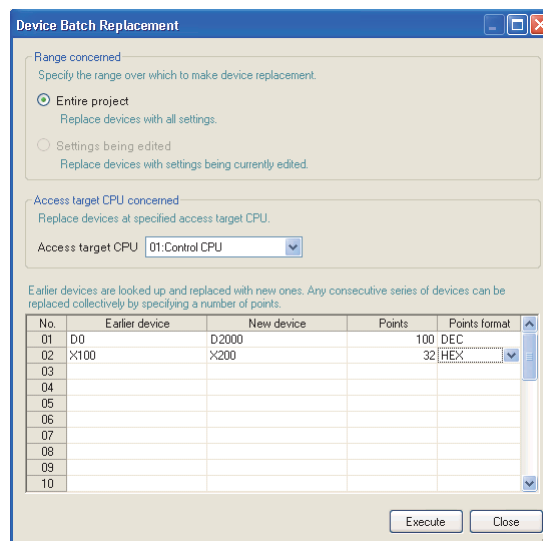

Item	Description
Range concerned	Specify the target range of devices to be replaced.
Entire project	Select this to set the replacement target to the entire project.
Settings being edited	Select this to set the replacement target to the settings being edited (data logging/event logging/report setting).
Access target CPU concerned	Specify the access target CPU of the devices to be replaced.
Replace device list	-
Earlier device	Specify the replacement target start device.
New device	Specify the start device after replacement.
Points	Specify the number of device points for the replacement target.
Points format	Select the specification format of points (DEC/HEX).
Execute button	Executes device block replacement.
Close button	Closes the screen.

11 FUNCTIONS OF CONFIGURATION TOOL (MODULE SETTINGS)

11.2.9 Data setting screen

This screen is displayed when setting programmable controller CPU data. It is a common screen called from various screens when setting programmable controller CPU data.

Operating procedure

Select "(Add)" on the calling screen and click .

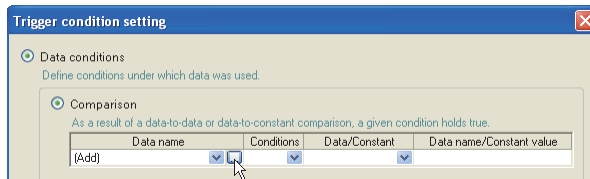

Setting screen

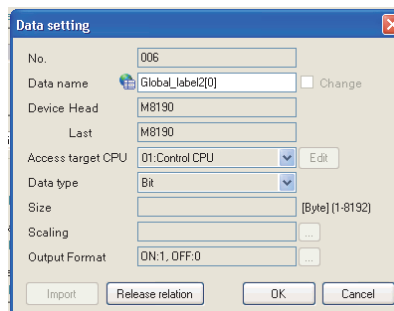



The setting details are described on the next page.

11 FUNCTIONS OF CONFIGURATION TOOL (MODULE SETTINGS)

Item	Description	Reference
No.*3	Displays the index of data to be set.	-
Data name	Displays the data name, or used to change the data name. (Up to 32 characters)	-
Change	Check to specify the data name. When it is not checked, displays the start device.	-
Device	-	-
Head*3	Set the start device.	-
Last*3	Updates the end device display according to the data type and size.	-
Access target CPU*3	Select the access target CPU.*1 The access target CPU can be added by selecting "(Add)" and clicking the <input type="button" value="Edit"/> button.	Section 11.4.3
Data type*3*4	Select the data type from the following. <ul style="list-style-type: none"> • Bit • Word [signed] • Double word [signed] • Word [unsigned] • Double word [unsigned] <ul style="list-style-type: none"> • Double word [unsigned] • FLOAT (single precision) • FLOAT (double precision) • 16bit BCD • 32bit BCD <ul style="list-style-type: none"> • 32bit BCD • String • Raw Select the data type from the following when specifying the saved file name. <ul style="list-style-type: none"> • Word [unsigned] • Double word [unsigned] • 16bit BCD • 32bit BCD • String*2 	-
Size*3	Displays the size of the data in bytes. If the data type is "String" or "Raw", the size (1 to 8192) must be specified. For the saved file name setting, specify the size between 1 and 16. For the e-mail detailed setting and e-mail notice setting, specify the size between 1 and 16.	-
Scaling	Set the equation to convert the data. Click <input type="button" value="Scaling"/> on the right of the input field and set on the displayed "Scaling" screen. Values after the scaling conversion are rounded off to the whole number when setting the saved file name. If values after scaling exceed the value range of Double word [unsigned], they are rounded to within the range. For details on the numerical range of output values, refer to the following section.  Section 3.9 Range of Values per Output Format	Section 11.5.6 (1)
Output Format	Displays the format (such as decimal format, exponential format) when outputting data to a file. To change the output format, click <input type="button" value="Output Format"/> on the right of the input field and change it on the displayed "Output format (integer/float)" screen. Change it on the "Output format" screen when setting the saved file name.	Section 11.5.6 (2) Section 11.5.15 (3) (b)
<input type="button" value="Import"/> button	Imports global labels or device comments.	Section 11.2.10 (1) Section 11.2.10 (4)
<input type="button" value="Release relation"/> button	Disables relations with global labels. (For related data only)	Section 11.2.10 (2)
<input type="button" value="OK"/> button	Reflects the settings and closes the screen.	-
<input type="button" value="Cancel"/> button	Discards the settings and closes the screen.	-

*1: For the high speed data sampling, only "Control CPU" can be selected.

*2: The usable ASCII characters in strings ( Appendix 4.1) are the same as characters usable in file names and folder (directory) names ( Appendix 4.2).

- If a character other than usable characters are output to the saved file name, it is replaced with "_" (under bar).
- If there is a string terminator (0) halfway in the data, the data after it are replaced with "_" (under bar).
- When using a high speed data logger module with a serial number whose first five digits are '12061' or lower, "[", "]", and "+" are replaced with "_" (under bar).

*3: These items cannot be edited for related data.

*4: For the Digit specified devices, the data types which can be selected are as follows.

- K1 to K4: Word [signed], Word [unsigned], 16bit BCD
- K5 to K8: Double word [signed], Double word [unsigned], 32bit BCD

POINT

Depending on the settings on the calling screen, inputs and selections may be restricted.

11 FUNCTIONS OF CONFIGURATION TOOL (MODULE SETTINGS)

11.2.10 Importing global labels and device comments

Global labels and device comments set in GX Works2 and device comments set in GX Developer are imported to the logging setting and recipe setting of high speed data logger module.

Data imported from global labels in GX Works2 are called 'related data'. Related devices can be updated corresponding to the changes of global labels in the GX Works2 project.

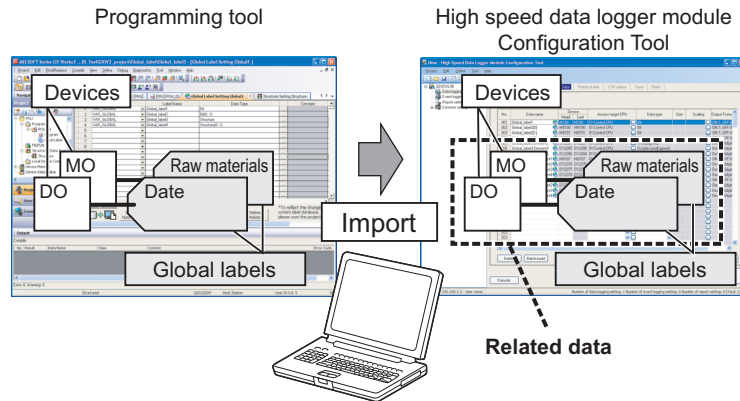

For details of global labels and device comments in GX Works2, refer to the following manuals.

- ☞ GX Works2 Version 1 Operating Manual Simple Project
- ☞ GX Works2 Version 1 Operating Manual Structured Project

For details of device comments in GX Developer, refer to the following manual.

- ☞ GX Developer Version 8 Operating Manual

< Applicable data >

Item	GX Works2	GX Developer
Global device comment (COMMENT)	○	○
Local device comment (Other than COMMENT)	×	×
Global variable	-	×
Local variable	-	×
Global label	○*1	-
Local label	×	-
System label	-	-

○: Applicable ×: Not applicable -: No data

*1: Data need to be converted/compiled in GX Works2 before importing them.

POINT

- (1) Importing global label
 - GX Works2 must be installed to import global labels or update related data.
 - Global labels of the projects which are configured the user authentication setting in GX Works2 are not applicable.
 - Global labels of devices (data types) which cannot be set in the Configuration Tool are not applicable. (Even though they are displayed in the list of global labels/device comments to be imported.)
 - When the global labels are set 32769 or more in 1 project, the global labels which exceed 32769 are not displayed in the list of global labels to be imported.
 - Do not import global labels during the save process of GX Works2 project. If attempted, the GX Works2 project may not be stored normally.
 - Data of a project with the checkbox of 'Enable the security check for the project' selected in GX Works2 cannot be imported.

- (2) Importing device comment
 - GX Works2 or GX Developer must be installed to import device comments.
 - Device comments of the projects which are configured the user authentication setting in GX Works2 are not applicable.
 - When the device comments are set 32769 or more in 1 project, the device comments which exceed 32769 are not displayed in the list of device comments to be imported.
 - Device comments which are set in the link direct devices (Jn\), module access devices (Un\)) are not applicable.
 - Not supported by the extension of the device comments (word device bit specification).
 - Do not import device comments during the save process of GX Works2 or GX Developer project. If attempted, the GX Works2 or GX Developer project may not be stored normally.
 - Data of a project with the checkbox of 'Enable the security check for the project' selected in GX Works2 cannot be imported.

(1) Importing global labels

Global labels set in GX Works2 are imported as data.

Operating procedure

- ① Open the "Import Global Label" screen or "Import" screen by one of the following methods.

- Select [Edit] → [Import Global Label].^{*1}
- Click the  button^{*2} on each screen.

^{*1}: The menu is valid in the following conditions only.

- When the "Data" screen of Data logging setting is displayed.
- When the "Recipe Editor" screen is displayed.

^{*2}: This button can be found on the following screens.

- "Data setting" screen displayed from "Data name" on the "Trigger condition setting" screen, "OR combine" screen, "AND combine" screen, "Number of times" screen, "Order" screen, "Setting a period of time" screen, "File switching condition setting" screen, "Save file name setting" screen, "E-mail content setting" screen, and "E-mail notice" screen
- Event setting screen
- "Current value layout" screen

- ② Select a global label import source project^{*3} on the "Import Global Label" screen or "Import" screen, and click the  button.

 (1) (a) in this section Import Global Label screen

^{*3}: When "(no setting)" is selected, the "Global label import setting" screen is displayed. ((1) (b) in this section Global label import setting screen). Select a global label import source project.

- ③ Select global labels on the "Import Global Label" screen, and click the  button.



 (1) (c) in this section Import global label screen

11 FUNCTIONS OF CONFIGURATION TOOL (MODULE SETTINGS)

(a) Import Global Label screen

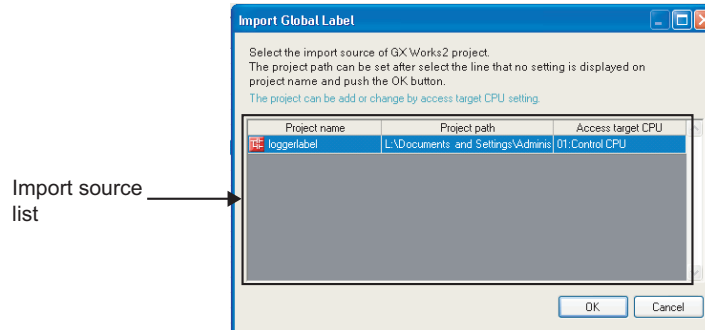
Setting screen



Item	Description
Import source list	Displays the GX Works 2 project () and the access target CPU which are set as global label import source. When the project is not set for the access target CPU, "(no setting)" is displayed.
 button	Reflects the settings and displays the screen to specify the import target global labels. When "(no setting)" is selected, the "Global label import setting" screen is displayed.
 button	Discards the settings and closes the screen.

9

REPORT FUNCTION

10

OTHER FUNCTIONS

11

FUNCTIONS OF CONFIGURATION TOOL (MODULE SETTINGS)

12

FUNCTIONS OF CONFIGURATION TOOL (WRITING/READING/VERIFYING DATA)

13

FUNCTIONS OF CONFIGURATION TOOL (CONFIRMING MODULE OPERATION)

14

FUNCTIONS OF CONFIGURATION TOOL (LOGGING FILE CONVERSION TOOL)

15

RECIPE FUNCTION

16

CompactFlash CARD

11 FUNCTIONS OF CONFIGURATION TOOL (MODULE SETTINGS)

(b) Global label import setting screen

Setting screen



For the setting items, refer to the following section.

☞ Section 11.4.3 (6) Global label/Device comment import setting

(c) Import global label screen

Setting screen

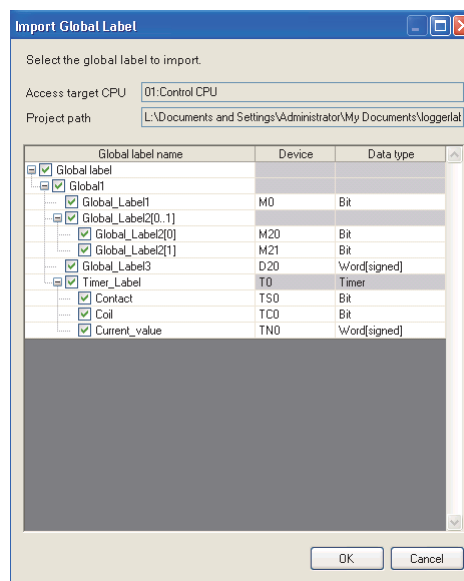

Item	Description	Reference
Access target CPU	Displays the access target CPU selected on the "Import Global Label" screen.	(1) (a) in this section
Project path	Displays the path of project selected on the "Import Global Label" screen.	section
Global label name	Displays global label names (set in GX Works2). Check boxes are displayed for each global label. Check global labels to be imported.	(1) (b) in this section
Device	Displays start device of global label.	-
Data type	Displays data type of global label.	-
<input type="button" value="OK"/> button	Imports the specified global labels and closes the screen.	-
<input type="button" value="Cancel"/> button	Discards the settings and closes the screen.	-

11 FUNCTIONS OF CONFIGURATION TOOL (MODULE SETTINGS)

(d) Global label name

① Elementary data

The following table shows the display example when a global label is an elementary data and the data name example when importing the data.

Type	Global label name display example	Import	Data name example
Elementary data	Global label 1	<input type="radio"/>	Global label 1

: Applicable

<Display example>

Global label name	Device	Data type
<input checked="" type="checkbox"/> Global label		
<input checked="" type="checkbox"/> Global1		
<input checked="" type="checkbox"/> Global_label1	M100	Bit

Elementary data →

② Array

The following table shows the display example when a global label is an array and the data name example when importing the data.

Type	Global label name display example	Import ^{*1}	Data name example
Array data	Global label 2[0..1]	×	-
Array element	Global label 2[1]	<input type="radio"/>	Global label 2[1]

: Applicable ×: Not applicable

*1: If the number of characters in the data name exceeds 32, the numbers beyond 32 are deleted from the beginning to match the number to 32.

<Display example>

Global label name	Device	Data type
<input type="checkbox"/> Global label		
<input type="checkbox"/> Global1		
<input type="checkbox"/> Global_label2[0..1]		
<input type="checkbox"/> Global_label2[0]	D12286	Word[signed]
<input checked="" type="checkbox"/> Global_label2[1]	D12287	Word[signed]

Array data →

Array element →

11 FUNCTIONS OF CONFIGURATION TOOL (MODULE SETTINGS)

③ Structure

The following table shows the display example when a global label is a structure and the data name example when importing the data.

Type	Global label name display example	Import ^{*1}	Data name example
Structure data	Global label 3	×	-
Structure element	Element 1	○	Global label 3. Element 1
Structure element [Array]	Element 2[0..1]	×	-
Array element	Element 2[1]	○	Global label 3. Element 2[1]

○: Applicable ×: Not applicable

*1: If the number of characters in the data name exceeds 32, the numbers beyond 32 are deleted from the beginning to match the number to 32.

<Display example>

Global label name	Device	Data type
Global_label3	M8191	Bit
Element2[0]	D12286	Word[signed]
Element2[1]	D12287	Word[signed]

④ Structured array

The following table shows the display example when a global label is a structured array and the data name example when importing the data.

Type	Global label name display example	Import ^{*1}	Data name example
Structured array data	Global label 4[0..1]	×	-
Structured array element	Global label 4[0]	×	-
Structure element	Element 1	○	Global label 4[0]. Element 1
Structure element [Array]	Element 2[0..1]	×	-
Array element	Element 2[1]	○	Global label 4[1]. Element 2[1]

○: Applicable ×: Not applicable

*1: If the number of characters in the data name exceeds 32, the numbers beyond 32 are deleted from the beginning to match the number to 32.

If the number of characters in the data with an expanded structure exceeds 32, the element name is used as the data name.

If the number of characters in the element name exceeds 32, the numbers beyond 32 are deleted from the beginning to match the number to 32.

<Display example>

Global label name	Device	Data type
Global_label4[0]	M1	Bit
Element2[0]	D10	Word[signed]
Element2[1]	D11	Word[signed]
Element2[0]	D12	Word[signed]
Element2[1]	D13	Word[signed]

11 FUNCTIONS OF CONFIGURATION TOOL (MODULE SETTINGS)

⑤ Timer/Counter/Retentive timer

The following shows a display example when the global label is timer/counter/retentive timer and the data name example at the time of importing.

Type	Global label name display example	Import ^{*1}	Data name example ^{*2}
Timer	Timer_Label	×	—
Contact	Contact	○	Timer_Label.Contact
Coil	Coil	○	Timer_Label.Coil
Current value	Current_value	○	Timer_Label.Current_value
Counter	Counter_Label	×	—
Contact	Contact	○	Counter_Label.Contact
Coil	Coil	○	Counter_Label.Coil
Current value	Current_value	○	Counter_Label.Current_value
Retentive timer	Retentive_timer	×	—
Contact	Contact	○	Retentive_timer.Contact
Coil	Coil	○	Retentive_timer.Coil
Current value	Current_value	○	Retentive_timer.Current_value

○: Applicable ×: Not applicable

*1: Importing to the global data name and data type is possible when both of them are applicable.

*2: If the number of characters in the label name exceeds 32, the numbers beyond 32 are deleted from the beginning to match the number to 32.

If the number of characters in the data (contacts, coils, current values) with an expanded timer/counter/retentive timer exceeds 32, the element name is used as the label name.

<Display example>

<input type="checkbox"/> Timer_Label	T0	Timer
<input type="checkbox"/> Contact	TS0	Bit
<input type="checkbox"/> Coil	TC0	Bit
<input type="checkbox"/> Current_value	TNO	Word[signed]

9

REPORT FUNCTION

10

OTHER FUNCTIONS

11

FUNCTIONS OF CONFIGURATION TOOL (MODULE SETTINGS)

12

FUNCTIONS OF CONFIGURATION TOOL (WRITING/READING/VERIFYING DATA)

13

FUNCTIONS OF CONFIGURATION TOOL (CONFIRMING MODULE OPERATION)

14

FUNCTIONS OF CONFIGURATION TOOL (LOGGING FILE CONVERSION TOOL)

15

RECIPE FUNCTION

16

CompactFlash CARD

11 FUNCTIONS OF CONFIGURATION TOOL (MODULE SETTINGS)

(e) Import applicability of global labels according to data type

The following table shows the import applicability of global labels according to the data types of GX Works2.

GX Works2 data type	Data type at import	Import	
		VAR_GLOBAL	VAR_GLOBAL_CONSTANT
Bit	Bit	○ ^{*1}	○ ^{*1}
Word [signed]	Word [signed]	○ ^{*1}	×
Double word [signed]	Double word [signed]	○ ^{*1}	×
Word [unsigned]/bit array [16 bits]	Word [unsigned]	○	×
Double word [unsigned]/bit array [32 bits]	Double word [unsigned]	○	×
FLOAT [single precision]	FLOAT [single precision]	○ ^{*1}	×
FLOAT [double precision]	FLOAT [double precision]	○ ^{*1}	×
String (N) ^{*2}	String (N) ^{*2}	○ ^{*2}	×
Time	Time	×	×
Timer	Timer	○	×
Counter	Counter	○	×
Retentive timer	Retentive timer	○	×
Pointer	Pointer	×	×

○: Applicable ×: Not applicable

*1: Not applicable when importing global labels to the saved file name data.

*2: N indicates the number of characters. Importing global labels to the saved file name data is applicable only when N is specified between 1 and 16.

POINT

The following table shows the data types and their corresponding devices when VAR_GLOBAL_CONSTANT is specified for the class in GX Works2.

Expression in GX Works2		Expression in Configuration Tool
Data type	Constant	Device
Bit	FALSE	SM401
	TRUE	SM400
Word [signed]	n	Kn
Double word [signed]	n	Kn
Word [unsigned]/bit array [16 bits]	n	Kn
Double word [unsigned]/bit array [32 bits]	n	Kn
FLOAT [single precision]	n	En
FLOAT [double precision]	n	En
String (N) ^{*1}	'n'	"n"
Time	T#nh	Kn*360000
	T#nm	Kn*60000
	T#ns	Kn*1000
	T#nms	Kn
Timer	-	-
Counter	-	-
Retentive timer	-	-
Pointer	-	-

n: A value entered to each data type -: Not applicable in GX Works2

*1: N indicates the number of characters.

(2) Disabling relations with global labels

Operating procedure

Select the related data, and disable the relation by one of the following methods.

- Select [Edit] → [Release Relation to Global Label].*¹
- Click the button*² on each screen.

*1: The menu is valid in the following condition only.

- When the "Data" screen of Data logging setting is displayed.

*2: This button can be found on the following screens.

- "Data setting" screen displayed from "Data name" on the "Trigger condition setting" screen, "OR combine" screen, "AND combine" screen, "Number of times" screen, "Order" screen, "Setting a period of time" screen, "File switching condition setting" screen, "Save file name setting" screen, "E-mail content setting" screen, and "E-mail notice" screen
- Event setting screen
- "Current value layout" screen

(3) Updating related data of global labels

Updates values of data related to global labels of GX Works2 project.

If data cannot be updated, the relation is disabled.

Operating procedure

- ① Select [Edit] → [Update Related to Global Label Data].
- ② Select a project on the "Update Related to Global Label Data" screen, and click the button.
 - ☞ (3) (a) in this section Update Related to Global Label Data screen
- ③ Select global labels to be updated on the "Update data" screen.
 - ☞ (3) (b) in this section Update data screen

(a) Update Related to Global Label Data screen

Setting screen

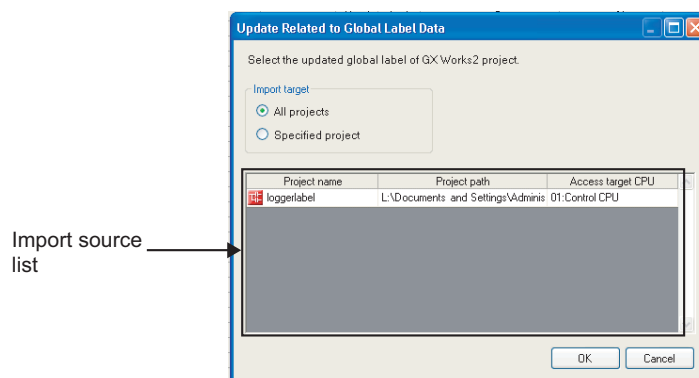

11 FUNCTIONS OF CONFIGURATION TOOL (MODULE SETTINGS)

Item	Description
All projects	Select this to update related data of all projects.
Specified project	Select this to update related data of specified project.
Import source list*1	Displays the GX Works 2 project () and the access target CPU which are set as global label import source. When the project is not set for the access target CPU, "(no setting) is displayed.
<input type="button" value="OK"/> button	Reflects the settings and displays the "Update data" screen.
<input type="button" value="Cancel"/> button	Discards the settings and closes the screen.

*1: A project can be selected only when "Specified project" is selected.

(b) Update data screen

Setting screen

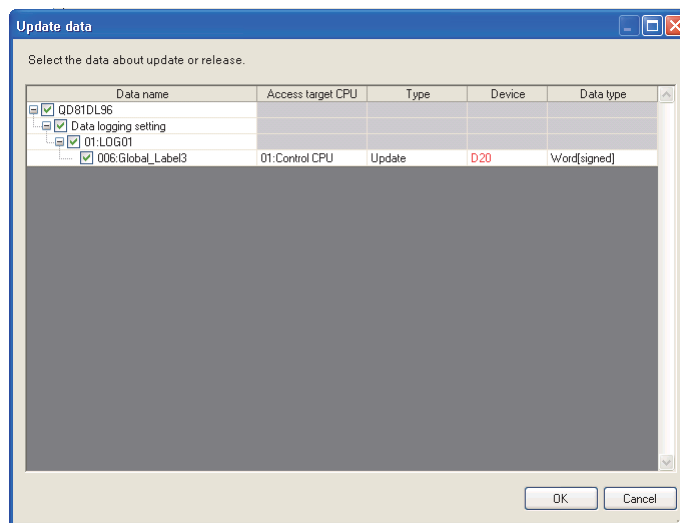

Item	Description
Data name	Displays setting names and related data names. Check the settings or related data to be updated.
Access target CPU	Displays the access target CPU.
Type	Displays the update status. <ul style="list-style-type: none"> • Refresh: Updates devices and data types to the most recent value. • Release: Relations are disabled when the global labels with the same name do not exist in the related data import source, or inconsistency occurs by the update.
Device	Displays the start device after the update. When the start device is changed after the update, the device name is displayed in red.
Data type	Displays the data type after the update. When the data type or size is changed after the update, the device name is displayed in red.
<input type="button" value="OK"/> button	Updates the specified related data, or disables relations.
<input type="button" value="Cancel"/> button	Discards the settings and closes the screen.

(4) Importing device comments

Operating procedure

- ① Open the "Import Device Comment" screen or "Import" screen by one of the following methods.

- Select [Edit] → [Import Device Comment].*¹
- Click the  button*² on each screen.

*1: The menu is valid in the following conditions only.

- When the "Data" screen of Data logging setting is displayed.
- When the "Recipe Editor" screen is displayed.

*2: This button can be found on the following screens.

- "Data setting" screen displayed from "Data name" on the "Trigger condition setting" screen, "OR combine" screen, "AND combine" screen, "Number of times" screen, "Order" screen, "Setting a period of time" screen, "File switching condition setting" screen, "Save file name setting" screen, "E-mail content setting" screen, and "E-mail notice" screen
- Event setting screen
- "Current value layout" screen

- ② Select a device comment import source project*³ on the "Import Device Comment" screen or "Import" screen, and click the  button.

 (4) (a) in this section Import Device Comment screen

*3: When "(no setting)" is selected, the "Global label import setting" screen is displayed. ((4) (b) in this section Device comment import setting screen). Select a device comment import source project.

- ③ Select device comments to be imported on the "Import Device Comment" screen, and click the  button.





 (4) (c) in this section Import Device Comment screen

11 FUNCTIONS OF CONFIGURATION TOOL (MODULE SETTINGS)

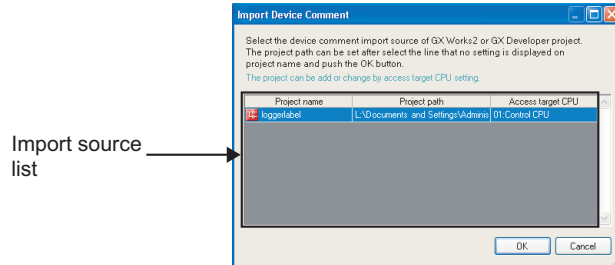
(a) Import Device Comment screen

Setting screen



Item	Description
Import source list	Displays the GX Works 2 project (), GX Developer project (), and the access target CPU which are set as device comment import source. When the project is not set for the access target CPU, "(no setting)" is displayed.
 button	Reflects the settings and displays the screen to specify the import target device comment. When "(no setting)" is selected, the "Device comment import setting" screen is displayed.
 button	Discards the settings and closes the screen.

11 FUNCTIONS OF CONFIGURATION TOOL (MODULE SETTINGS)

(b) Device comment import setting screen

Setting screen

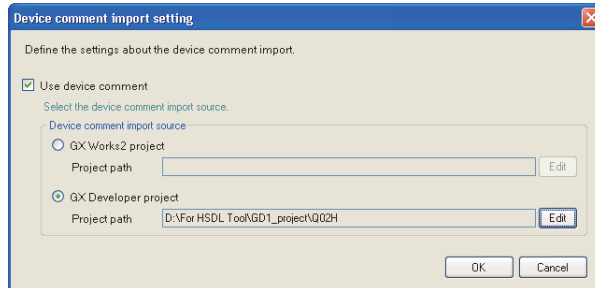

For the setting items, refer to the following section.

☞ Section 11.4.3 (6) Global label/Device comment import setting

(c) Import Device Comment screen

Setting screen

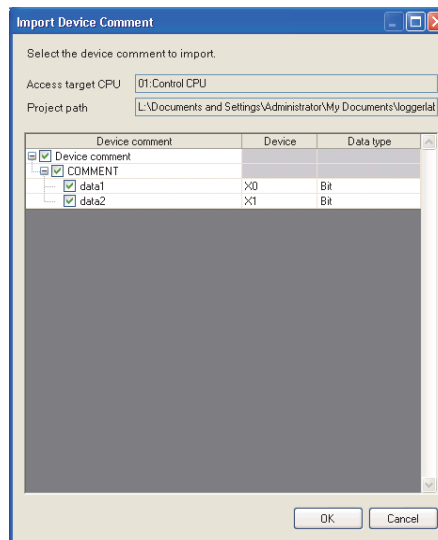

Item	Description	Reference
Access target CPU	Displays the access target CPU selected on the "Import Device Comment" screen.	(4) (a) in this section
Project path	Displays the path of project from which device comments are imported.	
Device comment	Displays device comments (COMMENT set in GX Works2 or GX Developer). Check boxes are displayed for each device comment. Check device comments to be imported.	-
Device	Displays devices contain device comments.	-
Data type	Displays data type of "Device". Bit device: Bit Word device: Word [signed]	-
button	Imports the specified device comments.	-
button	Discards the settings and closes the screen.	-

11 FUNCTIONS OF CONFIGURATION TOOL (MODULE SETTINGS)

11.3 Project Management

11.3.1 Creating a new project

This function creates a new project.
The project being edited is discarded.

Operating procedure

Select [Project] → [New] ().

11.3.2 Opening a project

This function reads a saved project.

Operating procedure

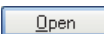
- ① Select [Project] → [Open] ().
- ② On the displayed "Open" screen, specify the project file to be read and click the  button.

Setting screen

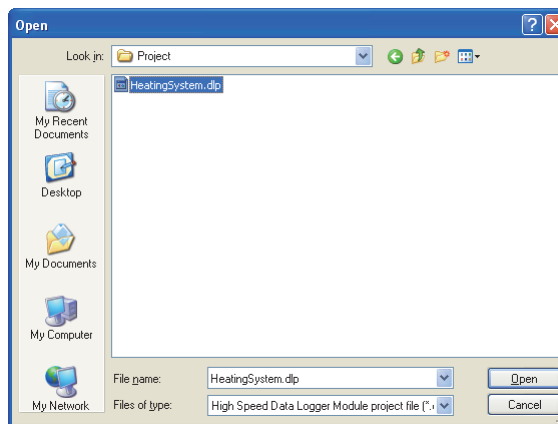

Item	Description
Look in	Select the folder where the project file is saved.
File name	Specify the name of the project file.
Files of type	Select the type (.dlp) of project file.

11 FUNCTIONS OF CONFIGURATION TOOL (MODULE SETTINGS)

11.3.3 Saving a project

This function saves the settings being edited to a project file.

Operating procedure

(a) To save

Select [Project] → [Save] ().

(b) To save the project with a new file name

① Select [Project] → [Save As].

② On the displayed "Save As" screen, specify the save location and file name and click the  button.

Setting screen

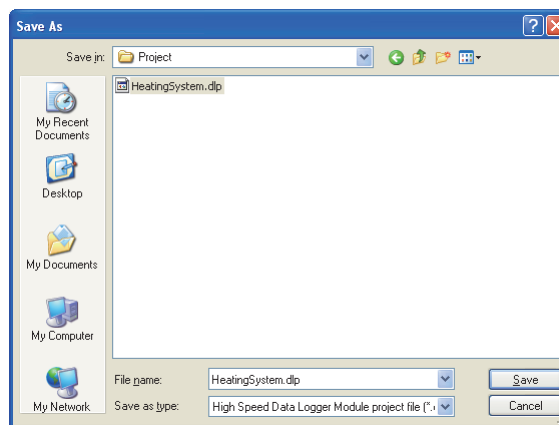

Item	Description
Save in	Select the folder to save the project file.
File name	Specify the name of the project file to save.
Save as type	Select the type (.dlp) of project file to save.

11 FUNCTIONS OF CONFIGURATION TOOL (MODULE SETTINGS)

11.3.4 Importing settings from project file

Specify settings (common settings, data logging settings, event logging settings, report settings) from the saved project and utilize them in the project being edited.

Operating procedure

- ① Select [Project] → [Import] → [Project File].
- ② On the "Open" screen (Section 11.3.2), specify the project file (.dlp) to be read and click the button.
- ③ Check settings to be imported from "Import source" on the "Import from project file" screen and click in the center. (Click to cancel the import.)
- ④ Click the button to execute the import.

Setting screen

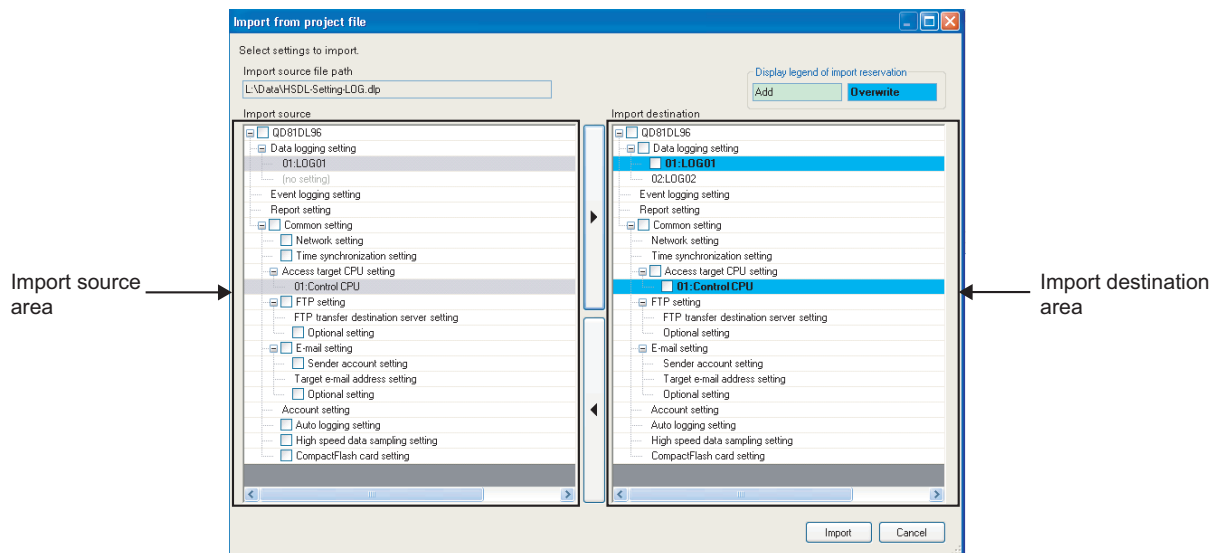

Setting screen

Item	Description
Import source file path	Displays the project file path of the import source.
Display legend of import reservation	Displays colors indicated in the import destination area for import reservation.
Import source area	Displays settings of project file which are specified for 'project file path of import source'.
<input type="button" value="▶"/> button (Import reservation)	Reserves the settings selected in the import source area. (Import reservation) If the same setting name exists in the import destination area, it will be overwritten.*1
<input type="button" value="◀"/> button (Import cancellation)	Cancels the import reservation of settings selected in the import destination area.
Import destination area	Displays the project status after importing the settings.
<input type="button" value="Import"/> button	Imports the settings according to the status in the 'import destination area'. After the import, the import destination area becomes the status of import completion, and the import reservation is canceled.
<input type="button" value="Cancel"/> button	Discards the settings reserved for the import and closes the screen.

*1: Access target CPUs are not included.

POINT

(1) Importing referenced settings

Some settings in the high speed data logger module are referenced.

Example

- Data logging setting: Access target CPUs are referenced from data
- Event logging setting: FTP transfer destination server settings are referenced from the transfer settings of "Save" screen.
- Report setting: Data logging settings are referenced from the layout settings

When a referenced setting is checked in the import source area, the settings related to the referenced setting are also checked.

To avoid importing the referenced settings, uncheck them.

(2) Note on same access target CPU names

The same access target CPU names can be assigned to the multiple settings in a single project. However, in such a case, the import function cannot be performed.

When using the import function, do not use the same access target CPU name in the projects of import source and import destination.

(3) The No. 01 item of the access target CPU (Default name: Control CPU) cannot be overwritten with the item other than the No. 01 item of the import source.

(4) Importing "FTP transfer destination server setting" of FTP setting

- FTP transfer destination server settings cannot be selected and imported individually.
- All settings are imported additionally when the total number of settings after the import is 16 or less.
- Only the referenced settings are imported additionally when the total number of settings after the import is 17 or more.
- Settings cannot be imported when only the referenced settings are imported and the total number of settings after the import is 17 or more.

11 FUNCTIONS OF CONFIGURATION TOOL (MODULE SETTINGS)

11.3.5 Exporting project to CSV file

Export settings (common settings, data logging settings, event logging settings, report settings) of the project being edited to the CSV file.

For details on the formats of setting information CSV file, refer to the following section.

☞ Appendix 10 Setting information CSV File Format

Operating procedure

- ① Select [Project] → [Export] → [CSV File].
- ② On the "Browse For Folder" screen, specify the export destination and click the

button.

Setting screen

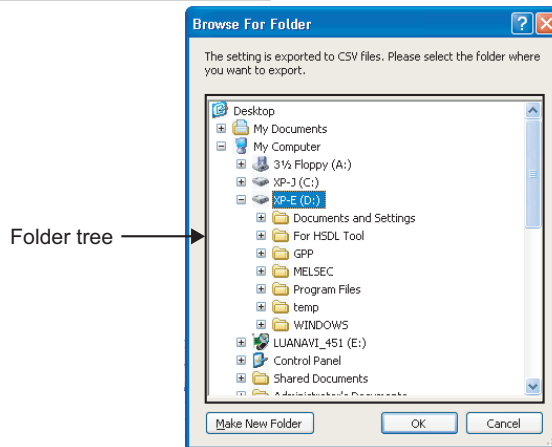

Item	Description
Folder tree	Select a folder to which settings are exported.
<input type="button" value="Make New Folder"/> button	Creates a new folder in the directory displayed in the folder tree.
<input type="button" value="OK"/> button	Exports CSV files to the selected folder, and closes the screen.
<input type="button" value="Cancel"/> button	Cancels the export and closes the screen.

11 FUNCTIONS OF CONFIGURATION TOOL (MODULE SETTINGS)

11.3.6 Exporting module operating file

This function exports the project being edited in a format which allows data to be operated on the module.

The project is exported to a CompactFlash card inserted in the personal computer and data can be used on the module as it is.

Operating procedure

- ① Select [Project] → [Export] → [Module Operating File].
- ② The following screen is displayed.

Select the export destination drive and click the button.

Setting screen

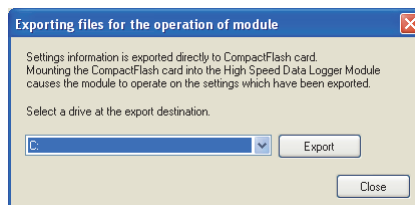

POINT

The auto logging function (☞ Section 10.2) can be executed by exporting setting data with the auto logging function set to be enabled (☞ Section 11.4.7) and inserting that CompactFlash card in the high speed data logger module.

11 FUNCTIONS OF CONFIGURATION TOOL (MODULE SETTINGS)

11.4 Common Setting

This section explains the initial settings in order to use the high speed data logger module. Click "Common setting" on the edit items tree of the Configuration Tool to display the Common setting screen.

Setting screen

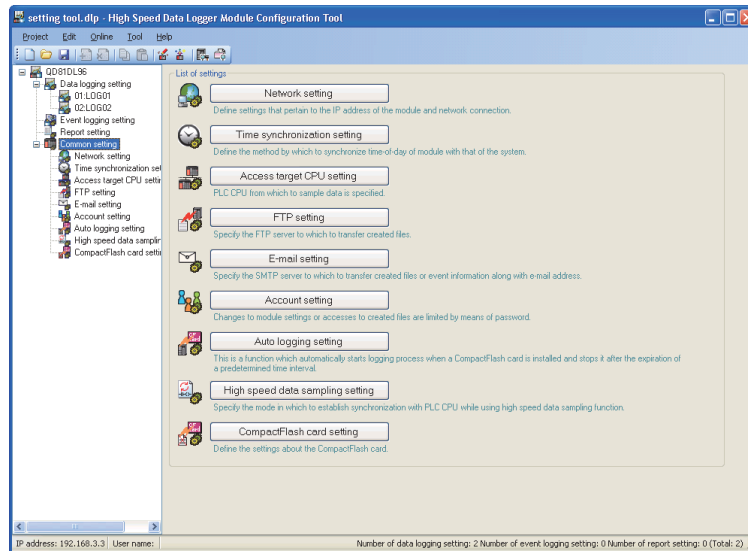

The following table shows the contents of the Common setting items.

Item	Description	Reference
Network setting	Set the settings related to the IP address of the module and network connection.	Section 11.4.1
Time synchronization setting	Set methods to synchronize the time of the module with the time of the system.	Section 11.4.2
Access target CPU setting	Specify the programmable controller CPUs which are the target of data sampling.	Section 11.4.3
FTP setting	Specify the FTP servers for transferring created files.	Section 11.4.4
E-mail setting	Specify the SMTP servers and e-mail addresses for sending created files and event information.	Section 11.4.5
Account setting	Restricts changing module settings and access to created files by password.	Section 11.4.6
Auto logging setting	Set the function to automatically start logging when a CompactFlash card is inserted and stop logging after the specified amount of time.	Section 11.4.7
High speed data sampling setting	Set the settings related to the high speed data sampling.	Section 11.4.8
CompactFlash card setting	Set the settings related to the CompactFlash card.	Section 11.4.9

Remark

The existing common setting data can be utilized by using "Import from project file" (📁 Section 11.3.4) function.

The setting time can be reduced by utilizing the existing settings.

11 FUNCTIONS OF CONFIGURATION TOOL (MODULE SETTINGS)

11.4.1 Network setting

This section explains the settings required for high speed data logger module to establish network connections.

Operating procedure

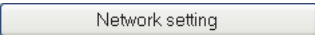
Click "Common setting" on the edit items tree of the Configuration Tool, then click the  button.

Setting screen

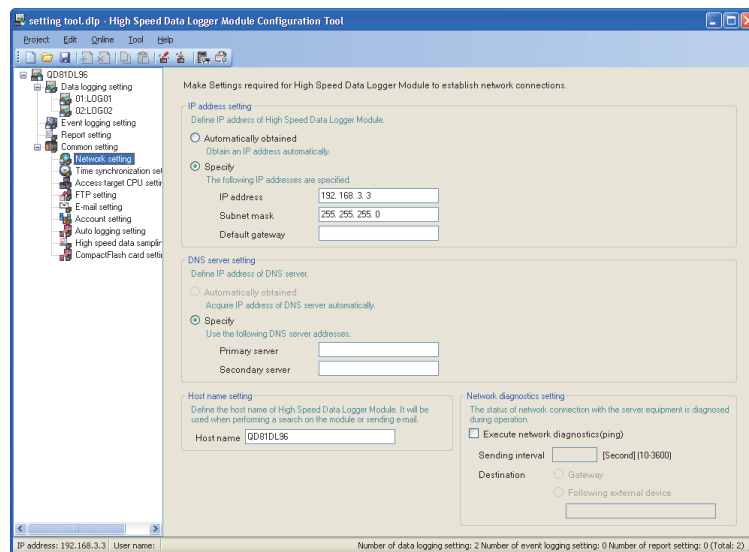

Item	Description	Reference
IP address setting	Set the IP address of the high speed data logger module.	(1) in this section
DNS server setting	Set the IP address of the DNS server.	(2) in this section
Host name setting	Set the host name of the high speed data logger module. Used for module search and when sending e-mails.	(3) in this section
Network diagnostics setting	Set whether to execute network diagnostics (ping). Execute ping when diagnosing the network connection status with the server device.	(4) in this section

Remark

When changing the network settings, they are enabled by resetting the programmable controller CPU.

11 FUNCTIONS OF CONFIGURATION TOOL (MODULE SETTINGS)

(1) IP address setting

Set the IP address necessary for the high speed data logger module network connection.

Setting screen

IP address setting
Define IP address of High Speed Data Logger Module.

Automatically obtained
Obtain an IP address automatically.

Specify
The following IP addresses are specified.

IP address: 192.168.3.3
Subnet mask: 255.255.255.0
Default gateway:

Item	Description
IP address setting	Select the method for specifying the IP address of the high speed data logger module.
Automatically obtained	Select to specify the IP address by automatically acquiring it.*1
Specify	Select to specify the IP address by directly entering it.
IP address	Set the IP address of the high speed data logger module in decimal notation.
Subnet mask	Set the subnet mask in decimal notation when used. All devices on the same network must use the same subnet mask.
Default gateway	Set the default gateway in decimal notation. Only one address can be registered on the high speed data logger module.*2

*1: "Automatically obtained" cannot be selected in [Common Setting] - [Access target CPU setting] when "Other station" is specified to the Access target CPU setting and "High Speed Data Logger Module Ethernet Port" is selected in AsNetwork routeAt tab from [Access source system] - [Module type].

*2: Can be omitted if only accessing the same network.

POINT

High speed data logger module settings are saved on the CompactFlash card. Therefore, the IP address of the high speed data logger module returns to the initial status (192.168.3.3) when turning the power OFF/ON or resetting the programmable controller CPU without a CompactFlash card inserted in the module or without the settings written to the CompactFlash card. When replacing or formatting the CompactFlash card, read the current settings as necessary and write them after replacing or formatting the card.

11 FUNCTIONS OF CONFIGURATION TOOL (MODULE SETTINGS)

(2) DNS server setting

Set the IP address of the DNS server.

Setting screen

Item	Description
DNS server setting	Select the method to specify the IP address of the DNS server.
Automatically obtained	Select this to specify the IP address of the DNS server by automatically acquiring it.
Specify	Select this to specify the IP address of the DNS server by directly entering it.
Primary server	Set the IP address of the primary DNS server in decimal notation.*1
Secondary server	Set the IP address of the secondary DNS server in decimal notation.*2

*1: When acquiring an IP address from a domain name, the IP address is searched in order from the DNS server specified as the primary DNS server.

*2: When acquiring an IP address from a domain name, if the IP address cannot be acquired from the primary DNS server, the IP address is searched from the DNS server specified as the secondary DNS server.

(3) Host name settings

Set the host name of high speed data logger module.

Setting screen

Item	Description
Host name	Set the host name for the high speed data logger module (up to 32 characters). '\ ' cannot be set. Used when performing a search on the module or sending e-mail.

11 FUNCTIONS OF CONFIGURATION TOOL (MODULE SETTINGS)

(4) Network diagnostics setting

Set the network diagnostics (ping) settings to diagnose the network connection status with the server device.

Setting screen

Network diagnostics setting

The status of network connection with the server equipment is diagnosed during operation.

Execute network diagnostics(ping)

Sending interval [Second] (10-3600)

Destination Gateway Following external device

Item	Description
Execute network diagnostics (ping)	If this setting is enabled, a ping packet (1 packet) is transmitted regularly to perform network diagnostics.* ¹ If enabled, set the transmission interval and destination.
Sending interval [Second](10-3600)	Set the ping packet transmission interval.* ²
Destination	Set the ping packet destination.
Gateway	Select this to send a ping packet to the gateway.
Following external device	Select this to send a ping packet to the specified external device.
(External device)	Specify the IP address or host name. (Up to 32 characters)

*1: When there is no response from the destination within 5 seconds, retries once. If there is still no response after that, the module error occurs.

*2: Set the transmission interval considering the load on the network.

11 FUNCTIONS OF CONFIGURATION TOOL (MODULE SETTINGS)

11.4.2 Time synchronization setting

This section explains the settings for synchronizing the time used by the high speed data logger module to a SNTP server computer on the network or the programmable controller CPU (CPU No. 1 in a multiple CPU system).

Operating procedure

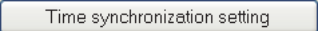
Click "Common setting" on the edit items tree of the Configuration Tool, then click the  button.

Setting screen

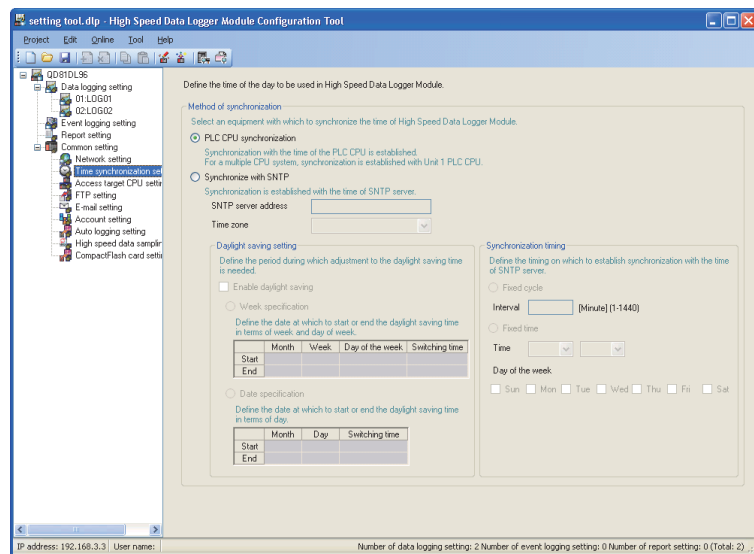

Item	Description	Reference
Method of synchronization	Select the equipment with which the time of high speed data logger module is synchronized.	-
PLC CPU synchronization	Select this to synchronize with the time of the programmable controller CPU. For a multiple CPU system, synchronizes with programmable controller CPU No. 1.	(3), (4) in this section
Synchronize with SNTP	Select this to synchronize with the time of the SNTP server computer.	(3), (5) in this section
SNTP server address	Set the IP address of the SNTP server in decimal notation.*1	-
Time zone	Select the time zone used for time synchronization.	-
Daylight saving setting	Set the period which requires adjustment of the daylight saving time.	(1) in this section
Synchronization timing	Set the timing to perform time synchronization.	(2) in this section

*1: NTP servers can also be used.

11 FUNCTIONS OF CONFIGURATION TOOL (MODULE SETTINGS)

(1) Daylight saving setting

Set the settings to use daylight saving time (summer time).

Setting screen

Daylight saving setting

Define the period during which adjustment to the daylight saving time is needed.

Enable daylight saving

Week specification

Define the date at which to start or end the daylight saving time in terms of week and day of week.

	Month	Week	Day of the week	Switching time
Start	Mar	2nd	Sun	02:00
End	Nov	1st	Sun	02:00

Date specification

Define the date at which to start or end the daylight saving time in terms of day.

	Month	Day	Switching time
Start			
End			

Item	Description
Enable daylight saving	Set whether to enable the daylight saving time.*1
Week specification	Select this to set the date at which to start or end the daylight saving time in terms of week and day of week.
Start - Month	Set the month to start daylight saving time.
Start - Week	Set the week to start daylight saving time.
Start - Day of the week	Set the day of week to start daylight saving time.
Start - Switching time	Set the time to start daylight saving time.
End - Month	Set the month to end daylight saving time.
End - Week	Set the week to end daylight saving time.
End - Day of the week	Set the day of week to end daylight saving time.
End - Switching time	Set the time to end daylight saving time.
Date specification	Select this to set the date at which to start or end the daylight saving time in terms of day.
Start - Month	Set the month to start daylight saving time.
Start - Day	Set the day to start daylight saving time.
Start - Switching time	Set the time to start daylight saving time.
End - Month	Set the month to end daylight saving time.
End - Day	Set the day to end daylight saving time.
End - Switching time	Set the time to end daylight saving time.

*1: When daylight saving time is enabled, the period of time from the specified start date/time to the end date/time is defined as daylight saving time, and that period's start time and end time are moved forward 1 hour.

POINT

- Before or after the start time/end time of daylight saving time, the data logging function, event logging function, and report function may not start with time as the condition. (When "Time interval specification" of general data sampling is specified, the data are not sampled because the time cannot be identified correctly while the time is adjusted one hour backward at the end of the daylight saving time.)
- February 29 cannot be directly set. To specify February 29, select 'last day of February'.

11 FUNCTIONS OF CONFIGURATION TOOL (MODULE SETTINGS)

(2) Synchronization timing

Set the timing to perform synchronization of the time used by the high speed data logger module.

Setting screen

Item	Description
Synchronization timing	Set the timing to synchronize to the SNTP server time.
Fixed cycle	Select this to synchronize time at the specified time interval (minutes).
Interval	Set the interval for fixed cycle. (1 to 1440 minutes)
Fixed time	Select this to synchronize time at the specified time.
Time - Hours	Set the time (0 to 23 hours) for fixed time.
Time - Minutes	Set the time (0 to 59 minutes) for fixed time.
Day of the week	Check the day of the week for fixed time. If not checked, synchronizes time everyday.

9

REPORT FUNCTION

10

OTHER FUNCTIONS

11

FUNCTIONS OF CONFIGURATION TOOL (MODULE SETTINGS)

12

FUNCTIONS OF CONFIGURATION TOOL (WRITING/READING/VERIFYING DATA)

13

FUNCTIONS OF CONFIGURATION TOOL (CONFIRMING MODULE OPERATION)

14

FUNCTIONS OF CONFIGURATION TOOL (LOGGING FILE CONVERSION TOOL)

15

RECIPE FUNCTION

16

CompactFlash CARD

11 FUNCTIONS OF CONFIGURATION TOOL (MODULE SETTINGS)

(3) Common precautions on synchronization with programmable controller CPU and SNTP

When synchronizing with the time of the programmable controller CPU or SNTP server, the time of the high speed data logger module is changed. Especially when the time of the programmable controller CPU is changed or when the synchronization with the SNTP is succeeded after the communications with the SNTP server fails, the time of the high speed data logger module may be greatly changed.

Since changing the time of the high speed logger module affects cycles, time determination, and time stamp of the data logging, event logging, and report functions, configure the module to synchronize its time as little as possible.

(a) When the time of the high speed data logger module is set forward by time synchronization

- Cycle determination
Sampling and condition establishment time may be shorter than the specified cycle.
- Time determination
Conditions may be established immediately after the time updates.

(b) When the time of the high speed data logger module is set back by time synchronization

- Cycle determination
Sampling and condition establishment time may be longer than the specified cycle.
- Time determination
Established condition may be established again.

(c) Effect on time stamps

When the time is set, there is a rare possibility that a deviation may occur in the time information of the data logging file, event logging file, or report file.

	2009/02/01 15:48:32.8	1028	30.5	21.8	15.9
Deviation	→ 2009/02/01 15:48:32.9	1029	31.5	22.8	16.9
	→ 2009/02/01 15:48:32.0	1030	32.5	23.8	17.9
	→ 2009/02/01 15:48:32.1	1031	33.5	24.8	18.9
	→ 2009/02/01 15:48:32.2	1032	34.5	25.8	19.9

Data are normally sampled in 100ms intervals.

(4) Precautions on synchronization with programmable controller CPU

- (a) Before using the high speed data logger module, set the time data of CPU No. 1. For the time data settings, refer to the user's manual of the CPU module used.
- (b) There is a deviation in the time data of CPU No. 1 used by the high speed data logger module. For the time data accuracy, refer to the user's manual of the CPU module used.
- (c) When the high speed data logger module obtains the time data of CPU No. 1, a maximum of 1 second of delay occurs as the transfer time. Therefore, there may be rare situations where a 1-second deviation occurs in logging data time when setting the time.

- (d) The time data of CPU No. 1 is obtained by the high speed data logger module once each 24 hours.

When the time data of a running CPU No. 1 is updated, turn ON the programmable controller CPU time synchronization request (YB). *1

*1: After updating the time data, wait for more than one second, and turn YB ON.

(5) Precautions on synchronization with SNTP

When the high speed data logger module cannot obtain time information from the SNTP server computer due to a network failure or time synchronization server failure, the module performs the operations as follows:

- (a) When time information cannot be obtained when the programmable controller CPU is powered ON from OFF, when the programmable controller CPU is reset, or when settings are updated
 - ① Synchronizes to the time of the programmable controller CPU (synchronized to the time of CPU No. 1). If the "Daylight saving setting" are configured, the daylight saving time function is enabled.
 - ② Outputs the error code 0B30H to the error log.
 - ③ Executes a time query to the SNTP server again one minute later.
 - ④ Repeats the operation ③ until the time query succeeds.
- (b) If time information cannot be obtained
 - ① Continues to operate based on the time information when the time query succeeded.
 - ② If the previous time query succeeded, outputs the error code 0B31H to the error log.
 - ③ Executes the time query at the next synchronization timing (refer to (2) Synchronization timing).

11 FUNCTIONS OF CONFIGURATION TOOL (MODULE SETTINGS)

(6) How to write the time data to the programmable controller CPU after synchronizing with SNTP

The correct time data after synchronizing with SNTP can be written to the programmable controller CPU with the program shown in the following figure.

(Example 1)

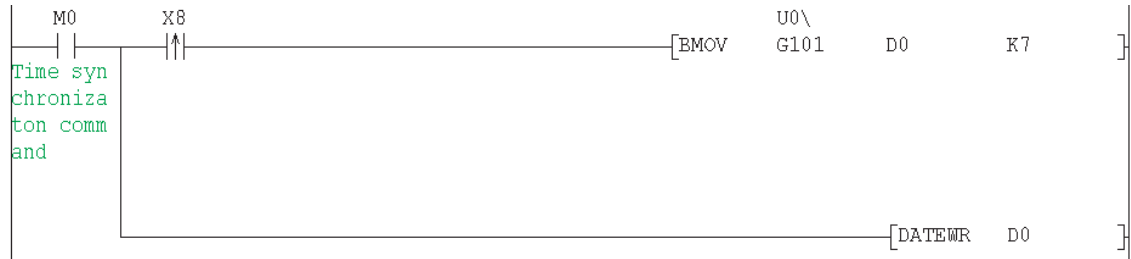

(Example 2)

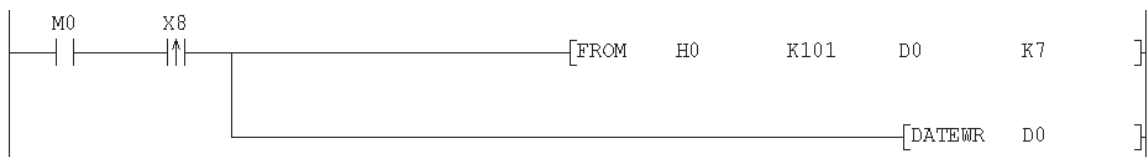

[Program explanation]

1. Set the start I/O address of the high speed data logger module to 0H.
2. X0B is 'SNTP time synchronization timing'.
☞ Section 3.3.2 I/O signal details
3. The time writing delay in these programs is a maximum of 2 scan times.
4. D0 to D6 are used as the work area.

11 FUNCTIONS OF CONFIGURATION TOOL (MODULE SETTINGS)

11.4.3 Access target CPU setting



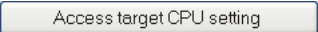

This section explains the settings for specifying the programmable controller CPUs which are the target of data sampling by the high speed data logger module. Up to 64 access target CPUs can be configured.

Operating procedure

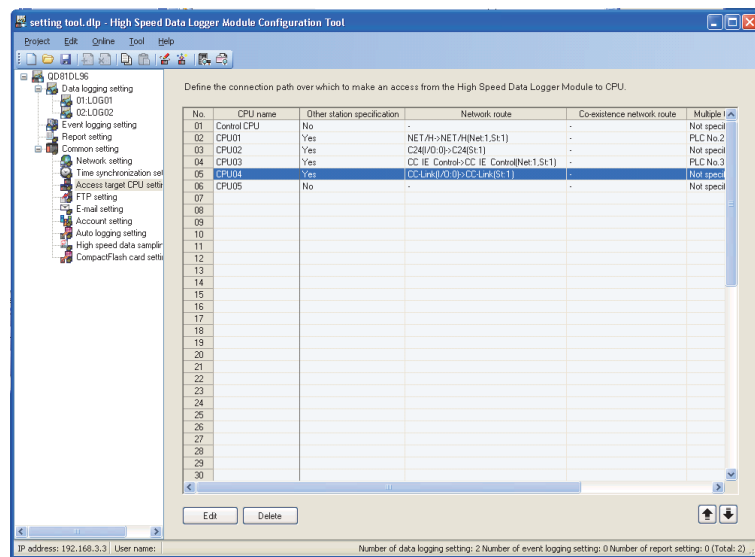
Click "Common setting" on the edit items tree of the Configuration Tool, then click the  button.

Setting screen



Item	Description	Reference
CPU name	Displays the access target CPU name.	-
Other station specification	Displays whether another station is specified for access target CPU.	-
Network route	Displays the accessed network information when other station is specified.	Remark in this section
Co-existence network route	Displays the co-existence network information for accessing a co-existence network when other station is specified.	Remark in this section
Multiple CPU specification	Displays the CPU number when the access target CPU is a multiple CPU.	-
Import setting	Displays the settings of "Global label/Device comment import setting".	(6) in this section
 button	Displays the setting screen to edit the selected access target CPU setting.	(1) in this section
 button	Deletes the selected access target CPU setting.*1	-
 button	Shifts the selected access target CPU setting to the row above.*1	-
 button	Shifts the selected access target CPU setting to the row below.*1	-

*1: Not valid when "Control CPU" is selected.

11 FUNCTIONS OF CONFIGURATION TOOL (MODULE SETTINGS)

Remark

The contents of the network route and co-existence network route settings are displayed in the format below.

① Displayed format

'Access source system format contents' → 'Access target (intervening) system format contents'

② Access source system format contents

Module type	Access source system format contents
CC-Link IE Controller Network Module	CC IE Control
CC-Link IE Field Network Module	CC IE Field
MELSECNET/H Module	NET/H
CC-Link Module	CC-Link (I/O: [start I/O address])
Ethernet Module	Ethernet
Serial Communication Module	C24 (I/O: [start I/O address])
High Speed Data Logger Module Ethernet Port	If the access target (intervening) system is a built-in Ethernet port CPU <ul style="list-style-type: none"> Built-in Ethernet If the access target (intervening) system is a Ethernet module <ul style="list-style-type: none"> Built-in Ethernet (Net:[network No.], St:[station No])

③ Access target (intervening) system format contents

Module type	Access target (intervening) system format contents
CC-Link IE Controller Network Module	CC IE Control (Net:[network No], St:[station No])
CC-Link IE Field Network Module	CC IE Field (Net:[network No], St:[station No])
MELSECNET/H Module	NET/H (Net:[network No], St:[station No])
CC-Link Module	CC-Link (St:[station No])
Ethernet Module	If the access source system is an Ethernet module <ul style="list-style-type: none"> Ethernet (Net:[network No], St:[station No]) If the access source system is the high speed data logger module Ethernet port <ul style="list-style-type: none"> Ethernet (IP:[IP address], St:[station No])
Serial Communication Module	C24 (St:[station No])
CPU (Built-in Ethernet Port)	CPU (Built-in Ethernet port) ([IP address])

POINT

The following conditions may affect the general sampling, FTP transfer function, and e-mail function: when the CPU which does not exist in the access target CPU is set, or the high speed data logger cannot communicate with the access target CPU temporary because of the power interruption of access target CPU or network failure.

Use high speed data logger modules with the status that can communicate with the CPU set as access target CPU.

☞ Section 3.4.8 General data sampling delay time area (address: 800 to 805)

☞ Appendix 8.2 Processing time of FTP transfer function and e-mail function

11 FUNCTIONS OF CONFIGURATION TOOL (MODULE SETTINGS)

(1) Access target CPU setting screen (<<Other station specification>> tab)

In the connection route setting from the high speed data logger module to the CPU to be accessed, set the CPU to be accessed and specify whether the access target CPU is own station or other station.

Operating procedure

With the screen for "Access target CPU setting" under "Common setting" on the edit items tree of the Configuration Tool is displayed, click the button.

The button is enabled when "CPU name" or "Other station specification" is set for the selected row.

The <<Other station specification>> tab is displayed as the initial screen.

Setting screen

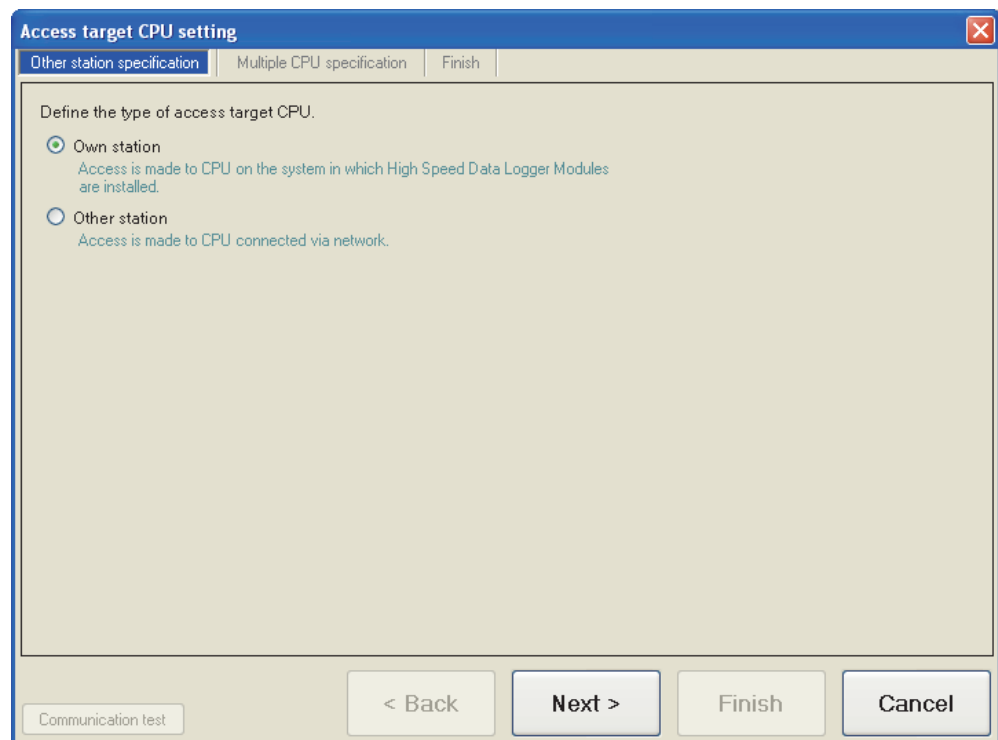

Item	Description	Reference
Own station	Select this to access to CPU on the system in which high speed data logger modules are installed.	-
Other station	Select this to access CPU connected via the network.	-
<input type="button" value="Next >"/> button	Switches to the <<Network route>> tab or <<Multiple CPU specification>> tab.*1	(2), (4) in this section
<input type="button" value="Cancel"/> button	Discards the settings and closes the screen.	-

*1: Switches to the <<Multiple CPU specification>> tab when the access target CPU type is set to "Own station", switches to the <<Network route>> tab when set to "Other station".

11 FUNCTIONS OF CONFIGURATION TOOL (MODULE SETTINGS)

Remark

Wizard overview when "Own station" is selected on the <<Other station specification>> tab

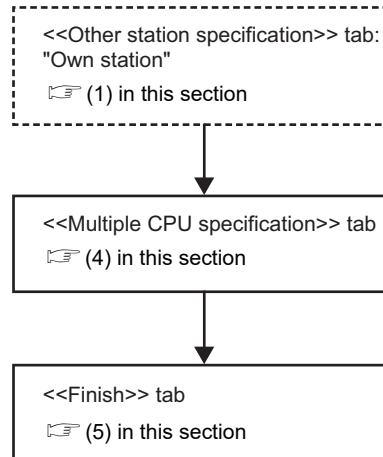

Wizard overview when "Other station" is selected on the <<Other station specification>> tab

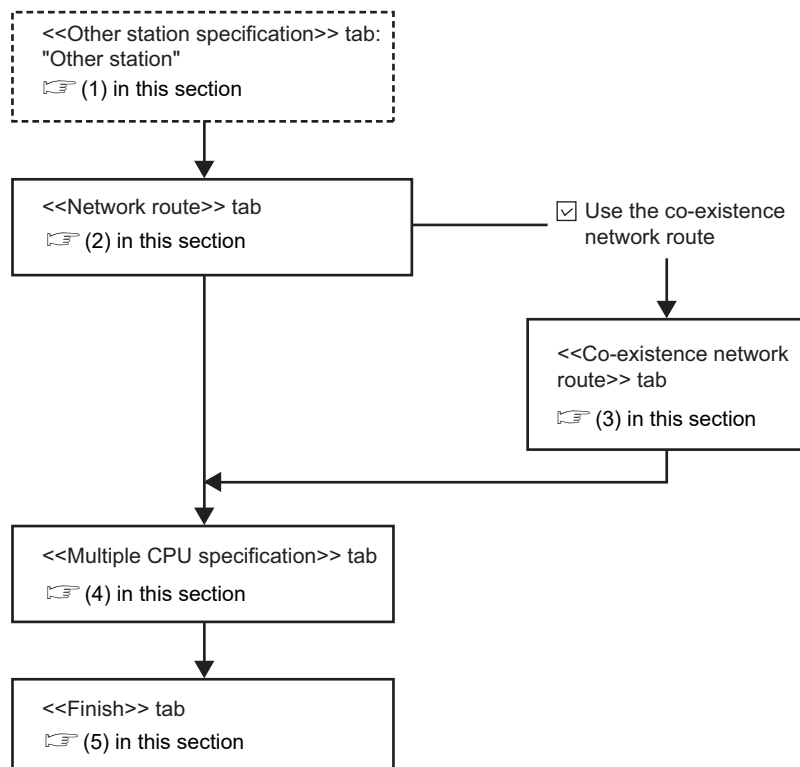

11 FUNCTIONS OF CONFIGURATION TOOL (MODULE SETTINGS)

(2) Access target CPU setting screen (<<Network route>> tab)

In the connection route setting from the high speed data logger module to the CPU to be accessed, set the network route.



Operating procedure

With the screen for "Access target CPU setting" under "Common setting" on the edit items tree of the Configuration Tool is displayed, click the <<Network route>> tab.

Setting screen

The setting details are described on the next page.

11 FUNCTIONS OF CONFIGURATION TOOL (MODULE SETTINGS)

Item	Description	Reference
Access source system	-	-
Module type	Set the access source module type.* ¹	-
Module setting	-	-
Head I/O	Set the start I/O address of the access source system module.* ²	-
Station No.	Set the station number of the access source system module.* ³	-
Access target (intervening) system	-	-
Module type	Displays or used to set the access target (intervening) module type.* ⁴	-
Module setting	-	-
IP address	Set the IP address of the access target (intervening) module.* ⁵	-
Network No.	Set the network number of the access target (intervening) module.* ⁶	-
Station No.	Set the station number of the access target (intervening) module.	-
Use the co-existence network route	Check when accessing a module on a different network via the system configured with the access target (intervening) system settings.* ⁷	-
 button	Returns to the <<Other station specification>> tab.	-
 button	Switches to the <<Co-existence network route>> tab* ⁸ or <<Multiple CPU specification>> tab.	(3), (4) in this section
 button	Discards the settings and closes the screen.	-

- *1: If "Automatically obtained" is selected for "IP address setting" on the "Network setting" screen of "Common setting", "High Speed Data Logger Module Ethernet Port" cannot be selected.
- *2: Set if the own station system module type is "CC-Link Module" or "Serial Communication Module".
- *3: When accessing an Ethernet module using the high speed data logger module Ethernet port, set the station number of the high speed data logger module Ethernet port.
- *4: If the access source system module type is "High Speed Data Logger Module Ethernet Port", select either "CPU (Built-in Ethernet Port)" or "Ethernet Module".
When selecting "CPU (Built-in Ethernet Port)", UDP (MELSOFT Connection) must be added to the open setting of a built-in Ethernet port for the access target CPU.
- *5: When accessing an Ethernet module using the high speed data logger module Ethernet port, specify the IP address of the module specified for access target (intervening) system module type.
- *6: Set the network No. in the following cases.
- The access source system module type is "CC-Link IE Controller Network Module", "CC-Link IE Field Network Module", "MELSECNET/H Module", or "Ethernet Module".
 - The access source system module type is "High Speed Data Logger Module Ethernet Port", and the access target (intervening) system module type is "Ethernet Module".
- *7: If "High Speed Data Logger Module Ethernet Port" is selected for access source system module type, "Use the co-existence network route" cannot be selected.
- *8: Switches to the <<Co-existence network route>> tab only when "Use the co-existence network route" is selected.

11 FUNCTIONS OF CONFIGURATION TOOL (MODULE SETTINGS)

(3) Access target CPU setting screen (<<Co-existence network route>> tab)

In the connection route setting from the high speed data logger module to the CPU to be accessed, set the co-existence network route.

Operating procedure

With the screen for "Access target CPU setting" under "Common setting" on the edit items tree of the Configuration Tool is displayed, click the <<Co-existence network route>> tab.

Setting screen



The screenshot shows the 'Access target CPU setting' dialog box with the 'Co-existence network route' tab selected. The dialog is titled 'Access target CPU setting' and has a close button in the top right corner. It contains the following elements:

- Other station specification** (tab): Other station specification, Network route, **Co-existence network route**, Multiple CPU specification, Finish.
- Define the second network communication path to access target CPU.**
- Intervening system**
 - Module type**: Select a module on the side of intervening system.
 - CC-Link IE Controller Network Module
 - CC-Link IE Field Network Module
 - MELSECNET/H Module
 - CC-Link Module
 - Ethernet Module
 - Serial Communication Module
 - Module setting**: Make settings for modules on the side of intervening system.
 - Head I/O: (0-FE0)
- Access target system**
 - Module type**: The following can be used for modules on the side of access target system:
 - CC-Link Module
 - Module setting**: Make settings for modules on the side of access target system.
 - Network No.: (1-239)
 - Station No.: (0-63)

Navigation buttons at the bottom: Communication test, < Back, Next >, Finish, Cancel.

The setting details are described on the next page.

11 FUNCTIONS OF CONFIGURATION TOOL (MODULE SETTINGS)

Item	Description	Reference
Intervening system	-	-
Module type	Set the module type on the relay system when accessing the access target CPU.*1	-
Module setting	-	-
Head I/O	Set the start I/O address (0 to FE0) of the module type on the relay system.*2	-
Access target system	-	-
Module type	Set the module type on the communication destination system when accessing the access target CPU.	-
Module setting	-	-
Network No.	Set the network number (1 to 239) of the module displayed by the module type on the communication destination system.*3	-
Station No.	Set the station number of the module displayed by the module type on the communication destination system.*4	-
 button	Returns to the <<Network route>> tab.	-
 button	Switches to the <<Multiple CPU specification>> tab.	(4) in this section
 button	Discards the settings and closes the screen.	-

*1: Module types which can be set are shown below according to the access source system module type on the <<Network route>> tab.

- For "CC-Link IE Controller Network Module", "CC-Link IE Field Network Module", "MELSECNET/H Module", "Ethernet Module"
Can be set when the access source system module type is other than "CC-Link IE Controller Network Module", "CC-Link IE Field Network Module", "MELSECNET/H Module", or "Ethernet Module".
- For "CC-Link Module", "Serial Communication Module"
Can be set when the access source system module type is other than "CC-Link Module" or "Serial Communication Module".

*2: Set if the access source module type is "CC-Link Module" or "Serial Communication Module".

*3: Set if the access source module type is in the following cases.

- "CC-Link IE Controller Network Module"
- "CC-Link IE Field Network Module"
- "MELSECNET/H Module"
- "Ethernet Module"

*4: The setting range of each module type is shown below.

Module type	Setting range
CC-Link IE Controller Network Module	0 to 120
CC-Link IE Field Network Module	
MELSECNET/H Module	
Ethernet Module	
CC-Link Module	0 to 63
Serial Communication Module	0 to 31

11 FUNCTIONS OF CONFIGURATION TOOL (MODULE SETTINGS)

(4) Access target CPU setting screen (<<Multiple CPU specification>> tab)

In the connection route setting from the high speed data logger module to the CPU to be accessed, set the multiple CPU specification.

Operating procedure

With the screen for "Access target CPU setting" under "Common setting" on the edit items tree of the Configuration Tool is displayed, click the <<Multiple CPU specification>> tab.

Setting screen

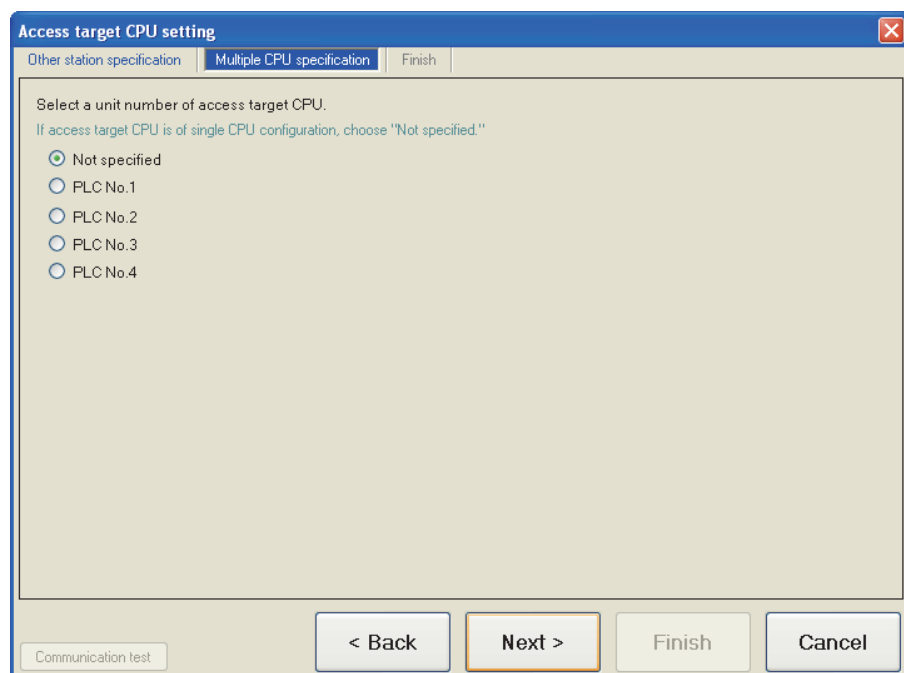

Item	Description	Reference
Multiple CPU specification	Select the CPU number when the access target CPU is a multiple CPU system.	-
< Back button	Returns to the <<Network route>> tab, <<Co-existence network route>> tab, or <<Other station specification>> tab.*1	-
Next > button	Switches to the <<Finish>> tab.	(5) in this section
Cancel button	Discards the settings and closes the screen.	-

*1: Returns to the <<Other station specification>> tab when "Own station" is set for the access target CPU type on the <<Other station specification>> tab.
Returns to the <<Network route>> tab when "Other station" is selected on the <<Other station specification>> tab.
Returns to the <<Co-existence network route>> tab only when "Other station" is selected and "Use the co-existence network route" is checked.

11 FUNCTIONS OF CONFIGURATION TOOL (MODULE SETTINGS)

(5) Access target CPU setting screen (<<Finish>> tab)

Gives the access target CPU a name and completes the access target CPU setting.

Operating procedure

With the screen for "Access target CPU setting" under "Common setting" on the edit items tree of the Configuration Tool is displayed, click the <<Finish>> tab.

Setting screen

Item	Description	Reference
Name of access target CPU	Set the access target CPU name. (Up to 32 characters)	-
Global label/Device comment import setting button	Edit the global label/device comment import settings. Set contents are displayed at the right of the button after the setting.	(6) in this section
Communication test button	Conducts a connection test to the CPU with the configured settings.	Section 12.1
< Back button	Returns to the <<Multiple CPU specification>> tab.	-
Finish button	Reflects the settings and closes the screen.	-
Cancel button	Discards the settings and closes the screen.	-

11 FUNCTIONS OF CONFIGURATION TOOL (MODULE SETTINGS)

(6) Global label/Device comment import setting

Configure the settings related to global labels and device comments which are imported as data.

Operating procedure

Click the  button on the <<Finish>> tab of the "Access target CPU setting" screen.

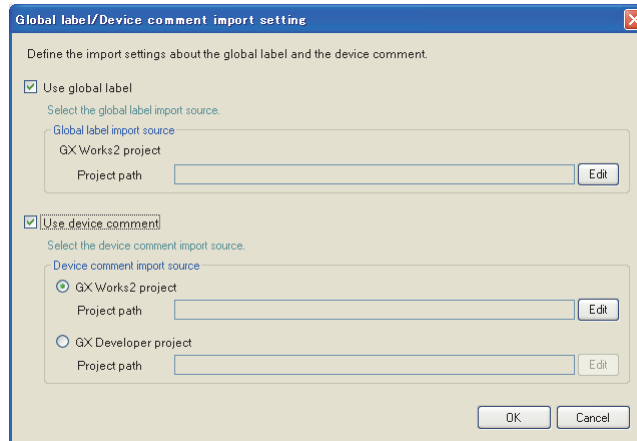

Setting screen

Item	Description	Reference
Use global label	Check this to import global labels.	-
Global label import source	Select a source from which global labels are imported.	-
GX Works2 project	-	-
Project path	Displays the GX Works2 project path specified for the import source.	-
Edit button	Displays the "GX Works2 project selection" screen.	(6) (a) in this section
Use device comment	Check this to import device comments.	-
Device comment import source	Select a source from which device comments are imported.	-
GX Works2 project	-	-
Project path	Displays a GX Works2 project path specified for the import source.	-
Edit button	Displays the "GX Works2 project selection" screen.	(6) (a) in this section
GX Developer project	-	-
Project path	Displays a GX Developer project path specified for the import source.	-
Edit button	Displays the "GX Developer project selection" screen.	(6) (b) in this section
OK button	Reflects the settings and closes the screen.	-
Cancel button	Discard the settings and closes the screen.	-

11 FUNCTIONS OF CONFIGURATION TOOL (MODULE SETTINGS)

(a) GX Works2 project selection screen

Setting screen

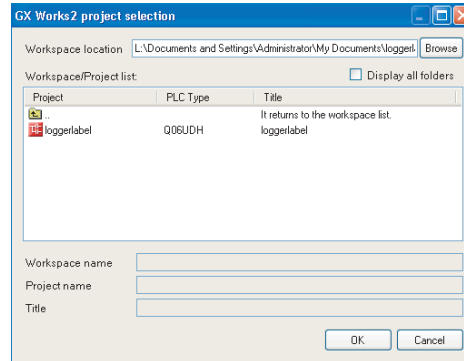

Item	Description
Workspace location	Specify the workspace or project save folder path.
Display all folders	When "Display all folders" is selected, the Workspace folders/project folders that were copied/moved in the Windows® Explorer are also displayed.
<input type="button" value="Browse"/> button	Opens the "Browse For Folder" screen.
Workspace/Project list*1 *2	Displays the following items for the project save folder path. <ul style="list-style-type: none"> • Project • PLC type • Title
Workspace name	Displays a name of workspace to which selected workspace or project belongs.
Project name	Displays a project name of the selected project.
Title	Displays the title of the selected project.
<input type="button" value="OK"/> button	Reflects the settings and closes the screen.
<input type="button" value="Cancel"/> button	Discards the settings and closes the screen.

1: As this is not supported for GX Works2 project files (.gwx) that were saved in a format using "Save as a Single File Format Project", this will not be displayed in the Workspace/Project list .

*2: When check the "Display all folders", the title is displayed "Folder list".

For details of GX Works2 projects, refer to the following manual.

 GX Works2 Version 1 Operating Manual (Common)

11 FUNCTIONS OF CONFIGURATION TOOL (MODULE SETTINGS)

(b) GX Developer project selection screen

Setting screen

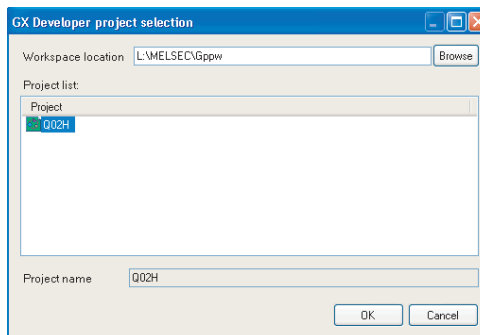

Item	Description
Workspace location	Specify the project save folder path.
<input type="button" value="Browse"/> button	Opens the "Browse For Folder" screen.
Project list	Displays folders which contain device comment files. (\Resource\Others\COMMENT.wcd)
Project name	Displays the project name of the selected project.
<input type="button" value="OK"/> button	Reflects the settings and closes the screen.
<input type="button" value="Cancel"/> button	Discards the settings and closes the screen.

For details of GX Developer projects, refer to the following manual.

☞ GX Developer Version 8 Operating Manual

9

REPORT FUNCTION

10

OTHER FUNCTIONS

11

FUNCTIONS OF CONFIGURATION TOOL (MODULE SETTINGS)

12

FUNCTIONS OF CONFIGURATION TOOL (WRITING/READING/VERIFYING DATA)

13

FUNCTIONS OF CONFIGURATION TOOL (CONFIRMING MODULE OPERATION)

14

FUNCTIONS OF LOGGING FILE CONVERSION TOOL

15

RECIPE FUNCTION

16

CompactFlash CARD

11 FUNCTIONS OF CONFIGURATION TOOL (MODULE SETTINGS)

11.4.4 FTP setting





This section explains the settings necessary for the high speed data logger module to access FTP servers.

Operating procedure

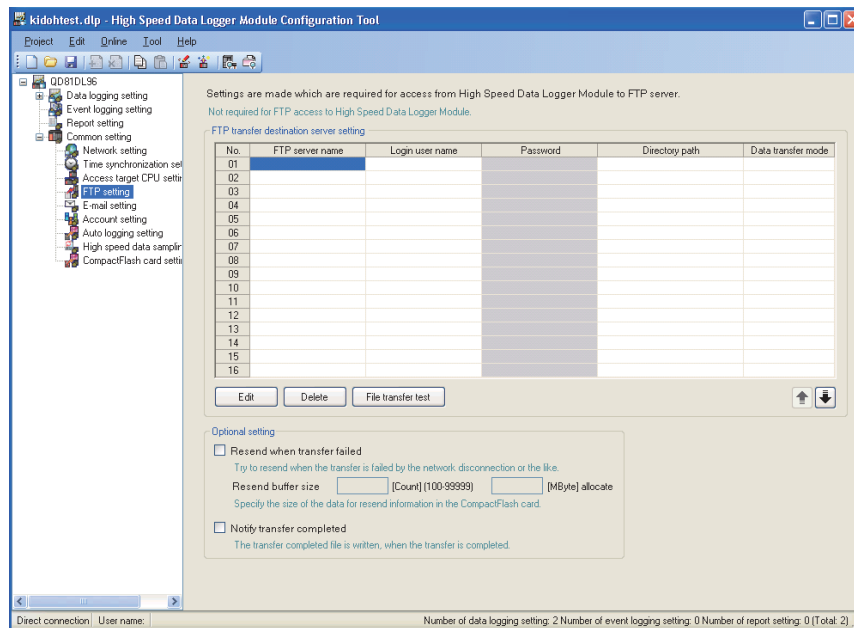
Click "Common setting" on the edit items tree of the Configuration Tool, then click the  button.

Screen display

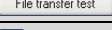

Item	Description	Reference
FTP server name	Displays the FTP server name of the file transfer destination.*1	-
Login user name	Displays the account (user name).*1	-
Password	Displays the login password for the FTP server.	-
Directory path	Displays the directory path of the file transfer destination.*1	-
Data transfer mode	Displays the FTP data transfer mode (PORT mode/PASV mode).*1	-
 button	Displays the setting screen to edit the selected FTP setting.	(1) in this section
 button	Deletes the selected FTP setting.	-
 button	Performs a file transfer test to the selected FTP server.*2, *3	-
 button	Shifts the selected FTP setting to the row above.	-
 button	Shifts the selected FTP setting to the row below.	-
Optional setting	Sets options for the FTP transfer.	(2) in this section

*1: The content of the selected cell can be directly edited by double clicking (or pressing F2).

*2: The results of the file transfer test are not reflected to the buffer memory or FTP transfer diagnostics screen.

*3: If the network setting is changed, reset the programmable controller CPU after writing the settings, and then perform the file transfer test.

11 FUNCTIONS OF CONFIGURATION TOOL (MODULE SETTINGS)

(1) FTP setting screen

Setting screen

Item	Description
FTP server name	Set the FTP server name of the file transfer destination as an IP address or domain name (up to 64 characters). ^{*1}
Login user name	Set the login user name to the FTP server (up to 32 characters).
Login password	Set the login password for the FTP server (up to 16 characters).
Confirm login password	Set the login password again for verification (up to 16 characters).
Directory path	Set the file directory path of the file transfer destination (up to 64 characters). ^{*2}
Data transfer mode	Set the FTP data transfer mode as "PORT mode (normal)" or "PASV mode" ^{*3} .
OK button	Reflects the settings and closes the screen.
Cancel button	Discards the settings and closes the screen.

*1: When the SMTP server name is set with a domain name, the DNS server needs to be set in "DNS server setting" on the Network settings screen (☞ Section 11.4.1).

*2: Use '/' or '\' as the delimiter between directories.

*3: Normally specify "PORT mode". Specify "PASV mode" when communications with the FTP server are only allowed in "PASV mode" by Windows firewall or other firewalls.

☒ POINT

Access port 21 of the FTP server.

You can change the port number based on the intelligent function module switch setting and buffer memory.

☞ Section 4.5 Intelligent Function Module Switch Setting

☞ Section 3.4.17 (1) FTP transfer port number (address: 7999)

(2) Optional setting

Set options for the FTP transfer.

"Resend when transfer failed" and "Notify transfer completed" are the two options.

Setting screen

Item	Description
Resend when transfer failed	Check this to perform the resend process when the FTP transfer failed.
Resend buffer size	The files to be resent are saved in the resend buffer of CompactFlash card until the resend is completed. Specify the maximum size to be reserved for resend buffer.
Notify transfer completed	Check this to send a file indicating an FTP transfer completion to the FTP server.

POINT

(1) Calculating resend buffer size

Calculate the resend buffer size using the following formula.

$$\text{Usage area [MB]} = (8 \text{ [KB]} \times \text{Number of files}) / 1024$$

(2) Extension for transfer completion notification file

Transfer completion notification files are stored in the same folder as the transfer files with a different extension. The following table shows the extensions correspond to each file.

Extension for transfer file	Extension for transfer completion notification file
.BIN	.BTC
.CSV	.CTC
.XLS	.XTC

(3) Based on the specified maximum size for resend buffer, spaces in the CompactFlash card are occupied according to the number of buffered data.

(4) Setting resend buffer size

Depending on the size of free space in the CompactFlash card, the specified size for resend buffer may not be reserved in the CompactFlash card.

11 FUNCTIONS OF CONFIGURATION TOOL (MODULE SETTINGS)

11.4.5 E-mail setting

This section explains the settings of the mail servers and account that are used for sending e-mails.

Operating procedure

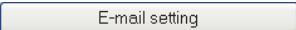
Click "Common setting" on the edit items tree of the Configuration Tool, then click the  button.

Setting screen

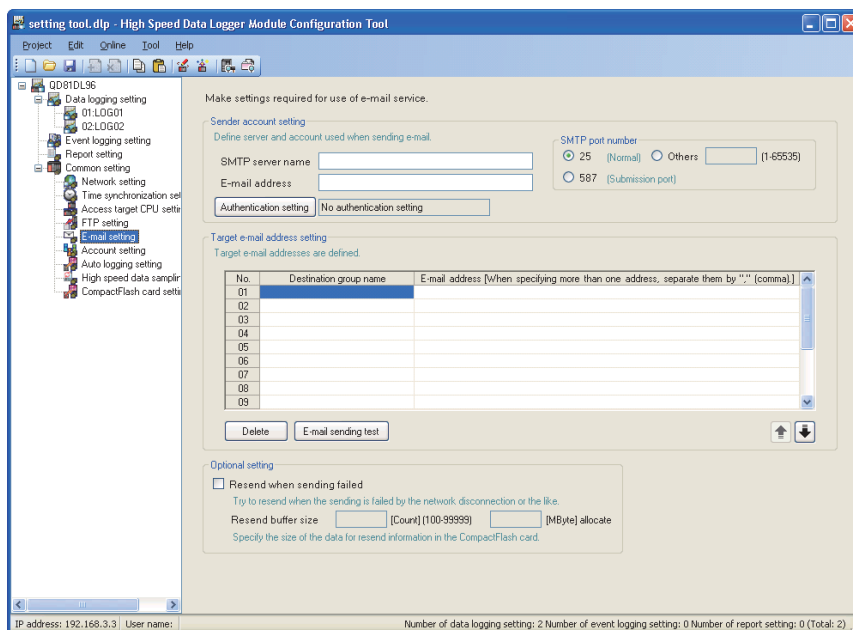

Item	Description	Reference
Sender account setting	Set the account necessary for the high speed data logger module to send e-mail.	(1) in this section
Target e-mail address setting	Set the destination e-mail addresses.	(3) in this section
Optional setting	Set the options for sending e-mail.	(4) in this section

11 FUNCTIONS OF CONFIGURATION TOOL (MODULE SETTINGS)

(1) Sender account settings

Set the account necessary for the high speed data logger module to send e-mails.

Setting screen

Sender account setting
Define server and account used when sending e-mail.

SMTP server name

E-mail address

Authentication setting

SMTP port number
 25 (Normal) Others (1-65535)
 587 (Submission port)

Item	Description	
SMTP server name	Set the SMTP server name with an IP address or a domain name (up to 64 characters). ^{*1}	-
E-mail address	Set the e-mail address for the high speed data logger module (up to 64 characters).	-
SMTP port number	Specify the port number (1 to 65535) when accessing the SMTP server.	-
<input type="button" value="Authentication setting"/> button	Displays the "Authentication setting" screen to configure the authentication settings for sending e-mail.	(2) in this section

*1: When the SMTP server name is set with a domain name, the DNS server needs to be set in "DNS server setting" on the Network settings screen (Section 11.4.1 (2)).

(2) Authentication setting screen

Setting screen

Authentication setting

Set about the e-mail authentication.

This server has authentication requirements which have to be met

Method of authentication SMTP-Auth POP before SMTP

User name

Password

Confirm password

POP server name

POP port number
 110 (Normal) Others (1-65535)

Item	Description
<input checked="" type="checkbox"/> This server has authentication requirements which have to be met	Check this when authentication is required to send e-mail.
Method of authentication	Select the authentication method when sending e-mail. ^{*1}
User name	Enter the mail server user name used for authentication when sending e-mail (Up to 32 characters).
Password	Enter the mail server password used for authentication when sending e-mail (Up to 16 characters).
Confirm password	Enter the password again for verification.
POP server name	Enter the POP server name (Up to 64 characters). ^{*2}
POP port number	Specify the port number (1 to 65535) when accessing the POP server. ^{*2}
<input type="button" value="OK"/> button	Reflects the settings and closes the screen.
<input type="button" value="Cancel"/> button	Discards the settings and closes the screen.

*1: Select the authentication method when sending e-mail. Specify according to the mail server.

*2: Required when the authentication method is set to "POP before SMTP".

11 FUNCTIONS OF CONFIGURATION TOOL (MODULE SETTINGS)

(3) Target e-mail address setting

Set the destination addresses to send e-mail from the high speed data logger module.

Setting screen

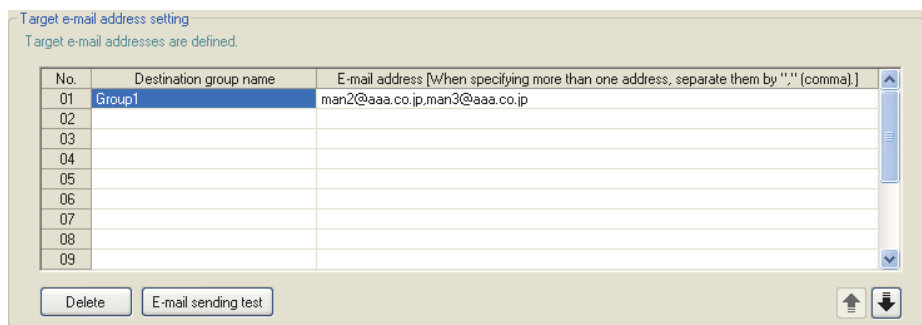

Item	Description
Destination group name	Set the group name for managing destinations as a group (up to 32 characters). ^{*1}
E-mail address	Set the destination e-mail addresses (up to 128 characters). ^{*1} When specifying multiple destinations, separate them with ',' (comma).
<input type="button" value="Delete"/> button	Deletes the selected destination e-mail address setting.
<input type="button" value="E-mail sending test"/> button	Performs an e-mail transmission test to the selected destination group. ^{*2, *3}
<input type="button" value="↑"/> button	Shifts the selected destination e-mail address setting to the row above.
<input type="button" value="↓"/> button	Shifts the selected destination e-mail address setting to the row below.

*1: The content of the selected cell can be directly edited by double clicking (or pressing F2).

*2: The results of the e-mail transmission test are not reflected in the buffer memory or e-mail transmission diagnostics screen.

*3: If the network setting is changed, reset the programmable controller CPU after writing the settings, and then perform the e-mail transmission test.

(4) Optional setting

Configure the resend setting when e-mail send failed.

Setting screen

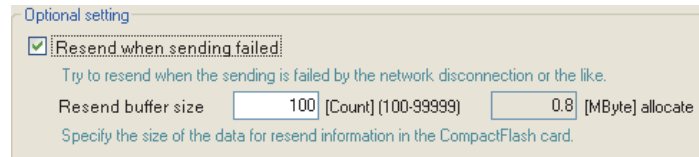

Item	Description	Reference
Resend when sending failed	Check this to perform the resend process when the e-mail send failed.	-
Resend buffer size	The files to be resent are saved in the resend buffer of CompactFlash card until the resend is completed. Specify the maximum size to be reserved for resend buffer.	-

POINT

- (1) Calculating resend buffer size
Calculate the resend buffer size using the following formula.
Usage area [MB] = (8 [KB] × Number of files) / 1024
- (2) Based on the specified maximum size for resend buffer, spaces in the CompactFlash card are occupied according to the number of buffered data.
- (3) Setting resend buffer size
Depending on the size of free space in the CompactFlash card, the specified size for resend buffer may not be reserved in the CompactFlash card.
- (4) The SMTP server name needs to be set with an IP address when using the resend function.

11 FUNCTIONS OF CONFIGURATION TOOL (MODULE SETTINGS)

11.4.6 Account setting

This section explains the settings of user authentication accounts used for accessing the high speed data logger module.



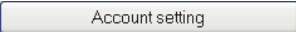

Up to 16 account settings can be configured.

Operating procedure

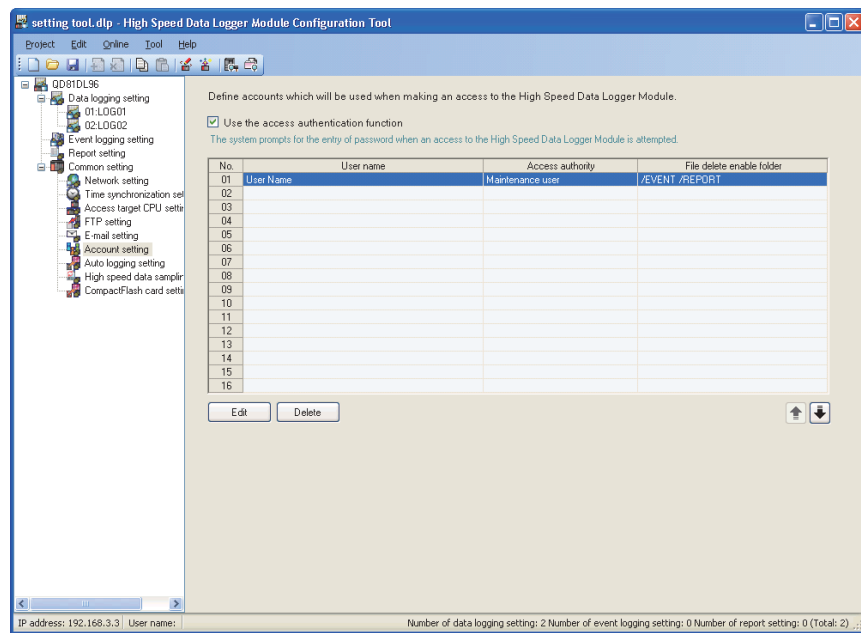
Click "Common setting" on the edit items tree of the Configuration Tool, then click the  button.

Setting screen



Item	Description
Use the access authentication function	Check to authenticate users accessing the high speed data logger module and restrict their access.* ¹
User name	Displays the user name.* ²
Access authority	Displays either Normal user, Maintenance user, or Administrator.
File delete enable folder	Displays folders where file deletion is permitted.
 button	Displays the setting screen to edit the selected account setting.* ³
 button	Deletes the selected account setting.
 button	Shifts the selected account setting to the row above.
 button	Shifts the selected account setting to the row below.

*1: When using the access authentication function, configure one or more users with administrator's access authority.

*2: Displayed user name is case-sensitive.

*3: For details on the setting screen, refer to (1) in this section.

11 FUNCTIONS OF CONFIGURATION TOOL (MODULE SETTINGS)

(1) Account setting screen

Setting screen

Item	Description	Reference
User name	Set the user name (1 to 20 characters). ^{*1}	Section 12.1
Password	Set the password (8 to 16 characters).	
Confirm password	Enter the password again.	
Access authority	For the access authority granted to the account, select from Administrator, Maintenance user, or Normal user.	(2) in this section
File delete enable folder	Select the folders where files can be deleted. ^{*2}	
OK button	Reflects the settings and closes the screen.	-
Cancel button	Discards the settings and closes the screen.	-

*1: User name is case-sensitive.

*2: Can be selected when "Maintenance user" is selected for access authority.

11 FUNCTIONS OF CONFIGURATION TOOL (MODULE SETTINGS)

(2) Access authority

The following tables in (a) and (b) show the access authority of the administrator/maintenance user/normal user.

(a) File access authority (when using file browser or FTP)

Operation	Directory	Access authority		
		Administrator	Maintenance user	Normal user
Write file (File browser: Transfer to module)	/LOGGING	×	×	×
	/EVENT	×	×	×
	/REPORT	×	×	×
	/RECIPE	○	△ ^{*1}	×
	/SYSTEM	×	×	×
Read file (File browser: Store to personal computer)	/LOGGING	○	○	○
	/EVENT	○	○	○
	/REPORT	○	○	○
	/RECIPE	○	○	○
	/SYSTEM	×	×	×
Delete file (File browser: Delete)	/LOGGING	○	△ ^{*1}	×
	/EVENT	○	△ ^{*1}	×
	/REPORT	○	△ ^{*1}	×
	/RECIPE	○	△ ^{*1}	×
	/SYSTEM	×	×	×

○: Authorized, △: Can be changed on the account setting screen, ×: Not authorized

*1: Enable/disable this access authority on the setting screen of (1) in this section.

11 FUNCTIONS OF CONFIGURATION TOOL (MODULE SETTINGS)

(b) Access authority for Configuration Tool operation

Item	Function	Access authority		
		Administrator	Maintenance user	Normal user
Access target CPU setting "Common setting"	Communication test	○	×	×
FTP settings "Common setting"	File transfer test	○	×	×
E-mail settings "Common setting"	E-mail sending test	○	×	×
Module diagnostics [Online] → [Diagnostics]	Module status acquisition	○	○	○
	Error history acquisition	○	○	○
	Error history display before operation	○	○	○
	Error clear	○	×	×
	History clear	○	×	×
	History file clear	○	×	×
	Module operation	○	×	×
	Module time	○	○	○
Access target CPU diagnostics [Online] → [Diagnostics]	CPU access status acquisition	○	○	○
FTP transfer diagnostics [Online] → [Diagnostics]	FTP transfer status acquisition	○	○	○
	FTP resend buffering status acquisition	○	○	○
	Buffer clear	○	×	×
E-mail send diagnostics [Online] → [Diagnostics]	E-mail sending status acquisition	○	○	○
	E-mail resend buffering status acquisition	○	○	○
	Buffer clear	○	×	×
Product information [Online] → [Diagnostics]	Product information acquisition	○	○	○
CompactFlash card diagnostics [Online] → [Diagnostics]	CompactFlash card operation	○	×	×
	CompactFlash card access status acquisition	○	○	○
	CompactFlash card formatting	○	×	×
	CompactFlash card information acquisition	○	○	○
Data logging diagnostics [Online] → [Diagnostics]	Data logging operation status acquisition	○	○	○
Event logging diagnostics [Online] → [Diagnostics]	Event logging operation status acquisition	○	○	○
Report diagnostics [Online] → [Diagnostics]	Report operation status acquisition	○	○	○
Ping test [Online] → [Diagnostics]	Ping test	○	×	×
	Ping test result	○	×	×

○: Authorized, ×: Not authorized
(Continued on the next page)

11 FUNCTIONS OF CONFIGURATION TOOL (MODULE SETTINGS)

(From the previous page)

Item	Function	Access authority		
		Administrator	Maintenance user	Normal user
Read [Online] → [Read]	Setting data read	○	×	×
Write [Online] → [Write]	Setting data write	○	×	×
Verify [Online] → [Verify]	Setting data verification	○	×	×
Recipe execution operation	File list acquisition	○	○	○
	Read	○	×	×
	Write	○	×	×
	Recipe execution history	○	○	○
	Clear history file	○	×	×

○: Authorized, ×: Not authorized

9
REPORT FUNCTION

10
OTHER FUNCTIONS

11
FUNCTIONS OF CONFIGURATION TOOL (MODULE SETTINGS)

12
FUNCTIONS OF CONFIGURATION TOOL (WRITING/READING/VERIFYING DATA)

13
FUNCTIONS OF CONFIGURATION TOOL (CONFIRMING MODULE OPERATION)

14
FUNCTIONS OF CONFIGURATION TOOL (LOGGING FILE CONVERSION TOOL)

15
RECIPE FUNCTION

16
CompactFlash CARD

11 FUNCTIONS OF CONFIGURATION TOOL (MODULE SETTINGS)

11.4.7 Auto logging setting

This section explains the settings of auto logging function (see Section 10.2) to start logging automatically and stop logging after the specified amount of time when a CompactFlash card is inserted.

Operating procedure

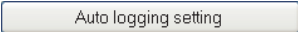
Click "Common setting" on the edit items tree of the Configuration Tool, then click the  button.

Setting screen

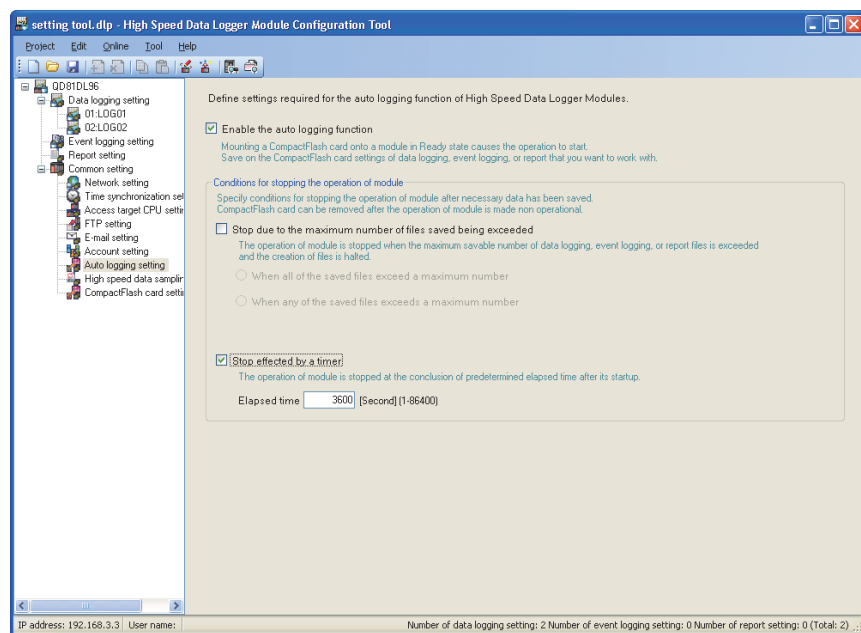

The setting details are described on the next page.

11 FUNCTIONS OF CONFIGURATION TOOL (MODULE SETTINGS)

Item	Description	Reference
Enable the auto logging function*1	Check to use the auto logging function.	-
Conditions for stopping the operation of module	-	(1) in this section
Stop due to the maximum number of files saved being exceeded	Check to stop the module operation when the maximum number of data logging, event logging, or report saved files is exceeded.	-
When all of the saved files exceed a maximum number	Select this to stop the module operation when the maximum number for all data logging, event logging, and report saved files is exceeded. In each "Save" setting for data logging, event logging, and reports, set all "Operation occurring when number of saved files is exceeded" to "Stop".	-
When any of the saved files exceeds a maximum number	Select this to stop the module operation when the maximum number of any of the data logging, event logging, and report saved files is exceeded. In each "Save" setting for data logging, event logging, and reports, set one or more "Operation occurring when number of saved files is exceeded" to "Stop".	-
Stop effected by a timer	Check this to stop module operation when the set time elapses after module operation starts.	-
Elapsed time	Specify the amount of time until the module stops when "Stop effected by a timer" is specified.	-

*1: By exporting setting data (☞ Section 11.3.6) with the auto logging function set to be enabled to the CompactFlash card, logging can be started without updating settings when the CompactFlash card is replaced.

(1) Details on conditions for stopping the operation of module

- (a) Stop due to the maximum number of files saved being exceeded
Specify to stop module operation when the maximum number of data logging, event logging, or report saved files is exceeded and put the module in a state where the CompactFlash card can be ejected.
Select the stop condition from the following.
- ① When the maximum number of all data logging, event logging, and report saved files is exceeded
 - ② When the maximum number of any of the data logging, event logging, or report saved files is exceeded
- (b) Stop effected by a timer
Specify when you wish to stop module operation after the set amount of time elapses from the X5 (module operating status) ON state and put the module in a state where the CompactFlash card can be ejected.
The elapsed time can be set in seconds from 1 to 86400 seconds (24 hours).

☒ POINT

- (1) CF LED turns OFF when the CompactFlash card is ready to be ejected.
 - (2) Be aware of the following points when starting (power ON or resetting the programmable controller CPU) the high speed data logger module without an inserted CompactFlash card in order to use the auto logging function.
 - Do not connect the high speed data logger module to a LAN line.
 - In the data logging setting, event logging setting, and report setting, do not configure them to perform FTP transfers or e-mail transmissions.
 - The high speed data logger module operates with the factory default IP address (192.168.3.3).
 - (3) To connect the Configuration Tool using the auto logging function, follow the instructions below.
 - ☞ Section 2.1.2 System configuration when performing initial setup, maintenance, and inspection
 - (4) When specifying "Stop effected by a timer" of the auto logging setting, set the elapsed time more than five seconds longer than the period of logging time. When module operation stops, unprocessed data (☞ Section 3.4.11 (5) (g)) are not logged.
-

11 FUNCTIONS OF CONFIGURATION TOOL (MODULE SETTINGS)

11.4.8 High speed data sampling setting

This section explains the settings to adjust the effect that the high speed data logger module has on the programmable controller CPU sequence scan time. Normally select "Batch data sampling mode". If the increase in sequence scan time becomes a problem, consider changing to "Split data sampling mode".

POINT

This setting configures the sampling timing when high speed data sampling is specified with the data logging setting, event logging setting, or report setting. If general data sampling is specified, neither setting has an effect.

Operating procedure

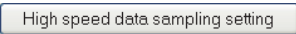
Click "Common setting" on the edit items tree of the Configuration Tool, then click the  button.

Setting screen

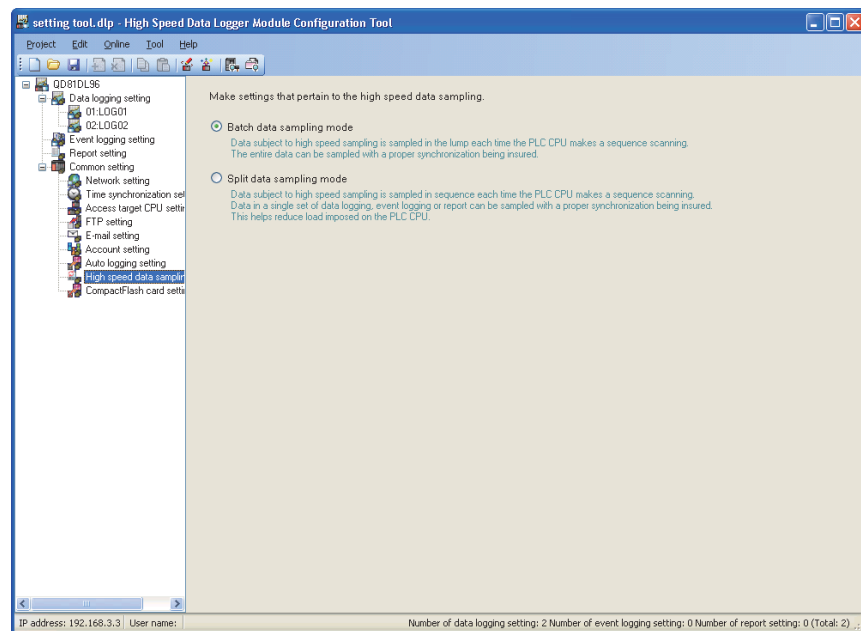

Item	Effect on scan time	Description
Batch data sampling mode ^{*1}	Large	For each programmable controller CPU sequence scan, samples all the high speed data sampling specified data in a batch. (All the data can be synchronized and sampled.)
Split data sampling mode	Small	For each programmable controller CPU sequence scan, splits the high speed data sampling specified data in order and samples them. <ul style="list-style-type: none"> The data inside a single data logging, event logging, or report setting can be synchronized and sampled. This helps reduce load imposed on the programmable controller CPU.

*1: Normally use this setting. If the effect on the sequence scan time becomes a problem, consider changing to "Split data sampling mode".

11 FUNCTIONS OF CONFIGURATION TOOL (MODULE SETTINGS)

11.4.9 CompactFlash card setting

This section explains the settings to delete old saved files automatically to ensure the free capacity in the CompactFlash card.

Set the settings to prevent a logging stop due to the capacity shortage in the CompactFlash card.

Operating procedure

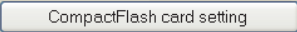
Click "Common setting" on the edit items tree of the Configuration Tool, then click the  button.

Setting screen

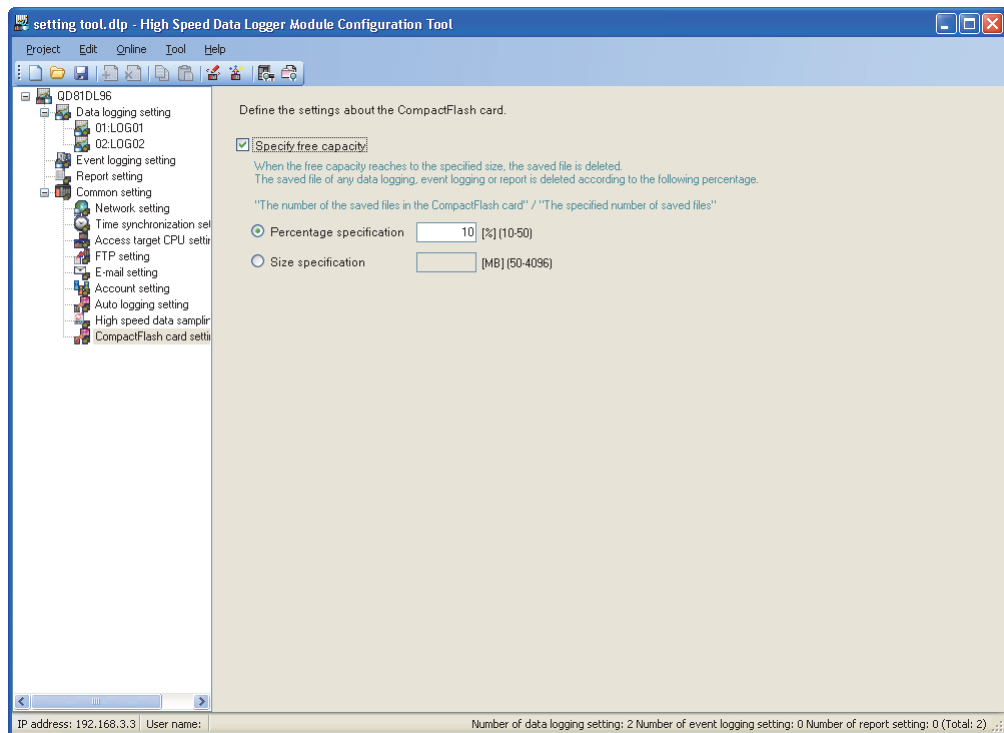

Item	Description
Specify free capacity	Check to delete saved files in the CompactFlash card automatically.
Percentage specification	Specify the free capacity of the CompactFlash card in a percentage (10 to 50%) to delete files.
Size specification ^{*1}	Specify the free capacity of the CompactFlash card in a size (50 to 4096MB) to delete files.

^{*1}: When the value specified in "Size specification" is greater than 50 percent of the total capacity of the CompactFlash card installed on the high speed data logger module, the same operation is performed as when '50%' is specified in "Percentage specification".

Example: When installing a 512MB CompactFlash card and specifying '400MB' in "Size specification", saved files are deleted as the free capacity of the CompactFlash card becomes 256MB or less.

POINT

- (1) The following processing is performed when the free capacity is specified in the CompactFlash card setting.
 - Checks the free capacity of the CompactFlash card in 10-second periods.
 - Deletes saved files of any of the data logging, event logging or report which takes the greatest share in the following rate.
(Number of saved files on the CompactFlash card)/(Specified number of saved files)
If the rates are the same, deletes saved files of any of the data logging, event logging or report of which the specified number of saved files is the greatest. If the specified numbers of saved files are the same, deletes the saved files of the data logging, event logging and report in that order from the smallest setting number.
- (2) The objects of deletion are saved files created by the data logging, event logging or report function operated on the high speed data logger module. The following files are not the objects of deletion. When the total size of these files is larger than the specified size of free capacity, files are not deleted and the specified size of free capacity cannot be ensured.
 - Storing file
 - Latest saved file
 - Saved files of the data logging/event logging/report whose "Operation occurring when number of saved files is exceeded" setting is set to 'Stop'
 - Saved files created by the data logging, event logging or report not registered on the high speed data logger module
 - Recipe file

11 FUNCTIONS OF CONFIGURATION TOOL (MODULE SETTINGS)

Example) Order of deletion of saved files under the free capacity setting
 Under the settings described in ①, saved files are deleted in the order shown in ②.

① Setting example and number of saved files on CompactFlash card

Setting	Specified number of saved files	Number of saved files on the CompactFlash card
Data logging 01	10	7
Data logging 02	10	5
Report 01	5	5

② Saved file deletion order based on setting example

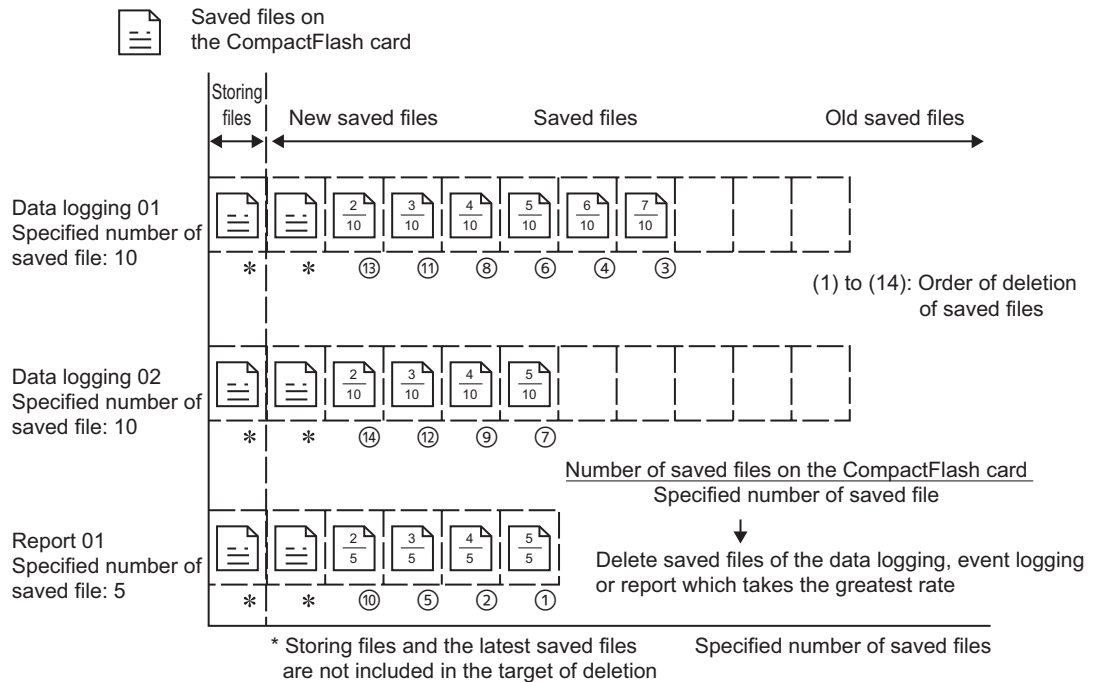

11.5 Data Logging Setting

This section explains the settings for the data logging function.
For an overview of the data logging function, refer to the following chapter.

☞ Chapter 7 DATA LOGGING FUNCTION

11.5.1 Data logging setting list

This section explains the items on the data logging setting list screen.

Operating procedure

Click "Data logging setting" on the edit items tree.

Setting screen

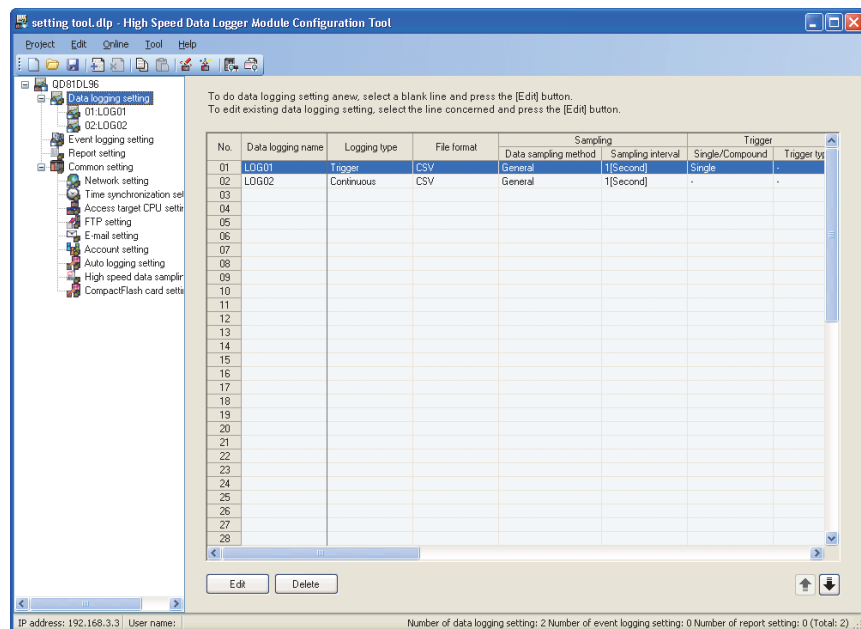

The setting details are described on the next page.

Remark

The existing data logging settings can be utilized by using "Import from project file" (☞ Section 11.3.4) function.



The setting time can be reduced by utilizing the existing settings.

11 FUNCTIONS OF CONFIGURATION TOOL (MODULE SETTINGS)



The following table shows the items displayed on the data logging setting list.

Item	Description	Reference
Data logging name	Displays the data logging name.	Section 11.5.16
Logging type	Displays "Continuous" or "Trigger".	Section 11.5.3
File format	Displays the file format of the data logging file.	
Sampling	Displays the sampling setting of the target data for data logging.	Section 11.5.4
Data sampling method	Displays "High speed" or "General".	
Sampling interval	Displays the sampling interval of the target data.	
Trigger	Displays the trigger settings for the trigger logging function.	Section 11.5.9
Single/compound	Displays "Single" or "Compound".	Section 11.5.10
Trigger type	Displays "OR Combine", "AND Combine", "Number of times", or "Order".	Section 11.5.11
Number of logging lines	Displays the number of trigger logging lines.	Section 11.5.12
Before trigger	Displays the number of logging lines before the trigger.	
After trigger	Displays the number of logging lines after the trigger.	
Total number of lines	Displays the total number of logging lines.	
CSV output	Displays the CSV output settings for the data logging file.	Section 11.5.13
Date	Displays if the date/time (time stamp) is output.	
Trigger information	Displays if trigger information is output.	
Binary output	Displays the binary output settings for the data logging file.	Section 11.5.14
Date	Displays if the date/time (time stamp) is output.	
Trigger information	Displays if trigger information is output.	
Save	Displays the save settings for the data logging file.	Section 11.5.15
File save destination	Displays the save destination.	
File switching timing	Displays the switching timing for the data logging file by separating with commas. Example) 1000[Line],16384[KB],Trigger logging.	
Saved file name	Displays the information to attach to the data logging file name.	
Number of saved files	Displays the upper limit of the number of saved files.	
Transfer	Displays the transfer settings for the data logging file.	
FTP transfer	Displays if there is an FTP transfer.	
E-mail sending	Displays if there is an e-mail transmission.	

The following table shows the buttons for operating the data logging setting list.

Item	Description	Reference
 button	Displays the 'Data logging setting' screen to edit the selected row of settings. If the selected row is empty, new data logging settings are added to that row.	Section 11.5.2
 button	Deletes the selected row of settings.	-
 button	Shifts the selected row one row up or one row down.	

POINT

- There is no difference in operation according to the order of the data logging settings.
- Multiple rows can be selected and deleted or moved in batch by clicking on them while pressing the  key or  key.

11 FUNCTIONS OF CONFIGURATION TOOL (MODULE SETTINGS)

11.5.2 Data logging setting screen transitions

Data logging settings are configured in a wizard format.

The title of each wizard screen is displayed in the 'edit item bar' in the upper portion of the detailed setting screen. Setting operations are performed in order from the items to the left in the 'edit item bar' to those in the right.

Screen display

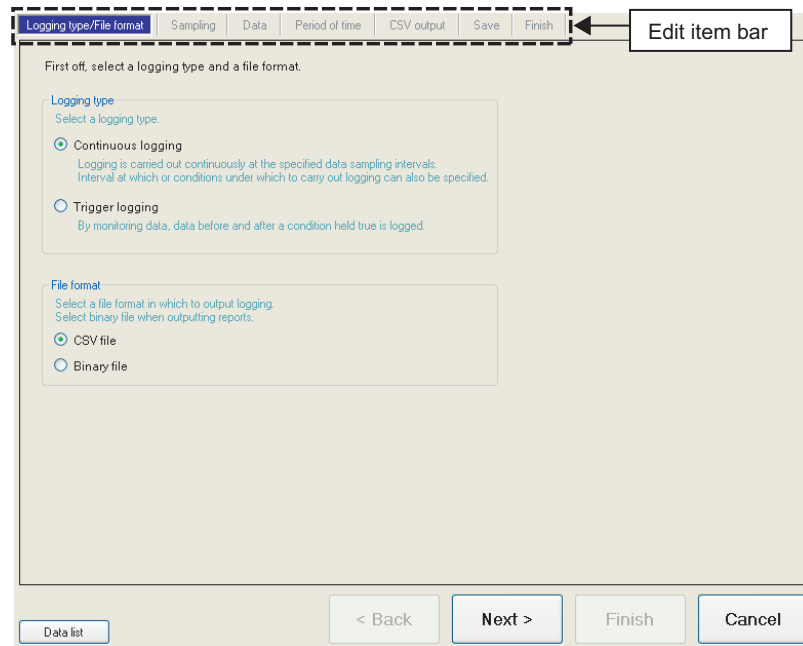

Item	Description	Reference
button	Displays a list of all data being used by all the data logging setting.	Section 11.2.7
button	Moves the setting wizard screen being edited to the previous screen (left).	(1) in this section
button	Moves the setting wizard screen being edited to the next screen (right).	
button	Confirms the data logging settings being edited and completes editing. After completing the settings, returns to the data logging setting list screen.	-
button	Discards the data logging settings being edited and ends editing. After cancelling the settings, returns to the data logging setting list screen.	-

11 FUNCTIONS OF CONFIGURATION TOOL (MODULE SETTINGS)



(1) Wizard display and operations

(a) Edit item status

The setting status of the wizards on the edit item bar can be checked by color.

Status	Configured	Being edited	Not configured
Text color	Blue	White	Gray
Background color	Light gray	Blue	Light gray
Example	Logging type/File format	Sampling	Data

(b) Screen transitions with the / buttons

Move between edit item screens with the  /  buttons.



(c) Screen transitions by mouse

The setting screen for configured items can be moved directly by clicking the 'edit item bar'.



11 FUNCTIONS OF CONFIGURATION TOOL (MODULE SETTINGS)

(d) Editing items of data logging setting

Editing items of data logging setting are made up of the following types.

① For continuous logging

Setting items	Reference
Logging type/File format	Section 11.5.3
Sampling	Section 11.5.4
Data	Section 11.5.5
Period of time	Section 11.5.8
CSV output* ¹	Section 11.5.13
Binary output* ¹	Section 11.5.14
Save	Section 11.5.15
Finish	Section 11.5.16

② For trigger logging

Setting items	Reference
Logging type/File format	Section 11.5.3
Sampling	Section 11.5.4
Data	Section 11.5.5
Trigger	Section 11.5.9
Number of logging lines	Section 11.5.12
CSV output* ¹	Section 11.5.13
Binary output* ¹	Section 11.5.14
Save	Section 11.5.15
Finish	Section 11.5.16

*1: Configures the output format setting selected in "Logging type/File format".

11.5.3 Logging type/file format

This section explains the settings for specifying the data logging type and the file format for saving the logging data.

For details on processes of each logging type, refer to the following section.

☞ Section 7.3 Logging Types

Setting screen

Item	Description	Reference
Logging type	Specify the data logging type.	-
Continuous logging	Always logs data at the specified interval.	Section 7.3.1
Trigger logging	Monitors data and only logs the data before and after the conditions are established.	Section 7.3.2
File format	Select the file format to save logging data.	-
CSV file	Saves in the CSV file format.	Section 3.6.2
Binary file	Saves in the binary file format.	Section 3.7.1

11 FUNCTIONS OF CONFIGURATION TOOL (MODULE SETTINGS)

11.5.4 Sampling

This section explains the settings for selecting the data sampling method for data logging target data and specifying the data sampling interval.

For details on processes of each sampling method, refer to the following section.

☞ Section 7.2 Target Data Sampling

Setting screen

Item	Description	Reference
High speed data sampling	High-speed data logging is possible using the high speed data sampling function.	Section 7.2.1
Sampling interval	-	-
Each scanning cycle	Samples data with each sequence scan.	-
Time specification	Samples data at the specified interval. • For continuous logging: 3 to 32767ms • For trigger logging: 1 to 32767ms	-
Sampling is made on a consecutive series of devices.	• Checked ^{*1} : Improves the efficiency of the data sampling and reduces the load imposed on the target programmable controller CPU. Data to be sampled must be one type of devices with consecutive device numbers. • Unchecked : Different types of devices with inconsecutive device numbers can be specified. The number of settings is up to 5 settings for all high speed data logger module settings combined (data logging settings, event logging settings, and report settings).	-

(Continued on the next page)

11 FUNCTIONS OF CONFIGURATION TOOL (MODULE SETTINGS)

(From the previous page)

Item	Description	Reference
General sampling	<ul style="list-style-type: none">• Set the data sampling interval in seconds. (0.1 to 0.9, 1 to 32767 seconds)• Select when sampling data which exceeds 256 points.• Select when sampling data from a programmable controller CPU via the network.	Section 7.2.2
Sampling interval	-	-
Time specification	Samples data at the specified interval. (0.1 to 0.9 seconds, 1 to 32767 seconds)	-
Time interval specification	Samples data at the time interval of every specified hour/minute/second.	(1) in this section

*1: When checked, there are the following restrictions.

- The trigger condition which can be set with the "Trigger" setting can only be a single condition. (☞ Section 11.5.9)
- Only the data set with the "Data" can be set as the data conditions in the "Trigger" setting. (☞ Section 11.5.10)
- Only the data set with the "Data" can be set as the data conditions in the "Period of time" setting. (☞ Section 11.5.8)
- Only the data set with the "Data" can be set as the data conditions in the file switching condition setting of the "Save" setting. (☞ Section 11.5.15)
- Information cannot be attached to the saved file name in the "Save" setting. (☞ Section 11.5.15)

(1) Available time intervals

The following shows the time units and their intervals which can be specified for sampling interval.

Hour: 1, 2, 3, 4, 6, 8, 12, 24

Minute: 1, 2, 3, 4, 5, 6, 10, 12, 15, 20, 30, 60

Second: 1, 2, 3, 4, 5, 6, 10, 12, 15, 20, 30, 60

POINT

- (1) For the types of programmable controller CPUs, product information, and system configurations of high speed data sampling, refer to the following section.
 - ☞ Section 7.2.1 (1) System configurations compatible with high speed data sampling
- (2) For devices which can be specified during high speed data sampling, refer to the following section.
 - ☞ Section 3.2 (3) Accessible devices
- (3) The total number of data logging, event logging, and report settings in which high speed data sampling is set, is a maximum of 32 settings.
- (4) When high speed data sampling is specified, there is an effect on the sequence scan time because of the data transfer from the programmable controller CPU to the high speed data logger module.
The sequence scan time delay can be adjusted with the high speed data sampling setting.
For the effect on the sequence scan time, refer to the following sections.
 - ☞ Section 17.3 Effect on Sequence Scanning Time
 - ☞ Section 11.4.8 High speed data sampling setting
- (5) Since general data sampling is not synchronized with the control CPU's sequence scan, data separation may occur.
 - ☞ Section 3.2 (6) Access units

To perform data sampling synchronized to the sequence scan, use high speed data sampling.

11 FUNCTIONS OF CONFIGURATION TOOL (MODULE SETTINGS)

11.5.5 Data setting list

This section explains the list of data set with data logging.

Screen display

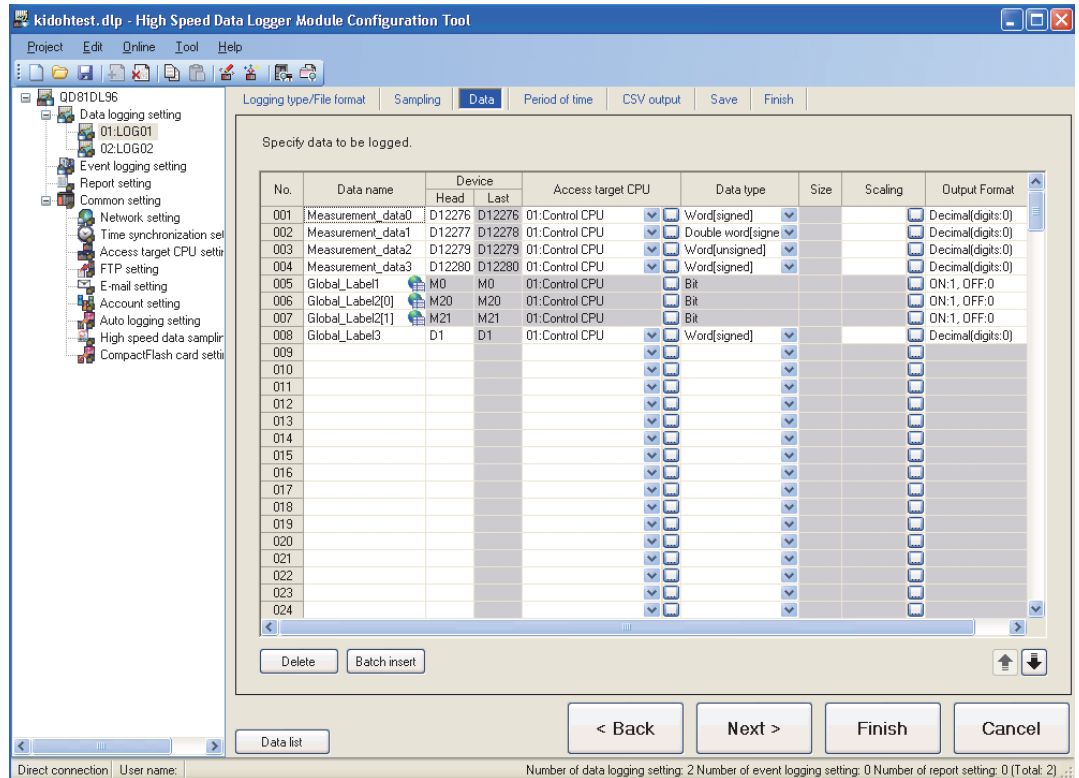

The following table shows the items displayed on the data list.

Item	Description	Reference
Data name	Displays the data name.	Section 11.5.6
Device	Displays the start device and the end device.	-
Access target CPU	Displays the access target CPU.	-
Data type	Displays the data type.	Section 11.5.6
Size	Displays the size if the data type is "String" or "Raw".	-
Scaling	Displays the conversion equation for the scaling conversion.	Section 11.5.6 (1)
Output Format	Displays the output format (such as decimal format, exponential format).	Section 11.5.6 (2)

The following table shows the buttons for operating the data list.

Item	Description	Reference
Delete button	Deletes the selected row of settings.	-
Batch insert button	Inserts data in batch.	Section 11.5.7
Up/Down button	Shifts the selected row one row up or one row down.	-

11 FUNCTIONS OF CONFIGURATION TOOL (MODULE SETTINGS)

POINT

The data configured in each row of data settings are saved to the data logging file in the order shown below.

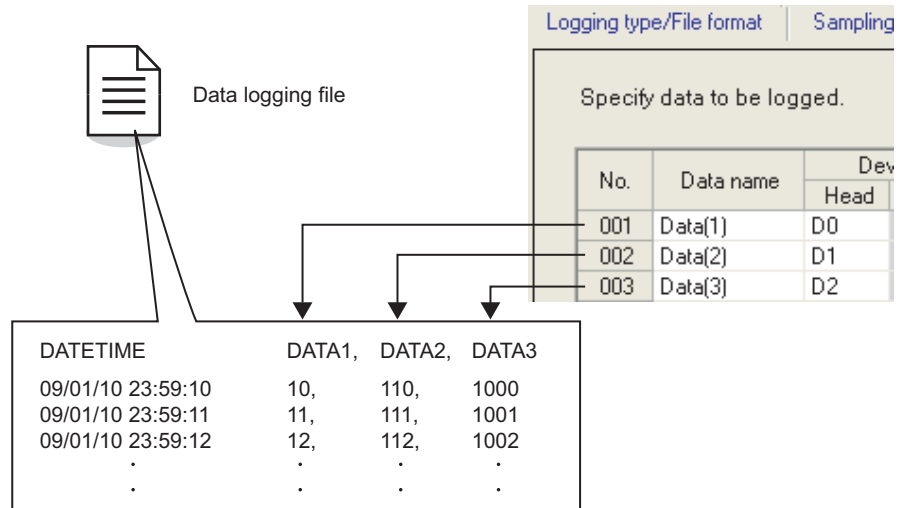

9	REPORT FUNCTION
10	OTHER FUNCTIONS
11	FUNCTIONS OF CONFIGURATION TOOL (MODULE SETTINGS)
12	FUNCTIONS OF CONFIGURATION TOOL (WRITING/READING/VERIFYING DATA)
13	FUNCTIONS OF CONFIGURATION TOOL (CONFIRMING MODULE OPERATION)
14	FUNCTIONS OF CONFIGURATION TOOL (LOGGING FILE CONVERSION TOOL)
15	RECIPE FUNCTION
16	CompactFlash CARD

11 FUNCTIONS OF CONFIGURATION TOOL (MODULE SETTINGS)

11.5.6 Data setting

This section explains the settings for devices that performs data logging.

Operating procedure

Select a cell on the data logging setting list screen (☞ Section 11.5.5) and enter data directly or select an item from the list box.

Setting screen

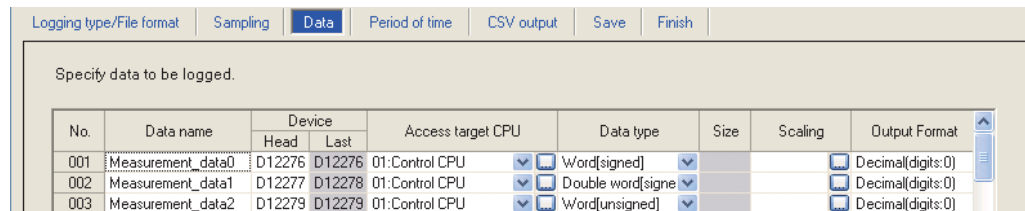

Item	Description	Reference
Data name	Specify the data name. (Up to 32 characters. Can be blank) For related data, an icon (🌐) is appended.	-
Device	Specify the device that performs data logging.	-
Head ^{*1}	Specify the start device.	Section 3.2 (3), (4)
Last	Displays the end device calculated from the data type and size.	-
Access target CPU ^{*1}	Select the access target CPU from the CPUs set with the access target CPU setting. To add an access target CPU, select "(Add)" from the list box and click  .	Section 11.4.3
Data type ^{*1}	Select the data type from the following. ^{*2} <ul style="list-style-type: none"> • Bit • Word [signed] • Double word [signed] • Word [unsigned] • Double word [unsigned] • FLOAT [single precision] • FLOAT [double precision] • 16bit BCD • 32bit BCD • String • Raw 	-
Size ^{*1}	Specify the size if the data type is "String" or "Raw". (1 to 8192 bytes)	-
Scaling	Set when performing a scaling conversion from the programmable controller CPU device value to the data.	(1) in this section
Output Format	Specify the format (such as decimal format, exponential format) when the data are output to a file.	(2) in this section

*1: Related data cannot be edited.

*2: Match to the data type with the one used for writing device values using a sequence program or HMI.

11 FUNCTIONS OF CONFIGURATION TOOL (MODULE SETTINGS)

(1) Scaling

Configure when setting a device value read from the programmable controller CPU as data calculated with a conversion equation. There are two methods to enter data for scaling.

- Enter the conversion equation directly in the cell.
- Click  and specify on the "Scaling" screen.

Example) To scale the floating point value stored in device D0 with the following equation
 $(D0 \times 10.4) + 0.1$

< Example of conversion equation direct input >

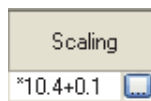

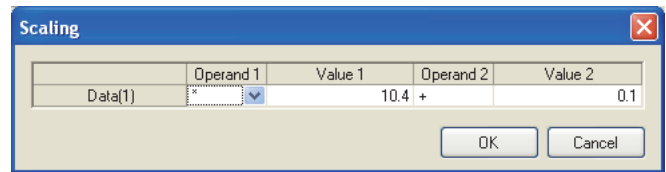

< Example of data input on the "Scaling" screen >



Item	Description
Data name	Displays the data name. If the data name is blank, shows the start device in parenthesis. Example 1) No. 3, data name is 'Word1' → "Word1" Example 2) No. 15, no data name, start device is 'D0' → "(D0)"
Operand 1	Select from [Blank], *, /.
Value 1	Set the value to be modified by Operand 1 as a numerical value up to a maximum of 10 characters including sign/decimal point. Example settings) • 9999999999 (10 character numerical value) • -999999999 (1 character sign, 9 character numerical value) • 0.00000001 (1 character decimal point, 9 character numerical value) • -0.0000001 (1 character sign, 1 character decimal point, 8 character numerical value)
Operand 2	Select from [Blank], +, -.
Value 2	Set the value modified by Operand 2. This setting is the same as "Value 1" in this chart.

POINT

- (1) Scaling cannot be performed if the data type is bit, string, or raw string.
- (2) If the 'data name' set with scaling is specified by other settings, those settings handle the value after the scaling conversion.
- (3) For operation processing specified with scaling, all values are calculated as double precision floating point numbers.
The result is output in the format specified with output format.
- (4) The data output when the calculation result is over the maximum value for the specified output format range or when under the minimum value differs according to file format.
For details, refer to the following sections.
For the CSV format :  Section 3.6.2 (2)(d) Data line
For the binary format :  Section 3.7.1 Data logging file

11 FUNCTIONS OF CONFIGURATION TOOL (MODULE SETTINGS)

(2) Output format

Specify the format when the data are output to a file.

The settings below can be configured for the output format according to the data type and file format.

Saved file format	Data type	Output format setting	Reference
CSV	Bit	Can be specified as a string up to 16 characters long.	(2) (a) in this section
	Word Double word Float BCD	Can be selected from the following. • Decimal format (example: "123.456789") • Exponential format (example: "1.234E2")	(2) (b) in this section
	String Raw	(Specification not required)	-
Binary	Word Double word Float BCD	Can be selected from the following. • Word [signed] • Double word [signed] • Word [unsigned] • Double word [unsigned] • FLOAT [single precision] • FLOAT [double precision] • 16bit BCD • 32bit BCD	(2) (b) in this section
	Bit String Raw	(Specification not required)	-

(a) When the data type is a bit

Setting screen

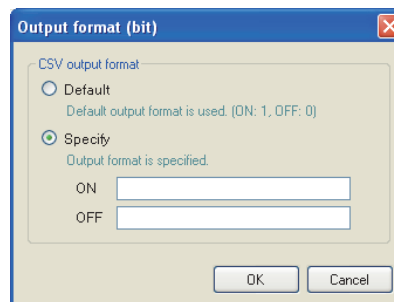

Item	Description
Default	Outputs '1' if ON, '0' if OFF.
Specify	-
ON	Specify the string to output when it is ON. (Up to 16 characters)
OFF	Specify the string to output when it is OFF. (Up to 16 characters)

11 FUNCTIONS OF CONFIGURATION TOOL (MODULE SETTINGS)

(b) When the data type is an integer or float

Setting screen

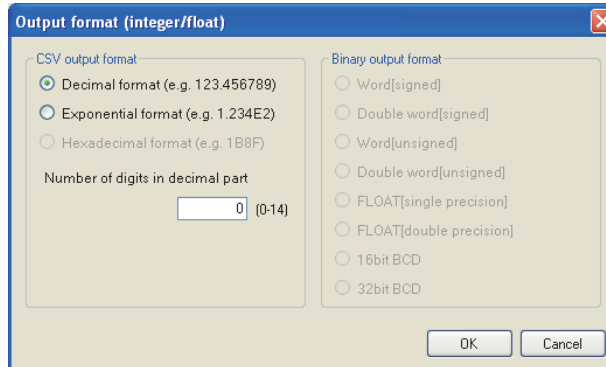

Item	Description
CSV output format ^{*1}	-
Decimal format	Select this to output in decimal format. Example) '123.456789'
Exponential format	Select this to output in exponential format. Example) '1.234E'
Hexadecimal format	Select this to output in hexadecimal integer format (characters are upper case). Example) '1B8F' Can be output in a range of -F0000000 to FFFFFFFF.
Number of digits in decimal part	Specify the number of digits in the decimal part. (0 to 14) Fixed as 0 when hexadecimal format is set.
Binary output format ^{*2 *3}	-
Word [signed]	Signed 16 bit integer
Double word [signed]	Signed 32 bit integer
Word [unsigned]	Unsigned 16 bit integer
Double word [unsigned]	Unsigned 32 bit integer
FLOAT [single precision]	Single precision float (32 bit)
FLOAT [double precision]	Double precision float (64 bit)
16bit BCD	Cannot be selected when scaling is set. Cannot be selected if the data type is 32 bit BCD when scaling is not set.
32bit BCD	Cannot be selected when scaling is set. Cannot be selected if the data type is 16 bit BCD when scaling is not set.
OK button	Confirms the settings and closes the screen.
Cancel button	Discards the settings and closes the screen.

*1: Can be set when CSV is selected for the output file format.

*2: Can be set when binary is selected for the output file format.

*3: For the range of values that can be output for each output format, refer to Section 3.9.

11 FUNCTIONS OF CONFIGURATION TOOL (MODULE SETTINGS)



11.5.7 Data batch insertion

This section explains the method for inserting data in the data list in batch.

Operating procedure

Click the  button on the "Data" screen ( Section 11.5.5).

Setting screen

Item	Description	Reference
Data name	Displays the data name, or used to change the data name.	Section 11.5.6
Change	Check to change the data name. If not checked, the data name is automatically set to the start device.	-
Append subscribers	Check to append a serial number to the data name set by the user.	(1) in this section
Device	-	
Head	Specify the start device.	
Last	Displays the end device by automatically calculating it from the settings of "Data type", and "Continuous setting".	
Access target CPU	Select the access target CPU from the CPUs set with the access target CPU setting. To add an access target CPU, select "(Add)" from the list box and click the  button.	Section 11.5.6
Data type	Specify the data type of data to batch insert.	
Size	Specify the size if the data type is "String" or "Raw". (1 to 8192 bytes)	
Scaling	Set when performing a scaling conversion on programmable controller CPU device values.	
Output Format	Specify the format (such as decimal format, exponential format) when the data are output to a file.	
Continuous setting	Set the total amount of devices to batch insert with a continuous number and the interval.	
Total number	Specify the total amount of data to batch insert. (2 to 256 points)	(2) in this section
Interval	Specify the device interval for the data to batch insert.*1 (1 to 2108416 points)	
Auto interval setting	Check to set the interval automatically in order to avoid gaps between the devices to be batch inserted.	
 button	Confirms the settings and closes the screen.	-
 button	Discards the settings and closes the screen.	-

*1: Cannot be specified when "Sampling is made on a consecutive series of devices." is checked on the "Sampling" screen.

11 FUNCTIONS OF CONFIGURATION TOOL (MODULE SETTINGS)

(1) Data names and subscripts in the continuous setting

The following shows how the data name is set by the "Change" and "Append subscripts" check boxes.

Example settings) Data name = LOGGINGNAME
 Start device = D0
 Continuous setting total number = 3
 Continuous setting interval = 1

For the above example settings, the data names are set as shown below.

Item	Example 1	Example 2	Example 3
Check box	<input type="checkbox"/> Change <input type="checkbox"/> Append subscripts	<input checked="" type="checkbox"/> Change <input type="checkbox"/> Append subscripts	<input checked="" type="checkbox"/> Change <input checked="" type="checkbox"/> Append subscripts
Data name	D0	LOGGINGNAME	LOGGINGNAME(1)
	D1	LOGGINGNAME	LOGGINGNAME(2)
	D2	LOGGINGNAME	LOGGINGNAME(3)

(2) Total number and interval in the continuous setting

Configure when setting devices by leaving a fixed interval.

Example settings) Data name = DATA
 Continuous setting total number = 3
 Continuous setting interval = 10
 Start device = D0

For the above settings, devices are set as shown below.



No.	Data name	Device	
		Head	Last
001	DATA(1)	D0	D1
002	DATA(2)	D10	D11
003	DATA(3)	D20	D21

11 FUNCTIONS OF CONFIGURATION TOOL (MODULE SETTINGS)

11.5.8 Period of time

Specify the period to execute data logging.





It is not necessary to configure these settings if always performing data logging.

For details on processes of each period condition, refer to the following section.

☞ Section 7.4 Data Logging Periods

If the logging type is trigger logging, this sets the trigger monitoring period.

Setting screen

Item	Description	Reference
Specify a period of time	Check if not always performing data logging.	-
Carry out the logging during the period of time which corresponds to prescribed conditions	Select this to execute continuous logging and monitors trigger logging triggers during the period corresponding to the conditions displayed in the list.	-
Don't carry out the logging during the period of time which corresponds to prescribed conditions	Select this to not execute continuous logging or monitor trigger logging triggers during the period corresponding to the conditions displayed in the list.	-
Type of condition	Displays the condition type. (Data condition, Date range, Time-of-the-day range, Day-of-the-week/ Week-of-the-month conditions)	-
Content	Displays the overview of the condition. To check the contents, select the corresponding row and click the  button.	-
 button	Displays the setting screen to edit the selected condition.	(1) in this section
 button	Deletes the selected condition.	-
Operator for combination	Specify how to combine the rows of conditions. (OR, AND)	(2) in this section
 button	Shifts the selected row one row up or one row down.	-

11 FUNCTIONS OF CONFIGURATION TOOL (MODULE SETTINGS)

(1) Setting a period of time screen

Specify the condition to define the period.

Setting screen

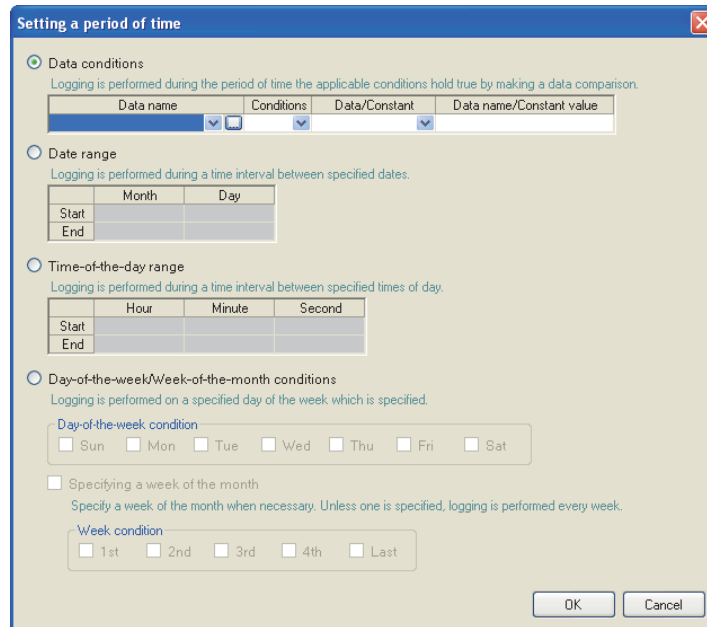



Item	Reference
Data conditions	(1) (a) in this section
Date range	(1) (b) in this section
Time-of-the-day range	(1) (c) in this section
Day-of-the-week/Week-of-the-month conditions	(1) (d) in this section

(a) Data conditions

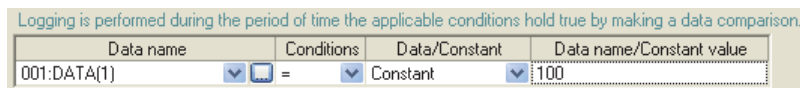
Compares data and executes data logging during the period when the condition is established.



Item	Description
Data name	Select the target data from the data set with "Data logging setting". To add a new data setting, select "(Add)" from the list box and click  .
Conditions ^{*1}	Select a comparison operator. (=, ≠, <, ≤, >, ≥)
Data/Constant	Select the type of data to compare to the target data. ("Data" or "Constant")
Data name/Constant value	Set the data or constant data (up to 16 characters) to compare to the target data. To add a new data setting, select "(Add)" from the list box and click  .

*1: When data of different data types are compared, the condition may not be established because of the difference in internal representations.

11 FUNCTIONS OF CONFIGURATION TOOL (MODULE SETTINGS)

(b) Date range

Performs data logging during the specified date*¹ period.

Example settings) For the date range specified below

	Month	Day
Start	Mar	28
End	Apr	2

For the above example settings, data logging is executed as shown in the table below.

Date	...	March 27	March 28	...	April 2	April 3
Carry out the logging during the period of time which corresponds to prescribed conditions	×	×	○	○	○	×	×
Don't carry out the logging during the period of time which corresponds to prescribed conditions	○	○	×	×	×	○	○

○: Executed ×: Not executed

*1: February 29 cannot be directly set. To specify February 29, select 'last day of February'.

(c) Time-of-the-day range

Executes data logging during the specified time period.

Example settings) For the time range specified below

	Hour	Minute	Second
Start	08	00	00
End	08	00	59

For the above example settings, data logging is executed as shown in the table below.

Time (hour:minute:second)	...	7:59:59	8:00:00	...	8:00:59	8:01:00
Carry out the logging during the period of time which corresponds to prescribed conditions	×	×	○	○	○	×
Don't carry out the logging during the period of time which corresponds to prescribed conditions	○	○	×	×	×	○

○: Executed ×: Not executed

11 FUNCTIONS OF CONFIGURATION TOOL (MODULE SETTINGS)

(d) Day-of-the-week/Week-of-the-month conditions

Performs data logging for the specified day of the week or week. The period can be specified by combining the day of the week and week.

- ① To perform data logging on the specified day of the week each week
Uncheck "Specifying a week of the month".

Example settings) For the day of the week condition specified below

Day-of-the-week condition

Sun
 Mon
 Tue
 Wed
 Thu
 Fri
 Sat

Specifying a week of the month

For the above example settings, data logging is executed as shown in the table below.

Day of the week	Sun	Mon	Tues	Wed	Thur	Fri	Sat	Sun	Mon	..
Carry out the logging during the period of time which corresponds to prescribed conditions	×	○	○	○	○	○	×	×	○	..
Don't carry out the logging during the period of time which corresponds to prescribed conditions	○	×	×	×	×	×	○	○	×	..

○: Executed ×: Not executed

9	REPORT FUNCTION
10	OTHER FUNCTIONS
11	FUNCTIONS OF CONFIGURATION TOOL (MODULE SETTINGS)
12	FUNCTIONS OF CONFIGURATION TOOL (WRITING/READING/VERIFYING DATA)
13	FUNCTIONS OF CONFIGURATION TOOL (CONFIRMING MODULE OPERATION)
14	FUNCTIONS OF CONFIGURATION TOOL (LOGGING FILE CONVERSION TOOL)
15	RECIPE FUNCTION
16	CompactFlash CARD

11 FUNCTIONS OF CONFIGURATION TOOL (MODULE SETTINGS)

- ② To perform data logging combining the week and day of the week
Check "Specifying a week of the month".

The following table shows the week conditions.

Week condition	Description
1st	From the 1st to the 7th
2nd	From the 8th to the 14th
3rd	From the 15th to the 21st
4th	From the 22nd to the 28th
Last	The 7 days at the end of the month for the corresponding month Example) If the 31st is the end of the month, the 25th to the 31st If the 30th is the end of the month, the 24th to the 30th

Example settings) For the day of the week conditions and week conditions specified below, with the period specified as "Carry out the logging during the period of time which corresponds to prescribed conditions"

Day-of-the-week condition

Sun Mon Tue Wed Thu Fri Sat

Specifying a week of the month
Specify a week of the month when necessary. Unless one is specified, logging is performed every week.

Week condition

1st 2nd 3rd 4th Last



Data logging is executed on the shaded portions.

January 2009						
Sun	Mon	Tue	Wed	Thu	Fri	Sat
				1	2	3
4	5	6	7	8	9	10
11	12	13	14	15	16	17
18	19	20	21	22	23	24
25	26	27	28	29	30	31

Day of week condition
"Mon/Tue/Wed/Thu/Fri"

1st
"1st to 7th"

4th
"22nd to 28th"

Last
"25th to 31st"

(2) Condition for combination

Multiple specified conditions can be combined.

"OR" or "AND" can be selected as the combine condition.

The combine condition is applied to all the conditions. "AND" and "OR" cannot be mixed.

(a) For OR combine

When "Carry out the logging during the period of time which corresponds to prescribed conditions" is selected for the period

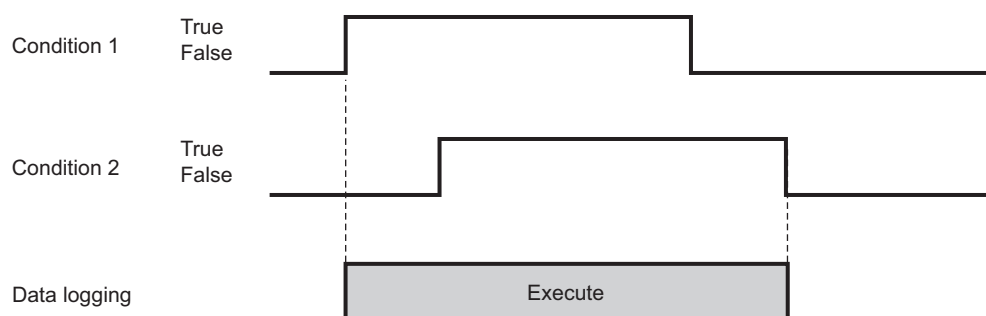

(b) For AND combine

When "Carry out the logging during the period of time which corresponds to prescribed conditions" is selected for the period

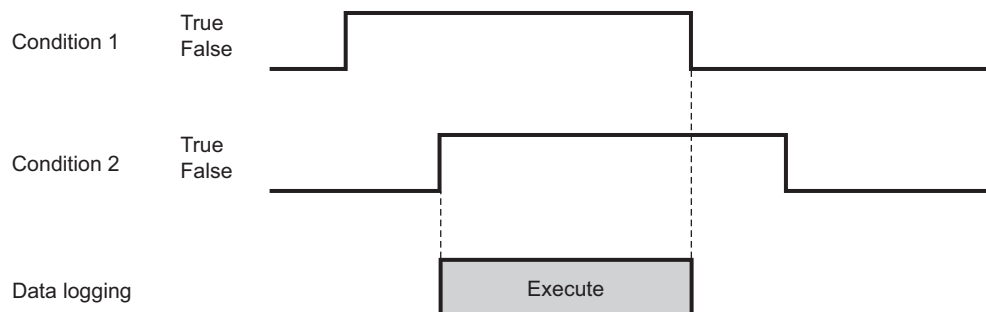

☒ POINT

If high speed data sampling is selected in the data sampling method, the number of conditions which can be combined is up to 4.

11.5.9 Trigger

This section explains the settings for specifying the trigger occurrence condition when the logging type is selected as "Trigger logging".

There are the two types of trigger occurrence conditions below depending on the number of conditions combined.

- Single condition (if the number of conditions is 1)
- Compound condition (if multiple conditions are combined)

For details on processes of each trigger condition, refer to the following section.

☞ Section 7.3.2 Trigger logging

(1) To select a single condition

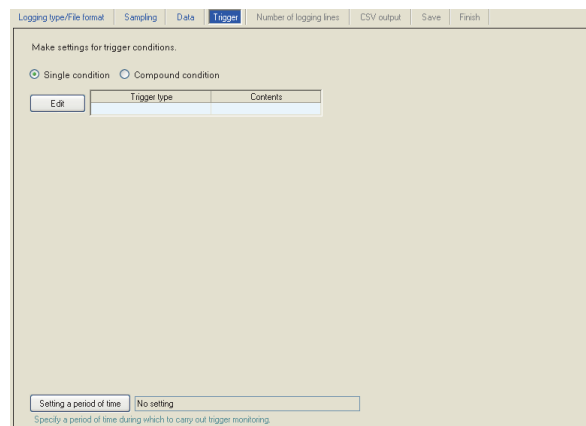

For the operations/settings after selecting a single condition, refer to the following section.

☞ Section 11.5.10 Trigger (single condition)

(2) To select a compound condition

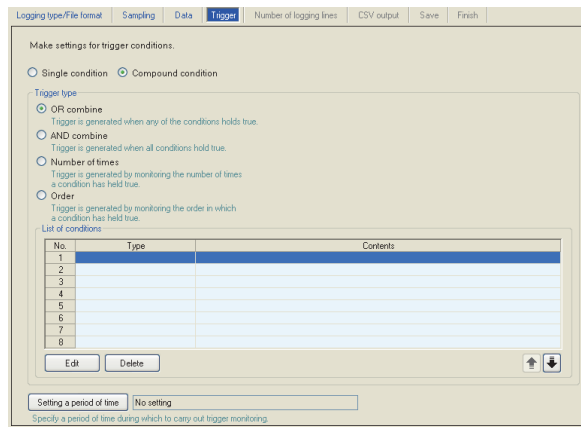

For the operations/settings after selecting a compound condition, refer to the following section.

☞ Section 11.5.11 Trigger (compound condition)

Remark

The period to monitor the trigger can be set by clicking the button. For details, refer to the following section.

☞ Section 11.5.8 Period of time

11 FUNCTIONS OF CONFIGURATION TOOL (MODULE SETTINGS)

11.5.10 Trigger (single condition)

This section explains the method for configuring a single trigger condition when the logging type is set to "Trigger logging".

For details on processes of each trigger (single condition), refer to the following section.

☞ Section 7.3.3 (1) Single condition

Operating procedure

Select "Single condition".

Setting screen

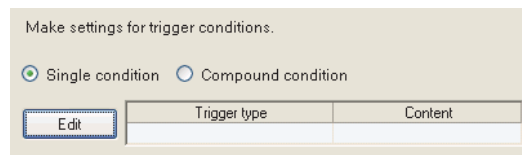

Make settings for trigger conditions.

Single condition Compound condition

Trigger type	Content

Item	Description	Reference
Single condition	Select this to set a single trigger condition.	-
Compound condition	Select this to set a combination of multiple trigger conditions.	Section 11.5.11
Trigger type	Displays the specified type of trigger condition (Data conditions (Comparison), Data conditions (At the time of change of value), Fixed cycle, Time interval specification, Specifying a time of day, At startup of module).	-
Content	Displays the overview of the trigger condition.	-
<input type="button" value="Edit"/> button	Displays the "Trigger condition setting" screen.	(1) in this section



11 FUNCTIONS OF CONFIGURATION TOOL (MODULE SETTINGS)

(1) Trigger condition setting screen

One type of trigger condition can be specified on the screen below.

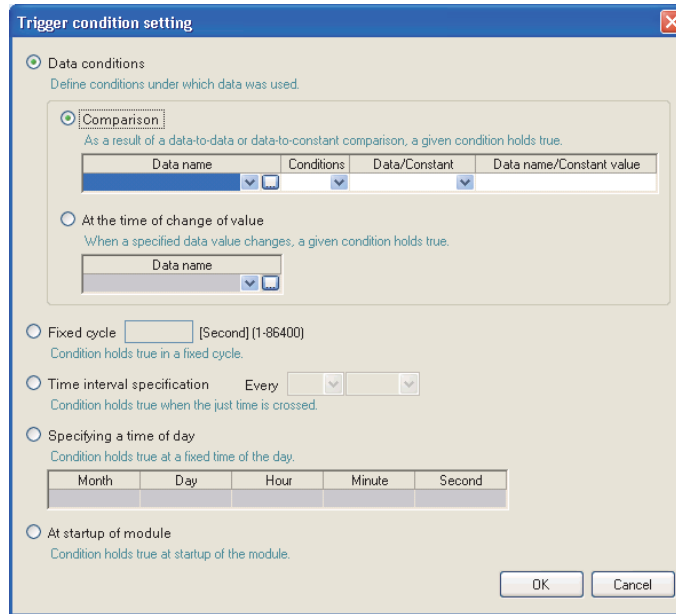
Setting screen



Item	Description	Reference
Data conditions	-	-
Comparison ^{*1}	Compares data, and the trigger occurs when the condition is established.	-
Data name	Select the target data from the data set with "Data logging setting". To add a new data setting, select "(Add)" from the list box and click  .	Section 11.5.6 Section 11.2.9
Conditions	Select a comparison operator. (=, ≠, <, ≤, >, ≥,)	-
Data/Constant	Select the type of data to compare to the target data. ("Data" or "Constant")	-
Data name/ Constant value	Set the data or constant data (up to 16 characters) to compare to the target data. Data can be selected from the data set with "Data logging setting". To add a new data setting, select "(Add)" from the list box and click  .	-
At the time of change of value	The trigger occurs when the value changes.	(1) (a) in this section
Data name	Select the data to monitor for the value change from the data set with "Data logging setting". To add a new data setting, select "(Add)" from the list box and click  .	
Fixed cycle	The trigger occurs at the specified cycle. (1 to 86400 seconds)	(1) (b) in this section
Time interval specification	The trigger occurs at the time interval of every specified hour/minute/second.	(1) (c) in this section
Specifying a time of day ^{*2*3}	The trigger occurs at the specified time.	(1) (d) in this section
Month	(Jan to Dec, Every)	
Day	(1 to 31, Every, Last)	
Hour	(00 to 23, Every)	
Minute	(00 to 59, Every)	
Second	(00 to 59)	
At startup of module	The trigger occurs when the high speed data logger module is powered ON or after reset.	-

*1: When data of different data types are compared, the condition may not be established because of the difference in internal representations.

*2: February 29 cannot be directly set. To specify February 29, select 'last day of February'.

11 FUNCTIONS OF CONFIGURATION TOOL (MODULE SETTINGS)

*3: If "Every" is specified, "Every" needs to be set for all date/time items above it.
Example: If "Every" is set for "Hour", "Month" and "Day" are also set to "Every".

POINT

Since the determination of the data condition is executed with the data sampled at the specified data sampling interval, it is not detected if the condition is not established at the data sampling.

Appendix 12 Sampling Processes of High Speed Data Logger Module

(a) Value changes

The following shows the timing of the trigger occurrences when value change is specified as the condition.

For a bit device:

The trigger occurs when it changes from ON to OFF and from OFF to ON.

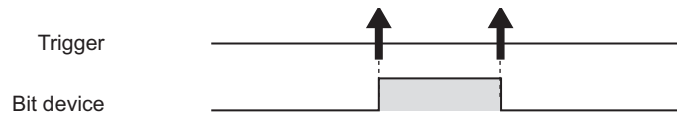

For a word device:

The trigger occurs with each change of the value.

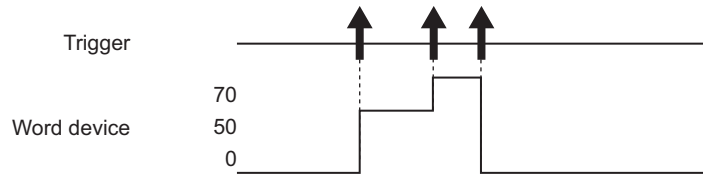

(b) Fixed cycle

The trigger occurs at the specified interval after power-ON or the settings are updated. However, the trigger does not occur at the first sampling. When the specified interval for the fixed cycle and the timing of sampling don't match, the trigger occurs at the first sampling after the specified fixed cycle interval elapses.

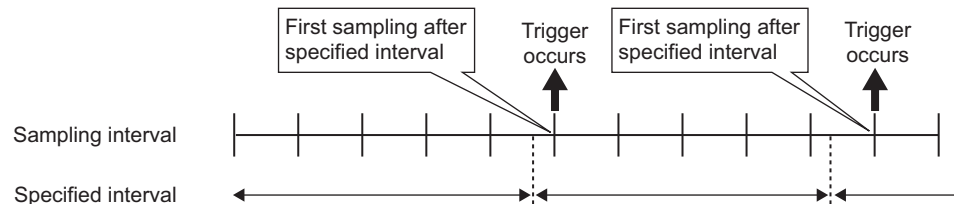

When the fixed cycle specified interval is shorter than the sampling interval, the trigger operates at the sampling interval.

11 FUNCTIONS OF CONFIGURATION TOOL (MODULE SETTINGS)

(c) Time interval specification

① Available unit that can be specified

Hour: 1, 2, 3, 4, 6, 8, 12, 24

Minute: 1, 2, 3, 4, 5, 6, 10, 12, 15, 20, 30, 60

Second: 1, 2, 3, 4, 5, 6, 10, 12, 15, 20, 30, 60

② Trigger occurrence timing

The trigger occurs every half hour from the top of the hour.

Example: The time interval of half hour is specified and the power is turned ON at 10:15.

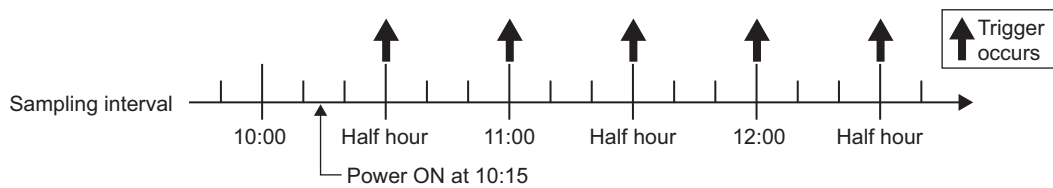

(d) Specifying time

The trigger occurs at the specified time.

However, when the specified time and the timing of sampling don't match, the trigger occurs at the first sampling after the specified time elapses.

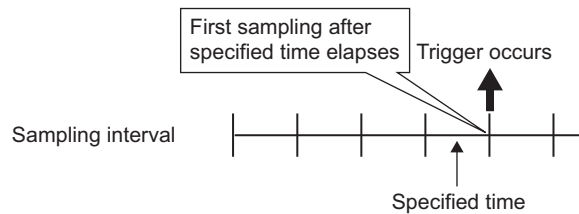

POINT

For trigger logging conditions, refer to the following section.

☞ Section 7.3.3 Trigger conditions

9

REPORT FUNCTION

10

OTHER FUNCTIONS

11

FUNCTIONS OF CONFIGURATION TOOL (MODULE SETTINGS)

12

FUNCTIONS OF CONFIGURATION TOOL (WRITING/READING/VERIFYING DATA)

13

FUNCTIONS OF CONFIGURATION TOOL (CONFIRMING MODULE OPERATION)

14

FUNCTIONS OF LOGGING FILE LOGGING FILE CONVERSION TOOL

15

RECIPE FUNCTION

16

CompactFlash CARD

11 FUNCTIONS OF CONFIGURATION TOOL (MODULE SETTINGS)

11.5.11 Trigger (compound condition)

This section explains the method for specifying a combination of multiple trigger conditions when the logging type is specified as "Trigger logging".

For details on processes of each trigger (compound condition), refer to the following section.

☞ Section 7.3.3 (2) Compound conditions

Operating procedure

Select "Compound condition".

Setting screen

Logging type/File format | Sampling | Data | **Trigger** | Number of logging lines | CSV output | Save | Finish

Make settings for trigger conditions.

Single condition Compound condition

Trigger type

- OR combine
Trigger is generated when any of the conditions holds true.
- AND combine
Trigger is generated when all conditions hold true.
- Number of times
Trigger is generated by monitoring the number of times a condition has held true.
- Order
Trigger is generated by monitoring the order in which a condition has held true.

List of conditions

No.	Type	Content
1		
2		
3		
4		
5		
6		
7		
8		

Edit Delete ↑ ↓





Setting a period of time No setting
Specify a period of time during which to carry out trigger monitoring.

Item	Description	Reference
OR combine	The trigger occurs when any of the conditions specified on the list of conditions are established.	(1) in this section
AND combine	The trigger occurs during the period when all of the conditions specified on the list of conditions are established.	(2) in this section
Number of times	The trigger occurs by monitoring the number of times the condition is established.	(3) in this section
Order	The trigger occurs by monitoring the order the conditions are established.	(4) in this section

(Continued on the next page)

11 FUNCTIONS OF CONFIGURATION TOOL (MODULE SETTINGS)

(From the previous page)

Item	Description	Reference
List of conditions	Displays the list of conditions.	-
Type	Displays any of the following items. <ul style="list-style-type: none"> • For OR combine: Data conditions (Comparison), Data conditions (At the time of change of value), Fixed cycle, Time interval specification, Specifying a time of day, At startup of module • For AND combine: Data conditions (Comparison) • For Number of times: Comparison, At the time of change of value • For Order: Comparison, At the time of change of value 	-
Content	Displays the overview of the condition.	-
 Edit button	Displays the setting screen to edit the condition in the selected row.	-
 Delete button	Deletes the condition in the selected row.	-
 button	Shifts the selected row one row up or one row down.	-
 button	Specify the trigger monitoring period.	Section 11.5.8

9

REPORT FUNCTION

10

OTHER FUNCTIONS

11

FUNCTIONS OF CONFIGURATION TOOL (MODULE SETTINGS)

12

FUNCTIONS OF CONFIGURATION TOOL (WRITING/READING/VERIFYING DATA)

13

FUNCTIONS OF CONFIGURATION TOOL (CONFIRMING MODULE OPERATION)

14

FUNCTIONS OF LOGGING FILE CONVERSION TOOL

15

RECIPE FUNCTION

16

CompactFlash CARD

11 FUNCTIONS OF CONFIGURATION TOOL (MODULE SETTINGS)

(1) OR combine

The trigger occurs when any of the conditions specified on the list of conditions are established.

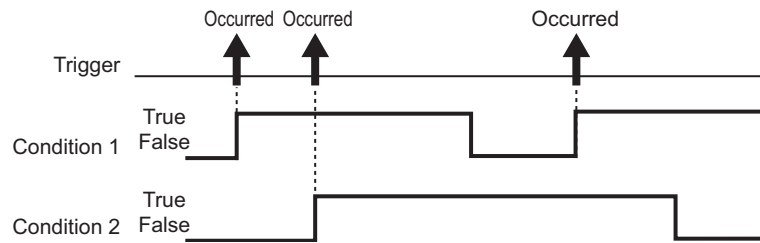

Setting screen

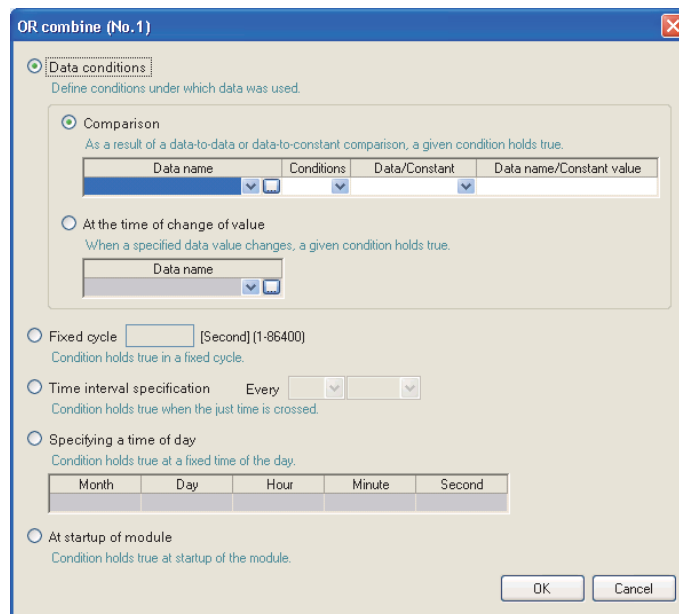

The items are the same as those of Single condition. Refer to the following section.

☞ Section 11.5.10 (1) Trigger condition setting screen

(2) AND combine

The trigger occurs during the period when all of the conditions specified on the list of conditions are established.

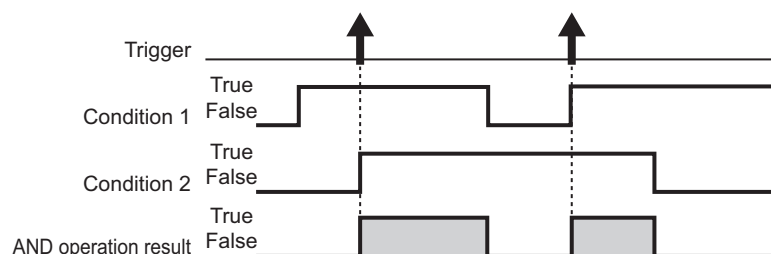

Setting screen

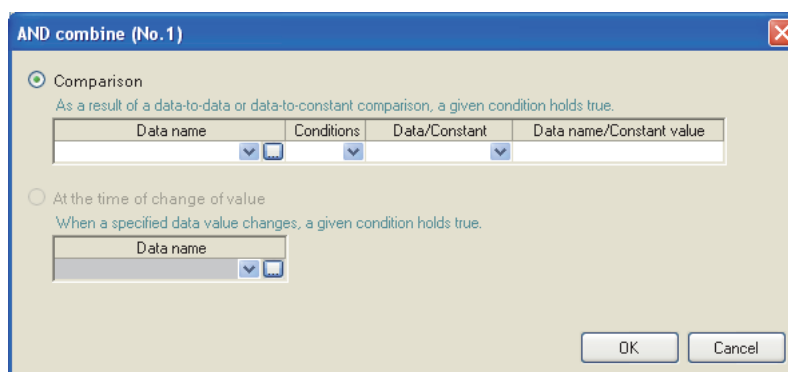

The items are the same as those of "Data conditions" of Single condition. Refer to the following section.

☞ Section 11.5.10 (1) Trigger condition setting screen

☒ POINT

If high speed data sampling is selected in the data sampling method, the number of conditions which can be combined is up to 4.

11 FUNCTIONS OF CONFIGURATION TOOL (MODULE SETTINGS)

(3) Number of times

Compares the number of times the count condition is established with the specified count and the trigger occurs.

Setting screen

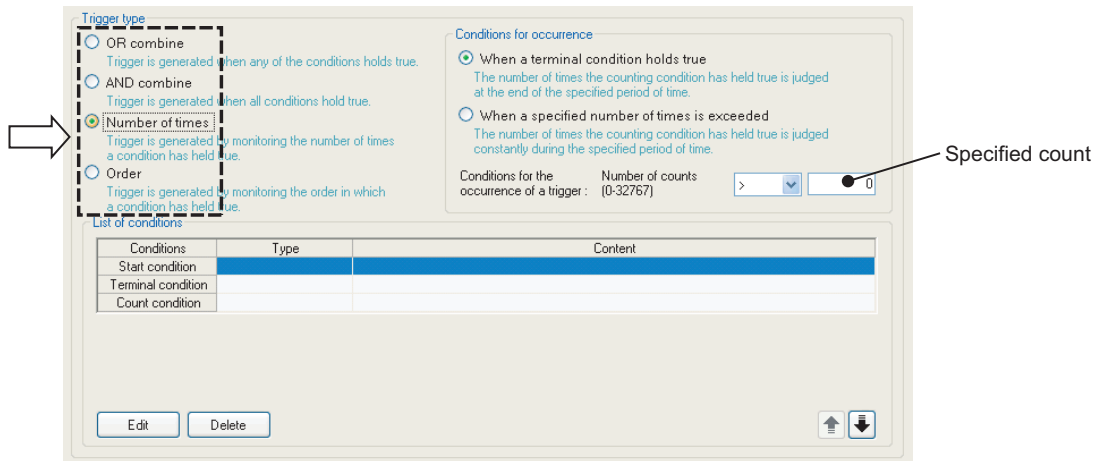

Item	Description	Reference
Conditions for occurrence	-	-
When a terminal condition holds true	Judges the number of times the count condition was established during the period at the end of the period.	(3) (b) in this section
When a specified number of times is exceeded	During the period, always judges the number of times the count condition is established.	(3) (c) in this section
Conditions for the occurrence of a trigger	Set the "Specified count" to compare with the number of times the count condition is established (established count) and the comparison operator (「=」, 「≠」, 「≤」, 「≥」, 「<」, 「>」). The trigger occurs if the comparison result is true. If "When a specified number of times is exceeded" is selected, the condition is fixed as ">".	-
Specified count	Set the count to compare to the established count. (0 to 32767)	-
List of conditions	Displays the list of conditions.	-
Start condition	Displays the condition to start counting for the established count.	-
Terminal condition	Displays the condition to stop counting for the established count.	-
Count condition	Displays the condition to increment the established count.	-
Type	Displays "Comparison" or "At the time of change of value".	-
Content	Displays the overview of the condition.	-
Edit button	Displays the setting screen to edit the condition in the selected row.	(3) (a) in this section
Delete button	Deletes the condition in the selected row.	-
Up/Down button	Shifts the selected row one row up or one row down.	-

POINT

Since the determination of the number of times is executed with the data sampled at the specified data sampling interval, it is not detected if the condition is not established at the data sampling.

Appendix 12 Sampling Processes of High Speed Data Logger Module

11 FUNCTIONS OF CONFIGURATION TOOL (MODULE SETTINGS)

- (a) Editing the count conditions
 Editing of the count conditions is performed on the "Number of times" screen. The settings on the "Number of times" screen are the same as those of the "AND combine" screen. For details, refer to the following section.
 Section 11.5.11 (2) AND combine
- (b) Count condition when terminal condition is established
 Counts the number of times the count condition was established from when the start condition is established until the terminal condition is established (count period).
The trigger occurrence condition is evaluated when the terminal condition is established and a trigger occurs if true.
 After that, the established count is reset when the terminal condition is established and the next count starts.
 The start, terminal, and count conditions are judged on the rise of the condition establishment.

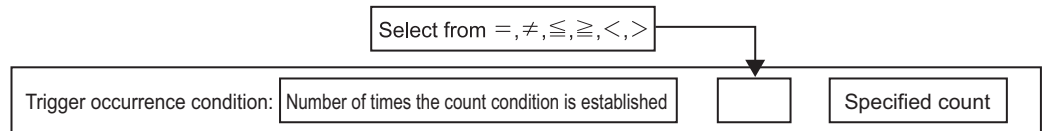

Example: For Trigger occurrence condition: (Established count) > 2 (specified count)

In the diagram below, the established count is 3 when the terminal condition is established, fulfilling the occurrence condition. The trigger occurs when the terminal condition is established.

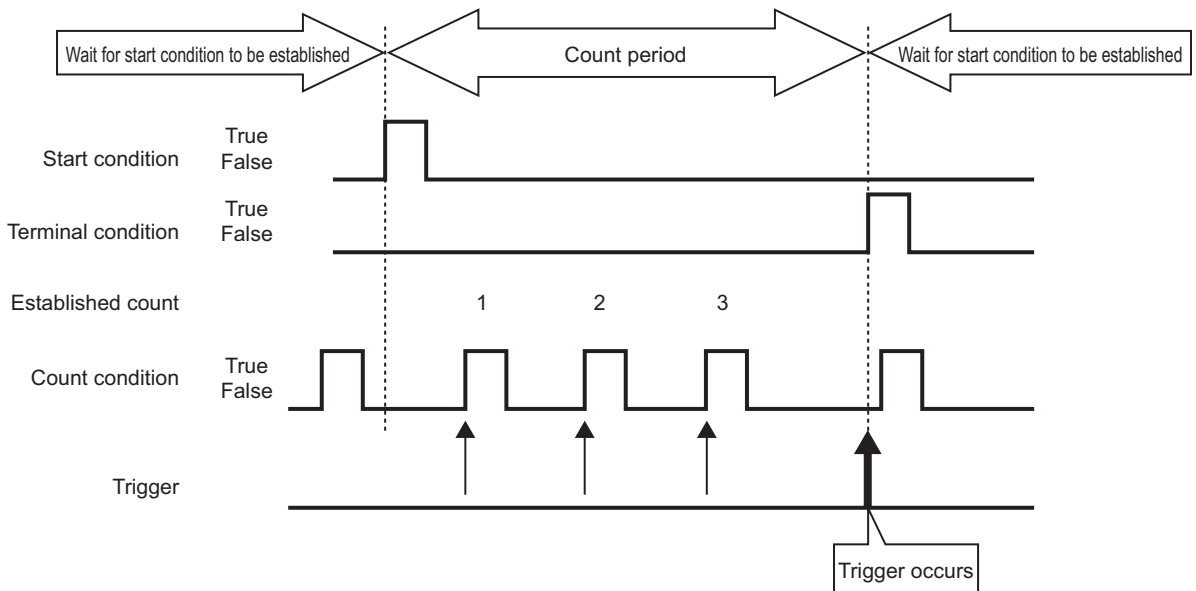

11 FUNCTIONS OF CONFIGURATION TOOL (MODULE SETTINGS)

(c) When specified count is exceeded

Counts the number of times the count condition was established from when the start condition is established until the terminal condition is established (count period).

During the count period, the trigger occurrence condition is always evaluated and a trigger occurs immediately if true.

After that, the established count is reset when the terminal condition is established and the next count starts.

The start, terminal, and count conditions are judged on the rise of the condition establishment.

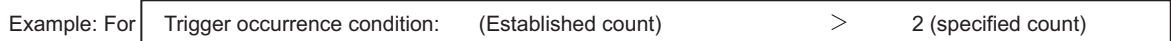
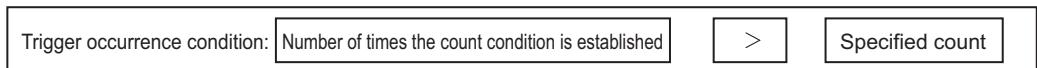

The trigger occurs when the trigger occurrence condition is fulfilled as shown below.

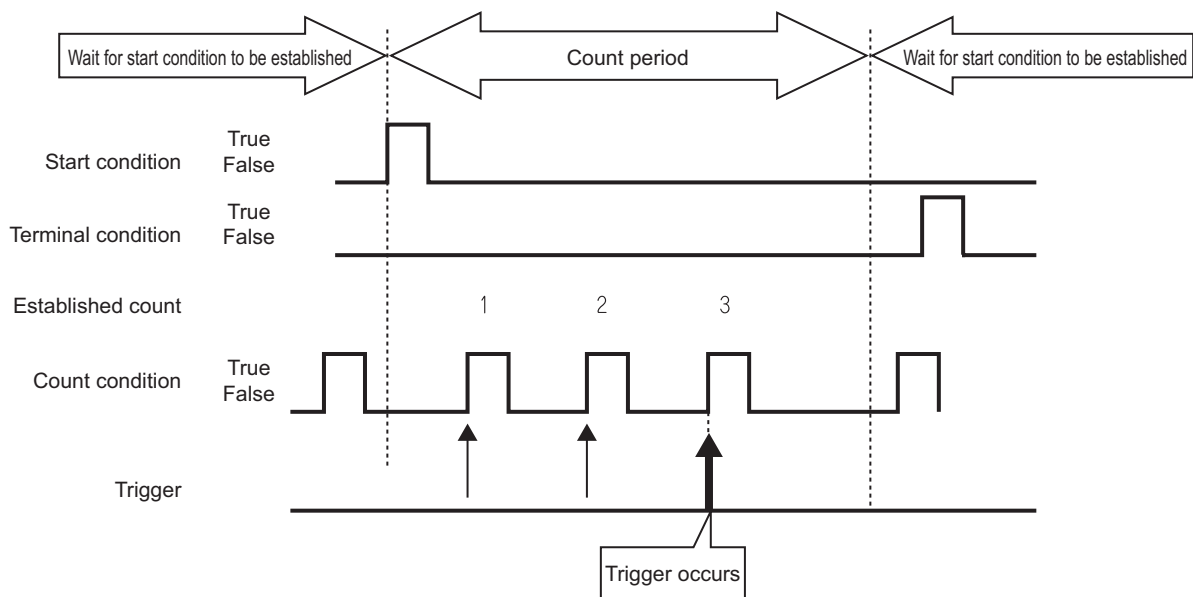

11 FUNCTIONS OF CONFIGURATION TOOL (MODULE SETTINGS)

(4) Order

Monitors the order that multiple conditions are established and the trigger occurs if they are out of order (when abnormal pattern is detected) or if in order (when normal pattern is detected).

Setting screen

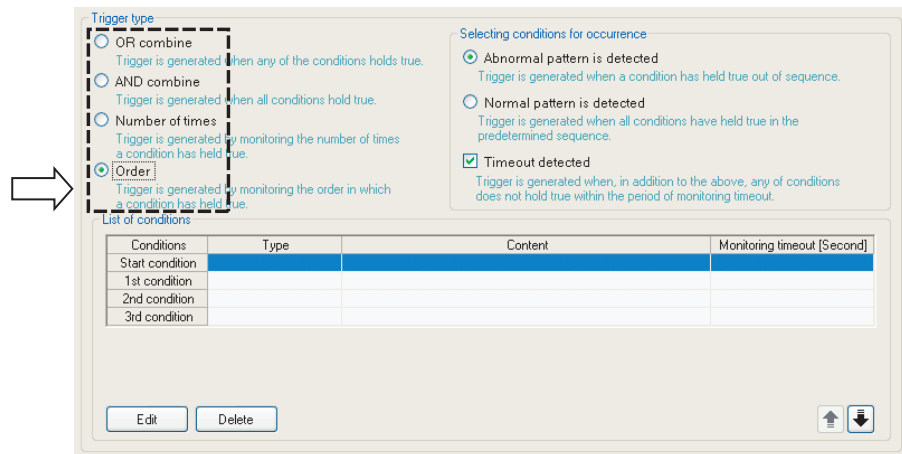

Item	Description	Reference
Selecting conditions for occurrence	-	-
Abnormal pattern is detected	The trigger occurs when conditions are established out of order.	(4) (b) in this section
Normal pattern is detected	The trigger occurs when conditions are all established in order.	(4) (c) in this section
Timeout detected	The trigger occurs when any of the conditions are not established within the monitoring timeout.	(4) (d) in this section
List of conditions	Displays the list of conditions.	-
Start condition	Displays the condition to start monitoring the condition establishment order.	
1st/2nd/3rd condition	Displays the conditions to monitor in order.	
Type	Displays "Comparison" or "At the time of change of value".	
Content	Displays the overview of the condition.	
Monitoring timeout [second]	Displays the timeout time when monitoring conditions in each order.	
Edit button	Displays the setting screen to edit the condition in the selected row.	(4) (a) in this section
Delete button	Deletes the condition in the selected row.	-
Up/Down button	Shifts the selected row one row up or one row down.	-

POINT

Since the determination of the order is executed with the data sampled at the specified data sampling interval, it is not detected if the condition is not established at the data sampling.

➡ Appendix 12 Sampling Processes of High Speed Data Logger Module

11 FUNCTIONS OF CONFIGURATION TOOL (MODULE SETTINGS)

(a) Editing the order conditions

Editing of the order conditions is performed on the "Order" screen.

Setting screen

Data name	Conditions	Data/Constant	Data name/Constant value

The items of "Comparison" and "At the time of change of value" are the same as those of "Data conditions" of Single condition.

For details, refer to the following section.

☞ Section 11.5.10 (1) Trigger condition setting screen

For "Monitoring timeout", refer to the following section.

☞ (4) (d) in this section

11 FUNCTIONS OF CONFIGURATION TOOL (MODULE SETTINGS)

(b) Detecting abnormal pattern

Starts monitoring the order from when the start condition is established, and detects a pattern of conditions established in an order which differs from the 1st condition, 2nd condition, 3rd condition order.

The trigger occurs when the conditions are established in an order which differs from the specified order.

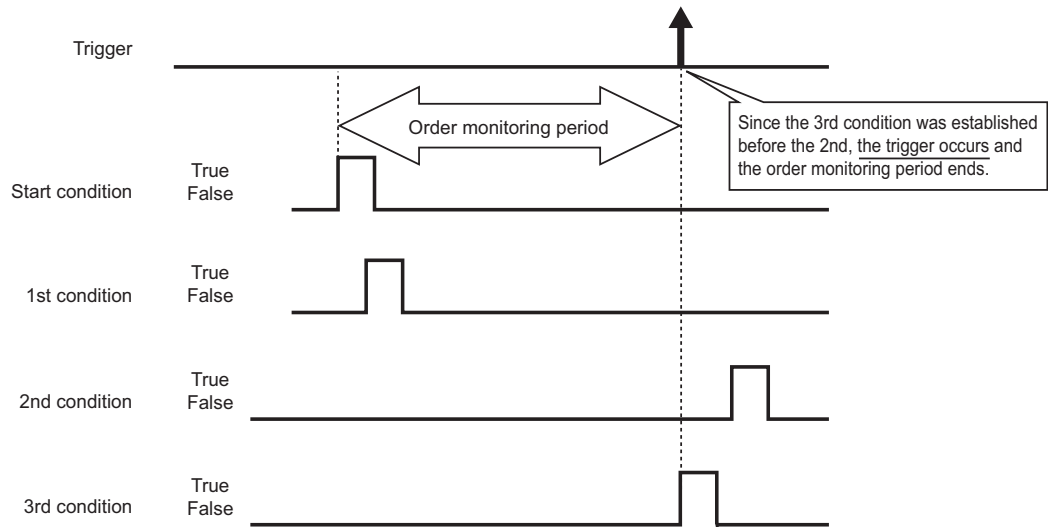

(c) Detecting normal pattern

Starts monitoring the order from when the start condition is established, and detects the pattern of conditions established in 1st condition, 2nd condition, 3rd condition order.

The trigger occurs when the conditions are established in the specified order.

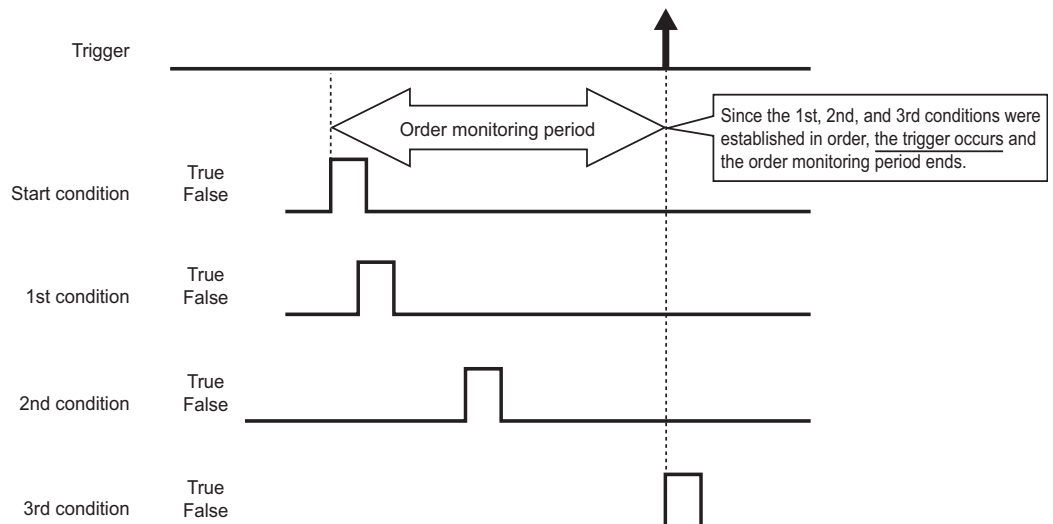

POINT

- (1) If the start condition is established again during the order monitoring period, monitoring returns to the 1st condition establishment wait state and order monitoring continues.
- (2) If two or more conditions are established simultaneously, the conditions are considered to have been established in the specified order, so the trigger will not occur when detecting an abnormal pattern.

11 FUNCTIONS OF CONFIGURATION TOOL (MODULE SETTINGS)

(d) Monitoring timeout

After one condition is established, monitors the condition until the next condition is established.

If the specified monitoring timeout time elapses and the next condition is not established, this is considered as a timeout and order monitoring ends, and it again waits for the order start condition to be established.

For the diagram below, after the 1st condition is established, because the 2nd condition was not established within the monitoring timeout time, this is a monitoring timeout.

If "Timeout detected" is checked on the "Order" list screen ( (4) in this section), a trigger occurs at the same time the timeout occurs.

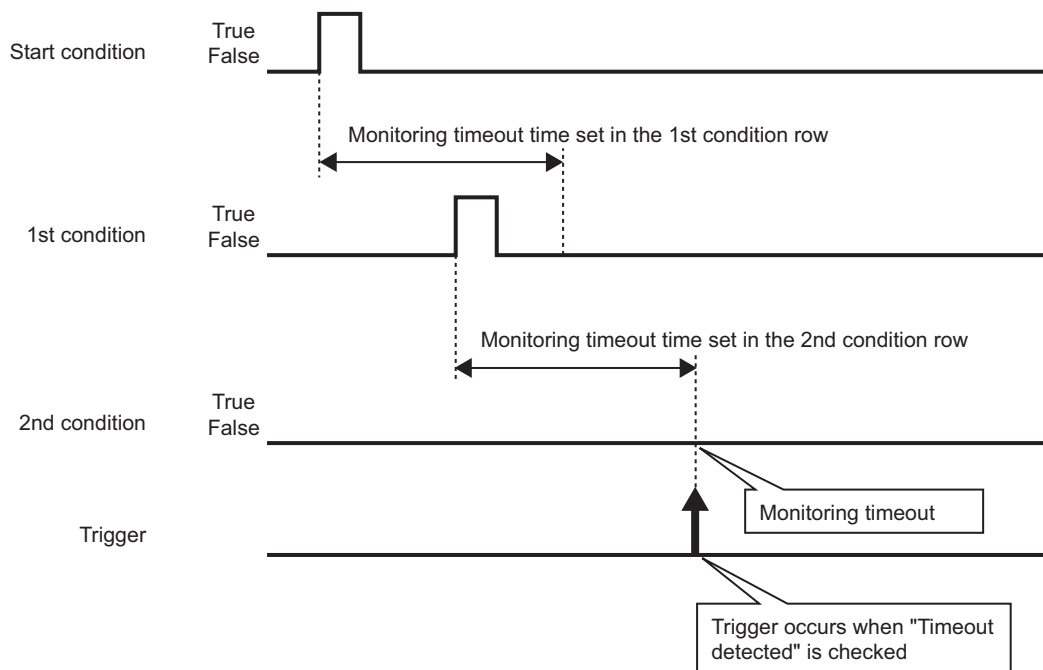

Set "Monitoring timeout" time on the "Order" screen.

 (4) (a) in this section Editing the order conditions

The setting range is shown below.

0.1 to 0.9, 1 to 32767 seconds

When the setting value of "Monitoring timeout" is smaller than that of the sampling interval, a timeout occurs. When "Timeout detected" is checked, a trigger occurs.

11.5.12 Number of logging lines

The number of logging lines is set when "Logging type" is specified as "Trigger logging" on the "Logging type/File format" screen.

Specify the number of lines of data output before and after the trigger occurs with this setting.

Setting screen

Logging type/File format | Sampling | Data | Trigger | **Number of logging lines** | CSV output | Save | Finish

Specify a number of lines to be outputted at the time of trigger logging.

Log data before and after the rising of trigger condition
 Log data before trigger condition rises, while trigger condition holds true, and after trigger condition falls

Before trigger: [Line] (0-65534)
 After trigger: [Line] (1-65535) Maximum setting
 Total number of lines: [Line] (1-65535)

Trigger buffer usage rate: [%]
 Total trigger buffer usage rate: [%]

For the total number of lines, define a number of lines consisting of one before and after the occurrence of trigger plus one assumed to become necessary while trigger conditions hold true.

Item	Description	Reference
Log data before and after the rising of trigger condition	Select this to log data before and after the trigger condition rise.	(1) in this section
Log data before trigger condition rises, while trigger condition holds true, and after trigger condition falls	Select this to log data before the trigger condition rise, while the trigger condition is established, and after the trigger condition fall.	(2) in this section
Before trigger	Set the number of lines to log before the trigger condition rise. (0 to 65534 lines)	(1), (2) in this section
After trigger	<ul style="list-style-type: none"> When "Log data before and after the rising of trigger condition": Specify the number of lines to log after the trigger condition rise. (1 to 65535 lines) When "Log data before trigger condition rises, while trigger condition holds true, and after trigger condition falls": Specify the number of lines to log after the trigger condition fall. (1 to 65535 lines) 	
Total number of lines ^{*1}	Specify the number of lines including the lines before and after the trigger and the lines assumed necessary while the trigger condition is established. (1 to 65535 lines)	(2) in this section
Maximum setting button	Set the maximum number of lines which can be set for before trigger and after trigger.	-
Trigger buffer usage rate	Displays the amount of trigger buffer being used with the data logging setting being edited as a percentage of the total amount.	(3) in this section
Total trigger buffer usage rate	Displays the necessary amount of trigger buffer for all data logging settings (including the one being edited) as a percentage of the total amount.	

*1: Can be specified only when "Log data before trigger condition rises, while trigger condition holds true, and after trigger condition falls" is set.

11 FUNCTIONS OF CONFIGURATION TOOL (MODULE SETTINGS)

(1) When logging data before and after the trigger condition rise

Specify the number of lines to log before the trigger condition rise (before trigger) and after the fall (after trigger).

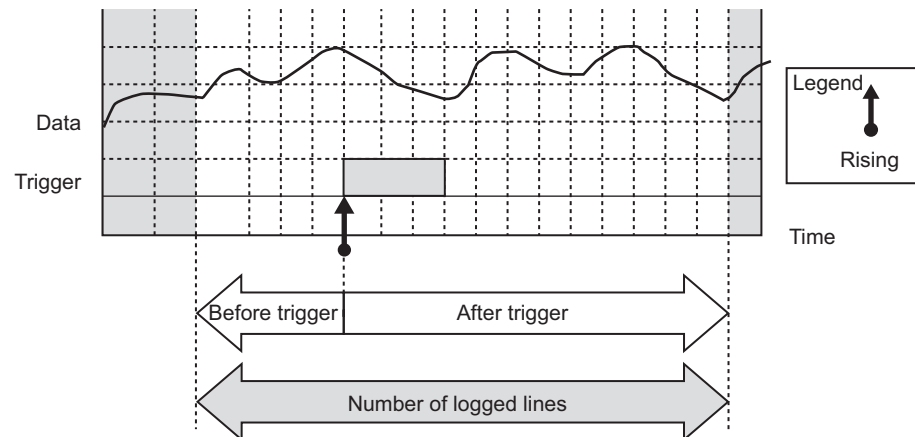

(2) When logging data before the trigger condition rise, while the trigger condition is established, and after the trigger condition fall

Specify the number of lines before the trigger condition rise (before trigger) and after the fall (after trigger), and the total number of lines.

With this setting, the logging range differs according to the length of time the trigger conditions are established.

Refer to (c) and (d).

(a) Total number of lines

Set "Total number of lines" to more than the total of the number of lines for "Before trigger" and "After trigger".

The number of lines which exceeds the total of "Before trigger" and "After trigger" is allocated to 'Number of logged lines' while the trigger condition is established.

(b) Specified conditions

This setting can be specified in the following situations.

- ① When "Single conditions" is selected with trigger, and "Comparison" is selected for the data condition
- ② When "Compound conditions" is selected with trigger, and "AND combine" is selected for the trigger type

11 FUNCTIONS OF CONFIGURATION TOOL (MODULE SETTINGS)

- (c) Number of lines logged when the time of the trigger condition establishment is long
 Logs the total number of lines worth of data.

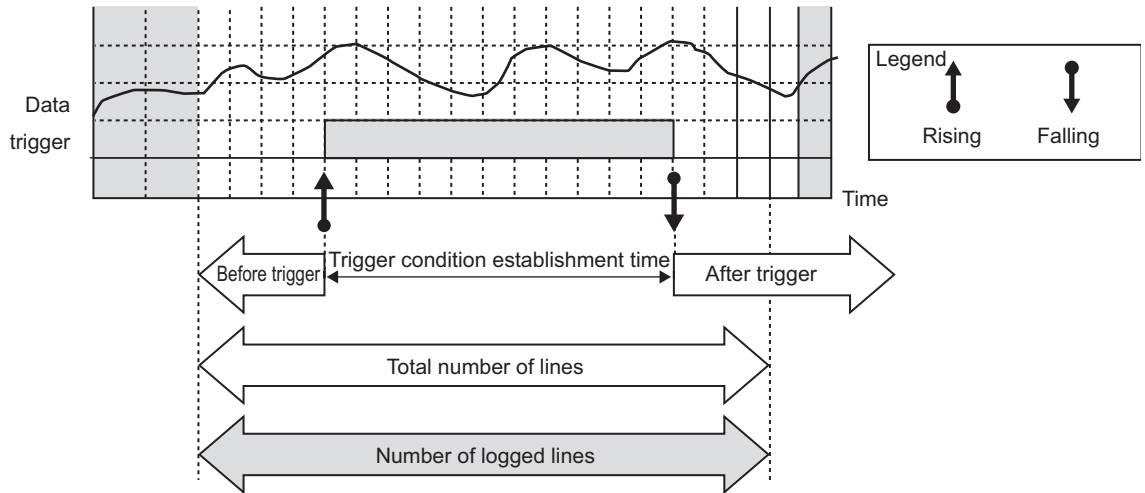

- (d) Number of lines logged when the time of the trigger condition establishment is short
 Logs the number of lines in "Before trigger" and "After trigger" and while the trigger condition is established.

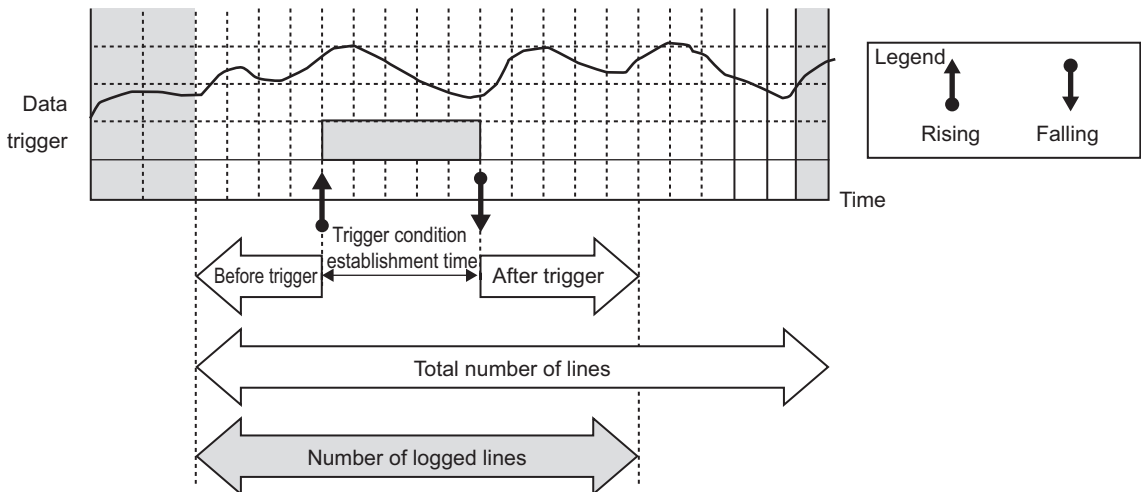

POINT

Immediately after switching the programmable controller system ON, if a trigger occurs before sampling the number of lines of data before the trigger, the data before the trigger become less than the specified number of lines.

11 FUNCTIONS OF CONFIGURATION TOOL (MODULE SETTINGS)

(3) Trigger buffer usage amount

Settings cannot be configured which exceed the overall trigger buffer usage amount on the high speed data logger module.

The overall trigger buffer usage amount is 8 megabytes (8388608 bytes).

The trigger buffer amount to be used can be found with the calculation formula below.

Trigger buffer usage amount per single logging = ((device count × 2+40) × (number of lines +1)) × 2

(a) Device points

The following table shows the device points of data types per single logging.

Data type	Device point
Bit	1 points
Word [signed]	1 points
Double word [signed]	2 points
Word [unsigned]	1 points
Double word [unsigned]	2 points
FLOAT [single precision]	2 points
FLOAT [double precision]	4 points
16bit BCD	1 points
32bit BCD	2 points
String	(Number of strings/2) points
Raw	(Binary size/2) points

(b) Number of lines

The number of lines per single logging differs depending on the specification method of the number of logging lines.

However, they are logged 100 lines or more for high speed data sampling and 30 lines or more for general data sampling.

Specification method of the number of logging lines	Number of lines per single logging
Log data before and after the rising of trigger condition	Number of lines of before trigger + after trigger
Log data before trigger condition rises, while trigger condition holds true, and after trigger condition falls	Total number of lines

Example) When "Log data before trigger condition rises, while trigger condition holds true, and after trigger condition falls" is selected, for trigger logging with high speed data sampling with the conditions below

(Conditions)

- Device: All 64 components are word [signed]
- Buffer size: 100 lines

(Trigger buffer usage amount and trigger buffer usage rate per single logging)

- Trigger buffer usage amount per single logging:
 $((64 \times 1 \times 2 + 40) \times (100 + 1)) \times 2 = 33936$ bytes
- Trigger buffer usage rate:
 $33936 / 8388608 \approx 0.4\%$

11 FUNCTIONS OF CONFIGURATION TOOL (MODULE SETTINGS)

11.5.13 CSV output

This section explains the settings related to CSV file output content. The "CSV output" screen is only displayed when CSV file is selected on the "Logging type/File format" screen.

POINT

For details on the CSV file format, refer to the following section.

☞ Section 3.6 CSV File Format

Setting screen

Item	Description	Reference
Output date column	Check to output the date column in the CSV file.	(1) in this section
Trigger information column	Specify the output of the trigger information. Can only be specified when trigger logging is specified on the "Logging type/File format" screen.	(2) in this section
Output index column	Check to output the index number in the file. The continuity of logging can be checked by the index.	Section 3.6.2

(1) Date column

Setting screen

Date column

Output date column
Carry out the logging with a time stamp attached to data.

Specify date format

Data name line string

Data line output format

Example of output

Item	Description
Output date column	Check to log data with attaching a time stamp.
Specify date format	Check to specify the format of the date column.
Data name line string ^{*2}	Specify the title of the date column data header line. (Up to 32 characters)
Data line output format ^{*1*2*3}	Specify the output format of the data line for the date column. (Up to 32 characters) <ul style="list-style-type: none"> • YYYY: Year (4 digits) • YY : Year (2 digits) • MM : Month (2 digits) • DD : Day (2 digits) • hh : Hour (2 digits) • mm : Minute (2 digits) • ss : Second (2 digits) • ms : Millisecond (3 digits)^{*4} • us : Microsecond (6 digits)^{*4} • .ss... : Digits after the decimal point in seconds (1 to 4 digits)^{*4} (example: ss.sss = 51.123)
Example of output	Displays an example of the date column output with the current settings.

- *1: The date units must be consecutively specified.
For example, you cannot specify 'year/day' with the month omitted. You must specify it as 'year/month/date'.
- *2: The date column can be split into multiple strings with commas.
In this case, enter the same number of commas in "Data name line string" and "Data line output format".
- *3: When CSV files are opened with Excel, the date column format is displayed in Excel's default setting.
Set the cell format as necessary.
Example: To display year, month, date, hour, minute, second, millisecond information
Specify the user defined display format below.
m/d/yyyy hh:mm:ss.000
- *4: Data value is rounded off to 0.1 millisecond unit when the high speed data sampling is specified, and to 100 millisecond unit when the general data sampling is specified.

11 FUNCTIONS OF CONFIGURATION TOOL (MODULE SETTINGS)

(2) Trigger information column

Setting screen

Trigger information column

Output trigger information column
 Data line on which a trigger occurred is logged after attached with a mark.

Data name line string

When trigger condition rises

When trigger condition falls

Item	Description
Output trigger information column	Check to log data with attaching the specified mark to the data row where the trigger occurred.
Data name line string	Specify the title of the trigger information column data header line. (Up to 32 characters)
When trigger condition rises	Specify the string to output at the trigger condition rise. (Up to 32 characters)
When trigger condition falls	Specify the string to output at the trigger condition fall. (Up to 32 characters)

9

REPORT FUNCTION

10

OTHER FUNCTIONS

11

FUNCTIONS OF CONFIGURATION TOOL (MODULE SETTINGS)

12

FUNCTIONS OF CONFIGURATION TOOL (WRITING/READING/VERIFYING DATA)

13

FUNCTIONS OF CONFIGURATION TOOL (CONFIRMING MODULE OPERATION)

14

FUNCTIONS OF CONFIGURATION TOOL (LOGGING FILE CONVERSION TOOL)

15

RECIPE FUNCTION

16

CompactFlash CARD

11.5.14 Binary output

This section explains the settings related to binary file output content. The "Binary output" screen is only displayed when binary file is selected on the "Logging type/File format" screen.

POINT

For details on the binary file format, refer to the following section.

☞ Section 3.7 Binary File Format

Setting screen

Logging type/File format | Sampling | Data | Trigger | Number of logging lines | **Binary output** | Save | Finish

Define the contents of data to be outputted to binary files.

Date information
 Output date information
 Carry out the logging with a time stamp attached to data.
 In second
 Output accumulated second count since 1970.
 In nanosecond
 Output the time in nanosecond as well as in second.

Index
 Index numbers are outputted to permit the checking of continuity in logging.
 Output indexes

Trigger information
 Data is logged after attached with flag information on a location where trigger occurred.
 Output trigger flag

Item	Description
Date information	-
Output date information	Check to log data by attaching time stamps.
In second	Select this to output the date data in second units. (Outputs the accumulated number of seconds since 1970)
In nanosecond*1	In addition to seconds, select this to output the date data in nanosecond units.
Index	-
Output indexes	Check to output the index number in the file. The continuity of logging can be checked by the index.
Trigger information	-
Output trigger flag	Check to output the occurrence flag at the data position where the trigger occurred.

*1: Data value is rounded off to 0.1 millisecond unit when the high speed data sampling is specified, and to 100 millisecond unit when the general data sampling is specified.

11 FUNCTIONS OF CONFIGURATION TOOL (MODULE SETTINGS)

11.5.15 Save

This section explains the method for setting the data logging file save destination and the saved file switching.

This setting is applied to both the "CSV file" and "Binary file" formats.

For details on processes of saving settings, refer to the following section.

☞ Section 7.5.2 Saving data logging files

Setting screen

Item	Description	Reference
File save destination	Specify the save directory (file name) for the data logging file. Data are added sequentially to the specified file.	(1) in this section
File switching setting	-	Section 7.5.2
File switching timing	Specify the timing to switch the file to a new file.	(2) in this section
Saved file name	Changes the name of the file up to then when the file is switched. Information to be attached to the changed file name can be set.	(3) in this section
Number of saved files	Specify the maximum number of files to be saved on the CompactFlash card.	(4) in this section
Transfer setting button	Displays the setting screen to edit the settings to transfer the saved file by FTP or to send it by e-mail.	(5) in this section
FTP transfer destination	Displays the FTP transfer destination setting. • If no setting : No setting • If there is a setting: Displays the FTP setting number	
E-mail address	Displays the e-mail destination setting. • If no setting : No setting • If there is a setting: Displays the target e-mail address setting number	

11 FUNCTIONS OF CONFIGURATION TOOL (MODULE SETTINGS)

(1) File save destination

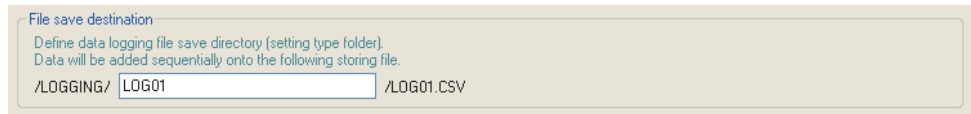

Item	Description
File save destination	<p>Specify the name of the folder to save files in.</p> <p>For the characters that can be set, refer to the section below.</p> <p>☞ Appendix 4.2 Characters usable in file names, folder (directory) names</p> <p>Specify a name that is not a duplicate of the file save destination of other data logging files. (Within 32 characters)</p>

256 data logging files are saved in a folder of the specified "File save destination". The files with low numbers which are deleted by the setting of "Number of saved files" are included in these files.

The 257th file is saved in a new folder.

The following table shows the saved file name when the save folder and additional information are not set.

File type folder	Save folder		Saved file name		
	Setting type folder	Number folder			
\LOGGING	\LOG01	\0000001	00000001.CSV (.BIN)	} 256	
			00000002.CSV (.BIN)		
			:		
			000000FF.CSV (.BIN)		
		00000100.CSV (.BIN)	} 256		
		\0000101			00000101.CSV (.BIN)
					00000102.CSV (.BIN)
					:
	000001FF.CSV (.BIN)				
	:	:	:	} 256	
	\LOG02	\0000001	00000001.CSV (.BIN)		} 256
			00000002.CSV (.BIN)		
			:		
			000000FF.CSV (.BIN)		
		00000100.CSV (.BIN)	} 256		
		\0000101			
00000102.CSV (.BIN)					
:					
000001FF.CSV (.BIN)					
:	:	:			

11 FUNCTIONS OF CONFIGURATION TOOL (MODULE SETTINGS)

Item	Description
File type folder	<p>Folders are created automatically according to the type of saved file.</p> <p>"LOGGING": Stores data logging files.</p> <p>"EVENT": Stores event logging files. (☞ Section 11.6.13 (1))</p> <p>"REPORT": Stores report files. (☞ Section 11.7.8 (1))</p>
Setting type folder	Files are sorted according to the save directory name set for "File save destination" on the <<Save>> tab of the data logging setting.
Number folder	<p>Files are sorted according to the specified number of saved file.</p> <p>Folder name: 100 x n + 1 is displayed in 8 digits (n=0, 1, 2, 3, ...)</p> <p>Example: 00000001, 00000101, 00000201, 00000301</p>
Saved file name	<p>A saved file name is expressed as 8 digits.</p> <p>The output format can be changed in the "Saved file name" setting on the <<Save>> tab of the data logging setting.</p>

9

REPORT FUNCTION

10

OTHER FUNCTIONS

11

FUNCTIONS OF CONFIGURATION TOOL (MODULE SETTINGS)

12

FUNCTIONS OF CONFIGURATION TOOL (WRITING/READING/VERIFYING DATA)

13

FUNCTIONS OF CONFIGURATION TOOL (CONFIRMING MODULE OPERATION)

14

FUNCTIONS OF CONFIGURATION TOOL (LOGGING FILE CONVERSION TOOL)

15

RECIPE FUNCTION

16

CompactFlash CARD

11 FUNCTIONS OF CONFIGURATION TOOL (MODULE SETTINGS)

(2) File switching timing

Specify the timing to switch the file to a new file.

If the condition specified with file switching timing is fulfilled, the file where data are being stored (storing file) is saved in the save folder/with the saved file name (☞ (1) in this section) as the data logging file.

Setting screen

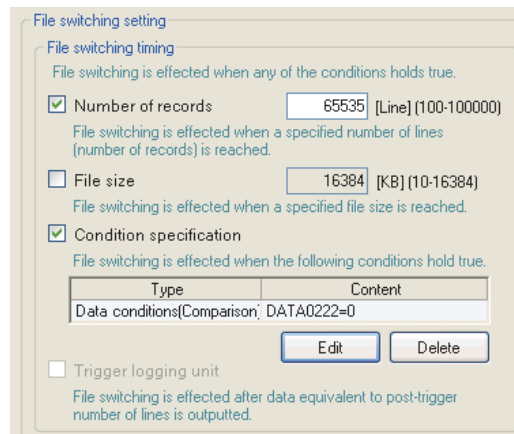

Item	Description	Reference
Number of records	Switches the file when the number of lines (records) reaches the specified number. (100 to 100000 lines)	-
File size	Switches the file when the specified file size is reached. (10KB to 16384KB)	-
Condition specification	Specify the condition to switch the file.	-
Type	Displays the type of condition specified on the "File switching condition setting" screen. (Data conditions, Fixed cycle, Time interval specification, Specifying a time of day, At startup of module) The file switching is performed even if the condition is fulfilled during the period when logging is not executed.	-
Content	Displays the content of the condition specified on the "File switching condition setting" screen.	-
Edit button	Opens the "File switching condition setting" screen to specify the condition. (Select either Single condition or Compound condition)	(2) (a) in this section
Delete button	Deletes the specified condition.	-
Trigger logging unit	After the trigger, outputs the number of lines worth of data and immediately switches the file. (Can only be set for trigger logging)	-

Even when the above file switching condition is not established, the file is switched in the following situations regardless of the set timing.

- When the number of lines (number of records for binary) reaches 65535 in case "Number of records" is not checked.
- When there is no e-mail destination setting and the file size reaches 16MB in case "File size" is not checked.
- When there is an e-mail destination setting and the file size reaches 512KB in case "File size" is not checked.

11 FUNCTIONS OF CONFIGURATION TOOL (MODULE SETTINGS)

POINT

- (1) [When "Fixed cycle" or "Specify a time of day" is selected for "Condition specification]

The file switching is performed at power on when the specified cycle elapses or the specified time comes during the period from power OFF to power ON.

- (2) By setting the following settings, only trigger logging data before and after the rising of trigger condition can be output to a report.

- [Data logging setting] → [save] → "File switching timing" → "Trigger logging unit" (☞ (2) in this section)
- [Report setting] → [Layout] → "Data logging layout" → "Source file" → "Saved file" (☞ Section 11.7.5 (1))
- [Report setting] → [Creation trigger] → "At the time of the data logging file is switched" (☞ Section 11.7.6)

9

REPORT FUNCTION

10

OTHER FUNCTIONS

11
FUNCTIONS OF CONFIGURATION TOOL (MODULE SETTINGS)

12

FUNCTIONS OF CONFIGURATION TOOL (WRITING/READING/VERIFYING DATA)

13

FUNCTIONS OF CONFIGURATION TOOL (CONFIRMING MODULE OPERATION)

14

FUNCTIONS OF CONFIGURATION TOOL (LOGGING FILE CONVERSION TOOL)

15

RECIPE FUNCTION

16

CompactFlash CARD

11 FUNCTIONS OF CONFIGURATION TOOL (MODULE SETTINGS)

(a) File switching condition setting screen

Setting screen

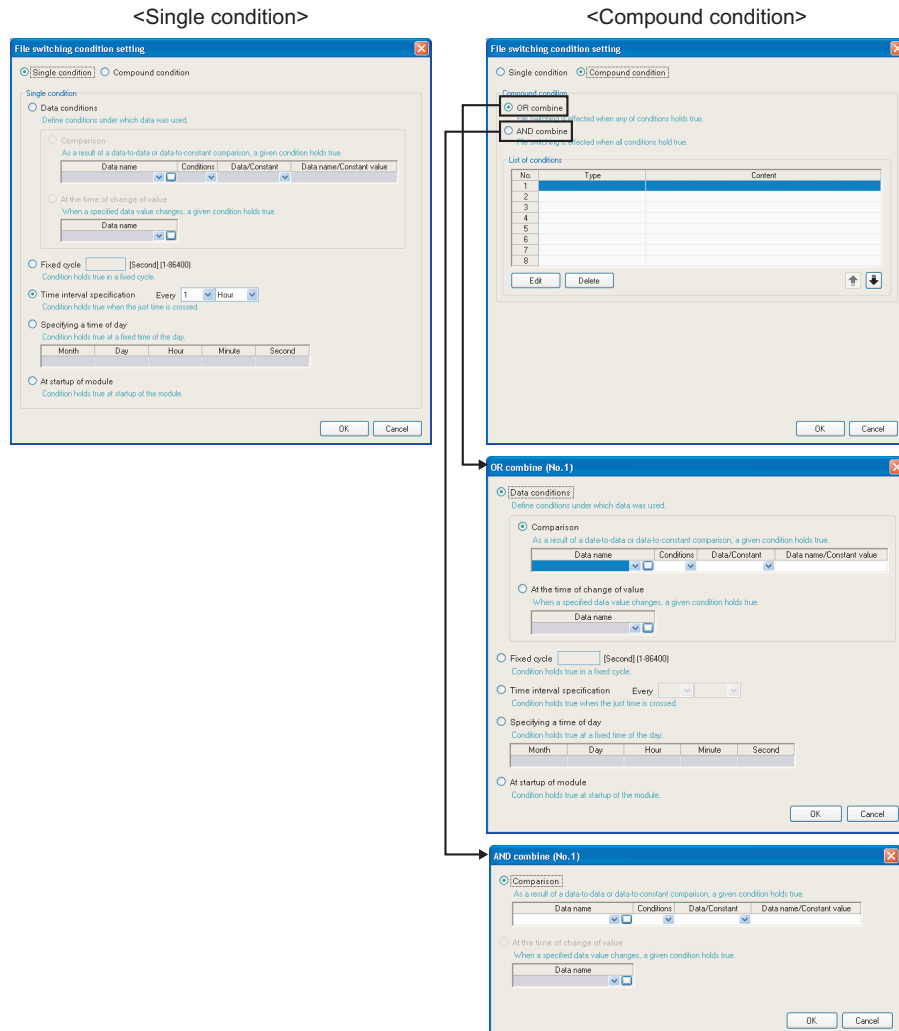

① Single condition

Switches files when the specified conditions are established.

The items of Single condition are the same as those of "Trigger condition setting" screen of the trigger (single condition).

For details, refer to the following section.

☞ Section 11.5.10 (1) Trigger condition setting screen

② Compound condition

Switches files when either specified condition is established for "OR combine", and when all the conditions are established for "AND combine".

The items of Compound condition are the same as those of "OR combine" or "AND combine" of the trigger (compound condition).

For details, refer to the following sections.

For OR combine: ☞ Section 11.5.11 (1) OR combine

For AND combine: ☞ Section 11.5.11 (2) AND combine

11 FUNCTIONS OF CONFIGURATION TOOL (MODULE SETTINGS)

(b) Operation example

The following show operation examples of the file switching under each setting. The file switching (processing described below) is performed at the timing of "** File switching" in each operation example.

- Create a saved file
- Delete data in the storing file (The storing file becomes to a header-only file)
- Transfer the saved file to the FTP server or mail server (When the transfer setting is set)

The file switching timing may differ with the high speed data logger module with a serial number whose first five digits are '11101' or lower.

☞ Appendix 8.1 (1) When the first five digits of a serial number are '11101' or lower

① Number of lines (number of records) specification

Example)"Number of records": 1000 lines

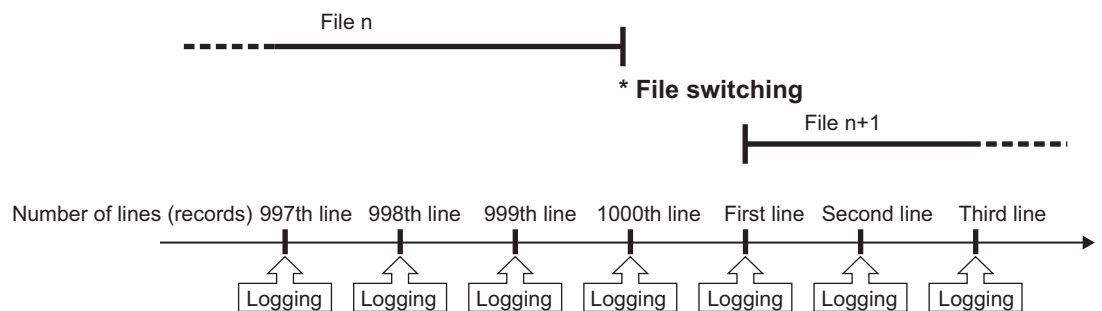

② File size specification

Example)"File size": 512KB

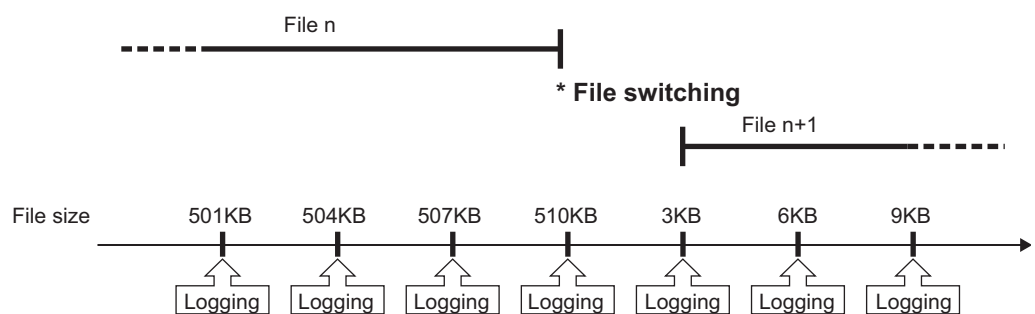

The file switching is performed at the timing before the file size exceeds the specified size.

Since the output size of one line (record) may vary depending on the data value when the file format is CSV file, the file switching timing is determined by predicting the next output size on the basis of the present output time.

11 FUNCTIONS OF CONFIGURATION TOOL (MODULE SETTINGS)

③ Condition specification (Data conditions)

Example)"Data condition": M0=ON

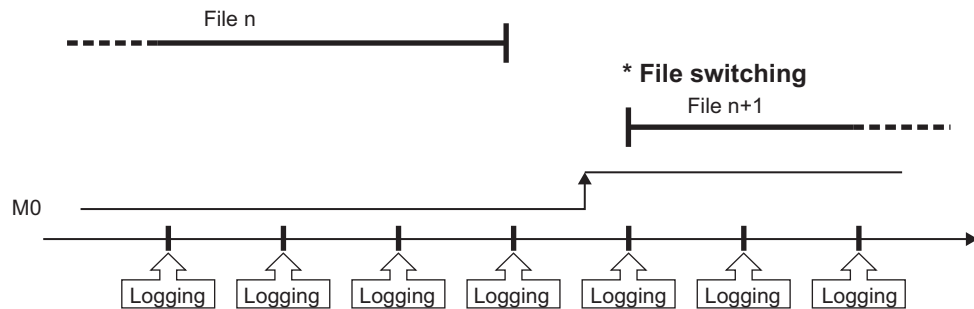

④ Condition specification (Fixed cycle/Specifying a time of day/At startup of module)

Example 1) "Specifying a time of day": 0 o'clock

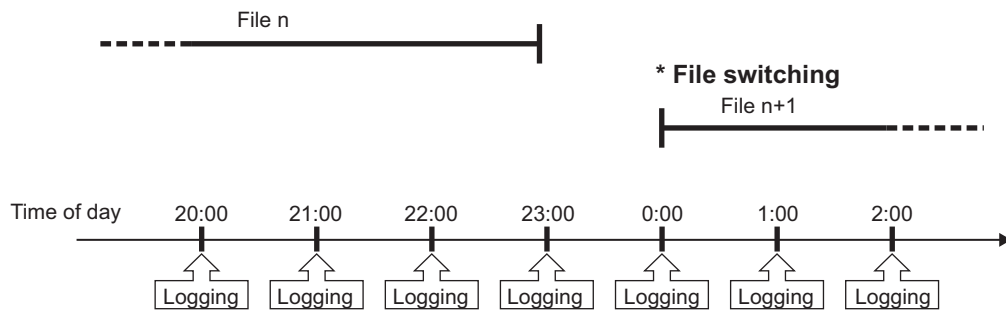

Example 2) "Specifying a time of day": 0 o'clock,
"Logging period": 1 to 22 o'clock

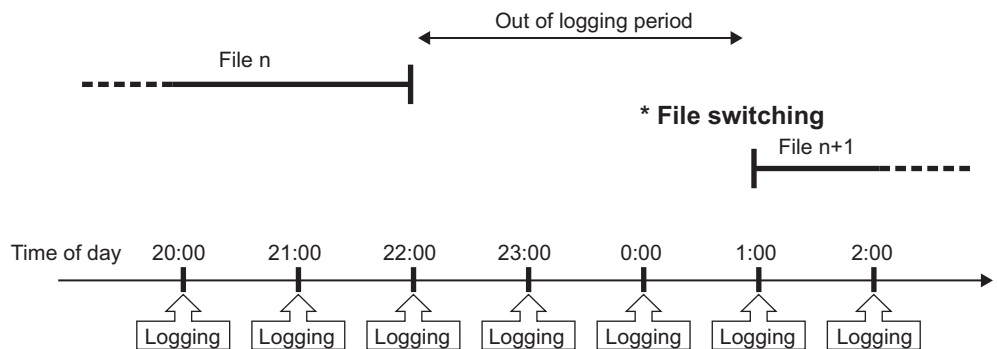

11 FUNCTIONS OF CONFIGURATION TOOL (MODULE SETTINGS)

Example 3) "Specifying a time of day": 0 o'clock,
Programmable controller system is OFF from 22:30 to 0:30

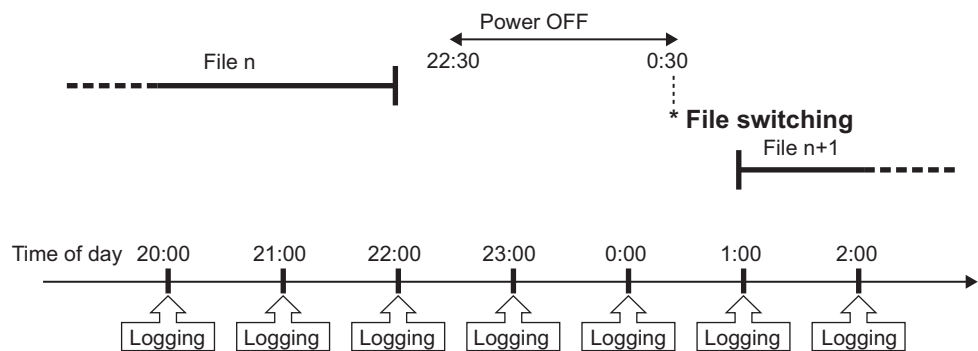

Example 4) Startup of module

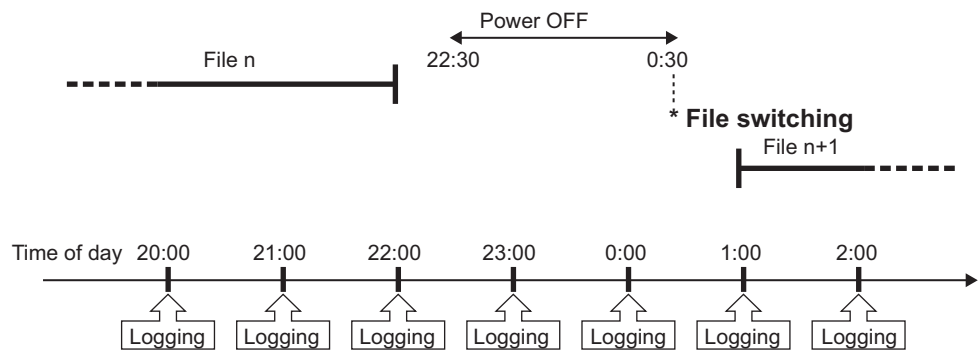

⑤ Trigger logging unit

Example) "Trigger condition": M0=ON, "Before trigger": 100 lines, "After trigger": 50 lines

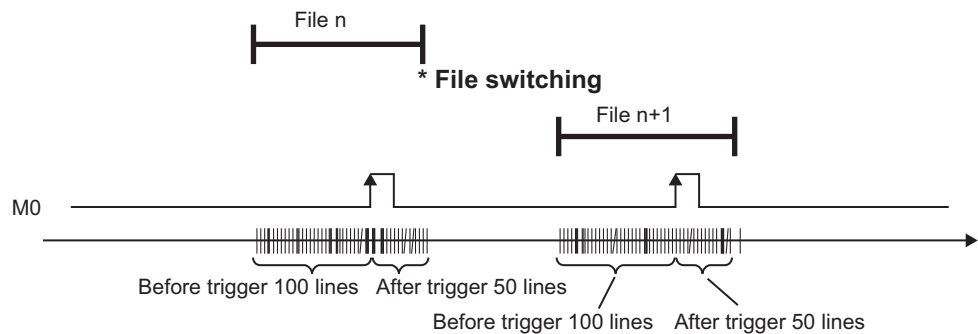

POINT

A file switching is performed at module startup and setting update when the file format is "CSV file" and the "Output index column" item is checked on the "CSV output" screen.

11 FUNCTIONS OF CONFIGURATION TOOL (MODULE SETTINGS)

(3) Saved file name

Set the information which is to be attached to the saved file name.

Setting screen

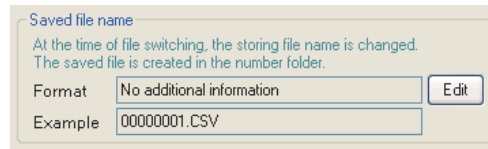

Item	Description	Reference
Format	Displays the output format of the saved file.	-
Example	Displays the output image of the file name in a current format.	-
 button	Opens the "Saved file name setting" screen to set the information which is to be attached to the saved file name.	(3) (a) in this section

POINT

The saved file number (00000001 to FFFFFFFF) to identify saved files is always attached to the saved file name.

Example of a saved file name: LOG01_20090410_00000001.CSV (Name and date are attached)

Name (optional) Date (optional) Saved file number (required)

11 FUNCTIONS OF CONFIGURATION TOOL (MODULE SETTINGS)

(a) Saved file name setting screen

Setting screen

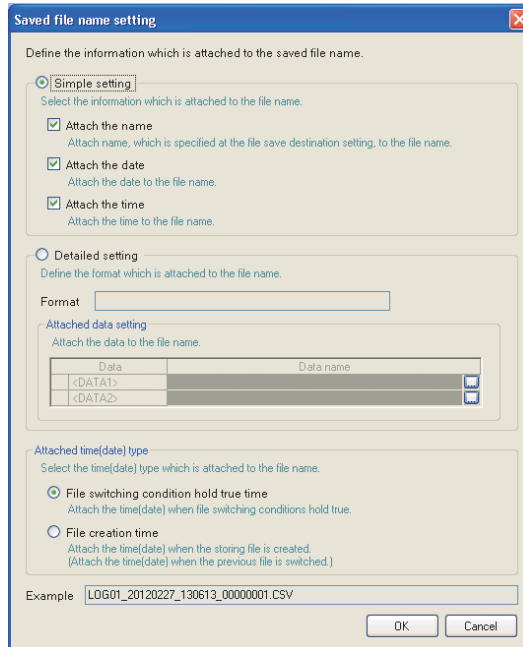

Item	Description	Reference																
Simple setting	Adds the information to the file name in a fixed format.	-																
Attach the name	Check to attach the characters, which are specified at the file save destination setting, to the file name.	-																
Attach the date	Check to attach the date to the file name. Year-month-day (YYYYMMDD) is attached.* ¹	-																
Attach the time	Check to attach the time to the file name. Hour-minute-second (hhmmss) is attached.* ¹	-																
Detailed setting	Specify the format of the information which is to be attached to the file name.	-																
Format	<p>Specify the output format of the information which is to be attached to the file name. Enter the output format using the characters usable in file names and folder (directory) names (Appendix 4.2). (Within 32 characters)</p> <p>Date and time, and data can be specified using the following reserved words.*^{2*3}</p> <ul style="list-style-type: none"> • YYYY : Year (4 digits) • YY : Year (2 digits) • MM : Month (2 digits) • DD : Day (2 digits) • ddd : Day of the week (3 digits) • hh : Hour (2 digits) • mm : Minute (2 digits) • ss : Second (2 digits) • <DATA1> :Content of data specified at <DATA1> • <DATA2> :Content of data specified at <DATA2> <p>The following abbreviations are output for days of the week.</p> <table border="1" style="width: 100%; text-align: center;"> <thead> <tr> <th></th> <th>Monday</th> <th>Tuesday</th> <th>Wednesday</th> <th>Thursday</th> <th>Friday</th> <th>Saturday</th> <th>Sunday</th> </tr> </thead> <tbody> <tr> <td>Abbreviation</td> <td>Mon</td> <td>Tue</td> <td>Wed</td> <td>Thu</td> <td>Fri</td> <td>Sat</td> <td>Sun</td> </tr> </tbody> </table>		Monday	Tuesday	Wednesday	Thursday	Friday	Saturday	Sunday	Abbreviation	Mon	Tue	Wed	Thu	Fri	Sat	Sun	-
	Monday	Tuesday	Wednesday	Thursday	Friday	Saturday	Sunday											
Abbreviation	Mon	Tue	Wed	Thu	Fri	Sat	Sun											

(Continued on the next page)

11 FUNCTIONS OF CONFIGURATION TOOL (MODULE SETTINGS)

(From the previous page)

Item	Description	Reference
Attached data setting	Set the data which are to be attached to the file name. The content of the set data is attached to the file name.	-
Data *4	Check to attach the data to the file name. Adds <DATA1><DATA2> to the end of the "Format".	-
Data name	Displays the data specified at <DATA1><DATA2>. To change the data to be attached to the file name, click  on the right of the input field and change it on the displayed "Data setting" screen.	Section 11.2.9
Attached time (date) type	Select the time (date) type to be attached to the file name.	-
File switching condition hold true time	Check to attach the time (date) when file switching conditions hold true.	-
File creation time	Check to attach the time (date) which is when the storing file was created or when the previous file switching was executed.	
Example	Displays the output image of the file name in a current format.	-

*1: When both of time and date are to be attached, the format is fixed as [YYYYMMDD_hhmmss].
Time cannot be attached before date.

*2: The number of "<DATA1>""<DATA2>" that can be set in the format is one each.

*3: A reserved word quoted with double quotes (") is attached as a string to the file name. A double quote (") itself is not attached as a string to the file name.
The reserved word <DATA1><DATA2> cannot be attached to the file name.

Example: When "Format" is ["HDD"_LOTNo_<DATA1>_YYYYMMDD] and settings of <DATA1> are "Device Head": D0, Word[signed], Zero padding, and "Number of total digits": 4.

HDD_LOTNo_0000_20090630_00000001.CSV

↑String

↑Reserved word

*4: When data cannot be sampled at the time of file switching, "NODATA" (fixed string) is added to the saved file name.

POINT

- (1) Regardless of selection of the simple setting or detailed setting, the saved file number is always attached to the saved file name.
- (2) Depending on the settings, the file switching process may take time.
In this case, a newer time than the time stamp of the first record in the logging file is attached even if "File creation time" is checked.
- (3) In the following cases, when "File creation time" is checked, the different time from the time stamp of the first record in the logging file may be attached to the file name depending on the length of file switching processing time or the timing of executing file switching.
 - "Trigger logging unit" is checked on "File switching timing".
 - File switching is executed while logging is not executed.
- (4) When "File creation time" is checked, the even number of seconds are attached to the file name. The odd number of seconds is rounded down to the even number of seconds.

11 FUNCTIONS OF CONFIGURATION TOOL (MODULE SETTINGS)

(b) Output format screen

Specify the output format of data which are to be attached to the file name.

Setting screen

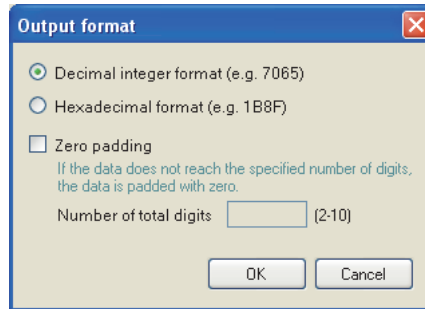

Item	Description
Decimal integer format	Select this to output in a decimal integer format.
Hexadecimal format	Select this to output in a hexadecimal integer format (characters are upper case).
Zero padding	Check to zero pad the output data. If the number of digits of output data is less than the specified number of digits, the data are zero padded.
Number of total digits	Specify the number of total digits of output data at zero padding. If the number of digits of the output data is the same as or more than the specified number of total digits, the data are not zero padded.

POINT

When "Zero padding" is checked, '0' is appended to the saved file name according to the specified number of total digits.

Example) When 'BAT<DATA1>_YYYYMMDD_ddd_hhmmss' is set as the format, and the start device D0 for <DATA1>, Word [Unsigned], 4 for the number of the total digits are specified

- For D0=12
BAT0012_20090410_Fri_154030_00000001.CSV
↑ '0' is appended to the value of D0 because the number of digits is less than the specified number of total digits.
- For D0=32768
BAT32768_20090410_Fri_154030_00000001.CSV
↑ Only the value of D0 itself is output because the number of digits is the same or more than the specified number of total digits.

11 FUNCTIONS OF CONFIGURATION TOOL (MODULE SETTINGS)

(4) Number of saved files

Set the maximum number of saved files and the operation when the maximum number is exceeded.

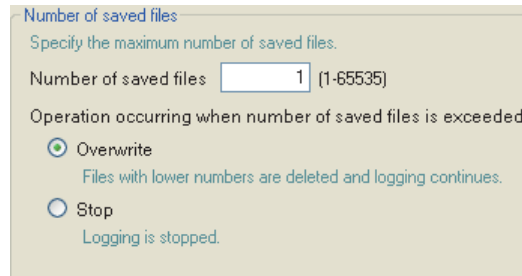

Item	Description
Number of saved files	Specify the maximum number of saved files. (1 to 65535)
Operation occurring when number of saved files is exceeded	-
Overwrite	Select this to delete files with low numbers and continue data logging when at file switching the number of saved files has already exceeded the specified number. When the folder where files with low numbers are deleted becomes empty, that folder is automatically deleted.
Stop	Select this to stop data logging when at file switching the number of saved files has already exceeded the specified number. *1. Turns ON the corresponding bit for 'Number of saved files exceeded information' in the buffer memory's data logging status area. Delete the latest saved file or the saved file with the lowest number via FTP or with the file browser of the Configuration Tool to restart data logging.

*1: The storing file and the specified number of saved files are saved on the CompactFlash card.

POINT



The number of saved files is calculated by the saved file number as shown below.

$$\text{Latest saved file number} - \text{Lowest saved file number} + 1$$

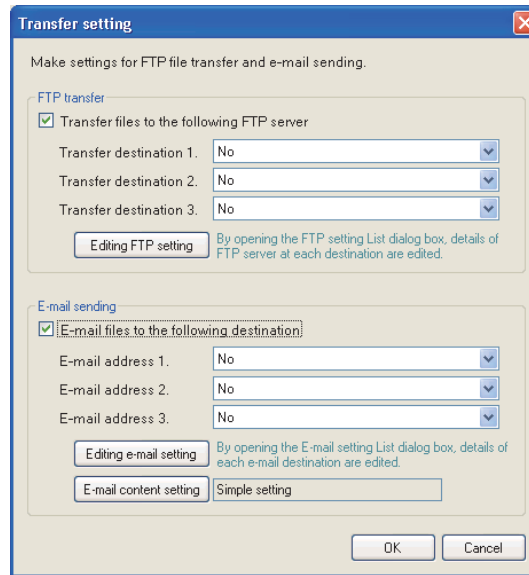

(5) Transfer setting screen

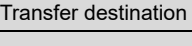
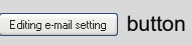
Transfers the latest saved file when the file is switched.



Item	Description	Reference
Transfer files to the following FTP server	Check to transfer the file to the FTP servers.	-
Transfer destination 1. to 3.	Select from the FTP servers registered on the "FTP setting" screen.	-
 button	Opens the "FTP setting" screen to edit the details of each destination FTP server.	(5) (a) in this section
E-mail files to the following destination	Check to attach the file to an e-mail and send it.	-
E-mail address 1. to 3.	Select from the destination group names registered with "E-mail setting" screen.	-
 button	Opens the "E-mail setting" screen to edit the e-mail destinations.	(5) (b) in this section
 button	Opens the "E-mail content setting" screen to edit the e-mail contents.	(5) (c) in this section

POINT

- (1) E-mail transmissions/file transfers by the saved file transfer function may take a few seconds to tens of seconds depending on the network line/transmission size.
Target files may be deleted before e-mail transmission/file transfer completes depending on the settings.
Review the file switching timing ( (2) in this section) and the number of saved files ( (4) in this section) setting and lengthen the time until the file is deleted.
- (2) Do not configure the transfer settings when performing data logging using the auto logging function ( Section 10.2).
When using the auto logging function, the high speed data logger module cannot connect to the LAN line, therefore FTP transfers and e-mail transmissions cannot be performed.

11 FUNCTIONS OF CONFIGURATION TOOL (MODULE SETTINGS)

(a) FTP setting screen

Setting screen

No.	FTP server name	Login user name	Password	Directory path	Data transfer mode
01					
02					
03					
04					
05					
06					
07					
08					
09					
10					
11					
12					
13					
14					
15					
16					

The items are the same as those of "FTP setting" screen of Common setting. For details, refer to the following section.

☞ Section 11.4.4 FTP setting

(b) E-mail setting screen

Setting screen

No.	Destination group name	E-mail address [When specifying more than one address, separate them by " , " (comma)]
01		
02		
03		
04		
05		
06		
07		
08		
09		

The items are the same as those of "E-mail setting" screen of Common setting. For details, refer to the following section.

☞ Section 11.4.5 E-mail setting

11 FUNCTIONS OF CONFIGURATION TOOL (MODULE SETTINGS)

(c) E-mail content setting screen

Setting screen

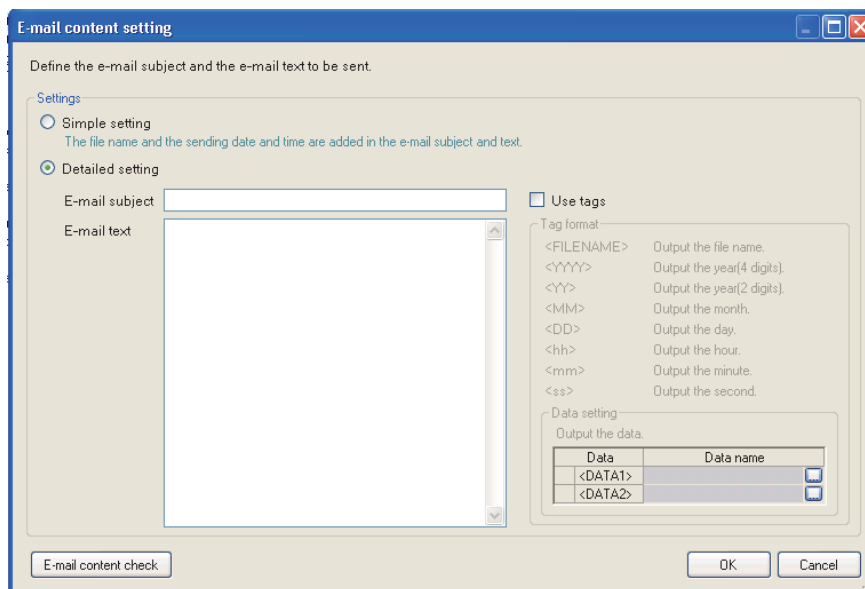

Item	Description	Reference
Settings	Set the subject and text.	-
Simple setting	Appends the file name and sent date/time to the e-mail subject and text.	-
Detailed setting	Specify the information to be appended to the e-mail subject and text.	-
E-mail subject	Specify the format of e-mail subject. The tag format can be used. (Up to 64 characters)	-
E-mail text	Specify the format of e-mail text. The tag format can be used. (Up to 2048 characters)	-
Use tags	Check this to validate the tag input. Specify the following tag items to append the sent date/time and data to the e-mail. *1*2	-
Tag format	<FILENAME>: File name <YYYY>: Year (4 digits) <YY>: Year (2 digits) <MM>: Month <DD>: Day <hh>: Hour <mm>: Minute <ss>: Second <DATA1>: Data set for <DATA1>. <DATA2>: Data set for <DATA2>.	-
Data setting	Set when data are output.	-
Data	Check this to append data to the E-mail subject or E-mail text.	-
Data name	Displays data names set for <DATA1> and <DATA2>.	-
Data name display field	Displays set data.	-
button	Displays "Data setting" screen.	Section 11.2.9
E-mail content check button	Displays "E-mail content check" screen.	(5) (d) in this section

*1: Total of 16 tags can be set for E-mail subject and E-mail text.

*2: Tags can be invalidated by adding another brackets.

(The item enclosed with outer brackets can be handled as a string.

Example: "<FILENAME>" is handled as a string by describing it as <<FILENAME>>.

11 FUNCTIONS OF CONFIGURATION TOOL (MODULE SETTINGS)

(d) E-mail content check screen

Setting screen

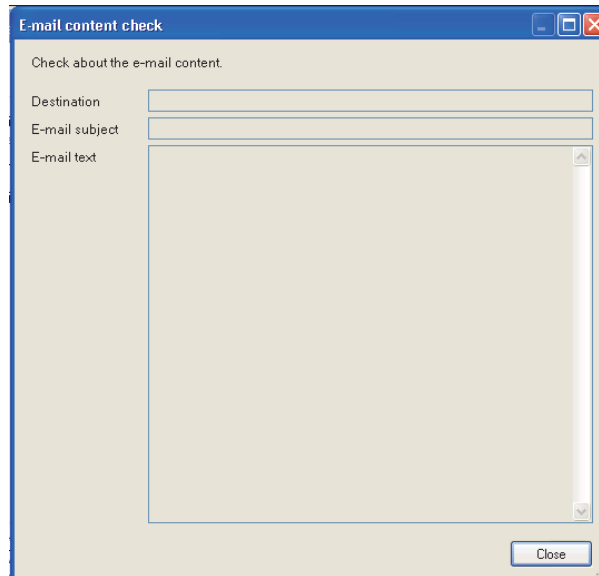

Item	Description
Destination	Displays the send target group name.
E-mail subject	Displays the contents entered in "E-mail subject" on the "E-mail content setting" screen.
E-mail text	Displays the contents entered in "E-mail text" on the "E-mail content setting" screen.

POINT

When the data tag (<DATA1>, <DATA2>) is used on the "E-mail content setting" screen, the following character is displayed on the "E-mail content check" screen.

Data setting	Output character
Decimal/Hexadecimal	0
String	s

The displayed value changes depending on the specified size or the number of digits specified for zero padding. As an output example, "ssssssss" is displayed when the specified size is 8, and "0000000000000000" is displayed when the number of digits specified for zero padding is 16 (size 8). (When the number of digits for zero padding is not specified, 0 is displayed.)

Display example

E-mail text <MM>/<DD>/<YYYY> <tt><mm><ss> Transferred

[Logging data contents]

Process name : <DATA1>

Line No. : <DATA2>

<DATA1>

Data type String

Size 8

<DATA2>

Data type Raw

Size 8

E-mail text 04/09/2010 18:48:57 Transferred

[Logging data contents]

Process name : SSSSSSSS



Line No. : 0000000000000000

11 FUNCTIONS OF CONFIGURATION TOOL (MODULE SETTINGS)

11.5.16 Completion

Gives a name to the data logging and completes the settings.

Setting screen

Item	Description
Data logging name	Specify the name of the setting being edited. For the characters that can be set, refer to the following chapter. 📖 Appendix 4 Usable Characters (Up to 32 characters)
 button	Confirms the settings being edited. After confirming the settings, the data logging name is displayed in the following. <ul style="list-style-type: none"> • On the edit items tree, under the "Data logging setting" folder • Data logging setting list
 button	Discards the data logging settings being edited and ends editing.

11 FUNCTIONS OF CONFIGURATION TOOL (MODULE SETTINGS)

11.6 Event Logging Setting

This section explains the settings for the event logging function.

For an overview of the event logging function, refer to the following chapter.

☞ Chapter 8 EVENT LOGGING FUNCTION

11.6.1 Event logging setting list

This section explains the items on the event logging setting list screen.

Operating procedure

Click "Event logging setting" on the edit items tree.

Screen display

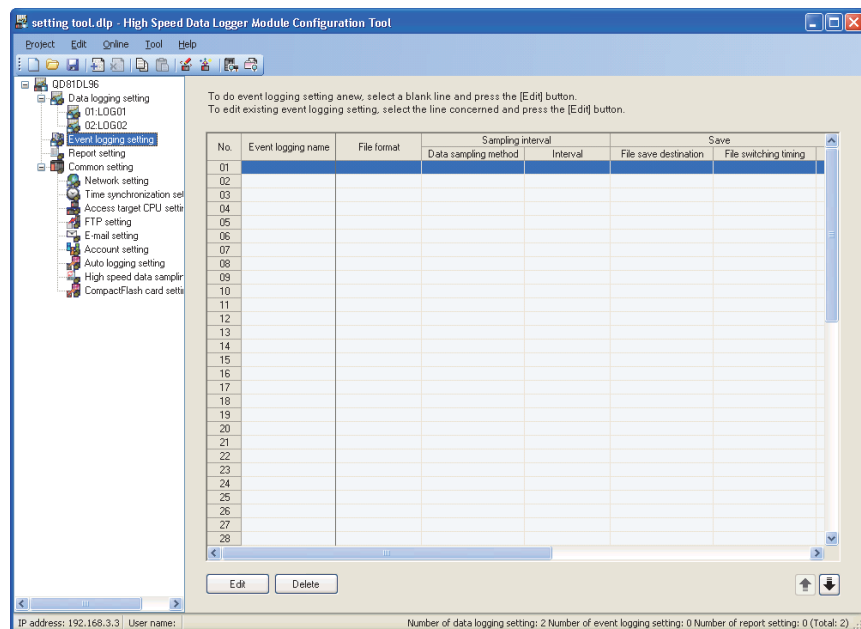

The setting details are described on the next page.

Remark

The existing event logging settings can be utilized by using "Import from project file" (☞ Section 11.3.4) function.



The setting time can be reduced by utilizing the existing settings.

11 FUNCTIONS OF CONFIGURATION TOOL (MODULE SETTINGS)



The following table shows the items displayed on the event logging setting list.

Item	Description	Reference
Event logging name	Displays the event logging name.	Section 11.6.15
File format	Displays the file format of the event logging file.	Section 11.6.3
Sampling interval	Displays the settings related to sampling target data for events.	Section 11.6.4
Data sampling method	Displays "High speed" or "General".	
Interval	Displays the sampling interval of the target data.	
Save	Displays the save settings of the event logging file.	Section 11.6.13
File save destination	Displays the save destination.	
File switching timing	Displays the switching timing for the event logging file by separating with commas. Example) 1000[Line],16384[KB].	
Saved file name	Displays the information to attach to the event logging file name.	
Number of saved files	Displays the upper limit of the number of saved files.	
Transfer	Displays the transfer settings of the event logging file.	-
FTP transfer	Displays if there is an FTP transfer.	Section 11.6.13
E-mail sending	Displays if there is an e-mail transmission when an event occurs.	
E-mail notice	Displays if there is an e-mail notification when an event occurs.	Section 11.6.14

The following table shows the buttons for operating the event logging setting list.

Item	Description	Reference
 button	Displays the 'Event logging setting' screen to edit the selected row of settings. If the selected row is empty, new event logging settings are added to that row.	Section 11.6.2
 button	Deletes the selected row of settings.	-
 button	Shifts the selected row one row up or one row down.	-

POINT

Multiple rows can be selected and deleted or moved in batch by clicking on them while pressing the  key or  key.

11 FUNCTIONS OF CONFIGURATION TOOL (MODULE SETTINGS)





11.6.2 Event logging setting screen transitions

Event logging settings are configured in a wizard format.

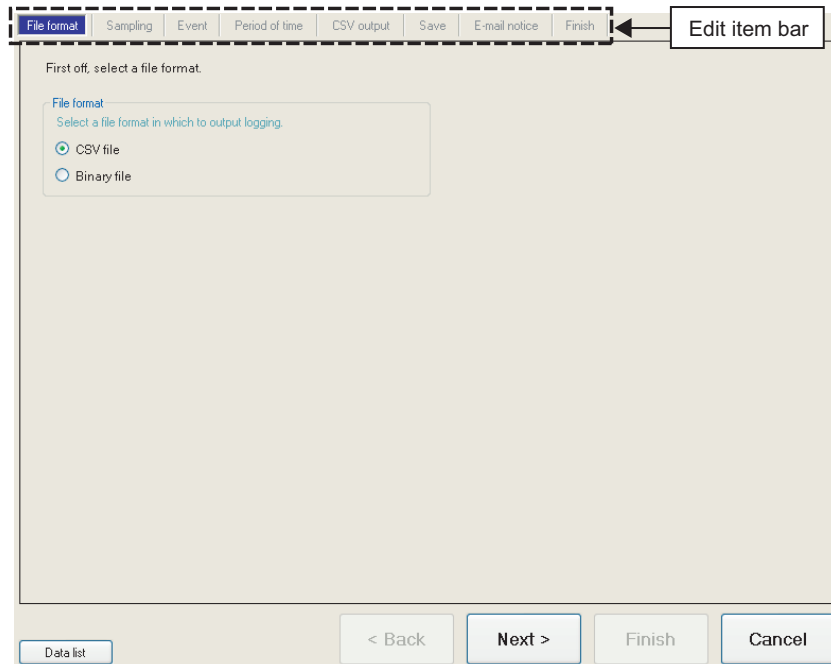
The title of each wizard screen is displayed in the 'edit item bar' in the upper portion of the detailed setting screen. Setting operations are performed in order from the items to the left in the 'edit item bar' to those in the right.

Setting screen



Item	Description	Reference
 button	Displays a list of all data being used by all the event logging setting.	Section 11.2.7
 button	Moves the setting wizard screen being edited to the previous screen (left).	(1) in this section
 button	Moves the setting wizard screen being edited to the next screen (right).	
 button	Confirms the event logging settings being edited and completes editing. After completing the settings, returns to the event logging setting list screen.	-
 button	Discards the event logging settings being edited and ends editing. After cancelling the settings, returns to the event logging setting list screen.	-

11 FUNCTIONS OF CONFIGURATION TOOL (MODULE SETTINGS)

(1) Wizard display and operations

(a) Edit item status

The setting status of the wizards on the edit item bar can be checked by color.

Status	Configured	Being edited	Not configured
Text color	Blue	White	Gray
Background color	Light gray	Blue	Light gray
Example	File format	Sampling	Event

(b) Screen transitions with the < Back / Next > buttons

Move between edit item screens with the < Back / Next > buttons.



(c) Screen transitions by mouse

The setting screen for configured items can be moved directly by clicking the 'edit item bar'.



(d) Editing items of event logging settings

Editing items of event logging settings are made up of the following types.

Setting items	Reference
File format	Section 11.6.3
Sampling	Section 11.6.4
Event	Section 11.6.5
Period of time	Section 11.6.10
CSV output* ¹	Section 11.6.11
Binary output* ¹	Section 11.6.12
Save	Section 11.6.13
E-mail notice	Section 11.6.14
Finish	Section 11.6.15

*1: Configures the output format setting selected in "File format".

11 FUNCTIONS OF CONFIGURATION TOOL (MODULE SETTINGS)

11.6.3 File format

This section explains the settings for specifying the file format for saving events.

Setting screen

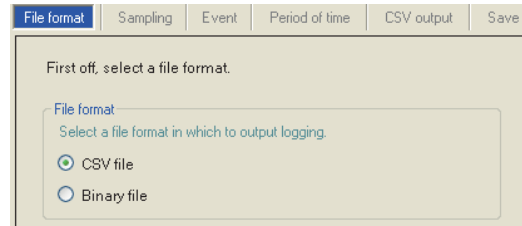

File format | Sampling | Event | Period of time | CSV output | Save

First off, select a file format.

File format
Select a file format in which to output logging.

CSV file
 Binary file

Item	Description	Reference
File format	Select the file format to save events.	-
CSV file	Saves in the CSV file format.	Section 3.6.3
Binary file	Saves in the binary file format.	Section 3.7.2

11.6.4 Sampling

This section explains the settings for selecting the data sampling method for event target data and specifying the data sampling interval.

For details on processes of each sampling method, refer to the following section.

☞ Section 8.2 Target Data Sampling

Setting screen

Item	Description	Reference
High speed data sampling	High-speed event logging is possible using the high speed data sampling function.	Section 8.2
Sampling interval	-	
Each scanning cycle	Samples data with each sequence scan.	
Time specification	Samples data at the specified interval. (1 to 32767ms)	
Sampling is made on a consecutive series of devices	<ul style="list-style-type: none"> • Checked^{*1} : Improves the efficiency of the data sampling and reduces the load imposed on the target programmable controller CPU. Data to be sampled must be one type of devices with consecutive device numbers. • Unchecked : Different types of devices with inconsecutive device numbers can be specified. The number of settings is up to 5 settings for all high speed data logger module settings combined (data logging settings, event logging settings, and report settings). 	-

(Continued on the next page)

11 FUNCTIONS OF CONFIGURATION TOOL (MODULE SETTINGS)

(From the previous page)

Item	Description	Reference
General sampling	<ul style="list-style-type: none"> Set the data sampling interval in seconds. (0.1 to 0.9, 1 to 32767 seconds) Select when sampling data which exceeds 256 points. Select when sampling data from a programmable controller CPU via the network. 	Section 8.2
Sampling interval	-	-
Time specification	Samples data at the specified interval. (0.1 to 0.9 seconds, 1 to 32767 seconds)	-
Time interval specification	Samples data at the time interval of every specified hour/minute/second.	(1) in this section

*1: When checked, there are the following restrictions.

- The trigger condition which can be set with the "Event" setting can only be a single condition. (☞ Section 11.6.6)
- Only the data set with the "Event" can be set as the data conditions in the "Period of time" setting. (☞ Section 11.6.10)
- Only the data set with the "Event" can be set as the data conditions in the file switching condition setting of the "Save" setting. (☞ Section 11.6.13)
- Information cannot be attached to the saved file name in the "Save" setting. (☞ Section 11.6.13)

(1) Available time intervals

The following shows the time units and their intervals which can be specified for sampling interval.

Hour: 1, 2, 3, 4, 6, 8, 12, 24

Minute: 1, 2, 3, 4, 5, 6, 10, 12, 15, 20, 30, 60

Second: 1, 2, 3, 4, 5, 6, 10, 12, 15, 20, 30, 60

POINT

- (1) For the types of programmable controller CPUs, product information, and system configurations of high speed data sampling, refer to the following section.
 - ☞ Section 7.2.1 (1) System configurations compatible with high speed data sampling
- (2) For devices which can be specified during high speed data sampling, refer to the following section.
 - ☞ Section 3.2 (3) Accessible devices
- (3) The total number of data logging, event logging, and report settings in which high speed data sampling is set, is a maximum of 32 settings.
- (4) When high speed data sampling is specified, there is an effect on the sequence scan time because of the data transfer from the programmable controller CPU to the high speed data logger module.
The sequence scan time delay can be adjusted with the high speed data sampling setting.
For the effect on the sequence scan time, refer to the following sections.
 - ☞ Section 17.3 Effect on Sequence Scanning Time
 - ☞ Section 11.4.8 High speed data sampling setting
- (5) Since general data sampling is not synchronized with the control CPU's sequence scan, data separation may occur.
 - ☞ Section 3.2 (6) Access unitsTo perform data sampling synchronized to the sequence scan, use high speed data sampling.

11 FUNCTIONS OF CONFIGURATION TOOL (MODULE SETTINGS)

11.6.5 Event setting list

This section explains the list of events set with event logging.

Screen display

No.	Event name	Event type	Conditions	Device	Occurrence	Restoration	Data value output
01	Event(1)	Single	1	D100	Occurrence	Restoration	Not to be outputted
02	Event(2)	Single	1	D101	Occurrence	Restoration	Not to be outputted
03	Event(3)	Single	1	D102	Occurrence	Restoration	Not to be outputted
04	Event(4)	Single	1	D103	Occurrence	Restoration	Not to be outputted
05	Event(5)	Single	1	D104	Occurrence	Restoration	Not to be outputted
06	Event(6)	Single	1	D105	Occurrence	Restoration	Not to be outputted
07	Event(7)	Single	1	D106	Occurrence	Restoration	Not to be outputted
08	Event(8)	Single	1	D107	Occurrence	Restoration	Not to be outputted
09	Event(9)	Single	1	D108	Occurrence	Restoration	Not to be outputted
10	Event(10)	Compound (Compari	1	M0	Occurrence	Restoration	Not to be outputted
11							
12							
13							
14							
15							
16							
17							
18							
19							
20							
21							
22							
23							
24							
25							
26							

The following table shows the items displayed on the event list.

Item	Description	Reference
Event name	Displays the event name.	Section 11.6.6
Event type	Displays the type of event. (Single, Compound (Comparison), Compound (Number of times), Compound (Order))	-
Conditions	Displays the number of conditions set for the event. (1 to 4)	-
Device	Displays the monitoring target devices used by the event setting.	-
Occurrence	Displays the comment when the event occurs.	Section 11.6.6
Restoration	Displays the comment when the event is restored.	
Data value output	Displays if there is output of the data value when the event occurs.	

The following table shows the buttons for operating the event list.

Item	Description	Reference
button	Displays the setting screen to edit the selected row of settings.	Section 11.6.6
button	Deletes the selected row of settings.	-
button	Inserts events in batch.	Section 11.6.9
button	Shifts the selected row one row up or one row down.	-

11 FUNCTIONS OF CONFIGURATION TOOL (MODULE SETTINGS)

11.6.6 Event setting

This section explains the settings of event occurrence conditions and the information to output to the event logging at the event occurrence/restoration.
 For details on processes of each event occurrence condition, refer to the following section.
 ← Section 8.1.2 Event conditions

Setting screen

The screenshot shows a dialog box titled "Event setting". It has a blue title bar with a close button. The main area is light beige and contains several sections:

- Event name:** A text box with the placeholder "Assign a name to the event." and a label "Event name".
- Comment:** Two text boxes labeled "Comment at event occurrence" (with "Occurrence" as a placeholder) and "Comment at event restoration" (with "Restoration" as a placeholder). Above them is the instruction "Output the comment at the occurrence of an event or at the restoration thereof."
- Data value output:** A checkbox labeled "Output data values" with the instruction "Output data values at the occurrence of an event."
- Condition type:** Two radio buttons: "Single condition" (which is selected) and "Compound condition".

Item	Description
Event name	Set the event name to be output at the event occurrence/restoration.
Event name	Set the event name. (Up to 32 characters)
Comment	Set the comments to be output at the event occurrence/restoration.
Comment at event occurrence	Specify the string to be output at the event occurrence. (Up to 32 characters)
Comment at event restoration	Specify the string to be output at the event restoration. (Up to 32 characters)
Data value output	-
Output data values	Check to output the data value at the event occurrence.
Single condition	Select this to set a single trigger condition.
Compound condition	Select this to set a combination of multiple trigger conditions.

POINT

Compound condition cannot be selected when "Sampling is made on a consecutive series of devices" is checked in the sampling settings.

11 FUNCTIONS OF CONFIGURATION TOOL (MODULE SETTINGS)



11.6.7 Event setting (single condition)

This section explains the event setting with a single event occurrence condition. For details on processes of each single condition, refer to the following section.

☞ Section 8.1.2 (1) Single condition

One type of event condition can be specified on the screen below.

Setting screen

Item	Description	Reference
Monitoring data	Set the monitoring target data.	-
No.	Displays the index number of the monitoring target data.	-
Data name	For related data, set the data name. An icon () is appended. For normal data, displays the start device.	-
Device	Specify the event monitoring device.	-
Head* ²	Specify the start device.	Section 3.2 (2), (3)
Last	Displays the end device calculated from the data type and size.	-
Access target CPU* ²	Select the access target CPU from the CPUs set with the access target CPU setting. To add an access target CPU, select "(Add)" from the list box and click the  button.	Section 11.4.3
Data type* ²	Select the data type for monitoring data from the following.* ¹ <ul style="list-style-type: none"> • Bit • Word [signed] • Double word [signed] • Word [unsigned] • Double word [unsigned] • FLOAT [single precision] • FLOAT [double precision] • 16bit BCD • 32bit BCD • String • Raw 	-
Size* ²	Specify the size if the data type is "String" or "Raw". (1 to 8192 bytes)	-
Scaling	Set when performing a scaling conversion from the programmable controller CPU device value to the monitoring data.	Section 11.5.6 (1)
Output Format	Specify the format (such as decimal format, exponential format) when the monitoring data are output to a file.	Section 11.5.6 (2)

(Continued on the next page)

11 FUNCTIONS OF CONFIGURATION TOOL (MODULE SETTINGS)

(From the previous page)

Item	Description	Reference
<input type="button" value="Import"/> button	Imports global labels or device comments.	Section 11.2.10 (1) Section 11.2.10 (4)
<input type="button" value="Release relation"/> button	Disables relations with global labels.	Section 11.2.10 (2)
Condition	-	-
=, ≠, <, ≤, >, ≥	Select the operator used to compare the trigger value with the monitoring data.	-
Value change	The event occurs when the value of the monitoring data changes. (When value change is specified, the event is not restored.)	(1) in this section
Trigger value	Specify the constant or string to compare with the monitoring data.	-
Trigger value	Specify the constant data (up to 16 characters) to compare with the monitoring data.	-
Specify restoration values	Check to specify the restoration value to suppress event occurrence.	(2) in this section
Restoration value	Specify the restoration value (up to 16 characters).	-
<input type="button" value="OK"/> button	Confirms the settings and closes the screen.	-
<input type="button" value="Cancel"/> button	Discards the settings and closes the screen.	-

*1: Match to the data type with the one used for writing device values using a sequence program or HMI.

*2: Related data cannot be edited.

(1) Value change

The following shows the timing of the event occurrence when value change is specified as the condition.

For a bit device:

The event occurs when it changes from ON to OFF and from OFF to ON.

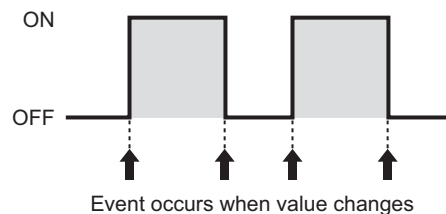

For a word device:

The event occurs with each change of the value.

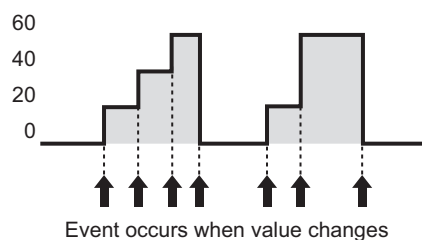

11 FUNCTIONS OF CONFIGURATION TOOL (MODULE SETTINGS)

(2) About restoration values

- ① Set the restoration value from the monitoring conditions.
- ② Can be set when the monitoring condition is \geq , $>$, $<$, or \leq
- ③ The event is restored in the situations below.

Monitoring condition	Restoration condition
Monitoring data = Trigger value	Monitoring data \neq Trigger value
Monitoring data \neq Trigger value	Monitoring data = Trigger value
Monitoring data \geq Trigger value	Monitoring data $<$ Restoration value
Monitoring data $>$ Trigger value	Monitoring data \leq Restoration value
Monitoring data $<$ Trigger value	Monitoring data \geq Restoration value
Monitoring data \leq Trigger value	Monitoring data $>$ Restoration value

Example 1) When a restoration value is not specified

Event condition	Restoration value
D0 > 100	-

When D0 > 100, the event occurs and the event is restored when D0 \leq 100. The event occurs frequently.

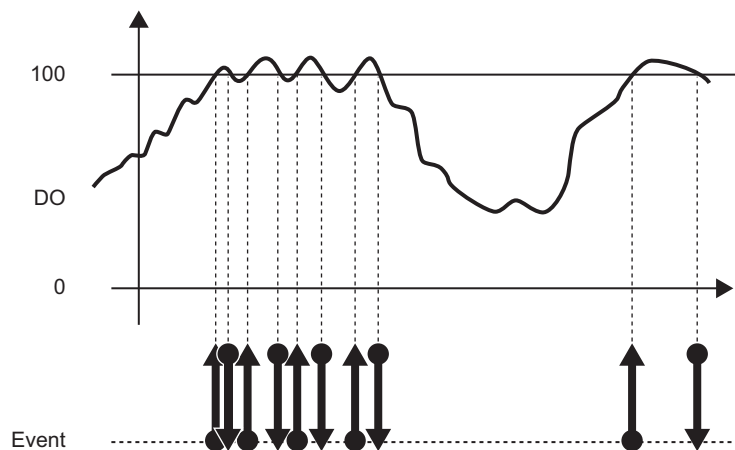

11 FUNCTIONS OF CONFIGURATION TOOL (MODULE SETTINGS)

Example 2) When a restoration value is specified

Event condition	Restoration value
D0>100	70

When $D0 > 100$, the event occurs and the event is restored when $D0 \leq 70$. Frequent occurrence of the event is suppressed by specifying a restoration value.

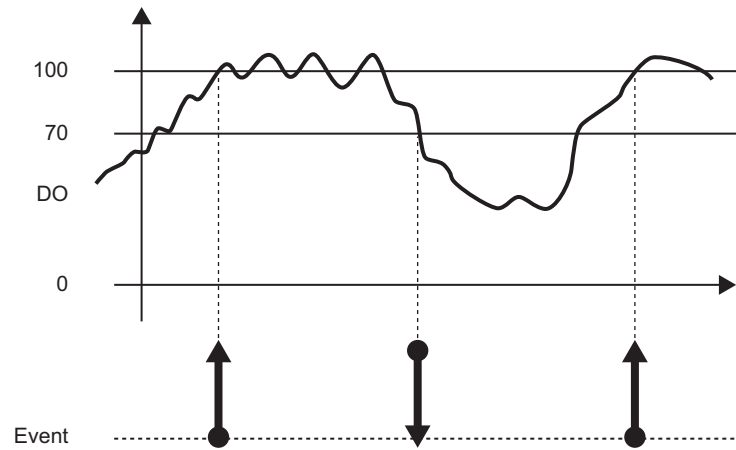

11.6.8 Event setting (compound condition)

This section explains the method for specifying a combination of multiple event occurrence conditions.

For details on processes of compound condition, refer to the following section.

☞ Section 8.1.2 (2) Compound conditions

(1) Comparison

Setting screen

(a) List items

Item	Description	Reference
Comparison	Compares monitoring data, the event occurs when the condition is established.	-
AND combine	The event occurs during the interval when all of the conditions specified on the list of conditions are established.	(1) (b) in this section
OR combine	The event occurs when any of the conditions specified on the list of conditions are established.	(1) (c) in this section
Number of times	The event occurs by monitoring the number of times the condition is established.	(2) in this section
Order	The event occurs by monitoring the order the conditions are established.	(3) in this section
List of conditions	Displays the list of conditions.	-
Type	Displays "Comparison" when comparison is selected.	
Content	Displays the overview of the condition.	
button	Displays the setting screen to edit the condition in the selected row.	(1) (a) in this section
button	Deletes the condition in the selected row.	-
button	Shifts the selected row one row up or one row down.	-
button	Confirms the settings and closes the screen.	-
button	Discards the settings and closes the screen.	-

11 FUNCTIONS OF CONFIGURATION TOOL (MODULE SETTINGS)

(b) Editing the comparison condition

Editing of the comparison condition is performed on the "Comparison" screen.

Setting screen

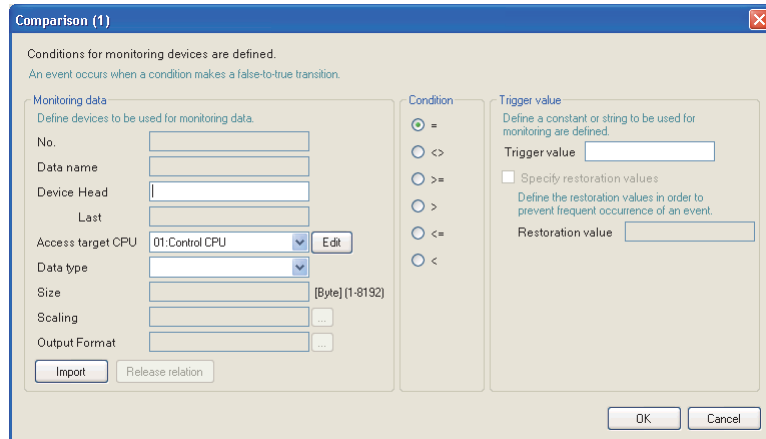

The items are the same as those of Single condition. Refer to the following section.

☞ Section 11.6.7 Event setting (single condition)

(c) For AND combine

The event occurs during the interval when all of the conditions specified on the list of conditions are established.

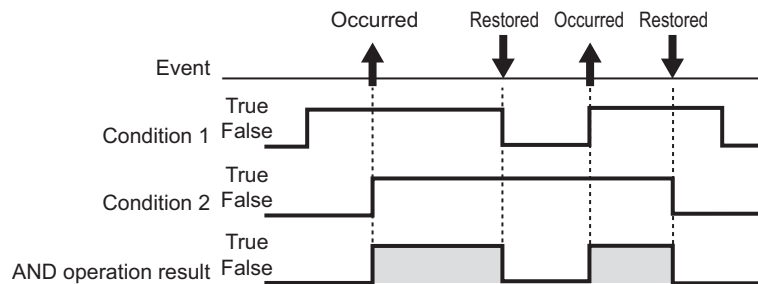

(d) For OR combine

The event occurs when any of the conditions specified on the list of conditions are established.

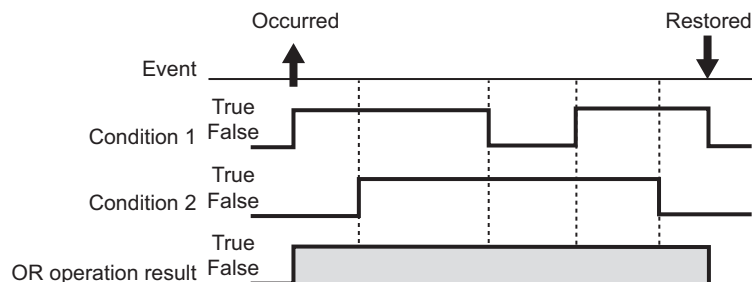

11 FUNCTIONS OF CONFIGURATION TOOL (MODULE SETTINGS)

(2) Number of times

Compares the number of times the count condition established with the specified count and the event occurs.

Setting screen

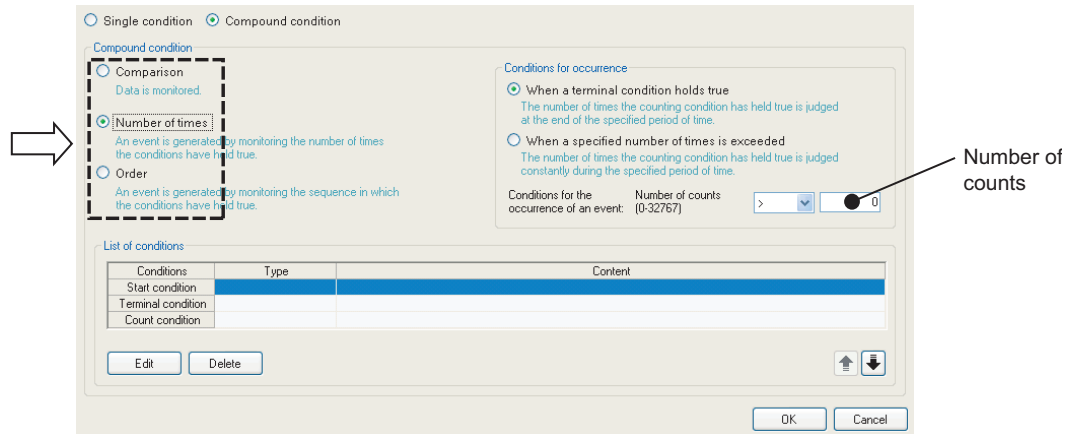

Item	Description	Reference
Comparison	Compares monitoring data, the event occurs when the condition is established.	(1) in this section
Number of times	The number of times the count condition is established is compared with the specified count and the event occurs.	
Conditions for occurrence	-	-
When a terminal condition holds true	Judges the number of times the count condition was established during the period when the end condition is established.	(2) (b) in this section
When a specified number of times is exceeded	The event occurs immediately when the established count exceeds the specified count.	(2) (c) in this section
Conditions for the occurrence of an event	Set the "Number of counts" to compare with the number of times the count condition is established (established count) and the comparison operator ("=", "≠", "≤", "≥", "<", ">"). The event occurs if the comparison result is true. If "When a specified number of times exceeded" is selected, the condition is fixed as ">".	-
Number of counts	Set the count to compare to the established count. (0 to 32767)	-
Order	The event occurs by monitoring the order the conditions are established.	(3) in this section
List of conditions	Displays the list of conditions.	
Start condition	Displays the condition to start counting for the established count.	
Terminal condition	Displays the condition to stop counting for the established count.	
Count condition	Displays the condition to increment the established count.	-
Type	Displays "Comparison" or "At the time of change of value".	
Content	Displays the overview of the condition.	
Edit button	Displays the setting screen to edit the condition in the selected row.	(2) (a) in this section
Delete button	Deletes the condition in the selected row.	-
Up/Down button	Shifts the selected row one row up or one row down.	-

11 FUNCTIONS OF CONFIGURATION TOOL (MODULE SETTINGS)

(a) Editing the conditions for number of times

Editing of the conditions for number of times is performed on the "Number of times" screen.

Setting screen

Number of times (Start conditions)

Comparison
As a result of a data-to-data or data-to-constant comparison, a given condition holds true.

Data name	Conditions	Data/Constant	Data name/Constant value

At the time of change of value
When a specified data value changes, a given condition holds true.

Data name

OK Cancel

The items on the "Number of times" screen are the same as those of "Data conditions" of the trigger (single condition) in Data logging setting. For details, refer to the following section.

☞ Section 11.5.10 (1) Trigger condition setting screen

11 FUNCTIONS OF CONFIGURATION TOOL (MODULE SETTINGS)

(b) Count condition when terminal condition is established

Counts the number of times the count condition was established from when the start condition is established until the terminal condition is established (count period).

The event occurrence condition is evaluated when the terminal condition is established and the event occurs if true.

After that, the established count is reset when the terminal condition is established and the next count starts.

The start, terminal, and count conditions are judged on the rise of the condition establishment.

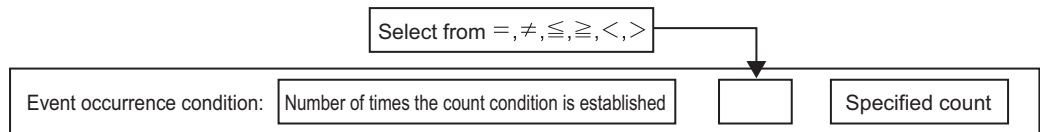

Example: For Event occurrence condition: (Established count) > 2 (specified count)

In the diagram below, the established count is 3 when the terminal condition is established, fulfilling the occurrence condition.

The event occurs when the terminal condition is established.

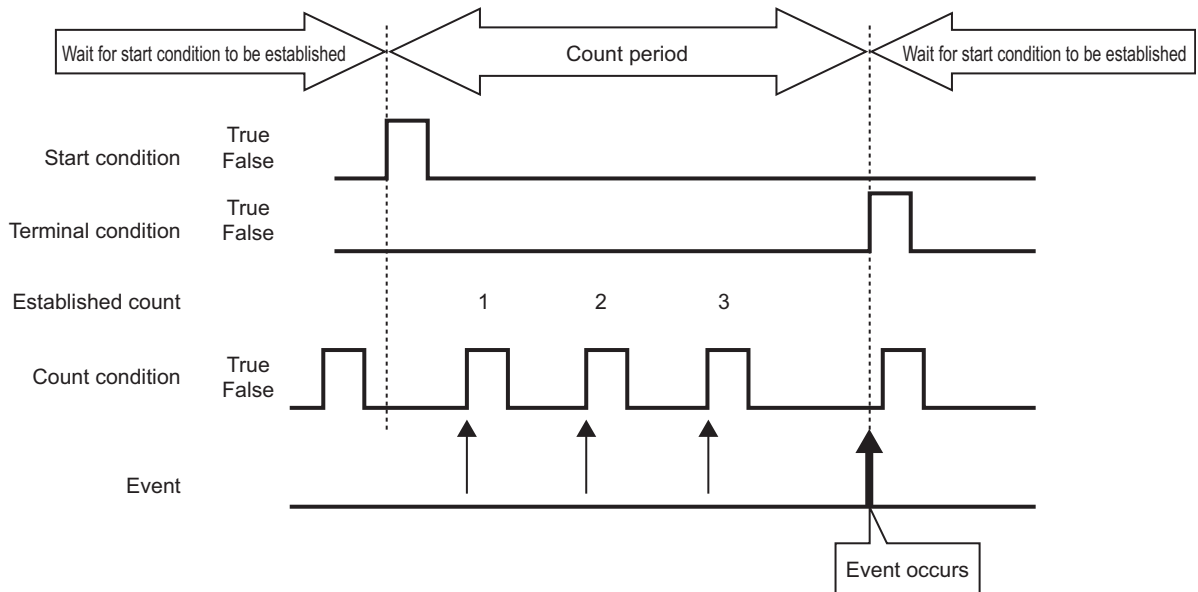

11 FUNCTIONS OF CONFIGURATION TOOL (MODULE SETTINGS)

(c) When specified count is exceeded

Counts the number of times the count condition was established from when the start condition is established until the terminal condition is established (count period).

During the count period, the event occurrence condition is always evaluated and the event occurs immediately if true.

After that, the established count is reset when the terminal condition is established and the next count starts.

The start, terminal, and count conditions are judged on the rise of the condition establishment.

Event occurrence condition:	Number of times the count condition is established	>	Specified count
-----------------------------	--	---	-----------------

Example: For Event occurrence condition: (Established count) > 2 (specified count)

The event occurs when the event occurrence condition is fulfilled as shown below.

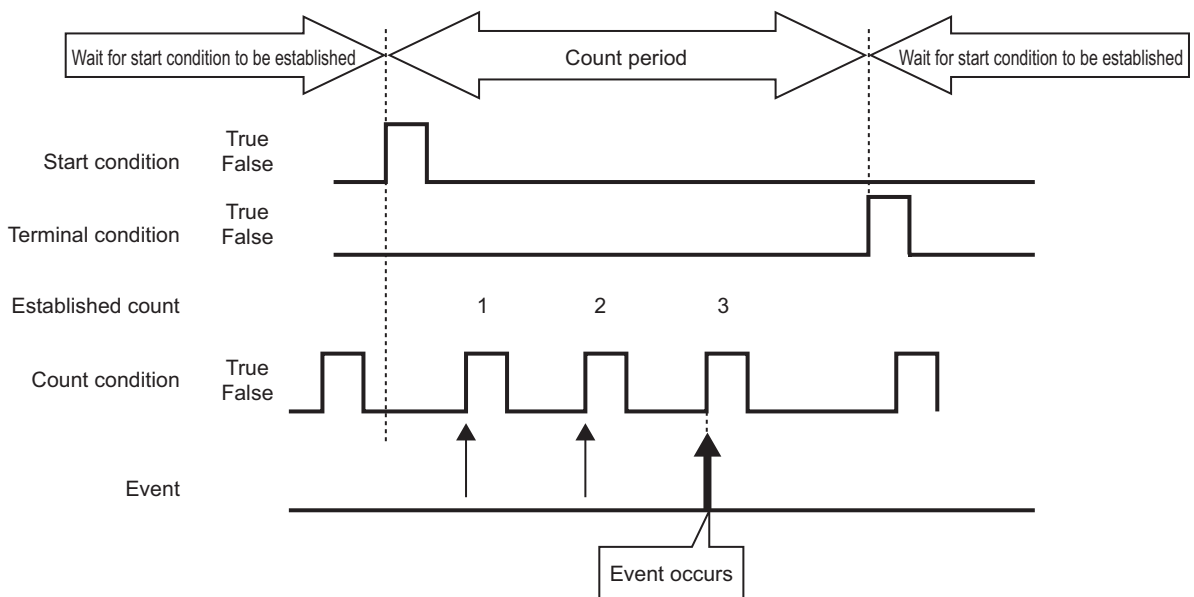

11 FUNCTIONS OF CONFIGURATION TOOL (MODULE SETTINGS)

(3) Order

Monitors the order that multiple conditions are established and the event occurs if they are out of order (when abnormal pattern is detected) or if in order (when normal pattern is detected).

Setting screen

Item	Description	Reference
Comparison	Compares monitoring data, the event occurs when the condition is established.	(1) in this section
Number of times	The number of times the count condition is established is compared with the specified count and the event occurs.	(2) in this section
Order	The event occurs by monitoring the order the conditions are established.	
Selecting conditions for occurrence	-	-
Abnormal pattern is detected	The event occurs when conditions are established out of order.	(3) (b) in this section
Normal pattern is detected	The event occurs when conditions are all established in order.	(3) (c) in this section
Timeout detected	The event occurs when any of the conditions are not established within the monitoring timeout.	(3) (d) in this section
List of conditions	Displays the list of conditions.	
Start condition	Displays the condition to start monitoring the condition establishment order.	
1st/2nd/3rd condition	Displays the conditions to monitor in order.	
Type	Displays "Comparison" or "At the time of change of value".	
Content	Displays the overview of the condition.	
Monitoring timeout [second]	Displays the timeout time when monitoring conditions in each order.	
Edit button	Displays the setting screen to edit the condition in the selected row.	(3) (a) in this section
Delete button	Deletes the condition in the selected row.	-
Up/Down button	Shifts the selected row one row up or one row down.	-

11 FUNCTIONS OF CONFIGURATION TOOL (MODULE SETTINGS)

(a) Editing the order conditions

Editing of the order conditions is performed on the "Order" screen.

Setting screen

Order (Start conditions)

Comparison
As a result of a data-to-data or data-to-constant comparison, a given condition holds true.

Data name	Conditions	Data/Constant	Data name/Constant value

At the time of change of value
When a specified data value changes, a given condition holds true.

Data name

Monitoring timeout
If a given condition does not occur within the specified period of time, monitoring is redone beginning with the start condition.

[] [Second] (0.1-0.9, 1-32767)

OK Cancel

The items of "Comparison" and "At the time of change of value" are the same as those of "Data conditions" of the trigger (single condition) in Data logging setting.

For details, refer to the following section.

☞ Section 11.5.10 (1) Trigger condition setting screen

For "Monitoring timeout", refer to the following section.

☞ (3) (d) in this section Monitoring timeout

9

REPORT FUNCTION

10

OTHER FUNCTIONS

11

FUNCTIONS OF CONFIGURATION TOOL (MODULE SETTINGS)

12

FUNCTIONS OF CONFIGURATION TOOL (WRITING/READING/VERIFYING DATA)

13

FUNCTIONS OF CONFIGURATION TOOL (CONFIRMING MODULE OPERATION)

14

FUNCTIONS OF LOGGING FILE CONVERSION TOOL

15

RECIPE FUNCTION

16

CompactFlash CARD

11 FUNCTIONS OF CONFIGURATION TOOL (MODULE SETTINGS)

(b) Detecting abnormal pattern

Starts monitoring the order from when the start condition is established, and detects a pattern of conditions established in an order which differs from the 1st condition, 2nd condition, 3rd condition order.

The event occurs when the conditions are established in an order which differs from the specified order.

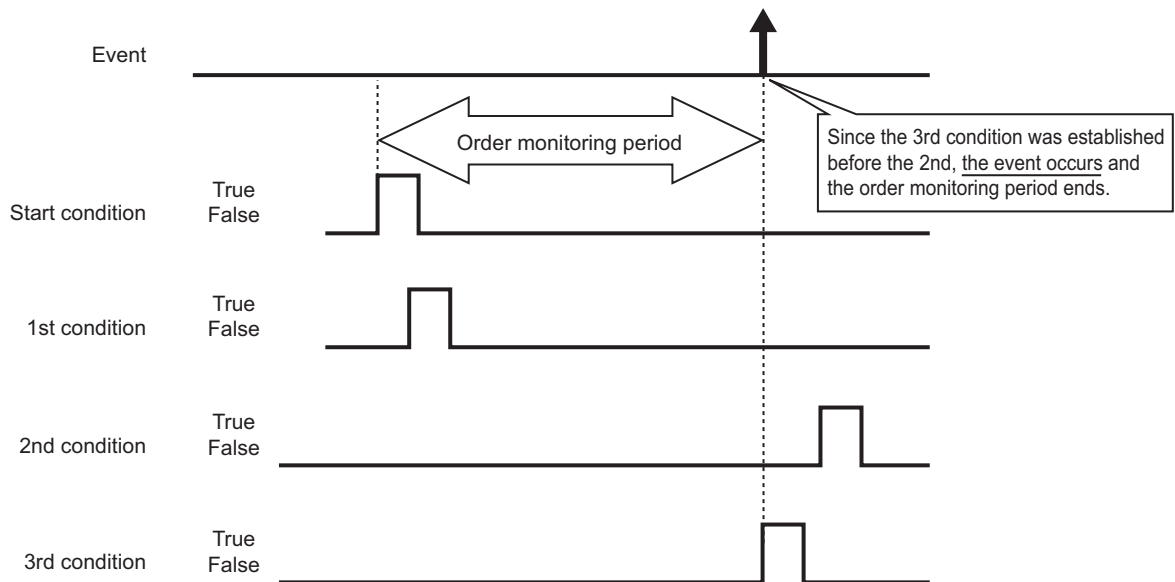

(c) Detecting normal pattern

Starts monitoring the order from when the start condition is established, and detects the pattern of conditions established in 1st condition, 2nd condition, 3rd condition order.

The event occurs when the conditions are established in the specified order.

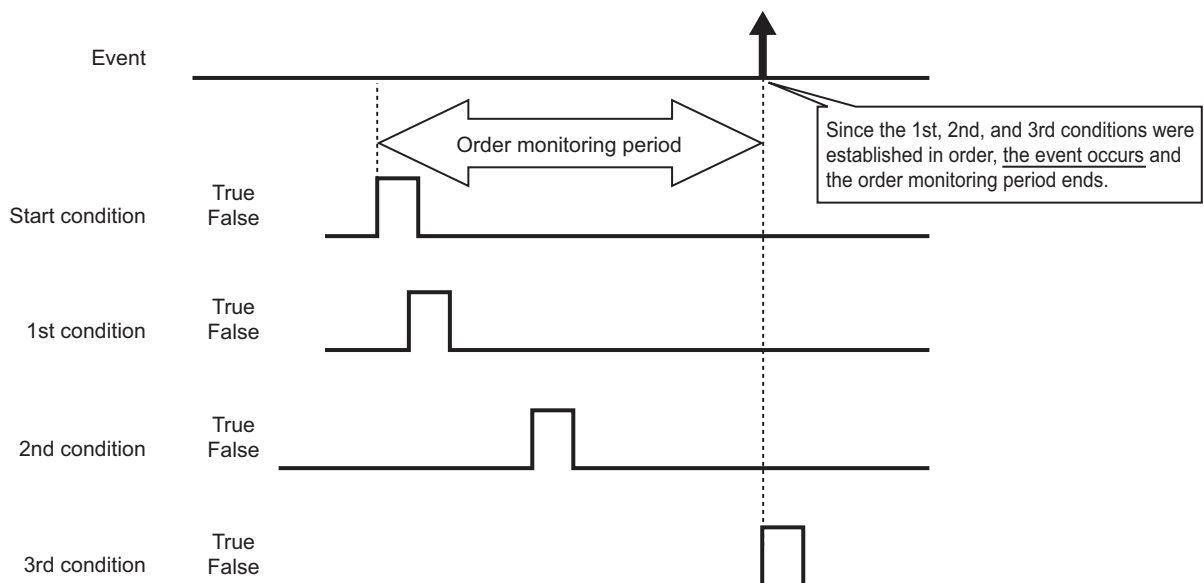

POINT

- (1) If the start condition is established again during the order monitoring period, monitoring returns to the 1st condition establishment wait state and order monitoring continues.
- (2) If two or more conditions are established simultaneously, the conditions are considered to have been established in the specified order, so the event will not occur when detecting an abnormal pattern.

(d) Monitoring timeout

After one condition is established, monitors the condition until the next condition is established.

If the specified monitoring timeout time elapses and the next condition is not established, this is considered as a timeout and order monitoring ends, and it again waits for the order start condition to be established.

For the diagram below, after the 1st condition is established, because the 2nd condition was not established within the monitoring timeout time, this is a monitoring timeout.

If "Timeout detected" is checked on the "Order" list screen ( (3) in this section), the event occurs at the same time the timeout occurs.

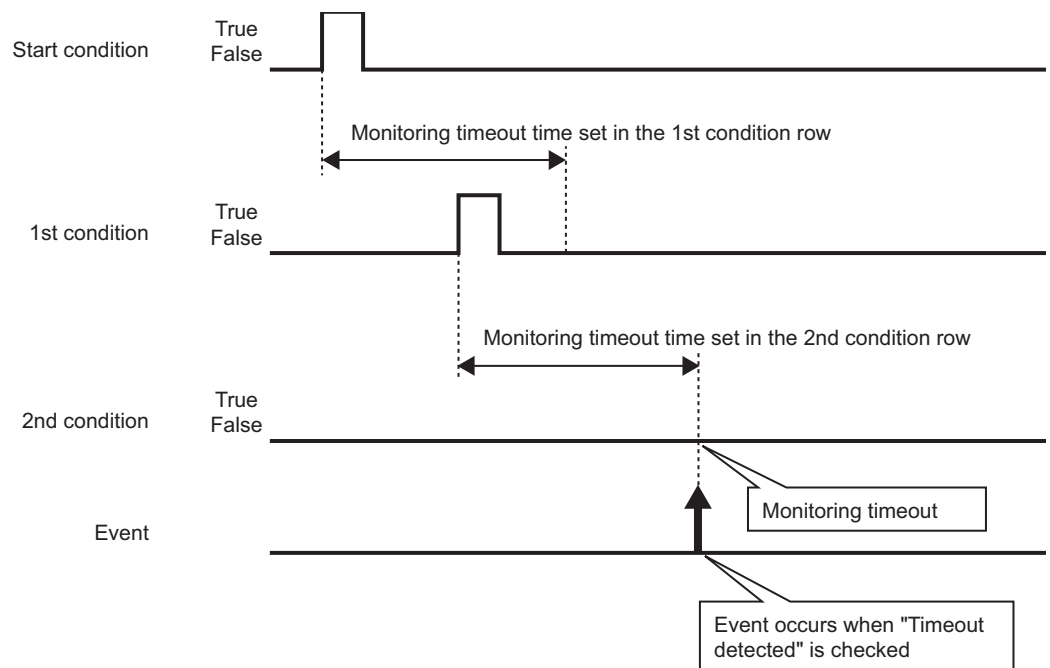

Set "Monitoring timeout" time on the "Order" screen.

 (3) (a) in this section Editing the order conditions

The setting range is shown below.

0.1 to 0.9, 1 to 32767 seconds



When the setting value of "Monitoring timeout" is smaller than that of the sampling interval, a timeout occurs. When "Timeout detected" is checked, an event occurs.

11 FUNCTIONS OF CONFIGURATION TOOL (MODULE SETTINGS)



11.6.9 Event batch insertion

This section explains the method for inserting events to the event logging setting list in batch.

Operating procedure

Click the  button on the "Event" screen ( Section 11.6.5).

Setting screen

Item	Description	Reference
Event name	Displays the event name, or used to change the event name. (Up to 32 characters)	Section 11.6.6
Append subscripts to event names	Check to append a serial number to the event name set by the user.	(1) in this section
Continuous setting	Set the total amount of events to batch insert with a continuous number and the interval.	(2) in this section
Total number	Specify the total amount of events to batch insert. (2 to 64 points)	
Interval	Specify the device interval of the monitoring data to batch insert.*1 (1 to 2108416 points)	
Auto interval setting	Check to set the interval automatically in order to avoid gaps between the devices to be batch inserted.	
Comment setting	Set the comments to be output at the event occurrence/restoration.	Section 11.6.6
Data value output	Outputs the data value at the event occurrence.	Section 11.6.6
Conditions	Specify the event occurrence condition.	Section 11.6.7 Section 11.6.8
 button	Confirms the settings and closes the screen.	-
 button	Discards the settings and closes the screen.	-

*1: Cannot be specified when "Sampling is made on a consecutive series of devices" is checked on the "Sampling" screen.

(1) Event names and subscripts in the continuous setting

The following shows how the event name is set by the "Append subscripts to event names" check box.

Example settings) Event name = Event
 Continuous setting total number = 3
 Continuous setting interval = 1

For the above example settings, the data names are set as shown below.

Item	Example 1	Example 2
A subscript is appended to event name	Unchecked	Checked
Event name	Event	Event(1)
	Event	Event(2)
	Event	Event(3)

(2) Total number and interval in the continuous setting

Configure when setting devices by leaving a fixed interval.

Example settings) Event name = Event
 Continuous setting total number = 3
 Continuous setting interval = 10
 Start device = D100

For the above settings, devices are set as shown below.



No.	Event name	Event type	Conditions	Device
01	Event(1)	Single	1	D0
02	Event(2)	Single	1	D10
03	Event(3)	Single	1	D20

11 FUNCTIONS OF CONFIGURATION TOOL (MODULE SETTINGS)

11.6.10 Period of time





Specify the period for monitoring the event occurrence.

It is not necessary to configure these settings if always performing event logging.

Processes of period condition are the same as those of Data logging setting. Refer to the following section.

☞ Section 7.4 Data Logging Periods

Setting screen

Item	Description	Reference
Specify a period of time	Check if not always performing event logging.	-
Monitor the event during the period of time which meets specified conditions*1	Select this to perform event logging during the period corresponding to the conditions displayed in the list.	-
Don't monitor the event during the period of time which meets specified conditions*1	Select this to not perform event logging during the period corresponding to the conditions displayed in the list.	-
Type of condition	Displays the condition type. (Data condition, date range, time range, day of week/week condition)	-
Content	Displays the overview of the condition. To check the content, select the corresponding row and click the  button.	-
 button	Displays the setting screen to edit the selected condition.	(1) in this section
 button	Deletes the selected condition.	-
Operator for combination	Specify how to combine the rows of conditions. (OR, AND)	(2) in this section
 button	Shifts the selected row one row up or one row down.	-

*1: Restoration of already occurred events can be monitored even outside the event monitoring period. If an event is restored outside the monitoring period, a restoration comment is output to the logging file.

(1) Setting a period of time screen

Specify the condition to define the period.

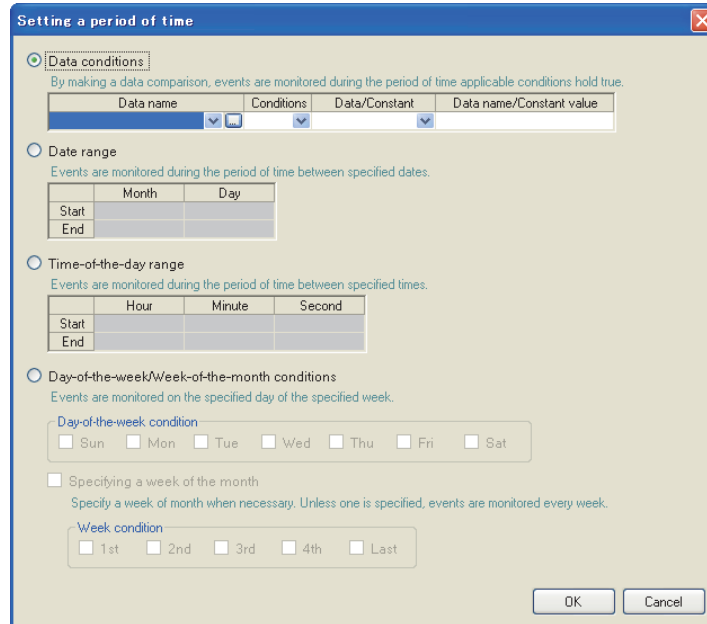



Item	Reference
Data conditions	(1) (a) in this subsection
Date range	(1) (b) in this subsection
Time-of-the-day range	(1) (c) in this subsection
Day-of-the-week/Week-of-the-month conditions	(1) (d) in this subsection

(a) Data conditions

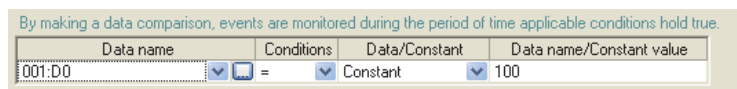
Compares data and executes event logging during the period when the condition is established.



Item	Description
Data name	Select the target data from the data set with "Event setting". To add a new data setting, select "(Add)" from the list box and click  .
Conditions ^{*1}	Select a comparison operator. (=, ≠, <, ≤, >, ≥)
Data/Constant	Select the type of data to compare to the target data. ("Data" or "Constant")
Data name/Constant value	Set the data or constant data (up to 16 characters) to compare to the target data. To add a new data setting, select "(Add)" from the list box and click  .

*1: When data of different data types are compared, the condition may not be established because of the difference in internal representations.

11 FUNCTIONS OF CONFIGURATION TOOL (MODULE SETTINGS)

(b) Date range

Performs event logging during the specified date*¹ period.

Example settings) For the date range specified below

	Month	Day
Start	Mar	28
End	Apr	2

For the above example settings, event logging is executed as shown in the table below.

Date	...	March 27	March 28	...	April 2	April 3	...
Monitor the event during the period of time which meets specified conditions	×	×	○	○	○	×	×
Don't monitor the event during the period of time which meets specified conditions	○	○	×	×	×	○	○

○: Executed ×: Not executed

*1: February 29 cannot be directly set. To specify February 29, select 'last day of February'.

(c) Time-of-the-day range

Executes event logging during the specified time period.

Example settings) For the time range specified below

	Hour	Minute	Second
Start	08	00	00
End	08	00	59

For the above example settings, event logging is executed as shown in the table below.

Time (hour:minute:second)	...	7:59:59	8:00:00	...	8:00:59	8:01:00
Monitor the event during the period of time which meets specified conditions	×	×	○	○	○	×
Don't monitor the event during the period of time which meets specified conditions	○	○	×	×	×	○

○: Executed ×: Not executed

11 FUNCTIONS OF CONFIGURATION TOOL (MODULE SETTINGS)

(d) Day-of-the-week/Week-of-the-month conditions

Performs event logging for the specified day of the week or week. The period can be specified by combining the day of the week and week.

- ① To perform event logging on the specified day of the week each week
Uncheck "Specifying a week of the month".

Example settings) Specify every Monday through Friday

For the above example settings, event logging is executed as shown in the table below.

Day of the week	Sun	Mon	Tues	Wed	Thur	Fri	Sat	Sun	Mon	..
Monitor the event during the period of time which meets specified conditions	×	○	○	○	○	○	×	×	○	..
Don't monitor the event during the period of time which meets specified conditions	○	×	×	×	×	×	○	○	×	..

○: Executed ×: Not executed

11 FUNCTIONS OF CONFIGURATION TOOL (MODULE SETTINGS)

- ② To perform event logging combining the week and day of the week
Check "Specifying a week of the month".

The following table shows the week conditions.

Week condition	Description
1st	From the 1st to the 7th
2nd	From the 8th to the 14th
3rd	From the 15th to the 21st
4th	From the 22nd to the 28th
Last	The 7 days at the end of the month for the corresponding month Example) If the 31st is the end of the month, the 25th to the 31st If the 30th is the end of the month, the 24th to the 30th

Example settings) For the day of the week conditions and week conditions specified below, with the period specified as "Monitor the event during the period of time which meets specified conditions"

Day-of-the-week condition
 Sun Mon Tue Wed Thu Fri Sat

Specifying a week of the month
Specify a week of the month when necessary. Unless one is specified, events are monitored every week.

Week condition
 1st 2nd 3rd 4th Last



Event logging is executed on the shaded portions.

January 2009						
Sun	Mon	Tue	Wed	Thu	Fri	Sat
				1	2	3
4	5	6	7	8	9	10
11	12	13	14	15	16	17
18	19	20	21	22	23	24
25	26	27	28	29	30	31

Day of week condition
"Mon/Tue/Wed/Thu/Fri"

1st
"1st to 7th"

4th
"22nd to 28th"

Last
"25th to 31st"

(2) Condition for combination

Multiple specified conditions can be combined.

"OR" or "AND" can be selected as the combine condition.

The combine condition is applied to all the conditions. "AND" and "OR" cannot be mixed.

(a) For OR combine

When "Monitor the event during the period of time which meets specified conditions" is selected for the period

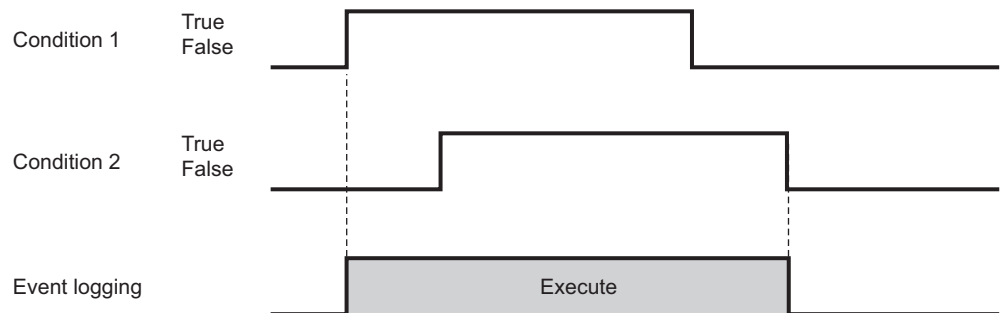

(b) For AND combine

When "Monitor the event during the period of time which meets specified conditions" is selected for the period

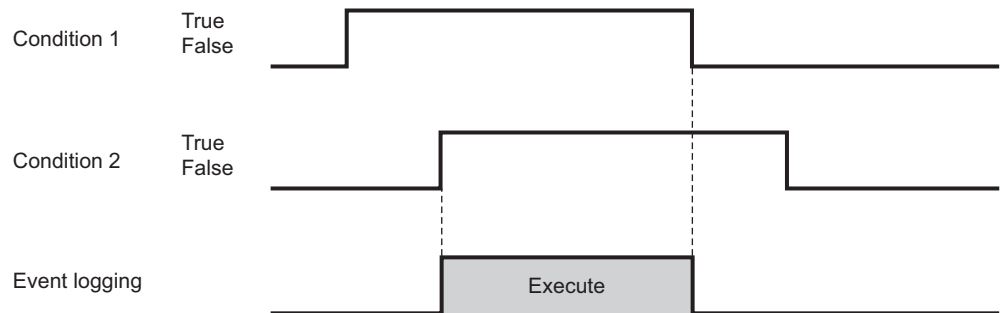

☒ POINT

If high speed data sampling is selected in the data sampling method, the number of conditions which can be combined is up to 4.

11.6.11 CSV output

This section explains the settings related to CSV file output content.
The "CSV output" screen is only displayed when CSV file is selected on the "File format" screen.

POINT

For details on the CSV file format, refer to the following section.

☞ Section 3.6 CSV File Format

Setting screen

Item	Description	Reference
Date column	-	
Specify data format	Check to specify the format of the date column.	
Data name line string	Specify the title of the date column data header line. (Up to 32 characters)	Section 11.5.13 (1)
Data line output format	Specify the output format of the data line for the date column. (Up to 32 characters)	
Example of output	Displays an example of the date column output with the current settings.	

POINT

When CSV files are opened with Excel, the date column format is displayed in Excel's default setting.

Set the cell format as necessary.

Example) To display year, month, date, hour, minute, second, millisecond information

Specify the user defined display format below.

m/d/yyyy hh:mm:ss.000

11.6.12 Binary output

This section explains the settings related to binary file output content. The "Binary output" screen is only displayed when binary file is selected on the "File format" screen.

POINT

For details on the binary file format, refer to the following section.
 Section 3.7 Binary File Format

Setting screen

Item	Description	Reference
Event name information* ¹	-	-
Output the list of event names into the header	Check to output the list of event name to the header in event number order.	Section 3.7.2
Output the event names into record data	Check to output event names that occurred to the record data.	
Data name information	-	
Output the list of data names into the header	Check to output the list of data name used by the event setting to the header.	
Date information	Logging performed by attaching time stamps to data.	
In second	Outputs the date data in second units. (Outputs the accumulated number of seconds since 1970)	-
In nanosecond* ²	In addition to seconds, outputs the date data in nanosecond units.	
Comment information	-	-
Output comment into record data	Check to output comments to record data.	Section 3.7.2

*1: File space can be saved by setting to only output the event name to the header and not to the record. In this case, the event name output to the header can be referred from the event number in the record data.

*2: Data value is rounded off to 0.1 millisecond unit when the high speed data sampling is specified, and to 100 millisecond unit when the general data sampling is specified.

11 FUNCTIONS OF CONFIGURATION TOOL (MODULE SETTINGS)

11.6.13 Save

This section explains the method for setting the event logging file save destination and saved file switching.

This setting is applied to both the "CSV file" and "Binary file" formats.

Processes of saving settings are the same as those of Data logging setting. Refer to the following section.

☞ Section 7.5.2 Saving data logging files

Setting screen

Item	Description	Reference
File save destination	Specify the save directory (file name) for the event logging file. Data are added sequentially to the specified file.	(1) in this section
File switching setting	-	Section 7.5.2
File switching timing	Specify the timing to switch the file to a new file.	(2) in this section
Saved file name	Changes the name of the file up to then when the file is switched. Information to be attached to the changed file name can be set.	(3) in this section
Number of saved files	Specify the maximum number of files to be saved on the CompactFlash card.	(4) in this section
<input type="button" value="Transfer setting"/> button	Displays the setting screen to edit the settings to transfer the saved file by FTP or to send it by e-mail.	(5) in this section
FTP transfer destination	Displays the FTP transfer destination setting. • If no setting : No setting • If there is a setting: Displays the FTP setting number	
E-mail address	Displays the e-mail destination setting. • If no setting : No setting • If there is a setting: Displays the target e-mail address setting number	

11 FUNCTIONS OF CONFIGURATION TOOL (MODULE SETTINGS)

(1) File save destination

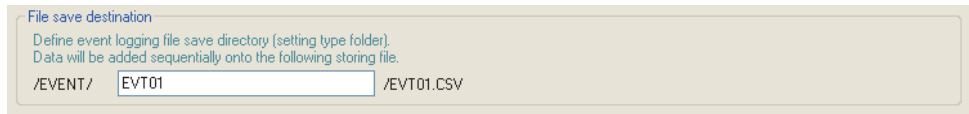

Item	Description
File save destination	Specify the name of the folder to save files in. For the characters that can be set, refer to the section below. Appendix 4.2 Characters usable in file names, folder (directory) names Specify a name that is not a duplicate of the file save destination of other event logging files. (Within 32 characters)

256 event logging files are saved in a folder of the specified "File save destination". The files with low numbers which are deleted by the setting of "Number of saved files" are included in these files.

The 257th file is saved in a new folder.

The following table shows the saved file name when the save folder and additional information are not set.

File type folder	Save folder		Saved file name		
	Setting type folder	Number folder			
\EVENT	\EVT01	\0000001	00000001.CSV (.BIN)	} 256	
			00000002.CSV (.BIN)		
			:		
			000000FF.CSV (.BIN)		
		00000100.CSV (.BIN)			
		\0000101	00000101.CSV (.BIN)		} 256
			00000102.CSV (.BIN)		
			:		
	000001FF.CSV (.BIN)				
	:	:	:		
	\EVT02	\0000001	00000001.CSV (.BIN)	} 256	
			00000002.CSV (.BIN)		
			:		
			000000FF.CSV (.BIN)		
		00000100.CSV (.BIN)			
		\0000101	00000101.CSV (.BIN)		} 256
			00000102.CSV (.BIN)		
			:		
	000001FF.CSV (.BIN)				
	:	:	:		

11 FUNCTIONS OF CONFIGURATION TOOL (MODULE SETTINGS)

Item	Description
File type folder	Folders are created automatically according to the type of saved file. "LOGGING": Stores data logging files. (☞ Section 11.5.15 (1)) "EVENT": Stores event logging files. "REPORT": Stores report files. (☞ Section 11.7.8 (1))
Setting type folder	Files are sorted according to the save directory name set for "File save destination" on the <<Save>> tab of the event logging setting.
Number folder	Files are sorted according to the specified number of saved file. Folder name: 100 x n + 1 is displayed in 8 digits (n=0, 1, 2, 3, ...) Example: 00000001, 00000101, 00000201, 00000301
Saved file name	A saved file name is expressed as 8 digits. The output format can be changed in the "Saved file name" setting on the <<Save>> tab of the event logging setting.

11 FUNCTIONS OF CONFIGURATION TOOL (MODULE SETTINGS)

(2) File switching timing



Specify the timing to switch the file to a new file.

If the condition specified with file switching timing is fulfilled, the file where data are being stored (storing file) is saved in the save folder/with the saved file name (👉 (1) in this section) as the event logging file.

Setting screen

The screenshot shows a dialog box titled "File switching setting". Inside, there is a section "File switching timing" with the instruction "File switching is effected when any of the conditions holds true." There are three options, all of which are checked:

- Number of records: 1000 [Line] (100-100000). Description: "File switching is effected when a specified number of lines (number of records) is reached."
- File size: 16384 [KB] (10-16384). Description: "File switching is effected when a specified file size is reached."
- Condition specification: D11=32252. Description: "File switching is effected when the following conditions hold true." Below this is a table with two columns: "Type" and "Content". The table contains one row: "Data conditions(Comparison)" and "D11=32252". There are "Edit" and "Delete" buttons below the table.

Item	Description	Reference
Number of records	Switches the file when the specified number of lines (records) is reached. (100 to 100000 lines)	-
File size	Switches the file when the specified size is reached. (10KB to 16384KB)	-
Condition specification	Specify the condition to switch the file.	-
Type	Displays the type of condition specified on the "File switching condition setting" screen. (Data conditions, Fixed cycle, Time interval specification, Specifying a time of day, At startup of module) The file switching is performed even if the condition is fulfilled during the period when logging is not executed.	-
Content	Displays the contents of the condition specified on the "File switching condition setting" screen.	-
 button	Opens the "File switching condition setting" screen to specify the condition. (Select either Single condition or Compound condition)	(2) (a) in this section
 button	Deletes the specified condition.	-

Even when the above file switching condition is not established, the file is switched in the following situations regardless of the set timing.

- When the number of lines (number of records for binary) reaches 65535 in case "Number of records" is not checked.
- When there is no e-mail destination setting and the file size reaches 16MB in case "File size" is not checked.
- When there is an e-mail destination setting and the file size reaches 512KB in case "File size" is not checked.

POINT

[When "Fixed cycle" or "Specify a time of day" is selected for "Condition specification"]

The file switching is performed at power on when the specified cycle elapses or the specified time comes during the period from power OFF to power ON.

(a) File switching condition setting screen

Setting screen

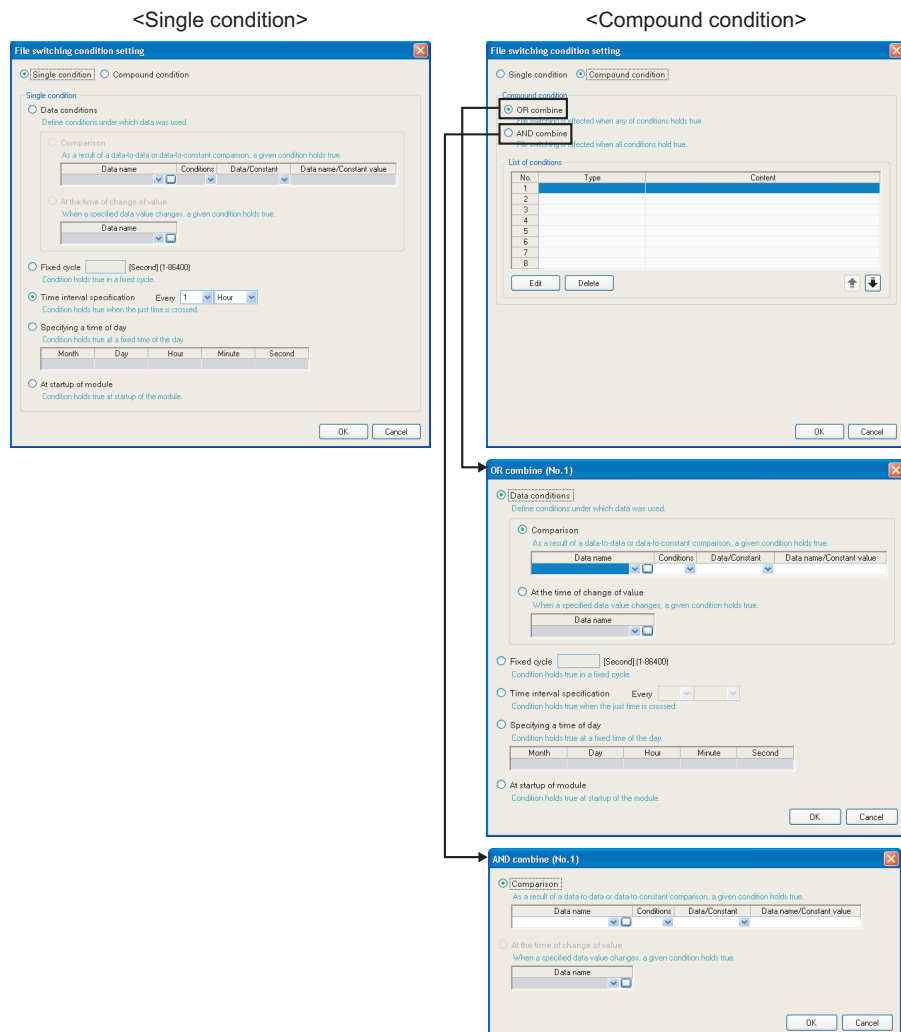

- ① **Single condition**
Switches files when the specified conditions are established.
The items of Single condition are the same as those of "Trigger condition setting" screen of the trigger (single condition).
For details, refer to the following section.
☞ Section 11.5.10 (1) Trigger condition setting screen
- ② **Compound condition**
Switches files when either specified condition is established for "OR combine", and when all the conditions are established for "AND combine".
The items of Compound condition are the same as those of "OR combine" or "AND combine" of the trigger (compound condition).
For details, refer to the following sections.
For OR combine: ☞ Section 11.5.11 (1) OR combine
For AND combine: ☞ Section 11.5.11 (2) AND combine

11 FUNCTIONS OF CONFIGURATION TOOL (MODULE SETTINGS)

(3) Saved file name

Set the information which is to be attached to the saved file name.

Setting screen

Saved file name
At the time of file switching, the storing file name is changed.
The saved file is created in the number folder.

Format:

Example:

Item	Description	Reference
Format	Displays the output format of the saved file.	-
Example	Displays the output image of the file name in a current format.	-
<input type="button" value="Edit"/> button	Opens the "Saved file name setting" screen to set the information which is to be attached to the saved file name.	Section 11.5.15 (3) (a)

POINT

The saved file number (00000001 to FFFFFFFF) to identify saved files is always attached to the saved file name.

Example of a saved file name: EVT01_20090410_00000001.CSV (Name and date are attached)

Name (optional) Date (optional) Saved file number (required)

11 FUNCTIONS OF CONFIGURATION TOOL (MODULE SETTINGS)

(4) Number of saved files

Set the maximum number of saved files and the operation when the maximum number is exceeded.

Setting screen

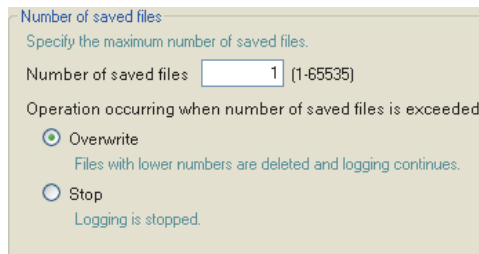

Item	Description
Number of saved files	Specify the maximum number of saved files. (1 to 65535)
Operation occurring when number of saved files is exceeded	-
Overwrite	Select this to delete files with low numbers and continue event logging when at file switching the number of saved files has already exceeded the specified number. When the folder where files with low numbers are deleted becomes empty, that folder is automatically deleted.
Stop	Select this to stop data logging when at file switching the number of saved files has already exceeded the specified number. *1 Turns ON the corresponding bit for 'Number of saved files exceeded information' in the buffer memory's event logging status area. Delete the latest saved file or the saved file with the lowest number via FTP or with the file browser of the Configuration Tool to restart event logging.

*1: The storing file and the specified number of saved files are saved on the CompactFlash card.

POINT

The number of saved files is calculated by the saved file number as shown below.
Latest saved file number - Lowest saved file number + 1

9

REPORT FUNCTION

10

OTHER FUNCTIONS

11

FUNCTIONS OF CONFIGURATION TOOL (MODULE SETTINGS)

12

FUNCTIONS OF CONFIGURATION TOOL (WRITING/READING/ VERIFYING DATA)

13

FUNCTIONS OF CONFIGURATION TOOL (CONFIRMING MODULE OPERATION)

14

FUNCTIONS OF CONFIGURATION TOOL (LOGGING FILE CONVERSION TOOL)

15

RECIPE FUNCTION

16

CompactFlash CARD

(5) Transfer setting screen

Transfers the latest saved file when the file is switched.

Setting screen

The items are the same as those of "Transfer setting" screen of Data logging setting.

☞ Section 11.5.15 (5) Transfer setting screen

POINT

- (1) E-mail transmissions/file transfers by the saved file transfer function may take a few seconds to tens of seconds depending on the network line/transmission size.
Target files may be deleted before e-mail transmission/file transfer completes depending on the settings.
Review the file switching timing (☞ (2) in this section) and the number of saved files (☞ (4) in this section) setting and lengthen the time until the file is deleted.
- (2) Do not configure the transfer settings when performing event logging using the auto logging function (☞ Section 10.2).
When using the auto logging function, the high speed data logger module cannot connect to the LAN line, therefore FTP transfers and e-mail transmissions cannot be performed.

11.6.14 E-mail notice

This section explains the settings to send notification when the event occurs by e-mail. It is not necessary to configure these settings if not sending e-mail notifications.



Setting screen

Item	Description	Reference
A notifying e-mail is sent at the occurrence of an event	Check this to send a notification e-mail at the event occurrence.	-
E-mail subject	Enter the notification e-mail subject. (Up to 64 characters)	-
E-mail text header	Specify a string for the header portion of the e-mail text. (Up to 512 characters)	-
E-mail text footer	Specify a string for the footer portion of the e-mail text. (Up to 512 characters)	-
E-mail address 1 to 3	Specify the notification e-mail destination.	-
button	Displays the "E-mail setting" screen. Edit sender account settings and destination e-mail address settings.	Section 11.4.5

(Continued on the next page)

11 FUNCTIONS OF CONFIGURATION TOOL (MODULE SETTINGS)

(From the previous page)

Item	Description	Reference
Use tags	-	-
Tag format	Check this to validate the tag input. Specify the following tag items to append the sent date/time and data to the e-mail.*1*2 <YYYY>: Year (4 digits) <YY>: Year (2 digits) <MM>: Month <DD>: Day <hh>: Hour <mm>: Minute <ss>: Second <DATA1>: Data set for <DATA1>. <DATA2>: Data set for <DATA2>.	-
Data setting	Set when data are output.	-
Data	Check this to append data to the E-mail subject, E-mail text header or E-mail text footer.	-
Data name	Displays data names set for <DATA1> and <DATA2>.	-
Data name display field	Displays set data.	-
 button	Displays "Data setting" screen.	Section 11.2.9
 button	Displays "E-mail content check" screen.	(1) in this section

*1: Total of 16 tags can be set for subject and text.

*2: Tags can be invalidated by adding another brackets.

(The item enclosed with outer brackets can be handled as a string.)

(1) E-mail content check screen

Setting screen

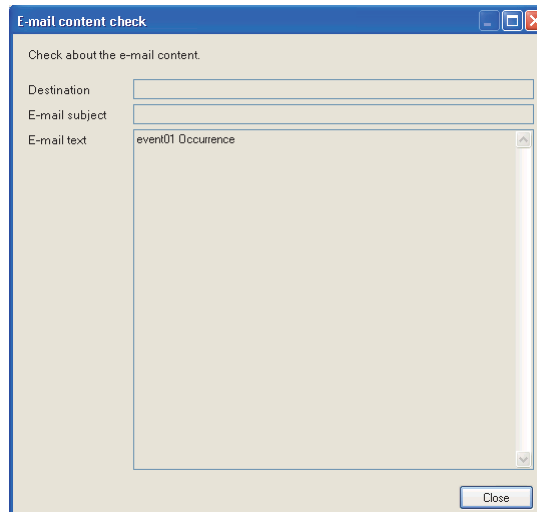

Item	Description
Destination	Displays the send target group name.
E-mail subject	Displays the contents entered in "E-mail subject" on the "E-mail notice" screen.
E-mail text	Displays the contents entered in "E-mail text header" or "E-mail text footer" on the "E-mail notice" screen.
 button	Closes the "E-mail content check" screen.

11 FUNCTIONS OF CONFIGURATION TOOL (MODULE SETTINGS)

Example of e-mail transmission contents

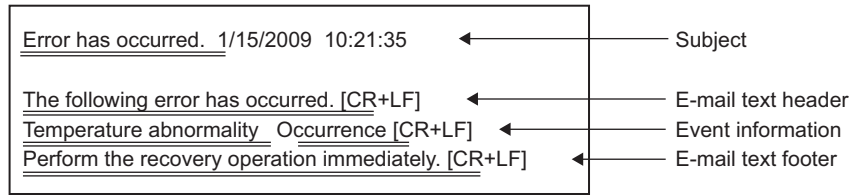

POINT

When the data tag (<DATA1>, <DATA2>) is used for "E-mail text" on the "E-mail notice" screen, the following character is displayed on the "E-mail content check" screen.

Data setting	Output character
Decimal/Hexadecimal	0
String	s

The displayed value changes depending on the specified size or the number of digits specified for zero padding. As an output example, "sssssss" is displayed when the specified size is 8, and "0000000000000000" is displayed when the number of digits specified for zero padding is 16 (size 8). (When the number of digits for zero padding is not specified, 0 is displayed.)

Display example

11 FUNCTIONS OF CONFIGURATION TOOL (MODULE SETTINGS)

11.6.15 Completion

Gives a name to the event logging and completes the settings.



Setting screen

All information necessary for event logging has been gathered. Press the [Finish] button to complete setting.
To have your settings reflected in the module, use the Online menu's Write command.

Assign a name to the event logging.

Event logging name

Data list < Back Next > Finish Cancel

Item	Description
Event logging name	Specify the name of the setting being edited. For the characters that can be set, refer to the following chapter. 📖 Appendix 4 Usable Characters (Up to 32 characters)
 button	Confirms the settings being edited. After confirming the settings, the event logging name is displayed in the following. <ul style="list-style-type: none">• On the edit items tree, under the "Event logging setting" folder• Event logging setting list
 button	Discards the event logging settings being edited and ends editing.

11.7 Report Setting

This section explains the settings for the report function.
For an overview of the report function, refer to the following chapter.

☞ Chapter 9 REPORT FUNCTION

11.7.1 Report setting list

This section explains the items on the report setting list screen.

Operating procedure

Click "Report setting" on the edit items tree.

Setting screen

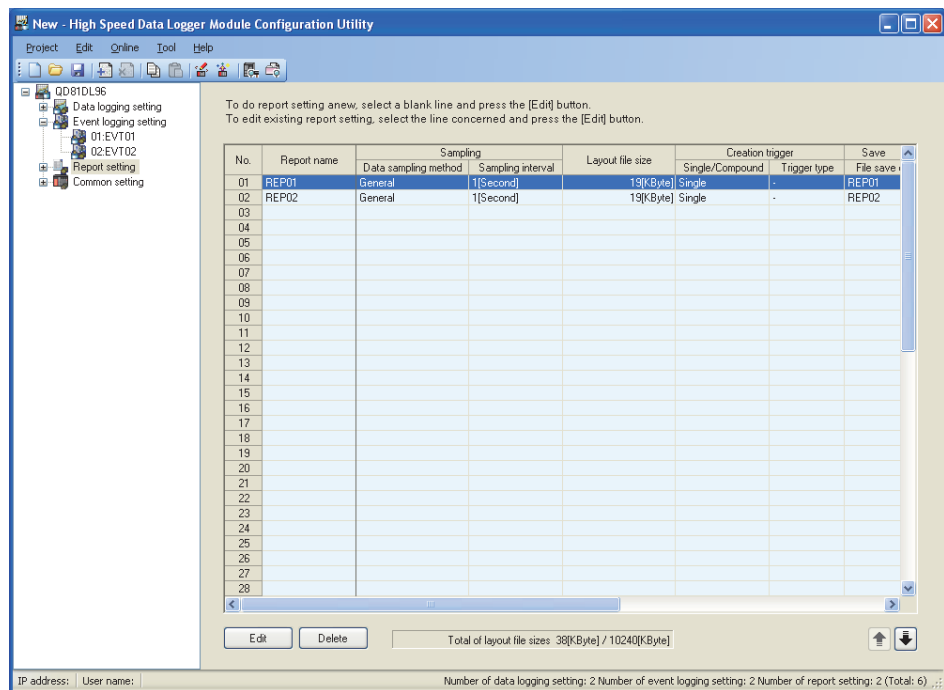

The setting details are described on the next page.

Remark

The existing report settings can be utilized by using "Import from project file" (☞ Section 11.3.4) function.



The setting time can be reduced by utilizing the existing settings.

11 FUNCTIONS OF CONFIGURATION TOOL (MODULE SETTINGS)



The following table shows the items displayed on the report setting list.

Item	Description	Reference
Report name	Displays the report name.	Section 11.7.9
Sampling	Displays the sampling interval of the data used by the report.	Section 11.7.3
Data sampling method	Displays "High speed" or "General".	
Sampling interval	Displays the sampling interval of the target data.	
Layout file size	Displays the size of the Excel layout file.	Section 11.7.4
Creation trigger	Displays the type of trigger for report creation.	Section 11.7.6
Single/Compound	Displays "Single" or "Compound".	
Trigger type	Displays "OR combine", "AND combine", "Number of times", or "Order".	
Save	-	Section 11.7.8 (1), (2), (3)
File save destination	Displays the save directory for the report file.	
Saved file name	Displays the information to be attached to the report file name.	
Number of saved files	Displays the number of saved files (maximum number of files to be saved on the CompactFlash card) and processing when the number of saved files is exceeded.	
Transfer	Displays the transfer settings for the report file.	Section 11.7.8 (4)
FTP transfer	Displays if there is an FTP transfer. To be transferred : Perform FTP transfer Not to be transferred: Does not perform FTP transfer	
E-mail sending	Displays if there is an e-mail transmission. To be sent : Perform e-mail transmission Not to be sent : Does not perform e-mail transmission	
Total of layout file sizes	Displays the total size of the Excel layout file of all report settings.	

The following table shows the buttons for operating the report setting list.

Item	Description	Reference
 button	Displays the report setting screen to edit the selected row of settings. If the selected row is empty, new report settings are added to that row.	Section 11.7.2
 button	Deletes the selected row of settings.	-
 button	Shifts the selected row one row up or one row down.	-

POINT

Multiple rows can be selected and deleted or moved in batch by clicking on them while pressing the  key or  key.

11.7.2 Report setting screen transitions

Report settings are configured in a wizard format.

The title of each wizard screen is displayed in the 'edit item bar' in the upper portion of the detailed setting screen. Setting operations are performed in order from the items to the left in the 'edit item bar' to those in the right.

Setting screen

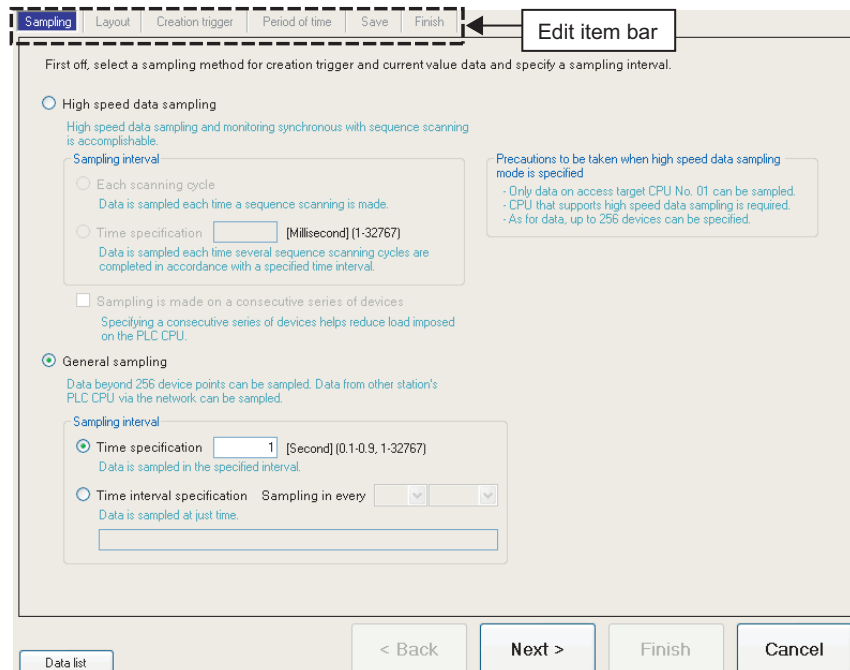

Item	Description	Reference
button	Displays a list of all data being used by all the report setting.	Section 11.2.7
button	Moves the setting wizard screen being edited to the previous screen (left).	(1) in this section
button	Moves the setting wizard screen being edited to the next screen (right).	
button	Confirms the report settings being edited and completes editing. After completing the settings, returns to the report setting list screen.	-
button	Discards the report settings being edited and ends editing. After cancelling the settings, returns to the report setting list screen.	-

11 FUNCTIONS OF CONFIGURATION TOOL (MODULE SETTINGS)



(1) Wizard display and operations

(a) Edit item status

The setting status of the wizards on the edit item bar can be checked by color.

Status	Configured	Being edited	Not configured
Text color	Blue	White	Gray
Background color	Light gray	Blue	Light gray
Example	Sampling	Layout	Create trigger

(b) Screen transitions with the buttons

Move between edit item screens with the   buttons.



(c) Screen transitions by mouse

The setting screen for configured items can be moved directly by clicking the 'edit item bar'.

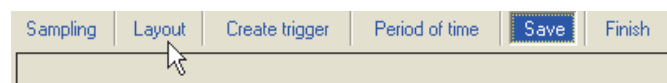

(d) Editing items of report setting

Editing items of report setting are made up of the following types.

Setting items	Reference
Sampling	Section 11.7.3
Layout	Section 11.7.4
Creation trigger	Section 11.7.6
Period of time	Section 11.7.7
Save	Section 11.7.8
Finish	Section 11.7.9

11 FUNCTIONS OF CONFIGURATION TOOL (MODULE SETTINGS)

11.7.3 Sampling

This section explains the settings for selecting the data sampling method for creation trigger and current value data of the reports and specifying the data sampling interval. For details on processes of each sampling method, refer to the following section.

☞ Section 9.2 Creation Trigger and Current Value Data Sampling

Setting screen

Item	Description	Reference
High speed data sampling	High-speed monitoring of report creation trigger and current value sampling are possible using the high speed data sampling function.	Section 9.2
Sampling interval	-	
Each scanning cycle	Samples data with each sequence scan.	
Time specification	Samples data at the specified interval. (1 to 32767ms)	
Sampling is made on a consecutive series of devices.	<ul style="list-style-type: none"> • Checked^{*1} : Check this when five 'unchecked' settings already exist. Data specified in the creation trigger setting can only be sampled and monitored at a high speed. • Unchecked : Different types of devices with inconsecutive device numbers can be specified. The number of settings is up to 5 settings for all high speed data logger module settings combined (data logging settings, event logging settings, and report settings). 	-

(Continued on the next page)

11 FUNCTIONS OF CONFIGURATION TOOL (MODULE SETTINGS)

(From the previous page)

Item	Description	Reference
General sampling	<ul style="list-style-type: none"> Set the data sampling interval in seconds. (0.1 to 0.9, 1 to 32767 seconds) Select when sampling data which exceeds 256 points. Select when sampling data from a programmable controller CPU via the network. 	Section 9.2
Sampling interval	-	-
Time specification	Samples data at the specified interval. (0.1 to 0.9 seconds, 1 to 32767 seconds)	-
Time interval specification	Samples data at the time interval of every specified hour/minute/second.	(1) in this section

*1: When checked, there are the following restrictions.

- The creation trigger condition which can be set with the "Creation trigger" setting can only be a single condition. (☞ Section 11.7.6)
- "Synchronize creation trigger with current value data" on the "Creation trigger" setting cannot be checked. (☞ Section 11.7.6)
- Device data cannot be specified for the data condition on the "Period of time" setting. (☞ Section 11.7.7)
- Information cannot be attached to the saved file name in the "Save" setting. (☞ Section 11.7.8)

(1) Available time intervals

The following shows the time units and their intervals which can be specified for sampling interval.

Hour: 1, 2, 3, 4, 6, 8, 12, 24

Minute: 1, 2, 3, 4, 5, 6, 10, 12, 15, 20, 30, 60

Second: 1, 2, 3, 4, 5, 6, 10, 12, 15, 20, 30, 60

POINT

- (1) For the types of programmable controller CPUs, product information, and system configurations of high speed data sampling, refer to the following section.
 - ☞ Section 7.2.1 (1) System configurations compatible with high speed data sampling
- (2) For devices which can be specified during high speed data sampling, refer to the following section.
 - ☞ Section 3.2 (3) Accessible devices
- (3) The total number of data logging, event logging, and report settings in which high speed data sampling is set, is a maximum of 32 settings.
- (4) When high speed data sampling is specified, there is an effect on the sequence scan time because of the data transfer from the programmable controller CPU to the high speed data logger module.
The sequence scan time delay can be adjusted with the high speed data sampling setting.
For the effect on the sequence scan time, refer to the following sections.
 - ☞ Section 17.3 Effect on Sequence Scanning Time
 - ☞ Section 11.4.8 High speed data sampling setting
- (5) Since general data sampling is not synchronized with the control CPU's sequence scan, data separation may occur.
 - ☞ Section 3.2 (6) Access units

To perform data sampling synchronized to the sequence scan, use high speed data sampling.

11 FUNCTIONS OF CONFIGURATION TOOL (MODULE SETTINGS)

11.7.4 Layout setting list

To create a report, an Excel format layout file must be created in advance. Layout the report's target data (data logging file, current values at the time the report was created or creation time) in the Excel format layout and save as the layout file.

Screen display

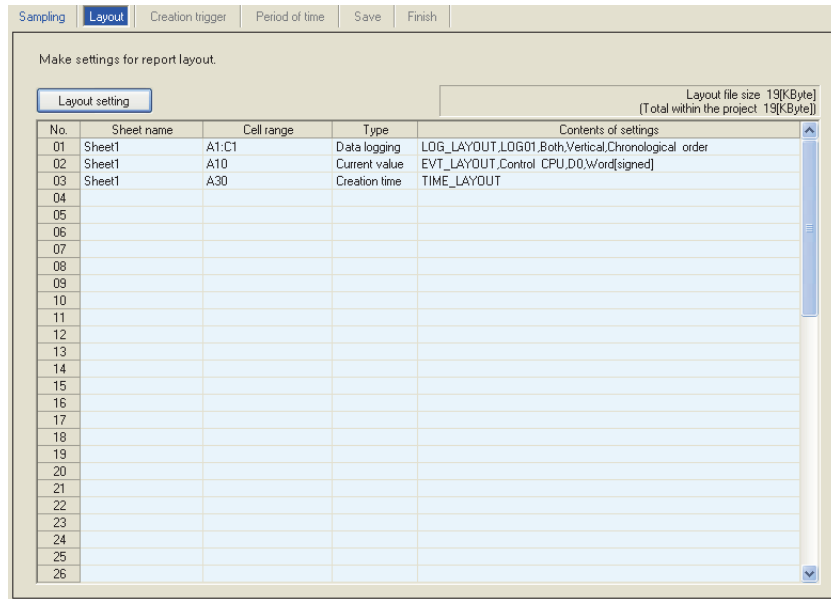

The following table shows the items displayed on the layout setting list.

Item	Description	Reference
Layout file size	Displays the size of the layout file being edited.	-
(Total within the project)	Displays the total size of all layout files including other report settings. (Total size within 10,240 kilobytes)	-
Sheet name	Displays the name of the sheet set with the layout.	-
Cell range	Displays the range of cells set with the layout.	-
Type	Displays the type of data laid out. (Data logging/current value/creation time)	-
Contents of settings	Displays the contents of the layout setting. <ul style="list-style-type: none"> • For data logging : layout name, data logging name, source file, output direction, output order • For current value: layout name, access target CPU, start device, data type • For creation time: layout name 	-

The following table shows the button displayed on the layout setting list.

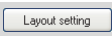
Item	Description	Reference
 button (POINT (4) in this section)	Starts Excel and displays the "Layout setting" screen.	Section 11.7.5

POINT

- (1) An Excel macro must be executed to configure the layout settings. Configure layout settings after configuring Excel to execute macros.
- (2) The layout settings cannot be configured if the VBA function is not installed when installing Microsoft Excel and Microsoft 365.
- (3) Some functions added to Microsoft® Excel® 2007 and later cannot be used.
- (4) When activating the Layout setting screen by clicking the button, the "Security Warning" screen or "Microsoft Office Excel Security Notice" screen may be displayed.
In this situation, close the screen with the procedure below and set it not to be displayed the next time it is activated.

(When using Microsoft Excel 2003)

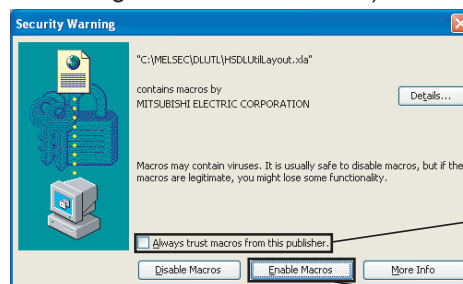

① Check "Always trust macros from this publisher."

② Click the [Enable Macros] button.

(When using Microsoft Excel 2007 or later)

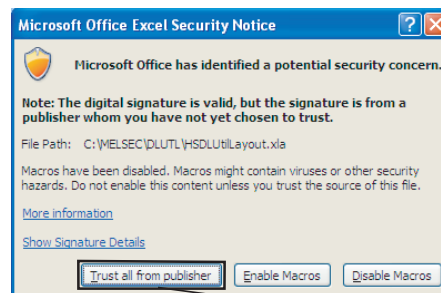

Click the [Trust all from publisher] button.

Note that, perform the above procedure within 60 seconds.

An error dialog is displayed when exceeding 60 seconds.

In that case, activate the layout setting screen with the procedure below.

- ① Close the error dialog with the button.
- ② Close the "Security Warning" screen or "Microsoft Office Excel Security Notice" screen following the procedure above.
- ③ Follow the message in the displayed dialog and close Excel.
- ④ After Excel is closed, click the button again to start the Layout setting screen.

(Continued on the next page)

11 FUNCTIONS OF CONFIGURATION TOOL (MODULE SETTINGS)

(From the previous page)

- (5) When activating the "Layout setting" screen by clicking the button, the "Windows Security" screen may appear. In that case, change the setting with any of the following procedure and activate the "Layout setting" screen.

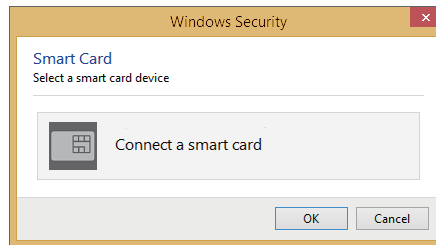

- Adding trusted locations
 - ① Click the [Cancel] button on the "Windows Security" screen to close the window.
 - ② Start Excel, and select [File] ⇒ [Options].
 - ③ Click the [Trust Center Settings] button on the [Trust Center] tab.
 - ④ Click the [Add new location] button in the [Trusted Locations] tab.
 - ⑤ Specify the path where the Configuration Tool is installed to "Path" on the "Microsoft Office Trusted Location" screen.
 - ⑥ Click the button.
 - ⑦ After closing Excel, click the button again to activate the "Layout setting" screen.
 - Enabling all macros
 - ① Click the [Cancel] button on the "Windows Security" screen to close the window.
 - ② Start Excel, and select [File] ⇒ [Options].
 - ③ Click the [Trust Center Settings] button on the [Trust Center] tab.
 - ④ Select "Enable all macros (not recommended; potentially dangerous code can run)" on the [Macro Settings] tab.
 - ⑤ After closing Excel, click the button again to activate the "Layout setting" screen.
 - ⑥ After completing the layout setting, return the setting of Excel to the original.
- (6) When using 64-bit version Microsoft Excel in Configuration Tool the version of which is 1.14Q or earlier, the layout setting cannot be configured. Install supported Configuration Tool or Microsoft Excel.
- (7) When the error message "Compile Error in Hidden Module: This Workbook." is displayed by clicking the button, the layout settings cannot be executed.

In this case, apply "2007 Microsoft® Office Suite Service Pack 3 (SP3)" provided by Microsoft®.

(Continued on the next page)

11 FUNCTIONS OF CONFIGURATION TOOL (MODULE SETTINGS)

(From the previous page)

- (8) When clicking the button, the report layout setting may not be able to be configured after starting Microsoft Excel due to add-ins installed in Microsoft Excel. In this case, disable the add-ins by the following procedure.
- ① Start Excel, and select [File] ⇒ [Options].
 - ② Select the target add-in type from "Manage" on the [Add-Ins] tab, and click the [Go] button.
 - ③ Unselect the checkbox of add-ins, and click the [OK] button.
 - ④ Close Excel.

9

REPORT FUNCTION

10

OTHER FUNCTIONS

11

FUNCTIONS OF CONFIGURATION TOOL (MODULE SETTINGS)

12

FUNCTIONS OF CONFIGURATION TOOL (WRITING/READING/VERIFYING DATA)

13

FUNCTIONS OF CONFIGURATION TOOL (CONFIRMING MODULE OPERATION)

14

FUNCTIONS OF LOGGING FILE CONVERSION TOOL

15

RECIPE FUNCTION

16

CompactFlash CARD

11 FUNCTIONS OF CONFIGURATION TOOL (MODULE SETTINGS)

11.7.5 Layout setting

The report layout is set by specifying data to be sampled and specifying cells of Excel.

Setting screen

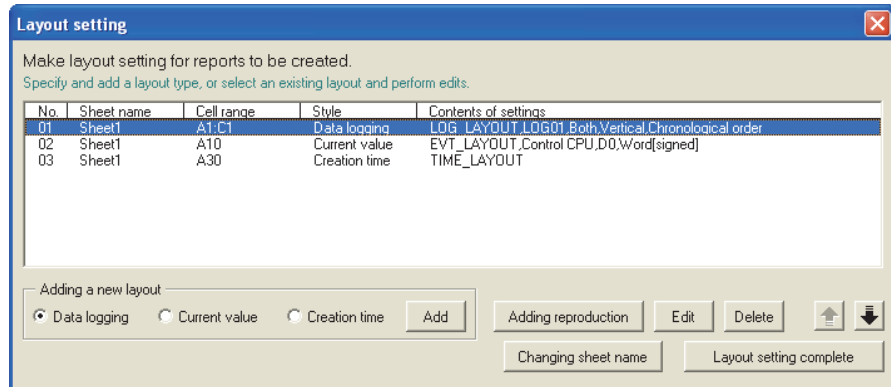

Item	Description	Reference
Layout setting list	Displays the contents of the layout setting.	-
Adding a new layout	-	-
Data logging	Select the data logging file as the layout target data.	-
Current value	Select the programmable controller CPU device value when the report is created as the layout target data.	-
Creation time	Select the time when the report is created as the layout target data.	-
Add button	Displays the layout screen for the selected target data.	(1), (2), (3) in this section
Adding reproduction button	Adds the layout selected in the layout setting list screen by copying it.	(4) in this section
Edit button	Displays the setting screen to edit the layout selected in the layout setting list screen.	(5) in this section
Delete button	Deletes the layout selected in the layout setting list screen.	-
Changing sheet name button	Changes the layout file sheet name. The report cannot be created correctly when the sheet name is changed without using this button.	(6) in this section
Layout setting complete button	Reflects the settings and closes the screen.	-
Up/Down arrow button	Shifts the selected row one row up or one row down.	-

POINT

- (1) Configure fixed strings, format settings (font type, color, etc.), and graphs while the Layout setting screen is displayed.
- (2) The layout file size of reports sent by e-mail is up to 512KB.
- (3) The size of the layout file created by the layout settings depends on the version of Excel installed.
Therefore, the upper limit of the layout file size may be exceeded by editing the project configured with the layout settings on a personal computer installed with a different version of Excel.
Plan the layout file with some allowance for its size.
- (4) In the merged cells, specify the upper left cell () as a range.

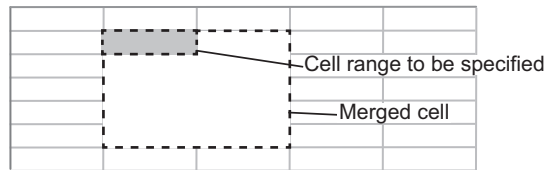

- (5) Do not specify the following types for the format of cells specified in the cell range. If specified, data may not be output normally.
 - Strings
 - User defined type contains @
- (6) Values in the cell range are cleared when the button is clicked.
- (7) Do not add the digital signature to the layout file.
The report files to which the digital signatures are added cannot be created.
- (8) Do not use Import external data function of Excel (Get external data function for Microsoft® Excel 2007 and Microsoft® Excel 2010 (32-bit version)).
The report files imported with Import external data function/Get external data function cannot be created.

11 FUNCTIONS OF CONFIGURATION TOOL (MODULE SETTINGS)



(1) Data logging layout screen

Configures layout settings of the records in the data logging file to be output to the report.

Operating procedure

Select "Data logging" for the layout type on the "Layout setting" screen and click the **Add** button.

Setting screen

Item	Description	Reference
Layout name	Enter the name of the layout. (Up to 64 characters)	-
Leading cell	Specify the leading cell to output the records in the data logging file. Can also be set with the  button.	-
 button (Input assistance button)	By clicking this button, the leading cell can be selected with the mouse.	(1) (a) in this section
Number of records	Specify the number of records to output from the leading cell.	-
Data logging name	Select the data logging name. To add a new data logging setting, select "(Add)" from the list box and click the Edit button.	Section 11.5.1
Source file	Select the file (Saved file/Storing file/Both) of which data logging records are to be output.	(1) (b) in this section
Outputting direction	Select the direction (vertical/horizontal) to output the records in the data logging file.	(1) (c) in this section
Outputting order	Select the order (oldest first/newest first) to output the records in the data logging file.	(1) (d) in this section

(Continued on the next page)

11 FUNCTIONS OF CONFIGURATION TOOL (MODULE SETTINGS)

(From the previous page)

Item	Description	Reference
Output data	-	(1) (e) in this section
Logging data	Select the data logging name to display output data candidates.	
Output data*1	Displays the selected output data.	
Sheet name	Displays the sheet name of the layout being edited.	-
Cell range	Displays the cell range of the layout being edited.	-
Output title (data name) at the head of data*2	Check to output the title (data name) in the first row (first column when the output direction is vertical) from the leading cell.	-

*1: When the data type of the logging data is string, characters outside the ASCII range are substituted with periods (.).

*2: For date information and index, character strings of "Logging output date" and "Index" are output respectively.

POINT

- (1) When "Saved file" is selected as the source file, adjust processing so that the creation trigger occurs after the file switching is once performed.
- (2) By setting the following settings, report files corresponding to data logging files one-to-one basis can be created.
 - [Report setting] → [Layout] → "Data logging layout" → "Source file" → "Saved file" (☞ (1) in this section)
 - [Report setting] → [Creation trigger] → "At the time of the data logging file is switched." (☞ Section 11.7.6 (3) (a))
- (3) By setting the following settings, only trigger logging data before and after the rising of trigger condition can be output to a report.
 - [Data logging setting] → [save] → "File switching timing" → "Trigger logging unit" (☞ Section 11.5.15 (2))
 - [Report setting] → [Layout] → "Data logging layout" → "Source file" → "Saved file" (☞ (1) in this section)
 - [Report setting] → [Creation trigger] → "At the time of the data logging file is switched" (☞ Section 11.7.6 (3) (a))

(a) Specifying the leading cell

By clicking the input assistance button (☞), the "Selection of leading cell" screen is displayed and the range of cells to layout data can be specified with the mouse. After specifying, click the button.

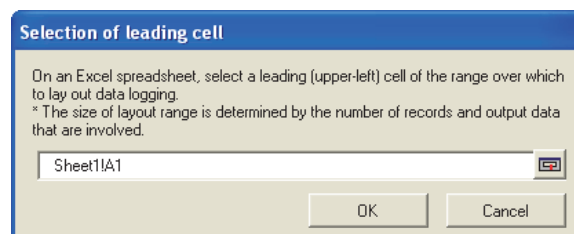

POINT

While selecting the cell range, a screen with the title "RefEdit" may be displayed, but ignore it and continue to select the leading cell.

11 FUNCTIONS OF CONFIGURATION TOOL (MODULE SETTINGS)

(b) Source file

Select the file of which data logging records are to be output. Select from the "storing file" or "latest saved file" stored in the CompactFlash card.

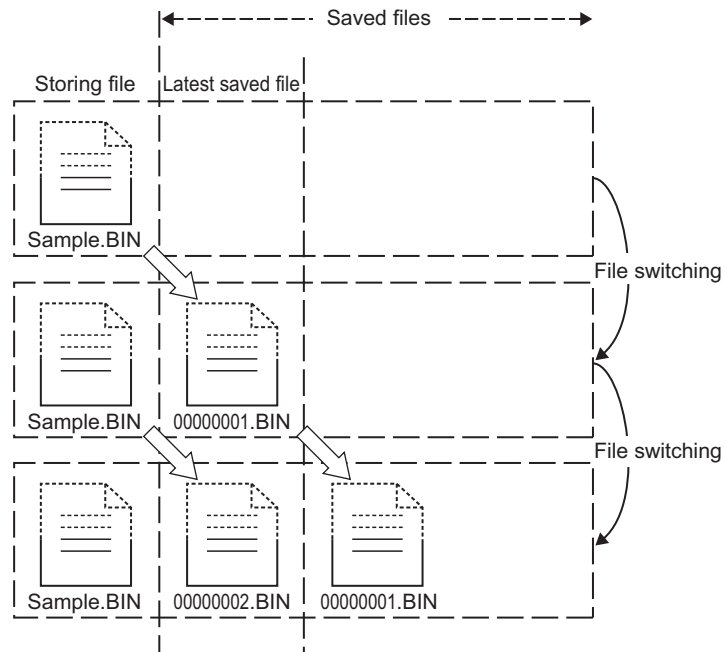

① Saved file: Outputs the data that have completed to be stored.

A report is output from the latest file among the data logging files, which have completed to be stored every file switching. Reports can be created from the logging data divided according to the data condition or time, or from the logging data before and after the rising of trigger condition.

Reports can be output according to the number of records which may differ in each saved file.

Example) Create a per-batch (per-lot) report when the data logging file is switched at the timing of the end of a batch or lot.

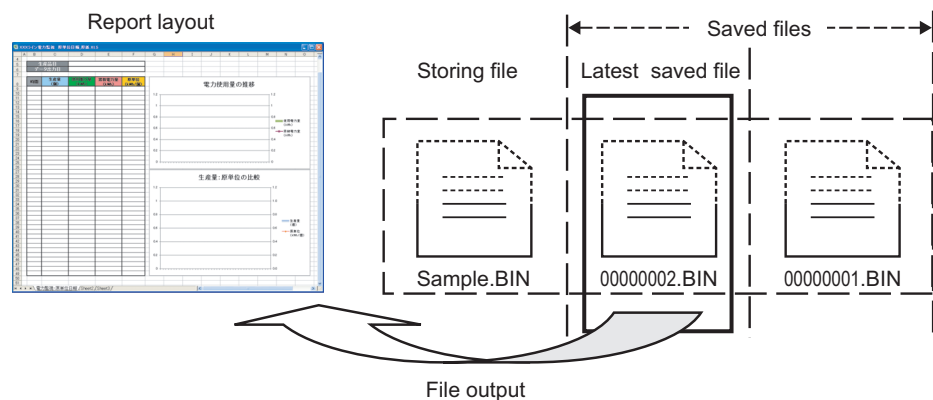

11 FUNCTIONS OF CONFIGURATION TOOL (MODULE SETTINGS)

② Storing file: Outputs the data that are being stored.

A report can be output from the data logging file which is being stored. The processing can be tracked by creating reports such as a daily report or per-process report from the data being stored.

Example) Output the latest logging data which is being stored when the data logging file is switched at the timing of the end of a batch or lot.

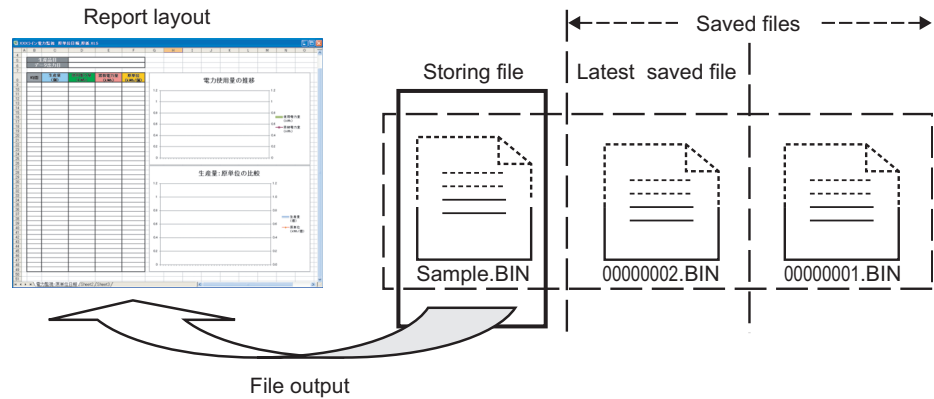

③ Both: Outputs the both data.

A report is created from the data of both the storing file and the latest saved file. Specifying the number of records, the latest logging data up to the timing of occurrence of the creation trigger can be output to a report.

In this case, specify the number of records of the file switching so that it is always greater than the number of records to be output to a report.

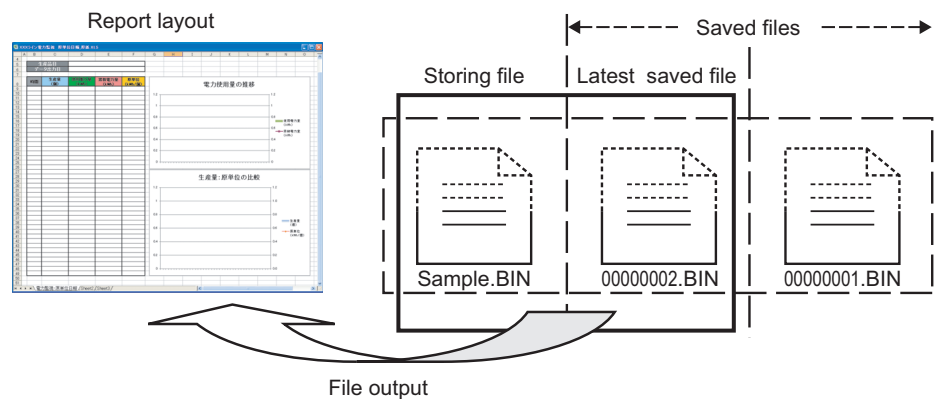

11 FUNCTIONS OF CONFIGURATION TOOL (MODULE SETTINGS)

- Difference of report operation due to difference of source files

The following explains the report operation of each source file: 'Saved file', 'Storing file', and 'Both'. The following shows how data are output when '100' to "Number of records" and 'Chronological order (old -> new)' to "Outputting order" are set in the data logging layout setting and 50 records in the saved file and 30 records in the storing file exist at the creation trigger execution.

① Operation when the source file is 'Saved file'

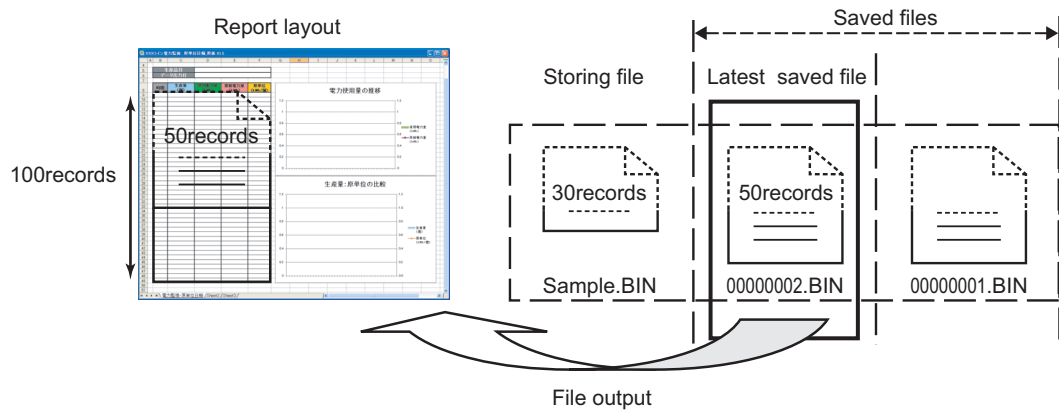

When the source file is 'Saved file', 50 records worth of data are output to the report file from the latest saved file.

(Because the specified number of records is 100, the remaining 50 records become blank.)

② Operation when the source file is 'Storing file'

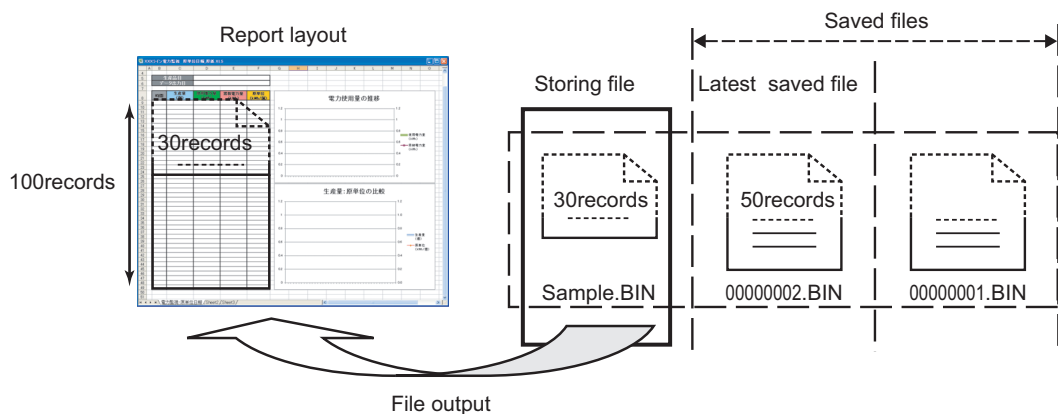

When the source file is 'Storing file', 30 records worth of data are output to the report file from the storing file.

(Because the specified number of records is 100, the remaining 70 records become blank.)

11 FUNCTIONS OF CONFIGURATION TOOL (MODULE SETTINGS)

③ Operation when the source file is 'Both'

The data for the specified number of records are read from the storing file and output to the report.

If the required number of records of data does not exist in the storing file, data are read from the latest saved file.

However, if data does not exist in the storing file, data are read from the latest saved file and the saved file one before the storing file.

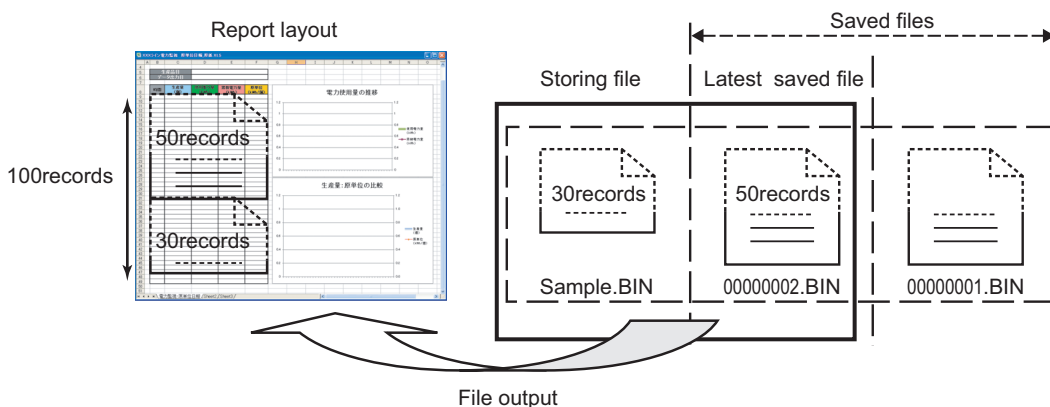

When the source file is 'Both', a total of 80 records worth of data: 30 records worth of data from the storing file and 50 records worth of data from the latest saved file are output to the report file.

(Because the specified number of records is 100, the remaining 20 records become blank.)

11 FUNCTIONS OF CONFIGURATION TOOL (MODULE SETTINGS)

[Number of records in layout is fewer than that in the source files]

When the specified number of records is 40, 30 records worth of data from the storing file and 10 records worth of data from the latest saved file are output to the report file.

(The remaining older 40 records worth of data in the latest saved file are not output.)

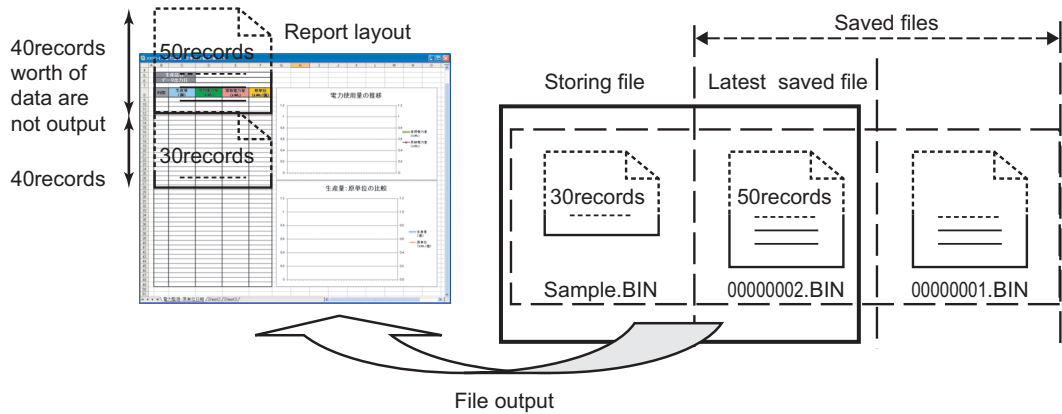

[When the creation trigger executes immediately after the output target data logging file is switched]

When the creation trigger executes immediately after the output target data logging file is switched, an unintended operation may occur due to the storing file which only has a header or too few number of records.

For example, when "At the time of the data logging file is switched" is selected as the creation trigger, only a header or one record worth of data may exist in the storing file. Therefore, no record or only one record may output when the source file is set to 'Storing file'.

Adjust the system so the creation trigger executes with the necessary number of records worth of data.

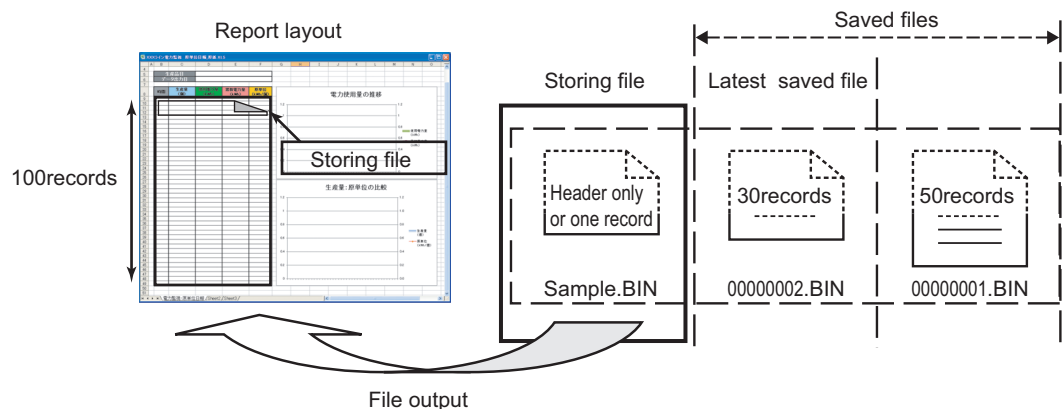

11 FUNCTIONS OF CONFIGURATION TOOL (MODULE SETTINGS)

(c) Select the direction (vertical/horizontal) to output the records in the data logging file.

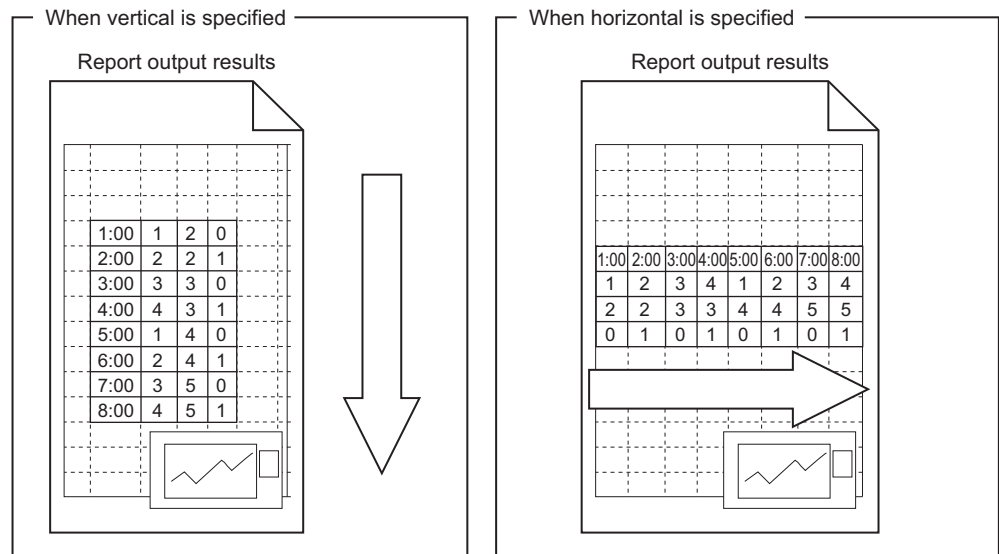

11 FUNCTIONS OF CONFIGURATION TOOL (MODULE SETTINGS)

(d) Output order

Select the order to output the records in the data logging file.

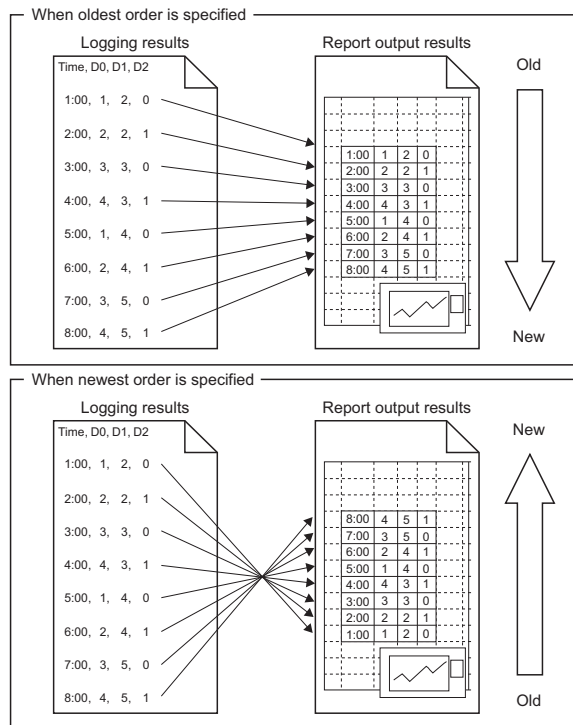

(e) Output data

The following table shows the operation buttons to select the data to output from the records in the data logging file and to specify the order.

Item	Description
button (add button)	Adds the selected data to the output data.
button (delete button)	Deletes the selected data from the output data.
button (batch add button)	Adds all the data to the output data.
button (batch delete button)	Deletes all the data from the output data.
button	Shifts the order of the selected output data up or down one row.

POINT

The format below is automatically set in the cell where output date/time is set.
yyyy/mm/dd ddd hh:mm:ss

To change the date/time display format, change the cell format setting in Excel. However, a display error (± 1) on the value of the last digit may occur due to a rounding error*1.

Example) To display year, month, date, hour, minute, second, millisecond information

Specify the user defined display format below.

m/d/yyyy hh:mm:ss.000

*1: A floating-point type approximate value including an error is stored as date data in Excel. Therefore the value of the last digit may be displayed shifting ± 1 due to rounding calculation even if the display accuracy of date data in Excel is the same as that of date data in sampled CSV files or date data displayed by the GX LogViewer.

11 FUNCTIONS OF CONFIGURATION TOOL (MODULE SETTINGS)

(2) Current value layout screen





Configures layout settings of the current value to be output to the report.

Operating procedure

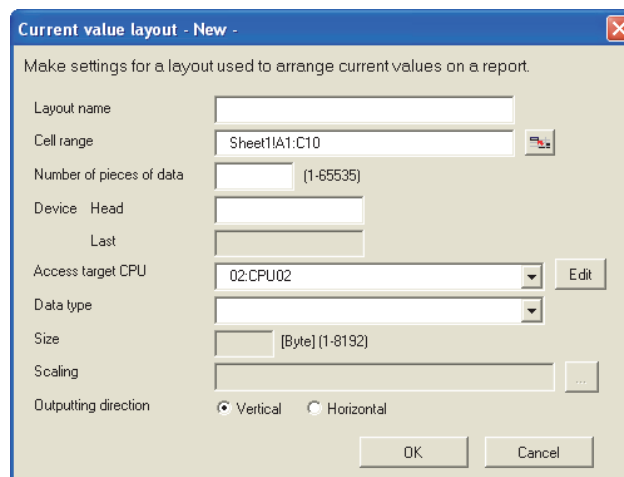
Select "Current value" for the layout type on the "Layout setting" screen and click the  button.

Setting screen







Item	Description	Reference
Layout name	Enter the name of the layout. (Up to 64 characters)	-
Cell range	Specify the range of cells to output the current value. Can also be specified with the  button.	-
 button (Input assistance button)	By clicking this button, the range of cells to output the current value can be selected with the mouse.	-
Number of pieces of data	Specify the number of consecutive devices to allocate within the cell range. The amount of data specified here is output in the order specified for output direction.	-
Data name	For related data, set the data name. An icon () is appended. For normal data, displays the start device.	Section 11.2.9
Device ^{*2*3}	-	-
Head	Enter the start device name to be output.	-
Last	Displays the end device automatically calculated from the start device, data count, and data type.	-
Access target CPU ^{*2}	Select the access target CPU from the CPUs set with the access target CPU setting. To add an access target CPU, select "(Add)" from the list box and click the  button.	Section 11.4.3
Data type ^{*1*2}	Select the data type.	Section 11.5.6
Size ^{*2}	Specify the size in bytes when string or raw is selected for data type.	Section 11.5.6

(Continued on the next page)

11 FUNCTIONS OF CONFIGURATION TOOL (MODULE SETTINGS)

(From the previous page)

Item	Description	Reference
Scaling	Enter the scaling formula for scaling.	Section 11.5.6
Outputting direction	Select the direction (vertical/horizontal) to output the records in the data logging file.	(2) (a) in this section
 button	Imports global labels or device comments.	Section 11.2.10 (1) Section 11.2.10 (4)
 button	Disables relations with global labels.	Section 11.2.10 (2)
 button	Confirms the settings and closes the screen.	-
 button	Discards the settings and closes the screen.	-

*1: When the data type of the logging data is string, characters outside the ASCII range are substituted with periods (.).

*2: Related data cannot be edited.

*3: If acquiring the device of which device number is multiples of 65536 (D65536 or ZR131072, etc.) as a current value, set any of the following settings;

- Specify the device number as a start device.
Example) Start device: D65536, Last device: D80000
- The remainder of the last device number and the start device number must be within 960.
Example) Start device: D65500, Last device: D66460

(a) Output direction

When the target data are current values, the values can be output in two types of output directions.

① When output direction is "Horizontal" (left to right)

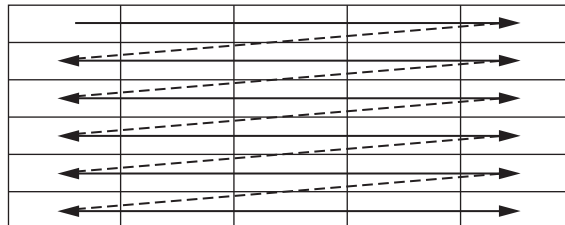

② When output direction is "Vertical" (top to bottom)

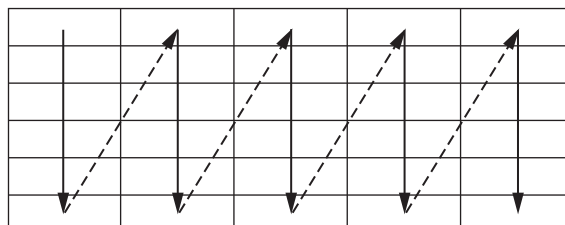

11 FUNCTIONS OF CONFIGURATION TOOL (MODULE SETTINGS)

(3) Creation time layout screen

Configures layout settings of the creation time to be output to the report.

Operating procedure

Select "Creation time" for the layout type on the "Layout setting" screen and click the **Add** button.

Setting screen

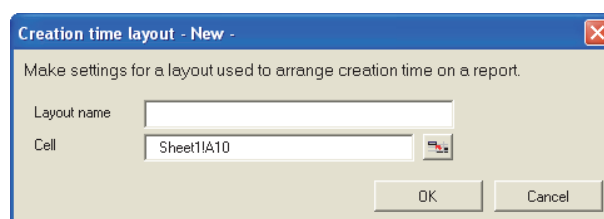

Item	Description
Layout name	Enter the name of the layout. (Up to 64 characters)
Cell	Specify the cell to output the creation time. Can also be specified with the button.
button (Input assistance button)	By clicking this button, the range of cells to output the creation time can be selected with the mouse.

POINT

The format below is automatically set in the cell where output date/time is set.
yyyy/mm/dd ddd hh:mm:ss

To change the date/time display format, change the cell format setting in Excel.

However, a display error (± 1) on the value of the last digit may occur due to a rounding error.

Example) To display year, month, date, hour, minute, second, millisecond information

Specify the user defined display format below.

m/d/yyyy hh:mm:ss.000

11 FUNCTIONS OF CONFIGURATION TOOL (MODULE SETTINGS)

(4) Adding reproduction

Copy the layout settings selected on the "Layout setting" screen and use them to add a new layout.

Operating procedure

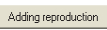
Select the layout setting to be copied on the "Layout setting" screen and then click the  button.

The copied layout setting screen is displayed according to the data type (data logging/current value/creation time).

Configure the blank setting items and click the  button.

Setting screen

Example) For a data logging layout

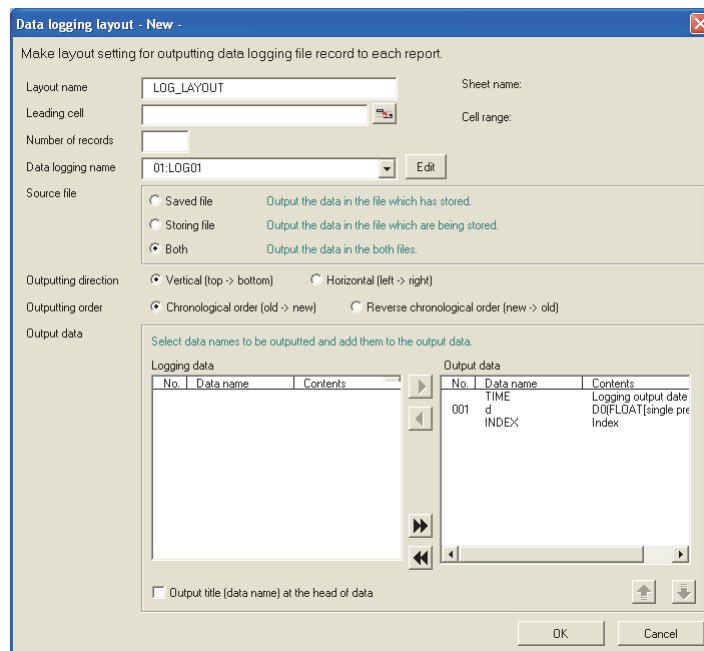

Make layout setting for outputting data logging file record to each report.

Layout name: LOG_LAYOUT Sheet name:

Leading cell: Cell range:

Number of records:

Data logging name: 01:LOG01 Edit

Source file

Saved file Output the data in the file which has stored.

Storing file Output the data in the file which are being stored.

Both Output the data in the both files.

Outputting direction

Vertical (top -> bottom) Horizontal (left -> right)

Outputting order

Chronological order (old -> new) Reverse chronological order (new -> old)

Output data



Select data names to be outputted and add them to the output data.

Logging data			Output data		
No.	Data name	Contents	No.	Data name	Contents
			001	d	Logging output date
				INDEX	D0(FLOAT)single pre Index

Output title (data name) at the head of data

OK Cancel

For the setting items on the "Layout setting" screen corresponding to the data type (data logging/current value/creation time), refer to the following sections.

-  (1) in this section Data logging layout screen
-  (2) in this section Current value layout screen
-  (3) in this section Creation time layout screen

11 FUNCTIONS OF CONFIGURATION TOOL (MODULE SETTINGS)

(5) Editing

Edit the layout setting selected on the "Layout setting" screen.

Operating procedure

Select the layout setting to be edited on the "Layout setting" screen and then click the **Edit** button.

The layout setting to be edited is displayed according to the data type (data logging/current value/creation time).

Change the necessary portions and click the **OK** button.

Setting screen

Example) For a data logging layout

Data logging layout - Edit Index No.01

Make layout setting for outputting data logging file record to each report.

Layout name: LOG_LAYOUT1 Sheet name: Sheet1

Leading cell: Sheet1!A1 Cell range: A1:C1

Number of records: 1

Data logging name: 01.LOG01 [Edit]

Source file

Saved file Output the data in the file which has stored.

Storing file Output the data in the file which are being stored.

Both Output the data in the both files.

Outputting direction

Vertical (top -> bottom) Horizontal (left -> right)

Outputting order

Chronological order (old -> new) Reverse chronological order (new -> old)

Output data

Select data names to be outputted and add them to the output data.

No.	Data name	Contents
INDEX	Index	
001	d	D0(FLOAT[single pre...

No.	Data name	Contents
TIME	Logging output date	

Output title (data name) at the head of data

OK Cancel

For the setting items on the "Layout setting" screen corresponding to the data type (data logging/current value/creation time), refer to the following sections.

- ☞ (1) in this section Data logging layout screen
- ☞ (2) in this section Current value layout screen
- ☞ (3) in this section Creation time layout screen

11 FUNCTIONS OF CONFIGURATION TOOL (MODULE SETTINGS)

(6) Changing sheet name

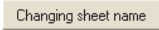

Change the Excel sheet name.

Operating procedure

Click the  button on the "Layout setting" screen.

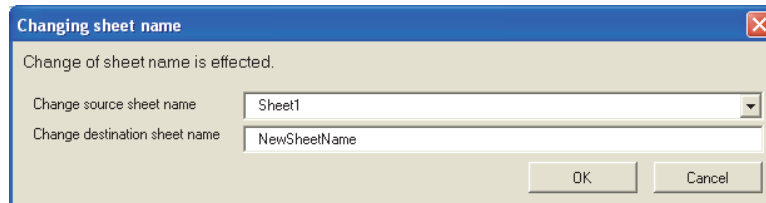
Setting screen



Item	Description
Change source sheet name	Select the change source sheet name.
Change destination sheet name	Enter the change destination sheet name.
 button	Confirms the settings and closes the screen.
 button	Discards the settings and closes the screen.

11.7.6 Creation trigger

This section explains the method for specifying the timing of trigger occurrence for creating the report file.

There are the two types of creation triggers below depending on the number of conditions combined.

- Single condition (if the number of conditions is 1)
- Compound condition (if multiple conditions are combined)

For details on processes of each trigger condition, refer to the following section.

☞ Section 9.3 Creation Trigger

(1) To select a single condition

The screenshot shows the 'Creation trigger' dialog box with the following elements:

- Buttons: Sampling, Layout, **Creation trigger**, Period of time, Save, Finish
- Text: Make settings for trigger conditions to create this report.
- Checkbox: Synchronize creation trigger with current value data
Trigger and current value data are sampled from access target CPU at all times.
 Unless specified, current value data is sampled after the occurrence of creation trigger.
- Radio buttons: Single condition Compound condition
- Table:

Trigger type	Contents
- Buttons: Edit

For the operations/settings after selecting a single condition, refer to the following section.

☞ (3) in this section Creation trigger (single condition)

(2) To select a compound condition

The screenshot shows the 'Creation trigger' dialog box with the following elements:

- Buttons: Sampling, Layout, **Creation trigger**, Period of time, Save, Finish
- Text: Make settings for trigger conditions to create this report.
- Checkbox: Synchronize creation trigger with current value data
Trigger and current value data are sampled from access target CPU at all times.
 Unless specified, current value data is sampled after the occurrence of creation trigger.
- Radio buttons: Single condition Compound condition
- Section: **Trigger type**
 - OR combine
Creation trigger is generated when any of conditions holds true.
 - AND combine
Creation trigger is generated when all conditions hold true.
 - Number of times
Creation trigger is generated by monitoring the number of times a condition has held true.
 - Order
Creation trigger is generated by monitoring the sequence in which conditions have held true.
- Section: **List of conditions**

No.	Type	Contents
1		
2		
3		
4		
5		
6		
7		
8		
- Buttons: Edit, Delete, Up arrow, Down arrow

For the operations/settings after selecting a compound condition, refer to the following section.

☞ (4) in this section Creation trigger (compound condition)

(3) Creation trigger (single condition)

Specify the creation trigger as a single condition.

Setting screen

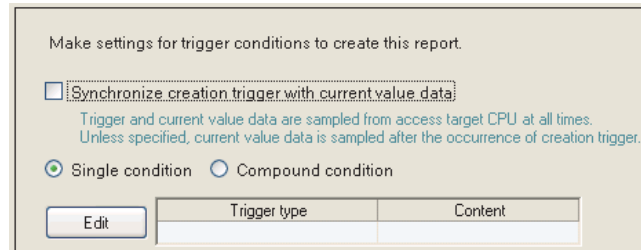

Item	Description	Reference
Synchronize creation trigger with current value data	If checked, the creation trigger and current value data are always sampled simultaneously from the access target CPU. If unchecked, the current value data are sampled after the creation trigger occurs.	-
Single condition	Select this to set a single trigger condition.	-
Compound condition	Select this to set a combination of multiple trigger conditions.	(4) in this section
Trigger type	Displays the specified type of trigger condition (Data conditions (Comparison), Data conditions (At the time of change of value), Fixed cycle, Time interval specification, Specifying a time of day, At startup of module, At the time of the data logging file is switched).	(3) (a) in this section
Content	Displays the overview of the trigger condition.	-
 button	Displays the "Trigger condition setting" screen.	(3) (a) in this section

POINT

- (1) The following are the operations when creation triggers continuously occur. After the creation trigger occurs, if the next creation trigger occurs while the report file is being created, report creation processing is not performed (the creation trigger is ignored). By checking the trigger reoccurrence count in 'report creation information 1 to 64' (☞ Section 3.4.13 (5)) in the buffer memory, the number of times the creation triggers were ignored can be checked.



The period when the report is being created can be checked with 'report creation execution information' (☞ Section 3.4.13 (2)) in the buffer memory. The time required to create the report can also be checked with report creation time in 'report creation information 1 to 64' in the buffer memory.

- (2) If "At startup of module" is selected for a creation trigger, data logging files output before the power was turned OFF or before the settings were updated can be output to a report depending on the data logging output setting. However, when configuring this setting when there are no data logging files, an error occurs because no output target data exists at module startup.

11 FUNCTIONS OF CONFIGURATION TOOL (MODULE SETTINGS)

(a) Trigger condition setting screen

Setting screen

Item	Description	Reference
Data conditions	-	-
Comparison*1	Compares data, and the trigger occurs when the condition is established.	-
Data name	Select the target data. To add a new data setting, select "(Add)" from the list box and click  .	Section 11.2.9 Section 11.5.6
Conditions	Select a comparison operator. (=, ≠, <, ≤, >, ≥,)	-
Data/Constant	Select the type of data to compare to the target data. ("Data" or "Constant")	-
Data name/ Constant value	Set the data or constant data (up to 16 characters) to compare to the target data. To add a new data setting and compare to the target data, select "(Add)" from the list box and click  .	-
At the time of change of value	The trigger occurs when the value changes.	Section 11.5.10 (1) (a)
Data name	Select the data to monitor for the value change. To add a new data setting, select "(Add)" from the list box and click  .	

(Continued on the next page)

11 FUNCTIONS OF CONFIGURATION TOOL (MODULE SETTINGS)

(From the previous page)

Item	Description	Reference
Fixed cycle	The trigger occurs at the specified cycle. (1 to 86400 seconds)	Section 11.5.10 (1) (b)
Time interval specification	The trigger occurs at the time interval of every specified hour/minute/second.	Section 11.5.10 (1) (c)
Specifying a time of day ^{*2*3}	The trigger occurs at the specified time.	Section 11.5.10 (1) (d)
Month	(Jan to Dec, Every)	
Day	(1 to 31, Every, Last)	
Hour	(00 to 23, Every)	
Minute	(00 to 59, Every)	
Second	(00 to 59)	
At startup of module	The trigger occurs when the high speed data logger module is powered ON or after reset.	-
At the time of the data logging file is switched. ^{*4*5}	The trigger occurs after the specified data logging file is switched.	-

*1: When data of different data types are compared, the condition may not be established because of the difference in internal representations.

*2: February 29 cannot be directly set. To specify February 29, select 'last day of February'.

*3: If "Every" is specified, "Every" needs to be set for all date/time items above it.

Example: If "Every" is set for "Hour", "Month" and "Day" are also set to "Every".

*4: Specify it from the specified data logging settings.

If the data logging layout is configured in the layout setting, the data logging name specified at the head is displayed.

*5: Cannot be specified when the data logging setting does not exist.

POINT

- (1) The following are the operations when creation triggers continuously occur. After the creation trigger occurs, if the next creation trigger occurs while the report file is being created, report creation processing is not performed (the creation trigger is ignored). By checking the trigger reoccurrence count in 'report creation information 1 to 64' (☞ Section 3.4.13 (5)) in the buffer memory, the number of times the creation triggers were ignored can be checked.

The period when the report is being created can be checked with 'report creation execution information'

(☞ Section 3.4.13 (2)) in the buffer memory. The time required to create the report can also be checked with report creation time in 'report creation information 1 to 64' in the buffer memory.

- (2) If "At startup of module" is selected for a creation trigger, data logging files output before the power was turned OFF or before the settings were updated can be output to a report depending on the data logging output setting. However, when configuring this setting when there are no data logging files, an error occurs because no output target data exists at module startup.

(4) Creation trigger (compound condition)

Specify the creation trigger as a compound condition.

Setting screen

Make settings for trigger conditions to create this report.

Synchronize creation trigger with current value data
Trigger and current value data are sampled from access target CPU at all times.
 Unless specified, current value data is sampled after the occurrence of creation trigger.

Single condition Compound condition

Trigger type

OR combine
Creation trigger is generated when any of conditions holds true.

AND combine
Creation trigger is generated when all conditions hold true.

Number of times
Creation trigger is generated by monitoring the number of times a condition has held true.

Order
Creation trigger is generated by monitoring the sequence in which conditions have held true.

List of conditions:

No.	Type	Content
1		
2		
3		
4		
5		
6		
7		
8		

Buttons: Edit, Delete, Up/Down arrows

Item	Description	Reference
Synchronize creation trigger with current value data	If checked, the creation trigger and current value data are always sampled simultaneously from the access target CPU. If unchecked, the current value data are sampled after the creation trigger occurs.	-
Single condition	Select this to set a single trigger condition.	(3) in this section
Compound condition	Select this to set a combination of multiple trigger conditions.	-
OR combine	The trigger occurs when any of the conditions specified on the list of conditions are established.	(4) (a) in this section
AND combine	The trigger occurs during the period when all of the conditions specified on the list of conditions are established.	(4) (b) in this section
Number of times	The trigger occurs by monitoring the number of times the condition is established.	(4) (c) in this section
Order	The trigger occurs by monitoring the order the conditions are established.	(4) (d) in this section
List of conditions	Displays the list of conditions.	-
Type	Displays any of the following items. <ul style="list-style-type: none"> For OR combine: Data conditions (Comparison), Data conditions (At the time of change of value), Fixed cycle, Time interval specification, Specifying a time of day, At startup of module For AND combine: Data conditions (Comparison) For Number of times: Comparison, At the time of change of value For Order: Comparison, At the time of change of value 	-
Content	Displays the overview of the condition.	-
Edit button	Displays the setting screen to edit the condition in the selected row.	-
Delete button	Deletes the condition in the selected row.	-
Up/Down button	Shifts the selected row one row up or one row down.	-

POINT

- (1) When AND combine or OR combine are specified, the number of conditions that can be combined is up to 8 with "Period of time".
- (2) If high speed data sampling is selected in data sampling method, the number of conditions that can be combined is up to 4 with "Period of time".

(a) OR combine

Setting screen

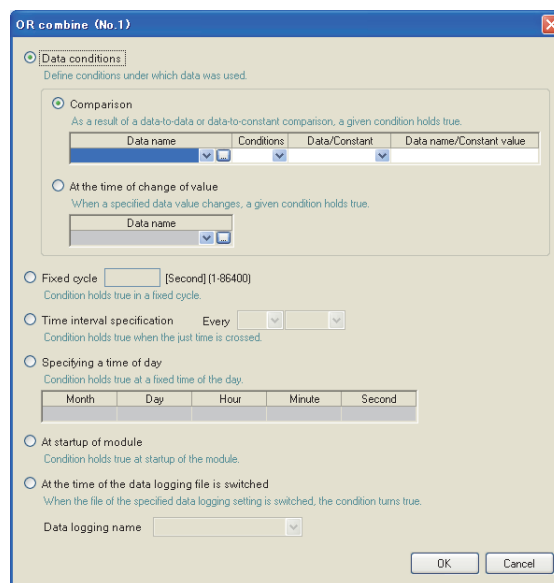

The items are the same as those of the creation trigger (single condition). Refer to the following section.

☞ Section 11.7.6 (3) Creation trigger (single condition)

(b) AND combine

The items are the same as those of "AND combine" of the trigger logging (compound condition). Refer to the following section.

☞ Section 11.5.11 (2) AND combine

(c) Number of times

The items are the same as those of "Number of times" of the trigger logging (compound condition). Refer to the following section.

☞ Section 11.5.11 (3) Number of times

(d) Order

The items are the same as those of "Order" of the trigger logging (compound condition). Refer to the following section.

☞ Section 11.5.11 (4) Order

11 FUNCTIONS OF CONFIGURATION TOOL (MODULE SETTINGS)

POINT

- (1) By setting the following settings, report files corresponding to data logging files one-to-one basis can be created.
 - [Report setting] → [Layout] → "Data logging layout" → "Source file" → "Saved file" (☞ Section 11.7.5 (1))
 - [Report setting] → [Creation trigger] → "At the time of the data logging file is switched"
- (2) By setting the following settings, only trigger logging data before and after the rising of trigger condition can be output to a report.
 - [Data logging setting] → [save] → "File switching timing" → "Trigger logging unit" (☞ Section 11.5.15 (2))
 - [Report setting] → [Layout] → "Data logging layout" → "Source file" → "Saved file" (☞ Section 11.7.5 (1))
 - [Report setting] → [Creation trigger] → "At the time of the data logging file is switched"

9

REPORT FUNCTION

10

OTHER FUNCTIONS

11

FUNCTIONS OF CONFIGURATION TOOL (MODULE SETTINGS)

12

FUNCTIONS OF CONFIGURATION TOOL (WRITING/READING/VERIFYING DATA)

13

FUNCTIONS OF CONFIGURATION TOOL (CONFIRMING MODULE OPERATION)

14

FUNCTIONS OF LOGGING FILE CONVERSION TOOL

15

RECIPE FUNCTION

16

CompactFlash CARD

11 FUNCTIONS OF CONFIGURATION TOOL (MODULE SETTINGS)





11.7.7 Period of time

Specify the period for monitoring the report creation trigger.

Processes of period condition are the same as those of Data logging setting. Refer to the following section.

☞ Section 7.4 Data Logging Periods

Setting screen

Item	Description	Reference
Specify a period of time	Check if not always monitoring the report creation trigger.	-
Carry out report creation during the period of time which corresponds to prescribed conditions	Select this to monitor the report creation trigger during the period corresponding to the conditions displayed in the list.	-
Don't carry out report creation during the period of time which corresponds to prescribed conditions	Select this to not monitor the report creation trigger during the period corresponding to the conditions displayed in the list.	-
Type of condition	Displays the condition type. (Data conditions, Date range, Time-of-the-day range, Day-of-the-week/Week-of-the-month conditions)	-
Content	Displays the overview of the condition. To check the content, select the corresponding row and click the  button.	-
 button	Displays the setting screen to edit the selected condition.	(1) in this section
 button	Deletes the selected condition.	-
Operator for combination	Specify how to combine the rows of conditions. (OR, AND)	(2) in this section
  button	Shifts the selected row one row up or one row down.	-

11 FUNCTIONS OF CONFIGURATION TOOL (MODULE SETTINGS)

(1) Specify a period of time

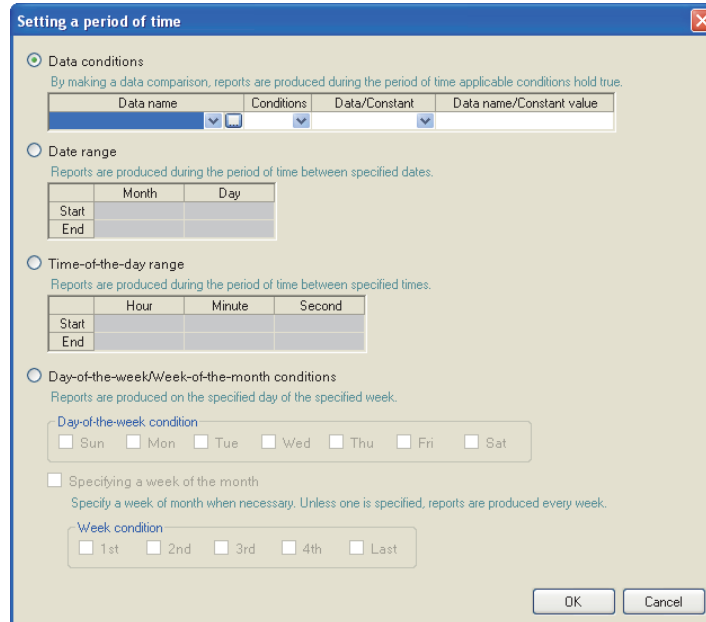

Specify the condition to define the period.

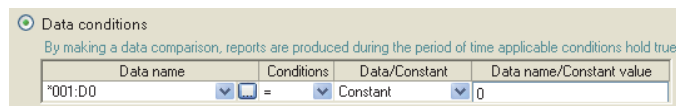

(a) Data conditions

Compares data, and monitors the report creation trigger during the period when the condition is established.



Item	Description
Data name	Select the target data from the data set with "Report setting". To add a new data setting, select "(Add)" from the list box and click  .
Conditions ^{*1}	Select a comparison operator. (=, ≠, <, ≤, >, ≥)
Data/Constant	Select the type of data to compare to the target data. ("Data" or "Constant")
Data name/Constant value	Set the data or constant data (up to 16 characters) to compare to the target data. To add a new data setting, select "(Add)" from the list box and click  .

*1: When data of different data types are compared, the condition may not be established because of the difference in internal representations.

11 FUNCTIONS OF CONFIGURATION TOOL (MODULE SETTINGS)

(b) Date range

Monitors the report creation trigger during the period specified date*1.

Example settings) For the date range specified below

	Month	Day
Start	Mar	28
End	Apr	2

For the above example settings, monitors the report creation trigger as shown in the table below.

Date	...	March 27	March 28	...	April 2	April 3	...
Carry out report creation during the period of time which corresponds to prescribed conditions	×	×	○	○	○	×	×
Don't carry out report creation during the period of time which corresponds to prescribed conditions	○	○	×	×	×	○	○

○: Executed ×: Not executed

*1: February 29 cannot be directly set. To specify February 29, select 'last day of February'.

(c) Time-of-the-day range

Monitors the report creation trigger during the specified time period.

Example settings) For the time range specified below

	Hour	Minute	Second
Start	08	00	00
End	08	00	59

For the above example settings, monitors the report creation trigger as shown in the table below.

Time (hour:minute:second)	...	7:59:59	8:00:00	...	8:00:59	8:01:00
Carry out report creation during the period of time which corresponds to prescribed conditions	×	×	○	○	○	×
Don't carry out report creation during the period of time which corresponds to prescribed conditions	○	○	×	×	×	○

○: Executed ×: Not executed

11 FUNCTIONS OF CONFIGURATION TOOL (MODULE SETTINGS)

(d) Day-of-the-week/Week-of-the-month conditions

Monitors the report creation trigger during the specified day of the week or week. The period can be specified by combining the day of the week and week.

- ① To perform report creation on the specified day of the week each week
Uncheck "Specifying a week of the month".

Example settings) For the day of the week condition specified below

For the above example settings, monitors the report creation trigger as shown in the table below.

Day of the week	Sun	Mon	Tues	Wed	Thur	Fri	Sat	Sun	Mon	..
Carry out report creation during the period of time which corresponds to prescribed conditions	×	○	○	○	○	○	×	×	○	..
Don't carry out report creation during the period of time which corresponds to prescribed conditions	○	×	×	×	×	×	○	○	×	..

○: Executed ×: Not executed

9 REPORT FUNCTION

10 OTHER FUNCTIONS

11 FUNCTIONS OF CONFIGURATION TOOL (MODULE SETTINGS)

12 FUNCTIONS OF CONFIGURATION TOOL (WRITING/READING/VERIFYING DATA)

13 FUNCTIONS OF CONFIGURATION TOOL (CONFIRMING MODULE OPERATION)

14 FUNCTIONS OF CONFIGURATION TOOL (LOGGING FILE CONVERSION TOOL)

15 RECIPE FUNCTION

16 CompactFlash CARD

11 FUNCTIONS OF CONFIGURATION TOOL (MODULE SETTINGS)

- ② To perform report creation combining the week and day of the week
Check "Specifying a week of the month".

The following table shows the week conditions.

Week condition	Description
1st	From the 1st to the 7th
2nd	From the 8th to the 14th
3rd	From the 15th to the 21st
4th	From the 22nd to the 28th
Last	The 7 days at the end of the month for the corresponding month Example) If the 31st is the end of the month, the 25th to the 31st If the 30th is the end of the month, the 24th to the 30th

Example settings) For the day of the week conditions and week conditions specified below, with the period specified as "Monitors the report creation trigger during the period of time which corresponds to prescribed conditions"

Day-of-the-week condition

Sun Mon Tue Wed Thu Fri Sat

Specifying a week of the month
Specify a week of month when necessary. Unless one is specified, reports are produced every week.

Week condition

1st 2nd 3rd 4th Last



Monitors the report creation trigger on the shaded portions.

January 2009						
Sun	Mon	Tue	Wed	Thu	Fri	Sat
				1	2	3
4	5	6	7	8	9	10
11	12	13	14	15	16	17
18	19	20	21	22	23	24
25	26	27	28	29	30	31

Day of week condition "Mon/Tue/Wed/Thu/Fri"

1st "1st to 7th"

4th "22nd to 28th"

Last "25th to 31st"

(2) Condition for combination

Multiple specified conditions in the 'condition table' can be combined.

"OR" or "AND" can be selected as the combine condition.

The combine condition is applied to all the conditions. "AND" and "OR" cannot be mixed.

(a) For OR combine

When "Carry out report creation during the period of time which corresponds to prescribed conditions" is selected for the period

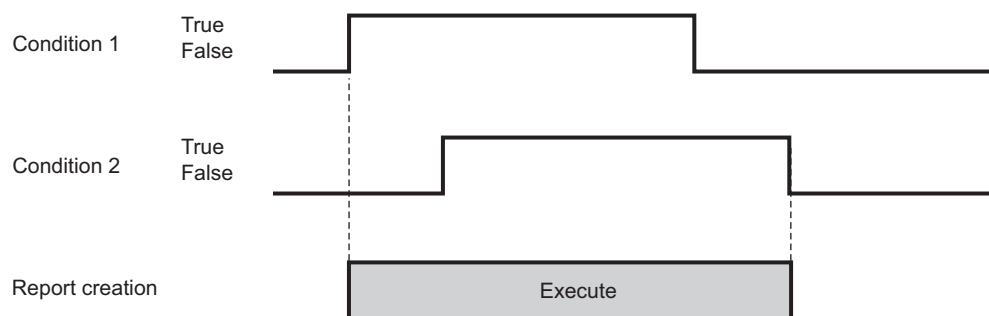

(b) For AND combine

When "Carry out report creation during the period of time which corresponds to prescribed conditions" is selected for the period

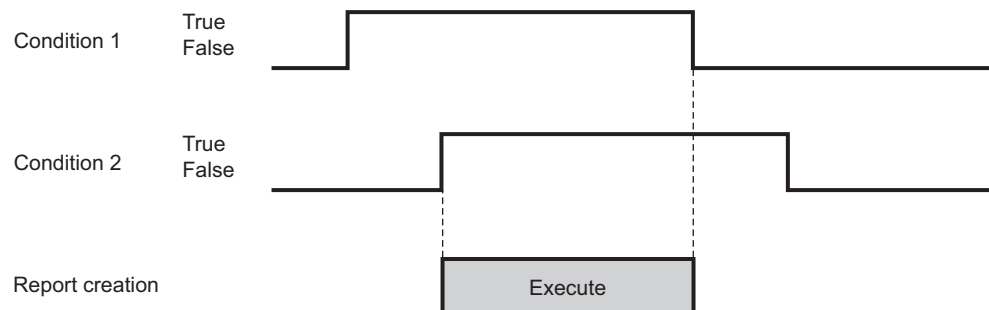

☒ POINT

- (1) The number of conditions that can be combined is up to 8 with 'creation trigger condition (AND combine or OR combine)'.
- (2) If high speed data sampling is selected in data sampling method, the number of conditions that can be combined is up to 4 with "Period of time".

11 FUNCTIONS OF CONFIGURATION TOOL (MODULE SETTINGS)

11.7.8 Save

This section explains the method for setting the report file save destination and saved file switching.

Processes of saving settings are the same as those of Data logging setting. Refer to the following section.

☞ Section 7.5.2 Saving data logging files

Setting screen

Item	Description	Reference
File save destination	Specify the save directory (file name) for the report file.	(1) in this section
Saved files	-	-
Saved file name	Set the information to attach to the report file name.	(2) in this section
Number of saved files	Specify the maximum number of files to be saved on the CompactFlash card.	(3) in this section
button	Displays the setting screen to edit the settings to transfer the saved file by FTP or to send it by e-mail.	(4) in this section
FTP transfer destination	Displays the FTP transfer destination setting. • If no setting : No setting • If there is a setting: Displays the FTP setting number	-
E-mail address	Displays the e-mail destination setting. • If no setting : No setting • If there is a setting: Displays the target e-mail address setting number	-

11 FUNCTIONS OF CONFIGURATION TOOL (MODULE SETTINGS)

(1) File save destination

File save destination
 Define report file save directory (setting type folder).

/REPORT/

Item	Description
File save destination	Specify the name of the folder to save files in. For the characters that can be set, refer to the section below. Appendix 4.2 Characters usable in file names, folder (directory) names Specify a name that is not a duplicate of the file save destination for other report files. (Within 32 characters)

256 report files are saved in a folder of the specified "File save destination".
 The files with low numbers which are deleted by the setting of "Number of saved files" are included in these files.
 The 257th file is saved in a new folder.
 The following table shows the saved file name when the save folder and additional information are not set.

Save folder			Saved file name
File type folder	Setting type folder	Number folder	
\REPORT	\REP01	\0000001	00000001.XLS
			00000002.XLS
			:
			000000FF.XLS
		\0000101	00000100.XLS
			00000101.XLS
			00000102.XLS
			:
	\REP02	\0000001	000000FF.XLS
			00000200.XLS
			:
			00000001.XLS
		\0000001	00000002.XLS
			:
			000000FF.XLS
			00000100.XLS
\0000101	00000101.XLS		
	00000102.XLS		
	:		
	000001FF.XLS		
		:	:

11 FUNCTIONS OF CONFIGURATION TOOL (MODULE SETTINGS)

Item	Description
File type folder	Folders are created automatically according to the type of saved file. "LOGGING": Stores data logging files. (☞ Section 11.5.15 (1)) "EVENT": Stores event logging files. (☞ Section 11.6.13 (1)) "REPORT": Stores report files.
Setting type folder	Files are sorted according to the save directory name set for "File save destination" on the <<Save>> tab of the report setting.
Number folder	Files are sorted according to the specified number of saved file. Folder name: 100 x n + 1 is displayed in 8 digits (n=0, 1, 2, 3, ...) Example: 00000001, 00000101, 00000201, 00000301
Saved file name	A saved file name is expressed as 8 digits. The output format can be changed in the "Saved file name" setting on the <<Save>> tab of the report setting.

11 FUNCTIONS OF CONFIGURATION TOOL (MODULE SETTINGS)

(2) Saved file name

Set the information which is to be attached to the saved file name.

Setting screen

Item	Description	Reference
Format	Displays the output format of the saved file.	-
Example	Displays the output image of the file name in a current format.	-
<input type="button" value="Edit"/> button	Opens the "Saved file name setting" screen to set the information which is to be attached to the saved file name.	Section 11.5.15 (3) (a)

POINT

The saved file number (00000001 to FFFFFFFF) to identify saved files is always attached to the saved file name.

Example of a saved file name: REP01_20090410_00000001.CSV (Name and date are attached)

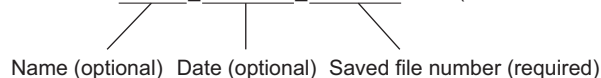

9

REPORT FUNCTION

10

OTHER FUNCTIONS

11

FUNCTIONS OF CONFIGURATION TOOL (MODULE SETTINGS)

12

FUNCTIONS OF CONFIGURATION TOOL (WRITING/READING/VERIFYING DATA)

13

FUNCTIONS OF CONFIGURATION TOOL (CONFIRMING MODULE OPERATION)

14

FUNCTIONS OF CONFIGURATION TOOL (LOGGING FILE CONVERSION TOOL)

15

RECIPE FUNCTION

16

CompactFlash CARD

11 FUNCTIONS OF CONFIGURATION TOOL (MODULE SETTINGS)

(3) Number of saved files

Set the maximum number of saved files and the operation when the maximum number is exceeded.

Setting screen

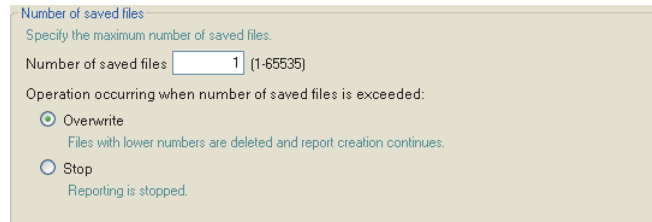

Number of saved files
Specify the maximum number of saved files.
Number of saved files: (1-65535)
Operation occurring when number of saved files is exceeded:
 Overwrite
Files with lower numbers are deleted and report creation continues.
 Stop
Reporting is stopped.

Item	Description
Number of saved files	Specify the maximum number of saved files. (1 to 65535)
Operation occurring when number of saved files is exceeded	-
Overwrite	Select this to delete files with low numbers and continue report creation when at the occurrence of a creation trigger the number of saved files has already exceeded the specified number. When the folder where files with low numbers are deleted becomes empty, that folder is automatically deleted.
Stop	Select this to stop report creation when at the occurrence of a creation trigger the number of saved files has already exceeded the specified number. Turns ON the corresponding bit for 'Number of saved files exceeded information' in the buffer memory's report creation status area. Delete the latest saved file or the saved file with the lowest number via FTP or with the file browser of the Configuration Tool to restart report creation.

POINT

The number of saved files is calculated by the saved file number as shown below.
Latest saved file number - Lowest saved file number + 1

(4) Transfer setting screen

When a report file is created, transfers that newest report file.

Setting screen

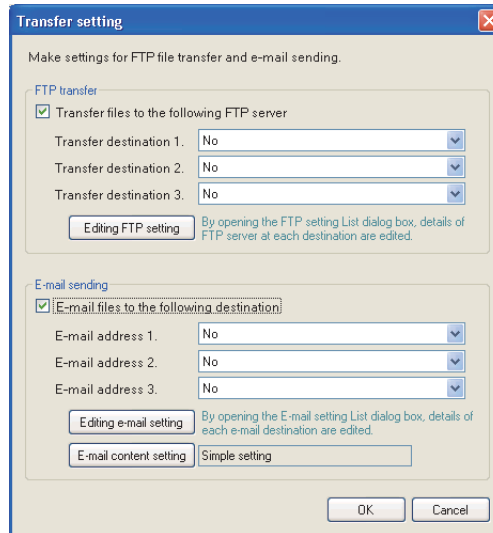

The items are the same as those of the "Transfer setting" screen of the Data logging setting.

☞ Section 11.5.15 (5) Transfer setting screen

☒ POINT

- (1) If report creation (creation trigger occurrence) and a data logging file switch occur at the same time, report creation has priority and the data logging file is switched after the report is created.
- (2) E-mail transmissions/file transfers by the saved file transfer function may take a few seconds to tens of seconds depending on the network line/transmission size.
Target files may be deleted before e-mail transmission/file transfer completes depending on the settings.
Review the number of saved files (☞ (3) in this section) setting and lengthen the time until the file is deleted.
- (3) Do not configure the transfer settings when performing report creation using the auto logging function (☞ Section 10.2).
When using the auto logging function, the high speed data logger module cannot connect to the LAN line, therefore FTP transfers and e-mail transmissions cannot be performed.

11 FUNCTIONS OF CONFIGURATION TOOL (MODULE SETTINGS)

11.7.9 Completion

Gives a name to the report and completes the settings.

Setting screen



Sampling Layout Create trigger Period of time Save **Finish**

All information necessary to create a report has been gathered. Press the [Finish] button to complete settings.
To have your settings reflected in the module, use the Online menu's Write command.

Assign a name to report creation task.

Report name REP01

Data list < Back Next > Finish Cancel

Item	Description
Report name	Specify the name of the setting being edited. For the characters that can be set, refer to the following chapter. Appendix 4 Usable Characters (Up to 32 characters)
 button	Confirms the settings being edited. After confirming the settings, the report name is displayed in the following. <ul style="list-style-type: none">On the edit items tree, under the "Report setting" folderReport setting list
 button	Discards the report settings being edited and ends editing.

CHAPTER 12 FUNCTIONS OF CONFIGURATION TOOL (WRITING/READING/VERIFYING DATA)

12.1 Transfer Setup

After starting the Configuration Tool, configure before connecting with the high speed data logger module.

Operating procedure

Select [Online] → [Transfer Setup].

Setting screen

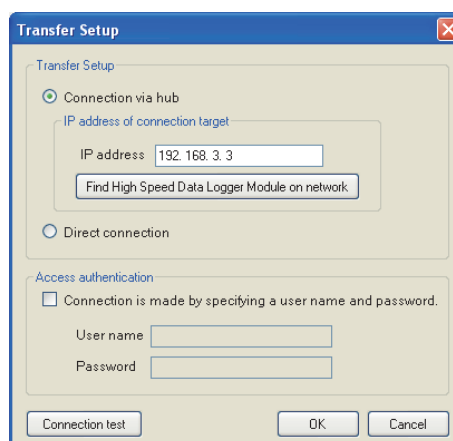

Item	Description	Reference
Transfer Setup	-	-
Connection via hub	Select this to connect via the network. The IP address of the high speed data logger module must be specified.	Section 2.1.3 (1)
IP address	Specify the IP address.	-
Find High Speed Data Logger Module on network button	Opens the "Find High Speed Data Logger Module" screen.	Section 12.2
Direct connection	Select this to connect directly to the high speed data logger module. Not necessary to specify the IP address of the high speed data logger module.	Section 2.1.3 (2)
Access authentication	-	-
Connection is made by specifying a user name and password	Check to perform access authentication.	
User name* ¹	Specify the user name to login with. (Up to 20 characters)	Section 11.4.6
Password* ¹	Specify the password for the user name to login with. (Up to 16 characters)	
Connection test button	Performs a connection test.	-
OK button	Confirms the settings and closes the screen.	-
Cancel button	Discards the settings and closes the screen.	-

*1: For the characters that can be used, refer to the following section.

➤ Appendix 4 Usable Characters

12.2 High Speed Data Logger Module Search

When the module is connected via a hub, the high speed data logger modules are searched on the same network as the configuration personal computer and the searched modules are displayed in a list.

Operating procedure

Click the button on the "Transfer Setup" ( Section 12.1) screen.

High speed data logger modules which are connected via a router are not searched.

Screen display

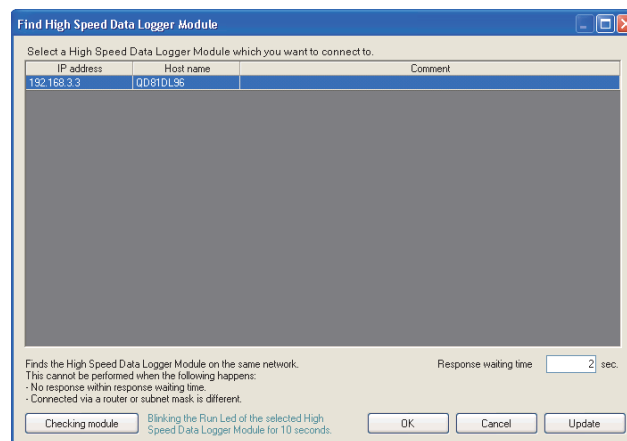

Item	Description
IP address	Displays the IP address of the searched high speed data logger module.
Host name	Displays the host name (the host name registered on Network setting) of the searched high speed data logger module.
Comment	Displays only the first line of the project comment written to the searched high speed data logger module. (Up to 160 characters)
Response waiting time	Specify the response waiting time for the module search. (1 to 99 seconds)
<input type="button" value="Checking module"/> button	In order to confirm the high speed data logger module of the selected row, flashes the "RUN" LED ( (Section 4.3 (3)) on the front of the module for 10 seconds.
<input type="button" value="OK"/> button	Reflects the IP address of the selected row to the "Transfer Setup" screen and closes the screen.
<input type="button" value="Cancel"/> button	Closes the screen without reflecting the IP address of the selected row to the "Transfer Setup" screen.
<input type="button" value="Update"/> button	Searches for high speed data logger modules again and updates the "Find High Speed Data Logger Module" screen.

POINT

High speed data logger modules may not be searched normally in a configuration where multiple IP addresses are enabled at the same time as shown below.

- IP addresses are assigned to each of multiple Ethernet ports (network devices) of a configuration/display personal computer.
- Aside from the Ethernet port of a configuration/display personal computer, a wireless LAN setting is enabled.
- Multiple IP addresses are assigned to a single Ethernet port of a configuration/display personal computer.

12.3 Writing Data

This function writes the settings to the CompactFlash card inserted in the high speed data logger module set with transfer setup (☞ Section 12.1).

Operating procedure

- ① Select [Online] → [Write] (🔧).
- ② Click the button on the dialog box shown in the figure of < Confirmation of the write execution >.
- ③ Click the button on the dialog box shown in the figure of < Confirmation of the setting reflection to the module operation >.

Screen display

< Confirmation of the write execution >

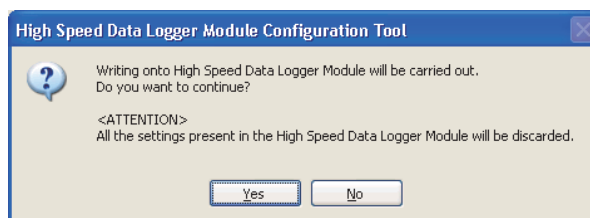

< Confirmation of the setting reflection to the module operation >

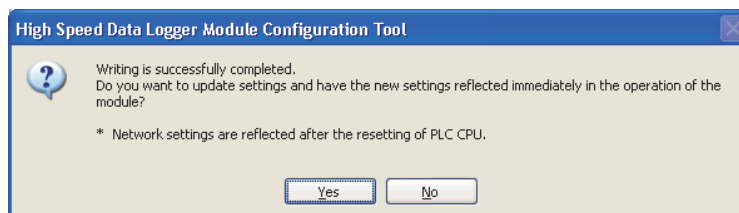

☒ POINT

- (1) While the write (update settings) processing is being performed, all functions including the data logging function, event logging function, and report setting function stop.
- (2) Network settings cannot be reflected by only performing the data write. Update the settings by performing one of the following operations.
 - Reset the programmable controller CPU
 - Restore the power of the programmable controller CPU

12.4 Reading Data

This function reads the settings from the high speed data logger module set with transfer setup (☞ Section 12.1).

Operating procedure

Select [Online] → [Read] (🖨️).

12.5 Verifying Data

This function compares the project settings currently opened in the Configuration Tool with the settings on the high speed data logger module set with transfer setup (☞ Section 12.1) and displays the result.

Operating procedure

Select [Online] → [Verify].

Screen display

<When there are no inconsistencies>

Displays the screen as shown below.

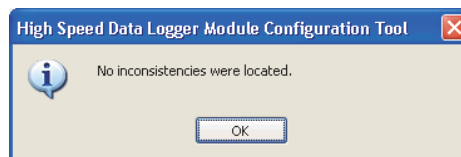

<When there are inconsistencies>

The inconsistencies are displayed in a list screen as shown below.

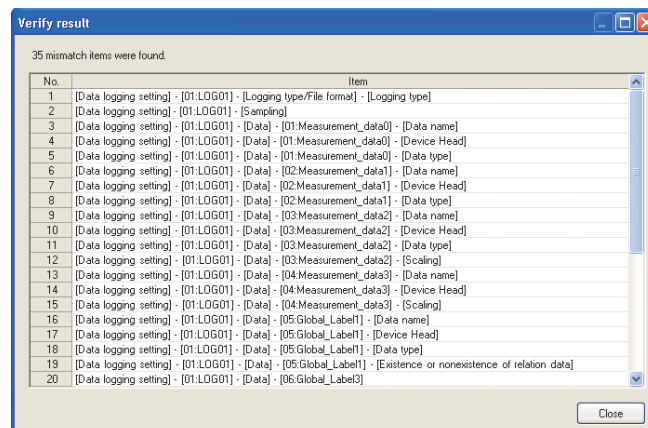

CHAPTER 13 FUNCTIONS OF CONFIGURATION TOOL (CONFIRMING MODULE OPERATION)

This chapter explains the method for connecting to a running high speed data logger module, confirming the operating status of the module, and executing module operations.

13.1 Diagnostics

Operating procedure

- ① Configure transfer setup. (☞ Section 12.1 Transfer Setup)
- ② Select [Online] → [Diagnostics].

Screen display

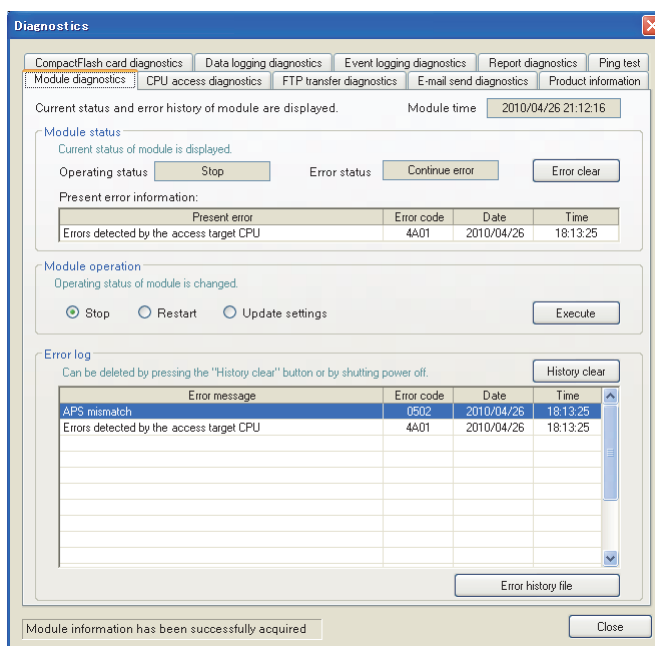

(1) Tab list

Tab name	Type	Description	Reference
Module diagnostics	Monitor	Displays current status and error log of module.	Section 13.1.1
CPU access diagnostics		Displays status of access to a target CPU.	Section 13.1.2
FTP transfer diagnostics		Displays results of file transfer to FTP server.	Section 13.1.3
E-mail send diagnostics		Displays results of sending e-mail.	Section 13.1.4
Product information		Displays product information of the module.	Section 13.1.5
CompactFlash card diagnostics	Operation	Change the access status to the CompactFlash card, and format the CompactFlash card.	Section 13.1.6
Data logging diagnostics	Monitor	Displays error code for each operation.	Section 13.1.7
Event logging diagnostics			Section 13.1.8
Report diagnostics			Section 13.1.9
Ping test			Section 13.1.10

13.1.1 Module diagnostics

Changes the operating status, and displays the operating status and error log for the high speed data logger module.

Operating procedure

- ① Select [Online] → [Diagnostics].
- ② Select the <<Module diagnostics>> tab.

Screen display

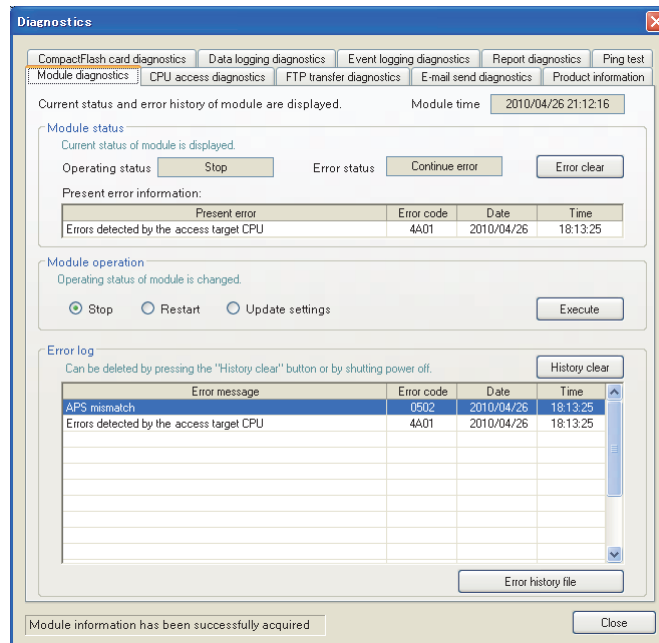



Item	Description	Reference
Module time* ¹	Displays current operating time of the module.	-
Module status	-	-
Operating status	Displays current operating status of the module.	(1) in this section
Error status	Displays current error status of the module.	(2) in this section
Error clear button	Deletes the current error information. The error lamp illuminated on the module also turns OFF.	-
Present error information	Displays the latest error code and time when it occurred.	-
Module operation	-	-
Stop	Select this to stop high speed data logger module operations (data logging function, event logging function, report function).	-
Restart	Select this to restart stopped high speed data logger module operations.	-
Update settings	Select this to read the settings on the CompactFlash card and reflects them.* ² While processing "Update settings", the operating status of the module is "Initialization in progress".	(1) in this section
Execute button	Executes the selected operation (Stop/Restart/Update settings).	-

(Continued on the next page)

13 FUNCTIONS OF CONFIGURATION TOOL (CONFIRMING MODULE OPERATION)

(From the previous page)

Item	Description	Reference
Error log	Displays the history of errors which occurred on the module. They are deleted by the  button. *3	-
 button	Deletes the history of errors which occurred on the module.	-
 button	Opens a screen which displays the contents of the error log file.	(3) in this section
Information acquisition status	Displays communications with the module and the information acquisition result in the lower left of the screen.	(4) in this section

*1: This item is supported by the high speed data logger module with a serial number whose first five digits are '12062' or higher only.

*2: While an error is occurring, settings cannot be updated.

While an error is occurring, perform "Update settings" while the procedure below.

1. Execute module operation "Stop".
2. Click the  button in the "Module status" to clear the error status.
3. Execute module operation "Update settings".

*3: If the same error occurs multiple times, only displays the date and time of occurrence for the first error which occurred.

(1) Operating status

Item	Description	Reference
In operation	Indicates that the module is operating normally.	-
Stop	Indicates that the module is in a stopped state. The data logging function, event logging function, and report function are not executed when stopped. Causes: <ul style="list-style-type: none"> • The execution of the auto logging setting is completed. • "Stop" is executed with module operation. • File access stop request (Y2) is ON. • After formatting the CompactFlash card 	Section 11.4.7 Section 13.1.6
Initialization in progress	Indicates that the module is starting. Displayed immediately after the programmable controller CPU is reset or settings are written and updated.	-
Stopping	Indicates the status when the module is in transition from "In operation" to "Stopped".	-

(2) Error status

Item	Description
No error	Indicates that the module is operating normally without errors.
Continuation error	Indicates the status where the module has a minor error, but is permitted to keep on operating.
Stop error	Indicates the status where the module has a critical error and is inoperable.

POINT

While the "Update settings" process is being performed, all functions including the data logging function, event logging function, and report function stop.

13 FUNCTIONS OF CONFIGURATION TOOL (CONFIRMING MODULE OPERATION)

(3) Error log file screen

Displays the history of errors which occurred on the module as a list.

Operating procedure

Click the button on the <<Module diagnostics>> tab.

Screen display

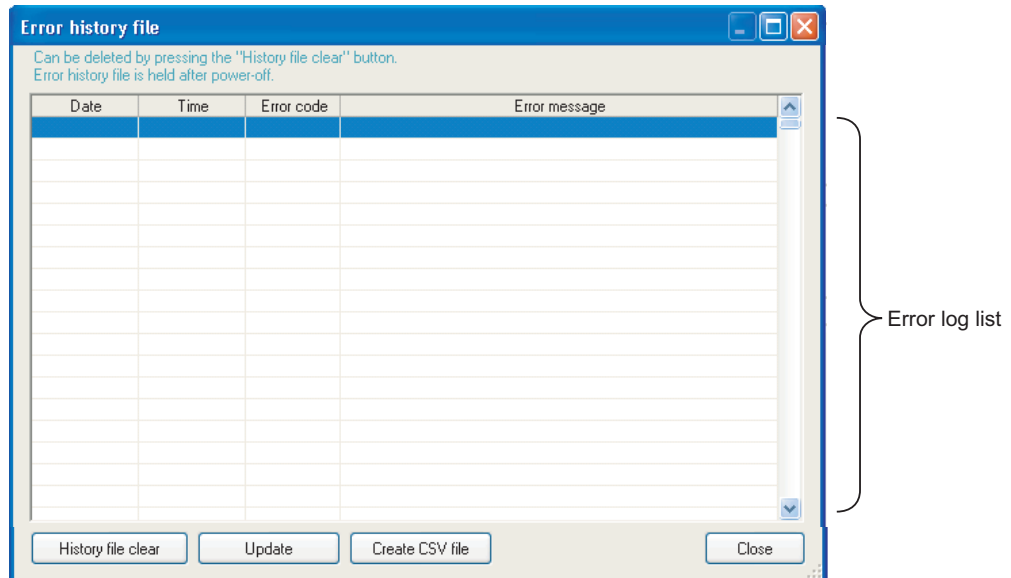

Item	Description
Error history list	Displays the error history list. The list is deleted by the <input type="button" value="History file clear"/> button.
<input type="button" value="Update"/> button	Displays the latest error history by reloading the file.
<input type="button" value="History file clear"/> button	Deletes the error history list.
<input type="button" value="Create CSV file"/> button	Save the error information of the error history file as a CSV file.
<input type="button" value="Close"/> button	Closes the screen.

(4) Information acquisition status

Displays communications with the module and the information acquisition result.

Display	Description
Module information has been successfully acquired.	Indicates the information was successfully acquired and the display was updated.
Module data acquisition in progress	Indicates the Configuration Tool is communicating with the module in order to update the display.
Module data acquisition failed	Indicates a failure to acquire the information. Check the module status, network and communication cable status, and the transfer setup settings.

13 FUNCTIONS OF CONFIGURATION TOOL (CONFIRMING MODULE OPERATION)

13.1.2 CPU access diagnostics

Monitors the status of the access target CPU.

Operating procedure

- ① Select [Online] → [Diagnostics].
- ② Select the <<CPU access diagnostics>> tab.

Screen display

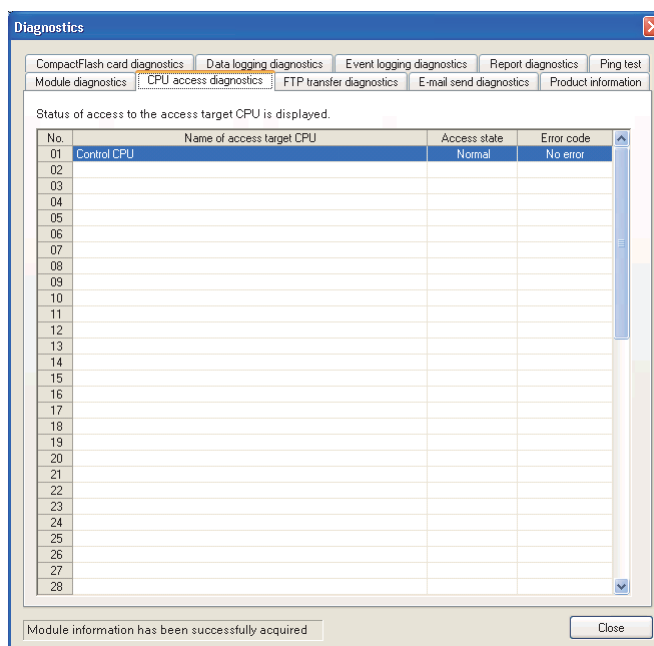

Item	Description
No.	Displays the index of the access target CPU setting.
Name of access target CPU	Displays the CPU name of the access target CPU setting.
Access state	Displays the current access target CPU access status (Normal, Error).
Error code	Displays the newest error code of the access target CPU. Section 18.2 Error Code List

9 REPORT FUNCTION
 10 OTHER FUNCTIONS
 11 FUNCTIONS OF CONFIGURATION TOOL (MODULE SETTINGS)
 12 FUNCTIONS OF CONFIGURATION TOOL (WRITING/READING/VERIFYING DATA)
 13 FUNCTIONS OF CONFIGURATION TOOL (CONFIRMING MODULE OPERATION)
 14 FUNCTIONS OF CONFIGURATION TOOL (LOGGING FILE CONVERSION TOOL)
 15 RECIPE FUNCTION
 16 CompactFlash CARD

13.1.3 FTP transfer diagnostics



Monitors the results of file transfers to FTP servers.

Operating procedure

- ① Select [Online] → [Diagnostics].
- ② Select the <<FTP transfer diagnostics>> tab.

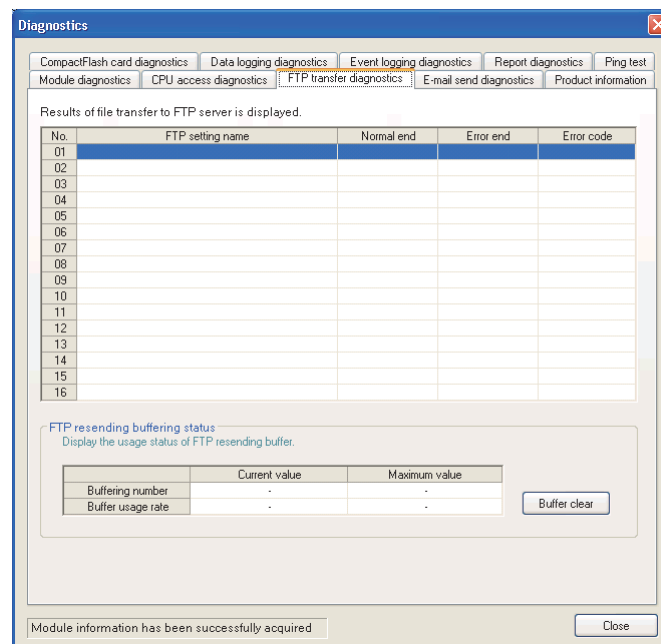
Screen display



Item	Description
No.	Displays the index of the FTP setting.
FTP setting name	Displays the name of the FTP setting.
Normal complete	Displays the number of times the FTP transfer completed normally.
Abnormal complete	Displays the number of times the FTP transfer completed in an error.
Error code	Displays the newest error code of the FTP transfer.  Section 18.2 Error Code List
FTP resending buffering status ^{*1*2}	-
Buffering Number ^{*3}	Displays the number of data stored in the FTP resend buffer memory. Current value : Current number of buffered data/Set number of buffered data Maximum value : The maximum number of buffered data up to the present/Set number of buffering data
Buffer usage rate ^{*3}	Displays the usage rate of the FTP resend buffer memory. Current value : Current usage rate Maximum value : The maximum usage rate up to the present
 Buffer clear button	Clears the FTP resend buffer memory and cancels resending the FTP transfer.

*1: The FTP resend function is supported by the high speed data logger module with a serial number whose first five digits are '12062' or higher only. "-" is displayed for unsupported modules.

*2: "-" is displayed when "Resend when transfer failed" is not set in the optional setting of the FTP setting.

*3: The maximum value is cleared when the high speed data logger module is turned OFF.

13.1.4 E-mail send diagnostics

Monitors the results of sending e-mails.

Operating procedure

- ① Select [Online] → [Diagnostics].
- ② Select the <<E-mail send diagnostics>> tab.

Screen display

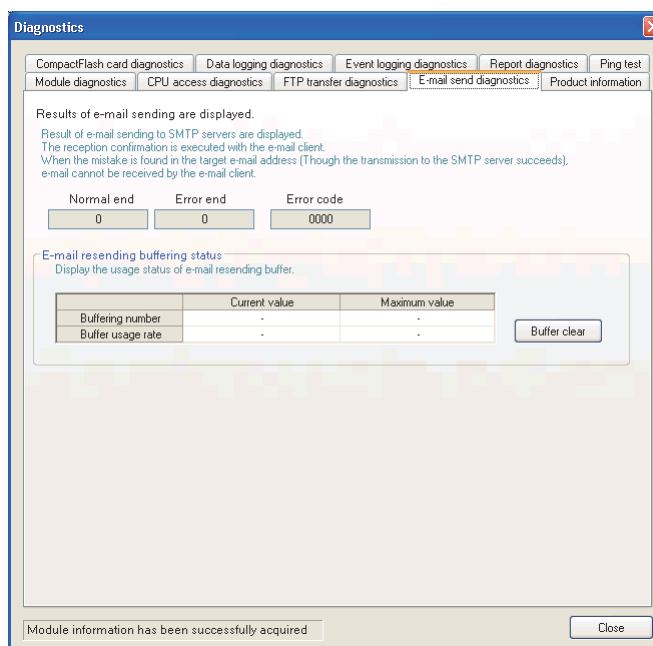

Item	Description
Normal end	Displays the number of times that sending e-mail with the high speed data logger module completed normally.
Error end	Displays the number of times that sending e-mail with the high speed data logger module completed in an error.
Error code	Displays the newest error code of the e-mail transmission. Section 18.2 Error Code List
E-mail resending buffering status ^{*1*2}	-
Buffering Number ^{*3}	Displays the number of data stored in the E-mail resend buffer memory. Current value : Current number of buffered data/Set number of buffered data Maximum value : The maximum number of buffered data up to the present/Set number of buffering data
Buffer usage rate ^{*3}	Displays the usage rate of the E-mail resend buffer memory. Current value : Current usage rate Maximum value : The maximum usage rate up to the present
button	Clears the FTP resend buffer memory and cancels resending the E-mail transfer.

*1: The FTP resend function is supported by the high speed data logger module with a serial number whose first five digits are '12062' or higher only. "-" is displayed for unsupported modules.

*2: "-" is displayed when "Resend when sending failed" is not set in the optional setting of the E-mail setting.

*3: The maximum value is cleared when the high speed data logger module is turned OFF.

13 FUNCTIONS OF CONFIGURATION TOOL (CONFIRMING MODULE OPERATION)

13.1.5 Product information

Displays the version information of the high speed data logger module.

Operating procedure

- ① Select [Online] → [Diagnostics].
- ② Select the <<Product information>> tab.

Screen display

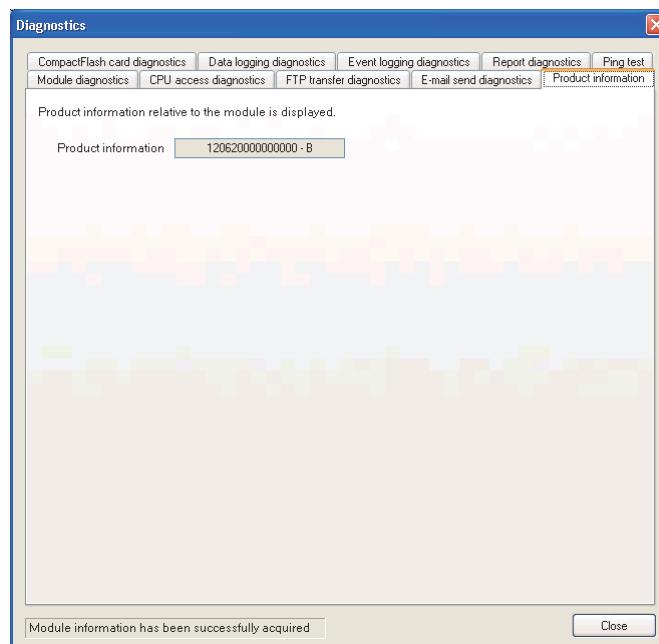

Item	Description	Reference
Product information	Displays product information of the module.	Section 2.5
 button	Closes the "Diagnostics" screen.	-

13.1.6 CompactFlash card diagnostics

Displays the access state and usage state of the CompactFlash card, changes the status of access to the CompactFlash card, and formats the CompactFlash card.

Operating procedure

- ① Select [Online] → [Diagnostics].
- ② Select the <<CompactFlash card diagnostics>> tab.

Screen display

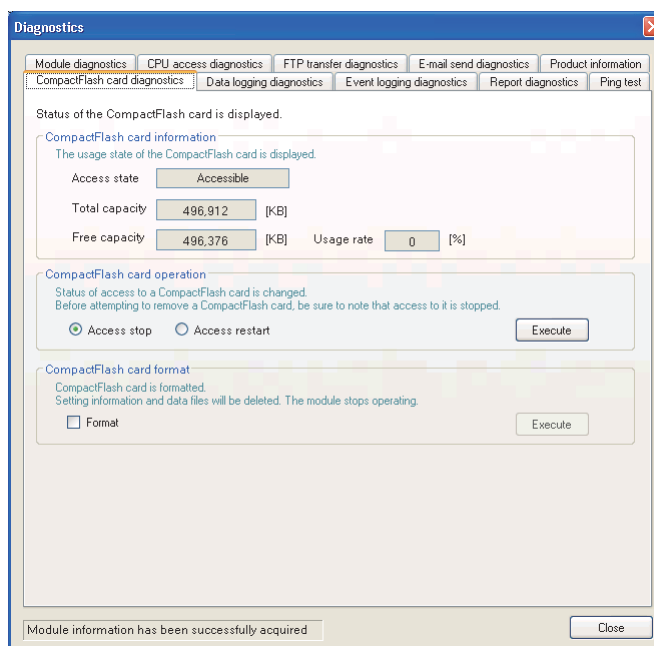

The setting details are described on the next page.

POINT

Do not reset the programmable controller CPU or turn the power OFF when formatting the CompactFlash card.

13 FUNCTIONS OF CONFIGURATION TOOL (CONFIRMING MODULE OPERATION)

Item	Description	Reference
CompactFlash card information ^{*1,*2}	-	-
Access state ^{*3,*4}	Displays the current state of the CompactFlash card. <ul style="list-style-type: none"> • Accessible : Status when accessing the CompactFlash card • Access stop : Status where access to the CompactFlash card is stopped • Formatting : Status when formatting the CompactFlash card • Preparing access : Status when preparing the access to the CompactFlash card • Card error detected: Status when an error occurs on the CompactFlash card 	
Total capacity	Displays the total capacity of the CompactFlash card in KB units.	-
Free capacity	Displays the free capacity of the CompactFlash card in KB units.	-
Usage rate	Displays the usage rate of the CompactFlash card in percent units.	-
CompactFlash card operation	-	-
Access stop ^{*5}	Select this to stop access to the CompactFlash card. The access status becomes "Access stop".	Section 3.3.2
Access restart	Select this to restart access to the CompactFlash card. The access status becomes "Accessible".	-
<input type="button" value="Execute"/> button	Executes the selected operation (Access stop/Access restart).	-
CompactFlash card format	-	-
Format	Check when formatting the CompactFlash card.	-
<input type="button" value="Execute"/> button ^{*6}	Formats the CompactFlash card. After formatting, the operating status of the module becomes "Stop".	Section 13.1.1

*1: Displayed "Free capacity" and "Usage rate" include the size of the file system.

*2: When the access state is other than 'Accessible', '-' is displayed instead of "Total capacity", "Free capacity", and "Usage rate".

When the high speed data logger module does not support the CompactFlash card information function, "Total capacity", "Free capacity", and "Usage rate" are not displayed. (Appendix 5)

Screen example when '-' is displayed

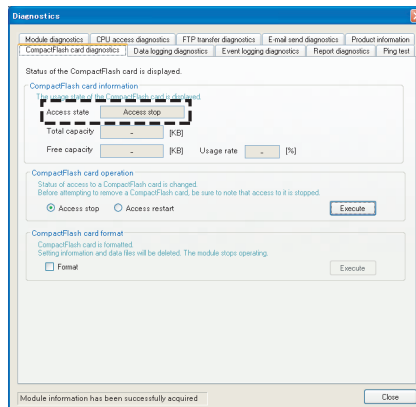

Screen example when information are not displayed

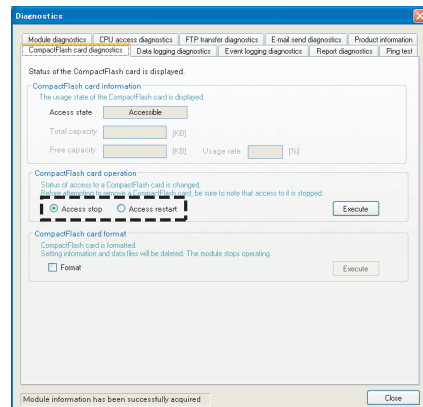

*3: Eject the CompactFlash card from the module when the access status is "Access stop".

*4: Can also be checked with the illumination status of the LEDs on the module (Section 4.3 (3)) or file access status (X2) (Section 3.3.2).

*5: Access can be stopped even when the file access stop request signal (Y2) is on.

*6: Formatting deletes all the data (common settings, data logging files, event logging files, report files) on the CompactFlash card.

☒ POINT

High speed data logger module settings are saved on the CompactFlash card. Therefore, the IP address of the high speed data logger module returns to the initial status (192.168.3.3) when turning the power OFF/ON or resetting the programmable controller CPU without a CompactFlash card inserted in the module or without the settings written to the CompactFlash card.

When ejecting or replacing the CompactFlash card, read the current settings before ejecting the CompactFlash card and after replacing, promptly write those settings to the CompactFlash card as necessary.

13.1.7 Data logging diagnostics

Confirms each data logging error code.

Operating procedure

- ① Select [Online] → [Diagnostics].
- ② Select the <<Data logging diagnostics>> tab.

Screen display

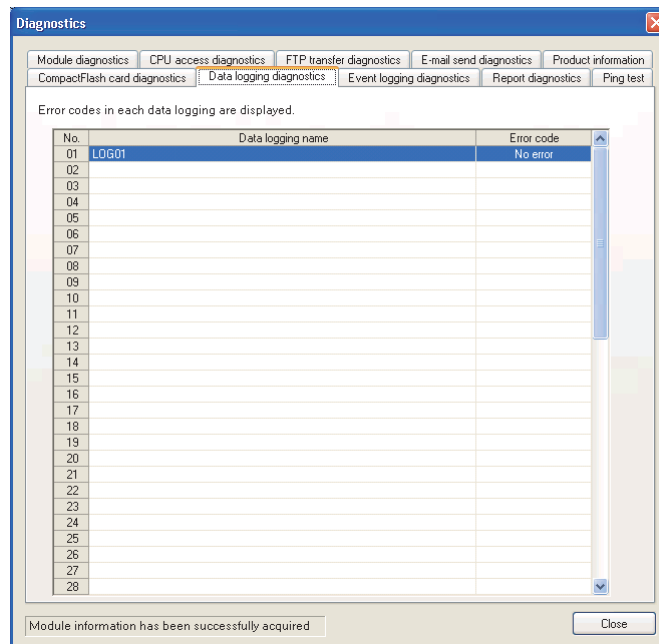

Item	Description	Reference
No.	Displays the index of the data logging setting.	-
Data logging name	Displays the data logging name.	-
Error code	Displays the newest error code of each data logging setting.	Section 18.2

13.1.8 Event logging diagnostics

Confirms each event logging error code.

Operating procedure

- ① Select [Online] → [Diagnostics].
- ② Select the <<Event logging diagnostics>> tab.

Screen display

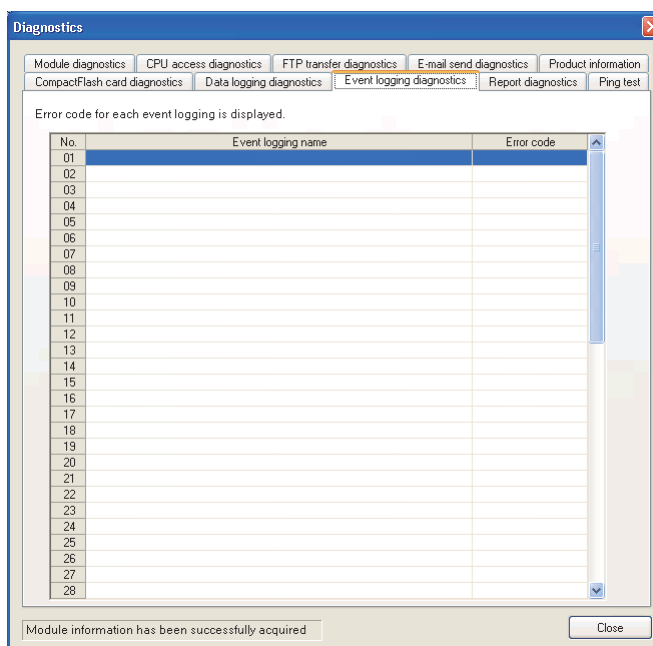

Item	Description	Reference
No.	Displays the index of the event logging setting.	-
Event logging name	Displays the event logging name.	-
Error code	Displays the newest error code of each event logging setting.	Section 18.2

13.1.9 Report diagnostics

Confirms each report's error code.

Operating procedure

- ① Select [Online] → [Diagnostics].
- ② Select the <<Report diagnostics>> tab.

Screen display

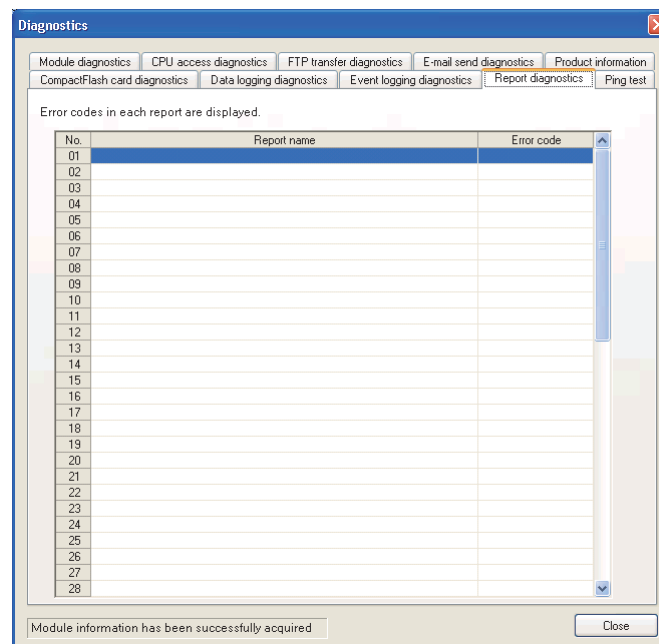

Item	Description	Reference
No.	Displays the index of the report setting.	-
Report name	Displays the report name.	-
Error code	Displays the newest error code of each report.	Section 18.2

13.1.10 Ping test

Tests the network connection status of external devices (such as mail server and FTP server) specified by the high speed data logger module.

Operating procedure

- ① Select [Online] → [Diagnostics].
- ② Select the <<Ping test>> tab.

Screen display

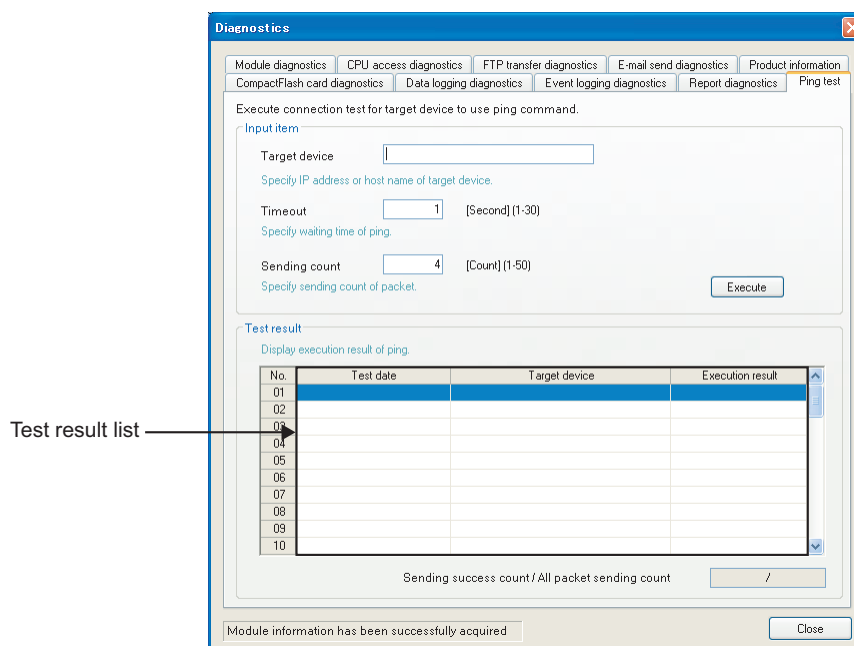

Item	Description	Reference
Input item	-	-
Target device	Specify the IP address (decimal format) or host name*1 of the target device to perform the ping test.	-
Timeout	Specify the response time for the ping test.	-
Sending count	Specify the packet sending counts for the ping test.	-
Execute button	Sends a ping packet to the specified target device.	-
Test result	-	-
Test result list	Displays the number of ping test results specified for "Sending count".	(1) in this section
Sending success count/ All packet sending count	Displays the sending success count and all packet sending count of the ping test.	-

*1: When specifying a host name, configure the DNS server setting of the network setting.

(1) Test result list

(a) Test date

Displays the time when the response from the target device is received.

(b) Target device

Displays the IP address when an IP address is specified for the target device.

Displays the host name [IP address] when a host name is specified for the target device.

Displays the tooltip by pointing the mouse cursor when all target devices are not displayed on the screen.

(c) Execution result

Displays the following execution results.

Execution result	Occurrence status
OK (ms) ^{*1}	Displayed when a ping packet is received normally.
TIMEOUT	Displayed when the target device did not receive the ping packet, or the high speed data logger module did not receive the response packet from the target device.

*1: When the response time is less than 1ms, 1ms is displayed after "OK".

Remark

Perform the PING test (➡ Appendix 2 PING Test) when checking the high speed data logger module on the network from the personal computer.

13.2 File Browser

Using the file browser, files on the CompactFlash card inserted in the high speed data logger module can be accessed.

This function is used to display/delete files, transfer files to module^{*1}, and save files to personal computer per directory.

*1: For RECIPE folders only

Operating procedure

- ① Configure transfer setup. (☞ Section 12.1)
- ② Select [Online] → [File Browser].

Screen display

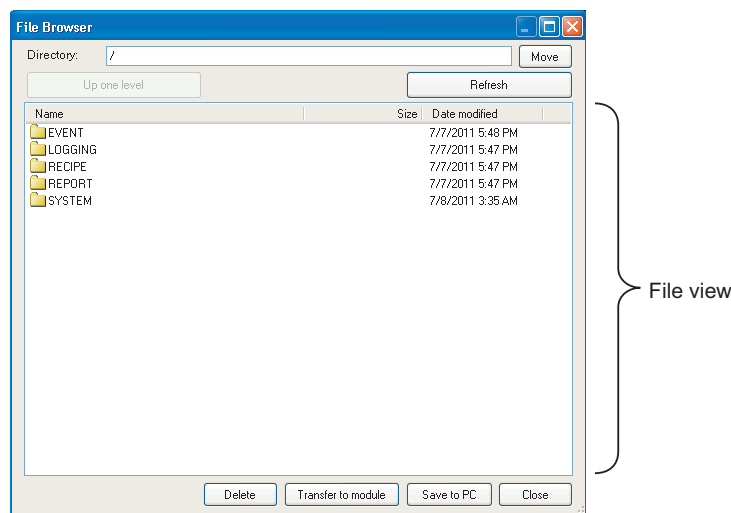

Item	Description	Reference
Directory	Displays the currently displayed directory path. The destination directory path can also be specified.	Section 3.5
Move button	Navigates to the specified directory.	-
Up one level button	Navigates to the directory one level up.	-
Refresh button	Updates the contents displayed in the file view.	-
File view ^{*1}	Displays a list of the files/folders in the directory specified in "Directory".	-
Delete button	Deletes the file selected in the file view.	-
Transfer to module button	Transfers the recipe files stored in the personal computer.	(1) in this section
Save to PC button	Saves the file selected in the file view to the personal computer.	-
Close button	Closes the screen.	-

*1: A file with the '.TMP' extension may be displayed when the RECIPE folder is displayed during the 'Write' process of the recipe function. This TMP file is deleted at the completion of the 'Write' process.

For details on the 'Write' process of the recipe function, refer to the following chapter.

☞ Chapter 15 RECIPE FUNCTION

(1) Transferring recipe files to module

Transfers recipe files stored in a personal computer to the CompactFlash card installed on a high speed data logger module.

Operating procedure

- ① Move the recipe file to the RECIPE folder.
- ② Click the button to display the "Transfer the file" screen.
- ③ Select a recipe file to be transferred*¹, and click the button.

*1: Multiple files cannot be selected. Use the FTP transfer function ( Section 10.3 (2) FTP server function) to transfer multiple files to a module.



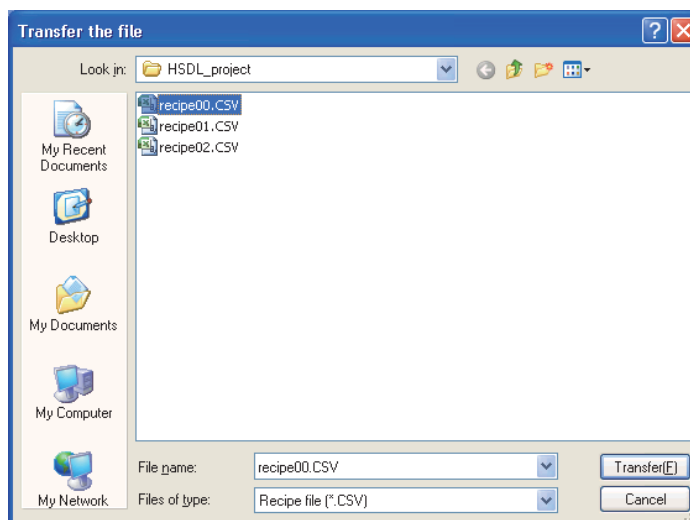

Setting screen



For details of the Recipe function, refer to the following chapter.

 Chapter 15 RECIPE FUNCTION

POINT

- (1) Access to files on the high speed data logger module is restricted by the access authority granted to a 'user' specified in "Transfer Setup".
For details, refer to the following sections.
 -  Section 11.4.6 Account setting
 -  Section 12.1 Transfer Setup
 -  Section 3.5 Directory Structure
- (2) When the recipe file to which the recipe execution operation is being performed is overwritten or deleted, an error may occur. Set the operating status of the module to "Stop" and transfer the recipe file.
 -  Section 13.1.1 Module diagnostics

13.3 Verifying Product Information

13.3.1 Version information

The version information of the Configuration Tool can be checked.

Operating procedure

Select [Help] → [About Configuration Tool].

13.3.2 Open the user's manual

Displays the user's manual for the high speed data logger module.

Operating procedure

Select [Help] → [Open User's Manual].

☒ POINT

For Windows® 8 or later, the user's manual cannot be opened with the Windows Reader. Adobe Reader is required.

Adobe Reader can be downloaded from the website of Adobe Systems Incorporated.

14 FUNCTIONS OF LOGGING FILE CONVERSION TOOL

CHAPTER 14 FUNCTIONS OF LOGGING FILE CONVERSION TOOL

The Logging File Conversion Tool is a tool to convert binary format logging files saved on a high speed data logger module to CSV format logging files.

The following operation can be performed with this tool.

- Convert binary format logging files to CSV format logging files.

This chapter explains the screen configuration after starting the Conversion Tool and the operation of the tool. For the method for starting the Conversion tool, refer to the following section.

☞ Section 5.4 Starting Conversion Tool





14.1 Screen Configuration of Conversion Tool

This section explains the screen configuration of the Conversion Tool.

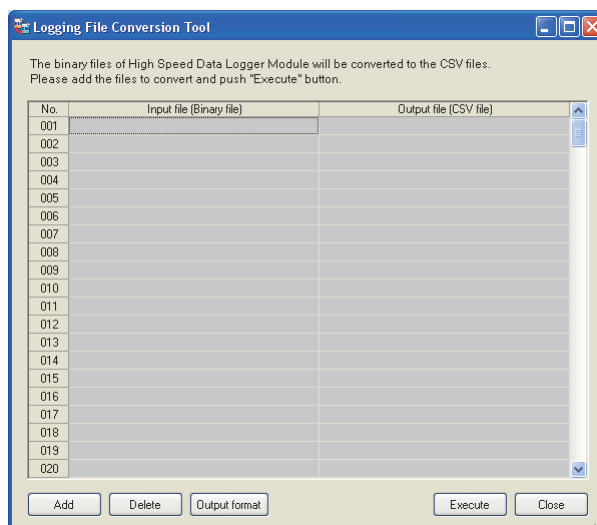
14.1.1 Main screen

Setting screen



Item	Description	Reference
List of conversion target	Specify the paths for the input file and the output file.	(1) in this section
 button	Displays the dialog to select input files.* ¹	-
 button	Deletes the selected row from the list of conversion target.	-
 button	Displays the output format screen.	Section 14.2
 button	Executes the file conversion.* ²	-
 button	Exits the Conversion Tool.	-

*1: Duplicated input files and files with .BIN extension cannot be added.

*2: Conversion-succeeded files are deleted from the list. If a conversion-failed file exists, a warning message is displayed after the completion of the conversion process.

(1) List of conversion target

Setting screen

No.	Input file (Binary file)	Output file (CSV file)
001		
002		
003		
004		
005		
006		
007		
008		
009		
010		
011		
012		
013		
014		
015		
016		
017		
018		
019		
020		

Item	Description
List of conversion target	Specify the paths for the binary file of input file and the CSV file of output file.* ¹
No.	Displays the data index.
Input file (Binary file)	Specify the binary file of the input file.
Output file (CSV file)	Specify the CSV file of the output file.* ² (up to 256 characters)

*1: Displays files in the ascending order of input file (binary file). (up to 256 files)

*2: Files can be changed by inputting/copying/pasting data. (up to 256 characters)
Relative paths and duplicated paths in the list cannot be specified.

(2) CSV file conversion

For the overview of binary file format and CSV file format for data logging and event logging, refer to the following sections.

(a) Data logging

- ☞ Section 3.6.2 Data logging file (CSV)
- ☞ Section 3.7.1 Data logging file (binary)

(b) Event logging

- ☞ Section 3.6.3 Event logging file (CSV)
- ☞ Section 3.7.2 Event logging file (binary)

14.2 Configuration of Output Format Screens

This section explains the configuration of the output format screen.

14.2.1 Main screen configuration

Setting screen

Item	Description	Reference
Data column	Specify the CSV output format of data column.	(1) in this section
Date column	Specify the CSV file format of date column.	(2) in this section
Trigger information column	Specify the CSV output format of trigger information column.	(3) in this section
<input type="button" value="Default"/> button	Apply the default setting on the output format screen.	-
<input type="button" value="OK"/> button	Apply the settings and close the screen.	
<input type="button" value="Cancel"/> button	Discard the settings and close the screen.	

(1) Data column

Setting screen

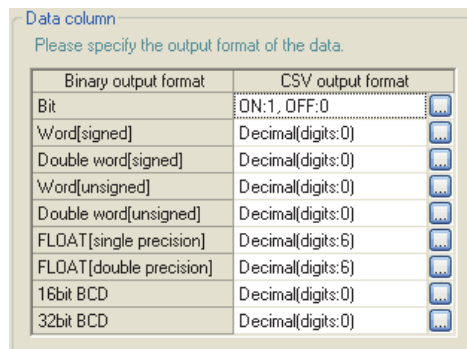

Item	Description	Reference
Data column	Set the data column format to be output to CSV file.	
Binary output format	Displays the data output type of input file. <ul style="list-style-type: none"> • Bit • Word [signed] • Double word [signed] • Word [unsigned] • Double word [unsigned] • FLOAT [single precision] • FLOAT [double precision] • 16bit BCD • 32bit BCD 	-
CSV output format	Displays the data output format of output file.	
button	Displays the output format (bit)/(integer/float) screen <ul style="list-style-type: none"> • Bit: Output format (bit) 	Section 14.2.2
	<ul style="list-style-type: none"> • Other than bit: Output format (integer/float) 	Section 14.2.3

(2) Date column

For details of date column, refer to the following section.

☞ Section 11.5.13 (1) Date column

(3) Trigger information column

For details of trigger information column, refer to the following section.

☞ Section 11.5.13 (2) Trigger information column

14 FUNCTIONS OF LOGGING FILE CONVERSION TOOL

14.2.2 Output format (bit) screen

Setting screen

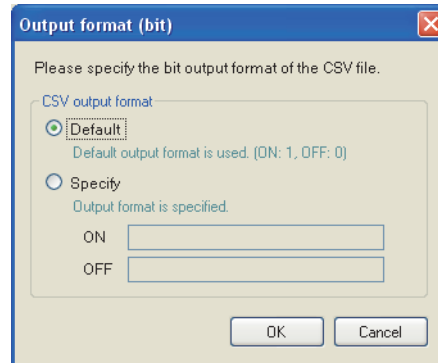

Item	Description	Reference
CSV output format	Specify the CSV output format of bit type data.	(1) in this section
<input type="button" value="OK"/> button	Apply the settings and close the screen.	-
<input type="button" value="Cancel"/> button	Discard the settings and close the screen.	

(1) CSV output format (bit)

Setting screen

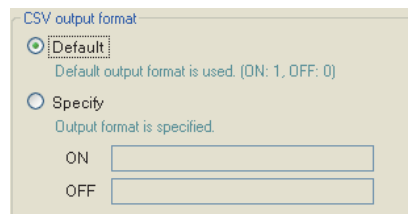

Item	Description
Default	Use the output format set by default.*1
Specify	Specify the output format.
ON	Specify the string to be output when it is ON. (up to 16 characters)
OFF	Specify the string to be output when it is OFF. (up to 16 characters)

*1: '1' is output when it is ON, and '0' is output when it is OFF.

14.2.3 Output format (integer/float) screen

Setting screen

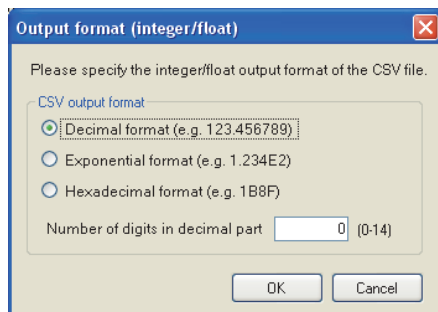

Item	Description	Reference
CSV output format	Specify the CSV output format of numerical type data.	(1) in this section
<input type="button" value="OK"/> button	Apply the settings and close the screen.	-
<input type="button" value="Cancel"/> button	Discard the settings and close the screen.	

(1) CSV output format (integer/float)

Setting screen

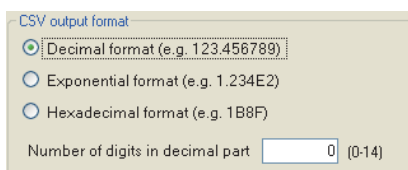

Item	Description
Decimal format	Select this to output in decimal format. Note that, when output numerical values are outside the range of -2147483648.0 to 2147483647.0, they are expressed in a format same as 'exponential format and 9 digits in the decimal part'.
Exponential format	Select this to output in exponential format
Hexadecimal format	Select this to output in hexadecimal integer format (characters are upper case). Can be output in a range of 0 to FFFFFFFF.
Number of digits in decimal part	Specify the number of digits in the decimal part. (0 to 14) Fixed as 0 when "Hexadecimal format" is set, and thus digits cannot be set.

CHAPTER 15 RECIPE FUNCTION

The recipe function performs following two processes according to the recipe file data stored in the CompactFlash card.

- 'Read' process: Transfers device values written on a recipe file to devices in a programmable controller CPU.
- 'Write' process: Transfers device values in a programmable controller CPU to a recipe file.

'Read' and 'Write' processes are executed by the dedicated instructions (☞ Section 15.6 Dedicated Instructions). The 'Read' or 'Write' process can also be executed by the "Recipe Execution Operation" function of the Configuration Tool.

With the recipe function, the information of each production process can be 'read' from recipe files and reflect them to devices in the programmable controller CPU. Specified device values can also be 'written' and saved in a recipe file after system adjustments.

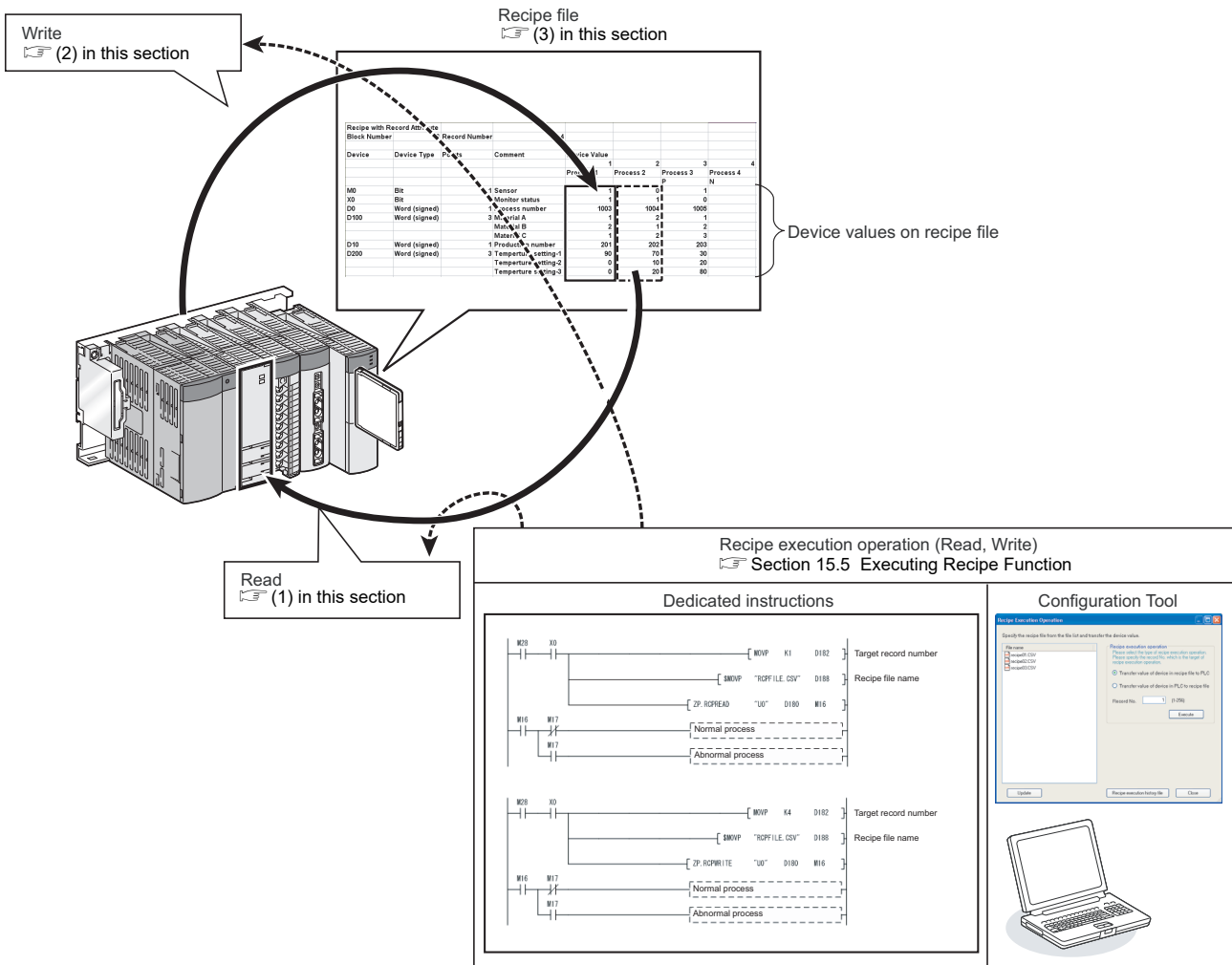

(1) Read process

This function transfers device values written on a recipe file ((3) in this section) to devices in a programmable controller CPU.

<Example: Execute the 'Read' process on the record number 1 (a recipe to change D10 to 100, and D11 to 200)>

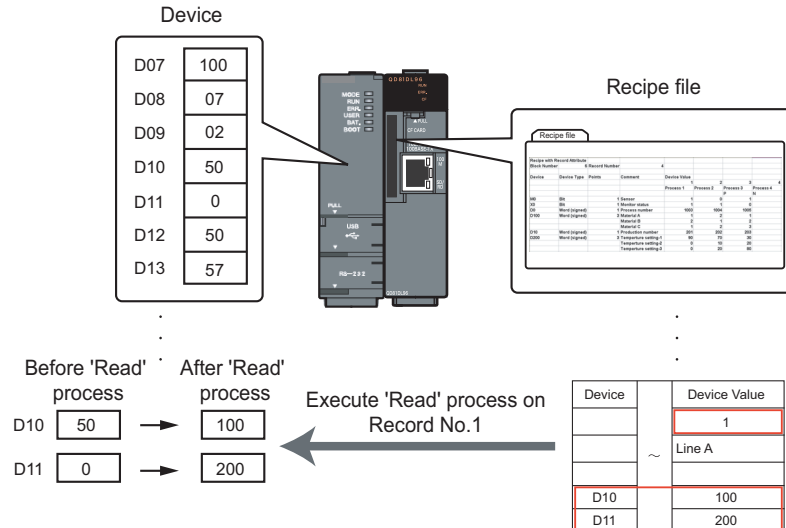

(2) Write process

This function transfers device values in a programmable controller CPU to a recipe file ((3) in this section).

<Example: Execute the 'Write' process on the record number 1 (a recipe to write values of D100 and D101 to the recipe file)>

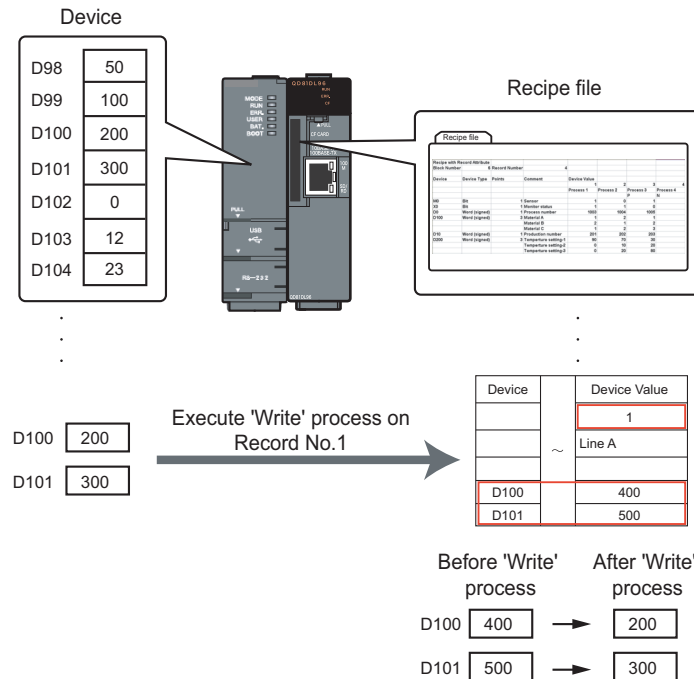

(3) Recipe files

Recipe files are CSV format files to which source data for 'Read' and 'Write' processes of the recipe function are written. (Section 3.8 Recipe File Format)

These files are created on the "Recipe Editor" screen of the Configuration Tool.

Units called 'Block' and 'Record', and attribute called 'Record attribute' are used for recipe files.

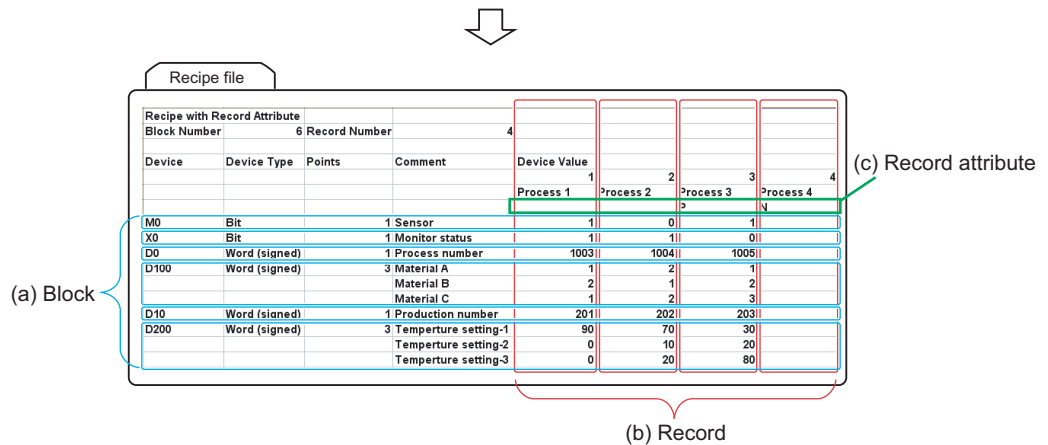
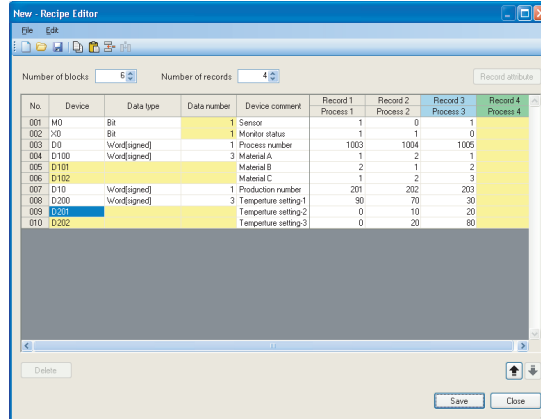

(a) Block

A unit used to set inconsecutive devices and different data types.

The following settings are applicable.

- ① A mix of devices with multiple data types.
- ② A mix of consecutive and inconsecutive devices

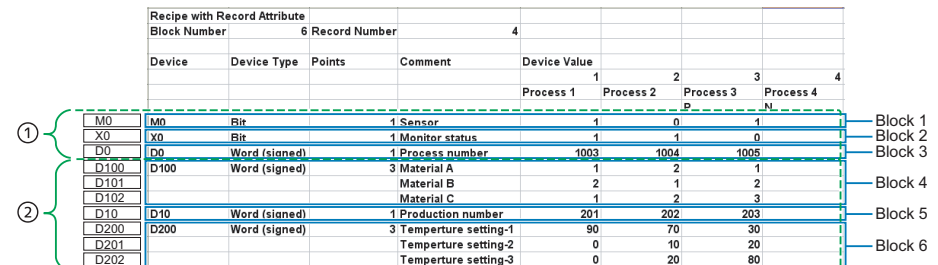

(b) Record

A unit used to distinguish the aggregation of device values on which 'Read' or 'Write' process is performed.

By specifying values for each record number, different values can be set for the same device.

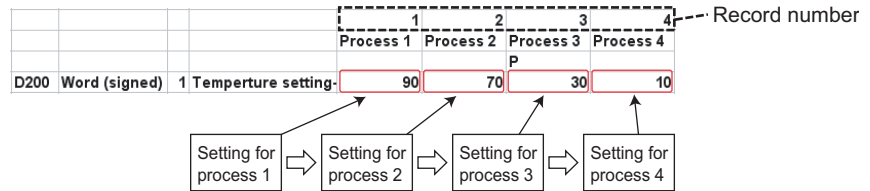

(c) Record attribute

The following are the three types of attribute for record.

- ① No attribute: 'Read' and 'Write' processes can be executed.

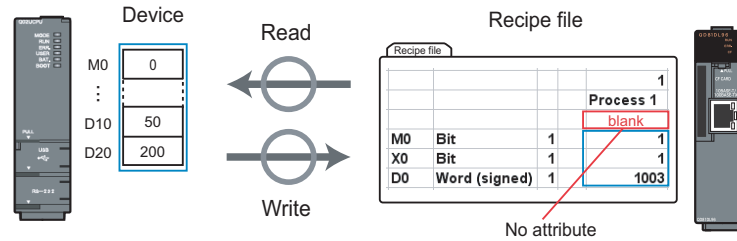

- ② N attribute: Only 'Write' process can be executed.

However, after executing the 'Write' process, the attribute type changes to no attribute. The device values are not entered to the recipe file before executing the 'Write' process.

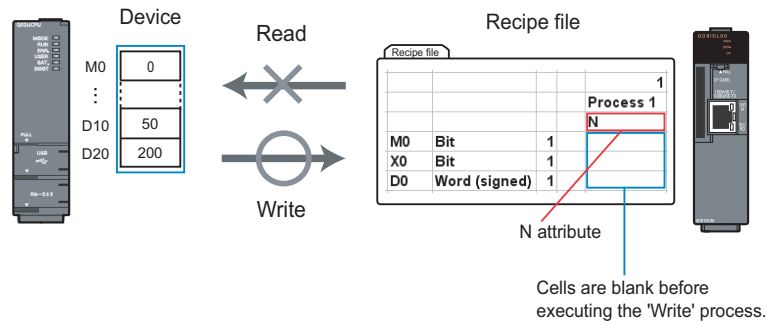

- ③ P attribute: Only 'Read' process can be executed.

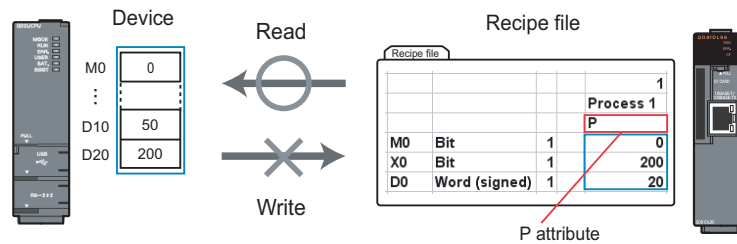

Set this attribute when you do not wish to change the device values on the recipe file with the dedicated instructions or the recipe execution operation of the Configuration Tool. Change the device values on the recipe file by editing data on the Configuration Tool, Excel or text editor.

15.1 Recipe Function Execution Procedure

This section explains the procedure for executing the recipe function. Before executing the recipe function, refer to the Section 4.2.1 and prepare for the operation.

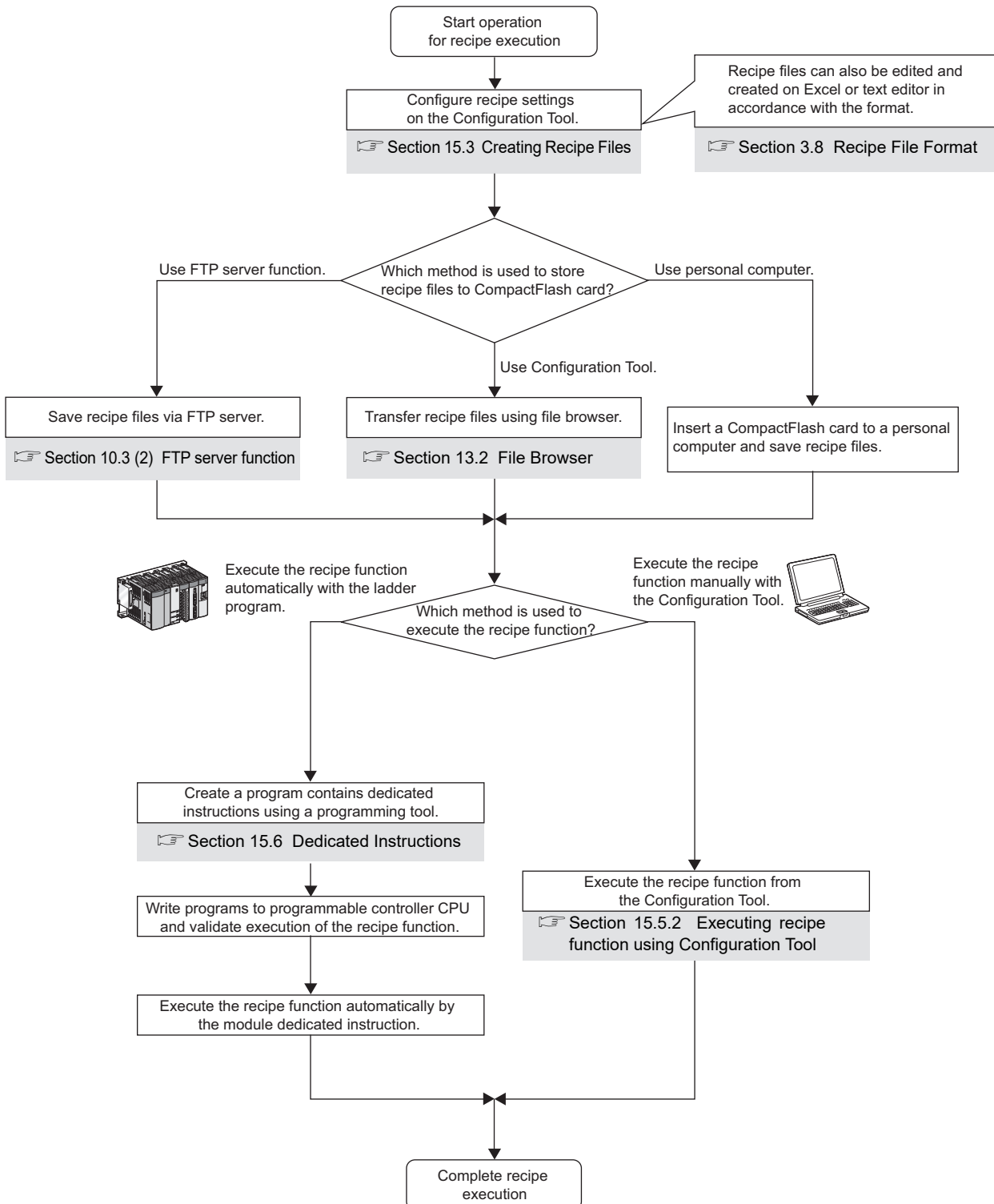

15.2 Screen Configuration

15.2.1 Recipe editor screen configuration

The following figure shows the "Recipe Editor" screen configuration to edit recipe data.

Screen display

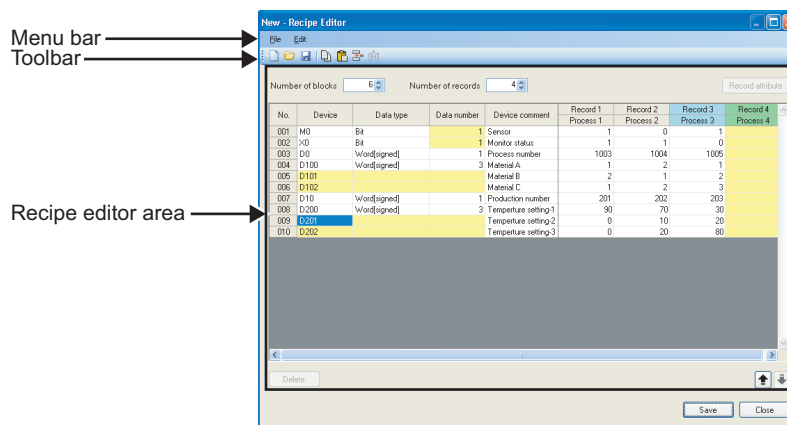

Item	Description	Reference
Menu bar	Displays menus to execute each function.	Section 15.2.2
Toolbar	Displays tool buttons to execute each function.	Section 15.2.3
Recipe editor area	Edit recipe data.	Section 15.2.4
<input type="button" value="Close"/> button	Discards the settings and closes the screen.	-

15.2.2 Menu configuration

The following tables show the menu configuration of the recipe function.

(1) File







Item	Description	Reference
New	Discards the recipe file being edited and creates a new recipe file.	Section 15.3.2
Open	Opens a recipe file saved to the local disk.	Section 15.3.3
Save	Saves the edited recipe file.	Section 15.3.4
Save As	Saves the edited recipe file under a new file name.	
Exit Recipe Editor	Closes the 'Recipe Editor' screen, and displays the main screen of the high speed data logger module Configuration Tool.	-

(2) Edit

Item	Description	Reference
Insert Block	Adds a block in front of the selected block. (up to 256 blocks)	Section 15.3.5 (2)
Insert Record	Adds a record in front of the selected record. (up to 256 records)	Section 15.3.5 (3)
Copy Settings	Copies the tabular format settings.	-
Paste Settings	Pastes the copied tabular format settings.	-
Delete	Deletes the selected blocks or records.	-
Clear	Clears the selected blocks, records or data.	-
Import Global Label	Imports global labels from project files of GX Works2 as data.	Section 11.2.10 (1)
Import Device Comment	Import device comments from project files of GX Works2 or GX Developer as data.	Section 11.2.10 (4)

15.2.3 Toolbar configuration

The following table shows the toolbar configuration of the recipe function.

Icon	Corresponding menu	Reference
	[File] → [New]	Section 15.3.2
	[File] → [Open]	Section 15.3.3
	[File] → [Save]	Section 15.3.4
	[Edit] → [Insert Block]	Section 15.3.5 (2)
	[Edit] → [Insert Record]	Section 15.3.5 (3)
	[Edit] → [Copy Settings]	-
	[Edit] → [Paste Settings]	-

15.2.4 Recipe editor area

The following shows the configuration of the recipe editor area.

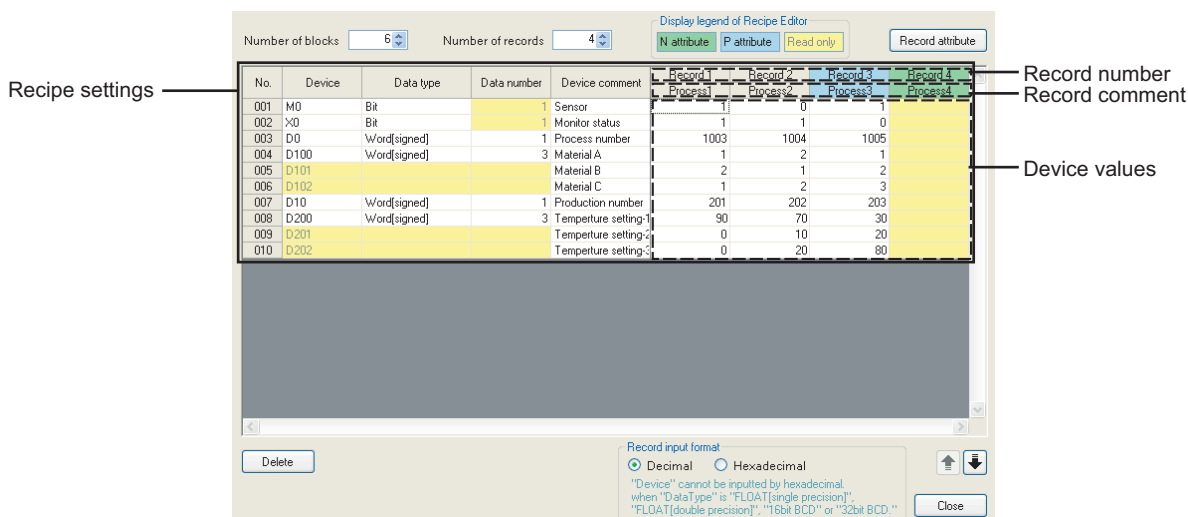

Setting screen



Item	Description	Reference
Block number	Displays the number of blocks. It is also used to specify the number of blocks.	Section 15.3.5 (2)
Record number	Displays the number of records. It is also used to specify the number of records	Section 15.3.5 (3)
Display legend of Recipe Editor	Displays the colors and contents displayed in a cell of the recipe editor.	-
<input type="button" value="Record attribute"/>	Displays the "Record attribute" screen to edit the record attribute.	Section 15.3.5 (4)
Recipe settings	-	-
Device ^{*2}	Specify devices for the recipe execution operation. When a value of 2 or more is entered in a "Data number" cell, consecutive devices are displayed.	-
Data type ^{*2}	Select a data type of the device from the following types. <ul style="list-style-type: none"> • Bit • Word [signed] • Double word [signed] • Word [unsigned] • Double word [unsigned] • FLOAT [single precision] • FLOAT [double precision] • 16bit BCD • 32bit BCD 	-
Data number ^{*1*2}	Specify the number of data for consecutive devices. When a value of 2 or more is entered, rows ("Data number" - 1) are automatically added under the selected row.	-
Device comment	Set device comments. (up to 32 characters)	-

(Continued on the next page)

(From the previous page)

Item	Description	Reference
Device values	Specify device values which are transferred to the programmable controller CPU at the recipe execution operation ('Read' process).	-
Record number	Displays record numbers. (Editing disabled) The background color changes to green for the N attribute, and light blue for the P attribute.	-
Record comment	Displays record comments. Set record comments on the "Record attribute" screen. The background color changes to green for the N attribute, and light blue for the P attribute.	Section 15.3.5 (4)
 button	Deletes the selected block(s) or record(s).	Section 15.3.5 (2) Section 15.3.5 (3)
Record input format ^{*3}	Select the input format for device values.	-
Decimal	Input device values in decimal format.	Section 15.2.4 (1)
Hexadecimal ^{*4}	Input device values in hexadecimal format	
 button	Switches the row of the selected block with the one above or one below.	-

*1: For bit devices, only 1 data can be set for a single block. When setting consecutive bit devices, add blocks.

*2: When a value of 2 or more is entered in a "Data number" cell, rows ("Data number" - 1) are automatically added under the selected row. The background color of "Device", "Data type", and "Data number" are displayed in yellow and cannot be edited.

*3: Device values are stored in decimal format even when "Hexadecimal" is selected for "Record input format".

*4: When "Hexadecimal" is selected, device values whose "Data type" is "FLOAT [single precision]", "FLOAT [double precision]", "16bit BCD" or "32bit BCD" cannot be entered.

(1) Value input range (Decimal-Hexadecimal)

Output format	Value input range	
	Decimal	Hexadecimal
Bit	0 to 1	0 to 1
Word [signed]	-32768 to 32767	0000 to FFFF ^{*1}
Double word [signed]	-2147483648 to 2147483647	00000000 to FFFFFFFF ^{*2}
Word [unsigned]	0 to 65535	0000 to FFFF
Double word [unsigned]	0 to 4294967295	00000000 to FFFFFFFF
FLOAT [single precision]	$\pm 3.4028235E+38$ to $\pm 1.401298E-45$	_*3
FLOAT [double precision]	$\pm 1.79769313E+308$ to $\pm 4.94065645E-324$	_*3
16bit BCD	0 to 9999	_*3
32bit BCD	0 to 99999999	_*3

-: Entry disabled

*1: Values in the range between 8000 and FFFF are treated as negative values.

*2: Values in the range between 80000000 and FFFFFFFF are treated as negative values.

*3: Values cannot be entered when "Hexadecimal" is selected for "Record input format".
Select "Decimal" and enter values.

15.3 Creating Recipe Files

15.3.1 Starting recipe editor screen

Start the "Recipe Editor" screen to edit the recipe data.

Operating procedure

Select [Tool] → [Display Recipe Editor] on the main screen of the Configuration Tool.

15.3.2 Creating new recipe file

Create a new recipe file.

Operating procedure

Select [File] → [New] ().

15.3.3 Opening recipe files

Open a saved recipe file.

Operating procedure

- ① Select [File] → [Open] ().
- ② On the "Open" screen, specify the recipe file and click the button.

Setting screen

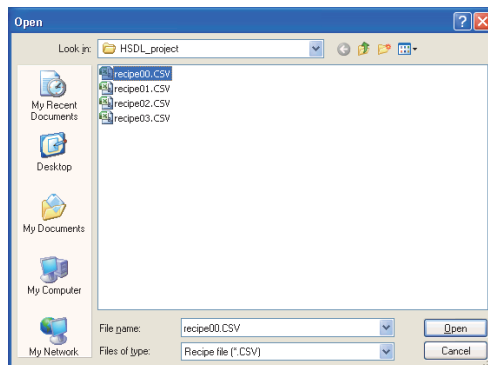

Item	Description
Look in	Select a folder where recipe files are saved.
File name	Specify a name of the recipe file.
Files of type	Select a type (.csv) of the recipe file.



POINT

- (1) The maximum file size of recipe file is 512KB. If the size exceeds 512KB, the file cannot be opened. Delete the records/blocks or change the device values/comments and adjust the file size.
- (2) When editing a recipe file stored in a CompactFlash card, save the recipe file to a personal computer using the file browser (Section 13.2).

15.3.4 Saving recipe files

Save the recipe file being edited.

Operating procedure

- (a) To save
 - Select [File] → [Save] ().
- (b) To save the file with a new name
 - ① Select [File] → [Save As].
 - ② On the "Save As" screen, specify the save destination and a file name, and click the  button.

Setting screen

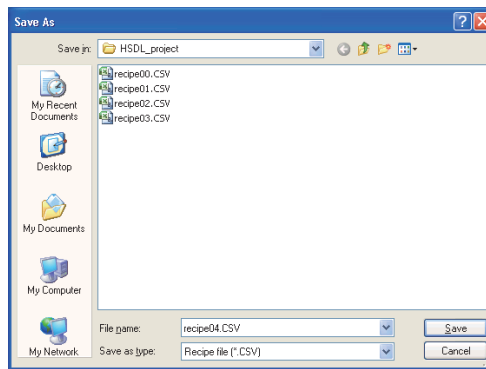

Item	Description
Save in	Select a folder to save the recipe file.
File name	Specify a name of the recipe file to be saved.*1
Save as type	Select a type (.csv) of the recipe file to be saved.

*1: Use alphanumeric within 32 characters for the file name when performing the recipe execution operation.

15.3.5 Editing recipe data

(1) Setting recipe data

Operating procedure

Enter data to cells of "Device", "Data type", "Data number", "Device comment", 'device values' and 'record comments'.

Remark

The work hours for setting recipe data can be reduced by the following functions.

- [Edit] → [Import Global Label]
 - [Edit] → [Import Device Comment]
-  Section 11.2.10 Importing global labels and device comments.

(2) Adding/deleting blocks

Operating procedure

(a) Add

- Select [Edit] → [Insert Block] () to add one block.
- Specify the total number of blocks (current number of blocks + number of blocks to be added) for "Block number". Blocks are added to configure the number of blocks that is specified.

(b) Delete

- Specify the total number of blocks (current number of blocks - number of blocks to be deleted) for "Block number". Blocks are deleted to configure the number of blocks that is specified.
- Select cell(s) whose data to be deleted (within the area for clearing blocks) and click the button.

No.	Device	Data type	Data number	Device comment	Record 1	Record 2	Record 3	Record 4
					Process 1	Process 2	Process 3	Process 4
001	M0	Bit	1	Sensor	1	0	1	
002	X0	Bit	1	Monitor status	1	1	0	
003	D0	Word[signed]	1	Process number	1003	1004	1005	
004	D100	Word[signed]	3	Material A	1	2	1	
005	D101			Material B	2	1	2	
006	D102			Material C	1	2	3	
007	D10	Word[signed]	1	Production number	201	202	203	
008	D200	Word[signed]	3	Temperature setting-1	90	70	30	
009	D201			Temperature setting-2	0	10	20	
010	D202			Temperature setting-3	0	20	80	

Area for clearing blocks

(3) Adding/deleting records

Operating procedure

(a) Add

- Select [Edit] → [Insert Record] () to add one record.
- Specify the total number of records (current number of records + number of records to be added) for "Record number". Records are added to configure the number of records that is specified.

(b) Delete

- Specify the total number of records (current number of records - number of records to be deleted) for "Record number". Records are deleted to configure the number of records that is specified.
- Select cell(s) whose data to be deleted (within the area for clearing records) and click the button.

No.	Device	Data type	Data number	Device comment	Record 1	Record 2	Record 3	Record 4
					Process 1	Process 2	Process 3	Process 4
001	M0	Bit	1	Sensor	1	0	1	
002	X0	Bit	1	Monitor status	1	1	0	
003	D0	Word[signed]	1	Process number	1003	1004	1005	
004	D100	Word[signed]	3	Material A	1	2	1	
005	D101			Material B	2	1	2	
006	D102			Material C	1	2	3	
007	D10	Word[signed]	1	Production number	201	202	203	
008	D200	Word[signed]	3	Temperature setting-1	90	70	30	
009	D201			Temperature setting-2	0	10	20	
010	D202			Temperature setting-3	0	20	80	



Area for clearing records

(4) Changing record attribute

For details of record attribute, refer to the following section.



☞ Chapter 15 (3) (c) Record attribute

Operating procedure

- ① Click the  button on the "Recipe Editor" screen, or double-click the record comment.
- ② Specify the record attribute on the "Record attribute" screen, and click the  button.

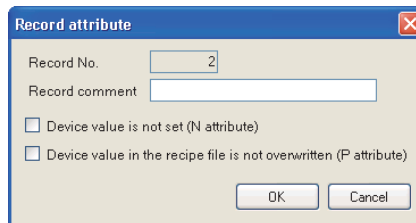
Setting screen



Item	Description
Record No.	Displays a record number selected on the "Recipe Editor" screen.
Record comment	Set the record comment. (up to 32 characters) The set record comment is displayed in the record comment cell on the "Recipe Editor" screen.
Device value is not set (N attribute)* ¹	Select this to append N attribute to the specified record. When selected, the color of the record header changes to green on the "Recipe Editor" screen.
Device value in the recipe file is not overwritten (P attribute)* ¹	Select this to append P attribute to the specified record. When selected, the color of the record header changes to light blue on the "Recipe Editor" screen.
 button	Reflects the settings and closes the "Record attribute" screen.
 button	Discards the settings and closes the screen.

*1: Only one attribute (no attribute, N attribute or P attribute) can be specified for record attribute.

POINT

Saved recipe files can be edited on Excel or text editor.
For details, refer to Section 3.8 Recipe File Format.

15.4 Transferring Recipe Files to Module

Use the file browser to transfer recipe files to a module.

For details, refer to the following section.

☞ Section 13.2 File Browser

The following are the methods other than using the file browser.

- Use the FTP server function and save files via FTP server (☞ Section 10.3 (2)).
- Insert a CompactFlash card to a personal computer and save files.

☒ POINT

Store only files whose extension is ".CSV" in the RECIPE folder of the high speed data logger module. Files whose extension is not '.CSV' may be deleted during the recipe execution operation.

15.5 Executing Recipe Function

The recipe function can be executed using the dedicated instructions or the "Recipe Execution Operation" screen of the Configuration Tool.

The recipe function is executed from the beginning of the recipe file. The function may not be processed normally when the same devices are set in a single recipe file.

15.5.1 Executing recipe function using module dedicated instructions

Create a program contains the dedicate instructions of high speed data logger module with a programming tool, and execute the recipe function according to the instructions in the program.

For details of the dedicated instructions, refer to the following section.

☞ Section 15.6 Dedicated Instructions

15.5.2 Executing recipe function using Configuration Tool

Execute the recipe function using the "Recipe Execution Operation" screen of the Configuration Tool.

(1) Executing recipe function

Operating procedure

- ① Select [Online] → [Recipe Execution Operation] on the main screen of the Configuration Tool.
- ② Select a file to execute the recipe function on the "Recipe Execution Operation" screen.
- ③ Select "Transfer value of device in recipe file to PLC" or "Transfer value of device in PLC to recipe file", then specify the record number, and click the button.

Setting screen

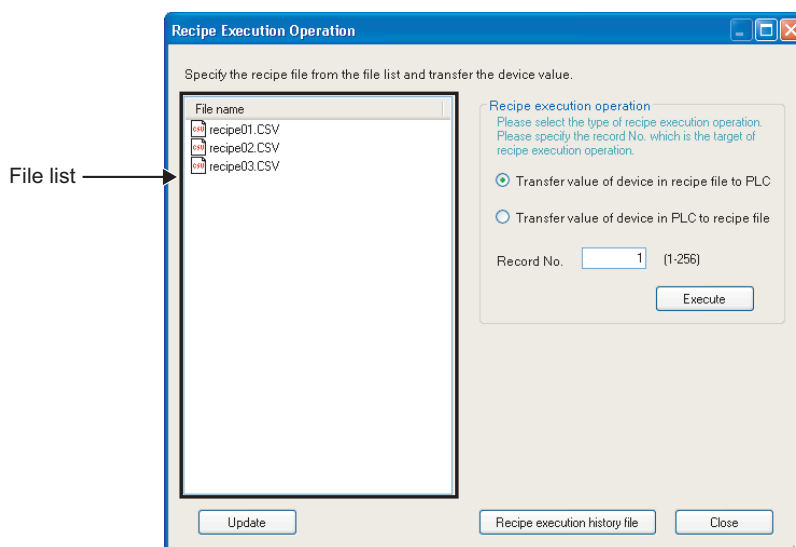

Item	Description	Reference
File list ^{*1*2}	Displays a list of recipe files (CSV file format) stored in the RECIPE folder of CompactFlash card installed on a high speed data logger module. The recipe function is executed on the selected file. Multiple files cannot be selected.	-
Recipe Execution Operation	-	-
Record No.	Specify a record number for the recipe execution operation.	-
Transfer value of device in recipe file to PLC	Select this to perform the 'Read' process on the specified recipe file.	Chapter 15 (2)
Transfer value of device in PLC to recipe file	Select this to perform the 'Write' process on the specified recipe file.	Chapter 15 (3)
button	Perform the recipe execution operation.	-
button	Updates the file list.	-
button	Displays the "Recipe execution history file" screen	(2) in this section
button	Closes the "Recipe Execution Operation" screen.	-

*1: Displays up to 256 files on the file list.

*2: Displays only files whose file name consists 32 characters or less.

POINT

When multiple recipe execution operations are executed on a single programmable controller CPU, only one recipe operation is executed and the rest of the recipe execution operations become an error. The current recipe execution operation status can be checked by the buffer memory.

Section 3.4.9 Recipe file area (address: 810 to 841)

☒ POINT

- (1) The recipe execution operation cannot be performed when the operating status of the module is "Stop" or the access status of the CompactFlash card is "Access stop".
 - (2) A file whose extension is '.TMP' is created in the RECIPE folder of the high speed data logger module during the 'Write' process.
 - (3) When the programmable controller CPU is powered OFF during the 'Write' process, the files whose extension is '.TMP' may remain in the RECIPE folder of the high speed data logger module.
 - (4) The recipe execution operation is performed to an own station CPU only. It cannot be performed to other station CPUs.
 - (5) When multiple recipe execution operations are executed on a single programmable controller CPU, only one recipe operation is executed and the rest of the recipe execution operations become an error. The current recipe execution operation status can be checked by the buffer memory.
 Section 3.4.9 Recipe file area (address: 810 to 841)
 - (6) Do not access the recipe file to overwrite or delete the file to which the recipe execution operation is being performed.
 - (7) Do not power OFF or reset the programmable controller CPU during the recipe execution operation. The recipe file being edited may be damaged. Power OFF or reset the programmable controller CPU after confirming the completion of the recipe execution operation.
-

15 RECIPE FUNCTION

(2) Recipe execution history

This function displays a list of the recipe execution history file stored in the CompactFlash card.

Operating procedure

Click the button on the "Recipe Execution Operation" screen.



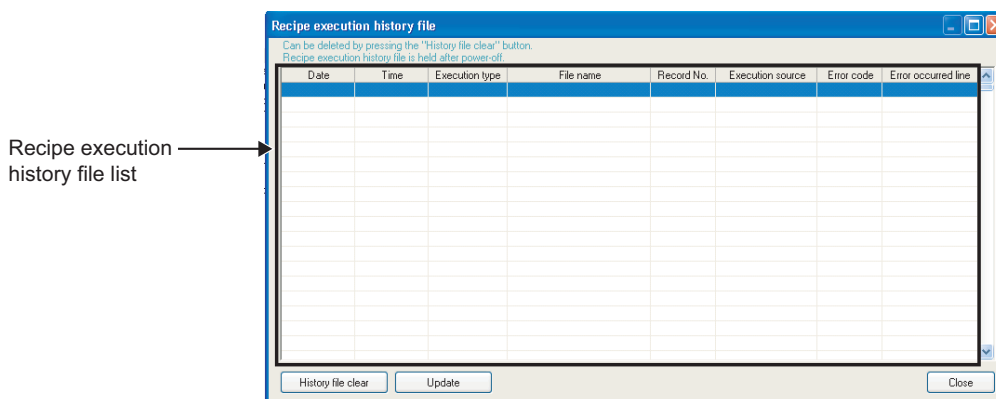





Screen display

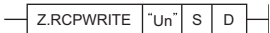

Item	Description	Reference
Recipe execution history file list	-	-
Date	Displays the completion date of the recipe execution operation.	-
Time	Displays the completion time of the recipe execution operation.	-
Execution type	Displays the recipe execution operation type (read, write).	-
File name	Displays the file name for the recipe execution operation.	-
Record No.	Displays the record number for the recipe execution operation.	-
Execution source	Displays the execution source (Configuration Tool, dedicated instructions) of the recipe execution operation.	-
Error code	Displays the recipe execution result. When an error occurs, displays the error code.	Section 18.2
Error occurred line	Displays the line in which the error occurred.	-
<input type="button" value="History file clear"/> button	Clears the recipe execution history file list.	-
<input type="button" value="Update"/> button	Updates the recipe execution history file list.	-
<input type="button" value="Close"/> button	Closes the "Recipe execution history file" screen.	-

15.6 Dedicated Instructions

This section explains the instructions of ladder program to use the recipe function of high speed data logger module.

Function	Instruction symbol	Symbol	Processing details	Execution condition	Reference
Read	RCPREAD		Transfers device values of the specified recipe file in the CompactFlash card to the programmable controller CPU.		Section 15.6.1
					
Write	RCPWRITE		Transfers device values in the programmable controller CPU to the specified recipe file in the CompactFlash card.		Section 15.6.2
					

POINT

- (1) Do not change the data (control data, request data) specified for the dedicated instruction until the execution of that dedicated instruction is completed.
- (2) When the high speed data logger module is mounted to the Redundant CPU, the dedicated instructions cannot be used. If any of those instructions are used, an "OPERATION ERROR" occurs in the Redundant CPU.

15.6.1 Recipe read (RCPREAD)

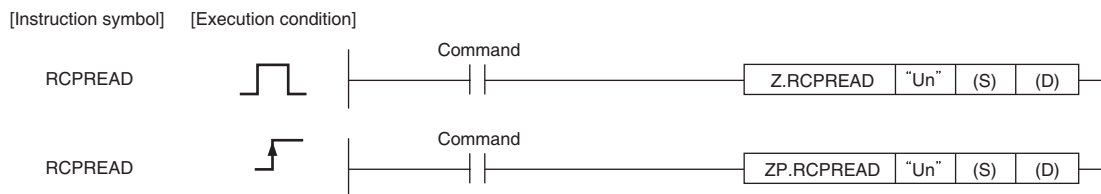

Un : Start I/O number of the module (BIN 16 bits)
(00 to FE: Higher two digits when expressing the I/O signal in three digits)

(S) : Start number of the device that stores the control data (Device name)

(D) : Start number of bit device to be turned ON for one scan at the instruction completion (Bit)

(D) +1 is also turned ON when the error occurs at the instruction completion.

Setting data	Internal device		R, ZR	J:G:G		U:G:G	Zn	Constant K, H	Others
	Bit	Word		Bit	Word				
(S)	-		○			-		-	-
(D)	○		○			-		-	-

Control Data

Device	Item	Setting data	Setting range	Set by ^{*1}
(S) +0	System area	-	-	-
(S) +1	Completion status	Status of the instruction completion is stored. 0 : Normal completion Other than 0: Error completion (Error code ^{*2})	-	System
(S) +2	Record number	Record number of data to be read.	1 to 256	User
(S) +3 to (S) +7	System area	-	-	-
(S) +8 to (S) +23	File name	Recipe file name for reading device values. (Up to 32 characters)	Character string	User
(S) +24 to (S) +31	System area	-	-	-

*1: Items under 'Set by' indicate as follows.

User: Data set by a user before executing the dedicated instruction.

System: Data (execution result of dedicated instruction) stored by the programmable controller CPU.

*2: For details on error codes, refer to the following section.

Section 18.2 Error Code List

★ Function

- (1) This instruction transfers device values of the specified recipe file in the CompactFlash card to the programmable controller CPU.
- (2) This instruction cannot be executed additionally while another RCPREAD instruction is being executed. (If attempted, the instruction is not processed.) For errors detected at the instruction execution, the completion device (Ⓢ +0) and completion status display device (Ⓢ +1) are not turned ON.
- (3) This instruction cannot be executed when the module stop error is being occurred, or the data logging function cannot be performed (X5 is OFF). (If attempted, an error occurs at the instruction completion.)
- (4) An error may occur when the instruction (RCPWRITE) other than this instruction is accessing the same file. Execute the instruction after setting the interlock between the dedicated instructions which access the same file.
- (5) This instruction cannot be executed in interrupt programs.
- (6) Recipe files can be specified under the directory '/RECIPE/' in the CompactFlash card.
- (7) The status of the execution and normal/error completion of the RCPREAD instruction can be checked by the completion device (Ⓢ +0) and completion status display flag (Ⓢ +1) set for the setting data.
 - (a) Completion device (Ⓢ +0)
Turns ON at the END process of the scan in which the RCPREAD instruction is completed, and turns OFF at the next END process.
 - (b) Completion status display device (Ⓢ +1)
Turns ON/OFF by the status of the RCPREAD instruction completion.
Normal completion: Stays OFF without any changes
Error completion : Turns ON at the END process of the scan in which the RCPREAD instruction is completed, and turns OFF at the next END process.

- Operation when the RCPREAD instruction is executed

Turns the completion device (bit device) set for (Ⓢ +0) ON at the END process of the scan in which the RCPREAD instruction is completed, and turns OFF at the next END process.

When an error occurs, the error completion device set for (Ⓢ +1) is turned ON, and the corresponding error code is stored to the completion status (word device) set for (Ⓢ +1).

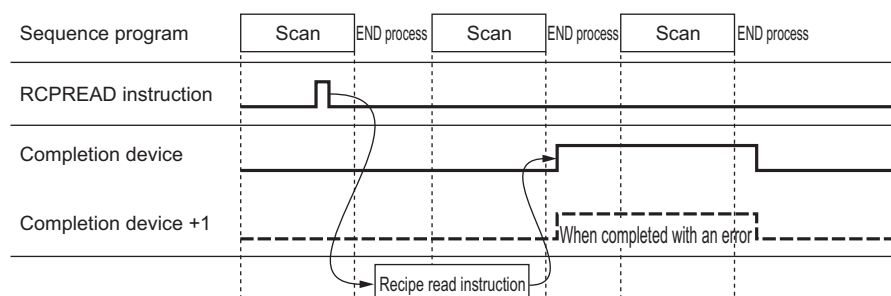

15 RECIPE FUNCTION

! Operation Error

When an error completion of the dedicated instruction occurs, the error completion signal (D +1) is turned ON, and the corresponding error code is stored to the completion status (S +1).

Program Example

In the following program, the device values set for Record 1 on the recipe file 'RCPFILE.CSV' are read by the programmable controller CPU from the high speed data logger module installed at the position where the I/O numbers are from X/Y00 to X/Y1F when M28 turns ON.

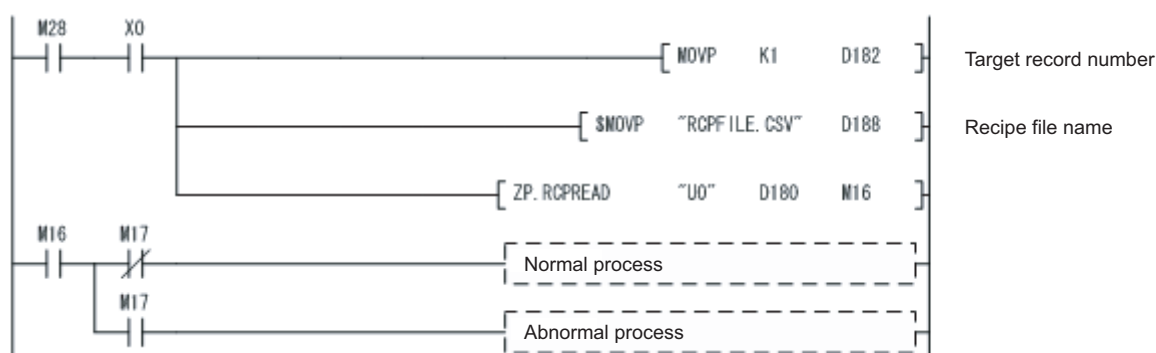

15.6.2 Recipe Write (RCPWRITE)

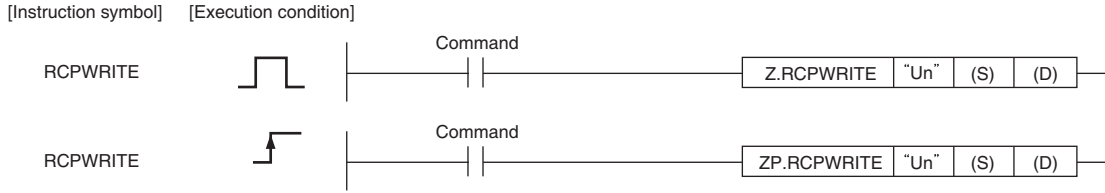

Un : Start I/O number of the module (BIN 16 bits)

(00 to FE: Higher two digits when expressing the I/O signal in three digits)

(S) : Start number of the device that stores the control data (Device name)

(D) : Start number of bit device to be turned ON for one scan at the instruction completion (Bit)

(D) + 1 is also turned ON when the error occurs at the instruction completion.

Setting data	Internal device		R, ZR	JOG		U:GO	Zn	Constant K, H	Others
	Bit	Word		Bit	Word				
(S)	-	○						-	-
(D)	○	○						-	-

Control Data

Device	Item	Setting data	Setting range	Set by ^{*1}
(S) +0	System area	-	-	-
(S) +1	Completion status	Status of the instruction completion is stored. 0 : Normal completion Other than 0: Error completion (Error code ^{*2})	-	System
(S) +2	Record number	Record number of data to be written.	1 to 256	User
(S) +3 to (S) +7	System area	-	-	-
(S) +8 to (S) +23	File name	Recipe file name for writing device values. (Up to 32 characters)	Character string	User
(S) +24 to (S) +31	System area	-	-	-

*1: Items under 'Set by' indicate as follows.

User: Data set by a user before executing the dedicated instruction.

System: Data (execution result of dedicated instruction) stored by the programmable controller CPU.

*2: For details on error codes, refer to the following section.

Section 18.2 Error Code List

★ Function

- (1) This instruction transfers device data in the programmable controller CPU to the specified recipe file in the CompactFlash card.
- (2) This instruction cannot be executed additionally while another RCPWRITE instruction is being executed. (If attempted, the instruction is not processed.) For errors detected at the instruction execution, the completion device (Ⓢ +0) and completion status display device (Ⓢ +1) are not turned ON.
- (3) This instruction cannot be executed when the module stop error is being occurred, or the data logging function cannot be performed (X5 is OFF). (If attempted, an error occurs at the instruction completion.)
- (4) An error may occur when the instruction (RCPREAD) other than this instruction is accessing the same file. Execute the instruction after setting the interlock between the dedicated instructions which access the same file.
- (5) This instruction cannot be executed in interrupt programs.
- (6) Recipe files can be specified under the directory '/RECIPE/' in the CompactFlash card.
- (7) The status of the execution and normal/error completion of the RCPWRITE instruction can be checked by the completion device (Ⓢ +0) and completion status display flag (Ⓢ +1) set for the setting data.
 - (a) Completion device (Ⓢ +0)
Turns ON at the END process of the scan in which the RCPWRITE instruction is completed, and turns OFF at the next END process.
 - (b) Completion status display device (Ⓢ +1)
Turns ON/OFF by the status of the RCPWRITE instruction completion.
Normal completion: Stays OFF without any changes
Error completion : Turns ON at the END process of the scan in which the RCPWRITE instruction is completed, and turns OFF at the next END process.

- Operation when the RCPWRITE instruction is executed

Turns the completion device (bit device) set for (Ⓢ +0) ON at the END process of the scan in which the RCPWRITE instruction is completed, and turns OFF at the next END process. When an error occurs, the error completion device set for (Ⓢ +1) is turned ON, and the corresponding error code is stored to the completion status (word device) set for (Ⓢ +1).

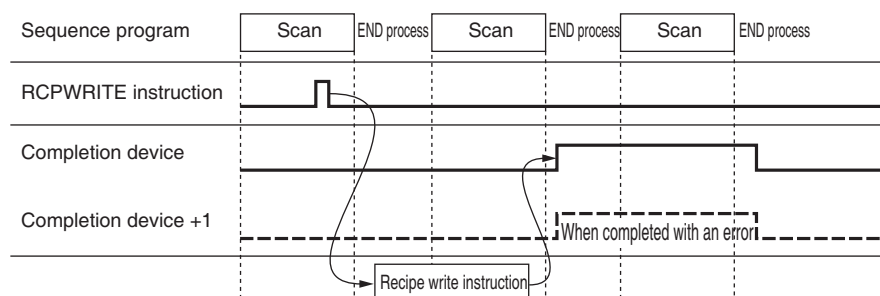

15 RECIPE FUNCTION



Operation Error

When an error completion of the dedicated instruction occurs, the error completion signal (Ⓢ +1) is turned ON, and the corresponding error code is stored to the completion status (Ⓢ +1).



Program Example

In the following program, the device values are written by the programmable controller CPU to Record 4 on the recipe file 'RCPFILE.CSV' in the high speed data logger module installed at the position where the I/O numbers are from X/Y00 to X/Y1F when M28 turns ON.

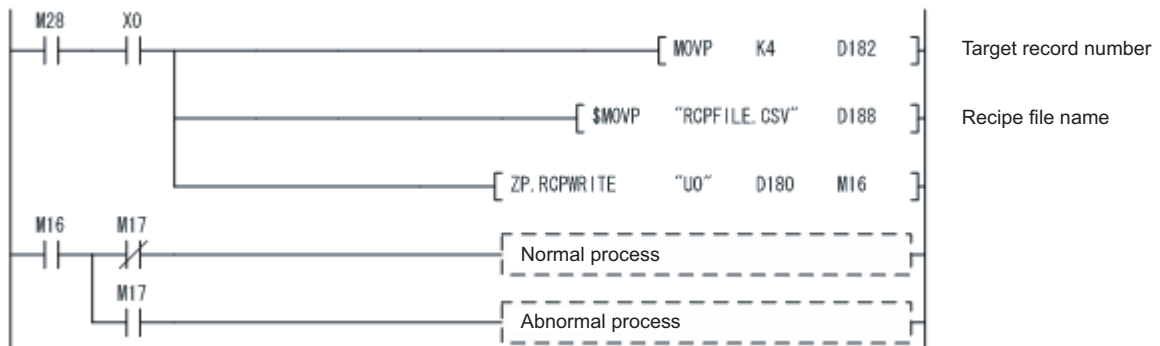

CHAPTER 16 CompactFlash CARD

16.1 CompactFlash Card Specifications

Item		Model				
		QD81MEM-512MBC	QD81MEM-1GBC	QD81MEM-2GBC	QD81MEM-4GBC	QD81MEM-8GBC
Memory capacity		512MB	1GB	2GB	4GB	8GB
Number of insertions/ejections		10,000 cycles				
External dimensions	H	36mm				
	W	43mm				
	D	3.3mm				
Weight		12g				

16.2 CompactFlash Card Part Names

This section explains the CompactFlash card part names.

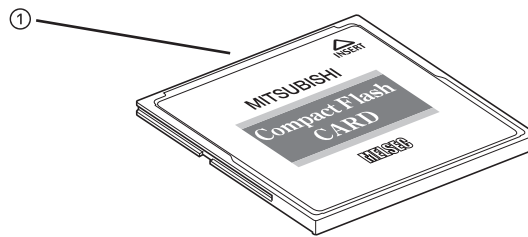

No.	Name	Description
①	Connector part	For CompactFlash card interface connection

16.3 Precautions when Using CompactFlash Card

This section explains the precautions when using a CompactFlash card.

(1) CompactFlash card file/directory names

- (a) Do not create files ^{*1} or folders on the CompactFlash card with a personal computer.

If files or folders are created on the CompactFlash card with a personal computer, they may be deleted.

*1: Excluding module operating files and recipe files

- (b) Do not store files with file name containing unusable characters to CompactFlash card.

For usable characters in file names, refer to the following section.

☞ Appendix 4.2 Characters usable in file names, folder (directory) names

(2) CompactFlash card to be used

Use CompactFlash cards listed in Section 2.3.

☞ Section 2.3 Connection System Equipment

If any other CompactFlash cards are used, a failure such as a data corruption on a CompactFlash card or a system shutdown (SP.UNIT DOWN occurs in the programmable controller CPU) may occur during an operation.

(3) When turning OFF or resetting programmable controller CPU

When a programmable controller CPU is turned OFF or reset while writing data to a CompactFlash card, the processing to write data to a CompactFlash card may not be completed. It may cause a loss of logging data during the processing, corruption of data in the CompactFlash card that is being accessed, or occurrence of a file system error. The file is automatically repaired when the high speed data logger module is turned ON again, but it will not succeed in some cases.

The operation, turning OFF or resetting the high speed data logger module after stopping file access, should be considered. For the important data, create backups by performing a backup operation such as saving data to other media.

☞ Section 16.6 (1) Stopping file access

(4) When ejecting or replacing the CompactFlash card

- (a) Be sure to stop file access before ejecting or replacing the CompactFlash card.
 - ☞ Section 16.5 Operations for Ejecting and Reinserting CompactFlash Card
- (b) Not following the procedure shown in Section 16.5 may cause a loss of logging data during processing, corruption of data on the CompactFlash card while accessing, or a file system error.
- (c) If an error occurs on the CompactFlash card, refer to the following section.
 - ☞ Section 18.3.8 Troubleshooting related to data management, CompactFlash cards
- (d) High speed data logger module settings are saved on the CompactFlash card. Therefore, the IP address of the high speed data logger module returns to the initial status (192.168.3.3) when turning the power OFF/ON or resetting the programmable controller CPU without a CompactFlash card inserted in the module or without the settings written to the CompactFlash card. As necessary, read the current settings before ejecting the CompactFlash card and after replacing the card, promptly write those settings to the new card.

(5) CompactFlash card capacity

- (a) Access speed to the CompactFlash card is affected by the amount of saved files. In particular, access speed becomes extremely slow when saving files up to the capacity limit of the CompactFlash card. Use the CompactFlash card maintaining 10% or more free space on the card.
- (b) A minimum size of the occupied file on the hard disk varies depending on the CompactFlash card capacity. Therefore, the actual file size and the occupied file size on the hard disk may differ.

(6) CompactFlash card diagnostic time

- (a) The high speed data logger module performs a diagnostics (file recovery, etc.) of the inserted CompactFlash card contents at the times listed below.
 - ① When powering ON from OFF, resetting the CPU module
 - ② Inserting a CompactFlash card when powered ON
- (b) The CompactFlash card diagnostic time takes longer when there are more files on the card. 100 files takes approximately 5 seconds, 1000 files takes approximately 10 seconds.
- (c) When many files are saved on the CompactFlash card, the following operations require longer time. Delete unnecessary files.
 - ① CompactFlash card status (X1) startup time
 - ② Time before the high speed data logger module can start processing (Module READY (X0) and module operating status (X5) startup time)

(7) CompactFlash card format

- (a) To format the CompactFlash card, use the high speed data logger module format function.

☞ Section 13.1.6 CompactFlash card diagnostics

Note that, since the CompactFlash card is formatted when shipped, it is not necessary to format it again.

- (b) Do not format the CompactFlash card using the Windows® format function.

- (c) Do not reset the control CPU or turn the power OFF when formatting the CompactFlash card.

The module may not be able to recognize the CompactFlash card.

- (d) High speed data logger module settings are saved on the CompactFlash card. Therefore, all settings are lost when formatting the card.

As necessary, read the current settings before formatting and promptly write those settings after formatting.

The IP address of the high speed data logger module returns to the initial status (192.168.3.3) when turning the power OFF/ON or resetting the programmable controller CPU without writing the settings to the CompactFlash card.

(8) CompactFlash card life duration (a limit for writing data)

The CompactFlash card has a life duration (a limit for writing data).

For details, refer to the following section.

☞ Section 16.7 CompactFlash Card Life Duration

16.4 Operations for Inserting CompactFlash Card

This section explains the method for inserting the CompactFlash card.

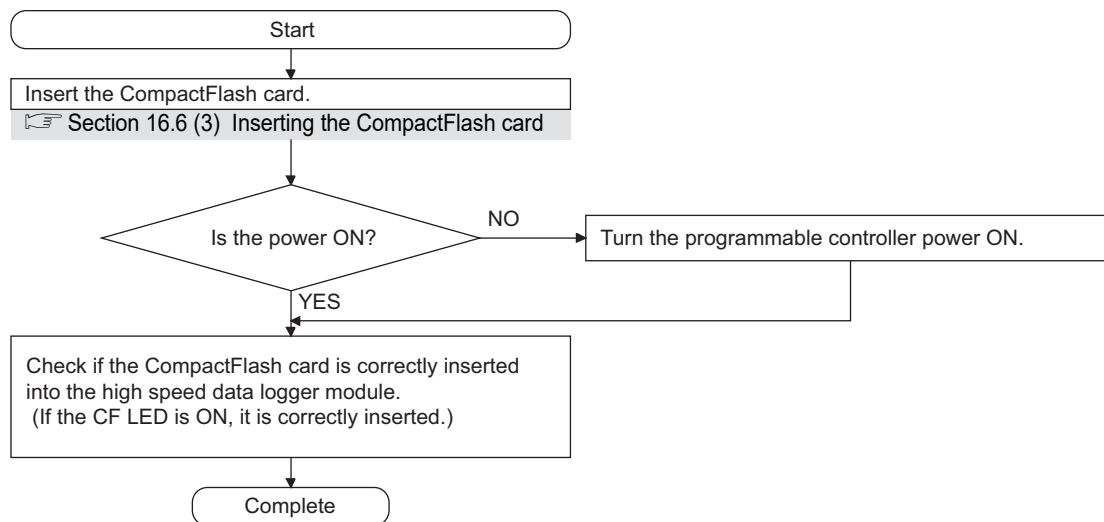

POINT

The CompactFlash card insertion status can be checked with the input signal. If CompactFlash card status (X1) is ON, the CompactFlash card has been correctly inserted.

16.5 Operations for Ejecting and Reinserting CompactFlash Card

When ejecting the CompactFlash card, always stop file access following the procedure below.

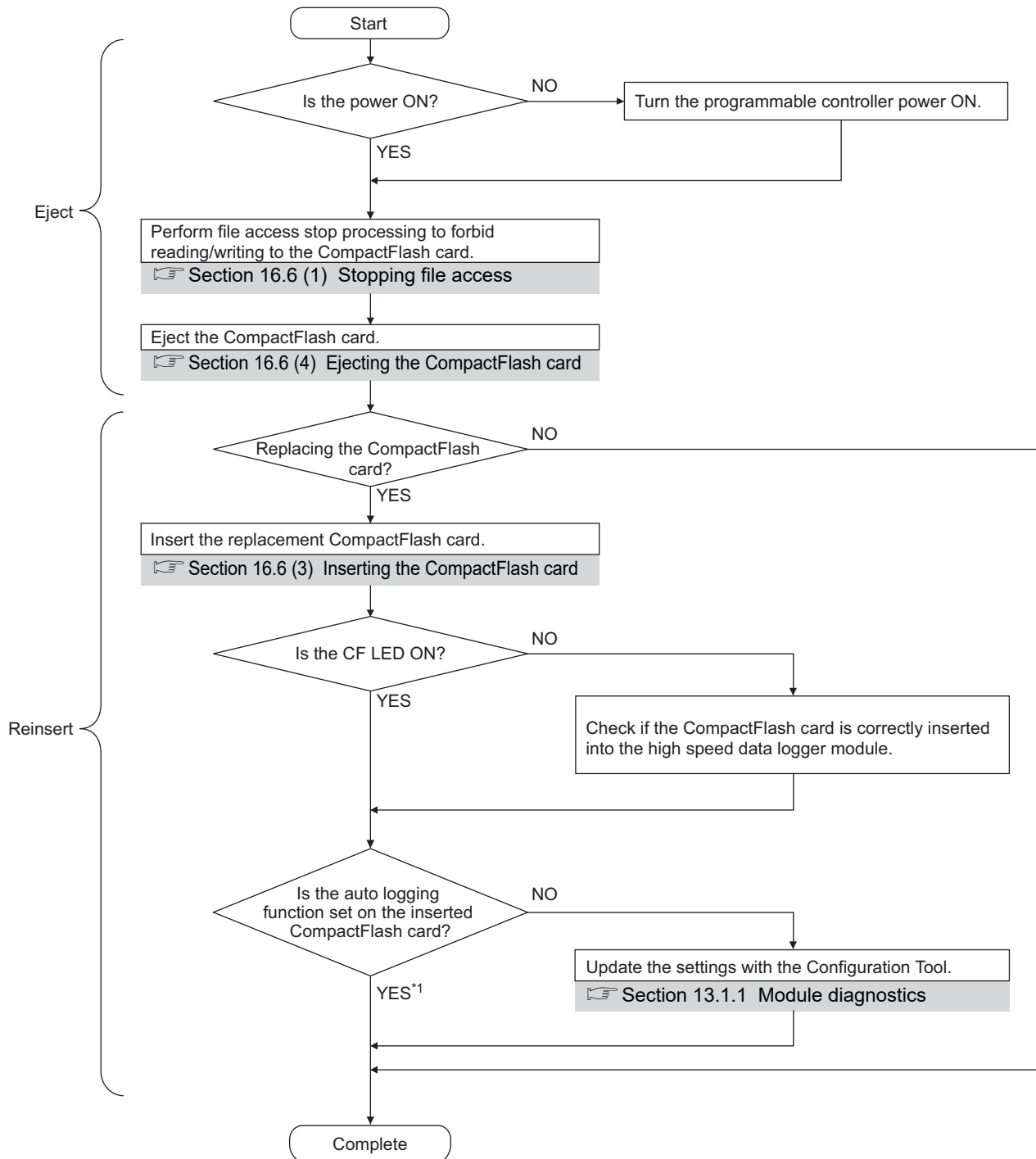

*1: When the CompactFlash card on which the auto logging function is set is inserted, the logging starts as the card is inserted.

POINT

- (1) Not following the procedure shown above may cause a loss of logging data during processing, corruption of data on the CompactFlash card while accessing, or a file system error.

If an error occurs on the CompactFlash card, refer to the following section.

☞ Section 18.3.8 Troubleshooting related to data management, CompactFlash cards

- (2) High speed data logger module settings are saved on the CompactFlash card. Therefore, the IP address of the high speed data logger module returns to the initial status (192.168.3.3) when turning the power OFF/ON or resetting the programmable controller CPU without a CompactFlash card inserted in the module or without the settings written to the CompactFlash card. As necessary, read the current settings before ejecting the CompactFlash card and after replacing the card, promptly write those settings to the new card.

16.6 Operations for Replacing New CompactFlash Card

When replacing the New CompactFlash card, always stop file access following the procedure below.

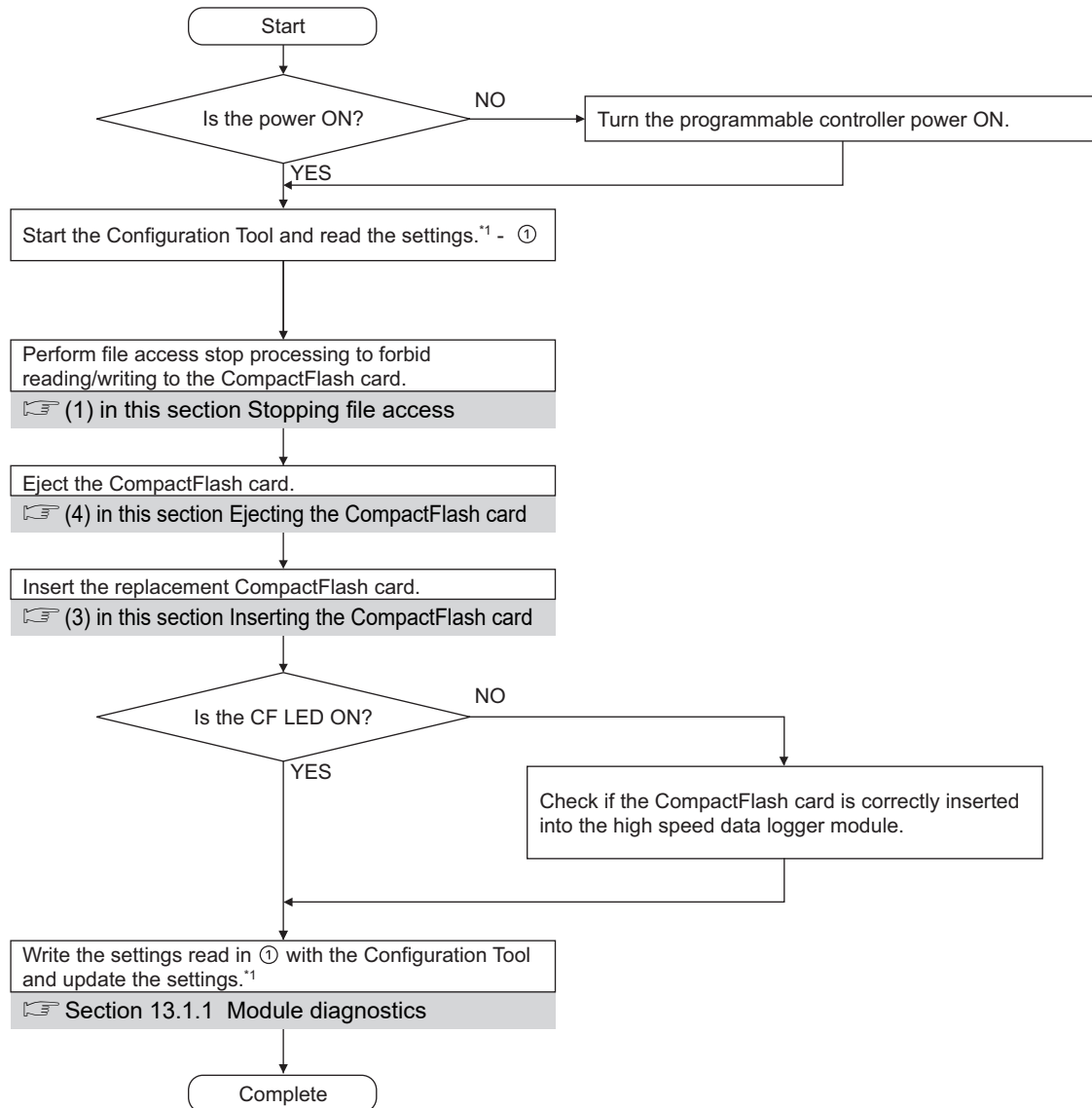

*1: By setting the auto logging function to the replacement CompactFlash card, the logging starts as the card is inserted.

For details on the auto logging function, refer to the following section.

☞ Section 10.2 Auto Logging Function

POINT

- (1) If the operation instructed on the previous page is not properly performed, logging data being processed may be lost, data in the CompactFlash card being accessed may be damaged, or a file system error may occur. When an error occurred to a CompactFlash card, refer to the following section.

☞ Section 18.3.8 Troubleshooting related to data management, CompactFlash cards

- (2) The settings of high speed data logger module are stored in the CompactFlash card. Therefore, when the programmable controller CPU is turned ON from OFF or reset without inserting a CompactFlash card or without writing settings to a CompactFlash card, the IP address of the high speed data logger module is reset to the default (192.168.3.3).

If necessary, read the current settings from the CompactFlash card before ejecting it, and write the settings to the new CompactFlash card as soon as it is replaced.

(1) Stopping file access

(a) When using the input signal

- ① Stopping file access.
Turn file access stop request (Y2) ON from OFF.
- ② Checking that file access has stopped.
 - CompactFlash card status (X1) is OFF
 - File access status (X2) is ON
 - Turn file access stop request (Y2) OFF from ON

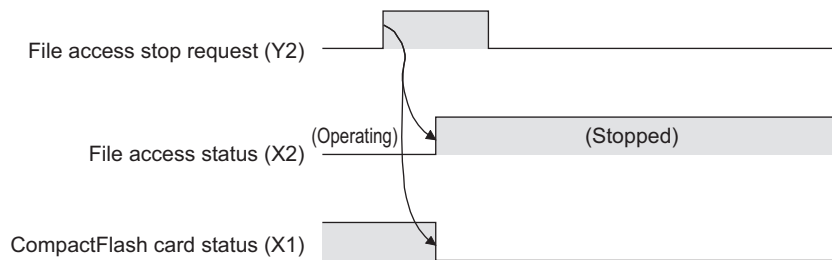

(b) When using the Configuration Tool (☞ Section 13.1.6 CompactFlash card diagnostics)

- ① Stopping file access.
Select [Online] → [Diagnostics...], and click the <<CompactFlash card diagnostics>> tab. Then select CompactFlash card operation "Access stop" and click the button
- ② Checking that file access has stopped.
Check that the access status is stopped

(2) Clearing file access stop

(a) When using the input signal

- ① Clearing the file access stop status.
Turn clear file access stop request (Y3) ON from OFF
- ② Checking that file access stop status has cleared.
 - CompactFlash card status (X1) is ON
 - File access status (X2) is OFF
 - Turn clear file access stop request (Y3) OFF from ON

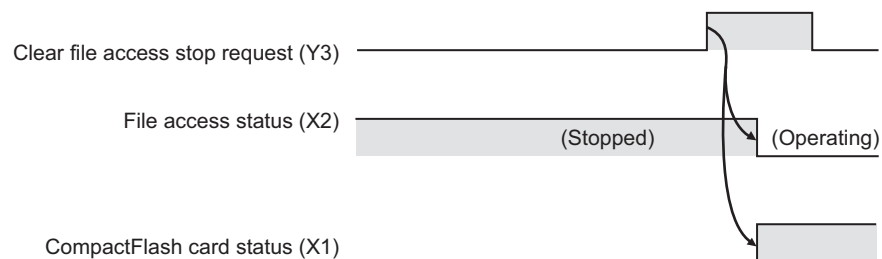

- (b) When using the Configuration Tool (☞ Section 13.1.6 CompactFlash card diagnostics)
- ① Clearing the file access stop status.
Select [Online] → [Diagnostics] and click the <<CompactFlash card diagnostics>> tab. Then select CompactFlash card operation "Access restart" and click the button
 - ② Checking that file access stop status has cleared.
Check that the access status is in action

(3) Inserting the CompactFlash card

- (a) Open the LED cover on the front of the high speed data logger module, then remove the CompactFlash card slot cover.

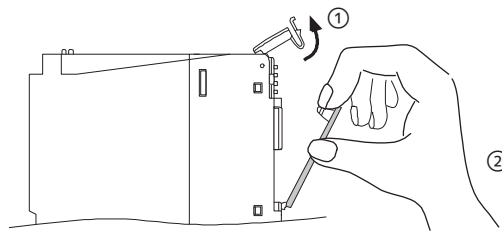

- ① Put your finger on the bottom of the LED cover on the front of the high speed data logger module and lift the LED cover up to open.
- ② Put your finger on the top of the CompactFlash card slot cover to remove the cover.

- (b) Insert the CompactFlash card.
Push the CompactFlash card securely into the slot until it is flush with the EJECT button.

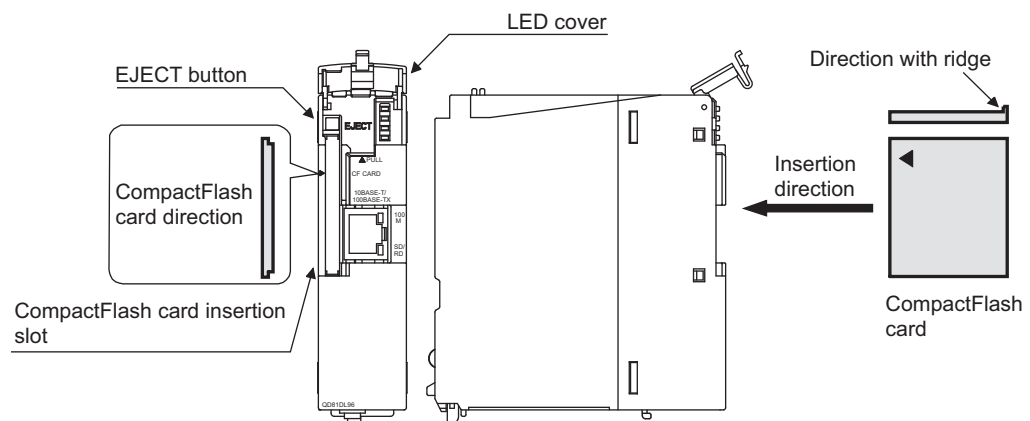

16 CompactFlash CARD

- (c) Lower the LED cover on the front of the high speed data logger module until it clicks.

Remark

When the CompactFlash card is inserted, the CompactFlash card slot cover cannot be attached to the high speed data logger module. Carefully save the removed CompactFlash card slot cover.

(4) Ejecting the CompactFlash card

- (a) Open the LED cover on the front of the high speed data logger module. Put your finger on the bottom of the LED cover on the front of the high speed data logger module and lift the LED cover up to open.

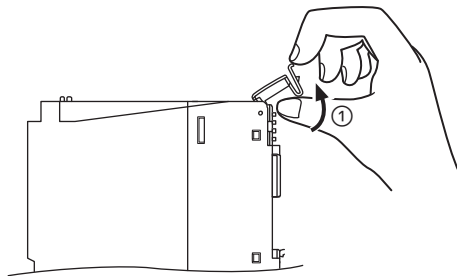

- (b) Eject the CompactFlash card. Push the EJECT button to push out the CompactFlash card.

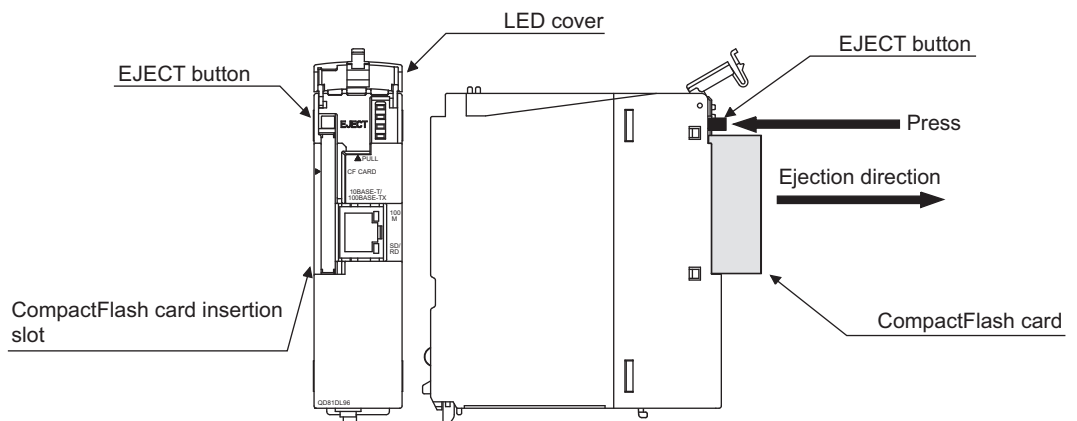

Remark

- (1) After removing the CompactFlash card, follow the procedure below when not inserting a CompactFlash card.
 - ① Attach the CompactFlash card slot cover.
 - ② Lower the LED cover on the front of the high speed data logger module until it clicks.
- (2) High speed data logger module settings are saved on the CompactFlash card. Therefore, the IP address of the high speed data logger module returns to the initial status (192.168.3.3) when turning the power OFF/ON or resetting the programmable controller CPU without a CompactFlash card inserted in the module.

When replacing, read the current settings before ejecting the CompactFlash card and after replacing the card, promptly write those settings to the new card as necessary.

16.7 CompactFlash Card Life Duration

The CompactFlash card has a life duration (a limit for writing data). The following shows the method for calculating the life duration of CompactFlash card (QD81MEM-512MBC, QD81MEM-1GBC, QD81MEM-2GBC, QD81MEM-4GBC, QD81MEM-8GBC). Note that the actual life duration depends on the operating conditions and environment. Use the following calculation only as a guide to determine the time for replacement.

(1) Life duration calculation

The life duration of the CompactFlash card can be found with the following calculation formula.

	Calculation formula
CompactFlash card life duration (years)	$= \text{Total writable size (GB)}^{*1} / 1 \text{ year write size (GB/year)}^{*2}$

*1: Refer to (2)

*2: Refer to (3)

(2) Total writable size

The total amount of data which can be written to the CompactFlash card is shown below.

Model	Total writable size (GB)
QD81MEM-512MBC	$0.5\text{GB (512MB)} \times 100,000 = 50,000$
QD81MEM-1GBC	$1\text{GB} \times 100,000 = 100,000$
QD81MEM-2GBC	$2\text{GB} \times 100,000 = 200,000$
QD81MEM-4GBC	$4\text{GB} \times 100,000 = 400,000$
QD81MEM-8GBC	$8\text{GB} \times 100,000 = 800,000$

(3) 1 year write size

The amount of data written to the CompactFlash card in 1 year can be found with the following calculation formula.

	Calculation formula ^{*3}
1 year write size (GB/year)	$= \{(\underline{\text{DS}}_1 + 1024 + 1536^{*4}) \times \text{DN}_1 + \dots + (\underline{\text{DS}}_n + 1024 + 1536^{*4}) \times \text{DN}_n$ $+ (\underline{\text{DCS}}_1 + 2048) \times \text{DCN}_1 + \dots + (\underline{\text{DCS}}_n + 2048) \times \text{DCN}_n$ $+ (\underline{\text{ES}}_1 + 1024) \times \text{EN}_1 + \dots + (\underline{\text{ES}}_n + 1024) \times \text{EN}_n$ $+ (\underline{\text{ECS}}_1 + 2048) \times \text{ECN}_1 + \dots + (\underline{\text{ECS}}_n + 2048) \times \text{ECN}_n$ $+ (\underline{\text{RS}}_1 + 2048) \times \text{RN}_1 + \dots + (\underline{\text{RS}}_n + 2048) \times \text{RN}_n\}$ $/ (1024 \times 1024 \times 1024)$

*3: For the underlined portions, calculate by rounding up to a multiple of 512.

Example) For $\text{DS}_n=600$, $\underline{\text{DS}}_n=1024$

*4: Add '1536' only to data logging No.n specified in any of data logging layouts for report.

DS_n : 1 record (line) size for data logging No.n

DN_n : Number of written records (lines) for data logging No.n for 1 year

DCS_n : Header size for data logging No.n

DCN_n : Number of file switches for data logging No.n for 1 year

ES_n : 1 record (line) size for event logging No.n

EN_n : Number of written records (lines) for event logging No.n for 1 year

ECS_n : Header size for event logging No.n

ECN_n : Number of file switches for event logging No.n for 1 year

RS_n : File size of report No.n

RN_n : Number of reports created of report No.n for 1 year

(4) Data logging write size and count

The data logging write size and count can be found in the following sections.

(a) 1 record (line) size for data logging (DSn)

- For the CSV format
Refer to the following section.
☞ Section 3.6.2 (2)(d) Data line
- For the binary format
Refer to the following section.
☞ Section 3.7.1 Data logging file

(b) Number of written records (lines) for data logging for 1 year (DNn)

① For continuous logging

	Calculation formula
DNn	$60 \times 60 \times 24 \times 365 / \text{data sampling interval (seconds)}^{*1} \times \text{operating rate}^{*2}$

*1: Data sampling interval is the data logging sampling setting value.

For high speed data sampling, milliseconds must be converted to seconds.

*2: Operating rate is calculated from the data logging period setting and programmable controller system operating time.

Example) When the period setting is 9:00 to 17:00 (8 hours)

$$8 \text{ (hours)} \div 24 \text{ (hours)} = 0.33$$

② For trigger logging

	Calculation formula
DNn	$\text{Total number of lines}^{*3} \times \text{trigger occurrence count for 1 year}^{*4}$

*3: Total number of lines is the data logging trigger setting value.

*4: Trigger occurrence count for 1 year is calculated with the anticipated count according to system operation.

(c) Header size for data logging (DCSn)

- For the CSV format
Refer to the following section.
☞ Section 3.6.2 (2)(c) Data name line
- For the binary format
Refer to the following section.
☞ Section 3.7.1 Data logging file

(d) Number of file switches for data logging for 1 year (DCNn)

This value is calculated by the data logging save setting and the anticipated count according to system operation.

(5) Event logging write size and count

The event logging write size and count can be found in the following sections.

(a) 1 record (line) size for event logging (ESn)

- For the CSV format

Refer to the following section.

☞ Section 3.6.3 (2)(d) Data line

- For the binary format

Refer to the following section.

☞ Section 3.7.2 Event logging file

(b) Number of written records (lines) for event logging for 1 year (ENn)

Use the event occurrence count anticipated according to system operation as the predicted value for the number of written records (lines).

(c) Header size for event logging (ECSn)

- For the CSV format

Refer to the following section.

☞ Section 3.6.3 (2)(c) Data name line

- For the binary format

Refer to the following section.

☞ Section 3.7.2 Event logging file

(d) Number of file switches for event logging for 1 year (ECNn)

This value is calculated by the event logging save setting and the anticipated count according to system operation.

(6) Report file size and number created

The report file size and number created can be found with the following calculation formula.

(a) File size of report (RSn)

	Calculation formula ^{*1}
RSn	$= LS \times 4 + (SS + BS) \times 2$ $SS = SS_1 + \dots SS_n$ $SS_n = (SN_n \times 2) + (SN_n \times 2) / 8192 \times 6^{*1}$ $BS = BS_1 + \dots BS_m$ $BS_m = (BN_m \times 4) + (BN_m \times 4) / 8192 \times 6^{*1}$

*1: Round up the results of division to a whole number.

- LS : Layout size (displayed in the report layout list screen)
- SS : String type data additional size
- SS_n : Size of output range of nth string type data set in the layout setting
- SN_n : Size of nth string type data set in the layout setting
- BS : Raw type data additional size
- BS_m : Size of output range of mth raw type data set in the layout setting
- BN_m : Size of mth raw type data set in the layout setting

(b) Number of reports created for 1 year (RNn)

This value is calculated by the report creation trigger setting and the anticipated count according to system operation.

CHAPTER 17 PROCESSING TIME

17.1 Processing Time

This section shows the results of measuring the processing time required for data logging under the following conditions.

Note that the processing time may be increased depending on any of the following factors.

- Sequence scan time
- Network speed and load status (when accessing other station's programmable controller CPUs)
- Target data value (for CSV files, output size varies according to value size)
- CompactFlash card type
- Number of files, file capacity on the CompactFlash card
- Access status from the Configuration Tool, GX LogViewer, or FTP client software to the high speed data logger module
- Access status from the personal computer, HMI, or other intelligent function to the high speed data logger module

Use the measurement results as a reference for processing time.

17.1.1 Trigger logging

(1) High speed data sampling

(a) Measurement conditions

Item		Description
Access target CPU	Programmable controller CPU	Q04UDHCPU
	Network	Own station (single CPU configuration)
	Sequence scan time	The sequence scan time which can be sampled is shown in the measurement results.
Data logging setting	Logging type	Trigger logging
	Sampling	Data logging 01 to 05: high speed data sampling (each scan) Data logging 06 to 32: high speed data sampling (each scan), sampling consecutive devices.
	Data	D devices Data type: Word [signed] decimal format (digits: 0)
	CSV output	• Output date column. • Output index column.
	Binary output	• Output date information. • Output index.
	Save	File switch timing: 1000 lines Number of save files: 256
	Data logging amount	Number of device points 16 to 256: Data logging 01 Number of device points 1024 : Data logging 01 to 04 Number of device points 4096 : Data logging 01 to 16 Number of device points 8192 : Data logging 01 to 32
CompactFlash card		QD81MEM-8GBC
Measuring method	Sampling speed	Measures the minimum value for the sequence scan time which can perform trigger logging for data each scan.
	File save time	Measures the time from when the amount of data before and after the trigger is sampled up to when saving to a file completes.

(b) Measurement results ^{*1}

Item	Number of device points						
	16	64	256	1024	4096	8192	
Sampling speed (milliseconds)	1	1	1	2	8	16	
Trigger logging interval ^{*2} (seconds)	58	24	7.9	3.7	3.7	3.7	
File save time ^{*3} (seconds)	Binary file	0.5	0.5	0.7	2.8	11	22
	CSV file	0.6	0.7	1.5	12	48	96

*1: Use as a reference for processing time. Processing time changes according to the settings and external factors such as access from GX LogViewer. (☞ Section 17.1 Processing Time)

*2: The maximum time before/after the trigger where data can be retained and output to a file when the trigger occurs.

*3: The time required to output 100 lines (records) of data before/after the trigger.

(2) General data sampling

(a) Measurement conditions

Item		Description
Access target CPU	Programmable controller CPU	Q04UDHCPU
	Network	Own station (single CPU configuration)
	Sequence scan time	20ms
Data logging setting	Logging type	Trigger logging
	Sampling	General data sampling Data sampling interval: The time which can be sampled is described in the measurement results.
	Data	D devices Data type: Word [signed] decimal format (digits: 0)
	CSV output	<ul style="list-style-type: none"> • Output date column. • Output index column.
	Binary output	<ul style="list-style-type: none"> • Output date information. • Output index.
	Save	File switch timing: 1000 lines Number of save files: 256
	Data logging amount	Number of device points 16 to 256: Data logging 01 Number of device points 1024 : Data logging 01 to 04 Number of device points 4096 : Data logging 01 to 16 Number of device points 16384 : Data logging 01 to 64
CompactFlash card		QD81MEM-8GBC
Measuring method	Sampling speed	Measures the data sampling interval where trigger logging can be performed in the specified time.
	File save time	Measures the time from when the amount of data before and after the trigger is sampled up to when saving to a file completes.

(b) Measurement results *1

Item	Number of device points						
	16	64	256	1024	4096	16384	
Sampling speed (seconds)	0.1	0.1	0.1	0.5	2.0	8.0	
Trigger logging interval*2 (seconds)	5800	2400	750	940	940	940	
File save time*3 (seconds)	Binary file	0.8	1.1	1.3	2.6	7.6	29
	CSV file	0.8	1.1	1.6	8.2	32	130

*1: Use as a reference for processing time. Processing time changes according to the settings and external factors such as access from GX LogViewer. (GX LogViewer Section 17.1 Processing Time)

*2: The maximum time before/after the trigger where data can be retained and output to a file when the trigger occurs.

*3: The time required to output 100 lines (records) of data before/after the trigger.

17.1.2 Continuous logging

(1) High speed data sampling

(a) Measurement conditions

Item	Description	
Access target CPU	Programmable controller CPU	Q04UDHCPU
	Network	Own station (single CPU configuration)
	Sequence scan time	The sequence scan time which can be sampled is shown in the measurement results.
Data logging setting	Logging type	Continuous logging
	Sampling	Data logging 01 to 05: high speed data sampling (each scan) Data logging 06 to 32: high speed data sampling (each scan), sampling consecutive devices.
	Data	D devices Data type: Word [signed] decimal format (digits: 0)
	CSV output	<ul style="list-style-type: none"> Output date column. Output index column.
	Binary output	<ul style="list-style-type: none"> Output date information. Output index.
	Save	File switch timing: 1000 lines Number of save files: 256
	Data logging amount	Number of device points 16 to 256: Data logging 01 Number of device points 1024 : Data logging 01 to 04 Number of device points 4096 : Data logging 01 to 16 Number of device points 8192 : Data logging 01 to 32
CompactFlash card	QD81MEM-8GBC	
Measuring method	Measures the minimum value for the sequence scan time which can perform continuous logging for data each scan.	

(b) Measurement results^{*1}

File format	Number of device points					
	16	64	256	1024	4096	8192
Binary file	3	4	10	40	160	390
CSV file	4	10	30	130	580	1400

(unit: ms)

*1: Use as a reference for processing time. Processing time changes according to the settings and external factors such as access from GX LogViewer. (☞ Section 17.1 Processing Time)

(2) General data sampling

(a) Measurement conditions

Item		Description
Access target CPU	Programmable controller CPU	Q04UDHCPU
	Network	Own station (single CPU configuration)
	Sequence scan time	20ms
Data logging setting	Logging type	Continuous logging
	Sampling	General data sampling Data sampling interval: The time which can be sampled is shown in the measurement results.
	Data	D devices Data type: Word [signed] decimal format (digits: 0)
	CSV output	<ul style="list-style-type: none"> Output date column. Output index column.
	Binary output	<ul style="list-style-type: none"> Output date information. Output index.
	Save	File switch timing: 1000 lines Number of save files: 256
	Data logging amount	Number of device points 16 to 256: Data logging 01 Number of device points 1024 : Data logging 01 to 04 Number of device points 4096 : Data logging 01 to 16 Number of device points 16384 : Data logging 01 to 64
CompactFlash card	QD81MEM-8GBC	
Measuring method	Measures the data sampling interval where sampling and continuous logging can be performed in the specified time.	

(b) Measurement results *1

File format	Number of device points					
	16	64	256	1024	4096	16384
Binary file	0.1	0.1	0.1	0.5	3.0	10.0
CSV file	0.1	0.1	0.1	0.5	3.0	10.0

(Unit: seconds)

*1: Use as a reference for processing time. Processing time changes according to the settings and external factors such as access from GX LogViewer. (☞ Section 17.1 Processing Time)

17.2 Checking Processing Time

The data logging, event logging, and report functions of the module are the best effort functions.

Since module processing time changes according to the settings and status of other devices, it may not operate with the set data sampling interval. Run the system by fully verifying the processing time of each function when constructing it.

The following figure shows the relationship of processing from when the high speed data logger module samples data from the programmable controller CPU up to outputting them to a file.

This section explains the check points for processing time related to the processing below.

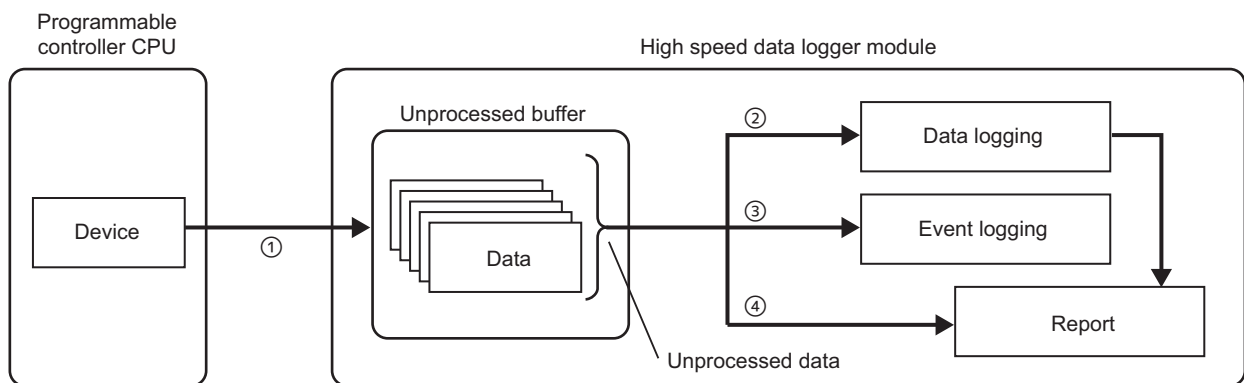

Processing	Description	Check point	Reference
① Sampling process	Samples data from the programmable controller CPU and temporarily stores sampled data in the unprocessed buffer (module's internal memory). The sampling process runs in the specified data sampling interval or synchronized to the sequence scan, but it may not be able to operate in the specified data sampling interval depending on the amount of data, network speed, or sequence scan time conditions. (Data are missed)	Check if the process to sample data from the programmable controller CPU is operating in the specified data sampling interval.	Section 17.2.1
② Data logging process* ¹	Saves the data stored in the unprocessed buffer to the data logging file. (If a trigger and period are set, determines if the condition has been established in advance.) When the data logging process is not in time for the data sampling process speed, a processing overload occurs and data are missed. (During the trigger or period setting, may not be able to detect the conditions being established.)	Check if the sampled data are all being processed.	Section 17.2.2
③ Event logging process* ¹	Using the data stored in the unprocessed buffer, determines if event conditions are established. When conditions are established, saves events in the event logging file. When the event logging process is not in time for the data sampling process speed, a processing overload occurs and the module may not be able to detect if event conditions are established.		Section 17.2.3
④ Report processing* ¹	Using the data stored in the unprocessed buffer, determines if the creation trigger occurs. When the condition is established, outputs the data in the data logging file and the data (current value data) in the unprocessed buffer to an Excel file. When the report process is not in time for the data sampling process speed, a processing overload occurs and the module may not be able to detect if a creation trigger executes.		Section 17.2.4

*1: The data logging process, event logging process, and report process are performed in order. Therefore, if the load is high for any of the functions, there will be an effect on the other functions.

17.2.1 Checking sampling process time

Check if the process to sample data from the programmable controller CPU is operating in the specified data sampling interval.

The following explains the I/O signal to be checked and the processing method when a problem occurs.

(1) For high speed data sampling

I/O signal to be checked	Processing method when a problem occurs	
X1A (high speed data sampling failure) ↓ if ON Cannot sample in the specified data sampling interval (each scan, specify time).	Change the settings in order to fulfill the conditions below.	
	Each scanning cycle	Change the number of settings in which high speed data sampling is specified or set the programmable controller CPU to constant scanning. Sequence scan time (ms) > $(0.5 \times \text{number of settings in which high speed data sampling is specified}^{*1} + 2.0 \times \text{number of realtime monitors}^{*2})$
	Time specification	Change the number of settings in which high speed data sampling is specified or set the data sampling interval. Data sampling interval (ms) > $(0.5 \times \text{number of settings in which high speed data sampling is specified}^{*1} + 2.0 \times \text{number of realtime monitors}^{*2})$ and; Data sampling interval (ms) > $(\text{Sequence scan time} \times \text{number of settings in which high speed data sampling is specified}^{*3})$

*1: When Split data sampling mode is selected on the High speed data sampling setting, calculate as 1.

*2: The number of windows executing realtime monitoring in GX LogViewer.

*3: When Batch data sampling mode is selected on the High speed data sampling setting, calculate as 1.

POINT

Sampling is executed at the END processing of the programmable controller CPU.

Therefore, the deviation below occurs for the specified data sampling interval. (A high speed data sampling failure does not occur in this case)

- If batch mode is selected in high speed data sampling setting
Sequence scan time
- If split mode is selected in high speed data sampling setting
Sequence scan time × the number of settings in which high speed data sampling is specified

(2) For general data sampling

I/O signal to be checked	Processing method when a problem occurs
X1E (general data sampling delay) ↓ if ON A delay occurred for the specified data sampling interval.	Take any of the following actions. <ul style="list-style-type: none"> • Decrease the number of settings in which general data sampling is specified. • Decrease the amount of sampled data. • Organize the data logging, event logging, and reports per access target CPU. (When data from multiple access target CPUs is mixed in a single data logging, event logging, or report setting, sampling takes time.) • Mount the high speed data logger module to the access target CPU station and perform high speed data sampling.

☒ POINT

If a delay occurs within the allowed general data sampling delay time, general data sampling delay (X1E) does not turn ON.
 The initial value of the allowed general data sampling delay time is half of the sampling time for data logging, event logging, and reports in which general data sampling is specified. This value can be changed with the allowed general data sampling delay time in the buffer memory.

17.2.2 Checking data logging process time

Check if the data sampled by data logging (trigger logging, continuous logging) can all be processed.

The following explains the I/O signal to be checked and the processing method when a problem occurs.

I/O signal to be checked	Processing method when a problem occurs
<p>X1B (processing overload) ↓ if ON</p> <p>Check the processing overload count in data logging information 1 to 64 in the buffer memory ↓ if not 0</p> <p>The data logging process (trigger determination and file save) is not in time for the sampling speed of the target data.</p>	<p>Take any of the following actions.</p> <ul style="list-style-type: none"> • Decrease the amount of target data. • Increase the data sampling interval. • Save only the necessary data to file. (Using the trigger logging function) • Stop access from GX LogViewer. • Adjust the system so the next trigger does not immediately occur after the trigger. <p>After taking action, check that the processing overload count is 0 and the unprocessed data count (current) did not increase together with the time.</p>
<p>X1C (trigger reoccurrence) ↓ if ON</p> <p>Check the trigger reoccurrence count in data logging information 1 to 64 in the buffer memory ↓ if not 0</p> <p>Not processed because the next trigger occurred immediately after the trigger.</p>	<p>Adjust the system so the next trigger does not immediately occur after the trigger.</p> <p>For operation when triggers continuously occur, refer to the following section.</p> <p>☞ Section 7.3.2 Trigger logging</p> <p>The period when data are being saved to a file can be checked with the data logging execution information (☞ Section 3.4.11).</p> <p>For the time after the trigger occurs up to when saving to the file finishes, refer to the file save time in the measurement results (☞ Section 17.1.1).</p>

17.2.3 Checking event logging process time

Check if the data sampled by event logging can all be processed.

The following explains the I/O signal to be checked and the processing method when a problem occurs.

I/O signal to be checked	Processing method when a problem occurs
<p>X1B (processing overload) ↓ if ON</p> <p>Check the processing overload count in event logging information 1-64 in the buffer memory ↓ if not 0</p> <p>The event logging process (event determination and file save) is not in time for the sampling speed of the target data.</p>	<p>Take any of the following actions.</p> <ul style="list-style-type: none"> • Decrease the number of events. • Increase the data sampling interval. • Lower the frequency of event occurrence. • Stop access from GX LogViewer. <p>After taking action, check that the processing overload count is 0 and the unprocessed data count (current) did not increase together with the time.</p>

17.2.4 Checking report process time

Check if the data sampled by the report can all be processed.

The following explains the I/O signal to be checked and the processing method when a problem occurs.

I/O signal to be checked	Processing method when a problem occurs
<p>X1B (processing overload) ↓ if ON Check the processing overload count in report creation information 1 to 64 in the buffer memory ↓ if not 0 The report process (trigger determination) is not in time for the sampling speed of the target data.</p>	<p>Take any of the following actions.</p> <ul style="list-style-type: none"> • Decrease the number of reports. • Increase the data sampling interval. <p>After taking action, check that the processing overload count is 0 and the unprocessed data count (current) did not increase together with the time.</p>
<p>X1D (creation trigger reoccurrence) ↓ if ON Check the creation trigger reoccurrence count in report creation information 1 to 64 in the buffer memory ↓ if not 0 Not processed because the next creation trigger occurred immediately after the creation trigger.</p>	<p>Take any of the following actions.</p> <ul style="list-style-type: none"> • Decrease the number of reports. • Increase the data sampling interval. • Adjust the system so the next creation trigger does not immediately occur after the creation trigger. <p>For operation when triggers continuously occur, refer to the following section.</p> <p>☞ Section 7.3.2 Trigger logging</p>

17.3 Effect on Sequence Scanning Time

If data logging, event logging, or the report function are used, they have an effect on the sequence scan time of the access target CPU.

17.3.1 For high speed data sampling

The following shows the necessary processing time on the access target CPU. The amount of processing time shown below is the time increase of the sequence scan time.

$$(\text{The time increase of the scan time}) = (K1 \times N) + (K2 \times M) + K3 \text{ [us]}$$

N: Total number of device points (the total number of points for all devices specified for high speed data sampling)

M: Number of high speed data sampling settings

(Total number of data logging, event logging, and report settings in which high speed data sampling is specified)

K1, K2, K3: Constants (Refer to the table below)

Constants to be used in the calculation formula for the time increase of the scan time

①Q04/06/10/13/20/26/50/100UD(E)HCPU

Constant name	Data sampling method ^{*1}	Base unit ^{*2}	Target device			
			Internal device		File register	
			Bit	Word	Standard RAM	Memory card
K1	Not consecutive	Main	1.13	1.10	1.35	1.50
		Extension	1.65	1.63	1.90	2.05
	Consecutive	Main	0.59	0.33	0.35	0.42
		Extension	1.09	0.86	0.85	0.85
K2	Not consecutive	Main	50	52	52	50
		Extension	60	66	65	63
	Consecutive	Main	45	40	40	42
		Extension	67	54	55	58
K3	Not consecutive	Main, extension	40	37	34	39
	Consecutive	Main, extension	65	45	48	51

*1: Method specified in the data logging, event logging, report sampling settings
 Not consecutive: "Sampling is made on a consecutive series of devices" not selected
 Consecutive: "Sampling is made on a consecutive series of devices" selected

*2: Type of base unit where the high speed data logger module is mounted
 Main: main base unit
 Extension: extension base unit

②Q03UD(E)CPU

Constant name	Data sampling method*1	Base unit*2	Target device			
			Internal device		File register	
			Bit	Word	Standard RAM	Memory card
K1	Not consecutive	Main	1.30	1.31	1.70	1.85
		Extension	1.89	1.80	2.20	2.30
	Consecutive	Main	0.58	0.33	0.36	0.50
		Extension	1.14	0.85	0.85	0.88
K2	Not consecutive	Main	52	52	54	54
		Extension	66	66	65	68
	Consecutive	Main	50	41	43	41
		Extension	59	55	58	60
K3	Not consecutive	Main, extension	50	57	41	40
	Consecutive	Main, extension	82	62	65	61

③Q03/04/06/13/26UDVCPU

Constant name	Data sampling method*1	Base unit*2	Target device			
			Internal device		File register	
			Bit	Word	Standard RAM	Memory card
K1	Not consecutive	Main	0.65	0.65	0.7	0.7
		Extension	1.2	1.2	1.3	1.3
	Consecutive	Main	0.4	0.37	0.38	0.39
		Extension	0.9	0.9	0.91	0.92
K2	Not consecutive	Main	30	30	32	32
		Extension	50	50	52	52
	Consecutive	Main	30	25	30	30
		Extension	50	45	48	48
K3	Not consecutive	Main, extension	35	35	28	28
	Consecutive	Main, extension	40	35	30	32

*1: Method specified in the data logging, event logging, report sampling settings
 Not consecutive: "Sampling is made on a consecutive series of devices" not selected
 Consecutive: "Sampling is made on a consecutive series of devices" selected
 *2: Type of base unit where the high speed data logger module is mounted
 Main: main base unit
 Extension: extension base unit

17.3.2 For general data sampling

General data sampling has an effect on the service processing time of the access target CPU.

Refer to the user's manual for the access target CPU.

For details, refer to the following manuals.

- ☞ QnUCPU User's Manual (Function Explanation, Program Fundamentals)
- ☞ Qn(H)/QnPH/QnPRHCPU User's Manual (Function Explanation, Program Fundamentals)
- ☞ MELSEC-L CPU Module User's Manual (Function Explanation, Program Fundamentals)

17.3.3 Calculation example for time increase of scan time

The following shows a calculation example for time increase of scan time in high speed data sampling.

For details of formulas and constants regarding time increase of scan time, refer to Section 17.3.1.

(1) Sampling condition

Item	Description
Access target CPU	Programmable controller CPU Q04UDHCPU (High speed data logger module is mounted in the main base unit.)
	Network Own station (single CPU configuration)
Data logging setting	Logging type Trigger logging
	Sampling Data logging 01: high speed data sampling (each scan)), sampling consecutive devices.
	Data logging amount Device M: 10 points Device D: 20 points Device R: 16 points

(2) Calculation of time increase of scan time

(a) Calculation regarding Constant K1 ($K1 \times N$)

- Bit device M (10 point worth)
 $0.59 \text{ (us)} \times 10 \text{ (points)} = 5.9 \text{ [us]}$
- Word device D (20 point worth)
 $0.33 \text{ (us)} \times 20 \text{ (points)} = 6.6 \text{ [us]}$
- File register R (16 point worth)
 $0.35 \text{ (us)} \times 16 \text{ (points)} = 5.6 \text{ [us]}$

($K1 \times N$) can be obtained by calculating the above values, as shown below.

$$5.9 \text{ (us)} + 6.6 \text{ (us)} + 5.6 \text{ (us)} = 18.1 \text{ [us]}$$

(b) Calculation regarding Constant K2 ($K2 \times M$)

- K2 value for Bit device M: 45 [us]
- K2 value for Word device D: 40 [us]
- K2 value for File register R: 40 [us]

The above worst value (45 [us]) is used for K2 and ($K2 \times M$) can be obtained as shown below.

$$45 \text{ (us)} \times 1 \text{ (set number of high speed data samplings)} = 45 \text{ [us]}$$

(c) Calculation regarding Constant K3 ($K3$)

- K3 value for Bit device M: 65 [us]
- K3 value for Word device D: 45 [us]
- K3 value for File register R: 48 [us]

The above worst value (65 [us]) is used for K3.

The time increase of scan time can be obtained by calculating the above values (a), (b), and (c), as shown below.

$$18.1 \text{ (us)} + 45 \text{ (us)} + 65 \text{ (us)} = 128.1 \text{ [us]}$$

CHAPTER 18 TROUBLESHOOTING

The following flowchart shows the troubleshooting procedure for errors that might occur during the operation of the high speed data logger module.

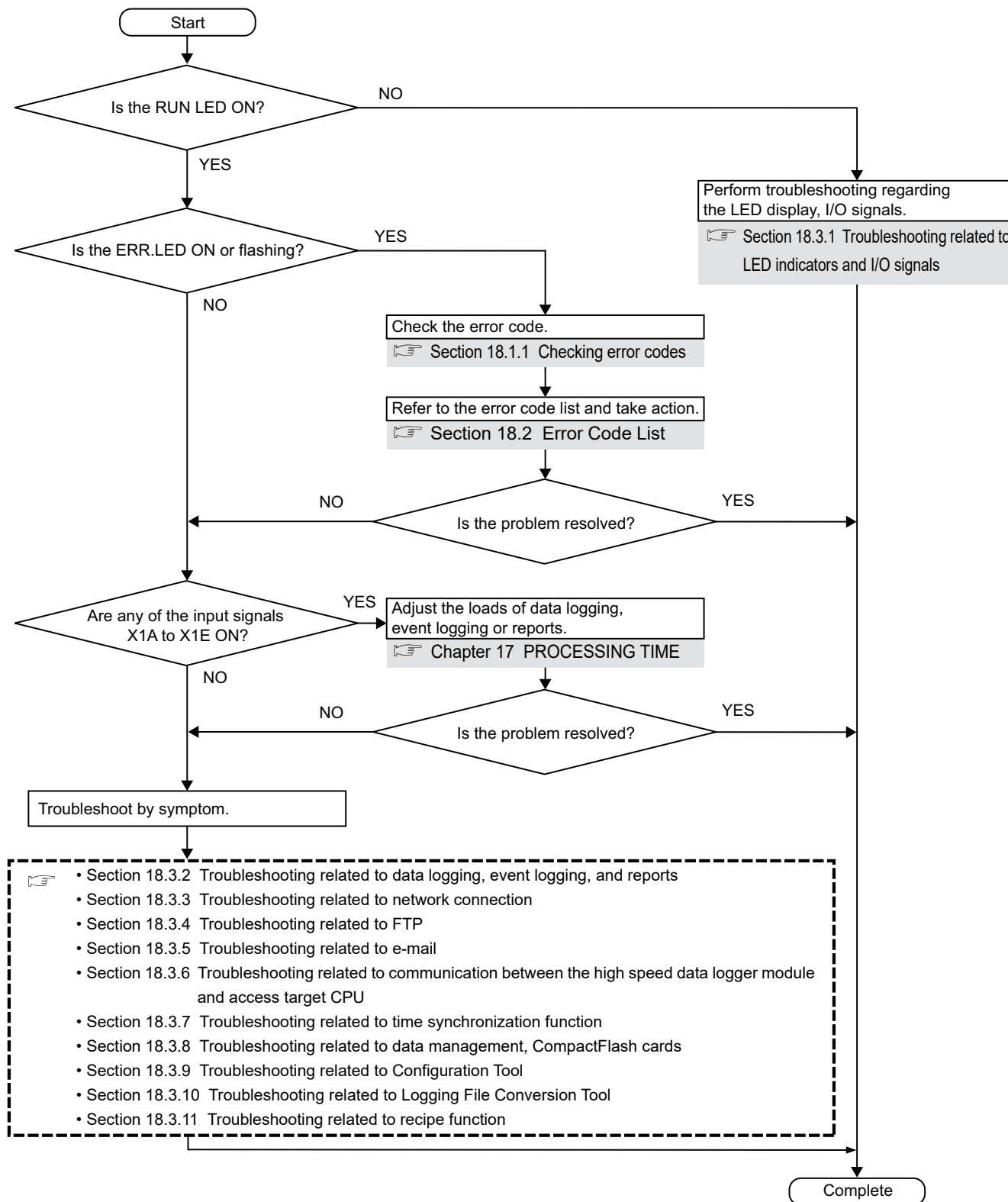

18.1 Error Codes

This section explains the method for checking the error codes and types of errors.

18.1.1 Checking error codes

Error codes can be checked on the high speed data logger module with the following methods.

(1) Check ERR.LED on the front of the high speed data logger module

Check if an error occurred with ERR.LED on the front of the high speed data logger module.

ON : module continuation error occurred

Flashing: module stop error occurred

(2) Use the Configuration Tool

Error codes can be checked on the <<Module diagnostics>> tab of the "Diagnostics" screen (displayed by selecting [Online] → [Diagnostics]).

Error codes for access target CPUs and per function can also be checked on the "Diagnostics" screen. (☞ Section 13.1.1)

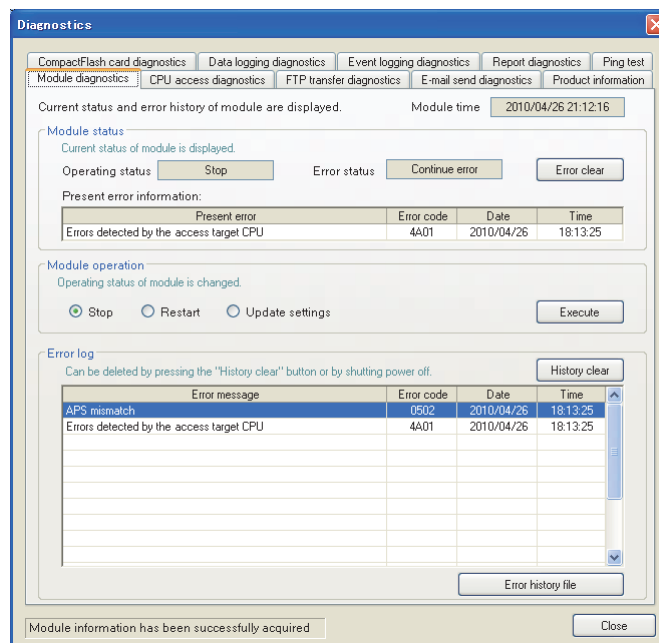

(3) Use GX Works2 or GX Developer

Error codes can be checked with "Module's Detailed Information" in "System Monitor".

Error codes can be checked in the corresponding current error area (☞ Section 3.4.6) and error log area (☞ Section 3.4.7) in the buffer memory.

For "System Monitor" details, refer to the following section.

☞ Section 18.1.3 System monitor

(4) Refer buffer memory

When an error occurs, the error detection input signal turns ON and the error code is stored in the buffer memory area shown below.

Refer to the address that corresponds to the error which occurred and check the contents.

Related error detection signal	Buffer memory		Reference
	Application	Name	
X19: Other errors	Current error area	Error code	Section 3.4.6
	Error log area	Error log 1 to 16	Section 3.4.7
X16: Access target CPU error	Access target CPU setting status area	Access target CPU 1 to 64 Error code	Section 3.4.10
X12: Data logging error	Data logging status area	Data logging information 1 to 64	Section 3.4.11
X13: Event logging error	Event logging status area	Event logging information 1 to 64	Section 3.4.12
X14: Report creation error	Report creation status area	Report creation information 1 to 64	Section 3.4.13
X17: E-mail transmission error	E-mail transmission status area	Error log 1 to 16	Section 3.4.14
X18: FTP transfer error	FTP client status (PUT) area	Error log 1 to 16	Section 3.4.16

POINT

If multiple errors have occurred simultaneously, take corrective action for those errors in chronological order.

18.1.2 Error types

Errors are divided into the following two types.

Name	ERR.LED	Operating status	Corrective action
Module stop error	Flashing	Stop	(1) Check the error code of the error that occurred and take corrective action for that error. (2) Turn OFF ERR.LED with any of the following operations. <ul style="list-style-type: none"> On the <<Module diagnostics>> tab of the "Diagnostics" screen of the Configuration Tool (displayed by selecting [Online] → [Diagnostics]), click the <input type="button" value="Error clear"/> button Section 13.1.1 Module diagnostics Turn ON error clear request (Y10) Power ON from OFF Reset the programmable controller CPU
Module continuation error	ON	Continue	

The operating status can be checked on the <<Module diagnostics>> tab of the "Diagnostics" screen (displayed by selecting [Online] → [Diagnostics]) of the Configuration Tool.

➔ Section 13.1 Diagnostics

<<Module diagnostics>> tab

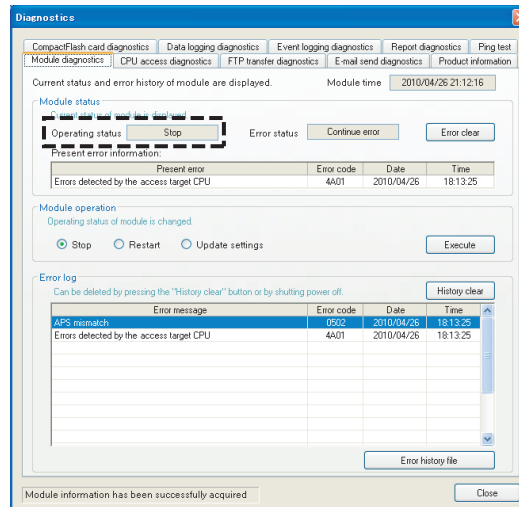

18.1.3 System monitor

The module status of the high speed data logger module can be checked from "System Monitor" of GX Developer.

(1) Checking the module status and error code with the diagnostics function "Module's Detailed Information"

Operating procedure

- ① Start GX Developer.
- ② Select [Diagnostics] → [System monitor].
- ③ Click the Module's Detailed Information... button on the "System Monitor" screen.

Screen display

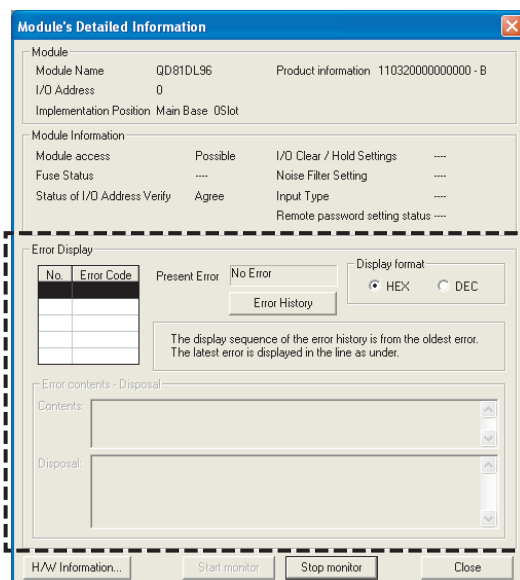

Item		Description	Reference
Error Display	Present Error	Displays the code for the most recent error which occurred. (Current error area value in the buffer memory)	Section 18.2
	Display format	Switches the displayed error code between decimal and hexadecimal.	
	Error History	Displays the history of error codes which occurred from power-ON to the present time. (Error log area values in the buffer memory)	

(2) Checking the LED status and the switch setting status with the diagnostics function "H/W Information"

Operating procedure

- ① Start GX Developer.
- ② Select [Diagnostics] → [System monitor].
- ③ Click the **Module's Detailed Information...** button on the "System Monitor" screen.
- ④ Click the **H/W Information...** button on the "Module's Detailed Information" screen.

Screen display

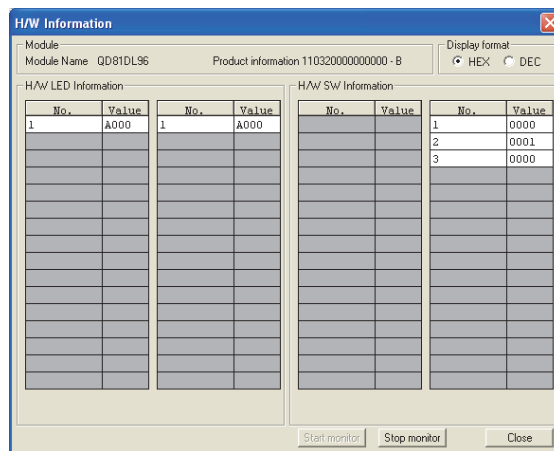

H/W Information	No.	Description	Buffer memory address ^{*1}
H/W LED Information	1	0000 : RUN LED OFF, ERR.LED OFF, CF LED OFF	0-2
		8000 : RUN LED ON, ERR.LED OFF, CF LED OFF	
		A000 : RUN LED ON, ERR.LED OFF, CF LED ON	
		C000 : RUN LED ON, ERR.LED ON, CF LED OFF	
		E000 : RUN LED ON, ERR.LED ON, CF LED ON	
H/W SW Information	1	Switch 1 status (Online/H/W test/loopback test)	3
	2	Switch 2 status (Account setting/Connection setting)	4
	3	Switch 3 status Response monitoring time (15 to 255 (seconds))	5

*1: For buffer memory details, refer to the following section.
 Section 3.4.1 Module status area (address: 0 to 20)

18.2 Error Code List

This section shows the description of error codes and corrective action.

POINT

When a 'system error' occurs, consult your local Mitsubishi representative.

Error code	Error name	Description	Action
0001H	System error	-	<ul style="list-style-type: none"> Please consult your local Mitsubishi representative, explaining a detailed description of the problem.
0002H	Response timeout error	No response has been received from the other station.	<ul style="list-style-type: none"> Correct "Access target CPU setting". Check the communication cable status and access target CPU status. Adjust the response monitoring time setting. <ul style="list-style-type: none">  Section 4.5 (3) Response monitoring time setting (Switch 3 (lower byte)) Check if the control CPU of the network module on the network route to the access target CPU is set to QCPU(Q mode). Check the routing parameter settings of the CPU(s) on the access route. Check the network on the access route. Adjust the service processing setting of the access target CPU. When the load of the network is high, adjust the system and lessen the processing load.
0041H to 0044H	System error	-	<ul style="list-style-type: none"> Please consult your local Mitsubishi representative, explaining a detailed description of the problem.
0045H	Processing code error	The issued processing code cannot be processed on the other end.	<ul style="list-style-type: none"> Check the CPU(s) on the access route.
0046H	Station No. specification error	The specified station number is incorrect.	<ul style="list-style-type: none"> Correct the station number setting in "Access target CPU setting".
0047H	Receive data error	Data has not been received.	<ul style="list-style-type: none"> Check the CPU(s) on the access route.
0048H	System error	-	<ul style="list-style-type: none"> Please consult your local Mitsubishi representative, explaining a detailed description of the problem.
0049H			
004DH			
004EH			
0050H			
0051H			
0055H	Channel number error	The RUN write setting of the Ethernet module is disabled.	<ul style="list-style-type: none"> Check the Ethernet module setting of the access target CPU.
0064H	System error	-	<ul style="list-style-type: none"> Please consult your local Mitsubishi representative, explaining a detailed description of the problem.
0065H	Routing parameter error	No routing parameter has been set.	<ul style="list-style-type: none"> Set routing parameters on the access route.
0066H	Data send error	Failed to send the data.	<ul style="list-style-type: none"> Check the CPU(s) on the access route. Check the network on the access route.

(Continued on the next page)

(From the previous page)

Error code	Error name	Description	Action
0067 _H	Data receive error	Failed to receive the data.	<ul style="list-style-type: none"> • When accessing via built-in Ethernet port, check if UDP (MELSOFT Connection) is added to the open setting of a built-in Ethernet port for the access target CPU. • Check the CPU(s) on the access route. • Check the network on the access route.
0080 _H	Read size error	The read size is not correct.	<ul style="list-style-type: none"> • Check the CPU(s) on the access route. • Check the network on the access route.
0081 _H	Device type error	The device type specified for the access target station is invalid.	<ul style="list-style-type: none"> • Correct the set device type.
0082 _H	Device number error	The device number specified for the access target station is out of range.	<ul style="list-style-type: none"> • Correct the set device number.
0083 _H	Device point error	The number of device points specified for the access target station is out of range.	
0084 _H	Write size error	The write size is not correct.	<ul style="list-style-type: none"> • Check the CPU(s) on the access route.
0085 _H	Link parameter error	The link parameter is corrupted.	<ul style="list-style-type: none"> • Check the link parameter settings for the CPU(s) on the access route.
0087 _H to 0089 _H	System error	-	<ul style="list-style-type: none"> • Please consult your local Mitsubishi representative, explaining a detailed description of the problem.
00D2 _H	RUN time disable error	A request that is not permitted during RUN was issued.	<ul style="list-style-type: none"> • Check the CPU(s) on the access route.
00D4 _H	System error	-	<ul style="list-style-type: none"> • Please consult your local Mitsubishi representative, explaining a detailed description of the problem.
00D7 _H	Receive data length error	The receive data length or the byte length exceeded the limit.	<ul style="list-style-type: none"> • Check the cables on the access route.
00D8 _H	Protocol error	The communication protocol is not correct.	
00D9 _H	Address error	The address is not correct.	<ul style="list-style-type: none"> • Check the CPU(s) on the access route.
00DB _H	Write error	Data cannot be written.	
00E0 _H	Station number error	The specified station number does not exist.	<ul style="list-style-type: none"> • Check the station number setting in "Access target CPU setting".
00E1 _H	Processing mode error	The access target CPU is not capable of processing the request.	<ul style="list-style-type: none"> • Check the CPU(s) on the access route.
00E2 _H	Intelligent function module specification error	The specified intelligent function module is faulty.	<ul style="list-style-type: none"> • Correct the set device (buffer memory specification 'U□G□').
00E3 _H	Other data error	The request data has an error.	<ul style="list-style-type: none"> • Check the CPU(s) on the access route.
00E4 _H	Link specification error	A link module on the access route received a request that cannot be handled. (The access route is not supported.)	<ul style="list-style-type: none"> • Check the access route referring to the accessible range.
00E8 _H	System error	-	<ul style="list-style-type: none"> • Please consult your local Mitsubishi representative, explaining a detailed description of the problem.
00E9 _H	Link timeout	The access target has disconnected from the link during the processing.	<ul style="list-style-type: none"> • Restore the link to connect the station on the access route.
00EA _H	Special module BUSY	The receive buffer of the access target is full.	<ul style="list-style-type: none"> • Examine the hardware of the intelligent function module. • Check the access target.
00EC _H	Access target BUSY	Or it is not ready for reception.	

(Continued on the next page)

(From the previous page)

Error code	Error name	Description	Action
00F0 _H	Link error	A request was made to a link stop station.	<ul style="list-style-type: none"> Restore the link to connect the station on the access route.
00F1 _H	Special module bus error	The specified intelligent function module is not ready for processing.	<ul style="list-style-type: none"> Examine the hardware of the intelligent function module.
00F2 _H	Special module timeout	No response has been received from the specified intelligent function module.	
0100 _H to 0104 _H 0110 _H 0112 _H	System error	-	<ul style="list-style-type: none"> Please consult your local Mitsubishi representative, explaining a detailed description of the problem.
0180 _H	Switch setting error	A switch setting error was detected in the hardware test.	<ul style="list-style-type: none"> Check the intelligent function switch setting. Perform the hardware test again.
0181 _H	ROM check sum error	A ROM error was detected in the hardware test.	<ul style="list-style-type: none"> Perform the hardware test again.
0182 _H	RAM test error	A RAM error was detected in the hardware test.	
0190 _H	Timeout error	An error occurred in the self-loopback test.	<ul style="list-style-type: none"> Hardware error Please consult your local Mitsubishi representative, explaining a detailed description of the problem.
0191 _H	Communication error		
0192 _H	Comparison error		
0193 _H	In-frame position error		
0200 _H to 0203 _H 0210 _H 0300 _H	System error		
0304 _H	DHCP parameter acquisition error	When set to automatically acquire an IP address in the LAN connection, failed to acquire the network parameter information from the DHCP server.	<ul style="list-style-type: none"> Check the connection status with the DHCP server. Check the connection cable. Check the DHCP server settings.
0305 _H to 0308 _H	System error	-	<ul style="list-style-type: none"> Please consult your local Mitsubishi representative, explaining a detailed description of the problem.
0319 _H	DHCP lease renewal failure	The automatic lease renewal process, which occurs when the IP address lease acquired from the DHCP server expires, failed.	<ul style="list-style-type: none"> Check the connection cable and status of the DHCP server (start status, secured allocated IP addresses).
031A _H	Network diagnostics error	Network diagnostics (ping transmission) failed.	<ul style="list-style-type: none"> Check the connection cable, status of the external device. Check if the destination for the network diagnostics setting in "Network setting" is correct.
0330 _H 0400 _H to 0402 _H	System error	-	<ul style="list-style-type: none"> Please consult your local Mitsubishi representative, explaining a detailed description of the problem.
0480 _H to 0483 _H	CompactFlash card mount failed	The CompactFlash card mount is failed because a failure was detected.	<ul style="list-style-type: none"> Check if the CompactFlash card was inserted properly. Replace the CompactFlash card.
0490 _H to 0493 _H	System error	-	<ul style="list-style-type: none"> Please consult your local Mitsubishi representative, explaining a detailed description of the problem.

(Continued on the next page)

(From the previous page)

Error code	Error name	Description	Action
0494 _H	CompactFlash card format error	Failed to format the CompactFlash card.	<ul style="list-style-type: none"> • Check if the CompactFlash card is inserted properly. • Replace the CompactFlash card.
0495 _H	CompactFlash card check error	Failed to check the CompactFlash card.	
0496 _H	CompactFlash card response error	Access to the CompactFlash card timed out while waiting for a response from the card.	<ul style="list-style-type: none"> • Replace the CompactFlash card.
0497 _H	CompactFlash card drive error	The CompactFlash card mount is failed because a failure was detected. Or the CompactFlash card drive is in error status because the CompactFlash card was ejected during file access.	<ul style="list-style-type: none"> • Cycle the power of the programmable controller where the high speed data logger module is mounted or reset the programmable controller CPU. • Stop file access, then remove the CompactFlash card. • Check if improper files or folders exist in the CompactFlash card.
04A0 _H	CompactFlash card mount failed	The CompactFlash card mount is failed because a failure was detected.	<ul style="list-style-type: none"> • Check if the CompactFlash card was inserted properly. • Replace the CompactFlash card.
04A1 _H to 04A4 _H	System error	-	<ul style="list-style-type: none"> • Please consult your local Mitsubishi representative, explaining a detailed description of the problem.
04D0 _H	CF card access error	An error occurred when accessing the file.	<ul style="list-style-type: none"> • Check if the CompactFlash card was inserted properly. • Replace the CompactFlash card.
04D1 _H	CF card response error	Access to the CompactFlash card timed out while waiting for a response from the card.	
0501 _H	CPU error detected	An error was detected in the CPU of the module mounted station.	<ul style="list-style-type: none"> • Check the CPU status of module mounted station.
0502 _H	APS mismatch	APS of the request packet does not match the one of the response packet. The start I/O in "Access target CPU setting" is incorrect.	<ul style="list-style-type: none"> • Retry the transmission. • Correct "Access target CPU setting".
0550 _H to 0554 _H	System error	-	<ul style="list-style-type: none"> • Please consult your local Mitsubishi representative, explaining a detailed description of the problem.
0556 _H	Setting file error	There is no setting file. Or the setting file is corrupted.	<ul style="list-style-type: none"> • Write the settings again with the Configuration Tool. • Replace the CompactFlash card.
0557 _H		The high speed data logger module version is older than the setting file version.	<ul style="list-style-type: none"> • Start the Configuration Tool online from the high speed data logger module to be used and write the settings.
0600 _H	File access stopped error	The access to the CompactFlash card was attempted when the file access was being stopped.	<ul style="list-style-type: none"> • Turn the clear file access stop request (Y3) ON, and retry after the file access status (X2) is turned OFF.
0601 _H	No CompactFlash card error	Access to the CompactFlash card was attempted with no card installed.	<ul style="list-style-type: none"> • Access after inserting a CompactFlash card.
0602 _H	Unformatted CompactFlash card error	The access to the unformatted CompactFlash card was attempted.	<ul style="list-style-type: none"> • Access after formatting the CompactFlash card.
0603 _H	CompactFlash card formatting error	The access to the CompactFlash card was attempted while it was being formatted.	

(Continued on the next page)

(From the previous page)

Error code	Error name	Description	Action
0604 _H to 0615 _H	System error	-	<ul style="list-style-type: none"> • Please consult your local Mitsubishi representative, explaining a detailed description of the problem.
0617 _H to 061D _H			
061E _H to 0622 _H	Setting file error	There is no setting file. Or the setting file is corrupted.	<ul style="list-style-type: none"> • Write the settings again with the Configuration Tool. • Replace the CompactFlash card. • Check if the power turned OFF or reset the programmable controller CPU without stopping file access.
0623 _H	System error	-	<ul style="list-style-type: none"> • Please consult your local Mitsubishi representative, explaining a detailed description of the problem.
0624 _H			
062D _H to 0656 _H			
0658 _H to 0664 _H			
0670 _H			
0671 _H			
0672 _H	Unsupported CPU error	Unsupported CPU is accessed.	<ul style="list-style-type: none"> • Check the type of access target CPU.
0680 _H	System error	-	<ul style="list-style-type: none"> • Please consult your local Mitsubishi representative, explaining a detailed description of the problem.
0681 _H			
0682 _H	Network communication route error	A nonexistent module was specified for the start I/O of the network route in "Access target CPU setting".	<ul style="list-style-type: none"> • Correct the start I/O address in "Access target CPU setting".
0683 _H	High speed data sampling setting illegal error	An invalid "High speed data sampling setting" was configured. Or the setting file is corrupted.	<ul style="list-style-type: none"> • Write the settings again with the Configuration Tool. • Replace the CompactFlash card.
0684 _H			
0685 _H	System error	-	<ul style="list-style-type: none"> • Please consult your local Mitsubishi representative, explaining a detailed description of the problem.
0686 _H	Device name error	The device name specified in the "Data logging setting", "Event logging setting", or "Report setting" is incorrect. Or an invalid device was specified.	<ul style="list-style-type: none"> • Correct the device name specified in the "Data logging setting", "Event logging setting", or "Report setting".
0687 _H			
0688 _H	System error	-	<ul style="list-style-type: none"> • Please consult your local Mitsubishi representative, explaining a detailed description of the problem.
0689 _H	Device name error	The device name specified in the "Data logging setting", "Event logging setting", or "Report setting" is incorrect. Or an invalid device was specified.	<ul style="list-style-type: none"> • Correct the device name specified in the "Data logging setting", "Event logging setting", or "Report setting".
068A _H			

(Continued on the next page)

(From the previous page)

Error code	Error name	Description	Action
068B _H to 068E _H	System error	-	<ul style="list-style-type: none"> • Please consult your local Mitsubishi representative, explaining a detailed description of the problem.
0690 _H to 0694 _H			
0696 _H			
0697 _H to 069A _H	High speed data sampling unsupported CPU error	The control CPU does not support high speed data sampling.	<ul style="list-style-type: none"> • Replace it with a CPU that supports high speed data sampling.
069B _H	High speed data sampling overlap error	Another intelligent function module is performing high speed data sampling.	<p>Execute either of the followings and cycle the power or reset the CPU module to restart the module.</p> <ul style="list-style-type: none"> • Specify general data sampling and write the settings. • Stop high speed data sampling on the other intelligent function module.
069C _H to 06A5 _H	System error	-	<ul style="list-style-type: none"> • Please consult your local Mitsubishi representative, explaining a detailed description of the problem.
06AA _H	Setting file error	There is no setting file. Or the setting file is corrupted.	<ul style="list-style-type: none"> • Write the settings again with the Configuration Tool. • Replace the CompactFlash card.
06AB _H	Logging setting error	The logging setting file is corrupted.	
06AC _H	Setting file error	There is no setting file. Or the setting file is corrupted.	
06AD _H	System error	-	<ul style="list-style-type: none"> • Please consult your local Mitsubishi representative, explaining a detailed description of the problem.
06AE _H to 06B0 _H	Device name error	The device name specified in the "Data logging setting", "Event logging setting", or "Report setting" is incorrect. Or an invalid device was specified.	<ul style="list-style-type: none"> • Correct the device name specified in the "Data logging setting", "Event logging setting", or "Report setting".
06B1 _H	Excessive number of device points for high speed data sampling	The number of high speed data sampling device points exceeded 256 in a single setting.	<ul style="list-style-type: none"> • Configure so that the number of high speed data sampling device points does not exceed 256 in a single setting.
06B2 _H	Excessive number of device points for general data sampling	The number of general data sampling device points exceeded 4096 in a single setting.	<ul style="list-style-type: none"> • Configure so that the number of general data sampling device points does not exceed 4096 in a single setting.
06B3 _H to 06B8 _H	System error	-	<ul style="list-style-type: none"> • Please consult your local Mitsubishi representative, explaining a detailed description of the problem.
06BB _H to 06BE _H			
06BF _H	Insufficient trigger buffer error	Total trigger buffer usage exceeds 100%.	<ul style="list-style-type: none"> • Write the settings again with the Configuration Tool. • Replace the CompactFlash card.
06C0 _H	System error	-	<ul style="list-style-type: none"> • Please consult your local Mitsubishi representative, explaining a detailed description of the problem.
06C1 _H	Insufficient trigger buffer error	Total trigger buffer usage exceeds 100%.	<ul style="list-style-type: none"> • Write the settings again with the Configuration Tool. • Replace the CompactFlash card.

(Continued on the next page)

(From the previous page)

Error code	Error name	Description	Action
06C2 _H	System error	-	<ul style="list-style-type: none"> • Please consult your local Mitsubishi representative, explaining a detailed description of the problem.
06C3 _H	Insufficient trigger buffer error	Total trigger buffer usage exceeds 100%.	<ul style="list-style-type: none"> • Write the settings again with the Configuration Tool. • Replace the CompactFlash card.
06C4 _H	System error	-	<ul style="list-style-type: none"> • Please consult your local Mitsubishi representative, explaining a detailed description of the problem.
06C5 _H to 06C6 _H	Setting file error	There is no setting file. Or the setting file is corrupted.	<ul style="list-style-type: none"> • Write the settings again with the Configuration Tool. • Replace the CompactFlash card.
0700 _H to 070B _H	System error	-	<ul style="list-style-type: none"> • Please consult your local Mitsubishi representative, explaining a detailed description of the problem.
0712 _H	E-mail address setting error	The destination specified in the e-mail notification settings for the "Event logging setting" is not registered. Or the setting file is corrupted.	<ul style="list-style-type: none"> • Write the settings again with the Configuration Tool. • Replace the CompactFlash card.
0713 _H	E-mail send queue full error	The queue for sending e-mails is full.	<ul style="list-style-type: none"> • Lower the frequency that e-mails are sent. • Decrease the settings that send e-mails. • Lower the frequency of file switching. • Check the communication cables and status of access target CPU. (☞ Appendix 8.2)
0714 _H	Setting file error	There is no setting file. Or the setting file is corrupted.	<ul style="list-style-type: none"> • Write the settings again with the Configuration Tool. • Replace the CompactFlash card.
0715 _H	E-mail address setting error	The destination specified with the save setting is not registered. Or the setting file is corrupted.	
0716 _H	E-mail transmission queue full error	The queue for sending e-mails is full.	<ul style="list-style-type: none"> • Lower the frequency that e-mails are sent. • Decrease the settings that send e-mails. • Lower the frequency of file switching. • Check the communication cables and status of access target CPU. (☞ Appendix 8.2)
0717 _H	Setting file error	There is no setting file. Or the setting file is corrupted.	<ul style="list-style-type: none"> • Write the settings again with the Configuration Tool. • Replace the CompactFlash card.
0718 _H	FTP transfer destination setting error	The destination specified with the save setting is not registered. Or the setting file is corrupted.	
0719 _H 071A _H	System error	-	<ul style="list-style-type: none"> • Please consult your local Mitsubishi representative, explaining a detailed description of the problem.
071B _H	FTP transfer queue full error	The queue for FTP transfers is full.	<ul style="list-style-type: none"> • Lower the frequency of FTP transfers. • Decrease the settings with FTP transfers. • Lower the frequency of file switching. • Check the communication cables and status of access target CPU. (☞ Appendix 8.2)

(Continued on the next page)

(From the previous page)

Error code	Error name	Description	Action
071C _H to 071F _H	System error	-	<ul style="list-style-type: none"> • Please consult your local Mitsubishi representative, explaining a detailed description of the problem.
0720 _H	FTP transfer failed	An error occurred during the FTP transfer. The saved file to transfer was deleted before the FTP transfer by file switching.	<ul style="list-style-type: none"> • Correct the "FTP setting". • Correct the FTP transfer port number. • Check the connection status with the FTP server. • Check the destination FTP server status. • Correct the save settings (file switch timing, number of saved files) ☞ Section 11.5.15 (5) POINT
0721 _H to 0724 _H	Setting file error	There is no setting file. Or the setting file is corrupted.	<ul style="list-style-type: none"> • Write the settings again with the Configuration Tool. • Replace the CompactFlash card. • Check if the power turned OFF or reset the programmable controller CPU without stopping file access.
0728 _H to 072A _H	System error	-	<ul style="list-style-type: none"> • Please consult your local Mitsubishi representative, explaining a detailed description of the problem.
0740 _H	Directory creation error	Failed to create the directory.	<ul style="list-style-type: none"> • Delete unnecessary files on the CompactFlash card to ensure free space. • Replace the CompactFlash card.
0741 _H	File open error	Failed to create the file.	
0744 _H 0745 _H	Setting file error	There is no setting file. Or the setting file is corrupted.	<ul style="list-style-type: none"> • Write the settings again with the Configuration Tool. • Replace the CompactFlash card.
0746 _H	File write error	Failed to write the file.	<ul style="list-style-type: none"> • Delete unnecessary files on the CompactFlash card to ensure free space. • Replace the CompactFlash card.
0747 _H	CSV file write error	Failed to write the CSV file.	
0748 _H	Binary file write error	Failed to write the binary file.	
0749 _H	Setting file error	There is no setting file. Or the setting file is corrupted.	<ul style="list-style-type: none"> • Write the settings again with the Configuration Tool.
074A _H	File write error	Failed to write the file.	<ul style="list-style-type: none"> • Replace the CompactFlash card.
074B _H	File open error	Failed to open the file.	<ul style="list-style-type: none"> • Delete unnecessary files on the CompactFlash card to ensure free space. • Replace the CompactFlash card.
074C _H 074D _H	System error	-	<ul style="list-style-type: none"> • Please consult your local Mitsubishi representative, explaining a detailed description of the problem.
074E _H	Data type setting error	An invalid setting has been made in the data type setting. Or the setting file is corrupted.	<ul style="list-style-type: none"> • Write the settings again with the Configuration Tool. • Replace the CompactFlash card.
074F _H	Output format setting error	An invalid CSV output format has been set. Or the setting file is corrupted.	
0750 _H	Data type setting error	An invalid setting has been made in the data type setting. Or the setting file is corrupted.	
0751 _H	Setting file error	There is no setting file. Or the setting file is corrupted.	

(Continued on the next page)

(From the previous page)

Error code	Error name	Description	Action
0752H to 075FH	Report source file error	Data logging file to be output to the report cannot be found.	<ul style="list-style-type: none"> • Configure and construct the system so that the creation trigger occurs after the specified number of records worth of data is saved in the data logging file. • Adjust the file switch timing for data logging. (☞ Section 9.1 (1) POINT) • Check if the data logging file is being deleted before the report is output. • Replace the CompactFlash card.
0762H to 0765H			
0767H			
0768H			
076BH to 076EH			
078AH			
078CH to 078FH	CSV file check error	Failed to check the CSV file.	<ul style="list-style-type: none"> • Replace the CompactFlash card.
0791H to 0797H	Binary file check error	Failed to check the binary file.	
0798H	File check error	Failed to check the file.	<ul style="list-style-type: none"> • Delete unnecessary files on the CompactFlash card to ensure free space. • Replace the CompactFlash card.
0799H 079AH	File open error	Failed to open the file.	
079BH	File read error	Failed to read the file.	
079CH	File write error	Failed to write the file.	
079DH	File read error	Failed to read the file.	
07ABH	Data type setting error	An invalid setting has been made in the data type setting. Or the setting file is corrupted.	<ul style="list-style-type: none"> • Write the settings again with the Configuration Tool. • Replace the CompactFlash card.
07ACH	CSV output format setting error	An invalid setting has been made in the CSV output setting. Or the setting file is corrupted.	
07ADH	Data type setting error	An invalid setting has been made in the data type setting. Or the setting file is corrupted.	
07AEH	CSV output format setting error	An invalid setting has been made in the CSV output setting. Or the setting file is corrupted.	
07AFH	Data type setting error	An invalid setting has been made in the data type setting. Or the setting file is corrupted.	
07B0H to 07B9H	Binary output format setting error	An invalid setting has been made in the binary output setting. Or the setting file is corrupted.	
07BAH 07BBH	Setting file error	There is no setting file. Or the setting file is corrupted.	
07BCH	File write error	Failed to write the file.	
07BDH	File creation error	Failed to create the file.	<ul style="list-style-type: none"> • Delete unnecessary files on the CompactFlash card to ensure free space. • Replace the CompactFlash card.

(Continued on the next page)

(From the previous page)

Error code	Error name	Description	Action
07BE _H	File format setting error	An invalid setting has been made in the file format. Or the setting file is corrupted.	<ul style="list-style-type: none"> • Write the settings again with the Configuration Tool. • Replace the CompactFlash card.
07BF _H	Setting file error	There is no setting file. Or the setting file is corrupted.	
07C0 _H 07C1 _H	Binary output format setting error	An invalid setting has been made in the binary output setting. Or the setting file is corrupted.	
07C2 _H	CSV file open error	Failed to open the CSV file.	<ul style="list-style-type: none"> • Delete unnecessary files on the CompactFlash card to ensure free space. • Replace the CompactFlash card.
07C3 _H	File check error	Failed to check the file.	
07C4 _H	Binary file creation error	Failed to create the binary file.	
07C7 _H	File format setting error	An invalid setting has been made in the file format setting. Or the setting file is corrupted.	<ul style="list-style-type: none"> • Write the settings again with the Configuration Tool. • Replace the CompactFlash card.
07C8 _H	Data type setting error	An invalid setting has been made in the data type setting. Or the setting file is corrupted.	
07C9 _H	Binary output format setting error	An invalid setting has been made in the binary output setting. Or the setting file is corrupted.	
07CA _H 07CB _H	File creation error	Failed to create the file.	<ul style="list-style-type: none"> • Delete unnecessary files on the CompactFlash card to ensure free space. • Replace the CompactFlash card.
07CC _H	Directory creation error	Failed to create the directory.	
07CD _H 07CE _H	File access error	An error occurred when accessing the file.	<ul style="list-style-type: none"> • Check if the file was deleted by external FTP. • Replace the CompactFlash card.
07D0 _H	File format setting error	An invalid setting has been made in the file format setting. Or the setting file is corrupted.	
07D1 _H	Data type setting error	An invalid setting has been made in the data type setting. Or the setting file is corrupted.	<ul style="list-style-type: none"> • Write the settings again with the Configuration Tool. • Replace the CompactFlash card.
07D2 _H	Binary output format setting error	An invalid setting has been made in the binary output setting. Or the setting file is corrupted.	
07D3 _H	File check error	Failed to check the file.	
07D4 _H 07D5 _H 07D6 _H	File open error File write error File open error	Failed to open the file. Failed to write the file. Failed to open the file.	<ul style="list-style-type: none"> • Delete unnecessary files on the CompactFlash card to ensure free space. • Replace the CompactFlash card.
07D7 _H	File information acquisition error	Failed to acquire the file information.	
07D8 _H to 07DE _H	File access error	An error occurred when accessing the file.	

(Continued on the next page)

(From the previous page)

Error code	Error name	Description	Action
07E1H to 07E4H	Report source file error	Data logging file to be output to the report cannot be found.	<ul style="list-style-type: none"> • Configure and construct the system so that the creation trigger occurs after the specified number of records worth of data is saved in the data logging file. • Adjust the file switch timing for data logging. (☞ Section 9.1 (1) POINT) • Check if the data logging file is being deleted before the report is output. • Replace the CompactFlash card.
07E5H to 07E9H	System error	-	<ul style="list-style-type: none"> • Please consult your local Mitsubishi representative, explaining a detailed description of the problem.
07F0H	Saved file name acquisition error	Failed to acquire the saved file name.	<ul style="list-style-type: none"> • Check if the file is being deleted. • Delete unnecessary files on the CompactFlash card to ensure free space. • Replace the CompactFlash card.
07F1H	Saved file name acquisition error	Failed to acquire the saved file name.	<ul style="list-style-type: none"> • Write the settings again with the Configuration Tool. • Replace the CompactFlash card.
07F2H	Saved file name acquisition error	Failed to acquire the saved file name.	<ul style="list-style-type: none"> • Delete unnecessary files on the CompactFlash card to ensure free space. • Replace the CompactFlash card.
07F3H	Saved file name acquisition error	Failed to acquire the saved file name.	<ul style="list-style-type: none"> • Write the settings again with the Configuration Tool. • Replace the CompactFlash card.
07F4H to 07F6H	File write error	Failed to write the file.	<ul style="list-style-type: none"> • Delete unnecessary files on the CompactFlash card to ensure free space. • Replace the CompactFlash card.
07F7H	Directory creation error	Failed to create the directory.	<ul style="list-style-type: none"> • Check if the file is being deleted. • Delete unnecessary files on the CompactFlash card to ensure free space. • Replace the CompactFlash card.
07F8H			
0800H to 0802H	Period of time setting error	An invalid setting has been made in the period setting. Or the setting file is corrupted.	<ul style="list-style-type: none"> • Write the settings again with the Configuration Tool. • Replace the CompactFlash card.
0803H	Trigger condition (the number of times) setting error	An invalid count condition has been set for the count trigger of trigger type in the trigger logging setting. Or the setting file is corrupted.	
0804H 0805H	Scaling setting error	An invalid setting has been made in the scaling setting. Or the setting file is corrupted.	
0806H	Data condition setting error	An invalid setting has been made in the data condition setting. Or the setting file is corrupted.	
0807H	Compound condition (trigger logging) setting error	An invalid setting has been made in the trigger compound condition setting of the trigger logging setting. Or the setting file is corrupted.	

(Continued on the next page)

18 TROUBLESHOOTING

(From the previous page)

Error code	Error name	Description	Action
0808 _H	Compound condition (event logging) setting error	An invalid setting has been made in the trigger compound condition settings of the "Event logging setting". Or the setting file is corrupted.	<ul style="list-style-type: none"> • Write the settings again with the Configuration Tool. • Replace the CompactFlash card.
0809 _H			
080A _H	Data condition setting error	An invalid setting has been made in the data condition setting. Or the setting file is corrupted.	<ul style="list-style-type: none"> • Delete unnecessary files on the CompactFlash card to ensure free space. • Replace the CompactFlash card.
080B _H	Rename error	Failed to rename.	
080C _H	File open error	Failed to open the file.	<ul style="list-style-type: none"> • Delete unnecessary files on the CompactFlash card to ensure free space. • Replace the CompactFlash card.
080D _H	File read error	Failed to read the file.	
080F _H	File write error	Failed to write the file.	
0810 _H	File creation error	Failed to create the file.	
0811 _H	File write error	Failed to write the file.	
0812 _H to 0815 _H	Setting file error	There is no setting file. Or the setting file is corrupted.	<ul style="list-style-type: none"> • Write the settings again with the Configuration Tool. • Replace the CompactFlash card.
0816 _H	Trigger condition setting error	An invalid setting has been made in the trigger condition setting of the trigger logging setting. Or the setting file is corrupted.	
0817 _H 0818 _H	Data condition setting error	An invalid setting has been made in the data condition setting. Or the setting file is corrupted.	
081A _H	Save file number excess error	The saved file number exceeded FFFFFFFF.	<ul style="list-style-type: none"> • Delete all the saved files on the CompactFlash card. • Replace the CompactFlash card.
081B _H	Directory creation error	Failed to create the directory.	<ul style="list-style-type: none"> • Delete unnecessary files on the CompactFlash card to ensure free space. • Replace the CompactFlash card.
081C _H	File information acquisition error	Failed to acquire the file information.	
081D _H	File creation error	Failed to create the file.	
081E _H	Data condition setting error	An invalid setting has been made in the data condition setting. Or the setting file is corrupted.	<ul style="list-style-type: none"> • Write the settings again with the Configuration Tool. • Replace the CompactFlash card.
081F _H	Data type setting error	An invalid setting has been made in the data type setting. Or the setting file is corrupted.	
0822 _H 0823 _H	Setting file error	There is no setting file. Or the setting file is corrupted.	
0824 _H	File switching setting error	An invalid file switch timing has been set in the file switch setting. Or the setting file is corrupted.	
0825 _H	System error	-	
0826 _H	Setting file error	There is no setting file. Or the setting file is corrupted.	<ul style="list-style-type: none"> • Write the settings again with the Configuration Tool. • Replace the CompactFlash card.
0900 _H to 0906 _H	System error	-	<ul style="list-style-type: none"> • Please consult your local Mitsubishi representative, explaining a detailed description of the problem.
0907 _H	Layout type specification error	An invalid layout type has been specified. Or the report setting file is corrupted.	<ul style="list-style-type: none"> • Write the settings again with the Configuration Tool. • Replace the CompactFlash card.

(Continued on the next page)

(From the previous page)

Error code	Error name	Description	Action
0909 _H	Current value sampling device information acquisition error	An invalid current value sampling device has been set. Or the current value sampling device information cannot be obtained because the report setting file is corrupt.	<ul style="list-style-type: none"> • Write the settings again with the Configuration Tool. • Replace the CompactFlash card.
090A _H	Layout type specification error	An invalid layout type has been specified. Or the report setting file is corrupted.	
090F _H	System error	-	<ul style="list-style-type: none"> • Please consult your local Mitsubishi representative, explaining a detailed description of the problem.
0912 _H to 0914 _H	Data sampling method specification error	An invalid data sampling method has been specified. Or the report setting file is corrupted.	<ul style="list-style-type: none"> • Write the settings again with the Configuration Tool. • Replace the CompactFlash card.
0915 _H	Data type specified error	An invalid data type has been specified. Or the report setting file is corrupted.	
091C _H	Layout type specification error	An invalid layout type has been specified. Or the report setting file is corrupted.	
091E _H	Saved file number excess error	The saved file number has reached FFFFFFFF.	<ul style="list-style-type: none"> • Delete all the saved files on the CompactFlash card. • Replace the CompactFlash card.
091F _H	Number of saved files excess error	The number of saved files has reached the upper limit.	<ul style="list-style-type: none"> • Delete the saved files on the CompactFlash card. • Change the number of saved files with the Configuration Tool.
0920 _H	Directory creation error	Failed to create the directory.	<ul style="list-style-type: none"> • Delete unnecessary files on the CompactFlash card to ensure free space. • Replace the CompactFlash card.
0921 _H	Rename error	Failed to rename.	<ul style="list-style-type: none"> • Delete unnecessary files on the CompactFlash card to ensure free space. • Check if the data logging file is being deleted before the report is output. • Replace the CompactFlash card.
0922 _H to 0929 _H	System error	-	<ul style="list-style-type: none"> • Please consult your local Mitsubishi representative, explaining a detailed description of the problem.
092B _H	Output format specification error	An invalid output format has been specified. Or the report setting file is corrupted.	<ul style="list-style-type: none"> • Write the settings again with the Configuration Tool. • Replace the CompactFlash card.
092C _H	Data type specified error	An invalid data type has been specified. Or the report setting file is corrupted.	
0930 _H	Setting file error	There is no setting file.	
0931 _H 0949 _H		Or the setting file is corrupted.	
094A _H	System error	-	<ul style="list-style-type: none"> • Please consult your local Mitsubishi representative, explaining a detailed description of the problem.
094B _H to 094D _H	Setting file error	There is no setting file. Or the setting file is corrupted.	<ul style="list-style-type: none"> • Write the settings again with the Configuration Tool. • Replace the CompactFlash card.

(Continued on the next page)

(From the previous page)

Error code	Error name	Description	Action
0950 _H	File open error	Failed to open the file.	<ul style="list-style-type: none"> • Check if the file in the /CF/SYSTEM directory was directly edited. • Delete unnecessary files on the CompactFlash card to ensure free space. • Replace the CompactFlash card.
0951 _H	File information acquisition error	Failed to acquire the file information.	<ul style="list-style-type: none"> • Replace the CompactFlash card.
0952 _H	File seek error	Failed to seek the file.	<ul style="list-style-type: none"> • Check if the file in the /CF/SYSTEM directory was directly edited. • Write the settings again with the Configuration Tool.
0953 _H	File read error	Failed to read the file.	<ul style="list-style-type: none"> • Delete unnecessary files on the CompactFlash card to ensure free space. • Replace the CompactFlash card.
0954 _H	File write error	Failed to write the file.	
0955 _H	File seek error	Failed to seek the file.	<ul style="list-style-type: none"> • Check if the file in the /CF/SYSTEM directory was directly edited. • Write the settings again with the Configuration Tool.
0956 _H	File read error	Failed to read the file.	<ul style="list-style-type: none"> • Delete unnecessary files on the CompactFlash card to ensure free space. • Replace the CompactFlash card.
0957 _H	File seek error	Failed to seek the file.	<ul style="list-style-type: none"> • Check if the file in the /CF/SYSTEM directory was directly edited. • Write the settings again with the Configuration Tool.
0958 _H	File write error	Failed to write the file.	<ul style="list-style-type: none"> • Delete unnecessary files on the CompactFlash card to ensure free space. • Replace the CompactFlash card.
095A _H	File information acquisition error	Failed to acquire the file information.	<ul style="list-style-type: none"> • Check if the file in the /CF/SYSTEM directory was directly edited. • Delete unnecessary files on the CompactFlash card to ensure free space. • Replace the CompactFlash card.
095B _H	File open error	Failed to open the file.	<ul style="list-style-type: none"> • Delete unnecessary files on the CompactFlash card to ensure free space. • Replace the CompactFlash card.
095C _H		Failed to open the file.	
095D _H	File read error	Failed to read the file.	
095E _H	File write error	Failed to write the file.	
095F _H	File read error	Failed to read the file.	
0960 _H	File write error	Failed to write the file.	
0961 _H	File read error	Failed to read the file.	
0962 _H		Failed to read the file.	
0963 _H	File write error	Failed to write the file.	
0964 _H			
0965 _H			
0966 _H			
0967 _H			

(Continued on the next page)

(From the previous page)

Error code	Error name	Description	Action
096A _H	File read error	Failed to read the file.	<ul style="list-style-type: none"> Delete unnecessary files on the CompactFlash card to ensure free space. Replace the CompactFlash card.
096B _H	File write error	Failed to write the file.	
096C _H to 096F _H	File read error	Failed to read the file.	<ul style="list-style-type: none"> Check if the report layout file is edited with a tool other than the Configuration Tool. Write the settings again with the Configuration Tool. Delete unnecessary files on the CompactFlash card to ensure free space. Replace the CompactFlash card.
0970 _H to 0978 _H	File write error	Failed to write the file.	<ul style="list-style-type: none"> Delete unnecessary files on the CompactFlash card to ensure free space. Replace the CompactFlash card.
0979 _H	Setting file error	The report layout file in the setting files is in unsupported format.	<ul style="list-style-type: none"> Check if the report layout file is edited with a tool other than the Configuration Tool. Configure the report layout settings with the Configuration Tool and save the Excel file again. Write the settings again with the Configuration Tool. Replace the CompactFlash card.
097A _H	Layout file read error	Failed to read the layout file.	<ul style="list-style-type: none"> Write the settings again with the Configuration Tool. Delete unnecessary files on the CompactFlash card to ensure free space. Replace the CompactFlash card.
097D _H			
097E _H	File read error	Failed to read the file.	<ul style="list-style-type: none"> Delete unnecessary files on the CompactFlash card to ensure free space. Replace the CompactFlash card.
0980 _H to 0985 _H	System error	-	<ul style="list-style-type: none"> Please consult your local Mitsubishi representative, explaining a detailed description of the problem.
0990 _H to 0997 _H	Report source file error	Data logging file to be output to the report cannot be found.	<ul style="list-style-type: none"> Configure and construct the system so that the creation trigger occurs after the specified number of records worth of data is saved in the data logging file. Adjust the file switch timing for data logging. (☞ Section 9.1 (1) POINT) Check if the data logging file is being deleted before the report is output. Replace the CompactFlash card.
0999 _H	Report file creation error	An error occurred while creating a report file.	<ul style="list-style-type: none"> Write the settings again with the Configuration Tool. Replace the CompactFlash card.
099A _H			
09B0 _H	Report source file error	Data logging file to be output to the report cannot be found.	<ul style="list-style-type: none"> Adjust the file switch timing for data logging. (☞ Section 9.1 (1) POINT) Check if the data logging file is being deleted before the report is output. Replace the CompactFlash card.

(Continued on the next page)

(From the previous page)

Error code	Error name	Description	Action
09B1 _H to 09B5 _H	File open error	Failed to open the file.	<ul style="list-style-type: none"> Delete unnecessary files on the CompactFlash card to ensure free space. Replace the CompactFlash card.
09B6 _H	Report source file error	Data logging file to be output to the report cannot be found.	<ul style="list-style-type: none"> Adjust the file switch timing for data logging. (☞ Section 9.1 (1) POINT) Check if the data logging file is being deleted before the report is output. Replace the CompactFlash card.
09B7 _H 09B8 _H	File read error	Failed to read the file	<ul style="list-style-type: none"> Delete unnecessary files on the CompactFlash card to ensure free space. Replace the CompactFlash card.
09BA _H 09BB _H	File write error	Failed to write the file.	
09BC _H	Setting file error	The report layout file in the setting files is in unsupported format.	
09BD _H	System error	-	
09BE _H 09BF _H	File write error	Failed to write the file.	<ul style="list-style-type: none"> Delete unnecessary files on the CompactFlash card to ensure free space. Replace the CompactFlash card.
09C0 _H	System error	-	<ul style="list-style-type: none"> Please consult your local Mitsubishi representative, explaining a detailed description of the problem.
09C2 _H 09C3 _H 09C5 _H 09C6 _H	File write error	Failed to write the file.	<ul style="list-style-type: none"> Delete unnecessary files on the CompactFlash card to ensure free space. Replace the CompactFlash card.
09C7 _H	Setting file error	There is no setting file. Or the setting file is corrupted.	<ul style="list-style-type: none"> Write the settings again with the Configuration Tool. Replace the CompactFlash card.
09D0 _H	E-mail transmission error	Tried to send a file of which the size exceeds 512KB by e-mail.	<ul style="list-style-type: none"> Configure the settings so that the size of report file does not exceed 512KB.
0B00 _H	FTP setting file error	Failed to read the FTP setting file.	<ul style="list-style-type: none"> Write the settings again with the Configuration Tool. Replace the CompactFlash card.
0B01 _H	Incorrect FTP transfer destination No. error	The FTP destination number is out of the range.	<ul style="list-style-type: none"> Check the FTP destination number for the save setting. Write the settings again with the Configuration Tool.
0B02 _H	FTP transfer destination No. non-setting error	Made a file transfer request for an FTP destination number which was not set in the FTP setting.	

(Continued on the next page)

(From the previous page)

Error code	Error name	Description	Action
0B03 _H	FTP file transfer error	An error occurred during the FTP file transfer. The saved file to be transferred was deleted before the FTP transfer by file switching.	<ul style="list-style-type: none"> • Correct the "FTP setting". • Correct the FTP transfer port number. • Check the connection status with the FTP server. • Check the destination FTP server status. • Correct the save settings (file switch timing, number of saved files) ☞ Section 11.5.15 (5) POINT
0B05 _H	System error	-	<ul style="list-style-type: none"> • Please consult your local Mitsubishi representative, explaining a detailed description of the problem.
0B06 _H			
0B07 _H	FTP server control port connection error	Failed to connect to the FTP server's control port.	<ul style="list-style-type: none"> • Correct the "FTP setting". • Correct the FTP transfer port number. • Check the network connection status with the ping test. • Check the destination FTP server status. • When turning the power ON immediately after it is turned OFF, wait a few minutes before turning it ON.
0B08 _H	FTP server control port disconnection error	Failed to disconnect from the FTP server's control port.	<ul style="list-style-type: none"> • Check the connection status with the FTP server. • Check the destination FTP server status.
0B09 _H	FTP server login error	Failed to login to the FTP server.	<ul style="list-style-type: none"> • Correct the "FTP setting". • Correct the FTP transfer port number. • Check the connection status with the FTP server. • Check the destination FTP server status.
0B0A _H	FTP server command execute error	Failed to execute the FTP command for the FTP server.	<ul style="list-style-type: none"> • Check the connection status with the FTP server. • Check the destination FTP server status. • Check if the write access authority is set on the destination FTP server.
0B0B _H	FTP server data transfer port connection error	Failed to connect to the FTP server's data transfer port.	<ul style="list-style-type: none"> • Correct the "FTP setting". • Correct the FTP transfer port number. • Check the connection status with the FTP server. • Check the destination FTP server status.
0B0C _H	FTP server data transfer port disconnection error	Failed to disconnect from the FTP server's data transfer port.	<ul style="list-style-type: none"> • Check the connection status with the FTP server. • Check the destination FTP server status.
0B0D _H	FTP file transfer not allowed	Made an FTP file transfer request during "Network setting" default operation.	<ul style="list-style-type: none"> • Clear "Network setting" default operation.
0B10 _H	E-mail setting file error	Failed to read the "E-mail setting" file, or failed to resolve the domain name.	<ul style="list-style-type: none"> • Write the settings again with the Configuration Tool. • Correct the "E-mail setting". • Set the "SMTP server name" with an IP address.
0B11 _H	Incorrect e-mail address No. error	The e-mail destination number is out of the range.	<ul style="list-style-type: none"> • Check the e-mail destination number for the save setting.
0B12 _H	E-mail address No. non-setting error	Made an e-mail transmission request for an e-mail destination number which was not set in the "E-mail setting".	<ul style="list-style-type: none"> • Write the settings again with the Configuration Tool.

(Continued on the next page)

(From the previous page)

Error code	Error name	Description	Action
0B13 _H	E-mail transmission error	An error occurred during the e-mail transmission.	<ul style="list-style-type: none"> • Correct the "E-mail setting". • Check the connection status with the mail server. • Check the destination mail server status. • Configure the authentication settings in "E-mail setting".
0B14 _H	System error	-	<ul style="list-style-type: none"> • Please consult your local Mitsubishi representative, explaining a detailed description of the problem.
0B15 _H	No attached file error	The saved file to be attached to the e-mail was deleted before transmission because of file switching.	<ul style="list-style-type: none"> • Correct the saved settings (file switch timing, number of saved files)  Section 11.5.15 (5) POINT
0B16 _H	SMTP server login error	Failed to connect to the mail server (SMTP server).	<ul style="list-style-type: none"> • Correct the "E-mail setting". • Check the connection status with the mail server. • Check the destination mail server status. • When turning the power ON immediately after it is turned OFF, wait a few minutes before turning it ON.
0B17 _H	E-mail header send error	Failed to send the e-mail header.	<ul style="list-style-type: none"> • Check the connection status with the mail server. • Check the destination mail server status.
0B18 _H	E-mail main text send error	Failed to send the e-mail body.	
0B19 _H	Attached file send error	Failed to send the attachment.	
0B1A _H	SMTP server logout error	Failed to disconnect from the mail server (SMTP server).	
0B1B _H	E-mail sending not possible	Made an e-mail transmission request during "Network setting" default operation.	<ul style="list-style-type: none"> • Clear "Network setting" default operation.
0B1C _H	POP server login error	Failed to connect to the mail server (POP server).	<ul style="list-style-type: none"> • Correct the "E-mail setting". • Check the connection status with the mail server. • When turning the power ON immediately after it is turned OFF, wait a few minutes before turning it ON.
0B1D _H	E-mail transfer error (a part of E-mail addresses)	Failed to send e-mail to a portion of destinations.	<ul style="list-style-type: none"> • Correct the destination e-mail address settings in "E-mail setting".
0B20 _H to 0B22 _H	System error	-	<ul style="list-style-type: none"> • Please consult your local Mitsubishi representative, explaining a detailed description of the problem.
0B23 _H	Resend buffer write error	Failed to write files to FTP resend buffer.	<ul style="list-style-type: none"> • Delete unnecessary files on the CompactFlash card to ensure free space. • Replace the CompactFlash card.
0B24 _H	Resend buffer write error	Failed to write files to FTP resend buffer.	<ul style="list-style-type: none"> • Write the settings again with the Configuration Tool. • Replace the CompactFlash card.
0B25 _H	Resend buffer write error	Failed to write files to FTP resend buffer.	<ul style="list-style-type: none"> • Write the settings again with the Configuration Tool. • Delete unnecessary files on the CompactFlash card to ensure free space. • Replace the CompactFlash card.

(Continued on the next page)

(From the previous page)

Error code	Error name	Description	Action
0B26 _H	Resend buffer excess error	The number of FTP resend buffered data has exceeded the resend buffer size set in the Configuration Tool.	<ul style="list-style-type: none"> • Check the network settings. • Clear the buffer by the FTP transfer diagnostics of the Configuration Tool. • Increase the resend buffer size.
0B28 _H to 0B2A _H	System error	-	<ul style="list-style-type: none"> • Please consult your local Mitsubishi representative, explaining a detailed description of the problem.
0B2B _H	Resend buffer write error	Failed to write files to e-mail resend buffer.	<ul style="list-style-type: none"> • Delete unnecessary files on the CompactFlash card to ensure free space. • Replace the CompactFlash card.
0B2C _H	Resend buffer write error	Failed to write files to e-mail resend buffer.	<ul style="list-style-type: none"> • Write the settings again with the Configuration Tool. • Replace the CompactFlash card.
0B2D _H	Resend buffer write error	Failed to write files to e-mail resend buffer.	<ul style="list-style-type: none"> • Write the settings again with the Configuration Tool. • Delete unnecessary files on the CompactFlash card to ensure free space. • Replace the CompactFlash card.
0B2E _H	Resend buffer excess error	The number of e-mail resend buffered data has exceeded the resend buffer size set in the Configuration Tool.	<ul style="list-style-type: none"> • Check the network settings. • Clear the buffer by the e-mail send diagnostics of the Configuration Tool. • Increase the resend buffer size.
0B30 _H	Initial SNTP server time query failure error	The initial time query to the SNTP server failed.	<ul style="list-style-type: none"> • Check the SNTP server address. • Check if the set server is operating as an SNTP server.
0B31 _H	SNTP server time query error	The time query to the SNTP server failed.	<ul style="list-style-type: none"> • Check if it is connected to the network.
0C00 _H	CompactFlash card access error	The access to the CompactFlash card was attempted when its access state was "Preparing access".	<ul style="list-style-type: none"> • Access the CompactFlash card again when the access state is "Accessible".  Section 13.1.6 CompactFlash card diagnostics
0C01 _H	CompactFlash card access error	The access to the CompactFlash card was attempted when the file access was being stopped.	<ul style="list-style-type: none"> • Check if a CompactFlash card is inserted. • Execute "Access restart" and retry.  Section 13.1.6 CompactFlash card diagnostics • Turn the clear file access stop request (Y3) ON, and retry after the file access status (X2) is turned OFF.
0C02 _H	CompactFlash card access error	The access to the unformatted CompactFlash card was attempted.	<ul style="list-style-type: none"> • After formatting the CompactFlash card, store recipe files to the CompactFlash card, and retry.
0C03 _H	CompactFlash card access error	The access to the CompactFlash card was attempted while it is being formatted.	<ul style="list-style-type: none"> • After formatting the CompactFlash card, store recipe files to the CompactFlash card, and retry.
0C05 _H	Record number specification error	A record number out of the range is specified in the RCPREAD instruction.	<ul style="list-style-type: none"> • Correct the control data of the RCPREAD instruction.  Section 15.6.1 Recipe read (RCPREAD)
0C06 _H	No specified file error	A file name which does not exist is specified.	<ul style="list-style-type: none"> • Specify the recipe file exists in the RECIPE folder.

(Continued on the next page)

(From the previous page)

Error code	Error name	Description	Action
0C07 _H	Incorrect file name error	A character which cannot be used for a file name is specified.	<ul style="list-style-type: none"> • Correct the control data of the RCPREAD instruction. ☞ Section 15.6.1 Recipe read (RCPREAD)
0C08 _H to 0C09 _H	Recipe file write error	Failed to write the files because of the insufficient CompactFlash card free space.	<ul style="list-style-type: none"> • Delete unnecessary files on the CompactFlash card to ensure free space. • Replace the CompactFlash card.
0C0A _H	Module suspension error	The recipe execution operation was performed when the operation of high speed data logger module was being suspended.	<ul style="list-style-type: none"> • Change the operating status of the module to "In operation". ☞ Section 13.1.6 CompactFlash card diagnostics
0C0B _H	Recipe file error	The recipe file is not correctly formatted, or corrupted recipe file is specified.	<ul style="list-style-type: none"> • Check the format of the specified recipe file. ☞ Section 3.8 Recipe File Format
0C0C _H	Incorrect data type error	A data type which is not compatible with the data type of the recipe file is specified.	<ul style="list-style-type: none"> • Check the data type of the recipe file.
0C0D _H	Incorrect data type error	A data type other than "Bit" is specified for the data type of bit device.	<ul style="list-style-type: none"> • Check the data type of the recipe file.
0C0E _H	File size error	A recipe file whose size exceeds 512KB is specified.	<ul style="list-style-type: none"> • Specify a file whose size is less than 512KB. • Correct the setting of the recipe file to be less than 512KB.
0C0F _H	Number of data error	The total of specified recipe file data exceeded 256.	<ul style="list-style-type: none"> • Correct the recipe file to obtain the total of data less than 256.
0C10 _H	Number of data error	A value other than 1 is specified for the number of bit device data.	<ul style="list-style-type: none"> • Change the number of bit device data to 1.
0C11 _H	Number of blocks error	Incorrect number of blocks is specified.	<ul style="list-style-type: none"> • Specify a value within the range. ☞ Section 3.8 Recipe File Format
0C12 _H	Number of blocks error	Insufficient number of blocks against specified number of blocks.	<ul style="list-style-type: none"> • Check the blocks and the number of blocks for recipe files.
0C13 _H	Number of records error	Incorrect number of records is specified.	<ul style="list-style-type: none"> • Specify a value within the range. ☞ Section 3.8 Recipe File Format
0C14 _H	Record number error	Record numbers are inconsecutive, or the same record numbers exist.	<ul style="list-style-type: none"> • Check the record numbers of the recipe file.
0C15 _H	Number of records error	Insufficient number of records against specified number of records.	<ul style="list-style-type: none"> • Check the records and the number of records for recipe files.
0C16 _H	Record attribute error	An incorrect character is specified for the record attribute.	<ul style="list-style-type: none"> • Check the record attribute for recipe file.
0C17 _H	Record attribute error	Multiple attributes are specified for a specified record. Or an incorrect character is specified for the record attribute.	<ul style="list-style-type: none"> • Check the record attribute for recipe file.
0C18 _H	Incorrect device value error	A value out of the range is specified for the data type "16bit BCD".	<ul style="list-style-type: none"> • Specify a value within the range of "16bit BCD" for the device value.
0C19 _H	Incorrect device value error	A value out of the range is specified for the data type "32bit BCD".	<ul style="list-style-type: none"> • Specify a value within the range of "32bit BCD" for the device value.
0C1A _H	Incorrect device value error	A value out of the range is specified for the data type "Bit".	<ul style="list-style-type: none"> • Specify 0 or 1 for the device value.
0C1B _H	Incorrect device value error	A value out of the range is specified for the data type "Double word [signed]".	<ul style="list-style-type: none"> • Specify a value within the range of "Double word [signed]" for the device value.

(Continued on the next page)

(From the previous page)

Error code	Error name	Description	Action
0C1C _H	Incorrect device value error	A value out of the range is specified for the data type "FLOAT [double precision]".	<ul style="list-style-type: none"> Specify a value within the range of "FLOAT [double precision]" for the device value.
0C1D _H	Incorrect device value error	A value out of the range is specified for the data type "Double word [unsigned]".	<ul style="list-style-type: none"> Specify a value within the range of "Double word [unsigned]" for the device value.
0C1E _H	Incorrect device value error	A value out of the range is specified for the data type "Word [signed]".	<ul style="list-style-type: none"> Specify a value within the range of "Word [signed]" for the device value.
0C1F _H	Incorrect device value error	A value out of the range is specified for the data type "FLOAT [single precision]".	<ul style="list-style-type: none"> Specify a value within the range of "FLOAT [single precision]" for the device value.
0C20 _H	Incorrect device value error	A value out of the range is specified for the data type "Word [unsigned]".	<ul style="list-style-type: none"> Specify a value within the range of "Word [unsigned]" for the device value.
0C21 _H	Incorrect attribute error	The write process is performed on the record with P attribute.	<ul style="list-style-type: none"> Check the specified record number. Check the specified recipe file name. Check the specified recipe file.
0C22 _H	Incorrect attribute error	The read process is performed on the record with N attribute.	<ul style="list-style-type: none"> Check the specified record number. Check the specified recipe file name. Check the specified recipe file.
0C23 _H	Incorrect device value error	A record number whose device value cell is blank is specified.	<ul style="list-style-type: none"> Check the device value of the specified record number.
0C24 _H	Incorrect data type error	"Bit" is specified for the data type of word device.	<ul style="list-style-type: none"> Check the data type of the recipe file.
0C25 _H	No authority error	The recipe execution operation was performed by a user who does not have a administrator's authority.	<ul style="list-style-type: none"> Retry with a user who has an administrator's authority. Uncheck "Use the access authentication function" in the Account setting.
0C26 _H	CompactFlash card access error	The access to the CompactFlash card was attempted when the file access was being stopped.	<ul style="list-style-type: none"> Check if a CompactFlash card is inserted. Execute "Access restart" and retry. <ul style="list-style-type: none"> Section 13.1.6 CompactFlash card diagnostics Turn the clear file access stop request (Y3) ON, and retry after the file access status (X2) is turned OFF.
0C27 _H	Module suspension error	The recipe execution operation was performed when the module suspended error is being occurred.	<ul style="list-style-type: none"> Remove the module suspended error factor, reset the CPU module, and retry.
0C28 _H	File size error	A recipe file whose file size is 0 is specified.	<ul style="list-style-type: none"> Check the specified recipe file.
0C29 _H	Module suspension error	The recipe execution operation was performed when the operation of high speed data logger module was being suspended.	<ul style="list-style-type: none"> Change the operating status of the module to "In operation". <ul style="list-style-type: none"> Section 13.1.6 CompactFlash card diagnostics
0C2A _H	Recipe execution operation error	The recipe execution operation is already being performed.	<ul style="list-style-type: none"> Retry after the recipe execution operation is completed.
0C2B _H	Incorrect operation type error	An incompatible recipe execution operation type is specified.	<ul style="list-style-type: none"> Correct the control data of the RCPREAD instruction. <ul style="list-style-type: none"> Section 15.6.1 Recipe read (RCPREAD)
0C2C _H	Module suspension error	The recipe execution operation was performed when the operation of high speed data logger module was being suspended.	<ul style="list-style-type: none"> Change the operating status of the module to "In operation". <ul style="list-style-type: none"> Section 13.1.6 CompactFlash card diagnostics

(Continued on the next page)

(From the previous page)

Error code	Error name	Description	Action
0C2D _H	Device error	An incorrect device is specified.	<ul style="list-style-type: none"> • Check the device of the specified recipe file.
0C2E _H	Number of data error	Number of data out of the range is specified.	<ul style="list-style-type: none"> • Specify 1 for "Number of data" when the data type is "Bit". • Specify 1 to 256 for "Number of data" when the data type is other than "Bit".
0C2F _H	Incorrect device value error	Failed to acquire the device value.	<ul style="list-style-type: none"> • Check the device value. • Check the records or blocks of the specified recipe file. • Check the specified recipe file.
0C30 _H	Device error	An incorrect device is specified.	<ul style="list-style-type: none"> • Check the device of the specified recipe file.
0C31 _H	Number of blocks error	An incorrect number of blocks is specified.	<ul style="list-style-type: none"> • Check the number of blocks.  Section 3.8 Recipe File Format
0C32 _H	Number of records error	An incorrect number of records is specified.	<ul style="list-style-type: none"> • Check the number of records.  Section 3.8 Recipe File Format
0C33 _H	Record number error	An incorrect value is specified for the start value of record number.	<ul style="list-style-type: none"> • Specify 1 for the start value of record number.  Section 3.8 Recipe File Format
0C34 _H	Recipe write error	Failed to write the files because of the insufficient CompactFlash card free space.	<ul style="list-style-type: none"> • Delete unnecessary files on the CompactFlash card to ensure free space. • Replace the CompactFlash card.
0C35 _H	CompactFlash card access error	The access to the CompactFlash card was attempted when its access state was "Preparing access".	<ul style="list-style-type: none"> • Access the CompactFlash card again when the access state is "Accessible".  Section 13.1.6 CompactFlash card diagnostics
0C36 _H	CompactFlash card access error	The access to the CompactFlash card was attempted when the file access was being stopped.	<ul style="list-style-type: none"> • Check if a CompactFlash card is inserted. • Execute "Access restart" and retry.  Section 13.1.6 CompactFlash card diagnostics • Turn the clear file access stop request (Y3) ON, and retry after the file access status (X2) is turned OFF.
0C37 _H	CompactFlash card access error	The access to the unformatted CompactFlash card was attempted.	<ul style="list-style-type: none"> • After formatting the CompactFlash card, store recipe files to the CompactFlash card, and retry.
0C38 _H	CompactFlash card access error	The access to the CompactFlash card was attempted while it is being formatted.	<ul style="list-style-type: none"> • After formatting the CompactFlash card, store recipe files to the CompactFlash card, and retry.
0C3A _H	Module suspension error	The recipe execution operation was performed when the operation of high speed data logger module was being suspended.	<ul style="list-style-type: none"> • Execute "Restart" of "Module operation" and retry.  Section 13.1.6 CompactFlash card diagnostics • Execute "Update settings" of "Module operation" and retry.  Section 13.1.6 CompactFlash card diagnostics
0C3B _H	Module suspension error	The recipe execution operation was performed when the module suspended error is being occurred.	<ul style="list-style-type: none"> • Remove the module suspended error factor, reset the CPU module, and retry.

(Continued on the next page)

(From the previous page)

Error code	Error name	Description	Action
0C3C _H	Module suspension error	The recipe execution operation was performed when the settings are being updated. Or the access to the CompactFlash card was attempted while it is being formatted.	<ul style="list-style-type: none"> • Retry after the operating status of the module is changed to "In operation". ☞ Section 13.1.6 CompactFlash card diagnostics • After formatting the CompactFlash card, store recipe files to the CompactFlash card, and retry.
0C3D _H	Recipe execution operation error	The recipe execution operation was performed when the recipe execution operation was already being performed.	<ul style="list-style-type: none"> • Retry after the recipe execution operation is completed.
0C3E _H	Record number specification error	A record number out of the range is specified in the RCPWRITE instruction.	<ul style="list-style-type: none"> • Correct the control data of the RCPWRITE instruction. ☞ Section 15.6.2 Recipe Write (RCPWRITE)
0C3F _H	No specified file error	A file name which does not exist is specified.	<ul style="list-style-type: none"> • Specify the recipe file exists in the RECIPE folder.
0C40 _H	Incorrect file name error	A character which cannot be used for a file name is specified.	<ul style="list-style-type: none"> • Correct the control data of the RCPWRITE instruction. ☞ Section 15.6.2 Recipe Write (RCPWRITE)
0C41 _H	File size error	A recipe file whose size exceeds 512KB is specified.	<ul style="list-style-type: none"> • Specify a file whose size is less than 512KB. • Correct the setting of the recipe file to be less than 512KB.
0C42 _H	File size error	The size of recipe file has exceeded 512KB by writing data.	<ul style="list-style-type: none"> • After writing data, adjust the number of blocks/records/data not to exceed 512KB.
0C44 _H to 0C46 _H	Recipe file error	The recipe file is not correctly formatted, or corrupted recipe file is specified.	<ul style="list-style-type: none"> • Check the format of the specified recipe file. ☞ Section 3.8 Recipe File Format
0C49 _H to 0C5A _H	Recipe file error	The recipe file is not correctly formatted, or corrupted recipe file is specified.	<ul style="list-style-type: none"> • Check the format of the specified recipe file. ☞ Section 3.8 Recipe File Format
0C5B _H	CompactFlash card access error	The access to the CompactFlash card was attempted when its access state was "Preparing access".	<ul style="list-style-type: none"> • Access the CompactFlash card again when the access state is "Accessible". ☞ Section 13.1.6 CompactFlash card diagnostics
0C5C _H	CompactFlash card access error	The access to the CompactFlash card was attempted when the file access was being stopped.	<ul style="list-style-type: none"> • Check if a CompactFlash card is inserted. • Execute "Access restart" and retry. ☞ Section 13.1.6 CompactFlash card diagnostics • Turn the clear file access stop request (Y3) ON, and retry after the file access status (X2) is turned OFF.
0C5D _H	CompactFlash card access error	The access to the unformatted CompactFlash card was attempted.	<ul style="list-style-type: none"> • After formatting the CompactFlash card, store recipe files to the CompactFlash card, and retry.
0C5E _H	CompactFlash card access error	The access to the CompactFlash card was attempted while it is being formatted.	<ul style="list-style-type: none"> • After formatting the CompactFlash card, store recipe files to the CompactFlash card, and retry.

(Continued on the next page)

(From the previous page)

Error code	Error name	Description	Action
0C60 _H	Module suspension error	The recipe execution operation was performed when the operation of high speed data logger module was being suspended.	<ul style="list-style-type: none"> Execute "Restart" of "Module operation" and retry. <ul style="list-style-type: none"> ☞ Section 13.1.6 CompactFlash card diagnostics Execute "Update settings" of "Module operation" and retry. <ul style="list-style-type: none"> ☞ Section 13.1.6 CompactFlash card diagnostics
0C61 _H	Module suspension error	The recipe execution operation was performed when the module suspended error is being occurred.	<ul style="list-style-type: none"> Remove the module suspended error factor, reset the CPU module, and retry.
0C62 _H	Module suspension error	The recipe execution operation was performed when the settings are being updated. Or the access to the CompactFlash card was attempted while it is being formatted.	<ul style="list-style-type: none"> Retry after the operating status of the module is changed to "In operation". <ul style="list-style-type: none"> ☞ Section 13.1.6 CompactFlash card diagnostics After formatting the CompactFlash card, store recipe files to the CompactFlash card, and retry.
0C63 _H	Recipe execution operation error	The recipe execution operation was performed when the recipe execution operation was already being performed.	<ul style="list-style-type: none"> Retry after the recipe execution operation is completed.
0C64 _H to 0C65 _H	CompactFlash card access error	The access to the CompactFlash card was attempted when the file access was being stopped.	<ul style="list-style-type: none"> Check if a CompactFlash card is inserted. Execute "Access restart" and retry. <ul style="list-style-type: none"> ☞ Section 13.1.6 CompactFlash card diagnostics Turn the clear file access stop request (Y3) ON, and retry after the file access status (X2) is turned OFF.
0C66 _H	File size error	A recipe file whose file size is 0 is specified.	<ul style="list-style-type: none"> Check the specified recipe file.
0C67 _H to 0C68 _H	Module suspension error	The recipe execution operation was performed when the operation of high speed data logger module was being suspended.	<ul style="list-style-type: none"> Change the operating status of the module to "In operation". <ul style="list-style-type: none"> ☞ Section 13.1.6 CompactFlash card diagnostics
0C69 _H to 0C6A _H	Recipe file error	The recipe file is not correctly formatted, or corrupted recipe file is specified.	<ul style="list-style-type: none"> Check the format of the specified recipe file. <ul style="list-style-type: none"> ☞ Section 3.8 Recipe File Format
0C6C _H	Number of blocks error	Insufficient number of blocks against specified number of blocks.	<ul style="list-style-type: none"> Check the blocks and the number of blocks for recipe files.
0C6D _H	Device error	An incorrect device is specified.	<ul style="list-style-type: none"> Check the device of the specified recipe file.
0C6E _H to 0C6F _H	Incorrect data type error	A data type that cannot be used for digit specified bit device is specified.	<ul style="list-style-type: none"> Check the data type of the recipe file. <ul style="list-style-type: none"> ☞ Section 3.8 Recipe File Format
0C70 _H	Number of records error	Insufficient number of records against specified number of records.	<ul style="list-style-type: none"> Check the records and the number of records for recipe files.
0C71 _H	Number of data error	The cell for the number of data is blank.	<ul style="list-style-type: none"> Check the number of data.
0C72 _H	Number of blocks error	The cell for the number of blocks is blank.	<ul style="list-style-type: none"> Check the number of blocks. <ul style="list-style-type: none"> ☞ Section 3.8 Recipe File Format
0C73 _H	Number of records error	The cell for the number of records is blank.	<ul style="list-style-type: none"> Check the number of records. <ul style="list-style-type: none"> ☞ Section 3.8 Recipe File Format

(Continued on the next page)

(From the previous page)

Error code	Error name	Description	Action
0C74 _H	CompactFlash card sector access error	Failed to access to the same sector of the CompactFlash card in a low. The CompactFlash card error might occur due to the power off or CPU module reset while writing to the Compact Flash card. The CompactFlash card was mounted again.	<ul style="list-style-type: none"> Execute the stopping file access before power off or resetting the CPU module. If this error occurs repetitively, replace the CompactFlash card.
0D80 _H to 0D82 _H	System error	-	<ul style="list-style-type: none"> Please consult your local Mitsubishi representative, explaining a detailed description of the problem.
100E _H			
2000 _H to 20FF _H			
4000 _H to 4FFF _H	Errors detected by the access target CPU ☞ QCPU User's Manual(Hardware Design, Maintenance and Inspection)		
7000 _H to 7FFF _H	Errors detected by the serial communication module ☞ User's manuals of Serial Communication Module and LCPUCPU		
9000 _H	System error	-	<ul style="list-style-type: none"> Please consult your local Mitsubishi representative, explaining a detailed description of the problem.
9006 _H			
9008 _H	Send buffer full	There is no available space in the send buffer.	<ul style="list-style-type: none"> Check the CPU(s) on the access route. Check if the control CPU of the network module on the network route to the access target CPU is set to QCPU (Q mode).
9202 _H	System error	-	<ul style="list-style-type: none"> Please consult your local Mitsubishi representative, explaining a detailed description of the problem.
9204 _H			
920A _H			
9920 _H			
9922 _H			
9923 _H			
9E20 _H	Processing code error	The issued processing code cannot be processed on the other end.	<ul style="list-style-type: none"> Check the CPU(s) on the access route.
9E81 _H	Device type error	The device type specified for the access target station is invalid.	<ul style="list-style-type: none"> Correct the set device type.
9E82 _H	Device number error	The device number specified for the access target station is out of range.	<ul style="list-style-type: none"> Correct the set device number.
9E83 _H	Number of device points error	The specified number of device points for the access target station is invalid.	
B000 _H to BFFF _H	Errors detected in the CC-Link system ☞ User's manual of CC-Link System Master/Local Module		
C000 _H to CFFF _H	Errors detected in the Ethernet interface module ☞ User's manual of Ethernet Interface Module		
D000 _H to DFFF _H	Errors detected in the CC-Link IE Field Network ☞ User's manual of CC-Link IE Field Network Master/Local Module		
E000 _H to EFFF _H	Errors detected in the CC-Link IE Controller Network ☞ Reference manual of CC-Link IE Controller Network		

(Continued on the next page)

(From the previous page)

Error code	Error name	Description	Action
F00 _H to FEFF _H	Errors detected in the MELSECNET/10(H) network system ☞ Reference manuals of MELSECNET/10(H) Network System		
FFD0 _H	System error	-	• Please consult your local Mitsubishi representative, explaining a detailed description of the problem.
FFD1 _H	Monitor condition dissatisfied error	Reading is not possible because the monitor condition is not established.	• Delete the monitor condition with GX Works2 or GX Developer.
FFD2 _H to FFD4 _H	System error	-	• Please consult your local Mitsubishi representative, explaining a detailed description of the problem.
FFD5 _H	ROM operation error	Writing a TC setting value was attempted to the programmable controller CPU that was running the ROM.	• Change the TC setting value during RAM operation.
FFD6 _H FFD7 _H FFD9 _H to FFDE _H	System error	-	• Please consult your local Mitsubishi representative, explaining a detailed description of the problem.
FFDF _H	Incorrect access target error	The setting for the access target CPU is incorrect.	• Correct "Access target CPU setting".
FFE0 _H	Communication timeout error	The communication did not established because the access to the other access target CPU failed.	• Correct "Access target CPU setting". • Check the communication cable status and access target CPU status.
FFE1 _H FFED _H to FFEF _H	System error	-	• Please consult your local Mitsubishi representative, explaining a detailed description of the problem.
FFF0 _H	Station No., Network No. error	The station or network number is out of range or the setting is wrong.	• Check the station and network number in "Access target CPU setting".
FFF1 _H	System error	-	• Please consult your local Mitsubishi representative, explaining a detailed description of the problem.
FFF2 _H	Memory cassette error	No memory cassette is installed in the accessed CPU module. Or an incorrect memory cassette has been installed.	• Check the memory cassette of the access target CPU.
FFF3 _H	Write protect error	The block number of the specified extension file register has been allocated to the write-protect area of the memory cassette.	• Check the block number of the extension file register (device type). • Check the write-protect DIP switch on the memory cassette of the access target CPU.
FFF4 _H	Block error	The block number of the specified extension file register is invalid.	• Check the block number of the extension file register (device type).
FFF5 _H FFF8 _H FFFA _H	System error	-	• Please consult your local Mitsubishi representative, explaining a detailed description of the problem.
FFFB _H	Size error	The device size exceeded the device range.	• Correct the set device number.
FFFC _H	CPU error	An invalid station was specified.	• Check the settings of the network module on the access route. • Check the station number setting in "Access target CPU setting".

(Continued on the next page)

18 TROUBLESHOOTING

(From the previous page)

Error code	Error name	Description	Action
FFFD _H	Device type error	The device type specified for the access target station is invalid.	• Correct the set device type.
FFFE _H	Device number error	The device number specified for the access target station is out of range.	• Correct the set device number.
FFFF _H	System error	-	• Please consult your local Mitsubishi representative, explaining a detailed description of the problem.

18.3 Troubleshooting by Symptom

This section explains the error definition and corrective action by function and symptom.

18.3.1 Troubleshooting related to LED indicators and I/O signals

Symptom	Check point	Corrective action
The RUN LED does not turn ON.	Is the module in preparation?	• Wait for startup of the module.
	Is the watchdog timer error (X1F) ON?	• Check if the compact flash card listed in the Section 2.3 is used. If the appropriate compact flash card is used, please consult your local Mitsubishi representative and provide them a detailed description of the problem.
	Has SP.UNIT DOWN occurred in the programmable controller CPU?	
	Check the error code. ☞ Section 18.1.1 Checking error codes	• Identify the error and take corrective actions by the error code. ☞ Section 18.2 Error Code List
Module READY (X0) does not turn ON, or it takes time to turn ON.	Are there any errors on the communication route between the high speed data logger module and the access target CPU?	• Check the communication route between the high speed data logger module and the access target CPU.
	Are there any errors in the "Access target CPU setting"?	• Check the "Access target CPU setting".
	Are there any unnecessary settings in the "Access target CPU setting"?	• Delete any unnecessary access target CPU settings. (Depending on the number of items set in access target CPU settings, it may take several minutes until X0 turns ON.)
	Is the module in preparation?	
	Are there many files on the installed CompactFlash card?	• Delete unnecessary files from the CompactFlash card. (If many files are stored on the CompactFlash card, it takes time to turn X0 ON.)
CompactFlash card status (X1) does not turn ON, or it takes time to turn ON.	Is file access stopped (X2 is ON)?	• Clear the file access stop. ☞ Section 16.6 (2) Clearing file access stop
	Are there many files on the installed CompactFlash card?	• Delete unnecessary files from the CompactFlash card. (If many files are stored on the CompactFlash card, it takes time to turn X1 ON.)

18.3.2 Troubleshooting related to data logging, event logging, and reports

Symptom	Check point	Corrective action
Cannot sample data per sequence scan.	Is high speed data sampling failure (X1A) ON?	<ul style="list-style-type: none"> Decrease the number of settings in which high speed data sampling is specified. Set a constant scan to the programmable controller CPU. ☞ Chapter 17 PROCESSING TIME
	Check the power supply status. (Has a momentary power failure occurred?)	<ul style="list-style-type: none"> Correct the power supply status.
Cannot sample data in the specified data sampling interval. (High speed data sampling)	Is high speed data sampling failure (X1A) ON?	<ul style="list-style-type: none"> Decrease the number of settings in which high speed data sampling is specified. Lengthen the data sampling interval for the high speed data sampling. ☞ Chapter 17 PROCESSING TIME
	Check the power supply status. (Has a momentary power failure occurred?)	<ul style="list-style-type: none"> Correct the power supply status.
Cannot sample data in the specified data sampling interval. (General data sampling)	Is general data sampling delay (X1E) ON?	<ul style="list-style-type: none"> Decrease the number of settings in which general data sampling is specified. Mount the high speed data logger module to the access target CPU station and perform high speed data sampling. ☞ Chapter 17 PROCESSING TIME
	Has the high speed data logger module's time been changed by the time synchronization function?	<ul style="list-style-type: none"> Change the timing of the time synchronization. (Do not synchronize time while the system is operating) ☞ Section 11.4.2 (3) Common precautions on synchronization with programmable controller CPU and SNTP
The CSV formatted data logging and event logging time/date information are not displayed correctly.	When the CSV file was opened with Excel, was the cell format set?	<ul style="list-style-type: none"> Set the Excel cell format matched to the desired date/time format for display. ☞ Section 11.5.13 (1) Date column
Data separation occurs.	Is the number of device points within the access units?	<ul style="list-style-type: none"> Set the number of device points sampled at one time to within the access units. ☞ Section 3.2 (6) Access units
	Is the report creation trigger set to synchronize with the current value data?	<ul style="list-style-type: none"> Check "Synchronize creation trigger with current value data." in the creation trigger settings. ☞ Section 11.7.6 (3) Creation trigger (single condition) ☞ Section 11.7.6 (4) Creation trigger (compound condition)
	Is general data sampling being used?	<ul style="list-style-type: none"> Use high speed data sampling. ☞ Section 7.2 Target Data Sampling ☞ Section 9.2 Creation Trigger and Current Value Data Sampling
	Is the data being changed after the report creation trigger occurs?	<ul style="list-style-type: none"> Adjust the system so that the devices sampled as current values for the report do not change during the period the report creation execution information is ON in the buffer memory.

(Continued on the next page)

(From the previous page)

Symptom	Check point	Corrective action
Cannot perform data logging in the specified data sampling interval.	Is high speed data sampling failure (X1A) ON?	<ul style="list-style-type: none"> Decrease the number of settings in which high speed data sampling is specified. Lengthen the data sampling interval for the high speed data sampling. Set a constant scan to the programmable controller CPU. ☞ Chapter 17 PROCESSING TIME
	Is general data sampling delay (X1E) ON?	<ul style="list-style-type: none"> Decrease the number of settings in which general data sampling is specified. Mount the high speed data logger module to the access target CPU station and perform high speed data sampling. ☞ Chapter 17 PROCESSING TIME
	Is processing overload (X1B) ON? (Data logging information 1 to 64 in the buffer memory (Check ☞ Section 3.4.11 (5)))	<ul style="list-style-type: none"> Decrease the amount of target data for data logging. Increase the data sampling interval. Use the trigger logging function. Stop access from GX LogViewer. ☞ Chapter 17 PROCESSING TIME
	Has an error occurred in data logging?	<ul style="list-style-type: none"> According to the error code obtained by the error, identify the error and take corrective actions. ☞ Section 18.2 Error Code List
	Has a communication error occurred with the access target CPU?	
	Has the high speed data logger module's time been changed by the time synchronization function?	<ul style="list-style-type: none"> Change the timing of the time synchronization. (Do not synchronize time while the system is operating) ☞ Section 11.4.2 (3) Common precautions on synchronization with programmable controller CPU and SNTP
	Check the power supply status. (Has a momentary power failure occurred?)	<ul style="list-style-type: none"> Correct the power supply status.
When performing the trigger logging, data cannot be output to the data logging file. (The trigger was not detected)	When specifying data condition in the trigger condition setting, is the time that the trigger condition is established longer than the data sampling interval?	<ul style="list-style-type: none"> Adjust the system so the time that the trigger condition is established is longer than the data sampling interval.
	Is high speed data sampling failure (X1A) ON?	<ul style="list-style-type: none"> Decrease the number of settings in which high speed data sampling is specified. Lengthen the data sampling interval for the high speed data sampling. Set a constant scan to the programmable controller CPU. ☞ Chapter 17 PROCESSING TIME
	Is general data sampling delay (X1E) ON?	<ul style="list-style-type: none"> Decrease the number of settings in which general data sampling is specified. Mount the high speed data logger module to the access target CPU station and perform high speed data sampling. ☞ Chapter 17 PROCESSING TIME
	Is trigger reoccurrence (X1C) ON? (Data logging information 1 to 64 in the buffer memory (Check ☞ Section 3.4.11 (5)))	<ul style="list-style-type: none"> Adjust the system so that triggers do not occur continuously. ☞ Chapter 17 PROCESSING TIME
	Is processing overload (X1B) ON? (Data logging information 1 to 64 in the buffer memory (Check ☞ Section 3.4.11 (5)))	<ul style="list-style-type: none"> Adjust the system so that triggers do not occur continuously. Correct the settings and lessen the processing load. ☞ Chapter 17 PROCESSING TIME
	Has the high speed data logger module's time been changed by the time synchronization function?	<ul style="list-style-type: none"> Change the timing of the time synchronization. (Do not synchronize time while the system is operating) ☞ Section 11.4.2 (3) Common precautions on synchronization with programmable controller CPU and SNTP
	Check the power supply status. (Has a momentary power failure occurred?)	<ul style="list-style-type: none"> Correct the power supply status.

(Continued on the next page)

(From the previous page)

Symptom	Check point	Corrective action
When performing trigger logging, the data before the trigger is less than the number of lines specified before the trigger.	After powering ON or updating the settings, is the trigger occurring before sampling the number of lines of data before the trigger?	<ul style="list-style-type: none"> Adjust the system so the trigger occurs after sampling the number of lines of data after the trigger. <ul style="list-style-type: none"> ☞ Section 7.3.2 (2) POINT
	Is the trigger continuously occurring?	<ul style="list-style-type: none"> Adjust the system so that the trigger occurs after the number of lines after the trigger for the previous trigger and the number of lines before the trigger for the next trigger are both sampled. <ul style="list-style-type: none"> ☞ Section 7.3.2 (2) POINT
When performing the trigger logging, device values sampled in another sequence scan as the one where a trigger occurred is included in one data row.	Is the number of device points less than the access units?	<ul style="list-style-type: none"> Set the number of device points sampled at one time to less than the access units. <ul style="list-style-type: none"> ☞ Section 3.2 (6) Access units
	Is general data sampling being used?	<ul style="list-style-type: none"> Use high speed data sampling. <ul style="list-style-type: none"> ☞ Section 7.2 Target Data Sampling
The event was not detected.	When specifying the data condition, is the time that the condition is established longer than the data sampling interval?	<ul style="list-style-type: none"> Adjust the system so the time that the event condition is established is longer than the sampling interval.
	Is high speed data sampling failure (X1A) ON?	<ul style="list-style-type: none"> Decrease the number of settings in which high speed data sampling is specified. Lengthen the data sampling interval for the high speed data sampling. Set a constant scan to the programmable controller CPU. <ul style="list-style-type: none"> ☞ Chapter 17 PROCESSING TIME
	Is general data sampling delay (X1E) ON?	<ul style="list-style-type: none"> Decrease the number of settings in which general data sampling is specified. Mount the high speed data logger module to the access target CPU station and perform high speed data sampling. <ul style="list-style-type: none"> ☞ Chapter 17 PROCESSING TIME
	Is processing overload (X1B) ON? (Event logging information 1 to 64 in the memory (Check ☞ Section 3.4.12 (4)))	<ul style="list-style-type: none"> Correct the settings and lessen the processing load. <ul style="list-style-type: none"> ☞ Chapter 17 PROCESSING TIME
	Check the power supply status. (Has a momentary power failure occurred?)	<ul style="list-style-type: none"> Correct the power supply status.
The report file was not created. (The report creation trigger was not detected)	When specifying data condition in the trigger condition setting, is the time that the creation trigger condition is established longer than the data sampling interval?	<ul style="list-style-type: none"> Adjust the system so the time that the creation trigger condition is established is longer than the data sampling interval.
	Is high speed data sampling failure (X1A) ON?	<ul style="list-style-type: none"> Decrease the number of settings in which high speed data sampling is specified. Lengthen the data sampling interval for the high speed data sampling. Set a constant scan to the programmable controller CPU. <ul style="list-style-type: none"> ☞ Chapter 17 PROCESSING TIME
	Is general data sampling delay (X1E) ON?	<ul style="list-style-type: none"> Decrease the number of settings in which general data sampling is specified. Mount the high speed data logger module to the access target CPU station and perform high speed data sampling. <ul style="list-style-type: none"> ☞ Chapter 17 PROCESSING TIME
	Is processing overload (X1B) ON? (Report creation information 1 to 64 in the memory (Check ☞ Section 3.4.13 (5)))	<ul style="list-style-type: none"> Correct the settings and lessen the processing load. <ul style="list-style-type: none"> ☞ Chapter 17 PROCESSING TIME
	Is creation trigger reoccurrence (X1D) ON? (Report creation information 1 to 64 in the buffer memory (Check ☞ Section 3.4.13 (5)))	<ul style="list-style-type: none"> Adjust the system so that triggers do not occur continuously. <ul style="list-style-type: none"> ☞ Chapter 17 PROCESSING TIME
	Has the high speed data logger module's time been changed by the time synchronization function?	<ul style="list-style-type: none"> Change the timing of the time synchronization. (Do not synchronize time while the system is operating) <ul style="list-style-type: none"> ☞ Section 11.4.2 (3) Common precautions on synchronization with programmable controller CPU and SNTP
	Check the power supply status. (Has a momentary power failure occurred?)	<ul style="list-style-type: none"> Correct the power supply status.

(Continued on the next page)





(From the previous page)

Symptom	Check point	Corrective action
The specified number of records worth of data are not output to the report.	When the creation trigger occurred, was the specified number of records worth of data saved to the data logging file?	<ul style="list-style-type: none"> Adjust the system so that the creation trigger occurs after the specified number of records worth of data is saved to the data logging file. Section 9.1 (1) POINT
	Is the creation trigger occurring immediately after the power is turned ON?	
	Is the data logging file, which includes the data at the time the creation trigger occurred, deleted before completing output to the report?	<ul style="list-style-type: none"> Adjust the file switch timing for data logging. Section 9.1 (1) POINT
Millisecond information is not displayed in the cell where the time/date was output in the report file.	Was the cell format configured when the layout was created?	<ul style="list-style-type: none"> Set the Excel cell format matched to the desired date/time format for display. Section 11.7.4 Layout setting list
The data are not correctly output to the report file.	Are there merged cells in the cell range where the layout is set?	<ul style="list-style-type: none"> Split the merged cells. Do not specify cells which are merged in the cell range.
	Are there data lines in the output source file of the data logging layout?	<ul style="list-style-type: none"> Adjust the settings and configurations so that a creation trigger occurs after data are output to the data logging file which is the output source for the report.
	Was the device of which device number is multiples of 65536 (D65536 or ZR131072, etc.) acquired as a current value?	<ul style="list-style-type: none"> Change any of the following settings. Specify the device number as a start device. Example) Start device: D65536, Last device: D80000 The remainder of the last device number and the start device number must be within 960. Example) Start device: D65500, Last device: D66460 Section 11.7.5 Layout setting
The report file is not displayed properly.	Is the report file created by the module set on the Japanese Configuration Tool opened on English Excel?	<ul style="list-style-type: none"> Open the report file on Japanese Excel.
Cannot start the "Layout setting" screen.	Are the authorities of the user logged on to Windows sufficient?	<ul style="list-style-type: none"> For Windows[®] XP, logon as a user with a 'limited' or higher user account. For Windows Vista[®] or later, logon as a user with a 'standard' or higher user account.
Cannot save the file to a personal computer from file browser.	Are the authorities of the user logged on to Windows sufficient?	<ul style="list-style-type: none"> For Windows[®] XP, logon as a user with a 'limited' or higher user account. For Windows Vista[®] or later, logon as a user with a 'standard' or higher user account.
Layout setting cannot be ended. ("Layout setting" screen is disappeared on Excel)	Was the following operation performed? 1. Display the directory in the CompactFlash card in an Explorer format using the FTP server function. (Section 10.3 File Access Function) 2. Open the report file directly from Explorer. 3. Close the opened report file.	<ul style="list-style-type: none"> Select [Window] → [Hide] from the Excel menu on the layout file on which the "Layout setting" screen was displayed. Then select [Window] → [Unhide].
A corrupted file is created.	Is the free space of the CompactFlash card sufficient?	<ul style="list-style-type: none"> Clear the logging file by configuration tool after backing up the file as necessary.



18.3.3 Troubleshooting related to network connection

Symptom	Check point	Corrective action
Cannot access the high speed data logger module.	Is the mode of the intelligent function module switch setting "Online"?	<ul style="list-style-type: none"> Set the mode to "Online". ☞ Section 4.5 Intelligent Function Module Switch Setting
	Is the high speed data logger module connected to the network? (X4=ON)	<ul style="list-style-type: none"> Connect the high speed data logger module to the network.
	Is there a disconnection along the connection route?	<ul style="list-style-type: none"> Connect the cables properly. Replace the cables to new ones.
	Is the IP address duplicated?	<ul style="list-style-type: none"> Correct the IP address. ☞ Section 11.4.1 Network setting
	Does a firewall or proxy server exist along the connection route?	<ul style="list-style-type: none"> Ask your network administrator about the firewall and proxy server settings.
	Is Windows firewall enabled on the personal computer?	<ul style="list-style-type: none"> Disable Windows firewall on the personal computer when using the module search function or direct connection.
	Is antivirus software blocking Ethernet communications?	<ul style="list-style-type: none"> Change the antivirus software settings to allow Ethernet communications. Lower the antivirus software's security settings level. Stop the antivirus software.
	Is there any problem on the personal computer?	<ul style="list-style-type: none"> Replace it with another personal computer.
	Are the authorities of the user logged on to Windows® sufficient?	<ul style="list-style-type: none"> For Windows® XP, logon as a user with a 'limited' or higher user account. For Windows Vista® or later, logon as a user with a 'standard' or higher user account.
	Is the IP address of the high speed data logger module specified in transfer setup correct? (When the power is turned ON without a CompactFlash card inserted, the module operates with the IP address in the initial status (192.168.3.3).)	<ul style="list-style-type: none"> Correct the IP address of the high speed data logger module specified in transfer setup. ☞ Section 4.2.2 Remarks Directly connect the personal computer and specify direct connection in transfer setup. ☞ Section 2.1.3 (2) For a direct connection
	Has an error occurred on the own station's programmable controller CPU?	<ul style="list-style-type: none"> Check the error code for the programmable controller CPU, take action according to the error code.
	Is the high speed data logger module mounting slot set to other than "Intelli." (other CPU in multiple CPU, I/O module) in the PLC parameter (I/O assignment) of the own station's programmable controller CPU?	<ul style="list-style-type: none"> Correct the PLC parameter (I/O assignment) of the programmable controller CPU.
	Are the high speed data logger module and personal computer connected to each other via a hub?	<ul style="list-style-type: none"> For a direct connection, connect the high speed data logger module to the personal computer on a 1:1 basis. ☞ Section 2.1.3 (2) For a direct connection
Are multiple IP addresses enabled at the same time in the personal computer side?	<ul style="list-style-type: none"> For a direct connection, make sure multiple IP addresses are not enabled at the same time in the personal computer. Disable the wireless LAN function. 	

18.3.4 Troubleshooting related to FTP

Symptom	Check point	Corrective action
Cannot transfer the file.	Is the high speed data logger module correctly connected to the network?	<ul style="list-style-type: none"> Check the module status, network connection status of the high speed data logger module.  Section 18.3.1, Section 18.3.3
426 error (Data connection error) occurs during the file transfer.	Was the FTP transfer executed specifying a large number of files at one time?	<ul style="list-style-type: none"> Decrease the number of files to transfer at one time and execute FTP again.
0x0B03 (FTP file transfer error) occurs during the file transfer.	Has the file already been deleted?	<ul style="list-style-type: none"> Review the file switch timing and the number of saved files setting and lengthen the time until the saved file is deleted.
The file downloaded from the high speed data logger module via FTP is old.	Were the settings for temporary internet files of Internet Explorer configured?	<ul style="list-style-type: none"> Configure the settings for temporary internet files of Internet Explorer.  Section 5.3.1 (3)
A file which does not contain data is transferred.	Have you transferred the saved file which only contains a header line?	<ul style="list-style-type: none"> Adjust the settings and configurations so that the file switching is performed after the data output.
File transfer may not be performed for a period of time.	Does 0002H (response timeout error) occur? When the error has been occurred, has the access target CPU which does not exist been specified to the access target CPU setting? Or can high speed data logger module communicate with the access target CPU?	<ul style="list-style-type: none"> Check the communication cables and the status of access target CPU.  Appendix 8.2 Processing time of FTP transfer function and e-mail function
The file does not exist at the transfer destination.	Is the referred FTP transfer directory correct?	<ul style="list-style-type: none"> Check the FTP transfer directory.  Appendix 11 FTP Transfer Directory Configuration
Files cannot be downloaded via FTP from the high speed data logger module using a web browser.	Is the FTP site opened in text format?	<ul style="list-style-type: none"> Open the FTP site in Explorer format.  Section 10.3 (2)

18.3.5 Troubleshooting related to e-mail

Symptom	Check point	Corrective action
Cannot send e-mail.	Is the high speed data logger module correctly connected to the network?	<ul style="list-style-type: none"> Check the module status, network connection status of the high speed data logger module.  Section 18.3.1, Section 18.3.3
0x0B15 occurs (no attachment error) when sending an attachment.	Has the attachment file already been deleted?	<ul style="list-style-type: none"> Review the file switch timing and the number of saved files setting and lengthen the time until the attachment file is deleted.
A file which does not contain data is transferred.	Have you transferred the saved file which only contains a header line?	<ul style="list-style-type: none"> Adjust the settings and configurations so that the file switching is performed after the data output.
E-mail may not be sent for a period of time.	Does 0002H (response timeout error) occur? When the error has been occurred, has the access target CPU which does not exist been specified to the access target CPU setting? Or can high speed data logger module communicate with the access target CPU?	<ul style="list-style-type: none"> Check the communication cables and the status of access target CPU.  Appendix 8.2 Processing time of FTP transfer function and e-mail function
Cannot resend e-mail.	Is the "SMTP server name" set with a host name?	<ul style="list-style-type: none"> Set the "SMTP server name" with an IP address.

18.3.6 Troubleshooting related to communication between the high speed data logger module and access target CPU

Symptom	Check point	Corrective action
Unable to access other station via Ethernet module.	Is a remote password set for the GX Works 2 or GX Developer communication port (UDP/IP) of the Ethernet module on the target or relay station?	<ul style="list-style-type: none"> Remove the remote password set for the GX Works2 or GX Developer communication port (UDP/IP) of the Ethernet module on the target or relay station.
A timeout error occurs.	Is a communication processing performed from multiple modules to the access target CPU in which a timeout error occurred?	<ul style="list-style-type: none"> Check the service processing setting of the access target CPU.
An error occurs when accessing the redundant CPU system.	Is high speed data logger module accessing the redundant CPU system of other station?	<ul style="list-style-type: none"> Mount the high speed data logger module to the extension base of the desired redundant CPU system for accessing.
	Is system switching occurring frequently?	<ul style="list-style-type: none"> Review the system so that system switching does not occur frequently.
Unable to access other station via the high speed data logger module built-in Ethernet port.	Are the devices (such as router) operating normally on the communication route?	<ul style="list-style-type: none"> Check the operating status of the devices (such as router) on the communication route. Turn OFF and ON the module of the own station after executing the PING test from the access target CPU (built-in Ethernet port QCPU or Q series-compatible E71) to the high speed data logger module.
	Has UDP (MELSOFT Connection) been added to the open setting for a built-in Ethernet port of the access target CPU?	<ul style="list-style-type: none"> Add UDP (MELSOFT Connection) to the open setting for a built-in Ethernet port of the access target CPU.
When accessing via the high speed data logger module built-in Ethernet port, an error such as timeout or missing data occurs.	Does the device (such as router) operate properly when the device (such as router) except Ethernet (twisted pair) cables and hubs exist on the access route?	<ul style="list-style-type: none"> Check the status of the devices (such as router) and the route on the communication route. Reconfigure the communication route to the access target CPU with Ethernet (twisted pair) cables and hubs.
When the high speed data logger module is started up, 'Errors detected by the access target CPU' (error code: 4B00h) occurs.	Is the high speed data logger module accessing other CPU, or accessing the other station via a network module controlled by other CPU, in the multiple CPU system?	<ul style="list-style-type: none"> Clear the error in the high speed data logger module after starting up the CPU module in the multiple CPU system. ☞ Section 2.6.3 Precautions for using multiple CPU system

18.3.7 Troubleshooting related to time synchronization function

Symptom	Check point	Corrective action
Time is not synchronized with the SNTP server computer.	Is the "SNTP server address" setting correct?	<ul style="list-style-type: none"> Correct the "SNTP server address" setting. ☞ Section 11.4.2 Time synchronization setting

18.3.8 Troubleshooting related to data management, CompactFlash cards





Symptom	Check point	Corrective action
Cannot format the CompactFlash card.	Is the CompactFlash card being accessed?	<ul style="list-style-type: none"> • Wait until the CompactFlash card access completes.
When the CompactFlash card is accessed by a personal computer, the following may occur. <ul style="list-style-type: none"> • File size displayed as 0 bytes. • Space added to the end of files. • File error, file entry error, file size error messages are displayed, and files cannot be opened. 	Was file access stopped before ejecting or replacing the CompactFlash card regardless of the power ON/OFF status?	<ul style="list-style-type: none"> • Always stop file access before ejecting or replacing the CompactFlash card regardless of the power ON/OFF status. <ul style="list-style-type: none"> ☞ Section 16.6 (1) Stopping file access • To repair a CompactFlash card with errors, execute either following option. <ol style="list-style-type: none"> ① Reinsert the CompactFlash card with errors in the high speed data logger module and after stopping file access, eject the CompactFlash card. <ul style="list-style-type: none"> ☞ Section 16.5 Operations for Ejecting and Reinserting CompactFlash Card ② Repair the CompactFlash card with the <code>chkdsk</code> command on the Microsoft® Windows® command prompt.
When the power switches OFF, the files on the CompactFlash card disappear.	Is there a problem with the type of CompactFlash card?	<ul style="list-style-type: none"> • Replace with one of the CompactFlash cards shown in the following section. <ul style="list-style-type: none"> ☞ Section 2.3 (1) CompactFlash card (sold separately, required)
	Was the power turned OFF or control CPU reset when writing data to the CompactFlash card?	<ul style="list-style-type: none"> • Stop file access before turning OFF the power or reset the control CPU. <ul style="list-style-type: none"> ☞ Section 16.6 (1) Stopping file access • Format the CompactFlash card again. <ul style="list-style-type: none"> ☞ Section 13.1.6 CompactFlash card diagnostics
Cannot recognize the CompactFlash card. (The CF LED does not turn ON)	Is the CompactFlash card inserted correctly?	<ul style="list-style-type: none"> • Eject the CompactFlash card once and insert it again. <ul style="list-style-type: none"> ☞ Section 16.5 Operations for Ejecting and Reinserting CompactFlash Card
	Has the CompactFlash card been formatted by a device other than the high speed data logger module, such as a personal computer?	<ul style="list-style-type: none"> • Format the CompactFlash card with the high speed data logger module. <ul style="list-style-type: none"> ☞ Section 13.1.6 CompactFlash card diagnostics
	Was the power turned OFF or control CPU reset when formatting the CompactFlash card?	<ul style="list-style-type: none"> • Stop file access before turning OFF the power or reset the control CPU. <ul style="list-style-type: none"> ☞ Section 16.6 (1) Stopping file access • Format the CompactFlash card again. <ul style="list-style-type: none"> ☞ Section 13.1.6 CompactFlash card diagnostics

(Continued on the next page)

(From the previous page)

Symptom	Check point	Corrective action
The access speed to the CompactFlash card becomes slower.	Are files being saved up the capacity limit of the CompactFlash card?	<ul style="list-style-type: none"> Use the CompactFlash card maintaining 10% or more free space on the card. ➤ Section 16.3 Precautions when Using CompactFlash Card
The specified size of free capacity cannot be ensured on the CompactFlash card.	Are there any files on the CompactFlash card other than saved files created by the data logging, event logging or report function operated on the high speed data logger module?	<ul style="list-style-type: none"> Delete unnecessary files from the CompactFlash card.
	Is the total size of files that are not the objects of deletion larger than the specified size of free capacity?	<ul style="list-style-type: none"> Configure the settings so that the total size of files that are not the objects of deletion is smaller than the specified size of free capacity. ➤ Section 11.4.9 CompactFlash card setting
Saved files are not created as many as specified.	Is the CompactFlash card setting configured?	<ul style="list-style-type: none"> Check the CompactFlash card setting. Delete unnecessary files from the CompactFlash card.
	Is the size of files reaching the capacity limit of the CompactFlash card?	<ul style="list-style-type: none"> Delete unnecessary files from the CompactFlash card.
The total capacity, free capacity, and usage rate of the CompactFlash card are not displayed.	Does the connected high speed data logger module support the CompactFlash card diagnostics function?	<ul style="list-style-type: none"> Check if the module supports the CompactFlash card diagnostics function. ➤ Appendix 5 Adding Function to High Speed Data Logger Module
	Is the access state 'Access stop'?	<ul style="list-style-type: none"> Execute 'Access restart'. ➤ Section 13.1.6 CompactFlash card diagnostics
	Is the access state 'Formatting'?	<ul style="list-style-type: none"> Wait until the access state becomes 'Accessible'.
	Is the access state 'Preparing access'?	
	Is the access state 'Card error detected'?	<ul style="list-style-type: none"> Format the CompactFlash card with the high speed data logger module. ➤ Section 13.1.6 CompactFlash card diagnostics Replace the CompactFlash card.
Logging is not started when the CompactFlash card is inserted.	Have the settings already been written to the CompactFlash card?	<ul style="list-style-type: none"> Write the settings to the high speed data logger module. ➤ Section 12.3 Writing Data
		<ul style="list-style-type: none"> Export the settings to the CompactFlash card to be inserted. ➤ Section 11.3.6 Exporting module operating file
	Have the settings already been updated?	<ul style="list-style-type: none"> Update the settings. ➤ Section 13.1.1 Module diagnostics
	Have the settings with the auto logging function set to be enabled already been written to the CompactFlash card?	<ul style="list-style-type: none"> Set the auto logging function. ➤ Section 11.4.7 Auto logging setting

18.3.9 Troubleshooting related to Configuration Tool

Symptom	Check point	Corrective action
When opening or saving a file, a message such as "Please insert a disk" is displayed.	Is a removable drive or network drive specified at the last time the file was opened or saved?	<ul style="list-style-type: none"> • Reselect a drive on the personal computer.
When configuring a layout setting, cannot close other Excel files.	Are other Excel files opened in the same Excel as the layout settings?	<ul style="list-style-type: none"> • When opening other Excel files, start Excel from the Microsoft® Windows® start menu.
When configuring the layout settings and selecting the leading cell, cell range, or cell selection, a small window titled "RefEdit" is displayed.	Are other Excel files opened in the same Excel as the layout settings?	<ul style="list-style-type: none"> • Select the cell(s) and click the OK button. • When opening other Excel files, start Excel from the Microsoft® Windows® start menu.
Cannot start the Configuration Tool online. (Cannot start from a web browser)	Are the authorities of the user logged on to Windows® sufficient?	<ul style="list-style-type: none"> • For Windows® XP, logon as a user with a 'limited' or higher user account. • For Windows Vista® or later, logon as a user with a 'standard' or higher user account.
	Is the parental control (family safety) enabled for the user logged on to Windows®?	<ul style="list-style-type: none"> • Disable parental control (family safety) for the user logged on to Windows®.
	Was the 'security' setting of Internet Explorer set?	<ul style="list-style-type: none"> • Set the "Security level for this zone" of Internet Explorer to 'Medium' or lower. <ul style="list-style-type: none"> ☞ Section 5.3.1 (3) Internet Explorer settings
	Does the hard disk have a sufficient free space?	<ul style="list-style-type: none"> • Check the free space of the hard disk. <ul style="list-style-type: none"> ☞ Section 2.4 Operating Environment
	Is the memory or the system resources on the personal computer sufficient? <ul style="list-style-type: none"> ●When the first five digits of a serial number are '26031' or lower Is .NET Framework 2.0 or .NET Framework 3.5 installed (enabled)? ●When the first five digits of a serial number are '26032' or higher Is .NET Framework 4.5 installed? Is the 'SmartScreen' function disabled? 	<ul style="list-style-type: none"> • Increase the necessary memory on the personal computer. <ul style="list-style-type: none"> ☞ Section 2.4 Operating Environment • Close other applications and restart Configuration Tool. ●When the first five digits of a serial number are '26031' or lower <ul style="list-style-type: none"> • .Install .NET Framework 2.0 or .NET Framework 3.5. For Windows 8® or later, enable the .NET Framework 3.5 (including .NET 2.0 or 3.0) in "Turn Windows features on or off" on the control panel. ●When the first five digits of a serial number are '26032' or higher <ul style="list-style-type: none"> • Install .NET Framework 4.5. • Disable the 'SmartScreen' function.
Cannot start the Configuration Tool online. (Source code is displayed.)	Does a proxy server exist along the connection route?	<ul style="list-style-type: none"> • Disable the proxy setting in a web browser. <ul style="list-style-type: none"> ☞ Section 5.3.1 Online startup • Execute the "Deleting temporary internet files" (☞ Section 5.3.1), or reload the screen on which source code is being displayed by  +  keys and retry online startup.
	Are temporary internet files of a web browser deleted?	<ul style="list-style-type: none"> • Execute the "Deleting temporary internet files" (☞ Section 5.3.1), or reload the screen on which source code is being displayed by  +  keys and retry online startup.

(Continued on the next page)

(From the previous page)

Symptom	Check point	Corrective action
Cannot communicate with the module. (Cannot operate online)	Are the rights of the user logged on to Windows® sufficient?	<ul style="list-style-type: none"> For Windows® XP, logon as a user with a 'limited' or higher user account. For Windows Vista® or later, logon as a user with a 'standard' or higher user account.
	Is Windows firewall enabled on the personal computer?	<ul style="list-style-type: none"> Disable Windows firewall on the personal computer when using the high speed data logger module search function or direct connection.
	Is antivirus software blocking Ethernet communications?	<ul style="list-style-type: none"> Change the antivirus software settings to allow Ethernet communications. Lower the antivirus software's security settings level. Stop the antivirus software.
	Is "Direct connection" selected in the transfer setup?	<ul style="list-style-type: none"> For a direct connection, connect the high speed data logger module to the personal computer on a 1:1 basis. ☞ Section 2.1.3 (2) For a direct connection
	Are multiple IP addresses enabled at the same time in the personal computer side?	<ul style="list-style-type: none"> For a direct connection, make sure multiple IP addresses are not enabled at the same time in the personal computer. Disable the wireless LAN function.
When editing the layout settings, the layout file size becomes larger regardless of not changing the layout.	Did you edit the layout settings with a version of Excel different from the one that first set the layout?	<ul style="list-style-type: none"> Edit the layout settings with the same version of Excel that was used to first set the layout. ☞ Section 11.7.4 Layout setting list
Cannot start the "Layout setting" screen.	Is the Excel VBA function installed?	<ul style="list-style-type: none"> Reinstall Excel. (When doing so, do not set "Do not install" or "Not Available, Hidden, Locked" for the VBA function installation options.)
	Is Microsoft® Excel® 2010 (64-bit version)/ Microsoft® Excel® 2013 (64-bit version) / Microsoft® Excel® 2016 (64-bit version) installed?	<ul style="list-style-type: none"> Reinstall the supported version of Excel. ☞ Section 2.4 Operating Environment
	Is Excel the version of which is earlier than Microsoft Excel 2003 installed?	
	Are add-ins installed in Excel?	<ul style="list-style-type: none"> Disable installed add-ins. ☞ Section 11.7 POINT
It takes time to communicate with the module.	Is the processing load of data logging, event logging, or report function high? (High number of sampling data, short data sampling interval, large layout file size of report, etc.)	<ul style="list-style-type: none"> Stop the module operation, and communicate with the module, then restart the module operation. Configure the settings to lessen the processing load. (Decrease the number of sampling data, set longer data sampling interval, reduce the layout file size of report, etc.)
	Are the DNS server settings of the personal computer correct? (Check the Internet protocol (TCP/IP) properties of the personal computer.) ☞ Section 4.2.2 Remarks	<ul style="list-style-type: none"> Set the correct DNS server. If no DNS server exists on the network, do not configure the DNS server (set to blank).

(Continued on the next page)

(From the previous page)

Symptom	Check point	Corrective action
It takes time to start the "Layout setting" screen.	Are the DNS server settings of the personal computer correct? (Check the Internet protocol (TCP/IP) properties of the personal computer.) ☞ Section 4.2.2 Remarks	<ul style="list-style-type: none"> Set the correct DNS server. If no DNS server exists on the network, do not configure the DNS server (set to blank).
	Is the "Import external data" function used for Excel file in which the layout settings are set?	<ul style="list-style-type: none"> Check the reference of the "Import external data function" in Excel. Delete the setting of the "Import external data" function in Excel.
Configuration Tool does not start.	Is the memory or the system resources on the personal computer sufficient? Is .NET Framework 2.0 or .NET Framework 3.5 installed (enabled)?	<ul style="list-style-type: none"> Increase the necessary memory on the personal computer. ☞ Section 2.4 Operating Environment Close other programs and restart Configuration Tool. Install .NET Framework 2.0 or .NET Framework 3.5. For Windows 8® or later enable the .NET Framework 3.5 (including .NET 2.0 or 3.0) in "Turn Windows features on or off" on the control panel.
The screen of Configuration Tool is not displayed correctly.		
Cannot operate Configuration Tool.		
Forced to terminate Configuration Tool.		
Characters on a screen are not displayed properly.	Is the setting created on the Japanese Configuration Tool opened on the English Configuration Tool?	<ul style="list-style-type: none"> Open the setting on the Japanese Configuration Tool.
	Is the module set on the Japanese Configuration Tool searched on the English Configuration Tool?	<ul style="list-style-type: none"> Search the module on the Japanese Configuration Tool.
	Is "Font size" set to "Large Fonts" or "Extra Large Fonts" on the "Display Property" screen of Windows® operating system?	<ul style="list-style-type: none"> Set "Font size" to "Normal" on the "Display Property" screen of Windows® operating system.
	Is the DPI setting set other than the normal size on the "Display Property" screen of Windows® operating system?	<ul style="list-style-type: none"> Set the normal size for the DPI setting on the "Display Property" screen of Windows® operating system.
Failed to read (verify) data.	Does Configuration Tool communicate with the module correctly?	<ul style="list-style-type: none"> Refer to the troubleshooting for "Cannot communicate with the module. (Cannot operate online)" shown on the previous page.
	Has the data write (export) not ever executed toward a now-installed CompactFlash card?	<ul style="list-style-type: none"> Execute the data write.
	Has the write data been cancelled during the processing? (Is there any communication problem?)	<ul style="list-style-type: none"> Execute the data write again.
	Are there any settings which are not supported by Configuration Tool in the module?	<ul style="list-style-type: none"> Start the Configuration Tool directly from the module. Upgrade to the latest version of the Configuration Tool.
"Specified setting does not exist in the module. Reading setting is aborted." message is displayed when writing (verifying) settings.	Are there any settings which are not supported by Configuration Tool in the module?	<ul style="list-style-type: none"> Start the Configuration Tool directly from the module. Upgrade to the latest version of the Configuration Tool.
	Is a CompactFlash card to which data have never been written (exported) inserted?	<ul style="list-style-type: none"> Write (export) data to the CompactFlash card.
Failed to select GX Works2 project.	Is GX Works2 installed?	<ul style="list-style-type: none"> Install GX Works2 Version 1.44W or later.
Some GX Works2 projects are not displayed in the "Workspace/Project list" on the "GX Works2 project selection" screen.	Are these GX Works2 projects saved in a Workspace format?	<ul style="list-style-type: none"> Select a Workspace format project.

(Continued on the next page)

(From the previous page)

Symptom	Check point	Corrective action
Some GX Works2 projects are not displayed in "Folder list" on the "GX Works2 project selection" screen.	Is GX Works2 installed?	<ul style="list-style-type: none"> • Install GX Works2 (Version 1.44W or later).
Failed to import the global label, the device comment of GX Works2.	Is GX Works2 installed?	<ul style="list-style-type: none"> • Install GX Works2 Version 1.44W or later.
	Does the import source project file exist?	<ul style="list-style-type: none"> • Check the import source project on the "Global label/Device comment import setting" screen.
	Is the import source project file corrupted?	<ul style="list-style-type: none"> • Check that the project can be opened in GX Works 2.
The data on the "Import Global Label" screen cannot be imported.	Is the data configurable in Configuration Tool?	<ul style="list-style-type: none"> • Check that the start device, the data type, and the number of strings are configurable value in Configuration Tool.
The data on the "Import Device Comment" screen cannot be imported.	Is the data configurable in Configuration Tool?	<ul style="list-style-type: none"> • Check that the start device is configurable value in Configuration Tool.
Failed to select GX Developer project.	Is GX Developer installed?	<ul style="list-style-type: none"> • Install GX Developer Version 8.90U or later.
Failed to import the device comment of GX Developer.	Is GX Developer installed?	<ul style="list-style-type: none"> • Install GX Developer Version 8.90U or later.
	Does the import source project file exist?	<ul style="list-style-type: none"> • Check the import source project on the "Global label/Device comment import setting" screen.
	Is the device comment corrupted?	<ul style="list-style-type: none"> • Check the device comment is displayed in GX Developer.
Failed to update the related data of the global label.	Is GX Works2 installed?	<ul style="list-style-type: none"> • Install GX Works2 Version 1.44W or later.
	Does the import source project file of the data to be updated exist?	<ul style="list-style-type: none"> • Check the import source project on the "Global label/Device comment import setting" screen.
	Is the import source project file of the data to be updated corrupted?	<ul style="list-style-type: none"> • Check that the project can be opened in GX Works 2.
The type of the data update screen is "release".	Does the global label to be updated exist?	<ul style="list-style-type: none"> • Open the project in GX Works 2 and check that the global label to be updated exist.
	Is the global label to be updated configurable in Configuration Tool?	<ul style="list-style-type: none"> • Open the project in GX Works 2 and check that the start device, the data type, and the number of strings of the global label to be updated are configurable value in Configuration Tool.
	Is inconsistency occurred when using the related data in conditional expression?	<ul style="list-style-type: none"> • Open the project in GX Works 2 and check that the related data used in conditional expression has been changed to the data type which is not configurable.
The project file of Configuration Tool cannot be imported.	Is specified project file incorrect?	<ul style="list-style-type: none"> • Specify the correct project file.
	Is inconsistency occurred by import?	<ul style="list-style-type: none"> • Correct the settings of import source. • Correct the settings of import destination. • Correct the settings to be imported.
	Is the upper limit of the number of settings exceeded?	<ul style="list-style-type: none"> • Correct the number of settings.
The string of exported setting information CSV file (a project path set on the "Global label/Device comment import setting" screen) is not displayed properly.	Is a project path which contains characters other than English specified on the "Global label/Device comment import setting" screen?	<ul style="list-style-type: none"> • Specify a project path contains English characters only.

(Continued on the next page)

18 TROUBLESHOOTING

(From the previous page)

Symptom	Check point	Corrective action
A timeout occurs when the settings are updated, or an update of the settings takes long time.	Are there any errors on the communication route between the high speed data logger module and the access target CPU?	<ul style="list-style-type: none">• Check the communication route between the high speed data logger module and the access target CPU.
	Are there any errors in the "Access target CPU setting"?	<ul style="list-style-type: none">• Check the "Access target CPU setting".
	Are there any unnecessary settings in the "Access target CPU setting"?	<ul style="list-style-type: none">• Delete any unnecessary access target CPU settings. (Depending on the number of items set in the "Access target CPU setting", it may take several minutes to complete the update of the settings.)

18.3.10 Troubleshooting related to Logging File Conversion Tool

Symptom	Check point	Corrective action
When opening or saving a file, a message such as "Please insert a disk" is displayed.	Is a removable drive or network drive specified at the last time the file was opened or saved?	<ul style="list-style-type: none"> • Reselect a drive on the personal computer.
The Conversion Tool does not start.	Is the memory or the system resources on the personal computer sufficient?	<ul style="list-style-type: none"> • Increase the necessary memory on the personal computer. ➡ Section 2.4 Operating Environment • Close other applications and restart the Conversion Tool.
The screen of the Conversion Tool is not displayed correctly.		
Cannot operate the Conversion Tool.		
Forced to terminate the Conversion Tool.		
Characters are not converted properly.	Is the binary file created on the high speed data logger module which is set on the Japanese Configuration Tool converted on the English Configuration Tool?	<ul style="list-style-type: none"> • Use the Japanese Configuration Tool.
Characters on a screen are not displayed properly.	Is "Font size" set to "Large Fonts" or "Extra Large Fonts" on the "Display Property" screen of Windows® operating system?	<ul style="list-style-type: none"> • Set "Font size" to "Normal" on the "Display Property" screen of Windows® operating system.
	Is the DPI setting set other than the normal size on the "Display Property" screen of Windows® operating system?	<ul style="list-style-type: none"> • Set the normal size for the DPI setting on the "Display Property" screen of Windows® operating system.

18.3.11 Troubleshooting related to recipe function

Symptom	Check point	Corrective action
Failed to read, write the recipe file.	Does specified record number exist in the recipe file?	<ul style="list-style-type: none"> • Check the setting of the recipe file. • Correct the value of the record number to be specified.
	Is the record number which is larger than the number of the records specified?	<ul style="list-style-type: none"> • Change the record number of the recipe file.
	Is the order of the record number in the recipe file in series (1, 2, ... 255, 256)?	<ul style="list-style-type: none"> • Correct the record number of the recipe file in series.
	Is the fixed string area as the format?	<ul style="list-style-type: none"> • Set the fixed string area as the recipe format.
	Is the upper limit of the number of blocks, the number of records, the number of data exceeded?	<ul style="list-style-type: none"> • Set each of the number of blocks, the number of records, the number of data in one recipe file not to exceed 256.
	Does the blank row, the blank column exist between the blocks, the records?	<ul style="list-style-type: none"> • Delete the blank row, the blank column between the blocks, the records.
	Is the data written in the record attribute "P"?	<ul style="list-style-type: none"> • Correct the attribute of the target record. • Change the specified record number.
	Does the blank exist in the device value of the record attribute other than "N"?	<ul style="list-style-type: none"> • Set the device value. • Add "N" to the record attribute.
	Is the data read when the device value of the record attribute "N" is blank?	<ul style="list-style-type: none"> • After executing writing, read the data.
	Is the device value within the range that can be expressed with specified data type?	<ul style="list-style-type: none"> • Correct the setting value of the device value.
	Is the data configurable in the recipe function?	<ul style="list-style-type: none"> • Check that the device, the data type, and the number of strings are configurable value in the recipe file.
	Is the access target CPU which does not exist specified?	<ul style="list-style-type: none"> • Check the setting of the access target CPU, and set the value of the exist access target CPU.
	Does specified recipe file exist in the recipe folder?	<ul style="list-style-type: none"> • Check the files in the recipe folder.
	Is the file which is occupied by other dedicated instruction specified?	<ul style="list-style-type: none"> • Interlock between the dedicated instructions which access to the same file.
	Is other dedicated instruction executing?	<ul style="list-style-type: none"> • Execute after other dedicated instruction completed.
	Is other recipe execution operation executing?	<ul style="list-style-type: none"> • Execute the recipe execution operation after other recipe execution operation completed.
Is the access state of the CompactFlash card "Access stop"?	<ul style="list-style-type: none"> • Execute "Access restart". ☞ Section 13.1.6 CompactFlash card diagnostics 	
Is the operating state of the module "Stop"?	<ul style="list-style-type: none"> • Execute "Restart" of "Module operation" and retry. ☞ Section 13.1.1 Module diagnostics • Execute "Update settings" of "Module operation" and retry. ☞ Section 13.1.1 Module diagnostics 	

(Continued on the next page)

(From the previous page)

Symptom	Check point	Corrective action
A file name is not displayed in the file list on the "Recipe Execution Operation" screen.	Does a recipe file exist in the RECIPE folder of the CompactFlash card?	<ul style="list-style-type: none"> • Store a recipe file in the RECIPE folder of the CompactFlash card.
	Is a unsupported character used for a recipe file name?	<ul style="list-style-type: none"> • Use supported characters for a recipe file name. <ul style="list-style-type: none"> ☞ Appendix 4.2 Characters usable in file names, folder (directory) names
	Does more than 257 CSV files exist in the RECIPE folder of the CompactFlash card?	<ul style="list-style-type: none"> • CSV files to be stored in the RECIPE folder of the CompactFlash card should be less than 256 files.
The file downloaded from the high speed data logger module via FTP is old. Its device values are the ones before executing the Write process.)	Were the settings for temporary internet files of Internet Explorer configured?	<ul style="list-style-type: none"> • Configure the settings for temporary internet files of Internet Explorer. <ul style="list-style-type: none"> ☞ Section 5.3.1 (3)
Recipe file data stored in a CompactFlash card which is inserted to a personal computer are changed.	Was the 'Write' process performed to the recipe files by the recipe function?	<ul style="list-style-type: none"> • Check the recipe execution history. <ul style="list-style-type: none"> ☞ Section 15.5.2 (2) Recipe execution history
	Was the file access stop performed before removing the CompactFlash card from the module disregarding the power ON/OFF status?	<ul style="list-style-type: none"> • Store the recipe files after performing the file access stop. <ul style="list-style-type: none"> ☞ Section 16.6 (1) Stopping file access • Use the file browser or FTP transfer function to store the recipe files. <ul style="list-style-type: none"> ☞ Section 13.2 File Browser ☞ Section 10.3 (2) FTP server function

APPENDIX

Appendix 1 External Dimensions

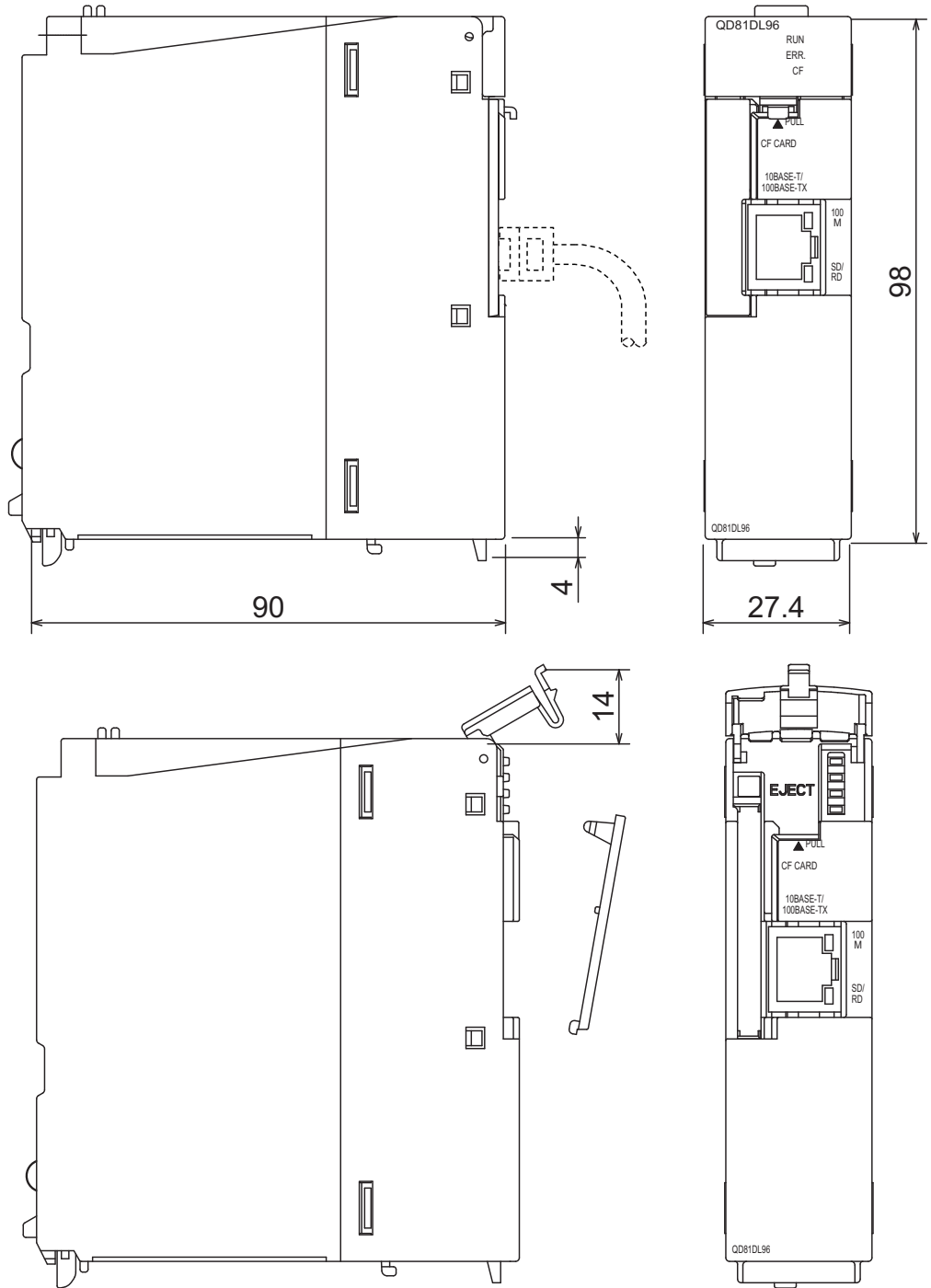

(unit: mm)

Appendix 2 PING Test

This section shows the example for checking the connection with the high speed data logger module by issuing the PING command to the high speed data logger module from an external device (DOS/V personal computer) connected on the same Ethernet network (LAN). (Example of checking the connection of the high speed data logger module with an external device on the same network address)

(1) Operating procedure

- ① Select [Start] → [Run] on the Windows® menu, enter 'cmd' and click the  button.

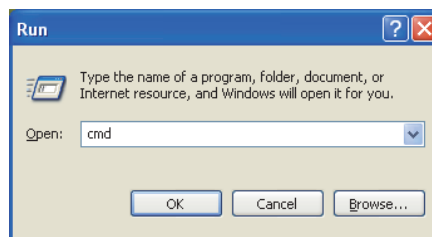

- ② Using the keyboard, enter the IP address of the high speed data logger module after 'ping'.

(2) Example

The following shows an example when the IP address of the high speed data logger module is 192.168.3.3.

```
>ping 192.168.3.3
```

(3) Output result

(a) When the communication was successful

```
>ping 192.168.3.3
Pinging 192.168.3.3 with 32 bytes of data:

Reply from 192.168.3.3: bytes=32 time<1ms TTL=128
Reply from 192.168.3.3: bytes=32 time<1ms TTL=128
Reply from 192.168.3.3: bytes=32 time<1ms TTL=128
Reply from 192.168.3.3: bytes=32 time<1ms TTL=128

Ping statistics for 192.168.3.3:
    Packets: Sent = 4, Received = 4, Lost = 0 (0% loss),
    Approximate round trip times in milli-seconds:
        Minimum = 0ms, Maximum = 0ms, Average = 0ms
```

(b) When the communication was unsuccessful

```
>ping 192.168.3.3
Pinging 192.168.3.3 with 32 bytes of data:

Request timed out.
Request timed out.
Request timed out.
Request timed out.

Ping statistics for 192.168.3.3:
    Packets: Sent = 4, Received = 0, Lost = 4 (100% loss),
```

When the communication was unsuccessful, check the following items and perform the PING test again.

- Network settings for the high speed data logger module or external device
- Cables, hub connection status, power status

POINT

The PING test is only valid when the transfer setup method is "Connection via hub".

It is invalid when the transfer setup method is "Direct connection".

Appendix 3 Data Sampling Method for CPUs that cannot be Accessed Directly

This section explains a method for sampling data from CPUs that cannot be accessed directly (hereafter, explained with Motion CPUs).

(1) Auto refresh using CPU shared memory in a multiple CPU system

By performing auto refresh using CPU shared memory between the QCPU and Motion CPU in a multiple CPU system, device values of the Motion CPU can be read to the QCPU.

By registering the device values read to the QCPU as data logging target data, data of the Motion CPU can be logged.

(2) Settings required for auto refresh

When the data logging function is executed to the Motion CPU, setting the auto refresh with GX Works 2 for the QCPU (CPU No. 1), and with MT Developer 2 for the Motion CPU (CPU No. 2) is required.

For auto refresh settings, refer to the manual below.

☞ QCPU User's Manual(Multiple CPU System)

(3) Example of acquiring the Motion CPU device values

(a) System configuration

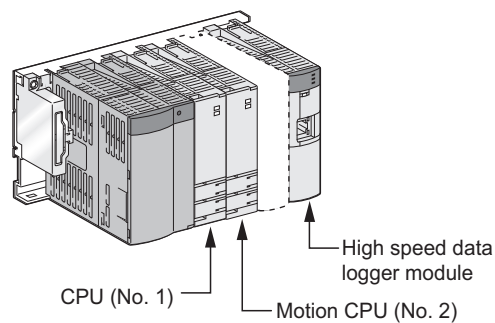

APPENDIX

(b) "Refresh settings" of the Motion CPU (CPU No. 2)

Set the number of transfer points and devices to be stored in the auto refresh area of the CPU shared memory of the Motion CPU with MT Developer 2.

(Example): Setting with MT Developer 2

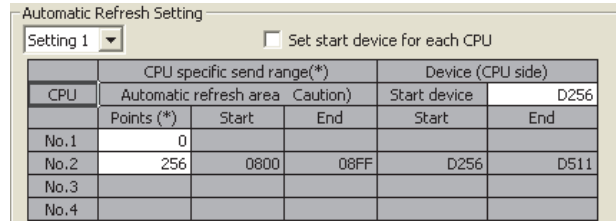

(c) "Refresh settings" of the QCPU (CPU No. 1)

Set the number of points and devices on the QCPU to which the data in the auto refresh area of the CPU shared memory of the Motion CPU are stored with GX Works 2.

(Example): Setting with GX Works 2

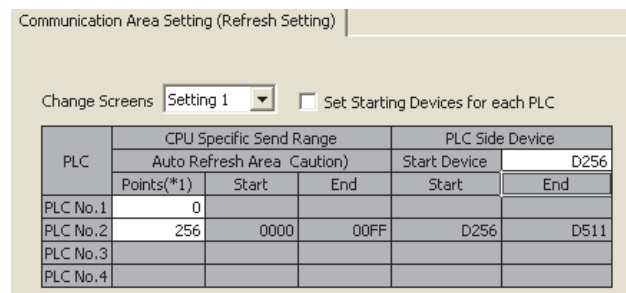

(d) High speed data logger module settings

Set the QCPU (CPU No. 1) devices (refresh configured devices) as the data logging target devices.

(Example): Set D256 to D511 as the data logging target devices.

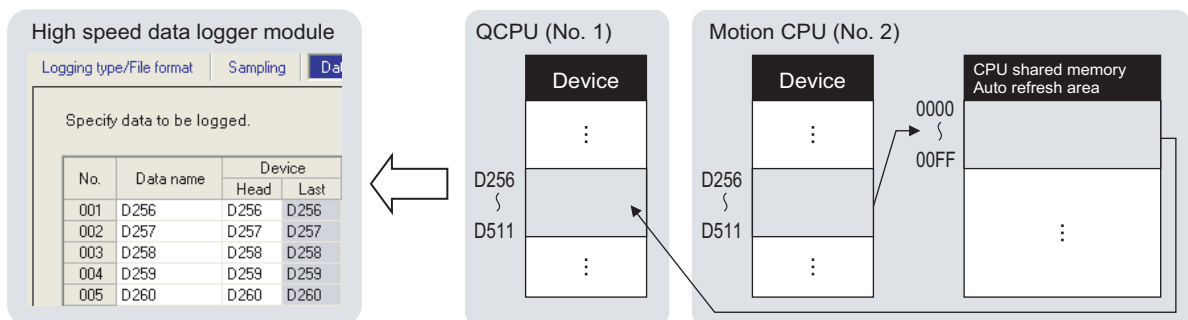

Remark

When the programmable controller CPU system is compatible with the 'multiple CPU high speed transmission function', a large amount of Motion CPU device values can be transferred to the QCPU (CPU No. 1) at an even faster speed. For 'multiple CPU high speed transmission function', refer to the manual below.

☞ QCPU User's Manual(Multiple CPU System)

APPENDIX

Appendix 4 Usable Characters

This section shows the characters which can be used in the setting items.

Appendix 4.1 Characters usable in high speed data logger module tool

(1) ASCII characters

The shaded portion can be used. However, there are characters which can only be used in the locations shown in (1) (b) Exception list (Configuration Tool), (1) (d) Exception list (Conversion Tool) in this section.

If entering of unusable characters is attempted, they cannot be entered in the entry field or there will be an error after entering them.

(a) Usable ASCII characters list

	0	1	2	3	4	5	6	7
0	NUL		(SP)	0	@	P	`	p
1			!	1	A	Q	a	q
2			"	2	B	R	b	r
3			#	3	C	S	c	s
4			\$	4	D	T	d	t
5			%	5	E	U	e	u
6			&	6	F	V	f	v
7			'	7	G	W	g	w
8			(8	H	X	h	x
9)	9	I	Y	i	y
A			*	:	J	Z	j	z
B			+	;	K	[k	{
C			,	<	L	\	l	
D			-	=	M]	m	}
E			.	>	N	^	n	~
F			/	?	O	_	o	

(b) Exception list (Configuration Tool)

No. *1	Corresponding ASCII character																
	(SP)*2	"	'*3	*	+	,	/	:	;	<	>	?	[\]		.
1	×	×	○	×	×	×	○	×	×	×	×	×	○	×	○	×	○
2	○	×	○	○	○	×	○	○	×	○	○	○	○	○	○	○	○
3	○	×	○	○	○	×	○	○	×	○	○	○	○	○	○	○	○
4	○	×	○	○	○	○	○	○	×	○	○	○	○	○	○	○	○
5	×	×	○	×	○	×	○	×	×	×	×	×	○	○	○	×	×
6	×	×	○	×	○	×	×	×	×	×	×	×	○	×	○	×	×
7	○	×	○	○	○	×	○	○	×	○	○	○	○	×	○	○	○
8	○	○	○	○	○	○	○	○	○	○	○	○	○	○	○	○	○
9	○	×	○	○	○	×	○	×	×	○	○	○	○	○	○	○	○
10	○	×	○	○	○	×	○	○	×	○	○	○	○	×	○	○	○
11	○	×	○	×	○	×	×	×	×	○	○	×	×	×	×	○	○
12	○	○	○	○	○	○	○	○	○	○	○	○	○	○	○	○	○

○: Usable ×: Unusable

*1: For the exception corresponding to No., refer to (1) (c) in this section.

*2: (SP) indicates a space.

*3: Cannot be used in the start/end of No. 11 (sheet name).

(c) Exception location list (Configuration Tool)

No.	Exception location
1	<ul style="list-style-type: none"> • Directory [File browser]
2	<ul style="list-style-type: none"> • Trigger value [Event logging setting] • Restoration value [Event logging setting] • FTP server name [FTP setting] • E-mail address [E-mail setting] • SMTP server name [E-mail setting] • POP server name [E-mail setting] • Following external device [Network setting] • Data name line string (Trigger information column) [Data logging setting] • Target device [Ping test]
3	<ul style="list-style-type: none"> • Name of access target CPU [Access target CPU setting] • Destination group name [E-mail setting] • Data logging name [Data logging setting] • Event logging name [Event logging setting] • Report name [Report setting] • Data name [Data logging setting/Event logging setting/Report setting] • ON (Output format (bit)) [Data logging setting] • OFF (Output format (bit)) [Data logging setting] • When trigger condition rises (Trigger information column) [Data logging setting] • When trigger condition falls (Trigger information column) [Data logging setting] • Event name [Event logging setting] • Comment at event occurrence [Event logging setting] • Comment at event restoration [Event logging setting] • E-mail subject [E-mail content setting] • E-mail text [E-mail content setting] • Device comment [Recipe editor] • Record comment [Recipe editor]
4	<ul style="list-style-type: none"> • Data name line string (Date column) [Data logging setting/Event logging setting] • Data line output format (Date column) [Data logging setting/Event logging setting] • E-mail address [E-mail setting]
5	<ul style="list-style-type: none"> • Directory path [FTP setting]
6	<ul style="list-style-type: none"> • File save destination [Data logging setting/Event logging setting/Report setting]
7	<ul style="list-style-type: none"> • Host name [Network setting]
8	<ul style="list-style-type: none"> • All passwords
9	<ul style="list-style-type: none"> • All user names
10	<ul style="list-style-type: none"> • Layout name (Data logging layout setting) [Report setting] • Layout name (Current value layout setting) [Report setting] • Layout name (Current time layout setting) [Report setting] • Leading cell (Data logging layout setting) [Report setting] • Cell range (Current value layout setting) [Report setting] • Cell (Current time layout setting) [Report setting]
11	<ul style="list-style-type: none"> • Sheet name [Report setting]
12	<ul style="list-style-type: none"> • Comment [Main screen] • Save folder path [GX Works2 project selection/GX Developer project selection]

APPENDIX

(d) Exception list (Conversion Tool)

No. *1	Corresponding ASCII character																	
	(SP)*2	"	'*3	*	+	,	/	:	;	<	>	?	[\]		.	
1*1	○	○	○	○	○	○	○	○	○	○	○	○	○	○	○	○	○	○
2	○	×	○	○	○	×	○	○	×	○	○	○	○	○	○	○	○	○
3	○	×	○	○	○	×	○	○	×	○	○	○	○	○	○	○	○	○
4	○	×	○	○	○	○	○	○	×	○	○	○	○	○	○	○	○	○

*1: When an incorrect file path is specified, an error occurs at the execution.

(e) Exception location list (Conversion Tool)

No.	Exception location
1	• Conversion target (CSV file) [Main screen]
2	• When trigger condition rises (Trigger information column) [Output format screen] • When trigger condition falls (Trigger information column) [Output format screen] • ON [Output format (bit) screen] • OFF [Output format (integer/float) screen]
3	• Data name line string (Trigger information column) [Output format screen]
4	• Data name line string (Date column) [Output format screen] • Data line output format (Date column) [Output format screen]

Appendix 4.2 Characters usable in file names, folder (directory) names

This section shows the characters which can be used in the file names of the logging file and recipe file, and folder (directory) names in the CompactFlash card.

The shaded portion can be used.

	0	1	2	3	4	5	6	7
0	NUL		(SP)	0	@	P	`	p
1			!	1	A	Q	a	q
2			"	2	B	R	b	r
3			#	3	C	S	c	s
4			\$	4	D	T	d	t
5			%	5	E	U	e	u
6			&	6	F	V	f	v
7			'	7	G	W	g	w
8			(8	H	X	h	x
9)	9	I	Y	i	y
A			*	:	J	Z	j	z
B			+	;	K	[k	{
C			,	<	L	\	l	
D			-	=	M]	m	}
E			.	>	N	^	n	~
F			/	?	O	_	o	

Appendix 4.3 Characters usable in output file

(1) Configuration Tool

The following table shows the characters which can be used in the CSV file and XLS file when the data type is String.

The shaded portion can be used.

	0	1	2	3	4	5	6	7
0	NUL		(SP)	0	@	P	`	p
1			!	1	A	Q	a	q
2			"*1	2	B	R	b	r
3			#	3	C	S	c	s
4			\$	4	D	T	d	t
5			%	5	E	U	e	u
6			&	6	F	V	f	v
7			'	7	G	W	g	w
8			(8	H	X	h	x
9)	9	I	Y	i	y
A			*	:	J	Z	j	z
B			+	;*1	K	[k	{
C			,"*1	<	L	\	l	
D			-	=	M]	m	}
E			.	>	N	^	n	~
F			/	?	O	_	o	

*1: The characters listed above cannot be used when outputting CSV file.

If the characters listed above are used when outputting CSV file, they are substituted with periods (.).

APPENDIX

(2) Conversion Tool

The following table shows the characters which can be used when the CSV file is output.

The shaded portion can be used. ("." is output for the characters which cannot be used.)

	0	1	2	3	4	5	6	7
0	NUL		(SP)	0	@	P	`	p
1			!	1	A	Q	a	q
2			"	2	B	R	b	r
3			#	3	C	S	c	s
4			\$	4	D	T	d	t
5			%	5	E	U	e	u
6			&	6	F	V	f	v
7			'	7	G	W	g	w
8			(8	H	X	h	x
9)	9	I	Y	i	y
A			*	:	J	Z	j	z
B			+	;*1	K	[k	{
C			,*1	<	L	\	l	
D			-	=	M]	m	}
E			.	>	N	^	n	~
F			/	?	O	_	o	

Appendix 5 Adding Function to High Speed Data Logger Module

The following table shows the added function of the high speed data logger module and high speed data logger module tool, and serial number and software version of the compatible module.

Added function ^{*1}	Corresponding function	First 5 digits of high speed data logger module serial number	Software version of high speed data logger module tool	Reference	
Compatible with the English version of Configuration Tool ^{*2} .	-	11052 or higher	1.01B or later	-	
"Module operation" is added to the module diagnostics.	Diagnostics	11102 or higher	1.02C or later	Section 13.1.1	
"CompactFlash card diagnostics" function is added.				Section 13.1.6	
The "Saved file name setting" screen on which additional information of the saved file name can be edited is added to add date/time/data name to the saved file name.	Data logging/Event logging/Report			Section 11.5.15	
"Data conditions" is added to the condition of the file switching timing.	Data logging / Event logging			Section 11.6.13	
"Source file" is added to "Data logging layout" screen.	Report			Section 11.7.8	
"At the time of the data logging file is switched" is added to the condition of the creation trigger.				Section 11.5.15	
"CompactFlash card setting" is added to "Common setting".				Section 11.6.13	
The time to create a report is shortened.	Common Setting			Section 11.7.5	
The function of copying/pasting in cell units is added in setting list of table format which can be entered.	-			-	Section 11.7.6
The viewer utility is separated from the high speed data logger module tool and its name is changed to GX LogViewer.	-			-	-
The software name 'High speed data logger module configuration utility' is changed to 'High speed data logger module Configuration Tool'.	-	-	-	Section 11.2.6	
"Recipe" function is added. ^{*3}	Recipe	-	-	Section 1.3	
The resend function when transfer and e-mail failed is added.	Saved file transfer	12062 or higher	1.03D or later	Chapter 15	
The notification function when FTP transfer completed is added.				Section 11.4.4	
The "Ping test" function is added.	Diagnostics			Section 11.4.5	
"Module time" is added to "Module diagnostics" function.				Section 11.4.4	
"Time interval specification" is added to general sampling.	Data logging/Event logging/Report			Section 13.1.10	
"Time interval specification" is added to trigger condition.	Data logging/ Report			Section 13.1.1	
"Time interval specification", "Compound condition" are added to the file switching timing.	Data logging/Event logging			Section 11.5.4	
"E-mail content setting" screen which e-mail transmission contents can be edited is added to use the tag format such as date and time, can be used in e-mail subject and text.	Data logging/Event logging/Report			Section 11.6.4	
				Section 11.7.3	
				Section 11.5.10	
		Section 11.5.11			
		Section 11.7.6			
		Section 11.5.15			
		Section 11.6.13			
		Section 11.5.15			
		Section 11.6.13			
		Section 11.7.8			

- : Function not related to a serial number or software version
(Continued on the next page)

APPENDIX

(From the previous page)

Added function*1	Corresponding function	First 5 digits of high speed data logger module serial number	Software version of high speed data logger module tool	Reference
Compatible with Windows® 7.	-	-	1.03D or later	Section 2.4
The function of importing global labels and device comments from programming tool is added.	Import global label/device comment			Section 11.2.10
The function of exporting the setting information of the project to CSV file is added.	Project management			Section 11.3.5
The function of importing the setting information from the saved project files is added.	Project management			Section 11.3.4
The number of logging lines before and after the trigger is extended.	Data logging			Section 11.5.12
The number of period and trigger conditions combined is extended.	Data logging/Event logging/Report			Section 3.1
"LCPUCPU", "C Controller" are added to the applicable systems (access target CPU).	-	12062 or higher	-	Section 2.2 Section 3.2
The function to fix a directory which transfers logging files to one directory is added.	FTP transfer	13012 or higher	-	Section 4.5 Appendix 11
Windows® 7 (64-bit version) is supported.	-	-	1.04E or later	Section 2.4
The function to output error history in the CSV file format is added.	Diagnostics	-	1.04E or later	Section 13.1.1
The time to write the settings to a module is shortened.	-	-	1.05F or later	-
Microsoft® Excel® 2010 (32-bit-version) is supported.	-	14042 or higher	1.06G or later	Section 2.4
The maximum number of lines (number of records) that can be logged is extended.	Data logging/ Event logging			Section 3.1
Multiple selection of "File switching timing" is enabled.				Section 11.5.15 Section 11.6.13
"Attached time (date) type" is added on the "Saved file name setting" screen.				Section 11.5.15
Accessing CC-Link IE Field network is enabled.				Access target CPU setting
The setting of station No.0 is enabled.	Section 4.5			
The setting of whether to fix the FTP transfer target folder can be selected.	FTP transfer	13092 or higher	-	Section 4.5
The Logging File Conversion Tool is added to the high speed data logger module tool.	-	-	1.07H or later	Chapter 14
Q03UDVCPUCPU, Q04UDVCPUCPU, Q06UDVCPUCPU, Q13UDVCPUCPU, Q26UDVCPUCPU, and Q24DHCCCPU-V are added to the applicable systems (access target CPUs).	-	14122 or higher	1.07H or later	Section 2.2 Section 3.2
L02SCPU, L02CPU-P, L26CPU, and L26CPUPBT are added to the access target CPU.	-	14122 or higher	-	Section 3.2
The function to import global labels/device comments in High-speed Universal model QCPU, Process CPU, or Redundant CPU is added.	Import global label/device comment	-	1.08J or later	Section 11.2.10
When the invalid merged cells are exist in the layout settings of report settings, an error message is displayed at the report setting completion.	Report setting	-		Section 11.7.5

- : Function not related to a serial number or software version
(Continued on the next page)

APPENDIX

(From the previous page)

Added function *1	Corresponding function	First 5 digits of high speed data logger module serial number	Software version of high speed data logger module tool	Reference
L02SCPU-P, L06CPU, L06CPU-P, L26CPU-P, Q24DHCCPU-LS are added to the access target CPU.	-	15102 or higher	1.09K or later	Section 3.2
Microsoft® Excel® 2013 (32-bit-version) is supported.	-	-		Section 2.4
Compatible with Windows® 8 and Windows®8.1.	-	-		
Internet Explorer® 9, Internet Explorer® 10, and Internet Explorer® 11 are supported.	-	-		
The extensions of the supported file types are displayed on the "Save As" dialog of file browser.	-	-		-
Processing time of FTP transfer function and e-mail function is changed.	-	15112 or higher	1.10L or later	Appendix 8.2
The port number of the FTP server to be accessed can be specified.	FTP transfer	17092 or higher	-	Section 4.5 Section 3.4.17
Compatible with Windows® 10.	-	-	1.13P or later	Section 2.4
Microsoft® Excel® 2016 (32-bit-version) is supported.	-	18122 or higher	1.14Q or later	Section 2.4
A function to disable periodic time synchronization (once in 24 hours) with a programmable controller CPU is added.	Switch settings for Intelligent function module	18122 or higher	-	Section 4.5 Section 10.1
Microsoft Excel 2019, Microsoft Excel 2021, and Microsoft 365 are supported.	-	26032 or higher	1.15R or later	Section 2.4

- : Function not related to a serial number or software version

- *1: When the 'Read' (Verify) function is performed in the Configuration Tool which does not support the added functions, an error message "Setting were not found on the module. Read is suspended." may be displayed. To use the added functions, use the Configuration Tool which supports the functions.
- *2: The English version of Configuration Tool is activated when the application is started online under the English operating system.
- *3: Using dedicated instruction, this function can be executed without using high speed data logger module tool.

Appendix 6 Numerical Type Comparison Accuracy

When a numerical type (integer type and float type shown in Section 3.9) data value and a constant are compared with a comparison operator ("=", "≠", "≤", "≥"), the fractional part of the data value is rounded off to the number of digits matched with the one for the comparison target constant.

For a data value used for scaling, it is rounded off after the scaling is performed.

Example) When a data value is: 11.23465673, and a comparison operator is: "≤"

① When a comparison target constant is: 11.23

The data value is rounded off to 11.23, and the condition ($11.23 \leq 11.23$) is established.

② When a comparison target constant is: 11.230

The data value is rounded off to 11.235, and the condition ($11.235 \leq 11.230$) is not established.

Appendix 7 Precautions when Replacing Older Version of Module

When a high speed data logger module is replaced, access the module after deleting the temporary Internet files of Web browser (cache). For deleting temporary Internet files, refer to Section 5.3.1.

Appendix 8 Process Modifications

This section shows the modifications to the process of the high speed data logger module.

Modified function	Setting	Reference
File switching timing	<ul style="list-style-type: none"> • [Data logging setting] → [Save] → "File switching timing" • [Event logging setting] → [Save] → "File switching timing" 	Appendix 8.1 Section 11.5.15 (2) Section 11.6.13 (2)
Processing time of FTP transfer function and e-mail function	-	Appendix 8.2

Appendix 8.1 File switching timing

Timing to save a storing file as a data logging file or event logging file may differ depending on the function version (the first five digits of a serial number) of the high speed data logger module.

(1) When the first five digits of a serial number are '11101' or lower

(a) Description

File switching timing	Description
Number of lines (number of records) specification	Switches the file when he specified number of lines (records) is exceeded. Example) When 1000 lines is specified, the file is switched immediately before the output of the 1001st line.
File size specification	Switches the file when the specified file size is exceeded. (10KB to 16384KB)
Condition specification	Switches the file when the specified condition is fulfilled. The file switching is not performed if the condition is fulfilled during the period when logging is not executed. [Fixed cycle/Specifying a time of day] The file switching is not performed at power on when the specified cycle elapses or the specified time comes during the period from power OFF to power ON.
Trigger logging unit	Outputs the number of lines worth of data after the trigger, and switches the file at the when the next trigger occurs.

The file switching timing is the timing when a storing file is saved to another directory with another specified name.

APPENDIX

(b) Operation example

The following show operation examples of the file switching under each setting. The file switching (processing described below) is performed at the timing of "** File switching" in each operation example.

- Create a saved file
- Transfer the saved file to the FTP server or mail server (When the transfer setting is set)

① Number of lines (number of records) specification

Example) "Number of records": 1000 lines

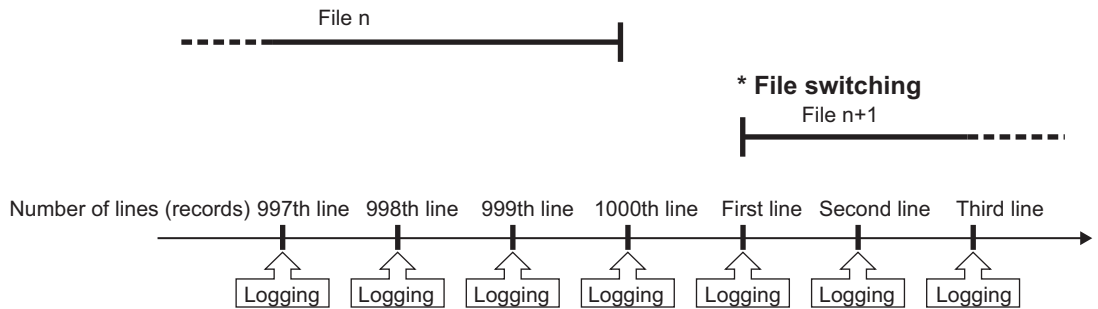

② File size specification

Example) "File size": 512KB

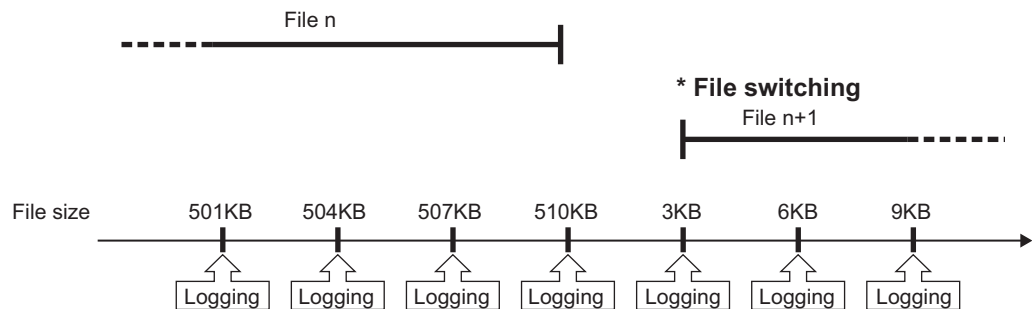

③ Condition specification (Fixed cycle/Specifying a time of day/At startup of module)

Example 1) "Specifying a time of day": 0 o'clock

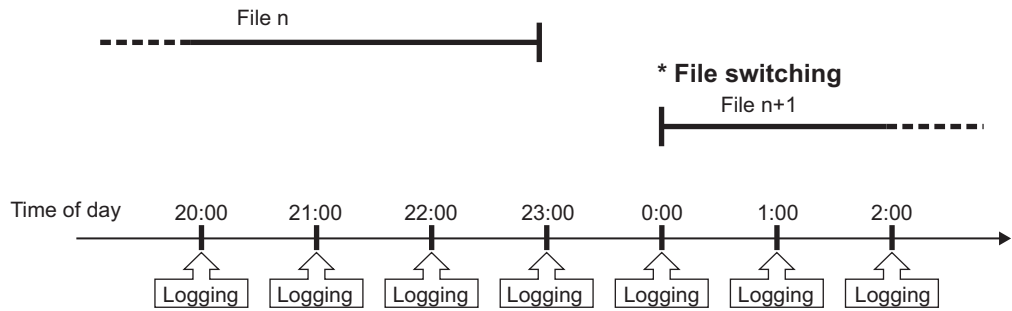

Example 2) "Specifying a time of day": 0 o'clock,
"Logging period": 1 to 22 o'clock

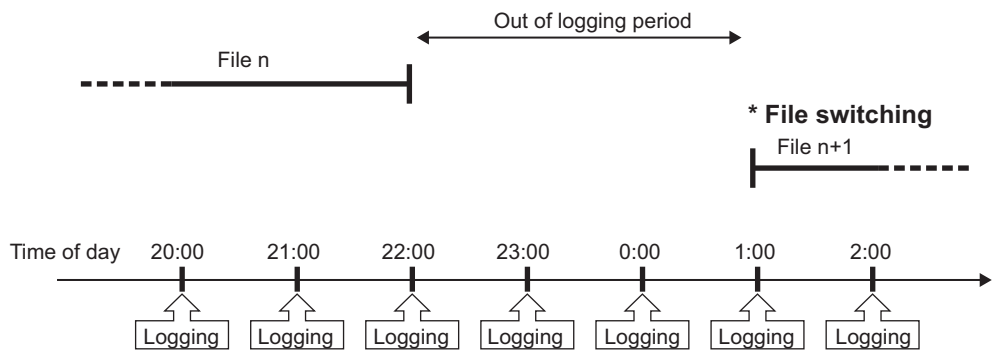

Example 3) "Specifying a time of day": 0 o'clock,
Programmable controller system is OFF from 22:30 to 0:30

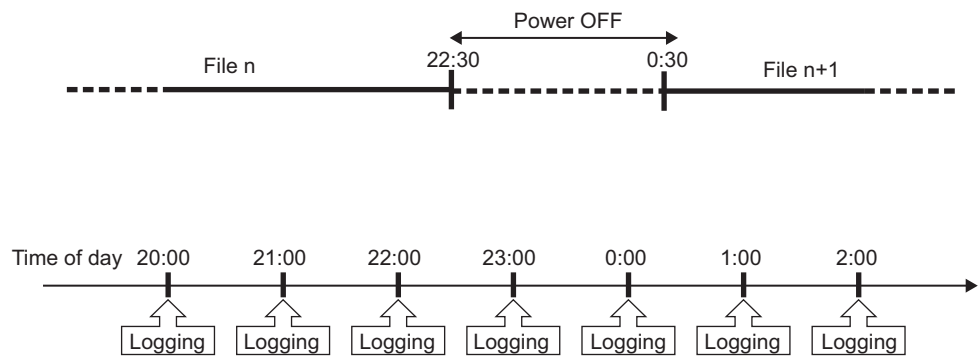

Data are continuously output to the file n.

Example 4) Startup of module

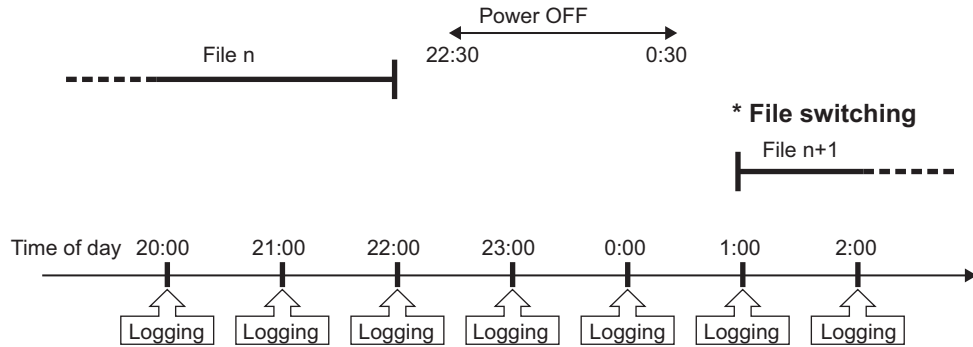

④ Trigger logging unit

Example) "Trigger condition": M0=ON, "Before trigger": 100 lines, "After trigger": 50 lines

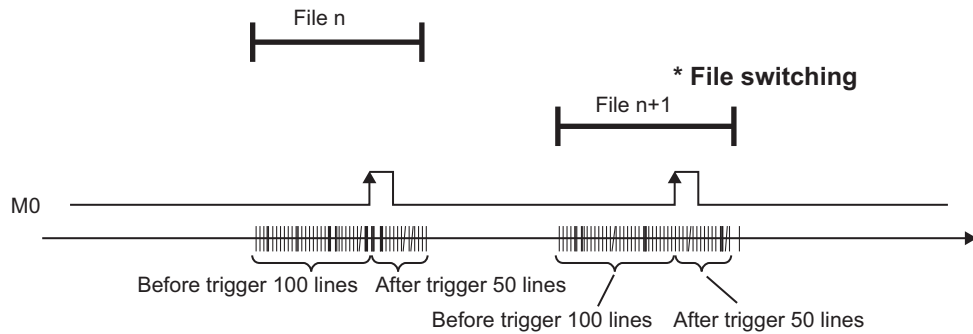

(2) When the first five digits of a serial number are '11102' or higher

For the operation at the timing of the file switching, refer to the following section.

☞ Section 11.5.15 (2) File switching timing

To perform the file switching at the same timing as that with the high speed data logger module with a serial number whose first five digits are '11101' or lower, set the compatibility setting (switch 4) of the intelligent function module switch setting.

☞ Section 4.5 (4) Compatibility setting (Switch 4)

Appendix 8.2 Processing time of FTP transfer function and e-mail function

Since the processing time of FTP transfer function and e-mail function changes depending on the settings, file size, and the status of network and server, the operation may not operate with the set timing.

Fully examine the processing time for each function at system construction before operating the system.

Additionally, the following conditions may affect the FTP transfer function and e-mail function: when the CPU which does not exist in the access target CPU is set using high speed data logger function version (first 5 digits of serial number) as shown below, or the high speed data logger cannot communicate with the access target CPU temporary because of the power interruption of access target CPU or network failure.

(1) Serial number whose first five digits are "15111"

When the following conditional expression is satisfied, 071BH (FTP transfer queue full error), 0713H, or 0716H (mail send queue full error) occurs, and FTP transfer and e-mail send may fail.

[Condition expression]

$$\text{Number of FTP transfer or e-mail send per minute} > \frac{384}{(RT1 + RT2 + \dots + RTn)}$$

RTn: Response monitoring time of nth access target CPU which cannot perform communication

( Section 4.5 (3) Response monitoring time setting (Switch 3 (lower byte)))

Use high speed data logger modules with the status that can communicate with the CPU set as access target CPU.

(2) Serial number whose first five digits are "15112"

There is no affection for the FTP transfer function and e-mail function.

Appendix 9 Supported FTP Command

The following table shows the FTP commands that are supported in the FTP server function of the high speed data logger module.

(1) FTP commands defined by RFC959

Command	Description
HELP	Help
USER	User name
PASS	Password
CWD	Change working directory
QUIT	Log out
PORT	Data port
PASV	Passive mode
TYPE	Transfer mode
RETR	Retrieve
DELE	Delete
RMD	Remove directory
PWD	Print working directory
LIST	File list
NLST	Name list
SYST	System
STOR	Store

(2) Windows standard FTP commands

Command	Description
binary	Notifies to transfer data without converting files.
bye	Disconnects and terminates a connection with an FTP server.
close	Disconnects a connection with an FTP server.
delete	Deletes a file in a high speed data logger module.
dir	Displays the file information of a high speed data logger module.
get	Reads a file from a high speed data logger module.
ls	Displays the file name of a high speed data logger module.
mdelete	Deletes a file in a high speed- data logger module.
mdir	Stores the file information of a high speed data logger module.
mget	Reads a file from a high speed data logger module.
mls	Reads the list of directories and files from a high speed data logger module.
mput	Writes files to a high speed data logger module.
open	Connects an FTP server with a personal computer.
put	Writes files to a high speed data logger module.
pwd	Displays the current directory of a high speed data logger module.
quit	Disconnects and terminates a connection with an FTP server.
quote ^{*1}	Sends the sub commands of an FTP server.
rename	Changes the file name of a high speed data logger module.
user	Enters the user name and password of a high speed data logger module.
ascii	Sets the mode of file transfer to ASCII.
cd	Changes the working directory.
disconnect	Returns to a command line by disconnecting a connection with an FTP server.
literal ^{*1}	Sends the sub commands of an FTP server.
recv	Acquires a file on an FTP server.
remotehelp	Displays the Help of an FTP command that can be executed on an FTP server.
rmdir	Deletes the directory of an FTP server.
send	Transfers a file to an FTP server.
type	Displays the current file transfer mode. (No FTP command transfer) By specifying a type name, the transfer mode is changed. (With FTP command transfer)

*1: These commands are supported, however, subcommands for high speed data logger modules are not provided.

Appendix 10 Setting information CSV File Format

(1) Format overview

Setting information CSV file is comprised of label column and setting area.

When multiple data is registered in one setting item, becomes array (array area) automatically.

Array area is the range between labels which are enclosed with '[', ']', and comprised of label column, item line and setting area.

The following diagram shows the format of setting information CSV file which is exported.

Example of a CSV file

Label column	Setting area
IPADTYPE	
IPADADRS	
IPADSUBNET	
IPADGATEWAY	
DNSSTYPE	
DNSSPRI	
DNSSSEC	
HOSTNAME	
DIAGNOSIS	
DIAGINTV	
DIAGDEST	
DIAGDEVICE	

Example of a CSV file that includes array area

Example: When 3 accounts are registered in the account setting function
(The area between [ACCOUNT_START] and [ACCOUNT_END] in label column becomes array area)

AUTH	TRUE					
[ACCOUNT_START]						
NO	USERNAME	AUTH	DELLOG	DELEVT	DELRPT	DELRCP
1	A	ADMIN				
2	B	MAINTE	YES	NO	YES	YES
3	C	NORMAL				
[ACCOUNT_END]						

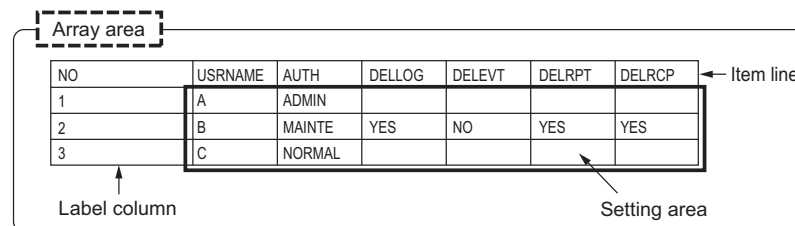

(2) CSV format specification

Item name	Description
Delimiter	Comma (,)
Linefeed code	CRLF (0x0D, 0x0A)
Character code	ASCII code
Field data	<ul style="list-style-type: none"> Not enclosed with double quotes ("). However, when double quotes ("), Comma (,), and CRLF(0x0D, 0x0A) are used in the field, enclosed with double quotes ("). When uses double quotes (") as characters, not as delimiter, use double quotes (") two consecutive times.
Number of lines	Maximum of 100003 lines*1
File size	Maximum of 16777216 bytes

*1: When using a high speed data logger module with a serial number whose first five digits are '14041' or lower, the maximum number of lines is 65538 (data lines + 3).

(3) Setting information CSV file list

The following explains the list of setting information CSV files which are exported. Only existing setting in data logging setting, event logging setting, and report setting are exported.

Setting	File name	Contents of settings
Common setting	QD81DL96.CSV	Project comment
	NETWORK.CSV	Network setting
	TIME.CSV	Time synchronization setting
	ACCESSCPU.CSV	Access target CPU setting
	FTP.CSV	FTP setting
	EMAIL.CSV	E-mail setting
	ACCOUNT.CSV	Account setting
	AUTOLOGGING.CSV	Auto logging setting
	HIGHSPEEDSAMP.CSV	High speed data sampling setting
	COMPACTFLASH.CSV	CompactFlash card setting
Data logging setting	CFG_LOG01.CSV	Data logging setting No.1
	CFG_LOG02.CSV	Data logging setting No.2
	:	:
	CFG_LOG64.CSV	Data logging setting No.64
Event logging setting	CFG_EVT01.CSV	Event logging setting No.1
	CFG_EVT02.CSV	Event logging setting No.2
	:	:
	CFG_EVT64.CSV	Event logging setting No.64
Report setting	CFG_REP01.CSV	Report setting No.01
	CFG_REP02.CSV	Report setting No.02
	:	:
	CFG_REP64.CSV	Report setting No.64

APPENDIX

(a) Project comment (QD81DL96.CSV)

Item	Setting	Description	Setting value	Remarks
CMNT	Project comment	-	String	-

(b) Network setting (NETWORK.CSV)

Item	Setting	Description	Setting value	Remarks
IPADTYPE	IP address setting	Obtain an IP address automatically.	AUTO	-
		Use the next IP address	SPECIFY	-
IPADADRS	IP address	When IPADTYPE is "SPECIFY"	*.*.*.*	This item is not applied in the following situation. • IPADTYPE is "AUTO"
IPADSUBNET	Subnet mask	When IPADTYPE is "SPECIFY"	*.*.*.*	This item is not applied in the following situation. • IPADTYPE is "AUTO"
IPADGATEWAY	Default gateway	When IPADTYPE is "SPECIFY"	*.*.*.* or (blank)	This item is not applied in the following situation. • IPADTYPE is "AUTO"
DNSSTYPE	DNS server setting	Acquire an IP address of DNS server automatically	AUTO	-
		Use the next DNS server address	SPECIFY	-
DNSSPRI	Primary server	When DNSSTYPE is "SPECIFY"	*.*.*.* or (blank)	This item is not applied in the following situation. • DNSSTYPE is "AUTO"
DNSSEC	Secondary server	When DNSSTYPE is "SPECIFY"	*.*.*.* or (blank)	This item is not applied in the following situation. • DNSSTYPE is "AUTO"
HOSTNAME	Host name	Host name	String	-
DIAGNOSIS	Execute network diagnoses	Turn on the checkbox	YES	-
		Turn off the checkbox	NO	-
DIAGINTV	Sending interval	When DIAGNOSIS is "YES"	10 to 3600	This item is not applied in the following situation. • DIAGNOSIS is "NO"
DIAGDEST	Destination	Specify "Gateway"	GATEWAY	This item is not applied in the following situation. • DIAGNOSIS is "NO"
		Specify following external device	FOLLOWING	
DIAGDEVICE	External device	When DIAGDEST is "FOLLOWING"	String	This item is not applied in the following situations. • DIAGNOSIS is "NO" • DIAGDEST is "GATEWAY"

APPENDIX

(c) Time synchronization setting (TIME.CSV)

Item	Setting	Description	Setting value	Remarks
SYNCTYPE	Method of synchronization	Specify PLC CPU synchronization	PLC	-
		Specify "Synchronize with SNTP"	SNTP	-
SNTPADRS	SNTP server address	When SYNCTYPE is "SNTP"	*.*.*	This item is not applied in the following situation. • SYNCTYPE is "PLC"
SNTPTIMEZONE	SNTP time zone	When SYNCTYPE is "SNTP"	+99:99	This item is not applied in the following situation. • SYNCTYPE is "PLC"
SNTPDST	Enable daylight saving	Turn on the checkbox	YES	This item is not applied in the following situation. • SYNCTYPE is "PLC"
		Turn off the checkbox	NO	
SNTPS_MONTH	Start - Month	When SNTPDST is "YES"	JAN, FEB, MAR, APR, MAY, JUN, JUL, AUG, SEP, OCT, NOV, DEC	This item is not applied in the following situations. • SYNCTYPE is "PLC" • SNTPDST is "NO"
SNTPS_TYPE	Specification method	Specify "Week"	WEEK	This item is not applied in the following situations. • SYNCTYPE is "PLC" • SNTPDST is "NO"
		Specify "Date"	DATE	
SNTPS_WEEKNUM	Start - Week	When SNTPS_TYPE is "WEEK"	1 to 4, LAST	This item is not applied in the following situations. • SYNCTYPE is "PLC" • SNTPDST is "NO" • SNTPS_TYPE is "DATE"
SNTPS_DAYWEEK	Start - Day of the week	When SNTPS_TYPE is "WEEK"	SUN, MON, TUE, WED, THU, FRI, SAT	This item is not applied in the following situations. • SYNCTYPE is "PLC" • SNTPDST is "NO" • SNTPS_TYPE is "DATE"
SNTPS_DAY	Start - Day	When SNTPS_TYPE is "DATE" and SNTPE_MONTH is 1, 3, 5, 7, 8, 10, 12	1 to 31, LAST	This item is not applied in the following situations. • SYNCTYPE is "PLC" • SNTPDST is "NO" • SNTPS_TYPE is "WEEK"
		When SNTPS_TYPE is "DATE" and SNTPE_MONTH is 4, 6, 9, 11	1 to 30, LAST	
		When SNTPS_TYPE is "DATE" and SNTPE_MONTH is 2	1 to 28, LAST	
SNTPS_HOUR	Start - Time	When SNTPDST is "YES"	00 to 23	This item is not applied in the following situations. • SYNCTYPE is "PLC" • SNTPDST is "NO"
SNTPE_MONTH	End - Month	When SNTPDST is "YES"	JAN, FEB, MAR, APR, MAY, JUN, JUL, AUG, SEP, OCT, NOV, DEC	This item is not applied in the following situations. • SYNCTYPE is "PLC" • SNTPDST is "NO"
SNTPE_TYPE	Specification method	Specify "Week"	WEEK	This item is not applied in the following situations. • SYNCTYPE is "PLC" • SNTPDST is "NO"
		Specify "Date"	DATE	

(Continued on the next page)

APPENDIX

(From the previous page)

Item	Setting	Description	Setting value	Remarks
SNTPE_WEEKNUM	End - Week	When SNTPE_TYPE is "WEEK"	1 to 4, LAST	This item is not applied in the following situations. • SYNCTYPE is "PLC" • SNTPDST is "NO" • SNTPE_TYPE is "DATE"
SNTPE_DAYWEEK	End - Day of the week	When SNTPE_TYPE is "WEEK"	SUN, MON, TUE, WED, THU, FRI, SAT	This item is not applied in the following situations. • SYNCTYPE is "PLC" • SNTPDST is "NO" • SNTPE_TYPE is "DATE"
SNTPE_DAY	End - Day	When SNTPE_TYPE is "DATE" and SNTPE_MONTH is 1, 3, 5, 7, 8, 10, 12	1 to 31, LAST	This item is not applied in the following situations. • SYNCTYPE is "PLC" • SNTPDST is "NO" • SNTPE_TYPE is "WEEK"
		When SNTPE_TYPE is "DATE" and SNTPE_MONTH is 4, 6, 9, 11	1 to 30, LAST	
		When SNTPE_TYPE is "DATE" and SNTPE_MONTH is 2	1 to 28, LAST	
SNTPE_HOUR	End - Time	When SNTPDST is "YES"	00 to 23	This item is not applied in the following situations. • SYNCTYPE is "PLC" • SNTPDST is "NO"
SNTPTIMING	Synchronization timing	Specify "Fixed cycle"	CYCLE	This item is not applied in the following situation. • SYNCTYPE is "PLC"
		Specify "Fixed time"	TIME	
SNTPINTERVAL	Interval	When SNTPTIMING is "CYCLE"	1 to 1440	This item is not applied in the following situations. • SYNCTYPE is "PLC" • SNTPTIMING is "TIME"
SNTPTIME	Time	When SNTPTIMING is "TIME"	99:99	This item is not applied in the following situations. • SYNCTYPE is "PLC" • SNTPTIMING is "CYCLE"
SNTPDAYWEEK_SUN	Sunday	Turn on the checkbox	YES	This item is not applied in the following situations. • SYNCTYPE is "PLC" • SNTPTIMING is "CYCLE"
		Turn off the checkbox	NO	
SNTPDAYWEEK_MON	Monday	Turn on the checkbox	YES	This item is not applied in the following situations. • SYNCTYPE is "PLC" • SNTPTIMING is "CYCLE"
		Turn off the checkbox	NO	
SNTPDAYWEEK_TUE	Tuesday	Turn on the checkbox	YES	This item is not applied in the following situations. • SYNCTYPE is "PLC" • SNTPTIMING is "CYCLE"
		Turn off the checkbox	NO	

(Continued on the next page)

APPENDIX

(From the previous page)

Item	Setting	Description	Setting value	Remarks
SNTPDAYWEEK_WED	Wednesday	Turn on the checkbox	YES	This item is not applied in the following situations. • SYNCTYPE is "PLC" • SNTPTIMING is "CYCLE"
		Turn off the checkbox	NO	
SNTPDAYWEEK_THU	Thursday	Turn on the checkbox	YES	This item is not applied in the following situations. • SYNCTYPE is "PLC" • SNTPTIMING is "CYCLE"
		Turn off the checkbox	NO	
SNTPDAYWEEK_FRI	Friday	Turn on the checkbox	YES	This item is not applied in the following situations. • SYNCTYPE is "PLC" • SNTPTIMING is "CYCLE"
		Turn off the checkbox	NO	
SNTPDAYWEEK_SAT	Saturday	Turn on the checkbox	YES	This item is not applied in the following situations. • SYNCTYPE is "PLC" • SNTPTIMING is "CYCLE"
		Turn off the checkbox	NO	

APPENDIX

(d) Access target CPU setting(ACCESSCPU.CSV)

Item	Setting	Description	Setting value	Remarks
[ACCESSCPU_START]	Start of the array area (access target CPU setting)	-	(blank)	-
((Array area))	Access target CPU setting	-	Refer to ① ACCESSCPU	-
[ACCESSCPU_END]	End of the array area (access target CPU setting)	-	(blank)	-

① ACCESSCPU

Item	Setting	Description	Setting value	Remarks
NO	No.	-	1 to 64	-
NAME	Access target CPU setting name	-	String	-
OTHETYPE	Other station specification	Specify "Own station"	OWN	-
		Specify "Other station"	OTHER	-
NT1MOD1	Module type (access source system)	When OTHETYPE is "OWN"	(blank)	-
		Specify "CC-Link IE Controller Network Module"	CCIEC	-
		Specify "CC-Link IE Field Network Module"	CCIEF	-
		Specify "MELSECNET/H Module"	NETH	-
		Specify "CC-Link Module"	CCLINK	-
		Specify "Ethernet Module"	ETHER	-
		Specify "Serial Communication Module"	SERIAL	-
NT1MOD1IO	Head I/O (module setting (access source system))	When OTHETYPE is "OWN"	(blank)	-
		In the following situations • NT1MOD1 is "CCIEC" • NT1MOD1 is "CCIEF" • NT1MOD1 is "NETH" • NT1MOD1 is "ETHER" • NT1MOD1 is "HSDL"	(blank)	-
		• NT1MOD1 is "CCLINK" • NT1MOD1 is "SERIAL"	0 to FE0	-
NT1MOD1STNO	Station No. (module setting (access source system))	When OTHETYPE is "OWN"	(blank)	-
		In the following situations • NT1MOD1 is "CCIEC" • NT1MOD1 is "CCIEF" • NT1MOD1 is "NETH" • NT1MOD1 is "ETHER" • NT1MOD1 is "CCLINK" • NT1MOD1 is "SERIAL"	(blank)	-
		When NT1MOD2 is "ETHERCPU"	(blank)	-
		When NT1MOD2 is "ETHERMOD"	1 to 64	-
NT1MOD2	Module type (access target (intervening) system)	When OTHETYPE is "OWN"	(blank)	-
		In the following situations • NT1MOD1 is "CCIEC" • NT1MOD1 is "CCIEF" • NT1MOD1 is "NETH" • NT1MOD1 is "ETHER" • NT1MOD1 is "CCLINK" • NT1MOD1 is "SERIAL"	(blank)	-
		Specify "Built-in Ethernet port"	ETHERCPU	-
	Specify "Ethernet module"	ETHERMOD	-	

(Continued on the next page)

APPENDIX

(From the previous page)

Item	Setting	Description	Setting value	Remarks
NT1MOD2ADRS	IP address (module setting (access target (intervening system))	When OTHERTYPE is "OWN"	(blank)	-
		In the following situations • NT1MOD1 is "CCIEC" • NT1MOD1 is "CCIEF" • NT1MOD1 is "NETH" • NT1MOD1 is "ETHER" • NT1MOD1 is "CCLINK" • NT1MOD1 is "SERIAL"	(blank)	-
		When NT1MOD1 is "HSDL"	**** (IP address)	-
NT1MOD2NETNO	Network No. (module setting (access target (intervening system))	When OTHERTYPE is "OWN"	(blank)	-
		In the following situations • NT1MOD1 is "CCIEC" • NT1MOD1 is "CCIEF" • NT1MOD1 is "NETH" • NT1MOD1 is "ETHER"	1 to 239	-
		In the following situations • NT1MOD1 is "CCLINK" • NT1MOD1 is "SERIAL"	(blank)	-
		When NT1MOD2 is "ETHERCPU"	(blank)	-
		When NT1MOD2 is "ETHERMOD"	1 to 239	-
NT1MOD2STNO	Station No. (module setting (access target (intervening system))	When OTHERTYPE is "OWN"	(blank)	-
		IN the following situations • NT1MOD1 is "CCIEC" • NT1MOD1 is "CCIEF" • NT1MOD1 is "NETH" • NT1MOD1 is "ETHER"	0 to 120	-
		When NT1MOD1 is "CCLINK"	0 to 63	-
		When NT1MOD1 is "SERIAL"	0 to 31	-
		When NT1MOD2 is "ETHERCPU"	(blank)	-
		When NT1MOD2 is "ETHERMOD"	1 to 120	-
NT1USECO	Use the co- existence network route	When OTHERTYPE is "OWN"	(blank)	-
		Turn on the checkbox	YES	-
		Turn off the checkbox	NO	-

(Continued on the next page)

APPENDIX

(From the previous page)

Item	Setting	Description	Setting value	Remarks	
NT2MOD1	Network route	Module type (intervening system)	When OTHERTYPE is "OWN"	(blank)	-
			When NT1USECO is "NO"	(blank)	-
			Specify "CC-Link IE Controller Network Module"	CCIEC	-
			Specify "CC-Link IE Field Network Module"	CCIEF	-
			Specify "MELSECNET/H Module"	NETH	-
			Specify "CC-Link Module"	CCLINK	-
			Specify "Ethernet Module"	ETHER	-
NT2MOD1IO	Head I/O (module setting (intervening system))	When OTHERTYPE is "OWN"	(blank)	-	
		When NT1USECO is "NO"	(blank)	-	
		In the following situations • NT2MOD1 is "CCIEC" • NT2MOD1 is "CCIEF" • NT2MOD1 is "NETH" • NT2MOD1 is "ETHER"	(blank)	-	
		In the following situations • NT2MOD1 is "CCLINK" • NT2MOD1 is "SERIAL"	0 to FE0	-	
NT2MOD1NETNO	Network route	Network No. (module setting (access target system))	When OTHERTYPE is "OWN"	(blank)	-
			When NT1USECO is "NO"	(blank)	-
			In the following situations • NT2MOD1 is "CCIEC" • NT2MOD1 is "CCIEF" • NT2MOD1 is "NETH" • NT2MOD1 is "ETHER"	1 to 239	-
			In the following situations • NT2MOD1 is "CCLINK" • NT2MOD1 is "SERIAL"	(blank)	-
NT2MOD1STNO	Co-existence network route	Station No. (module setting (access target system))	When OTHERTYPE is "OWN"	(blank)	-
			When NT1USECO is "NO"	(blank)	-
			In the following situations • NT2MOD1 is "CCIEC" • NT2MOD1 is "CCIEF" • NT2MOD1 is "NETH" • NT2MOD1 is "ETHER"	0 to 120	-
			When NT2MOD1 is "CCLINK"	0 to 63	-
			When NT2MOD1 is "SERIAL"	0 to 31	-
MLTCPU	Multiple CPU specification	Multiple CPU specification	Not specified	NOTSPECIFY	-
			Specify "Programmable controller CPU No. 1"	1st	-
			Specify "Programmable controller CPU No. 2"	2nd	-
			Specify "Programmable controller CPU No. 3"	3rd	-
			Specify "Programmable controller CPU No. 4"	4th	-

(Continued on the next page)

APPENDIX

(From the previous page)

Item	Setting	Description	Setting value	Remarks
CMPGLABL	Use global label	Turn on the checkbox	YES	-
		Turn off the checkbox	NO	-
CMPGLABLPATH	Project path	When CMPGLABL is "NO"	(blank)	-
		When CMPGLABL is "YES"	String	-
CMPDCMNT	Use device comment	Turn on the checkbox	YES	-
		Turn off the checkbox	NO	-
CMPDCMNTIMPTYPE	Device comment import source	When CMPDCMNT is "NO"	(blank)	-
		Specify "GX Works2 project"	GXW2	-
		Specify "GX Developer project"	GD	-
CMPDCMNTPATH	Project path	When CMPDCMNT is "NO"	(blank)	-
		When CMPDCMNT is "YES"	String	-

APPENDIX

(e) FTP setting (FTP.CSV)

Item	Setting	Description	Setting value	Remarks
[FTP_START]	Start of the array area (FTP setting)	-	(blank)	-
((Array area))	FTP setting	-	Refer to ① FTP	-
[FTP_END]	End of the array area (FTP setting)	-	(blank)	-
OPTRESEND	Resend at the time of the transfer failed	Turn on the checkbox	YES	-
		Turn off the checkbox	NO	-
OPTRESENBUFFNUM	Resend buffer size ([number of items])	When OPTRESEND is "YES"	100 to 99999	This item is not applied in the following situation. • OPTRESEND is "NO"
OPTNOTICOMP	Notify the transfer completed	Turn on the checkbox	YES	-
		Turn off the checkbox	NO	-

① FTP

Item	Setting	Description	Setting value	Remarks
NO	No.	-	1 to 16	-
SRVNAME	FTP server name	-	String	-
USERNAME	Login user name	-	String	-
DIRPASS	Directory path	-	String	-
TRNMODE	Data transfer mode	Specify "PORT mode"	PORT	-
		Specify "PASV mode"	PASV	-

APPENDIX

(f) E-mail setting (EMAIL.CSV)

Item	Setting	Description	Setting value	Remarks
SENDSMTPSRV	SMTP server name (sender account setting)	-	String	-
SENDEMAIL	E-mail address (sender account setting)	-	String	-
SENDSMTPPORT	SMTP port number (sender account setting)	-	1 to 65535	-
SENDAUTH	This server has authentication requirements which have to be met (authentication setting (sender account setting))	Turn on the checkbox	YES	-
		Turn off the checkbox	NO	-
SENDTYPE	Method of authentication (authentication setting (sender account setting))	Specify "SMTP-Auth"	SMTP	This item is not applied in the following situation. • SENDAUTH is "NO"
		Specify "POP before SMTP"	POP	
SENDUSRNAME	User name (authentication setting (sender account setting))	When SENDAUTH is "YES"	String	This item is not applied in the following situation. • SENDAUTH is "NO"
SENDPOPSRV	POP server name (authentication setting (sender account setting))	When SENDTYPE is "POP"	String	This item is not applied in the following situations. • SENDAUTH is "NO" • SENDTYPE is "SMTP"
SENDPOPPORT	POP port number (authentication setting (sender account setting))	When SENDTYPE is "POP"	1 to 65535	This item is not applied in the following situations. • SENDAUTH is "NO" • SENDTYPE is "SMTP"
[MAILTARGET_START]	Start of the array area (target e-mail address setting)	-	(blank)	-
((Array area))	Target e-mail address setting	-	Refer to ① MAILTARGET	-
[MAILTARGET_END]	End of the array area (target e-mail address setting)	-	(blank)	-
OPTRESEND	Resend at the time of the sending failed	Turn on the checkbox	YES	-
		Turn off the checkbox	NO	-
OPTRESENBUFFER	Resend buffer size ([number of items])	When OPTRESEND is "YES"	100 to 99999	This item is not applied in the following situation. • OPTRESEND is "NO"

① MAILTARGET

Item	Setting	Description	Setting value	Remarks
NO	No.	-	1 to 16	-
NAME	Name of target group	-	String	-
EMAIL	E-mail address	-	String	-

APPENDIX

(g) Account setting (ACCOUNT.CSV)

Item	Setting	Description	Setting value	Remarks
AUTH	Use Account authentication function	Turn on the checkbox	YES	-
		Turn off the checkbox	NO	-
[ACCOUNT_START]	Start of the array area (account setting)	-	(blank)	This item is not applied in the following situation. • AUTH is "NO"
((Array area))	Account setting	When AUTH is "YES"	Refer to ① ACCOUNT	
[ACCOUNT_END]	End of the array area (account setting)	-	(blank)	

① ACCOUNT

Item	Setting	Description	Setting value	Remarks
NO	No.	-	1 to 16	-
USRNAME	Login user name	-	String	-
AUTH	Access authority	Specify "Administrator"	ADMIN	-
		Specify "Maintenance user"	MAINTE	-
		Specify "Normal user"	NORMAL	-
DELLOG	/LOGGING (file delete enable folder)	In the following situations • AUTH is "ADMIN" • AUTH is "NORMAL"	(blank)	-
		Turn on the checkbox	YES	-
		Turn off the checkbox	NO	-
DELEVT	/EVENT (file delete enable folder)	In the following situations • AUTH is "ADMIN" • AUTH is "NORMAL"	(blank)	-
		Turn on the checkbox	YES	-
		Turn off the checkbox	NO	-
DELRPT	/REPORT (file delete enable folder)	In the following situations • AUTH is "ADMIN" • AUTH is "NORMAL"	(blank)	-
		Turn on the checkbox	YES	-
		Turn off the checkbox	NO	-
DELRCP	/RECIPE (file delete enable folder)	In the following situations • AUTH is "ADMIN" • AUTH is "NORMAL"	(blank)	-
		Turn on the checkbox	YES	-
		Turn off the checkbox	NO	-

APPENDIX

(h) Auto logging setting (AUTOLOGGING.CSV)

Item	Setting	Description	Setting value	Remarks
ATLG	Enable the auto logging function	Turn on the checkbox	YES	-
		Turn off the checkbox	NO	-
STOPFILEMAX	Stop due to the number of files saved being exceeded (conditions for stopping the operation of module)	Turn on the checkbox	YES	This item is not applied in the following situation. • ATLG is "NO"
		Turn off the checkbox	NO	
STOPFILEMAXTYPE	When all of the saved files exceed a maximum number/When any of the saved files exceeds a maximum number (conditions for stopping the operation of module)	When all of the saved files exceed a maximum number	ALL	This item is not applied in the following situations. • ATLG is "NO" • STOPFILEMAX is "NO"
		When any of the saved files exceeds a maximum number	ANY	
STOPTIMER	Stop effected by a timer (conditions for stopping the operation of module)	Turn on the checkbox	YES	This item is not applied in the following situation. • ATLG is "NO"
		Turn off the checkbox	NO	
STOPTIMERTIME	Elapsed time (conditions for stopping the operation of module)	When STOPTIMER is "YES"	1 to 86400	This item is not applied in the following situations. • ATLG is "NO" • STOPFILEMAX is "NO"

(i) High speed data sampling setting (HIGHSPEEDSAMP.CSV)

Item	Setting	Description	Setting value	Remarks
HSTYPE	Batch data sampling mode	-	BATCH	-
	Split data sampling mode	-	SPLIT	-

(j) CompactFlash card setting (COMPACTFLASH.CSV)

Item	Setting	Description	Setting value	Remarks
FRCP	Specify free capacity	Turn on the checkbox	YES	-
		Turn off the checkbox	NO	-
TYPE	Specify percentage/ Specify size	Specify "Percentage specification"	PERCENT	This item is not applied in the following situation. • FRCP is "NO"
		Specify "Size specification"	SIZE	
PERCENT	Specify percentage	When TYPE is "PERCENT"	10 to 50	This item is not applied in the following situations. • FRCP is "NO" • TYPE is "SIZE"
SIZE	Specify size	When TYPE is "SIZE"	50 to 4096	This item is not applied in the following situations. • FRCP is "NO" • TYPE is "PERCENT"

APPENDIX

(k) Data logging setting (CFG_LOGnn.CSV)

Item	Setting	Description	Setting value	Remarks
NAME	Data logging name	-	String	-
TFFLGTP	Logging type	Specify "Continuous logging"	CONT	-
		Specify "Trigger logging"	TRIGGER	-
TFFFILE	File format	Specify "CSV file"	CSV	-
		Specify "Binary file"	BINARY	-
SMPTYPE	Sampling	Specify "High speed data sampling"	HIGHSPEED	-
		Specify "General sampling"	GENERAL	-
SMPHSPDTYPE	Sampling interval (high speed data sampling)	Specify "Each scanning cycle"	EACHSCAN	This item is not applied in the following situation. • SMPTYPE is "GENERAL"
		Specify "Time specification"	TIME	
SMPHSPDTIME	Specify the time (high speed data sampling-Sampling interval)	When SMPHSTYPE is "TIME"	1 to 32767	This item is not applied in the following situations. • SMPTYPE is "GENERAL" • SMPHSDTYPE is "EACHSCAN"
SMPHSPDCONT	Sample a consecutive series of devices	Turn on the checkbox	YES	This item is not applied in the following situation. • SMPTYPE is "GENERAL"
		Turn off the checkbox	NO	
SMPGNRLTYPE	Sampling interval (general sampling)	Specify "Time specification"	TIME	This item is not applied in the following situation. • SMPTYPE is "HIGHSPEED"
		Specify "Time interval specification"	ONHR	
SMPGNRLTIME	Specify the time (general sampling-sampling interval)	When SMPGNRLTYPE is "TIME"	0.1 to 0.9, 1 to 32767	This item is not applied in the following situations. • SMPTYPE is "HIGHSPEED" • SMPGNRLTYPE is "ONHR"
SMPGNRLONHRTIME	Specify the time interval (interval)	When SMPGNRLTYPE is "ONHR"	1, 2, 3, 4, 5, 6, 8, 10, 12, 15, 20, 24, 30, 60	This item is not applied in the following situations. • SMPTYPE is "HIGHSPEED" • SMPGNRLTYPE is "TIME"
SMPGNRLONHRUNIT	Specify the time interval (unit)	Specify "Hour"	HOUR	This item is not applied in the following situations. • SMPTYPE is "HIGHSPEED" • SMPGNRLTYPE is "TIME"
		Specify "Minute"	MIN	
		Specify "Second"	SEC	
[DAT_START]	Start of the array area (data setting)	-	(blank)	-
((Array area))	Data setting	-	Refer to ① DATA	-
[DAT_END]	End of the array area (data setting)	-	(blank)	-
PRD	Specify the time	Turn on the checkbox	YES	-
		Turn off the checkbox	NO	-

(Continued on the next page)

APPENDIX

(From the previous page)

Item	Setting	Description	Setting value	Remarks
PRDTYPE	Carry out the logging during the period of time which corresponds to prescribed conditions (Monitor the trigger)/Do not carry out the logging during the period of time which corresponds to prescribed conditions (Do not monitor the trigger)	Carry out the logging during the period of time which corresponds to prescribed conditions (Monitor the trigger)	CARRYOUT	This item is not applied in the following situation. • PRD is "NO"
		Do not carry out the logging during the period of time which corresponds to prescribed conditions (Do not monitor the trigger)	NOTCARRYOUT	
PRDCOMB	Conditions for combination	Specify "AND"	AND	This item is not applied in the following situation. • PRD is "NO"
		Specify "OR"	OR	
[PRDCOND_START]	Start of the array area (period of time and condition)	-	(blank)	This item is not applied in the following situation. • PRD is "NO"
((Array area))	Period of time and condition	When PRD is "YES"	Refer to ② PERIODOFTIME CONDITION	
[PRDCOND_END]	End of the array area (period of time and condition)	-	(blank)	
TRGCONDTYPE	Single condition/ Compound condition	Specify "Single condition"	SINGLE	This item is not applied in the following situation. • TFFLGTP is "CONT"
		Specify "Compound condition"	COMBINE	
TRGCOMPTYPE	Trigger type (compound condition only)	Specify "OR combine"	OR	This item is not applied in the following situations. • TFFLGTP is "CONT" • TRGCONDTYPE is "SINGLE"
		Specify "AND combine"	AND	
		Specify "Number of times"	TIMES	
		Specify "Order"	ORDER	
TRGCOMPTIMESTYPE	Conditions for occurrence (Number of times)	Specify "When a terminal condition holds true"	TERMINAL	This item is not applied in the following situations. • TFFLGTP is "CONT" • TRGCONDTYPE is "SINGLE" • TRGCOMPTYPE is other than "TIMES"
		Specify "When a specified number of times is exceeded"	EXCEED	
TRGCOMPTIMESNUMOPE	Number of counts (symbols)	Specify =	EQUAL	This item is not applied in the following situations. • TFFLGTP is "CONT" • TRGCONDTYPE is "SINGLE" • TRGCOMPTYPE is other than "TIMES" • TRGCOMPTIMESTYPE is "EXCEED"
		Specify ≠	NOTEQUAL	
		Specify ≥	GREATERTHAN EQUAL	
		Specify >	GREATERTHAN	
		Specify ≤	LESSTHAN EQUAL	
		Specify <	LESSTHAN	

(Continued on the next page)

APPENDIX

(From the previous page)

Item	Setting	Description	Setting value	Remarks
TRGCOMPTIMESNUM	Number of counts (numerals)	-	0-32767	This item is not applied in the following situations. <ul style="list-style-type: none"> • TFFLGTP is "CONT" • TRGCONDTYPE is "SINGLE" • TRGCOMPTYPE is other than "TIMES"
TRGCOMPORDERTYPE	Conditions for occurrence (order)	Specify "Detect abnormal pattern"	ABNORMAL	This item is not applied in the following situations. <ul style="list-style-type: none"> • TFFLGTP is "CONT" • TRGCONDTYPE is "SINGLE" • TRGCOMPTYPE is other than "ORDER"
		Specify "Detect normal pattern"	NORMAL	
TRGCOMPORDERTIMEOUT	Timeout detected	Turn on the checkbox	YES	This item is not applied in the following situations. <ul style="list-style-type: none"> • TFFLGTP is "CONT" • TRGCONDTYPE is "SINGLE" • TRGCOMPTYPE is other than "ORDER"
		Turn off the checkbox	NO	
[TRGCOND_START]	Start of the array area (trigger condition)	-	(blank)	This item is not applied in the following situation. <ul style="list-style-type: none"> • TFFLGTP is "CONT"
((Array area))	Trigger condition	When TFFLGTP is "TRIGGER"	Refer to ③ TRIGGERCONDITION	
[TRGCOND_END]	End of the array area (trigger condition)	-	(blank)	
LLNTYPE	Log data before and after the rising of trigger condition/Log data before trigger condition rises, while trigger condition holds true, and after trigger condition falls	Log data before and after the rising of trigger condition	RIBERIAF	This item is not applied in the following situation. <ul style="list-style-type: none"> • TFFLGTP is "CONT"
		Log data before trigger condition rises, while trigger condition holds true, and after trigger condition falls	RIBERISEFLAF	
LLNBEFOR	Before trigger	When TFFLGTP is "TRIGGER"	0 to 65534	This item is not applied in the following situation. <ul style="list-style-type: none"> • TFFLGTP is "CONT"
LLNAFTER	After trigger	When TFFLGTP is "TRIGGER"	1 to 65535	This item is not applied in the following situation. <ul style="list-style-type: none"> • TFFLGTP is "CONT"
LLNTOTAL	Total number of lines	When TFFLGTP is "TRIGGER"	1 to 65535	This item is not applied in the following situation. <ul style="list-style-type: none"> • TFFLGTP is "CONT"
CSVDATE	Output date column	Turn on the checkbox	YES	This item is not applied in the following situation. <ul style="list-style-type: none"> • TFFFILE is "BINARY"
		Turn off the checkbox	NO	
CSVDATESPFRMT	Specify the date format	Turn on the checkbox	YES	This item is not applied in the following situations. <ul style="list-style-type: none"> • TFFFILE is "BINARY" • CSVDATE is "NO"
		Turn off the checkbox	NO	

(Continued on the next page)

APPENDIX

(From the previous page)

Item	Setting	Description	Setting value	Remarks
CSVDATEDATSTR	Data name line string	When CSVDATESPFRMT is "YES"	String	This item is not applied in the following situations. <ul style="list-style-type: none"> • TFFFILE is "BINARY" • CSVDATE is "NO" • CSVDATESPFRMT is "NO"
CSVDATEFRMT	Data line output format	When CSVDATESPFRMT is "YES"	String	This item is not applied in the following situations. <ul style="list-style-type: none"> • TFFFILE is "BINARY" • CSVDATE is "NO" • CSVDATESPFRMT is "NO"
CSVTRIG	Output trigger information column	Turn on the checkbox	YES	This item is not applied in the following situations. <ul style="list-style-type: none"> • TFFFILE is "BINARY" • TFFLGTP is "CONT"
		Turn off the checkbox	NO	
CSVTRIGDATSTR	Data name line string	When CSVTRIG is "YES"	String	This item is not applied in the following situations. <ul style="list-style-type: none"> • TFFFILE is "BINARY" • TFFLGTP is "CONT" • CSVTRIG is "NO"
CSVTRIGRISE	When trigger condition rises	When CSVTRIG is "YES"	String	This item is not applied in the following situations. <ul style="list-style-type: none"> • TFFFILE is "BINARY" • TFFLGTP is "CONT" • CSVTRIG is "NO"
CSVTRIGFALL	When trigger condition falls	When CSVTRIG is "YES"	String	This item is not applied in the following situations. <ul style="list-style-type: none"> • TFFFILE is "BINARY" • TFFLGTP is "CONT" • CSVTRIG is "NO"
CSVINDX	Output index column	Turn on the checkbox	YES	This item is not applied in the following situations. <ul style="list-style-type: none"> • TFFFILE is "BINARY" • TFFLGTP is "CONT"
		Turn off the checkbox	NO	
BINDATE	Output date information	Turn on the checkbox	YES	This item is not applied in the following situation. <ul style="list-style-type: none"> • TFFFILE is "CSV"
		Turn off the checkbox	NO	
BINDATETYPE	In second/In nanosecond	Specify "In second"	SEC	This item is not applied in the following situations. <ul style="list-style-type: none"> • TFFFILE is "CSV" • BINDATE is "NO"
		Specify "In nanosecond"	NANOSEC	
BININDX	Output indexes	Turn on the checkbox	YES	This item is not applied in the following situation. <ul style="list-style-type: none"> • TFFFILE is "CSV"
		Turn off the checkbox	NO	
BINTRIG	Output trigger flag	Turn on the checkbox	YES	This item is not applied in the following situations. <ul style="list-style-type: none"> • TFFFILE is "CSV" • TFFLGTP is "CONT"
		Turn off the checkbox	NO	
SAVDEST	File save destination	-	String	

(Continued on the next page)

APPENDIX

(From the previous page)

Item	Setting	Description	Setting value	Remarks
SAVSWICTMNTYPE	File switching timing	Turn on only "Number of records specification"	RECORD	-
		Turn on only "File size specification"	FILESIZE	-
		Turn on only "Condition specification"	CONDITION	-
		Turn on only "Trigger logging unit"	TRIGGER	-
		Turn on multiple checkboxes	MULTI	-
SAVSWICTMNTYPE REC	Number of records specification	Turn on the checkbox	YES	This item is not applied in the following situation. • SAVSWICTMNTYPE is other than "MULTI"
		Turn off the checkbox	NO	
SAVSWICTMNTYPE FILE	File size specification	Turn on the checkbox	YES	
		Turn off the checkbox	NO	
SAVSWICTMNTYPE COND	Condition specification	Turn on the checkbox	YES	
		Turn off the checkbox	NO	
SAVSWICTMNTYPE TRIG	Trigger logging unit	Turn on the checkbox	YES	This item is not applied in the following situations. • TFFLGTP is "CONT" • SAVSWICTMNTYPE is other than "MULTI"
		Turn off the checkbox	NO	
SAVSWICTMNTYPE UM	Number of records	In the following situations • SAVSWICTMNTYPE is "RECORD" • SAVSWICTMNTYPE is "MULTI", and SAVSWICTMNTYPEPEREC is "YES"	100 to 100000	This item is not applied other than the situations written on the left.
SAVSWICTMNTYPE ZE	File size	In the following situations • When SAVSWICTMNTYPE is "FILESIZE" • SAVSWICTMNTYPE is "MULTI", and SAVSWICTMNTYPEFILE is "YES"	10 to 16384	This item is not applied other than the situations written on the left.
SAVSWICTMNTYPE COND	Single condition/ Compound condition	Specify "Single condition"	SINGLE	This item is not applied in the following situations. • SAVSWICTMNTYPE is "RECORD", "FILESIZE", or "TRIGGER". • SAVSWICTMNTYPE is "MULTI", and SAVSWICTMNTYPECOND is "NO"
		Specify "Compound condition"	COMBINE	
SAVSWICTMNTYPE COMP	Trigger type (compound condition only)	Specify "OR combine"	OR	This item is not applied in the following situations. • SAVSWICTMNTYPE is other than "SINGLE" • SAVSWICTMNTYPE is "RECORD", "FILESIZE", or "TRIGGER" • SAVSWICTMNTYPE is "MULTI", and SAVSWICTMNTYPECOND is "NO"
		Specify "AND combine"	AND	

(Continued on the next page)

APPENDIX

(From the previous page)

Item	Setting	Description	Setting value	Remarks
[SAVSWICTMNCND_START]	Start of the array area (file switching condition (each condition))	-	(blank)	This item is not applied in the following situations. • SAVSWICTMNTYPE is "RECORD", "FILESIZE", or "TRIGGER" • SAVSWICTMNTYPE is "MULTI", and SAVSWICTMNTYPECOND is "NO"
((Array area))	File switching condition (each condition)	-	Refer to ③ TRIGGERCONDITION	
[SAVSWICTMNCND_END]	End of the array area (file switching condition (each condition))	-	(blank)	
SAVNAMETYPE	Saved file name setting	Specify "Simple setting"	SIMPLE	-
		Specify "Detailed setting"	DETAILED	
SAVNAMESIMPNAME	Attach the name	Turn on the checkbox	YES	This item is not applied in the following situation. • SAVNAMETYPE is "DETAILED"
		Turn off the checkbox	NO	
SAVNAMESIMPDATE	Attach the date	Turn on the checkbox	YES	This item is not applied in the following situation. • SAVNAMETYPE is "DETAILED"
		Turn off the checkbox	NO	
SAVNAMESIMPTIME	Attach the time	Turn on the checkbox	YES	This item is not applied in the following situation. • SAVNAMETYPE is "DETAILED"
		Turn off the checkbox	NO	
SAVNAMEDETLFRMT	Format	When SAVNAMETYPE is DETAILED	String	This item is not applied in the following situation. • SAVNAMETYPE is "SIMPLE"
SAVNAMEDETLDATA1	Attached data setting <DATA1>	Turn on the checkbox	001 to 256, *001 to *256	This item is not applied in the following situation. • SAVNAMETYPE is "SIMPLE"
		Turn off the checkbox	NO	
SAVNAMEDETLDATA2	Attached data setting <DATA2>	Turn on the checkbox	001 to 256, *001 to *256	This item is not applied in the following situation. • SAVNAMETYPE is "SIMPLE"
		Turn off the checkbox	NO	
SAVNAMEIMPTIME	Attached time (date) type	File switching condition hold true time	CONDITION	This item is not applied in the following situations. • SAVNAMETYPE is "SIMPLE", and SAVNAMESIMPDATE and SAVNAMESIMPTIME are "NO" • SAVNAMETYPE is "DETAILED", and SAVNAMEDETLFRMT does not have time (date) information
		File creation time	FILECREATION	
SAVFNUM	Number of saved files	-	1 to 65535	-
SAVFNUMTYPE	Operation occurring when number of saved files is exceeded	Specify "Overwrite"	OVERWRITE	-
		Specify "Stop"	STOP	-

(Continued on the next page)

APPENDIX

(From the previous page)

Item	Setting	Description	Setting value	Remarks
SAVFTPT	Transfer files to the following FTP server	Turn on the checkbox	YES	-
		Turn off the checkbox	NO	-
SAVFTPT1	Transfer destination 1	When SAVFTPT is "YES"	1 to 16, NO	This item is not applied in the following situation. • SAVFTPT is "NO"
SAVFTPT2	Transfer destination 2	When SAVFTPT is "YES"	1 to 16, NO	This item is not applied in the following situation. • SAVFTPT is "NO"
SAVFTPT3	Transfer destination 3	When SAVFTPT is "YES"	1 to 16 NO	This item is not applied in the following situation. • SAVFTPT is "NO"
SAVMAIL	Logging files are sent to the following address by e-mail	Turn on the checkbox	YES	-
		Turn off the checkbox	NO	-
SAVMAIL1	E-mail address 1	When SAVMAIL is "YES"	1 to 16, NO	This item is not applied in the following situation. • SAVMAIL is "NO"
SAVMAIL2	E-mail address 2	SAVMAIL is YES	1 to 16, NO	This item is not applied in the following situation. • SAVMAIL is "NO"
SAVMAIL3	E-mail address 3	SAVMAIL is YES	1 to 16, NO	This item is not applied in the following situation. • SAVMAIL is "NO"
SAVMAILTYPE	E-mail content setting	Specify "Simple setting"	SIMPLE	This item is not applied in the following situation. • SAVMAIL is "NO"
		Specify "Detailed setting"	DETAILED	
SAVMAILSUB	E-mail subject	When SAVMAILTYPE is "DETAILED"	String	This item is not applied in the following situations. • SAVMAIL is "NO" • SAVMAILTYPE is "SIMPLE"
SAVMAILBODY	E-mail body	When SAVMAILTYPE is "DETAILED"	String	This item is not applied in the following situations. • SAVMAIL is "NO" • SAVMAILTYPE is "SIMPLE"
SAVMAILTAGUSE	Use tags	Turn on the checkbox	YES	This item is not applied in the following situations. • SAVMAIL is "NO" • SAVMAILTYPE is "SIMPLE"
		Turn off the checkbox	NO	
SAVMAILDATA1	Data setting 1	Turn on the checkbox	001 to 256, *001 to *256	This item is not applied in the following situations. • SAVMAIL is "NO" • SAVMAILTYPE is "SIMPLE" • SAVMAILTAGUSE is "NO"
		Turn off the checkbox	NO	
SAVMAILDATA2	Data setting 2	Turn on the checkbox	001 to 256, *001 to *256	This item is not applied in the following situations. • SAVMAIL is "NO" • SAVMAILTYPE is "SIMPLE" • SAVMAILTAGUSE is "NO"
		Turn off the checkbox	NO	

APPENDIX

① DATA

Item	Setting	Description	Setting value	Remarks
NO	No.	-	001 to 256, *001 to *256	-
NAME	Name	-	String	-
LBL	Related data	Related data	YES	-
		Not related data	NO	-
DEVICE	Start device	-	String	-
CPU	Access target CPU	-	1 to 64	-
TYPE	Data type	Specify "Bit"	BIT	-
		Specify "Word [signed]"	SWORD	-
		Specify "Double word [signed]"	SDWORD	-
		Specify "Word [unsigned]"	UWORD	-
		Specify "Double word [unsigned]"	UDWORD	-
		Specify "FLOAT [single precision]"	FLOAT	-
		Specify "FLOAT [double precision]"	DFLOAT	-
		Specify "16bit BCD"	16BCD	-
		Specify "32bit BCD"	32BCD	-
		Specify "String"	STRING	-
Specify "Raw"	RAW	-		
SIZE	Size	When TYPE is "STRING" or "RAW"	1 to 8192	-
		Other than the above	(blank)	-
SCAL	Scaling	When TYPE is "SWORD", "SDWORD", "UWORD", "UDWORD", "FLOAT", "DFLOAT", "16BCD" or "32BCD"	String	-
		Other than the above	(blank)	-
OUTWORDCSVTYPE	CSV output format (word)	In the following situations • TYPE is "BIT", "STRING" or "RAW" • TFFFILE in the data logging setting is "BINARY" and other than the following conditions. (NO matches to "SAVMAILDATA1" or "SAVMAILDATA2", and TYPE is "SWORD", "SDWORD", "UWORD", "UDWORD", "FLOAT", "DFLOAT", "16BCD", or "32BCD")	(blank)	-
		Specify "Decimal format"	DECIMAL	-
		Specify "Exponential format"	EXPONENTIAL	-
		Specify "Hexadecimal format"	HEXADECIMAL	-

(Continued on the next page)

APPENDIX

(From the previous page)

Item	Setting	Description	Setting value	Remarks
OUTWORDCSVDIGIT	Number of digits in decimal part	In the following situations <ul style="list-style-type: none"> • TYPE is "BIT", "STRING" or "RAW" • TFFFILE in the data logging setting is "BINARY" and other than the following conditions. (NO matches to "SAVMAILDATA1" or "SAVMAILDATA2", and TYPE is "SWORD", "SDWORD", "UWORD", "UDWORD", "FLOAT", "DFLOAT", "16BCD", or "32BCD") • OUTWORDCSVTYPE is "HEXADECIMAL" 	(blank)	-
		Other than listed above	0 to 14	-
OUTWORDBINTYPE	Binary output format	In the following situations <ul style="list-style-type: none"> • TFFFILE in the data logging setting is "CSV" • TYPE is "BIT", "STRING" or "RAW" 	(blank)	-
		Specify "Word [signed]"	SWORD	-
		Specify "Double word [signed]"	SDWORD	-
		Specify "Word [unsigned]"	UWORD	-
		Specify "Double word [unsigned]"	UDWORD	-
		Specify "FLOAT [single precision]"	FLOAT	-
		Specify "FLOAT [double precision]"	DFLOAT	-
		Specify "16bit BCD"	16BCD	-
Specify "32bit BCD"	32BCD	-		
OUTBITCSVTYPE	CSV output format (bit)	In the following situations <ul style="list-style-type: none"> • TYPE is other than "BIT" • TFFFILE in the data logging setting is "BINARY" and other than the following conditions. (NO matches to "SAVMAILDATA1" or "SAVMAILDATA2", and TYPE is "BIT") 	(blank)	-
		Specify "Default"	DEFAULT	-
		Specify "Specification"	SPECIFY	-
OUTBITCSVON	String when CSV output format is ON	In the following situations <ul style="list-style-type: none"> • TYPE is other than "BIT" • OUTBITCSVTYPE is "DEFAULT" • "BINARY" and other than the following conditions. (NO matches to "SAVMAILDATA1" or "SAVMAILDATA2", and TYPE is "BIT") 	(blank)	-
		When OUTBITCSVTYPE is "SPECIFY"	String	-

(Continued on the next page)

APPENDIX

(From the previous page)

Item	Setting	Description	Setting value	Remarks
OUTBITCSVOFF	String when CSV output format is OFF	In the following situations <ul style="list-style-type: none"> • TYPE is other than "BIT" • OUTBITCSVTYPE is "DEFAULT" • "BINARY" and other than the following conditions. (NO matches to "SAVMAILDATA1" or "SAVMAILDATA2", and TYPE is "BIT") 	(blank)	-
		When OUTBITCSVTYPE is "SPECIFY"	String	-
OUTSAVETYPE	Output format (data which is to be attached to the saved file name)	The situation in which data is not attached to the saved file name	(blank)	-
		Specify "Decimal integer format"	DECIMALINT	-
		Specify "Hexadecimal format"	HEXADECIMAL	-
OUTSAVEZEROFILL	Zero padding (output format of data which is to be attached to the saved file name)	The situation in which data is not attached to the saved file name	(blank)	-
		Turn on the checkbox	YES	-
		Turn off the checkbox	NO	-
OUTSAVEDIGIT	Number of total digits (output format of data which is to be attached to the saved file name)	In the following situations <ul style="list-style-type: none"> • Data is not attached to the saved file name • OUTSAVEZEROFILL is "NO" 	(blank)	-
		When OUTSAVEZEROFILL is "YES"	2 to 10	-
LBLNAME	Label name	-	String	-

② PERIODOFTIMECONDITION

Item	Setting	Description	Setting value	Remarks
NO	No.	-	1 to 8	-
TYPE	Type of condition	Specify "Data conditions"	DATA	-
		Specify "Date range"	DATE	-
		Specify "Time-of-the-day range"	TIME	-
		Specify "Day-of-the-week/Week condition"	WEEK	-
DATA1	Data name	When TYPE is other than "DATE"	(blank)	-
		TYPE is DATA	001 to 256, *001 to *256	-
DATAOPE	Conditions	When TYPE is other than "DATE"	(blank)	-
		Specify =	EQUAL	-
		Specify ≠	NOTEQUAL	-
		Specify ≥	GREATERTHAN EQUAL	-
		Specify >	GREATERTHAN	-
		Specify ≤	LESSTHANEQU AL	-
		Specify <	LESSTHAN	-
DATA2TYPE	Data/Constant	TYPE is other than DATE	(blank)	-
		Specify "Data"	DATA	-
		Specify "Constant"	CONST	-

(Continued on the next page)

APPENDIX

(From the previous page)

Item	Setting	Description	Setting value	Remarks
DATA2	Data name (data name/ constant value)	In the following situations • TYPE is other than "DATE" • DATA2TYPE is "CONST"	(blank)	-
		When DATA2TYPE is "DATA"	001 to 256, *001 to *256	-
DATA2CONST	Constant value (data name/constant value)	In the following situations • TYPE is other than "DATE" • DATA2TYPE is "DATA"	(blank)	-
		When DATA2TYPE is "CONST"	String	-
DATES_MONTH	Start - Month	When TYPE is other than "DATE"	(blank)	-
		Specify "January"	JAN	-
		Specify "February"	FEB	-
		Specify "March"	MAR	-
		Specify "April"	APR	-
		Specify "May"	MAY	-
		Specify "June"	JUN	-
		Specify "July"	JUL	-
		Specify "August"	AUG	-
		Specify "September"	SEP	-
		Specify "October"	OCT	-
		Specify "November"	NOV	-
		Specify "December"	DEC	-
		Specify "Every month"	EVERY	-
DATES_DAY	Start - Day	When TYPE is other than "DATE"	(blank)	-
		When TYPE is "DATE"	1 to 31, LAST	-
DATEE_MONTH	End - Month	When TYPE is other than "DATE"	(blank)	-
		Specify "January"	JAN	-
		Specify "February"	FEB	-
		Specify "March"	MAR	-
		Specify "April"	APR	-
		Specify "May"	MAY	-
		Specify "June"	JUN	-
		Specify "July"	JUL	-
		Specify "August"	AUG	-
		Specify "September"	SEP	-
		Specify "October"	OCT	-
		Specify "November"	NOV	-
		Specify "December"	DEC	-
		Specify "Every month"	EVERY	-
DATEE_DAY	End - Day	When TYPE is other than "DATE"	(blank)	-
		When TYPE is "DATE"	1 to 31, LAST	-
TIMES_HOUR	Start - Hour	When TYPE is other than "DATE"	(blank)	-
		When TYPE is "DATE"	0 to 23, EVERY	-
TIMES_MIN	Start - Minute	When TYPE is other than "DATE"	(blank)	-
		When TYPE is "DATE"	0 to 59, EVERY	-
TIMES_SEC	Start - Second	When TYPE is other than "DATE"	(blank)	-
		When TYPE is "DATE"	0 to 59	-
TIMEE_HOUR	End - Hour	When TYPE is other than "DATE"	(blank)	-
		When TYPE is "DATE"	0 to 23, EVERY	-
TIMEE_MIN	End - Minute	When TYPE is other than "DATE"	(blank)	-
		When TYPE is "DATE"	0 to 59, EVERY	-

(Continued on the next page)

APPENDIX

(From the previous page)

Item	Setting	Description	Setting value	Remarks
TIMEE_SEC	End - Second	When TYPE is other than "DATE"	(blank)	-
		When TYPE is "DATE"	0 to 59	-
WEEKSUN	Day-of-the-week condition [Sunday]	When TYPE is other than "WEEK"	(blank)	-
		Turn on the checkbox	YES	-
		Turn off the checkbox	NO	-
WEEKMON	Day-of-the-week condition [Monday]	When TYPE is other than "WEEK"	(blank)	-
		Turn on the checkbox	YES	-
		Turn off the checkbox	NO	-
WEEKTUE	Day-of-the-week condition [Tuesday]	When TYPE is other than "WEEK"	(blank)	-
		Turn on the checkbox	YES	-
		Turn off the checkbox	NO	-
WEEKWED	Day-of-the-week condition [Wednesday]	When TYPE is other than "WEEK"	(blank)	-
		Turn on the checkbox	YES	-
		Turn off the checkbox	NO	-
WEEKTHU	Day-of-the-week condition [Thursday]	When TYPE is other than "WEEK"	(blank)	-
		Turn on the checkbox	YES	-
		Turn off the checkbox	NO	-
WEEKFRI	Day-of-the-week condition [Friday]	When TYPE is other than "WEEK"	(blank)	-
		Turn on the checkbox	YES	-
		Turn off the checkbox	NO	-
WEEKSAT	Day-of-the-week condition [Saturday]	When TYPE is other than "WEEK"	(blank)	-
		Turn on the checkbox	YES	-
		Turn off the checkbox	NO	-
WEEKSPECIFY	Specify a week of the month	When TYPE is other than "WEEK"	(blank)	-
		Turn on the checkbox	YES	-
		Turn off the checkbox	NO	-
WEEK1ST	Week condition [1st]	In the following situations • TYPE is other than "WEEK" • WEEKSPECIFY is "NO"	(blank)	-
		Turn on the checkbox	YES	-
		Turn off the checkbox	NO	-
WEEK2ND	Week condition [2nd]	In the following situations • TYPE is other than "WEEK" • WEEKSPECIFY is "NO"	(blank)	-
		Turn on the checkbox	YES	-
		Turn off the checkbox	NO	-
WEEK3RD	Week condition [3rd]	In the following situations • TYPE is other than "WEEK" • WEEKSPECIFY is "NO"	(blank)	-
		Turn on the checkbox	YES	-
		Turn off the checkbox	NO	-
WEEK4TH	Week condition [4th]	In the following situations • TYPE is other than "WEEK" • WEEKSPECIFY is "NO"	(blank)	-
		Turn on the checkbox	YES	-
		Turn off the checkbox	NO	-
WEEKLAST	Week condition [last]	In the following situations • TYPE is other than "WEEK" • WEEKSPECIFY is "NO"	(blank)	-
		Turn on the checkbox	YES	-
		Turn off the checkbox	NO	-

APPENDIX

③ TRIGGERCONDITION

Item	Setting	Description	Setting value	Remarks
NO	No.	-	1 to 8	-
TYPE	Type of condition	Specify "Data conditions (comparison)"	DATACOMP	-
		Specify "Data conditions (at the time of change of value)"	DATACHANGE	-
		Specify "Fixed cycle"	CYCLE	-
		Specify "Time interval specification"	ONHR	-
		Specify "Specify a time of day"	TIME	-
		Specify "At startup of module"	STARTMODULE	-
		Specify "When the data logging file is switched"	DATALOGCHANGE	-
DATA1	Data name	When TYPE is "CYCLE", "ONHR", "TIME", "STARTMODULE" or "DATALOGCHANGE"	(blank)	-
		When TYPE is "DATACOMP" or "DATACHANGE"	001 to 256, *001 to *256	-
DATAOPE	Conditions	When TYPE is other than "DATACOMP"	(blank)	-
		Specify =	EQUAL	-
		Specify ≠	NOTEQUAL	-
		Specify ≥	GREATERTHAN EQUAL	-
		Specify >	GREATERTHAN	-
		Specify ≤	LESSTHANEQU AL	-
		Specify <	LESSTHAN	-
DATA2TYPE	Data/Constant	When TYPE is other than "DATACOMP"	(blank)	-
		Specify "Data"	DATA	-
		Specify "Constant"	CONST	-
DATA2	Data name (data name/ Constant value)	In the following situations • TYPE is other than "DATACOMP" • DATA2TYPE is "CONST"	(blank)	-
		When DATA2TYPE is "DATA"	001 to 256, *001 to *256	-
DATA2CONST	Constant value (data name/constant value)	In the following situations • TYPE is other than "DATACOMP" • DATA2TYPE is "DATA"	(blank)	-
		When DATA2TYPE is "CONST"	String	-
CYCL	Fixed cycle	When TYPE is other than "CYCLE"	(blank)	-
		When TYPE is "CYCLE"	1 to 86400	-
ONHRTIME	Time interval specification (interval)	When TYPE is other than "ONHR"	(blank)	-
		When TYPE is "ONHR"	1, 2, 3, 4, 5, 6, 8, 10, 12, 15, 20, 24, 30, 60	-

(Continued on the next page)

APPENDIX

(From the previous page)

Item	Setting	Description	Setting value	Remarks
ONHRUNIT	Time interval specification (unit)	When TYPE is other than "ONHR"	(blank)	-
		Specify "Hour"	HOUR	-
		Specify "Minute"	MIN	-
		Specify "Second"	SEC	-
TIMEMONTH	Month	When TYPE is other than "TIME"	(blank)	-
		Specify "January"	JAN	-
		Specify "February"	FEB	-
		Specify "March"	MAR	-
		Specify "April"	APR	-
		Specify "May"	MAY	-
		Specify "June"	JUN	-
		Specify "July"	JUL	-
		Specify "August"	AUG	-
		Specify "September"	SEP	-
		Specify "October"	OCT	-
		Specify "November"	NOV	-
		Specify "December"	DEC	-
		Specify "Every month"	EVERY	-
TIMEDAY	day	When TYPE is other than "TIME"	(blank)	-
		When TYPE is "TIME"	1 to 31, LAST, EVERY	-
TIMEHOUR	Hour	When TYPE is other than "TIME"	(blank)	-
		When TYPE is "TIME"	0 to 23, EVERY	-
TIMEMINUTE	Minute	When TYPE is other than "TIME"	(blank)	-
		When TYPE is "TIME"	0 to 59, EVERY	-
TIMESECOND	Second	When TYPE is other than "TIME"	(blank)	-
		When TYPE is "TIME"	0 to 59	-
ORDDTIMEOUT	Monitoring timeout	In the following situations • COMPTYPE of TRIGGER is other than "ORDER" • NO is "1"	(blank)	-
		When NO is "2" to "8"	0.1 to 0.9, 1 to 32767	-
DATALOG	Data logging name	When TYPE is other than "DATALOGCHANGE"	(blank)	-
		When TYPE is "DATALOGCHANGE"	1 to 64	-

17
18
A
INDEX

APPENDIX

(l) Event logging setting (CFG_EVTnn.CSV)

Item	Setting	Description	Setting value	Remarks
NAME	Event logging name	-	String	-
TFFFILE	File format	Specify "CSV file"	CSV	-
		Specify "Binary file"	BINARY	-
SMPTYPE	Sampling	Specify "High speed data sampling"	HIGHSPEED	-
		Specify "General sampling"	GENERAL	-
SMPHSPDTYPE	Sampling interval (high speed data sampling)	Specify "Each scanning cycle"	EACHSCAN	This item is not applied in the following situation. • SMPTYPE is "GENERAL"
		Specify "Time specification"	TIME	
SMPHSPDTYPE	Time specification (high speed data sampling - Sampling interval)	When SMPHSTYPE is "TIME"	1 to 32767	This item is not applied in the following situations. • SMPTYPE is "GENERAL" • SMPHSDTYPE is "EACHSCAN" or "CONDITION"
SMPHSPDCONT	Sample a consecutive series of devices	Turn on the checkbox	YES	This item is not applied in the following situation. • SMPTYPE is "GENERAL"
		Turn off the checkbox	NO	
SMPGNRLTYPE	Sampling interval (general sampling)	Specify "Time specification"	TIME	This item is not applied in the following situation. • SMPTYPE is "HIGHSPEED"
		Specify "Time interval specification"	ONHR	
SMPGNRLTYPE	Time specification (general sampling - sampling interval)	SMPGNRLTYPE is "TIME"	0.1 to 0.9, 1 to 32767	This item is not applied in the following situations. • SMPTYPE is "HIGHSPEED" • SMPGNRLTYPE is "ONHR"
SMPGNRLONHRTIME	Time interval specification (Interval)	When SMPGNRLTYPE is "ONHR"	1, 2, 3, 4, 5, 6, 8, 10, 12, 15, 20, 24, 30, 60	This item is not applied in the following situations. • SMPTYPE is "HIGHSPEED" • SMPGNRLTYPE is "TIME"
SMPGNRLONHRUNIT	Time interval specification (unit)	Specify "Hour"	HOUR	This item is not applied in the following situations. • SMPTYPE is "HIGHSPEED" • SMPGNRLTYPE is "TIME"
		Specify "Minute"	MIN	
		Specify "Second"	SEC	
[DAT_START]	Start of the array area (data setting)	-	(blank)	-
((Array area))	data setting	-	Refer to (k)① DATA	-
[DAT_END]	End of the array area (data setting)	-	(blank)	-
[EVT_START]	Start of the array area (event)	-	(blank)	-
((Array area))	Event	-	Refer to ① EVENT	-

(Continued on the next page)

APPENDIX

(From the previous page)

Item	Setting	Description	Setting value	Remarks
[EVT_END]	End of the array area (event)	-	(blank)	-
[EVTCOND_START]	Start of the array area (event condition)	-	(blank)	-
((Array area))	Event condition	-	Refer to ② EVENTCOND	-
[EVTCOND_END]	End of the array area (event condition)	-	(blank)	-
PRD	Specify a period of time	Turn on the checkbox	YES	-
		Turn off the checkbox	NO	-
PRDTYPE	Monitor the event during the period of time which meets specified conditions/Do not monitor the event during the period of time which meets specified conditions	Monitor the event during the period of time which meets specified conditions	CARRYOUT	This item is not applied in the following situation. • PRD is "NO"
		Do not monitor the event during the period of time which meets specified conditions	NOTCARRYOUT	
PRDCOMB	Conditions for combination	Specify "AND"	AND	This item is not applied in the following situation. • PRD is "NO"
		Specify "OR"	OR	
[PRDCOND_START]	Start of the array area (period of time and condition)	-	(blank)	This item is not applied in the following situation. • PRD is "NO"
((Array area))	Period of time and condition	When PRD is "YES"	Refer to (k)② PERIODOFTIME CONDITION	
[PRDCOND_END]	End of the array area (period of time and condition)	-	(blank)	
CSVDATESPFRMT	Specify the date format	Turn on the checkbox	YES	This item is not applied in the following situation. • TFFFILE is "BINARY"
		Turn off the checkbox	NO	
CSVDATEDATSTR	Data name line string	When CSVDATESPFRMT is "YES"	String	This item is not applied in the following situations. • TFFFILE is "BINARY" • CSVDATESPFRMT is "NO"
CSVDATEFRMT	Data line output format	When CSVDATESPFRMT is "YES"	String	This item is not applied in the following situations. • TFFFILE is "BINARY" • CSVDATESPFRMT is "NO"
BINEVTNHEADLIST	Output the list of event names into the header	Turn on the checkbox	YES	This item is not applied in the following situation. • TFFFILE is "CSV"
		Turn off the checkbox	NO	
BINEVTNRECEVTNAME	Output the event names into record data	Turn on the checkbox	YES	This item is not applied in the following situation. • TFFFILE is "CSV"
		Turn off the checkbox	NO	
BINDATNHEADLIST	Output the list of data names into the header	Turn on the checkbox	YES	This item is not applied in the following situation. • TFFFILE is "CSV"
		Turn off the checkbox	NO	

(Continued on the next page)

APPENDIX

(From the previous page)

Item	Setting	Description	Setting value	Remarks
BINDATETYPE	In second/In nanosecond	Specify "In second"	SEC	This item is not applied in the following situation. • TFFFILE is "CSV"
		Specify "In nanosecond"	NANOSEC	
BINCMNTREC	Output comment into record data	Turn on the checkbox	YES	This item is not applied in the following situation. • TFFFILE is "CSV"
		Turn off the checkbox	NO	
SAVDEST	File save destination	-	String	-
SAVSWICTMNTYPE	File switching timing	Turn on only "Number of records specification"	RECORD	-
		Turn on only "File size specification"	FILESIZE	-
		Turn on only "Condition specification"	CONDITION	-
		Turn on multiple checkboxes	MULTI	-
SAVSWICTMNTYPE REC	Number of records specification	Turn on the checkbox	YES	This item is not applied in the following situation. • SAVSWICTMNTYPE is other than "MULTI"
		Turn off the checkbox	NO	
SAVSWICTMNTYPE FILE	File size specification	Turn on the checkbox	YES	
		Turn off the checkbox	NO	
SAVSWICTMNTYPE COND	Condition specification	Turn on the checkbox	YES	
		Turn off the checkbox	NO	
SAVSWICTMNTYPE REC NUM	Number of records	In the following situations • SAVSWICTMNTYPE is "RECORD" • SAVSWICTMNTYPE is "MULTI", and SAVSWICTMNTYPEPEREC is "YES"	100 to 100000	This item is not applied other than the situations written on the left.
SAVSWICTMNTYPE FILE SIZE	File size	In the following situations • When SAVSWICTMNTYPE is "FILESIZE" • SAVSWICTMNTYPE is "MULTI", and SAVSWICTMNTYPEFILE is "YES"	10 to 16384	This item is not applied other than the situations written on the left.
SAVSWICTMNTYPE COND TYPE	Single condition/ Compound condition	Specify "Single condition"	SINGLE	This item is not applied in the following situations. • SAVSWICTMNTYPE is "RECORD" or "FILESIZE". • SAVSWICTMNTYPE is "MULTI", and SAVSWICTMNTYPECOND is "NO"
		Specify "Compound condition"	COMBINE	
SAVSWICTMNTYPE COND TYPE	Trigger type (compound condition only)	Specify "OR combine"	OR	This item is not applied in the following situations. • SAVSWICTMNTYPE is other than "SINGLE" • SAVSWICTMNTYPE is "RECORD" or "FILESIZE" • SAVSWICTMNTYPE is "MULTI", and SAVSWICTMNTYPECOND is "NO"
		Specify "AND combine"	AND	

(Continued on the next page)

APPENDIX

(From the previous page)

Item	Setting	Description	Setting value	Remarks
[SAVSWICTMNCND_START]	Start of the array area (file switching condition (each condition))	-	(blank)	This item is not applied in the following situations. • SAVSWICTMNTYPE is "RECORD" or "FILESIZE"
((Array area))	File switching condition (each condition)	-	Refer to (k)③ TRIGGERCONDITION	• SAVSWICTMNTYPE is "MULTI", and SAVSWICTMNTYPECOND is "NO"
[SAVSWICTMNCND_END]	End of the array area (file switching condition (each condition))	-	(blank)	
SAVNAMEATYPE	Saved file name setting	Specify "Simple setting"	SIMPLE	-
		Specify "Detailed setting"	DETAILED	
SAVNAMEASIMPNAME	Attach the name	Turn on the checkbox	YES	This item is not applied in the following situation. • SAVNAMEATYPE is "DETAILED"
		Turn off the checkbox	NO	
SAVNAMEASIMPDATE	Attach the date	Turn on the checkbox	YES	This item is not applied in the following situation. • SAVNAMEATYPE is "DETAILED"
		Turn off the checkbox	NO	
SAVNAMEASIMPTIME	Attach the time	Turn on the checkbox	YES	This item is not applied in the following situation. • SAVNAMEATYPE is "DETAILED"
		Turn off the checkbox	NO	
SAVNAMEDETLFRMT	Format	SAVNAMEATYPE is DETAILED	String	This item is not applied in the following situation. • SAVNAMEATYPE is "SIMPLE"
SAVNAMEDETLDAT A1	Attached data setting <DATA1>	Turn on the checkbox	001 to 256, *001 to *256	This item is not applied in the following situation. • SAVNAMEATYPE is "SIMPLE"
		Turn off the checkbox	NO	
SAVNAMEDETLDAT A2	Attached data setting <DATA2>	Turn on the checkbox	001 to 256, *001 to *256	This item is not applied in the following situation. • SAVNAMEATYPE is "SIMPLE"
		Turn off the checkbox	NO	
SAVNAMEATIMETYPE	Attached time (date) type	File switching condition hold true time	CONDITION	This item is not applied in the following situations. • SAVNAMEATYPE is "SIMPLE", and SAVNAMEASIMPDATE and SAVNAMEASIMPTIME are "NO" • SAVNAMEATYPE is "DETAILED", and SAVNAMEDETLFRMT does not have time (date) information
		File creation time	FILECREATION	
SAVFNUM	Number of saved files	-	1 to 65535	-
SAVFNUMTYPE	Operation occurring when number of saved files is exceeded	Specify "Overwrite"	OVERWRITE	-
		Specify "Stop"	STOP	-

(Continued on the next page)

APPENDIX

(From the previous page)

Item	Setting	Description	Setting value	Remarks
SAVFTPT	Transfer files to the following FTP server	Turn on the checkbox	YES	-
		Turn off the checkbox	NO	-
SAVFTPT1	Transfer destination 1	When SAVFTPT is "YES"	1 to 16, NO	This item is not applied in the following situation. • SAVFTPT is "NO"
SAVFTPT2	Transfer destination 2	When SAVFTPT is "YES"	1 to 16, NO	This item is not applied in the following situation. • SAVFTPT is "NO"
SAVFTPT3	Transfer destination 3	When SAVFTPT is "YES"	1 to 16, NO	This item is not applied in the following situation. • SAVFTPT is "NO"
SAVMAIL	Logging files are sent to the following address by e-mail	Turn on the checkbox	YES	-
		Turn off the checkbox	NO	-
SAVMAIL1	E-mail address 1	When SAVMAIL is "YES"	1 to 16	This item is not applied in the following situation. • SAVMAIL is "NO"
SAVMAIL2	E-mail address 2	When SAVMAIL is "YES"	1 to 16, NO	This item is not applied in the following situation. • SAVMAIL is "NO"
SAVMAIL3	E-mail address 3	When SAVMAIL is "YES"	1 to 16, NO	This item is not applied in the following situation. • SAVMAIL is "NO"
SAVMAILTYPE	E-mail content setting	Specify "Simple setting"	SIMPLE	This item is not applied in the following situation. • SAVMAIL is "NO"
		Specify "Detailed setting"	DETAILED	
SAVMAILSUB	E-mail subject	When SAVMAILTYPE is "DETAILED"	String	This item is not applied in the following situations. • SAVMAIL is "NO" • SAVMAILTYPE is "SIMPLE"
SAVMAILBODY	E-mail body	When SAVMAILTYPE is "DETAILED"	String	This item is not applied in the following situations. • SAVMAIL is "NO" • SAVMAILTYPE is "SIMPLE"
SAVMAILTAGUSE	Use tags	Turn on the checkbox	YES	This item is not applied in the following situations. • SAVMAIL is "NO" • SAVMAILTYPE is "SIMPLE"
		Turn off the checkbox	NO	
SAVMAILDATA1	Data setting1	Turn on the checkbox	001 to 256, *001 to *256	This item is not applied in the following situations. • SAVMAIL is "NO" • SAVMAILTYPE is "SIMPLE" • SAVMAILTAGUSE is "NO"
		Turn off the checkbox	NO	

(Continued on the next page)

APPENDIX

(From the previous page)

Item	Setting	Description	Setting value	Remarks
SAVMAILDATA2	Data setting2	Turn on the checkbox	001 to 256, *001 to *256	This item is not applied in the following situations. • SAVMAIL is "NO" • SAVMAILTYPE is "SIMPLE" • SAVMAILTAGUSE is "NO"
		Turn off the checkbox	NO	
MLN	A notifying e-mail is sent at the occurrence of an event	Turn on the checkbox	YES	-
		Turn off the checkbox	NO	-
MLNSUB	E-mail subject	When MLN is "YES"	String	This item is not applied in the following situation. • MNL is "NO"
MLNHEAD	E-mail text header	When MLN is "YES"	String	This item is not applied in the following situation. • MNL is "NO"
MLNFOOT	E-mail text footer	When MLN is "YES"	String	This item is not applied in the following situation. • MNL is "NO"
MLNDEST1	E-mail address 1	When MLN is "YES"	1 to 16, NO	This item is not applied in the following situation. • MNL is "NO"
MLNDEST2	E-mail address 2	When MLN is "YES"	1 to 16, NO	This item is not applied in the following situation. • MNL is "NO"
MLNDEST3	E-mail address 3	When MLN is "YES"	1 to 16, NO	This item is not applied in the following situation. • MNL is "NO"
MLNTAGUSE	Use tags	Turn on the checkbox	YES	This item is not applied in the following situation. • MNL is "NO"
		Turn off the checkbox	NO	
MLNDATA1	Data setting1	Turn on the checkbox	001 to 256, *001 to *256	This item is not applied in the following situations. • MNL is "NO" • MLNTAGUSE is "NO"
		Turn off the checkbox	NO	
MLNDATA2	Data setting2	Turn on the checkbox	001 to 256, *001 to *256	This item is not applied in the following situations. • MNL is "NO" • MLNTAGUSE is "NO"
		Turn off the checkbox	NO	

APPENDIX

① EVENT

Item	Setting	Description	Setting value	Remarks
NO	No.	-	1 to 64	-
NAME	Event name	-	String	-
CMNTOCCUR	Comment at event occurrence	-	String	-
CMNTRESTOR	Comment at event restoration	In the following situations • CONDTYPE is "SINGLE" and corresponding TYPE of ② EVENTCOND is "DATACHANGE" • COMPTYPE is "TIMES", or "ORDER"	(blank)	-
		-	String	-
OUTD	Output data values	Turn on the checkbox	YES	-
		Turn off the checkbox	NO	-
CONDTYPE	Single condition/ Compound conditions	Specify "Single condition"	SINGLE	-
		Specify "Compound conditions"	COMBINE	-
COMPTYPE	Compound conditions	CONDTYPE is "SINGLE"	(blank)	-
		Specify "OR combine"	OR	-
		Specify "AND combine"	AND	-
		Specify "Number of times"	TIMES	-
		Specify "Order"	ORDER	-
COMPTIMESTYPE	Conditions for occurrence (number of times)	In the following situations • CONDTYPE is "SINGLE" • COMPTYPE is other than "TIMES"	(blank)	-
		When a terminal condition holds true	TERMINAL	-
		When a specified number of times is exceeded	EXCEED	-
COMPTIMESNUMOPE	Number of counts (symbols)	In the following situations • CONDTYPE is "SINGLE" • COMPTYPE is other than "TIMES" • COMPTIMESTYPE is "EXCEED"	(blank)	-
		Specify =	EQUAL	-
		Specify ≠	NOTEQUAL	-
		Specify ≥	GREATERTHAN EQUAL	-
		Specify >	GREATERTHAN	-
		Specify ≤	LESSTHANEQU AL	-
COMPTIMESNUM	Number of counts (numerals)	In the following situations • CONDTYPE is "SINGLE" • COMPTYPE is other than "TIMES"	(blank)	-
		Other than listed above	0 to 32767	-

(Continued on the next page)

APPENDIX

(From the previous page)

Item	Setting	Description	Setting value	Remarks
COMPODERTYPE	Conditions for occurrence (order)	In the following situations • CONDTYPE is "SINGLE" • COMPTYPE is other than "ORDER"	(blank)	-
		Specify "Abnormal pattern is detected"	ABNORMAL	-
		Specify "Normal pattern is detected"	NORMAL	-
COMPODERTIMEOUT	Timeout detected	In the following situations • CONDTYPE is "SINGLE" • COMPTYPE is other than "ORDER"	(blank)	-
		Turn on the checkbox	YES	-
		Turn off the checkbox	NO	-

② EVENTCOND

Item	Setting	Description	Setting value	Remarks
NO	No.	-	1-1 to 64-4	-
TYPE	Type of condition (comparison/value change)	Specify "Data conditions (comparison)"	DATACOMP	-
		Specify "Data conditions (at the time of change of value)" In the following situations • (COMPTYPE of ① EVENT is "TIMES", or "ORDER" • TYPE of ① EVENT is "SINGLE"	DATACHANGE	-
DATA1	Monitoring data	-	001 to 256, *001 to *256	-
DATAOPE	Condition	Specify =	EQUAL	This item is not applied in the following situation. • TYPE is DATACHANGE
		Specify ≠	NOTEQUAL	
		Specify ≥	GREATERTHAN EQUAL	
		Specify >	GREATERTHAN	
		Specify ≤	LESSTHANEQU AL	
		Specify <	LESSTHAN	
DATA2TYPE	Data/Constant	Specify "Data"	DATA	This item is not applied in the following situations. • COMPTYPE of ① EVENT is other than "TIMES", or "ORDER" • TYPE is "DATACHANGE"
		Specify "Constant"	CONST	
DATA2	Data name (data name/constant value)	When DATA2TYPE is "DATA"	*001 to *256	This item is not applied in the following situations. • COMPTYPE of ① EVENT is other than "TIMES", or "ORDER" • TYPE is "DATACHANGE" • DATA2TYPE is "CONST"

(Continued on the next page)

APPENDIX

(From the previous page)

Item	Setting	Description	Setting value	Remarks
DATA2CONST	Constant value (data name/constant value)	Other than listed above	String	This item is not applied in the following situations. <ul style="list-style-type: none"> • TYPE is "DATACHANGE" • COMPTYPE of ① EVENT is "TIMES", or "ORDER" and DATA2TYPE is "DATA"
DATA2REST	Specify restoration values	Turn on the checkbox	YES	This item is not applied in the following situations. <ul style="list-style-type: none"> • COMPTYPE of ① EVENT is "TIMES", or "ORDER" • TYPE is "DATACHANGE" • DATAOPE is "EQUAL", "NOTEQUAL"
		Turn off the checkbox	NO	
DATA2RESTVALUE	Restoration value	When DATA2REST is "YES"	String	This item is not applied in the following situations. <ul style="list-style-type: none"> • COMPTYPE of ① EVENT is "TIMES", or "ORDER" • TYPE is "DATACHANGE" • DATAOPE is "EQUAL", "NOTEQUAL" • DATA2REST is "NO"
ORDDTIMEOUT	Monitoring timeout	-	0.1 to 0.9, 1 to 32767	This item is not applied in the following situations. <ul style="list-style-type: none"> • COMPTYPE of EVENT is other than "ORDER" • NO is "*" "-1"

APPENDIX

(m) Report setting (CFG_REPnn.CSV)

Item	Setting	Description	Setting value	Remarks
NAME	Report name	-	String	-
SMPTYPE	Sampling	Specify "High speed data sampling"	HIGHSPEED	-
		Specify "General sampling"	GENERAL	-
SMPHSPDTYPE	Sampling interval (high speed data sampling)	Specify "Each scanning cycle"	EACHSCAN	This item is not applied in the following situation. • SMPTYPE is "GENERAL"
		Specify "Time specification"	TIME	
SMPHSPDTIME	Time specification (high speed data sampling - sampling interval)	When SMPHSTYPE is "TIME"	1 to 32767	This item is not applied in the following situations. • SMPTYPE is "GENERAL" • SMPHSDTYPE is "EACHSCAN"
SMPHSPDCONT	Sample a consecutive series of devices	Turn on the checkbox	YES	This item is not applied in the following situation. • SMPTYPE is "GENERAL"
		Turn off the checkbox	NO	
SMPGNRLTYPE	Sampling interval (general sampling)	Specify "Time specification"	TIME	This item is not applied in the following situation. • SMPTYPE is "HIGHSPEED"
		Specify "Time interval specification"	ONHR	
SMPGNRLTIME	Time specification (general sampling-Sampling interval)	When SMPGNRLTYPE is "TIME"	0.1 to 0.9, 1 to 32767	This item is not applied in the following situations. • SMPTYPE is "HIGHSPEED" • SMPGNRLTYPE is "ONHR"
SMPGNRLONHRTIME	Time interval specification (Interval)	When SMPGNRLTYPE is "ONHR"	1, 2, 3, 4, 5, 6, 8, 10, 12, 15, 20, 24, 30, 60	This item is not applied in the following situations. • SMPTYPE is "HIGHSPEED" • SMPGNRLTYPE is "TIME"
SMPGNRLONHRUNIT	Time interval specification (unit)	Specify "Hour"	HOURL	This item is not applied in the following situations. • SMPTYPE is "HIGHSPEED" • SMPGNRLTYPE is "TIME"
		Specify "Minute"	MIN	
		Specify "Second"	SEC	
[DAT_START]	Start of the array area (data setting)	-	(blank)	-
((Array area))	data setting	-	Refer to (k)① DATA	-
[DAT_END]	End of the array area (data setting)	-	(blank)	-
[LAYOUT_START]	Start of the array area (layout setting)	-	(blank)	-
((Array area))	Layout setting	-	Refer to ① LAYOUT	-
[LAYOUT_END]	End of the array area (layout setting)	-	(blank)	-

(Continued on the next page)

APPENDIX

(From the previous page)

Item	Setting	Description	Setting value	Remarks
TRGSYNC	Synchronize creation trigger with current value data	Turn on the checkbox	YES	-
		Turn off the checkbox	NO	-
TRGCONDTYPE	Single condition/ Compound condition	Specify "Single condition"	SINGLE	-
		Specify "Compound condition"	COMBINE	-
TRGCOMPTYPE	Trigger type (compound condition only)	Specify "OR combine"	OR	This item is not applied in the following situation. • TRGCONDTYPE is "SINGLE"
		Specify "AND combine"	AND	
		Specify "Number of times"	TIMES	
		Specify "Order"	ORDER	
TRGCOMPTIMESTYPE	Conditions for occurrence (Number of times)	Specify "When a terminal condition holds true"	TERMINAL	This item is not applied in the following situations. • TRGCONDTYPE is "SINGLE" • TRGCOMPTYPE is other than "TIMES"
		Specify "When a specified number of times is exceeded"	EXCEED	
TRGCOMPTIMESNUMOPE	Number of counts (symbols)	Specify =	EQUAL	This item is not applied in the following situations. • TRGCONDTYPE is "SINGLE" • TRGCOMPTYPE is other than "TIMES" • TRGCOMPTIMESTYPE is "EXCEED"
		Specify ≠	NOTEQUAL	
		Specify ≥	GREATERTHAN EQUAL	
		Specify >	GREATERTHAN	
		Specify ≤	LESS THANEQUAL	
		Specify <	LESSTHAN	
TRGCOMPTIMESNUM	Number of counts (numerals)	-	0-32767	This item is not applied in the following situations. • TRGCONDTYPE is "SINGLE" • TRGCOMPTYPE is other than "ORDER"
TRGCOMPORDERTYPE	Conditions for occurrence (order)	Specify "Detect abnormal pattern"	ABNORMAL	This item is not applied in the following situations. • TRGCONDTYPE is "SINGLE" • TRGCOMPTYPE is other than "ORDER"
		Specify "Detect normal pattern"	NORMAL	
TRGCOMPORDERTIMEOUT	Timeout detected	Turn on the checkbox	YES	This item is not applied in the following situations. • TRGCONDTYPE is "SINGLE" • TRGCOMPTYPE is other than "ORDER"
		Turn off the checkbox	NO	
[TRGCOND_START]	Start of the array area (creation trigger condition)	-	(blank)	-
((Array area))	Creation trigger condition	-	Refer to (k)③ TRIGGERCONDITION	-
[TRGCOND_END]	End of the array area (creation trigger condition)	-	(blank)	-
PRD	Specify a period of time	Turn on the checkbox	YES	-
		Turn off the checkbox	NO	-

(Continued on the next page)

APPENDIX

(From the previous page)

Item	Setting	Description	Setting value	Remarks
PRDTYPE	Reports are generated during the period of time which meets specified conditions. /Reports are not generated during the period of time which meets specified conditions.	Reports are generated during the period of time which meets specified conditions.	CARRYOUT	This item is not applied in the following situation. • PRD is "NO"
		Reports are not generated during the period of time which meets specified conditions.	NOTCARRYOUT	
PRDCOMB	Conditions for combination	Specify "AND"	AND	This item is not applied in the following situation. • PRD is "NO"
		Specify "OR"	OR	
[PRDCOND_START]	Start of the array area (period of time and condition)	-	(blank)	This item is not applied in the following situation. • PRD is "NO"
((Array area))	Period of time and condition	When PRD is "YES"	Refer to (k)② PERIODOFTIME CONDITION	
[PRDCOND_END]	End of the array area (period of time and condition)	-	(blank)	
SAVDEST	File save destination	-	String	-
SAVNAMETYPE	Saved file name setting	Specify "Simple setting"	SIMPLE	-
		Specify "Detailed setting"	DETAILED	-
SAVNAMESIMPNAME	Attach the name	Turn on the checkbox	YES	This item is not applied in the following situation. • SAVNAMETYPE is "DETAILED"
		Turn off the checkbox	NO	
SAVNAMESIMPDATE	Attach the date	Turn on the checkbox	YES	This item is not applied in the following situation. • SAVNAMETYPE is "DETAILED"
		Turn off the checkbox	NO	
SAVNAMESIMPTIME	Attach the time	Turn on the checkbox	YES	This item is not applied in the following situation. • SAVNAMETYPE is "DETAILED"
		Turn off the checkbox	NO	
SAVNAMEDETLFRMT	Format	When SAVNAMETYPE is "DETAILED"	String	This item is not applied in the following situation. • SAVNAMETYPE is "SIMPLE"
SAVNAMEDETLDAT A1	Attached data setting <DATA1>	Turn on the checkbox	001 to 256, *001 to *256	This item is not applied in the following situation. • SAVNAMETYPE is "SIMPLE"
		Turn off the checkbox	NO	
SAVNAMEDETLDAT A2	Attached data setting <DATA2>	Turn on the checkbox	001 to 256, *001 to *256	This item is not applied in the following situation. • SAVNAMETYPE is "SIMPLE"
		Turn off the checkbox	NO	
SAVFNUM	Number of saved files	-	1 to 65535	-
SAVFNUMTYPE	Operation occurring when number of saved files is exceeded	Specify "Overwrite"	OVERWRITE	-
		Specify "Stop"	STOP	-
SAVFTPT	Transfer files to the following FTP server	Turn on the checkbox	YES	-
		Turn off the checkbox	NO	-

(Continued on the next page)

APPENDIX

(From the previous page)

Item	Setting	Description	Setting value	Remarks
SAVFTPT1	Transfer destination 1	When SAVFTPT is "YES"	1 to 16, NO	This item is not applied in the following situation. • SAVFTPT is "NO"
SAVFTPT2	Transfer destination 2	When SAVFTPT is "YES"	1 to 16, NO	This item is not applied in the following situation. • SAVFTPT is "NO"
SAVFTPT3	Transfer destination 3	When SAVFTPT is "YES"	1 to 16, NO	This item is not applied in the following situation. • SAVFTPT is "NO"
SAVMAIL	Logging files are sent to the following address by e-mail	Turn on the checkbox	YES	-
		Turn off the checkbox	NO	-
SAVMAIL1	E-mail address 1	When SAVMAIL is "YES"	1 to 16, NO	This item is not applied in the following situation. • SAVMAIL is "NO"
SAVMAIL2	E-mail address 2	When SAVMAIL is "YES"	1 to 16, NO	This item is not applied in the following situation. • SAVMAIL is "NO"
SAVMAIL3	E-mail address 3	When SAVMAIL is "YES"	1 to 16, NO	This item is not applied in the following situation. • SAVMAIL is "NO"
SAVMAILTYPE	E-mail content setting	Specify "Simple setting"	SIMPLE	This item is not applied in the following situation. • SAVMAIL is "NO"
		Specify "Detailed setting"	DETAILED	
SAVMAILSUB	E-mail subject	When SAVMAILTYPE is "DETAILED"	String	This item is not applied in the following situations. • SAVMAIL is "NO" • SAVMAILTYPE is "SIMPLE"
SAVMAILBODY	E-mail body	When SAVMAILTYPE is "DETAILED"	String	This item is not applied in the following situations. • SAVMAIL is "NO" • SAVMAILTYPE is "SIMPLE"
SAVMAILTAGUSE	Use tags	Turn on the checkbox	YES	This item is not applied in the following situations. • SAVMAIL is "NO" • SAVMAILTYPE is "SIMPLE"
		Turn off the checkbox	NO	
SAVMAILDATA1	Data setting1	Turn on the checkbox	001 to 256, *001 to *256	This item is not applied in the following situations. • SAVMAIL is "NO" • SAVMAILTYPE is "SIMPLE" • SAVMAILTAGUSE is "NO"
		Turn off the checkbox	NO	
SAVMAILDATA2	Data setting2	Turn on the checkbox	001 to 256, *001 to *256	This item is not applied in the following situations. • SAVMAIL is "NO" • SAVMAILTYPE is "SIMPLE" • SAVMAILTAGUSE is "NO"
		Turn off the checkbox	NO	

APPENDIX

① LAYOUT

Item	Setting	Description	Setting value	Remarks
NO	No.	-	1 to 64	-
NAME	Layout name	-	String	-
TYPE	Data logging /Current value/Creation time	Specify "Data logging"	DATALOG	-
		Specify "Current value"	CURRENT	-
		Specify "Creation time"	CREATION	-
CELLRNG	Cell range	-	A1 reference style	-
RECNUM	Number of records	When TYPE is "CURRENT" or "CREATION"	(blank)	-
		When TYPE is "DATALOG"	1 to 65535	-
DATALOG	Data logging name	When TYPE is "CURRENT" or "CREATION"	(blank)	-
		When TYPE is "DATALOG"	1 to 64	-
SRCFILE	Source file	When TYPE is "CURRENT" or "CREATION"	(blank)	-
		Specify "Saved files"	SAVED	-
		Specify "Storing file"	STORING	-
		Specify "Both"	BOTH	-
DIRC	Outputting direction	When TYPE is "CREATION"	(blank)	-
		Specify "Vertical (top -> bottom)"	VERTICAL	-
		Specify "Horizontal (left -> right)"	HORIZONTAL	-
ORDER	Outputting order	When TYPE is "CURRENT" or "CREATION"	(blank)	-
		Specify "Chronological order (old -> new)"	CHRONO	-
		Specify "Reverse chronological order (new -> old)"	REVERSE	-
DATALIST	Output data	When TYPE is "CURRENT" or "CREATION"	(blank)	-
		When TYPE is "DATALOG"	Numerals separated by spaces (001 to 256, INDEX, TIME)	-
OUTTITLE	Output title (data name) at the head of data	When TYPE is "CURRENT" or "CREATION"	(blank)	-
		Turn on the checkbox	YES	-
		Turn off the checkbox	NO	-
DATANUM	Number of pieces of data	When TYPE is "DATALOG" or "CREATION"	(blank)	-
		When TYPE is "CURRENT"	1 to 65535	-
CURRENTDATA	Current value data	When TYPE is "DATALOG" or "CREATION"	(blank)	-
		When TYPE is "CURRENT"	001 to 256	-

Appendix 11 FTP Transfer Directory Configuration

When the FTP transfer function is used, files stored in the CompactFlash card inserted in a high speed data logger module are stored to the FTP server directory.

The following table shows a directory configuration in the save destination.
A directory of FTP server can be changed with the default operation setting (switch 2) of the intelligent function module switch setting.

☞ Section 4.5 (2) Default operation setting (Switch 2)

(1) When the directory configuration of FTP transfer directory is the same as that of CompactFlash card

FTP transfer directory				Transfer file name	
Home directory (FTP server)	User-specified directory	Setting type directory	Number directory		
\FTPServer	\WORK	\LOG01	\0000001	00000001.CSV	} 256
				00000002.CSV	
				:	
				000000FF.CSV	
				00000100.CSV	
			\0000101	00000101.CSV	} 256
				00000102.CSV	
				:	
				000001FF.CSV	
				00000200.CSV	
		:	:		
		\LOG02	\0000001	00000001.CSV	} 256
				00000002.CSV	
				:	
				000000FF.CSV	
				00000100.CSV	
			\0000101	00000101.CSV	} 256
				00000102.CSV	
				:	
				000001FF.CSV	
00000200.CSV					
:	:				

Directory configuration which does not exist in the CompactFlash card

Directory configuration which is the same as that of the CompactFlash card

(2) When fixed to one directory

When a directory which transfers logging files is fixed to one directory, set with the default operation setting (switch 2) of the intelligent function module switch setting.

☞ Section 4.5 (2) Default operation setting (Switch 2)

FTP transfer directory			Transfer file name
Home directory (FTP server)	User-specified directory	Setting type directory	
\FTPServer	WORK	\LOG01	00000001.CSV
			00000002.CSV
			:
			000000FF.CSV
			00000100.CSV
			00000101.CSV
			00000102.CSV
			:
			000001FF.CSV
			00000200.CSV
		:	
		\LOG02	00000001.CSV
			00000002.CSV
			:
			000000FF.CSV
			00000100.CSV
			00000101.CSV
			00000102.CSV
			:
			000001FF.CSV
00000200.CSV			
:			

No maximum number of files*1

No maximum number of files*1

Directory configuration which does not exist in the CompactFlash card

Only setting type directory of FTP transfer directory is the same directory configuration as that of the CompactFlash card

Item	Description
Home directory (FTP server)	A home directory set by the FTP server.
User-specified directory	Specify with "Directory path" in the "FTP setting". (up to 64 characters)
Setting type directory	A directory whose name is the same as the name of "setting type folder" exists in the CompactFlash card. Saved files are sorted by each setting.
Number directory	Saved files are sorted by the specified number of saved file. A save target file and a maximum number of storage files are the same as those of "Number folder" exists in a CompactFlash card.
Transfer file name*2	A name set for the transfer file. The same name as that of transfer target saved file is set.

*1: No maximum number of transfer files, however, it may take some time for referring directory if many transfer files exist in a directory.

*2: Files which are transferred to the FTP server are not deleted by a high speed data logger module.

Appendix 12 Sampling Processes of High Speed Data Logger Module

Appendix 12.1 Data changes between data sampling processes

Data changes occurred between the data sampling processes are not sampled because a high speed data logger module only samples data from a programmable controller CPU at the specified data sampling intervals.

Adjust the data sampling interval according to data to be sampled.

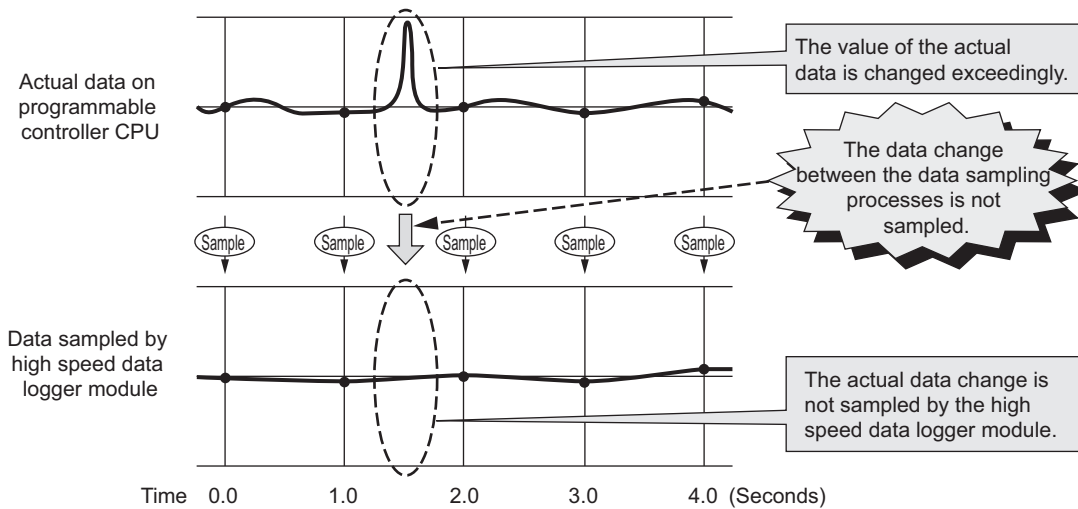

Appendix 12.2 Detecting data condition establishment

The determination of the data condition is executed with the data sampled at the specified data sampling interval.

When the data condition is specified for the trigger, event, or file switching, the determination of the data condition is not detected if the condition is not established at the data sampling.

Set a longer time for the condition establishment time than the data sampling interval.

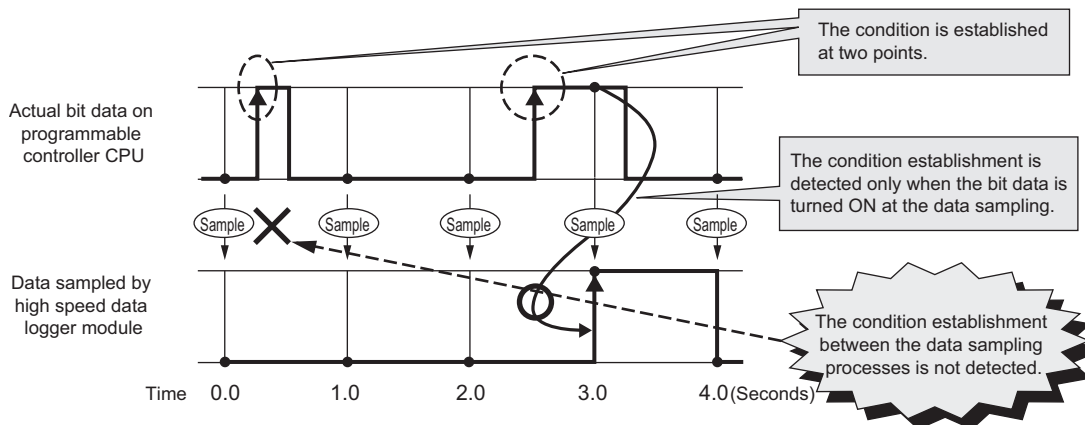

Use the following method to detect the data condition when the detection is difficult with the method described on the previous page.

- Prepare the device to record the number of condition establishments in a sequence program.
- Set a "value change" as a condition for the device on a high speed data logger module.

Since the device value changes when the condition is established, the "value change" between the data sampling processes can be detected. Even when the condition establishment time is less than the data sampling interval, the condition establishment can be detected.

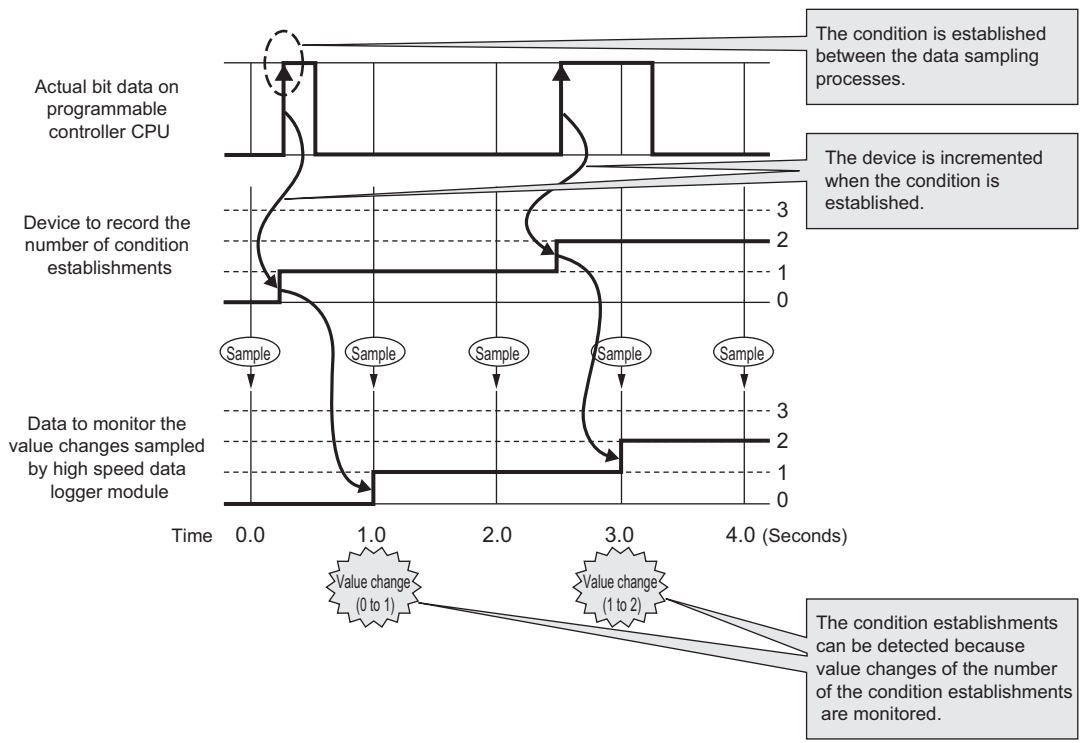

Remark

The following is an example of sequence program to record the number of condition establishments on the device.
(M0 = bit device to indicate the condition, D0 = device to record the number of condition establishments)



.....

INDEX

[A]

Access authentication..... 10-9,11-66,12-1
 Access authority 10-9
 Access target CPU 11-46,18-41
 Account setting 10-9,11-66
 Administrator 10-9,11-66
 Attached time (date) type 11-137
 Auto logging.....A-36,10-5,11-71

[B]

Binary file.....A-36,3-69
 Block..... 15-3
 Built-in Ethernet port QCPUA-35,1-6

[C]

Comment..... 11-154
 Common setting 4-3,11-35
 CompactFlash card A-36,2-9,16-1,18-42
 Configuration ToolA-35
 Continuous logging..... 7-9
 Conversion Tool 14-1
 Create trigger..... 9-6,9-8
 CSV file.....A-36,3-61
 Current values 9-2

[D]

Data logging A-12,A-36,7-1
 Data logging file..... 7-19
 Data logging setting..... 4-3,11-78
 Daylight saving time 10-4,11-41
 Dedicated Instructions 15-19
 device comments..... 11-15
 Diagnostics 13-1
 Direct connection 12-1
 DNS server 11-38

[E]

Edit items tree..... 11-2,11-6
 E-mail 8-12,11-62,18-40
 E-mail notification 8-12
 Error code..... 13-1,18-2
 Error log..... 13-3
 Ethernet (twisted pair) cable 2-9
 Event 8-2,11-154
 Event conditions 8-3
 Event logging..... A-12,A-36,8-1
 Event logging file 8-10
 Event logging setting 4-3,11-145
 Excel..... 2-10,9-1,11-199
 Exporting 11-33

[F]

File access function 10-7
 File browser 10-7,13-17

File switch 7-20
 File transfer..... 13-1
 Format 3-61,3-69,16-4
 FTP server2-1,7-21,10-7,11-59
 Function version 2-13

[G]

General sampling..... 11-85,11-151,11-197
 global labels..... 11-15
 GX Developer 2-14,4-14,18-2

[H]

Hardware test 4-20
 High speed data logger module toolA-35,5-1
 High-speed data sampling 11-84
 High-speed data sampling settings..... 11-74
 Host name 11-36,12-2

[I]

Importing 11-31
 Index 3-64
 Install 5-2
 Intelligent function module switch setting 4-14
 IP address..... 11-7,11-37,12-1
 Item..... 11-6

[L]

LED..... 4-11,18-6
 Logging fileA-36

[M]

Mail server2-1,7-21,8-12,11-62
 Maintenance user 10-9,11-66
 Missing data..... 7-22
 Module fixing screw 4-1
 Module operating file 11-34
 Module search 12-2
 Monitor..... 13-1
 Mountable modules 2-6
 Multiple CPU..... 2-8

[N]

N attribute 15-4
 Network setting 11-36
 Normal user 10-9,11-66

[O]

Offline startup 5-12
 Online startup 5-12

[P]

P attribute 15-4
 Password..... 10-9,12-1

ping.....11-39,13-15,App-2
 Processing timeA-13,17-1
 Product information 2-14,13-8

[R]

Read process 15-2
 RECIPE 15-1
 Recipe File..... 3-76
 Recipe files 15-3
 Record 15-4
 Record attribute 15-4
 Redundant CPU 2-16
 related data..... 11-15
 Report.....A-13,9-1
 Report file 9-9
 Report setting 4-3,11-192
 Resend function..... 10-10
 Restoration value..... 8-4,11-156

[S]

Sampling..... 7-3,8-7,9-6
 Save file 7-20
 Scaling..... 11-90
 Self-diagnostics tests..... 4-19
 Self-loopback test 4-19
 Sequence scan time 7-5,11-74,17-11
 Serial Number..... 2-13
 Setting information CSV File 11-33,App-23,App-65
 SNTP server 2-1,10-1,11-40
 Status bar 11-7
 Storage file 7-20

[T]

Target data 7-2,8-2,9-2
 Time interval specification 7-7,11-85,11-106
 Time synchronization..... 10-1,11-40,18-41
 Time zone 11-40
 Toolbar 11-5
 Tooltip..... 11-8
 Transfer completion notification function 10-12
 Transfer setup 12-1
 Trigger conditions 7-14
 Trigger logging..... 7-10

[U]

User name 10-9,11-7,12-1

[W]

Wizard 11-80,11-147,11-194
 Write process..... 15-2

WARRANTY

Please confirm the following product warranty details before using this product.

1. Gratis Warranty Term and Gratis Warranty Range

If any faults or defects (hereinafter "Failure") found to be the responsibility of Mitsubishi occurs during use of the product within the gratis warranty term, the product shall be repaired at no cost via the sales representative or Mitsubishi Service Company.

However, if repairs are required onsite at domestic or overseas location, expenses to send an engineer will be solely at the customer's discretion. Mitsubishi shall not be held responsible for any re-commissioning, maintenance, or testing on-site that involves replacement of the failed module.

[Gratis Warranty Term]

The gratis warranty term of the product shall be for one year after the date of purchase or delivery to a designated place. Note that after manufacture and shipment from Mitsubishi, the maximum distribution period shall be six (6) months, and the longest gratis warranty term after manufacturing shall be eighteen (18) months. The gratis warranty term of repair parts shall not exceed the gratis warranty term before repairs.

[Gratis Warranty Range]

- (1) The range shall be limited to normal use within the usage state, usage methods and usage environment, etc., which follow the conditions and precautions, etc., given in the instruction manual, user's manual and caution labels on the product.
- (2) Even within the gratis warranty term, repairs shall be charged for in the following cases.
 1. Failure occurring from inappropriate storage or handling, carelessness or negligence by the user. Failure caused by the user's hardware or software design.
 2. Failure caused by unapproved modifications, etc., to the product by the user.
 3. When the Mitsubishi product is assembled into a user's device, Failure that could have been avoided if functions or structures, judged as necessary in the legal safety measures the user's device is subject to or as necessary by industry standards, had been provided.
 4. Failure that could have been avoided if consumable parts (battery, backlight, fuse, etc.) designated in the instruction manual had been correctly serviced or replaced.
 5. Failure caused by external irresistible forces such as fires or abnormal voltages, and Failure caused by force majeure such as earthquakes, lightning, wind and water damage.
 6. Failure caused by reasons unpredictable by scientific technology standards at time of shipment from Mitsubishi.
 7. Any other failure found not to be the responsibility of Mitsubishi or that admitted not to be so by the user.

2. Onerous repair term after discontinuation of production

- (1) Mitsubishi shall accept onerous product repairs for seven (7) years after production of the product is discontinued. Discontinuation of production shall be notified with Mitsubishi Technical Bulletins, etc.
- (2) Product supply (including repair parts) is not available after production is discontinued.

3. Overseas service

Overseas, repairs shall be accepted by Mitsubishi's local overseas FA Center. Note that the repair conditions at each FA Center may differ.

4. Exclusion of loss in opportunity and secondary loss from warranty liability

Regardless of the gratis warranty term, Mitsubishi shall not be liable for compensation to:

- (1) Damages caused by any cause found not to be the responsibility of Mitsubishi.
- (2) Loss in opportunity, lost profits incurred to the user by Failures of Mitsubishi products.
- (3) Special damages and secondary damages whether foreseeable or not, compensation for accidents, and compensation for damages to products other than Mitsubishi products.
- (4) Replacement by the user, maintenance of on-site equipment, start-up test run and other tasks.

5. Changes in product specifications

The specifications given in the catalogs, manuals or technical documents are subject to change without prior notice.

INFORMATION AND SERVICES

For further information and services, please contact your local Mitsubishi Electric sales office or representative.
Visit our website to find our locations worldwide.

MITSUBISHI ELECTRIC Factory Automation Global Website

Locations Worldwide

www.MitsubishiElectric.com/fa/about-us/overseas/

TRADEMARKS

CompactFlash is either a registered trademark or a trademark of SanDisk Corporation.

Microsoft, Excel, Internet Explorer, Microsoft Edge, Windows, Windows Vista, and Windows XP are trademarks of the Microsoft group of companies.

The company names, system names and product names mentioned in this manual are either registered trademarks or trademarks of their respective companies.

In some cases, trademark symbols such as [™] or [®] are not specified in this manual.

COPYRIGHTS

The screens (screenshots) are used in accordance with the Microsoft Corporation guideline.

FlexGrid for .NET 4.0J

Copyright © 2001-2007 ComponentOne LLC.

ComponentOne Studio[®] for WinForms 2.0

Portions Copyright © ComponentOne, LLC 1987-2008. All Rights Reserved.

SH(NA)-080818ENG-Z(2403)KWIX

MODEL: QD81DL96-U-SY-E

MODEL CODE: 13JZ30

MITSUBISHI ELECTRIC CORPORATION

HEAD OFFICE: TOKYO BLDG., 2-7-3, MARUNOUCHI, CHIYODA-KU, TOKYO 100-8310, JAPAN
NAGOYA WORKS: 1-14, YADA-MINAMI 5-CHOME, HIGASHI-KU, NAGOYA 461-8670, JAPAN

When exported from Japan, this manual does not require application to the
Ministry of Economy, Trade and Industry for service transaction permission.

Specifications subject to change without notice.