

Programmable Controller

**MELSEC iQ-R**  
series

## MELSEC iQ-R Ethernet/CC-Link IE User's Manual (Startup)

---

-RJ71EN71  
-RJ71GP21-SX  
-RJ71GP21S-SX  
-RJ71GF11-T2  
-R00CPU  
-R01CPU  
-R02CPU  
-R04CPU  
-R04ENCPU  
-R08CPU  
-R08ENCPU  
-R08PCPU  
-R08PSFCPU  
-R08SFCPU  
-R16CPU  
-R16ENCPU  
-R16PCPU  
-R16PSFCPU  
-R16SFCPU  
-R32CPU  
-R32ENCPU  
-R32PCPU  
-R32PSFCPU  
-R32SFCPU  
-R120CPU  
-R120ENCPU  
-R120PCPU  
-R120PSFCPU  
-R120SFCPU



# SAFETY PRECAUTIONS

---



(Read these precautions before using this product.)

Before using this product, please read this manual and the relevant manuals carefully and pay full attention to safety to handle the product correctly. If the equipment is used in a manner not specified by the manufacturer, the protection provided by the equipment may be impaired.

The precautions given in this manual are concerned with this product only. For the safety precautions of the programmable controller system, refer to the MELSEC iQ-R Module Configuration Manual.

In this manual, the safety precautions are classified into two levels: "⚠️ WARNING" and "⚠️ CAUTION".

---

 <b>WARNING</b>	Indicates that incorrect handling may cause hazardous conditions, resulting in death or severe injury.
 <b>CAUTION</b>	Indicates that incorrect handling may cause hazardous conditions, resulting in minor or moderate injury or property damage.

---

Under some circumstances, failure to observe the precautions given under "⚠️ CAUTION" may lead to serious consequences.

Observe the precautions of both levels because they are important for personal and system safety.

Make sure that the end users read this manual and then keep the manual in a safe place for future reference.

## [Design Precautions]

---

### **WARNING**

---

- Configure safety circuits external to the programmable controller to ensure that the entire system operates safely even when a fault occurs in the external power supply or the programmable controller. Failure to do so may result in an accident due to an incorrect output or malfunction.
    - (1) Emergency stop circuits, protection circuits, and protective interlock circuits for conflicting operations (such as forward/reverse rotations or upper/lower limit positioning) must be configured external to the programmable controller.
    - (2) When the programmable controller detects an abnormal condition, it stops the operation and all outputs are:
      - Turned off if the overcurrent or overvoltage protection of the power supply module is activated.
      - Held or turned off according to the parameter setting if the self-diagnostic function of the CPU module detects an error such as a watchdog timer error.
    - (3) All outputs may be turned on if an error occurs in a part, such as an I/O control part, where the CPU module cannot detect any error. To ensure safety operation in such a case, provide a safety mechanism or a fail-safe circuit external to the programmable controller. For a fail-safe circuit example, refer to the MELSEC iQ-R Module Configuration Manual.
    - (4) Outputs may remain on or off due to a failure of a component such as a relay and transistor in an output circuit. Configure an external circuit for monitoring output signals that could cause a serious accident.
  - In an output circuit, when a load current exceeding the rated current or an overcurrent caused by a load short-circuit flows for a long time, it may cause smoke and fire. To prevent this, configure an external safety circuit, such as a fuse.
  - Configure a circuit so that the programmable controller is turned on first and then the external power supply. If the external power supply is turned on first, an accident may occur due to an incorrect output or malfunction.
  - Configure a circuit so that the external power supply is turned off first and then the programmable controller. If the programmable controller is turned off first, an accident may occur due to an incorrect output or malfunction.
  - For the operating status of each station after a communication failure, refer to manuals for the network used. For the manuals, please consult your local Mitsubishi representative. Incorrect output or malfunction due to a communication failure may result in an accident.
-



## [Design Precautions]

---

### **WARNING**

- When connecting an external device with a CPU module or intelligent function module to modify data of a running programmable controller, configure an interlock circuit in the program to ensure that the entire system will always operate safely. For other forms of control (such as program modification, parameter change, forced output, or operating status change) of a running programmable controller, read the relevant manuals carefully and ensure that the operation is safe before proceeding. Improper operation may damage machines or cause accidents. When a Safety CPU is used, data cannot be modified while the Safety CPU is in SAFETY MODE.
- Especially, when a remote programmable controller is controlled by an external device, immediate action cannot be taken if a problem occurs in the programmable controller due to a communication failure. To prevent this, configure an interlock circuit in the program, and determine corrective actions to be taken between the external device and CPU module in case of a communication failure.
- Do not write any data to the "system area" and "write-protect area" of the buffer memory in the module. Also, do not use any "use prohibited" signals as an output signal from the CPU module to each module. Doing so may cause malfunction of the programmable controller system. For the "system area", "write-protect area", and the "use prohibited" signals, refer to the user's manual for the module used. For areas used for safety communications, they are protected from being written by users, and thus safety communications failure caused by data writing does not occur.
- If a communication cable is disconnected, the network may be unstable, resulting in a communication failure of multiple stations. Configure an interlock circuit in the program to ensure that the entire system will always operate safely even if communications fail. Failure to do so may result in an accident due to an incorrect output or malfunction. When safety communications are used, an interlock by the safety station interlock function protects the system from an incorrect output or malfunction.

### [Precautions for using CC-Link IE Controller Network (when optical fiber cables are used)]

- The optical transmitter and receiver of the CC-Link IE Controller Network module use laser diodes (class 1 in accordance with IEC 60825-1). Do not look directly at a laser beam. Doing so may harm your eyes.
-

## [Design Precautions]

---

### **CAUTION**

- Do not install the control lines or communication cables together with the main circuit lines or power cables. Doing so may result in malfunction due to electromagnetic interference. Keep a distance of 100mm or more between those cables.
  - During control of an inductive load such as a lamp, heater, or solenoid valve, a large current (approximately ten times greater than normal) may flow when the output is turned from off to on. Therefore, use a module that has a sufficient current rating.
  - After the CPU module is powered on or is reset, the time taken to enter the RUN status varies depending on the system configuration, parameter settings, and/or program size. Design circuits so that the entire system will always operate safely, regardless of the time.
  - Do not power off the programmable controller or reset the CPU module while the settings are being written. Doing so will make the data in the flash ROM and SD memory card undefined. The values need to be set in the buffer memory and written to the flash ROM and SD memory card again. Doing so also may cause malfunction or failure of the module.
  - When changing the operating status of the CPU module from external devices (such as the remote RUN/STOP functions), select "Do Not Open by Program" for "Opening Method" of "Module Parameter". If "Open by Program" is selected, an execution of the remote STOP function causes the communication line to close. Consequently, the CPU module cannot reopen the line, and external devices cannot execute the remote RUN function.
- 

## [Security Precautions]

---

### **WARNING**

- To maintain the security (confidentiality, integrity, and availability) of the programmable controller and the system against unauthorized access, denial-of-service (DoS) attacks, computer viruses, and other cyberattacks from external devices via the network, take appropriate measures such as firewalls, virtual private networks (VPNs), and antivirus solutions.
- 

## [Installation Precautions]

---

### **WARNING**

- Shut off the external power supply (all phases) used in the system before mounting or removing the module. Failure to do so may result in electric shock or cause the module to fail or malfunction.
-

## [Installation Precautions]

---

### **CAUTION**

- Use the programmable controller in an environment that meets the general specifications in the MELSEC iQ-R Module Configuration Manual. Failure to do so may result in electric shock, fire, malfunction, or damage to or deterioration of the product.
  - To mount a module, place the concave part(s) located at the bottom onto the guide(s) of the base unit, and push in the module until the hook(s) located at the top snaps into place. Incorrect interconnection may cause malfunction, failure, or drop of the module.
  - To mount a module with no module fixing hook, place the concave part(s) located at the bottom onto the guide(s) of the base unit, push in the module, and fix it with screw(s). Incorrect interconnection may cause malfunction, failure, or drop of the module.
  - When using the programmable controller in an environment of frequent vibrations, fix the module with a screw.
  - Tighten the screws within the specified torque range. Undertightening can cause drop of the component or wire, short circuit, or malfunction. Overtightening can damage the screw and/or module, resulting in drop, short circuit, or malfunction. For the specified torque range, refer to the MELSEC iQ-R Module Configuration Manual.
  - When using an extension cable, connect it to the extension cable connector of the base unit securely. Check the connection for looseness. Poor contact may cause malfunction.
  - When using an SD memory card, fully insert it into the SD memory card slot. Check that it is inserted completely. Poor contact may cause malfunction.
  - Securely insert an extended SRAM cassette or a battery-less option cassette into the cassette connector of the CPU module. After insertion, close the cassette cover and check that the cassette is inserted completely. Poor contact may cause malfunction.
  - Beware that the module could be very hot while power is on and immediately after power-off.
  - Do not directly touch any conductive parts and electronic components of the module, SD memory card, extended SRAM cassette, battery-less option cassette, or connector. Doing so can cause malfunction or failure of the module.
- 

## [Wiring Precautions]

---

### **WARNING**

- Shut off the external power supply (all phases) used in the system before installation and wiring. Failure to do so may result in electric shock or cause the module to fail or malfunction.
- After installation and wiring, attach a blank cover module (RG60) to each empty slot before powering on the system for operation. Also, attach an extension connector protective cover<sup>\*1</sup> to each unused extension cable connector as necessary. Directly touching any conductive parts of the connectors while power is on may result in electric shock.

\*1 For details, please consult your local Mitsubishi Electric representative.

---

## [Wiring Precautions]

---

### CAUTION

- Individually ground the FG and LG terminals of the programmable controller with a ground resistance of 100 ohms or less. Failure to do so may result in electric shock or malfunction.
- Use applicable solderless terminals and tighten them within the specified torque range. If any spade solderless terminal is used, it may be disconnected when the terminal screw comes loose, resulting in failure.
- Check the rated voltage and signal layout before wiring to the module, and connect the cables correctly. Connecting a power supply with a different voltage rating or incorrect wiring may cause fire or failure.
- Connectors for external devices must be crimped or pressed with the tool specified by the manufacturer, or must be correctly soldered. Incomplete connections may cause short circuit, fire, or malfunction.
- Securely connect the connector to the module. Poor contact may cause malfunction.
- Do not install the control lines or communication cables together with the main circuit lines or power cables. Doing so may result in malfunction due to noise. Keep a distance of 100mm or more between those cables.
- Place the cables in a duct or clamp them. If not, dangling cables may swing or inadvertently be pulled, resulting in malfunction or damage to modules or cables.  
In addition, the weight of the cables may put stress on modules in an environment of strong vibrations and shocks.  
Do not clamp the extension cables with the jacket stripped. Doing so may change the characteristics of the cables, resulting in malfunction.
- Check the interface type and correctly connect the cable. Incorrect wiring (connecting the cable to an incorrect interface) may cause failure of the module and external device.
- Tighten the terminal screws or connector screws within the specified torque range. Undertightening can cause drop of the screw, short circuit, fire, or malfunction. Overtightening can damage the screw and/or module, resulting in drop, short circuit, fire, or malfunction.
- When disconnecting the cable from the module, do not pull the cable by the cable part. For the cable with connector, hold the connector part of the cable. For the cable connected to the terminal block, loosen the terminal screw. Pulling the cable connected to the module may result in malfunction or damage to the module or cable.
- Prevent foreign matter such as dust or wire chips from entering the module. Such foreign matter can cause a fire, failure, or malfunction.
- When a protective film is attached to the top of the module, remove it before system operation. If not, inadequate heat dissipation of the module may cause a fire, failure, or malfunction.
- Programmable controllers must be installed in control panels. Connect the main power supply to the power supply module in the control panel through a relay terminal block. Wiring and replacement of a power supply module must be performed by qualified maintenance personnel with knowledge of protection against electric shock. For wiring, refer to the MELSEC iQ-R Module Configuration Manual.
- For Ethernet cables to be used in the system, select the ones that meet the specifications in the user's manual for the module used. If not, normal data transmission is not guaranteed.

#### [Precautions for using CC-Link IE Controller Network (when optical fiber cables are used)]

- For optical fiber cables to be used in the system, select the ones that meet the specifications in this manual. If not, normal data transmission is not guaranteed.
-

## [Startup and Maintenance Precautions]

---

### **WARNING**

---

- Do not touch any terminal while power is on. Doing so will cause electric shock or malfunction.
  - Correctly connect the battery connector. Do not charge, disassemble, heat, short-circuit, solder, or throw the battery into the fire. Also, do not expose it to liquid or strong shock. Doing so will cause the battery to produce heat, explode, ignite, or leak, resulting in injury and fire.
  - Shut off the external power supply (all phases) used in the system before cleaning the module or retightening the terminal screws, connector screws, or module fixing screws. Failure to do so may result in electric shock.
-

## [Startup and Maintenance Precautions]

---

### CAUTION

- When connecting an external device with a CPU module or intelligent function module to modify data of a running programmable controller, configure an interlock circuit in the program to ensure that the entire system will always operate safely. For other forms of control (such as program modification, parameter change, forced output, or operating status change) of a running programmable controller, read the relevant manuals carefully and ensure that the operation is safe before proceeding. Improper operation may damage machines or cause accidents.
  - Especially, when a remote programmable controller is controlled by an external device, immediate action cannot be taken if a problem occurs in the programmable controller due to a communication failure. To prevent this, configure an interlock circuit in the program, and determine corrective actions to be taken between the external device and CPU module in case of a communication failure.
  - Do not disassemble or modify the modules. Doing so may cause failure, malfunction, injury, or a fire.
  - Use any radio communication device such as a cellular phone or PHS (Personal Handy-phone System) 25cm or more away in all directions from the programmable controller. Failure to do so may cause malfunction.
  - Shut off the external power supply (all phases) used in the system before mounting or removing the module. Failure to do so may cause the module to fail or malfunction.
  - Tighten the screws within the specified torque range. Undertightening can cause drop of the component or wire, short circuit, or malfunction. Overtightening can damage the screw and/or module, resulting in drop, short circuit, or malfunction.
  - After the first use of the product, do not perform each of the following operations more than 50 times (IEC 61131-2/JIS B 3502 compliant).  
Exceeding the limit may cause malfunction.
    - Mounting/removing the module to/from the base unit
    - Inserting/removing the extended SRAM cassette or battery-less option cassette to/from the CPU module
    - Mounting/removing the terminal block to/from the module
    - Connecting/disconnecting the extension cable to/from the base unit
  - After the first use of the product, do not insert/remove the SD memory card to/from the CPU module more than 500 times. Exceeding the limit may cause malfunction.
  - Do not touch the metal terminals on the back side of the SD memory card. Doing so may cause malfunction or failure of the module.
  - Do not touch the integrated circuits on the circuit board of an extended SRAM cassette or a battery-less option cassette. Doing so may cause malfunction or failure of the module.
  - Do not drop or apply shock to the battery to be installed in the module. Doing so may damage the battery, causing the battery fluid to leak inside the battery. If the battery is dropped or any shock is applied to it, dispose of it without using.
-

## [Startup and Maintenance Precautions]

---

### CAUTION

- Startup and maintenance of a control panel must be performed by qualified maintenance personnel with knowledge of protection against electric shock. Lock the control panel so that only qualified maintenance personnel can operate it.
  - Before handling the module, touch a conducting object such as a grounded metal to discharge the static electricity from the human body. Wearing a grounded antistatic wrist strap is recommended. Failure to discharge the static electricity may cause the module to fail or malfunction.
  - After unpacking, eliminate static electricity from the module to prevent electrostatic discharge from affecting the module. If an electrostatically charged module comes in contact with a grounded metal object, a sudden electrostatic discharge of the module may cause failure.  
For details on how to eliminate static electricity from the module, refer to the following. Antistatic Precautions Before Using MELSEC iQ-R Series Products (FA-A-0368)
  - Use a clean and dry cloth to wipe off dirt on the module.
- 

## [Operating Precautions]

---

### CAUTION

- When changing data and operating status, and modifying program of the running programmable controller from an external device such as a personal computer connected to an intelligent function module, read relevant manuals carefully and ensure the safety before operation. Incorrect change or modification may cause system malfunction, damage to the machines, or accidents.
  - Do not power off the programmable controller or reset the CPU module while the setting values in the buffer memory are being written to the flash ROM in the module. Doing so will make the data in the flash ROM and SD memory card undefined. The values need to be set in the buffer memory and written to the flash ROM and SD memory card again. Doing so can cause malfunction or failure of the module.
- 

## [Disposal Precautions]

---

### CAUTION

- When disposing of this product, treat it as industrial waste.
  - When disposing of batteries, separate them from other wastes according to the local regulations. For details on battery regulations in EU member states, refer to the MELSEC iQ-R Module Configuration Manual.
-

## [Transportation Precautions]

---

### **CAUTION**

---

- When transporting lithium batteries, follow the transportation regulations. For details on the regulated models, refer to the MELSEC iQ-R Module Configuration Manual.
  - The halogens (such as fluorine, chlorine, bromine, and iodine), which are contained in a fumigant used for disinfection and pest control of wood packaging materials, may cause failure of the product. Prevent the entry of fumigant residues into the product or consider other methods (such as heat treatment) instead of fumigation. The disinfection and pest control measures must be applied to unprocessed raw wood.
-



# CONDITIONS OF USE FOR THE PRODUCT

---

- (1) MELSEC programmable controller ("the PRODUCT") shall be used in conditions;
- i) where any problem, fault or failure occurring in the PRODUCT, if any, shall not lead to any major or serious accident; and
  - ii) where the backup and fail-safe function are systematically or automatically provided outside of the PRODUCT for the case of any problem, fault or failure occurring in the PRODUCT.
- (2) The PRODUCT has been designed and manufactured for the purpose of being used in general industries. MITSUBISHI ELECTRIC SHALL HAVE NO RESPONSIBILITY OR LIABILITY (INCLUDING, BUT NOT LIMITED TO ANY AND ALL RESPONSIBILITY OR LIABILITY BASED ON CONTRACT, WARRANTY, TORT, PRODUCT LIABILITY) FOR ANY INJURY OR DEATH TO PERSONS OR LOSS OR DAMAGE TO PROPERTY CAUSED BY THE PRODUCT THAT ARE OPERATED OR USED IN APPLICATION NOT INTENDED OR EXCLUDED BY INSTRUCTIONS, PRECAUTIONS, OR WARNING CONTAINED IN MITSUBISHI ELECTRIC USER'S, INSTRUCTION AND/OR SAFETY MANUALS, TECHNICAL BULLETINS AND GUIDELINES FOR the PRODUCT.
- ("Prohibited Application")
- Prohibited Applications include, but not limited to, the use of the PRODUCT in;
- Nuclear Power Plants and any other power plants operated by Power companies, and/or any other cases in which the public could be affected if any problem or fault occurs in the PRODUCT.
  - Railway companies or Public service purposes, and/or any other cases in which establishment of a special quality assurance system is required by the Purchaser or End User.
  - Aircraft or Aerospace, Medical applications, Train equipment, transport equipment such as Elevator and Escalator, Incineration and Fuel devices, Vehicles, Manned transportation, Equipment for Recreation and Amusement, and Safety devices, handling of Nuclear or Hazardous Materials or Chemicals, Mining and Drilling, and/or other applications where there is a significant risk of injury to the public or property.
- Notwithstanding the above restrictions, Mitsubishi Electric may in its sole discretion, authorize use of the PRODUCT in one or more of the Prohibited Applications, provided that the usage of the PRODUCT is limited only for the specific applications agreed to by Mitsubishi Electric and provided further that no special quality assurance or fail-safe, redundant or other safety features which exceed the general specifications of the PRODUCTS are required. For details, please contact the Mitsubishi Electric representative in your region.
- (3) Mitsubishi Electric shall have no responsibility or liability for any problems involving programmable controller trouble and system trouble caused by DoS attacks, unauthorized access, computer viruses, and other cyberattacks.

# INTRODUCTION

---

Thank you for purchasing the Mitsubishi Electric MELSEC iQ-R series programmable controllers.

This manual describes the procedures, system configuration, and wiring of the relevant products listed below.

Before using this product, please read this manual and the relevant manuals carefully and develop familiarity with the functions and performance of the MELSEC iQ-R series programmable controller to handle the product correctly.

When applying the program examples provided in this manual to an actual system, ensure the applicability and confirm that it will not cause system control problems.

Please make sure that the end users read this manual.

## Relevant products

---

RJ71EN71, CPU module, RJ71GP21-SX, RJ71GP21S-SX, RJ71GF11-T2

# COMPLIANCE WITH EMC AND LOW VOLTAGE DIRECTIVES

---

## Method of ensuring compliance

---

To ensure that Mitsubishi Electric programmable controllers maintain the EMC and Low Voltage Directives or other regulations when incorporated into other machinery or equipment, certain measures may be necessary. Please refer to one of the following manuals.

- MELSEC iQ-R Module Configuration Manual (SH-081262ENG)
- Safety Guidelines (IB-0800525)

Certification marks on the side of the programmable controller indicate compliance with the relevant regulations.

## Additional measures

---

To ensure that this product maintains the EMC and Low Voltage Directives or other regulations, please refer to the following.

- MELSEC iQ-R Module Configuration Manual (SH-081262ENG)
- Safety Guidelines (IB-0800525)

# CONTENTS

SAFETY PRECAUTIONS	1
CONDITIONS OF USE FOR THE PRODUCT	11
INTRODUCTION	12
COMPLIANCE WITH EMC AND LOW VOLTAGE DIRECTIVES	12
RELEVANT MANUALS	15
TERMS	17
GENERIC TERMS AND ABBREVIATIONS	19
<b>CHAPTER 1 PART NAMES</b>	<b>20</b>
1.1 RJ71EN71	20
Available combination of network	21
Network used and LED indication	23
1.2 CPU Module	27
Available combination of network	29
Network used and LED indication	30
1.3 RJ71GP21(S)-SX	31
1.4 RJ71GF11-T2	33
<b>CHAPTER 2 SPECIFICATIONS</b>	<b>35</b>
2.1 Performance Specifications of Ethernet	35
2.2 Performance Specifications of CC-Link IE Controller Network	36
2.3 Performance Specifications of CC-Link IE Field Network	37
2.4 Hardware Specifications	39
<b>CHAPTER 3 FUNCTION LIST</b>	<b>40</b>
3.1 Function List of Ethernet	40
RJ71EN71, RnENCPU (network part)	41
CPU module (built-in Ethernet port part)	42
3.2 Function List of CC-Link IE Controller Network	44
3.3 Function List of CC-Link IE Field Network	47
<b>CHAPTER 4 PROCEDURES BEFORE OPERATION</b>	<b>52</b>
<b>CHAPTER 5 SYSTEM CONFIGURATION</b>	<b>54</b>
5.1 Ethernet Configuration	55
5.2 CC-Link IE Controller Network Configuration	56
When optical fiber cables are used	56
When Ethernet cables are used	57
Precautions when Ethernet cables are used	59
5.3 CC-Link IE Field Network Configuration	62
Precautions	65
5.4 Precautions for System Configuration	68
<b>CHAPTER 6 WIRING</b>	<b>69</b>
6.1 Ethernet Wiring	69
6.2 Wiring of CC-Link IE Controller Network	71
Optical fiber cable	71
External power supply	72

Ethernet cables .....	73
<b>6.3 Wiring of CC-Link IE Field Network .....</b>	<b>75</b>
<b>CHAPTER 7 COMMUNICATION EXAMPLES .....</b>	<b>79</b>
<hr/>	
<b>7.1 Communication Examples of Ethernet .....</b>	<b>79</b>
System configuration example .....	79
Sending side .....	79
Receiving side .....	81
Program example .....	83
<b>7.2 Communication Examples of CC-Link IE Controller Network .....</b>	<b>89</b>
System configuration example .....	89
Setting in the control station .....	90
Setting in the normal stations .....	93
Checking the network status .....	95
Program example .....	96
<b>7.3 Communication Examples of CC-Link IE Field Network .....</b>	<b>100</b>
System configuration example .....	100
Setting in the master station .....	102
Setting in the local station .....	105
Checking the network status .....	107
Program example .....	108
<b>APPENDICES .....</b>	<b>109</b>
<hr/>	
<b>Appendix 1 External Dimensions .....</b>	<b>109</b>
<b>Appendix 2 Precautions of Firmware Update Function .....</b>	<b>111</b>
<b>INDEX .....</b>	<b>113</b>
<hr/>	
REVISIONS .....	115
WARRANTY .....	117
TRADEMARKS .....	118

# RELEVANT MANUALS

Manual name [manual number]	Description	Available form
MELSEC iQ-R Ethernet/CC-Link IE User's Manual (Startup) [SH-081256ENG] (this manual)	Specifications, procedures before operation, system configuration, wiring, and communication examples of Ethernet, CC-Link IE Controller Network, and CC-Link IE Field Network	Print book e-Manual PDF
MELSEC iQ-R Module Configuration Manual [SH-081262ENG]	The combination of the MELSEC iQ-R series modules, common information on the installation/wiring in the system, and specifications of the power supply module, base unit, SD memory card, and battery	Print book e-Manual PDF
MELSEC iQ-R Ethernet User's Manual (Application) [SH-081257ENG]	Functions, parameter settings, programming, troubleshooting, I/O signals, and buffer memory of Ethernet	Print book e-Manual PDF
MELSEC iQ-R CC-Link IE Controller Network User's Manual (Application) [SH-081258ENG]	Functions, parameter settings, troubleshooting, and buffer memory of CC-Link IE Controller Network	Print book e-Manual PDF
MELSEC iQ-R CC-Link IE Field Network User's Manual (Application) [SH-081259ENG]	Functions, parameter settings, programming, troubleshooting, I/O signals, and buffer memory of CC-Link IE Field Network	Print book e-Manual PDF
MELSEC iQ-R CPU Module User's Manual (Startup) [SH-081263ENG]	Performance specifications, procedures before operation, and troubleshooting of the CPU module	Print book e-Manual PDF
MELSEC iQ-R CPU Module User's Manual (Application) [SH-081264ENG]	Memory, functions, devices, and parameters of the CPU module	Print book e-Manual PDF
MELSEC iQ-R Programmable Controller CPU Module User's Manual [SH-082488ENG]	Procedures before operation, specifications, devices, memory, functions, parameters, and troubleshooting of the programmable controller CPU	Print book e-Manual PDF
MELSEC iQ-R Process CPU Module User's Manual [SH-082493ENG]	Procedures before operation, specifications, devices, memory, functions, parameters, and troubleshooting of the Process CPU	Print book e-Manual PDF
MELSEC iQ-R Programming Manual (Module Dedicated Instructions) [SH-081976ENG]	Dedicated instructions for the intelligent function modules	e-Manual PDF
MELSEC iQ-R Ethernet, CC-Link IE, and MELSECNET/H Function Block Reference [BCN-P5999-0381]	Specifications of the following MELSEC iQ-R series module FBs: Ethernet-equipped module FBs, CC-Link IE TSN module FBs, CC-Link IE Controller Network module FBs, CC-Link IE Field Network module FBs, and MELSECNET/H network module FBs	e-Manual PDF
GX Works3 Operating Manual [SH-081215ENG]	System configuration, parameter settings, and online operations of GX Works3	e-Manual PDF
MELSEC iQ-R MODBUS and MODBUS/TCP Reference Manual [BCN-P5999-1060]	The protocol used for data reading or writing from an external device to the Ethernet-equipped module	e-Manual PDF
SLMP Reference Manual [SH-080956ENG]	The protocol used to access an SLMP-compatible device from an external device (such as a personal computer or HMI (Human Machine Interface)) or an SLMP-compatible module (such as the Ethernet-equipped module or modules on CC-Link IE TSN).	Print book e-Manual PDF
iQ Sensor Solution Reference Manual [SH-081133ENG]	Operation methods of the online functions for iQ Sensor Solution	Print book e-Manual PDF
MELSEC iQ-R Simple Device Communication Library Reference Manual [SH-082515ENG]	Simple device communication library	e-Manual PDF

This manual does not include detailed information on the following:

- General specifications
- Applicable combinations of CPU modules and the other modules, and the number of mountable modules
- Installation

For details, refer to the following.

 MELSEC iQ-R Module Configuration Manual

---

**Point** 

e-Manual refers to the Mitsubishi Electric FA electronic book manuals that can be browsed using a dedicated tool.



e-Manual has the following features:

- Required information can be cross-searched in multiple manuals.
  - Other manuals can be accessed from the links in the manual.
  - The hardware specifications of each part can be found from the product figures.
  - Pages that users often browse can be bookmarked.
  - Sample programs can be copied to an engineering tool.
-

# TERMS

Unless otherwise specified, this manual uses the following terms.

Term	Description
Baton pass	A control mechanism in which transmission right (token) is passed around the network of CC-Link IE for data transmission.
Buffer memory	Memory in an intelligent function module to store data such as setting values and monitor values. For CPU modules, it refers to memory to store data such as setting values and monitor values of the Ethernet function, or data used for data communication of the multiple CPU system function.
Control CPU	A CPU module that controls connected I/O modules and intelligent function modules. In a multiple CPU system, a control CPU can be set for each module.
Control station	A station that controls the entire network on CC-Link IE Controller Network. This station can perform cyclic transmission and transient transmission with all stations. Only one master station can be used in a network.
Control system	A system that controls a redundant system and performs network communications in a redundant system
CPU module (built-in Ethernet port part)	A built-in Ethernet port part of a CPU module (CPU part for an RnENCPU) (☞ Page 27 CPU Module)
Data link	Communications that performed by cyclic transmission and transient transmission
Dedicated instruction	An instruction that simplifies programming for using functions of intelligent function modules
Device	A memory of a CPU module to store data. Devices such as X, Y, M, D, and others are provided depending on the intended use.
Device station <sup>*1</sup>	A station other than a master station on CC-Link IE Field Network: a local station, a remote I/O station, a remote device station, and an intelligent device station.
Device supporting iQSS	A device which supports iQ Sensor Solution
Engineering tool	A tool used for setting up programmable controllers, programming, debugging, and maintenance
Global label	A label that is valid for all the program data when multiple program data are created in the project. There are two types of global label: a module specific label (module label), which is generated automatically by GX Works3, and an optional label, which can be created for any specified device.
I/O master station	A station that controls the communications using link devices on CC-Link IE Controller Network. Up to two I/O master stations can be set for one network (block 1 and block 2), regardless of the status of control or normal station.
Intelligent device station	A station that exchanges I/O signals (bit data) and I/O data (word data) with CC-Link IE Field Network by cyclic transmission. This station responds to a transient transmission request from another station and also issues a transient transmission request to another station.
Intelligent function module	A module that has functions other than an input or output, such as an A/D converter module and D/A converter module
Link device	A device in a module on CC-Link IE
Link refresh	Automatic data transfer between a link device in a module on CC-Link IE and a device in a CPU module. Link refresh is performed in the END processing of the sequence scan in the CPU module.
Link scan (link scan time)	Time required for all the stations on the network of CC-Link IE to transmit data. The link scan time depends on data volume and the number of transient transmission requests.
Local station	A station that performs cyclic transmission and transient transmission with the master station and other local stations on CC-Link IE Field Network.
Master operating station	A station that controls the entire network when the submaster function of CC-Link IE Field Network is used. Only one master station can be used in a network.
Master station	A station that controls the entire network on CC-Link IE Field Network. This station can perform cyclic transmission and transient transmission with all stations. Only one master station can be used in a network.
MODBUS/TCP	A protocol for using MODBUS protocol messages on a TCP/IP network
Module label	A label that represents one of memory areas (I/O signals and buffer memory areas) specific to each module in a given character string. For the module used, GX Works3 automatically generates this label, which can be used as a global label.
New control system	A system that has switched to control system from standby system after system switching
Normal station	A station that performs cyclic transmission and transient transmission with the control station and other normal stations on CC-Link IE Controller Network
Predefined protocol support function	A function of GX Works3. This function sets protocols appropriate to each external device and reads/writes protocol setting data.
Process CPU	A CPU module that performs process control and sequence control. Process control function blocks and the online module change function can be executed. This module is also used with a redundant function module as a pair and configures a redundant system. The Process CPU models include the R08PCPU, R16PCPU, R32PCPU, and R120PCPU.
Process CPU (redundant mode)	A Process CPU operating in redundant mode. A redundant system is configured with this CPU module. Process control function blocks and the online module change function can be used even in this mode.

Term	Description
Redundant function module	A module that configures a redundant system and is used with a Process CPU (redundant mode) or a SIL2 Process CPU. The redundant function module model name is R6RFM.
Redundant system	A system consisting of two systems that have same configuration (CPU module, power supply module, network module, and other modules). Even after an error occurs in one of the two system, the other system takes over the control of the entire system.
Redundant system with redundant extension base unit	A redundant system that is configured using extension base unit(s)
Relay station	A station that relays data link to other station with mounting more than one network modules on one programmable controller.
Remote device station	A station that exchanges I/O signals (bit data) and I/O data (word data) with the master station of CC-Link IE Field Network by cyclic transmission. This station responds to a transient transmission request from another station.
Remote I/O station	A station that exchanges I/O signals (bit data) with the master station of CC-Link IE Field Network by cyclic transmission
RnENCPU (CPU part)	A module on the left-hand side of the RnENCPU (  Page 27 CPU Module)
RnENCPU (network part)	A module on the right-hand side of the RnENCPU (  Page 27 CPU Module)
Routing	A process of selecting paths for communication with other networks. There are two types of routing: dynamic routing that auto-selects the communication routes, and static routing where communication routes are arbitrarily set.
Safety CPU	A module that performs both standard control and safety control and is used with a safety function module. The Safety CPU models include the R08SFCPU, R16SFCPU, R32SFCPU, and R120SFCPU.
Shared group number	Number that is assigned to a station to allow it to share cyclic data with any given stations on CC-Link IE Controller Network. Cyclic data can be shared only with stations of the same group.
SIL2 Process CPU	This module is used with a SIL2 function module as a pair, and performs both standard control and safety control. This module is also used with a redundant function module as a pair and configures a redundant system. The SIL2 Process CPU models include the R08PSFCPU, R16PSFCPU, R32PSFCPU, and R120PSFCPU.
Standby system	A backup system in a redundant system
Submaster operating station	A station that monitors a master operating station when the submaster function of CC-Link IE Field Network is used. Only one master station can be used in a network.
Submaster station	A station that serves as a master station to control the entire network if the master station of CC-Link IE Field Network is disconnected. Only one master station can be used in a network.
Subnet mask	A number used to logically divide one network into multiple subnetworks and manage them easily. The following Ethernet network systems can be configured: <ul style="list-style-type: none"> <li>• A small-scale Ethernet network system in which multiple network devices are connected</li> <li>• A medium- or large-scale network system in which multiple small-scale network systems are connected via routers or other network communication devices</li> </ul>
System switching	A function which switches the systems between the control system and the standby system to continue operation of the redundant system when a failure or an error occurs in the control system
Transient transmission group number	Number that is assigned for transient transmission to any given stations on Ethernet and CC-Link IE Controller Network. By specifying a group of stations as transient transmission target, data can be sent to the stations of the same group number.

\*1 The term has not been replaced yet in some areas in the engineering tool, and there may be differences between some window images of the engineering tool and the corresponding description in this manual.  
In case of inconsistency, refer to the following.

Term used in software window	Term after change
Slave station	Device station



# GENERIC TERMS AND ABBREVIATIONS

Unless otherwise specified, this manual uses the following generic terms and abbreviations.

Generic term/abbreviation	Description
CC-Link IE	A generic term for CC-Link IE Controller Network and CC-Link IE Field Network
CC-Link IE Controller Network-equipped module	A generic term for the following modules: <ul style="list-style-type: none"> <li>• RJ71GP21-SX CC-Link IE Controller Network module</li> <li>• RJ71GP21S-SX CC-Link IE Controller Network module</li> <li>• RJ71EN71 (when the CC-Link IE Controller Network function is used)</li> <li>• RnENCPU (when the CC-Link IE Controller Network function is used)</li> </ul>
CC-Link IE Field Network-equipped master/local module	A generic term for the following modules: <ul style="list-style-type: none"> <li>• RJ71GF11-T2 CC-Link IE Field Network master/local module</li> <li>• RJ71EN71 (when the CC-Link IE Field Network function is used)</li> <li>• RnENCPU (when the CC-Link IE Field Network function is used)</li> </ul>
CC-Link IE module	A generic term for the CC-Link IE Controller Network-equipped module and CC-Link IE Field Network-equipped master/local module
Ethernet adapter module	An abbreviation for the NZ2GF-ETB CC-Link IE Field Network Ethernet adapter module
Ethernet device	A generic term for the devices supporting IP communication (such as a personal computer, a vision sensor, and a bar code reader)
Ethernet-equipped module	A generic term for the following modules: <ul style="list-style-type: none"> <li>• RJ71EN71 (when the Ethernet function is used)</li> <li>• CPU module (when the Ethernet function is used)</li> </ul>
LB	An abbreviation for the link relay of the CC-Link IE Controller Network. Bit data send from each station on CC-Link IE Controller Network.
LW	An abbreviation for the link register of the CC-Link IE Controller Network. Word data send from each station on CC-Link IE Controller Network.
LX	An abbreviation for the link input of the CC-Link IE Controller Network. Data input from the stations in a block to I/O master station.
LY	An abbreviation for the link output of the CC-Link IE Controller Network. Data output from the I/O master station to stations in a block.
MELSECNET/10	An abbreviation for the MELSECNET/10 network system
MELSECNET/H	An abbreviation for the MELSECNET/H network system
Network module	A generic term for the following modules: <ul style="list-style-type: none"> <li>• Ethernet interface module</li> <li>• A module on CC-Link IE TSN (the RJ71GN11-T2 and a module on a remote station)</li> <li>• CC-Link IE Controller Network module</li> <li>• A module on CC-Link IE Field Network (a master/local module, and a module on a remote I/O station, a remote device station, and an intelligent device station)</li> <li>• MELSECNET/H network module</li> <li>• MELSECNET/10 network module</li> <li>• RnENCPU (network part)</li> </ul>
Remote head module	An abbreviation for the RJ72GF15-T2 CC-Link IE Field Network remote head module
RJ71GP21(S)-SX	A generic term for the RJ71GP21-SX and RJ71GP21S-SX
RnENCPU	A generic term for the R04ENCPU, R08ENCPU, R16ENCPU, R32ENCPU, and R120ENCPU
RWr	An abbreviation for the remote register of the CC-Link IE Field Network. Word data (16-bit data) input from a device station to the master station. (For some areas in a local station, data are input in the opposite direction.)
RWw	An abbreviation for the remote register of the CC-Link IE Field Network. Word data (16-bit data) output from the master station to a device station. (For some areas in a local station, data are output in the opposite direction.)
RX	An abbreviation for the remote input of the CC-Link IE Field Network. Bit data input from a device station to the master station. (For some areas in a local station, data are input in the opposite direction.)
RY	An abbreviation for the remote output of the CC-Link IE Field Network. Bit data output from the master station to a device station. (For some areas in a local station, data are output in the opposite direction.)
SB	An abbreviation for the link special relay of the CC-Link IE Field Network. Bit data that indicates the operating status and data link status of a module on CC-Link IE Field Network.
SW	An abbreviation for the link special register of the CC-Link IE Field Network. Word data (16-bit data) that indicates the operating status and data link status of a module on CC-Link IE Field Network.

# 1 PART NAMES

## 1.1 RJ71EN71

This section describes the names of each part of the RJ71EN71.

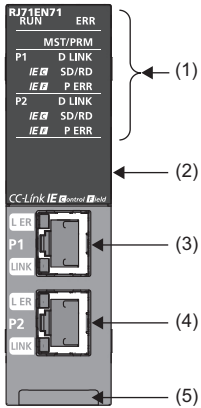

No.	Name	Description
(1)	Operation status indicator LED	Indicates the operating status of the module. (☞ Page 23 Network used and LED indication)
(2)	Dot matrix LED	Indicates the station number set in the module and the module communication test result. (☞ Page 26 Dot matrix LED indication) For indication of the module communication test result, refer to the following. ☞ MELSEC iQ-R Ethernet User's Manual (Application)
(3)	Ethernet port (P1)	PORT1 connector for network. Connect an Ethernet cable. For wiring methods and wiring precautions, refer to the following. (☞ Page 69 WIRING)
	L ER LED	Indicates the port status. (☞ Page 23 Network used and LED indication)
	LINK LED	Indicates the link status. (☞ Page 23 Network used and LED indication)
(4)	Ethernet port (P2)	PORT2 connector for network. Connect an Ethernet cable. For wiring methods and wiring precautions, refer to the following. (☞ Page 69 WIRING)
	L ER LED	Same as the P1 connector
	LINK LED	
(5)	Production information marking	Shows the production information (16 digits) of the module.

## Available combination of network

Ethernet port (P1 and P2) of the RJ71EN71 can be used in the following network depending on the engineering tool setting. (GX Works3 Operating Manual)

- Ethernet
- CC-Link IE Controller Network
- CC-Link IE Field Network
- Q-compatible Ethernet

The following table lists the available combination of network and setting in GX Works3.

Network combination	Setting in GX Works3			Description	Remarks
	Model*1	Port 1 network type	Port 2 network type		
Ethernet only	RJ71EN71 (E+E)	Ethernet	Ethernet	Different network between P1 and P2 can be connected to Ethernet.	—
CC-Link IE Controller Network only	RJ71EN71 (CCIEC)	CC-Link IE Control	CC-Link IE Control	P1 and P2 can be connected to CC-Link IE Controller Network.	<ul style="list-style-type: none"> <li>• P1 and P2 cannot be connected to different CC-Link IE Controller Network.</li> <li>• P1 and P2 cannot be set different station numbers.</li> <li>• When the RJ71EN71 is mounted on the extension base unit in the redundant system with redundant extension base unit, the model on the left cannot be set.</li> </ul>
CC-Link IE Field Network only	RJ71EN71 (CCIEF)	CC-Link IE Field	CC-Link IE Field	P1 and P2 can be connected to CC-Link IE Field Network.	<ul style="list-style-type: none"> <li>• P1 and P2 cannot be connected to different CC-Link IE Field Network.</li> <li>• P1 and P2 cannot be set different station numbers.</li> <li>• When the RJ71EN71 is mounted on the extension base unit in the redundant system with redundant extension base unit, the model on the left cannot be set.</li> </ul>
Ethernet + CC-Link IE Controller Network	RJ71EN71 (E+CCIEC)	Ethernet	CC-Link IE Control	P1 can be connected to Ethernet and P2 can be connected to CC-Link IE Controller Network.	<ul style="list-style-type: none"> <li>• CC-Link IE Controller Network cannot be configured in ring topology.</li> <li>• When the RJ71EN71 is mounted on the extension base unit in the redundant system with redundant extension base unit, the model on the left cannot be set.</li> </ul>
Ethernet + CC-Link IE Field Network	RJ71EN71 (E+CCIEF)	Ethernet	CC-Link IE Field	P1 can be connected to Ethernet and P2 can be connected to CC-Link IE Field Network.	<ul style="list-style-type: none"> <li>• CC-Link IE Field Network cannot be configured in ring topology.</li> <li>• When the RJ71EN71 is mounted on the extension base unit in the redundant system with redundant extension base unit, the model on the left cannot be set.</li> </ul>
Q-compatible Ethernet	RJ71EN71 (Q)	Q Compatible Ethernet	—	A setting for replacement from the MELSEC-Q series Ethernet interface module. The RJ71EN71 can be connected to Ethernet without changing I/O signal and buffer memory from the MELSEC-Q series Ethernet interface module.	<ul style="list-style-type: none"> <li>• Some parameters cannot be set.</li> <li>• P2 cannot be used.</li> </ul>

\*1 The name in parentheses is the abbreviation of the network type.

**Restriction** 

---

- When the RJ71EN71 is used in the redundant system of the CPU module or the system of the remote head module, CC-Link IE Controller Network and CC-Link IE Field Network cannot be used.
- When the control CPU of the RJ71EN71 is the Process CPU, CC-Link IE Controller Network cannot be used.
- When the control CPU of the RJ71EN71 is the Safety CPU and CC-Link IE Controller Network is used, the firmware versions of the Safety CPU have restrictions. For details, refer to the following.

 MELSEC iQ-R CPU Module User's Manual (Application)

---

## Network used and LED indication

LED indication of the RJ71EN71 differs depending on the network used.  
The following table lists the LED indication when each network is used.

### When Ethernet or Q-compatible Ethernet is used

LED name	Description
RUN LED	Indicates the operating status. On: Normal operation Off: Error (MELSEC iQ-R Ethernet User's Manual (Application))
ERR LED <sup>*1</sup>	Indicates the error status of the module. On, flashing: Error (MELSEC iQ-R Ethernet User's Manual (Application)) Off: Normal operation
MST/PRM LED <sup>*1</sup>	Indicates the operating status of CC-Link IE Controller Network when P2 is used in CC-Link IE Controller Network. (MST/PRM LED is always off when CC-Link IE Controller Network is not used) For the LED indication when CC-Link IE Controller Network is used, refer to the following. ☞ Page 24 When CC-Link IE Controller Network is used
	Indicates the operating status of CC-Link IE Field Network when P2 is used in CC-Link IE Field Network. (MST/PRM LED is always off when CC-Link IE Field Network is not used) For the LED indication when CC-Link IE Field Network is used, refer to the following. ☞ Page 25 When CC-Link IE Field Network is used
D LINK LED <sup>*1</sup>	Indicates the data link status of P2 when P2 is used in CC-Link IE Controller Network. (D LINK LED of P1 is always off) For the LED indication when CC-Link IE Controller Network is used, refer to the following. ☞ Page 24 When CC-Link IE Controller Network is used
	Indicates the data link status of P2 when P2 is used in CC-Link IE Field Network. (D LINK LED of P1 is always off) For the LED indication when CC-Link IE Field Network is used, refer to the following. ☞ Page 25 When CC-Link IE Field Network is used
SD/RD LED	Indicates the data sending/receiving status. On: Data being sent or received Off: Data not sent nor received
P ERR LED <sup>*1</sup>	Indicates the error status of P1 and P2. On, flashing: Error (MELSEC iQ-R Ethernet User's Manual (Application)) Off: Normal operation
IE C LED <sup>*1*2</sup>	Indicates the network type setting status when P2 is used in CC-Link IE Controller Network. (IE C LED of P1 is always off.) For the LED indication when CC-Link IE Controller Network is used, refer to the following. ☞ Page 24 When CC-Link IE Controller Network is used
IE F LED <sup>*1</sup>	Indicates the network type setting status when P2 is used in CC-Link IE Field Network. (IE F LED of P1 is always off.) For the LED indication when CC-Link IE Field Network is used, refer to the following. ☞ Page 25 When CC-Link IE Field Network is used
L ER LED	Indicates the port status when P2 is used in CC-Link IE Controller Network. (L ER LED of P1 is always off) For the LED indication when CC-Link IE Controller Network is used, refer to the following. ☞ Page 24 When CC-Link IE Controller Network is used
	Indicates the port status when P2 is used in CC-Link IE Field Network. (L ER LED of P1 is always off) For the LED indication when CC-Link IE Field Network is used, refer to the following. ☞ Page 25 When CC-Link IE Field Network is used
LINK LED	Indicates the link status. On (green): Link-up (1Gbps) On (yellow): Link-up (100Mbps) Off: Link-down, link-up (10Mbps)

\*1 The LED is always off in offline mode.

\*2 LED indication differs depending on the version of the RJ71EN71.  
(MELSEC iQ-R CC-Link IE Controller Network User's Manual (Application))

## When CC-Link IE Controller Network is used

LED name	Description
RUN LED	Indicates the operating status. On: Normal operation Off: Error (MELSEC iQ-R CC-Link IE Controller Network User's Manual (Application))
ERR LED <sup>*1</sup>	Indicates the error status of the module. On, flashing: Error (MELSEC iQ-R CC-Link IE Controller Network User's Manual (Application)) Off: Normal operation
MST/PRM LED <sup>*1</sup>	Indicates the operating status. On: Operating as a control station Off: Operating as a normal station
D LINK LED <sup>*1,3</sup>	Indicates the data link status. On: Data link (cyclic transmission being performed) Flashing: Data link (cyclic transmission stopped) Off: Data link not performed (disconnection)
SD/RD LED	Indicates the data sending/receiving status. On: Data being sent or received (The LED turns on only at the P1 side when setting "Port 1 Network Type" to "CC-Link IE Control" and "Network Topology" under "Basic Settings" of the control station to "Ring".) Off: Data not sent nor received
P ERR LED <sup>*1</sup>	Indicates the error status of P1 and P2. On, flashing: Error (MELSEC iQ-R CC-Link IE Controller Network User's Manual (Application)) Off: Normal operation
IE C LED <sup>*2</sup>	Indicates the network type setting status. Always on
IE F LED	Indicates the network type setting status. Always off
L ER LED	Indicates the port status. On: Abnormal data received or loopback being performed Off: Normal data received and loopback not performed
LINK LED	Indicates the link status. On: Link-up Off: Link-down

\*1 The LED is always off in offline mode.

\*2 LED indication differs depending on the version of the RJ71EN71.  
(MELSEC iQ-R CC-Link IE Controller Network User's Manual (Application))

\*3 The LED turns on only at the P1 side when "Port 1 Network Type" and "Port 2 Network Type" are set to "CC-Link IE Control".

## When CC-Link IE Field Network is used

LED name	Description
RUN LED	Indicates the operating status. On: Normal operation Off: Error (MELSEC iQ-R CC-Link IE Field Network User's Manual (Application))
ERR LED*1	Indicates the error status of the module. On, flashing: Error (MELSEC iQ-R CC-Link IE Field Network User's Manual (Application)) Off: Normal operation
MST/PRM LED	Indicates the operating status. On: Operating as a master station Flashing: Operating as a submaster station Off: Operating as a local station
D LINK LED*1*3	Indicates the data link status. On: Data link (cyclic transmission being performed) Flashing: Data link (cyclic transmission stopped) Off: Data link not performed (disconnection)
SD/RD LED	Indicates the data sending/receiving status. On: Data being sent or received (The LED turns on only at the P1 side when setting "Port 1 Network Type" to "CC-Link IE Field" and "Network Topology" under "Basic Settings" of the master station to "Ring".) Off: Data not sent nor received
P ERR LED*1	Indicates the error status of P1 and P2. On: Error or at error detection on all stations (MELSEC iQ-R CC-Link IE Field Network User's Manual (Application)) Flashing (500ms interval): A data link faulty station was detected. Flashing (200ms interval): Error (MELSEC iQ-R CC-Link IE Field Network User's Manual (Application)) Off: Normal operation
IE C LED*2	Indicates the network type setting status. Always off
IE F LED	Indicates the network type setting status. Always on
L ER LED	Indicates the port status. On: Abnormal data received or loopback being performed Off: Normal data received and loopback not performed
LINK LED	Indicates the link status. On: Link-up Off: Link-down

\*1 The LED is always off in offline mode.

\*2 LED indication differs depending on the version of the RJ71EN71.  
(MELSEC iQ-R CC-Link IE Controller Network User's Manual (Application))

\*3 The LED turns on only at the P1 side when "Port 1 Network Type" and "Port 2 Network Type" are set to "CC-Link IE Field".

## Dot matrix LED indication

The following table lists the station number indicated on the dot matrix LED.

Network combination	Setting in GX Works3			Display
	Model <sup>*1</sup>	Port 1 network type	Port 2 network type	
Ethernet only	RJ71EN71 (E+E)	Ethernet	Ethernet	Always off
CC-Link IE Controller Network only	RJ71EN71 (CCIEC)	CC-Link IE Control	CC-Link IE Control	Displays the current station number of CC-Link IE Controller Network. Station number not set: "— — —" Control station, normal station: 1 to 120
CC-Link IE Field Network only	RJ71EN71 (CCIEF)	CC-Link IE Field	CC-Link IE Field	Displays the current station number of CC-Link IE Field Network. Station number not set: "— — —" Master station: 0 Submaster station, local station: 1 to 120
Ethernet + CC-Link IE Controller Network	RJ71EN71 (E+CCIEC)	Ethernet	CC-Link IE Control	Displays the current station number of CC-Link IE Controller Network. Station number not set: "— — —" Control station, normal station: 1 to 120
Ethernet + CC-Link IE Field Network	RJ71EN71 (E+CCIEF)	Ethernet	CC-Link IE Field	Displays the current station number of CC-Link IE Field Network. Station number not set: "— — —" Master station: 0 Submaster station, local station: 1 to 120
Q-compatible Ethernet	RJ71EN71 (Q)	Q Compatible Ethernet	—	Always off
In offline mode				Displays "...".
At major error				Undefined

\*1 The name in parentheses is the abbreviation of the network type.



# 1.2 CPU Module

This section describes the part names of the CPU module related to the Ethernet function. For other names of each part, refer to the following.

📖 MELSEC iQ-R CPU Module User's Manual (Startup)

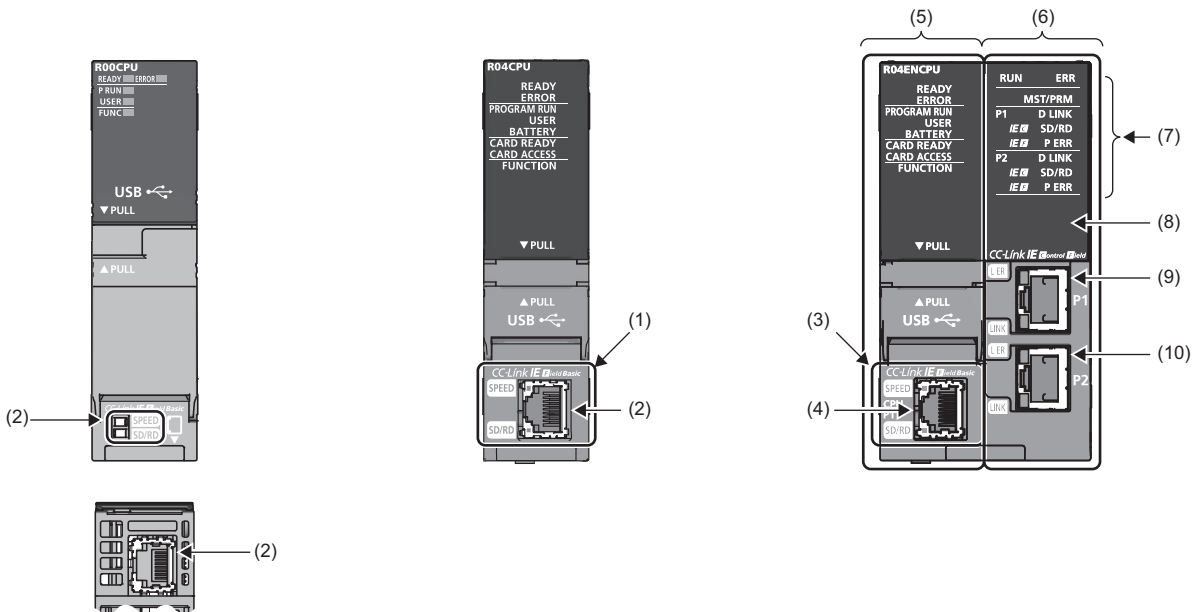

No.	Name	Description
(1)	Built-in Ethernet port part	A part to connect the CPU module to Ethernet
(2)	Ethernet port	A connector to connect the CPU module to the 10BASE-T/100BASE-TX (RJ45 connector) The CPU module determines whether to use 10BASE-T or 100BASE-TX according to the hub.
	SPEED LED	Indicates the link status. On: Link-up (100Mbps) Off: Link-down or link-up (10Mbps)
	SD/RD LED	Indicates the data sending/receiving status. On: Data being sent or received Off: Data not sent nor received
(3)	Built-in Ethernet port part	A part to connect the CPU module to Ethernet
(4)	Ethernet port (CPU P1)	A connector to connect the CPU module to the 10BASE-T/100BASE-TX (RJ45 connector) The CPU module determines whether to use 10BASE-T or 100BASE-TX according to the hub.
	SPEED LED	Indicates the link status. On: Link-up (100Mbps) Off: Link-down or link-up (10Mbps)
	SD/RD LED	Indicates the data sending/receiving status. On: Data being sent or received Off: Data not sent nor received
(5)	CPU part	A part that works as the CPU module
(6)	Network part	A part that has the functions of Ethernet, CC-Link IE Controller Network, and CC-Link IE Field Network.
(7)	Operation status indicator LED	Indicates the operating status of the module. (📖 Page 30 Network used and LED indication)
(8)	Dot matrix LED	Displays the station number set in the module and the module communication test result. (📖 Page 30 Dot matrix LED indication) For display of the module communication test result, refer to the following. 📖 MELSEC iQ-R Ethernet User's Manual (Application)
(9)	Ethernet port (P1)	PORT1 connector for network. Connect an Ethernet cable. For wiring methods and wiring precautions, refer to the following. (📖 Page 69 WIRING)
	L ER LED	Indicates the port status. (📖 Page 30 Network used and LED indication)
	LINK LED	Indicates the link status. (📖 Page 30 Network used and LED indication)

No.	Name	Description
(10)	Ethernet port (P2)	PORT2 connector for network. Connect an Ethernet cable. For wiring methods and wiring precautions, refer to the following. (☞ Page 69 WIRING)
	L ER LED	Same as the P1 connector
	LINK LED	

## Available combination of network

Ethernet port (P1 and P2) of the RnENCPU can be used in the following network depending on the engineering tool setting. (GX Works3 Operating Manual)

- Ethernet
- CC-Link IE Controller Network
- CC-Link IE Field Network

The following table lists the available combination of network and setting in GX Works3.

Network combination	Setting in GX Works3			Description	Remarks
	Model <sup>*1</sup>	Port 1 network type	Port 2 network type		
CC-Link IE Controller Network only	_RJ71EN71 (CCIEC)	CC-Link IE Control	CC-Link IE Control	P1 and P2 can be connected to CC-Link IE Controller Network.	P1 and P2 cannot be connected to different CC-Link IE Controller Network.
CC-Link IE Field Network only	_RJ71EN71 (CCIEF)	CC-Link IE Field	CC-Link IE Field	P1 and P2 can be connected to CC-Link IE Field Network.	P1 and P2 cannot be connected to different CC-Link IE Field Network.
Ethernet + CC-Link IE Controller Network	_RJ71EN71 (E+IEC)	Ethernet	CC-Link IE Control	P1 can be connected to Ethernet and P2 can be connected to CC-Link IE Controller Network.	CC-Link IE Controller Network cannot be configured in ring topology.
Ethernet + CC-Link IE Field Network	_RJ71EN71 (E+IEF)	Ethernet	CC-Link IE Field	P1 can be connected to Ethernet and P2 can be connected to CC-Link IE Field Network.	CC-Link IE Field Network cannot be configured in ring topology.

\*1 The name in parentheses is the abbreviation of the network type.



## Precautions

The following item cannot be set for the RnENCPU.

- Ethernet only (Port 1 network type: Ethernet, Port 2 network type: Ethernet)
- Q-compatible Ethernet

## Network used and LED indication

LED indication of the RnENCPU differs depending on the network used. For the LED indication when each network is used, refer to the following.

- When Ethernet is used:  Page 23 When Ethernet or Q-compatible Ethernet is used
- When CC-Link IE Controller Network is used:  Page 24 When CC-Link IE Controller Network is used
- When CC-Link IE Field Network is used:  Page 25 When CC-Link IE Field Network is used

### Dot matrix LED indication

The following table lists the station number indicated on the dot matrix LED.

Network combination	Setting in GX Works3			Display
	Model*1	Port 1 network type	Port 2 network type	
CC-Link IE Controller Network only	_RJ71EN71 (CCIEC)	CC-Link IE Control	CC-Link IE Control	Displays the current station number of CC-Link IE Controller Network. Station number not set: "— — —" Control station, normal station: 1 to 120
CC-Link IE Field Network only	_RJ71EN71 (CCIEF)	CC-Link IE Field	CC-Link IE Field	Displays the current station number of CC-Link IE Field Network. Station number not set: "— — —" Master station: 0 Submaster station, local station: 1 to 120
Ethernet + CC-Link IE Controller Network	_RJ71EN71 (E+IEC)	Ethernet	CC-Link IE Control	Displays the current station number of CC-Link IE Controller Network. Station number not set: "— — —" Control station, normal station: 1 to 120
Ethernet + CC-Link IE Field Network	_RJ71EN71 (E+IEF)	Ethernet	CC-Link IE Field	Displays the current station number of CC-Link IE Field Network. Station number not set: "— — —" Master station: 0 Submaster station, local station: 1 to 120
In offline mode				Displays "...".
At major error				Undefined

\*1 The name in parentheses is the abbreviation of the network type.

# 1.3 RJ71GP21(S)-SX

This section describes the names of each part of the RJ71GP21-SX and the RJ71GP21S-SX.

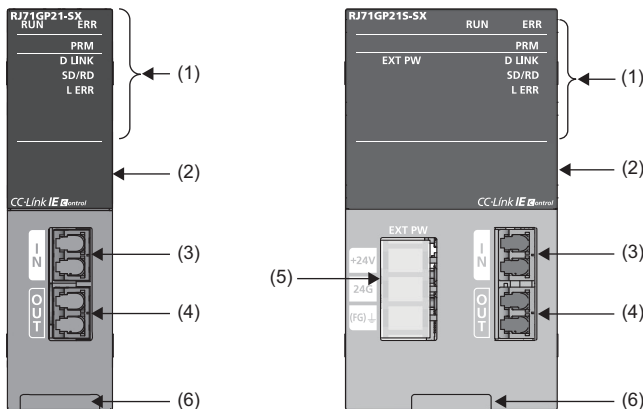

No.	Name	Description
(1)	RUN LED	Indicates the operating status. On: Normal operation Off: Error (MELSEC iQ-R CC-Link IE Controller Network User's Manual (Application))
	ERR LED*1	Indicates the error status of the module. On, flashing: Error (MELSEC iQ-R CC-Link IE Controller Network User's Manual (Application)) Off: Normal operation
	PRM LED*1	Indicates the operating status. On: Operating as a control station Off: Operating as a normal station
	D LINK LED*1	Indicates the data link status. On: Data link (cyclic transmission being performed) Flashing: Data link (cyclic transmission stopped) Off: Data link not performed (disconnection)
	SD/RD LED	Indicates the data sending/receiving status. On: Data being sent or received Off: Data not sent nor received
	L ERR LED*1	Indicates the line error status. On: The following errors has occurred in the line connected to the own station port. <ul style="list-style-type: none"> <li>• A receive data is faulty (receive frame error).<sup>2</sup></li> <li>• Loopback is performed in the own station.</li> <li>• Cable disconnection</li> <li>• Cable insertion error</li> </ul> Off: The module or line is in the following status. <ul style="list-style-type: none"> <li>• A received data is normal (receive frame normal)</li> <li>• Loopback is not performed in the own station.</li> </ul>
	EXT PW LED	Indicates the external power supply status. On: The external power being supplied Off: The external power not supplied
(2)	Dot matrix LED	Displays the station number set in the module and the module communication test result. Station number not set: "— — —" Control station, normal station: 1 to 120 In offline mode: "..." For display of the module communication test result, refer to the following. (MELSEC iQ-R CC-Link IE Controller Network User's Manual (Application))
(3)	Optical connector (IN connector)	A connector to connect the optical fiber cable. Connect to OUT connector of another station. (Page 71 Wiring methods)
(4)	Optical connector (OUT connector)	A connector to connect the optical fiber cable. Connect to IN connector of another station. (Page 71 Wiring methods)
(5)	External power supply terminal block	A terminal block to connect a wire for the external power supply to the RJ71GP21S-SX.
(6)	Production information marking	Shows the production information (16 digits) of the module.

- \*1 The LED is always off in offline mode.
- \*2 When once a receive frame error is detected, the L ERR LED remains on. ('IN-side error frame detection of own station (SB006E))' or 'OUT-side error frame detection of own station (SB006F)' also remains on.)  
To turn off the L ERR LED, perform troubleshooting for when the L ERR LED turns on. (📖 MELSEC iQ-R CC-Link IE Controller Network User's Manual (Application))  
After taking the action, turn on 'Clear IN-side transmission error count (SB0007)' or 'Clear OUT-side transmission error count (SB0008)'.

# 1.4 RJ71GF11-T2

This section describes the names of each part of the RJ71GF11-T2.

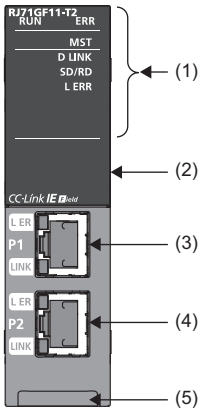

No.	Name	Description
(1)	RUN LED	Indicates the operating status. On: Normal operation Off: Error (Refer to MELSEC iQ-R CC-Link IE Field Network User's Manual (Application))
	ERR LED*1	Indicates the error status of the module. (Refer to MELSEC iQ-R CC-Link IE Field Network User's Manual (Application)) On: Error or at error detection on all stations Flashing (500ms interval): A data link faulty station was detected. Flashing (200ms interval): Error Off: Normal operation
	MST LED	Indicates the operating status. On: Operating as a master station Flashing: Operating as a submaster station Off: Operating as a local station
	D LINK LED*1	Indicates the data link status. On: Data link (cyclic transmission being performed) Flashing: Data link (cyclic transmission stopped) Off: Data link not performed (disconnection)
	SD/RD LED	Indicates the data sending/receiving status. On: Data being sent or received Off: Data not sent nor received
	L ERR LED*1	Indicates the receive data and line error status. When the L ERR. LED is on, the port in which the error was detected can be checked with the L ER LED of P1 or P2. On: Abnormal data received or loopback being performed Off: Normal data received and loopback not performed
(2)	Dot matrix LED	Displays the station number set in the module and the module communication test result. Station number not set: "— — —" Master station: 0 Submaster station, local station: 1 to 120 In offline mode: "..." For display of the module communication test result, refer to the following. (Refer to MELSEC iQ-R CC-Link IE Field Network User's Manual (Application))
(3)	Ethernet port (P1)	PORT1 connector for CC-Link IE Field Network Connect an Ethernet cable. For wiring methods and wiring precautions, refer to the following. (Refer to Page 75 Wiring of CC-Link IE Field Network)
	L ER LED	Indicates the port status. On: Abnormal data received or loopback being performed Off: Normal data received and loopback not performed
	LINK LED	Indicates the link status. On: Link-up Off: Link-down
(4)	Ethernet port (P2)	PORT2 connector for CC-Link IE Field Network. Connect an Ethernet cable. For wiring methods and wiring precautions, refer to the following. (Refer to Page 75 Wiring of CC-Link IE Field Network)
	L ER LED	Same as the P1 connector
	LINK LED	Same as the P1 connector

No.	Name	Description
(5)	Production information marking	Shows the production information (16 digits) of the module.

\*1 The LED is always off in offline mode.



# 2 SPECIFICATIONS

This chapter describes the performance specifications and hardware specifications of each module.

## 2.1 Performance Specifications of Ethernet

The following table lists the performance specifications of Ethernet.

Item		RJ71EN71		CPU module		
		Ethernet	Q-compatible Ethernet	Built-in Ethernet port part	RnENCPU (CPU part)	RnENCPU (network part)
Transmission specifications	Data transmission speed	1Gbps/100Mbps/10Mbps	1Gbps <sup>*1</sup> /100Mbps/10Mbps	100Mbps/10Mbps		1Gbps/100Mbps/10Mbps
	Communication mode	1000BASE-T	Full-duplex	—		Full-duplex
		100BASE-TX	Full-duplex/half-duplex			
		10BASE-T	Full-duplex/half-duplex			
	Interface	RJ45 connector (Auto MDI/MDI-X)				
	Transmission method	Base band				
	Maximum frame size	• 1518 bytes • 9022 bytes (when jumbo frames are used)	1518 bytes		• 1518 bytes • 9022 bytes (when jumbo frames are used)	
	Jumbo frame	Available	Not available		Available	
	Maximum segment length	100m (length between hub and node) <sup>*2</sup>				
	Number of cascade connections	1000BASE-T	*3		—	
100BASE-TX		2 levels maximum <sup>*4</sup>				
10BASE-T		4 levels maximum <sup>*4</sup>				
IP version	Compatible with IPv4					
Sending/receiving data storage memory	Number of simultaneous open connections	128 connections (connections usable on a program)	16 connections (connections usable on a program)		64 connections (connections usable on a program)	
	Fixed buffer	5K words × 16 (Only P1 is available.)	1K words × 16	—		5K words × 16
	Socket communications	• 5K words × 48 (when only P1 is used) • 5K words × 112 (when P1 and P2 are used)	—		5K words × 16	
	Random access buffer	6K words × 1		—		6K words × 1

\*1 When using 1Gbps, set "Communication Speed" under "Application Settings" to "Automatic Negotiation". ("1Gbps/Full Duplex" cannot be selected.)

\*2 For maximum segment length (length between hubs), consult the manufacturer of the hub used.

\*3 Consult the manufacturer of the switching hub used.

\*4 This applies when a repeater hub is used. For the number of levels that can be constructed when using a switching hub, consult the manufacturer of the switching hub used.



The operation of commercial devices used for the following applications is not guaranteed. Check the operation before using the module.

- Internet (general public line) (Internet-access service offered by an Internet service provider or a telecommunications carrier)
- Firewall device(s)
- Broadband router(s)
- Wireless LAN

## 2.2 Performance Specifications of CC-Link IE Controller Network

The following table lists the performance specifications of CC-Link IE Controller Network.

Item	RJ71GP21-SX	RJ71GP21S-SX	RJ71EN71, RnENCPU (network part)
Maximum number of link points per network	LB	<ul style="list-style-type: none"> <li>• 32K points (32768 points, 4K bytes): When "Link points extended setting" is set to "Not to Extend"</li> <li>• 64K points (65536 points, 8K bytes): When "Link points extended setting" is set to "Extend"</li> </ul>	
	LW	<ul style="list-style-type: none"> <li>• 128K points (131072 points, 256K bytes): When "Link points extended setting" is set to "Not to Extend"</li> <li>• 256K points (262144 points, 512K bytes): When "Link points extended setting" is set to "Extend"</li> </ul>	
	LX	8K points (8192 points, 1K bytes)	
	LY	8K points (8192 points, 1K bytes)	
Maximum number of link points per station	LB	<ul style="list-style-type: none"> <li>• 16K points (16384 points, 2K bytes)</li> <li>• 32K points (32768 points, 4K bytes): When extended mode is set and "Link points extended setting" is set to "Not to Extend"</li> <li>• 64K points (65536 points, 8K bytes): When extended mode is set and "Link points extended setting" is set to "Extend"</li> </ul>	
	LW	<ul style="list-style-type: none"> <li>• 16K points (16384 points, 32K bytes)</li> <li>• 128K points (131072 points, 256K bytes): When extended mode is set and "Link points extended setting" is set to "Not to Extend"</li> <li>• 256K points (262144 points, 512K bytes): When extended mode is set and "Link points extended setting" is set to "Extend"</li> </ul>	
	LX	8K points (8192 points, 1K bytes)	
	LY	8K points (8192 points, 1K bytes)	
Transient transmission capacity	1920 bytes maximum		
Communication speed	1Gbps		
Network topology	Duplex loop		Line topology, star topology (coexistence of line topology and star topology is also possible), and ring topology
Communication cable	Optical fiber cable which satisfies 1000BASE-SX standard: Multi-mode optical fiber (GI)		Ethernet cable which satisfies 1000BASE-T standard: Category 5e or higher, straight cable (double shielded, STP)
Maximum station-to-station distance	550m		100m (conforms to ANSI/TIA/EIA-568-B (Category 5e))
Overall cable distance	66000m (when 120 stations are connected)		Line topology: 11900m (when 120 stations are connected) Star topology: Depends on the system configuration. Ring topology: 12000m (when 120 stations are connected)
Number of cascade connections	—		20 levels maximum
Maximum number of connectable stations	120 stations (control station: 1, normal station: 119) <sup>*1</sup>		
Maximum number of networks	239		
Maximum number of groups	32		
Communication method	Token ring		Token passing
Optical fiber specifications	Standard: IEEE802.3, IEC 60793-2-10 Types A1a.1 Outside diameter of the core/clad: 50μm/125μm Transmission loss: 3.5dB/km or lower [ $\lambda=850\text{nm}$ ] Transmission band: 500MHz·km or higher ( $\lambda=850\text{nm}$ )		—
Connector specifications	Duplex LC connector Standard: IEC 61754-20 Type LC connector Connection loss: 0.3dB or lower Polished surface: PC (Physical Contact) polishing		RJ45 connector
Laser class (IEC 60825-1)	Class 1 laser product		—

\*1 When using a CC-Link IE Controller Network-equipped module in a normal station, maximum number of connectable stations differs depending on the CPU module used in a control station. For details, refer to the user's manual for the control station used.

## 2.3 Performance Specifications of CC-Link IE Field Network

The following table lists the performance specifications of CC-Link IE Field Network.

Item		RJ71GF11-T2	RJ71EN71, RnENCPU (network part)	
Maximum number of link points per network		RX	16K points (16384 points, 2K bytes)	
		RY	16K points (16384 points, 2K bytes)	
		RWr	8K points (8192 points, 16K bytes)	
		RWw	8K points (8192 points, 16K bytes)	
Maximum number of link points per station	Master station	RX	16K points (16384 points, 2K bytes)	
		RY	16K points (16384 points, 2K bytes)	
		RWr	8K points (8192 points, 16K bytes)	
		RWw	8K points (8192 points, 16K bytes)	
	When the submaster function is used <sup>*3</sup>	Master operating station	RX	16K points
			RY	16K points (Own station send range is 2K points.)
			RWr	8K points
			RWw	8K points (Own station send range is 1024 points.) 8K points when communication mode is "High-Speed" (Own station send range is 256 points.)
		Submaster operating station <sup>*1</sup>	RX	2K points (assigned for the station number 0 or submaster station)
			RY	2K points (assigned for the station number 0 or submaster station)
			RWr	1024 points (assigned for the station number 0 or submaster station) 256 points when communication mode is "High-Speed"
			RWw	1024 points (assigned for the station number 0 or submaster station) 256 points when communication mode is "High-Speed"
	Local station <sup>*1*3</sup>	RX	2K points (2048 points, 256 bytes)	
RY		2K points (2048 points, 256 bytes)		
RWr		1K points (1024 points, 2K bytes) 256 points (512 bytes) when communication mode is "High-Speed"		
RWw		1K points (1024 points, 2K bytes) 256 points (512 bytes) when communication mode is "High-Speed"		
Safety communication function <sup>*2</sup>	Maximum number of safety connections per network	1814 connections For the system with the SIL2 Process CPU: 120 connections	—	
	Maximum number of safety connections per station	120 connections		
	Maximum number of safety connections per the same communication destination station	1 connection For the system with the SIL2 Process CPU: 32 connections		
	Maximum number of link points per safety connection	• Input: 8 words • Output: 8 words		
Transient transmission capacity		1920 bytes maximum		
Communication speed		1Gbps		
Network topology		Line topology, star topology (coexistence of line topology and star topology is also possible), and ring topology		
Communication cable		Ethernet cable which satisfies 1000BASE-T standard: Category 5e or higher, straight cable (double shielded, STP)		
Maximum station-to-station distance		100m (conforms to ANSI/TIA/EIA-568-B (Category 5e))		
Overall cable distance		Line topology: 12000m (when 121 stations are connected) Star topology: Depends on the system configuration. Ring topology: 12100m (when 121 stations are connected)		
Number of cascade connections		20 levels maximum		
Maximum number of connectable stations		121 stations (master station: 1, device station: 120)		
Maximum number of networks		239		
Communication method		Token passing		

- \*1 The maximum number of points that a master station can assign to one station. A submaster station and a local station can receive the data from other stations in addition to this number of points.
- \*2 This function is not available for the RJ71EN71. For the RJ71GF11-T2, availability depends on the firmware version.  
( MELSEC iQ-R CC-Link IE Field Network User's Manual (Application))
- \*3 Submaster station and local stations cannot be connected when "Communication Mode" under "Application Settings" is "High-Speed Remote Net".

## 2.4 Hardware Specifications

The following table lists the hardware specifications of each module.

For the hardware specifications of the CPU module, refer to the following.

 MELSEC iQ-R CPU Module User's Manual (Startup)

Item		RJ71EN71	RJ71GP21-SX	RJ71GP21S-SX	RJ71GF11-T2
Number of occupied I/O points		32 points		48 points 2 slots (I/O assignment: empty 16 points + intelligent 32 points)	32 points
External power supply	Voltage	No external power supply function		20.4 to 31.2VDC	No external power supply function
	Current			0.28A	
	Terminal screw size			M3 screw	
	Applicable solderless terminal			R1.25-3	
	Applicable wire size			0.3 to 1.25mm <sup>2</sup> (22 to 16 AWG)	
	Tightening torque			0.42 to 0.58N·m	
	Allowable momentary power failure time			1ms (level PS1)	
	Noise immunity			Simulator noise 500Vp-p, noise width 1μs, noise frequency 25 to 60Hz (noise simulator condition)	
Internal current consumption (5VDC)		0.82A	0.88A	0.95A	0.82A
External dimensions	Height	106mm (Base unit mounting side: 98mm)			
	Width	27.8mm		56mm	27.8mm
	Depth	110mm			
Weight		0.17kg	0.18kg	0.26kg	0.17kg

# 3 FUNCTION LIST

---

The following are the symbols used for the availability column:

○: Available, △: Partially available, ×: Not available

## 3.1 Function List of Ethernet

---

For details on the function that has no reference, refer to the following.

 MELSEC iQ-R Ethernet User's Manual (Application)

# RJ71EN71, RnENCPU (network part)

The following table lists the functions of the RJ71EN71, RnENCPU (network part).

Function		Description	Availability
Connection with MELSOFT products and a GOT		Allows the programming and monitoring using the engineering tool, and monitoring and testing programmable controller from the GOT with Ethernet connection.	○
SLMP communication		Reads/writes the buffer memory, devices, and others from the external device such as a personal computer or an HMI (Human Machine Interface) to an SLMP-compatible device. Data can also be read/written to device in a CPU module.	○
Predefined protocol communication		Allows the communication processing only with the program of the start instruction when the protocol data for communication with the external device is registered using the engineering tool. The protocol required for communication with the external device (such as temperature controller and barcode reader) can be set easily using the engineering tool's communication protocol support function.	○
Socket communications		Exchanges arbitrary data with an external device connected by Ethernet over TCP/IP or UDP/IP using dedicated instructions.	△ <sup>*1</sup>
Fixed buffer communication		Exchanges arbitrary data between the CPU module and external device using the fixed buffer of the RJ71EN71 and the RnENCPU (network part).	○
Random access buffer communication		Reads/writes data from multiple external devices to the random access buffer of the RJ71EN71 and the RnENCPU (network part).	○
MODBUS/TCP communications		Sends/receives MODBUS protocol messages on a TCP/IP network. This function has the MODBUS/TCP master function and MODBUS/TCP slave function.	△ <sup>*1*2</sup>
Link dedicated instruction communication		Reads/writes data from/to other station CPU modules on other networks via Ethernet using the link dedicated instructions.	○
File transfer function (FTP server)		Reads/writes data in file units using the dedicated FTP commands from an external device.	○
Time setting function (SNTP client)		Automatically performs time setting of the CPU module by collecting clock data from the time information server (SNTP server) on the LAN.	△ <sup>*1</sup>
Security	IP filter	Identifies the IP address of the access source to limit access to the Ethernet-equipped module.	△ <sup>*1</sup>
	Remote password	Prevents illegal access of the CPU module from a remote location.	○
Simple CPU communication function		Allows data communications between specified devices at the specified timing just by doing simple settings from an engineering tool. This function is used to send/receive device data between the module and the programmable controller.	△ <sup>*1*2</sup>
Simple device communication function		Allows data communications by changing the same protocol as that of the communication destination just by doing simple settings from an engineering tool. This function is used to send/receive device-specific data (memory area) between the module and external devices such as an industrial robot.	△ <sup>*1*2</sup>
IP address change function		Changes the CPU module's IP address without changing the parameter settings.	△ <sup>*2</sup>
Redundant system function <sup>*2</sup>		Consists of a control system and standby system. When an error occurs in the control system, the standby system is switched to the new control system and the communications continue.	△
Firmware update function		Enables users to update the firmware versions of modules by obtaining firmware update files from the users' local Mitsubishi representatives. (MELSEC iQ-R Module Configuration Manual) <sup>*3</sup>	○
Discard received data at CPU STOP		Discards received data from the communication destination when the status of the CPU module is changed from RUN to STOP (PAUSE).	○
Troubleshooting	Module communication test	Checks whether no error occurs in the hardware of the module when the communication operation is unstable.	○
	Ethernet diagnostics	Monitors communication status on the Ethernet-equipped module and external device.	○
	Simple CPU communication diagnostics	Monitors communication status on the simple CPU communication function.	○

\*1 This function cannot be used when "Q Compatible Ethernet" is selected for the network type.

\*2 Availability depends on the network type and firmware version of the Ethernet-equipped module.

 MELSEC iQ-R Ethernet User's Manual (Application)

\*3 For precautions of the firmware update function, refer to the following.

 Page 111 Precautions of Firmware Update Function

## CPU module (built-in Ethernet port part)

The following table lists the functions of the CPU module (built-in Ethernet port part).

Rn: RnCPU, RnEN: RnENCPU, RnP(P): Process CPU (process mode), RnP(R): Process CPU (redundant mode), RnPSF: SIL2 Process CPU, RnSF: Safety CPU

Function		Description	Availability					
			Rn	RnEN	RnP(P)	RnP(R)	RnPSF	RnSF
Connection with MELSOFT products and a GOT		Allows the programming and monitoring using the engineering tool, and monitoring and testing programmable controller from the GOT with Ethernet connection.	○	○	○	○	○	○
SLMP communication		Reads/writes the buffer memory, devices, and others from the external device such as a personal computer or an HMI (Human Machine Interface) to an SLMP-compatible device. Data can also be read/written to device in a CPU module.	○	○	○	○	○	○
Predefined protocol communication		Allows the communication processing only with the program of the start instruction when the protocol data for communication with the external device is registered using the engineering tool. The protocol required for communication with the external device (such as temperature controller and barcode reader) can be set easily using the engineering tool's communication protocol support function.	○	○	○	○	○	○
Socket communications		Exchanges arbitrary data with an external device connected by Ethernet over TCP/IP or UDP/IP using dedicated instructions.	○	○	○	○	○	○
MODBUS/TCP communications		Sends/receives MODBUS protocol messages on a TCP/IP network. This function has the MODBUS/TCP master function and MODBUS/TCP slave function.	△ <sup>*3</sup>	△ <sup>*3</sup>	△ <sup>*3</sup>	△ <sup>*3</sup>	△ <sup>*3</sup>	△ <sup>*3</sup>
File transfer function (FTP server)		Reads/writes data in file units using the dedicated FTP commands from an external device.	○	○	○	○	○	○
File transfer function (FTP client)		Enables the CPU module, as an FTP client, to transfer files to an FTP server connected over Ethernet by using the file transfer function instructions.	△ <sup>*1</sup>	△ <sup>*1</sup>	△ <sup>*1</sup>	△ <sup>*1</sup>	×	×
Time setting function (SNTP client)		Automatically performs time setting of the CPU module by collecting clock data from the time information server (SNTP server) on the LAN.	○	○	○	○	○	○
Web server function		Monitors and diagnoses the CPU module via network using a Web browser.	△ <sup>*2</sup>	△ <sup>*2</sup>	△ <sup>*2</sup>	△ <sup>*2</sup>	×	×
Security	IP filter	Identifies the IP address of the access source to limit access to the Ethernet-equipped module.	○	○	○	○	○	○
	Remote password	Prevents illegal access of the CPU module from a remote location.	○	○	○	○	○	○
Simple CPU communication function		Allows data communications between specified devices at the specified timing just by doing simple settings from an engineering tool.	△ <sup>*1</sup>	△ <sup>*1</sup>	△ <sup>*1</sup>	△ <sup>*1</sup>	×	×
IP address change function		Changes the CPU module's IP address without changing the parameter settings.	○	○	○	○	○	○
Redundant system function		Consists of a control system and standby system. When an error occurs in the control system, the standby system is switched to the new control system and the communications continue.	×	×	×	△ <sup>*1</sup>	○	×
Discard received data at CPU STOP		Discards received data from the communication destination when the status of the CPU module is changed from RUN to STOP (PAUSE).	△ <sup>*1</sup>	△ <sup>*1</sup>	△ <sup>*1</sup>	△ <sup>*1</sup>	×	×



Function		Description	Availability					
			Rn	RnEN	RnP(P)	RnP(R)	RnPSF	RnSF
Troubleshooting	Module communication test	Checks whether no error occurs in the hardware of the module when the communication operation is unstable.	×	×	×	×	×	×
	Ethernet diagnostics	Monitors communication status on the Ethernet-equipped module and external device.	○	○	○	○	○	○
	Simple CPU communication diagnostics	Monitors communication status on the simple CPU communication function.	○	○	○	○	○	○
CPU module database access (from external device) function		Operates a database, which is built in an SD memory card inserted into the CPU module, from an application on a personal computer through the Ethernet port of the CPU module.	📖 MELSEC iQ-R Programmable Controller CPU Module User's Manual					

\*1 Availability depends on the firmware version or models.

📖 MELSEC iQ-R Ethernet User's Manual (Application)

\*2 Availability depends on the firmware version or models.

📖 MELSEC iQ-R/MELSEC iQ-F Web Server Function Guide Book

\*3 Only the MODBUS/TCP master function is available.

## iQ Sensor Solution

Sensor, programmable controller, HMI (Human Machine Interface), and engineering tool are interacted to start up the sensor, maintenance or others easily.

Function	Description	Availability
Automatic detection of connected devices	Detects devices supporting iQSS which are connected to the CPU module (built-in Ethernet port part), and automatically displays them on "List of devices" and "Device map area" using an engineering tool.	📖 iQ Sensor Solution Reference Manual
Communication setting reflection	Reflects the communication settings (such as IP addresses) in devices supporting iQSS in "Device map area" which are connected over Ethernet.	
Sensor parameter read/write	Reads/writes parameters from/to iQSS-compatible devices.	
Sensor/device monitor	Monitors the network status of device supporting iQSS graphically.	
Backup/restoration	Backs up (saves) information of device supporting iQSS in an SD memory card. The backed up (saved) information of the device supporting iQSS is also restored from the SD memory card.	

## 3.2 Function List of CC-Link IE Controller Network

For details on the function that has no reference, refer to the following.

📖 MELSEC iQ-R CC-Link IE Controller Network User's Manual (Application)

### Cyclic transmission

Data are periodically exchanged among stations on the network using link devices.

Function		Description	Availability	
			Control station	Normal station
Communications with other stations	Communications using LB and LW	Allows each station to write data to its own send range of a link device (LB, LW) to send them to all other stations on the network.	○	○
	Communications using LX and LY	Exchanges data between the I/O master station that controls LX and LY and another station on a one-to-one (1:1) basis.	○	○
Access to devices and link devices	Link refresh	Automatically transfers data between the link devices (LB, LW, LX, LY, SB, SW) of the CC-Link IE Controller Network-equipped module and devices of the CPU module, or between the link devices (SB, SW) of the CC-Link IE Controller Network-equipped module and the module labels of the CPU module.	○	○
	Direct access to link devices	Directly accesses the link devices of the CC-Link IE Controller Network-equipped module from the program.	○	○
Cyclic data integrity assurance		Assures the cyclic data integrity in units of 32 bits or station-based units.	○	○
Interlink transmission		Transfers the link device (LB, LW) data of a CC-Link IE Controller Network-equipped module to another network module at a relay station.	○	○
Cyclic transmission punctuality assurance		Keeps the link scan time constant using the following methods. <ul style="list-style-type: none"> <li>• Specification of the number of transient transmissions: Specifies the number of transient transmissions within one link scan.</li> <li>• Constant link scan: Specifies the link scan time.</li> </ul>	○	×
Group cyclic transmission		Divides the stations within the network into groups and specifies the stations that share cyclic data (shared group). This setting allows cyclic data to be shared among the stations having the same shared group number and not to be received from those having a different shared group number. Stations having no shared group number assigned will share cyclic data with all stations.	○	○
Number of send points extension by using extended mode		Sets a CC-Link IE Controller Network-equipped module to the extended mode using an engineering tool so that the number of send points per station will be extended to a maximum of 32K points for the link relay (LB) and 128K points for the link register (LW) in one module. When extended mode is set and "Link points extended setting" is set to "Extend", the number of send points per station will be extended to a maximum of 64K points for the link relay (LB) and 256K points for the link register (LW) in one module.*1	○	○
Number of send points extension by using link points extended setting*1		Sets "Extend" of "Link points extended setting" on a CC-Link IE Controller Network-equipped module using an engineering tool so that the maximum number of link points per network will be extended to 64K points for the link relay (LB) and 256K points for the link register (LW) in one network.	○	○
Cyclic transmission stop and restart		Stops the cyclic transmission during debugging and other operations. (Data reception from other stations and data sending from the own station are stopped.) Also, the stopped cyclic transmission is restarted. Transient transmission does not stop.	○	○

\*1 Availability depends on the firmware version of the CC-Link IE Controller Network-equipped master/local module.

📖 MELSEC iQ-R CC-Link IE Controller Network User's Manual (Application)

## Transient transmission

Data are exchanged at any timing.

Function	Description	Availability	
		Control station	Normal station
Communications within the same network	Performs the transient transmission to other stations using dedicated instructions and the engineering tool.	○	○
Communications with different networks	Performs the transient transmission seamlessly to stations on different networks using dedicated instructions and the engineering tool.	○	○
Dedicated instruction	An instruction for using functions of modules. (□ MELSEC iQ-R Programming Manual (Module Dedicated Instructions))	△	○
Group transient transmission	Sends data to all stations of the same transient transmission group number by dividing the transient transmission target stations into groups.	○	○

## RAS

RAS stands for Reliability, Availability, and Serviceability. This function improves overall usability of automated equipment.

Function	Description	Availability	
		Control station	Normal station
Automatic return	Automatically returns the station disconnected from the network due to a data link error to the network when it recovers and restarts data link.	○	○
Loopback function	Continues data link with normally operating stations even if a cable disconnection or faulty station occurs.	○	○
Control station switching	Continues data link with a normal station (sub-control station) that serves as a control station even if the control station goes down.	×	○
Normal station disconnection	Disconnects only the normal station where an error occurs, and continues the data link with the stations that are operating normally. In a line topology, all stations connected after the faulty station are disconnected.	○	×
External power supply function	Continues data link among the normally operating stations without being disrupted at the power-down station even if the CPU module power supply goes down in a network. Data link is also continued between more than one station where CPU module power supply has gone down.	○	○

## Troubleshooting

The status of modules or network is checked using diagnostics or operation test of the engineering tool.

Function	Description	Availability	
		Control station	Normal station
Communication test	Checks whether the communication route for transient transmission from the own station to the destination station is correct or not.	○	○
IP communication test	Checks whether no error occurs in the communication route when the IP packet transfer function is used.	○	○
Unit communication test	Checks whether no error occurs in the hardware of the module when the communication operation is unstable.	○	○
CC-Link IE Controller Network diagnostics	Checks the status of CC-Link IE Controller Network. The error locations, error causes, and corrective actions can be checked in the engineering tool.	○	○
Cable test	Checks the disconnection or no connection of the Ethernet cables. (The optical fiber cable cannot be checked.)	○	○

## Others

Function	Description	Availability	
		Control station	Normal station
Reserved station	Is set in the parameters and included as a station in the network when its number is counted. A reserved station is a normal station reserved for network extension in the future, and thus the station is not actually connected, and is not detected as a faulty station despite being not connected.	○	×
Interrupt Request to CPU Module	Makes an interrupt request to the CPU module to start the interrupt program if the interrupt conditions preset using the engineering tool are met. Interrupt conditions are based on the changes in the link devices (LB, LW, LX) and the network statuses (SB, SW) checked every link scan or the data reception status of the channel specified via the RECVS instruction.	○	○
IP packet transfer function	Performs communications in a protocol such as FTP and HTTP using the specified IP address of an Ethernet device, over CC-Link IE Controller Network. With this function, two networks of CC-Link IE Controller Network and Ethernet are not required, resulting in reduced wiring cost.	○	○
Station number setting using a program	Sets the station numbers of a normal station (own station) using a program. When there are normal stations with the same program and network parameters (excluding the station numbers), setting the station numbers using a program allows project data items other than the station number to be the same, leading to reduced development work hours. (MELSEC iQ-R Programming Manual (Module Dedicated Instructions))	×	○
Redundant system function <sup>*1</sup>	Consists of a control system and standby system. When an error occurs in the control system, the standby system is switched to the new control system and the communications continue.	○	○
Firmware update function	Enables users to update the firmware versions of modules by obtaining firmware update files from the users' local Mitsubishi representatives. (MELSEC iQ-R Module Configuration Manual)	○	○

\*1 This function is available only for the RJ71GP21(S)-SX. Availability for the RJ71GP21-SX depends on the firmware version.

# 3.3 Function List of CC-Link IE Field Network

For details on the function that has no reference, refer to the following.

📖 MELSEC iQ-R CC-Link IE Field Network User's Manual (Application)

## Cyclic transmission

Data are periodically exchanged among stations on the network using link devices.

Function		Description	Availability	
			Master station, submaster station	Local station
Communications using RX, RY, RWr, and RWw		Communicates I/O data in units of bits and words between the master station and other stations.	○	○
Link refresh		Automatically transfers data between the link device of the master/local module and the device of the CPU module	○	○
Direct access to link devices		Directly accesses the link devices of the master/local module from the program.	○	○
Cyclic data integrity assurance		Assures the cyclic data integrity in units of 32 bits or station-based units.	○	○
Interlink transmission		Transfers data in the link devices of the master station or submaster station to another network module on a relay station.	○	×
Mode selection for cyclic transmission		Selects the mode for optimizing the performance of cyclic transmission based on the cyclic transmission and transient transmission frequency. The mode is selected from "Normal", "High-Speed", or "High-Speed Remote Net".	○*1	×
Sequence scan synchronization specification		Selects whether link scan is set to asynchronous or synchronous with the sequence scan of the CPU module.	○	×
Cyclic transmission punctuality assurance		Keeps the link scan time constant by setting the constant link scan time.	○	×
I/O maintenance settings	Output mode upon CPU error	Sets whether to hold or clear output when a stop error occurs in the CPU module. Set it on the sending side.	○	○
	Output hold/clear setting during CPU STOP	Sets whether to hold or clear output when the status of the CPU module changes from RUN to STOP. Set it on the sending side.	○	○
	Data link faulty station setting	Sets whether to clear or hold input from a disconnected station. Set it on the receiving side.	○	○
Cyclic transmission stop and restart		Stops the cyclic transmission during debugging and other operations. (Data reception from a device station and data sending from the own station are stopped.) Also, the stopped cyclic transmission is restarted. Transient transmission does not stop.	○	○

\*1 The "High-Speed Remote Net" mode can be set only for the master station. Availability of "High-Speed Remote Net" depends on the firmware version of the CC-Link IE Field Network-equipped master/local module.

📖 MELSEC iQ-R CC-Link IE Field Network User's Manual (Application)

## Transient transmission

Data are exchanged at any timing.

Function		Description	Availability	
			Master station, submaster station	Local station
Communications within the same network		Performs the transient transmission to other stations using dedicated instructions and the engineering tool.	○	○
Communications with different networks		Performs the transient transmission seamlessly to stations on different networks using dedicated instructions and the engineering tool.	○	○
Dedicated instruction		An instruction for using functions of modules. (📖 MELSEC iQ-R Programming Manual (Module Dedicated Instructions))	○	△

## RAS

RAS stands for Reliability, Availability, and Serviceability. This function improves overall usability of automated equipment.

Function	Description	Availability	
		Master station, submaster station	Local station
Device station disconnection	Stops data link of the device station where an error occurred, and continues data link only for device stations that are operating normally. In a line topology, the device station where an error occurred and all subsequent stations are disconnected.	○	×
Automatic return	Restarts the data link automatically when the device station that was disconnected due to an error becomes normal again.	○	○
Loopback function	Continues data link with normally operating stations even if a cable disconnection or faulty station occurs. All stations after the cable disconnection point or faulty station are disconnected in a line topology. By using this function with ring topology, data link continues with normally operating stations.	○	○
Submaster function	Allows the submaster station to control device stations instead of the master station when the master station is disconnected in a system where the master station and submaster station are connected on the same network. Using this function prevents the entire network from going down due to disconnection of the master station.	○	×

## iQ Sensor Solution

Sensor, programmable controller, HMI (Human Machine Interface), and engineering tool are interacted to start up or maintain the sensor, or other operations easily.

 [iQ Sensor Solution Reference Manual](#)

Function	Description	Availability	
		Master station, submaster station	Local station
Automatic detection of connected devices	Reduces the time of setting parameters by automatically reading information of device stations.	△ (Master station only)	×
Sensor parameter read/write	Reads/writes parameters of a device station from/to a module. The parameters of multiple device stations with the same model or same device version can be batch read or written at a time. Set parameters from "Parameter Processing of Device Station" or "The Parameter of Same Device Station" of "Network Configuration" on "Basic Settings". (  MELSEC iQ-R CC-Link IE Field Network User's Manual (Application))	△ (Master station only)	×
iQ Sensor Solution data backup/restoration function	Backs up the setting data of the device station into the SD memory card of the CPU module on the master station. The setting data backed up on the SD memory card of the CPU module on the master station is restored into the device module.	△ (Master station only)	×

## Troubleshooting





Checks the status of modules or network using diagnostics or operation test of the engineering tool.

Function	Description	Availability	
		Master station, submaster station	Local station
Communication test	Checks whether the communication route for transient transmission from the own station to the destination station is correct or not.	<input type="radio"/>	<input type="radio"/>
IP communication test	Checks whether no error occurs in the communication route when the IP packet transfer function is used.	<input type="radio"/>	<input type="radio"/>
Unit communication test	Checks whether no error occurs in the hardware of the module when the communication operation is unstable.	<input type="radio"/>	<input type="radio"/>
CC-Link IE Field Network diagnostics	Checks the status of CC-Link IE Field Network. The error locations, error causes, and corrective actions can be checked in the engineering tool.	<input type="radio"/>	<input type="radio"/>
Cable test	Checks the disconnection or no connection of the Ethernet cables.	<input type="radio"/>	<input type="radio"/>

## Others

Function		Description	Availability	
			Master station, submaster station	Local station
CC-Link IE Field Network synchronous communication function <sup>*1*2</sup>		Synchronizes control intervals between device stations over CC-Link IE Field Network according to synchronization cycle specified in the master station. This allows different device stations on the same network to operate with the same timing. (📖 MELSEC iQ-R Inter-Module Synchronization Function Reference Manual)	△ <sup>*3*4</sup>	○
Reserved station		Is set in the parameters and included as a station in the network when its number is counted. A reserved station is a device station reserved for network extension in the future, and thus the station is not actually connected, and is not detected as a faulty station despite being not connected.	○	×
Error invalid station		A device station that is set to be not detected as a faulty station by the master station even if it is disconnected during data link. This setting is also useful when a device station is to be replaced during data link.	○	×
Interrupt request to CPU module		Checks interrupt conditions every link scan, and makes an interrupt request to the CPU module to start the interrupt program if the interrupt conditions are met.	○	○
IP packet transfer function		Enables communications in a protocol such as FTP and HTTP using the specified IP address of an Ethernet device, over CC-Link IE Field Network. With this function, two networks of CC-Link IE Field Network and Ethernet are not required, resulting in reduced wiring cost.	○	○
Station number setting using a program		Sets the station numbers of a local station (own station) using a program. When there are local stations with the same program and network parameters (excluding the station numbers), setting the station numbers using a program allows project data items other than the station number to be the same, leading to reduced development work hours. (📖 MELSEC iQ-R Programming Manual (Module Dedicated Instructions))	×	○
Redundant system function <sup>*5</sup>		Consists of a control system and standby system. When an error occurs in the control system, the standby system is switched to the new control system and the communications continue.	○	○
Safety communication function <sup>*5</sup>	System with the Safety CPU	Establishes a safety connection and enables one-on-one safety communications periodically between safety stations in the same network.	△ (Master station only) <sup>*3</sup>	○
	System with the SIL2 Process CPU	Establishes a safety connection and enables one-on-one safety communications periodically between safety stations in the same network. With a redundant configuration of RJ71GF11-T2 or remote head modules, the new control system can continue safety communications by the system switching if an error occurs in the control system.	△ (Master station only)	×
Remote device test <sup>*6</sup>		Output of the intelligent device station and remote device station can be turned on or off arbitrarily when the CPU module is in STOP state.	△ (Master station only)	×
Setting to wait cyclic data receive after system switching <sup>*5</sup>		When system switching is executed in the redundant line structure of CC-Link IE Field Network, set this item to start the execution of the program in the new control system with new cyclic data obtained after system switching. (📖 MELSEC iQ-R CPU Module User's Manual (Application))	△ (Master station only)	×
Firmware update function		Enables users to update the firmware versions of modules by obtaining firmware update files from the users' local Mitsubishi representatives. (📖 MELSEC iQ-R Module Configuration Manual) <sup>*7</sup>	○	○



- \*1 When the network synchronous communication is performed with local stations, set the inter-module synchronization cycle to any of the following.
- 0.888ms
  - 1.777ms
  - 3.555ms
  - 7.111ms
  - 0.8 to 10.0ms (set in increments of 0.05ms)
- For the inter-module synchronization cycle when the network synchronous communication is performed with the device stations other than local stations, refer to the manual for the device station used.
- For the setting method of the inter-module synchronization cycle, refer to the following.
-  MELSEC iQ-R Inter-Module Synchronization Function Reference Manual
- \*2 The network synchronous communication cannot be performed with the stations in a redundant system.
- \*3 This function cannot be used in the network including the submaster station.
- \*4 This function cannot be used when the control CPU of the CC-Link IE Field Network-equipped master/local module is the Safety CPU.
- \*5 This function is available only for the RJ71GF11-T2. Availability depends on the firmware version.
-  MELSEC iQ-R CC-Link IE Field Network User's Manual (Application)
- \*6 Availability depends on the firmware version of the CC-Link IE Field Network-equipped master/local module.
-  MELSEC iQ-R CC-Link IE Field Network User's Manual (Application)
- \*7 For precautions of the firmware update function, refer to the following.
-  Page 111 Precautions of Firmware Update Function

# 4 PROCEDURES BEFORE OPERATION

---

This chapter describes the procedures before operation.

## 1. Network construction

Configure the system and set the parameters which are required for start-up.

- Wiring (👉 Page 69 WIRING)
- Parameter setting (📖 User's Manual (Application) for each network)

## 2. Network diagnostics

Using network diagnostics, check if the cables are connected properly and communication is performed normally with the configured parameters.

For details, refer to the following.

📖 User's Manual (Application) for each network

## 3. Programming

Create a program. For details, refer to the following.

👉 Page 79 COMMUNICATION EXAMPLES



# 5 SYSTEM CONFIGURATION

This chapter describes the system configuration of each network.

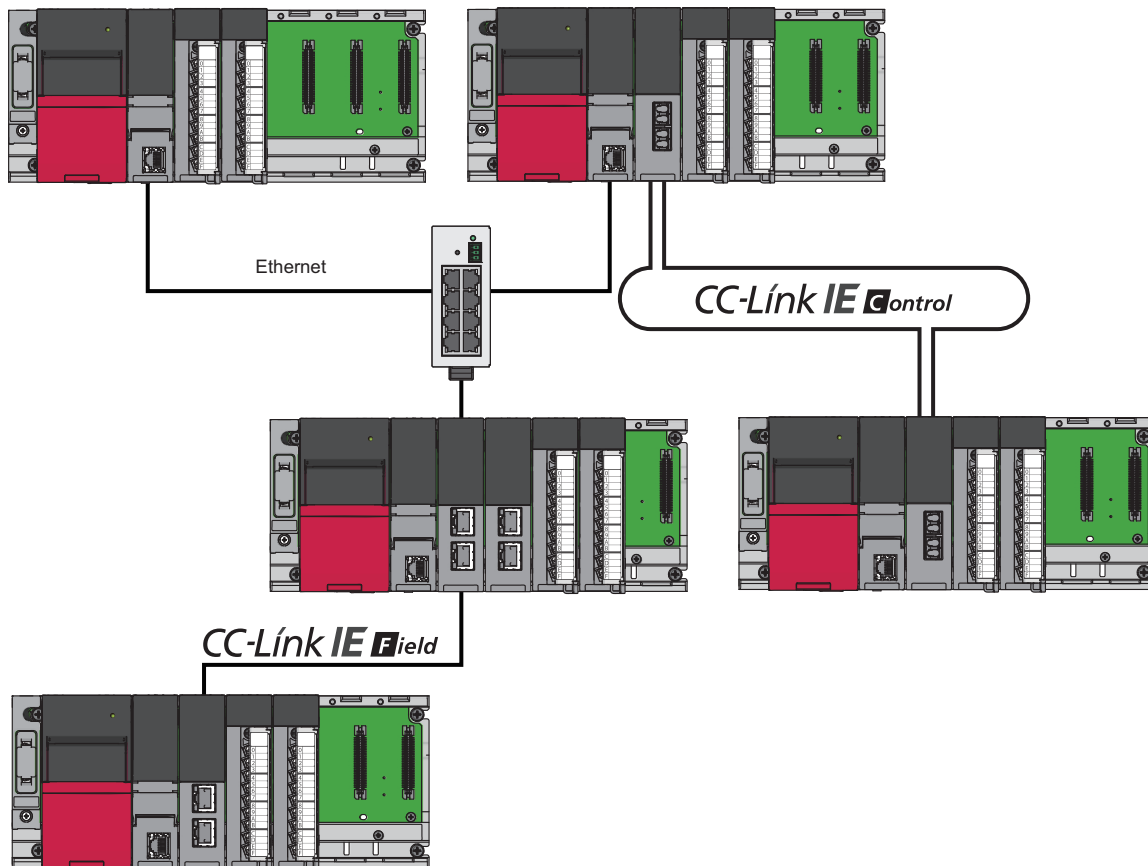

## Point

For applicable CPU modules and the number of mountable modules, refer to the following.

📖 MELSEC iQ-R Module Configuration Manual

# 5.1 Ethernet Configuration

This section describes the system configuration of Ethernet.

## Direct connection to an engineering tool

Engineering tool can be directly connected only with a single Ethernet cable, without using a hub.

In direct connection, communications can be performed simply by the transfer setup, without setting IP address.

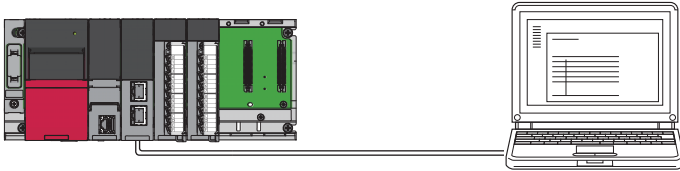

Direct connection can cause an unauthorized connection from a remote location as an Ethernet cable is longer than an USB cable.

Unauthorized connection can be prevented by setting "Disable" in the following item.

[Navigation window] ⇒ [Parameter] ⇒ Target module ⇒ [Application Settings] ⇒ [Security] ⇒ [Disable Direct Connection with MELSOFT]

## Connection with external devices and other stations

Connecting the module with external devices and other stations via Ethernet enables the collection or modification of programmable controller data, monitoring of CPU module operation, status control, and data communication.

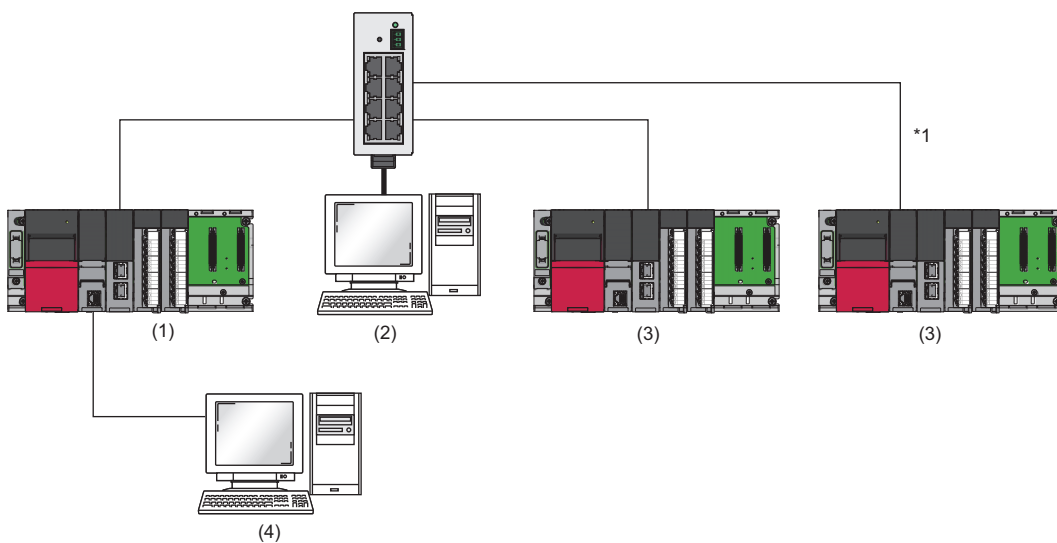

- (1) Own station
- (2) External device
- (3) Another station
- (4) Engineering tool

\*1 Connection is available with the CPU module which supports communications using a network number or a station number. MELSEC iQ-R Ethernet User's Manual (Application))

## Use in a redundant system

The RJ71EN71 can be used in a redundant system.

Using the redundant system function enables the module to track a system switching and to issue a system switching request to the CPU module when a communication error occurs.

For details on the redundant system function, refer to the following.

MELSEC iQ-R Ethernet User's Manual (Application)

## 5.2 CC-Link IE Controller Network Configuration

CC-Link IE Controller Network is configured using optical fiber cables or Ethernet cables.

### Precautions

CC-Link IE Controller Network of the optical fiber cable and CC-Link IE Controller Network of the Ethernet cable cannot be combined by using a media converter (optical fiber cable  $\leftrightarrow$  Ethernet cable).

### When optical fiber cables are used

#### Network topology

Connect the RJ71GP21(S)-SX in a loop by using optical fiber cables. (Duplex loop connection)

No.□ in the figure represents a station number.

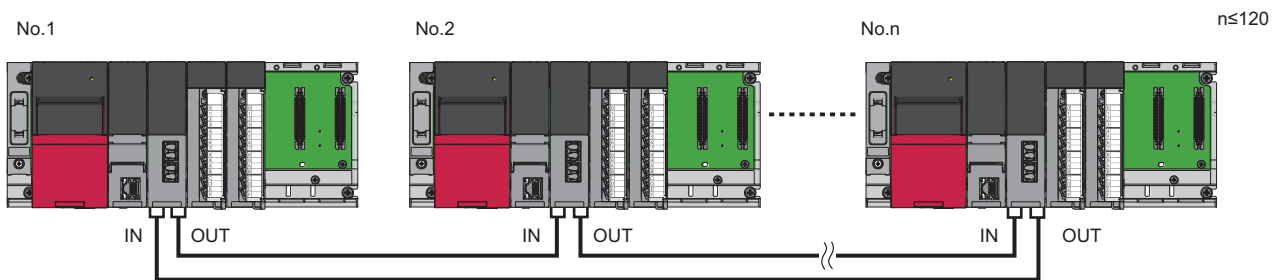

The RJ71GP21(S)-SX has IN connector and OUT connector. Connect the IN connector of own station to OUT connector of another station and OUT connector of own station to IN connector of another station.

#### Station number and connection position

Modules can be connected in any order regardless of the station number.

Each number in the figure, from No.1 to No.3, represents a station number.

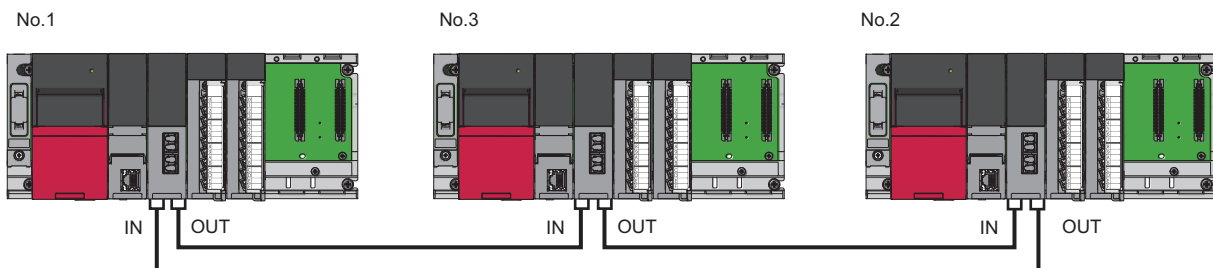

#### Use in a redundant system

The RJ71GP21(S)-SX can be used in a redundant system. (This module cannot be mounted on the extension base unit.)

Using the redundant system function enables the module to track a system switching and to issue a system switching request to the CPU module when a data link error occurs.

For details on the redundant system function, refer to the following.

 MELSEC iQ-R CC-Link IE Controller Network User's Manual (Application)

# When Ethernet cables are used

## Network topology

For the Ethernet-equipped module, configure the network in star topology, line topology, or ring topology using the Ethernet cables.

Star topology and line topology can be combined in a network. Ring topology cannot be combined with star or line topology.

### ■Star topology

The network is configured into a star shape using a switching hub and Ethernet cables. Normal stations can be easily added to the network using this topology.

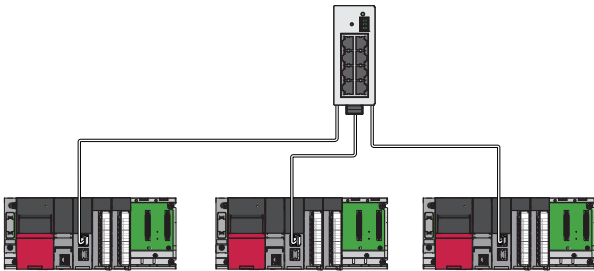

When an error occurs in a normal station, data link can be continued with the stations that are operating normally.

### ■Line topology

The network is configured into a line using Ethernet cables. A switching hub is not required.

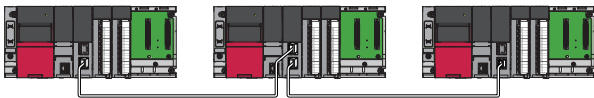

When an error occurs in a normal station, the stations connected after the faulty station will be disconnected.

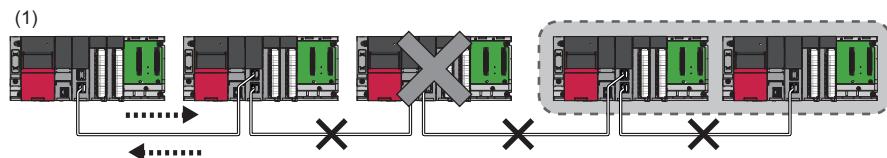

(1) Control station

### ■Star and line mixed

Star and line topology can be mixed.

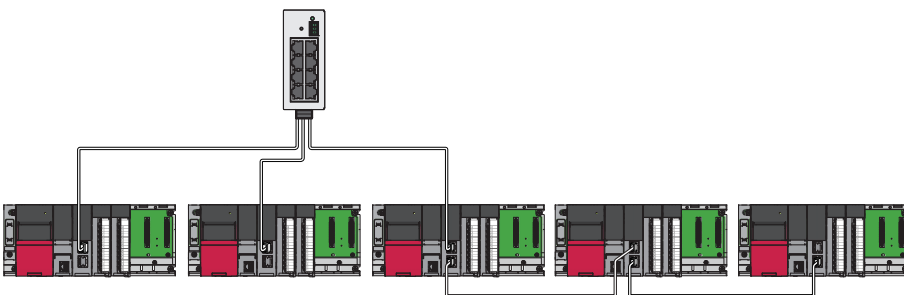

## ■ Ring topology

The network is configured into a ring using Ethernet cables. A switching hub is not required.

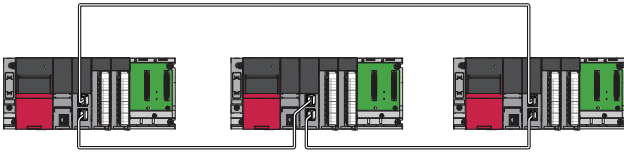

When an error occurs in a normal station, data link can be continued with the stations that are operating normally.

For the RJ71EN71, ring topology is available only when "CC-Link IE Control" is selected as network type for P1 connector.

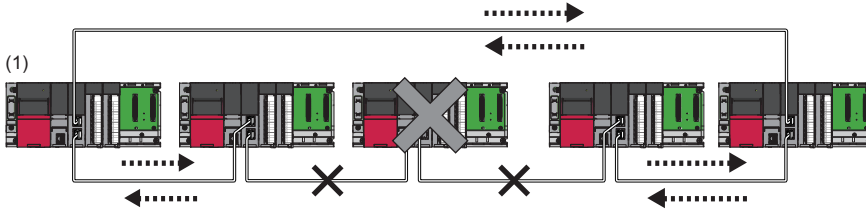

(1) Control station

## Station number and connection position

Modules can be connected in any order regardless of the station number.



(1) Station No. 1

(2) Station No.4 (control station)

(3) Station No.3

(4) Station No.2

## Cascade connection

Cascade connection of the switching hub is available up to 20 levels.

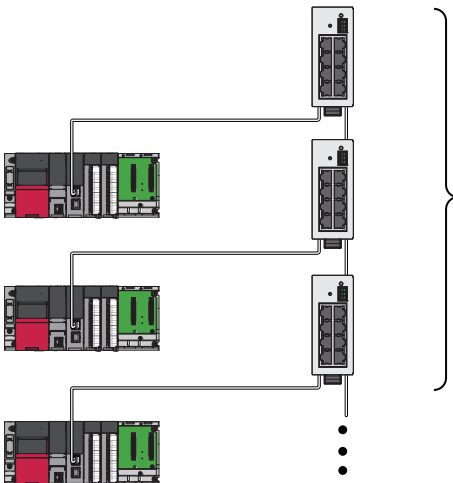



# Precautions when Ethernet cables are used

## Addition of the normal stations

Add/remove normal stations one by one. If multiple device stations are added/removed at a time, all stations on the network will be reconnected, and an error may momentarily occur in all the stations.

If a normal station is added to a system having 119 normal stations, the system operates as follows.

### ■When the firmware version of the control station is "05" or later

Baton pass and data link are not performed in the normal station added after the 120th station, and other stations continues baton pass and data link.

Even if the disconnected stations are returned to a system having 120 or more normal stations, the stations may not start data link.

#### Point

- Whether 120 or more normal stations are connected can be checked using 'Number of connected modules over occurrence status' (SB0099). Number of connected modules detected by 'Number of connected modules over occurrence status' (SB0099) is the total of the normal stations which are currently connected and the disconnected stations (normal stations which were previously connected).
- The number of stations which were previously connected can be cleared by executing the network map update of the CC-Link IE Controller Network diagnostics. ( MELSEC iQ-R CC-Link IE Controller Network User's Manual (Application))
- A data link error may be momentarily detected in all the stations since all stations on the network will be reconnected when executing the network map update.

### ■When the firmware version of the control station is "04" or earlier

All stations will fail and data link cannot be performed.

## Incorrectly configured ring topology

Do not use a switching hub for ring topology.

## Ring topology

When using a ring topology, select "Ring" in the following setting for the control station.

 [Navigation window] ⇒ [Parameter] ⇒ [Module Information] ⇒ Target module ⇒ [Basic Settings] ⇒ [Network Topology]

## Offline mode station in ring topology

In following conditions, the station connected to the offline mode station cannot detect loopback.

- One of the Ethernet cables connected to the offline mode station is disconnected.

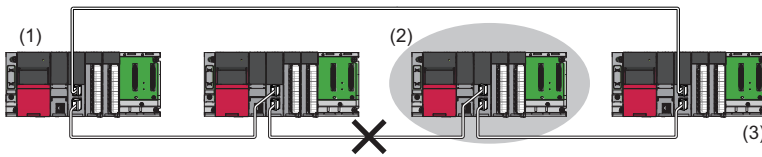

- (1) Control station
- (2) Station in offline mode
- (3) No loopback is detected.

- A station connected to the offline mode station is disconnected.

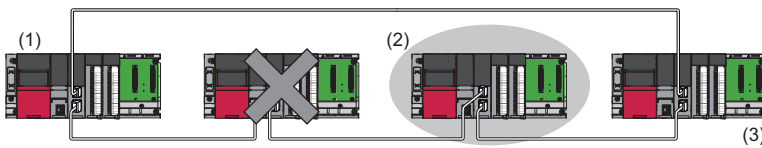

- (1) Control station
- (2) Station in offline mode
- (3) No loopback is detected.

To detect loopback, set the offline mode station as a reserved station.

When the offline mode station is disconnected, loopback can be detected.

### Point

Following stations operate as same as a station in the offline mode.

- A station during the RESET status
- A station with no station number setting

## Connecting/disconnecting a cable and powering off/on a device

When the operations listed below are performed, the following will occur depending on the firmware version of the control station.

Network configuration	Operation
Star topology	<ul style="list-style-type: none"><li>• Powering off and on a normal station or switching hub</li><li>• Connecting/disconnecting an Ethernet cable connected to the switching hub</li><li>• Disconnecting an Ethernet cable from a normal station and connecting it to another normal station or a switching hub</li><li>• Disconnecting more than 9 stations, or half the number of normal stations or more in the system</li><li>• Changing the network topology when adding a normal station</li></ul>
Line topology, ring topology	<ul style="list-style-type: none"><li>• Simultaneously powering off/on multiple stations</li><li>• Simultaneously connecting/disconnecting Ethernet cables to/from multiple stations (When a data link faulty station returns, a data link error will occur in all the stations.)</li><li>• Disconnecting more than 9 stations, or half the number of normal stations or more in the system</li><li>• Changing the network topology when adding a normal station</li></ul>

### ■When the firmware version of the control station is "05" or later

The actual network configuration and the network map of the CC-Link IE Controller Network diagnostics may be a mismatch. Whether mismatch is occurred or not can be checked using 'Network configuration mismatch occurrence status' (SB0098). When using a ring topology, the following may be occurred.

- The station number of the loopback station cannot be detected correctly.
- Even if a switching hub is used, data link does not stop.

#### Point

The actual network configuration and network map can be matched by executing the network map update of the CC-Link IE Controller Network diagnostics. ( MELSEC iQ-R CC-Link IE Controller Network User's Manual (Application))

A data link error may be momentarily detected in all the stations since all stations on the network will be reconnected when executing the network map update.

### ■When the firmware version of the control station is "04" or earlier

A data link error may occur in all the stations.

## Connected station numbers

Do not duplicate station numbers. Data link may be stopped when the station number is duplicated.

# 5.3 CC-Link IE Field Network Configuration

CC-Link IE Field Network is configured using Ethernet cables.

## Network topology

For the CC-Link IE Field Network-equipped master/local module, configure the network in star topology, line topology, or ring topology using the Ethernet cables.

Star topology and line topology can be combined in a network. Ring topology cannot be combined with star or line topology.

### ■Star topology

The network is configured into a star shape using a switching hub and Ethernet cables. Device stations can be easily added to the network using this topology.

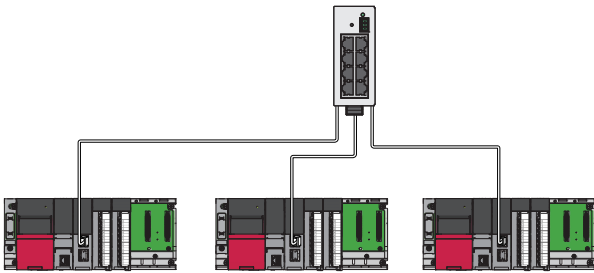

When an error occurs in a device station, data link can be continued with the stations that are operating normally.

### ■Line topology

The network is configured into a line using Ethernet cables. A switching hub is not required.

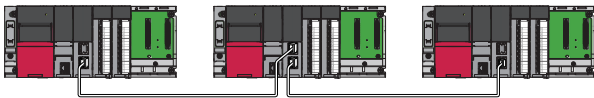

When an error occurs in a device station, the stations connected after the faulty station will be disconnected.

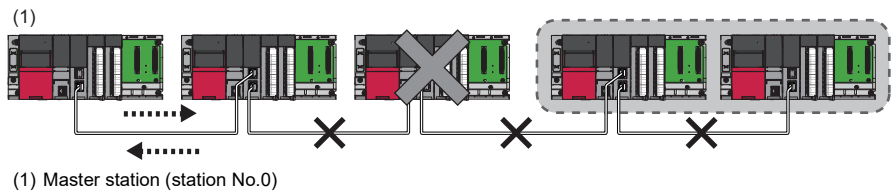

(1) Master station (station No.0)

### ■Star and line mixed

Star and line topology can be mixed.

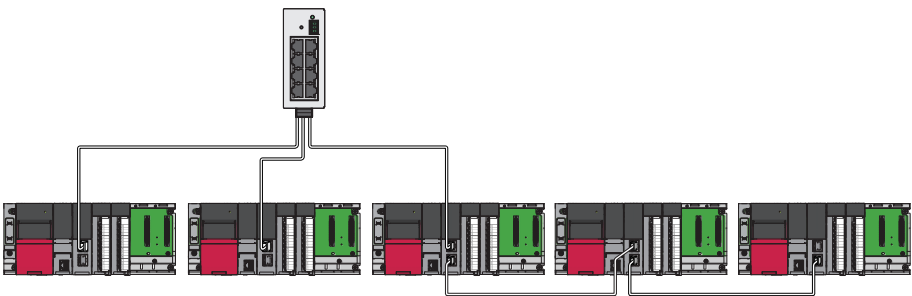

## ■ Ring topology

The network is configured into a ring using Ethernet cables. A switching hub is not required.

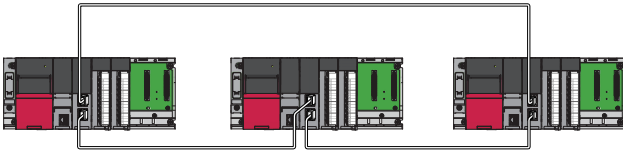

When an error occurs in a device station, data link can be continued with the stations that are operating normally.

For the RJ71EN71, ring topology is available only when "CC-Link IE Field" is selected as network type for P1 connector.

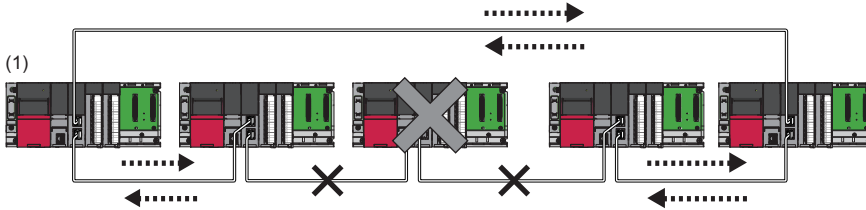

(1) Master station (station No.0)

## Station number and connection position

Modules can be connected in any order regardless of the station number.

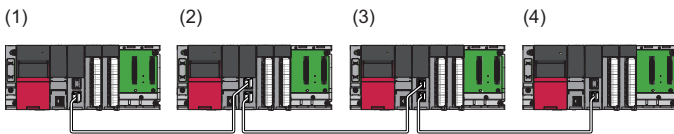

(1) Station No. 1

(2) Station number 0 (master station)

(3) Station No.3

(4) Station No.2

## Cascade connection

Cascade connection of the switching hub is available up to 20 levels.

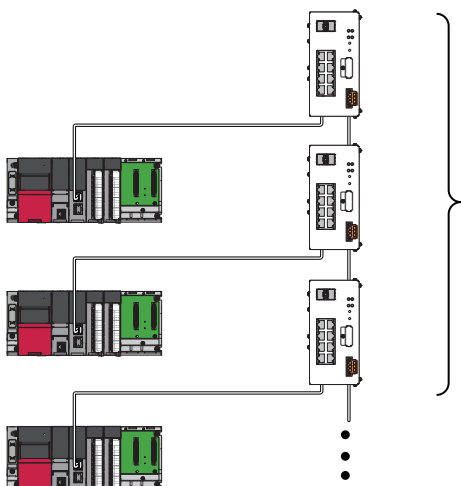

### Restriction

Maximum levels which can be connected differs depending on the hub used when the synchronous communication function of CC-Link IE Field is used. (☞ Page 76 Wiring products)

## In a redundant system

The RJ71GF11-T2 can be used in a redundant system. (This module cannot be mounted on the extension base unit.)

Using the redundant system function enables the module to track a system switching and to issue a system switching request to the Process CPU (redundant mode) when a data link error occurs.

For details on the redundant system function, refer to the following.

📖 MELSEC iQ-R CC-Link IE Field Network User's Manual (Application)

## With the Safety CPU

When the RJ71GF11-T2 is used with the Safety CPU, the safety communication function is available in addition to the standard communications (cyclic transmission and transient transmission).

For details on the safety communication function with the Safety CPU, refer to the following.

📖 MELSEC iQ-R CC-Link IE Field Network User's Manual (Application)

## With the SIL2 Process CPU

When the RJ71GF11-T2 is used with the SIL2 Process CPU, the safety communication function is available in addition to the standard communications (cyclic transmission and transient transmission).

Also, enables the module to track a system switching and to issue a system switching request to the SIL2 Process CPU when a data link error occurs.

For details on the safety communication function with the SIL2 Process CPU, refer to the following.

📖 MELSEC iQ-R CC-Link IE Field Network User's Manual (Application)

# Precautions

## Addition of device stations (including a submaster station)

Add/remove device stations one by one. If multiple device stations are added/removed at a time, all stations on the network will be reconnected, and an error may momentarily occur in all the stations.



If a device station (including a submaster station) is added to a system having 120 device stations (including a submaster station), the system operates as follows.

### ■When the firmware version of the master station is "05" or later

Baton pass and data link are not performed in the device stations (including a submaster station) added after the 121st station, and other stations continue baton pass and data link.

Even if the disconnected stations are returned to a system having 121 or more device stations (including a submaster station), the stations may not start data link.

#### Point

- Whether 121 or more device stations (including a submaster station) are connected can be checked using 'Number of connected modules over occurrence status' (SB0099). Number of connected modules detected by 'Number of connected modules over occurrence status' (SB0099) is the total of the device stations (including a submaster station) which are currently connected and the disconnected stations (device stations which were previously connected).
- The number of stations which were previously connected can be cleared by executing the network map update of the CC-Link IE Field Network diagnostics. ( MELSEC iQ-R CC-Link IE Field Network User's Manual (Application))
- A data link error may momentarily occur in all the stations and outputs of the connected device stations may turn off since all stations on the network will be reconnected when executing the network map update. Set output data if needed. ( Page 67 Output hold when a data link error occurs)

### ■When the firmware version of the master station is "04" or earlier

All stations will fail and data link cannot be performed.

## Incorrectly configured ring topology

Do not use a switching hub for ring topology.

## Ring topology

When using a ring topology, select "Ring" in the following setting for the master station.

 [Navigation window] ⇒ [Parameter] ⇒ [Module Information] ⇒ Target module ⇒ [Basic Settings] ⇒ [Network Topology]

## Offline mode station in ring topology

In following conditions, the station connected to the offline mode station cannot detect loopback.

- One of the Ethernet cables connected to the offline mode station is disconnected.

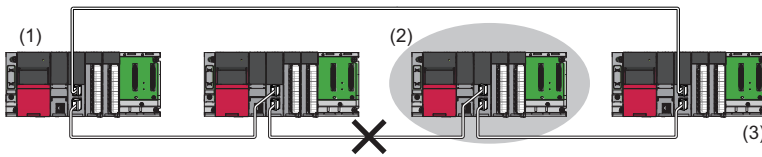

- (1) Master station
- (2) Station in offline mode
- (3) No loopback is detected.

- A station connected to the offline mode station is disconnected.

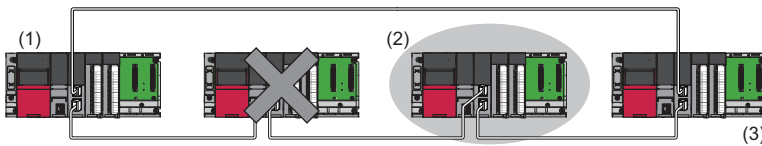

- (1) Master station
- (2) Station in offline mode
- (3) No loopback is detected.

To detect loopback, set the offline mode station as a reserved station.

When the offline mode station is disconnected, loopback can be detected.

### Point

Following stations operate as same as a station in the offline mode.

- A station during the RESET status
- A station with no station number setting



## Connecting/disconnecting a cable and powering off/on a device

When the operations listed below are performed, the following will occur depending on the firmware version of the control station.

Network configuration	Operation
Star topology	<ul style="list-style-type: none"><li>• Powering off and on a device station or switching hub</li><li>• Connecting/disconnecting an Ethernet cable connected to the switching hub</li><li>• Disconnecting an Ethernet cable from a device station and connecting it to another device station or a switching hub</li><li>• Disconnecting more than 9 stations, or half the number of device stations or more in the system</li><li>• Changing the network topology when adding a device station</li></ul>
Line topology, ring topology	<ul style="list-style-type: none"><li>• Simultaneously powering off/on multiple stations</li><li>• Simultaneously connecting/disconnecting Ethernet cables to/from multiple stations (When a data link faulty station returns, a data link error will occur in all the stations.)</li><li>• Disconnecting more than 9 stations, or half the number of device stations or more in the system</li><li>• Changing the network topology when adding a device station</li></ul>

### ■When the firmware version of the master station is "05" or later

The actual network configuration and the network map of the CC-Link IE Field Network diagnostics may be a mismatch. Whether mismatch is occurred or not can be checked using 'Network configuration mismatch occurrence status' (SB0098). When using a ring topology, the following may be occurred.

- The station number of the loopback station cannot be detected correctly.
- Even if a switching hub is used, data link does not stop.

#### Point

The actual network configuration and network map can be matched by executing the network map update of the CC-Link IE Field Network diagnostics. (📖 MELSEC iQ-R CC-Link IE Field Network User's Manual (Application))

A data link error may momentarily occur in all the stations and outputs of the connected device stations may turn off since all stations on the network will be reconnected when executing the network map update. Set output data if needed. (👉 Page 67 Output hold when a data link error occurs)

### ■When the firmware version of the master station is "04" or earlier

A data link error may momentarily occur in all the stations and outputs of the connected device stations may turn off since all stations on the network will be reconnected. Set output data if needed. (👉 Page 67 Output hold when a data link error occurs)

## Output hold when a data link error occurs

Setting the following allows to hold the outputs when a data link error occurs.

### ■Master/local module

Select the "Hold" in the following setting.

👉 [Navigation window] ⇨ [Parameter] ⇨ [Module Information] ⇨ Target module ⇨ [Application Settings] ⇨ [Supplementary Cyclic Settings] ⇨ [I/O Maintenance Settings] ⇨ [Data Link Error Station Setting]

### ■The LJ72GF15-T2 with a serial number (first five digits) of "12071" or earlier (head modules for MELSEC-L CC-Link IE Field Network)

Select the "Hold" in the following setting using GX Works2.

👉 Project window ⇨ [Parameter] ⇨ [PLC Parameter] ⇨ [I/O Assignment] ⇨ [Detailed Setting] button ⇨ [Error Time Output Mode]

This setting is not required for the LJ72GF15-T2 with a serial number (first five digits) of "12072" or later.)

## Connected station numbers

Do not duplicate station numbers. Data link may be stopped when the station number is duplicated.

## 5.4 Precautions for System Configuration

---

### Connecting devices to the same network

Do not connect the devices as described below. Doing so may cause the disconnection of all stations.

- The devices having different network types (such as CC-Link IE Controller Network and CC-Link IE Controller Network) are connected to the same network line.
- The Ethernet devices (such as personal computers) in multiple networks are connected to one switching hub.

### Connecting devices to the CPU module (built-in Ethernet port part)

When connecting devices to the CPU module (built-in Ethernet port part), power off the CPU module before connection.

# 6 WIRING

This chapter describes the wiring methods, wiring products, and wiring precautions when each network is used.

## 6.1 Ethernet Wiring

This section describes the wiring when Ethernet is used.

### Wiring methods

The following describes connection and disconnection of the Ethernet cable.

#### ■Connecting the cable

1. Push the Ethernet cable connector into the Ethernet-equipped module until it clicks. Pay attention to the connector's direction.
2. Lightly pull it to check that it is securely connected.
3. Check whether the LINK LED of the port connected with an Ethernet cable is on.\*1

\*1 The time between the cable connection and the LINK LED turning on may vary. The LINK LED usually turns on in a few seconds. Note, however, that the time may be extended further if the link-up processing is repeated depending on the status of the device on the line. Check whether the cables are connected properly if the LINK LED does not turn on. In addition, the LINK LED does not turn on if the communication speed is 10Mbps. Perform network diagnostics and check whether the cables are connected properly. (MELSEC iQ-R Ethernet User's Manual (Application))

#### ■Disconnecting the cable

1. Press the latch down and unplug the Ethernet cable.

#### ■Precautions

- Place the Ethernet cable in a duct or clamp them. If not, dangling cable may swing or inadvertently be pulled, resulting in damage to the module or cables or malfunction due to poor contact.
- Do not touch the core of the cable-side or module-side connector, and protect it from dirt or dust. If oil from your hand, dirt or dust is attached to the core, it can increase transmission loss, arising a problem in data link.
- Check that the Ethernet cable is not disconnected or not shorted and there is no problem with the connector connection.
- When connecting the Ethernet cable, refer to the CC-Link IE Field Network Cable Installation Manual available from the website of CC-Link Partner Association ([www.cc-link.org](http://www.cc-link.org)). The cable installation not following the contents of the manual may cause malfunction.
- Do not use Ethernet cables with broken latches. Doing so may cause the cable to unplug or malfunction.
- Hold the connector part when connecting and disconnecting the Ethernet cable. Pulling the cable connected to the module may result in malfunction or damage to the module or cable.
- For connectors without Ethernet cable, attached connector cover should be placed to prevent foreign matter such as dirt or dust.
- The maximum segment length of the Ethernet cable is 100m. However, the length may be shorter depending on the operating environment of the cable. For details, contact your cable manufacturer.
- The bend radius of the Ethernet cable is limited. For details, check the specifications of the Ethernet cable to be used.

## Wiring products

The following describes the devices used for Ethernet.

### Point

An Ethernet-equipped module determines whether to use 1000BASE-T/100BASE-TX/10BASE-T and the full-duplex/half-duplex communication mode based on the hub. For connection to the hub with no automatic negotiation function, set the communication mode on the hub side to meet the mode of the Ethernet-equipped module. (📖 Page 35 Performance Specifications of Ethernet)

## ■ Ethernet cable

Use Ethernet cable that meets the following standards.

Communication speed	Ethernet cable	Connector	Type		
1Gbps*1	Category 5e or higher, straight cable (shielded, STP)	RJ45 connector	1000BASE-T		
	Category 5e or higher, crossing cable (shielded, STP)				
100Mbps	Category 5 or higher, straight cable (shielded, STP)		RJ45 connector	100BASE-TX	
	Category 5 or higher, crossing cable (shielded, STP)				
10Mbps	Category 3 or higher, straight cable (shielded, STP)			RJ45 connector	10BASE-T
	Category 3 or higher, straight cable (UTP)				
	Category 3 or higher, crossing cable (shielded, STP)				
	Category 3 or higher, crossing cable (UTP)				

\*1 The CPU module (built-in Ethernet port part) does not support the communication speed.

### Point

A communication error may occur due to high-frequency noise from devices other than a programmable controller in a given connection environment. The following describes countermeasures to be taken on the Ethernet-equipped module side to avoid high-frequency noise influence.

#### Wiring

- Do not bundle the cable with the main circuit or power cable or do not place it near those lines.
- Place the cable in a duct.
- When using a UTP cable, use STP cables.

#### Communication method

- Use TCP/IP for data communications with connected devices.
- Increase the number of retries of communications if needed.

#### Transmission speed

- Change the communication speed to be slower than the speed of communications connected with an Ethernet cable in "Communication Speed" of "Application Settings". (📖 MELSEC iQ-R Ethernet User's Manual (Application))

## ■ Hubs

Use hubs that support the transmission speed of communication when using hub in the Ethernet.

## 6.2 Wiring of CC-Link IE Controller Network

This section describes the wiring when CC-Link IE Controller Network is used.

### Optical fiber cable

The following describes the wiring of the optical fiber cable when the RJ71GP21(S)-SX is used.

#### Wiring methods

The following describes connection and disconnection of the optical fiber cable.

The RJ71GP21(S)-SX has IN connector and OUT connector. Connect the IN connector of own station to OUT connector of another station and OUT connector of own station to IN connector of another station.

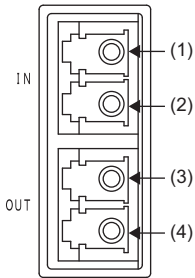

- (1) For receiving forward loop data
- (2) For sending reverse loop data
- (3) For receiving reverse loop data
- (4) For sending forward loop data

#### ■Connecting the cable

1. Push the optical fiber cable connector into the RJ71GP21(S)-SX until it clicks. Pay attention to the connector's direction.
2. Lightly pull it to check that it is securely connected.

#### ■Disconnecting the cable

1. Press the connector hook down and unplug the optical fiber cable.

#### ■Precautions

- The bend radius of the optical fiber cable is limited. For details, check the specifications of the cable to be used.
- Place the optical fiber cable in a duct or clamp them. If not, dangling cable may swing or inadvertently be pulled, resulting in damage to the module or cables or malfunction due to poor contact.
- When handling an optical fiber cable, do not touch the optical fiber core of the cable-side or module-side connector, and protect it from dirt or dust. If oil from your hand, dirt or dust is attached to the core, it can increase transmission loss, arising a problem in data link.
- Hold the connector part when connecting or disconnecting the optical fiber cable. Pulling the cable connected to the module may result in malfunction or damage to the module or cable.
- A tracking cable to connect the redundant function modules is a cable with the same specifications as the optical fiber cable to connect the RJ71GP21(S)-SX. Do not connect the RJ71GP21(S)-SX and the redundant function module by mistake.

## Wiring products

The following describes the devices used for CC-Link IE Controller Network (when optical fiber cables are used).

### ■Optical fiber cable

Use optical fiber cable that meets the following standards.

Optical fiber cable	Connector	Type
Optical fiber cable (multimode optical fiber (GI))	Duplex LC connector	The following conditioning cables: <ul style="list-style-type: none"> <li>• IEEE802.3 (1000BASE-SX)</li> <li>• IEC 60793-2-10 Types A1a.1</li> </ul>

Optical fiber cables with connectors are available from Mitsubishi Electric System & Service Co., Ltd. (Catalogs of the optical fiber cables are also available.)

In addition, on-site connector polishing, terminal assembly, and fusion splicing is available. Please consult your local Mitsubishi representative.

Type	Model (Manufacturer)
Multi-mode optical fiber (GI)	QG series (Mitsubishi Electric System & Service Co., Ltd.)

## External power supply

The following describes wiring of the external power supply when the RJ71GP21S-SX is used.

### Wiring diagram

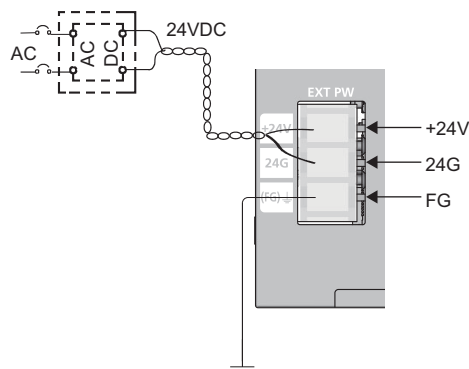

## Wiring products

The table below shows applicable solderless terminals connected to the external power supply terminal block. When wiring, use applicable wires and an appropriate tightening torque. Use UL Listed solderless terminals and, for processing, use a tool recommended by their manufacturer.

Solderless terminal		Wire			
Model	Tightening torque	Diameter	Type	Material	Temperature rating
R1.25-3	0.42 to 0.58N·m	22 to 16 AWG	Stranded/solid	Copper	75°C or more

## Precaution

Shut off the external power supply (all phases) with external devices before connecting to the external power supply terminal block. Failure to do so may result in electric shock or cause the module to fail or malfunction.

# Ethernet cables

The following describes wiring of Ethernet cables when the RJ71EN71 or the RnENCPU (Network part) is used.

## Wiring methods

The following describes connection and disconnection of the Ethernet cable.

### ■Connecting the cable

1. Push the Ethernet cable connector into the RJ71EN71 or the RnENCPU (network part) until it clicks. Pay attention to the connector's direction.
2. Lightly pull it to check that it is securely connected.
3. Check whether the LINK LED of the port connected with an Ethernet cable is on.\*1

\*1 The time between the cable connection and the LINK LED turning on may vary. The LINK LED usually turns on in a few seconds. Note, however, that the time may be extended further if the link-up processing is repeated depending on the status of the device on the line. If the LINK LED does not turn on, refer to the following and take corrective actions.

 MELSEC iQ-R CC-Link IE Controller Network User's Manual (Application)

### Point

Both P1 connector and P2 connector can be used. (Ring topology is available only when "CC-Link IE Control" is selected as network type for P1 connector.)

- When only one connector is used in star topology, either P1 connector or P2 connector is applicable.
- When two connectors are used in line topology and ring topology, the cable can be connected between P1 and P1, P2 and P2, or between P1 and P2.

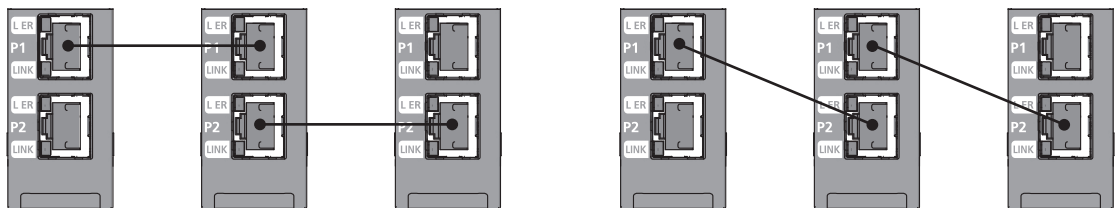

### ■Disconnecting the cable

1. Press the latch down and unplug the Ethernet cable.

## ■Precautions

- Place the Ethernet cable in a duct or clamp them. If not, dangling cable may swing or inadvertently be pulled, resulting in damage to the module or cables or malfunction due to poor contact.
- Do not touch the core of the cable-side or module-side connector, and protect it from dirt or dust. If oil from your hand, dirt or dust is attached to the core, it can increase transmission loss, arising a problem in data link.
- Check that the Ethernet cable is not disconnected or not shorted and there is no problem with the connector connection.
- When connecting the Ethernet cable, refer to the CC-Link IE Field Network Cable Installation Manual available from the website of CC-Link Partner Association ([www.cc-link.org](http://www.cc-link.org)). The cable installation not following the contents of the manual may cause malfunction.
- Do not use Ethernet cables with broken latches. Doing so may cause the cable to unplug or malfunction.
- Hold the connector part when connecting and disconnecting the Ethernet cable. Pulling the cable connected to the module may result in malfunction or damage to the module or cable.
- For connectors without Ethernet cable, attached connector cover should be placed to prevent foreign matter such as dirt or dust.
- The maximum station-to-station distance of the Ethernet cable is 100m. However, the length may be shorter depending on the operating environment of the cable. For details, contact your cable manufacturer.
- The bend radius of the Ethernet cable is limited. For details, check the specifications of the Ethernet cable to be used.

## Wiring products

The following describes the devices used for CC-Link IE Controller Network (when Ethernet cables are used).

### ■Ethernet cable

Use Ethernet cable that meets the following standards.

Ethernet cable	Connector	Type
Category 5e or higher, straight cable (double shielded, STP)	RJ45 connector	The following conditioning cables: <ul style="list-style-type: none"> <li>• IEEE802.3 (1000BASE-T)</li> <li>• ANSI/TIA/EIA-568-B (Category 5e)</li> </ul>

Cables for CC-Link IE Controller Network are available from Mitsubishi Electric System & Service Co., Ltd. (Catalogs for cable are also available.)

In addition, the connector processing of cable length is available for your preference. Please consult your local Mitsubishi representative.

Type	Model (Manufacturer)
Straight cable (double shielded, STP)	SC-E5EW series (Mitsubishi Electric System & Service Co., Ltd.)

### ■Hubs

Use hubs that meet all the conditions listed below. Operation is not guaranteed if the hubs do not meet these conditions.

- Compliance with the IEEE802.3 (1000BASE-T)
- Support of the Auto MDI/MDI-X function
- Support of the auto-negotiation function
- Switching hub (layer 2 switch) (A repeater hub is not available.)

Type	Model (Manufacturer)
Industrial managed switch	NZ2MHG-T8F2 (Mitsubishi Electric Corporation)
Industrial switching hub	<ul style="list-style-type: none"> <li>• NZ2EHG-T8N (Mitsubishi Electric Corporation)</li> <li>• NZ2EHG-T8 (Mitsubishi Electric Corporation) (discontinued)</li> </ul>



## 6.3 Wiring of CC-Link IE Field Network

This section describes the wiring when CC-Link IE Field Network is used.

### Wiring methods

The following describes connection and disconnection of the Ethernet cable.

#### ■Connecting the cable

1. Push the Ethernet cable connector into the CC-Link IE Field Network-equipped master/local module until it clicks. Pay attention to the connector's direction.
2. Lightly pull it to check that it is securely connected.
3. Check whether the LINK LED of the port connected with an Ethernet cable is on.\*1

\*1 The time between the cable connection and the LINK LED turning on may vary. The LINK LED usually turns on in a few seconds. Note, however, that the time may be extended further if the link-up processing is repeated depending on the status of the device on the line. If the LINK LED does not turn on, refer to the following and take corrective actions.

 MELSEC iQ-R CC-Link IE Field Network User's Manual (Application)

#### Point

Both P1 connector and P2 connector can be used. (For the RJ71EN71 and the RnENCPU (network part), ring topology is available only when "CC-Link IE Field" is selected as network type for P1 connector.)

- When only one connector is used in star topology, either P1 connector or P2 connector is applicable.
- When two connectors are used in line topology and ring topology, the cable can be connected between P1 and P1, P2 and P2, or between P1 and P2.

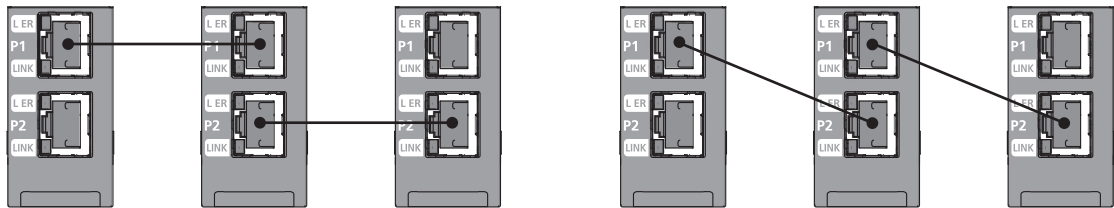

#### ■Disconnecting the cable

1. Press the latch down and unplug the Ethernet cable.

## ■Precautions

- Place the Ethernet cable in a duct or clamp them. If not, dangling cable may swing or inadvertently be pulled, resulting in damage to the module or cables or malfunction due to poor contact.
- Do not touch the core of the cable-side or module-side connector, and protect it from dirt or dust. If oil from your hand, dirt or dust is attached to the core, it can increase transmission loss, arising a problem in data link.
- Check that the Ethernet cable is not disconnected or not shorted and there is no problem with the connector connection.
- When connecting the Ethernet cable, refer to the CC-Link IE Field Network Cable Installation Manual available from the website of CC-Link Partner Association ([www.cc-link.org](http://www.cc-link.org)). The cable installation not following the contents of the manual may cause malfunction.
- Do not use Ethernet cables with broken latches. Doing so may cause the cable to unplug or malfunction.
- Hold the connector part when connecting and disconnecting the Ethernet cable. Pulling the cable connected to the module may result in malfunction or damage to the module or cable.
- For connectors without Ethernet cable, attached connector cover should be placed to prevent foreign matter such as dirt or dust.
- The maximum station-to-station distance of the Ethernet cable is 100m. However, the length may be shorter depending on the operating environment of the cable. For details, contact your cable manufacturer.
- The bend radius of the Ethernet cable is limited. For details, check the specifications of the Ethernet cable to be used.

## Wiring products

The following describes the devices used for CC-Link IE Field Network.

### ■Ethernet cable

Use Ethernet cable that meets the following standards.

Ethernet cable	Connector	Type
Category 5e or higher, straight cable (double shielded, STP)	RJ45 connector	The following conditioning cables: <ul style="list-style-type: none"><li>• IEEE802.3 (1000BASE-T)</li><li>• ANSI/TIA/EIA-568-B (Category 5e)</li></ul>

Cables for CC-Link IE Field Network are available from Mitsubishi Electric System & Service Co., Ltd. (Catalogs for cable are also available.)

In addition, the connector processing of cable length is available for your preference. Please consult your local Mitsubishi representative.

Type	Model (Manufacturer)
Straight cable (double shielded, STP)	SC-E5EW series (Mitsubishi Electric System & Service Co., Ltd.)

## ■Hubs

Use hubs that meet all the conditions listed below. Operation is not guaranteed if the hubs do not meet these conditions.

- Compliance with the IEEE802.3 (1000BASE-T)
- Support of the Auto MDI/MDI-X function
- Support of the auto-negotiation function
- Switching hub (layer 2 switch) (A repeater hub is not available.)

Type	Model (Manufacturer)
Industrial managed switch	NZ2MHG-T8F2 (Mitsubishi Electric Corporation)
Industrial switching hub	<ul style="list-style-type: none"> <li>• NZ2EHG-T8N (Mitsubishi Electric Corporation)</li> <li>• NZ2EHG-T8 (Mitsubishi Electric Corporation) (discontinued)</li> </ul>

Use any of the following hubs when using the CC-Link IE Field Network synchronous communication function.

Type	Model (Manufacturer)	Maximum number of connections when synchronous communication function is used
Industrial managed switch	NZ2MHG-T8F2 (Mitsubishi Electric Corporation)	20 levels <sup>*1</sup>
CC-Link IE Field Network synchronous communication-compatible switching hub	DT135TX (Mitsubishi Electric System & Service Co., Ltd.)	4 levels

- \*1 Maximum levels which can be connected differ depending on the firmware version of the CC-Link IE Field Network-equipped master/local module.
- Firmware version "10" or earlier: 4 levels maximum
  - Firmware version "11" or later: 20 levels maximum

## Media converter

When an Ethernet cable is converted into an optical fiber cable, use a media converter that satisfies the following conditions. If not, the operations are not guaranteed.

To check whether the media converter satisfies the conditions, consult the manufacturer of the media converter to be used.

- Compliance with the Gigabit Ethernet for all ports
- Compliance with the IEEE 802.3 (1000BASE-T) for the ports connected to the modules on CC-Link IE Field Network
- Using the shielded RJ45 connectors
- Support of the Auto MDI/MDI-X function
- Support of the auto-negotiation function
- Support of the link pass-through function

The link pass-through function means if a link-down occurs in a port of the source media converter (on the Ethernet cable side or optical fiber cable side), a link-down automatically occurs in a port of the destination media converter as well.

### Ex.

The link pass-through function operates as follows:

A link-down in the port (A1) of the media converter (A) causes a link-down in the port (A2) automatically. This results in a link-down in the port (B2), followed by a link-down in the port (B1) of the media converter (B) due to connection with the converter (A).

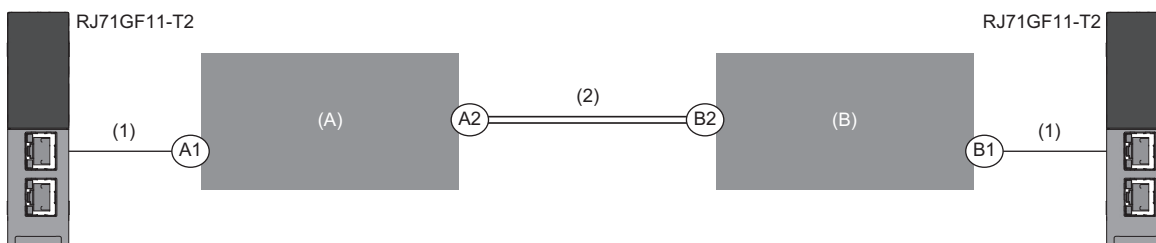

- (1) Ethernet cable  
(2) Optical fiber cable

### Point

When a ring topology is configured, use a media converter that does not support the MAC address learning function.

## Precautions

When a media converter is used in ring topology, powering on a device in the network may cause a temporary disconnection of device station. To prevent the device station disconnection, set 'Media converter use in ring topology' (Un\G29962)<sup>\*1</sup> to Use (1) in the master operating station.

Observe the following when 'Media converter use in ring topology' (Un\G29962) is set to Use (1).

- The device station may become disconnected temporarily by powering on a device in the network. Therefore, do not power off a device in another network or do not disconnect an Ethernet cable 20 seconds after the device power-on.
- It takes up to 20 seconds until the loopback stops after the cable is reconnected or the faulty station recovers.
- When a master operating station is switched, the new master operating station does not inherit the settings of the old master operating station. Therefore, create a program so that 'Media converter use in ring topology' (Un\G29962) turns on in the new master operating station after switching.

\*1 'Media converter use in ring topology' (Un\G29962) can be used for the CC-Link IE Field Network-equipped master/local module whose firmware version is "59" or later.

# 7 COMMUNICATION EXAMPLES

## 7.1 Communication Examples of Ethernet

This section describes the socket communications examples using Active open of TCP/IP communications.

### System configuration example

The following system configuration is used to explain socket communications.

#### System configuration

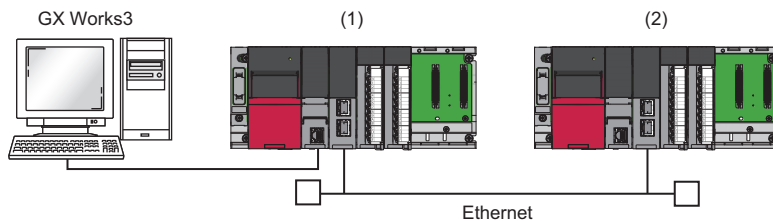

(1) Sending side (IP address: 192.0.1.100)

(2) Receiving side (IP address: 192.0.1.101)

### Sending side

Connect the engineering tool to the CPU module on the sending side and set the parameters.

1. Set the CPU module as follows.

 [Project] ⇒ [New]

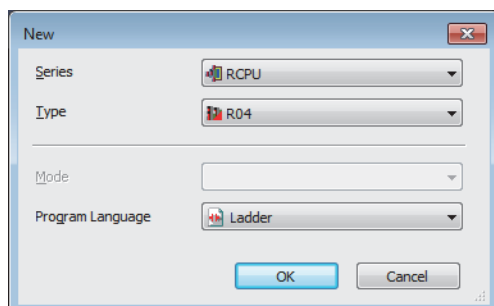

2. Click the [Setting Change] button in the following window and set the item to use module labels.

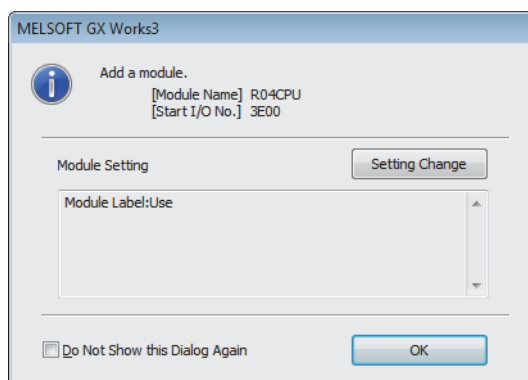

3. Click the [OK] button to add the module labels of the CPU module.

4. Set the RJ71EN71 as follows.

[Navigation window] ⇒ [Parameter] ⇒ [Module Information] ⇒ Right-click ⇒ [Add New Module]

5. Click the [OK] button to add the module labels of the RJ71EN71.

6. Set the items in "Basic Settings" as follows.

[Navigation window] ⇒ [Parameter] ⇒ [Module Information] ⇒ [RJ71EN71] ⇒ [Port 1 Module Parameter (Ethernet)] ⇒ [Basic Settings]

Item	Setting
<b>Own Node Settings</b>	
Parameter Setting Method	Parameter Editor
IP Address	
IP Address	192 . 0 . 1 . 100
Subnet Mask	. . .
Default Gateway	. . .
Communications by Network No./Station No.	Disable
Setting Method	Use IP Address
Network No.	-----
Station No.	-----
Transient Transmission Group No.	0
Enable/Disable Online Change	Disable All (SLMP)
Communication Data Code	Binary
Opening Method	Open by Program
<b>External Device Configuration</b>	
External Device Configuration	<Detailed Setting>

## 7. Set the network configuration as follows.

[Navigation window] ⇒ [Parameter] ⇒ [Module Information] ⇒ [RJ71EN71] ⇒ [Port 1 Module Parameter (Ethernet)] ⇒ [Basic Settings] ⇒ [External Device Configuration]

No.	Model Name	Communication Method	Protocol	Fixed Buffer Send/Receive Setting	PLC		Sensor/Device				Existence Confirmation	
					IP Address	Port No.	MAC Address	Host Name	IP Address	Port No.		Subnet Mask
	Host Station				192.0.1.100							
1	MELSOFT Connection Module	MELSOFT Connection	TCP		192.0.1.100							KeepAlive
2	MELSOFT Connection Module	MELSOFT Connection	TCP		192.0.1.100							KeepAlive
3	MELSOFT Connection Module	MELSOFT Connection	TCP		192.0.1.100							KeepAlive
4	MELSOFT Connection Module	MELSOFT Connection	TCP		192.0.1.100							KeepAlive
5	MELSOFT Connection Module	MELSOFT Connection	TCP		192.0.1.100							KeepAlive
6	MELSOFT Connection Module	MELSOFT Connection	TCP		192.0.1.100							KeepAlive
7	MELSOFT Connection Module	MELSOFT Connection	TCP		192.0.1.100							KeepAlive
8	MELSOFT Connection Module	MELSOFT Connection	TCP		192.0.1.100							KeepAlive
9	MELSOFT Connection Module	MELSOFT Connection	TCP		192.0.1.100							KeepAlive
10	MELSOFT Connection Module	MELSOFT Connection	TCP		192.0.1.100							KeepAlive
11	MELSOFT Connection Module	MELSOFT Connection	TCP		192.0.1.100							KeepAlive
12	MELSOFT Connection Module	MELSOFT Connection	TCP		192.0.1.100							KeepAlive
13	MELSOFT Connection Module	MELSOFT Connection	TCP		192.0.1.100							KeepAlive
14	MELSOFT Connection Module	MELSOFT Connection	TCP		192.0.1.100							KeepAlive
15	MELSOFT Connection Module	MELSOFT Connection	TCP		192.0.1.100							KeepAlive
16	MELSOFT Connection Module	MELSOFT Connection	TCP		192.0.1.100							KeepAlive
17	Active Connection Module	Socket Communication	TCP		192.0.1.100	8192			192.0.1.101	4096		KeepAlive

## 8. Write the set parameters to the CPU module. Then reset the CPU module or power off and on the system.

[Online] ⇒ [Write to PLC]

### Point

In this example, default values are used for parameters that are not shown above. For the parameters, refer to the following.

📖 MELSEC iQ-R Ethernet User's Manual (Application)

## Receiving side

Connect the engineering tool to the CPU module on the receiving side and set the parameters.

1. Set the CPU module and add a module label of the CPU module. The setting method of the CPU module and addition method of the module label are the same as those of when setting the sending side. (👉 Page 79 Sending side)
2. Set the RJ71EN71 and add the module labels of the RJ71EN71. The setting method of the RJ71EN71 and addition method of the module label are the same as those of when setting the sending side. (👉 Page 79 Sending side)

3. Set the items in "Basic Settings" as follows.

[Navigation window] ⇒ [Parameter] ⇒ [Module Information] ⇒ [RJ71EN71] ⇒ [Port 1 Module Parameter (Ethernet)] ⇒ [Basic Settings]

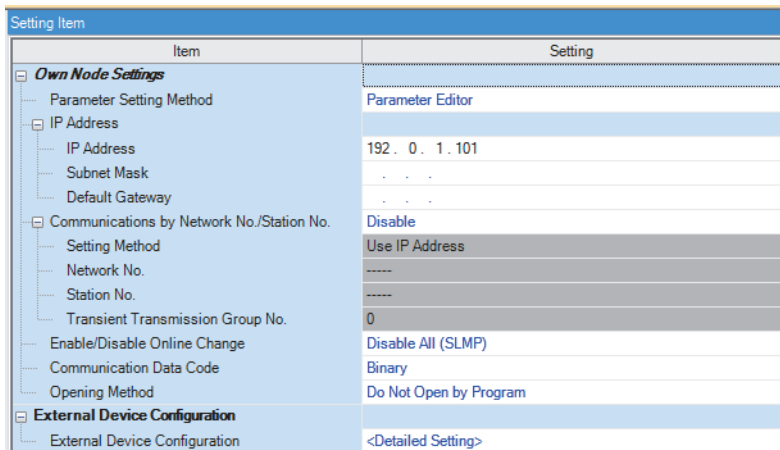

4. Set the network configuration as follows.

[Navigation window] ⇒ [Parameter] ⇒ [Module Information] ⇒ [RJ71EN71] ⇒ [Port 1 Module Parameter (Ethernet)] ⇒ [Basic Settings] ⇒ [External Device Configuration]

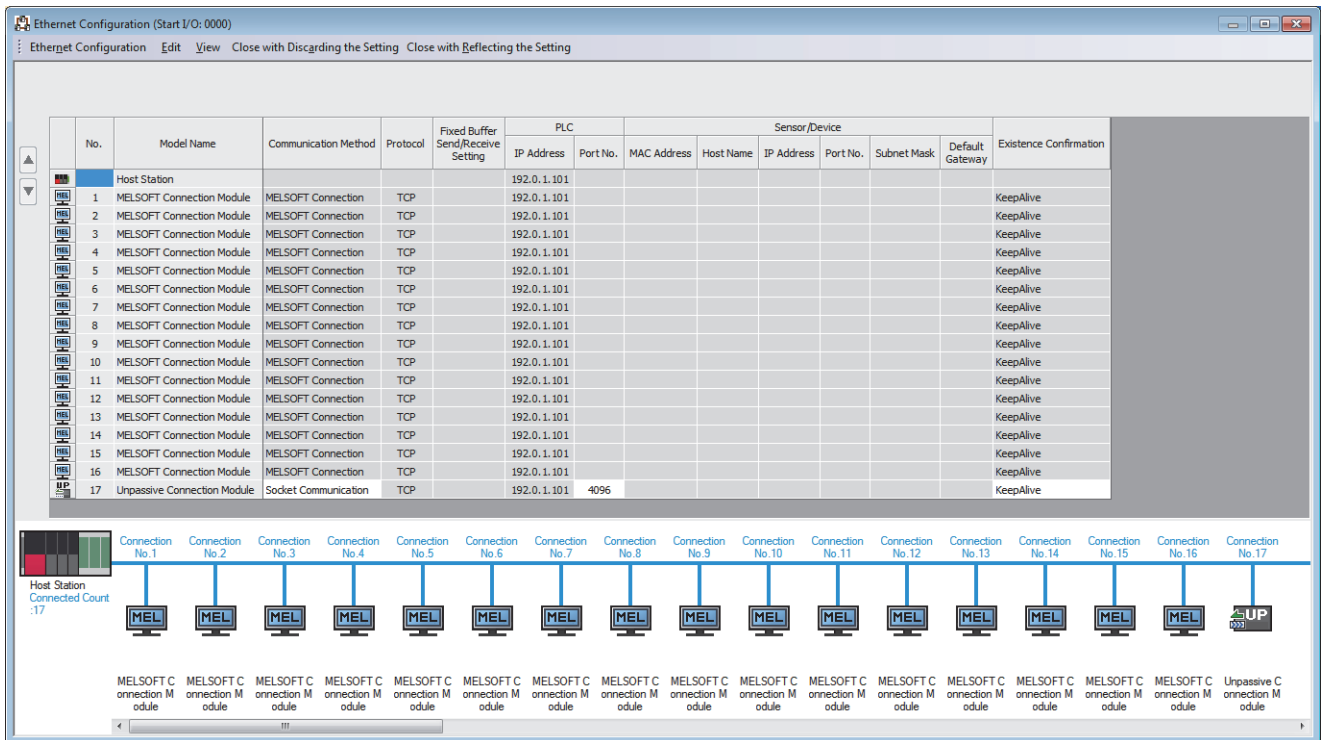

5. Write the set parameters to the CPU module. Then reset the CPU module or power off and on the system.

[Online] ⇒ [Write to PLC]

**Point**

In this example, default values are used for parameters that are not shown above. For the parameters, refer to the following.

📖 MELSEC iQ-R Ethernet User's Manual (Application)



# Program example

## Sending side

### Labels

Classification	Label name	Description	Device
Module label	RCPU.stSM.bAlways_ON	Always on	SM400
	EN71_EE_1.stPort1.uStatus_HUB_Connection_D.0	Connection status	U0\G5192.0
	EN71_EE_1.bnCompletion_ConnectionOpen[17]	Open completion signal (connection No.17)	U0\G190001.0
	EN71_EE_1.bnStatus_ConnectionOpenExecution[17]	Open request signal (connection No.17)	U0\G1900009.0
	EN71_EE_1.uCompletion_EthernetInitialized.0	Initial status	U0\G1900024.0

Label Name	Data Type	Class	Assign (Device/Label)
bRunRefresh	Bit	VAR_GLOBAL	M0
bStartOpen	Bit	VAR_GLOBAL	M1
bRunOpen	Bit	VAR_GLOBAL	M2
bOpen_OK	Bit	VAR_GLOBAL	M3
bOpen_NG	Bit	VAR_GLOBAL	M4
bStartSend	Bit	VAR_GLOBAL	M5
bRunSend	Bit	VAR_GLOBAL	M6
bSend_OK	Bit	VAR_GLOBAL	M7
bSend_NG	Bit	VAR_GLOBAL	M8
bStartClose	Bit	VAR_GLOBAL	M13
bRunClose	Bit	VAR_GLOBAL	M14
bClose_OK	Bit	VAR_GLOBAL	M15
bClose_NG	Bit	VAR_GLOBAL	M16
bStartOpenFB	Bit	VAR_GLOBAL	M20
bStartCloseFB	Bit	VAR_GLOBAL	M21
uOpenErrID	Word [Unsigned]/Bit String [16-bit]	VAR_GLOBAL	D0
uSendErrID	Word [Unsigned]/Bit String [16-bit]	VAR_GLOBAL	D10
uCloseErrID	Word [Unsigned]/Bit String [16-bit]	VAR_GLOBAL	D30
uSendData	Word [Unsigned]/Bit String [16-bit](0..3)	VAR_GLOBAL	D1000

### FBs

The following shows FBs to be used in the program example.

- M\_RJ71EN71\_EE\_Refresh\_Data
- M\_RJ71EN71\_EE\_ConnectionOpen
- M\_RJ71EN71\_EE\_Send\_Socket
- M\_RJ71EN71\_EE\_ConnectionClose

### Program

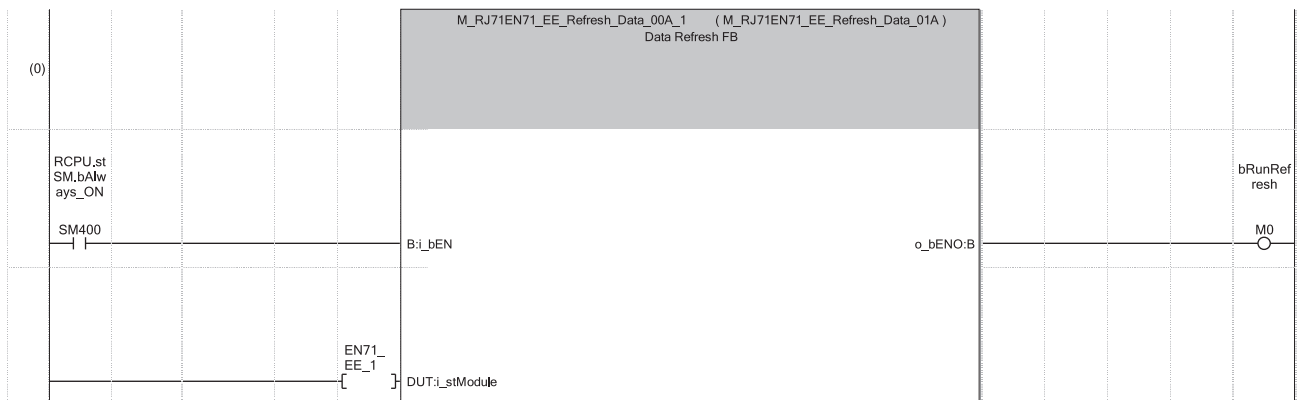

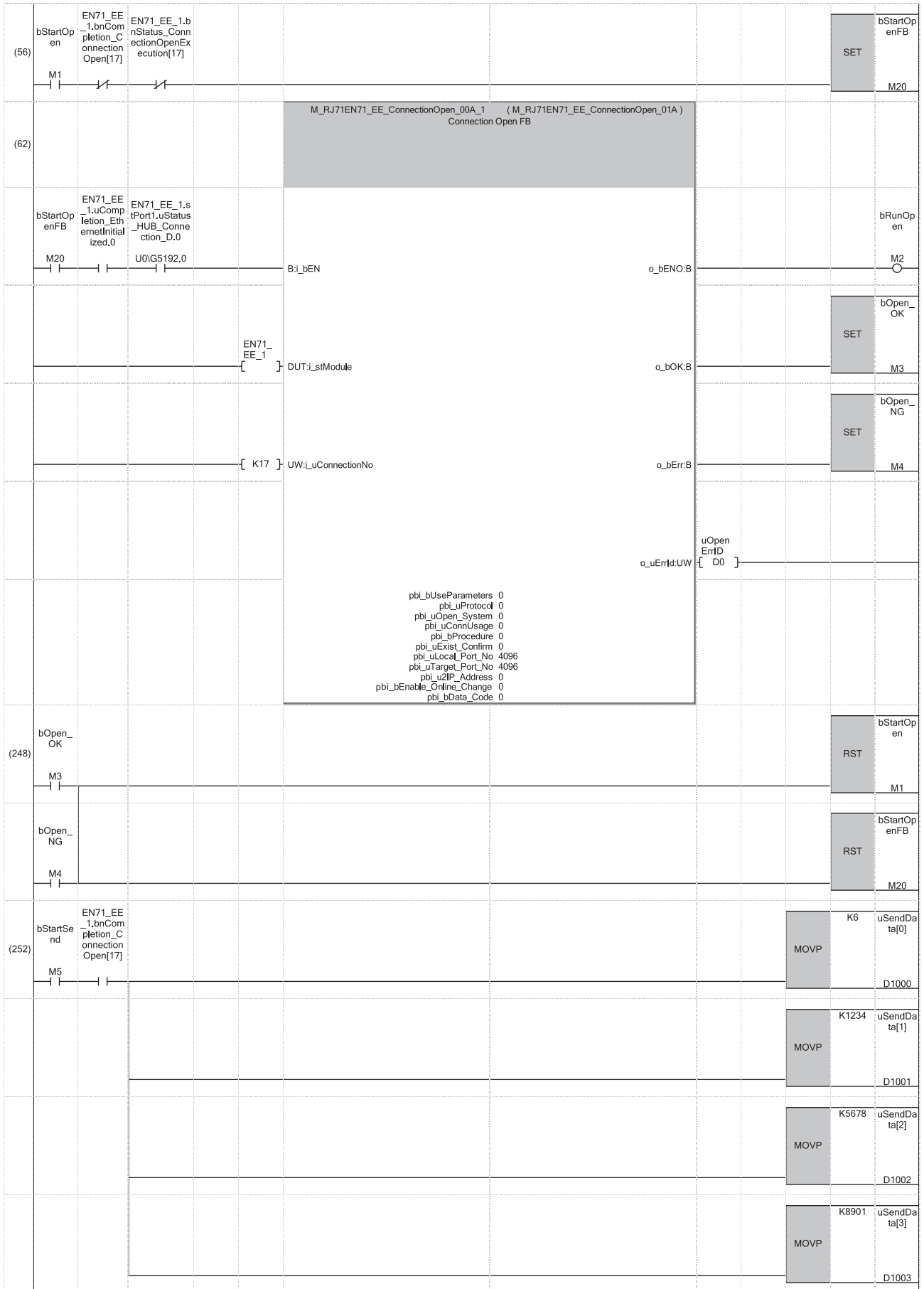

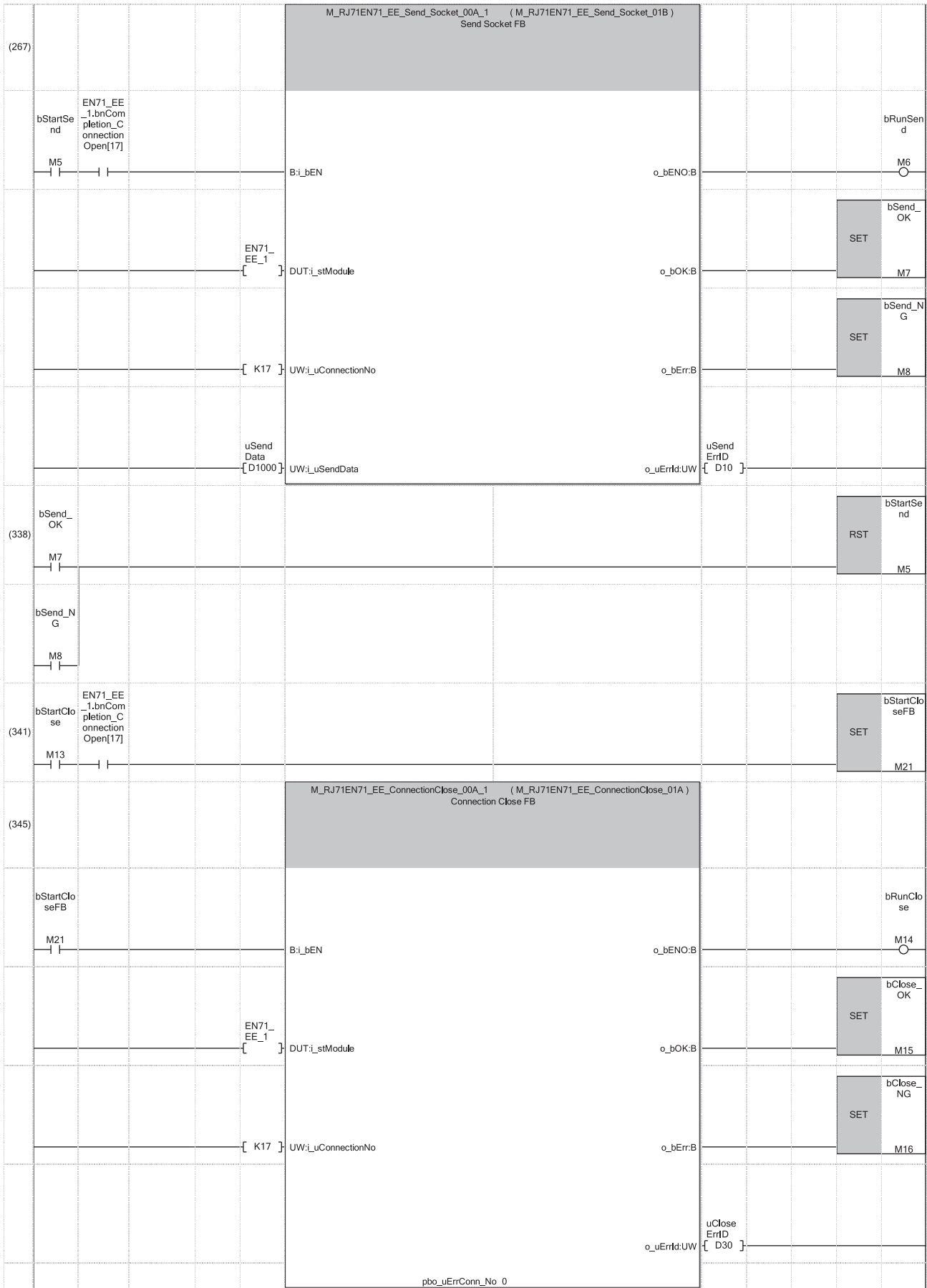



## Receiving side

### Labels

Classification	Label name	Description	Device																																				
Module label	RCPU.stSM.bAlways_ON	Always on	SM400																																				
	EN71_EE_1.bnCompletion_ConnectionOpen[17]	Open completion signal (connection No.17)	U0\G1900001.0																																				
	EN71_EE_1.bnCompletion_ReceiveSocket_FixedBuffer[17]	Socket/fixed buffer reception status signal (connection No.17)	U0\G1900017.0																																				
	EN71_EE_1.uCompletion_EthernetInitialized.0	Initial status	U0\G1900024.0																																				
Label to be defined	Define global labels as shown below:																																						
	<table border="1"> <thead> <tr> <th>Label Name</th> <th>Data Type</th> <th>Class</th> <th>Assign (Device/Label)</th> </tr> </thead> <tbody> <tr> <td>bRunRefresh</td> <td>Bit</td> <td>VAR_GLOBAL</td> <td>M0</td> </tr> <tr> <td>bStartRecv</td> <td>Bit</td> <td>VAR_GLOBAL</td> <td>M9</td> </tr> <tr> <td>bRunRecv</td> <td>Bit</td> <td>VAR_GLOBAL</td> <td>M10</td> </tr> <tr> <td>bRecv_OK</td> <td>Bit</td> <td>VAR_GLOBAL</td> <td>M11</td> </tr> <tr> <td>bRecv_NG</td> <td>Bit</td> <td>VAR_GLOBAL</td> <td>M12</td> </tr> <tr> <td>uRecvErrID</td> <td>Word [Unsigned]/Bit String [16-bit]</td> <td>VAR_GLOBAL</td> <td>D20</td> </tr> <tr> <td>uRecvData</td> <td>Word [Unsigned]/Bit String [16-bit][0..5119]</td> <td>VAR_GLOBAL</td> <td>D2000</td> </tr> <tr> <td>bStartRecvFB</td> <td>Bit</td> <td>VAR_GLOBAL</td> <td>M17</td> </tr> </tbody> </table>			Label Name	Data Type	Class	Assign (Device/Label)	bRunRefresh	Bit	VAR_GLOBAL	M0	bStartRecv	Bit	VAR_GLOBAL	M9	bRunRecv	Bit	VAR_GLOBAL	M10	bRecv_OK	Bit	VAR_GLOBAL	M11	bRecv_NG	Bit	VAR_GLOBAL	M12	uRecvErrID	Word [Unsigned]/Bit String [16-bit]	VAR_GLOBAL	D20	uRecvData	Word [Unsigned]/Bit String [16-bit][0..5119]	VAR_GLOBAL	D2000	bStartRecvFB	Bit	VAR_GLOBAL	M17
Label Name	Data Type	Class	Assign (Device/Label)																																				
bRunRefresh	Bit	VAR_GLOBAL	M0																																				
bStartRecv	Bit	VAR_GLOBAL	M9																																				
bRunRecv	Bit	VAR_GLOBAL	M10																																				
bRecv_OK	Bit	VAR_GLOBAL	M11																																				
bRecv_NG	Bit	VAR_GLOBAL	M12																																				
uRecvErrID	Word [Unsigned]/Bit String [16-bit]	VAR_GLOBAL	D20																																				
uRecvData	Word [Unsigned]/Bit String [16-bit][0..5119]	VAR_GLOBAL	D2000																																				
bStartRecvFB	Bit	VAR_GLOBAL	M17																																				

### FBs

The following shows FBs to be used in the program example.

- M\_RJ71EN71\_EE\_Refresh\_Data
- M\_RJ71EN71\_EE\_Recv\_Socket

### Program

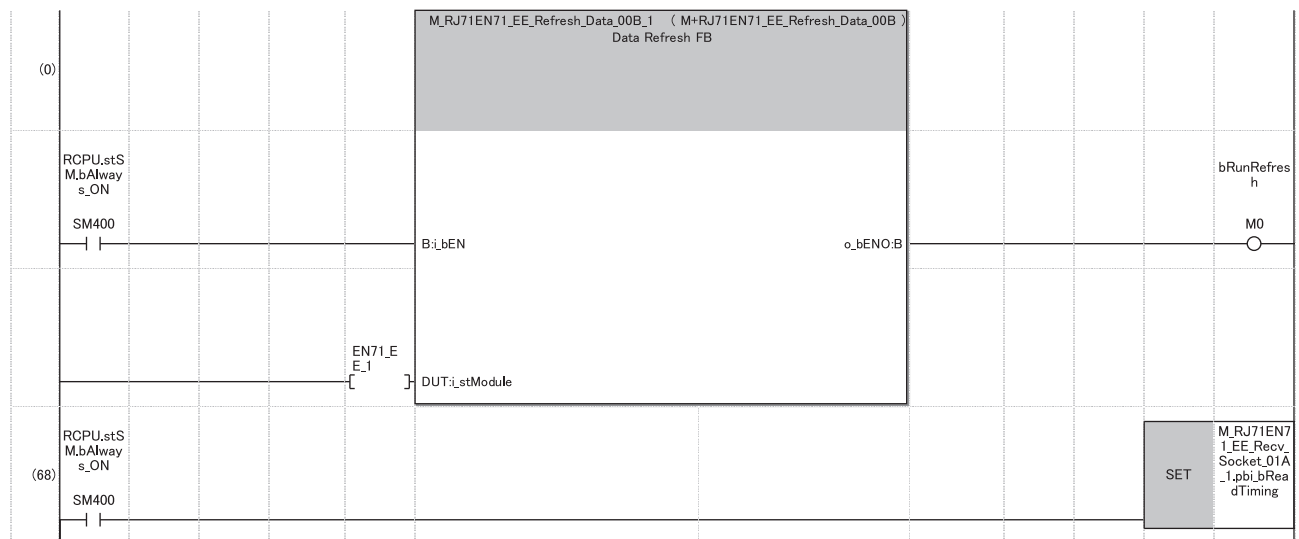

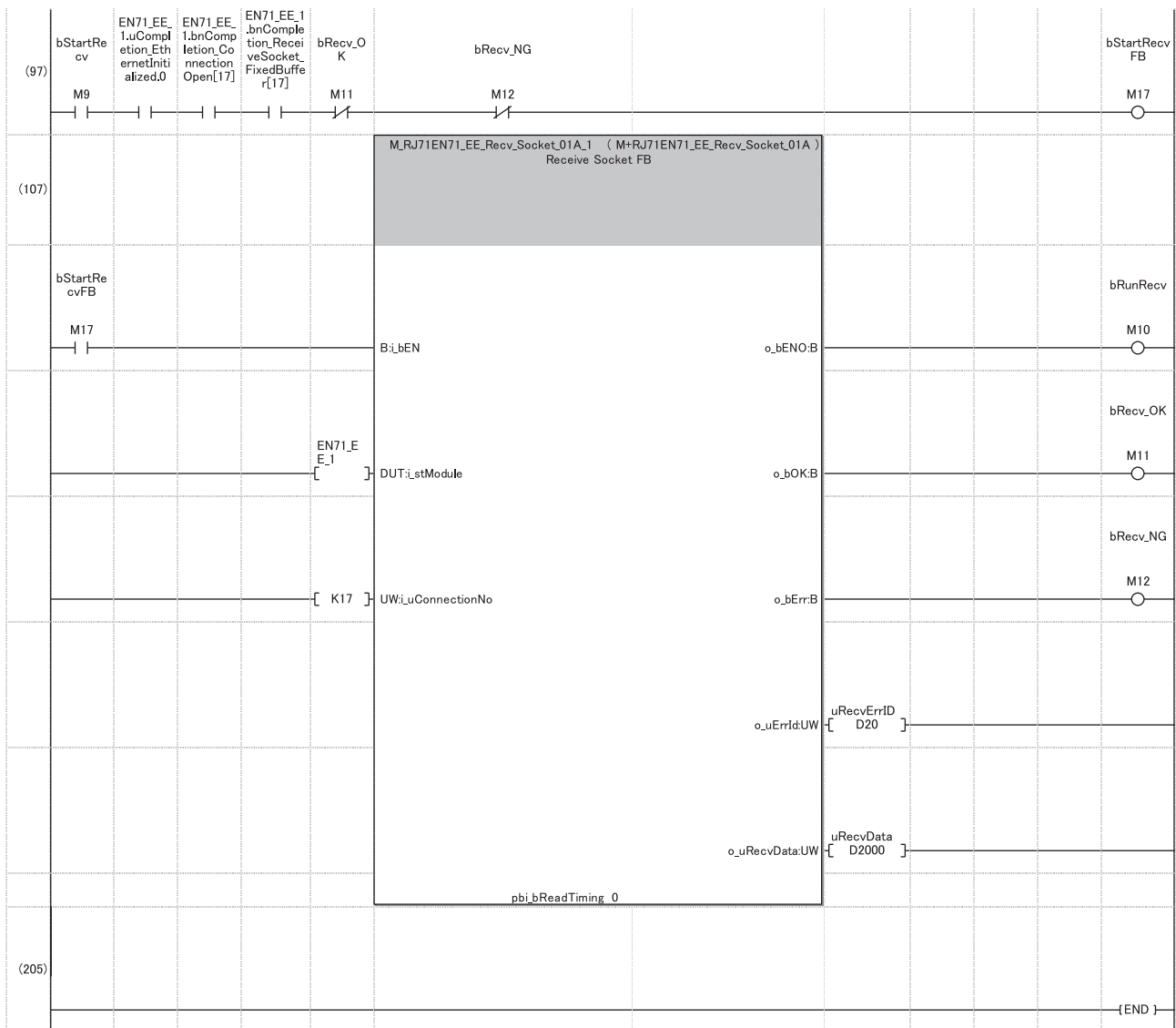

- (0) The refresh processing of the module label is performed. (The processing is required for when using the module function block.\*1)  
When the refresh processing is completed, 'bRunRefresh' (M0) is turned on.
- (97) When 'bStartRecv' (M9) is turned on, the data sent by the external device of connection No. 17 is received and stored in 'uRecvData' (D2000).  
(The device range in which data is stored varies depending on the data length of the received data.)  
When the data receive is completed successfully, 'bRecv\_OK' (M11) is turned on.

\*1 The refresh processing using the above FB is not required when the Ethernet function of the CPU module (CPU part for the RnENCPU) is used.

### Point

- Secure sufficient device areas according to the maximum length of data sent from the send source to prevent the device areas used for other purposes from being overwritten by the receive data.
- When the data receive is consecutively executed, turn on pbi\_bReadTiming (read timing) as shown in the above program.
- To receive data at shorter intervals than the scan time of the CPU module, add the normally closed contact of 'bRecv\_OK' (M11) and 'bRecv\_NG' (M12) to the execution conditions of FB for receiving as shown in the above program. When there is no normally closed contact of 'bRecv\_OK' (M11) and 'bRecv\_NG' (M12), 'bStartRecvFB' (M17) is not turned off and on and the FB for receiving may not be executed.

# 7.2 Communication Examples of CC-Link IE Controller Network

This section describes communications between the control station and normal station.

## System configuration example

The following system configuration is used to explain communication between the control station and normal station.

### System configuration

- Power supply module: R61P
- CPU Module: R04CPU
- CC-Link IE Controller Network-equipped module: RJ71GP21-SX (start I/O number: 0000H to 001FH)
- Input module: RX10 (start I/O number: 0020H to 002FH)
- Output module: RY10R2 (start I/O number: 0030H to 003FH)

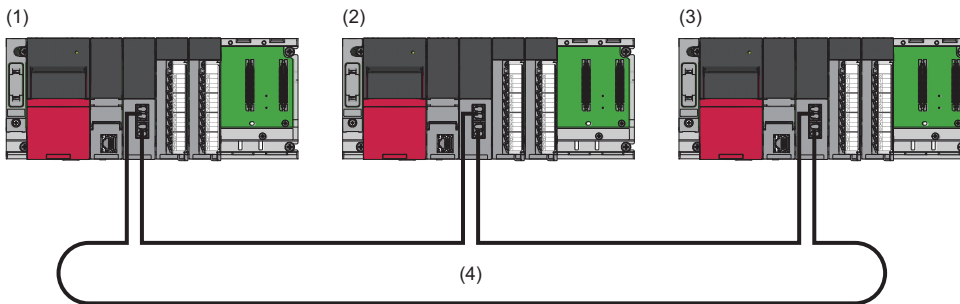

- (1) Control station (station No.1)
- (2) Normal station (station No.2)
- (3) Normal station (station No.3)
- (4) Network No.1

### Link device assignment

512 points are assigned to each station.

#### ■LB and LW assignment

Each number in the figure, from No.1 to No.3, represents a station number.

No.1 is control station, and No.2 and No.3 are normal stations.

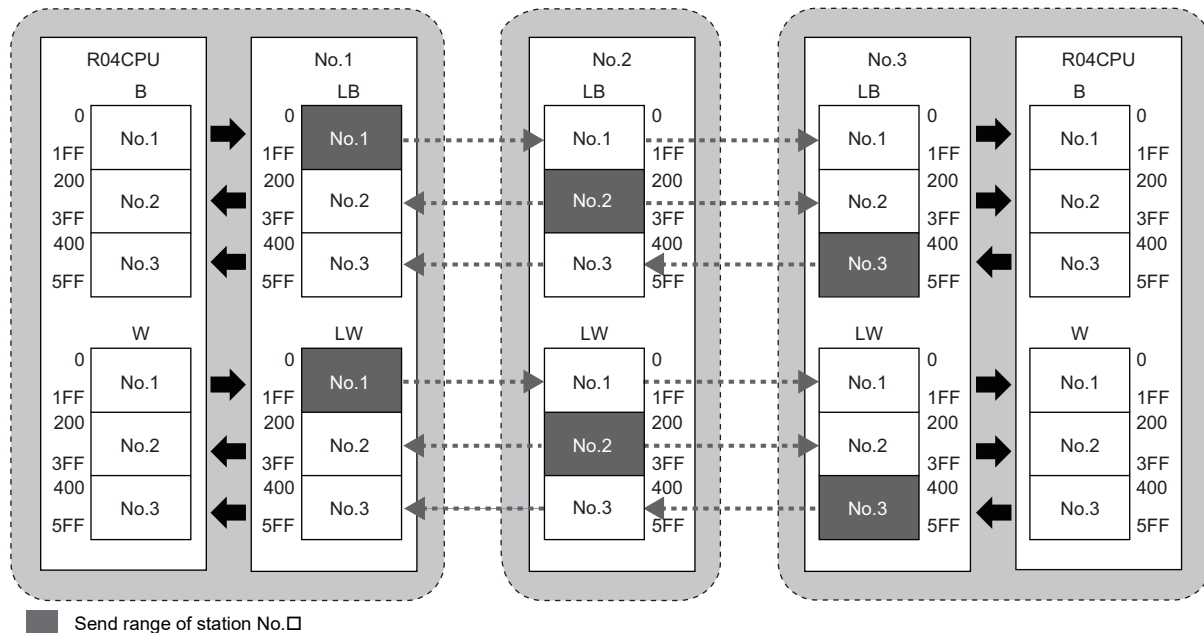

# Setting in the control station

Connect the engineering tool to the CPU module on the control station and set the parameters.

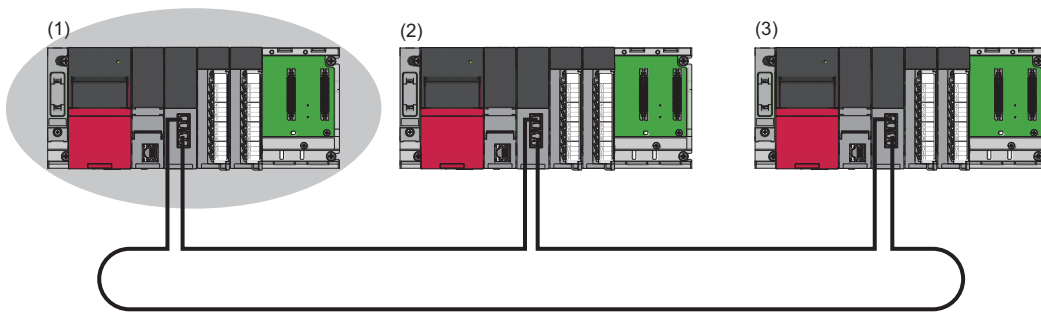

(1) Control station (station No.1)

(2) Normal station (station No.2)

(3) Normal station (station No.3)

**1.** Set the CPU module as follows.

 [Project] ⇨ [New]

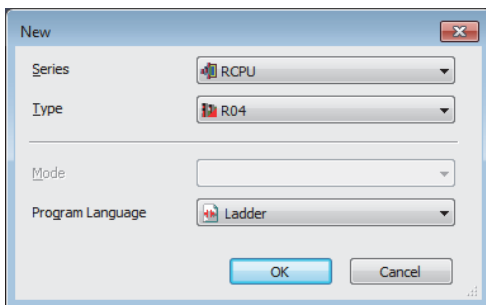

**2.** Click the [Setting Change] button in the following window and set the item to use module labels.

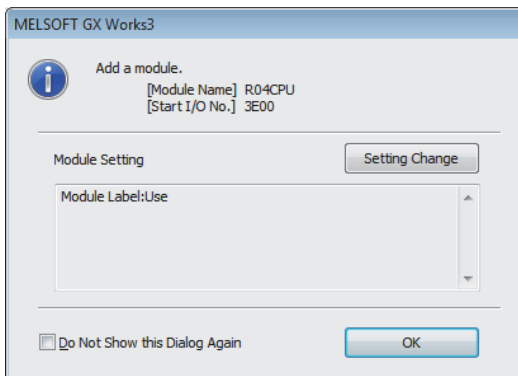

**3.** Click the [OK] button to add the module labels of the CPU module.



4. Set the CC-Link IE Controller Network-equipped module as follows.

[Navigation window] ⇒ [Parameter] ⇒ [Module Information] ⇒ Right-click ⇒ [Add New Module]

5. Click the [OK] button to add the module labels of the CC-Link IE Controller Network-equipped module.

6. Set the items in "Required Settings" as follows.

[Navigation window] ⇒ [Parameter] ⇒ [Module Information] ⇒ [RJ71GP21-SX] ⇒ [Required Settings]

Item	Setting
<b>Station Type</b>	
Station Type	Control Station
<b>Network No.</b>	
Network No.	1
<b>Station No.</b>	
Station No.	1
<b>Network Range Assignment</b>	
Network Range Assignment Setting	<Detailed Setting>





7. Set the network range assignment as follows.

[Navigation window] ⇒ [Parameter] ⇒ [Module Information] ⇒ [RJ71GP21-SX] ⇒ [Required Settings] ⇒ [Network Range Assignment]

Setting Item		LB/LW Setting (1)								
Station No.	Station Type	LB			LW			Reserved Station	Pairing	Shared Group
		Points	Start	End	Points	Start	End			
7	Control Station	512	0000	01FF	512	00000	001FF	No Setting	Disable	
2	Normal Station	512	0200	03FF	512	00200	003FF	No Setting	Disable	
3	Normal Station	512	0400	05FF	512	00400	005FF	No Setting	Disable	

**8.** Set the refresh settings as follows.

 [Navigation window] ⇒ [Parameter] ⇒ [Module Information] ⇒ [RJ71GP21-SX] ⇒ [Basic Settings] ⇒ [Refresh Setting]

No.	Link Side						CPU Side				
	Device Name	Points	Start	End	Target		Device Name	Points	Start	End	
-	SB	512	00000	001FF		Module Lab					
-	SW	512	00000	001FF		Module Lab					
1	LB	1536	00000	005FF		Device	B	1536	00000	005FF	
2	LW	1536	00000	005FF		Device	W	1536	00000	005FF	

**9.** Write the set parameters to the CPU module on the control station. Then reset the CPU module or power off and on the system.

 [Online] ⇒ [Write to PLC]

**Point** 

In this example, default values are used for parameters that are not shown above. For the parameters, refer to the following.

 MELSEC iQ-R CC-Link IE Controller Network User's Manual (Application)

## Setting in the normal stations

Connect the engineering tool to the CPU module on the normal station and set the parameters. Set the station number 2 and 3 to the same setting.

1. Set the CPU module and add a module label of the CPU module. The setting method of the CPU module and addition method of the module label are the same as those of the control station. (☞ Page 90 Setting in the control station)
2. Set the CC-Link IE Controller Network-equipped module as follows.

☞ [Navigation window] ⇒ [Parameter] ⇒ [Module Information] ⇒ Right-click ⇒ [Add New Module]





3. Add a module label of the CC-Link IE Controller Network-equipped module. The addition method of the module label is the same as that of the control station. (☞ Page 90 Setting in the control station)
4. Set the items in "Required Settings" as follows. For the station No.3, set "3" to "Station No.".

☞ [Navigation window] ⇒ [Parameter] ⇒ [Module Information] ⇒ [RJ71GP21-SX] ⇒ [Required Settings]

Setting Item	
Item	Setting
<b>Station Type</b>	
Station Type	Normal Station
<b>Network No.</b>	
Network No.	1
<b>Station No.</b>	
Setting Method	Parameter Editor
Station No.	2

5. Set the refresh settings as follows. Set the station number 2 and 3 of the normal station to the same refresh settings.

 [Navigation window] ⇒ [Parameter] ⇒ [Module Information] ⇒ [RJ71GP21-SX] ⇒ [Basic Settings] ⇒ [Refresh Setting]

No.	Link Side					CPU Side				
	Device Name	Points	Start	End		Target	Device Name	Points	Start	End
-	SB	512	00000	001FF		Module Lab				
-	SW	512	00000	001FF		Module Lab				
1	LB	1536	00000	005FF		Device	B	1536	00000	005FF
2	LW	1536	00000	005FF		Device	W	1536	00000	005FF

6. Write the set parameters to the CPU module on the normal station. Then reset the CPU module or power off and on the system.

 [Online] ⇒ [Write to PLC]

**Point** 

In this example, default values are used for parameters that are not shown above. For the parameters, refer to the following.

 MELSEC iQ-R CC-Link IE Controller Network User's Manual (Application)

## Checking the network status

Once parameters are set for the control station and normal station, the CC-Link IE Controller Network diagnostics of the engineering tool can be used to check whether data link is normally operating.

1. Connect the engineering tool to the CPU module on the control station.
2. Start the CC-Link IE Controller Network diagnostics.

[Diagnostics] ⇒ [CC-Link IE Control Diagnostics (Optical Cable)]

If the following display appears, data link is normal.

CC-Link IE Control Diagnostics

Change Module... Station 1 Change Station Start Monitoring Stop Monitoring

Module1 Network No.1 Total Number of Stations: 3/70 Master Station [Block1: 0,Block2: 0]  
Network Type:CC-Link IE Control

Connected Sta.  
3 1 2  
Present Control Station  
Specified Control Station

Previous<< Next>> Current Link Scan Time: 2ms

Display Selected Station Network Equipment Status

Station No. 1 Transient IP Address:--.--  
Transmission Group No.0 Mode: Online

Network Type:CC-Link IE Control

Test Confirmation

Communication Test... can check route from connected station to specified dest. station.

IP Communication Test... \* Check the IP communication route from the connected station to the destination station.

Link Start/Stop... can start or stop linking stations.

Selected Station Operation

Remote Operation... Able to change CPU status of the selected station.

Close

When an icon indicating an error is displayed in "Network information display" in the "CC-Link IE Control Diagnostics", use the CC-Link IE Controller Network diagnostics to identify the cause of the error and take actions. (MELSEC iQ-R CC-Link IE Controller Network User's Manual (Application))

# Program example

This section describes program examples.

## Program example of cyclic transmission

The following shows a program example of cyclic transmission.

### ■ Overview of the program example

D0 of the control station (station No.1) is sent to Y50 to Y5F of the normal station (station No.2) through cyclic transmission.

In the program example, an interlock is established with link relay (LB) and cyclic data is sent.

Each number in the figure, from No.1 to No.2, represents a station number.

No.1 is control station and No.2 is normal station.

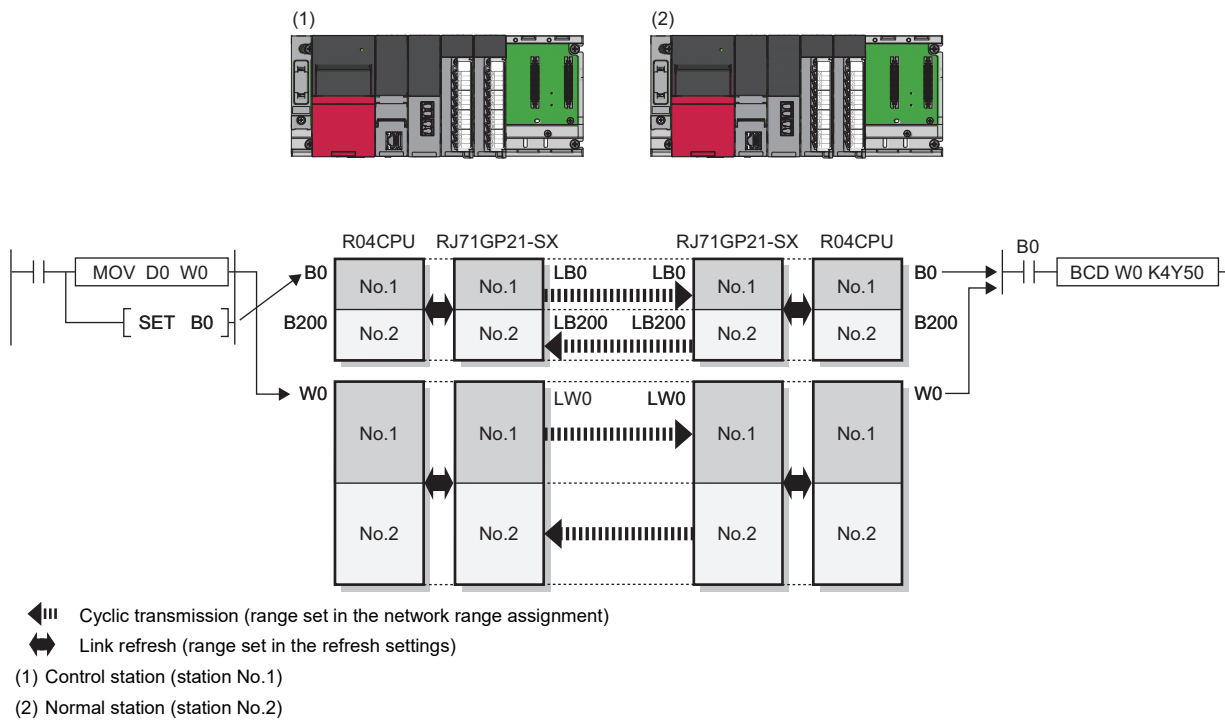

## Program example

When creating a cyclic communication program, establish an interlock using 'Data link error status of own station' (SB0049) and 'Data link status of each station' (SW00B0 to SW00B7).

- Control station (station No.1)

Classification	Label name	Description	Device																																			
Module label	GP21_1.bDetect_DataLinkError	Data link error status of own station	SB0049																																			
	GP21_1.bnSts_CyclicTransmissionError_Station[2]	Data link status of each station (station No.2)	SW00B0.1																																			
Label to be defined	Define global labels as shown below:																																					
	<table border="1"> <thead> <tr> <th></th> <th>Label Name</th> <th>Data Type</th> <th>Class</th> <th>Assign (Device/Label)</th> </tr> </thead> <tbody> <tr> <td>1</td> <td>bSendRequest</td> <td>Bit</td> <td>VAR_GLOBAL</td> <td>M300</td> </tr> <tr> <td>2</td> <td>bCommunicationFlag</td> <td>Bit</td> <td>VAR_GLOBAL</td> <td>M310</td> </tr> <tr> <td>3</td> <td>bHandShake1</td> <td>Bit</td> <td>VAR_GLOBAL</td> <td>B0</td> </tr> <tr> <td>4</td> <td>bHandShake2</td> <td>Bit</td> <td>VAR_GLOBAL</td> <td>B200</td> </tr> <tr> <td>5</td> <td>uData</td> <td>Word [Unsigned]/Bit String [16-bit]</td> <td>VAR_GLOBAL</td> <td>W0</td> </tr> <tr> <td>6</td> <td>uOutputData</td> <td>Word [Unsigned]/Bit String [16-bit]</td> <td>VAR_GLOBAL</td> <td>D0</td> </tr> </tbody> </table>				Label Name	Data Type	Class	Assign (Device/Label)	1	bSendRequest	Bit	VAR_GLOBAL	M300	2	bCommunicationFlag	Bit	VAR_GLOBAL	M310	3	bHandShake1	Bit	VAR_GLOBAL	B0	4	bHandShake2	Bit	VAR_GLOBAL	B200	5	uData	Word [Unsigned]/Bit String [16-bit]	VAR_GLOBAL	W0	6	uOutputData	Word [Unsigned]/Bit String [16-bit]	VAR_GLOBAL	D0
	Label Name	Data Type	Class	Assign (Device/Label)																																		
1	bSendRequest	Bit	VAR_GLOBAL	M300																																		
2	bCommunicationFlag	Bit	VAR_GLOBAL	M310																																		
3	bHandShake1	Bit	VAR_GLOBAL	B0																																		
4	bHandShake2	Bit	VAR_GLOBAL	B200																																		
5	uData	Word [Unsigned]/Bit String [16-bit]	VAR_GLOBAL	W0																																		
6	uOutputData	Word [Unsigned]/Bit String [16-bit]	VAR_GLOBAL	D0																																		

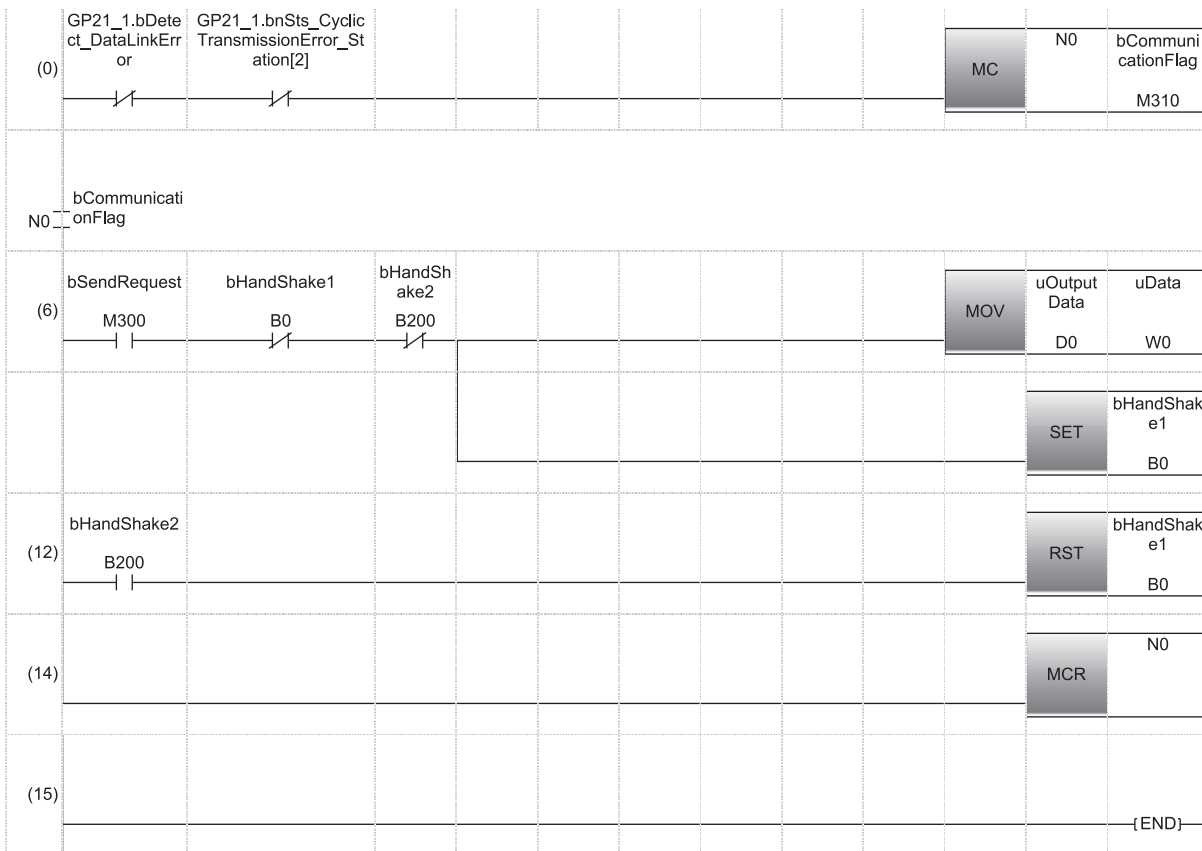

- (6) When 'bSendRequest' (M300) is turned on, the contents of 'uOutputData' (D0) is stored in 'uData' (W0).  
 When data storage is completed, 'bHandShake1' (B0) is turned on.  
 Link relay (LB) is sent through cyclic transmission after link register (LW).
- (12) When data are sent to the receiving station and 'bHandShake2' (B200) is turned on, 'bHandShake1' (B0) is turned off.

• Normal station (station No.2)

Classification	Label name	Description	Device																														
Module label	GP21_1.bDetect_DataLinkError	Data link error status of own station	SB0049																														
	GP21_1.bnSts_CyclicTransmissionError_Station[1]	Data link status of each station (station No.1)	SW00B0.0																														
Label to be defined	Define global labels as shown below:																																
	<table border="1"> <thead> <tr> <th></th> <th>Label Name</th> <th>Data Type</th> <th>Class</th> <th>Assign (Device/Label)</th> </tr> </thead> <tbody> <tr> <td>1</td> <td>bCommunicationFlag</td> <td>Bit</td> <td>VAR_GLOBAL</td> <td>M311</td> </tr> <tr> <td>2</td> <td>bHandShake1</td> <td>Bit</td> <td>VAR_GLOBAL</td> <td>B0</td> </tr> <tr> <td>3</td> <td>bHandShake2</td> <td>Bit</td> <td>VAR_GLOBAL</td> <td>B200</td> </tr> <tr> <td>4</td> <td>uData</td> <td>Word [Unsigned]/Bit String [16-bit]</td> <td>VAR_GLOBAL</td> <td>W0</td> </tr> <tr> <td>5</td> <td>uOutputData</td> <td>Word [Unsigned]/Bit String [16-bit]</td> <td>VAR_GLOBAL</td> <td>K4Y50</td> </tr> </tbody> </table>		Label Name	Data Type	Class	Assign (Device/Label)	1	bCommunicationFlag	Bit	VAR_GLOBAL	M311	2	bHandShake1	Bit	VAR_GLOBAL	B0	3	bHandShake2	Bit	VAR_GLOBAL	B200	4	uData	Word [Unsigned]/Bit String [16-bit]	VAR_GLOBAL	W0	5	uOutputData	Word [Unsigned]/Bit String [16-bit]	VAR_GLOBAL	K4Y50		
	Label Name	Data Type	Class	Assign (Device/Label)																													
1	bCommunicationFlag	Bit	VAR_GLOBAL	M311																													
2	bHandShake1	Bit	VAR_GLOBAL	B0																													
3	bHandShake2	Bit	VAR_GLOBAL	B200																													
4	uData	Word [Unsigned]/Bit String [16-bit]	VAR_GLOBAL	W0																													
5	uOutputData	Word [Unsigned]/Bit String [16-bit]	VAR_GLOBAL	K4Y50																													

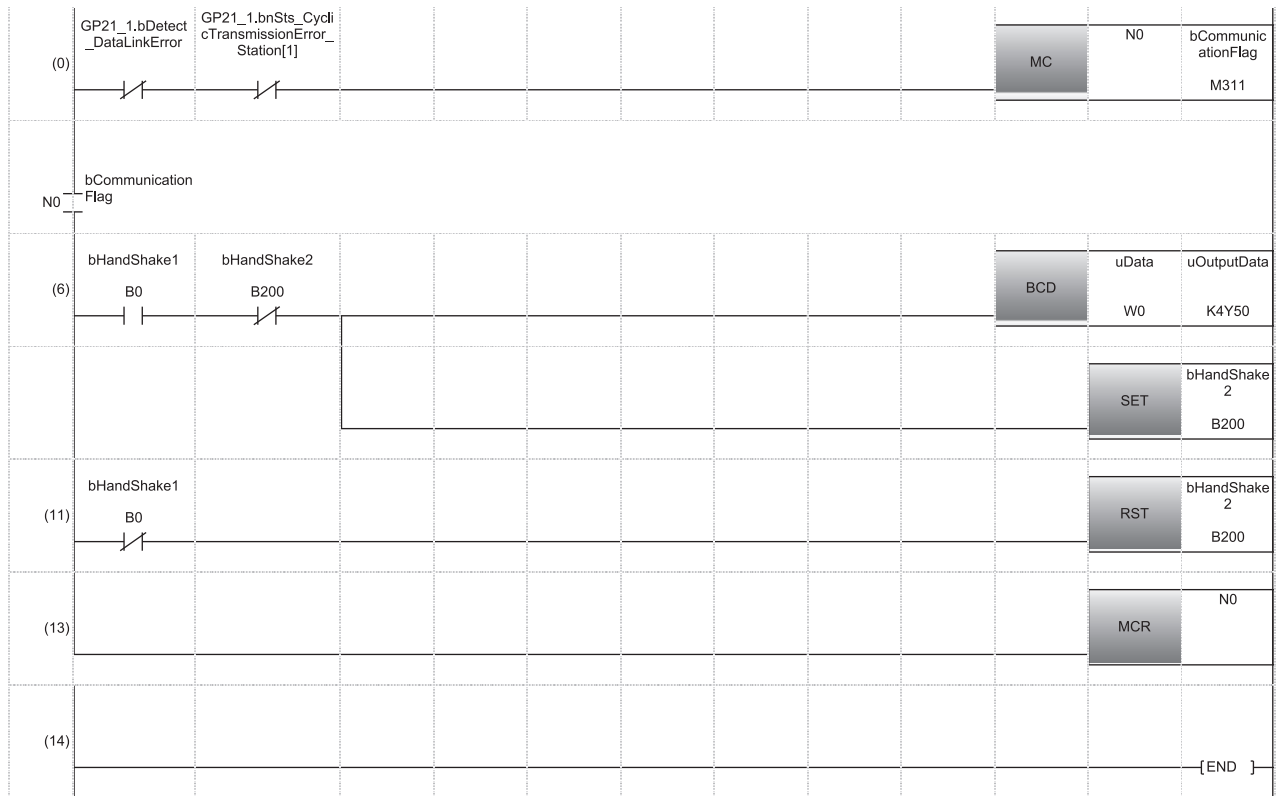

- (6) When 'bHandShake1' (B0) is turned on, the contents of 'uData' (W0) is stored in 'uOutputData' (Y50 to Y5F). When data storage is completed, 'bHandShake2' (B200) is turned on.



## Program example of error detection in other stations

### ■Data flow

In the program example, the baton pass status and cyclic transmission status of each station is monitored and some network errors in other stations are detected in a system configured with three stations.

#### Point

- When a disconnection or a reconnection of stations is detected, the CC-Link IE Controller Network executes the line control in all stations to reconstruct the loop.
- During the line control processing, the 'Baton pass status of each station' (SW00A0 to SW00A7) and 'Data link status of each station' (SW00B0 to SW00B7) are turned on for up to 100ms. (Normally for up to 50ms.) Therefore, set a value of error monitoring timer to more than 100ms and within the allowable range of your system.

### ■Program example

The setting value of error monitoring timer is 200ms.

Classification	Label name	Description	Device																									
Module label	GP21_1.bDetect_BatonPassError	Baton pass error status of own station	SB0047																									
	GP21_1.bDetect_DataLinkError	Data link error status of own station	SB0049																									
	GP21_1.bnSts_BatonPassError_Station[1]	Baton pass status of each station (station No.1)	SW00A0.0																									
	GP21_1.bnSts_BatonPassError_Station[2]	Baton pass status of each station (station No.2)	SW00A0.1																									
	GP21_1.bnSts_BatonPassError_Station[3]	Baton pass status of each station (station No.3)	SW00A0.2																									
	GP21_1.bnSts_CyclicTransmissionError_Station[1]	Data link status of each station (station No.1)	SW00B0.0																									
	GP21_1.bnSts_CyclicTransmissionError_Station[2]	Data link status of each station (station No.2)	SW00B0.1																									
	GP21_1.bnSts_CyclicTransmissionError_Station[3]	Data link status of each station (station No.3)	SW00B0.2																									
Label to be defined	Define global labels as shown below:																											
	<table border="1"> <thead> <tr> <th></th> <th>Label Name</th> <th>Data Type</th> <th>Class</th> <th>Assign (Device/Label)</th> </tr> </thead> <tbody> <tr> <td>1</td> <td>bOwnStationNormal</td> <td>Bit</td> <td>VAR_GLOBAL</td> <td>M10</td> </tr> <tr> <td>2</td> <td>bErrorStationExist</td> <td>Bit</td> <td>VAR_GLOBAL</td> <td>M20</td> </tr> <tr> <td>3</td> <td>tErrorCheckTimer</td> <td>Timer(0..2)</td> <td>VAR_GLOBAL</td> <td>T0</td> </tr> <tr> <td>4</td> <td>wErrorCount</td> <td>Word [Signed]</td> <td>VAR_GLOBAL</td> <td>D100</td> </tr> </tbody> </table>				Label Name	Data Type	Class	Assign (Device/Label)	1	bOwnStationNormal	Bit	VAR_GLOBAL	M10	2	bErrorStationExist	Bit	VAR_GLOBAL	M20	3	tErrorCheckTimer	Timer(0..2)	VAR_GLOBAL	T0	4	wErrorCount	Word [Signed]	VAR_GLOBAL	D100
	Label Name	Data Type	Class	Assign (Device/Label)																								
1	bOwnStationNormal	Bit	VAR_GLOBAL	M10																								
2	bErrorStationExist	Bit	VAR_GLOBAL	M20																								
3	tErrorCheckTimer	Timer(0..2)	VAR_GLOBAL	T0																								
4	wErrorCount	Word [Signed]	VAR_GLOBAL	D100																								

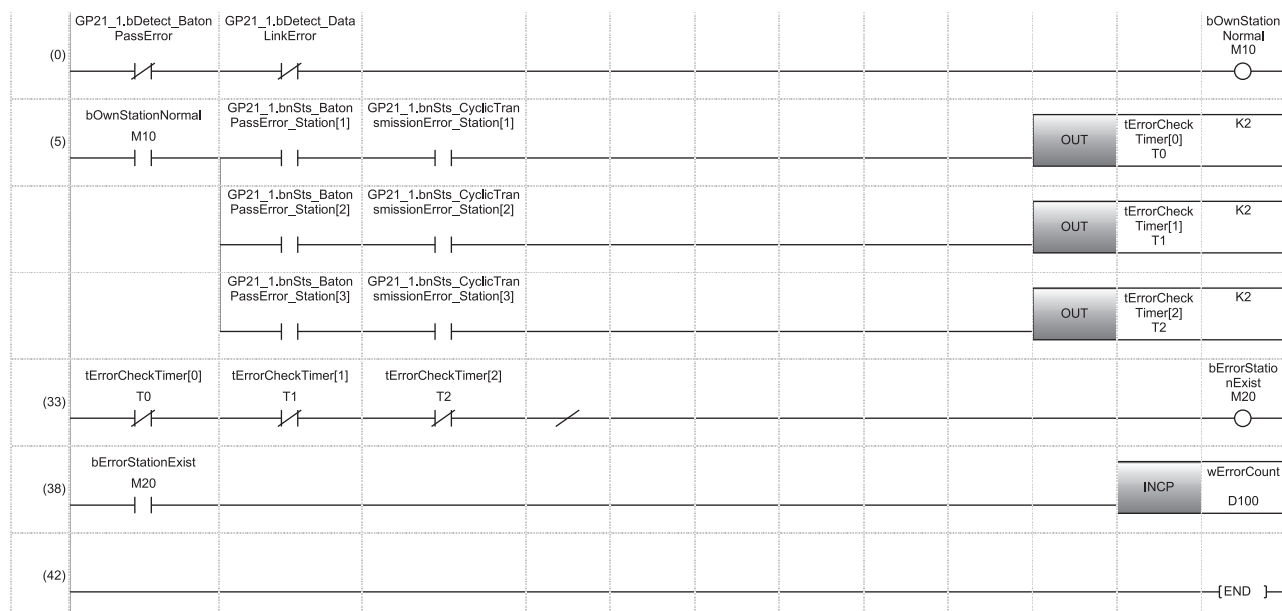

(38) Processing program for error detection

# 7.3 Communication Examples of CC-Link IE Field Network

This section describes communications between the master station and local station.

## System configuration example

The following system configuration is used to explain communication between the master station and local station.

### System configuration

- Power supply module: R61P
- CPU Module: R04CPU
- Master/local module: RJ71GF11-T2 (start I/O number: 0000H to 001FH)
- Input module: RX10 (start I/O number: 0020H to 002FH)
- Output module: RY10R2 (start I/O number: 0030H to 003FH)

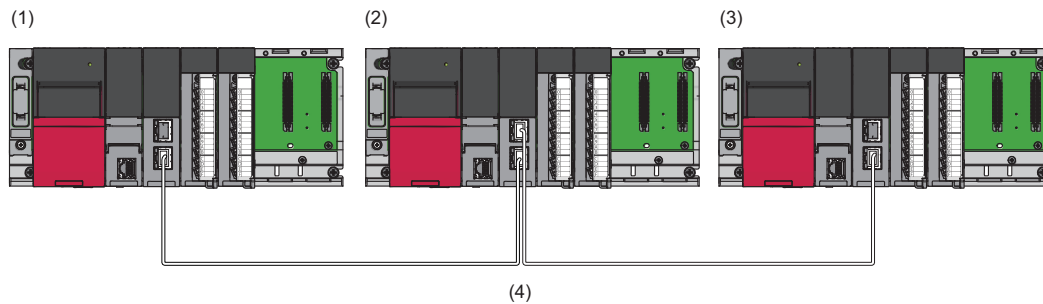

- (1) Master station (station No.0)
- (2) Local station (station No.1)
- (3) Local station (station No.2)
- (4) Network No.1

### Link device assignment

256 points are assigned to each station.

#### ■RX/RY assignment

Each number in the figure, from No.0 to No.2, represents a station number. No.0 is master station, and No.1 and No.2 are local stations.

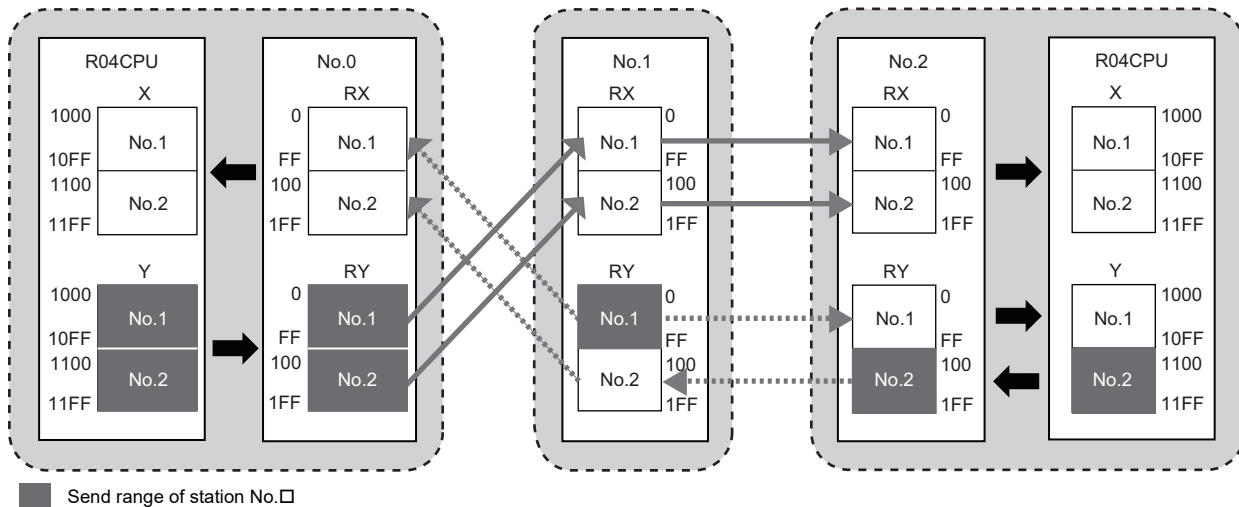

## ■RWr/RWw assignment

Each number in the figure, from No.0 to No.2, represents a station number.

No.0 is master station, and No.1 and No.2 are local stations.

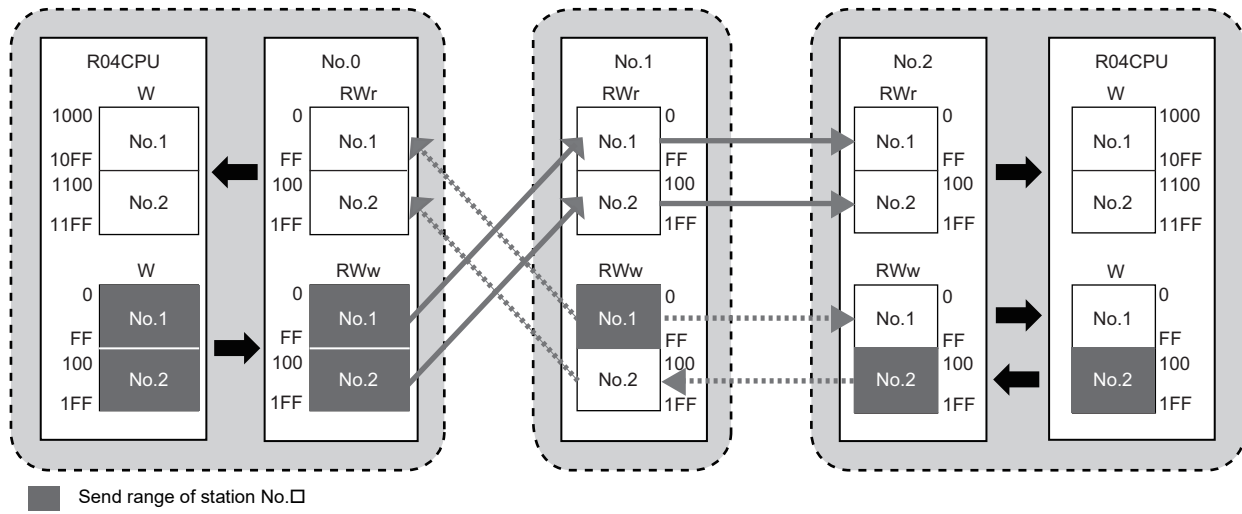

# Setting in the master station

Connect the engineering tool to the CPU module on the master station and set the parameters.

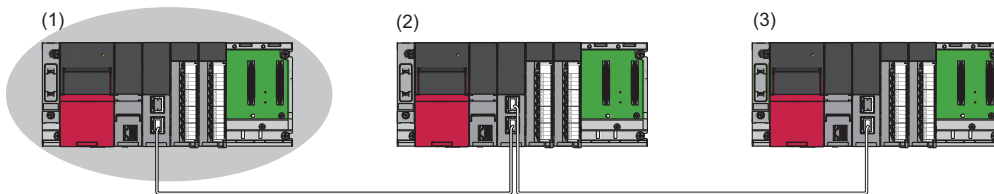

- (1) Master station (station No.0)
- (2) Local station (station No.1)
- (3) Local station (station No.2)

**1.** Set the CPU module as follows.

[Project] ⇒ [New]

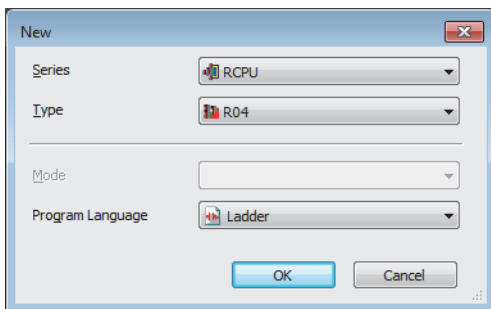

**2.** Click the [Setting Change] button in the following window and set the item to use module labels.

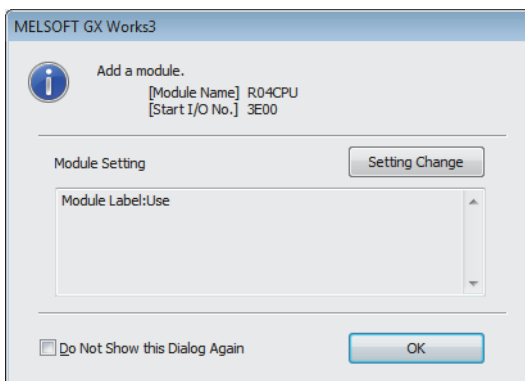

**3.** Click the [OK] button to add the module labels of the CPU module.

4. Set the master/local module as follows.

[Navigation window] ⇒ [Parameter] ⇒ [Module Information] ⇒ Right-click ⇒ [Add New Module]

5. Click the [OK] button to add the module labels of the master/local module.

6. Set the items in "Required Settings" as follows.

[Navigation window] ⇒ [Parameter] ⇒ [Module Information] ⇒ [RJ71GF11-T2] ⇒ [Required Settings]

Item	Setting
<b>Station Type</b>	
Station Type	Master Station
<b>Network No.</b>	
Network No.	1
<b>Station No.</b>	
Setting Method	Parameter Editor
Station No.	0
<b>Parameter Setting Method</b>	
Setting Method of Basic/Application Settings	Parameter Editor

**7.** Set the network configuration as follows.

[Navigation window] ⇒ [Parameter] ⇒ [Module Information] ⇒ [RJ71GF11-T2] ⇒ [Basic Settings] ⇒ [Network Configuration Settings]

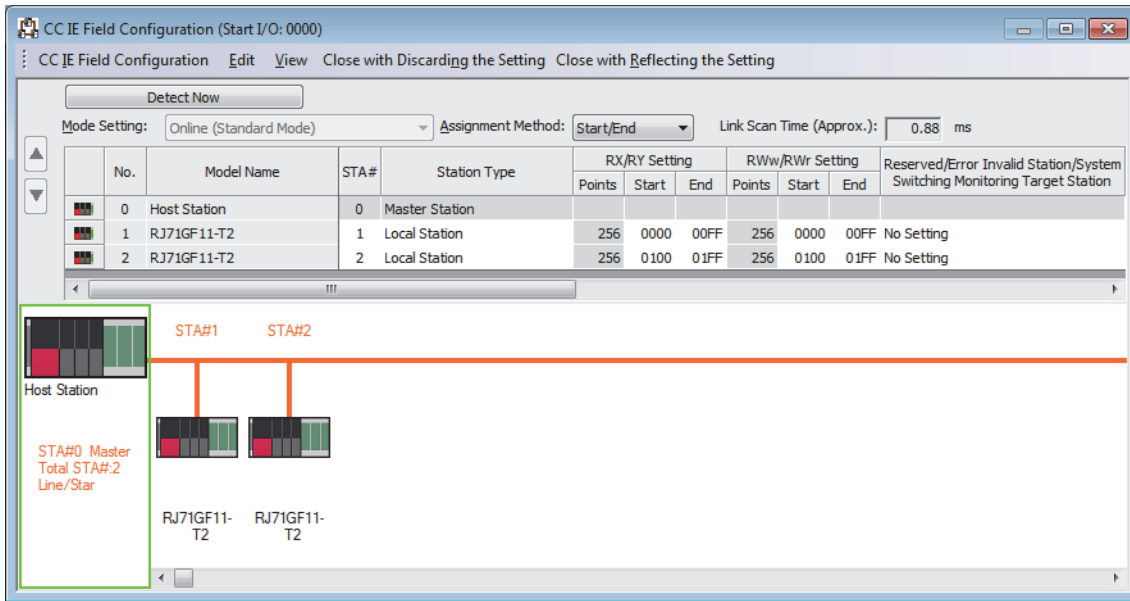

**8.** Set the refresh settings as follows.

[Navigation window] ⇒ [Parameter] ⇒ [Module Information] ⇒ [RJ71GF11-T2] ⇒ [Basic Settings] ⇒ [Refresh Setting]

No.	Link Side					CPU Side				
	Device Name	Points	Start	End		Target	Device Name	Points	Start	End
-	SB	512	00000	001FF	↔	Module Lab				
-	Sw	512	00000	001FF	↔	Module Lab				
1	RX	512	00000	001FF	↔	Device	X	512	01000	011FF
2	RY	512	00000	001FF	↔	Device	Y	512	01000	011FF
3	RWr	512	00000	001FF	↔	Device	W	512	01000	011FF
4	RWw	512	00000	001FF	↔	Device	W	512	00000	001FF

**9.** Write the set parameters to the CPU module on the master station. Then reset the CPU module or power off and on the system.

[Online] ⇒ [Write to PLC]

**Point**

In this example, default values are used for parameters that are not shown above. For the parameters, refer to the following.

📖 MELSEC iQ-R CC-Link IE Field Network User's Manual (Application)

# Setting in the local station

Connect the engineering tool to the CPU module on the local station and set the parameters. Set the station number 1 and 2 to the same setting.

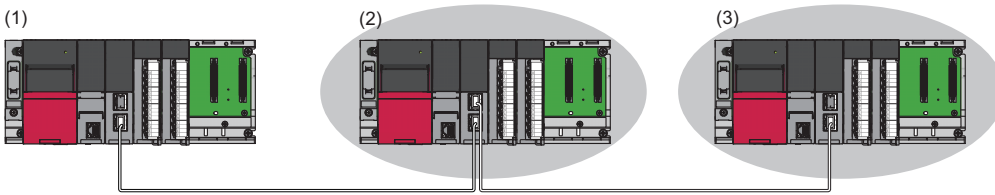

- (1) Master station (station No.0)
- (2) Local station (station No.1)
- (3) Local station (station No.2)

1. Set the CPU module and add a module label of the CPU module. The setting method of the CPU module and addition method of the module label are the same as those of the master station. (☞ Page 102 Setting in the master station)
2. Set the master/local module as follows.

☞ [Navigation window] ⇒ [Parameter] ⇒ [Module Information] ⇒ Right-click ⇒ [Add New Module]







3. Add a module label of the master/local module. The addition method of the module label is the same as that of the master station. (☞ Page 102 Setting in the master station)
4. Set the items in "Required Settings" as follows. For station No.2, set "Station No." to "2".

☞ [Navigation window] ⇒ [Parameter] ⇒ [Module Information] ⇒ [RJ71GF11-T2] ⇒ [Required Settings]

Item	Setting
<b>Station Type</b>	
Station Type	Local Station
<b>Network No.</b>	
Network No.	1
<b>Station No.</b>	
Setting Method	Parameter Editor
Station No.	1
<b>Parameter Setting Method</b>	
Setting Method of Basic/Application Settings	Parameter Editor

5. Set the refresh settings as follows. Set the station number 1 and 2 of the local station to the same refresh settings.

 [Navigation window] ⇒ [Parameter] ⇒ [Module Information] ⇒ [RJ71GF11-T2] ⇒ [Basic Settings] ⇒ [Refresh Setting]

No.	Link Side					CPU Side				
	Device Name	Points	Start	End		Target	Device Name	Points	Start	End
-	SB	512	00000	001FF		Module Lab				
-	SW	512	00000	001FF		Module Lab				
1	RX	512	00000	001FF		Device	X	512	01000	011FF
2	RY	512	00000	001FF		Device	Y	512	01000	011FF
3	RWr	512	00000	001FF		Device	W	512	01000	011FF
4	RWw	512	00000	001FF		Device	W	512	00000	001FF

6. Write the set parameters to the CPU module on the local station. Then reset the CPU module or power off and on the system.

 [Online] ⇒ [Write to PLC]

**Point** 

In this example, default values are used for parameters that are not shown above. For the parameters, refer to the following.

 MELSEC iQ-R CC-Link IE Field Network User's Manual (Application)



# Checking the network status

Once parameters are set for the master station and local station, the CC-Link IE Field Network diagnostics of the engineering tool can be used to check whether data link is normally operating.

1. Connect the engineering tool to the CPU module on the master station.
2. Start the CC-Link IE Field Network diagnostics.

[Diagnostics] ⇒ [CC-Link IE Field Diagnostics]

If the following display appears, data link is normal.

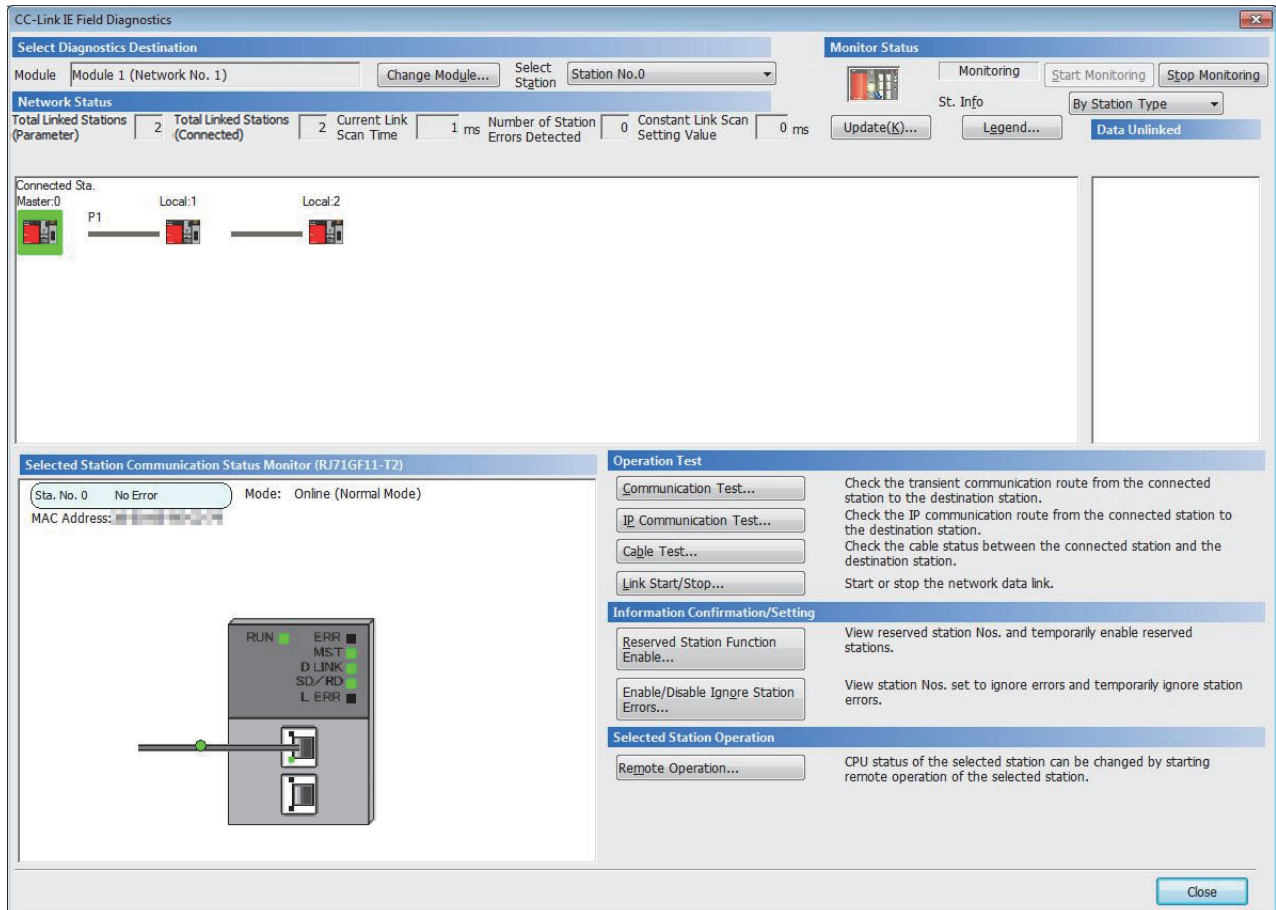

When an icon indicating an error is displayed in "Network Status" in "CC-Link IE Field Diagnostics", use the CC-Link IE Field Network diagnostics to identify the cause of the error and take actions. (MELSEC iQ-R CC-Link IE Field Network User's Manual (Application))

# Program example

- Master station (station No.0)

Classification	Label name	Description	Device																																			
Module label	GF11_1.bnSts_DataLinkError	Data link error status of own station	SB0049																																			
	GF11_1.bnSts_DataLinkError_Station[1]	Data link status of each station (station No.1)	SW00B0.0																																			
	GF11_1.bnSts_DataLinkError_Station[2]	Data link status of each station (station No.2)	SW00B0.1																																			
Label to be defined	Define global labels as shown below:																																					
	<table border="1"> <thead> <tr> <th></th> <th>Label Name</th> <th>Data Type</th> <th>Class</th> <th>Assign (Device/Label)</th> </tr> </thead> <tbody> <tr> <td>1</td> <td>bStartDirection_1</td> <td>Bit</td> <td>VAR_GLOBAL</td> <td>M0</td> </tr> <tr> <td>2</td> <td>bStartDirection_2</td> <td>Bit</td> <td>VAR_GLOBAL</td> <td>M1</td> </tr> <tr> <td>3</td> <td>wnSendDataStationNo1</td> <td>Word [Signed](0..255)</td> <td>VAR_GLOBAL</td> <td>D0</td> </tr> <tr> <td>4</td> <td>wnRecvDataStationNo1</td> <td>Word [Signed](0..255)</td> <td>VAR_GLOBAL</td> <td>D1000</td> </tr> <tr> <td>5</td> <td>wnSendDataStationNo2</td> <td>Word [Signed](0..255)</td> <td>VAR_GLOBAL</td> <td>D300</td> </tr> <tr> <td>6</td> <td>wnRecvDataStationNo2</td> <td>Word [Signed](0..255)</td> <td>VAR_GLOBAL</td> <td>D1300</td> </tr> </tbody> </table>				Label Name	Data Type	Class	Assign (Device/Label)	1	bStartDirection_1	Bit	VAR_GLOBAL	M0	2	bStartDirection_2	Bit	VAR_GLOBAL	M1	3	wnSendDataStationNo1	Word [Signed](0..255)	VAR_GLOBAL	D0	4	wnRecvDataStationNo1	Word [Signed](0..255)	VAR_GLOBAL	D1000	5	wnSendDataStationNo2	Word [Signed](0..255)	VAR_GLOBAL	D300	6	wnRecvDataStationNo2	Word [Signed](0..255)	VAR_GLOBAL	D1300
	Label Name	Data Type	Class	Assign (Device/Label)																																		
1	bStartDirection_1	Bit	VAR_GLOBAL	M0																																		
2	bStartDirection_2	Bit	VAR_GLOBAL	M1																																		
3	wnSendDataStationNo1	Word [Signed](0..255)	VAR_GLOBAL	D0																																		
4	wnRecvDataStationNo1	Word [Signed](0..255)	VAR_GLOBAL	D1000																																		
5	wnSendDataStationNo2	Word [Signed](0..255)	VAR_GLOBAL	D300																																		
6	wnRecvDataStationNo2	Word [Signed](0..255)	VAR_GLOBAL	D1300																																		

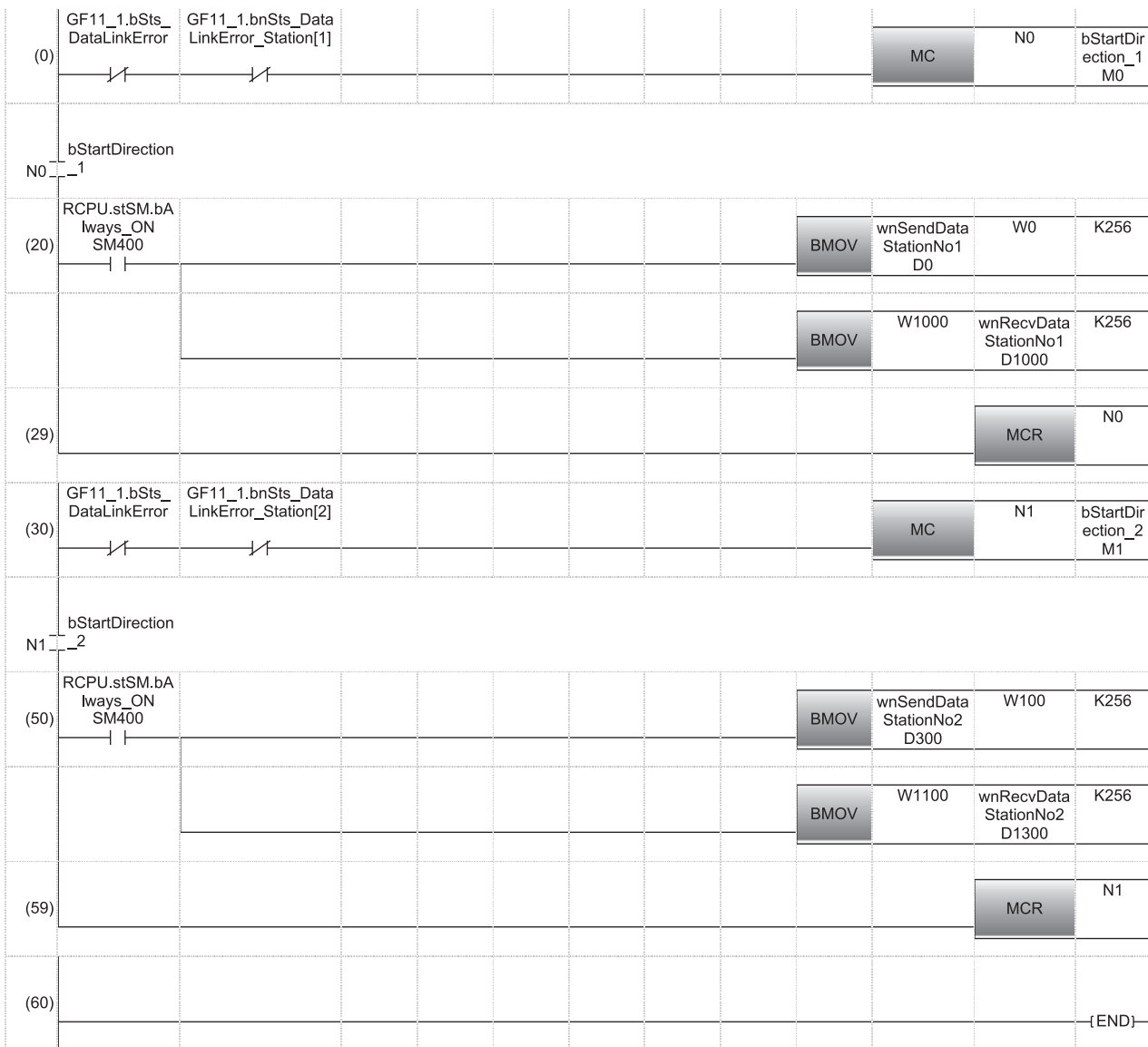

- (20) Communication program with station No.1  
 (50) Communication program with station No.2



If no response is received for several link scans, the 'Data link status of each station' (SW00B0 to SW00B7) is determined to be a cyclic transmission faulty station.

# APPENDICES

## Appendix 1 External Dimensions

This chapter describes the external dimensions of each module.

For the external dimensions of the CPU module, refer to the following.

📖 MELSEC iQ-R CPU Module User's Manual (Startup)

### RJ71EN71

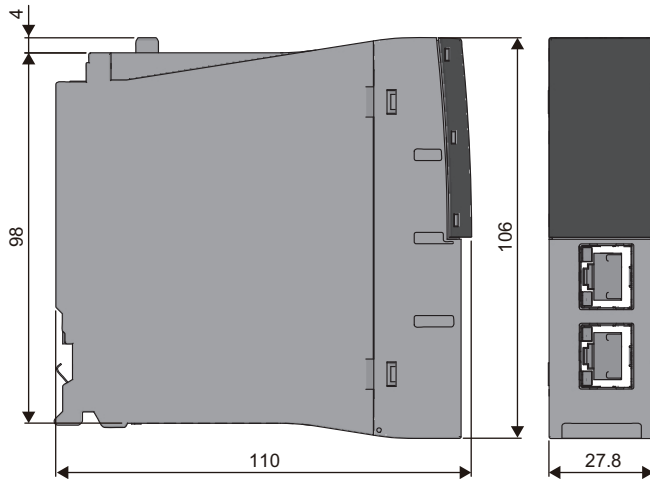

(Unit: mm)

### RJ71GP21-SX

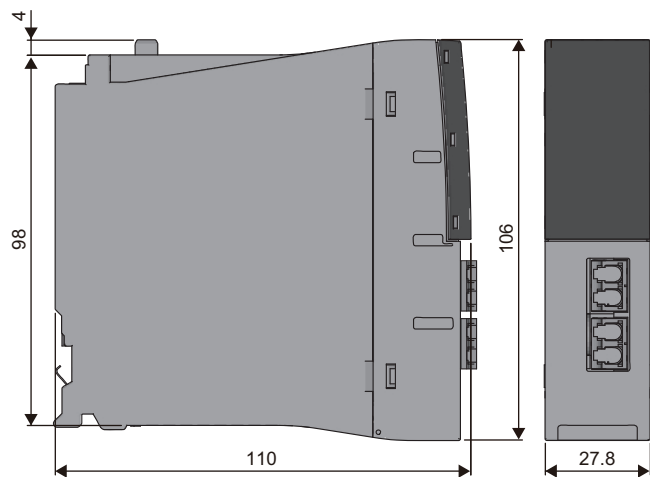

(Unit: mm)

A

## RJ71GP21S-SX

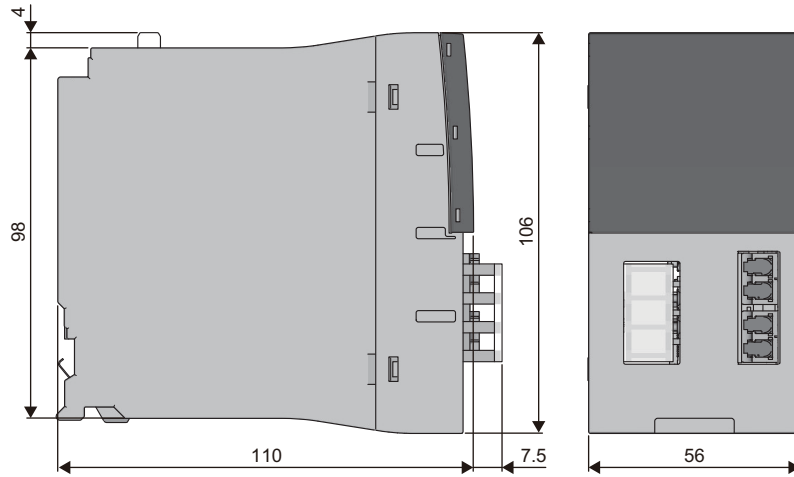

(Unit: mm)

## RJ71GF11-T2

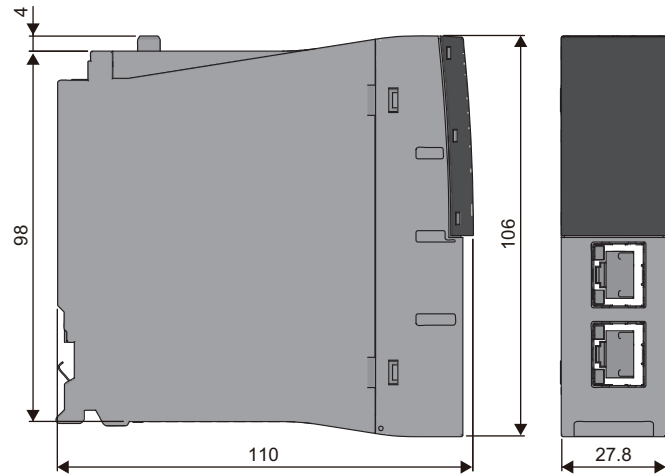

(Unit: mm)

# Appendix 2 Precautions of Firmware Update Function

This chapter describes the precautions of each module-specific when the firmware update function is used.

## Unavailable combination for updating

Their firmware versions cannot be updated with the combination of the following production information and firmware version.

Module to be updated	The third and fourth digits from the left of the production information	Firmware version
RJ71EN71	"18" or later	"51" or earlier
R04ENCPU (network part)	"37" or later	
R08ENCPU (network part)	"35" or later	
R16ENCPU (network part)	"32" or later	
R32ENCPU (network part)	"34" or later	
R120ENCPU (network part)	"26" or later	
RJ71GF11-T2	"17" or later	

Module to be updated	The third and fourth digits from the left of the production information	Firmware version
RJ71EN71	"25" or later	"72" or earlier
R04ENCPU (network part)	"56" or later	
R08ENCPU (network part)	"54" or later	
R16ENCPU (network part)	"51" or later	
R32ENCPU (network part)	"52" or later	
R120ENCPU (network part)	"44" or later	

# MEMO

---

# INDEX

---

## 0 to 9

---

1000BASE-T	70
100BASE-TX	70
10BASE-T	70

## C

---

Cascade connection	35,58,64
Combination of network	21
Communication mode	35
Connector specifications	36
Control station switching	45

## D

---

Data transmission speed	35
-------------------------	----

## E

---

External dimensions	39
External power supply	39

## I

---

Incorrectly configured ring topology	59,65
Internal current consumption (5VDC)	39

## J

---

Jumbo frame	35
-------------	----

## M

---

Maximum frame size	35
Maximum number of connectable stations	36
Maximum number of groups	36
Maximum number of link points per network	36,37
Maximum number of link points per station	36,37
Maximum number of networks	36,37
Maximum segment length	35
Maximum station-to-station distance	36
Media converter	78

## N

---

Network type	21
Number of occupied I/O points	39
Number of simultaneous open connections	35

## O

---

Optical fiber specifications	36
------------------------------	----

## R

---

RJ45 connector	70
----------------	----

## S

---

Sending/receiving data storage memory	35
---------------------------------------	----

Station number and connection position	56,58,63
--	----------

## T

---

Transmission method	35
Transmission specifications	35

## W

---

Weight	39
Wiring products	70,72,74,76

# MEMO

---



# REVISIONS

\*The manual number is given on the bottom left of the back cover.

Revision date	*Manual number	Description
June 2014	SH(NA)-081256ENG-A	First edition
July 2014	SH(NA)-081256ENG-B	Error correction
November 2014	SH(NA)-081256ENG-C	<ul style="list-style-type: none"> <li>■ Added function</li> <li>CC-Link IE Controller Network function of the RJ71EN71</li> <li>■ Added or modified parts</li> <li>TERMS, Section 1.1, 2.2, 3.2, 5.2, 5.4, 6.2</li> </ul>
February 2015	SH(NA)-081256ENG-D	<ul style="list-style-type: none"> <li>■ Added models</li> <li>R08PCPU, R16PCPU, R32PCPU, R120PCPU</li> <li>■ Added functions</li> <li>Automatic detection of connected device of the CC-Link IE Field Network-equipped master/local module</li> <li>Network map update in the CC-Link IE Controller Network diagnostics</li> <li>Network map update in the CC-Link IE Field Network diagnostics</li> <li>■ Added or modified parts</li> <li>RELEVANT MANUALS, Section 3.3, 5.2, 5.3, 7.1</li> </ul>
August 2015	SH(NA)-081256ENG-E	<ul style="list-style-type: none"> <li>■ Added models</li> <li>R04ENCPU, R08ENCPU, R08SF CPU, R16ENCPU, R16SF CPU, R32ENCPU, R32SF CPU, R120ENCPU, R120SF CPU</li> <li>■ Added functions</li> <li>Safety communication function in a system using the Safety CPU</li> <li>High-speed remote net mode setting of communication mode of the CC-Link IE Field Network-equipped master/local module</li> <li>Improvement of the CC-Link IE Field Network diagnostics</li> <li>Automatic detection of connected device, communication setting reflection, and sensor parameter read/write of the CPU module</li> <li>■ Added or modified parts</li> <li>TERMS, Section 1.2, 2.1, 2.2, 2.3, 3.1, 3.2, 3.3, 5.2, 5.3, 6.1, 7.1, 7.3</li> </ul>
May 2016	SH(NA)-081256ENG-F	<ul style="list-style-type: none"> <li>■ Added functions</li> <li>File transfer function (FTP client)</li> <li>iQ Sensor Solution data backup/restoration function</li> <li>Redundant system function</li> <li>■ Added or modified parts</li> <li>RELEVANT MANUALS, TERMS, Section 2.4, 3.1, 3.2, 3.3, 5.3, 6.2, 6.3, 7.1, 7.2, 7.3</li> </ul>
October 2016	SH(NA)-081256ENG-G	<ul style="list-style-type: none"> <li>■ Added or modified parts</li> <li>Section 1.2, 3.3</li> </ul>
July 2017	SH(NA)-081256ENG-H	<ul style="list-style-type: none"> <li>■ Added or modified parts</li> <li>SAFETY PRECAUTIONS, RELEVANT MANUALS, Section 2.2, 3.1, 6.1, 6.2, 6.3</li> </ul>
December 2017	SH(NA)-081256ENG-I	<ul style="list-style-type: none"> <li>■ Added models</li> <li>R00CPU, R01CPU, R02CPU, R08PSF CPU, R16PSF CPU, R32PSF CPU, R120PSF CPU</li> <li>■ Added functions</li> <li>Safety communication function in a system using the SIL2 Process CPU</li> <li>■ Added or modified parts</li> <li>SAFETY PRECAUTIONS, Section 1.2, 2.3, 3.1, 3.3, 5.3</li> </ul>
May 2018	SH(NA)-081256ENG-J	<ul style="list-style-type: none"> <li>■ Added model</li> <li>RJ71GP21S-SX</li> <li>■ Added functions</li> <li>External power supply function, Simple CPU communication function (CPU module (built-in Ethernet port part))</li> <li>■ Added or modified parts</li> <li>SAFETY PRECAUTIONS, INTRODUCTION, RELEVANT MANUALS, TERMS, Section 1.3, 2.2, 2.4, 3.1, 3.2, 5.2, 6.2, Appendix 1</li> </ul>
October 2018	SH(NA)-081256ENG-K	<ul style="list-style-type: none"> <li>■ Added functions</li> <li>MODBUS/TCP slave function, simple CPU communication function (RJ71EN71, RnENCPU (network part))</li> <li>■ Added or modified parts</li> <li>SAFETY PRECAUTIONS, RELEVANT MANUALS, TERMS, Section 2.1, 3.1, 3.3, Chapter 5</li> </ul>
April 2019	SH(NA)-081256ENG-M	<ul style="list-style-type: none"> <li>■ Added function</li> <li>Link points extended setting of the CC-Link IE Controller Network-equipped master/local module</li> <li>Remote device test of the CC-Link IE Field Network-equipped master/local module</li> <li>■ Added or modified parts</li> <li>Section 2.2, 3.2, 3.3</li> </ul>
August 2019	SH(NA)-081256ENG-N	Error correction

Revision date	*Manual number	Description
October 2019	SH(NA)-081256ENG-O	<ul style="list-style-type: none"> <li>■Added functions</li> <li>Discard received data at CPU STOP of the Ethernet-equipped module</li> <li>Firmware update for Ethernet-equipped module and CC-Link IE module</li> <li>■Added or modified parts</li> <li>TERMS, GENERIC TERMS AND ABBREVIATIONS, Chapter 3</li> </ul>
February 2020	SH(NA)-081256ENG-P	<ul style="list-style-type: none"> <li>■Added or modified part</li> <li>Section 3.1</li> </ul>
July 2020	SH(NA)-081256ENG-Q	<ul style="list-style-type: none"> <li>■Added or modified parts</li> <li>SAFETY PRECAUTIONS, CONDITIONS OF USE FOR THE PRODUCT</li> </ul>
October 2020	SH(NA)-081256ENG-R	<ul style="list-style-type: none"> <li>■Added or modified parts</li> <li>RELEVANT MANUALS, TERMS, Section 1.1, 5.1, 5.2, 5.3, 7.1</li> </ul>
January 2021	SH(NA)-081256ENG-S	<ul style="list-style-type: none"> <li>■Added or modified parts</li> <li>Section 3.1, 3.2, 3.3, Appendix 2</li> </ul>
April 2021	SH(NA)-081256ENG-T	<ul style="list-style-type: none"> <li>■Added or modified parts</li> <li>TERMS, Section 3.1, 6.3</li> </ul>
October 2021	SH(NA)-081256ENG-U	<ul style="list-style-type: none"> <li>■Added or modified part</li> <li>Section 6.3</li> </ul>
June 2022	SH(NA)-081256ENG-V	<ul style="list-style-type: none"> <li>■Added or modified parts</li> <li>SAFETY PRECAUTIONS, RELEVANT MANUALS, Section 3.1</li> </ul>
December 2022	SH(NA)-081256ENG-W	<ul style="list-style-type: none"> <li>■Added or modified parts</li> <li>SAFETY PRECAUTIONS, Section 1.1, 3.1</li> </ul>
July 2023	SH(NA)-081256ENG-X	<ul style="list-style-type: none"> <li>■Added or modified parts</li> <li>SAFETY PRECAUTIONS, RELEVANT MANUALS, Section 3.1, Appendix 2</li> </ul>
October 2023	SH(NA)-081256ENG-Y	<ul style="list-style-type: none"> <li>■Added or modified parts</li> <li>SAFETY PRECAUTIONS, TERMS, GENERIC TERMS AND ABBREVIATIONS, Section 2.3, 3.3, 5.2, 5.3, 6.3, 7.3</li> </ul>

Japanese manual number: SH-081252-Y

This manual confers no industrial property rights or any rights of any other kind, nor does it confer any patent licenses. Mitsubishi Electric Corporation cannot be held responsible for any problems involving industrial property rights which may occur as a result of using the contents noted in this manual.

© 2014 MITSUBISHI ELECTRIC CORPORATION

# WARRANTY

---

Please confirm the following product warranty details before using this product.

## **1. Gratis Warranty Term and Gratis Warranty Range**

If any faults or defects (hereinafter "Failure") found to be the responsibility of Mitsubishi occurs during use of the product within the gratis warranty term, the product shall be repaired at no cost via the sales representative or Mitsubishi Service Company.

However, if repairs are required onsite at domestic or overseas location, expenses to send an engineer will be solely at the customer's discretion. Mitsubishi shall not be held responsible for any re-commissioning, maintenance, or testing on-site that involves replacement of the failed module.

[Gratis Warranty Term]

The gratis warranty term of the product shall be for one year after the date of purchase or delivery to a designated place. Note that after manufacture and shipment from Mitsubishi, the maximum distribution period shall be six (6) months, and the longest gratis warranty term after manufacturing shall be eighteen (18) months. The gratis warranty term of repair parts shall not exceed the gratis warranty term before repairs.

[Gratis Warranty Range]

- (1) The range shall be limited to normal use within the usage state, usage methods and usage environment, etc., which follow the conditions and precautions, etc., given in the instruction manual, user's manual and caution labels on the product.
- (2) Even within the gratis warranty term, repairs shall be charged for in the following cases.
  1. Failure occurring from inappropriate storage or handling, carelessness or negligence by the user. Failure caused by the user's hardware or software design.
  2. Failure caused by unapproved modifications, etc., to the product by the user.
  3. When the Mitsubishi product is assembled into a user's device, Failure that could have been avoided if functions or structures, judged as necessary in the legal safety measures the user's device is subject to or as necessary by industry standards, had been provided.
  4. Failure that could have been avoided if consumable parts (battery, backlight, fuse, etc.) designated in the instruction manual had been correctly serviced or replaced.
  5. Failure caused by external irresistible forces such as fires or abnormal voltages, and Failure caused by force majeure such as earthquakes, lightning, wind and water damage.
  6. Failure caused by reasons unpredictable by scientific technology standards at time of shipment from Mitsubishi.
  7. Any other failure found not to be the responsibility of Mitsubishi or that admitted not to be so by the user.

## **2. Onerous repair term after discontinuation of production**

- (1) Mitsubishi shall accept onerous product repairs for seven (7) years after production of the product is discontinued. Discontinuation of production shall be notified with Mitsubishi Technical Bulletins, etc.
- (2) Product supply (including repair parts) is not available after production is discontinued.

## **3. Overseas service**

Overseas, repairs shall be accepted by Mitsubishi's local overseas FA Center. Note that the repair conditions at each FA Center may differ.

## **4. Exclusion of loss in opportunity and secondary loss from warranty liability**

Regardless of the gratis warranty term, Mitsubishi shall not be liable for compensation to:

- (1) Damages caused by any cause found not to be the responsibility of Mitsubishi.
- (2) Loss in opportunity, lost profits incurred to the user by Failures of Mitsubishi products.
- (3) Special damages and secondary damages whether foreseeable or not, compensation for accidents, and compensation for damages to products other than Mitsubishi products.
- (4) Replacement by the user, maintenance of on-site equipment, start-up test run and other tasks.

## **5. Changes in product specifications**

The specifications given in the catalogs, manuals or technical documents are subject to change without prior notice.

# TRADEMARKS

---

The company names, system names and product names mentioned in this manual are either registered trademarks or trademarks of their respective companies.

In some cases, trademark symbols such as <sup>™</sup> or <sup>®</sup> are not specified in this manual.



SH(NA)-081256ENG-Y(2310)MEE

MODEL: R-ETHER/CCIE-U-IN-E

MODEL CODE: 13JX09

## **MITSUBISHI ELECTRIC CORPORATION**

HEAD OFFICE : TOKYO BUILDING, 2-7-3 MARUNOUCHI, CHIYODA-KU, TOKYO 100-8310, JAPAN  
NAGOYA WORKS : 1-14, YADA-MINAMI 5-CHOME, HIGASHI-KU, NAGOYA, JAPAN

When exported from Japan, this manual does not require application to the  
Ministry of Economy, Trade and Industry for service transaction permission.

Specifications subject to change without notice.