



Programmable Controller

MELSEC iQ-R
series

MELSEC iQ-R High Speed Digital-Analog
Converter Module
User's Manual (Application)

-R60DAH4



SAFETY PRECAUTIONS

(Read these precautions before using this product.)

Before using this product, please read this manual and the relevant manuals carefully and pay full attention to safety to handle the product correctly.

The precautions given in this manual are concerned with this product only. For the safety precautions of the programmable controller system, refer to the MELSEC iQ-R Module Configuration Manual.

In this manual, the safety precautions are classified into two levels: "⚠ WARNING" and "⚠ CAUTION".

 WARNING	Indicates that incorrect handling may cause hazardous conditions, resulting in death or severe injury.
 CAUTION	Indicates that incorrect handling may cause hazardous conditions, resulting in minor or moderate injury or property damage.

Under some circumstances, failure to observe the precautions given under "⚠ CAUTION" may lead to serious consequences.

Observe the precautions of both levels because they are important for personal and system safety.

Make sure that the end users read this manual and then keep the manual in a safe place for future reference.

[Design Precautions]

WARNING

- Configure safety circuits external to the programmable controller to ensure that the entire system operates safely even when a fault occurs in the external power supply or the programmable controller. Failure to do so may result in an accident due to an incorrect output or malfunction.
 - (1) Emergency stop circuits, protection circuits, and protective interlock circuits for conflicting operations (such as forward/reverse rotations or upper/lower limit positioning) must be configured external to the programmable controller.
 - (2) When the programmable controller detects an abnormal condition, it stops the operation and all outputs are:
 - Turned off if the overcurrent or overvoltage protection of the power supply module is activated.
 - Held or turned off according to the parameter setting if the self-diagnostic function of the CPU module detects an error such as a watchdog timer error.
 - (3) All outputs may be turned on if an error occurs in a part, such as an I/O control part, where the CPU module cannot detect any error. To ensure safety operation in such a case, provide a safety mechanism or a fail-safe circuit external to the programmable controller. For a fail-safe circuit example, refer to "General Safety Requirements" in the MELSEC iQ-R Module Configuration Manual.
 - (4) Outputs may remain on or off due to a failure of a component such as a relay and transistor in an output circuit. Configure an external circuit for monitoring output signals that could cause a serious accident.
 - In an output circuit, when a load current exceeding the rated current or an overcurrent caused by a load short-circuit flows for a long time, it may cause smoke and fire. To prevent this, configure an external safety circuit, such as a fuse.
 - Configure a circuit so that the programmable controller is turned on first and then the external power supply. If the external power supply is turned on first, an accident may occur due to an incorrect output or malfunction.
 - Configure a circuit so that the external power supply is turned off first and then the programmable controller. If the programmable controller is turned off first, an accident may occur due to an incorrect output or malfunction.
 - For the operating status of each station after a communication failure, refer to manuals for the network used. For the manuals, please consult your local Mitsubishi representative. Incorrect output or malfunction due to a communication failure may result in an accident.
 - When connecting an external device with a CPU module or intelligent function module to modify data of a running programmable controller, configure an interlock circuit in the program to ensure that the entire system will always operate safely. For other forms of control (such as program modification, parameter change, forced output, or operating status change) of a running programmable controller, read the relevant manuals carefully and ensure that the operation is safe before proceeding. Improper operation may damage machines or cause accidents. When a Safety CPU is used, data cannot be modified while the Safety CPU is in SAFETY MODE.
 - Especially, when a remote programmable controller is controlled by an external device, immediate action cannot be taken if a problem occurs in the programmable controller due to a communication failure. To prevent this, configure an interlock circuit in the program, and determine corrective actions to be taken between the external device and CPU module in case of a communication failure.
-

[Design Precautions]

WARNING

- Do not write any data to the "system area" and "write prohibited area" of the buffer memory in the module. Also, do not use any "use prohibited" signals as an output signal from the CPU module to each module. Doing so may cause malfunction of the programmable controller system. For the "system area", "write prohibited area", and the "use prohibited" signals, refer to the user's manual for the module used. For areas used for safety communications, they are protected from being written by users, and thus safety communications failure caused by data writing does not occur.
 - If a communication cable is disconnected, the network may be unstable, resulting in a communication failure of multiple stations. Configure an interlock circuit in the program to ensure that the entire system will always operate safely even if communications fail. Incorrect output or malfunction due to a communication failure may result in an accident. When safety communications are used, an interlock by the safety station interlock function protects the system from an incorrect output or malfunction.
 - Analog outputs may remain on due to a failure of the module. Configure an external interlock circuit for output signals that could cause a serious accident.
-

[Design Precautions]

CAUTION

- Do not install the control lines or communication cables together with the main circuit lines or power cables. Doing so may result in malfunction due to electromagnetic interference. Keep a distance of 100mm or more between those cables.
 - During control of an inductive load such as a lamp, heater, or solenoid valve, a large current (approximately ten times greater than normal) may flow when the output is turned from off to on. Therefore, use a module that has a sufficient current rating.
 - After the CPU module is powered on or is reset, the time taken to enter the RUN status varies depending on the system configuration, parameter settings, and/or program size. Design circuits so that the entire system will always operate safely, regardless of the time.
 - Do not power off the programmable controller or reset the CPU module while the settings are being written. Doing so will make the data in the flash ROM and SD memory card undefined. The values need to be set in the buffer memory and written to the flash ROM and SD memory card again. Doing so also may cause malfunction or failure of the module.
 - When changing the operating status of the CPU module from external devices (such as the remote RUN/STOP functions), select "Do Not Open by Program" for "Opening Method" of "Module Parameter". If "Open by Program" is selected, an execution of the remote STOP function causes the communication line to close. Consequently, the CPU module cannot reopen the line, and external devices cannot execute the remote RUN function.
 - Power on or off the external power supply while the programmable controller is on. Failure to do so may result in incorrect output or malfunction.
 - At on/off of the power or external power supply, or at the output range switching, a voltage may occur or a current may flow between output terminals for a moment. In this case, start the control after analog outputs become stable.
-

[Security Precautions]

WARNING

- To maintain the security (confidentiality, integrity, and availability) of the programmable controller and the system against unauthorized access, denial-of-service (DoS) attacks, computer viruses, and other cyberattacks from external devices via the network, take appropriate measures such as firewalls, virtual private networks (VPNs), and antivirus solutions.
-

[Installation Precautions]

WARNING

- Shut off the external power supply (all phases) used in the system before mounting or removing the module. Failure to do so may result in electric shock or cause the module to fail or malfunction.
-

[Installation Precautions]

CAUTION

- Use the programmable controller in an environment that meets the general specifications in the MELSEC iQ-R Module Configuration Manual. Failure to do so may result in electric shock, fire, malfunction, or damage to or deterioration of the product.
 - To mount a module, place the concave part(s) located at the bottom onto the guide(s) of the base unit, and push in the module until the hook(s) located at the top snaps into place. Incorrect interconnection may cause malfunction, failure, or drop of the module.
 - To mount a module with no module fixing hook, place the concave part(s) located at the bottom onto the guide(s) of the base unit, push in the module, and fix it with screw(s). Incorrect interconnection may cause malfunction, failure, or drop of the module.
 - When using the programmable controller in an environment of frequent vibrations, fix the module with a screw.
 - Tighten the screws within the specified torque range. Undertightening can cause drop of the component or wire, short circuit, or malfunction. Overtightening can damage the screw and/or module, resulting in drop, short circuit, or malfunction. For the specified torque range, refer to the MELSEC iQ-R Module Configuration Manual.
 - When using an extension cable, connect it to the extension cable connector of the base unit securely. Check the connection for looseness. Poor contact may cause malfunction.
 - When using an SD memory card, fully insert it into the SD memory card slot. Check that it is inserted completely. Poor contact may cause malfunction.
 - Securely insert an extended SRAM cassette or a battery-less option cassette into the cassette connector of the CPU module. After insertion, close the cassette cover and check that the cassette is inserted completely. Poor contact may cause malfunction.
 - Beware that the module could be very hot while power is on and immediately after power-off.
 - Do not directly touch any conductive parts and electronic components of the module, SD memory card, extended SRAM cassette, battery-less option cassette, or connector. Doing so can cause malfunction or failure of the module.
-

[Wiring Precautions]

WARNING

- Shut off the external power supply (all phases) used in the system before installation and wiring. Failure to do so may result in electric shock or cause the module to fail or malfunction.
- After installation and wiring, attach a blank cover module (RG60) to each empty slot before powering on the system for operation. Also, attach an extension connector protective cover^{*1} to each unused extension cable connector as necessary. Directly touching any conductive parts of the connectors while power is on may result in electric shock.

*1 For details, please consult your local Mitsubishi Electric representative.

[Wiring Precautions]

CAUTION

- Individually ground the FG and LG terminals of the programmable controller with a ground resistance of 100 ohms or less. Failure to do so may result in electric shock or malfunction.
 - Use applicable solderless terminals and tighten them within the specified torque range. If any spade solderless terminal is used, it may be disconnected when the terminal screw comes loose, resulting in failure.
 - Check the rated voltage and signal layout before wiring to the module, and connect the cables correctly. Connecting a power supply with a different voltage rating or incorrect wiring may cause fire or failure.
 - Connectors for external devices must be crimped or pressed with the tool specified by the manufacturer, or must be correctly soldered. Incomplete connections may cause short circuit, fire, or malfunction.
 - Securely connect the connector to the module. Poor contact may cause malfunction.
 - Do not install the control lines or communication cables together with the main circuit lines or power cables. Failure to do so may result in malfunction due to noise. Keep a distance of 100mm or more between those cables.
 - Place the cables in a duct or clamp them. If not, dangling cables may swing or inadvertently be pulled, resulting in malfunction or damage to modules or cables.
In addition, the weight of the cables may put stress on modules in an environment of strong vibrations and shocks.
Do not clamp the extension cables with the jacket stripped. Doing so may change the characteristics of the cables, resulting in malfunction.
 - Check the interface type and correctly connect the cable. Incorrect wiring (connecting the cable to an incorrect interface) may cause failure of the module and external device.
 - Tighten the terminal screws or connector screws within the specified torque range. Undertightening can cause drop of the screw, short circuit, fire, or malfunction. Overtightening can damage the screw and/or module, resulting in drop, short circuit, fire, or malfunction.
 - When disconnecting the cable from the module, do not pull the cable by the cable part. For the cable with connector, hold the connector part of the cable. For the cable connected to the terminal block, loosen the terminal screw. Pulling the cable connected to the module may result in malfunction or damage to the module or cable.
 - Prevent foreign matter such as dust or wire chips from entering the module. Such foreign matter can cause a fire, failure, or malfunction.
 - When a protective film is attached to the top of the module, remove it before system operation. If not, inadequate heat dissipation of the module may cause a fire, failure, or malfunction.
 - Programmable controllers must be installed in control panels. Connect the main power supply to the power supply module in the control panel through a relay terminal block. Wiring and replacement of a power supply module must be performed by qualified maintenance personnel with knowledge of protection against electric shock. For wiring, refer to the MELSEC iQ-R Module Configuration Manual.
 - For Ethernet cables to be used in the system, select the ones that meet the specifications in the user's manual for the module used. If not, normal data transmission is not guaranteed.
-

[Startup and Maintenance Precautions]

WARNING

- Do not touch any terminal while power is on. Doing so will cause electric shock or malfunction.
 - Correctly connect the battery connector. Do not charge, disassemble, heat, short-circuit, solder, or throw the battery into the fire. Also, do not expose it to liquid or strong shock. Doing so will cause the battery to produce heat, explode, ignite, or leak, resulting in injury and fire.
 - Shut off the external power supply (all phases) used in the system before cleaning the module or retightening the terminal screws, connector screws, or module fixing screws. Failure to do so may result in electric shock.
-

[Startup and Maintenance Precautions]

CAUTION

- When connecting an external device with a CPU module or intelligent function module to modify data of a running programmable controller, configure an interlock circuit in the program to ensure that the entire system will always operate safely. For other forms of control (such as program modification, parameter change, forced output, or operating status change) of a running programmable controller, read the relevant manuals carefully and ensure that the operation is safe before proceeding. Improper operation may damage machines or cause accidents.
 - Especially, when a remote programmable controller is controlled by an external device, immediate action cannot be taken if a problem occurs in the programmable controller due to a communication failure. To prevent this, configure an interlock circuit in the program, and determine corrective actions to be taken between the external device and CPU module in case of a communication failure.
 - Do not disassemble or modify the modules. Doing so may cause failure, malfunction, injury, or a fire.
 - Use any radio communication device such as a cellular phone or PHS (Personal Handy-phone System) 25cm or more away in all directions from the programmable controller. Failure to do so may cause malfunction.
 - Shut off the external power supply (all phases) used in the system before mounting or removing the module. Failure to do so may cause the module to fail or malfunction.
 - Tighten the screws within the specified torque range. Undertightening can cause drop of the component or wire, short circuit, or malfunction. Overtightening can damage the screw and/or module, resulting in drop, short circuit, or malfunction.
 - After the first use of the product, do not perform each of the following operations more than 50 times (IEC 61131-2/JIS B 3502 compliant).
Exceeding the limit may cause malfunction.
 - Mounting/removing the module to/from the base unit
 - Inserting/removing the extended SRAM cassette or battery-less option cassette to/from the CPU module
 - Mounting/removing the terminal block to/from the module
 - Connecting/disconnecting the extension cable to/from the base unit
 - After the first use of the product, do not insert/remove the SD memory card to/from the CPU module more than 500 times. Exceeding the limit may cause malfunction.
 - Do not touch the metal terminals on the back side of the SD memory card. Doing so may cause malfunction or failure of the module.
 - Do not touch the integrated circuits on the circuit board of an extended SRAM cassette or a battery-less option cassette. Doing so may cause malfunction or failure of the module.
 - Do not drop or apply shock to the battery to be installed in the module. Doing so may damage the battery, causing the battery fluid to leak inside the battery. If the battery is dropped or any shock is applied to it, dispose of it without using.
 - Startup and maintenance of a control panel must be performed by qualified maintenance personnel with knowledge of protection against electric shock. Lock the control panel so that only qualified maintenance personnel can operate it.
-

[Startup and Maintenance Precautions]

CAUTION

- Before handling the module, touch a conducting object such as a grounded metal to discharge the static electricity from the human body. Wearing a grounded antistatic wrist strap is recommended. Failure to discharge the static electricity may cause the module to fail or malfunction.
 - After unpacking, eliminate static electricity from the module to prevent electrostatic discharge from affecting the module. If an electrostatically charged module comes in contact with a grounded metal object, a sudden electrostatic discharge of the module may cause failure.
For details on how to eliminate static electricity from the module, refer to the following.
Antistatic Precautions Before Using MELSEC iQ-R Series Products (FA-A-0368)
 - Use a clean and dry cloth to wipe off dirt on the module.
-

[Operating Precautions]

CAUTION

- When changing data and operating status, and modifying program of the running programmable controller from an external device such as a personal computer connected to an intelligent function module, read relevant manuals carefully and ensure the safety before operation. Incorrect change or modification may cause system malfunction, damage to the machines, or accidents.
 - Do not power off the programmable controller or reset the CPU module while the setting values in the buffer memory are being written to the flash ROM in the module. Doing so will make the data in the flash ROM and SD memory card undefined. The values need to be set in the buffer memory and written to the flash ROM and SD memory card again. Doing so can cause malfunction or failure of the module.
-

[Disposal Precautions]

CAUTION

- When disposing of this product, treat it as industrial waste.
 - When disposing of batteries, separate them from other wastes according to the local regulations. For details on battery regulations in EU member states, refer to the MELSEC iQ-R Module Configuration Manual.
-

[Transportation Precautions]

CAUTION

- When transporting lithium batteries, follow the transportation regulations. For details on the regulated models, refer to the MELSEC iQ-R Module Configuration Manual.
 - The halogens (such as fluorine, chlorine, bromine, and iodine), which are contained in a fumigant used for disinfection and pest control of wood packaging materials, may cause failure of the product. Prevent the entry of fumigant residues into the product or consider other methods (such as heat treatment) instead of fumigation. The disinfection and pest control measures must be applied to unprocessed raw wood.
-

CONDITIONS OF USE FOR THE PRODUCT

- (1) MELSEC programmable controller ("the PRODUCT") shall be used in conditions;
- i) where any problem, fault or failure occurring in the PRODUCT, if any, shall not lead to any major or serious accident; and
 - ii) where the backup and fail-safe function are systematically or automatically provided outside of the PRODUCT for the case of any problem, fault or failure occurring in the PRODUCT.
- (2) The PRODUCT has been designed and manufactured for the purpose of being used in general industries. MITSUBISHI ELECTRIC SHALL HAVE NO RESPONSIBILITY OR LIABILITY (INCLUDING, BUT NOT LIMITED TO ANY AND ALL RESPONSIBILITY OR LIABILITY BASED ON CONTRACT, WARRANTY, TORT, PRODUCT LIABILITY) FOR ANY INJURY OR DEATH TO PERSONS OR LOSS OR DAMAGE TO PROPERTY CAUSED BY the PRODUCT THAT ARE OPERATED OR USED IN APPLICATION NOT INTENDED OR EXCLUDED BY INSTRUCTIONS, PRECAUTIONS, OR WARNING CONTAINED IN MITSUBISHI ELECTRIC USER'S, INSTRUCTION AND/OR SAFETY MANUALS, TECHNICAL BULLETINS AND GUIDELINES FOR the PRODUCT.
- ("Prohibited Application")
- Prohibited Applications include, but not limited to, the use of the PRODUCT in;
- Nuclear Power Plants and any other power plants operated by Power companies, and/or any other cases in which the public could be affected if any problem or fault occurs in the PRODUCT.
 - Railway companies or Public service purposes, and/or any other cases in which establishment of a special quality assurance system is required by the Purchaser or End User.
 - Aircraft or Aerospace, Medical applications, Train equipment, transport equipment such as Elevator and Escalator, Incineration and Fuel devices, Vehicles, Manned transportation, Equipment for Recreation and Amusement, and Safety devices, handling of Nuclear or Hazardous Materials or Chemicals, Mining and Drilling, and/or other applications where there is a significant risk of injury to the public or property.
- Notwithstanding the above restrictions, Mitsubishi Electric may in its sole discretion, authorize use of the PRODUCT in one or more of the Prohibited Applications, provided that the usage of the PRODUCT is limited only for the specific applications agreed to by Mitsubishi Electric and provided further that no special quality assurance or fail-safe, redundant or other safety features which exceed the general specifications of the PRODUCTS are required. For details, please contact the Mitsubishi Electric representative in your region.
- (3) Mitsubishi Electric shall have no responsibility or liability for any problems involving programmable controller trouble and system trouble caused by DoS attacks, unauthorized access, computer viruses, and other cyberattacks.

INTRODUCTION

Thank you for purchasing the Mitsubishi Electric MELSEC iQ-R series programmable controllers.

This manual describes the functions, parameter settings, and troubleshooting of the relevant product listed below.

Before using this product, please read this manual and the relevant manuals carefully and develop familiarity with the functions and performance of the MELSEC iQ-R series programmable controller to handle the product correctly.

When applying the program examples provided in this manual to an actual system, ensure the applicability and confirm that it will not cause system control problems.

Please make sure that the end users read this manual.

Point

Unless otherwise specified, this manual provides program examples in which the I/O numbers of X/Y0 to X/YF are assigned to the D/A converter module. Assign I/O numbers when applying the program examples to an actual system. For I/O number assignment, refer to the following.

 MELSEC iQ-R Module Configuration Manual

Relevant product

R60DAH4

CONTENTS

SAFETY PRECAUTIONS	1
CONDITIONS OF USE FOR THE PRODUCT	10
INTRODUCTION	10
RELEVANT MANUALS	13
TERMS	13
GENERIC TERMS AND ABBREVIATIONS	14
MANUAL PAGE ORGANIZATION	15
CHAPTER 1 FUNCTIONS	16
1.1 Modes	16
1.2 Range Switching Function	20
1.3 D/A Conversion Enable/Disable Setting Function	22
1.4 D/A Output Enable/Disable Setting Function	22
1.5 Analog Output HOLD/CLEAR Function	23
1.6 Analog Output Test Function When the CPU Module is in STOP State	26
1.7 Scaling Function	28
1.8 Shift Function	31
1.9 Warning Output Function	33
1.10 Rate Control Function	35
1.11 External Power Supply Interruption Detection Function	39
1.12 Disconnection Detection Function	40
1.13 Interrupt Function	42
1.14 Wave Output Function	45
Initial settings of the wave output function	52
Execution of the wave output function	58
Points to use the wave output function	75
Wave output step action function	83
1.15 Inter-Module Synchronization Function	91
1.16 Error History Function	106
1.17 Event History Function	109
1.18 Backing up, Saving, and Restoring Offset/Gain Values	110
When the module-specific backup parameter is used	110
When the module-specific backup parameter is not used	113
CHAPTER 2 PARAMETER	117
2.1 Parameter Setting Procedure	117
2.2 Basic Setting	118
2.3 Application Setting	119
2.4 Interrupt Setting	120
2.5 Refresh Setting	121
Refresh processing time	122
CHAPTER 3 TROUBLESHOOTING	123
3.1 Troubleshooting with LEDs	123
3.2 Checking State of Module	124
3.3 Troubleshooting by Symptom	126
When the RUN LED flashes or turns off	126
When the ERR LED turns on	126

When the ALM LED turns on	126
When the analog output is not performed	127
When HOLD of an analog output value is not available	129
When the analog output is not performed in the wave output mode	130
When analog output stops during wave output	130
When synchronous output is not started	131
3.4 List of Error Codes	132
3.5 List of Alarm Codes	136

APPENDICES **137**

Appendix 1 Module Label	137
Appendix 2 I/O Signals	139
List of I/O signals	139
Details of input signals	140
Details of output signals	147
Appendix 3 Buffer Memory Areas	150
List of buffer memory areas	150
Details of buffer memory areas	157
Appendix 4 Dedicated Instructions	192
Instruction list	192
Appendix 5 Operation Examples of When the Remote Head Module Is Mounted	193
System configuration example	193
Settings in the master station	194
Settings in the intelligent device station	197
Checking the network status	200
Program examples	200
Appendix 6 Using the Module in the Redundant System with Redundant Extension Base Unit	203
Restrictions on functions and specifications	203
Precautions	204

INDEX **206**

REVISIONS	208
WARRANTY	209
TRADEMARKS	210

RELEVANT MANUALS

Manual name [manual number]	Description	Available form
MELSEC iQ-R High Speed Digital-Analog Converter Module User's Manual (Application) [SH-081657ENG] (this manual)	Functions, parameter settings, troubleshooting, I/O signals, and buffer memory of the D/A converter module	Print book e-Manual PDF
MELSEC iQ-R Module Configuration Manual [SH-081262ENG]	Combinations of MELSEC iQ-R series modules to be used, common information on installations/wiring for configuring systems, and specifications of the power supply module, base unit, SD memory card, and battery	Print book e-Manual PDF
MELSEC iQ-R High Speed Digital-Analog Converter Module User's Manual (Startup) [SH-081655ENG]	Performance specifications, procedures before operation, wiring, operation examples, and offset/gain setting of the D/A converter module	Print book e-Manual PDF
MELSEC iQ-R Programming Manual (Module Dedicated Instructions) [SH-081976ENG]	Dedicated instructions for the intelligent function modules	e-Manual PDF
MELSEC iQ-R Analog-Digital Converter Module/Digital-Analog Converter Module Function Block Reference [BCN-P5999-0375]	FBS of the A/D converter modules and D/A converter modules	e-Manual PDF
GX Works3 Operating Manual [SH-081215ENG]	System configuration, parameter settings, and online operations of GX Works3	e-Manual PDF

This manual does not include information on the module function blocks.

For details, refer to the Function Block Reference for the module used.



e-Manual refers to the Mitsubishi FA electronic book manuals that can be browsed using a dedicated tool.

e-Manual has the following features:

- Required information can be cross-searched in multiple manuals.
- Other manuals can be accessed from the links in the manual.
- The hardware specifications of each part can be found from the product figures.
- Pages that users often browse can be bookmarked.

TERMS

Unless otherwise specified, this manual uses the following terms.

Term	Description
Buffer memory	A memory in an intelligent function module for storing data (such as setting values and monitored values). For a CPU module, it refers to a memory for storing data (such as setting values and monitored values of the Ethernet function, data used for data communications of the multiple CPU system function).
Engineering tool	A tool used for setting up programmable controllers, programming, debugging, and maintenance
Global label	A label that is valid for all the program data when multiple program data are created in the project. The global label has two types: a module specific label (module label), which is generated automatically by GX Works3, and an optional label, which can be created for any specified device.
Module label	A label that represents one of memory areas (I/O signals and buffer memory areas) specific to each module in a given character string. For the module used, GX Works3 automatically generates this label, which can be used as a global label.
Offset/gain setting mode	The mode for the offset/gain setting
User range	An analog output range where any value can be set. This range can be set in the offset/gain setting.
Watchdog timer error	An error that occurs if the internal processing of the module is abnormal. Watchdog timer enables the module to monitor its own internal processing.

GENERIC TERMS AND ABBREVIATIONS

Unless otherwise specified, this manual uses the following generic terms and abbreviations.

Generic term/abbreviation	Description
D/A converter module	An abbreviation for the MELSEC iQ-R series high speed digital-analog converter module
Factory default setting	A generic term for analog output ranges of 4 to 20mA, 0 to 20mA, 1 to 5V, 0 to 5V, -10 to 10V
Remote head module	An abbreviation for the RJ72GF15-T2 CC-Link IE Field Network remote head module

MANUAL PAGE ORGANIZATION

In this manual, pages about functions, I/O signals, and buffer memory areas are organized and the symbols are used as shown below.

The following illustration is for explanation purpose only, and should not be referred to as an actual documentation.

1.6 Analog Output Test Function When the CPU Module is in STOP State

Normal
High speed
Synchronization

This function allows performing the analog output test when the CPU module is in the STOP state.

Operation

By forcibly turning on 'CH1 Output enable/disable flag' (Y1) when the CPU module is in the STOP state, the analog output value is changed from the offset value to the D/A-converted analog output value. Hereafter, when 'CH1 Digital value' (UnIG460) or 'CH1 Synchronization digital value' (UnIG9500) is updated, the analog output value is updated as well. The following figure shows the relation between 'CH1 Output enable/disable flag' (Y1) and the analog output value of the CPU module in the STOP state when 'Analog Output HOLD/CLEAR Setting' is set to 'CLEAR'.

Legend:
 -----> Performed by the D/A converter module
 -----> Performed by a program

(1) 'CH1 Output enable/disable flag' (Y1) turns off when the state of the CPU module is changed into STOP, and the offset value is output in analog.
 (2) By forcibly turning on 'CH1 Output enable/disable flag' (Y1), the analog output value is changed from the offset value to the D/A-converted analog output value.
 (3) At this time, when 'CH1 Digital value' (UnIG460) or 'CH1 Synchronization digital value' (UnIG9500) is changed, the analog output can be tested.

Enabled functions

The settings of the following functions are enabled during the analog output test.

Normal

- Scaling function
- Shift function
- Warning output function
- Rate control function

Synchronization

- Warning output function

12 1 FUNCTIONS
1.6 Analog Output Test Function When the CPU Module is in STOP State

① The following table lists the operation modes of the D/A converter module in which the corresponding functions and buffer memory areas can be used. Each icon indicates an operation mode as follows.

Icon	Description
Common	The corresponding functions and buffer memory areas can be used in all the operation modes.
High speed	The corresponding functions and buffer memory areas can be used in the high-speed output mode (conversion speed: 1μs/CH).
Normal	The corresponding functions and buffer memory areas can be used in the normal output mode (conversion speed: 10μs/CH).
Wave	The corresponding functions and buffer memory areas can be used in the wave output mode (conversion speed: 20μs/CH).
Synchronization	The corresponding functions and buffer memory areas can be used in the inter-module synchronization mode.

1 FUNCTIONS

This chapter describes the functions of the D/A converter module and the setting methods for those functions. For details on the I/O signals and the buffer memory, refer to the following.

☞ Page 139 I/O Signals

☞ Page 150 Buffer Memory Areas

Point

- This chapter describes I/O signals and buffer memory addresses for CH1. For details on the I/O signals and buffer memory addresses for CH2 and later, refer to the following.

☞ Page 139 List of I/O signals

☞ Page 150 List of buffer memory areas

- □ in error codes and alarm codes indicates a channel where an error or alarm has occurred. A numerical value corresponding to the error comes in △. For details on the numerical values, refer to the following.

☞ Page 132 List of Error Codes

☞ Page 136 List of Alarm Codes

1.1 Modes

The D/A converter module has the high-speed output mode, normal output mode, wave output mode, inter-module synchronization mode, and offset/gain setting mode. Change the operation mode according to the function used.

High-speed output mode

This operation mode is for performing the high-speed D/A conversion. The value set in 'CH1 Digital value' (Un\G460) is output in analog after the D/A conversion. Conversion speed is 1 μ s/CH.



Normal output mode

This operation mode is for performing the normal D/A conversion. The value set in 'CH1 Digital value' (Un\G460) is output in analog after the D/A conversion. Conversion speed is 10 μ s/CH.

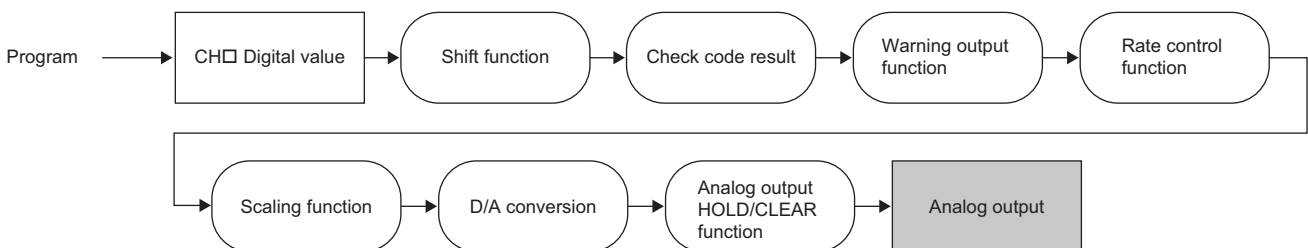

Wave output mode

This operation mode is for performing the wave output. The value set in Wave data registry area (Un\G10000 to Un\G99999) is continuously output in analog after sequent D/A conversion. Conversion speed is 20 μ s/CH.

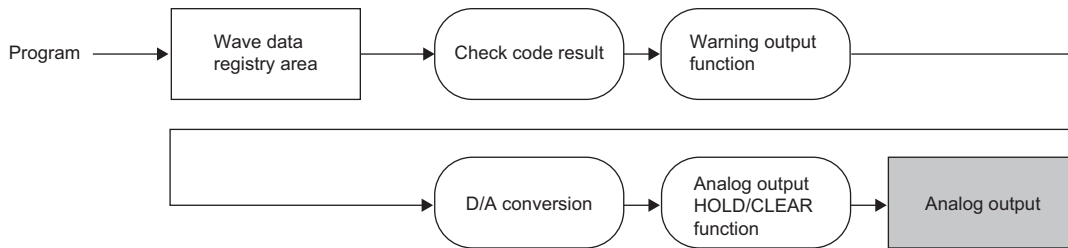

For details on the wave output function, refer to the following.

📖 Page 45 Wave Output Function

Inter-module synchronization mode

The D/A conversion is performed at the inter-module synchronization cycle in this mode. The value set in 'CH1 Synchronization digital value' (Un\G9500) is output in analog after the D/A conversion.

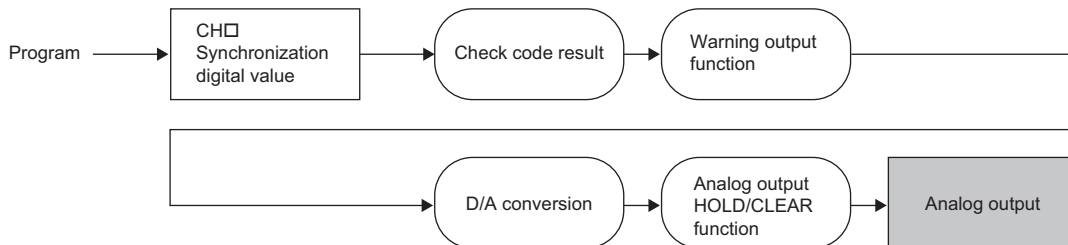

Offset/gain setting mode

The operation mode for the offset/gain setting

For details on the offset/gain setting, refer to the following.

📖 MELSEC iQ-R High Speed Digital-Analog Converter Module User's Manual (Startup)

Operation mode transition

The following figure and table describe the transition condition for each operation mode.

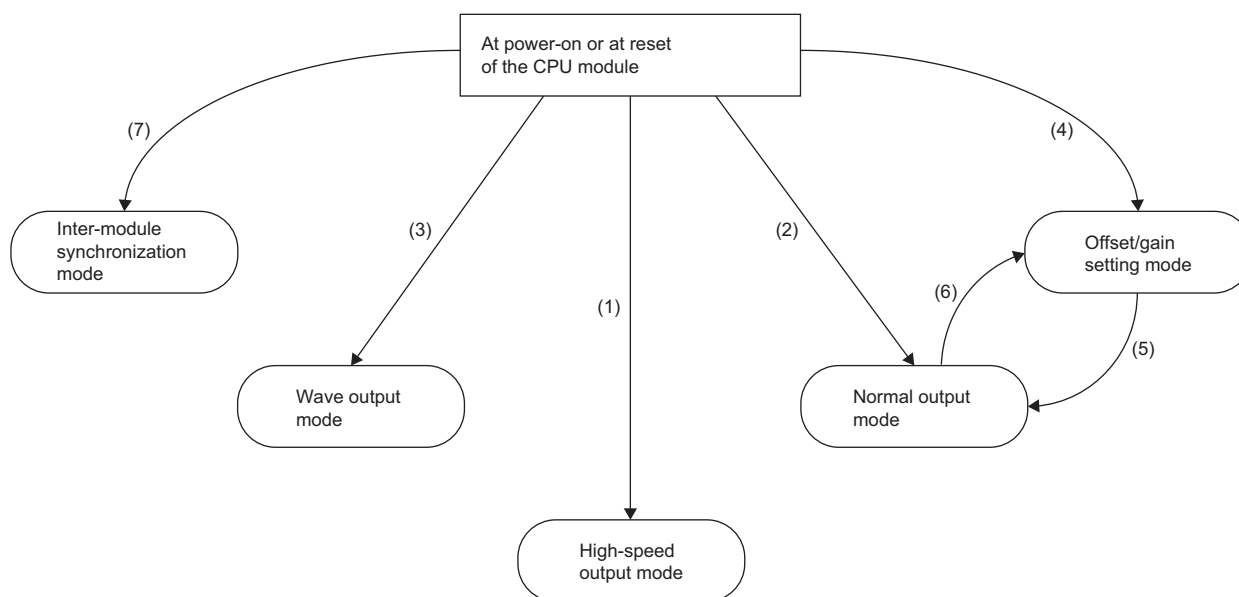

No.	Transition condition
(1) ^{*1}	Set "High speed output mode (1μs/CH)" for "Operation mode setting" in "Basic setting" of the engineering tool.
(2)	Set "Normal output mode (10μs/CH)" for "Operation mode setting" in "Basic setting" of the engineering tool.
(3) ^{*1}	Set "Wave output mode (20μs/CH)" for "Operation mode setting" in "Basic setting" of the engineering tool.
(4)	Set "Offset/gain setting mode" for "Operation mode setting" in "Basic setting" of the engineering tool.
(5)	Change the mode with one of the following methods.
	Method 1 Execute the G(P).OFFGAN (argument "S": 0: Shifting to the normal output mode).
	Method 2 Set the following values for 'Mode switching setting' (Un\G296, Un\G297) and turn on and off 'Operating condition setting request' (Y9). <ul style="list-style-type: none"> • Un\G296: 5260H • Un\G297: 4441H
(6)	Change the mode with one of the following methods.
	Method 1 Execute the G(P).OFFGAN (argument "S": 1: Shifting to the offset/gain setting mode).
	Method 2 Set the following values for 'Mode switching setting' (Un\G296, Un\G297) and turn on and off 'Operating condition setting request' (Y9). <ul style="list-style-type: none"> • Un\G296: 4441H • Un\G297: 5260H
(7) ^{*1*2}	Set "Synchronize" for the D/A converter module in the following parameter of the engineering tool. [System Parameter] ⇔ [Inter-module Synchronization Setting] ⇔ [Inter-module Synchronization Setting] ⇔ [Select Inter-module Synchronization Target Module]

*1 The high-speed output mode, wave output mode, and inter-module synchronization mode are independent from the other modes. After the module is started in the high-speed output mode, wave output mode, or the inter-module synchronization mode, the mode cannot be changed to the other operation modes. After the module is started in a mode other than the three modes, the mode cannot be switched to the high-speed output mode, wave output mode, and inter-module synchronization mode.

*2 When "Synchronize" is set for the D/A converter module in "Select Inter-module Synchronization Target Module", the module operates in the inter-module synchronization mode regardless of "Operation mode setting". To operate the module in the high-speed output mode, normal output mode, wave output mode, or offset/gain setting mode, set "Do Not Synchronize" for the D/A converter module in "Select Inter-module Synchronization Target Module".

Checking method

The current operation mode can be checked with the following items.

Operation mode	RUN LED status	Value stored in 'Operation mode monitor' (Un\G60)	'Offset/gain setting mode status flag' (XA)
High-speed output mode	ON	0	OFF
Normal output mode	ON	1	OFF ^{*1}
Wave output mode	ON	11	OFF
Inter-module synchronization mode	ON	4	OFF
Offset/gain setting mode	Flashing (1s cycle)	5	ON ^{*1}

*1 Status of when 'User range write request' (YA) is off.

1.2 Range Switching Function

Common

This function allows switching the output range of an analog output for each channel. Switching the range makes it possible to change the I/O conversion characteristic.

Operation

The set digital value is converted to an analog value within the analog output range of the output range set in "Output range setting" and the analog value is output.

The digital value used in the D/A conversion varies depending on the operation mode.

- High-speed output mode, normal output mode: 'CH1 Digital value' (Un\G460)
- Wave output mode: Wave data registry area (Un\G10000 to Un\G99999)
- Inter-module synchronization mode: 'CH1 Synchronization digital value' (Un\G9500)

Setting method

Set the output range to be used in "Output range setting".

 [Navigation window] ⇒ [Parameter] ⇒ [Module Information] ⇒ Module model name ⇒ [Basic setting] ⇒ [Range switching function]

Output range setting	Digital input range
4 to 20mA	0 to 32000
0 to 20mA	
1 to 5V	0 to 32000
0 to 5V	
-10 to 10V	-32000 to 32000
User range setting (voltage)	-32000 to 32000
User range setting (current)	-32000 to 32000

Point

The range can be switched or the set range can be monitored in the following buffer memory areas.

- 'CH1 Range setting' (Un\G598)
- 'CH1 Range setting monitor' (Un\G430)

For details on the buffer memory areas, refer to the following.

 Page 182 CH1 Range setting

 Page 167 CH1 Range setting monitor

Precautions

Common

- The output range cannot be changed for a channel where D/A conversion is disabled. Change the output range after setting "D/A conversion enable/disable setting" to "D/A conversion enable" and turning off 'CH1 Output enable/disable flag' (Y1).

Normal

- To prevent a sudden change of the analog output, Under-output range change denial alarm (alarm code: 0C0□H) occurs when the range switching is executed in the channel during analog output with the D/A conversion and output enabled. In this case, range switching is not executed. To switch the range, turn off 'CH1 Output enable/disable flag' (Y1), and turn on and off 'Operating condition setting request' (Y9). After switching the range, check 'CH1 Range setting monitor' (Un\G430) and the digital value, and then turn on 'CH1 Output enable/disable flag' (Y1) to start the analog output.

High speed

- A range change denial error during analog output in high-speed output mode (error code: 192□H) occurs when the range switching is executed in the channel during analog output with the D/A conversion and output enabled. Range switching is not executed. If an error occurs in any of the channels, all channels are set to D/A conversion disable, and 0V/0mA is output in analog. Turn off 'CH□ Output enable/disable flag' (Y1 to Y4) in all channels, and turn on and off 'Operating condition setting request' (Y9).

1.3 D/A Conversion Enable/Disable Setting Function

Common

Set whether to enable or disable the D/A conversion for each channel.

Disabling the D/A conversion for unused channels reduces the D/A conversion cycles.

The conversion cycle of the D/A converter module is the Conversion speed × Number of D/A conversion enabled channels.

Setting method

Set "D/A conversion enable/disable setting" to "D/A conversion enable" or "D/A conversion disable".

 [Navigation window] ⇒ [Parameter] ⇒ [Module Information] ⇒ Module model name ⇒ [Basic setting] ⇒ [D/A conversion enable/disable function]

1.4 D/A Output Enable/Disable Setting Function

Common

Specify whether to output the D/A conversion value or the offset value for each channel.

The conversion cycle is a constant, regardless of the D/A output enable/disable state.

Setting method

Set to enable or disable the D/A output for each channel with 'CH1 Output enable/disable flag' (Y1).

'CH1 Output enable/disable flag' (Y1)	Analog output
Enable (ON)	The D/A conversion value is output.
Disable (OFF)	The offset value is output.

1.5 Analog Output HOLD/CLEAR Function

Common

Set whether to hold or clear the analog output value that has been output when the operating status of the CPU module is RUN, STOP, or stop error.

The analog output HOLD/CLEAR function setting status can be checked with 'CH1 HOLD/CLEAR function setting monitor' (Un\G431).

Operation

Analog output status when the operating status of the CPU module is RUN, STOP, or stop error varies depending on the operation mode.

High-speed output mode or normal output mode

The analog output status changes as shown in the following table, depending on the combination of the settings for 'CH1 D/A conversion enable/disable setting' (Un\G500) and 'CH1 Output enable/disable flag' (Y1).

Execution status	'CH1 D/A conversion enable/disable setting' (Un\G500)	Enable		Disable
	'CH1 Output enable/disable flag' (Y1)	Enable	Disable	Enable or disable
	Analog output HOLD/CLEAR setting	HOLD	CLEAR	HOLD or CLEAR
Analog output produced when the CPU module is in the RUN state		The digital value converted in analog is output.		Offset value
Analog output produced when the CPU module is in the STOP state		Hold	Offset value	Offset value
Analog output produced when the CPU module is in the stop error state		Hold	Offset value	Offset value
Analog output status when 'External power supply READY flag' (X7) is off		0V/0mA	0V/0mA	0V/0mA
Analog output status when 'Disconnection detection signal' (XD) is on				
Analog output status when a watchdog timer error*1 occurs				

*1 The watchdog timer error is an error which occurs when internal processing is not normally carried out. When a watchdog timer error occurs, 'Module READY' (X0) turns off and RUN LED of the D/A converter module turns off.

■Wave output mode

The analog output status changes as shown in the following table, depending on the combination of 'CH1 D/A conversion enable/disable setting' (Un\G500), 'CH1 Output enable/disable flag' (Y1), and the wave output status.

Execution status	'CH1 D/A conversion enable/disable setting' (Un\G500)	Enable						Disable	
	'CH1 Output enable/disable flag' (Y1)	Enable						Disable	Enable or disable
	Analog output HOLD/CLEAR setting	HOLD			CLEAR			HOLD or CLEAR	HOLD or CLEAR
	Wave output status	Output	Stop	Pause	Output	Stop	Pause		
Analog output produced when the CPU module is in the RUN state	Wave data	*2	Hold		Wave data	*2	Offset value	Offset value	0V/0mA
Analog output produced when the CPU module is in the STOP state	Hold*3						Offset value	Offset value	0V/0mA
Analog output produced when the CPU module is in the stop error state	Hold*3						Offset value	Offset value	0V/0mA
Analog output status when 'External power supply READY flag' (X7) is off	0V/0mA				0V/0mA			0V/0mA	0V/0mA
Analog output status when 'Disconnection detection signal' (XD) is on									
Analog output status when a watchdog timer error*1 occurs									

*1 The watchdog timer error is an error which occurs when internal processing is not normally carried out. When a watchdog timer error occurs, 'Module READY' (X0) turns off and RUN LED of the D/A converter module turns off.

*2 Analog output set in 'CH1 Output setting during wave output stop (Un\G524)' is produced.

*3 When an external power supply disconnection or a disconnection is detected, the wave output status transits to the status of under wave output stop and 0V/0mA is analog output. Subsequently, if the status is recovered from the external power supply disconnected or disconnection detected status, the analog output value returns to the value before wave output stop. When the CPU module status is changed from STOP to RUN, the value is analog output according to the settings in 'CH1 Output setting during wave output stop' (Un\G524).

■Inter-module synchronization mode

The analog output status changes as shown in the following table, depending on the combination of the settings for 'CH1 D/A conversion enable/disable setting' (Un\G500) and 'CH1 Output enable/disable flag' (Y1).

Execution status	'CH1 D/A conversion enable/disable setting' (Un\G500)	Enable				Disable		
	'CH1 Output enable/disable flag' (Y1)	Enable		Disable		Enable or disable		
	Analog output HOLD/CLEAR setting	HOLD		CLEAR		HOLD or CLEAR		
Analog output produced when the CPU module is in the RUN state		The synchronization digital value converted in analog is output.				Offset value		0V/0mA
Analog output produced when the CPU module is in the STOP state	Hold			Offset value		Offset value		0V/0mA
Analog output produced when the CPU module is in the stop error state	Hold			Offset value		Offset value		0V/0mA
Analog output status when 'External power supply READY flag' (X7) is off	0V/0mA	0V/0mA		0V/0mA		0V/0mA		0V/0mA
Analog output status when 'Disconnection detection signal' (XD) is on								
Analog output status when a watchdog timer error occurs								

*1 The watchdog timer error is an error which occurs when internal processing is not normally carried out. When a watchdog timer error occurs, 'Module READY' (X0) turns off and RUN LED of the D/A converter module turns off.

Setting method

Set "Analog output HOLD/CLEAR setting" to "HOLD" or "CLEAR".

 [Navigation window] ⇒ [Parameter] ⇒ [Module Information] ⇒ Module model name ⇒ [Basic setting] ⇒ [Output mode setting function]

Precautions for when the remote head module has been mounted

When the D/A converter module has been mounted with the remote head module, set whether to hold or clear the analog output value that has been output when the own station is disconnected with "CPU error output mode setting" of the module parameter.

The following describes the settings required for using "CPU error output mode setting".

- Enable the station-based block data assurance for cyclic data on the sending side.
- To hold the analog output value, set "CPU error output mode setting" to "Hold". The analog output HOLD/CLEAR function setting is disabled.

This setting is enabled module by module. Setting by each channel is not available. To match the output status of when a stop error occurs or the CPU module is in the STOP state and that of when the own station is disconnected, set "Analog output HOLD/CLEAR setting" to the same value in all the channels.

Operating status	CPU error output mode setting ^{*1}	Analog output HOLD/CLEAR setting (Set the same value in all the channels.)
The analog output value is held.	Hold	HOLD
The analog output value is cleared. (The offset value is output.)	Clear	CLEAR

- *1 CPU error output mode setting is enabled in the following cases.
- When the own station is disconnected due to a network error
 - When the data link is stopped by the CC-Link IE Field Diagnostics of the engineering tool

1.6 Analog Output Test Function When the CPU Module is in STOP State

- Normal
- High speed
- Synchronization

This function allows performing the analog output test when the CPU module is in the STOP state.

Operation

By forcibly turning on 'CH1 Output enable/disable flag' (Y1) when the CPU module is in the STOP state, the analog output value is changed from the offset value to the D/A-converted analog output value. Hereafter, when 'CH1 Digital value' (Un\G460) or 'CH1 Synchronization digital value' (Un\G9500) is updated, the analog output value is updated as well. The following figure shows the relation between 'CH1 Output enable/disable flag' (Y1) and the analog output value of the CPU module in the STOP state when "Analog output HOLD/CLEAR setting" is set to "CLEAR".

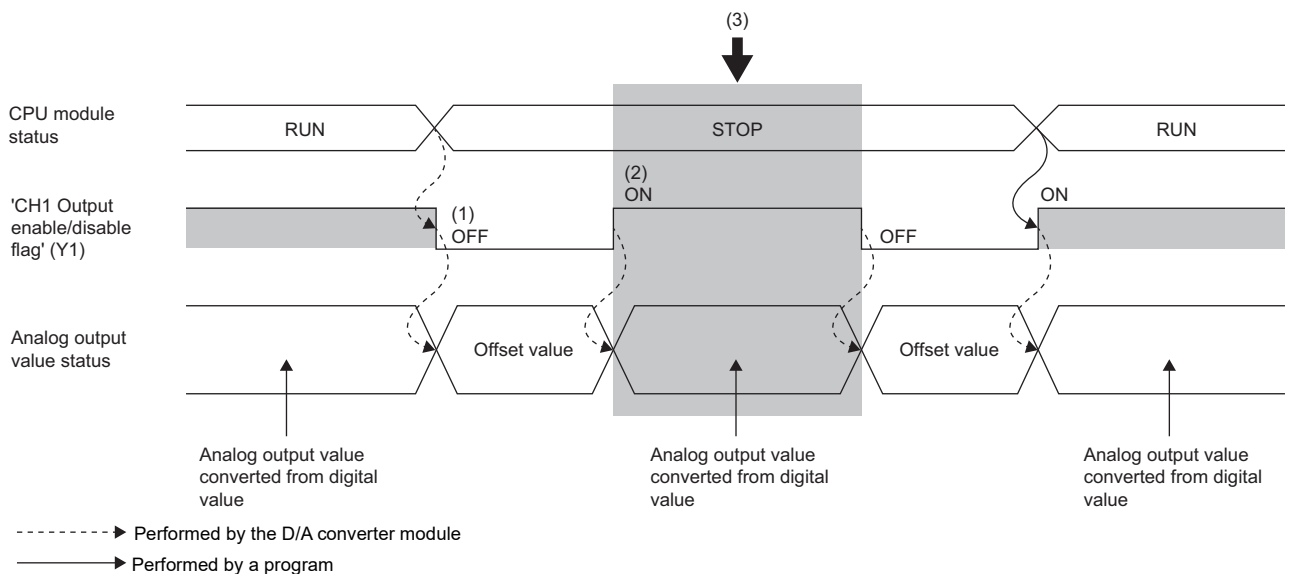

- (1) 'CH1 Output enable/disable flag' (Y1) turns off when the state of the CPU module is changed into STOP, and the offset value is output in analog.
- (2) By forcibly turning on 'CH1 Output enable/disable flag' (Y1), the analog output value is changed from the offset value to the D/A-converted analog output value.
- (3) At this time, when 'CH1 Digital value' (Un\G460) or 'CH1 Synchronization digital value' (Un\G9500) is changed, the analog output can be tested.

Enabled functions

The settings of the following functions are enabled during the analog output test.

- Normal

- Scaling function
- Shift function
- Warning output function
- Rate control function

- Synchronization

- Warning output function

Setting method

To perform an analog output test, configure the settings in the device test of the engineering tool following the procedure shown below.

1. Set 'CH1 D/A conversion enable/disable setting' (Un\G500) of the buffer memory to D/A conversion enabled (0).
2. Turn on 'Operating condition setting request' (Y9).
3. Check that 'Operating condition setting completed flag' (X9) has turned off, and turn off 'Operating condition setting request' (Y9).
4. Set the digital value equivalent to the analog value to be output for 'CH1 Digital value' (Un\G460) or 'CH1 Synchronization digital value' (Un\G9500) in the buffer memory.
5. Turn on 'CH1 Output enable/disable flag' (Y1).

Precautions

Normal

Synchronization

- When a digital value that is out of the setting range is written to each channel, a digital value setting range error (error code: 191□H) occurs and the corresponding check code is stored in 'CH1 Set value check code' (Un\G400).

High speed

- When a digital value that is out of the setting range is written to each channel, an error code and check code are not stored, but the analog output is limited to the upper limit or lower limit of the setting range.

Common

- Turning off 'CH□ Output enable/disable flag' (Y1 to Y4) ends the analog output test. If the status of the programmable controller CPU is changed from STOP to RUN while an analog output test is in progress, an offset value may be output temporarily due to the process of setting the module parameter when the analog output HOLD/CLEAR function is set to CLEAR.

1.7 Scaling Function

Normal

This function performs the scale conversion on digital values within a specified range between a scaling upper limit value and a scaling lower limit value. This function helps reduce the time taken for creating a scale conversion program.

Operation

The scale conversion is performed for the set 'CH1 Digital value' (Un\G460) using 'CH1 Scaling upper limit value' (Un\G504) and 'CH1 Scaling lower limit value' (Un\G506), and the value after the scale conversion is used for the D/A conversion. (In the scale conversion, values after the decimal point are rounded off.)

Concept of scaling setting

The necessary settings for the scaling lower limit value and scaling upper limit value depend on whether the factory default setting or the user range setting is used for the output range.

■When the factory default setting is used for the output range

- For the scaling upper limit value, set a value corresponding to the upper limit value of the set analog output value.
- For the scaling lower limit value, set a value corresponding to the lower limit value of the set analog output value.

■When the user range setting is used for the output range

- Set a value corresponding to the gain value for the scaling upper limit value.
- Set a value corresponding to the offset value for the scaling lower limit value.

Calculating the scaling value

For D/A conversion, the scaling value is calculated based on the following calculation formulas.

■When the factory default setting is used for the output range

- When the voltage is 1 to 5V or 0 to 5V, and current is 4 to 20mA or 0 to 20mA:

$$D_s = \frac{32000}{S_H - S_L} \times (D_x - S_L)$$

- When the voltage is -10 to 10V:

$$D_s = \frac{64000}{S_H - S_L} \times (D_x - S_L) - 32000$$

■When the user range setting is used for the output range

$$D_s = \frac{32000}{S_H - S_L} \times (D_x - S_L)$$

Item	Description
D_s	The digital value used in the D/A conversion
D_x	Digital value
S_H	Scaling upper limit value
S_L	Scaling lower limit value

Point

- If the relation between the values is the scaling lower limit value > the scaling upper limit value, the scale conversion can be performed according to a negative slope.
- Set the scaling with the condition "Scaling upper limit value ≠ Scaling lower limit value".

Setting method

1. Set "Scaling enable/disable setting" to "Enable".

[Navigation window] ⇒ [Parameter] ⇒ [Module Information] ⇒ Module model name ⇒ [Application setting] ⇒ [Scaling function]

2. Set values for "Scaling upper limit value" and "Scaling lower limit value".

Item	Setting range
Scaling upper limit value	-32000 to 32000
Scaling lower limit value	

Setting example of scaling

Ex.

When 14000 is set to the scaling upper limit value and 4000 is set to the scaling lower limit value for the channel with the output range of 0 to 5V

Analog output voltage (V)

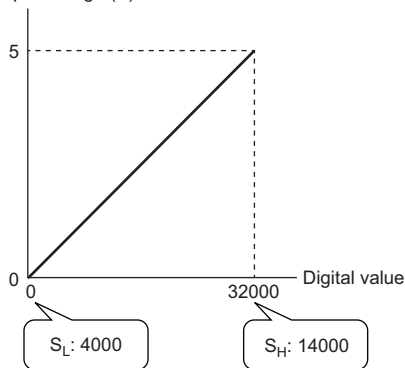

S_H : Scaling upper limit value

S_L : Scaling lower limit value

Digital value	Digital value after scaling	Analog output voltage (V)
4000	0	0
6000	6400	1
8000	12800	2
10000	19200	3
12000	25600	4
14000	32000	5

Precautions

- When the scaling function is used, the digital value can be set to a value out of the range between the scaling upper limit value and scaling lower limit value (in the dotted lines in the I/O conversion characteristic graph) before being scaled. However, use the scaling function within the range of the analog output practical range (in the solid line in the I/O conversion characteristic graph). If the value exceeds the analog output practical range, the maximum resolution and accuracy may not fall within the range of performance specifications. (📖 MELSEC iQ-R High Speed Digital-Analog Converter Module User's Manual (Startup))
- The default digital value "0" may not be appropriate, depending on the scaling function setting. In particular in the examples of when the output range is 0 to 5V, a digital value setting range error (error code: 191□H) occurs if 'CH1 Output enable/disable flag' (Y1) is turned on with the digital value "0". Therefore, set an appropriate digital value within the scaling range before turning on 'CH1 Output enable/disable flag' (Y1).
- When using the user range, note that the scaling lower limit value is equal to the offset value.
- When the scaling function is enabled and the digital value after the scaling conversion is out of the digital setting range, a digital value setting range error (error code: 191□H) occurs and the corresponding check code is stored in 'CH1 Set value check code' (Un\G400).

1.8 Shift Function

Normal

This function allows adding the set input value shift amount to the digital value. The analog output value reflects the change in the input value shift amount on a realtime basis. Therefore, fine adjustment can be easily performed when the system starts.

Operation

When the D/A conversion is performed on the digital value, the value obtained by adding 'CH1 Input value shift amount' (Un\G480) to 'CH1 Digital value' (Un\G460) is used for the D/A conversion. When the digital value after the addition exceeds the range as the result of the shift processing, the value is fixed to the lower limit value or the upper limit value. When a value is written to 'CH1 Input value shift amount' (Un\G480), the set value is added to the digital value even if 'Operating condition setting request' (Y9) is not turned on and off.

Setting method

Set a value for "Input value shift amount".

[Navigation window] ⇒ [Parameter] ⇒ [Module Information] ⇒ Module model name ⇒ [Application setting] ⇒ [Shift function]

Item	Setting range
Input value shift amount	-32768 to 32767

Setting example

Ex.

When the input value shift amount is set to +50 for the channel where the output range of 0 to 5V is set

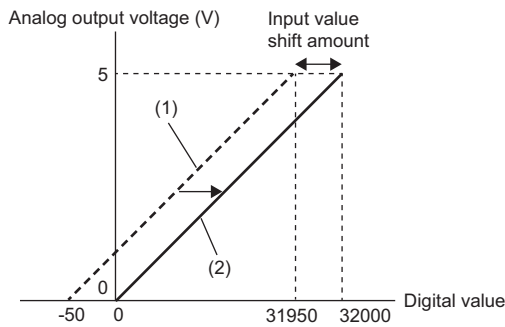

(1) Digital value before adjustment	(2) Digital value after adjustment	Analog output voltage (V)
-50	0	0
31950	32000	5

Precautions

- Based on the digital value obtained after the shift-and-add processing, the warning output function, scaling function, and rate control function are executed.
- When the value obtained by adding 'CH1 Input value shift amount' (Un\G480) to 'CH1 Digital value' (Un\G460) is out of the digital setting range, a digital value setting range error (error code: 191□H) occurs and the corresponding check code is stored in 'CH1 Set value check code' (Un\G400).

1.9 Warning Output Function

- Normal
- Wave
- Synchronization

This function outputs a warning when the digital value is larger than the warning output upper limit value or is smaller than the warning output lower limit value.

The warning target depends on the operation mode, as shown below.

- Normal output mode: 'CH1 Digital value' (Un\G460)
- Wave output mode: Wave data registry area (Un\G10000 to Un\G99999)
- Inter-module synchronization mode: 'CH1 Synchronization digital value' (Un\G9500)

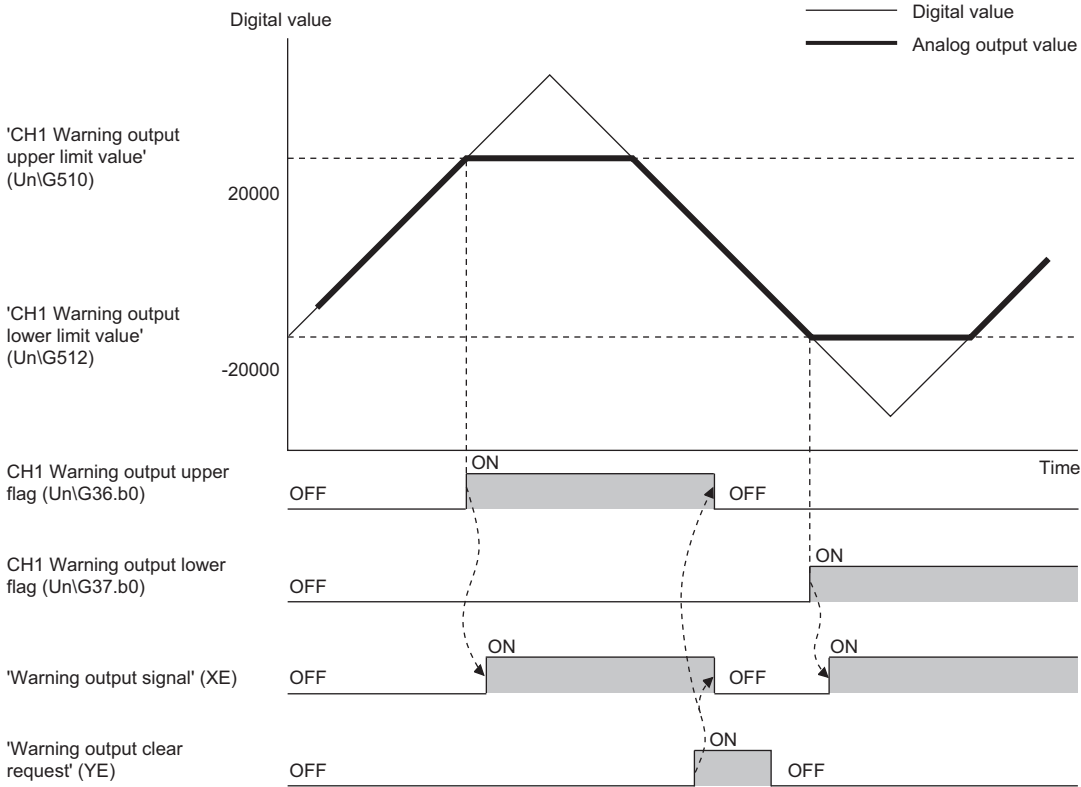

Warning output notification

This function outputs a warning as follows when the digital value is larger than 'CH1 Warning output upper limit value' (Un\G510) or is smaller than 'CH1 Warning output lower limit value' (Un\G512).

- Alarm ON (1) is stored in 'Warning output upper flag' (Un\G36) or 'Warning output lower flag' (Un\G37).
- 'Warning output signal' (XE) turns on.
- The ALM LED turns on.

An alarm code (080□H or 081□H) is stored in 'Latest alarm code' (Un\G2).

For details on the alarm codes, refer to the following.

☞ Page 136 List of Alarm Codes

Operation after a warning was output

When a warning has occurred, the set value of the warning output upper limit value or the warning output lower limit value is used as the digital value for the D/A conversion.

When the digital value is changed to 'CH1 Warning output upper limit value' (Un\G510) or smaller and 'CH1 Warning output lower limit value' (Un\G512) or larger after a warning has occurred, the analog output value returns to a normal value.

However, 'Warning output upper flag' (Un\G36), 'Warning output lower flag' (Un\G37), 'Warning output signal' (XE) and ALM LED are not cleared.

Clearing a warning

To clear the warning, turn on and off any of the following signals after setting the digital value to 'CH1 Warning output upper limit value' (Un\G510) or smaller and 'CH1 Warning output lower limit value' (Un\G512) or larger.

- 'Warning output clear request' (YE)
- 'Operating condition setting request' (Y9)

The D/A converter module arranges the following status when a warning is cleared.

- Normal (0) is stored in 'Warning output upper flag' (Un\G36) and 'Warning output lower flag' (Un\G37).
- 'Warning output signal' (XE) turns off.
- The ALM LED turns off.
- 'Latest alarm code' (Un\G2) is cleared.

Setting method

1. Set "Warning output setting" to "Enable".

 [Navigation window] ⇒ [Parameter] ⇒ [Module Information] ⇒ Module model name ⇒ [Application setting] ⇒ [Warning output function]

2. Set values for "Warning output upper limit value" and "Warning output lower limit value".

Item	Setting range
Warning output upper limit value	-32768 to 32767
Warning output lower limit value	

Point

Set the values that satisfy the condition "warning output upper limit value > warning output lower limit value".
When a value out of the range is set, a warning output upper/lower limit value inversion error (error code: 1B1□H) occurs.

Precautions

When the shift function is used, digital value obtained after the shift-and-add processing is the warning detection target. Set the 'CH1 Warning output upper limit value' (Un\G510) and 'CH1 Warning output lower limit value' (Un\G512) in consideration of the shift-and-add.

1.10 Rate Control Function

Normal

This function prevents the sudden change of the analog output value by limiting the increment/decrement of the analog output value per conversion cycle.

Operation

When the setting value of 'CH1 Digital value' (Un\G460) is changed, if the difference between the previously set digital value and the newly set digital value is larger than the digital limit values below, the rate control function will be executed.

- 'CH1 Increase digital limit value' (Un\G514)
- 'CH1 Decrease digital limit value' (Un\G516)

The analog output value gradually increases or decreases to the changed digital value. The analog output value is increased or decreased per conversion cycle ($10\mu\text{s} \times \text{Number of D/A conversion enabled channels}$). The increment and decrement are as follows:

- Increment: 'CH1 Increase digital limit value' (Un\G514) \times Number of D/A conversion enabled channels
- Decrement: 'CH1 Decrease digital limit value' (Un\G516) \times Number of D/A conversion enabled channels

Start timing of rate control

Rate control starts when 'CH1 Output enable/disable flag' (Y1) has turned on. Rate control is not executed if 'CH1 Output enable/disable flag' (Y1) is off.

Setting method

1. Set "Rate control enable/disable setting" to "Enable".

 [Navigation window] \Rightarrow [Parameter] \Rightarrow [Module Information] \Rightarrow Module model name \Rightarrow [Application setting] \Rightarrow [Rate control function]

2. Set values for "Increase digital limit value" and "Decrease digital limit value".

Item	Setting range
Increase digital limit value	0 to 64000
Decrease digital limit value	

Operation example of the rate control function

The following figure and table show an operation example when the rate control function is used for CH1 to CH3.

Setting item	CH1 setting	CH2 setting	CH3 setting	CH4 setting
D/A conversion enable/disable setting	Enable	Enable	Enable	Disable
Rate control enable/disable setting	Enable	Enable	Enable	Disable
Increase digital limit value	1500	1000	500	—
Digital value	Changed from 4000 to 16000	Changed from 4000 to 16000	Changed from 4000 to 16000	—

The increments of the analog output value by conversion cycle for each channel with the above settings are as follows:

- CH1: 4500 (CH1 Increase digital limit value × Number of D/A conversion enabled channels)
- CH2: 3000 (CH2 Increase digital limit value × Number of D/A conversion enabled channels)
- CH3: 1500 (CH3 Increase digital limit value × Number of D/A conversion enabled channels)

(Analog output)

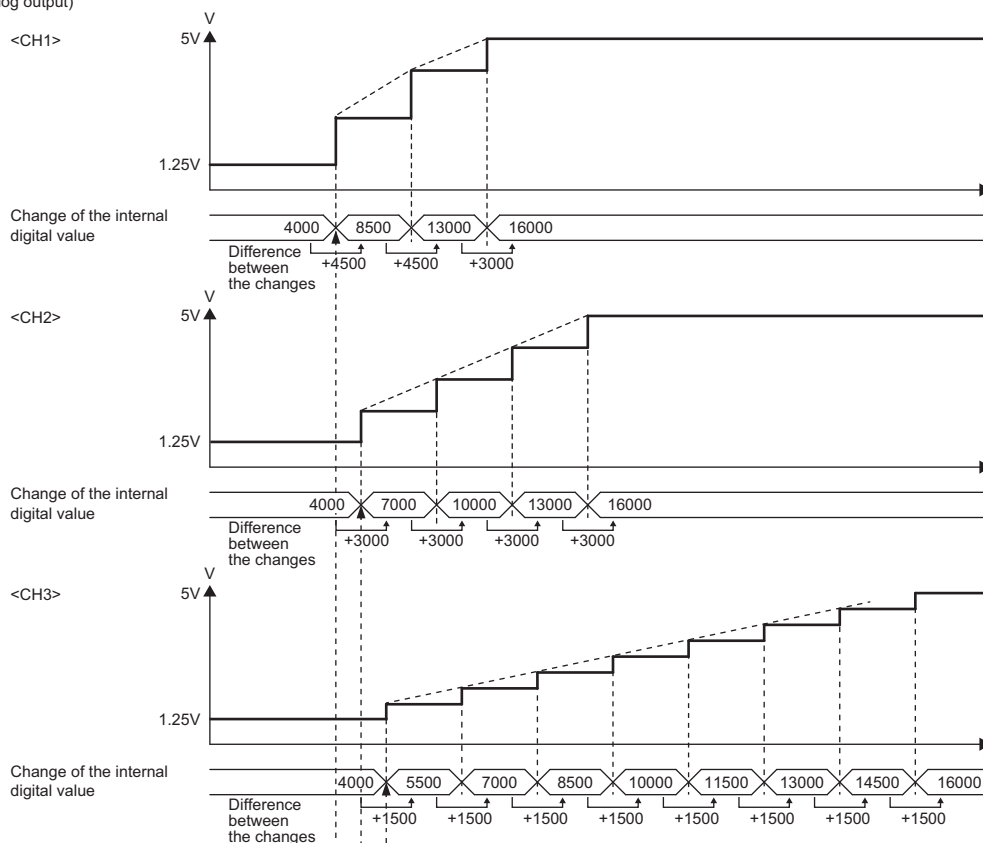

(Channel for the conversion)

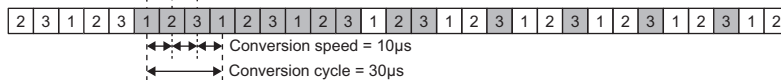

(Buffer memory)

'CH1 Digital value' (Un\G460)



'CH2 Digital value' (Un\G660)



'CH3 Digital value' (Un\G860)



Change of digital value during the rate control

When the digital value is changed again during the rate control, the rate control will continue until a new digital value is output in analog. In this case, setting the digital value that reverses the direction of increase or decrease changes the digital limit value used for the rate control depending on the direction of increase/decrease.

Ex.

The following figure shows the case where 'CH1 Digital value' (Un\G460) is set to 4000 → 8000 → 2000 with the following settings.

- Output range: -10 to 10V
- 'CH1 Increase digital limit value' (Un\G514): 300
- 'CH1 Decrease digital limit value' (Un\G516): 900

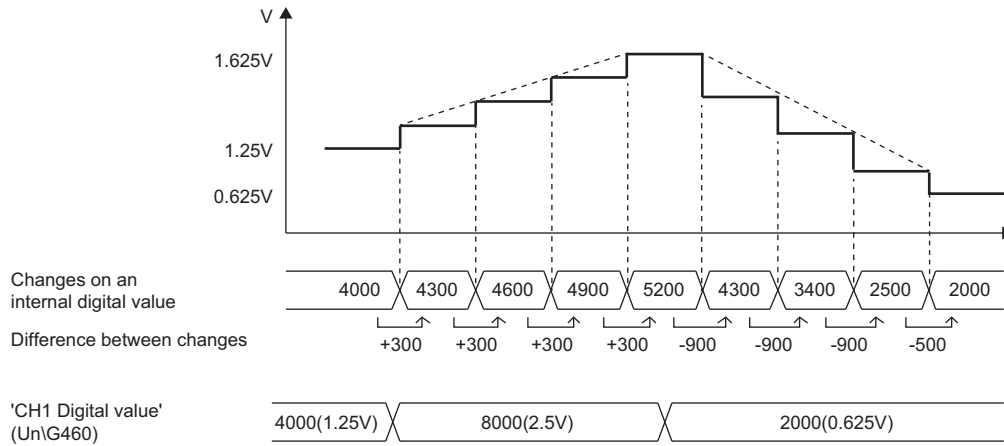

Relationship between CPU module status and analog output

When the CPU module status is changed, the operation of the rate control function varies depending on the setting of the analog output HOLD/CLEAR function as shown below.

■When the analog output HOLD/CLEAR function is set to CLEAR

If the status of CPU module changes from RUN to STOP (error), the rate control stops and offset value is output in analog. If the status of CPU module changes from STOP (error) to RUN, the rate control restarts from the offset value.

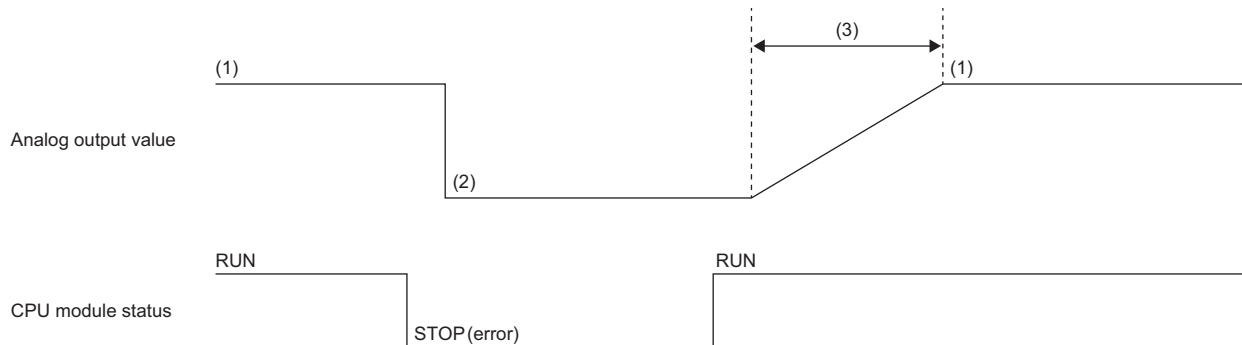

- (1) The D/A-converted 'CH1 Digital value' (Un\G460)
- (2) Offset value
- (3) Rate control enabled

■When the analog output HOLD/CLEAR function is set to HOLD

If the status of CPU module changes from RUN to STOP (error), the rate control stops and the current analog output value continues to be output in analog. If the status of CPU module changes from STOP (error) to RUN, the rate control restarts from the offset value.

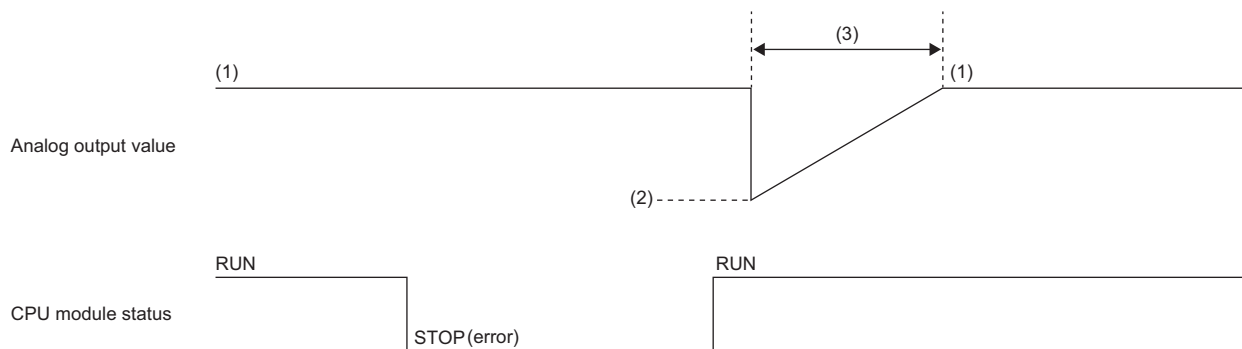

- (1) The D/A-converted 'CH1 Digital value' (Un\G460)
- (2) Offset value
- (3) Rate control enabled

Precautions

- The setting of the shift function is enabled during the rate control.
- When the warning output function is enabled, the warning determination is performed to the set 'CH1 Digital value' (Un\G460). The warning determination is not performed when the analog output value reaches the value corresponding to the warning output upper limit or warning output lower limit due to the rate control.
- The rate control is still valid during the analog output test when the CPU module is in the STOP state.
- When a value out of the setting range is written to 'CH1 Digital value' (Un\G460) during the rate control, the rate control is performed with the upper or lower limit value of the setting range.
- When the external power supply is turned off during the rate control, the rate control does not function and the analog output value changes to 0V/0mA. When the external power supply is recovered, the rate control is restarted from the offset value.
- When disconnection is detected during the rate control, the rate control does not function and the analog output value changes to 0V/0mA. When 'Disconnection detection signal' (XD) is cleared after recovery from the disconnection, the rate control is restarted from the offset value.

1.11 External Power Supply Interruption Detection Function

Common

This function detects that the external power supply 24VDC is not supplied or the supply stops. When the external power supply disconnection is detected, 'External power supply READY flag' (X7) turns off, and the analog output value becomes 0V/0mA regardless of the other settings.

Operation

If an external power supply is not input or when 200ms has not yet elapsed after the power supply is input, the external power supply is determined as disconnected and 'External power supply READY flag' (X7) turns off. When the external power supply input stops, the external power supply is regarded as disconnected and 'External power supply READY flag' (X7) turns off.

Precautions

When the external power supply does not satisfy the requirements of the performance specifications, the external power supply is regarded as disconnected.

For the performance specifications of the external power supply, refer to the following.

 MELSEC iQ-R High Speed Digital-Analog Converter Module User's Manual (Startup)

1.12 Disconnection Detection Function

Normal Wave Synchronization

This function allows detecting the disconnection by monitoring the analog output value. This function is enabled only when the output range is 4 to 20mA. A disconnection can be detected for each channel.

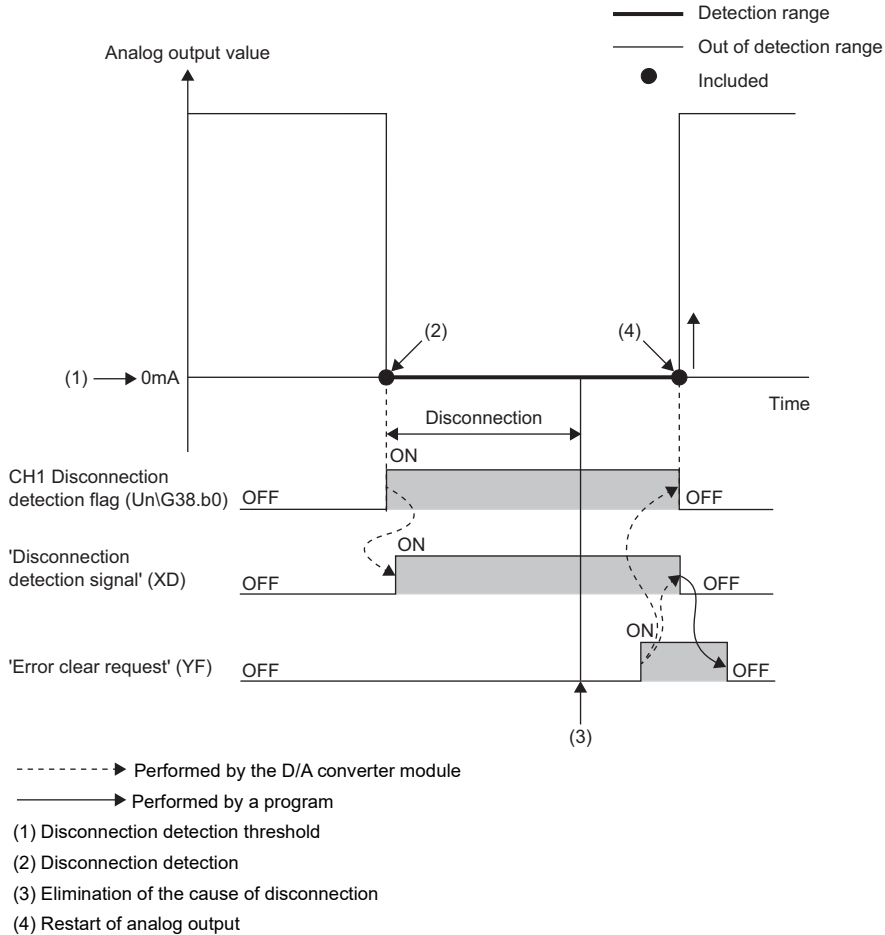

Operation

A disconnection can be detected when the output range is 4 to 20mA and 'CH1 D/A conversion enable/disable setting' (Un\G500) is set to D/A conversion enabled (0). Disconnection occurs when the analog output value falls to the disconnection detection threshold or less.

The detected disconnection is notified by the following.

- Disconnection detection (1) is stored in 'Disconnection detection flag' (Un\G38).
- 'Disconnection detection signal' (XD) turns on.
- The ERR LED turns on.

When a disconnection is detected, a disconnection detection error (error code: 1C4□H) is stored in 'Latest error code' (Un\G0).

Clearing disconnection detection

Even if the disconnection cause is eliminated, the analog output does not restart automatically to prevent an incorrect output. To clear the disconnection detection and restart analog output, execute the following operations for each operation mode. When the analog output restarts, bits of the corresponding channel of 'Disconnection detection flag' (Un\G38) are cleared. When the analog output of all the channels restarts, 'Disconnection detection signal' (XD) turns off.

■In the normal output mode or inter-module synchronization mode

To restart the analog output, check 'CH1 Digital value' (Un\G460) or 'CH1 Synchronization digital value' (Un\G9500) and turn on and off 'Error clear request' (YF). According to the status of 'CH1 Output enable/disable flag' (Y1), the analog output restarts.

■In the wave output mode

When a disconnection is detected, wave output stops. After turning on and off 'Error clear request' (YF), set 'CH1 Wave output start/stop request' (Un\G462) from Wave output stop request (0) to Wave output start request (1) again. According to the status of 'CH1 Output enable/disable flag' (Y1), the wave output restarts.

For details on the wave output function, refer to the following.

☞ Page 45 Wave Output Function

Precautions

Wave

When the wave output status switches to the during wave output stop under the following conditions, a disconnection may not be detected.

- 'CH1 D/A conversion enable/disable setting' (Un\G500) is set to D/A conversion enable (0).
- 'CH1 Output setting during wave output stop' (Un\G524) is set to 0V/0mA (0).
- 'CH1 Output enable/disable flag' (Y1) is on.

1.13 Interrupt Function

Normal

Wave

Synchronization

The D/A converter module executes the interrupt program of the CPU module when an interrupt factor such as a disconnection or warning output is detected.

For the D/A converter module, the maximum number of interrupt pointers available is 16 per module.

Operation

■Detecting an interrupt factor

An interrupt factor will be detected by setting "Interrupt setting" of Module Parameter and setting 'Interrupt factor mask [n]' (Un\G124 to Un\G139) to Mask clear (Interrupt used) (1) beforehand. When an interrupt factor occurs, an interrupt request is sent to the CPU module at the same time as 'Interrupt factor detection flag [n]' (Un\G4 to Un\G19) is turned to Interrupt factor (1).

■How to reset an interrupt factor

When Reset request (1) is set in 'Interrupt factor reset request [n]' (Un\G156 to Un\G171) corresponding to the interrupt factor, the specified interrupt factor is reset and the value of 'Interrupt factor detection flag [n]' (Un\G4 to Un\G19) changes to No interrupt factor (0).

Setting method

To use the interrupt function, set "Condition target setting", "Condition target channel setting", "Interrupt factor transaction setting", and "Interrupt pointer" with the engineering tool. After completing the settings, write the project to enable the settings.

 [Navigation window] ⇒ [Parameter] ⇒ [Module Information] ⇒ Module model name ⇒ [Interrupt setting]

Item	Description
Condition target setting	Select a factor of the target for the interrupt detection.
Condition target channel setting	Select a target channel when the condition target setting for the interrupt detection is channel specification.
Interrupt factor transaction setting	Set whether to send an interrupt request when the same interrupt factor occurs during the interrupt factor detection.
Interrupt pointer	Specify the number of an interrupt pointer that is started at the detection of an interrupt factor.

■Condition target setting

Select a factor of the condition target setting for the interrupt detection.

Setting value	Description
Disable	No interrupt is detected.
Error flag	A rise is detected at the timing of when 'Error flag' (XF) turns on.
Warning output flag	A rise is detected at the timing of when the corresponding bit of 'Warning output upper flag' (Un\G36) or 'Warning output lower flag' (Un\G37) turns on (A channel is specified).
Disconnection detection flag	A rise is detected at the timing of when the corresponding bit of 'Disconnection detection flag' (Un\G38) turns on (A channel is specified).
External power supply READY flag	A fall is detected at the timing of when 'External power supply READY flag' (X7) turns off.

If a value out of the setting range is set, a condition target setting range error (error code: 181△H) occurs.

■Condition target channel setting

Select a target channel when the condition target setting for the interrupt detection is channel specification.

■Interrupt factor transaction setting

Set whether to send an interrupt request when the same interrupt factor occurs during the interrupt factor detection.

- When "Interrupt reissue request" has been set and the same interrupt factor occurs while the interrupt factor has been detected, an interrupt request is sent to the CPU module again.
- When "No interrupt reissue request" has been set and the same interrupt factor occurs while the interrupt factor has been detected, an interrupt request is not sent to the CPU module.

■Interrupt pointer

Specify the number of an interrupt pointer that is started at the detection of an interrupt factor. For details on the interrupt pointers, refer to the following.

 MELSEC iQ-R CPU Module User's Manual (Application)

Precautions

- When 'Condition target setting [n]' (Un\G232 to Un\G247) is Disable (0), an interrupt request is not sent to the CPU module.
- When 'Interrupt factor mask [n]' (Un\G124 to Un\G139) is Mask (Interrupt unused) (0) and an interrupt factor occurs, an interrupt request is not sent to the CPU module. However, 'Interrupt factor detection flag [n]' (Un\G4 to Un\G19) changes to Interrupt factor (1).
- To reset the interrupt factor, set Reset request (1) until 'Interrupt factor detection flag [n]' (Un\G4 to Un\G19) changes to No interrupt factor (0).
- Resetting interrupt factors is executed only when 'Interrupt factor reset request [n]' (Un\G156 to Un\G171) changes from No reset request (0) to Reset request (1).
- Multiple interrupt pointers can share the same setting of 'Condition target setting [n]' (Un\G232 to Un\G247). When multiple interrupt pointers have shared the same setting of 'Condition target setting [n]' (Un\G232 to Un\G247) and interrupts occur, interrupt programs are executed in order of priority of the interrupt pointers. For the priority of the interrupt pointers, refer to the following.

 MELSEC iQ-R CPU Module User's Manual (Application)

- When All channels (0) is set for 'Condition target channel setting [n]' (Un\G264 to Un\G279) and an interrupt detection target is set for 'Condition target setting [n]' (Un\G232 to Un\G247) of each channel, the interrupt requests that have the same interrupt factor are sent to the CPU module if warnings are issued in multiple channels. In this case, the CPU module executes multiple interrupt programs and judges that the programs cannot be normally completed with the scan monitoring function, and a CPU error may occur. When a CPU error occurs, refer to the following.

 MELSEC iQ-R CPU Module User's Manual (Application)

Setting example

Ex.

When the interrupt program (I50) is executed at the disconnection detection in any channel

- Parameter settings

Set "Interrupt setting" of the module parameter as follows.

No.	Condition target setting	Condition target channel setting	Interrupt pointer
4	Disconnection detection flag	All CH specification	I50

- Label settings

Classification	Label name	Description	Device										
Module label	RCPU.stSM.bAlways_ON	Always ON	SM400										
	RCPU.stSM.bAfter_RUN1_Scan_ON	ON for one scan after RUN	SM402										
	R60DAH_1.unInterruptFactorMask_D[3].0	Interrupt factor mask [4]	U0\G127.0										
	R60DAH_1.unInterruptFactorResetRequest_D[3].0	Interrupt factor reset request [4]	U0\G159.0										
Label to be defined	<table border="1"> <thead> <tr> <th></th> <th>Label Name</th> <th>Data Type</th> <th>Class</th> <th>Assign (Device/Label)</th> </tr> </thead> <tbody> <tr> <td>1</td> <td>G_bDisconnectDetection</td> <td>Bit</td> <td>VAR_GLOBAL</td> <td>F0</td> </tr> </tbody> </table>				Label Name	Data Type	Class	Assign (Device/Label)	1	G_bDisconnectDetection	Bit	VAR_GLOBAL	F0
	Label Name	Data Type	Class	Assign (Device/Label)									
1	G_bDisconnectDetection	Bit	VAR_GLOBAL	F0									



(0) Enables only the interrupt pointer I50.

Interruption is enabled.

Clear 'Interrupt factor mask [4]' (U0\G127).

(83) If a disconnection is detected, the program of the interrupt pointer I50 is executed.

Turn on 'Interrupt factor reset request [4]' (U0\G159) and perform processing when a disconnection is detected.

1.14 Wave Output Function

Wave

This function registers the prepared wave data (digital value) on the D/A converter module and continuously outputs the data (analog value) in the set conversion cycle. A faster and smoother control than a program is achieved by the automatic output of the control wave data registered in the D/A converter module for the analog (torque) control such as pressing machines and injection molding units. The control can be executed only by registering the wave data to the D/A converter module. Therefore, the program-less control is available for the repeat control such as the line control, and man-hours for programming can be reduced.

In this section, the following items set in the wave output function are called wave output data.

- Wave data (👉 Page 47 Wave data)
- Parameters of the wave output function (👉 Page 56 Setting parameters of the wave output function)

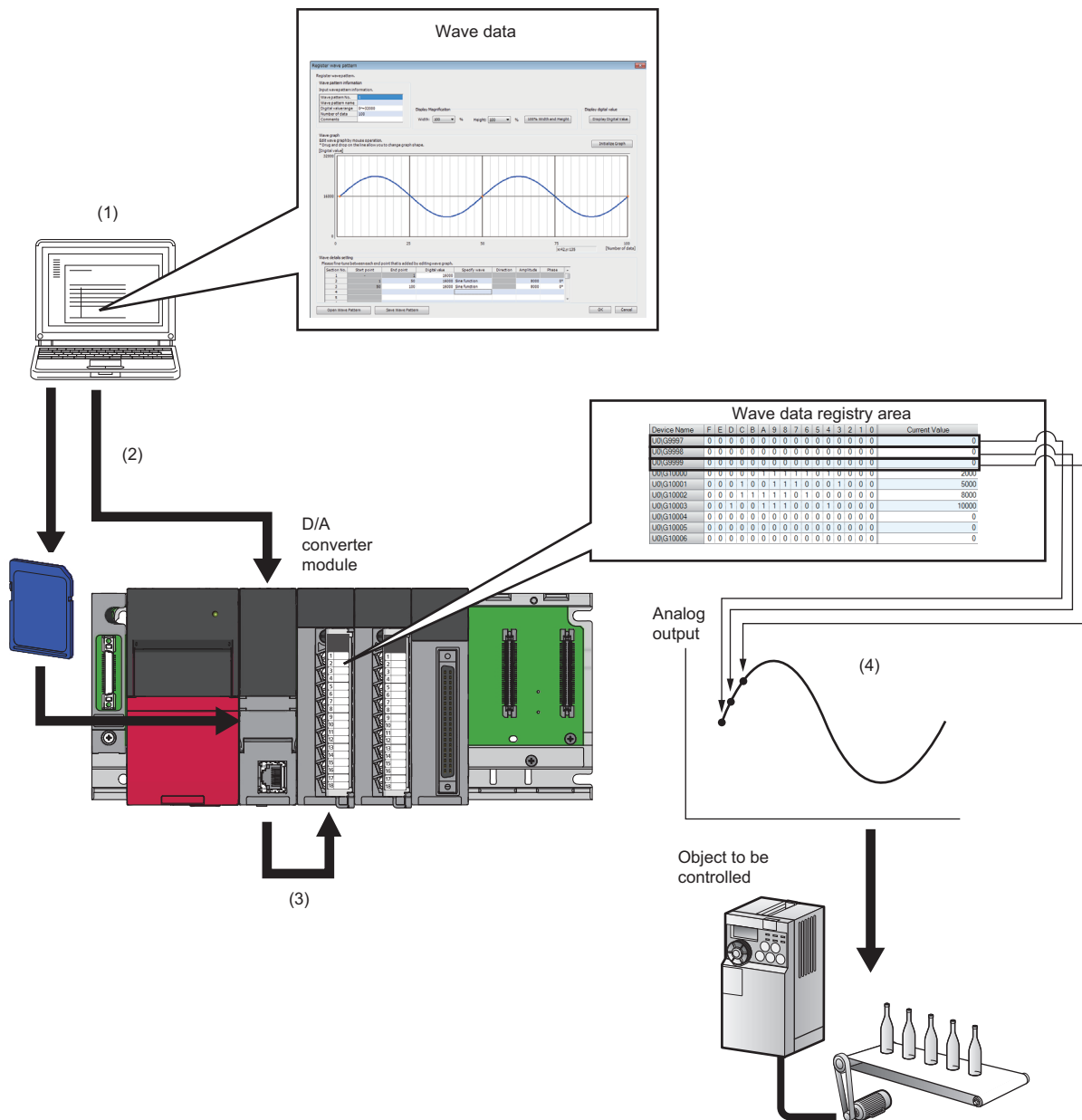

- (1) Wave data can be created from "Create Wave Output Data" of the engineering tool with easy mouse operation.
- (2) Wave data is stored to a CSV file or file register. CSV files are saved in an SD memory card.
- (3) Wave data is registered in the wave data registry area of D/A converter module with the function block (FB) for registering wave data.
- (4) The data is successively converted in the set conversion cycle and output in analog.

Wave output function procedure

The following shows how to use the wave output function.

1. Creating wave data

☞ Page 52 Creating wave data

2. Setting parameters of the wave output function

☞ Page 56 Setting parameters of the wave output function

3. Writing wave output data to a file register (ZR) or CSV file

☞ Page 57 Writing data to a file register (ZR) or CSV file

4. Setting parameters of D/A converter module

☞ Page 58 D/A conversion enable/disable setting

5. Registering wave output data

☞ Page 58 Registering wave output data

6. Starting/stopping/pausing wave output

☞ Page 60 Starting/stopping/pausing wave output

Wave output data can be created easily by using "Create Wave Output Data" of the engineering tool. This data can be saved in the CSV file or file register (ZR) of the CPU module.

For details on the function block (FB) for registering wave output data and executing wave output, refer to the following.

📖 MELSEC iQ-R Analog-Digital Converter Module/Digital-Analog Converter Module Function Block Reference

■ Feature of the file register (ZR) and CSV file to which wave data is saved

- When saving data to the file register (ZR), wave output data is held in the CPU module even after powering off or resetting the CPU module.
- When saving data to the CSV file, wave output data can easily be reused for the D/A converter module of other programmable controller systems by simply copying the CSV file.

Parameter settings for the wave output function

Set the parameters of the wave output function to the following buffer memory areas to use the wave output function.

Setting item	Details of buffer memory areas
Output setting during wave output stop	Page 178 CH1 Output setting during wave output stop
Output value during wave output stop	Page 179 CH1 Output value during wave output stop
Wave pattern start address setting	Page 180 CH1 Wave pattern start address setting
Wave pattern data points setting	Page 181 CH1 Wave pattern data points setting
Wave pattern output repetition setting	Page 181 CH1 Wave pattern output repetition setting
Constant for wave output conversion cycle	Page 182 CH1 Constant for wave output conversion cycle
Wave data registry area	Page 191 Wave data registry area

For details on the parameter settings for the wave output function, refer to the following.

☞ Page 56 Setting parameters of the wave output function

Restrictions and precautions

The wave output function has the following restrictions and precautions.

■Output range setting

The user range cannot be used. When executing the wave output function, use the range other than the user range.

For the setting method of the output range, refer to the following.

☞ Page 20 Range Switching Function

■Scaling function

The scaling function cannot be used in the wave output mode. When executing the wave output function, make sure to disable the scaling function.

■Shift function

The shift function cannot be used in the wave output mode. When executing the wave output function, make sure to set 'CH1 Input value shift amount' (Un\G480) to 0.

■Rate control function

The rate control function cannot be used in the wave output mode. When executing the wave output function, make sure to disable the rate control function.

■Analog output HOLD/CLEAR function

The operation of the analog output HOLD/CLEAR function differs from the operation in the normal output mode.

For details, refer to the following.

☞ Page 23 Analog Output HOLD/CLEAR Function

■Remote head module

When the D/A converter module is used with the remote head module, function block (FB) for registering wave output data cannot be used. To execute the wave output function, refer to the following.

☞ Page 64 How to register data when a remote head module is used

Wave data

The wave data indicate the time-series arrangement of the digital values to be output in analog. Up to 90000 points can be used. The wave data are registered in Wave data registry area (Un\G10000 to Un\G99999).

Wave pattern

To use the wave output function, select any points from the registered wave data for each channel and set the wave pattern. The following table lists the setting contents for the wave pattern.

Setting item	Description
Wave pattern start address setting	Set the start address of the wave pattern to be output for each channel. The D/A conversion starts from the digital value of the buffer memory address set in this area and the converted analog values are output sequentially.
Wave pattern data points setting	This area is for setting the points of the wave pattern to be output for each channel. From the start address of the wave pattern, the D/A conversion starts for the points of wave data set in this area and the converted analog values are output.

If the address value (total of the set values for Wave pattern start address setting and Wave pattern data points setting - 1) exceeds the last address (Un\G99999) of the wave data registry area, a wave data registry area setting range error (error code: 1D9□H) occurs.

Ex.

Setting example to output separate waves from CH1 and CH2

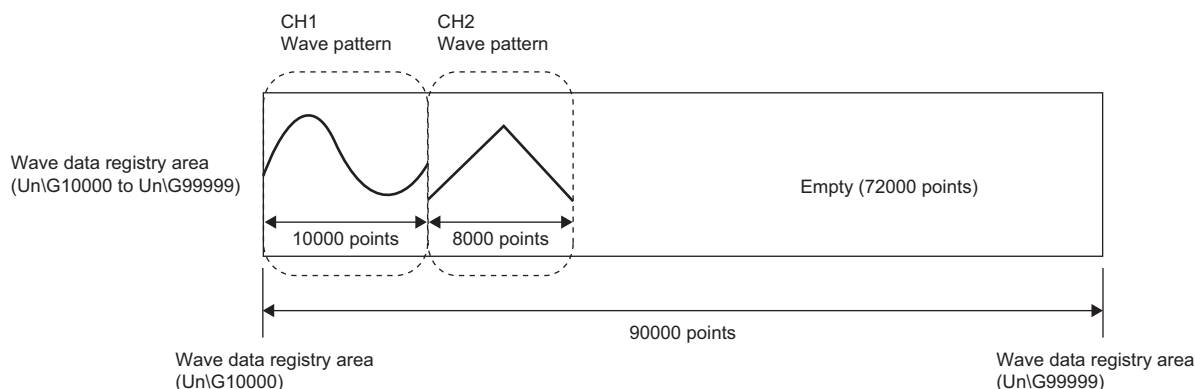

Setting item	Setting value
CH1 Wave pattern start address setting	10000
CH1 Wave pattern data points setting	10000
CH2 Wave pattern start address setting	20000
CH2 Wave pattern data points setting	8000

Ex.

Setting example to output the same waves from CH1 and CH2

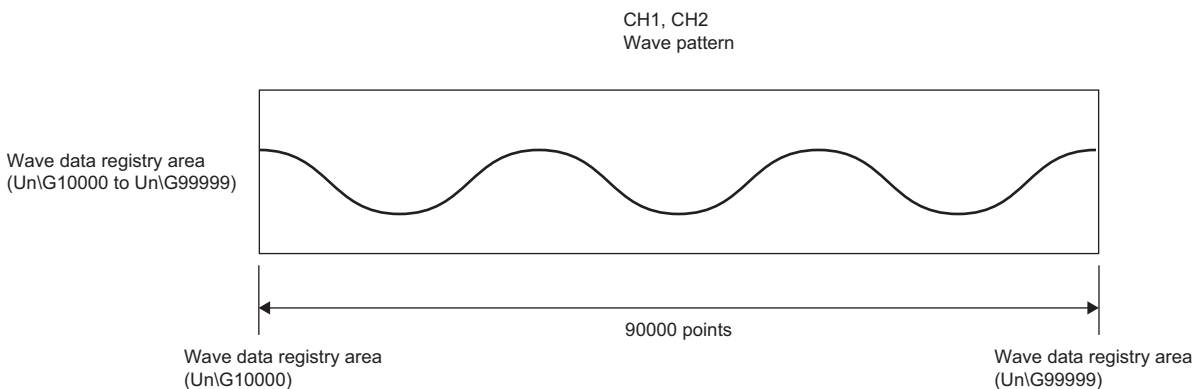

Setting item	Setting value
CH1 Wave pattern start address setting	10000
CH1 Wave pattern data points setting	90000
CH2 Wave pattern start address setting	10000
CH2 Wave pattern data points setting	90000

Wave pattern output count

The wave pattern can be output repeatedly according to the setting of 'CH1 Wave pattern output repetition setting' (Un\G530). Set the output count within 1 to 32767. The wave pattern also can be output in analog repeatedly and unlimitedly by setting 'CH1 Wave pattern output repetition setting' (Un\G530) to -1.

Ex.

When the wave pattern output count is set to three

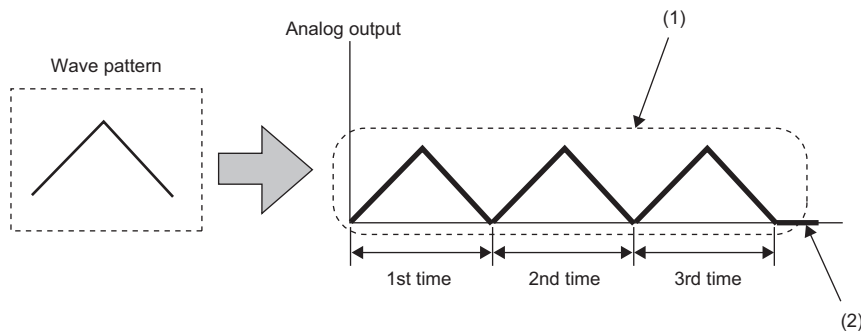

(1) The wave pattern is output repeatedly three times.

(2) After the wave pattern is output three times, the wave output stops and the data set in 'CH1 Output setting during wave output stop (Un\G524)' is output in analog.

The following section describes "repeat control" in which the same wave pattern is output repeatedly from the D/A converter module.

■When the digital values are same for the start point and the end point

An end point of a wave pattern overlaps with the start point of the wave pattern of the next iteration in the D/A converter module's processing; therefore, the end point is not output in analog. The analog output of the wave pattern end point varies as follows depending on the setting of 'CH1 Wave pattern output repetition setting' (Un\G530).

• Limited repetition:

When a value of 2 to 32767 is set to 'CH1 Wave pattern output repetition setting' (Un\G530), the digital value of the end point is not output in analog till the wave pattern of the final iteration output. After the digital value of the end point is output in analog at the wave pattern of the final iteration output, the value is output in analog according to the setting in 'CH1 Output setting during wave output stop' (Un\G524).

• Unlimited repetition:

The digital value of the wave pattern end point is not output in analog.

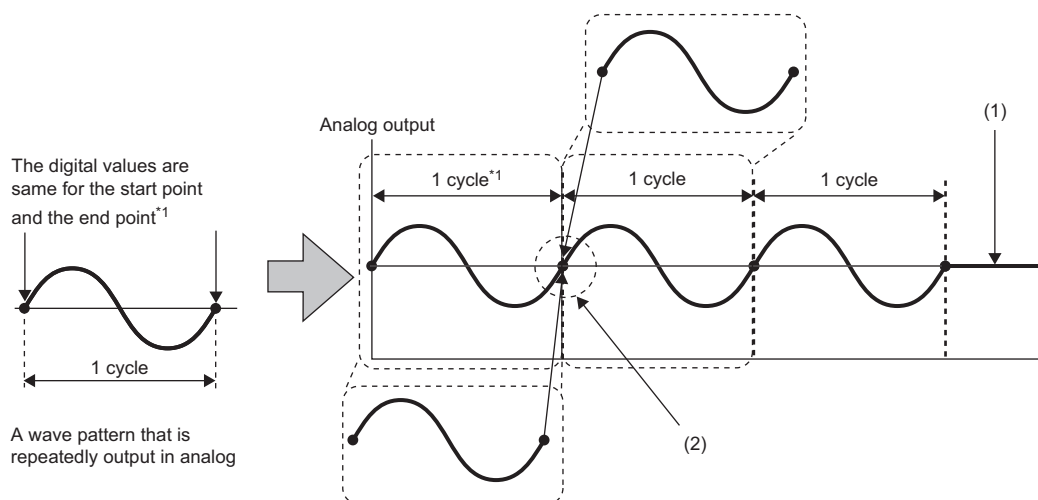

(1) In the limited repetition, after the value is output for the count set in the wave pattern output repetition setting, the analog value set in the output setting during wave output stop is output.

(2) The value at the start point of the next repetitive wave always comes after the value at the end point of the previous wave. Preventing the output of the value at the end point allows the wave to be connected seamlessly.

*1 The output cycle of a wave pattern is calculated by the following calculation formula.
 Output cycle of a wave pattern = (Wave output conversion cycle) × (Wave pattern data points - 1)
 For details on the wave output conversion cycle, refer to the following.
 ☞ Page 51 Wave output conversion cycle

Ex.

Calculating the output cycle of a wave pattern

Setting item	Setting value
CH1 D/A conversion enable/disable setting	D/A conversion enable (0)
CH1 Wave pattern data points setting	101
CH1 Wave pattern output repetition setting	3
CH1 Constant for wave output conversion cycle	1

With the above setting, the output cycle of a wave pattern becomes as follows. (When D/A conversion is enabled for CH1 only)

$$\begin{aligned}
 \text{Output cycle of a wave pattern } (\mu\text{s}) &= \text{Conversion speed} \times \text{Number of channels where D/A conversion is enabled} \times \text{Constant for wave output conversion cycle} \times (\text{Wave pattern data points} - 1) \\
 &= 20 \times 1 \times 1 \times 100 \\
 &= \underline{2000}
 \end{aligned}$$

■When the digital values are different between the start point and the end point

The wave pattern end point is output in analog as it is. The set wave patterns are continuously output in analog regardless of the setting in 'CH1 Wave pattern output repetition setting' (Un\G530).

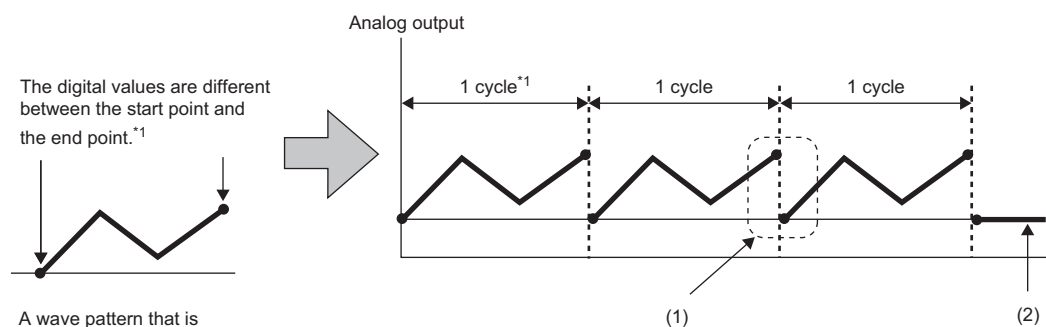

A wave pattern that is repeatedly output in analog

- (1) The digital value at the end point and the digital value at the start point of the next are continuously output in analog.
- (2) In the limited repetition, after the value is output for the count set in the wave pattern output repetition setting, the analog value set in the output setting during wave output stop is output.

*1 The output cycle of a wave pattern is calculated by the following calculation formula.
 Output cycle of a wave pattern = (Wave output conversion cycle) × (Wave pattern data points)
 For details on the wave output conversion cycle, refer to the following.
 ☞ Page 51 Wave output conversion cycle

Ex.

Calculating the output cycle of a wave pattern

Setting item	Setting value
CH1 D/A conversion enable/disable setting	D/A conversion enable (0)
CH1 Wave pattern data points setting	101
CH1 Wave pattern output repetition setting	3
CH1 Constant for wave output conversion cycle	1

With the above setting, the output cycle of a wave pattern becomes as follows. (When D/A conversion is enabled for CH1 only)

$$\begin{aligned}
 \text{Output cycle of a wave pattern } (\mu\text{s}) &= \text{Conversion speed} \times \text{Number of channels where D/A conversion is enabled} \times \text{Constant for wave output conversion cycle} \times \text{Wave pattern data points} \\
 &= 20 \times 1 \times 1 \times 101 \\
 &= \underline{2020}
 \end{aligned}$$

Wave output conversion cycle

The wave output conversion cycle is calculated by the following formula.

- Conversion cycle (μs) = Conversion speed ($20\mu\text{s}$) \times Number of D/A conversion enabled channels \times "Constant for wave output conversion cycle"

In the wave output function, the conversion cycle can be set by setting 'CH1 Constant for wave output conversion cycle' (Un\G531). The conversion cycle of the current output wave can be checked in 'CH1 Wave output conversion cycle monitor' (Un\G432, Un\G433).

Ex.

The conversion cycle and operation timing

Setting item	Setting value
D/A conversion enable/disable setting	D/A conversion enable (0) for CH1 to CH4
CH1 Constant for wave output conversion cycle	1
CH2 Constant for wave output conversion cycle	2
CH3 Constant for wave output conversion cycle	3
CH4 Constant for wave output conversion cycle	4

The following figure shows the conversion cycle of each channel with the above settings.

- CH1: $80\mu\text{s}$
- CH2: $160\mu\text{s}$
- CH3: $240\mu\text{s}$
- CH4: $320\mu\text{s}$

D/A conversion is performed with this conversion cycle, and an analog value is output.

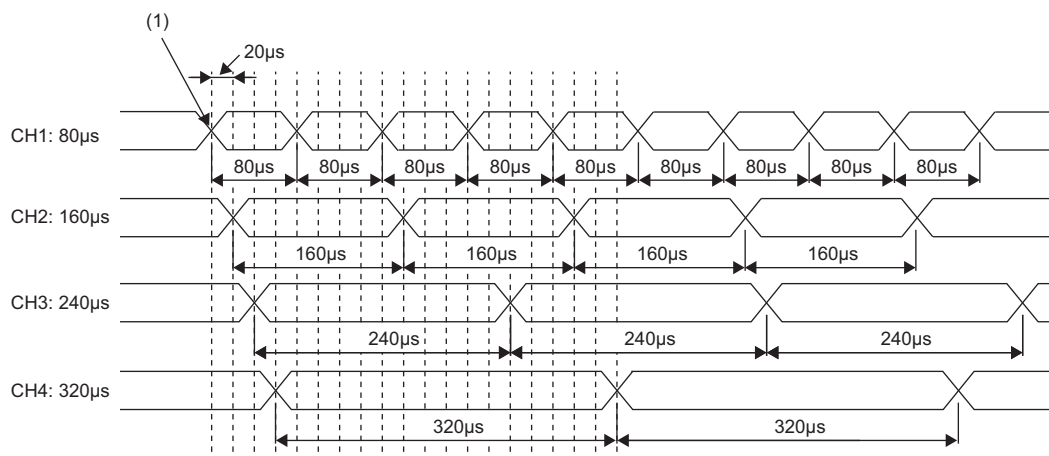

(1) Wave output start

Initial settings of the wave output function

For the wave output function, set the following items as the initial setting. Before using the wave output function, complete the procedures described in this section.

- Creating wave data ([Page 52 Creating wave data](#))
- Setting parameters of the wave output function ([Page 56 Setting parameters of the wave output function](#))
- Writing wave output data to a file register (ZR) or CSV file ([Page 57 Writing data to a file register \(ZR\) or CSV file](#))
- Setting parameters of D/A converter module ([Page 58 D/A conversion enable/disable setting](#))

Creating wave data

Create the wave data in "Create Wave Output Data" window of the engineering tool.

1. Start "Create Wave Output Data".

[Tool] ⇒ [Module Tool List] ⇒ [Analog Output] ⇒ [Create wave output data]

2. Select "R60DAH4" in "Module Type".

Restriction

If the type other than "R60DAH4" is selected, proper wave data cannot be created because a corresponding channel or a range of digital values differs.

In addition, the wave pattern and the wave output data are completely deleted by changing "Module Type". Therefore, set the correct value in "Module Type" and follow the step 3 and later.

3. Select the graph displayed in "Register wave pattern" and press the [Enter] key on the keyboard. The "Register wave pattern" window is displayed.

4. Set "Wave pattern information".

Item	Description	Setting range
Wave pattern No.	The wave pattern number selected in the "Create Wave Output Data" window is displayed. Up to 10 wave patterns can be created.	—
Wave pattern name	Set the name of the wave pattern.	16 characters
Digital value range	Select the setting range of the digital value according to the output range to be used.	<ul style="list-style-type: none"> • 0 to 32000 (default value) • -32000 to 32000
Number of data	Set the number of the digital values of the wave pattern.	1 to 90000 (default value: 100)
Comments	Set the comment of the wave pattern.	64 characters

5. Click any position on the wave graph to create an end point. The created end point is displayed with ■ .

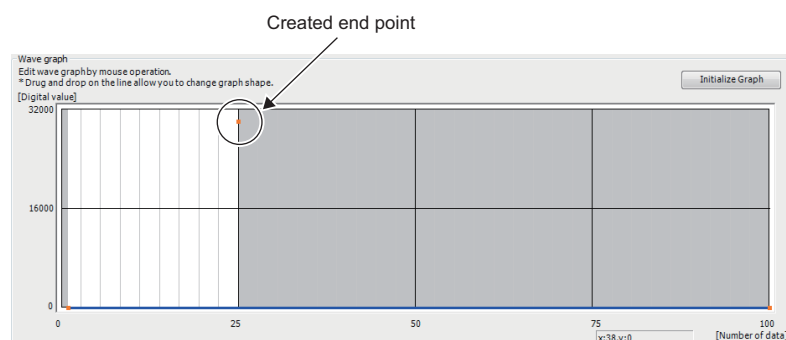

Restriction

The end point that can be created is up to 360. No points can be added if there are 360 points.

To delete the end point, move the mouse pointer to the point. Then select "Delete end point" from the right-click menu. When the mouse pointer is on the end point, the display of the mouse pointer is changed to \oplus .

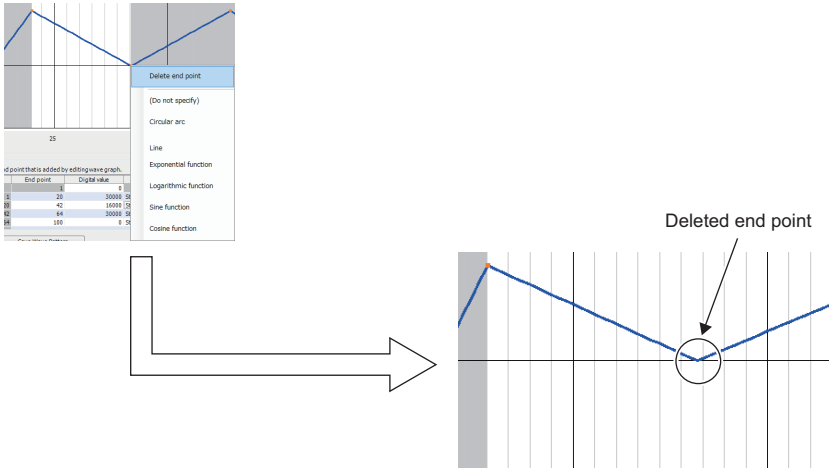

6. Set the wave between end points from the right-click menu or in "Specify wave" of "Wave details setting".

Item	Setting result												
Circular arc	<p>The interval of the start point and end point is drawn in a circular arc. When the circular arc is selected, the arc direction can be set in "Direction"; it can be inverted. The circular arc is drawn in the procedure below.</p> <p>Set "Direction".</p> <table border="1"> <thead> <tr> <th>Specify wave</th> <th>Direction</th> <th>Amplitude</th> </tr> </thead> <tbody> <tr> <td>Circular arc</td> <td>Upward</td> <td></td> </tr> <tr> <td>(Do not specify)</td> <td>Upward</td> <td></td> </tr> <tr> <td></td> <td>Downward</td> <td></td> </tr> </tbody> </table>	Specify wave	Direction	Amplitude	Circular arc	Upward		(Do not specify)	Upward			Downward	
Specify wave	Direction	Amplitude											
Circular arc	Upward												
(Do not specify)	Upward												
	Downward												
Straight line	<p>The interval of the start point and end point is drawn in a straight line.</p>												
Exponential function	<p>The graph is drawn with an adjustment so that the start point and end point are on the edge points of the exponential function of $y = e^x$ ($x = 0$ to 10).</p>												

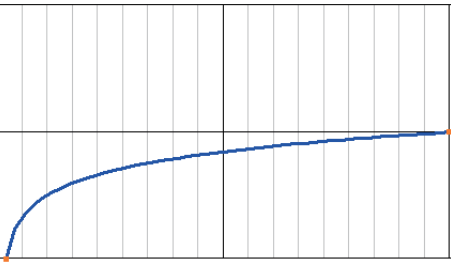
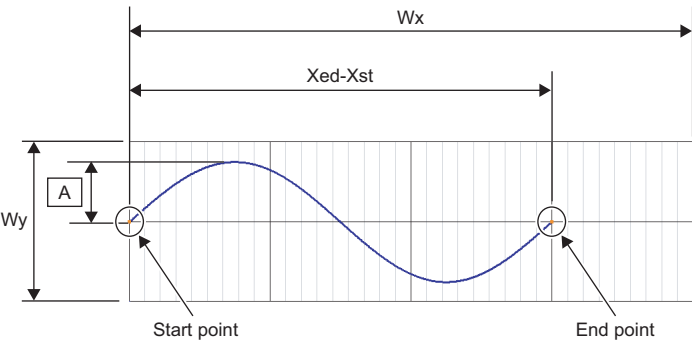
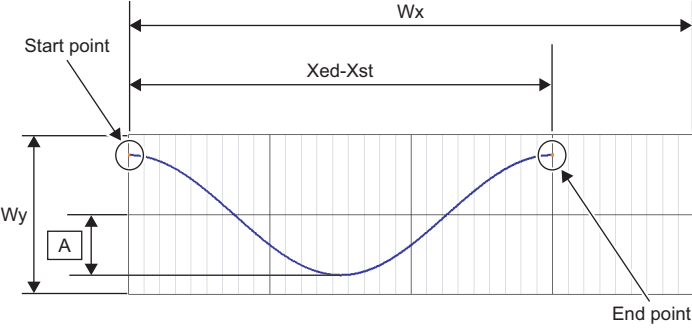
Item	Setting result
Logarithmic function	<p>The graph is drawn with an adjustment so that the start point and end point are on the edge points of the logarithmic function of $y = \log_e X$ ($x = 1$ to 101).</p> 
Sine function ^{*1}	<p>The interval between the start point and end point is drawn in a sine function wave. The amplitude A of the sine function to be drawn is the value set in "Amplitude". The start position can be changed by 180°; by setting "Phase".</p>  <p>Wx: Number of wave pattern data Wy: Digital value range Xst: Number of data at the start point Xed: Number of data at the end point</p>
Cosine function ^{*1}	<p>The interval between the start point and end point is drawn in a cosine function wave. The amplitude A of the cosine function to be drawn is the value set in "Amplitude". The start position can be changed by 180°; by setting "Phase".</p>  <p>Wx: Number of wave pattern data Wy: Digital value range Xst: Number of data at the start point Xed: Number of data at the end point</p>

*1 When setting the sine function and cosine function, set the same digital value for the start point and end point.

7. Drag the created end point to adjust the position.

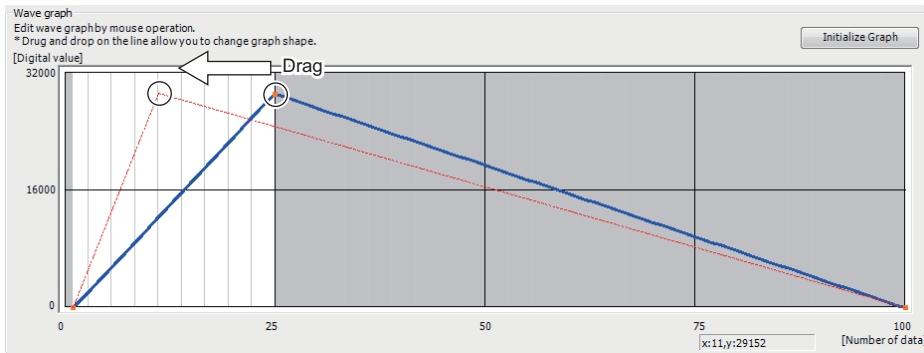

The end point position also can be adjusted by changing the value of "End point" and "Digital value" in "Wave details setting".

Item	Description
Start point	The end point of the previous interval is displayed. To change the start point, change the end point of the previous interval.
End point	Set the number of data (position) for the destination end point. Note that the section No.1 cannot be changed because it is the first point of the wave pattern.
Digital value	Set the digital value for the destination end point.

8. Repeat steps 5 to 7 to create the wave to be output.

Each digital value of the created wave pattern can be checked by clicking the [Display Digital Value] button. Click the [Initialize Graph] button to clear the created wave pattern contents. The graph and the contents of "Wave details setting" are cleared.

9. Click the [Save Wave Pattern] button.

The saved wave pattern can be opened by clicking the [Open Wave Pattern] button.

10. Set the save destination and the file name, then click the [Save] button.

11. Click the [OK] button in the "Register wave pattern" window to register the created wave pattern.

12. Repeat steps 3 to 11 to create other wave patterns.

Setting parameters of the wave output function

Set the parameters of the wave output function in the "Create Wave Output Data" window of the engineering tool. Before the parameter setting, create the wave data.

1. Start "Create Wave Output Data".

 [Tool] ⇒ [Module Tool List] ⇒ [Analog Output] ⇒ [Create wave output data]

2. Select "R60DAH4" in "Module Type".

3. Set the parameters of the wave output function in "Wave output data setting".

Item	Description	Setting range
Wave pattern No.	Up to three patterns can be specified at a time from registered wave patterns. When specifying multiple wave patterns, set the pattern No. as follows. <ul style="list-style-type: none"> • When No.1 and No.2 are used: 1, 2 • When No.1, No.5, and No.10 are used: 1, 5, 10 • When No.1 to No.3 are used: 1 to 3 	1 to 10
Output setting during wave output stop	Set the analog output during the wave output stop.	<ul style="list-style-type: none"> • 0: 0V/0mA • 1: Offset value (default value) • 2: Setting value during stop
Output value during wave output stop	Set the value to be output while the wave output is stopped. This setting is enabled only when "Output setting during wave output stop" is set to "2: Setting value during stop". Set the value within the output range to be used.	<ul style="list-style-type: none"> • 4 to 20mA, 0 to 20mA, 1 to 5V, 0 to 5V: 0 to 32767 (practical range: 0 to 32000) • -10 to 10V: -32768 to 32767 (practical range: -32000 to 32000)
Wave pattern start address setting	Set the start address of the wave pattern to be output in analog.	10000 to 99999 (default value: 10000)
Wave pattern data points setting	This setting is not required because the data points of the wave pattern to be used are stored automatically.	—
Wave pattern output repetition setting	This area is for setting the repeat count to output the wave pattern repeatedly.	<ul style="list-style-type: none"> • -1 (unlimited repeat output) • 1 to 32767 (default value: 1)
Constant for wave output conversion cycle	Set a constant to determine the conversion cycle (multiply the conversion speed). The conversion cycle of the wave output is determined from the combination of the conversion speed, number of channels where D/A conversion is enabled, and this setting. For the calculation method of the wave output conversion cycle, refer to the following.  Page 51 Wave output conversion cycle	1 to 5000 (default value: 1)

4. Click the [Save Wave Output Data to File] button.

The created wave pattern and the parameter setting of the wave output function are saved.

The saved wave pattern and parameter setting of the wave output function can be opened by clicking the [Open Wave Output Data from File] button.

Note that if the data created for the module type other than "R60DAH4" is opened, the module type cannot be changed by setting "R60DAH4" to "Module Type".

5. Set the save destination and the file name, then click the [Save] button.

Writing data to a file register (ZR) or CSV file

Write wave output data created in "Create Wave Output Data" to a file register (ZR) or CSV file.

Restriction

- Data unnecessary for control such as "Wave pattern name", "Comments", and "Wave details setting" is not written to the file register (ZR) or the CSV file. Saving the wave data and the parameter setting of the wave output function using the [Save Wave Output Data to File] button before writing them is recommended.
- When the setting of "Create Wave Output Data" is written in the project of the remote head module, the data cannot be written into the file register (ZR). Allow data to be written into the CSV file.

■ Writing data to a file register (ZR)

When writing the data to the file register (ZR), set the capacity of the file register (ZR) for the number of required data points. For the setting procedure, refer to the following.

 MELSEC iQ-R CPU Module User's Manual (Application)

1. Click the [Write to Device Memory] button of the "Create Wave Output Data" window.
2. Set "Device memory name" and "Start device". Then click the [OK] button.

Item	Description
Device memory name	Set the device memory to be written to the file register (ZR). Select the device memory to be written from the drop-down menu or enter the device memory name to be created.
Start device	Set the start address for the output of the device memory.
Target device to write to	The file register (ZR) range to write to is displayed.

3. Click the [Close] button in the "Create Wave Output Data" window to close the window.
4. Write the device memory to the CPU module from "Write to PLC".

 [Online] ⇒ [Write to PLC]

■ Writing data to a CSV file

When writing data to a CSV file, store the CSV file to an SD memory card.

1. Click the [Write Data for Memory Card] button of the "Create Wave Output Data" window.
2. Set the save destination and the file name, then click the [Save] button.
3. Click the [Close] button in the "Create Wave Output Data" window to close the window.
4. Store the CSV file to an SD memory card. Then install the SD memory card to the CPU module.

Point

Some oscilloscopes or pulse generators can output the input wave or output wave to the CSV file. To output the wave with the wave output function by using the CSV file data, convert the data format into the one described in the following manual. In addition, convert the fractional value into the integer because the fractional value is unavailable in the wave output function.

 MELSEC iQ-R Analog-Digital Converter Module/Digital-Analog Converter Module Function Block Reference

Execution of the wave output function

This section describes the execution procedures for the wave output function. Execute the contents in this section after the initial setting of the wave output function.

Registering wave output data

Register the wave output data created in "Create Wave Output Data" of the engineering tool in the D/A converter module. Use the function block (FB) for the wave output data registration. For how to use the function block (FB) for the wave output data registration, refer to the following.

 MELSEC iQ-R Analog-Digital Converter Module/Digital-Analog Converter Module Function Block Reference

■When a remote head module is used

Function block (FB) cannot be used for a D/A converter module mounted with a remote head module. For how to transfer the wave data and parameter settings for the wave output function, which is created from "Create Wave Output Data" of the engineering tool, to the D/A converter module, refer to the following.

 Page 64 How to register data when a remote head module is used

D/A conversion enable/disable setting

Change 'CH1 D/A conversion enable/disable setting' (Un\G500) using a program.

Make sure to register the wave data setting and parameter setting for the wave output function first, and then change D/A conversion enable/disable setting.

Precautions

D/A conversion enable/disable setting can also be executed using the module parameter.

1. Set "D/A conversion enable/disable setting" to "D/A conversion enable".

 [Navigation window] ⇒ [Parameter] ⇒ [Module Information] ⇒ Module model name ⇒ [Basic setting] ⇒ [D/A conversion enable/disable function]

When the setting is configured by the above procedure, a wave pattern data points setting range error (error code: 1D5□H) occurs if the setting is activated by resetting the CPU module or by turning off and on the power. This error occurs because the wave pattern data points setting is set to 0 (default value) for the channel where D/A conversion is enabled.

To clear this error, register wave output data first, and then turn on and off 'Operating condition setting request' (Y9).

Changing the module setting

The contents registered by the function block (FB) for the wave output data registration need to be enabled by turning on and off 'Operating condition setting request' (Y9). When the setting is enabled, the analog output value of the CH1 where the D/A conversion is enabled varies depending on the 'CH1 Output enable/disable flag' (Y1) status as shown below.

- 'CH1 Output enable/disable flag' (Y1) is off: The offset value is output.
- 'CH1 Output enable/disable flag' (Y1) is on: A value is output according to the setting of 'CH1 Output setting during wave output stop' (Un\G524).

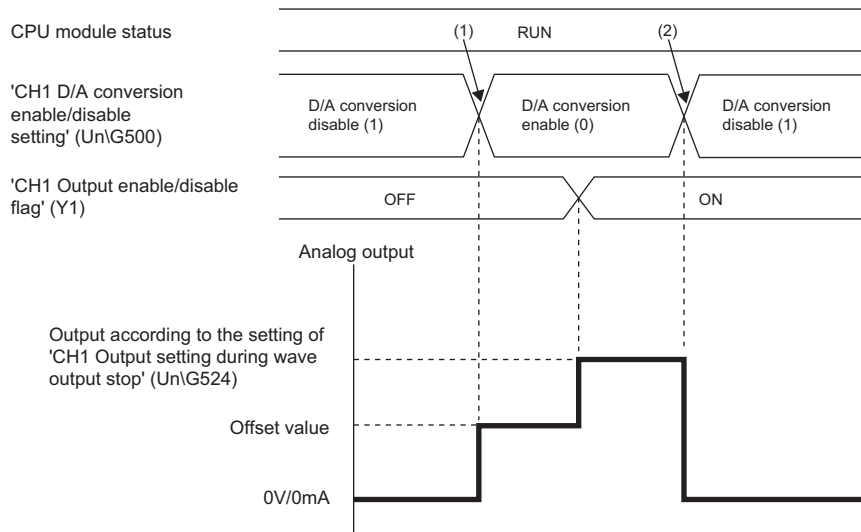

- (1) Set 'CH1 D/A conversion enable/disable setting' (Un\G500) to D/A conversion enable (0), and then turn on and off 'Operating condition setting request' (Y9).
 (2) Set 'CH1 D/A conversion enable/disable setting' (Un\G500) to D/A conversion disable (1), and then turn on and off 'Operating condition setting request' (Y9).

Restriction

With the wave output function being used, only when the wave output is stopped in all the channels (During wave output stop (0) is set to CH□ Wave output status monitor in all the channels), the parameter setting can be enabled by turning on and off 'Operating condition setting request' (Y9).

When 'Operating condition setting request' (Y9) is turned on and off with a channel being set to a value other than During wave output stop, an operating condition setting request error in a state other than wave output stop (alarm code: 0B0□H) occurs. The parameter setting cannot be enabled in this case.

Starting/stopping/pausing wave output

Starting the wave output

The wave output can be started by the following procedures after the wave data registration.

1. Turn on 'CH1 Output enable/disable flag' (Y1).

The value is output in analog according to the setting in 'CH1 Output setting during wave output stop' (Un\G524).

2. Set 'CH1 Wave output start/stop request' (Un\G462) to Wave output start request (1).

When Wave output stop request (0) or Wave output pause request (2) is changed to Wave output start request (1), the wave output is started.

Stopping the wave output

To stop the wave output at a desired timing during the wave output, set 'CH1 Wave output start/stop request' (Un\G462) to Wave output stop request (0). When Wave output start request (1) or Wave output pause request (2) is changed to Wave output stop request (0), the wave output is completely stopped. When the wave output is stopped, During wave output stop (0) is stored in 'CH1 Wave output status monitor' (Un\G401). The wave output cannot be restarted at the stop point.

When the wave pattern outputs for the count set in 'CH1 Wave pattern output repetition setting' (Un\G530) are finished, the wave output is also stopped.

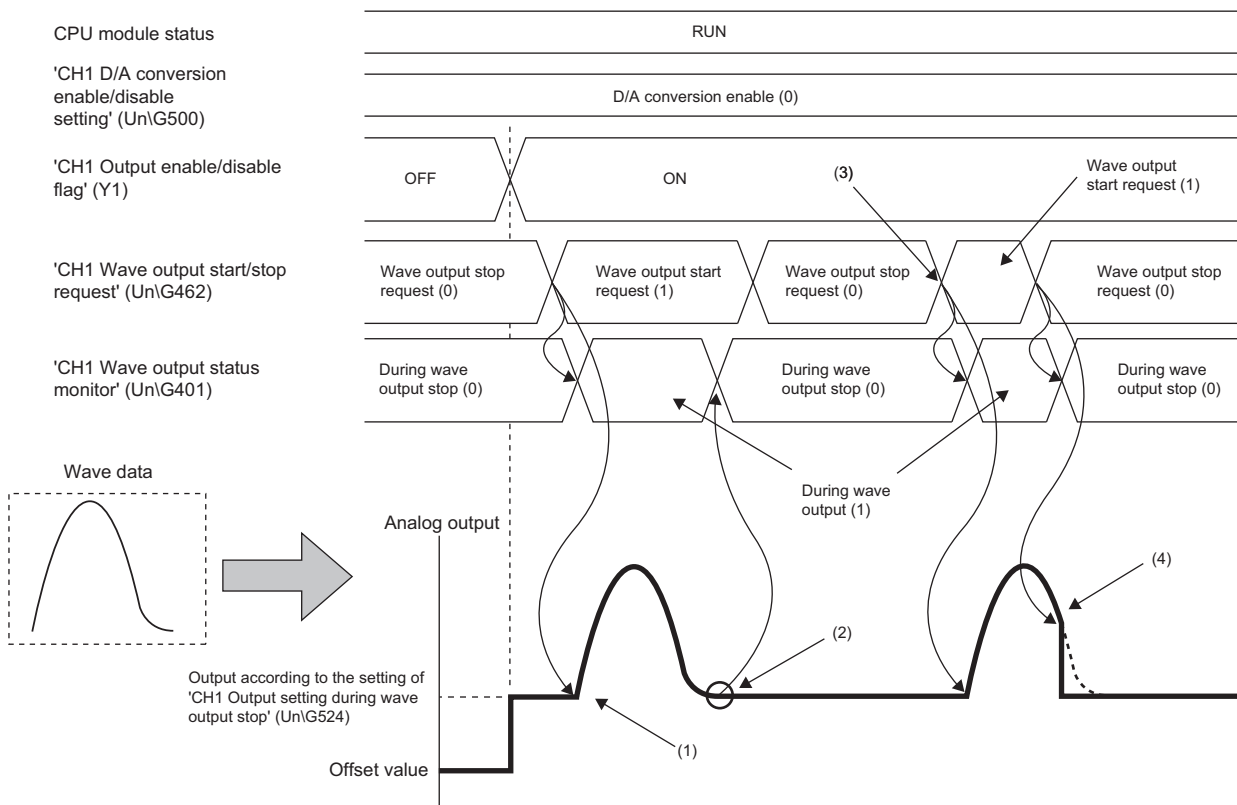

(1) Setting 'CH1 Wave output start/stop request' (Un\G462) to Wave output start request (1) starts the wave output.

(2) The wave output ends.

(3) To execute the wave output again, change 'CH1 Wave output start/stop request' (Un\G462) to Wave output stop request (0), and then change it to Wave output start request (1).

(4) During the wave output, setting 'CH1 Wave output start/stop request' (Un\G462) to Wave output stop request (0) stops the wave output.

■ Pausing the wave output

- To stop the wave output temporarily, set 'CH1 Wave output start/stop request' (Un\G462) to Wave output pause request (2). When Wave output start request (1) is changed to Wave output pause request (2), the wave output is paused. Wave output pause (2) is stored in 'CH1 Wave output status monitor' (Un\G401).
- To restart the wave output, change the value in 'CH1 Wave output start/stop request' (Un\G462) from Wave output pause request (2) to Wave output start request (1). The wave output is restarted from the paused point.
- When 'CH1 Wave output start/stop request' (Un\G462) is set to Wave output pause request (2) during the wave output stop, the digital value of the wave pattern start address is converted into an analog value and the analog value is output.

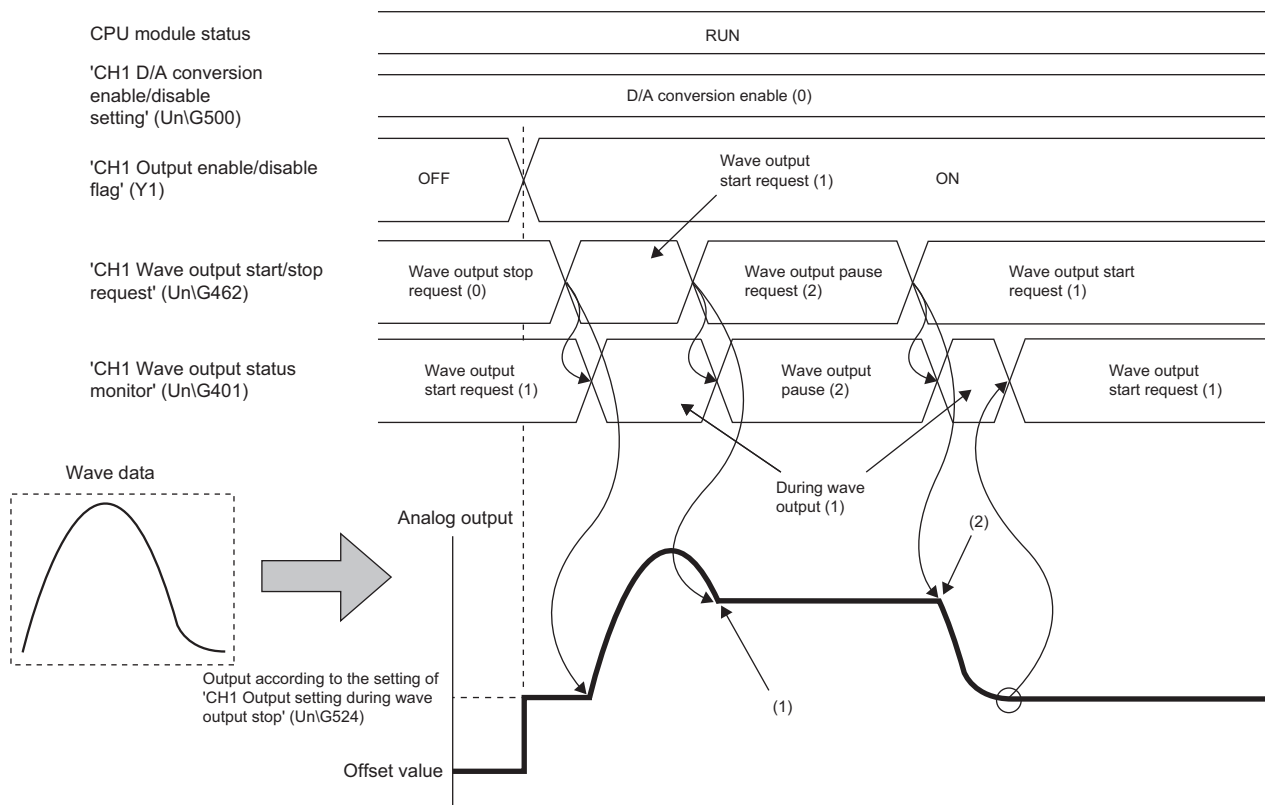

(1) During the wave output, setting 'CH1 Wave output start/stop request' (Un\G462) to Wave output pause request (2) pauses the wave output.

(2) During the wave output pause, setting 'CH1 Wave output start/stop request' (Un\G462) to Wave output start request (1) restarts the wave output.

The analog output value while the wave output is paused differs depending on the setting of the analog output HOLD/CLEAR function. For details, refer to the following.

☞ Page 23 Analog Output HOLD/CLEAR Function

- For HOLD setting

While the wave output is paused, analog output value during the pause is held.

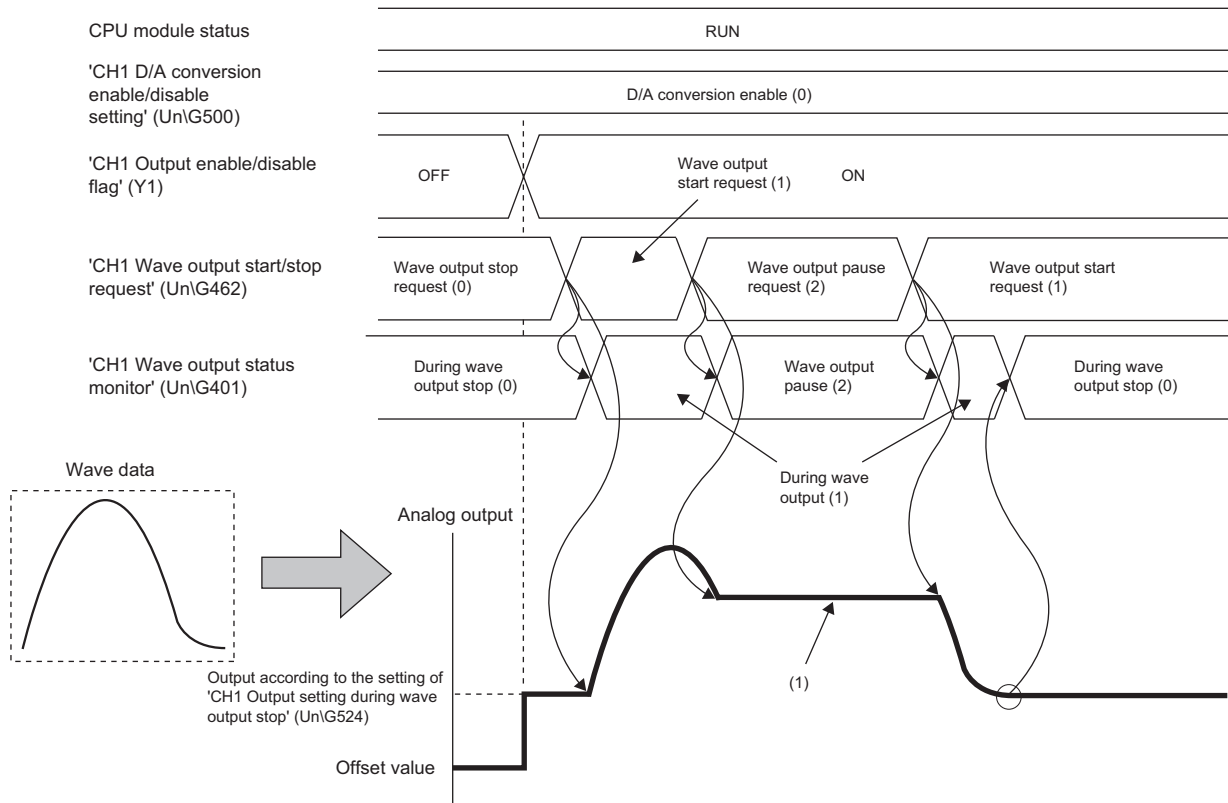

(1) When HOLD is set, analog output value is held.

- For CLEAR setting

While the wave output is paused, the offset value is output.

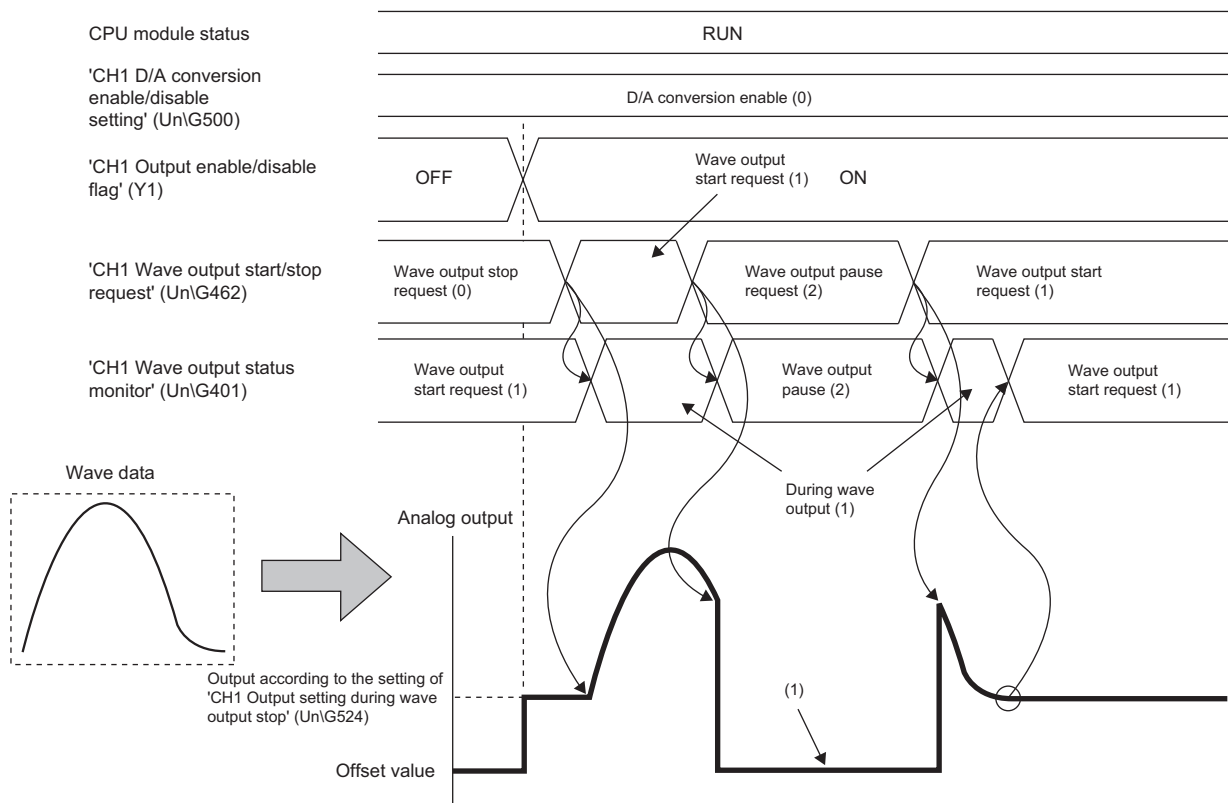

(1) When CLEAR is set, the offset value is output.

Point 

- Wave output start request is accepted only when the CPU module is in the RUN state. When a value in 'CH1 Wave output start/stop request' (Un\G462) is changed to Wave output start request (1) with a CPU module state other than the RUN state, the wave output is not started.
- Wave output stop request is accepted when the CPU module is in the RUN or STOP state.
- Wave output pause request is accepted only when the CPU module is in the RUN state.
- When a value out of the digital setting range, not the one set in the output range, is tried to be output, a digital value setting range error (error code: 191□H) occurs.

Checking the progress for the wave output function

The progress for the wave output function can be checked in the following buffer memory areas.

Item	Description
Wave output status monitor	The wave output status is stored in this area.
Wave output conversion cycle monitor	The conversion cycle of the wave output is stored in 32-bit signed binary in this area. The unit of the stored value is μs .
Wave pattern output count monitor	The output count of the wave pattern is stored in this area.
Wave output current address monitor	The buffer memory address of the currently output wave data is stored in 32-bit signed binary in this area.
Wave output current digital value monitor	The digital value which is being currently output is stored in this area.
Wave output digital value outside the range address monitor	When the wave data with the digital value out of the setting range is output, the buffer memory address where that wave data is registered is stored in 32-bit signed binary in this area. When the multiple wave data with the digital values out of the setting range are detected, only the buffer memory address of the wave data detected first is stored.
Wave output warning address monitor	The buffer memory address of the wave data where a warning has occurred is stored in 32-bit signed binary in this area. When a warning has occurred in the multiple wave data, only the buffer memory address of the wave data where the warning occurred first is stored.

For details on each buffer memory area, refer to the following.

 Page 157 Details of buffer memory areas

How to register data when a remote head module is used

For how to register the wave data and parameter settings for the wave output function, which is created from "Create Wave Output Data" of the engineering tool, in the D/A converter module, refer to the following.

Registration procedure

1. Write wave data and parameters for the wave output function to the file register (ZR) of the CPU module on the master station using "Create Wave Output Data" of the engineering tool.
2. Transfer the data and parameters from the file register (ZR) to the D/A converter module mounted with the remote head module using the JP.REMTOD instruction.

Register the wave data and parameters for the wave output function first, and then change 'CH1 D/A conversion enable/disable setting' (Un\G500).

3. Request a wave output start/stop through a program.

Program

This program is used to transfer the data and parameters from the file register (ZR) to the D/A converter module mounted with the remote head module using the JP.REMTOD instruction. The program in this section is described under the assumption that the data is written from "Create Wave Output Data" regarding the start device as ZR0. Depending on the specified start device, the file register (ZR) to which the parameter settings of the wave output function and wave data are written varies. For details on the file register (ZR) to which the data is written, refer to the following.

📖 MELSEC iQ-R Analog-Digital Converter Module/Digital-Analog Converter Module Function Block Reference

- System configuration

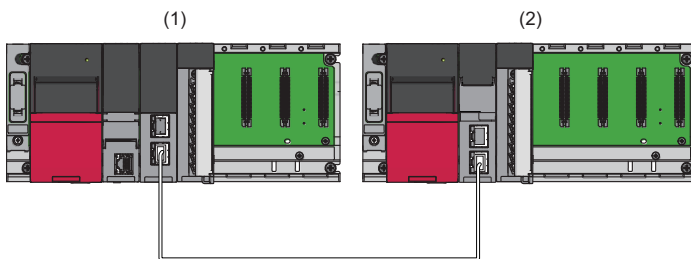

(1) Master station (Network number 1, station number 0)

- Power supply module: R61P
- CPU module: R04CPU
- Master/local module: RJ71GF11-T2 (Start I/O number: 0000H to 001FH)
- Input module: RX10 (Start I/O number: 0020H to 002FH)

(2) Intelligent device station (Network number 1, station number 1)

- Power supply module: R61P
- Remote head module: RJ72GF15-T2
- D/A converter module: R60DAH4 (Start I/O number: 0000H to 000FH^{*1})

*1 In the RX/RX setting of the master station, set 1000H to 100FH as the start I/O number of the D/A converter module.

• Label settings

Classification	Label name	Description	Device																																																																																																																																																																																									
Module label	GF11_1.bSts_DataLinkError* ²	Data link error status of own station	SB0049																																																																																																																																																																																									
	GF11_1.bnSts_DataLinkError_Station[1]* ²	Data link status of each station (station number 1)	SW00B0.0																																																																																																																																																																																									
Label to be defined	Define global labels as shown below:																																																																																																																																																																																											
	<table border="1"> <thead> <tr> <th></th> <th>Label Name</th> <th>Data Type</th> <th>Class</th> <th>Assign (Device/Label)</th> </tr> </thead> <tbody> <tr><td>1</td><td>Wave OutputSettingRepeatCtrl</td><td>Bit</td><td>VAR_GLOBAL</td><td>M1 000</td></tr> <tr><td>2</td><td>Wave OutputStopOutSelectStart</td><td>Bit</td><td>VAR_GLOBAL</td><td>M1 001</td></tr> <tr><td>3</td><td>Wave OutputStopOutSelectComp</td><td>Bit</td><td>VAR_GLOBAL</td><td>M1 002</td></tr> <tr><td>4</td><td>Wave OutputStopOutSelectErr</td><td>Bit</td><td>VAR_GLOBAL</td><td>M1 003</td></tr> <tr><td>5</td><td>Wave OutputStopOutSelectOK</td><td>Bit</td><td>VAR_GLOBAL</td><td>M1 004</td></tr> <tr><td>6</td><td>Wave OutputStopOutSettingStart</td><td>Bit</td><td>VAR_GLOBAL</td><td>M1 005</td></tr> <tr><td>7</td><td>Wave OutputStopOutSettingComp</td><td>Bit</td><td>VAR_GLOBAL</td><td>M1 006</td></tr> <tr><td>8</td><td>Wave OutputStopOutSettingErr</td><td>Bit</td><td>VAR_GLOBAL</td><td>M1 007</td></tr> <tr><td>9</td><td>Wave OutputStopOutSettingOK</td><td>Bit</td><td>VAR_GLOBAL</td><td>M1 008</td></tr> <tr><td>10</td><td>Wave PatternTopAddressStart</td><td>Bit</td><td>VAR_GLOBAL</td><td>M1 009</td></tr> <tr><td>11</td><td>Wave PatternTopAddressComp</td><td>Bit</td><td>VAR_GLOBAL</td><td>M1 010</td></tr> <tr><td>12</td><td>Wave PatternTopAddressErr</td><td>Bit</td><td>VAR_GLOBAL</td><td>M1 011</td></tr> <tr><td>13</td><td>Wave PatternTopAddressOK</td><td>Bit</td><td>VAR_GLOBAL</td><td>M1 012</td></tr> <tr><td>14</td><td>Wave PatternNumStart</td><td>Bit</td><td>VAR_GLOBAL</td><td>M1 013</td></tr> <tr><td>15</td><td>Wave PatternNumComp</td><td>Bit</td><td>VAR_GLOBAL</td><td>M1 014</td></tr> <tr><td>16</td><td>Wave PatternNumErr</td><td>Bit</td><td>VAR_GLOBAL</td><td>M1 015</td></tr> <tr><td>17</td><td>Wave PatternNumOK</td><td>Bit</td><td>VAR_GLOBAL</td><td>M1 016</td></tr> <tr><td>18</td><td>Wave OutputCntStart</td><td>Bit</td><td>VAR_GLOBAL</td><td>M1 017</td></tr> <tr><td>19</td><td>Wave OutputCntComp</td><td>Bit</td><td>VAR_GLOBAL</td><td>M1 018</td></tr> <tr><td>20</td><td>Wave OutputCntErr</td><td>Bit</td><td>VAR_GLOBAL</td><td>M1 019</td></tr> <tr><td>21</td><td>Wave OutputCntOK</td><td>Bit</td><td>VAR_GLOBAL</td><td>M1 020</td></tr> <tr><td>22</td><td>Wave OutputConvCircleStart</td><td>Bit</td><td>VAR_GLOBAL</td><td>M1 021</td></tr> <tr><td>23</td><td>Wave OutputConvCircleComp</td><td>Bit</td><td>VAR_GLOBAL</td><td>M1 022</td></tr> <tr><td>24</td><td>Wave OutputConvCircleErr</td><td>Bit</td><td>VAR_GLOBAL</td><td>M1 023</td></tr> <tr><td>25</td><td>Wave OutputConvCircleOK</td><td>Bit</td><td>VAR_GLOBAL</td><td>M1 024</td></tr> <tr><td>26</td><td>Wave DataWriteRequest</td><td>Bit</td><td>VAR_GLOBAL</td><td>M1 025</td></tr> <tr><td>27</td><td>Wave DataWriteComp</td><td>Bit</td><td>VAR_GLOBAL</td><td>M1 026</td></tr> <tr><td>28</td><td>Wave DataWriteErr</td><td>Bit</td><td>VAR_GLOBAL</td><td>M1 027</td></tr> <tr><td>29</td><td>Wave DataWriteRepeatCtrl</td><td>Bit</td><td>VAR_GLOBAL</td><td>M1 028</td></tr> <tr><td>30</td><td>BuffMemoryAddressIndex</td><td>Word [Signed]</td><td>VAR_GLOBAL</td><td>Z0</td></tr> <tr><td>31</td><td>Wave OutputSettingIndex</td><td>Word [Signed]</td><td>VAR_GLOBAL</td><td>Z1</td></tr> <tr><td>32</td><td>Wave DataIndex</td><td>Double Word [Unsigned]/Bit String [32-bit]</td><td>VAR_GLOBAL</td><td>L20</td></tr> <tr><td>33</td><td>Wave OutputSettingRequest</td><td>Bit</td><td>VAR_GLOBAL</td><td>X24</td></tr> <tr><td>34</td><td>Wave DataWriteFinalOK</td><td>Bit</td><td>VAR_GLOBAL</td><td>M1 030</td></tr> <tr><td>35</td><td>Connect_FormationFlg_St1</td><td>Bit</td><td>VAR_GLOBAL</td><td>M0</td></tr> <tr><td>36</td><td>Nesting_St1</td><td>Word [Signed]</td><td>VAR_GLOBAL</td><td>NO</td></tr> </tbody> </table>		Label Name	Data Type	Class	Assign (Device/Label)	1	Wave OutputSettingRepeatCtrl	Bit	VAR_GLOBAL	M1 000	2	Wave OutputStopOutSelectStart	Bit	VAR_GLOBAL	M1 001	3	Wave OutputStopOutSelectComp	Bit	VAR_GLOBAL	M1 002	4	Wave OutputStopOutSelectErr	Bit	VAR_GLOBAL	M1 003	5	Wave OutputStopOutSelectOK	Bit	VAR_GLOBAL	M1 004	6	Wave OutputStopOutSettingStart	Bit	VAR_GLOBAL	M1 005	7	Wave OutputStopOutSettingComp	Bit	VAR_GLOBAL	M1 006	8	Wave OutputStopOutSettingErr	Bit	VAR_GLOBAL	M1 007	9	Wave OutputStopOutSettingOK	Bit	VAR_GLOBAL	M1 008	10	Wave PatternTopAddressStart	Bit	VAR_GLOBAL	M1 009	11	Wave PatternTopAddressComp	Bit	VAR_GLOBAL	M1 010	12	Wave PatternTopAddressErr	Bit	VAR_GLOBAL	M1 011	13	Wave PatternTopAddressOK	Bit	VAR_GLOBAL	M1 012	14	Wave PatternNumStart	Bit	VAR_GLOBAL	M1 013	15	Wave PatternNumComp	Bit	VAR_GLOBAL	M1 014	16	Wave PatternNumErr	Bit	VAR_GLOBAL	M1 015	17	Wave PatternNumOK	Bit	VAR_GLOBAL	M1 016	18	Wave OutputCntStart	Bit	VAR_GLOBAL	M1 017	19	Wave OutputCntComp	Bit	VAR_GLOBAL	M1 018	20	Wave OutputCntErr	Bit	VAR_GLOBAL	M1 019	21	Wave OutputCntOK	Bit	VAR_GLOBAL	M1 020	22	Wave OutputConvCircleStart	Bit	VAR_GLOBAL	M1 021	23	Wave OutputConvCircleComp	Bit	VAR_GLOBAL	M1 022	24	Wave OutputConvCircleErr	Bit	VAR_GLOBAL	M1 023	25	Wave OutputConvCircleOK	Bit	VAR_GLOBAL	M1 024	26	Wave DataWriteRequest	Bit	VAR_GLOBAL	M1 025	27	Wave DataWriteComp	Bit	VAR_GLOBAL	M1 026	28	Wave DataWriteErr	Bit	VAR_GLOBAL	M1 027	29	Wave DataWriteRepeatCtrl	Bit	VAR_GLOBAL	M1 028	30	BuffMemoryAddressIndex	Word [Signed]	VAR_GLOBAL	Z0	31	Wave OutputSettingIndex	Word [Signed]	VAR_GLOBAL	Z1	32	Wave DataIndex	Double Word [Unsigned]/Bit String [32-bit]	VAR_GLOBAL	L20	33	Wave OutputSettingRequest	Bit	VAR_GLOBAL	X24	34	Wave DataWriteFinalOK	Bit	VAR_GLOBAL	M1 030	35	Connect_FormationFlg_St1	Bit	VAR_GLOBAL	M0	36	Nesting_St1	Word [Signed]	VAR_GLOBAL	NO		
	Label Name	Data Type	Class	Assign (Device/Label)																																																																																																																																																																																								
1	Wave OutputSettingRepeatCtrl	Bit	VAR_GLOBAL	M1 000																																																																																																																																																																																								
2	Wave OutputStopOutSelectStart	Bit	VAR_GLOBAL	M1 001																																																																																																																																																																																								
3	Wave OutputStopOutSelectComp	Bit	VAR_GLOBAL	M1 002																																																																																																																																																																																								
4	Wave OutputStopOutSelectErr	Bit	VAR_GLOBAL	M1 003																																																																																																																																																																																								
5	Wave OutputStopOutSelectOK	Bit	VAR_GLOBAL	M1 004																																																																																																																																																																																								
6	Wave OutputStopOutSettingStart	Bit	VAR_GLOBAL	M1 005																																																																																																																																																																																								
7	Wave OutputStopOutSettingComp	Bit	VAR_GLOBAL	M1 006																																																																																																																																																																																								
8	Wave OutputStopOutSettingErr	Bit	VAR_GLOBAL	M1 007																																																																																																																																																																																								
9	Wave OutputStopOutSettingOK	Bit	VAR_GLOBAL	M1 008																																																																																																																																																																																								
10	Wave PatternTopAddressStart	Bit	VAR_GLOBAL	M1 009																																																																																																																																																																																								
11	Wave PatternTopAddressComp	Bit	VAR_GLOBAL	M1 010																																																																																																																																																																																								
12	Wave PatternTopAddressErr	Bit	VAR_GLOBAL	M1 011																																																																																																																																																																																								
13	Wave PatternTopAddressOK	Bit	VAR_GLOBAL	M1 012																																																																																																																																																																																								
14	Wave PatternNumStart	Bit	VAR_GLOBAL	M1 013																																																																																																																																																																																								
15	Wave PatternNumComp	Bit	VAR_GLOBAL	M1 014																																																																																																																																																																																								
16	Wave PatternNumErr	Bit	VAR_GLOBAL	M1 015																																																																																																																																																																																								
17	Wave PatternNumOK	Bit	VAR_GLOBAL	M1 016																																																																																																																																																																																								
18	Wave OutputCntStart	Bit	VAR_GLOBAL	M1 017																																																																																																																																																																																								
19	Wave OutputCntComp	Bit	VAR_GLOBAL	M1 018																																																																																																																																																																																								
20	Wave OutputCntErr	Bit	VAR_GLOBAL	M1 019																																																																																																																																																																																								
21	Wave OutputCntOK	Bit	VAR_GLOBAL	M1 020																																																																																																																																																																																								
22	Wave OutputConvCircleStart	Bit	VAR_GLOBAL	M1 021																																																																																																																																																																																								
23	Wave OutputConvCircleComp	Bit	VAR_GLOBAL	M1 022																																																																																																																																																																																								
24	Wave OutputConvCircleErr	Bit	VAR_GLOBAL	M1 023																																																																																																																																																																																								
25	Wave OutputConvCircleOK	Bit	VAR_GLOBAL	M1 024																																																																																																																																																																																								
26	Wave DataWriteRequest	Bit	VAR_GLOBAL	M1 025																																																																																																																																																																																								
27	Wave DataWriteComp	Bit	VAR_GLOBAL	M1 026																																																																																																																																																																																								
28	Wave DataWriteErr	Bit	VAR_GLOBAL	M1 027																																																																																																																																																																																								
29	Wave DataWriteRepeatCtrl	Bit	VAR_GLOBAL	M1 028																																																																																																																																																																																								
30	BuffMemoryAddressIndex	Word [Signed]	VAR_GLOBAL	Z0																																																																																																																																																																																								
31	Wave OutputSettingIndex	Word [Signed]	VAR_GLOBAL	Z1																																																																																																																																																																																								
32	Wave DataIndex	Double Word [Unsigned]/Bit String [32-bit]	VAR_GLOBAL	L20																																																																																																																																																																																								
33	Wave OutputSettingRequest	Bit	VAR_GLOBAL	X24																																																																																																																																																																																								
34	Wave DataWriteFinalOK	Bit	VAR_GLOBAL	M1 030																																																																																																																																																																																								
35	Connect_FormationFlg_St1	Bit	VAR_GLOBAL	M0																																																																																																																																																																																								
36	Nesting_St1	Word [Signed]	VAR_GLOBAL	NO																																																																																																																																																																																								

*2 This module label is for the master/local module (RJ71GF11-T2). For details, refer to the MELSEC iQ-R CC-Link IE Field Network User's Manual (Application).

• Program

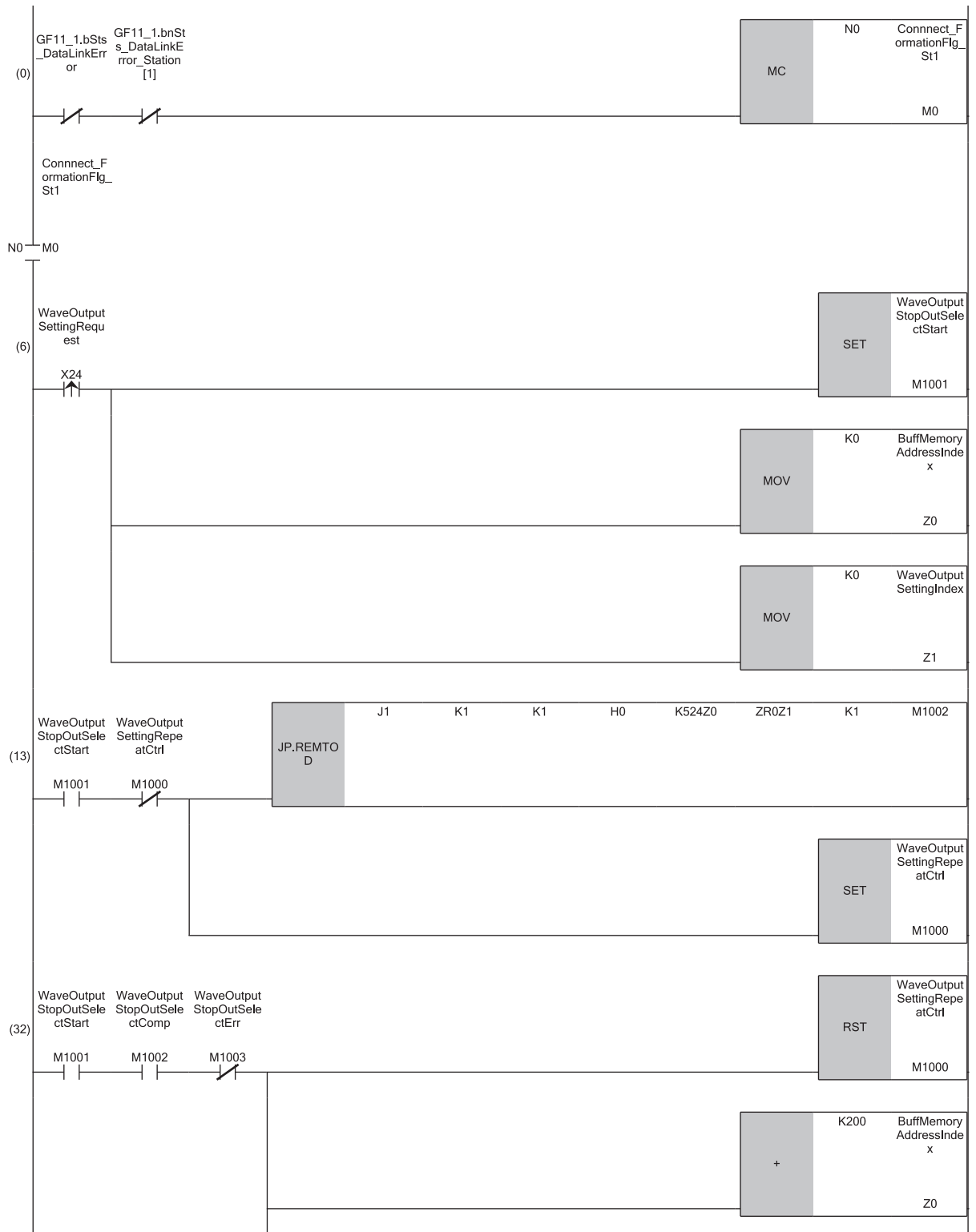

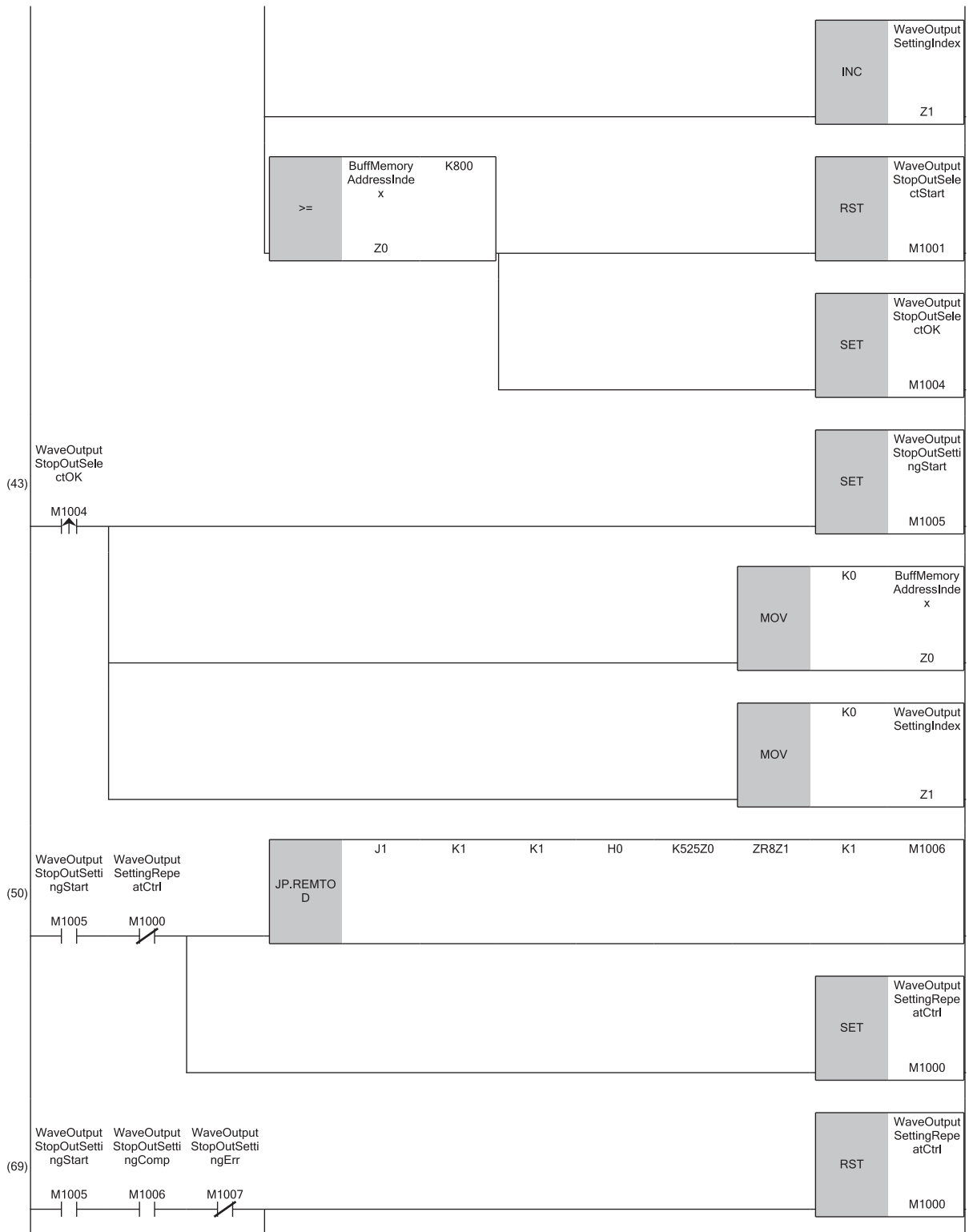

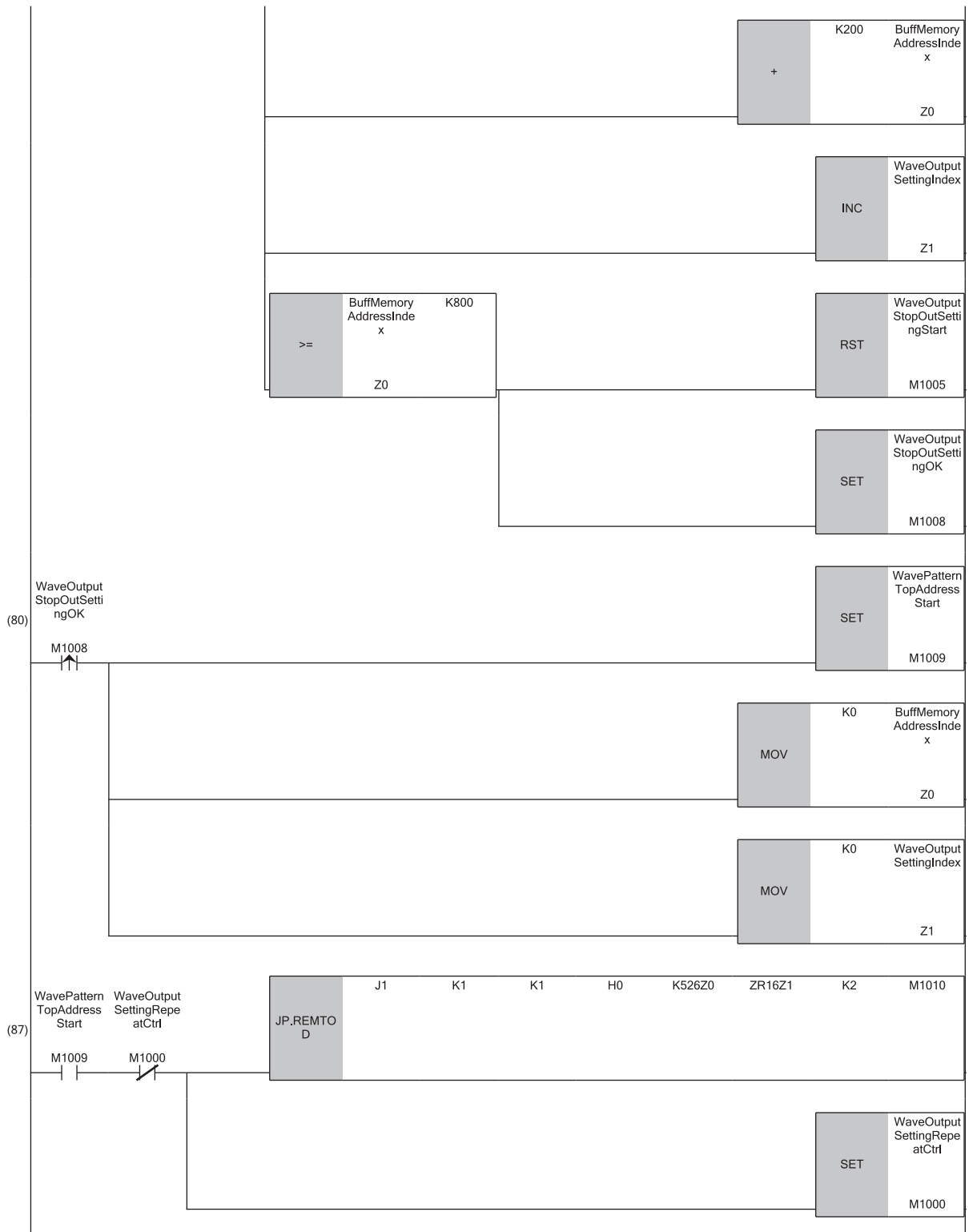

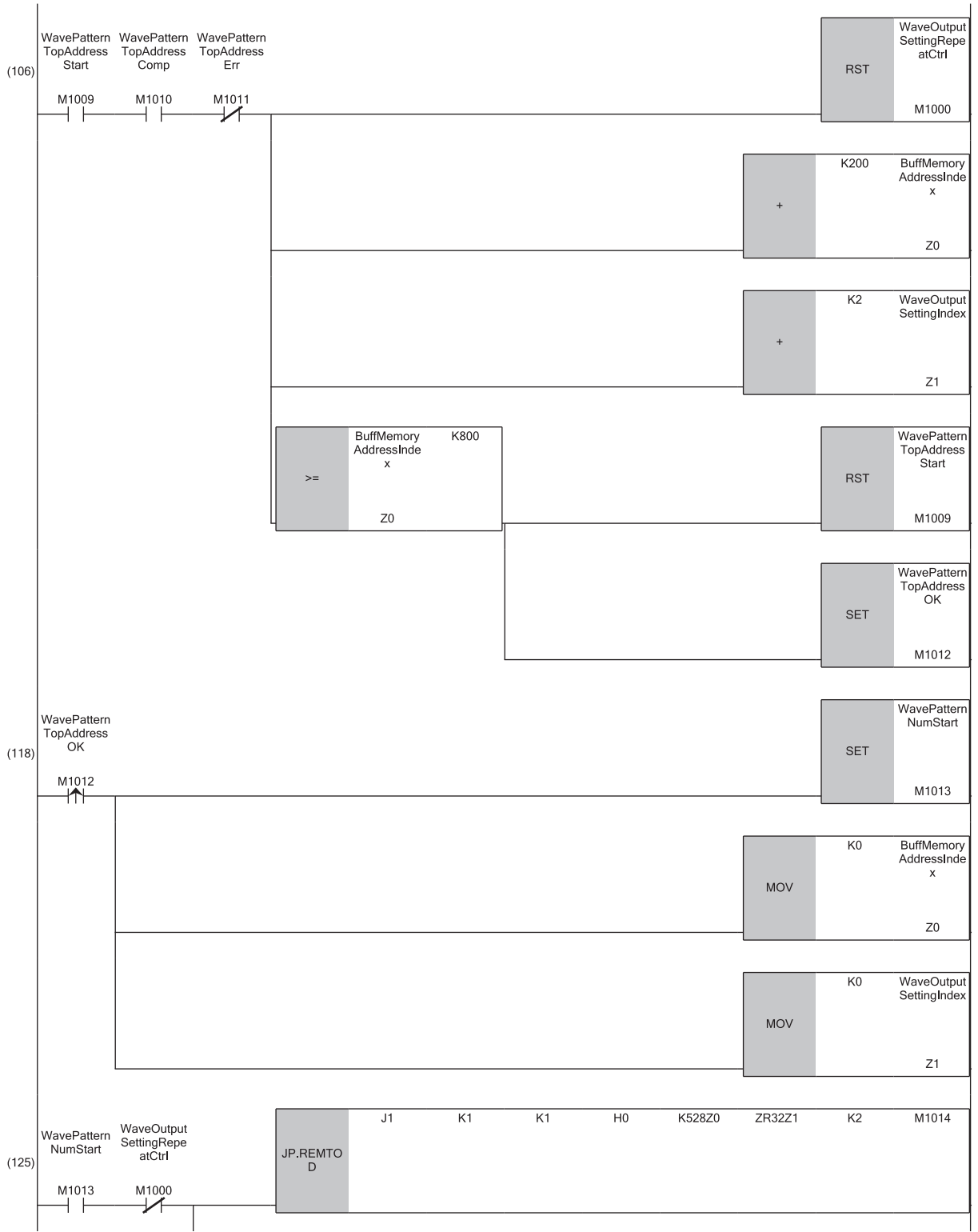

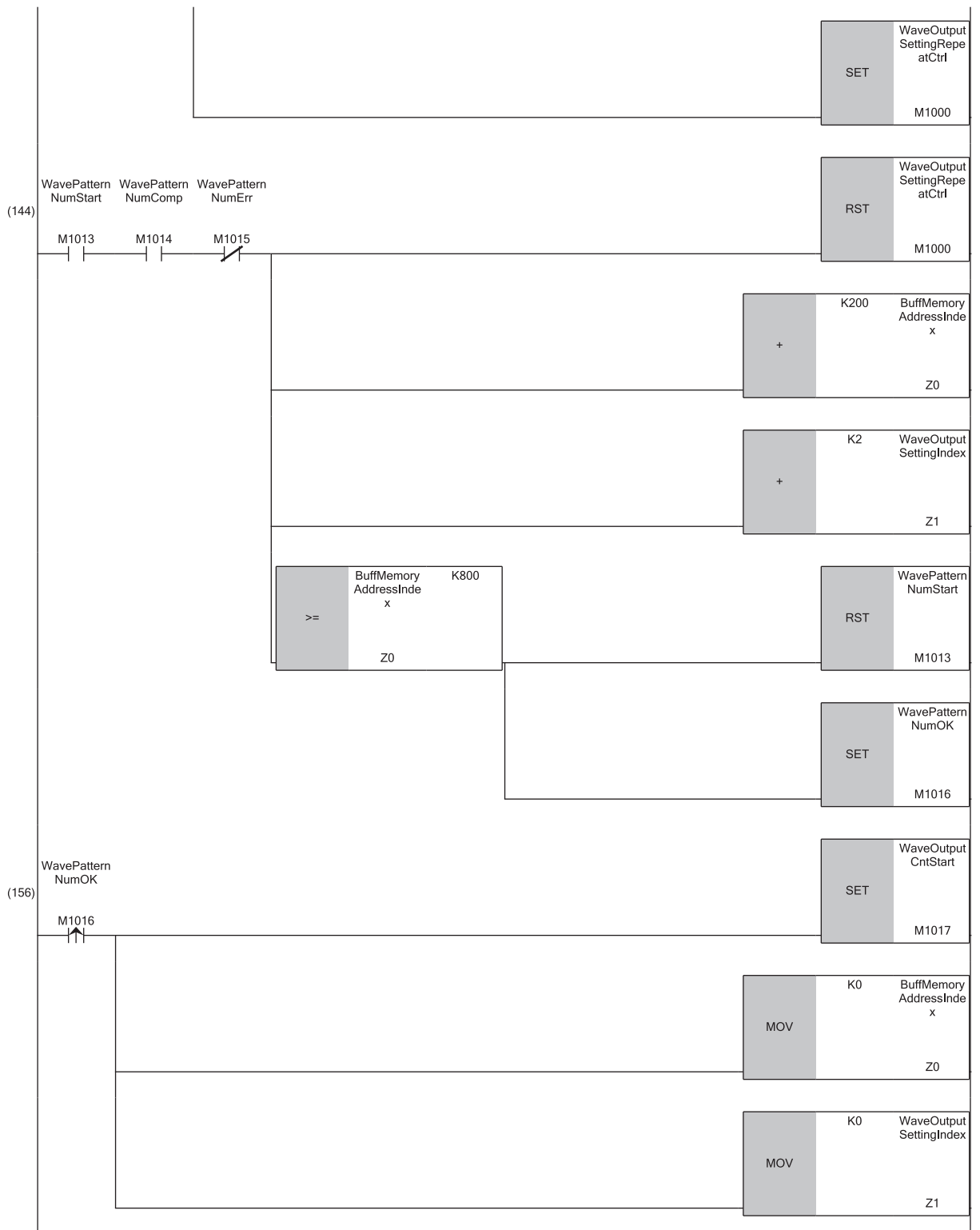

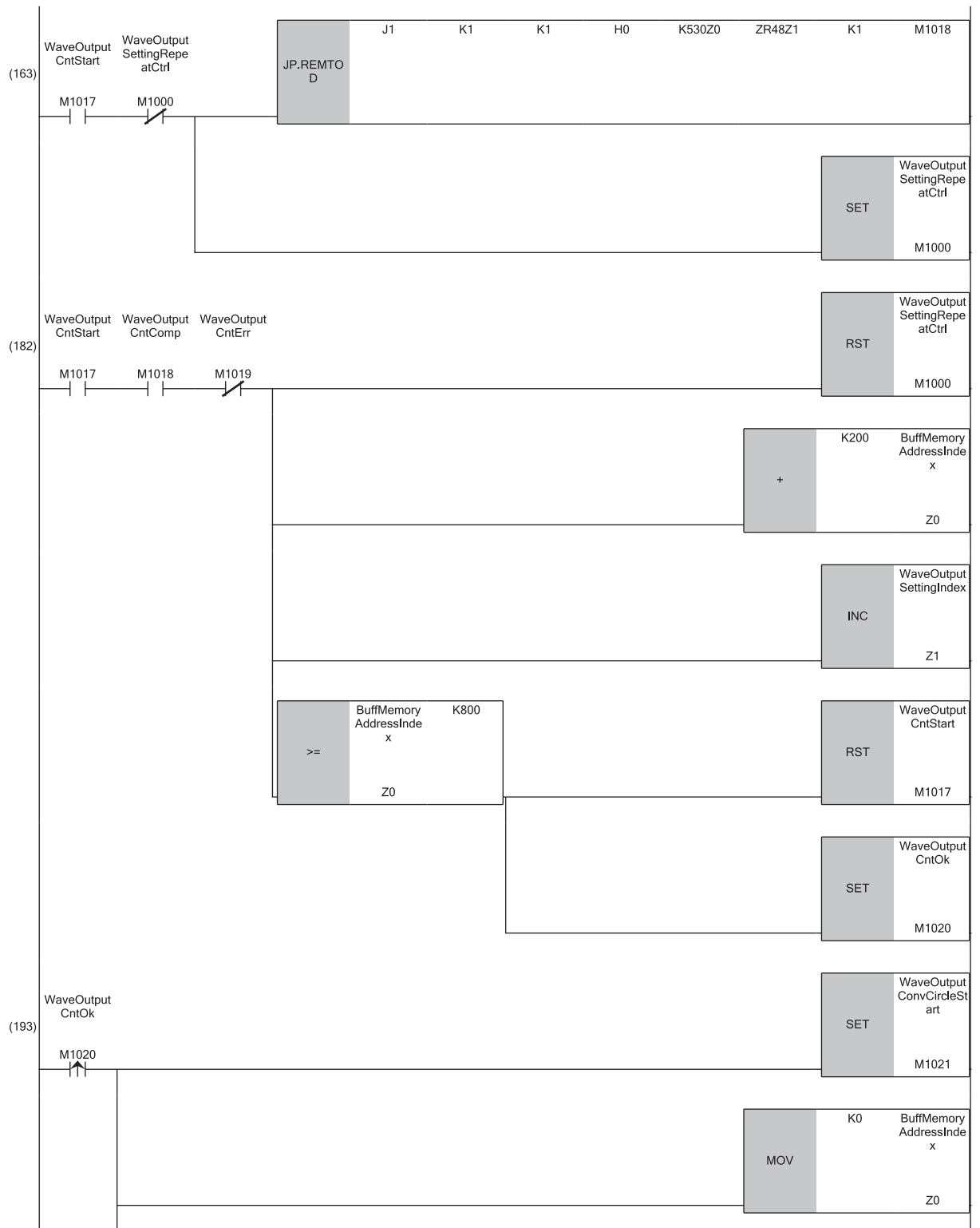

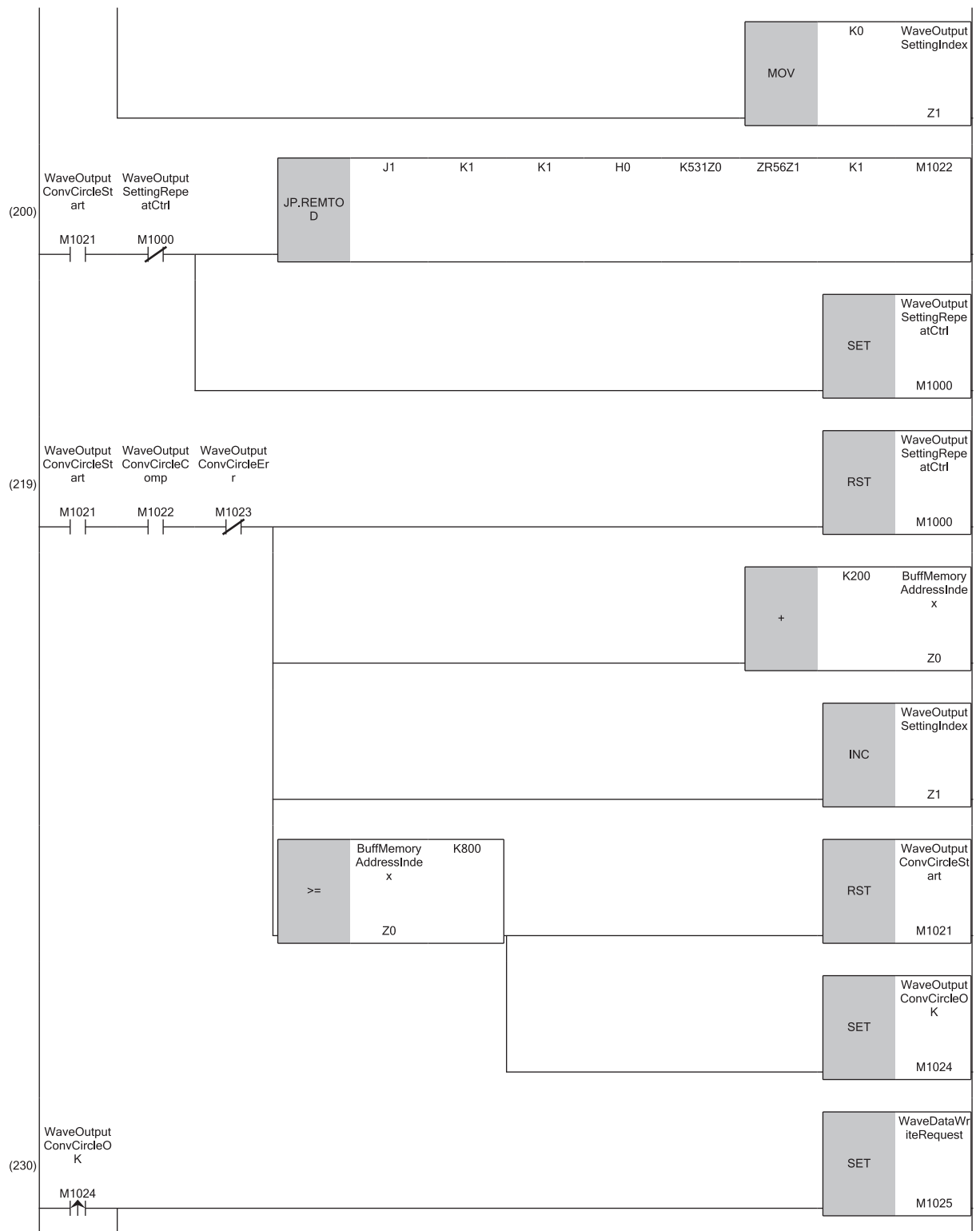

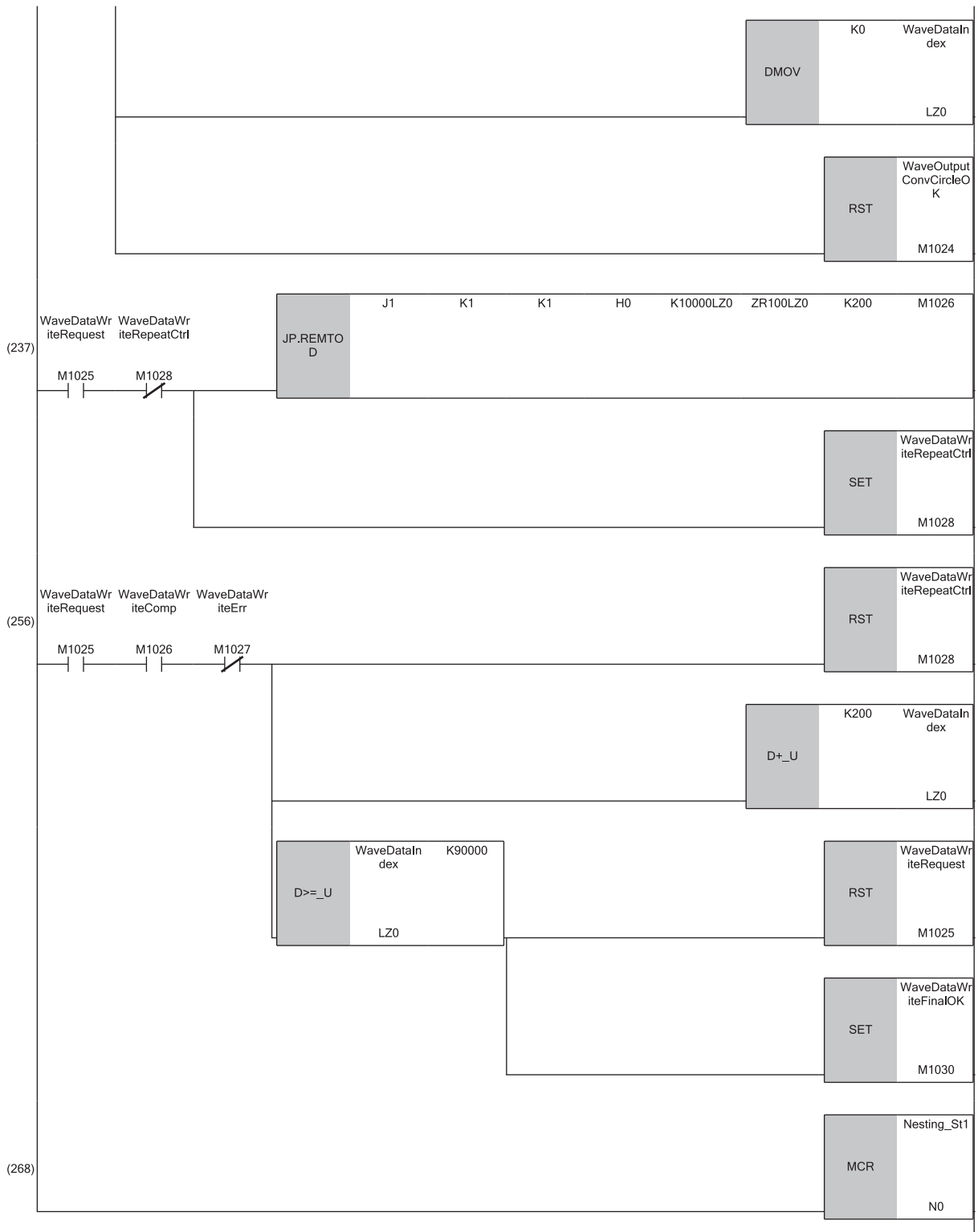

(269)

{END }

- (0) Checks the data link status of the remote head module (station number 1).
- (6) Turns on the write start flag of output setting during wave output stop (M1001) and clears the buffer memory address index (Z0) and wave output parameter setting index (Z1) to 0.
- (13) Writes the value from ZR0 to 'CH1 Output setting during wave output stop' (U0\G524).
- (32) Adds 200 to the buffer memory address index (Z0) and 1 to the wave output parameter setting index (Z1). Subsequently, repeats the process from step 13 to 32 until the values from ZR1 to ZR3 are written to Output setting during wave output stop between CH2 and CH4.
- (43) Turns on the write start flag of output value during wave output stop (M1005) and clears the buffer memory address index (Z0) and wave output parameter setting index (Z1) to 0.
- (50) Writes the value from ZR8 to 'CH1 Output value during wave output stop' (U0\G525).
- (69) Adds 200 to the buffer memory address index (Z0) and 1 to the wave output parameter setting index (Z1). Subsequently, repeats the process from step 50 to 69 until the values from ZR9 to ZR11 are written to Output value during wave output stop between CH2 and CH4.
- (80) Turns on the write start flag of wave pattern start address setting (M1009) and clears the buffer memory address index (Z0) and wave output parameter setting index (Z1) to 0.
- (87) Writes the values from ZR16 and ZR17 to 'CH1 Wave pattern start address setting' (U0\G526 and U0\G527).
- (106) Adds 200 to the buffer memory address index (Z0) and 2 to the wave output parameter setting index (Z1). Subsequently, repeats the process from step 87 to 106 until the values from ZR18 to ZR23 are written to Wave pattern start address setting between CH2 and CH4.
- (118) Turns on the write start flag of wave pattern data points setting (M1013) and clears the buffer memory address index (Z0) and wave output parameter setting index (Z1) to 0.
- (125) Writes the values from ZR32 and ZR33 to 'CH1 Wave pattern data points setting' (U0\G528, U0\G529).
- (144) Adds 200 to the buffer memory address index (Z0) and 2 to the wave output parameter setting index (Z1). Subsequently, repeats the process from step 125 to 144 until the values from ZR34 to ZR39 are written to Wave pattern data points setting between CH2 and CH4.
- (156) Turns on the write start flag of wave pattern output repetition setting (M1017) and clears the buffer memory address index (Z0) and wave output parameter setting index (Z1) to 0.
- (163) Writes the value from ZR48 to 'CH1 Wave pattern output repetition setting' (U0\G530).
- (182) Adds 200 to the buffer memory address index (Z0) and 1 to the wave output parameter setting index (Z1). Subsequently, repeats the process from step 163 to 182 until the values from ZR49 to ZR51 are written to Wave pattern output repetition setting between CH2 and CH4.
- (193) Turns on the write start flag of constant for wave output conversion cycle (M1021) and clears the buffer memory address index (Z0) and wave output parameter setting index (Z1) to 0.
- (200) Writes the value from ZR56 to 'CH1 Constant for wave output conversion cycle' (U0\G531).
- (219) Adds 200 to the buffer memory address index (Z0) and 1 to the wave output parameter setting index (Z1). Subsequently, repeats the process from step 200 to 219 until the values from ZR57 to ZR59 are written to Constant for wave output conversion cycle between CH2 and CH4.
- (230) Turns on the wave data write command (M1025), and clears the wave data index (LZ0) to 0.
- (237) Writes the values from the range between ZR100 and ZR299 to Wave data registry area (U0\G10000 to U0\G10199).
- (256) Adds 200 to the wave data index (LZ0). Subsequently, repeats the process from step 237 to 256 until the value ZR90099 is written to U0\G99999.

Points to use the wave output function

When 'CH1 Output enable/disable flag' (Y1) is changed

When 'CH1 Output enable/disable flag' (Y1) is turned off during the wave output, the analog output value becomes the offset value though the wave output is continued. The wave output continues to be updated while 'CH1 Output enable/disable flag' (Y1) is off. When 'CH1 Output enable/disable flag' (Y1) is turned on, the analog output is restarted.

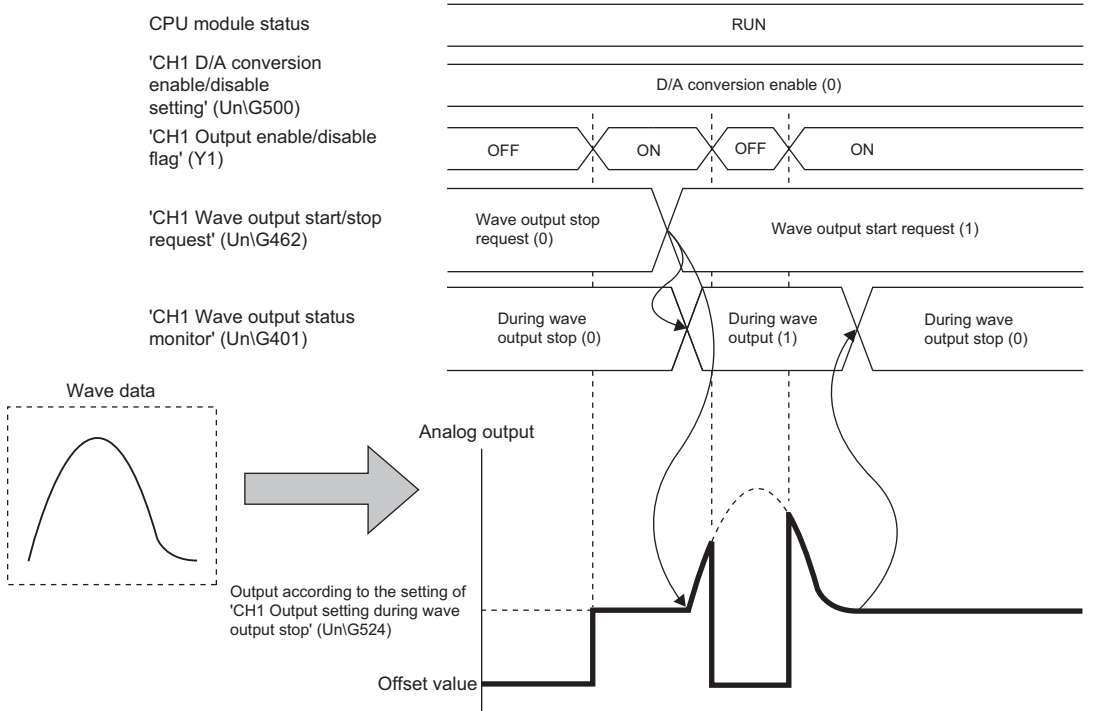

When the CPU module status is changed

When the CPU module status is changed during the wave output, the operation of the module varies depending on the setting of the analog output HOLD/CLEAR function as shown below.

■For HOLD setting

When the CPU module status is changed from RUN to STOP, the analog output at the change is maintained. When the CPU module status is changed from STOP to RUN, the wave output restarts. To prevent the wave output from restarting, set 'CH1 Wave output start/stop request' (Un\G462) to Wave output stop request (0) after changing the CPU module status from RUN to STOP.

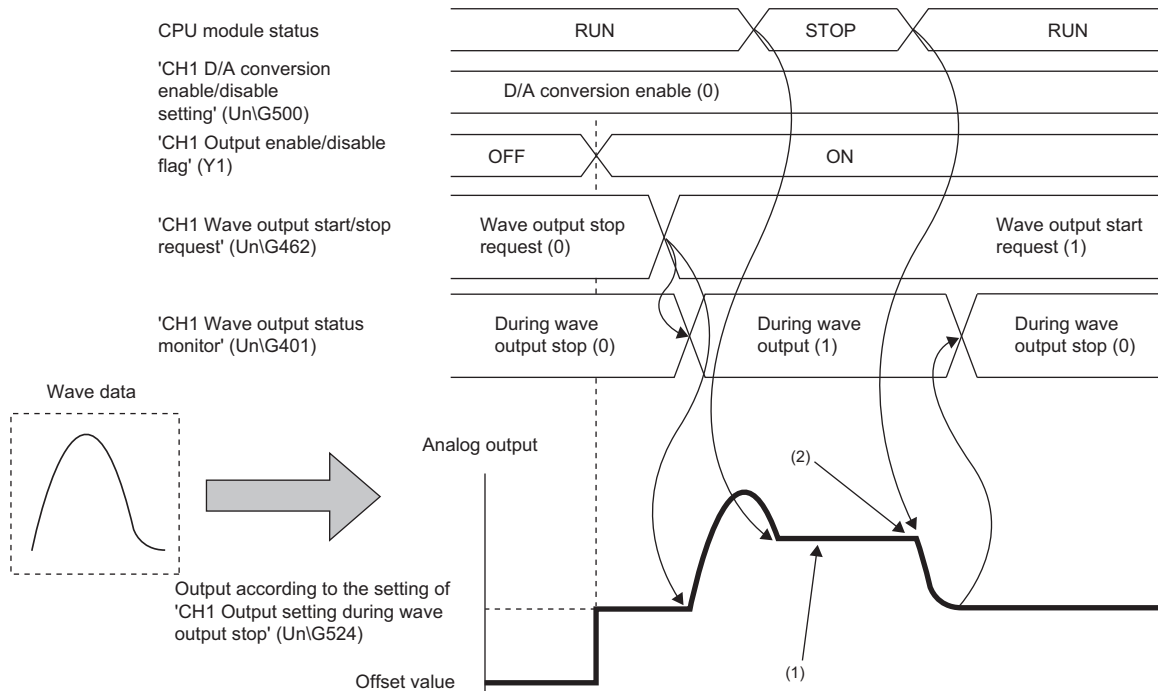

- (1) Analog output value is held.
- (2) The wave output restarts.

Precautions

Module parameter setting is reflected at the timing when the CPU module is changed from STOP to RUN.

At this time, the process same as the one executed when turning on and off 'Operating condition setting request' (Y9) is received inside the D/A converter module is executed. Therefore, if the CPU module is changed from STOP to RUN when 'CH1 Wave output status monitor' (Un\G462) is not During wave output stop (0), an operating condition setting request error in a state other than wave output stop (alarm code: 0B0□H) occurs.

To clear the alarm, turn on and off 'Warning output clear request' (YE).

■For CLEAR setting

When the CPU module status is changed from RUN to STOP, the wave output is finished and the offset value is output. When the CPU module status is changed from STOP to RUN, the value is output according to the setting in 'CH1 Output setting during wave output stop' (UnG524). The wave output does not restart.

To execute the wave output again, set 'CH1 Wave output start/stop request' (UnG462) to Wave output stop request (0) after changing the CPU module status from STOP to RUN. Then, change the value in 'CH1 Wave output start/stop request' (UnG462) from Wave output stop request (0) to Wave output start request (1).

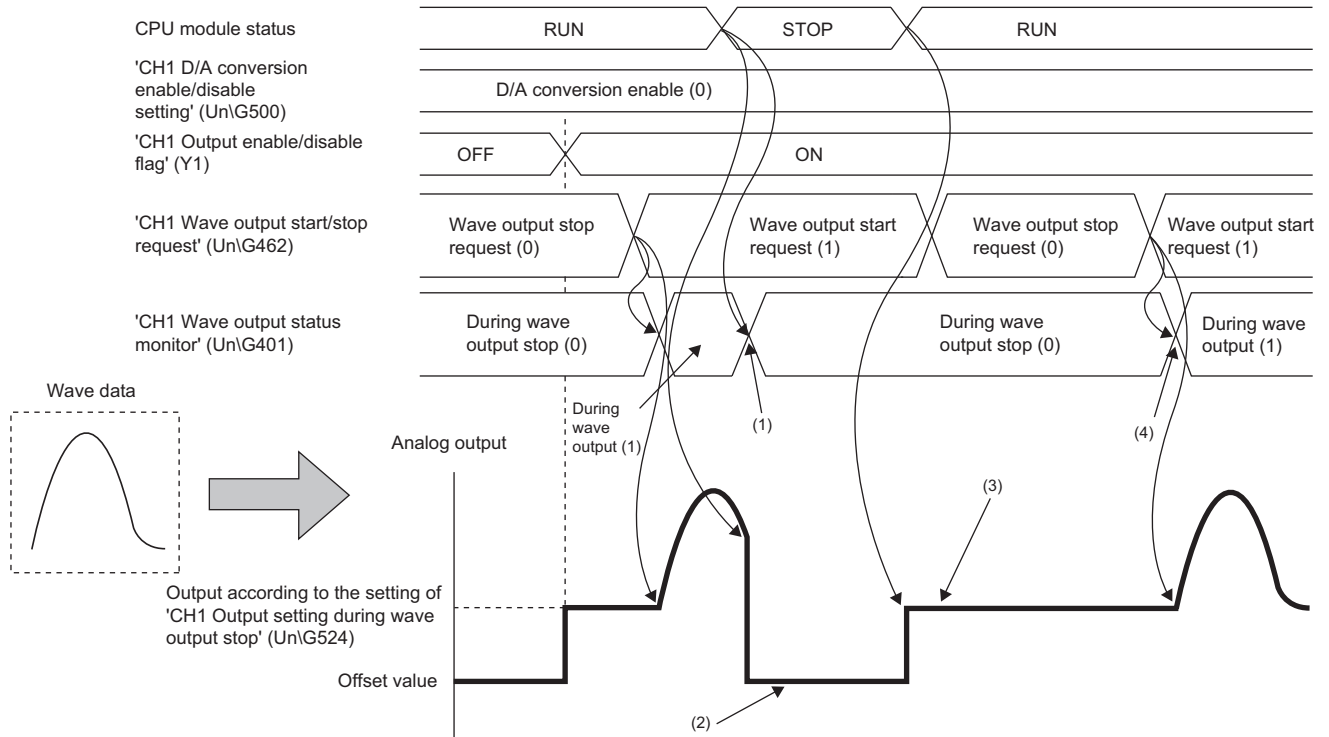

- (1) The wave output stops.
- (2) The offset value is output.
- (3) The wave output does not restart.
- (4) Setting 'CH1 Wave output start/stop request' (UnG462) from Wave output stop request (0) to Wave output start request (1) starts the wave output.

When an error occurs

When a value out of the setting range is tried to be output, a digital value setting range error (error code: 191□H) occurs. When a digital value setting range error (error code: 191□H) occurs during the wave output, the analog output value becomes as follows.

- If the value to be output is greater than the maximum value of the output range, the maximum value of the output range is output in analog.
- If the value to be output is smaller than the minimum value of the output range, the minimum value of the output range is output in analog.

When a digital value setting range error (error code: 191□H) has occurred, correct the digital value of the wave data so that the value is within the output range. Then, turn on and off 'Error clear request' (YF).

- When the output range is set to "0 to 5V":

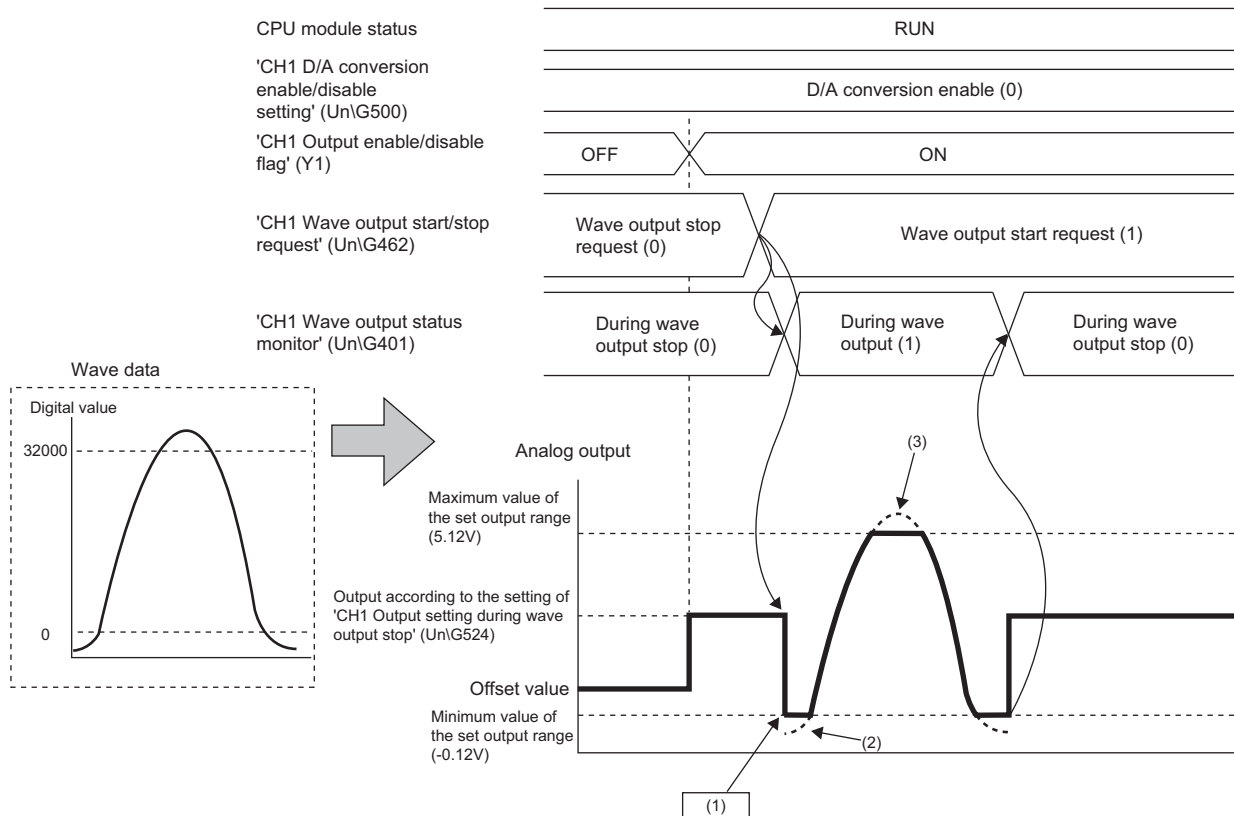

- (1) A digital value setting range error (error code: 191□H) occurs.
- (2) If the value to be output is smaller than the minimum value of the output range, the minimum value of the output range is output in analog.
- (3) If the value to be output is greater than the maximum value of the output range, the maximum value of the output range is output in analog.

To check the buffer memory address where the wave data with the value out of the range is registered, use 'CH1 Wave output digital value outside the range address monitor' (Un\G440, Un\G441).

When the external power supply turns off

When the external power supply is turned off during the wave output, the wave output status of all the channels becomes the during wave output stop (the wave output stops). The wave output does not automatically restart even when the external power supply is turned on.

To restart the wave output, check the D/A converter module and external devices after turning on the external power supply, and set 'CH1 Wave output start/stop request' (Un\G462) to Wave output start request (1).

Wave output start/stop request cannot be accepted when the external power supply is off.

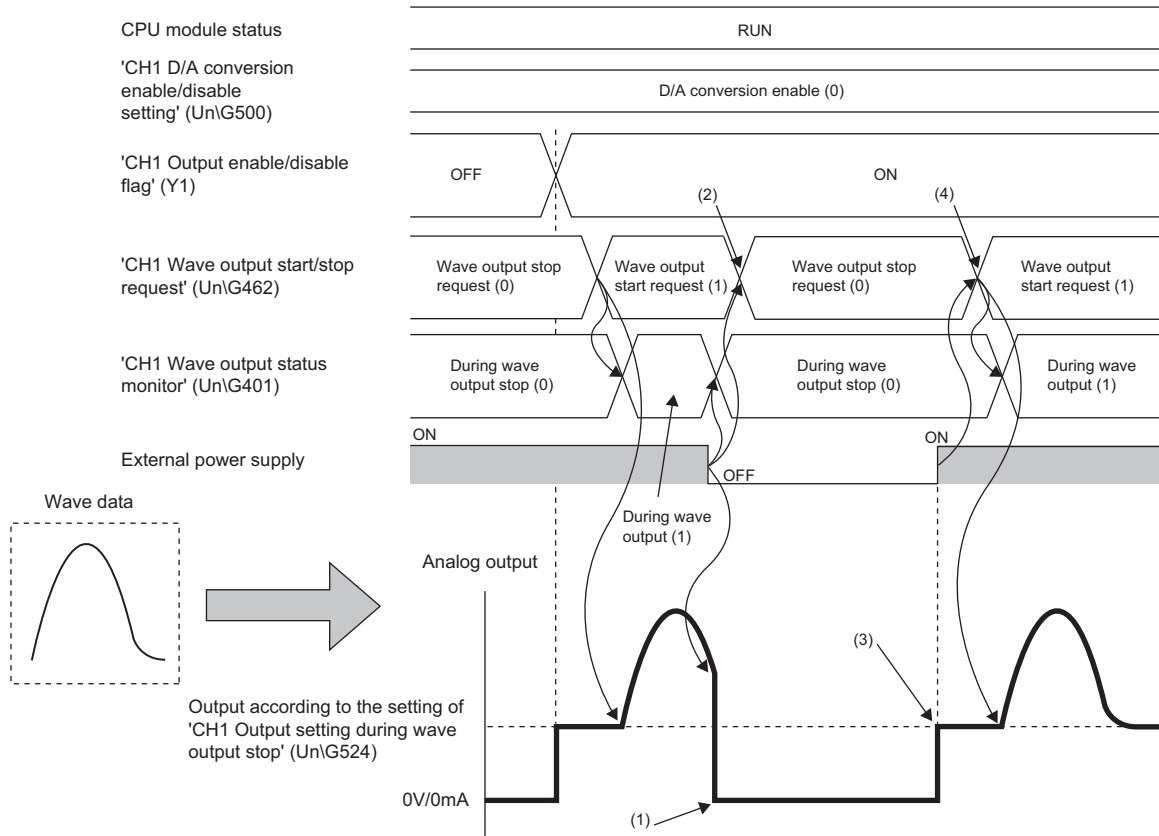

- (1) 0V/0mA is output in analog.
- (2) Since the external power supply has turned off and the wave output has stopped, change 'CH1 Wave output start/stop request' (Un\G462) to Wave output stop request (0).
- (3) The wave output does not restart.
- (4) To restart the wave output, change 'CH1 Wave output start/stop request' (Un\G462) to Wave output stop request (0), and then change it to Wave output start request (1).

When a disconnection is detected

When a disconnection is detected during the wave output, the wave output status of the channel where the disconnection was detected becomes the during wave output stop (the wave output stops). The wave output does not automatically restart even after the recovery from the disconnection.

To restart the wave output, follow the procedure below.

1. Set 'CH1 Wave output start/stop request' (Un\G462) to Wave output stop request (0).
2. Eliminate the cause of the disconnection to restore the connection.
3. Turn on and off 'Error clear request' (YF).
4. Check the status of the module and external devices.
5. Change the value in 'CH1 Wave output start/stop request' (Un\G462) from Wave output stop request (0) to Wave output start request (1).

Wave output start/stop request cannot be accepted during disconnection.

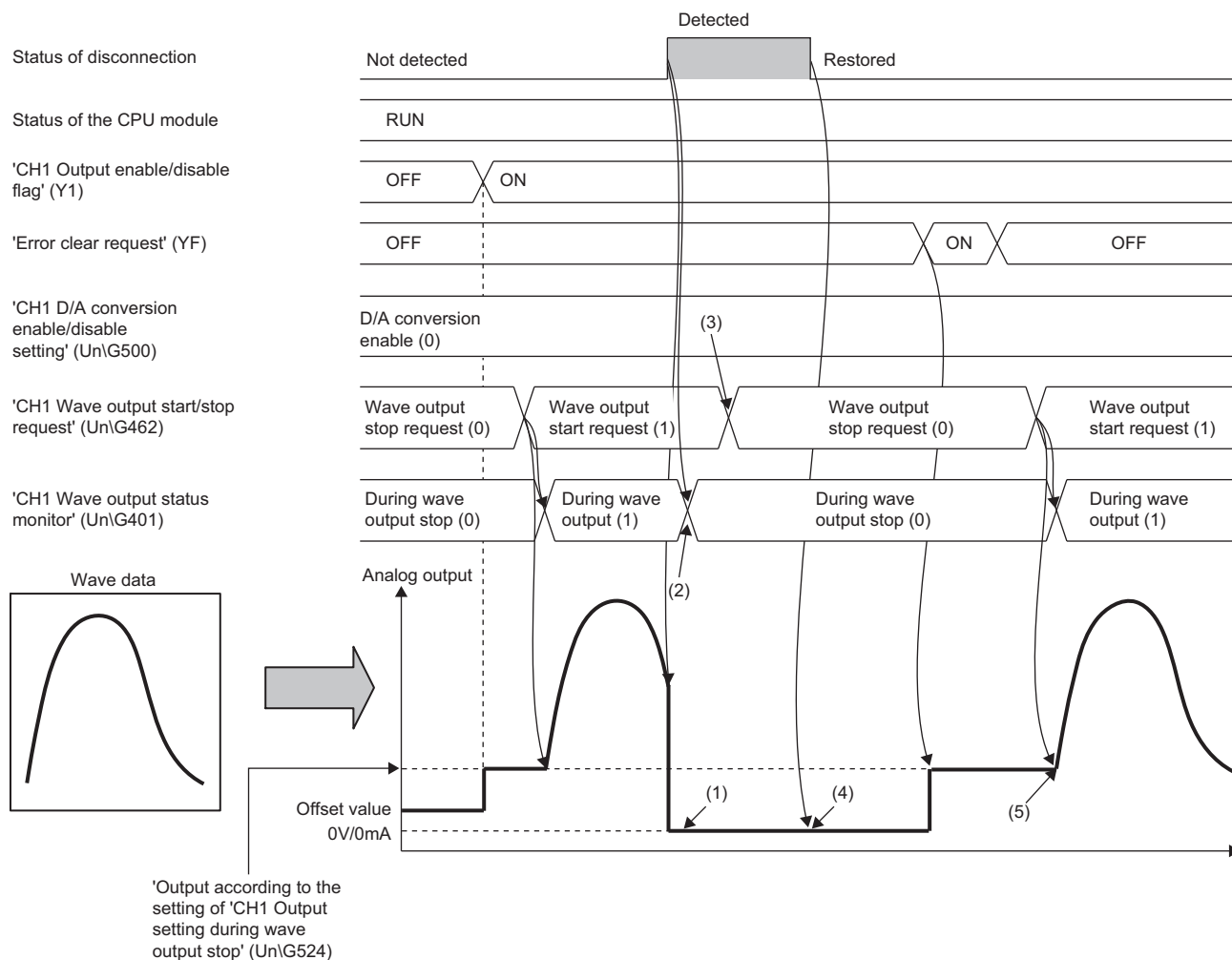

- (1) 0V/0mA is output in analog.
- (2) When a disconnection is detected, wave output stops.
- (3) Since a disconnection was detected and the wave output has stopped, change 'CH1 Wave output start/stop request' (Un\G462) to Wave output stop request (0).
- (4) The wave output does not restart even after the recovery from the disconnection.
- (5) To restart the wave output, turn on and off 'Error clear request' (YF). After that, change 'CH1 Wave output start/stop request' (Un\G462) to Wave output stop request (0), and then change it to Wave output start request (1) again.

When the wave output function is used as PWM

The wave output function can also be used as PWM with the minimum pulse width of 20 μ s.

Also the man-hours for programming can be reduced because necessary numbers of pulses can be output in analog by creating a wave pattern only for one pulse.

■ Example of wave pattern creation

When a wave pattern with a pulse width of 20 μ s, amplitude of 5V, and duty ratio of 50% is created

1. Set "Output range setting" to "0 to 5V".

 [Navigation window] \Rightarrow [Parameter] \Rightarrow [Module Information] \Rightarrow Module model name \Rightarrow [Basic setting] \Rightarrow [Range switching function]

2. Create a wave pattern for one pulse in "Create Wave Output Data".

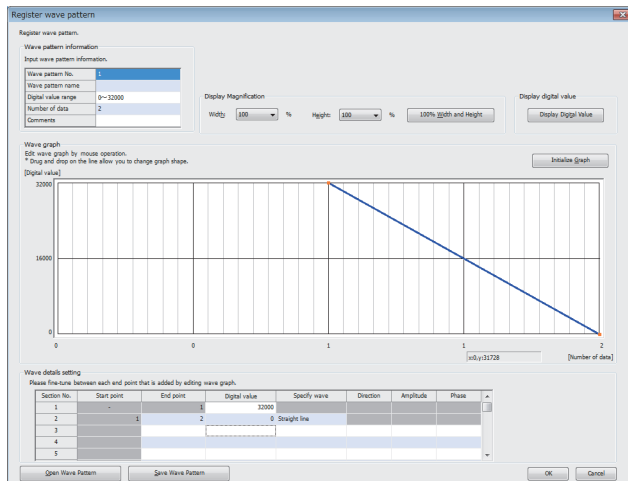

Setting item	Setting details	
Wave pattern information	Digital value range	0 to 32000
	Number of data	2
Wave details setting	Digital value for Section No.1	32000
	Digital value for Section No.2	0
	Wave specification for Section No.2	Straight line

The wave pattern to be output in analog differs from the one to be monitored on the engineering tool.

3. Configure "Wave output data setting" as shown below.

Setting item	Setting details
Wave pattern No. for CH1	Wave pattern created in step 2
Wave pattern start address setting for CH1	5000 (default value)
Wave pattern output repetition setting for CH1	Set the number of repetitions.
Constant for wave output conversion cycle for CH1	1 (default value)

4. Register the wave data and parameters of the wave output function to the D/A converter module. For how to register the wave data and parameters, refer to the following. ( Page 58 Registering wave output data)

5. Set 'CH1 D/A conversion enable/disable setting' (Un\G500) to D/A conversion enable (0).
6. Turn on and off 'Operating condition setting request' (Y9).
7. Turn on 'CH1 Output enable/disable flag' (Y1).
8. Start wave output by setting 'CH1 Wave output start/stop request' (Un\G462) to Wave output start request (1). Then the values are output in analog as shown below.

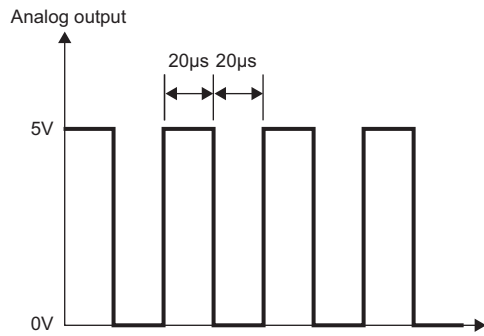

Wave output step action function

This function changes addresses and data values to be output to change the analog output flexibly at any timing in the wave output mode.

This function is useful for the analog output test in the wave output mode and for debugging the wave output function.

Ex.

Wave output step action on the following conditions:

- The output range is set to "-10 to 10V".
- During wave output
- The address of when the step action wave output request is accepted is 34990.

1. Set 'Step action wave output request' (Un\G188) to ON (1) during wave output.

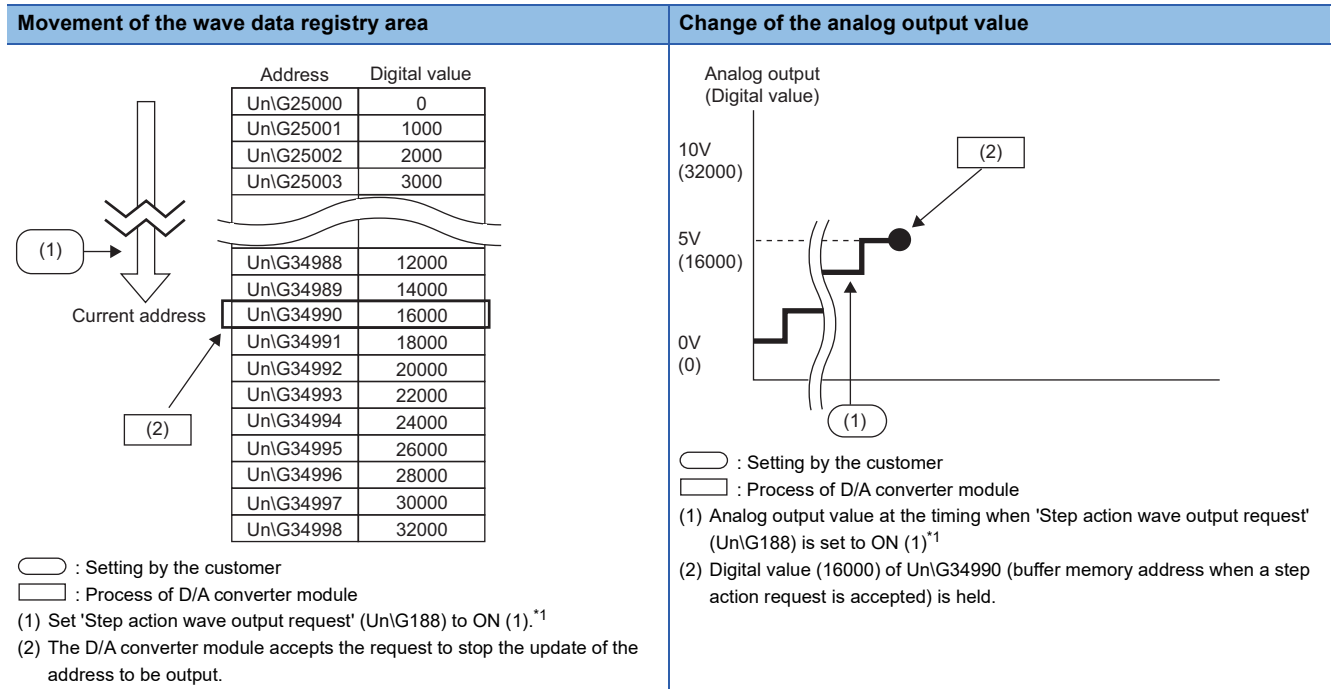

*1 This case is where the wave output status is "During wave output" at the timing of (1). Otherwise, the following values are output at the timing of (2).
 ·When the status is "During wave output stop", the digital value of the address set in Wave pattern start address setting is output in analog and held.
 ·When the status is "Wave output pause", the address data during the wave output pause (wave output current address) is held.

2. Set 'CH1 Wave output step action movement amount' (Un\G482) to 8 (8 in the forward direction).

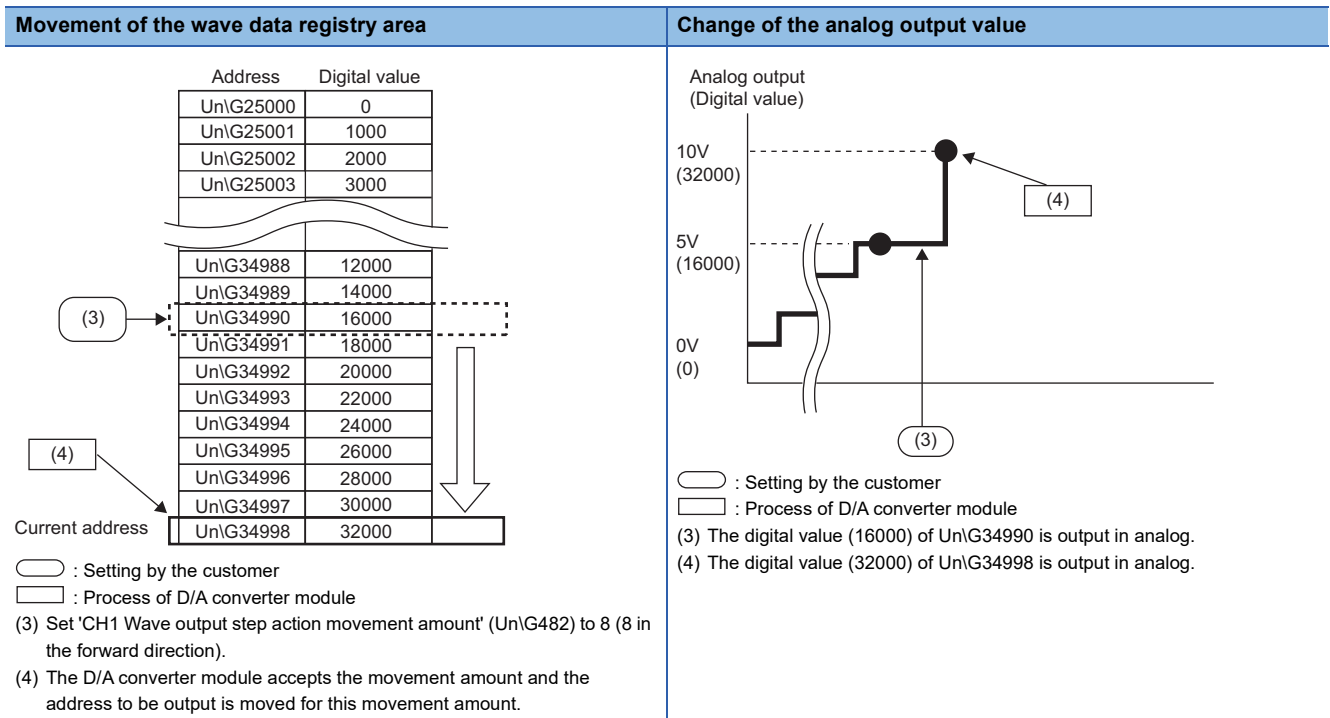

3. Change the digital value of Un\G34992 to 16000, and set 'CH1 Wave output step action movement amount' (Un\G482) to -6 (6 in the reverse run direction).

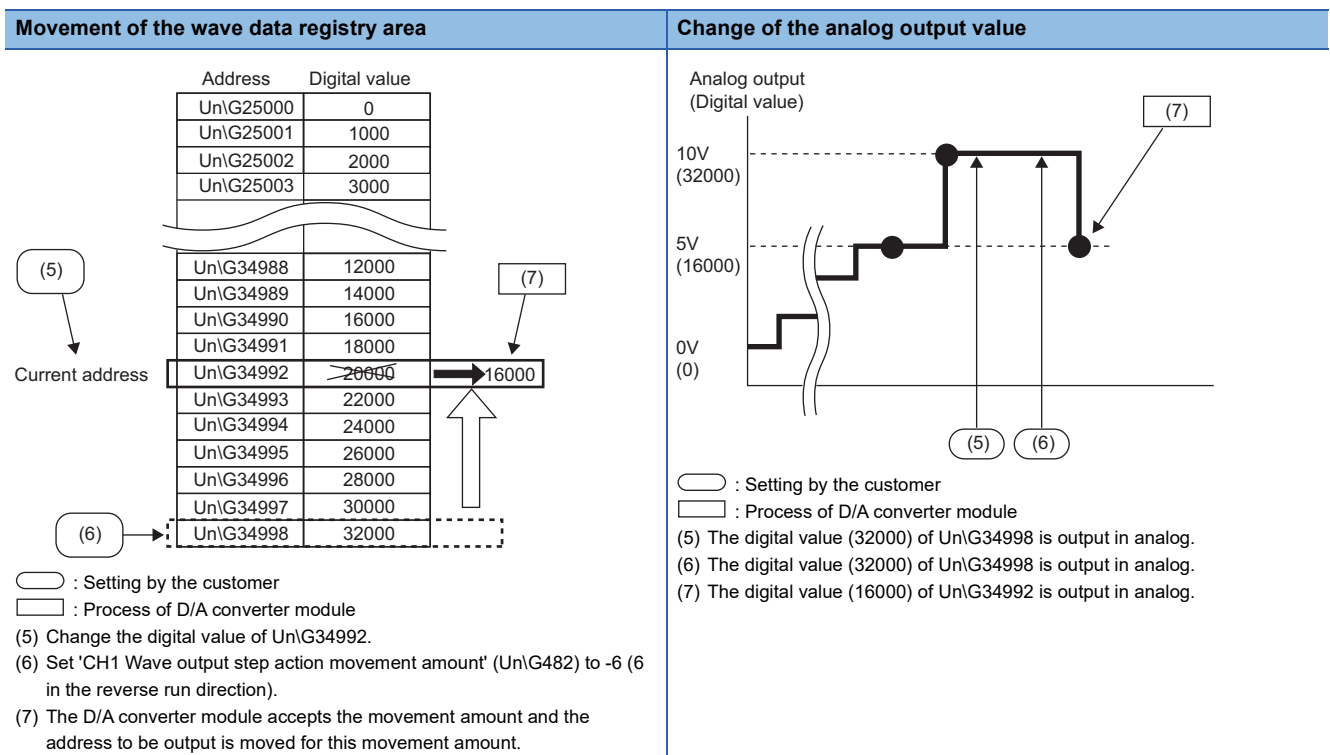

4. Set 'Step action wave output request' (Un\G188) to OFF (0) during wave output.

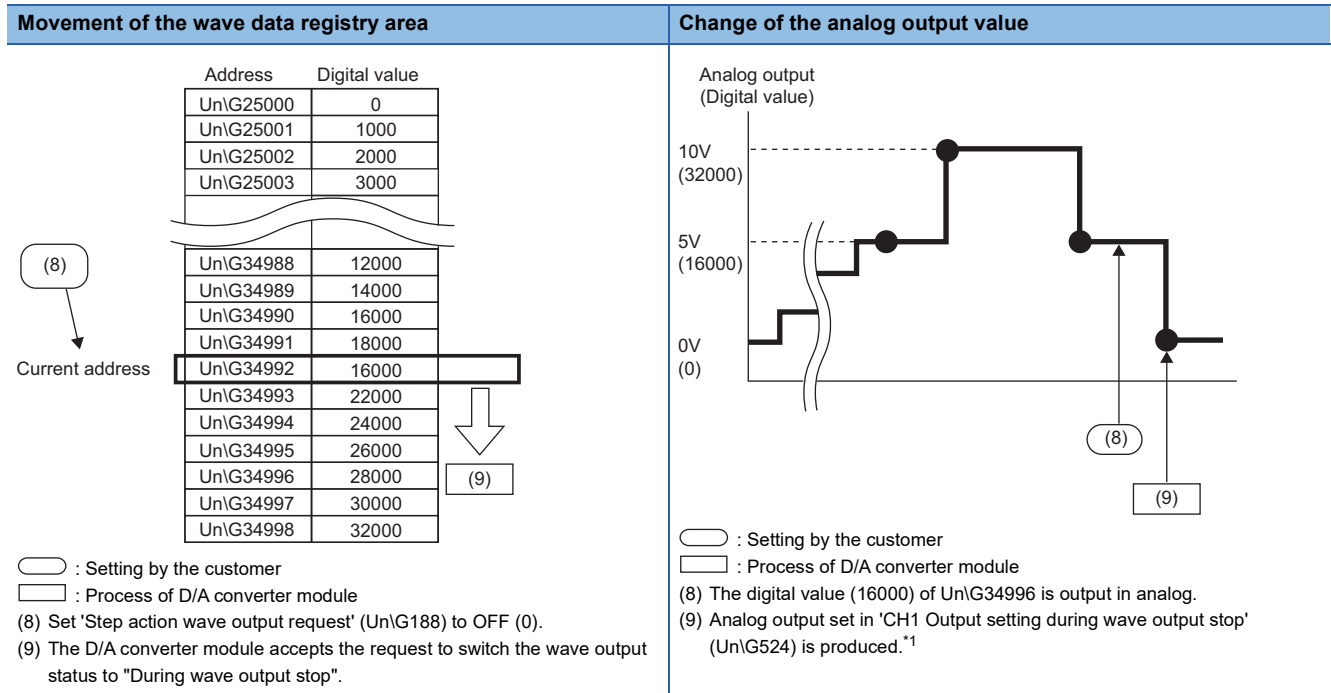

*1 This case is when 'CH1 Output setting during wave output stop' (Un\G524) is set to 0V/0mA (0).

Operation of the wave output step action function

The wave output step action function is executed as follows.

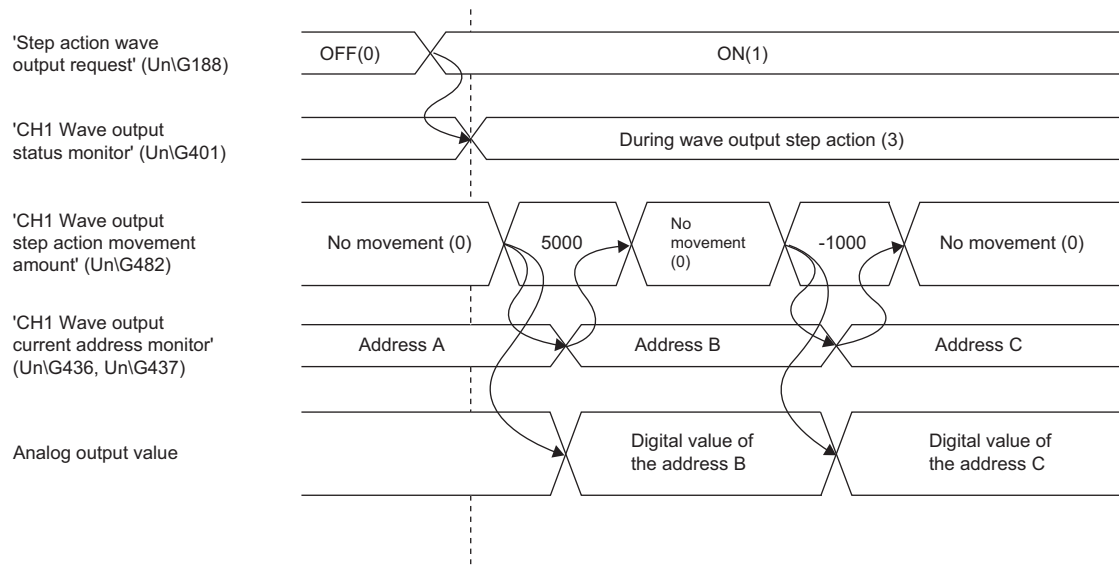

—————▶ Performed by the D/A converter module

Address B = Address A + 5000

Address C = Address B - 1000

Change the value in 'Step action wave output request' (UnG188) from OFF (0) to ON (1) to set the status to "During wave output step action". By setting a value in 'CH1 Wave output step action movement amount' (UnG482) during the wave output step action, the address moves to the address of the target wave data for the output test. Set the amount for movement from the current wave data address in 'CH1 Wave output step action movement amount' (UnG482).

After the movement, the value in 'CH1 Wave output step action movement amount' (UnG482) is changed to No movement (0) and the wave data of the target address is output in analog.

The available range for movement by using 'CH1 Wave output step action movement amount' (UnG482) depends on the setting values of Wave pattern start address setting and Wave pattern data points setting. The following shows the available range for movement.

$$\left(\begin{array}{c} \text{Wave pattern} \\ \text{start address} \end{array} \right) \text{ to } \left(\begin{array}{c} \text{Wave pattern} \\ \text{start address} \end{array} + \begin{array}{c} \text{Wave pattern} \\ \text{data points} \end{array} - 1 \right)$$

If a value of the wave pattern data points or greater is set for 'CH1 Wave output step action movement amount' (UnG482), the operation is proceeding using the value of wave pattern data points.

Execution of the wave output step action function

To use the wave output step action function, the initial setting for the wave output function must be set in advance. For details on the initial setting for the wave output function, refer to the following.

☞ Page 52 Initial settings of the wave output function

☞ Page 58 Registering wave output data

■ Switch to the wave output step action status

Switch the wave output status to the during wave output step action in the following procedure.

1. Change the value in 'Step action wave output request' (UnG188) from OFF (0) to ON (1).
2. Check that During wave output step action (3) has been set for CH□ Wave output status monitor in all the channels where the D/A conversion is enabled.

To execute the wave output step action, check 'Latest error code' (UnG0) and ERR LED first. Then, after checking that no error has occurred, change the value in 'Step action wave output request' (UnG188) from OFF (0) to ON (1). If the parameter setting for wave output is not set within the setting range in all the channels that are set to D/A conversion enable, the wave output step action cannot be executed in all channels.

■Execution of the wave output step action

After switching the status to the wave output step action status, execute the wave output step action in the following procedure. Repeating this procedure tests analog output in the wave output mode and debugs the wave output function.

1. Change the value of the target wave data for the wave output step action to any value.
2. Set a value for 'CH1 Wave output step action movement amount' (Un\G482).

Set the following value according to the direction to move.

Movement direction	Description	Setting value
No movement	The buffer memory address of the wave data to be output is not moved.	0
Forward movement	The buffer memory address of the wave data to be output is moved in the address increasing direction from the buffer memory address of the currently output wave data. ■When 10000 is set in 'CH1 Wave output step action movement amount' (Un\G482) with the buffer memory address of the currently output wave data Un\G20000: The buffer memory address for the wave output is moved to Un\G30000.	1 to 30000
Reverse movement	The buffer memory address of the wave data to be output is moved in the address decreasing direction from the buffer memory address of the currently output wave data. ■When -10000 is set in 'CH1 Wave output step action movement amount' (Un\G482) with the buffer memory address of the currently output wave data Un\G40000: The buffer memory address for the wave output is moved to Un\G30000.	-1 to -30000

3. Check that the value in 'CH1 Wave output step action movement amount' (Un\G482) has become No movement (0).
4. Check that 'CH1 Wave output current address monitor' (Un\G436, Un\G437) became the buffer memory addresses of the wave data to be output.
5. Check that proper analog values are output.



■End of the wave output step action

End the wave output step action in the following procedure.

1. Change the value in 'Step action wave output request' (Un\G188) from ON (1) to OFF (0).
2. Check that During wave output stop (0) has been set for CH□ Wave output status monitor in all the channels. If a value other than Wave output stop request (0) has been set for 'CH1 Wave output start/stop request' (Un\G462), the value is changed to Wave output stop request (0) forcibly at this timing. Also check the value of this buffer memory area.

To execute the wave output after the wave output step action, set Wave output start request (1) for 'CH1 Wave output start/stop request' (Un\G462).

Point

- Analog output may be changed suddenly when a value is set for 'CH1 Wave output step action movement amount' (Un\G482). To prevent a sudden change, use with 'CH1 Output enable/disable flag' (Y1) is recommended. For the combination, refer to the following.
 Page 23 Analog Output HOLD/CLEAR Function
- Analog output can be changed at any timing as well by using 'CH1 Output enable/disable flag' (Y1) during the wave output step action. For details, refer to the following.
 Page 88 Analog output test in the wave output mode
- During the wave output step action, the wave output status is not changed even when a value is set for 'CH1 Wave output start/stop request' (Un\G462). To change the wave output status, set 'Step action wave output request' (Un\G188) to OFF (0) (set the status to the during wave output stop).

Analog output test in the wave output mode

The following shows the procedure of the analog output test using the wave output step action function.

The example of testing analog output in CH1 is described as well.

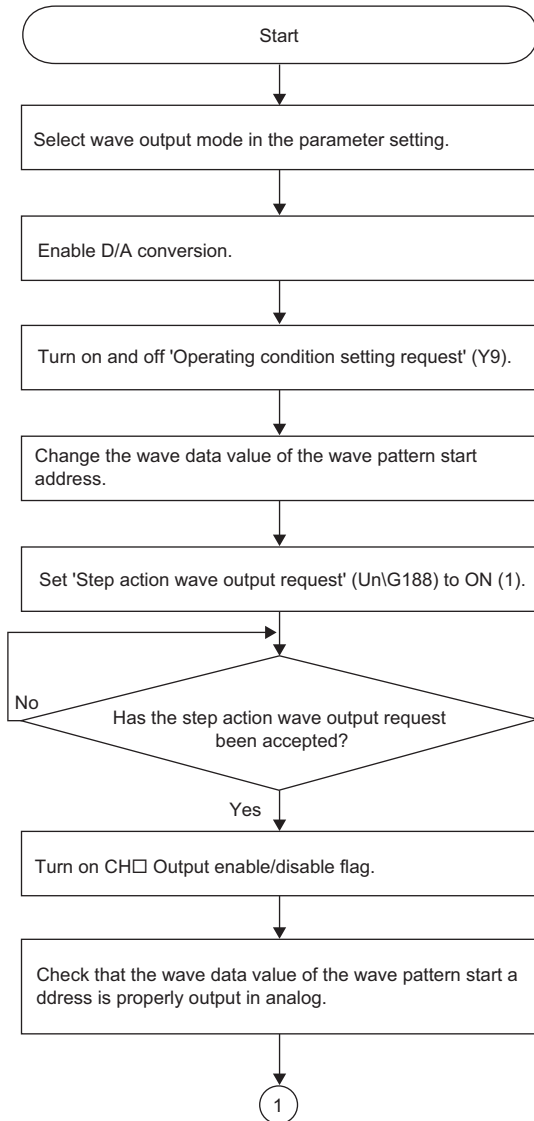

Example of testing analog output in CH1.

Set "Operation mode setting" of the module parameter so that the module is in wave output mode.

Set 'CH1 D/A conversion enable/disable setting' (UnG500) to D/A conversion enable (0).

Turn on and off 'Operating condition setting request' (Y9).
Even though the D/A conversion is enabled, the analog output value becomes the offset value because 'CH1 Output enable/disable flag' (Y1) is off.

When a value set in 'Step action wave output request' (UnG188) has been accepted, 'CH1 Wave output status monitor' (UnG401) changes to During wave output step action (3).

The analog output value changes from the offset value to the wave data value of the wave pattern start address.

Check that the analog output value is a proper one using a measuring instrument such as a tester.

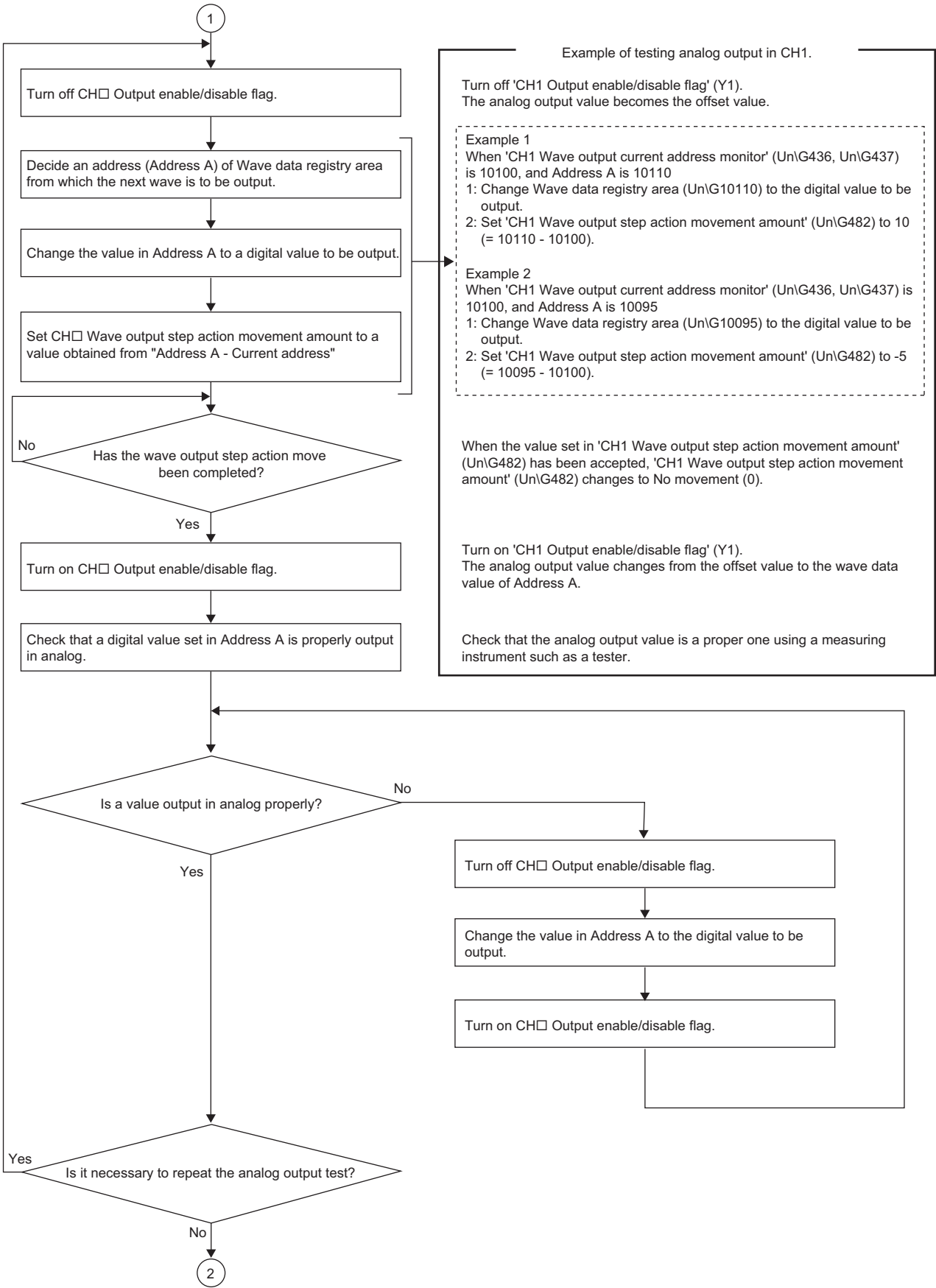

Example of testing analog output in CH1.

Turn off 'CH1 Output enable/disable flag' (Y1).
The analog output value becomes the offset value.

Example 1
When 'CH1 Wave output current address monitor' (Un\G436, Un\G437) is 10100, and Address A is 10110
1: Change Wave data registry area (Un\G10110) to the digital value to be output.
2: Set 'CH1 Wave output step action movement amount' (Un\G482) to 10 (= 10110 - 10100).

Example 2
When 'CH1 Wave output current address monitor' (Un\G436, Un\G437) is 10100, and Address A is 10095
1: Change Wave data registry area (Un\G10095) to the digital value to be output.
2: Set 'CH1 Wave output step action movement amount' (Un\G482) to -5 (= 10095 - 10100).

When the value set in 'CH1 Wave output step action movement amount' (Un\G482) has been accepted, 'CH1 Wave output step action movement amount' (Un\G482) changes to No movement (0).

Turn on 'CH1 Output enable/disable flag' (Y1).
The analog output value changes from the offset value to the wave data value of Address A.

Check that the analog output value is a proper one using a measuring instrument such as a tester.

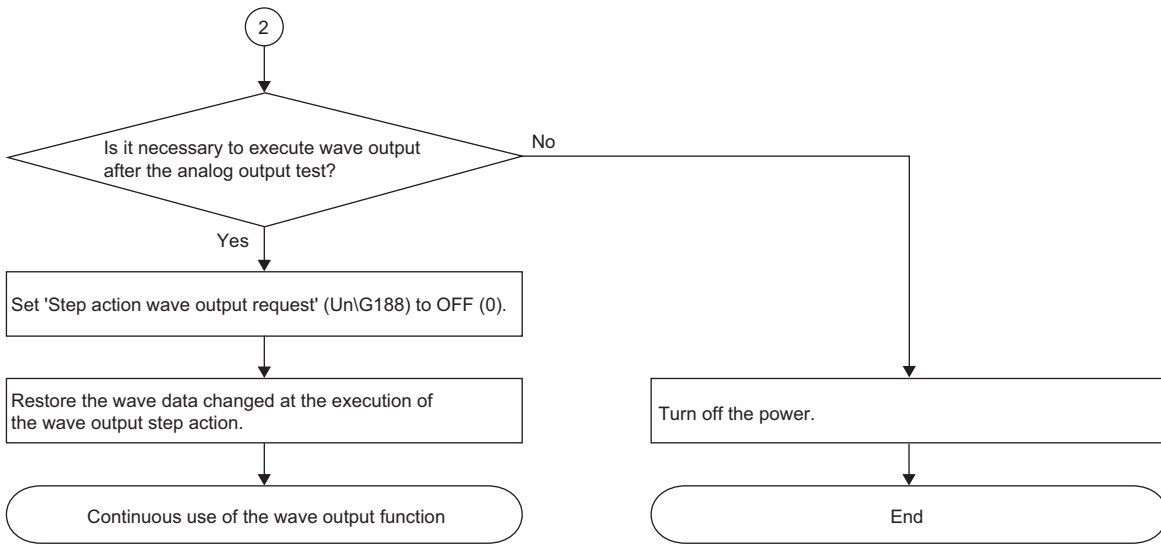

1.15 Inter-Module Synchronization Function

Synchronization

The operations of multiple D/A converter modules and the timing of D/A conversion of all channels can be synchronized. A D/A converter module uses the inter-module synchronization signal as a trigger to simultaneously execute the D/A conversion of all channels.

Setting method

■ Setting the system parameter

To use the inter-module synchronization function, configure the setting of the inter-module synchronization function in "System Parameter" to set the D/A converter module as the target module of the inter-module synchronization.

The setting method is shown below.

[Navigation window] ⇒ [Parameter] ⇒ [System Parameter] ⇒ [Inter-module Synchronization Setting]
 "I/O Assignment Setting" window

Slot	Module Name	Module Status Setting	Points	Start XY
Base				
CPU	R04CPU(Host Station)			3E00
0(*-0)	R60DAH4	No Setting	16 Points	0000
1(*-1)	R60DAH4	No Setting	16 Points	0010

"Inter-module Synchronization Setting" window

Item	Setting
Inter-module Synchronization Setting	
Use Inter-module Synchronization Function in System	Use
Select Inter-module Synchronization Target Module	<Detailed Setting>

"Select the Synchronous Target Module" window

Slot	Module Name	Management	Master/Local	Setting
Main				
CPU	R04CPU(Host Station)	1PLC No.		Synchronize
0(0-0)	R60DAH4	1PLC controlled		Synchronize
1(0-1)	R60DAH4	1PLC controlled		Synchronize

"Inter-module Synchronization Setting" window

Item	Setting
Inter-module Synchronization Setting	
Use Inter-module Synchronization Function in System	Use
Select Inter-module Synchronization Target Module	<Detailed Setting>
Fixed Scan Interval Setting of Inter-module Synchronization	
0.05ms Unit Setting	Set
Fixed Scan Interval Setting (Not set in 0.05ms unit)	0.000ms
Fixed Scan Interval Setting (Set in 0.05ms unit)	0.50 ms

1. Set the I/O assignment appropriate to the system in use.
2. Select "Use" for "Use Inter-module Synchronization Function in System".
3. Double-click "Detailed Setting" of "Select Inter-module Synchronization Target Module".
4. Set "Synchronize" for the D/A converter module.
5. Set the inter-module synchronization cycle in "Fixed Scan Interval Setting of Inter-module Synchronization".
6. Write the system parameter into the CPU module and change the status of the CPU module from RESET to RUN. When the inter-module synchronization function is enabled, whether the synchronization is in process or the synchronization is stopped can be monitored with 'Synchronization status monitor' (Un\G9600).

■Setting the module parameter

Set the module parameter to use the inter-module synchronization function.

The setting method is shown below.

"Basic setting" window

[Navigation window] ⇒ [Parameter] ⇒ [Module Information] ⇒
Module model name ⇒ [Basic setting]

Item	CH1	CH2	CH3	CH4
Range switching function	This function enables to select the output range to be used from multiple ranges.			
Output range setting	4 to 20mA	4 to 20mA	4 to 20mA	4 to 20mA
Operation mode setting function	Setting Operation mode			
Operation mode setting	Normal output mode(10 μs/CH)			
Output mode setting function	HOLD or CLEAR can be set in the analog output HOLD/CLEAR setting.			
Analog output HOLD/CLEAR setting	CLEAR	CLEAR	CLEAR	CLEAR

"Application setting" window

[Navigation window] ⇒ [Parameter] ⇒ [Module Information] ⇒
Module model name ⇒ [Application setting]

Inter-module synchronization function	D/A conversion is performed in the inter-module synchronization cycle.
Output selection during synchronous error	Inter-module synchronization continue
Online module change	The module can be changed without the system being stopped.
Auto restore of Offset/gain setting with the module change	Enable

1. Set "D/A conversion enable/disable setting" to "D/A conversion enable".
2. The setting of "Output range setting" is the same as the one for the normal output mode. Select an appropriate output range.
3. Set "Analog output HOLD/CLEAR setting" to "HOLD" or "CLEAR".
4. The setting of "Operation mode setting" is ignored.
5. Set "Output selection during synchronous error".
6. Write the module parameter into the CPU module and change the status of the CPU module from RESET to RUN.

In "Output selection during synchronous error", set whether to continue or stop the synchronization of D/A converter modules when an inter-module synchronization cycle crossing over error (error code: 2600H) or inter-module synchronization signal error (error code: 2610H) occurs.

■Interrupt program setting

When the inter-module synchronization function is used, 'CH1 Synchronization digital value' (Un\G9500) is converted to analog.

Write the value of 'CH1 Synchronization digital value' (Un\G9500) with an inter-module synchronous interrupt program (I44). The inter-module synchronous interrupt program (I44) contains the interrupt pointer (I44) to the IRET instruction set with the program, and the program is executed on the cycle set by a customer. The D/A converter module obtains 'CH1 Synchronization digital value' (Un\G9500) at the timing when the interrupt program is executed.

The following shows how to set an interrupt program.

[Navigation window] ⇒ [Parameter] ⇒ Model name of the CPU module ⇒ [CPU Parameter] ⇒ [Program Setting]

"CPU Parameter" window

Item	Setting
Program Setting	
Program Setting	<Detailed Setting>
FB/FUN File Setting	
FB/FUN File Setting	<Detailed Setting>

"Program Setting" window

Execute Order	Program Name	Execution Type		Refresh Group Setting
		Type	Detailed Setting Information	
1	MAIN	Scan		(Do not Set)
2	DOUKI	Event	Bit ON/Do Not Clear:SM401	(Do not Set)

"Event Execution Type Detailed Setting" window

Item	Setting
Trigger Type	Interruption Occurrence
Interruption Occurrence	I44

1. Double-click "Detailed Setting" of "Program Setting".
2. Set an arbitrary name of inter-module synchronous interrupt program (I44) for "Program Name".
3. Set "Event" for "Type" of "Execution Type".
4. Double-click "Detailed Setting Information" of "Execution Type".
5. Set "Interruption Occurrence" for "Trigger Type".
6. Set "I44" for "Interruption Occurrence".

7. Create an inter-module synchronous interrupt program (I44).

The inter-module synchronous interrupt program (I44) is executed at every inter-module synchronization cycle set by a customer. For details on interrupt programs, refer to the following.

 MELSEC iQ-R CPU Module User's Manual (Application)

■ Changing the module setting

- To write the default values with a program without using the module parameter or to change the parameter setting during module operation, the program that writes setting values and turns on and off 'Operating condition setting request' (Y9) is required to enable the setting.

Point

When the D/A converter module is set as the synchronization target, the I/O setting is refreshed before and after the execution of the inter-module synchronous interrupt program (I44). Thus, use the direct access (DY) to immediately reflect the setting into the D/A converter module by turning on and off 'Operating condition setting request' (Y9).

Operation example

When the inter-module synchronization function is used, control is basically performed with the inter-module synchronous interrupt program (I44).

To improve the synchronization performance of the entire system, the dedicated refresh target data is used when the inter-module synchronous interrupt program (I44) is executed. The following shows the refresh target data.

- 'CH1 Synchronization digital value' (Un\G9500)
- 'Synchronization status monitor' (Un\G9600)

Basic operation

The following shows the basic operation of when the settings have been correctly configured and two D/A converter modules operate in synchronization with each other.

This section describes the analog HOLD/CLEAR function for each module according to the following settings.

Target module	Analog HOLD/CLEAR function
Module A	HOLD
Module B	CLEAR

- Synchronized operation flow of when the status of the CPU module is changed from STOP to RUN

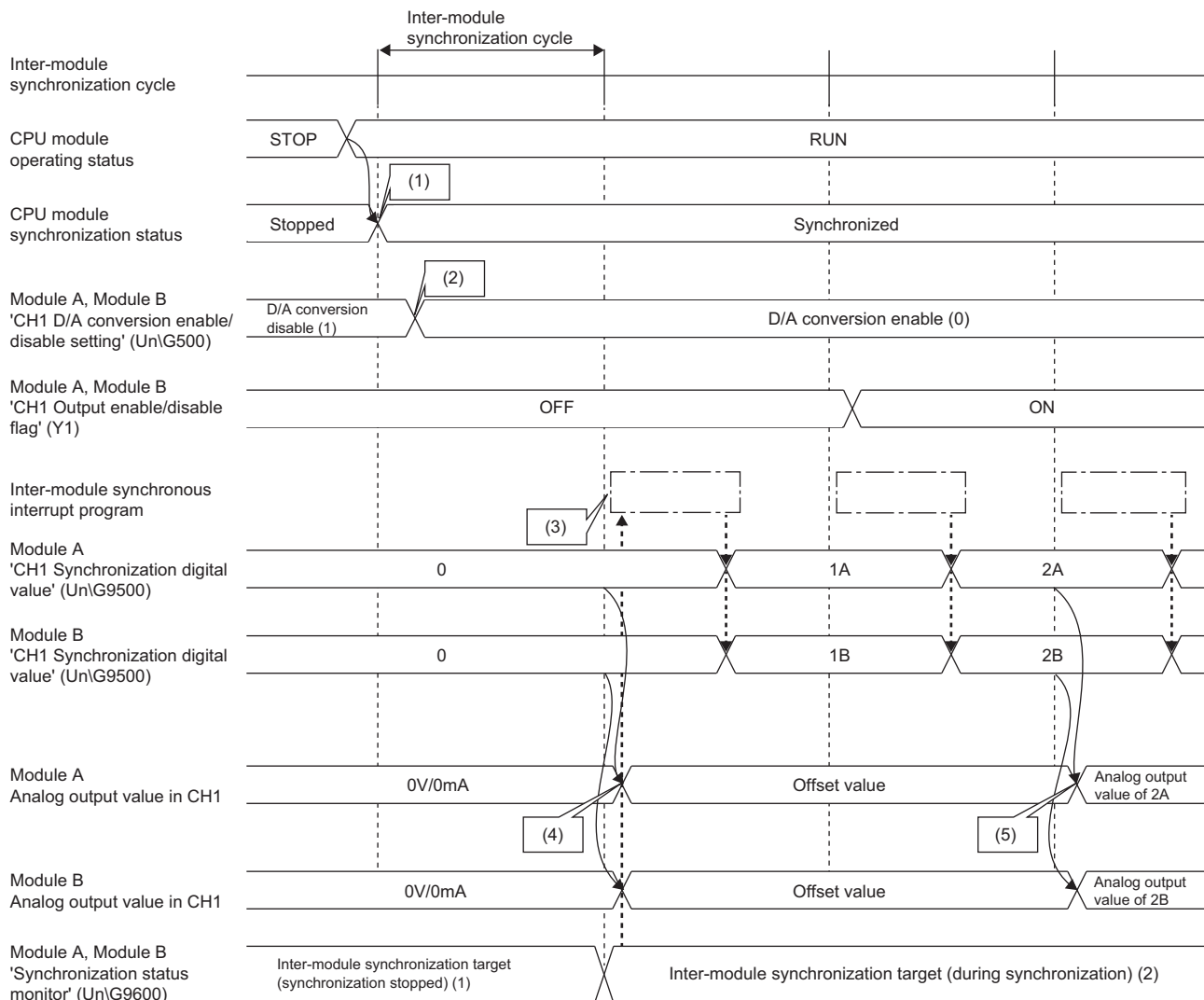

□ Inter-module synchronous interrupt program (I44)

- The synchronization of the modules is started at the timing of the next inter-module synchronization cycle after the status of the CPU module is changed from STOP to RUN.
- Set 'CH1 D/A conversion enable/disable setting' (UnG500) to D/A conversion enable (0), and then turn on and off 'Operating condition setting request' (Y9).
- The inter-module synchronous interrupt program (I44) is executed at the start timing of the second inter-module synchronization cycle. The inter-module synchronous interrupt program (I44) is not executed in the first inter-module synchronization cycle after the CPU module is set to RUN.
- Since both the D/A conversion enable and output disable are set, the offset value is output in analog.
- Since the output enable is set, the synchronization digital value is output in analog.

• Synchronized operation flow of when the CPU module is in the RUN state

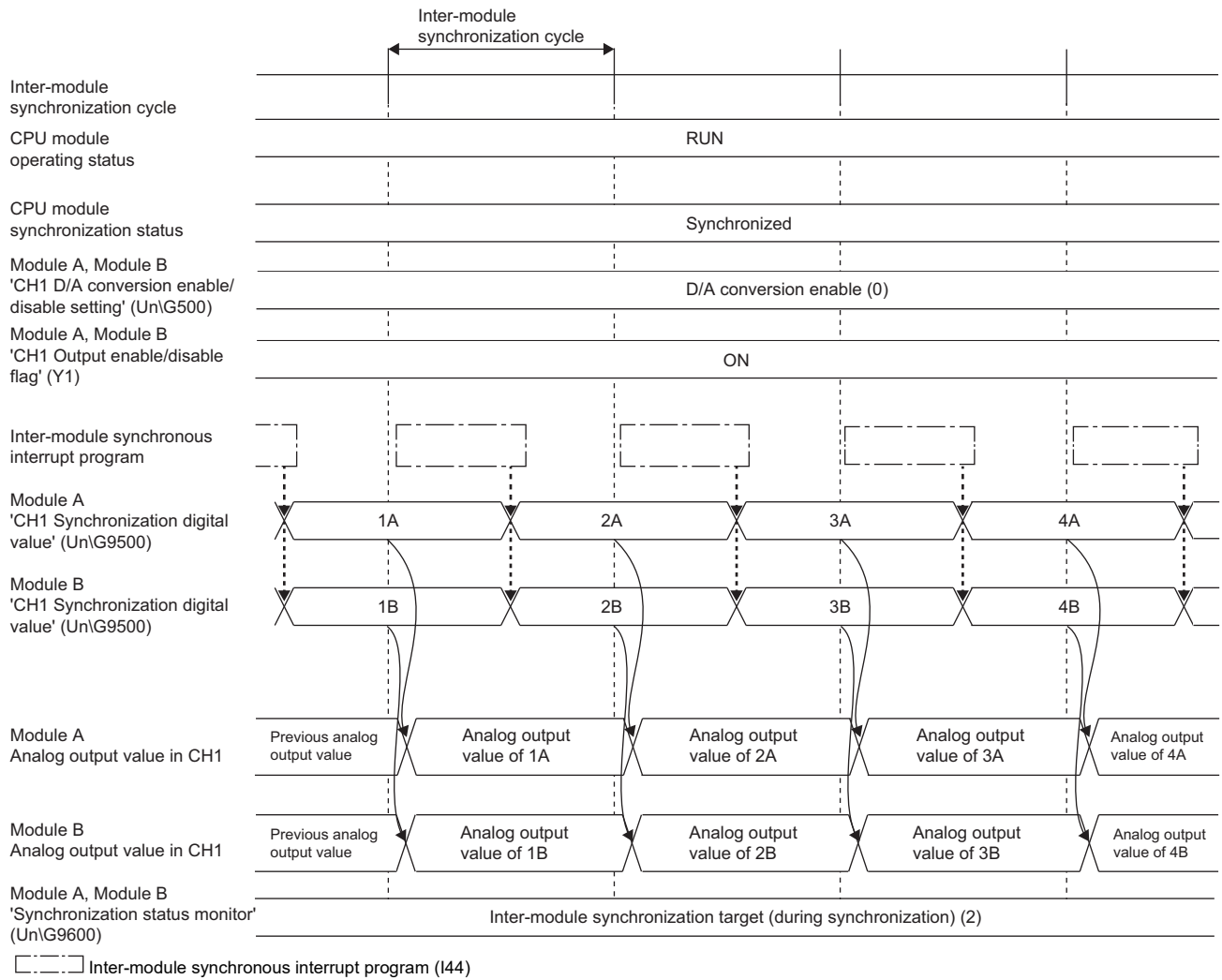

• Synchronized operation flow of when the status of the CPU module is changed from RUN to STOP

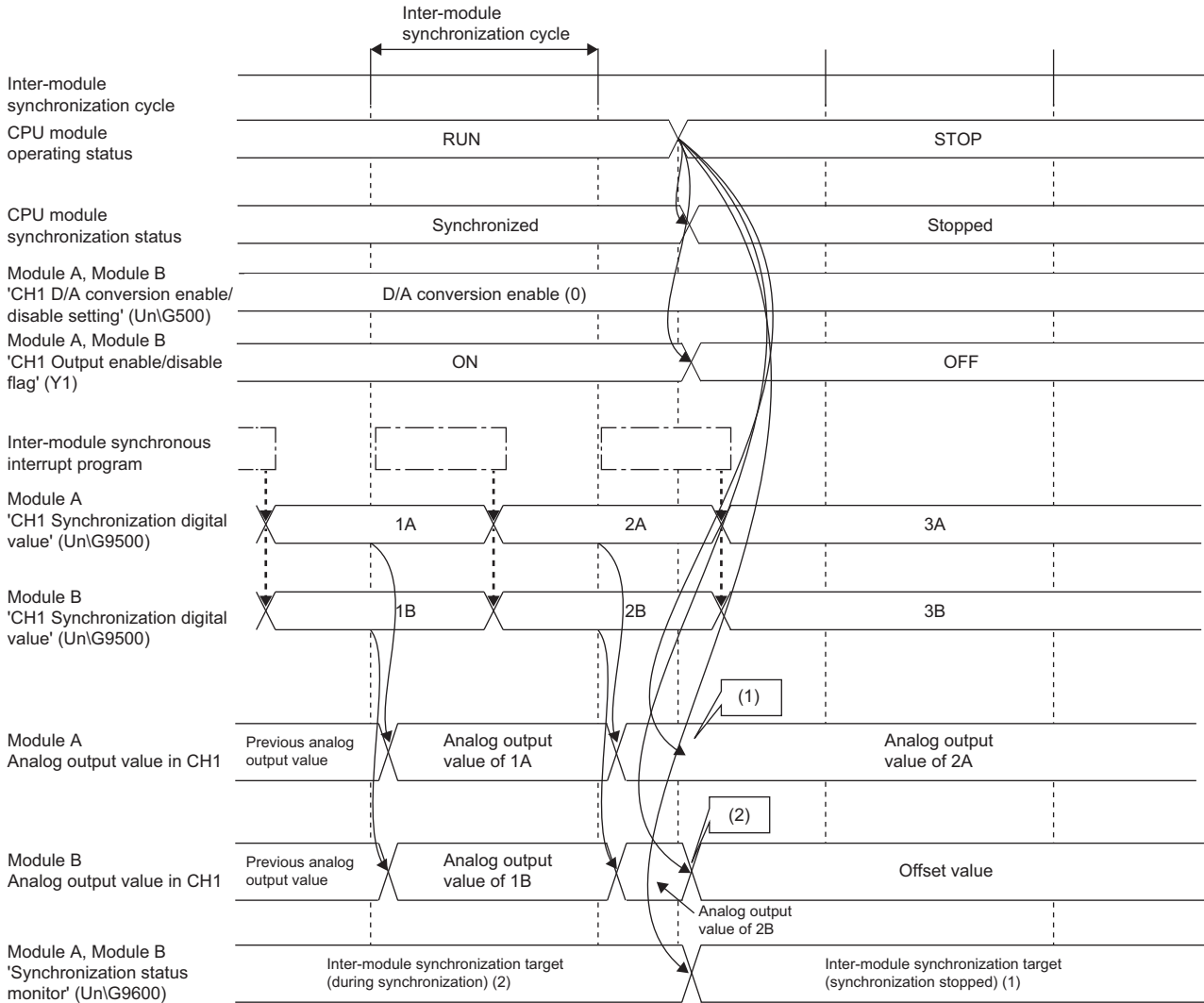

□ Inter-module synchronous interrupt program (I44)

(1) When Analog output HOLD/CLEAR setting is set to HOLD, analog output value is held.

(2) When Analog output HOLD/CLEAR setting is set to CLEAR, the offset value is output in analog.

■ Synchronous conversion processing in the D/A converter module

This function imports the synchronization digital values at the timing when the inter-module synchronous interrupt program is executed, and then simultaneously converts them to analog in the next inter-module synchronization cycle for all the channels.

The following shows the D/A conversion processing example of when D/A conversion is enabled in all channels.

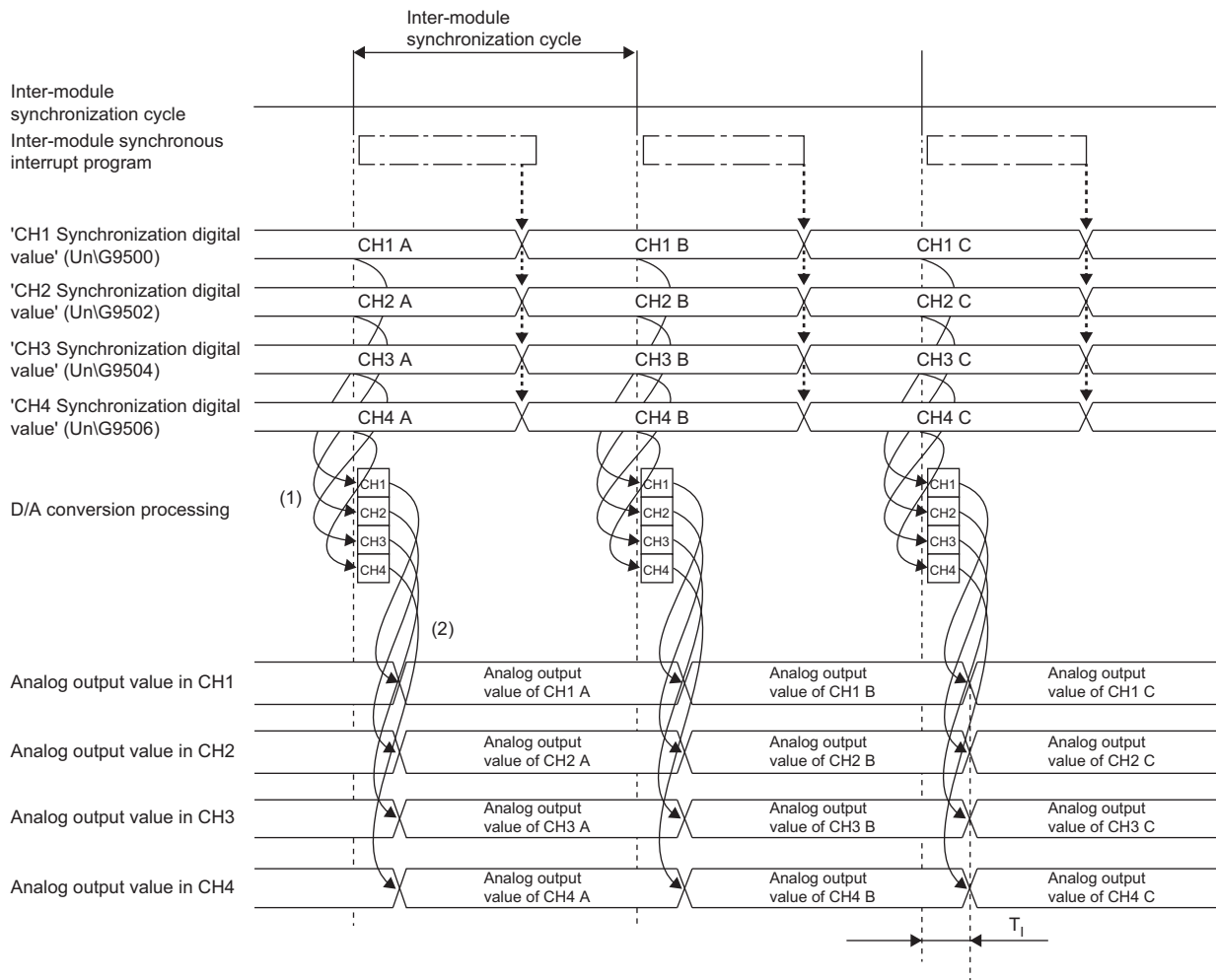

□ Inter-module synchronous interrupt program (I44)



T_i: D/A conversion time (approx. 20μs)

(1) Imports the synchronization digital values at the timing of the inter-module synchronization cycle, and then simultaneously converts them to analog for all the channels.

(2) The simultaneously analog converted values for all the channels are output in analog.

Faulty operation during synchronization

The causes of the faulty operation during synchronization are as follows:

- Cycle crossing ( Page 98 Operation when a cycle crossing occurs)
- Cycle skipping ( Page 100 Operation when a cycle skip occurs)
- Synchronization loss ( Page 101 Operation when a synchronization loss occurs)

■ Operation when a cycle crossing occurs

The phenomena that D/A conversion is processed across the inter-module synchronization cycle due to the operation timing of the inter-module synchronous interrupt program (I44) is called "cycle crossing". When a cycle crossing has occurred, an inter-module synchronization cycle crossing over error (error code: 2600H) occurs. The synchronization status of the D/A converter module when an error occurs becomes Synchronization stop or Synchronization continue depending on the setting of 'Output setting during synchronization error' (Un\G9532).

The following shows the operation of the D/A converter modules of when a cycle crossing has occurred.

- When 'Output setting during synchronization error' (Un\G9532) is set to Synchronization continue (0)

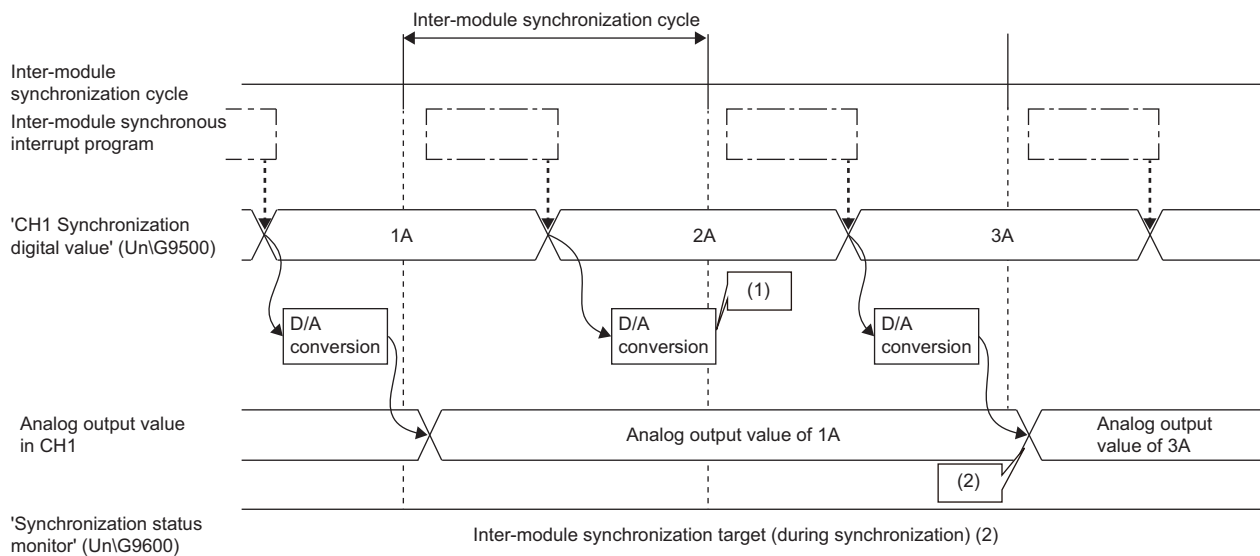

 Inter-module synchronous interrupt program (I44)

(1) A cycle crossing occurs since the D/A conversion has been processed across the inter-module synchronization cycle.

(2) Since the cycle crossing has occurred, 2A synchronization digital value is ignored. 3A synchronization digital value is converted to analog in the next inter-module synchronization cycle, and output in analog.

- When 'Output setting during synchronization error' (Un\G9532) is set to Synchronization stop (1)

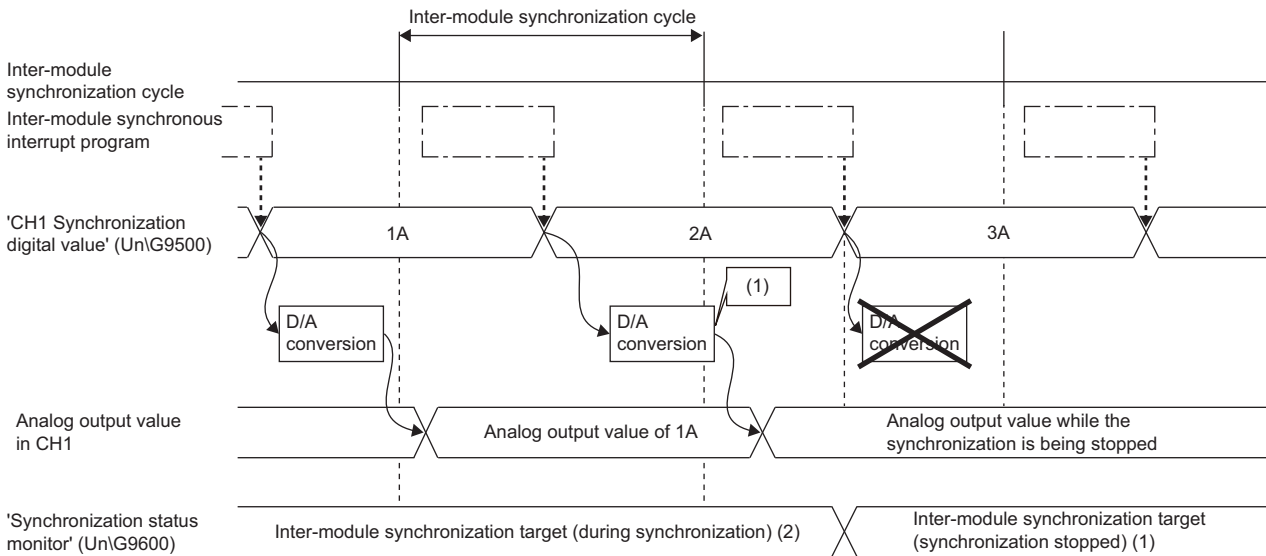

□ Inter-module synchronous interrupt program (I44)

(1) A cycle crossing occurs since the D/A conversion has been processed across the inter-module synchronization cycle. After that, the D/A converter module immediately stops the synchronized operation.

Point

When a cycle crossing has occurred, follow the methods below to resolve the issue.

- The inter-module synchronization cycle may be shorter for the time needed for the D/A conversion. Set a longer inter-module synchronization cycle so that the D/A conversion is completed within the inter-module synchronization cycle.
- The possible cause is that the execution time for an inter-module synchronous interrupt program (I44) is longer. Correct settings such as reducing the number of steps of the inter-module synchronous interrupt program (I44).

■ Operation when a cycle skip occurs

The phenomena that D/A conversion is not processed within an inter-module synchronization cycle due to the operation timing of the inter-module synchronous interrupt program (I44) is called "cycle skip". When a cycle skip has occurred, an inter-module synchronization cycle skip error (error code: 2601H) occurs. The operation of the D/A converter module stops when an error occurs regardless of the setting of 'Output setting during synchronization error' (UnG9532). Analog values are output according to the analog HOLD/CLEAR setting.

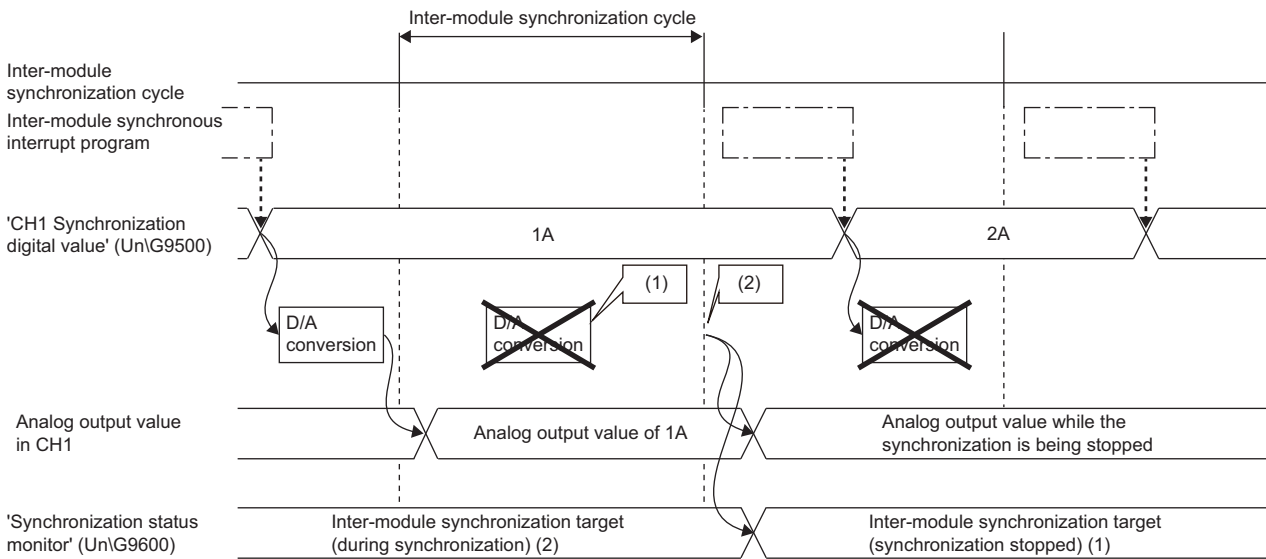

□ Inter-module synchronous interrupt program (I44)

(1) A cycle skip occurs since no D/A conversion has been processed within an inter-module synchronization cycle.

(2) An inter-module synchronization cycle skip error (error code: 2601H) occurs in the next inter-module synchronization cycle, and analog values are output according to the analog HOLD/CLEAR setting.

Point

When a cycle skip has occurred, follow the methods below to resolve the issue.

- Interrupt disable (EI instruction unexecuted) may be set. Execute the EI instruction in the main program and enable an interrupt.
- The possible cause is that the execution time for an inter-module synchronous interrupt program (I44) is longer for the inter-module synchronization cycle. Correct settings such as setting a longer inter-module synchronization cycle or reducing the number of steps of the inter-module synchronous interrupt program (I44).

If the error occurs again even after the above actions are taken, the possible cause is a failure of the module. Please consult your local Mitsubishi representative.

■ Operation when a synchronization loss occurs

The phenomenon that the D/A converter module cannot receive inter-module synchronization signals at a normal cycle, or receives at the timing far from the timing of inter-module synchronization cycle is called "synchronization loss". When a synchronization loss has occurred, an inter-module synchronization signal error (error code: 2610H) occurs. The synchronization status of the D/A converter module when an error occurs becomes Synchronization stop or Synchronization continue depending on the setting of 'Output setting during synchronization error' (Un\G9532).

The following shows the operation of the D/A converter modules of when a synchronization loss has occurred.

- When 'Output setting during synchronization error' (Un\G9532) is set to Synchronization continue (0)

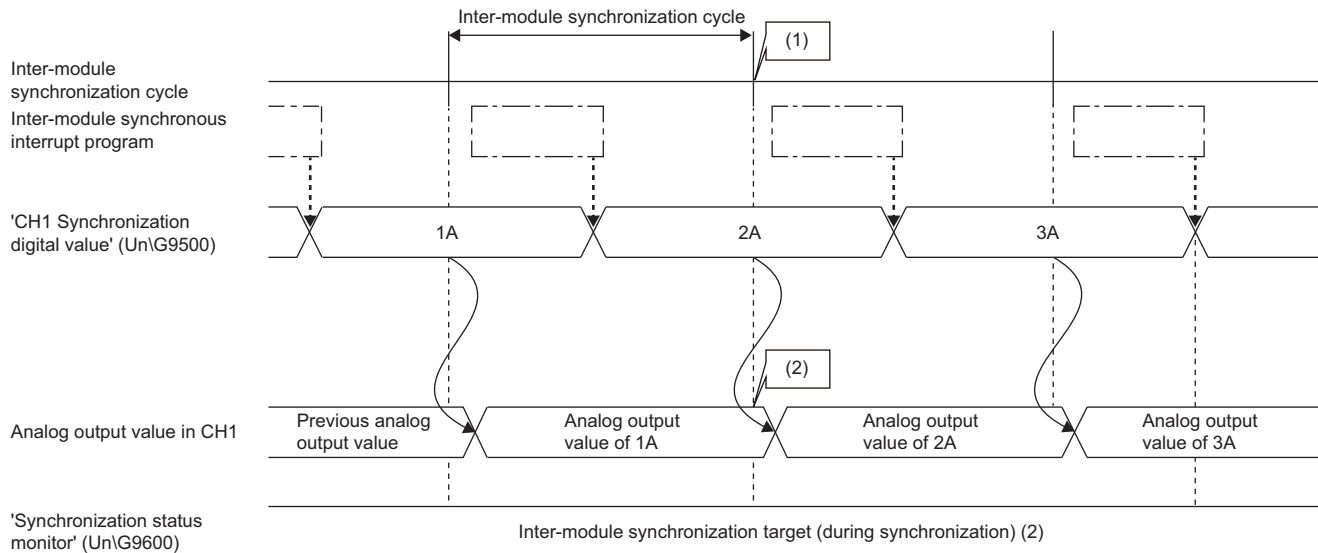

□ Inter-module synchronous interrupt program (I44)

- (1) A synchronization loss occurs when the D/A converter module cannot accept the inter-module synchronization cycle.
- (2) When the D/A converter module did not accept the inter-module synchronization cycle at the timing when the inter-module synchronization cycle was supposed to be accepted, an inter-module synchronization signal error (error code: 2610H) occurs, but the analog output is updated.
- (3) Even if a synchronization loss occurs, D/A conversion is processed in the next inter-module synchronization cycle.

- When 'Output setting during synchronization error' (Un\G9532) is set to Synchronization stop (1)

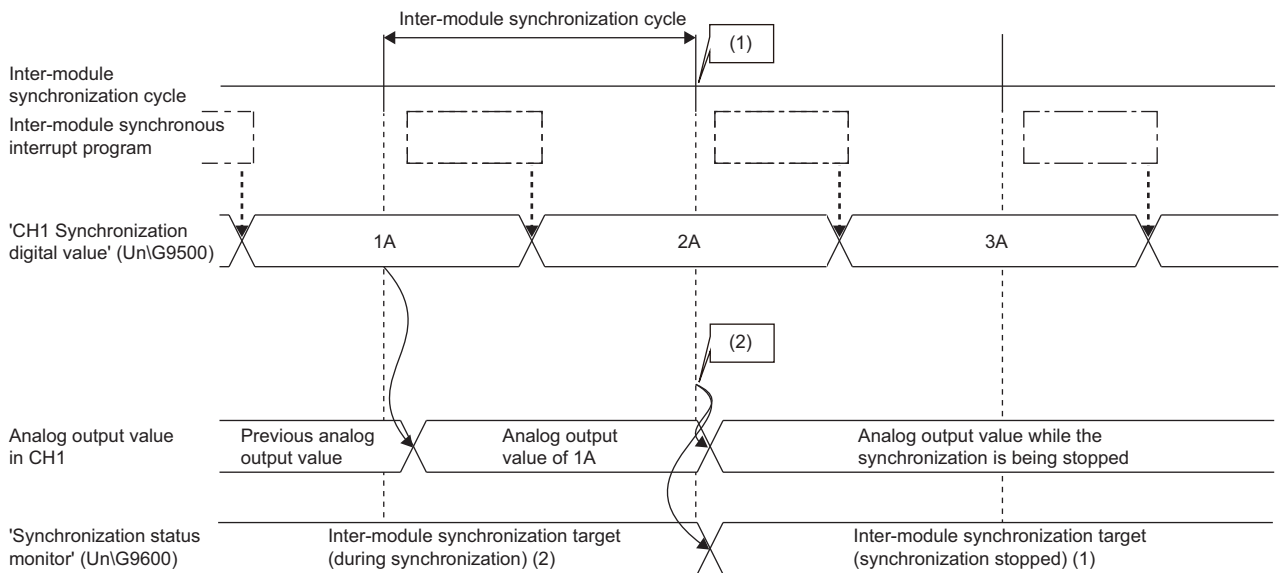

□ Inter-module synchronous interrupt program (I44)

(1) A synchronization loss occurs when the D/A converter module cannot accept the inter-module synchronization cycle.

(2) When the D/A converter module did not accept the inter-module synchronization cycle at the timing when the inter-module synchronization cycle was supposed to be accepted, an inter-module synchronization signal error (error code: 2610H) occurs. The analog output value differs depending on the setting of the analog output HOLD/CLEAR function as shown below.

- When HOLD is set, analog output value is held.
- When CLEAR is set, the offset value is output in analog.

Point

When a synchronization loss has occurred, the module may be affected by noise. Check and adjust the cable wiring and the installation environment of the programmable controllers, and restart the system. If the error reoccurs even after the adjustment, the possible cause is a failure of the module. Please consult your local Mitsubishi representative.

Warning output during synchronization

Regarding the warning output while the inter-module synchronization function is enabled, the update timing for ALM LED, 'Warning output signal' (XE), 'Warning output upper flag' (Un\G36), and 'Warning output lower flag' (Un\G37) are changed as described below.

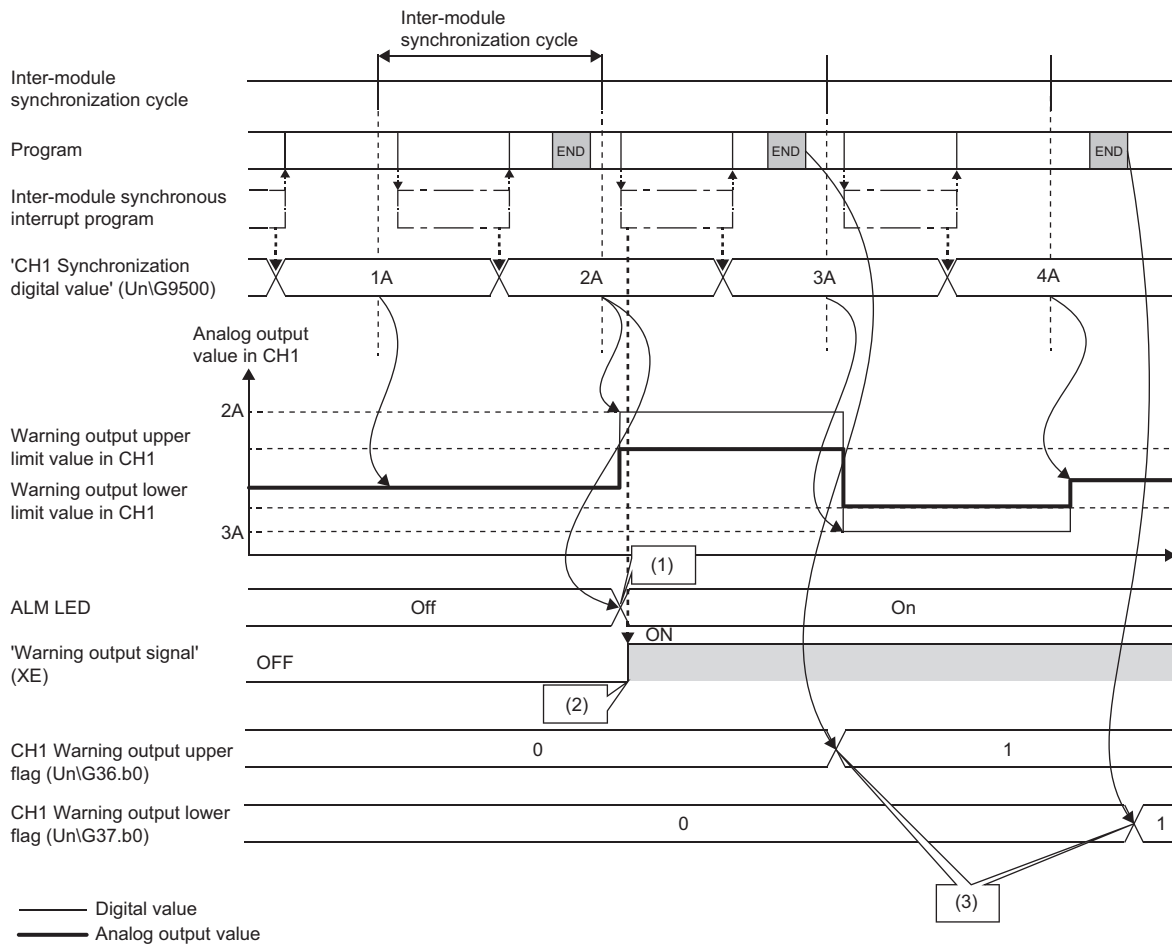

— Digital value
 — Analog output value

□ Inter-module synchronous interrupt program (I44)

(1) ALM LED turns on when a D/A conversion is completed (during warning detection).

(2) 'Warning output signal' (XE) is refreshed at the start of the synchronous interrupt program.

(3) 'Warning output upper flag' (Un\G36) and 'Warning output lower flag' (Un\G37) are refreshed at the END processing.

External power supply OFF during synchronization

When the external power supply is turned off while the inter-module synchronization function is operating, 0V/0mA is output in analog from all the channels. After the external power supply is turned on, and the next synchronous interrupt program is executed after 'External power supply READY flag' (X7) is turned on, analog output is restarted.

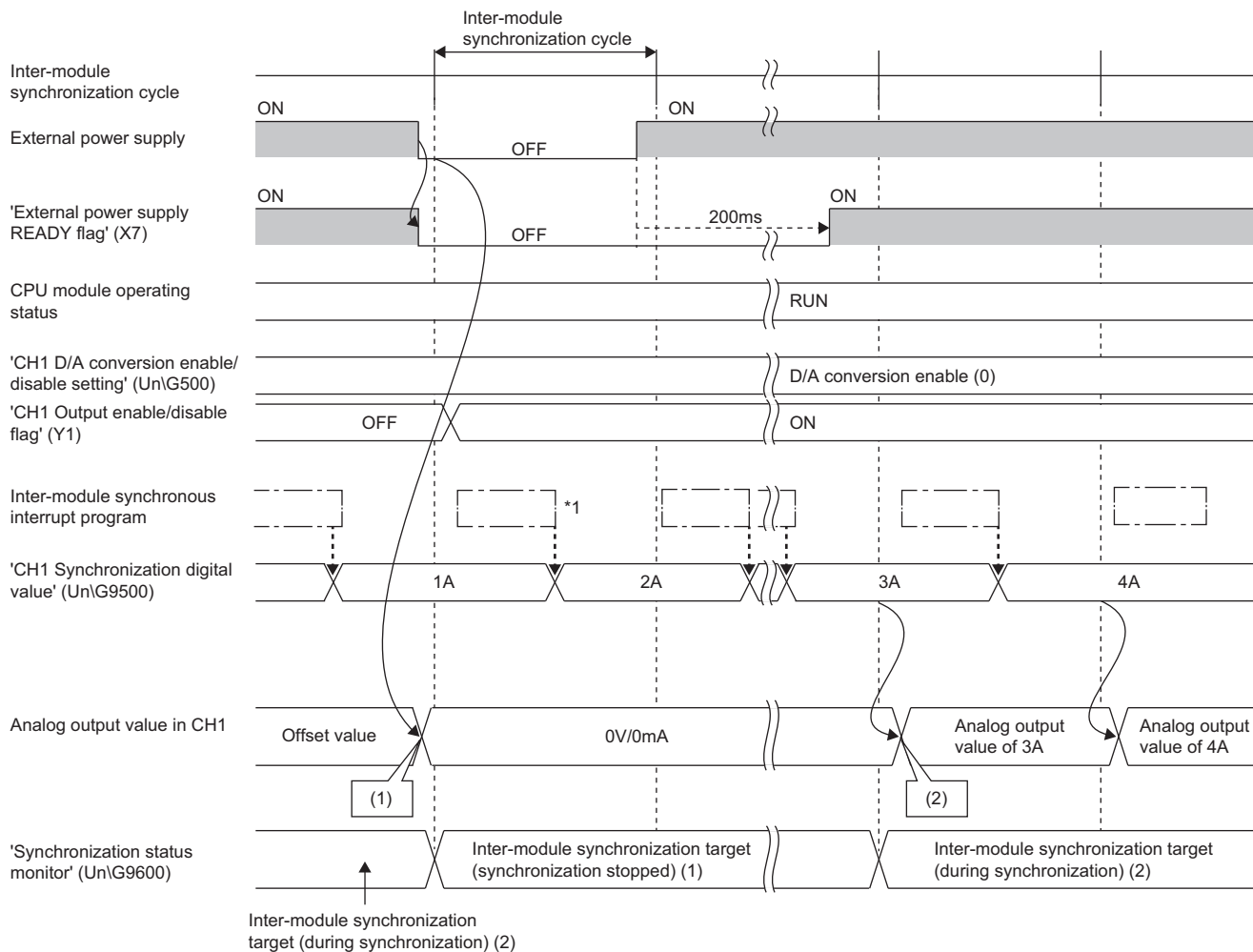

□ Inter-module synchronous interrupt program (I44)

(1) 0V/0mA is output in analog since the external power supply is turned off.

(2) The next synchronous interrupt program is executed after 'External power supply READY flag' (X7) is turned on, analog output is restarted.

*1 The inter-module synchronous interrupt program (I44) is executed even while 'External power supply READY flag' (X7) is off. To avoid any unnecessary change of 'CH1 Synchronization digital value' (Un\G9500) while the inter-module synchronous interrupt program (I44) is executed, set 'External power supply READY flag' (X7) to the interlock condition within the program.

*2 Note that after the next inter-module synchronous interrupt program (I44) is executed after 'External power supply READY flag' (X7) is turned on, the analog output is restarted according to D/A conversion enable/disable and output enable/disable.

Monitor

When the inter-module synchronization function is used, the inter-module synchronization status can be monitored.

For details, refer to the following.

📖 Page 190 Synchronization status monitor

Precautions

- The following table shows the availability of other functions of when the inter-module synchronization function is enabled.

Function	Availability	Remarks
Range switching function (Switching by program)	○	—
D/A conversion enable/disable setting function	○	—
D/A output enable/disable setting function	○	—
Analog output HOLD/CLEAR function	○	—
Analog output test function when the CPU module is in STOP state	○	—
Scaling function	×	The scaling function cannot be used. When the function is set to be enabled, the setting is ignored.
Shift function	×	The value set for 'CH1 Input value shift amount' (Un\G480) is disabled.
Warning output function	○	When the inter-module synchronization function is enabled, the digital value to be used by the warning output function is 'CH1 Synchronization digital value' (Un\G9500).
Rate control function	×	The rate control function cannot be used. When the function is set to be enabled, the setting is ignored.
External power supply interruption detection function	○	—
Disconnection detection function	○	—
Interrupt function	○	—
Wave output function	×	The module ignores the operation mode setting and operates in the inter-module synchronization mode if it is set as a target to be synchronized.
Error history function	○	—
Event history function	○	—
Offset/gain setting	×	—
Backing up, saving, and restoring offset/gain values	×	—
Online module change	×	During inter-module synchronization, the online module change is disabled. If the online module change is attempted during the inter-module synchronization, an online module change error (error code: 4206H) is stored in Online module change error code (SD1618) and the module cannot be changed. If the module is changed, a module verification error (error code: 2400H) occurs in the CPU module.

- When the inter-module synchronization function is enabled, the analog output value does not change even if a value is set to 'CH1 Digital value' (Un\G460). When the inter-module synchronization function is enabled, the digital value to be converted to analog is the value set in 'CH1 Synchronization digital value' (Un\G9500).
- If the module is set to the inter-module synchronization mode, the switching to the offset/gain setting mode is not allowed.
- When a mode switching setting value is set for 'Mode switching setting (L)' (Un\G296) and 'Mode switching setting (H)' (Un\G297) and then 'Operating condition setting request' (Y9) is turned on, the mode is not switched and inter-module synchronization continues.
- When performing the offset/gain setting, set the module as a synchronization non-target, and switch the mode to the normal output mode, and then switch the mode again to the offset/gain setting mode.
- Dedicated instructions cannot be used. The following shows the operation when a dedicated instruction has been executed.

Dedicated instruction	Operation
G(P).OFFGAN	The G(P).OFFGAN instruction is disabled.
G(P).OGLOAD	The G(P).OGLOAD instruction is disabled.
G(P).OGSTOR	If the G(P).OGSTOR instruction is executed, a G(P).OGSTOR instruction execution error (error code: 1860H) is stored in the dedicated instruction completion status.

For details on the dedicated instructions, refer to the following.

 MELSEC iQ-R Programming Manual (Module Dedicated Instructions)

1.16 Error History Function

Common

Up to 16 errors and alarms that have occurred in the D/A converter module are stored in the buffer memory as the error and alarm history.

Operation

When an error occurs, the error code and the error time are stored from Error history No.1 (Un\G3600 to Un\G3609) in order. When an alarm occurs, the alarm code and the alarm time are stored from Alarm history No.1 (Un\G3760 to Un\G3769) in order. Error time and alarm time are stored as follows:

Ex.

The following shows Error history No.1 and Alarm history No.1.

- Details of the error history

	b15	...	b8 b7	...	b0
Un\G3600	Error code				
Un\G3601	First two digits of the year		Last two digits of the year		
Un\G3602	Month		Day		
Un\G3603	Hour		Minute		
Un\G3604	Second		Day of the week		
Un\G3605	Millisecond (upper)		Millisecond (lower)		
Un\G3606	System area				
⋮					
Un\G3609					

- Details of the alarm history

	b15	...	b8 b7	...	b0
Un\G3760	Alarm code				
Un\G3761	First two digits of the year		Last two digits of the year		
Un\G3762	Month		Day		
Un\G3763	Hour		Minute		
Un\G3764	Second		Day of the week		
Un\G3765	Millisecond (upper)		Millisecond (lower)		
Un\G3766	System area				
⋮					
Un\G3769					

Item	Storage contents	Storage example ^{*1}
Error code or alarm code	An error code or alarm code is stored.	3030H
First two digits of the year	Stored in BCD code.	2016H
Month		1031H
Hour		1234H
Second		56H
Day of the week		One of the following values is stored in BCD code. Sunday: 0, Monday: 1, Tuesday: 2, Wednesday: 3 Thursday: 4, Friday: 5, Saturday: 6
Millisecond (higher-order digits)	Stored in BCD code.	7H
Millisecond (lower-order digits)		89H
System area	—	—

*1 Values stored when a flash memory error (error code: 3030H) occurs at 12:34:56.789 on Monday, October 31st, 2016.

How to clear error history function

Error history and alarm history can be cleared using one of the following methods.

■Error history

- Power off the programmable controller.
- Reset the CPU module.
- Set Clear setting of error history (Un\G3930) to Clear (1), and turn on and off 'Error clear request' (YF) or 'Operating condition setting request' (Y9).

■Alarm history

- Power off the programmable controller.
- Reset the CPU module.
- Set Clear setting of error history (Un\G3930) to Clear (1), and turn on and off 'Warning output clear request' (YE) or 'Operating condition setting request' (Y9).

Checking method

The start address of Error history where the latest error is stored can be checked in 'Latest address of error history' (Un\G1).

The start address of Alarm history where the latest alarm is stored can be checked in 'Latest address of alarm history' (Un\G3).

Ex.

The following shows an example of when the 3rd error occurs. The 3rd error is stored in Error history No.3, and the value 3620 (start address of Error history No.3) is stored in 'Latest address of error history' (Un\G1).

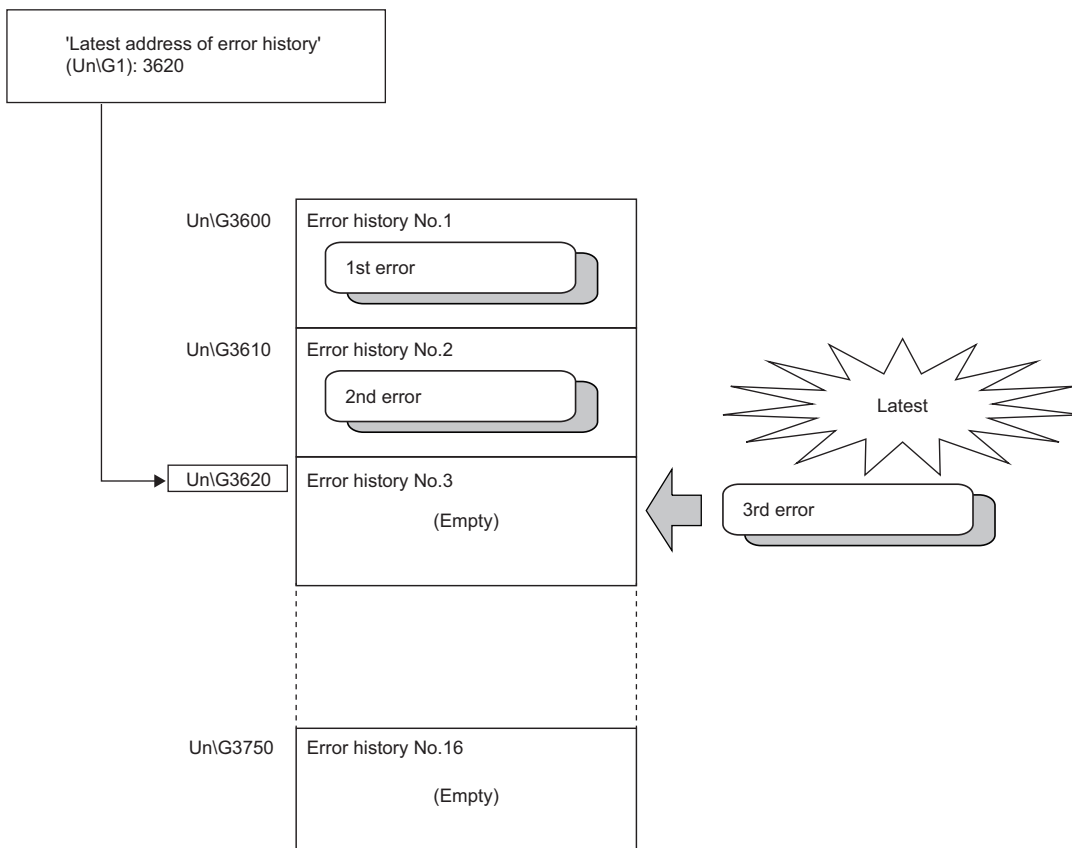

Ex.

The following shows an example of when the 17th error occurs. The 17th error is stored in Error history No.1, and 'Latest address of error history' (Un\G1) is overwritten with the value 3600 (start address of Error history No.1).

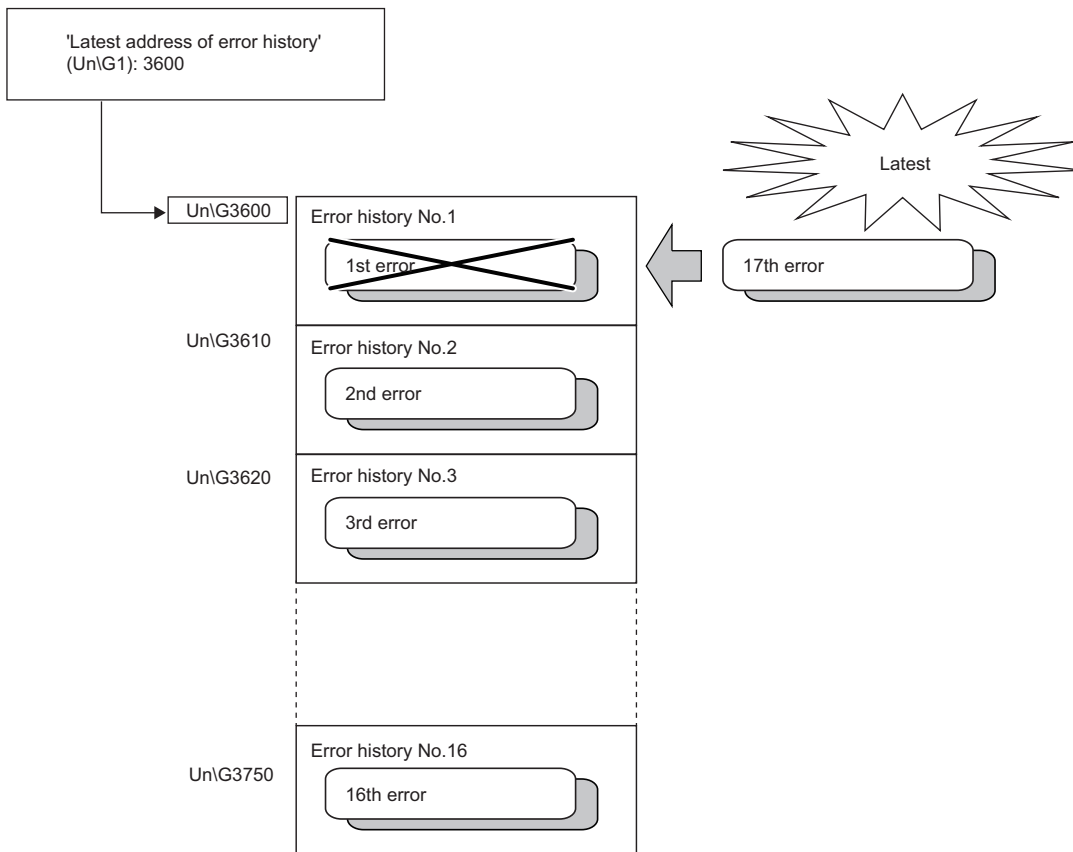
**Point**

- Once the error history storage area becomes full, subsequent error information will overwrite the existing data, starting from Error history No.1 (Un\G3600 to Un\G3609), and the overwriting continues sequentially thereafter. The overwritten history is deleted.
- The same processing is performed for Alarm history when an alarm occurs.

1.17 Event History Function

Common

This function collects generated errors, alarms, or executed operations in the D/A converter module as event information in the CPU module.

The CPU module collects the event information occurred in the D/A converter module and keeps them in the data memory inside of the CPU module or an SD memory card.

The event information collected by the CPU module can be displayed on an engineering tool to check the occurrence history in a time series.

Event type	Classification	Description
System	Error	An error detected by the self-diagnostics in each module.
	Warning	A warning (alarm) detected in each module.
	Information	The operation by the normal detection of the system that is not classified as Error or Warning, or the operation performed automatically by the system.
Security	Warning	Operation that is judged as an unauthorized access to each module.
	Information	Operation that is hard to be judged as the success of unlocking passwords or an unauthorized access.
Operation	Warning	Deleting (data clear) operations that may change the action. (These operations are not judged as errors by the self-diagnostics.)
	Information	Operations performed by a customer to change the system operation or configuration in the offset/gain setting.

Setting method

The event history function can be set from the event history setting window of the engineering tool. For the setting method, refer to the following.

 MELSEC iQ-R CPU Module User's Manual (Application)

Displaying event history

Access the menu window of the engineering tool. For details on the operating procedure and how to view the contents, refer to the following.

 GX Works3 Operating Manual

List of event history data

The following table lists the events that occur in the D/A converter module when the event type is Operation.

Event code	Event class	Event name	Event detail	Additional information
20010	Information	Offset/gain setting execution	In the user range setting, offset/gain values have been set.	Total number of writes
20100	Information	Error clear	The error clear request has been executed.	—

1.18 Backing up, Saving, and Restoring Offset/Gain Values

Normal

The D/A converter module makes it possible to back up, save, and restore the offset/gain values of the user range setting.

- **Back up:** Creates a module-specific backup parameter and saves offset/gain values.
- **Save:** Saves the offset/gain information, which was registered in this module by making the offset/gain setting, in the CPU module.
- **Restoration:** Writes the information backed up and saved in the CPU module to this module.

In the event that the module fails and needs to be replaced, the offset/gain values of the failed D/A converter module can be restored onto the new D/A converter module.

In addition, if multiple D/A converter modules are mounted on the same system, the offset/gain values set for one of the D/A converter modules can be applied to the other modules.

However, if the offset/gain values are saved and restored, the accuracy after the restoration decreases by approximately three times compared to that before the restoration. Reconfigure the offset/gain setting when required.

Only when the model where the offset/gain values are to be saved and the model where the offset/gain values are to be restored are the same, the offset/gain values can be saved and restored.

Each procedure differs depending on whether a module-specific backup parameter is used or not.

When the module-specific backup parameter is used

Normal

Offset/gain values are automatically restored when the failed module is replaced with a new one using the online module change.

For details on the online module change, refer to the following.

 MELSEC iQ-R Online Module Change Manual

Details of the module-specific backup parameter

A module-specific backup parameter is a file created in an SD memory card or the data memory of the control CPU.

The contents of the parameter are the offset/gain value of the user range stored in the flash memory of the D/A converter module.

The file name of a module-specific backup parameter is determined as follows based on the start I/O number of the D/A converter module.

UBPmmnn.BPR

- **mmm** indicates a value calculated by dividing the module I/O No. by 10H (3 digits in hexadecimal).
- **nn** indicates a consecutive number of the module-specific backup parameters for each module and fixed to 00.

Creating and updating a module-specific backup parameter

A module-specific backup parameter is created or updated when the offset/gain values stored in the flash memory of the D/A converter module are updated.

Timing when backup data is created or updated	Description
When the offset/gain setting is completed with "Offset/gain setting" of the engineering tool	A module-specific backup parameter is created or updated when the offset/gain setting is completed with "Offset/gain setting" of the engineering tool.
When 'User range write request' (YA) is turned on in the offset/gain setting mode	A module-specific backup parameter is created or updated when the offset/gain values of the user range are changed in the offset/gain setting mode.
When 'User range write request' (YA) is turned on in the normal output mode	When 'User range write request' (YA) is turned on in the normal output mode, the offset/gain values of the user range are restored based on the settings of the buffer memory areas (Save data type, CH1 Factory default setting offset value to CH4 User range setting gain value). At this timing, module-specific backup parameters are updated.
When the G(P).OGSTOR instruction is executed in the normal output mode	When the G(P).OGSTOR instruction is executed in the normal output mode, the offset/gain values of the user range are restored. At this timing, module-specific backup parameters are updated.
When a new module is recognized after the online module change	When a new module is mounted and recognized after the online module change, the offset/gain values of the user range are restored. At this timing, module-specific backup parameters are updated.

When no module-specific backup parameter exists in the data memory of the control CPU and a module-specific backup parameter needs to be created with the current setting, change the mode of the D/A converter module to the offset/gain setting mode and turn on 'User range write request' (YA). A module-specific backup parameter is created with the current setting of the flash memory.

■Precautions

If the creation of a module-specific backup parameter fails because the data memory of the control CPU does not have sufficient free space or the module-specific backup parameter is being used, a module-specific backup parameter creation error (error code: 17E1H) occurs.

Reading of module-specific backup parameters

To read a module-specific backup parameter and restore offset/gain values, set "Auto restore of Offset/gain setting with the module change" of the module parameter to "Enable" in advance.

 [Navigation window] ⇒ [Parameter] ⇒ [Module Information] ⇒ Module model name ⇒ [Application setting] ⇒ [Online module change]

■Reading timing

Module-specific backup parameters are read when a new module is mounted and recognized in the process of online module change. If the module is replaced with the programmable controller powered off, module-specific backup parameters are not read.

■Precautions

When the module-specific backup parameter for the target slot does not exist in an SD memory card or the data memory of the control CPU, the subsequent restoration of the offset/gain values is not performed. If the offset/gain values cannot be restored even though the module-specific backup parameter exists, a module-specific backup parameter restore error (error code: 17E0H) occurs.

Restoring the offset/gain values of the user range

Upon the successful completion of reading module-specific backup parameters, the values are converted (restored) into the offset/gain values of the user range for the new module, and stored in the flash memory. At the same time, the module-specific backup parameter in the data memory of the control CPU is updated with the setting of the new module.

Restrictions on the module-specific backup parameter

Offset/gain values cannot be backed up or restored with a module-specific backup parameter in the following cases.

- When the control CPU is not the process CPU
- When the programmable controller is powered off and the D/A converter module is replaced with a new one
- When "Auto restore of Offset/gain setting with the module change" of the module parameter is set to "Disable"

In any of the cases above, save and restore offset/gain values by referring to the following.

 Page 113 When the module-specific backup parameter is not used

When the module-specific backup parameter is not used

Normal

Save and restore offset/gain values by one of the following methods.

- Saving and restoring by dedicated instructions
- Saving and restoring by reading from and writing to the buffer memory

With the methods above, offset/gain values can be restored to a new module, or the offset/gain values set in one module can be applied to the other modules in the same system.

- To restore offset/gain values onto a new replaced module:

1. Save the offset/gain values.

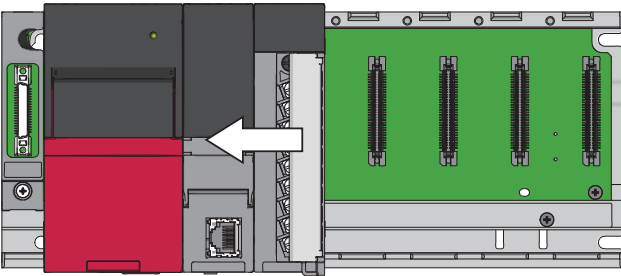

2. Replace the D/A converter module.

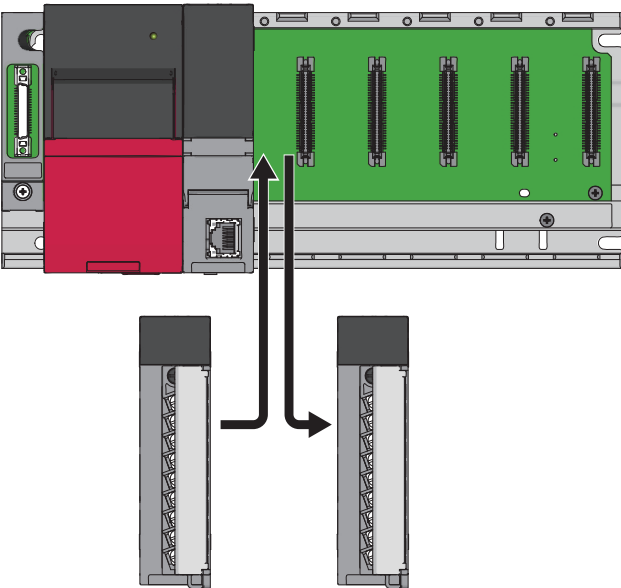

3. Restore the offset/gain values.

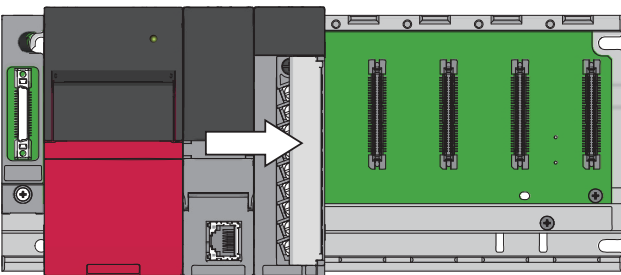

- To apply the offset/gain values set in one module to the other modules in the same system:

Ex.

When the offset/gain values in module No.1 are applied to modules No.2 to No.4

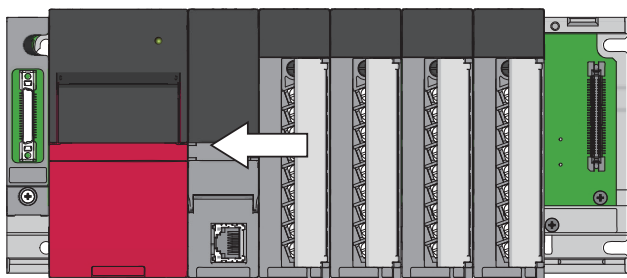

1. Save the offset/gain values of module No.1.

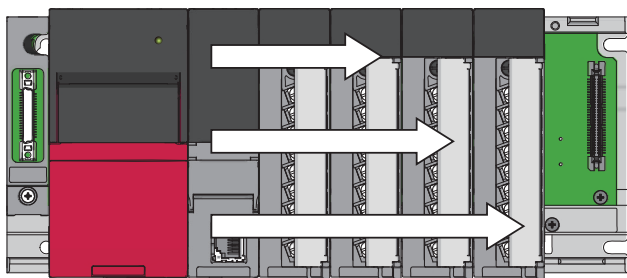

2. Apply the offset/gain values to modules No.2 to No.4.

Saving and restoring by dedicated instructions

Use the dedicated instruction G(P).OGLOAD to temporarily save the offset/gain values of the source D/A converter module to the internal device of the CPU module, then use the G(P).OGSTOR to write the values to the destination D/A converter module.

Prevent the saved offset/gain setting data from being deleted, by one of the following methods before replacing the modules:

- Use latch settings for the internal device of the destination module.
- Save the data onto an SD memory card. (To write data: use the SP.FWRITE instruction. To read data: use the SP.FREAD instruction.)
- Store the saved data.

For how to use dedicated instructions, refer to the following.

 MELSEC iQ-R Programming Manual (Module Dedicated Instructions)

Saving and restoring by reading from and writing to the buffer memory

Use Save data type setting (Un\G4002), CH1 Factory default setting offset value (Un\G4004) to CH4 User range setting gain value (Un\G4019), and 'User range write request' (YA) to read the offset/gain values from the source D/A converter module.

Use the buffer memory again to write the values to the destination D/A converter module.

The following describes the procedure for using the buffer memory.

■To restore offset/gain values onto a new replaced module:

Performing the operations to the source D/A converter module

1. Set Save data type setting (Un\G4002).
2. Turn on and off 'Operating condition setting request' (Y9).
3. Save the stored values of Save data type setting (Un\G4002) and CH1 Factory default setting offset value (Un\G4004) to CH4 User range setting gain value (Un\G4019).

Performing the operation when the power of the module is off

4. Replace the D/A converter module.

Performing the operations to the destination D/A converter module

5. Write the data saved in Save data type setting (Un\G4002) and CH1 Factory default setting offset value (Un\G4004) to CH4 User range setting gain value (Un\G4019).
6. Turn on 'User range write request' (YA).
7. Check that 'Offset/gain setting mode status flag' (XA) is on.
8. Turn off 'User range write request' (YA).
9. Check whether the destination D/A converter module operates with the offset/gain values that are restored.

Point

When replacing modules, prevent the saved offset/gain setting data from being deleted, by one of the following methods before powering off the module.

- Use latch settings for the internal device of the destination module.
- Save the data onto an SD memory card. (To write data: use the SP.FWRITE instruction. To read data: use the SP.FREAD instruction.)
- Store the saved data.

■To apply the offset/gain values set in one module to the other modules in the same system:

Performing the operations to the source D/A converter module

1. Set Save data type setting (Un\G4002).
2. Turn on and off 'Operating condition setting request' (Y9).
3. Save the stored values of Save data type setting (Un\G4002) and CH1 Factory default setting offset value (Un\G4004) to CH4 User range setting gain value (Un\G4019).

Performing the operations to the destination D/A converter module

4. Write the data saved in Save data type setting (Un\G4002) and CH1 Factory default setting offset value (Un\G4004) to CH4 User range setting gain value (Un\G4019).
5. Turn on 'User range write request' (YA).
6. Check that 'Offset/gain setting mode status flag' (XA) is on.
7. Turn off 'User range write request' (YA).
8. Check whether the destination D/A converter module operates with the offset/gain values that are restored.

Range reference table

The following shows the range reference tables to be used for saving and restoring offset/gain values.

■Range reference table of Factory default setting offset/gain value

Address (decimal)				Description	Save data type setting ^{*1}	Analog value	Reference value (hexadecimal)
CH1	CH2	CH3	CH4				
4004	4006	4008	4010	Factory default setting offset value	Voltage specification	0V	Approx. 8000H
					Current specification	0mA	Approx. 0AD9H
4005	4007	4009	4011	Factory default setting gain value	Voltage specification	10V	Approx. FD00H
					Current specification	20mA	Approx. E3CCH

*1 The reference values differ depending on the setting of Save data type setting (Un\G4002) (voltage or current).

■Range reference table of User range setting offset/gain value

The following values are stored as the user range setting by default.

Address (decimal)				Description	Range type	Setting details	Reference value (hexadecimal)
CH1	CH2	CH3	CH4				
4012	4014	4016	4018	User range setting offset value	Voltage	0V	Approx. 8000H
					Current	4mA	Approx. 363CH
4013	4015	4017	4019	User range setting gain value	Voltage	10V	Approx. FD00H
					Current	20mA	Approx. E3CCH

The following shows the range reference table of User range setting offset/gain value.

Offset/gain value	Reference value (hexadecimal)	
Voltage	0V	Approx. 8000H
	1V	Approx. 8C80H
	5V	Approx. BE80H
	10V	Approx. FD00H
Current	0mA	Approx. 0AD9H
	4mA	Approx. 363CH
	20mA	Approx. E3CCH

2 PARAMETER

This chapter describes the parameter settings of each channel.

Setting the parameters here eliminates the need for parameter setting by programming.

2

2.1 Parameter Setting Procedure

1. Add the D/A converter module to the engineering tool.

Navigation window ⇒ [Parameter] ⇒ [Module Information] ⇒ Right-click ⇒ [Add New Module]

2. The parameter setting includes four types of settings: basic setting, application setting, interrupt setting, refresh setting.

Set parameters by performing the following and selecting a desired setting from the tree displayed on the window.

[Navigation window] ⇒ [Parameter] ⇒ [Module Information] ⇒ Select D/A converter module

3. Write the settings to the CPU module using the engineering tool.

[Online] ⇒ [Write to PLC]

4. The settings are reflected by resetting the CPU module or powering off and on the system.

2.2 Basic Setting

Setting method

Open "Basic setting" of the engineering tool.

1. Start the module parameter.

[Navigation window] ⇒ [Parameter] ⇒ [Module Information] ⇒ Module model name ⇒ [Basic setting]

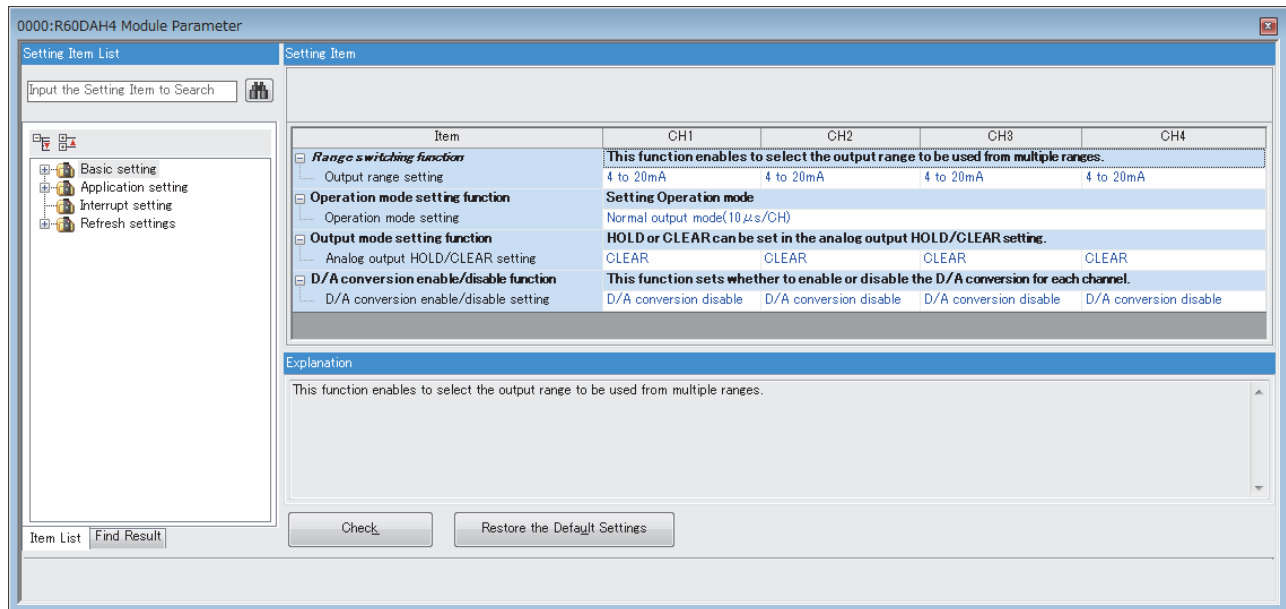

2. Click the item to be changed to enter the setting value.

- Item where a value is selected from the drop-down list

Click the [▼] button of the item to be set, and from the drop-down list that appears, select the item.

- Item where a value is entered into the text box

Double-click the item to be set to enter the numeric value.

2.3 Application Setting

Setting method

The settings are made in "Application setting" of the engineering tool.

1. Start the module parameter.

[Navigation window] ⇒ [Parameter] ⇒ [Module Information] ⇒ Module model name ⇒ [Application setting]

Item	CH1	CH2	CH3	CH4
Scaling function	This function enables to change the upper limit value or lower limit value of the digital value input range to any value.			
Scaling enable/disable setting	Disable	Disable	Disable	Disable
Scaling upper limit value	0	0	0	0
Scaling lower limit value	0	0	0	0
Shift function	This function adds the set amount to the digital value. A fine adjustment at the system startup can be easily performed.			
Input value shift amount	0	0	0	0
Warning output function	This function outputs an Warning when the digital value is outside the setting range.			
Warning output setting	Disable	Disable	Disable	Disable
Warning output upper limit value	0	0	0	0
Warning output lower limit value	0	0	0	0
Rate control function	This function controls the increasing and decreasing amount of the analog output value per conversion cycle for one channel.			
Rate control enable/disable setting	Disable	Disable	Disable	Disable
Increase digital limit value	64000	64000	64000	64000
Decrease digital limit value	64000	64000	64000	64000
Inter-module synchronization function	D/A conversion is performed in the inter-module synchronization cycle.			
Output selection during synchronous error	Inter-module synchronization continue			
Online module change	The module can be changed without the system being stopped.			
Auto restore of Offset/gain setting with the module change	Enable			
CPU error output mode setting	You can be the setting of whether to keep or not to clear the output of the module to the CPU stop error.			
CPU error output mode setting	Clear			

Explanation

This function enables to change the upper limit value or lower limit value of the digital value input range to any value.

2. Click the item to be changed to enter the setting value.

- Item where a value is selected from the drop-down list

Click the [▼] button of the item to be set, and from the drop-down list that appears, select the item.

- Item where a value is entered into the text box

Double-click the item to be set to enter the numeric value.

2.4 Interrupt Setting

Setting method

The settings are made in "Interrupt setting" of the engineering tool.

1. Start the module parameter.

[Navigation window] ⇒ [Parameter] ⇒ [Module Information] ⇒ Module model name ⇒ [Interrupt setting]

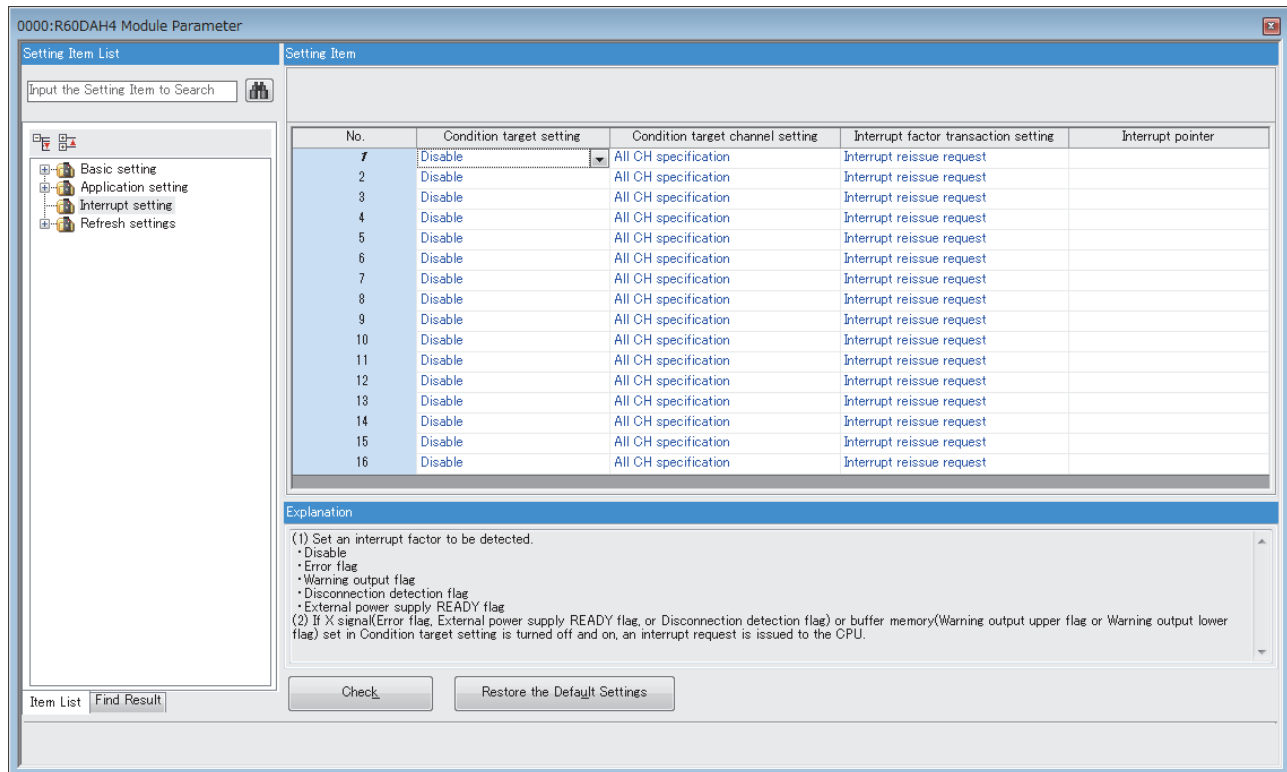

2. Click the interrupt setting number (No.1 to 16) to be changed to enter the setting value.

- Item where a value is selected from the drop-down list

Click the [▼] button of the item to be set, and from the drop-down list that appears, select the item.

- Item where a value is entered into the text box

Double-click the item to be set to enter the numeric value.

2.5 Refresh Setting

The buffer memory of the D/A converter module to be refreshed is set.
 This refresh setting eliminates the need for reading data by programming.

Setting method

The settings are made in "Refresh settings" of the engineering tool.

1. Start the module parameter.

[Navigation window] ⇒ [Parameter] ⇒ [Module Information] ⇒ Module model name ⇒ [Refresh settings]

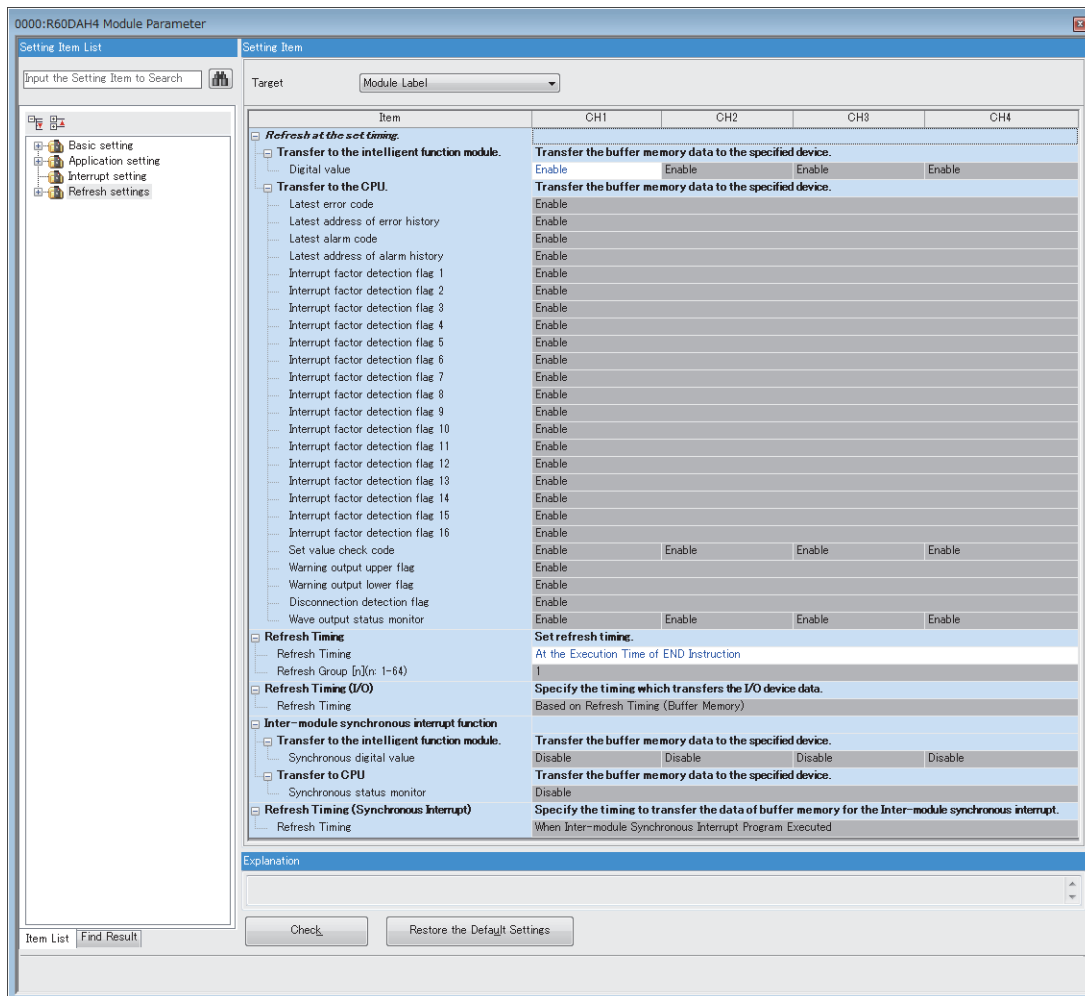

2. Click "Target" and set the refresh target.

- When "Target" is "Refresh Data Register (RD)"

Setting the start device in "Start Device Name" automatically sets the transfer destinations for all items.

- When "Target" is "Device"

Double-click the item to be set to enter the refresh target device.

3. Click "Refresh Timing" to set the refresh timing.

Set "Refresh Timing" to "At the Execution Time of END Instruction" or "At the Execution Time of Specified Program".

When "At the Execution Time of Specified Program" is set, double-click "Refresh Group [n] (n: 1-64)" and set a value of 1 to 64.

When the refresh is enabled, the values of the refresh target are enabled at the refresh timing set with the engineering tool. At this time, the buffer memory areas are overwritten with the values of the refresh target. To change a value in the refresh target buffer memory area, create a program to change the value in the module label and the device of the refresh source.

Refresh processing time

The refresh processing time [μs] is an element of the scan time of the CPU module. For details on the scan time, refer to the following.

 MELSEC iQ-R CPU Module User's Manual (Application)

The refresh processing time [μs], which is taken for refresh settings, is given by:

- Refresh processing time [μs] = Refresh read time (time for transferring refresh data to the CPU module) + Refresh write time (time for transferring refresh data to the intelligent function module)

According to the setting of "Target", the refresh read time and the refresh write time vary.

When "Target" is a module label or a refresh data register (RD)

The following table lists the refresh read time and the refresh write time when the R□CPU is used.

Model	Classification	When using the refresh settings	When using the inter-module synchronization function
R60DAH4	Refresh read time	18.85 μs	12.63 μs
	Refresh write time	11.5 μs	9.76 μs

When "Target" is a specified device

Calculate the refresh read time and refresh write time according to the number of items and the number of their transfer data (in units of word) that are set to be refreshed. For the calculation method, refer to the following.

 MELSEC iQ-R CPU Module User's Manual (Application)

3 TROUBLESHOOTING

This chapter describes errors that may occur while using the D/A converter module, and those troubleshooting.

3.1 Troubleshooting with LEDs

Check the state of the LEDs to narrow down the possible causes of the trouble. This step is the first diagnostics before using the engineering tool.

The D/A converter module status can be checked using the RUN LED, ERR LED, and ALM LED. The following table lists the correspondence relation between each LED and the D/A converter module status.

Name	Description
RUN LED	Indicates the operating status of the module. On: Normal operation Flashing (1s cycles): In offset/gain setting mode Flashing (400ms cycles): Selected as a module for the online module change Off: 5V power supply interrupted, watchdog timer error occurred, or module replacement allowed in the process of the online module change
ERR LED	Indicates the error status of the module.*1 On: Error occurred Off: Normal operation
ALM LED	Indicates the alarm status of the module.*2 On: Alarm occurred Off: Normal operation

*1 For details, refer to the following.

☞ Page 132 List of Error Codes

*2 For details, refer to the following.

☞ Page 136 List of Alarm Codes

3.2 Checking State of Module

The following functions are available in the "Module Diagnostics" window of the D/A converter module.

Function	Application
Error Information	Displays the errors that have occurred. Click the [Event History] button to check not only the errors and alarms that occurred in the D/A converter module, but also the errors detected by each module and the operation history.
Module Information List	Displays each status information of the D/A converter module.

Error Information

Check the details and actions for the errors that have occurred.

 [Diagnostics] ⇒ [System Monitor] ⇒ Right-click the module to be checked. ⇒ [Module Diagnostics]

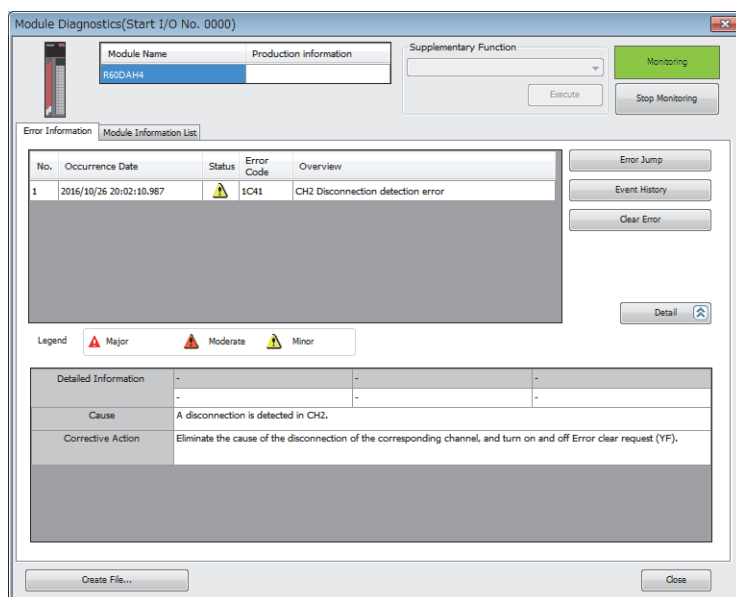

Item	Description
Cause	Displays detailed causes of the error.
Corrective Action	Displays the actions for the error.

Check alarm codes, error history, and alarm history on the "Event History" window of the engineering tool.

 [Diagnostics] ⇒ [System Monitor] ⇒ [Event History] button

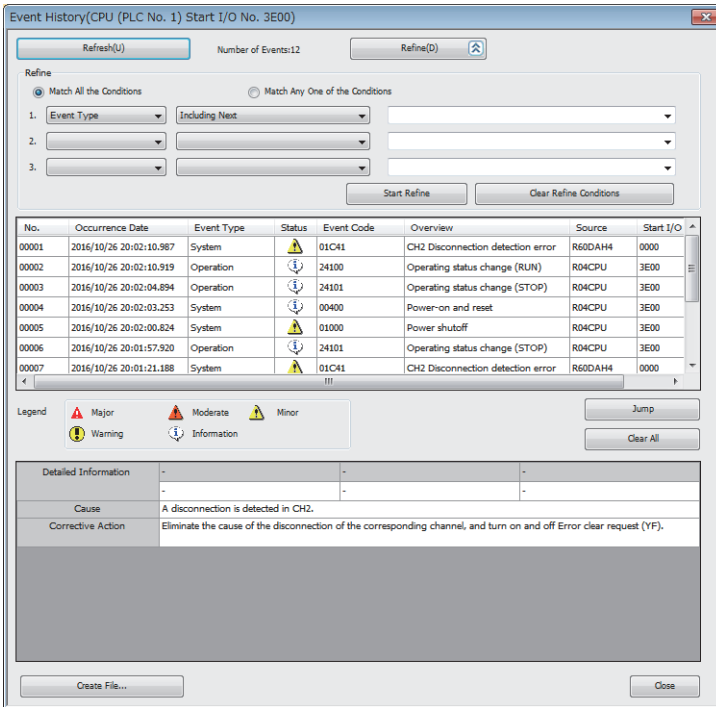

Event History(CPU (PLC No. 1) Start I/O No. 3E00)

Refresh(U) Number of Events:12 Refine(D)

Refine

Match All the Conditions Match Any One of the Conditions

1. Event Type Including Next

2.

3.

Start Refine Clear Refine Conditions

No.	Occurrence Date	Event Type	Status	Event Code	Overview	Source	Start I/O
00001	2016/10/26 20:02:10.987	System	Warning	01C41	CH2 Disconnection detection error	R60DAH	0000
00002	2016/10/26 20:02:10.919	Operation	Information	24100	Operating status change (RUN)	R04CPU	3E00
00003	2016/10/26 20:02:04.894	Operation	Information	24101	Operating status change (STOP)	R04CPU	3E00
00004	2016/10/26 20:02:03.253	System	Information	00400	Power-on and reset	R04CPU	3E00
00005	2016/10/26 20:02:00.824	System	Warning	01000	Power shutoff	R04CPU	3E00
00006	2016/10/26 20:01:57.920	Operation	Information	24101	Operating status change (STOP)	R04CPU	3E00
00007	2016/10/26 20:01:21.188	System	Warning	01C41	CH2 Disconnection detection error	R60DAH	0000

Legend

Major Moderate Minor Warning Information

Detailed Information Cause Corrective Action

Jump Clear All

Create File... Close

3

Module Information List

Switch the tab to the "Module Information List" tab and check each status information of the D/A converter module.

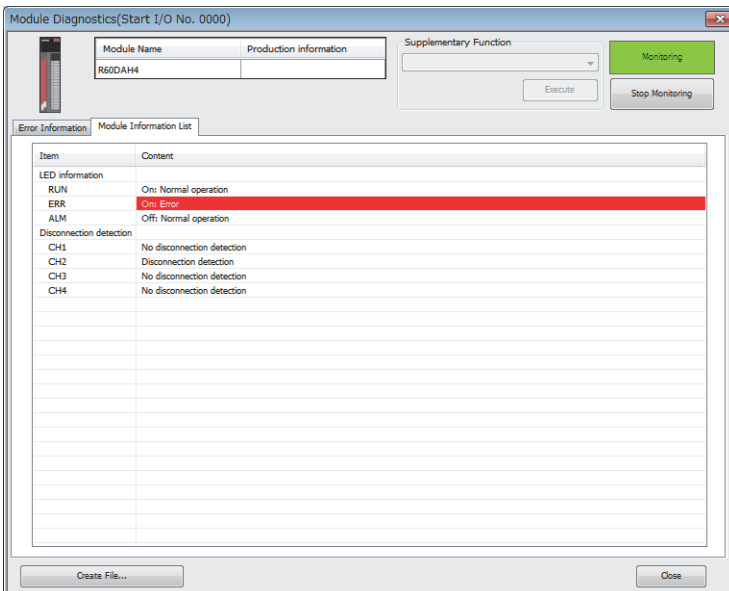

Module Diagnostics(Start I/O No. 0000)

Module Name Production information Supplementary Function

R60DAH

Monitoring Execute Stop Monitoring

Error Information Module Information List

Item	Content
LED information	
RUN	On: Normal operation
ERR	On: Error
ALM	Off: Normal operation
Disconnection detection	
CH1	No disconnection detection
CH2	Disconnection detection
CH3	No disconnection detection
CH4	No disconnection detection

Create File... Close

Item	Description
LED information	Displays the LED status of the D/A converter module.
Disconnection detection	Displays the detection status for the disconnection of the D/A converter module for each channel.

3.3 Troubleshooting by Symptom

When the RUN LED flashes or turns off

When flashing

Check item	Cause	Action
Check whether the module is in the offset/gain setting mode.	The programmable controller power supply has been turned off and on, or the CPU module has been reset with "Operation mode setting" set to "Offset/gain setting mode" in the module parameter setting of the engineering tool.	In the module parameter setting of the engineering tool, set "Operation mode setting" to other than "Offset/gain setting mode", and turn off and on the programmable controller power supply or reset the CPU module.
	The G(P).OFFGAN instruction has been executed with the mode being set to be switched to the offset/gain setting mode.	Review the program that uses the G(P).OFFGAN instruction to check whether the mode has been switched erroneously.
	The values in 'Mode switching setting (L)' (Un\G296) and 'Mode switching setting (H)' (Un\G297) have been changed and the mode has been switched to the offset/gain setting mode.	Review the program that uses 'Mode switching setting (L)' (Un\G296) and 'Mode switching setting (H)' (Un\G297) to check whether the mode has been switched erroneously.
Check whether the module is selected as the target module for the online module change.	The base number and slot number of the D/A converter module have been set in Module selection (base unit No.) (SD1600) and Module selection (slot No.) (SD1601).	Turn on Module selection cancellation request flag (SM1615).

When turning off

Check item	Action
Check whether the power is supplied.	Check that the supply voltage of the power supply module is within the rated range.
Check whether the capacity of the power supply module is enough.	Calculate the current consumption of mounted modules, such as the CPU module, I/O modules, and intelligent function modules to check that the power capacity is enough.
Check whether the module is mounted properly.	Check the mounting state of the module.
Check whether the module replacement is allowed in the process of the online module change.	Perform the online module change. For details, refer to the following.  MELSEC iQ-R Online Module Change Manual
The case other than the above	Reset the CPU module, and check whether the RUN LED turns on. If the RUN LED still remains off, the possible cause is a failure of the module. Please consult your local Mitsubishi representative.

When the ERR LED turns on

When turning on

Check item	Action
Check whether any error has occurred.	Check 'Latest error code' (Un\G0) and take actions described in the list of error codes.  Page 132 List of Error Codes

When the ALM LED turns on

When turning on

Check item	Action
Check whether any alarm has occurred.	Check 'Latest alarm code' (Un\G2) and take actions described in the list of alarm codes.  Page 136 List of Alarm Codes

When the analog output is not performed

Follow the steps in the table below to find the cause of the trouble.

Description	Procedure
<p>■Step 1: Checking the digital value Check whether the digital value is written.</p>	<pre> graph TD Start([When a value is not output in analog]) --> Check[Check the value stored in 'CH1 Digital value' (UnG460).] Check -.-> Callout1[Monitor the buffer memory area with the monitor function*1 of the engineering tool.] Check --> Decision{Is the stored value same as the set value?} Decision -- NO --> Callout2[The write program has an error or the CPU module is in STOP status. Check item 1] Decision -- YES --> Step1((1)) </pre>
<p>■Step 2: Checking the D/A conversion status Check the execution status of the D/A conversion in the module, such as whether the D/A converter module have executed the D/A conversion.</p>	<pre> graph TD Step1((1)) --> Check[Check the value stored in 'CH1 D/A conversion status monitor' (UnG459).] Check -.-> Callout1[Monitor the buffer memory area with the monitor function*1 of the engineering tool.] Check --> Decision1{Is External power supply OFF (-1) stored?*2} Decision1 -- YES --> Callout2[The external power supply 24VDC is not supplied. Check item 2] Decision1 -- NO --> Decision2{Is D/A conversion disabled (0) stored?} Decision2 -- YES --> Callout3[The D/A conversion is not enabled. Check item 3] Decision2 -- NO --> Decision3{Is Analog output disabled (1) stored?} Decision3 -- YES --> Callout4[The analog output is not enabled. Check item 4] Decision3 -- NO --> Step2((2)) </pre>

Description	Procedure
<p>■Step 3: Checking the output range setting Check whether the output range appropriate to the analog output is set.</p>	

*1 Monitor the buffer memory areas using "Device/Buffer Memory Batch Monitor" or "Intelligent Function Module Monitor".

*2 The status of external power supply 24VDC can be checked with 'External power supply READY flag' (X7) as well. (📖 Page 141 External power supply READY flag)

Point

If the analog output value does not come out even after the above actions are taken, the D/A converter module may have failed. Please consult your local Mitsubishi representative.

Check item 1

The write program is incorrect, or the CPU module is in STOP status. Check the following items.

Check item	Action
Check whether the program to write a digital value is correct.	Check 'CH1 Digital value' (Un\G460) using the monitor functions of the engineering tool ("Device/Buffer Memory Batch Monitor" or "Intelligent Function Module Monitor"). If the value is not stored as set, correct the write program.
Check whether the auto refresh setting is correct.	If the stored value in the device of the CPU module is transferred to 'CH1 Digital value' (Un\G460) using auto refresh, check that the auto refresh setting is correct.
Check whether the CPU module is in the STOP state.	Change the state of the CPU module to RUN.

Check item 2

The external power supply 24VDC is not supplied. Check the following items.

Check item	Action
Check whether the external power supply 24VDC is supplied. (1) Is the external power supply correctly wired? (2) Is the external power supply 24VDC supplied within the specified range?	(1) Wire the external power supply by referring to the "External Wiring" described in the manual. (📖 MELSEC iQ-R High Speed Digital-Analog Converter Module User's Manual (Startup)) (2) Supply 24VDC within the range of the performance specifications. (📖 MELSEC iQ-R High Speed Digital-Analog Converter Module User's Manual (Startup))
The case other than the above	The possible cause is a failure of the D/A converter module. Please consult your local Mitsubishi representative.

Check item 3

D/A conversion is disabled. Check the following items.

Check item	Action
Check whether 'CH1 D/A conversion enable/disable setting' (Un\G500) is set to D/A conversion disable (1).	Check 'CH1 D/A conversion enable/disable setting' (Un\G500) using the monitor functions of the engineering tool ("Device/Buffer Memory Batch Monitor" or "Intelligent Function Module Monitor"). When 'CH1 D/A conversion enable/disable setting' (Un\G500) is set to D/A conversion disable (1), change it to D/A conversion enable (0) with the engineering tool or a program.
Check whether Operating condition setting request (Y9) has been executed after parameter changes.	Turn on and off 'Operating condition setting request' (Y9) with the engineering tool, and check that the analog output is performed properly. If the analog output is performed properly, check the program whether the descriptions of 'Operating condition setting request' (Y9) is correct.

Check item 4

Analog output is disabled. Check the following item.

Check item	Action
Check whether 'CH1 Output enable/disable flag' (Y1) is off.	Check the status of 'CH1 Output enable/disable flag' (Y1). If 'CH1 Output enable/disable flag' (Y1) is off, correct the program.

Check item 5

Wiring or the offset/gain setting is incorrect. Check the following items.

Check item	Action
Check whether there is any problem with wiring, such as off or disconnection of analog signal lines.	Check the faulty area by checking the signal line visually or conductively.
Check whether the offset/gain setting is correct.	If the output range setting is the user range, turn on and off 'Operating condition setting request' (Y9) and compare CH□ User range setting offset/gain value (Un\G4012 to Un\G4019) with the range reference table. If the stored values are not desired offset/gain values, configure the offset/gain setting again. For the range reference table, refer to the following.  Page 116 Range reference table

Check item 6

The analog output and output range setting do not match. Check the following items.

Check item	Action
Check whether "Output range setting" of the module parameter is correct.	Check "Output range setting" of the module parameter and configure the setting again if the setting is incorrect.
When an output range is set in 'CH1 Range setting' (Un\G598) with a program, check whether the program has any error.	Check 'CH1 Range setting' (Un\G598) using the monitor functions of the engineering tool ("Device/Buffer Memory Batch Monitor" or "Intelligent Function Module Monitor"). If the set value is incorrect, correct the value with the engineering tool or a program.
Check whether 'Operating condition setting request' (Y9) has been executed after parameter changes.	Turn on and off 'Operating condition setting request' (Y9) with the engineering tool, and check that the analog output is performed properly. If the analog output is performed properly, check the program whether the descriptions of 'Operating condition setting request' (Y9) is correct.

When HOLD of an analog output value is not available

Check item	Action
Is the analog output HOLD/CLEAR function setting correct?	Check 'CH1 HOLD/CLEAR function setting monitor' (Un\G431) using the monitor functions of the engineering tool ("Device/Buffer Memory Batch Monitor" or "Intelligent Function Module Monitor"). If the setting is incorrect, set "Analog output HOLD/CLEAR setting" to "HOLD" in the module parameter, and turn off and on the programmable controller power supply or reset the CPU module.

When the analog output is not performed in the wave output mode

Check the following.

Check item		Action
Checking the module parameter of engineering tool	Is the drive mode setting correct?	Check that the wave output mode is set using 'Operation mode monitor' (Un\G60). If the wave output mode is not set, set "Operation mode setting" to "Wave output mode" in the module parameter.
	Is the user range setting selected?	If "Operation mode setting" is set to "Wave output mode", "User range setting (current)" or "User range setting (voltage)" cannot be selected for the output range. If "User range setting (current)" or "User range setting (voltage)" is set for the output range, set the value other than the user range settings.
Checking the program	Is 'CH1 D/A conversion enable/disable setting' (Un\G500) set to D/A conversion disable (1)?	Check 'CH1 D/A conversion enable/disable setting' (Un\G500) and set D/A conversion enable (0).
	Has 'Operating condition setting request' (Y9) been executed?	Turn on and off 'Operating condition setting request' (Y9) to enable the parameter setting of the wave output function.
	Is any value written to Wave data registry area (Un\G10000 to Un\G99999) which is used for the channel to output a wave signal?	Check the value in Wave data registry area (Un\G10000 to Un\G99999) which is used for the channel to output a wave signal. During a pause of the wave output, the monitors of the wave output function can be checked. After setting "Analog output HOLD/CLEAR setting" to "HOLD" in the module parameter, set 'CH1 Wave output start/stop request' (Un\G462) to Wave output pause request (2) to pause the analog output status. Then, check the monitors.
	Is 'CH1 Wave output start/stop request' (Un\G462) set to Wave output stop request (0)?	Check 'CH1 Wave output status monitor' (Un\G401). If 'CH1 Wave output status monitor' (Un\G401) is set to During wave output stop (0), set 'CH1 Wave output start/stop request' (Un\G462) to Wave output start request (1).
	Is 'CH1 Output enable/disable flag' (Y1) off?	Check the status of 'CH1 Output enable/disable flag' (Y1). If 'CH1 Output enable/disable flag' (Y1) is off, correct the program.
Checking the connection method	Is the external power supply 24VDC supplied? (1) Is the external power supply correctly wired? (2) Is the external power supply 24VDC supplied within the specified range?	(1) Wire the external power supply by referring to the "External Wiring" described in the manual. (📖 MELSEC iQ-R High Speed Digital-Analog Converter Module User's Manual (Startup)) (2) Supply 24VDC within the range of the performance specifications. (📖 MELSEC iQ-R High Speed Digital-Analog Converter Module User's Manual (Startup))
The case other than the above		The possible cause is a failure of the D/A converter module. Please consult your local Mitsubishi representative.



When analog output stops during wave output

Check the following.

Check item		Action
When the output range is 4 to 20mA	Has any disconnection detection error occurred?	When a disconnection detection error has occurred, the wave output stops. After reviewing the external wiring, turn on 'Error clear request' (YF). After the error has been resolved, restart the wave output.
When the output range is outside 4 to 20mA	Has each monitor for the wave output function been updated?	If each monitor for the wave output function has been updated, measure the terminal block using a tester and check the output. If output is identified, external wiring may be disconnected. Stop the wave output and review the external wiring.
Checking the connection method	Is the external power supply 24VDC supplied? (1) Is the external power supply correctly wired? (2) Is the external power supply 24VDC supplied within the specified range?	(1) Wire the external power supply by referring to the "External Wiring" described in the manual. (📖 MELSEC iQ-R High Speed Digital-Analog Converter Module User's Manual (Startup)) (2) Supply 24VDC within the range of the performance specifications. (📖 MELSEC iQ-R High Speed Digital-Analog Converter Module User's Manual (Startup))
The case other than the above		The possible cause is a failure of the D/A converter module. Please consult your local Mitsubishi representative.

When synchronous output is not started

Check the following.

Check item		Action
Checking the system parameter of engineering tool	Is the module set as the target module to be synchronized.	Check 'Synchronization status monitor' (Un\G9600). If the monitor status is Inter-module synchronization non-target (0), the module is not set as the target module to be synchronized. Set the module as the target to be synchronized in "Select Inter-module Synchronization Target Module" in the system parameter.
Checking the operating status of the CPU module	Does the RUN/STOP/RESET switch indicate the STOP state or has a stop error occurred?	Set the RUN/STOP/RESET switch to RUN. When a stop error has occurred, eliminate the cause according to the following.  Page 132 List of Error Codes
Checking the program	Is 'CH1 D/A conversion enable/disable setting' (Un\G500) set to D/A conversion disable (1)?	Check 'CH1 D/A conversion enable/disable setting' (Un\G500) and set D/A conversion enable (0).
	Has 'Operating condition setting request' (Y9) been executed?	Turn on and off 'Operating condition setting request' (Y9) to enable the parameter settings.
	Is 'CH1 Output enable/disable flag' (Y1) off?	Check the status of 'CH1 Output enable/disable flag' (Y1). If 'CH1 Output enable/disable flag' (Y1) is off, correct the program.
	Is the inter-module synchronous interrupt program (I44) prepared?	To execute synchronous output, write a value to 'CH1 Synchronization digital value' (Un\G9500) in the inter-module synchronous interrupt program.
	Has the EI instruction been executed?	To run the inter-module synchronous interrupt program, execute the EI instruction in the program. Execute the EI instruction.
	Has any value been written to 'CH1 Digital value' (Un\G460)?	To execute synchronous output, write a value to 'CH1 Synchronization digital value' (Un\G9500). If any value has been written to 'CH1 Digital value' (Un\G460), correct the program so that the value is written to 'CH1 Synchronization digital value' (Un\G9500).
Checking the connection method	Is the external power supply 24VDC supplied? (1) Is the external power supply correctly wired? (2) Is the external power supply 24VDC supplied within the specified range?	(1) Wire the external power supply by referring to the "External Wiring". ( MELSEC iQ-R High Speed Digital-Analog Converter Module User's Manual (Startup)) (2) Supply 24VDC within the range of the performance specifications. ( MELSEC iQ-R High Speed Digital-Analog Converter Module User's Manual (Startup))
The case other than the above		The possible cause is a failure of the D/A converter module. Please consult your local Mitsubishi representative.

3.4 List of Error Codes

When an error occurs during operation, the D/A converter module stores an error code in 'Latest error code' (Un\G0) of the buffer memory. In addition, 'Error flag' (XF) turns on. Turning on 'Error clear request' (YF) allows clearing of the error code of 'Latest error code' (Un\G0), and turning off of 'Error flag' (XF). The error code is also cleared by turning on and off 'Operating condition setting request' (Y9).

Error codes of the D/A converter module are classified in minor errors or moderate errors.

- Minor error: An error generated by an incorrect setting of a program or parameter. The D/A conversion continues with the parameter setting before the change. (1000H to 1FFFH)
- Moderate error: An error such as hardware failure. The D/A conversion does not continue. (2000H to 2FFFH, 3000H to 3FFFH)

The following table lists the error codes that may be stored.

□ in an error code: This symbol indicates the number of the channel where an error has occurred. A numerical value of 0 to 3 is used to correspond to CH1 to 4.

(CH1: 0, CH2: 1, CH3: 2, CH4: 3)

△ in an error code: For what this symbol indicates, refer to Description and cause.

Error code	Error name	Description and cause	Action
0000H	—	There is no error.	—
1080H	Number of writes to offset/gain settings reach limit error	The number of the offset/gain settings has exceeded the guaranteed maximum number.	Any further setting of offset/gain values may not be reflected correctly.
17E0H	Module-specific backup parameter restore error	Offset/gain values cannot be restored with the module-specific backup parameter.	The module-specific backup parameter file may be damaged. Readjust the user range.
17E1H	Module-specific backup parameter creation error	The module-specific backup parameter was not created.	Check the free space on the data memory of the control CPU and the SD memory card, and recreate a module-specific backup parameter. For how to create module-specific backup parameters, refer to the following. ☞ Page 111 Creating and updating a module-specific backup parameter
180△H	Interrupt factor generation setting range error	Interrupt factor generation setting [n] is set to a value other than Interrupt resend request (0) and No interrupt resend request (1). △ indicates the interrupt setting related to the error as follows: 0: Setting 1 to F: Setting 16	Set Interrupt factor generation setting [n] to Interrupt resend request (0) or No interrupt resend request (1).
181△H	Condition target setting range error	Condition target setting [n] is set to a value outside the range. △ indicates the interrupt setting related to the error as follows: 0: Setting 1 to F: Setting 16	Set Condition target setting [n] to a value within the range of Disable (0) to External power supply READY flag (X7) (4).
182△H	Condition target channel setting range error	Condition target channel setting [n] is set to a value outside the range. △ indicates the interrupt setting related to the error as follows: 0: Setting 1 to F: Setting 16	Set Condition target channel setting [n] to a value within the range of All channels (0) to CH4 (4).
1860H ¹	G(P).OGSTOR instruction execution error	<ul style="list-style-type: none"> • In offset/gain setting mode • In wave output mode • When the module is set as an inter-module synchronization target The G(P).OGSTOR instruction has been executed in above cases.	Execute the G(P).OGSTOR instruction in normal output mode.
1861H	Offset/gain setting continuous write occurrence error	The G(P).OGSTOR instruction has been executed continuously or a set value has been continuously written to the flash memory 26 times or more in the offset/gain setting.	For the G(P).OGSTOR instruction, execute it only once per module. For the offset/gain setting, write the set value only once per setting.
1862H	Model mismatch error at the execution of OGSTOR	The G(P).OGSTOR instruction has been executed on a module of the model different from the one on which the G(P).OGLoad instruction was executed. Or the G(P).OGSTOR instruction has been executed ahead of the G(P).OGLoad instruction.	Execute the G(P).OGLoad and G(P).OGSTOR instructions on a module of the same model. Moreover, execute the G(P).OGLoad instruction on the module from which data is saved, and then execute the G(P).OGSTOR instruction on the module to which the data is restored.

Error code	Error name	Description and cause	Action
190□H	Range setting range error	CH□ Range setting is set to a value outside the range.	Set CH□ Range setting to the following values: <ul style="list-style-type: none"> • 4 to 20mA (0H) to -10 to 10V (4H) • User range setting (voltage) (EH) • User range setting (current) (FH)
191□H	Digital value setting range error	■Normal output mode CH□ Digital value is set to a value outside the range.	■Normal output mode Set CH□ Digital value to a value within the setting range. The setting range varies depending on the set output range as shown below. <ul style="list-style-type: none"> • 4 to 20mA, 0 to 20mA, 1 to 5V, 0 to 5V: 0 to 32000 • -10 to 10V, user range: -32000 to 32000 However, when CH□ Scaling enable/disable setting is set to Enable (0) in normal output mode, the setting range is CH□ Scaling lower limit value to CH□ Scaling upper limit value.
		■Inter-module synchronization mode CH□ Synchronization digital value is set to a value outside the range.	■Inter-module synchronization mode Set CH□ Synchronization digital value to a value within the setting range. The setting range varies depending on the set output range as shown below. <ul style="list-style-type: none"> • 4 to 20mA, 0 to 20mA, 1 to 5V, 0 to 5V: 0 to 32000 • -10 to 10V, user range: -32000 to 32000
		■Wave output mode A part of 'Wave data registry area' (Un\G10000 to Un\G99999), which is used for a wave outputting channel, is set to a value outside the setting range.	■Wave output mode Set the corresponding area of 'Wave data registry area' (Un\G10000 to Un\G99999), which is used for the error channel, to a value within the setting range. The setting range varies depending on the set output range as shown below. <ul style="list-style-type: none"> • 4 to 20mA, 0 to 20mA, 1 to 5V, 0 to 5V: 0 to 32000 • -10 to 10V: -32000 to 32000
192□H	Range change denial error during analog output in high-speed output mode	The range has been switched in high-speed output mode, during analog output in CH□.	When switching the range in high-speed output mode, turn off 'CH□ Output enable/disable flag' (Y1 to Y4) in all channels. After that, change a value of CH□ Range setting and turn on and off 'Operating condition setting request' (Y9).
1A0□H	Scaling enable/disable setting range error	CH□ Scaling enable/disable setting is set to a value other than Enable (0) and Disable (1).	Set CH□ Scaling enable/disable setting to Enable (0) or Disable (1).
1A1□H	Scaling setting range error	CH□ Scaling lower limit value or CH□ Scaling upper limit value is set to a value other than -32000 to 32000.	Set CH□ Scaling lower limit value and CH□ Scaling upper limit value to values within -32000 to 32000.
1A2□H	Scaling upper/lower limit value setting error	CH□ Scaling upper limit value and CH□ Scaling lower limit value are set as the scaling upper limit value = the scaling lower limit value.	Set CH□ Scaling upper limit value and CH□ Scaling lower limit value as the scaling upper limit value ≠ the scaling lower limit value.
1B0□H	Warning output setting range error	CH□ Warning output setting is set to a value other than Enable (0) and Disable (1).	Set CH□ Warning output setting to Enable (0) or Disable (1).
1B1□H	Warning output upper/lower limit value inversion error	CH□ Warning output upper limit value and CH□ Warning output lower limit value are set to values that do not satisfy the following condition: Upper limit value > Lower limit value	Set values so that CH□ Warning output upper limit value is larger than CH□ Warning output lower limit value.
1B8□H	Rate control enable/disable setting range error	CH□ Rate control enable/disable setting is set to a value other than Enable (0) and Disable (1).	Set CH□ Rate control enable/disable setting to Enable (0) or Disable (1).
1B9□H	Digital limit value range error	CH□ Increase digital limit value or CH□ Decrease digital limit value is set to a value other than 0 to 64000.	Set CH□ Increase digital limit value and CH□ Decrease digital limit value to values within 0 to 64000.
1C4□H	Disconnection detection error	A disconnection was detected in CH□.	Eliminate the cause of the disconnection for the corresponding channel, and turn on and off 'Error clear request' (YF).
1D0□H	Wave output start/stop request setting range error	CH□ Wave output start/stop request is set to a value other than 0 to 2.	Set CH□ Wave output start/stop request to any of the following values: <ul style="list-style-type: none"> • Wave output stop request (0) • Wave output start request (1) • Wave output pause request (2)
1D1□H	User range specification error with the wave output function used	The operation mode setting of module parameter is set to wave output mode and CH□ Range setting is set to User range setting (voltage) (EH) or User range setting (current) (FH).	<ul style="list-style-type: none"> • When using the wave output function, set CH□ Range setting so that the output range becomes the range other than user range setting. • When using the user range setting, set the operation mode setting of module parameter to be normal output mode or high-speed output mode.

Error code	Error name	Description and cause	Action
1D2□H	Setting range error for Output setting during wave output stop	CH□ Output setting during wave output stop is set to a value other than 0 to 2.	Set CH□ Output setting during wave output stop to any of the following values: <ul style="list-style-type: none"> • 0V/0mA (0) • Offset value (1) • Output value during wave output stop (2)
1D3□H	Setting range error for Output value during wave output stop	CH□ Output value during wave output stop is set to a value outside the setting range.	Set CH□ Output value during wave output stop to a value within the setting range. The setting range varies depending on the set output range as shown below. <ul style="list-style-type: none"> • 4 to 20mA, 0 to 20mA, 1 to 5V, 0 to 5V: 0 to 32000 • -10 to 10V: -32000 to 32000
1D4□H	Wave pattern start address setting range error	CH□ Wave pattern start address setting is set to a value other than 10000 to 99999.	Set CH□ Wave pattern start address setting to a value within 10000 to 99999.
1D5□H	Wave pattern data points setting range error	CH□ Wave pattern data points setting is set to a value other than 1 to 90000.	Set CH□ Wave pattern data points setting to a value within 1 to 90000.
1D6□H	Wave pattern output repetition setting range error	CH□ Wave pattern output repetition setting is set to a value outside the range.	Set CH□ Wave pattern output repetition setting to any of the following values: <ul style="list-style-type: none"> • Unlimited repeat output (-1) • Output of the specified number of times (1 to 32767)
1D7□H	Setting range error for Constant for wave output conversion cycle	CH□ Constant for wave output conversion cycle is set to a value other than 1 to 5000.	Set CH□ Constant for wave output conversion cycle to a value within 1 to 5000.
1D80H	Step action wave output request setting range error	Step action wave output request is set to a value other than OFF (0) and ON (1).	Set Step action wave output request to OFF (0) or ON (1).
1D9□H	Wave data registry area setting range error	The value obtained by "CH□ Wave pattern start address setting + CH□ Wave pattern data points setting - 1" exceeded 99999 (the last address of Wave data registry area).	Set CH□ Wave pattern start address setting and CH□ Wave pattern data points setting so that the following condition is satisfied: <ul style="list-style-type: none"> • "Wave pattern start address setting" + "Wave pattern data points setting" - 1 ≤ 99999
1E50H	Offset/gain setting channel specification error	<ul style="list-style-type: none"> • Setting channel (1) is simultaneously set for multiple channels during the offset/gain setting. • In the offset/gain setting, both CH□ Offset/gain setting mode (offset specification) and CH□ Offset/gain setting mode (gain specification) are set to Setting channel (1), or both CH□ Offset/gain setting mode (offset specification) and CH□ Offset/gain setting mode (gain specification) for all channels are set to Disable (0). 	Correctly set CH□ Offset/gain setting mode (offset specification) and CH□ Offset/gain setting mode (gain specification).
1E51H	User range data invalid (CH identification disabled)	An invalid value is set in the offset/gain setting. The number of the channel in which this error occurs cannot be identified.	Perform the offset/gain setting again for all channels where the user range setting is used. If the error occurs again, the possible cause is a failure of the module. Please consult your local Mitsubishi representative.
1E52H	Analog adjustment output setting outside the range error	Offset/gain adjustment value specification is set to a value other than -3000 to 3000.	Set Offset/gain adjustment value specification to a value within -3000 to 3000.
1E6□H	User range data invalid (CH identification enabled)	An invalid value is set for CH□ in the offset/gain setting.	Perform the offset/gain setting again for the channels where the error has occurred. If the error occurs again, the possible cause is a failure of the module. Please consult your local Mitsubishi representative.
1E7□H	Offset/gain value inversion error	The offset value and gain value to be saved in the flash memory are as follows: Offset value ≥ Gain value	Perform the offset/gain setting again so that the following condition is satisfied: Offset value < Gain value
1E8□H	Offset/gain setting channel range error	CH□ Offset/gain setting mode (offset specification) and CH□ Offset/gain setting mode (gain specification) are set to values other than Disable (0) and Setting channel (1).	Set CH□ Offset/gain setting mode (offset specification) and CH□ Offset/gain setting mode (gain specification) to Disable (0) or Setting channel (1).
1E9□H	Offset/gain setting range error	In the offset/gain setting, CH□ Offset/gain setting mode (range specification) is set to a value other than User range setting (voltage) (E) and User range setting (current) (F).	Set CH□ Offset/gain setting mode (range specification) to User range setting (voltage) (E) or User range setting (current) (F).
1EA2H	Setting range error for Output setting during synchronization error	Output setting during synchronization error is set to a value other than Synchronization continue (0) and Synchronization stop (1).	Set Output setting during synchronization error to Synchronization continue (0) or Synchronization stop (1).

Error code	Error name	Description and cause	Action
2600H	Inter-module synchronization cycle crossing over error	It was detected that the processing was performed across the cycles with the inter-module synchronization function operating.	Correct settings to extend the inter-module synchronization cycle or reduce the number of steps of the inter-module synchronous interrupt program.
2601H	Inter-module synchronization cycle skip error	It was detected that the processing of a cycle was skipped with the inter-module synchronization function operating.	<ul style="list-style-type: none"> Execute the EI instruction in the main program and enable an interrupt. Correct settings to extend the inter-module synchronization cycle or reduce the number of steps of the inter-module synchronous interrupt program. If the error occurs again even after the above actions are taken, the possible cause is a failure of the module. Please consult your local Mitsubishi representative.
2610H	Inter-module synchronization signal error	A synchronization loss was detected with the inter-module synchronization function operating.	The module may be affected by noise. Check and adjust the cable wiring and the installation environment of the programmable controllers, and restart the system. If the error occurs again even after the adjustment, the possible cause is a failure of the module. Please consult your local Mitsubishi representative.
3001H	Hardware error	A hardware error has occurred in the module.	Power off and on the module. If the error occurs again, the possible cause is a failure of the module. Please consult your local Mitsubishi representative.
3030H	Flash memory error	The data in the flash memory is abnormal.	Check an analog output value. If the value is abnormal, please consult your local Mitsubishi representative.

*1 The error code is not stored in 'Latest error code' (Un\G0). It is stored in completion status area (S)+1 of the G(P).OGSTOR instruction. In addition, 'Error flag' (XF) does not turn on.

3.5 List of Alarm Codes

When an alarm occurs during operation, the D/A converter module stores an alarm code in 'Latest alarm code' (Un\G2) of the buffer memory. Turning on 'Warning output clear request' (YE) allows clearing of the alarm code of 'Latest alarm code' (Un\G2). The alarm code is also cleared by turning on and off 'Operating condition setting request' (Y9).

The following table lists the alarm codes that may be stored.

□ in an alarm code: This symbol indicates the number of the channel where an alarm has occurred. A numerical value of 0 to 3 is used to correspond to CH1 to 4.

(CH1: 0, CH2: 1, CH3: 2, CH4: 3)

Alarm code	Alarm name	Description and cause	Action
080□H	Warning output alarm (upper limit)	The warning output alarm (upper limit) has occurred in CH□.	<p>■Normal output mode Set CH□ Digital value to a value within the setting range, and turn on and off 'Warning output clear request' (YE). As a result, the corresponding bit of Warning output upper flag or Warning output lower flag, and 'Warning output signal' (XE) turn off. The setting range is shown below.</p> <ul style="list-style-type: none"> Warning output upper limit value \geq Setting value \geq Warning output lower limit value <p>■Inter-module synchronization mode Set CH□ Synchronization digital value to a value within the setting range, and turn on and off 'Warning output clear request' (YE). As a result, the corresponding bit of Warning output upper flag or Warning output lower flag, and 'Warning output signal' (XE) turn off. The setting range is shown below.</p> <ul style="list-style-type: none"> Warning output upper limit value \geq Setting value \geq Warning output lower limit value <p>■Wave output mode Set the corresponding area of 'Wave data registry area' (Un\G10000 to Un\G99999), which is used for the channel where the warning has occurred, to a value within the setting range. After that, turn on and off 'Warning output clear request' (YE). As a result, the corresponding bit of Warning output upper flag or Warning output lower flag, and 'Warning output signal' (XE) turn off. The setting range is shown below.</p> <ul style="list-style-type: none"> Warning output upper limit value \geq Setting value \geq Warning output lower limit value <p>(Error data can be checked with CH□ Wave output warning address monitor.)</p>
081□H	Warning output alarm (lower limit)	The warning output alarm (lower limit) has occurred in CH□.	
0B0□H	Operating condition setting request error in a state other than wave output stop	'Operating condition setting request' (Y9) was turned on and off in a state other than wave output stop.	Turn on and off 'Operating condition setting request' (Y9) after wave output stops in all channels.
0C0□H	Range change denial alarm during analog output in CH□	The range has been switched during analog output in CH□.	When switching the range, turn off 'CH□ Output enable/disable flag' (Y1 to Y4) for the channel where the range is to be switched. After that, change a value of CH□ Range setting and turn on and off 'Operating condition setting request' (Y9).

APPENDICES

Appendix 1 Module Label

The functions of the D/A converter module can be set by using module labels.

Module labels of I/O signals

The module label name of an I/O signal is defined with the following structure:

"Module name"_"Module number".b"Label name" or "Module name"_"Module number".b"Label name"_D

Ex.

R60DAH_1.bModuleREADY_D

■Module name

The character string of a module model name is given.

■Module number

A number starting from 1 is added to identify modules that have the same module name.

■Label name

The label identifier unique to a module is given.

■_D

This string indicates that the module label is for the direct access input (DX) or direct access output (DY). A module label without the string is for the input (X) or output (Y) of the refresh processing.

Module labels of buffer memory areas

The module label name of a buffer memory area is defined with the following structure:

"Module name"_"Module number"."Data type"_D["(Channel)"]."Data format""Label name"_D

Ex.

R60DAH_1.stnControl[0].wDigitalValue_D

■Module name

The character string of a module model name is given.

■Module number

A number starting from 1 is added to identify modules that have the same module name.

■Data type

The data type to sort a buffer memory area is given. Each data type is as follows:

Data type	Description
stnMonitor	Monitor
stnControl	Control
stnSetting	Setting

■Channel

The channel number corresponding to a module label is given. A numerical value of 0 to 3 is used to correspond to CH1 to 4. (CH1: 0, CH2: 1, CH3: 2, CH4: 3)

■Data format

The string that represents the data size of a buffer memory area is given. Each data format is as follows:

Data format	Description
u	Word [Unsigned]/Bit string [16-bit]
w	Word [Signed]
d	Double word [Signed]
z	System area

■Label name

The label identifier unique to a module is given.

■_D

This string indicates that the module label is for the direct access. A module label without the string is for the auto refresh. The following table shows the differences between the auto refresh and direct access.

Type	Description	Access timing	Example
Auto refresh	Values that are read from or written to the module label are reflected in the module collectively at the auto refresh. The run time of the program can be reduced. To use the auto refresh, set "Target" to "Module Label" in "Refresh settings" of "Module Parameter".	At auto refresh	R60DAH_1.stnControl[0].wDigitalValue
Direct access	Values that are read from or written to the module label are reflected in the module instantly. Compared with the auto refresh, the run time of the program becomes longer. However, the responsiveness is high. For the instruction processing time, refer to the following.  MELSEC iQ-R Programming Manual (CPU Module Instructions, Standard Functions/Function Blocks)	At reading/writing from/to the module label	R60DAH_1.stnControl_D[0].wDigitalValue_D

Appendix 2 I/O Signals

List of I/O signals

The following tables list the I/O signals of the D/A converter module.

For details on the I/O signals, refer to the following.

☞ Page 140 Details of input signals

☞ Page 147 Details of output signals

Point

- The I/O signals (X/Y) described below show the case that the start I/O number of the D/A converter module is set to 0.
- Do not use the Use prohibited signals shown below because the system uses them. If a customer uses (turns on) the signals, the functions of the D/A converter module cannot be guaranteed.

Input signal

Device number	Signal name
X0	Module READY
X1 to X6	Use prohibited
X7	External power supply READY flag
X8	Use prohibited
X9	Operating condition setting completed flag
XA	Offset/gain setting mode status flag
XB	Channel change completed flag
XC	Set value change completed flag
XD	Disconnection detection signal
XE	Warning output signal
XF	Error flag

Output signal

Device number	Signal name
Y0	Use prohibited
Y1	CH1 Output enable/disable flag
Y2	CH2 Output enable/disable flag
Y3	CH3 Output enable/disable flag
Y4	CH4 Output enable/disable flag
Y5 to Y8	Use prohibited
Y9	Operating condition setting request
YA	User range write request
YB	Channel change request
YC	Set value change request
YD	Use prohibited
YE	Warning output clear request
YF	Error clear request

A

Details of input signals

The following describes the details of the input signals for the D/A converter module which are assigned to the CPU module. The I/O numbers (X/Y) described in this section are for the case when the start I/O number of the D/A converter module is set to 0.

Point

This section describes buffer memory addresses for CH1. For details on the buffer memory addresses for CH2 and later, refer to the following.

 Page 150 List of buffer memory areas

Module READY

Common

'Module READY' (X0) turns on to indicate the preparation for the D/A conversion is completed after the power-on or the reset operation of the CPU module.

In the following cases, 'Module READY' (X0) turns off.

- In the offset/gain setting mode (In this case, the D/A conversion processing is performed.)
- When a watchdog timer error occurs in the D/A converter module (In this case, the D/A conversion processing is not performed.)

■Device number

The following shows the device number of this input signal.

Signal name	CH1	CH2	CH3	CH4
Module READY	X0			

External power supply READY flag

Common

■Device number

The following shows the device number of this input signal.

Signal name	CH1	CH2	CH3	CH4
External power supply READY flag	X7			

■When the external power supply is off, or when 200ms has not yet elapsed after the power-on
'External power supply READY flag' (X7) remains off and the D/A conversion processing is not performed. In this case, the analog output value is 0V/0mA.

■When the external power supply is turned on

After 200ms, 'External power supply READY flag' (X7) turns on. The D/A conversion processing is started on the channels where the D/A conversion is enabled.

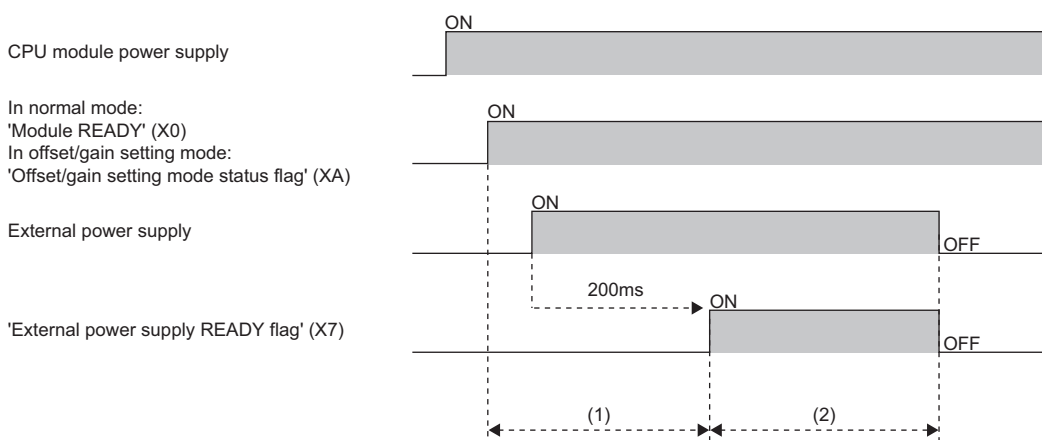

(1) The D/A conversion processing is not performed.

(2) The D/A conversion processing is performed.

■When the external power supply is turned off

'External power supply READY flag' (X7) turns off and the D/A conversion processing stops. In this case, the analog output value is 0V/0mA.

When the external power supply is turned off and on again, 'External power supply READY flag' (X7) turns on after 200ms as is the case when the external power supply is turned off and on, and the D/A conversion processing is restarted.

Restriction

Use the external power supply that satisfies the specifications described in the performance specifications. Otherwise, 'External power supply READY flag' (X7) does not turn on. For the performance specifications, refer to the following.

📖 MELSEC iQ-R High Speed Digital-Analog Converter Module User's Manual (Startup)

A

Operating condition setting completed flag

Common

When changing values of the buffer memory, use 'Operating condition setting completed flag' (X9) as an interlock condition to turn on and off 'Operating condition setting request' (Y9). For the buffer memory areas that require turning on and off of 'Operating condition setting request' (Y9) to enable the new values, refer to the following.

☞ Page 150 List of buffer memory areas

When 'Operating condition setting request' (Y9) is on, 'Operating condition setting completed flag' (X9) turns off.

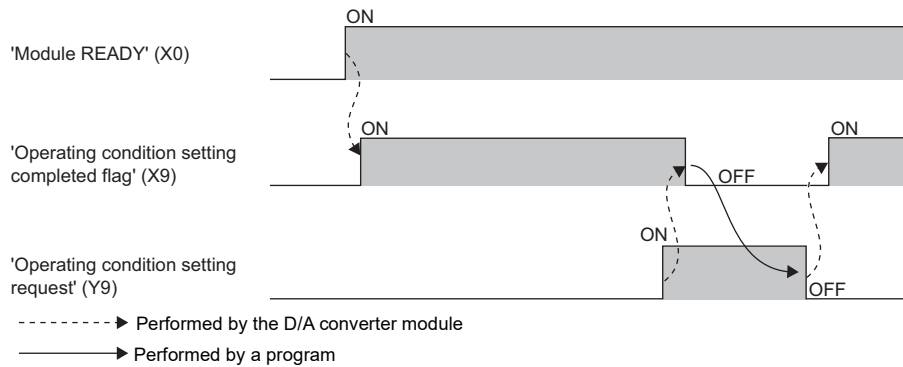

■ Device number

The following shows the device number of this input signal.

Signal name	CH1	CH2	CH3	CH4
Operating condition setting completed flag	X9			

Offset/gain setting mode status flag

Normal

■Device number

The following shows the device number of this input signal.

Signal name	CH1	CH2	CH3	CH4
Offset/gain setting mode status flag	XA			

■In the offset/gain setting mode

When registering the value that has been adjusted with the offset/gain setting, use this flag as an interlock condition to turn on and off 'User range write request' (YA).

When the offset/gain setting is configured from the offset/gain setting window of an engineering tool, the setting is performed properly on the window. Therefore, a program is not required to perform the setting.

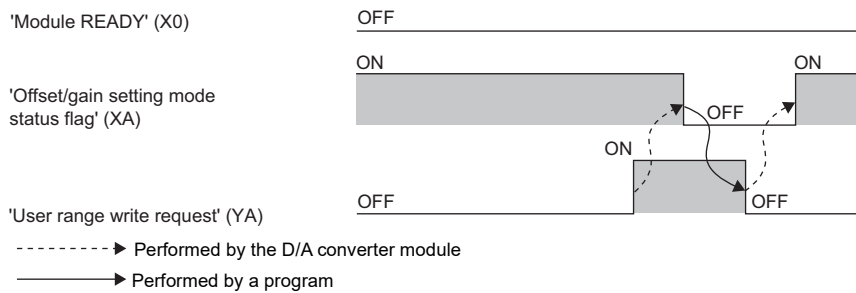

■In the normal output mode

This signal is used as an interlock condition to turn on and off 'User range write request' (YA) when the user range setting is restored.

For details on restoration of the user range setting, refer to the following.

📖 Page 110 Backing up, Saving, and Restoring Offset/Gain Values

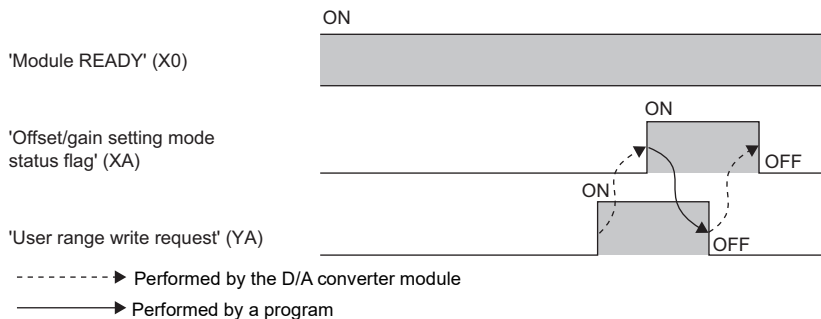

A

Channel change completed flag

Normal

When changing a channel to perform the offset/gain setting, use 'Channel change completed flag' (XB) as an interlock condition to turn on and off 'Channel change request' (YB).

When the offset/gain setting is configured from the offset/gain setting window of an engineering tool, the setting is performed properly on the window. Therefore, a program is not required to perform the setting.

CH1 Offset/gain setting mode
(offset specification) (Un\G4132)
CH1 Offset/gain setting mode
(gain specification) (Un\G4133)

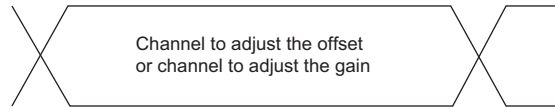

'Channel change completed flag' (XB)



'Channel change request' (YB)

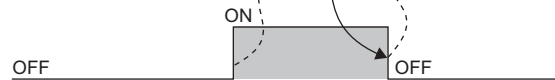

- > Performed by the D/A converter module
- > Performed by a program

■Device number

The following shows the device number of this input signal.

Signal name	CH1	CH2	CH3	CH4
Channel change completed flag	XB			

Set value change completed flag

Normal

When adjusting the offset/gain setting, use 'Set value change completed flag' (XC) as an interlock condition to turn on and off 'Set value change request' (YC).

When the offset/gain setting is configured from the offset/gain setting window of an engineering tool, the setting is performed properly on the window. Therefore, a program is not required to perform the setting.

'Set value change completed flag' (XC)



'Set value change request' (YC)



- > Performed by the D/A converter module
- > Performed by a program

■Device number

The following shows the device number of this input signal.

Signal name	CH1	CH2	CH3	CH4
Set value change completed flag	XC			

■When the external power supply is off

'Set value change completed flag' (XC) does not turn on. Turn on the external power supply, and turn on and off 'Set value change request' (YC) again.

Disconnection detection signal

Normal

Wave

Synchronization

'Disconnection detection signal' (XD) turns on when a disconnection is detected in a channel where the output range is 4 to 20mA.

'Disconnection detection signal' (XD) turns off by turning on and off 'Error clear request' (YF) or 'Operating condition setting request' (Y9) after the cause of the disconnection is eliminated.

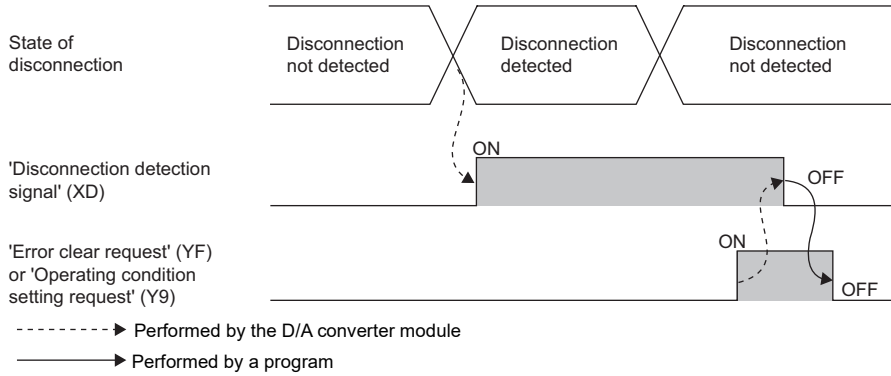

Device number

The following shows the device number of this input signal.

Signal name	CH1	CH2	CH3	CH4
Disconnection detection signal	XD			

Warning output signal

Normal

Wave

Synchronization

'Warning output signal' (XE) turns on when an alarm occurs in a channel where D/A conversion is enabled.

By turning on and off 'Warning output clear request' (YE) or 'Operating condition setting request' (Y9) after the cause of the alarm is eliminated, 'Warning output signal' (XE) turns off and 'Latest alarm code (Un\G2)' is cleared.

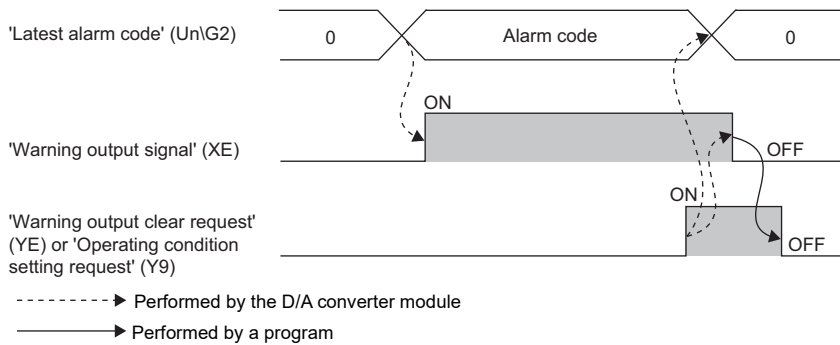

Device number

The following shows the device number of this input signal.

Signal name	CH1	CH2	CH3	CH4
Warning output signal	XE			

A

Error flag

Common

'Error flag' (XF) turns on when an error occurs.

By turning on and off 'Error clear request' (YF) or 'Operating condition setting request' (Y9) after the cause of the error is eliminated, 'Error flag' (XF) turns off and 'Latest error code' (Un\G0) is cleared.

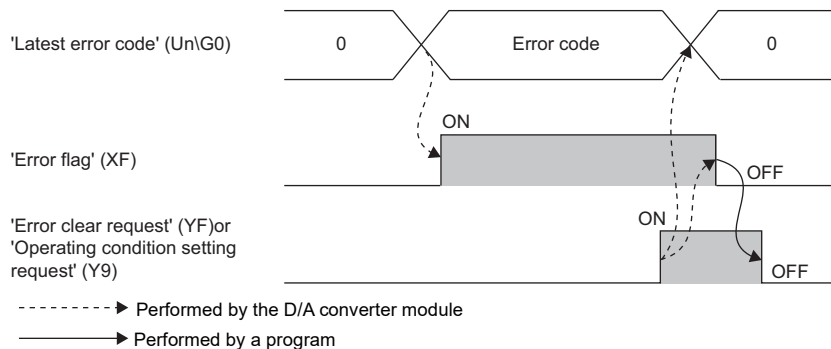

Device number

The following shows the device number of this input signal.

Signal name	CH1	CH2	CH3	CH4
Error flag	XF			

Restriction

When turning on 'Operating condition setting request' (Y9) in the high-speed output mode, if an error occurs in any of the channels, all channels are set to D/A conversion disable. To start the analog output, check the settings, and turn on and off 'Operating condition setting request' (Y9).

Details of output signals

The following describes the details of the output signals for the D/A converter module which are assigned to the CPU module. The I/O numbers (X/Y) described in this section are for the case when the start I/O number of the D/A converter module is set to 0.

Point

This section describes I/O signals and buffer memory addresses for CH1. For details on the buffer memory addresses for CH2 and later, refer to the following.

☞ Page 150 List of buffer memory areas

CH1 Output enable/disable flag

Common

Set whether to output the D/A conversion value or offset value.

On: D/A conversion value

Off: Offset value

Device number

The following shows the device number of this output signal.

Signal name	CH1	CH2	CH3	CH4
CH□ Output enable/disable flag	Y1	Y2	Y3	Y4

Operating condition setting request

Common

Turn on and off Operating condition setting request to enable the setting of the D/A converter module.

For the timing of turning on and off the signal, refer to the following.

☞ Page 142 Operating condition setting completed flag

For details on the buffer memory areas to be enabled, refer to the following.

☞ Page 150 List of buffer memory areas

Device number

The following shows the device number of this output signal.

Signal name	CH1	CH2	CH3	CH4
Operating condition setting request	Y9			

A

User range write request

Normal

■Device number

The following shows the device number of this output signal.

Signal name	CH1	CH2	CH3	CH4
User range write request	YA			

■In the offset/gain setting mode

Turn on and off User range write request to register values adjusted with the offset/gain setting in the D/A converter module. The data is written to the flash memory when this signal is turned on.

For the timing of turning on and off the signal, refer to the following.

☞ Page 143 Offset/gain setting mode status flag

■In the normal output mode

Turn on and off 'User range write request' (YA) to restore the user range.

For the timing of turning on and off the signal, refer to the following.

☞ Page 143 Offset/gain setting mode status flag

Channel change request

Normal

Turn on and off 'Channel change request' (YB) to change a channel to perform the offset/gain setting.

For the timing of turning on and off the signal, refer to the following.

☞ Page 144 Channel change completed flag

■Device number

The following shows the device number of this output signal.

Signal name	CH1	CH2	CH3	CH4
Channel change request	YB			

Set value change request

Normal

Turn on and off 'Set value change request' (YC) to change the analog output value to adjust the offset/gain setting.

The analog output value increases or decreases depending on the value set for 'Offset/gain adjustment value specification' (Un\G4130).

For the timing of turning on and off the signal, refer to the following.

☞ Page 144 Set value change completed flag

■Device number

The following shows the device number of this output signal.

Signal name	CH1	CH2	CH3	CH4
Set value change request	YC			

Warning output clear request

Normal

Wave

Synchronization

Turn on and off 'Warning output clear request' (YE) to clear 'Warning output signal' (XE) and 'Latest alarm code' (Un\G2).
For the timing of turning on and off the signal, refer to the following.

☞ Page 145 Warning output signal

■Device number

The following shows the device number of this output signal.

Signal name	CH1	CH2	CH3	CH4
Warning output clear request	YE			

Error clear request

Common

Turn on and off 'Error clear request' (YF) to clear 'Error flag' (XF) and 'Latest error code' (Un\G0).
For the timing of turning on and off the signal, refer to the following.

☞ Page 146 Error flag

■Device number

The following shows the device number of this output signal.

Signal name	CH1	CH2	CH3	CH4
Error clear request	YF			

A

Appendix 3 Buffer Memory Areas

List of buffer memory areas

The following table lists the buffer memory areas of the D/A converter module. For details on the buffer memory areas, refer to the following.

 Page 157 Details of buffer memory areas

The buffer memory areas of the D/A converter module are classified by the following data types.

Data type	Description	
Setting data	Description	Set this data according to the connected device and the application of the system.
	Read/write attribute	Data can be read and written from/to this area.
	Setting method	Set this data using an engineering tool or a program.
	Setting timing	After changing values, turn on and off 'Operating condition setting request' (Y9) to enable the set values.
Control data	Description	Use this data to control the D/A converter module.
	Read/write attribute	Data can be read and written from/to this area.
	Setting method	Set this data using an engineering tool or a program.
	Setting timing	As soon as values are changed, the set values are enabled.
Monitor data	Description	Use this data to monitor the status of the D/A converter module.
	Read/write attribute	Reading data is only allowed. Writing data is not allowed.
	Setting method	—
	Setting timing	—
User range setting data	Description	Use this data to update the user range setting of the D/A converter module.
	Read/write attribute	Data can be read and written from/to this area.
	Setting method	Set this data using an engineering tool or a program.
	Setting timing	After changing values, turn on and off 'User range write request' (YA) to enable the set values.

Point

Do not write data to the system areas and areas whose data types are monitor in the buffer memory. Writing data into these areas can cause the malfunction of the module.

Un\G0 to Un\G399

Address (decimal)	Address (hexadecimal)	Name	Default value	Data type	Auto refresh
0	0H	Latest error code	0	Monitor	○
1	1H	Latest address of error history	0	Monitor	○
2	2H	Latest alarm code	0	Monitor	○
3	3H	Latest address of alarm history	0	Monitor	○
4 to 19	4H to 13H	Interrupt factor detection flag [n] ^{*1}	0	Monitor	○
20 to 35	14H to 23H	System area	—	—	—
36	24H	Warning output upper flag	0000H	Monitor	○
37	25H	Warning output lower flag	0000H	Monitor	○
38	26H	Disconnection detection flag	0000H	Monitor	○
39 to 59	27H to 3BH	System area	—	—	—
60	3CH	Operation mode monitor	1	Monitor	×
61 to 69	3DH to 45H	System area	—	—	—
70	46H	RUN LED status monitor	0000H	Monitor	×
71	47H	ERR LED status monitor	0000H	Monitor	×
72	48H	ALM LED status monitor	0000H	Monitor	×
73 to 123	49H to 7BH	System area	—	—	—
124 to 139	7CH to 8BH	Interrupt factor mask [n] ^{*1}	0	Control	×
140 to 155	8CH to 9BH	System area	—	—	—
156 to 171	9CH to ABH	Interrupt factor reset request [n] ^{*1}	0	Control	×
172 to 187	ACH to BBH	System area	—	—	—
188	BCH	Step action wave output request	0	Control	×
189 to 199	BDH to C7H	System area	—	—	—
200 to 215	C8H to D7H	Interrupt factor generation setting [n] ^{*1}	0	Setting	×
216 to 231	D8H to E7H	System area	—	—	—
232 to 247	E8H to F7H	Condition target setting [n] ^{*1}	0	Setting	×
248 to 263	F8H to 107H	System area	—	—	—
264 to 279	108H to 117H	Condition target channel setting [n] ^{*1}	0	Setting	×
280 to 295	118H to 127H	System area	—	—	—
296, 297	128H, 129H	Mode switching setting	0	Setting	×
298 to 399	12AH to 18FH	System area	—	—	—

*1 [n] in the table indicates an interrupt setting number. (n = 1 to 16)

Un\G400 to Un\G3599

Address Decimal (hexadecimal)				Name	Default value	Data type	Auto refresh
CH1	CH2	CH3	CH4				
400 (190H)	600 (258H)	800 (320H)	1000 (3E8H)	CH□ Set value check code	0000H	Monitor	○
401 (191H)	601 (259H)	801 (321H)	1001 (3E9H)	CH□ Wave output status monitor	0	Monitor	○
402 to 429 (192H to 1ADH)	602 to 629 (25AH to 275H)	802 to 829 (322H to 33DH)	1002 to 1029 (3EAH to 405H)	System area	—	—	—
430 (1AEH)	630 (276H)	830 (33EH)	1030 (406H)	CH□ Range setting monitor	0000H	Monitor	×
431 (1AFH)	631 (277H)	831 (33FH)	1031 (407H)	CH□ HOLD/CLEAR function setting monitor	0	Monitor	×
432 (1B0H)	632 (278H)	832 (340H)	1032 (408H)	CH□ Wave output conversion cycle monitor (L)	0	Monitor	×
433 (1B1H)	633 (279H)	833 (341H)	1033 (409H)	CH□ Wave output conversion cycle monitor (H)		Monitor	×
434 (1B2H)	634 (27AH)	834 (342H)	1034 (40AH)	CH□ Wave pattern output count monitor	0	Monitor	×
435 (1B3H)	635 (27BH)	835 (343H)	1035 (40BH)	System area	—	—	—
436 (1B4H)	636 (27CH)	836 (344H)	1036 (40CH)	CH□ Wave output current address monitor (L)	0	Monitor	×
437 (1B5H)	637 (27DH)	837 (345H)	1037 (40DH)	CH□ Wave output current address monitor (H)		Monitor	×
438 (1B6H)	638 (27EH)	838 (346H)	1038 (40EH)	CH□ Wave output current digital value monitor	0	Monitor	×
439 (1B7H)	639 (27FH)	839 (347H)	1039 (40FH)	System area	—	—	—
440 (1B8H)	640 (280H)	840 (348H)	1040 (410H)	CH□ Wave output digital value outside the range address monitor (L)	0	Monitor	×
441 (1B9H)	641 (281H)	841 (349H)	1041 (411H)	CH□ Wave output digital value outside the range address monitor (H)		Monitor	×
442 (1BAH)	642 (282H)	842 (34AH)	1042 (412H)	CH□ Wave output warning address monitor (L)	0	Monitor	×
443 (1BBH)	643 (283H)	843 (34BH)	1043 (413H)	CH□ Wave output warning address monitor (H)		Monitor	×
444 to 458 (1BCH to 1CAH)	644 to 658 (284H to 292H)	844 to 858 (34CH to 35AH)	1044 to 1058 (414H to 422H)	System area	—	—	—
459 (1CBH)	659 (293H)	859 (35BH)	1059 (423H)	CH□ D/A conversion status monitor	0	Monitor	×
460 (1CCH)	660 (294H)	860 (35CH)	1060 (424H)	CH□ Digital value	0	Control	○
461 (1CDH)	661 (295H)	861 (35DH)	1061 (425H)	System area	—	—	—
462 (1CEH)	662 (296H)	862 (35EH)	1062 (426H)	CH□ Wave output start/stop request	0	Control	×
463 to 479 (1CFH to 1DFH)	663 to 679 (297H to 2A7H)	863 to 879 (35FH to 36FH)	1063 to 1079 (427H to 437H)	System area	—	—	—
480 (1E0H)	680 (2A8H)	880 (370H)	1080 (438H)	CH□ Input value shift amount	0	Control	×
481 (1E1H)	681 (2A9H)	881 (371H)	1081 (439H)	System area	—	—	—
482 (1E2H)	682 (2AAH)	882 (372H)	1082 (43AH)	CH□ Wave output step action movement amount	0	Control	×
483 to 499 (1E3H to 1F3H)	683 to 699 (2ABH to 2BBH)	883 to 899 (373H to 383H)	1083 to 1099 (43BH to 44BH)	System area	—	—	—
500 (1F4H)	700 (2BCH)	900 (384H)	1100 (44CH)	CH□ D/A conversion enable/disable setting	1	Setting	×
501 (1F5H)	701 (2BDH)	901 (385H)	1101 (44DH)	System area	—	—	—
502 (1F6H)	702 (2BEH)	902 (386H)	1102 (44EH)	CH□ Scaling enable/disable setting	1	Setting	×
503 (1F7H)	703 (2BFH)	903 (387H)	1103 (44FH)	System area	—	—	—
504 (1F8H)	704 (2C0H)	904 (388H)	1104 (450H)	CH□ Scaling upper limit value	0	Setting	×
505 (1F9H)	705 (2C1H)	905 (389H)	1105 (451H)	System area	—	—	—
506 (1FAH)	706 (2C2H)	906 (38AH)	1106 (452H)	CH□ Scaling lower limit value	0	Setting	×
507 (1FBH)	707 (2C3H)	907 (38BH)	1107 (453H)	System area	—	—	—
508 (1FCH)	708 (2C4H)	908 (38CH)	1108 (454H)	CH□ Warning output setting	1	Setting	×
509 (1FDH)	709 (2C5H)	909 (38DH)	1109 (455H)	CH□ Rate control enable/disable setting	1	Setting	×

Address Decimal (hexadecimal)				Name	Default value	Data type	Auto refresh
CH1	CH2	CH3	CH4				
510 (1FEH)	710 (2C6H)	910 (38EH)	1110 (456H)	CH□ Warning output upper limit value	0	Setting	×
511 (1FFH)	711 (2C7H)	911 (38FH)	1111 (457H)	System area	—	—	—
512 (200H)	712 (2C8H)	912 (390H)	1112 (458H)	CH□ Warning output lower limit value	0	Setting	×
513 (201H)	713 (2C9H)	913 (391H)	1113 (459H)	System area	—	—	—
514 (202H)	714 (2CAH)	914 (392H)	1114 (45AH)	CH□ Increase digital limit value	64000	Setting	×
515 (203H)	715 (2CBH)	915 (393H)	1115 (45BH)	System area	—	—	—
516 (204H)	716 (2CCH)	916 (394H)	1116 (45CH)	CH□ Decrease digital limit value	64000	Setting	×
517 to 523 (205H to 20BH)	717 to 723 (2CDH to 2D3H)	917 to 923 (395H to 39BH)	1117 to 1123 (45DH to 463H)	System area	—	—	—
524 (20CH)	724 (2D4H)	924 (39CH)	1124 (464H)	CH□ Output setting during wave output stop	1	Setting	×
525 (20DH)	725 (2D5H)	925 (39DH)	1125 (465H)	CH□ Output value during wave output stop	0	Setting	×
526 (20EH)	726 (2D6H)	926 (39EH)	1126 (466H)	CH□ Wave pattern start address setting (L)	10000	Setting	×
527 (20FH)	727 (2D7H)	927 (39FH)	1127 (467H)	CH□ Wave pattern start address setting (H)		Setting	×
528 (210H)	728 (2D8H)	928 (3A0H)	1128 (468H)	CH□ Wave pattern data points setting (L)	0	Setting	×
529 (211H)	729 (2D9H)	929 (3A1H)	1129 (469H)	CH□ Wave pattern data points setting (H)		Setting	×
530 (212H)	730 (2DAH)	930 (3A2H)	1130 (46AH)	CH□ Wave pattern output repetition setting	1	Setting	×
531 (213H)	731 (2DBH)	931 (3A3H)	1131 (46BH)	CH□ Constant for wave output conversion cycle	1	Setting	×
532 to 597 (214H to 255H)	732 to 797 (2DCH to 31DH)	932 to 997 (3A4H to 3E5H)	1132 to 1197 (46CH to 4ADH)	System area	—	—	—
598 (256H)	798 (31EH)	998 (3E6H)	1198 (4AEH)	CH□ Range setting	0000H	Setting	×
599 (257H)	799 (31FH)	999 (3E7H)	1199 (4AFH)	System area	—	—	—
1200 to 3599 (4B0H to E0FH)				System area	—	—	—

Error history and alarm history (Un\G3600 to Un\G3999)

Address (decimal)	Address (hexadecimal)	Name	Default value	Data type	Auto refresh				
3600	E10H	Error history No.1	0	Monitor	×				
3601	E11H					Error code	Error time	First two digits of the year	Last two digits of the year
3602	E12H							Month	Day
3603	E13H					Hour	Minute		
3604	E14H					Second	Day of the week		
3605	E15H					Millisecond			
3606 to 3609	E16H to E19H	System area	—	—	—				
3610 to 3615	E1AH to E1FH	Error history No.2	Same as error history No.1	0	Monitor	×			
3616 to 3619	E20H to E23H	System area	—	—	—				
3620 to 3625	E24H to E29H	Error history No.3	Same as error history No.1	0	Monitor	×			
3626 to 3629	E2AH to E2DH	System area	—	—	—				
3630 to 3635	E2EH to E33H	Error history No.4	Same as error history No.1	0	Monitor	×			
3636 to 3639	E34H to E37H	System area	—	—	—				
3640 to 3645	E38H to E3DH	Error history No.5	Same as error history No.1	0	Monitor	×			
3646 to 3649	E3EH to E41H	System area	—	—	—				
3650 to 3655	E42H to E47H	Error history No.6	Same as error history No.1	0	Monitor	×			
3656 to 3659	E48H to E4BH	System area	—	—	—				
3660 to 3665	E4CH to E51H	Error history No.7	Same as error history No.1	0	Monitor	×			
3666 to 3669	E52H to E55H	System area	—	—	—				
3670 to 3675	E56H to E5BH	Error history No.8	Same as error history No.1	0	Monitor	×			
3676 to 3679	E5CH to E5FH	System area	—	—	—				
3680 to 3685	E60H to E65H	Error history No.9	Same as error history No.1	0	Monitor	×			
3686 to 3689	E66H to E69H	System area	—	—	—				
3690 to 3695	E6AH to E6FH	Error history No.10	Same as error history No.1	0	Monitor	×			
3696 to 3699	E70H to E73H	System area	—	—	—				
3700 to 3705	E74H to E79H	Error history No.11	Same as error history No.1	0	Monitor	×			
3706 to 3709	E7AH to E7DH	System area	—	—	—				
3710 to 3715	E7EH to E83H	Error history No.12	Same as error history No.1	0	Monitor	×			
3716 to 3719	E84H to E87H	System area	—	—	—				
3720 to 3725	E88H to E8DH	Error history No.13	Same as error history No.1	0	Monitor	×			
3726 to 3729	E8EH to E91H	System area	—	—	—				
3730 to 3735	E92H to E97H	Error history No.14	Same as error history No.1	0	Monitor	×			
3736 to 3739	E98H to E9BH	System area	—	—	—				
3740 to 3745	E9CH to EA1H	Error history No.15	Same as error history No.1	0	Monitor	×			
3746 to 3749	EA2H to EA5H	System area	—	—	—				
3750 to 3755	EA6H to EABH	Error history No.16	Same as error history No.1	0	Monitor	×			
3756 to 3759	EACH to EAFH	System area	—	—	—				
3760	EB0H	Alarm history No.1	0	Monitor	×				
3761	EB1H					Alarm code	Alarm time	First two digits of the year	Last two digits of the year
3762	EB2H							Month	Day
3763	EB3H					Hour	Minute		
3764	EB4H					Second	Day of the week		
3765	EB5H					Millisecond			
3766 to 3769	EB6H to EB9H	System area	—	—	—				
3770 to 3775	EBAH to EBFH	Alarm history No.2	Same as alarm history No.1	0	Monitor	×			
3776 to 3779	EC0H to EC3H	System area	—	—	—				
3780 to 3785	EC4H to EC9H	Alarm history No.3	Same as alarm history No.1	0	Monitor	×			

Address (decimal)	Address (hexadecimal)	Name	Default value	Data type	Auto refresh	
3786 to 3789	ECAH to ECDH	System area	—	—	—	
3790 to 3795	ECEH to ED3H	Alarm history No.4	Same as alarm history No.1	0	Monitor	×
3796 to 3799	ED4H to ED7H	System area	—	—	—	
3800 to 3805	ED8H to EDDH	Alarm history No.5	Same as alarm history No.1	0	Monitor	×
3806 to 3809	EDEH to EE1H	System area	—	—	—	
3810 to 3815	EE2H to EE7H	Alarm history No.6	Same as alarm history No.1	0	Monitor	×
3816 to 3819	EE8H to EEBH	System area	—	—	—	
3820 to 3825	EECH to EF1H	Alarm history No.7	Same as alarm history No.1	0	Monitor	×
3826 to 3829	EF2H to EF5H	System area	—	—	—	
3830 to 3835	EF6H to EFBH	Alarm history No.8	Same as alarm history No.1	0	Monitor	×
3836 to 3839	EFCH to EFFH	System area	—	—	—	
3840 to 3845	F00H to F05H	Alarm history No.9	Same as alarm history No.1	0	Monitor	×
3846 to 3849	F06H to F09H	System area	—	—	—	
3850 to 3855	F0AH to F0FH	Alarm history No.10	Same as alarm history No.1	0	Monitor	×
3856 to 3859	F10H to F13H	System area	—	—	—	
3860 to 3865	F14H to F19H	Alarm history No.11	Same as alarm history No.1	0	Monitor	×
3866 to 3869	F1AH to F1DH	System area	—	—	—	
3870 to 3875	F1EH to F23H	Alarm history No.12	Same as alarm history No.1	0	Monitor	×
3876 to 3879	F24H to F27H	System area	—	—	—	
3880 to 3885	F28H to F2DH	Alarm history No.13	Same as alarm history No.1	0	Monitor	×
3886 to 3889	F2EH to F31H	System area	—	—	—	
3890 to 3895	F32H to F37H	Alarm history No.14	Same as alarm history No.1	0	Monitor	×
3896 to 3899	F38H to F3BH	System area	—	—	—	
3900 to 3905	F3CH to F41H	Alarm history No.15	Same as alarm history No.1	0	Monitor	×
3906 to 3909	F42H to F45H	System area	—	—	—	
3910 to 3915	F46H to F4BH	Alarm history No.16	Same as alarm history No.1	0	Monitor	×
3916 to 3929	F4CH to F59H	System area	—	—	—	
3930	F5AH	Clear setting of error history	0	Setting ^{*1}	×	
3931 to 3999	F5CH to F9FH	System area	—	—	—	

*1 As soon as a setting value is input, the setting is enabled. Turning on and off 'Operating condition setting request' (Y9) is not required.



Offset/gain setting (Un\G4000 to Un\G9499)

Address Decimal (hexadecimal)				Name	Default value	Data type	Auto refresh
CH1	CH2	CH3	CH4				
4000, 4001 (FA0H, FA1H)				System area	—	—	—
4002 (FA2H)				Save data type setting	0000H	Setting	×
4003 (FA3H)				System area	—	—	—
4004 (FA4H)	4006 (FA6H)	4008 (FA8H)	4010 (FAAH)	CH□ Factory default setting offset value	0	User range setting	×
4005 (FA5H)	4007 (FA7H)	4009 (FA9H)	4011 (FABH)	CH□ Factory default setting gain value	0	User range setting	×
4012 (FACH)	4014 (FAEH)	4016 (FB0H)	4018 (FB2H)	CH□ User range setting offset value	0	User range setting	×
4013 (FADH)	4015 (FAFH)	4017 (FB1H)	4019 (FB3H)	CH□ User range setting gain value	0	User range setting	×
4020 to 4129 (FB4H to 1021H)				System area	—	—	—
4130 (1022H)				Offset/gain adjustment value specification	0	Control ^{*1}	×
4131 (1023H)				System area	—	—	—
4132 (1024H)	4134 (1026H)	4136 (1028H)	4138 (102AH)	CH□ Offset/gain setting mode (offset specification)	0	Setting ^{*2}	×
4133 (1025H)	4135 (1027H)	4137 (1029H)	4139 (102BH)	CH□ Offset/gain setting mode (gain specification)	0	Setting ^{*2}	×
4140 to 4163 (102CH to 1043H)				System area	—	—	—
4164 (1044H)	4165 (1045H)	4166 (1046H)	4167 (1047H)	CH□ Offset/gain setting mode (range specification)	0	Setting ^{*2}	×
4168 to 9499 (1048H to 251BH)				System area	—	—	—

*1 Turn on 'Set value change request' (YC) to enable the set value.

*2 Turn on 'Channel change request' (YB) to enable the set value.

Inter-module synchronization (Un\G9500 to Un\G9999)

Address Decimal (hexadecimal)				Name	Default value	Data type	Auto refresh
CH1	CH2	CH3	CH4				
9500 (251CH)	9502 (251EH)	9504 (2520H)	9506 (2522H)	CH□ Synchronization digital value	0	Control	○
9501 (251DH)	9503 (251FH)	9505 (2521H)	9507 (2523H)	System area	—	—	—
9508 to 9531 (2524H to 253BH)				System area	—	—	—
9532 (253CH)				Output setting during synchronization error	0	Setting	×
9533 to 9599 (253DH to 257FH)				System area	—	—	—
9600 (2580H)				Synchronization status monitor	0	Monitor	○
9601 to 9999 (2581H to 270FH)				System area	—	—	—

Wave data registry area (Un\G10000 to Un\G99999)

Address Decimal (hexadecimal)				Name	Default value	Data type	Auto refresh
CH1	CH2	CH3	CH4				
10000 to 99999 (2710H to 1869FH)				Wave data registry area	0	Setting ^{*1}	×

*1 As soon as a setting value is input, the setting is enabled. Turning on and off 'Operating condition setting request' (Y9) is not required.

Details of buffer memory areas

The following section describes the details of the buffer memory areas of the D/A converter module.

Point

This section describes I/O signals and buffer memory addresses for CH1. For details on the I/O signals for CH2 and later, refer to the following.

☞ Page 139 List of I/O signals

Latest error code

Common

The latest error code detected in the D/A converter module is stored. For details, refer to the following.

☞ Page 132 List of Error Codes

■Buffer memory address

The following shows the buffer memory address of this area.

Buffer memory name	CH1	CH2	CH3	CH4
Latest error code	0			

■Clearing an error

Turn on and off 'Error clear request' (YF) or 'Operating condition setting request' (Y9). However, when 'Operating condition setting request' (Y9) is turned on and off, the D/A conversion is reset and the processing is started from the beginning.

Latest address of error history

Common

Among Error history (Un\G3600 to Un\G3759), a buffer memory address which stores the latest error code is stored.

■Buffer memory address

The following shows the buffer memory address of this area.

Buffer memory name	CH1	CH2	CH3	CH4
Latest address of error history	1			

Latest alarm code

Common

The latest alarm code detected in the D/A converter module is stored. For details, refer to the following.

☞ Page 136 List of Alarm Codes

■Buffer memory address

The following shows the buffer memory address of this area.

Buffer memory name	CH1	CH2	CH3	CH4
Latest alarm code	2			

■Clearing an alarm

Turn on and off 'Warning output clear request' (YE) or 'Operating condition setting request' (Y9). However, when 'Operating condition setting request' (Y9) is turned on and off, the D/A conversion is reset and the processing is started from the beginning.

A

Latest address of alarm history

Common

Among Alarm history □ (Un\G3760 to Un\G3919), a buffer memory address which stores the latest alarm code is stored.

■ Buffer memory address

The following shows the buffer memory address of this area.

Buffer memory name	CH1	CH2	CH3	CH4
Latest address of alarm history	3			

Interrupt factor detection flag [n]

Normal

Wave

Synchronization

The detection status of the interrupt factor is stored.

Monitored value	Description
0	No interrupt factor
1	Interrupt factor

When an interrupt factor occurs, an interrupt request is sent to the CPU module at the same time as when 'Interrupt factor detection flag [n]' (Un\G4 to Un\G19) is turned to Interrupt factor (1).

"n" indicates an interrupt setting number. (n = 1 to 16)

■ Buffer memory address

The following shows the buffer memory address of this area.

Buffer memory name	1	2	3	4	5	6	7	8	9	10	11	12	13	14	15	16
Interrupt factor detection flag [n]	4	5	6	7	8	9	10	11	12	13	14	15	16	17	18	19

Warning output upper flag

Normal

Wave

Synchronization

The upper limit warning can be checked for each channel.

b15	b14	b13	b12	b11	b10	b9	b8	b7	b6	b5	b4	b3	b2	b1	b0
0	0	0	0	0	0	0	0	0	0	0	0	CH4	CH3	CH2	CH1
(2)												(1)			

(1) 0: Normal, 1: Warning alarm ON

(2) b4 to b15 are fixed to 0.

■ Buffer memory address

The following shows the buffer memory address of this area.

Buffer memory name	CH1	CH2	CH3	CH4
Warning output upper flag	36			

■Warning output upper flag status

- When the detection target exceeds the value specified in 'CH1 Warning output upper limit value' (Un\G510), Warning alarm ON (1) is stored in the corresponding bit of 'Warning output upper flag' (Un\G36) corresponding to each channel. Detection target for outputting a warning varies depending on the operation mode.

Operation mode	Detection target for outputting a warning
Normal output mode	'CH1 Digital value' (Un\G460)
In wave output mode	Wave data registry area (Un\G10000 to Un\G99999)
Inter-module synchronization mode	'CH1 Synchronization digital value' (Un\G9500)

- When a warning is detected in any channel where the D/A conversion and the warning output setting are enabled, 'Warning output signal' (XE) also turns on.

■Clearing Warning output upper flag

Turn on and off 'Warning output clear request' (YE) or 'Operating condition setting request' (Y9) to clear the warning output upper flag.

Warning output lower flag



The lower limit warning can be checked for each channel.

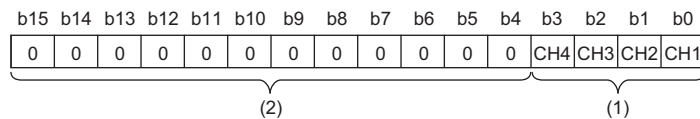

(1) 0: Normal, 1: Warning alarm ON

(2) b4 to b15 are fixed to 0.

■Buffer memory address

The following shows the buffer memory address of this area.

Buffer memory name	CH1	CH2	CH3	CH4
Warning output lower flag	37			



■Warning output lower flag status

- When the detection target falls below the value specified in 'CH1 Warning output lower limit value' (Un\G512), Warning alarm ON (1) is stored in the corresponding bit of 'Warning output lower flag' (Un\G37) corresponding to each channel. Detection target for outputting a warning varies depending on the operation mode.

Operation mode	Detection target for outputting a warning
Normal output mode	'CH1 Digital value' (Un\G460)
In wave output mode	Wave data registry area (Un\G10000 to Un\G99999)
Inter-module synchronization mode	'CH1 Synchronization digital value' (Un\G9500)

- When a warning is detected in any channel where the D/A conversion and the warning output setting are enabled, 'Warning output signal' (XE) also turns on.

■Clearing Warning output lower flag

Turn on and off 'Warning output clear request' (YE) or 'Operating condition setting request' (Y9) to clear the warning output lower flag.

Disconnection detection flag

Normal

Wave

Synchronization

By setting 4 to 20mA for the output range and enabling the D/A conversion, a disconnection can be detected for each channel.

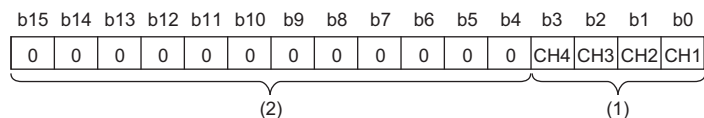

(1) 0: Normal, 1: Disconnection detection

(2) b4 to b15 are fixed to 0.

■Buffer memory address

The following shows the buffer memory address of this area.

Buffer memory name	CH1	CH2	CH3	CH4
Disconnection detection flag	38			

■Disconnection detection flag status

- When a disconnection is detected, Disconnection detection (1) is stored in the corresponding bit of 'Disconnection detection flag' (Un\G38) corresponding to each channel.
- When a disconnection is detected in any channel, 'Disconnection detection signal' (XD) turns on.

■Clearing Disconnection detection flag

The method to clear Disconnection detection flag varies depending on the operation mode. Even if the disconnection cause is eliminated, the analog output does not restart automatically to prevent an incorrect output. The method to clear Disconnection detection flag and restart analog output varies depending on the operation mode. ( Page 41 Clearing disconnection detection)

Operation mode monitor

Common

The current operation mode is stored.

Monitored value	Description
0	High-speed output mode (conversion speed: 1μs/CH)
1	Normal output mode (conversion speed: 10μs/CH)
4	Inter-module synchronization mode
5	Offset/gain setting mode
11	Wave output mode (conversion speed: 20μs/CH)

■Buffer memory address

The following shows the buffer memory address of this area.

Buffer memory name	CH1	CH2	CH3	CH4
Operation mode monitor	60			

RUN LED status monitor

Common

The current status of the RUN LED is stored.

Monitored value	Description
0	Off
1	On
2	Flashing (1s cycle)
3	Flashing (400ms cycle)

■Buffer memory address

The following shows the buffer memory address of this area.

Buffer memory name	CH1	CH2	CH3	CH4
RUN LED status monitor	70			

ERR LED status monitor

Common

The current status of the ERR LED is stored.

Monitored value	Description
0	Off
1	On

■Buffer memory address

The following shows the buffer memory address of this area.

Buffer memory name	CH1	CH2	CH3	CH4
ERR LED status monitor	71			

ALM LED status monitor

Common

The current status of the ALM LED is stored.

Monitored value	Description
0	Off
1	On

■Buffer memory address

The following shows the buffer memory address of this area.

Buffer memory name	CH1	CH2	CH3	CH4
ALM LED status monitor	72			

A

Interrupt factor mask [n]

Normal

Wave

Synchronization

Set whether to mask interrupt factors.

Setting value	Setting details
0	Mask (interrupt unused)
1	Mask clear (interrupt used)

When 'Interrupt factor mask [n]' (Un\G124 to Un\G139) is changed to Mask clear (interrupt used) (1) and an interrupt factor occurs, an interrupt request is sent to the CPU module. When the set value is two or larger, the setting is regarded as Mask clear (interrupt used) (1).

"n" indicates an interrupt setting number. (n = 1 to 16)

■Buffer memory address

The following shows the buffer memory address of this area.

Buffer memory name	1	2	3	4	5	6	7	8	9	10	11	12	13	14	15	16
Interrupt factor mask [n]	124	125	126	127	128	129	130	131	132	133	134	135	136	137	138	139

■Default value

The default value is Mask (interrupt unused) (0) for all areas.

Interrupt factor reset request [n]

Normal

Wave

Synchronization

Set whether to send the interrupt factor reset request.

Setting value	Setting details
0	No reset request
1	Reset request

When Reset request (1) is set in 'Interrupt factor reset request [n]' (Un\G156 to Un\G171) corresponding to the interrupt factor, the interrupt factor of the specified interrupt is reset. After that, 'Interrupt factor reset request [n]' (Un\G156 to Un\G171) turns to No reset request (0). When the set value is two or larger, the setting is regarded as Reset request (1).

Turning on and off 'Operating condition setting request' (Y9) also resets interrupt factors.

"n" indicates an interrupt setting number. (n = 1 to 16)

■Buffer memory address

The following shows the buffer memory address of this area.

Buffer memory name	1	2	3	4	5	6	7	8	9	10	11	12	13	14	15	16
Interrupt factor reset request [n]	156	157	158	159	160	161	162	163	164	165	166	167	168	169	170	171

■Default value

The default value is No reset request (0) for all areas.

Step action wave output request

Wave

This area is for setting whether to start or end the wave output step action function for all channels in a batch.

Step action wave output request	Setting value
OFF	0
ON	1

- The setting for this area is valid only in the wave output mode. In the other cases, changes of the value are ignored.
- Turning on the setting value (from (0) to (1)) changes the wave output status of all the channels where the D/A conversion is enabled to the during wave output step action, and the wave output step action function is enabled.
- Turning off the setting value (from (1) to (0)) changes the wave output status to the wave output stop status, and the wave output step action ends.
- Setting a value out of the setting range causes a step action wave output request setting range error (error code: 1D80H) and does not change the wave output status.

■Buffer memory address

The following shows the buffer memory address of this area.

Buffer memory name	CH1	CH2	CH3	CH4
Step action wave output request	188			

■Default value

The default value is OFF (0).

Interrupt factor generation setting [n]

Normal

Wave

Synchronization

Set whether to send an interrupt request when the same interrupt factor occurs during the interrupt factor detection.

Setting value	Setting details
0	Interrupt resend request
1	No interrupt resend request

- If a value other than the above is set, an interrupt factor generation setting range error (error code: 180△H) occurs.
- When 'Interrupt factor generation setting [n]' (Un\G200 to Un\G215) is Interrupt resend request (0) and the same interrupt factor occurs while the interrupt factor has been detected, an interrupt request is sent to the CPU module again.
- When 'Interrupt factor generation setting [n]' (Un\G200 to Un\G215) is No interrupt resend request (1) and the same interrupt factor occurs while the interrupt factor has been detected, an interrupt request is not sent to the CPU module. To send an interrupt request to the CPU module, do it after setting 'Interrupt factor reset request [n]' (Un\G156 to Un\G171) to Reset request (1) and resetting the interrupt factor.

"n" indicates an interrupt setting number. (n = 1 to 16)

■Buffer memory address

The following shows the buffer memory address of this area.

Buffer memory name	1	2	3	4	5	6	7	8	9	10	11	12	13	14	15	16
Interrupt factor generation setting [n]	200	201	202	203	204	205	206	207	208	209	210	211	212	213	214	215

■Enabling the setting

Turn on and off 'Operating condition setting request' (Y9).

■Default value

The default value is Interrupt resend request (0) for all areas.

A

Condition target setting [n]

Normal

Wave

Synchronization

Set an interrupt factor to be detected.

Setting value	Setting details
0	Disable
1	Error flag (XF)
2	Warning output flag
3	Disconnection detection flag
4	External power supply READY flag (X7)

- If a value other than the above is set, a condition target setting range error (error code: 181△H) occurs.
- When a condition set in 'Condition target setting [n]' (Un\G232 to Un\G247) is satisfied, an interrupt request is sent to the CPU module. The interrupt condition for each setting value is shown below.

Setting value	Description
Disable	An interrupt detection is not performed.
Error flag	A rise is detected at the timing of when 'Error flag' (XF) turns on.
Warning output flag	A rise is detected at the timing of when the corresponding bit of 'Warning output upper flag' (Un\G36) or 'Warning output lower flag' (Un\G37) turns on (A channel is specified).
Disconnection detection flag	A rise is detected at the timing of when the corresponding bit of 'Disconnection detection flag' (Un\G38) turns on (A channel is specified).
External power supply READY flag	A fall is detected at the timing of when 'External power supply READY flag' (X7) turns off.

"n" indicates an interrupt setting number. (n = 1 to 16)

■Buffer memory address

The following shows the buffer memory address of this area.

Buffer memory name	1	2	3	4	5	6	7	8	9	10	11	12	13	14	15	16
Condition target setting [n]	232	233	234	235	236	237	238	239	240	241	242	243	244	245	246	247

■Enabling the setting

Turn on and off 'Operating condition setting request' (Y9).

■Default value

The default value is Disable (0) for all areas.

Condition target channel setting [n]

Normal

Wave

Synchronization

Set a channel where an interrupt factor is detected.

Setting value	Setting details
0	All channels
1	CH1
2	CH2
3	CH3
4	CH4

When an interrupt factor with channel specification is set in 'Condition target setting [n]' (Un\G232 to Un\G247), an interrupt factor is monitored in the channel set by this area. When an input signal (X) is set as an interrupt factor, the setting in this area is ignored.

If a value other than the above is set, a condition target channel setting range error (error code: 182△H) occurs.

"n" indicates an interrupt setting number. (n = 1 to 16)

■Buffer memory address

The following shows the buffer memory address of this area.

Buffer memory name	1	2	3	4	5	6	7	8	9	10	11	12	13	14	15	16
Condition target channel setting [n]	264	265	266	267	268	269	270	271	272	273	274	275	276	277	278	279

■Enabling the setting

Turn on and off 'Operating condition setting request' (Y9).

■Default value

The default value is All channels (0) for all areas.

Mode switching setting

Normal

Set a setting value for the mode to be switched to.

Switching mode	Setting value	
Buffer memory address	296	297
Normal output mode	5260H	4441H
Offset/gain setting mode	4441H	5260H

When a value other than the above is set, the mode switching is not executed and only the operating condition is changed. When a setting value that corresponds to the current operation mode is written and 'Operating condition setting request' (Y9) is turned on and off, an error does not occur and only the operating condition is changed.

■Buffer memory address

The following shows the buffer memory address of this area.

Buffer memory name	CH1	CH2	CH3	CH4
Mode switching setting	296, 297			

■Enabling the setting

Turn on and off 'Operating condition setting request' (Y9).

■After the mode is switched

When the mode is switched, this area is cleared to 0 and 'Operating condition setting completed flag' (X9) turns off.

After checking that 'Operating condition setting completed flag' (X9) is off, turn off 'Operating condition setting request' (Y9).

A

CH1 Set value check code

Normal

Wave

Synchronization

When a set digital value is out of the setting range, a check code is stored.

■Buffer memory address

The following shows the buffer memory address of this area.

Buffer memory name	CH1	CH2	CH3	CH4
CH□ Set value check code	400	600	800	1000

■Check target

The check target varies depending on the operation mode.

Operation mode	Check target
Normal output mode	'CH1 Digital value' (Un\G460)
Wave output mode	Wave data registry area (Un\G10000 to Un\G99999)*1
Inter-module synchronization mode	'CH1 Synchronization digital value' (Un\G9500)

*1 The buffer memory addresses in which digital values outside the setting range have been registered can be checked in the following:
'CH1 Wave output digital value outside the range address monitor' (Un\G440, Un\G441) (Page 169 CH1 Wave output digital value outside the range address monitor)

■Stored check codes

Check code	Description
000FH	A digital value exceeding the setting range has been written.
00F0H	A digital value falling short of the setting range has been written.
00FFH	A digital value falling short of the setting range and a digital value exceeding the setting range have been written. This check code may be stored when a check code is not reset.

Once the check code is stored, the code is not reset even when the digital value falls within the setting range.

When the scaling function is used, the value of 'CH1 Digital value' (Un\G460) which has undergone a scale conversion is checked. Note that some errors may be observed in the target digital value for a check code to be stored due to the calculation error of scale conversion when a scale-converted value exceeds the setting range.

■Resetting the check codes

Set a digital value within the setting range and turn on and off 'Error clear request' (YF).

CH1 Wave output status monitor

Wave

The status of a wave output can be checked for each channel.

Monitored value	Description
0	During wave output stop
1	During wave output
2	Wave output pause
3	During wave output step action

■Buffer memory address

The following shows the buffer memory address of this area.

Buffer memory name	CH1	CH2	CH3	CH4
CH□ Wave output status monitor	401	601	801	1001

CH1 Range setting monitor

Common

The output range value set to the output range setting or 'CH1 Range setting' (Un\G598) can be checked.

Monitored value	Description
0H	4 to 20mA
1H	0 to 20mA
2H	1 to 5V
3H	0 to 5V
4H	-10 to 10V
EH	User range setting (voltage)
FH	User range setting (current)

■Buffer memory address

The following shows the buffer memory address of this area.

Buffer memory name	CH1	CH2	CH3	CH4
CH□ Range setting monitor	430	630	830	1030

Restriction

The output range cannot be changed for a channel where D/A conversion is disabled, and thus a value stored in this area is not updated. For details, refer to the following.

 Page 20 Range Switching Function

CH1 HOLD/CLEAR function setting monitor

Common

The setting status of the analog output HOLD/CLEAR function can be checked.

Monitored value	Description
0	CLEAR
1	HOLD

■Buffer memory address

The following shows the buffer memory address of this area.

Buffer memory name	CH1	CH2	CH3	CH4
CH□ HOLD/CLEAR function setting monitor	431	631	831	1031

CH1 Wave output conversion cycle monitor

Wave

This area stores the wave output conversion cycle in 32-bit signed binary for each channel.

The unit of the stored value is μs .

■Buffer memory address

The following shows the buffer memory address of this area.

Buffer memory name	CH1	CH2	CH3	CH4
CH□ Wave output conversion cycle monitor	432, 433	632, 633	832, 833	1032, 1033

■Update of the stored value

When 'Operating condition setting request' (Y9) is turned on and off, the stored value is updated.

A

CH1 Wave pattern output count monitor

Wave

The output count of the wave pattern is stored in this area.

■Buffer memory address

The following shows the buffer memory address of this area.

Buffer memory name	CH1	CH2	CH3	CH4
CH□ Wave pattern output count monitor	434	634	834	1034

■Count of the wave pattern output

The stored value increases by one every time one cycle of a wave pattern is output.

■Count range of the wave pattern output

The count range is from 0 to 32767.

When wave pattern output count is set to Unlimited repeat output, the count returns to 0 and starts again from 1 after the 32767th count. (...32766→32767→0→1→2...)

■Resetting the stored value

In the following cases, the stored value is reset.

- When 'Operating condition setting request' (Y9) is turned on and off
- When the wave output status transitions from its stop status to another

CH1 Wave output current address monitor

Wave

This area stores the buffer memory address of the currently output wave data in 32-bit signed binary for each channel.

■Buffer memory address

The following shows the buffer memory address of this area.

Buffer memory name	CH1	CH2	CH3	CH4
CH□ Wave output current address monitor	436, 437	636, 637	836, 837	1036, 1037

■Update of the stored value

The stored value is updated when the wave output status is During wave output or During wave output step action.

■Resetting the stored value

When 'Operating condition setting request' (Y9) is turned on and off, the stored value is reset.

CH1 Wave output current digital value monitor

Wave

This area stores the currently output digital value for each channel.

The stored value depends on the wave output status.

Wave output status	Stored value* ¹
During wave output stop* ²	The digital value of the output set in 'CH1 Output setting during wave output stop' (Un\G524) is stored. ■When set to 0V/0mA (0) or Offset value (1): 0 is stored. ■When set to Output value during wave output stop (2): The setting value of 'CH1 Output value during wave output stop' (Un\G525) is stored.
During wave output	The digital value stored in the buffer memory address indicated by 'CH1 Wave output current address monitor' (Un\G436, Un\G437) is stored.
Wave output pause	The stored value depends on the setting of the analog output HOLD/CLEAR function. ■When set to HOLD: The digital value stored in the buffer memory address indicated by 'CH1 Wave output current address monitor' (Un\G436, Un\G437) is stored. ■When set to CLEAR: 0 is stored.
During wave output step action	The digital value stored in the buffer memory address indicated by 'CH1 Wave output current address monitor' (Un\G436, Un\G437) is stored.

*1 The stored values shown are for when 'CH1 D/A conversion enable/disable setting' (Un\G500) is D/A conversion enable (0) and 'CH1 Output enable/disable flag' (Y1) is on. For the analog output in the other status, refer to the following.

☞ Page 23 Analog Output HOLD/CLEAR Function

*2 When an external power supply disconnection or a disconnection is detected, 0 is stored regardless of the setting in 'CH1 Output setting during wave output stop' (Un\G524).

■Buffer memory address

The following shows the buffer memory address of this area.

Buffer memory name	CH1	CH2	CH3	CH4
CH□ Wave output current digital value monitor	438	638	838	1038

■Resetting the stored value

When 'Operating condition setting request' (Y9) is turned on and off, the stored value is reset.

CH1 Wave output digital value outside the range address monitor

Wave

When a digital value, registered as wave data, is outside the setting range, this area stores the corresponding buffer memory address in 32-bit signed binary for each channel at the time of the value being output.

When the multiple wave data with the digital value out of the setting range are detected, only the buffer memory address of the wave data detected first is stored.

■Buffer memory address

The following shows the buffer memory address of this area.

Buffer memory name	CH1	CH2	CH3	CH4
CH□ Wave output digital value outside the range address monitor	440, 441	640, 641	840, 841	1040, 1041

■Update of the stored value

When the first detection of the digital value out of the range occurs in a wave output status other than "During wave output stop", the stored value is updated.

■Resetting the stored value

To reset the stored value, first change values of wave data that have been outside the setting range so that they fall within the setting range. After that, turn on and off 'Error clear request' (YF) or 'Operating condition setting request' (Y9) for resetting.

CH1 Wave output warning address monitor

Wave

When a digital value of wave data causes a warning, this area stores the corresponding buffer memory address in 32-bit signed binary for each channel.

When a warning has occurred in the multiple wave data, only the buffer memory address of the wave data where the warning occurred first is stored.

■Buffer memory address

The following shows the buffer memory address of this area.

Buffer memory name	CH1	CH2	CH3	CH4
CH□ Wave output warning address monitor	442, 443	642, 643	842, 843	1042, 1043

■Update of the stored value

When the first warning occurs in a wave output status other than "During wave output stop", the stored value is updated.

■Resetting the stored value

To reset the stored value, first change values of wave data that have been outside the setting range so that they fall within the setting range. After that, turn on and off 'Error clear request' (YF) or 'Operating condition setting request' (Y9) for resetting.

CH1 D/A conversion status monitor

Common

This area stores the D/A conversion status.

D/A conversion status	Description	Stored value
External power supply OFF	The external power supply 24VDC is not supplied.	-1
D/A conversion disabled	D/A conversion has been disabled. The D/A conversion in the corresponding channel is not executed.	0
Analog output disabled	Analog output has been disabled. (D/A conversion has been enabled.)* ¹	1
Analog output enabled	Analog output has been enabled. According to digital values, the analog equivalents are output.* ²	2

*¹ Depending on the status of the CPU module and the setting for the analog output HOLD/CLEAR function, the status of analog output varies. (Page 23 Analog Output HOLD/CLEAR Function)

*² In the wave output mode, analog wave data is output according to 'CH1 Wave output status monitor' (UnVG401).

■Buffer memory address

The following shows the buffer memory address of this area.

Buffer memory name	CH1	CH2	CH3	CH4
CH□ D/A conversion status monitor	459	659	859	1059

CH1 Digital value

High speed

Normal

Set the digital value in 16-bit signed binary for the D/A conversion from the CPU module.

Output range	When the scaling function is disabled	When the scaling function is enabled*1
	Setting range (practical range)	Setting range
4 to 20mA	-768 to 32767 (practical range: 0 to 32000)	-32000 to 32000
0 to 20mA		
1 to 5V		
0 to 5V		
-10 to 10V	-32768 to 32767 (practical range: -32000 to 32000)	
User range setting (voltage)		
User range setting (current)		

*1 The available setting range and practical range of when the scaling function is enabled differ depending on the setting of the scaling upper limit value and scaling lower limit value.

When a value out of the available setting range is written, the D/A conversion is performed with the upper or lower limit value of the available setting range.

A check code is stored in 'CH1 Set value check code' (Un\G400) and a digital value setting range error (error code: 191□H) is stored in 'Latest error code' (Un\G0).

■Buffer memory address

The following shows the buffer memory address of this area.

Buffer memory name	CH1	CH2	CH3	CH4
CH□ Digital value	460	660	860	1060

■Default value

The default value is 0 for all channels.

CH1 Wave output start/stop request

Wave

This area is for requesting the start, stop, and pause of the wave output in the wave output mode.

Request	Setting value
Wave output stop request	0
Wave output start request	1
Wave output pause request	2

While 'Step action wave output request' (Un\G188) is ON (1), changes of the setting value are ignored.

When 'Step action wave output request' (Un\G188) is set from ON (1) to OFF (0), the wave output status changes to During wave output stop, and Wave output stop request (0) is set in this area.

In the channel where a value out of the setting range is set, a wave output start/stop request setting range error (error code: 1D0□H) occurs, and 'Error flag' (XF) turns on. The operation of the wave output before the change continues.

■Buffer memory address

The following shows the buffer memory address of this area.

Buffer memory name	CH1	CH2	CH3	CH4
CH□ Wave output start/stop request	462	662	862	1062

■Default value

The default value is Wave output stop request (0) for all channels.

A

CH1 Input value shift amount

Normal

Set the desired shift amount to 'CH1 Digital value' (Un\G460). The set value is added to the digital value regardless of the on/off state of 'Operating condition setting request' (Y9).

For details on the shift function, refer to the following.

☞ Page 31 Shift Function

■Buffer memory address

The following shows the buffer memory address of this area.

Buffer memory name	CH1	CH2	CH3	CH4
CH□ Input value shift amount	480	680	880	1080

■Setting range

The setting range is from -32768 to 32767.

■Default value

The default value is 0 for all channels.

CH1 Wave step action movement amount

Wave

This area is for setting wave output step action movement amount and for checking if the movement has been completed. The value of wave data in the wave data registry area (Un\G10000 to Un\G99999) that is outputting in analog is moved to wave data in the buffer memory address that is obtained by adding or subtracting the set value. When a value is set in this area, the target address starts to be specified and when specifying the address is complete, No movement (0) is stored.

This area can be set only when the following conditions are satisfied.

- In the wave output mode
- During wave output step action (3) is stored in 'CH1 Wave output status monitor' (Un\G401).

■Buffer memory address

The following shows the buffer memory address of this area.

Buffer memory name	CH1	CH2	CH3	CH4
CH□ Wave step action movement amount	482	682	882	1082

■Setting range

- Setting range: -30000 to 30000
- Set the following value according to the direction to move.

Movement direction	Setting value
No movement	0
Forward movement (movement in address increasing direction)	1 to 30000
Reverse movement (movement in address decreasing direction)	-30000 to -1

- The following shows the available range for movement.

$$\left(\begin{array}{c} \text{Wave pattern} \\ \text{start address} \end{array} \right) \text{ to } \left(\begin{array}{c} \text{Wave pattern} \\ \text{start address} \end{array} + \begin{array}{c} \text{Wave pattern} \\ \text{data points} \end{array} - 1 \right)$$

- Even if a value set is outside the above range, no error occurs. When a value smaller than -30000 is set, the value is processed as -30000. When a value greater than 30000 is set, the value is processed as 30000.
- When a value greater than the wave pattern data point is set, only the value for the wave pattern data point is processed.

■Default value

The default value is No movement (0) for all channels.

CH1 D/A conversion enable/disable setting

Common

Set whether to enable or disable the D/A conversion.

For details on the D/A conversion enable/disable setting function, refer to the following.

☞ Page 22 D/A Conversion Enable/Disable Setting Function

Setting value	Description
0	D/A conversion enable
1	D/A conversion disable

When a value other than the above is set, the value is processed as D/A conversion disable (1).

■Buffer memory address

The following shows the buffer memory address of this area.

Buffer memory name	CH1	CH2	CH3	CH4
CH□ D/A conversion enable/disable setting	500	700	900	1100

■Enabling the setting

Turn on and off 'Operating condition setting request' (Y9).

■Default value

The default value is D/A conversion disable (1) for all channels.

CH1 Scaling enable/disable setting

Normal

Set whether to enable or disable the scaling.

For details on the scaling function, refer to the following.

☞ Page 28 Scaling Function

Setting value	Description
0	Enable
1	Disable

If a value other than the above is set, a scaling enable/disable setting range error (error code: 1A0□H) occurs.

■Buffer memory address

The following shows the buffer memory address of this area.

Buffer memory name	CH1	CH2	CH3	CH4
CH□ Scaling enable/disable setting	502	702	902	1102

■Enabling the setting

Turn on and off 'Operating condition setting request' (Y9).

■Default value

The default value is Disable (1) for all channels.

A

CH1 Scaling upper limit value

Normal

Set an upper limit value for the range of the scale conversion.

For details on the scaling function, refer to the following.

☞ Page 28 Scaling Function

■Buffer memory address

The following shows the buffer memory address of this area.

Buffer memory name	CH1	CH2	CH3	CH4
CH□ Scaling upper limit value	504	704	904	1104

■Setting range

- The setting range is from -32000 to 32000.
- In the channel where a value out of the range is set, a scaling setting range error (error code: 1A1□H) occurs.
- In the channel where a set value does not satisfy the condition "the scaling upper limit value ≠ the scaling lower limit value", a scaling upper/lower limit value setting error (error code: 1A2□H) occurs.
- When 'CH1 Scaling enable/disable setting' (Un\G502) is set to Disable (1), the setting for 'CH1 Scaling upper limit value' (Un\G504) is ignored.

■Enabling the setting

Turn on and off 'Operating condition setting request' (Y9).

■Default value

The default value is 0 for all channels.

CH1 Scaling lower limit value

Normal

Set a lower limit value for the range of the scale conversion.

For details on the scaling function, refer to the following.

☞ Page 28 Scaling Function

■Buffer memory address

The following shows the buffer memory address of this area.

Buffer memory name	CH1	CH2	CH3	CH4
CH□ Scaling lower limit value	506	706	906	1106

■Setting range

- The setting range is from -32000 to 32000.
- In the channel where a value out of the range is set, a scaling setting range error (error code: 1A1□H) occurs.
- In the channel where a set value does not satisfy the condition "the scaling upper limit value ≠ the scaling lower limit value", a scaling upper/lower limit value setting error (error code: 1A2□H) occurs.
- When 'CH1 Scaling enable/disable setting' (Un\G502) is set to Disable (1), the setting for 'CH1 Scaling lower limit value' (Un\G506) is ignored.

■Enabling the setting

Turn on and off 'Operating condition setting request' (Y9).

■Default value

The default value is 0 for all channels.

CH1 Warning output setting

Normal

Wave

Synchronization

Set whether to enable or disable the warning output.

For details on the warning output function, refer to the following.

☞ Page 33 Warning Output Function

Setting value	Description
0	Enable
1	Disable

If a value other than the above is set, a warning output setting range error (error code: 1B0□H) occurs.

■Buffer memory address

The following shows the buffer memory address of this area.

Buffer memory name	CH1	CH2	CH3	CH4
CH□ Warning output setting	508	708	908	1108

■Enabling the setting

Turn on and off 'Operating condition setting request' (Y9).

■Default value

The default value is Disable (1) for all channels.

CH1 Rate control enable/disable setting

Normal

Set whether to enable or disable the rate control.

For details on the rate control function, refer to the following.

☞ Page 35 Rate Control Function

Setting value	Description
0	Enable
1	Disable

If a value other than the above is set, a rate control enable/disable setting range error (error code: 1B8□H) occurs.

■Buffer memory address

The following shows the buffer memory address of this area.

Buffer memory name	CH1	CH2	CH3	CH4
CH□ Rate control enable/disable setting	509	709	909	1109

■Enabling the setting

Turn on and off 'Operating condition setting request' (Y9).

■Default value

The default value is Disable (1) for all channels.

A

CH1 Warning output upper limit value

Normal

Wave

Synchronization

Set an upper limit of digital value to output warnings.

For details on the warning output function, refer to the following.

☞ Page 33 Warning Output Function

■Buffer memory address

The following shows the buffer memory address of this area.

Buffer memory name	CH1	CH2	CH3	CH4
CH□ Warning output upper limit value	510	710	910	1110

■Setting range

- The setting range is from -32768 to 32767.
- Set the values that satisfy the condition "warning output upper limit value > warning output lower limit value". In the channel where a set value does not satisfy the condition, a warning output upper/lower limit value inversion error (error code: 1B1□H) occurs.
- When 'CH1 Warning output setting' (Un\G508) is set to Disable (1), the setting of 'CH1 Warning output upper limit value' (Un\G510) is ignored.

■Enabling the setting

Turn on and off 'Operating condition setting request' (Y9).

■Default value

The default value is 0 for all channels.

■Precautions

When the shift function is used, always set a value in consideration of 'CH1 Input value shift amount' (Un\G480).

CH1 Warning output lower limit value

Normal

Wave

Synchronization

Set a lower limit of digital value to output warnings.

For details on the warning output function, refer to the following.

☞ Page 33 Warning Output Function

■Buffer memory address

The following shows the buffer memory address of this area.

Buffer memory name	CH1	CH2	CH3	CH4
CH□ Warning output lower limit value	512	712	912	1112

■Setting range

- The setting range is from -32768 to 32767.
- Set the values that satisfy the condition "warning output upper limit value > warning output lower limit value". In the channel where a set value does not satisfy the condition, a warning output upper/lower limit value inversion error (error code: 1B1□H) occurs.
- When 'CH1 Warning output setting' (Un\G508) is set to Disable (1), the setting of 'CH1 Warning output lower limit value' (Un\G512) is ignored.

■Enabling the setting

Turn on and off 'Operating condition setting request' (Y9).

■Default value

The default value is 0 for all channels.

■Precautions

When the shift function is used, always set a value in consideration of 'CH1 Input value shift amount' (Un\G480).

CH1 Increase digital limit value

Normal

Set the increment value per 10 μ s when using the rate control function.

For details on the rate control function, refer to the following.

 Page 35 Rate Control Function

■ Buffer memory address

The following shows the buffer memory address of this area.

Buffer memory name	CH1	CH2	CH3	CH4
CH \square Increase digital limit value	514	714	914	1114

■ Setting range

- The setting range is from 0 to 64000 (FA00H).
- If a value out of the setting range is set for a channel where the conversion and rate control are enabled, a digital limit value range error (error code: 1B9 \square H) occurs.
- When the scaling setting is enabled, the increase digital limit value of the digital value converted within the scaling range is applied.

■ Enabling the setting

Turn on and off 'Operating condition setting request' (Y9).

■ Default value

The default value is 64000 for all channels.

■ Precautions

- When a value exceeding 32767 is set in 'CH1 Increase digital limit value' (Un\G514) with the program, the value must be input in hexadecimal.
- The cycle where actual digital values change (conversion cycle) is 10 μ s \times Number of D/A conversion enabled channels. The increment of digital value per conversion cycle is 'CH1 Increase digital limit value' (Un\G514) \times Number of D/A conversion enabled channels.

A

CH1 Decrease digital limit value

Normal

Set the decrement value per 10 μ s when using the rate control function.

For details on the rate control function, refer to the following.

 Page 35 Rate Control Function

■Buffer memory address

The following shows the buffer memory address of this area.

Buffer memory name	CH1	CH2	CH3	CH4
CH \square Decrease digital limit value	516	716	916	1116

■Setting range

- The setting range is from 0 to 64000 (FA00H).
- If a value out of the setting range is set for a channel where the conversion and rate control are enabled, a digital limit value range error (error code: 1B9 \square H) occurs.
- When the scaling setting is enabled, the decrease digital limit value of the digital value converted within the scaling range is applied.

■Enabling the setting

Turn on and off 'Operating condition setting request' (Y9).

■Default value

The default value is 64000 for all channels.

■Precautions

- When a value exceeding 32767 is set in 'CH1 Decrease digital limit value' (Un\G516) with the program, the value must be input in hexadecimal.
- The cycle where actual digital values change (conversion cycle) is 10 μ s \times Number of D/A conversion enabled channels. The decrement of digital value per conversion cycle is 'CH1 Decrease digital limit value' (Un\G516) \times Number of D/A conversion enabled channels.

CH1 Output setting during wave output stop

Wave

Set the analog output during the wave output stop.

Analog output	Description	Setting value
0V/0mA	0V or 0mA is output in analog.	0
Offset value	The offset value of the set output range is output in analog.	1
Output value during wave output stop	The value set in 'CH1 Output value during wave output stop (Un\G525)' is output in analog.	2

In the channel where a value out of the above setting range is set, a setting range error for Output setting during wave output stop (error code: 1D2 \square H) occurs. The operation of the wave output before the change is continued.

■Buffer memory address

The following shows the buffer memory address of this area.

Buffer memory name	CH1	CH2	CH3	CH4
CH \square Output setting during wave output stop	524	724	924	1124

■Enabling the setting

Turn on and off 'Operating condition setting request' (Y9) to enable the setting.

■Default value

The default value is Offset value (1) for all channels.

CH1 Output value during wave output stop

Wave

This area is for setting the value to be output in analog when 'CH1 Output setting during wave output stop' (Un\G524) is set to Output value during wave output stop (2).

The setting range varies depending on the output range setting. Follow the setting range below.

Output range	Setting range
0 to 5V	0 to 32767 (practical range: 0 to 32000)
1 to 5V	
0 to 20mA	
4 to 20mA	
-10 to 10V	-32768 to 32767 (practical range: -32000 to 32000)

- In the channel where a value out of the above setting range is set, a setting range error for Output value during wave output stop (error code: 1D3□H) occurs. The wave output does not start. However, when 'CH1 Output setting during wave output stop' (Un\G524) is set to a value other than Output value during wave output stop (2), the above error does not occur.
- As the default value, 0 is set. Thus change the setting value for 'CH1 Output value during wave output stop' if 'CH1 Output setting during wave output stop' (Un\G524) is set to Output value during wave output stop (2).

■Buffer memory address

The following shows the buffer memory address of this area.

Buffer memory name	CH1	CH2	CH3	CH4
CH□ Output value during wave output stop	525	725	925	1125

■Enabling the setting

Turn on and off 'Operating condition setting request' (Y9) to enable the setting.

■Default value

The default value is 0 for all channels.

CH1 Wave pattern start address setting

Wave

This area is for setting the start address of the wave pattern to be output. The digital value in the buffer memory address set in this area is the first target for D/A conversion. Subsequently, the successive values are converted to analog and output in turn. For this area, set a value in 32-bit signed binary.

■Buffer memory address

The following shows the buffer memory address of this area.

Buffer memory name	CH1	CH2	CH3	CH4
CH□ Wave pattern start address setting	526, 527	726, 727	926, 927	1126, 1127

■Setting range

- The setting range is from 10000 to 99999. Set an address within the range of the buffer memory addresses of Wave data registry area (Un\G10000 to Un\G99999).
- In the channel where a value out of the setting range is set, a wave pattern start address setting range error (error code: 1D4□H) occurs. The wave output does not start.
- Set the value so that the setting value in this area + 'CH1 Wave pattern data points setting' (Un\G528, Un\G529) - 1 is 99999 (the last address of wave data registry area) or less. In the channel where the value is over 99999, a wave data registry area setting range error (error code: 1D9□H) occurs. The wave output does not start.

■Enabling the setting

Turn on and off 'Operating condition setting request' (Y9) to enable the setting.

■Default value

The default value is 10000 for all channels.

CH1 Wave pattern data points setting

Wave

This area is for setting the points of the wave pattern to be output. From the start address of the wave pattern, the D/A conversion starts for the points of wave data set in this area and the converted analog values are output.

For this area, set a value in 32-bit signed binary.

■Buffer memory address

The following shows the buffer memory address of this area.

Buffer memory name	CH1	CH2	CH3	CH4
CH□ Wave pattern data points setting	528, 529	728, 729	928, 929	1128, 1129

■Setting range

- The setting range is from 1 to 90000. A number of data points corresponding to that of Wave data registry area (Un\G10000 to Un\G99999) can be set.
- In the channel where a value out of the setting range is set, a wave pattern data points setting range error (error code: 1D5□H) occurs. The wave output does not start. However, when the value of 'CH1 Wave pattern start address setting' (Un\G526, Un\G527) is outside the setting range, the above error does not occur.
- Set the value so that the setting value in this area + 'CH1 Wave pattern start address setting' (Un\G526, Un\G527) - 1 is 99999 (the last address of wave data registry area) or less. In the channel where the value is over 99999, a wave data registry area setting range error (error code: 1D9□H) occurs. The wave output does not start.

■Enabling the setting

Turn on and off 'Operating condition setting request' (Y9) to enable the setting.

■Default value

The default value is 0 for all channels.

CH1 Wave pattern output repetition setting

Wave

This area is for setting the repeat count to output the wave pattern repeatedly.

■Buffer memory address

The following shows the buffer memory address of this area.

Buffer memory name	CH1	CH2	CH3	CH4
CH□ Wave pattern output repetition setting	530	730	930	1130

■Setting range

- Follow the setting range below.

Setting value	Description
-1	The wave pattern is output in analog unlimitedly.
1 to 32767	The wave pattern is output in analog for the counts of the setting value.

- In the channel where a value out of the setting range is set, a wave pattern output repetition setting range error (error code: 1D6□H) occurs. The wave output does not start.

■Enabling the setting

Turn on and off 'Operating condition setting request' (Y9) to enable the setting.

■Default value

The default value is 1 (time) for all channels.

A

CH1 Constant for wave output conversion cycle

Wave

Set a constant to determine the conversion cycle (multiply the conversion speed). Use the value set in this area to set the conversion cycle in accordance with the following conditions.

- Conversion cycle = Conversion speed (20 μ s) \times Number of D/A conversion enabled channels \times Constant for wave output conversion cycle

■Buffer memory address

The following shows the buffer memory address of this area.

Buffer memory name	CH1	CH2	CH3	CH4
CH \square Constant for wave output conversion cycle	531	731	931	1131

■Setting range

- The setting range is from 1 to 5000.
- In the channel where a value out of the setting range is set, a setting range error for Constant for wave output conversion cycle (error code: 1D7 \square H) occurs. The wave output does not start.

■Enabling the setting

Turn on and off 'Operating condition setting request' (Y9) to enable the setting.

■Default value

The default value is 1 for all channels.

CH1 Range setting

Common

This area is for setting an output range.

Output range	Setting value
4 to 20mA	0H
0 to 20mA	1H
1 to 5V	2H
0 to 5V	3H
-10 to 10V	4H
User range setting (voltage)	EH
User range setting (current)	FH

- If a value other than the above is set, a range setting range error (error code: 190 \square H) occurs.
- To prevent a sudden change of the analog output, a range change denial alarm during analog output in CH \square (alarm code: 0C0 \square H) occurs when the range switching is attempted to be executed with the D/A conversion and output enabled. Thus, the range switching is not executed. To execute the range switching, turn off 'CH1 Output enable/disable flag' (Y1).
- The user range cannot be used in the wave output mode. If a user range is set in the wave output mode, a user range specification error with the wave output function used (error code: 1D1 \square H) occurs, and the wave output is not started.
- The output range cannot be changed for a channel where D/A conversion is disabled. To change the output range, set 'CH1 D/A conversion enable/disable setting' (Un\G500) to D/A conversion enable (0), turn off 'CH1 Output enable/disable flag' (Y1), and turn on and off 'Operating condition setting request' (Y9).

■Buffer memory address

The following shows the buffer memory address of this area.

Buffer memory name	CH1	CH2	CH3	CH4
CH \square Range setting	598	798	998	1198

■Enabling the setting

Turn on and off 'Operating condition setting request' (Y9) to enable the setting.

Error history

Common

Up to 16 errors that occurred in the module are recorded.

Ex.

For error history No.1

	b15	...	b8 b7	...	b0
Un\G3600	Error code				
Un\G3601	First two digits of the year		Last two digits of the year		
Un\G3602	Month		Day		
Un\G3603	Hour		Minute		
Un\G3604	Second		Day of the week		
Un\G3605	Millisecond (upper)		Millisecond (lower)		
Un\G3606	System area				
⋮					
⋮					
Un\G3609					

Item	Storage contents	Storage example ^{*1}
Error code	An error code is stored.	3030H
First two digits of the year	Stored in BCD code.	2016H
Month		1031H
Hour		1234H
Second		56H
Day of the week	One of the following values is stored in BCD code. Sunday: 0, Monday: 1, Tuesday: 2, Wednesday: 3 Thursday: 4, Friday: 5, Saturday: 6	1H
Millisecond (higher-order digits)	Stored in BCD code.	7H
Millisecond (lower-order digits)		89H
System area	—	—

*1 Values stored when a flash memory error (error code: 3030H) occurs at 12:34:56.789 on Monday, October 31st, 2016.

■ Buffer memory address

The following shows the buffer memory address of this area.

Buffer memory name	No.1 to No.16
Error history	3600 to 3759

A

Alarm history

Common

Up to 16 alarms that occurred in the module are recorded.

Ex.

For alarm history No.1

	b15	...	b8 b7	...	b0
Un\G3760	Alarm code				
Un\G3761	First two digits of the year		Last two digits of the year		
Un\G3762	Month		Day		
Un\G3763	Hour		Minute		
Un\G3764	Second		Day of the week		
Un\G3765	Millisecond (upper)		Millisecond (lower)		
Un\G3766	System area				
⋮					
Un\G3769					

Item	Storage contents	Storage example ^{*1}
Alarm code	An alarm code is stored.	0C00H
First two digits of the year	Stored in BCD code.	2016H
Last two digits of the year		1031H
Month		1234H
Day		56H
Hour	One of the following values is stored in BCD code. Sunday: 0, Monday: 1, Tuesday: 2, Wednesday: 3 Thursday: 4, Friday: 5, Saturday: 6	1H
Minute		
Second	Stored in BCD code.	7H
Day of the week		89H
Millisecond (higher-order digits)	—	—
Millisecond (lower-order digits)		
System area	—	—

*1 Values stored when a range change denial alarm during analog output in CH1 (alarm code: 0C00H) occurs at 12:34:56.789 on Monday, October 31st, 2016.

■ Buffer memory address

The following shows the buffer memory address of this area.

Buffer memory name	No.1 to No.16
Alarm history	3760 to 3919

Clear setting of error history

Common

Set whether to clear Error history No.1 to 16 (Un\G3600 to Un\G3759) and Alarm history No.1 to 16 (Un\G3760 to Un\G3919) when the following operations are performed.

- Turning on 'Error clear request' (YF) (clearing the error history)
- Turning on 'Warning output clear request' (YE) (clearing the alarm history)
- Turning on 'Operating condition setting request' (Y9) (clearing the error history and alarm history)

Setting value	Setting details
0	Not clear
1	Clear

When a value other than the above is set, the value is regarded as Not clear (0).

■Buffer memory address

The following shows the buffer memory address of this area.

Buffer memory name	CH1	CH2	CH3	CH4
Clear setting of error history	3930			

■Enabling the setting

As soon as a setting value is input, the setting is enabled. Turning on and off 'Operating condition setting request' (Y9) is not required.

■Default value

The default value is Not clear (0).

Save data type setting

Normal

This area is for saving and restoring the offset/gain setting value in the user range setting. Specify the data type of the offset/gain value to be saved and restored: voltage or current.

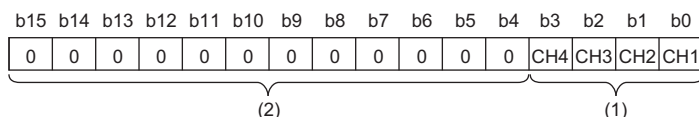

(1) 0: User range setting (voltage), 1: User range setting (current)

(2) b4 to b15 are fixed to 0.

■Buffer memory address

The following shows the buffer memory address of this area.

Buffer memory name	CH1	CH2	CH3	CH4
Save data type setting	4002			

■Default value

The default value is User range setting (voltage) (0) for all channels.

CH1 Factory default setting offset/gain value

Normal

This area is for restoring the offset/gain setting value in the user range setting. For details, refer to the following.

☞ Page 186 CH1 User range setting offset/gain value

A

CH1 User range setting offset/gain value

Normal

This area is for restoring the offset/gain setting value in the user range setting.

■Buffer memory address

The following shows the buffer memory address of this area.

Buffer memory name	CH1	CH2	CH3	CH4
CH□ Factory default setting offset value	4004	4006	4008	4010
CH□ Factory default setting gain value	4005	4007	4009	4011
CH□ User range setting offset value	4012	4014	4016	4018
CH□ User range setting gain value	4013	4015	4017	4019

When the following operations are performed, the data to be used is stored (saved).

- Writing the initial setting with an engineering tool
- Turning on 'Operating condition setting request' (Y9) (Data is not saved when the mode is switched from the normal output mode to the offset/gain setting mode by the mode switching setting.)
- Writing an offset/gain value in the offset/gain setting mode (When 'User range write request' (YA) is turned on)

When restoring the offset/gain setting value in user range setting, set the same data as the saved data in this area to the corresponding area of the D/A converter module that is the restoration destination.

For details on the offset/gain setting, refer to the following.

 MELSEC iQ-R High Speed Digital-Analog Converter Module User's Manual (Startup)

■Default value

The default value is 0 for all channels.

Offset/gain adjustment value specification

Normal

Set the adjustment amount of the analog output value in the offset/gain setting mode.

For details on the offset/gain setting, refer to the following.

 MELSEC iQ-R High Speed Digital-Analog Converter Module User's Manual (Startup)

■Buffer memory address

The following shows the buffer memory address of this area.

Buffer memory name	CH1	CH2	CH3	CH4
Offset/gain adjustment value specification	4130			

■Setting range

The setting range is from -3000 to 3000.

 Ex.

When the setting value is 1000

Analog output values are adjusted as shown below.

User range setting	Analog output value
User range setting (voltage)	Approx. 0.31V
User range setting (current)	Approx. 0.35mA

■Enabling the setting

Turn on 'Set value change request' (YC).

■Default value

The default value is 0.

A

CH1 Offset/gain setting mode

Normal

Specify the channel where the offset/gain setting is adjusted.

- Offset/gain setting mode (offset specification): Channel where the offset value is adjusted
- Offset/gain setting mode (gain specification): Channel where the gain value is adjusted

Setting value	Description
0	Disable
1	Setting channel

Set one of the offset specification or gain specification to Setting channel (1), and the other to Disable (0). When a value other than 0 and 1 is set, an offset/gain setting channel range error (error code: 1E8□H) occurs.

Multiple channels cannot be set at the same time.

In the following cases, an offset/gain setting channel specification error (error code: 1E50H) occurs.

- When both the offset specification and gain specification are set to Setting channel (1) at the same time
- When both the offset specification and gain specification of all channels are set to Disable (0)
- When multiple channels are set to Setting channel (1) at the same time

■Buffer memory address

The following shows the buffer memory address of this area.

Buffer memory name	CH1	CH2	CH3	CH4
CH□ Offset/gain setting mode (offset specification)	4132	4134	4136	4138
CH□ Offset/gain setting mode (gain specification)	4133	4135	4137	4139

■Enabling the setting

Turn on 'Channel change request' (YB).

■Default value

The default value is Disable (0) for all channels.

CH1 Offset/gain setting mode (range specification)

Normal

The output range can be changed in the offset/gain setting.

The output range is changed to the set one by 'Channel change request' (YB).

Setting value	Description
EH	User range setting (voltage)
FH	User range setting (current)

When a value other than the above is set, an offset/gain setting range error (error code: 1E9□H) occurs.

■Buffer memory address

The following shows the buffer memory address of this area.

Buffer memory name	CH1	CH2	CH3	CH4
CH□ Offset/gain setting mode (range specification)	4164	4165	4166	4167

■Enabling the setting

Turn on 'Channel change request' (YB).

■Default value

The default value is 0H for all channels.

CH1 Synchronization digital value

Synchronization

In the inter-module synchronization mode, set the digital value in 16-bit signed binary for the D/A conversion from the CPU module. A digital value set in this area is D/A-converted at the timing of inter-module synchronization cycle, and then output in analog at the timing of next inter-module synchronization cycle.

Output range	Setting range (practical range)
4 to 20mA	-768 to 32767 (practical range: 0 to 32000)
0 to 20mA	
1 to 5V	
0 to 5V	-32768 to 32767 (practical range: -32000 to 32000)
-10 to 10V	
User range setting (voltage)	
User range setting (current)	

When a value out of the available setting range is written, the D/A conversion is performed with the upper or lower limit value of the available setting range. A check code is stored in 'CH1 Set value check code' (Un\G400) and a digital value setting range error (error code: 191□H) is stored in 'Latest error code' (Un\G0).

■Buffer memory address

The following shows the buffer memory address of this area.

Buffer memory name	CH1	CH2	CH3	CH4
CH□ Synchronization digital value	9500	9502	9504	9506

■Default value

The default value is 0 for all channels.

A

Output setting during synchronization error

Synchronization

Set whether to continue or stop the synchronization of D/A converter modules when an inter-module synchronization cycle crossing over error (error code: 2600H) or inter-module synchronization signal error (error code: 2610H) occurs.

Setting value	Description
0	Synchronization continue
1	Synchronization stop

■Buffer memory address

The following shows the buffer memory address of this area.

Buffer memory name	CH1	CH2	CH3	CH4
Output setting during synchronization error	9532			

■Enabling the setting

Turn on and off 'Operating condition setting request' (Y9) to enable the setting.

■Default value

The default value is Synchronization continue (0).

Synchronization status monitor

Synchronization

The status of the inter-module synchronization (synchronization is in process or stopped) and whether the currently checked module is the target of the inter-module synchronization function can be checked.

Monitored value	Description
0	Inter-module synchronization non-target
1	Inter-module synchronization target (synchronization stopped)
2	Inter-module synchronization target (during synchronization)

If the currently checked module is not the inter-module synchronization target, the monitored value is Inter-module synchronization non-target (0).

If the currently checked module is the inter-module synchronization target and the inter-module synchronization is being executed, the monitored value is Inter-module synchronization target (during synchronization) (2).

When an error occurs in the CPU module or the D/A converter module and the synchronization stops, the monitored value is Inter-module synchronization target (synchronization stopped) (1).

■Buffer memory address

The following shows the buffer memory address of this area.

Buffer memory name	CH1	CH2	CH3	CH4
Synchronization status monitor	9600			

Wave data registry area

Wave

This area is used to register wave data for analog output in the wave output mode.

The setting range varies depending on the output range setting. The setting range is shown below.

Output range	Setting range
4 to 20mA	-768 to 32767 (practical range: 0 to 32000)
0 to 20mA	
1 to 5V	
0 to 5V	
-10 to 10V	-32768 to 32767 (practical range: -32000 to 32000)

In the channel where the wave data with a value outside the above setting range is output, a digital value setting range error (error code: 191□H) occurs. The wave output operations continue to be performed. However, the analog output value corresponding to a digital value outside the setting range is fixed to the maximum or minimum value of the output range.

■Buffer memory address

The following shows the buffer memory address of this area.

Buffer memory name	CH1	CH2	CH3	CH4
Wave data registry area	10000 to 99999			

Appendix 4 Dedicated Instructions

Instruction list

The following table lists the dedicated instructions that can be used in the D/A converter module.

Instruction	Description
G(P).OFFGAN	Switches the normal output mode to the offset/gain setting mode. Switches the offset/gain setting mode to the normal output mode.
G(P).OGLOAD	Reads out the offset/gain setting value in the user range setting to write it into the CPU module.
G(P).OGSTOR	Restores the offset/gain setting value in the user range setting stored in the CPU module into the D/A converter module.

For details on the dedicated instructions, refer to the following.

 MELSEC iQ-R Programming Manual (Module Dedicated Instructions)

Appendix 5 Operation Examples of When the Remote Head Module Is Mounted

This section describes operation examples of when the remote head module is mounted.

System configuration example

The following system configuration is used to explain an example of operation.

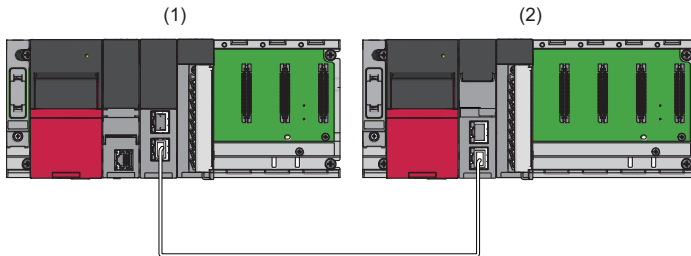

(1) Master station (Network number 1, station number 0)

- Power supply module: R61P
- CPU module: R04CPU
- Master/local module: RJ71GF11-T2 (Start I/O number: 0000H to 001FH)
- Input module: RX10 (Start I/O number: 0020H to 002FH)

(2) Intelligent device station (Network number 1, station number 1)

- Power supply module: R61P
- Remote head module: RJ72GF15-T2
- D/A converter module: R60DAH4 (Start I/O number: 0000H to 000FH)*1

*1 In the RX/RX setting of the master station, set 1000H to 100FH as the start I/O number of the D/A converter module.

Settings in the master station

Connect the engineering tool to the CPU module of the master station and set parameters.

1. Create the project with the following settings.

[Project] ⇒ [New]

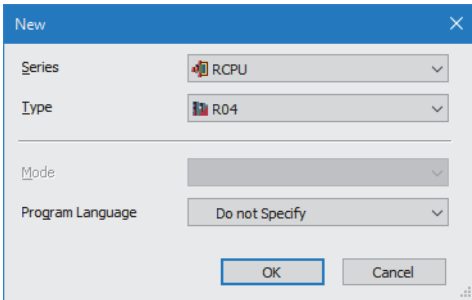

2. Click the [Setting Change] button and set the module to use the module labels.
3. Click the [OK] button in the following window to add the module labels of the CPU module.

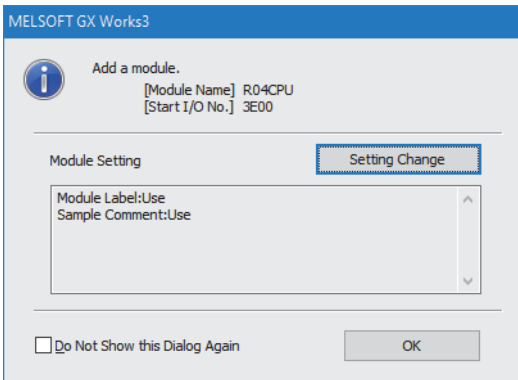

4. Add the master/local module with the following settings.

[Navigation window] ⇒ [Parameter] ⇒ [Module Information] ⇒ Right-click ⇒ [Add New Module]

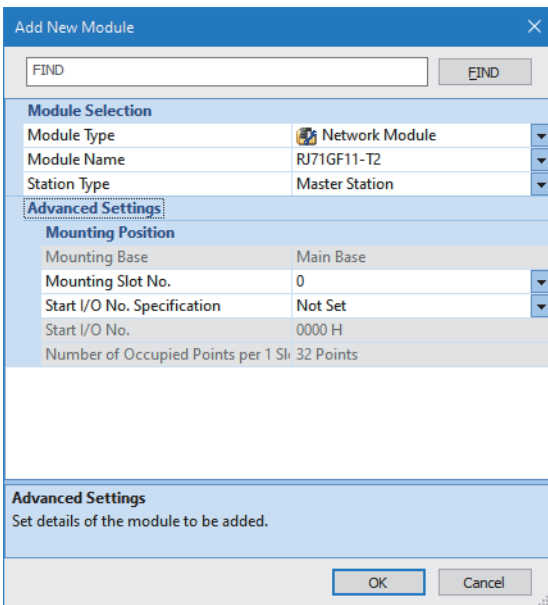

5. Configure the setting to use the module labels and add the module labels of the master/local module.

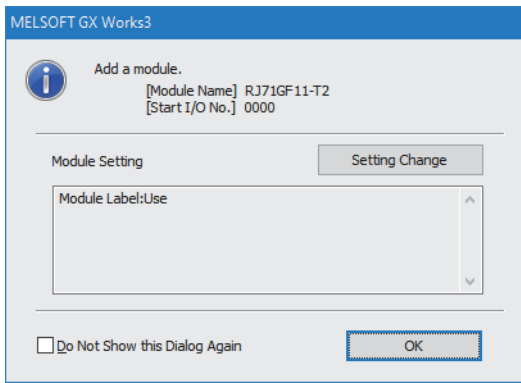

6. Set "Required Settings" of the module parameter of the master/local module as shown below.

[Navigation window] ⇒ [Parameter] ⇒ [Module Information] ⇒ [RJ71GF11-T2] ⇒ [Required Settings]

Item	Setting
Station Type	
Station Type	Master Station
Network Number	
Network Number	1
Station Number	
Setting Method	Parameter Editor
Station Number	0
Parameter Setting Method	
Setting Method of Basic/Application Settings	Parameter Editor

7. Set "Network Configuration Settings" of the module parameter of the master/local module as shown below.



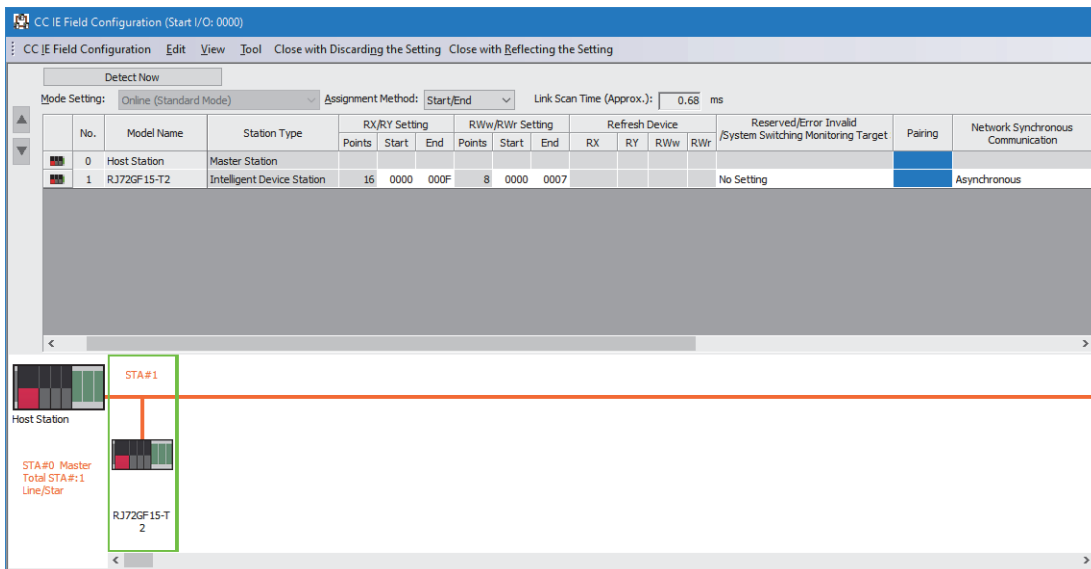



[Navigation window] ⇒ [Parameter] ⇒ [Module Information] ⇒ [RJ71GF11-T2] ⇒ [Basic Settings] ⇒ [Network Configuration Settings] ⇒ [Detailed Setting]



8. Click [Close with Reflecting the Setting] button and close the "CC IE Field Configuration" window.

9. Set "Refresh Setting" of the module parameter of the master/local module as shown below.

 [Navigation window] ⇒ [Parameter] ⇒ [Module Information] ⇒ [RJ71GF11-T2] ⇒ [Basic Settings] ⇒ [Refresh Setting] ⇒ [Detailed Setting]

No.	Link Side					CPU Side				
	Device Name	Points	Start	End		Target	Device Name	Points	Start	End
-	SB	512	00000	001FF		Module Label				
-	SW	512	00000	001FF		Module Label				
1	RX	256	00000	000FF		Specify Device	X	256	01000	010FF
2	RY	256	00000	000FF		Specify Device	Y	256	01000	010FF
3	RWw	256	00000	000FF		Specify Device	W	256	00000	000FF
4	RWr	256	00000	000FF		Specify Device	W	256	01000	010FF
5										

10. Click the [Apply] button.

11. Write the set parameters to the CPU module on the master station. Then reset the CPU module or turn off and on the power.

 [Online] ⇒ [Write to PLC]

Point 

For parameters of the master/local module which are not described in this procedure, set default values. For details on parameters of the master/local module, refer to the following.

 MELSEC iQ-R CC-Link IE Field Network User's Manual (Application)

Settings in the intelligent device station

Connect the engineering tool to the remote head module of the intelligent device station and set parameters.

1. Create the project with the following settings.

 [Project] ⇒ [New]

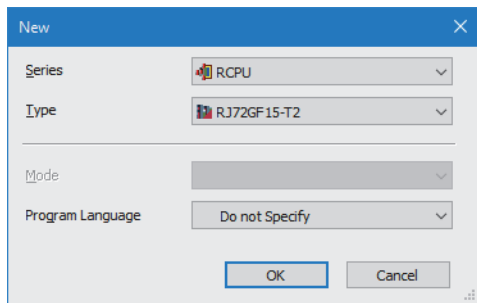

2. Set "Network Required Setting" of "CPU Parameter" of the remote head module as shown below.

 [Navigation window] ⇒ [Parameter] ⇒ [RJ72GF15-T2] ⇒ [CPU Parameter] ⇒ [Network Required Setting]

Item	Setting
[-] Network Number	
Network Number	1
[-] Station Number	
Station No.	1

3. Click the [Apply] button.

4. Add the D/A converter module with the following settings.

 [Navigation window] ⇒ [Parameter] ⇒ [Module Information] ⇒ Right-click ⇒ [Add New Module]

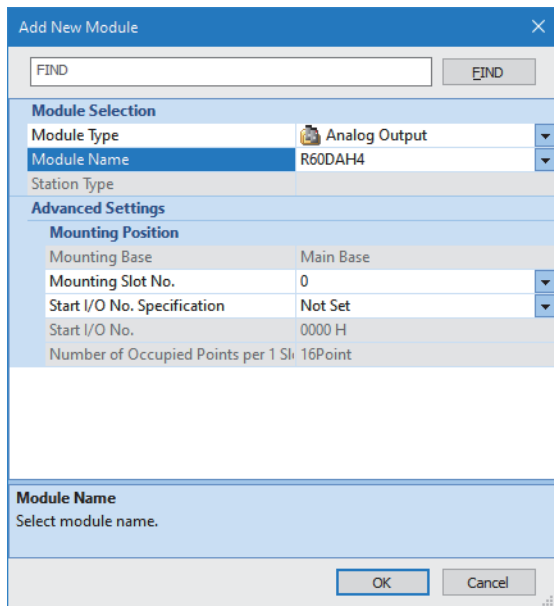

5. Configure the setting not to use the module labels.

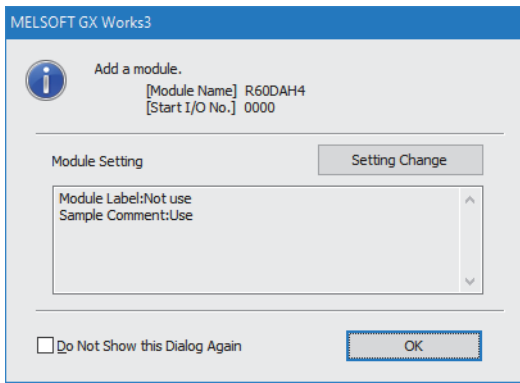

6. Set "Basic setting" of the module parameter of the D/A converter module as shown below.

[Navigation window] ⇒ [Parameter] ⇒ [Module Information] ⇒ [R60DAH4] ⇒ [Basic setting]

Item	CH1	CH2	CH3	CH4
Range switching function	This function enables to select the output range to be used from multiple ranges.			
Output range setting	-10 to 10V	-10 to 10V	0 to 20mA	4 to 20mA
Operation mode setting function	Setting Operation mode			
Operation mode setting	Normal output mode(10 μs/CH)			
Output mode setting function	HOLD or CLEAR can be set in the analog output HOLD/CLEAR setting.			
Analog output HOLD/CLEAR setting	HOLD	HOLD	HOLD	HOLD
D/A conversion enable/disable function	This function sets whether to enable or disable the D/A conversion for each channel.			
D/A conversion enable/disable setting	D/A conversion enable	D/A conversion enable	D/A conversion enable	D/A conversion enable

7. Set "Application setting" of the module parameter of the D/A converter module as shown below.

[Navigation window] ⇒ [Parameter] ⇒ [Module Information] ⇒ [R60DAH4] ⇒ [Application setting]

Item	CH1	CH2	CH3	CH4
Scaling function	This function enables to change the upper limit value or lower limit value of the digital value input range.			
Scaling enable/disable setting	Disable	Disable	Enable	Disable
Scaling upper limit value	0	0	16000	0
Scaling lower limit value	0	0	0	0
Shift function	This function adds the set amount to the digital value. A fine adjustment at the system startup can be made.			
Input value shift amount	0	0	2000	0
Warning output function	This function outputs an Warning when the digital value is outside the setting range.			
Warning output setting	Disable	Enable	Disable	Disable
Warning output upper limit value	0	32000	0	0
Warning output lower limit value	0	0	0	0
Rate control function	This function controls the increasing and decreasing amount of the analog output value per conversion.			
Rate control enable/disable setting	Enable	Disable	Disable	Disable
Increase digital limit value	8000	64000	64000	64000
Decrease digital limit value	1600	64000	64000	64000
Inter-module synchronization function	D/A conversion is performed in the inter-module synchronization cycle.			
Output selection during synchronous error	Inter-module synchronization continue			
Online module change	The module can be changed without the system being stopped.			
Auto restore of Offset/gain setting with the module change	Enable			
CPU error output mode setting	You can be the setting of whether to keep or not to clear the output of the module to the CPU stop.			
CPU error output mode setting	Hold			

8. Set "Refresh settings" of the module parameter of the D/A converter module as shown below.

 [Navigation window] ⇒ [Parameter] ⇒ [Module Information] ⇒ [R60DAH4] ⇒ [Refresh settings]

Setting Item				
Target	Device			
	Number of transfers to intelligent function module			4
	Number of transfers to CPU			4
Item	CH1	CH2	CH3	CH4
Refresh at the set timing.				
<input type="checkbox"/> Transfer to the intelligent function module.	Transfer the buffer memory data to the specified device.			
Digital value	W1	W2	W3	W4
<input type="checkbox"/> Transfer to the CPU.	Transfer the buffer memory data to the specified device.			
Latest error code	W1010			
Latest address of error history				
Latest alarm code				
Latest address of alarm history				
Interrupt factor detection flag 1				
Interrupt factor detection flag 2				
Interrupt factor detection flag 3				
Interrupt factor detection flag 4				
Interrupt factor detection flag 5				
Interrupt factor detection flag 6				
Interrupt factor detection flag 7				
Interrupt factor detection flag 8				
Interrupt factor detection flag 9				
Interrupt factor detection flag 10				
Interrupt factor detection flag 11				
Interrupt factor detection flag 12				
Interrupt factor detection flag 13				
Interrupt factor detection flag 14				
Interrupt factor detection flag 15				
Interrupt factor detection flag 16				
Set value check code				
Warning output upper flag	W1008			
Warning output lower flag	W1009			
Disconnection detection flag	W1011			
Wave output status monitor				

9. Write the set parameters to the remote head module on the intelligent device station. Then reset the remote head module or turn off and on the power.

 [Online] ⇒ [Write to PLC]

A

Point

For parameters of the remote head module which are not described in this procedure, set default values. For details on parameters of the remote head module, refer to the following.

 MELSEC iQ-R CC-Link IE Field Network Remote Head Module User's Manual (Application)

Checking the network status

After setting parameters to the master station and the intelligent device station, check whether data link is normally performed between the master station and the intelligent device station. Check the network status using the CC-Link IE Field Network diagnostics of the engineering tool.

For how to perform the CC-Link IE Field Network diagnostics from the master station, refer to the following.

📖 MELSEC iQ-R CC-Link IE Field Network User's Manual (Application)

Program examples

In the programs, the module labels of the master/local module are used.

Write the programs to the CPU module on the master station.

Classification	Label name	Description	Device	
Module label	GF11_1.bSts_DataLinkError	Data link error status of own station	SB0049	
	GF11_1.bnSts_DataLinkError_Station[1]	Data link status of each station (station number 1)	SW00B0.0	
Label to be defined	Define global labels as shown below:			
	Label Name	Data Type	Class	Assign (Device/Label)
1	ModuleREADY	Bit	VAR_GLOBAL	X1 000
2	ExternalPowerSupplyREADY_Flag	Bit	VAR_GLOBAL	X1 007
3	DisconnectionDetectionSignal	Bit	VAR_GLOBAL	X1 00D
4	WarningOutputSignal	Bit	VAR_GLOBAL	X1 00E
5	ErrorFlag	Bit	VAR_GLOBAL	X1 00F
6	CH1_OutputEnableDisableFlag	Bit	VAR_GLOBAL	Y1 001
7	CH2_OutputEnableDisableFlag	Bit	VAR_GLOBAL	Y1 002
8	CH3_OutputEnableDisableFlag	Bit	VAR_GLOBAL	Y1 003
9	CH4_OutputEnableDisableFlag	Bit	VAR_GLOBAL	Y1 004
10	WarningOutputClearRequest	Bit	VAR_GLOBAL	Y1 00E
11	ErrorClearRequest	Bit	VAR_GLOBAL	Y1 00F
12	CH1_DigInVal	Word [Signed]	VAR_GLOBAL	W1
13	CH2_DigInVal	Word [Signed]	VAR_GLOBAL	W2
14	CH3_DigInVal	Word [Signed]	VAR_GLOBAL	W3
15	CH4_DigInVal	Word [Signed]	VAR_GLOBAL	W4
16	WarningOutputUpperFlag	Word [Signed]	VAR_GLOBAL	W1 008
17	WarningOutputLowerFlag	Word [Signed]	VAR_GLOBAL	W1 009
18	DisconnectionDetectionFlag	Word [Signed]	VAR_GLOBAL	W1 011
19	CH2_AlmUpLimit	Bit	VAR_GLOBAL	F0
20	CH2_AlmLowLimit	Bit	VAR_GLOBAL	F1
21	CH4_DisconnectDetect	Bit	VAR_GLOBAL	F2
22	DigitWriteSig	Bit	VAR_GLOBAL	X20
23	DAOutputSig	Bit	VAR_GLOBAL	X21
24	WarningOutClrSig	Bit	VAR_GLOBAL	X22
25	ErrResetSig	Bit	VAR_GLOBAL	X23
26	Connect_FormationFlg_St1	Bit	VAR_GLOBAL	M0

Common program

The following figure shows a program example to check the data link status of the remote head module (station number 1).



(0) Checks the data link status of the remote head module (station number 1).

Add the MCR instruction shown below to the last of the program.

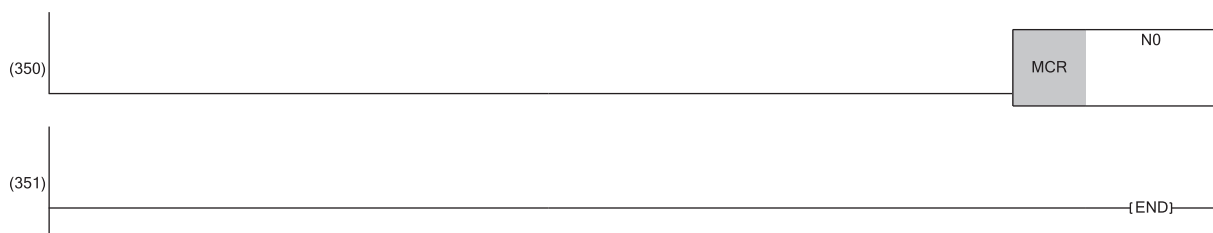

Program example 1

The following figure shows a program example to start D/A conversion by setting the digital values for D/A conversion for CH1 to CH4 and enabling analog output.

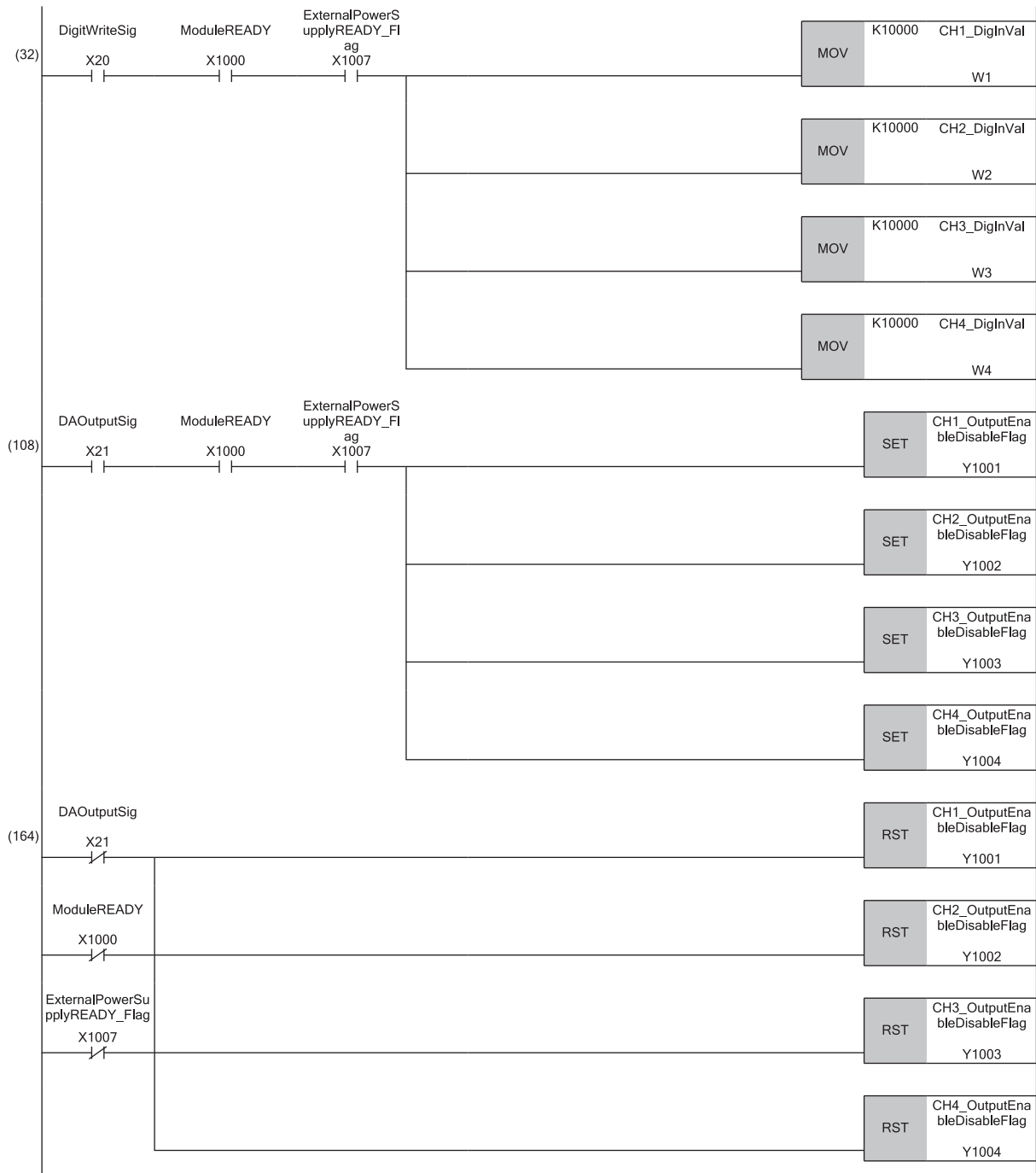

(32) Sets Digital value between CH1 and CH4.

(108) Enables output for CH1 to CH4.

(164) Disables output for CH1 to CH4 if any of the following signals is off.

- 'DA output enable command signal' (X21)
- 'Module READY' (X1000)
- 'External power supply READY flag' (X1007)

Program example 2

The following figure shows a program example to perform operations in reaction to a warning (such as processing for when a warning has occurred or clearing a warning) if a warning occurs in CH2.



(207) Carries out processing when an upper limit warning has occurred in CH2.

(236) Carries out processing when a lower limit warning has occurred in CH2.

(255) Turns on 'Warning output clear request' (Y100E).

(273) Turns off 'Warning output clear request' (Y100E).

Program example 3

The following figure shows a program example to clear Disconnection detection flag, Error flag, and Latest error code if a disconnection is detected in CH4 or an error occurs in any of the channels.

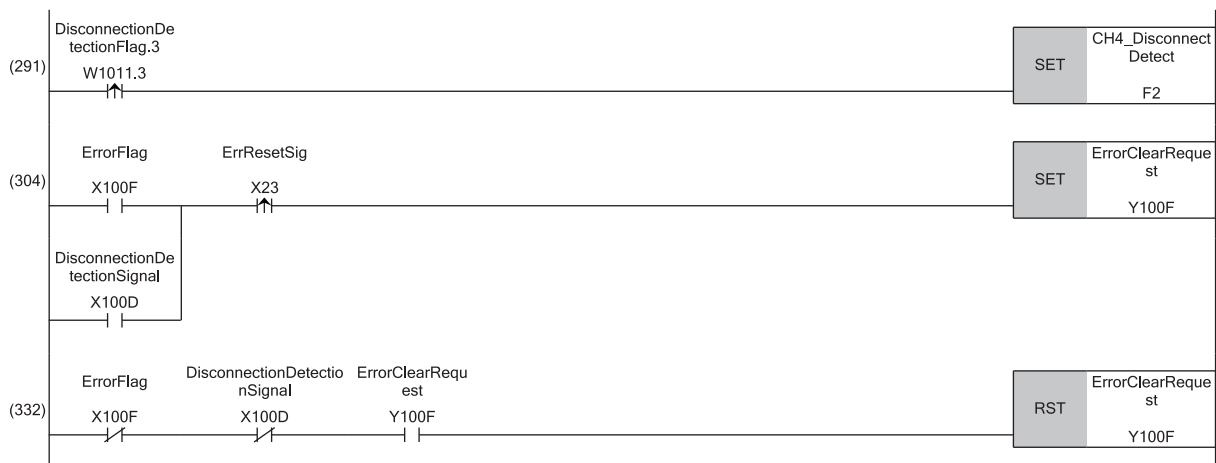

(291) Carries out processing when a disconnection is detected in CH4.

(304) Turns on 'Error clear request' (Y100F).

(332) Turns off 'Error clear request' (Y100F).

Appendix 6 Using the Module in the Redundant System with Redundant Extension Base Unit

This chapter describes restrictions and precautions for using the D/A converter module that is mounted on the extension base unit in the redundant system.

Restrictions on functions and specifications

Functions

Function	Restriction
D/A output enable/disable setting function	If system switching occurs while the setting change of D/A conversion enable/disable setting is being attempted, the change may affect the D/A output enable/disable setting with time delay. Therefore, configure the circuit to externally disable the D/A output (turn off 'CH1 Output enable/disable flag' (Y1)) if necessary.
Interrupt function	The interrupt program cannot be executed.
Wave output function	If system switching occurs while the setting change of 'CH1 Wave output start/stop request' (Un\G462) is being attempted, the change may take effect with time delay. Therefore, configure the circuit to externally turn off 'CH1 Output enable/disable flag' (Y1) if necessary, for the case where Wave output start request is changed to Wave output stop request or Wave output pause request.
Inter-module synchronization function	Cannot be used. When the function is used, proper operation cannot be guaranteed.
Backing up, saving, and restoring offset/gain values	The function cannot be used for either of the following cases. <ul style="list-style-type: none"> • When using the module-specific backup parameter • When saving and restoring the values using the dedicated instruction instead of the module-specific backup parameter

Dedicated instructions

Any dedicated instructions of the D/A converter module cannot be used.

Module FB

Name	Availability
M+R60DAH_WaveDataStoreCsv	Cannot be used. When the FB is used, proper operation cannot be guaranteed.

Module parameter

■Application setting

Set "Auto restore of Offset/gain setting with the module change" to "Disable".

A

Precautions

When configuring the offset/gain setting

Connect the engineering tool to the CPU module of the control system.

The engineering tool cannot recognize the D/A converter module if it is connected to the CPU module of the standby system.

Program examples

Unless otherwise specified, program examples provided in this manual and the following manual are for when the module is used in the single CPU system or in the multiple CPU system.

 MELSEC iQ-R High Speed Digital-Analog Converter Module User's Manual (Startup)

When using the module in the redundant system, refer to the following manual and observe the precautions on programming for when using the Process CPU (redundant mode).

 MELSEC iQ-R CPU Module User's Manual (Application)

Signal flow tracking setting

When using the module FBs and applying the program examples to an actual system, set "Signal Flow Memory Tracking Setting" to "Transfer". If not, the module FBs and programs may not work properly when system switching occurs.

 [CPU Parameter] ⇒ [Redundant System Settings] ⇒ [Tracking Setting]

MEMO

A

INDEX

A

Alarm history	184
ALM LED status monitor	161
Analog output HOLD/CLEAR function	23
Analog output test function when the CPU module is in STOP state	26

B

Backing up, saving, and restoring offset/gain values	110
--	-----

C

CH1 Constant for wave output conversion cycle	182
CH1 D/A conversion enable/disable setting	173
CH1 D/A conversion status monitor	170
CH1 Decrease digital limit value	178
CH1 Digital value	171
CH1 Factory default setting offset/gain value	185
CH1 HOLD/CLEAR function setting monitor	167
CH1 Increase digital limit value	177
CH1 Input value shift amount	172
CH1 Offset/gain setting mode	188
CH1 Offset/gain setting mode (range specification)	189
CH1 Output enable/disable flag	147
CH1 Output setting during wave output stop	178
CH1 Output value during wave output stop	179
CH1 Range setting	182
CH1 Range setting monitor	167
CH1 Rate control enable/disable setting	175
CH1 Scaling enable/disable setting	173
CH1 Scaling lower limit value	174
CH1 Scaling upper limit value	174
CH1 Set value check code	166
CH1 Synchronization digital value	189
CH1 User range setting offset/gain value	186
CH1 Warning output lower limit value	176
CH1 Warning output setting	175
CH1 Warning output upper limit value	176
CH1 Wave output conversion cycle monitor	167
CH1 Wave output current address monitor	168
CH1 Wave output current digital value monitor	169
CH1 Wave output digital value outside the range address monitor	169
CH1 Wave output start/stop request	171
CH1 Wave output status monitor	166
CH1 Wave output warning address monitor	170
CH1 Wave pattern data points setting	181
CH1 Wave pattern output count monitor	168
CH1 Wave pattern output repetition setting	181
CH1 Wave pattern start address setting	180
CH1 Wave step action movement amount	172
Channel change completed flag	144
Channel change request	148
Clear setting of error history	185
Condition target channel setting	165
Condition target setting	164
Conversion cycle	22

D

D/A conversion enable/disable setting function	22
D/A output enable/disable setting function	22
Dedicated instructions	192
Details of the module-specific backup parameter	110
Disconnection detection flag	160
Disconnection detection function	40
Disconnection detection signal	145

E

ERR LED status monitor	161
Error clear request	149
Error flag	146
Error history	183
Error history function	106
Event history function	109
External power supply interruption detection function	39
External power supply READY flag	141

H

High-speed output mode	16
----------------------------------	----

I

Inter-module synchronization function	91
Inter-module synchronization mode	17
Interrupt factor detection flag	158
Interrupt factor generation setting	163
Interrupt factor mask	162
Interrupt factor reset request	162
Interrupt function	42

L

Latest address of alarm history	158
Latest address of error history	157
Latest alarm code	157
Latest error code	157
List of alarm codes	136
List of error codes	132

M

Mode switching setting	165
Module label	137
Module READY	140

N

Normal output mode	16
------------------------------	----

O

Offset/gain adjustment value specification	187
Offset/gain setting mode	17
Offset/gain setting mode status flag	143
Operating condition setting completed flag	142

Operating condition setting request	147
Operation mode monitor	160
Output setting during synchronization error	190

R

Range reference table	116
Range switching function	20
Rate control function	35
Restrictions and precautions on the wave output function	47
RUN LED status monitor	161

S

Save data type setting	185
Scaling function	28
Set value change completed flag	144
Set value change request	148
Shift function	31
Step action wave output request	163
Synchronization status monitor	190

T

Troubleshooting	123
---------------------------	-----

U

User range write request	148
------------------------------------	-----

W

Warning output clear request	149
Warning output function	33
Warning output lower flag	159
Warning output signal	145
Warning output upper flag	158
Wave data	47
Wave data registry area	191
Wave output conversion cycle	51
Wave output function	45
Wave output mode	17
Wave output step action function	83
Wave pattern	48
Wave pattern output count	49



REVISIONS

*The manual number is given on the bottom left of the back cover.

Revision date	*Manual number	Description
February 2017	SH(NA)-081657ENG-A	First edition
October 2020	SH(NA)-081657ENG-B	■Added or modified parts SAFETY PRECAUTIONS, CONDITIONS OF USE FOR THE PRODUCT, RELEVANT MANUALS, TERMS, GENERIC TERMS AND ABBREVIATIONS, Section 1.3, 1.5, 1.7, 1.8, 1.9, 1.10, 1.13, 1.14, 1.15, 2.1, 2.2, 2.3, 2.4, Appendix 5, 6
February 2024	SH(NA)-081657ENG-C	■Added or modified parts SAFETY PRECAUTIONS, RELEVANT MANUALS, Section 1.6, 1.13, 1.14, 1.15, 1.18, Appendix 1, 4

Japanese manual number: SH-081656-D

This manual confers no industrial property rights or any rights of any other kind, nor does it confer any patent licenses. Mitsubishi Electric Corporation cannot be held responsible for any problems involving industrial property rights which may occur as a result of using the contents noted in this manual.

© 2017 MITSUBISHI ELECTRIC CORPORATION

WARRANTY

Please confirm the following product warranty details before using this product.

1. Gratis Warranty Term and Gratis Warranty Range

If any faults or defects (hereinafter "Failure") found to be the responsibility of Mitsubishi occurs during use of the product within the gratis warranty term, the product shall be repaired at no cost via the sales representative or Mitsubishi Service Company.

However, if repairs are required onsite at domestic or overseas location, expenses to send an engineer will be solely at the customer's discretion. Mitsubishi shall not be held responsible for any re-commissioning, maintenance, or testing on-site that involves replacement of the failed module.

[Gratis Warranty Term]

The gratis warranty term of the product shall be for one year after the date of purchase or delivery to a designated place. Note that after manufacture and shipment from Mitsubishi, the maximum distribution period shall be six (6) months, and the longest gratis warranty term after manufacturing shall be eighteen (18) months. The gratis warranty term of repair parts shall not exceed the gratis warranty term before repairs.

[Gratis Warranty Range]

- (1) The range shall be limited to normal use within the usage state, usage methods and usage environment, etc., which follow the conditions and precautions, etc., given in the instruction manual, user's manual and caution labels on the product.
- (2) Even within the gratis warranty term, repairs shall be charged for in the following cases.
 1. Failure occurring from inappropriate storage or handling, carelessness or negligence by the user. Failure caused by the user's hardware or software design.
 2. Failure caused by unapproved modifications, etc., to the product by the user.
 3. When the Mitsubishi product is assembled into a user's device, Failure that could have been avoided if functions or structures, judged as necessary in the legal safety measures the user's device is subject to or as necessary by industry standards, had been provided.
 4. Failure that could have been avoided if consumable parts (battery, backlight, fuse, etc.) designated in the instruction manual had been correctly serviced or replaced.
 5. Failure caused by external irresistible forces such as fires or abnormal voltages, and Failure caused by force majeure such as earthquakes, lightning, wind and water damage.
 6. Failure caused by reasons unpredictable by scientific technology standards at time of shipment from Mitsubishi.
 7. Any other failure found not to be the responsibility of Mitsubishi or that admitted not to be so by the user.

2. Onerous repair term after discontinuation of production

- (1) Mitsubishi shall accept onerous product repairs for seven (7) years after production of the product is discontinued. Discontinuation of production shall be notified with Mitsubishi Technical Bulletins, etc.
- (2) Product supply (including repair parts) is not available after production is discontinued.

3. Overseas service

Overseas, repairs shall be accepted by Mitsubishi's local overseas FA Center. Note that the repair conditions at each FA Center may differ.

4. Exclusion of loss in opportunity and secondary loss from warranty liability

Regardless of the gratis warranty term, Mitsubishi shall not be liable for compensation to:

- (1) Damages caused by any cause found not to be the responsibility of Mitsubishi.
- (2) Loss in opportunity, lost profits incurred to the user by Failures of Mitsubishi products.
- (3) Special damages and secondary damages whether foreseeable or not, compensation for accidents, and compensation for damages to products other than Mitsubishi products.
- (4) Replacement by the user, maintenance of on-site equipment, start-up test run and other tasks.

5. Changes in product specifications

The specifications given in the catalogs, manuals or technical documents are subject to change without prior notice.

TRADEMARKS

Ethernet is a registered trademark of Fuji Xerox Co., Ltd. in Japan.

The company names, system names and product names mentioned in this manual are either registered trademarks or trademarks of their respective companies.

In some cases, trademark symbols such as [™] or [®] are not specified in this manual.

SH(NA)-081657ENG-C(2402)MEE

MODEL: R60DAH4-U-OU-E

MODEL CODE: 13JX58

mitsubishi electric corporation

HEAD OFFICE : TOKYO BUILDING, 2-7-3 MARUNOUCHI, CHIYODA-KU, TOKYO 100-8310, JAPAN
NAGOYA WORKS : 1-14, YADA-MINAMI 5-CHOME, HIGASHI-KU, NAGOYA, JAPAN

When exported from Japan, this manual does not require application to the
Ministry of Economy, Trade and Industry for service transaction permission.

Specifications subject to change without notice.