

Programmable Controller

**MELSEC iQ-R**  
series

MELSEC iQ-R System Recorder  
User's Manual (Application)

---



# SAFETY PRECAUTIONS

---



(Read these precautions before using this product.)

Before using this product, please read this manual and the relevant manuals carefully and pay full attention to safety to handle the product correctly. If the equipment is used in a manner not specified by the manufacturer, the protection provided by the equipment may be impaired.

The precautions given in this manual are concerned with this product only. For the safety precautions of the programmable controller system, refer to the MELSEC iQ-R Module Configuration Manual.

In this manual, the safety precautions are classified into two levels: "⚠ WARNING" and "⚠ CAUTION".

---

 <b>WARNING</b>	Indicates that incorrect handling may cause hazardous conditions, resulting in death or severe injury.
 <b>CAUTION</b>	Indicates that incorrect handling may cause hazardous conditions, resulting in minor or moderate injury or property damage.

---

Under some circumstances, failure to observe the precautions given under "⚠ CAUTION" may lead to serious consequences.

Observe the precautions of both levels because they are important for personal and system safety.

Make sure that the end users read this manual and then keep the manual in a safe place for future reference.

## [Design Precautions]

---

### **WARNING**

---

- Configure safety circuits external to the programmable controller to ensure that the entire system operates safely even when a fault occurs in the external power supply or the programmable controller. Failure to do so may result in an accident due to an incorrect output or malfunction.
    - (1) Emergency stop circuits, protection circuits, and protective interlock circuits for conflicting operations (such as forward/reverse rotations or upper/lower limit positioning) must be configured external to the programmable controller.
    - (2) When the programmable controller detects an abnormal condition, it stops the operation and all outputs are:
      - Turned off if the overcurrent or overvoltage protection of the power supply module is activated.
      - Held or turned off according to the parameter setting if the self-diagnostic function of the CPU module detects an error such as a watchdog timer error.
    - (3) All outputs may be turned on if an error occurs in a part, such as an I/O control part, where the CPU module cannot detect any error. To ensure safety operation in such a case, provide a safety mechanism or a fail-safe circuit external to the programmable controller. For a fail-safe circuit example, refer to the MELSEC iQ-R Module Configuration Manual.
    - (4) Outputs may remain on or off due to a failure of a component such as a relay and transistor in an output circuit. Configure an external circuit for monitoring output signals that could cause a serious accident.
  - In an output circuit, when a load current exceeding the rated current or an overcurrent caused by a load short-circuit flows for a long time, it may cause smoke and fire. To prevent this, configure an external safety circuit, such as a fuse.
  - Configure a circuit so that the programmable controller is turned on first and then the external power supply. If the external power supply is turned on first, an accident may occur due to an incorrect output or malfunction.
  - Configure a circuit so that the external power supply is turned off first and then the programmable controller. If the programmable controller is turned off first, an accident may occur due to an incorrect output or malfunction.
  - For the operating status of each station after a communication failure, refer to manuals for the network used. For the manuals, please consult your local Mitsubishi representative. Incorrect output or malfunction due to a communication failure may result in an accident.
  - When connecting an external device with a CPU module or intelligent function module to modify data of a running programmable controller, configure an interlock circuit in the program to ensure that the entire system will always operate safely. For other forms of control (such as program modification, parameter change, forced output, or operating status change) of a running programmable controller, read the relevant manuals carefully and ensure that the operation is safe before proceeding. Improper operation may damage machines or cause accidents. When a Safety CPU is used, data cannot be modified while the Safety CPU is in SAFETY MODE.
  - Especially, when a remote programmable controller is controlled by an external device, immediate action cannot be taken if a problem occurs in the programmable controller due to a communication failure. To prevent this, configure an interlock circuit in the program, and determine corrective actions to be taken between the external device and CPU module in case of a communication failure.
-

## [Design Precautions]

---

### **WARNING**

- Do not write any data to the "system area" and "write-protect area" of the buffer memory in the module. Also, do not use any "use prohibited" signals as an output signal from the CPU module to each module. Doing so may cause malfunction of the programmable controller system. For the "system area", "write-protect area", and the "use prohibited" signals, refer to the user's manual for the module used. For areas used for safety communications, they are protected from being written by users, and thus safety communications failure caused by data writing does not occur.
  - If a communication cable is disconnected, the network may be unstable, resulting in a communication failure of multiple stations. Configure an interlock circuit in the program to ensure that the entire system will always operate safely even if communications fail. Incorrect output or malfunction due to a communication failure may result in an accident. When safety communications are used, an interlock by the safety station interlock function protects the system from an incorrect output or malfunction.
- 

## [Design Precautions]

---

### **CAUTION**

- Do not install the control lines or communication cables together with the main circuit lines or power cables. Doing so may result in malfunction due to electromagnetic interference. Keep a distance of 100mm or more between those cables.
  - During control of an inductive load such as a lamp, heater, or solenoid valve, a large current (approximately ten times greater than normal) may flow when the output is turned from off to on. Therefore, use a module that has a sufficient current rating.
  - After the CPU module is powered on or is reset, the time taken to enter the RUN status varies depending on the system configuration, parameter settings, and/or program size. Design circuits so that the entire system will always operate safely, regardless of the time.
  - Do not power off the programmable controller or reset the CPU module while the settings are being written. Doing so will make the data in the flash ROM and SD memory card undefined. The values need to be set in the buffer memory and written to the flash ROM and SD memory card again. Doing so also may cause malfunction or failure of the module.
  - When changing the operating status of the CPU module from external devices (such as the remote RUN/STOP functions), select "Do Not Open by Program" for "Opening Method" of "Module Parameter". If "Open by Program" is selected, an execution of the remote STOP function causes the communication line to close. Consequently, the CPU module cannot reopen the line, and external devices cannot execute the remote RUN function.
- 

## [Security Precautions]

---

### **WARNING**

- To maintain the security (confidentiality, integrity, and availability) of the programmable controller and the system against unauthorized access, denial-of-service (DoS) attacks, computer viruses, and other cyberattacks from external devices via the network, take appropriate measures such as firewalls, virtual private networks (VPNs), and antivirus solutions.
-

## [Installation Precautions]

---

### **WARNING**

- Shut off the external power supply (all phases) used in the system before mounting or removing the module. Failure to do so may result in electric shock or cause the module to fail or malfunction.
- 

## [Installation Precautions]

---

### **CAUTION**

- Use the programmable controller in an environment that meets the general specifications in the MELSEC iQ-R Module Configuration Manual. Failure to do so may result in electric shock, fire, malfunction, or damage to or deterioration of the product.
  - To mount a module, place the concave part(s) located at the bottom onto the guide(s) of the base unit, and push in the module until the hook(s) located at the top snaps into place. Incorrect interconnection may cause malfunction, failure, or drop of the module.
  - To mount a module with no module fixing hook, place the concave part(s) located at the bottom onto the guide(s) of the base unit, push in the module, and fix it with screw(s). Incorrect interconnection may cause malfunction, failure, or drop of the module.
  - When using the programmable controller in an environment of frequent vibrations, fix the module with a screw.
  - Tighten the screws within the specified torque range. Undertightening can cause drop of the component or wire, short circuit, or malfunction. Overtightening can damage the screw and/or module, resulting in drop, short circuit, or malfunction. For the specified torque range, refer to the MELSEC iQ-R Module Configuration Manual.
  - When using an extension cable, connect it to the extension cable connector of the base unit securely. Check the connection for looseness. Poor contact may cause malfunction.
  - When using an SD memory card, fully insert it into the SD memory card slot. Check that it is inserted completely. Poor contact may cause malfunction.
  - Securely insert an extended SRAM cassette or a battery-less option cassette into the cassette connector of the CPU module. After insertion, close the cassette cover and check that the cassette is inserted completely. Poor contact may cause malfunction.
  - Beware that the module could be very hot while power is on and immediately after power-off.
  - Do not directly touch any conductive parts and electronic components of the module, SD memory card, extended SRAM cassette, battery-less option cassette, or connector. Doing so can cause malfunction or failure of the module.
- 

## [Wiring Precautions]

---

### **WARNING**

- Shut off the external power supply (all phases) used in the system before installation and wiring. Failure to do so may result in electric shock or cause the module to fail or malfunction.
- After installation and wiring, attach a blank cover module (RG60) to each empty slot before powering on the system for operation. Also, attach an extension connector protective cover<sup>\*1</sup> to each unused extension cable connector as necessary. Directly touching any conductive parts of the connectors while power is on may result in electric shock.

\*1 For details, please consult your local Mitsubishi Electric representative.

---

## [Wiring Precautions]

---

### **CAUTION**

- Individually ground the FG and LG terminals of the programmable controller with a ground resistance of 100 ohms or less. Failure to do so may result in electric shock or malfunction.
  - Use applicable solderless terminals and tighten them within the specified torque range. If any spade solderless terminal is used, it may be disconnected when the terminal screw comes loose, resulting in failure.
  - Check the rated voltage and signal layout before wiring to the module, and connect the cables correctly. Connecting a power supply with a different voltage rating or incorrect wiring may cause fire or failure.
  - Connectors for external devices must be crimped or pressed with the tool specified by the manufacturer, or must be correctly soldered. Incomplete connections may cause short circuit, fire, or malfunction.
  - Securely connect the connector to the module. Poor contact may cause malfunction.
  - Do not install the control lines or communication cables together with the main circuit lines or power cables. Doing so may result in malfunction due to noise. Keep a distance of 100mm or more between those cables.
  - Place the cables in a duct or clamp them. If not, dangling cables may swing or inadvertently be pulled, resulting in malfunction or damage to modules or cables.  
In addition, the weight of the cables may put stress on modules in an environment of strong vibrations and shocks. Do not clamp the extension cables with the jacket stripped. Doing so may change the characteristics of the cables, resulting in malfunction.
  - Check the interface type and correctly connect the cable. Incorrect wiring (connecting the cable to an incorrect interface) may cause failure of the module and external device.
  - Tighten the terminal screws or connector screws within the specified torque range. Undertightening can cause drop of the screw, short circuit, fire, or malfunction. Overtightening can damage the screw and/or module, resulting in drop, short circuit, fire, or malfunction.
  - When disconnecting the cable from the module, do not pull the cable by the cable part. For the cable with connector, hold the connector part of the cable. For the cable connected to the terminal block, loosen the terminal screw. Pulling the cable connected to the module may result in malfunction or damage to the module or cable.
  - Prevent foreign matter such as dust or wire chips from entering the module. Such foreign matter can cause a fire, failure, or malfunction.
  - When a protective film is attached to the top of the module, remove it before system operation. If not, inadequate heat dissipation of the module may cause a fire, failure, or malfunction.
  - Programmable controllers must be installed in control panels. Connect the main power supply to the power supply module in the control panel through a relay terminal block. Wiring and replacement of a power supply module must be performed by qualified maintenance personnel with knowledge of protection against electric shock. For wiring, refer to the MELSEC iQ-R Module Configuration Manual.
  - For Ethernet cables to be used in the system, select the ones that meet the specifications in the user's manual for the module used. If not, normal data transmission is not guaranteed.
-

## [Startup and Maintenance Precautions]

---

### **WARNING**

- Do not touch any terminal while power is on. Doing so will cause electric shock or malfunction.
  - Correctly connect the battery connector. Do not charge, disassemble, heat, short-circuit, solder, or throw the battery into the fire. Also, do not expose it to liquid or strong shock. Doing so will cause the battery to produce heat, explode, ignite, or leak, resulting in injury and fire.
  - Shut off the external power supply (all phases) used in the system before cleaning the module or retightening the terminal screws, connector screws, or module fixing screws. Failure to do so may result in electric shock.
- 

## [Startup and Maintenance Precautions]

---

### **CAUTION**

- When connecting an external device with a CPU module or intelligent function module to modify data of a running programmable controller, configure an interlock circuit in the program to ensure that the entire system will always operate safely. For other forms of control (such as program modification, parameter change, forced output, or operating status change) of a running programmable controller, read the relevant manuals carefully and ensure that the operation is safe before proceeding. Improper operation may damage machines or cause accidents.
  - Especially, when a remote programmable controller is controlled by an external device, immediate action cannot be taken if a problem occurs in the programmable controller due to a communication failure. To prevent this, configure an interlock circuit in the program, and determine corrective actions to be taken between the external device and CPU module in case of a communication failure.
  - Do not disassemble or modify the modules. Doing so may cause failure, malfunction, injury, or a fire.
  - Use any radio communication device such as a cellular phone or PHS (Personal Handy-phone System) 25cm or more away in all directions from the programmable controller. Failure to do so may cause malfunction.
  - Shut off the external power supply (all phases) used in the system before mounting or removing the module. Failure to do so may cause the module to fail or malfunction.
  - Tighten the screws within the specified torque range. Undertightening can cause drop of the component or wire, short circuit, or malfunction. Overtightening can damage the screw and/or module, resulting in drop, short circuit, or malfunction.
  - After the first use of the product, do not perform each of the following operations more than 50 times (IEC 61131-2/JIS B 3502 compliant).  
Exceeding the limit may cause malfunction.
    - Mounting/removing the module to/from the base unit
    - Inserting/removing the extended SRAM cassette or battery-less option cassette to/from the CPU module
    - Mounting/removing the terminal block to/from the module
    - Connecting/disconnecting the extension cable to/from the base unit
  - After the first use of the product, do not insert/remove the SD memory card to/from the CPU module more than 500 times. Exceeding the limit may cause malfunction.
  - Do not touch the metal terminals on the back side of the SD memory card. Doing so may cause malfunction or failure of the module.
  - Do not touch the integrated circuits on the circuit board of an extended SRAM cassette or a battery-less option cassette. Doing so may cause malfunction or failure of the module.
-



## [Startup and Maintenance Precautions]

---

### CAUTION

- Do not drop or apply shock to the battery to be installed in the module. Doing so may damage the battery, causing the battery fluid to leak inside the battery. If the battery is dropped or any shock is applied to it, dispose of it without using.
  - Startup and maintenance of a control panel must be performed by qualified maintenance personnel with knowledge of protection against electric shock. Lock the control panel so that only qualified maintenance personnel can operate it.
  - Before handling the module, touch a conducting object such as a grounded metal to discharge the static electricity from the human body. Wearing a grounded antistatic wrist strap is recommended. Failure to discharge the static electricity may cause the module to fail or malfunction.
  - After unpacking, eliminate static electricity from the module to prevent electrostatic discharge from affecting the module. If an electrostatically charged module comes in contact with a grounded metal object, a sudden electrostatic discharge of the module may cause failure.  
For details on how to eliminate static electricity from the module, refer to the following.  
Antistatic Precautions Before Using MELSEC iQ-R Series Products (FA-A-0368)
  - Use a clean and dry cloth to wipe off dirt on the module.
- 

## [Operating Precautions]

---

### CAUTION

- When changing data and operating status, and modifying program of the running programmable controller from an external device such as a personal computer connected to an intelligent function module, read relevant manuals carefully and ensure the safety before operation. Incorrect change or modification may cause system malfunction, damage to the machines, or accidents.
  - Do not power off the programmable controller or reset the CPU module while the setting values in the buffer memory are being written to the flash ROM in the module. Doing so will make the data in the flash ROM and SD memory card undefined. The values need to be set in the buffer memory and written to the flash ROM and SD memory card again. Doing so can cause malfunction or failure of the module.
- 

## [Disposal Precautions]

---

### CAUTION

- When disposing of this product, treat it as industrial waste.
  - When disposing of batteries, separate them from other wastes according to the local regulations. For details on battery regulations in EU member states, refer to the MELSEC iQ-R Module Configuration Manual.
-

## [Transportation Precautions]

---

### **CAUTION**

---

- When transporting lithium batteries, follow the transportation regulations. For details on the regulated models, refer to the MELSEC iQ-R Module Configuration Manual.
  - The halogens (such as fluorine, chlorine, bromine, and iodine), which are contained in a fumigant used for disinfection and pest control of wood packaging materials, may cause failure of the product. Prevent the entry of fumigant residues into the product or consider other methods (such as heat treatment) instead of fumigation. The disinfection and pest control measures must be applied to unprocessed raw wood.
-

# CONDITIONS OF USE FOR THE PRODUCT

---

- (1) MELSEC programmable controller ("the PRODUCT") shall be used in conditions;
- i) where any problem, fault or failure occurring in the PRODUCT, if any, shall not lead to any major or serious accident; and
  - ii) where the backup and fail-safe function are systematically or automatically provided outside of the PRODUCT for the case of any problem, fault or failure occurring in the PRODUCT.
- (2) The PRODUCT has been designed and manufactured for the purpose of being used in general industries. MITSUBISHI ELECTRIC SHALL HAVE NO RESPONSIBILITY OR LIABILITY (INCLUDING, BUT NOT LIMITED TO ANY AND ALL RESPONSIBILITY OR LIABILITY BASED ON CONTRACT, WARRANTY, TORT, PRODUCT LIABILITY) FOR ANY INJURY OR DEATH TO PERSONS OR LOSS OR DAMAGE TO PROPERTY CAUSED BY the PRODUCT THAT ARE OPERATED OR USED IN APPLICATION NOT INTENDED OR EXCLUDED BY INSTRUCTIONS, PRECAUTIONS, OR WARNING CONTAINED IN MITSUBISHI ELECTRIC USER'S, INSTRUCTION AND/OR SAFETY MANUALS, TECHNICAL BULLETINS AND GUIDELINES FOR the PRODUCT.
- ("Prohibited Application")
- Prohibited Applications include, but not limited to, the use of the PRODUCT in;
- Nuclear Power Plants and any other power plants operated by Power companies, and/or any other cases in which the public could be affected if any problem or fault occurs in the PRODUCT.
  - Railway companies or Public service purposes, and/or any other cases in which establishment of a special quality assurance system is required by the Purchaser or End User.
  - Aircraft or Aerospace, Medical applications, Train equipment, transport equipment such as Elevator and Escalator, Incineration and Fuel devices, Vehicles, Manned transportation, Equipment for Recreation and Amusement, and Safety devices, handling of Nuclear or Hazardous Materials or Chemicals, Mining and Drilling, and/or other applications where there is a significant risk of injury to the public or property.
- Notwithstanding the above restrictions, Mitsubishi Electric may in its sole discretion, authorize use of the PRODUCT in one or more of the Prohibited Applications, provided that the usage of the PRODUCT is limited only for the specific applications agreed to by Mitsubishi Electric and provided further that no special quality assurance or fail-safe, redundant or other safety features which exceed the general specifications of the PRODUCTS are required. For details, please contact the Mitsubishi Electric representative in your region.
- (3) Mitsubishi Electric shall have no responsibility or liability for any problems involving programmable controller trouble and system trouble caused by DoS attacks, unauthorized access, computer viruses, and other cyberattacks.

# INTRODUCTION

---

Thank you for purchasing the Mitsubishi Electric MELSEC iQ-R series programmable controllers.

This manual describes the performance specifications and procedures for operation to use System Recorder.

Before using this product, please read this manual and the relevant manuals carefully and develop familiarity with the functions and performance of the MELSEC iQ-R series programmable controller to handle the product correctly.

When applying the program examples provided in this manual to an actual system, ensure the applicability and confirm that it will not cause system control problems.



Please make sure that the end users read this manual.

## COMPLIANCE WITH EMC AND LOW VOLTAGE DIRECTIVES

---

### Method of ensuring compliance



To ensure that Mitsubishi Electric programmable controllers maintain the EMC and Low Voltage Directives or other regulations when incorporated into other machinery or equipment, certain measures may be necessary. Please refer to one of the following manuals.

-  MELSEC iQ-R Module Configuration Manual (SH-081262ENG)
-  Safety Guidelines (IB-0800525)

Certification marks on the side of the programmable controller indicate compliance with the relevant regulations.

### Additional measures

To ensure that this product maintains the EMC and Low Voltage Directives or other regulations, please refer to the following.

-  MELSEC iQ-R Module Configuration Manual (SH-081262ENG)
-  Safety Guidelines (IB-0800525)

# CONTENTS

SAFETY PRECAUTIONS .....	1
CONDITIONS OF USE FOR THE PRODUCT .....	9
INTRODUCTION .....	10
COMPLIANCE WITH EMC AND LOW VOLTAGE DIRECTIVES .....	10
RELEVANT MANUALS .....	14
TERMS .....	15
<b>CHAPTER 1 FUNCTIONS</b> .....	<b>16</b>
<b>1.1 Recording Function</b> .....	<b>16</b>
Recording methods .....	19
Target data .....	32
Sampling methods of devices and labels .....	44
Video data receiving setting .....	48
Recording file .....	49
Flow to save data .....	58
Operating status .....	63
Operation of the recording function .....	65
Operation of the recording function when configuring multiple modules .....	67
Adding and changing a recording setting .....	73
Writing recording settings, parameters, and programs .....	75
Program change .....	76
Recording monitor .....	78
Errors that occur when using the recording function .....	78
Buffer memory used for the recording function .....	78
Project data saving function .....	79
Considerations .....	83
<b>1.2 Offline Monitor Function</b> .....	<b>92</b>
<b>1.3 Camera Recording Function</b> .....	<b>92</b>
<b>1.4 Data Flow Analysis Function</b> .....	<b>92</b>
<b>1.5 Co-recording Function</b> .....	<b>92</b>
<b>CHAPTER 2 PARAMETER SETTING</b> .....	<b>93</b>
<b>2.1 CPU Parameters</b> .....	<b>94</b>
Memory/device setting .....	94
<b>2.2 Module Parameters (Recorder Module/Camera Recorder Module)</b> .....	<b>95</b>
Basic settings .....	95
Application settings .....	100
Refresh setting .....	102
<b>2.3 Module Extended Parameters (Camera Recorder Module)</b> .....	<b>103</b>
<b>2.4 Preset Position Setting (Camera Recorder Module)</b> .....	<b>110</b>
<b>CHAPTER 3 RECORDING SETTING</b> .....	<b>114</b>
<b>3.1 Recording Setting Screen</b> .....	<b>114</b>
<b>3.2 Saving Period Setting</b> .....	<b>116</b>
<b>3.3 Device/Label Sampling Setting</b> .....	<b>117</b>
"Specify from the Device/Label List" screen .....	119
"Specify the Device Range" screen .....	131
"Device/Label Sampling Target List" screen .....	133

<b>3.4</b>	<b>File Saving Trigger Setting</b> .....	<b>134</b>
	Camera event trigger setting .....	135
<b>3.5</b>	<b>Saving Path Setting</b> .....	<b>136</b>
	File server setting .....	137
	Saving detail setting .....	138
<b>3.6</b>	<b>Video Data Receiving Target Setting</b> .....	<b>140</b>
<b>CHAPTER 4 RECORDING MONITOR</b>		<b>142</b>
<b>4.1</b>	<b>Recording Status Detailed Information Screen</b> .....	<b>144</b>
<b>4.2</b>	<b>Camera Monitor Screen</b> .....	<b>146</b>
<b>CHAPTER 5 TROUBLESHOOTING</b>		<b>148</b>
<b>5.1</b>	<b>Recording Function</b> .....	<b>148</b>
<b>5.2</b>	<b>Offline Monitor Function</b> .....	<b>153</b>
<b>5.3</b>	<b>Camera Recording Function</b> .....	<b>155</b>
<b>5.4</b>	<b>Data Flow Analysis Function</b> .....	<b>155</b>
<b>5.5</b>	<b>Co-recording Function</b> .....	<b>155</b>
<b>5.6</b>	<b>Recorder Module</b> .....	<b>156</b>
	Checking methods .....	156
	Checking the module status .....	157
	Troubleshooting by symptom .....	162
	Error code list .....	167
	Event code list .....	175
<b>5.7</b>	<b>Camera Recorder Module</b> .....	<b>177</b>
	Checking methods .....	177
	Checking the module status .....	178
	Troubleshooting by symptom .....	179
	Error code list .....	185
	Event code list .....	196
<b>CHAPTER 6 RECORDER MODULE (DETAILED SPECIFICATIONS)</b>		<b>199</b>
<b>6.1</b>	<b>Function Details</b> .....	<b>199</b>
	Recording function .....	199
	SD memory card format function .....	199
	Self-diagnostics function .....	199
	Co-recording function .....	200
<b>6.2</b>	<b>Module Labels</b> .....	<b>203</b>
<b>6.3</b>	<b>Input/Output Signals</b> .....	<b>204</b>
	Input/output signal list .....	204
	Input signal details .....	205
	Output signal details .....	207
<b>6.4</b>	<b>Buffer Memory</b> .....	<b>208</b>
	Buffer memory list .....	208
	Buffer memory details .....	215
<b>CHAPTER 7 CAMERA RECORDER MODULE (DETAILED SPECIFICATIONS)</b>		<b>234</b>
<b>7.1</b>	<b>Function Details</b> .....	<b>234</b>
	Recording function .....	234
	Network camera communication function .....	234
	Camera time synchronization function .....	240

Camera event function .....	242
Camera adjustment function (PTZ) .....	245
GOT linkage function .....	249
SD memory card format function .....	250
Self-diagnostics function .....	250
Co-recording function .....	251
<b>7.2 Module Labels .....</b>	<b>252</b>
<b>7.3 Input/Output Signals .....</b>	<b>253</b>
Input/output signal list .....	253
Input signal details .....	254
Output signal details .....	256
<b>7.4 Buffer Memory .....</b>	<b>257</b>
Buffer memory list .....	257
Buffer memory details .....	269
<b>APPENDIX .....</b>	<b>291</b>
<hr/>	
<b>Appendix 1 Available Characters in the Recording Setting .....</b>	<b>291</b>
<b>Appendix 2 Available Characters in the Camera Setting .....</b>	<b>295</b>
<b>Appendix 3 Processing Time .....</b>	<b>296</b>
<b>Appendix 4 Instruction List .....</b>	<b>300</b>
<b>Appendix 5 Number of Connected Network Cameras and Module Configuration .....</b>	<b>302</b>
Number of network cameras and module configuration list .....	302
<b>Appendix 6 Added and Changed Functions .....</b>	<b>307</b>
<b>INDEX .....</b>	<b>310</b>
<hr/>	
REVISIONS .....	312
WARRANTY .....	313
INFORMATION AND SERVICES .....	314
TRADEMARKS .....	314

# RELEVANT MANUALS

Manual name [manual number]	Description	Available form
MELSEC iQ-R System Recorder User's Manual (Application) [SH-082281ENG] (this manual)	Functions, parameter settings, recording settings, and troubleshooting of System Recorder, and detailed specifications of a recorder module/camera recorder module	Print book e-Manual PDF
MELSEC iQ-R System Recorder User's Manual (Startup) [SH-082279ENG]	Specifications, procedures for operation, and system configuration of System Recorder, and specifications of a recorder module/camera recorder module	Print book e-Manual PDF
MELSEC iQ-R System Recorder Co-recording Function Reference Manual [SH-082553ENG]	Function, system configuration, parameter settings, and troubleshooting for co-recording	e-Manual PDF
MELSEC iQ-R CPU Module User's Manual (Startup) [SH-081263ENG]	Specifications, procedures before operation, and troubleshooting of a CPU module	Print book e-Manual PDF
MELSEC iQ-R CPU Module User's Manual (Application) [SH-081264ENG]	Memory, functions, devices, and parameters of a CPU module	Print book e-Manual PDF
MELSEC iQ-R Programmable Controller CPU Module User's Manual [SH-082488ENG]	Procedures before operation, specifications, devices, memory, functions, parameters, and troubleshooting of the programmable controller CPU module	e-Manual PDF
GX Works3 Operating Manual [SH-081215ENG]	System configurations, parameter settings, and operation methods for the online function in GX Works3	e-Manual PDF
MELSEC iQ-R Module Configuration Manual [SH-081262ENG]	The combination of the MELSEC iQ-R series modules, common information on the installation/wiring in the system, and specifications of the power supply module, base unit, SD memory card, and battery	Print book e-Manual PDF
Camera Recording Package User's Manual [BCN-P5999-1324]	Network camera settings, programmable controller settings, and function blocks for the camera recording function	e-Manual PDF
Video Verification Tool Operating Manual [BCN-P5999-1327]	Basic operations and method for playing a video file in Video Verification Tool	e-Manual PDF
GX VideoViewer Version 1 Operating Manual [SH-082370ENG]	Basic operations and method for playing a video file in GX VideoViewer	e-Manual PDF

This manual does not include detailed information on the following:

- General specifications
- Applicable combinations of CPU modules and the other modules, and the number of mountable modules
- Applicable combinations of remote head modules and the other modules, and the number of mountable modules
- Installation

For details, refer to the following:

 MELSEC iQ-R Module Configuration Manual

## Point

e-Manual refers to the Mitsubishi Electric FA electronic book manuals that can be browsed using a dedicated tool.

e-Manual has the following features:

- Required information can be cross-searched in multiple manuals.
- Other manuals can be accessed from the links in the manual.
- Hardware specifications of each part can be found from the product figures.
- Pages that users often browse can be bookmarked.
- Sample programs can be copied to an engineering tool.



# TERMS

Unless otherwise specified, this manual uses the following terms.

Term	Description
Buffer area for data sampling	A memory area in a CPU module to pass sampled devices and labels to a recorder module/camera recorder module
ONVIF Profile S	Simple profiles that focus on functions to deliver and display videos compliant with ONVIF standards
ONVIF supported network camera	A network camera that supports ONVIF Profile S
ONVIF®	ONVIF (Open Network Video Interface Forum) is a forum for developing common standard interfaces between network camera products.
Recording file	A file that consists of folders to which information such as a date and time or character strings can be added and files saved in the folders
Recording setting	A setting for the recording function such as a sampling target, sampling interval, and saving period

For definitions of terms for safety CPUs, refer to the following:

 MELSEC iQ-R CPU Module User's Manual (Application)

# 1 FUNCTIONS

This chapter explains the details on the functions of System Recorder.

## 1.1 Recording Function

The recording function can be used to output data in a CPU module and video data captured by a network camera to a recording file and save them to a save destination specified in the recording setting when a file saving trigger is satisfied. The saved recording file can be reproduced by using the offline monitor function. This can facilitate identification and analysis of trouble factors and reduce the system downtime. (☞ Page 92 Offline Monitor Function)

The following data (recording target data) can be saved as a recording file.

Recording target data	Description
Device and label	Values in devices <sup>*1</sup> and labels of a CPU module, in the buffer memory of a module, and in link devices on a network. A value at any timing can be saved for a set period. When using a safety CPU, standard devices, safety devices, standard labels, safety labels, and standard/safety shared labels used in all programs including safety programs can be sampled.
Event history	Errors occurred on a network or in a module, and event information such as writing data to devices and labels
Video data <sup>*2</sup>	Video data captured by a network camera. Data at any timing can be saved for a set period. It is saved as a video file in a recording file.

\*1 When specifying SFC devices, check the versions of a CPU module, recorder module/camera recorder module, and GX Works3. ☞ Page 307 Added and Changed Functions

\*2 When specifying it as recording target data, use a camera recorder module.

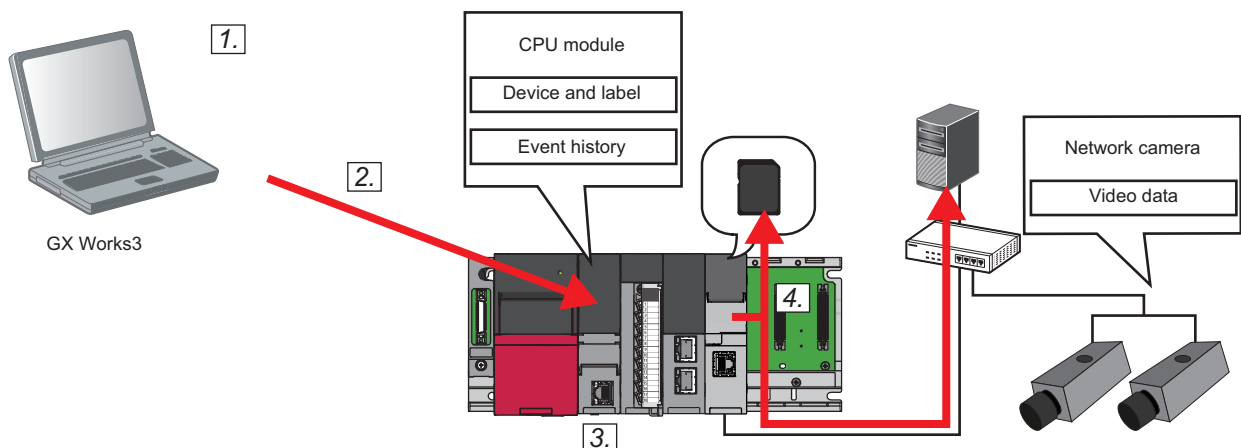

1. Set programs, parameters, and recording settings in GX Works3.
2. Write them to a CPU module.
3. Reset the CPU module or turn the power OFF and ON to switch the CPU module to RUN.

When the recording function is in preparation and the preparation is completed, the following operations start according to the recording settings.

- Sampling and accumulating devices and labels<sup>\*1</sup>
- Receiving and accumulating video data<sup>\*2</sup>

\*1 Link devices of a network module mounted on the base unit and values in the buffer memory of an intelligent function module can also be sampled and accumulated.

\*2 Does not start if the communication with a network camera is not established and video data is not delivered from the network camera. The timing when video data is delivered differs depending on the operating status, performance, and network configuration of a network camera.

#### 4. Satisfy a file saving trigger.

When the trigger is satisfied, accumulated data (devices, labels, and video data) and event history files saved in the CPU module are output to a recording file and saved to a save destination specified in the recording setting.

For the flow to save data, refer to the following:

 Page 58 Flow to save data

#### Point

- Up to four recording settings can be configured and the recording function can be performed for each setting at the same time.  
Configure multiple recording settings and perform the recording function in either of the following cases:
  - Setting multiple timings for data sampling, reception, and accumulation, such as each scan, per day, inter-module synchronization execution<sup>\*1</sup>, multiple CPU synchronization execution<sup>\*1</sup>, or safety program execution<sup>\*2</sup>
  - Accumulating data even while a file is being saved<sup>\*3\*4</sup> (The file can be saved without missing data by accumulating data in another recording setting.)
- To reproduce data properly on the offline monitor, the following information is checked for a match when starting the recording function. If it does not match, a recording setting error (error code: 3028H) occurs and the recording function does not start. In this case, write the recording setting to the CPU module again.
  - Project information<sup>\*5</sup> when the recording setting is configured (parameters and programs including device and label settings)
  - Parameters and programs written to the CPU module

However, when using a module with any of the following firmware versions, the recording function starts for the next time without a recording setting error even when changing the programs by performing the online program change or file batch online change while the recording function is running.

  - RnCPU or RnENCPU: '55' or later
  - RnSF CPU: '24' or later
  - Recorder module: '04' or later
  - Camera recorder module: '01' or later

\*1 Select "Trigger Instruction" for the sampling method and use the DATATRIG instruction in an inter-module synchronization or multiple CPU synchronization program.

 Page 44 Sampling methods of devices and labels

\*2 Supported for safety CPUs only.

\*3 Sampled and received data is not accumulated.

\*4 When using multiple recording settings in one module, a frame of video data being received may be lost if the video data is saved and received at the same time. To reduce the number of lost frames, refer to the following:

 Page 101 Operation setting at video data saving

\*5 Written to the recording setting.

## Precautions

- When using a module with any of the following firmware versions, select 'No' in the dialog displayed when enabling user authentication.  
If enabling the setting for communicating only with GX Works3 with an enhanced vulnerability measures version, an event history file is not saved.
  - RnSFCPU: '27' or later
  - Recorder module: '08' or earlier
  - Camera recorder module: '07' or earlier

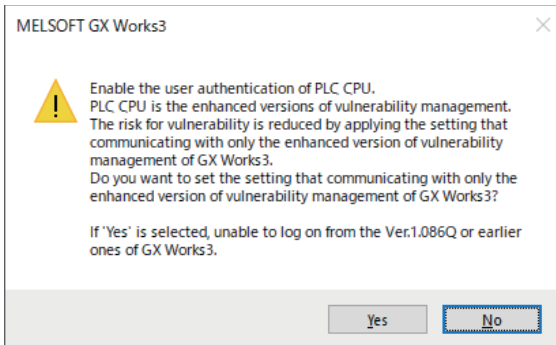

- Some functions are restricted depending on the version of a CPU module, recorder module/camera recorder module, or GX Works3. (☞ Page 307 Added and Changed Functions)

# Recording methods

The following table shows the recording methods.

Recording method	Description	Purpose
File saving trigger only	Data (devices, labels, and video data) after the operating status of the recording function switches to 'operating' can be sampled, received, and accumulated.	Select this method to check the status of a device before and after an error occurs in the device when the error occurrence timing is clear. (By specifying an error occurrence as a file saving trigger, the operating status of a device before and after the error occurs can be checked.)
Recording startup trigger + file saving trigger	Devices and labels after the operating status of the recording function switches to 'operating' and a recording startup trigger is satisfied can be accumulated for a specified period.	Select this method when the timing is different between when an error occurs and when it is detected, such as when an error occurs while a device is operating at regular intervals and it does not start operating at the next operation timing. (By using a recording startup trigger to specify a timing to start accumulating devices and labels and by including the timing when an error occurs in an accumulation period, the status of a device when it last operated can be checked.)

## File saving trigger only

This is a method for sampling, receiving, and accumulating data (devices, labels, and video data) after the operating status of the recording function switches to 'operating'.<sup>\*1</sup> (☞ Page 63 Operating status)

When a file saving trigger is satisfied, data accumulated during a period before and after the trigger is satisfied<sup>\*2</sup> is saved.<sup>\*3</sup> (☞ Page 28 File saving trigger)

A recording file is saved after a saving period elapses. Data accumulation stops during file saving and restarts after its completion.

- \*1 For video data, data reception and accumulation start when the operating status of the recording function switches to 'operating,' the communication with a network camera is established, and video data is delivered from the network camera.
- \*2 A period before or after a trigger is satisfied (saving period before trigger/saving period after trigger) can be set in the saving period setting in the recording setting.  
When setting the saving period after trigger to '0' seconds, a recording file is saved when a file saving trigger is satisfied.  
(☞ Page 116 Saving Period Setting)
- \*3 For video data, data accumulated approximately one second before the saving period may also be saved.

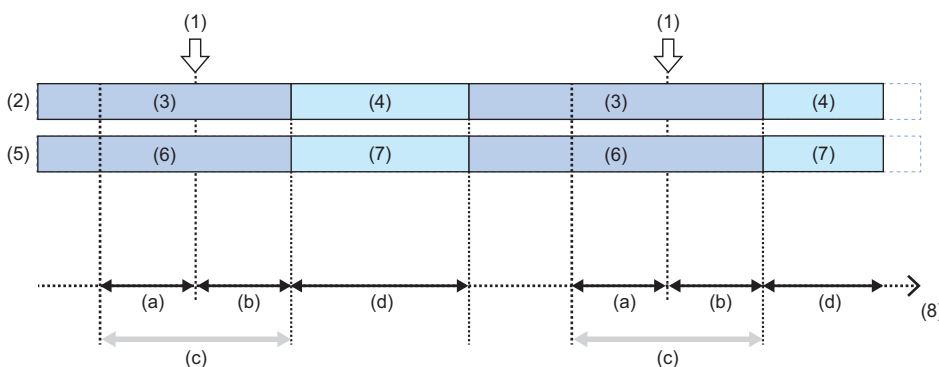

- (1) File saving trigger
- (2) Device and label
- (3) Sampling and accumulating
- (4) Sampling
- (5) Video data
- (6) Receiving and accumulating
- (7) Receiving
- (8) Time
- (a) Saving period before trigger
- (b) Saving period after trigger
- (c) Saving period
- (d) Period during which a recording file is saved

## ■When specifying CPU stop error detection as a file saving trigger

If a stop error is detected in a CPU module, accumulated data in the saving period before trigger is saved but data in the saving period after trigger is not saved.

When setting the saving period before trigger to '0' seconds, no data is saved because there is no data to save. Set the saving period before trigger to a length sufficient to sample, receive, and accumulate changed data.

The following shows an operation when specifying CPU stop error detection as a file saving trigger.

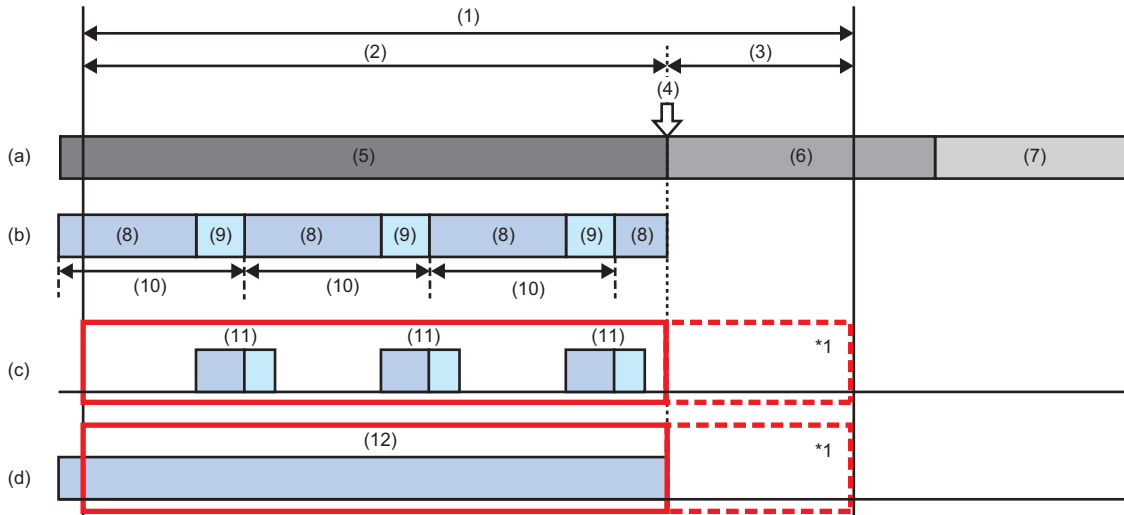

(1) Saving period before and after file saving trigger

(2) Saving period before trigger

(3) Saving period after trigger

(4) A CPU stop error is detected.

(5) Running

(6) Saving

(7) Stopped

(8) Program operation

(9) END processing

(10) Scan time

(11) Sampling and accumulating

(12) Receiving and accumulating

(a) Operating status of the recording function

(b) Scan execution program

(c) Device and label

(d) Video data

: Data to be saved

\*1 Data in the saving period after trigger is not saved.

## ■ If the communication with a network camera is disconnected

Video data cannot be received or accumulated.

Receiving and accumulating video data restart when a retry is successful.

If there is a period during which the communication is disconnected in a saving period, only video data in the period during which the communication is established can be saved.

The following shows the flow of receiving and accumulating video data if the communication with a network camera is disconnected.

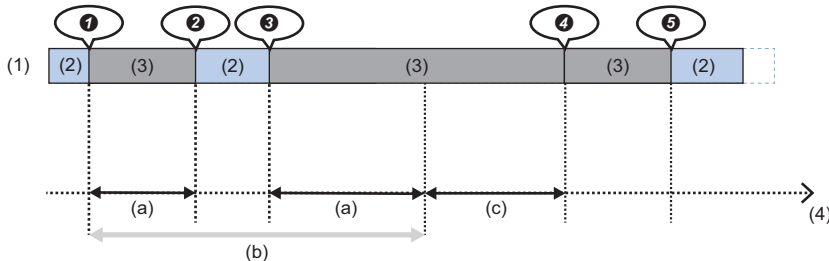

(1) Video data

(2) Receiving and accumulating

(3) Communication disconnected (Data cannot be received or accumulated.)

(4) Time

(a) Period during which video data cannot be saved

(b) Saving period

(c) Period during which a recording file is saved

❶ The communication is disconnected, and data reception and accumulation stop.

❷ A retry is successful, and the data reception and accumulation restart.

❸ The communication is disconnected, and the data reception and accumulation stop.

❹ The communication is disconnected; therefore, the data accumulation does not start even after the saving is completed (there is no video data, because accumulated video data is deleted when a recording file is saved).

❺ A retry is successful, and the data reception and accumulation restart.

### Point

- If the communication is disconnected, a communication retry start (event code: 00600) occurs.
- When a retry is successful, a communication retry recovery (event code: 00610) occurs.
- If the communication is disconnected for 10 seconds, a network camera communication error (error code: 1DF1H) occurs.
- Some network cameras stop delivering video data if disconnected for a long time.  
In this case, video data accumulated before the disconnection is discarded and video data accumulated after reception and accumulation restart is saved as a video file.

## ■ Considerations

- The saving period must be set to a length sufficient to sample, receive, and accumulate changed data.
- When switching a CPU module from RUN to STOP or stopping the recording function in the "Recording Monitor" screen or if a CPU stop error occurs in the CPU module during a saving period after trigger, data accumulated before the stop is saved. (☞ Page 142 RECORDING MONITOR)
- Only data after data sampling, reception, and accumulation started immediately before a file saving trigger is satisfied is saved, and data before that is not saved.
- If the time from when data sampling, reception, and accumulation start to when a file saving trigger is satisfied is shorter than a saving period before trigger, the total of the time and a saving period after trigger is regarded as a saving period.

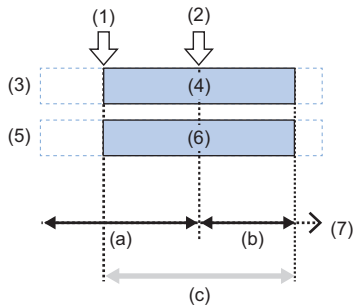

- (1) Data sampling, reception, and accumulation start
- (2) File saving trigger
- (3) Device and label
- (4) Sampling and accumulating
- (5) Video data
- (6) Receiving and accumulating
- (7) Time
- (a) Saving period before trigger
- (b) Saving period after trigger
- (c) Saving period

- Due to the time accuracy of a recorder module/camera recorder module, an error occurs between a set saving period and an actual one. For the time accuracy, refer to the following:

### ☞ MELSEC iQ-R System Recorder User's Manual (Startup)

- If the communication with a network camera is disconnected before a file saving trigger is satisfied, video data accumulated in the saving period before trigger may be saved.



## Recording startup trigger + file saving trigger

This is a method for accumulating devices and labels for a specified period<sup>\*1</sup> after the operating status of the recording function switches to 'operating' and a recording startup trigger is satisfied.<sup>\*2\*3</sup> (☞ Page 26 Recording startup trigger)

When a file saving trigger is satisfied, devices and labels accumulated after a recording startup trigger satisfied immediately before the file saving trigger are saved. (☞ Page 28 File saving trigger)

For video data, data reception and accumulation start when the operating status of the recording function switches to 'operating,' the communication with a network camera is established, and video data is delivered from the network camera. In addition, video data is saved for a period same as devices and labels when a file saving trigger is satisfied.<sup>\*4</sup>

A recording file is saved when a file saving trigger is satisfied.<sup>\*5</sup>

- \*1 Period from when a recording startup trigger is satisfied to when a time specified for "Saving Period After Recording Startup" in the saving period setting in the recording setting elapses  
☞ Page 116 Saving Period Setting
- \*2 Device and label sampling starts when the operating status of the recording function switches to 'operating.' (☞ Page 63 Operating status)
- \*3 Device and label accumulation stops after a specified period elapses and restarts after the recording startup trigger is satisfied again; however, the recording startup trigger is disabled during a certain period. (☞ Page 26 Period during which a recording startup trigger is enabled or disabled)
- \*4 For video data, data accumulated approximately one second before the saving period may also be saved.
- \*5 During file saving, video data accumulation stops, and restarts after the file saving is completed.

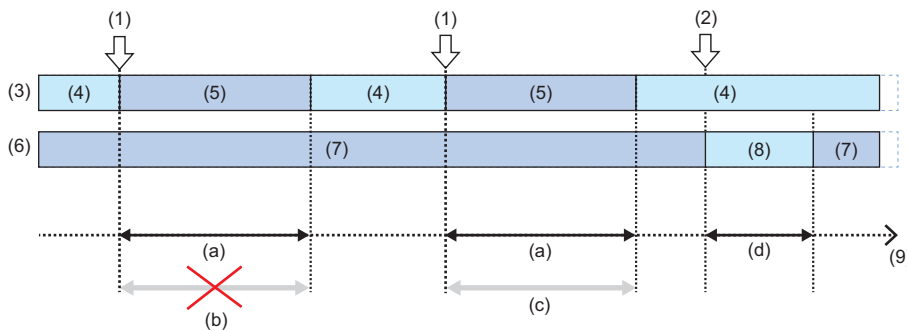

- (1) Recording startup trigger
- (2) File saving trigger
- (3) Device and label
- (4) Sampling
- (5) Sampling and accumulating
- (6) Video data
- (7) Receiving and accumulating
- (8) Receiving
- (9) Time
- (a) Set saving period
- (b) Period during which data is not saved
- (c) Period during which data is saved
- (d) Period during which a recording file is saved

## ■When specifying CPU stop error detection as a file saving trigger

If a stop error is detected in a CPU module, data accumulated before that is saved.

The following shows an operation when specifying CPU stop error detection as a file saving trigger.

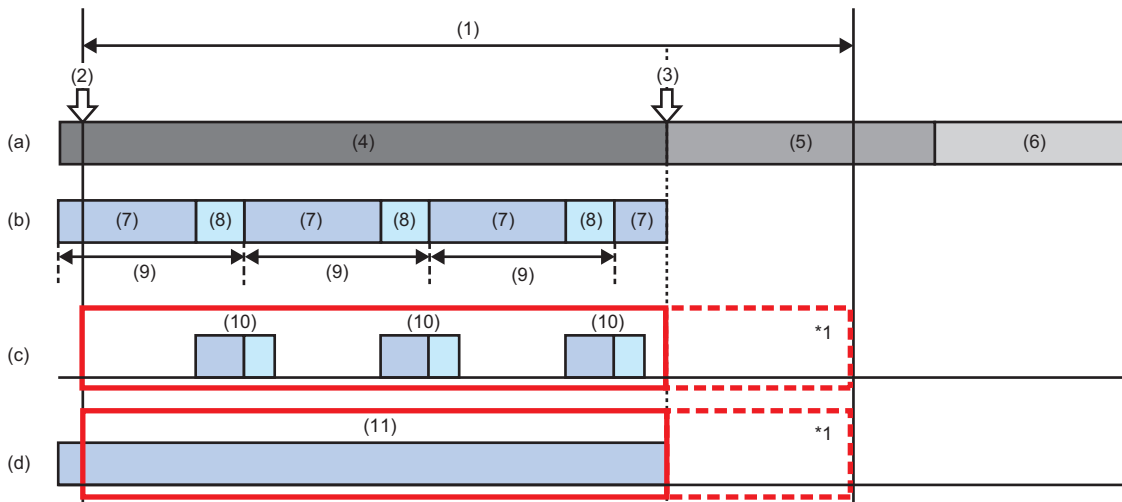

(1) Time after recording starts

(2) Recording startup trigger

(3) A CPU stop error is detected.

(4) Running

(5) Saving

(6) Stopped

(7) Program operation

(8) END processing

(9) Scan time

(10) Sampling and accumulating

(11) Receiving and accumulating

(a) Operating status of the recording function

(b) Scan execution program

(c) Device and label

(d) Video data

: Data to be saved

\*1 Data after a CPU stop error occurs is not saved.

## ■If the communication with a network camera is disconnected

For an operation in this case, refer to the following:

📄 Page 21 If the communication with a network camera is disconnected

## ■ Considerations

- The saving period must be set to a length sufficient to sample, receive, and accumulate changed data.
- If a file saving trigger is satisfied between when a recording startup trigger is satisfied and when a specified period elapses, data for the specified period is saved to a save destination specified in the recording setting when it is accumulated.

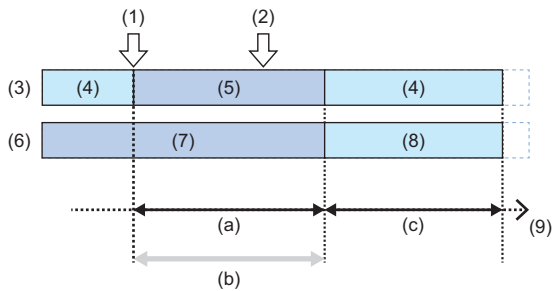

- (1) Recording startup trigger
- (2) File saving trigger
- (3) Device and label
- (4) Sampling
- (5) Sampling and accumulating
- (6) Video data
- (7) Receiving and accumulating
- (8) Receiving
- (9) Time
- (a) Set saving period
- (b) Saving period
- (c) Period during which a recording file is saved

- When switching a CPU module from RUN to STOP or stopping the recording function in the "Recording Monitor" screen or if a CPU stop error occurs in the CPU module between when a file saving trigger is satisfied and when a specified period elapses, data accumulated before the stop is saved. (📖 Page 142 RECORDING MONITOR)
- Due to the time accuracy of a recorder module/camera recorder module, an error occurs between a set saving period and an actual one. For the time accuracy, refer to the following:

📖 MELSEC iQ-R System Recorder User's Manual (Startup)

## Recording startup trigger

A recording startup trigger is used to start device and label accumulation, and satisfied when a specified device<sup>\*1</sup> rises or falls.

(☞ Page 63 Operating status)

Whether a recording startup trigger is satisfied is determined for each unit of END processing in sequence scans.<sup>\*2</sup>

\*1 For devices that can be specified, refer to the following:

☞ Page 43 Devices that can be specified as triggers

\*2 If a CPU module is operating with the constant scan set, whether a trigger is satisfied is determined between the execution of the END processing and the start of the next scan.

If the maximum scan time for a program becomes longer than the set constant scan time, whether a trigger is satisfied is determined during the END processing after the scan time for the program.

## Precautions

- Start the recording function and check that its operating status switches to 'operating' then satisfy a recording startup trigger. The operating status can be checked in 'In recording operation' (Un\G1501, Un\G1701, Un\G1901, Un\G2101)<sup>\*1</sup> of a recorder module/camera recorder module. (☞ Page 221 Recording status area (Un\G1500 to 3199), Page 271 Recording status area (Un\G1500 to 3199))

\*1 Buffer memory of a module set as the main one when configuring multiple modules

☞ Page 67 Operation of the recording function when configuring multiple modules

- If a recording startup trigger is satisfied again after it is satisfied and devices and labels are accumulated, the accumulated ones are discarded and the accumulation restarts.

## ■Period during which a recording startup trigger is enabled or disabled

A recording startup trigger is enabled except the period from when a file saving trigger is satisfied to when saving a recording file is completed.

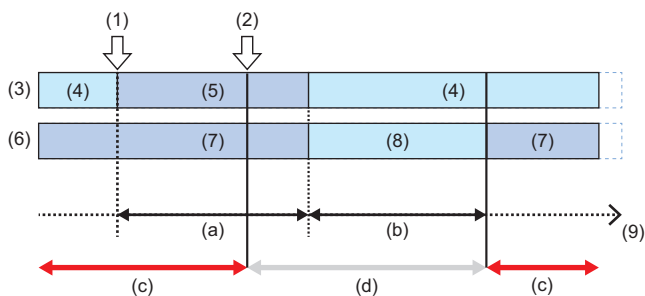
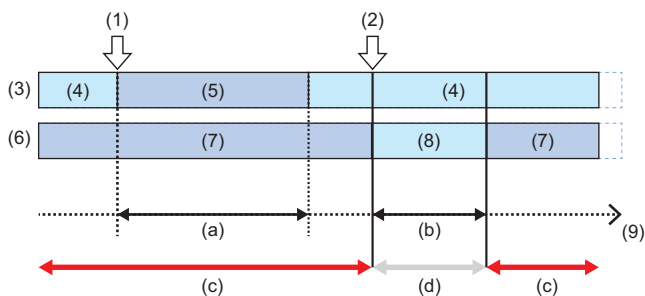

- (1) Recording startup trigger
- (2) File saving trigger
- (3) Device and label
- (4) Sampling
- (5) Sampling and accumulating
- (6) Video data
- (7) Receiving and accumulating
- (8) Receiving
- (9) Time
- (a) Saving period
- (b) Period during which a recording file is saved
- (c) Period during which the recording startup trigger is enabled
- (d) Period during which the recording startup trigger is disabled

Whether a recording startup trigger is enabled or disabled can be checked with the combination of the values in the following buffer memories<sup>\*1</sup> of a recorder module/camera recorder module. (☞ Page 221 Recording status area (Un\G1500 to 3199), Page 271 Recording status area (Un\G1500 to 3199))

\*1 Buffer memory of a module set as the main one when configuring multiple modules  
☞ Page 67 Operation of the recording function when configuring multiple modules

Buffer memory			Recording startup trigger
Data sampling	Recording buffer storing status	File saving trigger monitor	
0 (not sampling)	0 (no data)	0 (unsatisfied)	Enabled
		1 (satisfied)	Disabled
	1 (data exists)	0 (unsatisfied)	Enabled
		1 (satisfied)	Disabled
1 (sampling)	0 (no data)	0 (unsatisfied)	Enabled
		1 (satisfied)	Disabled
	1 (data exists)	0 (unsatisfied)	Enabled
		1 (satisfied)	Disabled

### Point









The number of detected or disabled triggers can be checked in 'Recording startup trigger count' (Un\G1575, Un\G1775, Un\G1975, Un\G2175)<sup>\*2</sup> or 'Invalid recording startup trigger count' (Un\G1576, Un\G1776, Un\G1976, Un\G2176)<sup>\*2</sup> of a recorder module/camera recorder module. (☞ Page 221 Recording status area (Un\G1500 to 3199), Page 271 Recording status area (Un\G1500 to 3199))

\*2 Buffer memory of a module set as the main one when configuring multiple modules  
☞ Page 67 Operation of the recording function when configuring multiple modules

## File saving trigger

A file saving trigger is used to specify when to save accumulated data, and satisfied at any of the following timings. (  Page 60 Recording buffer, Page 63 Operating status)

When a file saving trigger is satisfied in multiple recording settings, data is saved in order from a setting that can be saved.

Type	Description	Timing when a trigger is determined and satisfied
Rise, fall, or timeout of a specified device	<p>A trigger is satisfied by setting a device and condition in the file saving trigger setting and when the condition is met.</p> <ul style="list-style-type: none"> <li>• Rise: A trigger is satisfied when a specified device rises.</li> <li>• Fall: A trigger is satisfied when a specified device falls.</li> <li>• Timeout<sup>*1</sup>: A trigger is satisfied when there is no change in a specified device within a set timeout time.</li> </ul> <p>Conditions can be set for multiple devices, and a condition number is added to each of them. (Up to 16 conditions can be set.)</p> <p> Page 134 File Saving Trigger Setting</p> <p>For the devices that can be specified, refer to the following:</p> <p> Page 43 Devices that can be specified as triggers</p>	<ul style="list-style-type: none"> <li>• Rise: A trigger is satisfied when a specified device is determined to be a rise during the END processing in a sequence scan.<sup>*2</sup></li> <li>• Fall: A trigger is satisfied when a specified device is determined to be a fall during the END processing in a sequence scan.<sup>*2</sup></li> <li>• Timeout: A trigger is satisfied when the time after the value in a specified device changes is measured and a set time elapses during recording operation.</li> </ul>
Rise of the value in a specified buffer memory	<p>A trigger is satisfied when each bit rises in the following buffer memory<sup>*3</sup> of a recorder module/camera recorder module. (A condition number is added to each bit.)</p> <p> Page 228 File saving trigger (Un/G4007)</p>	<p>A trigger is satisfied when the value in the buffer memory is determined to be a rise during the END processing in a sequence scan.<sup>*2</sup></p>
Lapse of a specified time after the completion of data accumulation	<p>A trigger is satisfied when a set time elapses after a recording startup trigger is satisfied and data for a period is accumulated.</p> <p>This type can be set only when selecting "Recording Startup Trigger + File Saving Trigger" for the recording method.</p> <p>Due to the time accuracy of a recorder module/camera recorder module, an error occurs between a set timing and an actual one. For the time accuracy, refer to the following:</p> <p> IMELSEC iQ-R System Recorder User's Manual (Startup)</p>	<p>A trigger is satisfied when the time after a recording startup trigger is satisfied is measured and a set time elapses during recording operation.</p>
File saving in the "Recording Monitor" screen	<p>A trigger is satisfied when saving a file in the "Recording Monitor" screen.</p>	<p>A trigger is satisfied when a request is determined to have been received during the END processing in a sequence scan.<sup>*2</sup></p>
CPU stop error detection	<p>A trigger is satisfied when a CPU stop error is detected.</p> <p>For an operation when selecting "File Saving Trigger Only" for the recording method, refer to the following:</p> <p> Page 20 When specifying CPU stop error detection as a file saving trigger</p> <p>For an operation when selecting "Recording Startup Trigger + File Saving Trigger" for the recording method, refer to the following:</p> <p> Page 24 When specifying CPU stop error detection as a file saving trigger</p>	<p>A trigger is satisfied when a CPU stop error occurrence is detected during recording operation.</p>
Camera event detection	<p>A trigger is satisfied when a camera event detected by a network camera is received.</p> <p>This type can be set only when using a camera recorder module.</p> <p>Camera events can be set for multiple camera recorder modules and network cameras.</p> <p>When using four camera recorder modules set as sub ones and connecting four network cameras to each of them, up to 16 camera events can be set as triggers.</p> <p>For details on camera events, refer to the following:</p> <p> Page 239 Camera event reception</p> <p>For the camera event notification and setting method, refer to the following:</p> <p> Page 242 Camera event function</p>	<p>A trigger is satisfied when a camera event is determined to have been received during the END processing in a sequence scan.<sup>*2</sup></p>
Co-recording	<p>A trigger is satisfied when a co-recording trigger is received.</p> <p>For details on co-recording triggers, refer to the following:</p> <p> IMELSEC iQ-R System Recorder Co-recording Function Reference Manual</p>	<p>A trigger is satisfied when a co-recording trigger is received from another recording target device.</p>

\*1 For the considerations when specifying a timeout, refer to the following:

 Page 83 When specifying a timeout as a condition for satisfying a file saving trigger

\*2 If a CPU module is operating with the constant scan set, whether a trigger is satisfied is determined between the execution of the END processing and the start of the next scan.

If the maximum scan time for a program becomes longer than the set constant scan time, whether a trigger is satisfied is determined during the END processing after the scan time for the program.

\*3 Buffer memory of a module set as the main one when configuring multiple modules

 Page 67 Operation of the recording function when configuring multiple modules

## ■ Position where a file saving trigger is satisfied

The timing when a file saving trigger is satisfied is associated with that of device and label sampling and saved to a recording file, and can be checked as the position where the file saving trigger is satisfied on the offline monitor.\*1

The position where a file saving trigger is satisfied is displayed on the offline monitor as follows:

- When selecting "Each Scan" for the sampling method: Same timing as device and label sampling
- When selecting an item other than "Each Scan" for the sampling method: Same timing as device and label sampling immediately before a trigger is satisfied

\*1 The position can be checked with a trigger position marker even when playing a video file in GX VideoViewer.

The position where it is displayed is the same as the position where the file saving trigger is satisfied.

For details on the trigger position marker, refer to the following:

 GX VideoViewer Version 1 Operating Manual

### Point

Establishment of a trigger condition is registered as an event; therefore, its timing can be checked when reproducing data on the offline monitor.

Completion of saving a recording file is also registered as an event, but an event history is not output to the saved recording file.

## Precautions

Start the recording function and check that its operating status switches to 'operating' then satisfy a file saving trigger if data is accumulated in the recording buffer. The operating status can be checked in 'In recording operation' (Un\G1501, Un\G1701, Un\G1901, Un\G2101)\*1 of a recorder module/camera recorder module. ( Page 221 Recording status area (Un\G1500 to 3199), Page 271 Recording status area (Un\G1500 to 3199))

\*1 Buffer memory of a module set as the main one when configuring multiple modules

 Page 67 Operation of the recording function when configuring multiple modules

## ■Period during which a file saving trigger is enabled or disabled

This period differs depending on the recording method.

- When selecting "File Saving Trigger Only" for the recording method

A file saving trigger is enabled except the period from when it is satisfied to when saving a recording file is completed.

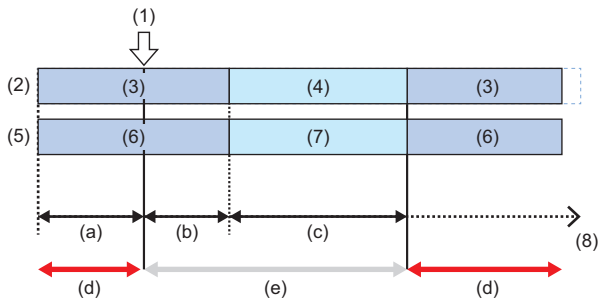

(1) File saving trigger

(2) Device and label

(3) Sampling and accumulating

(4) Sampling

(5) Video data

(6) Receiving and accumulating

(7) Receiving

(8) Time

(a) Saving period before trigger

(b) Saving period after trigger

(c) Period during which a recording file is saved

(d) Period during which the file saving trigger is enabled

(e) Period during which the file saving trigger is disabled

Whether a file saving trigger is enabled or disabled can be checked in 'File saving trigger monitor' (Un\G1504, Un\G1704, Un\G1904, Un\G2104)<sup>\*1</sup> of a recorder module/camera recorder module. (☞ Page 221 Recording status area (Un\G1500 to 3199), Page 271 Recording status area (Un\G1500 to 3199))

\*1 Buffer memory of a module set as the main one when configuring multiple modules

☞ Page 67 Operation of the recording function when configuring multiple modules

### Point

The number of detected or disabled triggers can be checked in 'File saving trigger count' (Un\G1577, Un\G1777, Un\G1977, Un\G2177)<sup>\*2</sup> or 'Invalid file saving trigger count' (Un\G1578, Un\G1778, Un\G1978, Un\G2178)<sup>\*2</sup> of a recorder module/camera recorder module. (☞ Page 221 Recording status area (Un\G1500 to 3199), Page 271 Recording status area (Un\G1500 to 3199))

\*2 Buffer memory of a module set as the main one when configuring multiple modules

☞ Page 67 Operation of the recording function when configuring multiple modules



- When selecting "Recording Startup Trigger + File Saving Trigger" for the recording method

A file saving trigger is enabled except the period from when it is satisfied to when saving a recording file is completed.

However, if a recording startup trigger is not satisfied after the recording function starts running or file saving is completed, the file saving trigger is disabled.\*1

\*1 Enabled if it is satisfied at the same time as a recording startup trigger.

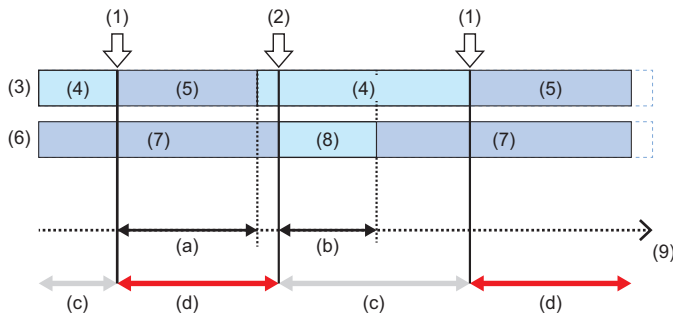

- (1) Recording startup trigger
- (2) File saving trigger
- (3) Device and label
- (4) Sampling
- (5) Sampling and accumulating
- (6) Video data
- (7) Receiving and accumulating
- (8) Receiving
- (9) Time
- (a) Saving period
- (b) Period during which a recording file is saved
- (c) Period during which the file saving trigger is disabled
- (d) Period during which the file saving trigger is enabled

Whether a file saving trigger is enabled or disabled can be checked with the combination of the values in the following buffer memories\*1 of a recorder module/camera recorder module. (Page 221 Recording status area (Un\G1500 to 3199), Page 271 Recording status area (Un\G1500 to 3199))

\*1 Buffer memory of a module set as the main one when configuring multiple modules  
 Page 67 Operation of the recording function when configuring multiple modules

Buffer memory			File saving trigger
Data sampling	Recording buffer storing status	File saving trigger monitor	
0 (not sampling)	0 (no data)	0 (unsatisfied)	Disabled*2
		1 (satisfied)	Disabled
	1 (data exists)	0 (unsatisfied)	Enabled
		1 (satisfied)	Disabled
1 (sampling)	0 (no data)	0 (unsatisfied)	Enabled
		1 (satisfied)	Disabled
	1 (data exists)	0 (unsatisfied)	Enabled
		1 (satisfied)	Disabled

\*2 Enabled if it is satisfied at the same time as a recording startup trigger.

**Point**

The number of detected or disabled triggers can be checked in 'File saving trigger count' (Un\G1577, Un\G1777, Un\G1977, Un\G2177)\*3 or 'Invalid file saving trigger count' (Un\G1578, Un\G1778, Un\G1978, Un\G2178)\*3 of a recorder module/camera recorder module. (Page 221 Recording status area (Un\G1500 to 3199), Page 271 Recording status area (Un\G1500 to 3199))

\*3 Buffer memory of a module set as the main one when configuring multiple modules  
 Page 67 Operation of the recording function when configuring multiple modules

# Target data

The following shows data used for the recording function.

## List of devices and labels that can be sampled for each sampling method

Devices and labels that can be sampled differ depending on the sampling method.

For details on each sampling method, refer to the following:

 Page 44 Sampling methods of devices and labels

○: Can be sampled, ×: Cannot be sampled

Sampling method	Standard device	Standard label	Safety device <sup>*1</sup>	Safety label <sup>*1</sup>	Standard/safety shared label <sup>*1</sup>
Each scan	○	○	○	○	○
Time specification	○	○	○	○	○
Trigger instruction	○	○	○	○	○
Safety cycle time	×	×	○	○	○

\*1 Can be sampled when using a safety CPU.

## Devices and labels that can be sampled

The following table shows the devices and labels that can be sampled by using the recording function.

For the method for specifying a device and label to be sampled, refer to the following:

 Page 36 Specifying a device and label to be sampled

## ■ Devices that can be sampled

The following table shows the devices that can be sampled.

Note that digit-specified bit devices, indirect-specified devices, and index-modified devices cannot be specified.

Device name (device)	Sampling unit (point)	Size (word)	Remarks	
User device <sup>*1</sup>	Input (X) <sup>*2</sup>	512	32	When specifying a DX, an X is sampled.
	Output (Y) <sup>*2</sup>	512	32	When specifying a DY, a Y is sampled.
	Internal relay (M/#M) <sup>*2</sup>	512	32	—
	Link relay (B) <sup>*2</sup>	512	32	—
	Annunciator (F) <sup>*2</sup>	512	32	—
	Link special relay (SB) <sup>*2</sup>	512	32	—
	Edge relay (V/#V) <sup>*2</sup>	512	32	—
	Timer (T/#T)	32	36	<ul style="list-style-type: none"> <li>When specifying a T, a contact (TS), coil (TC), and current value (TN) are sampled.</li> <li>Even when specifying a TS, TC, or TN individually, all of them are sampled.</li> </ul>
	Retentive timer (ST/#ST)	32	36	<ul style="list-style-type: none"> <li>When specifying an ST, a contact (STS), coil (STC), and current value (STN) are sampled.</li> <li>Even when specifying an STS, STC, or STN individually, all of them are sampled.</li> </ul>
	Long timer (LT/#LT)	8	32	<ul style="list-style-type: none"> <li>When specifying an LT, a contact (LTS), coil (LTC), and current value (LTN) are sampled.</li> <li>Even when specifying an LTS, LTC, or LTN individually, all of them are sampled.</li> </ul>
	Long retentive timer (LST/#LST)	8	32	<ul style="list-style-type: none"> <li>When specifying an LST, a contact (LSTS), coil (LSTC), and current value (LSTN) are sampled.</li> <li>Even when specifying an LSTS, LSTC, or LSTN individually, all of them are sampled.</li> </ul>
	Counter (C/#C)	32	36	<ul style="list-style-type: none"> <li>When specifying a C, a contact (CS), coil (CC), and current value (CN) are sampled.</li> <li>Even when specifying a CS, CC, or CN individually, all of them are sampled.</li> </ul>
	Long counter (LC/#LC)	32	68	<ul style="list-style-type: none"> <li>When specifying an LC, a contact (LCS), coil (LCC), and current value (LCN) are sampled.</li> <li>Even when specifying an LCS, LCC, or LCN individually, all of them are sampled.</li> </ul>
	Data register (D/#D) <sup>*3</sup>	32	32	—
Link register (W) <sup>*3</sup>	32	32	—	
Link special register (SW) <sup>*3</sup>	32	32	—	
Latch relay (L) <sup>*2</sup>	512	32	—	
System device <sup>*1</sup>	Special relay (SM) <sup>*2</sup>	512	32	—
	Special register (SD) <sup>*3</sup>	32	32	—
File register <sup>*1</sup>	(R) <sup>*3</sup>	32	32	—
	(ZR) <sup>*3</sup>	32	32	
Index register (Z, LZ) <sup>**5</sup>		24	24	<ul style="list-style-type: none"> <li>Even when specifying a Z or an LZ individually, all of them are sampled.</li> <li>Z or LZ is sampled in 24-word units even when specifying it individually.</li> </ul>
Refresh data register (RD) <sup>**3</sup>		32	32	—
Module access device (Un\G) <sup>**3</sup>		32	32	—
CPU buffer memory access device <sup>*1</sup>	(U3EnG) <sup>*3</sup>	32	32	—
	(U3EnHG) <sup>*3</sup>	32	32	—

Device name (device)		Sampling unit (point)	Size (word)	Remarks
Link direct device*1	Link input (Jn\X) <sup>2</sup>	512	32	—
	Link output (Jn\Y) <sup>2</sup>	512	32	—
	Link relay (Jn\B) <sup>2</sup>	512	32	—
	Link register (Jn\W) <sup>3</sup>	32	32	—
	Link special relay (Jn\SB) <sup>2</sup>	512	32	—
	Link special register (Jn\SW) <sup>3</sup>	32	32	—
Safety user device*4	Safety input (SA\X) <sup>2</sup>	512	32	—
	Safety output (SA\Y) <sup>2</sup>	512	32	—
	Safety internal relay (SA\I/SA\#M) <sup>2</sup>	512	32	—
	Safety link relay (SA\B) <sup>2</sup>	512	32	—
	Safety link register (SA\W) <sup>3</sup>	32	32	—
	Safety timer (SA\T/SA\#T)	32	36	<ul style="list-style-type: none"> <li>When specifying an SA\T, a contact (SA\TS), coil (SA\TC), and current value (SA\TN) are sampled.</li> <li>Even when specifying an SA\TS, SA\TC, or SA\TN individually, all of them are sampled.</li> </ul>
	Safety retentive timer (SA\ST/SA\#ST)	32	36	<ul style="list-style-type: none"> <li>When specifying an SA\ST, a contact (SA\STS), coil (SA\STC), and current value (SA\STN) are sampled.</li> <li>Even when specifying an SA\STS, SA\STC, or SA\STN individually, all of them are sampled.</li> </ul>
	Safety counter (SA\C/SA\#C)	32	36	<ul style="list-style-type: none"> <li>When specifying an SA\C, a contact (SA\CS), coil (SA\CC), and current value (SA\CN) are sampled.</li> <li>Even when specifying an SA\CS, SA\CC, or SA\CN individually, all of them are sampled.</li> </ul>
Safety data register (SA\D/SA\#D) <sup>3</sup>	32	32	—	
Safety system device*4	Safety special relay (SA\SM) <sup>2</sup>	512	32	—
	Safety special register (SA\SD) <sup>3</sup>	32	32	—
Other devices	Step relay with block specification (BL□\S) <sup>6</sup>	1	1	The start device is a multiple of 16 points, and the end device is variable in one bit units.

\*1 Cannot be sampled when selecting "Safety Cycle Time" for "Sampling Method."

\*2 When the number of device points is set to 512 points or less in the CPU parameter, the set number of points is sampled (the minimum is 64 points (bits)).

\*3 When the number of device points is set to 32 points or less in the CPU parameter, the set number of points is sampled (the minimum is 4 points (words)).

\*4 Can be sampled only when using a safety CPU.

\*5 Neither local index register nor local long index register can be specified.

When specifying either of them in a program, an index register or a long index register is sampled as a global device.

In addition, 32-bit index modification with ZZ expression cannot be specified.

\*6 When using 'include SFC device' of 'device/label batch specification,' information for the system is also sampled for displaying a program for monitoring in an SFC diagram on the offline monitor. (Page 40 When using 'include SFC device' of 'device/label batch specification')

SFC block devices (BL) in a ladder program or Zoom can be monitored only when selecting the above method.

## Precautions

When sampling file registers (R/ZR), select an item to use them in the file register setting in the CPU parameter.

If target file registers (R/ZR) do not exist at the time of sampling, intended values may not be sampled.

Do not change the file name or block number of a file register after the recording function starts running. Otherwise, the recording function may not run normally and a recording result may not be reproduced properly.

### ■Labels that can be sampled

Labels are sampled in 32-word units.

Bit type (BOOL) and word type (WORD) in a program are calculated as 32 points in a word conversion; therefore, a label that is not used in a program may be included in the sampling target.

When the label size is set to 32 points (words) or less, the set label size is sampled (the minimum is 4 points (words)).

Note that any labels cannot be specified individually.

Label name	Class	Size (word)	Data type
Global label <sup>*1*2</sup>	VAR_GLOBAL, VAR_GLOBAL_RETAIN	32	<ul style="list-style-type: none"> <li>■Simple data type               <ul style="list-style-type: none"> <li>• Bit</li> <li>• Word (signed)</li> <li>• Double word (signed)</li> <li>• Word (unsigned)</li> <li>• Double word (unsigned)</li> <li>• Float (single precision)</li> <li>• Float (double precision)</li> <li>• Time</li> </ul> </li> <li>• String</li> <li>• Timer</li> <li>• Retentive timer</li> <li>• Counter</li> <li>• Long timer</li> <li>• Long retentive timer</li> <li>• Long counter</li> <li>■Array</li> <li>■Structure</li> </ul>
Safety global label <sup>*2*3</sup>	VAR_GLOBAL	32	
Local label <sup>*1</sup>	VAR, VAR_RETAIN, VAR_INPUT, VAR_OUTPUT, VAR_OUTPUT_RETAIN, VAR_IN_OUT, VAR_PUBLIC, VAR_PUBLIC_RETAIN	32	
Safety local label <sup>*3</sup>	VAR, VAR_INPUT, VAR_OUTPUT, VAR_IN_OUT, VAR_PUBLIC	32	
Module label <sup>*1*4</sup>	—	32	
Standard/safety shared label <sup>*2*3</sup>	VAR_GLOBAL	32	

\*1 Cannot be sampled when selecting "Safety Cycle Time" for "Sampling Method."

\*2 When a device is assigned to a global label, safety global label, or standard/safety shared label, target data is treated as a device.

\*3 Can be sampled when using a safety CPU.

\*4 When a device (X, Y, or Un\G) is assigned to a module label, target data is treated as a device.

## Precautions

When sampling a global label to which a file register (R/ZR) is assigned, do not change the file name or block number of the file register after the recording function starts running. Otherwise, the recording function may not run normally and a recording result may not be reproduced properly.

## Specifying a device and label to be sampled

The following table shows the specification methods of devices and labels to be sampled.

Specification method	Description	Purpose	Screen	
Device/label batch specification	—	<p>Devices and labels used in a program can be specified as sampling targets in a batch.</p> <p>When enabling this method, devices and labels used in all programs and FBs set in the program setting and FB/FUN setting in the CPU parameter are sampled.</p> <p>■Target program<sup>*1*2*3</sup> Ladder, ST, SFC<sup>*4</sup>, and FBD/LD</p> <p>■Target data</p> <p>Refer to the following: ☞ Page 39 Target data in a program</p>	Use this method to easily sample devices and labels used in a program.	☞ Page 117 Device/Label Sampling Setting
	Include the parameter	<p>Select this method to also include devices and labels used in the CPU parameter or module parameter in the sampling target.</p> <p>■Target data</p> <p>Refer to the following: ☞ Page 41 Target data in a parameter</p>	<p>Use this method to easily sample devices and labels specified in a parameter.</p> <p>This method can also be used to check the module status if a trouble occurs.</p>	
	Include SFC device <sup>*5</sup>	<p>Select this method to also include the following in the sampling target.<sup>*6</sup></p> <ul style="list-style-type: none"> <li>• Active status of a block or step in an SFC program</li> <li>• SFC block device (BL) and step relay with block specification (BL□\S) used in a ladder program, etc.</li> </ul>	Use this method when using an SFC program (including when using an SFC device in a ladder program, etc.).	
Specify from the device/label list	—	<p>Any devices and labels can be specified as sampling targets from the list of devices and labels used in a program.</p> <p>■Target program<sup>*1*2*3*7</sup> Ladder, ST, SFC, and FBD/LD</p> <p>■Target data</p> <p>Refer to the following: ☞ Page 39 Target data in a program</p>	<p>Use this method in any of the following cases:</p> <ul style="list-style-type: none"> <li>• Narrowing down devices and labels to be sampled to shorten the sampling time or lengthen the saving period</li> <li>• Configuring multiple recording settings</li> <li>• Sampling data at a fixed cycle such as when using an interrupt program (when specifying "Trigger Instruction")</li> </ul>	☞ Page 119 "Specify from the Device/Label List" screen
	Include devices/labels used in parameter setting	<p>Select this method to display devices and labels used in the CPU parameter or module parameter in the list and specify any devices and labels as sampling targets.</p> <p>■Target data</p> <p>Refer to the following: ☞ Page 41 Target data in a parameter</p>		

Specification method	Description	Purpose	Screen
Specify the device range	Devices to be sampled can be specified individually.	Use this method in any of the following cases: <ul style="list-style-type: none"> <li>• Adding data not sampled by using 'device/label batch specification' and 'specify from the device/label list'</li> <li>• Configuring multiple recording settings</li> <li>• Sampling data at a fixed cycle such as when using an interrupt program (when specifying "Trigger Instruction")</li> <li>• Specifying a step in an SFC program not sampled by using 'include SFC device' of 'device/label batch specification'</li> </ul>	 Page 131 "Specify the Device Range" screen

- \*1 The following types of programs are excluded from the targets:  
Program the execution type of which is "No Execution Type"  
Unregistered program  
Unconverted program  
Program that is registered in the program setting in the CPU parameter but does not exist in the navigation window
- \*2 FUNs are not targets and only FBs used in a program are targets.
- \*3 Standard programs and standard FBs are not targets when selecting "Safety Cycle Time" for "Sampling Method."
- \*4 Zooms are targets. To include SFC diagrams in the target, select 'include SFC device.'
- \*5 Can be selected when using only one SFC program.
- \*6 Steps from the initial step (S0) to the maximum step number in each block in a created SFC program are included in the sampling target. Therefore, even if a step after the maximum step number in each block in an SFC program is used in a ladder program, it is not included in the sampling target.
- \*7 Devices and labels used in the following type of program do not appear in the "Specify from the Device/Label List" screen.  
Program that is secured and cannot be displayed

### Point

- By default, 'device/label batch specification' is enabled.  
In this case, all devices and labels in a program are set as sampling targets and they are automatically set as sampling targets even when adding or changing the program after configuring the recording setting. However, depending on an instruction used in the program, only the start device is set as a sampling target and all devices and labels used by the instruction may not be set.  
Specify sampling targets by using 'specify the device range' as necessary.
  - When specifying devices and labels in a batch, those numbers increase and the scan time becomes longer. Disable 'device/label batch specification' and use 'specify from the device/label list' or 'specify the device range' to specify only required devices and labels among those specified by using 'device/label batch specification' as sampling targets. Also, delete unnecessary programs from a project.
  - When configuring multiple recording settings or sampling data at a fixed cycle such as when using an interrupt program (when specifying "Trigger Instruction"), disable 'device/label batch specification' and use 'specify from the device/label list' or 'specify the device range' to specify only required devices and labels among those specified by using 'device/label batch specification' as sampling targets. If 'device/label batch specification' is enabled, the number of devices and labels to be sampled increases and the scan time becomes longer.
  - For using a global label, assign a device and use 'specify the device range' to specify the assigned device.
  - When not using 'include SFC device' of 'device/label batch specification,' the following operations are restricted on the offline monitor of GX Works3: displaying the retention status of a step in an SFC diagram, displaying SFC block devices (BL) on a circuit monitor, and monitoring the SFC block list and active steps.
- For details, refer to the following:

 GX Works3 Operating Manual

**Ex.**

Use 'specify from the device/label list' or 'specify the device range' in the following cases:

Case		Remarks
Sampling a device not sampled by using 'device/label batch specification'	Specifying index modification or indirect specification in a program	—
	Sampling data such as control data in an area required for the operation of an instruction	
	Specifying a device for a numerical value (n) such as the number of devices, transfers, units of data, or character strings	
Sampling a step in an SFC program not sampled by using 'include SFC device' of 'device/label batch specification'	Including multiple SFC programs	
	Specifying a step after the maximum step number in each block in an SFC program in a program (adding a block and step in the future)	
Sampling values in the buffer memory not used in a program such as data for monitoring a module (using for troubleshooting)		
Sampling parameters not used in a program		
Configuring multiple recording settings		Disable 'device/label batch specification' and specify only required devices as sampling targets to reduce the size of data to be sampled.
Sampling data at a fixed cycle such as when using an interrupt program (when specifying "Trigger Instruction")		

**Point**

When specifying devices and labels used in a project as sampling targets, the scan time can be shortened by selecting 'specify from the device/label list' and specifying required devices and labels only.

For the operation to specify sampling targets from the device/label list, refer to the following:

 Page 119 "Specify from the Device/Label List" screen



## ■ Target data in a program

When specifying a sampling target by using 'device/label batch specification' or 'specify from the device/label list,' the following types of data in a target program are to be sampled.

To sample a device not included in the following data, specify it by using 'specify the device range.'

Target data	Remarks
Start of data specified as an operand	☞ Examples of sampling targets for each instruction and operand
Range of devices according to the data type for an operand (number of elements)	Only when the data size is determined (excluding the string type)
Range of devices specified by an operand (n) (number of elements)	Only when the range is specified by a constant*1
Range of labels according to the data type of a label specified as an operand	☞ Examples of sampling targets for each instruction and operand
Device/label specified as an SFC information device	—

\*1 Excluding character strings and VAR\_CONSTANT

- Examples of sampling targets for each instruction and operand

For instructions that can determine the range of devices and labels when specified, target data within the range is sampled.

For the instructions, refer to the following:

☞ Page 300 Instruction List

For instructions that cannot determine the range of devices and labels when specified (ones not included in 'List of Instructions that can Determine the Range of Devices and Labels When Specified'), standard FUNs, and standard FBs, refer to the definition of each operand.

If a constant (excluding a character string and VAR\_CONSTANT) is specified for a variable-length argument (n) in an instruction that cannot determine the range of devices and labels when specified, a standard FUN, or standard FB, devices according to a specified size are sampled.

The following tables show examples of sampling targets for each instruction and operand.

### Examples of sampling targets for each instruction

Instruction	Sampling target	Example	
		Program	Sampling target
MOV	Specified device	MOV D0 W0	<ul style="list-style-type: none"> <li>• D0 to D31 (32 points)</li> <li>• W0 to W1F (32 points)</li> </ul>
BMOV (Number of transfers = constant)	Devices for the number of transfers	BMOV D31 D100 K10	<ul style="list-style-type: none"> <li>• D0 to D63 (64 points)</li> <li>• D96 to D127 (32 points)</li> </ul>
BMOV (Number of transfers = device)	Specified device (Devices for the number of transfers must be specified by using 'specify the device range.')	BMOV D31 D100 W0 • W0=10	<ul style="list-style-type: none"> <li>• D0 to 31 (32 points)</li> <li>• D96 to 127 (32 points)</li> <li>• W0 to 1F (32 points)</li> </ul>
GP.SWRITE (J/U) (s1) (s2) "(d1)" (d2) "(d3)"	<ul style="list-style-type: none"> <li>• s1 and s2: Specified device (A device such as control data for the area required for other operations must be specified by using 'specify the device range.')</li> <li>• d1 and d3: Not to be sampled</li> <li>• d2: Two points of the number of elements</li> </ul>	GP.SWRITE U0 D0 D100 "D100" M511 "B0"	<ul style="list-style-type: none"> <li>• D0 to 31 (32 points)</li> <li>• D96 to 127 (32 points)</li> <li>• M0 to 1023 (1024 points)</li> </ul>

## Examples of sampling targets for each operand

Operand		Sampling target	Example	
			Program	Sampling target
Timer, counter		Contact, coil, and current value of a specified device	OUTH T0 K10	T0 to 31 (TS, TC: 32 points, TN: 32 points)
Indirect specification		Specified device for indirect specification *1	MOV K100 @D0	D0 to D31 (32 points)
Index modification		Specified device and index register for index modification *2	MOV K100 D0Z0	• D0 to 31 (32 points) • Z0 to 23 (24 points)
			MOV K100 U04\G0Z0	U0\G0 to U0\G31 (32 points) Z0 to 23 (24 points)
			MOV K100 J1\W0Z0	J1\W0 to J1\W1F (32 points) Z0 to 23 (24 points)
32-bit index modification with ZZ expression		Specified device for index modification	DMOV K100 D0ZZ0	D0 to 31 (32 points)
Index-modified input/output numbers and network number		No target data	MOV K100 U0Z0\G0	N/A
			MOV K100 J1Z0\W0	N/A
Data specification	Bit-specified word device	Devices in a specified range	LD D0.0	D0 to 31 (32 points)
	Digit-specified bit device	Devices in a specified range	DMOV K4M497 D0	• M0 to 1023 (1024 points) • D0 to 31 (32 points)
Structure	—	All members of a specified structure	BMOV stLabel0 stLabel10 K10	• Entire stLabel0 • Entire stLabel10
	Member	Members of a specified structure	MOV K10 stLabel0.member1	stLabel0.member1 (Members other than stLabel0.member1 are not sampled.)
	Member (for block transfer instructions)	All members of a specified structure	BMOV stLabel0.member1 stLabel10 K10	• Entire stLabel0 • Entire stLabel10
	Timer, counter	Contact, coil, and current value of a specified device	LD tLabel0	tLabel0 (tLabel0.S, tLabel0.C, tLabel0.N)
Array label	—	All elements of a specified array	MOV K0 LabelA	LabelA [0] to LabelA [999] (all elements of LabelA)
	Element	All elements of a specified array	MOV K0 LabelA[K0] MOV K10 LabelA[D100]	• LabelA [0] to LabelA [999] (all elements of LabelA) • D96 to 127 (32 points)

\*1 A device specified for indirect specification is not set as a sampling target. Set it by using 'specify the device range' to sample.

\*2 A device specified for index modification is not set as a sampling target. Set it by using 'specify the device range' to sample.

### ■When using 'include SFC device' of 'device/label batch specification'

Items in the following table are sampling targets.

In addition, devices for the system are also sampling targets for monitoring an SFC program on the offline monitor (such as an SFC diagram monitor or SFC all blocks batch monitor).

Even if non-existent blocks or step relays with block specification (BL□\S) after the maximum step number are used in a program, they are not sampling targets for 'device/label batch specification.'

Sampling target	Remarks
Step in an SFC program	Step relays assigned based on a block number and step number used are targets. (Example) When using step No.20 in block No.1, BL1\S20 is a target.
Step relay with block specification (BL□\S) used in a ladder program, etc.	—

**■Considerations for sampling labels**

- Labels cannot be specified by using 'specify the device range.'
- By assigning a device to a global label, the assigned device can be set by using 'specify the device range.' (A device cannot be assigned to a local label.)
- When sampling a label specified as an operand that uses a variable-length value, all members of a structure or all elements of an array can be sampled by specifying a label defined as the structure or array as an operand. (  Examples of sampling targets for each instruction and operand)

**■Considerations for specifying "Safety Cycle Time"**

- When specifying "Safety Cycle Time" for the sampling method for a safety CPU, specify a time including the processing time of the recording function for the safety cycle time in the CPU parameter. Otherwise, a safety cycle processing error may occur due to delay in the processing time. Set the time to sample required devices and labels only.

**■Target data in a parameter**

Devices and labels specified in the following parameters can be specified as sampling targets.

The host CPU module and modules under its control\*1 are targets.

- \*1 Excluding the following types of modules:
- MELSEC-Q series module
  - Module not set in the I/O assignment setting in the system parameter
  - Module for which "Empty" is selected in the module status setting in the I/O assignment setting in the system parameter

Parameter type		Remarks
CPU parameter	Refresh setting between multiple CPUs	—
Module parameter	Refresh setting in the CC-Link IEF Basic setting	Devices specified for a CPU
	Refresh setting	Refresh target devices and module labels
	Simple CPU communication setting	Devices specified for the host station
	Safety data transfer device setting in safety communication setting	Only when using a safety CPU

**Point** 

When also including parameters in the sampling target, devices and labels specified in the CPU parameter or module parameter can also be included in the sampling target.

By including parameters to check the module status in the sampling target, the module status can be checked by playing it when a trouble occurs.\*2

However, the scan time becomes longer because the number of devices and labels to be sampled increases.

\*2 A recording result for devices and labels used in a parameter can be checked in the watch window or device batch monitor by starting offline monitoring.

## Video data that can be received

Video data delivered from a network camera connected to the Ethernet port of a camera recorder module can be received. The following table shows the specifications of video data that can be set as a receiving target.

Item	Setting item
Resolution <sup>*1</sup>	<ul style="list-style-type: none"><li>• FHD (1920 × 1080)</li><li>• SXVGA (1280 × 960)</li><li>• HD (1280 × 720)</li><li>• VGA (640 × 480)</li></ul>
Frame rate (fps) <sup>*1</sup>	<ul style="list-style-type: none"><li>• 10</li><li>• 30</li><li>• 120</li><li>• 180</li></ul>
Video codec <sup>*1</sup>	<ul style="list-style-type: none"><li>• H.264</li><li>• Motion JPEG</li></ul>
Video rotation angle <sup>*1</sup>	<ul style="list-style-type: none"><li>• 0°</li><li>• 180°</li></ul>
Video quality <sup>*1</sup>	<ul style="list-style-type: none"><li>• High</li><li>• Middle</li><li>• Low</li></ul>

\*1 For details on each item, refer to the following:

 Page 237 Video data delivery setting

## Precautions

Depending on the performance of a network camera used, setting items that can be set differ from those shown in the table above.

For details, refer to the manual for a network camera used.

## Devices that can be specified as triggers

The following table shows the devices that can be specified as triggers.

Device name (device)*1	Remarks	
User device	Input (X)	DXs cannot be specified.
	Output (Y)	DYs cannot be specified.
	Internal relay (M)	Local devices cannot be specified.
	Link relay (B)	—
	Annunciator (F)	—
	Link special relay (SB)	—
	Edge relay (V)	Local devices cannot be specified.
	Timer (T)	<ul style="list-style-type: none"> <li>• A contact (TS) is a target.</li> <li>• Local devices cannot be specified.</li> </ul>
	Retentive timer (ST)	<ul style="list-style-type: none"> <li>• A contact (STS) is a target.</li> <li>• Local devices cannot be specified.</li> </ul>
	Long timer (LT)	<ul style="list-style-type: none"> <li>• A contact (LTS) is a target.</li> <li>• Local devices cannot be specified.</li> </ul>
	Long retentive timer (LST)	<ul style="list-style-type: none"> <li>• A contact (LSTS) is a target.</li> <li>• Local devices cannot be specified.</li> </ul>
	Counter (C)	<ul style="list-style-type: none"> <li>• A contact (CS) is a target.</li> <li>• Local devices cannot be specified.</li> </ul>
	Long counter (LC)	<ul style="list-style-type: none"> <li>• A contact (LCS) is a target.</li> <li>• Local devices cannot be specified.</li> </ul>
	Data register (D)	<ul style="list-style-type: none"> <li>• Specify a word device as a bit (example: D0.0).</li> <li>• Local devices cannot be specified.</li> </ul>
	Link register (W)	Specify a word device as a bit (example: W0.0).
Link special register (SW)	Specify a word device as a bit (example: SW0.0).	
Latch relay (L)	—	
System device	Special relay (SM)	—
	Special register (SD)	Specify a word device as a bit (example: SD0.0).
File register	(R)	Specify a word device as a bit (example: R0.0).
	(ZR)	
Refresh data register (RD)	Specify a word device as a bit (example: RD0.0).	

\*1 Digit-specified bit devices or indirect-specified/index-modified devices cannot be specified.

### ■Selecting "Safety Cycle Time" for "Sampling Method"

When selecting "Safety Cycle Time" for the sampling method when using a safety CPU, specify a standard device as a file saving trigger and recording startup trigger, and create a standard program for a program for trigger detection.

### Precautions

- For operating a file saving trigger in a program, an engineering tool, or external device, specify a device specified as a file saving trigger.
- When specifying a file register (R/ZR), do not change its file name or block number after the recording function starts running. Otherwise, the recording function may not run normally and a recording result may not be reproduced properly.

# Sampling methods of devices and labels

The following table shows the sampling methods of devices and labels.

Sampling method	Description
Each scan	Data is sampled during the END processing in a scan of a CPU module.
Time specification	Data is sampled during the END processing in a scan executed first after a specified time elapses.
Trigger instruction	Data is sampled when executing the DATATRG instruction.
Safety cycle time	Data in a safety program and safety FB is sampled at the end of safety cycle processing.

## Point

When sampling a device and label in a periodic execution type program, an interrupt program, or a safety program, the program may be executed during data sampling if "Each Scan" or "Time Specification" is specified for the sampling method. In this case, inconsistency of sampled data occurs.

To avoid data inconsistency, configure a new setting with another setting number as follows:

- Periodic execution type program or interrupt program: Specify "Trigger Instruction" for the sampling method and set a device and label used in a periodic execution type program or an interrupt program as a sampling target. In addition, execute the DATATRG instruction immediately before the END processing.
- Safety program: Specify "Safety Cycle Time" for the sampling method and set a device and label used in a safety program as a sampling target.

## Precautions

When selecting "Recording Startup Trigger + File Saving Trigger" for the recording method, data is accumulated for a specified period after a recording startup trigger is satisfied. Therefore, no data is accumulated if the sampling timing is out of the specified period.

## Sampling timing when selecting "Each Scan"

The sampling timing is as follows:

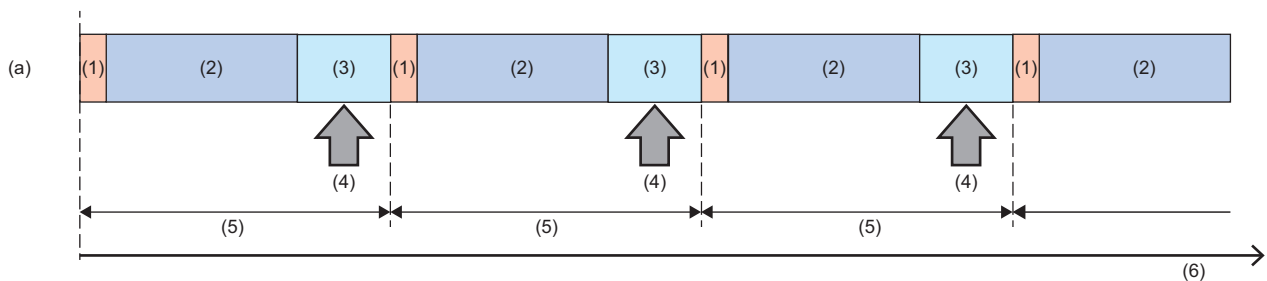

- (1) I/O refresh
- (2) Program operation
- (3) END processing
- (4) Sampling processing<sup>\*1\*2</sup>
- (5) Scan time
- (6) Time
- (a) Scan execution program

\*1 The time required for sampling processing is added to the scan time. For details on the sampling time, refer to the following:  
 ☞ Page 296 Sampling time

\*2 If an interrupt program is executed during the END processing, the execution time of the interrupt program is also included in the sampling time.

## Sampling timing when selecting "Time Specification"

The sampling timing is as follows:

**Ex.**

The timing is set to 10 milliseconds (10 ms).

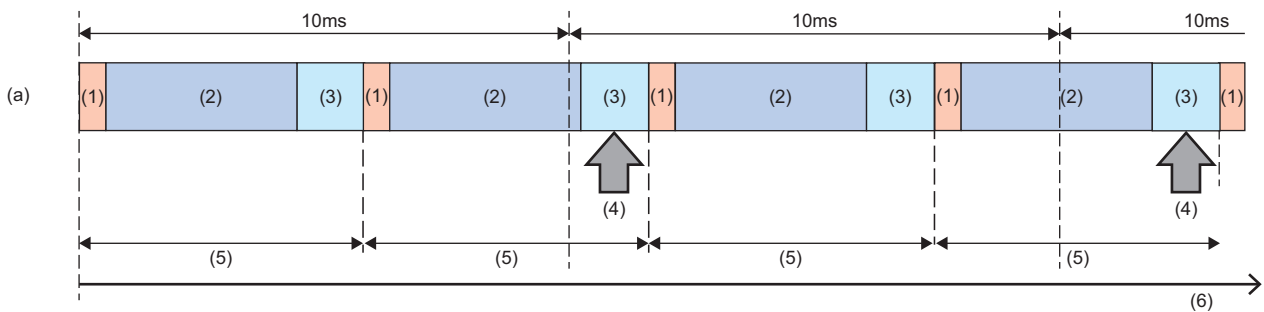

- (1) I/O refresh
- (2) Program operation
- (3) END processing
- (4) Sampling processing<sup>\*1\*2</sup>
- (5) Scan time
- (6) Time
- (a) Scan execution program

\*1 The time required for sampling processing is added to the scan time. For details on the sampling time, refer to the following:

☞ Page 296 Sampling time

\*2 If an interrupt program is executed during the END processing, the execution time of the interrupt program is also included in the sampling time.

### Precautions

- Set the timing so that the time specification is longer than the scan time; otherwise, data is sampled during the END processing only once if multiple sampling intervals and sampling timings for the time specification are included in one scan. In this case, data is sampled for each scan and the operation will be the same as the each scan.
- If a sampling interval is longer than a saving period, sampled data may not be included in the saving period. In this case, saving a file fails when a file saving trigger is satisfied and an error occurs in a recorder module/camera recorder module. A saving period differs depending on the recording method. (☞ Page 19 Recording methods)

## Sampling timing when selecting "Trigger Instruction"

The sampling timing is as follows:

**Ex.**

When executing the DATATRIG instruction in an interrupt program

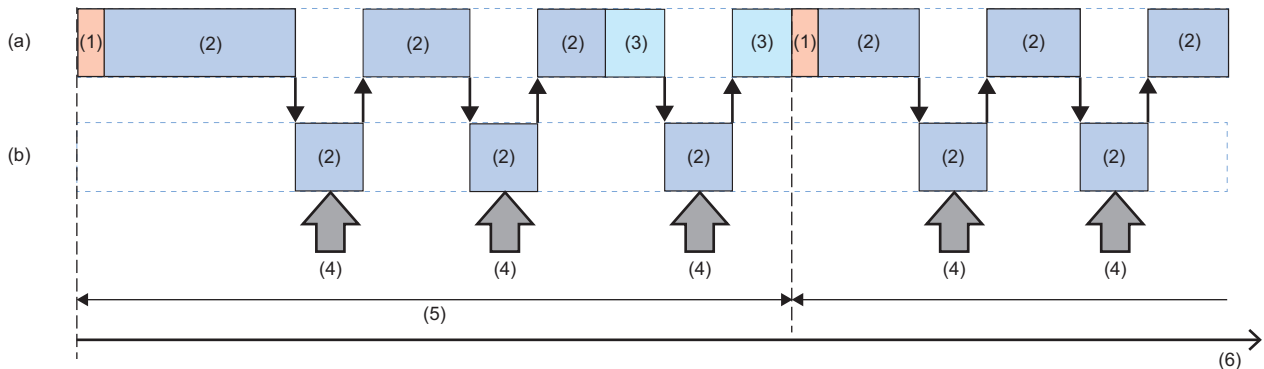

(1) I/O refresh

(2) Program operation

(3) END processing

(4) DATATRIG instruction execution sampling processing<sup>\*1</sup>

(5) Scan time

(6) Time

(a) Scan execution program

(b) Interrupt program

\*1 The time required for sampling processing for the number of times the DATATRIG instruction is executed is added to the scan time. For details on the sampling time, refer to the following:

☞ Page 296 Sampling time

### Point

When specifying "Trigger Instruction" for the sampling method and executing the DATATRIG instruction in a fixed cycle execution program and an interrupt program, a device and label can be sampled when executing these programs.

The DATATRIG instruction cannot be executed in a safety program. To sample a device and label when executing a safety program, specify "Safety Cycle Time" for the sampling method.

## Precautions

If an interval for trigger instruction execution is longer than a saving period, sampled data may not be included in the saving period. In this case, saving a file fails when a file saving trigger is satisfied and an error occurs in a recorder module/camera recorder module.

A saving period differs depending on the recording method. For details, refer to the following: (☞ Page 19 Recording methods)



## Sampling timing when selecting "Safety Cycle Time"

The sampling timing is as follows:

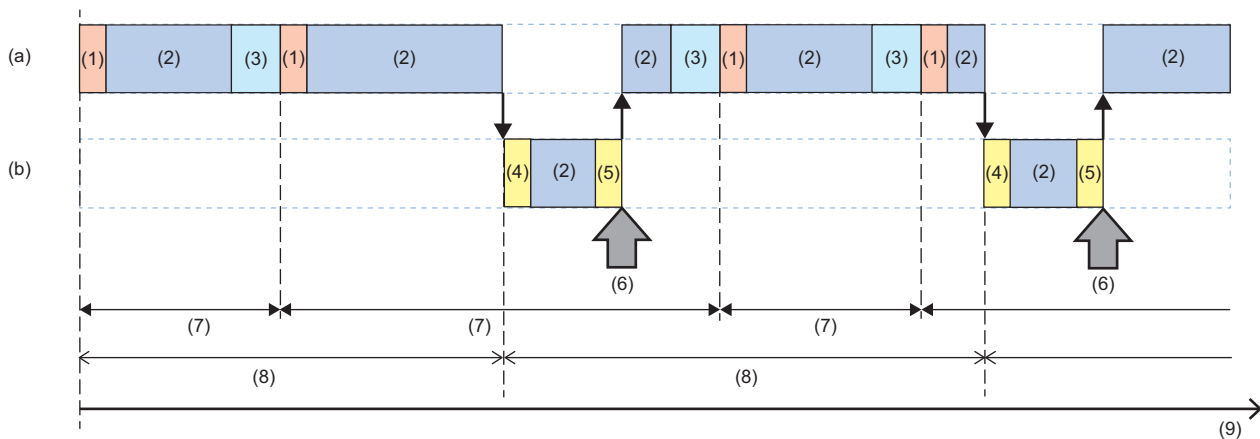

- (1) I/O refresh
- (2) Program operation
- (3) END processing
- (4) Safety input refresh
- (5) Safety output refresh
- (6) Sampling processing\*1
- (7) Scan time
- (8) Safety cycle time
- (9) Time
- (a) Scan execution program
- (b) Safety program

\*1 The time required for sampling processing is included in the safety cycle time. For details on the sampling time, refer to the following:

☞ Page 296 Sampling time

### Precautions

If a sampling interval is longer than a saving period, sampled data may not be included in the saving period. In this case, saving a file fails when a file saving trigger is satisfied and an error occurs in a recorder module/camera recorder module. A saving period differs depending on the recording method. For details, refer to the following: (☞ Page 19 Recording methods)

## Video data receiving setting

---

Video data is received from a network camera set as a receiving target in the recording setting when the recording function starts running.

However, if video data cannot be received from the network camera even after 10 seconds or more, a network camera communication start error (error code: 1DC0H) occurs.

Target video data can be set in the "Video Data Receiving Target Setting" screen of the recording setting.

For details on the screen, refer to the following:

 Page 140 Video Data Receiving Target Setting

In addition, the video data receiving status for each network camera can be checked in 'Video data receiving status' (Un\G34477, Un\G34977, Un\G35477, Un\G35977).

 Page 282 Network camera status area (Un\G34000 to 37999)

---

### Point

A predicted value of the recording buffer capacity of video data, which is calculated based on the network camera setting and video data receiving target status, is displayed in the "Video Data Receiving Target Setting" screen of the recording setting. ( Page 60 Recording buffer)

The actual recording time differs depending on the conditions and environment for capturing data.

(Example)

- If the change in a video to be captured is small, the size of a video file actually output is smaller than a predicted value.
- If the performance of a network camera is high, the size of a video file actually output is larger than a predicted value.

If a predicted value exceeds the maximum recording buffer capacity, the recording buffer capacity of video data is compressed by a camera recorder module so that it is included in the maximum recording buffer capacity.

As a result, if a calculated value of the recording buffer capacity is a decimal number, the first decimal place is rounded up to an integer value.

However, the recording buffer capacity is reserved to generate video files of one second or longer.

---

# Recording file

A recording file can be saved to either of the following save destinations.

Save destination	Save destination folder
SD memory card	RECORD\setting type folder <sup>*1</sup>
File server	(Save destination folder <sup>*2</sup> specified in the file server setting in the recording setting)\RECORD\setting type folder <sup>*1</sup>

\*1 The folder name differs for each recording setting.

Setting No.1: RC1  
 Setting No.2: RC2  
 Setting No.3: RC3  
 Setting No.4: RC4

\*2 For details on save destination folders, refer to the following:

 Page 137 File server setting

## Point

For centrally managing recording files saved in multiple systems, it is recommended to specify a file server as the save destination.

## Precautions

- Prepare a folder for saving recording files on a file server in advance; otherwise, recording files will not be saved.
- When using a file server in multiple systems to save recording files, specify a different folder for each system; otherwise, files may not be saved properly.
- Do not enable the read-only or encryption attribute for folders for saving recording files, or files and folders under these folders. If enabled, recording files may not be saved properly.

## Folder configuration in an SD memory card

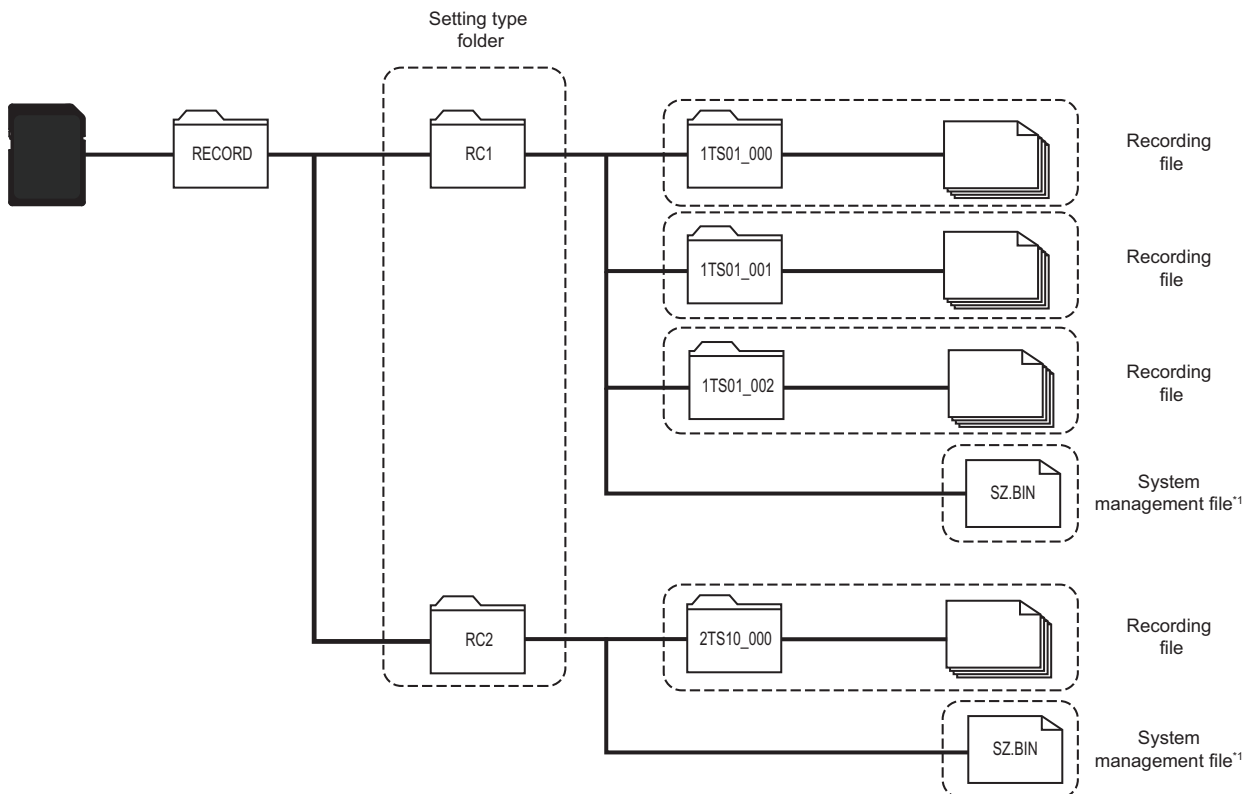

\*1 Do not edit or delete it.

## Folder configuration in an SD memory card (including video data)

When specifying video data as recording target data, it is saved as a video file to a recording file. (☞ Page 56 Name and save destination of a video file)

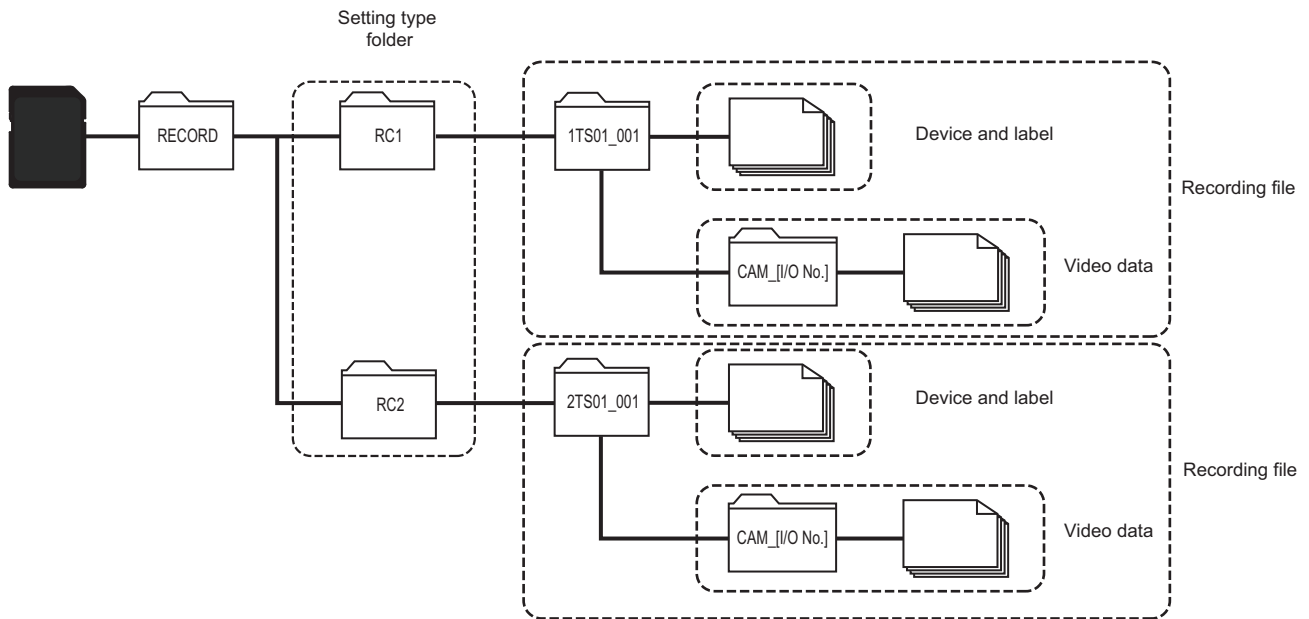

## Folder configuration in a file server

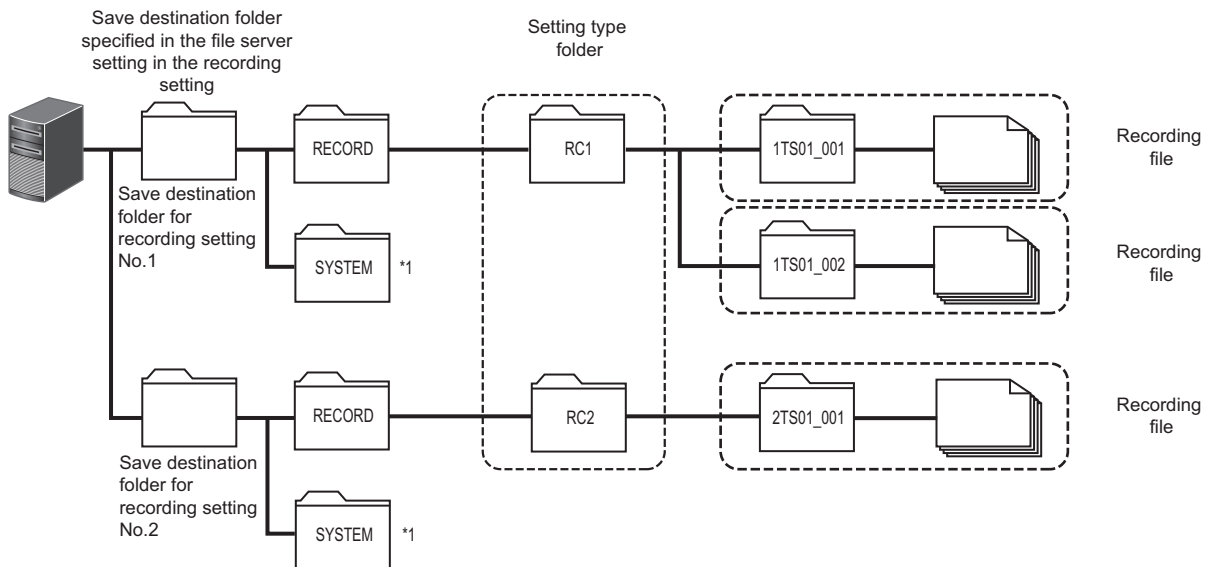

\*1 Do not directly operate files in the SYSTEM folder.

## Folder configuration in a file server (including video data)

When specifying video data as recording target data, it is saved as a video file to a recording file.

A video file is saved to a CAM\_[I/O No.] folder generated for each camera recorder module under the setting type folder of each recording setting. (☞ Page 56 Name and save destination of a video file)

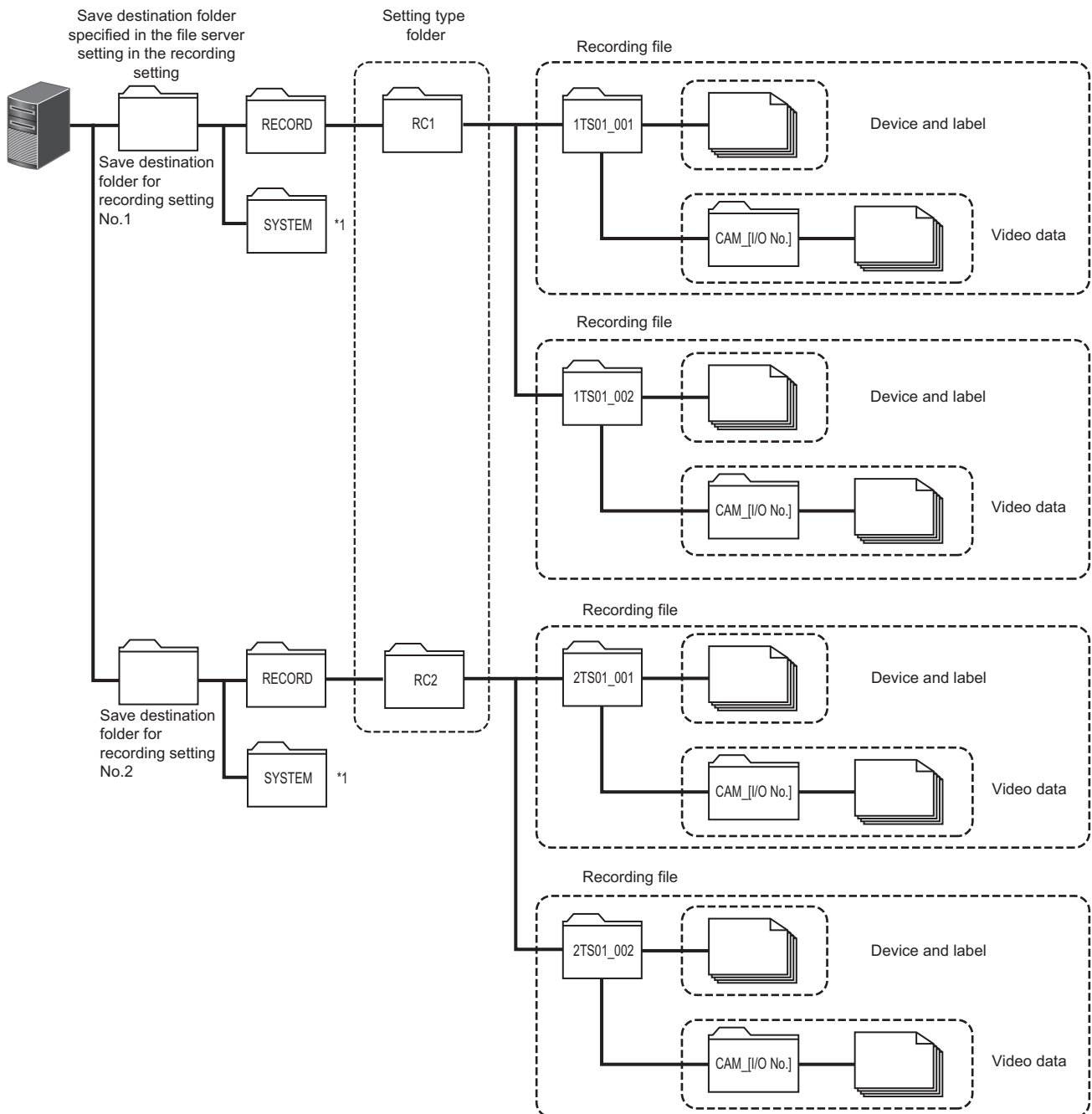

\*1 Do not directly operate files in the SYSTEM folder.

## Recording file name

The name of a recording file is set as follows:

- Without additional information: [Recording setting number][Saving cause]\_[Folder number]
- With additional information: [Additional information]\_[Recording setting number][Saving cause]\_[Folder number]

Item	Description
Additional information <sup>*1*2</sup>	The following information set in the saving detail setting in the recording setting: (☞ Page 138 Saving detail setting) <ul style="list-style-type: none"> <li>• Date and time (when a file saving trigger is satisfied or a recording file is saved)<sup>*3</sup></li> <li>• Numerical value data (data in the buffer memory when a file saving trigger is satisfied)<sup>*4*5*6*7</sup></li> <li>• String data (data in the buffer memory when a file saving trigger is satisfied)<sup>*7*8*9*10</sup></li> <li>• Any character strings</li> <li>• Trigger comment (comment for a satisfied file saving trigger)<sup>*10*11</sup></li> </ul>
Recording setting number	The number of a recording setting <ul style="list-style-type: none"> <li>• Setting No.1: 1</li> <li>• Setting No.2: 2</li> <li>• Setting No.3: 3</li> <li>• Setting No.4: 4</li> </ul>
Saving cause	A character string representing a timing when a file saving trigger is satisfied <sup>*12</sup> <ul style="list-style-type: none"> <li>• Rise, fall, or timeout of a device of a CPU module, or rise of the value in a buffer memory of a recorder module/camera recorder module<sup>*7</sup>: TS + number of a satisfied condition<sup>*13</sup> (two digits (decimal)) (Example) When the number of a satisfied condition is 3: TS03</li> <li>• Lapse of a specified time after the completion of data accumulation: AS</li> <li>• File saving in the "Recording Monitor" screen: MS</li> <li>• CPU stop error: ES</li> <li>• Camera event: CE</li> <li>• Co-recording: CO</li> </ul>
Folder number	A three-digit number (decimal) (001 to the upper limit set in the saving detail setting) ☞ Page 54 Example of adding folder numbers

\*1 Optional

\*2 If the number of available characters is exceeded, characters from the start to the number of available ones are added.

For the number of available characters, refer to the following:

☞ MELSEC iQ-R System Recorder User's Manual (Startup)

\*3 Time in a CPU module (local time)

\*4 Up to two units of data, <DATA1> and <DATA2>, can be set, and the following buffer memory addresses can be specified for each.  
(☞ Page 228 Recording operation specification area (Un\G4000 to 4799))

<DATA1>: Un\G4002 to 4003 (setting No.1), Un\G4102 to 4103 (setting No.2), Un\G4202 to 4203 (setting No.3), Un\G4302 to 4303 (setting No.4)

<DATA2>: Un\G4004 to 4005 (setting No.1), Un\G4104 to 4105 (setting No.2), Un\G4204 to 4205 (setting No.3), Un\G4304 to 4305 (setting No.4)

\*5 Decimal or hexadecimal can be selected for the output format.

\*6 The number of digits for zero padding can be specified. If the number of digits of data to be output is less than a specified one, '0' is added for padding.

If the number of digits of data to be output exceeds a specified one, the data is output according to its number of digits.

\*7 Buffer memory of a module set as the main one when configuring multiple modules

☞ Page 67 Operation of the recording function when configuring multiple modules

\*8 Up to two units of data, <DATA3> and <DATA4>, can be set, and the following buffer memory addresses can be specified for each.  
(☞ Page 228 Recording operation specification area (Un\G4000 to 4799))

<DATA3>: Un\G4009 to 4016 (setting No.1), Un\G4109 to 4116 (setting No.2), Un\G4209 to 4216 (setting No.3), Un\G4309 to 4316 (setting No.4)

<DATA4>: Un\G4025 to 4032 (setting No.1), Un\G4125 to 4132 (setting No.2), Un\G4225 to 4232 (setting No.3), Un\G4325 to 4332 (setting No.4)

\*9 Data for the number of characters specified in the saving detail setting is added.

If a string terminator (0) is used halfway in string data, characters from the terminator to the specified number of characters are replaced with underscores (\_).

☞ Page 138 Saving detail setting

\*10 Unavailable characters are replaced with underscores (\_).

For the available characters, refer to the following:

☞ Page 294 ASCII characters that can be used in the format in the saving detail setting

\*11 If a file saving trigger is satisfied by camera event reception, an event comment set in the "Camera Individual Settings" screen is added.  
Due to the system configuration, if multiple camera events occur at the same time, a camera event that occurs in a network camera with the smallest I/O number and network camera number is applied as a condition for satisfying a trigger.

\*12 If multiple triggers are satisfied at the same time, a file saving trigger with the highest priority is applied.

The priorities are as follows:

Priority 1: CPU stop error

Priority 2: File saving in the "Recording Monitor" screen

Priority 3: Lapse of a specified time after the completion of data accumulation

Priority 4: Rise, fall, or timeout of a device of a CPU module, or rise of the value in a buffer memory of a recorder module/camera recorder module

Priority 5: Camera event

Priority 6: Co-recording

\*13 If multiple conditions are satisfied at the same time, a condition with the smallest condition number is applied.

For the considerations for folders and files in an SD memory card, refer to the following:  
 MELSEC iQ-R System Recorder User's Manual (Startup)

## Example of adding folder numbers

The following shows an example of adding folder numbers when the upper limit is set to '5' in the saving detail setting.

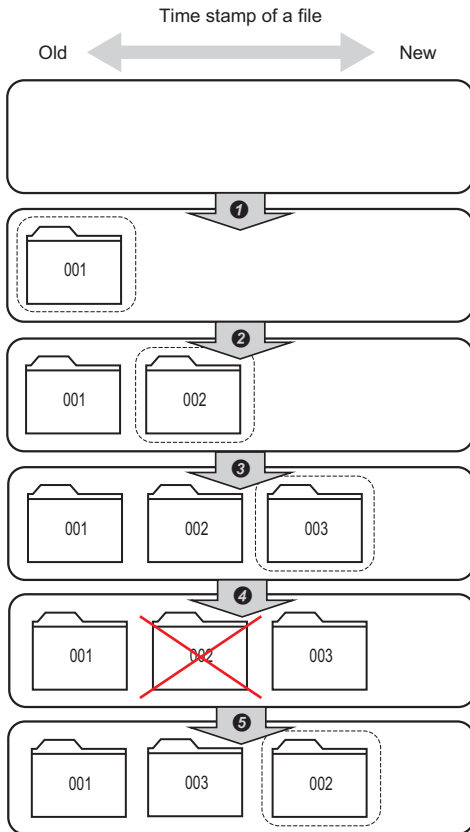

- ❶ The smallest number (001) among the numbers from 001 to 005 is added.
- ❷ The smallest number (002) excluding 001 among the numbers from 001 to 005 is added.
- ❸ The smallest number (003) excluding 001 and 002 among the numbers from 001 to 005 is added.
- ❹ The recording file with the folder number 002 is deleted by user operation.
- ❺ The smallest number (002) excluding 001 and 003 among the numbers from 001 to 005 is added.

When deleting an existing file while a new recording file is being saved, the smallest number available after the deletion is added to the new file.



## If there is no free folder number

If there is no free folder number (001 to the upper limit set in the saving detail setting), processing is performed according to an operation selected in "Operation at Saved Data Upper Limit" in the saving detail setting as follows:<sup>\*1</sup>

- \*1 The INFO LED turns ON in either of the following cases. The factor can be checked in 'INFO LED lighting factor' (Un\G12) of a recorder module/camera recorder module. (Page 216 Module status area (Un\G0 to 20), Page 269 Module status area (Un\G0 to 20))  
There is no more free folder number after saving a recording file.  
Saving a file failed because there was no free folder number.

### ■When selecting "Save data by deleting the one with the oldest timestamp"

A recording file with the oldest time stamp<sup>\*1\*2</sup> is deleted, and a new file is saved with the folder number of the deleted file.

- \*1 If there are multiple recording files with the same time stamp, a recording file with the smallest folder number is deleted.
- \*2 A recording file is not deleted if its folder number is out of the range of 001 to the upper limit set in the saving detail setting.

#### Ex.

Upper limit set in the saving detail setting: 5

Stored file: Files with the folder numbers 001 to 005

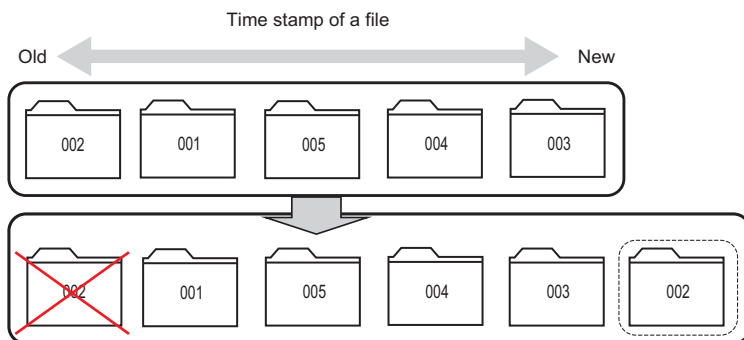

#### Ex.

Upper limit set in the saving detail setting: 5

Stored file: Files with the folder numbers 001 to 006

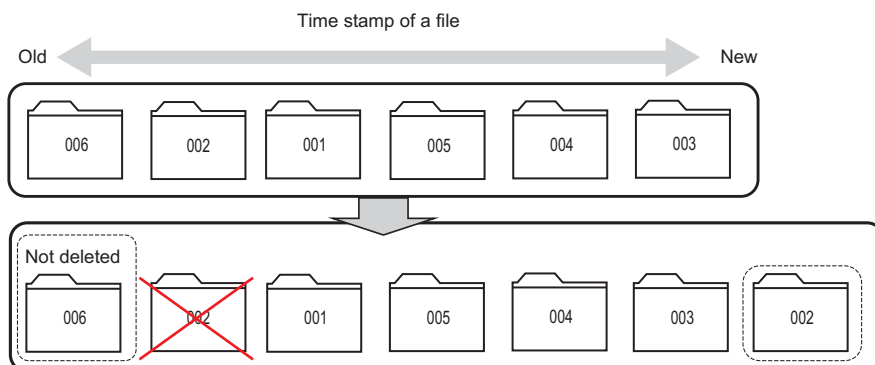

## Precautions

A recording file being read in GX Works3 may be deleted. To avoid this, select "Discard Data and Continue Sampling."

## ■When selecting "Discard Data and Continue Sampling"

A new recording file is not saved and data is discarded, and a saving error occurs. (  Page 86 If saving a file fails)

To save a new recording file, perform either of the following:

- Reduce the number of recording files in a save destination.\*<sup>1</sup>
- Increase the upper limit.

\*<sup>1</sup> For deleting a recording file saved to an SD memory card, refer to the following:

 Page 57 Deleting a recording file

## Name and save destination of a video file

### ■File name

The name of a video file is set as follows:

- [I/O No.]\_[Network camera No.]\_[Date]\_[Time].extension

Item name	Setting content
I/O No.	The start I/O number of a camera recorder module
Network camera No.	The number of a network camera <ul style="list-style-type: none"><li>• Camera No.1: 1</li><li>• Camera No.2: 2</li><li>• Camera No.3: 3</li><li>• Camera No.4: 4</li></ul>
Date	A date when recording starts for a video file <ul style="list-style-type: none"><li>• YYYYMMDD</li></ul>
Time	A time when recording starts for a video file <ul style="list-style-type: none"><li>• hhmmsssss</li></ul>
Extension	The extension of a video file <ul style="list-style-type: none"><li>• .mp4*<sup>1</sup></li><li>• .mov*<sup>2</sup></li></ul>

\*<sup>1</sup> When selecting H.264 for the video codec

 Page 42 Video data that can be received

\*<sup>2</sup> When selecting Motion JPEG for the video codec

 Page 42 Video data that can be received

### ■Save destination

A video file is saved to the following folder:

- CAM\_[I/O No.]

Item name	Setting content
I/O No.	The start I/O number of a camera recorder module

### Point

- A generated video file can be played in general-purpose playback tools.  
However, do not change the folder, file configuration, or the name of a file in which the video file is stored.  
If changed, the video file cannot be played in GX VideoViewer.
- If no network camera is set as a receiving target in the "Video Data Receiving Target Setting" screen, a video file and CAM\_[I/O No.] folder are not generated. (  Page 140 Video Data Receiving Target Setting)

## Recording file saving completion file

After a recording file is saved to a file server, a saving completion file is created as follows:

File name	Extension	Storage location
Same name as the recording file	.BTC	Setting type folder in the save destination folder

## Deleting a recording file

A recording file saved to an SD memory card can be deleted by any of the following methods:

- Select a recording file to be deleted and click the [Delete] button in the "Recording File Reading" screen of GX Works3. (GX Works3 Operating Manual)
- Remove an SD memory card from a recorder module/camera recorder module, and delete a file manually.
- Remove an SD memory card from a recorder module/camera recorder module, and replace it with a new one.

## Precautions

Do not delete any of the following folders or directly edit any files in the folders during recording operation; otherwise, files may not be saved properly.

- Save destination folder specified in the file server setting in the recording setting
- RECORD folder
- SYSTEM folder
- Setting type folder (RC1 to RC4)

# Flow to save data

The following shows the flow to save data.

## Saving a device and label

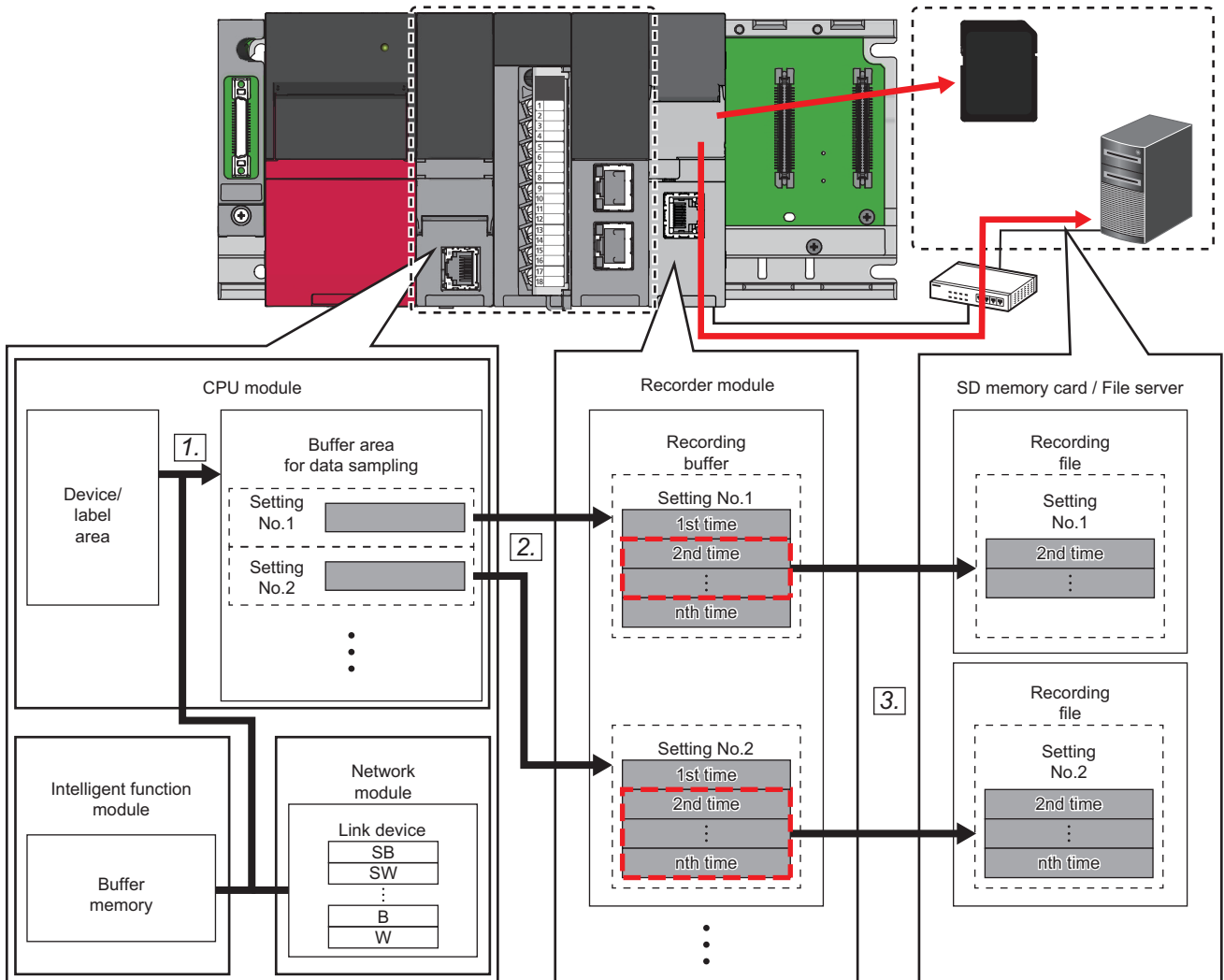

: Sampled data  
 : Saving period

1. A device and label specified as a sampling target are sampled in the buffer area for data sampling.  
[Page 94 Buffer area setting for data sampling](#)
2. The device and label sampled in the buffer area for data sampling are accumulated in the recording buffer.  
[Page 60 Recording buffer](#)
3. Data for a saving period is output to a recording file and saved to a save destination specified in the recording setting when a file saving trigger is satisfied.

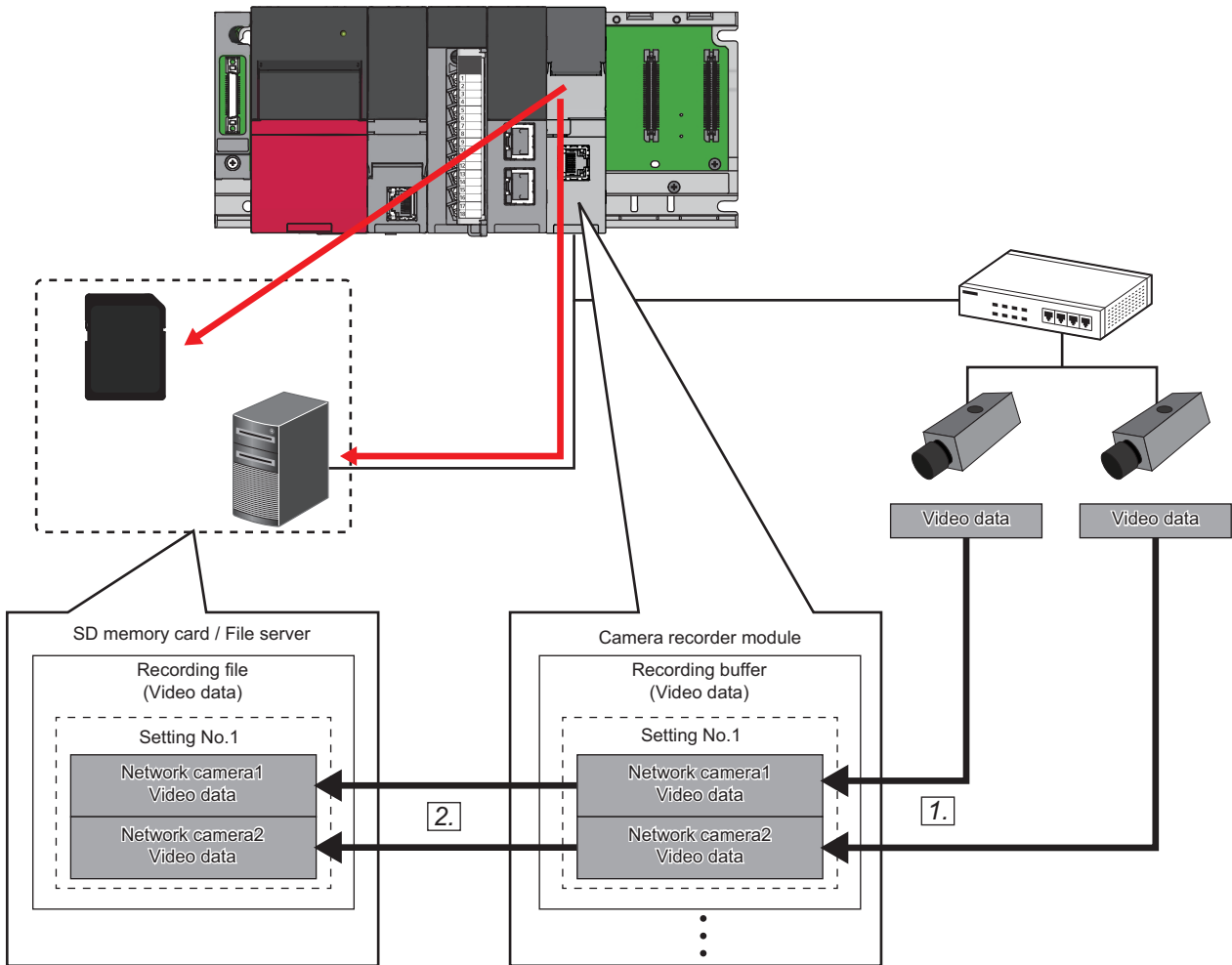

**1.** Video data received from a network camera is accumulated in the recording buffer.

☞ Page 60 Recording buffer

**2.** Data for a saving period is output to a recording file and saved to a save destination specified in the recording setting when a file saving trigger is satisfied.

## Recording buffer

A sampled device and label are accumulated in the internal buffer (recording buffer) of a recorder module/camera recorder module.

In addition, received video data is accumulated in the internal buffer (recording buffer) of a camera recorder module.

Accumulated data is output to a save destination specified in the recording setting as a recording file when a file saving trigger is satisfied.

The recording buffer capacity can be set for each recording setting, and a period during which data can be saved differs depending on the capacity. (☞ Page 98 Recording buffer setting (recorder module), Page 99 Recording buffer setting (camera recorder module))

### ■When the capacity of accumulated devices and labels exceeds the buffer capacity

Data for a set saving period may not be saved.

In this case, perform any of the following operations:

- Reduce the number of devices and labels to be sampled.
- Increase the recording buffer capacity.
- Shorten the saving period.
- Lengthen the sampling interval.

An operation when the buffer capacity is exceeded differs depending on the recording method as follows:

- When selecting "File Saving Trigger Only" for the recording method

Data is overwritten in chronological order when the buffer capacity is exceeded.

In addition, if the data capacity for a set saving period exceeds the recording buffer capacity, old data in the saving period is not saved.

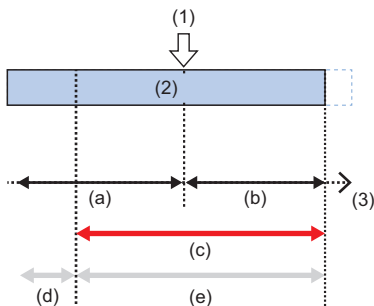

(1) File saving trigger

(2) Accumulating data

(3) Time

(a) Saving period before trigger

(b) Saving period after trigger

(c) Period during which data is accumulated in the recording buffer

(d) Period during which data is not saved

(e) Period during which data is actually saved

- When selecting "Recording Startup Trigger + File Saving Trigger" for the recording method

Data accumulation stops when the buffer capacity is exceeded.

In addition, if the data capacity for a set saving period exceeds the recording buffer capacity, new data in the saving period is not saved.

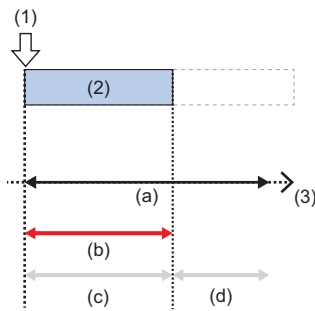

- (1) Recording startup trigger  
 (2) Accumulating data  
 (3) Time  
 (a) Set saving period  
 (b) Period during which data is accumulated in the recording buffer  
 (c) Period during which data is actually saved  
 (d) Period during which data is not saved

### ■ When the capacity of accumulated video data exceeds the buffer capacity

Data for a set saving period may not be saved.

A saving period for video data varies depending on the following conditions:

- Video codec
- Resolution
- Video frame rate
- Video quality
- Maximum video bit rate
- Environment for capturing data

If data for a set saving period is not saved, perform any of the following operations:

- Change the video codec (set it to H.264).
- Lower the resolution.
- Lower the frame rate.
- Lower the video quality.
- Reduce the number of network cameras for data reception.
- Lower the limit value of the maximum video bit rate.
- Increase the recording buffer capacity.
- Shorten the saving period.

Operations when the buffer capacity is exceeded are the same as those shown in the following:

☞ Page 60 When the capacity of accumulated devices and labels exceeds the buffer capacity

## ■Recording buffer batch saving mode

The recording buffer batch saving mode is a mode for saving all data accumulated in the recording buffer when selecting "File Saving Trigger Only" for the recording method.

When this mode is enabled and a file saving trigger is satisfied, all data accumulated in the recording buffer is saved.

This allows data in a period before a set saving period before trigger to be saved.

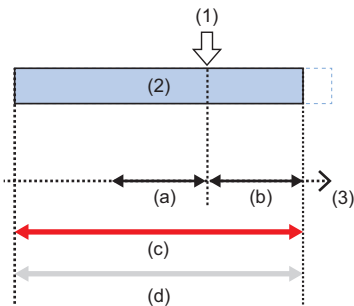

- (1) File saving trigger
- (2) Accumulating data
- (3) Time
- (a) Saving period before trigger
- (b) Saving period after trigger
- (c) Period during which data is accumulated in the recording buffer
- (d) Period during which data is actually saved

The recording buffer batch saving mode can be enabled or disabled in the following buffer memory<sup>\*1</sup> of a recorder module/ camera recorder module or in the "Recording Status Detailed Information" screen of GX Works3. (  Page 228 Recording operation specification area (Un\G4000 to 4799), Page 144 Recording Status Detailed Information Screen)

- Setting No.1: 'Recording buffer batch saving mode' (Un\G4001)
- Setting No.2: 'Recording buffer batch saving mode' (Un\G4101)
- Setting No.3: 'Recording buffer batch saving mode' (Un\G4201)
- Setting No.4: 'Recording buffer batch saving mode' (Un\G4301)

\*1 Buffer memory of a module set as the main one when configuring multiple modules

When the mode is enabled for a module set as the main one, this also applies to a module set as a sub one.

 Page 67 Operation of the recording function when configuring multiple modules



# Operating status

The following table shows the operating status of the recording function for each recording setting.

The operating status can be checked in the "Recording Monitor" screen or in the buffer memory<sup>\*1</sup> of a recorder module/camera recorder module. (☞ Page 142 RECORDING MONITOR, Page 221 Recording status area (Un\G1500 to 3199), Page 271 Recording status area (Un\G1500 to 3199))

\*1 Buffer memory of a module set as the main one when configuring multiple modules  
☞ Page 67 Operation of the recording function when configuring multiple modules

Operating status	Description
Stopped	The recording function is stopped. When configuring multiple modules, the function is stopped for all modules <sup>*2</sup> . (☞ Page 67 Operation of the recording function when configuring multiple modules) The status is 'stopped' in the following cases: <ul style="list-style-type: none"> <li>• After starting a recorder module/camera recorder module</li> <li>• After resetting a CPU module</li> <li>• No recording settings written</li> </ul>
Preparing	Operations such as analysis of a recording setting are being prepared. When configuring multiple modules, operations for all modules <sup>*2</sup> are being prepared. (☞ Page 67 Operation of the recording function when configuring multiple modules)
Operating	The function is running. When configuring multiple modules, the function is running on all modules <sup>*2</sup> . (☞ Page 67 Operation of the recording function when configuring multiple modules) In this state, devices and labels are sampled in a CPU module according to the sampling method regardless of whether a recording startup trigger is satisfied and a recording file is saved. (☞ Page 44 Sampling methods of devices and labels) Note that a period for data accumulation differs depending on the recording method. (☞ Page 19 Recording methods)
File saving trigger satisfied	A file saving trigger is satisfied and data for a remaining saving period is being sampled, received, and accumulated. When configuring multiple modules, data for a remaining saving period is being sampled, received, and accumulated for all modules <sup>*2</sup> . (☞ Page 67 Operation of the recording function when configuring multiple modules)
Saving	A recording file is being saved. When configuring multiple modules, recording files are being saved for all modules <sup>*2</sup> . (☞ Page 67 Operation of the recording function when configuring multiple modules) If the status switches to 'saving' for multiple recording settings, the settings are saved in order from one that switches first.

\*2 Main module and sub modules with recording target data

## Point

'1' is stored in 'Data sampling' (Un\G1506, Un\G1706, Un\G1906, Un\G2106) of a recorder module/camera recorder module while devices and labels are being sampled and accumulated.

When selecting "File Saving Trigger Only" for the recording method, '1' is stored in 'In recording operation' (Un\G1501, Un\G1701, Un\G1901, Un\G2101)<sup>\*3</sup> then in 'Data sampling.'

When selecting "Recording Startup Trigger + File Saving Trigger" for the recording method, '1' is stored in 'Data sampling' after a recording startup trigger is satisfied.

(☞ Page 221 Recording status area (Un\G1500 to 3199), Page 271 Recording status area (Un\G1500 to 3199))

\*3 Buffer memory of a module set as the main one when configuring multiple modules  
☞ Page 67 Operation of the recording function when configuring multiple modules

## Precautions

Regardless of the recording method, devices and labels are accumulated while '1' is stored in 'Data sampling' (Un\G1506, Un\G1706, Un\G1906, Un\G2106). For example, if "Trigger Instruction" is selected for the sampling method and '1' is not stored in 'Data sampling,' devices and labels are not accumulated even when executing the DATATRIG instruction.

(☞ Page 44 Sampling methods of devices and labels, Page 221 Recording status area (Un\G1500 to 3199), Page 271 Recording status area (Un\G1500 to 3199))

## Operating status for video data

The following table shows the operating status for video data for each network camera.

The operating status can be checked in 'Camera recording status' of a camera recorder module (Un\G1650 to 1653, Un\G1850 to 1853, Un\G2050 to 2053, Un\G2250 to 2253). (☞ Page 271 Recording status area (Un\G1500 to 3199))

Status	Description
Stopped	The recording function is stopped. The status is 'stopped' in the following cases: <ul style="list-style-type: none"><li>• After starting a camera recorder module</li><li>• After resetting a CPU module</li><li>• No recording settings written</li></ul>
Preparing	Operations such as analysis of module extended parameters and communication establishment and setting for a target network camera are being prepared.
No setting	The recording function is running and the communication with a target network camera is established, but no network camera is set in the video data receiving target setting.
Operating	The recording function is running for a target network camera. The status remains 'operating' even if the communication with the network camera is disconnected.
File saving trigger satisfied	A file saving trigger is satisfied and video data for a remaining saving period is being received and accumulated.
Saving	A recording file is being saved. If the status switches to 'saving' for multiple recording settings, the settings are saved in order from one that switches first.

### ■Status after starting the recording function

After starting the recording function, the camera recording status switches to 'preparing' for a target recording setting.

It switches to 'operating' when the preparation is completed in a camera recorder module, the communication with a network camera set as a receiving target is established, and video data is delivered.

For a network camera not set as a receiving target, it switches to 'no setting' even after the preparation is completed in the camera recorder module.

For the operation to start the recording function, refer to the following:

☞ Page 65 Start

### ■Status after stopping the recording function

After stopping the recording function, the camera recording status switches to 'stopped' for all network cameras for a recording setting.

However, it switches to 'stopped' after saving in a camera recorder module is completed when the status is 'file saving trigger satisfied' or 'saving.'

For the operation to stop the recording function, refer to the following:

☞ Page 66 Stop

# Operation of the recording function

The following shows the operations of the recording function.

## Start

To start the recording function, perform either of the following operations:

- Switch a CPU module from STOP to RUN.\*<sup>1</sup>
- Start the recording function in the "Recording Monitor" screen.\*<sup>2</sup> (  Page 142 RECORDING MONITOR)

\*<sup>1</sup> The operating statuses for all written recording settings switch to 'preparing,' then 'operating' after the preparation is completed.

\*<sup>2</sup> The operating status for a target recording setting switches to 'preparing,' then 'operating' after the preparation is completed.

### Point

Devices and labels are sampled in a CPU module while the recording function is running even if they are not accumulated in a recorder module/camera recorder module. Therefore, the END processing time is extended in a scan of a sampling timing.

Effect of the recording function on the END processing time can be checked in the "Recording Status Detailed Information" screen of the recording monitor. (  Page 144 Recording Status Detailed Information Screen)

## ■Data when configuring the recording setting and data written to a CPU module

To use the recording function, the following information must match\*<sup>1</sup> each other.

If they do not match, a recording setting error (3027H or 3028H) occurs and the recording function does not start. In this case, the recording setting must be written to a CPU module again.

- Project information (parameter and program including device and label settings) when configuring the recording setting
- Parameter and program written to a CPU module

However, when using a module with any of the following firmware versions, a recording setting error does not occur and the recording function starts for the next time (restart) even if the information above does not match due to program change while the recording function is running.

- RnCPU or RnENCPU: '55' or later
- RnSFCPU: '24' or later
- Recorder module: '04' or later
- Camera recorder module: '01' or later

For details on changing programs while the recording function is running, refer to the following:

 Page 76 Program change while the recording function is running

\*<sup>1</sup> Even when not editing programs, they may be different from those that were applied when configuring the recording setting after converting the programs. Make sure to write the recording setting and programs to the CPU module.

## Precautions

- The recording function starts running after preparation; therefore, it takes time to be ready for data sampling, reception, and accumulation.
- For devices and labels, a timing when sampling and accumulation start differs for each recording method.  
When selecting "File Saving Trigger Only" for the recording method: Sampling and accumulation start when the operating status switches to 'operating.'  
When selecting "Recording Startup Trigger + File Saving Trigger" for the recording method: Sampling starts when the operating status switches to 'operating' and accumulation starts when a recording startup trigger is satisfied.
- For video data, regardless of the recording method, reception and accumulation start when the operating status switches to 'operating,' the communication with a network camera is established, and video data is delivered from the network camera.

## Stop

To stop the recording function, perform any of the following operations:

- Switch a CPU module from RUN to STOP.\*1\*2\*3
- Switch a CPU module to PAUSE.\*1\*2
- Stop the recording function in the "Recording Monitor" screen.\*2 (☞ Page 142 RECORDING MONITOR)

\*1 The operating statuses for all recording settings switch to 'stopped.'

\*2 When the operating status for a recording setting is 'saving' or 'file saving trigger satisfied,' data sampling, reception, and accumulation stop and the operating status switches to 'stopped' after file saving is completed.

\*3 When the operating status for a recording setting is 'file saving trigger satisfied,' data sampling, reception, and accumulation stop and the operating status switches to 'saving' then 'stopped.'

## Precautions

- Sampling devices and labels stops in a CPU module and accumulating devices and labels stops in a recorder module/camera recorder module. Data sampled and accumulated before the stop is discarded.
- Delivering video data from a network camera stops and receiving and accumulating video data stop in a camera recorder module.
- If there is accumulated data, it is recommended to save it by an operation such as satisfying a file saving trigger before stop operation.

## Starting to save a recording file

To start saving a recording file, satisfy a file saving trigger. (☞ Page 28 File saving trigger)

After the file saving trigger is satisfied, a recorder module/camera recorder module outputs data accumulated in the recording buffer to a recording file and saves it to a save destination specified in the recording setting. (☞ Page 60 Recording buffer)

# Operation of the recording function when configuring multiple modules

The following shows the operation of the recording function when configuring multiple modules.

## Main and sub modules

When using multiple modules, configure the main module that controls all recording for the modules and a sub module that operates in synchronization with the main module.

One main module must be set.

After switching a CPU module to RUN, the main module and a sub module with recording target data start recording.

However, a sub module without recording target data does not start recording.

The following table shows the operations of the main module and a sub module.

Type	Description
Main	Controls all recording for a recorder module/camera recorder module, determines whether a recording startup trigger or file saving trigger is satisfied, accumulates devices and labels, and receives and accumulates video data* <sup>1</sup> . A recorder module is always set as the main module.* <sup>2</sup>
Sub	Performs recording in synchronization with the main module. A camera recorder module can be set as a sub module, and it receives and accumulates video data only.

\*1 Can be set when using a camera recorder module.

\*2 A recorder module with the firmware version '04' or later is required.

### ■ Configuration in which a recorder module is included

In this configuration, a recorder module is always set as the main module. Set a camera recorder module as a sub module.

### ■ Configuration in which only a camera recorder module is included

In this configuration, set a camera recorder module as the main module and another camera recorder module as a sub module.

If no module is set as the main one or multiple modules are set as the main ones, an error occurs in a CPU module.

Devices and labels are accumulated in a module set as the main one.

## Operating status after starting the recording function

After starting the recording function, the operating status switches to 'operating' when the operating status for a target recording setting switches to 'preparing,' the main module and all sub modules with recording target data complete preparation and start operating.

If a sub module cannot start operating, the operating status switches to 'operating' when the main module and the other sub modules start operating.

For the operating status of the recording function, refer to the following:

☞ Page 63 Operating status

For the operation to start the recording function, refer to the following:

☞ Page 65 Start

## Operating status after stopping the recording function

After stopping the recording function, the operating status switches to 'stopped' when the main module and all sub modules with recording target data stop operating.

However, when the operating status is 'file saving trigger satisfied' or 'saving,' it switches to 'stopped' after saving is completed for the main module and all sub modules with recording target data.

For the operating status of the recording function, refer to the following:

☞ Page 63 Operating status

For the operation to stop the recording function, refer to the following:

☞ Page 66 Stop

## Operation of the recording function when an error occurs

It differs for each module.

### ■When an error occurs in the main module

For a recording setting for which the main module cannot operate due to an error, the recording function stops running on all modules.

### ■When an error occurs in a sub module

For a recording setting for which a sub module cannot operate due to an error, the recording function starts or continues running on the main module and a sub module that can operate.

## Whether a trigger is satisfied

It is determined by the main module and reported to a sub module when the trigger is satisfied.

## When specifying an SD memory card as a save destination

For the main module, a recording file is saved to an inserted SD memory card according to the descriptions in the following:

☞ Page 52 Recording file name, Page 55 If there is no free folder number

For a sub module, a recording file is saved to an inserted SD memory card with the same name as one saved to the main module. If there is already a recording file with the same name, the file is saved after the existing one is deleted.\*1

\*1 The folder configuration in a save destination for recording files is the same as that in the main module.

### ■Reading or deleting a recording file in the "Recording File Reading" screen of GX Works3

Connect the main module and all sub modules to GX Works3.

If the main module is not connected, the "Recording File Reading" screen cannot be opened.

If a sub module is not connected, the "Recording File Reading" screen appears but data saved to an unconnected sub module cannot be read and deleted in the screen. (The [Delete] button is disabled.)

- When reading a recording file

Recording files saved to the main module are listed in the "Recording File Reading" screen.

By selecting a recording file and clicking the [Read to Personal Computer] button, recording files with the same name saved to a connected sub module are read together to a single recording file.

A recording file saved only to a sub module is not read.

For details on the "Recording File Reading" screen, refer to the following:

 GX Works3 Operating Manual

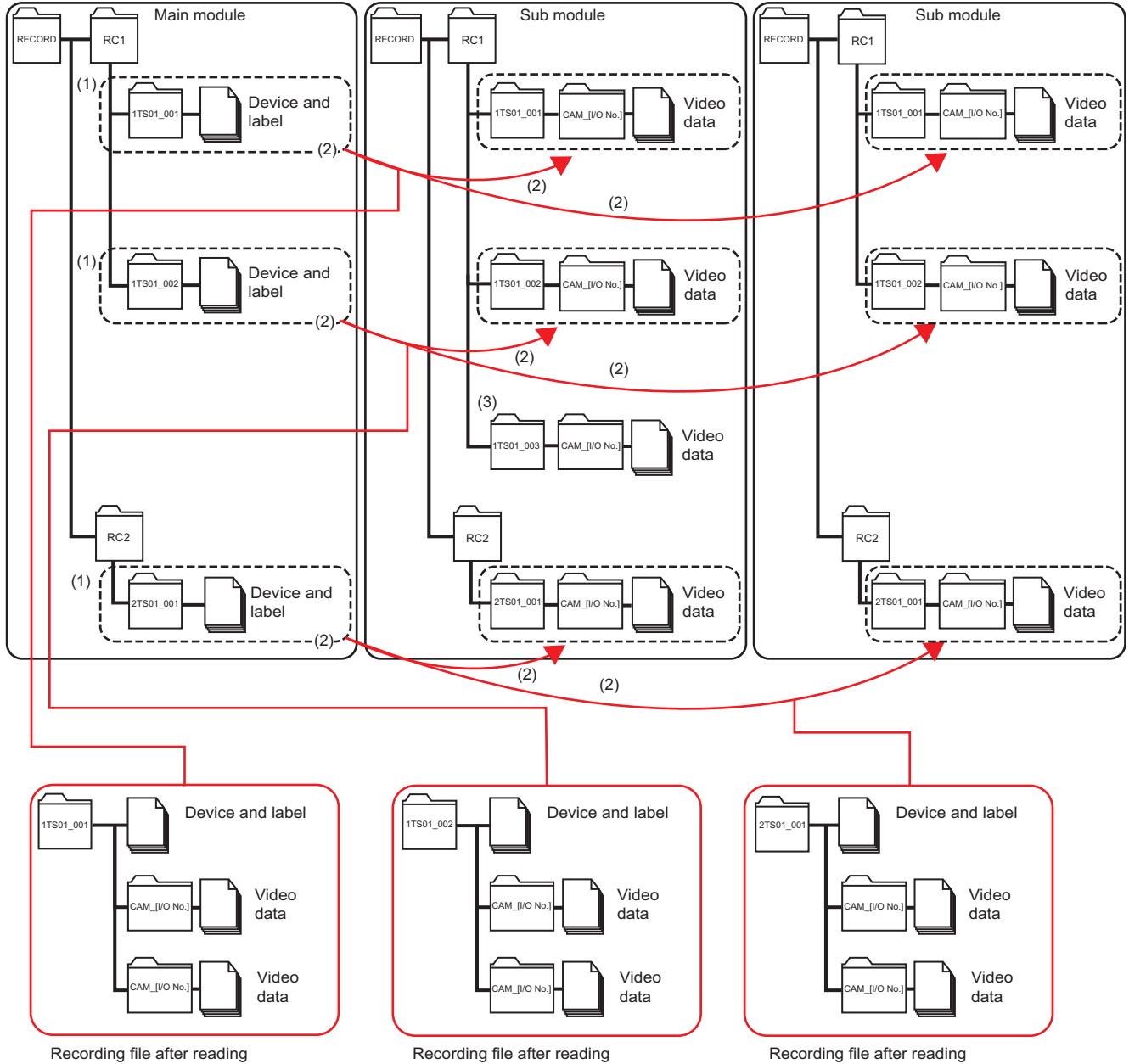

(1) Recording files saved to the main module are listed in the "Recording File Reading" screen.

(2) By selecting a recording file and clicking the [Read to Personal Computer] button, recording files with the same name saved to a connected sub module are read together to a single recording file.

(3) A recording file saved only to a sub module is not read.

### Point

The total size of recording files with the same name saved to the main module and a connected sub module is displayed in the "Size" column in the "Recording File Reading" screen.

- When deleting a recording file

Recording files saved to the main module are listed in the "Recording File Reading" screen.

By selecting a recording file and clicking the [Delete] button, a recording file with the same name saved to a sub module is also deleted.

A recording file saved only to a sub module is not deleted.

For details on the "Recording File Reading" screen, refer to the following:

 GX Works3 Operating Manual

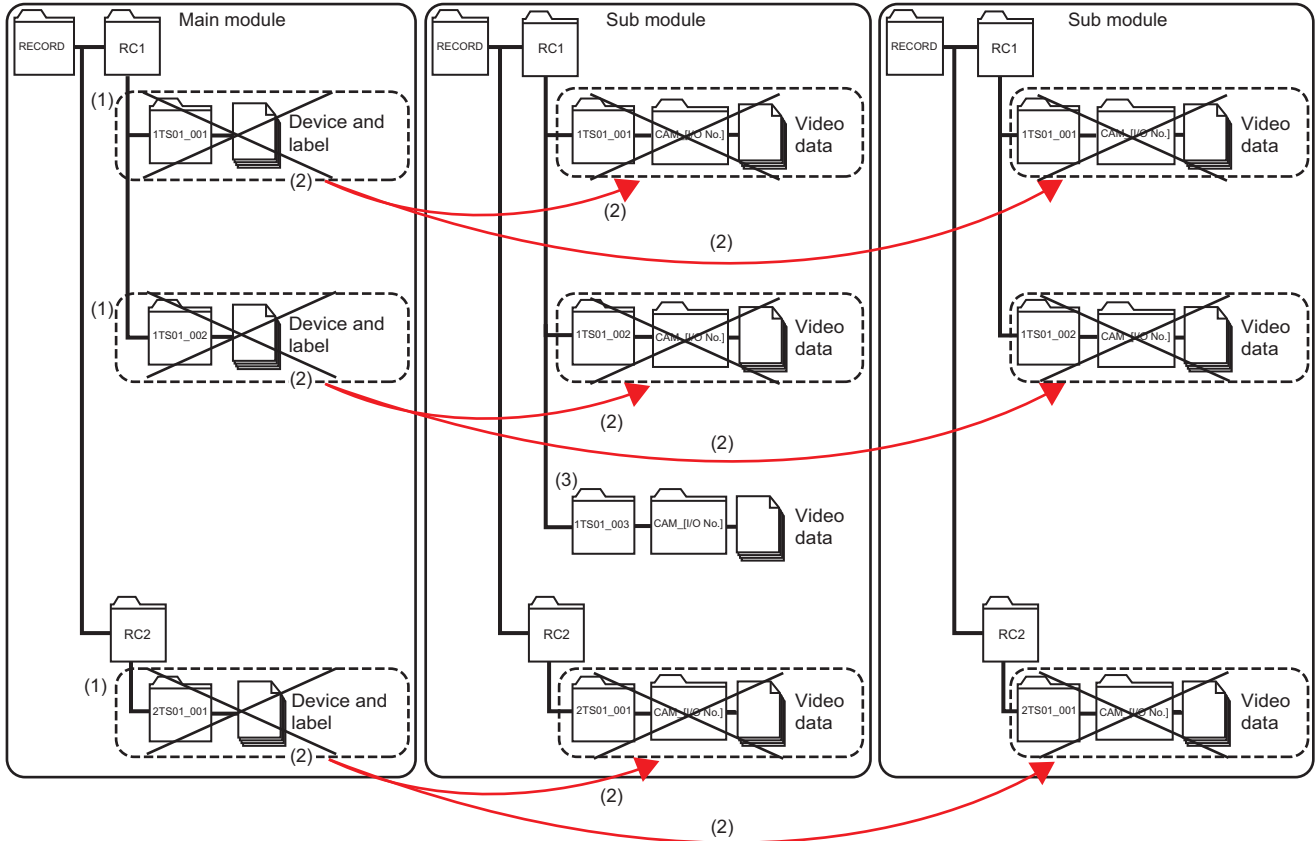

(1) Recording files saved to the main module are listed in the "Recording File Reading" screen.

(2) By selecting a recording file and clicking the [Delete] button, a recording file with the same name saved to a sub module is also deleted.

(3) A recording file saved only to a sub module is not deleted.

**Point** 

The total size of recording files with the same name saved to the main module and a sub module is displayed in the "Size" column in the "Recording File Reading" screen.



## Operation examples of each module

The following shows operation examples of each module according to each module configuration and recording setting.

### ■ Main module (recorder module) + four sub modules (camera recorder modules)

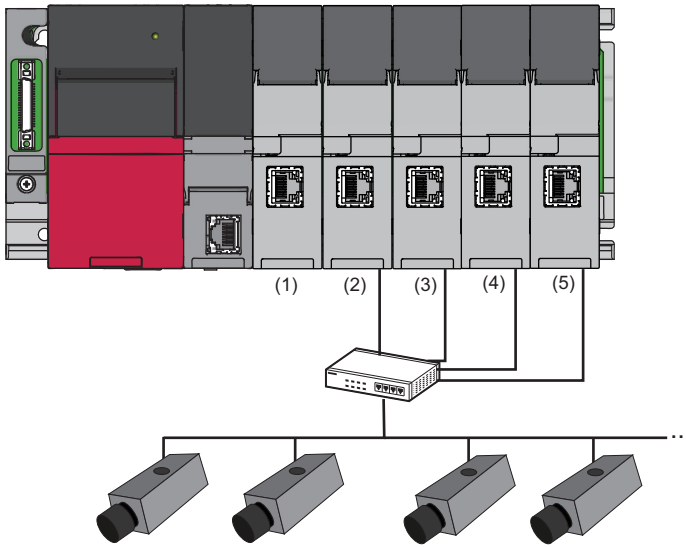

—: N/A

Connected device	(1) Main	(2) Sub 1	(3) Sub 2	(4) Sub 3	(5) Sub 4
Network camera*1	—	4 (camera ①, ②, ③, ④)	4 (camera ⑤, ⑥, ⑦, ⑧)	2 (camera ⑨, ⑩)	Not connected

\*1 Set a network camera in the module extended parameter of each camera recorder module.

☞ Page 103 Module Extended Parameters (Camera Recorder Module)

Ex.

#### Recording setting

—: Not set

Recording setting	Recording target data	
	Device and label	Video data
Setting No.1	Included	Not included
Setting No.2 and later	—	—

#### Operation of each module

Main	Sub 1	Sub 2	Sub 3	Sub 4
Operates	Does not operate	Does not operate	Does not operate	Does not operate

Ex.

#### Recording setting

Recording setting	Recording target data	
	Device and label	Video data
Setting No.1	Included	Included (camera ①, ②, ③, ④)
Setting No.2	Included	Included (camera ⑤, ⑥)
Setting No.3	Included	Included (camera ⑦, ⑧)
Setting No.4	Included	Not included

#### Operation of each module

Main	Sub 1	Sub 2	Sub 3	Sub 4
Operates	Operates	Operates	Does not operate*1	Does not operate

\*1 Because camera ⑨ and ⑩ are not set as targets.

## ■ Main module (camera recorder module) + three sub modules (camera recorder modules)

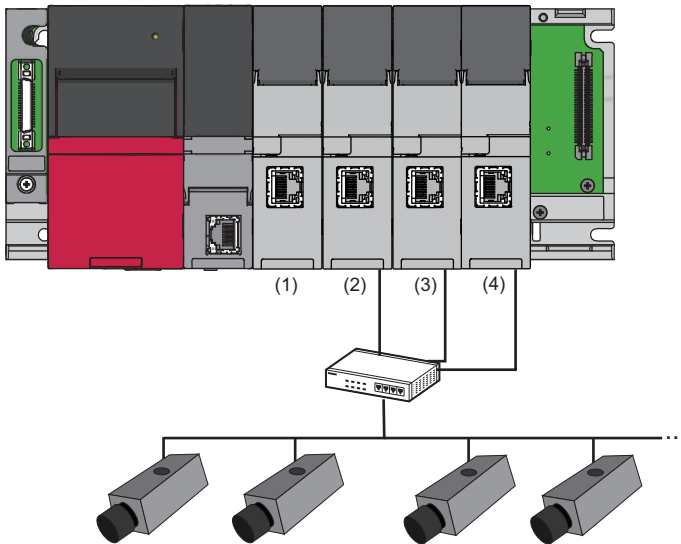

Connected device	(1) Main	(2) Sub 1	(3) Sub 2	(4) Sub 3
Network camera*1	2 (camera ①, ②)	4 (camera ③, ④, ⑤, ⑥)	2 (camera ⑦, ⑧)	Not connected

\*1 Set a network camera in the module extended parameter of each camera recorder module.

☞ Page 103 Module Extended Parameters (Camera Recorder Module)

Ex.

### Recording setting

—: Not set

Recording setting	Recording target data	
	Device and label	Video data
Setting No.1	Included	Not included
Setting No.2 and later	—	—

### Operation of each module

Main	Sub 1	Sub 2	Sub 3
Operates	Does not operate	Does not operate	Does not operate

Ex.

### Recording setting

—: Not set

Recording setting	Recording target data	
	Device and label	Video data
Setting No.1	Included	Included (camera ③, ④)
Setting No.2	Included	Included (camera ⑤, ⑥)
Setting No.3 and later	—	—

### Operation of each module

Main	Sub 1	Sub 2	Sub 3
Operates	Operates	Does not operate*1	Does not operate

\*1 Because camera ⑦ and ⑧ are not set as targets.

## Adding and changing a recording setting

A recording setting can be added and changed while the operation of the recording function is stopped.

The procedures for adding and changing a recording setting differ depending on the CPU module status.

In addition, a recording setting can be written when the recording function is stopped such as when a CPU module is in STOP.

To write a recording setting, and add or change a device and label to be sampled without stopping the system, stop the recording function while the CPU module is in RUN, write the recording setting, and start the recording function again.

Note that the recording function must be stopped in the "Recording Monitor" screen while the CPU module is in RUN.

☞ Page 142 RECORDING MONITOR

### Precautions

- After changing the buffer area setting for data sampling in the CPU parameter and the recording buffer setting in the module parameter, a programmable controller must be powered OFF and ON or reset.
- If the sampling size of a recording setting exceeds the capacity of the buffer area setting for data sampling of a CPU module, the recording function cannot be started and a recording setting error (error code: 3026H) occurs in a recorder module/camera recorder module. The sampling size of a recording setting and the required size of buffer area for data sampling can be checked in the "Recording Setting" screen. In addition, the capacity of the buffer area setting for data sampling of a CPU module can be checked in the CPU parameter.

☞ Page 114 Recording Setting Screen, Page 94 Buffer area setting for data sampling

### Without changing parameters

The following shows the procedure for adding and changing a recording setting without changing the buffer area setting for data sampling and the recording buffer setting.

1. Switch a CPU module to the STOP/PAUSE state.
2. Check that 'Stopped' is displayed for all recording settings.
3. Write a changed program and all recording settings to the CPU module.\*1
4. Switch the CPU module to RUN.

### ■ Adding or changing a recording setting while a CPU module is in the RUN state

A recording setting can be added or changed by starting/stopping the operation in the "Recording Monitor" screen even while a CPU module is in the RUN state.\*2

This allows a recording setting to be added or changed at the same time according to a changed program when changing the program and performing the online program change.

1. If the operating status for a recording setting is not 'stopped,' stop the operation in the "Recording Monitor" screen.  
(☞ Page 142 RECORDING MONITOR)
2. Check that 'Stopped' is displayed for all recording settings.
3. Write a changed program and all recording settings to a CPU module.\*1
4. Start the operation in the "Recording Monitor" screen.

\*1 When not changing a program, a recording setting can be added or changed individually.

Stop the operation for a recording setting to be changed in the "Recording Monitor" screen, and write the recording setting to the CPU module.

Before writing the recording setting, check the considerations shown in the following:

☞ Page 75 Writing recording settings, parameters, and programs

\*2 When adding a new recording setting, set the buffer area for data sampling and recording buffer for the setting, then write the CPU parameters and module parameters.

For the procedure, refer to the following:

☞ Page 74 With changing parameters

## Precautions

If the recording function continues running without changing a recording setting after changing a program and data is reproduced on the offline monitor after saving the data, the reproduced values of devices and labels may not be displayed properly.

## With changing parameters





The following shows the procedure after changing the buffer area setting for data sampling or the recording buffer setting.

- 1.** Switch a CPU module to the STOP/PAUSE state.
- 2.** Check that 'Stopped' is displayed for all recording settings.
- 3.** Write the CPU parameters, module parameters, programs, and all recording settings to the CPU module.
- 4.** Reset the CPU module or turn the power OFF and ON.
- 5.** Switch the CPU module to the RUN state.

## Writing recording settings, parameters, and programs

The following table shows operations when writing recording settings, CPU parameters, and programs to a CPU module individually.

○: Applicable, —: Not applicable

No.	Adding/ changing a recording setting	Changing CPU parameters	Adding/ changing a program <sup>*1</sup>	Condition
1	○	—	—	Write recording settings while the program setting in the CPU parameter and programs match between a CPU module and GX Works3. [Method for checking whether they match] Verify <sup>*1</sup> CPU parameters and programs with a CPU module. For details, refer to the following:  GX Works3 Operating Manual [Corrective action if they do not match] Create a new project, read CPU parameters and programs from a CPU module, then create recording settings again.
2	○	○	—	Write recording settings and CPU parameters while programs match between a CPU module and GX Works3. [Method for checking whether they match] Verify <sup>*1</sup> programs with a CPU module. For details, refer to the following:  GX Works3 Operating Manual [Corrective action if they do not match] Create a new project, read programs from a CPU module, then create recording settings and CPU parameters again.
3	○	—	○	Write recording settings and programs while the program setting in the CPU parameter matches between a CPU module and GX Works3. [Method for checking whether they match] Verify CPU parameters with a CPU module. For details, refer to the following:  GX Works3 Operating Manual [Corrective action if they do not match] Read CPU parameters from a CPU module.
4	○	○	○	Refer to the following:  Page 74 With changing parameters
5	—	○	—	Write CPU parameters, recording settings, and programs. Or, read recording settings and programs from a CPU module, then write them and CPU parameters.
6	—	○	○	Write CPU parameters, recording settings, and programs. Or, read recording settings from a CPU module, then write them, CPU parameters, and programs.
7	—	—	○	Write recording settings and programs. Or, read recording settings from a CPU module, then write them and programs. To add or delete a program or change its name, CPU parameters must be changed. Refer to the condition shown in No.6.

\*1 Even when not editing programs, they may be different from those that were applied when configuring the recording setting after converting the programs. Make sure to write the recording setting and programs to the CPU module.

# Program change

## Program change while the recording function is running

A program can be changed by performing the online program change or file batch online change even while the recording function is running, and the function continues running even after changing the program.

### ■Behavior when changing a program

When changing a program by performing the online program change or file batch online change while the recording function is running, a warning event (event code: 00C01) occurs in a recorder module/camera recorder module<sup>\*1</sup>, but the function continues running.<sup>\*2</sup>

\*1 When configuring multiple modules, a warning event occurs in a module set as the main one according to the module parameter setting.  
 Page 67 Operation of the recording function when configuring multiple modules

\*2 When using any of the following types of CPU modules or recorder modules, a warning event does not occur.  
- RnCPU and RnENCPU the firmware version of which is '54' or earlier  
- RnSFCPU the firmware version of which is '23' or earlier  
- Recorder module the firmware version of which is '03' or earlier

### ■Behavior when restarting the recording function

When starting (restarting) the recording function after changing a program while the function is running, a warning event (event code: 00C00) occurs in a recorder module/camera recorder module<sup>\*1</sup>, but the function starts running.<sup>\*2</sup>

\*1 When configuring multiple modules, a warning event occurs in a module set as the main one according to the module parameter setting.  
 Page 67 Operation of the recording function when configuring multiple modules

\*2 When using any of the following types of CPU modules or recorder modules, a recording setting error (error code: 3027H or 3028H) occurs and the recording function cannot be started.  
- RnCPU and RnENCPU the firmware version of which is '54' or earlier  
- RnSFCPU the firmware version of which is '23' or earlier  
- Recorder module the firmware version of which is '03' or earlier

### ■Changing a sampling target after changing a program

When changing a program after writing a recording setting, a changed device and label are not automatically set as sampling targets.

To include them in the sampling target, perform the following operations:

1. Stop the recording function.
2. Add/change a device and label to be sampled in the recording setting.<sup>\*1</sup>
3. Write the recording setting to a CPU module.
4. Start the recording function.

\*1 Not required when 'device/label batch specification' is enabled.

### ■Warning event

A warning event, which occurs when changing a program while the recording function is running and restarting the function, can be changed to a minor error.

This allows a warning event to be checked as an error with the ERROR LED, module diagnostics, or in the buffer memory of a recorder module/camera recorder module.

For details on the setting, refer to the following:

 Page 100 Operation setting at event detection

## Program change while the recording function is stopped

When changing a program by performing the online program change or file batch online change while the recording function is stopped, also write the recording setting.

When not writing the recording setting (program change only), project information does not match that in the recording setting the next time the recording function is started, resulting in a recording setting error.

In addition, changed devices and labels are not automatically set as sampling targets. To include them in the sampling target, add or change them in the recording setting then write them.\*1

\*1 Not required when 'device/label batch specification' is enabled.

## Recording monitor

---

The status of the recording function can be checked in the "Recording Monitor" screen of GX Works3.

In addition, the status of a network camera connected to a camera recorder module can be checked in the "Camera Monitor" screen.

For details, refer to the following:

☞ Page 142 RECORDING MONITOR

## Errors that occur when using the recording function

---

For details on the errors, refer to the following:

Note that errors for a CPU module do not occur when using the recording function.

- Recorder module: ☞ Page 167 Error code list
- Camera recorder module: ☞ Page 185 Error code list

## Buffer memory used for the recording function

---

For the buffer memory used for the recording function, refer to the following:

- Recorder module: ☞ Page 208 Buffer Memory
- Camera recorder module: ☞ Page 257 Buffer Memory



# Project data saving function

This function can be used to save project data used when playing a recording file to a save destination where the recording file is saved.

It is available when using an RnCPU or RnENCPU as a CPU module.

## Point

When configuring multiple modules, project data is saved in a module set as the main one.

 Page 67 Operation of the recording function when configuring multiple modules

## Precautions

If multiple peripheral devices communicate with a CPU module while project data is being saved in a recorder module/camera recorder module, a communication response to each peripheral device may decrease.

In consideration of the performance of the communication response, configure the setting according to the system, such as changing the setting in the parameter setting of the peripheral device so that the timeout time becomes longer.

When using multiple recording settings, the processing time for saving project data and the time during which a communication response decreases can be reduced by saving a recording file for each setting to the same save destination.

## Methods for saving project data

The following table shows the methods for saving project data.

Method	Timing	Purpose
Performing automatic saving in the module parameter	Recording starts.	Use this method to automatically save project data when recording starts.
Turning the buffer memory ON	The buffer memory of a recorder module/camera recorder module turns ON.	Use this method to save project data at any timing. It is available only during recording operation.*1

\*1 For details on the operating status of recording, refer to the following:

 Page 63 Operating status

### ■ Performing automatic saving in the module parameter

When specifying automatic saving in the module parameter of a recorder module/camera recorder module, project data is automatically saved to a save destination for a recording file specified in the recording setting for which the operation starts after starting recording.

By saving project data when recording starts, only project data during recording operation is saved.

Automatic saving is enabled by setting "Automatic Saving at Recording Start" to "Save" in the module parameter, writing the setting to a CPU module, and turning the power OFF and ON or resetting the CPU module.

For details on the module parameter, refer to the following:

 Page 99 Project data saving setting

Once enabled, even when changing a save destination for a recording file in the recording setting, the setting when recording starts is automatically applied to the save destination for project data.\*1

\*1 For changing the recording setting after stopping recording while project data is being saved, refer to the following:

 Page 88 When stopping recording during project data saving

## Point

When configuring multiple modules, set this method in the module parameter of a module set as the main one.

## ■Turning the buffer memory ON

When 'Project data saving specification' (Un\G14080 to 14083) is detected to be ON in a recorder module/camera recorder module, project data is saved to a save destination for a recording file specified in the recording setting.

The buffer memory of a recorder module/camera recorder module can be operated in a program or by using a function such as the device/buffer memory batch monitor or intelligent function module monitor function of GX Works3.

For details on the buffer memory, refer to the following:

☞ Page 232 Project data saving specification area (Un\G14080 to 14199)

Use this method in the following cases:

- Saving project data when the load is not high, such as when recording starts (STOP to RUN). If it is high, a communication response from a peripheral device to a CPU module decreases while project data is being saved.
- Saving changed project data after performing the online program change/file batch online change on a CPU module during recording operation

Even when turning ON the buffer memory of a recorder module/camera recorder module while recording is stopped, project data is not saved.

When starting recording while the buffer memory of a recorder module/camera recorder module is ON, project data is saved when recording starts.



When configuring multiple modules, operate the buffer memory of a module set as the main one.

## ■Operating the buffer memory of a recorder module/camera recorder module in a program

Project data can be saved by operating the buffer memory of a recorder module/camera recorder module in a program according to the recording operation.

The following timings are recommended to turn the buffer memory ON for each recording method set in the recording setting.

Recording method	Timing
File saving trigger only	A file saving trigger is satisfied.*1
Recording startup trigger + file saving trigger	A recording startup trigger is satisfied.

\*1 When turning the buffer memory ON at the same time as this timing, set the saving period after trigger longer than the interval for sampling devices and labels.

## ■If a program is changed while the recording function is running

Project data (program), which is changed by performing the online program change or file batch online change while the recording function is running, can be saved by turning ON the buffer memory of a recorder module/camera recorder module. However, when playing a recording file saved without changing the recording setting and without stopping recording on the offline monitor by using project data saved after changing the project data (program), reproduced device and label values may not be displayed correctly.

Therefore, when changing project data (program) by performing the online program change or file batch online change, it is recommended to stop the recording function and write the project data (program) at the same time as a recording setting as necessary, and to save the project data by using either of the specification methods.

For details on the project data (program) change during recording operation, refer to the following:

☞ Page 76 Program change

## Target

The following table shows project data to be saved.

Data name	
Parameter	CPU parameter
	System parameter
	Module parameter
	Module extended parameter
Sequence program	Program file
	FB file
Device comment	Device comment
Global label setting	
Recording setting	

## Save destination

Project data is saved to either of the following save destinations according to a save destination for a recording file.

Save destination	Save destination folder
SD memory card <sup>*1</sup>	RECORD\PRJ(save date and time folder)
File server	(Save destination folder specified in the file server setting in the recording setting)\RECORD\PRJ(save date and time folder)

\*1 One inserted in the main module when configuring multiple modules

Up to 10 units of project data can be saved.

If it is exceeded, old project data is deleted and new project data is saved.

### Point

- Multiple units of project data can be saved; therefore, past project data used to play a past recording file can be acquired from the save destination for the recording file and used.
- Project data in a CPU module is compared with the latest project data if there are multiple units of project data saved in a save destination, and it is saved only when there is an update.
- If there is no project data saved, it is saved without checking for any update.

## ■Configuring multiple recording settings

When specifying a different save destination for a recording file in multiple recording settings, project data is saved to each save destination and can be used to play each recording file.

When specifying a same save destination for a recording file in multiple recording settings, project data is saved to the same save destination. The saved project data can be used in common to play a recording file saved in each setting.

## ■Format of a save date and time folder name

The name of a save date and time folder is a date and time when saving project data starts in a recorder module/camera recorder module.

The time (local time) in a CPU module is used for the date and time.

Output format	Description
YYYYMMDDhhmmssms	YYYY: Year (4 digits)
YYYYMMDDhhmmssmsDST*1	MM: Month (2 digits) DD: Day (2 digits) hh: Hour (2 digits) mm: Minute (2 digits) ss: Second (2 digits) ms: Millisecond (3 digits)

\*1 'DST' is added to the end of the date and time for the daylight saving time.

### Ex.

When the date and time is 1:00:00:000 milliseconds on April 1st, 2021, the folder name is as follows:

Standard time: 20210401010000000

Daylight saving time: 20210401010000000DST

## Precautions

The file (UpDateTime.bin) stored immediately under a save date and time folder is a system management file. Do not edit or delete it.

## ■Project data saving completion file

When saving project data to a file server is completed, the saving completion file is created as follows:

File name	Extension	Storage location
Same name as a save date and time folder	BTC	PRJ folder

## Using saved project data

When specifying an SD memory card as a save destination, saved project data can be used to play a recording file by selecting the checkbox of "Read Project Data" in the "Recording File Reading" screen of GX Works3 and reading it from a recorder module/camera recorder module at the same time as the recording file.

When specifying a file server as a save destination, saved project data is opened at the same time when playing a recording file in the file server on the offline monitor of GX Works3, and can be used to play the recording file.

To read or open saved project data, GX Works3 supporting this function is required. (📖 Page 307 Added and Changed Functions)

For details on the "Recording File Reading" screen and offline monitor, refer to the following:

📖 GX Works3 Operating Manual

### Point

Project data to be read or opened is automatically selected from project data saved to a save destination according to the following rules:

- ① Project data saved immediately before a recording file to be read
- ② Project data saved immediately after a recording file to be read if there is no project data applying to ①

## Considerations

The following shows the considerations for the recording function.

### When using an SFC program

Make sure that only one SFC program is included in a project when using 'device/label batch specification.'  
 If multiple SFC programs are included in a project, 'include SFC device' of 'device/label batch specification' cannot be used.  
 To perform the recording function if multiple SFC programs are included, use 'specify the device range' to specify a step relay with block specification (BL□\S) to be sampled.  
 In addition, when specifying a block or step not included in an SFC diagram as a sampling target in advance for future use, use 'specify the device range' to specify a step relay with block specification (BL□\S) as a sampling target.

### When setting SFC devices as sampling targets

By changing programs (program files or FB files) or CPU parameters after writing them to a programmable controller, SFC devices may not be included or included in the sampling target.  
 After changing them, write them to the programmable controller again.  
 (When performing verification before writing, the result may be mismatched.)

### When starting the recording function

The recording function does not start if parameters, programs, and FBs written to a CPU module are different from those applied when configuring the recording setting.  
 When performing a function or an operation to change a file in a CPU module (such as boot operation<sup>\*1</sup> from an SD memory card or the backup/restore function of the CPU module), write parameters, programs, and FBs applied when configuring the recording setting to the CPU module.

\*1 Not supported by safety CPUs.

### Scan time extension

The scan time is extended while the recording function is running.  
 It is also affected by the size, device address (number), or type of data to be sampled, and devices (buffer memory, link devices) that access a module.  
 By default, 'device/label batch specification' is enabled; therefore, the number of devices and labels to be sampled increases and the scan time becomes longer.

### When specifying a timeout as a condition for satisfying a file saving trigger

#### ■Setting the timeout time

A value in a device of a CPU module specified as a condition for satisfying a file saving trigger is sampled during the END processing in a sequence scan.  
 Therefore, when specifying a timeout as a condition for satisfying a file saving trigger, set the timeout time longer than the scan time.  
 Otherwise, a file saving trigger is always satisfied by timeout detection for every scan.

#### ■Starting counting the timeout time

Counting the timeout time starts at the following timings:

- The value in 'Timeout detection of file saving trigger' (Un\G4008) is changed from 'disabled' to 'enabled.'
- The value in a specified device changes.

## ■ Stopping counting the timeout time

Counting the timeout time stops in the following cases:

- The value in 'Timeout detection of file saving trigger' (Un\G4008) is changed from 'enabled' to 'disabled.'
- The operating status switches to 'stopped' or 'preparing.'
- A file saving trigger is satisfied by timeout detection. (Counting the timeout time of the satisfied trigger stops; therefore, a trigger is not satisfied by timeout detection unless the counting starts again.)

## ■ Resetting the timeout time

The timeout time is reset at the following timings:

- The value in a specified device changes.
- The operating status switches to 'stopped' or 'preparing.'
- The value in 'Timeout detection of file saving trigger' (Un\G4008) is changed from 'enabled' to 'disabled.'

## ■ Timing when a change in a device is ignored

Even if the value in a specified device changes within a timeout time, a file saving trigger may be satisfied by timeout detection.

During a period from the END processing immediately before a timeout time elapses to the timeout time, a file saving trigger is satisfied by timeout detection even if the value in a specified device changes.

The following shows the flow.

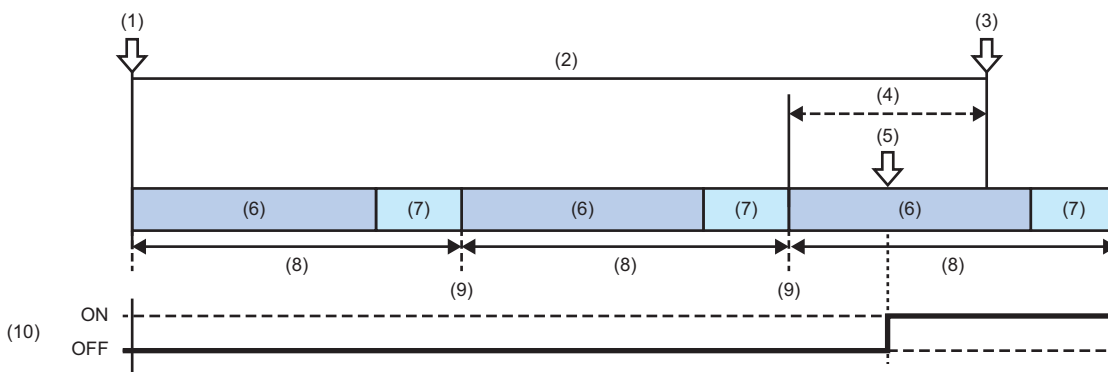

- (1) Counting the timeout detection starts.
- (2) Timeout time
- (3) A file saving trigger is satisfied.
- (4) Period during which a file saving trigger is satisfied even if the value in a specified device changes
- (5) A specified device value changes.
- (6) Program operation
- (7) END processing
- (8) Scan time
- (9) Whether a specified device value changes is determined.
- (10) Specified device value

## ■Timing when the value 'disabled' in 'Timeout detection of file saving trigger' (Un\G4008) is ignored

If there are two types of timings in one scan: when the value in 'Timeout detection of file saving trigger' (Un\G4008) changes to 'disabled' and when a timeout is detected, a file saving trigger may be satisfied even when changing the value before the trigger is satisfied.

The following shows a timing to determine which value, 'enabled' or 'disabled,' is stored in 'Timeout detection of file saving trigger' (Un\G4008).

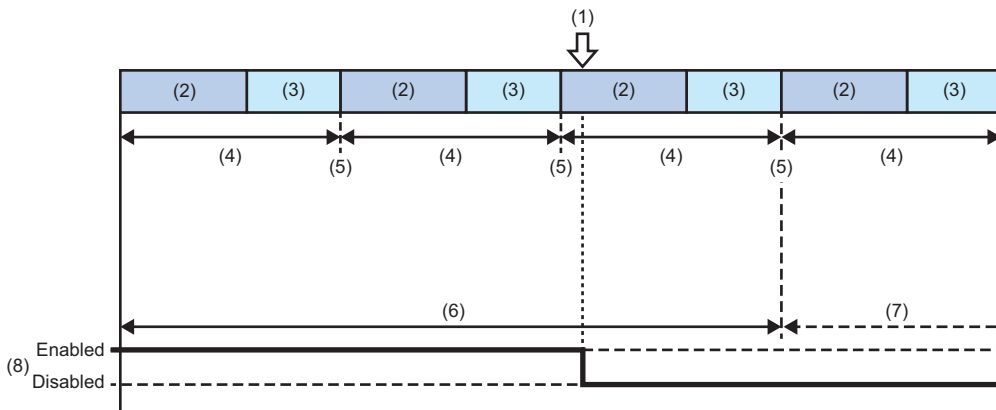

- (1) Timeout detection is disabled in the buffer memory.
- (2) Program operation
- (3) END processing
- (4) Scan time
- (5) Whether timeout detection is enabled or disabled is determined.
- (6) Timeout detection is enabled.
- (7) Timeout detection is disabled.
- (8) 'Enabled' and 'disabled' for 'Timeout detection of file saving trigger' (Un\G4008)

## ■Setting the saving period before trigger

When specifying a timeout as a condition for satisfying a file saving trigger, set the saving period before trigger so that the following conditions are satisfied:

- Device and label values before timeout detection starts can be sampled sufficiently.
- The saving period before trigger must be longer than the timeout time.

By sampling recording target data before timeout detection, the cause of timeout can be analyzed.

The following shows the timeout time and the saving period before trigger.

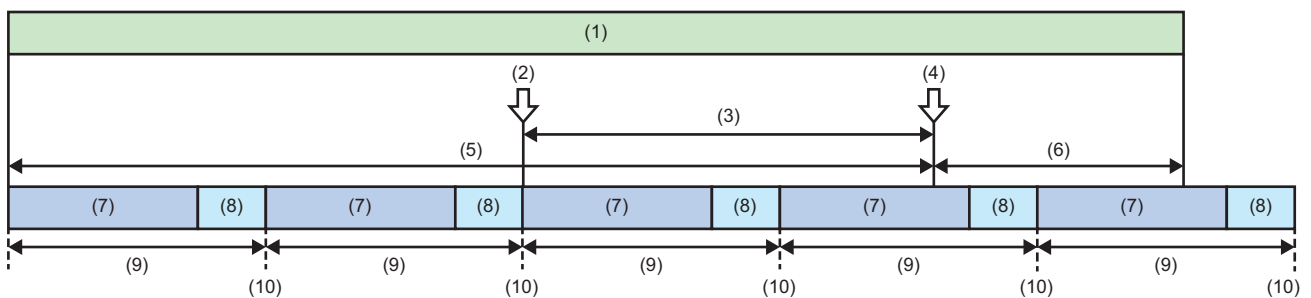

- (1) Data to be saved
- (2) Counting the timeout detection starts.
- (3) Specified timeout time
- (4) A file saving trigger is satisfied.
- (5) Saving period before trigger
- (6) Saving period after trigger
- (7) Program operation
- (8) END processing
- (9) Scan time
- (10) Recording target data is sampled.

## Saving a recording file

### ■If saving a file fails

If saving a file fails due to a cause such as an insufficient free space on an SD memory card or a file server, an error occurs. If saving device and label data fails, video data is not saved either. If saving only video data fails, data other than the failed video data is saved.

In addition, the following processing is performed according to the recording method.

- "File Saving Trigger Only" is selected for the recording method: Data that failed to be saved is discarded, and data sampling, reception, and accumulation continue.
- "Recording Startup Trigger + File Saving Trigger" is selected for the recording method: Data that failed to be saved is discarded, and data accumulation stops until the next recording startup trigger is satisfied.

It is recommended to check the free space on an SD memory card or a file server before satisfying the condition for a file saving trigger.

### ■When switching a CPU module from RUN to STOP or if a CPU stop error occurs in a CPU module during file saving

The processing continues until the file saving is completed.

When changing a recording setting and switching a CPU module from STOP to RUN before file saving is completed, the changed setting becomes enabled after the file saving is completed.

Whether the file saving is completed can be checked in 'Recording files saving completion' (Un\G1508, Un\G1708, Un\G1908, Un\G2108)\*<sup>1</sup> of a recorder module/camera recorder module. (☞ Page 221 Recording status area (Un\G1500 to 3199), Page 271 Recording status area (Un\G1500 to 3199))

- \*<sup>1</sup> Buffer memory of a module set as the main one when configuring multiple modules  
☞ Page 67 Operation of the recording function when configuring multiple modules

### ■When stopping the recording function in the "Recording Monitor" screen during file saving

The processing continues until the file saving is completed.

When changing a recording setting and starting the recording function in the "Recording Monitor" screen before file saving is completed, the changed setting becomes enabled after the file saving is completed.

Whether the file saving is completed can be checked in 'Recording files saving completion' (Un\G1508, Un\G1708, Un\G1908, Un\G2108)\*<sup>1</sup> of a recorder module/camera recorder module. (☞ Page 221 Recording status area (Un\G1500 to 3199), Page 271 Recording status area (Un\G1500 to 3199))

- \*<sup>1</sup> Buffer memory of a module set as the main one when configuring multiple modules  
☞ Page 67 Operation of the recording function when configuring multiple modules

### ■Formatting an SD memory card during file saving

An SD memory card cannot be formatted while a file is being saved to the SD memory card.

Format it after the file saving is completed.

Whether the file saving is completed can be checked in 'Recording files saving completion' (Un\G1508, Un\G1708, Un\G1908, Un\G2108)\*<sup>1</sup> of a recorder module/camera recorder module. (☞ Page 221 Recording status area (Un\G1500 to 3199), Page 271 Recording status area (Un\G1500 to 3199))

- \*<sup>1</sup> Buffer memory of a module set as the main one when configuring multiple modules  
☞ Page 67 Operation of the recording function when configuring multiple modules



**■When turning the power OFF or resetting a CPU module during file saving**

When turning the power OFF or resetting a CPU module while a file is being saved to an SD memory card, the file is deleted without being saved.

In addition, the SD memory card may be damaged. Stop file access, then turn the power OFF or reset the CPU module.

When turning the power OFF or resetting a CPU module while a file is being saved to a file server, the file is deleted without being saved.

Make sure that the file saving is completed in the "Recording Monitor" screen, then turn the power OFF or reset the CPU module.

**■When removing an SD memory card during file saving**

When removing an SD memory card without stopping file access while a file is being saved to the SD memory card, the file is deleted and the SD memory card may be damaged.

Read a required recording file in GX Works3 before removing the SD memory card.

**■If the network is disconnected during file saving**

If the network is disconnected between a recorder module/camera recorder module and a file server while a file is being saved to the file server, the file is deleted.

**■When displaying the event history during file saving**

An event history file is also saved as a recording result; therefore, when displaying the event history during file saving, it may take longer to display the event history or complete the file saving.

**■Saving a recording file when configuring multiple modules**

A recording file is saved to the main and sub modules at the same time.

Once saving a recording file starts, data accumulation stops until the file is saved to all the modules.

When the recording file is saved to all the modules, the data accumulation restarts.

If saving a recording file fails in the main module, it also fails in a sub one.

If there is video data that failed to be saved in a camera recorder module, video data other than the failed data is saved.

 Page 67 Operation of the recording function when configuring multiple modules

## Writing a recording setting

When adding or changing a program after configuring the recording setting if 'device/label batch specification' is enabled, devices and labels in the added or changed program are also specified as sampling targets. This may cause the sampling size to increase and exceed the capacity of the buffer size for data sampling when writing the recording setting.

## When using the project data saving function

### ■Changing project data during project saving

When performing the online program change or file batch online change, or accessing project data to be saved in a CPU module from a peripheral device while the project data is being saved in a recorder module/camera recorder module, the saving may fail, or an error may occur in these operations.

To perform these operations, make sure that the project data is not being saved in the buffer memory of a recorder module/camera recorder module.\*1\*2

\*1 The saving status of project data can be checked in the buffer memory of a recorder module/camera recorder module.

For details, refer to the following:

☞ Page 230 Project data saving status area (Un\G14000 to 14079), Page 281 Project data saving status area (Un\G14000 to 14079)

\*2 Buffer memory of a module set as the main one when configuring multiple modules

☞ Page 67 Operation of the recording function when configuring multiple modules

### ■When the automatic saving at the start of recording is enabled

If an access response is delayed from a peripheral device, etc. to a CPU module when switching from STOP to RUN, or if a file read error occurs, disable the automatic saving at the start of recording, and turn the buffer memory\*1 from OFF to ON to save project data while file access is not concentrated after switching to RUN.

\*1 Buffer memory of a module set as the main one when configuring multiple modules

☞ Page 67 Operation of the recording function when configuring multiple modules

### ■Operating the buffer memory during project data saving

While project data is being saved, 'Project data saving specification' (Un\G14080 to 14083)\*1 is disabled even if it is turned ON.

Make sure that the project data is not being saved, then turn ON the buffer memory of a recorder module/camera recorder module.

The buffer memory automatically turns OFF after the saving is completed.

\*1 Buffer memory of a module set as the main one when configuring multiple modules

☞ Page 67 Operation of the recording function when configuring multiple modules

### ■When stopping recording during project data saving

When switching the operating status of a CPU module to STOP or PAUSE or stopping the recording function in the "Recording Monitor" screen while project data is being saved, the processing continues until the saving is completed.

When changing a save destination for a recording file in the recording setting and starting the recording function before the saving is completed, the changed setting becomes enabled after the saving is completed.

Whether the saving is completed can be checked in 'Project data saving completion' (Un\G14001, Un\G14011, Un\G14021, Un\G14031)\*1.

\*1 Buffer memory of a module set as the main one when configuring multiple modules

☞ Page 67 Operation of the recording function when configuring multiple modules

### ■Setting a read-protected file password

Do not set a read-protected file password for data to be saved when using the project data saving function.

If there is any project data with a read-protected file password set, the project data is not saved.

For details on the file password, refer to the following:

📖 GX Works3 Operating Manual

### ■When turning the power OFF or resetting a CPU module during project data saving

When turning the power OFF or resetting a CPU module while project data is being saved to an SD memory card, the project data is deleted without being saved.

In addition, the SD memory card may be damaged. Stop file access, then turn the power OFF or reset the CPU module.

When turning the power OFF or resetting a CPU module while project data is being saved to a file server, the saving may not be completed or the file may be corrupted.

Turn the power OFF or reset the CPU module after the saving is completed.

Whether the saving is completed can be checked in 'Project data saving completion' (Un\G14001, Un\G14011, Un\G14021, Un\G14031)\*1.

\*1 Buffer memory of a module set as the main one when configuring multiple modules

☞ Page 67 Operation of the recording function when configuring multiple modules

### ■When removing an SD memory card during project data saving

When removing an SD memory card without stopping file access while project data is being saved to the SD memory card, the project data is deleted and the SD memory card may be damaged.

Read a required recording file and project data in GX Works3 before removing the SD memory card.

### ■If the network is disconnected during project data saving

If the network is disconnected between a recorder module/camera recorder module and a file server while project data is being saved to the file server, the project data is deleted.

### ■If saving project data fails

If saving project data fails due to a cause such as an insufficient free space on an SD memory card or a file server, the data is discarded.

In this case, check the cause in the "Module Diagnostics" screen and turn ON 'Project data saving specification' (Un\G14080 to 14083)\*1 of a recorder module/camera recorder module as necessary to save it again.

\*1 Buffer memory of a module set as the main one when configuring multiple modules

☞ Page 67 Operation of the recording function when configuring multiple modules

### ■Formatting an SD memory card during project data saving

When formatting an SD memory card while project data is being saved, the saving stops and the SD memory card is formatted.

If the project data is required, read a required recording file and project data in GX Works3 after the saving is completed, then format the SD memory card.

Whether the saving is completed can be checked in 'Project data saving completion' (Un\G14001, Un\G14011, Un\G14021, Un\G14031)\*1.

\*1 Buffer memory of a module set as the main one when configuring multiple modules

☞ Page 67 Operation of the recording function when configuring multiple modules

## When stopping using the project data saving function

The following shows the considerations when stopping using the project data saving function after using this function to save project data.

### ■When a recording file is saved in an SD memory card

When reading a recording file in GX Works3, project data in an SD memory card is preferentially read at the same time. If there is no project data in the SD memory card, it is read from a CPU module.

Therefore, when stopping using the project data saving function after using this function to save project data, it is recommended to format an SD memory card.

### ■When a recording file is saved in a file server

If there is project data in the save destination for a recording file when playing the recording file saved in a file server, the project data in the save destination is automatically opened and played on the offline monitor.

Therefore, when stopping using the project data saving function after using this function to save project data, it is recommended to perform either of the following operations:

- Change the save destination for a recording file to a different one from the one specified when using the project data saving function.
- Delete the PRJ folder<sup>\*1</sup> in the save destination for a recording file.

\*1 For details on the save destinations for project data, refer to the following:

 Page 81 Save destination

## When changing module parameters

When changing module parameters and writing them to a CPU module if devices and labels used in the parameters are specified as sampling targets, the recording setting must also be written to the CPU module.

When changing module parameters only and writing them to a CPU module, they cannot be reproduced properly on the offline monitor.

## Starting communication with a network camera

If a network camera is not started while the recording function is preparing to run, it takes time for the preparation.

It is recommended to start a network camera before switching a CPU module to RUN.

Note that even if it takes time to prepare to start the communication with a network camera, the recording function completes preparation for other operations and starts running.

## When using a camera event as a file saving trigger

Note the following:

Item	Description
Occurrence frequency of a camera event in a network camera	If a camera event occurs frequently in a network camera, the recording performance is affected (mainly video data reception and accumulation). For setting a network camera to detect camera events, note the following: <ul style="list-style-type: none"><li>• A camera event must not be detected too frequently.</li></ul>
Time lag between the detection of a camera event in a network camera and the notification to a camera recorder module	This time lag is caused because the network camera notifies the camera recorder module of the detection via a network. For setting the saving period, note the following: <ul style="list-style-type: none"><li>• The saving period before trigger must be set so that the video when a camera event occurs can be captured.</li></ul>

## Power ON/OFF of a network camera when a trigger occurs

Set a network camera in order not to be powered OFF when a trigger (recording startup trigger or file saving trigger) is satisfied. Otherwise, a created video file may not be played or a displayed time may not match.

## Formatting an SD memory card

Initialize an SD memory card inserted in a recorder module/camera recorder module before use. When configuring multiple modules, initialize all SD memory cards inserted in the main and sub modules before use.

 Page 67 Operation of the recording function when configuring multiple modules

## Folder name of a recording file

If the number of characters in a recording file name exceeds its available number as a result of adding additional information such as a date and time or trigger comment, those exceeding the number are truncated.

To avoid this, add additional information to the start of a format.

For the number of available characters, refer to the following:

 MELSEC iQ-R System Recorder User's Manual (Startup)

## 1.2 Offline Monitor Function

---

The offline monitor function can be used to reproduce the status of a program and operations (videos) of a device when a trouble occurs by using a recording file.

For details, refer to the following:

 GX Works3 Operating Manual

 GX VideoViewer Version 1 Operating Manual

## 1.3 Camera Recording Function

---

The camera recording function can be used to record camera videos linked with a CPU module by using Camera Recording Package and a network camera connected to the built-in Ethernet of the CPU module.

Recorded video files can be played in GX VideoViewer.

For details, refer to the following:

 Camera Recording Package User's Manual

 GX VideoViewer Version 1 Operating Manual

## 1.4 Data Flow Analysis Function

---

The data flow analysis function can be used to search for devices, labels, and parameters in a program and the event history of the current value change that cause selected devices and labels to be changed, and display their related items in a flow diagram.

For details, refer to the following:

 GX Works3 Operating Manual

## 1.5 Co-recording Function

---

The co-recording function can be used to perform recording synchronously on target devices by sending and receiving a co-recording trigger.

For details, refer to the following:

 MELSEC iQ-R System Recorder Co-recording Function Reference Manual

# 2 PARAMETER SETTING

This chapter shows each setting that can be configured in the parameter setting of GX Works3.

## Configuring multiple recording settings

The capacity of each setting in the following parameters must be changed before configuring recording settings.

If recording settings are written to a CPU module without changing each capacity, an error occurs when recording starts and the recording function does not run.

Target module	Parameter
CPU module	"CPU Parameter" ⇒ "Memory/Device Setting" ⇒ "Buffer Area Setting for Data Sampling" ⇒ "(setting number to be used)"*1
Recorder module	"(Recorder module)" ⇒ "Basic Settings" ⇒ "Recording Buffer Setting"*2 ⇒ "(setting number to be used)"
Camera recorder module	"(Camera recorder module)" ⇒ "Module Parameter" ⇒ "Basic Settings" ⇒ "Recording Buffer Setting"*2 ⇒ "(setting number to be used)"

\*1 The size required for the capacity of the buffer area setting for data sampling can be checked in the "Recording Setting" screen.

\*2 The "Recording Buffer Setting" screen appears by double-clicking the recording buffer setting icon .

# 2.1 CPU Parameters

This section shows the CPU parameters required to be set for using a CPU module for System Recorder.

## Memory/device setting

The following shows the screen for setting each item in the buffer area setting for data sampling of a CPU module.

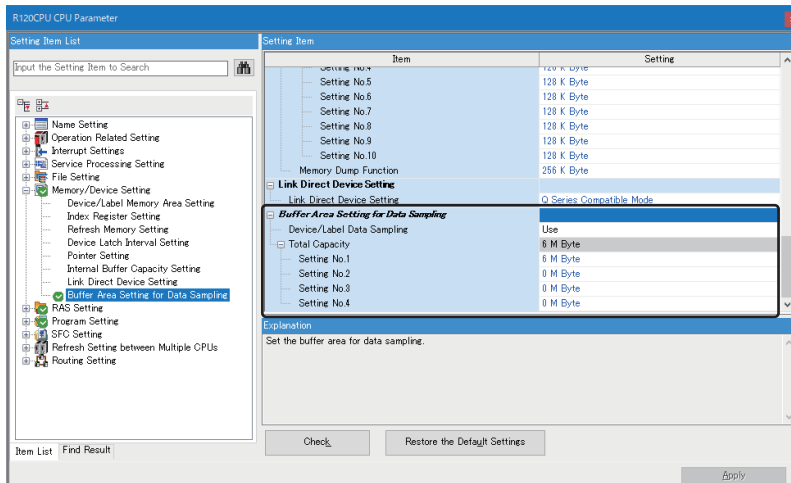

### Buffer area setting for data sampling

Item	Description	Setting range
Device/Label Data Sampling	Select "Use" or "Not to Use."	<ul style="list-style-type: none"> <li>Use</li> <li>Not to Use</li> </ul> (Default: Not to Use)
Total Capacity	The total capacity of an area used by a system to temporarily store device/label data is displayed.	—
Setting No.1 to 4*1	Set the capacity of an area used by a system to temporarily store device/label data.	0 to 4 M Byte or 0 to 6 M Byte*2 (Default: 4 M Byte or 6 M Byte (Setting No.1)*2, 0 M Byte (Setting No.2 to 4))

\*1 Can be set only when selecting "Use" for "Device/Label Data Sampling."

\*2 The maximum value and default of the capacity differ depending on the module type.  
 R04CPU, R04ENCPU, R08CPU, R08ENCPU, R08SFPCPU, R16CPU, R16ENCPU, R16SFPCPU: 4 M Byte  
 R32CPU, R32ENCPU, R32SFPCPU, R120CPU, R120ENCPU, R120SFPCPU: 6 M Byte

### Precautions

The buffer area for data sampling is a temporary area for sampling data. Set the total number of device and label points to be sampled to a value equal to or smaller than the capacity of the buffer area setting for data sampling. Otherwise, an error occurs when recording starts and the recording function does not run.



## 2.2 Module Parameters (Recorder Module/Camera Recorder Module)

This section shows the module parameters of a recorder module/camera recorder module.

### Basic settings

The following shows the screen for setting each item in the various operations settings, own node setting, and recording buffer setting of a recorder module/camera recorder module.

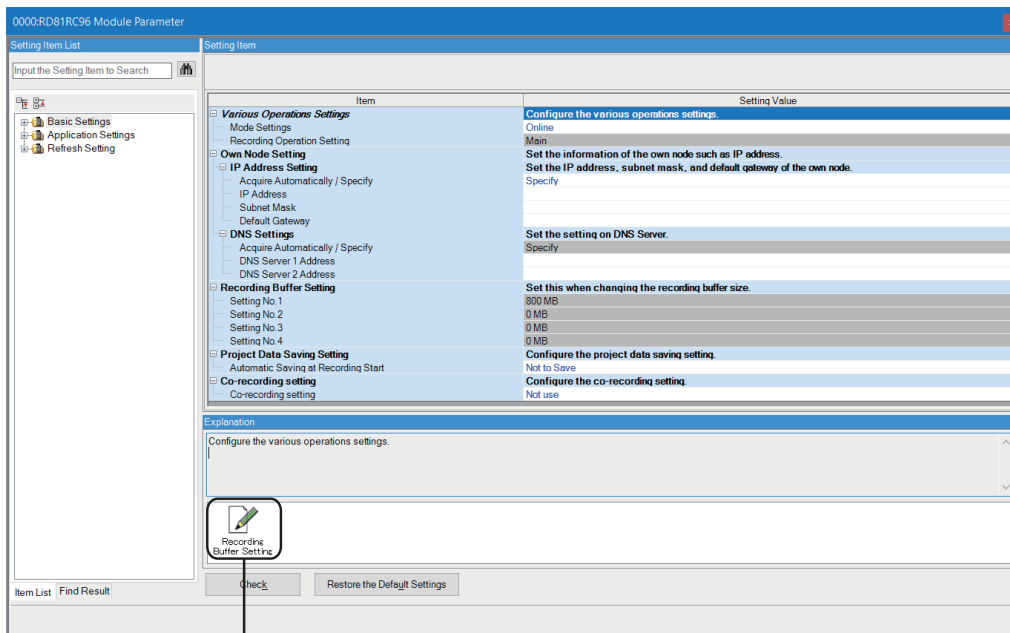

(1)

(1) Recording buffer setting icon

### Various operations settings



The following items can be set for a recorder module/camera recorder module.

Item	Description	Setting range
Mode Settings	Set the operation mode of a recorder module/camera recorder module. <ul style="list-style-type: none"> <li>• Online: Normal operation mode</li> <li>• Automatic Hardware Test: H/W such as ROM/RAM/Ethernet of the recorder module/camera recorder module is tested.</li> <li>• Hardware Test for LED Check: The LED of the recorder module/camera recorder module is tested.</li> <li>• Firmware Update: A mode to update the firmware of the recorder module/camera recorder module.</li> </ul>	<ul style="list-style-type: none"> <li>• Online</li> <li>• Automatic Hardware Test</li> <li>• Hardware Test for LED Check</li> <li>• Firmware Update</li> </ul> (Default: Online)
Recording Operation Setting	Select "Main" or "Sub" for the recording function.*1	<ul style="list-style-type: none"> <li>• Main</li> <li>• Sub</li> </ul> (Default: Main)

\*1 Only one main module can be set for one CPU module.

## Own node setting

The following items can be set for a recorder module/camera recorder module.

Item		Description	Setting range
IP Address Setting <sup>*1</sup>	Acquire Automatically/Specify	Select "Acquire Automatically" or "Specify" for the IP address.	<ul style="list-style-type: none"> <li>Acquire Automatically</li> <li>Specify</li> </ul> (Default: Specify)
	IP Address <sup>*2</sup>	Set an IP address, subnet mask, and default gateway.	 Page 97 IP address setting screen
	Subnet Mask <sup>*2</sup>	The "Setting for IP Address" screen appears by double-clicking a cell.	
	Default Gateway <sup>*2</sup>		
DNS Settings <sup>*1</sup>	Acquire Automatically/Specify	Select "Acquire Automatically" or "Specify" for the DNS server address. When selecting "Specify" for "Acquire Automatically/Specify" under "IP Address Setting," "Specify" is automatically set.	<ul style="list-style-type: none"> <li>Acquire Automatically</li> <li>Specify</li> </ul> (Default: Specify)
	DNS Server 1 Address <sup>*3</sup>	Specify the IP address of a preferred DNS server. The "DNS Settings" screen appears by double-clicking the cell.	 Page 97 DNS setting screen
	DNS Server 2 Address <sup>*3</sup>	Specify the IP address of an alternate DNS server. The "DNS Settings" screen appears by double-clicking the cell.	

\*1 Can be set only when selecting "Online" for "Mode Settings."

\*2 Can be set only when selecting "Specify" for "Acquire Automatically/Specify" under "IP Address Setting."

\*3 Can be set only when selecting "Specify" for "Acquire Automatically/Specify" under "DNS Settings."

## ■ IP address setting screen

The IP address, subnet mask, and default gateway of a recorder module/camera recorder module can be set.

Item	Description	Setting range
IP Address	<p>Set the IP address of the own node. Ensure that the own node and the external device to be communicated with have the same class and subnet address. Set the IP address in the range of class A/B/C. If IP address is not set, the module operates 192.168.3.3. Please note the following points to set the IP Address and the Subnet Mask setting.</p> <ul style="list-style-type: none"> <li>• Any of the bits of IP address's host address (that part of subnet mask that carries 0) is not set to 0 or 1.</li> <li>• Any of the bits of IP address's network address (that part of subnet mask that carries 1) is not set to 0 or 1.</li> </ul>	<ul style="list-style-type: none"> <li>• Empty (no setting)</li> <li>• 1.0.0.1 to 223.255.255.254 (The IP address must start with a value from 1 to 223, excluding 127.)</li> </ul> (Default: Empty)
Subnet Mask	<p>Set the subnet mask of the own node. Set to determine how many bits of the IP address are used as the network address, which is used to identify the network. For example, set '255.255.255.0' to assign the upper 24 bits of IP address to the subnet mask. Please note the following points to set the IP Address and the Subnet Mask setting.</p> <ul style="list-style-type: none"> <li>• Any of the bits of IP address's host address (that part of subnet mask that carries 0) is not set to 0 or 1.</li> <li>• Any of the bits of IP address's network address (that part of subnet mask that carries 1) is not set to 0 or 1.</li> </ul>	<ul style="list-style-type: none"> <li>• Empty</li> <li>• 128.0.0.0 to 255.255.255.252</li> </ul> (Default: Empty)
Default Gateway	<p>Set the IP address of the default gateway (the device which the own node passes through to access a device of another network). Please set subnet address of default gateway so that it is the same with the one of host station.</p>	<ul style="list-style-type: none"> <li>• Empty</li> <li>• 1.0.0.1 to 223.255.255.254 (The IP address must start with a value from 1 to 223, excluding 127.)</li> </ul> (Default: Empty)

## ■ DNS setting screen

The IP addresses of preferred and alternate DNS servers can be set.

Item	Description	Setting range
DNS Server 1 Address	Specify the IP address of a preferred DNS server.	<ul style="list-style-type: none"> <li>• Empty</li> <li>• 1.0.0.1 to 223.255.255.254 (The IP address must start with a value from 1 to 223, excluding 127.)</li> </ul> (Default: Empty)
DNS Server 2 Address	Specify the IP address of an alternate DNS server.	<ul style="list-style-type: none"> <li>• Empty</li> <li>• 1.0.0.1 to 223.255.255.254 (The IP address must start with a value from 1 to 223, excluding 127.)</li> </ul> (Default: Empty)

## Recording buffer setting (recorder module)

The following items can be set for a recorder module.

Item	Description	Setting range
Setting No.1 to 4	The recording buffer capacity used for each recording setting is displayed. The "Recording Buffer Setting" screen appears by double-clicking the recording buffer setting icon.	Page 98 Recording buffer setting screen

### ■Recording buffer setting screen

The recording buffer capacity can be set.

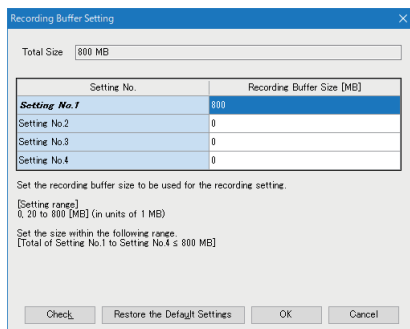

Item	Description	Setting range
Total Size	The total capacity of the recording buffer is displayed.	—
Setting No.1 to 4	Set the recording buffer capacity used for each recording setting.	<ul style="list-style-type: none"> <li>• 0</li> <li>• 20 to 800</li> </ul> (Default: 800 (Setting No.1), 0 (Setting No.2 to 4))

## Recording buffer setting (camera recorder module)

The following items can be set for a camera recorder module.

Item	Description	Setting range
Recording Buffer Setting (Device/label data)	Setting No.1 to 4 The recording buffer capacity (device/label data) used for each recording setting is displayed.*1	☞ Page 99 Recording buffer setting screen
Recording Buffer Setting (Video data)	Setting No.1 to 4 The recording buffer capacity (video data) used for each recording setting is displayed.*1	

\*1 The "Recording Buffer Setting" screen appears by double-clicking the recording buffer setting icon.

### ■Recording buffer setting screen

The recording buffer capacity can be set.

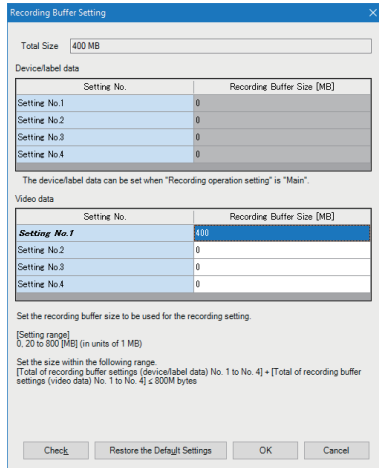

Item	Description	Setting range
Total Size	The total capacity of the recording buffer is displayed.	—
Device/label data	Setting No.1 to 4*1 Set the recording buffer capacity for accumulating device/label data.	<ul style="list-style-type: none"> <li>• 0</li> <li>• 20 to 800*2</li> </ul> (Default: 400 (Setting No.1), 0 (Setting No.2 to 4))
Video data	Setting No.1 to 4 Set the recording buffer capacity for accumulating video data.	

\*1 Can be set when selecting "Main" for "Recording Operation Setting."

\*2 When selecting "Main" for "Recording Operation Setting," device/label data and video data can be set up to 800 MB in total.

## Project data saving setting

The following item can be set in the project data saving setting.

Item	Description	Setting range
Automatic Saving at Recording Start*1*2	Set whether to automatically save project data when recording starts.	<ul style="list-style-type: none"> <li>• Not to Save</li> <li>• Save</li> </ul> (Default: Not to Save)

\*1 Can be set only when selecting "Main" for "Recording Operation Setting" and "Online" for "Mode Settings."

\*2 Available when using an RnCPU or RnENCPU as a CPU module.

## Co-recording setting

The following item can be set for co-recording.

For details on co-recording, refer to the following:

📖 MELSEC iQ-R System Recorder Co-recording Function Reference Manual

Item	Description	Setting range
Co-recording Setting*1	Set whether to use co-recording.	<ul style="list-style-type: none"> <li>• Not use</li> <li>• Use</li> </ul> (Default: Not use)

\*1 Can be set only when selecting "Main" for "Recording Operation Setting" and "Online" for "Mode Settings."

# Application settings

The following shows the screen for the operation setting at event detection for a recorder module/camera recorder module.

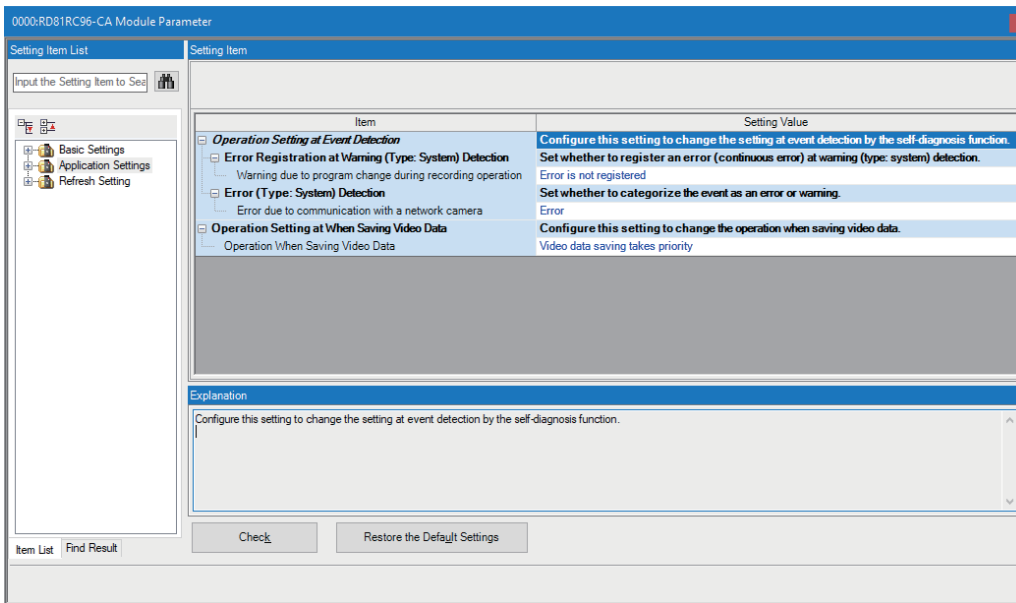

## Operation setting at event detection

Item	Description	Setting range
Error Registration at Warning (Type: System) Detection	Warning due to program change during recording operation* <sup>1</sup> Set whether to register an error (continuation error) when a warning (type: system) is detected due to a change in a program file or an FB/FUN file during recording operation. [Warning due to program change during recording operation] • Recording start with program inconsistency (event code: 0C00) • Program change during recording operation (event code: 0C01)	• Error is not registered • Error is registered (continuous error) (Default: Error is not registered)
Error (Type: System) Detection* <sup>2</sup>	Error due to communication with a network camera. Set whether to classify an event as an error or a warning when it occurs in the communication with a network camera.* <sup>3</sup>	• Error • Warning (Default: Error)

\*<sup>1</sup> Can be set only when selecting "Main" for "Recording Operation Setting."

\*<sup>2</sup> Can be set only when using a camera recorder module.

\*<sup>3</sup> The combinations of target errors (error codes) and warnings (event codes) are as follows:

Error code	Event code
1D01	0D01
1DC0	0DC0
1DF1	0DF1
1E72	0E72

For details on the error codes and event codes, refer to the following:

☞ Page 185 Error code list, Page 196 Event code list

## Operation setting at video data saving

Item	Description	Setting range
Operation at video data saving*1	Set whether to prioritize video data saving or reception in the operation at video data saving. When selecting "Video data receiving takes priority," the number of lost frames for video data being saved can be reduced. However, it takes longer to save video data than when selecting "Video data saving takes priority."	<ul style="list-style-type: none"> <li>• Video data saving takes priority</li> <li>• Video data receiving takes priority</li> </ul> (Default: Video data saving takes priority)

\*1 Can be set only when using a camera recorder module.

The following table shows the advantages and disadvantages of each setting for "Operation at video data saving."

Item	Advantage	Disadvantage
Video data saving takes priority	Video data saving takes less time than when selecting "Video data receiving takes priority."	When using multiple recording settings in one module, a frame of video data being received may be lost if the video data is saved and received at the same time.
Video data receiving takes priority	Even when using multiple recording settings in one module, the number of lost frames for video data being received, which is caused if the video data is saved and received at the same time, can be reduced.	Video data saving takes more time than when selecting "Video data saving takes priority."

# Refresh setting

The following shows the screen for setting the refresh timing of a specified refresh target.

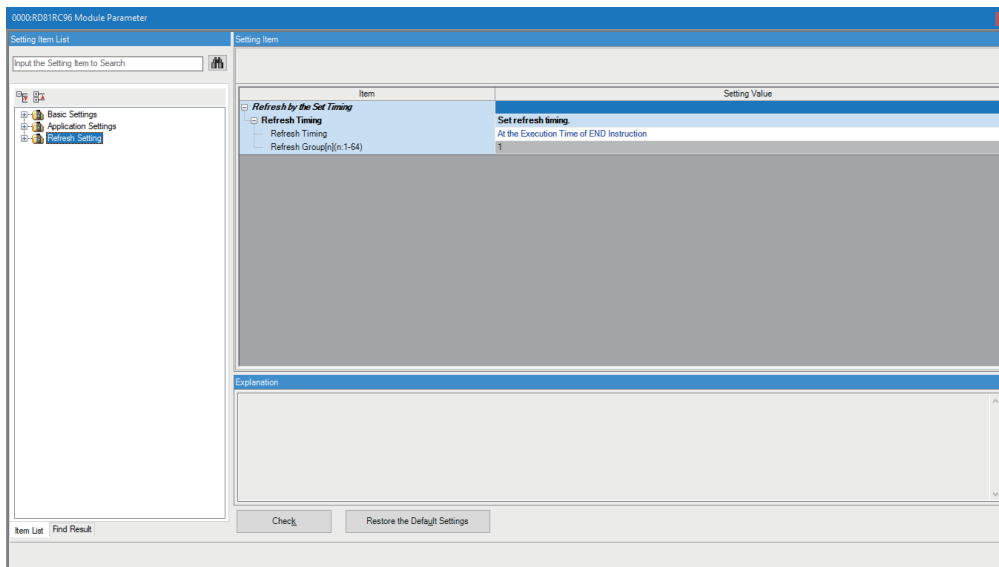

## Displayed items

Item	Description	Setting range
Refresh Timing	Set refresh timing.	<ul style="list-style-type: none"> <li>At the Execution Time of END Instruction</li> <li>At the Execution Time of Specified Program (Default: At the Execution Time of END Instruction)</li> </ul>
Refresh Group[n](n: 1-64)	Specify the refresh group of the program. Please set it through Program Setting of CPU Parameter.	1 to 64

## Refresh timing

### ■At the execution time of END instruction

The setting is refreshed at the END processing in the CPU module.

### ■At the execution time of specified program

The setting is refreshed when a program specified in "Refresh Group[n](n: 1-64)" is executed.





## 2.3 Module Extended Parameters (Camera Recorder Module)

This section shows the module extended parameters of a camera recorder module.

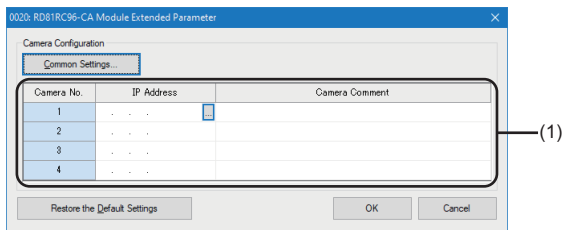
2



Item	Description
[Common Settings] button	Click this to display the "Common Settings" screen.  Page 104 Common setting
(1) Camera configuration setting* <sup>1</sup>	The IP address and camera comment of a network camera set in the "Camera Individual Settings" screen are displayed. The "Camera Individual Settings" screen can be displayed by clicking the [...] button in the "IP Address" or "Camera Comment" column.* <sup>2</sup>  Page 105 Camera individual setting The number of network cameras that can be set differs depending on the setting of a connected network camera. For details, refer to the following:  MELSEC iQ-R System Recorder User's Manual (Startup)

\*1 The setting in a selected row can be deleted by selecting and right-clicking the row then selecting [Delete].

\*2 Can also be displayed by selecting and right-clicking a row then selecting [Edit camera individual setting].

## Common setting

The following shows the screen for setting each item for GOT linkage.

This setting can be configured for each camera recorder module.

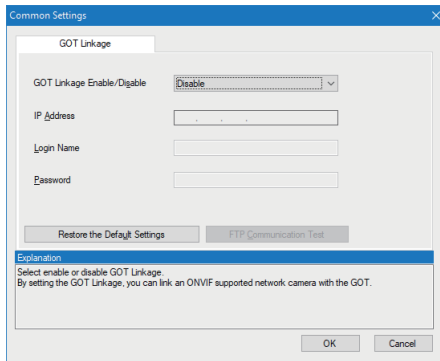

Item	Description	Setting range
GOT Linkage Enable/Disable	Select "Enable" or "Disable" for GOT linkage. By setting the GOT linkage, an ONVIF supported network camera can be linked with a GOT.	<ul style="list-style-type: none"> <li>• Enable</li> <li>• Disable</li> </ul> (Default: Disable)
IP Address* <sup>1</sup>	Specify the IP address of an FTP server.	<ul style="list-style-type: none"> <li>• Empty (no IP address set)</li> <li>• 1.0.0.1 to 223.255.255.254 (The IP address must start with a value from 1 to 223, excluding 127.)</li> </ul> (Default: Empty)
Login Name* <sup>1</sup>	Specify the login name of an FTP server.	<ul style="list-style-type: none"> <li>• Empty (no login name set)</li> <li>• Character string up to 16 characters</li> </ul> (Default: Empty)
Password* <sup>1</sup>	Specify the password for an FTP server.	<ul style="list-style-type: none"> <li>• Empty (no password set)</li> <li>• Character string up to 32 characters</li> </ul> (Default: Empty)
[FTP Communication Test] button* <sup>1</sup>	Click this to perform the communication test on a GOT based on the entered settings.	—

\*1 Can be specified or clicked only when selecting "Enable" for "GOT Linkage Enable/Disable."

## Camera individual setting

The following shows the screen for setting each item for a network camera.

Items and ranges that can be set differ for each network camera.

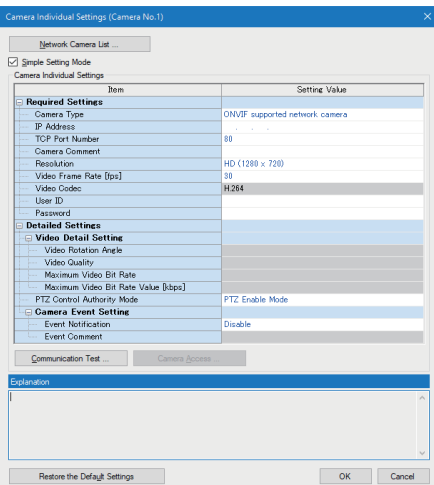

Item		Description	Setting range	
			ONVIF supported network camera	
[Network Camera List] button <sup>*1</sup>		Click this to display the "Network Camera List" screen. ☞ Page 107 Network camera list screen	—	
Simple Setting Mode		Select the checkbox to switch to the simple setting mode. ☞ Page 237 Simple setting mode	<ul style="list-style-type: none"> <li>Selected</li> <li>Unselected</li> </ul> (Default: Selected)	
Camera Individual Settings <sup>*2</sup>	Required Settings	Camera Type	Set the type of a network camera.	<ul style="list-style-type: none"> <li>ONVIF supported network camera</li> </ul> (Default: ONVIF supported network camera)
		IP Address	Set the IP address of a network camera.	<ul style="list-style-type: none"> <li>1.0.0.1 to 223.255.255.254 (The IP address must start with a value from 1 to 223, excluding 127.)</li> </ul> (Default: Empty)
		TCP Port Number <sup>*3</sup>	Set the TCP port number of a network camera.	<ul style="list-style-type: none"> <li>1 to 4999, 5010 to 65534</li> </ul> (Default: 80)
		Camera Comment <sup>*4</sup>	Set a comment to identify a network camera.	<ul style="list-style-type: none"> <li>Empty (no camera comment set)</li> <li>Character string up to 32 characters</li> </ul> (Default: Empty)
		Resolution	Set the resolution of a video captured by a network camera.	<ul style="list-style-type: none"> <li>VGA (640 × 480)</li> <li>HD (1280 × 720)</li> <li>SXVGA (1280 × 960)</li> <li>FHD (1920 × 1080)</li> </ul> (Default: HD (1280 × 720))
		Video Frame Rate [fps]	Set the frame rate of a video captured by a network camera.	<ul style="list-style-type: none"> <li>10</li> <li>30</li> <li>120</li> <li>180</li> </ul> (Default: 30)
		Video Codec	Set the codec for a video captured by a network camera.	<ul style="list-style-type: none"> <li>H.264</li> </ul>
		User ID <sup>*3</sup>	Set the user ID of a network camera.	<ul style="list-style-type: none"> <li>Character string up to 32 characters</li> </ul> (Default: Empty)
		Password <sup>*3</sup>	Set the password for a network camera.	<ul style="list-style-type: none"> <li>Character string up to 32 characters</li> </ul> (Default: Empty)

Item				Description	Setting range
ONVIF supported network camera					
Camera Individual Settings <sup>*2</sup>	Detailed Settings	Video Detail Setting	Video Rotation Angle <sup>*6</sup>	Set the rotation angle of a video captured by a network camera.	<ul style="list-style-type: none"> <li>• 0 degree</li> <li>• 180 degree</li> </ul> (Default: 0 degree)
			Video Quality <sup>*6*7</sup>	Set the quality of a video captured by a network camera. Select a video quality according to the compression ratio of a video.	<ul style="list-style-type: none"> <li>• High</li> <li>• Middle</li> <li>• Low</li> </ul> (Default: Middle)
			Maximum Video Bit Rate <sup>*6</sup>	Set whether to limit the bit rate of a video delivered from a network camera. It can be set when the video codec is H.264.	<ul style="list-style-type: none"> <li>• Unlimited</li> <li>• Limited</li> </ul> (Default: Unlimited)
			Maximum Video Bit Rate Value [kbps] <sup>*6*8</sup>	Set the maximum bit rate of a video captured by a network camera.	1 to 50000 (Default: 50000)
	PTZ Control Authority Mode		Set the PTZ control authority mode of a network camera.	<ul style="list-style-type: none"> <li>• PTZ Enable Mode</li> <li>• PTZ Preset Mode</li> <li>• PTZ Disable Mode</li> </ul> (Default: PTZ Enable Mode)	
	Camera Event Setting	Event Notification	Set the event notification received from a network camera.	<ul style="list-style-type: none"> <li>• Motion Detection</li> <li>• Disable</li> </ul> (Default: Disable)	
		Event Comment <sup>*5</sup>	Set a comment for a camera event. It can be set when selecting "Motion Detection" for "Event Notification."	<ul style="list-style-type: none"> <li>• Empty (no event comment set)</li> <li>• Character string up to 32 characters</li> </ul> (Default: Empty)	
[Communication Test] button				Click this to display the "Communication Test" screen.  Page 108 Communication test screen	—
[Camera Access] button <sup>*9</sup>				Click this to start a web browser (default browser for the operating system) to access a network camera based on a set IP address. <sup>*10*11</sup> The URL of a connection destination is as follows: <ul style="list-style-type: none"> <li>• http://(IP address):(TCP port number)/</li> </ul>	—

\*1 Can be clicked only when selecting "ONVIF supported network camera" for "Camera Type."

\*2 Each item is displayed in black when its initial value is changed.

\*3 Available when selecting "ONVIF supported network camera" for "Camera Type."

\*4 Control characters defined in Unicode cannot be set.

\*5 Can be set as additional information for a recording file name.

For the available characters when adding it to a recording file name, refer to the following. (Unavailable characters are replaced with underscores (\_).)

 Page 294 ASCII characters that can be used in the format in the saving detail setting

\*6 The setting is not required when the simple setting mode is enabled. A value set for a network camera is applied for the operation.

\*7 Video quality settings correspond to compression ratios as follows:

High: 20%

Middle: 50%

Low: 80%

\*8 Available when all of the following conditions are satisfied:

"ONVIF supported network camera" is selected for "Camera Type."

"Limited" is selected for "Maximum Video Bit Rate."

\*9 Can be clicked only when "ONVIF supported network camera" is selected for "Camera Type" and an IP address is already set.

\*10 For access, a personal computer and network camera must be connected via Ethernet.

\*11 It is not guaranteed that a set IP address is available to access a network camera.

The operation when the network camera cannot be accessed depends on the web browser.

## ■ Network camera list screen

Network cameras on the same network as a camera recorder module can be searched for.

By selecting a network camera in the search results list and clicking the [OK] button, the IP address and TCP port number of the selected network camera can be applied to the "Camera Individual Settings" screen.

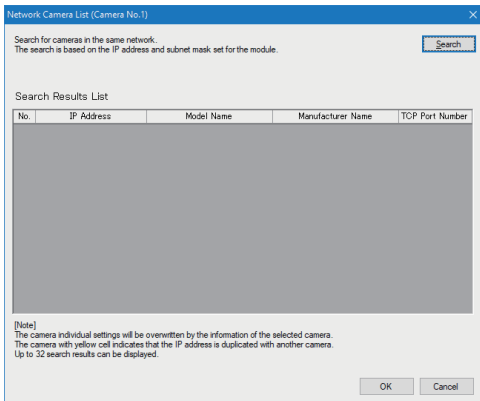

Item	Description	Setting range
[Search] button	Click this to search for a network camera on the same network as a camera recorder module.	—
Search Results List	The IP address, model name, manufacturer name, and TCP port number of a found network camera are displayed.* <sup>1</sup> Note that the display contents of the model name and manufacturer name differ for each manufacturer of network camera. (Example) The manufacturer name is displayed including the model name.	—

\*1 Up to 32 network cameras can be displayed. If 33 or more network cameras are connected, 32 ones are displayed in order from a found one. (Displayed network cameras differ depending on the network status, etc.)

### Point

- A search result is retained until the screen for setting module extended parameters is closed.
- If a communication error occurs during search, the search result is not updated and the previous search result remains displayed.

## ■Communication test screen

The communication test can be performed between a camera recorder module and a network camera based on a set IP address, user ID, password, and TCP port number.

When the communication test is successful, basic and support information of the network camera can be acquired. In addition, the acquired resolution, frame rate, or event notification can be applied to the "Camera Individual Settings" screen.

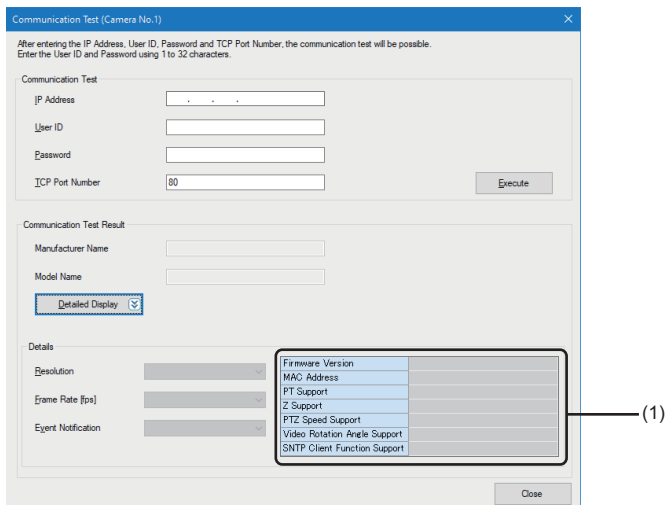

Item	Description	Setting range
Communication Test	IP Address <sup>*1</sup>	Set the IP address of a network camera.  • 1.0.0.1 to 223.255.255.254 (The IP address must start with a value from 1 to 223, excluding 127.) (Default: Value set in the "Camera Individual Settings" screen)
	User ID <sup>*1*2</sup>	Set the user ID of a network camera.  • Character string up to 32 characters (Default: Value set in the "Camera Individual Settings" screen)
	Password <sup>*1*2</sup>	Set the password for a network camera.  • Character string up to 32 characters (Default: Value set in the "Camera Individual Settings" screen)
	TCP Port Number <sup>*1*2</sup>	Set the TCP port number of a network camera.  • 1 to 4999, 5010 to 65534 (Default: Value set in the "Camera Individual Settings" screen)
	[Execute] button	Click this to perform the communication test based on the IP address, user ID, password, and TCP port number. <sup>*3</sup>  —

Item		Description	Setting range	
Communication Test Result	Manufacturer Name	The manufacturer name of a network camera connected by performing the communication test is displayed.*4	—	
	Model Name	The model name of a network camera connected by performing the communication test is displayed.*4	—	
	[Detailed Display] button	Click this to expand and collapse detailed information.	—	
	Details*5	Resolution	Set the resolution of a network camera.	<ul style="list-style-type: none"> <li>• FHD (1920 × 1080)*6</li> <li>• SXVGA (1280 × 960)*6</li> <li>• HD (1280 × 720)*6</li> <li>• VGA (640 × 480)*6</li> <li>• Not set</li> </ul> (Default: Not set)
		Frame Rate [fps]	Set the frame rate of a network camera.	<ul style="list-style-type: none"> <li>• 10*6</li> <li>• 30*6</li> <li>• 120*6</li> <li>• 180*6</li> <li>• Not set</li> </ul> (Default: Not set)
Event Notification		Set the event notification reported from a network camera.	<ul style="list-style-type: none"> <li>• Motion Detection*6</li> <li>• Not set</li> </ul> (Default: Not set)	
(1) Basic and support information	Basic and support information of a network camera connected by performing the communication test is displayed.	—		

\*1 If the setting is changed, it can be applied to the "Camera Individual Settings" screen when closing this screen.

\*2 Available when selecting "ONVIF supported network camera" for "Camera Type" in the "Camera Individual Settings" screen.

\*3 The time required for the communication test differs for each network camera model.

\*4 The display contents differ for the manufacturer of each network camera.

\*5 Appears when expanding detailed information.

\*6 Only the following items can be displayed: items that can be set for a network camera connected by performing the communication test, and ones set for "Camera Type" in the "Camera Individual Settings" screen.  
Selected items can be applied to the "Camera Individual Settings" screen when closing this screen.

## 2.4 Preset Position Setting (Camera Recorder Module)

This section shows the procedure and screen for registering and deleting a preset position for a network camera connected to a camera recorder module, and moving the range of data captured by a network camera to a registered preset position.

### Window

1. Select [Tool] ⇒ [Module Tool List] in GX Works3.
2. Select [Preset Position Settings] in the "Module Tool List" screen, and click the [OK] button.
3. Select a camera recorder module (RD81RC96-CA) in the "Module Selection" screen, and click the [OK] button.

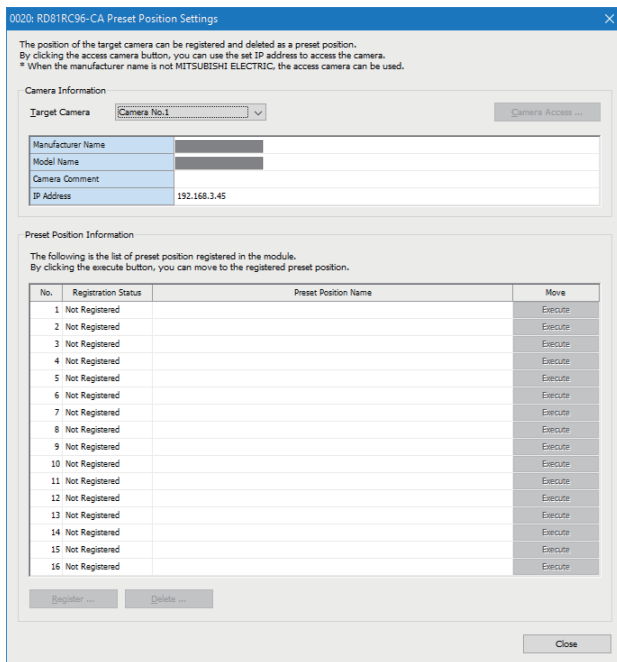

### Displayed items

Item	Description	
Camera Information	Target Camera	Select a target network camera number.*1
	[Camera Access] button	Click this to start a web browser (default browser for the operating system) to access a network camera.*2 The URL of a connection destination is as follows: • http://(IP address):(TCP port number)
	Manufacturer Name	The manufacturer name of a network camera with the number selected for "Target Camera" is displayed.
	Model Name	The model name of a network camera with the number selected for "Target Camera" is displayed.
	Camera Comment	The camera comment set for a network camera with the number selected for "Target Camera" is displayed.
	IP Address	The IP address of a network camera with the number selected for "Target Camera" is displayed.
Preset Position Information*3	No.	The preset position numbers are displayed.
	Registration Status	The registration status of a preset position is displayed.
	Preset Position Name	The name of a preset position is displayed.
	Move*4	Click the [Execute] button to move the range of data captured by a target network camera to a registered preset position.*5 While the range is being moved, "Moving" is displayed. (In this case, the [Register] and [Delete] buttons cannot be clicked.)
[Register] button*6	Click this to display the "Preset Position Registration" screen. ☞ Page 112 Preset position registration	
[Delete] button*6	Click this to display the "Preset Position Delete" screen. ☞ Page 113 Preset position deletion	

\*1 Only enabled network cameras can be selected.

Whether it is enabled can be checked in 'Network camera setting enabled/disabled' (Un\G34000, Un\G34500, Un\G35000, Un\G35500)



of a camera recorder module. (☞ Page 282 Network camera status area (Un\G34000 to 37999))

- \*2 For access, a personal computer and network camera must be connected via Ethernet.
- \*3 When selecting and double-clicking a row, the "Preset Position Registration" screen opens with the number of the selected row selected.  
☞ Page 112 Preset position registration
- \*4 The [Execute] button can be clicked only when selecting "PTZ Enable Mode" or "PTZ Preset Mode" for "PTZ Control Authority Mode" of a target network camera.
- \*5 To check the status, click the [Camera Access] button to access the network camera in advance.
- \*6 Can be clicked only when selecting "PTZ Enable Mode" for "PTZ Control Authority Mode" of a target network camera.

### Point

Registering or deleting a preset position, or moving to a preset position is performed in the communication route set in the "Specify Connection Destination" screen of GX Works3.

## Precautions

- The range that can be set differs for the manufacturer and type of each network camera. If a position registered as a preset position exceeds the range for a network camera when replacing it, moving to the preset position is not guaranteed. In addition, preset position information is not initialized when replacing a network camera.
- When moving the range of captured data to a preset position in this screen and in a dedicated tool for the network camera at the same time, it is moved in order of request.
- If this screen is opened before the communication between a network camera and a camera recorder module is completed, the manufacturer name and model name may not be displayed in the camera information when starting the system. To display them, wait a few minutes until the communication is completed, and then open this screen again. Note that the manufacturer name and model name are always blank if a network camera is not connected.

## Preset position registration

The following shows the screen for registering the current position of a network camera as a preset position. By registering a preset position, the range of data captured by a network camera can be moved to the registered preset position.

### Window

Click the [Register] button in the "Preset Position Settings" screen.

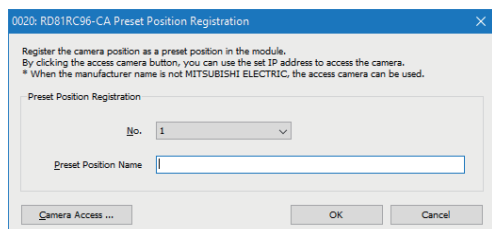

### Displayed items

Item	Description
No.	Select the preset position number of a registration destination (1 to 16).
Preset Position Name	Set the name of a preset position (up to 32 characters).
[Camera Access] button	Click this to start a web browser (default browser for the operating system) to access a network camera.*1 The URL of a connection destination is as follows: • http://(IP address):(TCP port number)/

\*1 For access, a personal computer and network camera must be connected via Ethernet.

## Preset position deletion

The following shows the screen for deleting an unnecessary preset position.

### Window

Click the [Delete] button in the "Preset Position Settings" screen.

2

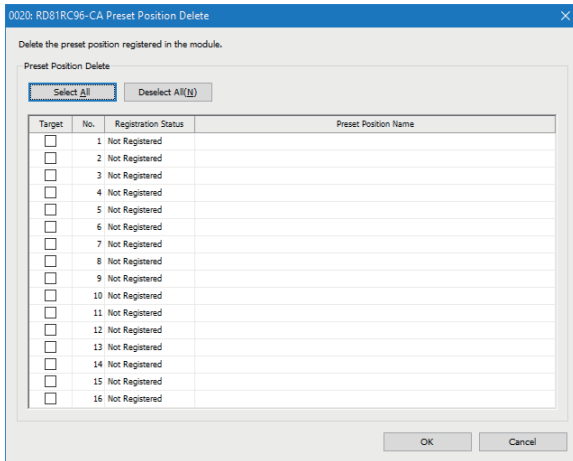

### Displayed items

Item	Description
[Select All] button	Click this to select all the checkboxes in the "Target" column.
[Deselect All] button	Click this to unselect all the checkboxes in the "Target" column.
Target	Select the checkbox of a preset position to delete.
No.	The preset position numbers are displayed.
Registration Status	The registration status of a preset position is displayed.
Preset Position Name	The name of a preset position is displayed.

# 3 RECORDING SETTING

This chapter explains the recording setting.

## 3.1 Recording Setting Screen

This section shows the recording setting screen.

### Window

#### ■For creating a new setting

[Navigation window] ⇒ [Parameter] ⇒ [Recording Setting] ⇒ right-click ⇒ [New]

#### ■For editing a setting

[Navigation window] ⇒ [Parameter] ⇒ [Recording Setting] ⇒ [(setting number)]

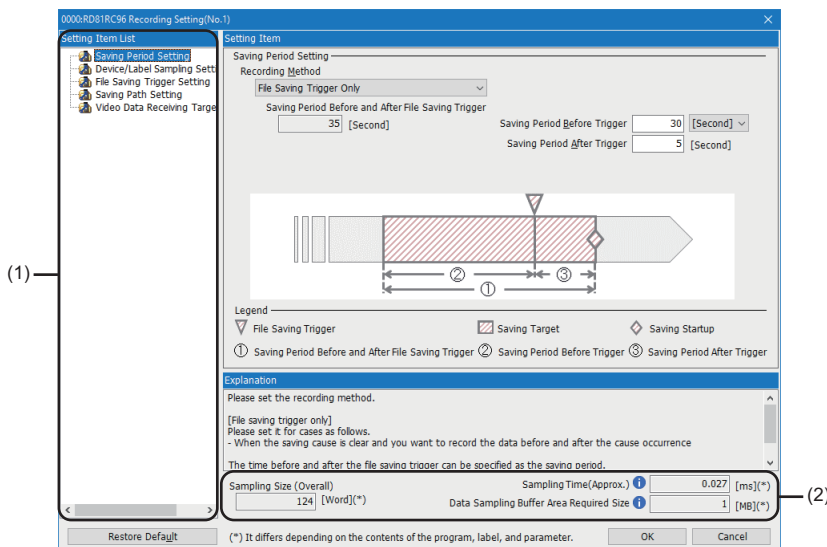

### Displayed items

Item	Description	Reference	
(1) Setting item list	Saving Period Setting	Set a saving period for accumulated data.	Page 116 Saving Period Setting
	Device/Label Sampling Setting	Set a device and label to be sampled and their sampling method.	Page 117 Device/Label Sampling Setting
	File Saving Trigger Setting	Set a device specified as a file saving trigger for saving accumulated data when a device of a CPU module rises or falls.	Page 134 File Saving Trigger Setting
	Saving Path Setting	Set a path to save accumulated data.	Page 136 Saving Path Setting
	Video Data Receiving Target Setting <sup>*1</sup>	Set a network camera from which video data is received.	Page 140 Video Data Receiving Target Setting
(2) Sampling size	Sampling Size (Overall) <sup>*2</sup>	The total size of devices and labels to be sampled is displayed.	—
	Sampling Time (Approx.) <sup>*3*4</sup>	A standard for processing time of a CPU module to sample a device and label is displayed. It differs depending on the sampling size.	—
	Data Sampling Buffer Area Required Size <sup>*3*4</sup>	A size required for the buffer area setting for data sampling in the CPU parameter (memory/device setting) is displayed based on the sampling size.	Page 94 Buffer area setting for data sampling

- \*1 Does not appear in the following cases:  
 No camera recorder module is included in a project.  
 A recorder module and a camera recorder module set as the main module are included in a project, and the slot number of the camera recorder module is larger than that of the recorder module.
- \*2 Displayed in red and a warning icon appears in any of the following cases:  
 An unconverted program is included in a target program when using 'device/label batch specification.'  
 The checkbox of "Include the Parameter" is selected and a project is unconverted when using 'device/label batch specification.'  
 A target program exists in the program setting in the CPU parameter but not in the navigation window when using 'device/label batch specification.'  
 A local device and local label used in a program other than a target one are specified as sampling targets when using 'specify from the device/label list.'  
 A global label (no device assigned) is specified as a sampling target but an unconverted program is included in a target program when using 'specify from the device/label list.'  
 A module label (no device assigned) is specified as a sampling target but a project is unconverted when using 'specify from the device/label list.'  
 A local device in an unconverted or a non-existent program is specified as a sampling target when using 'specify the device range.'
- \*3 Placing the cursor on the information icon (i) displays the tooltip.
- \*4 Displayed in red in any of the following cases:  
 An unconverted program is included in a target program when using 'device/label batch specification.'  
 The checkbox of "Include the Parameter" is selected and a project is unconverted when using 'device/label batch specification.'  
 A target program exists in the program setting in the CPU parameter but not in the navigation window when using 'device/label batch specification.'  
 A local device and local label used in a program other than a target one are specified as sampling targets when using 'specify from the device/label list.'  
 A global label (no device assigned) is specified as a sampling target but an unconverted program is included in a target program when using 'specify from the device/label list.'  
 A module label (no device assigned) is specified as a sampling target but a project is unconverted when using 'specify from the device/label list.'  
 A local device in an unconverted or a non-existent program is specified as a sampling target when using 'specify the device range.'

### Point

For the saving period, refer to the following:

 Page 298 Period during which devices and labels can be saved, Page 299 Period during which video data can be saved

## Precautions

- If a sampling size exceeds the capacity of the buffer area setting for data sampling in the CPU parameter, the recording function cannot be started and a recording setting error (error code: 3026H) occurs in a recorder module/camera recorder module.
- If a warning icon appears in the sampling size and it persists even after converting a program, a non-existent program may be set in the CPU parameter. Check the program registered in the program setting in the CPU parameter.

## 3.2 Saving Period Setting

This section shows the screen for setting a saving period for accumulated data.

### Window

Click "Saving Period Setting" in the setting item list.

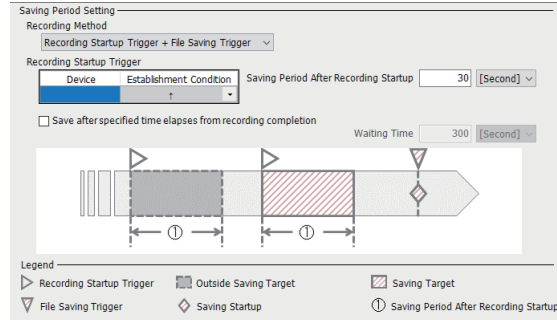
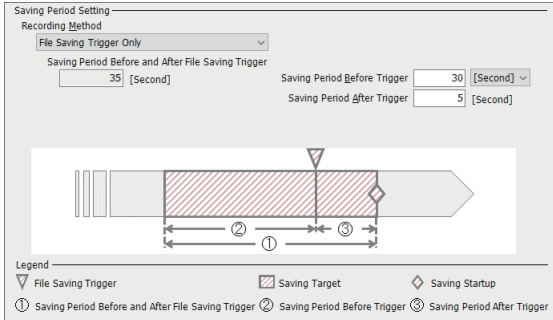

### Displayed items

#### ■When selecting "File Saving Trigger Only" for "Recording Method"

Item	Description
Recording Method	Select "File Saving Trigger Only."
Saving Period Before and After File Saving Trigger	The total of set saving periods before and after trigger is displayed (1 to 86400 seconds).
Saving Period Before Trigger	Set the saving period before trigger. The range of values that can be set differs depending on each unit as follows: <ul style="list-style-type: none"> <li>• Second: 0 to 86400</li> <li>• Minute: 0 to 1440</li> <li>• Hour: 0 to 24</li> </ul>
Saving Period After Trigger	Set the saving period after trigger (up to 60 seconds).

#### ■When selecting "Recording Startup Trigger + File Saving Trigger" for "Recording Method"

Item	Description	
Recording Method	Select "Recording Startup Trigger + File Saving Trigger."	
Recording Startup Trigger	Device	Specify a device used to determine whether a recording startup trigger is satisfied. <sup>*1*</sup> <sup>*2</sup>
	Establishment Condition <sup>*3</sup>	Select a condition for satisfying a recording startup trigger. <ul style="list-style-type: none"> <li>• ↑: When the bit rises</li> <li>• ↓: When the bit falls</li> </ul>
Saving Period After Recording Startup	Set the accumulation period after a recording startup trigger is satisfied. The range of values that can be set differs depending on each unit as follows: <ul style="list-style-type: none"> <li>• Second: 1 to 86400</li> <li>• Minute: 1 to 1440</li> <li>• Hour: 1 to 24</li> </ul>	
Save after specified time elapses from recording completion	Select the checkbox to automatically save a recording file after data accumulation is completed and a specified time elapses.	
Waiting Time <sup>*4</sup>	Set the time from when data accumulation is completed to when a recording file is saved. The range of values that can be set differs depending on each unit as follows: <ul style="list-style-type: none"> <li>• Second: 0 to 86400</li> <li>• Minute: 0 to 1440</li> <li>• Hour: 0 to 24</li> </ul>	

\*1 For devices that can be specified, refer to the following:

☞ Page 43 Devices that can be specified as triggers

\*2 Displayed in red when specifying a device not included in the range set in the device setting in the CPU parameter.

\*3 Can be selected when specifying a device in the "Device" column.

\*4 Can be set when selecting the checkbox of "Save after specified time elapses from recording completion."

# 3.3 Device/Label Sampling Setting

This section shows the screen for setting a device and label to be sampled and their sampling method.

## Window

Click "Device/Label Sampling Setting" in the setting item list.

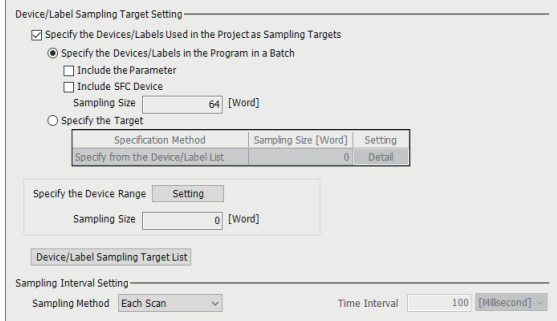

## Displayed items

Item			Description	Reference	
Device/Label Sampling Target Setting	Specify the Devices/Labels Used in the Project as Sampling Targets	—	Select the checkbox to specify a device and label used in a project (program or parameter) as a sampling target.	—	
		Specify the Devices/Labels in the Program in a Batch <sup>*1</sup>	—	Select this to specify a sampling target by using 'device/label batch specification.'	Page 36 Specifying a device and label to be sampled
			Include the Parameter <sup>*2</sup>	Select the checkbox to include a parameter in the target.	
			Include SFC Device <sup>*2</sup>	Select the checkbox to also include SFC devices in the target.	
	Specify the Target <sup>*1</sup>	Sampling Size <sup>*3</sup>	The total size of devices and labels specified as sampling targets by using 'device/label batch specification' is displayed.	—	
		—	Select this to specify a sampling target by using 'specify from the device/label list.'	Page 36 Specifying a device and label to be sampled	
		Specification Method	"Specify from the Device/Label List" is displayed.	—	
		Sampling Size [Word] <sup>*4</sup>	The total size of devices and labels specified as sampling targets in the "Specify from the Device/Label List" screen is displayed.	—	
	Specify the Device Range	Setting	Click the [Detail] button to open the "Specify from the Device/Label List" screen. <sup>*5</sup>	Page 119 "Specify from the Device/Label List" screen	
		—	Click the [Setting] button to open the "Specify the Device Range" screen.	Page 36 Specifying a device and label to be sampled Page 131 "Specify the Device Range" screen	
	Sampling Size <sup>*6</sup>	The total size of devices specified as sampling targets in the "Specify the Device Range" screen is displayed.	—		
	[Device/Label Sampling Target List] button		Click this to open the "Device/Label Sampling Target List" screen.	Page 133 "Device/Label Sampling Target List" screen	

Item	Description	Reference	
Sampling Interval Setting	Sampling Method	Select a sampling method for a device and label. <ul style="list-style-type: none"> <li>• Each Scan</li> <li>• Time Specification</li> <li>• Trigger Instruction</li> <li>• Safety Cycle Time<sup>*7</sup></li> </ul>	Page 44 Sampling methods of devices and labels
	Time Interval	Set a sampling interval when selecting "Time Specification" for "Sampling Method." The range of values that can be set differs depending on each unit as follows: <ul style="list-style-type: none"> <li>• Millisecond: 1 to 60000</li> <li>• Second: 1 to 86400</li> <li>• Minute: 1 to 1440</li> <li>• Hour: 1 to 24</li> </ul>	—

\*1 Can be selected when selecting the checkbox of "Specify the Devices/Labels Used in the Project as Sampling Targets."

\*2 Can be selected when selecting "Specify the Devices/Labels in the Program in a Batch."

\*3 Displayed in red and a warning icon appears in any of the following cases:

An unconverted program is included in a target program.

A project is unconverted when the checkbox of "Include the Parameter" is selected.

A target program exists in the program setting in the CPU parameter but not in the navigation window.

\*4 Displayed in red in any of the following cases:

A local device and local label used in a program other than a target one are specified as sampling targets.

A global label (no device assigned) is specified as a sampling target but an unconverted program is included in a target program.

A module label (no device assigned) is specified as a sampling target but a project is unconverted.

\*5 Can be clicked when selecting "Specify the Target."

\*6 Displayed in red and a warning icon appears if it is undetermined.

\*7 Can be selected only when using a safety CPU.

### Point

- If the checkbox of "Specify Device/Label in batch" is selected in this screen of GX Works3 the version of which is 1.070Y or earlier, the setting is retained with "Specify the Devices/Labels in the Program in a Batch" selected when opening the setting file in GX Works3 the version of which is 1.072A or later.
- If the checkbox of "Include the Parameter" is selected or "Specify the Target" is selected, the setting file does not match that created in GX Works3 the version of which is 1.070Y or earlier when they are verified.

## Precautions

- When changing the following settings before writing the recording setting to a CPU module after selecting "Specify the Devices/Labels in the Program in a Batch" in this screen, sampling target devices and labels may change according to the setting change. Sampling target devices and labels after the change can be checked in the "Device/Label Sampling Target List" screen. (☞ Page 133 "Device/Label Sampling Target List" screen)

- Program

- Label setting

- Memory/device setting in the CPU parameter

- Program setting in the CPU parameter

When including parameters, the following settings are also targets:

- Refresh setting between multiple CPUs (CPU parameter)

- Refresh setting in the CC-Link IEF Basic setting (module parameter)

- Refresh setting (module parameter)

- Simple CPU communication setting (module parameter)

- Safety data transfer device setting in the safety communication setting (module parameter)



# "Specify from the Device/Label List" screen

A device and label to be sampled can be specified from the list of devices and labels used in a project (program or parameter).

In addition, devices and labels to be sampled can be filtered and sorted in the list. This allows them to be narrowed down and easily specified as sampling targets.

## Window

1. Select the checkbox of "Specify the Devices/Labels Used in the Project as Sampling Targets" under "Device/Label Sampling Target Setting," and select "Specify the Target."
2. Click the [Detail] button for which "Specify from the Device/Label List" is displayed in "Specification Method."

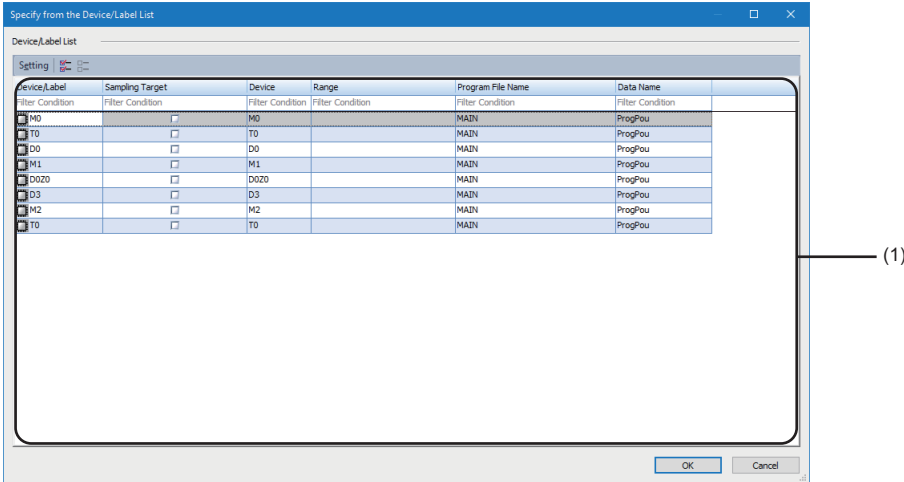

## Displayed items

Item	Description
[Setting] button	Click this to open the "Setting" screen. By selecting the checkbox of "Include Devices/Labels Used in Parameter Setting" in the "Setting" screen, devices and labels used in parameters are also displayed in the list.
	Select this to select the checkbox of a selected row in the "Sampling Target" column.
	Select this to unselect the checkbox of a selected row in the "Sampling Target" column.

Item	Description
(1) Device and label list	— Devices and labels used in a project (program or parameter <sup>*1</sup> ) are listed. <sup>*2</sup> They can also be filtered to display.  Page 128 Filtering display
Device/Label	The name of a device and label is displayed.
Sampling Target	Select the checkbox to specify the device and label as sampling targets.
Class <sup>*3*4</sup>	If a class is set for the label, the class is displayed.
Label Data Type <sup>*3*4</sup>	If a data type is set for the label, the data type is displayed.
Device <sup>*4</sup>	The assigned device is displayed.
Range <sup>*4</sup>	The device range is displayed. It is blank if there is only one device.
Instruction <sup>*3*4</sup>	For a device and label used in a program, an instruction that uses them is displayed.
FB/FUN <sup>*3*4</sup>	For a device and label used as an argument of an FB/FUN, the function block name used as the argument is displayed.
Program File Name <sup>*4</sup>	For a device and label used in a program (program file or FB file), the program file name or FB file name is displayed.
Data Type <sup>*3*4</sup>	A data type is displayed. <ul style="list-style-type: none"> <li>• When data is used in a program (program file): Program</li> <li>• When data is used in an FB (FB file): FB</li> <li>• When data is used in the CPU parameter: CPU parameter</li> <li>• When data is used in the module parameter: Module parameter</li> <li>• When data is used in [Properties] ⇨ [Detail] ⇨ [Block Information] of an SFC block: Block information</li> </ul>
Data Name <sup>*4</sup>	A data name is displayed. <ul style="list-style-type: none"> <li>• When data is used in a program (program file): Program block name</li> <li>• When data is used in an FB (FB file): Function block name</li> <li>• When data is used in a parameter: Module name</li> </ul>
Comment <sup>*3*4*5</sup>	If a comment is set for the device and label, the comment is displayed.

\*1 Can be specified when selecting the checkbox of "Include Devices/Labels Used in Parameter Setting" in the "Setting" screen.

\*2 If a device and label are used in multiple locations in a program, each of them is displayed in the list.

\*3 Does not appear when the screen opens.

\*4 By right-clicking the column header and selecting or unselecting the checkbox of each item, items can be displayed or hidden.

\*5 If the checkbox of "Enable Multiple Comments Display" is selected in the "Multiple Comments Display Setting" screen, which is displayed by selecting [View] ⇨ [Multiple Comments] ⇨ [Display Setting] in GX Works3, the comment title the "Target" column of which is selected is displayed in the column header. If the checkbox is not selected, "Comment" is displayed instead.

### Point

When selecting only a specific program or device as a sampling target, any targets can easily be selected by filtering them. For details, refer to the following:

 Page 130 Operation examples

## Precautions

### ■When using a program other than a target one

Devices and labels used in a program other than a target one are not displayed in the list. In addition, they are excluded from the sampling target when writing a recording setting to a CPU module. To set the program as a target, convert it, change the program setting in the CPU parameter, and remove the security protection in advance.

For target programs, refer to the following:

☞ Page 36 Specifying a device and label to be sampled

### ■Local labels in an FB

If an FB instance is defined as a local label in a program block, it is treated as a local label. If it is defined as a global label, it is treated as a global label.

However, depending on the definition method of an FB instance, it may be defined as both a global label and local label because it is not distinguished for each FB instance. In this case, it is treated as both a global label and local label.\*1

\*1 For a structure label defined as a local label in an FB, all the members are treated as global labels and local labels.

### ■When specifying a device as a sampling target

Devices included in a sampling unit (point) shown in the following section are also specified as sampling targets.\*1\*2

☞ Page 33 Devices that can be sampled

These devices are specified as sampling targets when closing this screen, and the checkboxes of the devices in the list are selected in the "Sampling Target" column when opening this screen again. To exclude them from the sampling target, unselect all the checkboxes.\*3

\*1 When specifying any one of the following devices and its contact, coil, or current value as sampling targets, the contact, coil, and current value are specified as sampling targets.

- Timer
- Retentive timer
- Long timer
- Long retentive timer
- Counter
- Long counter
- Safety timer
- Safety retentive timer
- Safety counter

\*2 When specifying either an index register or a long index register as a sampling target, the other one is also specified.

\*3 The selection status of a device in the "Sampling Target" column changes at the same time as that of a device and label in the list that satisfy the conditions shown in the following section.

Therefore, the selection status of another device and label may also change.

☞ Page 123 Selection status of a device in the "Sampling Target" column

Ex.

When selecting D70 as a sampling target, devices in the range of D64 to D95 (32 words) are specified as sampling targets.

Device/Label	Sampling Target	Device	Range
Filter Condition	Filter Condition	Filter Condition	Filter Condition
<input type="checkbox"/> D0	<input type="checkbox"/>	D0	
<input type="checkbox"/> D15	<input type="checkbox"/>	D15	
<input type="checkbox"/> D20	<input type="checkbox"/>	D20	D20-D29
<input checked="" type="checkbox"/> D70	<input checked="" type="checkbox"/>	D70	
<input type="checkbox"/> D80	<input type="checkbox"/>	D80	
<input type="checkbox"/> D90	<input type="checkbox"/>	D90	D90-D99
<input type="checkbox"/> X0	<input type="checkbox"/>	X0	



Device/Label Sampling Target List			
Sampling Target Device List			
No.	Device/Local Device	Start Device	End Device
1	Device	D64	D95

When opening this screen again, the checkboxes of these devices are selected in the "Sampling Target" column.

To exclude them from the sampling target, unselect all the checkboxes in the "Sampling Target" column.

Device/Label	Sampling Target	Device	Range
Filter Condition	Filter Condition	Filter Condition	Filter Condition
<input type="checkbox"/> D0	<input type="checkbox"/>	D0	
<input type="checkbox"/> D15	<input type="checkbox"/>	D15	
<input type="checkbox"/> D20	<input type="checkbox"/>	D20	D20-D29
<input checked="" type="checkbox"/> D70	<input checked="" type="checkbox"/>	D70	
<input checked="" type="checkbox"/> D80	<input checked="" type="checkbox"/>	D80	
<input type="checkbox"/> D90	<input type="checkbox"/>	D90	D90-D99
<input type="checkbox"/> X0	<input type="checkbox"/>	X0	

(1)

(2)



Device/Label	Sampling Target	Device	Range
Filter Condition	Filter Condition	Filter Condition	Filter Condition
<input type="checkbox"/> D0	<input type="checkbox"/>	D0	
<input type="checkbox"/> D15	<input type="checkbox"/>	D15	
<input type="checkbox"/> D20	<input type="checkbox"/>	D20	D20-D29
<input type="checkbox"/> D70	<input type="checkbox"/>	D70	
<input type="checkbox"/> D80	<input type="checkbox"/>	D80	
<input type="checkbox"/> D90	<input type="checkbox"/>	D90	D90-D99
<input type="checkbox"/> X0	<input type="checkbox"/>	X0	

(3)

(1) The checkboxes of devices in the range of D64 to D95 are selected in the "Sampling Target" column.

(2) Devices in the range of D90 to D99 are not selected as sampling targets because they are not included in the range of D64 to D95.

(3) Unselect the checkboxes of all the devices in the range of D64 to D95.

## ■ Selection status of a device in the "Sampling Target" column

When changing the selection status of a device in the "Sampling Target" column, the statuses of other devices and labels in the list that satisfy the following conditions also change at the same time. (This change also applies to devices and labels that are hidden by filtering.)

- The device type is the same as a changed device. <sup>\*1\*2\*3</sup>
- The device range is included in the range of a changed device. <sup>\*1\*2</sup>
- The device range partially overlaps with the range of a changed device, and devices in the remaining range are already specified as sampling targets. <sup>\*4</sup>

\*1 For example, when changing the selection status of a device in the range of D0 in the "Sampling Target" column, those of devices in the same range also change. (The selection statuses of devices in the ranges of D1, Z0, D0-D1, and D0Z0, etc. do not change.)

\*2 For example, when changing the selection status of a device in the range of D0-D1 in the "Sampling Target" column, those of devices in the ranges of D0, D1, and D0-D1 also change. (The selection statuses of devices such as those in the range of D1-D2 do not change.)

\*3 The following devices and their contacts, coils, or current values are treated as other device types in this screen; therefore, the selection status does not change at the same time. (For example, the selection status of a coil T0, TS0, TC0, or TN0 does not change at the same time even if that of another one changes.)

- Timer
- Retentive timer
- Long timer
- Long retentive timer
- Counter
- Long counter
- Safety timer
- Safety retentive timer
- Safety counter

\*4 For example, when selecting the checkbox of a device in the range of D0 in the "Sampling Target" column, those of devices in the range of D0-D1 are also selected if D1 is already specified as a sampling target. (When unselecting the checkbox of D0, those of devices in the range of D0-D1 are also unselected; however, D1 remains a sampling target.)

## ■ When specifying a label (no device assigned) as a sampling target

Other labels in a project that satisfy the following conditions are also specified as sampling targets according to specified label types.

Therefore, when changing the selection status in the "Sampling Target" column, the statuses of other labels in the list that satisfy the following conditions also change at the same time. (This change also applies to labels that are hidden by filtering.)

Label type		Condition
<ul style="list-style-type: none"> <li>• Global label</li> <li>• Standard/safety shared global label</li> </ul>		All global labels (no device assigned)
Local label	Used in a program file (program block)	<ul style="list-style-type: none"> <li>• All local labels in a program file to which a local label belongs<sup>*1</sup></li> <li>• All local labels in an FB used in a program file to which a local label belongs<sup>*1</sup></li> </ul>
	Used in an FB file (FB)	<ul style="list-style-type: none"> <li>• All local labels in an FB file to which a local label belongs<sup>*1</sup></li> <li>• All local labels in a program file that uses an FB in an FB file to which a local label belongs<sup>*1</sup></li> <li>• All local labels in another FB file used in an FB file to which a local label belongs<sup>*1</sup></li> </ul>
Module label		All module labels (no device assigned)

\*1 Based on a local label specified as a sampling target, other local labels that satisfy their respective conditions are also specified as sampling targets.

For examples of specifying other local labels when specifying a local label as a sampling target, refer to the following:

- ☞ Examples of specifying other local labels when specifying a local label as a sampling target

- Examples of specifying other local labels when specifying a local label as a sampling target

The following configuration is used for specification examples.

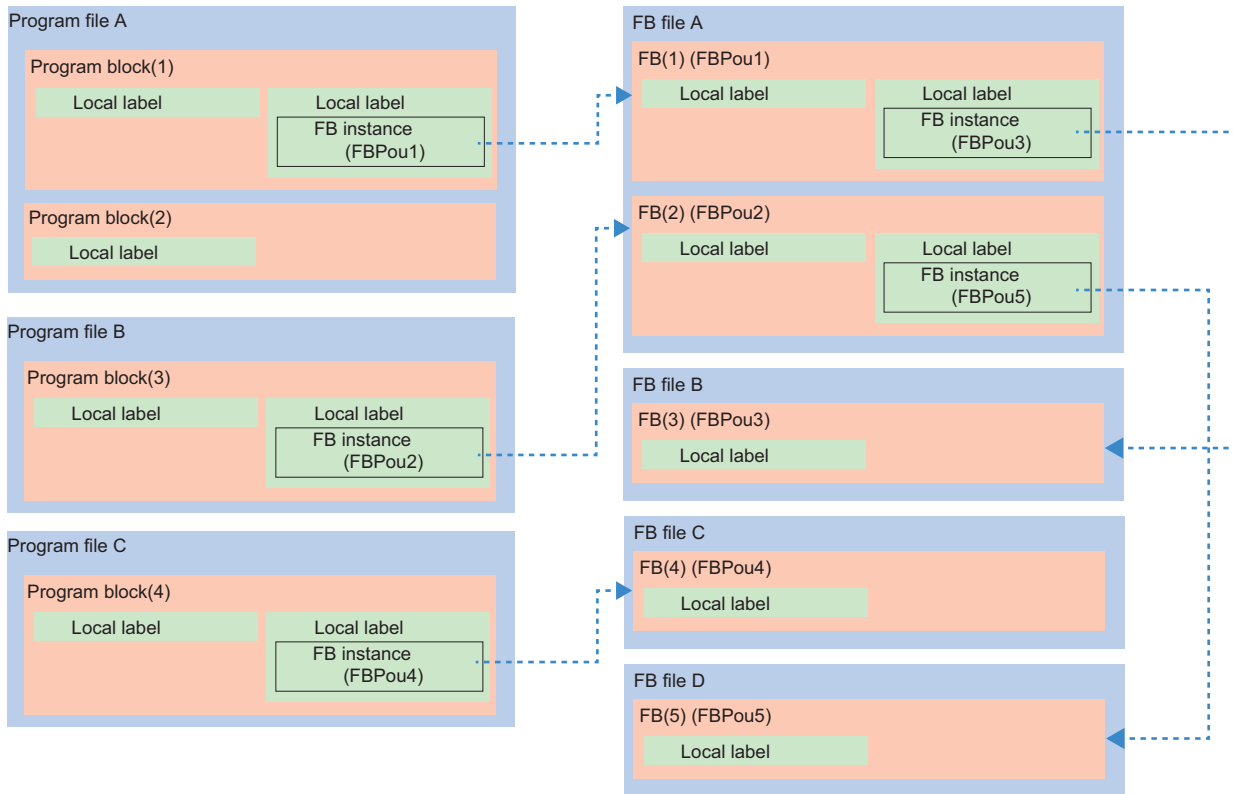

--->: FB specified as the data type of an FB instance

① When specifying a local label in program block (1) as a sampling target, local labels in the following blocks are also specified as sampling targets.

- Program block (2) (3)
- FB (1) (2) (3) (5)

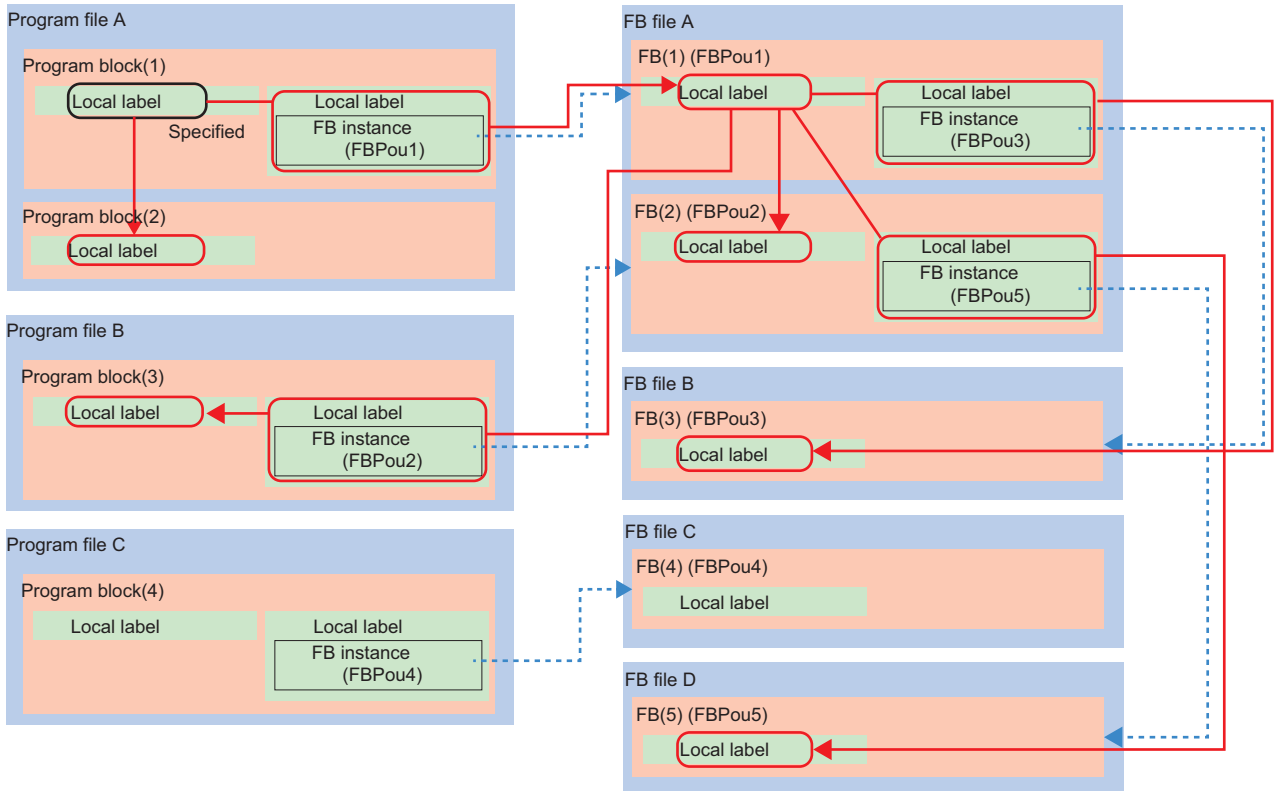

--->: FB specified as the data type of an FB instance  
 ->: Local label specified as a sampling target

② When specifying a local label in FB (1) as a sampling target, local labels in the following blocks are also specified as sampling targets.

- Program block (1) (2) (3)
- FB (2) (3) (5)

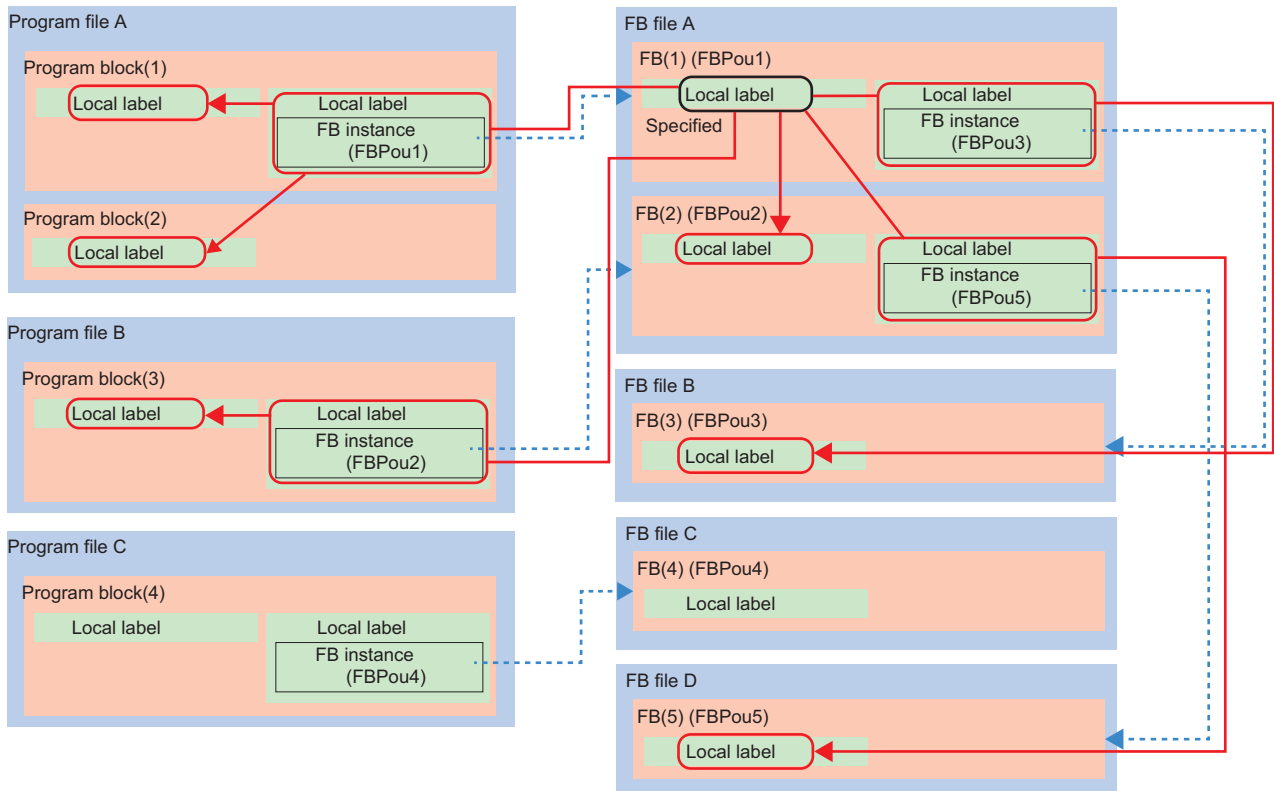

--->: FB specified as the data type of an FB instance  
 ->: Local label specified as a sampling target

### ■When specifying a label (device assigned) as a sampling target

Labels (device assigned) are treated the same as global devices. For details, refer to the following:

☞ Page 121 When specifying a device as a sampling target

### ■When specifying a structure label/member as a sampling target

Devices and labels that satisfy the following conditions are set as sampling targets.

Structure label/member	Condition
Structure label	All members*1 in a structure and labels that satisfy the conditions shown in the following: ☞ Page 123 When specifying a label (no device assigned) as a sampling target
Simple data type member (device assigned)	Same as a device. For details, refer to the following: ☞ Page 121 When specifying a device as a sampling target
Simple data type member (no device assigned)	Same as a label (no device assigned). For details, refer to the following: ☞ Page 123 When specifying a label (no device assigned) as a sampling target
Structure type member	Same as a label (no device assigned). For details, refer to the following: ☞ Page 123 When specifying a label (no device assigned) as a sampling target

\*1 The selection status in the "Sampling Target" column does not change at the same time. Members are specified as sampling targets when closing this screen and other devices and labels that satisfy their respective conditions are also specified as sampling targets based on a member specified as a sampling target.



### ■When changing a program setting or others after specifying a sampling target in this screen

When changing the following settings before writing the recording setting to a CPU module after specifying sampling targets in this screen, sampling target devices and labels may change according to the setting change. Sampling target devices and labels after the change can be checked in the "Device/Label Sampling Target List" screen. (☞ Page 133 "Device/Label Sampling Target List" screen)

- Program
- Label setting
- Memory/device setting in the CPU parameter
- Program setting in the CPU parameter

When including parameters, the following settings are also targets:

- Refresh setting between multiple CPUs (CPU parameter)
- Refresh setting in the CC-Link IEF Basic setting (module parameter)
- Refresh setting (module parameter)
- Simple CPU communication setting (module parameter)
- Safety data transfer device setting in the safety communication setting (module parameter)

The following describes the cases in which sampling target devices and labels change or not after changing any of the settings above.

#### Cases in which sampling targets change

- Whether to use a label (no device assigned) is changed.
- A device is assigned to a sampling target label (no device assigned).
- The program number of a sampling target local label is changed and a local label in the program is excluded from the sampling target.
- The range of sampling target devices is changed and the devices are excluded from the sampling target.

(Example)

- The program corresponding to the program number of a sampling target local device is deleted.
- The type of the program corresponding to the program number of a sampling target local device is changed (such as a change from a safety program to a standard one).

#### Case in which sampling targets do not change

- Whether to use a sampling target device is changed.

### ■When displaying this screen after changing SFC block information (only when using GX Works3 Version 1.090U)

When changing block information in the properties of an SFC block then displaying this screen, information before the change may be displayed.

After changing block information, save and close the project then open it again.

## Filtering display

Displayed devices and labels can be filtered.

The following table shows filtering conditions that can be specified for each column.

Column	Description
Device/Label	Any characters can be specified (up to 32 characters).
Sampling Target	Either of the following items can be selected: <ul style="list-style-type: none"> <li>• Enable (Sampling Target)</li> <li>• Disable (Sampling Target Excluded)</li> </ul>
Class	Any characters can be specified (up to 32 characters).
Label Data Type	
Device	
Range	
Instruction	
FB/FUN	
Program File Name	
Data Type	Any of the following items can be selected: <ul style="list-style-type: none"> <li>• Program</li> <li>• FB</li> <li>• CPU Parameter</li> <li>• Module Parameter</li> <li>• Block Information</li> </ul>
Data Name	Any characters can be specified (up to 32 characters).
Comment	Any characters can be specified (up to 32 characters).

### ■Filtering condition

A previously entered condition can be selected from the pull-down list.<sup>\*1\*2</sup>

A program file name and data name displayed in the list can also be selected in the "Program File Name" and "Data Name" columns.<sup>\*2</sup>

In addition, conditions can be specified in multiple columns. In this case, only devices and labels that match all the conditions are displayed.

\*1 Up to 10 conditions are displayed in the following columns. If 11th one is entered, 10 conditions are displayed in order from an added one. Note that the filter history is cleared when closing the project.

Device/Label  
Class  
Label Data Type  
Device  
Range  
Instruction  
FB/FUN  
Comment

\*2 Up to 50 conditions are displayed in the "Program File Name" and "Data Name" columns (up to 50 program file names and data names in the list are displayed by default).

If 51st one is entered, 50 conditions are displayed in order from an added one. Note that the filter history returns to the default when closing this screen or changing the selection status of the checkbox of "Include Devices/Labels Used in Parameter Setting" in the "Setting" screen.

### ■Deleting a filtering condition

Filtering of a column can be cleared by deleting the keyword entered as a filtering condition for the column.

### ■Keywords for a filtering condition

The following table shows the wild cards that can be set as keywords in filtering conditions to search for a character string.

Wild card	Target	Example	Result
*	Any character string	*D30*	red301, @D30, XD30, D30, D30:U
?	Any one character	K4?30	K4X30, K4Y30
[ ]	Any one of specified characters ■Case in which an error occurs '[' and ']' are not paired. (Example) X[0, X1]	[XY]8	X8, Y8

Wild card	Target	Example	Result
[!]	Any one character except for one in the brackets	K4X[!3]0 K[!1-3]X0	K4X10, K4X20, K4X40 K4X0
[-]	Character strings within the range in the brackets <b>■Case in which an error occurs</b> <ul style="list-style-type: none"> <li>Only the upper or lower limit value is specified or neither is specified. (Example) [-], X[-], X[0-], X[-9]</li> <li>A value of two or more digits is set for the upper or lower limit value. (Example) X[100-5], X[0-100], X[10-20]</li> <li>The lower limit value is equal to or greater than the upper limit value. (Example) X[0-0], X[9-0]</li> <li>A hyphen (-) is specified more than once. (Example) bLabel[a-x0-1]</li> </ul>	[B-D]0 D[0-2] K4X[!3-4]0	B0, C0, D0 D0, D1, D2 K4X10, K4X20, K4X50

## Precautions

### ■When specifying an array element as a filter

An array element is regarded as a wild card '['.]' This causes an unexpected result.

(Example) When specifying "bLabel1[9]" as a filter if 'bLabel1[9]' and 'bLabel19' are included in the list, 'bLabel19' is displayed.

(Example) When specifying "bLabel1[[0-9]]" as a filter if 'bLabel1[0]' and 'bLabel1[9]' are included in the list, an error occurs.

### ■When specifying a data type that includes '[' ]' as a filter

A data type is regarded as a wild card '['.]' This causes an unexpected result.

(Example) When specifying "Word [Signed]" as a filter, it is not displayed.

### ■When specifying a comment that includes a wild card as a filter

When specifying a comment that includes a wild card (\*, ?, or '[' ]') as a filter, an expected result may not be obtained.

(Example) When specifying "Detailed Information [1]" as a filter if 'detailed information [A],' 'detailed information [1],' and 'detailed information 1' are included in the list, 'detailed information 1' is displayed.

## Operation examples

### ■When specifying only a specific program as a sampling target

#### Operating procedure

1. Select "Filter Condition" in the "Program File Name" column, and select a program to specify as a sampling target. Only the devices and labels used in the selected program are displayed.

Device/Label	Sampling Target	Device	Range	Program File Name
Filter Condition	Filter Condition	Filter Condition	Filter Condition	MAIN1
<input type="checkbox"/> X0	<input type="checkbox"/>	X0		MAIN1
<input type="checkbox"/> D0	<input type="checkbox"/>	D0		MAIN2
<input type="checkbox"/> D15	<input type="checkbox"/>	D15		MAIN3
<input type="checkbox"/> X2	<input type="checkbox"/>	X2		MAIN1
<input type="checkbox"/> D70	<input type="checkbox"/>	D70		MAIN1
<input type="checkbox"/> D80	<input type="checkbox"/>	D80		MAIN1
<input type="checkbox"/> X1	<input type="checkbox"/>	X1		MAIN1

2. Move the focus to the list.
3. Press the **Ctrl** + **A** keys to select all the devices and labels.
4. Press the **Ctrl** + **T** keys to select the checkboxes of the selected rows in the "Sampling Target" column.

#### Point

By pressing the **Ctrl** + **D** keys, the checkboxes of the selected rows can be unselected in the "Sampling Target" column.

### ■When specifying only a device of a specific device type as a sampling target

#### Operating procedure

1. Specify a device to specify as a sampling target for "Filter Condition" in the "Device" column. (Example) To specify a D device as a sampling target, specify "D\*"; only D devices are displayed.

Device/Label	Sampling Target	Device	Range
Filter Condition	Filter Condition	D*	Filter Condition
<input type="checkbox"/> D0	<input type="checkbox"/>	D0	
<input type="checkbox"/> D15	<input type="checkbox"/>	D15	
<input type="checkbox"/> D70	<input type="checkbox"/>	D70	
<input type="checkbox"/> D80	<input type="checkbox"/>	D80	
<input type="checkbox"/> D20	<input type="checkbox"/>	D20	D20-D29
<input type="checkbox"/> D90	<input type="checkbox"/>	D90	D90-D99

2. Move the focus to the list.
3. Press the **Ctrl** + **A** keys to select all the devices.
4. Press the **Ctrl** + **T** keys to select the checkboxes of the selected rows in the "Sampling Target" column.

#### Point

By pressing the **Ctrl** + **D** keys, the checkboxes of the selected rows can be unselected in the "Sampling Target" column.

# "Specify the Device Range" screen

The range of devices to be sampled can be specified individually.

## Window

Click the [Setting] button next to "Specify the Device Range" under "Device/Label Sampling Target Setting."

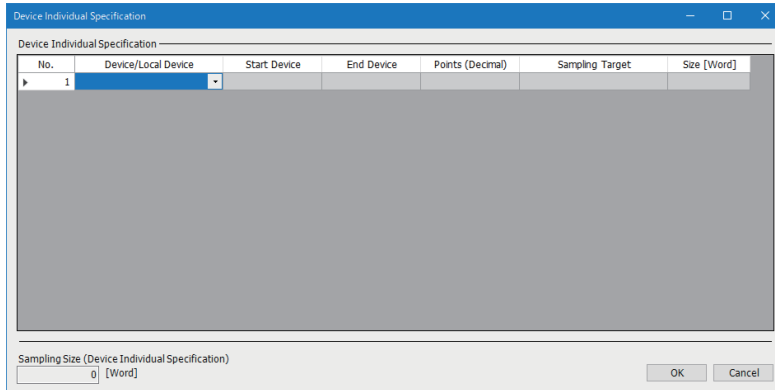

## Displayed items

Item	Description
Specify the Device Range <sup>*1</sup>	Specify a device. The following two types of setting methods are available and can be switched by right-clicking in the screen and selecting [Setting Method] ⇔ [Start/End] or [Points/Start]. <ul style="list-style-type: none"> <li>• Start/End: To set the start and end devices to automatically acquire the number of points.</li> <li>• Points/Start: To set the start device and the number of points to automatically acquire the end device.</li> </ul> When entering a device corresponding to the current value, coil, or contact of a timer or counter, it is replaced with its base device symbol.
Device/Local Device	Select the type of a device (local device or global device). <sup>*2</sup> For a local device, also select a program to which the device belongs. A program name displayed in this item depends on the execution program number.
Start Device	Specify the start of devices to be sampled. <sup>*3*4</sup>
End Device	Specify the end of devices to be sampled. <sup>*4*5</sup>
Points (Decimal)	Specify the number of device points to be sampled. <sup>*6</sup>
Sampling Target	The range of devices to be sampled is displayed based on the sampling unit. <sup>*7</sup> For the sampling unit of each device, refer to the following: 📄 Page 32 Devices and labels that can be sampled
Size [Word]	The size of a device to be sampled is displayed.
Sampling Size (Specify the Device Range)	The total size of sampling target devices specified by using 'specify the device range' is displayed. <sup>*8*9</sup>

\*1 Up to 65536 rows can be set.

\*2 Displayed in red for a local device when any of the following conditions is satisfied.

No program file is registered in the corresponding execution program number.

The program file of the corresponding execution program number does not exist in the navigation window.

A program file registered in the corresponding execution program number is unconverted.

A program file registered in the corresponding execution program number is a standard program when "Safety Cycle Time" is selected for "Sampling Method."

\*3 Cannot be set in any of the following cases:

The cell in "Device/Local Device" is blank.

For a local device, no program file is registered in the corresponding execution program number.

For a local device, a program file registered in the corresponding execution program number is a standard program when "Safety Cycle Time" is selected for "Sampling Method."

\*4 Displayed in red in any of the following cases:

A standard device is specified when "Safety Cycle Time" is selected for "Sampling Method."

The device range is not set in the CPU parameter.

The specified device is out of the range set in the CPU parameter.

For a local device, a safety device is specified when a program file registered in the corresponding execution program number is a standard program.

For a local device, a standard device is specified when a program file registered in the corresponding execution program number is a

safety program.

- \*5 Cannot be set in any of the following cases:
  - The cell in "Device/Local Device" is blank.
  - For a local device, no program file is registered in the corresponding execution program number.
  - For a local device, a program file registered in the corresponding execution program number is a standard program when "Safety Cycle Time" is selected for "Sampling Method."
  - The cell in "Start Device" is blank.
  - "Points/Start" is selected for the setting method.
  - A standard device is specified for "Start Device" when "Safety Cycle Time" is selected for "Sampling Method."
  - A device specified for "Start Device" is one for which the device range is not set in the CPU parameter.
  - A device specified for "Start Device" is out of the range set in the CPU parameter.
- \*6 Cannot be set in any of the following cases:
  - The cell in "Device/Local Device" is blank.
  - For a local device, no program file is registered in the corresponding execution program number.
  - For a local device, a program file registered in the corresponding execution program number is a standard program when "Safety Cycle Time" is selected for "Sampling Method."
  - The cell in "Start Device" is blank.
  - "Start/End" is selected for the setting method.
  - A standard device is specified for "Start Device" when "Safety Cycle Time" is selected for "Sampling Method."
  - A device specified for "Start Device" is one for which the device range is not set in the CPU parameter.
  - A device specified for "Start Device" is out of the range set in the CPU parameter.
- \*7 "-" is displayed in any of the following cases:
  - Some items are not entered.
  - For a local device, no program file is registered in the corresponding execution program number.
  - For a local device, a program file registered in the corresponding execution program number is unconverted.
  - A standard device is specified for "Start Device" when "Safety Cycle Time" is selected for "Sampling Method."
  - For a local device, a safety device is specified for "Start Device" or "End Device" when a program file registered in the corresponding execution program number is a standard program.
  - For a local device, a standard device is specified for "Start Device" or "End Device" when a program file registered in the corresponding execution program number is a safety program.
  - A device that is not set as available in the CPU parameter is specified.
  - The device range set in the CPU parameter is out of the range of the start to end devices.
- \*8 Displayed in red in any of the following cases:
  - A local device, for which no program file is registered in the corresponding execution program number, is specified.
  - A local device, for which the program file of the corresponding execution program number does not exist in the navigation window, is specified.
  - A local device, for which a program file registered in the corresponding execution program number is unconverted, is specified when an item other than "Safety Cycle Time" is selected for "Sampling Method."
  - A local device, for which a program file registered in the corresponding execution program number is an unconverted safety program, is specified when "Safety Cycle Time" is selected for "Sampling Method."
- \*9 A warning icon appears in any of the following cases:
  - A local device, for which no program file is registered in the corresponding execution program number, is specified.
  - A local device, for which a program file registered in the corresponding execution program number is unconverted, is specified.
  - A standard device is specified when "Safety Cycle Time" is selected for "Sampling Method."

## Precautions

- Devices out of the range set in "Device Setting" in the CPU parameter cannot be specified.
  - In addition, devices out of the range are displayed in red if they are changed in "Device Setting" in the CPU parameter after specified in the "Specify the Device Range" screen.
  - For an actual range, check the sampling target column.
- When changing the program execution order in the program setting of GX Works3 after setting a local device, set an item in "Device/Local Device" again.

# "Device/Label Sampling Target List" screen

Devices and labels specified as sampling targets by using each specification method are listed.

## Window

Click the [Device/Label Sampling Target List] button under "Device/Label Sampling Target Setting."

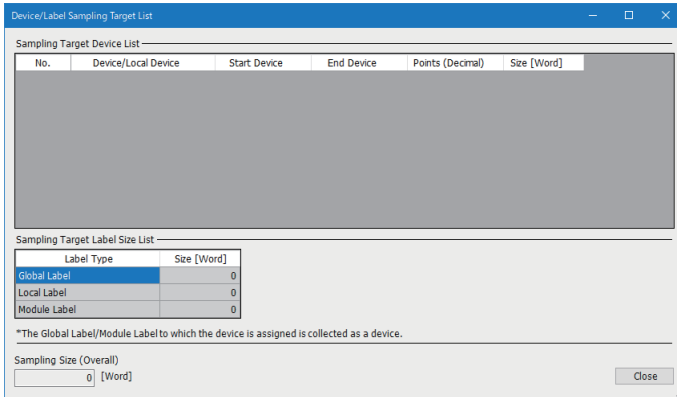

## Displayed items

Item		Description
Sampling Target Device List	—	Sampling target devices are listed. <ul style="list-style-type: none"> <li>If a sampling target is specified for multiple specification methods, it is displayed without duplication. (Example) When specifying D0 to D31 for 'device/label batch specification' and 'specify the device range,' they are displayed for one of the methods only.</li> <li>A device is not displayed if "-" is displayed in the "Sampling Target" column when using 'specify the device range.'</li> <li>If the ranges of devices to be sampled are continuous or overlap, they are displayed as one range. (Example) When specifying D0 to D31 for 'device/label batch specification' and D32 to D95 for 'specify the device range,' D0 to D95 are displayed.</li> <li>When using 'include SFC device' of 'device/label batch specification,' "Devices for the System" is displayed in the bottom row.</li> </ul>
	Device/Local Device	The type of a device is displayed. For a local device, a program to which the device belongs is also displayed.
	Start Device	The start of devices to be sampled is displayed.
	End Device	The end of devices to be sampled is displayed.
	Points (Decimal)	The number of device points to be sampled is displayed.
	Size [Word]	The size of a device to be sampled is displayed.
Sampling Target Label Size List	—	The total size of labels to be sampled is displayed for each type.
	Label Type	The type is displayed.
	Size [Word]	The total size is displayed.
Sampling Size (Overall)		The total size of devices and labels to be sampled is displayed.*1

\*1 Displayed in red and a warning icon appears in any of the following cases:  
 An unconverted program is included in a target program when using 'device/label batch specification.'  
 The checkbox of "Include the Parameter" is selected and a project is unconverted when using 'device/label batch specification.'  
 A target program exists in the program setting in the CPU parameter but not in the navigation window when using 'device/label batch specification.'  
 A local device and local label used in a program other than a target one are specified as sampling targets when using 'specify from the device/label list.'  
 A global label (no device assigned) is specified as a sampling target but an unconverted program is included in a target program when using 'specify from the device/label list.'  
 A module label (no device assigned) is specified as a sampling target but a project is unconverted when using 'specify from the device/label list.'  
 A local device in an unconverted or a non-existent program is specified as a sampling target when using 'specify the device range.'

## 3.4 File Saving Trigger Setting

This section shows the screen for setting a device specified as a file saving trigger for saving accumulated data at a timing such as when a device of a CPU module rises or falls.

CPU stop error detection can also be specified as a condition for satisfying a trigger.

In addition, camera events can be specified as file saving triggers in the camera event trigger setting.

### Window

Click "File Saving Trigger Setting" in the setting item list.

### Displayed items

Item	Description
No.	The condition numbers are displayed.
Device	Specify a device used to determine whether a file saving trigger is satisfied. <sup>*1*2</sup>
Establishment Condition <sup>*3</sup>	Select a condition for satisfying a file saving trigger. <ul style="list-style-type: none"> <li>• ↑: When the bit rises</li> <li>• ↓: When the bit falls</li> <li>• Timeout: When the bit does not change within a time set in the "Time-out Period" column</li> </ul>
Time-out Period <sup>*3*4</sup>	Specify a time before a timeout is detected. The range of values that can be set differs depending on each unit as follows: <ul style="list-style-type: none"> <li>• Second: 1 to 86400</li> <li>• Minute: 1 to 1440</li> <li>• Hour: 1 to 24</li> </ul>
Unit <sup>*3*4</sup>	Specify the unit of time before a timeout is detected.
Comment <sup>*3</sup>	Set a comment to supplement a saving cause (up to 64 characters).
Save when CPU stop error is detected	Select the checkbox to specify CPU stop error detection as a trigger.
[Camera Event Trigger Setting] button <sup>*5</sup>	Click this to open the "Camera Event Trigger Setting" screen. When setting one or more camera event trigger settings, "Already Set" is displayed to the right of this button.

\*1 For devices that can be specified, refer to the following:

☞ Page 43 Devices that can be specified as triggers

\*2 Displayed in red when specifying a device not included in the range set for "Device Setting" in the CPU parameter.

\*3 Can be edited when specifying a device in the "Device" column.

\*4 Can be edited when selecting "Timeout" in the "Establishment Condition" column.

\*5 Appears when one or more camera recorder modules are set in the I/O assignment setting.



# Camera event trigger setting

The following shows the screen for setting a camera event trigger for each network camera set in the module extended parameter.

## Window

Click the [Camera Event Trigger Setting] button under "File Saving Trigger Setting."

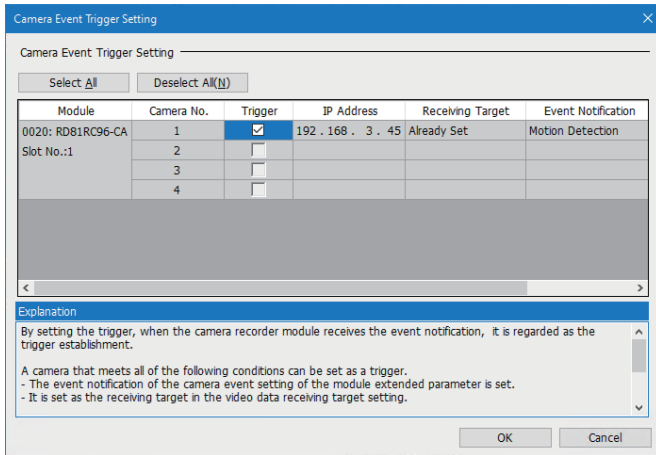

## Displayed items

Item	Description
[Select All] button	Click this to select all the checkboxes in the "Trigger" column.
[Deselect All] button	Click this to unselect all the checkboxes in the "Trigger" column.
Module	The start I/O number, module name, and slot number of a camera recorder module are displayed.
Camera No.	The number of a network camera set in the module extended parameter is displayed.
Trigger	Select the checkbox to specify an event notification from a network camera as a file saving trigger. This checkbox can be selected when both of the following are satisfied: <ul style="list-style-type: none"> <li>The camera event setting is configured in the module extended parameter.</li> <li>A network camera is set as a receiving target in the video data receiving target setting.</li> </ul>
IP Address	The IP address set for a network camera is displayed.
Receiving Target	Whether a network camera is set as a receiving target in the video data receiving target setting is displayed.
Event Notification	The event notification set in the module extended parameter is displayed.
Event Comment	An event comment set in the module extended parameter is displayed.

## Precautions

- Even when changing system parameters, module parameters, or module extended parameters after setting each item in the "Camera Event Trigger Setting" screen, the selection status in the "Trigger" column does not automatically change accordingly. After changing these parameters, open this screen again to review the setting.
- Up to four camera recorder modules are displayed in ascending order of their slot numbers.
- If there are multiple camera recorder modules set as the main ones on the four ascending slot numbers, only the module on the smallest slot number is displayed. The other modules are not displayed.

## 3.5 Saving Path Setting

This section shows the screen for setting a path to save accumulated data.

### Window

Click "Saving Path Setting" in the setting item list.

The screenshot shows the 'Saving Path Setting' window. At the top, it says 'Saving Path Setting'. Below that, there are two rows of controls. The first row is 'Saving Destination' with a dropdown menu showing 'SD Memory Card' and a 'Detail' button. The second row is 'Saving Path' with a text input field containing '/1.TS01\_001' and a 'Detail' button.

The screenshot shows the 'Saving Path Setting' window. At the top, it says 'Saving Path Setting'. Below that, there are two rows of controls. The first row is 'Saving Destination' with a dropdown menu showing 'File Server' and a 'Detail' button. The second row is 'Saving Path' with a text input field containing 'Not Set' and a 'Detail' button.

### Displayed items

Item		Description	Reference
Saving Path Setting	Saving Destination	Select a save destination. When selecting "File Server," the "File Server Setting" screen appears by clicking the [Detail] button.	Page 137 File server setting
	Saving Path	A saving path set in the "Saving Detail Setting" screen is displayed.	—
	[Detail] button	Click this to open the "Saving Detail Setting" screen.	Page 138 Saving detail setting

# File server setting

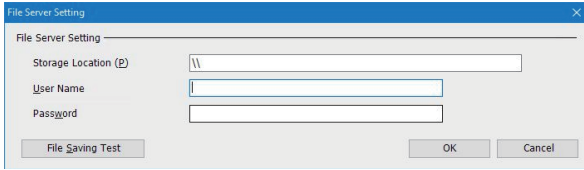

## Window

Click the [Detail] button next to the cells of "Saving Destination" in the saving path setting.



## Displayed items

Item	Description
Storage Location	Specify the folder path to a save destination in the following format (1 to 142 characters): <sup>*1*2*3</sup> • \\(host name <sup>*4*5</sup> or IP address)(folder path)
User Name	Specify a user name <sup>*6</sup> to access a file server (1 to 20 characters).
Password	Specify a password to access a file server (1 to 127 characters).
[File Saving Test] button	Click this to perform the file saving test for a save destination. <sup>*7</sup> When the test is successful, a file (0 bytes) with the following name is stored in the save destination folder. • MELSEC_SMB_TEST_(setting number)(start I/O number of a recorder module/camera recorder module).txt

- \*1 A save destination folder is not generated automatically. Create one in advance.
- \*2 Use '\' as a delimiter between directories.
- \*3 When using a multiple CPU system, do not specify the same folder.
- \*4 Specify it within 64 characters.
- \*5 To specify a host name, the DNS setting must be configured in the module parameter of a recorder module/camera recorder module.  
 Page 95 Module Parameters (Recorder Module/Camera Recorder Module)
- \*6 A file cannot be saved by specifying a user name that is joined to a domain. Specify one that is not joined to any domain.
- \*7 When configuring multiple modules, the test is also performed between a sub module and file server.  
 Page 67 Operation of the recording function when configuring multiple modules

# Saving detail setting

## Window

Click the [Detail] button in the saving path setting.

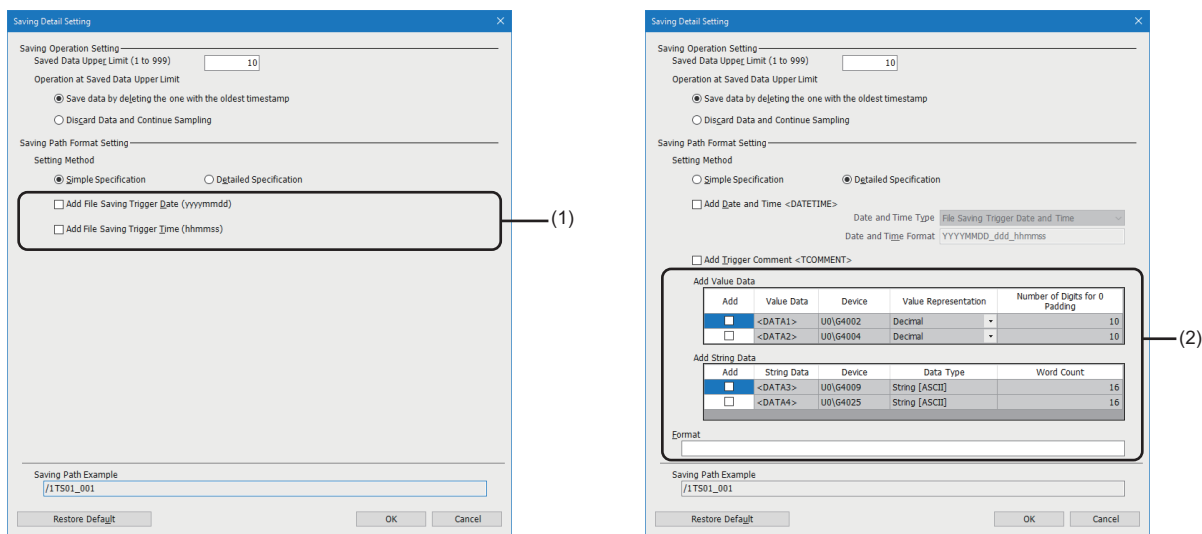

## Displayed items

Item	Description		
Saving Operation Setting	Saved Data Upper Limit (1 to 999)	Set the upper limit of saved recording files.	
	Operation at Saved Data Upper Limit	Select an operation performed when the upper limit of saved recording files is exceeded. <ul style="list-style-type: none"> <li>Save data by deleting the one with the oldest timestamp: A recording file with the oldest time stamp is deleted and a new file is saved.</li> <li>Discard Data and Continue Sampling: A new recording file is not saved, and data is discarded. In addition, a saving error occurs. (Page 86 If saving a file fails)</li> </ul>	
Saving Path Format Setting	Setting Method	Select "Simple Specification" or "Detailed Specification." <ul style="list-style-type: none"> <li>Simple Specification: To set only whether to add the date and time when a file saving trigger is satisfied to a file name.</li> <li>Detailed Specification: To set whether to add the following items to a file name: <ul style="list-style-type: none"> <li>Date and time (when a file saving trigger is satisfied or a recording file is saved)<sup>*1</sup></li> <li>Numerical value data (data in the buffer memory when a file saving trigger is satisfied)</li> <li>Any character strings</li> </ul> </li> </ul>	
	(1) Simple specification	Add File Saving Trigger Date (yyyymmdd)	Select the checkbox to add the date and time when a file saving trigger occurs to a file name. (Example) February 23, 2019: 20190223
		Add File Saving Trigger Time (hhmmss)	Select the checkbox to add the time when a file saving trigger occurs to a file name. (Example) 18:53:04: 185304

Item		Description	
Saving Path Format Setting	(2) Detailed specification	Add Date and Time <DATETIME>	Select the checkbox to add a date and time to a file name. A date and time according to the settings for "Date and Time Type" and "Date and Time Format" is added to the position of <DATETIME> specified for "Format."
		Date and Time Type <sup>*2</sup>	Select the type of date and time information to be added ("File Saving Trigger Date and Time" or "File Creation Date and Time").
		Date and Time Format <sup>*2</sup>	Set the output format of the date and time column (2 to 24 characters). The following reserved words <sup>*3</sup> can be specified. <ul style="list-style-type: none"> <li>• YYYY: Year (4 digits)</li> <li>• YY: Year (2 digits)</li> <li>• MM: Month (2 digits)</li> <li>• DD: Day (2 digits)</li> <li>• ddd: Day of the week (3 digits)</li> <li>• hh: Hour (2 digits)</li> <li>• mm: Minute (2 digits)</li> <li>• ss: Second (2 digits)</li> </ul>
		Add Trigger Comment <TCOMMENT>	Select the checkbox to add a trigger comment to a file name. A trigger comment is added to the position of <TCOMMENT> specified for "Format."
	Add Value Data	Add	Select the checkbox to add numerical value data to a file name. Numerical value data according to the settings for "Add Value Data" is added to the position of <DATA1> or <DATA2> specified for "Format."
		Value Data	<DATA1> or <DATA2> is displayed.
		Device	The address of the buffer memory that stores numerical value data is displayed.
		Value Representation <sup>*4</sup>	Select an output format of numerical value data to be added (decimal or hexadecimal).
		Number of Digits for 0 Padding <sup>*4</sup>	Specify the number of digits for zero padding in numerical value data to be added. The range of numerical values that can be set differs depending on the data format as follows: <ul style="list-style-type: none"> <li>• Decimal: 2 to 10</li> <li>• Hexadecimal: 2 to 8</li> </ul>
	Add String Data	Add	Select the checkbox to add string data to a file name. String data according to the settings for "Add String Data" is added to the position of <DATA3> or <DATA4> specified for "Format."
		String Data	<DATA3> or <DATA4> is displayed.
		Device	The address of the buffer memory that stores string data is displayed.
		Data Type	The data type of string data is displayed.
		Word Count <sup>*4</sup>	Specify the number of characters in string data (1 to 16).
Format		Set the format of a file name (up to 34 characters). <sup>*5</sup> ASCII characters and the following reserved words can be entered. <ul style="list-style-type: none"> <li>• &lt;DATETIME&gt;</li> <li>• &lt;TCOMMENT&gt;</li> <li>• &lt;DATA1&gt;</li> <li>• &lt;DATA2&gt;</li> <li>• &lt;DATA3&gt;</li> <li>• &lt;DATA4&gt;</li> </ul>	
Saving Path Example		A file name example is displayed based on the current setting. <ul style="list-style-type: none"> <li>• /XXXX_nTS01_001</li> </ul> <p>XXXX: Additional information based on the current setting _: Omitted when not adding additional information n: Number of a recording setting (1 to 4) TS01: Always displayed as a character indicating a saving cause _001: Always displayed as a folder number</p> <p>For details on save destinations and file names, refer to the following:   Page 49 Recording file</p>	

\*1 A format can be specified.

\*2 Can be set only when selecting the checkbox of "Add Date and Time <DATETIME>."

\*3 Case-sensitive

\*4 Can be set only when selecting the checkbox of "Add."

\*5 Up to 64 characters for a recording file name. If the number of characters in information added to a recording file name exceeds 54 characters, the first 54 ones are added.

## 3.6 Video Data Receiving Target Setting

This section shows the screen for setting a network camera from which video data is received.

### Window

Click "Video Data Receiving Target Setting" in the setting item list.

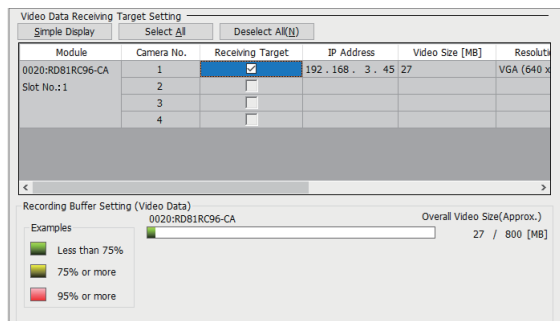

### Displayed items

Item	Description
[Detailed Display]/[Simple Display] button	Click this to switch between the detailed display and the simple display.
[Select All] button	Click this to select all the checkboxes in the "Receiving Target" column.
[Deselect All] button	Click this to unselect all the checkboxes in the "Receiving Target" column.
Module	The start I/O number, module name, and slot number of a camera recorder module are displayed.
Camera No.	The number of a network camera set in the module extended parameter is displayed.
Receiving Target	Select the checkbox to receive video data captured by a network camera. <sup>*1</sup>
IP Address	The IP address set for a network camera is displayed. <sup>*2</sup>
Video Size [MB]	The buffer capacity, which is calculated based on the network camera setting and the recording saving time, is displayed. <sup>*2</sup> However, if a calculated value of the buffer capacity is a decimal number, the first decimal place is rounded up.
Resolution <sup>*3</sup>	The resolution set for a network camera is displayed. <sup>*2</sup>
Video Frame Rate [fps] <sup>*3</sup>	The video frame rate set for a network camera is displayed. <sup>*2</sup>
Video Codec <sup>*3</sup>	The video codec set for a network camera is displayed. <sup>*2</sup>
Video Quality <sup>*3*4</sup>	The video quality set for a network camera is displayed. <sup>*2</sup>
Camera Comment	The camera comment set for a network camera is displayed. <sup>*2</sup>
Recording Buffer Setting (Video Data)	The video data capacity, which is calculated based on the network camera setting and the selection status in the "Receiving Target" column, is displayed for each camera recorder module in the following format: • Video data capacity/recording buffer setting assigned in the module parameter (video data) [MB] <sup>*5</sup>

\*1 Can be selected only when a network camera is enabled.

Whether it is enabled can be checked in 'Network camera setting enabled/disabled' (Un\G34000, Un\G34500, Un\G35000, Un\G35500) of a camera recorder module. (Page 282 Network camera status area (Un\G34000 to 37999))

\*2 Blank when a network camera is disabled.

Whether it is disabled can be checked in 'Network camera setting enabled/disabled' (Un\G34000, Un\G34500, Un\G35000, Un\G35500) of a camera recorder module. (Page 282 Network camera status area (Un\G34000 to 37999))

\*3 Appears only for the detailed display. (The simple display is selected by default.)

\*4 Blank when enabling the simple setting mode. The video size is calculated with the video quality equivalent to middle.

\*5 If the video data capacity is larger than a value assigned in the recording buffer setting (video data) in the module parameter, the video data capacity is displayed in red. In this case, data for a set saving period may not be saved. Perform any of the operations shown in the following:

Page 61 When the capacity of accumulated video data exceeds the buffer capacity

## Precautions

- Even when changing system parameters, module parameters, or module extended parameters after setting each item in the "Video Data Receiving Target Setting" screen, the selection status in the "Receiving Target" column does not automatically change accordingly. After changing these parameters, review the setting.
- Up to four camera recorder modules are displayed in ascending order of the slot number even in the following states:
  - "Empty" is selected in the module status setting in the system parameter.
  - An item other than "Online" is selected for the mode setting in the module parameter.
- If there are multiple camera recorder modules set as the main ones on the four ascending slot numbers, only the module on the smallest slot number is displayed. The other modules are not displayed.

# 4 RECORDING MONITOR

This chapter shows the "Recording Monitor" screen of GX Works3 for checking the status of the recording function. The status of a network camera connected to a camera recorder module can also be checked in the "Camera Monitor" screen.

## Window

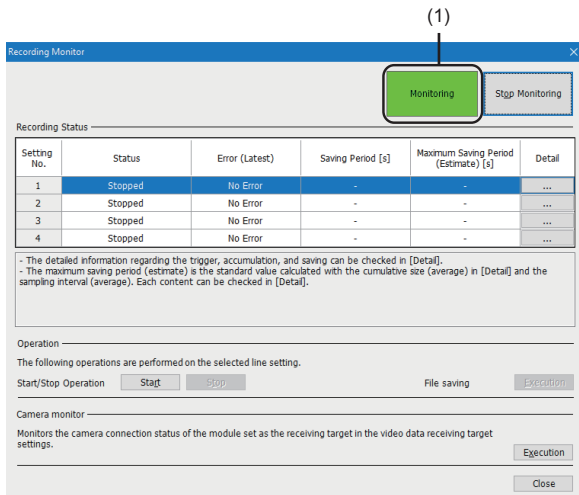

Select [Diagnostics] ⇨ [Recording Monitor].



## Displayed items

Item	Description	
(1) Monitoring status	The monitoring status is displayed.	
[Start Monitoring]/[Stop Monitoring] button	Click this to start or stop monitoring.	
Recording Status	Status	The operating status of the recording function is displayed. <sup>*1</sup> ☞ Page 63 Operating status
	Error (Latest)	An error is displayed for each recording setting. If no error occurs, "No Error" is displayed. <sup>*2</sup> If an error occurs, the latest error code is displayed. The error description and corrective action can be checked in the module diagnostics of a recorder module/camera recorder module in which an error occurred.
	Saving Period [s] <sup>*3*4</sup>	A saving period set in the recording setting is displayed.
	Maximum Saving Period (Estimate) [s] <sup>*4*5</sup>	A standard for a saving period during which data can be accumulated in the recording buffer is displayed. It is calculated based on the cumulative size (average) and the sampling interval (average). The cumulative size (average) and the sampling interval (average) can be checked in the "Recording Status Detailed Information" screen. ☞ Page 144 Recording Status Detailed Information Screen
	Detail	Click a cell in the "Detail" column to open the "Recording Status Detailed Information" screen. ☞ Page 144 Recording Status Detailed Information Screen
Start/Stop Operation	[Start] button <sup>*6</sup>	Click this to start the recording function that runs for a selected recording setting.
	[Stop] button <sup>*7</sup>	Click this to stop the recording function that is running for a selected recording setting.



Item		Description
File saving	[Execution] button <sup>*7</sup>	<p>Click this to perform file saving of the recording function that is running for a selected recording setting.</p> <p>Note that it is not performed if data has never been accumulated and there is no accumulated data.</p> <p>In addition, data is not accumulated if a recording startup trigger has never been satisfied when selecting "Recording Startup Trigger + File Saving Trigger" for "Recording Method" in the saving period setting.</p> <p>Accumulated data and the number of successful recording startup triggers can be checked in the "Recording Status Detailed Information" screen.</p> <p> Page 144 Recording Status Detailed Information Screen</p>
Camera monitor	[Execution] button <sup>*8</sup>	<p>Click this to open the "Camera Monitor" screen.</p> <p> Page 146 Camera Monitor Screen</p>

\*1 The progress rate (%) is also displayed when "Saving" is displayed.

\*2 If data is cleared, "No Error" is displayed.

For the conditions under which data is cleared, refer to the following:

 Page 224 Recording start error (Un\G1502), Page 224 Recording start error cause (Un\G1503)

\*3 "-" is displayed when "Stopped" or "Preparing" is displayed in the "Status" column.

\*4 If the maximum saving period (estimate) is shorter than the saving period, the cell is displayed in yellow. In this case, data for a set saving period may not be saved. Perform any of the operations shown in the following:

 Page 60 When the capacity of accumulated devices and labels exceeds the buffer capacity

\*5 "-" is displayed in any of the following cases:

"Stopped" is displayed in the "Status" column.

"Preparing" is displayed in the "Status" column.

'0' (no data) is stored in 'Recording buffer storing status' (Un\G1507, Un\G1707, Un\G1907, Un\G2107).

\*6 Can be clicked when "Stopped" is displayed in the "Status" column.

\*7 Can be clicked when an item other than "Stopped" or "Preparing" is displayed in the "Status" column and '1' (data exists) is stored in 'Recording buffer storing status' (Un\G1507, Un\G1707, Un\G1907, Un\G2107).

\*8 Can be clicked only during monitoring.

# 4.1 Recording Status Detailed Information Screen

This section shows the screen for displaying detailed information on the recording function status.

## Window

Click a [...] button in the "Detail" column.

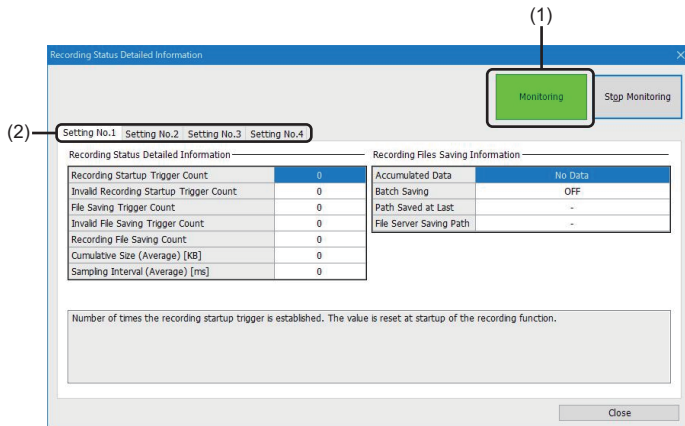

## Displayed items

Item	Description	
(1) Monitoring status	The monitoring status is displayed.	
[Start Monitoring]/[Stop Monitoring] button	Click this to start or stop monitoring.	
(2) Setting tab	Select the tab of a recording setting to display its detailed information. The tab of a recording setting selected in the "Recording Monitor" screen is selected by default.	
Recording Status Detailed Information	Recording Startup Trigger Count <sup>*1</sup>	The number of times that a recording startup trigger was detected to have been satisfied is stored. (Value to be stored: 0 to 65535)
	Invalid Recording Startup Trigger Count <sup>*1</sup>	The number of invalid recording startup triggers among the recording startup triggers detected to have been satisfied is stored. (Value to be stored: 0 to 65535)
	File Saving Trigger Count <sup>*1</sup>	The number of times that a file saving trigger was detected to have been satisfied is stored. (Value to be stored: 0 to 65535)
	Invalid File Saving Trigger Count <sup>*1</sup>	The number of invalid file saving triggers among the file saving triggers detected to have been satisfied is stored. (Value to be stored: 0 to 65535)
	Recording File Saving Count <sup>*1</sup>	The number of times that a recording file was saved (total of successful and failed ones) is stored. (Value to be stored: 0 to 65535)
	Cumulative Size (Average) [KB] <sup>*1</sup>	The average size of devices and labels accumulated at a time is stored.
	Sampling Interval (Average) [ms] <sup>*1</sup>	The average value of device and label sampling intervals is stored. When selecting "Trigger Instruction" for the sampling method, the execution interval of the DATATRG instruction is the sampling interval.

Item		Description
Recording Files Saving Information	Accumulated Data <sup>*1</sup>	When data accumulation is performed once, "Data Exists" is stored. When using a recording startup trigger, data is not accumulated before the trigger is satisfied. Depending on the timings of data accumulation and a recording startup trigger, accumulated data may not be included in a saving period and may not be saved to a recording file.
	Batch Saving <sup>*2</sup>	Whether the recording buffer batch saving mode is enabled is stored. (Page 62 Recording buffer batch saving mode) <ul style="list-style-type: none"> <li>• OFF: Disabled</li> <li>• ON: Enabled</li> </ul> The mode can be switched by right-clicking the cell and selecting [ON] or [OFF].
	Path Saved at Last <sup>*1*3</sup>	The path to a last saved recording file is stored. (Example) 1TS01_001
	File Server Saving Path <sup>*4</sup>	When specifying a file server as the save destination, the path to a folder that saves a recording file is stored.

\*1 For the conditions under which data is cleared, refer to the following:

☞ Page 221 Recording status area (Un\G1500 to 3199)

\*2 For the conditions under which data is cleared, refer to the following:

☞ Page 228 Recording buffer batch saving mode (Un\G4001)

\*3 A NULL character is used as a termination character, and characters out of the specification range before the termination character are replaced with periods (.) and displayed.

For available characters, refer to the following:

☞ Page 294 ASCII characters that can be used in the format in the saving detail setting

\*4 For the conditions under which data is cleared, refer to the following:

☞ Page 229 File server saving information area (Un\G9000 to 10999)

## 4.2 Camera Monitor Screen

This section shows the screen for displaying the status of a network camera connected to a camera recorder module.

### Window

Click the [Execution] button in "Camera monitor."

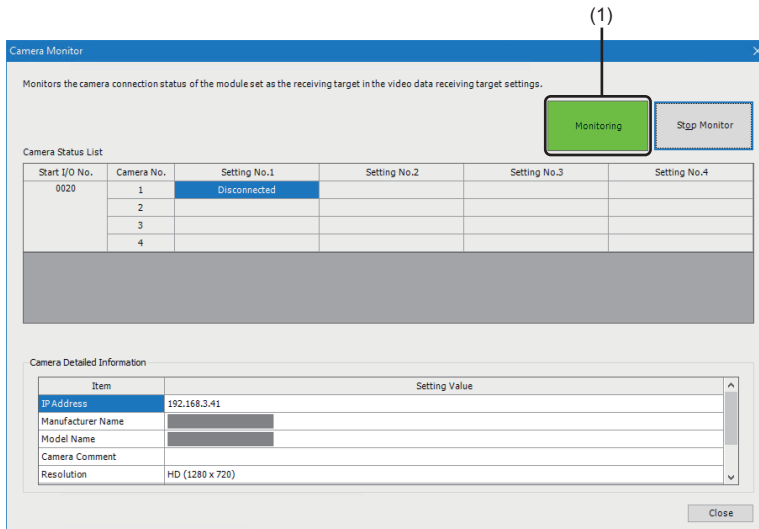

### Displayed items

Item	Description																		
(1) Monitoring status	The monitoring status of the network camera status is displayed.																		
[Start Monitor]/[Stop Monitor] button	Click this to start or stop monitoring the status of a network camera. Even when clicking the [Stop Monitor] button, the monitoring status in the "Recording Monitor" screen is not changed to 'stopped.'																		
Camera Status List	<table border="1"> <tr> <td>Start I/O No.</td> <td>The start I/O number of a camera recorder module is displayed.</td> </tr> <tr> <td>Camera No.</td> <td>The number of a network camera is displayed.</td> </tr> <tr> <td>Setting No.1 to 4</td> <td>The status of a network camera is displayed for each recording setting. A displayed state is determined by the combination of values in the buffer memories of a camera recorder module. (Page 147 Status of a network camera) If a network camera is disabled, the cell is grayed out and the display content is not updated.*1</td> </tr> </table>	Start I/O No.	The start I/O number of a camera recorder module is displayed.	Camera No.	The number of a network camera is displayed.	Setting No.1 to 4	The status of a network camera is displayed for each recording setting. A displayed state is determined by the combination of values in the buffer memories of a camera recorder module. (Page 147 Status of a network camera) If a network camera is disabled, the cell is grayed out and the display content is not updated.*1												
Start I/O No.	The start I/O number of a camera recorder module is displayed.																		
Camera No.	The number of a network camera is displayed.																		
Setting No.1 to 4	The status of a network camera is displayed for each recording setting. A displayed state is determined by the combination of values in the buffer memories of a camera recorder module. (Page 147 Status of a network camera) If a network camera is disabled, the cell is grayed out and the display content is not updated.*1																		
Camera Detailed Information*2	<table border="1"> <tr> <td>—</td> <td>Detailed information on a network camera selected in the camera status list is displayed.</td> </tr> <tr> <td>IP Address</td> <td>The IP address of a network camera is displayed.</td> </tr> <tr> <td>Manufacturer Name</td> <td>The manufacturer name of a network camera is displayed.</td> </tr> <tr> <td>Model Name</td> <td>The model name of a network camera is displayed.</td> </tr> <tr> <td>Camera Comment</td> <td>The camera comment set for a network camera is displayed.</td> </tr> <tr> <td>Resolution</td> <td>The resolution set for a network camera is displayed.</td> </tr> <tr> <td>Video Frame Rate</td> <td>The video frame rate set for a network camera is displayed.</td> </tr> <tr> <td>Video Codec</td> <td>The video codec set for a network camera is displayed.</td> </tr> <tr> <td>Video Quality</td> <td>The video quality set for a network camera is displayed.</td> </tr> </table>	—	Detailed information on a network camera selected in the camera status list is displayed.	IP Address	The IP address of a network camera is displayed.	Manufacturer Name	The manufacturer name of a network camera is displayed.	Model Name	The model name of a network camera is displayed.	Camera Comment	The camera comment set for a network camera is displayed.	Resolution	The resolution set for a network camera is displayed.	Video Frame Rate	The video frame rate set for a network camera is displayed.	Video Codec	The video codec set for a network camera is displayed.	Video Quality	The video quality set for a network camera is displayed.
—	Detailed information on a network camera selected in the camera status list is displayed.																		
IP Address	The IP address of a network camera is displayed.																		
Manufacturer Name	The manufacturer name of a network camera is displayed.																		
Model Name	The model name of a network camera is displayed.																		
Camera Comment	The camera comment set for a network camera is displayed.																		
Resolution	The resolution set for a network camera is displayed.																		
Video Frame Rate	The video frame rate set for a network camera is displayed.																		
Video Codec	The video codec set for a network camera is displayed.																		
Video Quality	The video quality set for a network camera is displayed.																		

\*1 Whether it is enabled can be checked in 'Network camera setting enabled/disabled' (Un\G34000, Un\G34500, Un\G35000, Un\G35500) of a camera recorder module. (Page 282 Network camera status area (Un\G34000 to 37999))

\*2 Values acquired from the buffer memory of a camera recorder module are displayed. When enabling the simple setting mode, some items are blank or hidden.

## Precautions

- When changing the configuration or start I/O number of a camera recorder module, the status cannot be monitored properly and the operation is not guaranteed. The settings in the "Video Data Receiving Target Setting" screen of the recording setting must also be changed.

☞ Page 140 Video Data Receiving Target Setting

- If this screen is opened before the communication between a network camera and a camera recorder module is completed, the manufacturer name and model name may not be displayed in the camera detailed information. To display them, wait a few minutes until the communication is completed, and then open this screen again.

Note that the manufacturer name and model name are always blank if a network camera is not connected.

- Even when deleting a recording setting in the "Online Data Operation" screen, the setting may remain displayed in this screen. It is updated by opening this screen again after resetting a CPU module and switching it to RUN.

## Status of a network camera

A displayed state is determined by the combination of values in the following buffer memories of a camera recorder module.

- Network camera connection status (Un\G34300, Un\G34800, Un\G35300, Un\G35800) (☞ Page 282 Network camera status area (Un\G34000 to 37999))
- Camera recording status (Un\G1650 to 1653, Un\G1850 to 1853, Un\G2050 to 2053, Un\G2250 to 2253) (☞ Page 271 Recording status area (Un\G1500 to 3199))

Displayed state	Buffer memory	
	Network camera connection status	Camera recording status
Stopped	Connected	Stopped
Preparing		Preparing
Operating		Operating
Saving Trigger Establishment		File saving trigger satisfied
Saving		Saving
No Setting		No setting
Disconnected	Disconnected	—
Retrying	Retrying	
No Setting	No setting	

# 5 TROUBLESHOOTING

This chapter explains the errors which may occur in System Recorder and the troubleshooting.

## 5.1 Recording Function

This section shows the troubleshooting on the recording function.

### Troubleshooting on starting the recording function

Symptom	Check point	Corrective action
Unable to start the recording function.	Is a recording setting for which the recording function starts written?	<ul style="list-style-type: none"> <li>• Write a recording setting for which the recording function starts.</li> </ul>
	Is a CPU module in the RUN state?	<ul style="list-style-type: none"> <li>• Switch the CPU module to the RUN state.</li> </ul>
	Are programs and parameters when configuring a recording setting written to a CPU module?	<ul style="list-style-type: none"> <li>• Write the programs and parameters to the CPU module.</li> </ul>
	Are devices and labels that do not exist in the CPU parameter and modules that are not mounted specified in the device/label sampling setting in the recording setting? (☞ Page 117 Device/Label Sampling Setting)	<ul style="list-style-type: none"> <li>• Review the recording setting.</li> </ul>
	Does the sampling size of a recording setting (total size of devices and labels specified in the device/label sampling setting) exceed the capacity of the buffer area for data sampling in the CPU parameter? (☞ Page 117 Device/Label Sampling Setting, Page 94 Buffer area setting for data sampling)	<ul style="list-style-type: none"> <li>• Review the recording setting.</li> <li>• Review the buffer area setting for data sampling in the CPU parameter.</li> </ul>
	Is the buffer capacity of a recording setting for which the recording function starts set in the recording buffer setting in the module parameter? (☞ Page 98 Recording buffer setting (recorder module), Page 99 Recording buffer setting (camera recorder module))	<ul style="list-style-type: none"> <li>• Review the recording buffer setting in the module parameter.</li> </ul>
	Does a program run properly when the device/label batch specification is enabled in the device/label sampling setting in the recording setting? (Is a program accessing an unmounted module running?) (☞ Page 117 Device/Label Sampling Setting)	<ul style="list-style-type: none"> <li>• Check the mounted module.</li> <li>• Review the program accessing an unmounted module.</li> </ul>
	Is a condition for a device, which is specified as a recording startup trigger in a recording setting for which the recording function starts, satisfied when selecting "Recording Startup Trigger + File Saving Trigger" for "Recording Method" in the saving period setting? (☞ Page 116 When selecting "Recording Startup Trigger + File Saving Trigger" for "Recording Method", Page 26 Recording startup trigger)	<ul style="list-style-type: none"> <li>• Satisfy the condition for the device.</li> </ul>
	Is a condition for a device, which is specified as a recording startup trigger in a recording setting for which the recording function starts, satisfied while the recording startup trigger is enabled when selecting "Recording Startup Trigger + File Saving Trigger" for "Recording Method" in the saving period setting? (☞ Page 116 When selecting "Recording Startup Trigger + File Saving Trigger" for "Recording Method", Page 26 Recording startup trigger)	<ul style="list-style-type: none"> <li>• Satisfy the condition for the device.</li> </ul>
Is a recorder module with a firmware version supporting the function used in the following cases? <ul style="list-style-type: none"> <li>• Using a safety CPU</li> <li>• Specifying a file server as the save destination for recording files</li> </ul> (☞ Page 307 Added and Changed Functions)	<ul style="list-style-type: none"> <li>■When using a safety CPU <ul style="list-style-type: none"> <li>• Update the module to a firmware version supporting a safety CPU.</li> </ul> </li> <li>■When specifying a file server as the save destination for recording files <ul style="list-style-type: none"> <li>• Change the save destination to an SD memory card.</li> <li>• Update the module to a firmware version supporting saving to a file server.</li> </ul> </li> </ul>	

Symptom	Check point	Corrective action
Unable to start the recording function.	Is a CPU module <sup>*1</sup> or recorder module <sup>*2</sup> with a firmware version supporting a configuration with multiple modules used, when using a camera recorder module with "Sub" selected for the recording operation setting in the module parameter? (☞ Page 95 Various operations settings)	• Update the module to a firmware version supporting the configuration.
	Is a program changed by performing the online program change or file batch online change?	• Write the recording setting.
	Is a program changed by performing the online program change or file batch online change while the battery voltage of a CPU module is low?	• Replace the battery with another one, then write the recording setting.
Unable to restart the recording function.	Is the operating status of the recording function 'saving'?	• Wait for a recording file to be saved.
	Is a recorder module/camera recorder module <sup>*2</sup> with a firmware version supporting SFC device sampling used when setting SFC devices as sampling targets?	• Update the recorder module/camera recorder module to a firmware version supporting it.

\*1 The following firmware versions are supported:

RnCPU or RnENCPU: '55' or later

RnSFCPU: '24' or later

\*2 For the firmware versions, refer to the following:

☞ Page 307 Added and Changed Functions

## Troubleshooting on saving recording files

Symptom	Check point	Corrective action
Unable to save a recording file.	Is the operating status of the recording function 'operating'? (☞ Page 63 Operating status)	<ul style="list-style-type: none"> <li>Switch the operating status to 'operating.'</li> </ul> For the operation method, refer to the following: ☞ Page 65 Operation of the recording function
	Does an SD memory card satisfy the following conditions when it is specified as the save destination for the recording file? <ul style="list-style-type: none"> <li>It is inserted in a recorder module/camera recorder module.</li> <li>An available one is used.</li> <li>There is free space.</li> </ul>	<ul style="list-style-type: none"> <li>Check the SD memory card.</li> <li>Replace or initialize the SD memory card.</li> </ul> (☞ MELSEC iQ-R System Recorder User's Manual (Startup))
	Is a condition for a device or buffer memory, which is specified as a file saving trigger in a recording setting for which the recording function started, satisfied? (☞ Page 28 File saving trigger)	<ul style="list-style-type: none"> <li>Satisfy the condition for the device or buffer memory.</li> </ul>
	Is a file saving trigger satisfied after a condition for a device specified as a recording startup trigger in a recording setting for which the recording function started is satisfied when selecting "Recording Startup Trigger + File Saving Trigger" for "Recording Method" in the saving period setting? (☞ Page 116 When selecting "Recording Startup Trigger + File Saving Trigger" for "Recording Method", Page 26 Recording startup trigger, Page 28 File saving trigger)	<ul style="list-style-type: none"> <li>Satisfy the file saving trigger after the condition for the device is satisfied.</li> </ul>
	Is a condition for a device, buffer memory, or camera event, which is specified as a file saving trigger in a recording setting for which the recording function has started, satisfied while the file saving trigger is enabled? (☞ Page 28 File saving trigger)	<ul style="list-style-type: none"> <li>Satisfy the condition while the file saving trigger is enabled.</li> </ul>
	Is a file server running when it is specified as the save destination for the recording file?	<ul style="list-style-type: none"> <li>Start the file server.</li> </ul>
	Is there any problem in the connection route when a file server is specified as the save destination for the recording file?	<ul style="list-style-type: none"> <li>Check if there is any problem in the connection route to the file server.</li> </ul>
	Is the user name or password correct when a file server is specified as the save destination for the recording file?	<ul style="list-style-type: none"> <li>Review the specified user name or password.</li> </ul>
	Is an operation performed on a buffer memory related to a file saving trigger of a camera recorder module with "Sub" selected for the recording operation setting in the module parameter? (☞ Page 95 Various operations settings)	<ul style="list-style-type: none"> <li>Operate the buffer memory of a module with "Main" selected.</li> </ul>
	Is 'operating' stored in 'Camera recording status' (Un\G1650 to 1653, Un\G1850 to 1853, Un\G2050 to 2053, Un\G2250 to 2253) and 'connected' in 'Network camera connection status' (Un\G34300, Un\G34800, Un\G35300, Un\G35800) of a camera recorder module, when video data is specified as recording target data? (☞ Page 271 Recording status area (Un\G1500 to 3199), Page 282 Network camera status area (Un\G34000 to 37999)) Is the time set correctly for a camera recorder module and receiving target network camera?	<ul style="list-style-type: none"> <li>Check that 'operating' is stored in 'Camera recording status' and 'connected' is stored in 'Network camera connection status' of the camera recorder module.</li> </ul> For the transition of the status in 'Camera recording status,' refer to the following: ☞ Page 64 Operating status for video data <ul style="list-style-type: none"> <li>Check if a correct value is set for the time in the camera recorder module and network camera.</li> </ul> Check the time in the network camera by using a dedicated tool for the camera. For details, refer to the manual for the network camera used.
Has video data reception failed due to the high processing load on a module caused by network communication as a result of receiving and saving the video data at the same time with the following settings? <ul style="list-style-type: none"> <li>Multiple recording settings are used in one module.</li> <li>A file server is specified as the save destination in the saving path setting.</li> </ul>	<ul style="list-style-type: none"> <li>Set "Operation at video data saving" to "Video data receiving takes priority" in the module parameter.</li> <li>Change the save destination to an SD memory card in the saving path setting if a file server is specified.</li> </ul>	
A recording file is not saved at an intended timing.	Is the condition number of a device different from that of a buffer memory when specifying the device as a file saving trigger and operating the buffer memory specified as a file saving trigger in a program? (☞ Page 28 File saving trigger)	<ul style="list-style-type: none"> <li>Use a buffer memory with a condition number different from the device.</li> </ul>
	Is the timeout time set longer than the scan time when using a timeout as a condition for satisfying a file saving trigger?	<ul style="list-style-type: none"> <li>Set the timeout time longer than the scan time.</li> </ul>



Symptom	Check point	Corrective action
A recording file is not saved with an intended folder name.	Is a value stored in each corresponding buffer memory when numerical value data and string data are added in a recording setting? (☞ Page 228 Recording operation specification area (Un\G4000 to 4799))	<ul style="list-style-type: none"> <li>• Store a value in the buffer memory for a recording setting in which data is added.</li> </ul> For details on the recording file name, refer to the following: ☞ Page 52 Recording file name
	Does the number of characters set in the saving detail setting match the character string length in the buffer memory storing string data, when the string data is added in the recording setting?	<ul style="list-style-type: none"> <li>• Set them to match.</li> </ul> For details on the recording file name, refer to the following: ☞ Page 52 Recording file name
	Does the number of characters in information added to the recording file name exceed the number of available characters?	Set the number of characters within the number of available ones. For the number of available characters for a recording file name, refer to the following: MELSEC iQ-R System Recorder User's Manual (Startup)
	Are the characters in a trigger comment or string data available ones?	<ul style="list-style-type: none"> <li>• Change them to available ones.</li> </ul> For details on the available characters, refer to the following: ☞ Page 294 ASCII characters that can be used in the format in the saving detail setting
A file saving trigger is not satisfied even if a camera event is detected.	Is the event detection function of a network camera running?	<ul style="list-style-type: none"> <li>• Make sure that the event detection function of the network camera is running.</li> </ul> If the function does not run, refer to the manual for the network camera to take corrective action.
	Is a network camera set to detect camera events?	<ul style="list-style-type: none"> <li>• Set it to detect camera events.</li> </ul> The setting procedure differs depending on a network camera used. Refer to the manual for the network camera to take corrective action.
	Is a recorder module or camera recorder module with a firmware version supporting camera events used?	<ul style="list-style-type: none"> <li>• Update the module to a firmware version supporting camera events.</li> </ul> For the applicable firmware versions, refer to the following: ☞ Page 307 Added and Changed Functions
	Are the camera event setting and the camera event trigger setting disabled?	<ul style="list-style-type: none"> <li>• Enable the camera event setting in the module extended parameter and the camera event trigger setting in the recording setting.</li> </ul>

## Troubleshooting on saving project data

Symptom	Check point	Corrective action
Unable to save project data.	Is a recording setting written?	Write the recording setting.
	Is the operating status of the recording function 'operating'? (☞ Page 63 Operating status)	<ul style="list-style-type: none"> <li>• Switch the operating status to 'operating.'</li> </ul> For the operation method, refer to the following: ☞ Page 65 Operation of the recording function
	Does an SD memory card satisfy the following conditions when it is specified as the save destination for the recording file? <ul style="list-style-type: none"> <li>• It is inserted in a recorder module/camera recorder module.</li> <li>• An available one is used.</li> <li>• There is free space.</li> </ul>	<ul style="list-style-type: none"> <li>• Check the SD memory card.</li> <li>• Replace or initialize the SD memory card.</li> </ul> (☞ MELSEC iQ-R System Recorder User's Manual (Startup))
	Does a file server satisfy the following conditions when it is specified as the save destination for the recording file? <ul style="list-style-type: none"> <li>• The file server is running.</li> <li>• There is no problem in the connection route.</li> <li>• The user name or password is correct.</li> </ul>	<ul style="list-style-type: none"> <li>• Start the file server.</li> <li>• Check if there is any problem in the connection route to the file server.</li> <li>• Review the user name and password for the file server in the recording setting.</li> </ul>
	Is a recorder module or camera recorder module with a firmware version supporting the project data saving function used as the main one?	Use a recorder module or camera recorder module with a firmware version supporting the function.
	Is an RnCPU or RnENCPU used as a CPU module?	<ul style="list-style-type: none"> <li>• If neither is used, the project data saving function does not work.</li> <li>• Read project data used to play a recording file from the CPU module or prepare it separately.</li> </ul>
Unable to automatically save project data when recording starts.	Is "Automatic Saving at Recording Start" set to "Save" under "Project Data Saving Setting" in the module parameter of a module set as the main one? (☞ Page 99 Project data saving setting)	Set "Automatic Saving at Recording Start" to "Save" under "Project Data Saving Setting" in the module parameter of the module.
Unable to save project data by operating the buffer memory.	Is an operation performed on the buffer memory of the corresponding recording setting number of a module set as the main one in a program, an engineering tool, or external device, etc.? (☞ Page 232 Project data saving specification area (Un\G14080 to 14199))	Perform an operation on the buffer memory of the corresponding recording setting number of the module.





## 5.2 Offline Monitor Function

This section shows the troubleshooting on reading recording files and starting offline monitoring.

For the other items, refer to the following:

 GX Works3 Operating Manual

### Troubleshooting on reading recording files





Symptom	Check point	Corrective action
Unable to read a recording file in GX Works3.	Is a recorder module/camera recorder module connected? Is a CPU module connected when reading project data?	<ul style="list-style-type: none"> <li>Connect a cable to the Ethernet port of the recorder module/camera recorder module.</li> <li>Connect a CPU module when reading project data.</li> </ul>
	Is there any disconnection in the connection route?	<ul style="list-style-type: none"> <li>Connect the cables properly.</li> <li>Replace the cables with new ones.</li> </ul>
	Is the IP address of a recorder module/camera recorder module the same as that of another device?	<ul style="list-style-type: none"> <li>Review the IP address set in the module parameter. ( Page 95 Module Parameters (Recorder Module/Camera Recorder Module))</li> </ul>
	Check that the operation mode of a recorder module/camera recorder module is in the online mode in the system monitor* <sup>1</sup> of GX Works3.	<ul style="list-style-type: none"> <li>Set the mode setting to "Online" in GX Works3, and reset a CPU module. ( Page 95 Various operations settings)</li> </ul>
	Is there a firewall or proxy server in the connection route?	<ul style="list-style-type: none"> <li>Check the firewall or proxy server settings with the network administrator.</li> </ul>
	Is the firewall of a personal computer enabled?	<ul style="list-style-type: none"> <li>Disable the firewall when using a direct connection.</li> </ul>
	Is antivirus software blocking Ethernet communications?	<ul style="list-style-type: none"> <li>Allow Ethernet communications with the antivirus software.</li> <li>Lower the level of the security settings of the antivirus software.</li> <li>Stop the antivirus software.</li> </ul>
	Check if an SD memory card is accessible by checking either of the following points: <ul style="list-style-type: none"> <li>Is the CARD RDY LED ON?</li> <li>Is '1' (ON) stored in 'CARD RDY LED status' (Un\G4)? ( Page 216 Module status area (Un\G0 to 20), Page 269 Module status area (Un\G0 to 20))</li> </ul>	<ul style="list-style-type: none"> <li>Insert an SD memory card.</li> <li>If an SD memory card is inserted, turn 'Clear file access stop request' (Y1) ON or remove the SD memory card once and insert it again.</li> <li>Set the write protect switch of the SD memory card to be inserted to OFF.</li> <li>If the SD memory card is being mounted or unmounted, wait until it is accessible.</li> <li>If the SD memory card is being formatted, wait until the formatting is completed.</li> </ul>
	Is the write access right set for a folder to which a file is read on a personal computer?	<ul style="list-style-type: none"> <li>Set the write access right for the folder to which a file is read.</li> </ul>
	Is there sufficient free space on a folder to which a file is read on a personal computer?	<ul style="list-style-type: none"> <li>Secure free space for the recording file to be read.</li> </ul>
Is a file server specified as the save destination in the saving path setting? (  Page 136 Saving Path Setting)	<ul style="list-style-type: none"> <li>Check recording files saved in the save destination folder specified in the saving path setting. When reproducing a recording file on the offline monitor, select a saved one.</li> </ul>	
Unable to read project data in GX Works3.	For details on troubleshooting when data cannot be read from a programmable controller, refer to the following:  MELSEC iQ-R Programmable Controller CPU Module User's Manual	
Reading a recording file takes time.	Are files saved up to the capacity limit of an SD memory card?	<ul style="list-style-type: none"> <li>Delete unnecessary recording files from the SD memory card, and always secure 10% or more free space of the capacity of the SD memory card for operation.</li> </ul>
The following message appears even though there is a recording file in a recorder module/camera recorder module: 'No recording file exists in the Recorder Module.'	Is there any disconnection in the connection route?	<ul style="list-style-type: none"> <li>Check the following items again, then click the [Refresh] button.</li> <li>Connect the cables properly.</li> <li>Replace the cables with new ones.</li> </ul>

\*1 Can be checked in the "Module Diagnostics" screen of the system monitor. ( Page 158 Module information list)

## Troubleshooting on starting offline monitoring

Symptom	Check point	Corrective action
Unable to start offline monitoring in GX Works3.	Does the following message appear when starting offline monitoring? 'Unable to read the data because the target model set in file and the one set in project is different.'	<ul style="list-style-type: none"> <li>Open a project written to a CPU module when a recording file was saved in GX Works3 before starting offline monitoring.</li> </ul>

## Troubleshooting on playing a video file

Symptom	Check point	Corrective action
The playback time does not match between devices/ labels and video data.	Is the time synchronized between a camera recorder module and a network camera?	<ul style="list-style-type: none"> <li>Check if a correct value is set for the time in the network camera. The time can be checked by using a dedicated tool for the camera. For details, refer to the manual for the network camera used.</li> </ul>
	Is a network camera being restarted when a trigger (recording startup trigger or file saving trigger) is satisfied?	Review the system configuration so that the power of the network camera does not turn OFF when a trigger is satisfied.
Unable to play a video file.	Has an error occurred in GX VideoViewer?	<ul style="list-style-type: none"> <li>Refer to the troubleshooting described in the following manual to take corrective action.  GX VideoViewer Version 1 Operating Manual</li> </ul>
	Is the file name of the video file changed?	Open the recording.xml file in the recording file and refer to the contents the element name of which is 'FileName' to restore the file name.
	Is a network camera being restarted when a trigger (recording startup trigger or file saving trigger) is satisfied?	Review the system configuration so that the power of the network camera does not turn OFF when a trigger is satisfied.
Unable to record a video at a set frame rate. (Any gray frame is included in a video file being played/sought.)	<ul style="list-style-type: none"> <li>Is the captured video playing smoothly without being distorted?</li> <li>Is the load high on a network camera, such as event settings other than capturing data or recording for another setting in the network camera?</li> <li>Is the communication volume large on the network to which a camera recorder module and network camera are connected?</li> </ul> <p>Check the points above in 'Number of lost frames' (Un\G34475, Un\G34975, Un\G35475, Un\G35975) of a camera recorder module. ( Page 282 Network camera status area (Un\G34000 to 37999))</p> <ul style="list-style-type: none"> <li>Has video data reception failed due to the high processing load on a module caused by network communication as a result of receiving and saving the video data at the same time with the following settings? <ul style="list-style-type: none"> <li>- Multiple recording settings are used in one module.</li> <li>- A file server is specified as the save destination in the saving path setting.</li> </ul> </li> </ul>	<ul style="list-style-type: none"> <li>Change the setting values of resolution, video frame rate, and video quality to lower ones in the module extended parameter. ( Page 103 Module Extended Parameters (Camera Recorder Module))</li> <li>If there is a time when the communication load is significantly high, consider countermeasures.</li> <li>Set "Operation at video data saving" to "Video data receiving takes priority" in the module parameter.</li> <li>Change the save destination to an SD memory card in the saving path setting if a file server is specified.</li> </ul>
	Does a camera event occur frequently in a network camera?	<ul style="list-style-type: none"> <li>Review the setting for the event detection function of the network camera.</li> </ul>
A time is not saved according to the setting.	Is a value in a device or label changing constantly? Or, is video data playing smoothly without being distorted?	<ul style="list-style-type: none"> <li>Review the module extended parameters. ( Page 103 Module Extended Parameters (Camera Recorder Module))</li> </ul>
There is no video data when a camera event occurs.	Is the saving period before trigger set longer sufficient to capture the video when a camera event is detected in the saving period setting in the recording setting?	<ul style="list-style-type: none"> <li>Set it longer sufficient to capture a video when a camera event occurs.</li> </ul>

## 5.3 Camera Recording Function

---

For details, refer to the following:

📖 Camera Recording Package User's Manual

## 5.4 Data Flow Analysis Function

---

For details, refer to the following:

📖 GX Works3 Operating Manual

## 5.5 Co-recording Function

---





For details, refer to the following:

📖 MELSEC iQ-R System Recorder Co-recording Function Reference Manual

## 5.6 Recorder Module

This section explains the errors which may occur in a recorder module and the troubleshooting.

### Checking methods

Checking method	Details
System monitor of GX Works3	Error codes can be checked in the system monitor of GX Works3.  Page 157 Checking the module status
Buffer memory	Error codes can be checked in the following buffer memory:  Page 218 Current error area (Un\G140 to 149)  Page 219 Error log area (Un\G150 to 311)
Recording monitor	The operating status of the recording function for each recording setting can be checked in the recording monitor.  Page 142 RECORDING MONITOR



If multiple errors occur at the same time, take corrective action for the errors in chronological order.

### Error code types

The status of an error that occurs in a recorder module can be determined with the statuses of the RUN LED and ERR LED.

RUN LED	ERR LED	Error status	Error code	Description
OFF	ON, flashing	Major error	3C00H to 3FFFH	An error such as a hardware or memory error that causes a module to stop operating.
ON	Flashing	Moderate error	2000H to 3BFFH	An error such as one in a setting or the firmware that causes a module to stop operating.
ON	ON	Minor error	1000H to 1FFFH	An error such as a failure in saving a recording file that causes a module to continue or stop operating.

### Error types

There are two types of errors of a recorder module as follows:

Error type	Category	Module status	Corrective action
Module stop error	Moderate error Major error	A module stops operating.	Take corrective action for the error according to the error code, and turn OFF the ERR LED by either of the following operations: <ul style="list-style-type: none"> <li>• Turn the power OFF and ON.</li> <li>• Reset the CPU module.</li> </ul>
Module continuation error	Minor error	A module continues operating.	Take corrective action for the error according to the error code, and turn OFF the ERR LED by any of the following operations: <ul style="list-style-type: none"> <li>• Error clear request (Y3)</li> <li>• Click the [Clear Error] button in the "Module Diagnostics" screen.</li> <li>• Turn the power OFF and ON.</li> <li>• Reset the CPU module.</li> </ul>

# Checking the module status

The status of a module can be checked by using the following functions or testing operations in the "Module Diagnostics" screen of GX Works3.

Function	Purpose
Error information	To display the description of an error occurring. The history of errors detected and operations performed in a module can be checked by clicking the [Event History] button.
Module information list	To display the information on each status of a module.
Supplementary function	SD memory card operation To check the free space on an SD memory card inserted in a module or format the SD memory card.
Self-diagnostic tests	To perform a test to check the hardware of a module.

## Error information

The description of an error occurring and its corrective action can be checked.

### Window

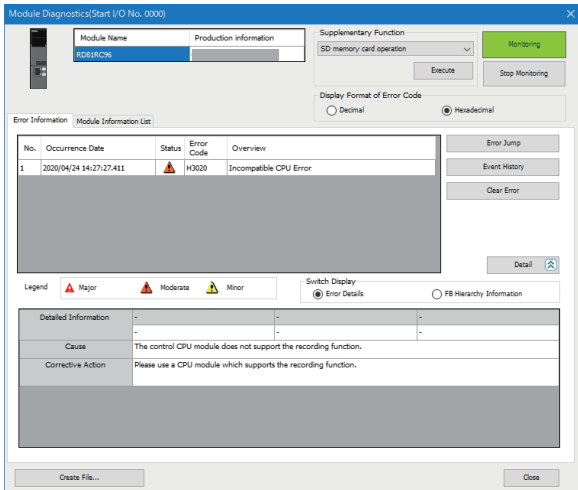

### Displayed items

Item	Description
Detailed Information	Up to three details of each error are displayed.
Cause	The details of an error cause is displayed.
Corrective Action	A corrective action for an error is displayed.

### Point

Up to 15 continuation errors and 1 stop error can be displayed. If 15 continuation errors are displayed, new continuation errors will not be displayed. In addition, if the new error has the same error code as the already displayed error, the error occurrence date/time and its detailed information will not be updated.

## Module information list

The information on each status of a module can be checked by switching to the [Module Information List] tab.

### Window

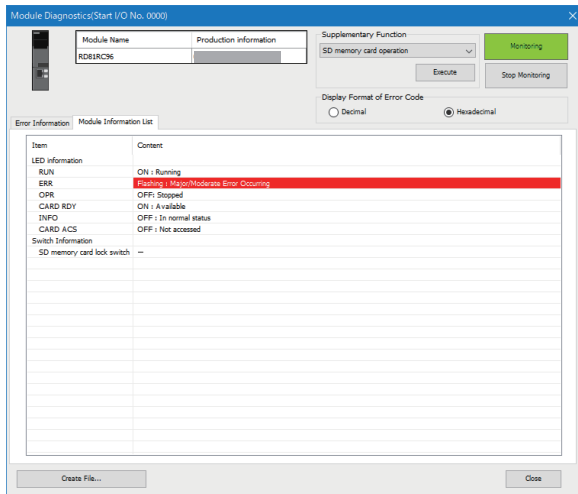

### ■Checking LED information

The LED status or the self-diagnostic status of a module can be checked.

When executing the automatic hardware test or the hardware test for LED check, or updating the firmware, "Automatic Hardware Test being Executed," "Hardware Test for LED Check being Executed," or "Firmware update being Executed" is displayed for all LED information.

If an error occurs, refer to the following section to take corrective action.

☞ Page 163 Troubleshooting on RUN LED

Item	Description
RUN	<ul style="list-style-type: none"> <li>• ON (green): Running</li> <li>• OFF: Hardware Error Occurring</li> </ul>
ERR	<ul style="list-style-type: none"> <li>• ON (red): Module Normal Error Occurring/Hardware Error Occurring</li> <li>• Flashing (red): Major/Moderate Error Occurring</li> <li>• OFF: Normally</li> </ul>
OPR	<ul style="list-style-type: none"> <li>• ON (green): Running</li> <li>• OFF: Stopped</li> </ul>
CARD RDY	<ul style="list-style-type: none"> <li>• ON (green): Available</li> <li>• Flashing (green): Ready or SD memory card format in progress</li> <li>• OFF: Not available</li> </ul>
INFO	<ul style="list-style-type: none"> <li>• ON (green): Caution information available</li> <li>• OFF: In normal status</li> </ul>
CARD ACS	<ul style="list-style-type: none"> <li>• ON (green): Being accessed</li> <li>• OFF: Not accessed</li> </ul>

### ■Checking the switch information

When executing the automatic hardware test or the hardware test for LED check, "Automatic Hardware Test being Executed" or "Hardware Test for LED Check being Executed" is displayed.

Item	Description
SD memory card lock switch	<ul style="list-style-type: none"> <li>• The switch is not pressed, or the firmware is being updated: —</li> <li>• The switch is pressed: Stop instructions available</li> </ul>



## SD memory card operation

The following shows the screen for checking the free space on an SD memory card inserted in a module and formatting the SD memory card.

### Window

Select [Diagnostics] ⇒ [System Monitor] ⇒ (model name of a module), then select "SD memory card operation" in "Supplementary Function" and click the [Execute] button.

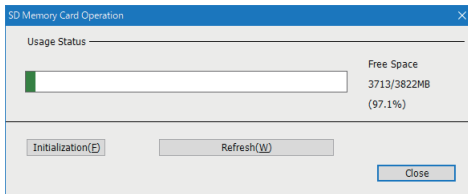

### Displayed items

Item	Description
Free Space	The free space on an SD memory card is displayed as follows: • Free space <sup>*1</sup> / <sup>*2</sup> Total capacity <sup>*1</sup> / <sup>*2</sup>
[Initialization] button <sup>*3</sup>	Click this to format an SD memory card.
[Refresh] button	Click this to update the status of an SD memory card to the latest information.

\*1 A value after the decimal point is rounded off.

\*2 If the capacity of an SD memory card cannot be acquired, '0' is displayed.

\*3 Can be clicked when the capacity of an SD memory card can be acquired.

## Self-diagnostic tests

### ■ Automatic hardware test

The following explains the test on hardware such as ROM/RAM/Ethernet of a module.

#### Restriction

- The values in the buffer memory cannot be referenced in GX Works3 during the automatic hardware test.
- If the automatic hardware test is completed abnormally, the error details cannot be checked even if the error code is displayed in GX Works3.

### Operating procedure

1. Select "Automatic Hardware Test" in [Basic Settings] ⇒ [Various Operations Settings] ⇒ [Mode Settings] in the module parameter of a module in the parameter setting of GX Works3.
2. Disconnect a cable if it is connected to a 1000BASE-T/100BASE-TX/10BASE-T interface.
3. Remove an SD memory card if it is inserted.
4. Set the CPU module to the STOP state, and write the parameters.
5. Reset the CPU module.
6. After the CPU module is reset, the automatic hardware test is performed automatically.

The LED display for the automatic hardware test is as follows:

Status		RUN LED status	ERR LED status
Automatic hardware test is in process		Flashing	OFF
Automatic hardware test is complete.	Normal completion	ON	OFF
	Abnormal completion	ON	ON

7. When the test is completed normally, select "Online" in "Basic Settings" ⇒ "Various Operations Settings" ⇒ "Mode Settings" in the module parameter of the module in the parameter setting of GX Works3, and reset the CPU module.
8. When the test is completed abnormally, check if measures are taken to reduce noise of the system, and perform the test again.

If it is completed abnormally again, a hardware failure may occur in the module. Please contact your local Mitsubishi Electric sales office or representative.

Do not use an electric screwdriver when removing the module. Loose the module fixing screws completely to remove the module.

## ■Hardware test for LED check

The following explains the LED hardware diagnostic of a module. For the diagnostic, the LED of a module needs to be turned ON.



The values in the buffer memory cannot be referenced in GX Works3 during the hardware test for LED check.

### Operating procedure

1. Select "Hardware Test for LED Check" in "Basic Settings" ⇒ "Various Operations Settings" ⇒ "Mode Settings" in the module parameter of a module in the parameter setting of GX Works3.
2. Set the CPU module to the STOP state, and write the parameters.
3. Reset the CPU module.
4. After the CPU module is reset, the hardware test for LED check is performed automatically.

The following contents are displayed. Check visually whether there is no error.

LED name	Display color	Display status
RUN	Green	ON
ERR	Red	ON
OPR	Green	ON
CARD RDY	Green	ON
INFO	Green	ON
CARD ACS	Green	ON

5. When the test is completed normally, select "Online" in "Basic Settings" ⇒ "Various Operations Settings" ⇒ "Mode Settings" in the module parameter of the module in the parameter setting of GX Works3, and reset the CPU module.
6. When the test is completed abnormally, check if measures are taken to reduce noise of the system, and perform the test again.









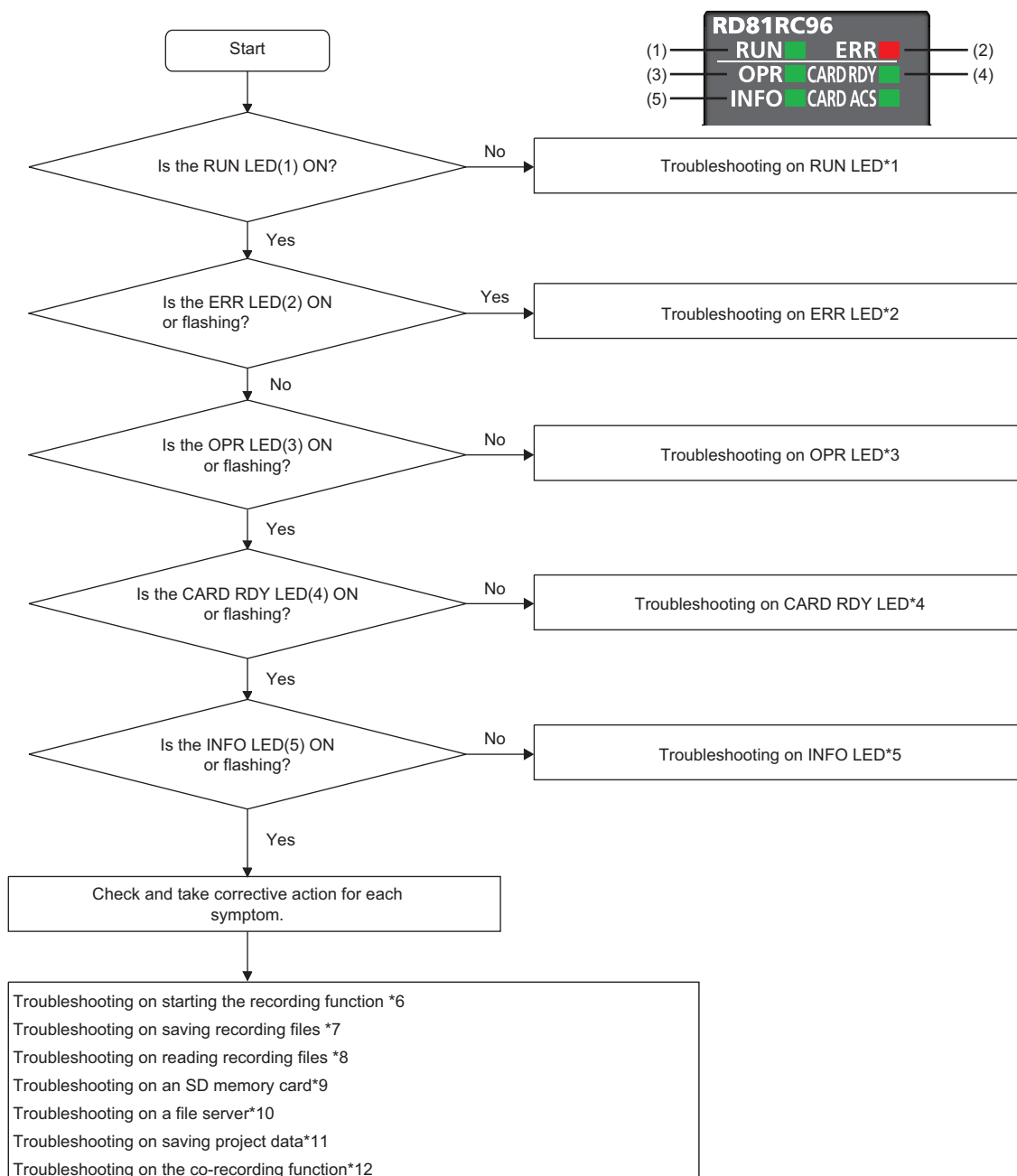



If it is completed abnormally again, a hardware failure may occur in the module. Please contact your local Mitsubishi Electric sales office or representative.

# Troubleshooting by symptom

The following shows the flowchart for troubleshooting while a recorder module is operating.

The LED status can be checked in the "Module Diagnostics" screen of the system monitor. (  Page 158 Module information list)



- \*1  Page 163 Troubleshooting on RUN LED
- \*2  Page 163 Troubleshooting on ERR LED
- \*3  Page 163 Troubleshooting on OPR LED
- \*4  Page 163 Troubleshooting on CARD RDY LED
- \*5  Page 164 Troubleshooting on INFO LED
- \*6  Page 148 Troubleshooting on starting the recording function
- \*7  Page 150 Troubleshooting on saving recording files
- \*8  Page 153 Troubleshooting on reading recording files
- \*9  Page 164 Troubleshooting on an SD memory card
- \*10  Page 165 Troubleshooting on a file server
- \*11  Page 152 Troubleshooting on saving project data
- \*12  Page 166 Troubleshooting on the co-recording function

## Troubleshooting on RUN LED

Symptom	Check point	Corrective action
The RUN LED does not turn ON.	Is the module properly mounted on the base unit?	• Mount the module properly.
	Has an error occurred in a CPU module?	• Take corrective action for the error occurred in the CPU module.
	Is the ERR LED flashing?	• Refer to the following section to take corrective action. ☞ Page 163 Troubleshooting on ERR LED
The RUN LED is flashing in red or ON in red.	Is "Firmware Update" displayed in [Module Diagnostics] ⇒ [Module Information List] <sup>*1</sup> of GX Works3?	• Wait until the firmware update is completed, and check the error code and take corrective action if it is completed abnormally. (☞ Page 229 Firmware update history information area (Un\G13392 to 13427))

\*1 Can be checked in the "Module Diagnostics" screen of the system monitor. (☞ Page 158 Module information list)

## Troubleshooting on ERR LED

Symptom	Check point	Corrective action
The ERR LED is ON or flashing.	Check the error code in the system monitor of GX Works3.	• Check the error description and take corrective action according to the error code.
	Is "Automatic Hardware Test" displayed in [Module Diagnostics] ⇒ [Module Information List] <sup>*1</sup> of GX Works3?	• Wait until the automatic hardware test is completed, and check the error code and take corrective action if it is completed abnormally. ☞ Page 160 Automatic hardware test

\*1 Can be checked in the "Module Diagnostics" screen of the system monitor. (☞ Page 158 Module information list)

## Troubleshooting on OPR LED

Symptom	Check point	Corrective action
The OPR LED does not turn ON.	Check if a recording setting is written to a CPU module by reading the project from the CPU module in GX Works3.	• Write the recording setting to the CPU module. (☞ MELSEC iQ-R System Recorder User's Manual (Startup))
	Is the operating status of the recording function 'operating'? (☞ Page 63 Operating status)	• Switch the operating status to 'operating.' For the operation method, refer to the following: ☞ Page 65 Operation of the recording function
	Has the SD memory card been removed while being formatted?	• Reset the CPU module or cycle the power of the programmable controller. (Do not remove an SD memory card while being formatted.)

## Troubleshooting on CARD RDY LED

Symptom	Check point	Corrective action
The CARD RDY LED does not turn ON.	Is an SD memory card inserted?	• Insert an SD memory card. (☞ MELSEC iQ-R System Recorder User's Manual (Startup))
	Is 'File access status' (X2) ON (file access stopped)?	• Release the file access stop state. (☞ MELSEC iQ-R System Recorder User's Manual (Startup))
	Is a supported SD memory card used?	• Use a supported SD memory card. (☞ MELSEC iQ-R System Recorder User's Manual (Startup))
	Has the power been turned OFF or a CPU module been reset during file saving?	• Use the SD memory card format function to format the SD memory card. (☞ Page 199 SD memory card format function)
	Has the SD memory card been formatted in another device such as a personal computer?	• Use the SD memory card format function to format the SD memory card again. (☞ Page 199 SD memory card format function)
	Has the power been turned OFF or a CPU module been reset while formatting an SD memory card?	• Use the SD memory card format function to format the SD memory card again. (☞ Page 199 SD memory card format function)
It takes time for the CARD RDY LED to turn ON.	Is the number of files in the inserted SD memory card large?	• Delete unnecessary files from the SD memory card.
The CARD RDY LED remains flashing after removing an SD memory card.	Has the SD memory card been removed while being mounted (while the CARD RDY LED is flashing)?	• Reset the CPU module or cycle the power. (Do not remove an SD memory card while being mounted.)

## Troubleshooting on INFO LED

Symptom	Check point	Corrective action
The INFO LED is ON.	Is 'SD memory card free capacity lowering' (b0) in 'INFO LED lighting factor' (Un\G12) ON? (☞ Page 216 Module status area (Un\G0 to 20))	• Delete unnecessary recording files from the SD memory card, and always secure 10% or more free space of the capacity of the SD memory card for operation.*1
	Is 'No save folder free number' (b1) in 'INFO LED lighting factor' (Un\G12) ON?*2 (☞ Page 216 Module status area (Un\G0 to 20))	• Increase the upper limit of saved files in the saving detail setting.*2 (☞ Page 138 Saving detail setting) • Delete unnecessary recording files from the save destination specified in the saving path setting.*1

\*1 Recording files can be deleted in the "Recording File Reading" screen of GX Works3. For details, refer to the following:  
☞ GX Works3 Operating Manual

\*2 For the folder number and the number of saved files, refer to the following:  
☞ Page 49 Recording file

## Troubleshooting on an SD memory card

Symptom	Check point	Corrective action
Unable to reproduce a recording file on the offline monitor of GX Works3.	Has the power been turned OFF or a CPU module been reset while accessing a file in an SD memory card?	• Use the SD memory card format function to format the SD memory card. (☞ Page 199 SD memory card format function)
Files in an SD memory card disappear when the power is interrupted.	Is a supported SD memory card used?	• Use a supported SD memory card. (☞ MELSEC iQ-R System Recorder User's Manual (Startup))
	Has the power been turned OFF or a CPU module been reset while writing a file to the SD memory card?	• Use the SD memory card format function to format the SD memory card. (☞ Page 199 SD memory card format function) • Stop file access before turning the power OFF or resetting the CPU module. (☞ MELSEC iQ-R System Recorder User's Manual (Startup))
The access speed to an SD memory card becomes slower.	Are files saved up to the capacity limit of the SD memory card?	• Delete unnecessary recording files from the SD memory card, and always secure 10% or more free space of the capacity of the SD memory card for operation.
Formatting an SD memory card is not completed in GX Works3.	Has the SD memory card been removed while being formatted?	• Reset the CPU module or cycle the power of the programmable controller. (Do not remove an SD memory card while being formatted.)
A recording file is not saved.	Is a file server specified as the save destination in the saving path setting? (☞ Page 136 Saving Path Setting)	Check recording files saved in the save destination folder specified in the saving path setting. When reproducing a recording file on the offline monitor, select a saved one.

## Troubleshooting on a file server

Symptom	Check point	Corrective action
A recording file is not saved.	Is an SD memory card specified as the save destination in the saving path setting? (☞ Page 136 Saving Path Setting)	Specify a file server as the save destination.
	Is the path to the save destination specified in the saving path setting correct? (☞ Page 136 Saving Path Setting)	Review the specified path.
	Is the DNS setting in the module parameter correct when the save destination is specified by using its host name? (☞ Page 136 Saving Path Setting, Page 97 DNS setting screen)	Review the DNS setting in the module parameter.
	Is the same path specified for the save destination in multiple systems?	Specify a different path for the save destination for each system.
	Is there any disconnection in the connection route?	<ul style="list-style-type: none"> <li>• Connect the cables properly.</li> <li>• Replace the cables with new ones.</li> </ul>
	Are there a firewall and proxy server in the connection route?	Check the firewall and proxy server settings with the network administrator.
	Is the firewall of a personal computer enabled?	Disable the firewall when using a direct connection.
	Is antivirus software blocking Ethernet communications?	<ul style="list-style-type: none"> <li>• Change the antivirus software settings to allow Ethernet communication.</li> <li>• Lower the level of the security settings of the antivirus software.</li> <li>• Stop the antivirus software.</li> </ul>
	Is there any problem with the network of the connection route?	<ul style="list-style-type: none"> <li>• Reduce the load on the network by separating the network.</li> <li>• Review the connection route settings.</li> </ul>
	Is there any problem with the load on a file server?	<ul style="list-style-type: none"> <li>• Reduce the load on the file server by reviewing the antivirus software and Windows update settings.</li> <li>• Reduce access to the file server.</li> </ul>
The file saving test fails.	Is there any disconnection in the connection route?	<ul style="list-style-type: none"> <li>• Connect the cables properly.</li> <li>• Replace the cables with new ones.</li> </ul>
	Is the path to the save destination specified in the saving path setting correct? (☞ Page 136 Saving Path Setting)	Review the specified path.
	Is the DNS setting in the module parameter correct when the save destination is specified by using its host name? (☞ Page 136 Saving Path Setting, Page 97 DNS setting screen)	Review the DNS setting in the module parameter.
	Are the user name and password for connecting to a file server correct?	Review the user name and password specified in the saving path setting. (☞ Page 136 Saving Path Setting)
	Is the write access right set for the save destination specified in the saving path setting?	Set the write access right for the save destination.
	Is there sufficient free space on a file server?	Secure sufficient free space for saving recording files.
	Are there a firewall and proxy server in the connection route?	Check the firewall and proxy server settings with the network administrator.
	Is the firewall of a personal computer enabled?	Disable the firewall when using a direct connection.
	Is antivirus software blocking Ethernet communications?	<ul style="list-style-type: none"> <li>• Change the antivirus software settings to allow Ethernet communication.</li> <li>• Lower the level of the security settings of the antivirus software.</li> <li>• Stop the antivirus software.</li> </ul>
	Is there any problem with the network of the connection route?	<ul style="list-style-type: none"> <li>• Reduce the load on the network by separating the network.</li> <li>• Review the connection route settings.</li> </ul>
	Is there any problem with the load on a file server?	<ul style="list-style-type: none"> <li>• Reduce the load on the file server by reviewing the antivirus software and Windows update settings.</li> <li>• Reduce access to the file server.</li> </ul>
	Are multiple modules or applications accessing the save destination specified in the saving path setting at the same time?	Perform the file saving test to the save destination while multiple modules or applications are not accessing it at the same time.

## Troubleshooting on the co-recording function

The following shows the troubleshooting on the co-recording function.

For the other items, refer to the following:

 MELSEC iQ-R System Recorder Co-recording Function Reference Manual

Symptom	Check point	Corrective action
A recording file is not saved in a module.	Is a recorder module/camera recorder module with a firmware version supporting the co-recording function used?	Use a module with a firmware version supporting the function.
	Is the co-recording setting set to "Use" for a recorder module/camera recorder module (main)?	Set the co-recording setting to "Use" then write it.
	Is a CPU module with a firmware version supporting the co-recording function used?	Use a module with a firmware version supporting the function.
	Is the co-recording setting set to "Use" for a CPU module?	Set the co-recording setting to "Use" then write it.
	Has the recording function been started?	Start the recording function.
	Was a recording file ready to be saved when a co-recording trigger was received?	A recording file is not saved even when a co-recording trigger is received while the file is not ready to be saved such as during file saving. For details, refer to the following:  Page 16 Recording Function
A recording file is not saved in another module.	Is a recorder module/camera recorder module with a firmware version supporting the co-recording function used?	Use a module with a firmware version supporting the function.
	Is the co-recording setting set to "Use" for a recorder module/camera recorder module (main)?	Set the co-recording setting to "Use" then write it.
	Is a CPU module with a firmware version supporting the co-recording function used?	Use a module with a firmware version supporting the function.
	Is the co-recording setting set to "Use" for a CPU module?	Set the co-recording setting to "Use" then write it.



## Error code list

The following table shows the error code list of a recorder module.

Error code	Error name	Error description	Corrective action
0C00H <sup>*1</sup>	Recording Start with Program Inconsistency	It is different from the project (program, FB/FUN) at the recording setting because a program file or FB/FUN file in the CPU module was changed during recording operation. When a device/label that is not a sampling target is added, the added device/label cannot be saved and replayed.	When a device/label that is not a sampling target is added, stop recording, write the recording setting file to the CPU module again, and restart recording. When the devices/labels in the program are not specified in a batch in the device/label sampling target setting, please review the recording setting so that the added devices/labels are included in the sampling targets and write it to the CPU module.
0C01H <sup>*1</sup>	Program Inconsistency during Recording Operation	It is different from the project (program, FB/FUN) at the recording setting because a program file or FB/FUN file in the CPU module was changed during recording operation. When a device/label that is not a sampling target is added, the added device/label cannot be saved and replayed.	When a device/label that is not a sampling target is added, stop recording, write the recording setting file to the CPU module again, and restart recording. When the devices/labels in the program are not specified in a batch in the device/label sampling target setting, please review the recording setting so that the added devices/labels are included in the sampling targets and write it to the CPU module.
1300H	Co-recording setting error	The co-recording function does not operate because it is not supported by the firmware version of the CPU module.	Please check the version of the CPU module, use a compatible product, and then write the CPU parameter again.
1301H	Co-recording setting error	The co-recording function does not operate because the co-recording setting of the CPU module is not set to "Use".	Please set the co-recording setting of the CPU parameter to "Use".
1810H	Recording Setting Acquisition Error	Failed to acquire the recording setting.	Please write the recording setting with the engineering tool.
1811H to 1813H	Recording Setting Error	The contents of the recording setting file are broken.	<ul style="list-style-type: none"> <li>• Please write the recording setting again with the engineering tool.</li> <li>• Please check that the versions of the recorder module, CPU module, and engineering tool are appropriate to be used together.</li> </ul>
1814H	Recording Start Error in Sub	A recording start error has occurred in the Sub.	Please check the details of the Sub error by the module diagnostics of the engineering tool, and clear the error.
1815H	Recording Start Error in Sub	<ul style="list-style-type: none"> <li>• The mode of the module parameter is not set to "Online" in some Sub.</li> <li>• The module status setting is set to "Empty" with the system parameter (I/O assignment setting) in some Sub.</li> <li>• The Sub is not mounted.</li> </ul>	<ul style="list-style-type: none"> <li>• Please set the operation mode of the module parameter of the Sub whose recording function is to be used to "Online".</li> <li>• Please set the module status setting of the system parameter (I/O assignment setting) of the Sub whose recording function is to be used to "No setting".</li> <li>• Please check the system parameter and actual system configuration, please review the recording setting.</li> </ul>
1816H	Module Error	An unrecognized error has been detected by the firmware version of the target recorder module.	Please check that the versions of the recorder module, CPU module, and engineering tool are appropriate to be used together.
1817H	Recording Setting Error	The contents of the recording setting file are broken.	<ul style="list-style-type: none"> <li>• Please write the recording setting again with the engineering tool.</li> <li>• Please check that the versions of the recorder module, CPU module, and engineering tool are appropriate to be used together.</li> </ul>
1818H	Co-recording unsupported sub error	The sub version not supported by the co-recording function is provided.	Please check the sub version and use a product supported by the co-recording function.
1830H	Recording Setting Error	A recording setting file which is not supported by the firmware version of the target recorder module was written.	Please check the version of the recorder module, use a compatible product, and then write the recording file again.
1850H	Recording Setting Error	The size is not set in the buffer area for data sampling of the CPU parameter.	Please set the size in the buffer area for data sampling of the CPU parameter.
1851H	Recording Setting Error	The size is not set in the recording buffer of the basic settings of the module parameter.	Please set the size in the recording buffer of the basic settings of the module parameter.
1900H	Recording Files Saving Error	Failed to save recording files because there is no free folder number for recording folders.	Please delete unnecessary recording folders in the setting-specific folder in which the error has occurred.

Error code	Error name	Error description	Corrective action
1901H	Recording Files Saving Error	Failed to save recording files because accessing the SD memory card failed.	<ul style="list-style-type: none"> <li>• Please save files after checking that the SD memory card is not being initialized.</li> <li>• Please save files after checking that the SD memory card is in the accessible state (mount state).</li> </ul>
1902H	Recording Files Saving Error	Failed to save recording files because accessing the SD memory card failed.	<ul style="list-style-type: none"> <li>• Please check whether the SD memory card is inserted.</li> <li>• Please save files after checking that the SD memory card is in the accessible state (mount state).</li> <li>• If the write-protect switch of the SD memory card is enabled, please insert the SD memory card after disabling it.</li> </ul>
1904H	Recording Files Saving Error	Failed to save recording files because the control file could not be saved due to the insufficient free space in the SD memory card.	Please delete unnecessary files in the SD memory card to allocate free space.
1905H	Recording Files Saving Error	Failed to save some recording files because the free space in the SD memory card was insufficient.	Please delete unnecessary files in the SD memory card to allocate free space.
1906H	Recording Files Saving Error	Failed to save recording files because old recording files could not be deleted.	<ul style="list-style-type: none"> <li>• Please initialize the SD memory card.</li> <li>• Please replace the SD memory card.</li> </ul>
1910H	Event History File Acquisition Error	<ul style="list-style-type: none"> <li>• The event history file could not be acquired because no event history file was created in the control CPU module.</li> <li>• The event history file could not be acquired because the setting to communicate with only engineering tool with enhanced security measures on user authentication function of the control CPU module is enabled.</li> </ul>	<p>Please perform any one of the following.</p> <ul style="list-style-type: none"> <li>• Writing parameters to the control CPU module</li> <li>• Inserting the SD memory card (when the save destination of the event history is the SD memory card)</li> <li>• Initializing the SD memory card</li> <li>• Resetting the control CPU</li> <li>• Turning the power off and on</li> <li>• Disable the setting to communicate with only engineering tool with enhanced security measures on user authentication function of the control CPU module.</li> </ul>
1911H	Control CPU Communication Error	Failed to save recording files because the data communication with the control CPU module failed.	<ul style="list-style-type: none"> <li>• Please take anti-noise measures.</li> <li>• Please switch the CPU module to RUN after resetting it. If the same error is displayed, a hardware error may have occurred in the recorder module. Please consult your local Mitsubishi representative.</li> </ul>
1913H	Recording Files Saving Error	No recording files were saved because no device/label data was collected during the retention period.	Please check the sampling method and saving period of the device/label data.
1914H	Recording Files Saving Error	Failed to save Recording file because the data communication with the management CPU module timed out.	<ul style="list-style-type: none"> <li>• Please take anti-noise measures.</li> <li>• Please switch the CPU module to RUN after resetting it. If the same error is displayed, a hardware error may have occurred in the recorder module. Please consult your local Mitsubishi representative.</li> </ul>
1920H	Recording Files Saving Error	Failed to save recording files because an error of the SD memory card was detected.	<ul style="list-style-type: none"> <li>• Please initialize the SD memory card.</li> <li>• Please replace the SD memory card.</li> </ul>
1921H	Recording Files Saving Error	<p>Failed to save recording files.</p> <ul style="list-style-type: none"> <li>• The free space in the SD memory card was insufficient.</li> <li>• An error of the SD memory card was detected.</li> </ul>	<ul style="list-style-type: none"> <li>• Please delete unnecessary files in the SD memory card to allocate free space.</li> <li>• Please initialize the SD memory card.</li> <li>• Please replace the SD memory card.</li> </ul>
1930H	Recording Files Saving Error	Failed to save recording files because the connection to the file server failed.	<ul style="list-style-type: none"> <li>• Please save files after checking that the host name and IP address of the file server are correct.</li> <li>• Please save files after checking that the file server is connected to the network.</li> <li>• If the load on the network is high, please reduce the load by separating the network and save files.</li> <li>• If the load on the file server is high, please reduce the load by reducing the access to the file server and save files.</li> <li>• When the file server is specified by the host name, please save files after checking that the DNS server setting of the recorder module is correct.</li> <li>• When the file server is specified by the host name, please save files after checking that the DNS server is connected to the network.</li> </ul>

Error code	Error name	Error description	Corrective action
1931H	Recording Files Saving Error	Failed to save recording files because the connection to the file server failed.	Please save files after checking that the user name/ password used for the connection to the file server is correct.
1932H	Recording Files Saving Error	Failed to save recording files because the connection to the file server failed.	Please save files after checking that the folder name set in the saving path setting exists in the file server.
1934H	Recording Files Saving Error	Failed to save recording files because the access to the file server failed.	Please save files after checking that the file server is connected to the network.
1935H	Recording Files Saving Error	Failed to save recording files because the management file could not be saved due to the insufficient free space in the file server.	Please delete unnecessary files in the file server to allocate free space.
1936H	Recording Files Saving Error	Failed to save some recording files because the free space in the file server was insufficient.	Please delete unnecessary files in the file server to allocate free space.
1937H	Recording Files Saving Error	Failed to save recording files because old recording files could not be deleted.	<ul style="list-style-type: none"> <li>• Please check if the user set in the saving path setting has write authority to the saving path.</li> <li>• Please check if several modules and applications are accessing the saving destination folder in the file server simultaneously.</li> <li>• Please check if files and folders under the saving destination folder in the file server are not set Read-only or Encrypt attributes.</li> </ul>
1938H	Recording Files Saving Error	Failed to save recording files because an error was detected at the time of access to the file in the file server.	<ul style="list-style-type: none"> <li>• Please check if the user set in the saving path setting has write authority to the saving path.</li> <li>• Please check if several modules and applications are accessing the saving destination folder in the file server simultaneously.</li> <li>• Please check if files and folders under the saving destination folder in the file server are not set Read-only or Encrypt attributes.</li> </ul>
1939H	Recording File Saving Error Detection of Sub	An error has been detected in the recording file saving processing of the Sub.	Please check the details of the Sub error by the module diagnostics of the engineering tool, and clear the error.
1981H	SD Memory Card Initialization Error	Failed to initialize the SD memory card.	<ul style="list-style-type: none"> <li>• Please check whether the SD memory card is inserted without fail.</li> <li>• Please check the SD memory card is not initializing.</li> <li>• If the write-protect switch of the SD memory card is enabled, please insert the SD memory card after disabling it.</li> <li>• If the recording function is active, stop it.</li> <li>• Please replace the SD memory card.</li> </ul>
1982H	SD Memory Card Error	An error of the SD memory card was detected.	<ul style="list-style-type: none"> <li>• If the write-protect switch of the SD memory card is enabled, please insert the SD memory card after disabling it.</li> <li>• Please format the SD memory card, or insert the SD memory card again. If the same error is displayed, a hardware error may have occurred in the SD memory card. Please replace the SD memory card.</li> </ul>
1A80H	IP Address Automatic Acquisition Error	Failed to acquire the network parameter information from the DHCP server.	<ul style="list-style-type: none"> <li>• Please check the status of the connection with the DHCP server.</li> <li>• Please check the connection cable.</li> <li>• Please review the DHCP server setting.</li> </ul>
1A81H	IP Address Automatic Acquisition Update Error	Failed to perform the automatic lease update processing which is performed when the lease term of the IP address acquired from the DHCP server expires.	Please check the connection cable and status of the DHCP server (operating status and whether the IP address to be assigned is allocated).
1A82H	IP Address Setting Error	The setting value of the IP address setting is incorrect.	Please review the IP address setting in the basic settings of the module parameter.
1A83H	DNS Setting Error	The setting value of the DNS setting is incorrect.	Please review the DNS setting in the basic settings of the module parameter.
2440H	Module Major Error	<ul style="list-style-type: none"> <li>• In the multiple CPU system, the control CPU setting in the system parameter is set to the one different from those set in the other CPU Nos.</li> <li>• An error of the I/O module or intelligent function module was detected at the initial processing.</li> </ul>	<ul style="list-style-type: none"> <li>• Please review the system parameters of CPU No. 2 and later, unify them to the one set in the CPU whose CPU No. is the smallest.</li> <li>• A hardware error may have occurred in the module in which the error occurred. Please consult your local Mitsubishi representative.</li> </ul>

Error code	Error name	Error description	Corrective action
2450H	Module Major Error	A major error occurrence notification from the I/O module or intelligent function module was detected.	<ul style="list-style-type: none"> <li>• Please check the connection status of the extension cable.</li> <li>• Please check that the I/O module or intelligent function module is correctly mounted.</li> <li>• Please switch the CPU module to RUN after resetting it. If the same error is displayed, a hardware error may have occurred in the module in which the error occurred. Please consult your local Mitsubishi representative.</li> </ul>
24C0H to 24C1H	System Bus Error	An error of the system bus was detected.	<ul style="list-style-type: none"> <li>• Please take anti-noise measures.</li> <li>• Please switch the CPU module to RUN after resetting it. If the same error is displayed, a hardware error may have occurred in the CPU module, I/O module, intelligent function module, base unit, or extension cable. Please consult your local Mitsubishi representative.</li> </ul>
24C2H	System Bus Error	An error of the system bus was detected.	<ul style="list-style-type: none"> <li>• Please check the connection status of the extension cable.</li> <li>• Please take anti-noise measures.</li> <li>• Please switch the CPU module to RUN after resetting it. If the same error is displayed, a hardware error may have occurred in the CPU module, I/O module, intelligent function module, base unit, or extension cable. Please consult your local Mitsubishi representative.</li> </ul>
24C3H	System Bus Error	An error of the system bus was detected.	<ul style="list-style-type: none"> <li>• Please take anti-noise measures.</li> <li>• Please switch the CPU module to RUN after resetting it. If the same error is displayed, a hardware error may have occurred in the CPU module, I/O module, intelligent function module, base unit, or extension cable. Please consult your local Mitsubishi representative.</li> </ul>
24C4H to 24C5H	System Bus Error	An error of the system bus was detected.	<ul style="list-style-type: none"> <li>• Please take anti-noise measures.</li> <li>• Please switch the CPU module to RUN after resetting it. If the same error is displayed, a hardware error may have occurred in the I/O module, intelligent function module, base unit, or extension cable. Please consult your local Mitsubishi representative.</li> </ul>
24C6H	System Bus Error	An error of the system bus was detected.	<ul style="list-style-type: none"> <li>• Please take anti-noise measures.</li> <li>• Please switch the CPU module to RUN after resetting it. If the same error is displayed, a hardware error may have occurred in the CPU module or extension cable. Please consult your local Mitsubishi representative.</li> </ul>
24C8H	System Bus Error	An error of the system bus was detected.	<ul style="list-style-type: none"> <li>• Please take anti-noise measures.</li> <li>• Please switch the CPU module to RUN after resetting it. If the same error is displayed, a hardware error may have occurred in the I/O module, intelligent function module, or extension cable. Please consult your local Mitsubishi representative.</li> </ul>
24E0H	System Bus Error	An error of the system bus was detected.	<ul style="list-style-type: none"> <li>• Please take anti-noise measures.</li> <li>• Please switch the CPU module to RUN after resetting it. If the same error is displayed, a hardware error may have occurred in the CPU module or base unit. Please consult your local Mitsubishi representative.</li> </ul>
3000H	Module Parameter Error	There is no module parameter.	<ul style="list-style-type: none"> <li>• Please check the module position set in the system parameter of the CPU module (I/O assignment setting) and the module position of the implemented module. If they are different, please match the parameter and implementation status.</li> <li>• Please write the module parameter again with the engineering tool. If the same error is displayed again, please consult your local Mitsubishi representative.</li> </ul>
3001H	Module Parameter Error	The contents in the module parameter are broken.	Please write the module parameter again with the engineering tool. If the same error is displayed again, please consult your local Mitsubishi representative.

Error code	Error name	Error description	Corrective action
3002H	Module Parameter Error	<ul style="list-style-type: none"> <li>A parameter which is not supported by the firmware version of the target recorder module was written.</li> <li>The contents in the module parameter are broken.</li> </ul>	<ul style="list-style-type: none"> <li>Please check the version of the recorder module, use a compatible product, and then write the module parameter again.</li> <li>Please write the module parameter again with the engineering tool. If the same error is displayed again, please consult your local Mitsubishi representative.</li> </ul>
3010H	Module Error	—	<ul style="list-style-type: none"> <li>Please take anti-noise measures.</li> <li>Please switch the CPU module to RUN after resetting it. If the same error is displayed, a hardware error may have occurred in the recorder module. Please consult your local Mitsubishi representative.</li> </ul>
3013H	Module Error	—	<ul style="list-style-type: none"> <li>Please take anti-noise measures.</li> <li>Please switch the CPU module to RUN after resetting it. If the same error is displayed, a hardware error may have occurred in the recorder module. Please consult your local Mitsubishi representative.</li> </ul>
3020H	Incompatible CPU Error	The control CPU module does not support the recording function.	Please use a CPU module which supports the recording function.
3021H	Recording Setting Error	A recording setting file which is not supported by the firmware version of the target CPU module was written.	Please check the version of the CPU module, use a compatible product, and then write the recording file again.
3022H	Recording Setting Error	<ul style="list-style-type: none"> <li>A recording setting file which is not supported by the firmware version of the target CPU module was written.</li> <li>The contents of the recording setting file are broken.</li> </ul>	<ul style="list-style-type: none"> <li>Please check the version of the CPU module, use a compatible product, and then write the recording file again.</li> <li>Please take anti-noise measures.</li> <li>Please write the recording setting file again. If the same error is displayed, a hardware error may have occurred in the data memory of the CPU module. Please consult your local Mitsubishi representative.</li> </ul>
3023H to 3024H	Recording Setting Error	<ul style="list-style-type: none"> <li>A recording setting file which is not supported by the firmware version of the target recorder module was written.</li> <li>The contents of the recording setting file are broken.</li> </ul>	<ul style="list-style-type: none"> <li>Please check the version of the recorder module, use a compatible product, and then write the recording file again.</li> <li>Please take anti-noise measures.</li> <li>Please write the recording setting file again. If the same error is displayed, a hardware error may have occurred in the data memory of the CPU module. Please consult your local Mitsubishi representative.</li> </ul>
3025H	Recording Setting Error	The module type set in the engineering tool does not match the CPU module which is the write destination of the recording setting file.	Please read the recording setting file, and match the write destination CPU module and model type.
3026H	Recording Setting Error	Device/label data which exceeds the size of the buffer area for data sampling in the CPU parameter is specified in the recording setting file.	Please read the CPU parameter and recording setting file, and reduce the device/label data to be saving targets so that the size is within the buffer area for data sampling in the CPU parameter. Or, please increase the size of the buffer area for data sampling in the CPU parameter.
3027H	Recording Setting Error	The program setting and FB/FUN file setting in the CPU parameter in the CPU module are different from the project (program setting and FB/FUN file setting in the CPU parameter) at recording setting.	<ul style="list-style-type: none"> <li>Please write the CPU parameter and recording setting file to the CPU module.</li> <li>Please read the CPU parameter and recording setting file, and write them to the CPU module again.</li> </ul>
3028H	Recording Setting Error	<ul style="list-style-type: none"> <li>The program file and FB/FUN file in the CPU module are different from the project (program, FB/FUN) at recording setting.</li> <li>They are different from the program file and FB/FUN file in the CPU module at recording setting because the project (program, FB/FUN) was changed during recording operation.</li> </ul>	<ul style="list-style-type: none"> <li>Please write the program file, FB/FUN file, and recording setting file to the CPU module.</li> <li>When the program file and FB/FUN file in the CPU module were changed during recording operation, please write the recording setting file to the CPU module again.</li> <li>Please read the program file, FB/FUN file, and recording setting file, and write them to the CPU module again.</li> </ul>
3029H	Recording Setting Error	The device/label operation is not set to "Save" in the event history setting of the CPU parameter.	Please set device/label operation to "Save" in the event history setting of the CPU parameter.
3030H to 3031H	Recording Setting Error	A recording setting file which is not supported by the firmware version of the target recorder module was written.	Please check the version of the recorder module, use a compatible product, and then write the recording file again.

Error code	Error name	Error description	Corrective action
3032H	Recording Setting Error	<ul style="list-style-type: none"> <li>The mounting position and control CPU of the recorder module are different from the ones of the system parameter at the recording setting.</li> <li>The mode of the module parameter is not set to "Online" or the module status setting of the system parameter (I/O assignment setting) is set to "Empty" in some Main.</li> </ul>	<ul style="list-style-type: none"> <li>Please check the mounting position and control CPU of the recorder module.</li> <li>Please check the system parameter and actual system configuration.</li> <li>Please review the recording operation setting of the module parameter and set the number of modules of "Main" to one.</li> <li>Please remove the module from Main where the module status setting of the system parameter (I/O assignment setting) is set to "Empty".</li> </ul>
3033H	Recording Setting Error	A recording setting file which is not supported by the firmware version of the target recorder module was written.	Please check the version of the recorder module, use a compatible product, and then write the recording file again.
3034H	Recording Setting Error	The link-direct device, module access device, or CPU buffer memory access device specified for collection does not have an access destination or is out of range.	<ul style="list-style-type: none"> <li>Please review the device/label sampling target setting in the recording setting.</li> <li>If the Device/Label sampling target setting is set to the Device/Label batch specification, review the program used to set recording.</li> </ul>
3040H to 3044H	Control CPU Communication Error	Failed to communicate data with the control CPU module.	<ul style="list-style-type: none"> <li>Please take anti-noise measures.</li> <li>Please switch the CPU module to RUN after resetting it. If the same error is displayed, a hardware error may have occurred in the recorder module. Please consult your local Mitsubishi representative.</li> </ul>
3045H	Control CPU Communication Timeout	The data communication with the control CPU module has timed out.	<ul style="list-style-type: none"> <li>Please take anti-noise measures.</li> <li>Please switch the CPU module to RUN after resetting it. If the same error is displayed, a hardware error may have occurred in the recorder module. Please consult your local Mitsubishi representative.</li> </ul>
3050H to 3064H	Module Error	—	<ul style="list-style-type: none"> <li>Please take anti-noise measures.</li> <li>Please switch the CPU module to RUN after resetting it. If the same error is displayed, a hardware error may have occurred in the recorder module. Please consult your local Mitsubishi representative.</li> </ul>
3070H to 3071H	Module Error	—	<ul style="list-style-type: none"> <li>Please take anti-noise measures.</li> <li>Please switch the CPU module to RUN after resetting it. If the same error is displayed, a hardware error may have occurred in the recorder module. Please consult your local Mitsubishi representative.</li> </ul>
3080H to 308AH	Module Error	—	<ul style="list-style-type: none"> <li>Please take anti-noise measures.</li> <li>Please switch the CPU module to RUN after resetting it. If the same error is displayed, a hardware error may have occurred in the recorder module. Please consult your local Mitsubishi representative.</li> </ul>
3090H	Module Error	—	<ul style="list-style-type: none"> <li>Please take anti-noise measures.</li> <li>Please switch the CPU module to RUN after resetting it. If the same error is displayed, a hardware error may have occurred in the recorder module. Please consult your local Mitsubishi representative.</li> </ul>
3092H to 309AH	Module Error	—	<ul style="list-style-type: none"> <li>Please take anti-noise measures.</li> <li>Please switch the CPU module to RUN after resetting it. If the same error is displayed, a hardware error may have occurred in the recorder module. Please consult your local Mitsubishi representative.</li> </ul>
30A0H to 30A2H	Module Error	—	<ul style="list-style-type: none"> <li>Please take anti-noise measures.</li> <li>Please switch the CPU module to RUN after resetting it. If the same error is displayed, a hardware error may have occurred in the recorder module. Please consult your local Mitsubishi representative.</li> </ul>
30A8H to 30AAH	Module Error	—	<ul style="list-style-type: none"> <li>Please take anti-noise measures.</li> <li>Please switch the CPU module to RUN after resetting it. If the same error is displayed, a hardware error may have occurred in the recorder module. Please consult your local Mitsubishi representative.</li> </ul>

Error code	Error name	Error description	Corrective action
3140H to 3142H	Module Error	—	<ul style="list-style-type: none"> <li>• Please take anti-noise measures.</li> <li>• Please switch the CPU module to RUN after resetting it. If the same error is displayed, a hardware error may have occurred in the recorder module. Please consult your local Mitsubishi representative.</li> </ul>
3150H	Module Error	—	<ul style="list-style-type: none"> <li>• Please take anti-noise measures.</li> <li>• Please switch the CPU module to RUN after resetting it. If the same error is displayed, a hardware error may have occurred in the recorder module. Please consult your local Mitsubishi representative.</li> </ul>
31C0H to 31C4H	Module Error	—	<ul style="list-style-type: none"> <li>• Please take anti-noise measures.</li> <li>• Please switch the CPU module to RUN after resetting it. If the same error is displayed, a hardware error may have occurred in the recorder module. Please consult your local Mitsubishi representative.</li> </ul>
31C5H	Module Parameter Error	<ul style="list-style-type: none"> <li>• A module parameter of the recording operation setting which is not supported by the firmware version of the target recorder module was written.</li> <li>• The contents in the module parameter are broken.</li> </ul>	<ul style="list-style-type: none"> <li>• Please check the version of the recorder module, use a compatible product, and then write the module parameter again.</li> <li>• Please write the module parameter again with the engineering tool. If the same error is displayed again, please consult your local Mitsubishi representative.</li> </ul>
31C6H to 31CAH	Module Error	—	<ul style="list-style-type: none"> <li>• Please take anti-noise measures.</li> <li>• Please switch the CPU module to RUN after resetting it. If the same error is displayed, a hardware error may have occurred in the recorder module. Please consult your local Mitsubishi representative.</li> </ul>
3300H to 3303H	Module Error	—	<ul style="list-style-type: none"> <li>• Please take anti-noise measures.</li> <li>• Please switch the CPU module to RUN after resetting it. If the same error is displayed, a hardware error may have occurred in the recorder module. Please consult your local Mitsubishi representative.</li> </ul>
3305H	Module Configuration Error	The number of modules set in "Sub" in the camera recorder module has exceeded the available number.	Please set "Sub" in the camera recorder module less than the available number.
3306H	Recording Setting Error	<ul style="list-style-type: none"> <li>• The start I/O No. and mounting position of the camera recorder module are different from the ones of the system parameter at the recording setting.</li> <li>• The recording operation setting of the camera recorder module is different from the one at the recording setting.</li> </ul>	<ul style="list-style-type: none"> <li>• Please check the system parameter and actual system configuration, and review the video data receiving target settings in the recording setting.</li> <li>• Please check the recording operation setting with the module parameter of the camera recorder module and review the video data receiving target settings in the recording setting.</li> </ul>
3405H	Recording Setting Error	A recording setting file which is not supported by the firmware version of the target recorder module was written.	Please check the version of the recorder module, use a compatible product, and then write the recording file again.
3C00H to 3C03H	Hardware Error	A hardware error was detected.	<ul style="list-style-type: none"> <li>• Please take anti-noise measures.</li> <li>• Please switch the CPU module to RUN after resetting it. If the same error is displayed, a hardware error may have occurred in the recorder module. Please consult your local Mitsubishi representative.</li> </ul>
3C0FH	Hardware Error	A hardware error was detected.	<ul style="list-style-type: none"> <li>• Please take anti-noise measures.</li> <li>• Please switch the CPU module to RUN after resetting it. If the same error is displayed, a hardware error may have occurred in the recorder module. Please consult your local Mitsubishi representative.</li> </ul>
3C22H	Memory Error	A memory error was detected.	<ul style="list-style-type: none"> <li>• Please take anti-noise measures.</li> <li>• Please switch the CPU module to RUN after resetting it. If the same error is displayed, a hardware error may have occurred in the recorder module. Please consult your local Mitsubishi representative.</li> </ul>

Error code	Error name	Error description	Corrective action
3C2FH	Memory Error	A memory error was detected.	<ul style="list-style-type: none"> <li>• Please take anti-noise measures.</li> <li>• Please switch the CPU module to RUN after resetting it. If the same error is displayed, a hardware error may have occurred in the recorder module. Please consult your local Mitsubishi representative.</li> <li>• If this error occurs during the automated hardware test, perform a firmware update and perform the automated hardware test again. If the same error is displayed again, the recorder module may have a hardware error. Contact the nearest Mitsubishi Electric System Service Co., Ltd. or Mitsubishi Electric Corporation branch office or agent.</li> </ul>
3C32H	Memory Error	A memory error was detected.	<ul style="list-style-type: none"> <li>• Please take anti-noise measures.</li> <li>• Please switch the CPU module to RUN after resetting it. If the same error is displayed, a hardware error may have occurred in the recorder module. Please consult your local Mitsubishi representative.</li> </ul>
3EA0H	Module Error	—	<ul style="list-style-type: none"> <li>• Please take anti-noise measures.</li> <li>• Please switch the CPU module to RUN after resetting it. If the same error is displayed, a hardware error may have occurred in the recorder module. Please consult your local Mitsubishi representative.</li> </ul>

\*1 An event is registered as a continuation error when "Error is registered (continuous error)" is selected for "Warning due to program change during recording operation" under "Operation Setting at Event Detection" in the application setting in the module parameter.



## Event code list

The following table shows the event code list of a recorder module.





Event code	Event type	Event classification	Overview	Cause
00170	System	Information	Co-recording trigger sending	The co-recording trigger has been sent.
00171	System	Information	Co-recording trigger receiving	The co-recording trigger has been received.
00C00	System	Warning	Recording Start with Program Inconsistency	It is different from the project (program, FB/FUN) at the recording setting because a program file or FB/FUN file in the CPU module was changed during recording operation. When a device/label that is not a sampling target is added, the added device/label cannot be saved and replayed.
00C01	System	Warning	Program Inconsistency during Recording Operation	It is different from the project (program, FB/FUN) at the recording setting because a program file or FB/FUN file in the CPU module was changed during recording operation. When a device/label that is not a sampling target is added, the added device/label cannot be saved and replayed.
20400	Operation	Information	Firmware update succeeded(Recorder module)	The firmware of the Recorder module was successfully updated.
20401	Operation	Information	Firmware update failed(Recorder module)	The firmware update of the Recorder module failed.
24020	Operation	Information	Recording Operation Start	The recording operation has been started.
24021	Operation	Information	Recording Operation Stop	The recording operation has been stopped.
24030	Operation	Information	File Saving Trigger Establishment	The file saving trigger has been established.
24031	Operation	Information	Recording Files Saving Completion	Saving the recording files has been completed.
24040	Operation	Information	Error Clear	Errors have been cleared.
24044	Operation	Information	INFO LED Off	INFO LED has been turned off.
24050	Operation	Information	Project Data Saving Start	Saving the project data has been started.
24051	Operation	Information	Project Data Saving Completion	Saving the project data has been completed.
2A010	Operation	Warning	SD Memory Card Initialization	The SD memory card has been initialized.
2A030	Operation	Warning	Recording Files Saving Completion	<ul style="list-style-type: none"> <li>• Saving the recording files has been completed.</li> <li>• Failed to save the event history file.</li> </ul>
2A032	Operation	Warning	Recording Files Saving Completion	<ul style="list-style-type: none"> <li>• Saving the recording files has been completed.</li> <li>• The sampled device and label data have exceeded the size that can be stored in the recording buffer.</li> <li>• Please set a sufficient size for the recording buffer in the basic settings of the module parameter.</li> <li>• Please set a shorter saving period before and after the file saving trigger or saving period after the recording startup trigger in the saving period setting of the recording setting.</li> <li>• Please reduce some device and label data to be stored in the Device/Label sampling target setting of the recording settings.</li> </ul>
2A040	Operation	Warning	Recording Files Saving Completion	<ul style="list-style-type: none"> <li>• Saving the recording files has been completed.</li> <li>• Failed to save some video data.</li> </ul>
2A050	Operation	Warning	Project Data Saving Failure	Failed to save the project data because accessing the SD memory card failed due to any one of the following causes. <ul style="list-style-type: none"> <li>• The SD memory card is not inserted.</li> <li>• The access status of the SD memory card is the unmount state.</li> <li>• The write-protect switch of the SD memory card is enabled.</li> </ul>
2A051	Operation	Warning	Project Data Saving Failure	Failed to save the project data to the SD memory card due to any one of the following causes. <ul style="list-style-type: none"> <li>• The free space in the SD memory card is insufficient.</li> <li>• An error of the SD memory card has been detected.</li> </ul>

Event code	Event type	Event classification	Overview	Cause
2A052	Operation	Warning	Project Data Saving Failure	Failed to save the project data because connecting to the file server (the saving path set in the recording setting) failed due to any one of the following causes. <ul style="list-style-type: none"> <li>• The saving path set in the saving path setting does not exist.</li> <li>• The user name/password set in the saving path setting is incorrect.</li> <li>• The host name/IP address set in the saving path setting is incorrect.</li> <li>• Any item in the DNS setting (the basic settings of the module parameter) is incorrect.</li> <li>• The file server is not connected to the network.</li> <li>• The saving path set in the saving path setting or files and folders under them are set Read-only or Encrypt attributes.</li> </ul>
2A053	Operation	Warning	Project Data Saving Failure	Failed to save the project data to the file server (the saving path set in the recording setting) due to any one of the following causes. <ul style="list-style-type: none"> <li>• The free space in the file server is insufficient.</li> <li>• The user set in the saving path setting does not have write authority to the saving path.</li> <li>• An error has been detected at the time of access to the save destination folder due to network disconnection.</li> <li>• An error has been detected since several modules and applications were accessing the saving destination folder simultaneously.</li> <li>• The saving path set in the saving path setting or files and folders under them are set Read-only or Encrypt attributes.</li> </ul>
2A054	Operation	Warning	Project Data Saving Failure	Since the CPU module is not supported by the project data saving function, the project data was not saved.
2A055	Operation	Warning	Project Data Saving Failure	Since the project data in the CPU module was changed while the project data was being saved, the project data was not saved.
2A056	Operation	Warning	Project Data Saving Failure	Failed to save the project data because acquiring the project data from the CPU module failed due to any one of the following causes. <ul style="list-style-type: none"> <li>• The file password (read) is set.</li> <li>• Several modules and applications are accessing the CPU module.</li> </ul>
2A057	Operation	Warning	Project Data Saving Failure	Since initializing the SD memory card was requested, the project data was not saved.

# 5.7 Camera Recorder Module

This section explains the errors which may occur in a camera recorder module and the troubleshooting.

## Checking methods

Checking method	Details
System monitor of GX Works3	Error codes can be checked in the system monitor of GX Works3.  Page 157 Checking the module status
Buffer memory	Error codes can be checked in the following buffer memory:  Page 269 Current error area (Un\G140 to 149)  Page 270 Error log area (Un\G150 to 311)
Recording monitor	The operating status of the recording function for each recording setting can be checked in the recording monitor.  Page 142 RECORDING MONITOR
Camera monitor	The connection status with a network camera can be checked in the camera monitor.  Page 146 Camera Monitor Screen

### Point

- If multiple errors occur at the same time, take corrective action for the errors in chronological order.
- If an error occurs in connection or communication with a network camera, the operation may be recovered automatically from the error by retrying it from a camera recorder module. ( Page 238 Alive check)

## Error code types

For details, refer to the following:

 Page 156 Error code types

## Error types

For details, refer to the following:

 Page 156 Error types

## Checking the module status

---

For details, refer to the following:









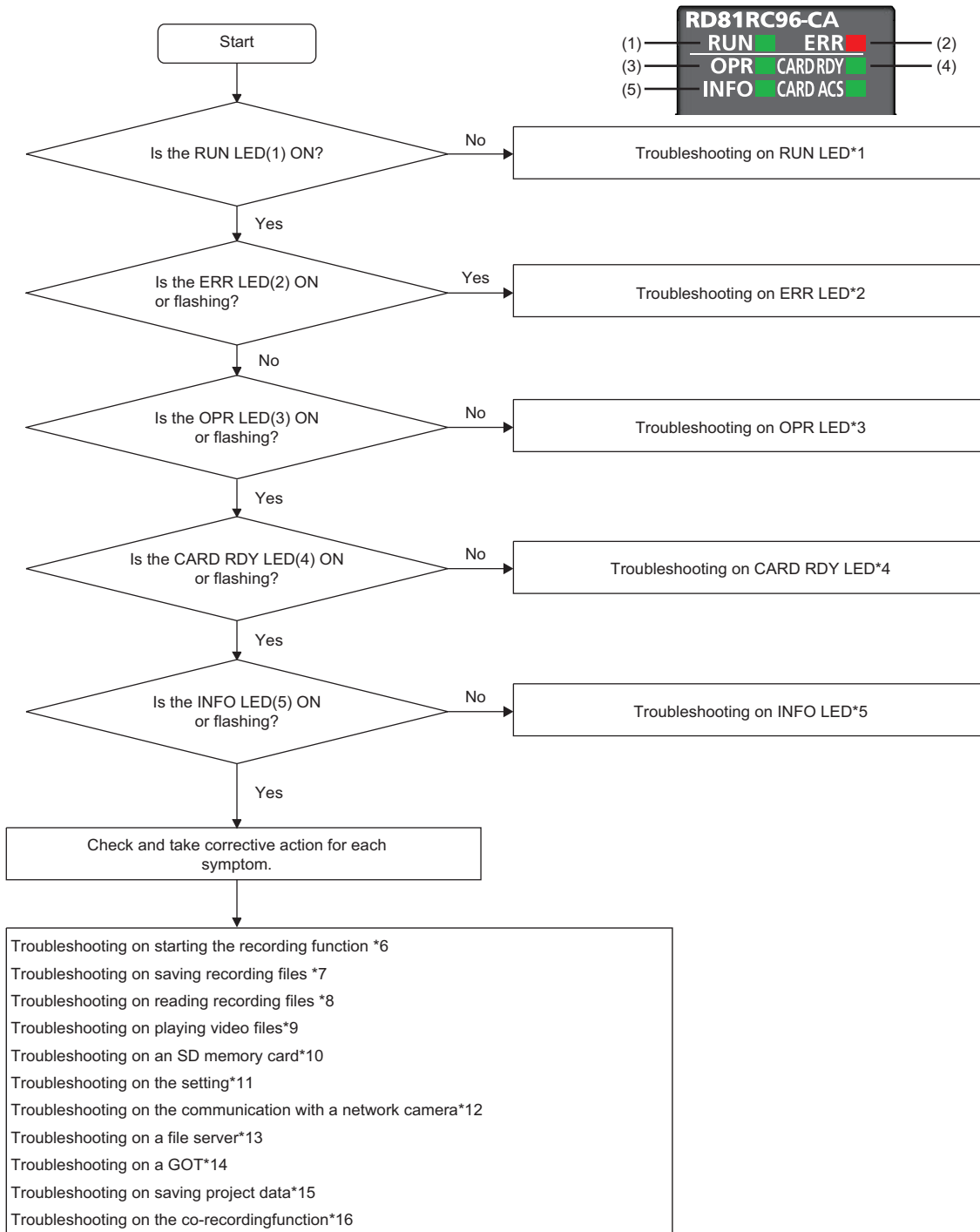

 Page 157 Checking the module status







# Troubleshooting by symptom

The following shows the flowchart for troubleshooting while a camera recorder module is operating.

The LED status can be checked in the "Module Diagnostics" screen of the system monitor. (  Page 158 Module information list)



- \*1  Page 180 Troubleshooting on RUN LED
- \*2  Page 180 Troubleshooting on ERR LED
- \*3  Page 180 Troubleshooting on OPR LED
- \*4  Page 180 Troubleshooting on CARD RDY LED
- \*5  Page 180 Troubleshooting on INFO LED
- \*6  Page 148 Troubleshooting on starting the recording function
- \*7  Page 150 Troubleshooting on saving recording files
- \*8  Page 153 Troubleshooting on reading recording files
- \*9  Page 154 Troubleshooting on playing a video file
- \*10  Page 180 Troubleshooting on an SD memory card

- \*11  Page 181 Troubleshooting on settings
- \*12  Page 183 Troubleshooting on communication with a network camera
- \*13  Page 183 Troubleshooting on a file server
- \*14 Refer to the following: (It can be downloaded from the Mitsubishi Electric FA website.)  
 Mitsubishi Electric Programmable Controller Camera Recorder Module RD81RC96-CA Sample Screen Manual (BCN-P5999-1333)
- \*15  Page 152 Troubleshooting on saving project data
- \*16  Page 184 Troubleshooting on the co-recording function

## Troubleshooting on RUN LED

For details, refer to the following:

-  Page 163 Troubleshooting on RUN LED

## Troubleshooting on ERR LED

For details, refer to the following:

-  Page 163 Troubleshooting on ERR LED

## Troubleshooting on OPR LED

For details, refer to the following:

-  Page 163 Troubleshooting on OPR LED

## Troubleshooting on CARD RDY LED

For details, refer to the following:

-  Page 163 Troubleshooting on CARD RDY LED

## Troubleshooting on INFO LED

For details, refer to the following:

-  Page 164 Troubleshooting on INFO LED

## Troubleshooting on an SD memory card

For details, refer to the following:

-  Page 164 Troubleshooting on an SD memory card

## Troubleshooting on settings

Symptom	Check point	Corrective action
Unable to search for a network camera.	Check each network environment. <ul style="list-style-type: none"> <li>• Is PoE power supplied when using a PoE network camera?</li> <li>• Is the power of a hub turned ON?</li> <li>• Is there any disconnection in the connection route?</li> </ul>	Take any of the following corrective actions according to the check result. <ul style="list-style-type: none"> <li>• Supply PoE power to the network camera.</li> <li>• Turn the power of the hub ON.</li> <li>• Connect the cables properly, or replace them with new ones.</li> </ul>
	Are the IP address, subnet mask, and default gateway set for the network camera? (Check the IP address set for the network camera by using a dedicated tool for the camera.)	Set the IP address, subnet mask, and default gateway of the network camera according to those of a camera recorder module by using a dedicated tool for the camera. For details, refer to the manual for the network camera used.
	Does the IP address (first octet to third octet) set for the network camera match that of a camera recorder module? (Check the IP address set for the network camera by using a dedicated tool for the camera.)	Set the IP address of the network camera according to that of the camera recorder module by using a dedicated tool for the camera. For details, refer to the manual for the network camera used.
	Is the default gateway set for the network camera correct?	Check if the network configuration is correct. If another LAN segment is relayed via a gateway, contact the network administrator of the connected LAN.
	Is the IP address duplicated in the system?	Review the setting to avoid IP address duplication in the system.
	Are 33 or more network cameras connected on the same network to which a camera recorder module is connected?	Perform either of the following operations to reduce the number of connected network cameras to 32 or less for search. <ul style="list-style-type: none"> <li>• Power OFF a network camera that is not a target for search.</li> <li>• Disconnect the cable to a network camera that is not a target for search.</li> </ul>
The communication test fails.	Check each network environment. <ul style="list-style-type: none"> <li>• Is PoE power supplied when using a PoE network camera?</li> <li>• Is the power of a hub turned ON?</li> <li>• Is there any disconnection in the connection route?</li> </ul>	Take any of the following corrective actions according to the check result. <ul style="list-style-type: none"> <li>• Supply PoE power to the network camera.</li> <li>• Turn the power of the hub ON.</li> <li>• Connect the cables properly, or replace them with new ones.</li> </ul>
	Is a user created for a network camera?	Create a user by using a dedicated tool for the network camera. For some network cameras, create another account for ONVIF communication. For details, refer to the manual for the network camera.
	Does each item (IP address/user ID/password/TCP port number) set in the communication test screen in the module extended parameter match a corresponding setting value of a network camera? (For the method for checking setting values of a network camera, refer to the manual for the network camera used.) (  Page 108 Communication test screen)	Enter each setting value of the network camera (IP address/user ID/password/TCP port number).
	Are four network cameras connected to a camera recorder module?	Reduce the number to three or less.
The communication test fails. (When connecting an ONVIF supported network camera)	Are the following values set in the network camera setting? <ul style="list-style-type: none"> <li>• Video codec: Value other than H.264</li> <li>• Communication with a camera recorder module: Value other than HTTP protocol</li> </ul>	Change the values to the following ones: <ul style="list-style-type: none"> <li>• Video codec: H.264</li> <li>• Communication with a camera recorder module: HTTP protocol</li> </ul>

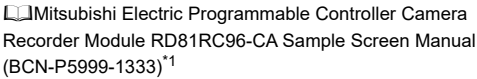
Symptom	Check point	Corrective action
A video is not displayed according to the setting for PTZ control of a network camera.	Is PTZ operation performed in multiple devices?	Do not perform PTZ control for a network camera in multiple devices. (Some network cameras have the camera control authority for performing PTZ control. For details, refer to the manual for the network camera.)
	Has an operation been performed while a value other than 'not requested' is stored in 'PTZ operation status' (Un\G38002, Un\G38702, Un\G39402, Un\G40102)? (☞ Page 287 PTZ control area (Un\G38000 to 43599))	Perform an operation while 'not requested' is stored in 'PTZ operation status.'
	Is 'PTZ preset mode' or 'PTZ disable mode' stored in 'PTZ control authority mode' (Un\G38000, Un\G38700, Un\G39400, Un\G40100)? (☞ Page 287 PTZ control area (Un\G38000 to 43599))	Change the value to "PTZ Enable Mode" for "PTZ Control Authority Mode" in the module extended parameter. (☞ Page 103 Module Extended Parameters (Camera Recorder Module))
	Check each network environment. • Is PoE power supplied when using a PoE network camera? • Is the power of a hub turned ON? • Is there any disconnection in the connection route?	Take any of the following corrective actions according to the check result. • Supply PoE power to the network camera. • Turn the power of the hub ON. • Connect the cables properly, or replace them with new ones.
	Has the network camera been restarted?	Perform PTZ or preset operation, because the home position specific to the network camera is the direction to capture data when restarting the network camera.
A video when performing PTZ control is not displayed.	Is the setting of a GOT or SoftGOT correct?	Refer to the troubleshooting described in the following manual to take corrective action. 
The camera event type does not appear as supported in the communication test result.	Is a network camera set to detect camera events?	• Set it to detect camera events. The setting procedure differs depending on a network camera used. Refer to the manual for the network camera to take corrective action.
	Is a camera recorder module with a firmware version supporting camera events used?	• Update the module to a firmware version supporting camera events. For the applicable firmware versions, refer to the following: ☞ Page 307 Added and Changed Functions

\*1 Can be downloaded from the Mitsubishi Electric FA website.



## Troubleshooting on communication with a network camera

Symptom	Check point	Corrective action
Unable to start communication with a network camera.	Is the Ethernet cable connected properly?	If it is not connected properly, take the following actions: <ul style="list-style-type: none"> <li>• Lock the cable securely.</li> <li>• Check the wiring. (☞ MELSEC iQ-R System Recorder User's Manual (Startup))</li> </ul>
	Is the power of the network camera, PoE switching hub, or router, etc. turned ON?	Turn the power ON.
	Has an error occurred in the network camera, PoE switching hub, or router, etc.?	Refer to the manual for each device to take corrective action.
	Has a device on the line been replaced (with one with the same IP address), such as a CPU module, connected device (personal computer), hub, or router, etc.?	Reset the devices on the line.*1
	Is the IP address of the network camera specified correctly?	Search for the network camera in the module extended parameter. (☞ Page 103 Module Extended Parameters (Camera Recorder Module)) If whether the network camera exists cannot be checked, there is any problem in the network configuration used. In this case, contact the system administrator or network administrator.
	Is the network camera supported by a camera recorder module?	Check if a network camera supported by the camera recorder module is used. (☞ MELSEC iQ-R System Recorder User's Manual (Startup))
	Is the IP address duplicated in the system?	<ul style="list-style-type: none"> <li>• Review the setting to avoid IP address duplication in the system.</li> <li>• Review the settings for all modules used to avoid IP address duplication of the network camera in the module extended parameter.</li> </ul>
	Are there a firewall and proxy server in the connection route?	Check the firewall and proxy server settings with the network administrator.
	Is the network camera in a state where it cannot respond, such as while being started?	<ul style="list-style-type: none"> <li>• Make sure that the network camera is ready to respond.</li> <li>• Refer to the manual for the network camera to take corrective action.</li> </ul>
The communication is frequently disconnected. ('00600: communication retry start' occurs in the event history.)	Is the bit rate high to the communication band?	<ul style="list-style-type: none"> <li>• Lower the maximum video bit rate in the module extended parameter. (☞ Page 103 Module Extended Parameters (Camera Recorder Module))</li> <li>• For the network configuration used, contact the system administrator or network administrator.</li> </ul>
The communication with a network camera does not restart after it is disconnected.	Is the time in a CPU module changed after starting the operation of a camera recorder module?	If the clock data in the CPU module is changed after starting the operation of the system, it may take time to synchronize the time between the camera recorder module and network camera. In this case, wait until the time synchronization is completed.
An error occurs in the communication with a network camera even when "Warning" is set for "Error due to communication with a network camera" under "Operation Setting at Event Detection."	Is a camera recorder module with a firmware version supporting this setting used?	Update the module to a firmware version supporting this setting. For the applicable firmware versions, refer to the following: ☞ Page 307 Added and Changed Functions

\*1 Devices on Ethernet have the correspondence table between IP addresses and MAC addresses called the ARP cache. When replacing a device on the line with one with the same IP address, the MAC address does not match between the ARP cache and the new device and the communication may not be established normally. The ARP cache is updated when the device is reset or a certain period of time elapses. The time differs depending on the device.

## Troubleshooting on a file server

For details, refer to the following:

☞ Page 165 Troubleshooting on a file server

## Troubleshooting on the co-recording function

For details, refer to the following:

☞ Page 166 Troubleshooting on the co-recording function

# Error code list

The following table shows the error code list of a camera recorder module.

Error code	Error name	Error description	Corrective action
0C00H <sup>*1</sup>	Recording Start with Program Inconsistency	It is different from the project (program, FB/FUN) at the recording setting because a program file or FB/FUN file in the CPU module was changed during recording operation. When a device/label that is not a sampling target is added, the added device/label cannot be saved and replayed.	When a device/label that is not a sampling target is added, stop recording, write the recording setting file to the CPU module again, and restart recording. When the devices/labels in the program are not specified in a batch in the device/label sampling target setting, please review the recording setting so that the added devices/labels are included in the sampling targets and write it to the CPU module.
0C01H <sup>*1</sup>	Program Inconsistency during Recording Operation	It is different from the project (program, FB/FUN) at the recording setting because a program file or FB/FUN file in the CPU module was changed during recording operation. When a device/label that is not a sampling target is added, the added device/label cannot be saved and replayed.	When a device/label that is not a sampling target is added, stop recording, write the recording setting file to the CPU module again, and restart recording. When the devices/labels in the program are not specified in a batch in the device/label sampling target setting, please review the recording setting so that the added devices/labels are included in the sampling targets and write it to the CPU module.
1300H	Co-recording setting error	The co-recording function does not operate because it is not supported by the firmware version of the CPU module.	Please check the version of the CPU module, use a compatible product, and then write the CPU parameter again.
1301H	Co-recording setting error	The co-recording function does not operate because the co-recording setting of the CPU module is not set to "Use".	Please set the co-recording setting of the CPU parameter to "Use".
1810H	Recording Setting Acquisition Error	Failed to acquire the recording setting.	Please write the recording setting with the engineering tool.
1811H to 1813H	Recording Setting Error	The contents of the recording setting file are broken.	<ul style="list-style-type: none"> <li>• Please write the recording setting again with the engineering tool.</li> <li>• Please check that the versions of the camera recorder module, CPU module, and engineering tool are appropriate to be used together.</li> </ul>
1814H	Recording Start Error in Sub	A recording start error has occurred in the Sub.	Please check the details of the Sub error by the module diagnostics of the engineering tool, and clear the error.
1815H	Recording Start Error in Sub	<ul style="list-style-type: none"> <li>• The mode of the module parameter is not set to "Online" in some Sub.</li> <li>• The module status setting is set to "Empty" with the system parameter (I/O assignment setting) in some Sub.</li> <li>• The Sub is not mounted.</li> </ul>	<ul style="list-style-type: none"> <li>• Please set the operation mode of the module parameter of the Sub whose recording function is to be used to "Online".</li> <li>• Please set the module status setting of the system parameter (I/O assignment setting) of the Sub whose recording function is to be used to "No setting".</li> <li>• Please check the system parameter and actual system configuration, please review the recording setting.</li> </ul>
1816H	Module Error	An unrecognized error has been detected by the firmware version of the target camera recorder module.	Please check that the versions of the camera recorder module, CPU module, and engineering tool are appropriate to be used together.
1817H	Recording Setting Error	The contents of the recording setting file are broken.	<ul style="list-style-type: none"> <li>• Please write the recording setting again with the engineering tool.</li> <li>• Please check that the versions of the camera recorder module, CPU module, and engineering tool are appropriate to be used together.</li> </ul>
1818H	Co-recording unsupported sub error	The sub version not supported by the co-recording function is provided.	Please check the sub version and use a product supported by the co-recording function.
1830H	Recording Setting Error	A recording setting file which is not supported by the firmware version of the target camera recorder module was written.	Please check the version of the camera recorder module, use a compatible product, and then write the recording file again.
1850H	Recording Setting Error	The size is not set in the buffer area for data sampling of the CPU parameter.	Please set the size in the buffer area for data sampling of the CPU parameter.
1851H	Recording Setting Error	The size is not set in the recording buffer of the basic settings of the module parameter.	Please set the size in the recording buffer of the basic settings of the module parameter.
1900H	Recording Files Saving Error	Failed to save recording files because there is no free folder number for recording folders.	Please delete unnecessary recording folders in the setting-specific folder in which the error has occurred.

Error code	Error name	Error description	Corrective action
1901H	Recording Files Saving Error	Failed to save recording files because accessing the SD memory card failed.	<ul style="list-style-type: none"> <li>• Please save files after checking that the SD memory card is not being initialized.</li> <li>• Please save files after checking that the SD memory card is in the accessible state (mount state).</li> </ul>
1902H	Recording Files Saving Error	Failed to save recording files because accessing the SD memory card failed.	<ul style="list-style-type: none"> <li>• Please check whether the SD memory card is inserted.</li> <li>• Please save files after checking that the SD memory card is in the accessible state (mount state).</li> <li>• If the write-protect switch of the SD memory card is enabled, please insert the SD memory card after disabling it.</li> </ul>
1904H	Recording Files Saving Error	Failed to save recording files because the control file could not be saved due to the insufficient free space in the SD memory card.	Please delete unnecessary files in the SD memory card to allocate free space.
1905H	Recording Files Saving Error	Failed to save some recording files because the free space in the SD memory card was insufficient.	Please delete unnecessary files in the SD memory card to allocate free space.
1906H	Recording Files Saving Error	Failed to save recording files because old recording files could not be deleted.	<ul style="list-style-type: none"> <li>• Please initialize the SD memory card.</li> <li>• Please replace the SD memory card.</li> </ul>
1910H	Event History File Acquisition Error	<ul style="list-style-type: none"> <li>• The event history file could not be acquired because no event history file was created in the control CPU module.</li> <li>• The event history file could not be acquired because the setting to communicate with only engineering tool with enhanced security measures on user authentication function of the control CPU module is enabled.</li> </ul>	<p>Please perform any one of the following.</p> <ul style="list-style-type: none"> <li>• Writing parameters to the control CPU module</li> <li>• Inserting the SD memory card (when the save destination of the event history is the SD memory card)</li> <li>• Initializing the SD memory card</li> <li>• Resetting the control CPU</li> <li>• Turning the power off and on</li> <li>• Disable the setting to communicate with only engineering tool with enhanced security measures on user authentication function of the control CPU module.</li> </ul>
1911H	Control CPU Communication Error	Failed to save recording files because the data communication with the control CPU module failed.	<ul style="list-style-type: none"> <li>• Please take anti-noise measures.</li> <li>• Please switch the CPU module to RUN after resetting it. If the same error is displayed, a hardware error may have occurred in the camera recorder module. Please consult your local Mitsubishi representative.</li> </ul>
1913H	Recording Files Saving Error	No recording files were saved because no device/label data was collected during the retention period.	Please check the sampling method and saving period of the device/label data.
1914H	Recording Files Saving Error	Failed to save Recording file because the data communication with the management CPU module timed out.	<ul style="list-style-type: none"> <li>• Please take anti-noise measures.</li> <li>• Please switch the CPU module to RUN after resetting it. If the same error is displayed, a hardware error may have occurred in the camera recorder module. Please consult your local Mitsubishi representative.</li> </ul>
1920H	Recording Files Saving Error	Failed to save recording files because an error of the SD memory card was detected.	<ul style="list-style-type: none"> <li>• Please initialize the SD memory card.</li> <li>• Please replace the SD memory card.</li> </ul>
1921H	Recording Files Saving Error	<p>Failed to save recording files.</p> <ul style="list-style-type: none"> <li>• The free space in the SD memory card was insufficient.</li> <li>• An error of the SD memory card was detected.</li> </ul>	<ul style="list-style-type: none"> <li>• Please delete unnecessary files in the SD memory card to allocate free space.</li> <li>• Please initialize the SD memory card.</li> <li>• Please replace the SD memory card.</li> </ul>

Error code	Error name	Error description	Corrective action
1930H	Recording Files Saving Error	Failed to save recording files because the connection to the file server failed.	<ul style="list-style-type: none"> <li>• Please save files after checking that the host name and IP address of the file server are correct.</li> <li>• Please save files after checking that the file server is connected to the network.</li> <li>• If the load on the network is high, please reduce the load by separating the network and save files.</li> <li>• If the load on the file server is high, please reduce the load by reducing the access to the file server and save files.</li> <li>• When the file server is specified by the host name, please save files after checking that the DNS server setting of the camera recorder module is correct.</li> <li>• When the file server is specified by the host name, please save files after checking that the DNS server is connected to the network.</li> <li>• If video data receiving targets set in the recording setting, please reduce the load by modifying the module extended parameter.</li> </ul>
1931H	Recording Files Saving Error	Failed to save recording files because the connection to the file server failed.	<ul style="list-style-type: none"> <li>• Please save files after checking that the user name/ password used for the connection to the file server is correct.</li> <li>• If video data receiving targets set in the recording setting, please reduce the load by modifying the module extended parameter.</li> </ul>
1932H	Recording Files Saving Error	Failed to save recording files because the connection to the file server failed.	<ul style="list-style-type: none"> <li>• Please save files after checking that the folder name set in the saving path setting exists in the file server.</li> <li>• If video data receiving targets set in the recording setting, please reduce the load by modifying the module extended parameter.</li> </ul>
1934H	Recording Files Saving Error	Failed to save recording files because the access to the file server failed.	<ul style="list-style-type: none"> <li>• Please save files after checking that the file server is connected to the network.</li> <li>• If video data receiving targets set in the recording setting, please reduce the load by modifying the module extended parameter.</li> </ul>
1935H	Recording Files Saving Error	Failed to save recording files because the management file could not be saved due to the insufficient free space in the file server.	Please delete unnecessary files in the file server to allocate free space.
1936H	Recording Files Saving Error	Failed to save some recording files because the free space in the file server was insufficient.	Please delete unnecessary files in the file server to allocate free space.
1937H	Recording Files Saving Error	Failed to save recording files because old recording files could not be deleted.	<ul style="list-style-type: none"> <li>• Please check if the user set in the saving path setting has write authority to the saving path.</li> <li>• Please check if several modules and applications are accessing the saving destination folder in the file server simultaneously.</li> <li>• If video data receiving targets set in the recording setting, please reduce the load by modifying the module extended parameter.</li> <li>• Please check if files and folders under the saving destination folder in the file server are not set Read-only or Encrypt attributes.</li> </ul>
1938H	Recording Files Saving Error	Failed to save recording files because an error was detected at the time of access to the file in the file server.	<ul style="list-style-type: none"> <li>• Please check if the user set in the saving path setting has write authority to the saving path.</li> <li>• Please check if several modules and applications are accessing the saving destination folder in the file server simultaneously.</li> <li>• If video data receiving targets set in the recording setting, please reduce the load by modifying the module extended parameter.</li> <li>• Please check if files and folders under the saving destination folder in the file server are not set Read-only or Encrypt attributes.</li> </ul>
1939H	Recording File Saving Error Detection of Sub	An error has been detected in the recording file saving processing of the Sub.	Please check the details of the Sub error by the module diagnostics of the engineering tool, and clear the error.

Error code	Error name	Error description	Corrective action
1981H	SD Memory Card Initialization Error	Failed to initialize the SD memory card.	<ul style="list-style-type: none"> <li>• Please check whether the SD memory card is inserted without fail.</li> <li>• Please check the SD memory card is not initializing.</li> <li>• If the write-protect switch of the SD memory card is enabled, please insert the SD memory card after disabling it.</li> <li>• If the recording function is active, stop it.</li> <li>• Please replace the SD memory card.</li> </ul>
1982H	SD Memory Card Error	An error of the SD memory card was detected.	<ul style="list-style-type: none"> <li>• If the write-protect switch of the SD memory card is enabled, please insert the SD memory card after disabling it.</li> <li>• Please format the SD memory card, or insert the SD memory card again. If the same error is displayed, a hardware error may have occurred in the SD memory card. Please replace the SD memory card.</li> </ul>
1A80H	IP Address Automatic Acquisition Error	Failed to acquire the network parameter information from the DHCP server.	<ul style="list-style-type: none"> <li>• Please check the status of the connection with the DHCP server.</li> <li>• Please check the connection cable.</li> <li>• Please review the DHCP server setting.</li> </ul>
1A81H	IP Address Automatic Acquisition Update Error	Failed to perform the automatic lease update processing which is performed when the lease term of the IP address acquired from the DHCP server expires.	Please check the connection cable and status of the DHCP server (operating status and whether the IP address to be assigned is allocated).
1A82H	IP Address Setting Error	The setting value of the IP address setting is incorrect.	Please review the IP address setting in the basic settings of the module parameter.
1A83H	DNS Setting Error	The setting value of the DNS setting is incorrect.	Please review the DNS setting in the basic settings of the module parameter.
1C40H	PTZ Control Request Error	The network camera setting is not written.	Please write the module extended parameter with the engineering tool.
1C50H	PTZ Control Error	Failed to perform the PTZ control of the network camera.	<ul style="list-style-type: none"> <li>• Please check the operation status of the target network camera.</li> <li>• Please check if the connection cable is not disconnected.</li> <li>• Please perform the PTZ control again. If the same error is displayed again, the camera recorder module may be defective. Please consult your local Mitsubishi representative.</li> </ul>
1C51H	PTZ Function Unsupported Error	The target network camera does not support the PTZ function.	Please review the network camera specified as the PTZ control target.
1C60H	Preset Position Registration Error	Failed to register the specified preset position.	<ul style="list-style-type: none"> <li>• Please register the preset position again.</li> <li>• If the same error is displayed again, the camera recorder module may be defective. Please consult your local Mitsubishi representative.</li> </ul>
1C70H	Preset Position Deletion Error	Failed to delete the specified preset position.	<ul style="list-style-type: none"> <li>• Please delete the preset position again.</li> <li>• If the same error is displayed again, the camera recorder module may be defective. Please consult your local Mitsubishi representative.</li> </ul>
1C80H	Preset Position Unregistered Error	The specified preset position is not registered.	Please specify the number of the registered preset position.
1C90H	Preset Position Execution Error	Unable to move to the specified preset position.	<ul style="list-style-type: none"> <li>• Please check the operation status of the target network camera.</li> <li>• Please check if the connection cable is not disconnected.</li> <li>• Please check if the specified preset position No. and preset position speed are within the settable ranges.</li> </ul>
1CA0H	Preset Position Registration Count Upper Limit Reach Error	The number of preset registration counts has exceeded the guaranteed maximum value.	Even if more preset positions are registered, the setting value cannot be guaranteed.
1CB0H	PTZ Authority Mode Unexecutable Error	Moving to the preset position was performed while the PTZ control authority mode is "PTZ disabled mode".	Please perform moving to the preset position while the PTZ control authority mode is "PTZ enabled mode" or "PTZ preset mode".

Error code	Error name	Error description	Corrective action
1D00H	Module Extended Parameter Error	<ul style="list-style-type: none"> <li>A parameter which is not supported by the firmware version of the target camera recorder module was written.</li> <li>The contents in the module extended parameter are broken.</li> </ul>	<ul style="list-style-type: none"> <li>Please check the version of the camera recorder module, use a compatible product, and then write the module extended parameter again.</li> <li>Please write the module extended parameter again with the engineering tool. If the same error is displayed again, the camera recorder module may be defective. Please consult your local Mitsubishi representative.</li> </ul>
1D01H	Network Camera Undetected Error	The target network camera cannot be found.	<ul style="list-style-type: none"> <li>Please check the operation status of the other device.</li> <li>Please check if the set camera type, IP address, and TCP port number are correct.</li> <li>Please change the IP addresses of the network camera and this product to the same segment.</li> <li>If a LAN of different segments is communicated via a gateway, please consult the network administrator of the connected LAN.</li> <li>Please change the IP address of the module to the same segment as the network camera to be connected. (Please do not select automatic acquisition.)</li> <li>Please check that the following values are set in the network camera setting when using ONVIF supported network camera. <ul style="list-style-type: none"> <li>- Video codec: H.264</li> <li>- Connection method: HTTP protocol</li> </ul> </li> </ul>
1D10H	Parameter Inconsistency Error	The number of network cameras that receive video data is inconsistent between the module extension parameter and the recording setting.	Please exclude the network camera(s) that is(are) disabled in the module extension parameter from the receiving targets in the recording setting.
1D11H	Parameter Inconsistency Error	The number of network cameras that receive video data is inconsistent between the recording operation setting of the module parameter and the recording setting.	Please set the number of network cameras that receive video data to two or less in the camera recorder module set to "Main" in the module parameter.
1D30H	Network Camera Account Authentication Error	Failed to authenticate the target network camera.	<ul style="list-style-type: none"> <li>Please review the account information (user ID, use password).</li> <li>Please check the account information (use ID, use password) set for the network camera.</li> <li>An account for ONVIF communication exists in some network cameras. If the account exists, please check the account information for ONVIF communication of the network camera. For details, please refer to the manual of the network camera to be used.</li> </ul>
1D40H	Network Camera Video Maximum Bit Rate Limit Unsupported Error	The target network camera does not support the function which limits the maximum video bit rate.	Please review the resolution, frame rate, video quality, and codec to reduce the bit rate.
1D41H	Camera Event Type Unsupported Error	The target network camera does not support the set camera event type.	<ul style="list-style-type: none"> <li>Please review the camera event notification setting.</li> <li>Please enable the event detection function of the network camera. For details, please refer to the manual of the network camera to be used.</li> <li>Immediately after starting the network camera, it may take some time for the event detection function to be enabled, so make sure that the network camera is started in advance.</li> </ul>
1D50H	Network Camera Video Setting Error	The resolution of the target network camera is incorrect.	Please set the resolution that can be set for the network camera.
1D51H	Network Camera Video Setting Error	The frame rate setting of the target network camera is incorrect.	Please set the frame rate that can be set for the network camera.
1D52H	Network Camera Video Setting Error	The combination of the resolution and frame rate of the target network camera is incorrect.	Please review the combination of the resolution and frame rate that can be set for the network camera.
1D53H	Network Camera Video Setting Error	The number of connected network cameras exceeds the upper limit.	Please review the number of network cameras connected to the module and the setting value of the network camera.
1D54H	Camera Event Setting Inconsistency Error	The combination of the camera event settings is inconsistent.	Please enable the camera event notification setting or disable the camera event trigger settings.

Error code	Error name	Error description	Corrective action
1D80H	Network Camera Video Rotation Angle Unsupported Error	The specified target network camera does not support the video rotation function.	<ul style="list-style-type: none"> <li>• Please clear the setting of the video rotation angle with the engineering tool. After changing the setting, please write the network camera setting again with the engineering tool.</li> <li>• Please enable the simple setting mode of the module extension parameter with the engineering tool, then execute writing.</li> </ul>
1D81H	Network Camera Video Rotation Angle Setting Error	The video rotation angle of the target network camera is incorrect.	<ul style="list-style-type: none"> <li>• Please set the video rotation angle that can be set for the network camera.</li> <li>• Please enable the simple setting mode of the module extension parameter with the engineering tool, then execute writing.</li> </ul>
1D90H	Network Camera SNTP Client Unsupported Error	The target network camera does not support the SNTP client function.	Please use a network camera that supports the SNTP client function.
1DB0H	Network Camera Time Synchronization Setting Error	Failed to set the time synchronization of the network camera.	<ul style="list-style-type: none"> <li>• Please check the operation status of the target network camera.</li> <li>• Please check if the connection cable is not disconnected.</li> <li>• Please check the time in the programmable controller.</li> </ul>
1DC0H	Network Camera Communication Start Error	Failed to communicate with the target network camera.	<ul style="list-style-type: none"> <li>• Please check the operation status of the target network camera.</li> <li>• Please check if the connection cable is not disconnected.</li> </ul>
1DE0H	Network Camera Video Data Storage Start Error	Failed to store video data of the target network camera.	<ul style="list-style-type: none"> <li>• Please check the operation status of the target network camera.</li> <li>• Please check if the connection cable is not disconnected.</li> </ul>
1DF1H	Network Camera Communication Error	Unable to connect with the target network camera.	<ul style="list-style-type: none"> <li>• Please check the operation status of the target network camera.</li> <li>• Please check if the connection cable is not disconnected.</li> <li>• The line may be busy with packets. Please consult the network administrator of the connected LAN.</li> </ul>
1E10H	Recording Files (Video Data) Saving Failure	Because the video data of the target network camera has never been stored in the saving target period, the recording files (video data) were not saved.	<ul style="list-style-type: none"> <li>• Please check that the time of the target network camera and the camera recorder module are synchronized.</li> <li>• Please check the status receiving the video data from the target network camera.</li> <li>• If the load on the network is high, please reduce the load by modifying the module extended parameter.</li> <li>• If the error due to communication with the network camera is set to be categorized as "warning" in the module parameters, please check the event code and take the corrective action.</li> <li>• Set the operation at video data saving to "Video data receiving takes priority" in the module parameters.</li> </ul>
1E11H	Recording Files (Video Data) Saving Failure	Failed to save the video file of the target network camera.	<ul style="list-style-type: none"> <li>• If the load on the network is high, please reduce the load by modifying the module extended parameter.</li> <li>• Please restart the network camera.</li> <li>• Please switch the CPU module to RUN after resetting it. If the same error is displayed again, the camera recorder module may be defective. Please consult your local Mitsubishi representative.</li> </ul>
1E71H	Network Camera Setting Error	A setting error has occurred in the target network camera.	<ul style="list-style-type: none"> <li>• Please restart the network camera.</li> <li>• Please enable the simple setting mode of the module extension parameter with the engineering tool, then execute writing.</li> <li>• Please switch the CPU module to RUN after resetting it. If the same error is displayed again, the camera recorder module may be defective. Please consult your local Mitsubishi representative.</li> <li>• Please check the time setting of the CPU module.</li> </ul>
1E72H	Network Camera Communication Error	An error has occurred in the communication with the target network camera.	<ul style="list-style-type: none"> <li>• Please restart the network camera.</li> <li>• Please switch the CPU module to RUN after resetting it. If the same error is displayed again, the camera recorder module may be defective. Please consult your local Mitsubishi representative.</li> </ul>



Error code	Error name	Error description	Corrective action
1E73H	Network Camera Communication Error (Camera Event)	For the camera event, an error has occurred in the communication with the target network camera.	<ul style="list-style-type: none"> <li>The number for the notification of event from a network camera may have reached the upper limit. Please wait for several minutes until the notify of camera event from a network camera is canceled, and then clear the error. If the same error occurs again, please review the network camera detection function.</li> <li>Please restart the network camera.</li> <li>Please switch the CPU module to RUN after resetting it. If the same error is displayed again, the camera recorder module may be broken. Please consult your local Mitsubishi representative.</li> </ul>
1E80H	Network Camera Error	An error has occurred in the target network camera.	<ul style="list-style-type: none"> <li>Please restart the network camera.</li> <li>Please check the target network camera. For details, please refer to the manual of the network camera to be used.</li> </ul>
2440H	Module Major Error	<ul style="list-style-type: none"> <li>In the multiple CPU system, the control CPU setting in the system parameter is set to the one different from those set in the other CPU Nos.</li> <li>An error of the I/O module or intelligent function module was detected at the initial processing.</li> </ul>	<ul style="list-style-type: none"> <li>Please review the system parameters of CPU No. 2 and later, unify them to the one set in the CPU whose CPU No. is the smallest.</li> <li>A hardware error may have occurred in the module in which the error occurred. Please consult your local Mitsubishi representative.</li> </ul>
2450H	Module Major Error	A major error occurrence notification from the I/O module or intelligent function module was detected.	<ul style="list-style-type: none"> <li>Please check the connection status of the extension cable.</li> <li>Please check that the I/O module or intelligent function module is correctly mounted.</li> <li>Please switch the CPU module to RUN after resetting it. If the same error is displayed, a hardware error may have occurred in the module in which the error occurred. Please consult your local Mitsubishi representative.</li> </ul>
24C0H to 24C1H	System Bus Error	An error of the system bus was detected.	<ul style="list-style-type: none"> <li>Please take anti-noise measures.</li> <li>Please switch the CPU module to RUN after resetting it. If the same error is displayed, a hardware error may have occurred in the CPU module, I/O module, intelligent function module, base unit, or extension cable. Please consult your local Mitsubishi representative.</li> </ul>
24C2H	System Bus Error	An error of the system bus was detected.	<ul style="list-style-type: none"> <li>Please check the connection status of the extension cable.</li> <li>Please take anti-noise measures.</li> <li>Please switch the CPU module to RUN after resetting it. If the same error is displayed, a hardware error may have occurred in the CPU module, I/O module, intelligent function module, base unit, or extension cable. Please consult your local Mitsubishi representative.</li> </ul>
24C3H	System Bus Error	An error of the system bus was detected.	<ul style="list-style-type: none"> <li>Please take anti-noise measures.</li> <li>Please switch the CPU module to RUN after resetting it. If the same error is displayed, a hardware error may have occurred in the CPU module, I/O module, intelligent function module, base unit, or extension cable. Please consult your local Mitsubishi representative.</li> </ul>
24C4H to 24C5H	System Bus Error	An error of the system bus was detected.	<ul style="list-style-type: none"> <li>Please take anti-noise measures.</li> <li>Please switch the CPU module to RUN after resetting it. If the same error is displayed, a hardware error may have occurred in the I/O module, intelligent function module, base unit, or extension cable. Please consult your local Mitsubishi representative.</li> </ul>
24C6H	System Bus Error	An error of the system bus was detected.	<ul style="list-style-type: none"> <li>Please take anti-noise measures.</li> <li>Please switch the CPU module to RUN after resetting it. If the same error is displayed, a hardware error may have occurred in the CPU module or extension cable. Please consult your local Mitsubishi representative.</li> </ul>

Error code	Error name	Error description	Corrective action
24C8H	System Bus Error	An error of the system bus was detected.	<ul style="list-style-type: none"> <li>• Please take anti-noise measures.</li> <li>• Please switch the CPU module to RUN after resetting it. If the same error is displayed, a hardware error may have occurred in the I/O module, intelligent function module, or extension cable. Please consult your local Mitsubishi representative.</li> </ul>
24E0H	System Bus Error	An error of the system bus was detected.	<ul style="list-style-type: none"> <li>• Please take anti-noise measures.</li> <li>• Please switch the CPU module to RUN after resetting it. If the same error is displayed, a hardware error may have occurred in the CPU module or base unit. Please consult your local Mitsubishi representative.</li> </ul>
3000H	Module Parameter Error	There is no module parameter.	<ul style="list-style-type: none"> <li>• Please check the module position set in the system parameter of the CPU module (I/O assignment setting) and the module position of the implemented module. If they are different, please match the parameter and implementation status.</li> <li>• Please write the module parameter again with the engineering tool. If the same error is displayed again, please consult your local Mitsubishi representative.</li> </ul>
3001H	Module Parameter Error	The contents in the module parameter are broken.	Please write the module parameter again with the engineering tool. If the same error is displayed again, please consult your local Mitsubishi representative.
3002H	Module Parameter Error	<ul style="list-style-type: none"> <li>• A parameter which is not supported by the firmware version of the target camera recorder module was written.</li> <li>• The contents in the module parameter are broken.</li> </ul>	<ul style="list-style-type: none"> <li>• Please check the version of the camera recorder module, use a compatible product, and then write the module parameter again.</li> <li>• Please write the module parameter again with the engineering tool. If the same error is displayed again, please consult your local Mitsubishi representative.</li> </ul>
3010H	Module Error	—	<ul style="list-style-type: none"> <li>• Please take anti-noise measures.</li> <li>• Please switch the CPU module to RUN after resetting it. If the same error is displayed, a hardware error may have occurred in the camera recorder module. Please consult your local Mitsubishi representative.</li> </ul>
3013H	Module Error	—	<ul style="list-style-type: none"> <li>• Please take anti-noise measures.</li> <li>• Please switch the CPU module to RUN after resetting it. If the same error is displayed, a hardware error may have occurred in the camera recorder module. Please consult your local Mitsubishi representative.</li> </ul>
3020H	Incompatible CPU Error	The control CPU module does not support the recording function.	Please use a CPU module which supports the recording function.
3021H	Recording Setting Error	A recording setting file which is not supported by the firmware version of the target CPU module was written.	Please check the version of the CPU module, use a compatible product, and then write the recording file again.
3022H	Recording Setting Error	<ul style="list-style-type: none"> <li>• A recording setting file which is not supported by the firmware version of the target CPU module was written.</li> <li>• The contents of the recording setting file are broken.</li> </ul>	<ul style="list-style-type: none"> <li>• Please check the version of the CPU module, use a compatible product, and then write the recording file again.</li> <li>• Please take anti-noise measures.</li> <li>• Please write the recording setting file again. If the same error is displayed, a hardware error may have occurred in the data memory of the CPU module. Please consult your local Mitsubishi representative.</li> </ul>
3023H to 3024H	Recording Setting Error	<ul style="list-style-type: none"> <li>• A recording setting file which is not supported by the firmware version of the target camera recorder module was written.</li> <li>• The contents of the recording setting file are broken.</li> </ul>	<ul style="list-style-type: none"> <li>• Please check the version of the camera recorder module, use a compatible product, and then write the recording file again.</li> <li>• Please take anti-noise measures.</li> <li>• Please write the recording setting file again. If the same error is displayed, a hardware error may have occurred in the data memory of the CPU module. Please consult your local Mitsubishi representative.</li> </ul>
3025H	Recording Setting Error	The module type set in the engineering tool does not match the CPU module which is the write destination of the recording setting file.	Please read the recording setting file, and match the write destination CPU module and model type.

Error code	Error name	Error description	Corrective action
3026H	Recording Setting Error	Device/label data which exceeds the size of the buffer area for data sampling in the CPU parameter is specified in the recording setting file.	Please read the CPU parameter and recording setting file, and reduce the device/label data to be saving targets so that the size is within the buffer area for data sampling in the CPU parameter. Or, please increase the size of the buffer area for data sampling in the CPU parameter.
3027H	Recording Setting Error	The program setting and FB/FUN file setting in the CPU parameter in the CPU module are different from the project (program setting and FB/FUN file setting in the CPU parameter) at recording setting.	<ul style="list-style-type: none"> <li>• Please write the CPU parameter and recording setting file to the CPU module.</li> <li>• Please read the CPU parameter and recording setting file, and write them to the CPU module again.</li> </ul>
3028H	Recording Setting Error	<ul style="list-style-type: none"> <li>• The program file and FB/FUN file in the CPU module are different from the project (program, FB/FUN) at recording setting.</li> <li>• They are different from the program file and FB/FUN file in the CPU module at recording setting because the project (program, FB/FUN) was changed during recording operation.</li> </ul>	<ul style="list-style-type: none"> <li>• Please write the program file, FB/FUN file, and recording setting file to the CPU module.</li> <li>• When the program file and FB/FUN file in the CPU module were changed during recording operation, please write the recording setting file to the CPU module again.</li> <li>• Please read the program file, FB/FUN file, and recording setting file, and write them to the CPU module again.</li> </ul>
3029H	Recording Setting Error	The device/label operation is not set to "Save" in the event history setting of the CPU parameter.	Please set device/label operation to "Save" in the event history setting of the CPU parameter.
3030H to 3031H	Recording Setting Error	A recording setting file which is not supported by the firmware version of the target camera recorder module was written.	Please check the version of the camera recorder module, use a compatible product, and then write the recording file again.
3032H	Recording Setting Error	<ul style="list-style-type: none"> <li>• The mounting position and control CPU of the camera recorder module are different from the ones of the system parameter at the recording setting.</li> <li>• The mode of the module parameter is not set to "Online" or the module status setting of the system parameter (I/O assignment setting) is set to "Empty" in some Main.</li> </ul>	<ul style="list-style-type: none"> <li>• Please check the mounting position and control CPU of the camera recorder module.</li> <li>• Please check the system parameter and actual system configuration.</li> <li>• Please review the recording operation setting of the module parameter and set the number of modules of "Main" to one.</li> <li>• Please remove the module from Main where the module status setting of the system parameter (I/O assignment setting) is set to "Empty".</li> </ul>
3033H	Recording Setting Error	A recording setting file which is not supported by the firmware version of the target camera recorder module was written.	Please check the version of the camera recorder module, use a compatible product, and then write the recording file again.
3034H	Recording Setting Error	The link-direct device, module access device, or CPU buffer memory access device specified for collection does not have an access destination or is out of range.	<ul style="list-style-type: none"> <li>• Please review the device/label sampling target setting in the recording setting.</li> <li>• If the Device/Label sampling target setting is set to the Device/Label batch specification, review the program used to set recording.</li> </ul>
3040H to 3044H	Control CPU Communication Error	Failed to communicate data with the control CPU module.	<ul style="list-style-type: none"> <li>• Please take anti-noise measures.</li> <li>• Please switch the CPU module to RUN after resetting it. If the same error is displayed, a hardware error may have occurred in the camera recorder module. Please consult your local Mitsubishi representative.</li> </ul>
3045H	Control CPU Communication Timeout	The data communication with the control CPU module has timed out.	<ul style="list-style-type: none"> <li>• Please take anti-noise measures.</li> <li>• Please switch the CPU module to RUN after resetting it. If the same error is displayed, a hardware error may have occurred in the camera recorder module. Please consult your local Mitsubishi representative.</li> </ul>
3050H to 3064H	Module Error	—	<ul style="list-style-type: none"> <li>• Please take anti-noise measures.</li> <li>• Please switch the CPU module to RUN after resetting it. If the same error is displayed, a hardware error may have occurred in the camera recorder module. Please consult your local Mitsubishi representative.</li> </ul>
3070H to 3071H	Module Error	—	<ul style="list-style-type: none"> <li>• Please take anti-noise measures.</li> <li>• Please switch the CPU module to RUN after resetting it. If the same error is displayed, a hardware error may have occurred in the camera recorder module. Please consult your local Mitsubishi representative.</li> </ul>

Error code	Error name	Error description	Corrective action
3080H to 308AH	Module Error	—	<ul style="list-style-type: none"> <li>• Please take anti-noise measures.</li> <li>• Please switch the CPU module to RUN after resetting it. If the same error is displayed, a hardware error may have occurred in the camera recorder module. Please consult your local Mitsubishi representative.</li> </ul>
3090H	Module Error	—	<ul style="list-style-type: none"> <li>• Please take anti-noise measures.</li> <li>• Please switch the CPU module to RUN after resetting it. If the same error is displayed, a hardware error may have occurred in the camera recorder module. Please consult your local Mitsubishi representative.</li> </ul>
3092H to 309AH	Module Error	—	<ul style="list-style-type: none"> <li>• Please take anti-noise measures.</li> <li>• Please switch the CPU module to RUN after resetting it. If the same error is displayed, a hardware error may have occurred in the camera recorder module. Please consult your local Mitsubishi representative.</li> </ul>
30A0H to 30A2H	Module Error	—	<ul style="list-style-type: none"> <li>• Please take anti-noise measures.</li> <li>• Please switch the CPU module to RUN after resetting it. If the same error is displayed, a hardware error may have occurred in the camera recorder module. Please consult your local Mitsubishi representative.</li> </ul>
30A8H to 30AAH	Module Error	—	<ul style="list-style-type: none"> <li>• Please take anti-noise measures.</li> <li>• Please switch the CPU module to RUN after resetting it. If the same error is displayed, a hardware error may have occurred in the camera recorder module. Please consult your local Mitsubishi representative.</li> </ul>
3140H to 3142H	Module Error	—	<ul style="list-style-type: none"> <li>• Please take anti-noise measures.</li> <li>• Please switch the CPU module to RUN after resetting it. If the same error is displayed, a hardware error may have occurred in the camera recorder module. Please consult your local Mitsubishi representative.</li> </ul>
3150H	Module Error	—	<ul style="list-style-type: none"> <li>• Please take anti-noise measures.</li> <li>• Please switch the CPU module to RUN after resetting it. If the same error is displayed, a hardware error may have occurred in the camera recorder module. Please consult your local Mitsubishi representative.</li> </ul>
31C0H to 31C4H	Module Error	—	<ul style="list-style-type: none"> <li>• Please take anti-noise measures.</li> <li>• Please switch the CPU module to RUN after resetting it. If the same error is displayed, a hardware error may have occurred in the camera recorder module. Please consult your local Mitsubishi representative.</li> </ul>
31C5H	Module Parameter Error	<ul style="list-style-type: none"> <li>• A module parameter of the recording operation setting which is not supported by the firmware version of the target camera recorder module was written.</li> <li>• The contents in the module parameter are broken.</li> </ul>	<ul style="list-style-type: none"> <li>• Please check the version of the camera recorder module, use a compatible product, and then write the module parameter again.</li> <li>• Please write the module parameter again with the engineering tool. If the same error is displayed again, please consult your local Mitsubishi representative.</li> </ul>
31C6H to 31CAH	Module Error	—	<ul style="list-style-type: none"> <li>• Please take anti-noise measures.</li> <li>• Please switch the CPU module to RUN after resetting it. If the same error is displayed, a hardware error may have occurred in the camera recorder module. Please consult your local Mitsubishi representative.</li> </ul>
3300H to 3303H	Module Error	—	<ul style="list-style-type: none"> <li>• Please take anti-noise measures.</li> <li>• Please switch the CPU module to RUN after resetting it. If the same error is displayed, a hardware error may have occurred in the camera recorder module. Please consult your local Mitsubishi representative.</li> </ul>
3305H	Module Configuration Error	The number of modules set in "Sub" in the camera recorder module has exceeded the available number.	Please set "Sub" in the camera recorder module less than the available number.
3306H	Recording Setting Error	<ul style="list-style-type: none"> <li>• The start I/O No. and mounting position of the camera recorder module are different from the ones of the system parameter at the recording setting.</li> <li>• The recording operation setting of the camera recorder module is different from the one at the recording setting.</li> </ul>	<ul style="list-style-type: none"> <li>• Please check the system parameter and actual system configuration, and review the video data receiving target settings in the recording setting.</li> <li>• Please check the recording operation setting with the module parameter of the camera recorder module and review the video data receiving target settings in the recording setting.</li> </ul>

Error code	Error name	Error description	Corrective action
3405H	Recording Setting Error	A recording setting file which is not supported by the firmware version of the target camera recorder module was written.	Please check the version of the camera recorder module, use a compatible product, and then write the recording file again.
3600H to 3606H	Module Error	—	<ul style="list-style-type: none"> <li>• Please take anti-noise measures.</li> <li>• Please switch the CPU module to RUN after resetting it. If the same error is displayed, a hardware error may have occurred in the camera recorder module. Please consult your local Mitsubishi representative.</li> </ul>
360AH	Module Error	—	<ul style="list-style-type: none"> <li>• Please take anti-noise measures.</li> <li>• Please switch the CPU module to RUN after resetting it. If the same error is displayed, a hardware error may have occurred in the camera recorder module. Please consult your local Mitsubishi representative.</li> </ul>
3C00H to 3C03H	Hardware Error	A hardware error was detected.	<ul style="list-style-type: none"> <li>• Please take anti-noise measures.</li> <li>• Please switch the CPU module to RUN after resetting it. If the same error is displayed, a hardware error may have occurred in the camera recorder module. Please consult your local Mitsubishi representative.</li> </ul>
3C0FH	Hardware Error	A hardware error was detected.	<ul style="list-style-type: none"> <li>• Please take anti-noise measures.</li> <li>• Please switch the CPU module to RUN after resetting it. If the same error is displayed, a hardware error may have occurred in the camera recorder module. Please consult your local Mitsubishi representative.</li> </ul>
3C22H	Memory Error	A memory error was detected.	<ul style="list-style-type: none"> <li>• Please take anti-noise measures.</li> <li>• Please switch the CPU module to RUN after resetting it. If the same error is displayed, a hardware error may have occurred in the camera recorder module. Please consult your local Mitsubishi representative.</li> </ul>
3C2FH	Memory Error	A memory error was detected.	<ul style="list-style-type: none"> <li>• Please take anti-noise measures.</li> <li>• Please switch the CPU module to RUN after resetting it. If the same error is displayed, a hardware error may have occurred in the camera recorder module. Please consult your local Mitsubishi representative.</li> <li>• If this error occurs during the automated hardware test, perform a firmware update and perform the automated hardware test again. If the same error is displayed again, the camera recorder module may have a hardware error. Contact the nearest Mitsubishi Electric System Service Co., Ltd. or Mitsubishi Electric Corporation branch office or agent.</li> </ul>
3C32H	Memory Error	A memory error was detected.	<ul style="list-style-type: none"> <li>• Please take anti-noise measures.</li> <li>• Please switch the CPU module to RUN after resetting it. If the same error is displayed, a hardware error may have occurred in the camera recorder module. Please consult your local Mitsubishi representative.</li> </ul>
3EA0H	Module Error	—	<ul style="list-style-type: none"> <li>• Please take anti-noise measures.</li> <li>• Please switch the CPU module to RUN after resetting it. If the same error is displayed, a hardware error may have occurred in the camera recorder module. Please consult your local Mitsubishi representative.</li> </ul>

\*1 An event is registered as a continuation error when "Error is registered (continuous error)" is selected for "Warning due to program change during recording operation" under "Operation Setting at Event Detection" in the application setting in the module parameter.

## Event code list

The following table shows the event code list of a camera recorder module.

Event code	Event type	Event classification	Overview	Cause
00170	System	Information	Co-recording trigger sending	The co-recording trigger has been sent.
00171	System	Information	Co-recording trigger receiving	The co-recording trigger has been received.
00600	System	Information	Communication Retry Start	<ul style="list-style-type: none"> <li>Because the communication with the network camera was disconnected, the communication retry processing was performed.</li> <li>Unable to receive or store the video shot by the network camera during the communication disconnected period.</li> </ul>
00610	System	Information	Communication Retry Recovery	The communication with the network camera has been recovered.
00C00	System	Warning	Recording Start with Program Inconsistency	It is different from the project (program, FB/FUN) at the recording setting because a program file or FB/FUN file in the CPU module was changed during recording operation. When a device/label that is not a sampling target is added, the added device/label cannot be saved and replayed.
00C01	System	Warning	Program Inconsistency during Recording Operation	It is different from the project (program, FB/FUN) at the recording setting because a program file or FB/FUN file in the CPU module was changed during recording operation. When a device/label that is not a sampling target is added, the added device/label cannot be saved and replayed.
00D01	System	Warning	Network Camera Undetected	Failed to find the target network camera.
00DC0	System	Warning	Network Camera Communication Start Failure	Failed to start communication with the target network camera.
00DF1	System	Warning	Network Camera Communication Failure	Failed to connect to the target network camera.
00E72	System	Warning	Network Camera Communication Failure	Failed to communicate with the target network camera.
20400	Operation	Information	Firmware update succeeded(Camera recorder module)	The firmware of the Camera recorder module was successfully updated.
20401	Operation	Information	Firmware update failed(Camera recorder module)	The firmware update of the Camera recorder module failed.
24020	Operation	Information	Recording Operation Start	The recording operation has been started.
24021	Operation	Information	Recording Operation Stop	The recording operation has been stopped.
24030	Operation	Information	File Saving Trigger Establishment	The file saving trigger has been established.
24031	Operation	Information	Recording Files Saving Completion	Saving the recording files has been completed.
24040	Operation	Information	Error Clear	Errors have been cleared.
24044	Operation	Information	INFO LED Off	INFO LED has been turned off.
24050	Operation	Information	Project Data Saving Start	Saving the project data has been started.
24051	Operation	Information	Project Data Saving Completion	Saving the project data has been completed.
26030	Operation	Information	Execution of Saving by Camera Event Detection	The recording files were saved by camera event detection.
26190	Operation	Information	Live Video Delivery Failure	Failed to perform the live video delivery start processing.
261A0	Operation	Information	Live Video Delivery Failure	Failed to deliver the live video.
261B0	Operation	Information	Live Video Delivery Failure	An error has occurred on the live video receiving side.
261C0	Operation	Information	Live Video Delivery Failure	Failed to perform the live video delivery stop processing.
2A010	Operation	Warning	SD Memory Card Initialization	The SD memory card has been initialized.
2A030	Operation	Warning	Recording Files Saving Completion	<ul style="list-style-type: none"> <li>Saving the recording files has been completed.</li> <li>Failed to save the event history file.</li> </ul>

Event code	Event type	Event classification	Overview	Cause
2A032	Operation	Warning	Recording Files Saving Completion	<ul style="list-style-type: none"> <li>• Saving the recording files has been completed.</li> <li>• The sampled device and label data have exceeded the size that can be stored in the recording buffer.</li> <li>• Please set a sufficient size for the recording buffer in the basic settings of the module parameter.</li> <li>• Please set a shorter saving period before and after the file saving trigger or saving period after the recording startup trigger in the saving period setting of the recording setting.</li> <li>• Please reduce some device and label data to be stored in the Device/Label sampling target setting of the recording settings.</li> </ul>
2A040	Operation	Warning	Recording Files Saving Completion	<ul style="list-style-type: none"> <li>• Saving the recording files has been completed.</li> <li>• Failed to save some video data.</li> </ul>
2A050	Operation	Warning	Project Data Saving Failure	<p>Failed to save the project data because accessing the SD memory card failed due to any one of the following causes.</p> <ul style="list-style-type: none"> <li>• The SD memory card is not inserted.</li> <li>• The access status of the SD memory card is the unmount state.</li> <li>• The write-protect switch of the SD memory card is enabled.</li> </ul>
2A051	Operation	Warning	Project Data Saving Failure	<p>Failed to save the project data to the SD memory card due to any one of the following causes.</p> <ul style="list-style-type: none"> <li>• The free space in the SD memory card is insufficient.</li> <li>• An error of the SD memory card has been detected.</li> </ul>
2A052	Operation	Warning	Project Data Saving Failure	<p>Failed to save the project data because connecting to the file server (the saving path set in the recording setting) failed due to any one of the following causes.</p> <ul style="list-style-type: none"> <li>• The saving path set in the saving path setting does not exist.</li> <li>• The user name/password set in the saving path setting is incorrect.</li> <li>• The host name/IP address set in the saving path setting is incorrect.</li> <li>• Any item in the DNS setting (the basic settings of the module parameter) is incorrect.</li> <li>• The file server is not connected to the network.</li> <li>• The saving path set in the saving path setting or files and folders under them are set Read-only or Encrypt attributes.</li> </ul>
2A053	Operation	Warning	Project Data Saving Failure	<p>Failed to save the project data to the file server (the saving path set in the recording setting) due to any one of the following causes.</p> <ul style="list-style-type: none"> <li>• The free space in the file server is insufficient.</li> <li>• The user set in the saving path setting does not have write authority to the saving path.</li> <li>• An error has been detected at the time of access to the save destination folder due to network disconnection.</li> <li>• An error has been detected since several modules and applications were accessing the saving destination folder simultaneously.</li> <li>• The saving path set in the saving path setting or files and folders under them are set Read-only or Encrypt attributes.</li> </ul>
2A054	Operation	Warning	Project Data Saving Failure	<p>Since the CPU module is not supported by the project data saving function, the project data was not saved.</p>
2A055	Operation	Warning	Project Data Saving Failure	<p>Since the project data in the CPU module was changed while the project data was being saved, the project data was not saved.</p>

Event code	Event type	Event classification	Overview	Cause
2A056	Operation	Warning	Project Data Saving Failure	Failed to save the project data because acquiring the project data from the CPU module failed due to any one of the following causes. <ul style="list-style-type: none"> <li>• The file password (read) is set.</li> <li>• Several modules and applications are accessing the CPU module.</li> </ul>
2A057	Operation	Warning	Project Data Saving Failure	Since initializing the SD memory card was requested, the project data was not saved.



# 6 RECORDER MODULE (DETAILED SPECIFICATIONS)

This chapter explains the function details, module labels, input/output signals, and buffer memory of a recorder module.

## 6.1 Function Details

This section shows the details on the functions of a recorder module.

### Recording function

This function can be used to accumulate devices and labels sampled in a CPU module, and output them and an event history of the CPU module to a recording file and save the file to a save destination specified in the recording setting when a file saving trigger is satisfied.

For details, refer to the following:

☞ Page 16 Recording Function

### SD memory card format function

This function can be used to format an SD memory card inserted in a recorder module.

The procedure is as follows:

#### Operating procedure

1. Check that 'Recording function operation status' (X3) is 'stopped.'
2. If it is 'operating,' switch it to 'stopped' by either of the following operations:
  - Switch a CPU module from RUN to STOP.
  - Stop the recording function in the "Recording Monitor" screen. (☞ Page 142 RECORDING MONITOR)
3. Use GX Works3 to format an SD memory card.

☞ Page 159 SD memory card operation

After formatting, the volume label will be RD81RC96.

### Self-diagnostics function

This function is an internal function to check the hardware health of a recorder module and diagnose whether the module operates properly.

There are two main functions for the self-diagnostics function.

- Automatic hardware test (☞ Page 160 Automatic hardware test)
- Hardware test for LED check (☞ Page 161 Hardware test for LED check)

## Co-recording function

This function can be used to perform recording synchronously on target devices by sending and receiving a co-recording trigger.

For details, refer to the following:

 MELSEC iQ-R System Recorder Co-recording Function Reference Manual

The following explains the operations for sending and receiving a trigger, events when co-recording runs, and considerations for a recorder module when using the co-recording function.

### Sending a co-recording trigger

A co-recording trigger is sent from a recorder module to a CPU module when a trigger condition for a file saving trigger is satisfied.

When configuring multiple modules, a co-recording trigger is sent from the main module.

#### ■Conditions for sending a trigger

A co-recording trigger is sent when all of the following conditions are satisfied:

- The firmware version of a CPU module supports the co-recording function.
- The co-recording setting is set to "Use" in the module parameter. \*1
- The co-recording setting is set to "Use" for a CPU module.
- A file saving trigger satisfied while the operating status of the recording function is 'operating'\*2 is enabled in any of the recording settings. \*3
- A file saving trigger is satisfied but it is not due to receiving a co-recording trigger.
- A CPU module is not in a relay pause period. \*4

\*1 If "Not use" is set, an error occurs.

\*2 The operating status of the recording function can be checked in 'In recording operation' (Un\G1501, Un\G1701, Un\G1901, Un\G2101).

\*3 For whether a file saving trigger is enabled or disabled, refer to the following:

 Page 30 Period during which a file saving trigger is enabled or disabled

\*4 For details on the relay pause period, refer to the following:

 MELSEC iQ-R System Recorder Co-recording Function Reference Manual

#### ■Number of sent or discarded triggers

The number of sent or discarded co-recording triggers can be checked in the following:

- Number of sent co-recording triggers: 'Sent co-recording trigger total count' (Un\G14200)
- Number of discarded co-recording triggers sent: 'Sent co-recording trigger cancel count' (Un\G14201)

## Receiving a co-recording trigger

When a co-recording trigger sent from a CPU module is received, a file saving trigger is satisfied.

When configuring multiple modules, a co-recording trigger is received in the main module.

A sub module operates accordingly when a co-recording trigger is received in the main module and a file saving trigger is satisfied.

### ■Condition for receiving a trigger

A co-recording trigger is received when setting the co-recording setting to "Use" in the module parameter.

When a co-recording trigger is received while the recording function is not running for any of the recording settings<sup>\*1</sup>, it is ignored.

When it is received while the recording function is running for any of the recording settings<sup>\*1</sup>, a file saving trigger is satisfied.

For the operation after a file saving trigger is satisfied, refer to the following:

☞ Page 16 Recording Function

\*1 The operating status of the recording function can be checked in 'In recording operation' (Un\G1501, Un\G1701, Un\G1901, Un\G2101).

#### Point

- After starting a module, it starts receiving a co-recording trigger. (It is ready to receive.)
- If a co-recording trigger sent from a module is received in the module itself, it is ignored.

### ■Number of received or ignored triggers

The number of received or received but ignored co-recording triggers can be checked in the following:

- Number of received co-recording triggers: 'Received co-recording trigger total count' (Un\G14202)
- Number of ignored co-recording triggers received: 'Received co-recording trigger discard count' (Un\G14203)

## Event when co-recording runs

Events are registered in a recorder module when a co-recording trigger is sent and received.<sup>\*1</sup>

For details on the events, refer to the following:

☞ Page 175 Event code list, Page 196 Event code list

\*1 Registered in a main module when configuring multiple modules.

## Considerations

The following shows the considerations for the co-recording function.

### ■Operation when starting a module

When setting the co-recording setting to "Use" in the module parameter, the firmware version<sup>\*1</sup> of a CPU module is checked when starting the module.

If the firmware version does not support co-recording, an error occurs.

After that, when starting the recording function, it starts running but co-recording does not run. (No co-recording triggers are sent or received.)

\*1 For the firmware versions of a CPU module supporting the co-recording function, refer to the following:

📖 MELSEC iQ-R System Recorder Co-recording Function Reference Manual

### ■When configuring multiple modules

If the co-recording setting is set to "Use" in the module parameter and the versions of some sub modules do not support the co-recording function, the recording function starts only on sub modules with versions supporting the co-recording function.<sup>\*1</sup>

\*1 When starting a module, the recording function stops running on sub modules with versions not supporting the function and an error (error code: 1818H) occurs in the main module.

### ■When saving a file in multiple recording settings at the same time

When using the co-recording function, even if a file saving trigger is satisfied in a recording setting of a module and a co-recording trigger is sent, a file is not saved in other recording settings.

To save a file in multiple recording settings at the same time, set the same condition for satisfying a file saving trigger in each recording setting.

# 6.2 Module Labels

This section shows the module labels used to set the input/output signals and buffer memory of a recorder module.

## Module label configuration

The name of a module label is defined in the following configurations:

"Instance name"\_"Module number"."Label name"

"Instance name"\_"Module number"."Label name"\_D

**Ex.**

RC96\_1.stlOSignal.bModuleReady

### ■ Instance name

The instance name of a recorder module (RD81RC96) is 'RC96.'

### ■ Module number

A module number is a number starting from 1, which is added to identify a module that has the same instance name.

### ■ Label name

This is a label name unique to a module.

### ■ \_D

This indicates that the module label is for direct access. Without this symbol, the label is for refresh. There are some differences between refresh and direct access as shown below.

Type	Description	Access timing
Refresh	Values written to/read from a module label are applied to a module in a batch at the time of refresh. This shortens the program execution time.	At the time of refresh
Direct access	Values written to/read from a module label are immediately applied to a module. Although the program execution time is longer than refresh, the responsiveness will be increased.	At the time of writing to/reading from a module label

## 6.3 Input/Output Signals

This section explains the input/output signals of a recorder module.

The following shows an example of assigning input/output signals when the start input/output number of a module is '0.'

A device X indicates an input signal from a module to a CPU module.

A device Y indicates an output signal from a CPU module to a module.

### Precautions

As for input/output signals to a CPU module, do not output (turn ON) 'Use prohibited' signals. Doing so may cause malfunction of a programmable controller system.

### Input/output signal list

The following shows the input/output signal list of a module.

For details on the input/output signals, refer to the following:

☞ Page 205 Input signal details

☞ Page 207 Output signal details

#### Input signals

Device No.	Signal name
X0	Module READY
X1	SD memory card status
X2	File access status
X3	Recording function operation status
X4	INFO LED status
X5	Module stop error status
X6	Module continuation error status
X7 to X1F	Use prohibited

#### Output signals

Device No.	Signal name
Y0	File access stop request
Y1	Clear file access stop request
Y2	Clear INFO LED request
Y3	Error clear request
Y4 to Y1F	Use prohibited

# Input signal details

The following shows the details on the input signals to a CPU module.

## Module READY (X0)

This signal turns ON when a module is ready after turning the power OFF and ON or resetting a CPU module. It turns OFF when a hardware error occurs.

## SD memory card status (X1)

This signal turns ON when an SD memory card is inserted and 'File access status' (X2) is OFF. It turns OFF when an SD memory card is not inserted or 'File access status' (X2) is ON.

## File access status (X2)

● This signal turns ON while file access is stopped or an SD memory card is write-protected.

The following operations can be performed while file access is stopped.

- Insertion/removal method of an SD memory card (MELSEC iQ-R System Recorder User's Manual (Startup))

The status is in the following state while file access is stopped.

- SD memory card read/write-protected
- This signal turns OFF when a file is accessible.

The following shows time charts of 'File access status' (X2) and its related input/output signals.

- When inserting or removing an SD memory card

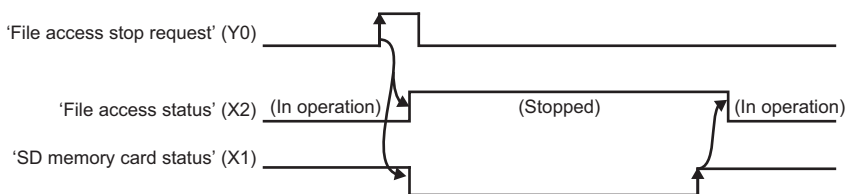

- When not inserting or removing an SD memory card

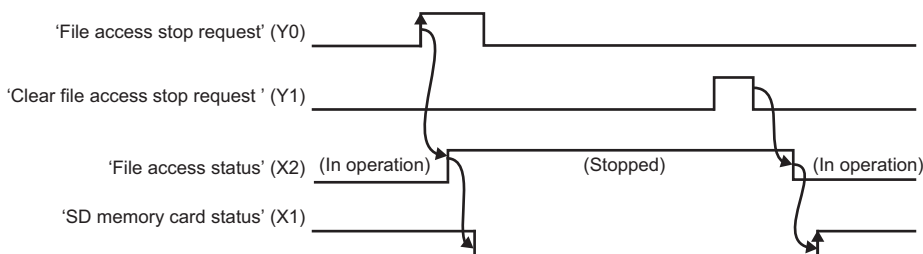

## Recording function operation status (X3)

This signal turns ON while the recording function is running for any of the recording settings. (Page 114 RECORDING SETTING)

It turns OFF when the recording function is stopped for all recording settings.

For the operating status for a recording setting, refer to the following:

Page 63 Operating status

## INFO LED status (X4)

This signal turns ON when the INFO LED turns ON.

For the factor that the INFO LED turns ON, refer to the following:

☞ Page 158 Module information list

It turns OFF when turning 'Clear INFO LED request' (Y2) ON while the INFO LED is ON.

In addition, it turns OFF when switching the status of a CPU module from STOP to RUN.

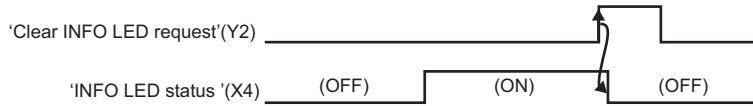

## Module stop error status (X5)

This signal is ON while a module stop error is occurring.

## Module continuation error status (X6)

This signal is ON while a module continuation error is occurring.

It turns OFF when turning 'Error clear request' (Y3) ON.



# Output signal details

The following shows the details on the output signals to a CPU module.

## Point

The output signals will be enabled when they turn from OFF to ON. In addition, they are not turned from ON to OFF by a system. To turn the signals ON again, turn them from ON to OFF once, then OFF to ON.

### File access stop request (Y0)

When turning this signal ON, accessing a file in an SD memory card is stopped.

For details, refer to the following:

☞ Page 205 File access status (X2)

### Clear file access stop request (Y1)

Turn this signal ON when 'File access stop request' is accidentally turned ON.

When turning this signal ON without replacing an SD memory card after turning 'File access stop request' ON, file access restarts.

For details, refer to the following:

☞ Page 205 File access status (X2)

### Clear INFO LED request (Y2)

When turning this signal ON while the INFO LED is ON, the following operations are performed:

- The INFO LED is turned OFF.
- 'INFO LED status' (X4) is turned OFF.
- 'INFO LED lighting factor' (Un\G12) is cleared.

### Error clear request (Y3)

When turning this signal ON while a module continuation error is occurring, the following operations are performed:

- The ERR LED is turned OFF.
- 'Module continuation error status' (X6) is turned OFF.
- 'Current error area' (Un\G140 to 149) are cleared.
- 'Error log' (Un\G150 to 311) are cleared.

## 6.4 Buffer Memory

This section explains the buffer memory of a recorder module.

### Precautions

- Do not write any data in the "system area" of the buffer memory. Doing so may cause malfunction of a programmable controller system.

### Buffer memory list

The following table shows the buffer memory list of a recorder module.

R: Read-only, W: Write-only, R/W: Readable/Writable

Address Dec (Hex)	Application	Name	Initial value	R/W
0 (0H)	Module status area	RUN LED status	0	R
1 (1H)		ERR LED status	0	R
2 (2H)		CARD RDY LED status	0	R
3 (3H)		System area	—	—
4 (4H)		OPR LED status	0	R
5 (5H)		INFO LED status	0	R
6 to 11 (6H to BH)		System area	—	—
12 (CH)		INFO LED lighting factor	0	R
13 to 16 (DH to 10H)		System area	—	—
17 (11H)		Recording operation setting	0	R
18 to 20 (12H to 14H)		System area	—	—
21 to 22 (15H to 16H)		SD memory card information area	SD memory card total capacity	0
23 to 24 (17H to 18H)	SD memory card free capacity		0	R
25 (19H)	SD memory card usage rate		0	R
26 to 27 (1AH to 1BH)	SD memory card usage capacity		0	R
28 to 46 (1CH to 2EH)	System area	—	—	

Address Dec (Hex)	Application	Name	Initial value	R/W	
47 to 54 (2FH to 36H)	Network connection status area	IP address (string notation)	—	R	
55 to 56 (37H to 38H)		IP address	0	R	
57 to 58 (39H to 3AH)		Subnet mask	0	R	
59 to 60 (3BH to 3CH)		Default gateway	0	R	
61 to 62 (3DH to 3EH)		DNS server 1 address	0	R	
63 to 64 (3FH to 40H)		DNS server 2 address	0	R	
65 to 69 (41H to 45H)		System area	—	—	
70 (46H)	Common setting status area	IP address specification method	0	R	
71 to 72 (47H to 48H)		IP address	0	R	
73 to 74 (49H to 4AH)		Subnet mask	0	R	
75 to 76 (4BH to 4CH)		Default gateway	0	R	
77 to 78 (4DH to 4EH)		DNS server 1 address	0	R	
79 to 80 (4FH to 50H)		DNS server 2 address	0	R	
81 to 86 (51H to 56H)		System area	—	—	
87 to 139 (57H to 8BH)	System area		—	—	
140 (8CH)	Current error area	Error code	0	R	
141 (8DH)		System area	—	—	
142 to 147 (8EH to 93H)		Time	0	R	
148 to 149 (94H to 95H)		System area	—	—	
150 (96H)	Error log area	Error count	0	R	
151 (97H)		Error log write pointer	0	R	
152 (98H)		Error log 1	Error code	0	R
153 (99H)			System area	—	—
154 to 159 (9AH to 9FH)			Time	0	R
160 to 161 (A0H to A1H)		System area	—	—	
162 to 311 (A2H to 137H)		Error log 2 to 16	Same as error log 1		
312 to 809 (138H to 329H)	System area		—	—	
810 (32AH)	Operation setting at event detection area	Error registration at warning (type: system) detection	Warning due to program change during recording operation	0	R
811 to 841 (32BH to 349H)		System area		—	—

Address Dec (Hex)	Application	Name	Initial value	R/W
842 to 1499 (34AH to 5DBH)	System area		—	—

Address Dec (Hex)	Application	Name	Initial value	R/W	
1500 (5DCH)	Recording status area	Recording status 1	System area	—	—
1501 (5DDH)			In recording operation	0	R
1502 (5DEH)			Recording start error	0	R
1503 (5DFH)			Recording start error cause	0	R
1504 (5E0H)			File saving trigger monitor	0	R
1505 (5E1H)			Recording files saving	0	R
1506 (5E2H)			Data sampling	0	R
1507 (5E3H)			Recording buffer storing status	0	R
1508 (5E4H)			Recording files saving completion	0	R
1509 (5E5H)			Recording files saving error	0	R
1510 (5E6H)			Recording files saving completion code	0	R
1511 (5E7H)			Recording files saving count	0	R/W
1512 to 1513 (5E8H to 5E9H)			System area	—	—
1514 (5EAH)			Recording files saving progress	0	R
1515 to 1522 (5EBH to 5F2H)			Recording files saving path (setting type folder)	0	R
1523 to 1555 (5F3H to 613H)			Recording files saving path (under setting type folder)	0	R
1556 to 1574 (614H to 626H)			System area	—	—
1575 (627H)			Recording startup trigger count	0	R
1576 (628H)			Invalid recording startup trigger count	0	R
1577 (629H)			File saving trigger count	0	R
1578 (62AH)			Invalid file saving trigger count	0	R
1579 to 1580 (62BH to 62CH)			Average device/label sampling interval	0	R
1581 to 1582 (62DH to 62EH)			Average device/label sampling size	0	R
1583 to 1584 (62FH to 630H)			Device/label maximum sampling period	0	R
1585 (631H)			Recording buffer status	0	R
1586 (632H)			Sampling execution time (ms unit)	0	R
1587 (633H)			Sampling execution time ( $\mu$ s unit)	0	R
1588 (634H)			Accumulating execution time (ms unit)	0	R
1589 (635H)			Accumulating execution time ( $\mu$ s unit)	0	R
1590 to 1699 (636H to 6A3H)			System area	—	—

Address Dec (Hex)	Application	Name		Initial value	R/W		
1700 to 2299 (6A4H to 8FBH)	Recording status area	Recording status 2 to 4	Same as recording status 1				
2300 to 3199 (8FCH to C7FH)		System area		—	—		
3200 (C80H)	Recording setting information area	Recording setting information 1	Recording buffer size	0	R		
3201 to 3202 (C81H to C82H)			Saving period	0	R		
3203 (C83H)			Saving setting when there is no free folder number	0	R		
3204 (C84H)			Recording startup trigger specification	0	R		
3205 (C85H)			Recording startup trigger establishment condition	0	R		
3206 (C86H)			Saving specification after the specified time has elapsed from recording completion	0	R		
3207 to 3208 (C87H to C88H)			Waiting time from recording completion to file saving	0	R		
3209 (C89H)			Establishment condition of file saving trigger	0	R		
3210 (C8AH)			Recording files saving destination	0	R		
3211 to 3249 (C8BH to CB1H)			System area		—	—	
3250 (CB2H)			Saving specification when CPU stop error is detected	0	R		
3251 to 3266 (CB3H to CC2H)			Establishment condition of file saving trigger (Extended)	0	R		
3267 to 3299 (CC3H to CE3H)			System area		—	—	
3300 to 3599 (CE4H to E0FH)			Recording setting information 2 to 4		Same as recording setting information 1		
3600 to 3999 (E10H to F9FH)			System area		—	—	

Address Dec (Hex)	Application	Name	Initial value	R/W		
4000 (FA0H)	Recording operation specification area	Recording operation specification 1	System area	—	—	
4001 (FA1H)			Recording buffer batch saving mode	0	R/W	
4002 to 4003 (FA2H to FA3H)			Folder name additional data 1	0	R/W	
4004 to 4005 (FA4H to FA5H)			Folder name additional data 2	0	R/W	
4006 (FA6H)			System area	—	—	
4007 (FA7H)			File saving trigger	0	R/W	
4008 (FA8H)			Timeout detection of file saving trigger	0	R/W	
4009 to 4016 (FA9H to FB0H)			Folder name additional data 3	0	R/W	
4017 to 4024 (FB1H to FB8H)			System area	—	—	
4025 to 4032 (FB9H to FC0H)			Folder name additional data 4	0	R/W	
4033 to 4099 (FC1H to 1003H)			System area	—	—	
4100 to 4399 (1004H to 112FH)			Recording operation specification 2 to 4	Same as recording operation specification 1		
4400 to 4799 (1130H to 12BFH)			System area	—	—	
4800 to 8999 (12C0H to 2327H)	System area		—	—		
9000 to 9255 (2328H to 2427H)	File server saving area	File server saving 1	Recording files saving path (setting type folder)	0	R	
9256 to 9399 (2428H to 24B7H)			System area	—	—	
9400 to 10599 (24B8H to 2967H)		File server saving 2 to 4	Same as file server saving 1			
10600 to 10999 (2968H to 2AF7H)		System area	—	—		
11000 to 13391 (2AF8H to 344FH)	System area		—	—		

Address Dec (Hex)	Application	Name			Initial value	R/W		
13392 (3450H)	Firmware update history information	Firmware update completion with/without an error			0	R		
13393 to 13401 (3451H to 3459H)		System area			—	—		
13402 (345AH)	Firmware update history information	Latest firmware update information	History information	Execution time (year)	0	R		
13403 (345BH)				Execution time (month)	0	R		
13404 (345CH)				Execution time (day)	0	R		
13405 (345DH)				Execution time (hour)	0	R		
13406 (345EH)				Execution time (minute)	0	R		
13407 (345FH)				Execution time (second)	0	R		
13408 (3460H)				Execution time (day of the week)	0	R		
13409 (3461H)				Firmware version after update	0	R		
13410 (3462H)				Firmware version before update	0	R		
13411 (3463H)				Latest firmware update result		Firmware update target	0	R
13412 (3464H)						Firmware update result	0	R
13413 (3465H)				Previous firmware update information	History information	Execution time (year)	0	R
13414 (3466H)		Execution time (month)	0			R		
13415 (3467H)		Execution time (day)	0			R		
13416 (3468H)	Execution time (hour)	0	R					
13417 (3469H)	Execution time (minute)	0	R					
13418 (346AH)	Execution time (second)	0	R					
13419 (346BH)	Execution time (day of the week)	0	R					
13420 (346CH)	Firmware version after update	0	R					
13421 (346DH)	Firmware version before update	0	R					
13422 (346EH)	Previous firmware update result		Firmware update target			0	R	
13423 (346FH)			Firmware update result	0	R			
13424 to 13427 (3470H to 3473H)	System area			—	—			
13428 to 13999 (3474H to 36AFH)	System area			—	—			



Address Dec (Hex)	Application	Name	Initial value	R/W		
14000 (36B0H)	Project data saving status area	Project data saving status 1	Project data saving	0	R	
14001 (36B1H)			Project data saving completion	0	R	
14002 (36B2H)			Project data saving result	0	R	
14003 to 14004 (36B3H to 36B4H)			Project data saving completion code	0	R	
14005 (36B5H)			Project data saving progress	0	R	
14006 to 14009 (36B6H to 36B9H)			System area	—	—	
14010 to 14039 (36BAH to 36D7H)		Project data saving status 2 to 4	Same as project data saving status 1			
14040 to 14079 (36D8H to 36FFH)	System area	—				
14080 (3700H)	Project data saving specification area	Project data saving specification 1		0	R/W	
14081 to 14083 (3701H to 3703H)		Project data saving specification 2 to 4	Same as project data saving specification 1			
14084 to 14199 (3704H to 3777H)		System area	—			
14200 (3778H)	Co-recording status area	Sent co-recording trigger total count		0	R	
14201 (3779H)		Sent co-recording trigger cancel count		0	R	
14202 (377AH)		Received co-recording trigger total count		0	R	
14203 (377BH)		Received co-recording trigger discard count		0	R	
14204 to 14249 (377CH to 37A9H)		System area			—	—
14250 (37AAH)	Co-recording setting information area	Co-recording setting		0	R	
14251 to 14299 (37ABH to 37DBH)		System area			—	—
14300 to 30003 (37DCH to 7533H)	System area			—	—	
30004 to 30011 (7534H to 753BH)	SD memory card history information area	System area			—	—
30012 to 30013 (753CH to 753DH)		Write count		0	R	
30014 (753EH)		System area			—	—
30015 to 48025 (753FH to BB99H)	System area			—	—	

## Buffer memory details



The following explains the buffer memory details of a recorder module.

## Module status area (Un\G0 to 20)

The status of each LED of a recorder module can be checked.

Buffer memory name	Address	Description
RUN LED status	Un\G0	0: OFF 1: ON
ERR LED status	Un\G1	0: OFF 1: ON 2: Flashing
CARD RDY LED status	Un\G2	0: OFF 1: ON
OPR LED status	Un\G4	0: OFF 1: ON
INFO LED status	Un\G5	0: OFF 1: ON
INFO LED lighting factor <sup>*1</sup>	Un\G12	The factor that the INFO LED turns ON is stored. • b0: ON: SD memory card free capacity lowering • b1: ON: No save folder free number
Recording operation setting <sup>*2</sup>	Un\G17	The recording operation setting of a recorder module is stored. 0: Main

\*1 Check the INFO LED lighting factor, and take a corrective action shown in the following table:

Lighting factor	Location to check	Corrective action
SD memory card free capacity lowering	b0	Check 'SD memory card information area' (Un\G21 to 27) in the buffer memory to make sure that there is a sufficient free space. Delete unnecessary recording files in an SD memory card for a required capacity.  Page 164 Troubleshooting on INFO LED
No save folder free number	b1	It turns ON if there is no free folder number when and after saving a recording file. Delete unnecessary recording files from an SD memory card as necessary.  Page 164 Troubleshooting on INFO LED

\*2 Only for a recorder module the version of which is 04 or later.

## SD memory card information area (Un\G21 to 27)

The status of an SD memory card inserted in a recorder module can be checked.

Buffer memory name	Address	Description
SD memory card total capacity	Un\G21 to 22	The capacity of an SD memory card is stored (unit: KB).
SD memory card free capacity	Un\G23 to 24	The free space on an SD memory card is stored (unit: KB).
SD memory card usage rate	Un\G25	The usage rate of an SD memory card is stored (unit: %).
SD memory card usage capacity	Un\G26 to 27	The usage capacity of an SD memory card is stored (unit: KB).

## Network connection status area (Un\G47 to 69)

The network connection status of a recorder module can be checked.

Buffer memory name	Address	Description
IP address (string notation)	Un\G47 to 54	Stored as a string.
IP address	Un\G55 to 56	Stored as a double word (32-bit value). • Un\G55: Third octet, fourth octet • Un\G56: First octet, second octet
Subnet mask	Un\G57 to 58	Stored as a double word (32-bit value). • Un\G57: Third octet, fourth octet • Un\G58: First octet, second octet
Default gateway	Un\G59 to 60	Stored as a double word (32-bit value). • Un\G59: Third octet, fourth octet • Un\G60: First octet, second octet
DNS server 1 address	Un\G61 to 62	Stored as a double word (32-bit value). • Un\G61: Third octet, fourth octet • Un\G62: First octet, second octet
DNS server 2 address	Un\G63 to 64	Stored as a double word (32-bit value). • Un\G63: Third octet, fourth octet • Un\G64: First octet, second octet

## Common setting status area (Un\G70 to 86)

The status of the own node setting in the common setting can be checked.

Buffer memory name	Address	Description
IP address specification method	Un\G70	The specification method of an IP address is stored. 0: Acquire Automatically 1: Specify
IP address	Un\G71 to 72	Stored as a double word (32-bit value). • Un\G71: Third octet, fourth octet • Un\G72: First octet, second octet
Subnet mask	Un\G73 to 74	Stored as a double word (32-bit value). • Un\G73: Third octet, fourth octet • Un\G74: First octet, second octet
Default gateway	Un\G75 to 76	Stored as a double word (32-bit value). • Un\G75: Third octet, fourth octet • Un\G76: First octet, second octet
DNS server 1 address	Un\G77 to 78	Stored as a double word (32-bit value). • Un\G77: Third octet, fourth octet • Un\G78: First octet, second octet
DNS server 2 address	Un\G79 to 80	Stored as a double word (32-bit value). • Un\G79: Third octet, fourth octet • Un\G80: First octet, second octet

## Current error area (Un\G140 to 149)

The latest code of an error occurring can be checked.

Buffer memory name	Address	Description
Error code	Un\G140	The latest error code is stored.
Time	Un\G142	b0 to 7: Time zone and summer time flag b8 to 15: System area
	Un\G143	b0 to 7: Last two digits of the year b8 to 15: Month (01 to 12)
	Un\G144	b0 to 7: Day (01 to 31) b8 to 15: Hour (00 to 23)
	Un\G145	b0 to 7: Minute (00 to 59) b8 to 15: Second (00 to 59)
	Un\G146	b0 to 7: Day of the week (0: Sun, 1: Mon, 2: Tue, 3: Wed, 4: Thu, 5: Fri, 6: Sat) b8 to 15: First two digits of the year
	Un\G147	b0 to 7: First two digits of the millisecond b8 to 15: Last two digits of the millisecond

### ■Error code (Un\G140)

An error code is stored.

### ■Time (Un\G142 to 149)

The time when an error occurred is stored as a BCD code.

	b15	...	b8	b7	...	b0
Un\G142	System area			Time zone and summer time flag *1		
Un\G143	Month (01H to 12H)			Year (00H to 99H) last 2 digits		
Un\G144	Hour (00H to 23H)			Day (01H to 31H)		
Un\G145	Second (00H to 59H)			Minute (00H to 59H)		
Un\G146	Year (00H to 99H) first 2 digits			Day of the week (0H to 6H)		
Un\G147	Lower milliseconds (00H to 99H)			Upper milliseconds (00H to 09H)		

\*1 Time zone and summer time flag details are as follows:

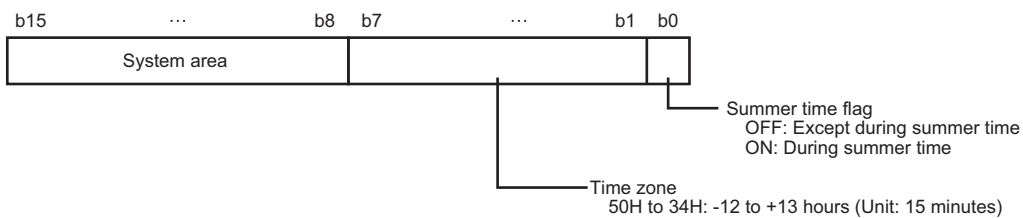

## Error log area (Un\G150 to 311)

The history of an error occurred in a recorder module can be checked.

Buffer memory name	Address	Description	
Error count	Un\G150	The total number of times an error log is registered in the error log area is stored.	
Error log write pointer	Un\G151	An error log number in which the latest error log is registered is stored. 0: No error 1 to 16: Error log number	
Error log 1	Error code	Un\G152	An error code is stored.
	Time	Un\G154	b0 to 7: Time zone and summer time flag b8 to 15: System area
		Un\G155	b0 to 7: Last two digits of the year b8 to 15: Month (01 to 12)
		Un\G156	b0 to 7: Day (01 to 31) b8 to 15: Hour (00 to 23)
		Un\G157	b0 to 7: Minute (00 to 59) b8 to 15: Second (00 to 59)
		Un\G158	b0 to 7: Day of the week (0: Sun, 1: Mon, 2: Tue, 3: Wed, 4: Thu, 5: Fri, 6: Sat) b8 to 15: First two digits of the year
Un\G159	b0 to 7: First two digits of the millisecond b8 to 15: Last two digits of the millisecond		
Error log 2 to 16	Un\G162 to 311	Details are the same as error log 1.	

### ■Error count (Un\G150)

The total number of times an error log is registered in the error log area is stored.

### ■Error log write pointer (Un\G151)

An error log number in which the latest error log is registered is stored. (When '16' is stored, the latest error log is registered in the area of error log 16.)

Up to 15 continuation errors and 1 stop error are registered.

If 15 continuation errors are displayed, new continuation errors will not be registered. If the new error has the same error code as the already registered error, the error occurrence date/time and its detailed information will not be updated.

Even if a new error occurs after a stop error occurs, the new one is not registered.

## ■ Error log (Un\G152 to 311)

The history of an error occurred in a recorder module is stored.

The error log area consists of 16 error logs with the same data configuration.

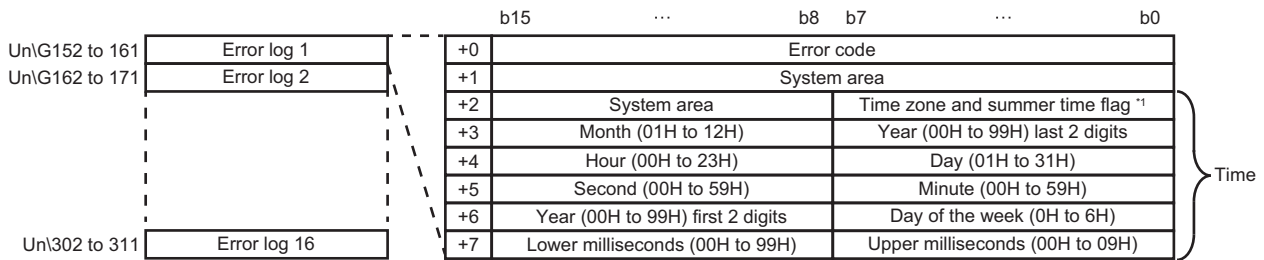

\*1 Time zone and summer time flag details are as follows:

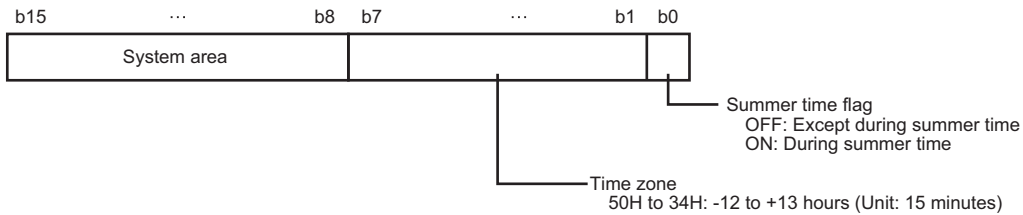

### ● Error code

An error code is stored.

### ● Time

The time when an error occurred is stored as a BCD code.

## Operation setting at event detection area (Un\G810 to 841)

The operation setting at event detection can be checked.

Buffer memory name	Address	Description
Error registration at warning (type: system) detection	Un\G810	The status for "Warning due to program change during recording operation" set in the module parameter is stored. 0: Error is not registered 1: Error is registered (continuous error)

## Recording status area (Un\G1500 to 3199)

The recording status can be checked.

Buffer memory name	Address	Description
Recording status 1	Un\G1501	The operating status of the recording function is stored. (☞ Page 63 Operating status) 0: Stopped 1: Operating The timing when a value is stored differs depending on the version of a recorder module used. For details, refer to the following: ☞ Page 224 In recording operation (Un\G1501)
Recording start error* <sup>1</sup>	Un\G1502	The status of an error when the recording function starts running is stored. 0: No error 1: Error exists The timing when a value is stored differs depending on the version of a recorder module used. For details, refer to the following: ☞ Page 224 Recording start error (Un\G1502)
Recording start error cause* <sup>1</sup>	Un\G1503	The code of an error that occurs when the recording function starts running is stored. 0: No error Values other than 0: Error code The timing when a value is stored differs depending on the version of a recorder module used. For details, refer to the following: ☞ Page 224 Recording start error cause (Un\G1503)
File saving trigger monitor	Un\G1504	The status of a file saving trigger is stored. 0: Unsatisfied 1: Satisfied When '1' (satisfied) is stored, recording startup triggers and file saving triggers are disabled. The period during which '1' (satisfied) is stored differs depending on the version of a recorder module used. For details, refer to the following: ☞ Page 225 File saving trigger monitor (Un\G1504)
Recording files saving	Un\G1505	The saving status of a recording file is stored. 0: Not saving 1: Saving The timing when a value is stored differs depending on the version of a recorder module used. For details, refer to the following: ☞ Page 225 Recording files saving (Un\G1505)
Data sampling	Un\G1506	The sampling or accumulation status of devices and labels is stored. 0: Not sampling 1: Sampling ■When selecting "File Saving Trigger Only" for the recording method • '1' (sampling) is stored when the recording function starts running ('1' (operating) is stored in 'In recording operation' (Un\G1501)) after starting the function. • '0' (not sampling) is stored when saving a recording file starts, and '1' (sampling) is stored after the file saving is completed. • '0' (not sampling) is stored when stopping the operation of the recording function or a module stop error occurs. ■When selecting "Recording Startup Trigger + File Saving Trigger" for the recording method • '1' (sampling) is stored when a recording startup trigger is satisfied, and '0' (not sampling) is stored after devices and labels for a saving period are accumulated. • When '1' (sampling) is stored, data accumulation stops and '0' (not sampling) is stored if the capacity of accumulated data exceeds that of the recording buffer. (☞ Page 60 Recording buffer) • '0' (not sampling) is stored when stopping the operation of the recording function or a module stop error occurs.

Buffer memory name		Address	Description
Recording status 1	Recording buffer storing status* <sup>1</sup>	Un\G1507	Whether data in a sampled device and label is accumulated in the recording buffer is stored. 0: No data 1: Data exists '1' (data exists) is stored when a device and label are sampled and data is accumulated in the recording buffer. '0' (no data) is stored when saving a recording file starts. When a recording startup trigger is satisfied, accumulated data is discarded and '0' (no data) is stored. When the operating status switches to 'operating' after starting the recording function, '0' (no data) is stored. (It is initialized to '0' (no data).)
	Recording files saving completion* <sup>1</sup>	Un\G1508	The completion status of recording file saving is stored. 0: Not completed 1: Completed The timing when a value is stored differs depending on the version of a recorder module used. For details, refer to the following: ☞ Page 225 Recording files saving completion (Un\G1508)
	Recording files saving error* <sup>1</sup>	Un\G1509	The status of an error when saving a recording file is stored. 0: No error 1: Error exists The timing when a value is stored differs depending on the version of a recorder module used. For details, refer to the following: ☞ Page 225 Recording files saving error (Un\G1509)
	Recording files saving completion code* <sup>1</sup>	Un\G1510	The code of an error occurred when saving a recording file is stored. 0: No error Values other than 0: File saving failed (error code) The timing when a value is stored differs depending on the version of a recorder module used. For details, refer to the following: ☞ Page 225 Recording files saving completion code (Un\G1510)
	Recording files saving count* <sup>1</sup>	Un\G1511	The number of recording file saving executions (both successful and failed) is stored. It is initialized to '0' when the operating status switches to 'operating' after turning the power ON or resetting a CPU module and starting the recording function. In addition, it is initialized to '0' when the operating status switches to 'operating' after adding or changing a recording setting and starting the recording function. When it reaches 65535 times, it returns to 1 and continues counting. If it is reset, '0' is stored. (Value to be stored: 0 to 65535)
	Recording files saving progress* <sup>1</sup>	Un\G1514	The progress rate (%) of recording file saving is stored. For a recorder module the version of which is 04 or later, the progress rate of all recording settings including sub modules is stored. It is initialized to '0' when the operating status switches to 'operating' after a file saving trigger is satisfied or starting the recording function. (Value to be stored: 0 to 100%)



Buffer memory name	Address	Description
Recording status 1	Recording files saving path (setting type folder) <sup>*1</sup>	Un\G1515 to 1522 The path to the setting type folder for a recording file last saved to an SD memory card is stored. It is initialized to '0' when the operating status switches to 'operating' after a file saving trigger is satisfied or starting the recording function. (Example) When the path to a recording file is /SD/RECORD/RC1/1TS01_001, /SD/RECORD/RC1/ is stored.
	Recording files saving path (under setting type folder) <sup>*1</sup>	Un\G1523 to 1555 The path under the setting type folder to a last saved recording file is stored. It is initialized to '0' when the operating status switches to 'operating' after a file saving trigger is satisfied or starting the recording function. (Example) When the path to a recording file is /SD/RECORD/RC1/1TS01_001, 1TS01_001 is stored.
	Recording startup trigger count <sup>*1*2</sup>	Un\G1575 When the operating status of the recording function is 'operating,' the number of times that a recording startup trigger was detected to have been satisfied is stored. (Value to be stored: 0 to 65535)
	Invalid recording startup trigger count <sup>*1*2</sup>	Un\G1576 When the operating status of the recording function is 'operating,' the number of invalid recording startup triggers among the recording startup triggers detected to have been satisfied is stored. (Value to be stored: 0 to 65535)
	File saving trigger count <sup>*1*2</sup>	Un\G1577 When the operating status of the recording function is 'operating,' the number of times that a file saving trigger was detected to have been satisfied is stored. (Value to be stored: 0 to 65535)
	Invalid file saving trigger count <sup>*1*2</sup>	Un\G1578 When the operating status of the recording function is 'operating,' the number of invalid file saving triggers among the file saving triggers detected to have been satisfied is stored. (Value to be stored: 0 to 65535)
	Average device/label sampling interval <sup>*1*3</sup>	Un\G1579 to 1580 The average value of device and label sampling intervals is stored (unit: millisecond). It is calculated based on eight moving averages. If an average value exceeds 4294967295 milliseconds, 4294967295 is stored.
	Average device/label sampling size <sup>*1*3</sup>	Un\G1581 to 1582 The average size of devices and labels to be sampled at a time is stored (unit: KB).
	Device/label maximum sampling period <sup>*1*3</sup>	Un\G1583 to 1584 The maximum period during which a device and label can be sampled in the current setting is stored (unit: second). A period is calculated with the following formula each time a device and label are sampled. • Recording buffer size ÷ Average device/label sampling size × Average device/label sampling interval If a period exceeds 4294967295 seconds, 4294967295 is stored.
	Recording buffer status <sup>*1</sup>	Un\G1585 Whether the recording buffer capacity is sufficient for a saving period set in the recording setting is stored. 0: Sufficient 1: Insufficient '1' (insufficient) is stored when a value in 'Device/label maximum sampling period' (Un\G1583 to 1584) is smaller than a set saving period. If a value in 'Device/label maximum sampling period' (Un\G1583 to 1584) and a set saving period are extremely close, '0' (sufficient) and '1' (insufficient) may be stored alternately in a short time. It is initialized to '0' (sufficient) when the operating status switches to 'operating' after starting the recording function.
	Sampling execution time (ms unit)	Un\G1586 The data sampling execution time of a CPU module is stored. <sup>*4*5*6</sup> When using a recording startup trigger or specifying a device as a file saving trigger, the time required for trigger detection is also included.
	Sampling execution time (μs unit)	Un\G1587 Note that when an interrupt program is executed during the END processing, the execution time of the interrupt program is also included in the sampling time, and if the program execution time of a CPU module is shorter than the accumulating execution time of a recorder module, the accumulating execution time is included in the sampling execution time of the CPU module. • Sampling execution time (ms unit): An ms digit is stored (value to be stored: 0 to 65535). • Sampling execution time (μs unit): A μs digit is stored (value to be stored: 0 to 999).

Buffer memory name		Address	Description
Recording status 1	Accumulating execution time (ms unit)	Un\G1588	The data accumulating execution time of a recorder module is stored. <sup>*6*7*8</sup> <ul style="list-style-type: none"> <li>Accumulating execution time (ms unit): An ms digit is stored (value to be stored: 0 to 65535).</li> <li>Accumulating execution time (μs unit): A μs digit is stored (value to be stored: 0 to 999).</li> </ul>
	Accumulating execution time (μs unit)	Un\G1589	
Recording status 2 to 4		Un\G1700 to 2299	Details are the same as recording status 1.

\*1 A value is not updated when the operating status is 'stopped.'

\*2 '0' is stored when powering ON or resetting a CPU module.

It starts from '0' when the operating status switches to 'operating' after adding or changing a recording setting and starting the recording function. When it reaches 65535 times, it returns to 1 and continues counting.

\*3 If the number of times for data sampling is not sufficient for calculation after data sampling starts, an error occurs.

It is cleared to the initial value (0) when the operating status switches to 'operating' after starting the recording function.

\*4 A value is updated when data in a CPU module is sampled.

\*5 When the sampling execution time is 23.6 ms, it is stored as follows:

Sampling execution time (ms unit): 23

Sampling execution time (μs unit): 600

\*6 Initialized to '0' in any of the following cases:

The power is turned ON.

A CPU module is reset.

The recording function is started.

\*7 A value is updated when data accumulation for a recorder module is completed.

\*8 When the accumulating execution time is 23.6 ms, it is stored as follows:

Accumulating execution time (ms unit): 23

Accumulating execution time (μs unit): 600

### ■ In recording operation (Un\G1501)

Each value is stored at each timing as follows:

Value	Version 03 or earlier	Version 04 or later
0 (stopped)	<ul style="list-style-type: none"> <li>The recording function is stopped<sup>*1</sup> or a module stop error occurs.</li> </ul>	<ul style="list-style-type: none"> <li>The recording function is stopped, and a recorder module and all sub modules with recording target data stop operating.<sup>*1</sup></li> <li>A module stop error occurs in a recorder module.</li> </ul>
1 (operating)	<ul style="list-style-type: none"> <li>The recording function starts running after starting the function.</li> </ul>	<ul style="list-style-type: none"> <li>A recorder module and all sub modules with recording target data start operating after starting the recording function.<sup>*2</sup></li> </ul>

\*1 When the operating status is 'saving trigger establishment' or 'saving,' a value is stored at either of the following timings:

Version 03 or earlier: After saving is completed

Version 04 or later: After saving is completed in a recorder module and all sub modules with recording target data

\*2 If there is any sub module that cannot start operating, a value is stored when the other sub modules and a recorder module start operating.

### ■ Recording start error (Un\G1502)

Each value is stored at each timing as follows:

Value	Version 03 or earlier	Version 04 or later
0 (no error)	<ul style="list-style-type: none"> <li>The operating status switches to 'preparing' after starting the recording function. (It is initialized to '0' (no error).)</li> </ul>	<ul style="list-style-type: none"> <li>The operating status of a recorder module switches to 'preparing' after starting the recording function. (It is initialized to '0' (no error).)</li> </ul>
1 (error exists) <sup>*1</sup>	<ul style="list-style-type: none"> <li>A CPU module or recorder module cannot start recording due to an error after starting the recording function.</li> </ul>	<ul style="list-style-type: none"> <li>A CPU module or recorder module cannot start recording due to an error after starting the recording function.</li> <li>There is any sub module with recording target data that cannot start recording after starting the recording function.</li> </ul>

\*1 An error cause can be checked in 'Recording start error cause' (Un\G1503).

### ■ Recording start error cause (Un\G1503)

Each value is stored at each timing as follows:

Value	Version 03 or earlier	Version 04 or later
0 (no error)	<ul style="list-style-type: none"> <li>The operating status switches to 'preparing' after starting the recording function. (It is initialized to '0' (no error).)</li> </ul>	<ul style="list-style-type: none"> <li>The operating status of a recorder module switches to 'preparing' after starting the recording function. (It is initialized to '0' (no error).)</li> </ul>
Values other than 0 (error code)	<ul style="list-style-type: none"> <li>A CPU module or recorder module cannot start recording due to an error after starting the recording function.</li> </ul>	<ul style="list-style-type: none"> <li>A CPU module or recorder module cannot start recording due to an error after starting the recording function.</li> <li>There is any sub module with recording target data that cannot start recording after starting the recording function.</li> </ul>

### ■File saving trigger monitor (Un\G1504)

'1 (satisfied)' is stored during either of the following periods:

Value	Version 03 or earlier	Version 04 or later
1 (satisfied)	<ul style="list-style-type: none"> <li>From when a file saving trigger is satisfied to when saving is completed</li> </ul>	<ul style="list-style-type: none"> <li>From when a file saving trigger is satisfied to when saving is completed in a recorder module and all sub modules with recording target data</li> </ul>

### ■Recording files saving (Un\G1505)

Each value is stored at each timing as follows:

Value	Version 03 or earlier	Version 04 or later
0 (not saving)	<ul style="list-style-type: none"> <li>Saving a recording file is completed.</li> </ul>	<ul style="list-style-type: none"> <li>Saving a recording file is completed in a recorder module and all sub modules with recording target data.</li> </ul>
1 (saving)	<ul style="list-style-type: none"> <li>Saving a recording file is started.</li> </ul>	<ul style="list-style-type: none"> <li>Saving a recording file is started.</li> </ul>

### ■Recording files saving completion (Un\G1508)

Each value is stored at each timing as follows:

Value	Version 03 or earlier	Version 04 or later
0 (not completed)	<ul style="list-style-type: none"> <li>A file saving trigger is satisfied.</li> <li>The operating status switches to 'operating' after starting the recording function. (It is initialized to '0' (not completed).)</li> </ul>	<ul style="list-style-type: none"> <li>A file saving trigger is satisfied.</li> <li>The operating status of a recorder module switches to 'operating' after starting the recording function. (It is initialized to '0' (not completed).)</li> </ul>
1 (completed)	<ul style="list-style-type: none"> <li>Saving a recording file is completed.</li> </ul>	<ul style="list-style-type: none"> <li>Saving a recording file is completed in a recorder module and all sub modules with recording target data.</li> </ul>

### ■Recording files saving error (Un\G1509)

Each value is stored at each timing as follows:

Value	Version 03 or earlier	Version 04 or later
0 (no error)	<ul style="list-style-type: none"> <li>A file saving trigger is satisfied.</li> <li>The operating status switches to 'operating' after starting the recording function. (It is initialized to '0' (no error).)</li> </ul>	<ul style="list-style-type: none"> <li>A file saving trigger is satisfied.</li> <li>The operating status of a recorder module switches to 'operating' after starting the recording function. (It is initialized to '0' (no error).)</li> </ul>
1 (error exists)	<ul style="list-style-type: none"> <li>Saving a recording file fails.</li> </ul>	<ul style="list-style-type: none"> <li>Saving a recording file fails in a recorder module.</li> <li>Saving a recording file fails in a sub module with recording target data.</li> <li>There is video data that failed to be saved in all sub modules with recording target data.</li> </ul>

### ■Recording files saving completion code (Un\G1510)

Each value is stored at each timing as follows:

Value	Version 03 or earlier	Version 04 or later
0 (no error)	<ul style="list-style-type: none"> <li>A file saving trigger is satisfied.</li> <li>The operating status switches to 'operating' after starting the recording function. (It is initialized to '0' (no error).)</li> </ul>	<ul style="list-style-type: none"> <li>A file saving trigger is satisfied.</li> <li>The operating status of a recorder module switches to 'operating' after starting the recording function. (It is initialized to '0' (no error).)</li> </ul>
Values other than 0 (error code)	<ul style="list-style-type: none"> <li>Saving a recording file fails.</li> </ul>	<ul style="list-style-type: none"> <li>Saving a recording file fails in a recorder module.</li> <li>Saving a recording file fails in a sub module with recording target data.</li> <li>There is video data that failed to be saved in all sub modules with recording target data.</li> </ul>

## Recording setting information area (Un\G3200 to 3999)

Setting information of recording settings can be checked.

Buffer memory name	Address	Description
Recording setting information 1 <sup>*1</sup>	Recording buffer size	Un\G3200 The recording buffer capacity set in the module parameter is stored (unit: MB).
	Saving period	Un\G3201 to 3202 A saving period set in the recording setting is stored (unit: second). ■When selecting "File Saving Trigger Only" for the recording method Total saving period before and after trigger ■When selecting "Recording Startup Trigger + File Saving Trigger" for the recording method Accumulation period
	Saving setting when there is no free folder number	Un\G3203 A saving setting when there is no free folder number set in the recording setting is stored. 0: Overwrite 1: Not save
	Recording startup trigger specification	Un\G3204 A recording startup trigger specification set in the recording setting is stored. 0: Not specify (when selecting "File Saving Trigger Only" for the recording method) 1: Specify (when selecting "Recording Startup Trigger + File Saving Trigger" for the recording method)
	Recording startup trigger establishment condition <sup>*2</sup>	Un\G3205 The condition for satisfying a recording startup trigger set in the recording setting is stored in b0. OFF: Rising ON: Falling
	Saving specification after the specified time has elapsed from recording completion <sup>*2</sup>	Un\G3206 The saving specification after the specified time has elapsed from recording completion set in the recording setting is stored. 0: Not specify 1: Specify
	Waiting time from recording completion to file saving <sup>*3</sup>	Un\G3207 to 3208 The waiting time from recording completion to file saving set in the recording setting is stored (unit: second).
	Establishment condition of file saving trigger <sup>*4</sup>	Un\G3209 The condition for satisfying a file saving trigger set in the recording setting is stored. OFF: Rising <sup>*5</sup> ON: Falling
	Recording files saving destination	Un\G3210 The save destination for a recording file set in the recording setting is stored. 0: SD memory card 1: File server
	Saving specification when CPU stop error is detected	Un\G3250 The saving specification when a CPU stop error is detected set in the recording setting is stored. 0: Not specify 1: Specify
Recording setting information 2 to 4 <sup>*1</sup>	Establishment condition of file saving trigger (Extended) <sup>*6</sup>	Un\G3251 to 3266 The condition for satisfying a file saving trigger set in the recording setting is stored. 0: Rising 1: Falling 2: Timeout
		Un\G3300 to 3599 Details are the same as recording setting information 1.

- \*1 A value is updated when the operating status switches to 'operating.'
- \*2 Enabled only when specifying a recording startup trigger.
- \*3 Enabled only when specifying a recording startup trigger and selecting the checkbox of "Save after specified time elapses from recording completion."
- \*4 Check the set condition in each of the following buffer memories:

Condition number	1	2	3	4	5	6	7	8	9	10	11	12	13	14	15	16
Recording setting No.1: Un\G3209	b0	b1	b2	b3	b4	b5	b6	b7	b8	b9	b10	b11	b12	b13	b14	b15
Recording setting No.2: Un\G3309	b0	b1	b2	b3	b4	b5	b6	b7	b8	b9	b10	b11	b12	b13	b14	b15
Recording setting No.3: Un\G3409	b0	b1	b2	b3	b4	b5	b6	b7	b8	b9	b10	b11	b12	b13	b14	b15
Recording setting No.4: Un\G3509	b0	b1	b2	b3	b4	b5	b6	b7	b8	b9	b10	b11	b12	b13	b14	b15

- \*5 'OFF' is stored even when specifying a timeout as the condition. Check the condition in 'Establishment condition of file saving trigger (Extended)' (Un\G3251 to 3266).
- \*6 Check the set condition in each of the following buffer memories:

Condition number	1	2	3	4	5	6	7	8	9	10	11	12	13	14	15	16
Recording setting No.1: Un\G	3251	3252	3253	3254	3255	3256	3257	3258	3259	3260	3261	3262	3263	3264	3265	3266
Recording setting No.2: Un\G	3351	3352	3353	3354	3355	3356	3357	3358	3359	3360	3361	3362	3363	3364	3365	3366
Recording setting No.3: Un\G	3451	3452	3453	3454	3455	3456	3457	3458	3459	3460	3461	3462	3463	3464	3465	3466
Recording setting No.4: Un\G	3551	3552	3553	3554	3555	3556	3557	3558	3559	3560	3561	3562	3563	3564	3565	3566

## Recording operation specification area (Un\G4000 to 4799)

File saving triggers for recording, the recording buffer batch saving mode, and data values added to save folder names can be checked.

Buffer memory name	Address	Description
Recording operation specification 1	Recording buffer batch saving mode	Un\G4001 Use this to specify the recording buffer batch saving mode. When enabling this mode, '1' (ON) is stored. 0: Not use the batch saving mode (OFF) 1: Use the batch saving mode (ON)
	Folder name additional data 1	Un\G4002 to 4003 Data 1 added to a recording file save folder name. Use this when specifying "DATA1" as additional information for a recording file save folder name.
	Folder name additional data 2	Un\G4004 to 4005 Data 2 added to a recording file save folder name. Use this when specifying "DATA2" as additional information for a recording file save folder name.
	File saving trigger	Un\G4007 Use this for file saving triggers.
	Timeout detection of file saving trigger*1	Un\G4008 Use this to specify whether to enable or disable timeout detection. 0: Enabled 1: Disabled
	Folder name additional data 3	Un\G4009 to 4016 Data 3 added to a recording file save folder name. Use this when specifying "DATA3" as additional information for a recording file save folder name.
	Folder name additional data 4	Un\G4025 to 4032 Data 4 added to a recording file save folder name. Use this when specifying "DATA4" as additional information for a recording file save folder name.
Recording operation specification 2 to 4	Un\G4100 to 4399	Details are the same as recording operation specification 1.

\*1 '0' is stored when powering ON or resetting a CPU module.

### ■Recording buffer batch saving mode (Un\G4001)

Use this to specify the recording buffer batch saving mode. (☞ Page 62 Recording buffer batch saving mode)

A value when a file saving trigger is satisfied will be valid.

'0' (not use the batch saving mode) is stored at either of the following timings:

- A CPU module is powered ON or reset.
- The operating status switches to 'operating' after writing a recording setting.

### ■Folder name additional data 1 to 4 (Un\G4002 to 4003, Un\G4004 to 4005, Un\G4009 to 4016, Un\G4025 to 4032)

Use these to specify data added to a recording file save folder name. (☞ Page 49 Recording file)

When setting "DATA1," "DATA2," "DATA3," or "DATA4" as additional information for a folder name, a value in the buffer memory is added to the folder name.

A value when a file saving trigger is satisfied will be valid.

A value is cleared to the initial value (0) at either of the following timings:

- A CPU module is powered ON or reset.
- The operating status switches to 'operating' after writing a recording setting.

### ■File saving trigger (Un\G4007)

Use this for file saving triggers.

It can be used in bit units.

A condition number is added to each bit as follows:

Condition number	1	2	3	4	5	6	7	8	9	10	11	12	13	14	15	16
Recording setting No.1: Un\G4007	b0	b1	b2	b3	b4	b5	b6	b7	b8	b9	b10	b11	b12	b13	b14	b15
Recording setting No.2: Un\G4107	b0	b1	b2	b3	b4	b5	b6	b7	b8	b9	b10	b11	b12	b13	b14	b15
Recording setting No.3: Un\G4207	b0	b1	b2	b3	b4	b5	b6	b7	b8	b9	b10	b11	b12	b13	b14	b15
Recording setting No.4: Un\G4307	b0	b1	b2	b3	b4	b5	b6	b7	b8	b9	b10	b11	b12	b13	b14	b15

A value is cleared to the initial value (OFF) at either of the following timings:

- A module is started.
- The operating status switches to 'operating' after writing a recording setting.

## File server saving information area (Un\G9000 to 10999)

The path to the setting type folder for a recording file saved to a file server can be checked.

Buffer memory name	Address	Description
File server saving 1	Recording files saving path (setting type folder)	Un\G9000 to 9255
		The path to the setting type folder for a last saved recording file is stored in Unicode. It is initialized to '0' when the operating status switches to 'operating' after a file saving trigger is satisfied or starting the recording function. A value is not updated when the operating status is 'stopped.' (Example) When the path to a recording file is /HOSTNAME/SAVE/RECORD/RC1/1TS01_001, /HOSTNAME/SAVE/RECORD/RC1/ is stored.*1
File server saving 2 to 4		Un\G9400 to 10599
		Details are the same as file server saving 1.

\*1 '1TS01\_001' is stored in 'Recording files saving path (under setting type folder)' (Un\G1523 to 1555).

## Firmware update history information area (Un\G13392 to 13427)

The firmware update history information of a recorder module can be checked.

Buffer memory name	Address	Description		
Firmware update completion with/without an error	Un\G13392	The error occurrence state on the firmware update function is stored. <ul style="list-style-type: none"> <li>• 0: Update completed without an error (including successful completion)</li> <li>• 1: Update completed with an error</li> </ul> When any of 100 to 300H is stored in 'Firmware update result' (Un\G13412), '1' is stored.		
System area	Un\G13393 to 13401	Use prohibited		
Latest firmware update information	History information	Execution time (year)	Un\G13402	The value of the year (four digits) when the firmware update was executed is stored as a BIN code.
		Execution time (month)	Un\G13403	The value of the month when the firmware update was executed is stored as a BIN code.
		Execution time (day)	Un\G13404	The value of the day when the firmware update was executed is stored as a BIN code.
		Execution time (hour)	Un\G13405	The value of the hour when the firmware update was executed is stored as a BIN code.
		Execution time (minute)	Un\G13406	The value of the minutes when the firmware update was executed is stored as a BIN code.
		Execution time (second)	Un\G13407	The value of the seconds when the firmware update was executed is stored as a BIN code.
		Execution time (day of the week)	Un\G13408	The value of the day of the week when the firmware update was executed is stored as a BIN code. (0: Sun, 1: Mon, 2: Tue, 3: Wed, 4: Thu, 5: Fri, 6: Sat)
		Firmware version after update	Un\G13409	The firmware version after update is stored. (When the update is completed with an error, '0' is stored.)
		Firmware version before update	Un\G13410	The firmware version before update is stored.
Latest firmware update result	Firmware update target	Un\G13411	The start input/output number of the module where the firmware update was executed is stored.	
	Firmware update result	Un\G13412	The execution result of the firmware update is stored. <ul style="list-style-type: none"> <li>• 1H: Normal end</li> <li>• 100H: Flash ROM error</li> <li>• 200H: Model mismatched</li> <li>• 201H: File invalid</li> <li>• 203H: Firmware update prohibited state</li> <li>• 300H: Firmware data error</li> </ul>	

Buffer memory name		Address	Description
Previous firmware update information	History information	Execution time (year)	Un\G13413 The value of the year (four digits) when the firmware update was executed is stored as a BIN code.
		Execution time (month)	Un\G13414 The value of the month when the firmware update was executed is stored as a BIN code.
		Execution time (day)	Un\G13415 The value of the day when the firmware update was executed is stored as a BIN code.
		Execution time (hour)	Un\G13416 The value of the hour when the firmware update was executed is stored as a BIN code.
		Execution time (minute)	Un\G13417 The value of the minutes when the firmware update was executed is stored as a BIN code.
		Execution time (second)	Un\G13418 The value of the seconds when the firmware update was executed is stored as a BIN code.
		Execution time (day of the week)	Un\G13419 The value of the day of the week when the firmware update was executed is stored as a BIN code. (0: Sun, 1: Mon, 2: Tue, 3: Wed, 4: Thu, 5: Fri, 6: Sat)
		Firmware version after update	Un\G13420 The firmware version after update is stored. (When the update is completed with an error, '0' is stored.)
		Firmware version before update	Un\G13421 The firmware version before update is stored.
Previous firmware update result	Firmware update target	Un\G13422 The start input/output number of the module where the firmware update was executed is stored.	
	Firmware update result	Un\G13423 The execution result of the firmware update is stored. • 1H: Normal end • 100H: Flash ROM error • 200H: Model mismatched • 201H: File invalid • 203H: Firmware update prohibited state • 300H: Firmware data error	

## Project data saving status area (Un\G14000 to 14079)

The saving status of project data can be checked for each recording setting.

A value in this area is cleared to the initial value (0) at the following timing:

- A CPU module is powered ON or reset.

Buffer memory name		Address	Description
Project data saving status 1	Project data saving	Un\G14000	The saving status of project data for recording setting No.1 is stored. • 0: Not saving • 1: Saving • 2: Preparing for saving
	Project data saving completion	Un\G14001	Whether saving project data for recording setting No.1 is completed is stored. • 0: Not completed • 1: Completed
	Project data saving result	Un\G14002	The saving result of project data for recording setting No.1 is stored. • 0: No failure • 1: Failure
	Project data saving completion code	Un\G14003 to 14004	The saving completion code of project data for recording setting No.1 is stored. • 0: No failure • Values other than 0: Failure (event code)
	Project data saving progress	Un\G14005	The progress rate (%) of project data saving to the save destination for recording setting No.1 is stored. It is initialized to '0' when starting project data saving. (Value to be stored: 0 to 100%)
Project data saving status 2 to 4		Un\G14010 to 14039	Details are the same as project data saving status 1.

### ■Project data saving

Whether project data is being saved to the save destination for a recording file set in the recording setting is stored.

Each value is stored at each timing as follows:

- Not saving (0): Saving project data is completed.
- Saving (1): Saving project data starts.
- Preparing for saving (2): Preparation for project data saving starts.



### ■Project data saving completion

Whether saving project data is completed is stored.

Each value is stored at each timing as follows:

- Not completed (0): Preparation for project data saving starts.
- Completed (1): Saving project data is completed.

### ■Project data saving result

The saving result of project data is stored.

Each value is stored at each timing as follows:

- No failure (0): Preparation for project data saving starts.
- Failure (1): Saving project data fails.

### ■Project data saving completion code

The saving completion code for project data is stored. If the saving fails, an event code is stored.

Each value is stored at each timing as follows:

- No failure (0): Preparation for project data saving starts.
- Event code: Saving project data fails.

## Project data saving specification area (Un\G14080 to 14199)

Whether to save project data to a save destination for a recording file can be specified for each recording setting.

Buffer memory name	Address	Description
Project data saving specification 1	Un\G14080	Use this to specify whether to save project data to a save destination for a recording file specified in recording setting No.1. • 0: OFF (not save) • 1: ON (save)
Project data saving specification 2 to 4	Un\G14081 to 14083	Details are the same as project data saving specification 1.

### ■Project data saving specification 1 to 4 (Un\G14080 to 14083)

Use this to specify whether to save project data to a save destination for a recording file set in the recording setting for each recording setting.

A value is cleared to the initial value (0) at either of the following timings:

- A CPU module is powered ON or reset.
- Saving project data is completed.

'ON' (1) is stored in the following case:

- "Save" is selected for "Automatic Saving at Recording Start" in the module parameter when the recording function starts running.

### Precautions

The operation is disabled while project data is being saved or prepared for saving.

Whether project data is being saved can be checked in 'Project data saving' (Un\G14000, Un\G14010, Un\G14020, Un\G14030).

## Co-recording status area (Un\G14200 to 14249)

The co-recording status can be checked.

A value in this area is cleared to the initial value (0) at the following timing:

- A CPU module is powered ON or reset.

Buffer memory name	Address	Description
Sent co-recording trigger total count	Un\G14200	The number of sent co-recording triggers is stored. (Value to be stored: 0 to 65535)* <sup>1</sup>
Sent co-recording trigger cancel count	Un\G14201	The number of unsent co-recording triggers is stored. (Value to be stored: 0 to 65535)* <sup>1</sup>
Received co-recording trigger total count	Un\G14202	The number of received co-recording triggers is stored. (Value to be stored: 0 to 65535)* <sup>1</sup>
Received co-recording trigger discard count	Un\G14203	The number of disabled co-recording triggers among those received is stored. (Value to be stored: 0 to 65535)* <sup>1</sup>

\*<sup>1</sup> When it reaches 65535 times, it returns to 1 and continues counting.

## Co-recording setting information area (Un\G14250 to 14299)

The co-recording setting can be checked.

A value in this area is cleared to the initial value (0) at the following timing:

- A CPU module is powered ON or reset.

Buffer memory name	Address	Description
Co-recording setting	Un\G14250	Whether to use co-recording is stored. 0: Not use 1: Use

## SD memory card history information area (Un\G30004 to 30014)

The history information of an SD memory card inserted in a recorder module can be checked.

Buffer memory name	Address	Description
Write count*1	Un\G30012 to 30013	The number of writes to an SD memory card is stored.*2 An SD memory card has a life (a limit on the number of times for writing data), and use a value in this buffer memory as a guide to determine the time for replacement.

\*1 Available for SD memory cards manufactured by Mitsubishi Electric only. For the SD memory cards, refer to the following:

📖 MELSEC iQ-R System Recorder User's Manual (Startup)

\*2 The update frequency of the write count may differ depending on an SD memory card used.

# 7 CAMERA RECORDER MODULE (DETAILED SPECIFICATIONS)

This chapter explains the function details, module labels, input/output signals, and buffer memory of a camera recorder module.

## 7.1 Function Details

This section shows the details on the functions of a camera recorder module.

### Recording function

This function can be used to accumulate data (devices and labels) sampled in a CPU module and video data delivered from a network camera, and save them and an event history of the CPU module as a recording file when a file saving trigger is satisfied.

For details, refer to the following:

 Page 16 Recording Function

### Network camera communication function

This function can be used to communicate with a network camera via a network.

By communicating with a network camera, the following functions can be used.

Function	Description	Reference
Search	To search for up to 32 ONVIF supported network cameras in the same network as a camera recorder module.	Page 235 Search
Account authentication	To authenticate an account to connect a camera recorder module to an ONVIF supported network camera.	Page 235 Account authentication
Specific information monitoring <sup>*1</sup>	To acquire specific information of a network camera.	Page 236 Specific information monitoring
Video data delivery setting <sup>*1</sup>	To set parameters of a network camera connected to a camera recorder module.	Page 237 Video data delivery setting
Video data reception and accumulation <sup>*1</sup>	To receive and accumulate video data delivered from a network camera.	Page 238 Video data reception and accumulation
Time synchronization control <sup>*1</sup>	To synchronize the time between a camera recorder module and a network camera.	Page 238 Time synchronization control
PTZ control <sup>*1</sup>	To perform PTZ control on a network camera if it is supported by the network camera.	Page 238 PTZ control
Alive check <sup>*1</sup>	To periodically monitor whether the communication is established with a network camera.	Page 238 Alive check
Camera event reception	To configure the camera event notification setting for a network camera. With this setting, camera events can be received from a network camera.	Page 239 Camera event reception

\*1 Can be used after account authentication is successful.

#### Point

A minor error that occurs in the communication with a network camera can be changed to a warning.

If changed, it is not displayed as an error for the ERROR LED, in the module diagnostics, and buffer memory of a camera recorder module.

For details on the setting, refer to the following:

 Page 100 Operation setting at event detection

## Search

Up to 32 ONVIF supported network cameras in the same network as a camera recorder module can be searched for. This function can be performed in the "Network Camera List" screen in the module extended parameter. (☞ Page 107 Network camera list screen)

By using this function, an ONVIF supported network camera can be detected from an actual system configuration and information on the network camera (IP address and TCP port number) can be applied to the "Camera Individual Settings" screen. (☞ Page 105 Camera individual setting)

## Precautions

- This function can be used when 'stopped' is stored in 'In recording operation' (Un\G1501, Un\G1701, Un\G1901, Un\G2101) of a camera recorder module.
- If 33 or more ONVIF supported network cameras are connected on the same network, the 33rd and later ones are not recognized. They are recognized in order from a found one.
- A manufacturer name may be displayed including a model name in the "Network Camera List" screen.

## Account authentication

An account can be authenticated to connect a camera recorder module to an ONVIF supported network camera. For account authentication, the camera type, IP address, TCP port number, user ID, and password of a target network camera must be specified in the module extended parameter and written to a camera recorder module. (☞ Page 103 Module Extended Parameters (Camera Recorder Module))

### Point

- Before writing module extended parameters, a user ID and password can be checked in advance by performing the communication test in the "Communication Test" screen in the module extended parameter. (☞ Page 108 Communication test screen)
- The communication test can be performed if both of the following conditions are satisfied:
  - 'Stopped' is stored in 'In recording operation' (Un\G1501, Un\G1701, Un\G1901, Un\G2101) of a camera recorder module.
  - Three or less network cameras are connected to a camera recorder module.\*1

\*1 Check the number of connected network cameras in 'Network camera setting enabled/disabled' (Un\G34000, Un\G34500, Un\G35000, Un\G35500). (☞ Page 282 Network camera status area (Un\G34000 to 37999))

## Precautions

- Specify the values set for a network camera to be connected for the IP address, TCP port number, user ID, and password in the module extended parameter.
- An account is authenticated when the communication with a network camera starts. If the camera type, IP address, or TCP port number is incorrect, a network camera undetected error (error code: 1D01H) occurs. In addition, if the user ID or password is incorrect, a network camera account authentication error (error code: 1D30H) occurs.
- Some ONVIF supported network cameras may require an account for ONVIF communication. For details, refer to the manual for a network camera used or visit the ONVIF website ([www.onvif.org/conformant-products](http://www.onvif.org/conformant-products)).

## Specific information monitoring

Specific information of a network camera can be acquired.

Acquired information can be checked in the following screens or buffer memory; however, information that can be checked differs for each screen.

- "Network Camera List" screen in the module extended parameter (☞ Page 107 Network camera list screen)
- "Communication Test" screen in the module extended parameter (☞ Page 108 Communication test screen)
- Buffer memory of a camera recorder module (setting information in the network camera 1 to 4 status areas) (☞ Page 282 Network camera status area (Un\G34000 to 37999))

○: Can be checked, ×: Cannot be checked

Information	Network camera list screen <sup>*1</sup>	Communication test screen <sup>*1</sup>	Buffer memory <sup>*2</sup>
Camera manufacturer name	○	○	○
Camera model name	○	○	○
IP address	○	×	○
TCP port number	○	×	○
Camera F/W version	×	○	○
MAC address	×	○	○
Resolution support list <sup>*3</sup>	×	○	○
Frame rate support upper/lower limit value	×	○	○
PT support	×	○	○
Z support	×	○	○
PTZ speed support	×	○	○
Video rotation angle support <sup>*4</sup>	×	○	○
SNTP client function support	×	○	○
Camera event type support list <sup>*5</sup>	×	○	○

\*1 Information on a network camera acquired when searching for the network camera or performing the communication test is displayed.

\*2 Information on a network camera acquired when starting the communication with the network camera is displayed.

\*3 A resolution that can be set for a network camera in a camera recorder module is displayed.

\*4 Whether the video rotation angle can be set for a network camera in a camera recorder module is displayed.

\*5 A camera event type that can be set for a network camera in a camera recorder module is displayed.

## Video data delivery setting

Parameters of a network camera connected to a camera recorder module can be set.

When setting an ONVIF supported network camera for the camera type, the simple setting mode can be used. (☞ Page 237 Simple setting mode)

The parameters can be set in the "Camera Individual Settings" screen in the module extended parameter. (☞ Page 105 Camera individual setting)

Items that can be set are as follows:

Item	Description
Resolution	Set the resolution of video data. The higher the resolution, the larger the file size and the shorter the saving period.
Video Frame Rate	Set the number of frames of video data delivered from a network camera per second. The higher the video frame rate, the larger the file size and the shorter the saving period.
Video Codec	Set the encoding method for video data. <ul style="list-style-type: none"> <li>• Motion JPEG: The video quality does not deteriorate because JPEG still images are played continuously. The bit rate is higher than H.264; therefore, the file size is larger and the saving period is shorter.</li> <li>• H.264: Only the part of a video changed from the reference frame is sent. The video quality is lower than Motion JPEG, but the file size can be reduced and the saving period is longer.</li> </ul>
Video Rotation Angle	Set the video rotation angle of video data.
Video Quality	Set the video quality of video data. The higher the video quality, the larger the file size and the shorter the saving period. <ul style="list-style-type: none"> <li>• High: The video quality is high, but the file size is large.</li> <li>• Middle: The video quality and file size are intermediate values between 'high' and 'low.'</li> <li>• Low: The video quality is low, but the file size is small.</li> </ul>
Maximum Video Bit Rate	Set the maximum bit rate of video data delivered from a network camera per second. By limiting the bit rate of video data, the video quality becomes lower but the effect on other network devices can be reduced. Even when limiting the maximum video bit rate, a network camera operates to maintain the video quality; therefore, the bit rate value may exceed a set value depending on the combination of setting values of resolution/frame rate/video codec/video quality. When selecting Motion JPEG for the video codec under the required settings, the maximum video bit rate is not applied.

## Precautions

- The range that can be set differs for each network camera. For details, refer to the manual for a network camera used or perform the communication test in the "Communication Test" screen in the module extended parameter to check the range. (☞ Page 108 Communication test screen)
- If setting a parameter out of the setting range, either of the following errors occurs:
  - Network camera video setting error (error code: 1D50H, 1D51H, 1D52H)
  - Network camera video rotation angle unsupported error (error code: 1D80H)

## Simple setting mode

The parameter setting can be configured with the minimum required items for an ONVIF supported network camera connected to a camera recorder module.

Set whether to enable the simple setting mode in the "Camera Individual Settings" screen in the module extended parameter. The resolution and video frame rate can be set for a network camera in the simple setting mode, and the video rotation angle, video quality, and maximum video bit rate are automatically set according to a network camera used.

## Video data reception and accumulation

Video data delivered from a network camera can be received and accumulated.

Based on information set in the following section, video data is delivered from a network camera.

☞ Page 237 Video data delivery setting

For details on video data reception and accumulation, refer to the following:

☞ Page 16 Recording Function

### Point

When using multiple recording settings in one module, a frame of video data being received may be lost if the video data is saved and received at the same time. To reduce the number of lost frames, refer to the following:

☞ Page 101 Operation setting at video data saving

## Time synchronization control

The time can be synchronized between a camera recorder module and a network camera.

For details, refer to the following:

☞ Page 240 Camera time synchronization function

## PTZ control

PTZ control can be performed on a network camera if it is supported by the network camera.

For details, refer to the following:

☞ Page 245 Camera adjustment function (PTZ)

## Alive check

Whether the communication is established with a network camera can be monitored periodically.

If the communication is interrupted, retries are performed every one second.

If 10 seconds elapse for a retry, a network camera communication error (error code: 1DF1H) occurs.

The retry continues even if an error occurs, and video data reception from a network camera restarts when the retry is successful.

In addition, a communication retry start (event code: 00600) and communication retry recovery (event code: 00610) are registered in the event history.

### Point

The connection status can be checked for each network camera in 'Network camera connection status' (Un\G34300, Un\G34800, Un\G35300, Un\G35800) of a camera recorder module. (☞ Page 282 Network camera status area (Un\G34000 to 37999))

## Precautions

- When replacing a network camera with one with the same IP address, the communication restarts if the new network camera can operate with the same network camera setting.
- Some network cameras stop delivering video data if disconnected for a long time. In this case, it may take a long time to recover by a communication retry.



## Camera event reception

Camera events detected by a network camera can be received in a camera recorder module.

To receive camera events, the camera event setting is required.

The camera event setting can be configured in the "Camera Individual Settings" screen in the module extended parameter. (  Page 105 Camera individual setting)

The following type of camera event can be received from a network camera.

Camera event type	Description
Motion detection	Videos are compared in a network camera, and a camera event is reported if there is any change.

The camera event receiving status of a network camera can be monitored for each recording setting in 'Camera event receiving status' (Un\G1593 to Un\G1596). (  Page 271 Recording status area (Un\G1500 to 3199))

Note that there is a period during which camera event reception is disabled.

Whether a file saving trigger is satisfied by camera event reception is determined for each unit of END processing in sequence scans of a CPU module while the recording function is running.

Therefore, if multiple camera events are received before the END processing, the second and subsequent ones are invalid.

The numbers of camera events and invalid camera events received can be monitored for each recording setting.

Check the numbers in 'Number of camera events receiving' (Un\G1601 to Un\G1604) and 'Number of invalid camera events receiving' (Un\G1609 to Un\G1612). (  Page 271 Recording status area (Un\G1500 to 3199))

### Precautions

There is a limit to the number of events detected by a network camera (example: the destination for motion detection), and its total number depends on the network camera.

If the upper limit is reached for a network camera, a camera event can no longer be received from the network camera.

In this case, a network camera communication error (camera event) (error code: 1E73H) occurs.

# Camera time synchronization function

This function can be used to synchronize the time between a camera recorder module and a network camera. Time information set by using this function is used for the time in a network camera and a time stamp of video data delivered from the network camera.

## Precautions

To use this function, account authentication is required. (☞ Page 235 Account authentication)

## Time synchronization method

Time can be synchronized by using SNTP. The time synchronization destination, timing, and interval are as follows:

Destination	Timing	Interval
Camera recorder module	On request from a network camera	Depends on the specifications of a network camera used.

The flow of time synchronization is as follows:

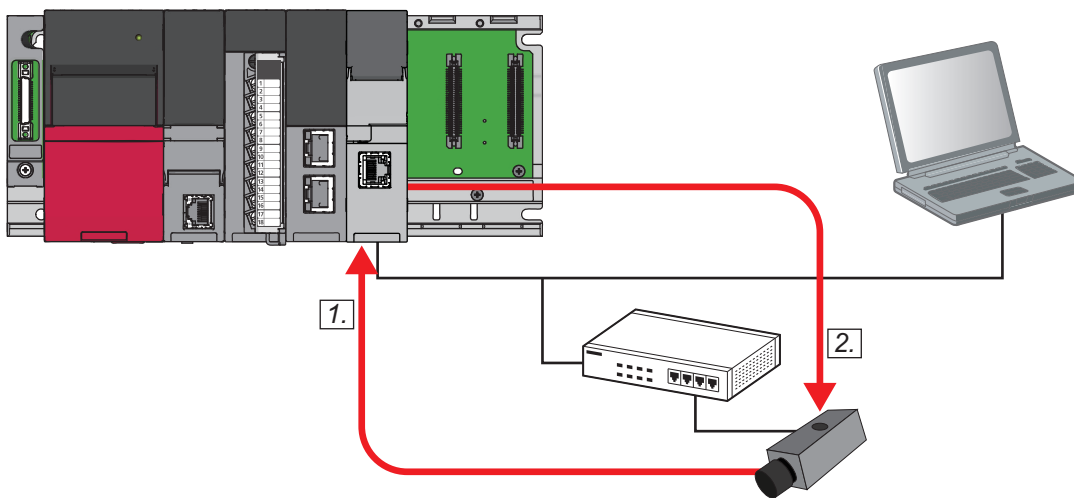

1. A request for the time is sent.
  2. The time in the camera recorder module is set for the network camera.
- Steps 1 and 2 are repeated periodically.

## Precautions

- When using an ONVIF supported network camera that does not support the SNTP client function, a network camera SNTP client unsupported error (error code: 1D90H) occurs.
- If the time synchronization setting from a camera recorder module to a network camera fails, a network camera time synchronization setting error (error code: 1DB0H) occurs.

## Considerations

### ■Clock data setting of a CPU module

Before operating a camera recorder module, set the clock data in a CPU module. If the clock data is changed after operating the camera recorder module and the time does not match between the camera recorder module and a network camera, a network camera communication error (error code: 1DF1H) occurs.

For details on the clock data setting, refer to the following:

📖 MELSEC iQ-R Programmable Controller CPU Module User's Manual

### ■Time synchronization using SNTP

When setting the time synchronization by using SNTP, the synchronization timing and interval depend on the specifications of a network camera used.

### ■Time zone and daylight saving time

The time zone and daylight saving time are not set for a network camera from a camera recorder module.

### ■Time setting using a dedicated tool for a network camera

Do not use a dedicated tool for a network camera for the time setting.

If it is used, the time information does not match that of a camera recorder module.

### ■Synchronization with the time information of a device and label

It may take time to synchronize a time stamp of video data delivered from a network camera with the time information of a device and label. Check the synchronization status in 'Time synchronization status' of a camera recorder module.

If the time synchronization is not completed, a video file is generated with a time when video data is received by a camera recorder module, not a time when video data is captured by a network camera. This may cause an error due to network delay.

## Camera event function

This function can be used to notify the recording function of a camera event such as motion detection received from a network camera set as a connection target as a trigger. This trigger can be used as a file saving trigger for the recording function. The target is a network camera for which the video data receiving target setting is enabled in the recording setting. The following shows the flow from when a camera event is detected by a network camera to when a file saving trigger is satisfied.

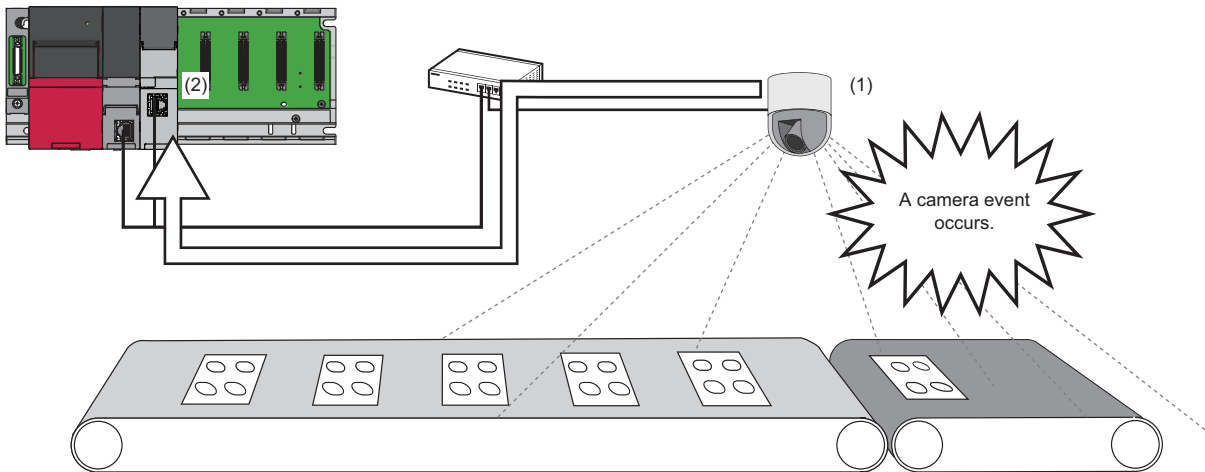

(1) A network camera detects a camera event and sends it to a camera recorder module.

(2) The camera recorder module receives and analyzes it.  
When the condition is met, a file saving trigger is satisfied.

For details on the camera event reception, refer to the following:

➤ Page 239 Camera event reception

For the flow from when a file saving trigger is satisfied to when data is saved, refer to the following:

➤ Page 59 Saving video data

Note that whether a trigger is satisfied by camera event reception is determined for each unit of END processing in sequence scans of a CPU module while the recording function is running.

### Point

If a recording file is saved by camera event reception, an execution of saving by camera event detection (event code: 26030) is output to the event history.

There is a time lag between when an event is detected by a network camera and when a file saving trigger is satisfied. For the event detection time<sup>\*1</sup> in the network camera, refer to the detailed information of an execution of saving by camera event detection (event code: 26030).

\*1 The accuracy of the event detection time in a network camera differs for each manufacturer.

## Setting procedure

To use a camera event as a file saving trigger in a camera recorder module, set the following items:

Item	Description	Setting location
Camera event detection setting for a network camera <sup>*1</sup>	Set a network camera to detect camera events in a dedicated configuration tool for the camera manufacturer (such as a web browser). For the setting method, refer to the manual for a network camera used.	Configuration tool for a network camera (such as a web browser)
Camera event notification setting	Configure the camera event setting.	Camera individual setting screen ☞ Page 105 Camera individual setting
Video data receiving target setting	Set a network camera from which video data is received. For a network camera with this setting enabled, the camera event trigger setting is available.	Recording setting screen (video data receiving target setting) ☞ Page 140 Video Data Receiving Target Setting
Camera event trigger setting	Set a camera event as a file saving trigger.	Recording setting screen (file saving trigger setting) ☞ Page 134 File Saving Trigger Setting

\*1 A setting for a network camera. To use the camera event function, this setting is required.

## Camera event notification setting

To notify a camera recorder module of camera events detected by a network camera, configure the camera event setting in the camera individual setting screen in the module extended parameter.

With this setting, camera events can be received.

For the setting method, refer to the following:

☞ Page 105 Camera individual setting

The camera event notification setting can be monitored for each network camera in 'Camera event notification' (Un\G34254, Un\G34754, Un\G35254, Un\G35754). (☞ Page 282 Network camera status area (Un\G34000 to 37999))

### Precautions

Camera event types that can be set differ for each network camera used.

For details, refer to the manual for a network camera used.

Otherwise, perform the communication test in the "Communication Test" screen in the module extended parameter to check.

If setting a parameter out of the setting range, the following error occurs:

- Camera event type unsupported error (error code: 1D41H)

## Camera event trigger setting

The camera event notification set in the camera event setting can be set as a condition for satisfying a file saving trigger in the file saving trigger setting screen in the recording setting.

For the setting method, refer to the following:

☞ Page 134 File Saving Trigger Setting

The file saving trigger setting for a network camera can be monitored for each recording setting in 'Camera event trigger settings' (Un\G3211, Un\G3311, Un\G3411, Un\G3511). (☞ Page 278 Recording setting information area (Un\G3200 to 3999))

### Considerations

- Camera events can be used as file saving triggers only.
- If a camera event occurs while a file saving trigger is satisfied in the same recording setting, it is treated as a disabled trigger.
- If the camera event trigger setting is enabled and the camera event notification setting is disabled, a camera event setting inconsistency error (error code: 1D54H) occurs when starting recording.
- If a camera event occurs and a network camera is disconnected at the same time, and when the camera event is reported from the network camera after recovery, a time lag occurs between when the camera event occurs and when a file saving trigger is satisfied.
- If a camera event occurs frequently in a network camera, the recording performance is affected (mainly video data reception and accumulation).

## Camera adjustment function (PTZ)

This function can be used to adjust the range of data captured by a network camera set in the module extended parameter. An adjusted range can also be registered in a camera recorder module as a preset position.

This function can be set and performed in the following:

- "Camera Individual Settings" screen in the module extended parameter (☞ Page 105 Camera individual setting)
- "Preset Position Settings" screen (☞ Page 110 Preset Position Setting (Camera Recorder Module))
- Sample screen of a GOT (📖 Mitsubishi Electric Programmable Controller Camera Recorder Module RD81RC96-CA Sample Screen Manual (BCN-P5999-1333)\*1)

\*1 Can be downloaded from the Mitsubishi Electric FA website.

- Buffer memory of a camera recorder module

The following table shows the list of functions included in the camera adjustment function.

○: Can be performed/set, ×: Cannot be performed/set

Item	Description	Operation/setting availability			
		"Camera Individual Settings" screen	"Preset Position Settings" screen	Sample screen of a GOT	Buffer memory
PTZ control function	To adjust the range of data captured by a network camera by performing PTZ control.	×	×	○	×
Preset position function	To register an adjusted range (PTZ values) as a preset position. Moving to a registered preset position is also available.	×	○	○	○ (Moving to a preset position only)
PTZ control authority mode function	To set the authority to perform the PTZ control function and preset position function.	○	×	×	×

### Precautions

To use this function, account authentication is required. (☞ Page 235 Account authentication)

### PTZ control function

This function can be used to adjust the range of data captured by a network camera by setting PTZ values (pan, tilt, and zoom) and a movement speed value for a specified network camera in a camera recorder module.

The following table shows the setting items used for PTZ control.

Setting item	Description
Specified pan value	Specify a position to move the range of data captured by a network camera horizontally (-1000 to 1000).
Specified tilt value	Specify a position to move the range of data captured by a network camera vertically (-1000 to 1000).
Specified zoom value	Specify a position to zoom in or out the range of data captured by a network camera (0 to 1000).
Specified movement speed value	Specify a movement speed of the range of captured data by performing PTZ control (0 to 1000).

PTZ control can be performed in a sample screen of a GOT. (📖 Mitsubishi Electric Programmable Controller Camera Recorder Module RD81RC96-CA Sample Screen Manual (BCN-P5999-1333)\*1)



\*1 Can be downloaded from the Mitsubishi Electric FA website.

## Preset position function

This function can be used to register and delete up to 16 patterns of the current ranges of captured data (PTZ values) as preset positions for one specified network camera.

Moving to a registered preset position is also available.

Registering and deleting preset positions, and moving to a registered preset position can be performed in the "Preset Position Settings" screen or a sample screen of a GOT.

- "Preset Position Settings" screen (  Page 110 Preset Position Setting (Camera Recorder Module) )
- Sample screen of a GOT (  Mitsubishi Electric Programmable Controller Camera Recorder Module RD81RC96-CA Sample Screen Manual (BCN-P5999-1333) \*1 )

\*1 Can be downloaded from the Mitsubishi Electric FA website.

Moving to a preset position is also available in the buffer memory of a camera recorder module.

### ■Registering a preset position

The range of data captured by a specified network camera can be written to the flash memory of a camera recorder module.

Up to 16 patterns of preset positions can be registered for one network camera.

Each preset position is numbered, and the current range of data captured by a network camera is stored as preset position information for each number.

If registering preset position information fails, a preset position registration error (error code: 1C60H) occurs.

Preset position information that can be registered is as follows:

Name	Description	Range
Preset position name	The name of a preset position	Number of characters: Up to 32 characters Available characters: Basic Multilingual Plane in UTF-16LE*1
Position information (P)	A pan value (horizontal direction) when registering a preset position	-1000 to 1000
Position information (T)	A tilt value (vertical direction) when registering a preset position	-1000 to 1000
Position information (Z)	A zoom value (zoom in/out) when registering a preset position	0 to 1000

\*1 The following cannot be used. (Note that no error message is output when entering surrogate pair characters and combining characters.)

Characters other than ones in the Basic Multilingual Plane (U+10000 to U+10FFFF)

Line feed codes (U+2028, U+2029)

Surrogate pairs (0xD800 to 0xDBFF, 0xDC00 to 0xDFFF)

Control codes (U+0000 to U+001F, U+0080 to U+009F, U+00A0 to U+00BF, U+FFFE, U+FFFF)

Combining characters

#### Point

- If preset position information is already registered, it is overwritten when registering a preset position. Check the current preset position information before registering it.
- If the power of a camera recorder module is turned OFF while registering a preset position, the preset position information may be lost. Do not turn the power OFF during registration.
- If the preset position registration count upper limit is reached, a preset position registration count upper limit reach error (error code: 1CA0H) occurs.

### ■Deleting a preset position

Registered preset position information can be deleted from a camera recorder module.

After deletion, preset position information returns to its initial value.

When deleting a network camera in the setting screen of the module extended parameter and writing module extended parameters to a camera recorder module, preset position information of the corresponding network camera retained at the time of startup is also deleted from the camera recorder module.

If deleting preset position information fails, a preset position deletion error (error code: 1C70H) occurs.



## ■ Moving to a preset position

The range of data captured by a network camera can be moved to a preset position registered in advance.

- Operation using the buffer memory of a camera recorder module

The following shows the operating procedure using the buffer memory.

1. Check the preset position registered for the number of a network camera to adjust the captured position. It can be checked in 'Preset position 1 to 16' in 'Network camera 1 to 4 PTZ information' (Un\G38010 to 38649, Un\G38710 to 39349, Un\G39410 to 40049, Un\G40110 to 40749) of the camera recorder module. (☞ Page 287 PTZ control area (Un\G38000 to 43599))
2. Set a preset position number of a move destination in 'Specified preset position No.' (Un\G38006, Un\G38706, Un\G39406, Un\G40106) of the camera recorder module. (☞ Page 287 PTZ control area (Un\G38000 to 43599))
3. Change the value from '0' to '1' in 'Preset position execution request' (Un\G38008, Un\G38708, Un\G39408, Un\G40108) of the camera recorder module. (☞ Page 287 PTZ control area (Un\G38000 to 43599))

The range is adjusted by PTZ values of the specified preset position.

After adjustment, the value in 'PTZ operation status' (Un\G38002, Un\G38702, Un\G39402, Un\G40102) of the camera recorder module changes from 'preset request being executed: 7H' to 'preset request completed successfully: 8H.' (☞ Page 287 PTZ control area (Un\G38000 to 43599))

After '8H: preset request completed successfully' is stored in 'PTZ operation status,' return the value in 'Preset position execution request' from '1H: requested' to '0H: not requested.' The value in 'PTZ operation status' returns to '0H: not requested.'

Even if the value in 'Preset position execution request' is not returned to '0H: not requested,' the value in 'PTZ operation status' automatically returns to '0H: not requested' when 30 seconds elapses after '8H: preset request completed successfully' is stored.

### Errors that occur

An error occurs if any of the following cases is applied when changing the value from '0' to '1' in 'Preset position execution request' (Un\G38008, Un\G38708, Un\G39408, Un\G40108) of a camera recorder module.

- If an unregistered preset position number is specified in 'Preset position 1 to 16' in 'Network camera 1 to 4 PTZ information' (Un\G38010 to 38649, Un\G38710 to 39349, Un\G39410 to 40049, Un\G40110 to 40749) of a camera recorder module, a preset position unregistered error (error code: 1C80H) occurs.
- When changing the value from '0' to '1' in 'Preset position execution request' of a camera recorder module for a network camera that does not support the PTZ control function, a PTZ function unsupported error (error code: 1C51H) occurs.
- If a value out of the range is specified in 'Specified preset position No.' (Un\G38006, Un\G38706, Un\G39406, Un\G40106) or 'Specified preset position movement speed' (Un\G38007, Un\G38707, Un\G39407, Un\G40107), a preset position execution error (error code: 1C90H) occurs. (☞ Page 287 PTZ control area (Un\G38000 to 43599))

### **Point**

When moving the range to a preset position by using the buffer memory, check 'PTZ support' (Un\G34235 for network camera 1) of the network camera and change the value in 'Preset position execution request' to '1: ON.'

If the value in 'Preset position execution request' is changed to '1: ON' for a network camera that does not support the PTZ function or it is changed before the bit information (supported) is applied to 'PTZ support' even for a network camera that supports the PTZ function, a PTZ function unsupported error (error code: 1C51H) occurs.

## ■ Considerations

- PTZ control, registering and deleting preset positions, and moving to a preset position cannot be performed on one network camera at the same time.
- The direction to capture data when starting a network camera differs depending on a network camera used. To change the direction, move it to an intended position when starting the network camera.
- When moving to the range set by registering a preset position, an error may occur in the range depending on the operation accuracy of a network camera.

## PTZ control authority mode function

This function can be used to set the authority to perform the PTZ control function and preset position function for each network camera.

The following table shows the availability for each mode of the PTZ control authority mode.

○: Available, ×: Not available

PTZ control authority mode	Description	Operation availability for each mode			
		PTZ control function	Preset position function		
			Registration	Deletion	Movement
PTZ enable mode	The PTZ control function and preset position function can be performed.	○	○	○	○
PTZ preset mode	Only the movement of the preset position function can be performed.	×	×	×	○
PTZ disable mode	Neither the PTZ control function nor the preset position function can be performed.	×	×	×	×

The authority can be set in the "Camera Individual Settings" screen in the module extended parameter. (  Page 105 Camera individual setting)

If "PTZ Disable Mode" is selected for the PTZ control authority mode, a PTZ authority mode unexecutable error (error code: 1CB0H) occurs when moving to a preset position is performed by using the buffer memory.

The PTZ control authority mode of a network camera can be checked in 'PTZ control authority mode' (Un\G38000, Un\G38700, Un\G39400, Un\G40100) of a camera recorder module. (  Page 287 PTZ control area (Un\G38000 to 43599))

# GOT linkage function

This function can be used to check a live video of a network camera and adjust its PTZ in a GOT connected to a CPU module on the same network as the network camera.

To use this function, the setting in a GOT is required.

The following table shows the list of functions included in the GOT linkage function.

Function	Description
Live video display function	To display a live video from a network camera set as a connection target in a GOT.
Camera adjustment function (PTZ)	To adjust the range of data captured by a network camera set as a connection target in a GOT. In addition, an adjusted range can be registered as a preset position. For details, refer to the following:  Page 245 Camera adjustment function (PTZ)

For details on the setting in a GOT and the combinations of versions of a sample screen and camera recorder module, refer to the following:

 Mitsubishi Electric Programmable Controller Camera Recorder Module RD81RC96-CA Sample Screen Manual (BCN-P5999-1333)\*<sup>1</sup>

\*1 Can be downloaded from the Mitsubishi Electric FA website.

## Point

- This function can be used only for one GOT per camera recorder module.
- A CPU module and GOT must be connected via Ethernet; otherwise, this function cannot be used.

## Precautions

To use the GOT linkage function, select "Enable" for "GOT Linkage Enable/Disable" in the "Common Settings" screen in the module extended parameter.

When selecting "Enable" for "GOT Linkage Enable/Disable," a GOT with the IP address set in the "Common Settings" screen in the module extended parameter can be linked.

For details on the module extended parameter, refer to the following:

 Page 103 Module Extended Parameters (Camera Recorder Module)

## Live video display function

This function can be used to display a live video of a network camera in a GOT connected to a CPU module on the same network as the network camera.

To use this function, the login name and password set in the FTP server setting in a GOT must be specified in the "Common Settings" screen in the module extended parameter.

Note that when enabling the simple setting mode, the video rotation angle and video quality are automatically set according to a network camera used; therefore, they cannot be set in a GOT.

The following table shows the items that can be set in a GOT.

Item	Description	Setting value										
Resolution	Specify the resolution of a live video to be displayed in a GOT.	A value is fixed for each sample project as follows: <table border="1"><thead><tr><th>Sample project</th><th>Live video</th></tr></thead><tbody><tr><td>VGA</td><td>QVGA(320×240)</td></tr><tr><td>XGA</td><td>VGA(640×480)</td></tr><tr><td>SoftGOT(1024×631)</td><td>VGA(640×480)</td></tr><tr><td>SoftGOT(1920×960)</td><td>SVGA(800×600)</td></tr></tbody></table>	Sample project	Live video	VGA	QVGA(320×240)	XGA	VGA(640×480)	SoftGOT(1024×631)	VGA(640×480)	SoftGOT(1920×960)	SVGA(800×600)
Sample project	Live video											
VGA	QVGA(320×240)											
XGA	VGA(640×480)											
SoftGOT(1024×631)	VGA(640×480)											
SoftGOT(1920×960)	SVGA(800×600)											
Video rotation angle	Specify the rotation angle of a live video to be displayed in a GOT.	<ul style="list-style-type: none"><li>• 0°</li><li>• 180°</li></ul>										
Video quality	Set the quality of a live video to be displayed in a GOT.	<ul style="list-style-type: none"><li>• High</li><li>• Middle</li><li>• Low</li></ul>										

For the procedure for setting each item in a GOT, refer to the following:

 Mitsubishi Electric Programmable Controller Camera Recorder Module RD81RC96-CA Sample Screen Manual (BCN-P5999-1333)\*<sup>1</sup>

\*1 Can be downloaded from the Mitsubishi Electric FA website.

### Point

- Whether an FTP login name and FTP password to be set in the "Common Settings" screen in the module extended parameter are correct can be checked by performing the FTP communication test. Use this function to check that those set in a GOT in advance are correct.

## Precautions

- The live video display function can be used only for one network camera.

## SD memory card format function

This function can be used to format an SD memory card inserted in a camera recorder module.

The procedure is the same as a recorder module.

However, the volume label after formatting will be RD81RC96\_CA.

 Page 199 SD memory card format function

## Self-diagnostics function

This function is an internal function to check the hardware health of a camera recorder module and diagnose whether the module operates properly.

Details are the same as a recorder module.

 Page 199 Self-diagnostics function

## Co-recording function

---

This function can be used to perform recording synchronously on target devices by sending and receiving a co-recording trigger.

For details, refer to the following:

 MELSEC iQ-R System Recorder Co-recording Function Reference Manual

The following are the same as a recorder module: operations for sending and receiving a trigger, events when co-recording runs, and considerations for a camera recorder module when using the co-recording function.

 Page 200 Co-recording function

## 7.2 Module Labels

This section shows the module labels used to set the input/output signals and buffer memory of a camera recorder module.

### Module label configuration

The name of a module label is defined in the following configurations:

"Instance name"\_"Module number"."Label name"

"Instance name"\_"Module number"."Label name"\_D

**Ex.**

RC96C\_1.stlOSignal.bModuleReady

#### ■ Instance name

The instance name of a camera recorder module (RD81RC96-CA) is 'RC96C.'

#### ■ Module number

A module number is a number starting from 1, which is added to identify a module that has the same instance name.

#### ■ Label name

This is a label name unique to a module.

#### ■ \_D

This indicates that the module label is for direct access. Without this symbol, the label is for refresh. There are some differences between refresh and direct access as shown below.

Type	Description	Access timing
Refresh	Values written to/read from a module label are applied to a module in a batch at the time of refresh. This shortens the program execution time.	At the time of refresh
Direct access	Values written to/read from a module label are immediately applied to a module. Although the program execution time is longer than refresh, the responsiveness will be increased.	At the time of writing to/reading from a module label

## 7.3 Input/Output Signals

This section explains the input/output signals of a camera recorder module.

The following shows an example of assigning input/output signals when the start input/output number of a module is '0.'

A device X indicates an input signal from a module to a CPU module.

A device Y indicates an output signal from a CPU module to a module.

### Precautions

As for input/output signals to a CPU module, do not output (turn ON) 'Use prohibited' signals. Doing so may cause malfunction of a programmable controller system.

### Input/output signal list

The following shows the input/output signal list of a module.

For details on the input/output signals, refer to the following:

☞ Page 254 Input signal details

☞ Page 256 Output signal details

#### Input signals

Device No.	Signal name
X0	Module READY
X1	SD memory card status
X2	File access status
X3	Recording function operation status
X4	INFO LED status
X5	Module stop error status
X6	Module continuation error status
X7 to X1F	Use prohibited

#### Output signals

Device No.	Signal name
Y0	File access stop request
Y1	Clear file access stop request
Y2	Clear INFO LED request
Y3	Error clear request
Y4 to Y1F	Use prohibited

# Input signal details

The following shows the details on the input signals to a CPU module.

## Module READY (X0)

This signal turns ON when a module is ready after turning the power OFF and ON or resetting a CPU module. It turns OFF when a hardware error occurs.

## SD memory card status (X1)

This signal turns ON when an SD memory card is inserted and 'File access status' (X2) is OFF. It turns OFF when an SD memory card is not inserted or 'File access status' (X2) is ON.

## File access status (X2)

● This signal turns ON while file access is stopped or an SD memory card is write-protected.

The following operations can be performed while file access is stopped.

- Insertion/removal method of an SD memory card (📖 MELSEC iQ-R System Recorder User's Manual (Startup))

The status is in the following state while file access is stopped.

- SD memory card read/write-protected

● This signal turns OFF when a file is accessible.

The following shows time charts of 'File access status' (X2) and its related input/output signals.

- When inserting or removing an SD memory card

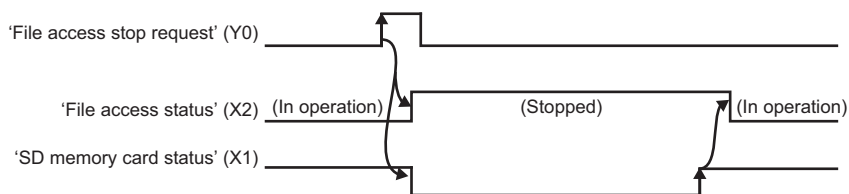

- When not inserting or removing an SD memory card

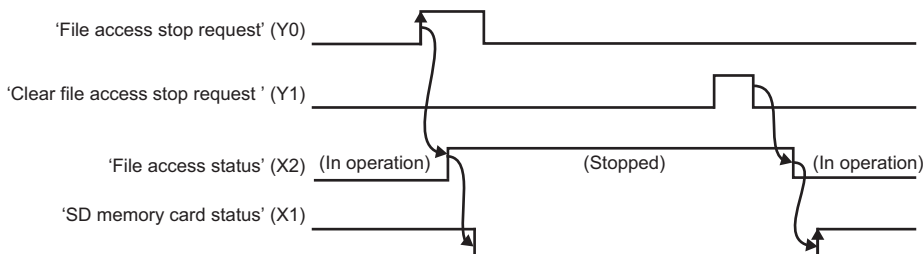

## Recording function operation status (X3)

This signal turns ON while the recording function is running for any of the recording settings regardless of the communication status with a connected network camera. (📖 Page 114 RECORDING SETTING)

It turns OFF when the recording function is stopped for all recording settings.

For the operating status for a recording setting, refer to the following:

📖 Page 63 Operating status



## INFO LED status (X4)

This signal turns ON when the INFO LED turns ON.

For the factor that the INFO LED turns ON, refer to the following:

☞ Page 158 Module information list

It turns OFF when turning 'Clear INFO LED request' (Y2) ON while the INFO LED is ON.

In addition, it turns OFF when switching the status of a CPU module from STOP to RUN.

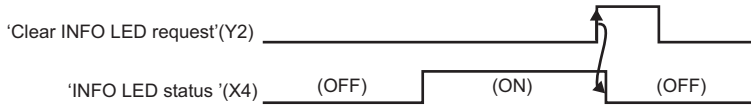

## Module stop error status (X5)

This signal is ON while a module stop error is occurring.

## Module continuation error status (X6)

This signal is ON while a module continuation error is occurring.

It turns OFF when turning 'Error clear request' (Y3) ON.

## Output signal details

---

The following shows the details on the output signals to a CPU module.

### Point

The output signals will be enabled when they turn from OFF to ON. In addition, they are not turned from ON to OFF by a system. To turn the signals ON again, turn them from ON to OFF once, then OFF to ON.

---

### File access stop request (Y0)

---

When turning this signal ON, accessing a file in an SD memory card is stopped.

For details, refer to the following:

 Page 254 File access status (X2)

### Clear file access stop request (Y1)

---

Turn this signal ON when 'File access stop request' is accidentally turned ON.

When turning this signal ON without replacing an SD memory card after turning 'File access stop request' ON, file access restarts.

For details, refer to the following:

 Page 254 File access status (X2)

### Clear INFO LED request (Y2)

---

When turning this signal ON while the INFO LED is ON, the following operations are performed:

- The INFO LED is turned OFF.
- 'INFO LED status' (X4) is turned OFF.
- 'INFO LED lighting factor' (Un\G12) is cleared.

### Error clear request (Y3)

---

When turning this signal ON while a module continuation error is occurring, the following operations are performed:

- The ERR LED is turned OFF.
- 'Module continuation error status' (X6) is turned OFF.
- 'Current error area' (Un\G140 to 149) are cleared.
- 'Error log' (Un\G150 to 311) are cleared.
- A part of 'Network camera status area' (Un\G34301 to 34472, Un\G34801 to 34972, Un\G35301 to 35472, Un\G35801 to 35972) is cleared.

# 7.4 Buffer Memory

This section explains the buffer memory of a camera recorder module.

## Precautions

- Do not write any data in the "system area" or an area with "R" (read-only) of the buffer memory. Doing so may cause malfunction of a programmable controller system.

## Buffer memory list

The following table shows the buffer memory list of a camera recorder module.

R: Read-only, W: Write-only, R/W: Readable/Writable

Address Dec (Hex)	Application	Name	Initial value	R/W	
0 (0H)	Module status area	RUN LED status	0	R	
1 (1H)		ERR LED status	0	R	
2 (2H)		CARD RDY LED status	0	R	
3 (3H)		System area	—	—	
4 (4H)		OPR LED status	0	R	
5 (5H)		INFO LED status	0	R	
6 to 11 (6H to BH)		System area	—	—	
12 (CH)		INFO LED lighting factor	0	R	
13 to 16 (DH to 10H)		System area	—	—	
17 (11H)		Recording operation setting	0	R	
18 to 20 (12H to 14H)		System area	—	—	
21 to 22 (15H to 16H)		SD memory card information area	SD memory card total capacity	0	R
23 to 24 (17H to 18H)			SD memory card free capacity	0	R
25 (19H)			SD memory card usage rate	0	R
26 to 27 (1AH to 1BH)	SD memory card usage capacity		0	R	
28 to 46 (1CH to 2EH)	System area	—	—		

Address Dec (Hex)	Application	Name	Initial value	R/W	
47 to 54 (2FH to 36H)	Network connection status area	IP address (string notation)	—	R	
55 to 56 (37H to 38H)		IP address	0	R	
57 to 58 (39H to 3AH)		Subnet mask	0	R	
59 to 60 (3BH to 3CH)		Default gateway	0	R	
61 to 62 (3DH to 3EH)		DNS server 1 address	0	R	
63 to 64 (3FH to 40H)		DNS server 2 address	0	R	
65 to 69 (41H to 45H)		System area	—	—	
70 (46H)	Common setting status area	IP address specification method	0	R	
71 to 72 (47H to 48H)		IP address	0	R	
73 to 74 (49H to 4AH)		Subnet mask	0	R	
75 to 76 (4BH to 4CH)		Default gateway	0	R	
77 to 78 (4DH to 4EH)		DNS server 1 address	0	R	
79 to 80 (4FH to 50H)		DNS server 2 address	0	R	
81 to 86 (51H to 56H)		System area	—	—	
100 to 139 (64H to 8BH)	System area		—	—	
140 (8CH)	Current error area	Error code	0	R	
141 (8DH)		System area	—	—	
142 to 149 (8EH to 95H)		Time	0	R	
150 (96H)	Error log area	Error count	0	R	
151 (97H)		Error log write pointer	0	R	
152 (98H)		Error log 1	Error code	0	R
153 (99H)			System area	—	—
154 to 161 (9AH to A1H)			Time	0	R
162 to 311 (A2H to 137H)	Error log 2 to 16	Same as error log 1			
312 to 809 (138H to 329H)	System area		—	—	
810 (32AH)	Operation setting at event detection area	Error registration at warning (type: system) detection	Warning due to program change during recording operation	0	R
811 to 825 (32BH to 339H)		System area		—	—
826 (33AH)		Error (type: system) detection	Error due to communication with a network camera	0	R
827 to 841 (33BH to 349H)		System area		—	—
842 to 859 (34AH to 35BH)	System area		—	—	

Address Dec (Hex)	Application	Name	Initial value	R/W		
860 (35CH)	Operation setting at video data saving area	Operation at video data saving	0	R		
861 to 1499 (35DH to 5DBH)	System area		—	—		
1500 (5DCH)	Recording status area	Recording status 1	System area	—	—	
1501 (5DDH)			In recording operation	0	R	
1502 (5DEH)			Recording start error	0	R	
1503 (5DFH)			Recording start error cause	0	R	
1504 (5E0H)			File saving trigger monitor	0	R	
1505 (5E1H)			Recording files saving	0	R	
1506 (5E2H)			Data sampling	0	R	
1507 (5E3H)			Recording buffer storing status	0	R	
1508 (5E4H)			Recording files saving completion	0	R	
1509 (5E5H)			Recording files saving error	0	R	
1510 (5E6H)			Recording files saving completion code	0	R	
1511 (5E7H)			Recording files saving count	0	R/W	
1512 to 1513 (5E8H to 5E9H)			System area		—	—
1514 (5EAH)			Recording files saving progress	0	R	
1515 to 1522 (5EBH to 5F2H)			Recording files saving path (setting type folder)	0	R	
1523 to 1555 (5F3H to 613H)			Recording files saving path (under setting type folder)	0	R	
1556 to 1574 (614H to 626H)			System area		—	—
1575 (627H)			Recording startup trigger count	0	R	
1576 (628H)			Invalid recording startup trigger count	0	R	
1577 (629H)			File saving trigger count	0	R	
1578 (62AH)			Invalid file saving trigger count	0	R	
1579 to 1580 (62BH to 62CH)			Average device/label sampling interval	0	R	
1581 to 1582 (62DH to 62EH)			Average device/label sampling size	0	R	
1583 to 1584 (62FH to 630H)			Device/label maximum sampling period	0	R	
1585 (631H)			Recording buffer status	0	R	

Address Dec (Hex)	Application	Name	Initial value	R/W	
1586 (632H)	Recording status area	Recording status 1	Sampling execution time (ms unit)	0	R
1587 (633H)			Sampling execution time (μs unit)	0	R
1588 (634H)			Accumulating execution time (ms unit)	0	R
1589 (635H)			Accumulating execution time (μs unit)	0	R
1590 to 1592 (636H to 638H)		System area	—	—	
1593 (639H)		Camera event receiving status	Network camera 1	0	R
1594 (63AH)			Network camera 2	0	R
1595 (63BH)			Network camera 3	0	R
1596 (63CH)			Network camera 4	0	R
1597 to 1600 (63DH to 640H)			System area	—	—
1601 (641H)		Number of camera events receiving	Network camera 1	0	R
1602 (642H)			Network camera 2	0	R
1603 (643H)			Network camera 3	0	R
1604 (644H)			Network camera 4	0	R
1605 to 1608 (645H to 648H)			System area	—	—
1609 (649H)		Number of invalid camera events receiving	Network camera 1	0	R
1610 (64AH)			Network camera 2	0	R
1611 (64BH)			Network camera 3	0	R
1612 (64CH)			Network camera 4	0	R
1613 to 1616 (64DH to 650H)			System area	—	—
1617 to 1649 (651H to 671H)	System area	—	—		
1650 (672H)	Camera recording status	Network camera 1	0	R	
1651 (673H)		Network camera 2	0	R	
1652 (674H)		Network camera 3	0	R	
1653 (675H)		Network camera 4	0	R	
1654 to 1657 (676H to 679H)		System area	—	—	

Address Dec (Hex)	Application	Name			Initial value	R/W	
1658 to 1659 (67AH to 67BH)	Recording status area	Recording status 1	Video data maximum accumulation period	Network camera 1	0	R	
1660 to 1661 (67CH to 67DH)				Network camera 2	0	R	
1662 to 1663 (67EH to 67FH)				Network camera 3	0	R	
1664 to 1665 (680H to 681H)				Network camera 4	0	R	
1666 to 1673 (682H to 689H)				System area	—	—	
1674 (68AH)		Recording buffer storing status		Network camera 1	0	R	
1675 (68BH)				Network camera 2	0	R	
1676 (68CH)				Network camera 3	0	R	
1677 (68DH)				Network camera 4	0	R	
1678 to 1699 (68EH to 6A3H)			System area		—	—	
1700 to 2299 (6A4H to 8FBH)			Recording status 2 to 4	Same as recording status 1			
2300 to 3199 (8FCH to C7FH)			System area			—	—

Address Dec (Hex)	Application	Name		Initial value	R/W
3200 (C80H)	Recording setting information area	Recording setting information 1	Recording buffer size	0	R
3201 to 3202 (C81H to C82H)			Saving period	0	R
3203 (C83H)			Saving setting when there is no free folder number	0	R
3204 (C84H)			Recording startup trigger specification	0	R
3205 (C85H)			Recording startup trigger establishment condition	0	R
3206 (C86H)			Saving specification after the specified time has elapsed from recording completion	0	R
3207 to 3208 (C87H to C88H)			Waiting time from recording completion to file saving	0	R
3209 (C89H)			Establishment condition of file saving trigger	0	R
3210 (C8AH)			Recording files saving destination	0	R
3211 (C8BH)			Camera event trigger settings	0	R
3212 (C8CH)			System area	—	—
3213 (C8DH)			Recording buffer size (video data)	Network camera 1	0
3214 (C8EH)		Network camera 2		0	R
3215 (C8FH)		Network camera 3		0	R
3216 (C90H)		Network camera 4		0	R
3217 to 3249 (C91H to CB1H)		System area	—	—	
3250 (CB2H)		Saving specification when CPU stop error is detected	0	R	
3251 to 3266 (CB3H to CC2H)		Establishment condition of file saving trigger (Extended)	0	R	
3267 to 3299 (CC3H to CE3H)		System area	—	—	
3300 to 3599 (CE4H to E0FH)		Recording setting information 2 to 4	Same as recording setting information 1		
3600 to 3999 (E10H to F9FH)		System area	—	—	



Address Dec (Hex)	Application	Name		Initial value	R/W
4000 (FA0H)	Recording operation specification area	Recording operation specification 1	System area	—	—
4001 (FA1H)			Recording buffer batch saving mode	0	R/W
4002 to 4003 (FA2H to FA3H)			Folder name additional data 1	0	R/W
4004 to 4005 (FA4H to FA5H)			Folder name additional data 2	0	R/W
4006 (FA6H)			System area	—	—
4007 (FA7H)			File saving trigger	0	R/W
4008 (FA8H)			Timeout detection of file saving trigger	0	R/W
4009 to 4016 (FA9H to FB0H)			Folder name additional data 3	0	R/W
4017 to 4024 (FB1H to FB8H)			System area	—	—
4025 to 4032 (FB9H to FC0H)			Folder name additional data 4	0	R/W
4033 to 4099 (FC1H to 1003H)			System area	—	—
4100 to 4399 (1004H to 112FH)			Recording operation specification 2 to 4	Same as recording operation specification 1	
4400 to 4799 (1130H to 12BFH)		System area	—	—	
4800 to 8999 (12C0H to 2327H)	System area		—	—	
9000 to 9255 (2328H to 2427H)	File server saving information area	File server saving information 1	Recording files saving path (setting type folder)	0	R
9256 to 9399 (2428H to 24B7H)			System area	—	—
9400 to 10599 (24B8H to 2967H)		File server saving information 2 to 4	Same as file server saving information 1		
10600 to 10999 (2968H to 2AF7H)		System area	—	—	
11000 to 13391 (2AF8H to 344FH)	System area		—	—	

Address Dec (Hex)	Application	Name			Initial value	R/W		
13392 (3450H)	Firmware update history information	Firmware update completion with/without an error			0	R		
13393 to 13401 (3451H to 3459H)		System area			—	—		
13402 (345AH)		Latest firmware update information	History information	Execution time (year)	0	R		
13403 (345BH)				Execution time (month)	0	R		
13404 (345CH)				Execution time (day)	0	R		
13405 (345DH)				Execution time (hour)	0	R		
13406 (345EH)				Execution time (minute)	0	R		
13407 (345FH)				Execution time (second)	0	R		
13408 (3460H)				Execution time (day of the week)	0	R		
13409 (3461H)				Firmware version after update	0	R		
13410 (3462H)				Firmware version before update	0	R		
13411 (3463H)				Latest firmware update result		Firmware update target	0	R
13412 (3464H)						Firmware update result	0	R
13413 (3465H)				Previous firmware update information	History information	Execution time (year)	0	R
13414 (3466H)		Execution time (month)	0			R		
13415 (3467H)		Execution time (day)	0			R		
13416 (3468H)		Execution time (hour)	0			R		
13417 (3469H)		Execution time (minute)	0			R		
13418 (346AH)		Execution time (second)	0			R		
13419 (346BH)		Execution time (day of the week)	0			R		
13420 (346CH)		Firmware version after update	0			R		
13421 (346DH)		Firmware version before update	0			R		
13422 (346EH)		Previous firmware update result				Firmware update target	0	R
13423 (346FH)				Firmware update result	0	R		
13424 to 13427 (3470H to 3473H)		System area			—	—		
13428 to 13999 (3474H to 36AFH)		System area			—	—		

Address Dec (Hex)	Application	Name		Initial value	R/W
14000 (36B0H)	Project data saving status area	Project data saving status 1	Project data saving	0	R
14001 (36B1H)			Project data saving completion	0	R
14002 (36B2H)			Project data saving result	0	R
14003 to 14004 (36B3H to 36B4H)			Project data saving completion code	0	R
14005 (36B5H)			Project data saving progress	0	R
14006 to 14009 (36B6H to 36B9H)			System area	—	—
14010 to 14039 (36BAH to 36D7H)		Project data saving status 2 to 4	Same as project data saving status 1		
14040 to 14079 (36D8H to 36FFH)	System area	—			
14080 (3700H)	Project data saving specification area	Project data saving specification 1		0	R/W
14081 to 14083 (3701H to 3703H)		Project data saving specification 2 to 4	Same as project data saving specification 1		
14084 to 14199 (3704H to 3777H)		System area		—	—
14200 (3778H)	Co-recording status area	Sent co-recording trigger total count		0	R
14201 (3779H)		Sent co-recording trigger cancel count		0	R
14202 (377AH)		Received co-recording trigger total count		0	R
14203 (377BH)		Received co-recording trigger discard count		0	R
14204 to 14249 (377CH to 37A9H)		System area		—	—
14250 (37AAH)	Co-recording setting information area	Co-recording setting		0	R
14251 to 14299 (37ABH to 37DBH)		System area		—	—
14300 to 30003 (37DCH to 7533H)	System area				
30004 to 30011 (7534H to 753BH)	SD memory card history information area	System area		—	—
30012 to 30013 (753CH to 753DH)		Write count		0	R
30014 (753EH)		System area		—	—
30100 to 33999 (7594H to 84CFH)	System area				

Address Dec (Hex)	Application	Name			Initial value	R/W
34000 (84D0H)	Network camera status area	Network camera 1 status area	Setting information	Network camera setting enabled/disabled	0	R
34001 to 34008 (84D1H to 84D8H)				IP address (string)	0	R
34009 to 34010 (84D9H to 84DAH)				IP address	0	R
34011 to 34014 (84DBH to 84DEH)				System area	—	—
34015 (84DFH)				TCP port number	80	R
34016 to 34047 (84E0H to 84FFH)				Network camera comment	0	R
34048 to 34079 (8500H to 851FH)				Network camera manufacturer name	0	R
34080 to 34111 (8520H to 853FH)				Network camera model name	0	R
34112 to 34143 (8540H to 855FH)				Network camera firmware version	0	R
34144 to 34207 (8560H to 859FH)				System area	—	—
34208 to 34223 (85A0H to 85AFH)				Network camera MAC address	0	R
34224 (85B0H)				System area	—	—
34225 (85B1H)				Simple setting mode	1	R
34226 (85B2H)				Resolution	2	R
34227 (85B3H)				Video frame rate	30	R
34228 (85B4H)				Video codec	0	R
34229 (85B5H)				Max. video bit rate	0	R
34230 (85B6H)				Video quality	FFFFH	R
34231 (85B7H)				Video rotation angle	FFFFH	R
34232 (85B8H)				Resolution support list	0	R
34233 (85B9H)				Frame rate support upper limit value	0	R
34234 (85BAH)				Frame rate support lower limit value	0	R
34235 (85BBH)				PTZ support	0	R
34236 (85BCH)				PTZ speed support	0	R
34237 (85BDH)				Video rotation angle support	0	R
34238 (85BEH)				SNTP client function support	0	R
34239 to 34253 (85BFH to 85CDH)				System area	—	—

Address Dec (Hex)	Application	Name		Initial value	R/W			
34254 (85CEH)	Network camera status area	Network camera 1 status area	Setting information	Camera event notification	0	R		
34255 to 34286 (85CFH to 85EEH)				Camera event comment	0	R		
34287 (85EFH)				Camera event type support list	0	R		
34288 to 34299 (85F0H to 85FBH)				System area	—	—		
34300 (85FCH)		Network status		Network camera connection status	0	R		
34301 (85FDH)				Current error	0	R		
34302 (85FEH)				System area	—	—		
34303 to 34310 (85FFH to 8606H)				Time	0	R		
34311 (8607H)				Number of error occurrence	0	R		
34312 (8608H)				Error log writing pointer	0	R		
34313 (8609H)				Error log 1	Error code	0	R	
					System area	—	—	
					Time	0	R	
34314 (860AH)				Error log 2 to 16	Same as error log 1			
34315 to 34322 (860BH to 8612H)								
34323 to 34472 (8613H to 86A8H)								
34473 to 34474 (86A9H to 86AAH)						Average bit rate	0	R
34475 (86ABH)						Number of lost frames	0	R
34476 (86ACH)		Time synchronization status	0			R		
34477 (86ADH)		Video data receiving status	0			R		
34478 to 34479 (86AEH to 86AFH)	System area	—	—					
34480 to 34499 (86B0H to 86C3H)	System area	—	—					
34500 to 35999 (86C4H to 8C9FH)	Network camera 2 to 4 status area	Same as network camera 1 status area						
36000 to 37999 (8CA0H to 946FH)	System area	—						

Address Dec (Hex)	Application	Name	Initial value	R/W		
38000 (9470H)	PTZ control area	Network camera 1 PTZ information	PTZ control authority mode	0	R	
38001 (9471H)			PTZ operation processing requestor	0	R	
38002 (9472H)			PTZ operation status	0	R	
38003 to 38005 (9473H to 9475H)			System area	—	—	
38006 (9476H)			Preset	Specified preset position No.	0	R/W
38007 (9477H)				Specified preset position movement speed	500	R/W
38008 (9478H)				Preset position execution request	0	R/W
38009 (9479H)			System area	—	—	
38010 to 38041 (947AH to 9499H)			PTZ control area	Network camera 1 PTZ information	Preset position 1	Preset position name
38042 (949AH)	Position information (P)	FFFFH				R
38043 (949BH)	Position information (T)	FFFFH				R
38044 (949CH)	Position information (Z)	FFFFH				R
38045 to 38049 (949DH to 94A1H)	System area	—			—	
38050 to 38649 (94A2H to 96F9H)	Preset position 2 to 16	Same as preset position 1				
38650 to 38699 (96FAH to 972BH)	System area	—			—	
38700 to 40799 (972CH to 9F5FH)	Network camera 2 to 4 PTZ information	Same as network camera 1 PTZ information				
40800 to 43599 (9F60H to AA4FH)	System area	—			—	
43600 to 47099 (AA50H to B7FBH)	System area	—	—			
47100 (B7FCH)	GOT registration area	GOT linkage enabled/disabled	0	R		
47101 to 47102 (B7FDH to B7FEH)		IP address	0	R		
47103 to 47110 (B7FFH to B806H)		IP address (string)	0	R		
47111 (B807H)		GOT registration status	0	R		
47112 to 47129 (B808H to B819H)		System area	—	—		
47130 to 48025 (B81AH to BB99H)	System area	—	—			

# Buffer memory details



The following explains the buffer memory details of a camera recorder module.

## Module status area (Un\G0 to 20)

The status of each LED of a camera recorder module can be checked.

Buffer memory name	Address	Description
RUN LED status	Un\G0	0: OFF 1: ON
ERR LED status	Un\G1	0: OFF 1: ON 2: Flashing
CARD RDY LED status	Un\G2	0: OFF 1: ON
OPR LED status	Un\G4	0: OFF 1: ON
INFO LED status	Un\G5	0: OFF 1: ON
INFO LED lighting factor*1	Un\G12	The factor that the INFO LED turns ON is stored. • b0: ON: SD memory card free capacity lowering • b1: ON: No save folder free number
Recording operation setting	Un\G17	The recording operation setting of a camera recorder module is stored. 0: Main 1: Sub

\*1 Check the INFO LED lighting factor, and take a corrective action shown in the following table:

Lighting factor	Location to check	Corrective action
SD memory card free capacity lowering	b0	Check 'SD memory card information area' (Un\G21 to 27) in the buffer memory to make sure that there is a sufficient free space. Delete unnecessary recording files in an SD memory card for a required capacity.  Page 164 Troubleshooting on INFO LED
No save folder free number	b1	It turns ON if there is no free folder number when and after saving a recording file. Delete unnecessary recording files from an SD memory card as necessary.  Page 164 Troubleshooting on INFO LED

## SD memory card information area (Un\G21 to 27)

This area is the same as a recorder module.

 Page 217 SD memory card information area (Un\G21 to 27)

## Network connection status area (Un\G47 to 69)

This area is the same as a recorder module.

 Page 217 Network connection status area (Un\G47 to 69)

## Common setting status area (Un\G70 to 86)

This area is the same as a recorder module.

 Page 217 Common setting status area (Un\G70 to 86)

## Current error area (Un\G140 to 149)

This area is the same as a recorder module.

 Page 218 Current error area (Un\G140 to 149)

## Error log area (Un\G150 to 311)

This area is the same as a recorder module.

 Page 219 Error log area (Un\G150 to 311)

### Point

If multiple errors with the same error code occur, only the log of the first error is stored in this area.

Logs of errors with the same error code occurred in each network camera can be checked in the following buffer memories:

- 'Current error' (Un\G34301, Un\G34801, Un\G35301, Un\G35801)
- 'Error log 1 to 16' (Un\G34313 to 34470, Un\G34813 to 34970, Un\G35313 to 35470, Un\G35813 to 35970)

For details, refer to the following:

 Page 282 Network camera status area (Un\G34000 to 37999)

## Operation setting at event detection area (Un\G810 to 841)

The operation setting at event detection can be checked.

Buffer memory name		Address	Description
Error registration at warning (type: system) detection	Warning due to program change during recording operation	Un\G810	The status for "Warning due to program change during recording operation" set in the module parameter is stored. 0: Error is not registered 1: Error is registered (continuous error)
Error (type: system) detection	Error due to communication with a network camera	Un\G826	The status for "Error due to communication with a network camera" set in the module parameter is stored. 0: Error 1: Warning

## Operation setting at video data saving area (Un\G860)

The operation setting at video data saving can be checked.

Buffer memory name		Address	Description
Operation at video data saving		Un\G860	The operation status when saving video data set in the module parameter is stored. 0: Video data saving takes priority 1: Video data receiving takes priority



## Recording status area (Un\G1500 to 3199)

The recording status can be checked.

Buffer memory name		Address	Description
Recording status 1	In recording operation	Un\G1501	The operating status of the recording function is stored. (☞ Page 63 Operating status) 0: Stopped 1: Operating The timing when a value is stored differs depending on the recording operation setting of a camera recorder module used. For details, refer to the following: ☞ Page 276 In recording operation (Un\G1501)
	Recording start error* <sup>1</sup>	Un\G1502	The status of an error when the recording function starts running is stored. 0: No error 1: Error exists The timing when a value is stored differs depending on the recording operation setting of a camera recorder module used. For details, refer to the following: ☞ Page 276 Recording start error (Un\G1502)
	Recording start error cause* <sup>1</sup>	Un\G1503	The code of an error that occurs when the recording function starts running is stored. 0: No error Values other than 0: Error code The timing when a value is stored differs depending on the recording operation setting of a camera recorder module used. For details, refer to the following: ☞ Page 277 Recording start error cause (Un\G1503)
	File saving trigger monitor	Un\G1504	The status of a file saving trigger is stored. 0: Unsatisfied 1: Satisfied If '1' (satisfied) is stored in 'File saving trigger monitor' of the main module, a recording startup trigger and file saving trigger are disabled. The period during which '1' (satisfied) is stored differs depending on the recording operation setting of a camera recorder module used. For details, refer to the following: ☞ Page 277 File saving trigger monitor (Un\G1504)
	Recording files saving	Un\G1505	The saving status of a recording file is stored. 0: Not saving 1: Saving The timing when a value is stored differs depending on the recording operation setting of a camera recorder module used. For details, refer to the following: ☞ Page 277 Recording files saving (Un\G1505)

Buffer memory name		Address	Description
Recording status 1	Data sampling <sup>*2</sup>	Un\G1506	<p>The sampling or accumulation status of devices and labels is stored.</p> <p>0: Not sampling 1: Sampling</p> <p>■When selecting "File Saving Trigger Only" for the recording method</p> <ul style="list-style-type: none"> <li>• '1' (sampling) is stored when the recording function starts running ('1' (operating) is stored in 'In recording operation' (Un\G1501)) after starting the function.</li> <li>• '0' (not sampling) is stored when saving a recording file starts, and '1' (sampling) is stored after the file saving is completed.</li> <li>• '0' (not sampling) is stored when stopping the operation of the recording function or a module stop error occurs.</li> </ul> <p>■When selecting "Recording Startup Trigger + File Saving Trigger" for the recording method</p> <ul style="list-style-type: none"> <li>• '1' (sampling) is stored when a recording startup trigger is satisfied, and '0' (not sampling) is stored after devices and labels for a saving period are accumulated.</li> <li>• When '1' (sampling) is stored, data accumulation stops and '0' (not sampling) is stored if the capacity of accumulated data exceeds that of the recording buffer. (Page 60 Recording buffer)</li> <li>• '0' (not sampling) is stored when stopping the operation of the recording function or a module stop error occurs.</li> </ul>
	Recording buffer storing status <sup>*1*2</sup>	Un\G1507	<p>Whether data in a sampled device and label is accumulated in the recording buffer is stored.</p> <p>0: No data 1: Data exists</p> <p>'1' (data exists) is stored when a device and label are sampled and data is accumulated in the recording buffer.</p> <p>'0' (no data) is stored when saving a recording file starts.</p> <p>When a recording startup trigger is satisfied, accumulated data is discarded and '0' (no data) is stored.</p> <p>When the operating status switches to 'operating' after starting the recording function, '0' (no data) is stored. (It is initialized to '0' (no data).)</p>
	Recording files saving completion <sup>*1</sup>	Un\G1508	<p>The completion status of recording file saving is stored.</p> <p>0: Not completed 1: Completed</p> <p>The timing when a value is stored differs depending on the recording operation setting of a camera recorder module used. For details, refer to the following: Page 277 Recording files saving completion (Un\G1508)</p>
	Recording files saving error <sup>*1</sup>	Un\G1509	<p>The status of an error when saving a recording file is stored.</p> <p>0: No error 1: Error exists</p> <p>The timing when a value is stored differs depending on the recording operation setting of a camera recorder module used. For details, refer to the following: Page 277 Recording files saving error (Un\G1509)</p>
	Recording files saving completion code <sup>*1</sup>	Un\G1510	<p>The code of an error occurred when saving a recording file is stored.</p> <p>0: No error</p> <p>Values other than 0: File saving failed (error code)</p> <p>The timing when a value is stored differs depending on the recording operation setting of a camera recorder module used. For details, refer to the following: Page 278 Recording files saving completion code (Un\G1510)</p>

Buffer memory name	Address	Description
Recording status 1	Recording files saving count <sup>*1</sup>	Un\G1511 The number of recording file saving executions (both successful and failed) is stored. The definition of the number of saving executions differs depending on the recording operation setting of a camera recorder module used. <ul style="list-style-type: none"> <li>• Main module: Number of saving executions of recording settings</li> <li>• Sub module: Number of saving executions in the camera recorder module itself</li> </ul> It is initialized to '0' when the operating status switches to 'operating' after turning the power ON or resetting a CPU module and starting the recording function. In addition, it is initialized to '0' when the operating status switches to 'operating' after adding or changing a recording setting and starting the recording function. When it reaches 65535 times, it returns to 1 and continues counting. If it is reset, '0' is stored. (Value to be stored: 0 to 65535)
	Recording files saving progress <sup>*1</sup>	Un\G1514 The progress rate (%) of recording file saving is stored. The definition of the progress rate differs depending on the recording operation setting of a camera recorder module used. <ul style="list-style-type: none"> <li>• Main module: Progress rate of recording file saving for all recording settings including sub modules</li> <li>• Sub module: Progress rate of recording file saving in the camera recorder module itself</li> </ul> It is initialized to '0' when the operating status switches to 'operating' after a file saving trigger is satisfied or starting the recording function. (Value to be stored: 0 to 100%)
	Recording files saving path (setting type folder) <sup>*1</sup>	Un\G1515 to 1522 The path to the setting type folder for a recording file last saved to an SD memory card is stored. It is initialized to '0' when the operating status switches to 'operating' after a file saving trigger is satisfied or starting the recording function. (Example) When the path to a recording file is /SD/RECORD/RC1/1TS01_001, /SD/RECORD/RC1/ is stored.
	Recording files saving path (under setting type folder) <sup>*1*2</sup>	Un\G1523 to 1555 The path under the setting type folder to a last saved recording file is stored. It is initialized to '0' when the operating status switches to 'operating' after a file saving trigger is satisfied or starting the recording function. (Example) When the path to a recording file is /SD/RECORD/RC1/1TS01_001, 1TS01_001 is stored.
	Recording startup trigger count <sup>*1*2*3</sup>	Un\G1575 When the operating status of the recording function is 'operating,' the number of times that a recording startup trigger was detected to have been satisfied is stored. (Value to be stored: 0 to 65535)
	Invalid recording startup trigger count <sup>*1*2*3</sup>	Un\G1576 When the operating status of the recording function is 'operating,' the number of invalid recording startup triggers among the recording startup triggers detected to have been satisfied is stored. (Value to be stored: 0 to 65535)
	File saving trigger count <sup>*1*2*3</sup>	Un\G1577 When the operating status of the recording function is 'operating,' the number of times that a file saving trigger was detected to have been satisfied is stored. (Value to be stored: 0 to 65535)
	Invalid file saving trigger count <sup>*1*2*3</sup>	Un\G1578 When the operating status of the recording function is 'operating,' the number of invalid file saving triggers among the file saving triggers detected to have been satisfied is stored. (Value to be stored: 0 to 65535)
	Average device/label sampling interval <sup>*1*2*4</sup>	Un\G1579 to 1580 The average value of device and label sampling intervals is stored (unit: millisecond). It is calculated based on eight moving averages. If an average value exceeds 4294967295 milliseconds, 4294967295 is stored.

Buffer memory name		Address	Description
Recording status 1	Average device/label sampling size <sup>*1*2*4</sup>	Un\G1581 to 1582	The average size of devices and labels to be sampled at a time is stored (unit: KB).
	Device/label maximum sampling period <sup>*1*2*4</sup>	Un\G1583 to 1584	The maximum period during which a device and label can be sampled in the current setting is stored (unit: second). A period is calculated with the following formula each time a device and label are sampled. • Recording buffer size ÷ Average device/label sampling size × Average device/label sampling interval If a period exceeds 4294967295 seconds, 4294967295 is stored.
	Recording buffer status <sup>*1*2</sup>	Un\G1585	Whether the recording buffer capacity (device/label data) is sufficient for a saving period set in the recording setting is stored. 0: Sufficient 1: Insufficient '1' (insufficient) is stored when a value in 'Device/label maximum sampling period' (Un\G1583 to 1584) is smaller than a set saving period. If a value in 'Device/label maximum sampling period' (Un\G1583 to 1584) and a set saving period are extremely close, '0' (sufficient) and '1' (insufficient) may be stored alternately in a short time. It is initialized to '0' (sufficient) when the operating status switches to 'operating' after starting the recording function.
	Sampling execution time (ms unit) <sup>*2</sup>	Un\G1586	The data sampling execution time of a CPU module is stored. <sup>*5*6*7</sup>
	Sampling execution time (μs unit) <sup>*2</sup>	Un\G1587	When using a recording startup trigger or specifying a device as a file saving trigger, the time required for trigger detection is also included. Note that when an interrupt program is executed during the END processing, the execution time of the interrupt program is also included in the sampling time, and if the program execution time of a CPU module is shorter than the accumulating execution time of a camera recorder module, the accumulating execution time is included in the sampling execution time of the CPU module. • Sampling execution time (ms unit): An ms digit is stored (value to be stored: 0 to 65535). • Sampling execution time (μs unit): A μs digit is stored (value to be stored: 0 to 999).
	Accumulating execution time (ms unit) <sup>*2</sup>	Un\G1588	The data accumulating execution time of a camera recorder module is stored. <sup>*7*8*9</sup>
	Accumulating execution time (μs unit) <sup>*2</sup>	Un\G1589	• Accumulating execution time (ms unit): An ms digit is stored (value to be stored: 0 to 65535). • Accumulating execution time (μs unit): A μs digit is stored (value to be stored: 0 to 999).
Camera event receiving status	Network camera 1	Un\G1593	The camera event receiving status is stored. (☞ Page 278 Camera event receiving status (Un\G1593 to 1600)) 0: Not set 1: Not receiving 2: Waiting for receiving
	Network camera 2	Un\G1594	Details are the same as network camera 1.
	Network camera 3	Un\G1595	
	Network camera 4	Un\G1596	
Number of camera events receiving <sup>*3</sup>	Network camera 1	Un\G1601	The number of times for camera event reception is stored. When the operating status of the recording function is 'operating' and the camera event receiving status is 'waiting for receiving,' the number of times for camera event reception is stored. (Value to be stored: 0 to 65535)
	Network camera 2	Un\G1602	Details are the same as network camera 1.
	Network camera 3	Un\G1603	
	Network camera 4	Un\G1604	

Buffer memory name		Address	Description
Recording status 1	Number of invalid camera events receiving* <sup>3</sup>	Network camera 1	Un\G1609 The number of invalid camera events among those received is stored. When the operating status of the recording function is 'operating' and the camera event receiving status is 'waiting for receiving,' the number of invalid camera events among those received is stored. (Value to be stored: 0 to 65535)
		Network camera 2	Un\G1610 Details are the same as network camera 1.
		Network camera 3	Un\G1611
		Network camera 4	Un\G1612
	Camera recording status	Network camera 1	Un\G1650 The operating status for video data is stored. (Page 278 Camera recording status (Un\G1650 to 1657)) 0: Stopped 1: Preparing 2: No setting 3: Operating 4: File saving trigger satisfied 5: Saving
		Network camera 2	Un\G1651 Details are the same as network camera 1.
		Network camera 3	Un\G1652
		Network camera 4	Un\G1653
	Video data maximum accumulation period* <sup>1*10</sup>	Network camera 1	Un\G1658 to 1659 The maximum period (seconds) during which video data can be accumulated is stored at the current bit rate. It is calculated with the following formula each time video data from a network camera is accumulated. • Accumulation period = Recording buffer size ÷ Average bit rate If a period exceeds 4294967295 seconds, 4294967295 is stored.
		Network camera 2	Un\G1660 to 1661 Details are the same as network camera 1.
		Network camera 3	Un\G1662 to 1663
		Network camera 4	Un\G1664 to 1665
Recording buffer storing status	Network camera 1	Un\G1674 Whether received video data is accumulated in the recording buffer is stored. 0: No data 1: Data exists '1' (data exists) is stored when video data is received and accumulated in the recording buffer. '0' (no data) is stored when saving a recording file starts. When a recording startup trigger is satisfied, accumulated data is discarded and '0' (no data) is stored. When the operating status switches to 'operating' after starting the recording function, '0' (no data) is stored. (It is initialized to '0' (no data).)	
	Network camera 2	Un\G1675 Details are the same as network camera 1.	
	Network camera 3	Un\G1676	
	Network camera 4	Un\G1677	
Recording status 2 to 4		Un\G1700 to 2299	Details are the same as recording status 1.

- \*1 A value is not updated when the operating status is 'stopped.'
- \*2 Available only for a camera recorder module with "Main" selected for the recording operation setting.
- \*3 '0' is stored when powering ON or resetting a CPU module.  
It starts from '0' when the operating status switches to 'operating' after adding or changing a recording setting and starting the recording function. When it reaches 65535 times, it returns to 1 and continues counting.
- \*4 If the number of times for data sampling is not sufficient for calculation after data sampling starts, an error occurs.  
It is cleared to the initial value (0) when the operating status switches to 'operating' after starting the recording function.
- \*5 A value is updated when data in a CPU module is sampled.
- \*6 When the sampling execution time is 23.6 ms, it is stored as follows:  
Sampling execution time (ms unit): 23  
Sampling execution time (μs unit): 600
- \*7 Initialized to '0' in any of the following cases:  
The power is turned ON.  
A CPU module is reset.  
The recording function is started.
- \*8 A value is updated when data accumulation for a camera recorder module is completed.
- \*9 When the accumulating execution time is 23.6 ms, it is stored as follows:  
Accumulating execution time (ms unit): 23  
Accumulating execution time (μs unit): 600
- \*10 A value is not stored before the number of average bit rates required for calculation is sampled after data accumulation starts.  
It is cleared to the initial value (0) when the operating status switches to 'operating' after starting the recording function.  
For details on 'Average bit rate' (Un\G34473 to 34474), refer to the following:  
☞ Page 282 Network camera status area (Un\G34000 to 37999)

### ■ In recording operation (Un\G1501)

Each value is stored at each timing as follows:

Value	Main module	Sub module
0 (stopped)	<ul style="list-style-type: none"> <li>• The recording function is stopped, and the main module and all sub modules with recording target data stop operating.<sup>*1</sup></li> <li>• A module stop error occurs in the main module.</li> </ul>	<ul style="list-style-type: none"> <li>• The recording function is stopped, and the camera recorder module itself stops operating.<sup>*1</sup></li> <li>• A module stop error occurs in the camera recorder module itself.</li> <li>• A module stop error occurs in the main module.</li> </ul>
1 (operating)	<ul style="list-style-type: none"> <li>• The main module and all sub modules with recording target data start operating after starting the recording function.<sup>*2</sup></li> </ul>	<ul style="list-style-type: none"> <li>• The camera recorder module itself starts operating after starting the recording function.</li> </ul>

- \*1 When the operating status is 'saving trigger establishment' or 'saving,' a value is stored at either of the following timings:  
Main module: After saving is completed in the main module and all sub modules with recording target data  
Sub module: After saving is completed
- \*2 If there is any sub module that cannot start operating, a value is stored when the other sub modules and main module start operating.

### ■ Recording start error (Un\G1502)

Each value is stored at each timing as follows:

Value	Main module	Sub module
0 (no error)	<ul style="list-style-type: none"> <li>• The operating status of the main module switches to 'preparing' after starting the recording function. (It is initialized to '0' (no error).)</li> </ul>	<ul style="list-style-type: none"> <li>• The operating status of the camera recorder module itself switches to 'preparing' after starting the recording function. (It is initialized to '0' (no error).)</li> </ul>
1 (error exists) <sup>*1</sup>	<ul style="list-style-type: none"> <li>• A CPU module or the main module cannot start recording due to an error after starting the recording function.</li> <li>• There is any sub module with recording target data that cannot start recording after starting the recording function.</li> </ul>	<ul style="list-style-type: none"> <li>• The camera recorder module itself cannot start recording due to an error after starting the recording function.</li> </ul>

- \*1 An error cause can be checked in 'Recording start error cause' (Un\G1503).

### ■Recording start error cause (Un\G1503)

Each value is stored at each timing as follows:

Value	Main module	Sub module
0 (no error)	<ul style="list-style-type: none"> <li>The operating status of the main module switches to 'preparing' after starting the recording function. (It is initialized to '0' (no error).)</li> </ul>	<ul style="list-style-type: none"> <li>The operating status of the camera recorder module itself switches to 'preparing' after starting the recording function. (It is initialized to '0' (no error).)</li> </ul>
Values other than 0 (error code)	<ul style="list-style-type: none"> <li>A CPU module or the main module cannot start recording due to an error after starting the recording function.</li> <li>There is any sub module with recording target data that cannot start recording after starting the recording function.</li> </ul>	<ul style="list-style-type: none"> <li>The camera recorder module itself cannot start recording due to an error after starting the recording function.</li> </ul>

### ■File saving trigger monitor (Un\G1504)

'1 (satisfied)' is stored during either of the following periods:

Value	Main module	Sub module
1 (satisfied)	<ul style="list-style-type: none"> <li>From when a file saving trigger is satisfied to when saving is completed in the main module and all sub modules with recording target data</li> </ul>	<ul style="list-style-type: none"> <li>From when a file saving trigger is satisfied to when saving is completed in the camera recorder module itself</li> </ul>

### ■Recording files saving (Un\G1505)

Each value is stored at each timing as follows:

Value	Main module	Sub module
0 (not saving)	<ul style="list-style-type: none"> <li>Saving a recording file is completed in the main module and all sub modules with recording target data.</li> </ul>	<ul style="list-style-type: none"> <li>Saving a recording file is completed in the camera recorder module itself.</li> </ul>
1 (saving)	<ul style="list-style-type: none"> <li>Saving a recording file is started.</li> </ul>	<ul style="list-style-type: none"> <li>Saving a recording file is started in the camera recorder module itself.</li> </ul>

### ■Recording files saving completion (Un\G1508)

Each value is stored at each timing as follows:

Value	Main module	Sub module
0 (not completed)	<ul style="list-style-type: none"> <li>A file saving trigger is satisfied.</li> <li>The operating status of the main module switches to 'operating' after starting the recording function. (It is initialized to '0' (not completed).)</li> </ul>	<ul style="list-style-type: none"> <li>A file saving trigger is satisfied.</li> <li>The operating status of the camera recorder module itself switches to 'operating' after starting the recording function. (It is initialized to '0' (not completed).)</li> </ul>
1 (completed)	<ul style="list-style-type: none"> <li>Saving a recording file is completed in the main module and all sub modules with recording target data.</li> </ul>	<ul style="list-style-type: none"> <li>Saving a recording file is completed in the camera recorder module itself.</li> </ul>

### ■Recording files saving error (Un\G1509)

Each value is stored at each timing as follows:

Value	Main module	Sub module
0 (no error)	<ul style="list-style-type: none"> <li>A file saving trigger is satisfied.</li> <li>The operating status of the main module switches to 'operating' after starting the recording function. (It is initialized to '0' (no error).)</li> </ul>	<ul style="list-style-type: none"> <li>A file saving trigger is satisfied.</li> <li>The operating status of the camera recorder module itself switches to 'operating' after starting the recording function. (It is initialized to '0' (no error).)</li> </ul>
1 (error exists)	<ul style="list-style-type: none"> <li>Saving a recording file fails in the main module.</li> <li>Saving a recording file fails in a sub module with recording target data.</li> <li>There is video data that failed to be saved in the main module and all sub modules with recording target data.</li> </ul>	<ul style="list-style-type: none"> <li>Saving a recording file fails in the camera recorder module itself.</li> <li>There is video data that failed to be saved in the camera recorder module itself.</li> </ul>

## ■Recording files saving completion code (Un\G1510)

Each value is stored at each timing as follows:

Value	Main module	Sub module
0 (no error)	<ul style="list-style-type: none"> <li>A file saving trigger is satisfied.</li> <li>The operating status of the main module switches to 'operating' after starting the recording function. (It is initialized to '0' (no error).)</li> </ul>	<ul style="list-style-type: none"> <li>A file saving trigger is satisfied.</li> <li>The operating status of the camera recorder module itself switches to 'operating' after starting the recording function. (It is initialized to '0' (no error).)</li> </ul>
Values other than 0 (error code)	<ul style="list-style-type: none"> <li>Saving a recording file fails in the main module.</li> <li>Saving a recording file fails in a sub module with recording target data.</li> <li>There is video data that failed to be saved in the main module and all sub modules with recording target data.</li> </ul>	<ul style="list-style-type: none"> <li>Saving a recording file fails in the camera recorder module itself.</li> <li>There is video data that failed to be saved in the camera recorder module itself.</li> </ul>

## ■Camera event receiving status (Un\G1593 to 1600)

The camera event receiving status is stored.

Value	Description
0 (not set)	There is no camera event notification setting. If the camera event notification setting is not enabled in the module extended parameter or the camera event type is not supported, 'not set' is stored.
1 (not receiving)	A camera recorder module is not waiting to receive camera events from a network camera.
2 (waiting for receiving)	A camera recorder module is waiting to receive camera events from a network camera. Camera events detected by a network camera can be received.

## ■Camera recording status (Un\G1650 to 1657)

The operating status for video data is stored.

Value	Description
0 (stopped)	The recording function is stopped. The status switches to 'stopped' in the following cases: <ul style="list-style-type: none"> <li>After starting a camera recorder module</li> <li>After resetting a CPU module</li> <li>No recording settings written</li> </ul>
1 (preparing)	An operation is being prepared (such as analyzing recording settings or establishing the communication with a target network camera).
2 (no setting)	The recording operation status is 'operating' and the communication with a target network camera is established, but the network camera is not set in the receiving target setting.
3 (operating)	The recording function is running for a target network camera. The status remains 'operating' even if the communication with the network camera is disconnected.
4 (file saving trigger satisfied)	A file saving trigger is satisfied and video data for a remaining saving period is being received and accumulated.
5 (saving)	A video file is being saved.

## Recording setting information area (Un\G3200 to 3999)

Setting information of recording settings can be checked.

Buffer memory name	Address	Description
Recording setting information 1 <sup>*1</sup>	Recording buffer size	Un\G3200 The recording buffer capacity set in the module parameter is stored (unit: MB).
	Saving period	Un\G3201 to 3202 A saving period set in the recording setting is stored. (Unit: second) ■When selecting "File Saving Trigger Only" for the recording method Total saving period before and after trigger ■When selecting "Recording Startup Trigger + File Saving Trigger" for the recording method Accumulation period
	Saving setting when there is no free folder number	Un\G3203 A saving setting when there is no free folder number set in the recording setting is stored. 0: Overwrite 1: Not save



Buffer memory name		Address	Description	
Recording setting information 1 <sup>*1</sup>	Recording startup trigger specification	Un\G3204	A recording startup trigger specification set in the recording setting is stored. 0: Not specify (when selecting "File Saving Trigger Only" for the recording method) 1: Specify (when selecting "Recording Startup Trigger + File Saving Trigger" for the recording method)	
	Recording startup trigger establishment condition <sup>*2</sup>	Un\G3205	The condition for satisfying a recording startup trigger set in the recording setting is stored in b0. OFF: Rising ON: Falling	
	Saving specification after the specified time has elapsed from recording completion <sup>*2</sup>	Un\G3206	The saving specification after the specified time has elapsed from recording completion set in the recording setting is stored. 0: Not specify 1: Specify	
	Waiting time from recording completion to file saving <sup>*3</sup>	Un\G3207 to 3208	The waiting time from recording completion to file saving set in the recording setting is stored (unit: second).	
	Establishment condition of file saving trigger <sup>*4</sup>	Un\G3209	The condition for satisfying a file saving trigger set in the recording setting is stored. OFF: Rising <sup>*5</sup> ON: Falling	
	Recording files saving destination	Un\G3210	The save destination for a recording file set in the recording setting is stored. 0: SD memory card 1: File server	
	Camera event trigger settings	Un\G3211	Whether a camera event that occurs in each network camera is applied as a condition for satisfying a file saving trigger is stored. (0: Disabled/1: Enabled) b0: Network camera 1 b1: Network camera 2 b2: Network camera 3 b3: Network camera 4	
	Recording buffer size (video data)	Network camera 1	Un\G3213	The recording buffer capacity (MB) set for network camera 1 in the recording setting is stored. The total value of the recording buffer capacities of network cameras 1 to 4 is equal to a value of the recording buffer capacity (video data) assigned to the corresponding setting number set in the module parameter.
		Network camera 2	Un\G3214	Details are the same as network camera 1.
		Network camera 3	Un\G3215	
		Network camera 4	Un\G3216	
	Saving specification when CPU stop error is detected	Un\G3250	The saving specification when a CPU stop error is detected set in the recording setting is stored. 0: Not specify 1: Specify	
	Establishment condition of file saving trigger (Extended) <sup>*6</sup>	Un\G3251 to 3266	The condition for satisfying a file saving trigger set in the recording setting is stored. 0: Rising 1: Falling 2: Timeout	
Recording setting information 2 to 4 <sup>*1</sup>		Un\G3300 to 3599	Details are the same as recording setting information 1.	

- \*1 A value is updated when the operating status switches to 'operating.'
- \*2 Enabled only when specifying a recording startup trigger.
- \*3 Enabled only when specifying a recording startup trigger and selecting the checkbox of "Save after specified time elapses from recording completion."
- \*4 Check the set condition in each of the following buffer memories:

Condition number	1	2	3	4	5	6	7	8	9	10	11	12	13	14	15	16
Recording setting No.1: Un\G3209	b0	b1	b2	b3	b4	b5	b6	b7	b8	b9	b10	b11	b12	b13	b14	b15
Recording setting No.2: Un\G3309	b0	b1	b2	b3	b4	b5	b6	b7	b8	b9	b10	b11	b12	b13	b14	b15
Recording setting No.3: Un\G3409	b0	b1	b2	b3	b4	b5	b6	b7	b8	b9	b10	b11	b12	b13	b14	b15
Recording setting No.4: Un\G3509	b0	b1	b2	b3	b4	b5	b6	b7	b8	b9	b10	b11	b12	b13	b14	b15

- \*5 'OFF' is stored even when specifying a timeout as the condition. Check the condition in 'Establishment condition of file saving trigger (Extended)' (Un\G3251 to 3266).
- \*6 Check the set condition in each of the following buffer memories:

Condition number	1	2	3	4	5	6	7	8	9	10	11	12	13	14	15	16
Recording setting No.1: Un\G	3251	3252	3253	3254	3255	3256	3257	3258	3259	3260	3261	3262	3263	3264	3265	3266
Recording setting No.2: Un\G	3351	3352	3353	3354	3355	3356	3357	3358	3359	3360	3361	3362	3363	3364	3365	3366
Recording setting No.3: Un\G	3451	3452	3453	3454	3455	3456	3457	3458	3459	3460	3461	3462	3463	3464	3465	3466
Recording setting No.4: Un\G	3551	3552	3553	3554	3555	3556	3557	3558	3559	3560	3561	3562	3563	3564	3565	3566

### **Recording operation specification area (Un\G4000 to 4799)**

This area is the same as a recorder module.

It is available only for a camera recorder module with "Main" selected for the recording operation setting.

☞ Page 228 Recording operation specification area (Un\G4000 to 4799)

### **File server saving information area (Un\G9000 to 10999)**

This area is the same as a recorder module.

It is available only for a camera recorder module with "Main" selected for the recording operation setting.

☞ Page 229 File server saving information area (Un\G9000 to 10999)

### **Firmware update history information area (Un\G13392 to 13427)**

This area is the same as a recorder module.

☞ Page 229 Firmware update history information area (Un\G13392 to 13427)

### **Project data saving status area (Un\G14000 to 14079)**

This area is the same as a recorder module.

It is available only for a camera recorder module with "Main" selected for the recording operation setting.

☞ Page 230 Project data saving status area (Un\G14000 to 14079)

### **Project data saving specification area (Un\G14080 to 14199)**

This area is the same as a recorder module.

It is available only for a camera recorder module with "Main" selected for the recording operation setting.

☞ Page 232 Project data saving specification area (Un\G14080 to 14199)

### **Co-recording status area (Un\G14200 to 14249)**

This area is the same as a recorder module.

It is available only for a camera recorder module with "Main" selected for the recording operation setting.

☞ Page 232 Co-recording status area (Un\G14200 to 14249)

### **Co-recording setting information area (Un\G14250 to 14299)**

This area is the same as a recorder module.

It is available only for a camera recorder module with "Main" selected for the recording operation setting.

☞ Page 232 Co-recording setting information area (Un\G14250 to 14299)

### **SD memory card history information area (Un\G30004 to 30014)**

This area is the same as a recorder module.

☞ Page 233 SD memory card history information area (Un\G30004 to 30014)

## Network camera status area (Un\G34000 to 37999)

The operating status of a network camera can be checked.

Buffer memory name	Address	Description
Network camera 1 status area	Setting information	Network camera setting enabled/disabled Un\G34000 Whether the setting for a network camera connected to a camera recorder module is enabled or disabled is stored. 0: Disabled 1: Enabled
	IP address (string)	Un\G34001 to 34008 The IP address of a network camera set as a connection target for a camera recorder module is stored as a character string.
	IP address	Un\G34009 to 34010 The IP address of a network camera set as a connection target for a camera recorder module is stored. • Un\G34009: Third octet, fourth octet • Un\G34100: First octet, second octet
	TCP port number	Un\G34015 The TCP port number of a network camera set as a connection target for a camera recorder module is stored. (Value to be stored: 0 to 4999, 5010 to 65534)
	Network camera comment	Un\G34016 to 34047 A set camera comment is stored.
	Network camera manufacturer name	Un\G34048 to 34079 The manufacturer name of a network camera is stored.
	Network camera model name	Un\G34080 to 34111 The model name of a network camera is stored.
	Network camera firmware version	Un\G34112 to 34143 The firmware version of a network camera is stored as a character string.
	Network camera MAC address	Un\G34208 to 34223 The MAC address of a network camera is stored.
	Simple setting mode	Un\G34225 Whether the simple setting mode is enabled or disabled is stored. • 0: Disabled • 1: Enabled
	Resolution	Un\G34226 The resolution of a network camera is stored. • 1: VGA (640 × 480) • 2: HD (1280 × 720) • 3: FHD (1920 × 1080) • 4: SXVGA (1280 × 960)
	Video frame rate	Un\G34227 The frame rate (fps) <sup>*1</sup> of a network camera is stored. • 10 • 30 • 120 • 180 <sup>*2</sup>
	Video codec	Un\G34228 The video codec of a network camera is stored. 0: H.264 1: Motion JPEG
	Max. video bit rate	Un\G34229 The maximum video bit rate (kbps) <sup>*3</sup> of a network camera is stored. When the simple setting mode is enabled, '0' is stored. (Value to be stored: 1 to 50000, FFFFH: Unlimited, 0: No setting)
	Video quality	Un\G34230 The video quality is stored. 0: High 1: Middle 2: Low FFFFH: No setting When the simple setting mode is enabled, 'FFFFH' is stored.
Video rotation angle <sup>*4</sup>	Un\G34231 The rotation angle of a video captured by a network camera is stored. 0: 0 degrees 180: 180 degrees FFFFH: No setting When the simple setting mode is enabled, 'FFFFH' is stored.	

Buffer memory name		Address	Description	
Network camera 1 status area	Setting information	Resolution support list	Un\G34232 A resolution that can be set for a network camera in a camera recorder module is stored. (OFF: Cannot be set/ ON: Can be set) b0: QVGA (320 × 240) b1: VGA (640 × 480) b2: HD (1280 × 720) b3: FHD (1920 × 1080) b4: SVGA (800 × 600) b5: SXVGA (1280 × 960) b6 to b15: Not used	
		Frame rate support upper limit value	Un\G34233 The upper limit value of a frame rate supported by a network camera is stored.	
		Frame rate support lower limit value	Un\G34234 The lower limit value of a frame rate supported by a network camera is stored.	
		PTZ support	Un\G34235 Whether PTZ for a network camera is supported is stored. (OFF: Not supported/ON: Supported) 0b: PT supported 1b: Z supported	
		PTZ speed support	Un\G34236 Whether PTZ speed for a network camera is supported is stored. 0: Not supported 1: Supported	
		Video rotation angle support	Un\G34237 Whether the video rotation angle can be set for a network camera in a camera recorder module is stored. 0: Not supported 1: Supported	
		SNTP client function support	Un\G34238 Whether the SNTP client function is supported is stored. 0: Not supported 1: Supported	
		Camera event notification	Un\G34254 The camera event notification setting for a network camera is stored. 0: Invalid 1: Motion detection	
		Camera event comment	Un\G34255 to 34286 A camera event comment set for a network camera is stored.	
		Camera event type support list	Un\G34287 A camera event type that can be set for a network camera in a camera recorder module is stored. (OFF: Cannot be set/ON: Can be set) b0: Motion detection b1 to b15: Not used	
Network status	Network status	Network camera connection status	Un\G34300 The connection status of a network camera is stored. (☞ Page 285 Network camera connection status (Un\G34300)) 0: No setting 1: Disconnected 2: Connected 3: Retrying	
		Current error <sup>*5</sup>	Un\G34301 The code of the latest error occurred for a network camera is stored.	
		Time <sup>*5</sup>	Un\G34303	b0 to 7: Time zone and summer time flag b8 to 15: System area
			Un\G34304	b0 to 7: Last two digits of the year b8 to 15: Month (01 to 12)
			Un\G34305	b0 to 7: Day (01 to 31) b8 to 15: Hour (00 to 23)
			Un\G34306	b0 to 7: Minute (00 to 59) b8 to 15: Second (00 to 59)
			Un\G34307	b0 to 7: Day of the week (0: Sun, 1: Mon, 2: Tue, 3: Wed, 4: Thu, 5: Fri, 6: Sat) b8 to 15: First two digits of the year
Un\G34308	b0 to 7: First two digits of the millisecond b8 to 15: Last two digits of the millisecond			

Buffer memory name		Address	Description		
Network camera 1 status area	Network status	Number of error occurrence <sup>*6</sup>	Un\G34311	The total number of times an error log is registered in the error log area is stored.	
		Error log writing pointer <sup>*6</sup>	Un\G34312	An error log number in which the latest error log is registered is stored. 0: No error 1 to 16: Error log number	
		Error log 1 <sup>*6</sup>	Error code	Un\G34313	The code of an error occurred for a network camera is stored.
			Time	Un\G34315	b0 to 7: Time zone and summer time flag b8 to 15: System area
				Un\G34316	b0 to 7: Last two digits of the year b8 to 15: Month (01 to 12)
				Un\G34317	b0 to 7: Day (01 to 31) b8 to 15: Hour (00 to 23)
				Un\G34318	b0 to 7: Minute (00 to 59) b8 to 15: Second (00 to 59)
				Un\G34319	b0 to 7: Day of the week (0: Sun, 1: Mon, 2: Tue, 3: Wed, 4: Thu, 5: Fri, 6: Sat) b8 to 15: First two digits of the year
				Un\G34320	b0 to 7: First two digits of the millisecond b8 to 15: Last two digits of the millisecond
		Error log 2 to 16 <sup>*6</sup>	Un\G34323 to 34472	Details are the same as error log 1.	
		Average bit rate <sup>*7</sup>	Un\G34473 to 34474	An average bit rate value (kbps) in communication with a network camera is stored.	
		Number of lost frames	Un\G34475	The total number of frames lost while receiving video data for the past 60 seconds is stored. If incomplete data due to packet loss, etc. is included in a frame that configures video data received from a network camera, it is deleted for each frame and the cumulative number of deletions is stored.	
Time synchronization status	Un\G34476	The status of time synchronization between a camera recorder module and a network camera is stored. 0: Time not synchronized 1: Time synchronized Time is synchronized when the time stamp of video data delivered from a network camera and the time information of a device and label are synchronized. It may take time to complete.			
Video data receiving status	Un\G34477	The video data receiving status of a camera recorder module is stored. 0: Not receiving 1: Receiving			
Network camera 2 status area		Un\G34500 to 34999	Details are the same as network camera 1 status area.		
Network camera 3 status area		Un\G35000 to 35499			
Network camera 4 status area		Un\G35500 to 35999			

\*1 A unit that indicates the maximum number of frames delivered from a network camera per second.

\*2 Supported for ONVIF supported network cameras only.

\*3 The maximum bit rate depends on the performance of a network camera used; therefore, a setting value and an actual bit rate may differ.

For details, refer to the manual for a network camera used.

\*4 The setting is applied when '1: supported' is stored in 'Video rotation angle support' (Un\G34237).

\*5 For details, refer to the following:

☞ Page 285 Current error area (Un\G34301 to 34310)

\*6 For details, refer to the following:

☞ Page 286 Error log area (Un\G34311 to 34472)

\*7 An average value calculated based on eight moving averages is stored.

It is not stored in the buffer memory before eight values are sampled.

## ■ Network camera connection status (Un\G34300)

The connection status of a network camera is stored.

Value	Description
0 (no setting)	No network camera is set. '0 (no setting)' is stored for a network camera number not set in the module extended parameter.
1 (disconnected)	A network camera is not connected yet.
2 (connected)	A network camera is connected properly. '2 (connected)' is stored for a network camera not set as a receiving target in the "Video Data Receiving Target Setting" screen when the communication is established. '2 (connected)' is stored for a network camera set as a receiving target in the "Video Data Receiving Target Setting" screen when video data is being received by using the recording function.
3 (retrying)	The connection with a network camera is disconnected and it is being retried. '3 (retrying)' is stored for a network camera set as a receiving target in the "Video Data Receiving Target Setting" screen when video data can no longer be received while it is being received by using the recording function.

## ■ Current error area (Un\G34301 to 34310)

The code of the latest error occurred for a network camera is stored.

- Current error (Un\G34301)

An error code is stored.

- Time (Un\G34303 to 34310)

The time when an error occurred is stored as a BCD code.

	b15	...	b8	b7	...	b0
Un\G34303	System area			Time zone and summer time flag *1		
Un\G34304	Month (01H to 12H)			Year (00H to 99H) last 2 digits		
Un\G34305	Hour (00H to 23H)			Day (01H to 31H)		
Un\G34306	Second (00H to 59H)			Minute (00H to 59H)		
Un\G34307	Year (00H to 99H) first 2 digits			Day of the week (0H to 6H)		
Un\G34308	Lower milliseconds (00H to 99H)			Upper milliseconds (00H to 09H)		

\*1 Time zone and summer time flag details are as follows:

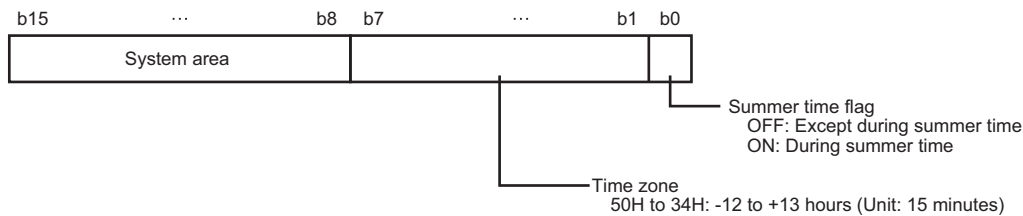

## ■ Error log area (Un\G34311 to 34472)

The history of an error occurred for a network camera is stored.

- Number of error occurrence (Un\G34311)

The total number of times an error log is registered in the error log area is stored.

- Error log writing pointer (Un\G34312)

An error log number in which the latest error log is registered is stored. (When '16' is stored, the latest error log is registered in the area of error log 16.)

Up to 16 minor errors are registered.

If 16 minor errors are displayed, new minor errors will not be registered. If the new error has the same error code as the already registered error, the error occurrence date/time and its detailed information will not be updated.

Even if a new error occurs after a stop error occurs, the new one is not registered.

- Error log (Un\G34313 to 34472)

The history of an error occurred for a network camera is stored.

The error log area consists of 16 error logs with the same data configuration.

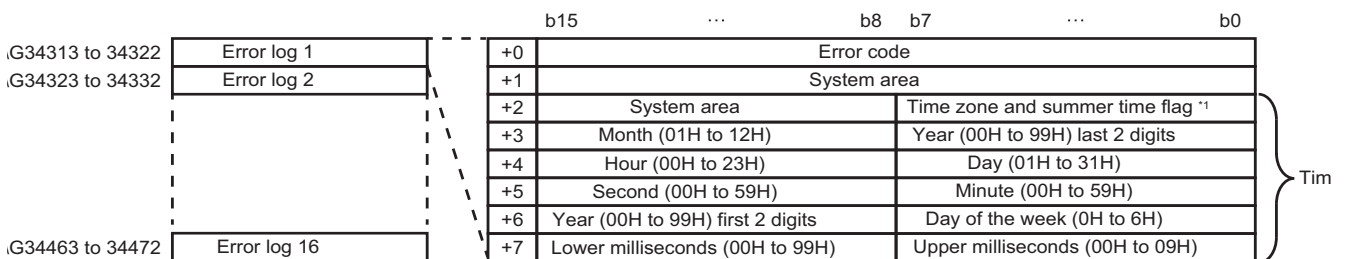

\*1 Time zone and summer time flag details are as follows:

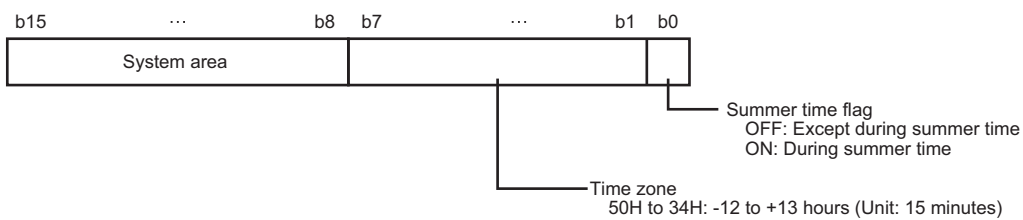

### ● Error code

An error code is stored.

### ● Time

The time when an error occurred is stored as a BCD code.



## PTZ control area (Un\G38000 to 43599)

Information on PTZ control can be checked.

Buffer memory name		Address	Description	
Network camera 1 PTZ information	PTZ control authority mode	Un\G38000	The operation mode of PTZ control authority mode is stored. 0: PTZ enable mode 1: PTZ preset mode 2: PTZ disable mode	
	PTZ operation processing requestor	Un\G38001	The request source for PTZ operation processing to a camera recorder module is stored. (☞ Page 288 PTZ operation processing requestor (Un\G38001)) 0H: Not requested 1H: Tool 2H: GOT 3H: Ladder program	
	PTZ operation status	Un\G38002	The current PTZ operation status is stored. (☞ Page 288 PTZ operation status (Un\G38002)) 0H: Not requested 1H: PTZ control being performed 2H: PTZ control completed successfully 3H: Preset position being registered 4H: Preset position registered successfully 5H: Preset position being deleted 6H: Preset position deleted successfully 7H: Preset request being executed 8H: Preset request completed successfully FFFFH: Error completion	
	Preset	Specified preset position No.	Un\G38006	Specify the preset position number of a move destination (setting range: 1 to 16).
		Specified preset position movement speed <sup>*1</sup>	Un\G38007	Specify a movement speed to adjust the range captured by a specified network camera (setting range: 0 to 1000).
		Preset position execution request	Un\G38008	Request to move the range to a specified preset position. (☞ Page 289 Preset position execution request (Un\G38008)) 0: Not requested 1: Requested
	Preset position 1	Preset position name	Un\G38010 to 38041	The name of a preset position set for preset position 1 is stored.
		Position information (P) <sup>*2</sup>	Un\G38042	A value of the pan (P) (horizontal direction), which is position information of preset position 1, is stored. (Value to be stored: -1000 to 1000)
		Position information (T) <sup>*2</sup>	Un\G38043	A value of the tilt (T) (vertical direction), which is position information of preset position 1, is stored. (Value to be stored: -1000 to 1000)
		Position information (Z) <sup>*3</sup>	Un\G38044	A value of the zoom (Z) (zoom in/out), which is position information of preset position 1, is stored. (Value to be stored: 0 to 1000)
Preset position 2 to 16		Un\G38050 to 38649	Details are the same as preset position 1.	
Network camera 2 PTZ information		Un\G38700 to 39399	Details are the same as network camera 1 PTZ information.	
Network camera 3 PTZ information		Un\G39400 to 40099		
Network camera 4 PTZ information		Un\G40100 to 40799		

- \*1 The setting is applied when '1: supported' is stored in 'PTZ speed support' (Un\G34236).  
When '0: not supported' is stored in 'PTZ speed support,' a set value is ignored.
- \*2 A value stored in this area is converted to a relative value in the range of -1000 to 1000 for an actual position (coordinate) captured by a network camera.
- \*3 A value stored in this area is converted to a relative value in the range of 0 to 1000 for an actual position (coordinate) captured by a network camera.

### ■PTZ operation processing requestor (Un\G38001)

The request source for PTZ operation processing to a camera recorder module is stored.

Value	Description
0H (not requested)	PTZ operation is not requested.
1H (tool)	A PTZ operation request was sent from a tool.
2H (GOT)	A PTZ operation request was sent from a GOT.
3H (ladder program)	A PTZ operation request was sent from a program.

### ■PTZ operation status (Un\G38002)

The current PTZ operation status is stored.

Value	Description
0H (not requested)	PTZ operation is not requested.
1H (PTZ control being performed)	PTZ control is being performed on a network camera in a direction specified in a camera recorder module.
2H (PTZ control completed successfully)	PTZ control is completed for a network camera in a direction specified in a camera recorder module.
3H (preset position being registered)	A preset position is being registered in the flash memory of a camera recorder module.
4H (preset position registered successfully)	Registering a preset position in the flash memory of a camera recorder module is completed.
5H (preset position being deleted)	A preset position registered in the flash memory of a camera recorder module is being deleted.
6H (preset position deleted successfully)	Deleting a preset position registered in the flash memory of a camera recorder module is completed.
7H (preset request being executed)	PTZ control is being performed on a network camera for a preset position specified in a camera recorder module.
8H (preset request completed successfully)	PTZ control is completed for a network camera for a preset position specified in a camera recorder module.
FFFFH (error completion)	An error occurred in PTZ operation.

### ■Preset position execution request (Un\G38008)

Adjusting the range to a specified preset position number can be requested.

When adjusting the range of data captured by a network camera, change the value in 'Preset position execution request' (Un\G38008) to '1: requested.' For details on the procedure, refer to the following:

☞ Page 247 Moving to a preset position

Return the value in 'Preset position execution request' (Un\G38008) from '1H: requested' to '0H: not requested' after '8H: preset request completed successfully' is stored in 'PTZ operation status' (Un\G38002). The value in 'PTZ operation status' returns to '0H: not requested.'

Even if the value in 'Preset position execution request' (Un\G38008) is not returned to '0H: not requested,' the value in 'PTZ operation status' (Un\G38002) automatically returns to '0H: not requested' when 30 seconds elapses after '8H: preset request completed successfully' is stored.

• Timing chart

The following shows a timing chart for moving to the PTZ values of preset position number 1 for network camera 1 by using a program.

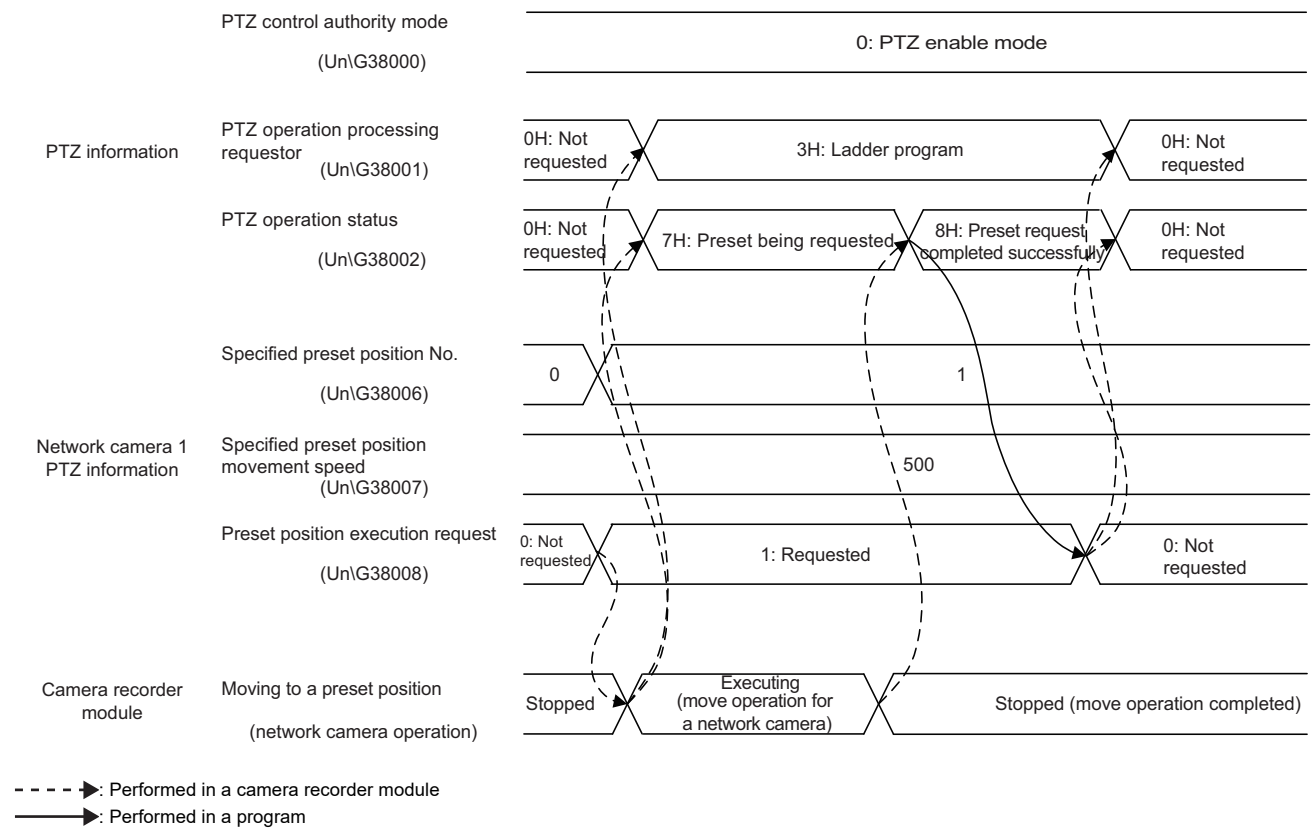

### Precautions

A preset position execution request is not accepted in the following cases:

- 'PTZ control authority mode' (Un\G38000) is set to '2: PTZ disable mode.'
- 'PTZ operation status' (Un\G38002) is set to a value other than '0H: not requested.'

## GOT registration area (Un\G47100 to 47129)

Information on the GOT linkage function of a camera recorder module can be checked.

Buffer memory name		Address	Description
GOT registration area	GOT linkage enabled/ disabled	Un\G47100	Whether the GOT linkage is enabled or disabled is stored. 0H: Disable 1H: Enable
	IP address	Un\G47101 to 47102	The IP address of a GOT set as a connection target for a camera recorder module is stored. • Un\G47101: Third octet, fourth octet • Un\G47102: First octet, second octet
	IP address (string)	Un\G47103 to 47110	The IP address of a GOT set as a connection target for a camera recorder module is stored as a character string.
	GOT registration status	Un\G47111	The GOT registration status is stored. 0H: Not registered 1H: Registering 2H: Registered

# APPENDIX

## Appendix 1 Available Characters in the Recording Setting

This section shows the characters that can be used for each setting item in the recording setting.

Screen	Item	Available character	Reference
Saving Period Setting	Recording Startup Trigger	☞ Page 291 ASCII characters that can be used for a device name	Page 116 Saving Period Setting
	Device		
Specify the Device Range	Start Device		Page 131 "Specify the Device Range" screen
	End Device		
File Saving Trigger Setting	Device	Basic Multilingual Plane in UTF-16LE (without BOM)*1	Page 134 File Saving Trigger Setting
	Comment		
File Server Setting	Storage Location (host name)	☞ Page 292 Storage location (host name)	Page 137 File server setting
	Storage Location (folder path)	Basic Multilingual Plane in UTF-16LE (without BOM)*1 and the ASCII characters shown in the following: ☞ Page 292 Storage location (folder path)	
	User Name	☞ Page 292 User name	
	Password	☞ Page 293 Password	
Saving Detail Setting	Date and Time Format	☞ Page 294 ASCII characters that can be used in the format in the saving detail setting	Page 138 Saving detail setting
	Format		

\*1 The following cannot be used. (Note that no error message is output when entering surrogate pair characters and combining characters.)

Characters other than ones in the Basic Multilingual Plane (U+10000 to U+10FFFF)

Line feed codes (U+2028, U+2029)

Surrogate pairs (0xD800 to 0xDBFF, 0xDC00 to 0xDFFF)

Control codes (U+0000 to U+001F, U+0080 to U+009F, U+00A0 to U+00BF, U+FFFE, U+FFFF)

Combining characters

### ASCII characters that can be used for a device name

Characters in the shaded area can be used.

	0	1	2	3	4	5	6	7
0	NUL		(SP)	0	@	P	`	p
1			!	1	A	Q	a	q
2			"	2	B	R	b	r
3			#*1	3	C	S	c	s
4			\$	4	D	T	d	t
5			%	5	E	U	e	u
6			&	6	F	V	f	v
7			'	7	G	W	g	w
8			(	8	H	X	h	x
9			)	9	I	Y	i	y
A			*	:	J	Z	j	z
B			+	;	K	[	k	{
C			,	<	L	\*1	l	
D			-	=	M	]	m	}
E			.?2	>	N	^	n	~
F			/	?	O	_	o	

\*1 Cannot be used for "Device" in the "Saving Period Setting" and "File Saving Trigger Setting" screens.

\*2 Cannot be used for "Start Device" and "End Device" in the "Specify the Device Range" screen.

## ASCII characters that can be used in the file server setting

### ■Storage location (host name)

Characters in the shaded area can be used.

	0	1	2	3	4	5	6	7
0	NUL		(SP)	0	@	P	`	p
1			!	1	A	Q	a	q
2			"	2	B	R	b	r
3			#	3	C	S	c	s
4			\$	4	D	T	d	t
5			%	5	E	U	e	u
6			&	6	F	V	f	v
7			'	7	G	W	g	w
8			(	8	H	X	h	x
9			)	9	I	Y	i	y
A			*	:	J	Z	j	z
B			+	;	K	[	k	{
C			,	<	L	\'	l	
D			-	=	M	]	m	}
E			.	>	N	^	n	~
F			/	?	O	_	o	

### ■Storage location (folder path)

Characters in the shaded area can be used.

	0	1	2	3	4	5	6	7
0	NUL		(SP)	0	@	P	`	p
1			!	1	A	Q	a	q
2			"	2	B	R	b	r
3			#	3	C	S	c	s
4			\$	4	D	T	d	t
5			%	5	E	U	e	u
6			&	6	F	V	f	v
7			'	7	G	W	g	w
8			(	8	H	X	h	x
9			)	9	I	Y	i	y
A			*	:	J	Z	j	z
B			+	;	K	[	k	{
C			,	<	L	\'	l	
D			-	=	M	]	m	}
E			.	>	N	^	n	~
F			/	?	O	_	o	

### ■User name

Characters in the shaded area can be used.

	0	1	2	3	4	5	6	7
0	NUL		(SP)	0	@	P	`	p
1			!	1	A	Q	a	q
2			"	2	B	R	b	r
3			#	3	C	S	c	s
4			\$	4	D	T	d	t
5			%	5	E	U	e	u
6			&	6	F	V	f	v
7			'	7	G	W	g	w
8			(	8	H	X	h	x
9			)	9	I	Y	i	y
A			*	:	J	Z	j	z
B			+	;	K	[	k	{
C			,	<	L	\'	l	
D			-	=	M	]	m	}
E			.	>	N	^	n	~
F			/	?	O	_	o	

## ■ Password

Characters in the shaded area can be used.

	0	1	2	3	4	5	6	7
0	NUL		(SP)	0	@	P	`	p
1			!	1	A	Q	a	q
2			"	2	B	R	b	r
3			#	3	C	S	c	s
4			\$	4	D	T	d	t
5			%	5	E	U	e	u
6			&	6	F	V	f	v
7			'	7	G	W	g	w
8			(	8	H	X	h	x
9			)	9	I	Y	i	y
A			*	:	J	Z	j	z
B			+	;	K	[	k	{
C			,	<	L	\`	l	
D			-	=	M	]	m	}
E			.	>	N	^	n	~
F			/	?	O	_	o	

## ASCII characters that can be used in the format in the saving detail setting

Characters in the shaded area can be used.

	0	1	2	3	4	5	6	7
0	NUL		(SP)	0	@	P	`	p
1			!	1	A	Q	a	q
2			"	2	B	R	b	r
3			#	3	C	S	c	s
4			\$	4	D	T	d	t
5			%	5	E	U	e	u
6			&	6	F	V	f	v
7			'	7	G	W	g	w
8			(	8	H	X	h	x
9			)	9	I	Y	i	y
A			*	:	J	Z	j	z
B			+	;	K	[	k	{
C			,	<¹	L	\	l	
D			-	=	M	]	m	}
E			.	>¹	N	^	n	~
F			/	?	O	_	o	

\*1 Can be used when entering the following keywords in "Format" (cannot be used for "Date and Time Format").  
 <DATETIME>, <DATA1>, <DATA2>, <DATA3>, <DATA4>, <TCOMMENT>



# Appendix 2 Available Characters in the Camera Setting

This section shows the characters that can be used for each setting item in the camera setting (module extended parameter and preset position setting).

Screen	Item	Available character	Reference
Common Settings	FTP Login Name	Basic Multilingual Plane in UTF-16LE <sup>*1*2</sup>	Page 104 Common setting
	FTP Password	Basic Multilingual Plane in UTF-16LE <sup>*1*3</sup>	
Camera Individual Settings	Camera Comment	Basic Multilingual Plane in UTF-16LE <sup>*4</sup>	Page 105 Camera individual setting
	User ID	Basic Multilingual Plane in UTF-16LE <sup>*1*3</sup>	
	Password		
	Event Comment	Basic Multilingual Plane in UTF-16LE <sup>*4</sup>	
Communication Test	User ID	Basic Multilingual Plane in UTF-16LE <sup>*1*3</sup>	Page 108 Communication test screen
	Password		
Preset Position Registration	Preset Position Name	Basic Multilingual Plane in UTF-16LE <sup>*4</sup>	Page 112 Preset position registration

\*1 Available characters are also compliant with the specifications of a network camera. Refer to the manual for a network camera used.

\*2 Alphanumeric characters can be used.

\*3 The following characters can be used:

Alphanumeric characters

Space

!, ", #, \$, %, &, ', (, ), \*, +, ,, -, ., /, :, ;, <, =, >, ?, @, [, \, ], ^, \_ ` , {, |, }, ~

\*4 The following cannot be used. (Note that no error message is output when entering surrogate pair characters and combining characters.)

Characters other than ones in the Basic Multilingual Plane (U+10000 to U+10FFFF)

Line feed codes (U+2028, U+2029)

Surrogate pairs (0xD800 to 0xDBFF, 0xDC00 to 0xDFFF)

Control codes (U+0000 to U+001F, U+0080 to U+009F, U+00A0 to U+00BF, U+FFFE, U+FFFF)

Combining characters

# Appendix 3 Processing Time

This section shows the processing time of the recording function.

## Sampling time

The following shows the processing time of a CPU module required to sample a device and label.

It is added to the END processing when selecting "Each Scan" or "Time Specification" for the sampling method and to the program execution time when selecting "Trigger Instruction" (processing time for the DATATRG instruction). (Page 44 Sampling methods of devices and labels)

In addition, when selecting "Safety Cycle Time" for the sampling method, the processing time of a CPU module (sampling time) is included in the safety cycle time. (Page 44 Sampling methods of devices and labels)

When an interrupt program is executed during the END processing, the execution time of the interrupt program is included in the sampling time.

In addition, if the program execution time of a CPU module is shorter than the accumulating execution time of a recorder module/camera recorder module, the accumulating execution time is also included in the sampling time.

Note that the time required for data sampling differs depending on the CPU module type, device number of a sampling target, type, and memory of a module (buffer memory, link device).

The sampling time is calculated with the following formula:

$$\text{Sampling time } (\mu\text{s unit}) = 25 + (1) + (2) + (3) + (4) + (5) + (6) + (7) + (8) + (9) + (10) + (11)$$

The following table shows the details of each variable in the calculation formula.

Variable	Details (device type)		R04(EN)CPU	R08/16/32/120(EN)CPU	R08/16/32/120SFCPU
(1)	Global device <sup>*1</sup> and global/local label <sup>*2</sup> other than those listed below		$0.016 \times \text{Number of sampling points}^{*3}$	$0.016 \times \text{Number of sampling points}^{*3}$	$0.016 \times \text{Number of sampling points}^{*3}$
(2)	File register (R, ZR)	Without an extended SRAM cassette and a battery-less option cassette	$0.110 \times \text{Number of sampling points}^{*3}$	$0.064 \times \text{Number of sampling points}^{*3}$	$0.064 \times \text{Number of sampling points}^{*3}$
		When using an extended SRAM cassette	$0.135 \times \text{Number of sampling points}^{*3}$	$0.135 \times \text{Number of sampling points}^{*3}$	$0.135 \times \text{Number of sampling points}^{*3}$
		When using a battery-less option cassette	$0.135 \times \text{Number of sampling points}^{*3}$	$0.135 \times \text{Number of sampling points}^{*3}$	— (Cannot be used)
(3)	Local device <sup>*4</sup> , latch label <sup>*5</sup>		$0.110 \times \text{Number of sampling points}^{*3}$	$0.064 \times \text{Number of sampling points}^{*3}$	$0.064 \times \text{Number of sampling points}^{*3}$
(4)	Refresh data register (RD)		$0.048 \times \text{Number of sampling points}^{*3}$	$0.048 \times \text{Number of sampling points}^{*3}$	$0.048 \times \text{Number of sampling points}^{*3}$
(5)	CPU buffer memory access device	Host CPU U3En\G	$0.075 \times \text{Number of sampling points}^{*3}$	$0.075 \times \text{Number of sampling points}^{*3}$	$0.075 \times \text{Number of sampling points}^{*3}$
(6)		Host/another CPU U3En\HG	$0.064 \times \text{Number of sampling points}^{*3}$	$0.064 \times \text{Number of sampling points}^{*3}$	$0.064 \times \text{Number of sampling points}^{*3}$
(7)		Another CPU U3En\G	$0.025 \times \text{Number of sampling points}^{*3} + 11.3 \times \text{Number of blocks}^{*6} + 13.4^{*7}$	$0.025 \times \text{Number of sampling points}^{*3} + 11.3 \times \text{Number of blocks}^{*6} + 13.4^{*7}$	$0.025 \times \text{Number of sampling points}^{*3} + 11.3 \times \text{Number of blocks}^{*6} + 13.4^{*7}$
(8)	Module access device (Un\G)		$0.025 \times \text{Number of sampling points}^{*3} + 15.6 \times \text{Number of blocks}^{*6} + 9.4^{*7}$	$0.025 \times \text{Number of sampling points}^{*3} + 15.6 \times \text{Number of blocks}^{*6} + 9.4^{*7}$	$0.025 \times \text{Number of sampling points}^{*3} + 15.6 \times \text{Number of blocks}^{*6} + 9.4^{*7}$
(9)	Link direct device (Jn\□)		$0.028 \times \text{Number of sampling points}^{*3} + 51.6 \times \text{Number of blocks}^{*6} + 2.4^{*7}$	$0.028 \times \text{Number of sampling points}^{*3} + 51.6 \times \text{Number of blocks}^{*6} + 2.4^{*7}$	$0.028 \times \text{Number of sampling points}^{*3} + 51.6 \times \text{Number of blocks}^{*6} + 2.4^{*7}$
(10)	Step relay with block specification (BL□\S)		$0.180 \times \text{Number of sampling points}^{*3} + 4.60 \times \text{Number of blocks}^{*6} + 42.0$	$0.180 \times \text{Number of sampling points}^{*3} + 4.60 \times \text{Number of blocks}^{*6} + 42.0$	—
(11)	Device for the system <sup>*8</sup> (When sampling SFC devices)		$0.030 \times \text{Number of sampling points}^{*9} + 1.23 \times \text{Number of blocks}^{*10} + 52.36$	$0.030 \times \text{Number of sampling points}^{*9} + 1.23 \times \text{Number of blocks}^{*10} + 52.36$	—

\*1 A standard global device including a safety global device and safety local device when using a safety CPU

\*2 A standard global label and standard local label including a safety global label, safety local label, and standard/safety shared label when using a safety CPU

- \*3 Total number of sampling points in word conversion
- \*4 A standard local device when using a safety CPU
- \*5 A standard latch label when using a safety CPU
- \*6 The number of settings (number of No.s) in GX Works3
- \*7 '0' if the corresponding device is not set
- \*8 Set as a sampling target when using 'include SFC device' of 'device/label batch specification'
- \*9 Same as a step relay with block specification (BL□\S)
- \*10 Same as a step relay with block specification (BL□\S)

## Period during which devices and labels can be saved

A period during which devices and labels can be saved is calculated with the following formula:

$$\text{Saving possible period (second)} = \text{①} \div (\text{②} \times \text{③}) \times \text{④} \times 471,859.2$$

A saving possible period calculated with this formula is an approximate value because the rate of change and sampling interval vary depending on the program and operating status.

The following table shows the details of each variable in the calculation formula.

Variable	Item	Details
①	Recording buffer capacity [MB]	The buffer capacity for devices and labels accumulated by a recorder module/camera recorder module. It can be set in the module parameter of a recorder module/camera recorder module.
②	Sampling size [word]	The size of all sampling targets set in the recording setting. It can be checked in "Sampling Size (Overall)" in the "Recording Setting" screen.
③	Rate of change	The rate of values of sampled devices and labels that have changed since the last sampling. It is 1 when all values of devices and labels to be sampled are assumed to change per sampling, and 0.5 when half of them are assumed to change.*1 It is calculated with the following formula: Rate of change = Size of changed data ÷ Sampling size (overall)
④	Sampling interval [second]	The sampling interval for devices and labels. It differs depending on the sampling method. <ul style="list-style-type: none"> <li>• Each scan: Scan time</li> <li>• Time specification: Sampling interval set in the recording setting*2</li> <li>• Trigger instruction: Execution interval of a trigger instruction*3</li> <li>• Safety cycle time: Safety cycle time for executing a safety program</li> </ul>

\*1 The minimum saving possible period (approximate value) can be calculated by calculating the rate of change as 1.

\*2 When selecting "Time Specification" for the sampling method, the sampling interval for devices and labels will not be shorter than the scan time. Set a value greater than or equal to the scan time for the sampling interval for calculation.

\*3 When selecting "Trigger Instruction" for the sampling method and executing a trigger instruction once per program execution, the saving possible period (approximate value) can be calculated by calculating the sampling interval as the scan time.

Ex.

For calculating the saving possible period under the following conditions:

- ① Recording buffer capacity: 400 MB
- ② Sampling size (overall): 10,000 words
- ③ Rate of change: 0.3
- ④ Sampling interval: 100 ms

Saving possible period (second):

$$\boxed{400} \div (\boxed{10,000} \times \boxed{0.3}) \times (\boxed{100 \times 0.001}) \times 471,859.2 \approx 6,291.5(\text{seconds})$$

## Period during which video data can be saved

The following table shows periods during which video data can be saved.

### Point

- These periods are applied in the following cases:
  - One network camera is connected to one camera recorder module.
  - The upper limit of the recording buffer capacity (800 MB) is all assigned to video data.
- An actual period differs depending on each condition and environment and others for capturing data.

### ■ ONVIF supported network camera

When the simple setting mode is enabled, the video quality is regarded as middle equivalent.

- When using H.264 codec

Video data			Period
Resolution	Frame rate	Video quality	
FHD (1920 × 1080)	30	High	Approx. 2 min 50 sec
		Middle	Approx. 12 min
		Low	Approx. 41 min
	10	High	Approx. 6 min
		Middle	Approx. 25 min
		Low	Approx. 94 min
HD (1280 × 720)	180	High	Approx. 2 min
		Middle	Approx. 2 min 10 sec
		Low	Approx. 4 min
	120	High	Approx. 5 min 30 sec
		Middle	Approx. 17 min
		Low	Approx. 64 min
	30	High	Approx. 6 min
		Middle	Approx. 25 min
		Low	Approx. 89 min
	10	High	Approx. 16 min
		Middle	Approx. 67 min
		Low	Approx. 247 min
VGA (640 × 480)	180	High	Approx. 2 min 30 sec
		Middle	Approx. 4 min
		Low	Approx. 11 min
	120	High	Approx. 9 min
		Middle	Approx. 27 min
		Low	Approx. 103 min
	30	High	Approx. 13 min
		Middle	Approx. 57 min
		Low	Approx. 200 min
	10	High	Approx. 36 min
		Middle	Approx. 147 min
		Low	Approx. 540 min
SXVGA (1280 × 960)	30	High	Approx. 3 min
		Middle	Approx. 13 min
		Low	Approx. 41 min
	10	High	Approx. 7 min
		Middle	Approx. 31 min
		Low	Approx. 97 min

# Appendix 4 Instruction List

The following table shows the instructions that can determine the range of devices and labels to be used when the instructions are specified.

Instruction					
ACOSD	ACOSDP	ACOSP	ADRSET	ADRSETP	ANDD<
ANDD<=	ANDD<>	ANDD=	ANDD>	ANDD>=	ANDDT<
ANDDT<=	ANDDT<>	ANDDT=	ANDDT>	ANDDT>=	ANDE<
ANDE<=	ANDE<>	ANDE=	ANDE>	ANDE>=	ANDED<
ANDED<=	ANDED<>	ANDED=	ANDED>	ANDED>=	ANDF
ANDFI	ANDP	ANDPI	ANDTM<	ANDTM<=	ANDTM<>
ANDTM=	ANDTM>	ANDTM>=	ASIND	ASINDP	ASINP
ATAND	ATANDP	ATANP	BCDDA	BCDDAP	BINDA
BINDAP	BINHA	BINHAP	COSD	COSDP	DABCD
DABCDP	DABIN	DABINP	DAND	DANDP	DB+
DB+P	DB-	DB-P	DBAND	DBANDP	DBCD
DBCDDA	DBCDDAP	DBCDP	DBIN	DBINDA	DBINDAP
DBINHA	DBINHAP	DBINP	DBL	DBL2DINT	DBL2DINTP
DBL2FLT	DBL2FLTP	DBL2INT	DBL2INTP	DBLP	DCML
DCMLP	DDABCD	DDABCDP	DDABIN	DDABINP	DDEC
DDECP	DEGD	DEGDP	DEGP	DELTA	DELTP
DFLT	DFLTD	DFLTDP	DFLTP	DGBIN	DGBINP
DGRY	DGRYP	DHABIN	DHABINP	DINC	DINCP
DINT	DINT2DBL	DINT2DBLP	DINT2FLT	DINT2FLTP	DINT2INT
DINT2INTP	DINTD	DINTDP	DINTP	DLIMIT	DLIMITP
DMOV	DMOVP	DNEG	DNEGP	DOR	DORP
DSCL	DSCL2	DSCL2P	DSCLP	DSQRT	DSQRTP
DSUM	DSUMP	DSWAP	DSWAPP	DTEST	DTESTP
DXCH	DXCHP	DXNR	DXNRP	DXOR	DXORP
DZONE	DZONEP	E/	E/P	ECON	ECONP
ED+	ED+P	ED-	ED-P	ED/	ED/P
EDCON	EDCONP	EDMOV	EDMOVP	EDNEG	EDNEGP
EDSQRT	EDSQRTP	EMOV	EMOVP	ENEG	ENEGP
EVAL	EVALP	EXPD	EXPDP	EXPP	FIFR
FIFRP	FIFW	FIFWP	FLT	FLT2DBL	FLT2DBLP
FLT2DINT	FLT2DINTP	FLT2INT	FLT2INTP	FLTD	FLTDP
FLTP	FPOP	FPOPP	GBIN	GBINP	HABIN
HABINP	ICCNTRD1	ICCNTRD1P	ICCNTRD2	ICCNTRD2P	ICFCNT1
ICFCNT2	ICPLSRD1	ICPLSRD1P	ICPLSRD2	ICPLSRD2P	ICPREWR1
ICPREWR1P	ICPREWR2	ICPREWR2P	ICPWM1	ICPWM2	ICRCNT1
ICRCNT2	ICRNGWR1	ICRNGWR1P	ICRNGWR2	ICRNGWR2P	ICSMPRD1
ICSMPRD1P	ICSMPRD2	ICSMPRD2P	INSTR	INSTRP	INT2DBL
INT2DBLP	INT2DINT	INT2DINTP	INT2FLT	INT2FLTP	INTD
INTDP	INTP	IPSTOP1	IPSTOP2	IPTPCHG1	IPTPCHG1P
IPTPCHG2	IPTPCHG2P	LDD<	LDD<=	LDD<>	LDD=
LDD>	LDD>=	LDDT<	LDDT<=	LDDT<>	LDDT=
LDDT>	LDDT>=	LDE<	LDE<=	LDE<>	LDE=
LDE>	LDE>=	LDED<	LDED<=	LDED<>	LDED=
LDED>	LDED>=	LDF	LDFI	LDP	LDPI
LDTM<	LDTM<=	LDTM<>	LDTM=	LDTM>	LDTM>=
LEDR	LENP	LIMIT	LIMITP	LOG	LOG10
LOG10D	LOG10DP	LOG10P	LOGD	LOGDP	LOGP
LOGTRG	LOGTRGR	NDIS	NDISP	NEXT	NUNI

Instruction					
NUNIP	ORD<	ORD<=	ORD<>	ORD=	ORD>
ORD>=	ORDT<	ORDT<=	ORDT<>	ORDT=	ORDT>
ORDT>=	ORE<	ORE<=	ORE<>	ORE=	ORE>
ORE>=	ORED<	ORED<=	ORED<>	ORED=	ORED>
ORED>=	ORTM<	ORTM<=	ORTM<>	ORTM=	ORTM>
ORTM>=	PIDCONT	PIDCONTP	PIDINIT	PIDINITP	PIDPRMW
PIDPRMWP	PIDRUN	PIDRUNP	PIDSTOP	PIDSTOPP	POWD
POWDP	RADD	RADDP	RBMOV	RBMOVP	RND
RNDP	RSET	RSETP	SCL2	SCL2P	SIND
SINDP	SINP	SQRT	SRND	SRNDP	STOP
STRINS	STRINSP	TAND	TANDP	TANP	TIMCHK
WAND	WANDP	WDT	WDTP	WOR	WORD
WORDP	WORP	WXNR	WXNRP	WXOR	WXORP
XCH	XCHP	ZONE	ZONEP	ZPOP	ZPOPP
ZPUSH	ZPUSHP	ZRRDB	ZRRDBP	ZRWRB	ZRWRBP

# Appendix 5 Number of Connected Network Cameras and Module Configuration

This section shows the number of connected network cameras and module configuration.

## Number of network cameras and module configuration list

The following table shows the number of modules (recorder module/camera recorder module per CPU module) required for each number of connected network cameras.

Up to 16 network cameras can be set in the recording setting.

Note that the numbers shown in the following table are minimum required ones because the number of required modules differs depending on the type, frame rate, and resolution of a network camera used.

No.	Maximum number of connected network cameras	Number of required modules		Reference
		Camera recorder module	Recorder module	
1	0	0	1 <sup>*1</sup>	Page 302 Configuration No.1
2	2	1	0	Page 303 Configuration No.2
3	4	1	1 <sup>*1</sup>	Page 303 Configuration No.3
4	6	2	0	Page 304 Configuration No.4
5	8	2	1 <sup>*1</sup>	Page 304 Configuration No.5
6	10	3	0	Page 305 Configuration No.6
7	12	3	1 <sup>*1</sup>	Page 305 Configuration No.7
8	14	4	0	Page 306 Configuration No.8
9	16 <sup>*2</sup>	4	1	Page 306 Configuration No.9

\*1 A camera recorder module can be used instead.

\*2 Only when the frame rate of a network camera is 30 fps or lower.

## Number of connectable network cameras for each module configuration

### ■ Configuration No.1

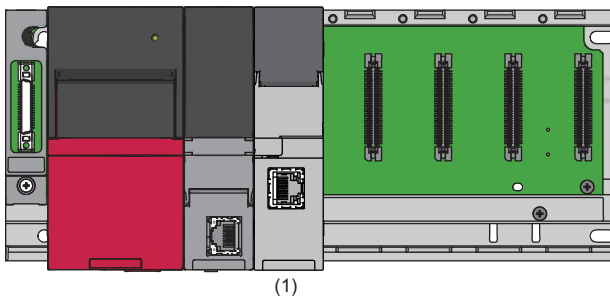

—: N/A

Item	(1)	
Module type	Recorder module	
Recording operation setting	Main	
Number of connectable network cameras	Only network cameras with frame rates of 30 fps or lower	—
	Even one network camera with a frame rate of 120 fps included	—
	Even one network camera with a frame rate of 180 fps included	—



## ■ Configuration No.2

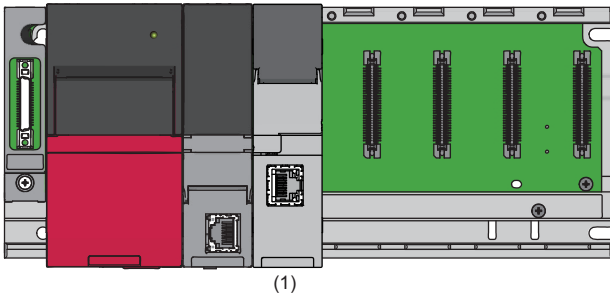

Item	(1)	
Module type	Camera recorder module	
Recording operation setting	Main	
Number of connectable network cameras	Only network cameras with frame rates of 30 fps or lower	2
	Even one network camera with a frame rate of 120 fps included	2 <sup>*1</sup>
	Even one network camera with a frame rate of 180 fps included	1

\*1 For ONVIF supported network cameras with VGA resolution.  
1 for ONVIF supported network cameras with HD resolution.

## ■ Configuration No.3

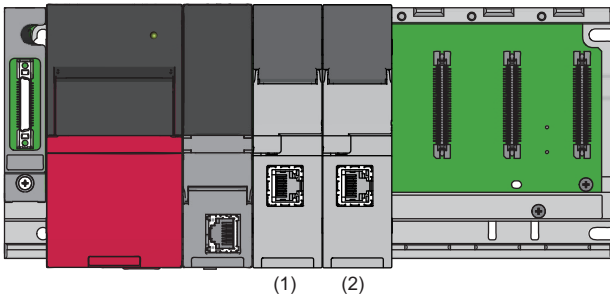

—: N/A

Item	(1)	(2)
Module type	Recorder module	Camera recorder module
Recording operation setting	Main	Sub
Number of connectable network cameras	Only network cameras with frame rates of 30 fps or lower	4
	Even one network camera with a frame rate of 120 fps included	2 <sup>*1</sup>
	Even one network camera with a frame rate of 180 fps included	1

\*1 For ONVIF supported network cameras with VGA resolution.  
1 for ONVIF supported network cameras with HD resolution.

A

## ■ Configuration No.4

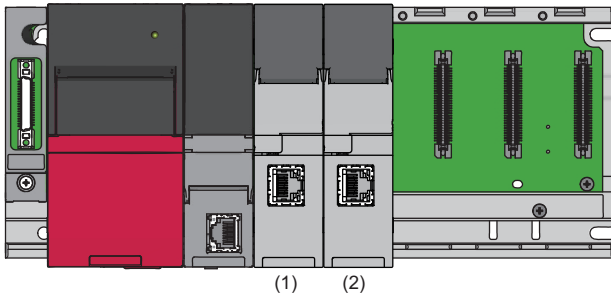

Item	(1)	(2)
Module type	Camera recorder module	Camera recorder module
Recording operation setting	Main	Sub
Number of connectable network cameras	Only network cameras with frame rates of 30 fps or lower	2
	Even one network camera with a frame rate of 120 fps included	2 <sup>*1</sup>
	Even one network camera with a frame rate of 180 fps included	1

\*1 For ONVIF supported network cameras with VGA resolution.  
1 for ONVIF supported network cameras with HD resolution.

## ■ Configuration No.5

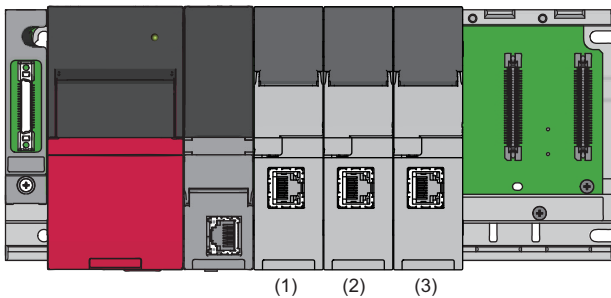

—: N/A

Item	(1)	(2)	(3)
Module type	Recorder module	Camera recorder module	Camera recorder module
Recording operation setting	Main	Sub	Sub
Number of connectable network cameras	Only network cameras with frame rates of 30 fps or lower	—	4
	Even one network camera with a frame rate of 120 fps included	—	2 <sup>*1</sup>
	Even one network camera with a frame rate of 180 fps included	—	1

\*1 For ONVIF supported network cameras with VGA resolution.  
1 for ONVIF supported network cameras with HD resolution.

## ■ Configuration No.6

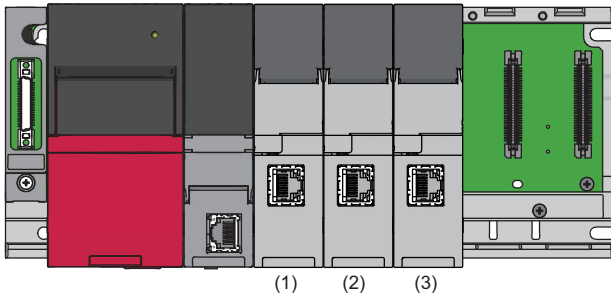

Item		(1)	(2)	(3)
Module type		Camera recorder module	Camera recorder module	Camera recorder module
Recording operation setting		Main	Sub	Sub
Number of connectable network cameras	Only network cameras with frame rates of 30 fps or lower	2	4	4
	Even one network camera with a frame rate of 120 fps included	2 <sup>*1</sup>	2 <sup>*1</sup>	2 <sup>*1</sup>
	Even one network camera with a frame rate of 180 fps included	1	1	1

\*1 For ONVIF supported network cameras with VGA resolution.  
1 for ONVIF supported network cameras with HD resolution.

## ■ Configuration No.7

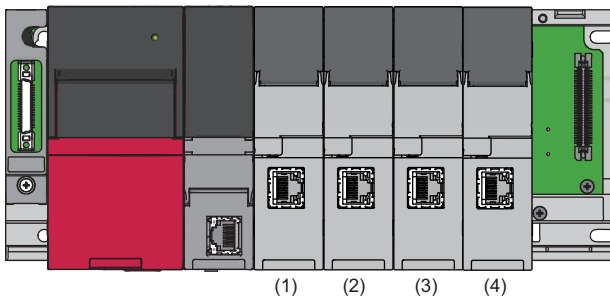

—: N/A

Item		(1)	(2)	(3)	(4)
Module type		Recorder module	Camera recorder module	Camera recorder module	Camera recorder module
Recording operation setting		Main	Sub	Sub	Sub
Number of connectable network cameras	Only network cameras with frame rates of 30 fps or lower	—	4	4	4
	Even one network camera with a frame rate of 120 fps included	—	2 <sup>*1</sup>	2 <sup>*1</sup>	2 <sup>*1</sup>
	Even one network camera with a frame rate of 180 fps included	—	1	1	1

\*1 For ONVIF supported network cameras with VGA resolution.  
1 for ONVIF supported network cameras with HD resolution.

## ■ Configuration No.8

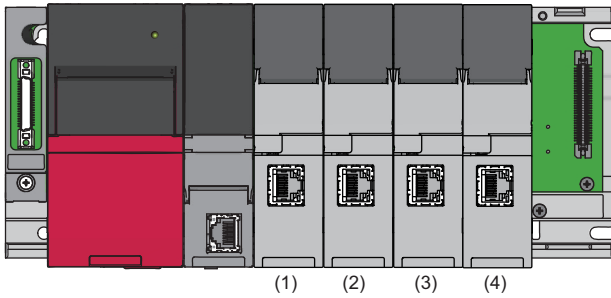

Item		(1)	(2)	(3)	(4)
Module type		Camera recorder module	Camera recorder module	Camera recorder module	Camera recorder module
Recording operation setting		Main	Sub	Sub	Sub
Number of connectable network cameras	Only network cameras with frame rates of 30 fps or lower	2	4	4	4
	Even one network camera with a frame rate of 120 fps included	2 <sup>*1</sup>	2 <sup>*1</sup>	2 <sup>*1</sup>	2 <sup>*1</sup>
	Even one network camera with a frame rate of 180 fps included	1	1	1	1

\*1 For ONVIF supported network cameras with VGA resolution.  
1 for ONVIF supported network cameras with HD resolution.

## ■ Configuration No.9

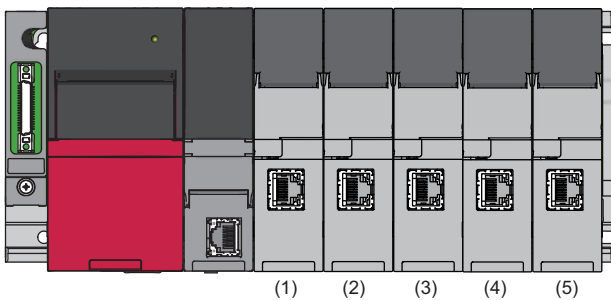

—: N/A

Item		(1)	(2)	(3)	(4)	(5)
Module type		Recorder module	Camera recorder module	Camera recorder module	Camera recorder module	Camera recorder module
Recording operation setting		Main	Sub	Sub	Sub	Sub
Number of connectable network cameras	Only network cameras with frame rates of 30 fps or lower	—	4	4	4	4
	Even one network camera with a frame rate of 120 fps included	—	2 <sup>*1</sup>	2 <sup>*1</sup>	2 <sup>*1</sup>	2 <sup>*1</sup>
	Even one network camera with a frame rate of 180 fps included	—	1	1	1	1



\*1 For ONVIF supported network cameras with VGA resolution.  
1 for ONVIF supported network cameras with HD resolution.

# Appendix 6 Added and Changed Functions

This section shows the added and changed functions of System Recorder.

Recording function					
Added/changed contents	Firmware version of a module			Software version	Reference
	Recorder module	Camera recorder module	CPU module	GX Works3	
Safety devices, safety labels (standard/safety shared labels), and safety cycle time are supported. (Safety CPUs are supported.)	03 or later	01 or later	RnSFCPU: 23 or later	<ul style="list-style-type: none"> <li>When using a recorder module: 1.070Y or later</li> <li>When using a camera recorder module: 1.072A or later</li> </ul>	<ul style="list-style-type: none"> <li>IMELSEC iQ-R System Recorder User's Manual (Startup)</li> </ul>
Files can be saved to a file server.			—		Page 16 Recording Function
Video data can be saved.	—		<ul style="list-style-type: none"> <li>RnCPU or RnENCPU: 55 or later</li> <li>RnSFCPU: 24 or later</li> </ul>	1.072A or later	Page 16 Recording Function
Multiple modules can be configured.	04 or later				<ul style="list-style-type: none"> <li>IMELSEC iQ-R System Recorder User's Manual (Startup)</li> <li>Page 67 Operation of the recording function when configuring multiple modules</li> </ul>
Restarting recording after performing the online change is improved.					Page 76 Program change
The project data saving function is supported.	06 or later	03 or later	—*1	1.077F or later	Page 79 Project data saving function
The simple setting mode is added.	—		—		<ul style="list-style-type: none"> <li>Page 105 Camera individual setting</li> <li>Page 237 Simple setting mode</li> </ul>
A resolution is added in the camera setting. <ul style="list-style-type: none"> <li>SXVGA (1280 × 960)</li> </ul>					Page 105 Camera individual setting
A frame rate is added in the camera setting. <ul style="list-style-type: none"> <li>180 fps</li> </ul>					
The CPU stop error saving function is supported.	07 or later	05 or later		1.085P or later	<ul style="list-style-type: none"> <li>Page 28 File saving trigger</li> <li>Page 134 File Saving Trigger Setting</li> </ul>
Items can be added as additional information to a recording file save folder name. <ul style="list-style-type: none"> <li>Trigger comment</li> <li>ASCII data</li> </ul>					<ul style="list-style-type: none"> <li>Page 52 Recording file name</li> <li>Page 138 Saving detail setting</li> </ul>
A condition for satisfying a file saving trigger is added. <ul style="list-style-type: none"> <li>Timeout</li> </ul>					<ul style="list-style-type: none"> <li>Page 28 File saving trigger</li> <li>Page 134 File Saving Trigger Setting</li> </ul>
Camera events are supported.					<ul style="list-style-type: none"> <li>Page 28 File saving trigger</li> <li>Page 134 File Saving Trigger Setting</li> <li>Page 242 Camera event function</li> </ul>
Events detected by a camera can be classified as errors or warnings.	—				Page 100 Application settings
The operation setting at video data saving is supported.					



Added/changed contents	Firmware version of a module			Software version	Reference
	Recorder module	Camera recorder module	CPU module	GX Works3	
The co-recording function is supported.	08 or later	06 or later	RnCPU: 65 or later	1.090U or later	 MELSEC iQ-R System Recorder Co-recording Function Reference Manual Page 33 Devices that can be sampled Page 36 Specifying a device and label to be sampled Page 117 Device/Label Sampling Setting
SFC devices are supported.					
Logging files of the servo system recorder can be read simultaneously.	—	—	—	1.105K or later	 GX Works3 Operating Manual

\*1 Excluding RnSFC CPUs.

# MEMO

---

A

# INDEX

---

## A

---

Adding and changing recording setting . . . . . 73

## B

---

Buffer memory of a camera recorder module . . . . . 257  
Buffer memory of a recorder module . . . . . 208

## C

---

Camera recorder module . . . . . 234  
Camera recording function . . . . . 92

## D

---

Data flow analysis function . . . . . 92  
Device and label . . . . . 16  
Device and label that can be sampled . . . . . 32  
Device individual specification . . . . . 37  
Device that can be specified as a trigger . . . . . 43  
Device/label batch specification . . . . . 36  
Device/label sampling setting . . . . . 117  
Device/label sampling target list screen . . . . . 133

## E

---

Error code list of a camera recorder module . . . . . 185  
Error code list of a recorder module . . . . . 167  
Event code list of a camera recorder module . . . . . 196  
Event code list of a recorder module . . . . . 175  
Event history . . . . . 16

## F

---

File saving trigger . . . . . 28  
File saving trigger only . . . . . 19  
File saving trigger setting . . . . . 134

## I

---

Input/output signals of a camera recorder  
module . . . . . 253  
Input/output signals of a recorder module . . . . . 204

## O

---

Offline monitor function . . . . . 92  
Operating status . . . . . 63  
Operation of the recording function . . . . . 65

## P

---

Parameter setting . . . . . 93

## R

---

Recorder module . . . . . 199  
Recording buffer . . . . . 60  
Recording buffer batch saving mode . . . . . 62  
Recording file . . . . . 49  
Recording function . . . . . 16

Recording monitor . . . . . 142  
Recording setting . . . . . 114  
Recording startup trigger . . . . . 26  
Recording startup trigger + file saving trigger . . . . . 19  
Recording target data . . . . . 16

## S

---

Sampling method . . . . . 44  
Saving path setting . . . . . 136  
Saving period setting . . . . . 116  
SD memory card format function . . . . . 199,250

## T

---

Troubleshooting . . . . . 148

## V

---

Video data . . . . . 16



# MEMO

---

# REVISIONS

\*The manual number is given on the bottom left of the back cover.

Revision date	*Manual number	Description
June 2020	SH(NA)-082281ENG-A	First edition
June 2020	SH(NA)-082281ENG-B	Partial correction
October 2020	SH(NA)-082281ENG-C	■Added or modified parts TERMS, Section 1.1, Section 1.3, Section 2.1, Section 2.2, Section 3.1, Section 3.3, Section 3.5, Section 4.1, Section 5.1, Section 5.2, Section 5.5, Section 6.1, Section 6.4, Appendix 1, Appendix 2, Appendix 4
February 2021	SH(NA)-082281ENG-D	■Added or modified parts TERMS, Section 1.1, Section 2.2, Section 2.3, Section 2.4, Section 3.1, Section 3.2, Section 3.3, Section 3.6, Chapter 4, Section 5.1, Section 5.2, Section 5.5, Section 5.6, Section 6.4, Chapter 7, Appendix 2, Appendix 3, Appendix 5, Appendix 6
March 2021	SH(NA)-082281ENG-E	Partial correction
July 2021	SH(NA)-082281ENG-F	■Added or modified parts Section 1.1, Section 2.2, Section 2.3, Section 3.6, Section 4.2, Section 5.1, Section 5.5, Section 5.6, Section 6.4, Section 7.1, Section 7.4, Appendix 3, Appendix 5, Appendix 6
September 2021	SH(NA)-082281ENG-G	■Added or modified parts Section 7.1, Section 7.4
April 2022	SH(NA)-082281ENG-H	■Added or modified parts Section 1.1, Section 2.2, Section 2.3, Section 3.4, Section 3.5, Section 5.1, Section 5.2, Section 5.5, Section 5.6, Section 6.4, Section 7.1, Section 7.4, Appendix 1, Appendix 6
October 2022	SH(NA)-082281ENG-I	■Added or modified parts Section 1.1, Section 1.5, Section 2.2, Section 3.3, Section 5.5, Section 5.6, Section 6.1, Section 6.4, Section 7.1, Section 7.4, Appendix 3, Appendix 6
April 2023	SH(NA)-082281ENG-J	■Added or modified parts Section 1.1, Section 2.3, Section 3.3, Section 5.6, Section 5.7, Section 7.1, Appendix 6
November 2023	SH(NA)-082281ENG-K	■Added or modified parts SAFETY PRECAUTIONS, Section 1.1
April 2024	SH(NA)-082281ENG-L	■Added or modified part Appendix 6

Japanese manual number: SH-082280-L

This manual confers no industrial property rights or any rights of any other kind, nor does it confer any patent licenses. Mitsubishi Electric Corporation cannot be held responsible for any problems involving industrial property rights which may occur as a result of using the contents noted in this manual.

© 2020 MITSUBISHI ELECTRIC CORPORATION

# WARRANTY

---

Please confirm the following product warranty details before using this product.

## **1. Gratis Warranty Term and Gratis Warranty Range**

If any faults or defects (hereinafter "Failure") found to be the responsibility of Mitsubishi occurs during use of the product within the gratis warranty term, the product shall be repaired at no cost via the sales representative or Mitsubishi Service Company.

However, if repairs are required onsite at domestic or overseas location, expenses to send an engineer will be solely at the customer's discretion. Mitsubishi shall not be held responsible for any re-commissioning, maintenance, or testing on-site that involves replacement of the failed module.

[Gratis Warranty Term]

The gratis warranty term of the product shall be for one year after the date of purchase or delivery to a designated place. Note that after manufacture and shipment from Mitsubishi, the maximum distribution period shall be six (6) months, and the longest gratis warranty term after manufacturing shall be eighteen (18) months. The gratis warranty term of repair parts shall not exceed the gratis warranty term before repairs.

[Gratis Warranty Range]

- (1) The range shall be limited to normal use within the usage state, usage methods and usage environment, etc., which follow the conditions and precautions, etc., given in the instruction manual, user's manual and caution labels on the product.
- (2) Even within the gratis warranty term, repairs shall be charged for in the following cases.
  1. Failure occurring from inappropriate storage or handling, carelessness or negligence by the user. Failure caused by the user's hardware or software design.
  2. Failure caused by unapproved modifications, etc., to the product by the user.
  3. When the Mitsubishi product is assembled into a user's device, Failure that could have been avoided if functions or structures, judged as necessary in the legal safety measures the user's device is subject to or as necessary by industry standards, had been provided.
  4. Failure that could have been avoided if consumable parts (battery, backlight, fuse, etc.) designated in the instruction manual had been correctly serviced or replaced.
  5. Failure caused by external irresistible forces such as fires or abnormal voltages, and Failure caused by force majeure such as earthquakes, lightning, wind and water damage.
  6. Failure caused by reasons unpredictable by scientific technology standards at time of shipment from Mitsubishi.
  7. Any other failure found not to be the responsibility of Mitsubishi or that admitted not to be so by the user.

## **2. Onerous repair term after discontinuation of production**

- (1) Mitsubishi shall accept onerous product repairs for seven (7) years after production of the product is discontinued. Discontinuation of production shall be notified with Mitsubishi Technical Bulletins, etc.
- (2) Product supply (including repair parts) is not available after production is discontinued.

## **3. Overseas service**

Overseas, repairs shall be accepted by Mitsubishi's local overseas FA Center. Note that the repair conditions at each FA Center may differ.

## **4. Exclusion of loss in opportunity and secondary loss from warranty liability**

Regardless of the gratis warranty term, Mitsubishi shall not be liable for compensation to:

- (1) Damages caused by any cause found not to be the responsibility of Mitsubishi.
- (2) Loss in opportunity, lost profits incurred to the user by Failures of Mitsubishi products.
- (3) Special damages and secondary damages whether foreseeable or not, compensation for accidents, and compensation for damages to products other than Mitsubishi products.
- (4) Replacement by the user, maintenance of on-site equipment, start-up test run and other tasks.

## **5. Changes in product specifications**

The specifications given in the catalogs, manuals or technical documents are subject to change without prior notice.

# INFORMATION AND SERVICES

---

For further information and services, please contact your local Mitsubishi Electric sales office or representative.  
Visit our website to find our locations worldwide.

MITSUBISHI ELECTRIC Factory Automation Global Website

Locations Worldwide

[www.MitsubishiElectric.com/fa/about-us/overseas/](http://www.MitsubishiElectric.com/fa/about-us/overseas/)

## TRADEMARKS

---

ONVIF is a trademark of Onvif, Inc.

The company names, system names and product names mentioned in this manual are either registered trademarks or trademarks of their respective companies.

In some cases, trademark symbols such as <sup>™</sup> or <sup>®</sup> are not specified in this manual.



SH(NA)-082281ENG-L(2404)KWIX

MODEL: SYSRECORDER-U-OU-E

MODEL CODE: 13JX3B

## **MITSUBISHI ELECTRIC CORPORATION**

HEAD OFFICE: TOKYO BLDG., 2-7-3, MARUNOUCHI, CHIYODA-KU, TOKYO 100-8310, JAPAN  
NAGOYA WORKS: 1-14, YADA-MINAMI 5-CHOME, HIGASHI-KU, NAGOYA 461-8670, JAPAN

When exported from Japan, this manual does not require application to the  
Ministry of Economy, Trade and Industry for service transaction permission.

Specifications subject to change without notice.